

# National Best Practices Manual

## For Building High Performance Schools

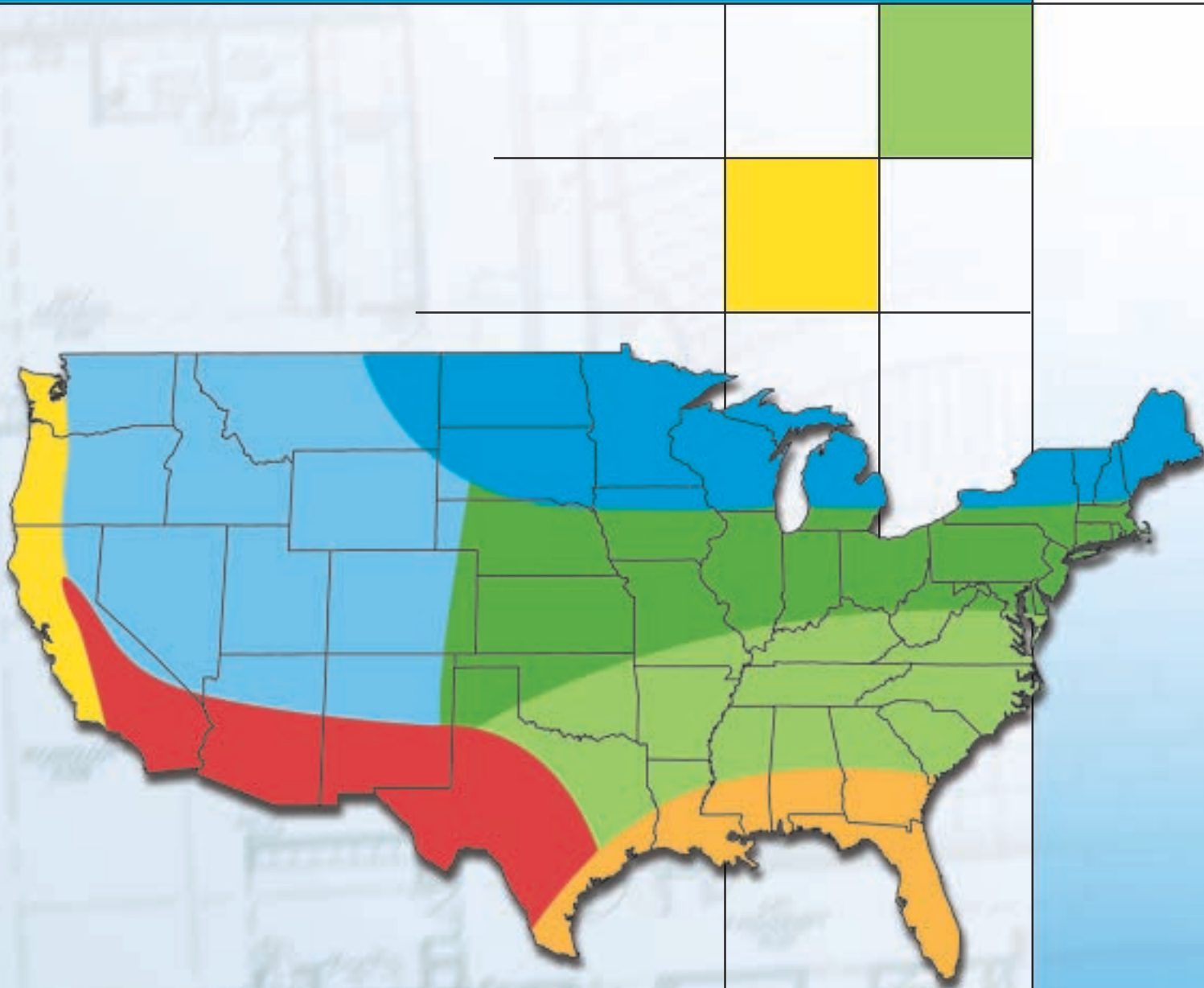

# Acknowledgements

The U.S. Department of Energy would like to acknowledge the help and assistance of the EnergySmart Schools team and the many authors and reviewers that provided input and feedback during the process of developing the report. Those include:

**US Department of Energy:** David Hansen, Daniel Sze; **EnergySmart Schools Team:** Larry Schoff; **US Environmental Protection Agency:** Melissa Payne, Bob Thompson; **Lawrence Berkeley National Laboratory:** Rick Diamond; **National Renewable Energy Laboratory:** Ren Anderson, Zahra Chaudhry, Jeff Clarke, Kyra Epstein, Tony Jimenez, Patty Kappaz, Patricia Plympton, Byron Stafford, Marcy Stone, John Thornton, Paul Torcellini; **Oak Ridge National Laboratory:** Andre Desjarlais, Michael MacDonald, W.A. Miller, Terry Sharp, Ronald Shelton, John Shonder; **Eley Associates:** Patricia Adamos, Anamika Prasad, Charles Eley, Kimberly Got, Debra Janis, Randy Karels, Joe Kastner, Erik Kolderup, Arman Shehabi; **Rahus Institute:** Tor Allen; **Southern California Edison:** Manuel Alvarez, Gregg Ander, Jan Johnson, Lisa Stoddard; **California Division of the State Architect:** Panama Bartholomy; **Benya Lighting Design:** Jim Benya; **SMWM:** Anthony Bernheim; **Flansburgh Associates Inc.:** James Carr; **HMC Architects:** Dennis Dunston; **Cascadia Conservation:** Barbara Erwine; **Sustainable Buildings Industries Council:** Deane Evans; **Geothermal Heat Pump Consortium:** Wael El-Sharif; **California Energy Commission:** Gary Flamm; **Shen Milsom & Wilke/Paoletti:** Andrew Gorton, Dennis Paoletti; **Quattrocchi/Kwok Architects:** John Guill; **Heschong Mahone Group:** Lisa Heschong; **Geller Associates Inc.:** Phil Lasker; **Building Ecology Research Group:** Hal Levin; **Wolfe Mason Associates:** Gary Mason; **O'Brien and Company:** Kathleen O'Brien, Jane Simmons; **California Integrated Waste Management Board:** Bill Orr, Dana Papke; **TMAD Engineers:** Kerry Parker; **California Air Resources Board:** Tom Phillips; **Simon & Associates:** Lynn N. Simon; **HMFH Architects, Inc.:** Doug Sacra; **Wendel, Rosen, Black & Dean:** Donald Simon; **HL Turner Group:** Bill Turner; **California Department of Health Services:** Jed Waldman; **WLC Architects:** George Wiens.

The National Best Practices Manual for High Performance Schools was adapted from the Collaborative for High Performance Schools Inc.'s Best Practices Manual, Volume II. The CHPS Best Practices Manual is copyrighted by CHPS, Inc. End users of the National Best Practices Manual are permitted to use and or copy the National Best Practices Manual without further consent. However, CHPS, Inc. prior permission must be granted in order to re-license, publish or develop derivative works from CHPS copyrighted materials. Modifications were developed by Eley Associates and the National Renewable Energy Laboratory. The adaptation was funded by the U.S. Department of Energy's Office of Building Technology, State and Community Programs. The program is led by Deputy Assistant Secretary Mark Ginsberg, National Program Manager Daniel Sze, and Outreach and Communications Manager Lani MacRae.

*The commissioning section of this manual is a modified version of the Building Commissioning Guidelines prepared for Pacific Gas & Electric Company by Portland Energy Conservation, Inc. for the Energy Design Resources program. Certain sections of this document were excerpted and modified from Commissioning for Better Buildings in Oregon, written by PECl for the Oregon Office of Energy, and Building Commissioning: The Key to Quality Assurance, written by PECl for the U.S. Department of Energy's Rebuild America program.*

*This report was prepared as an account of work sponsored by an agency of the United States government. Neither the United States government nor any agency thereof, nor any of their employees, makes any warranty, express or implied, or assumes any legal liability or responsibility for the accuracy, completeness, or usefulness of any information, apparatus, product, or process disclosed, or represents that its use would not infringe privately owned rights. Reference herein to any specific commercial product, process, or service by tradename, trademark, manufacturer, or otherwise does not necessarily constitute or imply its endorsement, recommendation, or favoring by the United States Government or any agency thereof. The views and opinions of authors expressed herein do not necessarily state or reflect those of the United State government or any agency thereof.*

Available electronically at <http://www.doe.gov/bridge>.

Table of Contents

**Introduction to the Manual ..... 1**

[The Design Process](#)..... 2

[Integrated Design](#)..... 4

[Goals and Cross-Cutting Issues](#)..... 6

[Commissioning, Operation, and Maintenance](#)..... 19

[Material Selection and Research](#)..... 21

[General Purpose Design and Evaluation Tools](#)..... 24

[Anatomy of a Guideline](#)..... 25

[Climates](#)..... 27

**Site Design.....29**

[Overview](#)..... 33

[Guideline SD1: Optimum Building Orientation](#)..... 41

[Guideline SD2: Landscaping to Provide Shade to HVAC Equipment, Buildings, and Paved Areas](#)... 42

[Guideline SD3: Landscape Design and Management](#)..... 43

[Guideline SD4: Impervious Surfaces](#)..... 44

[Guideline SD5: Native and Drought-Tolerant Plants](#)..... 45

[Guideline SD6: Landscaping Soil, Amendments, and Mulch](#)..... 46

[Guideline SD7: Integrated Weed, Disease, and Pest Management](#)..... 48

[Guideline SD8: Environmentally Responsible Job-Site Operations Plan](#)..... 51

[Guideline SD9: Indoor Air Quality During Construction](#)..... 53

[Guideline SD10: Site Protection During Construction](#)..... 56

**Daylighting and Windows .....65**

[Overview](#)..... 66

[Guideline DL1: View Windows](#)..... 81

[Guideline DL2: High Sidelighting—Clerestory](#)..... 86

[Guideline DL3: High Sidelighting—Clerestory with Light Shelf or Louvers](#)..... 90

[Guideline DL4: Classroom Daylighting—Wall Wash Toplighting](#)..... 95

[Guideline DL5: Central Toplighting](#)..... 99

[Guideline DL6: Patterned Toplighting](#)..... 103

[Guideline DL7: Linear Toplighting](#)..... 106

[Guideline DL8: Tubular Skylights](#)..... 109

**Energy-Efficient Building Shell..... 113**

[Overview](#)..... 113

[Guideline EB1: Wall Insulation](#)..... 128

<a href="#">Guideline EB2: Roof Insulation</a> .....	131
<a href="#">Guideline EB3: Cool Roofs</a> .....	133
<a href="#">Guideline EB4: Radiant Barriers</a> .....	137
<a href="#">Guideline EB5: Air Barriers and Other Methods to Reduce Infiltration</a> .....	139
<a href="#">Guideline EB6: Concrete Masonry</a> .....	143
<b><a href="#">Lighting and Electrical Systems</a> .....</b>	<b>145</b>
<a href="#">Overview</a> .....	145
<a href="#">Guideline EL1: Pendant-Mounted Lighting</a> .....	165
<a href="#">Guideline EL2: Troffer Lighting</a> .....	168
<a href="#">Guideline EL3: Industrial-Style Classrooms</a> .....	171
<a href="#">Guideline EL4: Lighting Controls for Classrooms</a> .....	174
<a href="#">Guideline EL5: Gym Lighting</a> .....	178
<a href="#">Guideline EL6: Corridor Lighting</a> .....	182
<a href="#">Guideline EL7: Lighting for a Multi-Purpose Room</a> .....	185
<a href="#">Guideline EL8: Lighting for a Library or Media Center</a> .....	188
<a href="#">Guideline EL9: Lighting for Offices and Teacher Support Rooms</a> .....	191
<a href="#">Guideline EL10: Lighting for Locker and Toilet Rooms</a> .....	193
<a href="#">Guideline EL11: Outdoor Lighting</a> .....	195
<b><a href="#">Mechanical and Ventilation Systems</a> .....</b>	<b>199</b>
<a href="#">Overview</a> .....	199
<a href="#">Guideline MV1: Cross Ventilation</a> .....	217
<a href="#">Guideline MV2: Stack Ventilation</a> .....	222
<a href="#">Guideline MV3: Ceiling Fans</a> .....	225
<a href="#">Guideline MV4: Gas/Electric Split System</a> .....	229
<a href="#">Guideline MV5: Packaged Rooftop System</a> .....	233
<a href="#">Guideline MV6: Displacement Ventilation System</a> .....	237
<a href="#">Guideline MV7: Hydronic Ceiling Panel System</a> .....	240
<a href="#">Guideline MV8: Unit Ventilator System</a> .....	244
<a href="#">Guideline MV9: Ductless Split System</a> .....	248
<a href="#">Guideline MV10: Evaporative Cooling System</a> .....	251
<a href="#">Guideline MV11: VAV Reheat System</a> .....	254
<a href="#">Guideline MV12: Radiant Slab System</a> .....	258
<a href="#">Guideline MV13: Baseboard Heating System</a> .....	261
<a href="#">Guideline MV14: Gas-Fired Radiant Heating System</a> .....	264
<a href="#">Guideline MV15: Water-Loop Heat Pumps</a> .....	266



<a href="#">Guideline MV16: Evaporatively Precooled Condenser</a> .....	268
<a href="#">Guideline MV17: Dedicated Outside Air Systems</a> .....	270
<a href="#">Guideline MV18: Economizers</a> .....	272
<a href="#">Guideline MV19: Air Distribution Design Guidelines</a> .....	275
<a href="#">Guideline MV20: Duct Sealing and Insulation</a> .....	281
<a href="#">Guideline MV21: Hydronic Distribution</a> .....	283
<a href="#">Guideline MV22: Chilled Water Plants</a> .....	287
<a href="#">Guideline MV23: Boilers</a> .....	293
<a href="#">Guideline MV24: Adjustable Thermostats</a> .....	296
<a href="#">Guideline MV25: EMS/DDC</a> .....	298
<a href="#">Guideline MV26: Demand Controlled Ventilation</a> .....	301
<a href="#">Guideline MV27: CO Sensors for Garage Exhaust Fans</a> .....	303
<a href="#">Guideline MV28: Timers for Recirculating Hot Water Systems</a> .....	305
<b><a href="#">Renewable Energy Systems</a> .....</b>	<b>307</b>
<a href="#">Overview</a> .....	307
<a href="#">Guideline RE1: Passive Heating and Cooling</a> .....	309
<a href="#">Guideline RE2: Solar Thermal Hot Water Systems</a> .....	312
<a href="#">Guideline RE3: Solar Pool Heating</a> .....	315
<a href="#">Guideline RE4: Wind</a> .....	319
<a href="#">Guideline RE5: Geothermal Heat Pumps</a> .....	323
<a href="#">Guideline RE6: Photovoltaics</a> .....	327
<b><a href="#">Water Conservation</a> .....</b>	<b>333</b>
<a href="#">Overview</a> .....	333
<a href="#">Guideline WC1: Water-Efficient Irrigation Systems</a> .....	336
<a href="#">Guideline WC2: Stormwater Management, Groundwater Management, and Drainage Materials</a> .....	338
<a href="#">Guideline WC3: Rainwater Collection Systems</a> .....	341
<a href="#">Guideline WC4: Gray Water Systems</a> .....	346
<a href="#">Guideline WC5: Waterless Urinals</a> .....	350
<a href="#">Guideline WC6: Efficient Terminal Devices</a> .....	352
<b><a href="#">Recycling Systems and Waste Management</a> .....</b>	<b>355</b>
<a href="#">Overview</a> .....	355
<a href="#">Guideline RS1: Paper, Plastics, Glass, and Aluminum Recycling</a> .....	356
<a href="#">Guideline RS2: Composting</a> .....	359
<a href="#">Guideline RS3: Construction and Demolition (C&amp;D) Waste Management</a> .....	364

<b><u>Transportation</u></b> .....	<b>367</b>
<a href="#">Overview</a> .....	367
<a href="#">Alternative fuels</a> .....	368
<a href="#">Guideline TR1: Transportation and Site Design</a> .....	371
<a href="#">Guideline TR2: Alternative Fuel Vehicles</a> .....	373
<b><u>Resource-Efficient Building Products</u></b> .....	<b>375</b>
<a href="#">Overview</a> .....	375
<a href="#">Guideline BP1: Carpeting</a> .....	391
<a href="#">Guideline BP2: Resilient Flooring</a> .....	396
<a href="#">Guideline BP3: Ceramic Tile / Terrazzo</a> .....	399
<a href="#">Guideline BP4: Concrete Flooring</a> .....	402
<a href="#">Guideline BP5: Wood Flooring</a> .....	404
<a href="#">Guideline BP6: Bamboo Flooring</a> .....	407
<a href="#">Guideline BP7: Gypsum Board</a> .....	409
<a href="#">Guideline BP8: Acoustical Wall Panels and Ceilings</a> .....	411
<a href="#">Guideline BP9: Paints and Coatings</a> .....	414
<a href="#">Guideline BP10: Casework and Trim</a> .....	417
<a href="#">Guideline BP11: Interior Doors</a> .....	420
<a href="#">Guideline BP12: Toilet Partitions</a> .....	422
<b><u>Commissioning And Maintenance</u></b> .....	<b>423</b>
<a href="#">Introduction</a> .....	423
<a href="#">What Exactly Is Building Commissioning?</a> .....	423
<a href="#">Commissioning Approaches</a> .....	424
<a href="#">Benefits of Commissioning</a> .....	425
<a href="#">Costs of Building Commissioning</a> .....	427
<a href="#">Savings from Building Commissioning</a> .....	427
<a href="#">Selecting a Commissioning Provider</a> .....	428
<a href="#">The Commissioning Team</a> .....	432
<a href="#">Commissioning Phases</a> .....	435
<a href="#">Operation and Maintenance for Persistence</a> .....	440
<a href="#">List of Commissioning References and Resources</a> .....	448

# Introduction to the Manual

The U.S. Department of Energy's Rebuild America EnergySmart Schools program provides school boards, administrators, and design staff with guidance to help make informed decisions about energy and environmental issues important to school systems and communities. The *National Best Practices Manual for Building High Performance Schools* is a part of the suite of products developed to promote energy efficiency and renewable energy in schools. It was developed specifically for architects and engineers who are responsible for designing or retrofitting schools, and for the project managers who work with the design teams.

The *Energy Design Guidelines for High Performance Schools*, available for seven climate zones across the United States, was developed for school boards, administrators, and design staff to help make informed design decisions about energy and environmental issues important to school systems and communities. To obtain a copy of the *Energy Design Guidelines for High Performance Schools* for a particular climate zone (shown in the map on the following page), contact the U.S. Department of Energy's Energy Efficiency and Renewable Energy Clearinghouse (EREC) at 800-DOE-EREC (800-363-3732).

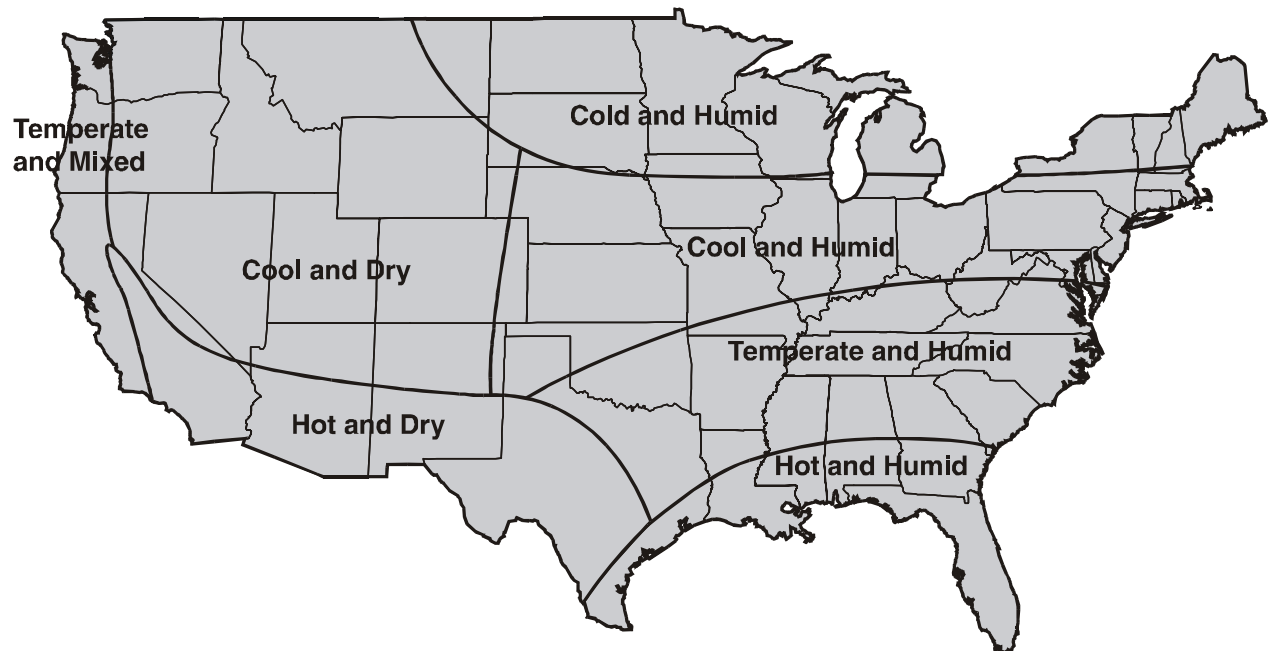

*Figure 1 – Seven U.S. Climate Zones*

The design strategies presented here are organized into 10 chapters covering important design disciplines and goals: site design; daylighting and windows; energy-efficient building shell; lighting and electrical systems; mechanical and ventilation systems; renewable energy systems; water conservation; recycling systems and waste management; transportation; and resource-efficient building products. An additional chapter addresses commissioning and maintenance practices. Applying these guidelines will result in schools that are healthy, comfortable, energy efficient, resource efficient, water efficient, safe, secure, adaptable, and easy to operate and maintain.

---

## THE DESIGN PROCESS

---

The characteristics of a high performance school reflect a mix of environmental, economic, and social objectives. The design process used to achieve high performance schools is fundamentally different from conventional practice. To be most effective, this process requires a significant commitment on the part of design professionals to:

- Meet energy and environmental performance criteria.
- Maintain a view of the building and site as a seamless whole within the context of its community.
- Work with the understanding that the building exists within the context of a natural ecosystem even when the setting is urban.
- Incorporate interdisciplinary collaboration throughout the design and construction process.
- Maximize student performance by keeping standards high for air quality and increasing the use of daylighting.
- Integrate all significant building design decisions and strategies — beginning no later than the programming phase.

- Optimize design choices through simulations, models, or other design tools.
- Employ life-cycle cost analysis in all decision making.
- Design all systems to be easy to maintain and operate.
- Commission all building equipment and systems to assure continued optimum performance.
- Document high performance materials and techniques in the building so that maintenance and repairs can be made in accordance with the original design intent.
- Encourage resource-efficient construction operations and building maintenance.
- Provide clear guidance, documentation, and training for operation and maintenance staff.

The typical design process for schools begins with programming and selection of the architectural-engineering team. It then proceeds through schematic design, design development, contract documents, construction, commissioning, and occupancy. The sooner high performance goals are considered in the design process, the easier and less costly they are to incorporate. Many of the guidelines presented in this document must be considered early in the design process for them to be successful. Figure 2 below shows a timeline through the design process and indicates the types of measures and design strategies that can be considered along the way.

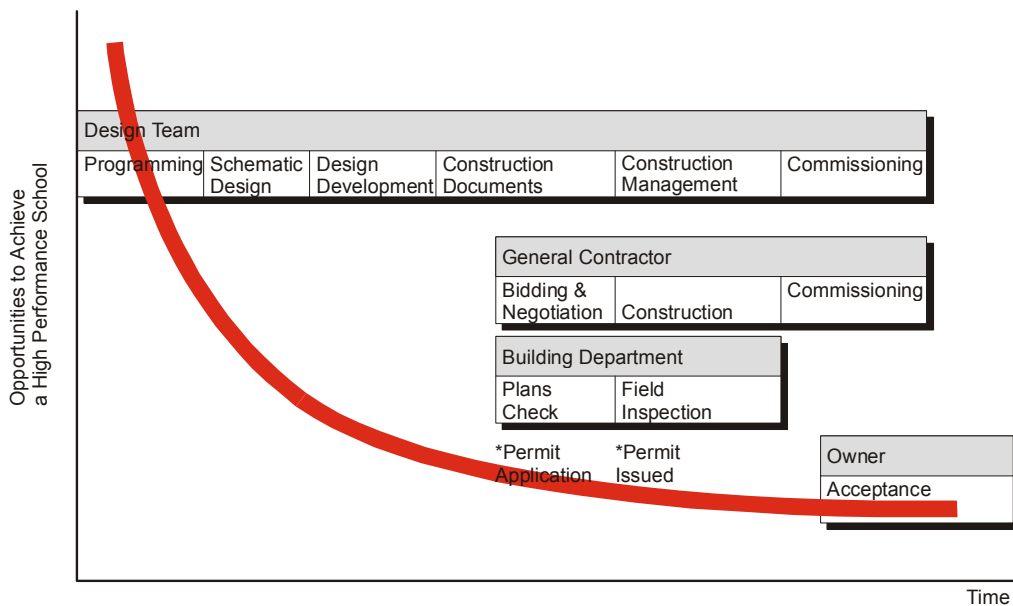

Figure 2 – Opportunities in the Design Process

For best results, these high performance goals should be reflected in all aspects of project documentation. High performance goals established during programming should be clearly stated in the educational specifications, in the request for proposals (RFP) to select the design team, in the instructions to bidders, and as part of the project summary. These goals are best expressed in terms of performance.

## INTEGRATED DESIGN

---

Integrated design is the consideration and design of all building systems and components together. It brings together the various disciplines involved in designing a building and reviews their recommendations as a whole. It recognizes that each discipline's recommendations have an impact on other aspects of the building project. This approach allows for optimization of both building performance and cost. Too often, heating, ventilation, and cooling (HVAC) systems are designed independently of lighting systems, for example, and lighting systems are designed without consideration of daylighting opportunities. The architect, mechanical engineer, electrical engineer, contractors, and other team members each have their scope of work and often pursue it without adequate communication and interaction with other team members. This can result in oversized systems or systems that are optimized for non-typical conditions.

Even a small degree of integration provides some benefits. It allows professionals working in various disciplines to take advantage of efficiencies that are not apparent when they are working in isolation. It can also point out areas where trade-offs can be implemented to enhance resource efficiency. Design integration is the best way to avoid redundancy or conflicts with aspects of the building project planned by others.

The earlier that integration is introduced in the design process, the greater the benefit. For a high performance school, project team collaboration and integration of design choices should begin no later than the programming phase. In addition, the project team is likely to be more broadly defined than in the past, and may include energy analysts, materials consultants, lighting designers, life-cycle cost consultants, and commissioning agents. Design activities may expand to include charrettes, modeling exercises, and simulations.

This manual provides details and implementation rules for individual design strategies. Though these individual strategies can improve a building's energy efficiency, only through whole-building analysis and integrated design can energy and cost concerns be balanced most effectively.

### ***Integrated Design and Portable Classrooms***

Integrated design concepts should be used in all types of school construction: new buildings, renovations, and even portable classrooms. A feature of U.S. schools for years, portable—or "relocatable"—classrooms appeal to school districts because of their low initial cost and short time between specification and occupancy. They are intended to provide flexibility, enabling quick response to demographic changes and providing



*This modular relocatable structure is a prototype and contains a variety of high performance features such as daylighting, high indoor air quality, significant energy savings, and resource efficient materials.*

NREL/PIX 11440



the ability to be moved from one school to another as demographics change. However, in reality, relocatable classrooms are seldom moved and become permanent fixtures of the school.

While most high performance strategies tend to be overlooked in portables, the effects of poor indoor environmental quality (IEQ) in relocatable classrooms are no different from those in permanent classrooms. All school buildings use similar construction and furnishing materials, so the types of chemicals present in indoor air are not likely to be different for relocatable versus permanent classrooms. However, pressed-wood products (often with high concentrations of formaldehyde) are used more in the factory-built relocatable units than in buildings constructed on-site. As a result, levels of airborne chemicals may be higher in new relocatable classrooms, especially if ventilation is reduced.

The most common problems with relocatable classrooms include:

- Poorly functioning HVAC systems that provide minimal ventilation of outside air.
- Poor acoustics from loud ventilation systems.
- Chemical off-gassing from pressed wood and other high-emission materials, compounded by quick occupation after construction or installation of carpets.
- Site pollution from nearby parking lots or loading areas.

Relocatable classrooms should be subject to the same high performance goals and concepts as the main school building. The solutions to these problems are the same as the recommendations presented in this manual for permanent structures.

## GOALS AND CROSS-CUTTING ISSUES

This manual is organized into 10 chapters that address the major high performance design goals and disciplines. The guidelines presented in each chapter are directed toward building schools that achieve the following goals, which are issues that cut across each of the major disciplines:

- Health and Indoor Air Quality (IAQ)
- Ecosystem Protection
- Thermal Comfort
- Energy Efficiency
- Visual Comfort
- Water Efficiency
- Acoustic Comfort
- Materials Efficiency
- Security and Safety
- Buildings as a Teaching Tool

Table 1 below shows which of the goals (or cross-cutting issues) apply to each of the chapters. The rest of this section describes these relationships in more detail and provides checklists that summarize the key high performance design strategies for each discipline.

*Table 1 – Relationship Between Goals and Technical Chapters*

		Goals/Cross-Cutting Issues									
Technical Chapters		Health and IAQ	Thermal Comfort	Visual Comfort	Acoustic Comfort	Security and Safety	Ecosystem Protection	Energy Efficiency	Water Efficiency	Materials Efficiency	Building as a Teaching Tool
	Site Design	●	●	●	●	●	●	●	●	●	●
	Daylighting and Windows		●	●		●		●		●	●
	Energy-Efficient Building Shell		●		●			●		●	●
	Lighting and Electrical Systems		●	●				●			●
	Mechanical and Ventilation Systems	●	●		●	●		●	●	●	●
	Renewable Energy Systems		●					●			●
	Water Conservation								●		●
	Recycling Systems and Waste Management						●			●	●
	Transportation					●	●	●			
Resource-Efficient Building Products	●			●		●	●		●	●	

## Health and IAQ

The quality of the air inside a school is critical to the health and performance of children, teachers, and staff. A high performance school should provide superior quality indoor air by: eliminating and controlling the sources of contamination; providing adequate ventilation; preventing unwanted moisture accumulation; and implementing effective operation and maintenance procedures.

According to the U.S. Environmental Protection Agency (EPA), the concentration of pollutants inside a building may be two to five times higher than outside levels. Children are particularly vulnerable to such pollutants because their breathing and metabolic rates are high relative to their size. Maintaining a high level of IAQ is therefore critical for schools. Failure to do so may, according to the EPA, negatively impact student and teacher performance; increase the potential for long- and short-term health problems for students and staff; increase absenteeism; accelerate deterioration; reduce efficiency of the school's physical plant; create negative publicity; and create potential liability problems.

To eliminate or control contamination, select materials that are low emitters of substances such as volatile organic compounds (VOCs) or toxins. Some of these building materials may be unfamiliar to custodial staff, so provide training to the staff, and select durable products and avoid products that unnecessarily complicate operation and maintenance. Any material can affect the acoustic and visual quality of a school; be sure to consider this when evaluating these materials. The following checklist summarizes strategies to improve a school's IAQ.

### **A Closer Look – Boscawen Elementary School, Boscawen, NH**

*This 53,000 ft<sup>2</sup>, 420-student school north of Concord, NH is the first in the country to use a combined displacement and demand-control ventilation system to provide superior IAQ and thermal comfort with reduced overall energy costs.*

*In this system, students and teachers are constantly surrounded by outside air. Stale air rises above them and is then vented out. None of it is recirculated. The result is a school with exemplary IAQ that is, at the same time, energy and cost efficient.*

*As Dr. G.W. Porter of the New Hampshire State Department of Education notes, "Despite the innovative engineering, its cost was equal, or possibly less than, other typical schools.*

*Maintenance costs, such as heating, are expected to be lower; and even without air-conditioning, the building will be even cooler in spring and fall. Air quality, a problem that's plagued a number of our schools, will also be vastly improved."*

#### **Eliminate or control contamination at the source**

- ✓ *Require a construction IAQ plan.*
- ✓ *Test the site for sources of contamination such as radon, hazardous waste, or fumes from nearby industrial or agricultural uses.*
- ✓ *Locate sources of exhaust fumes (e.g., from vehicles) away from air intake vents.*
- ✓ *Use recessed grates, "walk off" mats and other techniques to reduce dirt entering the building.*

#### **Avoid materials that contaminate indoor air**

- ✓ *Use materials that pass the emissions limits in the Specifications Section 1350.*
- ✓ *Specify composite wood or agrifiber products containing no urea-formaldehyde resins.*

#### **Provide adequate ventilation**

- ✓ *Allow adequate time for installed materials and furnishings to "off-gas" before the school is occupied. Run the HVAC system continuously at the highest possible outdoor air supply setting for at least 72 hours after all materials and furnishings have been installed.*
- ✓ *Design the ventilation system to provide a minimum of 15 cfm/person of filtered outdoor air to all occupied spaces.*

- ✓ *Ensure that ventilation air is effectively delivered to and distributed through the rooms in a school.*
- ✓ *Provide local exhaust for restrooms, kitchens, labs, janitor's closets, copy rooms, and shop rooms.*

#### **Prevent unwanted moisture accumulation**

- ✓ *Design the ventilation system to maintain the indoor relative humidity between 30% and 50%.*
- ✓ *Design to minimize water vapor condensation, especially on walls, the underside of roof decks, around pipes or ducts.*
- ✓ *Design to keep precipitation out of the building, off the roof, and away from the walls.*

#### **Operate and maintain the building effectively**

- ✓ *Regularly inspect and maintain the ventilation system so that it continues to operate as designed.*
- ✓ *Install CO<sub>2</sub> sensors in large assembly areas for real-time monitoring of air quality.*
- ✓ *Minimize the use of toxic cleaning materials.*
- ✓ *Use the EPA's "Indoor Air Quality—Tools for Schools" to guide the operation and maintenance process.*
- ✓ *Use the EPA's "Mold Remediation in Schools and Commercial Buildings" to control moisture problems. <http://www.epa.gov/iaq/molds> or (800) 438-4318.*

## Thermal Comfort

Thermal comfort is an important variable in student and teacher performance. Hot, stuffy rooms — and cold, drafty ones — reduce attention spans and limit productivity. They also waste energy, adding unnecessary cost to a school's bottom line.

Excessively high humidity levels can also contribute to mold and mildew. Thermal comfort is primarily a function of the temperature and relative humidity in a room, but air speed and the temperature of the surrounding surfaces also affect it. A high performance school should ensure that rooms and HVAC systems are designed to allow temperature and humidity levels to remain within the “comfort zone” at all points in an occupied space. Thermal comfort guidelines are provided in the technical chapter on Mechanical and Ventilation Systems.

Thermal comfort is strongly influenced by how a specific room is designed (for example, the amount of heat its walls and roof gain or lose, the amount of sunlight its windows let in, whether the windows can be opened) and by how effectively the HVAC system can meet the specific needs of that room. Balancing these two factors — room design and HVAC system design — is a back-and-forth process that continues throughout all the stages of developing a new facility. In a high performance school, the process ends with an optimal blend of both components: rooms configured for high student and teacher productivity served by an energy-efficient HVAC system designed, sized, and controlled to maintain thermal comfort under all conditions.

### A Closer Look – Designing for Thermal Comfort

*A design concept that provides superior thermal comfort through combining low velocity ventilation, room air stratification, and dehumidification cooling has been applied successfully at more than 20 schools in New England. This design approach, called The Advantage Classroom developed by The H. L. Turner Group in Concord, NH, reduces drafts and “hot spots,” enhances efficiency and control by including thermostats in each room, reduces room noise, and ensures optimal temperature and humidity levels by ongoing monitoring of room conditions.*

*Kim Cheney, a teacher at one school built with this design concept, is very satisfied with the results: “Everything about it is incredible; the whiteboards eliminate chalk dust, the air is clean, the temperature is perfect, it’s all so comfortable. In the old school . . . we’d be really cold, but if you turned on the heat it would get so hot the students would get tired in the afternoon. In moving into the new school we went from the 19th century straight to the 21st.”*

### Thermal Comfort Checklist

#### Design in accordance with ASHRAE standards

- ✓ Design systems to provide comfort in accord with American Society of Heating, Refrigerating and Air Conditioning Engineers (ASHRAE) Standard 55–1992 (with 1995 Addenda) Thermal Environmental Conditions for Human Occupancy.
- ✓ When a design incorporates natural ventilation (e.g., operable windows to provide direct outdoor air during temperate weather), consider adjusting the requirements of ASHRAE Standard 55–1992 to account for the impact.

#### Install controls and monitor system performance

- ✓ Install controls in each classroom to give teachers direct control over thermal comfort. Evaluate the potential impact of such controls on the overall efficiency of the HVAC system.

- ✓ Consider providing a temperature and humidity monitoring system to ensure optimal thermal comfort performance.
- ✓ Consider including temperature and humidity monitoring as part of the building's overall energy management system.

#### Analyze room and system layouts

- ✓ Analyze room configurations and HVAC distribution layouts to ensure all parts of a room are receiving adequate ventilation.
- ✓ Analyze placement of windows and skylights and provide adequate, controllable shading to avoid “hot spots” caused by direct sunlight.

## Visual Comfort

Performing visual tasks is a central component of the learning process for both students and teachers. A high performance school should provide a rich visual environment — one that enhances, rather than hinders, learning and teaching — by carefully integrating natural and electric lighting strategies, by balancing the quantity and quality of light in each room, and by controlling or eliminating glare.

Students spend much of their day engaged in visual tasks — writing, reading printed material, reading from visual display terminals, or reading from blackboards, whiteboards, and overheads. They must constantly adjust their vision from a “heads-up” to “heads-down” position and back again. Inadequate lighting and/or glare can seriously affect a student’s ability to learn. On the other hand, a comfortable, productive visual environment — one that takes into account more than simply the amount of light hitting the desktop — will enhance the learning experience for both students and teachers.

Visual comfort results from a well-designed, well-integrated combination of natural and artificial lighting systems. Any strategy for enhancing the visual environment will therefore strongly affect the size and configuration of both these systems (for example, number, type, and placement of windows; number, type, and placement of light fixtures; etc.). The final configurations will, in turn, affect a school’s HVAC systems.

An optimized overall design will provide a high quality luminous environment and will use daylight effectively to reduce the need for artificial lighting. Less artificial lighting means lower electricity bills and less waste heat that, in turn, means less demand for cooling and lower HVAC operating expenses.

### Visual Comfort Checklist

#### Integrate natural and artificial lighting strategies

- ✓ Take the amount of daylight entering a room into account when designing and sizing the artificial lighting system for that room.
- ✓ Provide controls that turn off lights when sufficient daylight exists.
- ✓ Consider dimming controls that continuously adjust lighting levels to respond to daylight conditions.

#### Balance the quantity and quality of light in each room

- ✓ Avoid excessively high horizontal light levels.
- ✓ Use the revised 9th edition of the Illuminating Engineering Society of North America (IESNA)’s *Lighting Handbook: Design and Application as a guide*.
- ✓ Design for “uniformity with flexibility.”
- ✓ Illuminate spaces as uniformly as possible, avoiding shadows or sharp distinctions between dark and light.
- ✓ Provide task or accent lighting to meet specific needs (e.g., display areas, whiteboards, team areas).

#### A Closer Look – Durant Road Middle School, Wake County, NC

*Daylighting and electric lighting are seamlessly integrated in this 1,300-student school in Raleigh, NC. The design team repeatedly analyzed the interactions between the size and location of the roof monitors; the size and configuration of the electric lighting fixtures; the color and reflectance of the walls, floor, and ceiling; and the amount of light hitting the desks.*

*“We worked the problem using computer simulation tools until we had just the right combination. The result is a group of classrooms that are bright, fun places to be; that rely on natural sunlight for the bulk of their lighting needs; that virtually eliminate glare; and that save the school money on energy; all at the same time,” notes Mike Nicklas, chief architect for the project.*

*Because of the school’s exceptional daylighting design, it was featured on CNN’s “Science and Technology Week” series.*

- ✓ Develop individual lighting strategies for individual rooms or room types (e.g., classrooms, hallways, cafeteria, library, etc.). Avoid “one size fits all” approaches.

#### Control or eliminate glare

- ✓ Consider how light sources in a room will affect work surfaces. Design to avoid direct glare (from sources in front or to the side of a work area), overhead glare (from sources above the work area), and reflected glare (from highly reflective surfaces, including glossy paper and computer terminals).
- ✓ Consider increasing the brightness of surrounding surfaces, decreasing the brightness of light sources, or both as control methods.
- ✓ Consider interior (shades, louvers, blinds) or exterior (overhangs, trees) strategies to filter daylight and control glare from sunlight.

## Acoustic Comfort

Parents, students, teachers, and administrators across the country are increasingly concerned that classroom acoustics are inadequate for proper learning. Noise from outside the school (from vehicles and airplanes, for example), hallways (foot traffic and conversation), other classrooms (amplified sound systems and inadequate sound transmission loss), mechanical equipment (compressors, boilers, and ventilation systems), and even noise from inside the classroom itself (reverberation) can hamper students' concentration.

### **A Closer Look – Sterling Montessori Academy, Morrisville, NC**

*The roof monitors that bring daylight into the classrooms of this 200-student elementary school in a Raleigh, NC, suburb provide an added benefit: improved acoustics. The large, open space under the monitors, plus the baffles used to control glare, help dampen sound throughout the classroom. The result is an improved environment for teaching and learning.*

*Though daylighting was expected to be the most noticeable change for teachers and students, one teacher said the improved acoustics was the best feature.*

Trying to hear in a poor acoustical environment is like trying to read in a room with poor lighting: stress increases, concentration decreases, and learning is impaired. This is especially true for younger students (the ability to sort meaningful sounds from noise is not fully developed until children reach their teens), those for whom English is a second language, and those with hearing impairments. Although little consideration has historically been given to acoustic design in classrooms — as opposed to lighting and ventilation — this situation is beginning to change. The information and tools needed to design classrooms for high acoustical performance now exist. They can be used to ensure that any newly constructed classroom provides an acoustic environment that positively enhances the learning experience for students and teachers.

## Acoustic Comfort Checklist

### Ensure a superior acoustical environment

- ✓ *Reduce sound reverberation time inside the classroom.*
- ✓ *Limit transmission of noise from outside the classroom.*
- ✓ *Minimize background noise from the building's HVAC system.*



## Security and Safety

Safety and security have become critical concerns for students, teachers, and parents across the country. A high performance school should create a safe and secure environment by design.

Opportunities for natural surveillance should be optimized; a sense of territoriality should be reinforced; access should be controlled; and

technology should be used to complement and enhance, rather than substitute for, a facility's security-focused design features.

Crime and vandalism — and the fear they foster — are problems facing school populations throughout the United States. While better buildings alone cannot solve these problems, they can be powerful factors in helping reduce crime and other antisocial behavior. Thoughtful design that builds on basic “Crime Prevention through Environmental Design” principles is the key.

Security-based design strategies will influence a school's basic layout and site plan. If properly integrated from the beginning of the development process, these influences will complement and enhance other high performance design strategies used in the facility. For example, daylit classrooms can “share” their natural light with adjacent corridors through windows or glass doors provided primarily for surveillance purposes. This “free” natural light can, in turn, be used to offset the need for electrical lighting in the corridors. Security technology strategies will not strongly impact other systems in the school, unless they are incorporated into a comprehensive automated control system for the whole facility.

### **A Closer Look – Boscawen Elementary School, Boscawen, NH**

*“Room-like,” non-institutional corridors, plenty of views out and in, and windows between the classrooms and the hallway, all combine to improve the safety and sense of security in this 53,000-ft<sup>2</sup>, 420-student school north of Concord, NH.*

## Security and Safety Checklist

### **Increase opportunities for natural surveillance**

- ✓ *Design landscaping to minimize places that are hidden from view. Ensure that key areas — parking, bicycle storage, drop-off points, play equipment, entries — are easily observable from inside the building.*
- ✓ *Design exterior lighting to facilitate nighttime surveillance.*
- ✓ *Consider providing views through glazed doors or windows from classrooms into circulation corridors.*
- ✓ *Design to minimize areas within the building that are hidden from view.*
- ✓ *Consider open stairwells.*

### **Reinforce a sense of territoriality**

- ✓ *Foster a sense of “ownership” of the school for students and teachers by clearly defining borders — what is part of the school and what is not.*
- ✓ *Consider decorative fencing and special paving treatments to delineate the boundaries of the school grounds.*
- ✓ *Consider designing common areas, particularly corridors, so that they are less institutional and more “room-like.”*

### **Design for easy maintenance**

- ✓ *Consider graffiti-resistant materials and finishes.*

### **Control access to the building and grounds**

- ✓ *Consider decorative fencing to control access to school grounds.*
- ✓ *Limit the number of entries to the building. Allow visual surveillance of all entries from inside the school.*
- ✓ *Provide capability to “lock-down” parts of the school when the facility is used for after-hours activities.*

### **Integrate security technology**

- ✓ *Consider incorporating interior and exterior surveillance cameras.*
- ✓ *Ensure that all high-risk areas (office, cafeteria, shops, labs, etc.) are protected by high security locks.*
- ✓ *Consider metal detectors and other security technologies as appropriate.*
- ✓ *Motion sensors for lighting can also provide effective security control.*

## Ecosystem Protection

A high performance school protects the natural ecosystem. As much as possible, the school incorporates products and techniques that do not introduce pollutants or degradation at the project site or at the site of extraction, harvest, or production. Give preference to materials that are locally extracted or harvested or locally manufactured to eliminate potential air pollution due to petroleum-based transportation.

Some of these building materials may be unfamiliar to custodial staff. Avoid products that unnecessarily complicate operation and maintenance procedures, and provide training to ensure proper upkeep and ensure full service life. When evaluating materials, be sure to consider their impact on the acoustic and visual quality of a school.

High performance school design is environmentally responsive to the site, incorporating natural conditions such as wind, solar energy, and moisture to enhance the building's performance. Natural features and areas of the site should be preserved; damaged areas should be restored. Take steps to eliminate stormwater runoff and erosion that can affect local waterways and adjacent ecosystems.

Using these strategies can help teach students about the importance of protecting natural habitats and the impact of human activities on ecological systems.

### Ecosystem Protection Checklist

#### Specify indigenous materials

- ✓ Specify materials appropriately adapted for the building and site, such as native landscaping and locally extracted building materials.

#### Specify wood products that are harvested responsibly

- ✓ Set a goal of having 50% of the school's wood-based materials certified in accordance with the Forest Stewardship Guidelines for wood-based components.

#### Avoid materials that harm the ecosystem

- ✓ Eliminate materials that harm the natural ecosystem through toxic releases or by producing unsafe concentrations of substances.
- ✓ Eliminate the use of ozone-depleting chlorofluorocarbons (CFCs) and hydrochlorofluorocarbons (HCFCs) as refrigerants in all HVAC systems.
- ✓ Give preference to locally manufactured materials and products to eliminate air pollution due to transportation.

#### A Closer Look – Sakai Intermediate School, Bainbridge Island, WA

*This new facility is an excellent example of a school project that went the extra mile to protect the natural environment. The building and sports field's footprint was reduced to increase a buffer zone far beyond what was required in order to protect an adjacent wetland and salmon stream. A culvert that blocked salmon passage was removed. A system separating groundwater from stormwater allowed the groundwater to recharge the natural wetland, and allowed designers to reduce the size of the stormwater retention pond.*

*Students and other community members were involved in restoring the salmon stream and building an outdoor classroom platform, and they acted as tour guides for the open house explaining the special site protection features.*

- ✓ Eliminate products that pollute water, air, or other natural resources where they are extracted, manufactured, used, or disposed of.
- ✓ Evaluate the potential impact of specified site materials on natural ecosystems located on site or adjacent to the site.

#### Preserve and restore natural features and areas on, and near, the site

- ✓ During construction, develop and implement a construction operations plan to protect the site.
- ✓ Develop the site to prevent stormwater runoff and erosion.
- ✓ Restore damaged natural areas.
- ✓ Maintain connection to nearby natural ecosystems.

## Energy Efficiency

Energy-efficient schools cost less to operate, which means that more money can be used for books, computers, teacher salaries, and other items essential to the educational goals of schools. Energy-efficient schools also reduce emissions to the environment, since energy use is related to emissions of carbon dioxide (CO<sub>2</sub>), sulfur oxides (SO<sub>x</sub>), nitrous oxides (NO<sub>x</sub>), and other pollutants. Smaller air conditioners also reduce the likelihood of ozone-depleting gases escaping to the atmosphere. All the chapters and guidelines in this manual relate to energy efficiency in some meaningful way.

Guidelines explicitly related to energy efficiency are provided in five of the chapters: daylighting and windows; lighting and electrical systems; energy-efficient building shell; mechanical and ventilation systems; and renewable energy systems. The key issues are summarized below.

### **Daylighting and Fenestration Design**

Daylighting is the controlled admission of natural light into a space through windows, skylights, or roof monitors. A high performance school should use as much daylight as possible, especially in classrooms, while avoiding excessive heat loss, heat gain, and glare.

Access to natural light may be one of the most important attributes of a high performance school. Daylight is the highest quality light source for visual tasks, enhancing the color and appearance of objects. Studies clearly indicate that daylighting can enhance student performance. Views from windows also provide a connection with the natural world and contribute to eye health by allowing frequent changes in focal distance.

Daylighting can also save schools money.

Properly designed systems can substantially reduce the need for electric lighting, which can account for 35% to 50% of a school's electrical energy consumption. As an added benefit, waste heat from the lighting system is reduced, lowering demands on the school's cooling equipment. The savings can be as much as 10% to 20% of a school's cooling energy use. And daylight provides these savings during the day when demand for electric power is at its peak and electricity rates are at their highest.

#### **A Closer Look – Dena Boer Elementary School, Salida, CA**

*Skylights are used to distribute natural daylight to the classrooms, library, multipurpose room and offices of this 800-student, K-5 school near Modesto, CA. Louvers installed in the skylight wells help control daylight levels and can be used to darken rooms when necessary. Classroom windows provide additional daylight and are protected by deep overhangs to control direct sunlight and glare.*

*All these “extras” were provided within the standard construction budget for the school, which was completed in 1997. The key was making daylighting a priority for the school and then shifting funds from elsewhere in the budget to pay for it.*

*The extra sunlight has proven very popular. “The skylights create an open, bright work environment. We just seem to have more room. Visitors say it sure is a pleasant place to come into,” notes school principal Rick Bartkowski.*

### **Energy Efficiency Checklist for Daylighting**

#### **Avoid direct beam sunlight and glare**

- ✓ Consider interior (shades, louvers, or blinds) and exterior (overhangs, trees) strategies to control glare and filter daylight.
- ✓ Consider skylights (horizontal glass), roof monitors (vertical glass), light from two sides, and/or clerestory windows.
- ✓ Lay out the room to take advantage of daylight. Consider sloped ceilings. Consider light-colored ceiling surfaces to help reflect daylight within the room.

#### **Design for diffuse, uniform daylight that penetrates deep into the space**

- ✓ Use a daylighting analysis tool to help guide the design process.
- ✓ Design windows to allow daylight to penetrate as far as possible into a room. Consider using light shelves (solid horizontal elements placed above eye level, but below the top of the window) to reflect daylight deep into a room.

#### **Integrate daylighting with the electric lighting system**

- ✓ Provide controls that turn off lights when sufficient daylight exists. Consider dimming controls that continuously adjust light levels to respond to daylight conditions.

## Electric Lighting

Electric lighting systems interact closely with a school's daylighting and HVAC systems. Daylighting strategies that are well integrated with lighting equipment and controls will reduce the demand for electric light. This decrease in demand, if it is met by a combination of high efficiency electric lighting equipment and controls, can substantially lower a school's electricity usage.

An added benefit: more efficient lighting produces less waste heat, reducing the need for cooling and further reducing operating costs. Cooling equipment can be downsized, resulting in first cost and operating cost savings to the school.

These savings are achievable now — in any school — using readily available equipment and controls.

### A Closer Look – Ross Middle School, Ross, CA

*This 200-student facility north of San Francisco, CA incorporates a full range of high performance electric lighting features. Direct/indirect pendant luminaires provide high quality light at low footcandle levels. In the daylight classrooms, dimming ballasts and photosensors are also used, so light output can vary depending on daylight availability. Used properly, this strategy alone can save up to 60% of the electrical energy needed for lighting these rooms.*

*Lights have two bulbs that are separately switched, so that half the lamps can be turned off at one time, further reducing energy consumption. Some lights are also tied to occupancy sensors so that they automatically turn off when a room is unoccupied. Finally, the entire lighting system is on a timer to ensure all lights are shut off at night.*

*These features, combined with daylighting, create a total system that delivers high quality lighting that is energy and cost efficient. Architect Scott Shell hopes that these features, "...will not only make the school a better place for teaching and learning, but will also be used as tools that help make children more aware of how buildings and their use of energy impact the environment." Electric lighting can account for 30% to 50% of a school's electric power consumption. Even modest efficiency improvements can mean substantial bottom-line savings.*

## Energy Efficiency Checklist for Electric Lighting

### Design for high efficiency and visual comfort

- ✓ Develop individual lighting designs for individual rooms or room types (classrooms, hallways, cafeteria, etc.). Avoid overlighting any space.
- ✓ Consider a mix of direct and indirect light sources for each design.
- ✓ Optimize each design so that overall lighting levels ( $W/ft^2$ ) are as low as possible while still providing optimal task illumination.
- ✓ Analyze the impact of the lighting system on the HVAC system and resize the HVAC system as appropriate.
- ✓ Design systems to facilitate cleaning/lamp replacement.

### Specify high efficiency lamps and ballasts

- ✓ Use "Super" T-8 fluorescent lamps with electronic ballasts for most general lighting applications (classrooms, offices, multipurpose rooms, cafeterias). Consider using T-5 lamps if justified by life-cycle cost.
- ✓ Consider dimmable ballasts, especially in daylight rooms.

### Optimize the number and type of luminaires

- ✓ Use suspended indirect or direct/indirect luminaires in classrooms to provide soft uniform illumination.

- ✓ Consider using additional accent and directional task lighting for specific uses (such as display areas).
- ✓ Consider using a smaller number of higher efficiency luminaires to light specific spaces, resulting in fewer fixtures to purchase, install, maintain, and clean.

### Incorporate controls to ensure peak system performance

- ✓ Use occupancy sensors with manual overrides to control lighting (on-off) in classrooms, offices, restrooms, and other intermittently occupied spaces. Consider scheduled dimming and/or time clocks in other rooms.
- ✓ Consider incorporating lighting controls into the facility's overall energy management system.

### Integrate electric lighting and daylighting strategies

- ✓ Treat the electric lighting system as a supplement to natural light. Design for daylighting first and use the electric system to add light as needed during the day and provide sufficient illumination at night.
- ✓ Provide controls to dim or turn off lights at times when daylight is sufficient. Consider photoelectric controls that are sensitive to levels of daylight.
- ✓ Consider controls that provide continuous, rather than stepped, dimming.

## Building Enclosures

The building enclosure (walls, roofs, floors, and windows) of a high performance school should enhance energy efficiency without compromising durability, maintainability, or acoustic, thermal, or visual comfort. An energy-efficient building enclosure is one that integrates and optimizes moisture control, insulation levels, glazing, shading, thermal mass, air leakage control, and light-colored exterior surfaces. An energy-efficient building enclosure will reduce a school's overall operating expenses and will also help the environment. Many of the techniques employed — high performance glazing, shading devices, light-colored surfaces — are easy for students to understand and can be used as instructional aids.

The key to optimizing the building enclosure is an integrated approach to design that considers how all the components of the building shell interact with each other and with the building's HVAC systems. Tools to analyze these interactions are readily available and can be used to create the optimal building enclosure based on total system performance. As part of an integrated approach, consider the actions described below.

### **A Closer Look – Oquirrh Hills Elementary School, Kearns, UT**

*Well-insulated metal stud and brick veneer walls, a light-colored roof with R-30 rigid insulation, and windows with low-e glass all contribute to the superior energy performance of this elementary school near Salt Lake City.*

*The school, completed in 1996, replaced a previous facility that had been destroyed by fire. The new building saves roughly \$22,000 per year in operating costs compared to its predecessor—a result of careful design combined with high performance systems and an energy-efficient building enclosure.*

*Based on its experience with Oquirrh Hills, the Jordan School District has embraced high performance as a procurement goal and has gone on to build six more energy-efficient schools.*

*“High performance, energy smart school design means going ‘beyond code’...cost effectively. That’s just what the architects did at Oquirrh Hills,” notes Duane Devey, Director of Energy and Utility Resources for Jordan School District.*

### **Energy Efficiency Checklist for the Building Enclosure**

#### **Specify high performance glazing**

- ✓ *Specify glazing that offers the best combination of insulating value, daylight transmittance, and solar heat gain coefficient for the specific application.*

#### **Control heat gain and glare**

- ✓ *Consider exterior shading devices to reduce solar heat gain and minimize glare.*
- ✓ *Consider using light-colored materials for walls and roofs to reflect, rather than absorb, solar energy.*
- ✓ *Provide an appropriate level of insulation for each climate zone.*

#### **Control moisture**

- ✓ *Provide a drainage plane in the outside layer to ensure that moisture has a path to exit the wall.*
- ✓ *Provide an appropriate moisture barrier and ensure that it is in direct thermal contact with the warm wall surface.*

#### **Consider high mass materials, like concrete or brick**

- ✓ *Use the building's thermal mass to store heat and temper heat transfer.*
- ✓ *Consider adding thermal mass to increase the storage capacity and energy efficiency of the building.*
- ✓ *Do not substitute thermal mass for insulation.*

#### **Control air leakage**

- ✓ *Consider air retarder systems (also referred to as “air infiltration barriers”) as a means to improve energy performance and comfort.*
- ✓ *Ensure that an air barrier is continuous from the foundation to the ceiling.*

## Efficient HVAC Systems

A school's HVAC system provides the heating, ventilating and air-conditioning necessary for the comfort and well-being of students, staff, and visitors. To ensure peak operating efficiency, the HVAC system in a high performance school should: use high efficiency equipment, be "right sized" for the estimated demands of the facility, and include controls that boost system performance.

The HVAC system is one of the largest energy consumers in a school. Even modest improvements in system efficiency can represent relatively large savings to a school's operating budget. With the highly efficient systems available today — and the sophisticated analysis tools that can be used to select and size them — there's no reason why every school HVAC system can't be designed to the highest levels of performance.

The key to optimizing HVAC system performance is an integrated design approach that considers the building as an interactive whole rather than as an assembly of individual systems. For example, the benefits of an energy-efficient building enclosure may be wasted if the HVAC equipment is not sized to take advantage of it. Oversized systems, based on rule-of-thumb sizing calculations, will not only cost more, but will be too large to ever run at peak efficiency and will waste energy every time they turn on. An integrated approach, based on an accurate estimate of the impact of the high efficiency building enclosure, will allow the HVAC system to be sized for optimum performance. The resulting system will cost less to purchase, will use less energy, and will run more efficiently over time.

### **A Closer Look – Newport Mesa Elementary School, Costa Mesa, CA**

*After careful analysis of first costs versus performance benefits, high efficiency heat pumps—one for each classroom—were selected for this 400–700 student school south of Los Angeles. The equipment was designed and sized to work well with the natural ventilation systems built into each classroom. Controls for both systems are provided in each classroom so that teachers can maintain optimal conditions at all times. The result is a school that provides a high performing HVAC system and empowers teachers to run it at peak efficiency.*

### **Energy Efficiency Checklist for HVAC Systems**

#### **Use high efficiency equipment**

- ✓ Specify non-CFC-based refrigerants for systems using large chillers.
- ✓ Specify equipment that meets or exceeds the U.S. Department of Energy's "Energy Conservation Voluntary Performance Standards for New Buildings."
- ✓ Use ENERGY STAR-approved products.
- ✓ Consider recovery systems that pre-heat or pre-cool incoming ventilation air.
- ✓ Consider "economizer cycles" for small, packaged systems in mild climates.
- ✓ In hot, dry climates, consider indirect evaporative cooling.
- ✓ Investigate the potential for on-site cogeneration.
- ✓ Locate ducts in conditioned or semi-conditioned spaces.

#### **"Right-size" the system**

- ✓ Consider standard HVAC sizing safety factors as upper limits.
- ✓ Apply any safety factors to a reasonable base condition for the building: not the hottest or coldest day of the year with maximum attendance; not the most temperate day of the year with the school half full.
- ✓ Select systems that operate well under part-load conditions.
- ✓ Monitor existing local systems to size future systems.

#### **Incorporate controls that boost system performance**

- ✓ Consider integrated building management systems that control HVAC, lighting, outside air ventilation, water heating, and building security.
- ✓ Consider individual HVAC controls for each classroom.



## Water Efficiency

Fresh water is an increasingly scarce resource. A high performance school should control and reduce water runoff from its site, consume fresh water as efficiently as possible and recover and reuse gray water to the extent feasible.

Basic efficiency measures can reduce a school's water use by 30% or more. These reductions help the environment, locally and regionally. They also lower a school's operating expenses. While the cost savings may be modest now, since water is relatively inexpensive in most areas of the country, there is a strong potential that these savings will rise over time, especially in areas where water is scarce and becoming more expensive.

The technologies and techniques used to conserve water — especially landscaping, water treatment, and recycling strategies — can be used to help instruct students about ecology and the environment. Guidelines covering issues such as efficient irrigation systems, water reclamation, and low-flow devices are featured in the Water Conservation chapter. The use of drought-resistant plants is discussed in the Site Design chapter. The following checklist summarizes the key issues related to water efficiency.

### Water Efficiency Checklist

#### Design landscaping to use water efficiently

- ✓ Reduce water use.
- ✓ Consider innovative wastewater treatment options.
- ✓ Specify hardy, native vegetation.
- ✓ Consider using an irrigation system for athletic fields only, not for plantings near buildings or in parking lots.
- ✓ Use high efficiency irrigation technology (e.g., drip irrigation in lieu of sprinklers).
- ✓ Use captured rain or recycled site water for irrigation.
- ✓ "Design in" cisterns for capturing rainwater.

#### Set water use goals for the school

- ✓ Recommended goal: 20% less than the baseline calculated for the building (not including irrigation) after meeting the Energy Policy Act of 1992 fixture performance requirements.

#### **A Closer Look – Roy Lee Walker Elementary School McKinney, TX, Independent School District**

Rain is "harvested" from the roof of this 608-student, K-5 school 30 miles north of Dallas, and is used to water the grounds and flush the toilets year round. The water is stored in six above-ground cisterns designed as integral components of the overall architecture of the facility.

The system shows how incredibly efficient rainwater collection can be, even in relatively dry locations. According to architect Gary Keep, just using the roof, "...enough water can be collected in a one-year period to flush toilets and water the grounds for about six years."

#### Specify water-conserving fixtures and equipment

- ✓ Specify water-conserving plumbing fixtures that exceed Energy Policy Act of 1992 requirements.
- ✓ Specify high efficiency equipment (dishwashers, laundry, cooling towers).
- ✓ Consider single temperature fittings for student toilets/locker rooms.
- ✓ Consider automatic lavatory faucet shutoff controls.
- ✓ Consider low-flow showerheads with pause control.

#### Consider using recycled or rainwater for non-potable uses

- ✓ Decrease use of potable water for sewage conveyance by using gray and/or black water systems. Opportunities include toilet flushing, landscape irrigation, etc.
- ✓ Consider on-site wastewater treatment, including full or partial "solar aquatics" systems on large sites.
- ✓ Possible applications include HVAC and process make-up water.

## Material Efficiency

Material efficiency in this manual refers specifically to two overarching goals: 1) waste reduction — including construction and demolition (C&D) source reduction, reuse, and recycling; and 2) the use of building products that are manufactured in ways that conserve raw materials, including the use of recycled content products, that conserve energy and water, that are reused or salvaged, or that can be recycled or reused at the end of the building's service life.

Addressing these goals provides significant environmental benefit. According to WorldWatch, buildings account for 40% of many processed materials used (such as stone, gravel, and steel) and 25% of virgin wood harvested. These withdrawals can cause landscape destruction, toxic runoff from mines, deforestation, biodiversity losses, air pollution, water pollution, siltation, and other problems.

The checklist below summarizes key material efficiency strategies. When considering recycled content products or other materials-efficient products, be sure to consider their effect on acoustic, visual, and indoor air quality. Be aware that using certain recycled products may conflict with goals for long-term materials efficiency, since a product's recycled composite may be difficult to recycle. Avoid products that unnecessarily complicate operation and maintenance procedures, and be sure that the custodial staff receives training in proper upkeep of the products. Using these strategies can help teach students about the role of waste reduction in protecting the environment.

### A Closer Look – Ocean Park School, Santa Monica, CA

*Certified sustainable yield lumber, formaldehyde-free particleboard and insulation, non-VOC sealants, and recycled plastic bathroom partitions were all incorporated into this 45,000 ft<sup>2</sup>, K-8 school in Santa Monica.*

*"It's not difficult to make our schools healthier and more environmentally responsible, but you have to start early in the process by 'designing in' high performance, non-toxic materials and products from the very beginning," says Betsy Dougherty, lead architect for the project.*

## Material Efficiency Checklist

### Design to facilitate recycling

- ✓ *"Design in" an area within the building dedicated to separating, collecting, storing, and transporting materials for recycling including paper, glass, plastics, and metals.*

### Reduce the amount of construction waste going to landfills

- ✓ *Develop and implement a management plan for sorting and recycling construction waste.*
- ✓ *Consider a goal of recycling or salvaging 50% (by weight) of total construction, demolition, or land clearing waste.*

### Specify salvaged or refurbished materials

- ✓ *Evaluate the potential impact of salvaged materials on overall performance, including energy and water efficiency and operation and maintenance procedures.*

### Maximize recycled content of all new materials

- ✓ *Use EPA-designated recycled content products to the maximum extent practicable.*
- ✓ *Use materials and assemblies with the highest available percentage of post-consumer or post-industrial recycled content.*
- ✓ *Set a goal to achieve a minimum recycled content rate of 25%.*

### Eliminate materials that may introduce indoor air pollutants

- ✓ *Use materials or assemblies with the lowest level of (VOCs).*
- ✓ *Evaluate the potential impact of specified materials on the indoor air quality of the school.*

## COMMISSIONING, OPERATION, AND MAINTENANCE

---

Building commissioning is the process of ensuring that systems in schools are designed, installed, tested, and verified as being capable of operating according to the school's needs and the designer's intent. The term comes from shipbuilding where "commissioning a ship" means thoroughly testing it to ensure that it is seaworthy. For buildings, commissioning has a similar meaning, which is, testing the important building systems to ensure that they operate the way the designers expect and that they serve the needs of teachers, students, and school districts.

High performance schools can only be achieved with some level of commissioning. Higher test scores, increased average daily attendance, reduced operational costs, staff retention, and reduced liability may be compromised unless critical systems are commissioned to achieve proper performance. Because it anticipates problems, commissioning can avoid costly change orders, delays, and litigation. In addition to commissioning building systems, design professionals can commission high performance materials by making sure they are installed as specified and that proper documentation exists so the design intent is not compromised in the event of cleaning, repair, or replacement.

Studies show that building systems will not operate as expected unless they are commissioned. One study of 60 newly constructed nonresidential buildings showed that more than half had controls problems, 40% had malfunctioning HVAC equipment, and one-third had sensors that did not operate properly. In many of the buildings, equipment called for on the plans and specifications was actually missing. One-fourth of the buildings had energy management control systems, economizers, or variable-speed drives that did not run properly.<sup>1</sup>

Additional information on commissioning can be found in the Commissioning chapter at the end of this manual.

### **Systems that Require Commissioning**

Commissioning can reduce these problems by systematically assuring that the critical systems are properly installed, calibrated, and working. Systems for which commissioning is essential include lighting sweep systems, photocell daylighting controls, energy management systems, variable-speed motor drives, building pressurization control, floating head pressure in refrigeration equipment, anti-condensate heaters in refrigeration systems, and capacity controls in central heating and cooling plants. A more comprehensive list of systems that might require commissioning include:

- HVAC plant
- Air and water delivery system
- Energy management system
- Electrical and lighting system
- Fire/life safety system
- Kitchen equipment and fume hoods
- Building envelope
- Renewable energy system
- Science lab gas delivery system
- Emergency power supply

---

<sup>1</sup> Piette, Mary Ann. 1994. Quantifying savings from commissioning: Preliminary results from the Northwest. Lawrence Berkeley National Laboratory.

- Data networks/communications
- Security system
- Plumbing
- Irrigation system.

### ***The Commissioning Agent***

The commissioning agent is responsible for coordinating and carrying out the commissioning process. For complex projects, the commissioning agent should be brought on as part of the design phase. However, for most schools, commissioning may not be needed until construction start-up, and knowledgeable in-house personnel may fill the role of the commissioning agent. Commissioning should continue well into start-up, and be integrated into the operation and maintenance plan.

The responsibilities of the commissioning agent include:

- Assisting with a clear statement of the design intent for each building system.
- Writing the commissioning specifications and incorporating them in the appropriate divisions of the construction specifications.
- Carrying out pre-functional and functional testing of all equipment and systems to be commissioned, using procedures designed in advance.
- Reviewing operation and maintenance documents to be provided by the contractor.
- Developing operation and maintenance training curricula and materials to ensure they meet needs of staff.
- Writing a final report including all commissioning documentation and recommendations for the district.

### ***Cost of Commissioning***

For schools, the cost of commissioning can range between \$0.10/ft<sup>2</sup> to \$0.60/ft<sup>2</sup> of building area. Studies show that commissioning can be very cost effective, with simple paybacks ranging between 4 and 20 months.<sup>2</sup>

### ***Commissioning References***

- American Society of Heating, Refrigerating and Air-Conditioning Engineers (ASHRAE). 1996. *The HVAC Commissioning Process, ASHRAE Guideline 1-1996*. Available on-line at: <http://www.ashrae.org/>.
- Commissioning Specifications, C-2000 Program*, Canada, 1995.
- NEBB. 1993. *Procedural Standards for Building Systems Commissioning*.
- U.S. Department of Energy (DOE). 1998. *Model Commissioning Plan and Guide Specifications*. NTIS #DE97004564. Available on-line at: <http://www.peci.org/>.
- U.S. Green Building Council. *LEED 2.0 Reference Guide* (for commercial buildings). Available at <http://www.usgbc.org/>.

---

<sup>2</sup> Gregerson, Joan. 1997. Cost effectiveness of commissioning 44 existing buildings.

## MATERIAL SELECTION AND RESEARCH

---

In a high performance school, materials are selected for several characteristics beyond the traditional issues of performance, price, availability, and aesthetics. Designers should look for environmentally preferable materials that are:

- **Durable.** Offers (proven) longer service life compared to other options in a given product category.
- **“Healthy.”** Does not introduce toxic or polluting emissions into the building.
- **Made with recycled content.** Includes materials that have been recovered or otherwise diverted from the solid waste stream, either during the manufacturing process (pre-consumer), or after consumer use (post-consumer).
- **Salvaged or reused.** Includes materials that are refurbished and used for a similar purpose; not processed or remanufactured for another use.
- **Recyclable.** Can be collected, separated, or otherwise recovered from the solid waste stream for reuse, or in the manufacture or assembly of another package or product.
- **Responsibly produced.** Extracted, harvested, or manufactured in an environmentally friendly manner (includes certified wood products).
- **Environmentally benign.** Includes or introduces no, or low amounts of, known pollutants to the natural ecosystem (includes non ozone-depleting or toxic materials).
- **Low in embodied energy.** Does not require significant amounts of energy to produce or transport the material (includes locally manufactured or extracted options in a given product category).
- **Produced from rapidly renewable material.** Includes material that is grown or cultivated and can be replaced in a relatively short amount of time (defined by the type of material).
- **Made with industrial byproducts.** Includes material that is created as a result of an industrial process (flyash, for example).
- **Marketed in an environmentally responsible manner.** Includes products available with minimal packaging.

For the high performance label to be meaningful, it's important for designers to ensure that a significant number of materials used for the project meet one or more of the above attributes. This will require research and documentation. Many sources of information are available to help with this process.

### **Product Suppliers**

Some building material suppliers are making significant efforts to incorporate resource-efficient goals in their processes and operations and in their products. Companies serious about this commitment will provide detailed information about their product's performance. When investigating products, it is always recommended that the design team consult with the manufacturer's technical rather than sales staff.

### **Material Safety Data Sheets**

Material Safety Data Sheets (MSDS), which must be prepared by product manufacturers, can provide some information and in particular can help "red flag" problem ingredients that may be toxic or emit significant VOCs. For example, the Health Hazard Rating (zero is low, five is high) found on an MSDS provides some indication of whether a product is appropriate for indoor school environments. MSDSs are often incomplete, however. Generally they do not include information about environmental attributes other than toxicity of regulated ingredients. MSDS's are primarily useful for eliminating building materials that may cause serious environmental problems.

### **Product Certification**

Product certification programs can help identify environmentally preferable products. Many product suppliers have increased the credibility of their environmental claims by obtaining industry or independent certifications of their products' environmental attributes. Independent programs provide the most objective documentation and include:

- *ENERGY STAR*. A program of the federal government, manufacturers are allowed to use the ENERGY STAR label only if the product meets certain energy efficiency levels set by either the U.S. EPA or U.S. Department of Energy. Tel: (888) STAR-YES. Web site: <http://www.energystar.gov/>.
- *Green Seal*. Green Seal standards are based on environmental protection. They focus on reduced air and water pollution, reduced consumption of energy and other resources, protection of wildlife and habitats, reduced packaging, quality, and performance. Tel: (202) 588-8400. Web site: <http://www.greenseal.org/>.
- *Scientific Certification Systems (SCS)*. SCS is a nonprofit organization that assesses products based on a life-cycle or "cradle to grave" evaluation. Their Environmental Report Card gives detailed information about the environmental burdens associated with the production, use and disposal of the product. Tel: 800-ECO-FACTS. Web site: <http://www.scs1.com/>.
- *Forest Stewardship Council*. A product bearing the Forest Stewardship Council (FSC) trademark is made with wood certified to have come from a forest that is well managed according to strict environmental, social, and economic standards. Look for FSC-certification as opposed to self-certification of forest management practices. FSC is an international nonprofit association working in partnership with industry and other groups to improve forest management worldwide. Tel: (802) 244-6257. Web site: <http://www.fscoax.org/>. Also see Smart Wood, a U.S.-based program of the Rainforest Alliance, accredited by the FSC for the certification of forest management. Tel: (802) 434-5491. Web site: <http://www.smartwood.org/>.



## **Environmentally Preferable Product Directories**

There are several good directories that identify environmentally preferable product options. Some focus on a product category (for example, recycled content products), while others cross categories.

- Architects/Designers/Planners for Social Responsibility (ADPSR). *Architectural Resource Guide*. Organized by CSI, this guide lists environmentally friendly, less polluting, local, and recycled building products as well as related information and a recommended reading list. Available as hard copy or CD. Web site: <http://www.adspr.org/>.
- U.S. EPA's *Preliminary Guidelines for Recycled Content*. Web site: <http://www.epa.gov/epaoswer/non-hw/procure/products.htm>.
- *Guide to Resource Efficient Building Elements (GREBE)*. 1998. Edited by T. Mumma. Contact: Center for Resourceful Building Technology, Box 100, Missoula, MT 59806. Tel: (406) 549-7678. Web site: <http://www.montana.com/crbt>. Resource book on resource-efficient building systems. Updated regularly.
- *GreenSpec: The Environmental Building News Product Directory and Guidelines Specifications*. 1999. Published by E Build, Inc., Brattleboro, VT. Tel: (802) 257-7300. Web site: <http://www.buildinggreen.com/>. *GreenSpec* is organized in standard CSI divisions.
- California Integrated Waste Management Board's web site provides a "Recycled Content Product Procurement List" at <http://www.ciwmb.ca.gov/RCP/>. The database is searchable by CSI section number and provides links to manufacturers. The CIWMB also sponsors many Buy Recycled programs. Information on these programs can be found at <http://www.ciwmb.ca.gov/BuyRecycled/>.
- Sustainable Products Purchasers Coalition (SPPC). Web site: <http://www.sppcoalition.org/>.
- U.S. EPA's *Comprehensive Procurement Guidelines (CPG)*. The CPG program promotes the use of materials recovered from solid waste. Web site: <http://www.epa.gov/epaoswer/non-hw/procure/index.htm>. The products page, <http://www.epa.gov/epaoswer/non-hw/procure/products.htm>, provides an online list of construction, landscaping, and other categories of products. The web site briefly describes each of the listed products. You also can view EPA's recommended recycled content ranges and a list of manufacturers, vendors, and suppliers for each item. Also see the *Database for Environmentally Preferred Products*: <http://www.notes.erg.com> (this is an EPA contractor's web site).

## **Environmentally Preferable Product Evaluation Tools**

The following resources provide methodologies or suggestions for evaluating products:

- BEES (Building for Environmental and Economic Sustainability) software helps analyze the environmental and economic performance of some building products. The software is downloadable at <http://www.bfrl.nist.gov/oae/software/bees.html>.
- *Environmental Resource Guide*. 1996. Edited by Joseph A. Demkin. Offers a methodology for preparing life-cycle assessments of building materials, materials comparisons, and case study information about how high performance buildings have worked in practice. Tel: (800) 346-0104.
- *Environmental Building News (EBN)*. Brattleboro, VT. Tel: (802) 257-7300. Web site: <http://www.buildinggreen.com/>. The leading green building professional journal. Offers excellent articles, product reviews, book reviews, and resources. Online EBN product reviews available. Two pertinent articles are: "What Makes a Product Green?" (Vol. 9, No. 1: January 2000), which offers a simple methodology for evaluating a product; and "Material Selection Tools, Resources and Techniques for Choosing Green," (Vol. 6, No. 1: January 1997), which offers a survey of analytical tools and references for evaluating environmentally preferable materials.

- *Proceedings from the LAUSD Workshop on Sustainable Schools*. February 16, 2000. See the Breakout Session section on “Green” Materials and Systems, and other related sections. Available online at <http://www.eley.com/lausd>.

## GENERAL PURPOSE DESIGN AND EVALUATION TOOLS

---

Appropriate design tools are discussed in the overview of each technical chapter and within each guideline. Some general design and analysis tools are addressed here because they are common to many of the technical chapters that follow. More information on design tools can be found at [http://www.eren.doe.gov/buildings/energy\\_tools/](http://www.eren.doe.gov/buildings/energy_tools/).

### **Conceptual Design Tools**

Energy-10 is an educational tool that provides an overview of the performance interactions between different design strategies during conceptual design. For more information, visit the National Renewable Energy Laboratory’s (NREL) Energy-10 web site at <http://www.nrel.gov/buildings/energy10/> or the Sustainable Buildings Industry Council (SBIC) web site at <http://www.sbicouncil.org>.

Green Building Advisor™ (GBA) is a CD-ROM-based software tool that can be used as a “first cut” to help designers identify building design strategies that can be incorporated into specific projects. Based on inputs provided by the user, GBA generates a list of prioritized strategies organized by categories. The software provides information on relative cost as well as case studies where the strategy has been implemented. Registered users get a user’s manual and free technical support. For more information, call (802) 257-7300 or visit <http://www.buildinggreen.com/>.

### **Energy Analysis Tools**

These are computer programs designed to predict the annual energy consumed by a building. They can be used to evaluate the energy impacts of various design alternatives and, in particular, to compare specific low-energy strategies (for example, higher insulation levels, better glazing, increased thermal mass) in terms of their impacts on overall building performance. Combined with accurate cost estimates, they can help create a high performance school that is optimized in terms of its overall energy performance, which can save money on initial construction costs as well as on long-term operating expenses.

For example, a school that combines daylighting strategies and highly efficient electric lighting in its classrooms will require less electricity to illuminate those classrooms, providing a long-term operating savings. In addition, the rooms, because they take advantage of daylight and use high efficiency lamps, may need fewer light fixtures overall to achieve a high quality visual environment, providing an upfront savings on initial costs. Finally, highly efficient lighting — and, potentially, fewer light fixtures — will result in less waste heat in each classroom. This, in turn, will allow the cooling system for the classrooms to be smaller, generating additional upfront savings.

A wide number of energy analysis tools are currently available, some appropriate for the early stages of a project, some for the later phases. A sampling of these tools is provided below. Energy performance analyses using one or a combination of these tools should be conducted during each of the following

design phases: programming, schematic design, design development, construction documents, and bidding and negotiation.

### **Architectural Design Tools**

These are used primarily during a project's programming, schematic design, and design development phases.

- *Building Design Advisor*. Contact: Lawrence Berkeley National Laboratory. Web site: <http://www.lbl.gov/>.
- *Energy Scheming*. Contact: Iris Communications. Web site: <http://www.oikos.com/esb/37/scheming.html>.
- *VisualDOE*. Contact: Eley Associates. Web site: <http://www.greendesigntools.com>.

### **Load Calculation and HVAC Sizing**

These are used primarily during a project's design development and construction documents phases.

- *EnergyPlus*. This computer program, which is being developed by the U.S. Department of Energy, is considered to be the successor to both DOE-2 and BLAST. It combines features from both programs and includes modules for the thermal analysis of windows, radiant transfer within spaces and other features. Contact: Lawrence Berkeley National Laboratory. Web site: <http://www.lbl.gov/>.
- *DOE-2*. This widely used program for analyzing the energy efficiency of buildings uses an hourly weather file and simulates energy performance during a typical year. Contact: Lawrence Berkeley National Laboratory. Web site: <http://www.lbl.gov/>. There are several Windows user interfaces that make it easier to use DOE-2, including VisualDOE, PowerDOE, and EnergyPro.
- *BLAST*. Contact: University of Illinois. Web site: <http://www.bso.uiuc.edu/>.

---

## **ANATOMY OF A GUIDELINE**

---

Each guideline in this manual follows the format outlined below. Information relevant to multiple guidelines is typically discussed in the Overview for that chapter.

- **Recommendation:** A brief description of how to apply the high performance design concept to the building feature.
- **Description:** More detailed information on the technology or design strategy.
- **Applicability chart:** Indicates the applicability of the guideline to particular spaces, climate zones, and design process steps. (See the end of this section for more information on the climate zones covered in this manual.) In the example below, the black areas indicate the guideline's strong applicability and the gray areas represent limited applicability. Unshaded areas indicate that the guideline is not applicable.

**Applicable Climates**

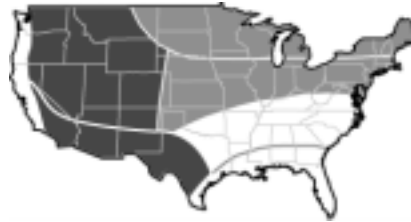

**Applicable Spaces**

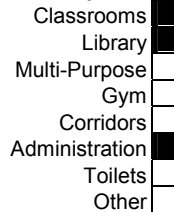

**When to Consider**

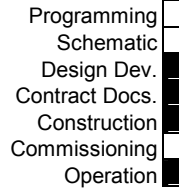

- **Integrated Design Implications:** Describes the implications that the design strategy or technology might have on other building systems (e.g., if cooling load is significantly reduced by high performance fenestration, the HVAC system might be made smaller and natural ventilation might become more viable). Discusses the phase of design when the strategy or technology might best be implemented.
- **Cost Effectiveness:** Describes the benefits and costs of the strategy/technology on both a system basis and an overall project basis. The chart below shows construction costs on the vertical scale, ranging from low to medium to high. The horizontal scale represents benefits, also categorized from low to medium to high. A black mark shows the overall project impact and a gray mark represents the system impact. In the diagram below, the system benefits are medium and the system costs low, while the overall cost is high and benefits are low.

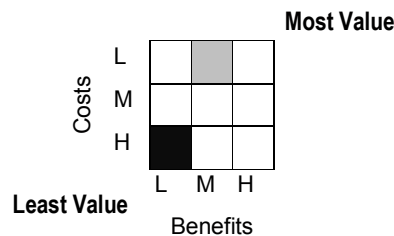

For ranking the *system* benefits and costs:

- Low represents an increase in costs or benefits of 0% to 20% over the basecase system.
- Medium is a cost or benefit increase of 20% to 50% over the basecase system.
- High is an increase in costs or benefits of more than 50% over the basecase system.

For ranking the *overall* benefits and costs:

- Low represents an increase in costs or benefits of 0% to 2% over the basecase system.
- Medium is a cost or benefit increase of 2% to 8% over the basecase system.
- High is an increase in costs or benefits of more than 8% over the basecase system.

The cost scale refers only to the initial construction cost, which is a significant issue for schools and their architects. On an overall basis, low means that the incremental construction cost is small or even negligible and that the district should be able to afford the strategy/technology with the normal school construction budget. Medium cost means that the strategy/technology will cost a little more and the school construction budget will need to be supplemented or will need to realize savings from other systems (e.g., HVAC downsizing).

This section also presents general information on construction costs on a \$/ft<sup>2</sup> or \$/classroom basis, when possible. It identifies and quantifies operation and maintenance costs if applicable and/or possible. The section describes environmental costs or externalities that cannot be given a dollar value.

- **Benefits:** Outlines the benefits expected from the implementation of the measure including energy savings, improvements in indoor environmental quality, productivity benefits, and possible impact on average daily attendance.
- **Design Tools:** Lists any applicable design tools, including software that can be used to optimize the design, quantify the benefits, or estimate construction costs. In some cases, the section will describe a technique for using a general-purpose tool such as DOE-2 to evaluate and analyze the design.
- **Design Details:** Contains more thorough details on the design, such as rules of thumb, specific recommendations, sample specifications, or schematic diagrams.
- **Operation and Maintenance Issues:** Outlines potential operation and maintenance concerns and requirements for keeping the strategy/technology operating at optimal performance.
- **Commissioning:** Discusses the need for calibration, functional tests, static tests, commissioning plan requirements, statement of design intent, post-occupancy tests, and other issues and requirements related to ensuring that the strategy/technology was implemented as the designer intended.
- **References / Additional Information:** Provides a sampling of documents, websites, etc. where additional information about the strategy/technology can be found.

## CLIMATES

---

The guidelines have been tailored for the seven U.S. climate regions shown at the beginning of this manual.

*Table 2 – Climate Zone Details*

Climate	Model City	Location	Summers	Winters
Hot and Humid	Orlando	Gulf Coast	Hot and humid, long	Mild, short
Temperate and Humid	Atlanta	Southeast	Hot and humid	Cold
Cool and Humid	Boston	Northeast, Mid-West, Southern Plains	Warm and humid	Cold snowy
Cold and Humid	Minneapolis	Northern Plains	Short in duration, but warm and humid	Long in duration, very cold
Hot and Dry	Phoenix	Southwest Desert	Hot and dry	Clear and mild
Cool and Dry	Denver	Western states	Warm and clear	Clear and cold
Temperate and Mixed	Seattle	Pacific Coast	Clear mild	Long, overcast and mild

One city in each climate served as the model city for that zone. Many of the recommendations vary depending on the climate where the school is constructed. In these cases, the recommendations, and their applicable climate zones, will be indicated in both the guideline text and the applicability chart described in the previous section.

# SITE DESIGN

This chapter provides guidelines for:

Optimum Building Orientation (Guideline SD1)

Landscaping to Provide Shade to HVAC Equipment, Buildings, and Paved Areas (Guideline SD2)

Landscape Design and Management (Guideline SD3)

Impervious Surfaces (Guideline SD4)

Native and Drought-Tolerant Plants (Guideline SD5)

Landscaping Soil, Amendments, and Mulch (Guideline SD6)

Integrated Weed, Disease, and Pest Management (Guideline SD7)

Environmentally Responsible Job-Site Management (Guideline SD8)

Indoor Air Quality During Construction (Guideline SD9)

Site Protection During Construction (Guideline SD10)

## OVERVIEW

---

Site design is a fundamentally important aspect of high performance design. The choices made during site selection and site planning reverberate throughout the entire school. All aspects of high performance design — from energy and water efficiency, to acoustic comfort and environmental impacts — are affected. Furthermore, every site and district will face unique constraints. Some districts have the luxury of choosing between several options while other districts have known for years the precise site that must be used. It is important to remember that regardless of what site is chosen, and whether it is in an urban or rural landscape, the site can be developed wisely to incorporate ideas that support the high performance goals of the entire project.

Open spaces at schools typically fall into two categories: hard surfaces and lawn. Districts can and should move beyond this approach to create more vibrant and environmentally responsive site designs. Even if the opportunities for a particular site seem modest, there are better ways to pave a parking lot, water a soccer field, and manage stormwater than are typically practiced.



*Objectives regarding the protection and retention of existing landscaping as well as the site's natural contours and features should be established early during the programming phase. NREL/PIX 11341*

Site selection and design can either support or detract from the overall performance of the building. Table 3 summarizes some of the benefits associated with wise site planning.

*Table 3 – Site Design Considerations*

<b>Goal</b>	<b>Site Design Considerations</b>
Energy Efficiency	Energy efficiency is improved with effective building location, orientation and massing, and the placement of vegetation for shade or wind protection.
Water Efficiency	Standard irrigation practices typically waste significant amounts of water. Using native plants and water-efficient irrigation technologies are two straightforward methods of reducing demand. More resource-efficient water management might include captured water, green roofs, and natural stormwater management strategies like vegetated swales and ponds. (See the Water Conservation chapter for more information on irrigation and stormwater management.)
Protection of the Natural Ecosystem	The majority of site planning decisions will directly affect the overall level of impact to the natural environment: water conservation, treatment of surface water, building orientation, preservation and restoration of natural habitats, use of native plants and appropriate landscaping materials, etc.
Material Efficiency	The site should incorporate salvaged landscaping materials or those made from recycled materials. Vegetation waste should be composted.
Acoustic, Thermal, and Visual Comfort	Comfort is heavily dependent upon orientation and building envelope. Glazing type, size, and orientation are particularly important.  The relationship of buildings, especially classrooms, to sources of exterior noise such as roadways must be taken into account to achieve adequate background noise levels. Double glazed windows will reduce excessive exterior noise. Conversely, the relationship of HVAC equipment, recreation areas, and other noise producers will impact the surrounding neighborhood.  Reducing the “heat island effect” decreases air conditioning loads during the summer by minimizing hard surfaces and using trees or shade structures.
Health and Indoor Air Quality	Sites cannot contain hazardous chemicals or airborne pollutants that endanger student health. Well-designed sites improve opportunities for natural ventilation and reduce carbon dioxide levels.
Security and Safety	Building placement, landscaping, protected courtyards, and well-situated access and circulation points all heavily impact safety and security.
Connection to Neighborhood and Surrounding Community	Consider community gardens, school parks, meeting rooms, multi-use facilities such as day care, laundry, café, etc, to connect the school to the community. Joint-use partnerships with local nonprofit organizations are an excellent way to fund and share facilities or park space and improve security.
Learning	Use nature as a teaching tool for science, math, history, art, and health programs; use gardens to connect students to natural concepts. Consider the potential opportunities for real-life lessons in business and economics through on-site programs involving growing and selling or trading products.
Playing	Install creative play areas utilizing a wide variety of natural elements. Consider a schoolyard landscape rich with soil, water, and “critters,” rather than simply formal, planted hedges and groomed turf.

### **Resource-Efficient Site Design Process**

Resource-efficient site planning is adaptable to all school sites. It balances ecological, social, and economic needs and emphasizes long-term, cost-effective strategies over immediate short-term results. It should be an open process and include the input of the school staff and local community.

Site selection is crucial in the resource efficiency of school design, and districts must balance cost, student demographics, and environmental concerns during the site selection process. In some cases, school sites have been determined years in advance, eliminating some options for districts and designers when the school is being built. However, when the district can select sites, being conscious of ecosystem protection, careful building orientation, and a design that controls urban heat islands can significantly lower the school’s environmental impact.



When selecting a site, maintaining the health of students should be the first concern. Sites must not contain toxins, pollutants, or safety hazards that will impact student health, such as:

- Hazardous agents, including industrial, agricultural, and naturally occurring pollutants such as asbestos and heavy metals.
- Nearby facilities that might emit hazardous air emissions or handle hazardous or acutely hazardous materials.
- Other objects that are potentially harmful near a school, such as hazardous pipelines, high voltage power-line easements, railroad tracks, adverse levels of traffic noise, and airports.



*Once a site is selected, address areas of the site targeted for conservation, development, or natural enhancement. NREL/PIX 11333*

The district should also address issues of land use and open space, including:

- Developing sites that are centrally located for the student population. Both schools and parents spend significant time, energy, and money transporting students to and from school. Cars driven by parents, guardians, or the students themselves are the largest resource users and producers of transportation-related pollution. Centrally located sites mean that cars do not have to travel as far and encourage more students to walk or bike to school.
- Develop joint-use agreements with community organizations to share parts of the school buildings, parks, or recreation space. As part of a growing trend, schools are being integrated with a variety of organizations, from laundromats and coffee shops, to police stations and park districts. Benefits include better campus security, improved community relationships, and reduced site acquisition and construction costs.
- Avoiding development on prime farmland, public parkland, flood zones, and on habitats for threatened or endangered species.
- Preserve undeveloped lands. By not developing on greenfields, which are sites that have not been previously developed, or have been restored to park or farm use, urban redevelopment can reduce environmental impacts.
- Promoting alternative transportation, by locating the school close to public transportation and creating bike facilities. (See the Transportation chapter for additional information.)

Once a site is selected, use educational specifications and the schematic design to address areas of the site targeted for conservation, development, or natural enhancement. Select and specify environmentally preferable site materials — building products that use raw materials efficiently and do not introduce pollutants or degradation to the project site or atmosphere, and building systems that conserve water and energy. (For additional information about materials, see the Resource-Efficient Building Products chapter.) All stakeholders should meet to review the baseline data and discuss the opportunities and constraints based upon the initial site analysis and program. These stakeholders help define the project's "vision," which guides development of the plan. Their involvement is essential

throughout the planning and design process. The plan, developed by the design team and approved by the community, might include many, or all, of these principles:

- Identify and protect existing natural features and ecosystems.
- Repair and restore damaged natural areas and create habitat to promote biodiversity.
- Respect and incorporate historic, cultural, and artistic resources.
- Use stormwater management to reduce pollution and the load on local infrastructure.
- Create healthy landscapes that evolve over time and survive intensive use.
- Develop a responsible maintenance and management program that incorporates an objective monitoring and evaluation strategy.
- Provide a strong link to the surrounding neighborhood and become an active part of the community.

### ***Design Goals and Guidelines***

Site design activities for a high performance school seek to achieve one or more of the following three primary goals:

1. Protect and/or restore the site.
2. Incorporate the site's natural features to achieve high performance.
3. Select environmentally preferable products.

### ***Protect and Restore the Site***

During construction, literally hundreds of opportunities exist to work toward fulfilling the environmental goals of a high performance school or, alternatively, to compromise them. To ensure the construction process is consistent with these goals, contractors should be made aware of them up front, as part of the bidding process. Ideally, the selected contractor should have experience with some of the practices recommended in this Best Practices Manual. At a minimum, they should be aware of, and responsive to, the goals set for the project. The clearer the expectation that contractors will play an important role in achieving these goals, the more likely the construction process will go smoothly in this regard.

In practice, requiring the contractor to produce and implement a job-site operations plan has proven to be the most effective way to ensure that environmental goals will be given equal treatment along with other project goals. In addition, including a requirement to produce and implement a job-site operations plan in bid documents and in the contract language of specifications, levels the bidding playing field.

Environmentally responsible job-site operational costs are generally minimal, and cost benefits can be significant. Planning helps minimize costs and liabilities, including expensive delays, stoppages, and callbacks due to mistakes made during construction. Savings resulting from job-site waste reduction practices are well documented. Contractors familiar with environmentally responsible job-site operations will know the benefits and understand that these are not complicated practices. Contractors unfamiliar with them, however, will assume they cost more and bid accordingly. Bid packages should contain references to existing resources to help contractors familiarize themselves with these types of plans as well as provide tools to estimate costs and benefits more accurately.

An environmentally friendly job-site operation will use a combination of contract language, signage, weekly job-site meetings, and incentives/rewards to educate and motivate field personnel to ensure everyone works towards this goal. Brief presentations, signage that both informs and motivates by reporting progress on environmental goals, and contractor's field guides can be helpful communication aids. On most construction sites, signage and other printed instructions will need to be written so individuals for whom English is a second language can easily understand.

In addition, the most successful contractors identify an individual (often the safety officer) who can enforce the job-site operations plan on a day-to-day basis. With many recommended job-site practices, it is difficult to determine whether they actually occur without regular monitoring. Ideally, the same individual monitoring compliance would take an active role in training and other on-site educational efforts.

The natural functions of a site (hydrologic, geologic, and micro-climatic) can also be seriously disrupted by the operation of a building. The design of a high performance school will consider ways that natural site features can be protected — perhaps even restored — through the design, development, and construction processes. For example, preserving natural vegetation reduces overall disturbance to the site. Soil amendments help restore the health of disturbed soils. And designing to reduce impervious surfaces mitigates stormwater runoff caused by construction and protects the hydrologic functions of the site.

Site protection and restoration objectives include:

- Minimizing disturbance to the site.
- Mimicking (or restoring) natural processes in disturbed areas.
- Protecting water quality.

### ***Incorporate the Site's Natural Features to Achieve High Performance***

A high performance school responds to the site. Building placement, orientation, massing, and layout decisions made early in the school design process can profoundly affect the energy impacts of the building. These decisions also bear on the resulting indoor environment since they either capture or lose opportunities for daylighting and natural ventilation. Other implications include acoustic comfort, safety, and visual quality. The design of a high performance school incorporates the site's natural advantages and features to achieve the school's high performance goals.

In addition, the high performance school site and building should “teach” environmental protection concepts. Site design will take into consideration opportunities for outdoor classrooms and environmental learning projects. With careful planning and coordination with school staff, such projects can be identified and then facilitated during construction. For example, stream restoration by students



*Site design can create opportunities for outdoor classrooms and environmental learning projects. NREL/PIX 02682*

and staff can take place more easily if a culvert has been removed during construction. Or a wetland graded during construction can be planted as part of lessons about the natural ecosystems.

Site planning objectives that fall into this category include:

- Reducing the demand for water
- Reducing energy demand
- Selecting environmentally preferable materials.

A steadily increasing number and variety of environmentally preferable products are available for sitework and landscaping. Salvaged materials, originating from both on-site and off-site, should also be used where possible. These products include landscaping accessories made with post-consumer and post-industrial recycled materials (parking stops, bike racks, tree cuffs, grates, landscaping ties, planters, outdoor furniture, and lighting and sign posts), recycled concrete asphalt aggregate for fill or road base, concrete made with flyash, and recycled content soil amendments.

Specific examples include:

- Synthetic surfacing for exterior sports surfaces, playgrounds, and other surfaces. Made from 84% to 98% post-consumer rubber from used tires.
- Fencing made with recycled plastic or salvaged wood or metal.
- Running track surfaces made with 100% recycled rubber/tires.

While maintenance will vary by product, in most cases maintenance needs are reduced compared to conventional products. For example, plastic lumber is more durable and requires less ongoing maintenance than wood.

In addition, the selection of environmentally preferable materials has an added benefit as a teaching tool. Prominent interpretive signage can inform students, staff, parents, and the community about environmentally preferable materials and their attributes.

Table 4 summarizes the site design goals and objectives described above, and shows the correspondence of these objectives to the guidelines provided in this chapter.

Table 4 – Site Planning Goals and Relationship to Guidelines

	SD1: Optimum Building Orientation	SD2: Landscaping to Provide Shade to HVAC Equipment, Buildings, and Paved Areas	SD3: Landscape Design and Management	SD4: Impervious Surfaces	SD5: Native and Drought-Tolerant Plants	SD6: Landscaping Soil Amendment and Mulch	SD7: Integrated Weed, Disease, and Pest Management	SD8: Environmentally Responsible Job-Site Management	SD9: Indoor Air Quality During Construction	SD10: Site Protection During Construction
<b>Goals</b>										
<b>Protect and Restore the Site</b>										
<i>Minimize disturbance to the site</i>					●			●		●
<i>Mimic natural process</i>				●		●				
<i>Protect water quality</i>						●	●			
<b>Incorporate the Site's Natural Features to Achieve High Performance</b>										
<i>Reduce water demand</i>			●		●	●	●			
<i>Reduce energy demand</i>	●	●								
<b>Select Environmentally Preferable Materials</b>			●	●		●			●	

## Resources

- Architects, Designers and Planners for Social Responsibility (ADPSR) West Coast. 1998. *Architectural Resource Guide*. Contact: ADPSR, PO Box 9126, Berkeley CA. Tel: (510) 273-2428. Resources and information on green and healthy buildings, including many sources for materials.
- Barnett, D.L. 1995. *A Primer on Sustainable Building*. Snowmass, CO: Rocky Mountain Institute. An excellent overview of issues and benefits of sustainable building. <http://www.rmi.org>.
- Center of Excellence for Sustainable Development, U.S. Department of Energy, Energy Efficiency and Renewable Energy Network (EEN). Provides web pages on green building and green development. <http://www.sustainable.doe.gov>.
- Crowther, R.L. 1992. *Ecological Architecture*. Boston: Butterworth Architecture. Primer on ecological design, emphasizing the importance of holistic building design and its integration with natural systems. Includes design guidelines for design, landscaping, and planning.
- King County, Washington. *Construction and Landscaping Materials Specifications*. <http://www.metrokc.gov/procure/green/const.htm>.
- Los Angeles, City of. *Sustainable Building Reference Manual*. Contact: Nady Maechling. Tel: (213) 473-8226. Contains local information and resources.
- Lyle, J.T. 1994. *Regenerative Design for Sustainable Development*. New York: John Wiley & Sons. One of the seminal books on the theory, design, and construction of regenerative systems and the practical application of ecological design.

- Marsh, W. M. 1991. *Landscape Planning: Environmental Applications*. New York: John Wiley & Sons. A definitive reference for landscape architects, planners, and designers on the definition and application of environmental design principles to landscape and site planning.
- Maryland State Department of Education. *Conserving and Enhancing the Natural Environment, A Guide for Planning, Design, Construction, and Maintenance on New & Existing School Sites and Building Ecology and School Design*. 1999. To order, contact the Maryland State Department of Education, Division of Business Services, School Facilities Branch, 200 W. Baltimore St., Baltimore, MD 21201. Phone for Capital Projects Assistant Manager: (410) 767-0097
- Mason, Gary et al. *An Ecosystem-based Approach to Planning Communities: An Ecosystem Manager's Workbook*, USDA Forest Service, Center for Urban Forestry, 1994, 1996, 1998.
- Moore, Robin C. and Wong, Herb H. 1997. *Natural Learning: Creating Environments for Rediscovering Nature's Way of Teaching*, MIG Communications.
- Rocky Mountain Institute. 1998. *Green Development: Integrating Ecology and Real Estate*. New York: John Wiley & Sons.
- Second Nature: Adapting Los Angeles's Landscape for Sustainable Living*. 1999. Published by TreePeople.
- Sorvig, K. 1996. *Sustainable Building Technical Manual*. Washington DC: Public Technologies Inc. Chapter 7, Site Materials and Equipment, offers a concise, valuable overview that highlights design considerations for soil amendments, plant materials and management, paving materials, and materials for site construction and furnishings.
- Spurgeon, Richard. 1988. *Ecology: A Practical Introduction with Projects & Activities*. Osborne Publishing Ltd.

For additional information about environmentally preferable materials, see the Material Selection and Research section in the Introduction to this manual.

## Acknowledgments

The following resources were particularly useful for developing this chapter on site planning:

- BUILT GREEN™ Handbook. 1999. BUILT GREEN is a program of the Master Builders Association of King and Snohomish Counties (MBA) in partnership with King County, Washington, and Snohomish County, Washington. <http://www.builtgreen.net/>.
- Partnership for Resource-Efficient Schools. 1998. *Recommended Best Management Practices Promoting Energy Efficiency, Resource Conservation, and Environmental Quality*. A publication of the Seattle Public Schools Building Excellence Program and the City of Seattle (Solid Waste Utility, Water Department and Seattle City Light). The following web site provides information about the Partnership for Resource-Efficient Schools project and a link to download the Best Management Practices manual: <http://www.cityofseattle.net/util/rescons/susbuid/partnership.htm>
- Santa Monica, City of. 1999. *Santa Monica Green Building Design and Construction Guidelines*. Available on-line at <http://greenbuildings.santa-monica.org/main.htm>.
- Sustainable Building Task Force. The Sustainable Building Task Force was formed by a number of California agencies to institutionalize resource-efficient building practices into state construction projects. The task force meets on a monthly basis to discuss strategies for implementing resource-efficient building practices in all future and current state buildings, including those leased by the State. See <http://www.ciwmb.ca.gov/GreenBuilding/TaskForce/> for more information and links to member agencies.

# GUIDELINE SD1: OPTIMUM BUILDING ORIENTATION

## Recommendation

When site conditions permit, orient buildings so that major windows face either north or south. Position classrooms so that light and air can be introduced from two sides. Solar orientation should guide the placement of building and site features. Reduce the impact of exterior noise sources by locating noise sensitive areas, such as classrooms, away from noise producers, like roadways, train tracks, etc.



Orientation plays a key role in the landscaping and daylighting design. NREL/PIX09704

## Description

Space heating and cooling accounts for nearly 20% of all energy consumption in the U.S. Optimal orientation of the building creates opportunities to utilize the potential contributions of the sun, topography, and existing vegetation for increased energy efficiency by maximizing heat gain (or minimizing heat loss) in winter and minimizing heat gain in summer. In the case of existing buildings, arrangement of interior spaces, strategic landscaping, and modifications to the building envelope can mitigate unfavorable orientation.

## Applicable Climates



## Applicability

All climates. Primarily for new buildings and site planning, with some applicability to retrofitting existing buildings for greater efficiency.

## Applicable Spaces

- Classrooms
- Library
- Multi-Purpose
- Gym
- Corridors
- Administration
- Toilets
- Other

## When to Consider

- Programming
- Schematic
- Design Dev.
- Contract Docs.
- Construction
- Commissioning
- Operation

## Integrated Design Implications

Knowledge of the existing site soils, vegetation, and microclimate are critical to understanding how to best arrange site elements to create the least disruption to the site and orient structures and spaces appropriately. Integrate existing site features; proposed landscape design; orientation, height, and finish of walls; architectural design; impervious surfaces; location of heating and cooling equipment. Refer to guideline: SD2: Landscaping to Provide Shade to HVAC Systems, Buildings, and Paved Areas and TR2: Safe and Energy-Efficient Transportation.

## Cost Effectiveness

Cost implications exist mainly in the design phase. Resulting cost savings will be demonstrated during building operation with lowered heating and cooling requirements.

Costs	L			
	M			
	H			
		L	M	H
		Benefits		

## Benefits

Reduced energy consumption will result in cost savings for year-round heating and cooling. The arrangement of interior and outdoor spaces with thoughtful solar orientation allows optimal natural lighting and user-friendly spaces. Studies have shown that students in classrooms with the most daylighting have

a 21% improvement in learning rates over students in classrooms with poor natural light.<sup>1</sup> See the Daylighting and Windows chapter for more information on this research.

### **Design Tools**

Many utilities offer the use of heliodons for accurate modeling of daylighting effects. A physical model is mounted on the heliodon and a simulated sun shows shadows and solar exposure for different times of the day and the year. Most are coupled with a video camera for recording the test.

A sun angle calculator is a handy tool for studying sun position for different times of the day and year. It can be used to determine the required distance between buildings needed for adequate solar exposure and for determining the effect of shading obstructions such as adjacent buildings.

### **Design Details**

Consider east-west orientation to maximize north-south daylighting opportunities. Single-story designs offer toplighting daylight strategies for all spaces. Keep width of building to less than 60 ft to increase daylight and ventilation opportunities.

*Timesaver Standards for Landscape Architects* presents the following site planning and building orientation information:

- Plan site clearing and planting to take advantage of solar access. Solar orientation, cloud cover, and topography create unique site attributes. A site's latitude determines the sun's altitude and associated azimuth for a given time or day. Orient the building to take advantage of solar energy for passive and active solar systems. The building should take advantage of shade and airflows to maximize summer cooling and to optimize passive solar energy for heating and wind protection during winter months. Orient solar collectors for maximum sun exposure.
- Orient building entrances and outdoor gathering spaces to maximize safety, ease of access, and protection from elements.

Solar angles, soils, and topography determine plant species and distribution, as well as vulnerability of the land to erosion by runoff. The extent of disruption to the site during construction can be minimized with careful orientation of buildings and site elements. Align long buildings and parking areas parallel to landscape contours.

Building orientation can have a significant impact on the acoustical performance of a building. Locating noise producers away from noise sensitive areas is the primary goal. Barriers of solid walls or berms of earth, which break the line-of-sight between the noise source and the receiver (e.g. classroom), can be effective in reducing sound intrusion. A single row of trees or shrubs will be ineffective in reducing unwanted sound. Since windows are frequently the "weakest link" acoustically in a building structure, double glazed windows are often the only alternative to controlling exterior noise. Normal thermal-pane double paned windows with ¼ in. or ½ in. airspace are not effective acoustically. The small airspace, and the two panes of similar glass severely limit its acoustical performance. To be effective acoustically, at least the outer pane should be laminated glass. Additional airspace between the two panes of glass is also very important. It is not uncommon to require 2 in. to 4 in. airspace and thicker laminated glass to control exterior traffic and/or aircraft noise, which contain substantial low frequency energy.

### **Operation and Maintenance Issues**

None.

---

<sup>1</sup> Heschong Mahone Group and New Building Institute. "Re-Analysis Summary: Daylighting in Schools, Additional Analysis." On behalf of the California Energy Commission Public Interest Energy Research (PIER) Program, February 2002.



## Commissioning

None.

## References/Additional Information

- American Institute of Architects Research Corporation. *Solar Dwelling Design Concepts*. Washington, DC: U.S. Department of Housing and Urban Development, 1976.
- Balcomb, John Douglas. "Using Energy-10 to Design Low Energy Buildings." National Renewable Energy Laboratory, 1999. A summary report that describes Energy-10 and presents a detailed worked example carrying a particular building from pre-design through preliminary design. <http://www.nrel.gov/buildings/energy10/resources.html>.
- Buffo, John, et al. "Direct Solar Radiation on Various Slopes from 0 to 60 Degrees North Latitude." U.S. Department of Agriculture Forest Service Research Paper PNW-142, 1972, 74pp.
- DeChiara, Joseph. *Site Planning Standards*. McGraw-Hill, Inc. 1978.
- Durant Road Middle School, Wake County, NC, utilized many recommendations from this guideline.
- Harris, Charles. *Timesaver Standard for Landscape Architecture: Design and Construction Data*. McGraw-Hill, Inc. 1998.
- Land Design/Research, Inc. *Energy Conserving Site Design Case Study*, Burke Center, Virginia. Washington, DC: U.S. Department of Energy, 1979, 60pp.
- Marsh, W.M. *Landscape Planning: Environmental Applications*. John Wiley & Sons, New York. 1991.
- Marsh, William M., and Dozier, Jeff. "The Radiation Balance." *Landscape: An Introduction to Physical Geography*. Reading, MA: Addison-Wesley, 1981, pp. 21-35.
- Sizemore and Associates. *Methodology for Energy Management Plans for Small Communities*. Washington, DC: U.S. Department of Energy, 1978.
- Sterling, Raymond, et al. *Earth Sheltered Community Design*. New York: Van Nostrand Reinhold, 1981, 270 pp.

## GUIDELINE SD2: LANDSCAPING TO PROVIDE SHADE TO HVAC EQUIPMENT, BUILDINGS, AND PAVED AREAS

### Recommendation

Shade HVAC equipment from direct sun. Ensure landscaping does not block air circulation to or from the building. Use landscaping to shade windows on the east- and west-facing building facades. Use landscaping or shade structures to shade paved areas to reduce the heat island effect.

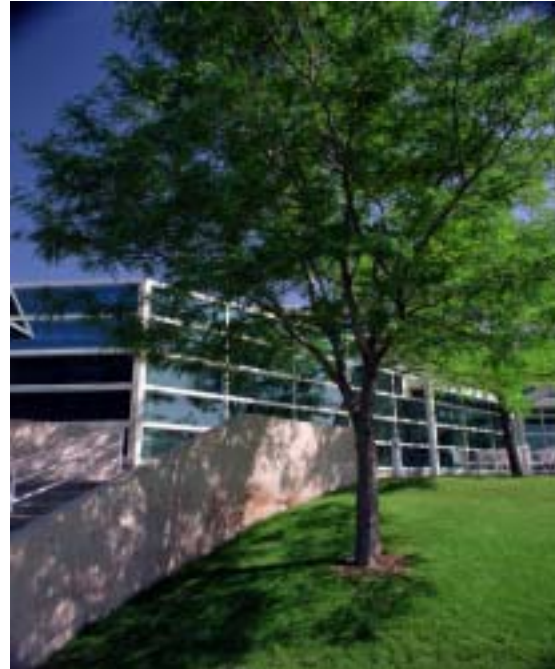

*Landscaping and trees help minimize heat gain to the building and surrounding concrete. NREL/PIX03779*

### Description

Shading HVAC equipment from direct sunlight can significantly lower the cooling demand. Landscaping can greatly reduce the impacts of heavy radiation loads on the roof, and east and west exposure in summer. In temperate regions, site planning and design should seek to promote shade and evaporative cooling in warm periods, and block winds and promote heat gain in cool periods, without disrupting favorable summer wind patterns. In hot, arid regions, plan to balance daily temperature extremes by storing energy, increasing humidity, and diverting desiccating winds.

### Applicability

All climates.

#### Applicable Climates



### Integrated Design Implications

Integrate landscaping, HVAC design, parking lot design, lighting design, irrigation, and preservation of existing plants with building design and orientation. Wind and moisture patterns should be considered during site planning in conjunction with goals to provide building shade. Design coordination will be needed so that trees and lighting are placed without conflicting with the shade or footcandle requirements. Refer to guideline SD1: Optimum Building Orientation; TR1: Transportation and Site Design; SD4: Impervious Surfaces; Mechanical and Ventilation Systems guidelines; as well as guidelines in the Energy-Efficient Building Shell chapter.

#### Applicable Spaces

Classrooms	□
Library	□
Multi-Purpose	□
Gym	□
Corridors	□
Administration	□
Toilets	□
Other	■

#### When to Consider

Programming	■
Schematic	■
Design Dev.	■
Contract Docs.	□
Construction	□
Commissioning	□
Operation	□

### Cost Effectiveness

Costs will vary depending on the type and extent of vegetation or shading structures used. Costs are minimal for HVAC shading, particularly if incorporated into overall HVAC system and landscaping design. Consult with a qualified HVAC engineer regarding opportunities for downsizing systems due to decreased system load.

Costs	L	■	□	□
	M	□	□	□
	H	□	□	□
		L	M	H
		Benefits		

## **Benefits**

Lower energy costs from reduced solar loads on building. Shading HVAC equipment lowers demand for electricity and reduces heat islands.

## **Design Tools**

Charts illustrating distance required between buildings or landscaping to avoid shadows and minimum spacing required to assure adequate light penetration. Solar path, latitude, and altitude charts should also be utilized.

## **Design Details**

Building orientation should be closely integrated with landscape design. Planting deciduous trees on the southeast, southwest, and west side of the building will reduce solar gain in summer during the morning and afternoon. Deciduous vines on arbor structures will provide shade, particularly when used adjacent to the building on the south or west face, sheltering the interior from summer midday sun while allowing solar penetration in winter. Plant low branching deciduous trees on the west side to keep low afternoon sun off west and north walls in summer.

Consider the use of vines against south- and west-facing walls to reduce reflected and absorbed heat and light. This can reduce the temperatures in courtyards and outdoor spaces as well as adjacent buildings and interior spaces.

In urban environments, the site context may include solar windows (gaps between buildings) and shadow corridors (elongated zones which block the sun), which should be considered during site design to maintain sunlight to structures.

Parking lots and paved areas can reflect sunlight and absorb heat that raises temperatures. Shading with trees, shade structures or structures with vines can help lower temperatures.

Locate HVAC equipment so that it is shaded from afternoon sun during the cooling season. Plant trees so that at maturity their canopies shade the unit and the adjacent area during the entire cooling season.

## **Operation and Maintenance Issues**

Design criteria and maintenance guidelines will be needed so that trees shading parking lots and other paved areas can grow to full maturity without excessive pruning. However, care must be taken to avoid contaminating HVAC equipment with leaves or other organic debris. Maintenance must keep plantings from growing too dense and preventing the proper circulation of air around the unit.

## **Commissioning**

None.

## **References/Additional Information**

DeChiara, Joseph. *Site Planning Standards*. McGraw-Hill, Inc. 1978.

Harris, Charles. *Timesaver Standard for Landscape Architecture: Design and Construction Data*. McGraw-Hill, Inc. 1998.

Marsh, W.M. *Landscape Planning: Environmental Applications*. John Wiley & Sons, New York. 1991.

Parker, D.S. "Measured Impacts of Air Conditioner Condensor Shading." The Tenth Symposium on Improving Building Systems in Hot and Humid Climates. Fort Worth, TX, 1996. Archived at <http://www.fsec.ucf.edu/~bdac/pubs/PF302/PF302.htm>, 12/15/2000.

Parker, J.H. "The Impact of Vegetation on Air Conditioning Consumption." Proceedings of the Workshop on Saving Energy and Reducing Atmospheric Pollution by Controlling Summer Heat Islands, Berkeley, CA, pp. 45-52, 1989.

## GUIDELINE SD3: LANDSCAPE DESIGN AND MANAGEMENT

### Recommendation

Develop a landscape plan based on an ecological approach, emphasizing plant diversity, natural lawn care, and resource conservation. Use this plan to guide site preparation, site design, and ongoing care of the site. Include objective plans, tasks, standards, and requirements that provide information about how to create a healthy and attractive landscape.



*High performance landscape design emphasizes plant diversity, natural lawn care, and resource conservation.  
NREL/PIX 11335*

### Description

Every site has an ecological dynamism that involves all the physical elements of the landscape. A high performance approach to landscape design and management should be guided by four basic principles that respect this dynamism: resource conservation, diversity, connectivity, and environmental responsibility.

- **Resource Conservation.** Identify, use, and recycle available natural and physical resources that do not degrade the ecosystem. This principle should also be applied to site and landscape accessories.
- **Diversity.** Maintain a healthy natural system that gives primary consideration to habitat, species, and genetic diversity.
- **Connectivity.** Maintain networks of natural resources and interconnecting habitats to maximize healthy ecological functions.
- **Environmental Responsibility.** Protect, restore, and manage resources to maintain a healthy ecosystem in perpetuity.

### Applicable Climates



#### Applicable Spaces

Classrooms	<input type="checkbox"/>
Library	<input type="checkbox"/>
Multi-Purpose	<input type="checkbox"/>
Gym	<input type="checkbox"/>
Corridors	<input type="checkbox"/>
Administration	<input type="checkbox"/>
Toilets	<input type="checkbox"/>
Other	<input checked="" type="checkbox"/>

#### When to Consider

Programming	<input checked="" type="checkbox"/>
Schematic	<input checked="" type="checkbox"/>
Design Dev.	<input checked="" type="checkbox"/>
Contract Docs.	<input checked="" type="checkbox"/>
Construction	<input checked="" type="checkbox"/>
Commissioning	<input checked="" type="checkbox"/>
Operation	<input checked="" type="checkbox"/>

To apply these principles to landscape care, it's important to understand the difference between landscape *maintenance* and landscape *management*. Maintaining a landscape implies that the landscape deteriorates and needs to be returned to a "correct" condition by the maintenance crew. This static vision belies the natural dynamism of the landscape. Seeking to simply maintain landscapes works against the dynamic tendencies of nature, resulting in great expense of time, energy, and money.

Management, on the other hand, acknowledges the constant change of nature. To manage a landscape is to work with the basic tendency of nature to change. Management based on ecological principles does not try to always return the landscape to a single, static state. Management — as opposed to maintenance — recognizes the dynamic qualities of landscapes and takes advantage of interconnected elements such as water, soil, and pests.

### Applicability

All climate regions.

## Integrated Design Implications

Planning for landscape management should be integrated and coordinated with Guideline SD5: Native and Drought-Tolerant Plants; Guideline SD6: Landscaping Soil, Amendments, and Mulch; and Guideline SD7: Integrated Weed, Disease, and Pest Management. All landscape planning should also take into account irrigation system parameters to help maximize water efficiency (see Guideline WC1: Water-Efficient Irrigation Systems).

## Cost Effectiveness

Costs will vary depending on the extent of the site and scope of management plan. Native grasses save money on maintenance with reduced or eliminated mowing schedules. Recycled-content landscaping products are comparable in cost to conventional options.

Costs	L	■	■	□
	M	□	□	□
	H	□	□	□
		L	M	H
		Benefits		

## Benefits

High performance landscape design and management, which seeks to bring the designed landscape into a closer adherence with the region's natural systems, provides a high level of benefit. A well-designed and implemented landscape management plan results in water conservation; soil improvement; the use of less intensive practices to manage plants; and the preservation, enhancement, or creation of habitat. The use of recycled content products helps alleviate waste disposal problems and reduces energy use and consumption of natural resources during manufacturing.

Landscape management, including natural lawn care practices, can help make the school grounds healthier for students and staff; protect beneficial soil organisms; and protect the environment through reduced use of water, pesticides, fertilizers, and pollution-producing mowers and maintenance equipment.

Properly designed earth berms can shield the school from nearby roadways, train tracks, etc. However, landscaping, trees, and shrubs cannot be used to reduce the level of exterior noise at the building façade.

## Design Tools

To identify high performance landscape and site planning strategies, consider consulting with a landscape professional that has expertise in ecological approaches to vegetation management.

## Design Details

### Key Elements of a Landscape Management Plan

A landscape management plan needs to take into account three different functions: managing the vegetation, including lawn care; managing the site's infrastructure; and managing those responsible for its care. A landscape management plan should contain the following components:

- *Management vs. Maintenance:* Briefly discuss the basis of an ecological approach, the concept of maintenance vs. management, and the principles of ecosystem-based management.
- *Vegetation Types and Locations:* Discuss the concept of vegetation types, including diversity of vegetation. Also describe the landscape management zones, and list and describe the types of vegetation to be included in each zone. Provide standards that describe the desired condition of each vegetation type. Vegetation types include trees (young, street, native, ornamental, naturalized, riparian); shrubs (ornamental, naturalized, riparian, native); perennials; vegetables; meadow; lawn; groundcover; vines; and weeds and undesirable plants.
- *Infrastructure Standards:* Discuss standards for infrastructure care to achieve the desired condition.
- *Designating Responsibility:* Discuss who is responsible for each aspect of the landscape management, and delineate responsibility on a site map.

- *Sustaining the Landscape:* Describe the general tasks necessary to implement the landscape management specifications, including a yearly calendar of tasks as well as monthly task checklists to monitor the work and the health of the landscape.

### ***Establishing Landscape Management Zones***

A high performance design should divide a landscape into management zones based on each zone's differing design intents and maintenance requirements. In general, three landscape management zones exist:

- *Ornamental Zone:* The more traditional landscape areas next to buildings, parking areas, streets, and other public use facilities. This zone creates strong identity and focus for the schools. The landscape in this zone is typically designed to be organized, attractive, and lush. This zone requires the highest level of management to maintain a visually pleasing and healthy appearance.
- *Natural or Native Zone:* Existing natural areas on, or adjacent to, the site that are to be preserved, enhanced, or expanded.
- *Buffer Zone:* The interface areas between the other two zones. The management goal is to provide a visually pleasing landscape that bridges the ornamental zone and the native, or more natural, areas.

### ***Natural Lawn Care***

Lawns are typically the most intensively managed type of vegetation on a school site. A high performance approach to lawn care starts with lawn placement at the site. Lawn can be divided into different zones, based on how it will be used and how it needs to be cared for. Typically, three standards of care should be considered:

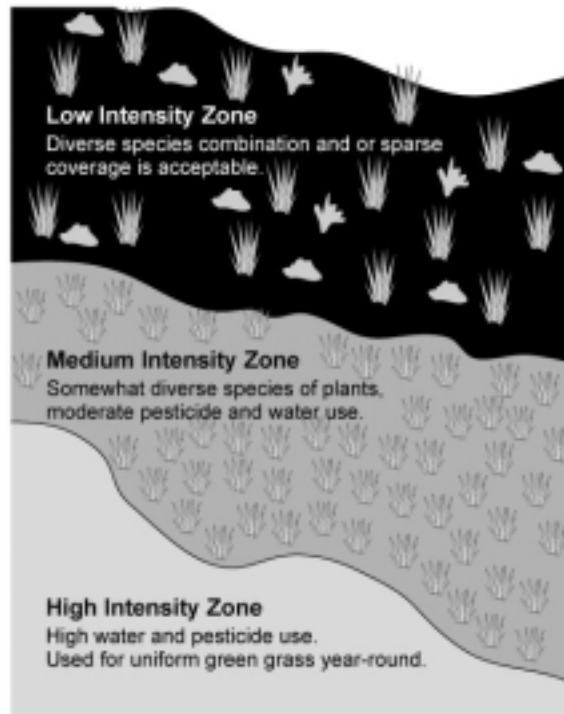

*Figure 3 – Landscape Management Zones*

- *High Intensity:* Requires uniform species composition, high irrigation demands, high synthetic fertilizer use, and regular pesticide and herbicide use. Used when primarily concerned with having uniform green grass year round with no weed, pest, or soil organisms.

- *Medium Intensity*: Allows for more diverse species composition, less demanding irrigation, moderate organic fertilizer use, and integrated pest management approach. Green is important, but not essential year round. Building soil structure over time is an important goal.
- *Low Intensity*: Diverse species composition and/or sparse coverage is tolerable. Alternatives to lawn are considered, with other vegetation taking precedence over lawn.

Plants depend on soil organisms to recycle nutrients, protect them from disease, and build loose fertile soil. Overusing soluble fertilizers and pesticides can disrupt this ecosystem and contribute to landscape and lawn problems like thatch buildup and soil compaction. Ecological approaches to landscape management and natural lawn care practices can help make lawns healthier for students and staff, protect beneficial soil organisms, and protect the environment.

A natural approach to lawn care produces lawns that stay healthy and are easier on the environment. Strategies include soil preparation/amendment, choosing groundcovers or no-mow lawn varieties, minimizing turf areas, “grass cycling” (leaving clippings to decompose quickly, releasing valuable nutrients back into the soil), mowing at the proper height, minimal use of pesticides, applying smaller amounts of fertilizers at regular intervals, appropriate watering, and accepting an appropriate threshold for some weeds.

### **Operation and Maintenance Issues**

Consider a variety of alternatives to traditional school staff for maintenance. For example, Conservation Corps or job training programs for restoration and habitat areas.

Landscape management is a different approach from conventional landscape maintenance. Planning, education, and training are key to a program’s success. Each school district should develop and implement a written landscape management policy and program.

### **Commissioning**

None.

### **References/Additional Information.**

- Clean Air Lawn Care*, South Coast Air Quality Management District. Available on-line at <http://www.aqmd.gov/monthly/garden.html>.
- Cook, Tom and Roy L. Goss. *Construction and Maintenance of Natural Grass Athletic Fields*. Washington State University Cooperative Extension, Publication PNW0240. This bulletin provides the basis for developing and maintaining high quality fields for different purposes under different conditions. Explains construction, establishment, drainage, irrigation, maintenance, and some troubleshooting. Rev. 1992. 28 pages. To order, call (800) 723-1763.
- Craul, Phillip J. *Urban Soil in Landscape Design*. John Wiley & Sons, Inc. 1992.
- Hunter, Charles D. *Suppliers of Beneficial Organisms in North America*. California Environmental Protection Agency, Department of Pesticide Regulation, Environmental Monitoring and Pest Management Branch. 1997.
- Los Angeles County Department of Public Works. *The Natural Approach to Lawn Care*. Available on-line at <http://www.smartgardening.com/grassrecycling.htm>.
- Olkowski, William et al. *Common Sense Pest Control*. The Taunton Press. 1991.
- People’s Park Landscape Management: Vegetation and Infrastructure Program*. A program developed for the University of California, City of Berkeley, and the Park/Community Advisory Group. This program uses an ecological approach to the renovation and care of the landscape. Information available from Wolfe Mason Associates at <http://www.wolfemason.com>.
- Profiles: A Special Report on Grounds Care*. A report of grounds maintenance challenges at Georgetown University, Washington, DC, the University of Texas Southwestern Medical Center in Dallas, and the Orange County Public School District in Orlando, Florida. Available on-line at <http://www.facilitiesnet.com/fn/NS/NS3m9li.html>.



## GUIDELINE SD4: IMPERVIOUS SURFACES

### Recommendation

Minimize impervious surface areas to reduce stormwater runoff. Use material-efficient products for installed pervious and impervious surfaces.

### Description

Impervious areas, such as roofs, driveways, sidewalks, and streets, increase stormwater runoff by preventing the infiltration of surface water into the ground. This increased stormwater runoff results in increased erosion, higher flow rates, higher ambient temperatures, and increased sediment in nearby waterways. Additionally, as stormwater flows over buildings, parking lots, and play fields, it collects pollutants, such as oil, litter, and dirt. These waterborne pollutants often discharge directly into waterways. Conversely, permeable surfaces reduce peak stormwater runoff and treat stormwater pollutants. In addition, impervious surfaces create higher ambient temperatures on the site compared to permeable or vegetated alternatives.

Strategies to limit impervious surfaces on the building site include:

- Using permeable (or porous) pavement systems in lieu of impervious asphalt or concrete. Examples:
  - Porous asphalt, paver blocks, or large aggregate concrete for parking and high use bicycle and pedestrian areas.
  - Lattice blocks that permit grass growth for fire lanes and overflow parking.
  - Crushed stone or brick for lightly used pedestrian paths.
- Minimizing the amount of paving by designing for multiple uses. Uses can include access, parking, pathways, meeting places, and game courts. Surfacing materials can vary depending on intensity of use, e.g., access roads paved and parking gravel, turf block for emergency access, and decomposed granite for secondary paths. All surfacing materials can utilize porous paving techniques.
- Retaining or substituting vegetation in lieu of hard surfaces.
- Designing to distribute runoff from impervious surfaces over large vegetated areas prior to reaching a stormwater conveyance system. This reduces the flow velocity, removes pollutants, and promotes groundwater infiltration.
- Installing a vegetated roof.



*Minimizing impervious surfaces maximizes the area available for soils and vegetation to receive and treat surface water.  
NREL/PIX 11414*

### Applicable Climates



#### Applicable Spaces

Classrooms	<input type="checkbox"/>
Library	<input type="checkbox"/>
Multi-Purpose	<input type="checkbox"/>
Gym	<input type="checkbox"/>
Corridors	<input type="checkbox"/>
Administration	<input type="checkbox"/>
Toilets	<input type="checkbox"/>
Other	<input checked="" type="checkbox"/>

#### When to Consider

Programming	<input type="checkbox"/>
Schematic	<input type="checkbox"/>
Design Dev.	<input checked="" type="checkbox"/>
Contract Docs.	<input type="checkbox"/>
Construction	<input type="checkbox"/>
Commissioning	<input type="checkbox"/>
Operation	<input type="checkbox"/>



- Using natural or constructed wetlands to provide on-site retention and treatment of stormwater.
- Minimizing the building footprint through design. (Note: Minimizing building footprint usually means building “up” rather than “out.” For schools, this may not be desirable because of conflicts with higher priority goals, such as daylighting and natural ventilation.)

Where impervious surfaces are necessary, use resource-efficient materials. Examples include:

- Rubber modified asphalt or recycled concrete asphalt.
- Recycled aggregate for base course of new parking lots and roadways.
- Concrete made using flyash, a byproduct of coal combustion, to replace a portion of the Portland cement, a high-embodied energy material.

*Note: One limitation of porous pavement is its tendency to clog if improperly maintained. Once it is clogged, it is difficult and costly to rehabilitate and often must be completely replaced. Clogging can be prevented most easily by not installing it in areas where erosion is a concern and by waiting until all other phases of construction are complete and vegetation is stabilized to install the pavement. Other concerns include the lack of expertise of pavement engineers and pavement contractors. Also, some studies indicate that porous systems have slightly higher deformation in porous pavement compared to conventional.*

### Applicability

All climates.

### Integrated Design Implications

Strategies to minimize impervious surfaces should be integrated with decisions about landscaping design; shading of the building, site, and heat rejection equipment; building orientation and design (footprint); roofing selection; stormwater management; parking lot and paving design; building layout; vegetated roof design; and parking lot design.



*A vegetated roof reduces the amount of rainwater runoff while simultaneously minimizing heat build-up and providing insulation.*

NREL/PIX 11411

Costs	L			
	M	■		
	H		■	
		L	M	H
		Benefits		

### Cost Effectiveness

Minimizing paved areas means less paving material overall, which translates into lower initial cost.

The cost of permeable paving systems will vary depending on the system used. For example, porous (no fines) concrete may be comparable to conventional pavement. (This material requires a contractor familiar with the process, however.) Grid types, pavers, and brick systems have a cost premium. Cost is offset by its dual purpose as a stormwater system. Less land is needed for this type of system, because an area for detention, retention, or infiltration is not necessary.

### Benefits

Minimizing impervious surfaces helps preserve the hydrological and geological functions of a developed site by maximizing the area available for soils and vegetation to receive and treat surface water and facilitates groundwater recharge. The flow, velocity, and quantity of surface water is decreased overall, reducing the sediment and pollutant load on local waterways as well as the burden on municipal water management systems.

Ancillary benefits include reduced heat, local heat build-up (heat islands) from the shading and cooling effects of vegetation, vegetated roofing, and whitetopping. These translate into reduced cooling loads and energy consumption. Several permeable pavement systems are manufactured with recycled content, making them material efficient. Impervious paving that uses recycled concrete aggregate for base or flyash in concrete is also material efficient.

## Design Tools

Applicable state and local stormwater and surface water management design manuals.

### **Permeable Paving**

Specifications, if any, for porous pavement will vary from state to state. As an example of the types of guidelines states can provide, the documents listed below are used in Washington State:

*Interim Guidelines for the Construction of Portland Cement Pervious Pavement or "No Fines" Concrete*, a working document of the Washington State Aggregates and Concrete Association, soon to be updated.

*BMP T3.40, Porous Pavement*, from the *Final Draft, Stormwater Management Manual for Western Washington, Volume V, Runoff Treatment BMPs*. Washington State Department of Ecology, Water Division. August 1999, revised August 2000. This document can be downloaded at <http://www.ecy.wa.gov/biblio/9915.html> or call (360) 407-6614.

### **Whitetopping**

American Concrete Paving Association (ACPA), Whitetopping, State of the Practice. Publication EB210P. This engineering bulletin covers all aspects of concrete overlays on existing asphalt pavement. Its five chapters include: Introduction (uses and benefits), History and Performance, Design Practices (conventional whitetopping), Construction Practices, and Ultra-Thin Whitetopping (UTW). The last chapter presents the interim procedure for determining the load-carrying capacity of UTW based on research and performance surveys. 1998. Order from the ACPA, <http://www.pavement.com/>.

## Design Details

*Effective* surfaces are those, pervious or impervious, that are connected via sheet flow (shallow or concentrated surface flow) or discrete conveyance (such as drainage ditch) to a drainage system. *Effective impervious surface* is a measure of the performance of the lot with respect to stormwater flows, which provides a way of monitoring impact due to construction. Methods to minimize runoff can be expressed: (1) prescriptively, such as using pervious surfaces, or (2) performance-based, such as providing zero effective impervious surface (no net increase in runoff). Specific strategies will depend upon the specific site and local requirements.



*Concrete manufactured with flyash can be used for paving.  
NREL/PIX04358*

Where impervious pavement must be used, specify the use of recycled asphalt, concrete manufactured with flyash for paving, and/or rubberized asphalt pavement. In hot climates, look for opportunities to whitetop asphalt surfaces with heat-reflecting white concrete.

For concrete work, use reusable steel forms, expansion joint filler with recycled content, and least toxic release methods.

When using porous paving or on-site bio-filtration swales, it is critical that sub-base soils are tested so that designs are sufficient to process the stormwater flow.

Utilize surface stormwater flow wherever possible. Introduce oil/water separators at catch basins.

Note that design considerations should assume a minor loss in porosity in the first four to six years.

Avoid compaction of site soils in adjacent areas during construction to retain infiltration and water holding capacity of existing soils.

## **Operation and Maintenance Issues**

For bio-swales and constructed wetlands, the design intent is to create a self-sustaining system that requires little maintenance. Monitoring and maintenance as the landscape matures provide educational opportunities. As bio-swales and constructed wetlands provide wildlife habitat, mowing and thinning plants should be minimal unless soils testing shows that impurities from runoff are high. In that case, mowing and thinning will help remove toxins that may accumulate in the vegetation.

In parking areas, prune plants as needed to maintain sight lines and the desired aesthetic. If storm drains are used, clear as needed to prevent blockages. Avoid soil compaction in vegetated areas.

For porous asphalt and concrete, vacuum with a hydrovac to maintain or restore porosity by removing sediment from the paving surface. If areas become deformed by traffic, drill compacted areas to restore porosity. Keep underdrains, overflow drains, and edge drains clear.

Grassed paving systems need to be mowed. Tall grasses create a less-permeable surface. If this type of system is perceived as unmaintained, it may discourage potential users. The durability of the system depends on soil type and climate; however, maintenance is decreased with the use of appropriate groundcover plants in lieu of lawn. Some groundcovers can take foot traffic but lawn, in turf block or grids, is best used where there is auto traffic.

Unit pavers on a permeable subgrade settle after the initial installation, and therefore require that a joint-filler material be swept in. Permeability decreases over time as the joints become compacted.

The systems mentioned above are conducive to “spot fixes” should replacement of small areas be required due to damage. It should also be noted that maintenance is reduced where snow removal is significant, as snow melts faster on permeable surfaces.

Longevity of the system depends on the type of system used, the amount of use it receives, and the appropriate match of system to site.

## **Commissioning**

None.

## **References/Additional Information**

- California Integrated Waste Management Board. *Designing with Vision: A Technical Manual for Material Choices in Sustainable Construction*. See Chapter 8, “Strategies to Reuse Materials and Reduce Material Use in Construction,” *Designing with Vision* can be downloaded in four parts from <http://www.ciwmb.ca.gov/GreenBuilding>. Chapter 8 is in Part D. Revised July 2000.
- International Erosion Control Association. Provides technical assistance and an annual Erosion Control Products and Services Directory. (800) 455-4322. <http://www.ieca.org/>.
- Stormwater and Urban Runoff Seminars — Guide for Builders and Developers*, NAHB, Edited by Susan Asmus, Washington DC, (800) 368-5242 x538 or <http://www.nahb.com/>.
- Stockdale, E.C. *Freshwater Wetlands, Urban Stormwater, and Nonpoint Pollution Control: A Literature Review and Annotated Bibliography*. 2nd Ed. WA Dept. of Ecology, Olympia, WA. 1991.
- Strecker, E.W., J.M. Kersnar, E.D. Driscoll & R.R. Horner. *The Use of Wetlands for Controlling Stormwater Pollution*. The Terrene Institute, Washington, DC. April 1992.
- U.S. Environmental Protection Agency. *Natural Wetlands and Urban Stormwater: Potential Impacts and Management*. EPA843-R-001. Office of Wetlands, Oceans and Watersheds, Washington, DC. February 1993.
- U.S. Environmental Protection Agency. *Stormwater Management For Construction Activities: Developing Pollution Prevention Plans And Best Management Practices: Summary Guidance*. EPA#833-R-92-001, Office of Wastewater Management, 401 M St. SW, Mail Code EN-336, Washington DC, 20460. October 1992. (800) 245-6510, (202) 260-7786 or <http://www.epa.gov/owm/sw/construction/>.

## GUIDELINE SD5: NATIVE AND DROUGHT-TOLERANT PLANTS

### Recommendation

Use vegetation that is drought-tolerant and native to the school's climate area. Preserve existing vegetation, especially groups of plants or significant specimens wherever possible. Design for plant survival since many landscape areas in schools can be destroyed by intensive use. Design landscapes with a minimal water-use budget, using low-flow irrigation systems.



Water needs for irrigation can be minimized by protecting existing vegetation and using native planting.

NREL/PIX 11340

### Description

Native vegetation is adapted to regional climate conditions. They are easy to establish, are drought-tolerant (require little or no irrigation once established), and are naturally disease-resistant and pest-resistant. Planting for minimal water use is also referred to as "xeriscaping" or "drought-tolerant" landscaping. Existing vegetation is the easiest and most cost-effective way to landscape the site. It also provides historical connection to the surrounding neighborhood.

### Applicable Climates



Plant survival can be increased by using tough plants that can take foot traffic such as plants grown from corms or bulbs. Good examples include *Dietes vegeta*, *Acanthus mollis*, *Phorium sp.*, and many of the grasses, reeds and sedges. These tough plants should anchor corners and edges of planted areas. Also raised beds, curbs, and temporary but artistic barriers can help protect plants into maturity. Preparing designs and management programs that layer plant types, use a mixture of sizes at initial plantings, and plan for plant succession will also help.

### Applicable Spaces

Classrooms	<input type="checkbox"/>
Library	<input type="checkbox"/>
Multi-Purpose	<input type="checkbox"/>
Gym	<input type="checkbox"/>
Corridors	<input type="checkbox"/>
Administration	<input type="checkbox"/>
Toilets	<input type="checkbox"/>

### When to Consider

Programming	<input type="checkbox"/>
Schematic	<input type="checkbox"/>
Design Dev.	<input checked="" type="checkbox"/>
Contract Docs.	<input checked="" type="checkbox"/>
Construction	<input checked="" type="checkbox"/>
Commissioning	<input type="checkbox"/>
Operation	<input checked="" type="checkbox"/>

### Applicability

This guideline applies to all climates

### Integrated Design Implications

Drought-tolerant landscaping should be integrated/coordinated with Guideline SD2: Landscaping to Provide Shade to HVAC Systems, Buildings, and Paved Areas; Guideline SD3: Landscape Design and Management; and Guideline SD7: Integrated Weed, Disease, and Pest Management. All landscape planning should also take into account irrigation system parameters to assist in the goal of maximum efficiency. See Guideline WC1: Water-Efficient Irrigation Systems.

### Cost Effectiveness

Costs are competitive with, or only slightly higher than, conventional landscape design. Additional cost benefit occurs if reusing existing vegetation.

Costs	L	<input checked="" type="checkbox"/>	<input type="checkbox"/>	<input type="checkbox"/>
	M	<input type="checkbox"/>	<input type="checkbox"/>	<input type="checkbox"/>
	H	<input type="checkbox"/>	<input type="checkbox"/>	<input type="checkbox"/>
		L	M	H
		Benefits		

## **Benefits**

The use of drought-tolerant, native species conserves water (thereby reducing water costs), provides lots of attractive planting options, presents minimal disease and pest problems, thrives with little fertilization, requires low pruning and maintenance, provides wildlife habitat, and saves valuable landfill space. If retaining native vegetation in a landscape (rather than removing them and then replanting), added benefits include excellent erosion, sediment, dust, and pollution control.

## **Design Tools**

Landscaping for minimal irrigation also requires careful planning of plant groupings, the “right plant, right place” concept, soil considerations, and other landscape design practices. The use of a landscape professional with expertise in native and drought-tolerant vegetation for the school’s climate region is recommended.

Landscape Auditors certified by the Irrigation Association (703) 536-7080, Web site:  
<http://www.irrigation.org/>.

## **Design Details**

Add language into construction specs to protect existing plants, especially trees and root systems.

Soils are often disturbed during construction activities, and native vegetation may not thrive in degraded soils. Unless soil amendments are used to restore disturbed soil, it may be more appropriate to use water-efficient, non-native vegetation. See Guideline SD6 for using soil amendments.

Clearly define planting zones by intended use, e.g., lawns for play, tree groves for shade and habitat, shrub masses for buffering and screening.

Introduce plants to increase habitat, e.g., butterflies and hummingbirds.

Create a diversity of landscape areas, e.g., ponds, meadows and groves; community gardens; vines and perennials.

## **Operation and Maintenance Issues**

Native, drought-tolerant plants are usually hardier and more pest-resistant, requiring less fertilizer and pesticide use. Use organic, slow release fertilizers and integrated pest management for pest control. See Guideline SD7 on integrated pest management.

Recommend that the landscape contractor specify in the maintenance contract that new landscaped areas be maintained for a two to three year plant establishment period. Monthly findings on plant establishment should be reported to the owner.

## **Commissioning**

None.

## **References/Additional Information**

Arizona Native Plant Society, <http://www.aznps.org/>.

Arkansas Native Plant Society, <http://www.anps.org/>

Carnegie Library of Pittsburgh, <http://www.trfn.clpgh.org/Lifestyle/Gardening/nativeplants.html>. The Native Plants page has links to Pennsylvania resources, as well as national information.

City of Fort Collins. (March 1999). Xeriscape: a New Kind of Landscaping.

A summary of environmentally responsive landscaping resources, including a list of very low, low, and moderate water consumption.

<http://www.ci.fort-collins.co.us/utilities/water/conserv/xeriscap.htm>.

Connecticut Botanical Society, <http://www.ct-botanical-society.org/>

Florida Native Plant Society, <http://www.fnps.org/>.

Gardening to Preserve Maine's Native Landscape, University of Maine Cooperative Extension Bulletin #2500, <http://www.nps.gov/plants/pubs/gardenME/>

Georgia Native Plant Society, <http://www.gnps.org/>.

Idaho Native Plant Society, <http://www.idahonativeplants.org/Index2.html>.

Illinois Native Plant Society, <http://www.inhs.uiuc.edu/inps/>

Indiana Native Plant and Wildflower Society, <http://www.inpaws.org/>

Marsh, W. M. 1991. *Landscape Planning: Environmental Applications*. John Wiley & Sons, New York. A definitive reference for landscape architects, planners, and designers on the definition and application of environmental design principles to landscape and site planning.

Maryland Native Plant Society, <http://www.mdflora.org/>

Minnesota Native Plant Society, <http://www.stolaf.edu/depts/biology/mnps/>

Missouri Native Plant Society, [http://www.missouri.edu/~umo\\_herb/monps/](http://www.missouri.edu/~umo_herb/monps/)

Montana Native Plant Society, <http://www.umt.edu/mnps/>

Nevada Native Plant Society, <http://www.state.nv.us/nvnhp/nnnps.htm>

Texas Native Plant Database. Run by Texas A&M University and the Dallas Arboretum, this site features a searchable database with photos of native Texas trees and plants. <http://www.dallas.tamu.edu/native>

The Lady Bird Johnson Wildflower Center. Links page has contact information for native plant organizations for most states. <http://www.wildflower.org/links.html>.

U.S. Environmental Protection Agency, Great Lakes Region. This site is a thorough resource for native landscaping in the Great Lakes area. <http://www.epa.gov/greenacres/>

Utah Native Plant Society, <http://www.unps.org/>.

Virginia Native Plant Society, <http://www.vnps.org/>.

WaterWiser — a program of the American Water Works Association operated in cooperation with the U.S. Bureau of Reclamation. The web site provides information and resources including links for all aspects of outdoor and indoor water conservation, recycled water collection and reuse, irrigation, landscaping, and efficient fixtures and appliances. AWWA number is (202) 628-8303. <http://www.waterwiser.org/>.

Washington State University Cooperative Extension. This site contains a database with detailed information on plants native to the Pacific Northwest. <http://www.gardening.wsu.edu/nwnative/>



# GUIDELINE SD6: LANDSCAPING SOIL, AMENDMENTS, AND MULCH

## Recommendation

Use organic soil amendments to help restore the health of disturbed soils. Where feasible and appropriate, use soil amendments and mulch with recycled content.

## Description

The appropriate use of organic soil amendment will offset degradation in soil health due to construction activities, reduce runoff, help treat stormwater pollutants, and help ensure establishment of vegetation. Where feasible, use soil amendments from composted green waste and mulch from shredded bark, which adheres better to the soil.



Amendments protect the health of soil. NREL/PIX01791

## Applicability

All climates.

## Applicable Climates



## Integrated Design Implications

Soil amending should be integrated/coordinated with Guideline SD2: Landscaping to Provide Shade to HVAC Systems, Buildings, and Paved Areas; Guideline SD3: Landscape Design and Management; and Guideline SD5: Native and Drought-Tolerant Plants.

## Cost Effectiveness

Medium.

### Applicable Spaces

Classrooms	□
Library	□
Multi-Purpose	□
Gym	□
Corridors	□
Administration	□
Toilets	□
Other	■

### When to Consider

Programming	□
Schematic	■
Design Dev.	■
Contract Docs.	□
Construction	□
Commissioning	□
Operation	■

## Benefits

Research at the University of Washington has shown that, compared to traditional lawn installations, landscape grown on composted-amended soils:

- Uses less water for irrigation.
- Requires less fertilizer and pesticide.
- Covers and “greens up” more quickly.
- Has improved appearance.
- Reduces stormwater runoff.

Costs	L	□	□	
	M	■	■	
	H	□	□	
		L	M	H
		Benefits		

## Design Tools

Appropriate use of soil amendments requires site soil testing and analysis to determine type and amount of amendment.

## Design Details

Key steps in creating and maintaining healthy soil and amendments include:

- Minimize disturbance of existing soil.
- Test the horticultural suitability of existing soil.
- Strip and save suitable existing soil for re-use in landscape areas.
- All existing soil in areas to be planted that have been degraded and compacted from building construction must be scarified before planting. In general, and depending on soil type, planting soils can not be compacted more than 80% so that air and water can percolate through the soil cross section.
- Incorporate organic soil amendments from composted green waste to help restore the health of disturbed soils.
- Use a minimum 3 in. to 4 in. layer of mulch at all planting areas to help retain soil moisture and discourage weed growth. Some types of mulch can also take foot traffic.

Urban development often involves clearing, removing topsoil, cuts, and fills. Once the work is done, the remaining soil is often much less healthy than the original, native soil.

*Table 5 – Characteristics of Healthy vs. Disturbed Urban Soil*

Healthy Native Soil	Disturbed Urban Soil
<ul style="list-style-type: none"><li>• Stores water and nutrients — Contains a rich, diverse makeup of organisms, organic matter, and pores. Healthy soil acts like a giant sponge, storing and slowly releasing water, oxygen, and nutrients to plants as needed.</li><li>• Regulates water flow — Maintains the natural water cycle by slowly discharging to streams and lakes and recharging aquifers.</li><li>• Neutralizes pollutants — Soil rich in organic matter contains microorganisms that can immobilize or degrade pollutants.</li></ul>	<ul style="list-style-type: none"><li>• Compacted — The removal of topsoil exposes subsoil that is often compacted. Heavy construction equipment can further compact soils. These dense layers resist plant root penetration and lack pores needed for adequate aeration. As a result, the soil is less able to absorb, retain, and filter (purify) groundwater.</li><li>• Reduced storage capacity — Because subsoil is less able to retain water, more stormwater ends up as runoff, disrupting the natural water cycle and degrading the health of nearby streams and waterways.</li><li>• Poorer quality — The subsoil layer generally contains less organic matter and fewer nutrients than rich topsoil. This soil is less able to immobilize or degrade pollutants.</li></ul>

The result is increased erosion and stormwater runoff, as well as higher flow rates, higher temperatures, and increased sediment in nearby streams from disturbed urban soil. In addition, developed sites with poor soil typically require more irrigation, pesticides, and fertilizers to establish and maintain landscaping. Increased water usage as well as pesticide/fertilizer runoff causes further habitat damage.

## Operation and Maintenance Issues

Vegetation grown on amended soils establishes more quickly and requires less ongoing maintenance compared to vegetation grown on un-amended, disturbed urban soil.

## Commissioning

None.

## References/Additional Information.

U.S. Composting Council. This non-profit organization is involved in research, public education, composting, and compost standards. Their website has links to composting resources throughout the country. Web site: <http://www.compostingcouncil.org/>



## GUIDELINE SD7: INTEGRATED WEED, DISEASE, AND PEST MANAGEMENT

### Recommendation

Control and manage weeds, disease, and pests within tolerable limits to maintain the landscape in a manner that achieves attractive and healthy growth for plants, animals, and people while conserving energy and water.

### Description

The most effective weed, pest, and disease control measure is to keep plants healthy. When a problem is caused by an adverse environmental condition, chemically treating the problem will not prevent its recurrence, but will only treat the symptoms. Control of disease and pests includes, but is not limited to, rust, scale, aphids, mealy bugs, pine shoot moths, snails, and rodents.

Once viewed as safe and effective for insect control, chemical pesticides and herbicides are now recognized poisons that can contaminate the soil and harm wildlife and humans — especially children. Some of this poison finds its way into lakes, streams, and groundwater supplies, where it disrupts the balance of life. Reducing the use of pesticides protects lakes and contributes to a healthier environment for fish, wildlife, and people.

Integrated pest management (IPM) is a horticultural practice that stresses the application of biological and cultural pest control techniques with selective pesticides, when necessary, to achieve acceptable control levels with the least possible harm to human health and safety, non-target organisms, and the environment.

IPM encompasses various environmentally sound strategies, including:

- Use of appropriate, adapted plant varieties
- Installation of a compatible, supportive landscape/site design (such as incorporating concrete mow strips near fencing to eliminate the need for herbicide use in these areas)
- Providing the necessary nutrients and moisture
- Following through with good maintenance practices.

### Applicability

All climates.



*Outdoor learning areas like this must be kept free of harmful chemical pesticides and herbicides. NREL/PIX10675*

### Applicable Climates



#### Applicable Spaces

Classrooms	<input type="checkbox"/>
Library	<input type="checkbox"/>
Multi-Purpose	<input type="checkbox"/>
Gym	<input type="checkbox"/>
Corridors	<input type="checkbox"/>
Administration	<input type="checkbox"/>
Toilets	<input type="checkbox"/>
Other	<input checked="" type="checkbox"/>

#### When to Consider

Programming	<input type="checkbox"/>
Schematic	<input type="checkbox"/>
Design Dev.	<input checked="" type="checkbox"/>
Contract Docs.	<input checked="" type="checkbox"/>
Construction	<input checked="" type="checkbox"/>
Commissioning	<input checked="" type="checkbox"/>
Operation	<input checked="" type="checkbox"/>

## Integrated Design Implications

Planning for IPM should be integrated/coordinated with Guideline SD2: Landscaping to Provide Shade to HVAC Systems, Buildings, and Paved Areas; Guideline SD3: Landscape Design and Management; Guideline SD5: Native and Drought-Tolerant Plants; and Guideline SD6: Landscaping Soil, Amendments, and Mulch.

Landscape design that employs IPM will help limit the release of potential stormwater pollutants.

## Cost Effectiveness

Medium. IPM may have a higher initial cost than pesticide programs, but it is cost effective over the life of the building and produces safer school grounds, healthier vegetation, and lower spraying costs. Frequent pesticide use can result in a chemical dependent situation, where an insect comes back stronger than it was before. Increasing doses and frequency of application are then needed for attempted control of the pest. For example, pesticides that kill aphids also kill aphid predators. Since aphids reproduce more quickly than their predators, when they return to the plant, their natural enemies will be gone, and they may also become resistant to the pesticide. IPM means less pesticide/herbicide use, but may entail additional ongoing labor for maintenance as well as additional training, documentation, and policy development costs.

Costs	L			
	M	■	■	
	H			
		L	M	H
		Benefits		

## Benefits

Decreased pesticide use means less health risk to students and staff, and lower maintenance costs associated with the purchase of pesticides.

## Design Tools

None.

## Design Details

There are four key issues for weeds, disease, and pests:

- Planting appropriate species and maintaining them in a healthy condition since most weeds and pests are more attracted to weak or over-fertilized plants than to those in good health.
- Determining what really is a weed or pest. A plant is a weed only if it is in an undesirable location or is out-competing more desired species. Many "bugs" are essential to plant propagation and are beneficial to the health of plant.
- Maintaining weeds and pests on vegetation (grass, groundcover and shrubs, grasses and turf, gardens and perennials) within tolerable levels using the IPM approach.
- Controlling damage from water fowl, gophers, and other rodents by replacing inappropriate plants with those that are less susceptible, and by adding mechanical protection devices (cages, mesh, etc.) during the early growth period of the new plants, as needed.

Consult a landscape professional with expertise in IPM to identify landscape and site design strategies that will support ongoing IPM. Select plant species less prone to disease.

Perform weed control by hand, pulling and hoeing whenever possible. It is important to do this frequently enough so that weeds do not have a chance to go to seed. Remove weeds from pavement and all vegetative areas. If there is a persistent problem, a pre-emergent herbicide may be considered for the large or particularly troublesome areas *only* after review and approval.

IPM requires a proactive management program with a good system of monitoring and record keeping as the first line of defense. Contractors' monthly reports shall include all weed, pest, or disease observations and actions taken for review by the management team. Mechanical and biological control measures, such as hand picking, water jets, safer soap, barriers (e.g., organic pastes or poly mesh), biological controls (e.g., *Bacillus thuringiensis*), and less toxic sprays (e.g., dormant/summer oil, sulfur fungicides,

pyrethrum, or rotenone) are first considered for use, often in combination. Less toxic chemicals will be considered before stronger chemicals.

Controlling pests is the subject of several research projects, particularly in grass areas. Herbicides and sprays used to eliminate broadleaf weeds or fungus have caused numerous injuries, studies, and debates. If grass areas are properly located and receive proper care, weeds and disease should not be a major problem. If problems do arise, they are to be reviewed with the consulting architect, and physical or biological solutions explored before chemicals are requested. Broadleaf weeds are to be kept to a minimum but multiple grass varieties are acceptable. The use of green dyes in particularly noticeable brown spots is an option.

### **Operation and Maintenance Issues**

IPM is a different approach and requires planning, education, and training to succeed. Each school district should develop and implement a written pest management policy.

### **Commissioning**

None.

### **References/Additional Information**

*Overview of Pest Management Policies, Programs, and Practices in Selected California Public School Districts.* This is a report of a study conducted by the Environmental Monitoring and Pest Management Branch of the Department of Pesticide Regulation (DPR) of pest management programs in California's public school districts. The study was conducted in cooperation with the California Department of Education (CDE) to: (1) obtain an overview of district pest management policies, programs, and practices, (2) identify policy and program constraints, and (3) identify ways that DPR can work cooperatively with CDE to assist school districts in implementing pest management programs based on the principles of IPM. The report is available on-line at <http://www.cdpr.ca.gov/docs/dprdocs/schools/schools.htm>.

*Reducing Pesticides in Schools: How Two Elementary Schools Control Common Pests Using Integrated Pest Management Strategies.* The Pesticides Reduction in Schools (PRI-School) Project explored the potential for reducing risks associated with unnecessary pesticide use by implementing IPM programs in schools throughout Santa Barbara County. The main goals of the project were to identify the local administrative, technical and social barriers to implementing effective IPM programs and to explore ways to overcome these barriers. Funding for the PRI-School Project was provided by the U.S. Environmental Protection Agency and the Santa Barbara Foundation. The project was managed jointly by the Community Environmental Council and Organic Consulting Services, both from Santa Barbara. The report is available on-line at [http://www.grc.org/cec/pubs/IPM\\_report2.html](http://www.grc.org/cec/pubs/IPM_report2.html).

University of California's Statewide Integrated Pest Management Project, web site:  
<http://www.ipm.ucdavis.edu/default.html>.

# GUIDELINE SD8: ENVIRONMENTALLY RESPONSIBLE JOB-SITE OPERATIONS PLAN

## Recommendation

Require a job-site operations plan that includes protocols for Job-Site Waste Reduction (Guideline RS3), IAQ (Guideline SD9), and Site Protection (Guideline SD10).

## Description

A job-site operations plan will describe goals, construction practices to achieve those goals, methods to train or otherwise communicate these goals to field personnel, and methods to track and assess progress towards those goals. For each component of the plan (waste reduction, IAQ, and site protection), these elements will be specified. In addition, the plan will specify the method of documenting compliance with these goals, including in the case of product substitutions.

## Applicability

Job-site management is applicable to all spaces in schools and to all climates. While it is carried out in the construction phase, the contract documents must clearly specify the expectations of the general contractor.

## Integrated Design Implications

An environmentally responsible job-site operations plan protects the integrity of design goals to reduce waste, improve air quality, and protect the site and surrounding waterways from degradation.

## Cost Effectiveness

Costs for implementing the plan will include labor for overseeing and documenting compliance and should not be significant.

## Benefits

Having a plan in place helps minimize costs and liabilities, including delays, stoppages, and residual problems in the completed school building. Proper planning is always more cost-effective than cleaning up after a mistake.

## Design Tools

None.

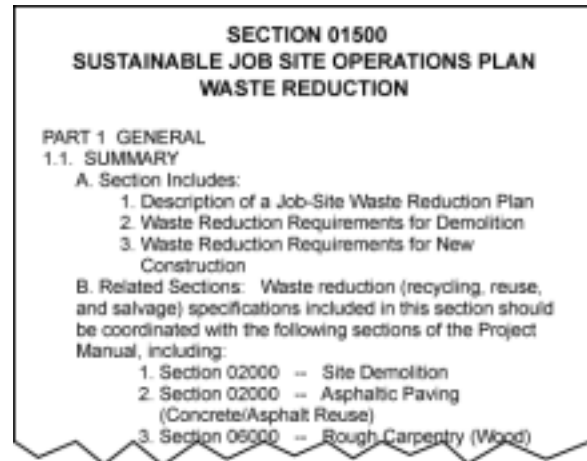

*Sample job site operations plan.*

## Applicable Climates



### Applicable Spaces

Classrooms	█
Library	█
Multi-Purpose	█
Gym	█
Corridors	█
Administration	█
Toilets	█
Other	█

### When to Consider

Programming	□
Schematic	□
Design Dev.	█
Contract Docs.	█
Construction	█
Commissioning	□
Operation	□

Costs	L	█	□
	M	□	□
	H	□	□
		L M H	
		Benefits	

### ***Design Details***

The requirement for an environmentally responsible job-site operations plan would appear in the “Temporary Controls” section(s) of specifications. The more clearly a plan allocates responsibilities and expectations, the less likely the project will generate unpleasant surprises during and after construction. Ideally, the plan should specify a time requirement for when a plan must be submitted, such as within 14 days of Notice of Award and prior to applicable construction activities. In addition, it can include sample forms, references, or other resources for the contractor to help facilitate development of an effective plan.

### ***Operation and Maintenance Issues***

The plan should specify a method of providing documentation for products substituted in the field, so that information is available to custodial staff should a replacement or repair be required. In addition, when dealing with non-conventional or innovative materials, information about how a product behaves during installation and pre-occupancy maintenance (such as during cleanup), as well as other “lessons learned” noted in a field log can be helpful.

### ***Commissioning***

None.

### ***References/Additional Information***

See the References listed for individual components of the plan in the following guidelines: RS3, SD9, SD10.

# GUIDELINE SD9: INDOOR AIR QUALITY DURING CONSTRUCTION

## Recommendation

Require indoor air quality (IAQ) planning and preventive job-site practices.

## Description

Preventive job-site practices can reduce residual problems with IAQ in the completed building and eliminate undue health risks for workers. "Healthy" job-site planning will adequately address problem substances, including construction dust, chemical fumes, off-gassing materials, and moisture. It will make sure these problems are not introduced during construction, or, if they must be, eliminates or reduces their impact. Areas of planning will include product substitutions and materials storage, safe installation, proper sequencing, regular monitoring, as well as safe and thorough cleanup.

## Applicability

Maintaining healthy job-site conditions is important for all spaces and all climates. The activity is carried out in the construction phase, but must be planned in the design development and contract documents phases.

## Integrated Design Implications

When identifying "healthy" materials for use in buildings, the focus is generally on preventing problems during occupancy. This guideline implies that some responsibility for air quality occurs during installation, which may impact the choice of material and/or the method of installation. Also, since substitutions may happen in the field, it is important to outline the approval process for these substitutions clearly. For materials with off-gassing potential, require specific ingredient information about the product itself (as well as any adhesives, solvents, or other products that might be used during installation or maintenance). Designing to use mechanical fasteners (screws, Velcro) rather than chemical adhesives and solvents can reduce potential problems with IAQ during construction.

## Cost Effectiveness

Implementing this guideline should not necessarily add cost to the project. The one area where it might add cost is in potential delays due to sequencing and ventilation requirements. However, this cost can be avoided by proper planning.

Risk managers will be reluctant to take on the added responsibility of requiring IAQ planning and preventive job-site practices. However, school districts and project architects across the country have



Healthy job site signage.  
NREL/PIX 11408

## Applicable Climates



## Applicable Spaces

Classrooms	█
Library	█
Multi-Purpose	█
Gym	█
Corridors	█
Administration	█
Toilets	█
Other	█

## When to Consider

Programming	█
Schematic	█
Design Dev.	█
Contract Docs.	█
Construction	█
Commissioning	█
Operation	█

Costs	L	█	█	
	M	█	█	
	H	█	█	
		L	M	H
		Benefits		

experienced litigation related to poor IAQ resulting from construction activities. Addressing these issues before and during construction will reduce exposure of the district and designers to potentially expensive litigation in the future.

### **Benefits**

The costs of poor IAQ are difficult to quantify, but considerable. They include the sum of illness and decreased student productivity paid by students and teachers, along with the district's cost of equipment replacement, workers' compensation claims, and in the most severe cases, potential litigation. Unfortunately, serious health complaints have resulted from careless acts during construction projects, such as failure to clean up spilled adhesives or neglecting to properly ventilate during and after applying sealants in an occupied building. These mistakes have led to school closures, unpleasant headlines, and costly lawsuits. Good IAQ strategies during construction will help eliminate these potential liabilities.

### **Design Tools**

The U.S. Environmental Protection Agency has an online checklist available for IAQ issues at all stages and aspects of construction. Visit <http://www.epa.gov/iaq/schools/tools4s2.html>.

### **Design Details**

IAQ goals (as with all other resource-efficient building goals) should be outlined in the Instructions to Bidders as part of the Project Summary addition. IAQ specifications should be included in the Temporary Controls sections of General Conditions.

The specifications should describe what is included in an IAQ construction plan, outline submittal requirements, and reference the SMACNA IAQ Guidelines for Occupied Buildings Under Construction 1995, with the goals of:

- Protect the ventilation system components from contamination, or provide cleaning of the ventilation components exposed to contamination during construction prior to occupancy.
- Provide a minimum continuous ventilation rate of one air change per hour during construction, or conduct a building flush-out with new filtration media at 100% outside air after construction ends (following issuance of Occupancy Certificate) and prior to occupancy for seven days (one week). Provide a minimum of 85% filtration (as determined by ASHRAE Standard 52.1-1992) on any return air systems operational during construction, and replace filtration media prior to occupancy. Note that seven days is considered a minimum. IAQ specialists recommend flushing the building with 100% outside air for 30 days prior to substantial completion.

If the contractor is required by the specification to be responsible for protecting IAQ during construction, it is not necessary to detail methods by which the contractor can achieve it. However, it is informative for contractors to include a list of proven air quality protection strategies, such as:

- Use supplemental (temporary) ventilation when installing carpet, paints, furnishings, and other VOC-emitting products, for at least 72 hours after work is completed. Preferred HVAC system operation uses supply air fans and ducts only, with windows providing exhaust. Use exhaust fans to pull air from deep interior locations. Stair towers and other paths to the exterior can be useful during this process.
- Perform regular inspection and maintenance of IAQ measures, including ventilation system protection and ventilation rate.
- Provide VOC-safe masks for workers installing VOC-emitting products (interior and exterior), which are defined as products that emit 150 grams per liter (gpl) or more. If local jurisdiction's requirements are stricter, the strictest requirement should be followed for using VOC-safe masks.
- Provide low-toxic cleaning supplies for surfaces, equipment, and worker's personal use. Options include several soybean-based solvents and cleaning options and citrus-based cleaners.

- Wet sand gypsum board assemblies. Exceptions should be clearly defined and include full isolation of space undergoing finishing or closure of all air system devices and ductwork. Additional conditions can be set.
- Use safety meetings, signage, and subcontractor agreements to communicate the goals of the construction IAQ plan.

The IAQ construction plan is also a good opportunity to proscribe unacceptable behaviors that represent a potentially negative impact on long term IAQ such as smoking, using chew tobacco, or wearing contaminated work clothes.

### **Operation and Maintenance Issues**

Contractors should be required to provide information on product substitutions sufficient to enable operation and maintenance staff to properly maintain and repair low-emitting or otherwise “healthy” materials.

### **Commissioning**

None.

### **References/Additional Information**

U.S. Green Building Council's *Reference Manual* for LEED Green Building Rating System (Commercial, Version 2) at <http://www.usgbc.org>. Also see Carpet and Rug Institute (CRI) guidelines for carpet installation. The Painting Contractors Union (New York City local) has reportedly developed guidelines for ventilation during painting.

U.S. Environmental Protection Agency. [www.epa.gov/iaq/schools/tfs/renovate.html](http://www.epa.gov/iaq/schools/tfs/renovate.html). A checklist for IAQ issues at all stages of construction.



# GUIDELINE SD10: SITE PROTECTION DURING CONSTRUCTION

## Recommendation

Require best management practices for site protection during construction.

## Description

An effective job-site protection plan will describe construction practices that eliminate unnecessary site disturbance, minimize impact on the site's natural (soil and water) functions, and eliminate water pollution and water quality degradation.

Primarily it will include protocols for:

- Construction equipment operation and parking
- Topsoil and vegetation protection and reuse
- Hazardous materials management
- Installation and maintenance of erosion control and stormwater management measures.



*Silt fencing helps to avoid construction delays and work stoppages due to erosion. NREL/PIX 11409*

## Applicability

This guideline applies to all climates and spaces.

### Applicable Climates



## Integrated Design Implications

The plan should be integrated with stormwater management and erosion control measures. In addition, a requirement to submit ingredient information about in-field product substitutions to avoid degradation of water quality on the site is important.

### Applicable Spaces

Classrooms	■
Library	■
Multi-Purpose	■
Gym	■
Corridors	■
Administration	■
Toilets	■
Other	■

### When to Consider

Programming	□
Schematic	□
Design Dev.	□
Contract Docs.	□
Construction	■
Commissioning	□
Operation	□

## Cost Effectiveness

This guideline recommends going beyond typical site practices. The project architect needs to evaluate the risk of erosion problems to determine whether redundant erosion control measures are cost effective. Least-toxic pest and weed control is quite cost effective, as it can provide savings and an increased level of safety for students who will be using the school grounds.

Costs	L	□	□	■
	M	□	□	■
	H	□	□	□
		L	M	H
		Benefits		

## Benefits

Construction delays and work stoppages due to erosion control failure are avoided. Water quality in surrounding waterways and groundwater supplies are protected. Health risks to students due to residual toxicity on the site can be reduced.

## Design Tools

None.

## **Design Details**

Site protection (as with all other resource-efficient building goals) should be referenced in the Instructions to Bidders as part of the Project Summary. In addition, site protection specifications should be included in the Temporary Controls sections of General Conditions. The specifications should describe what is included in a site protection plan, outline submittal requirements, and recommend strategies, including:

- Regular inspection and maintenance of site protection measures. At a minimum, inspection of all erosion and sedimentation measures after a heavy rainfall, which is defined as 0.5 in. in less than 24 hours.
- Redundant mechanisms for site protection of any critical or sensitive areas, as identified in the site plan. Silt fencing fabric and other temporary site protection measures should be selected to last for the life of the project.
- Measures to ensure that detergent does not get into soil and sediment separators.
- Posted protocol for construction vehicles regarding parking and access on the site.
- Rocked heavy construction vehicle entrance and tire wash.
- Posted clean-up procedures for spills to prevent illicit discharges.
- Measures to minimize risk of the toxic release of hazardous wastes, including paints and other finish products, solvents, adhesives, and oils as follows:
  - Avoid overstocking.
  - Adopt a first-in, first-out policy.
  - Label containers properly.
  - Control access to storage areas and routinely inspect containers.
  - Inspect all containers upon receipt. Reject leaking or damaged containers.
- Topsoil preparation, planting, and maintenance using Integrated Pest Management (least-toxic) protocol. Least-toxic products for controlling pests and insects in detention ponds and for soil prep. No chemical weed eradication.
- Safety meetings, signage, and subcontractor agreements that communicate the goals of the site protection plan.

## **Operation and Maintenance Issues**

Operation and maintenance staff should be informed so that least-toxic products have been used for soil preparation and for controlling pests and insects in detention ponds. Also, contractors should be required to provide information on product substitutions sufficient to enable operation and maintenance staff to properly maintain site protection measures.

## **Commissioning**

None.

## **References/Additional Information**

Ross Middle School. Ross School District, CA. Completed in 1999. For more information contact Dana Papke, DPapke@CIWMB.ca.gov.

U.S. Green Building Council's *Reference Manual* for LEED Green Building Rating System (Commercial, Version 2) at <http://www.usgbc.org>. Also see the Environmental Protection Agency (EPA) publication: *Stormwater Management for Construction Activities, Chapter 3*

# DAYLIGHTING AND WINDOWS

Daylighting forms the cornerstone of resource efficient, high performance design for schools. Affecting individuals on both conscious and subconscious levels, it provides light to see the work environment, a natural rhythm that determines the cycles of days and seasons, and biological stimulation for hormones that regulate body systems and moods. In addition, it offers opportunities for natural ventilation and, if properly integrated with the electric lighting system, can provide tremendous energy savings. The advantages of daylighting translate to higher performance in schools. Research has shown that children achieve significantly higher test scores in classrooms that are daylit than in those that are not,<sup>1</sup> making daylighting one of the best building-related investments for the learning environment.



*Gentle, diffuse daylight permeates a classroom with both sidelight and toplight. Note that all surfaces are painted white to distribute light more efficiently and reduce contrast glare. NREL/PIX 11392*

This chapter provides an overview of daylighting and fenestration design. It also presents eight daylighting guidelines for specific sidelighting and toplighting schemes.

View Windows (Guideline DL1)

High Sidelighting—Clerestory (Guideline DL2)

High Sidelighting—Clerestory with Light Shelf or Louvers (Guideline DL3)

Classroom Daylighting—Wall Wash Toplighting (Guideline DL4)

Central Toplighting (Guideline DL5)

Patterned Toplighting (Guideline DL6)

Linear Toplighting (Guideline DL7)

Tubular Skylights (Guideline DL8)

To fully daylight most spaces, the guidelines should be combined with each other or repeated as a pattern across the space. For example, Wall Wash Toplighting (Guideline DL4) on an interior wall could be combined with High Clerestory Sidelighting (Guideline DL2) and View Windows (Guideline DL1) on an

<sup>1</sup> Heschong Mahone Group, "Daylighting in Schools—An Investigation into the Relationship between Daylighting and Human Performance," prepared for Pacific Gas & Electric Company and funded by California utility customers, 1999. Heschong Mahone Group and New Buildings Institute, "Re-Analysis Summary: Daylighting in Schools, Additional Analysis." February 2002.

exterior wall to fully daylight a classroom. Since daylight is additive, the total amount of daylight in the space is the sum of the daylight available from each individual pattern. Each guideline represents a daylight delivery system with inherent advantages and disadvantages, which are summarized below in Table 6.

Table 6 – Selection Criteria for Daylighting Strategies

Design Criteria	View Windows (DL1)	High Sidelight w/ Light Shelf (DL2 & DL3)	Wall Wash Toplighting (DL4)	Central & Patterned Toplighting (DL5 & DL6)	Linear Toplighting (DL7)	Tubular Skylights (DL8)
Uniform Light Distribution	○○	●/○	●	●●	○	○
Low Glare	○	●	●	●	●	●/○
Reduced Energy Costs	○	●	●	●●	●	●
Cost Effectiveness	●	●	●	●	●	●●
Safety/Security Concerns	○	●/○	●	●	●	●●
Low Maintenance	○	●	●	●	●	●

●● Extremely good application ● Good application ○ Poor application ○○ Extremely poor application ○ Depends on space layout and number and distribution of daylight apertures ●/○ Mixed benefits

## OVERVIEW

Daylight can be provided via windows and glazed doors, as well as via skylights and other forms of toplighting. These glazed openings are collectively referred to as "fenestration." The placement, design, and selection of materials for fenestration are extremely important and can tip the balance between a high performance and low performance building. Fenestration impacts building energy efficiency by affecting cooling loads, heating loads, and lighting loads. Visual comfort is strongly affected by the window location, shading, and glazing materials. Well-designed windows can be a visual delight. But poorly designed windows can create a major source of glare. Thermal comfort can also be compromised by poor fenestration design. Poorly insulated windows add to a winter chill or summer sweat, while windows with low U-values keep glass surface temperatures closer to the interior air temperature, improving thermal comfort. In addition, east-west windows and unshaded south windows can cause excessive cooling loads. And although windows and skylights provide opportunities for natural ventilation, they must be designed to ensure a safe, secure, and easily maintained facility.



Guideline DL5: Central Toplighting from a sawtooth monitor with sun baffles is combined with DL1: View Windows to provide balanced illumination in a classroom. NREL/PIX 11406

### Benefits of Daylighting

There are several advantages to the use of daylight in schools.

### ***Academic Performance***

Studies indicate that well-designed daylighting is associated with enhanced student performance, evidenced by 13% to 26% higher scores on standardized tests, while poor daylighting design has been shown to correlate with reduced student performance.<sup>2</sup> It makes sense that students and teachers perform better in stimulating, well-lit environments. Daylighting can provide high quality light, stimulating views, and an important communication link between the classroom and adjacent spaces.

### ***Energy Savings***

Daylighting can save energy and reduce peak electricity demand if electric lights are turned off or dimmed when daylight is abundant. Nationally, K-12 schools spend more than \$6 billion a year on energy. For most school buildings, electric lights are the largest energy consumer. For instance, in California, about 40% of school building energy use is attributable to just electric lighting. Daylighting per se, however, saves no energy unless the electric lighting system is appropriately controlled. To be effective, daylighting must be thoughtfully designed, avoiding glare and overheating, and must include dimming or switching of the electric lighting system, preferably with automatic photocell control. Designing systems for supplementary electric lighting and controls is addressed in the chapter on electric lighting.

### ***Better Light***

Daylight provides the highest quality light source for visual tasks. It enhances the color and visual appearance of objects, and helps students to see small details better.

### ***Connection to Nature***

Daylight provides a connection to the natural world by supplying information on time of day, season, and weather conditions. In doing so, it enriches the learning environment and may also help to make lessons more memorable. The constant variety in the quality and quantity of daylight also helps keep students and staff more alert.

### ***Improved Health***

Views provided by windows contribute to eye health by providing frequent changes in focal distance, which helps to relax eye muscles. Daylight, whether associated with a view or not, may also reduce stress for both students and teachers. Research in Sweden showed that work in classrooms without daylight “may upset the basic hormone pattern, and this in turn may influence the children’s ability to concentrate or co-operate, and also eventually have an impact on annual body growth and sick leave.”<sup>3</sup>

### ***Environmental Education***

Windows and solar gain through windows can present opportunities to teach how the sun moves through the sky and how daylight can be controlled by carefully designed overhangs and other shading devices. These observations can form part of an experiential learning unit for environmental education as students plot the movement of the sun on a sundial or across a schoolyard wall

---

<sup>2</sup> Ibid.

<sup>3</sup> Kuller and Lindsten. 1992. *Journal of Environmental Psychology* 12:305-317.

## Basic Daylighting Principles

The following six principles, described in more detail below, provide fundamental guidance in designing daylit schools.

1. Prevent direct sunlight penetration into glare-sensitive teaching spaces.
2. Provide gentle, uniform light throughout space.
3. Avoid creating sources of glare.
4. Allow teachers to control the daylight with operable louvers or blinds.
5. Design the electric lighting system to complement the daylighting design, and encourage maximum energy savings through the use of lighting controls.
6. Plan the layout of interior spaces to take advantage of daylight conditions.

### 1. Prevent Direct Sunlight Penetration

One of the delights of daylight is that it changes in quality throughout the day and with each season. The daily and seasonal path of the sun is the prime determinate of sunlight availability, while the presence of clouds and moisture in the air affect the quality and intensity of light from the sky. It is essential that designers understand the basic principles of solar orientation, climate conditions, and shading systems to design successful daylit buildings.

### Sunlight Versus Daylight

Direct beam *sunlight* is an extremely strong source of light, providing up to 10,000 footcandles of illumination. It is so bright, and so hot, that it can create great visual and thermal discomfort. *Daylight*, on the other hand, which comes from the blue sky, from clouds, or from diffused or reflected sunlight, is much more gentle and can efficiently provide excellent illumination without the negative impacts of direct sunlight. Good daylighting design typically relies on maximizing the use of gentle, diffuse daylight, and minimizing the penetration of direct beam sunlight. In general, sunlight should only be allowed to enter a space in small quantities, as dappled light, and only in areas where people are not required to do work.

The best daylighting designs are initiated early in the design process of new buildings. The first step in good daylighting design is the thoughtful orientation of the buildings on the site and orientation of the fenestration openings. A carefully oriented building design will allow maximum daylight while minimizing unwanted solar gains. It is easiest to provide excellent daylight conditions using north-facing windows, since the sun only strikes a north-facing window in early morning and late evening during midsummer. South-facing windows are the next best option because the high angle of the south sun can be easily shaded with a horizontal overhang. East- and west-facing windows are more problematic because when the sun is low in the sky, overhangs or other fixed shading devices are of limited utility. Any window



*A skylit library provides a stimulating yet peaceful environment. Colorful banners enliven the space while blocking glare from the skylights and helping to diffuse the daylight. NREL/PIX 11393*



orientation more than 15° off of true north or south requires careful assessment to avoid unwanted sun penetration.

For sidelighting, carefully designed shading devices both inside and outside the building can limit direct sun penetration while allowing diffuse daylight. For toplighting, avoid direct sun by using glazing that diffuses the sunlight, or by reflecting it off baffles, louvers, or light well walls. The sections on Sidelighting and Toplighting below give strategies for designing shading devices for optimum performance.



*North versus south windows-south windows are shaded from direct sun-but receive daylight reflected off of concrete walk and white painted overhangs. North windows are large and unshaded.*

NREL/PIX 11394

## **2. Provide Gentle, Uniform Illumination**

Daylight is most successful when it provides gentle, even illumination throughout a space. Evenly diffused daylight will provide the most energy savings and the best visual quality. Achieving this balanced diffuse daylight throughout a space is one of the greatest achievements of a good daylight designer.

It is easiest to achieve uniform daylight illumination from toplighting strategies that distribute light evenly across a large area. The next best approach is to provide daylight from two sides of a space with a combination of view windows and high windows, preferably no more than 30 ft to 50 ft apart. Combinations of sidelighting with toplighting can also be successful in providing uniform illumination levels. The most challenging condition is a room with windows on only one side. There, daylight illumination levels will be very high right next to the window and drop off quickly. Various strategies to distribute light deeper into the space are available, but require more design skill and construction cost.

Daylight can most easily be used to provide a base level of illumination throughout a space, referred to as the ambient illumination, which is often on the order of 20 to 30 footcandles. Individual work areas can then be highlighted with electric task lights to bring the illumination levels in specific areas to higher task level requirements, such as 50 or 75 footcandles. Alternatively, if the daylighting fenestration area is increased to provide the higher task illumination for most of the day, the electric lighting energy savings will be maximized while heating and cooling costs may increase. The best daylighting designs balance these energy costs with the desired lighting quality.

### ***Walls, Ceilings, And Other Reflective Surfaces***

The arrangement of reflective surfaces that help to distribute the light are just as important as the arrangement of daylight openings for providing gentle, uniform illumination. Whenever possible, place daylight apertures next to a sloped or perpendicular surface so the daylight washes either a ceiling or a wall plane, and is reflected deeper into the space. It is essential to recognize that walls and ceilings are part of the daylighting design. For greatest efficiency and visual comfort, they should be painted white, or a very light color. Even pastel-colored paint absorbs 50% of the light that strikes it, correspondingly reducing daylight levels. Saturated colors should be used only in small areas, for accents or special effects.

Advanced daylighting designs take advantage of additional exterior and interior reflecting surfaces to shape the distribution of daylight in the space. Light-colored walkways and overhangs can help reflect daylight. Light shelves can be used to bounce daylight deeper in the space (see Guideline DL3), or a series of reflective or refractive surfaces built into the glazing itself can redirect sunlight onto the space's ceiling. These approaches are integral to the architecture of the building and are designed differently for each cardinal orientation. For example, classrooms may have light shelves on the south side of the building, but none on the north. In this way, the design is "fine tuned" to optimize the daylight delivery for each orientation.



*Deeply coffered ceiling helps to diffuse light from four skylights. There are no electric lights on in this photo. NREL/PIX 11470*

### **3. Avoid Glare**

Excessively high contrast causes glare. Direct glare is the presence of a bright surface relative to the surroundings (for example, a bright diffusing glazing or direct view of the sun) in the field of view that causes discomfort or loss in visual performance. This glare can have negative effects on student and staff performance. A recent study showed that skylights admitting direct sun (and presumably glare) into classrooms correlated with a *decrease* in student performance on standardized tests.<sup>4</sup> Eliminate glare by obscuring the view of bright sources and surfaces with blinds, louvers, overhangs, reflectors, and similar devices.

Placing daylight apertures next to reflective surfaces reduces glare and distributes the daylight more evenly. It brightens interior surfaces to reduce their contrast with the bright glazing surface. If washing a wall with daylight is not possible, some glare reduction can be achieved by splaying window reveals and skylight wells. Blinds or drapes can also reduce contrast by controlling the amount of brightness at the windows, and diffusing the light. Punched windows (simple holes in the middle of a wall) represent the worst scenario for glare and are not recommended.

Glare can also occur when daylight strikes a reflective surface, like a computer screen or a whiteboard, and produces shiny reflections that make it difficult or impossible to see. You can

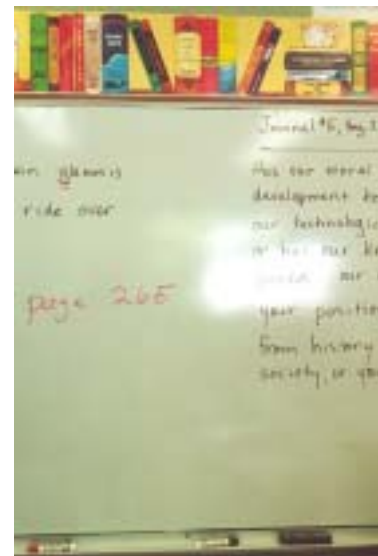

*Glare from windows or light fixtures reflecting off of shiny surfaces, such as computer screens or whiteboards, can reduce student performance.*

*NREL/PIX 11395*

<sup>4</sup> Heschong Mahone Group, "Daylighting in Schools—An Investigation into the Relationship between Daylighting and Human Performance," prepared for Pacific Gas & Electric Company and funded by California utility customers, 1999. Heschong Mahone Group and New Buildings Institute, "Re-Analysis Summary: Daylighting in Schools, Additional Analysis." February 2002.



predict when these reflections will be a problem by placing an imaginary (or real) mirror on the screen or whiteboard and seeing if any bright light sources or surfaces are visible in the mirror. If they are visible, reorient the screen/whiteboard or redesign the apertures to eliminate their reflection in the surface.

**VDT Screens**

When video display terminals (VDTs) are located in daylit spaces, the designer must take great care to minimize daylight reflections from the VDT screen. This problem is especially acute when the computer screen is oriented so that the screen is facing the daylighting aperture (that is, the student's back is to the window or skylight). Under these conditions, reflected glare may completely wash out the screen, making work impossible without completely closing window blinds or drapes. If the VDT screen is located so that the screen viewing orientation is parallel to or 45° to the windows (see figure on left), reflected glare poses less of a problem and, if present, can usually be reduced by using polarizing filters or meshes attached directly to the screen. Flat screen monitors have fewer glare problems.



*Automatic photosensor controls turn off first bank of lights next to skylight well. The light fixtures are arranged parallel to skylights to left and windows (out of picture) to right, while whiteboard is located perpendicular to windows and skylights.*

NREL/PIX 11398

**4. Provide Control of Daylight**

Daylight is highly variable throughout the day and the year, requiring careful design to provide adequate illumination for the maximum number of hours while contributing the least amount possible to the cooling load. The ideal daylighting design would have variable apertures that respond to changes in the availability of daylight. The apertures would become smaller when daylighting is abundant and larger on cloudy days or at times when daylight is less available. While electrochromic glazing may permit variable daylighting apertures in the future, with today's technology the size of the aperture and its transmission are fixed. The principal means of



*Horizontal blinds allow control of brightness from lower view windows. Note that high clerestory windows have no blinds so that daylight can reach deep into classroom. Most classrooms do not need complete black out capability for viewing of modern video equipment.*

NREL/PIX 11396



*Reflections of luminaires in computer screens can cause veiling glare. Careful lighting and daylighting design avoids these problems.*

NREL/PIX 11397

control is through the use of shades or blinds located inside or outside the window.

Teachers should have easy access to controls for these shades or blinds to adjust light levels as needed throughout the day. These systems should be reliable, as well as easy and economical to clean and repair. Manually operated controls are slightly less convenient but also less expensive and less likely to need repair. They may, however, be used less by teachers due to their awkward functionality for many skylights at significant heights above the floor. Avoid the use of moveable exterior shades; they are exposed to weather conditions that may degrade their performance. Ensure that fixed exterior shading devices are sloped slightly so they drain water.

### **5. Integrate with Electric Lighting Design**

The daylight and the electric light systems must be designed together so they complement each other to create high quality lighting and produce energy savings. This requires an understanding of how both systems deliver light to the space. For example, if daylight lights the two sidewalls, electric light may be used to highlight the teaching wall. The Design and Analysis Tools section later in this chapter discusses tools to help visualize the overall light distribution in the space.

#### **Color**

Daylight is a “bluer” light source than most electric lighting. Fluorescent lights that are designed to match the color of incandescent light will appear yellow in comparison with daylight. The color temperature of a light source is a number that describes its relative blueness or yellowness. When mixing daylight and electric light, most designers choose fluorescent lamps in the blues range, with a color temperature of 3500°K to 4100°K or even higher.

#### **Controls**

Daylighting is also more thermally efficient than electric lighting, meaning that the cooling load created by daylighting illumination is much lower than that created by electric lighting providing the same light level. Since electric lighting is a major contributor to the cooling load in schools, substituting daylight for electric lighting reduces cooling costs as well as lighting costs. But these energy savings will only be achieved if the electric lights are turned off or dimmed in response to the daylight.

The electric lighting should be circuited and controlled to coincide with the patterns of daylight in the space, so that the lights can be turned off in areas where daylight is abundant and left on where it is deficient. Controls can either be manual or automatic. Automatic controls use a small photosensor that monitors light levels in the space. Manual controls are substantially less expensive, but need to be convenient and well labeled to ensure their use. Automatic controls guarantee savings, but are more expensive and must have overrides so the teacher can darken the room for audio/visual use. Lighting controls are discussed in more detail in the chapter on Electric Lighting and Controls.

### **6. Plan the Layout of Interior Spaces**

Successful daylighting designs must include careful consideration of interior space planning. Since daylighting illuminance can vary considerably within the space, especially with sidelighting, it is important to locate work areas where appropriate daylighting exists. Perhaps more importantly, visual tasks (especially the teaching wall) should be located to reduce the probability of discomfort or disabling glare. In general, work areas should be oriented so that daylighting is available from the side or from

above. Facing a window may introduce direct glare into the visual field, while facing away from a window may produce shadows or reflected glare.

### ***Sidelighting vs. Toplighting***

The location, orientation, and size of the daylighting apertures are of paramount importance, as is the selection of the glazing materials used and how they are shaded from direct sun. When possible, it is always better to locate daylighting apertures in the ceiling plane — a strategy known as toplighting. This reduces the likelihood of glare and allows for a more even distribution of daylight within the space. Toplighting, of course, can only be provided for one-story buildings or for the top floor of multi-story buildings. The other basic strategy, sidelighting, allows daylight to enter through windows in vertical walls. With windows, uniform illuminance is more difficult to provide, as there is always more light next to the window. Glare is also more difficult to control. But there are design techniques that can substantially reduce problems associated with sidelighting.



*Toplighting reduces the glare and allows for a more even distribution of daylight within a space. NREL/PIX08834*

The basic sidelighting pattern provides windows on one or more walls of the space. The depth of daylighting penetration from vertical windows is largely dependent on the height of the window head (that is, the top of the window). For a simple sidelighting scheme, a rough rule of thumb is that useable daylight will be available about 1.5 times the window head height. So for good daylight delivery, sidelighting windows should be located as high as possible in the wall. However, to provide exterior views, windows need to be at eye level. Since these requirements clearly conflict, advanced daylighting designs differentiate between the functions of view and task daylighting, frequently providing separate windows for each of these.

The orientation of a sidelighting aperture strongly affects the quantity, quality, and distribution of daylight. For sidelighting and no shading, north-facing windows provide the most even illuminance. The quantity of light is diminished, but a larger aperture will compensate, providing adequate and more even illumination.

### ***Exterior Shading Strategies***

Shading devices for sidelighting strategies minimize solar gains and glare, and can also be designed to increase illumination levels. Shading devices — both overhangs and fins — can be either opaque or translucent, and solid or louvered. It is best to place shading devices outside the glazing to stop solar gains before they hit the window and to reduce potential glare from bright window views.

Exterior overhangs should be deep enough to minimize direct sun on the window for the hottest hours of the day during the cooling season. For south-facing windows in sunny (clear sky) climates with very high air conditioning loads, a good rule of thumb is to design the overhang with a shading cutoff angle about equal to  $90^\circ$  minus the site latitude. This provides full shading between March 21 and September 21. Many areas are likely to experience their hottest weather in September, and still need full shading

that time of year. Overhangs for climates with lower air conditioning loads and/or more summer overcast can increase this angle by 5° to 15°. Overhangs or fins for windows facing east or west do not lend themselves to simple rules of thumb and should be carefully designed for the specific site, climate, and space. North-facing windows usually do not need exterior overhangs or fins, but may occasionally require interior blinds or louvers to control glare.

### ***Interior Shading Strategies***

Interior shading devices for windows reduce solar heat gain somewhat (by reflecting solar gain back out through the glazing) but are most effective at controlling glare. The most common interior glare control devices are horizontal mini-blinds, vertical blinds, shade screens, and curtains. Mini-blinds positioned between the panes of glass in double-glazed fenestration do not have to be cleaned and may have the lowest maintenance costs, but their initial cost is substantially higher. They can also pose replacement problems if a window is broken. Interior shading devices can also be used for security purposes to obscure the view of room contents when a space is unoccupied. Many school spaces will also require blackout shades. All these operable devices should have robust, reliable controls that are easily accessible to the teacher. However, operable louvers, blinds, and drapes are frequently left in a non-optimal daylighting setting—either fully closed or fully open. Systems that have fixed louvers or settings for the daylight glazing and operable glare control for view glazing will be more likely to deliver dependable daylight throughout the year.



*Monitors provide diffuse light into gymnasiums. NREL/PIX 11338*

### ***Landscaping***

Daylight is also affected by obstructions on the site, such as trees and other buildings. Landscaping can serve an important shading and sun control function if it is strategically placed or incorporated into a trellis device. Deciduous trees and vines positioned to the south of a window are extremely useful for providing shade during overheated summer months while admitting more sun in areas with cold or overcast winters. Evergreens provide shade year-round in consistently overheated climates. They are also useful for blocking low east and west sun.

### ***Toplighting***

Providing daylight from above, generically referred to as “toplighting,” can generally provide the most uniform illumination throughout a space. Examples of toplighting strategies include roof monitors, unit skylights, and tubular skylights. The vast majority of schools are one or two stories, and so a large proportion of school spaces can easily be lit from above. Toplighting schemes have many other advantages, including freeing up walls for tack space or storage, and increasing security by reducing access to fenestration.

Toplighting schemes can provide much more useful illumination from smaller apertures than sidelighting when they capture and diffuse sunlight. Sunlight is roughly 10 times brighter than light from

the sky or clouds. If the sunlight is diffused through the use of lenses, baffles, or reflecting surfaces, it can be diffused and spread over a large area. Thus, one ft<sup>2</sup> of a diffusing skylight can provide illumination to about 10 times the area of one ft<sup>2</sup> of equivalent window glazing.

As with any lighting design, it is important to strive for good lighting quality with toplighting, which is best done in two ways. First, design openings so that they maximize illumination on vertical surfaces. Skylights or roof monitors should be placed preferentially adjacent to important walls that should be highlighted. Be careful that ceiling returns or structural members do not create shadows on important vertical surfaces. Secondly, design for uniform illumination by using many openings spread out uniformly across the space. The higher the daylight aperture, the more broadly the light will diffuse in the space. Thus, it is easier to successfully toplight spaces with high ceilings. As a rule of thumb, skylights should be spaced apart no more than one-and-a-half times the ceiling height. (When the skylight well is broadly splayed, the vertical distance can be measured to the top of the splay.) This means that spaces with low ceilings will require more small skylights spaced closer together than the spaces with the same floor area but a higher ceiling. Some software tools feature a calculator that helps to figure out appropriate skylight spacing relative to ceiling heights and structural grids.

Glare is also an issue with skylights. Diffuse glazing, such as fiberglass or white acrylic, can become extremely bright in direct sunlight, and should be kept out of direct view of the occupants. Recessing skylight diffusers behind other elements, such as structural members, banners, or splayed wells, all help prevent glare. Lensed glazing can also help to break sunlight up into smaller bits, reducing glare potential. The designer should assess glare potential of any toplighting product and design in direct sunlight conditions.

### ***Horizontal vs. Vertical Glazing***

Toplighting designs can have either horizontal or vertical glazing. Because the sun is higher in the sky during the summer than in the winter, toplighting schemes with horizontal glazing receive more direct sun in the summer (when it is generally not needed) and less in the winter (when it is needed). The opposite is true with south-facing vertical glazing schemes. So in terms of optimizing yearly heating and cooling balance, south-facing vertical glazing tends to be most efficient. North facing glazing will receive much lower and more uniform levels of diffuse daylight, and thus need to be sized significantly larger than south-facing apertures to achieve equivalent illumination levels. East and west orientations show large variations in light levels throughout the day and the greatest solar gains in the summertime, and therefore are not recommended.

However, horizontal glazing or skylights have several other advantages. First of all, skylights' energy performance on a flat roof is fairly independent of orientation, allowing more architectural freedom on other issues. Skylights actually deliver more daylight into a space over the course of a year than comparable vertically oriented glazing. Pyramid, bubble, or arched-shaped diffusing skylights are effective at collecting daylight during the very low sun angles of early morning or late afternoon when it is most needed. And during overcast days, the sky is brightest straight up, so horizontal glazing will deliver the most light under these conditions. Solar heat gains in skylights tend to be less than expected due to stratification of heated air in the skylight wells. The advantages of skylights in collecting daylight



throughout the year allow them to have a smaller aperture than vertical glazing for the same amount of illumination delivered, which also reduces relative heat loss and heat gain.

Another consideration in the decision between vertical versus horizontal glazing is cost. Prefabricated skylights, which are inserted into a roofing system, can be much less expensive than custom-built roof monitors requiring extensive structural modifications and flashing. Integration of the toplighting scheme with the HVAC, ceiling, and lighting systems is also an important concern. The final decision for horizontal or vertical glazing is a balance of these concerns for the specific building and climate, as well as the ability to integrate into the architecture.

### ***Toplighting Shading Strategies***

Shading for monitors may not be needed if the light well design prevents direct sun from entering the space. Exterior shading devices for skylights are available, but are not recommended due to maintenance problems. Rooftop devices are usually exposed to more severe weather, dust, and debris but have less maintenance supervision than windows. Sturdy, dependable performance is an essential criterion. Thus, it is a good idea to protect any shading or operable equipment for skylights below at least the first layer of skylight glazing. Some skylight manufacturers offer fixed or operable louver options for sun and daylight control, to reduce solar gain and excessive daylight. Others offer movable insulation devices that can be operated, either manually or automatically, to reduce both solar gain and nighttime heat losses. Recent advances allow some blinds within the glazing system to be manual or automatic and also reduce maintenance and cleaning issues. One foreseeable issue for these devices is that internal systems may require complete removal of the glazing system if shading devices break down and require replacement.



*Linear skylight in multipurpose room includes electrically operated louvers to reduce brightness when needed.*

*NREL/PIX 11399*

### ***Structural Considerations***

All toplighting schemes represent penetrations through the roof diaphragm, which is often a critical part of the building's structural system, designed to stiffen the building and resist forces that tend to twist the structural frame. This structural diaphragm can have various numbers and sizes of holes in it and still continue to function. But at some point, additional holes will weaken its strength, limiting the size and location of toplighting apertures. However, if more toplighting apertures are desired than allowed by the structural system, the project's structural engineer may be able to devise ways to strengthen the diaphragm to allow additional penetrations.

The light well connecting the toplighting aperture with the space below may also intersect HVAC ducting, electric lighting layouts, and fire sprinkler systems. Careful coordination of the structural and mechanical designs will ensure compatibility among these systems.

## Fenestration Products

High performance fenestration features include double and triple glazing, low-emissivity coatings, and blue/green tints. These have become a very important means of energy conservation in modern construction to reduce both thermal losses and solar gains, while maintaining light transmittance. Fenestration has three principal energy performance characteristics, which have been identified by the National Fenestration Rating Council (NFRC) to be tested and labeled on manufactured windows: Visible light transmittance, solar heat gain coefficient, and U-factor. Site-built windows and skylights may or may not have such tested information available.



*Pyramid skylights on experimental portable classroom design integrate skylights into a high efficiency modular design. NREL/PIX 11400*

- **Visible light transmittance (VLT)** is the fraction of light that is transmitted through the glazing. Light is that portion of solar radiation that is visible, meaning it has a wavelength between about 380 and 780 nanometers. Single clear glass has a VLT of about 0.9, while highly reflective glass can have a VLT as low as 0.05. The quantity of daylight that enters a window or skylight is directly proportional to the VLT. In general, VLT should be as high as possible, provided it does not create glare or other visibility problems.
- **Solar heat gain coefficient (SHGC)** measures the solar heat gain through a window. A window that has no solar gain would have a SHGC value of zero, while a perfectly transmissive glazing would have a SHGC of 1.0. These extremes are both theoretical concepts that are not possible in the real world. Except in passive solar applications where solar heat gain is desired, everything else being equal, glazing materials should be selected with the lowest possible SHGC. However, glazing materials with a low SHGC (like dark gray and bronze tints) may also have a low VLT, so the challenge is to identify specialized “selective” low-e products and blue/green tints that combine the lowest SHGC with the highest VLT.
- **U-factor** measures the heat flow through a window assembly due to the temperature difference between the inside and outside. The lower the U-factor, the lower the rate of heat loss and of heating energy consumption. Everything else being equal, the U-factor should be as low as possible. The fenestration frame and glazing edge spacers degrade the U-factor of an insulated glass assembly. So two U-factors are frequently specified: the center of glass (COG) value, which is the U-factor measured at the center of the assembly, and the whole-window value, which is the overall U-factor of the glazing plus the spacer and frame system. (The whole-unit value will be higher than the COG value.) Single pane windows typically have a U-factor in the range of 1.0 to 1.2 COG; double pane windows range from 0.65 to 0.45 COG. With low-e coatings, inert gas fills, and multiple glazings, the U-factor can be as low as 0.1 COG.

Other glazing considerations include diffusion, transparency, and durability:

- **Diffusion and Transparency.** Transparent glazing materials provide views, but diffuse materials can spread daylight better in the space. Diffusion is one of the most important characteristics in selecting a skylight. Good diffusing glazings maximize the spread of light in the space and minimize “hot spots” and glare. Diffusion may be accomplished by using a white pigment, a prismatic surface, or embedded fibers. Unfortunately, specifications on diffusion properties are rarely available for fenestration products. Thus, samples of diffusing glazing materials should be visually evaluated to see how well they diffuse direct sunlight. A simple test is to place the product in the sun and see if it allows your hand to cast a shadow. A fully diffusing material will blur the shadow beyond recognition and will not concentrate the sunlight into local hot spots. Note that diffusing glazing placed in direct

sunlight can be glaringly bright if it is within the field of view. It should be placed above the direct line of sight or be obscured by baffles.

- *Durability.* Characteristics such as UV degradation (yellowing and other aging effects), structural strength, scratch resistance, breaking and fire resistance, along with replacement cost and availability, should be considered in selecting a glazing material.

The fenestration frame holds the glazing material in place and forms the structural link with the building envelope. The frame and the spacer between the glazing panes in multiple glazed units form a thermal short circuit in the insulating value of the fenestration. This degradation of the U-factor at the fenestration perimeter can be minimized with high performance frame and spacer technologies now available. This is important both for energy conservation and the potential for condensation on the frame.

Frames are available in metal, wood, vinyl, composite, and fiberglass. Metal frames conduct the most heat and must have a thermal break for good performance. Insulated vinyl and fiberglass frames have the lowest U-factor. The NFRC has established a rating system to evaluate the whole window performance including the frame, spacer, and glazing. More information can be found at their website, <http://www.nfrc.org>. The whole-window U-factor, VLT, and SHGC is shown on a label attached to all rated windows. Rated windows should be purchased for all school projects and frame/spacer performance should be compared based on these overall ratings. Site-built windows and skylights will not have these ratings available.

## **Design and Analysis Tools**

There are three general categories of tools for evaluating daylighting and fenestration: physical models, lighting computer simulation programs, and whole-building energy simulation programs.

### **Physical Models**

Physical scale models are probably the easiest and most intuitive way to understand daylighting design options. Scale models can be easily built that quickly and accurately illustrate the daylighting conditions created by any given design. They also help non-professionals, such as teachers and parents, to see lighting quality issues directly, and understand why one design might work better than another. Photographs of the interior of scale models are an easy way to record the impacts of various design options. Many daylighting textbooks include a chapter on the construction and testing of daylight models. An excellent training video — *Daylight Models*, available from the Lighting Design Lab in Seattle — also describes how to build and test these models. (See the References section below for more information.)

Daylighting models can also be used for numerical analysis. The models may be tested either outside under real sky conditions or in artificially constructed overcast sky and direct sun simulators. Small light measuring devices (photocells) can be used to record light levels within the model. Sun simulators (heliostats) can be set to represent the correct sun angle for the site latitude and hour of day and are used to visualize the movement of light during a typical day. Measurements in a simulated sun or sky are more reproducible than in the real sky, which is constantly changing. Several universities and electric utilities have sun and overcast sky simulators, associated video equipment, and photocell arrays.



### ***Lighting and Daylighting Computer Simulations***

Electric lighting and daylighting computer simulations give information about the distribution of lighting in spaces with contributions from windows and skylights as well as electric lighting systems. Unlike the energy simulation programs described below, these programs produce results for a single instant in time. Multiple calculations are needed to study varying sky and solar conditions. These computer-based tools give light level values and gradients for both daylight and electric light across the space. Some of these tools also produce realistic renderings of lighting within the space, which may be linked to generate an automated “walkthrough” of the space for a particular day and time or to simulate the daylight variations through the hours of the day. The programs that are easiest to use may be constrained by the complexity of shapes they can simulate. The more complex programs can simulate almost any room shape or material, but require significantly more expertise and modeling time.

### ***Whole Building Energy Simulations***

Whole building energy simulation tools, such as DOE-2, EnergyPlus, BLAST, and spreadsheet estimating programs consider all aspects of the fenestration’s impact on building energy use, including solar gains, impact on HVAC equipment sizes, and reduction of electric lighting energy. Many of the energy simulation programs have user-friendly interfaces to make it easier to construct models and evaluate results. Most of these tools have simplified daylighting simulation algorithms that may not accurately represent daylight levels from complex designs (like light shelves). For these designs, daylight predictions from one of the computer simulations mentioned above may need to be input to the energy program to accurately predict daylight’s potential to save energy by turning off or dimming electric lights.

### ***Resource Efficiency***

In terms of energy performance, windows and skylights are two of the most important considerations in building design. They also provide an opportunity to address other environmental objectives, including material efficiency, indoor air quality (IAQ), and pollution prevention during manufacturing.

To achieve material efficiency, windows are now being manufactured with durable alternatives to wood frames and sashes, including options made with post-industrial waste. Unfortunately, many of these products can contribute to pollution during manufacture, and possibly even to IAQ problems. For now, the best environmental performance strategy is to select durable frame and sash options that enhance energy performance as well as meet programming and daylighting needs. Table 7 lists currently available options that are environmentally preferable from a material efficiency perspective.

Table 7 – Strategies for Constructing Resource Efficient Fenestration Systems

Window Frame and Sash	Strategies	Environmental Benefits & Considerations
Wood	Select windows produced with wood certified by Forest Stewardship Council (FSC), Scientific Certification Service (SCS). Specify factory-applied finish.	Prevents degradation to forest and wildlife habitat; wood can be high maintenance. Good energy performance. Typically more durable than field-applied. More controlled finishing environment prevents pollution.
Wood and Plastic Composite	Durable options combine wood fiber and post-consumer waste plastic and combine recycled PVC scrap, virgin PVC, and fiber from recycled wood scrap.	Utilizes industrial waste, stretching the wood supply. Very durable and low maintenance. Manufacture of PVC can contribute to pollution, however. Good energy performance
Vinyl	Vinyl frames include foamed PVC insulating core.	Low maintenance. Needs no paint. Manufacture of PVC can contribute to pollution, however, and high coefficient of thermal expansion can lead to premature failure of seal. Excellent energy performance.
ABS Plastic		Low maintenance. Needs no paint. Manufacture can contribute to pollution, however, and high coefficient of thermal expansion can lead to premature failure of seal. Moderately good energy performance.
PVC Plastic		Low maintenance. Manufacture can contribute to pollution, however, and high coefficient of thermal expansion can lead to premature failure of seal.
Fiberglass	Pultruded fiberglass frame members have a hollow profile usually insulated with fiberglass or polyurethane foam.	Promotes durability. However, difficult to recycle. Emissions contribute to IAQ problems and manufacture contributes to air pollution. Moderately good energy performance.
Metal	Specify durable, factory-applied finishes, anodized, polyvinylidene fluoride, and siliconized polyester.	Promotes durability and reduces potential pollution on site. Energy-intensive production however. Not the best energy performance. Do not use metal frames that lack thermal break.

Source: GreenSpec: The Environmental Building News Product Directory and Guideline Specifications.

For specific product recommendations, see GreenSpec: The Environmental Building News Product Directory and Guideline Specifications, <http://www.buildinggreen.com> and OIKOS's Redi Guide (Resources for Environmental Design Index). Iris Communications, 800-346-0104, <http://www.oikos.com>.

## References/Additional Information

- Ander, Gregg D. *Daylighting Performance and Design*. New York: John Wiley & Sons, 1995.
- Eley, Charles, ed. *The Advanced Lighting Guidelines 2001*. New Buildings Institute, 2001. Available at <http://www.newbuildings.org/>.
- Heschong, Lisa et al. *The Skylighting Guidelines*. Southern California Edison, 1998. Heschong Mahone Group. "Daylighting in Schools: An Investigation in the Relationship Between Daylighting and Human Performance" for Pacific Gas and Electric, 1999. William, M.C. *Sunlighting as Formgiver for Architecture*. New York: Van Nostrand Reinhold, 1986.
- Lighting Design Lab. *Daylighting Models* (video). Seattle, WA: Lighting Design Lab, 1998. 400 E. Pine St., Suite 100, Seattle, Washington 98122. (800) 354-3894.
- Millett, Marietta S. *Light Revealing Architecture*. New York: Van Nostrand Reinhold, 1996.
- Moore, Fuller. "Chapter 1: Historical Response." In *Concepts and Practice of Architectural Daylighting*. New York: Van Nostrand Reinhold, 1991, pp. 3-16.
- National Renewable Energy Laboratory. Energy-10 website. <http://www.nrel.gov/buildings/energy10/>.
- O'Conner, Jennifer et al. *Tips for Daylighting with Windows*. Lawrence Berkeley National Labs, 1997. Available at <http://windows.lbl.gov/daylighting/designguide/download.html>.
- Rea, Mark S., ed. *The IESNA Lighting Handbook*. Ninth Edition. Illuminating Engineering Society of North America, 2000.
- Robbins, Claude. *Daylighting Design and Analysis*. New York: Van Nostrand Reinhold, 1986.

# GUIDELINE DL1: VIEW WINDOWS

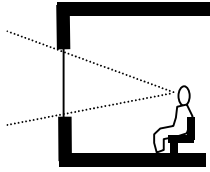

## Recommendation

Provide access to exterior views through view windows for all interior spaces where students or staff will be working for extended periods of time.

## Description

A view window is vertical glazing at eye level, which provides a view to the exterior or interior adjacent spaces.

## Applicability

View windows are essential in all school spaces (except spaces requiring visual privacy) to provide relaxing views and information about exterior natural conditions and to allow people outside of a space to view and connect with activities inside. They are applicable to all climate regions and should be planned in the schematic design phase.

## Integrated Design Implications

- Balance with other program needs.** View windows serve a broad range of important functions for view, social communication, egress, ventilation, and energy conservation (see Benefits below). However, view windows are often inefficient at supplying working daylight to the space. The square footage of view windows will reduce the allowable area for windows and skylights placed higher in the wall and ceiling that can be designed to deliver more useful daylight across the space. However, areas where many buildings will be multi-story, sidelighting is the only option for lower floor spaces and should be designed to provide as much useful daylight as possible with the least problematic glare. View windows also decrease valuable classroom wall space and pose potential acoustic and vandalism problems. A balance should be achieved among these conflicting needs.
- Integration with mechanical ventilation.** Operable view windows should be used to naturally ventilate the space and reduce mechanical ventilation needs. Evaluate prevailing wind conditions to assess the feasibility. A statistical analysis of 650 schools by the Florida Solar Energy Center found a strong correlation between the presence of operable windows and a decrease in indoor air quality complaints.<sup>5</sup>



View windows at Camaron Library expand the space outward and connect the reading area with the natural landscape. NREL/PIX 11401

## Applicable Climates



### Applicable Spaces

Classrooms	█
Library	█
Multi-Purpose	█
Gym	█
Corridors	█
Administration	█
Toilets	□
Other	□

### When to Consider

Programming	█
Schematic	█
Design Dev.	█
Contract Docs.	█
Construction	█
Commissioning	█
Operation	█

<sup>5</sup> M. Callahan et. al. Energy Efficiency for Florida Educational Facilities: 1996 Energy Survey of Florida Schools Final Report. Report # FSEC-CR-951-97. Florida Solar Energy Center. Submitted to Florida department of Education, July 1997.

- **Integration with HVAC.** View windows should decrease overall seasonal heating and cooling loads on the building if they are oriented, glazed, and shaded correctly. This can reduce the initial size of the HVAC system and annual energy costs. The analysis of Florida schools noted above also found that the presence of windows strongly correlated with an overall reduction in total building energy use.
- **Thermal Comfort.** Window surfaces that are considerably above or below the mean radiant temperature of other room surfaces will be uncomfortable for occupants adjacent to them. Shade the windows, use high performance glazing, and design HVAC to minimize radiant thermal discomfort.
- **Space Planning.** View windows should be oriented relative to the location of stationary tasks, such as desks, teaching wall, computer locations, and reading areas. Avoid reflected glare from windows in computer screens or on whiteboard surfaces. The best classroom location for view windows is perpendicular to the teaching wall.
- **Design Phase.** To function well, view windows must be at eye level, glare-free, oriented toward views that will not distract occupants, and designed to reduce building energy loads. A requirement for view windows should be identified in the building program; their location and design objectives should be determined in the early phases of schematic design.

### Cost Effectiveness

Costs for view windows are typically low. View windows are (or should be!) standard practice for classrooms. The incremental cost of energy-efficient glazing ranges from \$0.75/ft<sup>2</sup> to \$2.50/ft<sup>2</sup> of glass. Daylight energy savings from view windows are negligible because the shading elements required to minimize glare usually render them unreliable for reducing electric light consumption.

Costs	L			
	M			
	H			
		L	M	H
		Benefits		

### Benefits

View windows provide numerous benefits, serving a broad range of important functions for view, social communication, egress, ventilation, and energy conservation

The outward views they provide are essential for mental stimulation and relaxation for eye muscles. Optometrists recommend access to long views for any sedentary workers (such as students) for frequent shifting of eye focal length, which promotes eye health and good vision. This may be especially important for young children while their eyes are still developing.

View windows provide occupants a connection with nature, weather, cardinal orientation, and some natural light (though not evenly distributed across the space). Occupant productivity and connection with place may increase through the associated views. Studies have shown that the primary reason people prefer having a window is view, preferably a view of nature. Research suggests that natural views elicit positive feelings, hold interest, and reduce fear and stress.<sup>6</sup> Teachers have reported a reduction in stress levels when they have access to a relaxing view from their classroom.<sup>7</sup>

View windows, especially on the first floor of school buildings, also provide an important social communication function, allowing teachers, administrators, and parents to quickly assess what is going on inside a classroom. When installed with clear glass, they are often used to display art work and current student projects, contributing to both pride and awareness of other's efforts.

<sup>6</sup> Norris and Tillett. 1997. "Daylight and productivity: Is there a causal link?" Glass Processing Days Conference, Tampere, Finland (September).

<sup>7</sup> Heschong Mahone Group, "Daylighting in Schools—An Investigation into the Relationship between Daylighting and Human Performance." Prepared for Pacific Gas & Electric Company and funded by California utility customers, 1999.

Operable view windows provide emergency egress and natural ventilation. A recent study has shown that natural ventilation in classrooms correlates with higher student test scores.<sup>8</sup>

Well-designed view windows can reduce the overall building heating and cooling loads and north-facing view windows can also deliver enough dependable daylight to reduce electric lighting loads with manual or photocontrols. Other orientations, however, often have blinds or curtains drawn. Thus, unless a view window faces north or has a head height over 8 ft, and separate glare control for at least 2 ft of the top glazed area, it should not be counted on to provide sufficient daylight to merit the installation of automatic photocontrols and reap predictable savings from reduced electric lighting use.

### Design Tools

The physical models and daylight simulation tools noted in the Overview can be used to evaluate potential daylight levels, and energy programs can be used to understand building energy implications.

For critical view areas, access to views and view angles from various positions in the space can be evaluated graphically with scaled drawings or with the use of a scale physical model. For a physical model analysis, it is helpful to have a “lipstick” video camera head, which can be moved around inside the model to record the views available at each location. Alternatively, view ports for standard cameras can be built into several walls of a model for various views.

### Design Details

- **Orientation.** Orient view windows toward the north or south to avoid low angle east/west sun. Up to 15° variance from true north or south is acceptable, but will reduce performance.
- **Shading devices.** Because view windows are within the occupants’ normal field of view, the contrast between the bright window view and other interior surfaces is an important glare consideration. Use exterior shading devices (overhangs, fins, etc.) or landscaping to eliminate direct sun and reduce brightness. If this is not possible, use a lower transmission glazing adjusted for the window orientation (about 40% transmission for south windows, 30% for east/west windows and 60% to 85% for north windows). On south, east, and west orientations, add an interior shade (shade screen, blinds, or drapes) so the teacher can adjust brightness and sun penetration as needed. In general, visible transmission of view glazing should not be reduced below 30% in clear sky climates or below 50% in heavily overcast climates. If tinted glazing is used, evaluate its effect on distortion of colors (for example, the graying of greens and blues in the landscape) in both overcast and clear skies. Provide blackout capability for view windows as needed.



*View windows are separated from the daylight feature overhead and use lower transmission glass to reduce glare.*

NREL/PIX 11402



*View windows promote communication between interior and exterior spaces. NREL/PIX 11403*

<sup>8</sup> Ibid.

- **Reflectance.** Deep splayed walls or mullions will also reduce glare and contrast. Paint all surfaces near windows white or off-white to further reduce contrast between the brightness of the window and its surrounding wall. The adjacent spaces that are daylit will not reduce the light level at the window, but will provide a transitional element providing physical separation between the bright window area and less bright interior surfaces. The eye is more comfortable with this stepped down light level effect. Place view windows adjacent to a perpendicular surface to reflect daylight onto adjacent surfaces. Placing view windows adjacent to walls is best. Avoid punched holes in walls, as they create the worst glare conditions.
- **Outside reflective surfaces.** Be aware of bright reflective surfaces outside the view window that may create glare when they are in sunlight. Reflected sun off a car windshield can be especially troublesome. However, when glare is less of a concern (for instance, in a more overcast area), light-colored ground surfaces outside the windows may also be used as a giant light shelf to bounce light through the view windows onto the ceiling. Light-colored walls or glass walls within view can also create glare sources when they are in direct sun. Plant hedges or trees to reduce the glare potential from these exterior sources.
- **Thermal comfort.** Window surfaces that are considerably above or below the mean radiant temperature of other room surfaces will feel uncomfortably cold or hot for occupants sitting next to them. In very cold or hot climates use double glazing with a low-e coating to maximize comfort and energy efficiency. In cold climates, use a minimum of double glazing with a low-e coating to provide comfort and energy efficiency. Provide additional layers of films or triple glazing, gas filling, warm glazing edges, improved thermal breaks in window frames, etc., to maximize thermal comfort near windows.
- **Views.** In classrooms, orient views toward “passive” nature scenes. In administration areas, views may be oriented toward the school entry or other security concerns.
- **Teaching surface.** In classrooms, the teaching wall should be perpendicular to the window wall for best illumination.
- **Computer screen location.** Orient computers at a 45° angle from view windows to avoid glare from reflections of the window in the VDT screen. Flat screen computers and adjustable-angle LED screens also help to reduce glare.
- **Security.** Provide operable interior shades and/or laminated glass for security in ground level rooms that contain computers or other valuables.
- **Durability and accessibility.** Use sturdy mechanisms for all operable ventilation and shading devices. Make them easily accessible to the teacher and easily repairable.
- **Noise transmission.** Because windows are frequently the “weakest link” acoustically in a building structure, double glazed windows are often the only alternative to controlling exterior noise. Normal therma-pane double-paned windows with ¼ in. or ½ in. airspace are not acoustically effective. For better acoustic performance, windows should have laminated glass on at least one pane, as well as significant airspace between the two panes. In high noise areas (from exterior traffic and/or aircraft), it is not uncommon to require thicker laminated glass and 2 in. to 4 in. of airspace between the panes.
- **Balancing with electric light.** If view windows are the only daylight apertures in the room, and they appear on only one wall of the space, balance their brightness in the room by washing other interior walls with electric light.

### ***Operation and Maintenance Issues***

View windows should be washed on a schedule. Elements provided to reduce glare and allow blackout conditions (blinds, drapes, blackout shades, etc.) need to be cleaned and replaced over time. Give consideration to the robustness of operable shade mechanisms that are accessible to students. Coordinate selection of glazing materials with the maintenance staff to ensure ease of cleaning and replacement. Districts may have district-wide standards to ensure quick replacement of broken glass, but ensure that it is replaced with the same type of glass.

Design ventilation devices to prevent physical entry as well as any rain or maintenance water penetration.

### ***Commissioning***

None.

### ***References/Additional Information***

See this chapter's Overview.

## GUIDELINE DL2: HIGH SIDELIGHTING—CLERESTORY

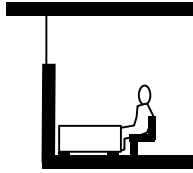

### Recommendation

Use high clerestories in perimeter walls to increase daylight delivery deeper in classrooms, offices, libraries, multipurpose rooms, gymnasiums, and administrative areas.

### Description

High sidelighting clerestories are vertical glazing in an exterior wall above eye level (usually above 7 ft). Because the penetration of daylight from vertical glazing is about two times the window head height, moving the window higher in the wall increases daylight penetration in the space.

### Applicability

High clerestory windows can be used in all school spaces to provide deep penetration of daylight. They are applicable to all climate regions and should be planned in the schematic design phase.

### Integrated Design Implications

- Design phase.** High sidelighting requires high ceilings and perimeter walls. North and (shaded) south orientations are preferable, although east, and west orientations can be acceptable if diffusing glazing is used, or if low-angle sun penetration will not be bothersome in the space. High sidelighting is most appropriate for open plan interior layouts that allow unobstructed daylight penetration. It should be considered in the early schematic design phase.
- Balance with other daylight needs.** Applied to one wall, this approach creates a decreasing gradient of useable daylight about two times the clerestory head height into the space. Spaces of 20 ft to 40 ft in width (classrooms, etc.) can be balanced with a daylighting scheme on the opposite wall to provide even lighting across the entire space. View windows should also be provided. The total glazing area should be apportioned among these needs.



*Clerestory windows provide a more uniform distribution of daylight across the space. NREL/PIX 11404*

### Applicable climates:



### Applicable Spaces

Classrooms	█
Library	█
Multi-Purpose	█
Gym	█
Corridors	█
Administration	█
Toilets	█
Other	█

### When to Consider

Programming	█
Schematic	█
Design Dev.	█
Contract Docs.	█
Construction	█
Commissioning	█
Operation	█



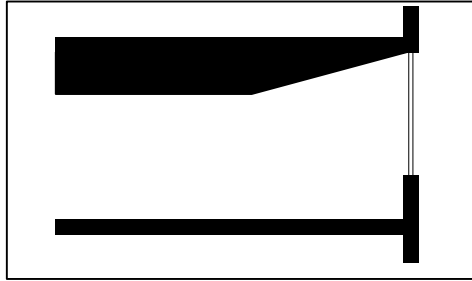

Figure 4 – Sloped Ceiling

*Sloped ceiling at perimeter increases window head height by reducing plenum space.*

- **Reduced plenum space.** Clerestory sidelighting requires ceiling heights of 9.5 ft or more at the window wall. This extra ceiling height may be accomplished with minimal increase of the floor-to-floor height by careful integration of the structural system, HVAC ducts, and electric lighting in the plenum space. Sloping (or stepping) the ceiling upward at the perimeter (see figure) — essentially reducing the plenum space there — can also yield additional perimeter ceiling height. For ceiling-ducted HVAC systems, this requires routing ducts away from perimeter walls.
- **Natural ventilation.** High windows can be especially beneficial for natural ventilation, by allowing heated air to escape out near the ceiling. The ideal location for high operable windows is on the leeward side of a building
- **Integration with HVAC.** High sidelighting glazing impacts HVAC loads by its vulnerability to solar gains during the cooling season and heat loss in the heating season. Good design (appropriate glazing orientation, size, glazing materials, shading, and photocontrol of electric lights) can reduce the overall HVAC loads and potentially reduce HVAC system size and first costs.
- **Duct work.** Keep ductwork away from high windows to avoid blocking daylight.
- **Integration with electric lighting.** High sidelighting creates linear zones of daylight that run parallel to the clerestory windows. Electric lighting should be circuited parallel to this and photocontrolled (or manually controlled) in response to available daylight.

### Cost Effectiveness

Costs for high sidelighting are low to moderate. Windows are standard practice for classrooms. A balance of view and clerestory windows can be provided for each classroom with minimal increase to the overall glazed area. The incremental cost of energy efficient glazing ranges from \$0.75/ft<sup>2</sup> to \$2.50/ ft<sup>2</sup>.

Costs	L			
	M			
	H			
		L	M	H
		Benefits		

### Benefits

High sidelighting provides a moderate level of benefits. The general energy saving, productivity, and visual comfort benefits of daylighting are discussed in the Overview section to this chapter. Clerestory sidelighting both saves energy and improves lighting quality. Energy savings come from reduced electric lighting energy use. Lighting quality is improved by a more uniform distribution of daylight across the space.

### Design Tools

Computer simulation programs and scale models as outlined in the Overview can be used to demonstrate daylight distribution. If the design includes sloped surfaces, check to ensure the simulation program can accommodate these. Check for daylight levels across the space under both clear sky and overcast sky conditions and check direct sun penetration through the clerestory glazing for the lowest expected sun angles. Even occasional penetration of low sun angles can be extremely bothersome to occupants and may lead to blocking a window.

Energy savings from minimized HVAC loads and control of electric lighting in response to daylight can be estimated with the DOE-2, EnergyPlus, and Energy-10 programs available.

### Design Details

- **Ceiling height.** High sidelighting glazing works best in spaces with high ceilings. A minimum perimeter ceiling height of 9.5 ft is recommended. Generally, the higher the ceiling height, the better.
- **Balancing with view windows.** Lower view windows are frequently coupled with high sidelighting schemes, but they do not have to coincide for the whole perimeter. The high glazing should be continuous along the whole area to be daylit. View windows can be selectively spaced beneath these high windows as needed. This balance between high clerestories and view windows can leave lower perimeter wall space available for other uses.
- **Shading devices.** Design high sidelighting clerestories with exterior shading, diffusing glazing, operable blinds, or light shelves to eliminate direct sun penetration. Horizontal blinds are better for bouncing light deeper into a room, especially when facing south. Vertical blinds may be more appropriate to catch low angle east and west sunlight and bounce it into the room, while allowing south-facing light to enter directly. Mini-blinds positioned between the panes of glass in a double glazed window accomplish this with minimal maintenance. (A light shelf or louver system may also be used; see Guideline DL3.) Dedicated blinds or shades for the upper clerestory glazing can allow lower view windows to be controlled separately for glare. Blackout shades may need to be provided.
- **Glazing materials.** New glazing materials (prismatic, lensed, holographic, or laser cut acrylic) may be available to redirect daylight to the ceiling from the clerestory. These can deliver daylight deeper in the space but may cause very bright glazed areas and should be tested to see if they produce glare.
- **Orientation.** Clerestories are most effective on south and north orientations, but should be carefully evaluated on east and west orientations to assure that low sun angle penetration and direct solar gain into the space is minimized. Shade exterior glazing with an overhang on east-, west-, and south-facing glazing to minimize solar gain or use a selective low-e coating (SHGC less than .45).
- **Visible transmission.** Use high transmission, clear glazing (visible transmission 60% to 90%) on the upper window to admit the maximum daylight to the space
- **Stepped ceiling.** Clerestories may create a comparatively dark area along the wall directly beneath them. An interior stepped ceiling in a multi-story building can create a clerestory that reflects daylight back onto the wall to brighten it and deliver reflected daylight to the space. Alternatively, this space may be used for purposes where relatively lower light levels are appropriate, such as for computer stations.

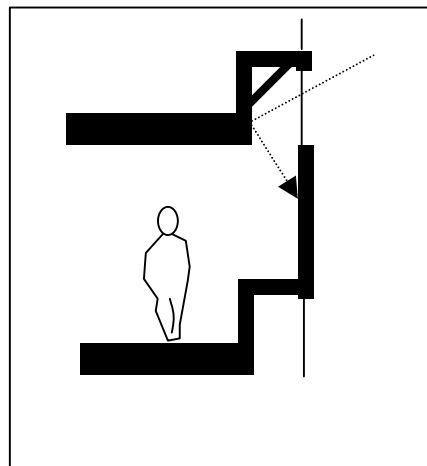

Figure 5 – Clerestories in Multistory Buildings

*Clerestories in multistory buildings can redirect daylight onto the perimeter wall to brighten it.*

- **Reflectance.** Paint all surfaces near the clerestories white or off-white to reduce contrast between the brightness of the clerestory and its surrounding wall. The adjacent ceiling should also have a highly reflective (>70%) white or off-white surface to help diffuse a maximum amount of daylight into the space. Use specially designed “high reflectance” ceiling tiles (>83%) if the budget allows.
- **Teaching surface.** In classrooms, the teaching surface should be perpendicular to the window wall for best illumination. Avoid orientations that will put students’ or teachers’ faces in silhouette or cause reflected glare on whiteboards or computer screens.

### ***Operation and Maintenance Issues***

For operable louvers, it is best to have preset angles that are seasonally adjusted by maintenance staff so the louvers are not inadvertently closed and forgotten or left at a non-optimal angle.

For shades or blinds that are operated by teachers, ensure that their control mechanisms are accessible, robust, and easily repaired.

Clerestory windows should be washed on a regular schedule.

### ***Commissioning***

Set adjustable louvers at their correct seasonal angle to eliminate direct sun penetration.

### ***References/Additional Information***

See this chapter’s Overview.

# GUIDELINE DL3: HIGH SIDELIGHTING—CLERESTORY WITH LIGHT SHELF OR LOUVERS

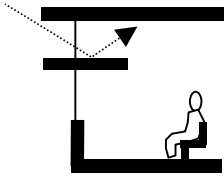

## Recommendation

Use light shelves or louvers with high clerestory glazing to improve daylight distribution; block direct sun penetration; and minimize glare in classrooms, offices, libraries, multipurpose rooms, gymnasiums, and administrative areas.

## Description

A light shelf is a horizontal panel placed below high clerestory glazing (with a view window generally below it) to bounce daylight deeper into the space. Light distribution is improved as daylight reflects off the top surface of the light shelf or louver onto the ceiling. There is a common misconception that light shelves increase light levels deep within the room. However, light levels are instead reduced near the windows, while being maintained deep in the room, keeping the contrast significantly lower within the room, as well as reducing glare near the windows.

A series of smaller horizontal louvers (6 in. to 24 in. wide) can replace a single large light shelf with a slight sacrifice in performance. The larger the louver, the deeper it will deliver daylight into the space. Light shelves and louvers can be located on the exterior, interior, or both. Exterior shelves shade the lower window from solar heat gain and reflect high angle summer sun into the room. Interior shelves reflect lower angle winter sun while blocking the penetration of direct sun and reducing glare from the upper glazing.

## Applicability

High clerestory windows can be used in most school spaces to provide deep penetration of daylight. They are applicable to all climate regions and should be planned in the schematic design phase.



Exterior lightshelves reflect sunlight onto classroom ceilings.  
NREL/PIX 11435

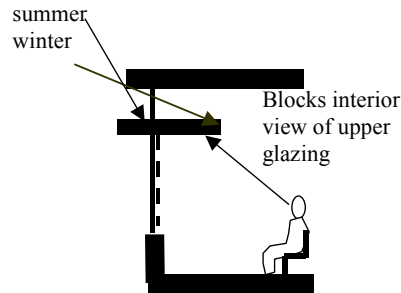

Exterior light shelves shade lower window and reflect summer sun into room. Interior shelves reflect winter sun while reducing glare.

## Applicable Climates

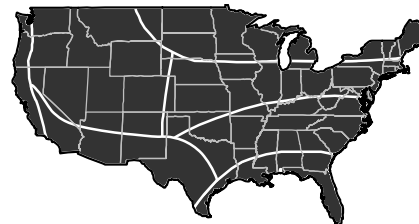

### Applicable Spaces

Classrooms	█
Library	█
Multi-Purpose	█
Gym	█
Corridors	█
Administration	█
Toilets	□
Other	□

### When to Consider

Programming	█
Schematic	█
Design Dev.	█
Contract Docs.	█
Construction	█
Commissioning	█
Operation	□

## Integrated Design Implications

- Design Phase.** Clerestories with light shelves require perimeter access to south-facing (+/- 15°) sidelighting and impact many aspects of building massing. They also benefit from open plan interior layouts that allow unobstructed daylight penetration. They should be considered in the early schematic design phase. Calculating the size and cutoff angles of the light shelf or louver system is critical. In some climates, depending on the hours of air conditioning use, interior light shelves may be more appropriate than exterior only shelves because they bounce the light deeper into the room and reduce glare, but only after allowing the passive solar gain to enter the school. Additionally, interior light shelves allow a more traditional aesthetic for the outside of schools, allowing them to be used in retrofits and new schools where more traditional aesthetics might not allow exterior light shelves.
- Balance with Other Daylight Needs.** Applied to one wall, this approach creates a decreasing gradient of useable daylight about 2.5 times the clerestory head height into the space. Spaces of 20 ft to 50 ft in width (such as classrooms) can be balanced with a daylighting scheme on the opposite wall to provide even lighting across the entire space. Lower view windows are frequently coupled with light shelf schemes, but they do not have to coincide for the whole length of the light shelf. The high glazing with light shelf should be continuous along the whole area to be daylighted. View windows can be selectively spaced beneath the light shelf as needed. This balance between high sidelighting and view windows leaves some lower perimeter wall space available for other uses. Total glazing area should be apportioned among these needs.
- Integration with Ceiling Plenum.** Clerestories with light shelves require ceiling heights of 9.5 ft or more at the window wall. This extra ceiling height may be accomplished with minimal increase of the floor-to-floor height by carefully integrating the structural system, HVAC ducts, and electric lighting in the plenum space. Sloping (or stepping) the ceiling upward at the perimeter — essentially reducing the plenum space there — can also yield additional perimeter ceiling height. For ceiling-ducted HVAC systems, this requires routing ducts away from perimeter walls.
- Integration with HVAC.** Glazing above a light shelf impacts HVAC loads by its vulnerability to solar gains during the cooling season and heat loss in the heating season. Good design (appropriate glazing orientation, size, performance, shading, and photocontrol of electric lights) can reduce the overall HVAC loads and potentially reduce HVAC system size and first costs. Light shelves also must be designed so as not to interfere with circulation of air from the HVAC system. It is typically desirable in climates with cold winters to wash exterior glazing with heat to avoid drafts on the room occupants. If window systems with extremely high U-values (over .12, for example) have not been used, the light shelf should be designed to allow this heat wash over the windows. If fin tube radiation occurs below the windows, this is not a problem but if ceiling diffused air is used, there may be eddies of cool air below the light shelf if other modifications are not made.
- Integration with Electric Lighting.** Clerestories with light shelves create linear zones of daylight that run parallel to the clerestory windows. Electric lighting should be circuited parallel to this and photocontrolled (or manually controlled) in response to available daylight. Light shelves and louvers deliver daylight indirectly to the space; they work well when coupled with direct/indirect pendant electric lighting. Sometimes the first row of electric lighting is incorporated into the light shelf itself. Design electric lighting to provide adequate daylighting and/or electric light under the light shelf on the wall and work surfaces directly adjacent to the wall, especially for evening use or where view windows are not located under interior light shelves.
- Integration with Other Mechanical Systems.** Design light shelves so they do not interfere with the operation of a fire sprinkler system.

## Cost Effectiveness

Clerestories with light shelves or louvers are relatively expensive, but downsizing cooling systems may offset some cost (if electric lights are automatically switched or dimmed in response to daylight). Energy savings from reduced lighting and cooling energy are adequate to recover the initial investment in about 8 to 12 years.

Costs	L			
	M			
	H			
		L	M	H
		Benefits		

## Benefits

Clerestories with light shelves or louvers produce a high level of benefits. The general energy saving, productivity, and visual comfort benefits of daylighting are discussed in the Overview section to this chapter. Clerestories with light shelves or louvers both save energy and improve lighting quality. Energy savings come from reduced solar gains (when an exterior light shelf shades lower glazing) and reduced lighting energy use.

Lighting quality is improved because daylight is delivered deeper in the space, creating a more even distribution. Interior light shelves and louvers restrict the view of the bright upper glazing and eliminate the direct sunlight hitting the desk level, which minimizes glare.

## Design Tools

Computer simulation programs and scale models as outlined in the Overview can be used to demonstrate daylight distribution. If the design includes sloped surfaces, check to ensure the simulation program can accommodate these. Check for daylight levels across the space under both clear sky and overcast sky conditions, and check direct sun penetration through the upper glazing for the lowest expected sun angles.

Most whole-building energy simulation programs (like DOE-2 and EnergyPlus) do not accurately represent the increased daylight distribution from a light shelf or louver system. For more accurate simulations of electric lighting energy savings, the daylight distribution should be simulated with a physical scale model or daylight simulation program and then input to the energy program.

## Design Details

- **Ceiling height.** Provide a minimum perimeter ceiling height of 9.5 ft (the higher, the better). Position the light shelf at 7 ft or more above the floor. Coordinate shelf position and design with pendant electric lighting, door headers, shelving, fire sprinklers, and other interior features.
- **Orientation.** Light shelves are most effective on south orientations and occasionally on the north (to reduce glare from the upper glazing). They should be avoided on east and west orientations.

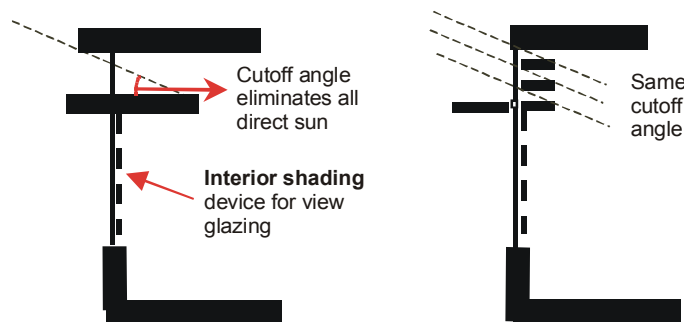

Figure 6 – Cutoff Angle of Light Shelves

*Set the cutoff angle of light shelves or louvers to eliminate direct sun penetration during normal school hours.*

- **Cutoff angle.** Set the cutoff angle of the light shelf or louvers (see the figure above) to eliminate direct sun penetration during normal school hours. Cutoff angle can be increased by 10° if there are operable shades on the upper glazing, and increased by 20° if operable louvers will be seasonally adjusted.
- **Visible transmission.** Use high transmission, clear glazing (visible transmission 60% to 90%) on the upper window to admit the maximum daylight to the space.
- **Reflectance.** The top surface of the light shelf or louvers should be highly reflective (greater than 80% reflectance and with a diffuse, not mirrored, surface). Paint all surfaces near the clerestories white or

off-white to reduce contrast between the brightness of the clerestory and its surrounding wall. The adjacent ceiling should also have a highly reflective (>70%) white or off-white surface to help diffuse a maximum amount of daylight into the space. Use specially designed “high reflectance” ceiling tiles if the budget allows.

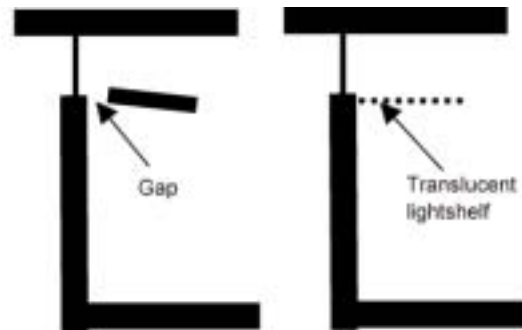

Figure 7 – Creating a Wall Wash

*If opaque light shelves aren't coupled with view windows, consider leaving a gap between the light shelf and the wall to create a wall wash. Translucent shelves provide a soft light under them.*

- **Materials.** Light shelves and louvers may be opaque or translucent and constructed of wood, metal panels, glass fiber-reinforced concrete (GFRC), plastic, fabric, or acoustic ceiling materials. Material choice should include consideration of reflectivity, structural strength, cost, ease of maintenance, and durability. Some curtain wall or window manufacturers can assist in developing details for light shelves and offer add-on products as part of their service. Fabric “shelves” can be suspended from the ceiling at their interior edge.
- **Top surface.** The top surface of a row of lockers or casework that lines a perimeter wall can also be used as a light shelf if its reflectivity and dimensions are appropriate. Slope the top surface so it will not be used for storage.
- **Opaque vs. translucent shelves.** Opaque shelves may create a dark space along the wall directly under them if they are not coupled with a view window. Leave a gap between the light shelf and the wall to create a wall wash or use electric lighting to brighten this wall. Translucent shelves provide a soft light under them but must be carefully evaluated so the direct view of the under side does not create glare. See Figure 7 above.
- **Dirt accumulation.** To reduce accumulation of dirt, exterior shelves should be sloped at least .25 in./ft so that rain can help keep it clean and not pool on the shelf. Also slope interior shelves so they are not used for storage. Fabric construction is another way of preventing this.
- **Accessibility.** Both exterior and interior light shelves can be an “attractive nuisance” in school buildings, inviting students to climb or hang on them. Minimize access to the shelf or use a series of louvers instead.
- **Access for cleaning.** Detail the light shelf or louver system so it is easy to clean the glass above it, both inside and out. Large light shelves may need to be moved away from the window by six inches to allow for window cleaning equipment to be inserted from below the shelf. Light shelves without access space should be structured to carry the weight of cleaning staff.
- **Teaching surface.** In classrooms, the teaching surface should be perpendicular to the window wall for best illumination.

### Operation and Maintenance Issues

The glazing and light shelf/louver system forms a light delivery system that must be kept clean to ensure maximum delivery of daylight to the space. The top surface of the shelf or louvers should be cleaned each time the windows are washed. Make sure light shelves or louvers are detailed correctly to allow easy window cleaning. For operable louvers, it is best to have preset angles that are seasonally adjusted by

maintenance staff so the louvers are not inadvertently closed and forgotten or left at a non-optimal angle. Interior light shelves must be designated by design, signage, or through staff education to not be used as a storage shelf.

### ***Commissioning***

Unless the light shelf or louvers are moveable, commissioning should not be necessary. Set adjustable louvers at their correct seasonal angle to eliminate direct sun penetration.

### ***References/Additional Information***

See this chapter's Overview.



## GUIDELINE DL4: CLASSROOM DAYLIGHTING—WALL WASH TOPLIGHTING

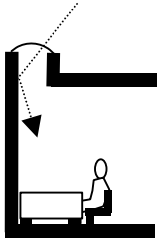

### Recommendation

Use wall wash toplighting for interior classroom walls to balance daylight from window walls, brighten interior classrooms, and make them seem more spacious.

### Description

Wall wash toplighting provides daylight from above through a linear skylight or monitor to wash an interior wall. The glazing is obscured from direct view by the skylight or monitor well. Daylight is diffused with diffusing glazing, baffles, or reflections off of matte reflective light well and interior walls.

### Applicability

A toplighting scheme applies to single-story buildings or the top floor only of a multistory building. Appropriate spaces for wall wash toplighting may include classrooms, libraries, multipurpose spaces, gyms, corridors, and administration offices. It is applicable to all climate regions and must be planned for in schematic design.

### Integrated Design Implications

- **Balance with other daylight.** Applied to one wall, this approach creates even daylight across a classroom that is roughly 1.5 times the height of the daylit wall. It should be balanced with a daylighting scheme on the opposite wall to provide even lighting across the entire classroom. View windows should also be provided. The total glazing area should be apportioned among these needs.
- **Skylights vs. vertical glazing.** The glazing for this wall wash toplighting scheme may be either horizontal or vertical (facing north, east, south, or west). Skylights can offer an advantage of lower construction costs.



*Skylit wall wash delivers daylight across two-thirds of this classroom.*

NREL/PIX 11405

### Applicable Climates



### Applicable Spaces

Classrooms	█
Library	█
Multi-Purpose	█
Gym	█
Corridors	█
Administration	█
Toilets	█
Other	█

### When to Consider

Programming	█
Schematic	█
Design Dev.	█
Contract Docs.	█
Construction	█
Commissioning	█
Operation	█

- **Integration with HVAC.** Placement of skylights and monitors and their associated light wells must be coordinated with the location of rooftop HVAC equipment and interior duct runs. If it is oriented, glazed, shaded, and integrated with electric lighting controls, toplighting should decrease overall seasonal heating and cooling loads on the building. This can reduce the initial size of the HVAC system and annual energy costs.
- **Integration with mechanical ventilation.** Operable rooftop fenestration can be used to naturally ventilate the space. Evaluate thermal stratification of air in the space and prevailing wind conditions to assess the feasibility.
- **Integration with structural system.** Skylights and monitors interrupt the roof diaphragm and structural system. Their size and location may be limited by this and must be coordinated with the structural system to maintain its strength and integrity
- **Safety and security.** Toplighting scenarios on relatively flat roofs have liabilities for both safety and security.

### Cost Effectiveness

Costs for wall wash toplighting are moderate to high, depending on design. Commercial, single glazed skylights are usually the least expensive approach.

Costs	L			
	M		■	■
	H		■	■
		L	M	H
		Benefits		

### Benefits

Wall wash toplighting provides a moderate to high level of benefits. This approach washes a wall with light, and bounces glare-free daylight into the classroom. It will make the space appear larger and brighter. The uniform light from this approach can easily light the inner two-thirds of a classroom. It is excellent when combined with another wall wash or a sidelighting technique that increases daylight on the opposite side of the room (for example, a perimeter window) to create even, balanced daylight across the whole room.

This approach saves electric lighting energy if the first row or two of lights adjacent to the wall wash are switched off or dimmed in response to the daylight. Savings for controlled fixtures may be 40% to 80% during daylight hours.

If this scheme is used to provide natural ventilation, it may increase student performance. Natural ventilation has been correlated with higher student scores on standardized tests and lower overall building energy use. In climates where natural ventilation will only be a viable option for a much smaller portion of the year, it is assumed the improvement in student performance would be more muted.

### Design Tools

The computer simulation programs and scale models described in this chapter's Overview can be used to demonstrate daylight distribution. If the design includes sloped surfaces, check to ensure the simulation program can handle this situation.

### Design Details

#### General

- **Orientation.** Optimize the toplighting design for the climate, orientation, and budget. A skylight will perform better in a predominantly overcast sky condition and for non-north/south orientations. A well-designed monitor with north- or south-facing glazing will be more expensive, but may perform better than a skylight in sunny climates with high air conditioning loads.
- **Diffusion.** Diffuse the daylight before it washes the wall. Eliminate direct sun patches with diffusing glazing, baffles, or a deep well. For skylights, use a high performance diffusing material, such as prismatic acrylic, to maximize light transmission while minimizing hot spots. For clear glazed, baffled systems, design fixed baffles to cut off all expected sun angles or provide adjustable baffles.

- **Visible transmittance.** Use glazing with the highest ratio of visible transmittance to thermal resistance to bring in the most daylight relative to the glazed area while minimizing energy loss. For vertical glass, use a low-e coating to minimize heat loss; use a selective low-e coating to minimize solar gain on solar orientations. Review energy performance based on proposed building scheduled use and percentage of air conditioning use.
- **Light wells.** A light well connects the upper aperture with the ceiling plane of the classroom. Light well walls should be highly reflective (>80% reflectance). Diffusely reflecting light wells should be less than 8 ft deep; mirrored reflecting wells can be used for deeper wells when necessary.
- **Surface colors.** The top of the wall that is washed should be light in color (>70% reflectance) so it can reflect daylight into the space. It should not have protrusions that will cast objectionable shadows.
- **Balancing daylight.** Combine wall wash toplighting approach with another linear approach on the opposite wall to balance daylight in the space.
- **Insulation.** Insulate light well walls to minimize thermal losses and reduce condensation.
- **Task and accent lighting.** In addition to ambient lighting, this approach can be used for task lighting on the wall (lighting lockers) or accent lighting (lighting artwork). It is excellent for corridors and other circulation spaces.
- **Blackout capability.** The aperture will need blackout capability for most classrooms.
- **Integrating with electric light.** Consider an electric lighting wall wash luminaire to illuminate the wall at night, or during heavily overcast conditions. Photoswitch this light in response to daylight levels.
- **Safety and security.** Operable mechanisms should prevent any physical entry. A safety/security grating can be placed in the light well under the glazing for this toplighting scheme. (Light control louvers and baffles may also serve this function.) Make sure this grating does not create a shadow pattern on the wall.
- **Leakage.** All roof penetrations have leakage liabilities. Use well-tested curb design details and flashing kits provided by the manufacturer. Any operable opening should prevent rain penetration.

### **Monitors**

Monitors with glazing oriented north/south (elongated east/west, or a double-sided, monitor-oriented east/west (elongated north/south), will exhibit the least variation of daylight levels throughout the day and will be easiest to design for good energy performance. South-facing vertical glazing should have an overhang, or spectrally selective low-e coating (SHGC less than .45) to reduce solar gains during the cooling season, combined with baffles or diffusing glazing to eliminate direct sun. Monitors with glazing oriented east or west are more likely to show variations in light level and quality from morning to afternoon unless it is provided with glazing in both directions. This allows the classroom below to enjoy the benefits of daylight as well as the energizing effects of changing light directions with the natural movement of the sun throughout the day. If the east-west orientation is required, a skylight may perform better than a monitor.

### **Operation and Maintenance Issues**

- Educate teachers about how wall wash toplighting delivers daylight to the space; discourage them from placing dark colored artwork and posters high on the washed wall.
- Clean glazing on a schedule. Horizontal glazing needs more frequent cleaning in climates with low rainfall.
- The mechanisms for operable louvers and blackout shades should be robust, accessible to the instructor, and easily repaired.

- The janitorial service should check all operable windows or skylights for closure daily.

### ***Commissioning***

Check to ascertain that operable louvers and shades are working. Set angles of adjustable louvers to eliminate direct sun penetration.

### ***References/Additional Information***

See this chapter's Overview.

## GUIDELINE DL5: CENTRAL TOPLIGHTING

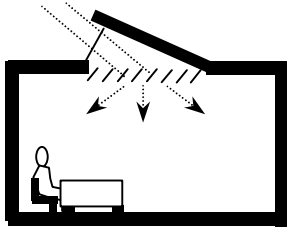

### Recommendation

Use central toplighting in single-story classrooms to provide high levels of even, balanced daylight across the entire room.

### Description

Central toplighting uses a central monitor or skylight (or cluster of skylights) to distribute daylight evenly across the room. Daylight is diffused with diffusing glazing or baffles that can be fixed or operable. Daylight levels are highest directly under the aperture and gradually reduce toward the perimeter of the space.

### Applicability

Central toplighting is applicable in single-story or top floor spaces including classrooms, libraries, multipurpose spaces, and administrative offices. It is appropriate for all climate regions and should be considered during the programmatic, schematic, and design development phases of a school building project.

### Integrated Design Implications

- **Integration with site plan.** This toplighting scheme applies to single-story buildings or the top floor only of a multi-story building. It must be planned for in the schematic design.
- **Skylight vs. vertical glazing.** The glazing for a central toplighting scheme may be either horizontal or vertical (facing north, east, south, or west). In climates where a high percentage of solar gain from skylights is desirable due to the long heating season, it is often more energy efficient to provide skylights than monitors. Schools that are in operation later in the day as well as throughout the summer when peak cooling loads are highest, will see greater energy advantages to monitors than schools with less cooling hours.
- **Balance with other daylight.** This scheme may be combined with view windows in perimeter walls. Since the toplighting aperture provides most of the ambient daylight, smaller windows can be judiciously spaced in exterior walls to optimize views and valuable wall space can be relinquished for other needs. The total glazing area should be apportioned among these needs.
- **Integration with HVAC.** Placement of skylights and monitors, and their associated light wells, must be coordinated with the location of rooftop HVAC equipment and interior ducts.



Central sawtooth monitor provides even illumination across desktops in this classroom. NREL/PIX 11406

### Applicable Climates



### Applicable Spaces

Classrooms	■
Library	■
Multi-Purpose	■
Gym	■
Corridors	■
Administration	■
Toilets	■
Other	□

### When to Consider

Programming	■
Schematic	■
Design Dev.	■
Contract Docs.	■
Construction	■
Commissioning	■
Operation	□

- **Integration with structural system.** Skylights and monitors interrupt the roof diaphragm and structural system. Their size and location may be limited by this and must be coordinated with the structural system to maintain its strength and integrity.
- **Integration with electric lighting.** Central daylighting schemes often fail to provide bright illumination on interior walls. Electric lighting wall wash fixtures may be needed to supplement the daylight.
- **Integration with mechanical ventilation.** If the toplighting fenestration is operable, it can be used to naturally ventilate the space. Evaluate the percentage of the year this would be functional based on the climate, then consider the thermal stratification of air in the space and the prevailing wind conditions to assess the feasibility.
- **Safety and security.** Toplighting scenarios on relatively flat roofs have both safety and security issues that should be considered.



*Toplighting reduces glare and allows for a more even distribution of daylight within a space. NREL/PIX 08834*

### Cost Effectiveness

Costs for central toplighting are medium to high, depending on design. Commercial, double glazed skylights or a diffusing, double wall panel system with a sheetrocked well will be the least expensive. Site-built monitors with vertical or sloped glazing will cost more.

Costs	L			
	M			■
	H			■
		L	M	H
		Benefits		

### Benefits

Central toplighting provides a high level of benefits. With good diffusion, this approach creates even, balanced daylight across the classroom, which has been correlated with higher standardized test scores. (However, uncontrolled direct sun toplighting in classrooms has been associated with lower standardized test scores. See this chapter's Overview for details.)

This approach saves electric lighting energy if the electric lights are switched off or dimmed in response to the daylight. Savings may be 40% to 80% during daylight hours.

Operable louvers can provide variable amounts of daylight for different classroom activities.

Operable skylights or monitor glazing can provide the top outlet for a natural ventilation scheme that draws fresh air in through a lower aperture. Natural ventilation may improve student performance, having been positively correlated with higher student scores on standardized tests. In climates where natural ventilation will only be a viable option for a much smaller portion of the year, it is assumed the improvement in student performance would be more muted.

### Design Tools

The computer simulation programs and scale models described in this chapter's Overview can be used to demonstrate daylight distribution and resultant daylight levels. If the design includes sloped surfaces, check that the simulation program can handle this.

## Design Details

### General

- **Visible transmittance.** Use high visible transmission glazing materials (greater than 60%) to maximize daylight, use glazing with the highest affordable visible transmission to thermal resistance ratio, while minimizing the size of the glazed area with its relatively low U-factor. Alternatively, larger areas of low-transmission glazing with high insulation levels, such as insulated fiberglass panels, may be used successfully. Relatively new double wall polycarbonate glazing materials are now available with electronically controlled, built-in shading devices that automatically close down as lumen levels increase within the space, reducing unwanted solar heat gain. Additionally, these automatic devices close at night, reducing radiation losses to the cold night sky. The balance between visible transmittance and insulation levels, as well as automatic shading, is best studied with an hourly climate simulation software tool.
- **Orientation.** Optimize the toplighting design for the climate and budget. A skylight will perform better in a predominantly overcast sky condition, or non-optimum orientation. A well-designed, north- or south-facing monitor will be more expensive, but may perform better than a skylight for sunny climates with high air conditioning loads. A two-sided monitor with glazing facing both east and west will also be more expensive but is another way to use monitors even in non-optimal orientations while still providing even light levels throughout the day.
- **Reflective materials.** A light well connects the upper aperture with the ceiling plane of the classroom. Light well walls should be highly reflective (>80% reflectance). Bright white, flat paint works best. Diffusely reflecting light wells should be less than 8 ft deep; specular reflecting wells can be used for deeper wells when necessary.
- **Diffusion.** Diffuse the daylight with diffusing glazing or baffles. Design baffles to cut off all expected sun angles or to be adjustable. Avoid placing diffusing glazing within the normal field of view, as it will cause excessive glare.
- **Splayed light wells.** Splay light well walls to spread the daylight more effectively in the space and reduce glare. A 45° to 60° angle works best.
- **Insulation.** Insulate light well walls to an R-value at least equivalent to the code requirement for wall insulation to minimize thermal losses and reduce condensation.
- **Blackout capability.** Add blackout capability, as needed, and louvers to modulate the daylight levels.
- **Integration with electric lighting.** If the light well is visible (not obscured by baffles), provide some electric light so it does not become a “dark hole” at night. Pendant upright fixtures work well. Photoswitch these lights in response to daylight levels. See the Lighting and Electrical Systems chapter for information about controlling electric lights in response to available daylight.
- **Safety and security.** A safety/security grating can be placed in the light well under the glazing for this toplighting scheme. (Light control louvers and baffles can also serve this function.) Make sure this grating does not create a shadow pattern on the wall.
- **Leakage.** All roof penetrations have leakage liabilities. Use well-tested curb design details and flashing kits provided by the manufacturer.
- **Reflectors.** A reflecting device may be placed below the light well to redirect daylight onto the ceiling or walls of the space. This ceiling/wall wash will make the space appear larger and brighter, even though horizontal footcandles measured at desk height may be reduced. The reflector may consist of flat or curved mirrored or matte reflective surfaces. It may also be partially translucent (fabric, plastic, or perforated metal). This device will require extra floor to ceiling height and should be studied with a physical scale model to evaluate daylight distribution.

### ***Skylights***

Use a glazed area of about 3% to 12% of the floor area. Use the lower end of this range for spaces with high air conditioning or heating loads, and the higher end for temperate climates with more overcast skies. In cold climates, consider south-facing clerestories instead of skylights.

### ***Monitors***

A sawtooth monitor with glazing oriented north will exhibit the least variation of daylight levels throughout the day and will have better energy performance than east or west glazing. South-facing vertical glazing should have an overhang or spectrally selective low-e (SHGC less than .45) to reduce solar gains during the cooling season. Avoid sawtooth monitors with glazing oriented east or west; they will show large variations in light level and quality from morning to afternoon and will have poor thermal performance. Double-sided monitors with glazing facing both east and west will provide more even lighting but will also cost more.

## ***Operation and Maintenance***

Clean glazing on a regular schedule. Horizontal glazing needs more frequent cleaning in climates with low rainfall.

Mechanisms for operable louvers and blackout shades should be robust, accessible to the teacher, and easily repaired.

## ***Commissioning***

Check that operable louvers and shades are working. Set angles of adjustable louvers to eliminate direct sun penetration.

## ***References/Additional Information***

See this chapter's Overview.



## GUIDELINE DL6: PATTERNED TOPLIGHTING

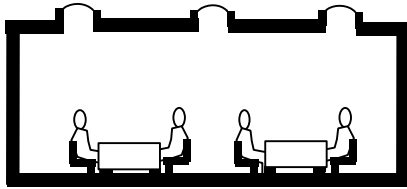

### Recommendation

Use patterned toplighting in interior spaces that need even, low-glare illumination across a large area.

### Description

Patterned toplighting provides daylight through a two-dimensional grid of skylights or rows of linear monitors (sawtooth or square). It provides even, glare-free daylight across large areas. Spacing of the pattern is largely a function of the ceiling height.

### Applicability

This daylighting pattern is useful for any large area that needs even daylight levels. It is especially good for gymnasium, library, multipurpose, or cafeteria spaces. For gymnasium ball courts, add baffles or high light well cutoff angles to minimize direct views of bright glazing surfaces during ball games (See Design Details below). Patterned toplighting is appropriate for all climate regions and should be considered during the programmatic, schematic, and design development phases.

### Integrated Design Implications

- **Integration with site plan.** This toplighting scheme applies to single-story buildings or the top floor only of a multi-story building. It must be planned for in the schematic design.
- **Skylight vs. vertical glazing.** The glazing for these patterned toplighting schemes may be either horizontal or vertical (preferably facing north or south).
- **Balance with other daylight.** This scheme may be combined with view windows in perimeter walls. Since the toplighting aperture provides most of the ambient daylight, smaller windows can be judiciously spaced in exterior walls to optimize views, and valuable wall space can be relinquished for other needs. The total glazing area should be apportioned among these needs.
- **Integration with HVAC.** Placement of skylights and monitors and their associated light wells must be coordinated with the location of rooftop HVAC equipment and interior duct runs.
- **Integration with mechanical ventilation.** If the toplighting fenestration is operable, it could be used to naturally ventilate the space. Evaluate the percentage of the year this would be functional based on



Grid of skylights provide even illumination across the space.

NREL/PIX 11434

### Applicable Climates



### Applicable Spaces

Classrooms	█
Library	█
Multi-Purpose	█
Gym	█
Corridors	█
Administration	█
Toilets	█
Other	█

### When to Consider

Programming	█
Schematic	█
Design Dev.	█
Contract Docs.	█
Construction	█
Commissioning	█
Operation	█

climate, and then consider the thermal stratification of air in the space and prevailing wind conditions to assess the feasibility.

- **Integration with structural system.** Skylights and monitors interrupt the roof diaphragm and structural system. Their size and location may be limited by this and must be coordinated with the structural system to maintain its strength and integrity
- **Safety and security.** Toplighting scenarios on relatively flat roofs have both safety and security issues that should be considered.

### Cost Effectiveness

Costs for patterned toplighting range from low to high, depending on design. A grid of skylights with unfinished wells will be the least expensive; monitors with reflecting devices will be much more expensive. Costs include the expense of the skylight or monitor device, rooftop installation, curbs and waterproofing, interior well construction and finish, and electric lighting controls to switch or dim in response to daylight.

Costs	L			
	M			
	H			
		L	M	H
		Benefits		

### Benefits

Patterned toplighting provides a high level of benefits. This approach creates even, balanced, low-glare daylight across the space. This approach saves electric lighting energy if the electric lights are switched off or dimmed in response to the daylight. Savings may be 40% to 80% during daylight hours.

Operable louvers can provide variable amounts of daylight for different activities. Operable skylights or monitor glazing can provide the top outlet for a natural ventilation scheme that draws fresh air in through a lower aperture. Natural ventilation may improve student performance, having been positively correlated with higher student scores on standardized tests. In climates where natural ventilation will only be a viable option for a much smaller portion of the year, it is assumed the improvement in student performance would be more muted.

### Design Tools

The computer simulation programs and scale models described in this chapter's Overview can be used to demonstrate daylight distribution and resultant daylight levels. If the design includes sloped surfaces, check to ensure the simulation program can handle this.

### Design Details

#### General

- **Optimize for climate and budget:** A grid of skylights will perform better in a predominantly overcast sky condition where air conditioning loads are low. A series of well-designed monitors will be more expensive, but will perform better than a skylight for sunny climates with high air conditioning loads.
- **Visible transmittance:** Use high visible transmission glazing materials (greater than 60%) to maximize daylight and glazing with the highest affordable visible transmission to the thermal resistance ratio, while minimizing the size of the glazed area with its relatively low U-factor.
- **Diffusion:** Diffuse the daylight with diffusing glazing or baffles. Design baffles to cut off all expected sun angles or to be adjustable. Avoid placing vertical diffusing glazing within the normal field of view.
- **Splayed light wells:** For deeper, narrow light wells, splay the light well walls to spread the daylight more effectively in the space and reduce glare. A 45° to 60° angle works best.
- **Reflectance:** A light well connects the upper aperture with the ceiling plane of the classroom. Light well walls should be highly reflective (>80% reflectance). Bright white flat paint works best. Diffusely

reflecting light wells should be a maximum of 6 to 8 ft deep; specular reflecting wells can be used for deeper wells when necessary.

- **Insulation:** Insulate light well walls to minimize thermal losses and reduce condensation. Use an R-value at least equivalent to the code requirement for wall insulation.
- **Blackout capability:** Add blackout capability, as needed, and louvers to modulate the daylight levels.
- **Safety and security:** A safety/security grating can be placed in light wells under the glazing for this toplighting scheme. (Light control louvers and baffles can also serve this function.)
- **Leakage:** All roof penetrations have leakage liabilities. Use well-tested curb design details and flashing kits provided by the manufacturer.

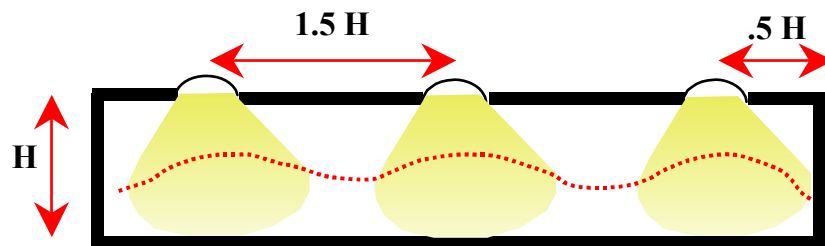

Figure 8 – Skylight Grid Spacing

### **Skylight Grid**

As a rough rule of thumb, skylights should be spaced about one-and-a-half times the floor-to-ceiling height ( $H$  in Figure 8 above). Their glazing should be about 3% to 12% of the floor area to be lighted.

### **Series of Monitors**

Sawtooth monitors with glazing oriented north will exhibit the least variation of daylight levels throughout the day and will have better energy performance than east or west glazing. South-facing vertical glazing should be smaller and should have an overhang or spectrally selective low-e coating (SHGC less than .45) to reduce solar gains during the cooling season. Avoid sawtooth monitors with glazing oriented east or west; they will show large variations in light level and quality from morning to afternoon and poor energy performance.

## **Operation and Maintenance**

Clean glazing on a regular schedule. Horizontal glazing needs more frequent cleaning in climates with low rainfall.

Mechanisms for operable louvers and blackout shades should be robust, accessible to the instructor, and easily repaired.

## **Commissioning**

Check that operable louvers and shades are working. Set angles of adjustable louvers to eliminate direct sun penetration.

## **References/Additional Information**

See this chapter's Overview.

## GUIDELINE DL7: LINEAR TOPLIGHTING

### Recommendation

Use linear toplighting as a single downlighting element in a long, linear space (such as a corridor) to direct movement or establish a visual orientation. Use it on two sides of a space to define separate functions or activities, to define edges in a larger space, and/or to downlight the space from two directions.

### Description

Linear toplighting is a downlighting scheme that provides a line of high intensity daylight directly under it, which diminishes as an individual moves perpendicularly away from it. It establishes a strong longitudinal orientation in the space and is best coupled with a corresponding circulation pattern or linear visual cue. Used bilaterally (from two sides), it can frame a larger space.

### Applicability

This daylighting pattern is useful for enclosed hallways and linear walkways within a larger space, or for use bilaterally to frame centrally focused areas like gymnasiums, libraries, and multipurpose areas. Linear toplighting may also be used in covered exterior walkways to minimize their shadow, especially in covered walkways adjacent to rooms with sidelighting.

### Integrated Design Implications

- **Design Phase.** This toplighting scheme applies to single-story buildings or the top floor only of a multistory building. It must be integrated with the site plan and building massing and should be planned for in the schematic design phase.
- **Balance with other daylight.** Since overall glazing area is limited, the amount of glazing in a linear toplighting scheme must be balanced with the need for view windows and other apertures in the space.
- **Integration with electric lighting.** Electric lighting should be aligned with the toplighting without blocking it and causing shadows on the floor.
- **Integration with structural system.** Skylights and monitors interrupt the roof diaphragm and structural system. Their size and location may be limited by this and must be coordinated with the structural system to maintain its strength and integrity



*Libraries with skylights create bright welcoming corridors.  
Photo by Peter Vanderwalker, courtesy of HMFH Architects.*

### Applicable Climates



#### Applicable Spaces

Classrooms	<input type="checkbox"/>
Library	<input checked="" type="checkbox"/>
Multi-Purpose	<input checked="" type="checkbox"/>
Gym	<input checked="" type="checkbox"/>
Corridors	<input checked="" type="checkbox"/>
Administration	<input type="checkbox"/>
Toilets	<input type="checkbox"/>
Other	<input type="checkbox"/>

#### When to Consider

Programming	<input checked="" type="checkbox"/>
Schematic	<input checked="" type="checkbox"/>
Design Dev.	<input checked="" type="checkbox"/>
Contract Docs.	<input type="checkbox"/>
Construction	<input type="checkbox"/>
Commissioning	<input type="checkbox"/>
Operation	<input type="checkbox"/>

- **Integration with HVAC.** Placement of the linear toplight and its associated light well must be coordinated with the location of rooftop HVAC equipment and interior duct runs. Interruptions in the linear run of this toplight may be required to accommodate these other needs. The interruptions should be sequenced in a regular manner to prevent a random pattern of light and dark.
- **Integration with mechanical ventilation.** If the toplighting fenestration is operable, it could be used to naturally ventilate the space. Evaluate percentage of the year this would be functional based on climate, and then consider thermal stratification of air in the space and prevailing wind conditions to assess the feasibility.
- **Safety and security.** Toplighting scenarios on relatively flat roofs have both safety and security issues that should be considered.

### Cost Effectiveness

Costs for linear toplighting range from moderate to high, depending on design. A linear row of skylights will be the least expensive; monitors with reflecting devices will be more expensive. Costs include the expense of the skylight or monitor device, rooftop installation, curbs and waterproofing, interior well construction and finish, and electric lighting controls to switch or dim in response to daylight.

Costs	L			
	M			
	H			
		L	M	H
		Benefits		

### Benefits

Linear toplighting provides a high level of benefits. This approach creates bright, welcoming corridors that link important functions in the building. It can provide a strong visual cue for circulation that guarantees daytime egress lighting independent of electric power. In a bilateral scenario, it can provide balanced daylighting that graduates from high at the perimeter to moderate between the two linear toplights

This approach saves electric lighting energy if the electric lights are switched off or dimmed in response to the daylight. Savings may be 40% to 80% during daylight hours.

Operable skylights or monitor glazing can provide the top outlet for a natural ventilation scheme that draws fresh air in through a lower aperture. Natural ventilation may improve student performance, having been positively correlated with higher student scores on standardized tests. In climates where natural ventilation will only be a viable option for a much smaller portion of the year, it is assumed the improvement in student performance would be more muted.

### Design Tools

The computer simulation programs and scale models described in this chapter's Overview can be used to demonstrate daylight distribution and resultant daylight levels. If the design includes sloped surfaces, check to ensure the simulation program can handle this.

### Design Details

- **Visible transmittance.** Use high visible transmission glazing materials (greater than 60%) to maximize daylight while minimizing the size of the glazed area with its relatively low U-factor. Alternatively, larger areas of low-transmission glazing with high insulation levels, such as insulated fiberglass panels, may be used successfully. The balance between visible transmittance and insulation levels is best studied with an hourly climate simulation software tool.
- **Glazing area vs. floor area.** Use a glazed area of about 3% to 12% of the floor area. Use the lower end of this range for spaces with high air conditioning or heating loads, and the higher end for temperate climates with more overcast weather.
- **Circulation.** When applicable, coordinate linear toplighting with major circulation areas in the school. Increase light levels at major intersections and at hallway ends to draw students in that direction.
- **Diffusion.** Either diffuse daylight or direct sun may be used in circulation and transition areas. Daylight diffused with translucent glazing or baffles will spread the daylight evenly in the space, making the

most effective use of the light. Occasional patches of direct sun can create a vibrant splash of light to emphasize major intersections and circulation spines. Some designs have successfully combined patterns of diffusing glazing with smaller areas of transparent glazing to animate a circulation space. It is pleasant to see the blue sky, as well as the daylight in spaces where some glare will not impede the performance of the space.

- **Shared daylighting.** Consider sharing diffuse corridor daylight with adjacent spaces by glazing the upper portion of the wall. Avoid this in areas where acoustic separation is important. In multistory buildings, consider sharing daylight from the top floor corridor with the lower floor by periodically cutting light wells to the lower level.
- **Splayed light wells.** For diffusing skylights with deeper, narrow light wells, splay the light well walls to spread the daylight more effectively in the space and reduce glare. A 45° to 60° angle works best.
- **Insulation.** Insulate light well walls to an R-value at least equivalent to the code requirement for wall insulation to minimize thermal losses and reduce condensation.
- **Safety and security.** A safety/security grating can be placed in the light well under the glazing for this toplighting scheme. (Light control louvers and baffles can also serve this function.) Make sure this grating does not create a shadow pattern on the wall.
- **Leakage.** All roof penetrations have leakage liabilities. Use well-tested curb design details and flashing kits provided by the manufacturer.

### ***Operation and Maintenance***

Clean glazing on a schedule. Horizontal glazing (and clear glazing) needs more frequent cleaning in climates with low rainfall.

### ***Commissioning***

Check that operable louvers and shades are working. Set angles of adjustable louvers to eliminate direct sun penetration.

### ***References/Additional Information***

See this chapter's Overview.

## GUIDELINE DL8: TUBULAR SKYLIGHTS

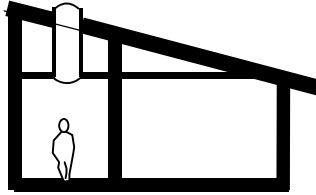

### Recommendation

Use tubular skylights for toplighting in areas with relatively deep roof cavities and for low-cost retrofits to existing spaces.

### Description

Tubular skylights are small clear-domed skylights with mirrored reflective ducts connecting them to the ceiling plane of the space. They have an interior diffuser at the ceiling plane to spread daylight in the space. They may have electric lighting within the duct or diffuser that is switched or dimmed in response to the available daylight. Since they depend on multiple reflections to deliver daylight to the space, they perform better under direct sun than overcast sky conditions.

### Applicability

Tubular skylights are especially good for small spaces, such as toilet rooms, locker rooms, kitchens, interior corridors, enclosed staff work areas, and other interior spaces that are sporadically occupied and would benefit from a low-cost toplighting solution. They are also good for retrofit into any existing school space that needs extra daylight or needs to balance an existing asymmetric daylight distribution.

These units will work significantly better in clear sky climates than in overcast climates. As the duct gets longer, less daylight is delivered; so they are limited to spaces with roof cavities of 8 ft or less.

### Integrated Design Implications

- **Integration with site plan.** This toplighting scheme applies to single-story buildings or the top floor only of a multistory building. It must be planned for in schematic design.
- **Balance with other daylight.** This scheme may be combined with view windows in perimeter walls. Since the toplighting aperture provides most of the ambient daylight, smaller windows can be judiciously spaced in exterior walls to optimize views and valuable wall space can be relinquished for other needs. The total glazing area should be apportioned among these needs.

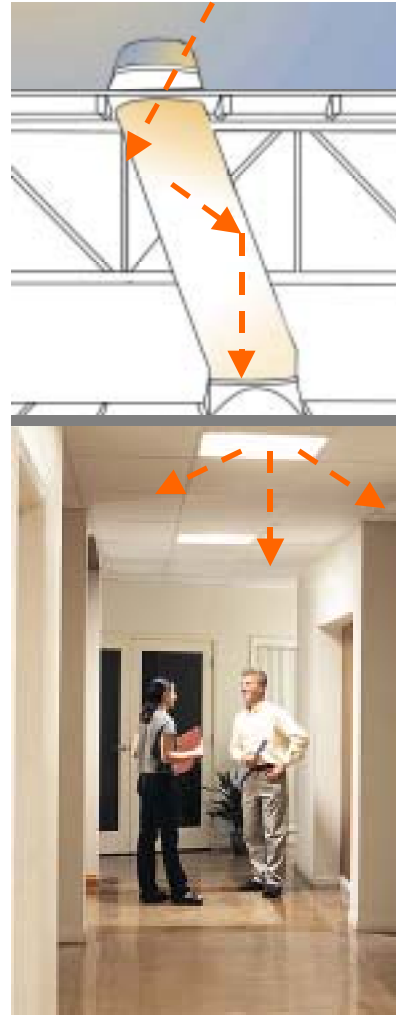

*Tubular skylights work well for small spaces, such as toilet rooms, locker rooms, kitchens, and interior corridors.*

*NREL/PIX 11430*

- **Integration with HVAC.** Placement of tubular skylights must be coordinated with the location of rooftop HVAC equipment and interior duct runs. Although the reflective ducts can jog to avoid barriers in the ceiling plenum space (within reason), efficiency of daylight delivery is reduced with each change in direction.
- **Integration with structural system.** Skylights interrupt the roof diaphragm and structural system. Their size and location may be limited by this and must be coordinated with the structural system to maintain its strength and integrity. The small diameter of these units reduces their impact on the structural system relative to larger framed skylights.
- **Integration with electric lighting.** Some tubular skylights come equipped with compact fluorescent (or incandescent) electric lights within the duct or ceiling plane diffuser that can be switched or dimmed in response to daylight. Ascertain that any included electric light not block the daylight delivered through the device.
- **Safety and security.** Unless these skylights are larger than 16 in.<sup>2</sup>, they should not pose a safety or security liability.

#### Applicable Climates



#### Applicable Spaces

Classrooms	Light Gray
Library	Light Gray
Multi-Purpose	Light Gray
Gym	Light Gray
Corridors	Dark Gray
Administration	Light Gray
Toilets	Dark Gray
Other	Dark Gray

#### When to Consider

Programming	Dark Gray
Schematic	Dark Gray
Design Dev.	Dark Gray
Contract Docs.	Light Gray
Construction	Light Gray
Commissioning	Light Gray
Operation	White

### Cost Effectiveness

Costs for tubular skylights are low. For smaller spaces like hallways and offices, 10 in. and 14 in. tubular skylights cost approximately \$300 and \$400 (not including installation costs), respectively.

Costs	L	Dark Gray	Light Gray	
	M	Light Gray	White	
	H	Light Gray	White	
		L	M	H
		Benefits		

### Benefits

Tubular skylights provide a moderate level of benefits. This approach provides daylight “fixtures” that deliver daylight through a ceiling plenum to an interior space. Arranged in a grid, they can provide even, balanced daylight across the space, though daylight levels will fluctuate widely between direct sun and overcast sky conditions. Daylight in classrooms has been correlated with higher standardized test scores. See this chapter’s Overview for details.

This approach saves electric lighting energy if the electric lights are switched off or dimmed in response to the daylight. Savings may be 20% to 60% during daylight hours

### Design Tools

The specular reflective tube makes it difficult to simulate the performance of these skylights with physical scale models and computer tools. Local case studies, test installations, and estimating tools from the manufacturers are the best tools for evaluating performance. Designers should take note that many manufacturers of tubular skylights have made exaggerated claims about both daylight delivery and R-value of their products.

Energy performance of these skylights is also handicapped by the lack of U-factor and SHGC data. As this information becomes available, hourly building energy evaluation programs like DOE-2, EnergyPlus, and Energy-10 can be used to evaluate the energy impacts.

### Design Details

- **Length and bends.** Minimize the overall length and minimize bends in the reflective duct running from the skylight to the ceiling plane.



- **Reflective ducts.** Use a product with a highly reflective cylindrical duct. Do not use a corrugated duct; the corrugations trap light.
- **Half dome vs. full dome.** In predominantly sunny climates, use a tubular skylight with a south-facing, reflective half-dome under the skylight “bubble” to increase the reflection of low angle winter sun into the skylight (see Figure 9 below). In predominantly overcast climates, use a full clear dome. Special lenses or geometric shapes can also help to catch low angle sun and direct it downward.



*Tubular skylights in interior administrative office provide high lighting levels even when electric lights are off. Skylight diffuser panel fits into a standard suspended ceiling system.*

NREL/PIX 11427

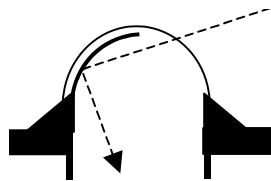

*Figure 9 – Section of Reflective Half Dome NREL/PIX 11432*

- **Diffusers.** Some products have a flat bottom diffuser that fits into a standard 2 ft x 2 ft or 2 ft x 4 ft dropped ceiling grid. These may incorporate the electric lighting in them or may alternate in a grid with recessed fluorescent electric lighting fixtures.
- **Insulation.** For ducts installed in uninsulated ceiling or attic spaces, insulate the duct to an R-level at least equivalent to the code requirement for air ducts to minimize thermal losses and reduce condensation.
- **Leakage:** All roof penetrations have leakage liabilities. Use well-tested curb design details and flashing kits provided by the manufacturer.

### **Operation and Maintenance**

Clean glazing on a schedule. Horizontal glazing needs more frequent cleaning in climates with low rainfall.

### **Commissioning**

None.

### **References/Additional Information**

See this chapter’s Overview.



# ENERGY-EFFICIENT BUILDING SHELL

Designing the school building enclosure — or envelope — entails many considerations. The materials — both indoors and out — must be durable, resistant to water damage and vandalism, easy to clean, and inexpensive. They must be strong enough to meet seismic codes, yet appear inviting. Add energy efficiency and resource-efficiency to this list and the design team’s job is even more complex.

This chapter provides technical guidelines for the school building enclosure, including:

Wall Insulation (Guideline EB1)

Roof Insulation (Guideline EB2)

Cool Roofs (Guideline EB3)

Radiant Barriers (Guideline EB4)

Reduce Infiltration (Guideline EB5)

Concrete Masonry (Guideline EB6)

Fenestration (windows and skylights) is addressed in the chapter on Daylighting and Fenestration Design.

The construction of the building enclosure, especially its air and vapor permeability, color, levels of insulation, resistance to unplanned air leakage, and thermal mass, has a significant effect both on energy efficiency and occupant comfort. The building enclosure also affects acoustic comfort as it can attenuate site and traffic noise. Selecting materials for the construction of the building enclosure affects school resource efficiency, including transport energy, the volume and type of raw materials that must be extracted from the earth, the energy required for manufacturing, and packaging. Building shell construction also affects thermal comfort. Even when heating and cooling systems are large enough to make up for poorly insulated components, the building’s surface temperature may be cold or hot (depending on season), and this affects the radiant temperature of the space and the comfort of the occupant.

## OVERVIEW

### ***Heat Transfer through the Building Enclosure***

Heat transfer through envelope components is quite complex and dynamic. The direction and magnitude of heat flow is affected by solar gains from the sun, outdoor temperature, and indoor temperature. Building envelope components have four important characteristics that affect their performance: their U-factor or thermal resistance (R-value); their air and vapor permeability; their thermal mass or ability to store heat, measured as heat capacity (HC); and their exterior surface condition/finish (for example, are they light in color to reflect the sun or dark to absorb solar heat?).

These concepts are explained in greater detail below. Also discussed below is the use of radiant barriers to reduce heat transfer in certain situations.

### **U-factor**

The U-factor is the rate of steady-state heat flow. It is the amount of heat in British thermal units (Btu) that flows each hour through 1 ft<sup>2</sup> of surface area when there is a 1°F temperature difference between the inside and outside air. Heat flow can be in either direction, as heat will flow from the warmer side to the cooler side. Insulation and most other building materials affect heat flow equally in both directions, but some construction elements, such as radiant barriers, may reduce heat flow entering the building, but have little impact on heat leaving the building.

Steady-state heat flow assumes that temperatures on both sides of the building envelope element (while different) are held constant for a sufficient period so that heat leaving one side of the assembly is equal to heat entering the opposite side. The concept of steady-state heat flow is a simplification, because in the real world, temperatures change constantly. However, U-factor can predict average heat flow rates over time and is commonly used to explain the thermal performance of construction assemblies. Because they are easy to understand and use, the terms for steady-state heat flow (R-values and U-factors) are part of the basic vocabulary of building energy performance.

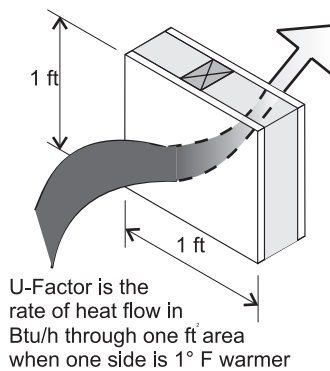

*Figure 10 – Concept of U-factor*

With metal framing, thermal bridges significantly impact the performance of the overall assembly, sometimes reducing the insulation effectiveness to less than half. The U-factor accounts for thermal bridges and the conductance of every element of the construction assembly, including the air film conductances on the interior and exterior surfaces. The air film conductances quantify the rate at which heat is transferred between the surface of the construction assembly and the surrounding environment. This conductance depends on the orientation and roughness of the surface and the wind speed across the surface.

For light frame walls, U-factors provide an adequate description of heat transfer. For heavy concrete and masonry walls, however, this is only true under constant temperature conditions. The dynamic heat storage properties of concrete and masonry alter the thermal behavior of the wall, and the U-factor becomes less accurate as a predictor of heat flow (see discussion of Heat Capacity below).

**R-values**

R-values are also used to describe steady-state heat flow but in a slightly different way. The R-value is a material property that is proportional to resistance to heat flow. A larger R-value has greater thermal resistance, or more insulating ability, than a smaller R-value. The opposite is true with U-factors, that is, the lower the better.

R-values are widely recognized in the building industry and are used to describe insulation effectiveness. The insulation R-value does not describe the overall performance of the complete assembly, however. It only describes the thermal resistance of the insulation material and does not take into account the impact of air leakage in the wall or roof assembly. The performance of the entire wall assembly can be significantly lower when metal framing, steel beams, metal window casements, or other elements penetrate the insulation.

Most construction assemblies include more than one material in the same layer. For example, a wood stud wall includes cavity areas where the insulation is located and other areas where there are solid wood framing members. The wood areas have a lower R-value and conduct heat more readily than the insulated areas. Framing members must be considered when calculating the U-factor of a wall, roof, or floor assembly. See the Design and Analysis Tools section below for more details.

**Thermal Mass**

Thermal mass is another important characteristic that affects the thermal performance of construction assemblies. Heavy walls, roofs, and floors have more thermal mass than light ones. Thermal mass both delays and dampens heat transfer (see Figure 11). The time lag between peak outdoor temperature and interior heat transfer is between 4 and 12 hours depending on the thickness and the heat capacity of the construction and other characteristics. For buildings like schools that are often not heated or cooled at night, delaying heat transfer can be just as effective as reducing it, so long as the outside air cools down at night. However, in humid climates, there is a small diurnal temperature swing on hot days, so this effect is not as significant as it is in climates such as desert areas, where the diurnal temperature swing can be 30°F or more.

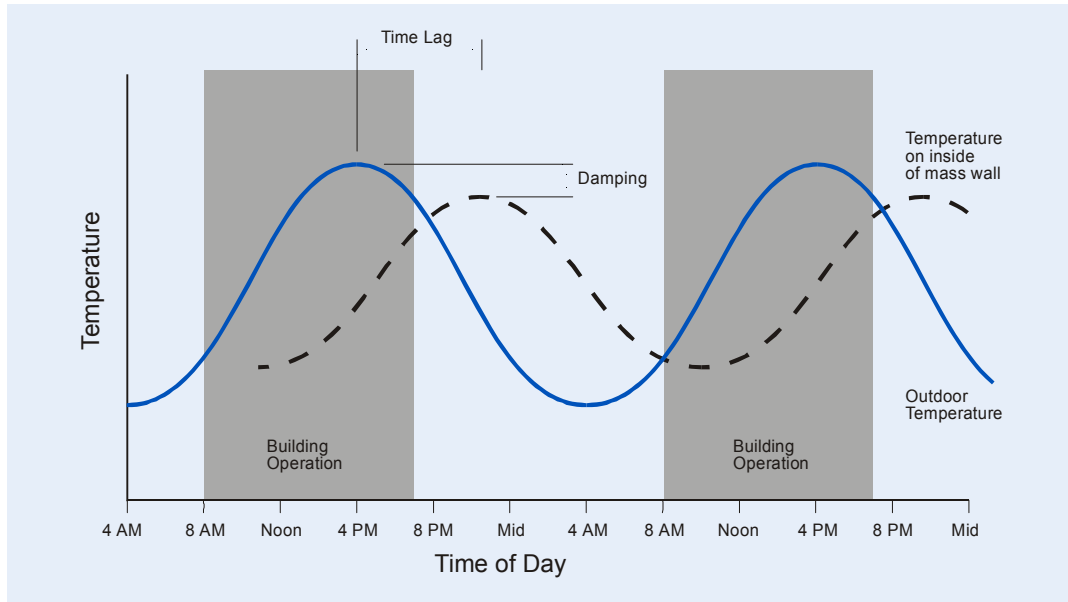

Figure 11 – Temperature Swing

Thermal mass that is exposed to interior air has other benefits as well. If the mass is allowed to cool at night, it will absorb heat during the morning and reduce the cooling load. If the interior thermal mass is exposed to sunlight, it will warm during the day and release the heat at night. Thermal mass used this way is a basic principal of passive solar design and may be appropriate in the Cool and Humid, Cold and Humid, and Cool and Dry climates.

Figure 12 shows examples of mass walls commonly used in school construction.

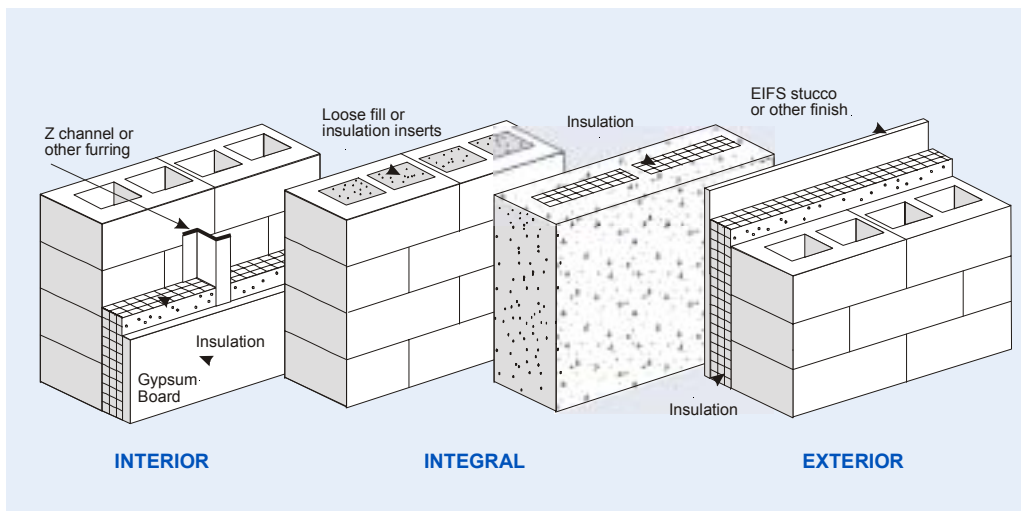

Figure 12 – Mass Wall Constructions

### Heat Capacity

Heat capacity (HC) is the metric used to quantify thermal mass. HC is the amount of heat in Btu that must be added to 1 ft<sup>2</sup> of surface area to uniformly elevate the temperature of the construction by 1°F. The units are Btu/ft<sup>2</sup>·°F. HC is the sum of the heat capacity of each individual layer in the wall. The heat

capacity of each layer is the density of the material times its thickness times its specific heat (all in consistent units). HC can be approximated by multiplying the weight of a ft<sup>2</sup> of wall, roof, or floor by 0.2. For example, a wall with a weight of 100 lb/ft<sup>2</sup> has an HC of approximately 20 Btu/ft<sup>2</sup>·°F.

Many energy standards consider HC as a factor in the overall performance of a building envelope component. ASHRAE/IESNA Standard 90.1-1999, for instance, has a mass wall class of construction with separate thermal performance criteria.

Concrete is not a very good insulating material. However, some varieties are better than others. There is a class of materials called aerated concrete that has air bubbles entrained in the concrete, which makes the concrete lighter and also improves its insulating ability. Low-density aggregates such as perlite or vermiculite can be used to produce lightweight concrete. The moisture transport characteristics of the materials must also be considered.

### ***Cool Roofs***

Heat transfer is also affected by the exterior surface. This is especially important for roofs. In fact, the term “cool roof” is used to describe those with favorable surface characteristics. Cool roofs have two key features. First, they have a high solar reflectance, which usually means that they are light in color. The high reflectance means that solar radiation is reflected rather than absorbed by the roof surface, keeping the surface temperature lower and reducing heat gain, which will reduce the need for air conditioning and significantly reduce the amount of heat that a rooftop ventilation unit will pick up while providing economizer cooling or bringing in outside air ventilation. This will extend the amount of time that outdoor air without mechanical cooling will be able to keep a classroom from overheating. Second, cool roofs have a high or normal emittance. Emittance is a little harder to understand than reflectance, but it can be just as important to energy performance. Emittance is that percentage of energy that would be radiated to the sky from a surface. Galvanized metal and other metallic finishes have a low emittance, which means that when they warm up, they cannot easily release their heat by radiating it back to the sky. Keeping the roof cool reduces cooling loads but also reduces expansion and contraction of the roofing materials, which dramatically increases the life of the system. Cool roofs also decrease the heat island effect of buildings, an especially important factor in dense urban areas.

### ***Radiant Barriers***

One last feature of construction assemblies that deserves some discussion is radiant barriers. Many construction assemblies have a large cavity. An attic, for instance, is a cavity separating the roof from the ceiling. Radiant barriers are not typically installed in walls. In construction assemblies that have a cavity, much of the heat transfer from the warmer surface to the colder surface is due to radiation. A radiant barrier can reduce this component of heat transfer. A radiant barrier is a shiny metallic surface on one or more sides of the cavity that has a low emittance. Radiant barriers are commonly installed in attics.

## ***Applicable Codes***

Many states have energy efficiency standards that establish minimum insulation levels in schools. Adopted standards vary from state to state, but the standards in many states are based on ASHRAE/IESNA Standard 90.1-2001 (referenced in this section as Standard 90.1). Standard 90.1 has

both prescriptive criteria expressed as minimum R-values (see Table 8) and component performance criteria expressed as maximum U-factors (see Table 9). The Standard 90.1 recommendations are minimum requirements. For most schools, it will be cost effective to exceed these requirements. Specific recommendations are contained in the guidelines that follow.

**Table 8 – Minimum R-values from ASHRAE/IESNA Standard 90.1-2001**

*This table shows the prescriptive building envelope criteria from Standard 90.1, expressed as minimum R-values. The columns show the criteria for each of the seven climate zones (and representative cities) covered by the National Best Practices Manual. The rows show the criteria for various classes of construction. The designation “ci” means that the insulation must be installed in a continuous manner so that framing members do not interrupt it. Table 9 shows the same criteria, but expressed as maximum U-factors.*

	Climate Region						
	Hot and Dry	Hot and Humid	Temperate and Humid	Temperate Mixed	Cool and Humid	Cool and Dry	Cold and Humid
	(Phoenix)	(Orlando)	(Atlanta)	(Seattle)	(Boston)	(Denver)	(Minneapolis)
<b>Roofs</b>							
Insulation Entirely above Deck	R-15 ci	R-15 ci	R-15 ci	R-15 ci	R-15 ci	R-15 ci	R-15 ci
Attic and Other	R-30	R-30	R-30	R-30	R-30	R-30	R-38
<b>Walls, Above Grade</b>							
Mass	NR	NR	R-5.7 ci	R-5.7 ci	R-7.6 ci	R-7.6 ci	R-9.5 ci
Steel Framed	R-13	R-13	R-13	R-13	R-13+3.8 ci	R-13+3.8 ci	R-13+3.8 ci
Wood Framed and Other	R-13	R-13	R-13	R-13	R-13	R-13	R-13
<b>Wall, Below Grade</b>							
Below Grade Wall	NR	NR	NR	NR	NR	NR	NR
<b>Floors</b>							
Mass	R-4.2 ci	R-4.2 ci	R-6.3 ci	R-6.3 ci	R-8.3 ci	R-8.3 ci	R-8.3 ci
Steel Joist	R-19	R-19	R-19	R-19	R-19	R-19	R-30
Wood Framed and Other	R-19	R-19	R-19	R-19	R-30	R-30	R-30
<b>Slab-On-Grade Floors</b>							
Unheated	NR	NR	NR	NR	NR	NR	NR
Heated	R-7.5@12 in.	R-7.5@12 in.	R-7.5@12 in.	R-7.5@24 in.	R-10@36 in.	R-10@36 in.	R-10@36 in.

Note: “ci” means continuous insulation. “NR” means no requirement.



**Table 9 – Maximum U-factors from ASHRAE/IESNA Standard 90.1-2001**

This table shows the component performance building envelope criteria from Standard 90.1, expressed as maximum U-factors. The columns show the criteria for each of the seven climate zones (and representative cities) covered by the National Best Practices Manual. The rows show the criteria for various classes of construction. The designation “ci” means that the insulation must be installed in a continuous manner so that framing members do not interrupt it. Table 8 shows the same criteria, but expressed as minimum R-values.

	Climate Region						
	Hot and Dry	Hot and Humid	Temperate and Humid	Temperate Mixed	Cool and Humid	Cool and Dry	Cold and Humid
	(Phoenix)	(Orlando)	(Atlanta)	(Seattle)	(Boston)	(Denver)	(Minneapolis)
<b>Roofs</b>							
Insulation Entirely above Deck	0.063	0.063	0.063	0.063	0.063	0.063	0.063
Attic and Other	0.034	0.034	0.034	0.034	0.034	0.034	0.027
<b>Walls, Above Grade</b>							
Mass	NR	NR	0.151	0.151	0.123	0.123	0.104
Steel Framed	0.124	0.124	0.124	0.124	0.084	0.084	0.084
Wood Framed and Other	0.089	0.089	0.089	0.089	0.089	0.089	0.089
<b>Wall, Below Grade</b>							
Below Grade Wall	NR	NR	NR	NR	NR	NR	NR
<b>Floors</b>							
Mass	0.137	0.137	0.107	0.107	0.087	0.087	0.087
Steel Joist	0.052	0.052	0.052	0.052	0.052	0.052	0.038
Wood Framed and Other	0.051	0.051	0.051	0.051	0.033	0.033	0.033
<b>Slab-On-Grade Floors (F-factor)</b>							
Unheated	NR	NR	NR	NR	NR	NR	NR
Heated	1.020	1.020	1.020	0.950	0.840	0.840	0.840

Note: “ci” means continuous insulation. “NR” means no requirement.

The requirements of Standard 90.1 are code minimums. The cost effective levels of insulation for schools exceeds these values and are shown in Table 10 and Table 11. These recommendations are based on:

**Table 10 – Recommended Minimum R-values for Schools**

This table shows the recommended minimum R-values for building envelope components in schools. The columns show the criteria for each of the seven climate zones (and representative cities) covered by the National Best Practices Manual. The rows show the criteria for various classes of construction. The designation “ci” means that the insulation must be installed in a continuous manner so that framing members do not interrupt it. Table 11 shows the same recommendations, but expressed as maximum U-factors.

	Climate Region						
	Hot and Dry	Hot and Humid	Temperate and Humid	Temperate Mixed	Cool and Humid	Cool and Dry	Cold and Humid
	(Phoenix)	(Orlando)	(Atlanta)	(Seattle)	(Boston)	(Denver)	(Minneapolis)
<b>Roofs</b>							
Insulation Entirely above Deck	R-20 ci	R-20 ci	R-20 ci	R-20 ci	R-20 ci	R-20 ci	R-20 ci
Attic and Other	R-38	R-38	R-38	R-38	R-38	R-38	R-60
<b>Walls, Above Grade</b>							
Mass	R-7.6 ci	R-7.6 ci	R-9.5 ci	R-11.4 ci	R-13.3 ci	R-13.3 ci	R-15.2 ci
Steel Framed	R-13+3.8 ci	R-13+3.8 ci	R-13+7.5 ci	R-13+7.5 ci	R-13+7.5 ci	R-13+7.5 ci	R-13+7.5 ci
Wood Framed and Other	R-13	R-13	R-13	R-13	R-13+7.5 ci	R-13+7.5 ci	R-13+7.5 ci
<b>Wall, Below Grade</b>							
Below Grade Wall	NR	NR	NR	R-7.5 ci	R-7.5 ci	R-7.5 ci	R-7.5 ci
<b>Floors</b>							
Mass	R-8.3 ci	R-8.3 ci	R-8.3 ci	R-10.4 ci	R-12.5 ci	R-12.5 ci	R-14.6 ci
Steel Joist	R-30	R-30	R-30	R-30	R-30	R-30	R-38
Wood Framed and Other	R-30	R-30	R-30	R-30	R-30	R-30	R-30
<b>Slab-On-Grade Floors</b>							
Unheated	NR	NR	NR	NR	R-10@24 in.	R-10@24 in.	R-15@24 in.
Heated	R-7.5@12 in.	R-7.5@12 in.	R-10@36 in.	R-10@36 in.	R-10	R-10	R-15

Note: “ci” means continuous insulation. “NR” means no requirement.

**Table 11 – Recommended Maximum U-factors for Schools**

This table shows the recommended maximum U-factors for building envelope components in schools. The columns show the criteria for each of the seven climate zones (and representative cities) covered by the National Best Practices Manual. The rows show the criteria for various classes of construction. The designation “ci” means that the insulation must be installed in a continuous manner so that framing members do not interrupt it. Table 10 shows the same recommendations, but expressed as minimum R-values.

	Climate Region						
	Hot and Dry	Hot and Humid	Temperate and Humid	Temperate Mixed	Cool and Humid	Cool and Dry	Cold and Humid
	(Phoenix)	(Orlando)	(Atlanta)	(Seattle)	(Boston)	(Denver)	(Minneapolis)
<b>Roofs</b>							
Insulation Entirely above Deck	0.048	0.048	0.048	0.048	0.048	0.048	0.048
Attic and Other	0.027	0.027	0.027	0.027	0.027	0.027	0.017
<b>Walls, Above Grade</b>							
Mass	0.123	0.123	0.104	0.090	0.080	0.080	0.071
Steel Framed	0.084	0.084	0.064	0.064	0.064	0.064	0.064
Wood Framed and Other	0.089	0.089	0.089	0.089	0.051	0.051	0.051
<b>Wall, Below Grade (C-factor)</b>							
Below Grade Wall	C-1.140	C-1.140	C-1.140	C-0.119	C-0.119	C-0.119	C-0.119
<b>Floors</b>							
Mass	0.087	0.087	0.087	0.074	0.064	0.064	0.057
Steel Joist	0.038	0.038	0.038	0.038	0.038	0.038	0.032
Wood Framed and Other	0.033	0.033	0.033	0.033	0.033	0.033	0.033
<b>Slab-On-Grade Floors (F-factor)</b>							
Unheated	F-0.730	F-0.730	F-0.730	F-0.730	F-0.540	F-0.540	F-0.520
Heated	F-1.020	F-1.020	F-0.840	F-0.840	F-0.550	F-0.550	F-0.440

Note: “ci” means continuous insulation

## Design Tools

The thermal performance of construction assemblies can be calculated in many ways. The appropriate method depends on the type and complexity of construction. The basic calculation methods include:

- **Series Calculation Method.** This is the easiest way of calculating U-factor, but its use is limited to constructions that have no framing and are made of homogenous materials.
- **Parallel Path Calculation Method.** This simple extension of the series calculation method can be used for wood-framed assemblies.
- **Effective R-value (Isothermal Planes).** This method uses principles similar to the series and parallel path calculation methods, and is appropriate for construction assemblies such as concrete masonry and metal-framed walls/roofs where highly conductive materials are used in conjunction with insulated or hollow cavities.
- **Two-Dimensional Calculation Method.** Two-dimensional heat flow analysis may be used to accurately predict the U-factor of a complex construction assembly. Calculating two-dimensional heat flow involves advanced mathematics and is best performed with a computer.
- **Testing.** This is the most accurate way to determine the U-factor for all types of construction, except slabs-on-grade. But it is costly and time consuming, and because a large variety of possible construction assemblies exist, it is impractical to test them all. Calculation methods are usually more cost-effective.

Table 12 provides guidelines on which method can be used with different types of construction assemblies.

Table 12 – Procedures for Determining U-factors for Opaque Assemblies

	Series Calculation Method	Parallel Path Calculation Method	Effective R-value (Isothermal Planes)	Two-dimensional Calculation Method	Testing
<b>Roofs</b>					
Insulation above Deck	✓			✓	✓
Attic (wood joists)		✓		✓	✓
Attic (steel joists)			✓	✓	✓
Other				✓	✓
<b>Walls</b>					
Mass			✓	✓	✓
Wood Framed		✓		✓	✓
Steel Framed			✓	✓	✓
Other				✓	✓
<b>Below-Grade Walls</b>					
Mass			✓	✓	✓
Other				✓	✓
<b>Floors</b>					
Mass	✓		✓	✓	✓
Steel Joist			✓	✓	✓
Wood Framed		✓	✓	✓	✓
Other				✓	✓

### Computer Programs

The calculation methods described above are implemented several design tools and computer programs.

- The Therm program available from Lawrence Berkeley National Laboratory is designed primarily to analyze window frames, but can be used for any type of two-dimensional heat transfer analysis. This program can be downloaded from [http://windows.lbl.gov/software/therm/therm\\_getacopy.htm](http://windows.lbl.gov/software/therm/therm_getacopy.htm).
- General-purpose energy simulation programs such as DOE-2 and EnergyPlus can be used to calculate the energy savings of various construction assemblies. With these programs, the dynamics of heat transfer are modeled. In fact, EnergyPlus models the temperature gradient in constructions. DOE-2, on the other hand, uses a more simple response factor method. Energy-10, available from SBIC, is a simple energy-modeling program that architects can use. It is very limited in capabilities but can provide quick relative analysis for simple buildings.

### Pre-calculated Data

The U-factor of common constructions has been calculated and values are published in several sources.

- Appendix A of ASHRAE/IESNA Standard 90.1-1999 has published values in both inch-pound and metric (SI) units. Constructions include walls, roofs, floors, slabs, and below-grade walls. These values are also contained in the EnvStd 4.0 computer program, which can be downloaded from <http://www.eley.com>.

## ***Indoor Air Quality and Moisture***

It is extremely important to provide an exterior weather barrier with drainage plane to prevent moisture from entering construction cavities. It is also very important to design a wall, roof, and foundations system, so that if water enters, it can dry out. Wet or damp construction cavities, attics, and plenums are a major source of mold and can contribute significantly to IAQ problems. In addition, moisture can damage the structure and degrade the performance of insulation, increasing energy and operating costs. Many IAQ complaints received by local schools are related to leaky roofs that have resulted in the growth of mold in a plenum, wall system, attic space, or in part of a foundation space such as a crawl space or utility trench.

Water vapor can also enter construction cavities through a process of moisture migration. Moisture migrates from the warm and humid side of the construction assembly to the cold dry side of the construction assembly. The vapor cools as it moves through the wall and, as it reaches dewpoint conditions, may condense into water molecules that can accumulate to cause damage and create mold. Moisture also follows air leakage through a construction assembly. To prevent water vapor migration, framed walls, floors, and roofs should have a vapor barrier on the warm moist side. For non-humid climates, this means that the vapor barrier should be on the interior side, with the opposite being true for humid areas. Vapor barriers also are available as part of most insulation products and consist of an asphalt-impregnated paper or metal foil. Care should be taken during construction to ensure that this vapor barrier is continuous, tightly secured at the framing members, and not damaged. Special care should be taken in lockers, showers, food preparation areas, and other spaces that are likely to have high humidity.

In addition to correctly installing a vapor retarder, it is important to provide adequate ventilation to dry spaces where moisture can build up. Most building codes require that attics and crawl spaces be ventilated, and some require a minimum one-inch clear airspace above the insulation for ventilation of vaulted ceilings. Even the wall cavity may need to be ventilated in extreme climates. An infiltration barrier should be installed under slabs with ventilated gravel in areas with soil gas contaminants like radon or methane.

## ***Air Infiltration***

Controlling infiltration is very important to achieving energy-efficient buildings. Air leakage introduces sensible heat into conditioned and semi-heated spaces. In climates with moist outdoor conditions during the day or night, it is also a major source of latent heat. Latent heat must be removed by the air conditioning system at considerable expense. Many state building codes require air barriers in walls and roofs to control air leakage. These barriers must be durable or maintainable. They also must be capable of withstanding both positive and negative pressure as well as transferring loads to the structure, which means they must permanently adhere to a durable substrate or be sandwiched between materials like gypsum sheathing and rigid insulation. The barriers must be continuous with all adjacent envelope parts and tie continuously to the foundation, the roof air barrier, and across all control, construction, and expansion joints.

## ***Insulation Protection***

Insulation should be protected from sunlight, moisture, landscaping equipment, wind, and other physical damage. Rigid insulation used at the slab perimeter of the building should be covered to prevent damage from gardening or landscaping equipment. Rigid insulation used on the exterior of walls and roofs should be protected by a permanent waterproof membrane or exterior finish, and often a drainage plane is required behind most EFIS systems to allow wind-driven rain to escape. In cold climates, mechanical or other equipment should not be installed in attics, since it can generate heat and cause uneven snow melting and ice dams. For moderate climates, access to equipment installed in attic spaces should be provided in a way that will not cause compression or damage to the insulation, which may mean using walking boards, access panels, and other techniques.

In situations where insulation is left exposed (including return air plenums), fiberglass insulation products should be encapsulated in a manner that prevents fibers from becoming airborne. To maintain a continuous vapor barrier, all seams should be sealed with tape or mastic. In this application, simply stapling the insulation is not adequate.

## ***Material Efficiency and Other Environmental Considerations***

One of the most effective ways to achieve material efficiency in a building is to reuse all or part of an existing building enclosure. This reduces solid waste produced by a project and avoids the environmental burdens associated with production and delivery of materials for a new building enclosure. Saving the building enclosure, however, may not be appropriate if the existing structure is not energy efficient and cannot be adequately upgraded to meet high performance objectives.

When designing a new building enclosure, material efficiency can be achieved by:

- Using panelized, pre-cut, and engineered construction products.
- Designing with standard dimensions to reduce on-site waste.
- Designing a compact building (this also reduces impervious surface on the site, but may conflict with daylighting objectives).
- Planning for future adaptability to extend the life of the building.
- Choosing durable materials and systems.

In addition, building enclosure and insulation materials exist that are recyclable, include recycled or resource-efficient content, or have other environmentally preferred characteristics. The materials may, for example, avoid introducing toxics into the building or natural environment, or they may be produced using environmentally friendly methods. In addition to the design strategies above, refer to Table 13 below for some easily achievable strategies that will improve the resource efficiency of the building enclosure and insulation.

Table 13 – Strategies for Constructing Resource-Efficient Building Enclosures

Building Component	Strategies	Environmental Benefits & Considerations
Foundation and Concrete Work	For concrete materials, specify flyash as replacement, not addition. 10%–25% replacement is commonly specified, but higher percentages are possible, depending on application.	Formerly landfilled as industrial waste, flyash is now used to replace energy-intensive Portland cement in concrete mix. Flyash adds workability and strength.
	Use autoclaved and/or aerated concrete for appropriate concrete applications.	Aerated concrete is lighter and has better insulating properties than standard concrete.
	Prohibit dumping concrete waste anywhere intended to be pervious.	Prevents degradation of the site and permits infiltration.
	Use steel rather than wood forms.	Although energy intensive, steel is reusable, contains recycled content and can be recycled at the end of service life.
	If wood forms are used, reuse wood in framing and sheathing.	Reduces resources used. Reduces waste.
	Use low and non-toxic form releases. Bio-based products are available.	Prevents soil contamination, and reduces human health risk. Promotes worker safety. Water-based products should be protected from freezing during storage.
	Use expansion joint fillers with recycled content.	Appropriate use of recycled, relatively low-strength materials, such as waste cellulose from recycled newspapers.
	Use rebar supports with recycled content. DOT-approved products are available with 100% recycled content, including engineered plastics and fiberglass.	Rebar supports in concrete form-work have minimal structural requirements; appropriate use of recycled waste plastic.
	If using ICFs, use options with ozone-friendly foam ingredients. (ICFs are permanent forms with integral insulation that are not disassembled after the concrete is cured. Note: not all ICFs are alike; field R-values can differ significantly so rely on results from completed projects.)	ICFs can provide significant improvements in energy efficiency and can reduce the use of energy-intensive Portland cement. Using ozone-friendly options (with EPS foam) eliminates a source of global warming.
	Use sill sealers to limit infiltration at the foundation.	Increases energy efficiency.
Use sub-slab ventilation in areas with radon or potential soil gas submissions.	Improves indoor air quality.	

Table 13 – Strategies for Constructing Resource Efficient Building Enclosures (Continued)

Building Component	Strategies	Environmental Benefits & Considerations
Masonry Walls	Use mortar dropping control product to prevent blocking of weep holes. Product available with 100% recycled polyethylene.	Maintains air flow and allows moisture migration from behind masonry veneer facades. Improves building durability.
	For concrete masonry units (CMUs): maximize recycled content. Typically available with 10% recycled content.	Reduces resources used to produce new CMU material. No difference in product performance or application.  Products are high strength, highly fire resistant, and highly durable.
	For CMUs: use CMUs containing flyash.	Formerly landfilled as industrial waste, flyash is now used to replace energy-intensive Portland cement in concrete mix. Flyash adds workability and strength.
	For CMUs: consider using lightweight CMUs.	Reduces transportation-related impacts.
	For CMUs: pull watermark line down below window framing to eliminate finishing details.	Reduces maintenance over the life of the building.
	For CMUs: do not paint, order with color.	Avoids resources used to produce paint. Avoids use of VOC-emitting paints generally used to finish CMUs. The pigments typically used in colored CMU are nontoxic and contain none of the solvents associated with painting and re-painting. Products are low maintenance.
Steel Framing	Use systems with highest level of recycled content. Although steel may have as little as 25% recycled content, most structural steel framing has as much as 90% or more. Many load-bearing stud systems include up to 60% recycled content.	High recycled-content steel uses less embodied energy, and minimizes mining waste and pollution associated with virgin steel production. Also generally reduces job site waste, as waste steel is highly recyclable. Transportation of steel uses less energy and creates less pollution compared to dimensional lumber due to weight.  Steel conducts heat efficiently. When using light-gauge steel, ensure that insulation is adequate to prevent thermal bridging and heat loss.
	Use fireproofing available with recycled EPS foam and recycled newsprint.	Traditionally, products contained fiberglass and asbestos for this use. More benign products that make efficient use of recycled materials are preferable.
Wood Framing	Use advanced or intermediate framing systems where applicable and accounting for seismic requirements for building site. Example framing elements include 24 in. on-center framing, insulated headers, two stud corners with drywall clips, ladder partitions. References: <i>Builder's Guide</i> – Building Science Corporation, and <i>Efficient Wood Use in Residential Construction</i> – Natural Resources Defense Council.	This both allows for more insulation, less "cold" spots, and increased wood efficiency, thus improving both energy and materials efficiency.
	Use engineered wood products in place of dimensional lumber such as floor joists and roof joists.	Engineered wood products are lighter weight and use fewer resources for the same function as dimensional timbers.
	Use wood certified with FSC or SCS. A variety of certified dimensional and engineered wood products are available.	Prevents degradation to forest and wildlife habitat.



Table 13 – Strategies for Constructing Resource Efficient Building Enclosures (Continued)

Building Component	Strategies	Environmental Benefits & Considerations
Siding	Use fiber cement siding. Most available factory primed; suggest back priming. Proper painting is important for the siding's long-term durability.	Reduces virgin wood use and can be a durable option.
Roofing	Use metal roofing.	Includes recycled content, is durable, and can be recycled at the end of service life.
	Consider a green or vegetated roof system for low-slope roofs. These roofs contain plants in a lightweight soil to absorb and slow runoff that would otherwise pour from rooftops. These roof systems typically consist of drainage, soil, and vegetation layers. Be sure to use native plants and grasses in green roof systems.	Can absorb and slow rainwater runoff to reduce peak loads on sewer systems. Helps reduce building heat gain and prevents urban heat islands. Plantings also absorb carbon dioxide. Helps conserve energy in the winter by insulating rooftops.  Green roofs, however, require structural steel to support their weight. Because steel has high-embodied energy, this may offset some of the environmental benefits of using green roofs.
Moisture and Waterproofing	Sealants and repellants: Limit use of sealants through proper detailing. Use least-toxic options. Avoid products containing methylene chloride, chlorinated hydrocarbons, aromatic and aliphatic solvents, styrene butadiene, or products containing bactericides and fungicides classified as phenol mercury acetates, phenol phenates, or phenol formaldehyde.	Combining good detailing and low toxicity will prevent air quality problems while promoting long service life of the building.
	Do not rely on caulking for waterproofing. Proper flashing will prevent water from entering the building.	In addition to adding durability to shell, proper flashing prevents mold and mildew build up, reducing health risk.
	If using a vapor retarder, select film available with up to 100% LDPE (plastic).	Utilizes plastic waste that would otherwise be landfilled. Reduces resources required to produce virgin-based material.
Insulation	Use fiberglass insulation with up to 30% verified (SCS) recycled content. Formaldehyde-free fiberglass option also available (price premium).	Uses glass collected at curbside recycling programs. Formaldehyde-free option promotes good indoor air quality and promotes worker safety.
	Use cellulose insulation produced with 100% recycled newsprint.	Utilizes paper waste that would otherwise be put in landfills.
	If using rigid insulation with polyisocyanurate foam, use ozone-friendly option.	Prevents further degradation of the earth's atmosphere through global warming.
Exterior Doors (for window recommendations, see Daylighting chapter)	Use doors produced with reclaimed lumber.	Reduces pressure on timber supply, as well as degradation of forest habitat.

Source: Adapted from *GreenSpec: The Environmental Building News Product Directory and Guideline Specifications*

# GUIDELINE EB1: WALL INSULATION

## Recommendation

**Wood-Framed Walls.** Install a minimum of R-13 cavity insulation in all climates. In the Cool and Humid, Cold and Humid, and Cool and Dry climates, also install R-7.5 insulating sheathing. See Table for equivalent U-factor recommendations.

**Metal-Framed Walls.** Install a minimum of R-13 cavity insulation in all climates. In the Hot and Humid and Hot and Dry climates, also install R-3.8 continuous insulating sheathing. In the other climates, use R-7.5 continuous insulating sheathing.

**Mass Walls.** Install R-7.6 continuous insulation in the Hot and Dry and Hot and Humid climates. Upgrade this to R-9.5 in the Temperate and Humid climate, to R-13.3 in the Cool and Humid and Cool and Dry climates, and to R-15.2 in the Cold and Humid climate. Higher levels of insulation may be appropriate depending on local climate.

Note: Even though R-13 is recommended for both wood-framed and metal-framed walls, the U-factor, or overall thermal performance, will be better for wood-framed walls since the metal studs are more conductive.



*Well-insulated and sealed walls can result in smaller HVAC equipment and reduced costs. NREL/PIX 11418*

### Applicable Climates



## Description

The construction of exterior walls affects comfort, operating costs, acoustic separation, and the size of heating and cooling systems. The class of construction (wood-framed, steel-framed, or mass) is usually determined by size and height of a building, budget, requirements for fire separation between spaces, durability, or other issues. The recommended insulation levels for these classes are based on life-cycle cost analysis and are presented separately for each class and climate region. More insulation is justified in colder climates and less in more temperate climates.

Concepts of thermal heat transfer are presented in this chapter's Overview and should be reviewed, since they apply to walls as well as other building enclosure components.

<p>Applicable Spaces</p> <ul style="list-style-type: none"> <li>Classrooms</li> <li>Library</li> <li>Multi-Purpose</li> <li>Gym</li> <li>Corridors</li> <li>Administration</li> <li>Toilets</li> <li>Other</li> </ul>	<p>When to Consider</p> <ul style="list-style-type: none"> <li>Programming</li> <li>Schematic</li> <li>Design Dev.</li> <li>Contract Docs.</li> <li>Construction</li> <li>Commissioning</li> <li>Operation</li> </ul>
---	---

## Applicability

These recommendations apply to all exterior walls in all spaces that are heated or cooled. Design decisions that affect wall thickness must be considered in the schematic design phase of the project.

## Integrated Design Implications

Well-insulated and sealed walls with a continuous air barrier sealed to all adjacent materials can reduce moisture intrusion from wind-driven rain, cold drafts, and thermal loads in buildings, which can result in smaller HVAC equipment and reduced costs.

## Cost Effectiveness

The cost of insulating the cavity of wood- and steel-framed walls is low, but the value of this insulation is also low because of the thermal compromising of the system by the studs, especially with metal framing. Continuous insulation is required by the building code and is most cost effective outboard of the framing. Once a significant layer of continuous insulation has been provided, the actual R-value of the insulation between the studs is significantly improved because the temperature gradient from one side of the studs to the other is much smaller.

Costs	L			
	M		■	
	H		■	
		L	M	H
		Benefits		

However, insulating mass walls is more difficult and expensive. Insulating the cavity of mass walls is not very effective because of thermal bridges across the concrete webs, and seismic safety requires that most of the hollow cells be grouted and reinforced. The most effective way to insulate mass walls is to use an Exterior Insulation Finish System (EIFS), which costs \$7/ft<sup>2</sup> for 1-in. insulation and \$8/ft<sup>2</sup> for 2-in. insulation. If budget permits, this is the preferred method, since the benefits of the thermal mass are maximized. As an alternative, steel or wood furring can be used on the interior of the wall, batt insulation can be placed in the cavities between the furring strips, and gypsum board can be used as the interior finish.



*Rigid Insulation is the most effective way to insulate metal studs.*

NREL/PIX 11419

## Benefits

Insulating walls and reducing air infiltration has several important benefits for high performance schools:

- Energy use is reduced.
- Natural ventilation can be used for a greater number of hours.
- Indoor air quality is improved by reduced mold and mildew.
- Smaller HVAC equipment can be purchased, which can reduce initial cost.
- Greater acoustic separation is provided from the outdoors.
- Spaces are more comfortable because the interior surface temperature will be closer to room temperature, which provides more uniform interior temperatures and can reduce drafts.

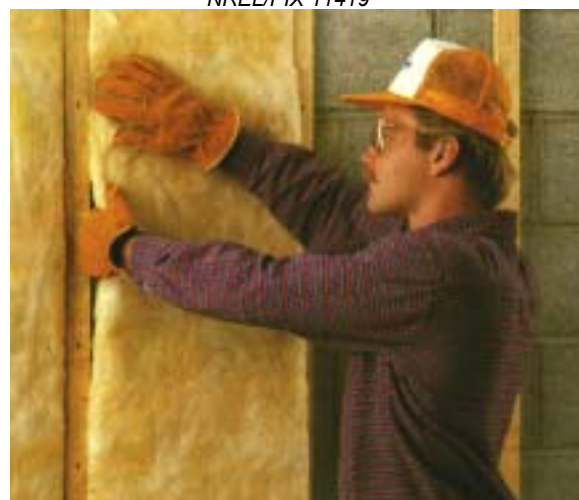

*Masonry walls can be insulated on the interior, but the benefits of thermal mass are mostly lost.*

NREL/PIX 11420

## Design Tools

The Overview section of this chapter discusses methods and procedures for calculating U-factors. Energy simulation programs are recommended for

analyzing insulation options for mass walls, because of the time delays and dynamic effects inherent with this type of construction.

### ***Design Details***

- For framed walls in cold climates, provide a continuous vapor barrier on the inside surface of walls. However, for hot, humid climates and air-conditioned buildings, the vapor barrier should be placed on the exterior. If the vapor barrier that comes with batt insulation is used, then the paper or foil should be stapled to the face of the studs, not the inside. This will provide a more secure and continuous vapor barrier and will reduce compression of insulation.
- Provide a continuous air barrier that is durable or maintainable. Provide details that demonstrate how it is tied to the foundation, windows, and doors; between different wall systems; to the roof; across construction, control, and expansion joints; and to wall, floor, and roof utility, pipe, and duct penetrations.
- For wood framing in the Hot and Dry, Cool and Humid, and Cool and Dry climates, use 2x6 framing. The studs should be spaced at 24 in. on center (o.c.), the headers over doors and windows should be insulated with rigid insulation, and minimum wood framing should be used at corners, wall intersections, and openings.
- EIFS systems used with mass walls should be installed according to manufacturers' instructions. Make sure that the exterior finish is durable and weather resistant. Include a drainage plane to prevent moisture from being trapped in the wall.
- Electrical and mechanical equipment should be minimized for exterior walls. Equipment such as electrical outlets and other recessed equipment can create thermal bridges and increase infiltration. If insulation is used in stud cavities, exterior wall outlet boxes should be provided with air-tight back boxes that are sealed both around wires and to the gypsum wall board. Outlets can also often be located on wing and interior walls.
- For wood-framed walls, use wood products that are produced through environmentally friendly forest practices. Require that framing members be certified by the Forest Stewardship Council.
- For metal-framed walls, specify that the steel used for manufacturing have 30% recycled content.
- Seal drywall at the top and bottom of the walls to ensure a continuous air barrier.

### ***Operation and Maintenance Issues***

Exterior and interior wall finishes must be maintained. The interior finish should be maintained for aesthetic reasons, but also light colors should be maintained to enhance the performance of the electric lighting and daylighting systems. Exterior surfaces should be maintained to be waterproof or water resistant and secure. This is important to prevent water from entering construction cavities, which can cause the growth of mold, damage the structure, and deteriorate the performance of thermal insulation. Mold can be a major source of indoor air quality problems and needs to be avoided. All wall systems must be designed to let moisture that may enter from the wind-driven rain to escape back out.

### ***Commissioning***

No commissioning of exterior walls is needed other than normal construction administration.

### ***References/Additional Information***

See this chapter's Overview.

## GUIDELINE EB2: ROOF INSULATION

### Recommendations

**Insulation Entirely Above Deck.** Install R-20 insulation above the structural deck. The thickness of the insulation will depend on the type of insulation that is used.

**Attic and Other Construction.** Install R-38 insulation in all climates except the Cold and Humid climate, where R-60 insulation should be used.

### Description

The construction of roof assemblies affects comfort, operating costs, acoustic separation, and the size of heating and cooling systems. The class of construction (wood-framed, steel-framed, or mass) is usually determined by the size and height of the building, requirements for fire separation between spaces, durability, or other issues. The recommended insulation levels for these classes are based on life-cycle cost analysis and are presented separately for each class and climate region. More insulation is justified in colder climates, with less in more temperate climates.

Concepts of thermal heat transfer are presented in the Overview to this chapter and should be reviewed, since they apply to roofs as well as other building enclosure components.

### Applicability

This roof insulation guideline is applicable for all spaces in schools that are heated or cooled. The class of construction is usually determined in schematic design, but the insulation level can be set in design development or even contract documents.

### Integrated Design Implications

Well-insulated roofs and roof cavities can reduce drafts and thermal loads in buildings. HVAC ducts located in ceiling cavities can be leaky and can be a significant component of thermal loads. These losses are far less significant when ducts are located in sealed and insulated ceiling cavities. Reduced loads can result in smaller HVAC equipment and reduced costs.

### Cost Effectiveness

The cost of roof insulation varies with the class of construction. Insulating attics and the cavity of wood- and steel-framed roof assemblies is low since labor is minimal and the roof cavity is readily accessible during construction. Rigid insulation installed over structural decks is more expensive because of construction details and the added cost of rigid insulation.



*Well-insulated roofs and roof cavities can reduce drafts and thermal loads in buildings. NREL/PIX 11421*

### Applicable Climates



### Applicable Spaces

Classrooms	■
Library	■
Multi-Purpose	■
Gym	■
Corridors	■
Administration	■
Toilets	■
Other	■

### When to Consider

Programming	□
Schematic	□
Design Dev.	■
Contract Docs.	□
Construction	□
Commissioning	□
Operation	□

Costs	L	□	□	□
	M	□	■	□
	H	□	□	■
		L	M	H
		Benefits		

## **Benefits**

Insulating roofs and ceilings has several important benefits for high performance schools:

- Energy use is reduced.
- Natural ventilation can be used for a greater number of hours.
- Smaller HVAC equipment can be purchased, which can reduce initial cost.
- Spaces are more comfortable because the interior surface temperature will be closer to room temperature, which provides more uniform interior temperatures and can reduce drafts.

## **Design Tools**

This chapter's Overview discusses methods and procedures for calculating U-factors. Energy simulation programs are recommended for analyzing insulation options for mass roofs.

## **Design Details**

- For attics with sloped roofs, make sure that the insulation over the ceiling has full depth all the way to the edge. This may mean installing a raised heel truss or other special construction techniques. There are two reasons for this. The first is to provide a continuous and effective thermal barrier, but another equally important reason is to assure that the temperature of the roof is constant. If the insulation is thinner near the edge, then more heat escapes at the eave. This can cause snow to melt near the eave, only to freeze again as an ice dam. This can cause water leakage as well as structural damage to the roof and building.
- Do not locate heat-producing equipment such as furnaces, water heaters, or air handlers in attics because these can cause uneven roof temperatures that could result in ice dams (see above).
- Insulation should not be installed in exposed applications or in return air plenums. If no other location is possible, it should be either encapsulated or otherwise sealed from contact with moving air. It should never be left exposed.
- Make sure that insulation is dry before walls or other cavities are enclosed. Moisture in building cavities can be a source of mold, which can cause building damage and indoor air contamination.
- Do not install insulation over suspended ceilings, because the insulation's continuity is likely to be disturbed by maintenance workers. Also, a suspended ceiling is a poor barrier to infiltration. If the insulation is located at the ceiling, many building codes will consider the space above the ceiling to be an attic and require that it be ventilated to the exterior. If vented to the exterior, air in the attic could be quite cold (or hot) and the impact of the leaky suspended ceiling would be worsened.
- Use type IC light fixtures in insulated gypsum board ceilings.
- Consider recycled insulation materials for attics and other places where loose-fill insulation is used. If cellulose (recycled paper) is used, make sure that the chemicals used as a fire retardant contain no VOCs and are not a possible source of pollution.

## **Operation and Maintenance Issues**

The roof membrane must be maintained to prevent moisture from entering. Moisture in ceiling/roof constructions is a source of mildew, which causes serious indoor air quality problems. Insulation materials themselves require no maintenance. Roof drainage systems must be maintained on low-pitch roofs.

## **Commissioning**

No commissioning is needed for roof insulation systems.

## **References/Additional Information**

See this chapter's Overview.



## GUIDELINE EB3: COOL ROOFS

### Recommendation

In air-conditioned buildings, use a roof surface that is light in color (high reflectance), yet has a non-metallic finish (high emissivity). Asphalt roofs with a cap sheet and modified bitumen roofs should be coated with a material having an initial reflectance greater than 0.7 and an emittance<sup>1</sup> greater than 0.8. Single-ply roofing material should be selected with the same surface properties.

### Description

Solar gain on roofs is a significant component of heat gain, and using materials that have a high reflectance and a high emittance can significantly reduce the load. The high reflectance keeps much of the sun's energy from being absorbed. The high emittance allows radiation to the sky. Cool roofs are typically white and have a smooth texture. Commercial roofing products that qualify as cool roofs fall in two categories: single-ply and liquid-applied. Examples of single-ply products include:

- White PVC (polyvinyl chloride)
- White CPE (chlorinated polyethylene)
- White CPSE (chlorosulfonated polyethylene, e.g. Hypalon)
- White TPO (thermoplastic polyolefin).

Liquid-applied products may be used to coat asphalt cap sheets, modified bitumen, and other substrates. Products include:

- White elastomeric coatings
- White polyurethane coatings
- White acrylic coatings
- White paint (on metal or concrete).

Cool roofs are becoming available in different colors. Table 14 shows reflectance and emittance for some typical roofing products.



*Because solar gain on roofs is a significant component of heat gain, using materials that have a high reflectance can significantly reduce the load. NREL/PIX 03510*

### Applicable Climates



### Applicable Spaces

Classrooms	█
Library	█
Multi-Purpose	█
Gym	█
Corridors	█
Administration	█
Toilets	█
Other	█

### When to Consider

Programming	█
Schematic	█
Design Dev.	█
Contract Docs.	█
Construction	█
Commissioning	█
Operation	█

<sup>1</sup> Heat radiated from a roof surface is proportional to the 4<sup>th</sup> power of the absolute temperature and depends on emittance. Emittance is the ratio of radiant heat flux emitted by a specimen to that emitted by a black body at the same temperature and under the same conditions.

Table 14 – Solar Reflectance and Emittance of Different Roofing Materials.

Source: Berdahl and Bretz 1995, Akbari 1990, Parker et al. 1993, LBNL Cool Roofing Materials Database

	Material	Total Solar Reflectance	Emittance
Reflective Coatings	Elastomeric coating over asphalt shingle	0.71	0.91
	Aged elastomeric on plywood	0.73	0.86
	Elastomeric coating on shingle	0.65	0.89
	Aluminum pigmented roof coating	0.30 - 0.55	0.42 - 0.67
	Lo-mit on asphalt shingle	0.54	0.42
White Metal Roofing	Siliconized white	0.59	0.85
Single-Ply Roof Membrane	Black EPDM	0.06	0.86
	Grey EPDM	0.23	0.87
	White EPDM	0.69	0.87
	White T-EPDM	0.81	0.92
Paint	White	0.85	0.96
	Aluminum paint	0.80	0.40
Asphalt Shingles	Black	0.03 - 0.05	0.91
	Dark brown	0.08 - 0.10	0.91
	Medium brown	0.12	0.91
	Light brown	0.19 - 0.20	0.91
	Green	0.16 - 0.19	0.91
	Grey	0.08 - 0.12	0.91
	Light grey	0.18 - 0.22	0.91
	White	0.21 - 0.31	0.91

Note: Shaded products all have a reflectivity greater than 0.70 and an emittance greater than 0.80.

### Applicability

Cool roofs are applicable to all spaces in schools and to most climates. The benefits are less, however, in the Cool and Humid and Cold and Humid regions. To take advantage of equipment downsizing, cool roofs should be considered in the schematic design phase.

### Integrated Design Implications

Cool roofs can significantly reduce cooling loads, resulting in smaller air conditioning equipment or, in some cases, eliminating air conditioning entirely in favor of natural ventilation. Like all roofing systems, skylights and other roof penetrations, as well as the rooftop equipment mounts, should be considered when designing the roof. Equipment access should be provided in a manner that does not create undue wear or damage to the roof membrane.

### Cost Effectiveness

The additional cost for coating an asphalt cap sheet or modified bitumen roof is about \$1/ft<sup>2</sup> to \$2/ft<sup>2</sup>. The cost premium between a conventional single-ply roof membrane and one with a high reflectance (all have high emittance) is negligible.

Costs	L		
	M		
	H		
	L	M	H
	Benefits		

### Benefits

Cool roofs can save demand charges and energy charges. They are highly cost effective, especially in the Hot and Dry climate. However, there are other benefits as well. Since solar radiation (especially ultraviolet light) is a major cause of roof deterioration, cool roof coatings can significantly increase the life of the roof membrane. Cool roofs also can help make the whole community cooler by reducing the “heat island” effect.



## Design Tools

Cool roofs are effective for several complex reasons. They reflect heat from the sun, and assessing this benefit requires a model that accounts for the position and intensity of the sun. Sun that is absorbed by the roof (that which is not reflected) increases the surface temperature of the roof and induces heat gain in addition to that driven by temperature differences. At night and at other times, hot roof surfaces radiate heat to the cool night sky. This is a valuable benefit that requires knowledge of the roof surface temperature and the sky temperature. Because of the complexity of heat transfer related to cool roofs, energy simulation programs are necessary to accurately assess their benefits and must be tailored for the scheduled use of this particular school to accurately reflect energy savings.

Oak Ridge National Laboratory's Radiation Control Calculator can be used to estimate energy savings. See <http://www.ornl.gov/roofs+walls>.

## Design Details

- The performance of cool roofs is affected by the accumulation of dirt. Dirt accumulation can be reduced if roof surfaces slope at least 0.25 in./ft.
- When liquid-applied coatings are used, carefully select coatings that are compatible with the underlying substrate.
- Liquid-applied cool roof coatings should comply with ASTM Standard 6083-97 for durability and elongation and have a minimum thickness of 20 mils.



Elastomeric or other coating can be field applied to many roof substrates.

NREL/PIX 11472

## Operation and Maintenance Issues

To assure continued performance of cool roofs, they will need to be cleaned each year with a high-pressure water spray. (Verify that doing this does not void the product warranty.) Liquid-applied coatings may need to be refinished every five years or so.

## Commissioning

No commissioning is needed.

## References/Additional Information

- Akbari H., et al. 1997. "Peak Power and Cool Energy Savings of High-Albedo Roofs." *Energy and Buildings*, Berkeley, CA. Vol. 25, pp. 117 - 126.
- Akbari H. and S. Bretz. 1997. "Long Term Performance Of High-Albedo Roof Coatings." *Energy and Buildings*, Berkeley, CA. Vol. 25, pp. 159 - 167.
- Akbari H., et al. 1995. "Mitigation of Urban Heat Islands: Materials, Utility Programs and Updates." *Energy and Buildings*, Berkeley, CA, Vol. 22, pp. 255 - 265. Also Lawrence Berkeley National Laboratory Report LBL-36587, Berkeley, CA.
- Berdahl, P. and S. Bretz. 1997. "Preliminary Survey of the Solar Reflectance of Cool Roofing Materials." *Energy and Buildings - Special Issue on Urban Heat Islands and Cool Communities*, 25(2), pp. 149-158. Also, Lawrence Berkeley National Laboratory Report LBL-36020, Berkeley, CA.
- Berdahl, 2000. Cool Roofing Materials Database. Lawrence Berkeley National Laboratory, Berkeley, CA. <http://eetd.lbl.gov/coolroof/>.
- Gartland, L. 1999. "Cool Coatings Heat Up Savings." Trade Press Publishing Corporation.
- Parker D. S. et al. 1993. "Laboratory Testing of The Reflectance Properties of Roofing Materials." Florida Solar Energy Center Report FSEC-CR-670-93, Cocoa FL.
- Parker D.S. and S.F. Barkazi. 1997. "Roof Solar Reflectance and Cooling Energy Use: Field Results from Florida." *Energy and Buildings*, Berkeley, CA, Vol. 25, pp. 105 - 115.

- Simpson, J. R. and E. G. McPherson. 1997. "The Effects of Roof Albedo Modification on Cooling Loads of Scale Model Residences in Tucson, Arizona." *Energy and Buildings*, Berkeley, CA. Vol. 25, pp. 127 - 137.
- Taha, H. 1997. "Urban Climates and Heat Islands: Albedo, Evapo-transpiration, and Anthropogenic Heat." *Energy and Buildings*, Berkeley, CA. Vol. 25, pp. 99 - 103.
- U.S. Environmental Protection Agency. 1998. Roof Products MOU - Version 1.0.

## GUIDELINE EB4: RADIANT BARRIERS

### Recommendation

Use a radiant barrier in conjunction with attic construction in schools in all climates except for the Cool and Humid and Cold and Humid climates.

### Description

A radiant barrier is a surface with a low emittance that is installed at the ceiling of attics. The radiant barrier surface is usually aluminum foil or another shiny metallic finish that has a low emittance. A couple of installation methods exist. The least costly method is to use plywood or composition board with a film that is pre-applied to the board. An alternate, but more effective method, is to drape foil over the rafters before the sheathing is installed (see photo).



*Radiant barriers are recommended for hot and coastal climates, over spaces cooled by air conditioners or natural ventilation. NREL/PIX 11331*

Radiant barriers are effective because they reduce one of the major components of heat gain, which is radiation from the hot attic ceiling to the cooler attic floor. The amount of heat that is radiated from the attic ceiling to the floor is directly proportional to the emissivity of the surfaces. Uncoated plywood and most other conventional building materials have an emittance of about 0.8, while the surface of a radiant barrier has an emittance of around 0.1. The radiation component of heat transfer can, therefore, be as much as eight times lower than without a radiant barrier.

Radiant barriers are effective in reducing cooling loads, but not heating loads. Radiant barriers can also improve the system efficiency of HVAC air distribution ducts that are located in attics. Duct losses during cooling mode are proportional to the temperature difference between air inside the duct and the temperature of the attic. Radiant barriers reduce the temperature of the attic during cooling conditions, and therefore, duct system efficiency is improved.

### Applicable Climates



#### Applicable Spaces

Classrooms	<input checked="" type="checkbox"/>
Library	<input checked="" type="checkbox"/>
Multi-Purpose	<input checked="" type="checkbox"/>
Gym	<input type="checkbox"/>
Corridors	<input checked="" type="checkbox"/>
Administration	<input checked="" type="checkbox"/>
Toilets	<input checked="" type="checkbox"/>
Other	<input type="checkbox"/>

#### When to Consider

Programming	<input type="checkbox"/>
Schematic	<input type="checkbox"/>
Design Dev.	<input checked="" type="checkbox"/>
Contract Docs.	<input type="checkbox"/>
Construction	<input type="checkbox"/>
Commissioning	<input type="checkbox"/>
Operation	<input type="checkbox"/>

### Applicability

Radiant barriers are highly recommended in the hot climates. They can also be effective in coastal climates. They are recommended for attics over any spaces that are cooled by air conditioners or natural ventilation. Radiant barriers should be considered no later than the design development phase so that the HVAC equipment may be appropriately downsized.

### Integrated Design Implications

Radiant barriers directly reduce cooling loads, which can result in smaller air conditioners. HVAC air duct efficiency is also improved when air distribution ducts are located in attics.

## Cost Effectiveness

When applied to sheathing, the cost premium for radiant barriers is on the order of \$0.10/ft<sup>2</sup> to \$0.15/ft<sup>2</sup>. Cost is a little higher for draped installation, mainly because additional labor is required.

Costs	L	■		
	M			
	H			
		L	M	H
		Benefits		

## Benefits

Radiant barriers reduce cooling loads and energy costs. They can also result in smaller air conditioners, which can more than compensate for the added cost of the radiant barrier. Attics where radiant barriers are installed have a lower temperature, which results in improved HVAC duct efficiency and other benefits.

## Design Tools

Estimating the benefits of radiant barriers can be approximated by making an adjustment to the U-factor of the ceiling/roof construction. The problem with this approach is that radiant barriers only have a benefit in reducing cooling loads. In fact, they can have a slightly negative effect on heating loads, since solar gains are reduced, which might be useful when schools are in a heating mode. The most accurate way to evaluate radiant barriers in attics is to use an hourly simulation model where the attic itself is modeled as a separate, unconditioned thermal zone, and where radiation transfer can be explicitly modeled. The only models with these capabilities are for research purposes and are difficult for practitioners to use. However, the U.S. Department of Energy released a tool called EnergyPlus, which has these capabilities. Version 1.0 was released in April 2001.

## Design Details

- Choose radiant barrier surfaces that have an emittance less than 0.1, when tested in accordance with ASTM E408. When comparing products, select a product with the lowest emittance. Some have an emittance as low as 0.05.
- Install radiant barriers so that the shiny surface faces down to prevent dirt from accumulating on the surface. Dirt can depreciate performance.
- When using radiant barriers that are pre-applied to sheathing, make sure that care is taken to not damage the surface during shipping and installation.
- When using the draped method of installation, let the radiant barrier sag about an inch from the sheathing, creating an additional air gap. This accounts for the improved performance of the draped installation method.

## Operation and Maintenance Issues

Radiant barriers rarely require any maintenance, unless they are damaged while other maintenance work is being performed in an attic.

## Commissioning

No commissioning is necessary.

## References/Additional Information

Ross Middle School, Ross, CA. Architect: Esherick Homsey Dodge & Davis.

U.S. Department of Energy, Radiant Barrier Fact Sheet, June 1991. Prepared by Oak Ridge National Laboratory.

## GUIDELINE EB5: AIR BARRIERS AND OTHER METHODS TO REDUCE INFILTRATION

### Recommendation

Design and construct the building envelope to limit the uncontrolled entry of outside air into the building. This is achieved through building envelope sealing (caulking and weather stripping), specifying windows and doors that have been tested to have low rates of infiltration, and by using air lock entries in cold climates.

### Recommendation

Design and construct the building envelope to limit the uncontrolled entry of outside air into the building. This is achieved by providing a continuous air barrier on roof and walls, tied to all adjacent materials including windows, doors, and penetrating pipes or ducts. Specify windows and doors that have tested, low rates of infiltration and are appropriately weather sealed. Install airlock vestibules at all major entries.

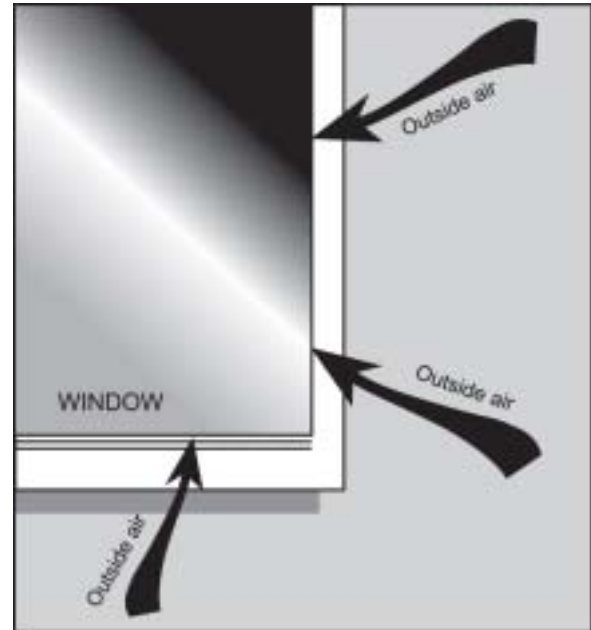

*Reducing entry of outside air into a building can be beneficial in preventing energy loss.*

### Description

Controlling infiltration is very important to achieving energy-efficient buildings. Air leakage introduces sensible heat into conditioned and semi-heated spaces. In the winter, it also causes buildings to become very dry. In climates with moist outdoor conditions during the day or night, it is also a major source of latent heat. Latent heat must be removed by the air-conditioning system at considerable expense. The ASHRAE 90.1-2001 Standard has requirements for sealing building envelope elements, infiltration through doors and windows, air seals at loading dock doors, and vestibules to limit infiltration at main entrance doors to buildings.

### Applicable Climates



#### Applicable Spaces

- Classrooms
- Library
- Mult-Purpose / Gym
- Corridors
- Administration
- Toilets
- Other

#### When to Consider

- Programming
- Schematic
- Design Dev.
- Contract Docs.
- Construction
- Commissioning
- Operation

### Applicability

Schools in all climates should be sealed to reduce infiltration, but it is especially important in the more harsh climates such as the Cool and Humid, Cold and Humid, Cool and Dry, and Hot and Dry climates. The recommendations apply to all spaces in schools.

Sealing and infiltration control should be first considered in the design development phase, but details should be specified in the contract documents. Tight construction is mainly a matter of care during construction and should be verified during construction as well as during the commissioning phase.

### **Integrated Design Implications**

Poorly sealed buildings can cause problems for maintaining comfort conditions when additional infiltration loads exceed the HVAC design assumptions.

### **Integrated Design Implications**

Uncontrolled air infiltration carrying untempered air as well as high moisture levels is the main source of water condensation in walls leading to mold and mildew. Poorly sealed buildings also waste energy and can compromise the ability of building systems to maintain comfortable conditions when additional infiltration loads exceed the HVAC design assumptions.

### **Cost Effectiveness**

The cost of controlling infiltration is minimal. Mainly it is a standard of care that must be exercised during the construction phase.

Costs	L	<b>■</b>	
	M		
	H		
	L	M	H
	Benefits		

### **Benefits**

Controlling infiltration makes it easier to balance and maintain HVAC systems. Energy costs are also reduced in a cost-effective manner.

### **Benefits**

Controlling air infiltration saves energy and improves indoor environmental quality. Uncontrolled air infiltration carrying untempered air, as well as high moisture levels, is the main source of water condensation in walls leading to mold and mildew. Poorly sealed buildings also waste energy and can compromise the ability of building systems to maintain comfortable conditions when additional infiltration loads exceed the HVAC design assumptions.

### **Design Tools**

All energy calculation methods are capable of accounting for infiltration in some manner. Some use an air-changes-per-hour method, while others are based on the concept of an effective leakage area. Many hourly simulation methods are capable of modeling infiltration using either calculation method.

At the start of the air barrier construction process, the Air Barrier Association of America (ABAA) recommends a review of design intent between designers and contractors. A mockup or in-place sample of construction should be visually and quantitatively tested for air leakage in accordance with ASTM standards, and bond adhesion tests should be performed on air-barrier membrane systems.

During construction, air leaks can be detected and repaired through pressurization tests, often called blower door tests. With this procedure, a building or space is pressurized with a large fan that is usually mounted in the door (thus, blower door). The space is pressurized to about 50 Pascals of pressure and leakage is measured. The location of leaks can be identified using smoke sticks. These tests are difficult on typical large schools facilities that may be well over 100,000 ft<sup>2</sup> and require many zones for testing and the installation of temporary infiltration barriers between zones. For this reason, the ABAA recommends the smaller in-place sample testing which makes greater improvements at a lower cost at a time when improvements are practical, even though it does not measure total performance.

## Design Details

Air barriers must:

- Be continuous with airtight joints
- Be capable of withstanding positive and negative pressure without damage or displacement (polyethylene sheets flapping in the breeze are no longer acceptable)
- Transfer all loads to the structure
- Be durable or maintainable
- Be joined in an airtight and flexible manner to all adjacent materials
- Use material with an air permeability not to exceed 0.004 cfm/ft<sup>2</sup> under a pressure of 1.57 psf.

ABAA recommends the installed and tested system not exceed five times the allowable air leakage rate of .004 cfm/ft<sup>2</sup> at 1.57 psf.

Doors and access openings leading to shafts, stairwells, and elevator lobbies need to be equipped with weatherseals.

Operable dampers that penetrate the air barrier, such as at mechanical equipment air intakes or elevator shaft louvers, are required to be airtight.

Recessed light fixtures installed in the building envelope are required to be insulation cover-rated and to meet air infiltration standards.

### **Building Envelope Sealing**

Exterior joints, cracks, and holes in the building envelope shall be caulked, gasketed, weather stripped, or otherwise sealed. The construction drawings and specifications should require the sealing, but special attention is needed in the construction administration phase to assure proper workmanship. A tightly constructed building envelope is largely achieved through careful construction practices and attention to detail. Special attention should be paid to several areas of the building envelope including:

- Joints around fenestration and door frames
- Junctions between walls and foundations, between walls at building corners, between walls and structural floors or roofs, and between walls and roof or wall panels
- Openings at penetrations of utility services through roofs, walls, and floors
- Site-built fenestration and doors
- Building assemblies used as ducts or plenums
- Joints, seams, and penetrations of vapor retarders
- All other openings in the building envelope.

Standard 90.1 also has requirements for limiting infiltration through mechanical air intakes and exhausts. These requirements are addressed in the mechanical section (§ 6) of the Standard, not in the building envelope section.

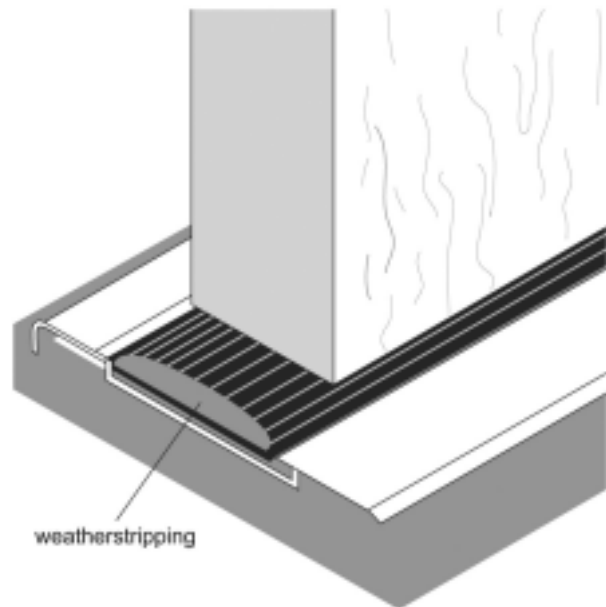

*Door weatherstripping is one method for reducing infiltration.  
Figure 13*

### **Fenestration and Doors**

Fenestration products, including doors, can significantly contribute to infiltration. Most fenestration products should have an infiltration rate less than 0.4 cfm/ft<sup>2</sup>. For glazed entrance doors that open with a swinging mechanism and for revolving doors, the infiltration should be limited to 1.0 cfm/ft<sup>2</sup>. Infiltration rates should be verified with NFRC 400. A laboratory accredited by the NFRC or other nationally recognized accreditation organizations must perform the ratings.

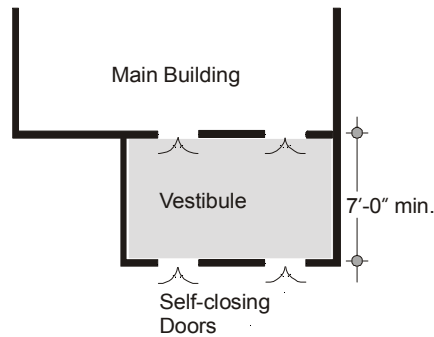

*Figure 14 – Vestibule Diagram*

### **Vestibules**

In cold climates, vestibules should be created at the main entrance to schools. All the doors entering and leaving the vestibule must be equipped with self-closing devices and the distance between the doors should be at least 7 ft.

## **Operation and Maintenance Issues**

Weatherstripping around doors and other openings must be maintained and replaced every 5 to 10 years. Caulking in exposed locations will need to be replaced or touched up each time the exterior of the school is painted.

Air barriers are to be durable or maintainable, according to MSBC. Since most air barriers are permanently installed within the interior of a wall or roof system where maintenance is not possible, they should be durable for the expected life of the building and not require any maintenance.

## **Commissioning**

See the Design Tools section above for construction-phase quality assurance procedures. It is critical to complete the majority of quality assurance work before construction ends. If commissioning work, such as blower door testing, is completed too late in the project, it is often too late to correct any issues, beyond ripping walls down and rebuilding them. The commissioning agent should verify that weather stripping, expanding foam sealants, spray foam sealants, contractors sealing tape, and caulking is properly installed. Fenestration products should be labeled by NFRC to enable easy field verification of the specified infiltration requirements.

## **References/Additional Information**

See this chapter's Overview.



## GUIDELINE EB6: CONCRETE MASONRY

### Recommendation

Specify colored concrete masonry for concrete masonry unit (CMU) wall applications.

### Description

CMU construction is high-strength, fire-resistant, durable, and economical. Improvements in manufacturing and quality control of colored concrete masonry assure greater CMU uniformity and color consistency, reduced porosity, and reduced shrinkage. In addition, high-performance water repellents can be applied to walls or added to the concrete and mortar mixes so that it is unnecessary to paint or coat the units with block-filler to avoid water penetration.

### Applicability

All climates.

### Integrated Design Implications

Recycle waste CMUs, if possible, and require the supplier/subcontractor to take them back for recycling.

### Cost Effectiveness

The first cost of masonry walls is considerably more than for traditional, framed walls. In cold climates, masonry walls exposed to the exterior must be insulated, entailing additional cost in materials and labor. However, not having to paint or coat a colored CMU wall saves time and money during construction, and additional savings accrue throughout the lifetime of the building since colored concrete is a permanent material that requires little or no maintenance.

### Benefits

Masonry is a material-efficient, high-strength, durable material with high fire resistance and low maintenance requirements. The integral color pigments typically used in colored CMU are non-toxic and contain none of the solvents associated with painting and re-painting.

### Design Tools

See Design Tools listed in this chapter's Overview and:

American Concrete Institute ACI 530.1, *Specifications for Masonry Structures*

ASTM C90, *Specification for Loadbearing Concrete Masonry Units*

ASTM C270, *Specification for Mortar for Unit Masonry*



The concrete masonry unit used at this market had considerably lower first costs than would traditional, framed walls. NREL/PIX 11412

### Applicable Climates



### Applicable Spaces

Classrooms	█
Library	█
Multi-Purpose	█
Gym	█
Corridors	█
Administration	█
Toilets	█
Other	█

### When to Consider

Programming	█
Schematic	█
Design Dev.	█
Contract Docs.	█
Construction	█
Commissioning	█
Operation	█

Costs	L	█	█	
	M	█	█	
	H	█	█	
		L	M	H
		Benefits		

ASTM C979, *Pigments for Integrally Colored Concrete*.

### **Design Details**

In general, colored CMU is specified and installed in the same way as other high-quality masonry construction.

To assure uniform colors, all CMU used on a particular project should be produced with consistent manufacturing and curing techniques and with cement and aggregates from a single source. Pigments should comply with ASTM C979 Pigments for Integrally Colored Concrete, which establishes criteria for the pigment's resistance to weather and light and its compatibility with concrete. Mortar can be tinted with the same pigments used in the CMU to match or complement the hue of the masonry units. Some variation in appearance is a normal design feature of CMU and mortar, whether colored or not. Mortar lightens as it cures; allow up to 28 days for this process.

Specify the submittal of samples showing the range of each CMU to be used on the job. On jobs with critical appearance tolerances or unique requirements, specify a mock-up to demonstrate that the materials and workmanship to be used will produce the desired results.

Efflorescence, a white crystalline deposit that can form on concrete surfaces, can be especially visible on colored CMU surfaces. To minimize the potential for efflorescence, detail and build the wall to avoid penetration of water into the masonry, and keep the top of the wall covered when work is stopped.

Efflorescence is easiest to remove if it is cleaned promptly after it appears. A water-repellent or clear glaze coating also can help reduce water penetration; test any surface-applied treatment or coating before proceeding with the application to determine the effect on masonry appearance. Caulking materials used to seal joints can be specified in colors to match the masonry.

### **Operation and Maintenance Issues**

Colored concrete is a permanent material that normally requires little or no maintenance. Sandblasting will remove graffiti.

### **Commissioning**

None.

### **References/Additional Information**

American Concrete Institute (ACI), PO Box 9094, Farmington Hills, MI 48333-9094. Tel: (248) 848-3800. Fax: (248) 848-3801. Web site: <http://www.aci-int.org/>.

National Concrete Masonry Association (NCMA). 2302 Horse Pen Road, Herndon, VA 20171-3499. Tel: (703) 713-1900. Fax: (703) 713-1910. Web site: <http://www.ncma.org/>. The web site provides a list of certified masonry consultants.

# LIGHTING AND ELECTRICAL SYSTEMS

Electric lighting is one of the major energy consumers in schools. Enormous energy savings are possible using efficient equipment, effective controls, and careful design. Using less electric lighting reduces heat gain, thus saving air-conditioning energy, increasing the potential for natural ventilation, and reducing the space's radiant temperature (improving thermal comfort). In cold, predominately heating climates, reducing electric lighting use does decrease heat gain from lights, which in turn, increases conventional energy use for space heating during the winter. However, this increase in heating energy is more than made up for in electrical savings. Electric lighting design also strongly affects visual performance and visual comfort by aiming to maintain adequate, appropriate illumination while controlling reflectance and glare. Finally, visual and accessible light and power meters can educate students and faculty about how lighting systems and energy controls work.

This chapter provides guidelines for:

Pendant-Mounted Lighting (Guideline EL1)

Troffer Lighting (Guideline EL2)

Industrial-Style Classrooms (Guideline EL3)

Lighting Controls for Classrooms (Guideline EL4)

Gym Lighting (Guideline EL5)

Corridor Lighting (Guideline EL6)

Lighting for a Multi-Purpose Room (Guideline EL7)

Lighting for a Library or Media Center (Guideline EL8)

Lighting for Offices and Teacher Support Rooms (Guideline EL9)

Lighting for Locker and Toilet Rooms (Guideline EL10)

Outdoor Lighting (Guideline EL11)

---

## OVERVIEW

---

This section outlines lighting quality, lighting technology, lighting energy use, and other important lighting issues such as design criteria, maintenance, and commissioning. These factors all affect the design, installation, and maintenance of lighting systems in different school building spaces.

## **Visual Tasks in Schools**

### **Common Visual Tasks**

School visual tasks vary in terms of size, contrast, viewing angle, and distance. Many of these activities require close attention for prolonged periods of time. Critical visual tasks common to all school environments include:

- Writing
- Reading printed material
- Reading material on visual display terminals (VDTs)
- Reading from blackboards, whiteboards, overhead and video projections, and bulletin boards.

### **Additional School Tasks**

In addition to the reading and writing visual tasks common to all school environments, several more specialized activities may occur in specific circumstances, which require specialized lighting equipment and design. Examples include:

- Drawing, painting, and other artwork
- Laboratory work
- Food preparation
- Performance activities, such as dramatic productions and debates
- Sports
- Home economics activities, including sewing and cooking
- Industrial education activities, such as metal shop and wood shop.

One notable difference between schools and other environments is that students must constantly adapt their vision between “heads-up” and “heads-down” reading conditions. Copying a homework assignment from the blackboard into a notebook, for instance, requires the eyes to adjust for differences in visual target size, distance, contrast, and viewing angle. To create comfortable and productive spaces, the lighting design must address the quality of the entire visual environment instead of merely accounting for horizontal illuminance, as is too often the case.

## **Lighting Quality Issues**

Lighting in schools should provide a visual environment that enhances the learning process for both students and teachers, allowing them to perform their visual tasks quickly and comfortably. Several lighting quality issues important in school lighting are outlined below. Table 15 provides information about the relative importance of various lighting quality issues for specific school spaces.

Table 15 – Lighting Quality Issues for Sample School Building Spaces

	General Classroom	Computer Classroom	Multipurpose Classroom	Corridor
Control of Direct and Reflected Glare	●	●	●	○
Light on Walls and Ceiling	●	●	●	●
Fixture Location Related to People	●	●	●	○
Light Patterns – Uniformity vs. Shadows	●	●	●	○
Daylight	●	○	●	●
Color Rendering and Color Temperature	●	●	●	●
Lighting Controls, Flexibility	●	●	●	○

● Very Important   ● Important   ○ Somewhat Important

### Quantity of Light

In design, the quantity of light is measured in footcandles, taken in the horizontal plane at the task. IESNA publishes illumination level recommendations. With the ninth edition of the *IESNA Lighting Handbook (2000)*, IESNA revised its recommended lighting design procedure and issued the latest recommendations for horizontal illuminance. For most typical classroom and office reading tasks, the current recommended light level is 30 footcandles, as shown in Table 16. However, because some classroom tasks may justify up to 50 footcandles, choosing a level between 30 and 50 is an excellent compromise. Exceptions include art classrooms, shops, laboratories, and other spaces where tasks may require light levels as high as 70 to 100 footcandles.

Even if designing electric light levels for 30 to 50 footcandles of electric illumination, higher light levels – up to about 150 to 200 footcandles under peak solar conditions – can be provided by properly designed daylighting systems in most classrooms. (Computer labs and similar spaces are the exception – high daylight levels cause visual difficulties, so daylight, if introduced at all, should be done carefully and at very low light levels.) To take advantage of natural light, electric lighting systems should be dimmed or extinguished to fully harvest the energy and maintenance savings.

Previously, many published school lighting design guides recommended much higher levels, but the combination of better visual materials and other media, such as video and computer, permit current light level standards. Designers taking advantage of the latest light level recommendations can specify lighting systems that use less energy and require less maintenance than designs performed to older standards.

Note that lower lighting levels (15 to 30 footcandles) are suggested for computer classrooms. Moreover, providing a low ambient light level (5 to 10 footcandles) and task lighting is often preferred for computer spaces.

Table 16 – IESNA Recommended Illuminance Levels

Category	Description	Recommended Illuminance (fc)
Orientation and Simple Visits	Public spaces	3 fc
	Simple orientation for short visits	5 fc
	Working spaces where simple visual tasks are performed	10 fc
Common Visual Tasks	Performance of visual tasks of high contrast and large size	30 fc
	Performance of visual tasks of high contrast and small size, or visual tasks of low contrast and large size	50 fc
	Performance of visual tasks of low contrast and small size	100 fc
	Performance of visual tasks near threshold	300 – 1,000 fc

Source: IESNA *Lighting Handbook*, 9<sup>th</sup> ed. (2000), p. 10-13

### Lighting Quality

IESNA's current lighting design procedure consists of a six-step process that emphasizes the relative importance of numerous design issues for specific applications. In addition to issues such as color appearance, daylighting integration and control, luminances of room surfaces, and many others, topics addressed include vertical illumination, glare control, uniformity, and color rendering.

*Vertical Illumination.* Vertical illumination is one of the more critical design issues in school lighting. With the exception of desktop reading, many school visual tasks are “heads-up” type activities, requiring proper vertical illumination of chalkboards and other displays. In addition, the perception of what comprises lighting quality is strongly influenced by vertical illumination. For example, wall illumination is a critical factor in the sense of brightness and cheerfulness of a room. In nighttime environments, vertical illumination that promotes facial recognition is important in creating a sense of safety and security. Appealing vertical illumination promotes the important school activity of social communication.

*Glare Control.* Light sources that are too bright create uncomfortable glare. In extreme cases, direct or reflected glare can also impair visual performance by reducing task visibility. In such a case, fatigue results from the eye having to work much harder to perform. All sources of light, including daylight, must be carefully controlled to avoid causing discomfort or disabling glare. Common glare problems in classrooms include uncomfortable overhead glare from direct distribution luminaires, reflected luminaire imaging on VDTs and whiteboards, and direct glare from uncontrolled windows or skylights. Very bright sources, such as T-5 straight, twin tube, and T-5HO straight lamps, should only be used in high spaces like gyms, or in cove lighting and indirect luminaires in ordinary classrooms and other spaces. Indirect and direct/indirect lighting systems tend to provide superior glare control as compared to more conventional, direct lighting systems.

*Uniformity.* For the most part, building spaces should be as uniformly illuminated as possible, avoiding shadows or sharp patterns of light and dark. For classrooms, luminance contrast ratios between the visual task and its immediate surround should not exceed 3:1, and contrast between the brightest surfaces in the visual field and the visual task should not exceed 10:1. Higher ratios contribute to fatigue because the eye is constantly adapting to differing light levels. Recessed or surface-mounted parabolic fixtures should be avoided in most spaces, because they block light from reaching the upper portion of the wall and create a shadowy, cave-like environment. Exceptions might include lighting systems for theaters and social spaces in the school, where a downlighting system might be used to create a dramatic atmosphere.

Maximize overall lighting uniformity by following guidelines for maximum spacing of luminaires. The best method of maximizing uniformity is to make a concerted effort to light vertical surfaces, as well as the ceiling (using indirect or indirect/direct luminaires) whenever possible. Using light-colored, diffuse surface materials also optimizes lighting uniformity.

*Color Rendering.* Light sources that render color well enhance the visual environment. Light sources should have a minimum color-rendering index (CRI) of 80 for most interior spaces. Ceramic metal halide lamps, the latest “second generation” T-8 lamps, T-5 lamps, and most compact fluorescent lamps have a CRI in the range of 82 to 86.

### ***Lighting Control Flexibility***

Lighting controls should be designed for flexibility to accommodate the varying nature of many school spaces. In addition to saving energy, bi-level or multiple-level switching enables different light levels to respond to changing requirements. Separate circuiting of luminaires in daylight zones also enhances space flexibility and energy savings. Control flexibility improves lighting energy performance by encouraging the use of lights that are only needed for the activity at hand.

Control flexibility is especially important in classrooms, which typically must be responsive to varying illumination schemes due to a wide variety of conditions and activities that occur. It is critical that teachers have the ability to override any automatic dimming and/or occupancy sensor controls, so that they can switch the lights off manually when necessary.

In multi-purpose spaces, several different lighting control schemes may need to be designed to account for all the different activities. In these cases, it may make sense to specify a preset dimming or switching system, allowing one-button scene changing.

Lighting control systems must also be easy to understand and operate. Non-intuitive control interfaces are likely to be ignored at best, and disabled in more extreme cases.

### ***Integration with Daylight***

Properly controlled daylight promotes comfort and productivity. To achieve energy savings, electric lights must be turned off (either manually or automatically) when sufficient daylight is available. Many teachers and students are quite conscientious in manually turning off the lights when not needed, but automatic systems tend to result in greater energy savings over the long run.

The first and most important step in integrating electric lighting with daylighting is to make sure that the electric lights are circuitied so they can be logically switched off or dimmed in proportion to the presence of daylight in the room. This generally means that the electric lights should be circuitied in lines parallel to the daylighting contours in the space. The areas of the room with the most daylight, the space adjacent to windows or skylights for example, should be turned off or dimmed first. A good rule of thumb for daylighting integration: control electric lights with a minimum of three separate circuits in daylighted spaces.

The electric lighting should be designed to provide balanced and sufficient illumination under nighttime conditions, but it should also be circuitied to supplement partial daylight when needed on dark days. The electric lighting designer should thoroughly understand the patterns of daylight illumination expected

during different times of the day and year, so that the electric lighting design can supplement the daylight, filling in darker areas of the room or highlighting a wall when needed.

The choices of switching versus dimming, and manual versus automatic photosensor controls, are partly cost issues, and partly operational issues. The pros and cons of each are discussed in Guideline EL4: Lighting Controls for Classrooms. Issues of daylighting design are discussed in the following chapter.

## **Light Sources**

A wide variety of light sources are available for schools. Light source selection critically affects building space appearance, visual performance, and comfort. This section outlines the different types of sources available to the designer

### ***Incandescent and Halogen Lamps***

Incandescent lamps represent the oldest of electric lighting technologies. Advantages of incandescent technology include point source control, high color performance, instant starting, and easy and inexpensive dimming. Disadvantages range from low efficacy and short lamp life to high maintenance costs.

Incandescent sources should not be used in new schools except in very limited and special accent lighting circumstances. Examples might include dimming applications where color performance, beam control, and/or dramatic effect is critical, such as teleconferencing rooms, theaters, and the highlighting of artwork. In most of these cases, halogen sources, which offer longer life, better point source control, and crisper color performance, are superior to standard incandescent lamps. The most efficient halogen technology is “infrared reflecting” or “IR,” which should be used whenever possible. T-5 or compact fluorescent lamps can also be considered for many accent lighting applications.

### ***Fluorescent Lamps***

Fluorescent lamps can and should be used to light nearly all types of school building spaces. They offer long life, high efficacy, good color performance, and low operating and maintenance costs. Fluorescent lamps are typically straight or bent tubes, which limit their use somewhat. Dimming fluorescent lamps require special electronic ballasts that cost more than standard high frequency ballasts.

Several different types of fluorescent lamps are worth noting, as described in Table 17.



Table 17 – Summary of Fluorescent Lamp Technology

Type of Lamp	Advantages/Disadvantages	Applications
T-12	Antiquated technology. Relatively low efficacy. Supplanted by newer technologies such as T-8 and T-5.	Should not be used in new school construction.
Standard T-8 (7xx and 8xx color)	Smaller diameter standard lamps now in general use throughout the world. Offer 10% to 20% higher energy efficiency than T-12 lamps and other performance improvements when used with electronic ballasts. Low-cost lamps and ballasts.	Most general lighting applications in schools, including classrooms, offices, multipurpose rooms, and libraries.
Premium and Super T-8 (8xx color only)	So-called “super” and other “premium” T-8 lamps offer higher color rendition, higher maintained lumens, and a 20% to 50% increase in lamp life over standard T-8s. Energy efficiency can be 10% to 20% greater than standard T-8 lamps depending on brand and type.	Same.
T-5	Similar performance to “super” T-8 lamps, but a more compact lamp envelope (5/8 in. vs. 1 in. diameter). T-5 luminaires should be well-shielded to minimize glare. More expensive than the T-8 lamp and ballast system.	Smaller profile luminaires. Especially effective in indirect luminaires, cove lighting systems, and wall washers.
T-5 High Output (T-5HO)	Light generation per unit length is the highest. Very good energy efficiency, long lamp life, and high optical efficiency. Currently more expensive than T-8 lamp and ballast system.	Smaller profile suspended luminaires for offices and classrooms. Also, for direct “high bay” applications such as gyms.

For schools, the best choices are T-8 premium and super lamps, T-5, and T-5HO lamps. If taken into account during design, the added energy efficiency and longer life of these slightly more expensive lamps more than pay for the initial cost difference.

### Fluorescent Ballasts

All fluorescent lamps require a ballast, which is an electric device that starts and regulates power to the lamp. Electronic high frequency ballasts are now standard equipment for most fluorescent sources. In addition to their efficiency advantages, electronic ballasts have minimal flicker and ambient noise, and are available in a variety of *ballast factor* configurations, allowing the designer to “tune” light levels based on the ballast specification.

Consider the following recommendations for fluorescent ballasts.

There are four different ballast types:

- Instant start ballasts, which have high energy efficiency but may reduce lamp life. A standard T-8 lamp operated for more than three hours per start on an instant-start ballast will last about 15,000 hours. However, if the lamp is operated a short time each start (such as when controlled by a motion sensor), lamp life can drop to less than 5,000 hours. Choose instant-start ballasts for locations with constant light operation.
- Rapid-start ballasts, which are increasingly rare because they are less energy efficient and offer no significant lamp life advantages.
- Program start ballasts, which are both energy efficient and significantly reduce the effect of controls and operating cycle. A standard T-8 lamp operated on a program start ballast will last 24,000 hours at three hours per start, and premium or “super” lamps can last as long as 30,000 hours at three hours per start. Equally important, a “super” lamp operated on a motion sensor will still last over 20,000 hours. Note that all T-5 ballasts are program start. Choose program start for all applications, especially those with short-cycle lamp operation.
- Dimming ballasts will be discussed later.
- The “ballast factor” of the ballast, which describes the percentage of rated lamp lumens generated and power used, is variable and can be used to tune lighting systems, especially T-8 lighting systems.

- The standard or “normal light output” (NLO) system produces 87% of the rated light output of the lamp. This is the most common ballast system and it is normally furnished unless otherwise requested.
- In renovation projects, use reduced light output (RLO) electronic ballasts in building spaces lighted with fluorescent lamps where slightly lower light levels will suffice. RLO ballasts produce approximately 75% of rated light output and use 12% to 20% less power than standard NLO ballasts. Applicable spaces might include corridors, rest rooms, and storage areas. In new construction, simply specifying lower wattage fixtures or increasing fixture spacing would result in greater initial construction cost savings as well as energy savings.
- Use high light output (HLO) electronic ballasts where a modest increase in light output is required. A typical HLO ballast produces 115% to 120% of the lamp’s rated light output for a 15% to 20% increase in power, but does not materially affect lamp life. Clever designs can sometimes employ two lamps and an HLO ballast rather than three lamps and an NLO or RLO ballast, permitting the use of a smaller luminaire or simply fewer lamps.

**Table 18 – Fluorescent Lamp/Ballast Power and Light Level (Based on Mean Lamp Lumens) Using Generic T-8 Lamp and Ballast as the Reference**

For the numbers in parentheses following the lamp name, the first digit represents the Color Rendering Index (CRI) and the final two digits indicate the color temperature.

\* Lamps rated 3000 initial lumens and high lumen maintenance

\*\* Lamps rated 3200 initial lumens and high lumen maintenance

Lamps	Type of Ballast	Relative Light	Relative Power
Standard T-8 (735)	NLO instant start	100%	100%
Standard T-8 (735)	RLO instant start	89%	87%
Standard T-8 (735)	HLO instant start	135%	134%
Standard T-8 (835)	NLO instant start	106%	100%
Standard T-8 (835)	RLO instant start	94%	87%
Standard T-8 (835)	HLO instant start	141%	134%
Premium* T-8 (835)	NLO instant start	111%	100%
Premium* T-8 (835)	RLO instant start	99%	87%
Premium* T-8 (835)	HL) instant start	149%	134%
Super** T-8 (835)	NLO instant start	119%	100%
Super** T-8 (835)	RLO instant start	106%	87%
Super** T-8 (835)	HLO instant start	158%	134%
Super** T-8 (835)	RLO program start	100%	80%
T-5 (835)	Program start	125%	100%
T-5HO (835)	Program start	214%	200%

Dimming ballasts for fluorescent lamps require an additional investment, but increase lighting system performance by optimizing space appearance, occupant satisfaction, system flexibility, and energy efficiency. Dimming fluorescent ballasts should be considered in all cases requiring maximum energy performance and light level flexibility. They are particularly effective in daylit classrooms, computer classrooms, audio video rooms, and similar spaces.

### **Compact Fluorescent Lamps**

Compact fluorescent lamps (CFLs) can be used in nearly all applications that traditionally have employed incandescent sources. CFLs offer excellent color rendition, rapid starting, and dimmability. A large palette of different lamp configurations enhances design flexibility. Principal advantages of CFLs over incandescent sources include higher efficacy and longer lamp life. They can be dimmed, though dimming CFL ballasts are expensive. In colder outdoor environments, CFLs can be slow to start and to achieve full light output.



*Compact fluorescent lamps can be used in nearly all applications. NREL/PIX06244*

Use CFL lamps extensively in task and accent lighting applications, including wall washing, supplementary lighting for visual tasks requiring additional task illumination above ambient levels, and portable task lighting in computer environments. They are also valuable for medium-to-low level general illumination in spaces such as lobbies, corridors, restrooms, storage rooms, and closets. In climates where the temperature does not often drop below 20°F, they are quite suitable for outdoor corridors, step lighting, and lighting over doorways. High wattage BIAx-type CFLs can be used for general space illumination in recessed lay-in troffers (see Luminaires section below), as well as in more decorative direct/indirect luminaires for office lobbies, libraries, and other spaces requiring a more “high-end” look.

### **High Intensity Discharge (HID) Lamps**

HID lamps provide the highest light levels of any commercially available light source and come in a wide variety of lamp wattages and configurations. In addition, they offer medium-to-high efficacy and relatively long lamp life. The principal disadvantage to HID sources is that they start slowly and take time to warm up before coming to full brilliance, making them difficult to use in many automatic lighting control scenarios without expensive two-level switching systems. As a result, these lamps may not work well in daylit interior spaces where lights may be turned on and off. In some applications, such as warehouses and vehicle maintenance areas, this may be cost effective when evaluated from a life-cycle cost perspective, but be prepared for reduced color performance and lamp life if used with metal halide lamps. Dimming HID lamps are expensive and unreliable and are not recommended.

### **Low Mercury Lamps**

Rising concern over mercury disposal has increased the importance of using low mercury content lamps. Low mercury versions of all fluorescent and compact fluorescent lamps, as well as some HID lamps, are available from most manufacturers and should be used. Initial lamp costs may be slightly higher, but when disposed of, these lamps will no longer be treated as hazardous waste with those associated high costs. See the section below on Mercury and Lamp Recycling.

### ***Light Emitting Diodes (LEDs)***

LEDs are semiconductor devices that generate an intensely directional, monochromatic light. Research today is directed at producing a commercially viable white LED source. Because selection is mainly limited to red, blue, or green products at this time, using LED as a light source in schools is generally limited to exit and other signs. The principal advantage of LEDs over other sources is their extremely long life. In addition, a two-sided LED exit sign can usually be illuminated with less than 5W.

LEDs are highly recommended for use in school exit signs. They offer high efficacy and very low maintenance costs when compared with either incandescent or fluorescent products, and are available in most of the popular exit sign configurations.

### ***Energy Efficient Choices***

Lamps convert electricity (Watts) to light energy (lumens), and most modern lamps require a ballast to regulate the power flow into the lamp. The efficacy of the conversion is measured in lumens of light output divided by Watts of electric power input. The input Watts includes both the lamp and the ballast. **In general, it is best to use the system with the highest possible efficacy that is suited for the project.**

Some electric lamps emit less light as they age, called *lumen depreciation*. Significant improvements in certain lamps make lumen depreciation a very important consideration. Lamps are now rated in *mean lumens per Watt (MLPW)*, which better represents the efficacy of the lamp over its life.

Table 19 gives the MLPW for a variety of lamp/ballast systems and may be used to select light sources. Follow it closely to get the best efficacy. For instance, "premium" T-8 lamps are the best overall choice for most applications, and you can use 835 (neutral color), 830 (warm color) or 841 lamps (cool color) and get the same efficacy. But by substituting 735 color (which is cheaper), the MLPW drops to less than 80.

Table 19 – Lamp Application Guidelines

MLPW*	Lamp Type	CRI	Ballast	Good Applications	Limitations
93	T-8 "super" lamps (F32T8/835)	86	Electronic program start	General lighting. The most energy-efficient lighting and longest life system available for most uses.	Not for general exterior lighting; not for very high spaces (20 feet or above).
92	T-5 standard 4' lamps (F28T5/835)	86	Electronic program start	Specialty lighting such as valences, undercabinet, coves, and wallwash.	Not for troffers; produce a limited amount of light.
90	T-8 premium 4' lamps (F32T8/835)	86	Electronic instant start (IS)	General lighting. The lowest cost and most efficient system available. Dimmable.	Not for general exterior lighting; not for very high spaces.
87	T-8 premium 8' lamps (F96T8/835)	86	Electronic IS	General commercial and institutional lighting. Dimmable.	8' long lamps generally best in large spaces only.
81	T-5HO high output 4' lamps (F54T5/835)	86	Electronic program start	Indirect office lighting; high ceiling industrial lighting and specialty applications such as coves and wallwash. Gyms. Dimmable.	Very bright lamps should not be used in open fixtures unless mounted very high.
80	Metal halide lamps, pulse start, M141 (1000 watt class)	65	Magnetic CWA	Very high bay spaces such as sports arenas, stadiums, and other locations above 30'.	Very long warm up and restrike times prevent rapid switching and dimming.
79	T-8 premium "U"-bent lamps (F32T8/U/835)	86	Electronic IS	Recessed commercial lighting. Dimmable.	More expensive than straight lamps.
78	T-5 twin tube ("biax") 40-50 watt (FT40T5/835)	82	Electronic IS	General commercial and institutional lighting; track mounted wallwash and display lighting. Dimmable.	More expensive than straight lamps – can be too bright in open fixtures.
78	Metal halide lamps, pulse start, 450 watt class	65	Magnetic CWA	General high bay lighting for gyms, stores, and other applications to about 30'; parking lots.	Very long warm up and restrike times prevent rapid switching and dimming.
76	Standard T-8 generic lamps (F32T8/735)	75	Electronic IS	General commercial lighting. Dimmable.	Not for general exterior lighting; not for very high spaces.
75	T-8 premium 2' lamps (F17T8/835)	86	Electronic IS	General commercial lighting. Dimmable.	Not for general exterior lighting; not for very high spaces.
67	Metal halide lamps, pulse start, M137 (175 watt class)	65	Magnetic CWA	Parking lots and site roadway lighting.	Very long warm up and restrike times prevent rapid switching and dimming.
64	Metal halide lamps, pulse start, M142 (150 watt class) compact T-6 high CRI	85	Electronic (CWA magnetic <60 MLPW)	Track and recessed mounted display lighting.	May not be suitable for general illumination due to lamp cost; very long warm up and restrike times prevent rapid switching and dimming.
63	Metal halide lamps, pulse start, ED-17 M140 (100 watt class) high CRI	85	Electronic or magnetic HX or CWA	Recessed and track mounted display lighting.	May not be suitable for general illumination due to lamp cost; very long warm up and restrike times prevent rapid switching and dimming.
62	Compact fluorescent 18-42 watt triple	82	Electronic	Downlights, sconces, wallwashers, pendants and other compact lamp locations; can also be used outdoors in most climates. Dimmable.	Modest efficacy is still far better than incandescent.
30	Halogen infrared reflecting lamps in PAR-30, PAR-38, MR16 and T-3 shapes	100	None required	Localized accent lighting and where full range, color consistent dimming is absolutely required such as fine restaurants, hotels, high end retail, etc	Cost effective technology must be used in limited amounts.

\*Mean lumens per watt vary depending on specific ballast. Values given are optimum lamp-ballast combinations, and other combinations may be lower.

## Luminaires

Luminaires (light fixtures) generally consist of lamps, lamp holders or sockets, ballasts or transformers (where applicable), reflectors to direct light into the task area, and/or shielding or diffusing media to reduce glare and distribute the light uniformly. An enormous variety of luminaire configurations exist. This section briefly outlines some of the more important types for school lighting design.

### Recessed Luminaires

Recessed luminaires represent a large segment of the overall luminaire market. There are two basic variations, lay-in troffers and downlights. The primary use of lay-in troffers is as a direct general light source. Downlights are relatively compact luminaires used for wall washing, accent lighting, supplemental general or task illumination, as well as for lower levels of ambient illumination.

A relatively new type of recessed luminaire is the indirect troffer. It is meant to soften the distribution pattern of a direct distribution luminaire without losing lighting uniformity. However, in many cases the surface brightness of the exposed reflector is actually higher than that of a standard troffer. Use them with caution, and do not use them in larger building spaces such as classrooms and open offices.

### Suspended Classroom Luminaires

Suspended indirect or direct/indirect luminaires are the preferred luminaires for lighting classrooms. They are also appropriate for offices, administrative areas, library reading areas, and other spaces. Typically these luminaires employ T-8, T-5, or T-5HO lamps, and mount in continuous row configurations. See Guideline EL1: Pendant-Mounted Lighting.

### Suspended High Ceiling Luminaires

Both fluorescent and HID suspended luminaires are useful for illuminating building spaces such as gymnasiums and other high-ceilinged spaces. HID luminaires can be classified as either high bay (>25 ft mounting height) or low bay, depending on the configuration. Compact fluorescent, high bay luminaires are also available to light high ceiling spaces. They employ up to eight compact fluorescent lamps to approximate the light output of an HID luminaire, while allowing for additional control flexibility. See Guideline EL5: Gym Lighting for more information. Linear hooded industrial fluorescent luminaires can be extremely effective at lighting high ceiling spaces.



Recessed luminaires are direct general light source.

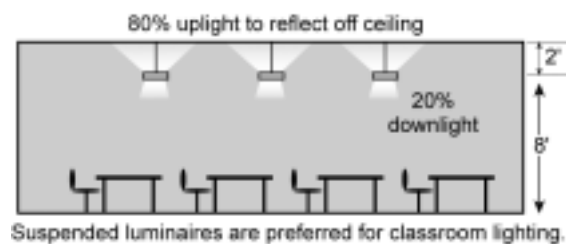

Figure 15 – Recessed vs. Suspended Luminaires

### **Surface-Mounted Luminaires**

Surface-mounted fluorescent, compact fluorescent, and HID luminaires are valuable for wall and ceiling mounting situations, particularly when ceiling access is a problem.

### **Specialty Luminaires**

Several specialty luminaires are available for specific school lighting applications, including specialty wall wash luminaires to illuminate blackboards, task lighting luminaires to supplement general illumination, wet location luminaires for exterior areas open to the elements, and high-abuse luminaires designed to withstand vandalism in school and other institutional environments.

### **Exit Signs**

Numerous exit sign configurations are available for schools. LED exit signs offer the best alternatives for minimizing energy use and maintenance. Avoid self-luminous atomic exit signs because they are difficult to dispose of and may not provide adequate surface luminance.

## **Lighting Controls**

Lighting controls are critical for minimizing lighting energy use and maximizing space functionality and user satisfaction. Control techniques range from simple to extremely sophisticated. Lighting control strategies are most successful when people can easily understand their operating characteristics. Another critical factor is the proper commissioning of lighting control systems so that they operate according to design intent. Finally, regularly scheduled maintenance of control equipment will improve the long-term success of the system. Poorly designed, commissioned, or maintained automatic lighting controls can actually increase lighting energy use and cause user dissatisfaction.

This section provides a brief overview of lighting control hardware available for school applications.

### **Switches**

Manual switches are the simplest form of user-accessible lighting control. Minimal compliance with most codes requires individual manual switching for each separate building

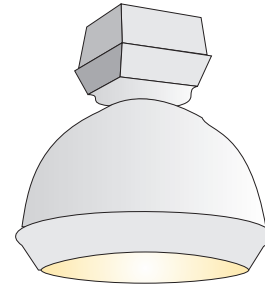

*Figure 16 – Low-bay HID Luminaire*

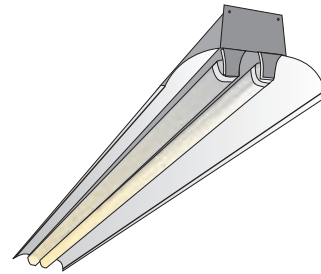

*Figure 17 – Hooded Industrial Fluorescent Luminaire*



*Compact fluorescent lighting fixture. NREL/PIX 09211*

ASHRAE 90.1-2001 mandates that buildings larger than 5,000 ft<sup>2</sup> have an automatic control device that can turn off lighting in all spaces without occupant intervention. This automatic control can be based on a time schedule or occupancy sensor. Manual switches are especially valuable in daylit building spaces because they allow people to turn off electric lights when daylight is adequate. Manual switches should also be installed in spaces with occupancy sensors to increase the energy savings by allowing people to turn off the lights when they are not needed.

### **Occupancy Sensors**

Occupancy sensors employ motion detectors to shut lights off in unoccupied spaces. The primary detection technology can be either passive infrared (PIR) or ultrasonic. Some sensors employ both passive infrared and either ultrasonic or microphonic detection. Mounting configurations include simple wall box sensors appropriate for small spaces such as private offices, and ceiling- or wall-mounted sensors that provide detection of areas up to 2,000 ft<sup>2</sup>.



*Figure 18 – Occupancy Sensor*

Occupancy sensors are most effective in spaces that are intermittently occupied, or where the lights are likely to be left on when unoccupied. The best school applications include classrooms, private offices, restrooms, and storage areas. Use occupancy sensors in combination with manual overrides whenever possible to maximize energy savings, space flexibility, and occupant satisfaction. Including manual off override to the control scheme allows the teacher to turn the lights off for video presentations or other situations requiring the lights to be off. See Guideline EL4: Lighting Controls for Classrooms.

Timing and sensitivity for occupancy sensors should be carefully reviewed for the optimum compromise between energy savings and appropriate function. It has been found that if lights often automatically shut off when students and teachers sit still for several minutes during tests, the sensors will require re-adjustment or simply be disconnected. If staff is driven to disconnect occupancy sensors, the school incurs the increased initial construction costs but loses any energy savings. This type of dissatisfaction also makes it more difficult to include these energy saving features in the next project.

### **Time Controls**

Time controls save energy by reducing lighting time of use through preprogrammed scheduling. Time control equipment ranges from simple devices designed to control a single electrical load to sophisticated systems that control several lighting zones.

Time controls make sense in applications where the occupancy hours are predictable, and where occupancy sensor automatic control is either impractical or undesirable. Candidate building spaces include classrooms, offices, library stacks (local digital time switches), auditoriums, and exteriors.



### ***Energy Management Systems (EMS)***

Typically an EMS controls lighting via a time clock. However, many building operators take advantage of the built-in EMS functions to monitor lighting usage on a space-by-space basis. EMS control of lighting systems may also allow building operators to dim or turn off lights to shed non-essential lighting loads during peak demand periods.

### ***Manual Dimmers***

Next to standard wall switches, manual dimmers are the simplest of lighting control devices. Manual dimmers serve two important functions. First, dimming lights reduces lighting demand and energy usage. With incandescent and halogen sources, there is the additional benefit of extended lamp life. However, more importantly, dimmers allow people to tune the lights to optimum levels for visual performance and comfort.

Consider manual dimmers (combined with dimming ballasts, where applicable) for many school building spaces, including classrooms, computer classrooms, and office spaces. Audio/visual rooms *require* manual dimming to function properly.

### ***Photosensor controls***

Photosensor control systems are used to control electric illumination levels in daylit spaces. A photosensor detects the daylight illumination level and sends a signal to a logic controller to switch off or dim the electric lights in response. In *open-loop* systems, the sensor is placed so that it “sees” a representative daylight level, such as looking up into a skylight or out a window. In a *closed-loop* system, the sensor is placed so that it “sees” both the daylight and electric illumination level combined. Closed-loop systems tend to be more difficult to calibrate since they are partially responding to the light source that they are also controlling. Different photosensors are designed to be used as open- or closed-loop systems, and should be selected specifically by their intended use and location. Compatibility between photosensor, logic controller, and ballasts should also be carefully reviewed. Finally, calibration is important and should be done after the space is painted and furnished with carpets, blinds, and furniture, so that illumination levels are as the occupants will experience them.

### ***Occupant Education***

It is extremely helpful to educate the building occupants in how lighting controls work, so that they are less likely to be surprised or annoyed by their operation. A brief tutorial for teachers on occupancy, a one-page explanation taped to the light switch, or best yet, some type of permanent explanation affixed to the classroom wall will greatly aid in the acceptance and appropriate use of the controls. Even manual switches benefit from some education, as teachers often do not realize they have control of more than one light level in their rooms.

## ***Analysis and Design Tools***

Several high-quality analysis tools can help professionals design lighting systems. The simplest of these programs provide rudimentary zonal cavity calculations to predict average horizontal footcandles, while the most sophisticated tools can handle extensive calculations and produce realistic renderings.

Many of the major luminaire manufacturers offer standard computational software that can predict the performance of their (or other's) luminaires in typical lighting designs. Typically, these programs can calculate horizontal and vertical illuminance for a number of points within the space. Some can produce rudimentary renderings as well. Most can export output to CAD software.

Companies that specialize in lighting software offer the most sophisticated lighting software packages. These products are typically much more robust than the manufacturer-provided packages, and can handle more complex problems, such as surface luminances, daylight effects, irregularly shaped rooms, and high resolution rendering.

However, minimally acceptable results may be obtained using the lumen or Watts/ft<sup>2</sup> methods.

## **Applicable Codes**

Several codes or standards affect the design and installation of lighting equipment. Some of the relevant considerations are outlined below.

### ***ASHRAE/IESNA Standard 90.1-2001***

Many states and local governments have adopted energy efficiency standards that apply to the design of new schools and major renovations. While these are quite varied, many are based on ASHRAE/IESNA Standard 90.1-2001, a consensus standard approved by the IESNA. Standard 90.1 has requirements on minimum lighting controls and maximum lighting power in spaces.

### ***Americans with Disabilities Act (ADA)***

The ADA affects the selection and installation of lighting equipment. For the most part, ADA only affects wall-mounted luminaires, which cannot protrude more than 4 in. when mounted less than 80 in. above the finished floor.

### ***Egress and Emergency Lighting***

Emergency egress and exit lighting requirements are mandated in the Universal Building Code (UBC), National Electric Code (NEC), and National Fire Prevention Association (NFPA) codes. Lighting design must address the minimum lighting levels for egress, as well as include the necessary exit signage. Most counties and municipalities require at least minimal compliance with NEC, and some may require additional measures.

### ***UL Listing***

According to the NEC, all luminaires used in construction must be listed by an approved testing agency, such as Underwriters Laboratory (UL). The designer must be sure that all luminaires specified are properly listed by a testing agency recognized by the local electrical inspector. In addition, there are distinctions that must be made for special applications, such as damp, wet, and hazardous locations.

## **Resource Efficiency**

The overall value of energy-efficient lighting systems is reduced energy use and cost, less air pollution, lower maintenance costs, and reduced material requirements. Properly designed lighting systems

minimize lighting demand and energy use. In addition, effective use of lighting controls can extend the service life of lighting equipment, reducing maintenance costs and replacement equipment inventories.

Although lighting's environmental impacts primarily relate to energy performance and enhanced indoor environmental quality, other environmental considerations include materials efficiency and pollution prevention during manufacturing:

- *Materials efficiency:* Metal components of lighting fixtures can be recycled, and whole fixtures can be salvaged during building deconstruction. These fixtures can be refurbished and reused. The metal components of fixtures may include recycled content, although data is not readily available as to the amount.
- *Pollution prevention:* Powder finishes on luminaires may pose a problem during manufacture, but information about these finishes is not readily available.

### **Mercury and Lamp Recycling**

Mercury in fluorescent lamps is a serious issue that has been documented and is being addressed by the lighting industry. Mercury is a toxic element and there are significant concerns about mercury being emitted into the atmosphere or released into groundwater when fluorescent lamps are discarded.

Fluorescent lamps use electricity to excite mercury gas so that it emits ultraviolet light, which in turn causes the phosphor coating to fluoresce and emit light. According to a 1999 National Electrical Manufacturers Association (NEMA) study, the average new fluorescent lamp contained approximately 12 milligrams (mg) of mercury per 4-ft lamp in 1999. Recent developments in lamp coating technology have resulted in lower mercury lamps that contain between 3 and 9 mg of mercury per 4-ft lamp. Three-mg lamps are available with up to 90% efficiency over the life of the lamp, while 9- to 10-mg lamps can be specified with up to 94% efficiency. Environmental concerns are complicated by the fact that mercury is also sent into the atmosphere during the combustion of coal, oil, or gas burning at power plants in the production of electricity. Because of the high percentage of mercury from power production, less mercury may actually be produced from using the 9-mg mercury lamps with 94% efficiency than using the 3- to 4-mg lamps with lower efficiencies because of the former's reduced energy consumption. Lamps with less than 3.8 mg mercury pass California's TTLTC test. Lamps with less than 9 mg mercury pass the TCLP test by using additives. Another way to reduce mercury use is to specify lamps with higher-rated life hours. Lamps with 30,000 average rated life hours will last 50% longer than standard lamps and will therefore reduce mercury in the environment. The U.S. Environmental Protection Agency (EPA) has declared that lamps containing mercury are hazardous materials requiring special handling. This mandate applies to most fluorescent lamps, and in some cases may also be defined to include HID lamps. Spent lamps may be disposed of in special landfills; however, it is much more ecologically responsible to recycle them. Most lamps used in schools can be completely recycled by a number of different recycling companies. Current costs for recycling lamps average about \$0.06/lin ft. When preparing a maintenance plan for a lighting system, include a lamp recycling procedure.

School districts should be good environmental stewards and engage in recycling programs for fluorescent lamps. For demolition and renovation projects, recycling lamps should be required where local recycling options are available.

## **Maintenance**

Maintaining lighting systems is critical to the performance, lighting quality, and energy efficiency of lighting systems. Establishing proper maintenance procedures is as much a responsibility of the designer as it is of the custodian who changes lamps. A good lighting maintenance plan should be included within the building specifications.

### ***Luminaire Cleaning and Troubleshooting***

Luminaires need to be cleaned at regular intervals. Consistent maintenance ensures that the lighting system will continue to perform as designed, thereby maximizing lighting quality and space appearance. When cleaning luminaires, maintenance personnel should also check for and replace any broken or malfunctioning equipment, such as lenses, louvers, and ballasts.

### ***Group Relamping***

Lighting systems perform best when they are maintained at regular intervals. Group relamping is a maintenance strategy aimed at maximizing lighting system performance and maintenance economy by changing out all lamps at regular intervals, as opposed to relamping only when lamps have burned out. In the long run, group relamping reduces the cost of maintaining lighting systems through simple economy of scale. Furthermore, relamping luminaires at regular intervals maintains light levels and lighting quality according to design intent and establishes good lighting maintenance procedures. For cost effectiveness, group relamping should be combined with luminaire cleaning and troubleshooting. Lamps using with dimming ballasts should be properly seasoned prior to being dimmed. See discussion under Commissioning below.

### ***Specifications***

Designers of school lighting systems have several specification tools available to promote proper maintenance and reduce maintenance costs. For example:

- Specify premium or super T-8 lamps whenever possible to extend lamp life by 20% (lamps rated 24,000 hours) or up to 30,000 hours with specific program start ballasts.
- Try to limit the number of different lamp types specified, which will simplify maintenance and allow for reduced lamp backup stocks.
- Include specification language that requires the contractor to supply the school district with manuals for occupancy sensors and other automatic control hardware.
- Include a maintenance manual in the lighting specification (see below).

### ***Maintenance Manual***

Include a detailed maintenance package with the building specifications. At a minimum, the package should contain the following:

- As-built plans showing the installed lighting systems
- Luminaire schedule that includes detailed lamp and ballast information
- Luminaire cut sheets
- Lamp inventory list, including recommended stocking quantities
- Manufacturer data for all lighting controls, including operating documentation and tuning procedures

- Procedures for maintaining lighting controls
- Luminaire cleaning and troubleshooting procedures
- Group relamping procedure
- Lamp recycling plan and contacts.

## **Commissioning**

All automatic lighting control systems must be tuned after installation to ensure optimal performance and energy efficiency. Malfunctioning automatic control systems waste energy and will disturb students, teachers, and staff. Building specifications should include a commissioning plan that identifies the commissioning agent and details the required procedures. The commissioning plan should include the following items:

*Dimmed Fluorescent Lamps.* Manufacturers recommend that fluorescent lamps be fully seasoned prior to being dimmed. Dimming the lamps without this “burn-in” period can result in unstable light output and/or shorter lamp life. Recommendations vary from 10 to 100 hours, depending on the manufacturer. Eventually this requirement may become unnecessary by the use of “smart” ballasts that can sense a lamp’s status. Until such ballasts are available, both new and replacement lamps should be seasoned before dimming.

*Occupancy Sensor Sensitivity/Time Delay.* Motion sensors must be adjusted to ensure that they only sense motion in the controlled space. Motion in adjoining spaces can cause false triggering or cause the lights to remain on needlessly, thereby wasting energy. Similarly, sensor sensitivity should be set to a high level so that the sensors do not turn lights off when spaces are occupied but students or teachers are not moving much. An additional adjustment to the sensors can control the time delay period between last detection and lights off. In most cases, this period can be set to 10 minutes for good results.

*Photosensors.* Photosensors designed for use in open-loop daylighting control systems must be mounted so that they cannot detect the lights they control. This may require some tweaking or relocation of the unit after installation. Consult the manufacturer’s recommendations for proper commissioning procedures for photosensor devices.

*Dimming Controllers:* Dimming controllers for lighting systems should be tuned so that illuminance at the high dimming range will not exceed design parameters. Only a simple adjustment is required on most dimming boards. Similarly, the commissioning agent can also set the minimum light level.

*Stepped or Relay Controllers.* If a stepped lighting control system is employed for daylight harvesting, it is important to adjust the deadband between the on and off switching thresholds so that the system does not cycle on cloudy days. Continuous on-off cycling is annoying to building occupants and reduces lamp life.

## **References/Additional Information**

*Advanced Lighting Guidelines: 2001 Edition*, New Buildings Institute. <http://www.newbuildings.org/>.

*IESNA Lighting Handbook*. Illuminating Engineering Society of North America. <http://www.iesna.org/>.

*IESNA RP-3-00: Lighting for Educational Facilities*. Illuminating Engineering Society of North America. <http://www.iesna.org/>.

# GUIDELINE EL1: PENDANT-MOUNTED LIGHTING

## Recommendation

Classrooms should have ceilings at least 10 ft above the finished floor, which permits the use of either:

- Luminaires with a semi-indirect or indirect distribution and at least 85% luminaire efficiency, using T-5HO, T-5 or T-8 premium lamps, and electronic ballasts; or
- Luminaires with direct/indirect distribution and at least 75% luminaire efficiency, using T-8 premium lamps and electronic ballasts.

In either case, the design should usually operate at between 0.9 W/ft<sup>2</sup> and 1.1 W/ft<sup>2</sup>, and it will generate 40 to 50 footcandles, maintained throughout the student desk area.

## Description

There are two primary, appropriate types of suspended fluorescent luminaires, which are classified according to the fraction of uplight and downlight.

- Direct/indirect luminaires designed for general classroom use. Ceiling, walls, and floor are all illuminated relatively evenly.
- Indirect and semi-indirect luminaires originally designed for office lighting. The ceiling and upper walls are brightest, reflecting light downward onto tasks.

Most direct/indirect luminaires are rated according to the percentages of uplight and downlight. In a direct/indirect luminaire, the amount of uplight and downlight is roughly the same. The type of luminaire shown here is 60% uplight and 40% downlight. While a light colored ceiling is preferred to take advantage of the uplight, a direct/indirect lighting system can be used with light colored wood or other materials. Darker colored ceilings reduce the efficiency of the lighting system. The suspension length of direct/indirect lighting is less critical than for indirect lighting.

In an indirect luminaire, the amount of uplight is at least 90%. If there is any downlight from the luminaire, it is only intended to create a sense of brilliance. Most of the illumination in the room is caused by reflected light from the ceiling. Indirect lighting requires a white ceiling and a minimum suspension length of 18 in., with 21 in. or greater strongly preferred. A semi-indirect luminaire has between 10% and 40% downlight, and suspension length is less critical.

In all cases, affordable luminaires are made of steel bodies, and steel or plastic louvers. More sophisticated luminaires employ extruded aluminum housings, but this generally incurs significant cost increases.

INDIRECT LUMINAIRE  
At least 90% uplight

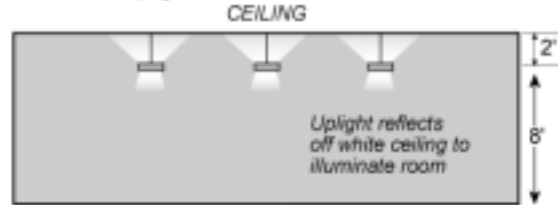

DIRECT LUMINAIRE  
Roughly half downlight, half uplight

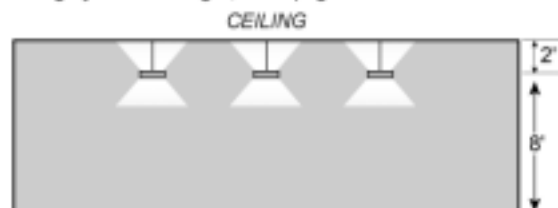

The two primary types of suspended fluorescent luminaires.

## Applicable Climates



### Applicable Spaces

Classrooms	█
Library	█
Multi-Purpose	█
Gym	█
Corridors	█
Administration	█
Toilets	█
Other	█

### When to Consider

Programming	█
Schematic	█
Design Dev.	█
Contract Docs.	█
Construction	█
Commissioning	█
Operation	█

## Applicability

Pendant mounted lighting is appropriate for all classrooms, libraries, multi-purpose spaces, and administration spaces.

## Integrated Design Implications

Suspended lighting systems can work well with almost all ceiling systems that are at least 9 ft-6 in. high. However, ceilings with dark stained wood or dark colored paint must be avoided. For direct/indirect luminaires, ceilings should be light colored; for indirect fixtures, ceilings must be white or off-white, as should upper walls. A direct/indirect luminaire with a greater percentage of downlight (50% or more) should be used for rooms with extremely high ceilings, such as above 14 ft. Note that for maximum efficiency with indirect and semi-indirect lighting systems, it is best to employ ceiling systems with very high reflectivity. Modern white paints and certain ceiling tiles with reflectance of 90% or greater can dramatically increase system performance.

Pendant indirect or direct/indirect lighting systems are particularly well suited for integration with daylight systems, since both approaches require higher ceilings and the use of secondary reflective surfaces. In daylit rooms, pendant systems should be run parallel to the primary windows or daylight source, so that they can be switched or dimmed in response to daylight gradients. In a classroom, three rows of pendants will allow a more gradual response to daylight than just two rows. Daylight controls can then switch or dim each row separately.

## Cost Effectiveness

Suspended lighting systems costs are shown in Table 20. Suspended lighting systems provide a high degree of cost effectiveness in most applications. Non-dimming, indirect steel luminaires are the lowest cost, but optimum solutions are generally steel luminaires with steel or plastic louvers providing 35% to 50% downlight.

Costs	L			
	M			■
	H			
		L	M	H
		Benefits		

Table 20 – Indirect/Direct Lighting Costs

Lighting System Type	Cost per Linear Foot, Installed*
Steel Indirect Luminaires, 90%+ Uplight, T-8 Lamps, Non-dimming	\$35
Steel Direct/Indirect Luminaires, Plastic Louvers, 65% Uplight, T-8 Lamps, Non-dimming	\$40
Steel Direct/Indirect Luminaires, Steel Louvers, 50% Uplight, T-8 Lamps, Non-dimming	\$45
Extruded Aluminum Luminaires, Parabolic Louvers, 75% Uplight, T-8 Lamps, Non-dimming	\$50
Add for Dimming Ballasts Using Standard 0-10 volt type	\$12-15

\*Approximate cost to owner, including labor, materials, overhead, profit, and costs of construction for lighting, including luminaires, lamps, and suspension hardware. Includes connecting luminaire to branch circuit. Controls and branch circuit costs not included. Based on July 2000 prices. Costs can vary depending on market conditions.

## Benefits

Direct/indirect lighting systems generally offer an optimum combination of efficiency and visual comfort, and make excellent use of the low-cost, widely used T-8 lamp system. Systems operating at about 0.9 W/ft<sup>2</sup> to 1.0 W/ft<sup>2</sup> will generate between 40 and 50 footcandles on average, with excellent uniformity. Indirect lighting systems are generally less efficient, requiring 1.0 W/ft<sup>2</sup> to 1.1 W/ft<sup>2</sup> to achieve 40 to 50 footcandles.

## Design Tools

See this chapter's Overview.

## Design Details

This type of lighting provides good, general lighting throughout the room and is suitable for most types of classroom work. Some types of direct/indirect lighting are optimized for computer CRT work, although



they tend to be expensive. It may be necessary to provide separate chalkboard illumination, especially if the suspended lighting system is manually dimmed. Be certain to employ premium T-8 lamps with 835 or 841 color, rated 24,000 hours. For non-dimming applications, luminaire light and power can be varied through choice of ballast factor. Use Table 18 and specify ballasts accordingly.

A typical classroom is shown in the figure below with three rows of two lamp suspended luminaires. Not including daylight contribution, most of the room is between 40 and 60 footcandles at 0.9 W/ft<sup>2</sup>. A slight increase in power will result in a proportional increase in light level; at 1.1 W/ft<sup>2</sup>, the light levels will range between 49 and 73 footcandles.

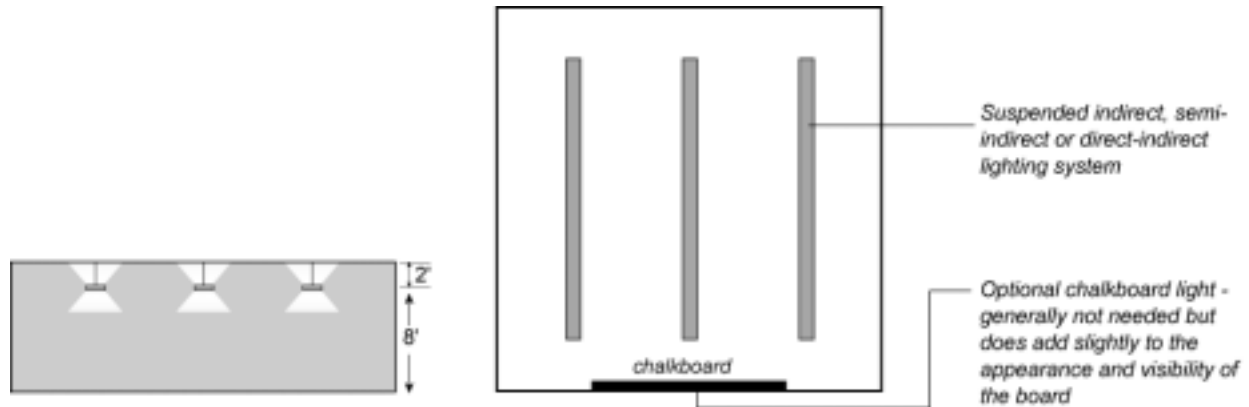

*Figure 19 – Classroom Pendant-Mounted Lighting Design*

*This classroom design uses three rows of suspended fluorescent luminaires.  
An optional blackboard light can be mounted at the teaching wall.*

### **Operation and Maintenance Issues**

These lighting systems rarely need maintenance. As with all fluorescent systems, lamps should be replaced at approximately 12,000 to 16,000 hours of operation, which, with normal school use, could be as seldom as every six years. (Using certain lamps and ballasts can extend this period to 20,000 to 22,000 hours). Luminaires should be cleaned annually. Open louvered luminaires, especially those using plastic louvers, require less cleaning and are the most tolerant of poor maintenance and abuse. Indirect fixtures require more regular cleaning and dusting.

### **Commissioning**

No commissioning is needed, other than pre-seasoning of lamps in dimming applications.

### **References/Additional Information**

See this chapter's Overview.

## GUIDELINE EL2: TROFFER LIGHTING

### Recommendation

This recommendation is **only** for spaces having no ceiling or a low ceiling (less than 9 ft-6 in.) where pendant mounted lighting is inappropriate. In these cases, use surface or recessed fluorescent troffers having at least 78% luminaire efficiency, T-8 premium lamps and electronic ballasts, and a connected lighting power of 0.9 W/ft<sup>2</sup> to 1.1 W/ft<sup>2</sup>.

### Description

Fluorescent troffers are designed to replace an acoustical tile in grid tee-bar ceiling systems. The most common and cost effective size is 2 ft x 4 ft; less common sizes include 2 ft x 2 ft and 1 ft x 4 ft. Two (or more) T-8 lamps are inside.

The three common troffer types are:

- *Lens troffers*, in which the down-facing side of the luminaire is covered with a plastic lens.
- *Parabolic troffers*, in which the down-facing side of the luminaire is enclosed by a metal louver having aluminum blades.
- *Basket troffers*, in which the down-facing side of the luminaire is partially covered by a perforated basket to hide the lamps.

While parabolic troffers and basket troffers may be used in schools, lens troffers generally should be chosen because of their specific light distribution and economy. Parabolics tend to create a cave-like appearance that may be suitable for some types of spaces, but typically should be avoided for general use in schools. They do decrease glare, which is important in low-ceiling work areas and office spaces. Basket luminaires are relatively expensive and have poor light distribution qualities for classrooms, although they might be used in other spaces, especially corridors.

In a modern lens troffer, the interior reflector should be either high-reflectance white paint or highly-polished (“specular”) silvered coating or aluminum. Silvered coating increases the cost considerably but also increases efficiency to over 85%. The lens should be an industry standard “Pattern 12” prismatic acrylic lens, with a minimum lens thickness of 0.125 in. for durability and appearance.

The luminaires can be laid out in rows or in a grid pattern, although many architects prefer a doughnut configuration for classrooms. See the examples, below.

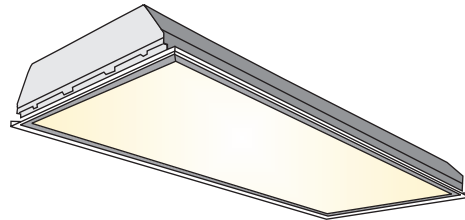

Modern lens recessed troffer (above); surface troffer (below)



### Applicable Climates



### Applicable Spaces

Classrooms	█
Library	█
Multi-Purpose	█
Gym	█
Corridors	█
Administration	█
Toilets	█
Other	█

### When to Consider

Programming	█
Schematic	█
Design Dev.	█
Contract Docs.	█
Construction	█
Commissioning	█
Operation	█

## Applicability

Lens troffers have a distinctly inexpensive and institutional appearance. Also, the light quality is marginal. Nonetheless, under correct circumstances, troffer lighting is appropriate for classrooms, libraries, multipurpose spaces, administration spaces, and corridors.

## Integrated Design Implications

This type of lighting should only be used in flat acoustic tile ceilings, and then only when ceiling height and/or budget prevents consideration of other options.

In daylit classrooms, three circuits for switching or dimming are recommended. The troffers should be circuited into zones that respond to the daylight gradients in the space, such as defining an outer zone along a window wall, a central zone, and an inner wall zone.

## Cost Effectiveness

Recessed lighting systems cost about \$120 per luminaire<sup>1</sup> for basic, white interior luminaires with 0.125 in. lens, two premium T-8 lamps, and electronic ballast. A dimming ballast will add about \$40 to \$50 to each luminaire. Although lens troffer lighting systems are extremely low cost, their inexpensive appearance can be a drawback.

Costs	L	■	□
	M	□	□
	H	□	□
	L	M	H
	Benefits		

## Benefits

Troffer lighting systems generally offer excellent efficiency, but with some loss of visual comfort. They make excellent use of the low-cost, widely used T-8 lamp system. Systems operating at about 1 W/ft<sup>2</sup> will generate between 50 and 60 footcandles maintained average, with very good uniformity.

## Design Tools

See Overview section of this chapter.

## Design Details

There are a number of troffer variations. These include:

- *Quality or price class.* A “specification grade” troffer is generally deeper, heavier gauge metal and costs more. A basic troffer works just as well, but is flimsier.
- *Door type.* A flat steel door with butt joints costs the least; a regressed aluminum door with mitered corners costs quite a bit more, but looks better.
- *Lens.* In addition to the industry standard “Pattern 12” lens, there are other lens designs that can provide increased efficiency and other benefits, but at greater cost.
- *Air Handling.* “Static” troffers are enclosed boxes that do not interface with HVAC equipment. “Heat extraction” troffers serve as a return path for HVAC systems using the ceiling plenum for return, and they cool lamps in the process (not necessary with two-lamp systems). “Air handling” troffers are connected to special HVAC supply or return devices. The cost of HVAC attachments is high, and they do not fully eliminate the need for conventional HVAC diffusers and grilles.

While this type of lighting is suitable for most types of classroom work, lens troffers are not recommended for computer workspaces. Separate chalkboard illumination is usually not required. It is best to employ premium or super T-8 lamps with 835 or 841 color. For non-dimming applications, luminaire light and power can be varied through choice of ballast factor. Use Table 4 and specify ballasts accordingly.

<sup>1</sup> Approximate cost to owner, including labor, materials, overhead, profit, and costs of construction for lighting, including luminaires, lamps, and suspension hardware. Includes connecting luminaire to branch circuit. Controls and branch circuit costs not included. Based on July 2000 prices. Costs can vary depending on market conditions.

Luminaires need to be restrained in case of an earthquake or other natural disaster. In general, this means that each luminaire must be hung from the structure with hanger wires independent of the ceiling system.

There are two common designs:

- A typical classroom with a “modified doughnut” pattern of two lamp troffers (see Figure 20 below). By orienting luminaires parallel to all walls, superior upper wall lighting occurs, although this pattern may cause slightly more glare than by simply using a grid layout.
- A conventional layout of troffers in a simple grid. Upper wall illumination of the end walls is not as good, but the lighting system will produce less glare.

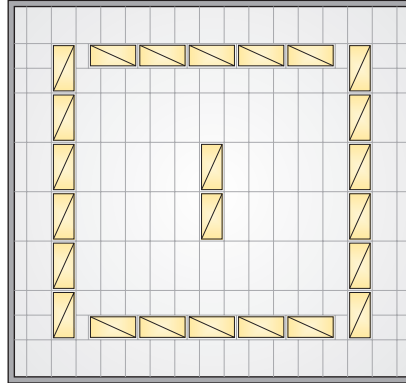

Figure 20 – “Modified Doughnut” Classroom Recessed Lighting Design

### **Operation and Maintenance Issues**

These lighting systems rarely need maintenance. As with all fluorescent systems, lamps should be replaced at approximately 12,000 to 16,000 hours of operation, which, with normal school use, could be as seldom as every six years (consider premium lamps and specific lamp/ballast systems for even longer life and less maintenance). Luminaires should be cleaned annually. Lensed luminaires require periodic cleaning and are occasionally abused. Lens replacement is relatively inexpensive.

### **Commissioning**

No commissioning is needed, other than pre-seasoning of lamps in dimming applications.

### **References/Additional Information**

See this chapter’s Overview.

## GUIDELINE EL3: INDUSTRIAL-STYLE CLASSROOMS

### Recommendation

This recommendation applies to rooms without a finished ceiling and to classroom and office spaces designed to have an industrial, exposed construction style.

Use direct or semi-direct fluorescent industrial luminaires that have T-5HO or T-8 premium lamps and electronic ballasts and have at least 70% efficiency. Lighting power should be approximately 1 W/ft<sup>2</sup> to 1.4 W/ft<sup>2</sup>.

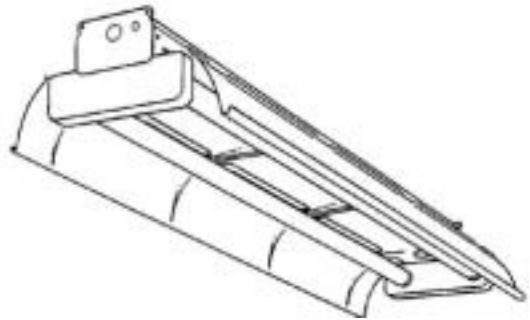

*Industrial fluorescent with uplight*

### Description

In rooms without finished ceilings, some creativity may be needed to implement a lighting solution that is both attractive and performs as well as those designed for more finished spaces. This system may also be appropriate in shop areas where tops of uplights would slowly get caked with sawdust. Depending on budget and architectural requirements, designs may employ strip lights with reflectors, true industrial-style fluorescent luminaires, or styled industrial-like luminaires.

#### Applicable Climates



In general, the following strategies should be employed:

- Use either direct lighting systems (up to 10% uplight), or semi-direct lighting systems (up to 40% uplight). The majority of the light needs to be directed downward since the ceiling of the space, often a metal deck or other unfinished surface, can not be relied on to efficiently reflect light.
- Include some form of glare shielding for the downlight component, although this can often be ignored if the lighting systems are mounted relatively high in the space.
- Have an uplight component to produce balancing luminance and comfortable light, but without being wasteful. The uplight component may be omitted in dusty environments.
- Use simple ideas to make the luminaires visually appealing.

#### Applicable Spaces

Classrooms	■
Library	□
Multi-Purpose	□
Gym	□
Corridors	□
Administration	■
Toilets	□
Other	■

#### When to Consider

Programming	□
Schematic	□
Design Dev.	■
Contract Docs.	■
Construction	□
Commissioning	□
Operation	□

### Applicability

This type of lighting should only be used in very specific applications, such as high-bay industrial spaces like industrial arts rooms and art studios. Rooms with unusual architecture, especially if the school is within an existing building or structure, may also benefit from this type of lighting system. This type of lighting system has gained wider acceptance recently as architects explore more “industrial” and constructed forms of design. However, it is best reserved for spaces where it truly suits the aesthetic.

### Integrated Design Implications

Designing spaces with unfinished ceilings should be carefully contemplated, since light colored and reflective ceilings tend to improve the efficiency of light utilization.

## Cost Effectiveness<sup>2</sup>

An industrial lighting system can be very cost effective, even in unusually high open spaces. Industrial-style lighting systems will cost about \$35/ft to \$75/ft of luminaire depending on the quality and style aspects of the chosen product. To minimize costs, consider using HLO ballasts or T-5HO lamps to increase the power of each luminaire and reduce the number of lights required. If the space is sufficiently high, mounting luminaires in continuous rows reduces mounting and wiring costs.

Costs	L			
	M		■	
	H		■	
		L	M	H
		Benefits		

## Benefits

Industrial lighting systems generally offer excellent efficiency, but with varying degrees of visual comfort. For instance, the strip light, the most basic industrial lighting system, is very efficient but also produces glare. Industrial luminaires make excellent use of the low-cost, widely used 4-ft T-8 lamp system, as well as the less common but equally efficient 8-ft lamp system. For most situations, installations operating at less than 1.5 W/ft<sup>2</sup> will generate appropriate lighting with very good uniformity.

Power use will be affected by the system's mounting height. The efficiency of a luminaire decreases as the mounting height increases. Many spaces without finished ceilings may have a roof structure 20 ft or more in the air, but the luminaires may be suspended as low as 12 ft above floor. In general, power use will range from 1 W/ft<sup>2</sup> to 1.2 W/ft<sup>2</sup> with luminaires at 12 ft, and between 1.2 W/ft<sup>2</sup> to 1.4 W/ft<sup>2</sup> at 16 ft.

## Design Tools

See this chapter's Overview.

## Design Details

- A reflector directing the light downward is necessary, which means strip lights without reflectors are probably not an acceptable choice. Determining the amount of uplight needed is a balance between comfort (more uplight) and efficiency (less uplight). The reflectivity of the ceiling cavity affects this decision a little; the more reflective (such as white painted roof deck), the more benefit will be gained from uplighting.
- Contemplate shielding. Most ordinary industrial lighting systems are open, exposing the lamps to view. However, shielding with louvers or lenses decreases overall efficiency. As a rule of thumb, the need for shielding tends to decrease with ceiling height.
- Choose luminaires with an appropriate distribution of light. As the luminaire is mounted higher, the distribution pattern should become narrower and the spacing to mounting height (S/MH) of the luminaire should become smaller. At lower mounting heights, luminaires rated 1.2 S/MH or more are generally acceptable, but at 15 ft or more, a fluorescent luminaire with S/MH of 1 or less may be the best choice. Avoid wide throw luminaires such as wraparounds.
- Evaluate lamp and ballast options. If the lighting system can be mounted above 12 ft, the use of high light output ballasts on T-8 lamps (up to 1,025 initial lumens per lamp-foot), or even T-5HO lamps (up to 1,250 initial lumens per lamp-foot), can reduce the number of lamps – and luminaires – needed to light the space, which saves costs and complexity. Use Table 4 in this chapter's Overview and specify ballasts accordingly.
- Fluorescent luminaires are strongly encouraged over HID sources due to superior color rendering, energy efficiency, immediate starting and restarting, long lamp life, low flicker, and other qualities. Fluorescent luminaires designed specifically for high-bay spaces like gyms can also be used in high-bay industrial spaces, such as industrial arts and shops. In some extreme situations, metal halide

<sup>2</sup> Approximate cost to owner, including labor, materials, overhead, profit, and costs of construction for lighting including luminaires, lamps, and suspension hardware. Includes connecting luminaire to branch circuit. Controls and branch circuit costs not included. Based on July 2000 prices. Costs can vary depending on market conditions.

high-bay or low-bay luminaires may be used, although fluorescent solutions should always be considered first.

- Some spaces, such as precision industrial arts and art studios, may benefit from higher light levels. Provide up to 1.6 W/ft<sup>2</sup> in these spaces.
- Consider using 8 ft lamps if enough space exists to warrant the introduction of this less-common lamp type.
- If luminaires are mounted sufficiently high in the space, they may be best installed in rows (see Figure 21 below), which in turn permits luminaires to be wired end-to-end, minimizing electrical construction and reducing the number of points where structural support or seismic bracing are required. Luminaires may be suspended on aircraft cables, chains, rigid stems, or may be attached to the surface of the roof or structure above. The lighting system should be mounted to maintain clearances for equipment, overhead doors, etc.
- See Guidelines EL1 and EL2 for examples on using indirect, semi-indirect, and direct luminaires in classrooms with ceilings. These lighting systems can often be applied to spaces with relatively high ceilings as well.

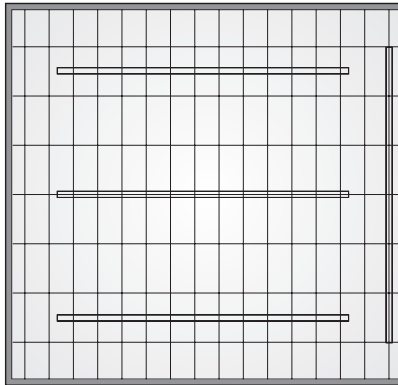

*Figure 21 – Industrial Classroom Suspended Lighting Design*

### ***Operations and Maintenance***

These lighting systems rarely need maintenance. As with all fluorescent systems, lamps should be replaced at approximately 12,000 to 16,000 hours of operation (longer with certain lamps and lamp ballast systems), which with normal school use could be as seldom as every six years. Luminaires should be cleaned annually. Lensed luminaires require periodic cleaning and are occasionally abused. Open luminaires tend to require less maintenance.

### ***Commissioning***

No commissioning is needed.

### ***References/Additional Information***

See this chapter's Overview.

## GUIDELINE EL4: LIGHTING CONTROLS FOR CLASSROOMS

### Recommendation

All lighting systems in spaces with daylight should be circuited so that lighting can be turned off to respond to daylighting availability. Depending on daylight availability and the audio/visual needs of the classroom (including extensive computer work), the following recommendations should be followed:

**Daylit classroom:** To meet the classroom's audio/visual needs, the lighting system should include dimming ballasts, automatic daylight sensing, manual dimming, and manual override. If the classroom has no special audio/visual needs, dimming ballasts and automatic daylight sensing should still be included, as well as motion sensing with manual override.

**Classroom with minimum daylighting:** If the classroom has audio/visual needs, the lighting system should include dimming ballasts, automatic daylight sensing, manual dimming, and manual override. If the room has no special audio/visual requirements, a motion sensing system with manual override should be used.



*Light sensors, like the one being tested here, can dramatically affect both energy use and usability.*

NREL/PIX 05171

### Description

Lighting controls can dramatically affect both the energy use of a lighting system and the usability of the lighting when the classroom is being used for audio/visual or computer education.

As a minimum, all classrooms should employ motion sensors, preferably in conjunction with a switch that can turn lights off regardless of sensor "state." Most sensors are passive infrared and respond to the movement of warm bodies. Upper wall and corner sensors are the best choice, and dual mode sensors employing ultrasonic, microphonic, or another form of backup sensing are strongly recommended. These types of sensors generally require a power pack (transformer-relay) that actually switches the circuit.

Wallbox sensors that replace wall switches are not a good choice for classrooms. For maximum flexibility, manual switches should be wired in series with the motion sensor relay so that lights can be turned off manually, regardless of whether there is motion in the room.

The falling cost of dimming ballasts for T-8 lamps makes dimming possible for many projects. Dimming ballasts permit both manual dimming, allowing the teacher to adjust lighting levels, and automatic dimming, especially to respond to daylight. Ballasts should be specified in conjunction with an overall dimming system to ensure compatibility.

Spaces with audio/visual needs that require manual dimming should use a wall-mounted dimmer controller.

### Applicable Climates





## Applicability

These lighting control strategies are appropriate for classrooms and some areas in administration spaces and libraries.

## Integrated Design Implications

Controls are essential in achieving the overall goal of reduced energy consumption. The mechanical engineer should be informed of expected changes in the lighting system's pattern of operation due to automatic controls. Reduction in the operating hours or the power of the lighting system will lower the internal heat gain in the space, changing the needs for supplemental heating, cooling, and ventilation.

For spaces with daylight, automatic daylight sensors are recommended for lights near the window wall or underneath skylights. Lighting control circuits should be designed to parallel daylight contours. Two switches should be located close to the room entrance, one enabling the lighting fixtures near the window and the other controlling the lighting fixtures away from the window. The lighting circuit next to the window should also be controlled by an "open loop" photosensor. "Open loop" sensors that are not affected by room light are strongly recommended since they are more reliable and easier to calibrate. A third "energy management" switch is recommended to toggle the central row of fixtures so that they can be grouped either on the photosensor circuit or the non-daylighted circuit, depending on the season of the year and other factors that affect daylight availability. See Figure 22 below.

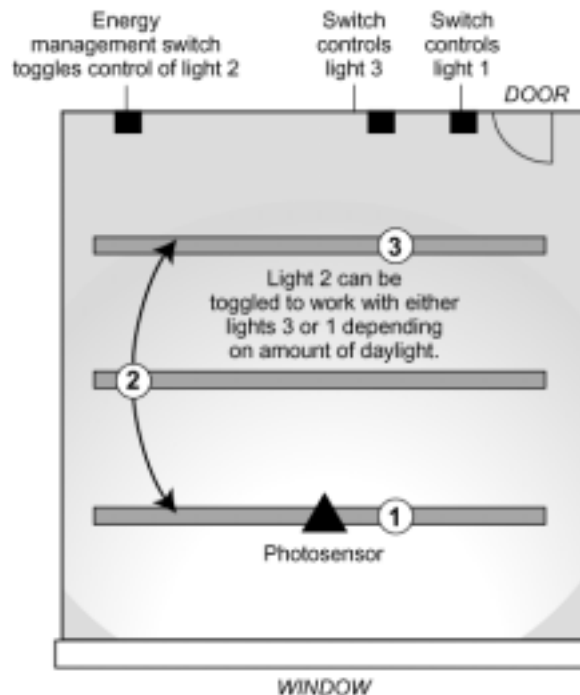

Figure 22 – Simple Windowed Classroom Control

## Cost Effectiveness

For motion sensing, cost effectiveness varies depending on the overall energy management skills of teachers and staff. People who are personally careful with energy outperform motion sensors, but for less well managed spaces, motion sensors are worthwhile.

Daylight sensors and dimming ballasts are worthwhile if the daylighting is designed correctly. Systems employing manual dimming, daylighting, and motion sensing are presently only cost effective if audio/visual or computer requirements of the building use need to be met.

Costs	L			
	M			
	H		■	■
		L	M	H
		Benefits		

Controls are an evolving area of lighting technology for buildings. While cost effectiveness is good at present, costs remain relatively high.

A pair of motion sensors and one power pack adds about \$200 per classroom. Dimming ballasts add approximately \$40 to \$50 per ballast, or up to \$1,200 per classroom. Automatic daylighting control without manual dimming adds about \$200 per classroom, in addition to the costs of ballasts.

A control system that permits manual dimming in conjunction with motion sensing and daylighting will cost about \$1,000 per classroom,<sup>3</sup> in addition to the costs of the dimming ballasts.

### **Benefits**

Each added control element saves energy. Depending on the school's operating months, the quality of daylight, the climatic zone, whether the building is air conditioned or not, and other factors, energy cost savings can vary from good to dramatic.

### **Design Tools**

Very few useful design tools exist for this evolving field. The best information is usually obtained from controls manufacturers and their representatives.

### **Design Details**

- Use two dual-technology motion sensors, set in the corners of the classroom opposite the door. Wire the power for the lights in series with the sensors' transformer-relay and wall switches. Use one switch if automatic daylight controls are being used, and two switches if not. Multiple circuit switching allows teachers flexibility in providing lower light levels for various activities such as nap times or watching a video.
- Use 0-10 volt dimming ballasts unless employing a complete manufacturer-integrated system of control. 0-10 volt controls are the most universal at present and there is more competition in the market.
- Use "open loop" daylight sensors located within 5 ft of the window.

### **Operation and Maintenance Issues**

In operation, a properly commissioned system needs only periodic maintenance to ensure optimum performance. Refer to the manufacturer's recommended recalibration and cleaning cycle for sensors.

### **Commissioning**

Commissioning of motion sensor systems and daylighting controls is critical to their success. Systems that work properly will be left alone; systems that have false tripping and other unwanted behavior will be disconnected or bypassed by occupants.

Good rules of thumb:

- The sensitivity of motion sensors should be set according to the manufacturer's instructions. A proper setting will minimize false tripping and unwanted cycling. Because sensors are both physically and electronically adjustable, care should be taken to ensure the sensors are working as intended.
- The time-out setting of motion sensors is also critical. A setting too short may cause false tripping; a setting too long fails to save energy as well. A preliminary time-out setting of 10 to 15 minutes is usually the right balance.

---

<sup>3</sup> Approximate cost to owner, including labor, materials, overhead, profit, and costs of construction for lighting including luminaires, lamps, and suspension hardware. Includes connecting luminaire to branch circuit. Controls and branch circuit costs not included. Based on July 2000 prices. Costs can vary depending on market conditions.

- Daylight sensor settings should be made and checked several times. Use a good light meter (Minolta TL-1 or better).

### **References/Additional Information**

See this chapter's Overview, and:

*Controls: Patterns for Design.* Electric Power Research Institute. <http://www.epri.com/>.

## GUIDELINE EL5: GYM LIGHTING

### Recommendation

Over basketball courts, volleyball areas, gymnastics areas, and other portions of the gymnasium with a high ceiling and structure, three choices for lighting exist:

1. **T-5HO High-Bay Fluorescent.** Use industrial high-bay luminaires with T-5HO or T-8 lamps. Each luminaire should have symmetric reflectors for downlight distribution, and a wire cage or lens should be used to protect the lamps from flying balls. Four-ft luminaires with four or six lamps and two-lamp ballasts produce similar results as a like number of metal halide luminaires, but with fewer watts and greater versatility.
2. **Compact Fluorescents.** Employ industrial-style luminaires having multiple compact fluorescent lamps in a single housing. Each luminaire should use eight 32-W or 42-W compact fluorescent triple-tube lamps, with electronic ballasts. The fixture should not have a lens, but consider adding a wire cage to open luminaires that may be exposed to flying balls or other damage.
3. **Metal Halide.** Use metal halide industrial-style “high bay” luminaires. The metal halide luminaires should employ 320-W to 450-W “pulse-start” lamps and 277-volt reactor ballasts, if possible. They will provide at least 50 footcandles of general lighting. Use a protected lamp suitable for open luminaries, not a lensed or enclosed lamp. Slightly higher light levels may be provided for the main basketball court in middle schools and high schools. Consider adding a wire cage to open luminaires that may be exposed to flying balls or other damage.



*Metal halide luminaires are one option for general lighting in gymnasiums. NREL/PIX 11437*

### Applicable Climates



### Applicable Spaces

Classrooms	<input type="checkbox"/>
Library	<input type="checkbox"/>
Multi-Purpose	<input type="checkbox"/>
Gym	<input checked="" type="checkbox"/>
Corridors	<input type="checkbox"/>
Administration	<input type="checkbox"/>
Toilets	<input type="checkbox"/>
Other	<input type="checkbox"/>

### When to Consider

Programming	<input checked="" type="checkbox"/>
Schematic	<input checked="" type="checkbox"/>
Design Dev.	<input checked="" type="checkbox"/>
Contract Docs.	<input checked="" type="checkbox"/>
Construction	<input checked="" type="checkbox"/>
Commissioning	<input type="checkbox"/>
Operation	<input type="checkbox"/>

Whichever system is used, it will probably be necessary to design at about 1 W/ft<sup>2</sup> to meet modern expectations for gym lighting. Gyms where significant television broadcasts occur may also employ a separate television lighting system.

It will also be necessary to provide an *emergency lighting system*. In addition to self-illuminated exit signs, provide either:

- Some luminaires powered by batteries or a generator in a high-bay fluorescent system or compact fluorescent system.
- Use quartz auxiliary lamps powered from batteries or an emergency generator in a metal halide system.

Also consider providing a separate halogen downlight system for “house” lighting during dramatic and social uses of the gym. This system may also be powered in full or in part from an emergency generator or battery backup power source. As a basic design, use suspended cylinder downlights with halogen IR

PAR-38 flood lamps. Design the system to provide at least two footcandles of illumination with normal power and one footcandle from an emergency source. This system provides both egress lighting and serves other uses (see below). It must be controlled to prevent concurrent operation with the general lighting system.

### **Description**

The height of the gym space's ceiling plays a major role in choosing gym lighting systems. This can be partly assessed by examining the coefficient of utilization (CU) at Room Cavity Ratio (RCR) = 2.5 of candidate systems. It is also useful to examine their spacing to mounting height (S/MH) as well.

Fluorescent systems using multiple T-5HO or T-8 lamps are preferred for ordinary gyms and other high ceiling spaces. Superior color, elimination of flicker, and the ability to turn lights on and off as needed are major advantages over HID systems. The added cost of the fluorescent system is offset by much lower energy use, estimated to be as much as 50% less if the multiple light level capability of a fluorescent system is utilized. Systems using multiple compact fluorescent lamps also provide these benefits, although without the high efficacy of the linear fluorescent lamps.

In general, metal halide high-bay lighting systems tend to be more appropriate when ceilings are especially tall, such as in a field house. Long lamp life and a minimum number of luminaires keep costs down. The color of metal halide is suitable for television as well as everyday use. The long warm-up and restrike periods of metal halide lighting are a drawback since switching lights off regularly is not recommended for these systems. Be certain to use pulse-start lamps. These systems are, however, compatible with daylight gyms if they have switched lighting levels.

Multiple compact fluorescent "high bay" lights are a distant third choice. These systems are less energy efficient and require more costly and frequent maintenance than the other choices.

A separate downlight system using halogen lamps is highly recommended for two reasons:

- It is an instant-on, instant-off system that can be dimmed inexpensively. This feature is especially important if metal halide lights are accidentally extinguished, as they will require a five to 10 minute cool-off and restrike delay.
- A dimmable tungsten downlighting system can make the gym more appealing for social events, and can also serve as a "house" lighting system for many of the gym's performance and entertainment uses.

Lighting quality is a crucial issue in gym spaces. Avoiding direct view of an extra bright light source, such as a metal halide lamp, high output lamp, or skylight, can be especially critical in a gymnasium where athletes must scan for the ball and react quickly. Even though a luminaire may normally be out of the line of sight, it can still create a devastating glare source to a volleyball or basketball player.

### **Applicability**

This guideline can be used in most schools, including colleges and universities, public K-12, private, and parochial schools, and similar facilities such as churches, sports clubs, and private institutions.

### **Integrated Design Implications**

High bay luminaires are easily attached to most structures. It is recommended that the luminaires be suspended within the "truss space" or, in other words, with the bottom of the luminaire not lower than the lowest beam or truss member. In the rare instance where the gym has a finished ceiling, recessed lighting should be considered.

Daylighting design is especially well suited to the high ceilings and large open space of gymnasiums. Gentle diffuse systems, which avoid creating excessive bright spots within the athletes' critical viewing directions, are especially appropriate. For example, side lighting should be placed perpendicular to the primary basketball walls. Wall wash top lighting or high sidelighting with light shelves or louvers can be

effective techniques for gyms, since both involve secondary reflections on room surfaces that prevent direct view of the window or skylight. Direct sun penetration into gyms should be prevented at all times.

### Cost Effectiveness<sup>4</sup>

Each metal halide luminaire costs about \$325, or about 79 mean lumens/dollar. A multiple compact fluorescent luminaire costs about \$425, or about 52 mean lumens/ dollar. A T-5HO 6-lamp luminaire costs about \$375, or about 76 mean lumens/dollar. Each PAR38 downlight costs about \$150. Dimming, switching, and emergency power costs vary and are in addition to the luminaire costs.

Costs	L			
	M			
	H			
		L	M	H
		Benefits		

### Benefits

The best solution for a particular gym depends on hours of use and other variables.

- A metal halide lighting system has the lowest first cost. There is no less expensive way to provide the necessary quantity of light from this mounting height. The use of high Watt metal halide lamps minimizes the number of luminaires (first costs) and the number of lamps (maintenance costs).
- A system employing multiple T-5HO or T-8 lamps offers the least energy use and longest life lamps (lowest maintenance costs). Multiple light level capability saves additional energy and extends maintenance periods.
- A system using multiple compact fluorescent lamps combines the flexibility of fluorescent systems with the appearance of HID. While most costly to build and to operate, this approach results in a flexible design that can be energy effective if multiple light levels are used, and the system looks like a metal halide system.

### Design Tools

See this chapter's Overview.

### Design Details

- Fluorescent high-bay lighting is a relatively new solution. Consider both T-8 and T-5HO systems. This choice requires specific considerations for reflector shape, photometry, and lamp protection. Products are available from some major fluorescent manufacturers and several specialty fluorescent makers. Careful study to ensure proper lighting levels is recommended.
- Any fluorescent choice permits the use of multiple level switching, including automatic daylight control. Take advantage of this feature in gyms with skylights and clerestories.
- Metal halide "high bay" luminaires are commonly available in a number of reflector types including aluminum, ribbed acrylic, and ribbed glass. Among these, ribbed acrylic offers the best combination of efficiency and uplight, and is sufficiently durable for the application.
- It is critical to specify the 320-W to 450-W, pulse-start, 277-volt reactor ballast system. If 277-volt (three-phase) power is not available, then use a 120-volt CWA ballast, although it is less energy efficient. Do not use the standard (probe-start) 400-W metal halide system, as it produces less maintained light than the 320 pulse-start system.
- In gyms with skylights (highly recommended), using a two-level controller for the metal halide lamps should be considered. A photoelectric switch, sensing when adequate daylight is present to turn lights down to the low setting, should control the action.

<sup>4</sup> Approximate cost to owner, including labor, materials, overhead, profit, and costs of construction for lighting including luminaires, lamps, and suspension hardware. Includes connecting luminaire to branch circuit. Controls and branch circuit costs not included. Based on July 2000 prices. Costs can vary depending on market conditions.

- Switches for metal halide lamps should NOT be readily accessible. They should be in a controlled location such as an electric room, press box, teacher/coach's office, or other location where inadvertent operation of the lights will not occur. This adds support to the concept of a separate halogen system in which the switch is quite accessible. It would be a good idea to interlock the two systems so that the halogen system cannot operate once the metal halides are at, or near, full light.

### ***Operations and Maintenance***

This design should be easy to operate and manage. Dimming on the halogen system (if used) will extend lamp life, and a metal halide system will require relamping every 12,000 to 14,000 hours (depending on hours of operation, this could be three to five years). System cleaning should be simple. Linear fluorescent systems require relamping every 15,000 to 20,000 hours, but compact fluorescent systems require relamping every 8,000 to 10,000 hours. However, if both fluorescent lamp systems rotate lamp operation at reduced light levels, relamping cycles can be very long.

The control system should be designed for easy use. Automatic time-of-day control with manual override is an acceptable means to control the metal halide lamps, but make certain that the controller is easily programmed for days on and off, holiday schedules, etc.

### ***Commissioning***

These systems are relatively easy to commission. Perhaps the most critical step is ensuring that automatic lighting controls, such as a photoelectric controller for a high-low system or an automatic time-of-day controller, are properly set up.

### ***References/Additional Information***

See this chapter's Overview.

## GUIDELINE EL6: CORRIDOR LIGHTING

### Recommendation

There are two principal choices for illuminating corridors in schools:

- Use recessed fluorescent luminaires that have a means to both protect the lamp and create relatively high angle light perpendicular to the corridor axis.
- Use surface-mounted corridor “wrap-around” fluorescent luminaires designed for rough service applications.
- In either case, luminaires should use T-5 or T-8 lamps and electronic ballasts. Caution should be employed to ensure that the luminaires are not overly “institutional” in appearance. Align luminaires parallel to corridor walls to provide good quality of light and to make light useful for lockers.

Outdoor corridors and corridors with plentiful daylight should employ automatic daylight switching or dimming to reduce electric lighting by day.

It will be necessary to provide emergency lighting with this lighting system. Some of these luminaires must be powered from an emergency generator or battery backup power source.



*Corridor lighting that emits light to the sides allows for more illumination of the walls and minimizes downlighting.  
NREL/PIX 11438*

### Description

It is important to minimize downlighting so that the walls of the corridor will be better illuminated. Lights that emit very well to the sides should be chosen. Choose from among the following types of products:

- Interior corridors may employ “recessed indirect” luminaires. Luminaires should be oriented with the lamp’s long axis along the corridor long axis. This design is suited for all ceiling types.
- As an alternative, especially for schools where vandalism is a concern, use surface ceiling wrap-around luminaires, preferably vandal-resistant or high abuse types.
- Exterior corridors should employ surface-mounted wrap-arounds or ceiling-mounted, high abuse luminaires. In some cases, wall-mounted, high abuse luminaires may be acceptable.

#### Applicable Climates



#### Applicable Spaces

Classrooms	<input type="checkbox"/>
Library	<input type="checkbox"/>
Multi-Purpose / Gvm	<input type="checkbox"/>
Corridors	<input checked="" type="checkbox"/>
Administration	<input type="checkbox"/>
Toilets	<input type="checkbox"/>
Other	<input type="checkbox"/>

#### When to Consider

Programming	<input checked="" type="checkbox"/>
Schematic	<input checked="" type="checkbox"/>
Design Dev.	<input checked="" type="checkbox"/>
Contract Docs.	<input checked="" type="checkbox"/>
Construction	<input checked="" type="checkbox"/>
Commissioning	<input type="checkbox"/>
Operation	<input type="checkbox"/>



## Applicability

This guideline can be used in most schools, including colleges and universities, public K-12, private, and parochial schools, and similar facilities such as churches, sports clubs and private institutions.

## Integrated Design Implications

Given the luminaire choices that are available, it should be possible to find an attractive solution that is suitable for any type of corridor ceiling construction, including indoor and outdoor corridors, acoustical tile or wallboard ceilings, etc.

Corridors are generally excellent spaces for daylighting. Furthermore, daylight in corridors provides an important safety feature of guaranteed lighting during any daytime emergencies. For single story or top floor corridors, linear toplighting is especially appropriate. For corridors not directly under a roof or adjacent to an exterior wall, pools of light from intermittent sidelighting or toplighting borrowed from the floor above can create important social spaces, with higher levels of illumination than that provided by the electric lighting system. Daylight introduced at the end of a long corridor can have a glaring effect, making the corridor feel more like a tunnel. Daylight introduced from the side or above is generally more effective with less glare. As with electric lighting, illuminating the corridor walls should be the primary objective.

Corridor daylighting may be less costly than classroom daylighting because glare control is not as critical as in a learning environment. For this reason, glare-control sun shades or overhangs may be value-engineered out of the corridor portion of a project without creating significant learning rate issues. However, corridor daylighting may also not enhance the accelerated learning rates provided by daylighting in teaching spaces.

## Cost Effectiveness

The corridor lighting systems recommended here are very cost effective. Each corridor luminaire costs about \$200.<sup>5</sup> Dimming, switching, and emergency power costs vary and are in addition to the luminaire costs.

Costs	L			
	M			
	H			
		L	M	H
		Benefits		

## Benefits

Fluorescent corridor lighting systems provide solid results for a modest investment. Long product life will result from carefully choosing a rough service grade luminaire.

## Design Tools

See this chapter's Overview.

## Design Details

The following are typical lighting layouts for corridors:

<sup>5</sup> Approximate cost to owner, including labor, materials, overhead, profit, and costs of construction for lighting including luminaires, lamps, and suspension hardware. Includes connecting luminaire to branch circuit. Controls and branch circuit costs not included. Based on July 2000 prices. Costs can vary depending on market conditions.

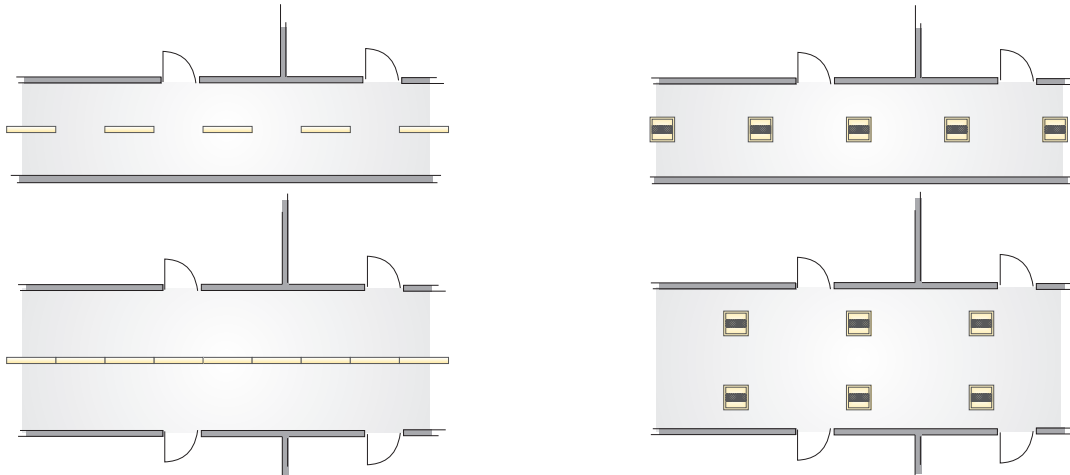

*Figure 23 – Corridor Lighting Designs*

- If required by the application, choose one of many modern “rough-service” luminaires that are attractive as well as durable.
- In general, recessed downlights generally have insufficient vertical illumination to provide good service in corridors. However, recessed downlights using compact fluorescent lamps may be preferred for lobbies and similar applications where a dressier appearance is desired.
- Switching of the lighting system should NOT be readily accessible. In general, switching should utilize an automatic time of day control system with motion sensor override during normally “off” hours.
- In addition, provide automatic daylighting controls, including dimming or switching off lights in corridors having windows, skylights, or other forms of natural lighting.

### **Operation and Maintenance Issues**

This design should be easy to operate and manage. As with most fluorescent lighting systems, relamping every 12,000 to 14,000 hours is recommended. Ballast life extends 10 years or more. System cleaning should be simple.

The control system should be designed for easy management. Automatic time-of-day control with override is an acceptable means to control corridor lights, but make certain that the controller is easily programmed for days on and off, holiday schedules, etc.

### **Commissioning**

These systems are relatively easy to commission. Perhaps the most critical step is ensuring that automatic lighting controls, such as a photoelectric controller for a high-low system or an automatic time-of-day controller, are properly set up.

### **References/Additional Information**

See this chapter’s Overview.

## GUIDELINE EL7: LIGHTING FOR A MULTI-PURPOSE ROOM

### Recommendation

As a minimum, a multi-purpose room should have at least two independent lighting systems:

- A general lighting system providing 20 to 30 footcandles of uniform illumination using standard T-8 lamps or other high efficiency lighting; and
- A dimmable “house lighting” system supporting audio/visual and social uses of the room, producing no more than 5 footcandles.

In addition, theatrical lighting may be added to illuminate specific stage or performance locations.



*A multi-purpose room should have at least two independent lighting systems for flexibility of use. NREL/PIX 11436*

### Description

The general lighting system should probably be one of the types previously suggested for classroom lighting in Guidelines EL1 through EL3. If suspended luminaires are chosen, be careful to locate luminaires so as not to interfere with audio/visual and other uses of the room. If the room’s uses include any sports or games, all lighting systems should be recessed or otherwise protected from damage similar to Guideline EL5: Gym Lighting.

The house lighting system should probably employ recessed or surface downlights. Narrow beam downlights should be chosen, and halogen lighting is recommended due to its superior color, inexpensive dimming, and good light control. Luminaires should use standard IR halogen PAR lamps. Black baffles or black alzak cone trims are recommended for audio/visual applications. The house lighting system should be laid-out to prevent light from striking walls or screens. Note that some general lighting systems might also serve as the house lighting system if properly laid out and equipped with electronic dimming ballasts, but most general lighting systems generate too much diffuse light, even when dimmed, for audio/visual use.

As with corridors and other common spaces, a control system that activates the general lighting system according to a calendar program and employs motion sensing for “off” hours should be used. Rooms with plentiful daylight should employ automatic daylight switching or dimming to reduce electric lighting by day. A manual override switch should be provided. Manual dimming of the house lighting system should be provided along with an interlock switch preventing simultaneous operation of both general and house lighting.

It will be necessary to provide emergency lighting with this lighting system. Some of these luminaires must be powered from an emergency generator or battery backup power source.

### Applicable Climates



### Applicable Spaces

Classrooms	<input type="checkbox"/>
Library	<input type="checkbox"/>
Multi-Purpose	<input checked="" type="checkbox"/>
Gym	<input type="checkbox"/>
Corridors	<input type="checkbox"/>
Administration	<input type="checkbox"/>
Toilets	<input type="checkbox"/>
Other	<input type="checkbox"/>

### When to Consider

Programming	<input checked="" type="checkbox"/>
Schematic	<input checked="" type="checkbox"/>
Design Dev.	<input checked="" type="checkbox"/>
Contract Docs.	<input checked="" type="checkbox"/>
Construction	<input checked="" type="checkbox"/>
Commissioning	<input type="checkbox"/>
Operation	<input type="checkbox"/>

## Applicability

This guideline can be used in most schools, including colleges and universities, public K-12, private and parochial schools, and similar facilities such as churches, sports clubs, and private institutions.

## Integrated Design Implications

Because multi-purpose rooms often serve as a cafeteria, study hall, social gathering spot, special event space, community meeting hall, and audio/visual facility, it is extremely important to ensure that the lighting and controls provide proper operation for every intended use of the room. Moreover, this room may benefit from greater architectural design than other spaces, and lighting designers should be prepared to creatively provide the functions of the lighting described here, but use other types of equipment better suited to the specific architecture.

Multipurpose rooms can be successfully daylit, either from high clerestories or toplighting approaches. However, near-blackout capability for the daylight system is probably most important in this type of space, so operable louvers or blinds are highly recommended. If the daylight system can be reduced to a minimum of one to three footcandles, most reduced light functions, including stage performances, can operate effectively. A small amount of sunlight can be a cheerful presence in multipurpose rooms used as a cafeteria, as long as it can be blocked when needed.

## Cost Effectiveness<sup>6</sup>

In general, two separate lighting systems, with one being a dimmed halogen system, is the most cost effective. A single fluorescent lighting system with dimming system is usually more costly and less flexible.

Each downlight costs about \$175 (see the other guidelines in this chapter for general lighting costs). Dimming, switching, and emergency power costs vary and are in addition to the luminaire costs.

Costs	L			
	M			■
	H			
		L	M	H
		Benefits		

## Benefits

This “two component” lighting design approach, when combined with effective controls, permits a wide range of uses of the multipurpose room, exactly what these rooms are designed for.

## Design Tools

See this chapter’s Overview.

## Design Details

The figure below shows a typical multipurpose room with two lighting schemes. The left side uses pendant-mounted luminaires, and the right side shows recessed troffers.

<sup>6</sup> Approximate cost to owner, including labor, materials, overhead, profit, and costs of construction for lighting including luminaires, lamps, and suspension hardware. Includes connecting luminaire to branch circuit. Controls and branch circuit costs not included. Based on July 2000 prices. Costs can vary depending on market conditions.

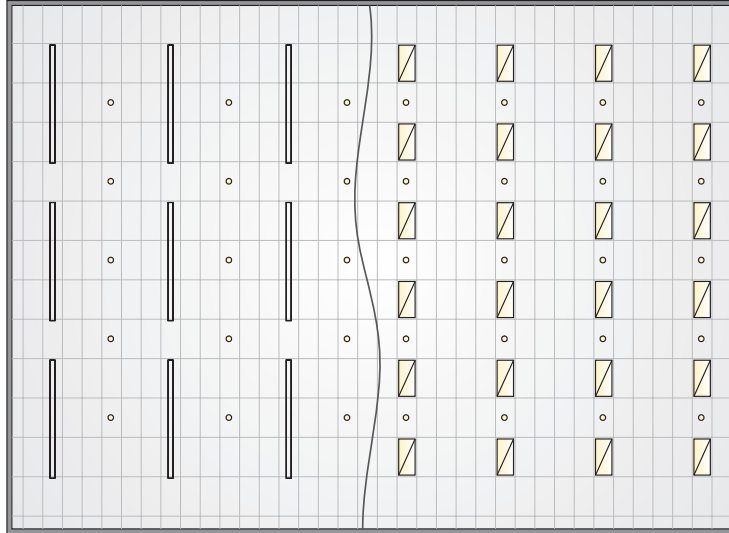

*Figure 24 – Multipurpose Lighting Designs*

*This figure shows two approaches to lighting multipurpose rooms. Both schemes have a separate system of downlights to serve as “house” lights for social and A/V use.*

- In this room, self-contained emergency ballast/battery units should be avoided unless specially designed to employ an external voltage sense connection. Leaving any general lighting luminaire operating in the dimmed mode is usually not acceptable.
- Consider placing the lighting in zones that have individual manual override switches to permit deactivating a zone when not occupied.
- Switching and dimming of the lighting system should NOT be readily accessible. Locate controls in a supervised location.
- Consider a modern preset dimming or control system, especially if touch-screen control and other modern audio/video interfaces are planned.

### **Operation and Maintenance Issues**

This design should be easy to operate and manage. As with most fluorescent lighting systems, the general lighting system should be relamped every 12,000 to 14,000 hours. Ballast life should cover 10 years or more. Spot relamping is recommended for the house lighting system. Cleaning of both systems should be simple.

The control system should be designed for easy management. Automatic time of day control with override is an acceptable means to control corridor lights, but make certain that the controller is easily programmed for days on and off, holiday schedules, etc.

### **Commissioning**

These systems are relatively easy to commission. Perhaps the most critical step is ensuring that automatic lighting controls, such as a photoelectric controller for a high-low system or an automatic time-of-day controller, are properly set up. Also, if fluorescent dimming is used, make sure that lamps are pre-seasoned, i.e., operated at full light for 100 hours prior to dimming them.

### **References/Additional Information**

See this chapter’s Overview.

# GUIDELINE EL8: LIGHTING FOR A LIBRARY OR MEDIA CENTER

## Recommendation

Provide lighting for a library as follows:

- A lighting system providing 20 to 50 footcandles of general illumination in casual reading, circulation, and seating areas using standard T-8 lamps.
- Overhead task lighting at locations such as conventional card files, circulation desks, etc.
- Task lighting at carrels and other obvious task locations, using compact fluorescent or T-8 lamps.
- Stack lights using T-8 or T-5 lamps in areas where stack locations are fixed, and general overhead lighting in areas employing high density stack systems.
- Special lighting for media rooms, as required.



*This library uses a combination of daylighting for ambient light and task lighting above desks and card files.*

NREL/PIX 11439

## Description

The general lighting system may be one of the types previously suggested for classroom lighting (Guidelines EL 1-3 and EL9). As long as adequate ceiling height is present, suspended lighting systems are preferable. Overhead lighting systems for task locations should also be selected from among choices suitable for classrooms or offices.

Task lighting at carrels and other spots should be selected according to architecture and finish details. Two common options include:

- Under-shelf task lights using T-8 or modern T-5 lamps (e.g., F14T5/8xx, F21T5/8xx, or F28T5/8xx).
- Table or floor lamp equipped with a compact fluorescent lamp up to 40 W.

Stack lighting should utilize luminaires specifically designed for lighting stacks. A number of choices exist, but generally, a single continuous T-8 or T-5 lamp system will provide adequate illumination.

Media rooms, such as video monitoring and editing, sound monitoring and editing, distance learning, and video teleconferencing all have special requirements. It is important that lighting be designed to meet those specific needs and that lighting controls be provided to enable room use. No specific recommendations for those spaces are made here, but depending on the room, professional lighting design services may be needed to assist the standard design team.

A control system that activates the general lighting system according to a calendar program and employs motion sensing for “off” hours should be used. In areas with plentiful daylight, employ automatic daylight switching or dimming to reduce electric lighting by day. In addition, in areas of the library that are less frequently used, such as reference stacks, consider providing individual motion sensors or digital time switches for stack aisles that are connected to dimming ballasts, producing low light levels (but not completely off) until the aisle is occupied. Individual reading and study rooms should employ motion

### Applicable Climates



#### Applicable Spaces

Classrooms	<input type="checkbox"/>
Library	<input checked="" type="checkbox"/>
Multi-Purpose	<input type="checkbox"/>
Gym	<input type="checkbox"/>
Corridors	<input type="checkbox"/>
Administration	<input type="checkbox"/>
Toilets	<input type="checkbox"/>
Other	<input type="checkbox"/>

#### When to Consider

Programming	<input type="checkbox"/>
Schematic	<input type="checkbox"/>
Design Dev.	<input type="checkbox"/>
Contract Docs.	<input type="checkbox"/>
Construction	<input type="checkbox"/>
Commissioning	<input type="checkbox"/>
Operation	<input type="checkbox"/>

sensors, with “personal” motion sensors and plug strips used at study carrels, especially those with fixed computers.

It will be necessary to provide emergency lighting with this system. Some of the general lighting luminaires must be powered from an emergency generator or backup battery power source.

### **Applicability**

This guideline can be used in most schools, including colleges and universities, public K-12, private and parochial schools, and similar facilities containing libraries, such as churches and private institutions.

### **Integrated Design Implications**

Libraries are often more highly designed than other spaces. In some designs, other lighting systems that integrate better with the architecture should be considered.

Daylight is an excellent choice for providing basic ambient light in a library. Reading areas and storytelling niches especially benefit from the presence of gentle daylight and view windows. With thoughtful daylight design, only the task lighting at checkout desks or stack areas needs to be on during the day. And these can be connected to occupancy sensors to reduce their hours of operation.

If the library has computers for research or card catalog searches, special care should be taken to avoid glare sources on the computer monitors from light fixtures or windows.

### **Cost Effectiveness**

Library spaces will tend to be among the most expensive to light. These recommendations provide a good balance between cost, energy efficiency, and good lighting practice.

A 4-ft-long stack light is approximately \$200. A 3-ft-long undercabinet task light costs about \$175. A high-quality compact fluorescent desk lamp falls in the \$300 price range.

Dimming, switching, and emergency power costs vary and are in addition to the luminaire costs.

Costs	L			
	M			■
	H			
		L	M	H
		Benefits		

### **Benefits**

These recommendations provide proper light for a library and media center. Task light levels are provided only at task locations, while ambient and general light levels are lower to ensure energy efficient operation.

### **Design Tools**

See this chapter’s Overview.

### **Design Details**

Below is a lighting design for a typical library:

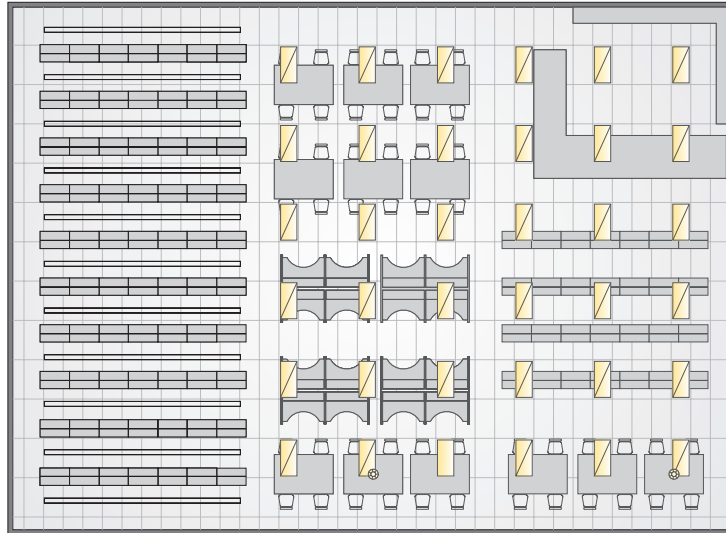

*Figure 25 – Library Lighting Design*

*This design illustrates general lighting using troffers, table lights for study desks, task lights at kiosks, and stack lights. Using high ballast factor 2-lamp troffers, this design works at an overall power density of 1.27 W/ft<sup>2</sup>. Increasing stack lights to high ballast factor increases overall connected power to 1.38 W/ft<sup>2</sup>. Note that the stacks to the right on the plan are half height.*

- The general lighting system can be designed to become more “dense” in task areas such as circulation desks, thus minimizing the number of different lighting types.
- Undercabinet task lights should be specified carefully. Avoid traditional “inch light” systems with magnetic ballasts that use twin tube compact fluorescent lamps and old-style linear lamps like the F6T5 (9 in.), F8T5 (12 in.), and F13T5 (21in.). Use task lights employing modern F14T5 (22 in.), F21T5 (34 in.), F28T5 (46 in.), F17T8, F25T8, or F32T8 lamps. Always use electronic ballasts, and consider dimming for all task lights.
- Desk lamps and table lamps with compact fluorescent hardwired lamps should be used. Relatively few products exist. Medium-based screw-in compact fluorescent lamps are not a good choice for new projects.
- Switching and dimming of the lighting system should NOT be readily accessible. Locate controls in a supervised location.
- In media rooms, consider a modern preset dimming or control system, especially if touch-screen control and other modern audio/video interfaces are planned.

### **Operation and Maintenance Issues**

This design should be easy to operate and manage. As with most fluorescent lighting systems, the general lighting system should be relamped every 12,000 to 14,000 hours. Ballast life lasts 10 years or more. Spot relamping is recommended for the house lighting system. Cleaning of both systems should be simple.

### **Commissioning**

These systems are relatively easy to commission. Perhaps the most critical step is ensuring that automatic lighting controls, such as a photoelectric controller for a high-low system or an automatic time-of-day controller, are properly set up. Also, if fluorescent dimming is used, make sure that lamps are pre-seasoned (i.e., operated at full light for 100 hours prior to dimming them).

### **References/Additional Information**

See this chapter’s Overview.



# GUIDELINE EL9: LIGHTING FOR OFFICES AND TEACHER SUPPORT ROOMS

## Recommendation

This recommendation is for offices and teacher support rooms having a ceiling no more than 12 ft high and a flat suspended acoustical tile ceiling. There are three choices:

1. Use recessed fluorescent lens troffers having at least 78% luminaire efficiency, using T-8 premium lamps and electronic ballasts. The connected lighting power should be 0.9 W/ft<sup>2</sup> to 1.1 W/ft<sup>2</sup>.
2. Use recessed fluorescent troffers with parabolic reflectors in low ceiling offices where glare or institutional feel of lensed troffers are unacceptable.
3. Use suspended indirect lighting to produce an ambient level of 15 to 20 footcandles (about 0.6 W/ft<sup>2</sup>) and task lighting where required.

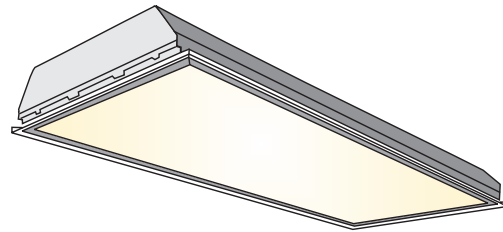

*Recessed fluorescent lens troffer.*

### Applicable Climates



## Description

See Guidelines EL1 and 2.

## Applicability

This guideline can be used in most schools, including colleges and universities, public K-12, private and parochial schools, and similar facilities such as churches, sports clubs, and private institutions.

## Integrated Design Implications

This type of lighting should only be used in flat acoustic tile ceilings and then only when ceiling height and/or budget prevents consideration of other options.

### Applicable Spaces

Classrooms	
Library	
Multi-Purpose	
Gym	
Corridors	
Administration	
Toilets	
Other	

### When to Consider

Programming	
Schematic	
Design Dev.	
Contract Docs.	
Construction	
Commissioning	
Operation	

## Cost Effectiveness

Lens troffer lighting systems are low in cost, but their inexpensive appearance can be a drawback. Suspended lighting systems provide a high degree of cost effectiveness and improved appearance in most applications.

Costs	L			
	M			
	H			
		L	M	H
		Benefits		

## Benefits

Troffer lighting systems generally offer excellent efficiency, but with some loss of visual comfort. Troffers with parabolic reflectors provide improved visual comfort but have poorer cut off angles so the walls tend to be darker near the ceiling than with lensed fixtures. They make excellent use of the low-cost, widely used T-8 lamp system. Systems operating at about 1 W/ft<sup>2</sup> will generate between 50 and 60 footcandles maintained average, with very good uniformity. Separate task and ambient systems may create a more comfortable atmosphere.

### ***Design Tools***

See this chapter's Overview.

### ***Design Details***

See Guidelines EL1 and 2.

For non-dimming applications, luminaire light and power can be varied through choice of ballast factor. Use Table 4 in this chapter's Overview and specify ballasts accordingly.

### ***Operation and Maintenance Issues***

These lighting systems rarely need maintenance. As with all fluorescent systems, lamps should be replaced at approximately 12,000 to 16,000 hours of operation, which with normal school use could be as seldom as every six years. Luminaires should be cleaned annually. Lensed luminaires require periodic cleaning and are occasionally abused. Lens replacement is relatively inexpensive.

### ***Commissioning***

No commissioning is needed, other than pre-seasoning of lamps in dimming applications.

### ***References/Additional Information***

See this chapter's Overview.

## GUIDELINE EL10: LIGHTING FOR LOCKER AND TOILET ROOMS

### Recommendation

Over mirrors and vanities, employ rough-service-grade fluorescent wall-mounted lights. Over stalls and locker areas, use recessed or surface-mounted, rough-service-area fluorescent lights. In showers, employ ceiling-mounted, watertight, rough-service-grade fluorescent lights.

In general, choose luminaires that are attractively styled to prevent an overly institutional appearance.

### Description

This guideline generally recommends fluorescent luminaires using standard T-8 or compact fluorescent lamps. These luminaires are part of a relatively new generation of “vandal-resistant” or “rough-service” lights that are considerably more attractive than previous products. These luminaires should be specified with UV-stabilized, prismatic polycarbonate lenses for maximum efficiency and resistance to abuse. The use of tamper-resistant hardware is also recommended.

Wall-mounted rough-service lights include:

- Linear lights using T-8 lamps and electronic ballasts.
- Rectangular, oval, and round lights that can be equipped with compact fluorescent lamps (low Watt HID lamps can also be used in these luminaires, but are not recommended).

Recessed ceiling lights are generally troffers (see Guideline EL2) that employ the polycarbonate lens and tamper-resistant hardware, as well as more robust components. These luminaires are available in 1 ft x 4 ft, 2 ft x 2 ft, and 2 ft x 4 ft versions with standard T-8 lamps and electronic ballasts.

For showers, employ either surface or recessed luminaires designed for compact fluorescent lights. Due to the long warm-up and restrike times, HID lamps should not be used. In either case, luminaires should be listed for wet applications.

### Applicability

This guideline can be used in most schools, including colleges and universities, public K-12, private and parochial schools, and similar facilities such as churches, sports clubs, and private institutions.

### Integrated Design Implications

These types of spaces are historically the most abused interior portions of school buildings. Durable lighting is unfortunately less attractive and less integrated than other lighting types.



*Rough service grade fluorescent lights, like the ones over these mirrors, last long, continue to look good, and do not suffer from cracks and other signs of abuse.*

NREL/PIX 11471

### Applicable Climates



#### Applicable Spaces

Classrooms	<input type="checkbox"/>
Library	<input type="checkbox"/>
Multi-Purpose	<input type="checkbox"/>
Gym	<input type="checkbox"/>
Corridors	<input type="checkbox"/>
Administration	<input type="checkbox"/>
Toilets	<input checked="" type="checkbox"/>
Other	<input type="checkbox"/>

#### When to Consider

Programming	<input checked="" type="checkbox"/>
Schematic	<input checked="" type="checkbox"/>
Design Dev.	<input checked="" type="checkbox"/>
Contract Docs.	<input checked="" type="checkbox"/>
Construction	<input type="checkbox"/>
Commissioning	<input type="checkbox"/>
Operation	<input type="checkbox"/>

Daylight is a welcome addition to any locker or toilet room. The high light levels from daylight promote good maintenance and sunlight can actually help sanitize the spaces by killing bacteria. For privacy and security reasons, daylight is often best provided in these spaces via diffusing skylights. Often these spaces can be designed to need no additional electric light during the day.

**Cost Effectiveness**

The investment in rough-service equipment is paid back over time. In high schools and colleges, the payback can be rapid, especially if the students are particularly rough or abusive.

Rough-service lighting systems will cost about \$200 to \$300 per luminaire for the types listed above, with compact fluorescent or T-8 lamps and an electronic ballast.

Costs	L			
	M			
	H			■
		L	M	H
		Benefits		

**Benefits**

Rough-service lighting will last longer in these applications while continuing to look good and not suffer from cracks and other signs of abuse.

**Design Tools**

See this chapter’s Overview.

**Design Details**

Be certain to employ premium T-8 lamps with 835 or 841 color, rated at 24,000 hours. For non-dimming applications, luminaire light and power can be varied through choice of ballast factor. Use Table 4 in this chapter’s Overview and specify ballasts accordingly.

Controls should perform in one of the following ways:

- Continuously on during normal school hours, with a night/emergency light on all the time; or
- Continuously on during normal school hours, with both a night/emergency light on at all times and a motion sensor override for full lighting during “off” hours.

**Operation and Maintenance Issues**

These lighting systems rarely need maintenance. As with all fluorescent systems, lamps should be replaced at approximately 12,000 to 16,000 hours of operation, which with normal school use could be as seldom as every six years. Luminaires should be cleaned annually. Lensed luminaires require periodic cleaning and are occasionally abused. Lens replacement is relatively cheap.

**Commissioning**

No commissioning is needed, other than pre-seasoning of lamps in dimming applications.

**References/Additional Information**

See this chapter’s Overview.

# GUIDELINE EL11: OUTDOOR LIGHTING

## Recommendation

As a minimum, provide the following exterior lighting systems:

- At every door, place canopy or wall-mounted lights to illuminate the general area.
- For parking lots, use pole-mounted, full cut-off lights to illuminate the lot as well as surrounding walks and other areas.
- For driveways intended for night use, have pole-mounted, full cut-off lights for the drive and associated sidewalks.
- For walkways intended for night use, use suitable walkway lighting systems, such as pedestrian light poles or bollards.
- Other lighting as called for by the site or local requirements.

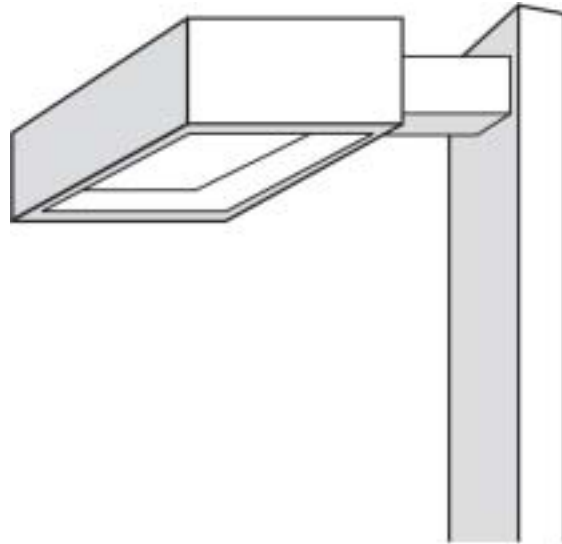

## Description

Lights under canopies or mounted to walls should be attractive, rough-service, semi-recessed, or surface luminaires with lens. The lens should be a UV-stabilized polycarbonate prismatic lens. If mounted to walls, use designs that direct light downward and minimize light trespass and light pollution.

Parking lots and driveways should be illuminated using pole-mounted full-cutoff luminaires. Luminaires should be at least 17 ft above grade; actual pole height depends on the type of pole and base. Direct burial, color-impregnated composition or fiberglass poles are recommended if soil and other site conditions are acceptable; if used in the center of a large parking area, however, consider steel or aluminum poles that are anchor-bolt mounted to foundations. Typically, luminaires will employ 150-W or 175-W pulse start metal halide lamps, and in parking lots, two luminaires may be mounted to a single pole.

Lower level lights may be used for walkways, especially if located away from buildings and parking lots. Choose between short poles (8 ft to 12 ft) using compact fluorescent or low Watt HID lamps, or bollards using compact fluorescent lamps.

A control system that activates the exterior lighting system according to an astronomic clock, instead of a photocell, should be used. The system should permit activation at sunset and deactivation at a programmable time, allowing the school to be “dark” and save energy as much of the night as possible. Separate “off” times programmed for parking lot, driveway, and building lighting are highly desirable. This system should be located where accessible to administration personnel; it must be easy to set and permit manual override.

### Applicable Climates



### Applicable Spaces

Classrooms	<input type="checkbox"/>
Library	<input type="checkbox"/>
Multi-Purpose	<input type="checkbox"/>
Gym	<input type="checkbox"/>
Corridors	<input type="checkbox"/>
Administration	<input type="checkbox"/>
Toilets	<input type="checkbox"/>
Other	<input checked="" type="checkbox"/>

### When to Consider

Programming	<input checked="" type="checkbox"/>
Schematic	<input checked="" type="checkbox"/>
Design Dev.	<input checked="" type="checkbox"/>
Contract Docs.	<input checked="" type="checkbox"/>
Construction	<input checked="" type="checkbox"/>
Commissioning	<input type="checkbox"/>
Operation	<input type="checkbox"/>

In many suburban or rural locations, a “dark” school after hours is highly desirable. Carefully located motion sensors can be used to activate low-cost compact fluorescent or quartz lights that serve as both safety lighting and as a deterrent against vandalism.

It may be necessary to provide emergency lighting with this system. Some of these luminaires must be powered from an emergency generator or battery backup power source.

All lights should be chosen with consideration of the weather conditions under which they will operate. In most cases, the primary consideration is lamp-starting temperature, which is a function of both lamp and ballast.

Photovoltaic-powered lights should be considered for locations where grid power is not easily available.

### **Applicability**

This guideline can be used in most schools, including colleges and universities, public K-12, private and parochial schools, and similar facilities such as churches, sports clubs, and private institutions.

### **Integrated Design Implications**

Exterior lights should be chosen with the architectural impact to the building’s exterior in mind. Select the proper color, shape, and style to reinforce architectural themes of the building.

### **Cost Effectiveness**

The cost of exterior lighting tends to be relatively high. However, compromising on costs, such as using lower quality products, will result in needing to replace the lighting system sooner, thus making it a poor choice when considering life-cycle cost.

Costs	L			
	M			■
	H			
		L	M	H
		Benefits		

- A typical pole luminaire, 17 ft high, 175 W, type III distribution, with steel pole and anchor base, costs approximately \$1,500.
- A bollard, contemporary, with 42-W compact fluorescent and concrete anchor base costs \$600.
- A canopy-mounted, rough-service luminaire, with two 32-W compact fluorescent, contemporary style costs \$300.
- A high quality motion sensor floodlight, 350-W quartz, costs \$250.

Switching and emergency power costs vary and are in addition to the luminaire costs.

### **Benefits**

Properly designed exterior lighting systems permit the extended use of the facility, promoting increased personal safety and security and reduced vandalism.

### **Design Tools**

See this chapter’s Overview.

### **Design Details**

- Pole lights should use a variation of the classic “shoebox” full cutoff lights. Avoid traditional lights or contemporary lights that do not produce full shielding to help prevent light trespass and light pollution.
- Many choices in wall lights exist, and this is one situation where aesthetics may be critical. Be certain to choose die-cast aluminum bodies, rough-service polycarbonate lenses or diffusers, and/or other heavy-duty construction. Several look-alike products made of lightweight and inferior materials are on the market, so be especially wary of imitations and substitutes.
- If choosing a “dark” school approach to security, use of motion sensors and quartz floodlights may be warranted. Either separate or integrated units may be used. Quality is especially important in choosing

exterior motion sensors because a faulty sensor will give false indications and activate lights (and concerned neighbors) needlessly.

- Lighting layouts for parking lots and the direct pedestrian access should be performed using an outdoor lighting analysis computer program. Design criteria should be at least 0.5 footcandle in parking lots, with an average light level of 2.0 footcandles and average minimum uniformity of 4:1 or better.
- Consider zoning exterior lighting so that the parking lot zone nearest the building can be activated separately from the majority of the lot.
- Manual override switching of the lighting system should NOT be readily accessible. Locate controls in a supervised location. Use a digital controller, not a mechanical “time clock.”

### ***Operation and Maintenance Issues***

This design should be easy to operate and manage. As with most HID and compact fluorescent lighting systems, the lighting system should be group relamped every 8,000 hours, or about every two years. Ballast life should cover 10 years or more. Spot relamping is recommended to ensure security and safety. The design should make system cleaning simple.

### ***Commissioning***

These systems are relatively easy to commission. Perhaps the most critical step is ensuring that the lighting controls are properly set.

### ***References/Additional Information***

See this chapter’s Overview.





# MECHANICAL AND VENTILATION SYSTEMS

This chapter presents guidelines for mechanical ventilation, heating, and cooling systems. This chapter also presents strategies that can enhance the effectiveness of natural ventilation when the outdoor temperature and humidity is suitable to provide improved thermal comfort during the spring and fall. Presented together in one chapter, the organization emphasizes the interrelationship between these systems. Guidelines are provided for the following technologies and design strategies:

Cross Ventilation (Guideline MV1)	Water-Loop Heat Pumps (Guideline MV15)
Stack Ventilation (Guideline MV2)	Evaporatively Precooled Condenser (Guideline MV16)
Ceiling Fans (Guideline MV3)	Dedicated Outside Air System (Guideline MV17)
Gas/Electric Split System (Guideline MV4)	Economizers (Guideline MV18)
Packaged Rooftop System (Guideline MV5)	Air Distribution Design Guidelines (Guideline MV19)
Displacement Ventilation System (Guideline MV6)	Duct Sealing and Insulation (Guideline MV20)
Hydronic Ceiling Panel System (Guideline MV7)	Hydronic Distribution (Guideline MV21)
Unit Ventilator System (Guideline MV8)	Chilled Water Plants (Guideline MV22)
Ductless Split System (Guideline MV9)	Boilers (Guideline MV23)
Evaporative Cooling System (Guideline MV10)	Adjustable Thermostats (Guideline MV24)
VAV Reheat System (Guideline MV11)	EMS/DDC (Guideline MV25)
Radiant Slab System (Guideline MV12)	Demand Controlled Ventilation (Guideline MV26)
Baseboard Heating System (Guideline MV13)	CO Sensors for Garage Exhaust Fans (Guideline MV27)
Gas-Fired Radiant Heating System (Guideline MV14)	Timers for Recirculating Hot Water Systems (Guideline MV28)

---

## OVERVIEW

---

The main purposes of HVAC systems are to provide thermal comfort and to maintain good IAQ. These conditions are essential for a quality, high performance learning environment. HVAC systems are also one

of the largest energy consumers in schools, and relatively small improvements in design or equipment selection can mean large long-term savings in energy expenditures over the life cycle of the system.

The choice and design of HVAC systems can affect many other high performance goals as well. Water-cooled air conditioning equipment is generally more efficient than air-cooled equipment, but increases water consumption and maintenance. HVAC systems are the major source of outside air ventilation in schools, making their operation and maintenance mission critical for IAQ. The acoustic environment of classrooms, libraries, and other school spaces can be adversely affected by noise created by the movement of air through ducts and air diffusers and from the operation of HVAC equipment. Properly designed, installed, and operated HVAC systems and controls minimize these issues as well as provide a key component of the “buildings that teach” theme.

### **Integrated Design**

To achieve a high performance design, it is very important to integrate the HVAC systems with the building envelope and lighting system. Integrated design creates opportunities for greater comfort, lower first costs, easier equipment maintenance, and lower operating costs. Some of the ways in which high performance can be achieved through integrated design are:

- Careful attention to shading, the locations of windows and glazing types, roof colors, building thermal mass, and enhanced natural ventilation may reduce, or even eliminate, the need for cooling in many locations, and can reduce cooling loads in all climates.
- Natural ventilation can eliminate the need for ductwork in some climates, allowing higher ceilings and more opportunities for daylighting savings.
- Under-floor air distribution allows access for future power and communication needs. The system can also be designed to work in harmony with natural ventilation.
- Attention to the radiant temperature of surfaces through careful envelope design reduces heating and cooling energy requirements. This is especially true of windows.
- Using a central heating and chilled water plant can allow for future installation of a thermal solar or geo-exchange source for heating or cooling energy, or for the use of a thermal energy storage system or other peak electric demand-reducing measures.
- Integrating HVAC, multiple light switches, and lighting occupancy sensor controls can reduce operating costs for both systems.

### **Thermal Comfort**

Thermal comfort is affected by air temperature, humidity, air velocity, and mean radiant temperature (MRT).<sup>1</sup> Non-environmental factors such as clothing, gender,<sup>2</sup> age,<sup>3</sup> and metabolic activity also affect thermal comfort.

- Air temperature is measured with a normal thermometer, and most people are comfortable between about 70°F and 76°F. However, an individual’s preferred temperature is higher in the summer and lower in the winter, mostly because of differences between summer and winter wardrobes.

---

<sup>1</sup> MRT is the temperature of an imaginary enclosure where the radiant heat transfer from a human body equals the radiant heat transfer to the actual non-uniform temperature surfaces of an enclosure.

<sup>2</sup> Women generally prefer temperatures about 1° warmer.

<sup>3</sup> Persons over 40 generally prefer temperatures about 1° warmer.

- The relative humidity range for human comfort is between about 20% in the winter and 60% in the summer. The moisture content of air can also be expressed as the wetbulb temperature, humidity ratio, or dew point temperature.
- Ceiling fans, circulation fans, or operable windows can provide air movement, and such air movement increases the upper temperature limit of comfort by about two degrees.
- The temperature of the surfaces surrounding a person (walls, ceiling, floor, and especially windows) affects the mean radiant temperature (MRT) especially during hot and cold days. Caves have a low MRT, which makes them comfortable even when the air temperature is high. Likewise, rooms with heated floors are comfortable, although the air temperature may be cooler.

The most accepted definition of thermal comfort is ASHRAE Standard 55, but recent research is resulting in a reevaluation of this definition. Standard 55 currently defines comfort in terms of operative temperature and humidity, and represents the range of thermal conditions when 80% of sedentary, or slightly active, people find the environment thermally acceptable (see Figure 26). Operative temperature is the average of the mean radiant and ambient air temperatures, weighted by their respective heat transfer coefficients. The Standard 55 definition of comfort does not consider air movement or velocity. Most occupants do not feel comfortable when it is drafty and cold.

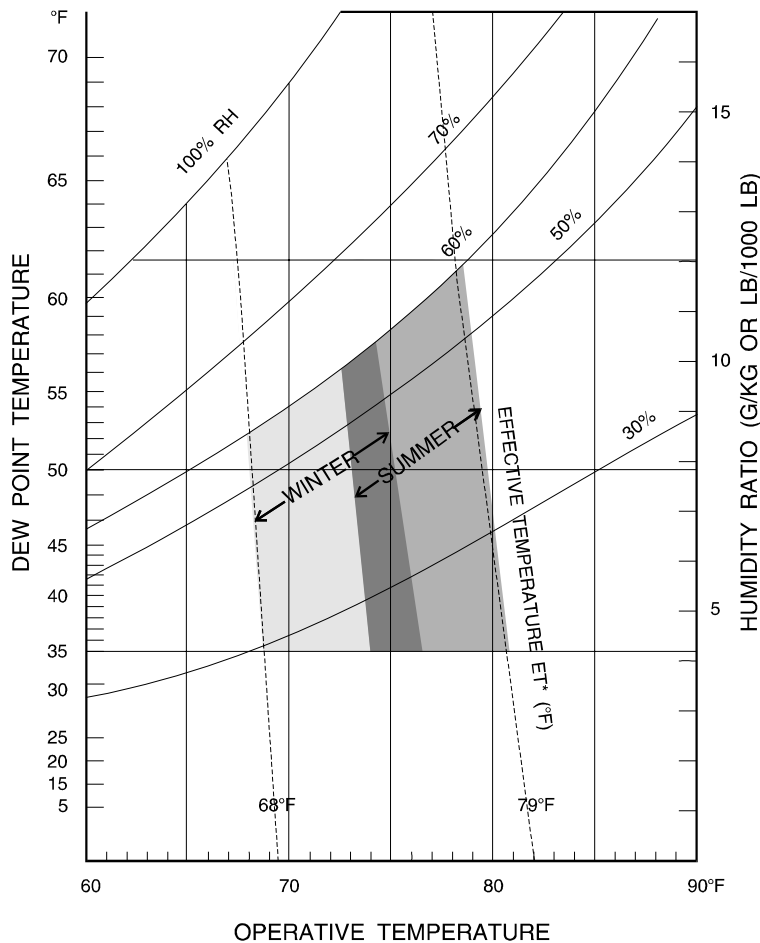

Figure 26 – ASHRAE Standard 55 Comfort Envelope

Source: 2001 ASHRAE Handbook – Fundamentals. This figure shows the temperature and humidity ranges within which about 80% of the population will be comfortable while wearing typical summer and winter clothing and being in a sedentary or slightly active state.

Much of the research on thermal comfort is based on asking people if they are hot or cold, and correlating their response to measurements of air temperature, humidity, air velocity, and MRT. The ASHRAE thermal sensation scale is commonly used for such surveys (see Table 21). Some of this research has been conducted in test environments where temperature and humidity can be tightly controlled. Other research has been conducted in workplaces.

*Table 21 – ASHRAE Thermal Sensation Scale*

Cold	Cool	Slightly cool	Neutral	Slightly warm	Warm	Hot
-3	-2	-1	0	+1	+2	+3

Since thermal comfort is not an absolute condition but varies with each individual, statistical measures of thermal comfort are sometimes used. One statistical measure is the Predicted Mean Vote (PMV). PMV predicts the mean response of a large population on the ASHRAE thermal sensation scale (see Table 1). A PMV of +1 means that, on average, people are slightly warm. PMV can be calculated if information is known about the metabolic rate, typical clothing, and environmental conditions such as temperature and humidity. Once PMV is known, it can be translated to another statistical factor called percent of population dissatisfied (PPD).

Air movement also affects comfort. Operable windows, ceiling fans or circulation fans create or enable air movement. Too much air movement is uncomfortable, especially when it is cold. When it is hot, air velocities up to about 200 ft/minute are pleasant and enable most occupants to be equally comfortable at 2°F higher temperatures. Air speeds higher than about 200 ft/minute should be avoided because they can create drafts and be annoying (see Table 22).

*Table 22 – Effect of Air Movement on Occupants*

Source: Victor Olgyay, *Design with Climate*, Princeton University Press, 1963

Air Velocity	Probable Impact
Up to 50 ft/minute	Unnoticed
50 to 100 ft/minute	Pleasant
100 to 200 ft/minute	Generally pleasant, but causes a constant awareness of air movement
200 to 300 ft/minute	From slightly drafty to annoyingly drafty
Above 300 ft/minute	Requires corrective measures if work and health are to be kept in high efficiency

Research by Gail Brager and others at the University of California, Berkeley, shows that students and teachers in naturally ventilated schools are comfortable in a wider range of thermal conditions than in schools that have continuous mechanical cooling. Occupants of air-conditioned schools develop high expectations for even and cool temperatures and are quickly critical if thermal conditions drift from these expectations. Occupants in naturally ventilated schools adapt to seasonal changes in mean outdoor temperature and are comfortable in a wider range of conditions. They even prefer a broader range of thermal conditions. The comfort range for naturally ventilated buildings is considerably larger than the common definition of comfort published in ASHRAE Standard 55-1992.

Research shows that part of the difference in comfort expectations is due to behavioral adaptations: occupants in naturally ventilated schools wear appropriate clothing and open windows to adjust air speeds. However, some of the difference is due to physiological factors. The human body’s thermal expectations actually change through the course of a year, possibly because of a combination of higher

levels of perceived control (occupants can open and close windows) and a greater diversity of thermal experiences in the building.

Using an adaptive model of thermal comfort, instead of ASHRAE Standard 55, allows schools to be designed and operated to both optimize thermal comfort and reduce energy use. In many climates, maintaining a narrowly defined, constant temperature range is unnecessary and expensive. Brager's research is the foundation of changes currently being considered to ASHRAE Standard 55.

### **Potential for Natural Ventilation**

Natural ventilation is an effective and energy-efficient way to provide outside air for ventilation and to provide cooling in many climates during certain times of the spring and fall. In the winter, the challenge is to temper the cold ventilation air as it is brought into the classroom. Humidity is the challenge in the warm portions of the season. Schools that are operated throughout the year should have some means of dehumidification or air conditioning. Historically, schools have not been air conditioned and natural ventilation (cooling with outside air) has been the only means of cooling. Prior to the widespread availability of mechanical cooling, the classic classroom had high, large operable windows to provide both natural ventilation and daylighting.

In most climates, natural ventilation is a useful strategy only during the spring and fall. When any significant number of operable windows are utilized, the building as a system must be carefully designed to minimize glare and heat gain from the sun shining in through the glass, and to maintain a safe and secure facility while still allowing air to enter and escape. Use of ventilation in the off-hours must be approached very carefully as the humidity load from damp nighttime air can lead to moisture problems in some climates. This is especially important if some areas of the facility are mechanically cooled or have any cold surfaces that might be below the dew point of the damp nighttime air.

Figure through Figure contain weather data and analysis of the seven national climates. The figures include data from a typical school year: Monday through Friday, from 7 am to 3 pm, September through June. These figures show drybulb temperature on the vertical axis and relative humidity on the horizontal axis. The figures in the cells are the number of hours during the year when a particular combination of relative humidity and drybulb temperatures exist. The preferred humidity and temperature ranges (30% to 55% and 68°F to 77°F) are shaded gray. The overlapping area indicates when outdoor temperature and humidity are within the ASHRAE 55 Comfort Zone.

Natural ventilation is an effective and energy-efficient way to provide outside air for ventilation and to provide cooling in many climates. However, in climates with extreme cold and/or humid weather, the challenge is to temper the cold ventilation air as it is brought into the classroom during the winter months. Humidity is the challenge in the warm portions of the season. Historically, schools have not been air conditioned and natural ventilation has been the only means of cooling. The classic classroom has high windows to provide both natural ventilation and daylighting.

**Seattle, WA**  
**September - June**  
**7 am - 3 pm, weekdays**

Dry Bulb Temp																	Total	
	20%-25%	25%-30%	30%-35%	35%-40%	40%-45%	45%-50%	50%-55%	55%-60%	60%-65%	65%-70%	70%-75%	75%-80%	80%-85%	85%-90%	90%-95%	95%-100%	>100%	
98-102	1																	1
93-97	2																	2
88-92		1	2															3
83-87				7	2													9
78-82		1	1		3	1	1	1										8
73-77		2	1	7	4	3	5	6										28
68-72		1	5	5	11	15	12	11	6	2								68
63-67		2	4	6	14	6	19	17	30	12	8	2						120
58-62		4	2	2	12	28	30	28	31	38	24	21	10	19	1			250
53-57			2	5	5	10	20	35	19	15	16	37	56	30	23	2	3	278
48-52		4	1	3	5	4	11	15	23	32	27	17	29	41	39	6	3	260
43-47		1	2	7	10	8	13	15	27	21	71	66	19	52	42	8	3	365
38-42		2	3	1	5	8	6	10	14	23	3	52	79		34	7	12	271
33-37		1			3		5	2	8	6	7		21		10	18	7	88
28-32						3		1		2		9		3		4	4	26
23-27												3		1			3	7
Total	6	19	21	47	77	84	128	141	158	151	156	207	214	146	149	45	35	1784

**ASHRAE 55 Comfort Zone**      **Total Hours**      **68**

**Relative Humidity**

Figure 27 – Climate Analysis, Temperate and Mixed (Seattle)

**Denver, CO**  
**September - June**  
**7 am - 3 pm, weekdays**

Dry Bulb Temp																	Total		
	<15%	15%-20%	20%-25%	25%-30%	30%-35%	35%-40%	40%-45%	45%-50%	50%-55%	55%-60%	60%-65%	65%-70%	70%-75%	75%-80%	80%-85%	85%-90%	90%-100%	>100%	
88-92	22	1																	23
83-87	22	9	3	1															35
78-82	49	16	5	4															74
73-77	58	21	12	11	7	5		1											115
68-72	34	14	22	12	15	19	4	4	1	3	1								129
63-67	21	30	12	8	10	8	9	14	5	5	5	1							128
58-62	37	28	12	18	17	6	1	7	8	13	10	5	3		1	1			167
53-57	46	34	18	14	21	14	6	10	6	4	3	9	4	5	1		1		196
48-52	25	27	18	20	23	12	8	8	5	4	10	8	1	1	2	3	1		176
43-47	21	13	23	10	12	16	10	7	6	7	6	1	6	12		2	1	2	155
38-42	5	7	9	17	18	15	12	9	10	9	7	10	1	5	6		2		142
33-37	4	7	11	6	14	11	18	17	10	5	13	8	7		7		5		144
28-32	2	1	9	1	8	4	5	8	6	16		17		14		16		3	113
23-27		1	1	1	3	16	1	3	11	2	15		4	4		19		2	86
18-22		1			1	1	6		4	8		8	14		1	2			48
13-17												6	5		5				16
<13			1		2	2	1	2	5	2	4		4	13					37
Total	346	210	156	123	151	129	81	89	78	78	80	72	44	54	23	43	10	5	12

**ASHRAE 55 Comfort Zone**      **Total Hours**      **56**

**Relative Humidity**

Figure 28 – Climate Analysis, Cool and Dry (Denver)

**Phoenix, AZ**  
**September - June**  
**7 am - 3 pm, weekdays**

Dry Bulb Temp																		Total		
	<15%	15%-20%	20%-25%	25%-30%	30%-35%	35%-40%	40%-45%	45%-50%	50%-55%	55%-60%	60%-65%	65%-70%	70%-75%	75%-80%	80%-85%	85%-90%	90%-95%	>100%		
108-113	10																			10
103-107	28	15	2																	45
98-102	37	13	14	2																66
93-97	36	20	12	7	7	2	1													85
88-92	66	40	18	11	12	8	3	2												160
83-87	65	45	39	19	11	5	7	5	6	1										203
78-82	44	47	23	27	13	7	2	2	3		7									175
73-77	25	28	49	24	25	14	7	6			2	2	2							184
68-72	15	28	35	29	15	22	9	5	3	1		1	1	1	2	2				169
63-67	6	12	24	24	33	12	11	12	5	5	2	2	2		1					151
58-62	4	8	17	22	15	38	19	11	11	2	3	4	2		2	3				161
53-57	3	10	8	6	12	14	18	21	12	8	6	4	4	6	3	5	2			142
48-52	1	2	6	6	13	7	7	8	10	9	16	11	4	2	2	2	6			112
43-47		4	5	5	3	3	3	5	4	9	6	3	8	5		4	3			70
38-42			2	2	2	2	3	1	4		2	7	1	7			3	1		37
33-37				1	2			1	1	1		1	2		2					11
28-32						1				1										2
23-27									1											1
<b>Total</b>	<b>340</b>	<b>272</b>	<b>254</b>	<b>185</b>	<b>163</b>	<b>135</b>	<b>90</b>	<b>73</b>	<b>66</b>	<b>37</b>	<b>44</b>	<b>35</b>	<b>26</b>	<b>21</b>	<b>12</b>	<b>16</b>	<b>14</b>	<b>1</b>		<b>1784</b>

**Relative Humidity**

**Total Hours**  
**ASHRAE 55 Comfort Zone 106**

*Figure 29 – Climate Analysis, Hot and Dry (Phoenix)*

**Minneapolis, MN**  
**September - June**  
**7 am - 3 pm, weekdays**

Dry Bulb Temp																	Total	
	20%-25%	25%-30%	30%-35%	35%-40%	40%-45%	45%-50%	50%-55%	55%-60%	60%-65%	65%-70%	70%-75%	75%-80%	80%-85%	85%-90%	90%-95%	95%-100%	>100%	
93-97						1												1
88-92					3	1	2	4	4									14
83-87	2	1		1	7	4	2	3	3	1							24	
78-82	3	5	6	5	10	9	6	9	3	5	1						62	
73-77	3	3	2	9	9	6	19	11	10	6	3	2	1	1			85	
68-72	1	1	3	12	7	17	7	7	12	5	8	5	2	4	1		92	
63-67			3	5	6	13	16	11	8	12	21	11	16	15	2		139	
58-62		2	9	12	11	14	14	19	9	8	5	12	5	14	2		136	
53-57		4	5	10	8	14	13	27	3	8	5	7	5	3	5		117	
48-52		10	9	8	15	15	7	16	17	13	6	2	3	6	11		138	
43-47		3	6	3	6	5	10	15	7	2	15	8	1	3	2	2	88	
38-42			1	1	4	3	17	17	8	19	4	14	15		18	1	123	
33-37					1	8	15	10	14	10	26		30		18	10	157	
28-32					1	6		18		28		36		18		6	115	
23-27						3	7	3	23		32	15		18		3	109	
18-22				2	8		11	10		22	29		21	13		3	122	
13-17					5	8	4		29	19			24			1	93	
<13		1	1	7	10	23	21	21	16	24	18	18				6	169	
<b>Total</b>	<b>9</b>	<b>30</b>	<b>46</b>	<b>78</b>	<b>109</b>	<b>150</b>	<b>173</b>	<b>201</b>	<b>162</b>	<b>182</b>	<b>173</b>	<b>130</b>	<b>123</b>	<b>95</b>	<b>59</b>	<b>32</b>	<b>32</b>	<b>1784</b>

**Total Hours**  
**ASHRAE 55 Comfort Zone 91**

Figure 30 – Climate Analysis, Cold and Humid (Minneapolis)



**Boston, MA**  
**September - June**  
**7 am - 3 pm, weekdays**

Dry Bulb Temp																	Total		
	15%-20%	20%-25%	25%-30%	30%-35%	35%-40%	40%-45%	45%-50%	50%-55%	55%-60%	60%-65%	65%-70%	70%-75%	75%-80%	80%-85%	85%-90%	90%-95%	95%-100%	>100%	
88-92				4	2	1													7
83-87				2	2	7	6	7	4										28
78-82	1	1		12	7	5	3	7	13	5	1							55	
73-77	1	3		4	4	3	10	9	14	6	12	8	5	1				80	
68-72		1		4	6	14	12	10	8	11	6	8	15	7	15	2	1	120	
63-67				3	10	10	15	17	14	6	11	21	13	6	8	8		1	143
58-62			1	6	12	6	15	8	13	10	6	10	12	15	21	10	1	1	147
53-57	1	2	8	13	7	13	12	11	8	11	5	4	1	10	13	24			143
48-52		2	2	7	11	11	14	11	11	13	10	12	1	5	29	26	3	2	170
43-47		3	12	10	11	19	19	22	18	14	2	10	28	4	16	23	3	5	219
38-42			2	13	12	14	11	20	12	4	10	1	12	18		7		4	140
33-37			8	16	20	19	15	18	15	10	10	18		26		20	3	5	203
28-32		1	3	16	16	17	33	4	28		23		14		6		3	1	165
23-27	2	1	5	3	14	7	11	11	4	11		3	6					2	80
18-22			5	5	13	11		7	9										50
13-17			3	4		6	3	4		2									22
<13				1	1	4	3	2	1										12
<b>Total</b>	<b>3</b>	<b>11</b>	<b>54</b>	<b>119</b>	<b>150</b>	<b>168</b>	<b>183</b>	<b>168</b>	<b>172</b>	<b>103</b>	<b>96</b>	<b>95</b>	<b>107</b>	<b>92</b>	<b>108</b>	<b>120</b>	<b>14</b>	<b>21</b>	<b>1784</b>

**Relative Humidity**

**Total Hours**  
**ASHRAE 55 Comfort Zone 76**

Figure 31 – Climate Analysis, Cool and Humid (Boston)

Atlanta, GA																				Total
September - June																				
7 am - 3 pm, weekdays																				
Dry Bulb Temp																				
	93-97																			1
88-92																			2 9 3	14
83-87																			4 6 8 14 23	70
78-82																			9 5 10 16 15	144
73-77																			8 10 13 16 17	177
68-72																			5 11 12 24 10	203
63-67																			11 16 9 19 11	231
58-62																			7 14 9 16 17	194
53-57																			9 14 10 7 8	168
48-52																			9 10 7 8 4	137
43-47																			7 11 3 17 7	142
38-42																			8 6 6 12 7	101
33-37																			5 9 9 10 7	109
28-32																			4 2 3 7 1	48
23-27																			5 1 1 1 7	27
18-22																			2 2 1 1	11
13-17																			1 2	6
<13																			1	1
Total	4	21	40	59	91	114	115	157	138	130	115	116	129	98	88	136	146	57	30	1784
10%- 15%- 20%- 25%- 30%- 35%- 40%- 45%- 50%- 55%- 60%- 65%- 70%- 75%- 80%- 85%- 90%- 95%- >100																				
15% 20% 25% 30% 35% 40% 45% 50% 55% 60% 65% 70% 75% 80% 85% 90% 95% 100% %																				
Total Hours																				
ASHRAE 55 Comfort Zone																				126

Figure 32 – Climate Analysis, Temperate and Humid (Atlanta)

Orlando, FL																				Total
September - June																				
7 am - 3 pm, weekdays																				
Dry Bulb Temp																				
	93-97																			2 3 1 4
88-92																			7 6 23 14 26	104
83-87																			2 7 26 44 57	326
78-82																			2 9 21 34 37	350
73-77																			6 13 13 27 31	318
68-72																			3 10 12 15 28	232
63-67																			7 5 6 12 17	167
58-62																			8 6 12 12 20	134
53-57																			4 5 5 2 8	67
48-52																			8 5 3 2 2	42
43-47																			4 1 4 2	20
38-42																			2 3 1 1	12
33-37																			1 1	2
Total	1	11	35	33	59	113	165	216	182	184	171	137	159	113	99	74	26	6	1784	
15%- 20%- 25%- 30%- 35%- 40%- 45%- 50%- 55%- 60%- 65%- 70%- 75%- 80%- 85%- 90%- 95%- >100																				
20% 25% 30% 35% 40% 45% 50% 55% 60% 65% 70% 75% 80% 85% 90% 95% 100% %																				
Total Hours																				
ASHRAE 55 Comfort Zone																				158

Figure 33 – Climate Analysis, Hot and Humid (Orlando)

## **Outside Air Ventilation**

Classrooms and other school spaces must be ventilated to remove carbon dioxide and other pollutants from breathing, odors, and other pollutants. The national consensus standard for outside air ventilation is ASHRAE Standard 62.

If outside air is provided through natural ventilation, then all spaces within the room must be within 20 ft of a window, door, or other ventilation opening, and the total area of ventilation openings must be greater than 5% of the floor area. For a typical 960-ft<sup>2</sup> (30 ft x 32 ft) classroom, the minimum free ventilation area must be at least 48 ft<sup>2</sup>. The 20-ft rule would also require that ventilation openings be provided on two sides of the room; otherwise some portions of the classroom would be further than 20 ft from a window.

If outside air is provided through a mechanical system, then at least 15 cubic feet per minute (cfm) of outside air must be provided for each occupant. A typical classroom with 30 people requires a minimum of 15 x 30 or 450 cfm per occupant. Other spaces in schools require differing levels of outside air ventilation, based on the expected occupant density of the space and the recommended ventilation rate of 15 cfm/occupant.

The number of occupants is highly variable in some school spaces such as gyms, auditoriums, and multi-purpose rooms. Many codes require systems to vary the quantity of outside air ventilation in these spaces based on the number of occupants. One technique for addressing this issue is to install carbon dioxide (CO<sub>2</sub>) sensors that measure concentrations and vary the volume of outside air accordingly. If an auditorium fills up for a school assembly, CO<sub>2</sub> concentrations will increase, the HVAC system will be signaled, and outside air volumes will be increased accordingly. This type of control can both save energy and significantly improve IAQ.

Systems must also be designed to provide at least three air changes per hour, or the required ventilation rate indicated above for the hour prior to normal occupancy of the building. This requirement ensures building-related contaminants that may have built up overnight while the system was shut down are flushed out.

The location of ventilation air intakes and exhausts is a critical aspect of integrated building design and sometimes difficult to coordinate or optimize. Outside air intake dampers must be carefully located to avoid pollution from sources such as parking lots, loading docks, adjacent roadways, sewer vents, or boiler exhaust fumes. Patterns of air movement around buildings can be quite complex and dynamic. Designers are advised to consult ASHRAE Fundamentals Chapter 15 airflow analysis models for exhaust stack reentrainment modeling. If major sources of industrial pollution exist nearby, more sophisticated models are often used for predicting downwind concentrations of pollutants. In the extreme case of urban settings with multiple building heights, designers should consider building scale models for testing in wind tunnels.

IAQ is also affected by the selection of interior finishes and materials. These issues are discussed in the Resource-Efficient Building Products chapter. The design of air distribution ducts and fan systems can also have a significant effect on IAQ. Exposed fiberglass and other porous or flaking materials should never be used on the interior of ducts, unless they are encapsulated with a surface finish that is robust, will not break down from atmospheric ozone exposure (smog), and can be cleaned with a mechanical brush without releasing particles.

## **Load Calculations**

Properly sizing HVAC systems in schools is critical to both energy efficiency and cost effectiveness. The compressors in oversized packaged air conditioners or heat pumps cycle frequently and overall efficiency drops with each cycle. Frequent cycling also reduces the efficiency of boilers, furnaces, and many other types of equipment. Properly sized equipment, with multiple firing rates and stages of cooling, reduces cycling and helps maintain efficient operation, but smaller, properly sized equipment that is matched to the building load is also often less expensive and can reduce initial construction costs.

Many computer programs and calculation methodologies can be used for load calculations. The assumptions used about infiltration rates, lighting levels, equipment, and occupant loads are often more important than the actual software that is used in the calculations. Engineers should take care to make assumptions that are consistent with the energy-efficient recommendations made in other chapters of the Best Practices Manual. An efficient building shell and lighting system should result in significant HVAC equipment size reductions and reduce cost.

## **Environmental Considerations**

In terms of environmental performance, the HVAC system primarily affects energy usage, acoustic comfort, the life of building materials, and indoor environmental quality. Other environmental considerations are relevant, such as using materials efficiently, employing energy recovery devices for heating or cooling, conserving water, using materials that can be readily recycled, and avoiding ozone-depleting refrigerants. The following specific measures can be used to reduce the environmental impact of HVAC systems.

- A well-designed building with integrated building systems will significantly reduce the requirements for heat and cooled air distribution. In addition to energy savings, significantly less equipment, or smaller equipment, is needed.
- A well-designed HVAC system always provides easy access for cleaning and repair, enhancing long-term ability to provide good IAQ and thermal comfort.
- Selection of equipment and materials play a part as well. Strategies and considerations include:
  - Specifying low-toxic (water-based) mastic to seal ducts, or in cases where round ducts are used, specify internal gasketed duct joint systems so that duct sealants are not needed.
  - Selecting durable long-life equipment with hinged access doors that allow for equipment service and that can be easily refurbished.
  - Limiting the use of equipment that uses CFC or HCFC refrigerants.
  - Consider alternatives to cooling towers, which use significant amounts of water.
  - Metal components of HVAC systems can be recycled. Suggest recycling equipment at the end of its life cycle. In addition, metal components of HVAC equipment typically include recycled content, although data is not readily available as to the amount.
  - Energy recovery equipment should always be considered for the ventilation system since heating and cooling the ventilation air accounts for the majority of the load that is placed on the systems in a well-designed facility. Payback periods for energy recovery are often 10 years; however the school systems are designed to last 30 to 50 years.
  - Consideration needs to be given to renewable energy heating and cooling sources such as geothermal standing column wells.

## **Commissioning**

Commissioning is the process of ensuring that the intent of the project program is properly reflected in the design and that the design intent is properly executed during construction and operation. Commissioning tasks start at the very beginning and continue throughout the project, even into the occupancy period. Experience has shown that most energy-efficient designs do not achieve intended savings without the oversight and testing provided by a commissioning process.

For larger facilities, the project manager should consider including an independent commissioning agent in the early planning process. A commissioning plan should be developed during schematic design and updated at each project phase. Typical elements of a commissioning process include:

- Commissioning plan development
- Documentation of design intent
- Design review
- Submittals review
- Inspections and system functional testing
- Enhanced operating and maintenance documentation, including hands-on training of the staff operating and maintaining the equipment
- Post-occupancy testing and operation evaluation.

For small schools with relatively simple mechanical systems, a detailed commissioning process may not be feasible. However, some form of a testing of the equipment and controls is essential to ensure systems are operating properly and at peak efficiency before, or soon after, occupancy.

Specific commissioning issues are discussed in each of the guidelines below. A number of sample commissioning plans and guidelines are also available. A good source is the Portland Energy Conservation Inc. at <http://www.peci.org/>. Other resources include the U.S. Department of Energy at <http://www.energy.gov/>, the American Society of Heating, Refrigerating and Air-Conditioning Engineers at <http://www.ashrae.org/>, and the Sheet Metal and Air Conditioning Contractors' National Association at <http://www.smacna.org/>.

## **Design Tools**

In addition to general energy simulation programs, many useful tools for optimizing mechanical design exist. Heating and cooling load calculation programs that are widely available from equipment manufacturers and commercial vendors are most commonly used. Other programs integrate with CAD software and aid the design of piping and duct systems. Many of these tools also have cost estimating capabilities, which are very helpful in design optimization and budget review.

Computational fluid dynamics (CFD) software can help in studies of natural and mechanical ventilation and is very useful in creatively integrating mechanical and architectural design. Historically, this type of analysis is expensive. Many manufacturers of air distribution equipment can now provide CFD graphic representation of the air distribution delivered by their products.

## Controls

HVAC, lighting, water heating, signal/communication wiring, and other systems need to be operated and controlled efficiently and effectively. With integrated design, the effective control of one system may depend on how another system is being operated. Building management systems offer integrated control of HVAC, lighting, outside air ventilation, natural ventilation, building security, and water heating systems. Energy can be saved through efficient control that turns off or slows down systems when they are not needed. In general, slowing down most fans by 25% cuts the electric energy the fan uses by 50%. Building management systems can also provide information for students and faculty to understand how the building is working and how much energy it is using. Building management systems should always be equipped with easy-to-use graphic interfaces to facilitate their proper use.

## System Selection

Figure illustrates a few important questions that help narrow the choice of HVAC system for each space. This decision tree leads to one of several categories of system types. There are three main questions:

1. Can natural ventilation meet all reasonable cooling needs? For many locations this is possible, especially with careful attention to architectural design. If cooling is unnecessary, then several heating-only options exist.
2. Can outdoor air ventilation be provided naturally or is mechanical ventilation required? This affects the system choice regardless of whether it is heating only, or heating and cooling. If fans are not required for ventilation, the design should allow them to be off for much of the year, saving fan energy.
3. If cooling is required, can an efficient evaporative cooling system be used? If not, compressor cooling, either with a direct expansion or chilled water system is required.

There are, of course, many other considerations in system selection. This chapter provides guidelines for most of the common HVAC system types used in schools. Table provides an overview of what systems are most applicable to each climate zone. The choice of optimal system type for a specific school is a complex decision based on many factors. Many tradeoffs are involved, especially price versus performance. Other important considerations are:

- Noise and vibration
- IAQ ventilation performance
- Thermal comfort performance
- Operating costs and energy efficiency
- Maintenance access, costs, and needs
- HVAC equipment space requirements (in the classroom, on the roof, in mechanical rooms)
- Durability and longevity
- The ability to provide individual control for classrooms and other spaces
- The type of refrigerant used and its currently understood ozone-depleting potential.

Table 24 compares system types using these criteria and others. More information regarding the applicability of each system type is discussed in the individual guidelines.

Phasing of construction projects also influences the decision between central systems and distributed systems. If a large facility is to be constructed in several phases, then it may be difficult to afford the upfront investment in the central plant option.

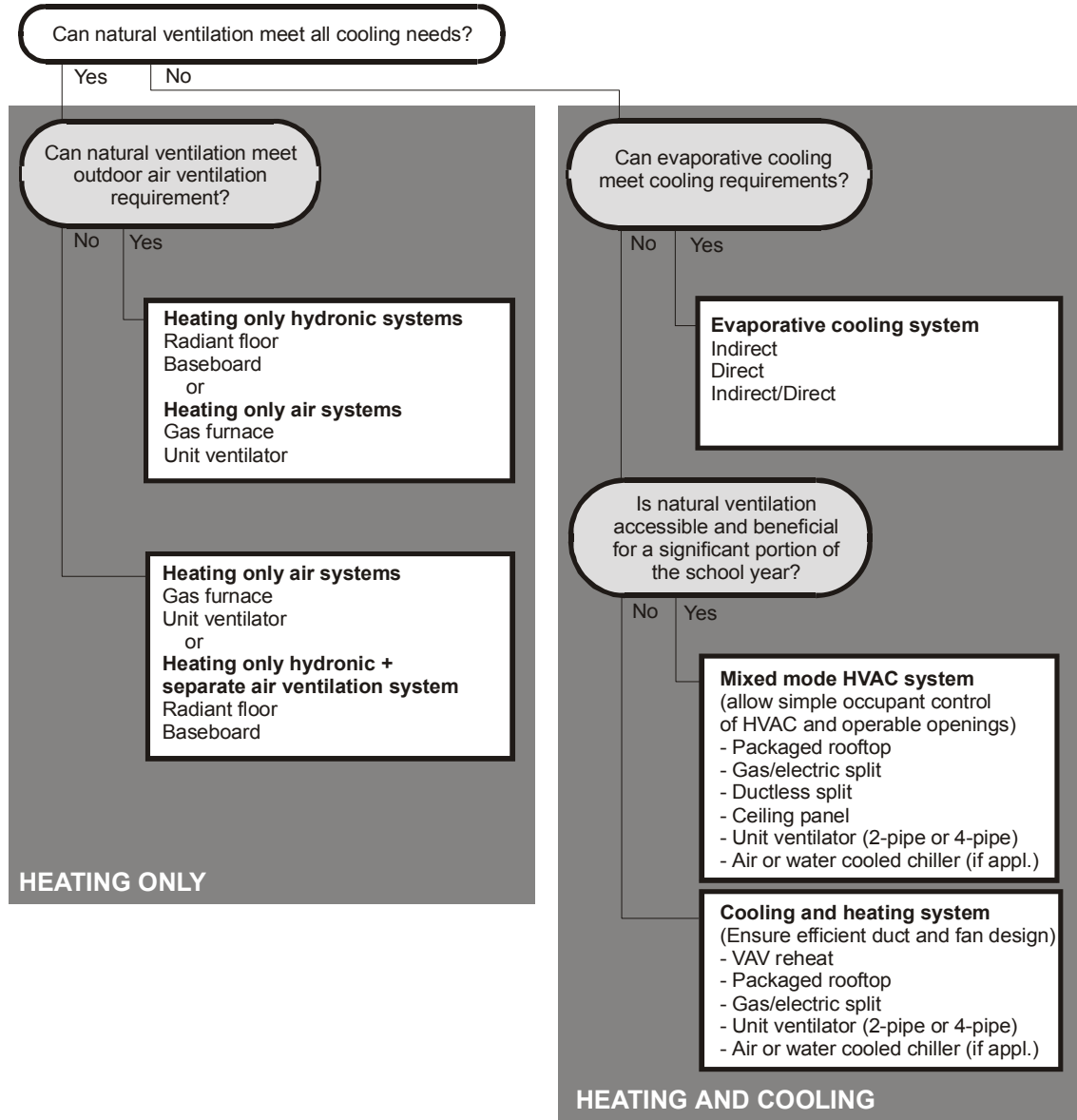

Figure 34 – HVAC System Selection Decision Tree

Table 23 – Climate Zone Applicability for HVAC Guidelines

Guideline	Temperate and Mixed	Cool and Dry	Hot and Dry	Cold and Humid	Cool and Humid	Temperate and Humid	Hot and Humid
MV1: Cross Ventilation	●	●	○	●	●	●	○
MV2: Stack Ventilation	●	●	●	●	●	●	○
MV3: Ceiling Fans	●	●	●	●	●	●	○
MV4: Gas/Electric Split System	○	●	●	○	●	●	●
MV5: Packaged Rooftop System	○	●	●	○	●	●	●
MV6: Displacement Ventilation System	●	●	●	○	●	●	●
MV7: Hydronic Ceiling Panel System	●	●	●	●	●	○	○
MV8: Unit Ventilator System	●	●	●	●	●	●	●
MV9: Ductless Split System	●	●	●	●	●	●	○
MV10: Evaporative Cooling System	○	●	●	●	●	○	○
MV11: VAV Reheat System	●	●	●	○	○	●	●
MV12: Radiant Slab System	●	●	○	●	●	●	○
MV13: Baseboard Heating System	●	●	○	●	●	●	○
MV14: Gas-Fired Radiant Heating System	●	●	●	●	●	●	●
MV15: Water-Loop Heat Pumps	●	●	○	●	●	●	○
MV16: Evaporatively Precooled Condenser	○	●	●	○	●	●	●
MV17: Dedicated Outside Air Systems	●	●	○	●	●	●	○
MV18: Economizers	●	●	●	●	●	●	●
MV19: Air Distribution Design Guidelines	●	●	●	●	●	●	●
MV20: Duct Sealing and Insulation	●	●	●	●	●	●	●
MV21: Hydronic Distribution	●	●	●	●	●	●	●
MV22: Chilled Water Plants	●	●	●	●	●	●	●
MV23: Boilers	●	●	●	●	●	●	●
MV24: Adjustable Thermostats	●	●	●	●	●	●	●
MV25: EMS/DDC	●	●	●	●	●	●	●
MV26: Demand Controlled Ventilation	●	●	●	●	●	●	●
MV27: CO Sensors for Garage Exhaust Fans	●	●	●	●	●	●	●
MV28: Timers for Recirculating Hot Water Systems	●	●	●	●	●	●	●

Legend: ● Best Applicability    ● Mid-Range Applicability    ○ Worst Applicability



Table 24 – HVAC Selection Criteria

Selection Criteria		Gas/Electric Split System	Rooftop Packaged System	Displacement Ventilation	Ceiling Panels	Unit Ventilator (4-pipe)	Unit Ventilator (2-pipe)	Ductless Split System	Evaporative Cooler	VAV/Reheat.	Radiant Floor	Baseboards	Gas-Fired Radiant System for Gyms	Chiller – Water Cooled	Chiller – Air Cooled
First Cost		●	●	○	○	○	●	●	●	●	○	●	●	○	●
Maintenance Cost		●	●	●	●	●	●	●	●	●	●	●	●	●	●
Cooling Effectiveness		●	●	●	●	●	●	○	●	●	N/A	N/A	N/A	●	●
Heating Effectiveness		●	●	○	○	●	○	○	N/A	●	●	●	●	N/A	N/A
Energy Operating Cost		●	●	●	●	●	●	●	●	●	●	●	●	●	●
Durability		●	●	●	●	●	●	●	●	●	●	●	●	●	●
Life-Cycle Cost		●	○	●	●	○	○	●	●	●	●	●	●	●	●
Noise (Acoustic Environment)		●	●	●	●	○	○	○	●	●	●	●	●	○	○
Roof Space Required		●	○	●	●	●	●	●	○	○	●	●	●	N/A	N/A
Water Consumption		●	●	●	●	●	●	●	○	●	●	●	●	●	●
Classroom Control		●	●	●	●	●	●	●	●	●	●	●	●	N/A	N/A
Multi-Zone Capability		○	○	○	●	○	○	○	○	●	●	●	●	N/A	N/A
Ozone Depletion		○	○	●	●	●	●	○	●	●	●	●	●	●	●
Outside Air Ventilation		●	●	●	○	●	●	○	●	●	○	○	○	N/A	N/A
Thermal Comfort		●	●	●	●	○	○	○	●	●	●	●	●	N/A	N/A
Natural Ventilation (Mixed Mode Method)	Compatibility (poor/fair/good)	●	●	●	●	●	●	●	●	○	●	●	●	N/A	N/A
	Change-Over (yes/no)	●	●	●	○	●	●	●	●	●	○	○	○	N/A	N/A
	Concurrent (yes/no)	○	○	○	●	○	○	○	○	○	●	●	●	N/A	N/A
Indoor Air Quality		●	●	●	●	●	●	●	●	●	●	●	●	N/A	N/A

Legend: ● Better than average (better performance or lower cost)   ● Average   ○ Worse than average (lower performance or higher cost)

Selection Criteria		Gas/Electric Split System	Rooftop Packaged System	Displacement Ventilation	Ceiling Panels	Unit Ventilator (4-pipe)	Unit Ventilator (2-pipe)	Ductless Split System	Evaporative Cooler	VAV/Reheat	Radiant Floor	Baseboards	Gas-Fired Radiant System for Gyms
Spaces Applicability (black, gray or clear)	Classrooms	●	○	●	●	○	○	○	○	○	●	○	○
	Library	○	○	○	○	○	○	○	○	○	○	○	○
	Multi-purpose	○	○	○	○	○	○	○	○	○	○	○	○
	Gym	○	○	○	○	○	○	○	○	○	○	○	○
	Corridors	○	○	○	○	○	○	○	○	○	○	○	○
	Admin	○	○	○	○	○	○	○	○	○	○	○	○
	Toilets	○	○	○	○	○	○	○	○	○	○	○	○
	Other	○	○	○	○	○	○	○	○	○	○	○	○
Possible Cooling Sources	DX	●	●	○	○	○	○	○	○	○	N/A	N/A	N/A
	CHW	○	○	○	○	○	○	○	○	○	N/A	N/A	N/A
Possible Heating Sources	HP	○	○	○	○	○	○	○	○	○	○	○	○
	HW	○	○	○	○	○	○	○	○	○	○	○	○
	Furnace	○	○	○	○	○	○	○	○	○	○	○	○
Optional Energy Efficient Features	Air Economizer	○	○	○	○	○	○	○	○	○	○	○	○
	Evaporative Precooler	○	○	○	○	○	○	○	○	○	○	○	○
	Variable Speed Fan	○	○	○	○	○	○	○	○	○	○	○	○
	High Efficiency Motors	○	○	○	○	○	○	○	○	○	○	○	○

Legend: ● Better than average (better performance or lower cost) ○ Average ○ Worse than average (lower performance or higher cost)

# GUIDELINE MV1: CROSS VENTILATION

## Recommendation

Provide equal area of operable openings on the windward and leeward side. Ensure that the windward side is well shaded to provide cool air intake. Locate the openings on the windward side at the occupied level.

## Description

Wind-driven ventilation is one of two methods of providing natural ventilation. All natural ventilation strategies rely on the movement of air through space to equalize pressure. When wind blows against a barrier, it is deflected around and above the barrier (in this case, a building). The air pressure on the windward side rises above atmospheric pressure (called the pressure zone). The pressure on the leeward side drops (suction zone), creating pressure stratification across the building. To equalize pressure, outdoor air will enter through available openings on the windward side and eventually be exhausted through the leeward side.

Pressure is not uniformly distributed over the entire windward face, but diminishes outwards from the pressure zone. The pressure difference between any two points on the building envelope will determine the potential for ventilation if openings were provided at these two points. The airflow is directly proportional to the effective area of inlet openings, wind speed, and wind direction.

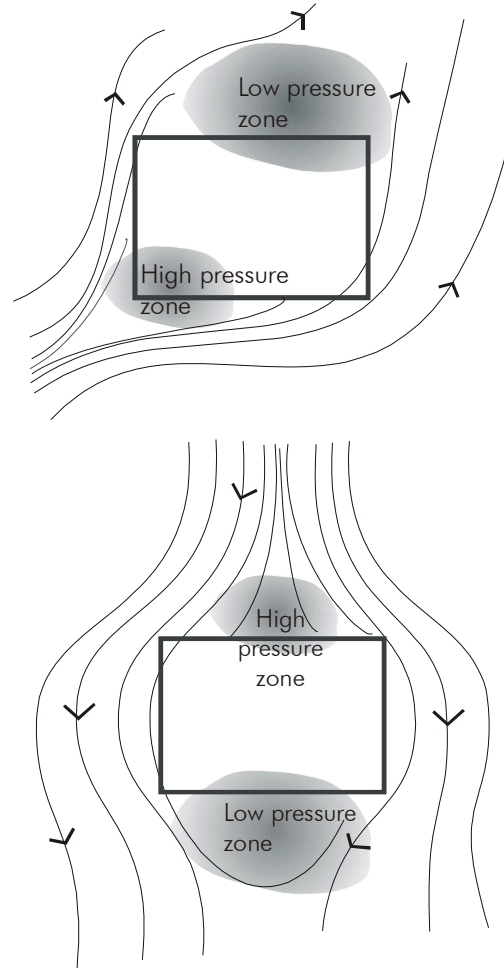

## Applicability

Cross ventilation is a very effective strategy for removing heat and providing airflow in mild climates. In coastal climates, the need for a cooling system may be eliminated by a carefully designed natural ventilation system. In most other climates, it can alter interior conditions only modestly. Hybrid systems work best in such situations. In humid climates, natural ventilation cannot replace the moisture-removing capabilities of air conditioning (although desiccant systems that remove moisture from the space can be used for more effective natural ventilation). Introducing humid air (even if it is relatively cool) into a space will add a substantial load on the cooling system in hybrid systems. However, even extreme climates experience moderate conditions during spring and fall, and natural ventilation should be designed to take full advantage of these conditions.

### Applicable Climates

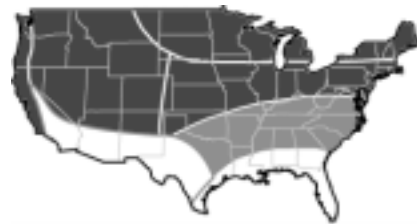

### Applicable Spaces

Classrooms	█
Library	█
Multi-Purpose	█
Gym	█
Corridors	█
Administration	█
Toilets	█
Other	█

### When to Consider

Programming	█
Schematic	█
Design Dev.	█
Contract Docs.	█
Construction	█
Commissioning	█
Operation	█

This strategy relies heavily on two parameters that may change continuously: wind availability and wind direction. Consequently, it is a somewhat unreliable source for thermal comfort. Spaces, like computer rooms and laboratories, that need strict maintenance of indoor temperature and humidity should definitely use hybrid systems for both cooling and ventilation. Introducing natural ventilation in a building may cause increased levels of dirt, dust, and noise, which could also be a serious limitation for certain types of spaces.

Cross ventilation has to be an integral part of the design schematic and design development phases. An effective natural ventilation design starts with limiting space sizes to facilitate inward flow of air from one face and outward flow from the other — architectural elements can be used to harness prevailing winds. This may alter building aesthetics and needs to be addressed early in the design phase.

### **Integrated Design Implications**

- **Design Phase.** Cross ventilation can (or should) very strongly influence building aesthetics and site planning. Natural ventilation codes will dictate space widths and minimum opening sizes. To maximize the effectiveness of openings, the long façade of a building should be perpendicular to the prevailing wind direction. Narrow and woven plans with more surfaces exposed to the outside will work better than bulky plans with concentrated volumes. Singly loaded corridors will provide better air flow than doubly loaded ones. An open building plan with plenty of surface area exposed to the outside will work well for cross ventilation. Architectural elements like fins, wing walls, parapets, and balconies will enhance wind speeds and should be an integral part of cross ventilation design.
- **Thermal Mass.** Cross ventilation should be combined with thermal mass to take advantage of large diurnal temperature swings. Mass walls can act as heat reservoirs, absorbing heat through the day and dissipating it at night. At night, natural ventilation can be used to increase the quantum of dissipated heat as well as to accelerate the process of dissipation (see section on Energy-Efficient Building Shell for details). This will reduce the load on the cooling system by pre-cooling the building. A large diurnal temperature swing (as in desert areas) will ensure that the building is more effectively “flushed.”
- **Integration with Daylighting and View Windows.** The apertures for cross ventilation will also serve as view windows and luminaires for side lighting. All architectural elements intended to enhance one strategy should also work for the other. Orientation that works for ventilation (openings on the windward side) may not be the ideal direction for bringing in daylight. West orientation for windows will increase heat gain and cause glare, but may be the best orientation for bringing in outside air in the coastal areas. Prioritize the needs of the space based on function and climate. For instance, benefits of daylighting in a cold climate outweigh those of cross ventilation, therefore orient the building based on daylighting considerations.
- **Integration with HVAC.** Natural ventilation may be intended to replace air conditioning entirely or, as is more often the case, to coexist with mechanical systems in a “hybrid mode.” Also, natural ventilation may occur in “change-over” (windows are shut when mechanical system is on) or “concurrent” modes. Fewer systems are compatible with the concurrent mode. These factors need to be carefully considered before selecting a system (for more information on system selection see this chapter’s Overview).

### **Cost Effectiveness**

Low to moderate. Buildings that use natural ventilation may have higher initial costs, due to the higher cost of operable windows. Operable windows typically cost 5% to 10% more than fixed glazing. Based on average installed cost for metal frame, double-glazed, fixed windows of \$20/ft<sup>2</sup> to \$30/ft<sup>2</sup>, the operable window should cost \$48 to \$72 more per classroom for buildings that meet their ventilation needs through natural ventilation only (based on code-prescribed minimum area of operable glazing per classroom). For “hybrid” buildings, the cost will be more modest because the operable window area can be less than the code prescribed minimum (5% of floor area). In buildings where natural ventilation is designed to occur concurrently, the initial costs may be higher due to limitations in system selection.

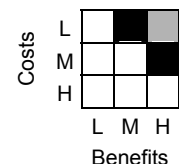

## Benefits

Moderate to high. This varies significantly depending on climatic conditions and natural ventilation design.

- In a moderate climate, wind-driven ventilation can meet the cooling loads most of the time. In such climates, the simple payback period will vary between 8 to 12 years. At times, a good natural ventilation design may completely eliminate the need for a cooling system. This design will result in huge savings that offsets the cost of installing operable windows and lowers the simple payback period to one to four years.
- Buildings located in harsher climates will use “mixed-mode” systems. In such climates, natural ventilation may have limited application resulting in higher payback periods of 12 to 15 years.
- Cross ventilation alleviates odors and quickly exhausts contaminants from a space.
- Increased airflow in a space results in higher thermal comfort levels and increased productivity.
- Operable openings at the occupied level instill the occupants with a sense of individual control over the indoor environment.
- An intangible benefit of natural ventilation is the establishment of a connection with the outdoors (both visual and tactile), weather patterns, and seasonal changes. This results in higher tolerances for variations in temperature and humidity levels.
- Natural ventilation systems are simple to install and require little maintenance.

## Design Tools

Opening areas may be derived using spreadsheet-based calculations. These estimates use approximation techniques but are good numbers to start with. The following algorithm shows the rate of wind-induced airflow through inlet openings:

$$Q = C_4 C_v A V$$

where,

Q = airflow rate, cfm

$C_v$  = effectiveness of openings ( $C_v$  is assumed to be 0.5-0.6 for perpendicular winds and 0.25 to 0.35 for diagonal winds)

A = free area of inlet openings

V = wind speed, mph

$C_4$  = unit conversion factor= 88.0

The following algorithm calculates the required airflow rate for removal of a given amount of heat from a space (see section on Load Calculations for estimating the amount of heat to be removed):

$$Q = \frac{60q}{c_p \rho (t_i - t_o)} \qquad Q = \frac{\text{Btu/h}}{1.08 \Delta T}$$

where,

Q = airflow rate required to remove heat, cfm

q = rate of heat removal, Btu/h

$C_p$  = specific heat of air Btu/lb°F (about 0.24)

$\rho$  = air density, lb<sub>m</sub>/cf (about 0.075)

$t_i - t_o$  = indoor-outdoor temperature difference, °F

Many computer programs are available for predicting ventilation patterns. Some that use the “zonal” method may be used to predict ventilation rate (mechanical and natural), magnitude and direction of air flow through openings, air infiltration rates as a function of climate and building air leakage, pattern of air flow between zones, internal room pressures, pollutant concentration, and back drafting and cross-contamination risks. These models take the form of a flow network in which zones or rooms of differing

pressure are interconnected by a set of flow paths. This network is approximated by a series of equations representing the flow characteristics of each opening and the forces driving the air flow process. Widely available codes include BREEZE and COMIS.

A computational fluid dynamics (CFD) program is a more accurate and complex tool for modeling airflow through a space based on pressure and temperature differentials. These programs can simulate and predict room airflow, airflow in large enclosures (atria, shopping malls, airports, exhibitions centers, etc.), air change efficiency, pollutant removal effectiveness, temperature distribution, air velocity distribution, turbulence distribution, pressure distribution, and airflow around buildings. FLUENT is a sophisticated analysis technique that can, among other things, model and/or predict fluid flow behavior, transfer of heat, and behavior of mass. This software is particularly geared towards ventilation calculations including natural and forced convection currents. It also accurately calculates air density as a function of temperature and predicts the resulting buoyancy forces that can give rise to important thermal stratification effects. Important outputs from FLOVENT are user variables, such as the comfort indices of predicted mean vote, percentage of people dissatisfied, mean radiant temperature, dry resultant temperature, and percentage saturation, including a visualization of their variation through space. A summary of minimum, maximum, mean, and standard deviation for all calculated variables is also available.

### Design Details

- Orient the building to maximize surface exposure to prevailing winds.
- Provide the inlets on the windward side (pressure zone) and the outlets on the leeward side (suction zone). Use architectural features like wing walls and parapets to create positive and negative pressure areas to induce cross ventilation. Air speed inside a space varies significantly depending on the location of openings (see table below). As far as possible, provide openings on opposite walls. Using singly loaded corridors will facilitate provision of openings on opposite walls. Limit room widths to 15 ft to 20 ft if openings cannot be provided on two walls. Windows placed on adjacent walls also perform very well due to the wall-jet phenomenon wherein the inflowing air moves along the nearest wall surfaces. This positioning should be limited to smaller spaces (less than 15 ft x 15 ft).
- Air inlet and outlets should be designed to minimize noise transfer from the exterior to the interior and to adjacent occupied spaces.

*Table 25 — Average Indoor Air Velocity as a Percentage of the Exterior Wind Velocity for Wind Direction Perpendicular to and 45° to the Opening*

Window Height as a Fraction of Wall Height	1/3	1/3	1/3
Window Width as a Fraction of Wall Height	1/3	2/3	3/3
Single Opening	12%-14%	13%-17%	16%-23%
Two Openings on Same Wall	-	22%	23%
Two Openings in Adjacent Walls	37%-45%	-	-
Two Openings on Opposite Walls	35%-42%	37%-51%	46%-65%

Source: *Givoni, Baruch; Man, Climate, and Architecture, London: Applied Science, 1976.*

- A free ventilation area of 1.5% to 2% (of the floor area), which is the recommended minimum area for operable windows only, will meet the ventilation requirements. Daylighting considerations will require a larger window area. Also, if the space is solely dependent on natural ventilation then code requirements will set the minimum operable window area to 5% of the floor area. Although this area will meet the ventilation requirements of a space during mild climatic conditions, larger window areas should be provided for occupant cooling through increased air movement. For cooling purposes provide 5% to 8% of the floor area as free ventilation area. Equal inlet and outlet areas maximize airflow, whereas outlets that are 2% to 5% larger than inlets produce higher air velocities. The inlet location affects airflow patterns far more significantly than outlet location. Inlet location should be a higher priority (if faced with a choice), as a high inlet will direct air towards the ceiling and will almost bypass the occupied level. Locate inlets at a low or medium height. For natural ventilation to function

properly, solar gains should be minimized. Direct sunlight penetrating into the space during periods of natural ventilation may make it difficult or impossible to achieve comfortable conditions with natural ventilation alone. Use shading devices such as overhangs, awnings, and fins to control solar gains.

- The incoming air may be cooled through good site planning, landscaping, and planting strategies. If a water body is planned for the site, place it on the windward side to pre-cool the incoming air through evaporative cooling. Planting tall deciduous trees on the windward side will lower the temperature of the inflow and shade the openings.
- Provide windows with shutters that can be opened or shut in increments. This allows the occupants to vary the inlet and outlet areas according to seasonal variations.
- Use features like overhangs, awning windows, eaves, and porches to protect the openings from rain and to minimize excess heat gain from direct sunlight. Awning windows work very well for cross ventilation because they provide more airflow than double-hung windows (for the same glazed area) and also provide protection from rain. Casement windows provide maximum airflow in both perpendicular and oblique wind conditions.
- Ensure that vents and windows are accessible and easy to use. Avoid blocking windows with exterior objects such as shrubs and fences, but do not eliminate shading.
- Provide inlets for cross ventilation openings at the occupied level. Stagger the outlet openings both vertically and horizontally by a few feet to achieve longer air paths. Concentrate ventilation openings in spaces most likely to require cooling.
- Use overhangs, porches, and eaves to protect windows and vents from rain to extend the amount of time that natural ventilation can be used.
- Ensure that openings can be tightly sealed in winter or when using air conditioning or dehumidification systems.
- HVAC systems should be designed to work in harmony with natural ventilation. The objective of a concurrent natural ventilation system is to meet the outside air requirement using the least possible opening area. The objective of a change-over natural ventilation system is to meet the outside air requirement as well as provide cooling. The HVAC and natural ventilation system are mutually dependent. See the Overview for a detailed discussion.

### **Operation and Maintenance Issues**

This strategy is largely dependent on manual operation for its success. Automated operation may make sense for very large commercial buildings, but not for schools.

- Encourage students and teachers to open/close openings regularly.
- The mechanisms for operable inlets and outlets should be well maintained and clean.
- Periodically clean windowsills, panes, fins, screens, and louvers to ensure healthy air intake for the space.
- Assign responsibility of ensuring that openings are shut during cold weather and the hours of operation of the mechanical system. Also ensure adequate opening area is available for nighttime ventilation in hot dry climates.

### **Commissioning**

None.

### **References/Additional Information**

- Cook, Jeffrey, Ed. *Passive Cooling*. Cambridge: MIT Press, 1989.
- Brown, G.Z. *Sun, Wind, and Light*. New York: John Wiley & Sons, 1986.

## GUIDELINE MV2: STACK VENTILATION

### Recommendation

Use inlets and outlets of equal area and maximize the vertical distance between these two sets of apertures. Place inlets close to the floor or at the occupied level. Locate the outlets closer to the ceiling on the opposite wall. To facilitate varying summer and winter strategies, provide incrementally operable shutters.

### Description

Stack ventilation is one of two methods of providing natural ventilation. Stack ventilation utilizes the difference in air densities to provide air movement across a space. At least two ventilation apertures need to be provided; one closer to the floor and the other high in the space. Warmed by internal loads (people, lights, equipment), the indoor air rises. This creates a vertical pressure gradient within the enclosed space. If an aperture is available near the ceiling, the warmer air at the upper levels will escape as the lower aperture draws in the cool outside air. Higher indoor temperatures are essential for causing a pressure difference such that the upper openings act as the outlet and cool air intake is induced at the lower opening.

The airflow induced by thermal force is directly proportional to the inlet-outlet height differential, the effective area of the aperture, and the inside-outside temperature differential.

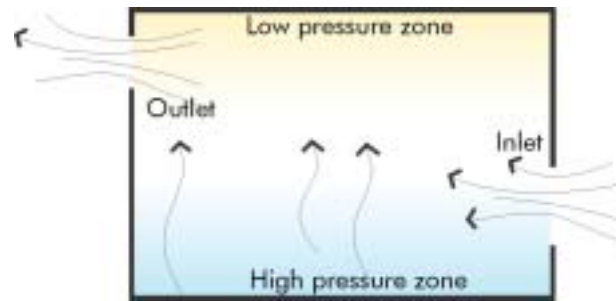

Applicable Climates

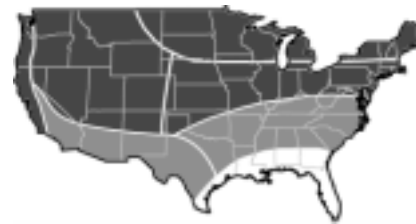

#### Applicable Spaces

Classrooms	█
Library	█
Multi-Purpose	█
Gym	█
Corridors	█
Administration	█
Toilets	█
Other	█

#### When to Consider

Programming	█
Schematic	█
Design Dev.	█
Contract Docs.	█
Construction	█
Commissioning	█
Operation	█

### Applicability

Pressure-differential-driven natural ventilation is an effective strategy for meeting minimum airflow requirements, especially during winter, when the inside-outside temperature differential is at a maximum. It is also appropriate for providing cooling during mild weather conditions when direct outside air is still sufficiently cool to meet interior space cooling requirements.

### Integrated Design Implications

- **Design Phase.** Using the stack effect for ventilation requires an integrated design approach. Stack ventilation will affect building mass and aesthetics. Vertical airshafts for providing stack ventilation also need to be considered early in the design phase.
- **Thermal Mass.** Nighttime ventilation coupled with thermal mass is a very effective strategy for heat removal in hot, dry climates.
- **Integration with Daylighting and View Windows.** Apertures for stack ventilation need to be located close to the floor and ceiling for best results. The high apertures can couple as clerestories or side-lighting luminaires. Benefits of daylighting and natural ventilation need to be considered in conjunction with each other to arrive at the ideal location and size for openings.
- **Integration with HVAC.** Stack ventilation will be used for meeting the outside air requirement in most climates other than Hot and Dry (where stack ventilation will also be used for nighttime cooling).



Carefully integrating this strategy with HVAC system selection and operation will maximize its benefits. For details, see the Overview section.

### Cost Effectiveness

Low to moderate.

Stack ventilation may not add to overall costs significantly if integrated with view windows, high side lighting, and other daylighting strategies. However, an additional cost of \$2/ft<sup>2</sup> may be associated with ensuring that all openings are operable. Adjustable frame intake louvers may cost up to \$25/ft<sup>2</sup> (this includes installation costs). Additional cost of installing windows high in the space will range from \$15/ft<sup>2</sup> to \$30/ft<sup>2</sup>.

Costs	L	■	■	
	M	□	□	
	H	□	□	
		L	M	H
		Benefits		

### Benefits

Low to moderate.

The benefits depend largely on weather conditions (indoor-outdoor temperature differential) and the design of openings.

- In a moderate climate, a combination of wind-driven and stack ventilation strategies can meet the cooling loads most of the time. In more extreme climates (with a large diurnal range of temperature), stack ventilation can operate in “mixed-mode” systems and reduce the peak demand through nighttime flushing, resulting in lower utility bills and first costs. In such climates, the simple payback period will be 8 to 12 years. For most other climates, the simple payback period will be 10 to 14 years.
- Stack ventilation apertures can also double as side and high side lighting strategies.
- Stack ventilation effectively removes contaminants and pollutants from space.

### Design Tools

The airflow (cfm) required can be reasonably estimated using spreadsheet-based calculations. The following algorithm defines the airflow as it varies with the area of openings, indoor temperature, outdoor temperature, and location of the inlet and outlet:

$$Q = 60C_D A \sqrt{2g\Delta H_{NPL}(T_i - T_o) / T_i}$$

Q = airflow rate, cfm

C<sub>D</sub> = discharge coefficient for opening

ΔH<sub>NPL</sub> = height from mid-point of lower opening to Neutral Pressure Level (NPL) ft

T<sub>i</sub> = indoor temperature, °F

T<sub>o</sub> = outdoor temperature, °F

Use this algorithm to estimate the aperture area for a particular hour of a day (with Q equal to 15 cfm).

Several computer tools are available for simulating pressure driven airflow. Refer to Guideline MV1: Cross Ventilation for details.

### Design Details

- Provide equal inlet and outlet areas to maximize airflow. Airflow will be dictated by the smaller of the inlet and outlet areas.
- The width to height ratio of openings should be more than one as far as possible (i.e., orient openings horizontally).
- The free ventilation area of the inlet and outlet should be at least 1% of the total floor area of the room (4.8 ft<sup>2</sup> each per classroom, based on 32 ft x 30 ft x 9 ft-6 in. classrooms). This is adequate to meet outdoor air requirements with perpendicular wind speeds as low as 2 mph and low temperature differentials that occur during summer months. Lowering the air intake of these openings during

winter or completely shutting some of these openings may avoid uncomfortable winter conditions. For extreme climates, all the available operable openings may remain open only for limited periods.

- Allow for at least a 5-ft center-to-center height difference between the inlet and the outlet. Increasing the height differential further will produce better airflow.
- Use stairwells or other continuous vertical elements as stack wells by providing adequate apertures. Such spaces may be used to ventilate adjacent spaces because of their ability to displace large volumes of air (because of greater stack height).
- Carefully control and minimize solar gains. For details see Guideline MV1: Cross Ventilation.
- Combine stack ventilation with cross ventilation elements. Set the inlet openings for cross ventilation lower in the wall so that they can double as inlets for stack ventilation.
- Use louvers on inlets to channel air intake. Use architectural features like wind towers and wind channels to effectively exhaust the hot indoor air.
- HVAC systems should be designed to work in harmony with stack ventilation (see the Overview section for a discussion).
- Air inlet and outlets should be located or designed to minimize noise transfer from the exterior to the interior and to adjacent occupied spaces.
- Large openings may require installing security grills to limit potential points of entry.

### **Operation and Maintenance Issues**

This strategy is largely dependent on manual operation for its success:

- Openings should be appropriately operated according to indoor-outdoor temperature differentials.
- The mechanisms for operable inlets and outlets should be well maintained and clean.
- Windowsills, fins, screens, and louvers should be periodically cleaned to ensure healthy air intake for the space.
- Assign responsibility of ensuring that openings remain shut during the mechanical system's hours of operation unless the ventilation is designed to work concurrently.
- Ensure that adequate opening area is available for nighttime ventilation in hot, dry climates.

### **Commissioning**

None.

### **References/Additional Information**

Cook, Jeffrey. *Passive Cooling*. Cambridge: MIT Press, 1989.

Brown, G.Z. *Sun, Wind, and Light*. New York: John Wiley & Sons, 1986.

## GUIDELINE MV3: CEILING FANS

### Recommendation

Use ceiling fans in classrooms to provide enhanced thermal comfort for occupants through higher air velocity. Use the ceiling fans instead of air conditioners in mild coastal climates. In more extreme climates, use ceiling fans as a supplement to cooling systems.

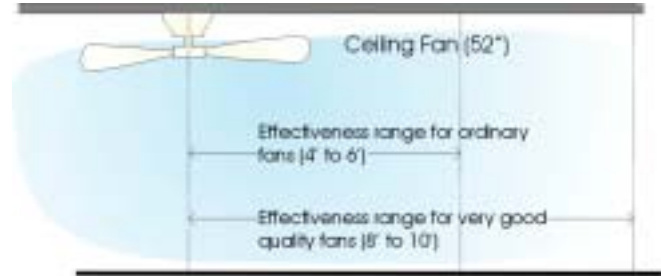

### Description

A ceiling fan is a device for creating interior air motion. It is a permanent fixture operated by a switch or a pull string. Acceptable comfort levels can be maintained above the customary comfort zone for air speeds exceeding 50 fpm by using a ceiling fan. Generally, for speeds above 30 fpm, most people will perceive a 15 fpm increase in air to be equal to 1°F decrease in temperature. This phenomenon is commonly called “chill factor.” Outside air can be introduced into a space through openings using a fan when outside air cannot enter the space on its own, because it is either too humid or too hot. A fan can also re-circulate air within a space. Fans also cool by increasing evaporation of moisture from the skin (skin moisture vaporizes using body heat to change phase).

### Applicable Climates

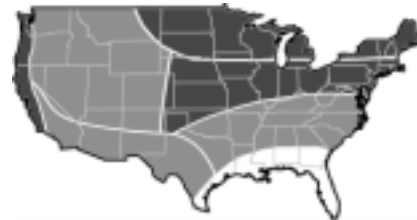

### Applicable Spaces

Classrooms	█
Library	█
Multi-Purpose	█
Gym	█
Corridors	█
Administration	█
Toilets	█
Other	█

### When to Consider

Programming	█
Schematic	█
Design Dev.	█
Contract Docs.	█
Construction	█
Commissioning	█
Operation	█

In a high ceiling space, ceiling fans can help “destratify” the warm air layer, which collects near the ceiling, and distribute it to the lower part of the space for thermal comfort. As a result, heating thermostats need not be set as high.

The interior air motion caused by ceiling fans varies as a function of fan position, power, blade speed (measured in rpm), blade size, and the number of fans within the space. Moreover, air speeds within a space vary significantly at different distances from the fan.

The normal current draw will range from approximately 15 W at low speed to 115 W at high speed.

### Applicability

Ceiling fans are appropriate for classrooms and administration areas. They may not be suitable for gyms because of the potential for rapid skin cooling (more skin moisture is secreted during intense physical activities). Nor are they appropriate for toilets as the space may be too small for a ceiling hung fan. Noise produced by ceiling fans may be an issue in auditoriums or classrooms if fans turn at too high a velocity.

Ceiling fans are suitable for most climates that require cooling. Combined with other passive strategies they may eliminate the need for air conditioning in the Temperate and Mixed region. They are not very useful in humid climates.

Ceiling fans should be considered in the design development stage due to electrical wiring and ceiling height issues, although adding fans to existing spaces is feasible too.

## Integrated Design Implications

Using ceiling fans does not significantly impact other design decisions, except when a displacement airflow design is being considered.

- A minimum ceiling height of 9 ft must be provided to accommodate a fan such that its blades are at a distance of 8 ft from the floor and 1 ft from the ceiling.
- Ceiling fans should be combined with natural ventilation strategies for best results.

## Cost Effectiveness

Ceiling fans cost between \$75 and \$200. The typical cost of a professionally installed fan is about \$250. Fans with features such as light fixtures, reverse or multiple speed settings, and extended warranties may cost more. Some ceiling fans are very economical to operate as they consume very little energy. Others have very inefficient motors and add considerable heat to the room. Careful selection should be made.

Costs	L			
	M			
	H			
		L	M	H
		Benefits		

## Benefits

- Moving air extends the comfort range and allows occupants to feel comfortable at higher temperatures. It also helps occupants feel dry. Wind speed is one of the six factors that affect thermal comfort indices like the predicted mean vote (PMV). Increasing air speeds results in PMVs that fall in the comfort zone (for detailed discussion, see this chapter's Overview section).
- Temperature settings for mechanical cooling equipment can be higher and an energy savings greater than the energy consumption of the fans can be realized. According to the Texas Energy Extension Service, for a three-ton cooling system costing \$550 per season, raising the thermostat from 75°F to 80°F can reduce the operating cost by \$151. Operating a ceiling fan 10 or more hours a day may cost less than \$3/month. For example, a typical fan operating at high speed uses approximately 100 W of power. Assuming that the fan is operated five hours/day with an energy cost of \$0.08/kWh, the cost of operation will be \$0.04/day. At lower speeds this operating cost will be even less. This low operating cost and the potential reduction in cooling and heating cost make the ceiling fan one of the better energy-saving devices on the market. As a rule of thumb — each degree rise in a thermostat setting (beyond 78°F) results in a 3% to 5% saving on cooling energy. If the ceiling fan is supplementing air conditioning, the thermostat of the air conditioning unit may be raised a full 4°F above the standard 78°F setting while still maintaining comfortable space conditions.
- In the heating season, ceiling fans can help bring the warmer air that stratifies near the ceiling down to where the occupants are located. A low speed that does not create a significant breeze is best for this heating season application. Again, the thermostat set point may be lowered by nearly 2°F.

## Design Tools

Use the following charts to size ceiling fans according to largest room dimension and room area:

Table 26 — Fan Diameter Selection Based on Space Dimensions

Largest Dimension of Room	Minimum Fan Diameter
12 ft or less	36 in.
12 - 16 ft	48 in.
16 - 17.5 ft	52 in.
17.5 - 18.5 ft	56 in.
18.5 ft or more	2 fans needed

Table 27 — Fan Diameter Selection Based on Space Area

Room Area	Minimum Fan Diameter
100 ft <sup>2</sup>	36 in.
150 ft <sup>2</sup>	42 in.
225 ft <sup>2</sup>	48 in.
375 ft <sup>2</sup>	52 in.
400+ ft <sup>2</sup>	2 fans needed

Sources: *Consumer Guide to Home Energy Saving (1995)* by the American Council for an Energy Efficient Economy.

### Design Details

- Use ceiling fans in frequently occupied spaces.
- Use “Quiet Type” energy-efficient fan and motor assemblies.
- A larger fan provides a greater range of airflow settings and ventilates a larger area at lower velocities, with less noise, and only slightly more power than similar smaller units. Use two 48-in. fans in classrooms (based on 30 ft x 32 ft classrooms). These will move air most effectively in a 4 ft to 6 ft radius, and somewhat less effectively for another 3 ft to 4 ft radius. At the level of seated occupants, this will achieve air speeds ranging from 50 fpm to 200 fpm. Beyond 30 fpm, every additional 15 fpm results in a perceived 1°F drop in temperature. The more blade surface, the more air it will catch.
- Ceiling fans work best when the blades are 8 ft to 9 ft above the floor and 10 in. to 12 in. below the ceiling. Placing fans so the blades are closer than 8 in. to the ceiling can decrease the efficiency by 40%. Fans also require at least 18 in. of clearance between the blade tips and walls. Two types of mountings are available for ceiling fans — rod and hugger. In rod fans, the motor housing is suspended from the mounting bracket by a rod. With hugger fans, the motor housing is mounted directly to the ceiling box. Hugger fans are not as efficient as rod fans in the down motion, especially at higher speeds. The blades will starve themselves for air when they are too close to the ceiling.
- Use ceiling fans to supplement air movement in natural ventilation strategies.
- Select a fan with at least a two-speed control for better regulation of air movement. Variable-speed fans are preferable so that the lowest speed can be used in the heating season to accomplish destratification without causing excessive draft. If using a reversible fan, ensure that the fan has a setting low enough to circulate the air without creating too much of a breeze. These fans are best for rooms that tend to build up heat.
- Fans should be on only when the space is occupied; otherwise the movement of the motor is also introducing some heat in the room without any cooling benefits. Remember that ceiling fans cool people, not spaces. Consider using an occupancy sensor.

### Operation and Maintenance Issues

- Ceiling fans should be operated only when the rooms are occupied. A motion sensor or a clear policy of operating ceiling fans only when using the room is needed. In the destratification mode, starting the fans several hours before occupancy would be beneficial for getting ceiling accumulated heat down.
- Ensure that all blades are screwed firmly into the blade holder and that all blade holders are tightly secured at the fan. This should be checked at least once a year.
- It is important to periodically clean the fan, as the blades tend to accumulate dust on the upper side. An anti-static agent can be used for cleaning, but do not use any cleaning agents that can damage the finish. Never saturate a cloth with water to clean the ceiling fan.
- For a fan to perform efficiently, it is very important that the blade be aerodynamically shaped to increase its efficiency, similar to an airplane propeller. “Balanced” blades; that is, blades that are electronically matched at the factory; are sold as balanced four- or five-blade sets, depending on the design of the fan. For this reason, never interchange blades between fans.

## **Commissioning**

- Use durable fans with longer warranties. Use fans with metal motor housings — these may require annual lubrication while plastic motor housings will not.

## **References/Additional Information**

*AIRBASE* (database of over 7,000 abstracts of international papers on infiltration and ventilation), Air Infiltration and Ventilation Centre, Sovereign Court, University of Warwick Science Park, Sir William Lyons Road, Coventry, CV4 7EZ, U.K. Tel: 44-203-692050, Fax: 44-203-416306.

American Society of Heating, Refrigerating and Air Conditioning Engineers. *ASHRAE 62-Ventilation for Acceptable Indoor Air Quality*. 1791 Tullie Circle NE, Atlanta, GA, 30329-2305. Tel:(404) 636-8400; Fax:(404) 321-5478.

Bower, John. *Understanding Ventilation: How to Design, Select, and Install Residential Ventilation Systems*. The Healthy House Institute, 430 N. Sewell Rd., Bloomington, IN 47408.

The Home Ventilating Institute. *The Certified Home Ventilating Products Directory*. 30 West University Dr., Arlington Heights, IL 60004-1893. Tel:(708) 394-0150.

## GUIDELINE MV4: GAS/ELECTRIC SPLIT SYSTEM

### Recommendation

When specifying a gas/electric split system, consider an add-on economizer, two-speed blower/furnace/compressor, high-efficiency furnace (AFUE 90+), and high-efficiency cooling (SEER 14+).

### Description

This system is similar to a typical residential heating and cooling system. The components include an indoor fan unit and outdoor compressor and condenser package. The indoor unit usually includes a cooling coil and furnace section, although the furnace can be omitted if the compressor is also used for heating in heat pump mode. The indoor and outdoor sections are connected via refrigerant tubing and control wires.

Supply air from the indoor unit is typically ducted to several supply diffusers in the ceiling. Return air may be ducted or returned directly to the unit through a grill.

While most residential systems recirculate indoor air only, an outside air duct is essential to supply ventilation air that is mixed with return air for schools.

### Variations and Options

An economizer is not standard with split systems but is available as an aftermarket option. The additional equipment includes a mixing box with outdoor and return air dampers and the associated controls. Check with split system manufacturer for control compatibility.

For climates where cooling is unnecessary, the system can be used for heating only, or for heating and ventilating. Eliminating the cooling coil and outdoor compressor unit reduces the cost significantly. An economizer may be installed to provide free cooling if the space design does not allow for convenient natural ventilation cooling (due to drafts, outdoor noise, dust, or similar problems).

Indoor units are available for either horizontal or vertical installation. Horizontal units are typically installed above the ceiling. Vertical units may be installed in a mechanical closet with flow direction either upwards or downwards.

A high-efficiency, condensing furnace is available as an option for most split systems. Annualized fuel utilization efficiency (AFUE) is 90% to 96%, compared to about 80% for standard units.

High-efficiency cooling is also an option provided by most manufacturers. Systems are available with efficiencies greater than seasonal energy efficiency ratio (SEER) 14, compared to typical units with SEER 10 to 11.

A two-speed blower and variable output furnace is an option that can provide significant fan energy savings and improve comfort through less on-off cycling.

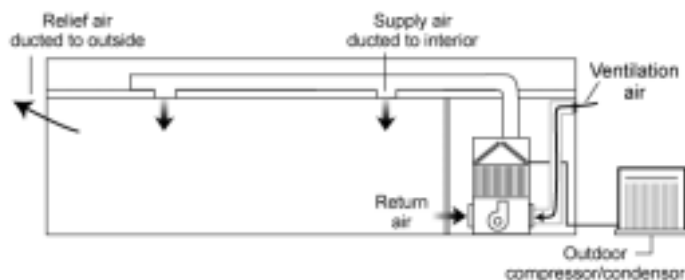

*Basic gas/electric split system.*

### Applicable Climates

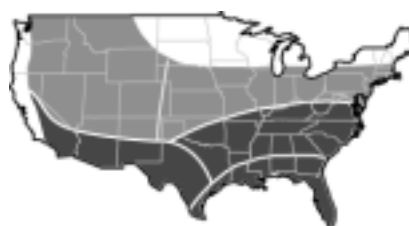

### Applicable Spaces

Classrooms	<input checked="" type="checkbox"/>
Library	<input type="checkbox"/>
Multi-Purpose	<input type="checkbox"/>
Gym	<input type="checkbox"/>
Corridors	<input type="checkbox"/>
Administration	<input type="checkbox"/>
Toilets	<input type="checkbox"/>
Other	<input type="checkbox"/>

### When to Consider

Programming	<input checked="" type="checkbox"/>
Schematic	<input type="checkbox"/>
Design Dev.	<input type="checkbox"/>
Contract Docs.	<input type="checkbox"/>
Construction	<input type="checkbox"/>
Commissioning	<input type="checkbox"/>
Operation	<input type="checkbox"/>

Two-speed compressors are available that can be controlled together with a two-speed indoor fan for better comfort and humidity control.

Heat pump heating is an option for locations without convenient natural gas access. In cool climates, a supplementary electric resistance heating element may be necessary, especially to handle relatively high ventilation air requirements for classrooms.

Natural gas engine-driven heat pumps are available; however, they are more expensive. These units use a reciprocating natural gas engine rather than an electric motor to drive the compressor and provide heating and cooling.

### **Applicability**

This system type is appropriate for classrooms or other single zone spaces up to about 2,500 ft<sup>2</sup>. Minimum cooling efficiency is SEER 10.0 for split systems smaller than 65,000 Btu/h of cooling capacity. Minimum heating efficiency is 78% AFUE for gas furnaces smaller than 225,000 Btu/h. These efficiency requirements are federal regulations.

### **Integrated Design Implications**

Location of the indoor and outdoor units needs to be considered early in the architectural design to ensure optimal performance. See Design Details below for important considerations. Similarly, the location of ducts and supply registers should be considered when making structural and lighting system decisions.

System controls should be specified so they integrate with natural ventilation design. Use automatic interlock controls to shutoff the system when windows are opened or allow manual fan shutoff. If the space is designed for good natural ventilation, then an economizer may not be necessary.

Try to place ducts within the conditioned envelope to minimize the impact of leakage and conduction losses, which can be very significant. Insulate under the roof deck rather than on top of a suspended ceiling. If possible, place the indoor unit within the conditioned envelope as well. Ensure, however, that combustion air is properly vented.

### **Cost Effectiveness**

Overall system cost for a gas/electric split system ranges from \$10/ft<sup>2</sup> to \$12/ft<sup>2</sup>.

A high-efficiency (condensing) furnace adds roughly \$700, compared to a standard efficiency unit with a base installed cost of about \$550. However, the extra cost may also cover multi-speed fan control and variable furnace output, in addition to better efficiency.

An efficient three-ton air conditioner with 13 SEER costs roughly \$2,500, compared to \$1,700 for a SEER 10. The incremental cost is roughly \$800.

An outside air economizer adds about \$300 to \$500.

For a 960-ft<sup>2</sup> classroom, incremental cost for combined measures is about \$2,000, or \$2/ft<sup>2</sup> of floor area.

High-efficiency cooling is generally cost effective in warm regions. A high-efficiency, condensing furnace should be cost effective in cool climates, especially considering construction cost savings due to more flexibility in locating the low temperature flue vent.

Costs	L			
	M		■	
	H			
		L	M	H
		Benefits		

### **Benefits**

#### **Advantages**

- High heating and cooling efficiencies are available. (By contrast, efficient heating options are seldom available for packaged rooftop units.)
- Two-speed fan and compressor options improve partial load efficiency, comfort, and humidity control.



- Numerous system capacities are possible with combinations of furnace units, cooling coils, and compressors.
- An economizer can be added to take advantage of outdoor air for free cooling.
- Outdoor unit is relatively small.
- It is possible to keep all ducts within the insulated building shell to minimize impact of duct losses.
- Moderate initial cost.
- This can be installed as a heating-only system at a lower cost. A cooling coil and outdoor condensing unit can be added later if desired. However, their ductwork and air distribution system would need to be sized for greater cooling airflow requirements.

#### ***Disadvantages***

- Space within the building shell is required for the indoor unit, either above the ceiling or in a closet.
- An indoor unit may create noise in the space if not carefully designed and installed.
- Air ducts are required, which can be leaky and inefficient if not installed properly.
- High-efficiency units have a significant cost premium.
- Limited multi-zone capability.
- Poor dehumidification control (better with two-speed compressor and fan).
- Higher maintenance cost for large facilities compared to central VAV system.

#### ***Design Details***

Indoor unit location considerations:

- To reduce noise, isolate the unit from the occupied space, and provide appropriate noise control measures at the intake and discharge and adequately sized ducts and registers to avoid excessive air velocity.
- Make sure that filters and coils are easily accessible for maintenance.
- Provide easy access for the outdoor air inlet, minimizing length of ducts and eliminating turns from ductwork if possible.
- Allow access to outdoors for furnace combustion air and provide a vent for flue gas as recommended by the manufacturer.
- Minimize the number of duct turns necessary to reach supply diffusers and return grilles, and minimize duct length (second priority compared to number of turns). At the same time, however, ensure that noise transmission through the ducts is controlled.
- Consider that cooling coil condensate must drain to a proper receptacle and condensate pan overflow should drain to a visible location.
- Provide adequate vibration isolation. Manufacturer may provide standard vibration isolation package.
- See also MV19: Air Distribution Design Guidelines for information about choosing locations for supply and return registers to minimize noise and maximize performance.

Outdoor unit location considerations:

- Typically, the unit is placed on a concrete pad alongside the building. However, rooftop installation is possible as well.
- To reduce noise, keep the unit away from operable windows and doors.
- Remember that outdoor units face the potential for vandalism and design accordingly.
- Provide access for maintenance.

- Try to choose a shaded location with the lowest possible ambient air temperature to improve cooling efficiency. Be especially careful to avoid direct exposure to afternoon sun.
- Provide adequate clearance around the outdoor unit to prevent airflow obstructions.
- If the outdoor unit is mounted on the rooftop, then consider using a reflective white roof membrane to reduce temperature and improve system performance. Standard roofs exceed 150°F on a sunny day, while white roofs can be 50°F cooler.

Match the compressor and indoor fan units for proper performance. See manufacturers' literature for combinations and their efficiency ratings.

Be sure to allow for furnace condensate drainage for high efficiency units, and provide condensate drainage for cooling coils.

Design the air distribution system to minimize pressure drop and set blower fan motor to low or medium speed to reduce fan energy consumption and minimize noise (see MV19: Air Distribution Design Guidelines).

Do not oversize heating and cooling capacities (see the topic Load Calculations in this chapter's Overview section).

If choosing a system with a multiple-speed fan as well as variable heating and cooling capacity, then specify a thermostat with those control capabilities.

### ***Operation and Maintenance Issues***

Maintenance requirements for a gas/electric split system are very similar to other system types. However, all compressor cooling systems require additional maintenance skills and cost more to maintain compared to heating-only systems.

Recommended maintenance tasks include:

- Replacing filters regularly
- Cleaning indoor and outdoor coils regularly
- Checking refrigerant charge
- Cleaning the cooling coil condensate pan and drain
- Lubricating and adjusting the fan as recommended by manufacturer.

### ***Commissioning***

Measure total supply airflow with a flow hood or comparable measuring device. Make sure that airflow is within 10% of design value. If airflow is low, then check ducts for leaks and constrictions, and check that filters and coils are free of obstructions. Larger ducts, or shorter duct runs, may be necessary. Reduce the number of duct turns to a minimum. If airflow is high, then reduce fan speed if possible according to manufacturer's instructions.

If an economizer is installed, then verify proper operation (see MV18: Economizers).

### ***References/Additional Information***

MV18: Economizers; MV19: Air Distribution Design Guidelines.

## GUIDELINE MV5: PACKAGED ROOFTOP SYSTEM

### Recommendation

If choosing a packaged rooftop system, specify a high-efficiency unit with an integrated economizer and design the duct system to allow proper airflow at low or medium fan speed.

### Description

A packaged rooftop system is fully self-contained, and most consist of a constant volume supply fan, direct expansion cooling coil, heating (when required) with gas furnace, filters, compressors, condenser coils, and condenser fans. Units are typically mounted on roof curbs but can also be mounted on structural supports or on grade. Packaged rooftop single-zone units are typically controlled from a single space thermostat with one unit provided for each zone. Supply air and return air ducts connect to the bottom (vertical discharge) or side (horizontal discharge) of the unit. Supply air and return air ducts connect to the bottom (vertical discharge) or side (horizontal discharge) of the unit.

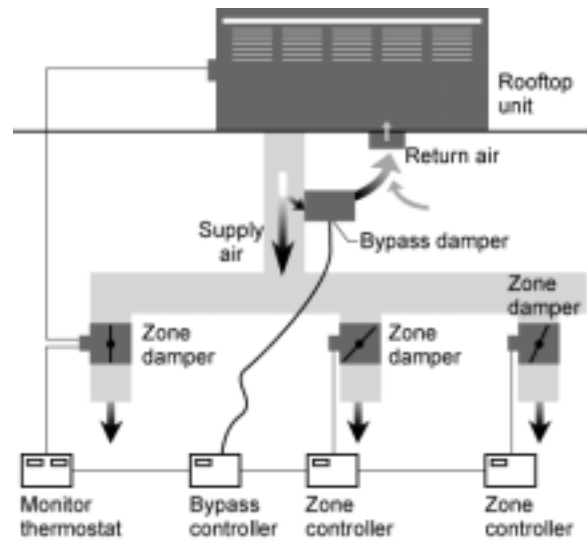

*Packaged rooftop system.*

### Variations and Options

Economizers are often standard, cost-effective options for rooftop units (see MV18: Economizers).

High-efficiency cooling with seasonal energy efficiency ratios in the range of 12 to 13 is commonly available.

Units can be purchased as heat pumps for use in areas without convenient access to natural gas for heating.

An evaporative precooler can be added to the condenser to increase capacity and efficiency during hot weather.

A “single zone” rooftop unit can condition multiple zones when equipped with special controls and hardware. This type of system includes an automatic damper in the ductwork for each zone, which modulates to control temperature. If some zones require cooling while others need heating, then the controller switches the rooftop unit between both modes and the zone dampers will open or close as appropriate. This system also includes a bypass damper between the supply and return that is opened to maintain constant airflow through the rooftop unit when one or more zone dampers are closed.

### Applicable Climates



### Applicable Spaces

- Classrooms
- Library
- Multi-Purpose
- Gym
- Corridors
- Administration
- Toilets
- Other

### When to Consider

- Programming
- Schematic
- Design Dev.
- Contract Docs.
- Construction
- Commissioning
- Operation

### Applicability

A packaged rooftop unit is applicable for spaces that require heating and cooling. However, due to their relatively low cost and expected short life (less than 30 years), they are sometimes installed where only heating is required.

Due to the constant-volume fan, this system is most applicable where loads and ventilation requirements are relatively constant, such as in classrooms, administration areas, and libraries. The system is less applicable for intermittent occupancies such as assembly areas.

Packaged rooftop units are available in capacities from 2 tons to more than 100 tons and can be used for single zones from 600 ft<sup>2</sup> to more than 30,000 ft<sup>2</sup>.

Multiple zones where the zone loads are not too different can be handled with special controls. There is no theoretical limit to the number of zones possible, and commercially available controllers will serve 32 or more. However, in practice, these controls should be used for no more than a handful of zones. For larger systems, variable air volume (VAV) controls will be more effective and efficient.

See Table 28 for minimum cooling efficiency requirements. For units smaller than 65,000 Btu/h, these efficiency requirements are federal regulations.

### **Integrated Design Implications**

Rooftop units can have a significant visual impact and can create concern regarding noise level at adjacent properties. Their location should be considered early in the architectural design process to allow for efficient duct layout. In addition, location of ducts and supply registers should be considered when making lighting system decisions.

System controls should be specified so they integrate with natural ventilation design. Use automatic interlock controls to shut off the system when windows are opened or allow manual fan shutoff. If the space is designed for good natural ventilation, an economizer may not be necessary.

Try to place ducts within the conditioned envelope as much as possible to minimize the impact of leakage and conduction losses, which can be very significant. This is only recommended, however, where approximately the first 20 ft of duct runs above spaces that are not sensitive to noise. Insulate under the roof deck rather than on top of a suspended ceiling.

### **Cost Effectiveness**

The overall cost for a packaged rooftop system can be as low as \$15/ft<sup>2</sup> to \$20/ft<sup>2</sup> (installed cost, including ductwork and controls).

The unit cost alone ranges from about \$1,500 for a two-ton unit to around \$2,000 for a five-ton unit. High-efficiency package units (when available) cost about 10% more than standard efficiency models and have paybacks of around three to four years in warm climates.

Packaged rooftop systems are often the lowest first-cost alternative when both heating and cooling are required. However, they are relatively costly to maintain, energy costs are higher than average, and life expectancy is less than 30 years.

Costs	L	■	■	■
	M	■	■	■
	H	■	■	■
		L	M	H
		Benefits		

### **Benefits**

#### **Advantages**

- Low initial cost.
- No inside mechanical equipment space is used.
- An added economizer can take advantage of outdoor air for free cooling (see MV18: Economizers).
- Systems are widely available.

#### **Disadvantages**

- Fewer efficiency options exist compared to gas/electric split systems (e.g. condensing furnace, two-speed fan, high efficiency cooling).
- Systems are relatively large and require roof space.
- Air ducts, which can be leaky and inefficient if not installed properly, are required.

- Systems have limited multi-zone capability.
- Poor dehumidification control can occur compared to VAV systems (due to compressor cycling).
- Higher maintenance costs occur for large facilities compared to central VAV systems.
- Systems have typically shorter lifetimes than central VAV systems.

### **Design Details**

Most packaged systems have several fan speed options that can be selected in the field when the unit is installed. Careful design of the air distribution system can reduce pressure drop and provide significant savings if the fan is wired for low or medium speed (see MV19: Air Distribution Design Guidelines).

The incremental equipment cost for packaged rooftop equipment is not too large to increase size from, say, two to four tons. Therefore, the temptation is strong to specify the larger unit for safety's sake. However, there are performance penalties for oversized systems. Bigger is not always better. Do not rely on rules of thumb to select airflow, cooling capacity, or heating capacity. See this chapter's Overview section for a discussion of load calculations and the impact of cooling capacity oversizing.

Table 28 lists recommended minimum efficiencies for packaged rooftop equipment.

Vibration isolation is often provided internally. Internal isolation should be reviewed for proper spring type and static deflection. If internal isolation is not provided, or is unacceptable, external spring isolators should be utilized. Refer to 1995 ASHRAE Handbook Chapter 43 for recommended vibration isolation. If external isolation is used, all internal spring isolators should not be released from their restraining bolt.

The unit should be located above unoccupied spaces (i.e. storage, stairwells, etc.).

Provide appropriate intake and discharge noise control consistent with meeting the Noise Criteria.

*Table 28 – Recommended Minimum Efficiencies for Air-Cooled Packaged Rooftop Equipment*

<b>Capacity</b>	<b>Recommendation</b>
< 65,000 Btuh	12.0 SEER
65,000 – 135,000 Btuh	11.0 EER
135,000 – 240,000 Btuh	10.5 EER
> 240,000 Btuh	10.0 EER

### **Operation and Maintenance Issues**

Maintenance requirements for a packaged rooftop system are very similar to other system types. However, all compressor cooling systems require additional maintenance skills and cost more to maintain compared to heating-only systems.

Recommended maintenance tasks include:

- Replacing filters regularly
- Cleaning indoor and outdoor coils regularly
- Checking refrigerant charge.
- Cleaning and draining cooling coil condensate pan, and specify pans that are pitched to drain continuously under all operating conditions
- Pitch and properly trap drain pan and drain condensate to a roof drain, not over the side of a building
- Lubricating and adjusting fan as recommended by the manufacturer.

### **Commissioning**

Measure total supply air flow with a flow hood or comparable measuring device. Make sure that airflow is within 10% of design value. If airflow is low, then check ducts for constrictions and check that filters and coils are free of obstructions. Larger ducts or shorter duct runs may be necessary. Reduce the number of

duct turns to a minimum. If airflow is high, then reduce fan speed if possible, according to manufacturers' instructions.

If an economizer is installed, then verify proper operation (see MV18: Economizers).

### ***References/Additional Information***

Guideline MV18: Economizers; Guideline MV19: Air Distribution Design Guidelines.

# GUIDELINE MV6: DISPLACEMENT VENTILATION SYSTEM

## Description

Displacement ventilation systems are different from most other HVAC systems for schools and offer a number of advantages. With displacement systems, air is delivered near the floor, at a low velocity, and at a temperature from 63°F to 65°F (compared to around 55°F for conventional air distribution cooling). The goal of displacement systems is not to cool the space, but to cool the occupants. Cool air flows along the floor until it finds warm bodies. As the air is warmed, it rises around occupants, bathing them in cool fresh air. Air quality improves because contaminants from occupants and other sources tend to rise out of the breathing zone rather than being mixed in the space. Similarly, cooling loads decrease significantly because much of the heat generated by occupants, lights, and computer equipment rises directly out of the occupied zone and is exhausted from the space. This is especially true in classrooms designed for 100% outside air with total energy recovery.

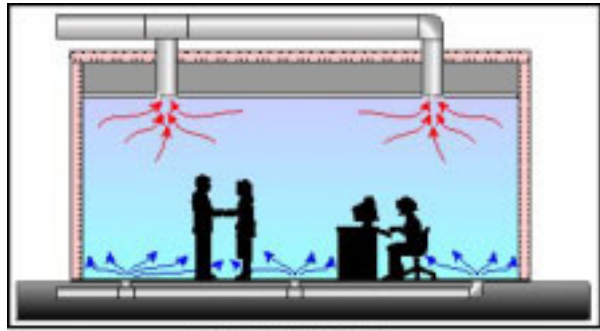

Ventilation system.

(source: <http://www.advancedbuildings.org>)

### Applicable Climates



### Variations and Options

There are several supply air distribution options:

- Access floor.
- Low wall outlets.
- Infloor outlets.

The best cooling source for a displacement ventilation system is a chilled water coil. The control valve in a hydronic system allows supply of constant 63°F to 65°F air. A typical direct exchange (DX) system is designed to provide colder 50°F to 55°F air while the compressor is running and cycles on and off to meet space loads. This lower temperature and temperature fluctuations would create a comfort problem in displacement ventilation when it comes in contact with occupants. However, larger DX systems with several compressors and temperature reset capabilities can be used as an alternative to a chilled water system. For example, a packaged rooftop VAV system serving 10 or more classrooms should be able to provide the necessary supply air temperature control.

Evaporative cooling is also a potential source because it typically produces higher air temperature than a DX system.

### Applicable Spaces

Classrooms	
Library	
Multi-Purpose	
Gym	
Corridors	
Administration	
Toilets	
Other	

### When to Consider

Programming	
Schematic	
Design Dev.	
Contract Docs.	
Construction	
Commissioning	
Operation	

## Applicability

Displacement ventilation is most appropriate for spaces with ceiling height of at least 10 ft to permit stratification. Systems that utilize 100% outside air design with enthalpy energy recovery are very suitable for high occupant density areas like classrooms and auditoriums. This distribution type is also a great choice where raised access floors are desired for flexibility of power and communication wiring (although access floors are not required for displacement ventilation).

## Integrated Design Implications

Supply air outlets must be coordinated with the location of furnishings and space usage. The outlets may be integrated with cabinets or seating.

There is an excellent opportunity to integrate electrical and communication wiring with the air distribution either under the floor or along the baseboard.

A displacement system can eliminate the need for a suspended ceiling and allow the ceiling to be clear of supply diffusers.

If the ceiling is high enough, displacement ventilation can be integrated into portable classroom design, where space for ducting exists in the crawlspace beneath the floor.

Slab floors may be designed with integral ducts or troughs for air distribution.

Consider using variable-speed heating and cooling sources to minimize the on-off cycling and variations in supply air temperature.

Ceiling fans are not recommended with displacement ventilation because they are designed to mix air in a space and will disrupt the stratification created by the displacement ventilation system.

## Cost Effectiveness

There is not a great deal of experience with displacement ventilation in classrooms, but it is growing in popularity for new commercial buildings. For the near future, costs are likely to be higher than standard overhead air distribution.

A displacement ventilation system will probably not provide a short payback based on energy savings alone. However, the system provides additional comfort and air quality benefits.

Costs	L			
	M			
	H			■
		L	M	H
		Benefits		

## Benefits

### Advantages

- Significantly lower cooling loads (1/3 lower) result from thermal stratification.
- Significantly low system capacities will be needed if enthalpy energy recovery is used in combination with this vertical displacement approach.
- Air quality will improve per cfm moved compared to systems that mix space air.
- Can provide equal or better air quality with less outdoor air due to stratification.
- Lower fan energy with lower static pressure may result (depends on distribution type and outlet type).
- Ceiling remains clear of supply registers, except for exhaust/return grills.
- Raised access floor systems are typically made up of 1-in. to 1.5-in.-thick concrete sections. This provides advantages from the standpoint of controlling duct noise breakout and/or radiated noise from VAV or fan powered boxes.

### Disadvantages

- Heating performance may be worse than systems providing air at greater velocities. Mixing (i.e., destratification) is desirable for heating.
- First cost may be higher with raised floor systems.
- Some floor area or low wall area is required for supply air outlets.



## ***Design Tools***

All manufacturers of sidewall displacement diffuser and floor systems offer design assistance and computational fluid dynamics (CFD)-generated graphics that depict air supply patterns with defined supply air temperatures and air flows.

CFD software that now runs on personal computers can help predict airflow patterns within a room, as well as help with the selection and location of supply outlets.

## ***Design Details***

Provide 20 cfm to 30 cfm per occupant (0.6 cfm/ft<sup>2</sup> to 0.9 cfm/ft<sup>2</sup>) for classrooms depending on cooling loads. At this relatively low airflow rate, 100% outside air may be necessary.

Deliver supply air at 63°F to 65°F.

Design for air velocity at supply outlets no greater than 25 ft/minute to 50 ft/minute. Therefore, displacement ventilation requires significantly larger supply outlets than an overhead distribution system. However, the system would be typically delivering close to half the airflow rate of a conventional mixed air system.

Try to place sidewall outlets at the corners of the room. Try to avoid situations where occupants are more than 15 ft from the nearest supply outlet.

Use barometric relief dampers to exhaust the 100% outside air.

Minimum ceiling height is about 10 ft for adequate stratification.

In choosing cooling capacity, consider that loads from lighting, computers, and occupants will be reduced by about one-third compared to a system type that mixes indoor air.

Higher air velocity is desirable in heating mode, so consider a design that reduces supply air outlet area (either manually or automatically) when the system provides heating, or that uses VAV in cooling and full airflow in heating. This is especially important in large halls, such as a gymnasium with sidewall supply. Consider demand control and variable frequency drive (VFD) in gyms, auditoriums, and cafeterias.

## ***Operation and Maintenance Issues***

Operating and maintenance requirements are similar to overhead air distribution systems.

## ***Commissioning***

Check for proper supply air temperatures. Ensure that air velocity at supply outlets is not too high for comfort. Verify that total airflow meets design requirement. Verify proper control operation and temperature reset for heating or cooling. Verify VAV or VFD operation if demand control is incorporated into an area such as a gym.

## ***References/Additional Information***

Boscawen School, NH implemented this type of system. H. L. Turner Group, Architects.

## GUIDELINE MV7: HYDRONIC CEILING PANEL SYSTEM

### Recommendation

Install radiant cooling ceiling panels in arid areas needing significant cooling.

### Description

A hydronic ceiling panel system provides thermal comfort predominately through radiation heat transfer with objects and occupants. Basic ceiling panel design consists of a metal sheet with copper tubing attached to the upper side and covered with insulation/acoustical inlay material. Applications can take the form of modular panels or wall-to-wall linear design. The system can be suspended, recessed, or placed in a grid configuration. A ceiling panel heating/cooling system involves the following:

- Ceiling panels
- Support system
- Control system
- Hydronic distribution system
- Hot/cold water source.

### Applicability

Most applicable in areas with low latent heat load, but can also work in more humid climates with a proper dehumidifying system.

Panels can also be used for heating, generally as a substitution for radiators around building perimeter.

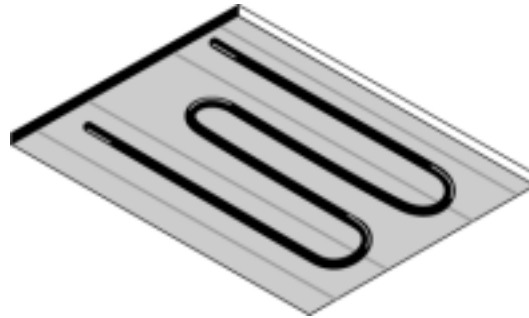

Applicable Climates

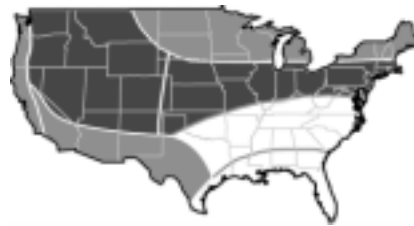

#### Applicable Spaces

Classrooms	█
Library	█
Multi-Purpose	█
Gym	█
Corridors	█
Administration	█
Toilets	█
Other	█

#### When to Consider

Programming	█
Schematic	█
Design Dev.	█
Contract Docs.	█
Construction	█
Commissioning	█
Operation	█

## Integrated Design Implications



*Extruded Aluminum Linear Panel. NREL/PIX 11422*

- Hydronic ceiling panel systems provide no outside air ventilation so fresh air must be supplied with either operable windows or an air-handling system.
- Choosing any hydronic cooling system affects hot and chilled water decisions (solar thermal, chiller, boiler, etc.).
- Placement of system components affects requirements of the hydronic distribution system. Try to make these decisions early to create a hydronic distribution layout that minimizes piping materials (pipes, bends, etc.) and head loss.
- Depending on regional weather characteristics and required panel water temperature, an air-conditioning system may be required to remove excess latent heat load and avoid condensation.
- Possibly integrate the system with building sprinkler systems to lower installation costs. Check with the fire marshal to ensure this does not violate fire code regulations.
- Use a heat pump or possibly a cooling tower to attain required temperatures.
- Acoustic properties of the panels need to be considered.
- If the system is to be used for both heating and cooling, a choice between a two-pipe and four-pipe system must be made. This decision will affect the hydronic distribution system.
- Use heavy-duty ceiling grid and provide space in plenum for hangar support.
- System can be integrated into a facility-wide hydronic heating and cooling system, including baseboards and radiant slabs.
- Effectiveness of panels relates to architectural and daylighting decisions regarding ceiling height. Performance of panel system degrades with increasing ceiling height.

## Cost Effectiveness

Price for installed panels is roughly \$18/ft<sup>2</sup> of active ceiling area. This does not include costs for control system, hot/cold water supply, or hydronic distribution. Installed cost for modular and linear panels is roughly equal.

Costs	L			
	M	■		
	H	■		
		L	M	H
		Benefits		

- Suppliers report that 10-year savings are substantial. Operation and maintenance costs are low. Fuel costs are lower due to increased efficiency compared to air handling systems. The system is generally most cost effective when part of a facility-wide hydronic heating and cooling system.

## Benefits

- Hydronic systems can decrease or eliminate the need for mechanical air-handling systems.
- The water pumping system does not create as much internal heat as air fans do.
- Aluminum panels present the possibility for high recycled-content material use.
- Added cooling comfort results from lower perceived temperature.
- The system's low noise makes it a good choice for classrooms.
- Energy demand is significantly lower than that for air systems due mostly to savings in fluid transport systems.
- Quick response time.

## Design Tools

- RADCOOL is a software program developed by the Lawrence Berkeley National Laboratory for modeling buildings with radiant cooling systems.
- Design and sizing procedure is documented in Chapter 6 of the 2000 ASHRAE Systems and Equipment Handbook.
- Additional tools are available that provide AutoCAD-based programs for layout design and Microsoft Excel-based spreadsheets for sizing calculations. Other software programs cover design for floor, ceiling, and baseboard radiant systems.

## Design Details

- If the panels are to be used for heating and cooling, a two- or four-pipe system can be used. A two-pipe system is less expensive and will work for applications with infrequent changeover from one mode of operation to another. If frequent changeovers occur, it is best to use a four-pipe system.
- Panel performance is dependent upon room air, panel water temperatures, and thermal resistance of the panel. Cooling performance for modular panels is generally around 27 Btu/h ft<sup>2</sup> with an 18°F temperature difference between room air temperature and mean water temperature. Extruded linear panels absorb from 40 Btu/h ft<sup>2</sup> to 50 Btu/h ft<sup>2</sup> with the same temperature difference. In either case, performance degrades with increasing ceiling height. Heating performance ranges from 40 Btu/h ft<sup>2</sup> to 200 Btu/h ft<sup>2</sup> for mean water temperatures of 120°F and 180°F and a 70°F room temperature.
- Cooling water temperatures are generally between 58°F and 65°F, depending on dewpoint.
- Heating water temperatures are usually between 120°F and 180°F.
- Panels located above occupants should not exceed a 95°F surface temperature for comfort reasons. Higher temperatures may be used for panels that do not extend more than 3 ft into the room. These high temperature panels can be used in lieu of baseboard radiators to heat glass surfaces and exterior walls to decrease downdrafts.
- Water temperature should be kept at least 1°F higher than the dewpoint temperature at all times.
- Temperature rise for cooling systems should be less than 5°F and temperature drop for heating systems less than 20°F.

- Be sure the water flow rate is in the proper range. Rates too high can cause noise and those too low can result in a significant decrease in heat transfer rate due to laminar flow.
- Panels can be perforated and installed with a special inlay material to improve acoustical properties.
- To avoid condensation, a control system must be used. The system can either use flow control or temperature control. A flow control system uses humidity sensors, temperature sensors, and control valves. It is an on-off system; as soon as the water temperature reaches the dew point temperature, the control valve closes. This system is cheap and simple, but can make the system useless for extended periods. A temperature control system uses similar sensors and a two- or three-way valve to adjust water temperature and avoid condensation. This system is more complex, but it allows for system operation when humid conditions exist.

### ***Operation and Maintenance Issues***

Normal hydronic operation and maintenance issues include checking pumps, valves, pipe leaks, chemical water treatment, and water quality/pipe fouling (important for sustaining maximum heat transfer and minimum pressure drop in open systems). Significant maintenance does not appear to be an issue. The ceiling panels have a life expectancy in excess of 30 years.

### ***Commissioning***

Commissioning should be performed throughout planning, design, construction, and operation to ensure proper installation, set-up, and integration with other facility components. The ceiling panel array(s) should be documented with an infrared camera during testing, adjusting, and balancing work to guarantee even cooling and/or heating.

### ***References/Additional Information***

Preparation room in the Challenger Learning Center, Phoenix, AZ, uses 2 ft x 4 ft REDEC CBA-C modular panels for 15/16 in. T-Grid with micro perforation and sound absorbing mats.

## GUIDELINE MV8: UNIT VENTILATOR SYSTEM

### Recommendation

If choosing a unit ventilator system, specify units with multiple-speed fans, two-way control valves, and economizer controls. Also specify variable-flow chilled water and hot water distribution systems.

### Description

Unit ventilators, sometimes called classroom ventilators, provide heating, cooling, and ventilation for a single space. The units consist of constant volume fans, chilled water and hot water coils (typical), filters, and outdoor and return air dampers, all enclosed in a heavy gauge metal housing. Ventilation and/or economizer air is drawn from adjacent openings in the outside wall. Relief is either by gravity or powered exhaust remote from the unit.

A unit ventilator can be mounted in a vertical or horizontal position. A typical installation is a vertical discharge unit on the floor against an exterior wall. However, horizontal discharge units may be suspended from the ceiling or hidden above the ceiling.

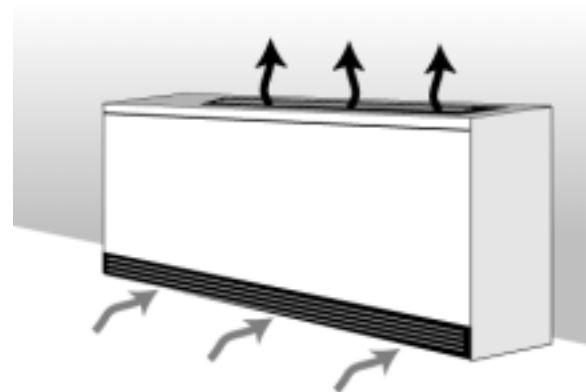

Unit Ventilator, aka Classroom Ventilator

### Applicable Climates

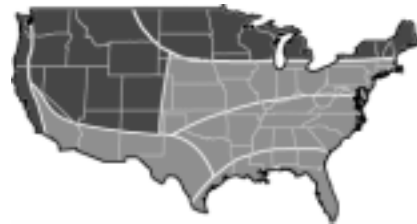

### Variations and Options

A unit ventilator may be part of a two-pipe or four-pipe hydronic distribution system.

A two-pipe system (i.e., one supply pipe and one return pipe) is also known as a changeover system, if it provides both heating and cooling. The same piping is used for both hot water and chilled water, and the central plant produces either one or the other. During mild weather periods, the system may be required to switch from heating to cooling as the day warms up. Therefore, two-pipe systems must be designed to account for the potential thermal shock to the equipment. Two-pipe systems likely need supplemental natural ventilation to accommodate swing seasons.

Four-pipe systems can circulate hot water and chilled water throughout the facility simultaneously. The advantage is better zone control because some zones may be heating while others are cooling. The main disadvantage is higher initial cost.

The control valve within a unit ventilator may be a two-way or three-way valve. In both cases, the valve modulates the flow of water through the coil. The difference is how the valve affects flow in the rest of the distribution system. A three-way valve provides a bypass so total flow through the unit ventilator is constant even though flow through the coil changes. A two-way valve modulates the total flow through the unit ventilator. A distribution system with two-way valves will have variable flow and potentially lower pumping energy consumption, especially if pumps are controlled with variable-speed drives.

Economizer controls are an option for some units. An actuator controls the integral outdoor air and return air dampers to take advantage of free cooling when it is available.

#### Applicable Spaces

Classrooms	<input checked="" type="checkbox"/>
Library	<input checked="" type="checkbox"/>
Multi-Purpose	<input type="checkbox"/>
Gym	<input type="checkbox"/>
Corridors	<input type="checkbox"/>
Administration	<input type="checkbox"/>
Toilets	<input type="checkbox"/>
Other	<input type="checkbox"/>

#### When to Consider

Programming	<input type="checkbox"/>
Schematic	<input checked="" type="checkbox"/>
Design Dev.	<input type="checkbox"/>
Contract Docs.	<input type="checkbox"/>
Construction	<input type="checkbox"/>
Commissioning	<input type="checkbox"/>
Operation	<input type="checkbox"/>

Direct expansion cooling may be an option in place of a chilled water-cooling coil.

Alternatives to hot water heating include steam coils and heat pumps.

Some unit ventilators offer a heat recovery option that uses exhaust air to either preheat or precool the outdoor ventilation air. Options for this heat recovery function include an air-to-air heat exchanger and a heat pipe.

Some manufacturers offer matched cabinetry to make the unit ventilator look like part of the furnishings.

### **Applicability**

Systems are applicable for classrooms and other spaces with exterior wall access.

The systems should also be used in facilities with central chilled water and hot water distribution. These are typically large schools that are fairly centralized (to minimize length of chilled water and hot water distribution piping).

In spaces where ceiling height is restricted, these systems can be useful because ducts are unnecessary.

### **Integrated Design Implications**

A unit ventilator requires more coordination with classroom space planning than most other system types. Casework systems are available to integrate the unit with classroom fixtures. An exterior wall with clean outdoor air must be available for unit ventilator installation.

Hydronic distribution may free up space normally reserved for ducts, permitting lower floor-to-floor heights or enabling higher ceilings and better daylighting performance. Hydronic piping should not be run in floor trenches as they are impossible to clean and often grow mold, which can impact indoor air quality since the unit ventilator always pulls some air from the trench.

With unit ventilators as well as other hydronic system types, pay attention to site planning and building layout to minimize the length and complexity of piping between the central plant (chiller and/or boiler) and the terminal units.

As with other system types, controls should be designed to allow simple manual or automatic interlock with natural ventilation systems. In addition, economizer controls may be unnecessary if the space is designed to encourage occupants to use operable ventilation openings during mild weather.

### **Cost Effectiveness**

A system consisting of unit ventilators, a chiller, boiler, and two-pipe distribution costs roughly \$14/ft<sup>2</sup> to \$16/ft<sup>2</sup> of floor area served. Cost for a four-pipe system is \$17/ft<sup>2</sup> to \$18/ft<sup>2</sup>, similar to central-type systems with energy recovery.

A unit ventilator system may be cost effective in specific cases, but in most cases other system types will be either lower cost and/or higher performance.

Costs	L			
	M		■	
	H			
		L	M	H
		Benefits		

### **Benefits**

#### **Advantages**

- Fan energy savings increase, as duct friction losses are avoided.
- Cooling can be very efficient if water-cooled chillers and a well-designed pumping system are installed.
- Constant, or slowly varying, supply air temperature (through modulation of control valves).
- Multiple-speed fans are available in some units.
- Provides flexibility for heating or cooling different parts of the building.

#### **Disadvantages**

- Poor air distribution, subject to drafts.

- Noise, particularly for student sitting adjacent to unit.
- Vulnerable to student abuse.
- Subject to turning-off or blocking air output by teachers.
- Air intakes can gather pollutants from mowing, rain intrusion, and vehicle exhaust.
- Relatively high first cost.
- Relatively inefficient fans.
- Console units take up floor space within the room.
- Significant maintenance needed in each classroom.
- Typically limited to poor air filtration.
- Energy recovery difficult or expensive.
- Multiple controls and valves located in every classroom.

### ***Design Details***

Ensure that the outdoor air intake area is free from potential pollution sources. Assure that buses will not be staged in areas with unit ventilators. Do not plant shrubs at unit ventilator air intakes. Also make sure to locate the unit to minimize drafts indoors. Air from the units must not be discharged on the occupants, and seating should never be immediately adjacent to the unit. The top of the unit should not be used for storage.

Specify the lowest possible noise levels. If possible, specify a unit with multiple-speed fan control so that normal ventilation occurs at low fan speed. For chiller, boiler, and hydronic distribution system design details, see those individual guidelines. Specify two-way valves in all unit ventilators and variable-flow chilled water and hot water systems.

Load calculations are important, but oversizing of cooling and heating capacity, as long as it is not excessive, is less of a concern with unit ventilators (and with most other hydronic system terminal units) because control valves can modulate output rate. On/off cycling and partial load efficiency degradation is less of a concern, especially with variable-speed fan control. Note, however, that overall facility load calculations are still very important for central plant equipment sizing, where oversizing penalties do occur.

Two-pipe systems should be avoided in climates where heating and cooling may be needed on the same day (or even the same week). The switch from heating to cooling wastes energy and can take a long time. In some cases, the cooling tower and a heat exchanger are used at switchover to cool the loop. The chillers are engaged once the loop has dropped to a tolerable temperature.

### ***Operation and Maintenance Issues***

Unit ventilator maintenance is significant, and requires a high skill level for all the controls that are involved in keeping discharge temperatures correct. They are often difficult to access due to classroom arrangements. Furniture should not be pushed up against the unit. Chiller and boiler maintenance requires a relatively high skill level.

Maintenance tasks include:

- Cleaning cooling coil condensate pans to prevent mold growth
- Replacing filters at least three times a year
- Cleaning coils to prevent mold growth
- Cleaning outdoor air intake louvers
- Lubricating fans if required by manufacturers



- Lubricating and adjusting outdoor air and return air dampers.

### ***Commissioning***

Check fan speed setting and airflow. Check control valve operation and thermostat operation. Confirm staging of fan speed if applicable. Check coil connections for proper water flow direction. Check outdoor air supply, economizer operation, and economizer airflow. Make sure the outside air duct boot is sealed to the building shell and that water will not enter into it.

### ***References/Additional Information***

Guideline MV18: Economizers; Guideline MV21: Hydronic Distribution; Guideline MV22: Chilled Water Plants; Guideline MV23: Boilers.

## GUIDELINE MV9: DUCTLESS SPLIT SYSTEM

### Recommendation

For ductless split systems, specify high efficiency, multiple fan speed, and low noise.

### Description

A ductless split system consists of two matched pieces of equipment: an indoor fan coil unit and an outdoor condenser and compressor unit connected by refrigerant tubing and control wiring run through the wall or roof. The indoor unit contains a cooling coil, fan, and filter. The outdoor unit includes compressor(s), condenser coil, and condenser fans.

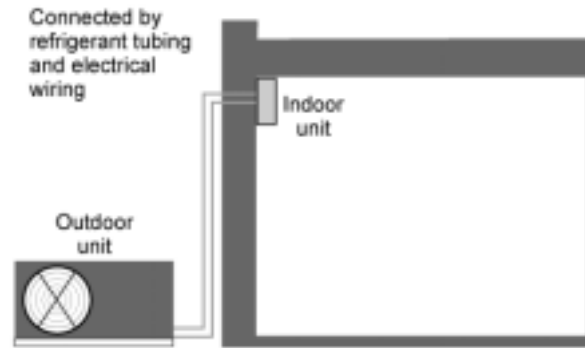

*Ductless split system.*

In its simplest form, a ductless split system recycles 100% indoor air. However, on many units, ventilation air can be supplied with an optional duct attachment that passes through the wall.

### Applicable Climates

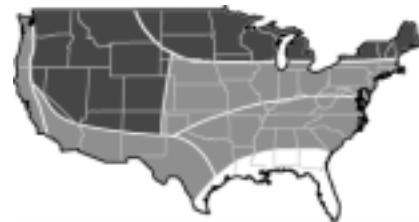

### Variations and Options

The indoor unit is available in several forms: high wall mount, ceiling mount, and above-ceiling mount. The high wall mount may be least costly but is usually limited in peak capacity to about two tons. Capacities up to five tons are available with suspended ceiling units. The above-ceiling units typically fit in a 2 x 2 suspended ceiling system and resemble a typical supply diffuser from below.

Many of these systems can be supplied with a heat pump option to provide heating as well as cooling. Alternatively, heating can be provided through a separate system such as a radiant floor.

### Applicable Spaces

Classrooms	<input checked="" type="checkbox"/>
Library	<input type="checkbox"/>
Multi-Purpose	<input type="checkbox"/>
Gym	<input type="checkbox"/>
Corridors	<input type="checkbox"/>
Administration	<input checked="" type="checkbox"/>
Toilets	<input type="checkbox"/>
Other	<input type="checkbox"/>

### When to Consider

Programming	<input type="checkbox"/>
Schematic	<input checked="" type="checkbox"/>
Design Dev.	<input type="checkbox"/>
Contract Docs.	<input type="checkbox"/>
Construction	<input type="checkbox"/>
Commissioning	<input type="checkbox"/>
Operation	<input type="checkbox"/>

Variable-speed fans are common and desirable to minimize cycling and reduce noise.

Economizers are typically not available for most ductless split systems.

Systems are available that allow two indoor units to be connected to a single outdoor unit, which can increase system capacity up to four tons.

### Applicability

A ductless split system can serve spaces up to about 1,000 ft<sup>2</sup>, or perhaps 2,000 ft<sup>2</sup> if multiple units are installed. They are most useful for buildings with indoor and/or outdoor space constraints, where rooftop space is unavailable or space for ducts is limited.

Ductless split systems are good choices when integrated with natural ventilation that can provide free cooling. For sealed spaces without operable openings, a split system is less desirable because it does not typically have capability to provide 100% outdoor air for free cooling.

This system is also applicable for retrofits where ducts do not currently exist.

## Integrated Design Implications

A ductless split system is a good complement to radiant heating for spaces where cooling is also necessary but infrequent.

## Cost Effectiveness

In North America, ductless split systems are usually more expensive than packaged rooftop systems due to higher equipment cost. The unit price for a typical two-ton unit is \$4,000 to \$5,000.

Due to the extra cost, a ductless split system will probably be cost effective only where space constraints prohibit the use of ducted system types.

Costs	L			
	M	■		
	H			
		L	M	H
		Benefits		

## Benefits

### Advantages

- Systems can be utilized where outdoor space is limited.
- Equipment is compact.
- No duct losses.
- Simple installation.
- Multiple-speed fans are commonly available.

### Disadvantages

- Does not provide good outside air ventilation.
- Relatively poor indoor air distribution and higher potential for drafts.
- Systems have limited capacity to handle ventilation air.
- Heating option is limited to heat pump.
- System use is less common in North America, where equipment cost is relatively high.

## Design Details

Place the indoor unit on an external wall for ventilation air access and for minimum distance to the outdoor unit. Follow manufacturers' recommendations for positioning the indoor unit to provide maximum air distribution and avoid drafts.

Pay attention to security, noise, and ambient temperature when positioning the outdoor unit.

Specify high efficiency units if they are available. Specify low-noise units.

- Fan coils should be isolated from occupied spaces. Locate rooftop units above unoccupied spaces.
- Provide appropriate intake and discharge noise control consistent with meeting the Noise Criteria.

Outdoor units should be located away from noise sensitive areas and windows.

Be very careful not to oversize the unit to avoid excessive cycling, which reduces humidity control and irritates occupants. Manufacturers even recommend choosing a system slightly smaller than peak load for these reasons.

Insulate suction and liquid refrigerant lines separately during installation. Otherwise, one heats the other causing capacity and efficiency loss.

Water may condense on the indoor cooling coil. Therefore, a condensate pump may be required to remove water from the condensate drain pan to an approved receptacle. Overflow from the drain pan must be routed to a visible location.

### ***Operation and Maintenance Issues***

Maintenance requirements and operator skills are similar to gas/electric split systems and rooftop packaged systems.

### ***Commissioning***

Verify proper multiple-fan-speed control operation and thermostat operation.

### ***References/Additional Information***

None.

# GUIDELINE MV10: EVAPORATIVE COOLING SYSTEM

## Recommendation

Consider evaporative cooling for spaces with high outside air ventilation requirements.

## Description

Evaporative cooling is an alternative way to provide air conditioning. Lower energy costs result because no compressor is needed, only a fan and pump.

Evaporative cooling can be “direct” or “indirect.” In a direct evaporative cooling system, the water is exposed to the supply air stream. Usually the water flows over a special medium designed to maximize the surface area of water in contact with air, and the air is cooled by the evaporation. The effectiveness can reach 80% to 90%, meaning that the drybulb temperature drops by 80% to 90% of the difference between the drybulb and wetbulb temperature of the entering air. For example, if entering air temperature is 80°F drybulb and 50°F wetbulb, then the leaving air is cooled to 53°F to 76°F drybulb.

Indirect evaporative cooling is not as effective as direct evaporative cooling, but adds no moisture to the supply air. In some systems, the air passes through a heat exchanger that is wetted on the outside, where cooling takes place in a secondary air stream. In other systems, air passes through a cooling coil supplied with water from a remote cooling tower. Indirect evaporative cooling can be approximately 60% effective in reducing the dry bulb temperature of the entering air to its wet bulb temperature. While direct cooling provides 72°F to 74°F air in the example above, indirect cooling could provide 78°F air.

Combining indirect and direct evaporative cooling (as shown in the figure above) further reduces the supply air temperature. When air passes through the indirect cooler first, then drybulb and wetbulb temperature is reduced through sensible cooling. Due to the lower wetbulb temperature, the direct cooler can achieve even cooler temperature for the supply air.

### Variations and Options

Packaged evaporative coolers are available in a wide range of sizes, approximately 3,000 cfm to 20,000 cfm. They are typically roof mounted to supply outside air for the indirect cooling stage.

Packaged air handlers are available that incorporate both indirect and direct evaporative cooling. The evaporative cooling system has an economizer that uses 100% outside airflow during cooling mode, and minimum outside airflow during heating mode. This allows the use of return air during the heating season to keep heating costs equivalent to a standard system. These package units can have hot water coils or duct furnaces installed to provide heating.

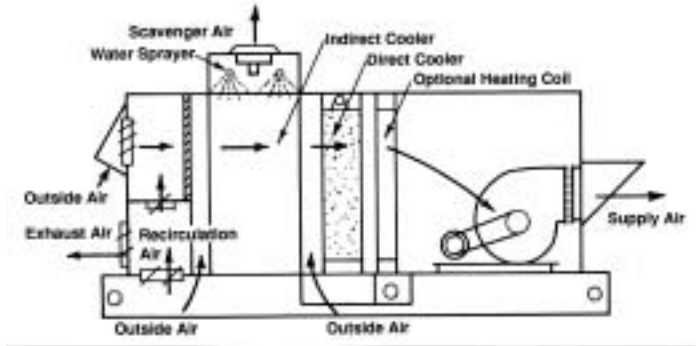

*Evaporative Cooling System*

### Applicable Climates

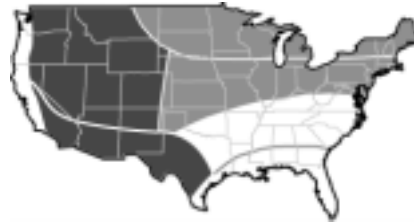

### Applicable Spaces

Classrooms	<input checked="" type="checkbox"/>
Library	<input checked="" type="checkbox"/>
Multi-Purpose	<input checked="" type="checkbox"/>
Gym	<input checked="" type="checkbox"/>
Corridors	<input checked="" type="checkbox"/>
Administration	<input checked="" type="checkbox"/>
Toilets	<input type="checkbox"/>
Other	<input type="checkbox"/>

### When to Consider

Programming	<input checked="" type="checkbox"/>
Schematic	<input type="checkbox"/>
Design Dev.	<input type="checkbox"/>
Contract Docs.	<input type="checkbox"/>
Construction	<input type="checkbox"/>
Commissioning	<input type="checkbox"/>
Operation	<input type="checkbox"/>

If evaporative cooling alone does not satisfy cooling loads, then it can be combined with packaged rooftop cooling by adding direct and/or indirect coolers onto the outside air intake of the packaged unit or it can be integrated directly into the mixed air stream (outside + return) of the packaged unit. Evaporative cooling reduces the load on the direct expansion (DX) cooling coil, allowing the compressor size to be reduced, and peak power to be reduced.

Alternatively, a combination of cooling tower and heat exchanger could be used with cooling coils and standard air handlers.

Some indirect evaporative cooling systems are designed to use exhaust air rather than outside air as the secondary air stream, providing heat recovery.

Other systems combine evaporative cooling with a desiccant wheel and/or enthalpy wheel as a method of precooling the outdoor air and increasing cooling capacity.

### **Applicability**

Evaporative cooling is most effective in hot, dry climates but it can also be used to completely replace compressor cooling in cold and coastal areas. For areas with higher design wetbulb temperatures, such as Phoenix, AZ (100°F/70°F), evaporative cooling can produce most of the space cooling needs. However, if evaporative cooling is used exclusively, space temperatures may rise above 80°F during design conditions a few hours each year. Direct evaporative cooling is only marginally applicable in the Cool and Humid and Cold and Humid climates. Indirect evaporative cooling may be a better approach in these climate zones.

Evaporative cooling is especially appropriate for spaces with high outside air ventilation requirements such as showers, locker rooms, kitchens, or shops. Compressor cooling is often too expensive to operate for these applications.

### **Integrated Design Implications**

Evaporative cooling is a good match for displacement ventilation systems, which are designed for higher supply air temperature than a typical overhead air distribution system. However, the design will need to accommodate higher airflow that could disrupt stratification. Therefore, careful attention is necessary in locating and sizing supply outlets.

Larger ducts are required compared to a typical compressor cooling system, and duct size may be a consideration in the architectural and structural design.

Direct evaporative cooling may not be appropriate for spaces with materials such as wood floors that might be damaged by high humidity.

These systems require regular maintenance and are difficult to seal against air infiltration in cold climates.

### **Cost Effectiveness**

Installed costs are typically greater than for typical packaged air-conditioning equipment.

Evaporative cooling is usually cost effective in warm and dry climates as long as somewhat higher indoor temperatures are acceptable during hot periods.

Costs	L			
	M			
	H			
		L	M	H
		Benefits		

### **Benefits**

#### **Advantages**

- Lower electricity consumption and lower peak electric demand result.
- Systems typically use 100% outside air in cooling mode, providing better air quality.
- Smaller electrical supply.

#### **Disadvantages**

- Regular maintenance is more critical than for compressor cooling systems.

- Higher airflow requirements lead to increased fan energy.
- Cooling unit requires water supply.
- On-site water consumption increases.
- Cooling requirements in some climates may not be completely satisfied.
- Direct evaporative cooling increases space humidity.
- First cost is higher.

### ***Design Details***

An evaporative cooling system requires higher airflow due to higher supply air temperature. Therefore, special attention to duct design and sizing is required to avoid high fan energy costs. The appropriate airflow depends on design conditions for the school's location.

A variable-speed or two-speed fan is a good idea to allow lower airflow in heating mode.

In warm climates, try to use exhaust air as the secondary air stream for indirect evaporative cooling systems.

Vibration isolation is often provided internally. Internal isolation should be reviewed for proper spring-type and static deflection. If internal isolation is not provided, or is unacceptable, external spring isolators should be utilized. Refer to 1995 ASHRAE Handbook Chapter 43 for recommended vibration isolation. If external isolation is used, all internal spring isolators should not be released from their restraining bolt.

- Locate rooftop units above unoccupied spaces.
- Provide appropriate intake and discharge noise control consistent with meeting the noise criteria.

### ***Operation and Maintenance Issues***

Evaporative coolers demand more maintenance than a typical compressor-based system, so they should be specified only for facilities with qualified maintenance staff or with a qualified outside service company.

To minimize maintenance requirements, specify adequate bleed-off rates to prevent mineral buildup (without causing excessive water consumption). Also specify controls that periodically flush the evaporative medium with water to remove dirt and scale. Finally, specify materials to minimize potential for corrosion.

### ***Commissioning***

Check for correct airflow.

Check for correct water flow rate over the evaporative media.

Check the bleed-off rate of water from the evaporative system to ensure that it is adequate to prevent mineral buildup but not too large to cause excessive water consumption.

Verify all modes of operation.

### ***References/Additional Information***

None.

# GUIDELINE MV11: VAV REHEAT SYSTEM

## Recommendation

Choose a VAV reheat system for large administration or classroom facilities, especially multi-story buildings. Specify variable-speed fan control, low face velocity cooling coil, bypass damper, monitored/measured outdoor air supply, supply air temperature reset control and supply duct pressure reset control and graphic-displayed direct digital controls (DCC).

## Description

VAV is a general term for a type of HVAC system that supplies only the amount of air needed to satisfy the load requirements of a building zone and can supply different volumes to different zones at the same time. The result is that the total supply of cool air changes over the course of the day, depending on the heat gains in different building areas at different times.

In a VAV system, a central supply fan sends air through medium-pressure ductwork to terminal units (VAV boxes) throughout the building. The airflow to each zone — a space or group of similar spaces — is controlled by the VAV box (a “smart damper”), which varies the airflow in response to the space temperature. As cooling loads in the zone drop, the damper continues to close until it reaches a minimum position. The minimum position provides the occupants of the zone with adequate ventilation air. Some VAV boxes, especially those in perimeter zones, contain a reheat coil for times when the minimum airflow provides too much cooling. The reheat coil — typically hot water — prevents zones from being overcooled. The reheat coil also provides winter heating, typically during a morning warm-up period prior to occupancy when the outdoor air dampers are closed.

A duct-mounted pressure sensor that decreases the fan output as the VAV box dampers close controls the main system fan.

### Variations and Options

VAV air handlers may be purchased as factory-fabricated units or may be assembled from components in the field (built-up). In either case, cooling can be provided with a chilled water coil or a direct expansion refrigerant coil.

- A common choice for schools is the packaged rooftop VAV air-conditioning system. The self-contained unit consists of a variable-volume supply fan; direct-expansion cooling coil; heating (when required) with gas furnace, hot water, or steam; filters; compressors; condenser coils; and condenser fans.
- Facilities with a central chilled water plant often use factory-fabricated air handlers with chilled water coils. In this case, the unit includes a supply fan, cooling coil, filters, and perhaps a heating coil.

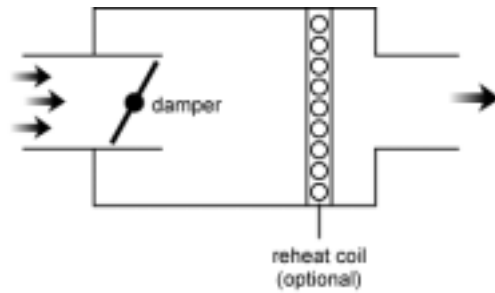

VAV Box

### Applicable Climates



### Applicable Spaces

Classrooms	<input checked="" type="checkbox"/>
Library	<input checked="" type="checkbox"/>
Multi-Purpose	<input type="checkbox"/>
Gym	<input type="checkbox"/>
Corridors	<input type="checkbox"/>
Administration	<input checked="" type="checkbox"/>
Toilets	<input type="checkbox"/>
Other	<input type="checkbox"/>

### When to Consider

Programming	<input checked="" type="checkbox"/>
Schematic	<input checked="" type="checkbox"/>
Design Dev.	<input type="checkbox"/>
Contract Docs.	<input type="checkbox"/>
Construction	<input type="checkbox"/>
Commissioning	<input type="checkbox"/>
Operation	<input type="checkbox"/>



VAV systems usually include economizer controls. Several VAV box types are available and some can be combined within the same system:

- Most common for new buildings are pressure-independent boxes with DDC-controlled actuators.
- Fan-powered mixing boxes recirculate room or plenum air and are available in two types: series fan or parallel fan. The series fan box requires the fan to operate at all times. The parallel fan box fan activates only when reheat is required.
- Dual-duct VAV boxes contain two dampers controlling a cool duct inlet and a warm duct inlet. Typically, the warm duct damper is closed during cooling periods. When cooling load drops and the cool duct damper reaches its minimum position, then the warm duct damper begins to open to prevent overcooling in the space.

A dual-fan, dual-duct VAV system is an alternative to VAV reheat and requires less reheat energy. The warm duct recirculates indoor air and adds heat if necessary. The cool duct provides ventilation air and cooling. Rather than using a reheat coil to avoid overcooling at minimum ventilation position, the dual duct system mixes warm return air to offset cooling.

### **Applicability**

VAV systems are appropriate for administration buildings or large classroom buildings with peak cooling load greater than 20 tons. The minimum size for a packaged VAV system is about 20 tons.

The overall efficiency of VAV systems depends on the diversity of zone heating and cooling loads. If a particular building has very similar zones and constant loads (such as classrooms with identical occupancy schedules in an extremely well-insulated building), the potential for savings from a VAV system are reduced.

### **Integrated Design Implications**

VAV systems require space for ductwork and should be considered early in the design process.

Requirements for fire separations can affect duct layout and architectural design. Fire separation is less of an issue with single-zone systems because all the ductwork is typically within a single fire zone.

Shaft space may be required in multi-story buildings to deliver air to the lower floors.

### **Cost Effectiveness**

A typical VAV reheat system costs \$16/ft<sup>2</sup> to \$18/ft<sup>2</sup> of floor area. This cost is greater than packaged single-zone systems and roughly equal to a unit ventilator system, but offers far greater performance and control.

A VAV system is usually cost effective for larger buildings. It is the most common system type for new multi-story commercial facilities.

Costs	L			
	M		■	
	H			
		L	M	H
		Benefits		

### **Benefits**

#### **Advantages**

- Better comfort control results from steady supply air temperature (vs. single-zone systems that are constant volume and variable temperature).
- Moderate initial cost for buildings that require multiple zones.
- Better dehumidification control than packaged single zones.
- Energy efficiency of variable air volume.
- Larger and more efficient fans than single-zone systems.
- Centralized maintenance for coil cleaning and filter replacement.
- Relatively simple to add or rearrange zones.

### ***Disadvantages***

- Sometimes higher fan pressure occurs than with variable-speed, single-zone systems, depending on load matching of design. This may lead to higher energy consumption.
- Requires more sophisticated controls than single-zone systems.
- VAV box can generate noise that radiates out of the sheet metal walls (radiated noise), and travels down the supply duct (discharge noise).

### ***Design Details***

Although several methods are possible, a variable-speed fan is the recommended approach to controlling duct air pressure in a VAV system. Variable-speed drives are the most efficient and have the added advantage of limiting current inrush for startup of large motors (“soft-start” feature). Other, less effective, duct pressure-control devices are variable inlet vanes, inlet cones, sliding covers, and discharge air dampers.

For direct-expansion VAV systems, multiple-step unloading or variable-speed compressors should be specified, which prevents frosting of the evaporator coil at low cooling loads (particularly important for units equipped with economizers). Greater numbers of unloading steps also improves supply air temperature control by allowing a smaller throttling range.

Supply air temperature reset. Specify controls that will adjust the supply air temperature according to demand for cooling. As cooling demand drops, supply air temperature may be increased so that compressors operate more efficiently, and outside air can provide a larger fraction of cooling. However, more airflow is required with higher supply air temperature and, at some point, the extra fan energy exceeds the cooling energy savings. Carefully consider the characteristics of a specific building when choosing a supply air reset schedule. Computer simulations can help to determine optimal settings.

Supply air pressure reset. Consider controls that will also minimize the supply air pressure required to meet all zone loads. Typically, the supply fan is controlled to maintain a constant static pressure of around 1.5 inches water column in the duct upstream of the VAV boxes. However, lower pressure may satisfy airflow demands at many times of the year and can save fan energy. Automatic reset controls can monitor damper position in all VAV boxes and lower the supply duct pressure when all dampers are partially closed.

Ventilation air control can be tricky in a VAV system due to varying supply airflow. One option is to modulate the outdoor air damper based on measurement of outdoor airflow. This modulating damper method can also allow demand ventilation control to reduce airflow when spaces have low occupancy (see Guideline MV26: Demand Controlled Ventilation). Another option is a separate outdoor air fan that injects a constant volume of ventilation air into the supply air stream when the system is not in economizer mode.

To minimize reheat energy consumption, set the minimum flow on each VAV box as low as possible. In many cases, reheat would be unnecessary if the minimum flow were zero. However, the need for ventilation air usually requires some minimum damper position. In some systems, heating occurs at minimum airflow. Therefore, heating load can also be a constraint on the minimum flow. In these situations, reverse acting damper control is recommended. As heating load increases, the damper reopens.

The zone thermostats should have separate setpoints for heating and cooling with a deadband in between. This control also helps to minimize reheat energy.

Zone controls should also be tied to a central energy management and control system (EMCS). An EMCS reduces operation and maintenance cost by allowing remote monitoring and control.

To minimize air pressure drop across the cooling coils, limit the face velocity to 300 fpm, which requires a larger coil as well as larger equipment and floorspace. Also consider specifying a bypass damper that opens when the cooling coil is not needed, such as in economizer mode. Both measures help reduce fan energy consumption.

Rather than installing a return air fan, consider using a relief fan or barometric relief dampers to minimize fan energy.

Design duct systems to minimize pressure drop and leakage. For recommendations on duct design, see Guideline MV19: Air Distribution Design Guidelines.

VAV boxes should not be located over noise-sensitive areas (i.e., classrooms) when an acoustical tile ceiling system is being used. A gypsum board ceiling will do a better job of reducing VAV-radiated noise than a typical ceiling tile system. For this reason, most VAV boxes can be located above noise-sensitive areas where a gypsum board ceiling, which has all penetrations and joints well sealed, is installed.

Oversizing VAV boxes is one way to reduce radiated and discharge noise levels. This has to do with the velocity of air as it enters the box and passes by the damper.

Static pressure drop across the VAV box also has an impact on the amount of noise generated. Designing the system so that the damper does not produce more than 0.5 in. of static pressure drop will minimize noise.

### ***Operation and Maintenance Issues***

VAV system operation requires a skilled commissioning staff to ensure that controls operate efficiently. However, maintenance is relatively simple once the system is operating. Maintenance is centralized for boilers and chillers rather than being distributed to individual units. Many tasks are centralized and take less time than for a system with single-zone units.

VAV boxes typically have DDC interfaces allowing space conditions to be monitored from a central building management system. The information and remote control capability helps reduce maintenance costs.

### ***Commissioning***

Calibrate zone airflow sensors, and confirm minimum and maximum flow for each VAV box.

Calibrate all system temperature and pressure sensors. Confirm supply air temperature, reset supply pressure, and reset control operation.

Calibrate outside airflow measurement (if one is installed) and ensure that minimum ventilation airflow is provided under varying conditions.

Confirm proper functioning of all valves and dampers.

### ***References/Additional Information***

None.

## GUIDELINE MV12: RADIANT SLAB SYSTEM

### Recommendation

Install radiant slab-on-grade systems in rooms with heating demand. When conditions permit, use a solar thermal, geothermal system, and/or recovered thermal energy for the hot water supply.

### Description

A radiant slab heating system consists of the following:

- Hydronic distribution
- Hot water source (boiler, solar, geothermal heat pump, etc.)
- Control system.

Like all radiant heating systems, radiant slab systems provide thermal comfort to building occupants predominantly through radiation heat transfer. In other words, the system heats or cools room objects and occupants, rather than the surrounding air. Two basic configurations exist for hydronic radiant slab heating and/or cooling. The first option involves the placement of pipes in the foundation slab itself, referred to as slab-on-grade. The second, called thin-slab, consists of piping placed in a thinner slab layer that is situated on top of the foundation slab or on suspended floors. Each consists of a loop of tubing (normally cross-linking polyethylene, PEX) that is imbedded in concrete or a similar material, such as gyp-crete. Hot water is passed through the tubing, which heats the slab, and in turn, the room.

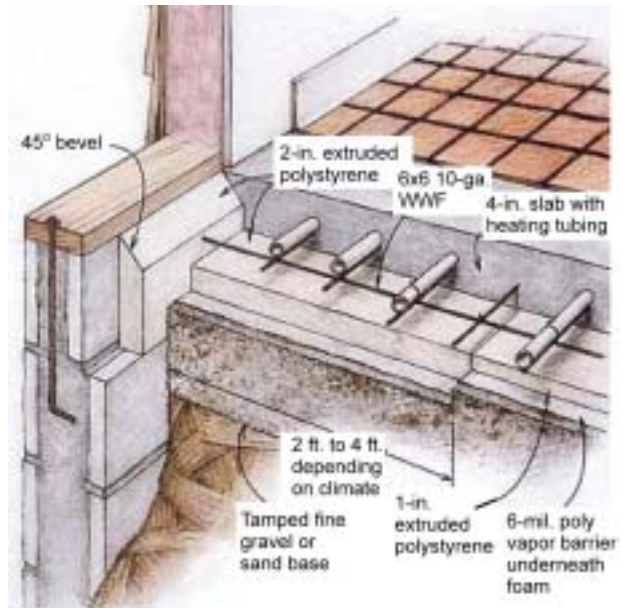

*Radiant slab*

### Applicable Climates

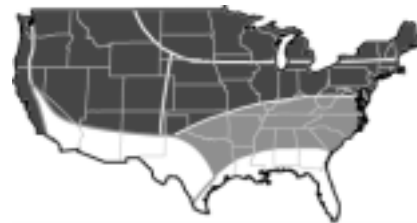

### Applicable Spaces

Classrooms	█
Library	█
Multi-Purpose	█
Gym	█
Corridors	█
Administration	█
Toilets	█
Other	█

### When to Consider

Programming	█
Schematic	█
Design Dev.	█
Contract Docs.	█
Construction	█
Commissioning	█
Operation	█

### Applicability

The use of radiant slabs for heating is applicable in all regions with a heating demand. However, due to condensation concerns, the use of radiant slabs for cooling should be limited to areas with a low latent cooling load.

### Integrated Design Implications

- Choosing any hydronic heating system affects boiler decisions (heat pump, solar, etc.).
- All radiant hydronic systems provide an alternative to large-scale air-handling systems. This impacts many aspects of the building design including the required plenum sizing, boiler/chiller sizing, and ducting, among other things.
- The slab system is a low-temperature application and is complemented well by alternative water heating methods including geothermal heat pumps and solar thermal systems. Typical hydronic heating systems, such as baseboard radiators, use water temperatures of 140°F to 200°F, whereas radiant floor heating uses temperatures between 90°F and 120°F.

- Consider framing strength when installing suspended-floor, thin-slab systems. It is much more cost effective to consider this during design rather than reinforcing the framing during construction.
- This system can be integrated into a facility-wide hydronic heating and cooling system including baseboards and ceiling panels.
- Placement of system components affects requirements of the hydronic distribution system. Try to make these decisions early to create a hydronic distribution layout that minimizes piping materials (pipes, bends, etc.) and head loss.

### Cost Effectiveness

- The installed cost of the slab only ranges from \$2/ft<sup>2</sup> to \$20/ft<sup>2</sup> depending upon application. PEX tubing costs around \$0.65/lin ft retail.
- Operation and maintenance costs are low. Fuel costs are lower due to increased efficiency compared to air-handling systems.
- The system is generally most cost effective when part of a facility-wide hydronic heating and cooling system.

Costs	L			
	M			
	H			
		L	M	H
		Benefits		

### Benefits

#### Advantages

- Hydronic systems can decrease or eliminate the need for mechanical air handling systems.
- Quiet operation.
- Better perceived comfort. Radiant slabs heat occupants from the bottom up and are purported to increase comfort. Allows for lower thermostat settings.
- Lower boiler temperatures of 90°F to 120°F compared to 140°F to 200°F for other heating systems. These temperatures can be accomplished by a geothermal heat pump or solar thermal system.
- Can provide fuel savings when compared to forced air systems.
- Aesthetically pleasing; no heat registers or visible radiators.

#### Disadvantages

- Hard to set back temperatures because of lag.
- Ground losses can reduce efficiency if insulation is not properly installed.

### Design Tools

- Using a CAD-based program to design the layout of the tubing will save time, materials, and money.

### Design Details

- Install edge insulation around radiant slab.
- Older installations used copper or other metal tubing, but these materials can react with the concrete and corrode if not properly treated. Copper has excellent heat transfer characteristics, but its short coil length and incomplete compatibility with concrete has caused a switch to polymer or synthetic rubber tubing. Most modern installations use cross-linked polyethylene (PEX) tubing. PEX tubing is usually layered with an oxygen diffusion barrier to extend the life of system components. Some installers use stainless steel components in lieu of the diffusion barrier. Another option is PEX-aluminum (PEX-AI-PEX) composite tubing, where the aluminum acts as a nearly perfect diffusion barrier. PEX-AI-PEX is also easier to bend than standard PEX.
- Any PEX tubing outside of the slab should be protected from sunlight to prevent corrosion.
- Tubing must be routed through the sub-soil or in a protective sleeve when passing through expansion joints.

- Before pouring the concrete, tubing should be laid out and pressurized to 100 psi for 24 hours to ensure no leakage. The tubing should remain pressurized throughout the pouring and curing process.
- Water should be delivered to the slab at a temperature that can maintain surface temperatures between 80°F and 85°F. The required inlet water temperature is dependent upon the thermal resistance of the slab and any floor finishing material.
- Tubes should be spaced between 6 in. and 15 in. apart, depending on application.
- Use tighter spacing for slabs with wood floor finishing. Even temperatures are critical to avoiding varying levels of expansion and contraction in wood floors.
- Early planning, including an accurate estimate of the load requirements in the rooms to be heated and cooled, is key for these systems. Due to the nature of the system (in the foundation slab), the earlier the decision is made the better.
- High quality control systems should be used that monitor both indoor and outdoor temperatures. The slab is a large thermal mass and care must be taken to avoid under or over shooting the prescribed temperature.

### ***Operation and Maintenance Issues***

- The slab system consists of a large thermal mass and thus takes a significant amount of time to respond to changes in control settings. The response time of the system can be through proper operation and maintenance practices that serve to avoid severely over or under shooting the desired temperature.
- Modern radiant slab systems require little maintenance and do not have the leakage concerns of earlier systems.

### ***Commissioning***

Commissioning should be performed throughout planning, design, construction, and operation to ensure proper installation, set-up, and integration with other facility components. Proper installation and management of the control system for a radiant slab are particularly important. Be sure indoor and outdoor sensors are sited correctly and functioning properly.

### ***References/Additional Information***

None.

# GUIDELINE MV13: BASEBOARD HEATING SYSTEM

## Recommendation

Use baseboard heating in areas experiencing periods of at or below-freezing temperatures, especially under areas of glass.

## Description

Hydronic radiant baseboard heating is a common application that has been used for over 50 years in the United States. The most common types are the finned-tube convector and radiant convector, both of which heat cold air at the floor of the room and induce an upward convective current. This is extremely effective in reducing downdrafts at cold facades and under windows. These models provide heat through a combination of convection and radiation. Another model is the panel, or flat pipe, radiator. Panel radiators are common in Europe and provide thermal comfort predominately through radiation heat transfer. A baseboard heating system requires the following:

- Baseboard heaters (convector or panel)
- Hydronic distribution system (piping, pumps, valves)
- Control system (sensors, thermostats)
- Hot water source (boiler, solar thermal, recovered thermal energy, geothermal heat pump)

## Applicability

These systems are applicable in all areas experiencing extreme cold, and are especially effective in areas of significant heat loss, such as entryways or under windows.

## Integrated Design Implications

- Baseboards are a good compliment for displacement ventilation systems. They can operate independently to maintain space temperature and to recover from night cool down.
- Choosing any hydronic heating system affects boiler decisions (heat pump, solar, etc.).
- All radiant hydronic systems provide an alternative to large-scale air-handling systems. This impacts many aspects of the building design including the required plenum sizing, boiler/chiller sizing, ducting, etc.
- The systems can be integrated into a facility-wide hydronic heating and cooling system including radiant slabs and ceiling panels.



*Baseboard heaters such as this are commonly used as an effective way to reduce downdrafts experienced at cold facades and under windows. NREL/PIX 11423*

## Applicable Climates

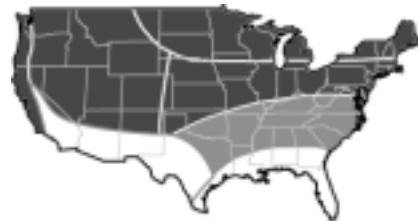

### Applicable Spaces

Classrooms	<input type="checkbox"/>
Library	<input type="checkbox"/>
Multi-Purpose	<input type="checkbox"/>
Gym	<input type="checkbox"/>
Corridors	<input type="checkbox"/>
Administration	<input type="checkbox"/>
Toilets	<input type="checkbox"/>
Other	<input type="checkbox"/>

### When to Consider

Programming	<input type="checkbox"/>
Schematic	<input type="checkbox"/>
Design Dev.	<input type="checkbox"/>
Contract Docs.	<input type="checkbox"/>
Construction	<input type="checkbox"/>
Commissioning	<input type="checkbox"/>
Operation	<input type="checkbox"/>

- They can be the main heat source, or integrated with another system and used primarily to reduce downdrafts at cold walls or glass, and can provide off-hours heating without running fans.
- Placement of system components affects requirements of the hydronic distribution system. Try to make these decisions early to create a hydronic distribution layout that minimizes piping materials (pipes, bends, etc.) and head loss.

### Cost Effectiveness

Baseboard heaters cost \$10/lin ft to \$25/lin ft.

- Operation and maintenance costs are low. Fuel costs and electric pumping costs in a well-designed system are lower due to increased efficiency compared to air-handling systems.
- The system is generally most cost effective when part of a facility-wide hydronic heating and cooling system.

Costs	L			
	M			
	H			
		L	M	H
		Benefits		

### Benefits

- Hydronic systems can decrease or eliminate the need for mechanical air-handling systems.
- These well-understood systems have been used for over 50 years.
- The systems are low maintenance.
- They can be more fuel efficient than air systems and use less power to move heat through the facility.
- Since they are quiet, these systems are good for classrooms.
- Cold downdrafts at outside walls and windows are stopped.
- Systems should be configured to allow for individual room control.

### Design Tools

- The *Advanced Installation Guide for Hydronic Heating Systems*, available from the Hydronics Institute, includes a design and sizing procedure for baseboard heating.
- *Hydronics Design Toolkit* software is available from the Radiant Panel Association.

### Design Details

- Baseboard systems can use zone control or individual room control. Zone control uses one thermostat to regulate several spaces in a single hydronic loop. This system is simple and cheap, but often involves large temperature drops and can be difficult to balance. Individual room control uses thermostatic radiator valves (TRV) to independently control baseboard elements in each space. The TRV allows educators to control the thermal environment of their own classroom.
- Flow rate must be controlled to ensure turbulent flow. If the flow rate is in the laminar regime, the heat transfer rate will be dramatically lower and more sensitive to flow rate changes causing difficulties in maintaining intended thermal conditions. Too high a flow rate can cause pipe noise.
- Proper water flow design is especially important if low temperature water will be used for heating, such as with a geothermal heat pump design.
- Increases in altitude can decrease the performance of finned-tube and radiant convectors.
- Painting panel radiators can affect performance. Aluminum and bronze paint can reduce total heat output by up to 10%.
- Make allowances for pipe expansion during installation to decrease audible disturbances.
- Water should be delivered to baseboard radiators between 140°F and 200°F.
- Care should be taken to ensure baseboard surface temperatures do not reach levels dangerous to young children.



- Output ranges from 300 Btu/hr/ft to 800 Btu/hr/ft depending on inlet/outlet temp and flow rate.
- Temperature drop across heater should not exceed 20°F to insure uniform heating.
- Be sure not to inhibit convective flow patterns when arranging furniture near baseboard heating elements.
- “Quiet Type” baseboard heaters (ie., heaters designed to produce less operating noise) should be specified for occupied areas.

### ***Operation and Maintenance Issues***

Operation and maintenance issues for baseboard heating systems are minimal. Heat transfer surfaces should be kept clean and free of dust. If the system is open to the potable water supply, some internal cleaning may be necessary to avoid fouling. Pipe fouling can lower efficiency by decreasing the heat transfer rate and increasing the pressure drop.

### ***Commissioning***

Commissioning should be performed throughout planning, design, construction, and operation to ensure proper installation, set-up, and integration with other facility components.

### ***References/Additional Information***

"Advanced Installation Guide for Hydronic Heating Systems." Available from Hydronics Institute. Berkeley Heights, NJ 07922.

Radiant Panel Association, PO Box 717, Loveland, CO 80539-0717. Phone: (800) 660-7187 or (970) 613-0100. Fax: (970) 613-0098. Email: [info@rpa-info.com](mailto:info@rpa-info.com).

# GUIDELINE MV14: GAS-FIRED RADIANT HEATING SYSTEM

## Recommendation

Consider gas-fired radiant heating for spaces with high ceilings and potentially high infiltration, or in large spaces with spot heating needs such as workshops or gymnasiums.

## Description

This class of radiant heaters burns gas to heat a steel tube or a ceramic surface. The heated surface emits infrared radiation that is absorbed by occupants, furniture, floor, and elements of the building in view of the heating element. Those objects then heat the air in the space through convection. An advantage to this type of radiant heating in high traffic areas is that the objects in the space remain warm even if cool air is introduced.

## Variations and Options

- Several configurations of gas-fired radiant heaters are available. Some are linear units consisting of a long steel pipe with a reflector above. Another option is a smaller unit with heated ceramic surface design to cover a rectangular area of floor.

## Applicability

Radiant heating is appropriate in spaces with high ceilings because it helps to overcome thermal stratification. Much of the heat is delivered directly to objects and occupants at floor level.

As mentioned earlier, radiant heating is also useful in areas with high traffic where infiltration can be a problem.

Appropriate spaces include gyms, shops, greenhouses, and high-traffic entrances or lobbies.

Radiant heaters can provide spot heating in large open spaces such as workshops or warehouses.

## Integrated Design Implications

Consider the need for combustion air and flue gas venting when choosing the location for a gas-fired radiant heater. Also allow for adequate clearance around the unit, as recommended by the manufacturer.

## Cost Effectiveness

Gas-fired radiant heaters are usually a cost-effective choice for spot heating in large open spaces. They may also be cost effective for general heating in spaces like gymnasiums when energy savings are considered.

## Benefits

### Advantages

- Equal comfort with lower indoor air temperatures results in lower heating energy consumption.
- Fan energy and/or pumping energy required for heating distribution is eliminated.



### Applicable Climates



### Applicable Spaces

Classrooms	<input type="checkbox"/>
Library	<input type="checkbox"/>
Multi-Purpose	<input checked="" type="checkbox"/>
Gym	<input checked="" type="checkbox"/>
Corridors	<input type="checkbox"/>
Administration	<input type="checkbox"/>
Toilets	<input type="checkbox"/>
Other	<input checked="" type="checkbox"/>

### When to Consider

Programming	<input type="checkbox"/>
Schematic	<input checked="" type="checkbox"/>
Design Dev.	<input type="checkbox"/>
Contract Docs.	<input type="checkbox"/>
Construction	<input type="checkbox"/>
Commissioning	<input type="checkbox"/>
Operation	<input type="checkbox"/>

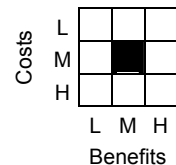

***Disadvantages***

Occupants may experience some discomfort due to warm heads and cool feet.

***Design Tools***

None.

***Design Details***

Provide protection for units installed in gymnasiums to prevent contact with sports equipment.

Follow the manufacturers guidelines for clearance above and to sides.

Provide an outdoor combustion air source and vent flue gas to outdoors.

“Quiet Type” unit should be specified.

***Operation and Maintenance Issues***

Gas-fired radiant heaters are relatively low maintenance systems.

***Commissioning***

None.

***References/Additional Information***

None.

# GUIDELINE MV15: WATER-LOOP HEAT PUMPS

## Recommendation

Consider using water-loop heat pumps if the building requires simultaneous heating and cooling, and has a minimum cooling capacity of 35 to 50 tons.

## Description

A water-loop heat pump system provides space heating and cooling for individual building zones. Each building space contains a separate heat pump connected to a single circulating water loop. The piping system adds or removes heat to the circulating water. When most of the pumps are working to cool building spaces, heat must be removed from the loop via a cooling tower or other means. If most of the pumps are heating building zones, a boiler must generate added heat for the loop.

When heat is being removed from some zones (i.e. certain heat pumps are working in cooling mode and rejecting heat to the loop) as well as being delivered to other spaces (i.e. other heat pumps are working in heating mode and using heat from the loop), the water loop remains within the desired temperature range without the addition or removal of heat.

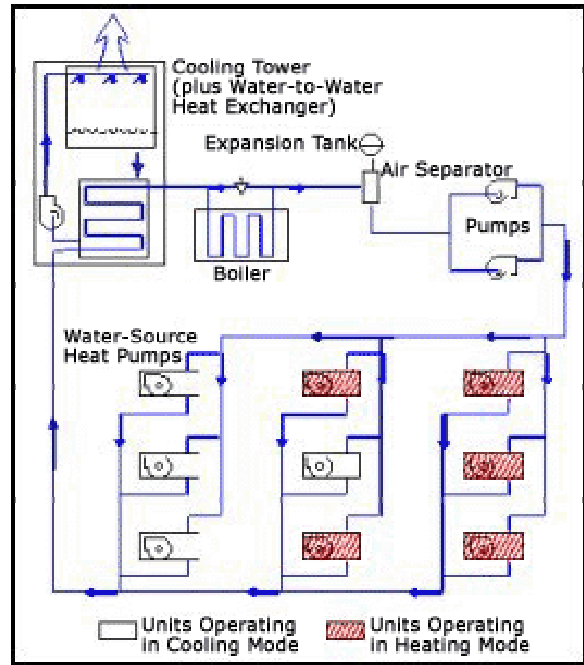

Typical commercial water source heat pump system

(Source: AdvancedBuildings.org)

## Applicability

This system is applicable to all interior school spaces. It is most effective in schools where simultaneous heating and cooling is required in different areas of the building.

This system offers limited benefits where cooling loads are small or non-existent.

## Integrated Design Implications

Water-loop heat pumps can be used as part of geothermal heat pump systems (See Guideline RE5).

## Cost Effectiveness

The cost of a water-loop heat pump system is generally more than a two-pipe fan/coil system, but less than a four-pipe fan/coil system.

## Benefits

### Advantages

- Ability to use unwanted heat from one zone to heat another zone.
- Provides easy temperature control for building spaces. Units in areas not requiring heating or cooling can be turned off and bypassed.
- Provides high reliability for both heating and cooling modes.

## Applicable Climates



### Applicable Spaces

Classrooms	
Library	
Multi-Purpose	
Gym	
Corridors	
Administration	
Toilets	
Other	

### When to Consider

Programming	
Schematic	
Design Dev.	
Contract Docs.	
Construction	
Commissioning	
Operation	

Costs	L			
	M			
	H			
		L	M	H
		Benefits		

- Do not require wall openings to reject heat from air-cooled condensers.
- Have a longer service life since they are not exposed to the weather.
- Failure of an individual water-source heat pump does not cause the entire system to fail.

#### ***Disadvantages***

- Failure of a loop pump, heat rejection device, or secondary heater can affect system operation.
- Increases electrical load in the winter.
- Requires a central boiler and cooling tower.

#### ***Design Tools***

See this chapter's Overview.

#### ***Design Details***

Water in the loop needs to be kept within a temperature range of 60°F to 90°F.

Due to the limited operating range, insulation is not required on the water loop.

Changes to building spaces can generally be accommodated by adding or removing individual pumps.

Heat pumps must be specified for the proper operating temperature. Do not use electric boilers for the auxiliary heating.

#### ***Operation and Maintenance Issues***

Typical life cycle for water-loop heat pumps is 15 to 20 years, depending on quality of maintenance. Regular cleanings of heat exchanger coils and regular air filter changes are required. This system can have higher maintenance costs because of the multiple compressors and fans.

#### ***Commissioning***

Flushing the loops will ensure the system is in good operating order.

#### ***References/Additional Information***

Advanced Buildings Technologies and Practices. <http://www.advancedbuilding.org/>.

Cooling System Alternatives. Tri-State Generation and Transmission Association.  
<http://www.tristate.apogee.net/>.

International Ground Source Heat Pump Association, Oklahoma State University, Stillwater, OK.  
<http://www.igshpa.okstate.edu/>.

Geothermal Heat Pump Consortium. <http://www.geoexchange.org/>.

# GUIDELINE MV16: EVAPORATIVELY PRECOOLED CONDENSER

## Recommendation

Specify an evaporatively precooled condenser for larger packaged units (10 tons or greater) in warm climates.

## Description

An evaporative precooler is an option available for some packaged air conditioners that cools the air entering the unit's condenser coils. The precooler reduces the temperature at which the condenser operates and increases the efficiency and capacity of the packaged unit.

The evaporative precooler consists of an evaporative medium several inches thick that replaces the inlet grill that typically protects the condenser coils. The medium is wetted using a recirculating system or a "once-through" system. Air drawn over the medium by the condenser fan is evaporatively cooled to a point close to the wetbulb temperature of outside air.

Precoolers are also available for outdoor units of some split systems.

## Applicability

These condensers are applicable for larger units, especially those serving spaces used in summer. They should be used in facilities with skilled maintenance staff.

## Integrated Design Implications

An evaporative precooler increases the capacity of air conditioners under hot conditions. Therefore, a smaller unit can be installed that will run more efficiently under normal partial load conditions. Water supply piping is required.

## Cost Effectiveness

Evaporative precooled condensers add about 10% to the cost of the equipment and can pay for themselves in two to three years.

An evaporatively precooled condenser is generally cost effective for units over 10 tons.

## Benefits

Condensers increase capacity and efficiency of packaged direct exchange air conditioners. They can also reduce summer demand peaks.

## Design Tools

None.



Evaporatively precooled condenser.

## Applicable Climates



## Applicable Spaces

Classrooms	■
Library	■
Multi-Purpose	■
Gym	■
Corridors	■
Administration	■
Toilets	□
Other	□

## When to Consider

Programming	□
Schematic	■
Design Dev.	■
Contract Docs.	□
Construction	□
Commissioning	□
Operation	□

Costs	L	■	□	
	M	□	□	
	H	□	□	
		L	M	H
		Benefits		

### ***Design Details***

Evaporative precoolers are typically controlled to operate only at higher outdoor air temperatures, approximately 80°F and above. At lower temperatures, less benefit occurs.

When sizing the packaged rooftop system, reduce the design outdoor drybulb temperature assuming that the evaporative precooler is about 50% effective. For example, in a climate with summer design conditions of 100°F drybulb and 70°F wetbulb, use an outdoor drybulb of 85°F for selecting the system capacity. This smaller system will run more efficiently at part load and have a smaller peak electric demand.

The addition of the evaporative precooler will reduce condenser airflow due to extra pressure drop. Check with the unit's manufacturer to make sure that airflow will be adequate.

Ensure that the precooler medium is properly designed and sized to prevent carry-over of water onto the condenser coils.

### ***Operation and Maintenance Issues***

To minimize maintenance requirements, specify adequate bleed-off rates to prevent mineral buildup (without causing excessive water consumption). Also specify controls that periodically flush the evaporative medium with water to remove dirt and scale. Finally, specify materials to minimize potential for corrosion.

Specify periodic cleaning of evaporative medium and periodic inspections of water circulation rate and bleed-off rate.

### ***Commissioning***

Check that the precooler is activated when system runs and outdoor air exceeds the minimum setpoint (typically 80°F).

### ***References/Additional Information***

None.

# GUIDELINE MV17: DEDICATED OUTSIDE AIR SYSTEMS

## Recommendation

Install dedicated outside air ventilation systems to supplement or replace natural ventilation. Install systems to provide dehumidification of outdoor air supply with or without air conditioning.

## Description

Dedicated outside air systems typically provide 100% outside air and deliver approximately 450 cfm to each classroom.

Outside air systems can be designed with ducted return or with relief dampers to outdoors. Systems with ducted return air can recover exhaust heat with an air-to-air heat exchanger. Systems without a heat exchanger usually need some means to temper the outside air, especially during winter.

Small systems are available that can serve individual rooms, while larger systems can serve an entire building. With larger centralized ventilation systems, evaporative cooling or waste heat recovery may be economical for tempering outdoor air.

## Applicability

This design strategy applies mainly to classrooms, or other areas with expected high occupant density, but can be used for spaces where hydronic heating systems and natural ventilation are appropriate. This design strategy is not as applicable for spaces that have conventional air conditioning, since outside air ventilation would be provided by the air-conditioning system.

Dedicated outside air ventilation is especially appropriate in combination with baseboard or radiant heating systems, where a fan is not required for heating. However, even with forced-air heating systems, a separate ventilation system may be appropriate if access to clean outdoor air is difficult from each individual room. In these cases, a central air handler can supply tempered ventilation air to each room, while each space heater recirculates indoor air and runs only when there is a demand for heating. Alternately, a separate baseboard system can be used to provide well-controlled heating in each zone.

A dedicated ventilation system may also be appropriate where natural ventilation access is difficult because of noise, extreme temperatures, dust, security, or lack of physical access to the outdoors.

## Integrated Design Implications

Special attention to controls is important to make sure that the ventilation system works together with the heating and/or cooling system. As with any ducted HVAC system, architectural coordination is important in locating relief dampers and routing ventilation ducts.



*Rooftop air-to-air heat exchangers are useful in systems with ducted return air for recovering exhaust heat.*  
NREL/PIX 11424

### Applicable Climates

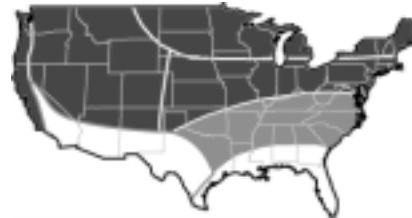

### Applicable Spaces

Classrooms	<input checked="" type="checkbox"/>
Library	<input checked="" type="checkbox"/>
Multi-Purpose	<input checked="" type="checkbox"/>
Gym	<input checked="" type="checkbox"/>
Corridors	<input type="checkbox"/>
Administration	<input type="checkbox"/>
Toilets	<input type="checkbox"/>
Other	<input type="checkbox"/>

### When to Consider

Programming	<input type="checkbox"/>
Schematic	<input checked="" type="checkbox"/>
Design Dev.	<input type="checkbox"/>
Contract Docs.	<input type="checkbox"/>
Construction	<input type="checkbox"/>
Commissioning	<input type="checkbox"/>
Operation	<input type="checkbox"/>



## Cost Effectiveness

A dedicated outside air system may add cost to the overall HVAC system, but when combined with a well-designed displacement system in a coordinated building, it would be expected to be competitive with a well-designed, high-quality conventional HVAC system.

Costs	L	■		
	M			
	H			
		L	M	H
		Benefits		

The U.S. EPA has created the School Advanced Ventilation Equipment Software (SAVES) that uses DOE-2 and code by the Florida Solar Energy Center and others to show that dedicated outdoor air supply systems with energy recovery ventilation components have a payback of under seven years in most areas (except the Hot and Dry and Temperate and Mixed climates).

## Benefits

These systems, especially when combined with enthalpy energy recovery, will reduce energy costs in most regions. In addition, they ensure proper ventilation, improving air quality and occupant well being.

## Design Tools

Most popular energy simulation programs, such as DOE-2, do not have the capability to directly model dedicated outside air distribution systems or 100% outdoor air systems with enthalpy energy recovery. However, there are some tricks that can give an approximation of the energy use, and some manufacturers of enthalpy energy recovery equipment can provide modeling.

## Design Details

- In both hot and cold climates, consider using an enthalpy air-to-air heat exchanger to precondition outside air that is brought into the building. This will also reduce winter dryness.
- In hot climates, evaporation can be used to lower the temperature of air that is delivered to the space.
- Provide VAV dampers that can automatically minimize and shut off ventilation air to each classroom if it is not occupied. Consider using a motion sensor already installed for lighting as a control.
- Consider variable-speed controls for central ventilation fans, so that airflow can be reduced when some rooms are unoccupied.
- Use gravity type or automatic relief dampers in each classroom, unless exhaust air is ducted to a central unit for heat recovery.
- Size the system to provide at least 15 cfm per person in classrooms and other spaces. If a classroom is expected to have 30 students, 450 cfm should be delivered. If a classroom is expected to have 24 students, 360 cfm is appropriate.
- Use filters to remove dust and other particles from outside air.
- Isolate unit from occupied spaces. Provide appropriate intake and discharge noise control consistent with meeting the Noise Criteria. Locate rooftop units above unoccupied spaces and away from pollution sources on the roof.

## Operation and Maintenance Issues

Replace filters on a regular basis.

## Commissioning

Provide documentation regarding the design intent to contractors and building operators to ensure that the system gets implemented properly. Systems should be balanced and controls commissioned so that adequate air is delivered to each classroom.

## References/Additional Information

None.

## GUIDELINE MV18: ECONOMIZERS

### Recommendation

Incorporate integrated economizer dampers and controls on HVAC systems that utilize return air. For units under five tons, use non-integrated economizers with two-stage cooling controls

### Description

Economizers consist of three sets of dampers with interlinked controls: an exhaust damper that relieves space return air to offset ventilation air brought in; an outside air damper that controls the amount of ventilation air brought into the system; and a return damper that balances the return and outside air portions of the economizers. At low outside air temperature (below 65°F), the economizer dampers modulate to minimum ventilation position unless more outside air is needed for cooling. This minimizes the heating load and protects the cooling coils from frosting at low loads. At high outside air temperature (above about 75°F), the economizer dampers return to this low ventilation position. At these temperatures, the recirculated space air takes less energy to cool. Between these points, the economizer dampers modulate from minimum ventilation to 100% outside air, acting as a first stage of cooling in an attempt to maintain the desired supply air temperature.

Integrated economizers allow simultaneous economizer and mechanical cooling. Non-integrated economizers first attempt to cool with outside air; if that does not satisfy the load, the economizer dampers return to minimum position and mechanical cooling is initiated.

There are three common control methods:

- **Fixed temperature setpoint** economizers close to minimum position when outdoor air exceeds a fixed temperature setpoint, typically 72° to 74°F.
- **Differential temperature** economizers will operate whenever the temperature of the outside air is below the temperature of the return air.
- **Differential enthalpy** economizers compare the enthalpy of the outside air and return air streams and operate whenever the outside air has less heat content. Enthalpy economizers are most important in humid climates.

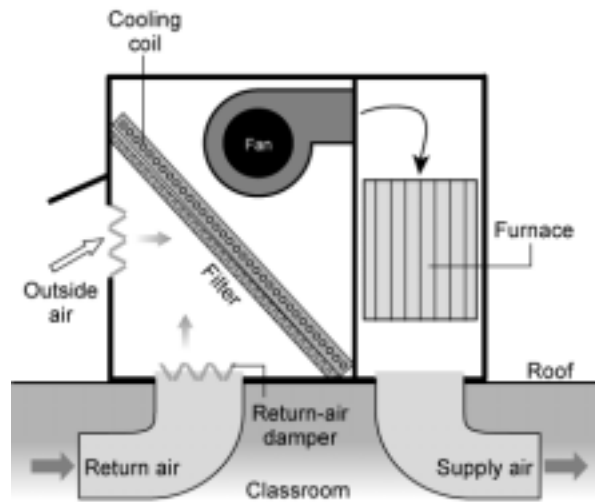

*Components of an economizer.*

### Applicable Climates



### Applicable Spaces

- Classrooms
- Library
- Multi-Purpose
- Gym
- Corridors
- Administration
- Toilets
- Other

### When to Consider

- Programming
- Schematic
- Design Dev.
- Contract Docs.
- Construction
- Commissioning
- Operation

For moderate climates, economizers can be a significant means of minimizing space-conditioning costs, because outside air will be within the comfort range for much of the school day throughout the year.

### **Applicability**

Economizers make the most difference for systems serving spaces with low occupant density, such as libraries, administration, and other areas. In those spaces, the normal ventilator rate is fairly low and little free cooling occurs without an economizer. In classrooms and assembly areas, where high occupant density will dictate a large minimum position on the outside air damper (30% or above), economizer controls will have less impact. However, they will still be cost effective due to higher cooling loads in these spaces.

On many existing systems, economizers can be added as a retrofit.

Economizers will not be as useful for spaces designed to use natural ventilation for cooling. In those cases, the cooling system may run only during hot periods when an economizer would be at minimum position anyway.

Economizers should not be installed in facilities that do not receive maintenance because a failure can increase energy consumption.

### **Integrated Design Implications**

Economizers are especially valuable with displacement ventilation systems because the higher supply air temperature may allow an economizer to provide 100% of the cooling demand for a greater number of hours each year.

An economizer may be unnecessary in spaces with exterior walls and good natural ventilation design.

### **Cost Effectiveness**

The cost premium is \$200 to \$500 to add an economizer to a small packaged rooftop system.

Economizers are very cost effective for spaces without natural ventilation.

Costs	L			
	M			
	H			
		L	M	H
		Benefits		

### **Design Tools**

None.

### **Design Details**

Economizers should be factory-installed or specified to be factory-designed if they are to be field-assembled. Improper installation may cause coil and/or compressor damage.

Differential temperature control is recommended for most climate areas. However, in humid climates a differential temperature economizer could actually increase the system energy use by imposing a latent cooling load during economizer operation. A differential enthalpy economizer is ideal for humid areas, but enthalpy sensors require maintenance and can be unreliable. Therefore, a fixed temperature economizer with a setpoint around 72°F is a good choice for coastal areas where mild temperatures are accompanied by fairly high humidity.

For retrofit applications, care must be taken to protect the direct exchange coil and compressor from damage during low loads. With existing direct exchange systems, either non-integrated economizers should be installed or controls should be added to prevent compressor cycling and cutout on low evaporator temperatures. Economizer retrofits are likely to be cost effective only for larger systems (above 7.5 tons).

### **Operation and Maintenance Issues**

Clean and lubricate dampers and control linkages. Maintenance is critical to ensure that economizers work properly for the lifetime of the system.

### ***Commissioning***

A functional test is critical to ensure that economizer controls are operating properly. With the system running during mild weather (outdoor cooler than indoor air), set the space thermostat to a low value to call for cooling and check that the outside air dampers are completely open. Then use a heat source, such as a hot-air gun, to warm the outside air temperature sensor and check that the outside air damper closes to its minimum position. Remove the heat source and check that the damper reopens (after the sensor has cooled).

For integrated economizers, also check that the outside air dampers remain completely open when the compressor is running and outdoor air is cool.

### ***References/Additional Information***

None.

# GUIDELINE MV19: AIR DISTRIBUTION DESIGN GUIDELINES

## Recommendation

Design the air distribution system to minimize pressure drop and noise by increasing duct size, eliminating duct turns, and specifying low-loss duct transitions and plenums. Use lowest possible fan speed that maintains adequate airflow. Pay special attention to the longest or most restricted duct branch. (See Guideline MV11: VAV Reheat System for information on variable volume systems.)

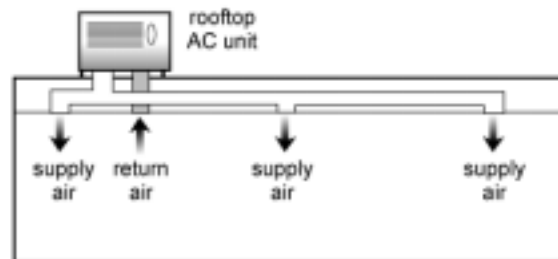

*Basic air distribution system.*

## Description

Optimal air distribution system design is fairly complicated. An optimal design balances the need for comfort and low noise with overall HVAC system cost, energy cost, and long-term maintenance and replacement costs. Many factors affect performance: diffuser type, number of diffusers, diffuser size, duct size, duct material, plenum type and size, fitting types, length of ducts, number of turns, type of turns, location of duct system (e.g., unconditioned attic or within conditioned space), priority for heating performance vs. cooling performance, and fan characteristics (pressure vs. airflow).

Due to the complexity of design, a detailed analysis is common for small systems. Typically, designers and contractors rely on experience or rules of thumb in choosing system components. Even if design calculations are performed, however, decisions are not always the best, in terms of energy efficiency and acoustic performance.

This guideline addresses small, constant-volume duct systems that are common in schools. It covers design targets for air velocities and pressure loss that help ensure an efficient and quiet system.

## Applicability

All ducted air systems.

## Integrated Design Implications

Air distribution design options are closely tied to the architectural design. The choice of duct type is often limited by space availability, but acoustics should be considered. Round ducts with no internal glass fiber lining tend to keep noise inside and not let it be reduced as it travels away from the noise source (i.e., fan). Rectangular ducts with no internal glass fiber lining allow more sound to escape than circular ducts, but can be problematic if the noise level traveling through the sheet metal walls of the duct is too high.

Ducts may be located outside, in unconditioned space, or within the conditioned space. The most energy-efficient option is usually within conditioned space, but excessive noise may require that the first section of duct to be attenuated over unoccupied areas for a considerable distance. More expensive sheet metal ducts are usually required, but they need not be insulated. If ducts are located in an unconditioned attic, then the roof must be insulated and/or equipped with a radiant barrier to reduce heat gain to the ducts. Outdoor ducts should not be used unless no other option is feasible, as they almost always get wet and become mold sites.

### Applicable Climates



### Applicable Spaces

- Classrooms
- Library
- Multi-Purpose
- Gym
- Corridors
- Administration
- Toilets
- Other

### When to Consider

- Programming
- Schematic
- Design Dev.
- Contract Docs.
- Construction
- Commissioning
- Operation

Location of supply air outlets must be coordinated with lighting design (if located in ceiling) or space plan and furniture (for wall or floor outlets).

### **Cost Effectiveness**

Sometimes extra costs for low-loss fittings or larger ducts are necessary to achieve a high performance design. However, these costs can often be offset by carefully sizing the heating and cooling system to reduce overall system size. In addition, many air distribution improvements have little or no extra cost, such as proper installation of flex duct that should be limited to the last 5 ft to 6 ft due to higher internal pressure drop.

### **Design Tools**

Numerous duct-sizing computer programs are commercially available.

### **Design Details**

These guidelines are intended to cover typical, small, single-zone systems. Additional criteria appropriate for multi-zone air distribution systems are not covered here.

#### **Airflow**

**System cooling airflow.** Total system airflow should generally fall between 350 cfm/ton and 450 cfm/ton for systems with cooling. If airflow is greater, condensation might blow off the cooling coil. If airflow is less than 350 cfm/ton, the cooling capacity and efficiency drop. The capacity loss due to low airflow is worst in dry climates where latent cooling loads are low.

**System heating airflow.** For heating-only systems, a good target is 25 cfm per kBtu/h of heating capacity, providing about 105°F supply air. Heating airflow should not be lower than 15 cfm per kBtu/h because supply air temperature will exceed 135°F. If the airflow is low, supply air will be too warm and air velocity too low, and poor mixing occurs in the room. Excessive airflow during heating creates more noise and can cause uncomfortable drafts.

**Airflow adjustment.** After system installation, airflow can be adjusted by either changing the fan speed or altering the duct system. To reduce airflow, lower the speed of the fan rather than install dampers. Try to use the lowest fan speed possible because fan energy consumption drops rapidly as fan speed decreases. If possible, specify a variable-speed or multiple-speed fan. To increase airflow, try to modify the duct system rather than increase the fan speed. Possible measures include replacing the most restrictive ducts with larger sizes, improving duct transitions to reduce pressure loss, and eliminating duct turns or constrictions (especially in flex duct).

**Supply diffuser.** Most diffusers also have a minimum velocity, both for proper mixing and to avoid dumping cool air on occupants. Refer to manufacturers' guidelines for specific types of supply diffusers. When choosing diffusers based on Noise Criteria (NC), remember that manufacturers' data are usually at ideal conditions (long, straight duct attached to diffuser) and actual noise level is likely to be higher. To account for this, diffusers should be selected for 5 to 10 NC points below the NC criteria of the room. Refer to Table 29 below for suggested air velocities.

Table 29 – Air Velocities for Supply Outlet and Return Inlet

	Design Criterion NC or RC(N)	Neck Air Velocity (fpm)
<b>Supply Outlet</b>	45	625
	40	560
	35	500
	30	425
	25	350
	20	300
<b>Return Inlet</b>	45	750
	40	675
	35	600
	30	500
	25	425
	20	375

(Source: 1999 ASHRAE APPLICATION HANDBOOK)

**Return grille.** The return air grille(s) must be larger than the total supply air diffuser area to avoid excessive noise. Refer to table above for suggested air velocities.

**Duct.** Air velocity should not exceed 700 fpm in flex ducts and 1,200 fpm in sheet metal ducts above occupied areas. Higher flow creates excessive turbulence and noise. There is usually a practical lower limit to duct air velocity, where the duct becomes too large and expensive.

**Cooling coil.** Air velocity through the cooling coils should be minimized to reduce pressure loss. A good target is 300 fpm. However, designers seldom have a choice of coil area in small packaged HVAC units, though it is possible to compare airflow and fan power data from different manufacturers to identify units with lower internal pressure loss.

#### **Duct type**

**Flex duct.** Flexible ducts are widely used. They offer several advantages when properly installed, but also have some disadvantages.

Flex ducts are most popular for their low cost and ease of installation. In addition, they attenuate noise much better than sheet metal ducts, but allow noise to escape into the ceiling plenum, which may not be acceptable if noise levels at the flex duct are excessive. Flex duct also offers lower air leakage, are usually pre-insulated, and provide some flexibility for future changes.

On the down side, pressure loss is greater in flex ducts, even when they are properly installed. They are also prone to kinking, sagging, and compression, which are problems that further reduce airflow and create noise. And since they are flexible, flex ducts are usually installed with more turns than sheet metal ducts. Actual performance of flex ducts in the field is often poor due to these installation problems. As a final disadvantage, flexible ducts are typically warranted for only about 10 years and will need replacement more often than a sheet metal equivalent.

If flex duct is used, several important points to consider are:

- The duct must be large enough for the desired airflow (see Table 30 below).
- The ducts must be properly suspended according to manufacturer guidelines without compressing or sagging.
- All ducts must be stretched to full length (see table notes below).
- Keep flexible duct bends as gentle as possible; allow no turns of more than 45°.
- Fasten all flex ducts securely to rigid sheet metal boots and seal with mastic (see Guideline MV20: Duct Sealing and Insulation).

- Limit duct lengths to no longer than about 5 to 10 ft to facilitate drop in ceiling designs (otherwise pressure loss may be too high).

Table 30 – Minimum and Maximum Airflow Values

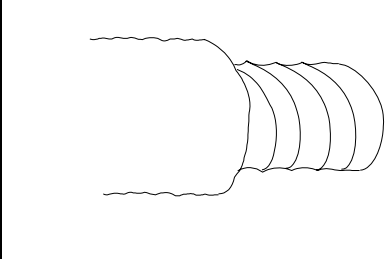

Flex Duct Diameter (in.)	Minimum Airflow (cfm)	Maximum Airflow (cfm)
4	20	60
5	40	100
6	60	140
7	90	190
8	130	240
9	175	310
10	230	380
12	380	550

Table Notes:

- Maximum airflow limits correspond to velocity of 700 fpm. Higher flows create turbulence and noise in flex ducts.
- Minimum airflow corresponds to a design friction rate of 0.06 in./100 ft.
- The airflow values in the table assume that the flex duct is stretched to its full length. Airflow resistance increases dramatically if flex duct is compressed in length. Pressure loss doubles if the duct is compressed to 90% of its full length and triples if it is 80% compressed.

**Sheet metal duct.** The advantages to sheet metal ducts are lower pressure loss, longer life, greater durability, and the potential for reuse or recycling at the end of the system’s life. They are the only option for long duct runs or medium- to-high-pressure duct systems. In addition, sheet metal ducts may remain exposed in conditioned spaces.

Disadvantages to sheet metal ducts are higher cost, higher sound transmission (sometimes they require noise attenuation measures that offset some of the pressure loss advantage), insulation requirement, and potentially greater leakage (though leakage is not an issue if they are properly sealed).

From a pressure loss standpoint, round sheet metal ducts are preferred over rectangular when adequate space is available. Round sheet metal ducts keep noise inside better than rectangular ducts. This may be preferred if the ducts are running over a noise sensitive space, and duct noise breakout is a concern. However, because round ducts do not allow noise to escape as easily as rectangular ducts, noise will not be reduced as quickly as the noise travels down the duct system. When ducts cannot be lined with internal glass fiber, rectangular ducts are preferred to allow low frequency noise to escape the duct before reaching the diffuser. Rectangular ducts are susceptible to noisy drumming at high airflow.

**Reducing pressure loss**

Several measures may be taken to reduce pressure loss and improve airflow. Knowledge of the following simple principles may help the designer improve airflow:

- **Air resists changing direction.** The pressure drop of a turn can be reduced dramatically by smoothing the inside and outside radius. When possible, avoid sharp turns in ducts and never allow kinks in flexible ducts. Turning vanes are another option to reduce the pressure drop in a sharp turn.



				
	<b>BEST</b>	<b>GOOD</b>	<b>FAIR</b>	<b>POOR</b>
Relative Pressure Loss	1.0	X 1.3	X 4.7	X 13.0

Figure 35 – Pressure Loss for Duct Turns

Note: Total pressure loss calculated at 800 fpm air velocity.

- **Airflow into branch ducts will be improved by using angled transitions (or conical taps) rather than typical straight connections.** The angled transition is especially useful for critical branches that are not getting enough air.

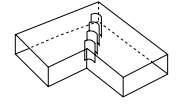
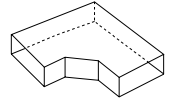
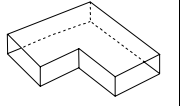
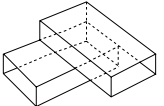
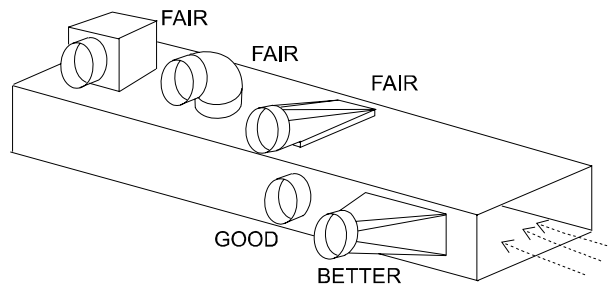

Figure 36 – Various Connections for Branch Ducts

From a pressure loss standpoint, the fewer turns the better. However, turns help reduce noise, particularly at high frequencies, as it travels through the duct system. For example, a side branch takeoff provides less flow resistance than a top branch takeoff because the top takeoff requires the air to turn twice.

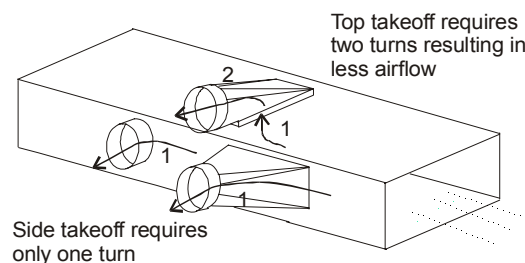

Figure 37 – Side Takeoff Vs. Top Takeoff

### Reducing noise

Noise reaching the space via the duct system is either transmitted from the air-conditioning unit or generated by air turbulence within the air distribution system.

There are several measures available to reduce noise as it travels through the duct system, such as sound absorbing duct liner, flex duct, duct turns, and sound attenuators (silencers). Each of these elements has different noise reduction characteristics that need to be considered when analyzing the system for noise. Duct lining thickness and duct dimensions control the amount of noise reduction per linear foot of duct. Thicker glass fiber lining will reduce noise faster. Length and diameter controls the amount of noise reduction across flex duct. Duct dimensions and the way in which the duct turns (i.e.,

turning vanes, radiused elbow, etc.) impacts the amount of noise reduction. Please bear in mind that noise reduction is frequency dependant. Noise reducing elements (i.e., elbows, flex duct, etc.) may reduce noise effectively at high or low frequencies, but seldom have the same amount of noise reduction across the audible frequency range.

The first three measures mentioned above are the most feasible for small, single-zone systems because they are not prohibitively expensive and do not necessarily cause excessive pressure loss (small packaged systems usually do not have a lot of pressure to spare). Careful design is important to balance noise attenuation benefits vs. additional pressure loss.

Limiting air velocity as described earlier in this guideline controls noise generation with the ducts, or at grilles and diffusers.

### **Other Design Issues**

Pay special attention to the duct branch with the greatest pressure drop, either the longest branch or the one with the most constricted turns. For longer branches, either larger duct size or low-loss duct transitions will be required to achieve proper airflow.

Do not place balancing dampers directly behind diffusers. If they are necessary, dampers should be located as close to the fan as possible to minimize noise and air leakage in the supply duct.

Connections to ceiling diffusers should have two diameters of straight duct leading into the diffuser. Otherwise noise and pressure drop can increase significantly.

Avoid placing ducts in a hot attic. The roof can reach 150°F on a sunny day and the radiant heat load on the duct is significant. If ducts are above the ceiling, insulation must be installed on or under the roof or a radiant barrier must be installed under the roof deck.

In many cases, if the pressure loss in the air distribution system can be reduced by as little as 0.15 in. SP, fan speed can be reduced and fan power decreases significantly. In the case of a three-ton rooftop packaged unit, energy savings can be \$200 to \$300 over a 10-year period. Manufacturer's data for a typical three-ton unit shows that the fan can supply 1,100 cfm at 0.8 in. w.c. external static pressure, if the fan is set to high speed. The fan can provide the same airflow at 0.65 in. w.c. at medium speed. Therefore, if the duct system is carefully designed and installed, it may be possible to run at medium speed. The fan power then drops from 590 W to 445 W. For typical operating hours and electricity rates, the savings are about \$30/year.

### **Operation and Maintenance Issues**

Filters must be replaced regularly to maintain airflow. Fans and drives must be lubricated to maintain proper operation.

### **Commissioning**

Measure supply airflow and external static pressure to compare with design values. If airflow is low, take measures to reduce restrictions in duct system rather than increasing fan speed.

### **References/Additional Information**

American Society of Heating, Refrigeration and Air Conditioning Engineers. *ASHRAE Handbook - 2001 Fundamentals*. Atlanta, GA.

Sheet Metal and Air Conditioning Contractors National Association. *HVAC Systems Duct Design*. Chantilly, VA.

# GUIDELINE MV20: DUCT SEALING AND INSULATION

## Recommendation

Create strong and long-lasting connections by mechanically fastening all duct connections and using mastic to seal connections and transverse joints (those perpendicular to airflow). If choosing pressure-sensitive tape as a sealant, then specify foil-backed tape with 15-mil butyl adhesive. Internal gasketing at joints is an excellent choice for round ducts.

## Description

Duct leakage has a big impact on system efficiency and capacity. Studies of residential systems conducted by the Lawrence Berkeley National Laboratory show that 20% loss is common.<sup>4</sup> Similar problems exist in commercial duct systems.

Other studies have shown that some types of pressure-sensitive tape fail quickly in the field. Therefore, duct sealing systems must be specified carefully for longevity as well as strength and air-tightness.

Depending on duct location, insulation also plays a critical role in ensuring system efficiency and capacity.

Supply and return air plenums must be sealed as well. These are usually the areas of greatest pressure in the air distribution system, and small holes create significant leaks.

## Applicability

All ducted air systems.

## Integrated Design Implications

Duct leakage problems can be avoided by placing ducts within the conditioned envelope or by eliminating them altogether (e.g., hydronic heating and cooling).

## Cost Effectiveness

Using mastic for duct sealing may increase material costs, but many find that labor costs drop compared to sealing with tape. Therefore, good duct sealing should not have a significant cost impact.

## Benefits

Careful duct sealing and insulation application will allow use of smaller cooling and heating equipment or at least allow the use of smaller safety margins in sizing calculations. Lower equipment cost may be a result.

**Do this (in all cases):**  
Mechanically fasten connections.

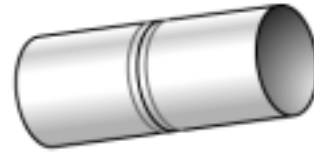

**then do one of these:**

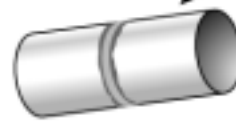

Seal with mastic and glass fiber tape.

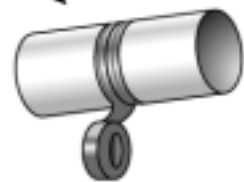

Seal with foil backed 15 mil butyl adhesive tape.

## Applicable Climates



### Applicable Spaces

- Classrooms
- Library
- Multi-Purpose
- Gym
- Corridors
- Administration
- Toilets
- Other

### When to Consider

- Programming
- Schematic
- Design Dev.
- Contract Docs.
- Construction
- Commissioning
- Operation

Costs	L			
	M			
	H			
		L	M	H
		Benefits		

<sup>4</sup> [http://www.lbl.gov/Science-Articles/Research-Review/Highlights/1998/v3/EES\\_duct.html](http://www.lbl.gov/Science-Articles/Research-Review/Highlights/1998/v3/EES_duct.html).

Lower cooling and heating costs result. Other benefits include improved system performance, potentially better comfort, and reduction in infiltration and potential moisture problems within envelope components.

### ***Design Tools***

None.

### ***Design Details***

Do not rely on sealants, such as tape or mastic, to provide a mechanical connection. Specify screws, draw bands, or other mechanical fastening devices as appropriate for the duct type.

As a first choice, use mastic to seal all connections and transverse joints. Mastic is a liquid applied sealant that can also be used together with a mesh or glass fiber tape to provide added strength or to span gaps of up to about ¼ in. Specify mastic in a water-based solvent with a base material of polyester/synthetic resins free of volatile organic content.

If choosing pressure-sensitive tape as a sealant, specify foil-backed tape with 15-mil butyl adhesive. Butyl tape has been found to have greater longevity in the field. Avoid using tape with rubber or acrylic adhesive.

Flexible ducts must be mechanically fastened with draw bands securing the inner and outer plastic layers to the terminal boot. Specify that the draw bands be tightened as recommended by the manufacturer using an adjustable tensioning tool.

Seal both supply and return ducts and plenums.

### ***Commissioning***

Inspect duct connections.

Test duct leakage with smoke testing or pressure testing.

### ***References/Additional Information***

None.

# GUIDELINE MV21: HYDRONIC DISTRIBUTION

## Recommendation

Consider using a variable flow system with variable-speed drive (VSD) pumps, but be careful to keep turbulent flow in the pipe during cold weather. Insulate exposed hydronic heating/cooling piping. Make early decisions regarding the placement of heating/cooling components (radiators, ceiling panels, slab floors, boilers, chillers). Use this information to create a system layout that minimizes piping material (pipes, bends) and head loss. When possible, use larger pipe diameters and smaller pumping equipment to conserve energy.

## Description

Significant amounts of energy must be used to distribute water for heating and cooling. Proper design can result in substantial economic and energy savings. Unfortunately, hydronic distribution design is often governed by *past* practices and not necessarily *best* practices. This factor makes the design process quick and easy, but not always the most economical or energy efficient. A hydronic distribution system consists of pipes, fittings, tanks, pumps, and valves.

## Applicability

Applicable in all areas. However, the system is most applicable to the Hot and Dry, Hot and Humid, and Temperate and Humid regions.

## Integrated Design Implications

Hydronic distribution is related to nearly all aspects of building design and construction. It is crucial that the HVAC piping contractor be involved throughout the design and construction process to maximize the efficiency and cost effectiveness of the hydronic distribution system. Simply laying out heating and cooling elements (baseboards, ceiling panels, chillers, boilers) in such a way that minimizes the required pipe material and maximizes straight-running pipe can save significant amounts of energy. Maximizing the amount of straight-running pipe also simplifies the insulating process.

## Cost Effectiveness

Initial cost for hydronic distribution depends on the quantity, size, and type of piping, valves, and pumps. Initial cost can be minimized through proper planning, sizing, and placement of each.

When doing life-cycle cost analysis, compare incremental cost of increased pipe diameter to energy savings, and savings from decreased size and cost of pumping system.

## Benefits

- A properly sized and installed system will provide quiet, efficient, and virtually maintenance-free operation at minimal cost.



*These loop water pumps and piping are part of a geothermal heat pump system being used by Nebraska schools to save money and energy on heating and cooling. NREL/PIX07415*

## Applicable Climates

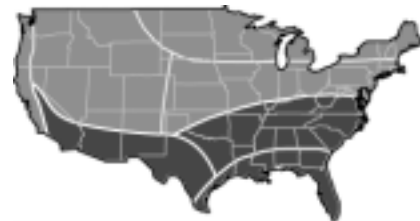

### Applicable Spaces

Classrooms  
Library  
Multi-Purpose  
Gym  
Corridors  
Administration  
Toilets  
Other

### When to Consider

Programming  
Schematic  
Design Dev.  
Contract Docs.  
Construction  
Commissioning  
Operation

- Properly insulating all exposed piping will save energy and money, which can be cost effective at levels beyond code requirements.
- Increasing piping diameter significantly decreases the pumping power required. Pressure head loss due to friction drops the fifth power with pipe diameter.
- Oversized piping allows for increases in load requirements from add-ons or renovations without complete system overhaul.

### **Design Tools**

- Use a CAD-based program to design pumping layout.
- ASHRAE Handbook - Fundamentals outlines the process for determining pressure drop through piping layout.
- Pipe diameter selection involves balancing the following:
  - Location of pipe in the system
  - First costs of installed piping
  - Pump costs (capital and energy)
  - Erosion considerations
  - Noise considerations
  - Architectural constraints
  - Budget constraints.

### **Design Details**

#### **Piping Circuits**

There are four general types of piping circuits: series, diverting series, parallel direct-return, and parallel reverse-return. The series circuits are one-pipe circuits and are the simplest and lowest-cost design. Both the series and diverting series involve large temperature drops; however, only the latter allows for control of individual load elements.

The advantage of parallel piping circuits is that they supply the same temperature water to all loads. Direct-return networks are sometimes hard to balance due to sub-circuits of varying length. Reverse-return networks are designed with sub-circuits of nearly equal length. Parallel circuits are two-pipe systems.

Piping attached to vibration-isolated equipment (typically within the first 25 ft to 30 ft from the equipment) should be supported with vibration isolators, similar in type and static deflection to the vibration isolation being used for the associated equipment.

Fluid flow should be limited to 4 fps in 2-in. diameter pipes and below. For larger pipes a flow velocity of 6 fps is recommended.

Maintain a maximum of 50 psig water pressure at plumbing fixtures.

#### **Valves**

In general, either two-way or three-way control valves are used to manage flow to the load. A two-way valve controls flow rate to the load through throttling, which causes a variable flow load response. Three-way valves are used in conjunction with a bypass line to vary flow to the load. Because the water that does not go to the load simply passes through the bypass line, three-way valves provide a constant flow load response. Significant energy savings can be realized when two-way control valves are used in conjunction with VSD pumps.

It is recommended that ball valves or butterfly valves be used for all isolation and balancing valves. These valves are reliable and offer a low-pressure drop at a low cost.

### ***Pumps***

Centrifugal pumps are most commonly used in hydronic distribution systems. The use of VSD pumps can save significant amounts of energy and simplify the distribution system. Pump power falls at a cubed rate with speed; thus, a VSD pump can be extremely cost effective for systems with significant load variations. Also, variable flow networks with VSD pumps use a simple two-way valve and do not require balancing valves. For systems that use supply air temperature reset controls, specify a clamp on the speed of the pump to avoid excessive energy use during system startup.

Refer to 1995 ASHRAE Handbook Chapter 43 for recommended vibration isolation.

### ***Dual-Temperature Systems***

When a space requires both heating and cooling, either a two-pipe or four-pipe system can be used. In a two-pipe system, all the loads must be either heating or cooling congruently. Two-pipe systems cannot be used when some spaces on the piping network need cooling, while others need heating. Switching from one mode of operation to the other increases overall energy usage and can be a fairly time-consuming process. A four-pipe system is more complex, but it allows for heating and cooling on the same network and is more convenient than a two-pipe system when frequent changeovers are required.

### ***Expansion Chamber***

- Closed systems should have only one expansion chamber.
- Expansion tanks open to the atmosphere must be located above the highest point in the circuit.

### ***Air Elimination***

Measures such as manual vents and air elimination valves should be taken to purge any gases from the flow circuit. Failure to do so can lead to corrosion, noise, and reduced pumping capacity.

### ***Insulation***

The insulation process becomes significantly easier when the piping network is laid out properly. Install all valves with extended bonnets to allow for the full insulation thickness without interference with valve operators. It may be cost effective to insulate pipes beyond code requirements.

### ***Water Treatment***

Care should be taken to avoid scaling and biological growth within the distribution system. Significant fouling resulting from either source is detrimental to system performance. The degree to which scaling can occur is dependent upon temperature, pH level, and the amount of soluble material present in the water. Scale formation can be controlled through several means including filtration and chemical treatments.

Biological growth is generally a larger problem for cooling systems. Heating systems typically operate at temperatures high enough to prohibit substantial biological growth. Chemical treatments with biocides such as chlorine and bromine have traditionally been used to control this growth. Alternatives to these chemicals include ozone and UV radiation. Ozone itself is toxic; however it readily breaks down into non-toxic compounds in the environment. UV radiation is completely non-toxic, but is only effective when turbidity levels are low. Mechanical methods such as blow downs can also be utilized to control fouling and decrease chemical use, but these methods increase water usage.

## ***Operation and Maintenance Issues***

- Water quality should be checked on a regular basis to ensure fouling due to scaling or biological growth is not occurring.
- Periodically check piping insulation. Insulation adhesive can fail and expose piping.
- Check pressures, pumps, and valves on regular basis to ensure system is performing as intended.

## **Commissioning**

Commissioning should be performed throughout planning, design, construction, and operation to ensure proper installation, set-up, and integration with other facility components. Water flow should be measured and adjusted accordingly. System head should be measured and compared to design system head.

## **References/Additional Information**

American Society of Heating, Refrigerating and Air Conditioning Engineers. *ASHRAE Handbook - HVAC Systems and Equipment*. 2000.

*CoolTools: Chilled Water plant Design Guide*. Available from Pacific Gas and Electric, P.O. Box 770000, B32. San Francisco, CA 94177.

Hydronics Institute, Berkeley Heights, NJ 07922. Phone: (908) 464-8200.



## GUIDELINE MV22: CHILLED WATER PLANTS

### Recommendation

Use high-efficiency, water-cooled, variable-speed chillers. Use chiller heat recovery if there is a reliable hot water demand. Install oversized induced-draft cooling towers with axial propeller fans. Use low approach temperatures and variable-speed fan control.

### Description

#### Chillers

There are two basic chiller classifications, air-cooled and water-cooled. Water-cooled chillers cost more (when considering the cooling tower and condenser water loop), but are more energy efficient. Several chiller types exist within the classifications, including electric (centrifugal, reciprocating, screw or scroll), gas-fired (engine-driven or double effect absorption), and steam absorption.

#### Towers

A cooling tower provides heat rejection for a water-cooled chiller by exposing as much water surface area to air as possible to promote the evaporation of the water and thus cooling. Cooling towers come in a variety of shapes and configurations. A “direct” tower, also known as an “open” tower, is one in which the fluid being cooled is in direct contact with the air. An “indirect” tower, or “closed-circuit fluid cooler,” is one in which the fluid being cooled is contained within a heat exchanger or coil, and the evaporating water cascades over the outside of the tubes. The tower airflow can be driven by a fan (mechanical draft) or can be induced by a high-pressure water spray. The mechanical draft units can blow the air through the tower (forced draft) or can pull the air through the tower (induced draft). The water invariably flows vertically from the top down, but the air can be moved horizontally through the water (cross flow) or can be drawn vertically upward against the flow (counterblow).

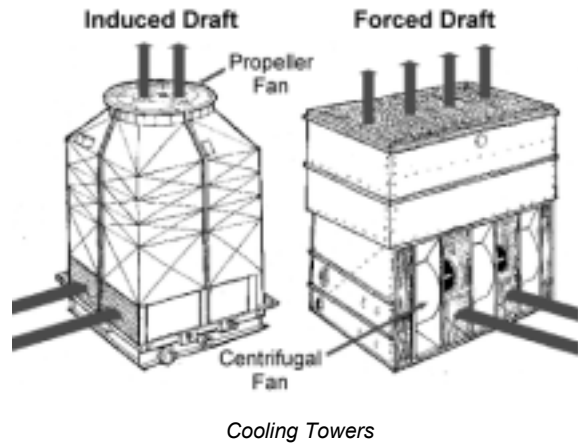

#### Applicable Climates



#### Applicable Spaces

Classrooms  
Library  
Multi-Purpose  
Gym  
Corridors  
Administration  
Toilets  
Other

#### When to Consider

Programming  
Schematic  
Design Dev.  
Contract Docs.  
Construction  
Commissioning  
Operation

### Applicability

These towers are applicable for a small percentage of schools in areas needing significant amounts of chilled water and space cooling.

Equipment should perform in accordance with efficiency guidelines in ASHRAE 90.1-2001. The energy performance requirements set forth by ASHRAE 90.1-2001 state that heat rejection devices must supply  $\geq 38.2$  gpm/hp for axial fan towers and  $\geq 20.0$  gpm/hp for centrifugal fan towers. The U.S. Environmental Protection Agency codes chemicals (usually chlorine) used for cleaning. Methods using ozone for cleaning are also an option, but this can lead to increased corrosion of internal systems.

## Integrated Design Implications

Chiller and tower decisions are related to many aspects of building design and construction including space considerations, cooling/heating choices, and the hydronic distribution system layout. Tower performance is related to facility layout and orientation. The tower should be sited properly to minimize recirculation of saturated air.

The placement of chilled water plant components affects requirements of the hydronic distribution system. Try to make these decisions early to create a hydronic distribution layout that minimizes piping materials (pipes, bends, etc.) and head loss.

## Cost Effectiveness

Installed estimates for chillers fall between \$575/ton and \$781/ton, depending on efficiency and drive choice. Installed tower cost estimates are between \$133/ton and \$178/ton.

Costs	L			
	M		■	
	H			
		L	M	H
		Benefits		

As a general rule, air-cooled chillers are more cost effective if the chiller plant is less than 300 tons. Water-cooled are more cost effective above 300 tons. However, many factors affect operating costs for a chilled water plant, and the best choice of type, size, efficiency, and controls is difficult to generalize. First-cost premium, when improving from an efficiency of 0.7 kW/ton to 0.6 kW/ton, is \$70/ton. This number increases to \$136/ton for variable-speed chillers. Simple payback periods vary from 3 to 11 years.

Increasing the cooling tower's size and efficiency is generally cost effective with a four- to seven-year payback. Annual energy savings are between \$0.01/ft<sup>2</sup> and \$0.04/ft<sup>2</sup>. Incremental costs are between \$0.08/ft<sup>2</sup> and \$0.12/ft<sup>2</sup>, depending upon climate.

## Design Tools

- CoolTools: Chilled Water Plant Design Guide available from Pacific Gas and Electric.
- The use of chillers with various efficiencies can be modeled using DOE-2 and VisualDOE.

## Design Details

### Vibration Isolation

Refer to 1995 ASHRAE Handbook Chapter 43 for recommended chiller and cooling tower vibration isolation.

### Chiller Type

The best choice among electric, gas, and steam chillers (or some combination thereof) is largely site specific. If a reliable source of free or very low cost steam is available on site, then steam absorption makes the most sense.

Gas versus electric or hybrid gas/electric will depend on utility rates. Gas-fired chillers can cost two times more than electrically driven machines and will require a larger cooling tower and condenser water pump. Gas engine chillers are more energy efficient than absorption machines and have high temperature heat readily available for recovery; however, are more maintenance intensive than absorption machines.

Chiller type has a significant impact on the level and quality of noise produced. Historically, rotary screw compressors produce very high levels of noise, which typically contain an annoying tonal component. Centrifugal compressors are usually quieter than screw chillers and do not contain a tonal component. Scroll compressors are the most quiet of the three, but are usually air-cooled. The predominant source of noise from air-cooled scroll compressor chillers is generated by the cooling fans. VSDs can reduce the amount of noise being generated by slowing the flow of refrigerant through the compressor.

The most cost-effective type of electric chiller is primarily a function of chiller size. General decision guidelines are listed in Table .

Table 31 – Recommended Electric Chiller Types

Chiller Size	Recommendation
<= 100 tons	1 <sup>st</sup> choice: reciprocating 2 <sup>nd</sup> choice: scroll 3 <sup>rd</sup> choice: screw
100 – 300 tons	1 <sup>st</sup> choice: screw 2 <sup>nd</sup> choice: scroll 3 <sup>rd</sup> choice: centrifugal
> 300 tons	1 <sup>st</sup> choice: centrifugal 2 <sup>nd</sup> choice: screw

### **Number of Chillers**

As a general rule:

- If the peak chilled water load is less than 300 tons, then a single chiller is usually most economical.
- If the load is greater than 300 tons, use two chillers. This offers better low-load capability and operating efficiency and offers some redundancy should one of the chillers fail.

Having one smaller or pony chiller (as opposed to two or more equally-sized chillers) can improve part-load efficiency of the plant. However, some operators prefer if all the machines are the same size due to familiarity and parts interchangeability.

### **Unloading Mechanism**

Centrifugal chillers typically use inlet vanes to control the chiller output at part-load. Using hot gas bypass as a means to control the chiller at very low loads should be avoided, if at all feasible, as this strategy results in significant energy penalties. Using a VSD instead of inlet vanes allows the compressor to run at lower speed at part-load conditions, thereby reducing the chiller kW/ton more than inlet vanes. The energy savings from a VSD chiller can be quite significant if the chiller operates many hours at low load. To capture the potential savings of VSD chillers, it is important that the condenser water temperature is reset when ambient conditions are below design conditions. This can be accomplished either by using a fixed setpoint (e.g., 70°F) that is below the design condenser water temperature (e.g., 85°F) or using wetbulb reset control, which produces the coldest condenser water the tower is capable of producing at a particular time. A gas engine chiller is also capable of unloading by decreasing engine speed.

### **Chiller Efficiency**

The ratings in Table 32 should be considered as upper bounds. Lower efficiencies are available and are often the lowest lifecycle cost option.

Table 32 – Recommended Chiller Rated Efficiency

Condenser Type	Compressor Type	Min Tons	Max Tons	Recommended kW/Ton	Recommended IPLV	Recommended C.O.P.
Water-Cooled	Scroll	1	80	0.79	0.78	
Water-Cooled	Screw	1	150	0.76	0.70	
Water-Cooled	Screw	151	300	0.72	0.70	
Water-Cooled	Screw	301	& up	0.64	0.61	
Water-Cooled	Reciprocating	1	80	0.84	0.75	
Water-Cooled	Reciprocating	81	& up	0.82	0.75	
Water-Cooled	Gas Engine	501	2000			1.80
Water-Cooled	Absorption (SE)	150	1000			0.65
Water-Cooled	Absorption (DE)	150	1000			1.00
Water-Cooled	Centrifugal	1	150	0.62	0.62	
Water-Cooled	Centrifugal	151	300	0.60	0.61	
Water-Cooled	Centrifugal	301	& up	0.56	0.56	
Air-Cooled	Scroll	1	80	1.25	1.10	
Air-Cooled	Absorption (SE)	1	& up			0.60
Air-Cooled	Screw	1	& up	1.21	1.00	
Air-Cooled	Reciprocating	1	& up	1.15	1.15	
Air-Cooled	Centrifugal	1	& up	1.30	1.30	

### Heat Recovery Chiller

Heat rejected from the condenser of a chiller can be recovered and used to drive a desiccant system or for preheating domestic hot water by routing the condenser water through a double-wall heat exchanger that is either an integral part of a storage tank or is remotely located with a circulation pump to the storage tank. Heat recovery chillers are typically used only for a portion of the total cooling load, because of the need to match hot water load and cooling load and because of the lower efficiency of heat recovery chillers. Heat recovery chillers are not typically piped in parallel with other chillers but rather are either piped for “preferential” loading or in series with other chillers, allowing the cooling load on the heat recovery chiller to be matched to the hot water load. Waste heat can also be recovered from the engine jacket and exhaust of gas engine-driven chillers.

The energy savings from chiller heat recovery are reduced when using economizers (air-side or water-side) because chillers are often not needed when the weather is mild or cold. Chiller heat recovery cannot eliminate the need for a DHW boiler but it can eliminate the need for some of the cooling towers at a site.

### Chiller Staging

For a plant composed of single-speed chillers, control systems should be designed to operate no more chillers than required to meet the load. A plant composed of variable-speed chillers should attempt to keep as many chillers running as possible, provided they are all operating at above approximately 20% to 35% load. For example, for the typical variable-speed chiller plant, it is more efficient to run three chillers at 30% load than to run one chiller at 90% load. The use of hot gas bypass at very low loads should be avoided, if at all feasible, as this strategy results in significant energy penalties.

### Tower Fan Speed Control

Two-speed (1,800 rpm/900 rpm) or variable-speed fan control is always more cost effective than single-speed fan control. For plants with multiple towers or multiple cells, provide two- or variable-speed control on all cells, not just the “lead” cells. The towers are most efficient when all cells are running at low speed rather than some at full speed and some off. For instance, two cells operating at half speed will use about 15% of full power compared to 50% of full power when one cell is on and the other is off.

### **Tower Oversizing**

The tower and fill can be oversized to reduce pressure drop, thereby allowing the fan to be slowed down, which reduces motor power and noise. Tower heat transfer area should be oversized to improve efficiency to at least 60 gpm/hp to 80 gpm/hp at CTI conditions.<sup>5</sup> The energy savings should outweigh the added cost to oversize the tower and to accommodate the larger tower footprint and weight.

A larger tower can also produce cooler water, allowing chillers to run more efficiently. Selecting towers for a 4% or 5% approach will generally be cost effective relative to a more typical 10%. Cooling towers are available with as low as 3% approach temperature, but the tower cost increases as the degree of approach drops. A life-cycle cost analysis should be performed to compare the extra cost to the energy impact on the tower, chiller, and pumps.

### **Tower Performance**

The performance of a cooling tower is a function of the ambient wetbulb temperature, entering water temperature, airflow, and water flow. The drybulb temperature has an insignificant effect on the performance of a cooling tower. “Nominal” cooling tower tons are the capacity based on a 3 gpm flow, 95°F entering water temperature, 85°F leaving water temperature, and 78°F entering wetbulb temperature. For these conditions, the range is 10°F (95°F-85°F) and the approach is 7°F (85°F-78°F).

Table 33 – Cooling Tower Design Considerations

	<b>Energy</b>	<b>Noise</b>	<b>Height</b>	<b>Chiller Fouling</b>	<b>Cost</b>	<b>Application</b>
Packaged Induced Draft, Axial Fan	Lower	Higher	Higher	Higher	Medium	Best for most plants.
Field-Erected Induced Draft, Axial Fan	Lowest	Higher	Higher	Higher	Higher	Very large plants.
Forced Draft, Centrifugal Fan	Higher	Lower	Lower	Higher	Lower	Best if noise or height constrained or large external static pressure (e.g., tower located indoors).
Closed Circuit Evaporative Cooler, Axial Fan	Higher	Higher	Higher	Lower	Highest	Appropriate for heat pumps, not most chillers.
Closed Circuit Evaporative Cooler, Centrifugal Fan	Highest	Lower	Lower	Lower	Highest	Appropriate for heat pumps, not most chillers.
Spray Towers	Lowest	Lowest	Higher	Higher	Lowest	Seldom used due to high maintenance and variable condenser water flow.

### **Operation and Maintenance Issues**

Periodic blow downs and scrubbing of cooling towers must be performed to avoid scaling of internal systems and biological growth. The condition of cooling tower fill is critical to performance. It should be inspected every year and the chemistry of the tower water should be maintained to minimize fouling.

### **Commissioning**

For chillers to operate efficiently, they must be properly commissioned. Part of this process is making sure that sensors (such as chilled water flow, chilled water supply and return temperatures, and chiller electric

<sup>5</sup> Tower efficiency (as defined in ASHRAE Standard 90.1-1999) is the ratio of the maximum tower flow rate (gpm) to the fan motor horsepower (hp) at standard CTI rating conditions (95°F to 85°F at 78°F wetbulb). Standard efficiency is about 35 gpm/hp to 40 gpm/hp efficiency.

demand), are specified and properly calibrated. Sensor data should be permanently stored by the energy management system and easily visualized graphically. Not only is this data valuable for insuring that the design intent is met in the construction process, but also for maintaining energy efficiency over the life of the chiller. For example, by monitoring the approach temperatures in the condenser and evaporator heat exchangers (as the heat exchanger surface becomes fouled, the approach temperature increases), maintenance can be scheduled when needed, as opposed to too often, which wastes maintenance resources, or too infrequently, which wastes energy. A detailed account of commissioning issues specific to chilled water plants can be found in the CoolTools design guide (see the References section below).

### **References/Additional Information**

*CoolTools: Chilled Water Plant Design Guide*. Available from Pacific Gas and Electric, P.O. Box 770000, B32, San Francisco, CA 94177.

*STD-201 (November 1996) Certification Standard for Commercial Water Cooling Towers*. Available from Cooling Tower Institute, Post Office Box 73383, Houston, Texas 77273. Phone: (281) 583-4087.

## GUIDELINE MV23: BOILERS

### Recommendation

Consider medium-to high-efficiency gas-fired boilers or medium efficiency oil-fired boilers for space heating and domestic hot water. If demand is large and variable, install several smaller modular boilers instead of one large unit.

### Description

Boilers are pressure vessels that transfer heat to a fluid. They are constructed of cast-iron, steel, aluminum, or copper. There are two basic types, fire-tube and water-tube. Fire-tube configurations heat water by passing heated combustion gases through conduit that is submerged in the water. This system generally uses natural gas or oil as the combustion fuel. Water-tube configurations pass water in pipes through the heated combustion gases and can use natural gas, oil, coal, wood, or other biomass. The air needed for combustion can be supplied by either mechanical or natural means. Hot water boilers are generally classified as either low temperature (less than 250°F) or high temperature (250°F to 430°F), and are rated by their maximum working pressure. All boiler systems have the following components in common:

- **Fuel supply:** natural gas, oil, wood, or other biomass.
- **Burner:** The burner injects a fuel-air mixture in the combustion chamber.
- **Combustion chamber:** Location in boiler where combustion occurs.
- **Heat exchange tubes:** Tubes within the boiler that contain water for a water-tube model and combustion gases in a fire-tube unit.
- **Stack:** The stack is the chimney through which combustion gases pass into the atmosphere.
- **Hydronic distribution system:** Supplies feed water to the boiler and distributes hot water to the facility.

### Applicability

Applicable in any situation where a significant amount of space heating and/or water heating are required.

The boiler should comply with the American Society of Mechanical Engineers (ASME) Boiler and Pressure Vessel Code. This includes codes regarding suggested maintenance. Stack placement should adhere to ASHRAE 62 standards. Stack emissions must conform to requirements set forth by the Clean Air Act under jurisdiction of the applicable air quality district. The stack will produce transmit vibration and



*This central, high-efficiency boiler supplies hot water to two insulated storage tanks, providing hot water to six baths and a radiant floor heating system. NREL/PIX07925*

### Applicable Climates



### Applicable Spaces

Classrooms  
Library  
Multi-Purpose  
Gym  
Corridors  
Administration  
Toilets  
Other

### When to Consider

Programming  
Schematic  
Design Dev.  
Contract Docs.  
Construction  
Commissioning  
Operation

noise if the stack is not decoupled from the building structure. Ensuring that the stack is isolated from the building structure is particularly important when the stack is close to occupied areas.

### **Integrated Design Implications**

A certain amount of hot service water will always be needed for restroom facilities. Any additional need is dependent upon the choice of space heating system (air or hydronic) and whether or not the building design includes a swimming pool and/or commercial sanitation and food preparation equipment. The actual heating load is dependent upon climate and decisions regarding fenestration, hydronic distribution, building envelope, indoor equipment, and building orientation. The placement of boiler affects requirements of the hydronic distribution system. Try to make these decisions early to create a hydronic distribution layout that minimizes piping materials (pipes, bends, etc.) and head loss.

If a central cooling plant is being considered for the facility, the possibility of using recovered thermal energy should be considered. Using this technique could affect many aspects of design including chiller choice.

### **Cost Effectiveness**

Total installed costs between \$35/kBtuh and \$52/kBtuh, depending on efficiency. Maintenance costs exist, but they will be less in comparison and can save huge future costs.

Costs	L			
	M			
	H			
		L	M	H
		Benefits		

Condensing boilers cost from 30% to 60% more than standard units up to 500 kBtu/hr. Incremental costs for more efficient boilers range from \$0.23/ft<sup>2</sup> to \$0.35/ft<sup>2</sup> depending on climate. The more efficient boilers realize a simple payback period of 5 to 10 years.

### **Benefits**

- Longer life span than standard storage water heaters.
- Can be more efficient than a furnace, but not always.
- Gas boilers burn significantly cleaner than oil-, coal-, and wood-fired units.

### **Design Tools**

The use of boilers with various efficiencies can be modeled using DOE-2 and VisualDOE.

### **Design Details**

- Large systems between 75% and 85% efficient.
- New condensing gas-fired boilers are up to 96% efficient.

Boiler Energy saving add-ons:

- Economizers preheat feed water with energy from stack gases before it goes to the boiler.
- Air preheaters preheat the air that is mixed with the fuel for combustion leaving more energy to heat the water.
- Turbulators increase the convective heat transfer rates in fire-tube boilers by inducing higher levels of turbulence.
- Oxygen trim controls measure and adjust oxygen levels in the inlet air before combustion.
- Boiler reset controls automatically change the high-limit set point based on changes in outdoor temperatures.
- Since boilers are generally most efficient at their rated capacity it is better to have several smaller boilers rather than one large unit that is rarely used at its most efficient setting.



- Condensing boilers produce acidic condensate that is corrosive to some materials such as steel or iron. Make sure to account for proper condensate drainage and follow manufacturers specifications for exhaust flue design if specifying a condensing boiler.
- Refer to 1995 ASHRAE Handbook Chapter 43 for recommended boiler vibration isolation.

### **Operation and Maintenance Issues**

Performing basic operating and maintenance practices on boilers is very important. Regular inspection of boiler system components ensures safe and efficient operation. Proper maintenance can lead to energy savings of 10% to 20%, reduce harmful emissions, and increase the lifespan of the system.

High efficiency boilers (<90% efficiency) need meticulous maintenance to keep them working correctly.

Fire-side maintenance:

- Minimize excess combustion air and monitor stack gas O<sub>2</sub> and CO<sub>2</sub> to ensure proper percentages. Too little air can cause increased CO and particulate emission, while too much can lower efficiency.
- Clean heat transfer surfaces.

Water-side maintenance:

- Perform regular "blow downs" to reduce the level of total dissolved solids (TDS) in the system. High TDS levels cause pipe fouling that reduces the heat transfer rate and increases the pressure drop.
- Insulate boiler walls and piping.

### **Commissioning**

Commissioning should be performed to ensure proper installation and operation. It is particularly important to properly train maintenance operators. The safety and efficiency of a boiler system is highly dependent upon the duties performed by boiler personnel.

### **References/Additional Information**

American Society of Mechanical Engineers. *Boiler and Pressure Vessel Codes*. New York: ASME, 1998.

# GUIDELINE MV24: ADJUSTABLE THERMOSTATS

## Recommendation

Specify thermostats or temperature sensors that will allow classroom teachers control over comfort conditions in their classroom including temperature (within limits) and noise.

## Description

Teachers find it helpful to have control over conditions in their classrooms because different conditions may be appropriate at different times. For example, cooler temperatures may be appropriate after recess or for a more active group. It may be appropriate to turn off mechanical ventilation for certain activities requiring acute hearing or when windows are open. Where an energy management system is not used for temperature control, programmable thermostats can allow implementation of energy-saving and comfort-enhancing measures, but only if programmed and maintained properly. Care should be taken to select a model that is very easy to program. Otherwise, it is likely to be overridden or set for continuous operation.



Adjustable thermostats allow the user to have control over the conditions of the room, which can improve overall comfort and create a better learning environment.

NREL/PIX04899

## Cost Effectiveness

\$50 to \$200 premium for programmable thermostat.

Programmable thermostats are highly cost effective. For a relatively small incremental increase over conventional thermostats, a carefully selected and programmed model will provide teachers with control over their classroom environment while combining time-of-day and override functions. DDC system sensors with adjustable set point have a greater incremental cost impact over plain sensors, but the benefits of giving teachers control should not be underestimated.

## Applicable Climates



### Applicable Spaces

Classrooms	█
Library	█
Multi-Purpose	█
Gym	█
Corridors	█
Administration	█
Toilets	█
Other	█

### When to Consider

Programming	█
Schematic	█
Design Dev.	█
Contract Docs.	█
Construction	█
Commissioning	█
Operation	█

## Benefits

Improved comfort and sense of control may foster a better attitude and teaching environment. Some energy savings may be realized due to stopping mechanical ventilation when windows are open. Service requests may be reduced compared to situations where teachers must request a set point change from operations and maintenance personnel. Programmable thermostats replace time clocks, eliminating associated first and maintenance costs.

Costs	L	█	█	█
	M	█	█	█
	H	█	█	█
		L	M	H
		Benefits		

## Design Tools

None.

## Design Details

- Specify programmable thermostats for control, adjustment, time clock, and override functions when no DDC system will be used for temperature control.

- Sensors with set point control and fan/unit on-off control should be specified for temperature control of classrooms using a DDC system. Also specify limits within which the set point may be varied and the time period after which an overridden value or state will revert to the standard “automatic” (default) value or state.
- If it is necessary to have thermostat covers that lock, provide a means for faculty access.
- Place the thermostat on an interior wall in a location out of direct sun and away from heat sources such as copiers or computers. A point close to the return air or exhaust air inlet is often a good choice.

### ***Operation and Maintenance Issues***

Faculty may require repeated training on programmable thermostat operation. Unlike DDC system temperature sensors with adjustable set point, which can be programmed to revert to standard operation after a specified period, programmable thermostats may allow the HVAC system to be switched off, rather than overridden. This can defeat morning warm-up, resulting in comfort problems and complaints. Specify that simplified one-page instructions be provided by the installing contractor and kept on file at school office with copies distributed to teachers for adjustable sensors or programmable thermostats. Programmable thermostats may require periodic replacement of back-up battery.

### ***Commissioning***

Proper functioning of any thermostat or temperature sensor must be verified prior to acceptance of the installation. Programmable thermostats and temperature sensors with adjustable set points necessitate a slightly more involved verification procedure.

### ***References/Additional Information***

None.

# GUIDELINE MV25: EMS/DDC

## Recommendation

Use a graphic-interfaced, DDC system to integrate multiple components of HVAC and other building systems and manage them from a single (local and/or remote) location.

## Description

Automatic control of multiple pieces of HVAC equipment and other systems may be integrated using computerized systems known variously as DDC, energy management systems (EMS), energy management and control systems (EMCS), building management systems (BMS), or building automation systems (BAS). The added expense and complexity may be justified by the equipment optimization and increased convenience of maintenance possible with such a system.

DDC systems generally perform three functions: equipment on/off control, space temperature control, and equipment status monitoring. A single system can control lighting, security, central plant equipment, and space conditioning equipment. Systems may be specified to allow local override and temperature adjustment at selected space temperature sensors. Graphical user interfaces may be custom configured with different levels of access to allow limited adjustment of schedules and other system parameters by various personnel. While a DDC system will permit the implementation of energy- and cost-saving measures not otherwise possible, the advantages will only be realized if the system is initially programmed correctly and checked periodically by adequately trained personnel.

DDC systems consist of individual controllers that communicate with one another over a network linked by two-conductor cable or other means. Each controller is wired directly to relays, valve and damper motors, and temperature sensors to control and monitor specific equipment. Controllers generally require line voltage power to control panels containing one or more controllers. All other wiring is generally low voltage. The systems may connect directly, via a local-area network (LAN) or modem to a desktop or laptop computer for monitoring and adjustment. A “user-friendly” graphical interface is desired. Systems may be programmed to retain and plot temperature and other status data for performance analysis over limited periods, but retention of historical data requires optional software and additional storage media.

## Applicability

DDC systems may not be appropriate for small schools with very simple HVAC systems. Their applicability increases with the size of the facility, the complexity of the HVAC system, and the size of the district.

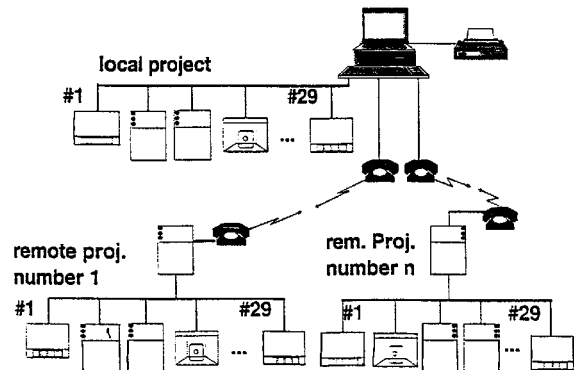

### Applicable Climates



### Applicable Spaces

- Classrooms
- Library
- Multi-Purpose
- Gym
- Corridors
- Administration
- Toilets
- Other

### When to Consider

- Programming
- Schematic
- Design Dev.
- Contract Docs.
- Construction
- Commissioning
- Operation

## Integrated Design Implications

Coordination between mechanical and electrical consultants is necessary for supplying power to a DDC system. If the system is to integrate control of lighting and other building systems, significantly greater coordination will be required. It may also be desirable to have the DDC system use the building (or district-wide, if available) LAN for communications between controllers and with users. These decisions must be made early in the design phase to allow for coordination throughout the design.

## Cost Effectiveness

\$0.50/ft<sup>2</sup> to \$1.50/ft<sup>2</sup>. \$300 to \$500 per input or output “point.” Special operation and maintenance training is required to operate, maintain, and troubleshoot DDC systems. Periodic recalibration of sensors may be required for precise control. Software upgrades are periodically required, and life expectancy of major system components may be as low as 8 to 10 years due to the rapid pace of computer technology development.

Costs	L	■	■	
	M	■	■	
	H	■	■	
		L	M	H
		Benefits		

Cost effectiveness can be very high, with simple paybacks commonly estimated at 4 to 15 years. However, benefits will only be realized when certain conditions are met: the system must be programmed carefully, checked out thoroughly, and maintained actively. If operation and maintenance personnel are not comfortable with the system, it is likely to be bypassed, so good training is critical. Many school districts find that the greatest benefit of a DDC system is as a maintenance tool, allowing remote adjustment and troubleshooting of equipment.

## Benefits

Energy savings may be realized from a DDC system that is correctly installed and actively maintained. Additionally, comfort conditions may be more easily and consistently attainable, and improvements can be made in operation and maintenance resource utilization, through the use of the DDC system for fine tuning, analysis, and trouble shooting.

Peak electric demand savings are possible through load management controls. A DDC system can be programmed to shutoff or reduce power to specific loads during times of high peak demand charges. The savings can be significant, especially if implemented throughout a district.

Comfort improvements and energy savings may be achieved through such features as adaptive optimum start programs that learn when to start morning warm-up to achieve comfort at occupancy time for different operating conditions such as Monday mornings (when the building may have cooled off more than on other mornings).

DDC systems can also offer remote monitoring of system status from a central office and help reduce time spent on maintenance and trouble calls.

DDC systems have the added benefit of eliminating the air compressors required for pneumatic control systems, together with associated maintenance costs, failures, etc.

## Design Tools

Control system manufacturers and their representatives are usually eager to assist with the design process (or take it over, if possible). This resource should be used with care, so as to not overlook the design engineer’s responsibility to specify a well-engineered system. Close attention to the development of operation sequence is always worthwhile. Software is available, both commercially and from control manufacturers, to chart sequences of operation in block diagrams or flow charts.

## Design Details

- Keep controls as simple as possible for a particular function. They will generally be operated (or bypassed) to the lowest level of understanding of any of the operation and maintenance personnel responsible for the HVAC system.
- Rooftop units are often available with optional factory-installed control modules that will interface with the DDC system as an independent “node,” allowing a high level of monitoring and control.

- Discharge air temperature sensors are necessary for troubleshooting, even if not required for control.
- Specify temperature sensors with adjustable set point to give teachers control.
- Specify training. Because operation and maintenance personnel will “inherit” the system, and its performance will ultimately depend on them, involve them as much as possible in design decisions.
- Specify at least a one-year warranty, including all programming changes.
- By specifying the configuration of specific data trend logs (not just the capability to collect them) and their submittal for review and approval at system completion, some system commissioning may be accomplished by the design engineer and/or other owner’s representatives.
- Specify all software necessary for efficient system operation by operation and maintenance personnel to be provided as part of the system installation.
- Local DDC contractors will usually be willing to provide design assistance or even a “complete” design package. Great care should be taken in such collaboration, for it is unlikely that thorough engineering will be applied to the design. The control system should be carefully specified by the design engineer, and details left up to the installing contractor only after careful consideration.
- Control algorithms that may be specified to increase energy efficiency include: optimal start time calculation based on learned building behavior; operation of central equipment based on zone demand, including supply temperature or pressure reset; night purge ventilation to cool building interiors with cool nighttime air in hot climates; heating and cooling system lockouts based on current or predicted outside air temperature; or heating and cooling lockout when windows or doors are opened for natural ventilation (using security system sensor switches).
- Automatic alternation of redundant and lead/lag equipment based on runtime should be accomplished by the DDC system, with provision for operator override.

### ***Operation and Maintenance Issues***

Calibrating critical points is required annually or semi-annually. Alternating redundant or lead/lag equipment for even wear may be triggered automatically or manually. Operation and maintenance requires special training, particularly in the case of software, and consistency with existing systems may be desirable. Permanent software changes should be carefully limited. Periodic checkout is necessary.

### ***Commissioning***

Careful commissioning is critical for the success of DDC system installations, and proper control operation is necessary for proper equipment operation. Since DDC software may be somewhat esoteric, lack of commissioning may mean that this important aspect of the contractor’s work may never be inspected and may never be finished to the desired level. Therefore, it is a very good idea to provide for some commissioning of the control system by an independent party or organization representing the owner’s interests. Submittal and review of contractor’s input and output point verification test documentation should be required. Field calibration of any temperature sensors that must be accurate for proper control is necessary. (Factory calibration is adequate only for non-critical sensors, such as room temperatures with adjustable set points.) One minimal but effective commissioning method is to specify submittal of trend data logs, showing system operation in specified modes, for review by the design engineer. User interfaces including graphics (when specified) should also be reviewed.

### ***References/Additional Information***

None.

# GUIDELINE MV26: DEMAND CONTROLLED VENTILATION

## Recommendation

Specify controls to adjust ventilation rate for spaces with varying occupancy to prevent unnecessary cooling or heating of large quantities of outside air, and insure that adequate ventilation *is* provided when needed.

## Description

Many spaces in schools require high ventilation rates due to dense “design” occupancy, but experience this occupancy level sporadically or occasionally. The outdoor air required may represent a very large heating or cooling load, depending on the season and climate. Therefore, reducing the amount of ventilation during those times the space is partly occupied or unoccupied may save substantial amounts of energy and wear on equipment, but temperature needs to be maintained. This may be accomplished using occupancy sensors or air quality (CO<sub>2</sub> concentration) sensors to control the quantity of ventilation air. This may be done either in conjunction with a DDC system or by independent controls.

## Applicability

For variable air volume, variable airflow with constant volume, multi-zone or small packaged unit zones, occupancy sensors may be applied but must be enabled/disabled to meet any pre-occupancy ventilation requirements. For larger intermittently occupied spaces such as multi-purpose rooms, auditoriums, cafeterias, and gyms, the energy savings may justify the added first cost, maintenance cost, and complexity of a CO<sub>2</sub>-sensing system that modulates the outside air quantity down from the design level when interior air CO<sub>2</sub> levels indicate partial occupancy.

## Cost Effectiveness

Each CO<sub>2</sub> sensor costs approximately \$400. Installation, testing, and adjustment ranges from \$500 to \$1,500 per system. A hand-held CO<sub>2</sub> sensor for calibration costs \$500.

Generally, cost effectiveness for occupancy sensor-based controls will be very high for larger systems. For CO<sub>2</sub> sensor-based control, it will depend on the climate being “severe” enough, and the required ventilation rate being large enough, so that the heating and cooling load reduction saves enough energy costs to offset the first cost of the CO<sub>2</sub> sensing equipment.

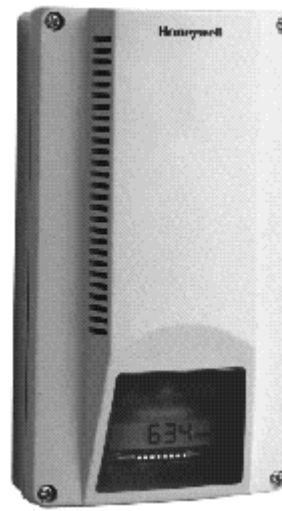

CO<sub>2</sub> sensors help indicate building occupancy levels, allowing for better control of the quantity of ventilation air needed. NREL/PIX 11425

## Applicable Climates



### Applicable Spaces

Classrooms	█
Library	█
Multi-Purpose	█
Gym	█
Corridors	█
Administration	█
Toilets	█
Other	█

### When to Consider

Programming	█
Schematic	█
Design Dev.	█
Contract Docs.	█
Construction	█
Commissioning	█
Operation	█

Costs	L	█	█	█
	M	█	█	█
	H	█	█	█
		L	M	H
		Benefits		

### **Benefits**

- Reduced energy consumption.
- Reduced wear on equipment.
- Confirmed/documented interior air quality.

### **Design Tools**

None.

### **Design Details**

- Demand-controlled ventilation responds to human occupancy only. Other sources of internal pollutants must be addressed with per-area baseline ventilation, targeted ventilation, etc. This should be considered very carefully before applying this type of control, especially to classrooms, where various odor sources may be used. Demand-controlled ventilation always results in worse interior air quality than a properly adjusted system constantly delivering ventilation for rated occupancy.
- CO<sub>2</sub> sensor-based ventilation control uses the measured CO<sub>2</sub> level as an indicator of the current occupancy level, so the ventilation rate may be adjusted accordingly. This is an important difference from using the CO<sub>2</sub> sensor as a direct indication of air quality.
- In areas where outdoor air CO<sub>2</sub> concentration is relatively constant, ventilation may be controlled by a single return air sensor to maintain a fixed CO<sub>2</sub> limit. Otherwise, outdoor and return air sensors should be used.
- The setpoint must be calculated based on occupancy and activity level. For example, the CO<sub>2</sub> concentration for an office space designed at 15 cfm per person (sedentary adult) can be calculated at 700 ppm above ambient.

### **Operation and Maintenance Issues**

Calibration is required.

### **Commissioning**

Review system operation under varying occupancy. Correlate with balance report data for minimum and maximum outdoor air damper positions. Verify acceptable levels of CO<sub>2</sub> concentration in space when occupied using hand-held sensor. Perform all testing in non-economizer mode.

### **References/Additional Information**

American Society of Heating, Refrigerating and Air Conditioning Engineers. *ASHRAE Journal*, April 1997. Interpretation of ventilation standard IC-62-1989-27.

American Society of Heating, Refrigerating and Air Conditioning Engineers. *ASHRAE Standard 62-99*.



# GUIDELINE MV27: CO SENSORS FOR GARAGE EXHAUST FANS

## Recommendation

Use carbon monoxide (CO) sensors to prevent parking garage exhaust fans operating when they are not needed.

## Description

Parking garage ventilation is often provided by an exhaust fan operated during normal occupancy hours. However, the high ventilation rate required when traffic is present need not be maintained most of the time, when no vehicles are operating. Substantial energy savings may be realized by limiting fan operation to only those periods during normal occupancy when CO concentration in the garage rises above acceptable levels. CO concentration-sensor technology has advanced substantially in recent years, reducing cost and improving reliability.

## Applicability

School buildings with enclosed parking garages requiring mechanical ventilation.

## Cost Effectiveness

\$0.20/ft<sup>2</sup> to \$0.40/ft<sup>2</sup> of garage. \$1,000 to \$2,000 per sensor installation.

## Benefits

Benefits include energy savings, wear reduction, and noise reduction.

## Design Tools

None.

## Design Details

- Diesel exhaust does not contain high levels of CO. Consider nitrogen dioxide (NO<sub>2</sub>) sensors if substantial traffic or idling of diesel vehicles is anticipated.
- Include time-of-day control in addition to CO concentration control.
- Sensor coverage area is limited, so multiple sensors may be required.
- Specify calibration tools provided to operation and maintenance personnel at time of training.

## Operation and Maintenance Issues

- Annual calibration of sensors is required.

## Commissioning

- Verify threshold adjustment and function. Also verify training of operation and maintenance personnel, including calibration.



Control strategies, like CO sensors, help reduce energy loads by preventing equipment from operating when not necessary. NREL/PIX 11332

## Applicable Climates



## Applicable Spaces

Classrooms	<input type="checkbox"/>
Library	<input type="checkbox"/>
Multi-Purpose	<input type="checkbox"/>
Gym	<input type="checkbox"/>
Corridors	<input type="checkbox"/>
Administration	<input type="checkbox"/>
Toilets	<input type="checkbox"/>
Other	<input type="checkbox"/>

## When to Consider

Programming	<input type="checkbox"/>		
Schematic	<input type="checkbox"/>		
Design Dev.	<input type="checkbox"/>		
Contract Docs.	<input type="checkbox"/>		
Construction	<input type="checkbox"/>		
Commissioning	<input type="checkbox"/>	<input type="checkbox"/>	<input type="checkbox"/>
Operation	<input type="checkbox"/>	<input type="checkbox"/>	<input type="checkbox"/>
Co	<input type="checkbox"/>	<input type="checkbox"/>	<input type="checkbox"/>
M	<input type="checkbox"/>	<input type="checkbox"/>	<input type="checkbox"/>
H	<input type="checkbox"/>	<input type="checkbox"/>	<input type="checkbox"/>
L M H			
Benefits			

***References/Additional Information***

None.

# GUIDELINE MV28: TIMERS FOR RECIRCULATING HOT WATER SYSTEMS

## Recommendation

Use recirculation timers to control circulation of hot water based on demand. Use separate hot water systems for areas with significantly different demand patterns.

## Description

Recirculating hot water systems connect to the hot water pipe and constantly circulate hot water through the pipes, from the heater to the furthest fixture and then back to the heater, making warm water immediately available upon turning the tap. Large facilities use recirculating hot water systems, which result in heat losses through the distribution piping. Installing timers ensures that hot water circulates only during times of need, which greatly reduces the heat loss through the distribution piping as well as the daily pumping load.

## Applicability

Timers are applicable for large facilities where hot water is recirculated. Timers will work effectively only when the hot water demand for a facility can be predicted accurately, as in the case of classrooms and school administrative areas.

## Cost Effectiveness

Timers are very cost effective and have a two- to five-year payback period.

Prices for recirculating system timers range between \$40 and \$50.

## Benefits

Timers greatly reduce heat losses through distribution piping. Daily pumping loads are also reduced considerably.

## Design Tools

None.

## Design Details

Most schools are ideal candidates for using timers because of the predictability of classroom schedules. Set the system to operate only between classes, just before and after the school day, and during lunch periods.

Administrative areas, locker rooms, and other areas may have a demand schedule different from that of the classroom facility. Separate hot water systems or gas-powered, instantaneous water heaters can be used to accommodate these areas. Avoid using timers for areas with random and intermittent schedules.

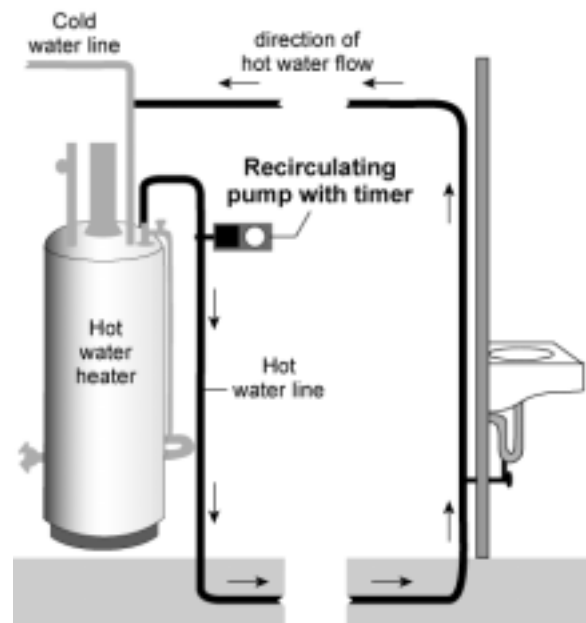

### Applicable Climates



### Applicable Spaces

Classrooms	■
Library	■
Multi-Purpose	■
Gym	■
Corridors	■
Administration	■
Toilets	■
Other	■

### When to Consider

Programming	□
Schematic	□
Design Dev.	□
Contract Docs.	□
Construction	■
Commissioning	■
Operation	■

Costs	L	■	■	
	M	□	□	
	H	□	□	
		L	M	H
		Benefits		

Consider using thermostats connected in series with the timers. The thermostat turns off the pump when the water in the pipes reaches a certain temperature. Once the water in the pipe is hot, the pump turns off. If the timer and thermostatic controls are installed together in series, the circulator operates only at the preset clock times and only when the temperature conditions of the thermostat are met. That is, if either the timer control or the thermostatic control switch is open (off), the circulator will not operate, which results in additional savings.

### ***Operation and Maintenance Issues***

- Adjust the initial timer schedule based on observed or monitored demand data. Schedules may vary from school to school, and it is important to fine-tune the timer settings based on specific demand patterns.
- Check the hot water supply every six months to ensure that the timer is functioning as expected.
- Always set the timer switch to the actual time by turning the programming ring in the direction of the arrow until the timing arrow points to the actual time on the ring.
- In a power outage, the timer will not keep time. After power has been restored, the correct time of day must be reset by rotating the programming ring in the direction of the arrow until the timing arrow points to the actual time on the ring.

### ***Commissioning***

If installing a thermostat along with the timer, ensure that the two devices are installed in series.

After wiring is completed and checked, install the timer control unit onto the terminal box bracket of the pump and reinsert the terminal box screw. Be careful not to bind or leave any terminal box wires exposed.

### ***References/Additional Information***

[http://www.eren.doe.gov/buildings/consumer\\_information/water/waterques.html#13](http://www.eren.doe.gov/buildings/consumer_information/water/waterques.html#13).

# RENEWABLE ENERGY SYSTEMS

This chapter provides guidelines for:

Passive Heating and Cooling (Guideline RE1)

Solar Thermal Hot Water Systems (Guideline RE2)

Solar Pool Heating (Guideline RE3)

Wind (Guideline RE4)

Geothermal Heat Pumps (Guideline RE5)

Photovoltaics (Guideline RE6)

## OVERVIEW

---

This chapter presents guidelines for using renewable energy systems for part of a school's required energy load. As demand on fossil fuel reserves and existing electricity grids increases, a growing number of states are facing energy shortages and skyrocketing utility costs. The problem will continue to worsen as the nation's energy needs are expected to grow by 33% during the next 20 years.<sup>1</sup> Renewable energy can help fill the gap. Renewable energy sources not only release less pollutants into the environment than traditional energy sources, but they save school districts money in the long term while also serving as valuable teaching tools for students and faculty.

### ***Environmentally Friendly Energy Resources***

Renewable energy systems are those that use fuels from renewable resources, including the sun, wind, and the Earth's heat. Renewable energy technologies are often referred to as "clean" or "green" because they produce few, if any, pollutants. Burning fossil fuels, however, sends greenhouse gases into the atmosphere, trapping the sun's heat and contributing to global warming.

Unlike fossil fuels, renewable energy resources are abundant. Every day, more energy falls on the United States than is used in an entire year. The total amount of solar energy per year falling on the conterminous 48 states is 46,700 Quads/year. (A Quad is one quadrillion ( $1.0 \times 10^{15}$ ) British thermal units (Btus). Compare this to 94.2 Quad/year, the U.S. energy consumption rate in 1997.<sup>2</sup>

Wind power is an increasingly common renewable energy source. Good wind areas, which cover 6% of the contiguous U.S. land area, could supply more than 1.5 times the 1993 electricity consumption of the entire country. California now has the largest number of installed turbines. Many turbines are also being installed across the Great Plains, reaching from Montana east to Minnesota and south through

---

<sup>1</sup> [http://www.eren.doe.gov/erec/factsheets/renew\\_energy.html](http://www.eren.doe.gov/erec/factsheets/renew_energy.html).

<sup>2</sup> Ibid.

Texas, to take advantage of its vast wind resource. North Dakota alone has enough wind to supply 36% of the total 1990 electricity consumption of the lower 48 states. Hawaii, Iowa, Minnesota, Oregon, Texas, Washington, Wisconsin, and Wyoming are among states where wind energy use is rapidly increasing.<sup>3</sup>

Geothermal power may be one of the lesser known renewable energy sources, but more than 500 schools nationwide have installed geothermal heat pump systems to provide their heating and cooling needs.<sup>4</sup>

### **Cost-Efficiency**

Over the past two decades, the cost of renewable energy systems has dropped dramatically. Improvements in analytical tools are making passive solar technologies cost effective as well; they can be implemented into schools with less than a two-year return on investment. Wind turbines can produce electricity at less than \$0.04/kWh — a seven-fold reduction in energy cost. Concentrating solar thermal technologies and photovoltaics have dropped more than three-fold during the last 20 years. GSHPs can have a 20% to 50% energy cost savings over traditional heating and cooling systems.<sup>5</sup>

By reducing its dependency on traditional electricity sources, the school will not only save in utility costs, but faces less risk of losing valuable teaching time due to rolling blackouts and power outages.

### **Renewable Energy as a Teaching Tool**

In addition to providing economic and environmental benefits, these renewable energy systems are an important “living laboratory” to teach students about energy technologies of the future. Input from teachers early in the design process ensures that energy features are incorporated in a way that optimizes the learning experience. Buildings that teach offer students an intriguing, interactive way to learn about relevant topics like renewable energy sources.

### **Resources**

The Center for Energy Efficiency and Renewable Technologies. <http://www.cleanpower.org/index.html>

The Renewable Resource Data Center. <http://www.rredc.nrel.gov/>.

U.S. Department of Energy's Energy Information Administration. “U.S. Renewable Energy Consumption.” *Renewable Energy Annual 2000*.  
[http://www.eia.doe.gov/cneaf/solar.renewables/page/rea\\_data/chapter1.html](http://www.eia.doe.gov/cneaf/solar.renewables/page/rea_data/chapter1.html).

U.S. Department of Energy's Energy Efficiency and Renewable Energy Network (EREN) “Renewable Energy: An Overview.” Consumer Energy Information: Erec Fact Sheets.  
[http://www.eren.doe.gov/erec/factsheets/renew\\_energy.html](http://www.eren.doe.gov/erec/factsheets/renew_energy.html).

U.S. Department of Energy's Energy Efficiency and Renewable Energy Network (EREN) “Geothermal Heat Pumps Score High Marks in Schools.” Geothermal Energy Program.  
[http://www.eren.doe.gov/geothermal/ghp\\_schools.html](http://www.eren.doe.gov/geothermal/ghp_schools.html).

---

<sup>3</sup> [http://www.eren.doe.gov/erec/factsheets/renew\\_energy.html](http://www.eren.doe.gov/erec/factsheets/renew_energy.html).

<sup>4</sup> [http://www.eren.doe.gov/geothermal/ghp\\_schools.html](http://www.eren.doe.gov/geothermal/ghp_schools.html).

<sup>5</sup> Ibid.

# GUIDELINE RE1: PASSIVE HEATING AND COOLING

## Recommendation

Increase energy efficiency and comfort in school buildings by incorporating passive solar design.

## Description

Sunlight can provide heat, light, and shade and induce summertime ventilation into the well-designed school. Passive solar design has been used for centuries, but now designers have access to building materials, methods, and software that can improve the design and integration of solar design principles into modern buildings.

## Applicability

Passive solar design strategies vary by building location and regional climate, but the basic techniques remain the same: maximize solar heat gain in the winter and minimize it in summer. For commercial and school buildings, the first priority is to use passive solar design for light.

Reduce the window area on east- and west-facing walls. In northern states such as Montana, also reduce north-facing windows. In most climates, north-facing windows offer good, diffuse light. Daylighting should be mostly achieved through north and south windows. South-facing windows should have a high Solar Heat Gain Coefficient (SHGC) — usually 0.60 or higher — to maximize solar heat gain, a low U-factor (0.35 or less) to minimize thermal loss, and good light transfer. The south windows should also be shaded to avoid summer overheating.

Use more north-facing windows and shade south-facing windows. Shading from overhangs, landscaping, shutters, and solar window screens helps lower heat gain on windows that receive full sun, but window shading design should still maximize daylighting efforts. Cost effective windows for cooling climates have a U-factor below 0.4 and a SHGC below 0.55 (a lower SHGC cuts cooling costs).

## Integrated Design Implications

Passive solar design should be considered using the whole-building approach. Specific techniques include:

- Start by using energy-efficiency design strategies.
- Orient the building with the long axis running east/west.
- Select, orient, and size glass to optimize winter heat gain and minimize summer heat gain for the specific climate. Consider selecting different glazings for different sides of the building (exposures).
- Size south-facing overhangs to shade windows in summer and allow solar gain in winter.



*Passive solar features such as additional glazing, added thermal mass, and larger roof overhangs can pay for themselves. NREL/PIX 10684*

### Applicable Climates



#### Applicable Spaces

- Classrooms
- Library
- Multi-Purpose
- Gym
- Corridors
- Administration
- Toilets
- Other

#### When to Consider

- Programming
- Schematic
- Design Dev.
- Contract Docs.
- Construction
- Commissioning
- Operation

- Direct solar gains may cause problems (hot spots, glare) that will make learning difficult. It may be better to optimize school design for daylighting instead of heating. Trombe walls should be looked at as an alternative to direct solar gains.
- Add thermal mass in walls or floors for heat storage.
- Use natural ventilation to reduce or eliminate cooling needs.
- Use daylighting to provide natural lighting.

### Cost Effectiveness

Passive solar features such as additional glazing, added thermal mass, and larger roof overhangs, or other shading features can pay for themselves. Passive solar design often means less heating and cooling requirements; therefore savings can accrue from reduced HVAC unit size, installation, operation, and maintenance costs. Passive solar design techniques often require higher first costs but are less expensive over the life-cycle costs of the building.

Costs	L			
	M		■	
	H			
		L	M	H
		Benefits		

### Benefits

Passive solar design can reduce heating and cooling energy bills, increase spatial vitality, and increase comfort.

### Design Tools

One of the best ways to design an energy-efficient building incorporating passive solar design techniques is to use a software simulation program. The U.S. Department of Energy sponsors a variety of appropriate software tools including its latest, EnergyPlus. Another tool, Energy-10 is a PC-based design tool that helps identify the best combination of energy-efficiency strategies including daylighting, passive solar heating, and high-efficiency mechanical systems. Another tool to optimize window size and aid in window selection is RESFEN.

### Design Details

Passive solar design integrates several building features to reduce or eliminate the need for mechanical heating and cooling and artificial daylighting. Designers and engineers need to pay particular attention to the sun to reap passive heating, cooling, and daylighting benefits. The design does not need to be complex, but it requires knowledge of solar geometry, window technology, and local climate. Given the proper building site, virtually any architecture can incorporate passive solar design.

Passive solar heating techniques generally fall into one of three categories: direct gain, indirect gain, and isolated gain. *Direct gain* is solar radiation that directly penetrates and is stored in the building space. *Indirect gain* collects, stores, and distributes solar radiation using some storage material (e.g., Trombe wall). Conduction, radiation, or convection then transfers the energy indoors. *Isolated gain* systems (e.g., hallways and atriums) collect solar radiation in an area that can be selectively closed off or exposed to the rest of the building.



### Solar Positioning Considerations

The south side of the school must be oriented to within 15 degrees of due south.



Figure 38 – Solar Positioning Considerations

For passive cooling, consider operable windows to provide an opportunity for natural ventilation in milder temperature months when interior loads on buildings exceed exterior temperatures. Night purging, letting cooler air into the building at night, can reduce HVAC startup loads the next morning. It is also necessary to optimize the building overhangs to reduce the cooling loads that result from unwanted solar gain.

### **Operation and Maintenance Issues**

Passive solar design offers many benefits with minimal maintenance risks over the life of the building.

### **Commissioning**

None.

U.S. Department of Energy-sponsored energy software tools including EnergyPlus, Energy-10, and RESFEN are available at [http://www.eren.doe.gov/buildings/energy\\_tools](http://www.eren.doe.gov/buildings/energy_tools).

Energy Efficiency and Renewable Energy Clearinghouse (EREC) 1-800-DOE-3732 or <http://www.eren.doe.gov/>.

Sustainable Buildings Industry Council, <http://www.sbic.org/>.

Efficient Window Collaborative website, <http://www.efficientwindows.org/>.

## GUIDELINE RE2: SOLAR THERMAL HOT WATER SYSTEMS

### Recommendation

If conditions permit, augment high-efficiency, gas-fired boilers used for space heating and domestic hot water with a solar thermal system and/or recovered thermal energy.

### Description

A solar thermal system can be either direct or indirect and classified as either active or passive. A direct system heats water directly in solar collectors. An indirect system uses a working fluid (usually a glycol-water mixture) in conjunction with a heat exchanger to increase the water temperature. Direct systems contain fewer elements and are less expensive, but they are prone to freezing and cannot be used in all climate zones without drain-back systems. Indirect systems use an antifreeze mixture and can be used in any climate zone. Active and passive refers to the method by which fluid reaches the collector. If the fluid moves through natural convection, the system is termed passive, and if pumps are used, it is active. Solar thermal systems consist of the following elements:

- **Solar radiation collector:** Collects solar radiation for heating.
- **Heat exchanger:** A heat exchanger is used in an indirect system to pass heat from the working fluid to the water supply.
- **Hydronic distribution system:** Supplies water to the collector for direct systems and to the facility for both direct and indirect systems.
- **Storage tank:** Stores heated water for facility use or for boiler feed water supply.



*Solar thermal hot water systems are applicable to any situation where a significant amount of space heating and/or water heating are required. NREL/PIX05183*

### Applicable Climates

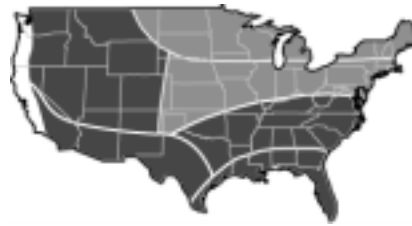

### Applicable Spaces

Classrooms  
Library  
Multi-Purpose  
Gym  
Corridors  
Administration  
Toilets  
Other

### When to Consider

Programming  
Schematic  
Design Dev.  
Contract Docs.  
Construction  
Commissioning  
Operation

### Applicability

Applicable in any situation where a significant amount of space heating and/or water heating are required. A solar thermal water heating system has the potential to be the main hot water source in some situations. For example, an elementary school in the desert could easily meet most of its hot water needs through solar energy utilization. In most areas it could at least augment the boiler system.

### Integrated Design Implications

A radiant slab heating system works extremely well with solar thermal water heating. Solar thermal systems can generally achieve the low inlet temperatures (90°F to 120°F) required by a radiant slab system.

Because the performance of a solar thermal system is dependent upon the weather, it works best when used in conjunction with another heating system. Depending upon the situation, the solar system can be

the primary heat source or can be used to augment and increase the efficiency of a boiler system. The increased efficiency is accomplished by preheating boiler feed water with solar thermal energy.

The use of a solar thermal system must be addressed early in the planning stages, as its viability is highly dependent upon available roof space and building orientation. It is also important to plan the placement of any other roof systems to avoid shading by packaged HVAC systems, stacks, walls, etc.

### Cost Effectiveness

Initial costs are higher than that for a boiler system. Most systems cost between \$30/ft<sup>2</sup> and \$90/ft<sup>2</sup> of collector area. Maintenance costs are low and fuel expenses are zero.

Costs	L			
	M			■
	H			■
		L	M	H
		Benefits		

The initial cost for solar thermal systems is somewhat more than boilers. However, the fuel is free and thus the system will eventually pay for itself. For a slab system, it may be the more cost-effective option since it is heating to its maximum while a boiler would need to be run at a lower, less efficient setting. The cost effectiveness of a solar system varies from site to site, as the payback period is dependent upon climate and available solar radiation. Solar thermal systems will be most cost effective in schools with substantial summer occupancy as this is the time of greatest available solar radiation.

### Benefits

- Free fuel.
- No worry about changing fuel prices.
- Non-polluting. No fumes means healthier for students and teachers. No operational greenhouse gas emissions
- Great for teaching. The system itself can be a topic in science classes.

### Design Tools

- The Transient System Simulation Program (TRNSYS), developed by the University of Wisconsin-Madison Solar Energy Laboratory is capable of modeling entire solar water heating systems.
- The National Renewable Energy Laboratory has extensive data regarding annual totals of solar radiation for different cities.
- *Solar Engineering of Thermal Processes* by John Duffie and William Beckman is a great resource for solar energy applications.

### Design Details

System requires a differential thermostat to ensure heat is not being dumped to the collectors. The most important element of a solar thermal system is the solar collector. Solar collectors can be either fixed or track the sun. The latter is generally more expensive and is saved for high-temperature applications. Fixed collectors should be oriented facing south and tilted based on seasonal load. A good rule of thumb is to use the location's latitude as the tilt angle with respect to the horizontal.

- Flat-plate collectors consist of a metal frame box containing a layer of edge and backing insulation, an absorber plate with parallel piping, and glazing. The absorber plate is generally constructed of copper or aluminum with a high-absorbance coating. The glazing layer reduces convective and radiation heat loss and involves one or more sheets of glass. Solar thermal systems with flat-plate collectors are very common.
- Integral Collector Storage (ICS) systems use the storage tanks themselves as solar collectors. The tanks are painted black and are set on the roof alone or in insulating boxes with transparent covers angled south. ICS systems are applicable only in mild climates, as freezing and significant heat loss become issues in colder regions. This system is very simple and cost-effective.

- The evacuated tube collector is a long, thin version of a flat-plate collector where the box has been replaced by a glass tube and the insulation by a vacuum. These collectors are extremely efficient but are fragile and expensive.
- Concentrating collectors use a curved surface to reflect and concentrate the solar radiation onto a pipe containing fluid. These collectors are generally used for high-temperature applications and almost always configured to track the movement of the sun.

### **Operation and Maintenance Issues**

- Collector glass should be cleaned regularly to ensure maximum efficiency.
- Direct systems must be drained when freezing conditions exist.
- Roof-integrated systems should be designed to allow easy removal when roof replacement is required.

### **Commissioning**

Commissioning is important for solar thermal systems because the general contractor may not be familiar with them. Solar systems must be considered whenever rooftop decisions are made. The efficiency of the system is wholly dependent upon collector orientation and minimizing shading. It is important to have a solar expert on hand whenever the system is being considered, even for such things as storing collectors before installation. (Some collectors can be damaged if stored in the sun without fluid passing through them.)

### **References/Additional Information**

*ASHRAE Handbook: HVAC Applications*, 2000.

*ASHRAE Handbook: HVAC System and Equipment*, 2000.

Beckman, J.A. and Beckman, W.A. *Solar Engineering of Thermal Processes*. New York: Wiley-Interscience, 1991.

Energy Efficiency and Renewable Energy Network. <http://www.eren.doe.gov/>.

Federal Energy Management Program. <http://www.eren.doe.gov/femp/>.

Solar Engineering Laboratory. University of Wisconsin-Madison, 1500 Engineering Drive, Madison, WI 53706. Phone: (608) 263-1589. Fax: (608) 262-8464. Email: [trnsys@sel.me.wisc.edu](mailto:trnsys@sel.me.wisc.edu). Web site: <http://www.sel.me.wisc.edu/trnsys>.

## GUIDELINE RE3: SOLAR POOL HEATING

### Recommendation

Use solar heaters for swimming pools as an environmentally friendly and cost-effective solution to pool heating requirements.

### Description

Most solar pool heating systems consist of three basic components: a collector, a pump, and a controller. Unlike domestic solar water heating systems, which raise a small amount of water to a high temperature of about 140°F, pool heaters raise the temperature of several thousand gallons of water to about 80°F by circulating the water at a relatively fast rate through the collectors. This circulation allows most of the solar energy falling on the collectors to transfer to the pool water.

The collector consists of a large area of pipes that absorb solar energy in the form of heat. They are made from plastic or rubber compounds that can withstand continuous exposure to sunlight. The collector is positioned for maximum access to sunlight. The pump circulates water through the collector to continually absorb heat. The hot water is then pumped back into the pool. This pump may be separate (especially in retrofit situations) from the regular pool pump that circulates pool water through a filter. The pump is automatically switched off when the temperatures of the water in the pool and the collector approach each other. The controller regulates the flow of water within the collector based on the temperature of the outgoing water using a diverting valve, the only moving part in a solar pool heating system. This valve controls whether or not the water circulates through the collector loop. When the collector temperature is sufficiently greater than the pool temperature, the water is diverted from the filter systems through the collector loop. The water bypasses the solar collectors during nighttime or cloudy periods. Some smaller systems are operated manually or with timers, but larger systems may be operated through electronic sensors.

Strip, panel, and tube systems are the three major types of solar collectors available. All three perform to a more or less equal standard, although strip systems are the most commonly used type.

### Applicability

Solar heating for swimming pools is feasible for all climate types, even those that experience sub-freezing temperatures. Waterways on strip systems can expand to accommodate the increased volume of frozen water.

Most sloping roofs can be fitted with solar collectors. Relatively lightweight strip systems are suitable for sloping roofs. Strip collectors can be fitted to follow the roof contours and can be curved around



*A solar heating system requires very little or no maintenance since it has no burners or moving parts. NREL/PIX08590*

### Applicable Climates



#### Applicable Spaces

Classrooms	<input type="checkbox"/>
Library	<input type="checkbox"/>
Multi-Purpose	<input type="checkbox"/>
Gym	<input type="checkbox"/>
Corridors	<input type="checkbox"/>
Administration	<input type="checkbox"/>
Toilets	<input type="checkbox"/>
Other	<input type="checkbox"/>

#### When to Consider

Programming	<input type="checkbox"/>
Schematic	<input type="checkbox"/>
Design Dev.	<input type="checkbox"/>
Contract Docs.	<input type="checkbox"/>
Construction	<input type="checkbox"/>
Commissioning	<input type="checkbox"/>
Operation	<input type="checkbox"/>

obstructions, such as chimneys and skylights. Panel collectors are limited by their rigid sheet design and can be applied to flat or plane roofs only.

### **Integrated Design Implications**

Although solar heated swimming pools can easily be accommodated later in the design or construction phases, the following issues should be considered beforehand:

- **Building aesthetics.** Installing solar collectors on rooftops may conflict with building aesthetics. Consider placement and orientation of the collectors early in the design phase to avoid this conflict.
- **Space availability.** Solar collectors may occupy an area equivalent to 75% of the pool’s surface area. This roof area must be available near the location of the swimming pool for unobstructed access to sunlight (although it’s possible to mount the collectors at ground level).

### **Cost Effectiveness**

Collectors made of copper are more expensive than those made of plastic, although they last longer. Plastic collectors are less conductive than copper, but are inert to chemicals and have about a 10-year lifespan. On an average, solar heating systems for pools cost around \$7.50/ft<sup>2</sup> to \$10/ft<sup>2</sup> (installed). An unglazed solar heating system for an average 600-ft<sup>2</sup> pool, including separate pump and automatic controller, costs around \$4,500 fully installed. The operating energy is practically free, as all the heating energy is solar.

Costs	L			
	M			
	H			
		L	M	H
		Benefits		

Pool covers for an average size 600 ft<sup>2</sup>-pool costs around \$400 to \$500 (not including the roller, which has a starting cost of around \$300). Using the above figures for the cost of running a gas heater, heating the pool with solar energy can save from 3.8 tons to 5.1 tons of greenhouse gas emissions (CO<sub>2</sub>) per year.

### **Benefits**

- Since solar pool heating collectors operate just slightly above the ambient air temperature (80°F), such systems typically use inexpensive, unglazed, low-temperature collectors made from especially formulated plastic materials.
- The alternative system — a gas pool heater — has a starting price of around \$2,000, plus additional heating costs varying from \$600 to \$900 per year. The solar heating system will therefore repay the extra cost in less than three to four years, and will have much lower running costs thereafter.
- A solar heating system requires very little or no maintenance since it has no burners or moving parts. A gas heater or heat pump requires far more maintenance and typically lasts only one-third the life span of a solar system.
- Solar heating systems' warranties are typically more inclusive and much longer (12 to 15 years) than warranties for gas heaters (five years) and heat pumps (typically 10 years).
- A good solar pool heating system can generally be expected to increase pool water temperature by 9°F to 18°F above the unheated water temperature from October through March. However, temperatures will vary depending on local climate conditions. The graphs below show the temperature differences claimed by one manufacturer in two climate extremes.
- Attic insulation gets saturated with radiant heat from roof decks that increases air conditioning bills. Collectors mounted on the roof will considerably lower air conditioning costs for that space.

Table 34 – Cost comparison for gas and solar pool heaters in a heating-dominated climate

Gas Pool Heater	Solar Pool Heater
Initial cost \$2,400	Initial cost \$3,495
Five year operating cost \$6,000	Five year operating cost \$0
Total five year cost \$8,400	Total five year cost \$3,495

### Design Tools

Use the following simplified algorithm for arriving at the required collector area:

$$A = A_p \times O \times S \times \text{Sol}_{\text{ins}}$$

where,

- A = Area of solar collector, ft<sup>2</sup>
- A<sub>p</sub> = Effective area of pool (multiply the surface area of the pool with the shape multiplier from Table below), ft<sup>2</sup>
- O = Orientation multiplier (from Table below)
- S = Shading multiplier (from Table below)
- Sol<sub>ins</sub> = Solar insolation (from the figure below)

Table 35 – Shape Multiplier

Shape	Multiplier
Rectangle	1.00
Kidney/Freeform	0.85
Oval	0.90
Round	0.79

Table 36 – Orientation Multiplier

Orientation	Multiplier
South facing	1.00
East or west facing	1.25
Flat	1.10

Table 37 – Shading Multiplier

Shading (from 9 a.m. to 5 p.m.)	Multiplier
No shade	1.00
25% shade	1.10
50% shade	1.25
75% shade	1.50
100% shade	1.75

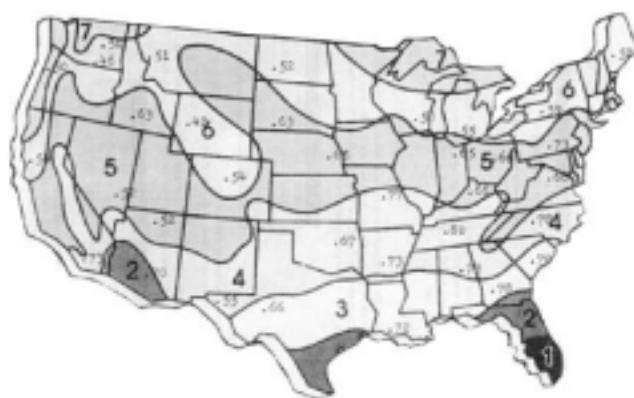

Figure 39 – Solar Insolation Levels in the United States

Free software is available from U.S. Department of Energy to analyze current energy consumption and project savings when implementing a variety of energy management systems from pool covers to solar systems. The *Energy Smart Pools* software uses hourly temperature and humidity data along with solar data to provide an accurate simulation of the heat losses and gains of a pool. Over 50 U.S. weather sites are currently available in the software. The program is intended to provide annualized simulation of

annual energy costs, other costs, savings, and payback of adding a pool cover system, as well as costs, savings, and payback of adding a solar heating system.

### **Design Details**

As in all solar heating, the primary factor in determining the effectiveness of the system is exposure to the sun. The size and the location of the collector, controller efficiency, local climate, wind protection, and roof orientation all influence the functioning of solar pool heating systems.

- Use a minimum collector area that is 60% of the pool's surface area. This applies only for ideal conditions (see the Design Tools section for simplified sizing). Whenever conditions are unfavorable, for example in colder climates, the size of the collector will need to be increased, with a minimum area of 80% recommended for such installations. Increase collector area to 75% of the pool surface area if collectors are laid flat or if collectors face west. Other orientations are not recommended. In general, for every 20% of the pool surface area that is installed as solar collector, a 3°F rise in water temperature can be expected (based on collector rating at 1,000 Btu/ft<sup>2</sup> of collector area).
- A south-facing roof is the best location for these systems. Use a west orientation or a flat roof if south orientation is unavailable.
- Ideally, tilt the south-facing collectors by 30° to 32°.
- Consider installing pool covers. They are the most cost effective measure for reducing heat loss, water evaporation, and chemical use.
- Manual operation or a simple timer may be substituted for expensive automatic controls.
- Indoor pools that are used year round require glazed flat plate collectors, which should slope between 35° and 45°.

### **Operation and Maintenance Issues**

Ensure that pools are manually and seasonally drained. In areas subject to winter freezing, the collectors and plumbing should be installed to allow all water to drain when the system is off.

Paint all exposed PVC plumbing to protect it from damage due to solar energy.

### **Commissioning**

Carefully check how long the manufacturer has been in business and what warranty services are available. Use the Florida Solar Energy Center rating system (see References for more information).

### **References/Additional Information**

American Solar Energy Society, Inc. (ASES). 2400 Central Avenue, G-1, Boulder, CO 80301. Phone: (303) 443-3130; Fax: (303) 443-3212, Email: [ases@ases.org](mailto:ases@ases.org). Web site: <http://www.ases.org>.

National Spa & Pool Institute (NSPI). Phone: (800) 323-3996. Web site: <http://www.nspi.org/>.

The Energy Efficiency and Renewable Energy Clearinghouse (EREC).. P.O. Box 3048, Merrifield, VA 22116. Phone: (800) DOE-EREC (800-363-3732). Email: [doe.erec@nciinc.com](mailto:doe.erec@nciinc.com). Florida Solar Energy Center. 1679 Clearlake Rd., Cocoa, FL 32922. Phone: (407) 638-1000, Fax: (407) 638-1010, Pamphlets available by mail - call for costs, Collector Thermal Performance Ratings (publication FSEC-GP-16), Design and Installation Manual (publication FSEC-IN-21-82), System Sizing (publication FSEC GP-13). Web site: <http://www.eren.doe.gov/consumerinfo>.

Solar Energy Industries Association (SEIA). 1616 H Street, NW, 8th Floor, Washington, DC 20006. Phone: (202) 628-7979, Fax: (202) 628-7779. <http://www.seia.org/>.



## GUIDELINE RE4: WIND

### Recommendation

Small wind electric systems may be an option to provide some of the required electrical load from renewable energy for some schools.

### Description

Wind is created by unequal heating of the Earth's surface by the sun. Wind turbines convert the kinetic energy in wind into mechanical energy that powers a generator to produce clean electricity. Turbine blades are aerodynamically designed to capture the maximum energy from the wind. The wind turns the blades, which then spin a shaft connected to a generator that makes electricity.



*Reducing energy consumption at the school before selecting a small electric wind system will significantly lower energy bills and the size of system needed.*

NREL/PIX 09043

### Applicability

A small wind electric system may be an appropriate technology to provide renewable power to a school if the following conditions are met:

- There is enough wind where the school is located (usually average wind speeds of 14 mph or greater are needed for cost effectiveness).
- Tall towers are allowed in the area.
- Enough space exists on the site.
- It makes financial sense for the school.

### Applicable Climates



### Integrated Design Implications

Before selecting a small electric wind system for the school, first make the building as energy efficient as possible. Reducing energy consumption will significantly lower the school's energy bills and will reduce the size of the wind energy system needed.

#### Applicable Spaces

Classrooms	
Library	
Multi-Purpose	
Gym	
Corridors	
Administration	
Toilets	
Other	

#### When to Consider

Programming	
Schematic	
Design Dev.	
Contract Docs.	
Construction	
Commissioning	
Operation	

### Cost Effectiveness

A small wind turbine can cost anywhere from \$3,000 to \$35,000 installed, depending on size, application, and service agreements with the manufacturer. A general rule of thumb for estimating the size of a small wind system is \$1,000/kW to \$3,000/kW. Wind energy becomes more cost effective as the size of the turbine's rotor increases. Although smaller turbines cost less in initial outlay, they are proportionally more expensive.

Costs	L			
	M			
	H			
		L	M	H
		Benefits		

Although wind energy systems involve a significant investment, they can be competitive with conventional energy sources when accounting for a lifetime of reduced or avoided utility costs. The length of the payback period depends on the system chosen, available wind resources, electricity costs, and how the wind system is utilized.

## Benefits

Depending on the wind resource, a small wind electric system can lower electricity bills by 50% to 90%, prevent power interruptions, and is non-polluting. A wind energy system can also be a good teaching tool.

The economics are best when:

- There is a good wind resource (greater than 14 mph average annual wind speed at the hub).
- There is net billing with 50 kW cap or higher, preferably annual over monthly netting period.
- Electric rates are above average (\$0.08/kWh or greater).
- Large kWh usage allows larger wind turbines, which improves payback due to economies of scale.

## When Does Installing a Wind Turbine Make Sense?

- When adequate wind exists at school location.
- When the site has acceptable space.
- When the state has policies that encourage renewable energy:
  - A good net billing law
  - Loan funds
  - Income tax credits
  - Buy down program
  - Property tax abatement
- When electric rates are above average (typically \$0.08/kWh or more).
- Single part rate is more favorable than two part rate (demand and energy charges).

## Design Tools

The formula for calculating the power from a wind turbine is:

$$\text{Power} = C_p 1/2 \rho A V^3$$

where :

$C_p$  = Power coefficient, ranging from 0.2 – 0.4, dimensionless (theoretical max = 0.59)

$\rho$  = air density, lb/ft<sup>3</sup>

$A$  = rotor swept area, or  $\pi D^2/4$  ( $D$  is the rotor diameter in feet,  $\pi = 3.1416$ )

$V$  = wind speed, mph.

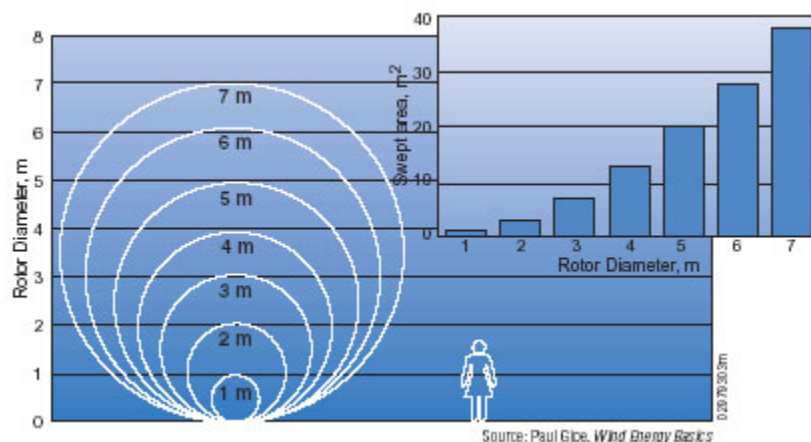

Figure 40 – Relative Size of Small Wind Turbines

The figure above shows the actual size of rotor diameters in relation to the size of an average person. This can help when examining the view of the turbine on a landscape.

The Wind Energy Design Payback Period Workbook, found at <http://www.nrel.gov/wind> under consumer information, is a spreadsheet tool that can help analyze the economics of small wind electric systems.

### Design Details

Mounting turbines on rooftops is not recommended. All wind turbines vibrate and transmit the vibration to the structure on which they are mounted. This can lead to noise and structural problems with the building.

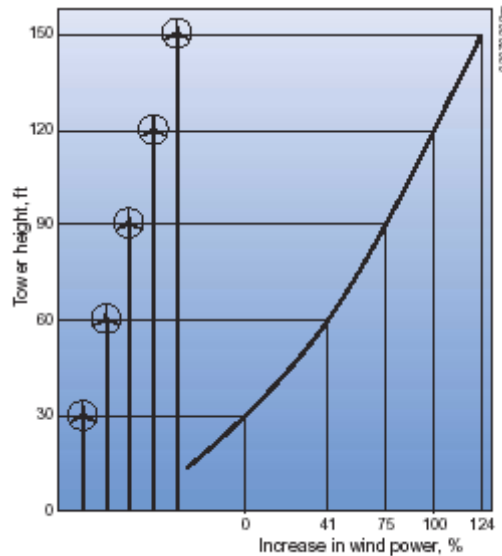

Figure 41 – Wind Speeds Increase with Height

Average wind speeds increase with height and may be 15% to 25% greater at a typical wind turbine hub height of 80 ft than at a typical airport anemometer height. As  $V^3$  increases, power increases by approximately 60%.

### Operation and Maintenance Issues

Although small wind turbines are sturdy machines, they do require some annual maintenance. Bolts and electrical connections should be checked and tightened. The machines should be checked for corrosion and the guy wires for proper tension. After 10 years, the blades or bearings may need to be replaced, but with proper installation and maintenance, the turbine should last 20 years or more.

Tilt-down towers provide easy maintenance for turbines.

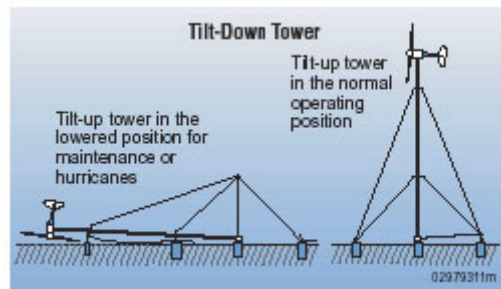

Figure 42 – Tilt-Down Towers

### Commissioning

None.

## References/Additional Information

Wind turbine manufacturers and dealers should be able to help size and install the system. A credible installer will provide many services, including permitting. State energy offices or local utilities can provide a list of local wind system installers.

More detailed wind resource information, including the *Wind Energy Resource Atlas of the United States*, published by the U.S. Department of Energy can be obtained at the National Wind Technology Center website at: <http://www.nrel.gov/wind> and the Windpowering America website at <http://www.eren.doe.gov/windpoweringamerica>. These sites also contain information on educational curriculum for teachers and students.

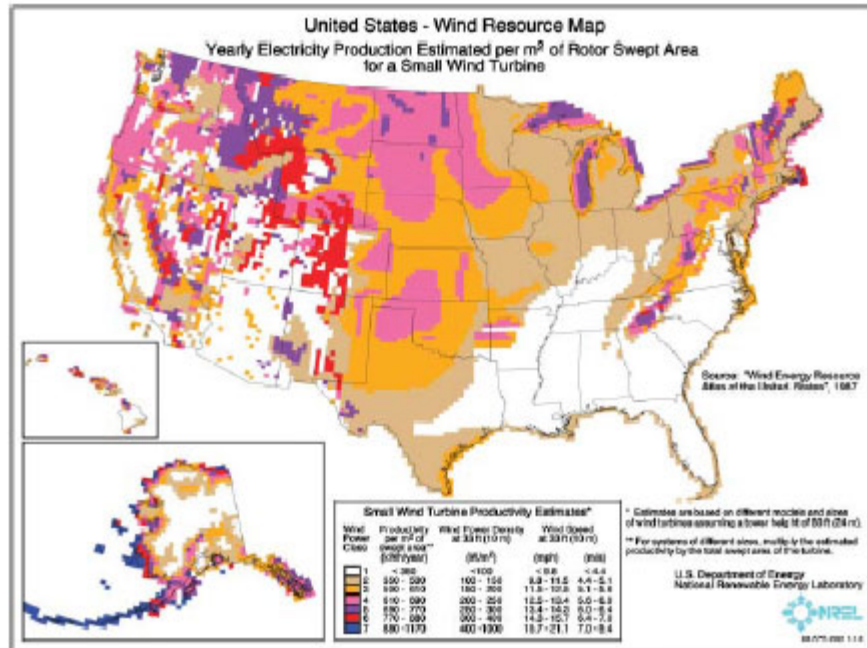

Figure 43 – Wind Resource Map

## GUIDELINE RE5: GEOTHERMAL HEAT PUMPS

### Recommendation

Consider ground source heat pump (GSHP) systems in locations with considerable heating and/or cooling loads, or when heating fuel is expensive.

### Description

GSHP systems are known by many names, including geothermal, earth-coupled, geexchange, water-coupled, groundwater, ground-coupled, closed-loop, coiled, open- and water-source heat pump systems.

GSHP systems use a refrigeration cycle to extract and transfer heat. A ground source heat pump uses the earth as a source of heat in the winter and as a tool for heat removal from the building space in the summer.

GSHP systems can be grouped into two types: closed-loop and open systems, such as standing wells. The selection of the type of system depends on many factors, including the availability of groundwater and surface water, soil type, energy requirements, size of lot, and the experience of the designer and contractor.

An open-loop system takes water directly from a well, a lake, a stream, or other source, then filters it and passes it directly through the condenser loop of the heat pump system. When in a cooling mode, the water is warmed; and in a heating mode the water is cooled. The heated or cooled water is then released into another well or stream. Open systems are not permitted in most areas.

The closed-loop systems circulate a fluid (usually an antifreeze solution) through a subsurface loop of pipe to a heat pump. The system uses a subsurface loop and a refrigerant loop. The subsurface loop typically consists of polyethylene pipe, which is placed horizontally in a trench or vertically in a bore hole. This thin-walled pipe is a heat exchanger, transferring heat to and from the earth. Fluids inside the pipe circulate to the heat exchanger of an indoor heat pump where they exchange heat with the refrigerant. The refrigerant loop typically consists of copper pipes that contain a refrigerant.



*Geothermal heat pump systems reduce peak energy demand and reduce the heat island effect, since waste heat is returned to the ground instead of the outside air.*  
NREL/PIX 07191

### Applicable Climates



### Applicable Spaces

Classrooms	<input type="checkbox"/>
Library	<input type="checkbox"/>
Multi-Purpose / Gym	<input type="checkbox"/>
Corridors	<input type="checkbox"/>
Administration	<input type="checkbox"/>
Toilets	<input type="checkbox"/>
Other	<input type="checkbox"/>

### When to Consider

Programming	<input type="checkbox"/>
Schematic	<input checked="" type="checkbox"/>
Design Dev.	<input type="checkbox"/>
Contract Docs.	<input type="checkbox"/>
Construction	<input type="checkbox"/>
Commissioning	<input type="checkbox"/>
Operation	<input type="checkbox"/>

### Applicability

These systems are applicable to all interior school spaces, including classrooms and administration facilities. The systems can also be used to heat water for the facility.

### Integrated Design Implications

With a good design that includes elements like daylighting, thermal mass, and photovoltaic systems, GSHP systems can help a building become a “net-zero” facility, where all energy needs are supported on-site.

## Cost Effectiveness

Large systems tend to have first costs that are similar, or slightly higher, to other high-quality HVAC systems with conventional energy sources. However, when compared to traditional HVAC systems, the energy savings offset the initial higher cost. GSHP systems can have 20% to 50% energy cost savings over conventional systems, with maintenance savings of approximately 30%.

Costs	L			
	M		■	
	H			
		L	M	H
		Benefits		

Also, the payback period for the GSHP systems generally falls between 5 to 10 years. Some utilities offer incentives that make the systems more affordable.

## Benefits

Energy use and fossil-fuel consumption in GSHP systems is reduced by 40% to 70% compared to systems that use air instead of the Earth to provide temperature control. Water consumption is also reduced since no cooling towers or water-cooled condensers are needed.

The systems reduce peak energy demand and reduce the heat island effect, since waste heat is returned to the ground, not the outside air.

The seasonal energy efficiency ratio (SEER) compares rejected heat to energy consumed to rate cooling efficiency. Higher numbers indicate more efficiency; values greater than eight are preferred. According to the Pennsylvania Ground Source Heat Pump Manual, advanced GSHPs are reaching SEER values of greater than 17.

Waste heat from the system can be used to heat water when the system is cooling the building.

Systems can be designed to use multiple heat pumps with dual-speed controls to improve part-load performance. Teachers can control the temperature in each classroom. Also, facilities staff can shut off unused zones during peak demand periods while allowing critical zones to operate normally without any decreased performance.

Since piping and pumps are buried or enclosed in the building, damage caused by inclement weather, insects, and vandalism can be greatly reduced.

Systems promote better aesthetics since no equipment needs to be placed on rooftops or outside the building envelope. They can be used with sloped roofs and work well with historic buildings, since the equipment is easily hidden from view.

## Design Tools

Design tools available for GSHP systems include:

- HEATMAP© Geo, Washington State University Energy Program.
- GchpCalc Design Software for vertical ground-coupled heat pump systems design for commercial and institutional buildings, Version 3.1, Energy Information Services, Tuscaloosa, AL.
- Cycle Analysis Software Tool, National Renewable Energy Laboratory.
- Geocrack2D, Kansas State University.
- GEOCALC, Design Software, developed by Ferris State University, released by Thermal Works Software, Grand Rapids, Michigan.
- Wright Soft Geothermal Heat Pump Software, Lexington, MA.
- GL/GW-Source, Design Software, Kansas Electric Utilities Research Program.
- Geothermal Heat Pump Pipe and Fitting Program, Geothermal Heat Pump Consortium.
- Energy-Smart Choice for Schools, HVAC comparison tool, Geothermal Heat Pump Consortium.
- BuilderGuide, National Renewable Energy Laboratory, Golden, CO.

## **Design Details**

In addition to the details below, it is recommended that the standards established by the International Ground Source Heat Pump Association (IGSHPA) for GSHP systems be followed.

### ***Closed-loop systems***

The heat transfer between the loop and the surrounding soil or rock depends on thermal conductivity, which is an important consideration when designing closed-loop systems. Consult a geological expert to evaluate the soil conditions at the site.

Non-toxic, biodegradable circulating fluids, such as food-grade propylene glycol or potassium acetate, are recommended for use in GSHP systems.

Loops should be at least 25 ft from any septic systems.

Configuration of subsurface loops can be almost any shape, including long trenches, parallel shorter trenches, radiating, coiled, and vertical borings.

Backfilling or grouting must be done at the end of the installation process to help provide good thermal contact and to protect the pipes.

### ***Open ground systems***

For standing column wells, the largest quantities of water will be produced during the coldest part of the winter, so the system must be sized to accommodate such a volume as well as handle extreme temperatures.

Selecting the appropriate groundwater pump size is important for open systems. The pump must be large enough to overcome the friction in the piping and to supply enough water for the heat pump and other uses. However, the pump must be small enough to be efficient in energy usage.

Subsurface disposal and recycling of water in a standing column well conserves groundwater and limits environmental problems.

At least 100 ft should separate wells from contamination sources such as septic tanks and livestock pens. Landfills should be separated by an even greater distance.

Acceptable drilling methods for wells include rotary, cable tool, and auger. The driller's method should be environmentally sound and prevent the introduction of any contamination.

Casing should be used when necessary to prevent collapse of the hole and the migration of surface pollutants into the drill hole.

Grout should be placed in the entire annular space between the surface casing and the drill hole.

## **Operation and Maintenance Issues**

GSHP systems require little maintenance aside from regular cleanings of heat exchanger coils and strainers that filter the ground water, as well as regular air filter changes. These systems generally have an expected 25- to 30-year life cycle.

If a closed system is properly designed and installed, soil-freezing conditions do not create any system problems. At a soil temperature of 30°F, latent heat moisture in the soil adds considerably to the capacity of the system, allowing for very successful performance in northern climates.

However, aging, poorly installed, or improperly operated GSHP systems have a greater risk for system failure.

## Commissioning

### **Closed loop**

Flushing the loops will help to ensure the system is in good operating order. This process consists of debris flushing, air purging, pressure testing, and final charging of the system with antifreeze.

Also, the system “heat of extraction” and/or “heat of rejection” needs to be calculated, which can be done by non-technical staff using a probe thermometer and a probe pressure gauge. By measuring the temperature and pressure across the source heat exchanger and performing some basic calculations, the operating capacity of the system is determined. This capacity value is then compared with the manufacturer’s printed capacity value.

## References/Additional Information

- American Society of Heating, Refrigerating and Air-Conditioning Engineers. *Design of Geothermal Systems for Commercial and Institutional Buildings*. 1997. <http://www.ashrae.org/BOOK/bookshop.htm>.
- Ankeny Elementary School, Ankeny, IA.
- Carlson, Steven. “Ground Source Heat Pumps” presentation. CDH Energy Corp. <http://www.cdhenergy.com/>.
- Commonwealth of Pennsylvania Department of Environmental Protection. *Ground Source Heat Pump Manual*, August 2000. <http://www.dep.state.pa.us/>.
- Energy Center of Wisconsin. “Report Summary: Market Assessment of New Heat Pump Technologies.” 1999. [www.ecw.org](http://www.ecw.org).
- Geothermal Heat Pump Consortium. *Earth Comfort Update*, Vol. 8, Issue 5. September/October 2001. <http://www.geoexchange.org/>.
- Geothermal Heat Pump Consortium and the Association for Efficient Environmental Energy Systems. Proposal for the California Building Energy Efficiency Standards – Revisions for July 2003 Adoption. November 2001.
- International Ground Source Heat Pump Association, Oklahoma State University, Stillwater, OK. <http://www.igshpa.okstate.edu/>.
- Manheim Township School District, Lancaster, PA.
- National Renewable Energy Laboratory’s Geothermal Technologies Program. <http://www.nrel.gov/geothermal/>.
- Oak Ridge National Laboratory. “Geothermal Heat Pumps in K-12 Schools: A Case Study of the Lincoln, Nebraska, Schools.” <http://www.ornl.gov/femp/pdfs/ghpsinschools.pdf>.
- Paint Lick Elementary School, Lancaster, KY.
- West Central Secondary School, Barrett, MN.
- U.S. Department of Energy’s Federal Energy Management Program. Geothermal Heat Pump Technical Resources. <http://www.eren.doe.gov/femp/financing/ghpresources.html>.
- U.S. Department of Energy’s Geothermal Energy Program. <http://www.eren.doe.gov/geothermal/>.



## GUIDELINE RE6: PHOTOVOLTAICS

### Recommendation

Install photovoltaic (PV) arrays to convert radiant energy from the sun to electricity. PV is ideal for isolated or stand-alone tasks, and can serve as an excellent teaching tool.

### Description

PV converts radiant energy from the sun into direct current electricity, without any environmental costs (greenhouse or acid gas emissions) associated with other methods of electricity generation.

PV produces electricity from an abundant, reliable, and clean source. In fact, the amount of solar energy striking the earth is greater than the worldwide energy demand each year.



*Photovoltaics are most cost effective in remote locations that are at a distance from an electrical grid, but they have zero environmental costs. NREL/PIX00006*

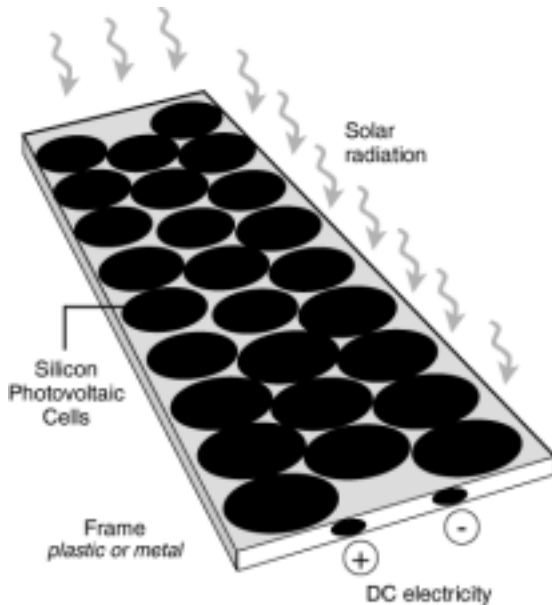

*Figure 44 – Photovoltaic Module*

### Applicable Climates



#### Applicable Spaces

- Classrooms
- Library
- Multi-Purpose
- Gym
- Corridors

#### When to Consider

- Programming
- Schematic
- Design Dev.
- Contract Docs.
- Construction

The basic component of a PV system is a solar cell. Most solar cells are made of specially treated silicon semiconductor materials. Sunlight striking the cells generates a flow of electrons. This flow is directly proportional to the surface area of the cells and the intensity of the radiation (a cell of area 6.25 in.<sup>2</sup> will produce 3.5 amperes in bright sunlight). Each solar cell produces approximately 0.5 volts. Higher voltages are obtained by connecting the solar cells in series. Solar cells are laminated; most have a tempered glass cover and a soft plastic backing sheet. This sealing protects the lodged electrical circuits from the outside elements and makes solar cells durable. Modules may be connected in series for higher voltages and in parallel for higher currents. The typical photovoltaic module uses 36 silicon solar cells, connected in series to provide enough voltage to charge a 12-volt battery. However, most schools do not require battery storage and can use grid-tied PV systems. A grid-tied system can provide electricity savings as well as provide additional shading or cooling benefit. Most schools can switch to a net metering rate schedule where utilities give credit for surplus electricity produced by PV systems.

Individual modules may be further combined into panels, sub arrays, and arrays. PV arrays with storage batteries are sources for uninterrupted power supply. Schools requiring emergency backup for communication systems in the case of an earthquake or rolling blackout can use this type of stand-alone system with batteries. Batteries store energy collected during the day for nighttime use. A battery charger controller may be included to avoid overcharging the battery. In addition, all systems include wire, connectors, switches, and electrical protective components. If the load requires alternating current (AC), an inverter is used to convert the direct current (DC) power to AC power. The energy collected during the day is stored for use during the night.

**Applicability**

- PV is very suitable for remote facilities that are more than one-third of a mile away from the electrical grid.
- PV is ideal for climates where plenty of sunlight is available. PV is also suitable for climates that may experience cloudy days periodically but have sunlight available on most other days. However, the availability of sunlight will influence the size and cost of the system. For example, a very small PV system designed to operate a 72-W load for eight hours/day would require a 120-W PV module in southern Arizona, as compared to a 240-W module in Wisconsin. This difference results from the fact that the daily solar insolation levels in southern Arizona are roughly twice the insolation levels in Wisconsin. Although applicable to a whole range of climates, including Hot and Dry and Cool and Dry, PV is more feasible in climates with high insolation levels. *The Solar Radiation Data Manual for Flat-Plate and Concentrating Collectors*, published by the National Renewable Energy Laboratory, provides an accurate assessment of available insolation for 239 U.S. locations.
- PV is ideal for providing power to exterior and parking lot lighting, and for school zone flashers.

**Integrated Design Implications**

**Building aesthetics.** In the early design stage, consider mounting PV on rooftops for best results.

**System integration.** Since PV is most likely to be used in hybrid systems, the mechanical engineer needs to perform detailed planning in the early design stages.

**Cost Effectiveness**

PV panels typically cost anywhere between \$3.50/W to \$6/W for modules and \$5/W to \$20/W for the system, depending on the size and capacity of the installation (each W of PV array will produce 2 Wh to 6 Wh of energy depending on availability of sunlight). One-hundred-W installations will cost between \$10/W to \$12/W. Using typical borrowing costs and equipment life, the life-cycle cost of PV-generated energy generally ranges from \$0.25/kWh to \$1/kWh. The simple payback period for this system is 25 to 30 years.

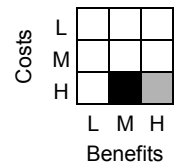

**Benefits**

- PV is most cost effective in remote locations that are at a distance from an electrical grid. PV is typically three to six times more expensive than utility-supplied electricity. However, this figure does not take into account the “real” or environmental cost of utility-generated electricity or local rebates.
- PV is environmentally benign during use and does not produce any greenhouse gases or acid gas emissions associated with other methods of generating electricity. It has zero environmental costs.
- PV produces electricity from an abundant and reliable “fuel” — sunlight. Coupled with storage batteries, PV is capable of supplying uninterrupted power.
- PV is available in modular building blocks; more arrays may be added as the demand for power increases.
- Wear and tear is minimized for PV, since it has no moving parts and produces power silently.
- Although PV may be combined with other power sources in hybrid systems to increase system reliability, PV itself requires no connection to an existing power source or fuel supply.

- For grid-tied PV systems, net metering allows schools to receive utility credits for the surplus electricity generated by PV systems.
- PV can withstand severe weather conditions including snow and ice.
- PV can be combined with other types of electric generators (wind, hydro, and diesel, for example) to charge batteries and provide power on demand.
- By putting power back into the electrical grid and shaving peak loads, PV can have far-reaching implications.

### **Design Tools**

Most PV dealers will work with designers to engineer the best-customized system for the school. System requirements are determined by:

- Estimating the daily load demand.
- Determining the solar resource in the location.
- Calculating the battery size. (Note: A lead-acid battery is not a viable option.)
- Calculating the number of PV modules required.

For first estimates of the array size needed, consider the following variables that effect the production of power in an array:

- Outside air temperature. Use average annual temperatures.
- Amount of sunlight received, or Incident Solar Radiation, which depends on latitude, cloud cover, and angle of the array.
- Efficiency of the photovoltaic cells. This information should be available from the manufacturer and varies between 13% at unfavorable conditions to 30% under lab conditions.

$$P = (Sol_{ins} + \Delta t) \times A \times Eff$$

where,

P = Power generated, W

Sol<sub>ins</sub> = Incident solar radiation, Wh/ft<sup>2</sup>

Δt = Difference between the control and design temperatures (use zero if the design temperature is between 50°F and 60°F; for control temperature, use 50°F for colder weather and 60°F for warm weather)

A = Area of the array, ft<sup>2</sup>

Eff = Efficiency of the system (multiply cell efficiency by efficiency of the storage unit)

A Macintosh software program is available for PV design and sizing, wherein designers can specify appliances and AC/DC loads, inverter efficiency, and site location. Based on these variables, the software recommends the number of solar modules and batteries. The software costs about \$15.

PVWatts is another PV software program. Researchers at NREL developed PVWatts to allow non-experts to quickly obtain performance estimates for grid-connected PV systems at no cost.

Trnsys, a program developed at the University of Wisconsin, also helps size and locate PV systems. See the References section at the end of this guideline for more information.

## Design Details

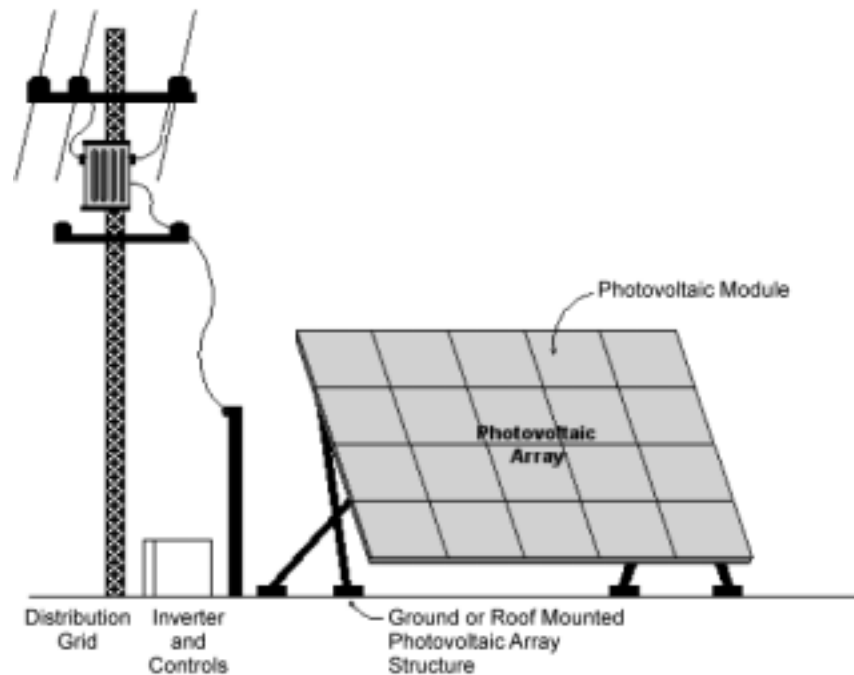

Figure 45 – PV Siting, Elevated

Source: Renewable Energy Project Analysis Software

- The most important aspect of installing PVs is siting. Shading can significantly reduce the output of solar cells. Mount PV arrays at an elevation or on roof tops. Consider both summer and winter sun paths and ensure that trees, neighboring buildings, or other obstructions do not shade any portion of the array between 10:00 AM and 3:00 PM.
- Mount the system for maximum southern exposure. The exact mounting angle will differ from site to site.
- Flat, grassy sites work better than steep, rocky sites.
- Use arrays as building components to economize on building materials and for unobtrusive design solutions. Arrays can be used as a finishing material on structures to create attractive roofs or skylights. Arrays can be used to break up and add interest to a large, uniform roof surface. They can double as shading devices, which not only block the sun but also capture it. Transparent arrays can be used as structural glazing instead of glass. Arrays can also be part of a curtain wall system.

## Operation and Maintenance Issues

- PV systems require occasional cleaning to remove dust and debris. In cold, snowy climates, care must be taken to keep the array surface clear of snow.
- Some PV systems contain storage batteries that may require some watering and maintenance similar to that required by batteries in automobiles.
- PV modules are the longest living components of a PV system (20 to 30 years) and will likely outlive the batteries. Batteries may need replacement every six or seven years.
- No PV system is maintenance-free. Schedule regular inspections of the system to ensure that the wiring and contacts are free from corrosion, the modules are clear of debris, and the mounting

equipment has tight fasteners. Roof-integrated systems should be designed to facilitate regular inspection and maintenance.

- Monitor the power output of PV modules, the state-of-charge and electrolyte level of the batteries, and the actual amount of power that building loads use. Writing this information in a notebook helps to track the system's performance and determine whether the system is operating as designed. Monitoring will also help understand the relationships between the system's power production, storage capability, and load requirements.
- Roof-integrated systems should be designed to allow easy removal if roof replacement is required.

### **Commissioning**

Do not compromise on the initial module cost of PV systems. Skimping on first costs results in having to pay later, in terms of higher operation (\$/kWh) costs that amount to a much higher figure over the lifespan of a system.

Purchase PV systems from established and knowledgeable dealers who can help determine requirements specific to the site. Look for warranties of 20 years or more. Thoroughly check the rating system that the dealer/manufacturer is using for reliability.

Always engage a professional to design and install PV systems. A preliminary design is a necessity to determine the size, layout, and potential energy output of the PV modules. This design can be performed with computer simulation tools using estimated hourly weather, solar resource, and load data. The time required to prepare the preliminary design and detailed cost estimate typically falls between 30 and 60 hours, with fees ranging from \$40/hour to \$100/hour. Smaller scale projects with simple structural requirements fall at the low end of this time range. Larger scale projects requiring more difficult structural integration into existing buildings will be at the high end of this time range.

Fully commission panels and the entire array to confirm rated power is achieved.

### **References/Additional Information**

U.S. Department of Energy, Energy Efficiency and Renewable Energy Network.

Maryland Solar Schools Program Plan. <http://www.energy.state.md.us/executiv.htm>.

Solar Engineering Laboratory, University of Wisconsin-Madison, 1500 Engineering Drive, Madison, WI 53706, Phone: (608) 263-1589; Fax: (608) 262-8464, Email: [trnsys@sel.me.wisc.edu](mailto:trnsys@sel.me.wisc.edu), Web site: <http://sel.me.wisc.edu/trnsys>.

Solar Schoolhouse. Developed by the Rarus Institute, this web site contains information on PV systems, a database on schools using solar power, DSA approval checklists, lesson plans, etc. Site is expected to launch in June 2002. Web site: <http://www.solarschoolhouse.org/>.

*Stand-Alone Photovoltaic Systems: Handbook of Recommended Design Practices*, Sandia National Laboratory.



# WATER CONSERVATION

This chapter provides guidelines for:

Water-Efficient Irrigation Systems (Guideline WC1)

Stormwater Management, Groundwater Management, and Drainage Materials (Guideline WC2)

Rainwater Collection Systems (Guideline WC3)

Gray Water Systems (Guideline WC4)

Waterless Urinals (Guideline WC5)

Efficient Terminal Devices (Guideline WC6)

---

## OVERVIEW

---

Fresh water is an increasingly scarce resource throughout the United States. A high performance school should control and reduce water runoff from its site, consume fresh water as efficiently as possible, and recover and reuse gray water to the extent feasible.

Basic efficiency measures can reduce a school's water use by 30% or more. These reductions help the local and regional environment while decreasing operating expenses. While the cost savings may be modest now, since water is relatively inexpensive in most areas of the country, there is a strong potential that these savings will rise over time, especially in areas where water is scarce and becoming more expensive.

To achieve water conservation in high performance schools, designers should:

- Design landscaping to use water efficiently by reducing water use and specifying hardy, native vegetation.
- Use recycled water for non-potable purposes.
- Set water use goals for the school.

### ***Water-Efficient Irrigation***

Reducing the amount of irrigation on a school site can significantly affect a school's overall water use. Preserving existing vegetation in combination with a landscape design that features drought-resistant plants is a simple and effective way to decrease the amount of irrigation needed for the site. (See the Site Design chapter for more information on landscape design for high performance schools.)

Even though native, drought-resistant plants can reduce the amount of water needed for irrigation, an in-ground irrigation system may still be required. Consider using an irrigation system for athletic fields only, not for plantings near buildings or in parking lots. Use high-efficiency irrigation technology (e.g., drip irrigation in lieu of sprinklers). Sprinkler systems are notoriously wasteful, with up to 45% of the

water used never reaching the vegetation at all. Drip systems are significantly more efficient, since delivering the water directly to the root area results in very little wasted water.

## **Recycled Water**

Significant environmental and financial costs exist when streams, rivers, lakes, and groundwater resources are tapped to provide water for irrigation or non-potable indoor purposes such as flushing toilets. Rather than using scarce, high-quality potable water in these cases, reclaimed water is an effective alternative. Reclaimed water is highly treated wastewater that is safe for non-potable purposes. Extensive testing is performed to assure water quality standards are met. In the United States, for example, reclaimed water has been used safely for municipal, industrial, and agricultural purposes for more than four decades. Reclaimed water is available in many areas at low and sometimes no cost.

Recycled water can be provided by gray water systems. Gray water is “used” water from showers, bathroom sinks, and washing machines. These systems divert the gray water from the existing drain line to a surge tank where it is filtered, sterilized, and recycled for use in irrigation and toilets. Since this water is treated on-site, gray water systems reduce the load on local water agencies and treatment plants.

Rainwater collection is another source of recycled water for schools. If local climate allows, use captured rain or recycled site water for irrigation and “design in” cisterns for capturing rainwater. After passing through a filtration system to settle and disinfect the water, it can be used for showers, sinks, laundries, dishwashers, and toilets. Captured rainwater has excellent quality and in some cases, can be used for potable purposes.

## **Water Use Goals**

A good starting point is using 20% less than the baseline calculated for the building after meeting the Energy Policy Act of 1992 fixture-performance requirements. This can be reached with a combination of water-conserving fixtures and equipment such as low-flow or waterless toilets and urinals, automatic lavatory faucet shut-off controls, low-flow showerheads, and high-efficiency dishwashers and laundry appliances. Low-flow devices can reduce water consumption by 15% to 20%. Low-flow toilets use only 1.6 gallons of water per flush, compared to the 3.5 gallons to 7 gallons used per flush by traditional toilets. Conventional faucets use between 3.5 gallons and 7 gallons per minute. Low-flow faucet aerators cut usage down to between 1.5 gallons to 2.5 gallons per minute.

Regular maintenance on this equipment can greatly reduce water use. Leaks are the biggest cause of wasted water in most buildings. A faucet drip or invisible leak in the toilet will add up to 15 gallons of water a day, or 105 gallons a week, which adds up to 5,475 gallons of wasted water a year.



## **Resources**

American Water Works Association. <http://www.awwa.org/>.

U.S. Department of Energy. Energy Efficiency and Renewable Energy Network,  
<http://www.eren.doe.gov/>.

Water Environment Federation. <http://www.wef.org/>.

WaterWiser is a program of the American Water Works Association operated in cooperation with the U.S. Bureau of Reclamation. <http://www.waterwiser.org/>.

# GUIDELINE WC1: WATER-EFFICIENT IRRIGATION SYSTEMS

## Recommendation

Install drip or other low-volume, water-efficient irrigation and/or systems connected to humidity sensors, where appropriate.

## Description

Supplemental irrigation accounts for most water use at schools during the summer and a significant amount during the spring and fall. Maximizing the water efficiency of irrigation systems supports healthy and attractive landscapes and sports fields.

## Applicability

All climates.

## Integrated Design Implications

Irrigation system design and installation should be closely coordinated with other landscape planning and water management activities. See Guideline SD3: Landscape Design and Management; Guideline SD5: Native and Drought-Tolerant Plants; Guideline SD6: Landscaping Soil, Amendments, and Mulch; Guideline SD7: Integrated Weed, Disease, and Pest Management; and Guideline WC3: Rainwater Collection Systems. Note: The soil should be amended and blended prior to installing the irrigation systems to avoid damage to the system.

## Cost Effectiveness

Drip systems and micro-emitters have become very cost effective when evaluated against water restrictions and rising water costs.

## Benefits

Benefits include significantly reduced irrigation water consumption, reduced utility costs, and increased water conservation. Conventional spray heads deliver only 55% to 65% of the water to the ground; the rest is blown away or evaporates, depending on weather conditions. In contrast, drip irrigation is up to 95% efficient. Plants establish and thrive better with drip irrigation since water is delivered to the root zone, where it is needed. Water-efficient irrigation systems are also waste-efficient — water and fertilizer are used only where needed, preventing nutrient-consuming and waste-generating weed growth in other areas and reducing costs associated with managing and disposing of undesired plant growth.

## Design Tools

None.



Conventional spray heads deliver only 55% to 65% of the water to the ground – drip irrigation is up to 95% efficient.

NREL/PIX 11426

## Applicable Climates



### Applicable Spaces

Classrooms	<input type="checkbox"/>
Library	<input type="checkbox"/>
Multi-Purpose	<input type="checkbox"/>
Gym	<input type="checkbox"/>
Corridors	<input type="checkbox"/>
Administration	<input type="checkbox"/>
Toilets	<input type="checkbox"/>
Other	<input type="checkbox"/>

### When to Consider

Programming	<input type="checkbox"/>
Schematic	<input type="checkbox"/>
Design Dev.	<input type="checkbox"/>
Contract Docs.	<input type="checkbox"/>
Construction	<input type="checkbox"/>
Commissioning	<input type="checkbox"/>
Operation	<input type="checkbox"/>

Costs	L	<input type="checkbox"/>	<input type="checkbox"/>	<input type="checkbox"/>
	M	<input type="checkbox"/>	<input type="checkbox"/>	<input type="checkbox"/>
	H	<input type="checkbox"/>	<input type="checkbox"/>	<input type="checkbox"/>
		L	M	H
		Benefits		

## **Design Details**

- First, aim to eliminate the need for an irrigation system entirely. An effective stewardship program combined with drought-tolerant plants (Guideline SD5) might eliminate the need for an in-ground system.
- Where an in-ground system is required, the design and installation should be completed by a certified irrigation specialist and should conform to local ordinances. The ordinances include specifics about efficient irrigation.
- Systems should be installed to avoid runoff, low-head drainage, overspray, or other similar conditions where irrigation water flows onto adjacent property, non-irrigated areas, or impervious surfaces. Some irrigation systems can be connected to humidity sensors to keep from operating when humidity is high or when it is raining.
- Consider special problems posed by irrigation on slopes, in median strips, and in narrow hydrozones. Installation should provide easy access to sprinkler heads for inspection and maintenance.
- Use irrigation zones to group plants with similar water needs close to a water source, which limits the scope and impact of an in-ground irrigation system.
- Where possible, use the minimum amount of polyvinyl chloride (PVC) products. PVC is highly toxic during manufacture and disposal. Unfortunately the alternatives, such as copper or clay piping, tend to be more expensive. If substitution for virgin PVC is not an option, the system should be designed to use the minimum length of piping possible.
- Consider using irrigation systems made with recycled-content plastic, tire-derived rubber, and other recycled-content materials.
- Preserve established vegetation to minimize irrigation needs. Avoid killing existing vegetation with too much water from new irrigation systems.

## **Operation and Maintenance Issues**

Requires regular monitoring to ensure system is operating properly. Develop a monthly schedule to visually inspect and monitor irrigation system(s) performance during irrigation season. Performance evaluation should be based upon original design intent, irrigation audit report, and water budget goals.

## **Commissioning**

Work with the commissioning agent and certified irrigation auditor to ensure compliance with the design documents. In addition to checking for proper irrigation equipment and installation, check the system for adherence to specified performance criteria and operation parameters as designed. Verify that maintenance personnel are trained and proficient in the ongoing programming and adjustments for the irrigation system.

## **References/Additional Information**

*Drip Irrigation for Every Landscape and All Climates*, Metamorphic Press, PO Box 1841, Santa Rosa, CA 95402.

Hawn, Joellyn. "Process Changes to Improve Commercial Landscape Viability." *New England Real Estate Journal*, May 31-June 6, 1996.

Irrigation Association, various publications, including *Common Obstacles to Irrigation Efficiency* and *Drip Irrigation Technology*. Available on-line at <http://www.igin.com/irrigation/irrigation.html>.

Kourik, Robert. *Landscape Water Management Principles*, Version 1.01. Cal Poly ITRC, San Luis Obispo, CA, 1994.

*WaterWiser* is a program of the American Water Works Association operated in cooperation with the U.S. Bureau of Reclamation. Web site: <http://www.waterwiser.org/>. AWWA number is (202) 628-8303.

# GUIDELINE WC2: STORMWATER MANAGEMENT, GROUNDWATER MANAGEMENT, AND DRAINAGE MATERIALS

## Recommendation

Manage stormwater with systems that slow water velocity, maximize its use for irrigation, and filter pollutants. Use material-efficient options for on-site drainage systems. Groundwater should be managed separately from surface water.

## Description

Stormwater management is vital to the safety and ecological health of a school site. Site planning and design should strive to balance water on the site and make effective use of the water for water supply and irrigation.

Water should always be absorbed and captured with the remainder moved slowly across the site into natural features wherever possible. Trying to move water quickly to gutters, downspouts, catch basins, and pipes increases water quantity and velocity, which requires the design of large and expensive drainage infrastructure. Options for material-efficient drainage include:

**For fill**

- Recycled concrete aggregate
- Crushed concrete
- Glass

**For pipes**

- EPS with recycled content

In areas where the water table is high, construction can cause groundwater to seep to the surface. In these cases, level spreaders should be used to pipe the discharge from curtain drains to trickle discharge onto fields or wetlands, in lieu of the stormwater system. It is important to manage groundwater separately from stormwater to prevent possible contaminants from destroying groundwater quality.



*Capturing and absorbing stormwater conserves water and can improve the health of on-site soils, vegetation, and habitat areas. NREL/PIX 11334*

**Applicable Climates**



**Applicable Spaces**

Classrooms	<input type="checkbox"/>
Library	<input type="checkbox"/>
Multi-Purpose	<input type="checkbox"/>
Gym	<input type="checkbox"/>
Corridors	<input type="checkbox"/>
Administration	<input type="checkbox"/>
Toilets	<input type="checkbox"/>
Other	<input checked="" type="checkbox"/>

**When to Consider**

Programming	<input type="checkbox"/>
Schematic	<input type="checkbox"/>
Design Dev.	<input type="checkbox"/>
Contract Docs.	<input checked="" type="checkbox"/>
Construction	<input checked="" type="checkbox"/>
Commissioning	<input type="checkbox"/>
Operation	<input checked="" type="checkbox"/>

## Applicability

All climates.

## Integrated Design Implications

Building design (especially roofs), site grading, erosion control, and bank stabilization need to be considered. Where applicable, the groundwater management system design should be integrated with the design of site-built stormwater system for greatest cost savings.

"Green" or living roofs present a possible alternative design strategy for managing site water that appears to exemplify the best principles of integrated design. Reducing the rate of runoff, developing natural

habitat for birds and insects, increasing insulation levels, cooling roof temperatures, saving energy — all are touted as benefits of this type of system. One consideration is the requirement of manufacturers that the systems be irrigated to prevent wind erosion of the topsoil. Unless rainwater collection (see SP10) is employed, this represents an environmental liability of these systems.

### **Cost Effectiveness**

On-site capture, absorption, and slowing of surface runoff usually has a lower first cost and ongoing maintenance expense than traditional underground retention structures and piping, which are very expensive and often fail. By managing groundwater separately from stormwater, the complexity and size of site-built stormwater systems can potentially be reduced, decreasing overall construction costs. Drainage material costs are comparable to, or less than, conventional materials. For example, recycled aggregate base is less expensive than virgin aggregate in the Los Angeles area. There also may be an economic advantage to crushing concrete, brick, and asphalt demolition debris on-site, where the material can be used as a base or sub-base. Analysis of these materials must be performed by a qualified soils and hazardous materials engineer to be sure that it is safe for such on-site re-use, in compliance with state and federal requirements. The economy of on-site crushing depends on several variables including the amount of rubble stockpiled, the capacity of the crushing equipment available (tons per hour), local tipping fees for the inert materials, the haul distance to local inert landfills, and the total cost of importing virgin or recycled aggregate base to the construction site.

Costs	L		■	■
	M			
	H			
		L	M	H
		Benefits		

### **Benefits**

Capturing and absorbing stormwater is good water conservation. It also can improve the health of on-site soils, vegetation, and habitat areas. Using recycled-content products helps alleviate waste disposal problems, reduces energy use, and lowers consumption of natural resources during manufacturing.

### **Design Tools**

None.

### **Design Details**

Stormwater management should begin with capture in cisterns or ponds and absorption into groundwater aquifers, or landscape areas. Excess percolated water from green roofs and pervious paving should be filtered through vegetated areas or filters.

Any remaining runoff water should be slowed down and spread slowly over the entire surface of roofs and paved areas before entering bioswales and surface runoff channels, such as brooks and creeks.

If pipes and catch basins are used, use perforated pipe and filters wherever possible, in keeping with the intent of the system design.

Natural boulders can be effective as energy dissipaters or as checkdams, creating riffles and pools in the channels.

Use green roofs on buildings and incorporate bioswales in the site grading. Use site grading with bioengineered banks and channels, energy dissipaters, and check dams.

### **Operation and Maintenance Issues**

Most traditional site maintenance programs at schools are limited to trash pickup and “mow and blow” cleanup. Local conservation corps, youth job training programs, experienced community gardeners, and neighborhood groups are good sources to help augment the school maintenance staff. They can help nurture a variety of landscapes, especially natural waterways and riparian corridors, ponds, meadows, and native planting beds.

If using level spreaders for groundwater management, they should be inspected after every runoff event to ensure proper functioning.

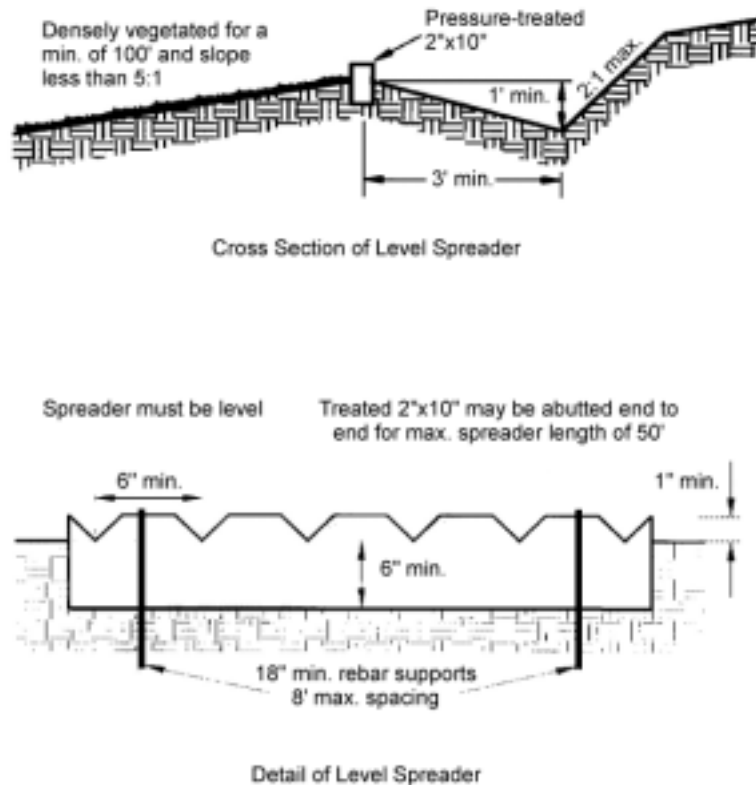

Figure 46 – Level Spreader, Cross Section & Detail

(Source: Washington State Department of Ecology, Stormwater Management Manual for Western Washington, Volume II, Construction Stormwater Pollution Prevention)

## Commissioning

None.

## References/Additional Information

- California Integrated Waste Management Board. *Recycled Aggregate* Fact Sheet, CIWMB publication #431-95-052. Also available to download from: <http://www.ciwmb.ca.gov/publications/condemo/43195052.doc>.
- International Erosion Control Association. Provides technical assistance and an annual Erosion Control Products and Services Directory. (800) 455-4322 or <http://www.ieca.org/>.
- Kids in Creeks Program for School Teachers. Aquatic Outreach Institute, Richmond, CA.
- Stream Corridor Restoration: Principles, Processes and Practices* developed by 14 federal agencies. Available at <http://www.usda.gov/streamrestoration/>.
- Stormwater and Urban Runoff Seminars — Guide for Builders and Developers, NAHB, Edited by Susan Asmus, Washington DC, (800) 368-5242 x538 or <http://www.nahb.com/>.
- Stormwater Management For Construction Activities: Developing Pollution Prevention Plans And Best Management Practices: Summary Guidance. EPA#833-R-92-001, October 1992, U.S. Environmental Protection Agency Office of Wastewater Management, 401 M St. SW, Mail Code EN-336, Washington DC, 20460. (800) 245-6510, (202) 260-7786 or <http://www.epa.gov/owm/sw/construction/>.

# GUIDELINE WC3: RAINWATER COLLECTION SYSTEMS

## Recommendation

Use rainwater-harvesting systems for supplying year-round, dependable potable or non-potable water. Due to the expense of building freeze-protected cisterns, these systems are probably not applicable in colder climates, except in special or very limited application.

## Description

Drawing excessive water and paving all available open lands have considerably hindered natural ground water recharge. Rainwater harvesting is merely “putting back rain water into the soil.” Rainwater is collected from roofs or ground-level surfaces and stored in a cistern. The water is then filtered and delivered to terminals through pumps. Rainwater is used for showers, sinks, laundries, dishwashers, and flushes. The components of a rain water system include:

- Catchment area/roof is the surface upon which the rain falls. Roofs are most commonly used as catchment areas although channeled gullies or other ground level features can serve the purpose equally well.
- Gutters and downspouts are the transport channels from catchment surface to storage. Water collected by the catchment area is delivered to the storage tank (or cistern) via gutters and downspouts. These need to be appropriately sized and sloped. Standard designs for these “transport systems” are readily available in the market.
- Leaf screens and roof washers remove contaminants and debris.
- Cisterns or storage tanks store the collected rainwater. Cisterns are the most expensive component of the rainwater system.
- The conveying or delivery system for the treated rainwater is accomplished through pumps or gravity. The water pressure for a gravity system depends on the difference in elevation between the storage tank and the faucet. Water gains 1 psi of pressure for every 2.31 ft of rise or lift. Many plumbing fixtures and appliances require 20 psi for proper operation, while standard municipal water supply pressures are typically in the 40 psi to 60 psi range. To achieve comparable pressure, a cistern would have to be 92.4 ft (2.31 ft X 40 psi = 92.4 ft) above the highest plumbing fixture of the facility. This means pumps are essential to convey the filtered water from cisterns to terminal devices.
- Water treatment, filters and equipment, and additives to settle, filter, and disinfect the collected water are important components of this system. It is essential that a professional decide the water treatment method to use for a given facility after conducting appropriate water tests in a laboratory to determine whether this water will be applicable to potable or non-potable uses. Types of treatment include filtration, disinfection, and buffering for pH control. Dirt, rust, scale, silt, and other suspended particles, bird and rodent feces, airborne bacteria, and cysts will inadvertently find their way into the cistern or storage tank even when design features such as roof washers, screens, and tight-fitting lids are

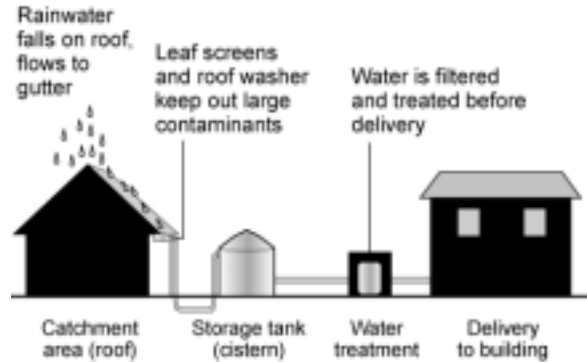

*Schematic of a rainwater collection system.*

### Applicable Climates

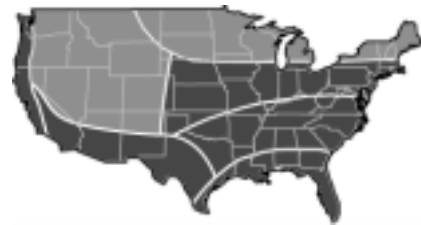

### Applicable Spaces

Classrooms	
Library	
Multi-Purpose	
Gym	
Corridors	
Administration	
Toilets	
Other	

### When to Consider

Programming	
Schematic	
Design Dev.	
Contract Docs.	
Construction	
Commissioning	
Operation	

properly installed. Water can be unsatisfactory without being unsafe; therefore, filtration and some form of disinfection is the minimum recommended treatment if the water is to be used for human consumption.

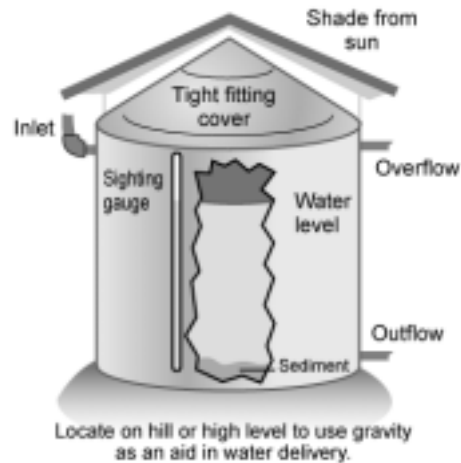

Figure 47 – Cistern for Rainwater Collection

The catchment area is the surface on which the rain that will be collected falls. While this guideline focuses on roofs as catchment areas, channeled gullies along driveways or yard swales can also serve as catchment areas, collecting and then directing the rain to a French drain or bermed detention area. Because composite asphalt, asbestos, chemically treated wood shingles, some membrane systems, and some painted roofs could leach toxic materials into the rainwater as it touches the roof surface, they are recommended only for non-potable water uses.

Gutters and downspouts are the components that catch the rain from the roof catchment surface and transport it to the cistern. Standard shapes and sizes are easily obtained and maintained, although custom fabricated profiles are also available to maximize the total amount of harvested rainfall. Gutters and downspouts must be properly sized, sloped, and installed to maximize the quantity of harvested rain. For various reasons, lead-coated copper should be avoided on school projects generally, but absolutely avoided in buildings with rainwater harvesting. If harvesting is planned for a renovation, special care should be taken to examine the existing roof and gutter system for hazardous materials, including lead and asbestos mastic.

Other than the roof, which is an assumed cost in most building projects, the storage tank represents the largest investment in a rainwater harvesting system. To maximize the system's efficiency, the building plan should reflect decisions about optimal placement, capacity, and material selection for the cistern.

### **Applicability**

Rainwater systems are appropriate for most climates, although their application may be limited for severely cold climates. In dry climates, enough rainwater is available to meet 75% of the total water requirement of a facility.

Rainwater harvesting should be considered early in the design phase for best (and safest) results.

### **Integrated Design Implications**

Site planning is an important consideration in designing rainwater systems. Decisions regarding placing the cistern, creating natural slopes or gullies for channeling rainwater, and creating a pressure difference between the gutter spout and the cistern inlet should be made at the site-planning stage.

Building aesthetics will also be impacted depending on the choice of rainwater collecting element.



## Cost Effectiveness

A rainwater harvesting system designed as an integrated component of a new construction project is generally more cost-effective than retrofitting a system onto an existing building. Many of the shared costs of roof and gutters can be designed to optimize system performance, and the investment can be amortized over time.

Costs	L		
	M	■	
	H	■	
	L	M	H
	Benefits		

Generally rainwater systems cost about \$1/gallon to \$1.50/gallon of collection capacity although factors like design, topography, and climate can significantly alter these numbers.

City-supplied water is relatively inexpensive, although it must be added that municipal water cost is a simple number and does not include hidden environmental costs. Consequently, the pay back period for a full-service rainwater harvesting system where city water is available is rarely less than 30 years and can be as high as 90 years, assuming present values for municipal water and approximate construction costs of \$1/gallon of collection capacity for a rainwater harvesting system.

## Benefits

- It is an environmentally benign system.
- Rainwater quality is excellent.
- The concept is simple and easy to build. Operation and maintenance of systems are easy.
- Water and sewer costs are reduced.

## Design Tools

For sizing catchment areas, it is reasonable to assume that 600 gallons is collected per inch of rain per 1,000 ft<sup>2</sup>:

$$\text{Catchment Area (ft}^2\text{)} = \frac{\text{Average Rainfall (inches)} \times 600}{1,000}$$

Several computer software programs are available for sizing purposes that simulate the performance of a rainwater collection system. For every month of the simulation, it subtracts the water that is used and adds in any rainwater that was collected. The amount of water remaining in the cistern at the end of the month is output to a graph. A total of 100 years' rainfall data may be added to certain programs. The following values are manipulated for simulation:

### Basic Method Using Annual Data<sup>1</sup>

1. Calculate roof catchment area.
2. Multiply the collection area in ft<sup>2</sup> by 0.6 gallons/ft<sup>2</sup>/in. of rain times the collection factor times the average annual rainfall and half of the average annual rainfall.  
*For example, if you have 2,500 ft<sup>2</sup> of collection area and live in Austin, where the average annual rainfall is 32 in. a year and the collection efficiency factor is 80%, the average amount of rain you can collect is:*  
$$2,500 \times 0.6 \times 32 = 38,400 \text{ gallons/year}$$
3. Dividing this by 365 days a year, the supply would be 105 gallons/day.
4. Using the rule-of-thumb that half of the average rainfall will provide a close estimate of the low expected rainfall for the area, in an extremely severe drought year, approximately 19,700 gallons could be collected. This would result in a supply of only 53 gallons/day.

<sup>1</sup> Texas Rainwater Guide.

- Size of the collection area in ft<sup>2</sup>.
- Number of gallons that will be used each month.
- Total size of storage capacity in gallons.
- Amount of water in storage at the beginning of the simulation, in gallons.
- Amount, if any, of water that will be put into storage if it is empty.

Companion programs calculate waste production and peak flow rate based on the collection area and peak design rainfall rates to be expected in this area once every 10 years. These programs are used to properly design the collection plumbing system to catch all rainfall flowing off the roof without losing any to system backup.

### ***Design Details***

- Collection area should be completely exposed and should not be shaded by trees. Rainwater yield and quality depends on the size and nature of the catchment area. Use smooth, impervious, and clean roofing for good quality yield. Textured roofing slows down water flow and is responsible for evaporative losses.
- Use pitched metal roofs to minimize losses. Metal roofs are also safe for potable water. Concrete or asphalt roofs increase losses to 10%. Further loss in volume could occur if built-up tar and gravel roofs are used. Clay and slate are also appropriate roofing choices for collecting potable water. Avoid roofing materials like asphalt, chemically treated wood, or asbestos for collecting potable water as they may introduce toxic matter in the rainwater.
- Surfaces like clay and slate should be treated with a special painted coating to discourage bacterial growth.
- Use aluminum copper or galvanized iron gutters and downspouts.
- Existing buildings should be fully examined for any lead or asbestos content in the planning stages of any rainwater collection project.
- Locate cisterns below ground to benefit from cooler year-round ground temperatures. However, this may involve extra excavation and maintenance costs. Above-ground cisterns also work well and may be installed if excavation costs are a major issue. Also, placing the cistern at the highest workable level will reduce pumping costs.
- Use durable cisterns (ferrocement or wood) with watertight exteriors. All joints should be sealed with a non-toxic joint sealant. The tank needs to be approved by the Food and Drug Administration if the water is intended for potable use. Use tight fitting covers to avoid losses due to evaporation and the entry of pollutants into the tanks.
- To maximize efficiency and minimize piping costs, locate cisterns close to both the rainwater collectors and the demand terminals.
- It is a good practice to shield cisterns from direct sunlight to prevent algae growth in the stored water.
- Site cisterns at least 50 ft away from sources of pollution like septic tanks.
- Cisterns should have vehicular access if the need to replenish the water through an auxiliary source arises.
- A settling compartment, which encourages any roof run-off sediment that may enter the tank to settle rather than be suspended in the tank, is an option that can be designed into the bottom of the cistern.

## Cistern Types<sup>2</sup>

Material	Feature	Caution
<b>PLASTICS</b>		
Garbage Cans (20-50 Gallon)	Commercially available, inexpensive.	Use only new cans.
Fiberglass	Commercially available, alterable, and moveable.	Degradable, requires interior coating.
Polyethylene/Polypropylene	Commercially available, alterable, and moveable.	Degradable, requires exterior coating.
<b>METALS</b>		
Steel Drums (55 gallon)	Commercially available, alterable, and moveable.	Verify prior use for toxics, corrodes and rusts, small capacity.
Galvanized Steel Tanks	Commercially available, alterable, and moveable.	Possible corrosion and rust.
<b>CONCRETE AND MASONRY</b>		
Ferrocement	Durable, immovable.	Potential to crack and fail.
Stone, Concrete Block	Durable, immovable.	Difficult to maintain.
Monolithic/Poured in Place	Durable, immovable.	Potential to crack.
<b>WOOD</b>		
Redwood, Douglas Fir, Cypress	Attractive, durable.	Expensive.

### ***Operation and Maintenance Issues***

- All tanks intended for storing potable water should be continually shaded from sunlight.
- Tanks should be regularly inspected and cleaned. The roof terrace (or rainwater collection system) should be regularly and thoroughly cleaned. Filters attached to rainwater-conveying systems should be frequently cleaned to ensure maximum yield.
- Water from the first rains of the season should not be collected as it may contain atmospheric impurities and pollutants.

### ***Commissioning***

Buy durable cisterns with good warranties.

### ***References/Additional Information***

American Rainwater Catchment Systems Association, P.O.Box 685283, Austin, TX 78768-5283.  
 Center for Maximum Potential Building Systems, 8604 F.M. 969, Austin, TX 78724. (512) 928-4786.  
 American Water Works Association, 6666 West Quincy Avenue, Denver, CO, 80235.  
 Water Quality Association, 4151 Naperville Road, Lisle, IL 60532.  
<http://www.waterwiser.org/>.

<sup>2</sup> Texas Rainwater Guide.

## GUIDELINE WC4: GRAY WATER SYSTEMS

### Recommendation

Use gray water systems for drought-resistant landscape irrigation and for flushing toilets.

### Description

Gray water is untreated “used” water that is not contaminated by toilet waste. The California Gray Water Standards define it to include used water from showers, bathroom washbasins, and water from washing machines. It does not include wastewater from dishwashers, kitchen sinks, or laundry water from soiled diapers. Gray water systems filter, sterilize, deodorize, and recycle this used water for irrigating landscapes or flushing toilets.

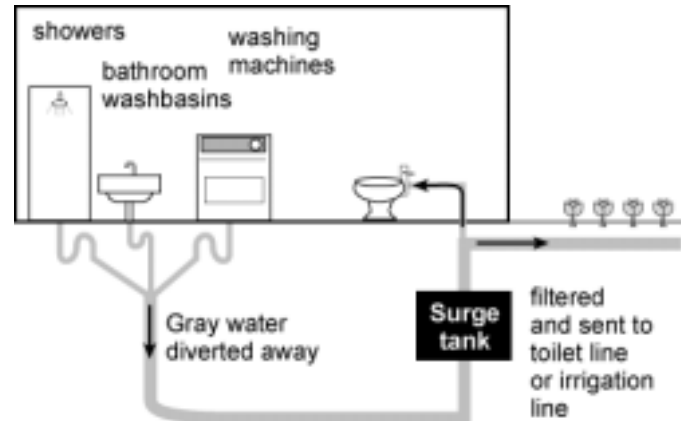

*Gray water systems can recycle up to 50% of the selected waste water from a school to use for irrigation and/or flushing toilets.*

Gray water systems have three major components: the drain-line plumbing, the surge tank and other equipment associated with it, and the delivery system. Surge tanks allow quicker inflow of water from the source than outflow to drainfields. The example schematic in Appendix J of the California Plumbing Code identifies the components of a gray water system where gray water is delivered to the landscape.

Plumbing work is required to divert the gray water from the existing drain lines. All drain lines from gray water sources should link to a common channel that connects to the surge tank. The surge tank contains filters, vents, valves, and pumps. Sand and settling (sedimentation) filters are most commonly used in large applications. Pumps deliver the gray water to toilets and the landscape (if drip irrigation is used).

Gray water composition varies depending on the water source, plumbing system, and user-specific variables (like cleaning products). At regular concentration levels, few components in gray water will damage trees and shrubs. Few detrimental soil changes will occur from well-managed gray water systems. Gray water contains high levels of grease, fibers, and particles (like dry skin), and is 5°F to 10°F warmer than non-gray water. Gray water does increase the number of soil organisms, but only slightly. Most harmful soil effects actually result from over-watering and prolonged saturation of the soil.

### Applicable Climates

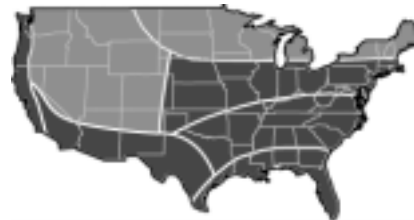

### Applicable Spaces

Classrooms	<input type="checkbox"/>
Library	<input type="checkbox"/>
Multi-Purpose	<input type="checkbox"/>
Gym	<input type="checkbox"/>
Corridors	<input type="checkbox"/>
Administration	<input type="checkbox"/>
Toilets	<input checked="" type="checkbox"/>
Other	<input checked="" type="checkbox"/>

### When to Consider

Programming	<input type="checkbox"/>
Schematic	<input type="checkbox"/>
Design Dev.	<input type="checkbox"/>
Contract Docs.	<input type="checkbox"/>
Construction	<input checked="" type="checkbox"/>
Commissioning	<input checked="" type="checkbox"/>
Operation	<input checked="" type="checkbox"/>

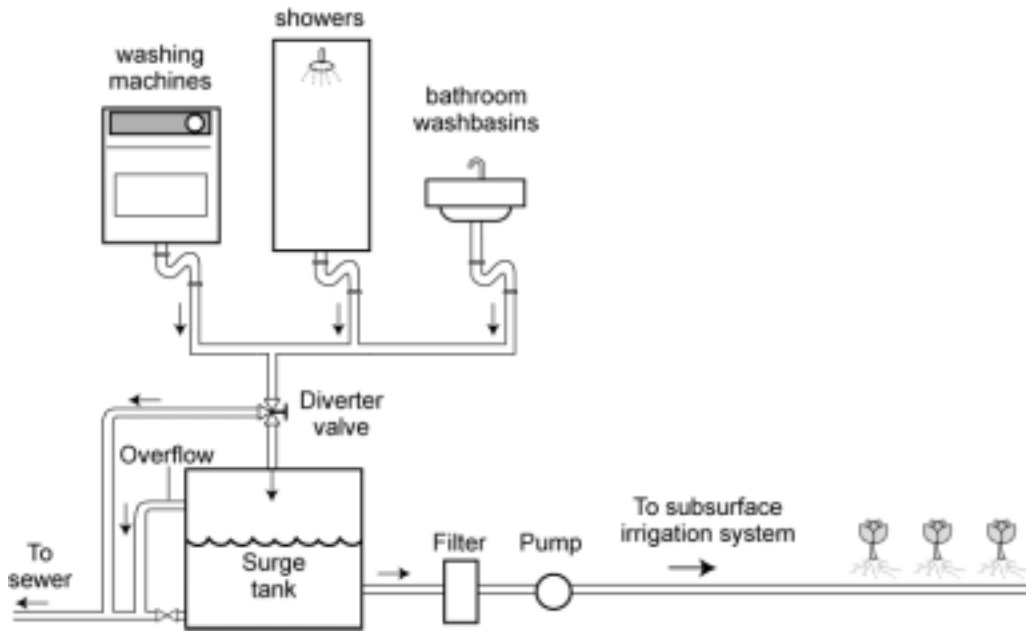

Figure 48 – Example Schematic of Gray Water System

### Applicability

- They are appropriate wherever supplemental irrigation is normally required.
- They are applicable for all climate types, although their uses may be limited in severely cold climates. However, in colder weather conditions, graywater can be drained into leaching trenches that are deep enough to resist freezing, but shallow enough to keep the nutrients within the root zones of surface plants. Freezing can be prevented by applying a mulch over the subsurface leaching trenches. Drought-prone climates will especially benefit from a reliable, year-round source for irrigation.
- Do *not* use gray water for plants with limited root areas or on hydroponic plants. Acid-loving trees and shrubs (azaleas, begonias, and rhododendrons) may be affected because gray water is alkaline. Do *not* use gray water on edible plant parts.

### Integrated Design Implications

Integrated gray water systems for new constructions are cost effective, although retrofitting is not a major issue either. Plumbing installation and surge tank location require consideration early in the design process.

### Cost Effectiveness

Installation costs for gray water systems can range from several hundred dollars to more than \$5,000 for small systems. Generally, systems will have an initial cost between \$8/gallon to \$15/gallon of stored gray water. The annual operating costs are between \$0.15/gallon to \$0.25/gallon of capacity.

Costs	L			
	M			
	H			
		L	M	H
		Benefits		

Table 38 – Types of Systems Currently Available

System Type	Source of Gray water	Features	Cost
Low-Tech Owner or Professional Installation	Washing machine only.	200 micron mesh filter. 55-gallon garbage can with locking lid.	\$400-\$800
Medium-Tech	Uses all gray water sources.	Sump pump to PVC tubing. Subsurface drip irrigation. 200-micron mesh filter. (2) 55-gallon storage tanks.	\$1,000- \$1,500
Fully Automated Professional Installation	Uses all gray water sources.	Automatically back-washed sand filter. 250-gallon storage tanks. Pumps at both source and tank/filter. Three-way valve, backflow preventers. Microprocessor controls all flows. Backed by potable water.	\$2,500- \$5,000

### Benefits

- Promotes conservation and reduces water bills by reusing water from baths and sinks that would have otherwise gone down the drain. At least 30% of total “used” water is reutilized by such systems.
- Drought-proof landscaping. More than half the indoor water can be recycled, ensuring a constant source of water even during shortages. The nutrients in the gray water may also benefit plants. Valuable plant nutrients, such as phosphorous and potassium, are often found in gray water that can result in healthier plants and in the reduced application of fertilizers. By leaving the soil surface drier, it may also make for a healthier landscape by reducing disease and pests.
- Using gray water improves the efficiency of applied water because it is delivered to the plants underground, eliminating runoff, over spray, and evaporation.
- The community benefits from gray water use because it reduces the amount of wastewater that is discharged to the local treatment facility. This has the potential to reduce wastewater treatment costs, and may even postpone or avoid the need for flow-related expansions of the facility. Local water and wastewater agencies also experience reduced pumping costs.

### Design Tools

One of the toughest challenges in designing the gray water system is laying out the irrigation system and determining the size of the area to be irrigated. The homeowner or designer must decide which plants can be irrigated with gray water. The size of the irrigated area is determined by the soil type, volume of gray water produced, and by the summer water requirements of the plants. A good rule of thumb is to expect 2 gallons to 2.5 gallons of water to effectively irrigate 1 ft<sup>2</sup>/day. Estimate the total daily water requirement and assume that only 50% of this estimate will make it into the gray water storage.

### Design Details

- Plumb “used” water from bathroom sinks, showers, and clothes washers separately from other wastewater. Kitchen sinks may be included if there are no in-sink garbage disposals. This water should drain by gravity into a surge tank.
- Surge tanks should have tightly fitted covers, vent stacks, and overflow drains attached. It should also have a one-way valve to prevent backflow. Install the tank such that the outflow can be gravity driven. If this is not possible, use pumps for delivering water for irrigation. Overflow pipes that redirect water to septic tanks or sewer lines are very important when the field gets saturated.
- The water in the surge tank should be filtered.
- Locate the distribution piping 9 in. below the soil surface to provide adequate decomposition and minimize health risks. Use dual pipes that consist of 1-in perforated pipes with 5/16-in holes at 6-in intervals lodged in pipes of larger diameters with slits at the bottom.
- Provide several independent drain areas with valves for alternate distribution.

- Use a check valve between the pump and outflow piping to restrict the gray water flow in one direction.
- It is a good practice to label and mark all piping, fixtures, and pumps that comprise a gray water system.

### **Operation and Maintenance Issues**

The success of gray water systems is completely dependent on careful operation and periodic maintenance. The following guidelines should be strictly followed for health and safety reasons.

- Paint thinners, paints, or pesticides should never be washed down the drain, and substances such as ammonia and chlorine should find their way into gray water plumbing in very limited quantities only. Drains in schools must be clearly labeled with bilingual signs.
- While most detergents can be used with gray water systems, there are several important exceptions and several cautions. Products that contain boron should not be used. Boron has been shown to be very toxic to most plants. Use biodegradable soaps as much as possible.
- If salt buildup in the landscape is a concern (it should be in most cases), it is better to use liquid detergents than powdered detergents. Powdered detergents contain excessive amounts of sodium.
- Chlorine is extremely toxic to plants, but it has not generally been a problem in gray water irrigation. This may be because chlorine breaks down fairly rapidly and its effects may also be dissipated or diluted in the soil. Having some residual chlorine present in the surge tank to minimize bacteria buildup also appears to be a benefit. Chlorine bleach may damage plants if it touches the foliage.
- Gray water should not be sprayed, allowed to puddle, or run off property.
- Gray water should be rotated with fresh water to leach out any harmful build-up. Biodegradable soaps appear to have the least harmful effects.

### **Commissioning**

For safety reasons, involve a soil engineer (or other experts) to assess available soil and the feasibility of the system based on soil quality. All purchased equipment should be accompanied by detailed installation information and all equipment should be professionally installed.

### **References/Additional Information**

National Park Service. *Guiding Principles of Sustainable Design* (Chapter 8).  
<http://www.nps.gov/dsc/dsgncnstr/gpsd>.

U. S. Environmental Protection Agency, Office of Water, <http://www.epa.gov/OW>.

Water Alliance for Voluntary Efficiency (WAVE), <http://www.epa.gov/owm/water-efficiency/faq.pdf>

WaterWiser — The Water Efficiency Clearinghouse. <http://www.waterwiser.org/>

## GUIDELINE WC5: WATERLESS URINALS

### Recommendation

Install waterless urinals wherever applicable.

### Description

Waterless urinal systems have been used in schools since 1993, and have some innovative features that distinguish the product from the conventional urinal systems available today. The products look, feel, and work like a conventional urinal system except for one difference: they do not require water to operate.

The system has three main components: a polypropylene trap insert, a sealant liquid, and a reinforced fiberglass urinal body.

The primary component of the product is the trap cartridge. This cartridge "traps" the 99% biodegradable sealant liquid, which is lighter than other liquids. It floats on and seals the contents from the atmosphere. This special liquid allows urine to sink through its layer, creating a pleasant and odor-free environment. Since urine is 90% water, it readily flows down and falls through the trap. This trap design allows immersed urine to be discharged into the drain without using any mechanical parts.

The system requires only about three ounces of sealant liquid per charge to operate and will last for about 1,500 sanitary uses. Then, the liquid is simply replenished. The trap needs to be replaced three to four times a year, depending on frequency of use.

Waterless urinals are becoming more accepted as people begin to understand that these systems are not unsanitary compared to traditional urinals.

### Applicability

Waterless urinals are applicable to all restroom modernizations and new construction.

### Cost Effectiveness

Costs for waterless urinals are comparable to regular manual flushed urinals, but are less than automatic-sensor flushed urinals.

The payback period for the system is one to four years. Savings due to waterless urinals are estimated between \$150/urinal/year and \$330/urinal/year depending on factors like number of users, cost of water, cost of sewer, volume of water use, and maintenance.



*Waterless urinals have no moving parts, resulting in easy maintenance and low operating costs. NREL/PIX 11413*

### Applicable Climates



### Applicable Spaces

Classrooms	<input type="checkbox"/>
Library	<input type="checkbox"/>
Multi-Purpose	<input type="checkbox"/>
Gym	<input type="checkbox"/>
Corridors	<input type="checkbox"/>
Administration	<input type="checkbox"/>
Toilets	<input checked="" type="checkbox"/>
Other	<input type="checkbox"/>

### When to Consider

Programming	<input type="checkbox"/>
Schematic	<input type="checkbox"/>
Design Dev.	<input type="checkbox"/>
Contract Docs.	<input type="checkbox"/>
Construction	<input checked="" type="checkbox"/>
Commissioning	<input type="checkbox"/>
Operation	<input type="checkbox"/>

Costs	L	<input checked="" type="checkbox"/>	<input type="checkbox"/>	
	M	<input type="checkbox"/>	<input type="checkbox"/>	
	H	<input type="checkbox"/>	<input type="checkbox"/>	
		L	M	H
		Benefits		



## ***Benefits***

Some benefits of waterless urinals include:

- Easy maintenance since it has durable, break-resistant fiberglass construction with no moving parts. This reduces operating costs by eliminating the problem of broken flush valves. However, more frequent washing may be required, as the inside of the urinals are not flushed out with water.
- Flushometer and valve replacements are common problems for flush urinals. Such repairs are not an issue for waterless urinals.
- Waterless urinals are simple to install and use. Replacing existing conventional urinals with waterless products is also relatively simple to accomplish, since they easily adapt to existing 2-in plumbing waste lines.
- They have a short payback period of one to four years.
- Fresh water supply will be preserved and can be applied in a more effective and meaningful way. In addition to saving water, they reduce the amount of water needing to be treated. Less water released into the treatment process lowers pollution and benefits the environment.
- Waterless urinals significantly reduce clogging and prevent overflows.

## ***Design Tools***

None.

## ***Design Details***

None.

## ***Operation and Maintenance Issues***

The smooth, simple design of the waterless system is easy to clean and maintain. Also, there are no costly repairs usually associated with the mechanical components of flush valves.

The trap cartridge should be replaced two or four times per year, depending on the frequency of use.

The sealant liquid is biodegradable and the trap cartridge should be recycled.

## ***Commissioning***

The drain line should be clear before installation, which may require snaking the drain line.

## ***References/Additional Information***

None.

## GUIDELINE WC6: EFFICIENT TERMINAL DEVICES

### Recommendation

Use low-flow toilets and low-flow devices on all terminals like faucets and showerheads. Use automatic faucets for controlling wastage of clean water.

### Description

Installing low-flow devices is simple and cost effective. In 1995, the National Energy Policy Act mandated the use of toilets that use no more than 1.6 gallons of water per flush (gpf), reduced from 3.5 gpf. Low-flow toilets use various technologies like large drain passages, redesigned bowls, and tanks for increased functionality and easier wash-downs.

Older showerheads typically deliver 4 to 5 gallons per minute (gpm) of water. Newer showerheads are more efficient and follow the National Energy Policy Act of 1992 that allows a maximum water flow rate of 2.5 gpm (at standard water pressure of 80 lb/in<sup>2</sup>). Showerheads should use aerator technology and multiple flow settings to save water. Conventional bathroom faucets use 3 gpm to 7 gpm. New faucets, designed to meet federal codes, use a maximum of 2.5 gpm (at 80 psi), although some are being designed to use 1.5 gpm or less.

The new low-flow faucets essentially operate in one of two ways: aeration or laminar flow. In laminar flow faucets, the water travels in parallel streams, producing a clear flow of water without being mixed with air (as in aeration), which produces superior wetting ability over aerating faucets. Laminar flow faucets are somewhat more expensive than aerating types. Conventional faucet aerators do not compensate for changes in inlet pressure, so with greater water pressure, more water is used. New technology compensates for this occurrence and provides the same flow regardless of pressure. Aerators are also available that allow water to be turned off at the aerator itself.

Some low-flow faucets are the metered-valve type; they deliver a fixed quantity of water and then shut off automatically. Other automatic faucets include sensed and self-closing. Sensed faucets, either infrared or ultrasonic, are designed to turn on when a user's hands are placed under the faucet, and turn off when the hands are removed.

### Applicability

Low-flow technology is applicable to all terminal devices that deliver water.



*Low-flow devices will reduce water consumption by 15% to 20%, resulting in lower environmental costs and reduced load on wastewater treatment plants. NREL/PIX00653*

### Applicable Climates



### Applicable Spaces

Classrooms	<input type="checkbox"/>
Library	<input type="checkbox"/>
Multi-Purpose	<input checked="" type="checkbox"/>
Gym	<input type="checkbox"/>
Corridors	<input type="checkbox"/>
Administration	<input type="checkbox"/>
Toilets	<input checked="" type="checkbox"/>
Other	<input checked="" type="checkbox"/>

### When to Consider

Programming	<input type="checkbox"/>
Schematic	<input type="checkbox"/>
Design Dev.	<input type="checkbox"/>
Contract Docs.	<input type="checkbox"/>
Construction	<input checked="" type="checkbox"/>
Commissioning	<input type="checkbox"/>
Operation	<input type="checkbox"/>

## Cost Effectiveness

A good quality, low-flow showerhead will cost \$10 to \$20. Low-flow faucet aerators cost \$4.50 to \$8. A sensed faucet is expensive and may cost up to \$160 per fixture more than the regular faucets.

Costs	L			
	M			
	H			
		L	M	H
		Benefits		

## Benefits

A low-flow device will pay for itself in energy saved within four to eight months.

Installing low-flow showerheads and faucet aerators can save significant amounts of hot water. Low-flow showerheads can reduce hot-water consumption for bathing by 30% while still providing a strong, invigorating spray.

Water consumption is reduced by 15% to 20%, resulting in lower environmental costs and reduced load on wastewater plants. Easy installation procedures make low-flow plumbing fixtures feasible for retrofitting. It is estimated that low-flow toilets alone could save up to 2,000 gallons of water per person.

## Design Tools

None.

## Design Details

Use aerators that deliver 0.5 gpm to 1 gpm of water for bathroom faucets.

Use aerators with higher flow rates (2 gpm to 3 gpm) for sink faucets that will be used for intensive washing purposes.

## Operation and Maintenance Issues

Faucets should be periodically checked for leaks and repaired as needed. Leaky faucets can waste enormous amounts of water (up to tens of gallons in a single day).

Faucet aerators need to be checked periodically for clogging, some models clog more easily than others and may need to be cleaned too often to be effective. Some aerators may cause unacceptable performance or the perception of poor performance, resulting in an increase in water use.

## Commissioning

Installation of low-flow plumbing fixtures is similar to that of conventional fixtures. Most of these fixtures require no special connections or fittings. Low quality showerheads may simply restrict water flow, which often results in poor performance.

## References/Additional Information

American Water Works Association. 1401 New York Ave. NW, Suite 640, Washington, DC 20005.  
Phone: (202) 628-8303. Web site: <http://www.awwa.org>.

Plumbing Manufacturers Institute (PMI). 800 Roosevelt Road, Building C, Suite 20, Glen Ellyn, IL 60137. Phone: (708) 858-9172. Web site: <http://www.pmihome.org>.



# RECYCLING SYSTEMS AND WASTE MANAGEMENT

This chapter provides guidelines for:

Paper, Plastics, Glass, and Aluminum Recycling (Guideline RS1)

Composting (Guideline RS2)

Construction and Demolition (C&D) Waste Management (Guideline RS3)

## OVERVIEW

---

This section gives guidance on recycling systems and waste management at schools. Neither recycling systems nor waste management systems, such as composting, require extensive design accommodations. However, consideration of these issues during the design process, rather than after, can minimize waste streams and lower disposal costs, conserve natural resources, and provide an educational opportunity for students as well as teachers and administrators. Often, once site and building accommodations have been made for these systems, students can design and manage the programs as part of science or math curriculum.

The following guidelines cover recycling design requirements for paper, plastics, glass, and aluminum, as well as requirements for composting. For both, a comprehensive recycling and waste reduction plan is recommended.

However, recycling and waste management should begin long before the building is occupied. Environmental goals should not be compromised during high performance school construction. Construction and demolition (C&D) debris includes concrete, asphalt, wood, drywall, metals, and many miscellaneous and composite materials. Land clearing debris, such as stumps, rocks, and dirt, are also included in some state definitions of C&D debris. C&D work generates significant waste, with current estimates at 28% of the total waste tonnage.<sup>1</sup> A C&D waste management plan should either be part of an overall resource-efficient job-site operations plan (See Site Design chapter) or developed as a separate document.

---

<sup>1</sup> <http://www.ciwmb.ca.gov/ConDemo/factsheets/RecyProg.htm>.

# GUIDELINE RS1: PAPER, PLASTICS, GLASS, AND ALUMINUM RECYCLING

## Recommendation

Require a comprehensive recycling and waste reduction plan. Develop a system for minimizing waste by recycling paper, plastics, glass, and aluminum products. Incorporate space for recycling receptacles in the design and construction of the school.

## Description

An effective waste reduction plan will incorporate an organized system for recycling paper, plastics, glass, and aluminum, and will designate space to do so.

## Applicability

Recycling is applicable in all climate zones and in all types of school spaces. While carried out during the operations phase, the recycling plan for a school should be considered throughout the design and construction process, ensuring that adequate space is designated for receptacles.

## Integrated Design Implications

Space needed for waste disposal will be minimized with designation of space for recycling receptacles. Plans for recycling and garbage pickup service must be coordinated.

## Cost Effectiveness

Implementing a well-coordinated school recycling plan is cost effective. If the school is also used as a recycling drop-off point for the community, it can be a cost-effective measure for the community as well. Minimal costs are involved, including the purchase or rental of recycling bins, possible pick-up costs, and possible labor costs associated with implementing and operating the recycling plan. The costs of a recycling program can be more than offset by the savings that result from reduced weekly trash pickups. Several cases indicate that a recycling program can result in a 40% to 60% reduction in number of weekly trash pickups. Recycling pickup should be coordinated with the garbage pickup service.

## Benefits

A recycling program reduces the amount of waste produced, thereby reducing waste disposal costs. Recycling helps to ensure an adequate supply of raw materials for manufacturing recycled



A well-coordinated school recycling plan requires minimal costs and can be more than offset by a reduction in waste pickup costs. NREL/PIX 11337

## Applicable Climates



### Applicable Spaces

- Classrooms
- Library
- Multipurpose
- Gym
- Corridors
- Administration
- Toilets
- Other

### When to Consider

- Programming
- Schematic
- Design Dev.
- Contract Docs.
- Construction
- Commissioning
- Operation

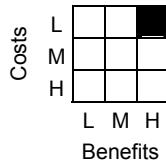

products. Environmental benefits include the conservation of energy, natural resources, and landfill capacity.

### **Design Tools**

None.

### **Design Details**

In several existing schools, space is an issue when it comes to recycling. School facility directors have commented on an inadequate amount of space, both indoors and outdoors, needed to accommodate the containment of recyclables. However, by keeping a recycling plan in mind during the design phase, recycling can become more convenient than disposal.

Collection points should be accessible throughout the school building and grounds. Recycling bins should be placed next to, or near, trash bins to make the choice to recycle easier.

Recommended collection points include:

- Classrooms (white and mixed paper)
- Break areas (aluminum cans, glass, and plastic bottles)
- Cafeterias (milk cartons, cardboard, aluminum and steel cans, glass, plastics)
- Supply or storage rooms (cardboard)
- Offices (white and mixed paper, cardboard)
- Near copiers and printers (paper)
- Machine shop areas (metals, wood, paper)
- Libraries (white paper, newspaper, magazines)
- Next to trash bins on the grounds of the facility.

In multi-floor areas of the school, chutes may be used to channel recyclables to central collection points. Glass, however, is not recommended for use in chutes, as potential for breakage increases with drop height.

The size of recycling bins should correlate with the amount of recyclables generated in particular areas. Smaller bins or containers (12 gallons to 18 gallons) can be used for collecting paper in classrooms or offices. Larger containers (30 gallons to 60 gallons) may be better suited near copy machines, in cafeterias, or in break rooms.

Space must be allocated on the school grounds for placing dumpsters for recycling and garbage pickup. At a minimum, allow space for one dumpster for cardboard, another for garbage, and one for glass/metal/plastic food and beverage containers. Depending on local sorting requirements for recyclables, glass, metals, and plastics may or may not need to be separated into their own receptacles. Accommodations for newspaper and white office paper recycling are also recommended.

In existing schools, conduct a waste audit to determine the amount of waste and recyclables generated on a monthly basis. Allocate space accordingly. The school's custodial staff can help design dedicated areas for recycling bins, recycling chutes, and other required elements.

For new school construction, determine the number of occupants who will be using the school. Contact existing schools of similar size who have conducted waste audits (or arrange to have one done for them) to estimate the typical amount of waste/recyclables generated and the subsequent space needed to accommodate them.

A typical elementary school cafeteria can distribute more than 1,000 milk cartons every week. Determine whether the local jurisdiction accepts this type of paper product for recycling. If so, allocate space and appropriately sized bins to accommodate milk cartons in cafeterias.

### **Operation and Maintenance Issues**

A comprehensive recycling program must involve a coordinated effort with parties involved in waste disposal and composting.

### **Commissioning**

None.

### **References/Additional Information**

Connecticut Department of Environmental Protection. "Designing for Recycling in Schools: A Fact Sheet for Architects and Engineers," at <http://www.dep.state.ct.us/wst/recycle/schplan.htm>.

Los Angeles Department of Public Works, Elementary School Environmental Education Program. "Organizing Cafeteria Recycling Programs in Elementary Schools," at <http://ladpw.org/epd/envdef/Teacher-PrincipalPacket.pdf>.

U.S. Environmental Protection Agency. Office of Solid Waste. "How to Start or Expand a Recycling Collection Program," at <http://www.epa.gov/epaoswer/non-hw/reduce/wstewise/pubs/howtopdf.pdf>. January 1994.

U.S. Environmental Protection Agency. Office of Solid Waste. *The Consumer's Handbook for Reducing Solid Waste* at <http://www.epa.gov/epaoswer/non-hw/reduce/catbook/>. August 1992.

U.S. Environmental Protection Agency. Office of Solid Waste. "WasteWi\$e Tip Sheet: Recycling Collection," at <http://www.epa.gov/wastewise/pubs/collpdf.pdf>. January 1994.



## GUIDELINE RS2: COMPOSTING

### Recommendation

Incorporate composting into the recycling and waste management plan for the school. Recover food discards (meal preparation scraps and students' leftovers) and yard trimmings/gardening clippings for use as compost.

### Description

Several methods exist for composting food discards and grass/yard clippings:

- Un-aerated static pile composting
- In-vessel composting
- Vermicomposting
- Aerated windrow/pile composting.

Un-aerated static pile composting is best suited for small operations like most schools; organic discards are piled and mixed with a bulking material. Un-aerated static piles can be used in schools (and are cheaper than other composting methods as they do not require purchasing any vessels), though it is recommended that these be placed away from operable windows to reduce potential odor problems.

In-vessel composting can process larger quantities of material in a relatively small area more quickly than windrow composting and can accommodate animal products. Odors are not as great a concern since the process is enclosed and temperature and moisture are controlled. For these reasons, in-vessel composting is recommended for schools. Vessels come in a variety of sizes and have some type of mechanical mixing or aerating system.

Vermicomposting, which uses worms to break down organic materials into nutrient-rich soil amendment, is a tried-and-true composting method and can be a valuable teaching tool in the classroom. This method is faster than windrow or in-vessel composting and produces high quality composts. However, it cannot accommodate animal products or grease. Odors can be minimized by using the appropriate composting materials (see Design Details below).

Aerated windrow/pile composting may be better suited for larger operations than schools, but can accommodate large quantities of organics — organics are formed in rows or long piles and aerated either passively or mechanically.

### Applicability

Composting is applicable in all climates and in the following spaces: cafeterias, landscaping, and classrooms. Consider a composting strategy during the design development and operation phases.



*Composting is applicable in all climates and reduces school waste streams. NREL/PIX 11336*

### Applicable Climates



#### Applicable Spaces

Classrooms	<input checked="" type="checkbox"/>
Library	<input type="checkbox"/>
Multipurpose	<input checked="" type="checkbox"/>
Gym	<input type="checkbox"/>
Corridors	<input type="checkbox"/>
Administration	<input type="checkbox"/>
Toilets	<input type="checkbox"/>
Other	<input checked="" type="checkbox"/>

#### When to Consider

Programming	<input type="checkbox"/>
Schematic	<input type="checkbox"/>
Design Dev.	<input checked="" type="checkbox"/>
Contract Docs.	<input type="checkbox"/>
Construction	<input type="checkbox"/>
Commissioning	<input type="checkbox"/>
Operation	<input checked="" type="checkbox"/>

## **Integrated Design Implications**

A comprehensive composting strategy that recycles food scraps and yard trimmings can significantly reduce the amount of solid waste produced at a school facility, and, therefore, may reduce the need for conventional waste bins. Bins targeted specifically for collecting composting materials should be used instead. Aside from small vermicomposting projects in the classroom, composting areas should be located away from operable windows to reduce potential odor problems.

## **Cost Effectiveness**

Composting can be quite cost effective. Materials costs are minimal and creating compost to use as a soil amendment saves on purchase costs for new soil amendments. Compost can even be sold to consumers, with some schools having sold their compost as a fundraiser. Incorporating the composting process into the school curriculum not only provides a powerful teaching tool for students, but also cuts down on operating costs.

Costs	L			
	M			
	H			
		L	M	H
		Benefits		

## **Benefits**

The benefits and applications of composting are numerous. Compost can be used for bioremediation and pollution prevention, disease control for plants and animals, erosion control and landscaping, treating contaminated soils, reforestation, wetlands restoration, and habitat revitalization. Economic benefits include avoided costs from reducing or eliminating the need for soil amendment purchases, as well as reduced or avoided landfill or combustor tipping fees. Where applicable, there may be an added benefit of revenue from selling the finished product or recyclable.

Environmental benefits of composting include extended landfill longevity. Compost-enriched soil can help suppress diseases and ward off pests, thereby reducing dependence on pesticides. It can also be used to reduce erosion and nutrient runoff and can alleviate soil compaction. Allowing students to play an active role in their school's composting program can be a valuable teaching tool.

## **Design Tools**

None.

## **Design Details**

Outdoor composting bins should be kept away from direct sunlight, which may dry out the pile, and from strong winds that may also dry and cool the pile. Locate bins close to a water source in case they become too dry. Ensure that the pile has good drainage, as this will avoid standing water and the build-up of anaerobic conditions. Compost piles should be kept at a distance from wooden structures or trees to avoid causing decay. Allocate space for temporary storage of organic wastes.

Composting inside the classroom can be carried out in containers as small as soda bottles or as large as garbage cans. They must be carefully designed to provide the proper aerobic, heat-producing conditions necessary for composting to occur. For different types of composting methods suitable for the classroom, consult Cornell University's "Composting in Schools" web site (listed in the References/Additional Information section below).

### **Yard Trimmings**

Leave grass clippings on lawns to reduce the amount of waste that must be collected. Grass clippings increase the soil's organic content, and also help the soil to retain moisture and nutrients, resist erosion, and maintain cooler temperatures in summer. Yard wastes such as leaves, grass, prunings, weeds, and remains of garden plants can all be used as compost, unless they have been chemically treated with pesticides or herbicides. Clip, saw down, or shred woody yard wastes to speed the composting process.

**Other Compostable Materials**

Other materials that can be composted include vacuum cleaner lint, wool and cotton rags, sawdust, shredded newspaper, and fireplace ashes. All of these compostable materials can be stored and composted together. Food discards should be kept in separate bins. For details on setting up and operating a compost system for yard trimmings, consult the links in the References/Additional Information section below.

**Vermicomposting with Food Discards**

Composting with worms is a method for recycling food waste into a rich, dark soil conditioner. It can be done indoors or outdoors, allowing for year-round composting. Use food scraps such as raw fruit and vegetable scraps, pulverized eggshells, tea bags, and coffee grounds. According to a U.S. General Accounting Office (GAO) report, on average, 30% of raw vegetables/salad and 22% of fresh fruit are wasted in school cafeterias. A breakdown of typical food portion wasted by food type in schools can be noted in the following graph from this GAO report.

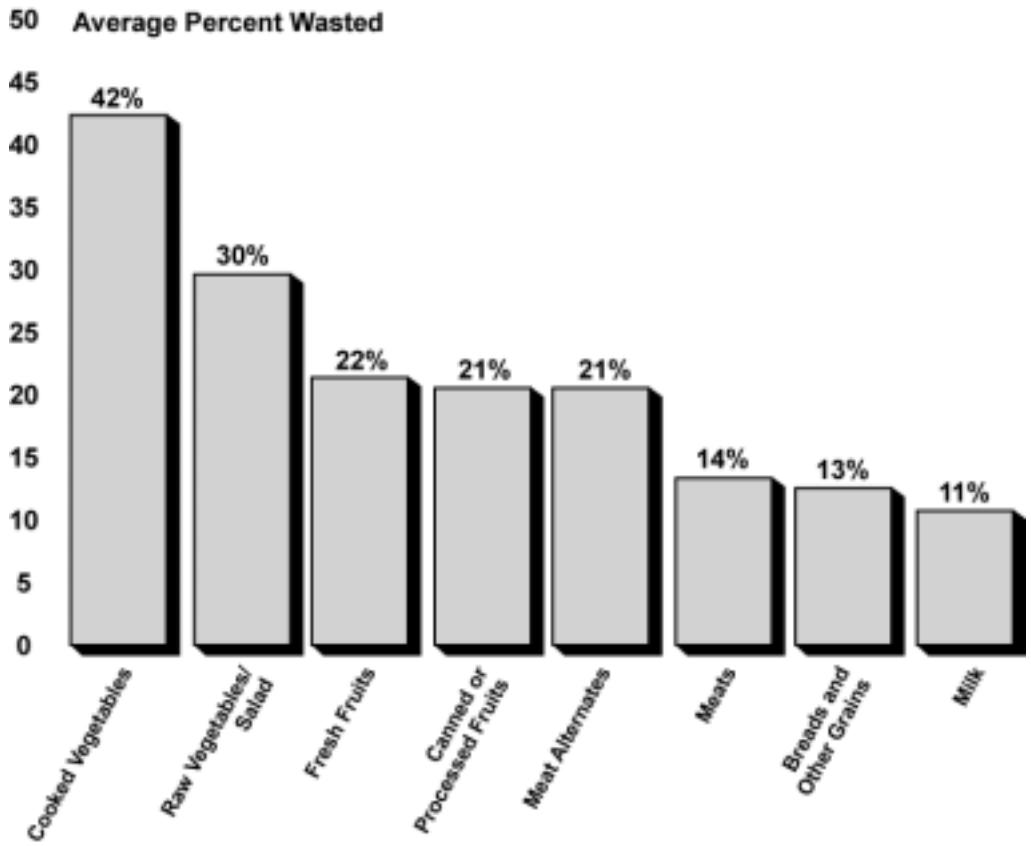

Table 49 – Amount of Food Portion Wasted by Food Type

The following figure from the same GAO report shows the percentage of foods wasted by school level (elementary, middle, high school).

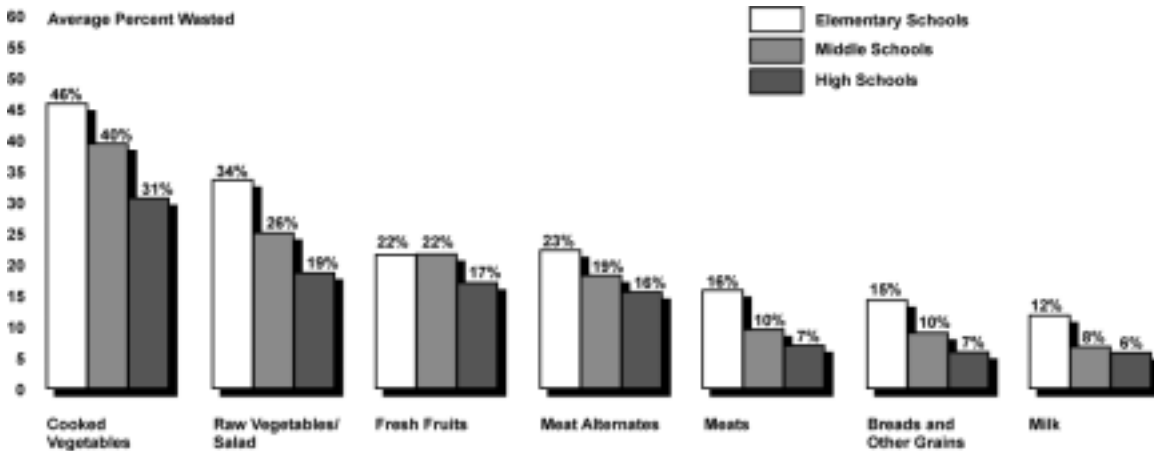

Figure 50 – Variation in Amount of Waste by School Level for Seven Food Types

Avoid foods such as orange rinds and other citrus fruits, which are too acidic and can attract fruit flies. Also try to avoid onions and broccoli because of their strong odor. Otherwise, the more vegetable matter, the better. Other foods that are not advisable for composting are oily foods, meats, dairy products, and grains — they take longer to break down which may attract pests and cause odor problems.

To set up the worm bin, use a box (provide 1 ft<sup>2</sup> of surface area/lb of food scraps), moist newspaper strips, and red or red wiggler worms (*Eisenia foetida* or *Lumbricus rubellus*), which can be ordered from a worm farm and mailed to the school. For every 1 lb of food waste, use 2 lbs of worms (roughly 2,000 worms). Temperatures for worm bins should be 40°F to 80°F. In colder weather, the bins should be well-insulated. For more details on setting up and operating a worm-composting bin, consult the links below.

### Operation and Maintenance Issues

A comprehensive composting program must involve a coordinated effort among all parties involved in waste disposal and recycling. In cases where composting is used as a teaching tool either in or out of the classroom, students can be responsible for maintaining the compost piles/bins with some guidance.

### Commissioning

None.

### References/Additional Information

- Cornell University. *Cornell Composting: Composting in Schools*. Web site at <http://www.cfe.cornell.edu/compost>. The Cornell University Resource Center ([resctr@cornell.edu](mailto:resctr@cornell.edu)) also has several resources available, both written and audio-visual.
- City Farmer, Canada's Office of Urban Agriculture. "Composting With Red Wiggler Worms." <http://www.cityfarmer.org/wormcom61.html>. 1995.
- New Hampshire Department of Environmental Services and New Hampshire Governor's Recycling Program. *Composting at New Hampshire Schools: a "How to" Guide*. <http://www.state.nh.us/recycle/guide.pdf>. Spring 1997.
- U.S. Environmental Protection Agency. Office of Solid Waste. *Composting Yard Trimmings and Municipal Solid Waste*. <http://www.epa.gov/epaoswer/non-hw/compost/cytmsw.pdf>. May 1994.

- U.S. Environmental Protection Agency. Office of Solid Waste. "Don't Throw Away That Food: Strategies for Record-Setting Waste Reduction." <http://www.epa.gov/epaoswer/non-hw/reduce/food/food.htm>.
- U.S. Environmental Protection Agency. Office of Solid Waste Environmental Fact Sheet, "Recycling Grass Clippings." <http://www.epa.gov/epaoswer/non-hw/recycle/grass.pdf>. July 1992.
- U.S. Environmental Protection Agency. Office of Solid Waste and Emergency Response Environmental Fact Sheet, "Yard Waste Composting." May 1991.
- U.S. General Accounting Office Report: RCED-96-191: "School Lunch Program...views on food wasted." <http://www.gao.gov/>. July 1996.

## GUIDELINE RS3: CONSTRUCTION AND DEMOLITION (C&D) WASTE MANAGEMENT

### Recommendation

Require waste reduction planning and job-site practices. These guidelines recommend that an environmentally friendly job-site operations plan (Guideline SD8) be developed that incorporates a job-site waste reduction component. An alternative is to develop a stand-alone Construction and Demolition (C&D) Waste Management Plan.



*A construction site waste audit can help reduce waste generated and divert materials through processes from disposal through reuse and recycling. NREL/PIX 11407*

### Description

Effective job-site waste management will reduce the amount of C&D waste generated, as well as divert materials generated through C&D processes from disposal through reuse (salvage) and recycling. This effort can be combined with a concerted use of salvaged or recycled-content building materials throughout the building project; specific materials would be called out in appropriate sections of project specifications.

C&D waste management will include developing a waste reduction plan, identifying personnel responsible for implementing and monitoring the plan, and outlining the consequences for non-compliance. Waste management should reflect the prioritized hierarchy of “Reduce, Reuse, and Recycle” with recycling efforts occurring in concert with *source reduction* and applying only to materials that *cannot be reused*. The concept of source reduction eliminates or reduces potential waste prior to generation. By reducing waste and using materials efficiently, money will be saved on purchasing and avoided disposal costs. If materials are not generated in the first place, recycling efforts should only apply to materials that cannot first be reused.

### Applicable Climates



### Applicable Spaces

Classrooms	█
Library	█
Multi-Purpose	█
Gym	█
Corridors	█
Administration	█
Toilets	█
Other	█

### When to Consider

Programming	□
Schematic	□
Design Dev.	□
Contract Docs.	□
Construction	█
Commissioning	□
Operation	□

### Applicability

Construction waste management is applicable in all climates and in all types of school spaces. While carried out during the construction phase, the contract documents must clearly lay out the responsibilities of the general contractor.

### Integrated Design Implications

Some waste reduction can be designed into the building project, such as standardized dimensioning, modular or panelized building units, and layout of openings (see the Energy-Efficient Building Shell chapter). Specifying the use of mechanical fasteners (screws, Velcro)

rather than chemical adhesives and solvents will allow components to be easily disassembled and reused.

It is important to make the intent of these design details clear to avoid in-the-field decisions that waste materials. Contractors are excellent problem solvers and should be encouraged to find cost-effective substitutes that they know will meet or exceed the environmental goals.

Improper materials handling on the job site can add to the construction waste. Materials contaminated by mildew and mold due to moisture exposure have to be discarded and replaced.

### Cost Effectiveness

Costs include labor for overseeing and implementing the C&D waste reduction (or waste management) plan, rental for additional bins or other containers used for recycling or salvage, and transportation. Research indicates labor costs decrease significantly as contractors become more familiar with job-site waste reduction techniques. Some contractors keep costs down by utilizing temporary lay down areas with plywood barriers to hold recyclables, rather than renting bins or containers. Alternatively, planning ahead and ordering bins only when needed can keep down costs, since C&D materials are typically generated at predictable phases of the project.

Costs	L			
	M			
	H			
		L	M	H
		Benefits		

Waste disposal/management is generally budgeted as a very small portion of overall job costs. However, the cost of purchasing materials to replace materials that are wasted is rarely taken into account. The tendency is to assume that effective waste reduction takes more time and results in higher costs, but case studies show that, if labor crews are adequately trained and a good plan is in place, costs do not increase.

### Benefits

In general, C&D waste reduction should also reduce overall construction costs, especially as the practice becomes a part of every job and the C&D recycling/reuse infrastructure matures. If revenues from waste reduction, reuse/salvage, and recycling are allocated to the contractor, the responsibility (and the incentive) for waste reduction clearly lies in the contractor's domain. Most contractors report that having a good waste reduction program in place results in a cleaner, safer site, resulting in less lost time and delay.

Environmentally, less waste means better use of limited raw materials and of the energy required to produce, transport, and dispose of building products used in the project. Also, recycling provides "stock" for new materials to be manufactured.

### Design Tools

See the sample specifications included in *Green Spec: The Environmental Building News Product Directory and Guideline Specifications*.

### Design Details

Scheduling should permit salvaging and deconstruction activities, as appropriate.

Waste reduction goals (as with all other resource-efficient building goals) should be outlined in the Instructions to Bidders section of the Project Summary. In addition, waste reduction specifications should be included in the Temporary Controls sections of General Conditions.

As part of identifying those materials that should be targeted for recycling or reuse in a particular project, contact the local waste authority for information about building materials that can be cost-effectively recycled or salvaged in the project area. These materials, an example being gypsum drywall, should be called out for recycling in the General Conditions specifications section pertaining to waste reduction and in other pertinent sections.

Waste reduction specifications should reflect local jurisdictional requirements, but should be organized using typical CSI convention. The specifications should describe what is included in the

job-site waste reduction plan, outline submittal and documentation requirements; indicate ownership of revenues resulting from waste reduction efforts; and include performance goals like minimum levels of waste reduction. The specifications should also outline remedies in the event those levels cannot be met.

If the contractor is required by ordinance or specification to be responsible for achieving waste reduction, it is not necessary to detail methods by which the contractor can achieve it. However, it is informative to contractors to include a list of proven waste reduction strategies, such as:

- A pre-C&D waste management meeting to discuss procedures, schedules, coordination, and special requirements for materials.
- A waste-reduction provision in supply agreements specifying a preference for reduced, U-turn, and/or recyclable packaging.
- Detailed take-offs that identify location and use in the structure to reduce risk of unplanned and potentially wasteful cuts.
- Proper storage for materials to avoid water or other damage as well as outdating. Materials that become wet or damp due to improper storage shall be replaced at contractor's expense.
- Safety meetings, signage, and subcontractor agreements that communicate the goals of the waste reduction plan. Signage should be clear and easy to understand for multiple languages (use graphic symbols).
- On-site instruction regarding appropriate separation, handling, recycling, salvage, reuse, and return methods to be used to achieve waste reduction goals.
- Discussion of C&D waste management during regular job meetings and safety meetings.
- Contamination protection for materials to be recycled.

### **Operation and Maintenance Issues**

Contractors should be required to provide sufficient information on product substitutions to enable the operation and maintenance staff to properly maintain, repair, and replace all products.

### **Commissioning**

None.

### **References/Additional Information**

- California Integrated Waste Management Board web site. In particular, see "Job Site Source Separation," a fact sheet located at <http://www.ciwmb.ca.gov/ConDemo/factsheets/JobSite.htm>. Also see the Clean Washington Center's *Recycling Plus Manual* at <http://www.ciwmb.ca.gov/ConDemo/Links.htm>. Use this resource to produce a step-by-step construction waste management and recovery plan. *Designing with Vision: A Technical Manual for Material Choices in Sustainable Construction*. Chapter 9, Managing Job-Site Waste, addresses C&D waste and is located at <http://www.ciwmb.ca.gov/ConDemo/Pubs.htm>.
- U.S. Environmental Protection Agency, *Characterization of Building-Related Construction and Demolition Debris in the United States*, June 1998, at <http://www.epa.gov/epaoswer/hazwaste/sqg/demol.htm>. Provides national data that a builder may find helpful to estimate and characterize his own waste generation.
- U.S. Green Building Council's *Reference Manual for LEED Green Building Rating System* (Commercial, Version 2) at <http://www.usgbc.org>.



# TRANSPORTATION

This chapter provides guidelines for:

Transportation and Site Design (Guideline TR1)

Alternative Fuel Vehicles (Guideline TR2)

## OVERVIEW

In many school districts across the country, more energy dollars are spent by the school system in transporting students to and from school than in meeting the energy needs of their school buildings. Careful site planning can help promote alternative transportation. Locating the site close to public transportation and offering bus service will help reduce the automobile-related congestion and pollution. Up to 40% of morning traffic congestion at schools is a result of parents driving children to school. Even if the school location has already been selected, the site design can include features to encourage students, staff, and parents to leave their cars at home. Incorporating a network of safe walkways, bike paths, and carpool and vanpool locations into a school design can reduce local traffic congestion, minimize busing costs, and reduce air pollution. The figure below shows the cost per driver, gallons of fuel used per driver, and annual delay per driver in 10 major cities across the country.

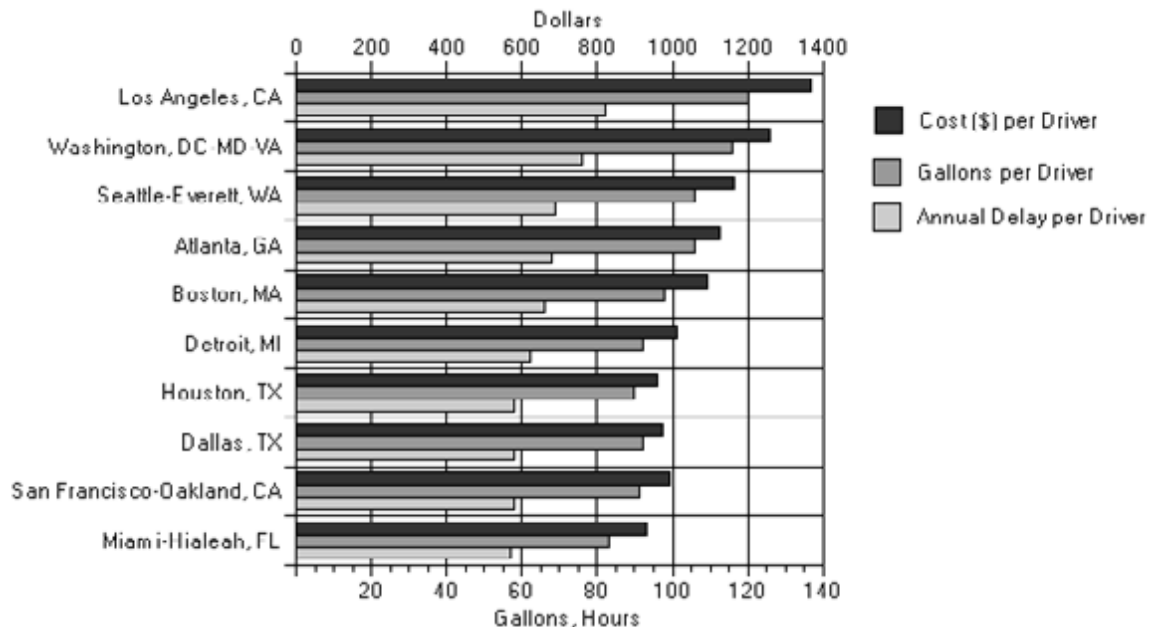

Source: Texas Transportation Institute, 1999 Urban Mobility Study, November 1999

Figure 51 – Comparison of Costs for Drivers in 10 U.S. Cities

## ALTERNATIVE FUELS

Incorporating natural gas, biodiesel, methanol, or electric vehicles into a district's existing vehicle fleet can help to reduce fuel costs, reliance on foreign oil, and harmful emissions — contributing to reduced operating and maintenance costs. The reduced cost of fuel will largely depend on individual state incentives and regional pricing of fuels.

Today, nearly 60% of all school buses run on diesel, a highly-polluting transportation fuel that poses considerable health risks.<sup>1</sup> Due to particulate emissions, the use of diesel fuel is increasingly becoming associated with increased asthma rates and other lung-related diseases. Alternative fuel buses and school fleet vehicles can be used to provide environmentally friendly alternatives to high-polluting vehicles. Options for alternative fuel buses include electric, hybrid electric, compressed natural gas, ethanol, methanol, and biodiesel — all of which are available on the market for a variety of vehicle types. In addition to long-term energy savings, these vehicles serve as great educational tools for the students and the community.

*Table 1 – Varieties of Alternative Fuels*

	<b>Compressed Natural Gas (CNG)</b>	<b>Ethanol (E85)</b>	<b>Methanol (M85)</b>
Chemical Structure	CH <sub>4</sub>	CH <sub>3</sub> CH <sub>2</sub> OH	CH <sub>3</sub> OH
Primary Components	Methane	Denatured ethanol and gasoline	Methanol and gasoline
Main Fuel Source	Underground Reserves	Corn, grain, or agricultural waste	Natural gas, coal, or woody biomass
Energy Content Lower Heating Value	20,550 Btu/lb	80,460 Btu/gallon	65,350 Btu/gallon
Energy Ratio Compared to Gasoline*	3.0 to 1 at 3600 psi	1.42 to 1	1.75 to 1
Liquid or Gas	Gas	Liquid	Liquid
*Ratio tells how much space is needed to store the same amount of energy. Source: <a href="http://www.afdc.doe.gov/questions.html">http://www.afdc.doe.gov/questions.html</a> , 2/13/02.			

### **Electric Vehicles**

Although a school bus can be powered by pure electricity, only a few electric school bus options are currently available due to the shorter driving range provided by electric power. However, small maintenance carts and other vehicles that are used by school officials and staff are available using electricity as a fuel. Electric vehicles typically have limited ranges based on the type of battery, so they can be great for short trips and stop-and-go driving. Electric vehicles reduce local pollution, and using a renewable energy source limits regional pollution.

<sup>1</sup> Alternative Fuels Data Center website: <http://www.afdc.doe.gov/questions.html>. 2/13/02.

Different types of batteries for electric vehicles are available, two of which are lead acid and nickel metal hydride.

### ***Lead Acid***

This is the most commonly used and least expensive battery technology. Generally, the vehicles have a range of less than 100 miles/charge, and the life of the battery is about three years. Chrysler, Ford, GM, and Toyota vehicles use this battery technology.

### ***Nickel Metal Hydride (NiMH)***

NiMH offers a range of about 100 miles/charge, but is more expensive. The life expectancy of the battery is about 100,000 miles. Chrysler, Ford (California only), GM, Honda, and Toyota offer vehicles with NiMH technology.

To ensure availability of “fuel,” the school or school system should provide a charging station for electric vehicles. These charging areas can be viewable by students to assist with teaching about renewable energy and can include displays to indicate the environmental benefits that the station is providing.

## ***Hybrid Electric Vehicles***

Hybrid electric vehicles (HEVs) combine the internal combustion engine of a conventional vehicle with the battery and electric motor of an electric vehicle to result in twice the fuel economy of conventional vehicles. This combination offers the extended range and rapid refueling that consumers expect from a conventional vehicle, with a significant portion of the energy and environmental benefits of an electric vehicle. HEVs can be fueled by conventional and alternative fuels. Propane- and natural gas-fueled hybrid electric buses are currently in service at several U.S. transit agencies. HEVs fueled by petroleum are not technically alternative fuel vehicles but they do help reduce petroleum use and produce fewer emissions than conventional gas and diesel vehicles. The practical benefits of HEVs include improved fuel economy and lower emissions compared to conventional vehicles. The flexibility of HEVs allow them to be used in a wide range of applications, from personal transportation to commercial hauling.

HEVs often have the same power as conventional vehicles, but do not have the reduced driving range that electric vehicles have. There are several options for HEV buses available today, and there are currently two HEV automobiles that can be used as school fleet vehicles. HEVs can be produced in a variety of ways, but typically the battery pack helps supplement the vehicles’ power when accelerating and hill climbing. During stop-and-go driving, both the internal combustion engine and batteries work together. For extended highway driving, the engine does most of the work because it operates most efficiently under those conditions. These vehicles provide much better gas mileage than conventional vehicles and are a valuable teaching tool to students.

The HEVs, in particular light-duty vehicles, available for sale are very cost competitive with similar conventional vehicles. Overall fuel savings and state and federal incentives can offset any financial premium that may be associated with HEVs.<sup>2</sup>

### **Ethanol**

Ethanol is typically produced from domestic-grown, plant-based materials such as corn or other grains. For school districts using ethanol fuel, several vehicle choices are available. Ethanol fuel can be found at fueling stations across the country; however, some areas have more stations than others. Vehicles using ethanol perform as well as typical conventional vehicles. Under current conditions, the use of ethanol-blended fuels such as E85 (85% ethanol and 15% gasoline) can reduce the net emissions of greenhouse gases by as much as 37%.

### **Compressed Natural Gas Vehicles**

Compressed natural gas (CNG) vehicles operate just like any other conventional vehicles — drivers cannot tell the difference in performance. Compressed natural gas buses are being used by many school districts across the nation. Compressed natural gas is recommended for schools because the vehicles are readily available and the fuel is considerably less expensive than gasoline. The San Marcos Unified School District in Northern San Diego County, CA, recently added six CNG buses to their fleet and report the cost per mile for CNG is \$0.12 compared to \$0.32 for diesel.<sup>3</sup> Several compressed natural gas sedans and trucks are also produced by auto manufacturers and would be good options for use in school fleets. Exhaust emissions of nitrogen oxides and particulates from natural gas vehicles are significantly lower than those from diesel powered vehicles.<sup>4</sup>

### **References/Additional information**

Alternative Fuels Data Center website: <http://www.afdc.doe.gov/questions.html>.

Office of Transportation Technology: [http://www.ott.doe.gov/vehicle\\_purchasing.shtml](http://www.ott.doe.gov/vehicle_purchasing.shtml).

Clean Cities Program website: <http://www.ccities.doe.gov/success/government.shtml> - school\_buses.

---

<sup>2</sup> For a list of state/federal incentives, go to the Office of Transportation Technology: [http://www.ott.doe.gov/vehicle\\_purchasing.shtml](http://www.ott.doe.gov/vehicle_purchasing.shtml).

<sup>3</sup> For success stories go to the Clean Cities Program website: [http://www.ccities.doe.gov/success/government.shtml#school\\_buses](http://www.ccities.doe.gov/success/government.shtml#school_buses)

<sup>4</sup> Ibid.

# GUIDELINE TR1: TRANSPORTATION AND SITE DESIGN

## Recommendation

Locate schools and design school sites to encourage car/vanpooling and pedestrian modes of transportation, rather than single-use automobile transportation.

Incorporate safe and effective parking and storage for bicycles, skateboards, roller blades, scooters, etc.

Use site design to connect the school to the community.



*Designing bike and pedestrian paths and facilities for shared vehicle transportation helps to reduce morning traffic congestion at schools. NREL/PIX 09075*

## Description

Up to 40% of morning traffic congestion at schools is a result of parents driving children to school. To reduce this congestion, schools should implement strategies encouraging the use of energy-efficient transportation alternatives including providing bike and pedestrian paths and providing facilities for shared vehicle transportation (car/vanpools, mass transit).

### Applicable Climates



## Applicability

All climates.

## Integrated Design Implications

This guideline should be addressed in the site selection and site planning stage. Also incorporate these strategies into the building and site design stages, especially when looking at access, circulation, and parking lot design. Be sure to locate parking lots and other sources of pollution away from fresh air intake ducts to preserve indoor air quality. Give adequate space for sidewalks, keeping the parking lot further from the school buildings.

### Applicable Spaces

Classrooms	□
Library	□
Multipurpose	□
Gym	□
Corridors	□
Administration	□
Toilets	□
Other	■

### When to Consider

Programming	■
Schematic	■
Design Dev.	■
Contract Docs.	□
Construction	□
Commissioning	□
Operation	■

## Cost Effectiveness

Costs will vary with the strategies selected. In most cases, additional costs are minimized when integrated early into site/building design. Added costs will be offset by reduction in parking lot size.

The cost premium for providing for energy-efficient and environmentally safe transportation may be offset by grants offered by various agencies.

Costs	L	■	■	
	M	□	□	
	H	□	□	
		L	M	H
		Benefits		

## Benefits

Benefits include reduced automobile use, reduced traffic congestion, improved urban air quality, improved sense of community, and more efficient use of site (if parking lot size is reduced).

## **Design Tools**

IESNA. 1980. RP-8 Roadway Lighting, Chapter 4, Pedestrian Walkway and Bikeway Lighting Design, Illuminating Engineering Society of North America (IESNA), New York. This document contains guidelines for designing fixed lighting for roadways, bikeways, and pedestrian paths.

## **Design Details**

- Provide good access to public transit.
- Require pedestrian- and bike-friendly features including pedestrian paths and walkways, bike paths, safe and accessible bike storage, and showers/changing facilities. Although cyclists and joggers can change in washrooms and store a change of clothes in the workplace, dedicated facilities are more likely to encourage regular human-powered commuting. Provide changing rooms, lockers, and showers for employees. Connect changing room, shower, and locker facilities with bicycle storage, washroom facilities, or pools. Provide sufficient showers to avoid wait at peak times, and to accommodate growing use. Provide separate change/shower rooms for males and females, if possible. Facilities must be accessible to building occupants, but not to the general public or visitors.
- Building design can encourage carpooling and vanpooling by giving priority to shared transportation and by making waiting areas convenient.
- Ensure commuter safety with building lobbies that view waiting, pick-up, and drop-off areas, occupied windows that overlook them, good lighting, and, if necessary, prominent surveillance cameras. Eliminate potential hiding places for criminals. Ensure that sheltered areas are visible from the street and/or parking areas, sidewalk, and school building. Heavy and massive arcades and other features can obscure visibility and affect pedestrian safety.
- Locate carpool and vanpool parking spaces closer to the building entrance than other single-use automobile parking. Post prominent signage to identify the location of carpool and vanpool parking and pick-up areas. Provide comfortable waiting areas to encourage carpool and vanpool commuters. Consider amenities such as sunshades, rain canopies, seating, and bulletin boards.
- Design the school so that the athletic fields, gymnasium, media center, and classrooms are accessible and can be shared at appropriate times with the community.

## **Operation and Maintenance Issues**

None. The work is done in designing stage.

## **Commissioning**

Discuss the layout of school in relation to the community. Closely examine the plans with a whole-community view to make sure all inter-related components work well together.

## **References/Additional Information**

Bicycle Federation of America. Internet Resource Center. Comprehensive coverage of a host of guidelines supporting bicycle use. <http://www.bikefed.org/>. April 1999.

Cox, E. *Long Term Bike Parking*. Useful overview of design considerations for long-term bicycle storage offering essential and optional features for caged facilities, bike rooms, bike lockers, and shower and clothes locker rooms. <http://www.jps.net/cbc/longbikepark.html>. April 1999.

Woodhull, J. 1992. *How Alternative Forms of Development Can Reduce Traffic Congestion*. Sustainable Cities; Concepts and Strategies for Eco-City Development, Ed. Bob Walter et al. Los Angeles: Eco-Home Media. Offers alternative approaches to traffic planning, concentrating on "access" rather than mobility. Covers densification, parking, and development patterns and offers solutions for pedestrian-friendly, transit-oriented development.

U.S. Department of Energy, Clean Cities Program. Program promotes building infrastructure to encourage smart transportation decisions. <http://www.ccities.doe.gov/>.

## GUIDELINE TR2: ALTERNATIVE FUEL VEHICLES

### Recommendation

Using alternative fuel vehicles can reduce criteria pollutants and greenhouse gas emissions as well as help educate students about greener alternatives for transportation. Alternative fuel vehicles are low-emission, high-efficiency vehicles that lower costs in the long-term, improve local air quality, and reduce reliance on petroleum.

### Description

The alternative fuel vehicles that currently exist on the market include electric, hybrid, ethanol, compressed natural gas, and biodiesel. Many of these vehicles are available as buses, but some are only available as cars or vans, in which case they can be used for transporting smaller groups or for within-town errands.

### Applicability

All climates.

### Integrated Design Implications

Fueling stations for compressed natural gas and ethanol-fueled vehicles will need to be provided or be locally accessible.

Education on alternative fuels can be promoted by including prominent signage.

### Cost Effectiveness

Compressed gas vehicles are very cost effective. Antelope Valley Schools Transportation Agency reports compressed natural gas buses with John Deere engines have maintenance costs of \$0.13/mile, versus \$0.24 for their standard diesel buses and \$0.21 for advanced diesel buses.

Biodiesel is an inexpensive and quick way to change fleets and reduce emissions. Biodiesel (B20) costs \$0.13 to \$0.22 more per gallon than diesel, but it uses existing infrastructure and vehicles with little or no modifications to the engine.

### Benefits

Alternative fuel vehicles have been shown to reduce operation and maintenance costs.

Propane and compressed natural gas cost less on an equivalent-gallon basis than gasoline or diesel, and natural gas results in reduced soot formation, less fouling of engine oil, and significantly less carbon deposits in these engines.



Alternative fuel vehicles have been shown to reduce operation and maintenance costs.

NREL/PIX 01552.

### Applicable Climates



### Applicable Spaces

Classrooms	<input type="checkbox"/>
Library	<input type="checkbox"/>
Multipurpose	<input type="checkbox"/>
Gym	<input type="checkbox"/>
Corridors	<input type="checkbox"/>
Administration	<input type="checkbox"/>
Toilets	<input type="checkbox"/>
Other	<input checked="" type="checkbox"/>

### When to Consider

Programming	<input type="checkbox"/>
Schematic	<input type="checkbox"/>
Design Dev.	<input checked="" type="checkbox"/>
Contract Docs.	<input type="checkbox"/>
Construction	<input type="checkbox"/>
Commissioning	<input type="checkbox"/>
Operation	<input checked="" type="checkbox"/>

Costs	L	<input type="checkbox"/>	<input type="checkbox"/>	<input type="checkbox"/>
	M	<input type="checkbox"/>	<input type="checkbox"/>	<input type="checkbox"/>
	H	<input type="checkbox"/>	<input type="checkbox"/>	<input checked="" type="checkbox"/>
		L	M	H
		Benefits		

Alternative fuel fleets also achieve improved emissions. Diesel engines emit, on the average, 58% more smog-forming NOx and 89% more particulate matter (PM10) than a natural gas engine, both certified within the same year. Biodiesel cuts exhaust emissions, minimizing black smoke, odor, greenhouse gas emissions, air toxics, and particulates. Biodiesel also does not contribute to sulfur dioxide emissions that result in acid rain.

### ***Design Tools***

Alternative Fuel Bus Utility Software Version 1.01 (01/2001). Provided by the U.S. Department of Energy, Clean Cities Program.

### ***Design Details***

None.

### ***Operation and Maintenance Issues***

In general, alternative fuel vehicles require less maintenance than conventional vehicles. The operators should be made aware of the type of vehicle that they are driving and know the best way to get the most from that machine. The savings in maintenance can be used to educate the operators.

### ***Commissioning***

None.

### ***References/Additional Information***

Center for Transportation Technologies and Systems: a division of the National Renewable Energy Laboratory that strives to develop alternative fuel and advanced vehicle technologies.  
<http://www.ctts.nrel.gov/>.

U.S. Department of Energy, Clean Cities Program. Program promotes building infrastructure to encourage smart transportation decisions, including alternative fuel vehicles. Web site:  
<http://www.cities.doe.gov/>.

U.S. Department of Energy, Clean Cities Program. "Making the Grade: Alternative Fuel School Buses." January 2001. Call 1-800-DOE-EREC for more information.

U.S. Department of Energy, Office of Energy Efficiency and Renewable Energy. "Biodiesel Offers Fleets a Better Alternative to Petroleum Diesel." Technical Assistance Fact Sheet. Clean Cities Alternative Fuel Information Series, May 2001.

U.S. Department of Energy. Office of Transportation Technologies, the Department of Energy's alternative fuel technology research center. <http://www.ott.doe.gov/>.



# RESOURCE-EFFICIENT BUILDING PRODUCTS

This chapter provides guidelines for:

## Guideline

---

Carpeting (Guideline BP1)

---

Resilient Flooring (Guideline BP2)

---

Ceramic Tile/Terrazzo (Guideline BP3)

---

Concrete Flooring (Guideline BP4)

---

Wood Flooring (Guideline BP5)

---

Bamboo Flooring (Guideline BP6)

---

Gypsum Board (Guideline BP7)

---

Acoustical Wall Panels and Ceilings (Guideline BP8)

---

Paints and Coatings (Guideline BP9)

---

Casework and Trim (Guideline BP10)

---

Interior Doors (Guideline BP11)

---

Toilet Partitions (Guideline BP12)

---

## OVERVIEW

---

The guidelines in this chapter provide advice on selecting flooring, wall and ceiling finishes, other interior surfaces, and their associated coatings and adhesives. When selecting interior surfaces for high performance schools, designers should consider two questions:

- Does this product introduce chemical compounds into the space that will affect IAQ?
- Is this a material-efficient product?

While many other characteristics, including acoustical performance and visual appearance, factor into product decisions, selecting material-efficient products that do not degrade IAQ are the main goals addressed in these guidelines. Evaluating resource efficiency and VOC emissions is an emerging science with many uncertainties. No material or product is going to be optimum with regard to all the

criteria. Choosing materials and products requires some professional judgment as to which of the criteria should be given the greatest weight.

## **Indoor Air Quality**

Since most school occupants are children or adolescents with still-developing respiratory systems, the importance of IAQ is heightened. The metabolic rates of children are significantly greater than adults, causing them to breathe more air and, as a result, absorb and retain more toxins. In addition, children's immune systems are less effective.

The U.S. EPA documents that Americans spend more than 90% of their lives indoors, and that pollutant concentrations inside buildings are two to five times greater than those outdoors. News reports and scientific inquiries have brought increased attention to the symptoms and causes of poor IAQ. Symptoms range from mild discomfort (sick building syndrome) to more severe illness and permanent injury (building-related illnesses and multiple chemical sensitivity). Health effects include headaches, fatigue, memory problems, eye irritation, and coughs.

Providing improved IAQ over the life of the building is a fundamental goal when designing high performance schools.

There are four principles in designing good IAQ and they all need to be implemented as a whole:

1. **Source control:** Reduce and/or eliminate the source of contaminants in buildings.
2. **Ventilation control:** Provide adequate ventilation to dissipate the contaminants in buildings. Contaminants emanate from the building contents, equipment, occupants, and outside air.
3. **Building commissioning:** Building commissioning is a process used during the design, construction, and post-occupancy phases of a project to ensure that the project is built and performs as designed, and that the systems and equipment function as intended.
4. **Building maintenance:** Buildings require regularly scheduled maintenance and cleaning to ensure that they perform throughout their life as they did when first constructed. Using environmentally friendly cleaning agents will reduce the opportunity for air contamination during the building's life.

Designers have a large impact on the selection of building materials, and therefore should seek to reduce or eliminate potential sources of indoor air pollution by selecting the lowest odor, least toxic, lowest emitting, most moisture resistant, and most durable materials that can be safely installed and maintained.

Indoor pollutants include VOCs, microbial volatile organic compounds (MVOCs), particulates, inorganic compounds (such as CO<sub>2</sub>, CO, and ozone), and semi-volatile organic compounds (SVOCs), such as pesticides and fire retardants. Pollutant sources include the outside air, construction materials, furnishings, the building envelope, equipment, maintenance, and the occupants themselves. VOCs are of special concern because they can damage the natural environment during building material production and disposal, create hazards for installers and manufacturers, as well as cause health problems for building occupants.

VOCs are some of the most commonly discussed chemical emissions that affect IAQ. VOCs can occur in the air at normal environmental conditions and are emitted from interior materials such as paints, adhesives, sealants, sealers, carpets, resilient flooring, furniture, and ceiling panels. Materials and products emit (“off-gas”) VOCs during and after installation, which can cause health problems for construction workers and building occupants.

Concentrations of several VOCs and formaldehyde are currently found in indoor air. In the indoor environment, formaldehyde can cause several health problems for occupants, including skin and eye irritation, upper respiratory system irritation, and symptoms of sick building syndrome. Formaldehyde is a known carcinogen so human exposure should be minimized, and indoor air concentrations should be kept as low as is reasonable to achieve.

In many cases, the best products, with the lowest VOC emissions, are made from water-based constituents. This said, it is also important to select materials that are easy to clean and maintain without the use of odorous, irritating, or toxic cleaning supplies.

Designers should also be aware that a product can be labeled as “low-VOC” or even zero-VOC and still emit VOCs that are odorous, toxic, or otherwise undesirable. Even small quantities of some chemicals can create problems indoors. The EPA VOC labeling requirements do not provide a straightforward way to compare VOC content since labels are required to only list chemicals classified as reactive, with the potential to create smog. Unlabeled non-reactive VOCs may react with oxidants to form odorous, irritating, or toxic chemicals in the indoor environment. While some VOC emissions may not cause an *air quality* problem for occupants, they may still be hazardous to installers and manufacturers.

VOC emissions are generally highest immediately after a new product is installed or a finish is applied, but emissions may continue for days, weeks, or months; and actual emission rates will be impacted by the ventilation conditions, indoor temperature, and humidity conditions. Even with low VOC-emitting materials, it is important to provide temporary ventilation during and after installation. However, the length of the required venting period depends on the amount of surface covered, as well as the volatility and toxicity of the finish. In addition, it is recommended that, prior to substantial completion, each school be flushed out with 100% outside air for about 15 calendar days, or as long as possible, to remove any remaining odor and VOCs.

Fleecy and absorbent surfaces such as carpets, wall coverings, window coverings, and ceiling tiles should be protected from exposure to the air during periods of high VOC emissions. Even better, construction work should be sequenced so that soft and/or porous materials are installed after VOC-emitting materials, finishes, or sealants have had a chance to “off-gas.” Otherwise, emitted chemicals will be absorbed by porous surfaces, increasing the time required to clear the chemicals from the building.

Understanding chemical emissions adds to the complexity of reviewing contractor-initiated material and product substitution requests. Construction specifications should require that product ingredients and VOC emissions be reported, as well as information about any adhesives or solvents that are required during installation or maintenance. However, substitutions should be welcomed when contractors and subcontractors can provide information about new and improved product alternatives.

To assist in understanding and limiting indoor VOC emissions, it is recommended that designers refer to a model Special Environmental Requirements Specification (Section 01350), which establishes modeled indoor air concentration limits for 75 chemical compounds. It also provides testing protocols and reporting requirements for building materials.

In addition to product selection, the designer should also look for other ways to mitigate potential IAQ problems during construction. Dust and mold are two common construction by-products that can compromise IAQ. Construction activities such as wood sanding and drywall finishing generate large amounts of dust and debris, which can become an IAQ problem. Thoughtful work practices and thorough cleaning before occupancy will mitigate this potential problem.

Mold growth requires moisture and warmth and a material on which to grow. Excess humidity, caused by moisture intrusion or condensation, will promote the growth of mold and other biological contaminants within building materials that impact human health. Mold growth is commonly found on ceiling tiles, gypsum board, carpet, and other finishes. Special care should be taken during the delivery, storage, and handling of these materials to prevent moisture contamination on the construction site. If any moisture damage occurs, the materials must be removed and replaced as soon as reasonably possible.

In summary, objectives and strategies used to protect IAQ include selecting interior surfaces that are:

- Made with water-based coatings and adhesives
- Nontoxic and non-polluting during installation and use (low VOC emitting)
- Resistant to moisture or inhibit the growth of biological contaminants
- Easy to clean with non-polluting maintenance products.

### ***Promoting Material Efficiency***

Selecting material-efficient interior building products is another high performance goal. Product material efficiency can be evaluated using several different factors including recycled content, product recyclability and reusability, embodied energy, durability, and location of mining and manufacture. The material-efficiency calculations are complex and involve making professional decisions about the efficiency of one material versus another with a slightly different performance. For example, one type of flooring may be made from rapidly renewable resources, but is not very durable. Another flooring type is highly durable, but cannot be recycled. Which product is the better choice? Every product has tradeoffs. Weighing these product pros and cons can make it difficult to determine which products are most environmentally preferable. It is anticipated that, some time in the future, a life-cycle assessment tool will be developed to assist designers with this analysis.

Designers should evaluate the material-efficient product options available and select materials based on the environmental priorities of their project.

### ***What Makes a Product Material Efficient?***

To be considered material efficient, products should meet one or more of the following criteria.

- Durable.
- Reused, salvaged, and refurbished material or structure.
- Movable, refinishable, and reusable.
- Made with recycled content. Using recycled content materials (preferably post-consumer content rather than post-industrial content) helps address problems of solid waste disposal and the consumption of virgin resources.
- Recyclable.
- Made from or use resources that are renewable.
- Preferably manufactured within 500 miles of the project site to reduce transportation energy use.
- Packaged in minimal, reusable, recycled content and recyclable containers.
- Purchased from a manufacturing source that embraces environmentally friendly corporate policy, which is reflected in the operation of the production plant.

### ***Reduce, Reuse, Recycle***

Interior finishes are important from a resource conservation perspective because they are used in large amounts and because they wear, requiring periodic maintenance or replacement. Material efficiency for building products should be approached in high performance school design according to the hierarchy of “Reduce, Reuse, Recycle.”

*Reduce.* Waste prevention is the highest priority within the material efficient hierarchy and encompasses several components, including:

- *Dimensional Planning.* Techniques like dimensional planning reduce the amount of waste generated at the construction site. This form of waste prevention includes designing a building using: standard dimensions, a minimal structural footprint, and modular or preconstructed panels and elements. Standard dimensions take into account the standard sizes of major building materials, such as wallboard and carpet, when designing the size of a space. For example, wallboard is generally manufactured in 4 ft by 8 ft sheets, and a standard carpet roll measures 12 ft wide. One potential standard dimension for a space would be 8 ft by 12 ft, because that would reduce the number of cut-offs and scraps produced when installing these major building materials. Reducing the size of a structural footprint in addition to building multiple stories rather than one level with the same square footage conserves resources and uses less material in the foundation and roof structure. Including preconstructed panels and elements into plans is also known as designing for flexibility and adaptability, which prevents waste when remodeling spaces. For more details on dimensional planning, See 8.3 of the CIWMB publication, “Designing with Vision...A Technical Manual for Material Choices in Sustainable Construction” (July 2000).
- *Design for Disassembly.* This concept factors in the possibility for a product and its parts to be reused, remanufactured, or recycled at the end of their “useful life,” reducing the amount of demolition waste generated. Additionally, these materials, which are typically considered a “waste,” can be another building’s raw material/resource.
- *Avoiding Unneeded Materials.* Material reduction can also be achieved by avoiding unneeded materials as a means to conserve raw resources. An example of this concept

is the elimination of finish materials such as ceilings, or staining and sealing concrete instead of applying a second layer of resilient flooring over a concrete slab. It is also important to select products that contain minimal packaging.

- *Durability.* Specifying products with high durability (which includes low maintenance requirements) can reduce waste, since building materials that have been discarded after a short service life account for much of the content in landfills.

*Reuse* is defined as using a material over again in its current form without breaking it down into a raw material. Designs can promote the reuse of materials by specifying salvaged and refurbished materials and structures. Commonly salvaged materials include lumber, pipes, steel, fencing, wood flooring, doors, windows, stone flooring and wall panels, appliances, lighting fixtures, and decorative accessories.

*Recycle.* Since it can be quantified, recycled content is one of the most common indicators of material efficiency. Recycled content products create markets for the tons of materials that people recycle. However, it is important to understand the distinction between recycled-content products and those that are recyclable. The preferred products are those that both contain recycled content and are recyclable at the end of their service life. However, when choosing between specifying a product that contains recycled content and one that could be recycled, the recycled-content product should always take precedence. While a product's recyclability is important, it does not reduce the consumption of raw materials, nor does it promote completion of the cycle for existing materials that have already been diverted from the waste stream. The designer, in collaboration with the client, should set recycled-content goals for all building materials.

The term "recycled content" can refer to two types of recycled materials: post-consumer and secondary (also known as post-industrial). Post-consumer recycled content is "a finished material which would have been disposed of as a solid waste, having completed its life-cycle as a consumer item."<sup>1</sup> Secondary, or post-industrial, recycled content is defined as "fragments of finished products or finished products of a manufacturing process, which has converted a resource into a commodity of real economic value, but does not include excess virgin resources of the manufacturing process."<sup>2</sup>

When selecting products to meet the recycled-content goal, always maximize the amount of post-consumer recycled content. For instance, if the project has a goal to achieve a recycled content rate of 50%, a product that contains 50% post-consumer recycled content and one with 30% post-consumer and 20% post-industrial content would both satisfy this goal. But the 50% recycled-content product would be the preferred choice.

Designers should set a minimum recycled-content goal of 25% for the project.

### ***Material-Efficient Examples***

Many building products that are material efficient in one or more ways are now available. Examples of material-efficient wood use include engineered lumber and composite wood products (FSC-certified),

---

<sup>1</sup> California Integrated Waste Management Board. "Manufacturer Identification of Recycled Content." <http://www.ciwmb.ca.gov/publications/buyrecycled/43301018.doc>.

<sup>2</sup> Ibid.

which can be used for casework and trim as well as for framing. Engineered lumber is manufactured by combining wood fibers with plastic resins to produce high quality, structural products such as I-joists, laminated veneer lumber (LVL), parallel strand lumber (PSL), and glue-laminated beams. Sheathing products manufactured in this manner, such as oriented strand board (OSB), wafer board, medium density fiberboard and particleboard, are made primarily of sawmill waste. While these products may be a potential source of indoor formaldehyde concentrations (see information below under Flooring), they promote source reduction. Likewise, finger-jointed lumber made from wood scraps uses material that would otherwise be wasted. And composite lumber composed of particleboard with a veneer of hardwood makes efficient use of fine hardwood for uses such as paneling and doors.

The design process also offers the opportunity to maximize material efficiency by using dimensional planning to reduce waste during construction. Toward this end, using modular systems such as carpet tile instead of carpet greatly minimizes this particular construction waste. Develop a Construction Waste Management Plan to target specific materials from construction that should be diverted from landfill to recycling facilities. A standard divergence goal is 75%, with an aim for 80% in the coming years.

### ***Special Environmental Requirements (Section 01350) for the Construction Document Specifications***

Reducing chemical emissions and providing for resource efficiency is relatively new to building design and construction. To assist owners, designers, and contractors, a model specification is available at <http://www.chps.net/>. This specification section, Special Environmental Requirements (Section 01350), has been used on several California state projects and is intended to be included in Division 1 of the Construction Document Specifications to lay out special environmental requirements related to IAQ, durability, recycled content and recyclability, wood from environmentally friendly sources, and product packaging. The intent of providing this sample specification is to give designers throughout the country a base environmental specification from which to work. It is expected that each designer will customize this specification section for their specific project and coordinate with the other specification sections and the other parts of their project manual. Prior to use, the designer is expected to check the websites referenced in this specification section for the latest list of chemicals. Specification Section 01350 is intended to be placed into Division 1 of the project manual, so that it will govern all the other divisions (as is the case with submittal requirements and substitution requests, etc.).

Specification Section 01350 sets out environmental goals (specifically needed by the contractor if they are considering substitution requests), product emission testing methods, test protocols, sample procedures, and reporting requirements. The specification section also identifies the chronic reference exposure levels (REL)<sup>3</sup> for 75 hazardous airborne substances and uses these OEHHA RELs to establish acceptable modeled indoor VOC concentrations for these substances. In addition, recycled content and recyclability requirements for building materials are provided.

---

<sup>3</sup>According to California's Office of Environmental Health Hazard Assessment website, "Chronic RELs are designed to protect the individuals who live or work in the vicinity of emissions of these substances. A chronic REL is an airborne level that would pose no significant health risk to individuals indefinitely exposed to that level. RELs are based solely on health considerations, and are developed from the best available data in the scientific literature." [http://www.oehha.org/air/chronic\\_rels/Jan2001ChREL.html](http://www.oehha.org/air/chronic_rels/Jan2001ChREL.html).

It is recommended that all interior materials that potentially emit VOCs (including adhesives, sealants, sealers, coatings, carpets, resilient flooring, ceiling materials, wall materials and coverings, architectural wood products, composite wood products, and furniture) meet the emissions criteria outlined in Specification Section 01350. The emissions data and modeled chemical concentration information required by Specification Section 01350 should be provided by the manufacturers to the general contractor, who in turn submits it to the designer for review. For a product to be compliant with Specification Section 01350, the modeled VOC concentrations for its chemical components must be no greater than half the RELs provided on the OEHHA website, other than for formaldehyde. The formaldehyde concentration provided in the OEHHA list is not achievable in reality and a recommendation for this concentration is provided in the specification. These recommendations apply to all products, whether they are standard products used in school construction or environmentally preferable products made with recycled or rapidly renewable content.

However, chemical testing alone cannot fully evaluate the potential for *odor* from VOC emissions. Relying on experience, and even ad hoc experiments such as carefully controlled clean glass jar “sniff” tests to determine the odor acceptability of a product, may also be necessary if there is a concern regarding the VOC emissions.

#### ***Other Material-Efficiency Considerations***

Embodied energy is the energy consumed during the entire life cycle of a product, including resource extraction, manufacturing, packaging, transportation, installation, use, maintenance, and when appropriate, even disposal. Products with low embodied energy are environmentally preferable. Since transportation is a component of embodied energy, give preference to products that are locally available.

Products produced in a way that protects the eco-system are also environmentally preferable. One example is certified wood products, which are produced from trees grown and harvested from Forest Stewardship Council (FSC)-certified forests. FSC is the accrediting agency for organizations such as Smart Wood and Scientific Certification Systems, which in turn oversee forestry practices and certify their environmentally friendly practices.

#### ***Other Considerations When Selecting Interior Surfaces***

Acoustical benefits can also factor into product selection. For instance, consider carpet for areas when noise control is a concern. Also, be aware of how the acoustical properties of certain products can be impacted by other interior materials. For example, most ceiling tiles will lose their acoustical benefits if painted.

A product’s color can also influence the decision-making process. While color is always a factor for visual appeal, it can also have a functional impact. Consider light-colored paints and coatings to enhance daylighting.

In summary, when selecting materials, including interior building materials, for a high performance school, designers should look for cost-effective, durable, and material-efficient products that protect IAQ and provide the desired acoustical performance and aesthetic qualities. In addition, high performance school designers should attempt to minimize the impact on the natural environment by selecting locally



produced materials, as well as those produced in an environmentally benign manner, preferably using suppliers and manufacturers that practice environmentally conscious management principles. Look for manufacturers that have a corporate policy incorporating these practices. The selection process should consider installation and maintenance requirements as well as how the material or furnishing performs during its service life.

Because of their high visibility, interior surfaces and furnishings provide an excellent opportunity to highlight the high performance approach. Environmentally preferable choices teach the importance of caring for the health of occupants, as well as the health of the natural environment.

Table 40 summarizes the interior surfaces goals and objectives and presents the predominant relationship between them and the guidelines that follow.

Table 40 – Interior Surfaces Goals and Relationship to Guidelines

	BP1: Carpeting	BP2: Resilient Flooring	BP3: Ceramic Tile/Terrazzo	BP4: Concrete Flooring	BP5: Wood Flooring	BP6: Bamboo Flooring	BP7: Gypsum Board	BP8: Acoustical Wall Panels and Ceilings	BP9: Paints and Coatings	BP10: Casework and Trim	BP11: Interior Doors	BP12: Toilet Partitions
<b>Goals</b>												
<b>Protect Indoor Environmental Quality</b>												
<i>Use low VOC-emitting coatings and adhesives.</i>	●	●	●	●	●	●	●	●	●	●	●	●
<i>Use low VOC-emitting materials.</i>	●	●	●	●	●	●	●	●	●	●	●	●
<i>Use moisture-resistant materials.</i>			●	●								
<i>Use low VOC-emitting maintenance products</i>	●	●	●	●	●	●				●		●
<i>Use sound-absorbing materials</i>	●							●				
<b>Materials Efficiency</b>												
<i>Made from sustainable resources</i>		●			●	●				●	●	
<i>Made with recycled content</i>	●	●	●	●			●	●				●
<i>Recyclable</i>	●	●	●	●	●		●	●		●		
<i>Movable, refinishable, and reusable</i>					●					●	●	●
<b>Other Environmental Considerations</b>												
<i>Locally available</i>	●	●	●*	●	●		●	●	●	●	●	●*
<i>Durable</i>	●	●	●	●	●	●	●					
<i>Low in embodied energy</i>					●							
<i>Eco-system protective</i>		●			●					●	●	
* Note: Verify that an in-state manufacturer exists.												

The discussions below provide a summary of the specific considerations, advantages, and disadvantages of materials choices addressed in these guidelines.

## The Vinyl Debate

Few building materials have generated more debate over material efficiency and the environment than those containing polyvinyl chloride (PVC). PVC is a highly versatile, stable compound used in numerous building products, including pipes, siding, wire and cable coatings, resilient flooring, carpets, wall coverings, and furniture. In fact, construction materials account for the largest percentage of PVC use.

Commonly referred to as “vinyl,” PVC products are highly durable and require low maintenance, which have made them a popular choice in schools. For instance, vinyl composition tile (VCT) is the most commonly used flooring material for non-carpeted areas in schools due to its long life, low maintenance requirement, and moisture-resistant properties. First cost for PVC products appears to be low.

Much of the debate focuses on environmental concerns with the production of PVC. PVC is derived from petroleum, which is a non-renewable resource and can be highly polluting during extraction, refinement, and manufacturing.<sup>4</sup> It should also be noted, however, that because many PVC products are manufactured in the United States, they can have lower embodied energy than other materials that are manufactured overseas.<sup>5</sup>

Vinyl chloride (VC), a colorless, flammable gas that serves as the building block for PVC, is a known human carcinogen. Studies of PVC factory workers have shown that long-term exposure (365 days or more) to high levels of VC can cause liver cancer, nerve damage, and immune system problems.<sup>6</sup> In response to these findings, the Occupational Safety and Health Administration in 1974 reduced the occupational exposure standard for VC gas in the air from 500 parts per million (ppm) to 1 ppm.<sup>7</sup> These tighter restrictions, in combination with a closed-loop polymerization process adopted by the industry in the United States, have reduced the high-risk exposure for workers.<sup>8</sup> While most of the studies on VC exposure have focused on long-term exposure in factory workers, breathing high levels of VC gas for short periods of time can cause dizziness and unconsciousness, while breathing extremely high levels in a short period of time can cause death.<sup>9</sup>

---

<sup>4</sup> U.S. Environmental Protection Agency, Environmentally Preferable Purchasing Program. “Leading by Example: Two Case Studies Documenting How the Environmental Protection Agency Incorporated Environmental Features into New Buildings.” December 1997. <http://www.epa.gov/opptintr/epp/pubs/grmbldg.pdf>.

<sup>5</sup> Ibid.

<sup>6</sup> U.S. Department of Health and Human Services, Agency for Toxic Substances and Disease Registry. “Vinyl Chloride Fact Sheet.” September 1997, CAS #75-01-04. <http://www.atsdr.cdc.gov/tfacts20.html>.

<sup>7</sup> Centers for Disease Control, Morbidity and Mortality Weekly Report. “Epidemiologic Notes and Reports: Angiosarcoma of the Liver Among Polyvinyl Chloride Workers – Kentucky.” 1974, update 1997. <http://www.cdc.gov/epo/mmwr/preview/mmwrhtml/00046136.htm>.

<sup>8</sup> Ibid.

<sup>9</sup> U.S. Department of Health and Human Services. “Vinyl Chloride Fact Sheet.”

Concerns also exist surrounding the disposal of PVC products. PVC products are not biodegradable, and since recycling options for PVC are currently limited, most products are not recycled. PVC can also cause air quality problems due to dioxins emitted during combustion in improper waste incineration<sup>10</sup> and building fires.

While some environmental organizations have serious concerns about its environmental impact, PVC also has some beneficial properties that have made it a widely used material in schools traditionally. The guidelines in this chapter discuss the pros and cons of using PVC products for various building surfaces, but neither recommends nor discourages their use.

## **Flooring**

Flooring should be durable to withstand heavy use without requiring frequent replacement, be easy to maintain, contain recycled content, be recyclable, contribute to a comfortable indoor environment, and not adversely affect human health. Based on life-cycle costs, highly durable materials are justified, especially for high-use areas.

Floor choices include resilient flooring, concrete, tile, wood, and carpet. When selecting these surfaces, review the cleaning products that might be used throughout the life of the flooring.

Carpet systems require maintenance, as do other flooring materials, and their need for more frequent replacement makes them materials- and energy-intensive over their lifetime. If selecting a carpet, select those carpets with a longer warranty to increase the service life and reduce the need for replacement. However, carpeting offers acoustical and comfort benefits that are generally not available with other flooring choices. For these reasons, carpeting is often used in classrooms and administrative areas.

Hard surfaces are often selected for use in high-traffic areas not requiring the acoustical benefit of carpet.

Walk-off mats are recommended for all school entrances to help minimize cross-contamination by pollutants brought into the building on occupants' shoes. Using walk-off mats to trap dirt, dust, grit, and moisture can also reduce maintenance costs, improve safety, and protect the life and appearance of the flooring.

Table 41 summarizes advantages and disadvantages of the flooring choices addressed in these guidelines.

---

<sup>10</sup> U.S. Environmental Protection Agency, Environmentally Preferable Purchasing Program. "Leading by Example: Two Case Studies Documenting How the Environmental Protection Agency Incorporated Environmental Features into New Buildings." December 1997.

*Table 41 – Environmental Criteria for Floors*

<i>Flooring Type</i>	<i>Advantages</i>	<i>Disadvantages</i>
Carpet Guideline BP1	<p>Material-efficient options available: minimum recycled content guideline of 50%, with at least 10% post-consumer recycled content</p> <p>Thermal comfort</p> <p>Physical comfort (cushion)</p> <p>Provides safety for small children</p> <p>Noise control</p> <p>Some recycling options are available</p>	<p>May emit some VOCs during and after installation.</p> <p>Can harbor dust and other allergy-causing particles.</p> <p>Requires regular maintenance. Requires frequent vacuuming, which stirs up dust.</p> <p>Can adsorb VOCs and re-emit (desorb) later.</p> <p>Adhesives and maintenance products can add to indoor pollution load (but low-toxic/low-VOC options are available).</p> <p>Potentially need to allow time to air out carpet (precondition off site) before occupancy.</p> <p>Less durable and stains easier than other flooring options.</p> <p>Significant debris generated when it must be replaced.</p> <p>Can be a source of mold/mildew if placed in contact with moisture.</p>
Resilient Flooring Guideline BP2	<p>First cost can vary from low to high, depending on product, but due to its high durability, this flooring type tends to cost less per year of use than carpet.</p> <p>Easy to clean.</p> <p>High reflectivity can enhance daylighting.</p>	<p>Flooring adhesives and maintenance products can add to indoor pollution load (but low-toxic/low-VOC options may be available).</p> <p>Most are not recyclable or biodegradable.</p>
Ceramic Tile / Terrazzo Guideline BP3	<p>Recycled content options available: minimum recycled content guideline of 55%–77%.</p> <p>Easy to clean and stain-resistant (some tile may need to be sealed first).</p> <p>Highly durable.</p> <p>High reflectivity can augment daylighting.</p>	<p>High cost.</p> <p>High embodied energy.</p> <p>Made from nonrenewable resources. Some ceramic tile is recycled as clean construction waste. When contaminated by bonding and setting agents, recycling is not feasible.</p> <p>Tile installation materials (mortar and grout) are sources of VOCs and toxic materials. (Portland cement-based mortar and grout appear to have less significant environmental impact than latex or solvent-based systems.)</p> <p>Terrazzo poses installation risks, depending upon type. (Cementitious type appears to have less significant environmental impacts than epoxy systems.)</p> <p>Hard finished surface can compromise physical comfort.</p> <p>Adhesives and maintenance products can add to indoor pollution load (but low-toxic/low-VOC options are available).</p>
Concrete Flooring Guideline BP4	<p>Material efficient if manufactured with high fly ash content.</p> <p>Highly durable.</p> <p>Low maintenance and low cost.</p>	<p>Sealers and wax products can add to indoor pollution load (but low-toxic/low-VOC options are available).</p>
Wood Flooring Guideline BP5	<p>Renewable resource, if properly managed (FSC-certified forests).</p> <p>Low embodied energy.</p> <p>Wood flooring is recyclable and the market for recycled wood flooring is expanding.</p> <p>Biodegradable.</p> <p>Easy to clean.</p> <p>“Warm,” comfortable surface.</p> <p>Durable and can be refinished to prolong its life.</p> <p>Good aesthetics.</p>	<p>High cost.</p> <p>Adhesives, sealants, and maintenance products can add to indoor pollution load (but low-toxic/low-VOC options are available).</p> <p>Requires special moisture-prevention care in handling and installation to prevent later IAQ problems.</p> <p>On-site sanding requires special measures.</p>
Bamboo Flooring Guideline BP6	<p>Material efficient.</p> <p>Durable and hard.</p> <p>Easy to clean.</p> <p>“Warm,” comfortable surface.</p>	<p>High cost.</p> <p>Adhesives, sealants, and maintenance products can add to indoor pollution load (but low-toxic/low-VOC options are available).</p>

## Walls and Ceilings

Walls and ceilings should be durable, be easy to clean, contain recycled content, and be recyclable, as well as contribute to a healthy and comfortable indoor environment. Classrooms and other rooms require plenty of tackable wall space for teaching aids and displaying student projects. The type and color of surfaces on teaching walls should also be visually comfortable and not detract from teacher presentations.

Drywall is potentially recyclable and can be composted. Recycled content gypsum board core is available, but it is important to explicitly specify recycled content to ensure its use. Although they may not advertise it as recycled, many manufacturers already use post-industrial recycled content in their drywall product, and virtually all make the facing paper component from post-consumer recycled content paper. To protect IAQ, it is recommended that all drywall products meet the emissions requirements outlined in Specification Section 01350. See the discussion on Special Environmental Requirements (Section 01350) above.

When using wall coverings, use biodegradable papers that contain recycled paper or fiber content. Vinyl wall coverings are widely used but are manufactured from PVC, which was banned in some areas of Europe because of the creation of toxic byproducts during manufacture. (For further discussion of vinyl, see the Vinyl Debate section above.) Installation of wall coverings using traditional wallpaper paste is preferable to using self-stick wall coverings, due to the levels of VOC content in the adhesive.

Avoid using ceiling tile and sprayed-on ceiling finishes containing asbestos, formaldehyde, or crystalline silica, as these items are possible cancer and respiratory tract hazards. Table 42 summarizes advantages and disadvantages of the wall and ceiling choices addressed in these guidelines.

Table 42 – Environmental Criteria for Walls and Ceilings

Type	Advantages	Disadvantages
Gypsum Board Guideline BP7	<p>Gypsum is highly recyclable if not contaminated (with paint, tape, compound, adhesives, or other coatings).</p> <p>Recycled content gypsum is readily available at no cost premium, and the paper facing is typically made with recycled paper.</p> <p>Durable, high-impact drywall contains up to 15% post-consumer recycled content.</p> <p>Recycled gypsum is more durable than conventional wallboard.</p> <p>Easy to repair.</p> <p>Low cost.</p>	<p>Dust generated during sanding (can specify “wet sanding” process).</p> <p>Gypsum surfaces are potent “sinks” for odors, which they can later re-release.</p> <p>Requires periodic painting. Paints and primers can add to indoor pollution load (but low-toxic/low-VOC options are available).</p> <p>Low durability compared to concrete block.</p>
Ceramic Tile Guideline BP3	See Table 2, Ceramic Tile/Terrazzo Flooring.	See Table 2, Ceramic Tile/Terrazzo Flooring.
Acoustical Wall Panels and Ceilings Guideline BP8	<p>Recycled-content materials readily available: minimum recycled content guidelines for ceiling tile is 79%–85%, for suspension system is 25%.</p> <p>Formaldehyde-free products available.</p> <p>Reclamation programs available (though limited).</p> <p>Easy installation.</p> <p>Acoustical ceiling tiles often cost less than wallboard ceilings.</p> <p>Do not require painting or other finish materials to complete the installation.</p> <p>Easy to reuse.</p> <p>Provides for easy relocation of fixtures, if required.</p>	<p>Tile collects dust and adsorbs odors. Tile and plenum requires periodic maintenance.</p> <p>Due to the grid organization, acoustical tile ceilings may not be as adaptable to renovations as a gypsum board ceiling.</p> <p>If the T-bar ceiling space has a return air plenum, as is common, this type of air handling design is difficult to clean. Many materials are used in the space above the T-bar ceiling. Material off-gassing, odors, and microorganisms in the plenum area can spread and be distributed to other areas. (Avoid this by installing return air systems using dedicated metal ductwork with access hatches for inspection and cleaning.)</p>

## Coatings

Paints and other coatings affect IAQ and may produce hazardous waste. Most conventional products off-gas VOCs, formaldehyde, and other chemicals that are added to enhance product performance and shelf life. These chemicals, especially in combination, may pose health concerns. Fortunately, high-quality, low-toxicity, and low-VOC substitutions are now available for all these products.

## Adhesives and Sealants

Many conventional construction adhesives, sealants, caulking, grouts, and mortars used to bond structural components are solvent-based, toxic, and may off-gas large amounts of toxic VOCs (including solvents and aromatic hydrocarbons). Avoid using products that include butyls and urethanes indoors. Low-VOC, low-toxic, water-based, formulations are now available for many more applications.

Specify the least toxic/lowest VOC product suitable for the application and require installer to use the smallest amount of adhesive necessary to fulfill the manufacturer's performance specifications for that product.

Non-solvent adhesives have 99% less hazardous emissions than solvent adhesives, although their emissions may last much longer. When used to adhere dense floor coverings, emissions will be low, but prolonged. Yellow and white glues are recommended. When specifying sealants, consider using only silicone sealants in interior areas. However, some silicone sealants do contain acetic acid, which has an unpleasant odor that may be irritating. Other environmentally preferable alternatives include acrylics and siliconized acrylics. They are typically the safest to handle and have the lowest solvent content. All other sealant types, especially butyl sealants, emit VOCs and other toxic compounds, and emission test data should be requested and reviewed prior to including the product in a specification.

## Applicable Codes

Applicable state and local school district design and materials standards.

## Design Tools

Alevantis, Leon. 1996. *Reducing Occupant Exposure to Volatile Organic Compounds from Office Building Construction Materials: Non Binding Guidelines*. Published by the CA Department of Health Services. Available on-line at <http://www.cal-iaq.org/VOC>.

American Society of Heating, Refrigerating and Air-Conditioning Engineers (ASHRAE). *ASHRAE Standard 62, Indoor Air Quality*. <http://www.ashrae.org>.

American Society for Testing and Materials (ASTM) Standard D5116-90, Small Scale Environmental Determination of Organic Emissions from Indoor Materials/Products.

King County, Washington. *Construction and Landscaping Materials Specifications*. Available on-line at <http://www.metrokc.gov/procure/green/const.htm>.

National Institute of Standards and Technology. Building for Environmental and Economic Sustainability (BEES) 2.0. BEES measures the environmental performance of building products by using the environmental life-cycle assessment approach specified in ISO 14000 standards. Download the program at: <http://www.bfri.nist.gov/oae/software/bees.html>

U.S. Environmental Protection Agency (EPA). *Tools for Schools Program and Tool Kit*. Available on-line at <http://www.epa.gov/region01/eco/iaq/index.html>.

U.S. Environmental Protection Agency (EPA). *Building Air Quality: A Guide for Building Owners and Facility Managers*. Ordering information: Tel: (800) 490-9198, order number EPA402F91102, or view at <http://www.epa.gov/iedweb00/base/baqtoc.html>.

## References/Additional Information

- Architects, Designers and Planners for Social Responsibility (ADPSR) West Coast. 1998. *Architectural Resource Guide*. Contact: ADPSR, P.O. Box 9126, Berkeley, CA. Tel: (510) 273-2428. Resources and information on green and healthy buildings, including many sources for materials in California.
- Bernheim, Anthony. "Indoor Air Quality." Sustainable Building Technical Manual, Green Design, Construction and Operations, Public Technology, Inc., DOE, USEPA, 1995.
- Bernheim, Anthony. "Saving Resources." Urban Land Institute, pp. 76-81, 94-95, June 2001.
- Bernheim, Anthony. "Measure and Cost of Green Building." AIA Convention 2000 Seminar S76. Download handout at <http://www.aiaconvention2000.com/conted/schedule.asp?HandOut=1>.
- Building Ecology Research Group/Hal Levin & Associates. 1999. *Indoor Air Bulletin*. Contact: PO Box 8446, Santa Cruz, CA, 95061-8446. Tel: (831) 426-6624. A newsletter for architects and building professionals on indoor air quality.
- California Integrated Waste Management Board (CIWMB) Database of Recycled Content Products. <http://www.ciwmb.ca.gov/rcp>.
- Center of Excellence for Sustainable Development, U.S. Department of Energy, Energy Efficiency and Renewable Energy Network (EREN). Provides web pages on green building and green development. <http://www.sustainable.doe.gov>.
- Maryland State Department of Education. *Building Ecology & School Design; Technical Bulletin: Carpet and Indoor Air Quality in Schools; and Interior Painting and Indoor Air Quality in Schools*. To order, contact the Maryland State Department of Education, Division of Business Services, School Facilities Branch, 200 W. Baltimore St., Baltimore, MD 21201. Phone for Capital Projects Assistant Manager, (410) 767-0097.
- National Clearinghouse for Educational Facilities (NCEF). *Managing Indoor Air Quality in Schools*. Available on-line at <http://www.edfacilities.org>.
- Spiegel, Ross and Dru Meadows. *Green Building Materials, A Guide to Product Selection and Specification*. New York: John Wiley & Sons, Inc., 1999. ISBN 0-471-29133-1.

## Acknowledgments

The following resources were particularly useful for developing this chapter:

- Sustainable Building Task Force. The Sustainable Building Task Force was formed by several state agencies to institutionalize sustainable building practices into state construction projects. The task force meets on a monthly basis to discuss strategies for implementing sustainable building practices in all future and current state buildings, including those leased by the State. Visit <http://www.ciwmb.ca.gov/GreenBuilding/TaskForce/> for more information and links to member agencies.
- Santa Monica, City of. 1999. *Santa Monica Green Building Design and Construction Guidelines*. Available on-line at <http://greenbuildings.santa-monica.org/main.htm>.
- Partnership for Resource-Efficient Schools. 1998. *Recommended Best Management Practices Promoting: Energy Efficiency, Resource Conservation, and Environmental Quality*. A publication of the Seattle Public Schools Building Excellence Program and the City of Seattle (Solid Waste Utility, Water Department, and Seattle City Light). The following web site provides information about the Partnership for Resource-Efficient Schools project and a link to download the Best Management Practices manual: <http://www.cityofseattle.net/util/rescons/susbuild/partnership.htm>.
- BUILT GREEN™ Handbook*. 1999. BUILT GREEN™ is a program of the Master Builders Association of King and Snohomish Counties (MBA) in partnership with King County and Snohomish County, Washington. <http://www.builtgreen.net/>.
- Maryland State Department of Education. *Building Ecology & School Design; Technical Bulletin: Carpet and Indoor Air Quality in Schools; and Interior Painting and Indoor Air Quality in Schools*. To order, contact the Maryland State Department of Education, Division of Business Services, School Facilities Branch, 200 W. Baltimore St., Baltimore, MD 21201, (410) 767-0097.



## GUIDELINE BP1: CARPETING

### Recommendation

Select a carpet, carpet tile, cushion, pad, and adhesives that:

- Cause minimal pollution (low-volatile organic compound, or VOC, emissions).
- Are durable. Compare warranties.
- Are made with recycled-content.
- Can be easily cleaned and maintained.
- Are constructed so as to prevent liquids from penetrating the backing layer where moisture under the carpet can result in mold growth.
- Can be easily removed without the use of toxic chemicals.
- Can be easily replaced.
- Absorb sound.

To reduce waste during construction and installation consider the use of carpet tile instead of broadloom carpet, if applicable.

Where practicable, select a carpet and pad that is recyclable at the end of its life. Even when made from recycled materials and/or with potential for recycling at the end of their useful lives, carpet service life is relatively short compared to other flooring -alternatives. Energy and other resources are consumed in the recycling process. Also, some carpet recycling does not re-use the material as carpet but rather in a lower form of carpet materials. Due to these factors, carpet should be used only when its performance characteristics outweigh its environmental costs.

Follow recommendations from the Carpet & Rug Institute (CRI) for installation and maintenance.

### Description

Because carpet systems off-gas when new, carpet is a potential source of indoor air pollution. (Typically, most VOCs are emitted from the backing, adhesive, and seam sealer rather than from the wear layer.) The specifications listed under the Design Details section below provide guidelines for procurement of low-emissions carpeting and adhesives.

Particles and debris accumulate on carpets, exposing occupants who regularly use the room. Easy and effective cleaning of carpets is critical to reduce long-term exposure to pollutants. Cleaning requirements include both vacuum use and wet-extraction processes.

Moisture trapped below a carpet can result in mold growth and the release of mold spores and mold metabolic products (microbial VOCs – MVOCs) into the air. Concrete must be sufficiently cured, dried, and sealed before carpet is installed over it.



*Carpet, even recycled, should be used only when its performance characteristics outweigh its environmental costs. NREL/PIX 11415*

#### Applicable Climates



#### Applicable Spaces

Classrooms	<input type="checkbox"/>
Library	<input type="checkbox"/>
Multi-Purpose	<input type="checkbox"/>
Gym	<input type="checkbox"/>
Corridors	<input type="checkbox"/>
Administration	<input type="checkbox"/>
Toilets	<input type="checkbox"/>
Other	<input type="checkbox"/>

#### When to Consider

Programming	<input type="checkbox"/>
Schematic	<input type="checkbox"/>
Design Dev.	<input type="checkbox"/>
Contract Docs.	<input type="checkbox"/>
Construction	<input type="checkbox"/>
Commissioning	<input type="checkbox"/>
Operation	<input type="checkbox"/>

## Applicability

Most suitable for classrooms, libraries, and administrative areas.

## Integrated Design Implications

Flooring type selection affects thermal comfort (carpeting retains heat longer than most resilient flooring, for example) and lighting (floor finishes with high reflectivity enhance daylighting). Recycle clean construction/installation waste carpet, if possible (require subcontractor to take back for recycling). Research carpet reclamation programs if the project involves disposing of an existing carpet. Flooring type also affects acoustics, noise control, safety, and maintenance. Complete all painting and other adhesive use prior to the installation of carpets to prevent VOC “sinks”.

## Cost Effectiveness

A typical nylon carpet installation costs between \$2.20/ft<sup>2</sup> and \$3/ft<sup>2</sup>. Recycled-content padding and carpeting are priced competitively, with a life expectancy between 10 and 15 years.

Costs	L	■	■	
	M	■	■	
	H	■	■	
		L	M	H
		Benefits		

## Benefits

Although not as materials-efficient as durable flooring, recycled content and recyclable flooring is material efficient. Carpeting provides acoustic benefits not available with other flooring types. Emissions specifications for carpeting in schools provides indoor air quality performance guidelines for school environments. Low-toxic adhesives minimize the indoor air pollution load and health risks to both installers and occupants.

## Design Tools

See this chapter’s Overview.

## Design Details

If regular, effective maintenance and cleaning cannot be assured (due to budget constraints, inadequately trained staff, or other reasons), carpeting should not be used. (See the Operations and Maintenance discussion below).

### Emissions Criteria

The adhesives used to attach face fibers to backing materials and the adhesives used to install carpets usually contain volatile organic compounds (VOCs). These compounds may not be listed on the container or on manufacturer’s literature if they are considered exempt under the definition of VOCs in the Clean Air Act regulating reactive chemicals known to be precursors of photochemical smog. However, many of the exempt VOCs are of concern for indoor air quality. Depending on the strength, type, and duration of emissions from these chemicals, carpet can be a significant source of indoor air contamination.

The CRI has developed a program known as the CRI Indoor Air Quality Carpet Testing Program (CRI “Green Label”). This label identifies carpets that after 24 hours of testing, have VOC emissions below levels established by the CRI. At the time the CRI program was established, many carpets exceeded these emissions levels. Currently, almost all carpets qualify for the CRI Green Label. While the CRI label should be a bare minimum requirement for carpet selection, it is not a sufficient indicator of carpet emissions into indoor air. A Maryland State Department of Education Technical Bulletin, Carpet and Indoor Air Quality in Schools, cautions that CRI certification “does not provide information on comfort and health effects of specific VOC emissions, and should not be misunderstood to assure a safe product.”

It is recommended that all carpet products (virgin and recycled content) meet the emissions criteria outlined in Specification Section 01350 to ensure improved IAQ benefits required for a high performance school. Additionally, the specific criterion for 4-PC emissions applies to carpets.

- Under a test over a 96-hour time period after 10 days of conditioning (as described in Specification Section 01350), the carpet should emit less than  $10 \mu\text{g}/\text{m}^2\text{-hr}$  of 4-PC.
- The proposed specifications should require that the contractor submit a compliance table, which documents the required performance criteria (as provided in the specifications) and actual test results.

School designers should also require manufacturers to submit the following information for each product making up the carpet system:

- The ingredients, including identification and quantified amounts of substances that are listed on either: (a) the International Agency for Research on Cancer List of Chemical Carcinogens; (b) the Carcinogen List of the National Toxicology Program; or (c) the Reproductive Toxin List of the Catalog of Teratogenic Agents.
- Emission factors for VOCs contained in the product, in milligrams per square meter per hour ( $\text{mg}/\text{m}^2\text{-hr}$ ).
- Product TVOC emission factor (after 10 days of conditioning in clean air at 1 air change per hour then tested at 24, 48, and 96 hours ( $\text{mg}/\text{m}^2\text{-hr}$ )).
- Emissions test protocol used.
- Organization evaluating the product.

### ***Type of Carpet***

When selecting carpet, space classification, desired design life, and desired aesthetics are the traditional considerations.

Look for low pile, dense loop, and needle-punch carpet types trap the least soil and show wear the least. One good choice for schools is a low nap, all-nylon carpet, which is less attractive to dust mites and mold.

Natural carpets are made from grasses, cotton and wool, with minimal treatment. However, natural carpet materials can harbor insects and support mold growth, as well as being more difficult to maintain. For these reasons, natural carpet is not recommended for schools.

### ***Recycled Content***

Select a carpet with a minimum of 50% total (yarn and backing) recycled content (minimum 10% post-consumer recycled content). The manufacturer's warranty period should be reserved for such carpets, and those with a shorter life span should be used in low-traffic areas. Type One Commercial Carpet is available, either a tile or a broadloom, with backing made with post-consumer plastic (typically nylon, polypropylene or a mix of these two plastics). Some manufacturers offer product lines that contain 50% or more recycled content plastic by weight and above. Generally commercial carpet made from nylon 6 or 6,6 is the most durable type of carpet. At this writing, at least two manufacturers supply products made with 100% recycled nylon. Many manufacturers will offer a surface wear warranty of 15 years or more (e.g., 10% surface wear by weight). Some carpet manufacturers also offer reclamation programs to facilitate carpet recycling at the end of its useful life.

The life expectancy of recycled content carpet is between 10 and 15 years.

### ***Carpet Tiles***

Carpet tile systems save money and resources. They generate less waste during installation. They are also easily removed and replaced during renovation, and individual tiles can be easily replaced as needed, considerably extending the average service life of the carpet. A few disadvantages to carpet

tiles are that they may be more subject to vandalism by students who discover the system is modular. Also, flooding or spills may cause moisture to infiltrate the joints, creating potential IAQ hazards.

### ***Refurbished Carpet***

At least one manufacturer refurbishes commercial carpet for reapplication as modular carpet tiles. The manufacturer super-cleans, re-textures and overprints new colors and patterns to previously used carpet. The end product has a warranty and costs about half of new. Refurbished carpet is considered a 100% post-consumer recycled content product. However, in some instances, manufacturers will add new backing to the refurbished product, which would reduce the amount of post-consumer recycled content.

### ***Pad***

Specify carpet pad with highest percentage of recycled content (and compatible with selected carpet product). Fibrous pad is also available in commercial grades made from recycled synthetic and natural fiber from textile mill waste.

### ***Recyclability***

Carpet recycling is a priority because of the large volumes being disposed and its resistance to decomposition. A national agreement for carpet stewardship called the Memorandum of Understanding for Carpet Stewardship (MOU) was signed on January 8, 2002. The MOU states that, "the amount of carpet that is reaching the end of its useful life and entering the waste stream is ever-increasing: estimated total discards for 2002 are **4.7 billion pounds**." Fully recyclable carpets are just newly available. Many manufacturers now take the carpet and carpet tile at the end of its useful life and will recycle it back into new carpet backing (i.e., closed loop system).

### ***Installation***

Where new carpet odor is a concern, require suppliers to unroll and air-out carpets in a warehouse before bringing them into the building. Tests indicate that carpet emissions will decrease significantly within 48 to 72 hours with proper ventilation.

When installing carpet over concrete floors, ensure that the concrete is sufficiently dry prior to installation. If water vapor emissions from the concrete floor are greater than 5 lb/1,000 ft<sup>2</sup>, a vapor emission control treatment should be applied to the floor until emissions meet the maximum levels allowed by the carpet manufacturer.

Specify the least toxic carpet adhesive system compatible with selected carpet products. Require installer to use the smallest amount of adhesive necessary to fulfill the manufacturer's performance specifications for that product. Alternately, specify tack-down carpet to eliminate gluing, while taking precautions to prevent potential mold and mildew growth under the carpet.

If covering a large surface area, carpet and other fabrics can act as "sinks" for the adsorption of VOCs from other sources (during application of paint and other finish coatings, for example) and re-emit them later. To minimize this "sink" effect and subsequent extended re-emitting of VOCs, install soft surfaces as late as possible and/or remove or cover all soft surfaces and use direct ventilation until the offensive coating dries.

Air out space(s) where carpet has been installed for a minimum of 72 hours. With a central HVAC system, the ventilation supply should be on, the return grille(s) sealed, and windows open.

In renovations, carpet installation should occur only when the school building is not in use. An exception would be for small installations in which the space can be exhausted directly to the outdoors, causing the room to be under negative pressure relative to adjacent spaces in the building. Extra ventilation should continue for a minimum of 72 hours after installation.

To reduce the risk of mold growth on carpet, do not install carpet near water fountains, sinks, showers, pools, or other locations where it may get wet.

## **Operation and Maintenance Issues**

Carpeting acts as a highly effective reservoir for allergens such as dirt, pollen, mold spores, pesticides and other toxins, which are everywhere present outdoors and often introduced into the indoor environment in dirt from occupants' shoes. Old carpeting may pose more health risks to its occupants than new. Microbial contamination resulting from water infiltration or inadequate cleaning procedures is a potential problem. The presence of fungi and dust mites can exacerbate allergies. To help ensure longer life, maintain appearance, and help protect indoor air quality, carpet requires regular vacuuming with a well-functioning vacuum cleaner equipped with strong suction and a high-performance filtration bag. Walk-off mats should also be provided at all entrances.

Spills must be cleaned up immediately and thoroughly. If carpet becomes saturated and water is not quickly removed (less than 24 hours), experience suggests that carpeting will have to be discarded.

## **Commissioning**

Airing out the space during and after carpet installation is essential and is recommended by the CRI, the U.S. Environmental Protection Agency, and the U.S. Consumer Product Safety Commission. The typical recommendation is to continuously operate the building ventilation system at normal temperature and maximum outdoor air during installation and for 72 hours after installation is completed. A longer flush-out of the entire building should also be considered. The CRI *Standard for Installation of Commercial Textile Floor Covering Materials* (CRI 104) addresses the topic of airing and other installation procedures.

## **References/Additional Information**

California Integrated Waste Management Board (CIWMB) Database of Recycled Content Products:  
<http://www.ciwmb.ca.gov/rcp>.

*Carpet and Indoor Air Quality in Schools*. Published by the School Facility Branch of the Maryland State Department of Education. To order, contact the Maryland State Department of Education, Division of Business Services, School Facilities Branch, 200 W. Baltimore St., Baltimore, MD 21201, phone for Capital Projects Assistant Manager, (410)-767-0097.

Carpet & Rug Institute (CRI) website, <http://www.carpet-rug.com>. Provides information on selection, installation, and maintenance.

*Comprehensive Procurement Guidelines*. The recommended recovered material content for polyester face carpet fiber is listed as 25-100% PET resin (recycled plastic soda bottles). Envirotech (Image) and Enviroton (Talisman) lines meet this standard. EPA is expanding its definition of environmentally preferred carpet by including nylon fiber with recycled-content backing (i.e., Collins and Aikman, Shaw, Interface). These new standards will soon be reflected in the CPGs. For more information on carpet manufacturers and suppliers and a GSA link, visit EPA's web site:  
<http://www.epa.gov/epaoswer/non-hw/procure/products/carpet.htm>.

*Environmentally Responsible Carpet Choices*, Sustainable Practices and Opportunities Plan, a project of the Department of Interior, National Park Services. <http://www.nps.gov/sustain/spop/carpet.htm>

The LaGrange Academy in LaGrange, GA. Several projects installed at this K-12 campus, including a multi-purpose building.

*Standard for Installation of Commercial Carpet*, CRI 104. An industry minimum commercial installation standard published by the Carpet and Rug Institute (CRI). Contains detailed outlines of technique, procedure, and terminology used in specification writing, planning, layout, and installation. Includes accepted tools and materials, floor preparation, installation in special areas, diagrams and charts. 25 pages, 8 1/2" x 11" \$6.00 each. ISBN #0-89275-010-3. To order, call CRI at 800-882-8846.

The Woodward Academy in Atlanta, GA, the largest private K-12 in the country. Five projects have now been installed on campus. Earth Square is now a standard for use based on environmental and economical reasons.

## GUIDELINE BP2: RESILIENT FLOORING

### Recommendation

Select resilient flooring and adhesives that are materials-efficient and non-polluting.

### Description

Vinyl composition tile (VCT) has been the finish of choice for uncarpeted areas in schools, due to its durability and low maintenance. However, VCT is made of non-renewable resources and there is concern about environmental degradation associated with its production.

Linoleum, often the choice of environmentally conscious designers, is durable as well and is produced from minimally processed, renewable materials. However, it also poses some risks, including offensive odor during its early months and, sometimes, much longer.

Chlorine-free resilient flooring and recycled content rubber (tire-derived) tile/sheet flooring can also be environmentally preferable options. Vinyl-free products are also becoming available.

With respect to materials efficiency and air quality, there are important distinctions between material types, installation methods, and maintenance requirements. Final selection will depend upon the application and cost constraints.

### Applicability

Most suitable for high traffic areas not requiring the acoustic benefits of carpet, such as hallways, kitchens, cafeterias, art rooms, toilets or anywhere that liquid spills are likely.

### Integrated Design Implications

Flooring type selection affects thermal comfort (carpeting reduces heat loss slightly more than resilient flooring, for example) and lighting (floor finishes with high reflectivity enhance daylighting). Resilient flooring does not generally provide the acoustic benefits of carpeting. Teacher preferences should also be considered, if feasible. Resilient flooring is more easily cleaned than carpeting and may last considerably longer. Some resilient flooring requires application of sealants and waxes, which result in periodic increases in occupant exposure to the chemicals emitted from these products. Recycle waste flooring, if possible (require subcontractor to take back for recycling).

While often considered environmentally preferable, linoleum contains linseed oil, which does off-gas. The oxidation products when the emissions occur are odorous compounds that may affect the acceptability of linoleum as a floor covering. It is recommended that designers obtain emissions test data from the



*Due to its durability, resilient flooring is highly suitable for heavy traffic areas such as hallways and cafeterias.*

NREL/PIX 03050

### Applicable Climates



#### Applicable Spaces

Classrooms	<input type="checkbox"/>
Library	<input type="checkbox"/>
Multi-Purpose	<input type="checkbox"/>
Gym	<input type="checkbox"/>
Corridors	<input type="checkbox"/>
Administration	<input type="checkbox"/>

#### When to Consider

Programming	<input type="checkbox"/>
Schematic	<input type="checkbox"/>
Design Dev.	<input type="checkbox"/>
Contract Docs.	<input type="checkbox"/>
Construction	<input type="checkbox"/>
Commissioning	<input type="checkbox"/>

producers of linoleum and other resilient floor products prior to specifying such products. Comparisons of emissions should be done prior to selection.

### Cost Effectiveness

Costs will vary with type of product chosen. Some newer environmentally friendly products are on the market and the designer should obtain cost data.

Other alternatives, including cork and newer resilient flooring products (vinyl-free, chlorine-free) may be more expensive.

Costs	L	■	□	□
	M	□	□	■
	H	□	□	□
		L	M	H
		Benefits		

### Benefits

Resilient flooring is highly durable.

Use of alternatives to VCT flooring is ecosystem-protective, avoiding environmental degradation attributed to the mining of limestone and production of PVC, which are both used in the manufacture of VCT.

Recycled content flooring and recyclable flooring are material efficient.

True linoleum is made with renewable materials (linseed oil, cork, wood dust and jute), does not contain the petrochemicals and chlorine found in vinyl and VCT flooring, or the plasticizers found in vinyl sheet flooring. Its known ingredients are minimally processed, commonly available, and biodegradable.

Linoleum is durable. Low-toxic adhesives and coatings minimize the indoor air pollution load and health risks to both installers and occupants.

### Design Tools

See this chapter's Overview.

### Design Details

Most resilient flooring products produce some air pollutant emissions; so do their setting and maintenance products. It is recommended that all resilient flooring products meet the emissions criteria outlined in Specification Section 01350.

Natural linoleum is another chlorine-free product, made out of nearly all-natural ingredients. At present, linoleum is produced only in Europe at only three companies. Linoleum emits a fairly strong smell when the flooring is newly installed. The smell comes from linseed oil's oxidation products, which are primarily fatty acids – compounds that react with oxidants to produce new chemicals that have a strong smell even at very low concentrations. Emissions of odors have been measured and observed on aged linoleum as well.

Resilient textile flooring is a newly formulated product that comes in 1-m<sup>2</sup> (39 in. x 39 in.) tiles, comprising a sandwich of very different materials that is designed to come apart for recycling. Developed as part of the specific manufacturer's corporate sustainability policy and initiative, resilient textile flooring is recyclable, durable and manufactured using renewable energy. Acoustically it performs like carpet, according to the company. The manufacturer has targeted schools and hospitals as its primary markets, because both environments benefit from the comfort and acoustic qualities of carpet but struggle with the maintenance and cleanliness issues.

Cork is a natural material and harvested from trees in a resource-efficient manner. Cork flooring is durable, fairly easy to clean, thermally insulating, and naturally moisture-, mold-, and rot-resistant. Drawbacks are its high cost and high-embodied energy (because it is imported and is energy-intensive to ship to North America). Also, some flooring manufacturers use hazardous materials as binders and in installation. It is recommended that binders, adhesives, and coatings meet Specification Section 01350 specifications. If Specification Section 01350 has not been used to test particular products, request and carefully review the MSDS and ASTM emissions test data for these materials. Emissions tests of cork

flooring have shown that some of the binder elements are emitted. Some chemicals emitted from cork flooring are toxic at elevated concentrations.

Recycled rubber tile and sheet goods made with waste tires are also available. These are materials efficient choices for heavy traffic and utility areas, but may be strong VOC emitters and odor sources.

Specifications should require installer to use the smallest amount of adhesive necessary to fulfill the manufacturer's performance specifications for that product. (In some applications, interlocked rubber tiles and heavy linoleum can be laid without adhesive).

When installing resilient flooring over concrete floors, ensure that the concrete is sufficiently dry prior to installation. If water vapor emissions from the concrete floor are greater than 3 lb/1,000 ft<sup>2</sup>, a vapor emission control treatment should be applied to the floor until emissions meet the maximum levels allowed by the flooring manufacturer.

Specify adequate ventilation during installation and flush out the building for a minimum of 72 hours after installation.

### ***Operation and Maintenance Issues***

Maintenance products are also significant pollution sources. Flooring with sealed "low maintenance" surfaces should be preferred, both for reducing maintenance costs and the use of cleaners and waxes. It may be possible to require manufacturers to provide cleaning and maintenance product specifications and application procedures. In these cases, the chemicals in these products should be evaluated along with the emissions from the flooring itself.

Low VOC cleaners and sealers are available. Be sure to consult with the manufacturer when specifying sealers and other maintenance products. Use of the wrong products can cause problems, especially with natural linoleum. To help ensure longer life, maintain appearance, and help protect indoor air quality, resilient flooring requires cleaning/vacuuming. Walk-off mats should also be provided at all entrances.

### ***Commissioning***

None.

### ***References/Additional Information***

See this chapter's Overview.



## GUIDELINE BP3: CERAMIC TILE / TERRAZZO

### Recommendation

Select locally available, recycled content ceramic or clay tile. If installing terrazzo, avoid the epoxy type; substitute cementitious terrazzo where appropriate. Specify low-toxic adhesives, grouts, caulks, sealants, and setting materials.



*Use of locally or regionally manufactured ceramics reduces the high transportation costs associated with importing.*  
NREL/PIX 11433

### Description

Recycled content ceramics, clay tiles, and terrazzo (made with cement and crushed stone) are durable and low emission interior finishes.

Terrazzo is a family of flooring materials that incorporates natural marble chips and other aggregates in a cementitious or epoxy mixture, which is usually applied wet and allowed to cure in place.

### Applicability

Most suitable for traffic areas requiring high durability and low maintenance, but not requiring the acoustic benefits of carpet, such as entryways and toilets.

### Applicable Climates



### Integrated Design Implications

Flooring type selection affects thermal comfort (carpeting retains heat longer than resilient flooring, for example) and lighting (floor finishes with high reflectivity enhance daylighting). Tile/terrazzo flooring does not provide the acoustic benefits (tile flooring does not absorb sound and does not reduce impact noise transmission to spaces below) of carpeting, so this, along with teacher preferences, should be considered. As part of the C&D plan, recommend that the subcontractor take back waste tile for recycling.

#### Applicable Spaces

Classrooms	<input type="checkbox"/>
Library	<input type="checkbox"/>
Multi-Purpose	<input type="checkbox"/>
Gym	<input type="checkbox"/>
Corridors	<input checked="" type="checkbox"/>
Administration	<input type="checkbox"/>
Toilets	<input checked="" type="checkbox"/>
Other	<input checked="" type="checkbox"/>

#### When to Consider

Programming	<input type="checkbox"/>
Schematic	<input type="checkbox"/>
Design Dev.	<input checked="" type="checkbox"/>
Contract Docs.	<input checked="" type="checkbox"/>
Construction	<input checked="" type="checkbox"/>
Commissioning	<input type="checkbox"/>
Operation	<input checked="" type="checkbox"/>

### Cost Effectiveness

Terrazzo costs between \$5/ft<sup>2</sup> and \$10/ft<sup>2</sup> to install, and will last the life of the building. Ceramic tile costs between \$6/ft<sup>2</sup> and \$12/ft<sup>2</sup> installed, and will last 40 to 80 years. Recycled-content tile can be higher priced than average tile products. Low-toxic adhesives used with tile and terrazzo are generally available locally and at competitive prices.

Costs	L	<input checked="" type="checkbox"/>	<input type="checkbox"/>	<input type="checkbox"/>
	M	<input type="checkbox"/>	<input checked="" type="checkbox"/>	<input type="checkbox"/>
	H	<input type="checkbox"/>	<input type="checkbox"/>	<input type="checkbox"/>
		L	M	H
		Benefits		

Though costly to purchase and install, the ceramic tile/terrazzo *life cycle* cost is among the lowest of all finishes for some applications, due to its long life and minimal maintenance. Ceramic tile with recycled content may cost 1.5 to 2 times more than conventional.

### Benefits

Use of local or regionally manufactured ceramics reduces the high transportation consumption/cost associated importing with this heavy building material. Ceramics and terrazzo (made with cement and

crushed stone) are durable and low emitting. Some tile is available with recycled content (up to 70%), such as scrap glass and feldspar waste from mining, which is material efficient, durable, and low- to non-emitting. Some manufacturers also have added heat recovery, water recovery, and clay mine restoration measures to their operations that exceed industry norms, which is ecosystem-protective.

Low toxic adhesives and coatings minimize the indoor pollution load and health risks to both installers and occupants.

## **Design Tools**

See this chapter's Overview.

## **Design Details**

Tile is a packaging-intensive product. Specify recyclable packaging. Check with the manufacturer to see if there is a collection program in place at no cost to owner or contractor.

### **Terrazzo**

The two types of binders used in terrazzo flooring raise different environmental issues during installation. Cementitious terrazzo is composed of inert ingredients mixed with water. The primary installation hazard is dust during mixing and grinding. The installation of epoxy terrazzo, however, requires the use of OSHA-approved respirators, protective gloves, and safety glasses, as well as ventilation with 100% fresh air. The epoxy matrix contains a number of toxic materials. For these reasons, use of the epoxy type terrazzo should be avoided.

### **Tile**

Avoid the use of imported tile. The glazing used on imported tiles can contain lead which is toxic and a potential health threat. Another disadvantage is that imported tiles have high-embodied energy.

### **Mortar, Adhesives, Caulking, and Sealants**

Cement mortars, usually modified with acrylic additives, are the safest to handle for tile setting and offer the best performance for most applications. All plastic adhesives contain some solvents and will contribute to indoor air pollution. Where adhesives and caulking must be used, such as for cove bases and flexible joints, choose a low solvent-content product such as an acrylic. Cement-based, cellulose-based and acrylic-modified grouts are safe and have low emissions. Glazed tile and high-fired tile usually do not require sealers. If a porous tile is chosen, the safest sealers are the low-VOC, acrylic or water-based silicone types. Check with the tile manufacturer to select the lowest VOC, low toxic mortars, sealers, caulks, and adhesives that will provide the desired performance. Review MSDS and emission test data for sealers, caulks and other adhesives to understand their impact on indoor air quality.

### **Installation**

Specify adequate ventilation during installation.

Tile is a non-porous surface and should be installed prior to porous, fleecy, and absorbent materials, which can act as "sinks", absorbing VOCs from other materials and later re-emitting them.

Require installer to use the smallest amount of adhesive and sealant necessary to fulfill the manufacturer's performance specifications for that product.

Perform building flush-out after floor installation.

## **Operation and Maintenance Issues**

Terrazzo flooring should be sealed to prevent absorption of dirt and stains. Water-based sealers are available. Maintenance for ceramic tile varies with the type of surface and grout. Most unglazed tile is sealed after installation. Once floors are sealed, they may require re-sealing throughout their lives, in

which the process may impact indoor air quality. Walk-off mats should also be provided at all entrances to help ensure longer life, maintain appearance, and help protect indoor air quality.

### ***Commissioning***

None.

### ***References/Additional Information***

See this chapter's Overview.

## GUIDELINE BP4: CONCRETE FLOORING

### Recommendation

Select concrete flooring, made with fly ash. Use low toxic adhesives, sealers, and wax.

### Description

Finished concrete flooring is an integral system of slab and finish, produced by adding colorants and a sealer to the topping concrete (colorized cement) either before or after it cures. The concrete is often stamped with tile patterns and grid lines that also control cracking.

Applying a colorized stain to a cured concrete surface produces stained concrete flooring.

Both types of concrete flooring provide a durable and low maintenance finish. Saw-cut and other designs and colors can add interest and educational value.

Fly ash is a by-product of the coal burning industry.



*Concrete flooring is highly durable and low maintenance, which conserves materials and reduces potential indoor air quality problems. NREL/PIX 11416*

### Applicability

Especially suitable for high traffic areas, such as hallways, cafeterias, and gathering areas. Staining existing concrete flooring is generally appropriate for renovation. Finished concrete flooring with integral colorants is generally applicable to new installations. Concrete may be used for other building surfaces.

### Integrated Design Implications

Flooring type selection affects thermal comfort (carpeting retains heat longer than resilient flooring, for example) and lighting (floor finishes with high reflectivity enhance daylighting). Concrete flooring adds thermal mass. Concrete floors do not absorb sound or reduce impact noise transmission to spaces below.

### Cost Effectiveness

Medium (\$3.00/ft<sup>2</sup>) to high first cost, depending upon complexity of the installation/design.

### Benefits

Concrete flooring is highly durable and low maintenance, which conserves materials and reduces potential indoor air quality problems due to maintenance products. Concrete with fly ash is material efficient. Low-toxic coatings minimize the indoor air pollution load and health risks to both installers and occupants.

### Design Tools

See this chapter's Overview.

### Applicable Climates



#### Applicable Spaces

Classrooms	
Library	
Multi-Purpose	
Gym	
Corridors	
Administration	
Toilets	
Other	

#### When to Consider

Programming	
Schematic	
Design Dev.	
Contract Docs.	
Construction	
Commissioning	
Operation	

Costs	L			
	M			
	H			
		L	M	H
		Benefits		

## ***Design Details***

### ***Selection***

Finished systems with integral color added to the entire topping layer are more resistant to damage, and less likely to require re-coloring than systems that are dyed after placing the concrete.

Ask supplier to recommend least toxic, VOC-compliant sealers and wax that will fulfill performance requirements.

Concrete staining is a technique often used in renovation of existing buildings with existing concrete sub-floors.

A variety of techniques are available to add designs – for example, cultural, school, community symbols – for use as teaching tools. Such artistic/educational amenities, however, will increase the cost.

### ***Installation***

Specify adequate ventilation during installation and flush out the building in accordance with project specifications.

Require installer to use the smallest amount of sealers and wax necessary to fulfill the manufacturer's performance specifications for that product.

## ***Operation and Maintenance Issues***

Proper sealing and re-waxing of stained concrete floors will ensure a long service life. Stained concrete flooring requires periodic re-waxing. Maintenance materials should be reviewed for low VOC emissions.

Walk-off mats should also be provided at all entrances to help ensure longer life, maintain floor appearance, and help protect IAQ.

## ***Commissioning***

None.

## ***References/Additional Information***

See this chapter's Overview.

# GUIDELINE BP5: WOOD FLOORING

## Recommendation

Select environmentally preferable products for wood flooring. Specify low-toxic adhesives, sealers, and finishes.

## Description

Environmentally preferable wood flooring types include Forest Stewardship Council (FSC)-certified hardwood, salvaged wood, and laminated or veneered wood products. When permitted by the school district, other environmentally preferable choices include salvaged or reclaimed wood. Salvaged flooring is material efficient and considered a 100% post-consumer recycled content product.

If using hardwood, specify products certified by the FSC. FSC is the accrediting agency for organizations that certify forests as well managed. Other environmentally preferable alternatives to conventional hardwood flooring include a wide range of veneered and laminated products that have a hardwood surface with plywood, MDF, or other materials in the core.

## Applicability

Wood flooring is typically now specified for schools only where its performance characteristics make it uniquely desirable: gymnasiums, stages, and dance studios. However, some studies suggest that wood flooring from resource-efficient forests may be an appropriate flooring material for more functions, including classrooms, especially in regions where desirable species are native.



Trademark reproduced with permission. FSC Trademark © 1998 Forest Stewardship Council A.C.

### Applicable Climates



### Applicable Spaces

Classrooms	
Library	
Multi-Purpose	
Gym	
Corridors	
Administration	
Toilets	
Other	

### When to Consider

Programming	
Schematic	
Design Dev.	
Contract Docs.	
Construction	
Commissioning	
Operation	

## Integrated Design Implications

Flooring type selection affects thermal comfort (carpeting retains heat longer than resilient flooring, for example) and lighting (floor finishes with higher reflectivity enhance daylighting). Wood floors do not absorb sound or reduce impact noise transmission to spaces below.

## Cost Effectiveness

Wood flooring costs between \$6/ft<sup>2</sup> and \$10/ft<sup>2</sup>. The life expectancy averages 38 years. The cost premium for certified wood ranges from modest to significant, depending upon quantity, type, and current availability.

Costs	L			
	M			
	H			
		L	M	H
		Benefits		

## Benefits

FSC-certified wood is eco-system protective. Low toxic adhesives and coatings minimize the indoor air pollution load and health risks to both installers and occupants. The factory pre-finished products have substantial air quality benefits because no sealer is applied, no sanding is performed, and no finishing is done on site.

## **Design Tools**

See this chapter's Overview, and:

*Certified Forest Products Database*, Certified Forest Products Council. Web site:

<http://www.certifiedwood.org>. Contact: 14780 SW Osprey Dr., Suite 285, Beaverton, OR 97007. Tel: (503) 590-6600. Industry information on suppliers and standards.

## **Design Details**

### **Selection**

Several FSC-certified hardwood-flooring products are available. Look for woods grown in regional forests, which reduce the energy consumption involved in transportation.

Veneered and laminated products that have plywood, composite wood products, or MDF cores material efficient, but are less easily repaired than solid wood. These are usually pre-finished at the factory with a very durable, low-maintenance finish.

Low-toxic, clear sealers are also available to use as finishes for woodwork. Water-based varnishes, polyurethane, and other finishes for hardwood floors are very durable and much safer to handle than traditional products. Low-toxic solvents, water-based strippers, and all-natural thinners are also locally available.

A word of caution: not all water-based products are low-emitters and, in fact, some emissions continue far longer than those from traditional, oil based sealers. For example, acid cured lacquers can be strong emitters of formaldehyde while they are curing and for considerable time afterwards. Formaldehyde-free alternatives should be specified for schools. It is recommended that all veneered and laminated products should meet the emissions requirements outlined in Specification Section 01350.

### **Handling**

Specify that woodwork be protected from water damage during transit, delivery, storage, and handling. In addition to saving materials, this helps prevent future moisture/indoor air quality (IAQ) problems.

### **Installation**

A steel track system using wedges to hold the flooring in place, or a "floating system," using edge gluing where necessary, makes wood floors easy to remove. A nail down system is also salvageable, but with some loss of material. Avoid parquet systems, which require a glue-down system and are therefore the least salvageable. Eliminating the use of adhesives reduces the impact on IAQ.

If sanding is done on the premises, the area must be carefully isolated, including sealing off the doors and HVAC system, and using temporary fans. Specify final cleanup with a HEPA filter-equipped vacuum.

Require installer to use the smallest amount of adhesive/coating necessary to fulfill the manufacturer's performance specifications for that product.

For finishing on site, use low-VOC emitting finishes. Hardening oils, varnishes and acid cured varnishes have prolonged emissions. If edge gluing is required, specify a low toxicity product such as white carpenters or woodworkers glue. If glue-down methods are required, such as for parquet, specify a low-VOC emitting flooring adhesive.

Specify adequate ventilation during installation and for 72 hours afterwards.

Woods naturally emit formaldehyde.

## **Operation and Maintenance Issues**

After being finished with a synthetic topcoat, maintenance requirements for wood floors are similar to VCT and terrazzo. A typical hardwood floor might need re-sanding (which generates airborne dust) every eight

to 10 years and can be re-sanded up to five times. Annual screening and re-coating maintains the protective wear layers. Wood flooring is easier to repair than most other materials.

### **Commissioning**

None.

### **References/Additional Information**

See this chapter's Overview, and:

For general information on certified lumber, contact: Certified Forest Stewardship Council, Jeff Wartelle. Tel: (503) 590-6600. Refer also to: <http://fscus.org/html/index.html>. Industry group provides information on distribution and other assistance.

*Certified Forest Products Database*, Certified Forest Products Council, <http://www.certifiedwood.org>. Contact: 14780 SW Osprey Dr., Suite 285, Beaverton, OR 97007. Tel: (503) 590-6600. Industry information on suppliers and standards.



# GUIDELINE BP6: BAMBOO FLOORING

## Recommendation

Specify domestically produced flooring made from rapidly renewable bamboo (it matures in less than five years). Install and finish with a low toxic, water-based sealer and wax.

## Description

Bamboo is a natural material, technically a grass that can reach timber height of 100 ft. It is a renewable resource, requiring no pesticides, fertilizers or irrigation, so it is not labor intensive to farm. Some manufacturers source their bamboo from managed forests using a harvesting method done by hand. This reduces the impact on the local environment in terms of erosion and habitat destruction. Most bamboo used in flooring production is grown in, and imported from, China. Boric acid is sometimes added during the manufacturing process. Bamboo flooring is harder than most common wood flooring, very durable, fast-growing, and dimensionally stable.



*Bamboo flooring is aesthetically pleasing, low emitting, durable, and produced from a renewable, harvested resource. NREL/PIX 11417*

## Applicability

Suitable wherever wood flooring would be used. Bamboo may also be used as plywood, paneling, and veneer.

## Applicable Climates



## Integrated Design Implications

Flooring type selection affects thermal comfort (carpeting retains heat longer than other flooring does, for example) and lighting (floor finishes with high reflectivity enhance daylighting). Bamboo floors do not absorb sound or reduce impact noise transmission to spaces below.

### Applicable Spaces

Classrooms	□
Library	■
Multi-Purpose / Gym	■
Corridors	■
Administration	■
Toilets	□
Other	□

### When to Consider

Programming	□
Schematic	□
Design Dev.	■
Contract Docs.	■
Construction	■
Commissioning	□
Operation	■

## Cost Effectiveness

Costs range from \$4/ft<sup>2</sup> to \$8/ft<sup>2</sup>, which is slightly more than domestic hardwoods. However, bamboo is more durable than wood (25% harder than oak, 12% harder by some tests than maple, and 2.5 times more dimensionally stable than maple).

Costs	L	■	□	□
	M	□	□	□
	H	□	□	■
		L	M	H
Benefits				

## Benefits

Bamboo flooring is aesthetically pleasing, low emitting, durable, and produced from a renewable, harvested resource. Low toxic adhesives and coatings minimize the indoor air pollution load and health risks to both installers and occupants.

## Design Tools

See this chapter's Overview.

### ***Design Details***

Specify use of adequate ventilation during installation. Flooring is best applied by nailing, stapling, or gluing to a wood sub-floor, but can be glued to concrete at or above grade. If installing over concrete, moisture testing is recommended prior to installation.

### ***Operation and Maintenance Issues***

Place mats at entrances and exits to trap dirt from incoming traffic. Bamboo floors must be vacuumed or swept regularly with a nylon broom. Use non-alkaline cleaning solutions. Do not mop with water, since excess water can damage the floor.

### ***Commissioning***

None.

### ***References/Additional Information***

See this chapter's Overview, and:

The American Bamboo Society. Web site: <http://www.bamboo.org/abs>.

## GUIDELINE BP7: GYPSUM BOARD

### Recommendation

Specify gypsum wallboard with a minimum 100% recycled content paper facing. Post-consumer recycled content gypsum board core is also available.

Gypsum used for recycling should be clean construction waste, uncontaminated by paint, tape, compounds, adhesives, or other coatings.

### Description

Gypsum products are the most common interior panels used due to their fire retardant characteristics and low cost.

### Applicability

Suitable for all spaces. High impact gypsum is appropriate for spaces requiring higher than normal durability.

### Integrated Design Implications

Wallboard installation should be coordinated with the job-site waste reduction plan. Recycle clean construction waste drywall (require subcontractor to take back to the manufacturer for recycling).

When recycling gypsum board from a demolition site, check to see if the joint or topping compounds contained asbestos fibers. Sanding such material will result in the release of fibers into the air. State and federal laws regulate disposal of asbestos-containing materials.

### Cost Effectiveness

Gypsum board is the lowest cost option for walls. However, for ceilings, it is competitively priced with drop-in ceiling.

### Benefits

Gypsum is highly recyclable if not contaminated (with paint or adhesives) and the paper facing is generally made with recycled paper. Use of recycled-content gypsum is material efficient. High impact gypsum is more durable than conventional wallboard and has higher recycled content.

### Design Tools

See this chapter's Overview.



*Gypsum is highly recyclable if not contaminated with paint or adhesives and is more durable than conventional wallboard.*  
NREL/PIX 11410

### Applicable Climates



#### Applicable Spaces

Classrooms	█
Library	█
Multi-Purpose	█
Gym	█
Corridors	█
Administration	█
Toilets	█
Other	█

#### When to Consider

Programming	█
Schematic	█
Design Dev.	█
Contract Docs.	█
Construction	█
Commissioning	█
Operation	█

Costs	L	█	█	█
	M	█	█	█
	H	█	█	█
		L	M	H
		Benefits		

## **Design Details**

### **Selection**

Specify a minimum 10% recycled content gypsum board core with 100% recycled content facing paper. (Recycled content board must be specified, since recycled content is not automatically provided). It is recommended that all gypsum board products (virgin and recycled content) meet the emissions standards outlined in Specification Section 01350.

Consider gypsum produced by a recent innovation, the fibergypsum process. This board, now available in the U.S., has no paper facing but contains recycled wood, paper fiber, and perlite. It is very strong and scratch-resistant, and appropriate for high-wear areas such as schools.

Another environmentally preferable option is the use of gypsum board made with synthetic gypsum. Synthetic gypsum is produced with flue-gas desulfurization (FGD) gypsum, fluorogypsum, citrogypsum, and titanogypsum. This technology is not available in all areas, so embodied energy loads should be considered when selecting synthetic gypsum. Synthetic gypsum should also meet the emissions testing standards in Specification Section 01350. (Synthetic gypsum can have a negative environmental impact on agricultural land if it is ever applied as a soil amendment, due to its heavy metal content.)

### **Installation**

Special care should be taken during the delivery, storage, and handling of gypsum board to prevent to accumulation of moisture on the material or within its packaging. Exposure to moisture can cause mold growth in the gypsum paper facing. To prevent possible interior mold problems, any stored or installed gypsum board showing evidence of moisture damage, including moisture stains, mildew, and mold, should be immediately removed from the site and disposed of properly. Replace contaminated gypsum board with new, undamaged materials.

Specify wet sanding processes during finishing. An exception is that dry sanding may be allowed subject to full isolation of the affected space(s), installation of protective plastic sheeting to provide air sealing during the sanding; closure of all air system devices and ductwork, sequencing of construction to prevent contaminating other spaces with gypsum dust, use of proper worker protection, and owner approval of these measures. Using vacuums during dry sanding to reduce dust can also help protect the health of installers.

Unpainted gypsum surfaces are potent “sinks” — they absorb volatile organic compounds (VOCs) and then re-emit them. Require adequate ventilation during installation of adhesives and other materials that emit indoor pollutants. Where feasible, sequence work to avoid exposing applying VOC-containing materials in spaces with exposed, unpainted gypsum surfaces.

## **Operation and Maintenance Issues**

Requires periodic painting for aesthetic purposes. Type of paint determines cleanability. Wallboard is easy to repair.

## **Commissioning**

None.

## **References/Additional Information**

See this chapter's Overview.

## GUIDELINE BP8: ACOUSTICAL WALL PANELS AND CEILINGS

### Recommendation

Select formaldehyde-free acoustical ceiling and wall systems with recycled-content.

### Description

Acoustical wall and ceiling systems are widely used in school for sound absorption. A variety of products are available including modular wall panels (textile and metal-covered), suspended ceiling tiles (t-bar ceilings), and surface mounted ceiling and wall panels.

Ceiling tile (usually in a T-bar ceiling) is the most common ceiling finish in schools. Because of the large ceiling surface area, the likelihood of its being disturbed during modifications/renovations, and its contact with HVAC systems, it is an important product to consider for air quality and materials efficiency.

Types currently available include recycled content ceiling tiles made of recycled newspaper, mineral wool, perlite, glass fiber, and clay. Look for a minimum recycled content of 79%. (A recent informal survey conducted by the California Integrated Waste Management Board indicates that the recycled content of acoustical ceiling tiles varies between 18% and 82%). New products on the market can attain 85% recycled content, but with some diminished noise reduction value. Natural fiber acoustic ceiling panels are also available, for both walls and ceilings.

### Applicability

Use anywhere sound absorption and easy ceiling plenum access is desired.

### Integrated Design Implications

The T-bar ceiling system integrates with HVAC system ducting layout and operation. Do not use the space above the T-bar ceiling as a return air plenum because it is difficult to clean, and, if there is any off-gassing, odors, or microorganisms from any material in this area, contaminants can spread throughout the air space and be distributed to other areas. Instead, install return air systems using dedicated metal ductwork with access hatches for inspection and cleaning. Recycle construction waste (require subcontractor to take back for recycling).

Make sure insulation is not installed directly over drop-in ceilings. Lighting fixtures, diffusers, and other equipment interrupt the insulating barrier, leading to poor insulating performance. (Often the space above the ceiling is considered an attic space, requiring outside air ventilation.)

Make sure no fiberglass is exposed in the plenum.



*Formaldehyde-free acoustical panels with recycled content are considered a material efficient, low-volatile organic compound product, promoting healthy indoor air.*

NREL/PIX 11441

### Applicable Climates



### Applicable Spaces

Classrooms	█
Library	█
Multi-Purpose	█
Gym	█
Corridors	█
Administration	█
Toilets	█
Other	█

### When to Consider

Programming	█
Schematic	█
Design Dev.	█
Contract Docs.	█
Construction	█
Commissioning	█
Operation	█

## Cost Effectiveness

Costs are low.

Costs	L	■	■	□
	M	□	□	□
	H	□	□	□
		L	M	H
		Benefits		

## Benefits

Formaldehyde-free acoustical panels with recycled content are available. These panels are considered a material efficient, low-volatile organic compound (VOC) product that promotes healthy indoor environmental air quality

Acoustical products from wood fiber and other resource-efficient raw materials are highly durable.

Ceiling tile waste, either from construction or demolition, is nontoxic (as long as lead paint and asbestos were not used on older ceiling installations).

## Design Tools

See this chapter's Overview.

## Design Details.

### General

It is recommended that ceiling tiles meet the emissions standards outlined in Specification Section 01350. Emission test data and MSDSs for ceiling tile materials should also be obtained and reviewed.

Acoustical materials, including acoustical ceiling tiles, can act as "sinks" for the adsorption of odorous or irritating VOCs from other sources (during application of paint and other finish coatings, for example, or from occupant activities) and re-emit them later. Where feasible, sequence work to avoid exposing acoustical ceiling and wall systems while applying VOC-containing materials in spaces with exposed acoustical surfaces. Require adequate ventilation during installation of finish materials that emit pollutants.

Consult with the manufacturer before painting/coating any acoustical material. For example, with most ceiling tiles, the material loses its acoustical properties once it has been painted.

Sound absorbing materials such as acoustical wall panels and ceiling tiles should have their sound absorbing properties measured in a laboratory environment. Sound absorption is typically rated in terms of NRC (Noise Reduction Coefficient). The NRC scale ranges from 0.00 (totally reflective) to 1.00 (totally absorptive). Materials with "good" sound absorbing capabilities should have a minimum rating of NRC 0.65. Another acoustical parameter to be considered is the Ceiling Attenuation Class (CAC). Ceiling tiles typically range from CAC 25 to 40. Ceiling tiles with higher CAC ratings allow less sound to pass through and tend to absorb less sound than those with lower CAC ratings. In areas that have noise producing elements (i.e. Variable Air Volume (VAV) or Fan Powered Boxes (FPB)) in the ceiling space and also have a need for low background noise levels, a high CAC ceiling tile may want to be considered to help reduce background noise from terminal air devices or other noise sources. As always, a qualified acoustical consultant should review material selections before final decisions are made.

### Acoustical Wall Panels

Low-density fiberboard is made from paper and wood fiber, and is available made from 100% recycled newsprint. Most processes use no glue. They are suitable for use as acoustic panels. Fiber-free foam panels are also available from some manufacturers.

### Ceilings

Coordinate placement of lighting fixtures and other equipment in ceilings to provide clear access for inspection and servicing of HVAC system air filters and other components.

Where daylighting has been incorporated as a design strategy, consider using ceiling tiles with high light reflectance as specified in ASTM Standard E1477 (0.83lr).

Special care should be taken during the delivery, storage, and handling of ceiling tiles to prevent to accumulation of moisture on the material or within its packaging. To prevent possible interior mold problems, any stored or installed ceiling tiles showing evidence of moisture damage, including moisture stains, mildew, and mold, should be immediately removed from the site and disposed of properly. Replace contaminated tiles with new, undamaged materials.

Lights should be chosen to maximize the total area of the exposed acoustical ceiling.

### ***Operation and Maintenance Issues***

Ceiling tiles and other acoustical materials collect dust as well as adsorb and re-emit VOCs. Tile with mineral fiber content may also begin to shed hazardous fiber if disturbed or as it deteriorates. Both problems are a particular concern where the ceiling is used for a return plenum to carry air back to the HVAC air handlers. If this type of return system is used, the tile should be checked for damage and the plenum space occasionally cleaned with a high performance vacuum. If possible, in new and renovation design, HVAC returns should be ducted instead of risking contamination by debris in suspended ceilings (See Integrated Design discussion above.)

### ***Commissioning***

None.

### ***References/Additional Information***

See this chapter's Overview, and:

"Natural-fiber Acoustic Ceiling Panels," Environmental Building News, Volume 7, No. 4 (April 1998).

## GUIDELINE BP9: PAINTS AND COATINGS

### Recommendation

Specify the least toxic, low-formaldehyde, low- or zero-volatile organic compound (VOC) paint that meets durability and other performance requirements.



### Description

Emissions from paints and coatings are primarily from evaporating solvents, other VOCs and by-products released after oxidation. Water-based paints acrylic latex paints are lower in VOCs (<250 mg/L) than solvent-based paints. Low-VOC is generally accepted to mean paint with a VOC content less than 100 mg/L.

Low-VOC paints are usually those in the lighter color ranges. Tinting may increase VOC emissions.

Formaldehyde-free paint is not yet available, but several low-formaldehyde options exist. Select paint with the lowest formaldehyde concentrations possible.

While a variety of low-VOC and zero-VOC paints are now available to choose from, they vary in cost, potential toxicity, and performance. Therefore, paint selection should consider VOC content as well as overall composition and required performance characteristics, including cleanability, hideability (i.e., how well a product conceals a surface), and durability.

Recycled content paint is now available and may be considered for interior and exterior use.

#### Applicable Climates



#### Applicable Spaces

Classrooms	█
Library	█
Multi-Purpose	█
Gym	█
Corridors	█
Administration	█
Toilets	█
Other	█

#### When to Consider

Programming	█
Schematic	█
Design Dev.	█
Contract Docs.	█
Construction	█
Commissioning	█
Operation	█

### Applicability

All interior painted surfaces.

### Integrated Design Implications

Light colors enhance daylighting. Integrate with ventilation system installation/operation to provide proper ventilation during application, curing, and occupancy. Change out HVAC filters following application and before occupancy.

### Cost Effectiveness

Costs vary widely with paint type and application. Low-VOC and zero-VOC paints have tended to cost 10% to 30% more than conventional paint, but prices are becoming more comparable as demand/production increases. Many low-VOC paints are now comparable in price to conventional paint.

Costs	L	█	█	
	M	█	█	
	H	█	█	
		L	M	H
		Benefits		

### Benefits

Zero-VOC or low-VOC paints minimize the indoor air pollution load, odors, and health risks to both workers and occupants. Water-based paints are generally safer to handle and can be cleaned up with



water, reducing health risks to workers and minimizing/avoiding hazardous waste. Leftover latex paint may be recyclable, thus reducing waste.

## Design Tools

See this chapter's Overview.

## Design Details

Where practicable, leave surfaces of exposed structure unpainted.

A paint can be labeled low-VOC yet still contain odorous, irritating, toxic, or otherwise undesirable ingredients such as ammonia, formaldehyde, crystalline silica (a known carcinogen in dust form),<sup>11</sup> acetone, odor masking agents, glycols, and many other compounds, including fungicides and bactericides. Some of these may not be an *air quality* problem for occupants, but they may be hazardous to painters and those involved in manufacture of the paint. In addition, hazardous ingredients can degrade the natural environment during production and after disposal. Look for water-based paints that are low-formaldehyde, zero- or low-VOC, *and* low toxic. While information supplied on manufacturers' data sheets may make certain claims about VOC content or toxicity, speak with technical staff at the manufacturers' headquarters or manufacturing facility to obtain detailed information on product performance and environmental hazards. It is recommended that all paints meet the emissions testing standards outlined in Specification Section 01350.

Specify products containing no lead, mercury, hexavalent chromium or cadmium. Though regulations have eliminated many toxic components from consumer paint lines, industrial and commercial paints may still contain them. Check the MSDSs; all hazardous contents present at 1% of total weight and listed by (OSHA) as hazardous must be disclosed. Besides using Specification Section 01350 and the MSDS review, more detailed information can be obtained from the manufacturer and by reviewing emissions test results to determine the type of biocides used as well as the presence of other potentially hazardous ingredients.

High-traffic areas or areas vulnerable to graffiti may call for a more durable and smoother (enamel) finish. These paints typically have a higher VOC content. While there is little test data comparing "high-durability" and low-VOC paints, anecdotal information suggests that "high-durability" (usually alkyd paint) products would be expected to show roughly twice the performance of low-VOC paints.

If possible, the selection process should include a side-by-side paint comparison of the various products being considered, and should include comparison of abrasion resistance (durability), hideability, volume solids, odor, and overall appearance. Final paint selection should consider the following elements:

1. What is the allowable drying cycle for initial painting and subsequent maintenance cycles? Is the paint locally available? (An important consideration for future maintenance.)
2. What is the expected durability or life expectancy required? Requirements will likely vary with the space. For example, one manufacturer had specific and different recommendations for gymnasiums, cafeterias, restrooms, general classrooms, and hallways.
3. What is the method of application? Choices, such as in-house versus contractor and spray versus roller, have a bearing on paint choice.
4. What are the budget constraints, including first-time and maintenance? Budget analysis should consider not just cost per gallon, but also evaluate area coverage per gallon and projected time between re-painting, which can vary greatly with conditions of use.

---

<sup>11</sup> Some low-VOC paints contain crystalline silica, a known carcinogen. This ingredient is not a hazard in the wet paint — it is an issue only when dried paint is sanded, and dust is generated.

### **Installation**

Paint should be installed prior to soft surfaces such as carpeting to prevent absorption of VOCs. Specify isolation requirements (isolation of construction zones from completed zones to prevent cross-contamination; removal, coverage, or isolation of porous materials to avoid their adsorption and subsequent re-emission of solvents, maintaining negative pressure by exhaust ventilation in construction areas). Low-VOC paints may require a longer airing out time than other paints, so be certain to specify appropriate ventilation. When sanding dried paint, a dust mask should be worn.

### **Operation and Maintenance Issues**

Review recommended duration between paint application and occupancy and review for compatibility with maintenance schedules/requirements. Ideally, work should be scheduled during unoccupied periods or periods of least occupancy. Large projects should be scheduled during the summer vacation months or other breaks. The maintenance schedule should also factor in manufacturer recommended air temperatures for application.

#### **Caution**

*In jobs that require removal of old paint and may require chemical strippers, closely observe manufacturers recommendations for use, including ventilation and personal protective equipment per OSHA.*

*If performing renovation at a school constructed prior to 1980, do not begin work until testing paint samples for possible lead contamination. If lead-containing paint is present, observe appropriate abatement controls.*

Where possible, perform painting and stripping off-site or select materials with factory-applied finishes. For on-site interior painting, cover surfaces, such as fabric-covered furnishings, to which VOCs may adsorb. Consider constructing barriers (for example, walls or curtains of plastic sheeting) to help isolate portions of larger areas and minimize the distribution of dust and other pollutants.

Wipe down all surfaces with a damp cloth as soon as practical after completing all dust-generating work typically associated with surface preparation.

Carefully observe manufacturers recommendation for cleanup, storage, and disposal, for paints, primers, and thinners. Some products are classified as “flammable liquids” under federal regulations and must be stored in a specifically constructed safety cabinet. Keep paint containers covered as much as possible during and following use to protect against VOC release. For excess paint, consider recycle/reuse options.

All paint containers with residual liquid must be disposed of as hazardous waste per U.S. Environmental Protection Agency regulations. Only dry containers can be placed in municipal landfills.

### **Commissioning**

None.

### **References/Additional Information**

See this chapter’s Overview, and:

*Interior Painting and Indoor Air Quality in Schools.* Published by the School Facility Branch of the Maryland State Department of Education. To order, contact the Maryland State Department of Education, Division of Business Services, School Facilities Branch, 200 W. Baltimore St., Baltimore, MD 21201. Phone for Capital Projects Assistant Manager: (410) 767-0097.

## GUIDELINE BP10: CASEWORK AND TRIM

### Recommendation

Specify casework and trim constructed from formaldehyde-free binders and other environmentally preferable materials. Design for easy future disassembly and reuse. Specify assembly off-site where major off-gassing can occur before products are brought into the building. Install with least hazardous, low-volatile organic compound (VOC) content adhesives and coatings.



### Description

Conventional particleboard is made with bonding agents including urea-formaldehyde, which can off-gas for years after application. (Please refer to the discussion of formaldehyde-related indoor air quality problems in the Overview.) Authorities recommend fully covering all six sides of each surface with plastic laminate, or coating the particle board with a sealer to prevent off-gassing of formaldehyde and other volatiles (see Caution callout, below). However, unless a product's particleboard is fully-covered, it is recommended to use only products that use formaldehyde-free binders for interior use in high performance schools.

Environmentally preferable product alternatives for interior casework and/or trim include exterior grade plywood with phenolic formaldehyde resin, formaldehyde-free medium density fiberboard (MDF), oriented strand board (OSB), certified wood, salvaged lumber, bamboo, recycled plastic, metal, biocomposites (only for areas not subject to frequent wetting), and engineered wood. Certified MDF and plywoods also exist. Pre-assembled cabinets made with low-toxic materials and finishes, solid wood, engineered wood, and enameled metal are also available.

OSB, MDF, and other composite wood products can be strong sources of VOCs. Some of the emitted VOCs are terpenes which, when oxidized, form formaldehyde, higher molecular weight aldehydes, and acidic aerosols. Some of these oxidation products are more irritating or toxic than the chemicals emitted from the wood products. For instance, composite wood is the leading contributor to indoor formaldehyde levels, so reducing the amount of composite wood used is crucial to protecting indoor air quality. Some composite wood products manufactured with urban waste wood can contain wood preservatives, lead-containing paint, and other toxic compounds.

Acid-cured lacquers applied as finishes to wood products can be long-lasting sources of formaldehyde emissions.

### Applicability

All interior casework and trim.

### Integrated Design Implications

None.

#### Applicable Climates



#### Applicable Spaces

Classrooms	█
Library	█
Multi-Purpose	█
Gym	█
Corridors	█
Administration	█
Toilets	█
Other	█

#### When to Consider

Programming	█
Schematic	█
Design Dev.	█
Contract Docs.	█
Construction	█
Commissioning	█
Operation	█

## Cost Effectiveness

There is a cost premium for certified wood, ranging from modest to significant, depending upon quantity, type, and current availability. Engineered wood often costs less than virgin lumber. MDF made with formaldehyde-free binders may also cost more.

Costs	L	■	□	□
	M	□	■	□
	H	□	□	□
		L	M	H

Benefits

## Benefits

Formaldehyde-free products and low toxic glues/adhesives and coatings minimize the indoor air pollution load and health risks to both installers and occupants. Certified wood is produced in a way that is ecosystem-protective. Products made from certified hardwoods are durable and reusable.

Engineered lumber makes use of wood waste that would otherwise be discarded. Products made with engineered wood have low moisture content and so are warp-resistant and shrink-resistant, adding to their durability. The products are strong, and their predictable qualities lead to less rework.

Bio-composites materials are made from natural, renewable resources including straw, recycled paper products, and a soy-based resin systems. These products have reduced emissions and are material efficient.

When plastic laminates are selected, look for options made from recycled laminating manufacturing wastes, which are material efficient and recyclable.

## Design Tools

See this chapter's Overview, and:

*Certified Forest Products Database*, Certified Forest Products Council, <http://www.certifiedwood.org>. 14780 SW Osprey Dr., Suite 285, Beaverton, OR 97007. (503) 590-6600. Industry information on suppliers and standards.

## Design Details

Design interior building components for future disassembly, reuse, and recycling.

### Selection

Environmentally preferable alternatives include:

- Using certified hardboards with woods grown in regional forests, which reduces the energy consumption involved in transportation.
- For casework, consider urea formaldehyde-free MDF, or equal, exterior grade plywood (made with phenolic formaldehyde, which emits far less formaldehyde than the urea formaldehyde in traditional interior grade products).
- Consider veneered wood panels, such as OSB with hardwood facing, for cabinets and millwork. If installed for easy removal, they are reusable.
- Bamboo can be used for countertops. Also consider biocomposites for countertops in reception or other high profile (but not wet) areas.
- Low-density fiberboard is made from paper and wood fiber, available made from 100% recycled newsprint. Most processes use no glue. They are suitable for uses such as underlayment and tackboards.

### Caution

*Many of the engineered lumber products contain formaldehyde or other chemicals that are detrimental to the environment and to indoor air quality. Some types of particleboard are now being manufactured with resin binders that do not contain formaldehyde. If formaldehyde-free particleboard or plywood products are not available, select exterior grade plywood in lieu of interior grade products. Exterior grade contains phenol formaldehyde, which is less harmful than the urea formaldehyde in interior grade plywood.*

*Note: Some practitioners recommend coating conventional particleboard with an impermeable sealant to prevent out-gassing of formaldehyde and other volatiles. However, others disagree that this is effective mitigation.*

- Recycled plastic panels made from consumer product waste are available for functional worktops. If installed for easy removal, they are reusable.
- Vegetable oil-based plastics are available in both flexible and rigid types. They can be colored and filled with minerals, metal shavings, or other plastic waste and wood fiber giving them a large range of texture and color possibilities. If installed for easy removal, these also have good reuse potential.
- Fiber reinforced cement boards made with recycled fiber are a durable, material efficient choice for use as substrates for tile and decorative finishes. If installed for easy removal, these also have good reuse potential.
- It is recommended that all casework assemblies and wood furnishes meet the emissions standards outlined in Specification Section 01350. It may also be beneficial to obtain and review MSDS and emission test data. Wood naturally emits formaldehyde, so test data should be carefully reviewed.

### ***Installation***

Dust from cutting and emissions from glues used for installation are indoor air quality issues during and after installation. Specify work to be performed in a shop off the premises where practicable. Require installer to use the smallest amount of adhesive/sealant necessary to fulfill the manufacturer's performance specifications for that product. Specify use of adequate ventilation and VOC-safe worker masks. Where appropriate, specify installation to permit easy removal and reuse, for example, screwed assembly instead of glued.

### ***Operation and Maintenance Issues***

Issues will vary with type of material selected, but are similar to requirements for traditional materials.

### ***Commissioning***

None.

### ***References/Additional Information***

See this chapter's Overview, and:

For general information on certified lumber, contact: Certified Forest Stewardship Council, Jeff Wartelle. Tel: (503) 590-6600. Industry group provides information on distribution and other assistance.

*Certified Forest Products Database*, Certified Forest Products Council. Web site: <http://www.certifiedwood.org>. Contact: 14780 SW Osprey Dr., Suite 285, Beaverton, OR 97007. Tel: (503) 590-6600. Industry information on suppliers and standards.

The American Bamboo Society. Web site: [http://www.bamboo.org/abs\\_](http://www.bamboo.org/abs_)

APA -The Engineered Wood Association. Tel: (206) 565-6600. Web site: <http://www.apawood.org>. Email: [product.support@apawood.org](mailto:product.support@apawood.org).

American Institute of Timber Construction. Tel: (303) 792-9559. Fax: (303) 792-0669. Web site: <http://www.aitc-glulam.org>. Email: [webmaster@aitc-glulam.org](mailto:webmaster@aitc-glulam.org).

American Wood Council. Tel: (202) 463-2700. Web site: <http://www.awc.org/>. Email: [AWCINFO@afandpa.ccmil.com](mailto:AWCINFO@afandpa.ccmil.com).

National Particleboard Association. Tel: (301) 670-0604. Web site: <http://www.pbmdf.com>. Email: [info@pbmdf.com](mailto:info@pbmdf.com).

Western Wood Products Association. Tel: (503) 224-3930. Web site: <http://www.wwpa.org>. Email: [info@wwpa.org](mailto:info@wwpa.org).

# GUIDELINE BP11: INTERIOR DOORS

## Recommendation

Select formaldehyde-free interior doors constructed with recycled content or from certified wood. Avoid particleboard core board doors, which contain urea-formaldehyde and luan doors, which are made from wood harvested from rain forests. Select pre-finished products, if possible. If finishing on-site, select low toxic, low-VOC coatings.

## Description

Interior doors are usually wood, molded hardboard, or hollow core. Luan plywood is harvested from rain forests, so it should be avoided unless it has a Forest Stewardship Council (FSC) or other certification. Molded hardboard is often made with recycled material and pressed into shape, but some is made with urea-formaldehyde and should be avoided.

If using solid wood doors, select products with FSC or other certification (clear stock is becoming rare and if uncertified, often comes from old-growth forests.)

## Applicability

All spaces.

## Integrated Design Implications

In areas where a high degree of speech privacy and/or sound isolation is required, doors should be solid core wood or hollow metal with acoustic fill. Full perimeter gaskets should also be included to reduce sound leaks around the edge of the door. Standard weather stripping with a door bottom sweep will minimize sound leaks, but wears down with use. Doors in areas that require a high degree of sound isolation should have heavy-duty adjustable sponge neoprene gaskets at the head and jamb. Automatic door bottoms with a neoprene element should also be used.

## Cost Effectiveness

Costs are low.

## Benefits

Avoiding luan and solid wood doors help protect limited forest resources. Formaldehyde-free materials protect indoor air quality and contribute to a more healthful environment. Low-toxic finish coatings minimize indoor air pollution load and health risks to both installers and occupants.



*Avoiding luan and solid wood doors helps protect limited forest resources and indoor air quality. NREL/PIX 11473*

## Applicable Climates



### Applicable Spaces

Classrooms	<input type="checkbox"/>
Library	<input type="checkbox"/>
Multi-Purpose /	<input type="checkbox"/>
Gym	<input type="checkbox"/>
Corridors	<input type="checkbox"/>
Administration	<input type="checkbox"/>
Toilets	<input type="checkbox"/>
Other	<input type="checkbox"/>

### When to Consider

Programming	<input type="checkbox"/>
Schematic	<input type="checkbox"/>
Design Dev.	<input checked="" type="checkbox"/>
Contract Docs.	<input checked="" type="checkbox"/>
Construction	<input checked="" type="checkbox"/>
Commissioning	<input checked="" type="checkbox"/>
Operation	<input checked="" type="checkbox"/>

### **Design Tools**

See this chapter's Overview.

### **Design Details**

Review emissions data and MSDS prior to specification of a recycled content molded hardboard product to ensure that it is urea-formaldehyde-free. It is recommended that all hardboard products meet the emissions specifications outlined in Specification Section 01350.

Costs	L	■	■	□
	M	□	□	□
	H	□	□	□
		L	M	H
		Benefits		

### **Operation and Maintenance Issues**

May require periodic re-coating for aesthetic purposes. Type of paint determines the ability to clean the surface.

### **Commissioning**

None.

### **References/Additional Information**

See this chapter's Overview.

# GUIDELINE BP12: TOILET PARTITIONS

## Recommendation

Select high durability, solid plastic toilet and shower partitions with recycled content.

## Description

Several styles of toilet partitions are available, including baked enamel over metal, plastic laminate over particleboard, and solid plastic panel. Solid plastic toilet/shower partitions are the most durable type overall. Recycled content products are made with a post-consumer, high-density polyethylene (HDPE) content between 20% and 35%, depending on the manufacturer. In addition, some brands contain postindustrial plastic material. Look for purified HDPE, as it contains a predominant amount of post-consumer waste.

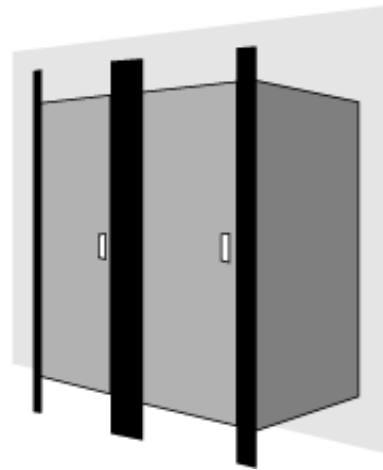

High-density polyethylene (HDPE) restroom partitions are maintenance-friendly and durable.

## Applicability

All toilet/shower partitions.

## Integrated Design Implications

None.

## Applicable Climates



## Cost Effectiveness

Recycled content units cost 20% more than conventional units, but are more durable, require less maintenance, and can be reused. In addition, recycled content toilet partitions generally have a 15-year warranty versus the standard five-year warranty of other partition products.

### Applicable Spaces

Classrooms	<input type="checkbox"/>
Library	<input type="checkbox"/>
Multi-Purpose	<input type="checkbox"/>
Gym	<input type="checkbox"/>
Corridors	<input type="checkbox"/>
Administration	<input type="checkbox"/>
Toilets	<input checked="" type="checkbox"/>
Other	<input checked="" type="checkbox"/>

### When to Consider

Programming	<input type="checkbox"/>
Schematic	<input type="checkbox"/>
Design Dev.	<input checked="" type="checkbox"/>
Contract Docs.	<input checked="" type="checkbox"/>
Construction	<input checked="" type="checkbox"/>
Commissioning	<input checked="" type="checkbox"/>
Operation	<input checked="" type="checkbox"/>

## Benefits

Recycled content partitions are material efficient, low maintenance, rot-resistant, and graffiti/vandal resistant.

Costs	L	<input checked="" type="checkbox"/>	<input type="checkbox"/>	<input type="checkbox"/>
	M	<input type="checkbox"/>	<input checked="" type="checkbox"/>	<input type="checkbox"/>
	H	<input type="checkbox"/>	<input type="checkbox"/>	<input type="checkbox"/>
		L	M	H
		Benefits		

## Design Tools

See this chapter's Overview.

## Design Details

None.

## Operation and Maintenance Issues

None.

## Commissioning

None.

## References/Additional Information

See this chapter's Overview.



# COMMISSIONING AND MAINTENANCE

## INTRODUCTION

---

Building owners spend more on complex building systems than ever before, yet many find they are not getting the performance they expect. A 1994 study of 60 commercial buildings found that more than half suffered from control problems. In addition, 40% had problems with HVAC equipment and one-third had sensors that were not operating properly.<sup>1</sup> An astonishing 15% of the buildings studied were actually missing specified equipment. And approximately one-quarter of them had energy management control systems, economizers, and/or variable-speed drives that did not run properly. Problems also frequently occur on the envelope, structural, and electrical systems of many new buildings.

Schools are investments, and every new school is unique. In essence, each school design is a prototype expected to perform as if it were something that had been built before. Combining a new school design with modern technology, a tight construction schedule, and a fixed budget can lead to a building that does not perform as anticipated.

Building commissioning is one way to improve the outcome of a construction project. Neither the design team nor the district desires a poorly performing school. Unfortunately, school districts frequently are the ones left to deal with the resulting financial implications, including excessive repair and replacement costs, student absenteeism, indoor air quality problems, and construction team liability. Building commissioning can ensure that a new school begins its life cycle at optimal productivity and improves the likelihood that it will maintain this level of performance.

Commissioning is a quality-assurance process that increases the likelihood that a newly constructed building will meet district expectations. Commissioning can optimize the energy-efficient design features and improve overall building performance. Districts can use this proven, systematic approach to reduce change orders and liability exposure, and to ensure that they receive buildings that function according to their original project requirements (design intent).

## WHAT EXACTLY IS BUILDING COMMISSIONING?

---

Commissioning is a systematic process of ensuring that all building systems perform interactively according to the contract documents, the design intent, and the school's operational needs. Ideally, this is achieved by beginning in the pre-design phase with design

---

<sup>1</sup> Piette, Mary Ann. "Quantifying Energy Savings from Commissioning: Preliminary Results from the Northwest," in *Proceedings of the National Conference on Building Commissioning*, 1996.

intent development and documentation, and continuing through design, construction, and the warranty period with actual verification through review, testing, and performance documentation. The commissioning process integrates and enhances the traditionally separate functions of design peer review, equipment startup, control system calibration, testing, adjusting and balancing, equipment documentation, and facility staff training, as well as adds the activities of documented functional testing and verification.

Commissioning is occasionally confused with testing, adjusting, and balancing. Testing, adjusting, and balancing measures building air and water flows, but commissioning encompasses a much broader scope of work. Commissioning typically involves four distinct “phases” in which specific tasks are performed by the various team members throughout the construction process. The four phases are pre-design, design, construction, and warranty. As part of the construction phase, commissioning involves functional testing to determine how well mechanical and electrical systems meet the operational goals established during the design process. Although commissioning can begin during the construction phase, districts receive the most cost-effective benefits when the process begins during the pre-design phase at the time the project team is assembled.

A properly commissioned school can result in fewer change orders during the construction process, fewer callbacks, long-term occupant satisfaction, lower energy bills, and avoided equipment-replacement costs. Commissioning also assures that the building’s operational staff is properly trained, with correctly compiled operation and maintenance manuals delivered at project turn-over.

---

## **COMMISSIONING APPROACHES**

---

In recent California focus group studies, building owners and their representatives repeatedly stressed the lack of communication between the design team and construction team as a major problem. This lack of communication means that the original design intent of a project is unlikely to be carried through to project completion. (Documenting design intent — the expectations for building performance — is a critical component of commissioning and is discussed in more detail later.) Commissioning provides a means of linking the traditionally fragmented phases of the design and construction process, because it encourages the project team to view the process holistically. The commissioning process encourages parties to communicate and solve problems earlier in the construction process. Beginning proper commissioning during the design phase can help identify and solve problems that later may turn into performance problems, occupant comfort complaints, indoor air quality issues, and decreased equipment life.

Although commissioning works best when it begins during design, projects already under construction can still benefit from commissioning. Bringing a commissioning provider into a project during the construction phase can be invaluable in helping solve start-up problems that have stumped both designers and contractors. The commissioning provider can also document the start-up and functional testing results, thereby reducing future liability exposure for the

designers and district. The provider also oversees operation/maintenance staff members training, thus improving the operating procedures of the facility.

## **BENEFITS OF COMMISSIONING**

---

Until recently, the most frequently mentioned benefit of commissioning was its energy-related value: building commissioning ensures that the energy savings expected from the design intent are implemented correctly. While these benefits are significant, the non-energy-related benefits of commissioning far outweigh them. Examples include:

- Proper and efficient equipment operation
- Improved coordination between design, construction, and occupancy
- Improved indoor air quality, occupant comfort, and productivity
- Decreased potential for liability related to indoor air quality, or other HVAC problems
- Reduced operation and maintenance costs.

### ***Proper and Efficient Equipment Operation***

Commissioning verifies that equipment is installed and operating properly. Equipment that operates as intended lasts longer, works more reliably, and needs fewer repairs during its lifetime. By promoting equipment reliability, commissioning can reduce service, energy, and maintenance costs. Equipment that operates properly tends to use less energy, require fewer service calls and replacement parts, and demands less “crisis maintenance” from onsite staff (or expensive outside contractors), allowing them to concentrate on their normal duties.

### ***Improved Coordination Between Design, Construction, and Occupancy***

Commissioning can result in greater cooperation among the professionals involved in the project and provides a platform for cross-checking the performance of a building’s equipment and combined systems, which ultimately leads to fewer callbacks and litigation problems.

A good design includes systems that are sized correctly, rather than the oversized mechanical systems found in many commercial buildings.<sup>2</sup> On many projects, a lack of understanding and coordination between the design, installation, and/or operational team members can lead to systems that function inefficiently. Commissioning allows for a broad perspective and consistent focus throughout the design and construction process on whether the building will function as intended and identifies the best long-term solutions for problems that arise during the project. Commissioning can facilitate improved integration and communication among team members throughout these phases and can also ensure that correctly sized systems function as intended and specified.

Many districts mistakenly believe that adding commissioning quality assurance procedures to their design process will delay the project’s schedule and increase costs. Many who have

---

<sup>2</sup> York, Dan. “Commissioning Green Buildings,” in *Proceedings of the National Conference on Building Commissioning*, 1998.

incorporated commissioning into the design phase of their projects have discovered that commissioning can significantly reduce change orders,<sup>3</sup> which in turn reduces the requests for project delays and decreases the use of contingency funds for change orders. Thus, beginning commissioning during design can actually contribute to the on-time and on-budget completion of projects. It should be noted that these benefits will not be realized if the commissioning process begins during the equipment start-up phase of a project.

### ***Improved Indoor Air Quality, Comfort, and Productivity***

The benefits of high performance schools are all dependent on how well the building performs.

Surveys indicate that comfort problems are common in many U.S. buildings. A recent OSHA report noted that 20% to 30% of commercial buildings suffer from IAQ problems. Building occupants complain of symptoms ranging from headaches and fatigue to severe allergic reactions. In the most severe cases, occupants have developed Legionnaire's disease, a potentially fatal bacterial illness. The National Institute of Occupational Safety and Health surveyed 350 buildings with deficient IAQ and found that more than half of the complaints stemmed from HVAC systems that were not operating properly.

Building commissioning is a tool districts can use to avoid the expenses and productivity losses associated with poor IAQ and student/teacher discomfort. Because commissioning assures that HVAC and other building systems are installed and operating properly, commissioned buildings tend to have fewer comfort-related problems.

### ***Liability Related to Indoor Air Quality***

Building commissioning protects schools in more than one way. First, it provides documented verification of a building's performance and operation. Ventilation rates are a good example of a primary factor that affects indoor air quality. HVAC commissioning typically includes testing these flow rates under varying load conditions to assure that the ventilation systems are operating properly. If a school has deficiencies, the commissioning provider documents the original condition and records the repairs made. Commissioning should be repeated throughout the life of the school, and performance documentation should be updated regularly. This documentation provides districts with a record of building performance that can be used as evidence in the event of a lawsuit.

Commissioning also helps prevent many IAQ problems through its focus on training the teachers and staff in the proper maintenance of building systems. Properly run and maintained HVAC systems, with clean coils and air intakes as well as regularly changed filters, are less likely to contribute to IAQ problems. In addition, trained school staff can spot potential air quality and ventilation problems before they develop.

Both local and state government agencies have begun using commissioning as a tool to ensure that indoor air quality standards are being met when a building is constructed.

---

<sup>3</sup> Savage, Jerry. "Commissioning a Materials Research Laboratory," in *Proceedings of the National Conference on Building Commissioning*, 2000.

## **Reduced Operation, Maintenance, and Equipment Replacement Costs**

Operation, maintenance, and equipment replacement costs will always consume a portion of building budgets. However, more operation and maintenance departments are realizing that they can minimize life-cycle costs by changing their practices. That is, proper operation and maintenance can actually save money compared to poor practices, and many businesses are reinvesting their operation and maintenance savings in more efficient building systems. The commissioning process establishes sound building operation and maintenance practices, and trains operators in carrying out these practices. (Some of these practices are discussed in more detail in the Operation and Maintenance for Persistence section of this chapter.)

## **The Bottom Line**

Commissioning improves a building's value. Properly functioning buildings with reliable equipment kept in good condition are worth more than their non-commissioned counterparts. Commissioned systems and equipment retain their value longer. Additionally, an ongoing demand exists for comfortable, healthy working space. Finally, systems that function properly use less energy, experience less down time, and require less maintenance, thereby saving money for districts.

## **COSTS OF BUILDING COMMISSIONING**

---

Currently, no standard method of reporting the costs and savings associated with commissioning exists. For many projects, commissioning costs are not separated from other project costs. For projects where these costs have been tracked separately, various methods have been used to report both the costs and associated benefits. The table below lists some of the most common cost-estimation methods. No matter which estimation method is used, however, commissioning accounts for only a very small portion of overall construction and retrofit budgets.

*Table 43 — Estimated Commissioning Costs for New Equipment<sup>4</sup>*

<b>Commissioning Scope</b>	<b>Estimated Cost Range</b>
Whole building (controls, electrical, mechanical) Commissioning from design through warranty	0.5% to 3% of total construction cost
HVAC and automated controls system only	1.5% to 2.5% of mechanical contract
Electrical system only	1% to 1.5% of electrical contract

## **SAVINGS FROM BUILDING COMMISSIONING**

---

Districts and their servicing utilities are interested in the energy (kWh) savings achieved from commissioning energy systems and equipment. Additionally, they are also interested in how much the commissioning will save them in operation and maintenance costs. Just as commissioning costs can vary from project to project, so do commissioning savings. Savings

---

<sup>4</sup> Estimated costs adopted from PECL Data and Ron Wilkinson's article "Establishing Commissioning Fees," ASHRAE Journal-February, 2000.

will depend on the scope of the commissioning. Table 44 shows the reported savings for three different types of commercial buildings commissioned during the past few years. When commissioning is done properly, the savings can be quite substantial for schools as well.

*Table 44 – The Savings from Commissioning New Equipment (Mechanical Systems)<sup>5</sup>*

Building Type	Annual \$ Savings	Annual Energy Savings
110,000-ft <sup>2</sup> Office	\$22,320	279,000 kWh
22,000-ft <sup>2</sup> Office	\$13,080	130,800 kWh
60,000-ft <sup>2</sup> High Tech Manufacturer	\$26,880	336,000 kWh

Many districts question how they can pay for commissioning with a limited design and construction budget. Because commissioning can identify potential problems earlier in the design or construction process, the result is a lower overall construction budget, fewer contractor callbacks, and lower operating costs during the first year of operation. By transferring those potential savings to the design and commissioning team budgets, the total project costs can be equivalent to a project that is not commissioned, as illustrated in Figure 52 below.



*Figure 52 – How to Pay for Commissioning-One Option*

*Shift 2% of total project costs to the commissioning provider and 3% to the design team.<sup>6</sup>*

## SELECTING A COMMISSIONING PROVIDER

One of the most important commissioning decisions is selecting the commissioning provider and determining who will hold the commissioning provider’s contract. Two primary methods exist for selecting a commissioning provider: competitive bid and selection by qualification. The Building Commissioning Association (BCA) can provide a list of commissioning providers. Contact information for the BCA can be found in the resources section at the end of this chapter. In the Request for Qualifications, be sure to ask for details on previous, relevant commissioning experience, including the depth of commissioning experience (what some call

<sup>5</sup> Annual energy savings calculated from three Northwestern United States commissioning projects. Cost savings estimates based on a blended 2000 California kWh rate of \$0.10 for smaller office buildings and \$0.08 for larger offices and industrial facilities.

<sup>6</sup> The Farnsworth Group, as presented in “How to Achieve Top Performance in Your Building: Commissioning Benefits, Process and Performance,” a workshop series by the Association of State Energy Research and Technical Transfer Institutes, 1998.

commissioning is no more than traditional equipment startup).<sup>7</sup> Make sure that the provider's definition of commissioning corresponds to the one at the beginning of this chapter. Recommended commissioning provider qualifications are discussed in more detail in the following pages. Based on the responses, develop a list of firms to receive a Request for Proposal that details exactly what services the construction project will need to be properly commissioned. Districts can also select a commissioning provider based on qualifications and rate schedules, rather than by competitive bid. This process warrants careful interviewing and contact with the providers' current or past clients.

Any of the following parties can be selected to manage the commissioning provider's contract:

- Project Manager
- Architect/Design Engineer
- Contractor.

Each option has its advantages and disadvantages. The final choice will depend on the complexity and the specific needs of the particular project. As building commissioning has evolved and more practitioners with different ideas have entered the field, a group of interested parties worked to form the BCA, a professional association, in 1998. According to the BCA website (<http://www.bcxa.org/>), "The BCA's goal is to achieve high professional standards, while allowing for diverse and creative approaches to building commissioning that benefit our profession and its clients. For this reason, their focus is on identifying critical commissioning attributes and elements, rather than attempting to dictate a rigid commissioning process". The association believes that "the basic purpose of building commissioning is to provide documented confirmation that building systems function in compliance with criteria set forth in the project documents to satisfy the owner's operational needs." Paramount to this is the understanding that if the commissioning provider is not an independent party under contract directly with the district/owner then he or she must develop a formal plan for managing the potential conflict of interest. One method that has been used successfully to manage, but not eliminate, these potential conflicts of interest is parallel and simultaneous reporting of all findings to the district's representative and contract manager for the commissioning services.

### ***Independent Third Party Under Contract to the District/Owner***

Many districts/owners who have commissioned their buildings recommend using an independent third party as the commissioning provider. An independent commissioning provider can play an objective role and ensure that the district will truly get the building performance expected. For large and/or complex projects, especially in buildings with highly integrated, sophisticated systems, future savings from commissioning outweigh the slightly higher costs with an additional contract. Independent third party commissioning providers bring a fresh perspective to the project as they collaborate with the design team. By joining the project team during the design, the commissioning provider can identify more opportunities for

---

<sup>7</sup>"Start up" refers to the process of starting up equipment to determine whether it operates. Commissioning goes beyond start up to ensure that new equipment performs in conformance with design expectations in all modes and conditions of operation.

improvements and savings early on when changes can be made on paper. This approach is preferable to waiting to fix the problems through the change-order process as the building is being constructed.

Independent commissioning providers, who are often trained as design engineers, should have the qualifications listed under “Commissioning Provider Qualifications,” plus they should be able to write commissioning specifications for bid documents. Hands-on experience with building systems is especially critical. It is important to involve the independent authority as early in the project as possible. This allows the authority the opportunity to review the design intent for the project, begin scheduling commissioning activities, and begin writing commissioning specifications into bid documents for other contractors.

### ***Architect or Engineer Overseeing the Commissioning Process***

If commissioning requirements in the project specifications are rigorous and detailed, districts may consider having the architect manage the contract of a commissioning provider. When the architect or the mechanical designer has qualified field engineers on staff and those engineers do not have responsibility for the design of the project, the architect or engineer may be considered for directly overseeing the commissioning process. One advantage of using the architect or mechanical designer is that he or she is already familiar with the design intent of the project. Districts considering this option should bear in mind that commissioning is not included in a design professional’s basic fees. Districts should require that all findings of the commissioning process be directly reported to both the designer and to the district as they occur to manage the potential conflict of interest created by having the commissioning services under the designer. Districts must also recognize that even if this option is not chosen and an independent third party is used, designers might increase their fees slightly to offset the additional time requirements to coordinate their work with the commissioning provider.

### ***Contractor***

It used to be standard practice for many contracting firms to conduct performance tests and systematic checkout procedures for equipment they installed. As construction budgets became tighter, this service was dropped from most projects. Although contractors may have the knowledge and capability to test the equipment they install, they may not be skilled at testing or diagnosing system integration problems. In addition, some contend that it is difficult for contractors to objectively test and assess their own work, especially since repairing deficiencies found through commissioning may increase their costs. For districts that only wish to have the commissioning process begin during the construction phase, it may be appropriate to use the installing contractor as the commissioning provider in cases where:

- The building size is less than 20,000 ft<sup>2</sup>.
- The project specifications clearly detail the commissioning requirements.
- The district has skilled staff that can review the contractor’s commissioning work.

Another option for districts that have a good relationship with the general contractor is to require that the general contractor hire a test engineer to commission the equipment. This scenario can work well when specifications and contract documents clearly detail the



commissioning requirements and when the district has technical staff that is qualified to oversee the test engineer. Still, many general contractors welcome the opportunity to work with an independent commissioning provider, because of the objectivity they bring and because they assist in ensuring that the subcontractors perform their work properly, improving client satisfaction and ultimately reducing callbacks.

## **Commissioning Provider Qualifications**

Currently, there is no broadly recognized and approved certification or licensing process for commissioning providers. Therefore, it is up to each district to determine the commissioning provider's qualifications appropriate for a given project. See the sidebar for guidelines on selecting a qualified commissioning provider.

Regardless of who is chosen to act as the commissioning provider, there are certain minimum qualifications any commissioning provider ought to have, and the following list is by no means all-inclusive. Certain projects may require more or less experience, depending on size, complexity, and specific building characteristics. Direct the commissioning provider to subcontract work in which he or she lacks sufficient experience.

## **THE COMMISSIONING TEAM**

Members of a design-construction project team, like components of integrated building systems, need to interact in order to perform their tasks successfully. Commissioning actually facilitates this interaction, because it sets clear performance expectations and requires communication among all team members.

Any project involving commissioning should begin with a commissioning scoping meeting, which all team members are required to attend. At this meeting, the roles of each team member are outlined, and the commissioning process and schedule are described.

Commissioning team members most often include the district representative or project manager, commissioning provider, design professionals, installing contractors, and

### **Commissioning Provider Qualifications Checklist**

*In general, for complex projects, a commissioning provider who will personally develop the commissioning test plans and directly supervise the commissioning work should meet these qualifications. These qualifications are focused on HVAC and control systems. Where electrical and other systems will be commissioned, the firm's experience in these areas should also be considered. However, often the prime commissioning provider will team with other subconsultants to provide a team that can expertly address all the systems being commissioned. In such cases, the management skill of the prime commissioning provider is also important.*

#### **Recommended Minimum Qualifications**

*Experience in design, specification, or installation of commercial building mechanical and control systems, as well as other systems being commissioned.*

*Experience commissioning projects within the last three years with similar size building systems.*

*History of responsiveness and proper references.*

*Meet district's liability requirements.*

*Experience working with project teams, project management, conducting scoping meetings, and good communication skills.*

*At least two projects involving commissioning of buildings of similar size and equipment to the current project. This experience includes writing functional performance test plans.*

#### **Optional Qualifications**

*Direct responsibility for project management of at least two commercial construction or installation projects with mechanical costs greater than or equal to current project costs.*

*Experience in design installation and/or troubleshooting of direct digital controls and energy management systems, if applicable.*

*Demonstrated familiarity with metering and monitoring procedures.*

*Knowledge and familiarity with air/water testing and balancing.*

*Experience in planning and delivering operation and maintenance training.*

*Building contracting background.*

*Overall understanding by the commissioning team of all building systems including building envelope, structural, and fire/life safety components.*

manufacturer's representatives. The team may also include facility staff and possibly testing or diagnostic specialists and utility representatives. The commissioning team does not manage the design and construction of the project. Its purpose is to promote communication among team members and to identify and resolve problems early in the process. To that end, the design professional and district representative are key members of the commissioning team.

Of course, few situations are ideal. Budget considerations and special project characteristics may expand or minimize the commissioning roles and responsibilities described below. Districts should consult with their commissioning providers about potentially combining some of the following roles. The commissioning provider can review the scope of commissioning and advise the district on how to consolidate roles and tasks to best fit the size and complexity of the project.

### ***District Representative***

The district's most significant responsibility is to clearly communicate expectations about the project outcome. The district's expectations are used by the designer to establish the design intent of the project and by the commissioning provider to evaluate whether this intent is met. Other responsibilities of the district representative include:

- Determining the objectives and focus of the project.
- Hiring the commissioning provider (if using an independent third party) and other members of the project team.
- Determining the project's budget, schedule, and operating requirements.
- Working with the commissioning provider to determine commissioning goals.
- Facilitating communication between the commissioning provider and other project team members.
- Approving start-up and functional test completion (or delegating this task to a construction or project manager).
- Attending building training sessions when appropriate.

### ***Commissioning Provider***

The commissioning provider's primary tasks include:

- Ensuring the completion of adequate design intent documentation.
- Providing input on design features that facilitate commissioning and future operation and maintenance.
- Assisting in developing commissioning specifications for the bid documents.
- Developing a commissioning plan that includes equipment and systems to be commissioned.
- Ensuring that team members understand their specified commissioning responsibilities; work to promote a positive, solutions-based team approach; and facilitate bringing a quality project to completion.
- Developing diagnostic and/or test plans for systems to be commissioned.
- Writing construction, functional, and performance tests.

- Submitting regular reports to the district representative.
- Witnessing selected contractor start-up tests, air and water testing and balancing, and duct pressure testing.
- Overseeing all functional and performance testing of systems.
- Reviewing and commenting on technical considerations from design through installation, to facilitate sound operation and maintenance of the building.
- Reviewing contractor and manufacturer training plans prior to delivery to facility staff.
- Reviewing operation and maintenance manuals documentation for completeness.
- Writing a final commissioning report documenting the final evaluation of the systems' capabilities to meet design intent and district needs.
- Developing a systems concepts and operations manual that details the most important operation parameters and equipment instructions.

### ***Design Professionals***

The responsibilities of the design professionals will vary with the interests of the designers and the needs of the project. The primary commissioning-related responsibilities of design professionals are to document the design intent for all systems, if this was not completed in pre-design; to write system descriptions and record design basis information; answer questions and issues brought up by the commissioning provider during design; and to make sure that commissioning is included in the bid specifications. If the design professional is hiring the commissioning provider, he or she should do so as early in the design process as possible. During construction, the designers are tasked with clarifying design issues related to system operation and design intent and to assist in resolving construction and operational deficiencies illuminated by the commissioning process. For complex projects, the designer may review commissioning plans, functional performance test plans, and may witness select functional testing. If this is the case, the design professional's proposal should include funds to cover these activities. As mentioned before, the design firm may be responsible for hiring and overseeing the commissioning provider.

### ***Installing Contractors and Manufacturer Representatives***

Contractors and manufacturer representatives are responsible for performing commissioning functions described in the specifications. These may include assisting with developing the commissioning schedule, conducting performance tests (under the supervision of the commissioning provider or facilities staff) of the systems they install, adjusting systems when commissioning indicates this is needed, and documenting system startup. Contractors and manufacturer representatives are also responsible for training building staff in the proper operation and maintenance of systems, and providing operation and maintenance manuals on the equipment they install.

### ***Facility Manager/Building Operator***

The building operator should assist with (or at least observe) as much of the functional testing as possible. To achieve even greater impact on the commissioning process as early as possible, the district should try to hire its new operator or assign an existing operator who will

be responsible for this building to become closely involved with the construction commissioning team. The insights of an operator in the final phases of design can be quite beneficial. Often times there are details of the design that can be adjusted and modified at no cost yet will provide significant benefits to the ongoing operation of the building. Specific examples might include point-naming conventions, alarm messages, and graphic layouts of the energy management system. The operator can also help in interfacing any existing facilities management software, district standards, and equipment preferences into the project. As this employee observes the commissioning tests, the operator's understanding of the equipment and control strategies will improve. It also trains the employee to be able to retest systems periodically as part of ongoing operation and maintenance. The operator should also attend training sessions provided by manufacturer's representatives and/or contractors.

### **Testing Specialists**

If the complexity of the project requires special testing, the specialists performing these tests should also be involved in commissioning. Test results and recommendations from these specialists should be submitted to the commissioning provider for review. They may also be required to review documentation relating to the systems they test and to train operators on the proper use of this equipment.<sup>8</sup>

## **COMMISSIONING PHASES**

---

The commissioning process helps facilitate and connect each step of the construction process. Commissioning enhances communication among project team members and ensures that they all understand the project goals. This allows the project team to identify problems early, before they can affect later phases of the project and cause delays.

### **Pre-design Phase**

The pre-design phase is the ideal time for the district to select a commissioning provider. Early selection allows the commissioning provider to play an advisory role during the conceptual process, suggesting ways to make the overall building more energy efficient and identifying key design strategies that can facilitate operation and maintenance. Involving the provider early can also increase buy-in for commissioning from other team members because the provider is involved from the beginning. Otherwise, the team may view the commissioning provider as an outsider who does not really understand the project. During this phase, the commissioning provider may assist in developing the district's goals or, at minimum, ensuring that these goals are clearly documented and distilled into a design intent narrative.

The design intent narrative, typically developed by the district, is an explanation of the ideas, concepts, and criteria that are important. It should generally describe the project both physically and functionally, and it should set the performance requirements for the design, construction, and operation. The level of detail will vary with the project's size and complexity,

---

<sup>8</sup> Dunn, Wayne. "Roles and Responsibilities," in *Proceedings of the National Conference on Building Commissioning*, 1995.

the district demands, and the design team's experience. The design intent should describe how the project will be used and operated, and should present known goals and objectives as measurable metrics when possible. It may also state specific contractual performance requirements or energy consumption targets, if the district establishes them. The design intent sets the criteria for all subsequent design decisions.

### **Design Phase**

The goal of commissioning during the design phase is to ensure that the efficiency and operational concepts for building systems that were developed during programming are included in the final design. The main commissioning tasks during this phase are compiling and reviewing design intent documents if not already developed, incorporating commissioning into bid specifications, and reviewing bid documents. During the beginning of design, the designer develops the design concepts that he or she proposes to use to meet the district's program and intent. The designer also documents the assumptions (design basis) used in the design for sizing and selecting systems (i.e., codes followed, temperature parameters, and occupancy loads). The design concepts and design basis are compiled into a design narrative document that the commissioning provider reviews for clarity, completeness, and compliance with the design intent. As the design progresses, the design narrative is updated and compared against the design intent.

The bid specifications developed during the design phase include commissioning requirements for the contractors. Specifications should include any special equipment or instrumentation that must be installed for obtaining measurements during performance testing. They should also describe the responsibility that contractors will have for preparing operation and maintenance manuals and for training facility staff. The commissioning provider reviews these bid documents, updated design narratives, and all other design intent and contract documents.

The optimum time to hold the commissioning scoping meeting is during the design phase. At this meeting, the commissioning provider outlines the roles and responsibilities of the project team members with respect to commissioning and reviews the commissioning plan outline and schedule. Team members provide comment on the plan and schedule, and the commissioning

#### **Expected Deliverables**

*Districts who decide to commission their buildings should expect to receive the following written deliverables:*

*Commissioning plan and schedule detailing each step of the commissioning process and each team member's role and responsibilities.*

*A diagnostic and functional test plan detailing the objective of each test, how each test will be accomplished, and noting expected performance parameters.*

*A list of findings and potential improvements identified by the commissioning provider for design phase and construction phase activities.*

*A training plan recommending specific topics and training schedules.*

*At the completion of the project, a final commissioning report detailing all of the commissioning provider's findings and recommendations, including copies of all functional performance testing data.*

*A systems concepts and operations manual which gives a description of each system with specific information about how to optimally operate and control the system during all modes of operation such as during fire, power outage, shutdown; etc., including special instructions for energy-efficient operation and recommissioning.*

*Energy savings and implementation cost estimates for recommendations developed in the process are also deliverables in retro-commissioning projects.*

provider uses these suggestions to complete the final commissioning plan. The final plan will include:

- The scope or level of commissioning
- Commissioning schedule
- Team member responsibilities
- Communication, reporting, and management protocols
- Documentation requirements of each team member
- Detailed scope of testing
- Detailed scope of monitoring
- Recommended training format.

The commissioning provider attends selected design team meetings and formally reviews and comments on the design at various stages of development. They note potential system performance problems, and may provide input on energy efficiency, indoor environmental quality, maintainability, commissionability, sustainability, and life-cycle cost, depending on the skills of the commissioning provider and design team and interests of the district. Making these changes during the design phase, rather than after construction begins, reduces costly change orders, which saves money in the long run. It is important for the district to understand that the commissioning provider does not approve the design. He or she makes recommendations to facilitate commissioning and improve building performance in a collegial manner in concert with the designated design team.

During this phase, the commissioning provider can also play a significant role in developing a building's operation and maintenance program or suggesting improvements for a program already in place. The provider interviews the facility manager to determine operating staff ability and availability to operate and maintain building equipment and systems. Careful consideration is given to whether the proper level of staffing resources is available to fully implement a successful long-term operation and maintenance system to ensure continued building performance. The commissioning provider also reviews the design documents and drawings to ensure that equipment is accessible for maintenance.

### **Construction Phase**

During this phase, the commissioning provider reviews contractor submittals of commissioned equipment and the operation and maintenance manuals and may write test plans for each system and piece of equipment to be commissioned. The provider also visits the construction site periodically and notes any conditions that might affect system performance or operation.

During the construction phase, construction checklists — sometimes referred to as “pre-functional tests” and usually completed by the contractors — are used to ensure that equipment is properly installed and ready for functional testing. The commissioning provider approves and may oversee start-up and the use of construction checklists, as well as making sure that any deficiencies are remedied before functional testing begins.

The commissioning provider should involve the building operation staff in the construction checklist procedures and functional testing as much as possible. Doing so improves staff understanding of the proper operation of equipment and systems. It also provides operators with valuable hands-on training in running and troubleshooting the equipment they will manage.

The commissioning provider may write various progress reports during construction that document testing progress as well as deficiencies that may affect future building performance. These reports may be submitted to the district, design engineer, project manager, or contractors, depending on the contract arrangements for the project. (Establishing a clear process prior to the construction phase for delivering correction orders to the responsible contractors and tracking their responses is critical to the success of commissioning.)

The commissioning provider uses the functional tests to document and verify the proper operation of equipment and systems according to the building specification plans and change orders, as well as the architect's instructions. Most often, the commissioning provider directs the tests, but the subcontractors, particularly the controls contractor, perform the actual equipment operation during the tests. If corrective measures are required, the commissioning provider ensures they meet the district's criteria and the design intent, involving the owner and architect to resolve responsibility or strategy when necessary. Acceptable performance is reached when equipment or systems meet specified design parameters under full-load and part-load conditions during all modes of operation, as outlined in the commissioning test plan.

After completing functional testing, the provider writes a final commissioning report and submits it to the district for review. In addition to the final report, some commissioning projects include a more comprehensive documentation package to assist the district in understanding, operating, and maintaining their systems. The American Society of Heating, Refrigerating, and Air Conditioning Engineers (ASHRAE) calls this package a systems manual and recommends that it include:<sup>9</sup>

- Index of all commissioning documents with notations as to their storage locations
- Commissioning report
- Initial and final design intent documents
- As-built documents
- Description of systems, including capabilities and limitations
- Operating procedures for all normal, abnormal, and emergency operation modes
- Sequence of operation as actually implemented, with control systems data including all set points and calibration data
- Location of all control sensors and test ports
- Seasonal start-up and shutdown procedures

---

<sup>9</sup> ASHRAE Guideline 1-1996-*American Society of Heating Refrigerating and Air-Conditioning Engineers*, Atlanta GA, 1996.



- Control schematics and computer graphics
- Complete terminal interface procedures and capabilities of the Direct Digital Control (DDC) system
- A list of recommended operation record-keeping procedures, including sample forms and trend logs
- Maintenance procedures.

The construction phase is complete when the facility has moved from the static construction state to the dynamic operating state essentially free of deficiencies. Control of the building may have been transferred from the design/construction team to the district and building operators prior to completing this phase. Part of this transfer involves training building operators how to operate and maintain the equipment and systems. Preferably, this training begins during the construction/installation phase, as discussed above.

The commissioning provider is responsible for interviewing the project manager and operation and maintenance staff to determine their training needs. With the district representative, the provider then selects the appropriate topics, level of detail, sequence of training, and training methods. Training may include both classroom sessions and hands-on site demonstrations of proper equipment operation and maintenance.

In addition, the commissioning provider oversees training sessions as specified in the bid documents that installing contractors, designers, and manufacturers' representatives will conduct. The provider also verifies that operation and maintenance manuals are complete and available for use during the training sessions. The commissioning provider may arrange for videotaping of the training and coordinate this videotaping with vendors. Videotaping training sessions often provides an extra incentive for vendors to ensure the quality of the sessions.

### **Warranty Phase**

Upon turnover, the building is in the hands of the owner and operators. Even though the project is considered complete, some commissioning tasks from the initial commissioning contract continue throughout the typical one-year warranty period to ensure that full operation of building systems is achieved.

Any testing that was delayed because of site or equipment conditions or inclement weather, will be completed during warranty. Although some testing of heating and cooling systems can be performed under simulated conditions during the off-season, natural conditions usually provide more reliable results. Seasonal testing is conducted to verify proper operation during, at minimum, both winter and summer.

When performing testing during post-occupancy, the commissioning provider or test engineer must be careful not to void any equipment warranties. The district should require that contractors provide the commissioning provider with a full set of warranty conditions for each piece of equipment to be commissioned. Some warranty provisions may require that the installing contractor actually perform the testing, under the supervision of the commissioning provider.

The commissioning provider may also be tasked with returning a few months prior to the expiration of the contractor's one-year warranty to review system operation and interview facility staff. Acting as the district's technical resource, he or she assists the facility staff in addressing any performance problems or warranty issues.

It is a good idea for districts to consider recommissioning their facilities periodically to ensure that equipment performance levels continue to meet design intent. If school staff has been involved in the original commissioning effort, and if they received training that included the components listed in the Suggested Training Topics sidebar, they may be able to conduct the recommissioning process themselves.

### ***When Does Commissioning End?***

Commissioning ensures that a building is performing as intended at the time that commissioning occurs. This means that to maintain this level of performance, commissioning, in a sense, never ends. Certainly no one could reasonably expect building operation staff to perform functional tests on equipment and systems daily. However, operation and management staff should be encouraged to recommission selected building systems on a regular basis, perhaps every two to three years depending on building usage, equipment complexity, and operating experience. The commissioning provider can recommend an appropriate interval for the building and systems. In the meantime, implementing regular, sound operation and maintenance practices ensures that the savings from commissioning last.

## **OPERATION AND MAINTENANCE FOR PERSISTENCE**

---

Sound operation and maintenance practices can help keep the school operating at commissioning levels. Some of these practices include:

- Establishing and implementing a preventive maintenance program for all building equipment and systems.
- Using commissioning documentation such as commissioning checklists and functional tests as a basis for periodic equipment testing.
- Reviewing monthly utility bills for unexpected changes in building energy use.
- Using energy accounting software to track building energy use.
- Tracking all maintenance, scheduled or unscheduled, for each piece of equipment. Periodic reviews of these documents will often indicate whether certain pieces of equipment require tuning up.
- Updating building documentation to reflect current building usage and any equipment change-outs.
- Establishing an indoor air quality program for the building.
- Assessing operator training needs annually.

### ***Good Operation and Maintenance Begins During Design***

Like commissioning, successful operation and maintenance begins in the design phase of a project. Soliciting input from operation and maintenance staff during the early stages of building

design can facilitate good operation and maintenance practices. The more convenient it is for staff to perform regular checks and maintenance on building systems, the better building performance needs can be met and costly maintenance can be avoided. In addition, the installing contractor's responsibilities concerning operation and maintenance should be clearly detailed in the project contract specifications during the design stage, so that the contractor can adjust the bid price accordingly. For instance, specifications should explicitly state that contractors will be required to provide information needed to facilitate the commissioning process and to coordinate activities with the commissioning provider as needed. The specifications should also require the contractor to provide comprehensive operation and maintenance manuals for equipment and provide training for staff.

### ***Operation and Maintenance Manuals***

The contractor prepares operation and maintenance manuals for each piece of equipment. The commissioning provider reviews each manual for compliance with the specifications as part of the commissioning process. Operation and maintenance manuals should contain:

- Name, address, and telephone number of installing contractor
- Product data
- Test data
- Performance curves (for pumps, fans, chillers, etc.)
- Installation instructions
- Operation requirements
- Preventive maintenance requirements
- Parts lists
- Troubleshooting procedures specific to the equipment design and application.

If the provider believes it would be beneficial, additional information, already gathered during the commissioning process, can also be included in the operation and maintenance manuals. This information may include equipment submittals, design intent documents including control strategies and sequence of operations (normal and emergency), and copies of the commissioning tests (pre-functional checklists and functional performance test forms).

Operation and maintenance manuals are useful reference tools for current facilities staff and can also be used as a training resource for new staff members. The operation and maintenance manuals should be placed in three-ring binders. Contractors should be required to provide at least three copies of each manual to the district. Typically, one copy becomes the master copy, and remains in the facility manager's office. "Hard binding" the master copy so that pages cannot be removed and misplaced is recommended. The second copy functions as a field copy, and selected pages from it may be removed for use during site work. The third copy resides at district offices. If building equipment will be maintained and operated by an outside firm, a fourth copy should be requested and provided to them as a reference. Because manuals lose their usefulness if they are not kept up to date, any pages added to them, such as checklists or preventive maintenance work orders, must be included in each copy.

## **Training**

Perhaps the most essential component of operation and maintenance is training. Unless building operators and managers are given the skills to perform quality operation and maintenance practices, there is no hope that a building will continue to perform optimally.

As with all training, instruction should be structured to meet the needs of building operator staff. Training session topics should ideally be specified in the bid documents.

By videotaping each training session, including the hands-on start-up and shutdown procedures for equipment, building operation staff gains a permanent and inexpensive onsite training aid. When new staff is hired, they can view the videos as part of their training.

For buildings where a facility manager without a technical background provides maintenance, the commissioning provider can still coordinate with contractors to ensure that the manager is educated about the capabilities, intended function, and required maintenance of the building systems. This education should enable the facility manager to respond to occupant complaints in a manner that does not circumvent the systems' design intent. It is important to provide a list of resources for the manager to call for maintenance assistance when necessary.

Once a building is operating and occupied, problems occasionally develop that were not apparent during the commissioning process. These problems often occur during the first year of operation after construction or renovation. Sometimes the service contractor or operating staff can effectively troubleshoot and solve the problem. However, if a problem becomes chronic (for example, repeated comfort complaints), or if operating staff is unable to solve a problem in a reasonable amount of time, the district should request expert troubleshooting assistance.

Because the commissioning provider and design engineer are very familiar with the building systems, the district may want to consider contracting with one and/or both of them for the first year of operation to provide troubleshooting assistance on an as-needed basis. In traditional construction projects, the mechanical engineer is only responsible to help correct problems if their contract stipulates a warranty period and the problems are “design” related. The district may find that it is more cost-effective to purchase troubleshooting services from the commissioning provider or engineer, because their knowledge of the building systems and design saves them time in diagnosing problems. This contract could be written in a “fee-for-service” or an “amount-not-to-exceed” manner.

In the long run, districts may also find it beneficial to train operation and maintenance staff in energy accounting. In addition to tracking the building’s energy use, energy accounting can also indicate problems or potential problems with equipment operation.

## **Preventive Maintenance**

Another important operation and maintenance practice is preventive maintenance. Preventive maintenance can save school districts time and money by:

- Maintaining facility operation
- Extending equipment life
- Identifying equipment degradation

### **Suggested Training Topics**

*Descriptions of equipment and systems installed and their warranties or guarantees.*

*Equipment start-up and shutdown procedures, operation in normal and emergency modes, seasonal changeover, and manual/automatic control.*

*Requirements and schedules for maintenance on all operation and maintenance-sensitive equipment.*

*Indoor air quality, health, visual comfort, acoustic comfort, and safety issues.*

*Recommendations for special tools and spare parts inventory.*

*Emergency procedures.*

*Operation and adjustment of dampers, valves, and controls.*

*Hands-on operation of equipment and systems.*

*Common troubleshooting problems, their causes, and corrective actions.*

*Review of operation and maintenance manuals, and their location onsite.*

*Building walk-through.*

*Review of related design intent documents.*

*Energy management control system operation and programming.*

*Control sequences and strategies.*

*Thermostat programming.*

*Relevant commissioning reports and documents.*

*When and how to recommission building systems.*

*The maintenance work order management system.*

*Sound energy management practices.*

- Preventing losses of equipment, time, productivity, and resulting revenue.

Effective maintenance and operations procedures are fundamentally important to sustaining the performance of all building systems. Student health and productivity can be affected when building systems fail to operate as designed. Sub-standard maintenance or incorrect operation of building systems usually results from a combination of factors. First, maintenance budgets are often the first to be reduced or eliminated when money becomes tight. Second, designers and contractors typically provide the building staff minimal or no training about how the building systems are supposed to operate or be maintained. Finally, schools eventually lose their institutional knowledge of the building systems because of staff turnover and lack of communication.

When estimating service life, manufacturers usually assume regular preventive maintenance of the equipment and system components. Many preventive maintenance procedures recommended by manufacturers are intended to extend the life of the component and the system as a whole. Lack of preventive maintenance reduces equipment life.

Identifying degradation of the system's components is another benefit of preventive maintenance. A proper facility operation and maintenance system that includes reporting and documentation reduces the incidence of failure. For example, if a component of the system is identified as potentially failing to operate as intended, a work order for replacement parts can

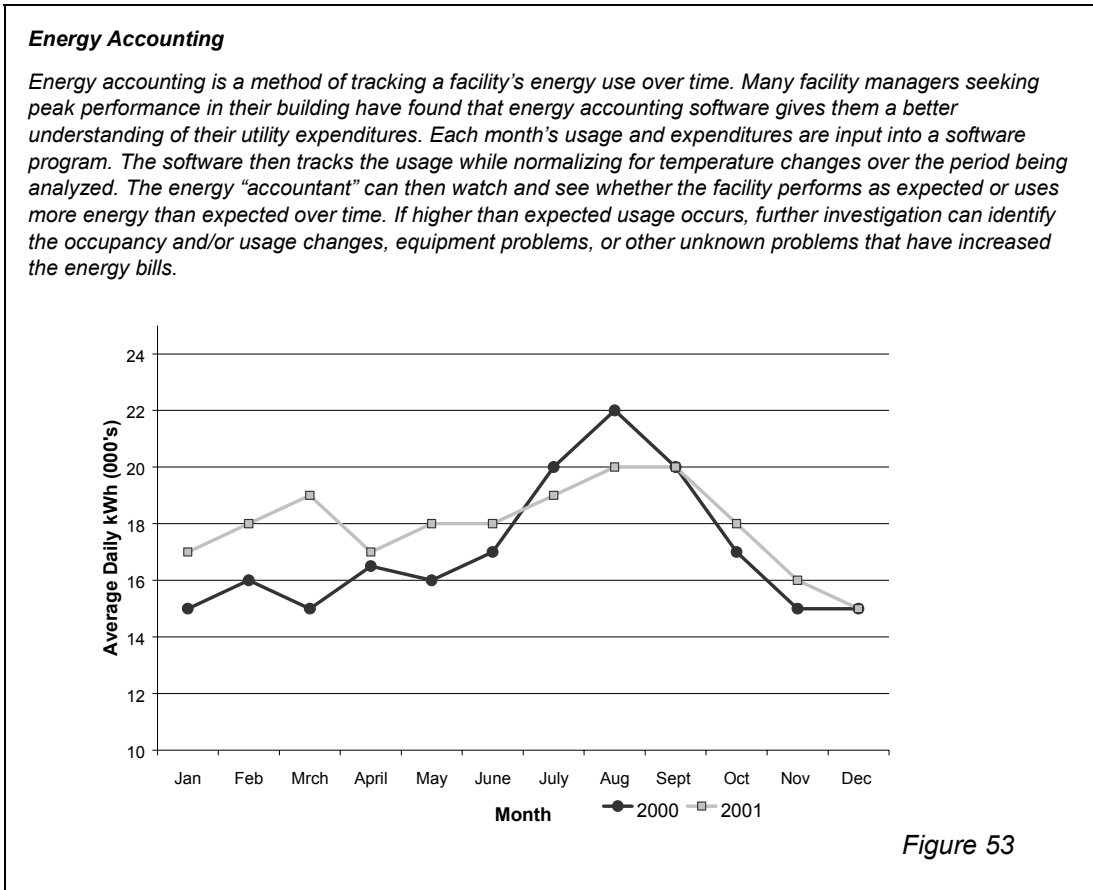

be set up immediately and work scheduled during unoccupied hours. Preventive maintenance can reduce the number and cost of emergency corrective maintenance bills.

Performing regular preventive maintenance can result in energy and cost savings. For example, simply replacing worn fan belts on a regular basis can save 2% to 4% of the energy used to run the fans. Cleaning air filters and cooling coils regularly can save 1% to 3% of the building's energy use for cooling. These basic activities cost very little to perform, but can add up to dramatic savings.

Preventive maintenance also makes buildings safer and can reduce potential district liability. Increasingly, building ventilation systems function as part of an engineered smoke-control system and, therefore, proper maintenance can decrease liability.

### **Developing a Preventive Maintenance Plan**

The commissioning provider can help the district or facility manager develop a preventive maintenance plan for a building's HVAC and electrical systems. Most of the information required for developing a preventive maintenance plan is gathered as part of the commissioning process or can be obtained from the operation and maintenance manuals.

#### **Preventive Maintenance Software Modules**

*Many major controls contractors also offer preventive maintenance modules for their software that will track and automatically advise operation and maintenance staff when equipment maintenance needs to occur. These systems can offer good value because the controls system already knows a lot about many of the building systems. To set these systems up properly to be operational when the building is first occupied, the district should allow some extra budget for a facilities operator to assist in set-up during construction. This will also allow the operator to become familiar with the system and maximize its benefits once the building is occupied.*

A preventive maintenance plan consists of a checklist of tasks that are performed at manufacturer-recommended intervals (usually measured in hours of equipment run time). This checklist is usually kept in the form of a log and is updated manually when tasks are performed. In buildings that use computerized maintenance management systems, the equipment that requires preventive maintenance should be entered into the system. If the computerized system is used for generating preventive maintenance work orders, update the system when work is performed and keep hard copies of completed work orders in a file or notebook. Another low-cost measure to consider is programming the energy management system to track and archive equipment run times. This option is easy and inexpensive if done when the initial system programming takes place, and it should be outlined in the original equipment specification in the contract.

The preventive maintenance plan for each piece of equipment should include the following fundamental information, gathered during the commissioning process:

- Unique equipment identification number
- Name plate information
- Manufacturer's name
- Vendor's name and telephone number
- Equipment location

- Date installed
- Expected equipment life
- Expected annual energy use.

Preventive maintenance should be performed according to manufacturer requirements. Consult the manufacturer's operation and maintenance manual for each piece of equipment for requirements such as frequency, chemical treatments, proper lubricants, special tools, etc. This information should also become a part of the preventive maintenance plan.

The preventive maintenance work order form or task list for each piece of equipment should have a verification section with at least two signature lines: one for the technician performing the preventive maintenance and one for the supervisor verifying that the maintenance was performed.

### ***Outsourcing Preventive Maintenance***

If a new piece of equipment does not require frequent maintenance, and current staff time is committed, a contract for outside help may be less costly than hiring and training full-time staff. If a sophisticated new piece of equipment is purchased, compare the cost of training in-house staff to the cost of hiring a trained outside contractor to perform maintenance on the equipment to determine the best option.

In buildings where operating staff is not available or trained to perform the required preventive equipment maintenance, districts may obtain a service contract from the vendor, installing contractor, or a maintenance service contractor. Ensure that the service contract covers all of the manufacturer's recommended preventive maintenance procedures as described in the operation and maintenance manuals. After each site visit, require the contractor to provide an invoice or preventive maintenance form stating clearly which preventive maintenance activities or repairs were performed. Keep these forms onsite in a file or three-ring binder for future reference. Regardless of who actually performs the preventive maintenance, the district is responsible for making sure that the preventive maintenance plans are complete.

Maintenance contracts tend to be site-specific, but in general, there are two basic types of services.

- **Preventive maintenance contract.** Normally, this type of contract does not cover the cost of replacement parts, but does include labor and supplies. The equipment owner is responsible for parts replacement. The duration of a preventive maintenance contract is usually one year. Frequency of site visits may depend on the equipment being serviced. Corrective maintenance may or may not be included.
- **Guaranteed service and repair contract.** Large maintenance contractors usually offer this type of contract. Under this arrangement, the contracting firm not only maintains but also replaces failed components. It is essentially an insurance policy with a low deductible, and typically is a multi-year contract. The cost for this type of contract is comparatively high.

Regardless of the type of contract used, it is important to carefully evaluate the cost for the service, quality of service, and the existing contractor's familiarization with the facility's



equipment and operating procedures when the contract is up for renewal. Because any new contractor will face a learning curve when taking over a facility, it might not be a wise decision to choose a new contractor just because they offer a lower price. Careful consideration of the quality service already received and successful renegotiations with the existing service contractor might provide better long-term value.

# LIST OF COMMISSIONING REFERENCES AND RESOURCES

Procedural Guidelines, Specifications and Functional Tests Last Updated: 10/25/01

\*Denotes documents available on electronic disk.

Legend: ● Comprehensive Information ● Average Information/Partial Information ○ No Information

Source	Design		Construction		Sample Tests
	Guidelines	Specs	Guidelines	Specs	
<i>Appendix VII Idaho New Building Commissioning Guidelines</i> , State of Idaho, 2000. Available at: <a href="http://www2.state.id.us/adm/pubworks/archengr/app7nbcg.pdf">http://www2.state.id.us/adm/pubworks/archengr/app7nbcg.pdf</a>	○	○	○	○	○
<i>Building Commissioning Assistance Handbook Appendices</i> . Seattle City Light, 1999. Standardized functional test procedures. <a href="http://www.ci.seattle.wa.us/seattle/light/conserve/business/bdgcoma/cv6_bcam.htm">http://www.ci.seattle.wa.us/seattle/light/conserve/business/bdgcoma/cv6_bcam.htm</a>	○	○	○	○	*●
<i>Procedural Standards for Building Systems Commissioning</i> , National Environmental Balancing Bureau (NEBB), 1999. (301) 977-3698.	●	●	●	●	●
<i>A Practical Guide for Commissioning Existing Buildings</i> , PECEI and Oak Ridge National Labs (ORNL), 1999. NTIS (800) 553-6847.	●	○	○	○	○
<i>Model Commissioning Plan and Guide Commissioning Specifications</i> , USDOE/PECEI, 1997. NTIS: # DE 97004564 (800) 553-6847. Or download from: <a href="http://www.peci.org/cx/mcpgs.html">http://www.peci.org/cx/mcpgs.html</a> .	*●	*●	●	●	*●
<i>Building Commissioning Guide</i> , U.S. GSA & USDOE, 1995, revised in 1998 (Ver. 2.2). Ver. 1 by Enviro-Management & Research, Inc. Version 2.2 available on the web: <a href="http://www.eren.doe.gov/femp/techassist/bldguide.pdf">http://www.eren.doe.gov/femp/techassist/bldguide.pdf</a> .	*●	○	●	○	○
<i>The HVAC Commissioning Process</i> , ASHRAE Guideline 1-1996, 1996. ASHRAE Publications Dept., 1791 Tullie Circle, NE, Atlanta, GA 30329. (404) 636-8400. <a href="http://www.ashrae.org">http://www.ashrae.org</a> .	●	●	●	●	○
<i>Functional Test Protocol Library</i> , Pacific Gas & Electric Company, 2001. Available on the EDR Commissioning Resources CD-ROM. For ordering information, call 925-866-5329.	○	○	○	○	●
<i>The Building Commissioning Handbook</i> , The Association of Higher Education Facilities Officers (APPA), written by John Heinz and Rick Casault, 1996. APPA, 1643 Prince Street, Alexandria, VA 22314. (703) 684-1446. <a href="http://www.appa.org">http://www.appa.org</a> .	●	○	●	●	○
<i>Beyond Lighting DSM: Life After Green Lights</i> , Montgomery Co., MD, 1995. Existing building commissioning case study with sample process and detailed procedures. 70 pgs. (301) 217-6000.	●	○	○	○	●
<i>Engineering and Design Systems Commissioning Procedures</i> , U.S. Army Corps of Engineers, 1995 (ER 1110-345-723). Dept. of the Army, U.S. Army Corps of Engineers, Washington, DC 20314-1000.	●	●	●	●	○
<i>Commissioning Specifications</i> , C-2000 Program, Canada, 1995. C-2000 Program, Energy Mines & Resources, Energy Efficiency Division, 7th Floor, 580 Booth St., Ottawa, Ontario, Canada K1A 0E4.	○	○	○	*●	○
<i>Model Construction Document Specifications and A/E Services Contract Clauses</i> , Bonneville Power Administration/John Heinz, U. of WA, 1995. 503-230-7334. Also available on the Univ. of Washington web site at: <a href="http://www.depts.washington.edu/fsesweb/fdi2001/15_mech/doc/19-15t.doc">http://www.depts.washington.edu/fsesweb/fdi2001/15_mech/doc/19-15t.doc</a> .	○	○	○	*●	●
<i>Commissioning Guidelines, Instructions for Architects &amp; Engineers</i> , State of WA., 1995. Dept. of General Admin., Div. of Engin. & Arch., (360) 902-7272.	●	○	●	○	○
<i>Commissioning of HVAC Systems</i> , seminar/workshop training materials, Univ. of Wisconsin, Madison, 1994. (800) 462-0876 or (608) 262-2061.	○	○	●	●	●

Source	Design		Construction		Sample Tests
	Guidelines	Specs	Guidelines	Specs	
<i>Laboratory HVAC Systems: Design, Validation and Commissioning</i> , ASHRAE collection of 11 papers, 1994. ASHRAE Publications Dept., 1791 Tullie Circle, NE, Atlanta, GA 30329. (404) 636-8400. <a href="http://www.ashrae.org/">http://www.ashrae.org/</a>	○	○	●	○	○
<i>Commissioning Smoke Management Systems, ASHRAE Guideline 5-1994</i> . ASHRAE Publications Dept., 1791 Tullie Circle, NE, Atlanta, GA 30329. (404) 636-8400. <a href="http://www.ashrae.org/">http://www.ashrae.org/</a>	●	○	●	○	○
<i>Standard HVAC Control Systems Commissioning and Quality Verification User Guide</i> , U.S. Army Const. Engineering Research Labs, 1994. Facilities Engineering Applications Program, U.S. Army Engineering and Housing Support Center, Ft. Belvoir, VA 22060-5516. FEAP-UG-GE-94/20.	○	○	○	○	●
<i>Contractor Quality Control and Commissioning Program—Guidelines and Specification</i> , Montgomery Co. Gov., St of Maryland, 1993. (301) 217-6071.	○	○	*●	*●	*●
<i>HVAC Systems Commissioning Manual</i> , Sheet Metal and Air Conditioning Contractors' National Association (SMACNA), 1993. SMACNA, 4201 Lafayette Center Dr., Chantilly, VA 22021.	○	○	●	●	●
<i>Commissioning Guide</i> , Public Works Canada, Western Region, 1993. (403) 497-3770.	●	●	●	●	○
<i>Guide Specification for Military Construction—Commissioning of HVAC Systems</i> , Dept. of the Army, U.S. Army Corps of Engineers, 1993. Washington, DC 20314-1000.	○	○	○	*●	*●
<i>Building Commissioning Guidelines</i> , Bonneville Power Administration/PECI, 1992. (503) 230-7334.	●	○	●	●	●
<i>HVAC Functional Inspection and Testing Guide</i> , U.S. Dept. of Commerce and the General Services Administration, 1992. NTIS: (800) 553-6847.	○	○	○	○	●
<i>AABC Master Specification</i> , Associated Air Balance Council. (Primarily for how the TAB fits into the commissioning process) AABC National Hdqrs, (202) 737-0202.	○	*●	○	●	○

### Commissioning Overviews and Case Studies

- Building Commissioning: The Key to Quality Assurance. U.S. DOE Rebuild America/PECI, 1998.
- Commissioning retrofits and existing buildings: overview, process, and case studies. Dedicated solely to retro-commissioning. 68 pgs. (800) 363-3736.
- Beyond Lighting DSM: Life After Green Lights, Urban Consortium Energy Task Force of Public Technologies, Submitted by Montgomery County Government, MD, Div. of Facilities and Services, 1998. Existing building commissioning case study with sample process and detailed procedures. 70 pgs. (301) 217-6000.
- Commissioning For Better Buildings in Oregon. Oregon Office of Energy/PECI, 1997.
- New construction overview, benefits, process, and case studies. Contains some data on recommissioning. 44pgs. (503) 378-4040 or download at: <http://www.energy.state.or.us/bus/comm/bldgcx.htm>
- What Can Commissioning Do For Your Building? PECI, 1997.
- Commissioning overview and report of 175 building case studies. Contains some data on recommissioning. 12pgs. (503) 248-4636.
- Commissioning Four New Science Laboratory Buildings (U. of WA). Bonneville Power Admin./Phoebe Caner, 1997. Commissioning case studies with detailed "lessons learned" information in all sections. ~70 pgs. (503) 230-7334.
- Commissioning the Physics/Astronomy Building Control System (U. of WA). Bonneville Power/Phoebe Caner, 1996. Commissioning case study and report with lessons learned. ~110 pgs. (503) 230-7334.
- A web site dedicated to providing access to documents dealing with the Guidelines for Total Building Commissioning is being developed under the auspices of the National Institute of

Building Sciences. The site is maintained by the Florida Design Initiative and is organized around the individual technical guidelines that will comprise the complete set of Guidelines for Total Building Commissioning.  
<http://www.sustainable.state.fl.us/fdi/edesign/resource/totalbcx>.

Implement Building Commissioning, published by U.S. Department of Energy, Rebuild America, EnergySmart Schools program (Washington, DC, 2000); available at:  
[http://www.eren.doe.gov/energysmartschools/om\\_implement.html](http://www.eren.doe.gov/energysmartschools/om_implement.html). Defines building commissioning; discusses the selection of a commissioning agent; the benefits, approaches, and components of commissioning; and lists resources.

Sustainable Building Technical Manual: Green Building Design, Construction, and Operations, produced by Public Technology, Inc., U.S. Green Building Council (USGBC), and U.S. Department of Energy, with support from EPA, 1996. See Chapter 15, "Building Commissioning." Available from USGBC, San Francisco, CA; Phone: (415) 445-9500 or download at: <http://www.sustainable.doe.gov/pdf/sbt>

Four case studies. Seattle City Light.  
[http://www.ci.seattle.wa.us/seattle/light/consERVE/business/bdgcoma/cv6\\_bcam.html](http://www.ci.seattle.wa.us/seattle/light/consERVE/business/bdgcoma/cv6_bcam.html).

### **Web Sites Containing Commissioning Documents**

Building Commissioning Association	<a href="http://www.bcx.org/">http://www.bcx.org/</a>
Florida Design Initiative	<a href="http://www.state.fl.us/fdi/index.html">http://www.state.fl.us/fdi/index.html</a> . Ongoing articles & forum.
National Institute of Health Model Commissioning Guide	<a href="http://www.des.od.nih.gov/farhad2/Commissioning/nih_cx_guide/ComGuideTitle.htm">http://www.des.od.nih.gov/farhad2/Commissioning/nih_cx_guide/ComGuideTitle.htm</a>
NEBB	<a href="http://www.nebb.org/">http://www.nebb.org/</a> . Certification program and manuals.
Oregon Office of Energy	<a href="http://www.energy.state.or.us/bus/comm/bldgcx.htm">http://www.energy.state.or.us/bus/comm/bldgcx.htm</a> Benefits of Cx, case study, the full text of <i>Commissioning for Better Buildings in Oregon</i> . Contains some data on recommissioning.
PECI	<a href="http://www.peci.org/">http://www.peci.org/</a> NCBC information, downloadable <i>Model Cx Plan and Guide Specifications</i> , Cx and O&M resources.
Seattle City Light	<a href="http://www.ci.seattle.wa.us/seattle/light/consERVE/business/bdgcoma/cv6_bcam.htm">http://www.ci.seattle.wa.us/seattle/light/consERVE/business/bdgcoma/cv6_bcam.htm</a> Standardized test procedures and case studies.
Texas A&M Energy Systems Lab	<a href="http://www-esl.tamu.edu/">http://www-esl.tamu.edu/</a> . Retrocommissioning process and software, for purchase. Dedicated solely to retrocommissioning.
University of Washington	<a href="http://www.depts.washington.edu/fsesweb/fdi2001/15_mech/doc/19-15t.doc">http://www.depts.washington.edu/fsesweb/fdi2001/15_mech/doc/19-15t.doc</a> . University Cx guide specs distributed throughout the specs. Vols 1-4.
USDOE / FEMP	<a href="http://www.eren.doe.gov/femp/techassist/bldgcomgd.html">http://www.eren.doe.gov/femp/techassist/bldgcomgd.html</a> . Full text of GSA/USDOE <i>Building Commissioning Guide</i> ; early version of <i>Model Cx Plan and Guide Specifications</i> .
USDOE	<a href="http://www.eren.doe.gov/">http://www.eren.doe.gov/</a> . Links to commissioning documents. Search on "commissioning."
Whole Building Design Guide (NIBS)	<a href="http://www.wbdg.org/">http://www.wbdg.org/</a> . National Institute of Building Sciences. Find commissioning information by searching on "commissioning."



Office of Energy Efficiency and Renewable Energy  
U.S. Department of Energy



Printed with a renewable-source ink on paper containing at least 50% wastepaper, including 20% postconsumer waste.

Revised October 2007 DOE/GO-102002-1610