

APPENDIX A

**Facility Detail
Drawings**

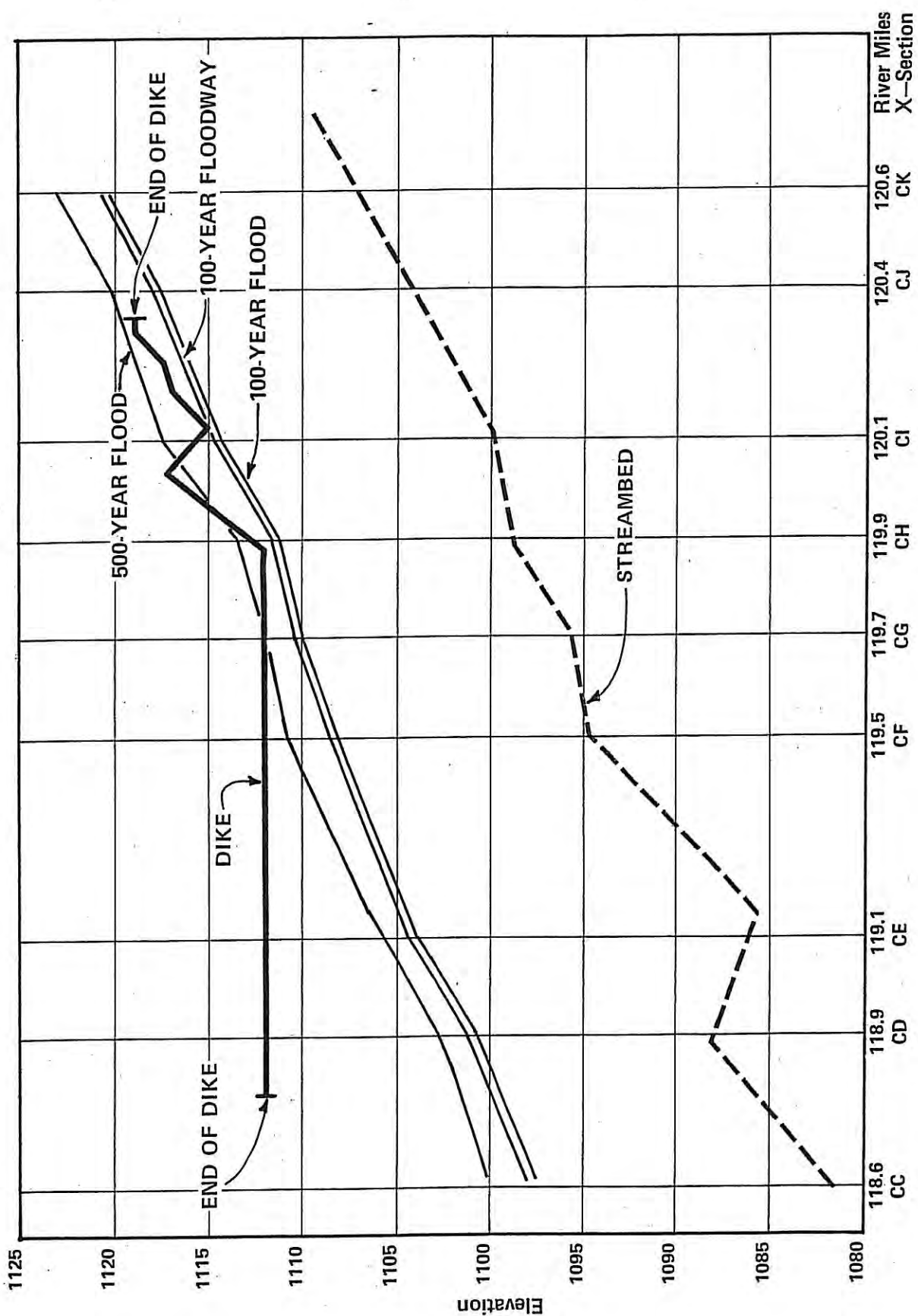
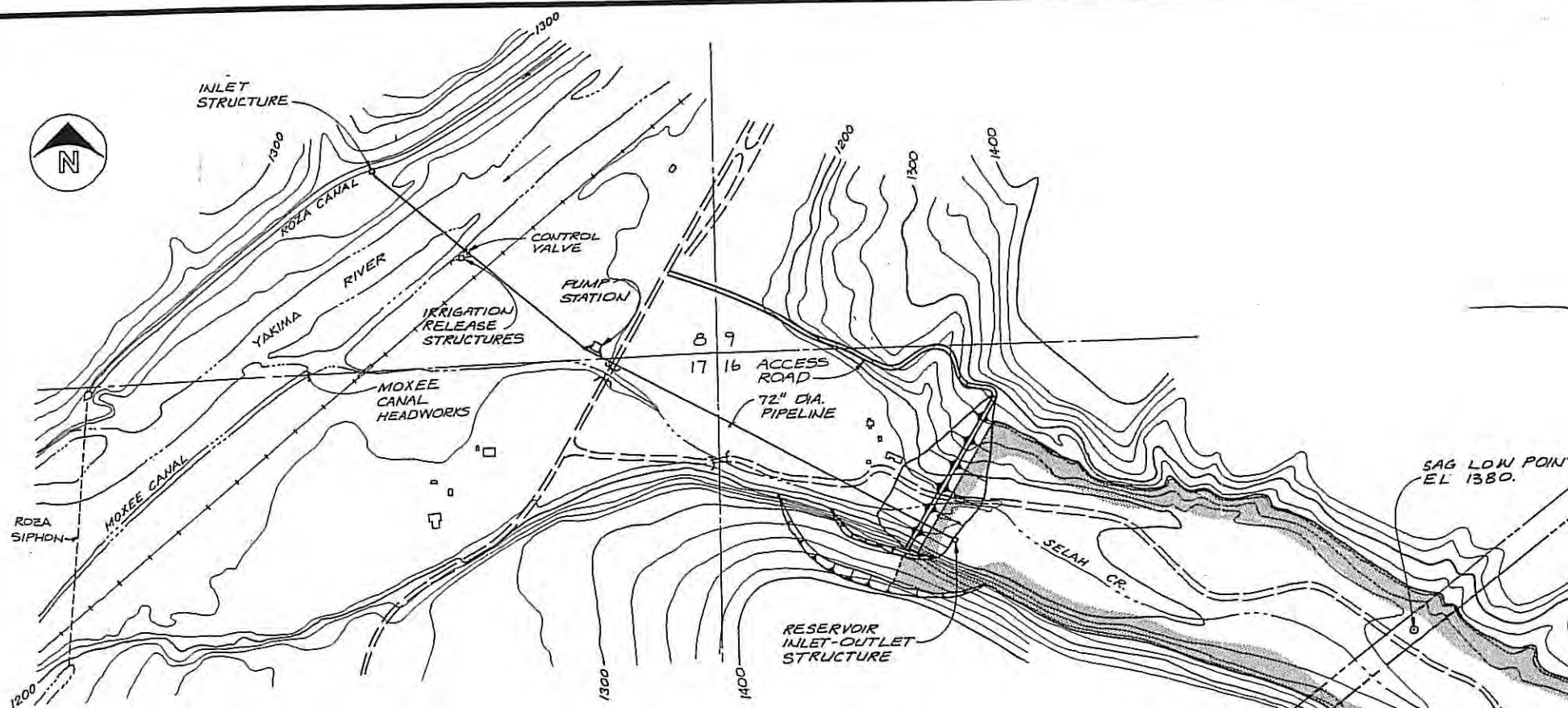
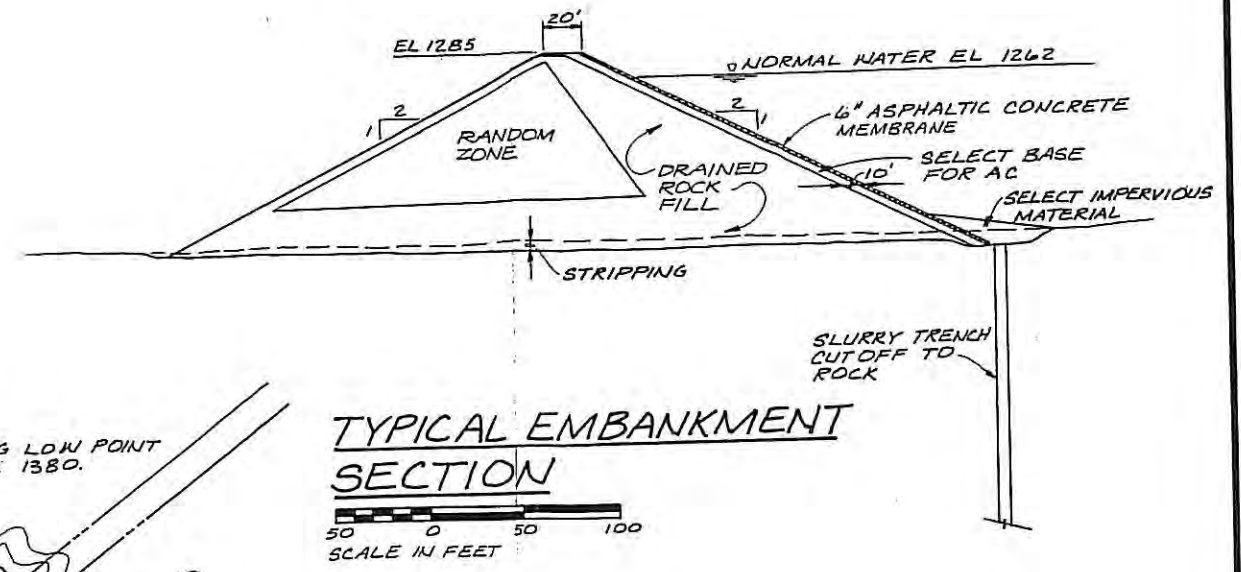


Figure A-8
 YAKIMA RIVER FLOOD PROFILES
 AT EAST SELAH GRAVEL PITS

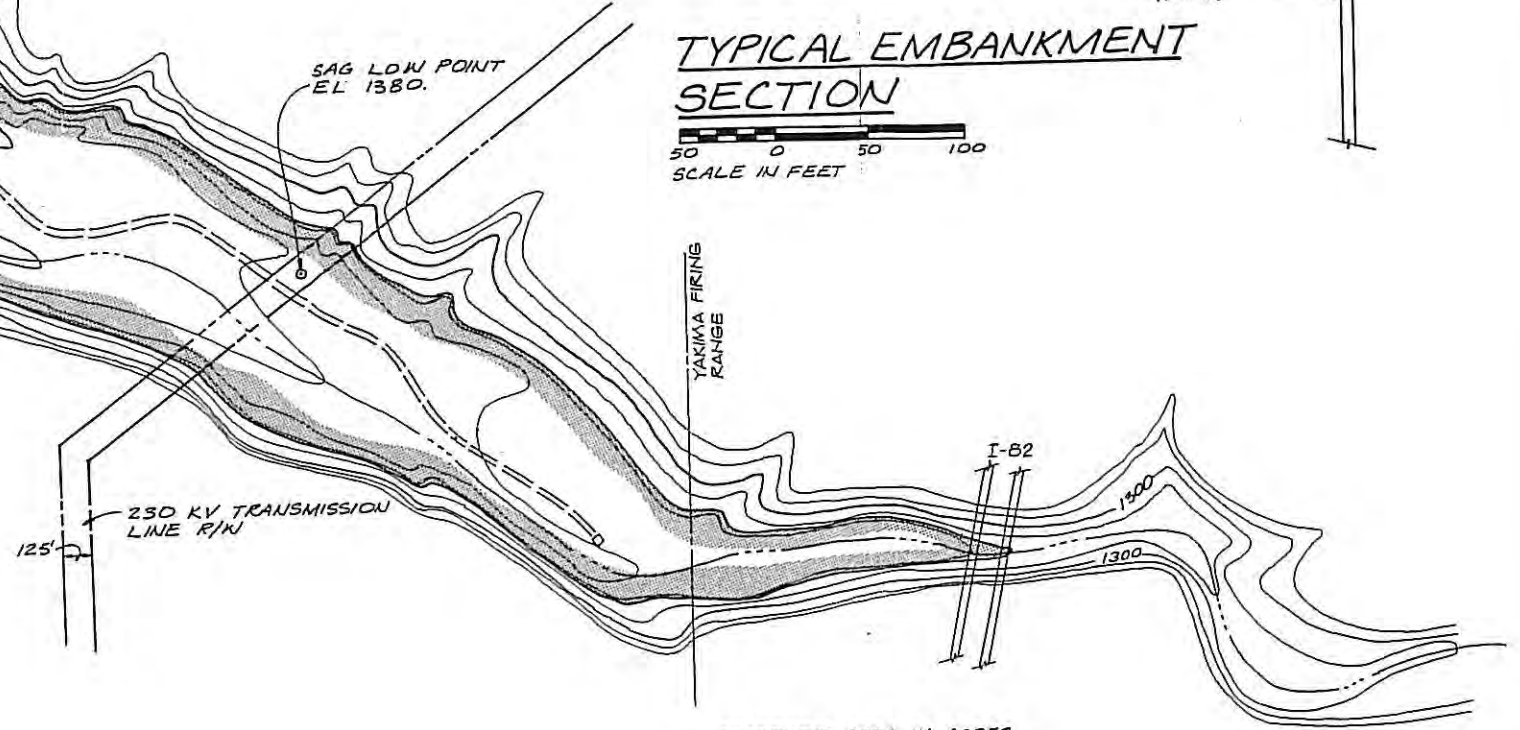
1"=1000'
 Source: Tudor Engineering Company



DAM AND RESERVOIR - PLAN
 SCALE IN FEET
 400 0 400 800

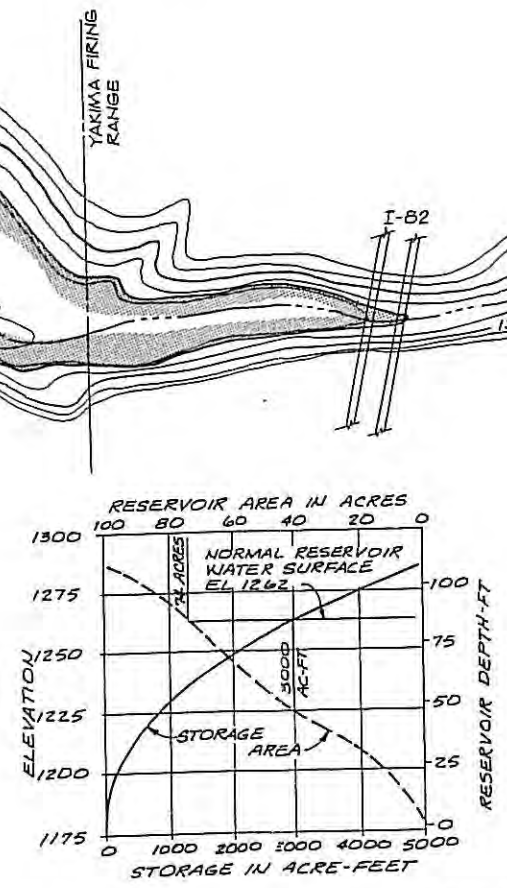


TYPICAL EMBANKMENT SECTION
 SCALE IN FEET
 50 0 50 100



CENTERLINE PROFILE OF DAM

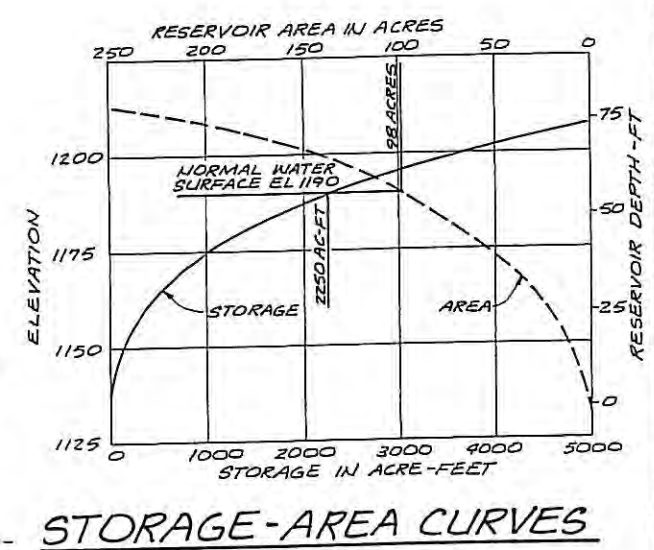
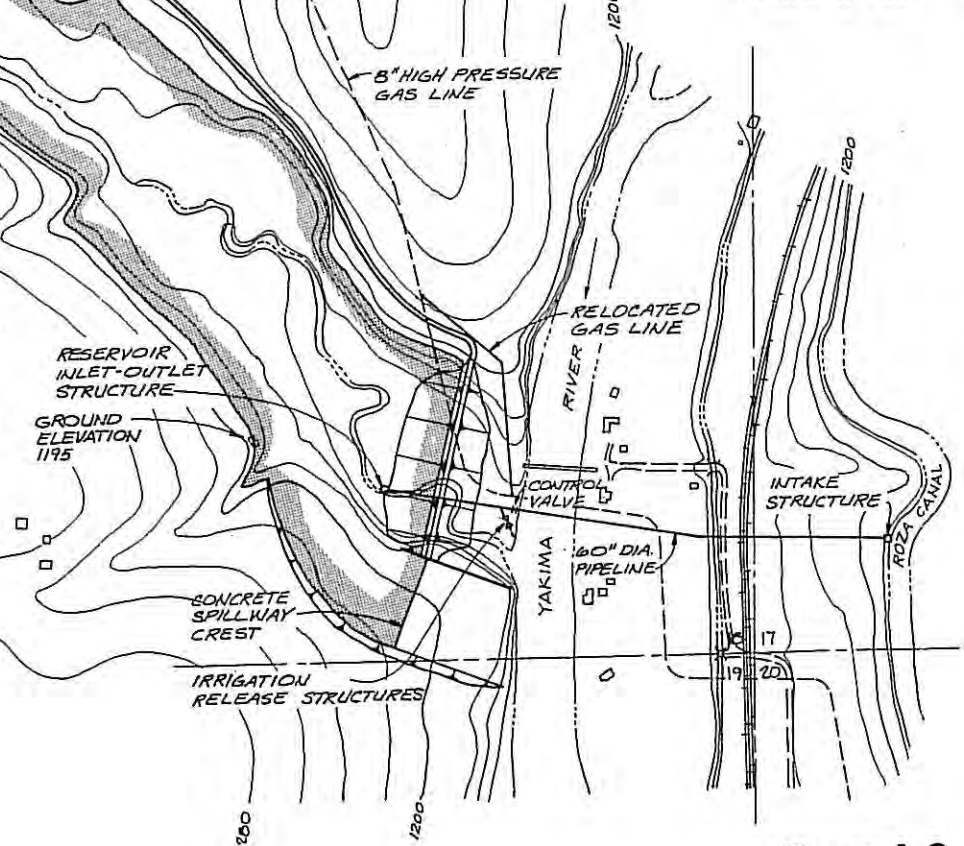
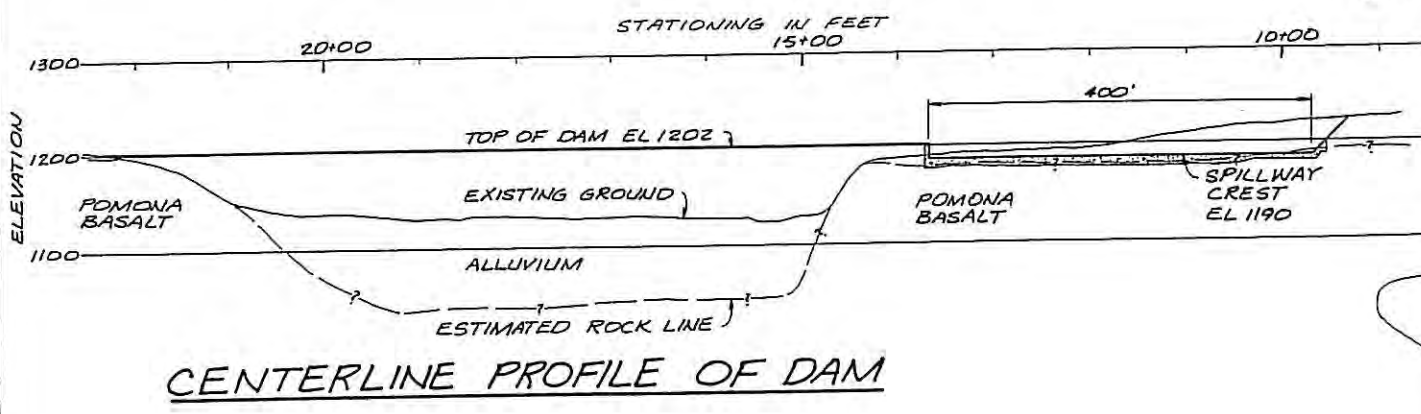
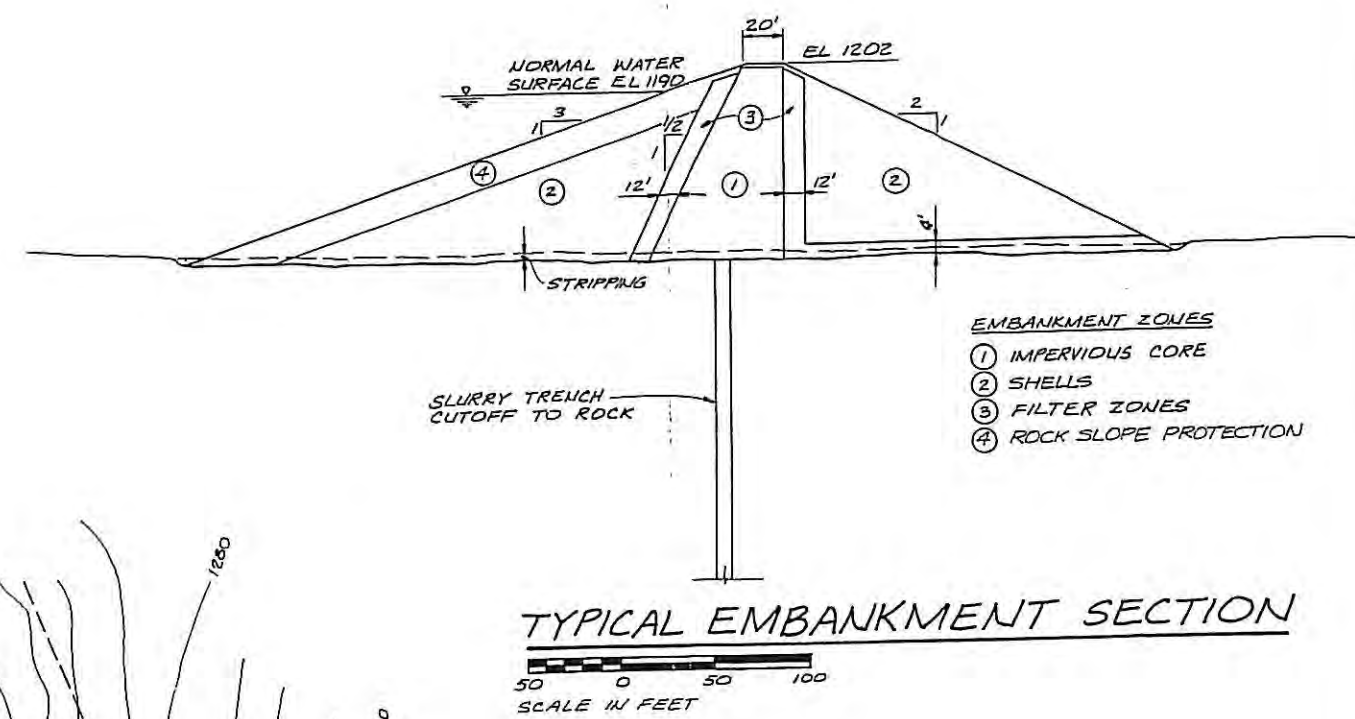
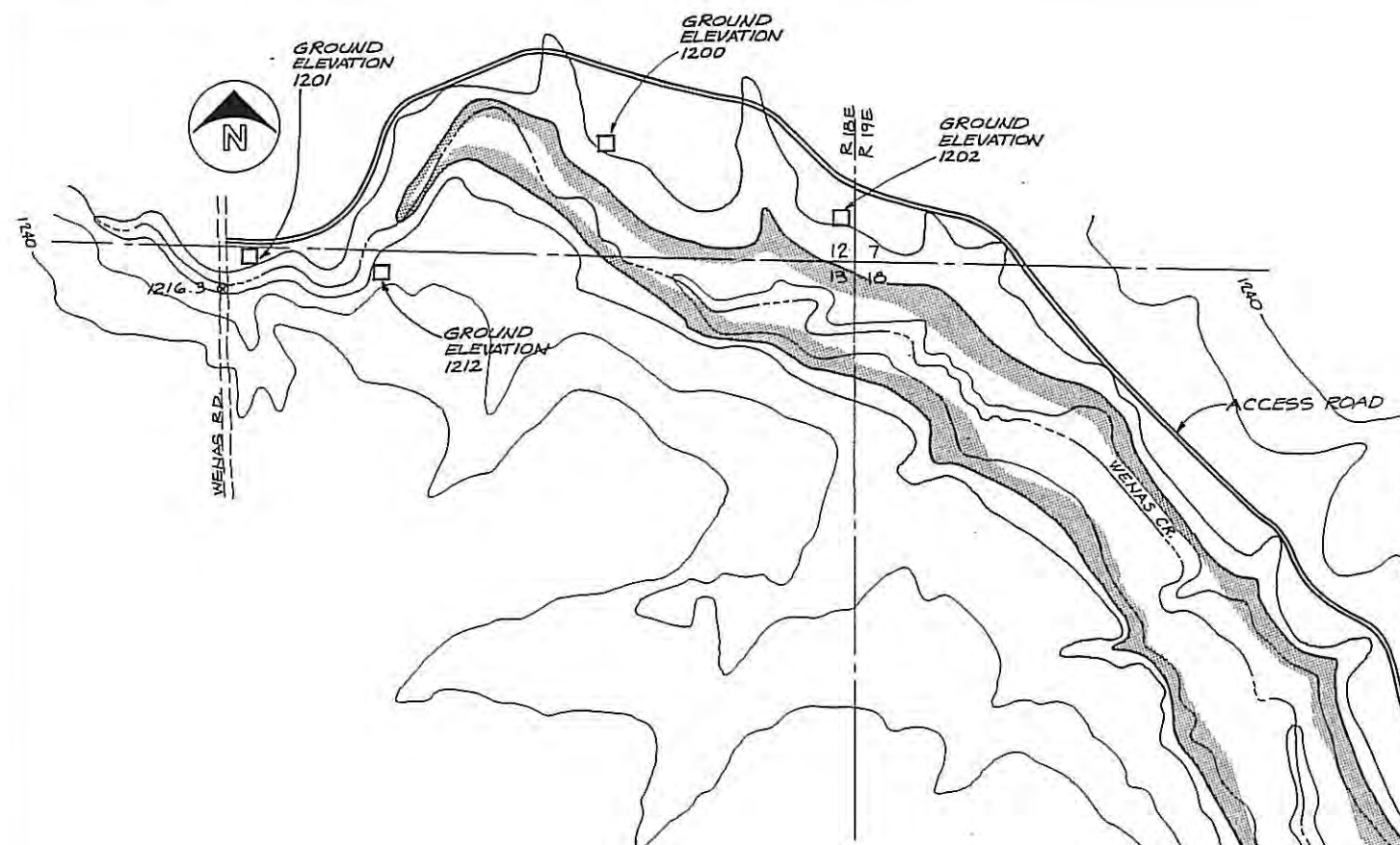
NOTE:
 1. SELAH MEMBER IS COMPOSED OF ANDESITIC AND PUMICEOUS SANDS, GRAVELS, AND SILTS



STORAGE-AREA CURVES

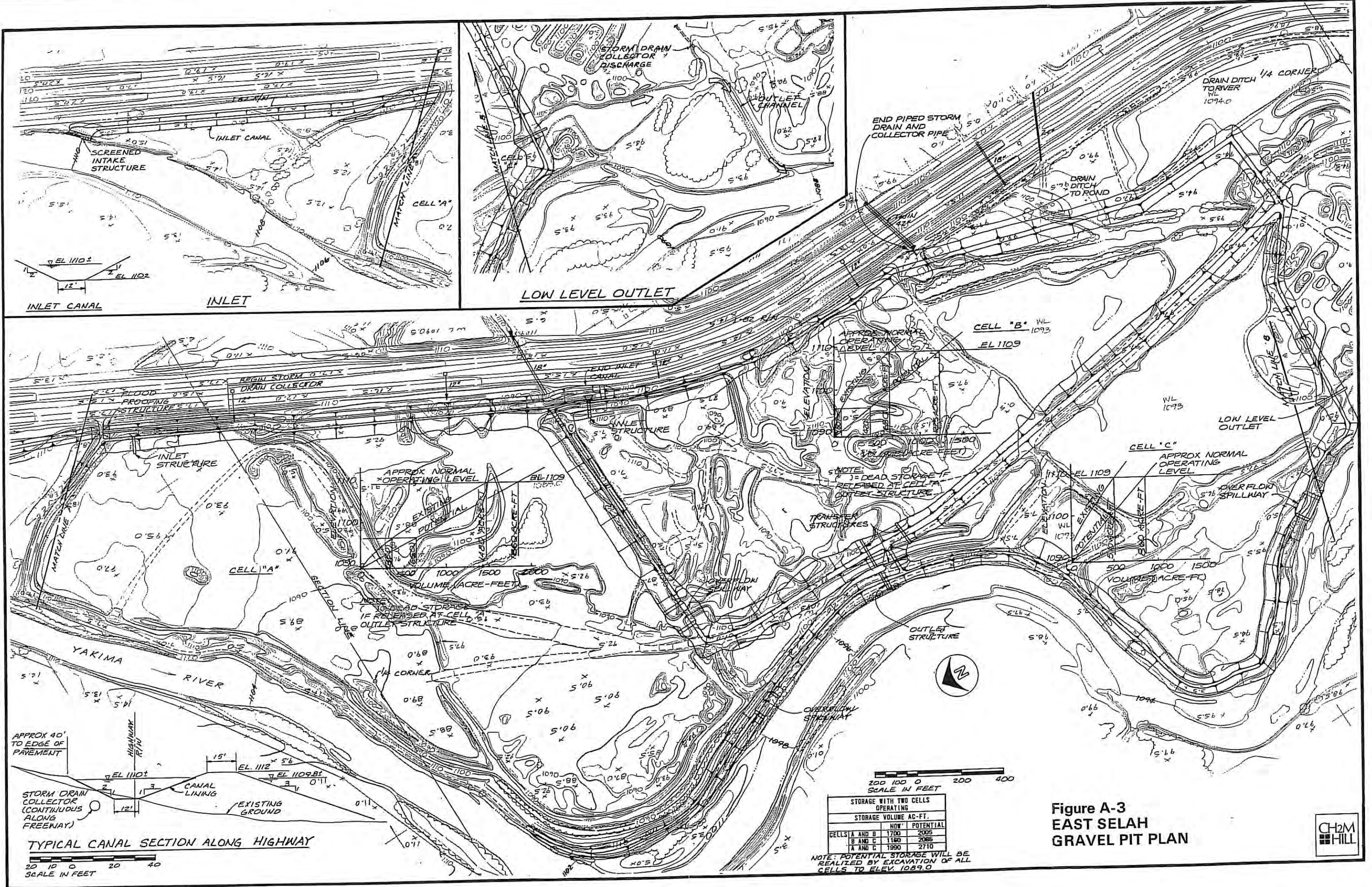
**Figure A-1
 SELAH CREEK DAMSITE
 PLAN AND SECTIONS**





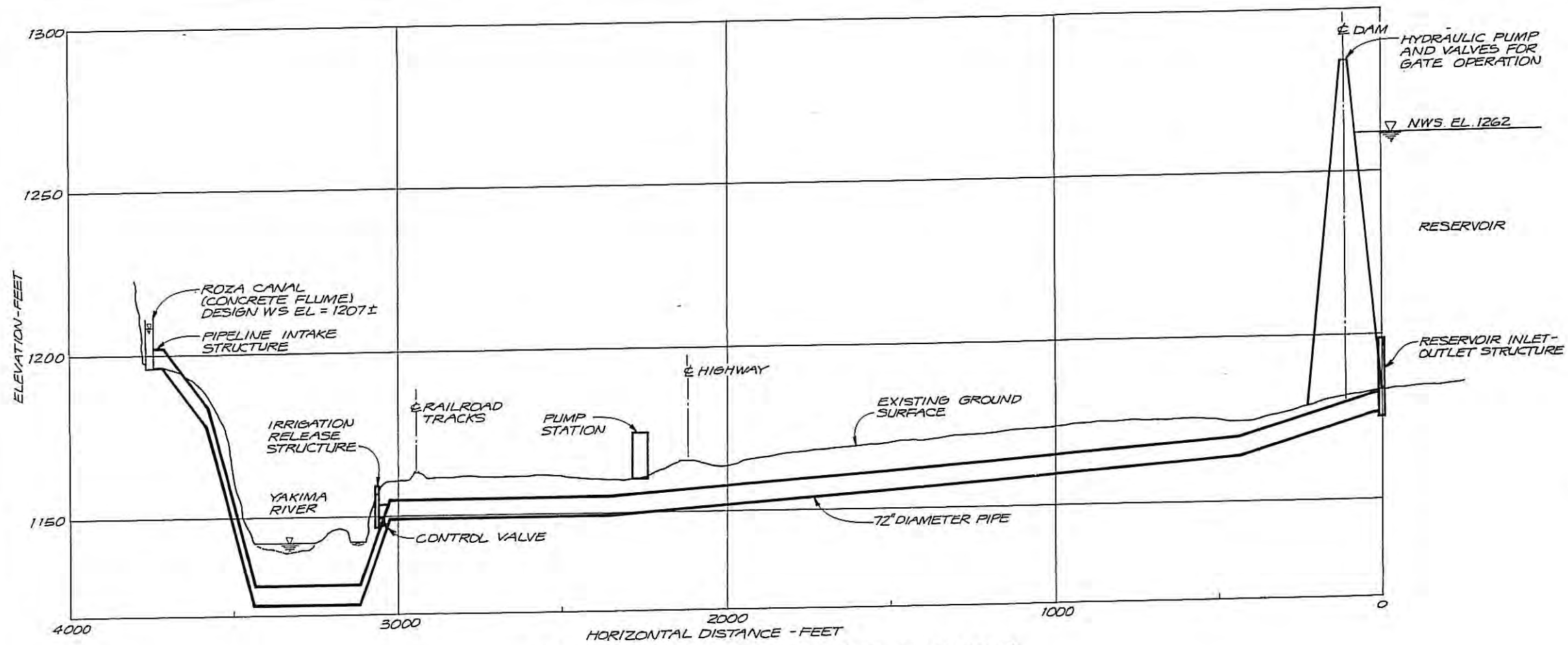
**Figure A-2
WENAS CREEK DAMSITE
PLAN AND SECTIONS**



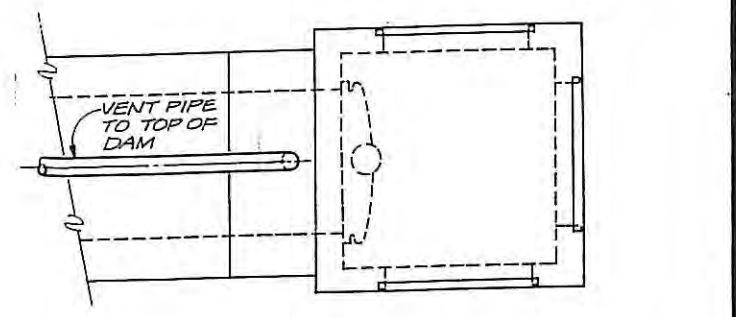


**Figure A-3
EAST SELAH
GRAVEL PIT PLAN**

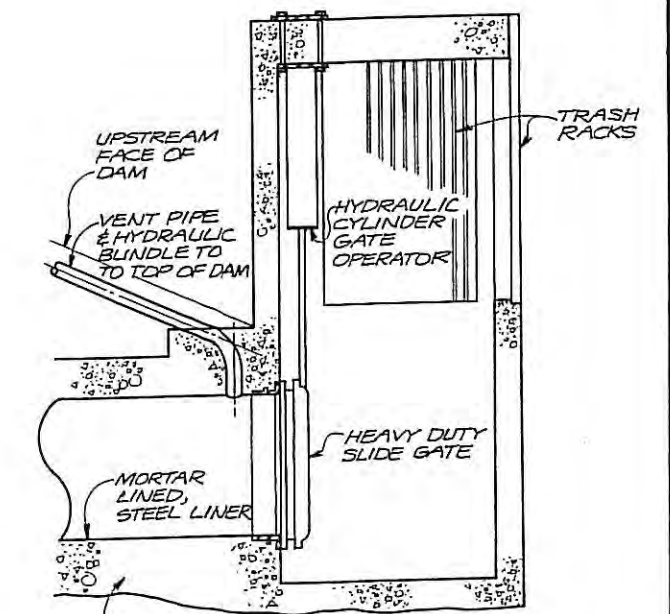




SELAH CREEK PIPELINE PROFILE



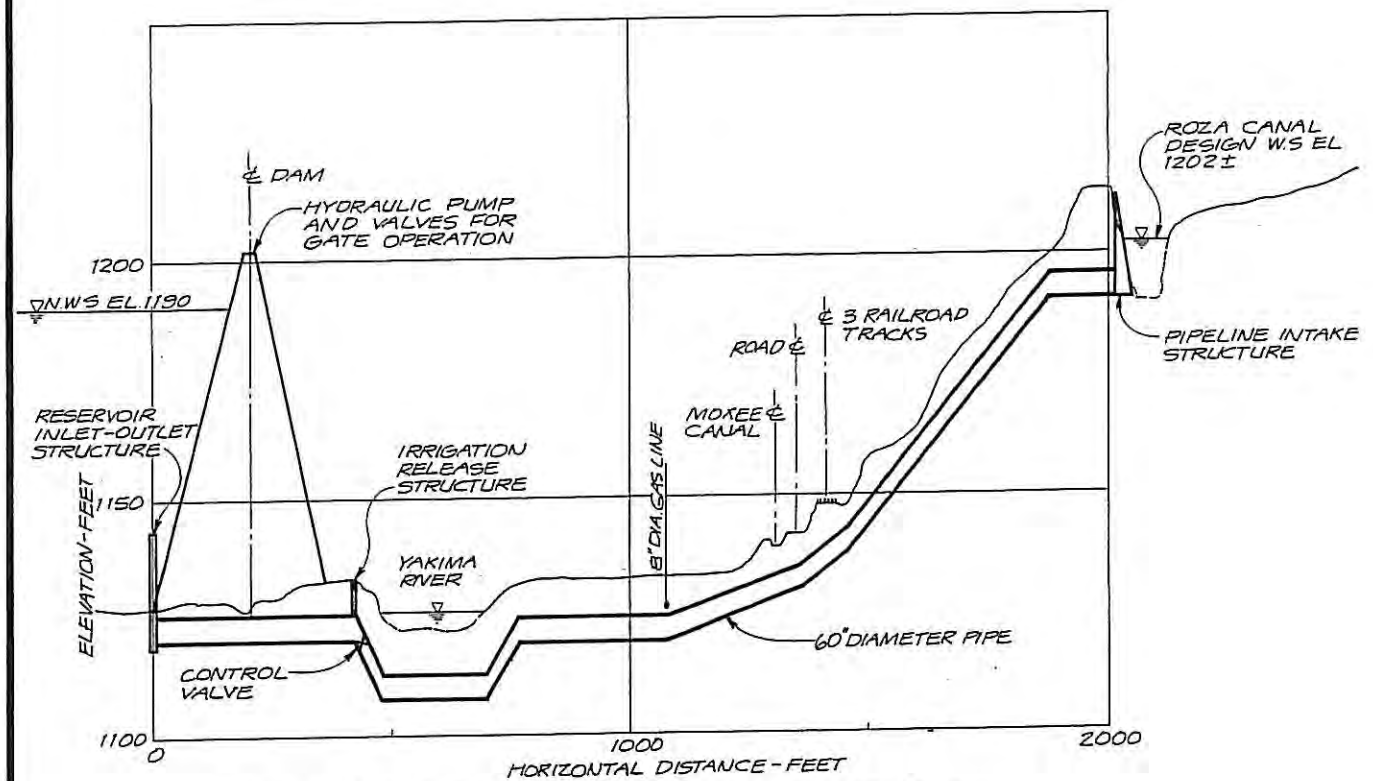
PLAN



SECTION

RESERVOIR INLET-OUTLET STRUCTURE

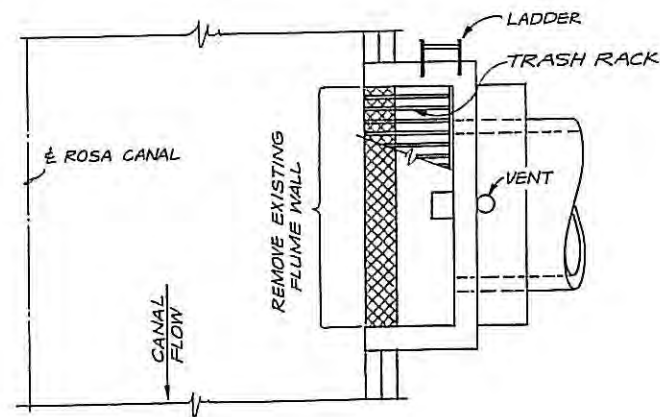
(TYPICAL BOTH RESERVOIR SITES)
 0 4 8
 SCALE IN FEET



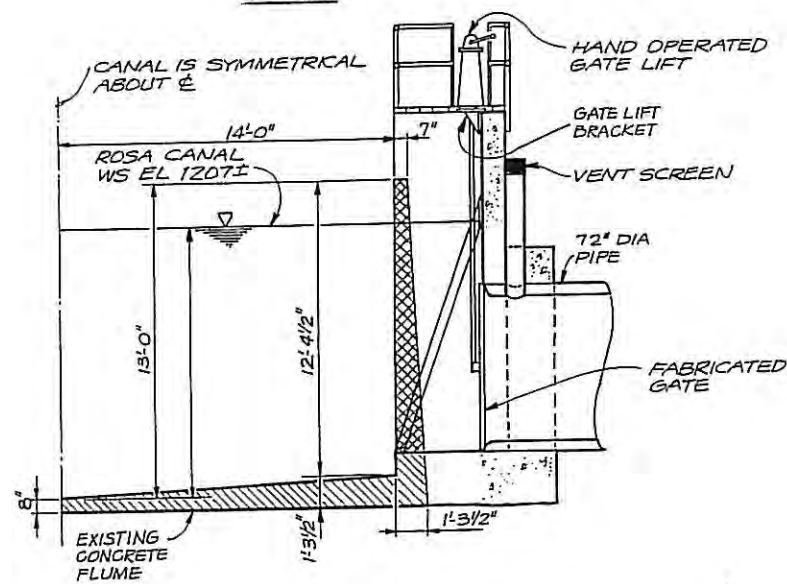
WENAS CREEK PIPELINE PROFILE

**Figure A-4
 DIVERSION PIPELINE PROFILES
 FOR SELAH AND WENAS DAMSITES**



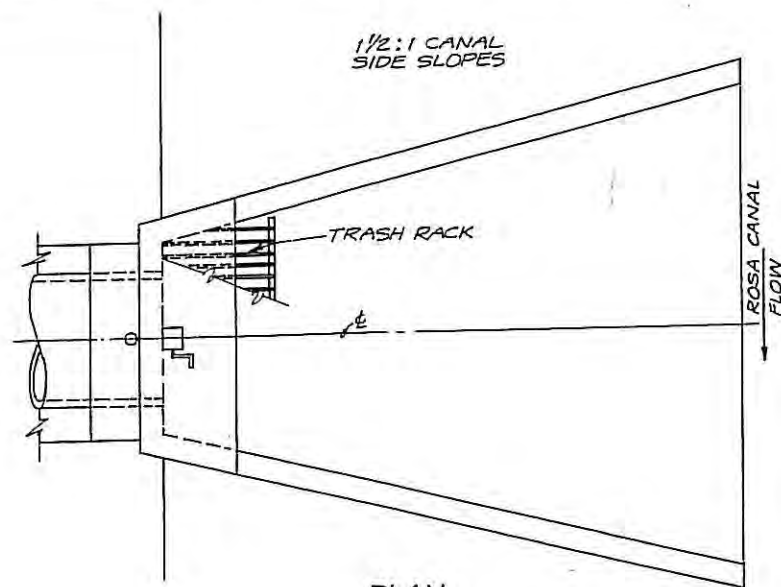
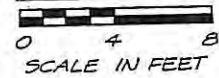


PLAN

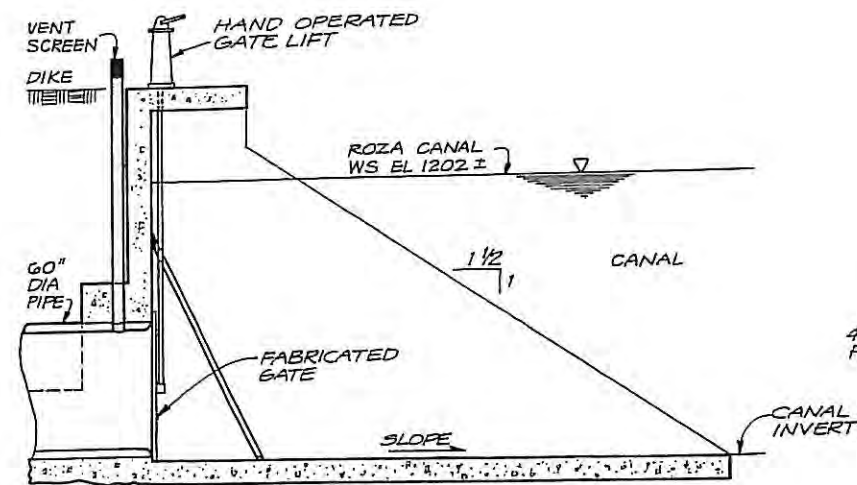


SECTION

SELAH PIPELINE INLET

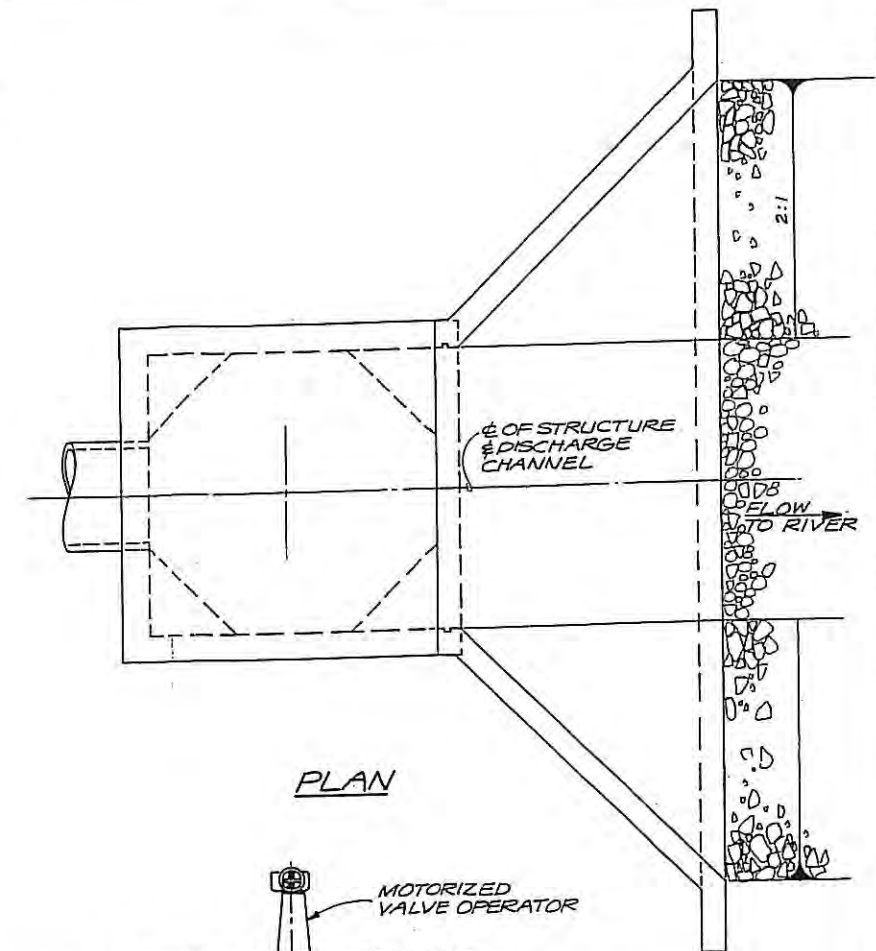
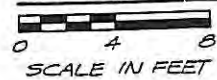


PLAN

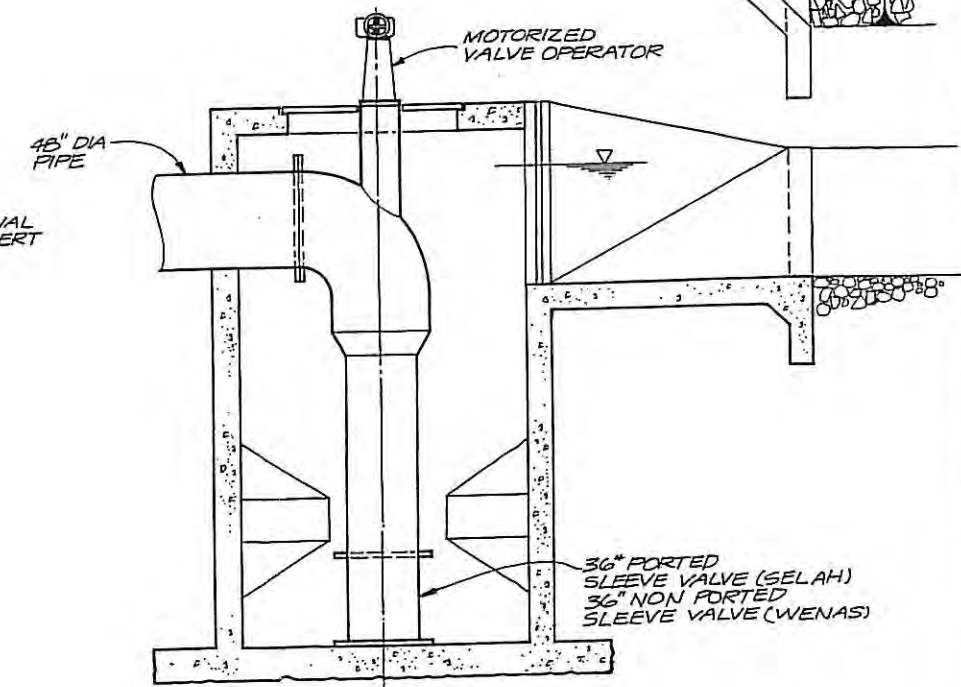


SECTION

WENAS PIPELINE INLET



PLAN



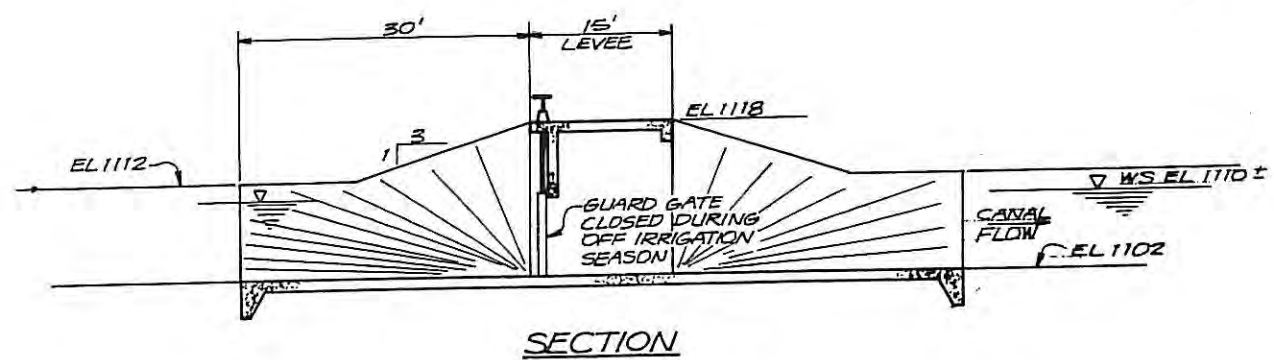
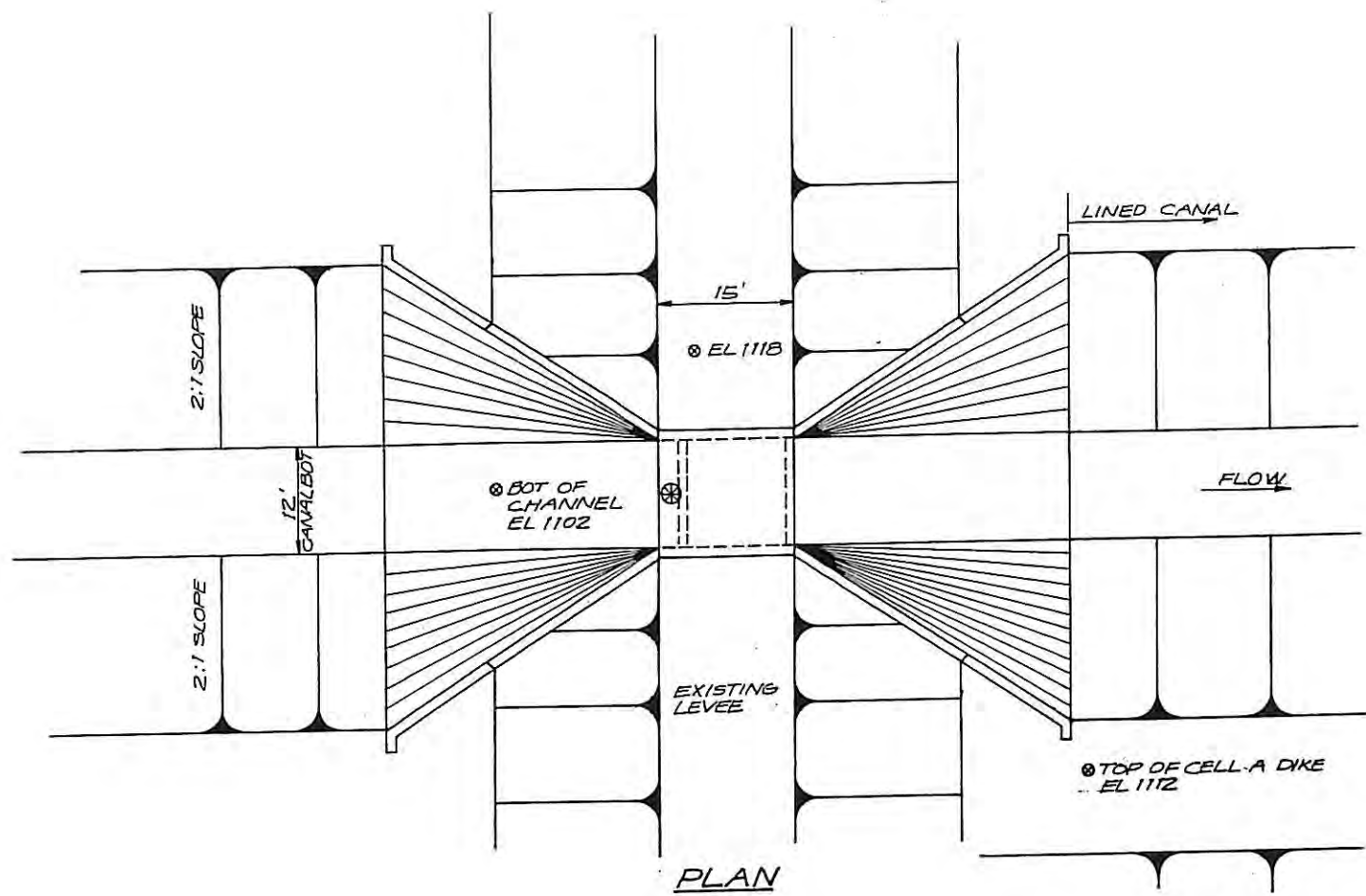
SECTION

SELAH & WENAS IRRIGATION RELEASE STRUCTURE

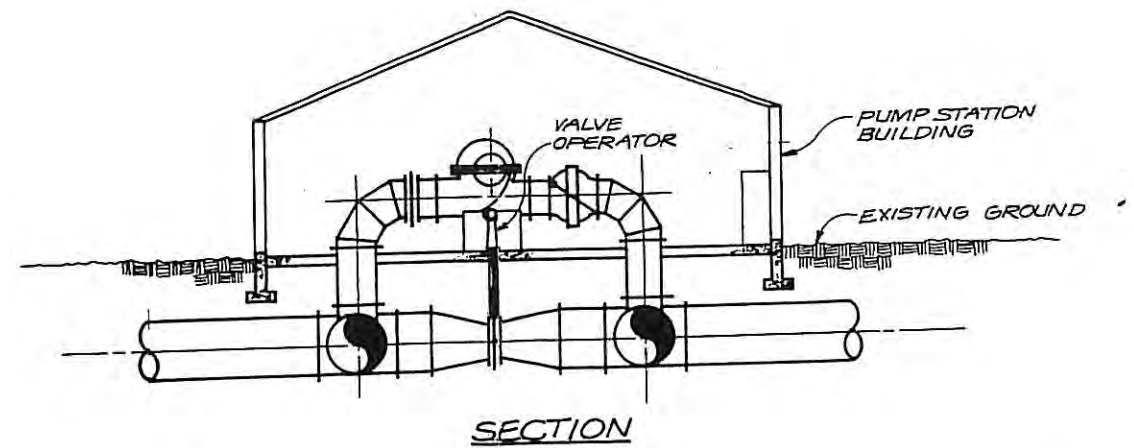
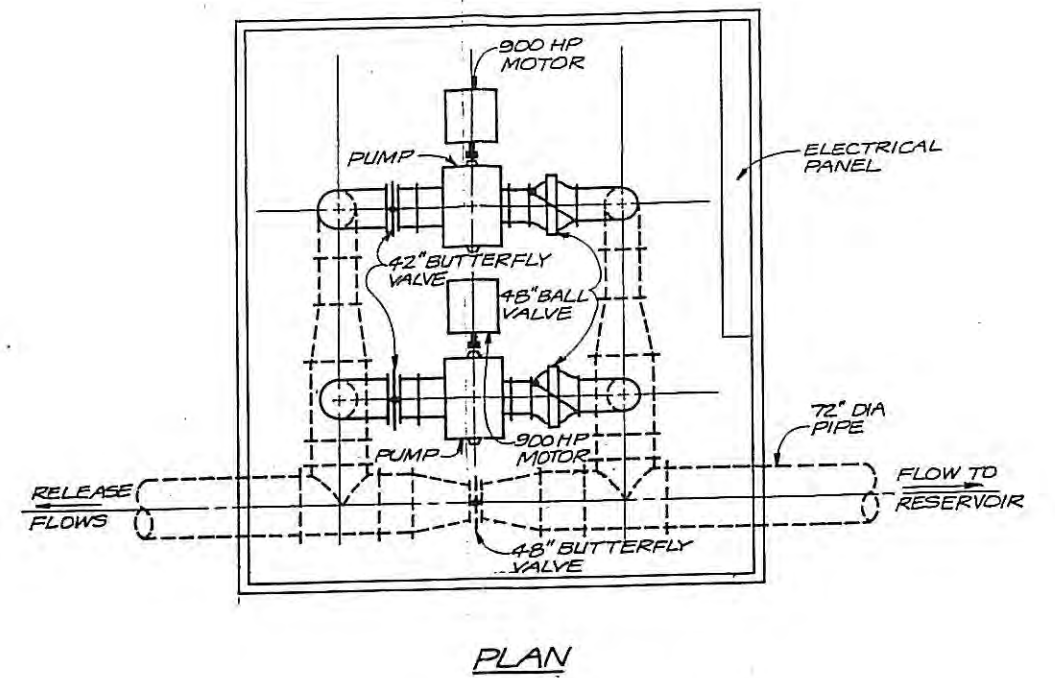


**Figure A-5
PIPELINE STRUCTURE DETAILS**





GRAVEL PIT FLOOD-PROOFING STRUCTURE
 0 10 20
 SCALE IN FEET



SELAH CREEK PUMP STATION
 0 10 20
 SCALE IN FEET

**Figure A-6
 SELAH CREEK PUMP STATION
 AND GRAVEL PIT
 FLOOD-PROOFING STRUCTURE**

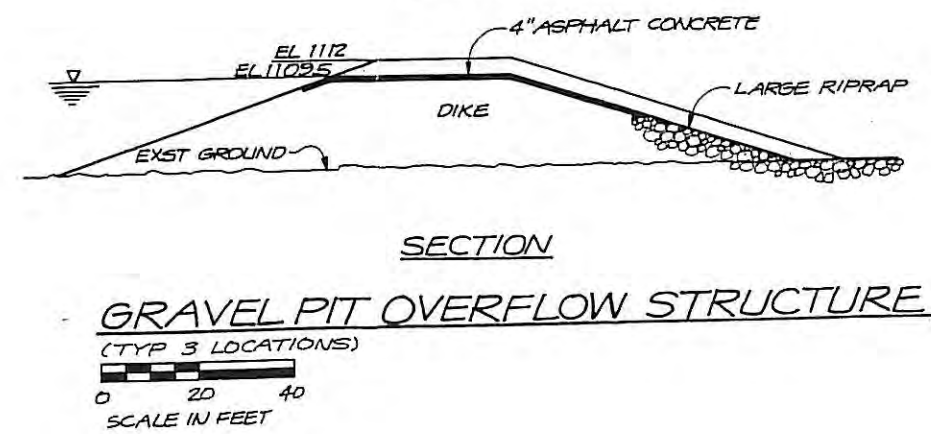
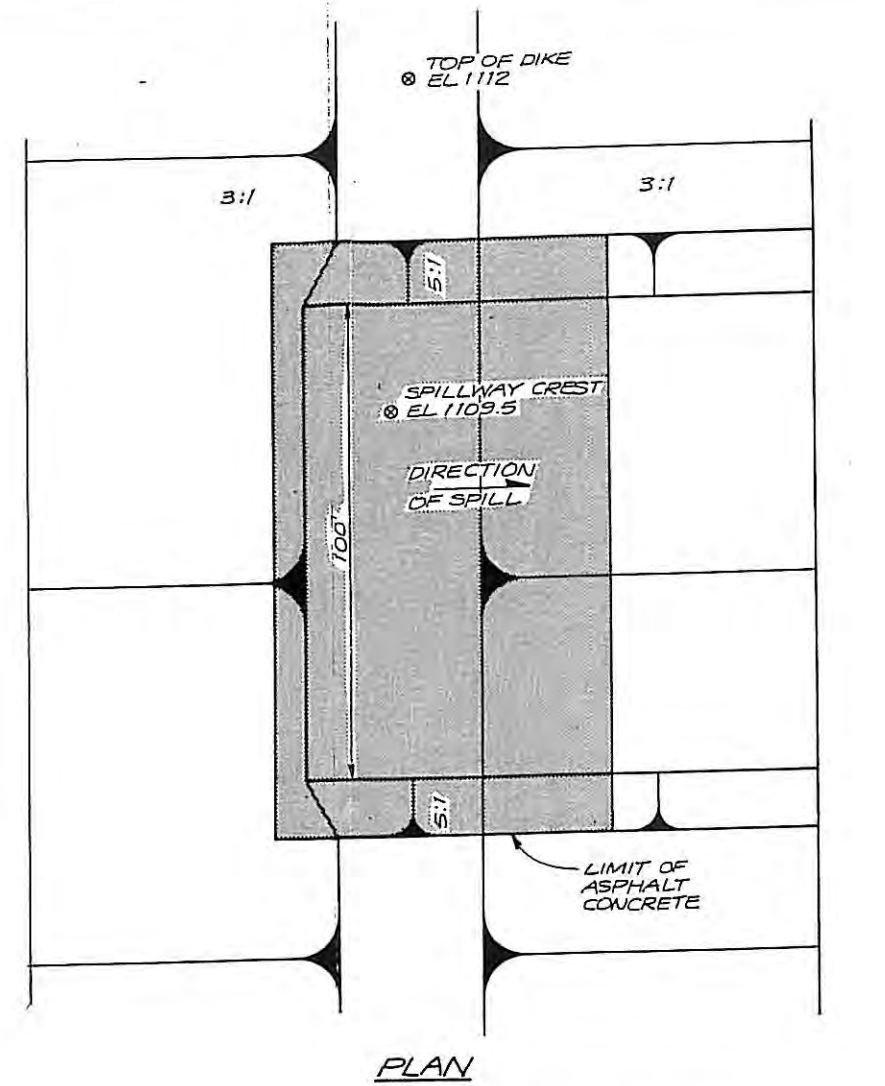
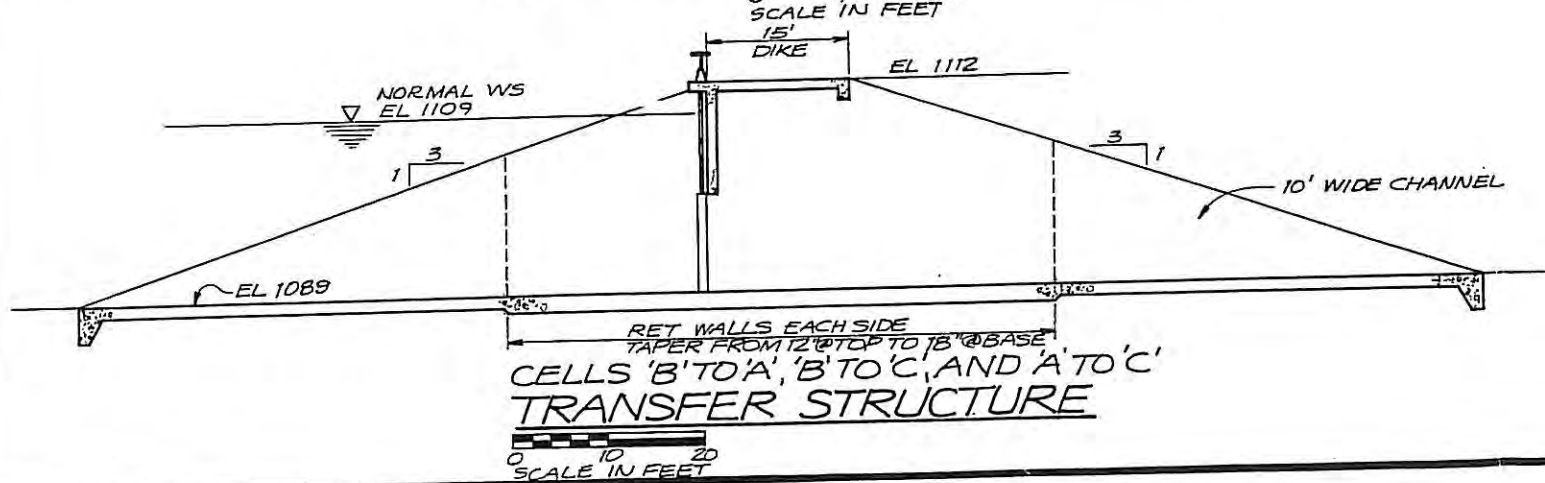
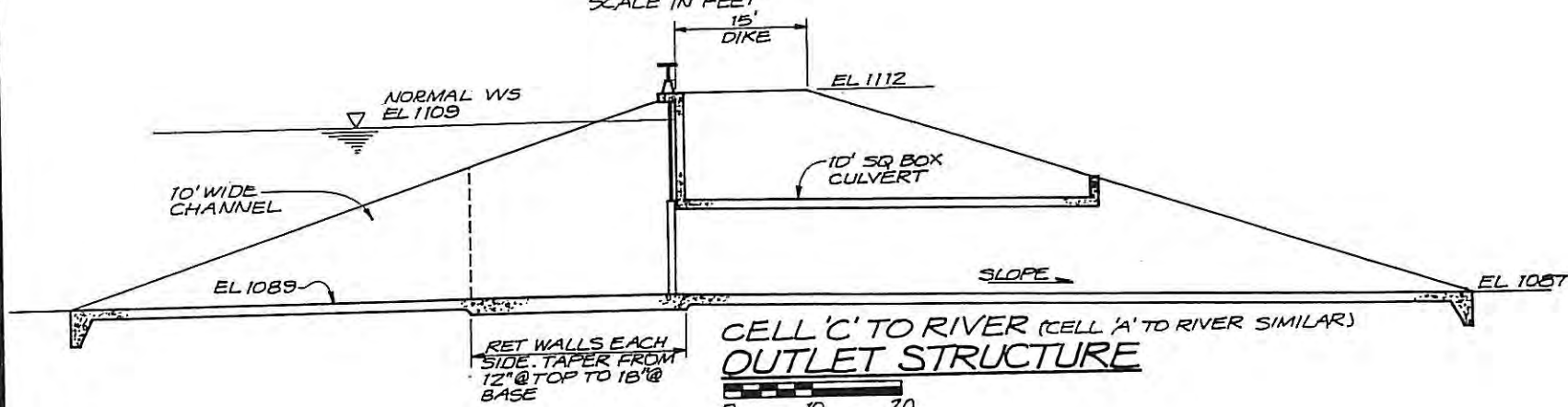
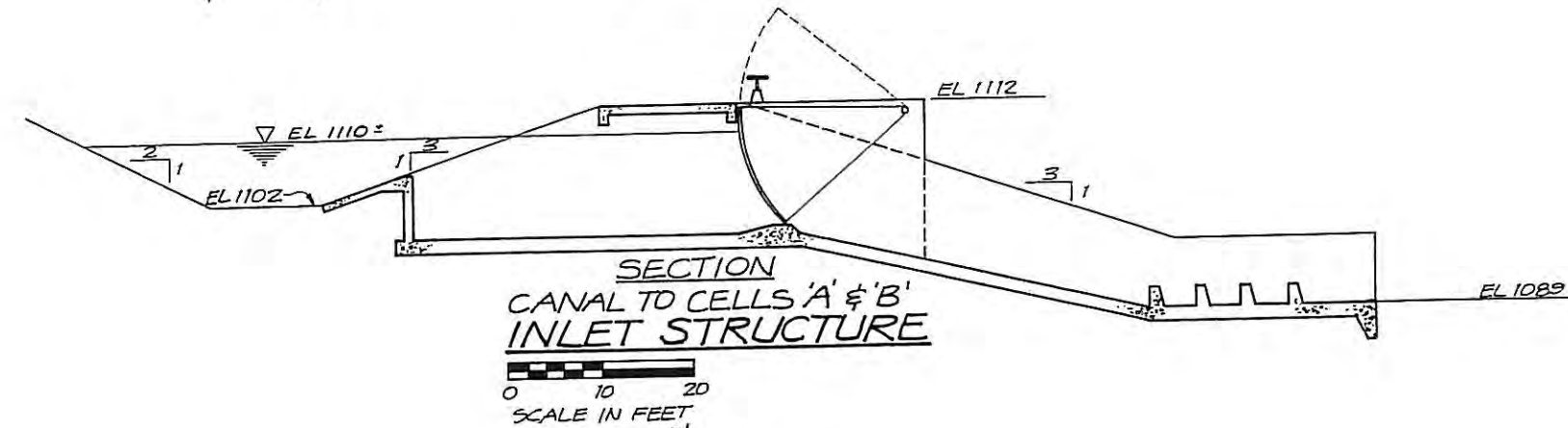
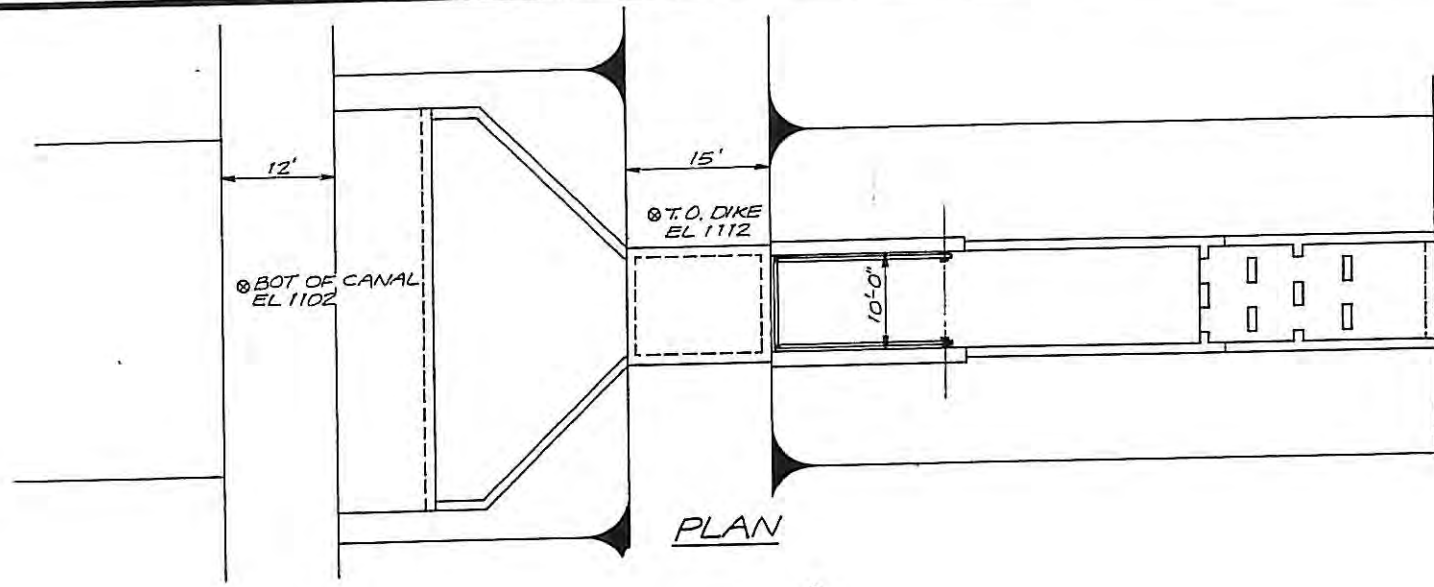


Figure A-7
GRAVEL PIT
STRUCTURES DETAILS

SITE LOCATION AND DESCRIPTION	DAM			RESERVOIR		MONITOR AND CONTROL EQUIPMENT				FLOW TIME TO SUNNY-SIDE DAM HOURS	MAJOR ENVIRONMENTAL IMPACTS	ECONOMICS			FINANCE (\$ X 1,000)		
	TYPE	LENGTH (FEET)	HEIGHT (FEET)	MAXIMUM SURFACE AREA	ACTIVE STORAGE VOL.	TELEMETRY EQUIPMENT		GATES AND VALVES	METERS AND GAGES			COST	BENEFITS	BENEFIT/COST RATIO	COST (MAY 1978)		ANNUAL COST
				(ACRES)	(AC-FT)	DATA LINKS	TRANS-MITTERS								PRESENT VALUE, MAY 1978	PRESENT VALUE, MAY 1978	
SELAH CREEK, EARTH FILL DAM AND RESERVOIR Diversion Pipeline from Roza Canal, 6' Diameter Outlet Pipe return to Yakima River, 6' Diameter Pumping 64' Maximum Static Lift Mostly Private Land	EARTH-ROCK	900	100 W.S. 1262	74	3000	11	3	2-36 inch Sleeve Valves - Remotely Operated 2-72 inch Slide Gates 2-72 inch Butterfly Valves - Remotely Operated 2-48 inch Butterfly Valves - Operated Manually 2-42 inch Ball Valves - Pump Control, Remotely Operated Modulating	Reservoir W.S. Gage Canal W.S. Gage 1-72 inch Flow Meter (Either Direction Measure)	9.9	No Serious Unavoidable Impacts; Possibility of Archeological Materials on Site Reservoir Could Enhance Landscape Possible Development for Recreation	9,640 <i>~ \$ 11.5 million</i> 3-80	11,140	1.16 <i>~ 1.0</i>	9,323	66	707
WENAS CREEK Diversion from Roza Canal, 5' Diameter Outlet return to Yakima River, 5' Diameter Mostly Private Land <i>Homes involved</i>	EARTH-FILL	800	70 W.S. 1190	98	2250	6	2	2-36 inch Sleeve Valves - Remotely Operated 2-60 inch Slide Gates - Manually Operated 1-60 inch Butterfly - Remotely Operated	Reservoir W.S. Gage Canal W.S. Gage 1-60 inch Flow Meter	9.3	Environmental Questions Concerning 4 Homes Adjacent to Maximum Pool Water Surface Known Archeological Sites(3) Partial Loss of Fishing/Spawning Stream Potential Damage in Event of Dam Failure Possible Development for Recreation	6,805 <i>~ \$ 8 million</i> 3-80	11,140	1.64 <i>~ 1.4</i>	6,807	31	499
EAST SELAH GRAVEL PITS Private Land Gravity Inflow and Outlet, 10' Diameter Pipe Open Diversion Channel	EARTH AND GRAVEL DIKE	17,500 New 3,500 Minor Improvement	Varies to 15 W.S. 1109 Three Ponds	199	1320 to 2800, Depending on Which Combination of Cells is Used for Storage	11	5	1 Manual Radial Gate 2 Remotely Operated Radial Gates 5 Remotely Operated 10 foot Slide Gates	1-Inlet Channel W.S. Gage 3-Cell W.S. Gages 2-10 foot Flow Meters	7.5	Near-Term Loss of Nesting and Other Riparian Habitat but Opportunity for Partial Mitigation. No Adverse Impact to Fish if Intake/Outlet Screened Fishing Could be Expanded in Reservoir Cells	7,791 <i>~ \$ 9.2 million</i> 3-80	11,140	1.43 <i>~ 1.2</i>	7,669	44	572

SITE EVALUATION MATRIX

APPENDIX B

Operations Modeling Procedure

APPENDIX B

OPERATIONS MODELING PROCEDURE

INTRODUCTION

To adequately evaluate the effects of reregulating the Yakima River with the three proposed structures, a computer program was developed. Using daily historical flow rate data at Parker, the computer program actually simulates the required operations of the proposed reregulation facilities. The computer looks at the historical flow data at Parker and decides when to store or release water from the reregulation structure. It also decides how much water to store or release. After the flow at Parker has been reregulated, the computer decides how much water can be saved by cutting back releases from the mountains and still provide the desired target flows at Parker.

NEED FOR MODEL

The need for this computer model became evident when evaluation of the large amount of daily data was considered. Hand calculation of water saved by reregulation for just one site location, one target flow, and one irrigation season proved very time consuming. With a carefully designed program, a large number of alternatives could be considered accurately and quickly. The computer program, within certain limitations, could actually model the daily operations of each site under consideration and evaluate the effectiveness of the reregulation of the Yakima River for various past years.

GOALS OF STUDY

The goals of the model study are (1) to minimize the number of water-short days by providing a minimum target flow over the Sunnyside Dam and (2) to conserve water when possible by cutting back water releases from the five mountain reservoirs. Experimentation with the model parameters (reservoir size, for example) showed us the importance of each feature toward achieving these goals.

ASSUMPTIONS

In order to model the reregulation structures, certain basic assumptions were necessary in the computer program. The assumptions made are as follows:

1. Operation of the reregulation dam is controlled by a demand for water at Parker.
2. No lag time exists between Parker and the three proposed reregulation sites. This assumption is valid for the prototype facility if the proposed gaging stations at the Harrison Bridge and Nelson Bridge sites are established.
3. For the purpose of the study, it is assumed that the natural runoff into the reregulation reservoirs equals the water lost to evaporation and leakage.
4. Only the summer months, April through September, are of concern to river reregulation for irrigation.
5. The reregulation reservoir starts full as of 1 April each year.
6. Only daily flow data were readily available; hence, computer decisions regarding reregulation were made on a 24-hour basis at the beginning of the day. The reregulation reservoir capacity was monitored at the end of each day for the feasibility study.

The actual reregulation facility would be monitored constantly.

RULES

The following rules of operation were programmed into the computer model.

1. Realizing that the prototype structure could rely only on past flow data and not future flow data to make a decision to reregulate the river flow, a system to evaluate the past 3 days' flow history at Parker was devised: if the reregulation reservoir is full and the previous 3-day average flow is 50 cfs or greater than the desired flow at Parker, subtract 50 cfs from the recorded flow for all days following. In other words, cut back release flows from the mountain reservoir if this condition prevails. This is how the program determines the amount of water that might be saved.
2. Conversely, if the reregulation reservoir is less than half full, add 100 cfs to the recorded flow for all days following. If this condition prevails, an increase in mountain reservoir releases is required to satisfy the water demands from the river minimum flows and refilling requirements of the reregulation reservoir.
3. A cutback in flows from mountain reservoirs can only be effected if the amount of the cutback is less than or equal to the sum total of all five mountain reservoir controlled releases. The release cutback amount is chosen as the lesser of the two values.
4. Filling rates vary as a function of reservoir characteristics and inlet pipe size. A 5-foot-diameter pipe was chosen for the Wenas site, to be filled by gravity head. A 6-foot-diameter pipe and pumping plant were selected for Selah Creek, and 10-foot-diameter gravity inlet-outlet pipes were selected for Selah gravel pits.
5. Filling rates are further limited by the amount of excess flow in river; for example, the reservoir may be capable of being filled at a rate that could produce a shortage in the river flow--only excess flow is diverted into storage.

6. Filling rates are further limited by maximum storage. For example, the maximum volume is, say, 3,000 acre-feet. The present volume is 2,600 acre-feet, limiting the 24-hour delivery to 200 cfs to fill the reservoir even though inlet works will handle more flow.
7. Discharging rates are independent of head behind the reservoir because of short pipes and relatively low discharge rates required. A shortage is detected in the river, and a decision to release water from the reregulation reservoir is made. Discharges are made in blocks. For the purposes of the study, discharges were made in blocks of 100 cfs to a maximum of 400 cfs. For example, if Parker were short 123 cfs, the reregulation structure would release 200 cfs. If the shortage were 750 cfs, however, the structure would only release up to 400 cfs.
8. Discharging rates are further limited by minimum storage. For example, say 400 acre-feet of storage in reservoir remains in the reservoir, then the maximum 24-hour discharge is 200 cfs, not 300 or 400 cfs.

DISCUSSION OF STUDY

A complete list of all the variables in the computer program (included in the documentation file) shows that the program is extremely flexible. By altering the values of some of these variables, an optimum design of the reregulation facility can be achieved. For example, the model study indicated that a 6-foot-diameter inlet-outlet pipe at Selah Creek was much more effective at reregulation than a 5-foot-diameter pipe. However, the benefits of a 7-foot-diameter pipe did not appear to warrant the extra costs in terms of water saved and minimized water-short days over the irrigation season.

As it turned out, the computer model developed was useful as both a study and design tool. By altering the program to accept gage flow input instead of historical flow data from the river, the program could be used to actually operate the facility, once constructed.

LIMITATIONS

Limitations of the computer program as it now exists are mainly in the area of mountain reservoir control. The program monitors the sum total of daily controllable releases from the mountain reservoirs but does not monitor the ability of each mountain reservoir to accept the release cutbacks as additional storage. In other words, any claim of water saved is contingent on available mountain storage capacity.

To adequately address the question of mountain reservoir control, a study of the water management for the entire Yakima Basin is indicated. The computer program model at present can easily be altered to encompass this additional requirement.

PROTOTYPE CONTROL

Actual control of the prototype reregulation structure with the present computer model would invalidate some of the basic assumptions. The assumption of no lag time between the reservoir site and the Sunnyside Dam would probably have the greatest effect on the dam operations. By establishing ratings for the proposed new gages, predicted flows at the Sunnyside Dam could be made by studying hydraulic effects of the river. The computer could be programmed so that the effects of lag time, channel storage, and uncontrolled diversions, etc., between the reregulation site and Sunnyside Dam could be dealt with more effectively.

Actual operation of the reregulation facility would warrant monitoring river flows on a continuous basis rather than the 24-hour interval assumed for the model study. The proposed new gaging stations, having been rated over a period of time, will eliminate the lag time concern between the reregulation structure and Parker.

CONCLUSIONS

The computer program model was a valuable tool in evaluating the benefits of each of the three proposed reregulation sites. With some modification, the program can be used to actually control the operation of the facility upon completion of the project.

The assumption of "no lag time" between the reregulation facility and Parker is valid for the prototype if the proposed new gages are established on the Yakima and Naches Rivers and the information received from these gages can accurately predict the expected flows over the Sunnyside Dam at Parker.

Automated control of the entire Yakima Basin, although not within the scope of this study, is a logical extension of this computer model. Efforts by the U.S. Bureau of Reclamation to automate the Yakima project are currently underway. The program model as conceived in this study might augment the Bureau's efforts to provide the much-needed automated control of the Yakima Basin.

APPENDIX C

Terrestrial Biology

TERRESTRIAL BIOLOGICAL ASSESSMENT
OF THREE POTENTIAL SITES FOR WATER STORAGE RESERVOIRS
NEAR YAKIMA, WASHINGTON

PREPARED FOR:

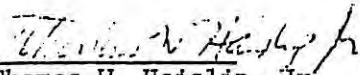
CH₂M HILL, INC.
1500 - 114th AVE. S.E.
BELLEVUE, WASHINGTON 98004

PREPARED BY:

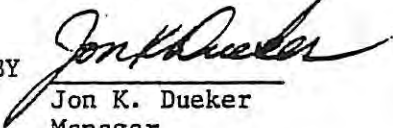
BEAK CONSULTANTS INCORPORATED
THIRD FLOOR, LOYALTY BUILDING
317 S.W. ALDER
PORTLAND, OREGON 97204

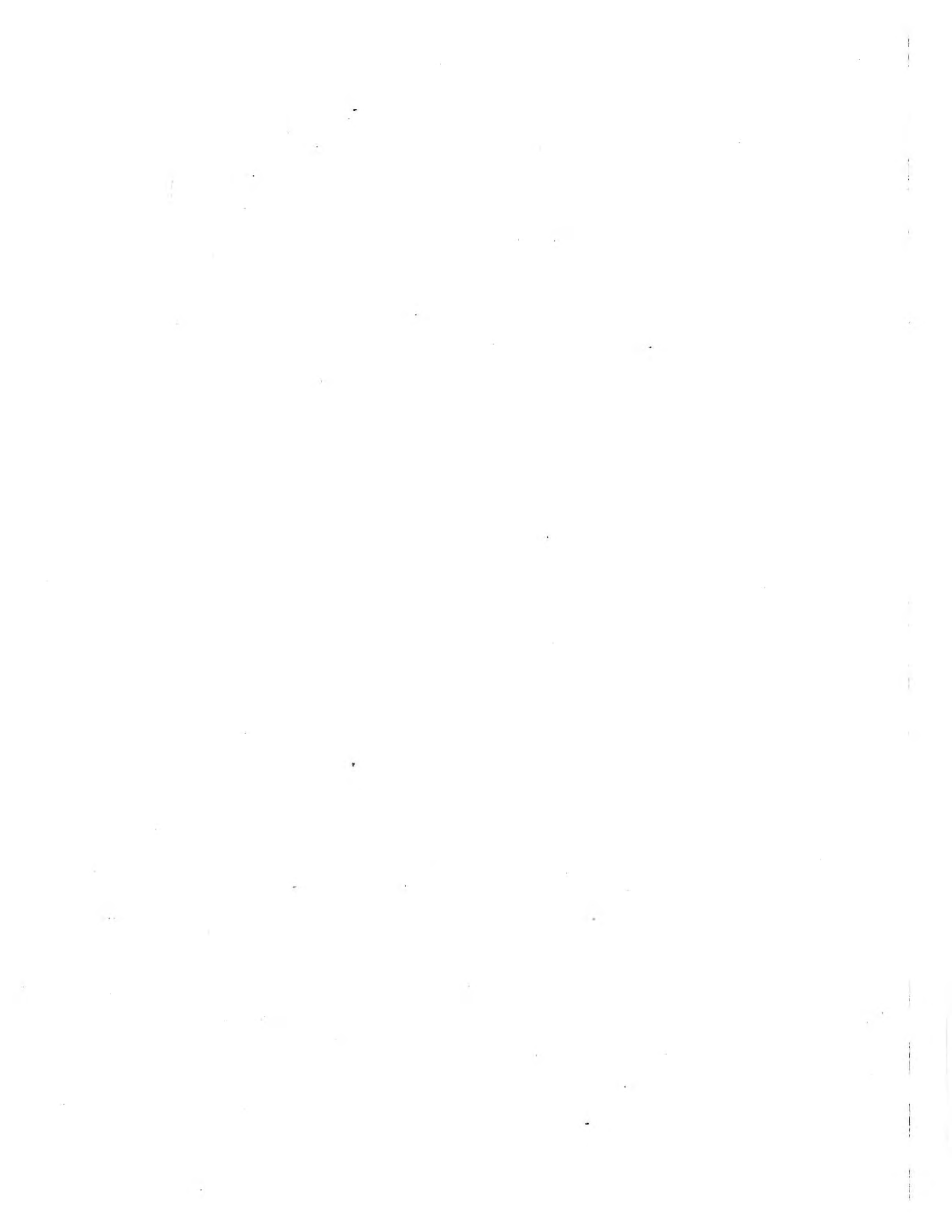
PROJECT D2315

SUPERVISED BY


Thomas W. Haislip, Jr.
Project Manager

APPROVED BY


Jon K. Dueker
Manager



INTRODUCTION

The feasibility study of the three potential water storage sites includes an assessment of the terrestrial fauna and flora occurring on each site. The input of the assessment is limited to a site visit. Its intent is to describe the biological character of the sites and compare their potential for impact and mitigation.

METHODS

A visit to each site was conducted on March 30, 1978. The study team included Bob Hogan and Don Holms, both of CH₂M Hill, Pete Rice, an archeologist from Natural Heritage Inc., and Tom Haislip of Beak Consultants who conducted the terrestrial biology survey. The Selah Creek and Wenas Creek sites were surveyed in the morning and the gravel pit visited in the afternoon. At each site the team spent about an hour walking and driving over the area taking notes on the pertinent features. All of Selah Creek and the gravel pits were inspected but only the lower half mile of Wenas Creek was surveyed. The terrestrial biology survey emphasized habitats and wildlife observed. Because of the brief visit and lack of appropriately scaled aerial photography, no habitat maps of the sites were prepared.

SITE DESCRIPTIONS

Selah Creek

The Selah Creek site consists of a valley bottom 600-800 feet wide with sides rising abruptly some 200 ft. The south wall is a sheer cliff face of about 50-100 feet at the top and talus slopes at the base. The north wall has less relief with more talus slopes and a shorter cliff face of 25-50 feet. The bottom is somewhat irregular with shallow rocky soil. A small trickle was flowing in Selah Creek at the time of our visit.

The dominant vegetation is big sagebrush with occasional spiny hopsage and horsebrush. Various grasses and weeds such as filaree make up much of

the sparse ground cover. No riparian vegetation is found along the creek although squaw current, golden current and western chokecherry are found at the base of the south wall not far from the creek bed. The area has been heavily grazed and thus supports a rather sparse and simple flora.

The wildlife of the site consists of desert oriented species, particularly those adapted to the sheer rock walls and talus slopes. Most noticeable are nesting birds such as Violet-green Swallows, White-throated Swifts, Rock Wrens, Canyon Wrens and a variety of raptors. Red-tailed Hawks, including a nonactive nest, and Sparrow Hawks were observed although the potential for Prairie Falcons, Golden Eagles and other broad-winged hawks nesting on the cliffs exists. The bottom area is used by Black-billed Magpies, Western Meadowlarks, Starlings, Robins and other birds. Evidence of mule deer and coyote use of the area was noted along with reports of a high population of rattlesnakes.

In general the Selah Creek site offers a moderate diversity of habitats, highlighted by the extensive cliff face environment, for birds, mammals and reptiles. However the extensive grazing has somewhat reduced an already limited plant productivity and associated wildlife. No endangered or threatened species are known or suspected of occurring on the site.

Wenas Creek

The Wenas Creek site is characterized by a relatively flat floodplain about 800 feet across at its widest. The relief is low with 40-50 foot cliffs at the mouth of the creek and diminishing upstream. The bottomland soil is deep with few rocks except at the perimeter where small talus slopes form the base of the cliffs. Wenas Creek was flowing full at the time of our visit.

The habitat is primarily a well-grazed pasture consisting of various grasses, clover, filaree and other forbs. The meadow covers nearly the entire

site. There is no riparian vegetation along the stream except for a one-acre patch of cattail marsh near a turn in the creek. A small cottonwood and willow thicket is found on the south perimeter near the mouth.

Few wildlife were recorded at Wenas Creek. Birds included Mallards, Ring-necked Pheasants, Red-winged Blackbirds, Killdeer, Western Meadowlarks, Rock Wrens and Black-billed Magpies. Other wildlife such as raccoon (tracks) and a wandering garter snake were also noted. No other mammal tracks were observed along the mud stream border.

Wenas Creek is relatively low in habitat diversity even though it may be fairly high in plant productivity. This is attributed to the rather simple structure of the habitat which is dominated by grass and is maintained in that state by grazing. No endangered or threatened species are known or suspected for the site.

Gravel Pit

The gravel pit site is located adjacent to the Yakima River in its flat floodplain. The site has been heavily disturbed over the years by the gravel removal that is still going on. Several different sized ponds have been created ranging from less than 5 acres to over 50 acres. The ponds are of varying age so that different levels of vegetation growth have developed at their perimeters. The north end appears to have been undisturbed the longest while active operations are going on at the south end. A garbage dump is located just north of the active pits.

The habitats are fairly diverse both in distribution and in kinds of vegetation. Scattered willows and cottonwoods line many of the older ponds and along the river dike. Most of these trees appear to be dead. An area of large cottonwood snags is found at the northern edge of the site. A number of the northern ponds have cattail marshes at their edges or in shallow areas. Most

of the upland areas between ponds have sparse grasses and weeds.

A considerable variety of wildlife occur in the habitats of the gravel pit. Waterfowl observed include Canada Geese, Whistling Swans, Mallards, American Wigeon, Wood Ducks and Coots. Other water oriented wildlife include gulls, Belted Kingfishers, Long-billed Marsh Wrens, Red-winged Blackbirds and Killdeer. In addition, a pair of Bald Eagles were recently recorded in the area. A muskrat lodge was observed in a well developed cattail marsh in the northern portion. The stand of large cottonwood snags are likely used for nesting by Wood Ducks, Magpies, Starlings and Common Flickers.

The gravel pit site appears to be quite diverse for habitat and wildlife. This has been brought about by major modifications of the terrain as part of the gravel operations but accentuated by the natural productivity of the floodplain and the extended time certain areas have had to develop. The Bald Eagle is now officially designated a threatened species by the U.S. Fish and Wildlife Service. Its use of the area appears to be sporadic and may occur only during migration periods. No other endangered or threatened species are known for the site.

DISCUSSION

In all cases, the development of water storage facilities would eliminate most or all of the existing habitat, forcing the displacement of its wildlife. The full extent of the losses can only be roughly estimated because of the very limited input available at this time. At Selah Creek all the bottomland and some of the lower talus slopes would be inundated. The sheer cliffs would be retained. At Wenas Creek all of the bottomland and most of the cliff faces would be lost. Some shallow areas would be created. At the Gravel Pit most of the riparian and marsh vegetation would be lost although various areas would be exposed if cells were used to rework selected portions.

The opportunity to mitigate for these losses is low at Selah Creek, moderate at Wenas Creek and high at the Gravel Pit. The water surface adjacent to high cliffs at Selah Creek may actually improve the area for cliff nesting raptors and other birds. This might be further enhanced if a fishery could be established. However it is unlikely that emergent vegetation can be established. Relatively shallow areas would be left in places at Wenas Creek which could be developed into marsh or riparian habitat. This could substantially improve the area for waterfowl and other marsh species. Since the riparian habitat at the Gravel Pit was created by major terrain modification, it could be replaced and enhanced by a similar approach. Shallow areas could be engineered to encourage the development of marsh vegetation. Contours of the cells could be created to maximize the perimeter for riparian habitat. In all areas plantings could be done to accentuate vegetative development.

Thus each site has its advantages and disadvantages regarding habitat and wildlife diversity, plant productivity and mitigation potential. Selah Creek has moderate diversity, low productivity and low mitigation potential. Wenas Creek has low diversity, high productivity and moderate mitigation opportunity. The Gravel Pit has high diversity, moderate productivity and high mitigation potential.

The result of this comparison is that no site proves to be substantially more acceptable than the other for development. Further, none of the sites appear to be especially valuable from a terrestrial biology point of view. This may well be related to their heavy use by man which has significantly modified their natural vegetation and use by wildlife. We therefore feel that terrestrial biology should not play a further role in site selection. Once a prime site is chosen, however, a better understanding of the terrestrial impacts should be gained and more precise mitigation measures determined.

APPENDIX D

Aquatic Biology

SELAH CREEK SITE

The aquatic habitat at the Selah Creek site is quite limited. No surface flow was present in Selah Creek (an ephemeral stream) during the 30 March 1978 reconnaissance at the point where the proposed dam would intersect the streambed. Farther upstream, surface flow amounted to less than 0.1 cfs, flowing over a bed consisting mainly of pebbles and coarse sand. Several pools up to 50 feet long and 1 foot deep were present between the highway bridge and the potential damsite.

While the water was clear and relatively cool, the ephemeral nature of the stream precludes colonization of the stream channel by most aquatic organisms. The major exceptions are insects with aquatic larval stages that can make use of the water on a seasonal basis.

Construction of a dam at this site would have little or no negative impact on aquatic communities and should therefore require no mitigation for loss of aquatic resources. Instead, new aquatic habitat would be created, with the potential for some year-round habitat. The extent of a permanent pool would, however, depend on irrigation demands, and it is anticipated that pool level would fluctuate throughout the irrigation season. Potential for meaningful aquatic and riparian habitat would therefore depend on agency management.

WENAS CREEK SITE

Although Wenas Creek was turbid and flowing at an almost bank-full level during the reconnaissance survey, irrigation diversions are responsible for greatly reduced flows in summer. This stream does, however, provide spawning habitat for steelhead, coho salmon, chinook salmon, rainbow trout, and whitefish, especially in the reach near its junction with the Yakima River. The reduced flows result in only moderate spawning success, but fish are present in the stream all year and the potential project area is a popular fishing spot, particularly in the early summer.

Construction of a dam at this site would block anadromous fish runs unless a fish ladder or other fish conveyance mechanism were incorporated in the project design. In addition, more than 2 miles of spawning habitat would be inundated. The large water level fluctuations behind the dam would probably preclude effective management of the reservoir for the species of fish now present in the affected reach of the stream.

It is anticipated that the Washington Department of Game might require mitigation of project impacts on aquatic resources. The extent of the mitigation would depend on the productivity of the area affected and would probably require studies specific to the affected reach of the stream.

EAST SELAH GRAVEL PITS

Of the three potential sites, the gravel pit site presently possesses the most productive aquatic habitat. The various mined-out pits that have been allowed to fill with water have been stocked with fish by the Washington Department of Game. While there is no trout reproduction, various spiny ray fish (yellow perch, large mouth bass, crappie, blue-gill, and pumpkinseed) do reproduce and are a self-sustaining fishery. Public access is available and these ponds are a popular fishing area.

Cattail-bulrush habitat has formed around the edges of some pits (especially the more northern ones), and this serves as a nursery area for young fish and provides good waterfowl cover. Water quality in these ponds is generally good and they are expected to continue to provide a minimal warm- and cool-water fishery.

Inundation of this area would not greatly alter the deeper portion of these ponds, and the present fish species would probably remain. Water quality, however, might suffer as continually changing water levels would increase disruption of bottom sediments that could in turn lead to increased turbidity. In addition, it is likely that the majority of the existing cattail-bulrush habitat would be lost and that this would lead to a reduction of fisheries and waterfowl productivity.

Possibilities for mitigation of loss of aquatic resources appear to lie mainly with development of an appropriate bottom contouring and water level management plan based on preferred depths and times of spawning. The existence of a large residual water supply and pre-established "cells" makes such a plan more possible at this site than at the Selah Creek or Wenas Creek sites. Some cutting and filling might be necessary to ensure the success of such a program.

APPENDIX E

Archeology

On March 30, 1978, a visit was made to three possible reservoir sites in the vicinity of Selah, Washington in order to estimate the potential for historical or archaeological resources at those sites and to rate them according to their potential. The field trip was conducted by CH2M HILL personnel. Approximately one and one-half hours were spent at each site in this initial visit -- not enough time certainly to make any meaningful evaluations beyond first impressions provided by some minimal field observations.

The locations visited are as follows:

Selah Creek Canyon The reservoir plan for this canyon would not impact any recorded archaeological sites. The reservoir would lie between a burial site (45YK14) near the mouth of the Canyon and a group of petroglyphs (45YK125) located on north side of the Canyon under the Interstate 82 highway bridge. The reservoir plan as described would not impact either of these sites.

A very cursory examination of the floor of the Canyon revealed a number of cryptocrystalline silica flakes which were produced by the activities of a stone tool maker. No concentration of flakes were found, but the inspection consisted of a single, rather hasty, walk down the Canyon. An exposure of what appeared to be redeposited volcanic ash, probably of Mt. Mazama origin (ca. 6700 yrs. B.P.), was noted in the Canyon.

The potential for archaeological resources in the project area of Selah Creek Canyon is very high. There is a recorded site at each end of the proposed reservoir and a lithic scatter between them. A thorough survey of the proposed project area is recommended if the plan for Selah Creek Canyon remains viable. This survey would aid in planning since mitigation of impacts to archaeological resources can become an important

consideration if such resources are present. Only a thorough survey can determine if significant archaeological resources are within the project area.

No attempt was made to evaluate historic resources at Sulah Creek, but there were no structures or foundations observed in the study area.

Wenas Creek Construction of a dam and reservoir at the mouth of Wenas Creek on the axis indicated by CH2M HILL personnel would damage archaeological resources. Archaeological sites 45YK16, 45YK17, and 45YK18 are located at the mouth of Wenas Creek. These sites were partially excavated by Claude Warren (1968) in 1956 as part of a salvage program for a natural gas pipeline. A later test of the main occupation site at the mouth of the Creek at site 45YK16 was made by David Rice (1969) [Rice lists the site as 45YK51]. This site was reported by both excavators to have been badly damaged by relic collectors. The cultural deposits are quite rich and are relatively recent by current archaeological chronologies.

Little evidence of past excavations by relic collectors or archaeologists can be seen at the site today. A lush green pasture covers the site area at present and the pits are hardly discernable.

There is, in all probability, data yet to be gained at this site. Warren's excavations were confined to the route of the pipeline and Rice dug only a two meter by two meter square.

Careful consideration must be given to any plan that would damage this site. Paradoxically, the proposed dam would probably impact a portion of the site, and also serve to protect what may be the main segment of 45YK16 from eventual destruction by the erosion from Wenas Creek. This possibility should be explored if the plan for Wenas Creek remains viable.

A PRELIMINARY EVALUATION OF
THREE POTENTIAL WATER STORAGE SITES
NEAR YAKIMA, WASHINGTON

by
Harvey S. Rice

National Heritage, Inc.
P.O. Box 185
Pullman, Washington 99163

Wenas Creek has been surveyed for archaeological sites by David Rice (1969) and only the sites mentioned are within the present study area. No structures or foundations were observed in the planned project area.

The Gravel Pit The gravel pit on the east bank of the Yakima River identified as a possible location for water storage appears to have no potential archaeological or historical resources. Disturbance to the original ground surface has reached magnificent proportions in the gravel pit thus precluding the possibility of undisturbed cultural resources.

In an effort to rank the three possible reservoir sites in order of archaeological potential, Selah Creek and Wenas Creek seem to be equal in possible importance. Selah Creek has indications of archaeological resources, but it has not been systematically surveyed and its potential will remain unknown until such a survey takes place. Wenas Creek, on the other hand, has been surveyed, has archaeological sites of which something is known through partial excavation, and which may be partially destroyed and partially protected by the construction of a dam.

The gravel pit site needs no further consideration from the standpoint of cultural resources.

Only further study can answer the questions at Selah Creek and Wenas Creek. A survey at Selah Creek would be the logical first step in research. Test excavations along the dam axis and consultation between archaeologists, hydrologists and construction engineers would be a useful approach at Wenas Creek.

REFERENCES

- Rice, David G. Archaeological Reconnaissance South-Central Cascades
1969 Washington. Occasional Paper No. 2. Washington
 Archaeological Society. Seattle.
- Warren, Claude N. The View From Wenas: A Study in Plateau Prehistory.
1968 Occasional Paper No 24. Idaho State University Museum.
 Pocatello.