

# MARKS PUBLISHED FOR OPPOSITION

The following marks are published in compliance with section 12(a) of the Trademark Act of 1946. Applications for the registration of marks in more than one class have been filed as provided in section 30 of said act as amended by Public Law 772, 87th Congress, approved Oct. 9, 1962, 76 Stat. 769. Opposition under section 13 may be filed within thirty days of the date of this publication. See rules 2.101 to 2.105.

A separate fee of three hundred dollars (\$300.00) for opposing each mark in each class must accompany the opposition.

## SECTION 1.— INTERNATIONAL CLASSIFICATION

The short titles associated below with the international class numbers are terms designed merely for quick identification and are not an official part of the international classification. The full names of international classes are given in section 6.1 of the trademark rules of practice.

The designation "U.S. Cl." appearing in this section refers to the U.S. class in effect prior to Sep. 1, 1973 rather than the international class which applies to applications filed on or after that date. For adoption of international classification see notice in the OFFICIAL GAZETTE of Jun. 26, 1973 (911 O.G. TM 210).

### Application in more than one class

SN 74-731,685. COMIC RELIEF, INC., LOS ANGELES, CA.  
FILED 9-20-1995.

SN 76-677,626. ASAHI GLASS COMPANY, LIMITED, CHIYO-  
DA-KU, TOKYO 100-8405, JAPAN, FILED 5-30-2007.

## COMIC RELIEF

The logo for AGC consists of the letters 'AGC' in a bold, blue, sans-serif font. The letter 'G' is partially red, with the red color filling the right side of the letter.

NO CLAIM IS MADE TO THE EXCLUSIVE RIGHT TO USE "COMIC", APART FROM THE MARK AS SHOWN.

### CLASS 9—ELECTRICAL AND SCIENTIFIC APPARATUS

FOR SOUND RECORDINGS AND VIDEO RECORDINGS, NAMELY, PRE-RECORDED VIDEO CASSETTES, VIDEO DISCS, AND MULTIMEDIA SOFTWARE RECORDED ON CD-ROM FEATURING COMEDIC PERFORMANCES AND COMEDY SHOWS (U.S. CLS. 21, 23, 26, 36 AND 38).

FIRST USE 5-0-1986; IN COMMERCE 5-0-1986.

### CLASS 16—PAPER GOODS AND PRINTED MATTER

FOR PRINTED MATERIALS, NAMELY, SOUVENIR PROGRAMS CONCERNING COMEDIC CONCERTS AND EVENTS AND NEWSLETTERS CONCERNING THE COMEDY ENTERTAINMENT INDUSTRY (U.S. CLS. 2, 5, 22, 23, 29, 37, 38 AND 50).

FIRST USE 5-0-1986; IN COMMERCE 5-0-1986.

### CLASS 41—EDUCATION AND ENTERTAINMENT

FOR ENTERTAINMENT SERVICES, NAMELY, PRODUCING TELEVISION COMEDY SHOWS AND PROGRAMS AND PRODUCING THEATRICAL PERFORMANCES IN THE NATURE OF PLAYS AND SHOWS IN THE FIELD OF COMEDY (U.S. CLS. 100, 101 AND 107).

FIRST USE 5-0-1986; IN COMMERCE 5-0-1986.  
SUSAN HAYASH, EXAMINING ATTORNEY

PRIORITY CLAIMED UNDER SEC. 44(D) ON JAPAN APPLICATION NO. 2006-115422, FILED 12-1-2006, REG. NO. 5090762, DATED 11-9-2007, EXPIRES 11-9-2017.

OWNER OF U.S. REG. NOS. 1,924,939, 2,104,794 AND 3,269,059.

THE COLOR(S) RED AND BLUE IS/ARE CLAIMED AS A FEATURE OF THE MARK.

THE MARK CONSISTS OF THE WORDING "AGC" WITH THE COLOR RED APPEARING IN PART OF THE LETTER "G" AND THE COLOR BLUE APPEARING IN THE REST OF THE WORDING OF THE MARK.

### CLASS 1—CHEMICALS

FOR CHEMICALS FOR USE IN INDUSTRY; ADHESIVES NOT FOR STATIONERY OR HOUSEHOLD PURPOSES; PLANT GROWTH REGULATING PREPARATIONS; CERAMIC GLAZINGS; PHOTOGRAPHIC CHEMICALS; UNPROCESSED PLASTIC MATERIALS IN POWDER, LIQUID, OR PASTE FORM; TRANSPARENT CONDUCTING OXIDE (TCO); SILICON CARBIDE FOR INDUSTRIAL FURNACES (U.S. CLS. 1, 5, 6, 10, 26 AND 46).

### CLASS 2—PAINTS

FOR PAINTS (U.S. CLS. 6, 11 AND 16).

### CLASS 3—COSMETICS AND CLEANING PREPARATIONS

FOR DE-GREASING PREPARATIONS FOR HOUSEHOLD PURPOSES; RUST REMOVING PREPARATIONS; PAINT STRIPPING PREPARATIONS; POLISHING PREPARATIONS; SOAPS AND DETERGENTS (U.S. CLS. 1, 4, 6, 50, 51 AND 52).

**CLASS 6—METAL GOODS**

FOR STEELS, NAMELY, GLASS-LINED STEEL DRAIN PIPES FOR CHEMICAL PLANTS; METAL MATERIALS FOR BUILDING OR CONSTRUCTION, NAMELY, METAL WINDOW SASHES; METAL HARDWARE, NAMELY, BOLTS, NUTS, WASHERS (U.S. CLS. 2, 12, 13, 14, 23, 25 AND 50).

**CLASS 7—MACHINERY**

FOR CHEMICAL PROCESSING MACHINES AND APPARATUS, NAMELY, DUST COLLECTING MACHINES FOR CHEMICAL PROCESSING; DRYING APPARATUS FOR CHEMICAL PROCESSING, NAMELY, RECIRCULATED AIR DRYERS FOR CHEMICAL PROCESSING (U.S. CLS. 13, 19, 21, 23, 31, 34 AND 35).

**CLASS 9—ELECTRICAL AND SCIENTIFIC APPARATUS**

FOR OPTICAL GLASSES; OPTICAL FILTER FOR PLASMA DISPLAY PANELS (PDP); ELECTROLYSERS; LABORATORY APPARATUS AND INSTRUMENTS, NAMELY, TEST TUBES, FLASKS, PIPETTES, BEAKERS, BOTTLE TOP FILTERS USED FOR THE PURIFICATION OF TISSUE CULTURE MEDIA, PETRI DISHES USED IN LABORATORY RESEARCH, GLASS SLIDES USED IN CHEMICAL AND BIOLOGICAL ANALYSIS, COVER GLASS FOR MICROSCOPE SLIDES; PHOTOGRAPHIC MACHINE PARTS, NAMELY, OPTICAL LENSES FOR PHOTOGRAPHIC MACHINES; CINEMATOGRAPHIC MACHINES PARTS, NAMELY, OPTICAL LENSES FOR MOVIE PROJECTORS, PHOTOGRAPHIC PROJECTORS AND SLIDE PROJECTORS; OPTICAL APPARATUS AND INSTRUMENTS, NAMELY, OPTICAL LENSES FOR DIGITAL CAMERAS AND CELL PHONE CAMERAS; MEASURING MACHINES AND INSTRUMENTS, NAMELY, GLASS DOSIMETER, OPTICAL READERS FOR GLASS DOSIMETERS; CHEMICAL MEASURING OR TESTING INSTRUMENTS, NAMELY, GRADUATED GLASSWARE, MEASURING GLASSWARE; BATTERIES AND CELLS, NAMELY, SOLAR CELLS, FUEL CELLS, BATTERIES, ANODES FOR LITHIUM ION BATTERIES, PHOTOVOLTAIC COVER GLASS FOR PHOTOVOLTAIC CELLS (SOLAR CELLS); MEMBRANE-ELECTRODE ASSEMBLY FOR FUEL CELLS, CONSISTING OF ELECTRODES AND MEMBRANES, FOR FUEL CELLS; ELECTRIC WIRES AND CABLES; SYNTHETIC QUARTZ GLASS PRODUCTS FOR USE IN TELECOMMUNICATION MACHINES AND APPARATUS, NAMELY, PHOTOMASK SUBSTRATES, NAMELY, SYNTHETIC QUARTZ GLASS PLATES BEING STRUCTURAL PARTS OF EXCIMER STEPPERS, FOR USE IN FABRICATION OF INTEGRATED CIRCUITS; MOLDED OPTICAL LENSES; ELECTRONIC MACHINES, APPARATUS AND THEIR PARTS, NAMELY, ELECTRON TUBES, CATHODE-RAY TUBES; PRINTED WIRING BOARDS CONSISTING PRIMARILY OF POWER WIRES AND PRINTED CIRCUIT BOARDS; OPTICAL APPARATUS AND INSTRUMENTS, NAMELY, STRUCTURAL PARTS FOR OPTICAL DISC DRIVES (U.S. CLS. 21, 23, 26, 36 AND 38).

**CLASS 11—ENVIRONMENTAL CONTROL APPARATUS**

FOR AIR-CONDITIONING APPARATUS FOR INDUSTRIAL PURPOSES, NAMELY, INDUSTRIAL AIR CONDITIONERS, INDUSTRIAL DEHUMIDIFIERS; WASTE WATER TREATMENT TANK PARTS FOR INDUSTRIAL PURPOSES, NAMELY, PLASTIC COVER FOR WASTE WATER TREATMENT TANKS; SEPTIC TANK PARTS FOR INDUSTRIAL PURPOSES, NAMELY, PLASTIC COVERS FOR SEPTIC TANKS; SOLAR WATER HEATER PARTS, NAMELY, GLASS COVERS FOR SOLAR WATER HEATERS; WATER PURIFYING APPARATUS, NAMELY, WATER PURIFIERS, INDUSTRIAL WATER PURIFYING APPARATUS; ELECTRIC LAMPS AND OTHER LIGHTING APPARATUS, NAMELY, GLASS TUBES AS STRUCTURAL PARTS FOR FLUORESCENT LAMPS; LAMP CHIMNEYS; LAMP REFLECTORS MADE OF GLASS FOR PROJECTOR LAMPS; OPTICAL LENSES MADE OF GLASS SOLD AS A COMPONENT FOR AUTOMOTIVE HEADLIGHTS (U.S. CLS. 13, 21, 23, 31 AND 34).

**CLASS 12—VEHICLES**

FOR AIRCRAFT AND THEIR PARTS AND FITTINGS, NAMELY, WINDOWS FOR AIRCRAFT; RAILWAY ROLLING STOCK AND THEIR PARTS AND FITTINGS, NAMELY, WINDOWS FOR RAILWAY ROLLING STOCK; AUTOMOBILE WINDOWS, AUTOMOBILE GLASS WINDOWS (U.S. CLS. 19, 21, 23, 31, 35 AND 44).

**CLASS 17—RUBBER GOODS**

FOR ELECTRICAL INSULATING MATERIALS; PLASTIC SEMI-WORKED PRODUCTS FOR USE AS MATERIAL, NAMELY, FLUOROPOLYMER IN THE FORMS OF PELLETS, BEADS, SHEETS, FILMS, TUBES, CRUMBS, POWDERS, PASTES, GRANULES AND CHIPS FOR INDUSTRIAL AND COMMERCIAL USE, AND FLUOROELASTOMER IN THE FORMS OF PELLETS, BEADS, SHEETS, FILMS, TUBES, CRUMBS, POWDERS, PASTES, GRANULES AND CHIPS FOR INDUSTRIAL AND COMMERCIAL USE; PLASTIC SHEETING FOR AGRICULTURAL PURPOSE; RUBBER, RAW OR SEMI-WORKED (U.S. CLS. 1, 5, 12, 13, 35 AND 50).

**CLASS 19—NON-METALLIC BUILDING MATERIALS**

FOR PLASTIC BUILDING MATERIALS, NAMELY, PLASTIC SHEETS AND FILMS USED AS AN INSULATING INFILTRATION BARRIER IN BUILDING CONSTRUCTION, PLASTIC WALLS, FENCES, ROOF COVERINGS; CEMENT MIXES; ALUMINA CEMENT MIXES USED AS A COMPONENT IN REFRACTORY MORTARS, CONSTRUCTION MATERIALS AND BUILDING MATERIALS; BUILDING GLASS (U.S. CLS. 1, 12, 33 AND 50).

**CLASS 20—FURNITURE AND ARTICLES NOT OTHERWISE CLASSIFIED**

FOR MIRRORS, MIRROR GLASS, GLASS FOR SHELVES AND FOR DISPLAYS (U.S. CLS. 2, 13, 22, 25, 32 AND 50).

**CLASS 21—HOUSEWARES AND GLASS**

FOR UNWORKED OR SEMI-WORKED GLASS NOT FOR BUILDING; UPRIGHT SIGNBOARDS OF GLASS; SEMI-FINISHED GLASS FOR FLAT PANEL DISPLAY, FOR CATHODE-RAY TUBE, FOR LENSES, FOR SOLAR CELLS, FOR HARD DISK DRIVE (HDD), FOR PHOTOMASKS, FOR LIGHT EMITTING DIODE (LED), FOR CHARGE COUPLED DEVICE (CCD) IMAGE SENSORS, FOR LIQUID CRYSTAL DISPLAY (LCD) BACK LIGHT TUBES, FOR REFLECTORS, FOR FREEZER AND REFRIGERATOR SHOW CASES, FOR LAMP CHIMNEYS, FOR ASPHERICAL LENSES, FOR INTEGRATOR LENSES, FOR INTEGRATOR LENSES IN REFLECTORS, FOR ASPHERICAL LENSES IN DIGITAL CAMERAS, FOR ASPHERICAL LENSES IN PROJECTORS, FOR ASPHERICAL LENSES IN MOBILE PHONES, FOR ASPHERICAL LENSES IN OPTICAL COMMUNICATION APPARATUS, FOR ESCALATORS, FOR ELEVATORS, FOR INDUSTRIAL APPLICATIONS, FOR CONSTRUCTION MACHINES, FOR AGRICULTURAL MACHINES, FOR DISPLAY PANEL COVERS FOR ELECTRONIC DEVICES, AND FOR LOADING-UNLOADING MACHINES; TRANSPARENT CONDUCTING OXIDE (TCO) UNWROUGHT GLASS FOR SOLAR CELLS; UNWROUGHT GLASS IN POWDER AND PASTE FORMS NOT FOR BUILDING PURPOSES; SEMI-FINISHED GLASS FOR REFRIGERATING OR FREEZING SHOWCASES; PRESSED GLASS FOR MIRRORS, SHELVES AND DISPLAYS (U.S. CLS. 2, 13, 23, 29, 30, 33, 40 AND 50).



**CLASS 37—CONSTRUCTION AND REPAIR**

FOR PLATE GLASS INSTALLATION FOR CONSTRUCTION USE; MAINTENANCE OF BUILDING CONSTRUCTION EQUIPMENT; BRICKLAYING; PAINTING AND APPLYING COATINGS TO BUILDING EXTERIORS; WATERPROOFING OF BASEMENTS; CONSULTANCY IN THE FIELD OF INSTALLATION OF INDUSTRIAL FURNACES; CONSTRUCTION OF RESIDENTIAL AND COMMERCIAL BUILDINGS; GLAZING; CONSTRUCTION CONSULTANCY; REPAIR OR MAINTENANCE OF AUTOMOBILE WINDOWS; REPAIR OR MAINTENANCE OF CHEMICAL PROCESSING MACHINES AND APPARATUS; REPAIR OR MAINTENANCE OF INDUSTRIAL FURNACES; REPAIR OR MAINTENANCE OF WATER PURIFYING APPARATUS; REPAIR OR MAINTENANCE OF CHEMICAL PLANTS (U.S. CLS. 100, 103 AND 106).

**CLASS 40—MATERIAL TREATMENT**

FOR CUSTOM MANUFACTURING OF GLASS AND CUSTOM FABRICATION OF GLASS PRODUCTS TO THE ORDER AND SPECIFICATION OF OTHERS; CONTRACT MANUFACTURE FOR OTHERS OF GLASS AND CUSTOM FABRICATION OF GLASS PRODUCTS FOR THE PRODUCTION OF RECOMBINANT PROTEIN BASED ON GENE ENGINEERING, OTHER RESEARCH AND DEVELOPMENT (U.S. CLS. 100, 103 AND 106).

**CLASS 42—SCIENTIFIC AND COMPUTER SERVICES**

FOR ENGINEERING CONSULTING SERVICES IN THE FIELDS OF DESIGNING FLOAT GLASS, AND SPUTTERED GLASS AND ROLLED GLASS MANUFACTURING PLANTS, DESIGNING FLOAT GLASS, ROLLED GLASS, SPUTTERED GLASS, AND GLASS PROCESSING, MANUFACTURING AND FABRICATION FACILITIES AND REDESIGNING EXISTING FLOAT GLASS MANUFACTURING PLANTS AND FURNACES; DESIGN FOR OTHERS AND ARCHITECTURAL DESIGN SERVICES IN THE FIELD OF BUILDING MATERIALS IN THE NATURE OF GLAZINGS, GLAZING STRUCTURES, WINDOWS, GLASS AND MIRRORS; PROVIDING CONSULTANCY, ADVISORY AND INFORMATION IN THE FIELD OF QUALITIES OF CONSUMER BUILDING MATERIALS OF OTHERS IN THE NATURE OF GLAZINGS, GLAZING STRUCTURES, WINDOWS, GLASS AND MIRRORS; PROVIDING CONSULTANCY, ADVISORY AND INFORMATION IN THE FIELD OF DESIGN OF GLAZINGS, GLAZING STRUCTURES, WINDOWS, GLASS AND MIRRORS; DESIGN FOR OTHERS OF INDUSTRIAL FURNACE; TECHNICAL SUPPORT SERVICES, NAMELY, MONITORING OF NETWORK SYSTEMS IN THE FIELD OF SOIL PURIFICATION; SCIENTIFIC RESEARCH IN THE FIELD OF SOIL POLLUTION; ARCHITECTURAL DESIGN; GEOLOGICAL SURVEYS OR RESEARCH; DESIGN FOR OTHERS OF BUILDING MATERIALS, NAMELY, GLASS; RESEARCH AND DEVELOPMENT IN THE FIELD OF BIOTECHNOLOGY FOR THE PRODUCTION OF RECOMBINANT PROTEIN BASED ON GENE ENGINEERING; SCIENTIFIC RESEARCH ON BUILDING CONSTRUCTION; TESTING OR RESEARCH ON PREVENTION OF POLLUTION; TESTING OR RESEARCH ON MACHINES, APPARATUS AND INSTRUMENTS (U.S. CLS. 100 AND 101).

DAWN HAN, EXAMINING ATTORNEY

SN 76-703,202. PPJ, LLC, NATICK, MA. FILED 6-1-2010.

**CUSTOMATIC ADJUSTABLE BEDZ**

THE MARK CONSISTS OF STANDARD CHARACTERS WITHOUT CLAIM TO ANY PARTICULAR FONT, STYLE, SIZE, OR COLOR.

NO CLAIM IS MADE TO THE EXCLUSIVE RIGHT TO USE "ADJUSTABLE BEDS", APART FROM THE MARK AS SHOWN.

**CLASS 20—FURNITURE AND ARTICLES NOT OTHERWISE CLASSIFIED**

FOR BEDS (U.S. CLS. 2, 13, 22, 25, 32 AND 50).

**CLASS 35—ADVERTISING AND BUSINESS**

FOR RETAIL STORE SERVICES FEATURING BEDS (U.S. CLS. 100, 101 AND 102).  
THOMAS MANOR, EXAMINING ATTORNEY

SN 76-705,456. ESSLOR OF AMERICA, INC., DALLAS, TX. FILED 11-23-2010.

**THINK ABOUT YOUR PRACTICE**

THE MARK CONSISTS OF STANDARD CHARACTERS WITHOUT CLAIM TO ANY PARTICULAR FONT, STYLE, SIZE, OR COLOR.

**CLASS 35—ADVERTISING AND BUSINESS**

FOR BUSINESS MANAGEMENT SERVICES DIRECTED TO EYE CARE PROFESSIONALS (U.S. CLS. 100, 101 AND 102).

**CLASS 41—EDUCATION AND ENTERTAINMENT**

FOR EDUCATIONAL AND TRAINING PROGRAMS DIRECTED TO EYE-CARE PROFESSIONALS, NAMELY, CONTINUING MEDICAL EDUCATION COURSES IN THE FIELD OF OPHTHALMOLOGY AND OPTOMETRY; PROVIDING EDUCATIONAL RESOURCES DIRECTED TO EYE-CARE PROFESSIONALS, NAMELY, PROVIDING A WEB SITE FEATURING NON-DOWNLOADABLE INSTRUCTIONAL VIDEOS IN THE FIELD OF OPHTHALMOLOGY AND OPTOMETRY, PROVIDING A WEBSITE FEATURING ONLINE COURSES OF INSTRUCTION IN THE FIELD OF OPHTHALMOLOGY AND OPTOMETRY (U.S. CLS. 100, 101 AND 107).

CHRISTOPHER BUONGIORNO, EXAMINING ATTORNEY

SN 76-705,584. STRONACH CORPORATION, TORONTO, ONTARIO, CANADA, FILED 12-7-2010.

**MAGNA VITA**

THE MARK CONSISTS OF STANDARD CHARACTERS WITHOUT CLAIM TO ANY PARTICULAR FONT, STYLE, SIZE, OR COLOR.

**CLASS 16—PAPER GOODS AND PRINTED MATTER**

FOR BOOKBINDING MATERIALS, PHOTOGRAPHS, STATIONERY, PRINTERS' TYPE, PRINTING BLOCKS, DISPLAY CARDS, BEER COASTERS, MEMO BLOCKS, CORRESPONDENCE NOTE PAPER, COMIC BOOKS, PAPER FLAGS AND PAPER PENNANTS, BOTTLE ENVELOPES OF CARDBOARD OR PAPER, CALENDARS, PAPER BOWS FOR GIFT WRAP, TABLE NAPKINS OF PAPER, PAPER BAGS, POSTERS, PRINTED ADVERTISING BOARDS OF PAPER AND CARDBOARD, BOXES OF PAPER OR CARDBOARD, DESK PADS, STAMPS, TABLE LINEN OF PAPER, PACKAGING PAPER, BLACKBOARDS, PRINTED PERIODICALS IN THE FIELD OF HEALTH AND WELLNESS, NEWSPAPERS (U.S. CLS. 2, 5, 22, 23, 29, 37, 38 AND 50).

**CLASS 25—CLOTHING**

FOR CLOTHING, NAMELY, SHORTS, SHIRTS, PANTS AND SOCKS, FOOTWEAR, HEADGEAR, NAMELY, CAPS, HATS AND BEANIES, CLOTHING FOR GYMNASTICS, NAMELY, LEOTARDS AND SINGLETTS, BELTS, SCARVES, GLOVES, SHIRTS, JUMPERS, HATS, JACKETS, OUTER CLOTHING, NAMELY, BIBS AND MASKS, CYCLISTS' CLOTHING, NAMELY, JERSEYS AND SHORTS, SCARVES, HEADBANDS, SWEATERS, T-SHIRTS (U.S. CLS. 22 AND 39).

**CLASS 32—LIGHT BEVERAGES**

FOR MINERAL AND AERATED WATERS AND OTHER NON-ALCOHOLIC DRINKS, NAMELY, BEER, CARBONATED BEVERAGES, CIDER, COCKTAIL MIXES, ENERGY DRINKS; FRUIT DRINKS AND FRUIT JUICES; CONCENTRATES, SYRUPS OR POWDERS USED FOR MAKING BEVERAGES (U.S. CLS. 46 AND 48).

PAUL E. FAHRENKOPF, EXAMINING ATTORNEY

---

SN 76-705,585. STRONACH CORPORATION, TORONTO, ONTARIO, CANADA, FILED 12-7-2010.

**CLASS 16—PAPER GOODS AND PRINTED MATTER**

FOR BOOKBINDING MATERIALS, PHOTOGRAPHS, STATIONERY, PRINTERS' TYPE, PRINTING BLOCKS, DISPLAY CARDS, BEER COASTERS, MEMO BLOCKS, CORRESPONDENCE NOTE PAPER, COMIC BOOKS, PAPER FLAGS AND PAPER PENNANTS, BOTTLE ENVELOPES OF CARDBOARD OR PAPER, CALENDARS, PAPER BOWS FOR GIFT WRAP, TABLE NAPKINS OF PAPER, PAPER BAGS, POSTERS, PRINTED ADVERTISING BOARDS OF PAPER AND CARDBOARD, BOXES OF PAPER OR CARDBOARD, DESK PADS, STAMPS, TABLE LINEN OF PAPER, PACKAGING PAPER, BLACKBOARDS, PRINTED PERIODICALS IN THE FIELD OF HEALTH AND WELLNESS, NEWSPAPERS (U.S. CLS. 2, 5, 22, 23, 29, 37, 38 AND 50).

**CLASS 25—CLOTHING**

FOR CLOTHING, NAMELY, SHORTS, SHIRTS, PANTS AND SOCKS, FOOTWEAR, HEADGEAR, NAMELY, CAPS, HATS AND BEANIES, CLOTHING FOR GYMNASTICS, NAMELY, LEOTARDS AND SINGLETTS, BELTS, SCARVES, GLOVES, SHIRTS, JUMPERS, HATS, JACKETS, OUTER CLOTHING, NAMELY, BIBS AND MASKS, CYCLISTS' CLOTHING, NAMELY, JERSEYS AND SHORTS, SCARVES, HEADBANDS, SWEATERS, T-SHIRTS (U.S. CLS. 22 AND 39).

**CLASS 32—LIGHT BEVERAGES**

FOR MINERAL AND AERATED WATERS AND OTHER NON-ALCOHOLIC DRINKS, NAMELY, BEER, CARBONATED BEVERAGES, CIDER, COCKTAIL MIXES, ENERGY DRINKS; FRUIT DRINKS AND FRUIT JUICES; CONCENTRATES, SYRUPS OR POWDERS USED FOR MAKING BEVERAGES (U.S. CLS. 46 AND 48).

PAUL E. FAHRENKOPF, EXAMINING ATTORNEY

---

SN 76-706,093. WEB 50 SOLUTIONS, INC., VERO BEACH, FL. FILED 1-24-2011.

**SEE YOU AT THE TOP**

THE MARK CONSISTS OF STANDARD CHARACTERS WITHOUT CLAIM TO ANY PARTICULAR FONT, STYLE, SIZE, OR COLOR.

**CLASS 35—ADVERTISING AND BUSINESS**

FOR INTERNET ADVERTISING SERVICES; ADVERTISING AND MARKETING SERVICES OF OTHERS VIA WEB PAGES OPTIMIZED FOR ONLINE SEARCH ENGINES; ADVERTISING AND MARKETING CONSULTATION SERVICES RELATED TO SEARCH ENGINE OPTIMIZATION (SEO) (U.S. CLS. 100, 101 AND 102).

**CLASS 42—SCIENTIFIC AND COMPUTER SERVICES**

FOR COMPUTER SERVICES, NAMELY, SEARCH ENGINE OPTIMIZATION (U.S. CLS. 100 AND 101).

PAM WILLIS, EXAMINING ATTORNEY

---

SN 76-707,421. GONZALEZ AND TAPANES FOODS, INC. MOONACHIE, NJ. FILED 4-26-2011.

**EL SABOR DE MI TIERRA**

THE MARK CONSISTS OF STANDARD CHARACTERS WITHOUT CLAIM TO ANY PARTICULAR FONT, STYLE, SIZE, OR COLOR.

OWNER OF U.S. REG. NO. 2,561,202.

THE ENGLISH TRANSLATION OF "EL SABOR DE MI TIERRA" IS "THE TASTE OF MY HOMETLAND".

**CLASS 25—CLOTHING**

FOR CLOTHING, NAMELY, SHIRTS (U.S. CLS. 22 AND 39).

FIRST USE 0-0-2001; IN COMMERCE 0-0-2001.

**CLASS 29—MEATS AND PROCESSED FOODS**

FOR CHEESE; OLIVE OILS FOR FOOD; CANNED AND DRIED BEANS; DRIED LENTILS; CANNED AND DRIED PEAS; SOY MILK FOR USE AS A MILK SUBSTITUTE; CANNED FRUIT; BAKED BEANS; REFRIED BEANS; PROCESSED OLIVES; SHOESTRING POTATOES BEING PROCESSED POTATOES; PROCESSED PEPPERS; DRIED PEPPERS BEING PROCESSED PEPPERS (U.S. CL. 46).

FIRST USE 0-0-2001; IN COMMERCE 0-0-2001.

**CLASS 30—STAPLE FOODS**

FOR SALT; SUGAR; SPICES; RICE; BROWN RICE; PASTAS; TOMATO SAUCE; SPAGHETTI SAUCE; VINEGAR; WHITE VINEGAR; FRUIT VINEGAR; MINCED GARLIC; DRIED CORN HUSKS FOR TAMALES; DRIED CHILI PEPPERS FOR USE AS SEASONING (U.S. CL. 46).

FIRST USE 0-0-2001; IN COMMERCE 0-0-2001.

**CLASS 32—LIGHT BEVERAGES**

FOR NON-ALCOHOLIC BEVERAGES, NAMELY, FRUIT JUICES AND ORANGE JUICE; NON-ALCOHOLIC BEVERAGES BREWED FROM CEREALS, NAMELY, NON-ALCOHOLIC MALT BEVERAGES (U.S. CLS. 45, 46 AND 48).

FIRST USE 0-0-2001; IN COMMERCE 0-0-2001.

HAI-LY LAM, EXAMINING ATTORNEY

SN 76-707,634. THE METROHEALTH SYSTEM, CLEVELAND, OH. FILED 5-16-2011.

**METROHEALTHY**

THE MARK CONSISTS OF STANDARD CHARACTERS WITHOUT CLAIM TO ANY PARTICULAR FONT, STYLE, SIZE, OR COLOR.

**CLASS 16—PAPER GOODS AND PRINTED MATTER**

FOR PUBLICATIONS, NAMELY, NEWSLETTERS, JOURNALS, MAGAZINES, BOOKS, CHARTS, WORKBOOKS, MANUALS, PRINTED PLANS, DAY PLANNERS, CALENDARS, PRINTED PRESENTATIONS, ALL IN THE FIELD OF HEALTH AND WELLNESS (U.S. CLS. 2, 5, 22, 23, 29, 37, 38 AND 50).

FIRST USE 3-1-2011; IN COMMERCE 3-1-2011.

**CLASS 35—ADVERTISING AND BUSINESS**

FOR ADVERTISING SERVICES IN CONNECTION WITH THE PROMOTION OF MEDICAL SERVICES AND OTHER HEALTH CARE SERVICES (U.S. CLS. 100, 101 AND 102).

FIRST USE 3-1-2011; IN COMMERCE 3-1-2011.

**CLASS 41—EDUCATION AND ENTERTAINMENT**

FOR MEDICAL EDUCATIONAL SERVICES, NAMELY, PROVIDING CONTINUING MEDICAL EDUCATION CLASSES FOR PHYSICIANS AND OTHER HEALTH CARE PROVIDERS; PROVIDING TRAINING IN THE FIELD OF MEDICINE FOR ALLIED MEDICAL PROFESSIONALS; PROVIDING SPECIAL EMPHASIS CLASSES FOR PATIENTS, NAMELY, PROVIDING CLASSES IN THE FIELD OF MEDICINE AND SELF-CARE (U.S. CLS. 100, 101 AND 107).

FIRST USE 3-1-2011; IN COMMERCE 3-1-2011.

**CLASS 42—SCIENTIFIC AND COMPUTER SERVICES**

FOR MEDICAL RESEARCH SERVICES (U.S. CLS. 100 AND 101).

FIRST USE 3-1-2011; IN COMMERCE 3-1-2011.

**CLASS 44—MEDICAL, BEAUTY AND AGRICULTURAL SERVICES**

FOR HOSPITAL SERVICES AND MEDICAL INFORMATION SERVICES, NAMELY, PROVIDING MEDICAL CARE FOR PATIENTS; PROVIDING GENERAL HEALTH WELLNESS AND MEDICAL INFORMATION TO PATIENTS AND THE PUBLIC (U.S. CLS. 100 AND 101).

FIRST USE 3-1-2011; IN COMMERCE 3-1-2011.

INGA ERVIN, EXAMINING ATTORNEY

SN 76-707,666. HOSIER, KATHY MAY, COOL, CA. FILED 5-16-2011.

**CHICKS FOR JESUS**

THE MARK CONSISTS OF STANDARD CHARACTERS WITHOUT CLAIM TO ANY PARTICULAR FONT, STYLE, SIZE, OR COLOR.

NO CLAIM IS MADE TO THE EXCLUSIVE RIGHT TO USE "JESUS", APART FROM THE MARK AS SHOWN.

**CLASS 16—PAPER GOODS AND PRINTED MATTER**

FOR EDUCATIONAL MATERIALS, NAMELY, BOOKS AND BOOKLETS ON THE DOCTRINE OF THE HOLY BIBLE (U.S. CLS. 2, 5, 22, 23, 29, 37, 38 AND 50).

FIRST USE 10-5-1998; IN COMMERCE 7-1-2002.

**CLASS 41—EDUCATION AND ENTERTAINMENT**

FOR RELIGIOUS INSTRUCTION SERVICES (U.S. CLS. 100, 101 AND 107).

FIRST USE 10-5-1998; IN COMMERCE 7-1-2002.

LIEF MARTIN, EXAMINING ATTORNEY

SN 76-707,829. BUCK COMMANDER, L.L.C., WEST MONROE, LA. FILED 6-3-2011.

**BUCKAHOLIC**

THE MARK CONSISTS OF STANDARD CHARACTERS WITHOUT CLAIM TO ANY PARTICULAR FONT, STYLE, SIZE, OR COLOR.

**CLASS 16—PAPER GOODS AND PRINTED MATTER**

FOR NEWSLETTERS FEATURING ARTICLES ABOUT BUCK HUNTING; CARDS, NAMELY, GREETING CARDS FEATURING PICTURES OF BUCK HUNTERS AND OTHER BUCK HUNTING THEMES (U.S. CLS. 2, 5, 22, 23, 29, 37, 38 AND 50).

**CLASS 38—COMMUNICATION**

FOR PROVIDING ON-LINE FORUMS FOR TRANSMISSION OF MESSAGES AMONG COMPUTER USERS CONCERNING BUCK HUNTING (U.S. CLS. 100, 101 AND 104).

SN 77-160,000. QUY BIOSCIENCES LIMITED, BURFORD, OXFORDSHIRE OX18 4DQ, UNITED KINGDOM, FILED 4-18-2007.

**CLASS 41—EDUCATION AND ENTERTAINMENT**

FOR PROVIDING ON-LINE INFORMATION IN THE FORM OF ARTICLES, PHOTO POSTS AND BONUS VIDEO FOOTAGES, TO PARTICIPATE IN COMPETITIONS AND DRAWINGS, AND TO SHOWCASE BUCK HUNTING SKILLS THROUGH PHOTO POSTS, ALL IN THE FIELD OF BUCK HUNTING; SOCIAL CLUB SERVICES FOR BUCK HUNTERS, NAMELY, ARRANGING, ORGANIZING, AND HOSTING SOCIAL EVENTS, GET-TOGETHERS, AND PARTIES FOR CLUB MEMBERS (U.S. CLS. 100, 101 AND 107).

**CLASS 45—PERSONAL AND LEGAL SERVICES**

FOR SOCIAL CLUB SERVICES FOR BUCK HUNTERS, NAMELY, PROVIDING A SOCIAL NETWORKING WEBSITE FOR ENTERTAINMENT PURPOSES (U.S. CLS. 100 AND 101).

SAMUEL E. SHARPER JR., EXAMINING ATTORNEY

---

SN 77-147,749. BIT BLOT, LLC, SAN MARINO, CA. FILED 4-3-2007.



THE MARK CONSISTS OF THE STYLIZED WORDING "AQUARIA".

**CLASS 9—ELECTRICAL AND SCIENTIFIC APPARATUS**

FOR COMPUTER GAME PROGRAM; VIDEO GAME PROGRAM FOR USE IN HAND-HELD UNITS; VIDEO GAME PROGRAM FOR USE IN STAND-ALONE VIDEO GAME MACHINES; VIDEO GAME PROGRAM FOR USE IN VIDEO GAME MACHINES CONNECTED TO TELEVISIONS; COMPACT DISCS AND DVDS STORING COMPUTER GAME PROGRAMS; VIDEO GAME CARTRIDGES (U.S. CLS. 21, 23, 26, 36 AND 38).

**CLASS 28—TOYS AND SPORTING GOODS**

FOR STAND-ALONE VIDEO GAME MACHINES; HAND-HELD UNITS FOR PLAYING ELECTRONIC GAMES (U.S. CLS. 22, 23, 38 AND 50).

LESLIE RICHARDS, EXAMINING ATTORNEY

# MEDCELL

THE MARK CONSISTS OF STANDARD CHARACTERS WITHOUT CLAIM TO ANY PARTICULAR FONT, STYLE, SIZE, OR COLOR.

PRIORITY CLAIMED UNDER SEC. 44(D) ON ERPN CMNTY TM OFC APPLICATION NO. 005836663, FILED 4-17-2007, REG. NO. 005836663, DATED 10-16-2008, EXPIRES 4-17-2017.

**CLASS 5—PHARMACEUTICALS**

FOR PHARMACEUTICAL AND VETERINARY PREPARATIONS FOR ORTHOPAEDIC, OPHTHALMIC, NEUROLOGIC, ONCOLOGIC AND IMMUNOLOGIC USE; PHARMACEUTICAL AND VETERINARY PREPARATIONS FOR USE IN REGENERATIVE MEDICINE; PHARMACEUTICALS AND VETERINARY PREPARATIONS FOR THE TREATMENT OF ORTHOPAEDIC, OPHTHALMIC, NEUROLOGIC, ONCOLOGIC AND IMMUNOLOGIC DAMAGE, TENDON AND LIGAMENT DAMAGE AND INJURIES, MUSCULOSKELETAL DAMAGE AND INJURIES; CHEMICAL PREPARATIONS ADAPTED FOR PHARMACEUTICAL, MEDICAL AND VETERINARY USE; DIFFERENTIATED CELLS, STEM CELLS AND CELLS DERIVED THERE FROM FOR MEDICAL, VETERINARY OR CLINICAL USE; STEM CELLS FOR CELLULAR THERAPEUTICS FOR MEDICAL, VETERINARY OR CLINICAL USE, CRYO-PRESERVED STEM CELLS; CELL-DERIVED PREPARATIONS FOR MEDICAL, VETERINARY OR CLINICAL USE (U.S. CLS. 6, 18, 44, 46, 51 AND 52).

**CLASS 10—MEDICAL APPARATUS**

FOR SURGICAL, MEDICAL, AND VETERINARY APPARATUS AND INSTRUMENTS FOR ORTHOPAEDIC, OPHTHALMIC, NEUROLOGIC, ONCOLOGIC AND IMMUNOLOGIC USE; MEDICAL AND VETERINARY APPARATUS AND INSTRUMENTS FOR CRYO-PRESERVATION OF STEM CELLS; SURGICAL, MEDICAL AND VETERINARY APPARATUS AND INSTRUMENTS FOR USE IN THE TREATMENT OF ORTHOPAEDIC, OPHTHALMIC, NEUROLOGIC, ONCOLOGIC AND IMMUNOLOGIC DAMAGE AND INJURIES, TENDON AND LIGAMENT DAMAGE AND INJURIES, MUSCULOSKELETAL DAMAGE AND INJURIES; SURGICAL, MEDICAL AND VETERINARY APPARATUS FOR USE IN THE ISOLATION, INSERTION, POSITIONING AND MAINTENANCE, INCLUDING STORAGE, OF DIFFERENTIATED CELLS, STEM CELLS AND CELLS DERIVED THEREFROM, CELL-DERIVED PRODUCTS AND REGENERATIVE TECHNOLOGY (U.S. CLS. 26, 39 AND 44).

**CLASS 16—PAPER GOODS AND PRINTED MATTER**

FOR PUBLICATIONS, NAMELY, BROCHURES, BOOKLETS AND PRINTED TEACHING MATERIALS IN THE FIELD OF ORTHOPAEDICS, OPHTHALMICS, NEUROLOGY, ONCOLOGY AND IMMUNOLOGY, REGENERATIVE MEDICINE, DIFFERENTIATED CELLS, STEM CELLS AND CELLS DERIVED THERE FROM, CELLULAR AND CELL-DERIVED THERAPEUTICS, BOOKS IN THE FIELD OF ORTHOPAEDICS, OPHTHALMICS, NEUROLOGY, ONCOLOGY, IMMUNOLOGY, REGENERATIVE MEDICINE, DIFFERENTIATED CELLS, STEM CELLS AND CELLS DERIVED THERE FROM, CELLULAR AND CELL-DERIVED THERAPEUTICS; PRINTED PERIODICALS IN THE FIELD OF ORTHOPAEDICS, OPHTHALMICS, NEUROLOGY, ONCOLOGY, IMMUNOLOGY, REGENERATIVE MEDICINE, DIFFERENTIATED CELLS, STEM CELLS AND CELLS DERIVED THERE FROM, CELLULAR AND CELL-DERIVED THERAPEUTICS; PRINTED INSTRUCTIONAL AND TEACHING MATERIALS IN THE FIELD OF ORTHOPAEDICS, OPHTHALMICS, NEUROLOGY, ONCOLOGY, IMMUNOLOGY, REGENERATIVE MEDICINE, DIFFERENTIATED CELLS, STEM CELLS AND CELLS DERIVED THERE FROM, CELLULAR AND CELL-DERIVED THERAPEUTICS; CARDBOARD AND PAPER BASED PACKAGING FOR PHARMACEUTICALS, MEDICAL AND VETERINARY PRODUCTS AND APPARATUS (U.S. CLS. 2, 5, 22, 23, 29, 37, 38 AND 50).

**CLASS 40—MATERIAL TREATMENT**

FOR CRYO-PRESERVATION OF STEM CELLS; CRYO-PRESERVATION SERVICES (U.S. CLS. 100, 103 AND 106).

**CLASS 42—SCIENTIFIC AND COMPUTER SERVICES**

FOR SCIENTIFIC RESEARCH AND DEVELOPMENT SERVICES AND DESIGN SERVICES FOR OTHERS IN THE FIELD OF ORTHOPAEDICS, OPHTHALMICS, NEUROLOGY, ONCOLOGY, IMMUNOLOGY, REGENERATIVE MEDICINE, DIFFERENTIATED CELLS, STEM CELLS AND CELLS DERIVED THERE FROM, CELLULAR AND CELL-DERIVED THERAPEUTICS; VETERINARY AND MEDICAL RESEARCH SERVICES; SCIENTIFIC AND INDUSTRIAL RESEARCH IN THE FIELD OF ORTHOPAEDICS, OPHTHALMICS, NEUROLOGY, ONCOLOGY, IMMUNOLOGY, REGENERATIVE MEDICINE, DIFFERENTIATED CELLS, STEM CELLS AND CELLS DERIVED THERE FROM, CELLULAR AND CELL-DERIVED THERAPEUTICS; SCIENTIFIC RESEARCH AND DEVELOPMENT SERVICES RELATING TO REGENERATIVE MEDICINE AND TECHNOLOGIES; SCIENTIFIC RESEARCH AND DEVELOPMENT RELATING TO DIFFERENTIATED CELLS, STEM CELLS AND CELLS DERIVED THERE FROM AND CELL-DERIVED THERAPEUTICS; SCIENTIFIC RESEARCH AND DEVELOPMENT RELATING TO CELLULAR AND CELL-DERIVED THERAPEUTICS; PROVIDING INFORMATION ON PHARMACEUTICAL, MEDICAL AND VETERINARY PRODUCTS AND SERVICES THROUGH AN ONLINE COMPUTER NETWORK (U.S. CLS. 100 AND 101).

**CLASS 44—MEDICAL, BEAUTY AND AGRICULTURAL SERVICES**

FOR MEDICAL SERVICES; VETERINARY SERVICES; MEDICAL AND VETERINARY SERVICES RELATING TO THE ISOLATION, INSERTION, POSITIONING, MAINTENANCE, AND STORAGE OF DIFFERENTIATED CELLS, STEM CELLS AND CELLS DERIVED THERE FROM, AND CELL-DERIVED PREPARATIONS; MEDICAL AND VETERINARY CONSULTANCY SERVICES (U.S. CLS. 100 AND 101).

MARK T. MULLEN, EXAMINING ATTORNEY

SN 77-340,284. 7215088 CANADA INC., DBA DISTRIBUTION ACCESS, TORONTO, ONTARIO, CANADA, FILED 11-29-2007.



PRIORITY CLAIMED UNDER SEC. 44(D) ON CANADA APPLICATION NO. 1349623, FILED 5-31-2007, REG. NO. TMA770,506, DATED 6-22-2010, EXPIRES 6-22-2025.

THE MARK CONSISTS OF A STYLIZATION OF THE WORD "CLEAN" IN THE SHAPE OF A FOOT.

**CLASS 9—ELECTRICAL AND SCIENTIFIC APPARATUS**

FOR PRE-RECORDED VIDEO TAPES, DVDS AND CD-ROMS IN THE FIELD OF ENVIRONMENTAL EDUCATION INFORMATION (U.S. CLS. 21, 23, 26, 36 AND 38).

**CLASS 16—PAPER GOODS AND PRINTED MATTER**

FOR PRINTED PUBLICATIONS, NAMELY, BOOKS, MANUALS, NEWSLETTERS, BROCHURES, PAMPHLETS AND CATALOGUES IN THE FIELDS OF THE ENVIRONMENT AND ENVIRONMENTAL ISSUES; MAGAZINES FEATURING ENVIRONMENTAL ISSUES; STICKERS (U.S. CLS. 2, 5, 22, 23, 29, 37, 38 AND 50).

**CLASS 35—ADVERTISING AND BUSINESS**

FOR PROMOTING PUBLIC AWARENESS OF THE ENVIRONMENT, WHEREBY EDUCATIONAL INSTITUTIONS AND STUDENTS EARN POINTS REDEEMABLE FOR A VARIETY OF PRODUCTS AND SERVICES BY PERFORMING ACTIVITIES THAT ARE BENEFICIAL TO THE ENVIRONMENT; PROMOTING THE GOODS AND SERVICES OF OTHERS THROUGH AN ENVIRONMENT-AWARENESS PROGRAM; CHARITABLE SERVICES, NAMELY, ORGANIZING AND CONDUCTING COMMUNITY SERVICE PROJECTS; RETAIL STORE SERVICES FEATURING PRE-RECORDED VIDEO TAPES, AUDIO AND VIDEO TAPES, CASSETTES, CDS, CD-ROMS, COMPUTER DISCS AND VIDEO DISCS; ONLINE RETAIL STORE SERVICES FEATURING PRE-RECORDED VIDEO TAPES, AUDIO AND VIDEO TAPES, CASSETTES, CDS, CD-ROMS, COMPUTER DISCS AND VIDEO DISCS (U.S. CLS. 100, 101 AND 102).

**CLASS 38—COMMUNICATION**

FOR TELEVISION BROADCASTING SERVICES; TELECOMMUNICATIONS SERVICES AND INTERACTIVE ELECTRONIC COMMUNICATIONS SERVICES, NAMELY, THE OPERATION OF AN INTERNET WEBSITE FOR THE PURPOSE OF PROVIDING ON-LINE CHAT ROOMS IN THE FIELD OF THE ENVIRONMENT AND ENVIRONMENTAL ISSUES, ELECTRONIC MAIL, AND TRANSMISSION OF WEBCASTS (U.S. CLS. 100, 101 AND 104).

**CLASS 41—EDUCATION AND ENTERTAINMENT**

FOR DEVELOPMENT AND DISSEMINATION OF EDUCATIONAL MATERIALS OF OTHERS IN THE FIELD OF THE ENVIRONMENT AND ENVIRONMENTAL ISSUES; PROVIDING EDUCATIONAL TELEVISION AND RADIO PROGRAMMING REGARDING THE ENVIRONMENT AND ENVIRONMENTAL ISSUES VIA THE MEDIA OF TELEVISION, COMPUTER, TELEPHONE, AUDIO, VIDEO, AND/OR VIA THE WORLD WIDE WEB ON THE GLOBAL INTERNET OR THROUGH ELECTRONIC MAIL; DISTRIBUTION SERVICES, NAMELY, DISTRIBUTING THEATRICAL, MADE FOR TV AND EDUCATIONAL MOVIES ON BEHALF OF OTHERS; PROVIDING ENTERTAINMENT SERVICES, NAMELY, PROVIDING RADIO PROGRAMS AND TELEVISION PROGRAMS IN THE FIELD OF THE ENVIRONMENT AND ENVIRONMENTAL ISSUES, VIA THE MEDIA OF TELEVISION, SATELLITE, COMPUTER, TELEPHONE, AUDIO, VIDEO, AND/OR VIA THE WORLD WIDE WEB ON THE GLOBAL INTERNET OR THROUGH ELECTRONIC MAIL; PRODUCTION, RECORDING AND DEVELOPMENT OF TELEVISION PROGRAMS; ENTERTAINMENT AND EDUCATIONAL SERVICES, NAMELY, PRODUCTION, RECORDING AND DEVELOPMENT OF AUDIO AND VIDEO TAPES, CASSETTES, CDS, CD-ROMS, COMPUTER DISCS AND VIDEO DISCS FEATURING EDUCATIONAL AND ENTERTAINMENT CONTENT (U.S. CLS. 100, 101 AND 107).

**CLASS 42—SCIENTIFIC AND COMPUTER SERVICES**

FOR PROVIDING INFORMATION REGARDING THE ENVIRONMENT AND ENVIRONMENTAL ISSUES, NAMELY, INFORMATION ABOUT GLOBAL WARMING AND ITS EFFECT ON NATURE AND THE ENVIRONMENT, INFORMATION ABOUT CLIMATE CHANGE AND BIO-DIVERSITY, INFORMATION ABOUT ENVIRONMENTAL PROTECTION, VIA THE MEDIA OF TELEVISION, COMPUTER, TELEPHONE, AUDIO, VIDEO, AND/OR VIA THE WORLD WIDE WEB ON THE GLOBAL INTERNET OR THROUGH ELECTRONIC MAIL (U.S. CLS. 100 AND 101).

JANET LEE, EXAMINING ATTORNEY

SN 77-368,251. PRIMAL FUSION INC., WATERLOO, ONTARIO, CANADA, FILED 1-10-2008.

**PRIMAL FUSION**

THE MARK CONSISTS OF STANDARD CHARACTERS WITHOUT CLAIM TO ANY PARTICULAR FONT, STYLE, SIZE, OR COLOR.

PRIORITY CLAIMED UNDER SEC. 44(D) ON CANADA APPLICATION NO. 1373719, FILED 11-27-2007, REG. NO. TMA784909, DATED 12-14-2010, EXPIRES 12-14-2025.

**CLASS 9—ELECTRICAL AND SCIENTIFIC APPARATUS**

FOR COMPUTER SOFTWARE FOR SEARCHING, RETRIEVING, COMPILING, ANALYZING, TRANSFORMING, AGGREGATING, INDEXING, CATEGORIZING, ORGANIZING, MANAGING, NAVIGATING AND PRESENTING DATA AND INFORMATION ON COMPUTER NETWORKS, GLOBAL COMPUTER NETWORKS, COMPUTERS, COMPUTER DEVICES AND MOBILE DEVICES (U.S. CLS. 21, 23, 26, 36 AND 38).

**CLASS 42—SCIENTIFIC AND COMPUTER SERVICES**

FOR PROVIDING TEMPORARY USE OF ONLINE NON DOWNLOADABLE SOFTWARE FOR SEARCHING, RETRIEVING, COMPILING, ANALYZING, TRANSFORMING, AGGREGATING, INDEXING, CATEGORIZING, ORGANIZING, MANAGING, NAVIGATING AND PRESENTING DATA AND INFORMATION ON COMPUTER NETWORKS, GLOBAL COMPUTER NETWORKS, COMPUTERS, COMPUTER DEVICES AND MOBILE DEVICES; CUSTOMIZATION SERVICES WITH RESPECT TO COMPUTER SOFTWARE FOR SEARCHING, RETRIEVING, COMPILING, ANALYZING, TRANSFORMING, AGGREGATING, INDEXING, CATEGORIZING, ORGANIZING, MANAGING, NAVIGATING AND PRESENTING DATA AND INFORMATION ON COMPUTER NETWORKS, GLOBAL COMPUTER NETWORKS, COMPUTERS, COMPUTER DEVICES AND MOBILE DEVICES; CONSULTATION SERVICES WITH RESPECT TO COMPUTER SOFTWARE FOR SEARCHING, RETRIEVING, COMPILING, ANALYZING, TRANSFORMING, AGGREGATING, INDEXING, CATEGORIZING, ORGANIZING, MANAGING, NAVIGATING AND PRESENTING DATA AND INFORMATION ON COMPUTER NETWORKS, GLOBAL COMPUTER NETWORKS, COMPUTERS, COMPUTER DEVICES AND MOBILE DEVICES; ON-LINE PUBLISHING OF WEB SITES, NAMELY, SERVICES OF DESIGN, INFORMATION ARCHITECTURE, NAMELY, THE ORGANIZATION OF INFORMATION AND CONTENT PROVISIONING, NAMELY, PROVIDING INFORMATION IN THE NATURE OF USER CREATED DATA FOR WEBSITE CONTENT; PROVIDING ON-LINE DATA FEEDS FOR THIRD PARTY WEBSITES; AND PROVIDING WEB SERVICES FOR THIRD PARTY WEBSITES, NAMELY, SERVICES OF INFORMATION EXTRACTION, NAMELY, EXTRACTING STRUCTURED INFORMATION FROM UNSTRUCTURED MACHINE-READABLE DOCUMENTS, INFORMATION ANALYSIS, NAMELY, PROVIDING TEXT AND SEMANTIC ANALYSIS AS WELL AS DATA MINING OF A DOMAIN OF INFORMATION, INFORMATION SYNTHESIS, NAMELY, SYNTHESIZING CONTENT, DOCUMENTS, AND DATA BY DIFFERENT ALGORITHMIC APPROACHES, INFORMATION AGGREGATION, NAMELY, DISPLAYING GROUPED OR SYNDICATED WEB CONTENT FROM DIVERSE SOURCES, AND INFORMATION INTEGRATION, NAMELY, MERGING INFORMATION FROM DISPARATE SOURCES WITH DIFFERING CONCEPTUAL, CONTEXTUAL AND TYPOGRAPHICAL REPRESENTATIONS (U.S. CLS. 100 AND 101).

SIMON TENG, EXAMINING ATTORNEY

SN 77-418,125. RAYTHEON COMPANY, WALTHAM, MA. FILED 3-10-2008.



THE MARK CONSISTS OF THE WORDING "MALD" WITH A STRAIGHT LINE BELOW IT. SUPERIMPOSED OVER THE TERM "MALD" IS THE DESIGN OF A MILITARY PROJECTILE.

SEC. 2(F) AS TO "MALD".

**CLASS 12—VEHICLES**

FOR AIRCRAFT; SPACE VEHICLES, NAMELY, SHUTTLES (U.S. CLS. 19, 21, 23, 31, 35 AND 44).

FIRST USE 11-24-2003; IN COMMERCE 11-24-2003.

**CLASS 13—FIREARMS**

FOR PROJECTILES; WEAPONRY, NAMELY, AIR DEFENSE DECOY SYSTEMS IN THE NATURE OF MINIATURE AIR LAUNCHED DECOYS; GUIDED MISSILES; GUIDED ARTILLERY PROJECTILES; GUIDED PROJECTILES (U.S. CLS. 2 AND 9).

FIRST USE 11-24-2003; IN COMMERCE 11-24-2003.  
MICHAEL WIENER, EXAMINING ATTORNEY

SN 77-522,330. MEGAROTIC LIMITED, HONG KONG, HONG KONG, FILED 7-15-2008.

# MEGAROTIC

THE MARK CONSISTS OF STANDARD CHARACTERS WITHOUT CLAIM TO ANY PARTICULAR FONT, STYLE, SIZE, OR COLOR.

**CLASS 38—COMMUNICATION**

FOR PROVIDING ACCESS TO INFORMATION, AUDIO, AND VIDEO VIA WEBSITES OVER THE INTERNET; ELECTRONIC TRANSMISSION OF DOWNLOADABLE AUDIO, VIDEO, AND OTHER MULTIMEDIA FILES VIA COMPUTER AND OTHER COMMUNICATIONS NETWORKS; ELECTRONIC TRANSMISSION OF STREAMED AUDIO, VIDEO, AND OTHER MULTIMEDIA FILES VIA COMPUTER AND OTHER COMMUNICATIONS NETWORKS; STREAMING OF VIDEO CONTENT VIA COMPUTER AND OTHER COMMUNICATIONS NETWORKS (U.S. CLS. 100, 101 AND 104).

FIRST USE 11-6-2006; IN COMMERCE 11-6-2006.

**CLASS 41—EDUCATION AND ENTERTAINMENT**

FOR ENTERTAINMENT SERVICES, NAMELY, PROVIDING A WEB SITE FEATURING ADULT-THEMED PHOTOGRAPHS AND VIDEOS (U.S. CLS. 100, 101 AND 107).

FIRST USE 11-6-2006; IN COMMERCE 11-6-2006.  
KIMBERLY FRYE, EXAMINING ATTORNEY

SN 77-465,863. CHARLOTTE CHECKERS PROFESSIONAL ICE HOCKEY, LLC, CHARLOTTE, NC. FILED 5-5-2008.



OWNER OF U.S. REG. NOS. 1,860,549, 2,090,707 AND 2,856,428.

NO CLAIM IS MADE TO THE EXCLUSIVE RIGHT TO USE "CHARLOTTE" AND "HOCKEY", APART FROM THE MARK AS SHOWN.

THE COLOR(S) WHITE, RED, BLACK AND LIGHT BLUE IS/ARE CLAIMED AS A FEATURE OF THE MARK.

THE MARK CONSISTS OF A WHITE BEAR'S HEAD OVER A BLACK CITY SKYLINE WITH A RED BACKGROUND, THE BEAR'S HEAD HAS LIGHT BLUE HIGHLIGHTS AND THE WORDS "CHARLOTTE" AND "HOCKEY" ARE IN RED THE WORD "CHECKERS" IS IN WHITE, THE ENTIRE LOGO IS FRINGED WITH LIGHT BLUE.

**CLASS 25—CLOTHING**

FOR CLOTHING, NAMELY, JACKETS, COATS, SWEAT PANTS, WARM-UP SUITS, HATS, CAPS, SWEATERS, SHIRTS, T-SHIRTS, SWEATSHIRTS, JERSEYS AND INFANT AND TODDLER CLOTHING, NAMELY, JUMPERS, T-SHIRTS, BIBS, SHIRT AND PANTS FLEECE SET, AND CAPS (U.S. CLS. 22 AND 39).

FIRST USE 8-1-2007; IN COMMERCE 8-1-2007.

**CLASS 41—EDUCATION AND ENTERTAINMENT**

FOR ENTERTAINMENT IN THE NATURE OF PROFESSIONAL ICE HOCKEY GAMES (U.S. CLS. 100, 101 AND 107).

FIRST USE 8-1-2007; IN COMMERCE 8-1-2007.  
DOMINICK J. SALEMI, EXAMINING ATTORNEY

SN 77-604,745. GOOD SAMARITAN THERAPIES, INC., JONESBORO, AR. FILED 10-31-2008.

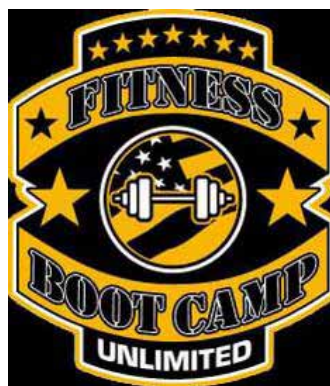

NO CLAIM IS MADE TO THE EXCLUSIVE RIGHT TO USE "FITNESS BOOT CAMP UNLIMITED", APART FROM THE MARK AS SHOWN.

THE COLOR(S) BLACK, GOLD AND WHITE IS/ARE CLAIMED AS A FEATURE OF THE MARK.

THE MARK CONSISTS OF A BLACK BACKGROUND, WITH A SERIES OF BANNERS AND A CIRCLE IN THE CENTER; THE INTERIOR OF THE CIRCLE CONTAINS A REPRESENTATION OF A FLAG HAVING WHITE STARS SET IN AN INCOMPLETE BLACK RECTANGLE AND ALTERNATING GOLD AND BLACK STRIPES AND IS OUTLINED IN BLACK AND WHITE; THE CENTER OF THE CIRCLE CONTAINS A WHITE BARBELL OUTLINED IN BLACK; THERE IS A GOLD STAR ON EITHER SIDE OF THE CIRCLE; WITH GOLD BANNERS ABOVE AND BELOW THE CIRCLE, THE BANNER ABOVE THE CIRCLE

CONSISTING OF TWO BLACK STARS AND THE WORD "FITNESS" IN BLACK AND OUTLINED IN WHITE; AND THE BANNER BELOW THE CIRCLE CONSISTING OF THE PHRASE "BOOTCAMP" IN BLACK AND OUTLINED IN WHITE WITH A BLACK BANNER AT THE TOP OF THE MARK CONSISTING OF SEVEN GOLD STARS; WITH A BLACK BANNER AT THE BOTTOM OF THE MARK CONSISTING OF THE WORD "UNLIMITED" IN WHITE; THE SERIES OF BANNERS ARE OUTLINED IN THEIR ENTIRETY IN BLACK, WHITE AND GOLD.

#### **CLASS 9—ELECTRICAL AND SCIENTIFIC APPARATUS**

FOR AUDIO AND VIDEO RECORDINGS FEATURING EXERCISE WORKOUT (U.S. CLS. 21, 23, 26, 36 AND 38).

#### **CLASS 28—TOYS AND SPORTING GOODS**

FOR EXERCISE PLATFORMS; PERSONAL EXERCISE MATS (U.S. CLS. 22, 23, 38 AND 50).  
JULIE GUTTADAURO, EXAMINING ATTORNEY

SN 77-623,067. GEA GROUP AKTIENGESELLSCHAFT, BOCHUM, FED REP GERMANY, FILED 11-28-2008.

# ECOBRAZE

THE MARK CONSISTS OF STANDARD CHARACTERS WITHOUT CLAIM TO ANY PARTICULAR FONT, STYLE, SIZE, OR COLOR.

PRIORITY CLAIMED UNDER SEC. 44(D) ON ERP NCMTY TM OFC APPLICATION NO. 006966808, FILED 5-28-2008, REG. NO. 006966808, DATED 8-1-2011, EXPIRES 5-28-2018.

#### **CLASS 7—MACHINERY**

FOR HEAT EXCHANGERS BEING PARTS OF MACHINES AND FITTINGS THEREFOR (U.S. CLS. 13, 19, 21, 23, 31, 34 AND 35).

#### **CLASS 11—ENVIRONMENTAL CONTROL APPARATUS**

FOR HEAT EXCHANGERS NOT BEING PARTS OF MACHINES AND FITTINGS THEREFOR (U.S. CLS. 13, 21, 23, 31 AND 34).

NICHOLAS ALTREE, EXAMINING ATTORNEY

SN 77-633,926. PLATINUM LINK HEALTH MANAGEMENT INC., VANCOUVER, CANADA, FILED 12-16-2008.

# IMEG HEALTH

THE MARK CONSISTS OF STANDARD CHARACTERS WITHOUT CLAIM TO ANY PARTICULAR FONT, STYLE, SIZE, OR COLOR.

PRIORITY CLAIMED UNDER SEC. 44(D) ON CANADA APPLICATION NO. 1,401,153, FILED 6-26-2008, REG. NO. TMA801,627, DATED 7-6-2011, EXPIRES 7-6-2026.

NO CLAIM IS MADE TO THE EXCLUSIVE RIGHT TO USE "HEALTH", APART FROM THE MARK AS SHOWN.

#### **CLASS 41—EDUCATION AND ENTERTAINMENT**

FOR EDUCATIONAL AND TRAINING SERVICES, NAMELY, CONDUCTING SEMINARS AND WORKSHOPS IN THE FIELDS OF TRADITIONAL MEDICINE AND HEALING, ACUPUNCTURE, MASSAGE THERAPY, MOXIBUSTION, SUCTION CUP THERAPY (BA GUAN), MANIPULATIVE THERAPY, ENERGY CONTROL THERAPY (QIGONG), REHABILITATION EXERCISES, NAMELY, SHADOW BOXING (TAI JI QUAN), REFLEXOLOGY, PRESCRIBING, COMPOUNDING OR DISPENSING FOOD CURE RECIPES AND HERBAL FORMULA FOR THE TREATMENT, PREVENTION, AND MANAGEMENT OF RESPIRATORY TRACT INFECTION, COLD, INFLUENZA, COUGH, ASTHMA, GASTRITIS, GASTROINTESTINAL DISORDERS, MENOPAUSAL SYNDROME, HORMONAL IMBALANCE, REPRODUCTIVE AND SEXUAL DYSFUNCTION AND IMPOTENCE, URINARY SYSTEM INFECTION, VERTIGO, INFLAMMATION, FEVER, INSOMNIA, HEADACHE, DIABETES, HYPERTENSION, CHRONIC PAIN, PAINS IN THE JOINTS, BACK AND WAIST, TRAUMA AND BURN, CANCER, NUTRITION MANAGEMENT, ALTERNATIVE MEDICINE, NUTRITION, EXERCISE, AND HEALTH AND WELLNESS MANAGEMENT; ORGANIZING AND CONDUCTING SEMINARS, WORKSHOPS, EDUCATIONAL CONFERENCES, PRIVATE EDUCATIONAL CONSULTATIONS, GROUP EDUCATIONAL CONSULTATIONS, PRIVATE EDUCATIONAL DISCUSSIONS AND GROUP EDUCATIONAL DISCUSSIONS IN THE FIELDS OF TRADITIONAL MEDICINE AND HEALING, ACUPUNCTURE, MASSAGE THERAPY, MOXIBUSTION, SUCTION CUP (BA GUAN), MANIPULATIVE THERAPY, ENERGY CONTROL THERAPY (QIGONG), REHABILITATION EXERCISES, NAMELY, SHADOW BOXING (TAI JI QUAN), REFLEXOLOGY, PRESCRIBING, COMPOUNDING OR DISPENSING FOOD CURE RECIPES AND HERBAL FORMULAE FOR THE TREATMENT, PREVENTION, AND MANAGEMENT OF RESPIRATORY TRACT INFECTION, COLD, INFLUENZA, COUGH, ASTHMA, GASTRITIS, GASTROINTESTINAL DISORDERS, MENOPAUSAL SYNDROME, HORMONAL IMBALANCE, REPRODUCTIVE AND SEXUAL DYSFUNCTION AND IMPOTENCE, URINARY SYSTEM INFECTION, VERTIGO, INFLAMMATION, FEVER, INSOMNIA, HEADACHE, DIABETES, HYPERTENSION, CHRONIC PAIN, PAINS IN THE JOINTS, BACK AND WAIST, TRAUMA AND BURN, CANCER, NUTRITION MANAGEMENT, ALTERNATIVE MEDICINE, NUTRITION, EXERCISE, AND HEALTH AND WELLNESS MANAGEMENT (U.S. CLS. 100, 101 AND 107).

#### **CLASS 44—MEDICAL, BEAUTY AND AGRICULTURAL SERVICES**

FOR OPERATION OF A MEDICAL CLINIC AND HEALTH WELLNESS CENTRE PROVIDING SERVICES IN TRADITIONAL MEDICINE, ACUPUNCTURE, MASSAGE THERAPY, MOXIBUSTION, SUCTION CUP (BA GUAN), MANIPULATIVE THERAPY, ENERGY CONTROL THERAPY (QIGONG), REHABILITATION EXERCISES, NAMELY, SHADOW BOXING (TAI JI QUAN), REFLEXOLOGY; MEDICAL SERVICES, NAMELY, PRESCRIBING FOOD CURE RECIPES AND HERBAL FORMULAE FOR THE TREATMENT, PREVENTION, AND MANAGEMENT OF RESPIRATORY TRACT INFECTION, COLD, INFLUENZA, COUGH, ASTHMA, GASTRITIS, GASTROINTESTINAL DISORDERS, SEXUAL DYSFUNCTION AND IMPOTENCE, URINARY SYSTEM INFECTION, VERTIGO, INFLAMMATION, FEVER, INSOMNIA, HEADACHE, DIABETES, HYPERTENSION, PAINS IN THE BACK AND WAIST, TRAUMA AND BURN, CANCER, NUTRITION MANAGEMENT, ALTERNATIVE MEDICINE, NUTRITION, AND HEALTH AND WELLNESS MANAGEMENT; PRESCRIBING OF PHARMACEUTICALS, NAMELY, TRADITIONAL CHINESE AND TRADITIONAL MEDICINES; PROVIDING MEDICAL INFORMATION, NAMELY, OPERATION OF AN INTERNET WEBSITE OFFERING INFORMATION IN THE FIELDS OF TRADITIONAL MEDICINE AND HEALING, ACUPUNCTURE, MASSAGE THERAPY, MOXIBUSTION, SUCTION CUP (BA GUAN), MANIPULATIVE THERAPY, ENERGY CONTROL THERAPY



(QIGONG), REHABILITATION EXERCISES, NAMELY, SHADOW BOXING (TAI JI QUAN), REFLEXOLOGY; MEDICAL AND PHARMACEUTICAL CONSULTATION, NAMELY, CONSULTING SERVICES IN THE FIELDS OF TRADITIONAL MEDICINE AND HEALING, ACUPUNCTURE, MASSAGE THERAPY, MOXIBUSTION, SUCTION CUP (BA GUAN), MANIPULATIVE THERAPY, ENERGY CONTROL THERAPY (QIGONG), REHABILITATION EXERCISES, NAMELY, SHADOW BOXING (TAI JI QUAN), REFLEXOLOGY, PRESCRIBING OF FOOD CURE RECIPES AND HERBAL FORMULAE FOR THE TREATMENT, PREVENTION, AND MANAGEMENT OF RESPIRATORY TRACT INFECTION, COLD, INFLUENZA, COUGH, ASTHMA, GASTRITIS, GASTROINTESTINAL DISORDERS, MENOPAUSAL SYNDROME, HORMONAL IMBALANCE, REPRODUCTIVE AND SEXUAL DYSFUNCTION AND IMPOTENCE, URINARY SYSTEM INFECTION, VERTIGO, INFLAMMATION, FEVER, INSOMNIA, HEADACHE, DIABETES, HYPERTENSION, CHRONIC PAIN, PAINS IN THE JOINTS, BACK AND WAIST, TRAUMA AND BURN, CANCER, NUTRITION MANAGEMENT, ALTERNATIVE MEDICINE, NUTRITION, EXERCISE, AND HEALTH AND WELLNESS MANAGEMENT (U.S. CLS. 100 AND 101).

MARY CRAWFORD, EXAMINING ATTORNEY

SN 77-635,746. FEY INDUSTRIES, INC., EDGERTON, MN. FILED 12-18-2008.

## REFLECTIX

THE MARK CONSISTS OF STANDARD CHARACTERS WITHOUT CLAIM TO ANY PARTICULAR FONT, STYLE, SIZE, OR COLOR.

OWNER OF U.S. REG. NO. 1,676,770.

### CLASS 9—ELECTRICAL AND SCIENTIFIC APPARATUS

FOR SAFETY PRODUCTS, NAMELY, CUSTOMIZED REFLECTIVE PATCHES TO BE WORN ON CLOTHING (U.S. CLS. 21, 23, 26, 36 AND 38).

FIRST USE 1-22-1991; IN COMMERCE 1-22-1991.

### CLASS 16—PAPER GOODS AND PRINTED MATTER

FOR REFLECTIVE STICKERS (U.S. CLS. 2, 5, 22, 23, 29, 37, 38 AND 50).

FIRST USE 1-22-1991; IN COMMERCE 1-22-1991.

### CLASS 18—LEATHER GOODS

FOR PLASTIC POUCHES SOLD EMPTY FOR ATTACHMENT TO SHOELACES (U.S. CLS. 1, 2, 3, 22 AND 41).

FIRST USE 1-22-1991; IN COMMERCE 1-22-1991.

### CLASS 25—CLOTHING

FOR WRIST BANDS, VESTS, T-SHIRTS (U.S. CLS. 22 AND 39).

FIRST USE 1-22-1991; IN COMMERCE 1-22-1991.

### CLASS 26—FANCY GOODS

FOR ZIPPER PULLS, SHOE LACES, ARMBANDS (U.S. CLS. 37, 39, 40, 42 AND 50).

FIRST USE 1-22-1991; IN COMMERCE 1-22-1991.  
GISELLE AGOSTO, EXAMINING ATTORNEY

SN 77-655,729. NANOSYS, INC., PALO ALTO, CA. FILED 1-23-2009.

## QDSOLEIL

THE MARK CONSISTS OF STANDARD CHARACTERS WITHOUT CLAIM TO ANY PARTICULAR FONT, STYLE, SIZE, OR COLOR.

### CLASS 1—CHEMICALS

FOR CHEMICALS, NAMELY, CHROMOPHORES; CHEMICALS, NAMELY, FLUOROPHORES; CHEMICALS IN THE NATURE OF CHROMOPHORIC AND FLUOROPHORIC NANOMATERIALS USED AS CHEMICALS AND NOT AS SEMICONDUCTORS, NAMELY, FULLERENES, BUCKY BALLS, AND CARBON NANOPARTICLES, ALL USED IN THE MANUFACTURE OF GOODS FOR CONVERTING SOLAR RADIATION INTO ELECTRICAL ENERGY; CHROMOPHORIC AND FLUOROPHORIC NANOMATERIALS, NAMELY, MOLECULAR SCALE CHEMICAL AGENTS ADDED TO COATINGS APPLIED TO MACHINERY AND COMPONENTS USED FOR PRODUCING SOLAR ENERGY (U.S. CLS. 1, 5, 6, 10, 26 AND 46).

### CLASS 2—PAINTS

FOR CHROMOPHORIC AND FLUOROPHORIC NANOMATERIALS CONTAINING NANOPARTICLES IN THE NATURE OF PAINTS, INKS AND POWDER COATINGS FOR USE IN ARTICLES FOR LIGHT CONVERSION AND LIGHT CONCENTRATOR PRODUCTS; INKS USED IN THE MANUFACTURE OF GOODS FOR CONVERTING SOLAR RADIATION INTO ELECTRICAL ENERGY (U.S. CLS. 6, 11 AND 16).

### CLASS 9—ELECTRICAL AND SCIENTIFIC APPARATUS

FOR ELECTRONIC COMPONENTS AND SUBSYSTEMS, NAMELY, PHOTOVOLTAIC DEVICES FOR CONVERTING RADIATION TO ELECTRICAL ENERGY, NAMELY, SOLAR CELLS, SOLAR CONCENTRATORS, SOLAR CONVERTERS IN THE NATURE OF PHOTOVOLTAIC SOLAR MODULES, SOLAR PANELS FOR THE PRODUCTION OF ELECTRICITY, USED FOR PRODUCING SOLAR ENERGY; PHOTOVOLTAICS, NAMELY, PHOTOVOLTAIC CELLS, PHOTOVOLTAIC SOLAR MODULES, PHOTOVOLTAIC CLADDING PANELS; SOLAR CELLS; NANOMATERIALS IN THE NATURE OF NANOSCALE ELECTRONIC COMPONENTS, NAMELY, NANORODS, NANOWIRES, QUANTUM DOTS, FLUORINES, NANOTUBES, BUCKY BALLS, NANOPARTICLES, NANOCRYSTALS FOR USE IN THE MANUFACTURE OF SOLAR CELLS; SEMICONDUCTOR PARTICLES FOR USE IN THE MANUFACTURE OF SOLAR ENERGY RELATED GOODS (U.S. CLS. 21, 23, 26, 36 AND 38).

### CLASS 11—ENVIRONMENTAL CONTROL APPARATUS

FOR SOLAR RADIANT HEATERS (U.S. CLS. 13, 21, 23, 31 AND 34).

### CLASS 17—RUBBER GOODS

FOR CHROMOPHORIC AND FLUOROPHORIC NANOMATERIALS, NAMELY, MOLECULAR SCALE SUBSTRATES PRIMARILY OF CERAMIC, SILICON AND NON-METALS FOR ELECTRICAL OR THERMAL INSULATION OF SOLAR CELLS, PHOTOVOLTAIC CELLS, AND SOLAR COLLECTORS (U.S. CLS. 1, 5, 12, 13, 35 AND 50).

**CLASS 45—PERSONAL AND LEGAL SERVICES**

FOR LICENSING OF INTELLECTUAL PROPERTY (U.S. CLS. 100 AND 101).  
RENEE SERVANCE, EXAMINING ATTORNEY

SN 77-701,949. CANDICE CREATIONS, LLC, MOORESTOWN, NJ. FILED 3-30-2009.

**LIVE FOR IT**

THE MARK CONSISTS OF STANDARD CHARACTERS WITHOUT CLAIM TO ANY PARTICULAR FONT, STYLE, SIZE, OR COLOR.

SN 77-666,715. DYNAMIC EDGE SPORTS VISION TRAINING CENTERS INC., OTTAWA, ONTARIO, CANADA, FILED 2-9-2009.

**SEE YOURSELF WINNING**

THE MARK CONSISTS OF STANDARD CHARACTERS WITHOUT CLAIM TO ANY PARTICULAR FONT, STYLE, SIZE, OR COLOR.

PRIORITY CLAIMED UNDER SEC. 44(D) ON CANADA APPLICATION NO. 1409778, FILED 9-5-2008, REG. NO. TMA806134, DATED 9-7-2011, EXPIRES 9-7-2026.

**CLASS 9—ELECTRICAL AND SCIENTIFIC APPARATUS**

FOR COMPUTER SOFTWARE USED FOR DATA ENTRY, ANALYSIS, AND REPORTING ON THE EVALUATION OF VISION AND VISION TRAINING DATA OF INDIVIDUALS; COMPUTER SOFTWARE USED IN THE GENERAL MANAGEMENT OF PERSONAL FITNESS FACILITIES, TRAINING FACILITIES, PHYSICAL AND VISION THERAPY CLINICS AND HOSPITALS, NAMELY, FOR MAINTAINING STORE RECORDS, STAFF RECORDS, CUSTOMER RECORDS, INVENTORY RECORDS, FRANCHISE AND CUSTOMER TRANSACTION ACCOUNTS, FOR CLIENTELE TRACKING OF TRAINING PROGRESS, MANAGEMENT OF PERSONAL INFORMATION, APPOINTMENT BOOKING, AND GENERATION OF REPORTS RELATED TO THESE RECORDS (U.S. CLS. 21, 23, 26, 36 AND 38).

**CLASS 25—CLOTHING**

FOR APPAREL, NAMELY, SHIRTS AND HATS (U.S. CLS. 22 AND 39).

**CLASS 41—EDUCATION AND ENTERTAINMENT**

FOR EDUCATIONAL SERVICES, NAMELY, PROVIDING CLASSES, WORKSHOPS, AND LECTURES IN THE FIELD OF VISION TRAINING; PERSONAL TRAINING SERVICES, NAMELY, VISION TRAINING FOR THE IMPROVEMENT OF VISION MOTOR PERFORMANCE AND COORDINATION AND PRE-TRAINING ASSESSMENT OF INDIVIDUALS' VISION-MOTOR PERFORMANCE AND COORDINATION (U.S. CLS. 100, 101 AND 107).

ELLEN B. AWRICH, EXAMINING ATTORNEY

**CLASS 18—LEATHER GOODS**

FOR SPORT BAGS, TRAVEL BAGS, DUFFEL BAGS, BACKPACKS, SACK PACKS, NAMELY, SPORTS PACKS AND PACKS FOR THE WAIST, AND BAGS FOR TOILETRY KITS SOLD EMPTY (U.S. CLS. 1, 2, 3, 22 AND 41).

**CLASS 25—CLOTHING**

FOR CLOTHING, NAMELY, SHIRTS, HATS, PANTS, T-SHIRTS, POLO SHIRTS, DRESSES, UNDERWEAR, BRASSIERES, SHORTS, HEADBANDS, WRISTBANDS, SOCKS, RAIN SUITS, JACKETS, SOCKS, SKIRTS, HOODS, VESTS, HATS, VISORS, LEGGINGS, HEADWEAR FOR WINTER AND SUMMER, TANK TOPS, BRAS, GLOVES, ATHLETIC FOOTWEAR, WRISTBANDS, LONG SLEEVE SHIRTS, MOCK TURTLE NECKS, JERSEYS, SHOES, WINTER CAPS, SWEAT SHIRTS/PULLOVERS, WOMEN'S BRAS (U.S. CLS. 22 AND 39).

HELENE LIWINSKI, EXAMINING ATTORNEY

SN 77-756,312. TARYN ROSE INTERNATIONAL, INC., CULVER CITY, CA. FILED 6-10-2009.

**FLAT-OUT SEXY**

THE MARK CONSISTS OF STANDARD CHARACTERS WITHOUT CLAIM TO ANY PARTICULAR FONT, STYLE, SIZE, OR COLOR.

**CLASS 25—CLOTHING**

FOR FOOTWEAR (U.S. CLS. 22 AND 39).

**CLASS 35—ADVERTISING AND BUSINESS**

FOR ON-LINE RETAIL STORE SERVICES FEATURING FOOTWEAR; RETAIL STORE SERVICES FEATURING FOOTWEAR (U.S. CLS. 100, 101 AND 102).

KIM SAITO, EXAMINING ATTORNEY

SN 77-757,976. SILEX MICROSYSTEMS AB, JÄRFÄLLA, SWEDEN, FILED 6-12-2009.

## MET-VIA

THE MARK CONSISTS OF STANDARD CHARACTERS WITHOUT CLAIM TO ANY PARTICULAR FONT, STYLE, SIZE, OR COLOR.

PRIORITY CLAIMED UNDER SEC. 44(D) ON ERPNCMNTY TM OFC APPLICATION NO. 008344236, FILED 6-5-2009, REG. NO. 008344236, DATED 1-19-2010, EXPIRES 6-5-2019.

### CLASS 40—MATERIAL TREATMENT

FOR MANUFACTURING, INCLUDING CONTRACT MANUFACTURING, OF PRODUCTS FOR USE IN INDUSTRIAL APPLICATIONS IN THE NATURE OF MICRO ELECTRO-MECHANICAL OR MEMS DEVICES, SYSTEMS AND COMPONENTS, AND OTHER DEVICES, SYSTEMS AND COMPONENTS HAVING MICRO-SCALE OR MESO-SCALE FEATURES, COMPRISED OF MECHANICAL, ELECTRICAL, OPTICAL, FLUIDIC ELEMENTS, OR ANY COMBINATION THEREOF TO ORDER AND/OR SPECIFICATION OF OTHERS; PROTOTYPE FABRICATION OF NEW PRODUCTS FOR OTHERS (U.S. CLS. 100, 103 AND 106).

FIRST USE 3-24-2009; IN COMMERCE 3-24-2009.

### CLASS 42—SCIENTIFIC AND COMPUTER SERVICES

FOR PRODUCT DEVELOPMENT AND DESIGN CONSULTING SERVICES AS WELL AS COMPUTER HARDWARE AND SOFTWARE CONSULTING SERVICES ALL IN THE FIELD OF INDUSTRIAL APPLICATIONS IN THE NATURE OF MICRO ELECTRO-MECHANICAL OR MEMS DEVICES, SYSTEMS AND COMPONENTS HAVING MICRO-SCALE OR MESO-SCALE FEATURES, COMPRISED OF MECHANICAL, ELECTRICAL, OPTICAL, FLUIDIC ELEMENTS, OR ANY COMBINATION THEREOF (U.S. CLS. 100 AND 101).

FIRST USE 3-24-2009; IN COMMERCE 3-24-2009.  
MORGAN WYNNE, EXAMINING ATTORNEY

SN 77-806,380. SPIN MASTER LTD., TORONTO, ONTARIO, CANADA, FILED 8-17-2009.

## LIV WORLD

THE MARK CONSISTS OF STANDARD CHARACTERS WITHOUT CLAIM TO ANY PARTICULAR FONT, STYLE, SIZE, OR COLOR.

OWNER OF CANADA REG. NO. TMA804,529, DATED 8-16-2011, EXPIRES 8-16-2026.

### CLASS 9—ELECTRICAL AND SCIENTIFIC APPARATUS

FOR COMPUTER GAMES AND COMPUTER GAME ACCESSORIES, NAMELY, COMPUTER GAME SOFTWARE, COMPUTER GAME CONSOLES FOR USE WITH AN EXTERNAL DISPLAY SCREEN OR MONITOR; PRERECORDED DVDS FEATURING FICTIONAL CHARACTERS AND FASHION ACTIVITIES (U.S. CLS. 21, 23, 26, 36 AND 38).

### CLASS 28—TOYS AND SPORTING GOODS

FOR TOYS, GAMES AND PLAYTHINGS, NAMELY, DOLLS, DOLL CLOTHING, DOLL FASHION ACCESSORIES AND DOLL ACCESSORIES (U.S. CLS. 22, 23, 38 AND 50).

### CLASS 41—EDUCATION AND ENTERTAINMENT

FOR ENTERTAINMENT SERVICES, NAMELY, PROVIDING ON-LINE COMPUTER GAMES IN SINGLE OR MULTI-USER FORMATS, FEATURING FICTIONAL CHARACTERS; ENTERTAINMENT SERVICES, NAMELY, PROVIDING ON-LINE COMPUTER GAMES (U.S. CLS. 100, 101 AND 107).

JOHN WILKE, EXAMINING ATTORNEY

SN 77-809,841. SHINHAN FINANCIAL GROUP CO., LTD., SEOUL, REPUBLIC OF KOREA, FILED 8-21-2009.



SHINHAN INVESTMENT CORP.

OWNER OF UNITED KINGDOM REG. NO. 2523929, DATED 8-17-2009, EXPIRES 8-17-2019.

NO CLAIM IS MADE TO THE EXCLUSIVE RIGHT TO USE "INVESTMENT CORP.", APART FROM THE MARK AS SHOWN.

THE MARK CONSISTS OF A CIRCLE DESIGN WITH AN "S" AND A FLOWER AND BIRD DESIGN WITH "SHINHAN INVESTMENT CORP.".

### CLASS 9—ELECTRICAL AND SCIENTIFIC APPARATUS

FOR AUTOMATIC CASH REGISTERS; AUTOMATED TELLER MACHINES (ATM); AUTOMATIC CASH SORTING AND COUNTING MACHINES; MONEY COUNTING AND SORTING MACHINES; MONEY COUNTING MACHINES; MAGNETIC CREDIT CARDS; ELECTRONIC MACHINES FOR READING CREDIT CARDS AND RECORDING FINANCIAL OPERATIONS; CALCULATING MACHINES; MAGNETICALLY ENCODED CREDIT CARDS (U.S. CLS. 21, 23, 26, 36 AND 38).

### CLASS 16—PAPER GOODS AND PRINTED MATTER

FOR PRINTED CALENDARS; CREDIT CARDS WITHOUT MAGNETIC CODING; BANK CHECKS; PRINTED FORMS; BLANK CARDS; CATALOGUES IN THE FIELD OF BANKING; HANDBOOK MANUALS ON BANKING; BOOKLETS, MAGAZINES, NEWSLETTERS IN THE FIELD OF BANKING (U.S. CLS. 2, 5, 22, 23, 29, 37, 38 AND 50).

### CLASS 35—ADVERTISING AND BUSINESS

FOR ADVERTISING AGENCIES; ADMINISTRATIVE ACCOUNTING; BUSINESS AUDITING; TAX CONSULTATIONS; ACCOUNTING CONSULTATION; BUSINESS MANAGEMENT INFORMATION; PROVIDING BUSINESS MARKETING INFORMATION; BUSINESS INFORMATION SERVICES AND APPRAISAL; MARKET REPORTS AND STUDIES; IMPORT-EXPORT AGENCIES; DESIGN OF ADVERTISING MATERIALS FOR OTHERS (U.S. CLS. 100, 101 AND 102).

**CLASS 36—INSURANCE AND FINANCIAL**

FOR INTERNATIONAL BANKING; CONSULTANCY SERVICES RELATING TO FINANCE; FINANCIAL ASSET MANAGEMENT; CORPORATE LENDING; MORTGAGE LENDING; MORTGAGE LOAN FINANCING; CREDIT CARD SERVICES; TRUSTEESHIP REPRESENTATIVES; FOREIGN EXCHANGE TRANSACTIONS; BANKING; SECURITIES BUSINESS, NAMELY, BROKERAGE OF SECURITIES, SHARES, AND PARTNERSHIP INTERESTS; FINANCIAL SERVICES RELATING TO INVESTMENT, NAMELY, MANAGEMENT AND BROKERAGE IN THE FIELDS OF STOCKS, BONDS, OPTIONS, COMMODITIES, FUTURES AND OTHER SECURITIES, AND THE INVESTMENT OF FUNDS OF OTHERS; INSURANCE SERVICES IN THE NATURE OF LOSS CONTROL MANAGEMENT FOR OTHERS; FISCAL VALUATIONS AND ASSESSMENTS; FINANCIAL CONSULTATION; CREDIT INQUIRY AND CONSULTATION; TECHNICAL RESEARCH IN THE FIELD OF BANKING (U.S. CLS. 100, 101 AND 102).

**CLASS 42—SCIENTIFIC AND COMPUTER SERVICES**

FOR COMPUTER SERVICES, NAMELY, HOSTING AND MAINTAINING AN ON-LINE WEB SITE FOR OTHERS TO ADVERTISE REAL ESTATE; CONVERSION OF DATA OR DOCUMENTS FROM PHYSICAL TO ELECTRONIC MEDIA; APPLICATION SERVICE PROVIDER, NAMELY, PROVIDING, HOSTING, MANAGING, DEVELOPING AND MAINTAINING WEB SITES OF OTHERS IN THE FIELD OF ELECTRONIC COMMERCE; UPDATING OF COMPUTER SOFTWARE, DATA CONVERSION OF COMPUTER PROGRAMS AND DATA, NOT PHYSICAL CONVERSION (U.S. CLS. 100 AND 101).  
STEPHANIE ALI, EXAMINING ATTORNEY

SN 77-835,235. STRATEGIC DIAGNOSTICS INC., NEWARK, DE. FILED 9-25-2009.

**SDIX**

THE MARK CONSISTS OF STANDARD CHARACTERS WITHOUT CLAIM TO ANY PARTICULAR FONT, STYLE, SIZE, OR COLOR.

OWNER OF U.S. REG. NO. 1,978,330.

**CLASS 1—CHEMICALS**

FOR TEST KITS CONSISTING PRIMARILY OF REAGENTS FOR SCIENTIFIC USE; DIAGNOSTIC PREPARATIONS IN THE NATURE OF ANTIBODIES FOR INDUSTRIAL, SCIENTIFIC AND RESEARCH USE; ANTIBODY COMPOSITIONS FOR THE DISCOVERY AND DEVELOPMENT OF BIOMARKERS AND CREATION OF BIOMARKER ASSAYS FOR SCIENTIFIC OR RESEARCH USE (U.S. CLS. 1, 5, 6, 10, 26 AND 46).

**CLASS 39—TRANSPORTATION AND STORAGE**

FOR HYBRIDOMA CELL LINE STORAGE (U.S. CLS. 100 AND 105).

**CLASS 40—MATERIAL TREATMENT**

FOR CUSTOM ANTIBODY PRODUCTION AND GENERATION; CUSTOM MANUFACTURE OF ANTIBODIES FOR OTHERS; ANTIBODY PURIFICATION; ANTIBODY FRAGMENTATION; CUSTOM MANUFACTURE OF MONOCLONAL AND POLYCLONAL ANTIBODIES FOR OTHERS (U.S. CLS. 100, 103 AND 106).

**CLASS 42—SCIENTIFIC AND COMPUTER SERVICES**

FOR SCIENTIFIC LABORATORIES PERFORMING ANTIBODY SCREENING, ANTIBODY LABELING, ANTIBODY TESTING AND HYBRIDOMA CELL LINE DEVELOPMENT; SCIENTIFIC RESEARCH AND DEVELOPMENT, NAMELY DEVELOPMENT OF MONOCLONAL AND POLYCLONAL ANTIBODIES FOR OTHERS; SCIENTIFIC RESEARCH AND DEVELOPMENT, NAMELY DEVELOPMENT OF IMMUNOASSAY TESTING PROCEDURES FOR OTHERS; RESEARCH AND DEVELOPMENT OF THERAPEUTICS (U.S. CLS. 100 AND 101).

DEZMONA MIZELLE, EXAMINING ATTORNEY

SN 77-837,253. TORISHIMA PUMP MFG. CO., LTD., OSAKA, JAPAN, FILED 9-29-2009.



PRIORITY CLAIMED UNDER SEC. 44(D) ON JAPAN APPLICATION NO. 2009-069111, FILED 9-9-2009, REG. NO. 5421028, DATED 6-24-2011, EXPIRES 6-24-2021.

NO CLAIM IS MADE TO THE EXCLUSIVE RIGHT TO USE "RE ENGINEERING & DESIGN", APART FROM THE MARK AS SHOWN.

THE MARK CONSISTS OF THE WORDING "TORISHIMA REDU RE ENGINEERING & DESIGN UP". THE TERM "TORISHIMA" APPEARS WITHIN A RECTANGLE WITH AN IMAGE OF A DIVIDED CIRCLE TO THE LEFT.

THE WORDING "TORISHIMA" HAS NO MEANING IN A FOREIGN LANGUAGE.

**CLASS 37—CONSTRUCTION AND REPAIR**

FOR REPAIR, MAINTENANCE AND INSTALLATION OF PUMPS; REPAIR, MAINTENANCE AND INSTALLATION OF AIR HEATING/COOLING APPARATUS AND AIR CONDITIONING APPARATUS; REPAIR, MAINTENANCE AND INSTALLATION OF IRRIGATION MACHINES AND APPARATUS; REPAIR, MAINTENANCE AND INSTALLATION OF ELECTRIC MOTORS; REPAIR, MAINTENANCE AND INSTALLATION OF POWER GENERATING APPARATUS; REPAIR, MAINTENANCE AND INSTALLATION OF APPARATUS FOR SEWAGE WATER TREATMENT AND SLUDGE TREATMENT; REPAIR, MAINTENANCE AND INSTALLATION OF DESALINATION PLANTS; REPAIR, MAINTENANCE AND INSTALLATION OF WATER DISTRIBUTION INSTALLATIONS; PROVING INFORMATION ON THE REPAIR, MAINTENANCE AND INSTALLATION OF ALL THE AFORESAID GOODS; CONSULTATION SERVICES ON THE REPAIR, MAINTENANCE AND INSTALLATION OF ALL THE AFORESAID GOODS (U.S. CLS. 100, 103 AND 106).

**CLASS 42—SCIENTIFIC AND COMPUTER SERVICES**

FOR PRODUCT TESTING, NAMELY, TESTING OF PUMPS, HEATING/COOLING APPARATUS AND AIR CONDITIONING APPARATUS; IRRIGATION MACHINES AND APPARATUS, ELECTRIC MOTORS, POWER GENERATING APPARATUS, APPARATUS FOR SEWAGE WATER TREATMENT AND SLUDGE TREATMENT, DESALINATION PLANTS AND WATER DISTRIBUTION INSTALLATIONS (U.S. CLS. 100 AND 101).

SKYE YOUNG, EXAMINING ATTORNEY

SN 77-850,552. LG HAUSYS, LTD., SEOUL, REPUBLIC OF KOREA, FILED 10-16-2009.

# HI-MED

THE MARK CONSISTS OF STANDARD CHARACTERS WITHOUT CLAIM TO ANY PARTICULAR FONT, STYLE, SIZE, OR COLOR.

PRIORITY CLAIMED UNDER SEC. 44(D) ON REPUBLIC OF KOREA APPLICATION NO. 40-2009-0036, FILED 7-31-2009, REG. NO. 0838982, DATED 10-11-2010, EXPIRES 10-11-2020.

## CLASS 17—RUBBER GOODS

FOR SEMI-WORKED PLASTIC FILM; VINYL SHEETS; FLEXIBLE PLASTIC PIPES AND TUBING FOR PLUMBING PURPOSES; PLASTIC RODS AND BARS; PLASTIC SHEETS; LAMINATED BOARDS OF PLASTICS FOR USE IN MANUFACTURING; SYNTHETIC PLASTIC AS SEMI-FINISHED PRODUCTS IN THE FORM OF BOARDS AND PLATES; PLASTIC FILM, NOT FOR WRAPPING; PLASTIC LAWN HOSES; PLASTIC PLUMBING HOSES; PLASTIC SWIMMING POOL HOSES; SYNTHETIC RESINS-FACED SHEETS (U.S. CLS. 1, 5, 12, 13, 35 AND 50).

## CLASS 19—NON-METALLIC BUILDING MATERIALS

FOR BUILDING PANELS, NOT OF METAL; FLOORING, NOT OF METAL; FLOORS, NOT OF METAL; CEILING PANELS, NOT OF METAL; DOORS, NOT OF METAL; WINDOW FRAMES, NOT OF METAL; CASEMENT WINDOWS, NOT OF METAL; TILES, NOT OF METAL; VINYL TILES; PLASTIC TILES (U.S. CLS. 1, 12, 33 AND 50).

## CLASS 27—FLOOR COVERINGS

FOR LINOLEUM SHEETS (U.S. CLS. 19, 20, 37, 42 AND 50).

SEAN CROWLEY, EXAMINING ATTORNEY

SN 77-852,149. FAIRPOINT COMMUNICATIONS, INC., CHARLOTTE, NC. FILED 10-19-2009.

# VANTAGEPOINT

THE MARK CONSISTS OF STANDARD CHARACTERS WITHOUT CLAIM TO ANY PARTICULAR FONT, STYLE, SIZE, OR COLOR.

## CLASS 38—COMMUNICATION

FOR TELECOMMUNICATIONS SERVICES, NAMELY, COMMUNICATIONS BY COMPUTER TERMINALS, FACSIMILE AND TELEPHONE; COMMUNICATION SERVICES, NAMELY, TRANSMISSION OF VOICE, AUDIO, VISUAL IMAGES AND DATA BY TELECOMMUNICATIONS NETWORKS, THE INTERNET, INFORMATION SERVICES NETWORKS AND DATA NETWORKS; DATA TRANSMISSION AND RECEPTION SERVICES VIA TELECOMMUNICATION MEANS; DIGITAL NETWORK TELECOMMUNICATIONS SERVICES; ELECTRONIC DELIVERY OF IMAGES AND PHOTOGRAPHS VIA A GLOBAL COMPUTER NETWORK;

ELECTRONIC MAIL AND MESSAGING SERVICES; ELECTRONIC TRANSMISSION OF VOICE, MESSAGES, MAIL, SIGNALS, DATA, DOCUMENTS, IMAGES, VIDEO, GRAPHICS AND PHOTOGRAPHS VIA COMPUTER TERMINALS AND ELECTRONIC DEVICES; ELECTRONIC VOICE MESSAGING, NAMELY, THE RECORDING AND SUBSEQUENT TRANSMISSION OF VOICE MESSAGING BY TELEPHONE; ELECTRONIC, ELECTRIC, AND DIGITAL TRANSMISSION OF VOICE, MESSAGES, MAIL, SIGNALS, DATA, DOCUMENTS, IMAGES, VIDEO, GRAPHICS AND PHOTOGRAPHS; E-MAIL DATA SERVICES; E-MAIL FORWARDING SERVICES; INFORMATION TRANSMISSION VIA ELECTRONIC COMMUNICATIONS NETWORKS; INTERNET SERVICE PROVIDER; INTRASTATE TELEPHONE SERVICES; LOCAL AND LONG DISTANCE TELEPHONE SERVICES; PBX DIALING SERVICES; PROVIDING COLOCATION SERVICES FOR VOICE, VIDEO AND DATA COMMUNICATIONS APPLICATIONS; PROVIDING HIGH SPEED ACCESS TO AREA NETWORKS AND A GLOBAL COMPUTER INFORMATION NETWORK; PROVIDING ACCESS TO TELECOMMUNICATION NETWORKS; PROVIDING ACCESS TO THE INTERNET; PROVIDING ELECTRONIC TELECOMMUNICATION CONNECTIONS; PROVIDING ELECTRONIC TRANSMISSION OF INFORMATION TO PERSONS WHO ARE DEAF OR HEARING IMPAIRED VIA THE INTERNET AND TELEPHONES; PROVIDING EMAIL SERVICES; PROVIDING FRAME RELAY CONNECTIVITY SERVICES FOR DATA TRANSFER; PROVIDING INTERNET ACCESS; PROVIDING MULTIPLE USER DIAL-UP AND DEDICATED ACCESS TO THE INTERNET; PROVIDING ON-LINE COMMUNICATIONS LINKS WHICH TRANSFER THE WEB SITE USER TO OTHER LOCAL AND GLOBAL WEB PAGES; PROVIDING PRIVATE AND SECURE REAL TIME ELECTRONIC COMMUNICATION OVER A COMPUTER NETWORK; PROVIDING REMOTE INTERNET ACCESS; PROVIDING TELECOMMUNICATIONS CONNECTIONS TO A GLOBAL COMPUTER NETWORK; PROVIDING TELEPHONE CONFERENCING SERVICES; PROVIDING VOICE COMMUNICATION SERVICES VIA THE INTERNET; PROVISION OF VIDEO CONFERENCING SERVICES; PROVIDING PAGING SERVICES; PROVIDING TELECOMMUNICATIONS SERVICES FOR DATA TRANSMISSION, NAMELY, ADSL, ALTERNATE INTERNET ACCESS WITH ACCESS TO INTERNET 2 (IPV6), ASYNCHRONOUS TRANSFER MODE (ATM), CARRIER ETHERNET SERVICES, LEASING OF TELECOMMUNICATIONS NETWORK INFRASTRUCTURE, NAMELY, DARK FIBERS, DEDICATED INTERNET SERVICES, DNS REDIRECT, ETHERNET LINE (E-LINE), ETHERNET-LOCAL AREA NETWORK (E-LAN), ENHANCED ETHERNET PRIVATE LINE, ETHERNET DEDICATED INTERNET ACCESS, ETHERNET MANAGED SERVICES, FRAME RELAY, LAYER 3 (L3) IP-VPN (VIRTUAL PRIVATE NETWORK), LOCAL AREA NETWORK (LAN), LAYER 2 IP-VPN (VIRTUAL PRIVATE NETWORK), POINT TO MULTIPOINT TRANSPORT, POINT TO POINT TRANSPORT, PRIVATE LINE, SESSION INITIATION PROTOCOL (SIP) TRUNKING, SYNCHRONOUS OPTICAL NETWORK (SONET), TLS IP-MPLS (MULTIPROTOCOL LABEL SWITCHING), TRANSPARENT LOCAL AREA NETWORK (LAN) SERVICES, AND DATA TRANSPORT BY WORLDWIDE INTEROPERABILITY FOR MICROWAVE ACCESS AND WIRELESS WIDE AREA NETWORKS; RENTAL OF COMMUNICATION APPARATUS AND IMPLEMENTS; TELECOMMUNICATION ACCESS SERVICES; TELECOMMUNICATIONS SERVICES, NAMELY, LOCAL AND LONG DISTANCE TRANSMISSION OF VOICE, MESSAGES, MAIL, SIGNALS, DATA, DOCUMENTS, IMAGES, VIDEO, GRAPHICS AND PHOTOGRAPHS BY MEANS OF TELEPHONE OR COMPUTER NETWORKS; TELECOMMUNICATIONS SERVICES, NAMELY, PROVIDING INTERNET ACCESS VIA BROADBAND AND OPTICAL NETWORKS; TELECOMMUNICATIONS SERVICES IN THE NATURE OF PROVIDING TELEPHONE AND VOICE SERVICES WITH VARIOUS FEATURES, NAMELY, A DEDICATED TOLL-FREE NUMBER, VOICEMAIL, THREE-WAY CALLING, AUDIO CONFERENCING, CALL FORWARDING, CALL MANAGEMENT, CALL SCREENING, CALL WAITING, CALLER IDENTIFICATION, CENTREX, HOME INTERCOM, OFF-PREMISES AND ON-PREMISES EXTENSIONS, PRIORITY RINGING, RINGER IDENTIFICATION, SPEED DIAL, TOLL RESTRICTION, INTERNATIONAL LONG DISTANCE, TOLL FREE SERVICES, INTERSTATE LONG DISTANCE, INTRASTATE

LONG DISTANCE, BUSINESS ACCESS LINES, CENTREX ENHANCED FLEXGROW, COLLOCATION, CONSUMER ACCESS LINES, DIGITAL PRIVATE BRANCH EXCHANGES (PBX), INSIDE WIRE, IP CENTREX, ISDN BRI, ISDN PRI, MESSAGING, AND VOICE MAIL; TELECOMMUNICATION ROUTING AND JUNCTION SERVICES; TELECOMMUNICATIONS SERVICES FOR BUSINESSES, NAMELY, PROVIDING LONG DISTANCE TELECOMMUNICATION SERVICES, VOICE TELECOMMUNICATION SERVICES, LOCAL TELEPHONE SERVICE, AND INTERNET ACCESS SERVICES; TELECOMMUNICATIONS SERVICES, NAMELY, ISDN SERVICES; TELECONFERENCING AND VIDEO CONFERENCING SERVICES; TELEPHONE CALL COMPLETION SERVICES FOR DIRECTORY ASSISTANCE CUSTOMER; TELEPHONE COMMUNICATIONS SERVICES; TELEPHONE VOICE MESSAGING SERVICES; TRANSFER OF DATA BY TELECOMMUNICATIONS; VOICE MAIL SERVICES; VOICE OVER INTERNET PROTOCOL (VOIP) SERVICES; WEB CONFERENCING SERVICES; VIRTUAL NETWORK TELECOMMUNICATIONS SERVICES; MESSAGING SERVICES, NAMELY, TELEPHONE VOICE MESSAGING; DATA TRANSMISSION PACKET SERVICES; PRIVATE LINE VOICE, TEXT, FACSIMILE, AND DATA TELECOMMUNICATIONS SERVICES; TOLL-FREE AND TOLL-BASED TELECOMMUNICATIONS GATEWAY SERVICES; AND SWITCHED VOICE, DATA, VIDEO, AND MULTIMEDIA TRANSMISSION SERVICES (U.S. CLS. 100, 101 AND 104).

#### **CLASS 42—SCIENTIFIC AND COMPUTER SERVICES**

FOR MAINTENANCE OF WEBSITES AND HOSTING ON-LINE WEBSITES AND WEB FACILITIES FOR OTHERS; ENGINEERING SERVICES FOR THE USE OF DARK FIBERS; ASSIGNING STATIC IP ADDRESSES; AND PROVIDING REMOTE ONLINE BACKUP AND STORAGE OF COMPUTER DATA (U.S. CLS. 100 AND 101).

#### **CLASS 45—PERSONAL AND LEGAL SERVICES**

FOR MONITORING OF HOME BURGLAR AND SECURITY ALARMS; DOMAIN NAME REGISTRATION SERVICES (U.S. CLS. 100 AND 101).  
JULIE WATSON, EXAMINING ATTORNEY

SN 77-856,201. BIEDERMANN MOTECH GMBH & CO. KG, VS-SCHWENNINGEN, FED REP GERMANY, FILED 10-23-2009.

## **FLEX FUSION**

THE MARK CONSISTS OF STANDARD CHARACTERS WITHOUT CLAIM TO ANY PARTICULAR FONT, STYLE, SIZE, OR COLOR.

PRIORITY CLAIMED UNDER SEC. 44(D) ON ERPNCMNTY TM OFC APPLICATION NO. 8496507, FILED 8-18-2009, REG. NO. 008496507, DATED 2-17-2010, EXPIRES 8-18-2019.

#### **CLASS 10—MEDICAL APPARATUS**

FOR SURGICAL APPARATUS AND INSTRUMENTS; MEDICAL APPARATUS AND INSTRUMENTS, NAMELY, INSTRUMENTS FOR SPINE AND BONE SURGERY; SURGICAL IMPLANTS COMPOSED OF ARTIFICIAL MATERIALS FOR SPINES, SKELETONS OR BONES, SPINAL FIXATION AND STABILIZATION DEVICES, BONE ANCHORS; ORTHOPEDIC ARTICLES, NAMELY, SURGICAL IMPLANTS OF ARTIFICIAL MATERIALS (U.S. CLS. 26, 39 AND 44).

#### **CLASS 44—MEDICAL, BEAUTY AND AGRICULTURAL SERVICES**

FOR MEDICAL SERVICES OF AN ORTHOPEDIC TECHNICIAN (U.S. CLS. 100 AND 101).  
STEVEN PEREZ, EXAMINING ATTORNEY

SN 77-857,014. FAIRPOINT COMMUNICATIONS, INC., CHARLOTTE, NC. FILED 10-26-2009.

## **Love Your Bundle**

THE MARK CONSISTS OF STANDARD CHARACTERS WITHOUT CLAIM TO ANY PARTICULAR FONT, STYLE, SIZE, OR COLOR.

#### **CLASS 38—COMMUNICATION**

FOR TELECOMMUNICATIONS SERVICES, NAMELY, COMMUNICATIONS BY COMPUTER TERMINALS, FACSIMILE AND TELEPHONE; COMMUNICATION SERVICES, NAMELY, TRANSMISSION OF VOICE, AUDIO, VISUAL IMAGES AND DATA BY TELECOMMUNICATIONS NETWORKS, THE INTERNET, INFORMATION SERVICES NETWORKS AND DATA NETWORKS; DATA TRANSMISSION AND RECEPTION SERVICES VIA TELECOMMUNICATION MEANS; DIGITAL NETWORK TELECOMMUNICATIONS SERVICES; ELECTRONIC DELIVERY OF IMAGES AND PHOTOGRAPHS VIA A GLOBAL COMPUTER NETWORK; ELECTRONIC MAIL AND MESSAGING SERVICES; ELECTRONIC TRANSMISSION OF VOICE, MESSAGES, MAIL, SIGNALS, DATA, DOCUMENTS, IMAGES, VIDEO, GRAPHICS AND PHOTOGRAPHS VIA COMPUTER TERMINALS AND ELECTRONIC DEVICES; ELECTRONIC VOICE MESSAGING, NAMELY, THE RECORDING AND SUBSEQUENT TRANSMISSION OF VOICE MESSAGING BY TELEPHONE; ELECTRONIC, ELECTRIC, AND DIGITAL TRANSMISSION OF VOICE, MESSAGES, MAIL, SIGNALS, DATA, DOCUMENTS, IMAGES, VIDEO, GRAPHICS AND PHOTOGRAPHS; E-MAIL DATA SERVICES; E-MAIL FORWARDING SERVICES; INFORMATION TRANSMISSION VIA ELECTRONIC COMMUNICATIONS NETWORKS; INTERNET SERVICE PROVIDER; INTRASTATE TELEPHONE SERVICES; LOCAL AND LONG DISTANCE TELEPHONE SERVICES; PBX DIALING SERVICES; PROVIDING COLOCATION SERVICES FOR VOICE, VIDEO AND DATA COMMUNICATIONS APPLICATIONS; PROVIDING HIGH SPEED ACCESS TO AREA NETWORKS AND A GLOBAL COMPUTER INFORMATION NETWORK; PROVIDING ACCESS TO TELECOMMUNICATION NETWORKS; PROVIDING ACCESS TO THE INTERNET; PROVIDING ELECTRONIC TELECOMMUNICATION CONNECTIONS; PROVIDING ELECTRONIC TRANSMISSION OF INFORMATION TO PERSONS WHO ARE DEAF OR HEARING IMPAIRED VIA THE INTERNET AND TELEPHONES; PROVIDING EMAIL SERVICES; PROVIDING FRAME RELAY CONNECTIVITY SERVICES FOR DATA TRANSFER; PROVIDING INTERNET ACCESS; PROVIDING MULTIPLE USER DIAL-UP AND DEDICATED ACCESS TO THE INTERNET; PROVIDING ON-LINE COMMUNICATIONS LINKS WHICH TRANSFER THE WEB SITE USER TO OTHER LOCAL AND GLOBAL WEB PAGES; PROVIDING PRIVATE AND SECURE REAL TIME ELECTRONIC COMMUNICATION OVER A COMPUTER NETWORK; PROVIDING REMOTE INTERNET ACCESS; PROVIDING TELECOMMUNICATIONS CONNECTIONS TO A GLOBAL COMPUTER NETWORK; PROVIDING TELEPHONE CONFERENCING SERVICES; PROVIDING VOICE COMMUNICATION SERVICES VIA THE INTERNET; PROVISION OF VIDEO CONFERENCING SERVICES; PROVIDING PAGING SERVICES; PROVIDING TELECOMMUNICATIONS SERVICES FOR DATA TRANSMISSION, NAMELY, ADSL, ALTERNATE INTERNET ACCESS WITH ACCESS TO INTERNET 2 (IPV6), ASYNCHRO-

NOUS TRANSFER MODE (ATM), CARRIER ETHERNET SERVICES, LEASING OF TELECOMMUNICATIONS NETWORK INFRASTRUCTURE, NAMELY, DARK FIBERS, DEDICATED INTERNET SERVICES, DNS REDIRECT, ETHERNET LINE (E-LINE), ETHERNET-LOCAL AREA NETWORK (E-LAN), ENHANCED ETHERNET PRIVATE LINE, ETHERNET DEDICATED INTERNET ACCESS, ETHERNET MANAGED SERVICES, FRAME RELAY, LAYER 3 (L3) IP-VPN (VIRTUAL PRIVATE NETWORK), LOCAL AREA NETWORK (LAN), LAYER 2 IP-VPN (VIRTUAL PRIVATE NETWORK), POINT TO MULTIPOINT TRANSPORT, POINT TO POINT TRANSPORT, PRIVATE LINE, SESSION INITIATION PROTOCOL (SIP) TRUNKING, SYNCHRONOUS OPTICAL NETWORK (SONET), TLS IP-MPLS (MULTIPROTOCOL LABEL SWITCHING), TRANSPARENT LOCAL AREA NETWORK (LAN) SERVICES, AND DATA TRANSPORT BY WORLDWIDE INTEROPERABILITY FOR MICROWAVE ACCESS AND WIRELESS WIDE AREA NETWORKS; RENTAL OF COMMUNICATION APPARATUS AND IMPLEMENTS; TELECOMMUNICATION ACCESS SERVICES; TELECOMMUNICATIONS SERVICES, NAMELY, LOCAL AND LONG DISTANCE TRANSMISSION OF VOICE, MESSAGES, MAIL, SIGNALS, DATA, DOCUMENTS, IMAGES, VIDEO, GRAPHICS AND PHOTOGRAPHS BY MEANS OF TELEPHONE OR COMPUTER NETWORKS; TELECOMMUNICATIONS SERVICES, NAMELY, PROVIDING INTERNET ACCESS VIA BROADBAND AND OPTICAL NETWORKS; TELECOMMUNICATIONS SERVICES IN THE NATURE OF PROVIDING TELEPHONE AND VOICE SERVICES WITH VARIOUS FEATURES, NAMELY, A DEDICATED TOLL-FREE NUMBER, VOICEMAIL, THREE-WAY CALLING, AUDIO CONFERENCING, CALL FORWARDING, CALL MANAGEMENT, CALL SCREENING, CALL WAITING, CALLER IDENTIFICATION, CENTREX, HOME INTERCOM, OFF-PREMISES AND ON-PREMISES EXTENSIONS, PRIORITY RINGING, RINGER IDENTIFICATION, SPEED DIAL, TOLL RESTRICTION, INTERNATIONAL LONG DISTANCE, TOLL FREE SERVICES, INTERSTATE LONG DISTANCE, INTRASTATE LONG DISTANCE, BUSINESS ACCESS LINES, CENTREX ENHANCED FLEXGROW, COLLOCATION, CONSUMER ACCESS LINES, DIGITAL PRIVATE BRANCH EXCHANGES (PBX), INSIDE WIRE, IP CENTREX, ISDN BRI, ISDN PRI, MESSAGING, AND VOICE MAIL; TELECOMMUNICATION ROUTING AND JUNCTION SERVICES; TELECOMMUNICATIONS SERVICES FOR BUSINESSES, NAMELY, PROVIDING LONG DISTANCE TELECOMMUNICATION SERVICES, VOICE TELECOMMUNICATION SERVICES, LOCAL TELEPHONE SERVICE, AND INTERNET ACCESS SERVICES; TELECOMMUNICATIONS SERVICES, NAMELY, ISDN SERVICES; TELECONFERENCING AND VIDEO CONFERENCING SERVICES; TELEPHONE CALL COMPLETION SERVICES FOR DIRECTORY ASSISTANCE CUSTOMER; TELEPHONE COMMUNICATIONS SERVICES; TELEPHONE VOICE MESSAGING SERVICES; TRANSFER OF DATA BY TELECOMMUNICATIONS; VOICE MAIL SERVICES; VOICE OVER INTERNET PROTOCOL (VOIP) SERVICES; WEB CONFERENCING SERVICES; VIRTUAL NETWORK TELECOMMUNICATIONS SERVICES; MESSAGING SERVICES, NAMELY, TELEPHONE VOICE MESSAGING; DATA TRANSMISSION PACKET SERVICES; PRIVATE LINE VOICE, TEXT, FACSIMILE, AND DATA TELECOMMUNICATIONS SERVICES; TOLL-FREE AND TOLL-BASED TELECOMMUNICATIONS GATEWAY SERVICES; AND SWITCHED VOICE, DATA, VIDEO, AND MULTIMEDIA TRANSMISSION SERVICES (U.S. CLS. 100, 101 AND 104).

#### **CLASS 42—SCIENTIFIC AND COMPUTER SERVICES**

FOR ASSIGNING STATIC IP ADDRESSES; AND ENGINEERING SERVICES FOR THE USE OF DARK FIBERS (U.S. CLS. 100 AND 101).  
JULIE WATSON, EXAMINING ATTORNEY

SN 77-857,583. CLEANINT, L.L.C., ROUND ROCK, TX.  
FILED 10-26-2009.

### **IT'S SIMPLE - IT'S CLEAN**

THE MARK CONSISTS OF STANDARD CHARACTERS WITHOUT CLAIM TO ANY PARTICULAR FONT, STYLE, SIZE, OR COLOR.

#### **CLASS 3—COSMETICS AND CLEANING PREPARATIONS**

FOR REFILL SPONGES IMPREGNATED WITH CLEANSER FOR APPARATUS FOR SANITIZING AND DISINFECTING WRITING INSTRUMENTS, TOOLS, HANDLES, AND SURFACES OF IMPLEMENTS (U.S. CLS. 1, 4, 6, 50, 51 AND 52).

#### **CLASS 10—MEDICAL APPARATUS**

FOR MANUAL APPARATUS FOR SANITIZING AND DISINFECTING WRITING INSTRUMENTS, TOOLS, HANDLES, AND SURFACES OF IMPLEMENTS (U.S. CLS. 26, 39 AND 44).

LINDA MICKLEBURGH, EXAMINING ATTORNEY

SN 77-859,168. IDQ OPERATING, INC., GARLAND, TX.  
FILED 10-28-2009.

THE MARK CONSISTS OF STANDARD CHARACTERS WITHOUT CLAIM TO ANY PARTICULAR FONT, STYLE, SIZE, OR COLOR.

#### **CLASS 1—CHEMICALS**

FOR AIR CONDITIONING SYSTEM KITS COMPRISING REFRIGERANT SYSTEM ADDITIVES IN THE NATURE OF CHEMICAL ADDITIVES FOR LUBRICATING, IMPROVING DURABILITY, QUIETING AIR CONDITIONING COMPRESSORS, RESTORING VISCOSITY, AND PREVENTING AND STOPPING LEAKS FOR AIR CONDITIONING REFRIGERANT SYSTEMS AND A METAL FITTING FOR A HOSE; AIR CONDITIONING SYSTEM KITS COMPRISING REFRIGERANT GAS AND A METAL FITTING FOR A HOSE; VEHICLE AIR CONDITIONING SYSTEM REPAIR KITS PRIMARILY COMPRISED OF REFRIGERANT GAS AND ALSO CONTAINING HOSE AND FITTINGS; VEHICLE AIR CONDITIONING CHARGING KITS PRIMARILY COMPRISED OF REFRIGERANT GAS AND ALSO CONTAINING HOSES AND FITTINGS; AIR CONDITIONING SYSTEM KITS COMPRISING REFRIGERATION SYSTEM ADDITIVES IN THE NATURE OF CHEMICAL ADDITIVES FOR LUBRICATING, IMPROVING DURABILITY, QUIETING AIR CONDITIONING COMPRESSORS, RESTORING VISCOSITY, AND PREVENTING AND STOPPING LEAKS FOR AIR CONDITIONING REFRIGERANT SYSTEMS AND A NONMETAL HOSE; AIR CONDITIONING SYSTEM KITS COMPRISING REFRIGERANT GAS AND A NONMETAL HOSE (U.S. CLS. 1, 5, 6, 10, 26 AND 46).

**CLASS 6—METAL GOODS**

FOR AIR CONDITIONING SYSTEM KITS PRIMARILY COMPRISED OF A METAL FITTING FOR A HOSE AND ALSO CONTAINING A PRESSURE GAUGE; AIR CONDITIONING SYSTEM CHARGING EQUIPMENT COMPRISING METAL FITTINGS FOR A HOSE AND A METAL REFRIGERANT DISPENSER; METAL CHARGING MANIFOLDS FOR AIR CONDITIONING SYSTEM CHARGING; VEHICLE AIR CONDITIONING SYSTEM REPAIR KITS PRIMARILY COMPRISED OF METAL HOSES AND FITTINGS AND ALSO CONTAINING REFRIGERANT; VEHICLE AIR CONDITIONING CHARGING KITS PRIMARILY COMPRISED OF METAL HOSES AND FITTINGS AND ALSO CONTAINING REFRIGERANT (U.S. CLS. 2, 12, 13, 14, 23, 25 AND 50).

**CLASS 9—ELECTRICAL AND SCIENTIFIC APPARATUS**

FOR AIR CONDITIONING SYSTEM LEAK DETECTORS; AIR CONDITIONING SYSTEM PRESSURE GAUGES; AIR CONDITIONING SYSTEM CHARGING LIGHTS; AIR CONDITIONING SYSTEM LEAK DETECTION LIGHTS; AIR CONDITIONING SYSTEM LEAK DETECTORS COMPRISED OF DYE INJECTORS; AIR CONDITIONING SYSTEM THERMOMETERS; AIR CONDITIONING SYSTEM KITS PRIMARILY COMPRISED OF A PRESSURE GAUGE AND ALSO CONTAINING A METAL FITTING FOR A HOSE; AIR CONDITIONING SYSTEM KITS PRIMARILY COMPRISED OF A PRESSURE GAUGE AND ALSO CONTAINING A NONMETAL FITTING FOR A HOSE (U.S. CLS. 21, 23, 26, 36 AND 38).

**CLASS 11—ENVIRONMENTAL CONTROL APPARATUS**

FOR METAL FITTING FOR A HOSE, AND METAL CONDUITS FOR AIR CONDITIONERS SOLD AS PART OF AN AIR CONDITIONING APPARATUS; NONMETAL HOSES SOLD AS AN INTEGRAL PART OF AN AIR CONDITIONING APPARATUS; NON-METAL FITTINGS FOR HOSE AND NON-METAL CONDUITS SOLD AS PART OF AN AIR CONDITIONING APPARATUS (U.S. CLS. 13, 21, 23, 31 AND 34).

**CLASS 17—RUBBER GOODS**

FOR AIR CONDITIONING SYSTEM KITS PRIMARILY COMPRISED OF A NONMETAL FITTING FOR A HOSE AND ALSO CONTAINING A PRESSURE GAUGE; NON-METAL HOSES FOR USE IN AIR CONDITIONERS (U.S. CLS. 1, 5, 12, 13, 35 AND 50).

MAYUR VAGHANI, EXAMINING ATTORNEY

**CLASS 3—COSMETICS AND CLEANING PREPARATIONS**

FOR (BASED ON 44(E)) BEAUTY CARE COSMETICS; HAIRCARE PRODUCTS AND PREPARATIONS, NAMELY, SHAMPOO, CONDITIONERS, SHAMPOO AND BODY WASH, LEAVE-IN CONDITIONER, DETANGLE SPRAY; HAIRCARE PRODUCTS IN THE FORM OF HAIR SPRAYS; HAIR CARE AGENTS, NAMELY, COLOURED HAIR SPRAY; HAIR CLEANING PREPARATIONS; GELS, MOUSSES, AND NON-MEDICATED BALMS FOR HAIRDRESSING AND HAIRCARE; HAIR LACQUERS; PREPARATIONS IN AEROSOL FORM FOR HAIRDRESSING AND HAIRCARE, NAMELY, SPRAYS FOR HAIR STYLING, GLITTER SPRAYS FOR HAIR STYLING, DETANGLE SPRAY, LEAVE-IN CONDITIONER; HAIR-COLOURING AND HAIR-DECOLOURING PREPARATIONS; PREPARATIONS FOR WAVING AND SETTING HAIR; NATURAL BODY CARE PRODUCTS FOR THE HAIR, NAMELY, NATURAL SHAMPOO, CONDITIONER, HAIR LOTION, HAIR GEL, HAIR DETANGLER, SWIMMERS SHAMPOO, LEAVE-IN CONDITIONER; OILS FOR USE IN HAIRCARE, NAMELY, HAIR OILS; PERFUMES, EAUX DE TOILETTE; NON-MEDICATED TOILETRIES; BATH AND SHOWER GELS; TOILET SOAPS; DEODORANTS FOR PERSONAL USE; COSMETICS; COSMETIC PREPARATIONS; BEAUTY CREAMS; CREAMS, MILKS, LOTIONS, AND NON-MEDICATED BALMS AND GELS FOR THE FACE, BODY AND HANDS; SKIN CLEANSING PREPARATIONS AND PRODUCTS FOR NON-MEDICAL USE; NON-MEDICATED SKIN CARE PREPARATIONS; SUN-TANNING AND AFTER-SUN PREPARATIONS, NAMELY, MILKS, GELS, OILS, SPRAYS, CREAMS, LOTIONS, BALMS, AND AFTER-SUN LOTION; MAKE-UP PREPARATIONS; BEAUTY FACE PACKS COMPRISING COSMETICS; BEAUTY TONICS FOR APPLICATION TO THE FACE AND BODY; ESSENTIAL OILS (U.S. CLS. 1, 4, 6, 50, 51 AND 52).

**CLASS 5—PHARMACEUTICALS**

FOR (BASED ON INTENT TO USE) (BASED ON 44(E)) LICE TREATMENT PREPARATIONS, NAMELY, PREVENTATIVE SHAMPOO AGAINST HEAD LICE (U.S. CLS. 6, 18, 44, 46, 51 AND 52).

**CLASS 35—ADVERTISING AND BUSINESS**

FOR (BASED ON INTENT TO USE) (BASED ON 44(E)) ESTABLISHMENT AND OPERATION OF BEAUTY SALONS AND BEAUTY PRODUCT BUSINESSES (U.S. CLS. 100, 101 AND 102).

**CLASS 44—MEDICAL, BEAUTY AND AGRICULTURAL SERVICES**

FOR (BASED UPON 44(E)) HAIRCARE SERVICES, NAMELY, HAIR SALON SERVICES; BEAUTY SERVICES, NAMELY, PERSONAL BEAUTY CONSULTATIONS AND TREATMENTS, NAMELY, HAIR CUTS, NAIL PAINTING; FACIAL TREATMENTS, NAMELY, FACIALS AND FACIAL PEELS; MANICURES, PEDICURES, AND MAKE UP APPLICATION PROVIDED VIA HOME VISITS AND ON-LINE; ADVISORY SERVICES RELATING TO BEAUTY TREATMENTS, NAMELY, HAIR CUTS, NAIL PAINTING, FACIALS AND FACIAL PEELS, MANICURES, PEDICURES, MAKE UP APPLICATION AND MASSAGES, HAIRCARE PROCESSES AND TECHNIQUES, AND SKIN CARE; BEAUTY SALON SERVICES; BEAUTY THERAPY SERVICES, NAMELY, MEDICATED SPA SERVICES, FACIALS AND FACIAL PEELS, MANICURES, PEDICURES, NAIL PAINTING, MAKE UP APPLICATION AND MASSAGES, AND IN PARTICULAR MINIMALLY AND NON-INVASIVE COSMETIC AND BODY FITNESS THERAPY SERVICES; FACIAL BEAUTY TREATMENT SERVICES, NAMELY, PROVIDING FA-

SN 77-861,019. RAPUNZEL HAIR LIMITED, LONDON, ENGLAND, FILED 10-29-2009.

# TANTRUM

THE MARK CONSISTS OF STANDARD CHARACTERS WITHOUT CLAIM TO ANY PARTICULAR FONT, STYLE, SIZE, OR COLOR.

OWNER OF UNITED KINGDOM REG. NO. 2499048, DATED 2-13-2009, EXPIRES 10-1-2018.



CIALS AND FACIAL PEELS; INFORMATION AND ADVISORY SERVICES RELATING TO BEAUTY AND HAIRCARE PRODUCTS AND THEIR USE, NAMELY, PROVIDING INFORMATION AND ADVICE CONCERNING SPECIFIC BEAUTY TREATMENTS, NAMELY, HAIR CUTS, NAIL PAINTING, FACIALS AND FACIAL PEELS, MANICURES, PEDICURES, AND MAKE UP APPLICATION, HAIRCARE PROCESSES AND TECHNIQUES, AND SKIN CARE; TECHNICAL, MANAGEMENT, CONSULTANCY, ADVISORY AND INFORMATION SERVICES RELATING TO ALL THE AFORESAID SERVICES (U.S. CLS. 100 AND 101).

NAKIA HENRY, EXAMINING ATTORNEY

#### **CLASS 41—EDUCATION AND ENTERTAINMENT**

FOR COMPUTER SERVICES, NAMELY, PROVIDING INFORMATION IN THE FIELD OF ENTERTAINMENT FOR CHILDREN VIA AN ELECTRONIC GLOBAL COMPUTER NETWORK; ENTERTAINMENT AND EDUCATION SERVICES IN THE NATURE OF ON-LINE MUSICAL PERFORMANCES FROM CARTOON CHARACTERS; ENTERTAINMENT SERVICES IN THE NATURE OF AN ANIMATION PROGRAM PROVIDED THROUGH THE GLOBAL COMPUTER INFORMATION NETWORK, INTERNET STREAMING, AND VIDEO-ON-DEMAND; ENTERTAINMENT SERVICES IN THE NATURE OF ONGOING TELEVISION PROGRAMS FOR CHILDREN IN THE FIELDS OF ENTERTAINMENT, MUSICAL PERFORMANCES, MUSICAL VIDEOS, RELATED FILM CLIPS, PHOTOGRAPHS, AND OTHER MULTIMEDIA MATERIALS FEATURING ANIMATED CHARACTERS; EDUCATIONAL AND ENTERTAINMENT SERVICES, NAMELY, PROVIDING ON-LINE INTERACTIVE CHILDREN'S STORIES; ENTERTAINMENT SERVICES, NAMELY, PROVIDING TEMPORARY USE OF NON-DOWNLOADABLE INTERACTIVE GAMES; ENTERTAINMENT SERVICES, NAMELY, PROVIDING A WEB SITE FEATURING MUSICAL PERFORMANCES, MUSICAL VIDEOS, RELATED FILM CLIPS, PHOTOGRAPHS, AND OTHER MULTIMEDIA MATERIALS FEATURING ANIMATED CHARACTERS; ENTERTAINMENT SERVICES, NAMELY, PROVIDING TEMPORARY USE OF NON-DOWNLOADABLE COMPUTER GAMES; ENTERTAINMENT SERVICES, NAMELY, THE PROVISION OF CONTINUING PROGRAMS, VIDEOS, VIDEO AND AUDIO SEGMENTS, MOVIES, AND ONLINE SHOWS FEATURING ANIMATION, COMEDY, ETC. DELIVERED BY ONLINE MEDIA, NAMELY, TELEVISION, RADIO, SATELLITE, THE INTERNET, AND LIVE; ENTERTAINMENT SERVICES, NAMELY, PROVIDING NONDOWNLOADABLE PRERECORDED MUSIC ON-LINE VIA A GLOBAL COMPUTER NETWORK; INTERACTIVE EDUCATIONAL AND ENTERTAINMENT SERVICES, NAMELY, PROVIDING A WEB-BASED VIRTUAL EDUCATIONAL THEME-PARK FEATURING ANIMATION, TOYS, VIDEO GAMES, AND ENTERTAINMENT OF INTEREST TO CHILDREN; ENTERTAINMENT SERVICES, NAMELY, PROVIDING AN ONGOING ON-LINE VIDEO PROGRAM IN THE NATURE OF INTERSTITIALS IN THE FIELDS OF ANIMATED CARTOONS; ENTERTAINMENT SERVICES, NAMELY, PROVIDING A WEB SITE FEATURING ANIMATION AND VIDEO GAMES; PROVIDING INFORMATION IN THE FIELD OF ENTERTAINMENT, FEATURING ANIMATION RENDERED BY MEANS OF A GLOBAL COMPUTER NETWORK; PROVIDING ON-LINE INTERACTIVE GAMES PLAYED VIA GLOBAL COMPUTER NETWORKS, GLOBAL COMMUNICATIONS NETWORKS OR THROUGH OTHER DISTRIBUTION PLATFORMS; PROVIDING A WEB SITE WHERE USERS CAN POST RATINGS, REVIEWS AND RECOMMENDATIONS ON EVENTS AND ACTIVITIES IN THE FIELD OF ENTERTAINMENT AND EDUCATION; PROVIDING A WEBSITE FEATURING EDUCATION AND ENTERTAINMENT FOR CHILDREN; PROVIDING ADVICE AND INFORMATION IN THE FIELD OF EDUCATIONAL AND ENTERTAINMENT ACTIVITIES AND EVENTS FOR CHILDREN; PROVIDING AN INTERNET WEBSITE PORTAL IN THE FIELD OF ENTERTAINMENT, CULTURAL AND SPORTING EVENTS; PROVIDING INFORMATION IN THE FIELD OF ENTERTAINMENT, FEATURING ANIMATION RENDERED BY MEANS OF A GLOBAL COMPUTER NETWORK; PRODUCTION OF ENTERTAINMENT SHOWS AND INTERACTIVE PROGRAMS, NAMELY, MUSICAL, VARIETAL, COMEDY, ACTION, HORROR, AND DRAMATIC PERFORMANCES FOR DISTRIBUTION VIA ELECTRONIC MEANS; PRODUCTION OF ENTERTAINMENT SHOWS AND INTERACTIVE PROGRAMS FOR DISTRIBUTION VIA ELECTRONIC MEANS, NAMELY, PRODUCTION OF TELEVISION PROGRAMS; PUBLICATION AND EDITING OF PRINTED MATTER, NAMELY, BOOKS, COMIC BOOKS, NEWSPAPERS, MAGAZINES, BROCHURES AND MANUALS (U.S. CLS. 100, 101 AND 107).

WANDA KAY PRICE, EXAMINING ATTORNEY

SN 77-861,872. UNGER, PAULA, SANTA BARBARA, CA.  
FILED 10-30-2009.

### **INTERNATIONAL ICON**

THE MARK CONSISTS OF STANDARD CHARACTERS WITHOUT CLAIM TO ANY PARTICULAR FONT, STYLE, SIZE, OR COLOR.

#### **CLASS 9—ELECTRICAL AND SCIENTIFIC APPARATUS**

FOR PRE-RECORDED DIGITAL VIDEO DISCS OR DVDS, AND PRE-RECORDED VIDEO TAPES, FEATURING ENTERTAINMENT FOR CHILDREN, NAMELY, MUSIC, STORIES, COSTUMED CHARACTERS AND ANIMATION, PERFORMANCES, EDUCATIONAL INSTRUCTION, AND RECORDED LIVE PERFORMANCES FOR CHILDREN; PRE-RECORDED AUDIO AND AUDIO VISUAL DEVICES, NAMELY, CDS, DVDS, AND CD-ROMS FEATURING CHILDREN'S EDUCATIONAL MATTER, CHILDREN'S MUSIC, AND CHILDREN'S ENTERTAINMENT AND TELEVISION PROGRAMS FOR CHILDREN; ELECTRONIC PUBLICATIONS, NAMELY, BOOKS RECORDED ON COMPUTER MEDIA, AND MAGAZINES RECORDED ON COMPUTER MEDIA ALL FEATURING CHILDREN'S EDUCATIONAL MATTER, CHILDREN'S STORIES, AND CHILDREN'S ENTERTAINMENT; PRE-RECORDED VIDEO TAPES FEATURING ANIMATED CARTOONS; SOUND RECORDINGS, NAMELY, MUSICAL SOUND RECORDINGS; SOUND RECORDINGS, NAMELY, CHILDREN'S STORIES RECORDED ON CD; PRE-RECORDED VIDEO RECORDINGS AND VIDEO DISC RECORDINGS FEATURING CHILDREN'S EDUCATIONAL MATTER IN THE FORM OF COMEDY, DRAMA, ACTION, ADVENTURE AND ANIMATION SHOWS, CHILDREN'S MUSIC, AND EDUCATIONAL AND ENTERTAINING ANIMATION FOR CHILDREN; INTERACTIVE MULTIMEDIA COMPUTER GAME PROGRAMS; COMPUTER GAME SOFTWARE; VIDEO GAME SOFTWARE; COMPUTER GAME PROGRAMS; VIDEO GAME PROGRAMS; DOWNLOADABLE SOFTWARE FOR USE IN CONNECTION WITH ONLINE VIEWING OF PRE-RECORDED PERFORMANCES IN THE FIELD OF COMEDY, DRAMA, ACTION, ADVENTURE AND ANIMATION; INTERACTIVE GAME PROGRAMS; DOWNLOADABLE FILMS AND TELEVISION PROGRAMS FEATURING COMEDY, DRAMA, ACTION, ADVENTURE AND ANIMATION PROVIDED VIA A VIDEO-ON-DEMAND SERVICE (U.S. CLS. 21, 23, 26, 36 AND 38).

SN 77-862,935. BINGGRAE CO., LTD., KYUNGGI-DO, REPUBLIC OF KOREA, FILED 11-2-2009.

# BINGGRAE

THE MARK CONSISTS OF STANDARD CHARACTERS WITHOUT CLAIM TO ANY PARTICULAR FONT, STYLE, SIZE, OR COLOR.

PRIORITY CLAIMED UNDER SEC. 44(D) ON REPUBLIC OF KOREA APPLICATION NO. 2009-0047215, FILED 9-25-2009, REG. NO. 0841417, DATED 11-1-2010, EXPIRES 11-1-2020.

PRIORITY CLAIMED UNDER SEC. 44(D) ON REPUBLIC OF KOREA APPLICATION NO. 40-2009-0047, FILED 9-25-2009, REG. NO. 0841387, DATED 11-1-2010, EXPIRES 11-1-2020.

OWNER OF U.S. REG. NOS. 2,944,698, 3,104,333 AND 3,310,270.

## CLASS 29—MEATS AND PROCESSED FOODS

FOR MILK; MILK BEVERAGES WITH HIGH MILK CONTENT; SOYBEAN MILK; APPLE PUREE; BACON; BEEF; BEEF SLICES; BEEF TALLOW FOR FOOD; BLENDED OIL FOR FOOD; BOUILLON; BOUILLON CONCENTRATES; BUTTER; CANNED COOKED MEAT; CANNED OR BOTTLED FRUITS; CANNED OR BOTTLED VEGETABLES; CANNED SNAILS; CANNED TOMATOES; CARP, NOT LIVE; CASEIN FOR FOOD; CAVIAR; CHARCUTERIE; CHEESE; CHEESE POWDER; CHEESE SPREADS; CHICKEN; CLAMS, NOT LIVE; COCONUT OIL; COCONUT OIL AND FAT FOR FOOD; COCONUT POWDER; CODS, NOT LIVE; CONDENSED MILK; COOKED SNAILS; CORN OIL FOR FOOD; CRABS, NOT LIVE; CREAM FRAICHE; CRYSTALLIZED FRUITS; CURD; DRIED BEEF; DRIED EGGS; DRIED FIGS; DRIED FRUIT MIXES; DRIED FRUITS; DRIED MEAT; DRINKING YOGURTS; DRINKS BASED ON YOGHURT; DUCK EGGS; EDIBLE FATS; EDIBLE OILS; EDIBLE OILS AND FATS; FERMENTED MILK; FISH SAUSAGES; FISHMEAL FOR HUMAN CONSUMPTION; FRESH UNRIPENED CHEESES; FRIED MEAT; FRIED POTATOES; FROSTED FRUITS; FROZEN EGGS; FROZEN FRUITS; FROZEN VEGETABLES; FRUIT AND VEGETABLE SALADS; FRUIT PEEL; FRUIT PULP; FRUIT SALADS; FRUIT-BASED SNACK FOOD; GAME, NOT LIVE; GHERKINS; GOAT MILK; HAM; JAMS; LACTIC ACID BACTERIA DRINKS; LACTIC ACID DRINKS; LIVER; LIVER PATE; MARGARINE; MARMALADE; MEAT; MEAT EXTRACTS; MEAT JELLIES; MILK PROTEINS; MOLD-RIPENED CHEESE; OLIVE PASTES; OYSTERS, NOT LIVE; PALM OIL FOR FOOD; PEANUT OIL FOR FOOD; PEELED TOMATOES; PICCALILLI; PICKLES; PORK; POTATO FRITTERS; POTATO STICKS; POULTRY, NOT LIVE; POWDERED OILS AND FATS FOR FOOD; PRAWNS, NOT LIVE; PREPARED WALNUTS; PROCESSED MEAT; PROCESSED OLIVE PUREE; QUAIL EGGS; RAISINS; RENNET; RICE BRAN OIL FOR FOOD; RIPENED CHEESE; SARDINES; SAUERKRAUT; SAUSAGES; SEA BASSES, NOT LIVE; SEA URCHINS, NOT LIVE; SEA-CUCUMBERS, NOT LIVE; SESAME OIL; SESAME OIL FOR FOOD; SHEEP CHEESE; SHEEP MILK; SHELLFISH, NOT LIVE; SHORTENING; SHORT-NECKED CLAMS, NOT LIVE; SHRIMPS, NOT LIVE; SOFT CHEESE; SOFT WHITE CHEESE; SOFT-SHELLED TURTLES, NOT LIVE; SPICY PICKLES; STRAINED CHEESE; SUNFLOWER OIL FOR FOOD; SWEET FISH, NOT LIVE; TINNED OLIVES; TOFU; TOMATO EXTRACTS; TOMATO PUREE; TRIPE; TUNA FISH; TURKEY; VEGETABLE PUREE; WHALE OIL AND FAT FOR FOOD; WHALES, NOT LIVE; WHEY; WHIPPED CREAM; WHITE CHEESE; YOGHURT; VEGETABLE JUICE FOR COOKING; PRESERVED PEAS; TOASTED LAVER (U.S. CL. 46).

## CLASS 30—STAPLE FOODS

FOR PROCESSED CEREALS; MEAT TENDERIZERS FOR HOUSEHOLD PURPOSES; CUBE SUGAR; SOY SAUCE; POTATO FLOUR FOR FOOD; DRIED PASTA; DRIED COOKED-RICE; MUSTARD; CINNAMON POWDER; MEAT PIES; HOT PEPPER POWDER; CEREAL-BASED SNACK FOODS; GOLDEN SYRUP; FRUIT ICE; FRUIT JELLIES; FRUIT TEAS; FRUIT CAKES; FRUIT FLAVORINGS, EXCEPT ESSENCES; PASTA-WRAPINGS FOR GYOZA; HOMINY GRITS; CRYSTAL SUGAR; OAT FLAKES; CHEWING GUMS; HONEY; FROZEN YOGURT CONFECTIONS; GREEN TEA; NOUGAT; BOILED SWEETS; MOLASSES SYRUP; HONEY SUBSTITUTES; TEA SUBSTITUTES; ARTIFICIAL COFFEE; DOUGHNUTS; SOYA BEAN PASTE; BUNS; DESERT PUDDINGS; RICE CAKES; INSTANT NOODLES; RAVIOLI; LIME TEA; RUSKS; BREAD ROLLS; MARINADES; MARSHMALLOW; MAYONNAISE; MARZIPAN; MACARONI; MACAROONS; DUMPLINGS; MALT BISCUITS; MUFFINS; NOODLES; PASTRY SHELLS FOR MONAKA; CAFFEINE-FREE COFFEE; STARCH SYRUP FOR FOOD; HOMINY; MUESLI; WHEAT FLOUR FOR FOOD; MILK CHOCOLATE; COFFEE BEVERAGES WITH MILK; COCOA BEVERAGES WITH MILK; PEPPERMINT SWEETS; WHITE SUGAR; BUTTER BISCUITS; FLAVORINGS FOR BUTTER; BAKING POWDER; GARDEN HERBS, PRESERVED; ROASTED COFFEE BEANS; GROUND COFFEE BEANS; POWDERED STARCH SYRUP FOR FOOD; BISCUITS; YEAST IN PILL FORM, NOT FOR MEDICAL USE; CHEWING GUM, NOT FOR MEDICAL PURPOSES; ICE SHERBETS; BREAD; BREADCRUMBS; POUNDED WHEAT; SAGO; SWEETMEATS; SANDWICHES; SALAD SAUCES; CELERY SALT; SAGE TEA; SUGAR; SUGAR-COATED HARD CARAMELS; SUGAR-COATED COFFEE BEANS; SHERBET; SAUCES; FILLED CHOCOLATE; PASTA FOR SOUPS; FLAVORINGS FOR SOUPS; SPAGHETTI; SPRING ROLLS; BREAD DOUGHS; FLOUR FOR FOOD; EDIBLE FRUIT ICES; GLUTEN FOR FOOD; MALT FOR FOOD PURPOSES; MALT EXTRACTS FOR FOOD; EDIBLE SALT; EDIBLE ICES; EDIBLE WAFERS; YEAST EXTRACTS FOR FOOD; CANDY FOR FOOD; GLUCOSE FOR FOOD; VINEGAR; TABLE SALT MIXED WITH SESAME SEEDS; YEAST; FRUIT PASTE FOR FLAVORING OF FOOD; FRESH PASTA; FRESH PIZZA; RICE FLOUR; RICE PUDDING; ALMOND CAKE; ALMOND PASTE; FLAVORINGS OF ALMOND; ICE CANDIES; ICED CAKES; ICE CREAM; CONES FOR ICE CREAM; ICE CREAM MIXES; ICED TEA; EDIBLE ICES; ICE BLOCKS; TOFFEE; ALIMENTARY PASTA; OATMEAL; ALLSPICE; WAFFLES; CHINESE NOODLES; THICKENING AGENTS FOR USE IN COOKING; COOKING SALT; WAFERS; ICE FOR REFRESHMENT; YEAST EXTRACTS; YEAST POWDER; INSTANT DOUGHNUT MIXES; INSTANT SOBA NOODLES; INSTANT UDON NOODLES; INSTANT CHINESE NOODLES; INSTANT COFFEE; INSTANT PANCAKE MIXES; INSTANT PUDDING MIXES; JAM BUNS; CLOVE POWDER; BAKING SPICES; TEA; FLAVORINGS OF TEA; TEA-BASED BEVERAGES; SWEETMEAT MADE OF SESAME OIL; FLOUR FOR MAKING DUMPLINGS OF GLUTINOUS RICE; NATURAL SWEETENERS; UNROASTED COFFEE; SUSHI; CHOCOLATE; CHOCOLATE BARS; CHOCOLATE CANDIES; CHOCOLATE PASTES; FLAVORINGS FOR CHEESES; CANNELLONI; CURRY POWDER; CURRY PASTES; CUSTARD; CANDY; COFFEE; COFFEE BASED BEVERAGES; CAKES; CAKE DOUGHS; FLAVORINGS FOR CAKES OTHER THAN ESSENTIAL OILS; CAPERS; COCOA; COCOA SPREADS; COCOA-BASED BEVERAGES; CANDY WITH COCOA; CORN CHIPS; CORN FLAKES; BREAD WITH SOY BEAN; COUSCOUS; COOKIES; CRACKERS; CREPES; CREAM BUNS; TABBOULEH; TACOS; TARTS; TAPIOCA; HUSKED OATS; HUSKED RICE; TAFFY; TORTILLAS; TOAST; WHOLE MEAL BREAD; PASTA; PIES; PANCAKES; PUFFED RICE; PASTRIES; PETIT-BEURRE BISCUITS; PETITS FOURS; FONDANTS; PUDDINGS; PRALINES; PIZZA; HALVAH; HOT DOG SANDWICHES; SPICES; FLAVORED VINEGAR; BLACK TEA; PEPPER (U.S. CL. 46).

DOMINIC FATHY, EXAMINING ATTORNEY

SN 77-866,878. CHIP MUSCLES LLC, NEW YORK, NY.  
FILED 11-6-2009.

SN 77-874,153. FURUNO ELECTRIC CO., LTD., HYOGO-PREF., JAPAN, FILED 11-17-2009.



THE COLOR(S) RED, WHITE AND BLACK IS/ARE CLAIMED AS A FEATURE OF THE MARK.

THE MARK CONSISTS OF A BLACK BACKGROUND WITH A LARGE POKER CHIP IN THE MIDDLE STANDING ON EDGE. THE LARGE POKER CHIP HAS ALTERNATING RED AND BLACK RECTANGLES ON THE OUTSIDE PERIMETER LAYER WITH SMALLER WHITE RECTANGLES IN BETWEEN THE ALTERNATING RED AND BLACK LAYER RECTANGLES WHICH THEN TRANSITIONS INTO AN ALL WHITE MIDDLE LAYER. THE MIDDLE OF THE CHIP IS A DARK RED TO RED TRANSITIONING CIRCLE WITH A GLARE ON THE TOP HALF. IN THE MIDDLE OF THE CIRCLE IS PRINTED A WHITE "CM" UTILIZING A COOLVETICA FONT WITH SHADOWING TO THE RIGHT. DIRECTLY BEHIND THE LARGE POKER CHIP ARE FIVE STACKS OF POKER CHIPS STACKED FLAT. ALL THE RIMS OF THE CHIPS ARE RED WITH ALTERNATING BLACK RECTANGLES AND WHITE SQUARES. THE CENTER STACK IS THE TALLEST AND IS DIRECTLY BEHIND THE POKER CHIP. ADJACENT TO THE CENTER STACK ON EITHER SIDE ARE SLIGHTLY SMALLER STACKS THAN THE CENTER STACK. ADJACENT TO THESE TWO STACKS ON EACH SIDE ARE SLIGHTLY SMALLER STACKS. THERE ARE A TOTAL OF FIVE STACKS THAT START FROM THE MIDDLE (THE HIGHEST) AND APPEAR TO BE DECREASING IN SIZE ON BOTH SIDES. AT THE BOTTOM OF THE FIVE STACKS AND LARGE POKER CHIP IS A MIRROR IMAGE OF THE LOWER HALF OF THE FIVE STACKS AND THE LARGE POKER CHIP DIRECTLY UNDER THE REFLECTING IMAGE IS THE WORD "CHIP MUSCLES" IN WHITE TRANSITIONING TO GRAY LETTERS IN THE CLAREDON LT BT FONT. UNDER THE WORD "CHIP MUSCLES", AND UTILIZING THE SAME FONT IN A SMALLER SIZE, ARE THE WORDS "THROW YOUR WEIGHT AROUND".

#### CLASS 21—HOUSEWARES AND GLASS

FOR BEER MUGS; COFFEE CUPS, TEA CUPS AND MUGS; GLASS MUGS (U.S. CLS. 2, 13, 23, 29, 30, 33, 40 AND 50).

#### CLASS 25—CLOTHING

FOR ATHLETIC APPAREL, NAMELY, SHIRTS, PANTS, JACKETS, FOOTWEAR, HATS AND CAPS, ATHLETIC UNIFORMS; CAP VISORS; CAPS WITH VISORS; HATS; SHORT-SLEEVED OR LONG-SLEEVED T-SHIRTS; T-SHIRTS (U.S. CLS. 22 AND 39).

#### CLASS 28—TOYS AND SPORTING GOODS

FOR CARD GAMES; CRAPS GAME PLAYING EQUIPMENT; GAMING EQUIPMENT, NAMELY, CHIPS; GAMING EQUIPMENT, NAMELY, POKER CHIPS; PLAYING CARD GAME ACCESSORIES, NAMELY, PLAYING CARD CASES, PLAYING CARD HOLDERS, MATS FOR USE IN CONNECTION WITH PLAYING CARD GAMES, PLAYING CARD SHUFFLING DEVICES AND DICE; PLAYING CARDS AND CARD GAMES (U.S. CLS. 22, 23, 38 AND 50).

TRACY WHITTAKER-BROWN, EXAMINING ATTORNEY

# eRide OPUS

OWNER OF U.S. REG. NOS. 2,654,798, 2,707,494 AND OTHERS.

THE MARK CONSISTS OF STYLIZED WORDING "ERIDE OPUS".

#### CLASS 9—ELECTRICAL AND SCIENTIFIC APPARATUS

FOR INTEGRATED CIRCUIT CHIPS WITH RECORDED SOFTWARE FOR THE ELECTRONIC DETERMINATION OF GEOGRAPHICAL POSITION, DIRECTION AND SPEED OF OBJECTS; SEMICONDUCTORS WITH RECORDED SOFTWARE FOR THE ELECTRONIC DETERMINATION OF GEOGRAPHICAL POSITION, DIRECTION AND SPEED OF OBJECTS; MICROPROCESSORS WITH RECORDED SOFTWARE FOR THE ELECTRONIC DETERMINATION OF GEOGRAPHICAL POSITION, DIRECTION AND SPEED OF OBJECTS; ELECTRONIC NAVIGATIONAL AND POSITIONING APPARATUS AND INSTRUMENTS; SOFTWARE FOR USE WITH MICROPROCESSORS FOR USE IN THE FIELD OF ELECTRONIC DETERMINATION OF GEOGRAPHICAL POSITION, DIRECTION AND SPEED OF OBJECTS FOR TRACKING PEOPLE, OBJECTS OR PETS USING GLOBAL NAVIGATION SATELLITE SYSTEM DATA; SOFTWARE FOR USE IN THE FIELD OF ELECTRONIC DETERMINATION OF GEOGRAPHICAL POSITION, DIRECTION AND SPEED OF OBJECTS FOR TRACKING PEOPLE, OBJECTS OR PETS USING GLOBAL NAVIGATION SATELLITE SYSTEM DATA; NETWORK ACCESS SERVER OPERATING SOFTWARE FOR USE IN THE FIELD OF ELECTRONIC DETERMINATION OF GEOGRAPHICAL POSITION, DIRECTION AND SPEED OF OBJECTS; COMPUTER SOFTWARE FOR CALCULATING, INTEGRATING, ORGANIZING AND EXTRAPOLATING INFORMATION RECEIVED FROM SATELLITES AND POSITIONING SYSTEM DEVICES, AND INSTRUCTION MANUALS SOLD AS A UNIT THEREWITH; ELECTRONIC DEVICES FOR THE STORAGE OF CUSTOMERS' SATELLITE AND OTHER POSITIONING SYSTEMS POSITIONS AND ASSOCIATED PROFILES, NAMELY, GLOBAL NAVIGATION SATELLITE SYSTEM (GNSS) RECEIVERS, SEMICONDUCTOR CHIPS, MODULES, AND ELECTRONIC MEDIA; AUTOMOTIVE TELEMATIC APPARATUS AND AUTONOMOUS TELEMATIC APPARATUS, NAMELY, WIRELESS NETWORK AND COMMUNICATION DEVICES WHICH PROVIDE TELEMATIC SERVICES AND HAVE A CELLULAR PHONE FUNCTION, NAMELY, ANTENNAS FOR DEDICATED SHORT RANGE COMMUNICATION (DSRC), DEDICATED SHORT RANGE COMMUNICATION (DSRC) RECEIVERS, ELECTRONIC TOLL COLLECTION (ETC) SYSTEMS AND ELECTRONIC TOLL COLLECTION (ETC) RECEIVERS; SOFTWARE FOR AUTOMOTIVE TELEMATIC APPARATUS AND ANY OTHER AUTONOMOUS TELEMATIC APPARATUS FOR USE IN THE FIELD OF ELECTRONIC DETERMINATION OF GEOGRAPHICAL POSITION, DIRECTION AND SPEED OF OBJECTS FOR CALCULATING, INTEGRATING, ORGANIZING AND EXTRAPOLATING INFORMATION RECEIVED FROM SATELLITES AND POSITIONING SYSTEM DEVICES; NETWORK ACCESS SERVER OPERATING SOFTWARE FOR AUTOMOTIVE TELEMATIC APPARATUS AND ANY OTHER AUTONOMOUS TELEMATIC APPARATUS FOR USE IN THE FIELD OF ELECTRONIC DETERMINATION OF GEOGRAPHICAL POSITION, DIRECTION AND SPEED OF OBJECTS; COMPUTER SOFTWARE FOR CALCULATING, INTEGRATING, ORGANIZING AND EXTRAPOLATING INFORMATION RECEIVED FROM INTELLIGENT TRANSPORTATION SYSTEMS (ITS) DEVICES, AND INSTRUCTION MANUALS SOLD AS A UNIT THEREWITH; ELECTRONIC DEVICE FOR THE STORAGE OF CUSTOMERS' INTELLIGENT TRANSPORTATION SYSTEMS (ITS) POSITIONS AND ASSOCIATED PROFILES, NAMELY, ANTENNAS FOR DEDICATED SHORT RANGE COMMUNICATION (DSRC) SYSTEMS, DEDICATED SHORT RANGE COM-

MUNICIPATION (DSRC) RECEIVERS, ELECTRONIC TOLL COLLECTION (ETC) SYSTEMS AND ELECTRONIC TOLL COLLECTION (ETC) RECEIVERS (U.S. CLS. 21, 23, 26, 36 AND 38).

SN 77-881.862. WIPRO GALLAGHER SOLUTIONS, INC., FRANKLIN, TN. FILED 11-30-2009.

### **CLASS 35—ADVERTISING AND BUSINESS**

FOR PROVIDING ELECTRONIC TRACKING OF FREIGHT INFORMATION FOR OTHERS, NAMELY, PROVIDING AN ONLINE ELECTRONIC DATABASE FEATURING FREIGHT TRACKING INFORMATION ABOUT CUSTOMERS' CARGO, PACKAGES, VESSELS, AUTOMOBILES, AIRCRAFTS, SPACECRAFTS, RAILWAY CARS OR TRAINS AND ANY OTHER MOVING OBJECTS, SUCH INFORMATION OBTAINED FROM GLOBAL POSITIONING SYSTEMS (U.S. CLS. 100, 101 AND 102).

### **CLASS 38—COMMUNICATION**

FOR TELECOMMUNICATION SERVICES IN THE NATURE OF ELECTRONIC TRANSMISSION OF DATA, MAIL, MESSAGES AND VOICE BETWEEN SERVERS AND RECEIVERS (U.S. CLS. 100, 101 AND 104).

### **CLASS 39—TRANSPORTATION AND STORAGE**

FOR ELECTRONIC STORAGE OF DATA FROM SATELLITE AND OTHER POSITIONING SYSTEMS ABOUT THE LOCATION OF CUSTOMERS' CARGOES, POSTAL MATTER, PACKAGES, VESSELS, AUTOMOBILES, AIRCRAFTS, SPACECRAFTS, RAILWAY CARS OR TRAINS AND ANY OTHER MOVING OBJECTS AND ASSOCIATED PROFILES; ELECTRONIC STORAGE OF DATA, NAMELY, CUSTOMERS' SATELLITE AND OTHER POSITIONING SYSTEMS POSITIONS AND ASSOCIATED PROFILES; ELECTRONIC STORAGE OF DATA, NAMELY, DATA FROM SATELLITE AND OTHER POSITIONING SYSTEMS ABOUT THE LOCATION OF ANIMALS, CUSTOMERS' SAFES, AND ANY OTHER PROPERTIES AND ASSOCIATED PROFILES (U.S. CLS. 100 AND 105).

### **CLASS 42—SCIENTIFIC AND COMPUTER SERVICES**

FOR COMPUTER SOFTWARE DESIGN; COMPUTER PROGRAMMING; MAINTENANCE OF COMPUTER SOFTWARE USED IN CHIPSETS; PROVIDING TECHNICAL ADVICE, NAMELY, COMPUTER CONSULTATION RELATING TO THE USE OF CHIPSETS FOR USE IN THE FIELD OF ELECTRONIC DETERMINATION OF GEOGRAPHICAL POSITION, DIRECTION AND SPEED OF OBJECTS; PROVIDING TECHNICAL ADVICE AND INFORMATION RELATING TO COMPUTER SOFTWARE DESIGN, COMPUTER PROGRAMMING, OR MAINTENANCE OF COMPUTER SOFTWARE; COMPUTER TECHNOLOGY SERVICES, NAMELY, PROVIDING AN ONLINE ELECTRONIC DATABASE ON GLOBAL COMPUTER NETWORKS FEATURING CUSTOMERS' SATELLITE AND POSITIONING SYSTEMS INFORMATION AND ASSOCIATED CUSTOMER PROFILES, INCLUDING GEOGRAPHICAL POSITION, DIRECTION, TIME, AND SPEED OF OBJECTS, THE SAID INFORMATION HAVING BEEN OBTAINED THROUGH SATELLITE AND POSITIONING SYSTEMS, AND HAVING BEEN TRACKED, STORED, AND/OR UPDATED, FOR THE PURPOSE OF ALLOWING USERS TO OBTAIN POSITIONING INFORMATION ON THEMSELVES, CARGO, POSTAL MATTER, PACKAGES, VESSELS, AUTOMOBILES, AIRCRAFT, SPACECRAFT, RAILWAY CARS OR TRAINS, MOVING OBJECTS, ANIMALS, AND PROPERTY SUCH AS SAFES (U.S. CLS. 100 AND 101).

EVELYN BRADLEY, EXAMINING ATTORNEY

## **NetOxygen Accelerator**

THE MARK CONSISTS OF STANDARD CHARACTERS WITHOUT CLAIM TO ANY PARTICULAR FONT, STYLE, SIZE, OR COLOR.

NO CLAIM IS MADE TO THE EXCLUSIVE RIGHT TO USE "ACCELERATOR", APART FROM THE MARK AS SHOWN.

### **CLASS 9—ELECTRICAL AND SCIENTIFIC APPARATUS**

FOR COMPUTER SOFTWARE, AND COMPUTER HARDWARE AND SOFTWARE SYSTEMS, ALL FOR USE IN MANAGING BUSINESS PROCESSES AND BUSINESS WORKFLOWS; COMPUTER SOFTWARE FOR DATA PROCESSING; INTEGRATED COMPLIANCE MANAGEMENT SYSTEM SOFTWARE FOR LOAN ORIGINATION FOR THE MORTGAGE LENDING INDUSTRY AND FOR DIRECT CONSUMER LENDING; COMPUTER PROGRAMS AND APPLICATIONS FOR REPORTING, PRODUCT PRICING AND SELECTION, CREDIT CHECKING AND DOCUMENT PREPARATION DESIGNED FOR USE WITH FINANCIAL PLANNING APPLICATIONS FOR THE MORTGAGE LENDING AND CONSUMER LENDING INDUSTRIES; COMPUTER SOFTWARE, AND COMPUTER HARDWARE AND SOFTWARE SYSTEMS, ALL FOR USE IN THE DEVELOPMENT OF ENTERPRISE WEB APPLICATIONS AND WEB BASED PLATFORMS IN THE FIELD OF CUSTOMER RELATIONSHIP MANAGEMENT; INTERFACES FOR COMPUTERS (U.S. CLS. 21, 23, 26, 36 AND 38).

### **CLASS 42—SCIENTIFIC AND COMPUTER SERVICES**

FOR CONSULTING AND PROVIDING INFORMATION IN THE FIELDS OF INFORMATION TECHNOLOGY, INFORMATION TECHNOLOGY ARCHITECTURE AND INFRASTRUCTURE AND COMPUTER SYSTEM INTEGRATION; INFORMATION TECHNOLOGY CONSULTATION AND PROVIDING INFORMATION RELATING TO INFORMATION TECHNOLOGY IN THE FIELDS OF ENTERPRISE RESOURCE PLANNING, BUSINESS PROCESS MANAGEMENT, CUSTOMER RELATIONSHIP MANAGEMENT; INFORMATION TECHNOLOGY CONSULTATION AND PROVIDING INFORMATION RELATING TO INFORMATION TECHNOLOGY IN THE FIELDS OF LOAN ORIGINATION PLATFORM SOFTWARE FOR THE MORTGAGE LENDING AND CONSUMER LENDING INDUSTRIES; ENGINEERING SERVICES RELATING TO INFORMATION TECHNOLOGY; RESEARCH AND DESIGN IN THE FIELD OF INFORMATION TECHNOLOGY, NAMELY, DESIGN OF COMPUTER SOFTWARE, COMPUTER FIRMWARE, COMPUTER HARDWARE AND COMPUTER SOFTWARE SYSTEMS INCLUDING COMPUTER SOFTWARE SYSTEMS FOR LOAN ORIGINATION IN THE MORTGAGE LENDING AND CONSUMER LENDING INDUSTRIES; IMPLEMENTATION AND MAINTENANCE OF COMPUTER SOFTWARE, COMPUTER FIRMWARE AND COMPUTER SOFTWARE SYSTEMS FOR LOAN ORIGINATION IN THE MORTGAGE LENDING AND CONSUMER LENDING INDUSTRIES; INFORMATION TECHNOLOGY TESTING SERVICES, NAMELY, TESTING OF COMPUTERS, COMPUTER SOFTWARE, COMPUTER HARDWARE AND COMPUTER SYSTEMS FOR OTHERS; QUALITY CONTROL SERVICES AND QUALITY CONTROL AUDITING IN THE FIELD OF INFORMATION TECHNOLOGY FOR OTHERS; CONSULTANCY IN THE FIELD OF COMPUTER HARDWARE, COMPUTER PROGRAMMING, MAINTENANCE OF COMPUTER SOFTWARE, UPDATING OF COMPUTER SOFTWARE, COMPUTER SOFTWARE DESIGN, COMPUTER SYSTEMS ANALYSIS AND INTEGRATION, RECOVERING OF COMPUTER DATA

IN THE FIELD OF LOAN ORIGATION FOR THE MORTGAGE LENDING AND CONSUMER LENDING INDUSTRIES; PROVIDING TEMPORARY USE OF NON-DOWNLOADABLE SOFTWARE FOR MANAGING BUSINESS PROCESSES AND BUSINESS WORK FLOWS, DATA PROCESSING, AND LOAN ORIGATION FOR THE MORTGAGE LENDING INDUSTRY AND DIRECT CONSUMER LENDING; PROVIDING TEMPORARY USE OF NON-DOWNLOADABLE SOFTWARE AND APPLICATIONS FOR REPORTING, PRODUCT PRICING AND SELECTION, CREDIT CHECKING AND DOCUMENT PREPARATION DESIGNED FOR USE WITH FINANCIAL PLANNING APPLICATIONS FOR THE MORTGAGE LENDING AND CONSUMER LENDING INDUSTRIES; PROVIDING TEMPORARY USE OF NON-DOWNLOADABLE SOFTWARE FOR USE IN THE DEVELOPMENT OF ENTERPRISE WEB APPLICATIONS AND WEB BASED PLATFORMS IN THE FIELD OF CUSTOMER RELATIONSHIP MANAGEMENT (U.S. CLS. 100 AND 101).

AMY KERTGATE, EXAMINING ATTORNEY

SN 77-903,150, EPIC PRODUCTS INC., SANTA ANA, CA.  
FILED 12-30-2009.

### CELEBRATE THE GOOD LIFE!

THE MARK CONSISTS OF STANDARD CHARACTERS WITHOUT CLAIM TO ANY PARTICULAR FONT, STYLE, SIZE, OR COLOR.

#### CLASS 16—PAPER GOODS AND PRINTED MATTER

FOR GIFT AND ENTERTAINMENT ITEMS, NAMELY, PAPER PARTY BAGS, DECORATIONS AND FAVORS; DECORATIVE CHALK BOARDS FOR USE AT PARTIES, DRY ERASE BOARDS OF CERAMIC FOR USE AT PARTIES, DRY ERASE WHITE BOARDS FOR USE AT PARTIES, GIFT BAGS OF FABRIC, GIFT BAGS OF PAPER, GIFT BOXES, GIFT TAGS OF PAPER, MARKING PENS FOR WRITING ON BOTTLES, NAPKINS OF PAPER, PRINTED INVITATIONS, STICKERS FOR GLASSES, ALL FOR USE WHILE ENTERTAINING (U.S. CLS. 2, 5, 22, 23, 29, 37, 38 AND 50).

FIRST USE 0-0-2004; IN COMMERCE 0-0-2004.

#### CLASS 18—LEATHER GOODS

FOR WINE BAGS WITH HANDLES FOR CARRYING OR HOLDING WINE (U.S. CLS. 1, 2, 3, 22 AND 41).

FIRST USE 0-0-2004; IN COMMERCE 0-0-2004.

#### CLASS 21—HOUSEWARES AND GLASS

FOR GIFT AND ENTERTAINMENT ITEMS, NAMELY, ABSINTHE SERVING SPOONS, BAR SERVING SPOONS, BOTTLE OPENERS, BOTTLE STOPPERS SPECIALLY ADAPTED FOR USE WITH WINE BOTTLES, BOTTLE POURERS, BRUSHES FOR WASHING GLASSES AND DISHES, DISHWASHING BRUSHES SOLD WITH HOLDERS, BUFFET PLATES, CADDIES FOR HANGING STEMMED GLASSWARE FROM NECK OF WINE BOTTLE, CANDLE HOLDERS OF METAL, CHAMPAGNE VACUUM BOTTLE STOPPERS, CHAMPAGNE FLUTES, CHARMS AS SUCTION CUPS FOR WINE GLASSES FOR ATTACHMENT TO WINE GLASSWARE FOR IDENTIFICATION PURPOSES, CHARMS FOR STEMS OF WINE GLASSES FOR ATTACHMENT TO WINE GLASSWARE FOR IDENTIFICATION PURPOSES, CHEESE BOARD WITH SLICER, CHEESE TOOTHPICK BUTTONS FOR SPEARING AND PICKING UP PIECES OF CHEESE, CHEESE MARKERS FOR IDENTIFYING CHEESE TYPES; CHEESE PLANES SOLD AS A SET WITH STAND, CHEESE SERVING DISHES, TRAYS AND

TONGS, CITRUS REAMERS FOR FRUIT JUICE, CLIPS FOR HOLDING STEMWARE TO PLATES, COASTERS OF CORK, COASTERS OF FELT AND OTHER THAN TABLE LINEN, COASTERS OF PRECIOUS METAL, COASTERS OF STONWARE, COASTERS THAT ARE RETAINED ON THE FOOT OF A WINE GLASS NOT OF PAPER AND NOT BEING TABLE LINEN, COCKTAIL SHAKERS, COCKTAIL PICKS, COCKTAIL STIRRING SPOONS, COCKTAIL STIRRERS, COCKTAIL STRAINERS, CORK SCREWS, CUTTING BOARDS OF GLASS, CUTTING BOARDS OF WOOD, DRYING RACKS FOR WINE DECANTERS, ELECTRIC CORKSCREWS, FILTER SCREENS FOR POURING WINE IN THE NATURE OF WINE STRAINERS, FLASHING LIGHT ICE CUBE MOLDS, FLASKS OF METAL, FLASKS OF PLASTIC, FUNNELS FOR FLASKS; FUNNELS WITH SCREENS FOR POURING WINE; GLASS COASTERS; GLASS RIMMERS; ICE BUCKETS OF ALUMINUM, ICE BUCKETS OF CERAMIC, ICE BUCKETS OF PLASTIC, ICE CUBE TRAYS, ICE SCOOPS OF METAL, INSULATED FABRIC WINE COOLER BAGS, KEY RING BOTTLE OPENERS, LEMON/LIME JUICERS, MANUALLY OPERATED CORKSCREWS, MARTINI COCKTAIL PICKS OF PRECIOUS METAL, MARTINI PITCHERS SOLD WITH STIRRER, NAPKIN RINGS OF METAL, NAPKIN RINGS OF WOOD, OLIVE PICKS OF PRECIOUS METAL, OLIVE SERVING TRAYS, CHAMPAGNE GLASSES, MARTINI GLASSES, SHOT GLASSES, WINE GLASSES, PLASTIC FOLDABLE DISKS FOR AIDING IN POURING WINE, PLATES OF CERAMIC, PNEUMATIC OPERATED CORK REMOVERS, REPLACEMENT LIDS FOR PLASTIC WINE CARAFES, WINE DRIP COLLARS PLACED ON WINE BOTTLE NECKS TO PREVENT DRIPPING, SAKE SERVING BOTTLES AND CUPS; SALT AND PEPPER SHAKERS OF PRECIOUS METAL, SERVING TRAY OF CHROME, SPOON RESTS, TEA LIGHT CANDLE HOLDERS, TOPPER PLATES USED TO HOLD FOOD ON TOP OF A GLASS, TRIVETS, VACUUM BOTTLE STOPS FOR WINE, WALL MOUNTED BOTTLE OPENERS, WINE AERATORS, WINE BOTTLE COOLERS OF ALUMINUM, WINE BOTTLE COOLERS OF CHROME, WINE BOTTLE COOLERS OF CERAMIC, WINE BOTTLE COOLERS OF GLASS, WINE BOTTLE COOLERS OF FABRIC, WINE BOTTLE OPENERS, WINE BOTTLE STOPPERS, WINE CARAFE OF PLASTIC, COOLERS FOR WINE, COOLER MUGS FOR WINE, INSULATING SLEEVE HOLDER FOR WINE BOTTLES OR GLASSES, WINE DECANTERS OF GLASS, VACUUM PUMPS FOR WINE BOTTLES, WINE BOTTLE STOPPERS, WINE BOTTLE STOPPERS OF PRECIOUS METAL, BAR SETS COMPRISING COCKTAIL SHAKER, STRAINER, ICE TONGS, AND BAR SPOON; TABLE PLACE CARD HOLDERS; ALL OF THE FOREGOING FOR USE WHILE ENTERTAINING (U.S. CLS. 2, 13, 23, 29, 30, 33, 40 AND 50).

FIRST USE 0-0-2004; IN COMMERCE 0-0-2004.

KYLE PEETE, EXAMINING ATTORNEY

SN 77-904,172, OUR DRINKS, LTD., BRITISH VIRGIN ISLANDS, BR.VIRGIN ISLANDS, FILED 1-4-2010.



NO CLAIM IS MADE TO THE EXCLUSIVE RIGHT TO USE "WATER", APART FROM THE MARK AS SHOWN.

THE COLOR(S) GREEN AND BLUE IS/ARE CLAIMED AS A FEATURE OF THE MARK.

THE MARK CONSISTS OF THE STYLIZED WORD "OUR" IN GREEN LETTERS SHOWING A "GLOBE DESIGN" WITH GREEN AND BLUE IN THE GLOBE WITHIN THE LETTER "R" WITH THE WORD "WATER" UNDERNEATH IN BLUE LETTERS.

**CLASS 32—LIGHT BEVERAGES**

FOR BEER, MINERAL WATERS, AERATED WATERS, BOTTLED WATER, FRUIT DRINKS, FRUIT FLAVORED DRINKS AND OTHER NON-ALCOHOLIC DRINKS, NAMELY, SPORTS DRINKS, ENERGY DRINKS, GLACIER WATER, CARBONATED BEVERAGES (U.S. CLS. 45, 46 AND 48).

**CLASS 33—WINES AND SPIRITS**

FOR ALCOHOLIC BEVERAGES EXCEPT BEERS, NAMELY, WINES, SPIRITS AND LIQUEURS (U.S. CLS. 47 AND 49).

**CLASS 43—HOTEL AND RESTAURANT SERVICES**

FOR PROVIDING OF FOOD AND DRINK (U.S. CLS. 100 AND 101).  
JOHN SCHÜYLER YARD, EXAMINING ATTORNEY

SN 77-911,070. LA TERRINE LLC, NEW YORK, NY. FILED 1-13-2010.

**LA TERRINE**

THE MARK CONSISTS OF STANDARD CHARACTERS WITHOUT CLAIM TO ANY PARTICULAR FONT, STYLE, SIZE, OR COLOR.  
SEC. 2(F).

**CLASS 21—HOUSEWARES AND GLASS**

FOR BEVERAGE GLASSWARE; CUPS AND MUGS; DINNERWARE, NAMELY, TABLEWARE, EXCLUDING EARTHENWARE CONTAINERS FOR COOKING AND SERVING GOOD; DRINKING GLASSES; GLASS CARAFES; VASES; WINE GLASSES (U.S. CLS. 2, 13, 23, 29, 30, 33, 40 AND 50).

FIRST USE 9-30-2006; IN COMMERCE 9-30-2006.

**CLASS 35—ADVERTISING AND BUSINESS**

FOR GIFT REGISTRY SERVICES; RETAIL STORE AND ON-LINE RETAIL STORE SERVICES FEATURING PLATES, TABLEWARE, GLASSWARE, FLATWARE, LINENS, LAMPS, HOUSEWARES, HOME DECORATIONS, GIFT ARTICLES (U.S. CLS. 100, 101 AND 102).

FIRST USE 9-30-2006; IN COMMERCE 9-30-2006.

WARREN L. OLANDRIA, EXAMINING ATTORNEY

SN 77-911,050. LA TERRINE LLC, NEW YORK, NY. FILED 1-13-2010.



NO CLAIM IS MADE TO THE EXCLUSIVE RIGHT TO USE "DISTINCTIVE TABLEWARE & FINE LINENS", APART FROM THE MARK AS SHOWN.

THE MARK CONSISTS OF A POT DESIGN, TO THE RIGHT OF WHICH APPEAR THE WORDS "LA TERRINE" IN STYLIZED SCRIPT WHERE THE DOT OF THE LETTER "I" IS A SHORT "DASH"; BELOW THOSE WORDS APPEAR THE WORDS "DISTINCTIVE TABLEWARE & FINE LINENS" REPRESENTED IN STYLIZED FONT.

SEC. 2(F) AS TO "LA TERRINE".

**CLASS 21—HOUSEWARES AND GLASS**

FOR BEVERAGE GLASSWARE; CUPS AND MUGS; DINNERWARE, NAMELY, PLATES; DRINKING GLASSES; GLASS CARAFES; VASES; WINE GLASSES; NONE OF THE FOREGOING BEING EARTHENWARE CONTAINERS FOR COOKING AND SERVING FOOD (U.S. CLS. 2, 13, 23, 29, 30, 33, 40 AND 50).

FIRST USE 9-30-2006; IN COMMERCE 9-30-2006.

**CLASS 35—ADVERTISING AND BUSINESS**

FOR GIFT REGISTRY SERVICES; RETAIL STORE AND ON-LINE RETAIL STORE SERVICES FEATURING PLATES, TABLEWARE, GLASSWARE, FLATWARE, LINENS, LAMPS, HOUSEWARES, HOME DECORATIONS, GIFT ARTICLES (U.S. CLS. 100, 101 AND 102).

FIRST USE 9-30-2006; IN COMMERCE 9-30-2006.

WARREN L. OLANDRIA, EXAMINING ATTORNEY

SN 77-912,934. JOSEPH CHOUKROUN, ROQUEBRUNE CAP MARTIN, FRANCE, FILED 1-15-2010.

**CHOUKROUN'S PRF**

THE MARK CONSISTS OF STANDARD CHARACTERS WITHOUT CLAIM TO ANY PARTICULAR FONT, STYLE, SIZE, OR COLOR.

OWNER OF FRANCE REG. NO. 073517058, DATED 7-31-2007. EXPIRES 7-31-2017.

NO CLAIM IS MADE TO THE EXCLUSIVE RIGHT TO USE "PRF", APART FROM THE MARK AS SHOWN.

THE NAME "CHOUKROUN" IDENTIFIES A LIVING INDIVIDUAL WHOSE CONSENT IS OF RECORD.

**CLASS 5—PHARMACEUTICALS**

FOR PHARMACEUTICAL PREPARATIONS FOR THE TREATMENT OF BLOOD DISORDERS AND FOR ACCELERATING HEALING OF BONE AND SOFT TISSUE, CONTAINING PLATELET-RICH FIBRIN (U.S. CLS. 6, 18, 44, 46, 51 AND 52).



**CLASS 41—EDUCATION AND ENTERTAINMENT**

FOR EDUCATIONAL AND TRAINING SERVICES, NAMELY, CONDUCTING CLASSES, WORKSHOPS AND SEMINARS IN THE FIELDS OF MEDICINE AND DENTISTRY; ARRANGING AND CONDUCTING OF COLLOQUIUMS, CONFERENCES, SEMINARS, CONGRESSES AND SYMPOSIUMS IN THE FIELD OF MEDICINE AND IN THE DENTAL FIELD; ORGANIZING AND CONDUCTING TRAINING WORKSHOPS IN THE FIELDS OF MEDICINE AND DENTISTRY; TEACHING AND TRAINING IN THE FIELDS OF MEDICINE AND DENTISTRY (U.S. CLS. 100, 101 AND 107).

ELISSA GARBER KON, EXAMINING ATTORNEY

EUGENIA MARTIN, EXAMINING ATTORNEY

SN 77-940,328, WELSPUN GLOBAL BRANDS LIMITED, MUMBAI, INDIA, FILED 2-19-2010.

# HYGRO

THE MARK CONSISTS OF STANDARD CHARACTERS WITHOUT CLAIM TO ANY PARTICULAR FONT, STYLE, SIZE, OR COLOR.

OWNER OF ERPN CMNTY TM OFC REG. NO. 008482317, DATED 3-22-2010, EXPIRES 8-10-2019.

OWNER OF U.S. REG. NO. 2,983,694.

SN 77-932,369, PROXENSE, LLC, BEND, OR. FILED 2-10-2010.



THE COLOR(S) BLACK AND RED IS/ARE CLAIMED AS A FEATURE OF THE MARK.

THE MARK CONSISTS OF LEGS OF THE "X" IN BLACK AND A CENTER DIAMOND IN RED.

**CLASS 22—CORDAGE AND FIBERS**

FOR ROPES, STRING, FABRIC AND POLYESTER MESH NET USED FOR STORING TOYS AND OTHER HOUSEHOLD ITEMS, TENTS, AWNINGS, TARPAULINS, SAILS, SACKS OR BAGS FOR THE TRANSPORTATION OR STORAGE OF MATERIALS IN BULK, CLOTH BAGS FOR LAUNDRY BUT NOT LUGGAGE OR TRAVEL, CLOTH BAGS FOR STORAGE BUT NOT LUGGAGE OR TRAVEL; PADDING AND STUFFING MATERIALS NOT OF RUBBER, PAPER OR PLASTIC; RAW FIBROUS TEXTILE MATERIALS (U.S. CLS. 1, 2, 7, 19, 22, 42 AND 50).

**CLASS 23—YARNS AND THREADS**

FOR YARNS AND THREADS, FOR TEXTILE USE; COTTON THREAD AND YARN; LINEN THREAD AND YARN; SPUN COTTON; THREAD; SPUN WOOL; WOOLEN THREAD AND YARN (U.S. CL. 43).

**CLASS 24—FABRICS**

FOR TEXTILE FABRICS FOR USE IN MAKING CLOTHING AND HOUSEHOLD FURNISHINGS; BED AND TABLE COVERS MADE OF FABRIC; BATH LINEN, EXCEPT CLOTHING; BED BLANKETS; BED SHEETS; BED COVERS; BED COVERS OF PAPER; BED LINEN; BEDSPREADS; BOLTING CLOTH; CHENILLE FABRIC; CHEESE CLOTH, COTTON CLOTH, CREPE CLOTH, DISH CLOTHS, FACE CLOTHS, FELT CLOTH, FLAX CLOTH, HEMP CLOTH, JUTE CLOTH, SAIL CLOTH, SILK CLOTH, TABLE CLOTH OF TEXTILE, WASH CLOTHS, COTTON FABRICS; UNFITTED FURNITURE COVERINGS OF TEXTILE; COVERLETS; COVERS FOR CUSHIONS; UNFITTED FABRIC FURNITURE COVERS; CURTAINS OF TEXTILE OR PLASTIC; DAMASK; DOOR CURTAINS; CASHMERE FABRIC; CHENILLE FABRIC; CHEVIOT FABRIC; CHIFFON FABRIC; COTTON BASE MIXED FABRICS; CURTAIN FABRIC; DENIM FABRIC; ELASTIC FABRICS FOR CLOTHING; FABRICS FOR TEXTILE USE; FELT AND NON-WOVEN TEXTILE FABRICS; FLAX FABRICS; FURNISHING AND UPHOLSTERY FABRICS; GAUZE FABRIC; HAND SPUN SILK FABRICS; HEMP BASE MIXED FABRICS; INTERIOR DECORATION FABRICS; JEANS FABRIC; JERSEY FABRICS FOR CLOTHING; JUTE FABRICS; KNITTED FABRICS; LINEN FABRIC; MESH-WOVEN FABRICS; MIXED FIBER FABRICS; NON-WOVEN FABRICS AND FELTS; NON-WOVEN TEXTILE FABRICS; NYLON FABRIC; PILED FABRICS; POLYESTER FABRIC; RAMIE FABRICS; RAYON FABRIC; SEMI-SYNTHETIC FIBER FABRICS; SILK BASE MIXED FABRICS; SILK FABRICS; SILK-COTTON MIXED FABRICS; SILK-WOOL MIXED FABRICS; SPANDEX FABRIC FOR USE IN THE MANUFACTURE OF CLOTHING; SPUN SILK FABRICS; SYNTHETIC FIBER FABRICS; TAFFETA FABRIC; UPHOLSTERY FABRICS; WOOL BASE MIXED FABRICS; WOOL YARN FABRICS; WOOL-COTTON MIXED FABRICS; WORSTED FABRICS; WOVEN FABRICS; FABRICS FOR TEXTILE USE; FACE TOWELS OF

**CLASS 9—ELECTRICAL AND SCIENTIFIC APPARATUS**

FOR COMPUTER SOFTWARE TO ALLOW USERS TO PERFORM ELECTRONIC BUSINESS TRANSACTIONS VIA A GLOBAL COMPUTER NETWORK; ELECTRONIC AND MAGNETIC IDENTIFICATION CARDS FOR USE IN CONNECTION WITH PAYMENT FOR GOODS AND SERVICES AND FOR TRACKING USERS AND ASSETS; ENCODED ELECTRONIC CHIP CARDS CONTAINING PROGRAMMING USED TO FUNCTION AS A TANGIBLE ELECTRONIC KEY STORING A SECURITY CODE THAT IS USED TO ACCESS DIGITAL CONTENT (U.S. CLS. 21, 23, 26, 36 AND 38).

FIRST USE 12-31-2005; IN COMMERCE 12-31-2005.

**CLASS 42—SCIENTIFIC AND COMPUTER SERVICES**

FOR PROVIDING TEMPORARY USE OF NON-DOWNLOADABLE SOFTWARE FOR USE IN THE PHYSICAL IDENTIFICATION AND TRACKING OF USERS AND ASSETS BASED ON PROXIMITY FOR USE VIA A GLOBAL COMPUTER NETWORK, NAMELY, SOFTWARE FOR THE PHYSICAL IDENTIFICATION AND TRACKING OF USERS AND ASSETS; PROVIDING TEMPORARY USE OF NON-DOWNLOADABLE SOFTWARE FOR USE IN THE ELECTRONIC PAYMENT FOR GOODS AND SERVICES, NAMELY, SOFTWARE FOR THE PROCESSING OF PAYMENTS; PROVIDING TEMPORARY USE OF NON-DOWNLOADABLE SOFTWARE FOR USE IN CREATING SECURE ELECTRONIC ACCESS TO DIGITAL CONTENT, NAMELY, SOFTWARE FOR CREATING AND ALLOWING SECURE ELECTRONIC ACCESS TO DIGITAL CONTENT (U.S. CLS. 100 AND 101).

FIRST USE 12-31-2005; IN COMMERCE 12-31-2005.

TEXTILE; FIBREGLASS FABRICS FOR TEXTILE USE; FLANNEL; FRIEZE; HANDKERCHIEFS OF TEXTILE; HOUSEHOLD LINEN; KNITTED FABRIC; LINEN CLOTH; TEXTILE USED AS LINING FOR CLOTHING; NAPKINS, OF CLOTH, FOR REMOVING MAKE-UP; MATTRESS COVERS; TABLE NAPKINS OF TEXTILE; NON-WOVEN TEXTILE FABRICS; PILLOW SHAMS; PILLOWCASES; PLACE MATS, NOT OF PAPER; QUILTS; TRAVELLING RUGS; BATH SHEETS; TOWEL SHEET, FITTED BED SHEET COVERS, BED FLAT SHEETS, CONTOUR SHEETS, SHEET SETS; SHOWER CURTAINS OF TEXTILE OR PLASTIC; SILK FABRICS FOR PRINTING PATTERNS; TABLE LINEN, NOT OF PAPER; TABLE NAPKINS OF TEXTILE; TABLECLOTHS, NOT OF PAPER; TABLEMATS, NOT OF PAPER; TISSUES OF TEXTILE FOR REMOVING MAKE-UP; TOWELS OF TEXTILE; VELVET; WOOLEN CLOTH AND WOOLEN FABRIC (U.S. CLS. 42 AND 50).

### CLASS 25—CLOTHING

FOR CLOTHING, NAMELY, SHIRTS, T-SHIRTS, BLOUSES, PANTS, JEANS, SKIRTS, SHORTS, DRESSES, JACKETS, COATS, BLAZERS, SOCKS AND STOCKINGS, BELTS, RAIN COATS, RAIN BOOTS, SCARVES, GLOVES; FOOTWEAR; HEADGEAR, NAMELY, HATS AND CAPS; BATHROBES (U.S. CLS. 22 AND 39).

### CLASS 26—FANCY GOODS

FOR LACE AND EMBROIDERY, RIBBONS AND BRAID; BUTTONS, HOOKS AND EYES, MARKING PINS, SAFETY PINS, SEWING PINS, CANVAS NEEDLES, EMBROIDERY NEEDLES, KNITTING NEEDLES, LACING NEEDLES, SEWING MACHINE NEEDLES AND SEWING NEEDLES; ARTIFICIAL FLOWERS; NEEDLE CUSHIONS AND PIN CUSHIONS (U.S. CLS. 37, 39, 40, 42 AND 50).

### CLASS 27—FLOOR COVERINGS

FOR CARPETS, RUGS, MATS AND MATTING AND LINOLEUM FOR COVERING EXISTING FLOORS; NON-TEXTILE WALL HANGINGS; ARTIFICIAL TURF; AUTOMOBILE CARPETS; BATH MATS; FLOOR COVERINGS; MATS OF WOVEN ROPE FOR SKI SLOPES; BATH MATS WITH NON-SLIP BACKING; FLOOR MATS WITH NON-SLIP BACKING (U.S. CLS. 19, 20, 37, 42 AND 50).

### CLASS 35—ADVERTISING AND BUSINESS

FOR RETAIL STORE SERVICES, ON-LINE RETAIL STORE SERVICES, AND MAIL ORDER SERVICES FEATURING ROPES, STRING, FABRIC AND POLYESTER MESH NET USED FOR STORING TOYS AND OTHER HOUSEHOLD ITEMS, TENTS, AWNINGS, TARPULINS, SAILS, SACKS AND BAGS NOT INCLUDED IN OTHER CLASSES, PADDING AND STUFFING MATERIALS EXCEPT OF RUBBER OR PLASTICS, RAW FIBROUS TEXTILE MATERIALS, YARNS AND THREADS FOR TEXTILE USE, COTTON THREAD AND YARN, LINEN THREAD AND YARN, SPUN COTTON, THREAD, SPUN WOOL, WOOLEN THREAD AND YARN, TEXTILE AND TEXTILE GOODS NOT INCLUDED IN OTHER CLASSES, BED AND TABLE COVERS, BATH LINEN EXCEPT CLOTHING, BED BLANKETS, BED CLOTHES, BED COVERS, BED COVERS OF PAPER, BED LINEN, BEDSPREADS, BOLTING CLOTH, CHENILLE FABRIC, CLOTH, COTTON FABRICS, FURNITURE COVERINGS OF TEXTILE, COVERLETS, COVERS FOR CUSHIONS, UNFITTED FABRIC FURNITURE COVERS, CURTAINS OF TEXTILE OR PLASTIC, DAMASK, DOOR CURTAINS, CASHMERE FABRIC, CHENILLE FABRIC, CHEVIOT FABRIC, CHIFFON FABRIC, COTTON BASE MIXED FABRICS, COTTON FABRIC, CURTAIN FABRIC, DENIM FABRIC, ELASTIC FABRICS FOR CLOTHING, FABRICS FOR TEXTILE USE, FELT AND NON-WOVEN TEXTILE FABRICS, FLAX FABRICS, FURNISHING AND UPHOLSTERY FABRICS, GAUZE FABRIC, HAND SPUN SILK FABRICS, HEMP BASE MIXED FABRICS, INTERIOR DECORATION FABRICS, JEANS FABRIC, JERSEY FABRICS FOR CLOTHING, JUTE FABRICS, KNITTED FABRICS, LINEN FABRIC, MESH-WOVEN FABRICS, MIXED FIBER FABRICS, NON-WOVEN FABRICS AND FELTS, NON-WOVEN TEXTILE FABRICS, NYLON FAB-

RIC, PILED FABRICS, POLYESTER FABRIC, RAMIE FABRICS, RAYON FABRIC, SEMI-SYNTHETIC FIBER FABRICS, SILK BASE MIXED FABRICS, SILK FABRICS, SILK-COTTON MIXED FABRICS, SILK-WOOL MIXED FABRICS, SPANDEX FABRIC FOR USE IN THE MANUFACTURE OF CLOTHING, SPUN SILK FABRICS, SYNTHETIC FIBER FABRICS, TAFFETA FABRIC, UPHOLSTERY FABRICS, WOOL BASE MIXED FABRICS, WOOL YARN FABRICS, WOOLEN FABRIC, WOOL-COTTON MIXED FABRICS, WORSTED FABRICS, WOVEN FABRICS, FABRICS FOR TEXTILE USE, FACE TOWELS OF TEXTILE, FIBREGLASS FABRICS FOR TEXTILE USE, FLANNEL, FRIEZE, HANDKERCHIEFS OF TEXTILE, HOUSEHOLD LINEN, KNITTED FABRIC, LINEN CLOTH, LININGS, NAPKINS OF CLOTH FOR REMOVING MAKE-UP, MATTRESS COVERS, TABLE NAPKINS OF TEXTILE, NON-WOVEN TEXTILE FABRICS, PILLOW SHAMS, PILLOWCASES, PLACE MATS NOT OF PAPER, QUILTS, TRAVELLING RUGS, BATH SHEETS, TOWEL SHEETS, BED SHEETS, FITTED BED SHEET COVERS, BED FLAT SHEETS, CONTOUR SHEETS, SHEET SETS, SHOWER CURTAINS OF TEXTILE OR PLASTIC, SILK, SILK FABRICS FOR PRINTING PATTERNS, TABLE LINEN NOT OF PAPER, TABLE NAPKINS OF TEXTILE, TABLECLOTHS NOT OF PAPER, TABLEMATS NOT OF PAPER, TISSUES OF TEXTILE FOR REMOVING MAKE-UP, TOWELS OF TEXTILE, VELVET, WOOLEN CLOTH, WOOLEN FABRIC; RETAIL STORE SERVICES, ON-LINE RETAIL STORE SERVICES, AND MAIL ORDER SERVICES FEATURING CLOTHING, NAMELY, SHIRTS, T-SHIRTS, BLOUSES, PANTS, JEANS, SKIRTS, SHORTS, DRESSES, JACKETS, COATS, BLAZERS, SOCKS AND STOCKINGS, BELTS, RAIN COATS, RAIN BOOTS, SCARVES, GLOVES, HEADGEAR, NAMELY, HATS AND CAPS, FOOTWEAR, BATHROBES, WATERPROOF CLOTHING, LACE AND EMBROIDERY, RIBBONS AND BRAID, BUTTONS, HOOKS AND EYES, PINS AND NEEDLES, ARTIFICIAL FLOWERS, NEEDLE CUSHIONS, PIN CUSHIONS, CARPETS, RUGS, MATS AND MATTING, AND LINOLEUM FOR COVERING EXISTING FLOORS, NON-TEXTILE WALL HANGINGS, ARTIFICIAL TURF, AUTOMOBILE CARPETS, BATH MATS, FLOOR COVERINGS, MATS OF WOVEN ROPE FOR SKI SLOPES, BATH MATS WITH NON-SLIP BACKING, AND FLOOR MATS WITH NON-SLIP BACKING (U.S. CLS. 100, 101 AND 102).

SHAILA SETTLES, EXAMINING ATTORNEY

SN 77-945.099, 9170-3173 QUEBEC INC., BLAINVILLE, QUEBEC, CANADA, FILED 2-25-2010.

**EH2**

THE MARK CONSISTS OF STANDARD CHARACTERS WITHOUT CLAIM TO ANY PARTICULAR FONT, STYLE, SIZE, OR COLOR.



**CLASS 11—ENVIRONMENTAL CONTROL APPARATUS**

FOR TIDAL POWER PLANTS; BIOGAS AND BIOMASS POWER PLANTS; HYDROELECTRIC POWER PLANTS, NUCLEAR POWER PLANTS FOR ELECTRICITY GENERATION, SOLAR POWER PLANTS FOR ELECTRICITY GENERATION; ELECTRICAL AND ELECTRONIC APPLIANCES AND EQUIPMENT USED TO PRODUCE, TRANSFORM, TRANSPORT, ACCUMULATE, REGULATE, AND CONTROL HYDROGEN-BASED ENERGY IN THE FORM OF ELECTRICITY, NAMELY, ENERGY STORAGE PLANTS, WATER RESERVOIRS, GAS RESERVOIRS, ELECTROLYZERS, LIQUID HYDROGEN GENERATORS, FREEZE DESALINATION UNITS, PRESSURIZED TANKS; HYDROGEN GENERATORS, OXYGEN GENERATORS, SENSORS, STORAGE CONTAINERS, METALHYDRIDES, NOZZLES, HOSES, HYDROGEN DISPENSERS, GENERATOR PARTS, NAMELY, ANODES, CATHODES, SEPARATORS, MEMBRANES, CIRCULATION FRAMES, END WALLS AND BOXES, COMPRESSORS, RECTIFYING DEMISTERS, GAS LIQUID SEPARATORS; SEAWATER DESALINATION SYSTEMS AND METHODS, NAMELY, DESALINATION UNITS, SUPERCONDUCTIVE MOTORS, DECONTAMINATION TOWER, FREEZE DESALINATION; ICE SLURRY CREATION SYSTEMS AND METHODS, NAMELY, MACHINES FOR THE CREATION OF ICE SLURRY, HEAT PUMP, DECONTAMINATION TOWER AND DIRECT CONTACT FREEZING METHODS; THERMAL POWER PLANTS; SYSTEMS AND METHODS FOR EXPLOITING THERMAL ENERGY, NAMELY, ENGINES, TURBINES, RANKINE CYCLE SYSTEM, THERMOELECTRIC SYSTEM; SYSTEMS, METHODS AND APPARATUS FOR EXPLOITING SOLAR ENERGY, NAMELY, SOLAR CONCENTRATOR SYSTEMS, SOLAR POWER PLANTS, PHOTOVOLTAIC CELLS, MINORS, SOLAR POWER PLANTS CONTROL SYSTEMS; SYSTEMS AND METHODS FOR OBTAINING HYDROGEN AND OXYGEN FROM AN OCEANS SOURCES, NAMELY, ELECTROLYZERS, PRESSURIZED TANK, SOFTWARE AND CONTROL SYSTEM FOR STORAGE AND USE OF HYDROGEN AND OXYGEN (U.S. CLS. 13, 21, 23, 31 AND 34).

**CLASS 42—SCIENTIFIC AND COMPUTER SERVICES**

FOR RESEARCH AND DEVELOPMENT OF ALTERNATIVE TECHNOLOGIES ALLOWING THE PRODUCTION, COLLECTION, STORAGE, TRANSFORMATION, AND TRANSPORT OF ENERGY AND OF HYDROGEN-BASED FUELS, NAMELY, NATURAL GAS, OIL, ELECTRICITY, AND THERMAL ENERGY; RESEARCH AND DEVELOPMENT OF TECHNOLOGIES FOR THE PRODUCTION, COLLECTION, STORAGE, TRANSFORMATION, AND TRANSPORT OF CLEAN WATER, AND LICENSING THIRD PARTIES TO USE THE FOREGOING TECHNOLOGIES; CONSULTATION SERVICES RELATED TO ALTERNATIVE METHODS OF EXPLOITATION OF HYDROGEN-BASED ENERGY; CONSULTING SERVICES TO IMPROVE EQUIPMENT PROVIDING HYDROGEN ENRICHED FOSSIL FUELS, GASOLINE AND DIESEL FOR INCREASED COMBUSTION AND REDUCED EXHAUSTED MISSIONS OF INTERNAL COMBUSTION ENGINES; DESIGN AND OPERATION OF ENVIRONMENTALLY RESPONSIBLE ENERGY TECHNOLOGIES, NAMELY, MOTORS POWERED BY WAVE ENERGY, NAMELY, MOTORS FOR UNDERWATER ELECTRICITY GENERATORS, ELECTRIC GENERATORS AND TURBINE GENERATORS POWERED BY WAVE ENERGY, HYDRO-ELECTRIC GENERATORS, HYDROELECTRIC DAM, COGENERATION WHICH USES A SMALL TEMPERATURE DIFFERENTIAL TO PRODUCE MECHANICAL ENERGY, THERMOELECTRIC SYSTEMS AND RANKINE CYCLE SYSTEMS, HEAT EXCHANGERS, THERMAL POWER PLANTS FOR ELECTRICITY GENERATION, SOLAR CONCENTRATOR SYSTEMS, SOLAR POWER PLANTS, PHOTOVOLTAIC CELLS, MIRRORS, SOLAR POWER PLANTS CONTROL SYSTEMS, BIOGAS AND BIOMASS POWER PLANTS, HYDROELECTRIC POWER PLANTS, NUCLEAR POWER PLANTS FOR ELECTRICITY GENERATION, SOLAR POWER PLANTS FOR ELECTRICITY GENERATION, HYDROGEN-BASED ENERGY SYSTEMS, NAMELY, MOTOR VEHICLE ENGINES, HYDROLYSERS, TIDAL POWER PLANTS; DEVELOPMENT OF ENVIRONMENTALLY RESPONSIBLE ENERGY TECH-

NOLOGIES; RESOURCE DEVELOPMENT CONSULTING, NAMELY, ADVISING ON THE CONVERSION OF RENEWABLE AND NON-RENEWABLE ENERGY RESOURCES INTO ENERGY PRODUCTS; SCIENTIFIC AND TECHNOLOGICAL SERVICES, NAMELY, RESEARCH AND DESIGN RELATING THERETO IN THE FIELD OF RENEWABLE ENERGY PRODUCTION; DESIGN AND DEVELOPMENT OF COMPUTER HARDWARE AND SOFTWARE IN THE FIELD OF ENVIRONMENTALLY RESPONSIBLE TECHNOLOGIES, ALTERNATIVE ENERGY, SCIENCE, HEALTH, SAFETY AND ENVIRONMENT, DESIGN OF ALTERNATIVE ENERGY POWER SYSTEMS, APPARATUS, INSTALLATIONS AND COMPONENTS, NAMELY, MOTORS POWERED BY WAVE ENERGY, NAMELY, MOTORS FOR UNDERWATER ELECTRICITY GENERATORS, ELECTRIC GENERATORS AND TURBINE GENERATORS POWERED BY WAVE ENERGY, HYDRO-ELECTRIC GENERATORS, HYDROELECTRIC DAM, COGENERATION WHICH USES A SMALL TEMPERATURE DIFFERENTIAL TO PRODUCE MECHANICAL ENERGY, THERMOELECTRIC SYSTEMS AND RANKINE CYCLE SYSTEMS, HEAT EXCHANGERS, THERMAL POWER PLANTS FOR ELECTRICITY GENERATION, SOLAR CONCENTRATOR SYSTEMS, SOLAR POWER PLANTS, PHOTOVOLTAIC CELLS, MIRRORS, SOLAR POWER PLANTS CONTROL SYSTEMS, BIOGAS AND BIOMASS POWER PLANTS, HYDROELECTRIC POWER PLANTS, NUCLEAR POWER PLANTS FOR ELECTRICITY GENERATION, SOLAR POWER PLANTS FOR ELECTRICITY GENERATION, HYDROGEN-BASED ENERGY SYSTEMS, NAMELY, MOTOR VEHICLE ENGINES, HYDROLYSERS, TIDAL POWER PLANTS; ANALYSIS RELATING TO ENERGY AND POWER NEEDS OF OTHERS; DEVELOPMENT OF ENERGY AND POWER MANAGEMENT SYSTEMS IN THE FIELD OF ENVIRONMENTALLY RESPONSIBLE TECHNOLOGIES; CONSULTING SERVICES, NAMELY, ON ENVIRONMENTAL INDICATORS, RENEWABLE ENERGY, ENVIRONMENTALLY RESPONSIBLE TECHNOLOGIES, ENVIRONMENTAL IMPACT ASSESSMENT; TECHNICAL CONSULTING, TECHNICAL DESIGN AND TECHNICAL PLANNING OF SOLAR ENERGY SYSTEMS AND INSTALLATIONS, WIND ENERGY SYSTEMS AND INSTALLATIONS, HYDROELECTRIC ENERGY SYSTEMS AND INSTALLATIONS, PHOTOVOLTAIC INSTALLATIONS; COMPUTER SOFTWARE CONSULTANCY; DEVELOPMENT OF ENVIRONMENTALLY RESPONSIBLE FORMS OF ENERGY AND POWER; TECHNICAL SERVICES, NAMELY, TECHNICAL SUPERVISION AND INSPECTION SERVICES RELATING TO THE DISTRIBUTION AND USE OF ELECTRICAL POWER; METEOROLOGICAL AND HYDROLOGICAL DATA SERVICES; CONSULTING SERVICES RELATING TO COMPUTER SOFTWARE, ELECTRICAL DISTURBANCE WARNING DEVICES, SURPLUS EQUIPMENT, NAMELY, SURGE PROTECTION DEVICES AND UNINTERRUPTIBLE ENERGY SUPPLY PRODUCTS (U.S. CLS. 100 AND 101).

ANNE E. GUSTASON, EXAMINING ATTORNEY

SN 77-957,331, MEDIA MATTERS ACTION NETWORK, WASHINGTON, DC. FILED 3-12-2010.

**MEDIA MATTERS ACTION NETWORK**

THE MARK CONSISTS OF STANDARD CHARACTERS WITHOUT CLAIM TO ANY PARTICULAR FONT, STYLE, SIZE, OR COLOR.

NO CLAIM IS MADE TO THE EXCLUSIVE RIGHT TO USE "NETWORK", APART FROM THE MARK AS SHOWN. SEC. 2(F) AS TO "MEDIA MATTERS".

**CLASS 35—ADVERTISING AND BUSINESS**

FOR PROVIDING THE PUBLIC, JOURNALISTS, AND POLICYMAKERS WITH FACT-CHECKING ASSISTANCE IN THE NATURE OF PUBLIC POLICY RESEARCH TO DOCUMENT THE VERACITY OR FALSEHOOD OF NEWS REPORTING TO REBUT FALSE MEDIA NEWS CLAIMS AND INFORMATION, TO ALLOW OTHERS TO TAKE DIRECT ACTION AGAINST OFFENDING MEDIA INSTITUTIONS; EMPOWERING AND EXPANDING PROGRESSIVE VOICES IN THE MEDIA BY PROVIDING RESEARCH TESTING OF POSSIBLE COMMUNICATIONS ABOUT CURRENT AND EMERGING PUBLIC POLICY ISSUES TO ASSIST THE LARGE PROGRESSIVE COMMUNITY IN CREATING AND DISSEMINATING PROGRESSIVE INFORMATION AND VIEWS; AND ENGAGING IN OTHER ACTIVITIES AT THE CONFLUENCE OF PROGRESSIVE THOUGHT, POLICY, AND MEDIA, NAMELY, CONDUCTING PAID ISSUE ADVERTISING RELATED TO PROGRESSIVE SOCIAL AND POLITICAL THOUGHT ON ISSUES OF PUBLIC POLICY AND MISINFORMATION ABOUT SUCH ISSUES IN THE MEDIA AND POLITICAL CAMPAIGNS (U.S. CLS. 100, 101 AND 102).  
FIRST USE 0-0-2004; IN COMMERCE 0-0-2004.

**CLASS 41—EDUCATION AND ENTERTAINMENT**

FOR PROVIDING COMMENTARY AND INFORMATION IN THE FIELD OF NEWS REPORTING OF OTHERS VIA THE INTERNET AND OTHER MEDIA NOT FOR BUSINESS PURPOSES; ANALYZING, MONITORING AND PROVIDING INFORMATION ON THE NEWS REPORTING ACTIVITIES OF THE NEWS MEDIA THROUGH BOTH RAPID-RESPONSE ITEMS AS WELL AS LONGER RESEARCH AND ANALYTIC REPORTS NOT FOR BUSINESS PURPOSES; PROVIDING AN ONLINE COMPUTER DATABASE IN THE FIELD OF THE GENERAL NEWS REPORTING INDUSTRY; CONDUCTING RESEARCH STUDIES AND REPORTS IN THE FIELD OF THE GENERAL NEWS REPORTING INDUSTRY, NOT FOR BUSINESS OR FINANCIAL PURPOSES; AND ENGAGING IN OTHER ACTIVITIES AT THE CONFLUENCE OF PROGRESSIVE THOUGHT, POLICY, AND MEDIA, NAMELY, CONDUCTING LIVE AND ONLINE TRAINING, AND CONFERENCES RELATED TO PROGRESSIVE SOCIAL AND POLITICAL THOUGHT ON ISSUES OF PUBLIC POLICY AND MISINFORMATION ABOUT SUCH ISSUES IN THE MEDIA AND POLITICAL CAMPAIGNS (U.S. CLS. 100, 101 AND 107).  
FIRST USE 0-0-2004; IN COMMERCE 0-0-2004.  
KARANENDRA S. CHHINA, EXAMINING ATTORNEY

SN 77-959,008. PROVENTIA EMISSION CONTROL OY, OULUNSALO, FINLAND, FILED 3-15-2010.

# CHILI

THE MARK CONSISTS OF STANDARD CHARACTERS WITHOUT CLAIM TO ANY PARTICULAR FONT, STYLE, SIZE, OR COLOR.

OWNER OF ERPN CMNTY TM OFC REG. NO. 8951972, DATED 2-3-2011, EXPIRES 3-15-2020.

**CLASS 1—CHEMICALS**

FOR ENVIRONMENTAL CATALYSTS USED IN INDUSTRY BOTH FOR PURPOSES OF ENVIRONMENTAL TECHNOLOGY AND OTHER SUSTAINABLE DEVELOPMENT TECHNOLOGY (U.S. CLS. 1, 5, 6, 10, 26 AND 46).

**CLASS 7—MACHINERY**

FOR ENGINE EXHAUST PURIFICATION SYSTEMS COMPRISING FILTERS AND CATALYSTS; EMISSION FILTERING APPARATUS FOR ENGINES; EMISSION FILTERS; VEHICLE ENGINE EMISSION CONTROL APPARATUS AND SYSTEMS COMPRISING FILTERS AND CATALYSTS (U.S. CLS. 13, 19, 21, 23, 31, 34 AND 35).

KEVON CHISOLM, EXAMINING ATTORNEY

SN 77-959,203. COLORADO INSTRUMENTS, INC., COLORADO SPRINGS, CO. FILED 3-15-2010.

# SOLARMADE

THE MARK CONSISTS OF STANDARD CHARACTERS WITHOUT CLAIM TO ANY PARTICULAR FONT, STYLE, SIZE, OR COLOR.

**CLASS 7—MACHINERY**

FOR SOLAR DIRECT CURRENT MOTORS FOR A VARIETY OF USES, NAMELY, FOR USE IN GEAR DRIVES AND HOBBY KITS (U.S. CLS. 13, 19, 21, 23, 31, 34 AND 35).

**CLASS 9—ELECTRICAL AND SCIENTIFIC APPARATUS**

FOR SOLAR CELLS, PHOTOVOLTAIC SOLAR PANELS AND MODULES FOR PRODUCTION OF ELECTRICITY; SOLAR BATTERY CHARGERS; SOLAR RECHARGEABLE BATTERIES AND BATTERY POWER PACKS COMPRISED OF PHOTOVOLTAIC SOLAR MODULES; SOLAR POWERED MESSAGE DISPLAYS, NAMELY, LUMINOUS VARIABLE/DYNAMIC SIGNS USING LIGHT EMITTING DIODES AND ELECTRONIC CONTROLLERS TO PRODUCE REAL-TIME AND PROGRAMMABLE MESSAGES AND INFORMATION DISPLAYS (U.S. CLS. 21, 23, 26, 36 AND 38).

**CLASS 11—ENVIRONMENTAL CONTROL APPARATUS**

FOR SOLAR LIGHT FIXTURES, NAMELY, INDOOR AND OUTDOOR SOLAR POWERED LIGHTING UNITS AND FIXTURES; SOLAR POWERED LIGHTS FOR USE IN ILLUMINATING SIGNS AND DISPLAYS; SOLAR LED (LIGHT EMITTING DIODE) LIGHTING FIXTURES (U.S. CLS. 13, 21, 23, 31 AND 34).

**CLASS 20—FURNITURE AND ARTICLES NOT OTHERWISE CLASSIFIED**

FOR SOLAR POWERED POINT OF PURCHASE DISPLAYS (U.S. CLS. 2, 13, 22, 25, 32 AND 50).

**CLASS 28—TOYS AND SPORTING GOODS**

FOR SOLAR POWERED NOVELTY GIFT ITEMS AND MODELS IN THE NATURE OF CRYSTAL RAINBOW MAKERS, WINDMILLS AND TURBINES, OIL DERICKS AND PUMPER, AIRPLANES, HELICOPTERS, SKI LIFTS, GOLD MINES, TEA JARS, MUSIC BOXES, FLYING SAUCERS AND FLOWERS; SOLAR EDUCATIONAL AND HOBBY CRAFT KITS CONSISTING PRIMARILY OF SOLAR PANELS, SOLAR CELLS, MOTORS, LED BULBS/LIGHTS, AND PARTS THEREFOR (U.S. CLS. 22, 23, 38 AND 50).

TIMOTHY FINNEGAN, EXAMINING ATTORNEY

SN 77-960,236. COLORADO INSTRUMENTS, INC., COLORADO SPRINGS, CO. FILED 3-16-2010.

TIMOTHY FINNEGAN, EXAMINING ATTORNEY



NO CLAIM IS MADE TO THE EXCLUSIVE RIGHT TO USE "SOLAR", APART FROM THE MARK AS SHOWN.

THE MARK CONSISTS OF THE WORD "SOLAR" IN THE UPPER PORTION OF A RECTANGLE, A CIRCLE BELOW WITH THREE RAYS EMANATING FROM THE CENTER OF THE CIRCLE TO THE RIGHT EDGE OF THE RECTANGLE, AND THE WORD "MADE" BELOW THE RECTANGLE.

#### CLASS 7—MACHINERY

FOR SOLAR DIRECT CURRENT MOTORS FOR A VARIETY OF USES, NAMELY, FOR USE IN GEAR DRIVES AND HOBBY KITS (U.S. CLS. 13, 19, 21, 23, 31, 34 AND 35).

#### CLASS 9—ELECTRICAL AND SCIENTIFIC APPARATUS

FOR SOLAR CELLS, PHOTOVOLTAIC SOLAR PANELS AND MODULES FOR PRODUCTION OF ELECTRICITY; SOLAR BATTERY CHARGERS; SOLAR RECHARGEABLE BATTERIES AND BATTERY POWER PACKS COMPRISED OF PHOTOVOLTAIC SOLAR MODULES; SOLAR POWERED MESSAGE DISPLAYS, NAMELY, LUMINOUS VARIABLE/DYNAMIC SIGNS USING LIGHT EMITTING DIODES AND ELECTRONIC CONTROLLERS TO PRODUCE REAL-TIME AND PROGRAMMABLE MESSAGES AND INFORMATION DISPLAYS (U.S. CLS. 21, 23, 26, 36 AND 38).

#### CLASS 11—ENVIRONMENTAL CONTROL APPARATUS

FOR SOLAR LIGHT FIXTURES, NAMELY, INDOOR AND OUTDOOR SOLAR POWERED LIGHTING UNITS AND FIXTURES; SOLAR POWERED LIGHTS FOR USE IN ILLUMINATING SIGNS AND DISPLAYS; SOLAR LED (LIGHT EMITTING DIODE) LIGHTING FIXTURES (U.S. CLS. 13, 21, 23, 31 AND 34).

#### CLASS 20—FURNITURE AND ARTICLES NOT OTHERWISE CLASSIFIED

FOR SOLAR POWERED POINT OF PURCHASE DISPLAYS (U.S. CLS. 2, 13, 22, 25, 32 AND 50).

#### CLASS 28—TOYS AND SPORTING GOODS

FOR SOLAR POWERED NOVELTY GIFT ITEMS AND MODELS IN THE NATURE OF CRYSTAL RAINBOW MAKERS, WINDMILLS AND TURBINES, OIL DERICKS AND PUMPERS, AIRPLANES, HELICOPTERS, SKI LIFTS, GOLD MINES, TEA JARS, MUSIC BOXES, FLYING SAUCERS AND FLOWERS; SOLAR EDUCATIONAL AND HOBBY CRAFT KITS CONSISTING PRIMARILY OF SOLAR PANELS, SOLAR CELLS, MOTORS, LED BULBS/LIGHTS, AND PARTS THEREFOR (U.S. CLS. 22, 23, 38 AND 50).

SN 77-963,571. SHEN MANUFACTURING COMPANY INCORPORATED, WEST CONSHOHOCKEN, PA. FILED 3-19-2010.

## DOGS UNLEASHED

THE MARK CONSISTS OF STANDARD CHARACTERS WITHOUT CLAIM TO ANY PARTICULAR FONT, STYLE, SIZE, OR COLOR.

NO CLAIM IS MADE TO THE EXCLUSIVE RIGHT TO USE "DOGS", APART FROM THE MARK AS SHOWN.

#### CLASS 21—HOUSEWARES AND GLASS

FOR PET PAW CLEANING MITTS OF FABRIC AND PET HAIR GROOMING MITTS (U.S. CLS. 2, 13, 23, 29, 30, 33, 40 AND 50).

#### CLASS 24—FABRICS

FOR PET TOWELS, PET POCKET TOWELS, AND TEXTILE PLACEMATS FOR PET BOWLS (U.S. CLS. 2 AND 50).

BERYL GARDNER, EXAMINING ATTORNEY

SN 77-964,491. MASSACHUSETTS INSTITUTE OF TECHNOLOGY, CAMBRIDGE, MA. FILED 3-22-2010.

# Technology Review

OWNER OF U.S. REG. NO. 668,713.

NO CLAIM IS MADE TO THE EXCLUSIVE RIGHT TO USE "REVIEW", APART FROM THE MARK AS SHOWN.

THE MARK CONSISTS OF THE WORDS "TECHNOLOGY REVIEW" IN STYLIZED FORM.

SEC. 2(F).

**CLASS 9—ELECTRICAL AND SCIENTIFIC APPARATUS**

FOR DOWNLOADABLE ELECTRONIC NEWSLETTERS AND ONLINE NEWSLETTERS IN THE FIELDS OF INFOTECHNOLOGY, BIOTECHNOLOGY, NANOTECHNOLOGY, COMPUTERS, COMPUTER SCIENCE, THE INTERNET, ENERGY, ENTREPRENEURSHIP, SCIENCE, GLOBALIZATION, GLOBAL ISSUES, INTERNATIONAL ISSUES, INDUSTRY, BUSINESS DEVELOPMENT AND GROWTH, BUSINESS STRATEGIES, PRODUCT RESEARCH AND DEVELOPMENT, ENVIRONMENTAL RESEARCH, PRIVACY AND SECURITY, PHARMACEUTICALS, MEDICINE, CULTURAL ISSUES, ECONOMIC ISSUES, HEALTHCARE, TELECOMMUNICATIONS, TRANSPORTATION, GOVERNMENT, AVIATION, AEROSPACE, AND EMERGING TECHNOLOGIES; DOWNLOADABLE ELECTRONIC MAGAZINES AND PERIODICALS IN THE FIELDS OF INFOTECHNOLOGY, BIOTECHNOLOGY, NANOTECHNOLOGY, COMPUTERS, COMPUTER SCIENCE, THE INTERNET, ENERGY, ENTREPRENEURSHIP, SCIENCE, GLOBALIZATION, GLOBAL ISSUES, INTERNATIONAL ISSUES, INDUSTRY, BUSINESS DEVELOPMENT AND GROWTH, BUSINESS STRATEGIES, PRODUCT RESEARCH AND DEVELOPMENT, ENVIRONMENTAL RESEARCH, PRIVACY AND SECURITY, PHARMACEUTICALS, MEDICINE, CULTURAL ISSUES, ECONOMIC ISSUES, HEALTHCARE, TELECOMMUNICATIONS, TRANSPORTATION, GOVERNMENT, AVIATION, AEROSPACE, AND EMERGING TECHNOLOGIES (U.S. CLS. 21, 23, 26, 36 AND 38).

**CLASS 16—PAPER GOODS AND PRINTED MATTER**

FOR PRINTED MATTER, NAMELY, MAGAZINES AND PERIODICALS IN THE FIELDS OF INFOTECHNOLOGY, BIOTECHNOLOGY, NANOTECHNOLOGY, COMPUTERS, COMPUTER SCIENCE, THE INTERNET, ENERGY, ENTREPRENEURSHIP, SCIENCE, GLOBALIZATION, GLOBAL ISSUES, INTERNATIONAL ISSUES, INDUSTRY, BUSINESS DEVELOPMENT AND GROWTH, BUSINESS STRATEGIES, PRODUCT RESEARCH AND DEVELOPMENT, ENVIRONMENTAL RESEARCH, PRIVACY AND SECURITY, PHARMACEUTICALS, MEDICINE, CULTURAL ISSUES, ECONOMIC ISSUES, HEALTHCARE, TELECOMMUNICATIONS, TRANSPORTATION, GOVERNMENT, AVIATION, AEROSPACE, AND EMERGING TECHNOLOGIES; NEWSLETTERS IN THE FIELDS OF INFOTECHNOLOGY, BIOTECHNOLOGY, NANOTECHNOLOGY, COMPUTERS, COMPUTER SCIENCE, THE INTERNET, ENERGY, ENTREPRENEURSHIP, SCIENCE, GLOBALIZATION, GLOBAL ISSUES, INTERNATIONAL ISSUES, INDUSTRY, BUSINESS DEVELOPMENT AND GROWTH, BUSINESS STRATEGIES, PRODUCT RESEARCH AND DEVELOPMENT, ENVIRONMENTAL RESEARCH, PRIVACY AND SECURITY, PHARMACEUTICALS, MEDICINE, CULTURAL ISSUES, ECONOMIC ISSUES, HEALTHCARE, TELECOMMUNICATIONS, TRANSPORTATION, GOVERNMENT, AVIATION, AEROSPACE, AND EMERGING TECHNOLOGIES (U.S. CLS. 2, 5, 22, 23, 29, 37, 38 AND 50).

**CLASS 41—EDUCATION AND ENTERTAINMENT**

FOR ORGANIZING AND CONDUCTING EDUCATIONAL EXHIBITIONS, CONFERENCES, SEMINARS, FORUMS, CLASSES, WORKSHOPS, PODCASTS, AND WEBCASTS IN THE FIELDS OF INFOTECHNOLOGY, BIOTECHNOLOGY, NANOTECHNOLOGY, COMPUTERS, COMPUTER SCIENCE, THE INTERNET, ENERGY, ENTREPRENEURSHIP, SCIENCE, GLOBALIZATION, GLOBAL ISSUES, INTERNATIONAL ISSUES, INDUSTRY, BUSINESS DEVELOPMENT AND GROWTH, BUSINESS STRATEGIES, PRODUCT RESEARCH AND DEVELOPMENT, ENVIRONMENTAL RESEARCH, PRIVACY AND SECURITY, PHARMACEUTICALS, MEDICINE, CULTURAL ISSUES, ECONOMIC ISSUES, HEALTHCARE, TELECOMMUNICATIONS, TRANSPORTATION, GOVERNMENT, AVIATION, AEROSPACE, AND EMERGING TECHNOLOGIES; ORGANIZING AND CONDUCTING EXHIBITIONS, CONFERENCES, SEMINARS, FORUMS, PODCASTS, WEBCASTS, MEETINGS, AND PROGRAMS IN THE

FIELDS OF INFOTECHNOLOGY, BIOTECHNOLOGY, NANOTECHNOLOGY, COMPUTERS, COMPUTER SCIENCE, THE INTERNET, ENERGY, ENTREPRENEURSHIP, SCIENCE, GLOBALIZATION, GLOBAL ISSUES, INTERNATIONAL ISSUES, INDUSTRY, BUSINESS DEVELOPMENT AND GROWTH, BUSINESS STRATEGIES, PRODUCT RESEARCH AND DEVELOPMENT, ENVIRONMENTAL RESEARCH, PRIVACY AND SECURITY, PHARMACEUTICALS, MEDICINE, CULTURAL ISSUES, ECONOMIC ISSUES, HEALTHCARE, TELECOMMUNICATIONS, TRANSPORTATION, GOVERNMENT, AVIATION, AEROSPACE, AND EMERGING TECHNOLOGIES (U.S. CLS. 100, 101 AND 107).

CIMMERIAN COLEMAN, EXAMINING ATTORNEY

SN 78-817,892. CAMBRIDGE CONSULTANTS LIMITED, CAMBRIDGE, UNITED KINGDOM, FILED 2-17-2006.

**XAP**

THE MARK CONSISTS OF STANDARD CHARACTERS WITHOUT CLAIM TO ANY PARTICULAR FONT, STYLE, SIZE, OR COLOR.

PRIORITY CLAIMED UNDER SEC. 44(D) ON ERPNCMNTY TM OFC APPLICATION NO. 004633723, FILED 9-14-2005, REG. NO. 004633723, DATED 11-5-2010, EXPIRES 9-14-2015.

**CLASS 9—ELECTRICAL AND SCIENTIFIC APPARATUS**

FOR ELECTRONIC GOODS FOR MICROPROCESSOR CORES EMBEDDED WITHIN INTEGRATED CIRCUITS, NAMELY, COMPUTER PERIPHERAL EQUIPMENT AND COMPUTER SOFTWARE FOR THE DESIGN, SIMULATION, PROGRAMMING, PRODUCTION AND TESTING OF MICROPROCESSOR CORES EMBEDDED WITHIN INTEGRATED CIRCUITS; ELECTRONIC GOODS FOR MICROPROCESSOR CORES EMBEDDED WITHIN INTEGRATED CIRCUITS, NAMELY, DOWNLOADABLE SCHEMATIC DIAGRAMS FOR BUILDING MICROPROCESSOR CORES TO BE EMBEDDED IN COMPUTER CIRCUITS (U.S. CLS. 21, 23, 26, 36 AND 38).

**CLASS 40—MATERIAL TREATMENT**

FOR PROFESSIONAL CONSULTANCY SERVICES IN THE FIELD OF THE CUSTOM MANUFACTURE OF EMBEDDED MICROPROCESSOR CORES AND ELECTRONIC INTEGRATED CIRCUITS HAVING EMBEDDED MICROPROCESSOR CORES (U.S. CLS. 100, 103 AND 106).

**CLASS 42—SCIENTIFIC AND COMPUTER SERVICES**

FOR PROFESSIONAL CONSULTANCY SERVICES IN THE FIELD OF DESIGN FOR OTHERS, COMPUTER PROGRAMMING AND PRODUCT TESTING, ALL IN THE FIELD OF EMBEDDED MICROPROCESSOR CORES AND ELECTRONIC INTEGRATED CIRCUITS HAVING EMBEDDED MICROPROCESSOR CORES; RENTAL OF COMPUTER HARDWARE, SOFTWARE AND PERIPHERAL EQUIPMENT IN THE FIELD OF DESIGN, SIMULATION, PROGRAMMING, PRODUCTION AND TESTING OF EMBEDDED MICROPROCESSOR CORES AND INTEGRATED CIRCUITS HAVING EMBEDDED MICROPROCESSOR CORES (U.S. CLS. 100 AND 101).

DAWN HAN, EXAMINING ATTORNEY

SN 79-051,086. SANDS INNOVATIONS PTY LTD, AUSTRALIA, FILED 5-2-2007.

# SNAPSIL

THE MARK CONSISTS OF STANDARD CHARACTERS WITHOUT CLAIM TO ANY PARTICULAR FONT, STYLE, SIZE, OR COLOR.

PRIORITY DATE OF 11-2-2006 IS CLAIMED.

OWNER OF INTERNATIONAL REGISTRATION 0956659 DATED 5-2-2007, EXPIRES 5-2-2017.

## CLASS 16—PAPER GOODS AND PRINTED MATTER

FOR PAPER, NAMELY, ACID RESISTANT PAPER, ABSORBENT PADS OF PAPER AND CELLULOSE FOR USE IN FOOD PACKAGING, ALUMINUM FOIL LAMINATED PAPER FOR PRINTING PURPOSES, ART PAPER, BLANK OR PARTIALLY PRINTED PAPER LABELS, PAPER BOXES; CARDBOARD; PRINTED ALUMINUM FOIL LAMINATED PAPER LABELS; CONTAINERS NOT OF METAL FOR COMMERCIAL USE, NAMELY, PACKAGING CONTAINERS MADE PRINCIPALLY OF PAPER; STATIONERY; ADHESIVES FOR STATIONERY OR HOUSEHOLD PURPOSES; ARTISTS' MATERIALS, NAMELY, ARTISTS' BRUSHES, ARTISTS' PASTELS, ARTISTS' PENCILS, ARTISTS' PENS, ARTS AND CRAFT PAINT KITS, LIQUID PAINT FELT TIP MARKING AND COLORING APPLICATORS, PAINT APPLICATOR ROLLERS, PAINT APPLICATORS, PAINT BOXES AND BRUSHES; OFFICE REQUISITES, NAMELY, CORRECTING FLUID FOR TYPE, ELASTIC BANDS FOR OFFICES, STAPLERS, STAMP PADS; PLASTIC MATERIALS FOR PACKAGING, NAMELY, PLASTIC BAGS FOR PACKAGING, PLASTIC BAGS FOR PACKING, PLASTIC FOILS; ADHESIVES AND BONDING MATERIALS, NAMELY, ADHESIVE MATERIALS FOR OFFICE USE, ADHESIVE FOILS STATIONERY, ADHESIVE LABELS, ADHESIVE TAPES FOR STATIONERY OR HOUSEHOLD PURPOSES AND, ADHESIVES FOR DO-IT-YOURSELF PURPOSES; INK, NAMELY, INK FOR WRITING INSTRUMENTS, STAMP PAD INKS, DUPLICATING INK, WRITING INK; CARDBOARD CARTONS; CARDBOARD BOXES; PAPER SACKS; PAPER BAGS; ENVELOPES; SACHETS AND POUCHES OF PAPER FOR PACKAGING; CARDBOARD, PLASTIC BAGS AND PLASTIC BUBBLE PACKS FOR WRAPPING, PACKING OR PACKAGING; PACKAGING, NAMELY, BLISTER CARDS; PLASTIC BUBBLE PACKS FOR USE IN WRAPPING, PACKING OR PACKAGING; SELF ADHESIVE PLASTIC FILM NOT FOR COMMERCIAL OR INDUSTRIAL PURPOSES; FOOD WRAPPING CLING PLASTIC FILM FOR HOUSEHOLD USE; PLASTIC FILM NOT FOR COMMERCIAL OR INDUSTRIAL PURPOSES, NAMELY, EXTENSIBLE PLASTIC FILM FOR FOOD WRAPPING; PLASTIC FILM NOT FOR COMMERCIAL OR INDUSTRIAL PURPOSES FOR USE IN WRAPPING, PACKING OR PACKAGING; PLASTIC BAGS FOR PACKING AND PACKAGING; NON-METALLIC FOILS FOR PACKAGING, NAMELY, PLASTIC FOILS; PLASTIC PACKAGING FILMS NOT FOR COMMERCIAL OR INDUSTRIAL PURPOSES; PACKAGING AND PACKAGING BAGS MADE OF PAPER, CARDBOARD, PLASTIC OR PLASTIC COATED PAPER OR CARDBOARD BAGS FOR PACKAGING AND PACKING; BAGS MADE OF PAPER FOR USE IN PACKAGING CONSUMER PRODUCTS, FOOD PRODUCTS, AND MEDICATION; BIODEGRADABLE AND AIRTIGHT PACKAGING AND PACKAGING BAGS MADE OF PLASTIC FOILS, PAPER OR CARDBOARD; PAINT TRAYS; PAINT BRUSHES (U.S. CLS. 2, 5, 22, 23, 29, 37, 38 AND 50).

## CLASS 20—FURNITURE AND ARTICLES NOT OTHERWISE CLASSIFIED

FOR COMMERCIAL PACKAGING MATERIALS, NAMELY, CORRUGATED PLASTIC BOXES, CORRUGATED PLASTIC TRAYS; PACKAGING CONTAINERS OF PLASTIC; PACKING CONTAINERS OF PLASTIC MATERIAL; PLASTIC BOXES FOR PACKAGING CONSUMER AND RETAIL ITEMS; PLASTIC MEDICATION CONTAINERS FOR COMMERCIAL USE; PACKAGING CONTAINERS, NAMELY, PLASTIC CONTAINERS FOR USE IN THE FAST FOOD INDUSTRY FOR MADE TO ORDER FOOD PRODUCTS, PLASTIC SQUEEZE TUBES SOLD EMPTY; PLASTIC CONTAINERS, NAMELY, TUBS FOR CONSUMER PRODUCTS PACKAGING; CONTAINERS NOT OF METAL FOR COMMERCIAL USE, NAMELY, PACKAGING CONTAINERS MADE PRINCIPALLY OF PLASTIC; PLASTIC GOODS, NAMELY, PLASTIC LABELS; CONTAINERS, NOT OF METAL FOR COMMERCIAL USE, NAMELY, PACKAGING CONTAINERS OF PLASTIC CONTAINING A BARRIER FILM LINING, OR IMPERMEABLE LINER; PLASTIC COMPONENTS BEING PARTS OF PACKAGING CONTAINERS, NAMELY, NON-METALLIC CLOSURES FOR CONTAINERS, FITTED PLASTIC INSERTS FOR USE AS CONTAINER LINERS, UNFILLED AND UNSEALED PLASTIC SHELLS TO BE SOLD EMPTY FOR FILLING WITH CONSUMER PRODUCTS AND SEALING; PACKAGING CONTAINERS OF BIODEGRADABLE PLASTIC FOR COMMERCIAL USE; PLASTIC CONTAINERS NOT OF METAL FOR COMMERCIAL USE TREATED WITH WATERPROOFING, BARRIER OR RELEASE AGENTS; PLASTIC STORAGE CONTAINERS FOR COMMERCIAL OR INDUSTRIAL USE; DISPOSABLE, NON-ELECTRIC INDUSTRIAL MIXERS AND CARTRIDGES, NAMELY, PLASTIC CONTAINERS USED FOR MIXING AND DISPENSING ADHESIVES, SEALANTS AND THE LIKE; NON-METAL AND NON-PAPER INSULATED SHIPPING CONTAINERS FOR TRANSPORTING FROZEN MATERIALS; CONTAINERS NOT OF METAL FOR COMMERCIAL USE, NAMELY, CONTAINERS FOR STORAGE OF SYNTHETIC MATERIALS; CONTAINERS NOT OF METAL HAVING A FILM OR PLASTIC LINING FOR COMMERCIAL USE; FLEXIBLE CONTAINERS OF PLASTIC FOR COMMERCIAL USE; NON-METALLIC AND NON-PAPER CLOSURES AND CAPS FOR CONTAINERS AND BOTTLES; PLASTIC LIDS FOR CONTAINERS AND BOTTLES; DRINKING STRAWS; BLANK PLASTIC ADHESIVE LABELS (U.S. CLS. 2, 13, 22, 25, 32 AND 50).

ANDREA K. NADELMAN, EXAMINING ATTORNEY

SN 79-065,782. DURAN, FRANCE, FILED 4-11-2008.

# D-VIZ

PRIORITY DATE OF 10-24-2007 IS CLAIMED.

OWNER OF INTERNATIONAL REGISTRATION 0994655 DATED 4-11-2008, EXPIRES 4-11-2018.

**CLASS 9—ELECTRICAL AND SCIENTIFIC APPARATUS**

FOR PHOTOGRAPHIC, CINEMATOGRAPHIC AND OPTICAL APPARATUS AND INSTRUMENTS, NAMELY, VIDEO CAMERAS, OPTICAL LENSES, COMPUTER HARDWARE IN THE NATURE OF GEOMETRIC TRACKING AND CAPTURE SYSTEMS; APPARATUS FOR RECORDING, TRANSMITTING, RECEIVING, REPRODUCING, ALTERING AND PROCESSING SOUND, IMAGES OR DATA, NAMELY, AUDIO TAPE RECORDERS, STEREO RECEIVERS, SIGNAL PROCESSORS; AUDIO AND VIDEO HEADPHONES AND EARPHONES; MICROPHONES; ELECTRICAL REWINDING APPARATUS FOR MAGNETIC TAPES AND CINEMA FILM, NAMELY, VIDEO CASSETTE REWINDERS; MAGNETIC, DIGITAL, ELECTRONIC AND ANALOGUE RECORDING MEDIA, NAMELY, MAGNETIC-TAPE RECORDERS, DIGITAL VIDEO RECORDERS; ACOUSTIC DISCS IN THE NATURE OF BLANK AUDIO DISCS AND BLANK AUDIOVISUAL DISCS; BLANK AUDIO AND VIDEO TAPES; COMPACT DISCS FEATURING MUSIC, COMEDY, MOVIES; OPTICAL PLAYERS, NAMELY, OPTICAL READERS, OPTICAL DISK DRIVES AND BLANK OPTICAL DISCS; BLANK MAGNETO-OPTICAL DISCS, BLANK RECORDABLE DVDS; IMAGE AND SOUND PLAYERS, NAMELY, VIDEO CASSETTE PLAYERS, COMPACT DISC PLAYERS; EXPOSED CINEMATOGRAPHIC FILMS; EXPOSED PHOTOGRAPHIC FILMS AND SLIDES, NAMELY, EXPOSED CAMERA FILM AND EXPOSED SLIDE FILMS; COMPUTER OPERATING SOFTWARE, NAMELY, OPERATING SOFTWARE FOR GEOMETRIC TRACKING AND CAPTURE SYSTEMS (U.S. CLS. 21, 23, 26, 36 AND 38).

**CLASS 35—ADVERTISING AND BUSINESS**

FOR ADVERTISING SERVICES; BUSINESS MANAGEMENT; DISSEMINATION OF ADVERTISING MATERIAL INCLUDING ON-LINE FROM A COMPUTERIZED DATA BASE OR THE INTERNET; BUSINESS ADMINISTRATION CONSULTANCY; IMPORT-EXPORT TRANSACTIONS IN THE NATURE OF IMPORT AND EXPORT AGENCIES; BUSINESS MANAGEMENT OF CINEMAS, INCLUDING MULTIPLEX HOUSES (U.S. CLS. 100, 101 AND 102).

**CLASS 38—COMMUNICATION**

FOR TELECOMMUNICATION SERVICES FOR FILMS, ENTERTAINMENT, NEW MEDIA, CINEMA AND THE INTERNET, NAMELY, LOCAL AND LONG DISTANCE TRANSMISSION OF VOICE, DATA, IMAGES, SOUNDS AND VIDEO VIA THE INTERNET, THROUGH SATELLITES AND ANALOGUE OR HERTZIAN TRANSMISSION; INTERACTIVE BROADCASTING SERVICES RELATING TO PRODUCT PRESENTATION, NAMELY, PROVIDING AN ONLINE FORUM FOR COMPANIES TO SHOWCASE, DISPLAY, DEMONSTRATE AND PROMOTE NEW AND INNOVATIVE IDEAS, PRODUCTS AND SERVICES AS WELL AS INTERNET BROADCASTING AND TELEVISION BROADCASTING; REMOTE ELECTRONIC TRANSMISSION OF TRANSACTION DATA; PRESS AND INFORMATION AGENCIES IN THE NATURE OF NEW AGENCIES, NAMELY, THE TRANSMISSION OF NEW ITEMS TO NEWS REPORTING ORGANIZATIONS; COMMUNICATIONS VIA RADIO, TELEGRAPH, TELEPHONE OR VIDEOPHONE, TELEVISION AND CABLE TELEVISION TRANSMISSION; TRANSMISSION OF INFORMATION BY TELE-MATIC MEANS; ELECTRONIC MESSAGE SENDING; TRANSMISSION OF TELEGRAMS; TRANSMISSION OF INFORMATION BY TELEPRINTER; TELEVISION PROGRAMS AND RADIO PROGRAM BROADCASTING, ESPECIALLY, BY RADIO, TELEVISION, CABLE, RADIO RELAY, SATELLITES AND FROM VIDEO GRAMS AND PHONOGRAMS; RENTAL OF MESSAGE SENDING APPARATUS, NAMELY, RENTAL OF TELECOMMUNICATION EQUIPMENT; COMMUNICATION VIA COMPUTER TERMINALS; COMMUNICATIONS, NAMELY, TRANSMISSIONS AND DISTRIBUTION OF DATA OR AUDIO VISUAL IMAGES VIA CLOSED AND OPEN GLOBAL COMPUTER NETWORKS; INFORMATION ON TELECOMMUNICATIONS; PROGRAMME TRANSMISSION SERVICES STEMMING FROM SIMULTANEOUS PROGRAMMING AND TELEVISION CHANNEL SELECTIONS, NAMELY, PAY-PER-VIEW

TELEVISION TRANSMISSION; PROVISION OF ACCESS TO A GLOBAL COMPUTER NETWORK (U.S. CLS. 100, 101 AND 104).

**CLASS 41—EDUCATION AND ENTERTAINMENT**

FOR EDUCATION AND TRAINING SERVICES, NAMELY, PROVIDING CLASSES, SEMINARS AND WORKSHOPS FOR STUDENTS AND ADULTS IN THE FIELD OF COMPUTER AND AUDIOVISUAL TECHNIQUES, CINEMAS AND NEW MEDIAS, TELEVISION AND INTERNET, NOTABLY FOR THE MAKING OF FILMS, TV FILMS, VIDEO, SOUND, MIXING, CUTTING VIDEO AND SOUNDS; TRAINING IN THE USE OF THE NEW AUDIOVISUAL TECHNOLOGY AND THEIR APPLICATION, NAMELY, DIGITAL CINEMAS, DISTRIBUTION VIDEO TV, INTERNET, CELLULAR PHONES; TRAINING IN THE FIELD OF COMPUTER TECHNOLOGY AND OF EXCHANGE IN DATE CONCEPTION OF INTERNET SITES, DATA BASE AND IN THE COMPUTER TECHNIQUE AND DIGITAL ANIMATION AND VISUAL EFFECT OF IMAGES; ENTERTAINMENT SERVICES, IN PARTICULAR, DESIGNED FOR CINEMAS INCLUDING MULTIPLEX HOUSES AND FOR AUDIOVISUAL INCLUDING FOR VIDEO CASSETTES AND DISCS, AUDIO TAPES AND COMPACT DISCS AND DVDS, NAMELY, PRODUCTION AND DISTRIBUTION OF MOVIES AND FILM AND VIDEO PRODUCTION; ORGANIZING COMMUNITY SPORTING AND CULTURAL EVENTS, NAMELY, ORGANIZING CULTURAL EVENTS AT CONCERTS, OUTDOOR FILMS PROJECTION, CULTURAL MEETINGS, ORGANIZATION OF FILM FESTIVALS; PROVIDING CINEMA THEATRES FOR THE SHOWING OF CINEMA AND CARTOON FILMS (U.S. CLS. 100, 101 AND 107).

**CLASS 42—SCIENTIFIC AND COMPUTER SERVICES**

FOR ENGINEERING, NAMELY, PROVIDING EVALUATIONS, ASSESSMENTS AND RESEARCH IN THE FIELDS OF SCIENCE AND TECHNOLOGY PROVIDED BY ENGINEERS; DESIGN AND DEVELOPMENT OF COMPUTER HARDWARE AND SOFTWARE; RESEARCH AND DEVELOPMENT OF NEW PRODUCTS FOR THIRD PARTIES; TECHNICAL PROJECT STUDIES IN THE NATURE OF SCIENTIFIC RESEARCH AND DEVELOPMENT IN THE FIELD OF REAL-TIME CINEMATIC REVISUALIZATION; ARCHITECTURE SERVICES, NAMELY, ARCHITECTURAL SERVICES, ARCHITECTURAL DESIGN AND ARCHITECTURAL CONSULTATION; INTERIOR DECORATION CONSULTATION; DEVELOPMENT, DESIGN, INSTALLATION, MAINTENANCE, UPDATING AND RENTAL OF COMPUTER SOFTWARE; COMPUTER PROGRAMMING; COMPUTER HARDWARE AND SOFTWARE CONSULTING; DATA CONVERSION OF COMPUTER PROGRAMS AND DATA, NOT PHYSICAL CONVERSION; CONVERSION OF DOCUMENTS FROM A PHYSICAL TO AN ELECTRONIC MEDIUM; TECHNICAL INSPECTION OF MOTOR VEHICLES; GRAPHIC ARTS DESIGN SERVICES; STYLING, NAMELY, INDUSTRIAL DESIGN; AUTHENTICATING WORKS OF ART; SCIENTIFIC RESEARCH FOR MEDICAL PURPOSES; PROVIDING ONLINE NON-DOWNLOADABLE SOFTWARE FOR PREVIEWING COMPUTER PRINTING LAYOUTS (U.S. CLS. 100 AND 101).

**CLASS 45—PERSONAL AND LEGAL SERVICES**

FOR LEGAL SERVICES; LEGAL RESEARCH; INTELLECTUAL PROPERTY CONSULTANCY; ISSUING OF LICENSES FOR INTELLECTUAL PROPERTY RIGHTS (U.S. CLS. 100 AND 101).

KEVIN CORWIN, EXAMINING ATTORNEY

SN 79-072,811. AURORA S.R.L., I-20040 USMATE VELATE (MI), ITALY, FILED 4-20-2009.



PRIORITY DATE OF 2-24-2009 IS CLAIMED.  
OWNER OF INTERNATIONAL REGISTRATION 1013051  
DATED 4-20-2009, EXPIRES 4-20-2019.

THE MARK CONSISTS OF THE WORD "AURORA" IN SPECIAL CHARACTERS, PARTIALLY CONTAINED IN A THREE-SIDED GEOMETRIC FIGURE OF WHICH TWO SIDES ARE DRAWN WITH A THICK LINE AND ONE WITH A THIN LINE.

#### CLASS 12—VEHICLES

FOR TROLLEYS FOR SHOPPING (U.S. CLS. 19, 21, 23, 31, 35 AND 44).

#### CLASS 18—LEATHER GOODS

FOR ALL-PURPOSE REUSABLE CARRYING BAGS; HANDBAGS; SUITCASES; RUCKSACKS; WALLETS; PURSES; SCHOOL SATCHELS; DOCUMENT SATCHELS OF LEATHER AND IMITATION LEATHER; SMALL BAGS FOR CARRYING BABIES' ACCESSORIES, FOR UMBRELLAS, TRUNKS; ANIMAL HIDES; ARTICLES MADE FROM HIDE, NAMELY, BRIEFCASES; LEATHER; LEATHER ARTICLES, NAMELY, LEATHER BRIEFCASES; IMITATION LEATHER; ARTICLES MADE FROM IMITATION LEATHER, NAMELY, IMITATION LEATHER KEY CHAINS; SUN UMBRELLAS; PARASOLS; UMBRELLAS; CANES; WHIPS; SADDLERY ARTICLES, NAMELY, HARNESES, HORN BAGS (U.S. CLS. 1, 2, 3, 22 AND 41).

LIEF MARTIN, EXAMINING ATTORNEY

SN 79-074,752. CHAILLAN, NICOLAS, FRANCE, FILED 6-12-2009.

# AFTER MOUSE

THE MARK CONSISTS OF STANDARD CHARACTERS WITHOUT CLAIM TO ANY PARTICULAR FONT, STYLE, SIZE, OR COLOR.

PRIORITY DATE OF 2-13-2009 IS CLAIMED.  
OWNER OF INTERNATIONAL REGISTRATION 1018312  
DATED 6-12-2009, EXPIRES 6-12-2019.

NO CLAIM IS MADE TO THE EXCLUSIVE RIGHT TO USE "MOUSE", APART FROM THE MARK AS SHOWN.

#### CLASS 9—ELECTRICAL AND SCIENTIFIC APPARATUS

FOR APPARATUS FOR RECORDING, TRANSMITTING, REPRODUCING OR PROCESSING SOUND OR IMAGES; DETECTORS, NAMELY, DETECTORS OF ELECTRONIC MOVEMENTS; ENCODED INTEGRATED CIRCUIT CARDS, NAMELY, WIFI CARDS, ETHERNET CARDS FOR COMPUTERS; COMPUTER HARDWARE; COMPUTER PERIPHERALS; DEVICES FOR POINTING BY MEANS OF TOUCH, NAMELY, FLAT PANEL DISPLAY SCREENS AND COMPUTER MONITORS CAPABLE OF SENSING THE LOCATION WHERE A HUMAN HAS TOUCHED SUCH DISPLAY SCREEN OR MONITOR AT MULTIPLE POINTS SIMULTANEOUSLY, COMPUTER CURSOR CONTROL DEVICES, NAMELY, DIGITI-

ZER TABLETS CAPABLE OF SENSING THE LOCATION WHERE A HUMAN HAS TOUCHED SUCH TABLET AT MULTIPLE POINTS SIMULTANEOUSLY, COMPUTER MICE IN THE NATURE OF A TRACKPAD, COMPUTER MICE, NAMELY, TRACKBALLS, COMPUTER MICE, NAMELY, TOUCHPADS, COMPUTER MICE; DEVICES FOR INDICATING LOCATION WITHIN AN ELECTRONIC DEVICE BY MEANS OF HUMAN TACTILE INPUT, NAMELY, FLAT PANEL DISPLAY SCREENS AND COMPUTER MONITORS CAPABLE OF SENSING THE LOCATION WHERE A HUMAN HAS TOUCHED SUCH DISPLAY SCREEN OR MONITOR AT MULTIPLE POINTS SIMULTANEOUSLY; COMPUTER SOFTWARE, NAMELY, UTILITY SOFTWARE USED TO SENSE AND RECORD INPUT FROM ANY OF THE AFOREMENTIONED TACTILE INPUT DEVICES; COMPUTER SCREENS, NAMELY, COMPUTER SCREENS CAPABLE OF SENSING THE LOCATION WHERE A HUMAN HAS TOUCHED SUCH COMPUTER SCREEN; COMPUTER SOFTWARE FOR COMPUTER TOUCHSCREENS, NAMELY, COMPUTER UTILITY SOFTWARE USED TO RECORD USER INPUT FROM A COMPUTER TOUCHSCREEN AND RETURN THE TIME AND LOCATION OF SUCH USER INPUT TO ANOTHER SOFTWARE PROGRAM; COMPUTER EQUIPMENT, NAMELY, PCS, PLASMA DISPLAY SCREENS, LCD PANELS, TOUCH WALLS, NAMELY, VIDEO WALLS COMPRISED OF MULTIPLE COMPUTER TOUCHSCREENS PLACED ADJACENT TO ONE ANOTHER SO AS TO CREATE THE ILLUSION OF A SINGLE OVER-SIZED DISPLAY AREA HAVING THE CAPABILITY OF RECORDING USER INPUT VIA USERS TOUCHING SUCH TOUCHSCREENS; VIDEO SOFTWARE GAMES, COMPUTER SOFTWARE GAMES; SOFTWARE FOR DATABASE MANAGEMENT AND PROJECT MANAGEMENT IN THE FIELD OF COMPUTER-AIDED DESIGN AND COMPUTER-AIDED ENGINEERING, SOFTWARE TO DETECT CANCER, SOFTWARE FOR THE MANAGEMENT OF DATABASES, SOFTWARE FOR USE AS A SPREADSHEET; DATA-PROCESSING SOFTWARE, COMMUNICATION SOFTWARE FOR CONNECTION TO WORLD NETWORKS; COMPUTER SEARCH ENGINE SOFTWARE; COMMUNICATION SOFTWARE TO ALLOW USERS TO REACH INFORMATION AND ACCESS THEIR BANK ACCOUNTS AND TO CARRY OUT BANKING TRANSACTIONS; COMPUTER E-COMMERCE SOFTWARE TO ALLOW USERS TO PERFORM ELECTRONIC BUSINESS TRANSACTIONS VIA A GLOBAL COMPUTER NETWORK; SOFTWARE TO TEACH TYPING SKILLS; SOFTWARE TO AUTOMATE DATA STORAGE; SOFTWARE TO CONTROL THE SOUND QUALITY OF DATA PROCESSING EQUIPMENT; AUDIOPHONIC OPERATING SOFTWARE FOR DATABASE MANAGEMENT; SOFTWARE FOR WORD PROCESSING; COMPUTER SOFTWARE TO ENHANCE THE AUDIO-VISUAL CAPABILITIES OF MULTIMEDIA APPLICATIONS, NAMELY, FOR THE INTEGRATION OF TEXT, AUDIO, GRAPHICS, STILL IMAGES AND MOVING PICTURES; SOFTWARE FOR MANAGEMENT OF DATABASES FOR USE ON TOUCH SCREENS; SOFTWARE FOR WORD PROCESSING IN THE FIELDS OF PROJECT MANAGEMENT, CUSTOMER MANAGEMENT, BUSINESS PLANNING, REAL ESTATE MANAGEMENT, BUSINESS MANAGEMENT, FOR USE ON A TOUCH-SENSITIVE MEDIUM; INTERACTIVE GAME PROGRAMS; COMPUTER MULTIMEDIA PRODUCTS, NAMELY, INTERACTIVE MULTIMEDIA SOFTWARE FOR EDITING TOGETHER VIDEO CLIPS AND FOR CREATING BUSINESS PRESENTATIONS, FEATURING AUDIO AND VIDEO INFORMATION ON THE SUBJECTS OF PROJECT MANAGEMENT, CUSTOMER MANAGEMENT, BUSINESS PLANNING, REAL ESTATE MANAGEMENT, BUSINESS MANAGEMENT; COMPUTERS HAVING TOUCHSCREENS WITH INTEGRATED COMPUTER SOFTWARE CAPABLE OF ALLOWING USERS TO VISUALIZE AND DISCOVER PRODUCTS OR SERVICES IN THE FIELDS OF THE REAL ESTATE, TOURISM, RESTAURANTS, RETAIL STORES, AND THEATER AND OTHER FINE ARTS; COMPUTER PROGRAMS FOR DRAWING ON A COMPUTER TOUCHSCREEN BY MEANS OF USER TACTILE INPUT; TACTILE TABLES, NAMELY, COMPUTERS HAVING INTEGRATED TOUCHSCREENS; PERSONAL DIGITAL ASSISTANTS; LAPTOP COMPUTERS (U.S. CLS. 21, 23, 26, 36 AND 38).

**CLASS 42—SCIENTIFIC AND COMPUTER SERVICES**

FOR DESIGN AND DEVELOPMENT OF COMPUTER HARDWARE AND SOFTWARE; RESEARCH AND DEVELOPMENT OF NEW PRODUCTS FOR OTHERS; COMPUTER PROGRAMMING; CONVERSION OF COMPUTER PROGRAMS AND DATA, OTHER THAN PHYSICAL CONVERSION; CONVERSION OF DATA OR DOCUMENTS FROM PHYSICAL TO ELECTRONIC MEDIA; DESIGN AND DEVELOPMENT OF CUSTOMIZED COMPUTER SOFTWARE APPLICATIONS, NAMELY, COMPUTER SOFTWARE USED TO ENABLE HUMAN INTERACTION WITH TOUCH-BASED DISPLAY SCREENS WITHIN ELECTRONIC DEVICES; RENTAL, MAINTENANCE AND UPDATING OF COMPUTER HARDWARE, SOFTWARE AND COMPUTER PROGRAMS USING TOUCH TECHNOLOGY; GENERATION, NAMELY, DEVELOPMENT OF DATA PROCESSING PROGRAMS BY ORDER OF THIRD PARTIES; CONSULTANCY AND ASSISTANCE, NAMELY, TECHNICAL SUPPORT SERVICES, NAMELY, TROUBLESHOOTING IN THE NATURE OF DIAGNOSING COMPUTER HARDWARE, COMPUTER SOFTWARE, AND COMPUTER NETWORKS PROBLEMS; COMPUTER SECURITY, NAMELY, UPDATING OF COMPUTER SOFTWARE RELATING TO COMPUTER SECURITY AND PREVENTION OF COMPUTER RISKS; PROVISION OF INFORMATION VIA NETWORKS IN THE FIELDS OF COMPUTER PROGRAMMING, COMPUTER HARDWARE DEVELOPMENT AND COMPUTER SOFTWARE INTERFACE DESIGN; PROVIDING ON-LINE NON-DOWNLOADABLE SOFTWARE FOR THE MANAGEMENT OF DATABASES, SOFTWARE SPREADSHEETS, AND WORD PROCESSING (U.S. CLS. 100 AND 101).  
JESSICA FATHY, EXAMINING ATTORNEY

SN 79-077,725. ARTHUR DE SOULTRAIT; C/O SÉGUR, OSNY, FRANCE, FILED 10-30-2009.



PRIORITY DATE OF 5-6-2009 IS CLAIMED.  
OWNER OF INTERNATIONAL REGISTRATION 1026014 DATED 10-30-2009, EXPIRES 10-30-2019.  
OWNER OF U.S. REG. NO. 3,505,548.

THE COLOR(S) RED (PANTONE RUBINE RED C) AND WHITE IS/ARE CLAIMED AS A FEATURE OF THE MARK.  
THE MARK CONSISTS OF THE INTERLACED LETTERS "V" AND "A", A CROWN DESIGN, AND THE WORDING "VICONTE A" ALL IN WHITE; THE BACKGROUND IS IN RED (PANTONE RUBINE RED C).

**CLASS 3—COSMETICS AND CLEANING PREPARATIONS**

FOR BLEACHING PREPARATIONS FOR COSMETIC PURPOSES; AROMATIC BODY CARE PRODUCTS, NAMELY, BODY LOTION, SHOWER GEL, CUTICLE CREAM, SHAMPOO, CONDITIONER, NON-MEDICATED LIP BALM, SOAP, BODY POLISH, BODY AND FOOT SCRUB AND NON-MEDICATED FOOT CREAM; ESSENTIAL OILS FOR PERSONAL USE; PERFUMES; EAU DE COLOGNES AND AFTERSHAVES; COSMETIC CREAMS FOR SKIN CARE; COSMETIC HAIR DRESSING PREPARATIONS; COSMETICS AND MAKE-UP; MAKE-UP REMOVING PREPARATIONS; SHAVING PREPARATIONS; LEATHER CLEANING PREPARATIONS; LEATHER POLISHES (U.S. CLS. 1, 4, 6, 50, 51 AND 52).

**CLASS 14—JEWELRY**

FOR JEWELRY, NAMELY, BRACELETS, CHAINS, KEY RINGS, AND MEDALS; JEWELRY AND WATCHES; CHRONOGRAPHS AS WATCHES; CHRONOMETERS; WATCHES; JEWELRY AND PRECIOUS STONES; JEWELRY BOXES OF PRECIOUS METAL; WATCH STRAPS (U.S. CLS. 2, 27, 28 AND 50).

**CLASS 18—LEATHER GOODS**

FOR LEATHER AND IMITATION LEATHER; LEATHER BAGS; SUITCASES; WALLET; LEATHER BRIEFCASES (U.S. CLS. 1, 2, 3, 22 AND 41).

**CLASS 25—CLOTHING**

FOR CLOTHING, NAMELY, T-SHIRTS, TANK TOPS, DRESSES, SWIMSUITS, SWIMWEAR, JACKETS, WIND RESISTANT JACKETS, VESTS, ROBES, SKIRTS, SARONGS, SCARVES, PANTS, GAUCHOS, SHIRTS, COATS, SHORTS, BERMUDA FABRIC BELTS, SWEATSHIRTS, JOGGING PANTS AND SWEATERS, SHAWLS, JEANS, LOUNGEWEAR, SOCKS; LEATHER BELTS; FOOTWEAR; FOOTWEAR, NAMELY, SPORTS SHOES, BEACH SHOES, CHILDREN SHOES, EVENING SHOES, SHOES, OUTDOOR SHOES FOR WINTER, SANDALS, BOOTS; HEADWEAR; HEADGEAR, NAMELY, HATS, BERETS, CAPS, BALACLAVAS, TOQUES, TURBANS (U.S. CLS. 22 AND 39).

ALEXANDER L. POWERS, EXAMINING ATTORNEY

SN 79-078,945. ZHONGSHAN TAILI HOUSEHOLD; PRODUCTS MANUFACTURING CO., LTD., CHINA, FILED 1-6-2010.

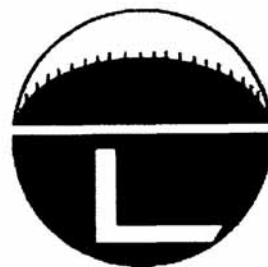

**TAILI 太力**

OWNER OF INTERNATIONAL REGISTRATION 1004937 DATED 4-21-2009, EXPIRES 4-21-2019.

THE MARK CONSISTS OF A CIRCLE DIVIDED BY A LINE CONTAINING AN "L" SHAPED DESIGN WITH THE WORD "TAILI" AND CHINESE CHARACTERS.

THE WORDING "TAILI" HAS NO MEANING IN A FOREIGN LANGUAGE.

THE TRANSLITERATION OF THE NON-LATIN CHARACTERS IN THE MARK IS: "TAILI".

**CLASS 16—PAPER GOODS AND PRINTED MATTER**

FOR FILTER PAPER; TABLE MATS OF PAPER; PLASTIC CLING FILM FOR PALLETIZATION; BOXES OF PAPER; PLASTIC OR PAPER BAGS FOR PACKAGING; FOOD WRAPPING PLASTIC FILM FOR HOUSEHOLD USE; BOXES OF CARDBOARD OR PAPER (U.S. CLS. 2, 5, 22, 23, 29, 37, 38 AND 50).



**CLASS 18—LEATHER GOODS**

FOR TRAVELING TRUNKS; TRAVELING BAGS; TRAVELING CASES, OF LEATHER OR LEATHER BOARD; TRUNKS; SUITCASES OF ARTIFICIAL LEATHER; SUITCASES OF CANVAS; LEATHER BAGS FOR MERCHANDISE PACKAGING; SPORT BAGS FOR CLIMBERS; FURNITURE COVERINGS OF LEATHER (U.S. CLS. 1, 2, 3, 22 AND 41).

**CLASS 20—FURNITURE AND ARTICLES NOT OTHERWISE CLASSIFIED**

FOR STORAGE RACKS FOR CLOTHS; CLOTH HANGERS FOR CLOTHES, BOOKSHELVES; CLOTH COVERS FOR STORAGE; CLOTH COVERS FOR WARDROBE; BINS NOT OF METAL; CLOTHES HOOKS NOT OF METAL; HOOKS NOT OF METAL FOR CLOTHES RAILS (U.S. CLS. 2, 13, 22, 25, 32 AND 50).

**CLASS 21—HOUSEWARES AND GLASS**

FOR KNIFE RESTS FOR THE TABLE; CRUET STANDS FOR OIL AND VINEGAR; CARDBOARD CUPS; HOUSEHOLD LAUNDRY BASKETS; CONTAINERS FOR HOUSEHOLD OR KITCHEN USE NOT OF PRECIOUS METAL; COCKTAIL SHAKERS; NON-ELECTRIC PRESSURE COOKERS; COFFEE FILTERS NOT OF PAPER BEING PART OF NON-ELECTRIC COFFEE MAKERS; SOAP DISPENSERS; SOAP BOXES; DISHES FOR SOAP; SOAP HOLDERS; PLASTIC NOZZLES FOR METAL WATERING CANS; RAILS AND RINGS FOR TOWELS; TOILET PAPER HOLDERS; CLOTHES RACKS, FOR DRYING; CLOTHING STRETCHERS; CLOTHES-PINS; TROUSERS STRETCHERS; DUSTBINS; GARBAGE CANS; BATH BRUSHES; SCRUBBING BRUSHES; BRUSHES FOR CLEANING TANKS AND CONTAINERS FOR HOUSEHOLD USE; DISHWASHING BRUSHES; SHAVING BRUSH STANDS; ISOTHERMIC BAGS, NAMELY, THERMALLY INSULATED CONTAINERS FOR FOOD; BROOMS; CARPET SWEEPERS; CLOTHS FOR CLEANING; CLEANING RAGS; DUSTING CLOTHS; CLOTHS FOR CLEANING FLOORS; MOPS; FURNITURE DUSTERS; BATHING SPONGE (U.S. CLS. 2, 13, 23, 29, 30, 33, 40 AND 50).

CHARLES L. JENKINS, EXAMINING ATTORNEY

**CLASS 9—ELECTRICAL AND SCIENTIFIC APPARATUS**

FOR COMPUTERS, SOFTWARE FOR ORGANIZATION AND MANAGEMENT OF DATA IN DISTRIBUTED COMPUTER STORAGE SYSTEMS, SOFTWARE FOR DATA ENCRYPTION, SOFTWARE FOR BACKING UP ENCRYPTED DATA FILES, SOFTWARE FOR ACCESSING AND RESTORING DATA FILES, SOFTWARE FOR DOWNLOADING COMPUTER FILES OVER A NETWORK, SOFTWARE FOR UPLOADING COMPUTER FILES OVER A NETWORK, SOFTWARE FOR FILE MANAGEMENT, SOFTWARE FOR ALLOWING COMPUTER FILES TO BE SHARED BY OTHERS, SOFTWARE FOR CREATING AND MAINTAINING A VIRTUAL FILE SERVER DISTRIBUTED OVER A NETWORK, SOFTWARE FOR CREATING AND MAINTAINING A DISTRIBUTED FILE SYSTEM; SOFTWARE FOR ALLOWING UNUSED DISK SPACE ON A USER'S COMPUTER TO PARTICIPATE IN FORMING PART OF A LARGE GRID NETWORK FOR DISTRIBUTED DATA STORAGE, SOFTWARE FOR OPTIMIZING ROUTING OVER A LARGE DISTRIBUTED GRID COMPUTER NETWORK; SOFTWARE FOR ONLINE PURCHASE OF STORAGE SPACE FOR COMPUTER DATA; SOFTWARE FOR PROVIDING STREAMING VIDEO OVER A NETWORK; SOFTWARE FOR PROVIDING AN APPLICATION PROGRAMMING INTERFACE ALLOWING THIRD PARTY DEVELOPERS TO CREATE APPLICATIONS; SOFTWARE FOR PROVIDING AND MANAGING A SOCIAL NETWORK; COMPUTER HARDWARE AND SOFTWARE FOR IMPLEMENTING A DATA CENTER FOR MASS STORAGE OF COMPUTER FILES, FOR STORING ENCRYPTED BACKUP COPIES OF COMPUTER FILES STORED ELSEWHERE; COMPUTER SOFTWARE DESIGNED TO ENCODE AND DECODE DATA; SOFTWARE FOR STORING, ACCESSING AND MANAGING DATA AND MULTIMEDIA CONTENT ON COMPUTER NETWORK; SOFTWARE FOR PUBLISHING DATA AND ALLOWING ACCESS TO DATA; SOFTWARE FOR PARTICIPATING IN A DECENTRALIZED STORAGE SYSTEM; DATA SEARCH SOFTWARE (U.S. CLS. 21, 23, 26, 36 AND 38).

**CLASS 42—SCIENTIFIC AND COMPUTER SERVICES**

FOR DESIGN AND DEVELOPMENT OF COMPUTERS; DESIGN, SERVICING, DEVELOPMENT AND UPDATING OF SOFTWARE; COMPUTER PROGRAMMING, NAMELY, ENCODING AND DECODING OF INFORMATION AND DATA FOR OTHERS, PROGRAMMING OF DATA PROTECTION SOFTWARE FOR USE IN TRANSMITTING DATA ELECTRONICALLY OVER GLOBAL COMPUTER NETWORKS INCLUDING THE INTERNET; COMPUTER HARDWARE CONSULTANCY; COMPUTER SOFTWARE CONSULTANCY; COMPUTER MAINTENANCE FOR OTHERS OF SOFTWARE FOR DATA MEMORY WITHIN A DECENTRALIZED COMPUTER STORAGE SYSTEM (U.S. CLS. 100 AND 101).

HEATHER BIDDULPH, EXAMINING ATTORNEY

SN 79-081,478. LACIE S.A., F-75015 PARIS, FRANCE, FILED 2-17-2010.



PRIORITY DATE OF 8-21-2009 IS CLAIMED.  
OWNER OF INTERNATIONAL REGISTRATION 1035727 DATED 2-17-2010, EXPIRES 2-17-2020.  
OWNER OF U.S. REG. NO. 3,540,524.  
THE MARK CONSISTS OF THE WORDING "WUALA" IN STYLIZED FORM INSIDE AN OVAL

SN 79-081,554. ROCKET INDUSTRIES PTY LTD, AUSTRALIA, FILED 3-24-2010.



OWNER OF INTERNATIONAL REGISTRATION 1035921 DATED 3-24-2010, EXPIRES 3-24-2020.

NO CLAIM IS MADE TO THE EXCLUSIVE RIGHT TO USE "PERFORMANCE PRODUCTS", APART FROM THE MARK AS SHOWN.

THE MARK CONSISTS OF THE WORDING "AERO FLOW PERFORMANCE PRODUCTS" IN A QUADRILATERAL DESIGN.

**CLASS 7—MACHINERY**

FOR PARTS AND ACCESSORIES FOR AUTOMOBILE MOTORS AND ENGINES, NAMELY, REPLACEMENT AND COMPONENT FITTINGS FOR AUTOMOBILE MOTORS AND ENGINES, NAMELY, 37 DEGREE JOINT INDUSTRY COUNCIL ARMY-NAVY FITTINGS, HOSE ENDS, TAPPER HOSE ENDS, CUTTER HOSE ENDS, FULL FLOW CUTTER HOSE ENDS, FULL FLOW TAPER HOSE ENDS, PUSH LOCK HOSE ENDS, FULL FLOW HOSE ENDS, HARD LINE FITTINGS, MALE NATIONAL PIPE THREAD HOSE ENDS, MALE ARMY-NAVY HOSE ENDS, HOSE BARBS, ARMY-NAVY FLARE BARB, FEMALE COUPLER, BULKHEAD FITTINGS, ARMY-NAVY BULKHEAD TEE, FLARE TEE, FEMALE AND MALE FLARE, MALE FLARE UNION, MALE FLARE REDUCERS, FLARE REDUCERS BEING FEMALE AND MALE, NATIONAL PIPE THREAD HEX HEAD PLUGS, ARMY-NAVY FLARE PLUGS, FEMALE TO MALE EXTENSIONS, FLARE CAPS, O-RING BOSS PORT PLUGS, O-RING BOSS PORT PLUG SLIM LINE, O-RING BOSS TO STRAIGHT ARMY-NAVY MALE FLARE ADAPTORS, FEMALE TEE O-RING BOSS, O-RING BOSS MALE TO MALE SWIVEL, METRIC TO MALE FLARE, TRANS COOLER FITTINGS, MALE NATIONAL PIPE THREAD TO FEMALE ARMY-NAVY, NATIONAL PIPE THREAD TO MALE FLARE, INVERTED SEAT ADAPTORS, NATIONAL PIPE THREAD TEE, NATIONAL PIPE THREAD COUPLER, NATIONAL PIPE THREAD FEMALE PIPE TEE, NATIONAL PIPE THREAD PIPE REDUCERS, QUICK RELEASE DRY BREAK COUPLINGS, FULL FLOW ADAPTORS, ADAPTORS BEING REPLACEMENT AND COMPONENT PARTS FOR AUTOMOBILE MOTORS AND ENGINES, NAMELY, 37 DEGREE JOINT INDUSTRY COUNCIL ARMY-NAVY FITTINGS, HOSE BARBS, ARMY-NAVY FLARE BARB, FEMALE COUPLER, BULKHEAD FITTINGS, ARMY-NAVY BULKHEAD TEE, FLARE TEE, FEMALE AND MALE FLARE, MALE FLARE UNION, MALE FLARE REDUCERS, FLARE REDUCERS BEING FEMALE AND MALE, NATIONAL PIPE THREAD HEX HEAD PLUGS, ARMY-NAVY FLARE PLUGS, FEMALE TO MALE EXTENSIONS, FLARE CAPS, O-RING BOSS PORT PLUGS, O-RING BOSS PORT PLUG SLIM LINE, O-RING BOSS TO STRAIGHT ARMY-NAVY MALE FLARE ADAPTORS, FEMALE TEE O-RING BOSS, O-RING BOSS MALE TO MALE SWIVEL, METRIC TO MALE FLARE, TRANS COOLER FITTINGS, MALE NATIONAL PIPE THREAD TO FEMALE ARMY-NAVY, NATIONAL PIPE THREAD TO MALE FLARE, INVERTED SEAT ADAPTORS, NATIONAL PIPE THREAD TEE, NATIONAL PIPE THREAD COUPLER, NATIONAL PIPE THREAD FEMALE PIPE TEE, NATIONAL PIPE THREAD PIPE REDUCERS, QUICK RELEASE DRY BREAK COUPLINGS, FULL FLOW ADAPTORS AND STAINLESS STEEL BRAKE ADAPTORS, FILTERS, NAMELY, PRO FILTERS WITH STAINLESS STEEL REPLACEABLE ELEMENTS, HIGH PRESSURE NITROUS FILTERS, BILLET FUEL FILTERS WITH BRONZE ELEMENT, INLINE FUEL AND OIL FILTERS, COTTON REPLACEMENT AIR FILTERS, POD FILTERS AND FILTER ASSEMBLIES, BILLET P CLAMPS BEING REPLACEMENT AND COMPONENT PARTS OF AUTOMOBILE MOTORS AND ENGINES, FUEL PUMP BRACKETS FOR MOUNTING AND SECURING FUEL PUMPS WITHIN AUTOMOBILES BEING REPLACEMENT AND COMPONENT PARTS OF AUTOMOBILE ENGINES AND MOTORS, Y-BLOCKS BEING COMPONENT PARTS OF MOTORS AND ENGINES, SHUT OFF VALVES BEING PARTS OF MOTORS AND ENGINES, HOSE SEPARATORS FOR SECURING HOSES WITHIN AUTOMOBILE MOTORS AND ENGINES BEING COMPONENT AND REPLACEMENT PARTS FOR AUTOMOBILE MOTORS AND ENGINES, CHECK VALVES BEING PARTS OF MOTORS AND ENGINES, FUEL LOGS FOR DELIVERING FUEL TO THE CARBURETOR BEING COMPONENT PARTS OF AUTOMOBILE MOTORS AND ENGINES, CARBURETOR ADAPTORS FOR ADAPTING HOSES AND PIPES TO THE CARBURETOR TO DELIVER FUEL TO THE ENGINE BEING COMPONENT AND REPLACEMENT PARTS OF CARBURETORS, CARBURETOR INLET RAIL KITS FOR CONSTRUCTING CARBURETOR INLET RAILS TO DELIVER FUEL TO MOTORS AND ENGINES, SUCH KITS BEING COMPRISED OF MALE ARMY-NAVY FITTINGS, STAINLESS STEEL BRAIDED HOSE, 1/8 NATIONAL PIPE THREAD PORT PLUG, CARBURETOR ADAPTORS MALE, ARMY-NAVY FLARE CAP, ALLOY CRUSH WASHERS AND ARMY-NAVY FLARE TEE ALL BEING COMPONENT AND

REPLACEMENT PARTS OF AUTOMOBILE MOTORS AND ENGINES, FUEL PRESSURE REGULATORS BEING COMPONENT AND REPLACEMENT PARTS OF AUTOMOBILE MOTORS AND ENGINES, FUEL PUMPS, CATCH CANS FOR COLLECTING EXCESS FLUIDS BEING COMPONENT AND REPLACEMENT PARTS FOR AUTOMOBILE MOTORS AND ENGINES, ROLL OVER VALVES BEING PARTS OF MOTORS AND ENGINES, FUEL PUMP BLOCK OFF PLATES FOR SEALING THE OPENING IN THE ENGINE BLOCK WHEN THE MECHANICAL FUEL PUMP IS NOT BEING USED BEING COMPONENT AND REPLACEMENT PARTS FOR AUTOMOBILE MOTORS AND ENGINES, CARBURETOR VELOCITY SPACERS FOR INCREASING THE VELOCITY OF THE FUEL AND AIR MIXTURE BEING COMPONENT AND REPLACEMENT PARTS OF AUTOMOBILE MOTORS AND ENGINES, TRANS BRACKETS FOR HOLDING KICK DOWN CABLES BEING COMPONENT AND REPLACEMENT PARTS OF AUTOMOBILE MOTORS AND ENGINES, RETURN SPRING ASSEMBLIES FOR HOLDING THE SPRING TENSION ON THE CARBURETOR BEING COMPONENT AND REPLACEMENT PARTS OF AUTOMOBILE MOTORS AND ENGINES, THROTTLE CABLE BRACKETS FOR MOUNTING AND SECURING THROTTLE CABLES BEING COMPONENT AND REPLACEMENT PARTS OF AUTOMOBILE MOTORS AND ENGINES, OIL BYPASS ELIMINATORS FOR FILTERING OIL AND FOR PREVENTING UNFILTERED OIL INTO THE ENGINE, GILMER DRIVES, OIL FILTER RELOCATION KITS, NAMELY, KITS FOR MOUNTING OIL FILTERS IN ENGINES, COMPRISED OF SANDWICH BLOCK, REMOTE FILTER MOUNT, HOSE ENDS AND HOSE, RADIATOR FILTERS, TIMING COVERS FOR COVERING THE TIMING CHAIN ON V8 ENGINES BEING COMPONENT AND REPLACEMENT PARTS OF AUTOMOBILE MOTORS AND ENGINES, TIMING POINTERS FOR SETTING THE TIMING OF THE ENGINE BEING COMPONENT AND REPLACEMENT PARTS OF AUTOMOBILE MOTORS AND ENGINES, DISTRIBUTOR HOLD DOWN CLAMPS, NAMELY, CLAMPS AND BRACKETS TO PREVENT THE DISTRIBUTOR FROM TWISTING AT HIGH RPM BEING COMPONENT AND REPLACEMENT PARTS OF AUTOMOBILE MOTORS AND ENGINES, PULLEYS BEING PARTS OF MOTORS AND ENGINES, ELECTRIC FANS, SHORT SHIFTERS FOR MECHANICALLY REDUCING TIME BETWEEN GEAR CHANGES BEING COMPONENT AND REPLACEMENT PARTS OF AUTOMOBILE MOTORS AND ENGINES, FLEX PLATES FOR CONNECTING AN ENGINE TO AN AUTOMATIC TRANSMISSION BEING COMPONENT AND REPLACEMENT PARTS OF AUTOMOBILE MOTORS AND ENGINES, ALTERNATOR BRACKETS FOR MOUNTING AND SECURING ALTERNATORS BEING COMPONENT AND REPLACEMENT PARTS OF AUTOMOBILE MOTORS AND ENGINES, AND FUEL RAILS; INJECTORS FOR AUTOMOBILE ENGINES; AUTOMOBILE FUEL INJECTOR SYSTEMS COMPRISED OF HOSE, FITTINGS AND ADAPTORS, INJECTOR BUNGS, FILTERS, SHUT OFF VALVES, FUEL PUMPS, SURGE TANKS, FUEL RAIL EXTRUSION AND FUEL RAILS; AUTOMOBILE FUEL INJECTOR COMPONENT PARTS, NAMELY, HOSE, FITTINGS AND ADAPTORS, INJECTOR BUNGS, FILTERS, SHUTOFF VALVES, FUEL PUMPS, SURGE TANKS, FUEL RAIL EXTRUSION AND FUEL RAILS; FUEL CONVERSION KITS FOR AUTOMOBILE INTERNAL COMBUSTION ENGINES COMPRISED OF FITTINGS, ADAPTORS, INJECTOR BUNGS, FILTERS, SHUT OFF VALVES, FUEL PUMPS, SURGE TANKS, FUEL RAIL EXTRUSION AND FUEL RAILS, ALL BEING COMPONENT AND REPLACEMENT PARTS OF AUTOMOBILE MOTORS AND ENGINES; FUEL CONVERSION APPARATUS FOR AUTOMOBILE INTERNAL COMBUSTION ENGINES, NAMELY, FUEL RAIL EXTRUSION FOR THE CUSTOM FABRICATION OF PIPES FOR THE DELIVERY OF FUEL TO FUEL INJECTORS, BEING COMPONENT AND REPLACEMENT PARTS FOR AUTOMOBILE MOTORS AND ENGINES; PUMPS FOR AUTOMOBILE ENGINES AND MOTORS; CONTROL MECHANISMS FOR AUTOMOBILE ENGINES AND MOTORS, NAMELY, FUEL SHUT OFF VALVES BEING PARTS OF MOTORS AND ENGINES, CONTROL MECHANISMS FOR AUTOMOBILE ENGINES AND MOTORS, NAMELY, FUEL PRESSURE REGULATORS BEING COMPONENT AND REPLACEMENT PARTS OF MOTORS AND ENGINES, AND OIL BYPASS ELIMINATORS, NAMELY, OIL BYPASS ELIMINATORS FOR FILTERING OIL AND FOR PREVENTING UNFIL-

TERED OIL INTO THE ENGINE; CYLINDER HEADS FOR AUTOMOBILE ENGINES; CARBURETORS FOR AUTOMOBILES; CARBURETOR FEEDERS BEING COMPONENT PARTS OF CARBURETORS, NAMELY, HOSE, FITTINGS, ADAPTORS, CARBURETOR ADAPTORS MALE, BILLET FUEL LOGS, CARBURETOR ADAPTORS FEMALE, AND KITS FOR CONSTRUCTING CARBURETOR INLET RAILS FOR DELIVERING FUEL TO THE ENGINE, COMPRISED OF MALE ARMY-NAVY FITTINGS, STAINLESS STEEL BRAIDED HOSE, 1/8 NATIONAL PIPE THREAD PORT PLUG, CARBURETOR ADAPTORS MALE, ARMY-NAVY FLARE CAP, ALLOY CRUSH WASHERS AND ARMY-NAVY FLARE TEE, ALL BEING FOR AUTOMOBILES; EXHAUST MANIFOLDS FOR AUTOMOBILE ENGINES; SUPERCHARGERS IN THE NATURE OF AIR COMPRESSORS USED FOR FORCED INDUCTION OF AUTOMOBILE VEHICLE ENGINES; TURBOCHARGERS FOR AUTOMOBILE VEHICLE ENGINES; SPARK PLUGS FOR AUTOMOBILE INTERNAL COMBUSTION ENGINES; AUTOMOBILE ENGINE VALVES, NAMELY, BILLET PCV VALVES; FLUID PUMPS FOR AUTOMOBILES, NAMELY, ENGINE FUEL PUMPS AND FUEL INJECTION PUMPS; IGNITING DEVICES FOR AUTOMOBILE INTERNAL COMBUSTION ENGINES; CATALYTIC CONVERTERS FOR AUTOMOBILES; NONE OF THE FOREGOING BEING FLUID FLOW CONTROL VALVES (U.S. CLS. 13, 19, 21, 23, 31, 34 AND 35).

#### CLASS 17—RUBBER GOODS

FOR FLEXIBLE HOSES, NAMELY, NON-METALLIC HOSES AND CONNECTING HOSES FOR MOTOR LAND VEHICLES; PIPE GASKETS; NON-METALLIC GASKETS FOR MOTOR LAND VEHICLES; RUBBER SEALS, NAMELY, RINGS OF RUBBER FOR USE AS PIPE CONNECTION SEALS; PACKING AND INSULATING MATERIALS; STOPPING MATERIALS, NAMELY, RUBBER STOPPERS, FOAM STOPPERS AND PLASTIC STOPPERS (U.S. CLS. 1, 5, 12, 13, 35 AND 50).  
LAURA HAMMEL, EXAMINING ATTORNEY

SN 79-082,152. CACTUS CORPORATION, JAPAN, FILED 3-1-2010.



OWNER OF INTERNATIONAL REGISTRATION 1037550 DATED 3-1-2010, EXPIRES 3-1-2020.

OWNER OF U.S. REG. NOS. 3,485,559 AND 3,518,446.  
THE MARK CONSISTS OF THE STYLIZED WORDING "D A D" WITH PART OF THE FIRST LETTER "D" IS INVERTED AND PART OF THE LAST LETTER "D" BEING PART OF THE LETTER "A".

#### CLASS 7—MACHINERY

FOR AUTOMOTIVE MUFFLER (U.S. CLS. 13, 19, 21, 23, 31, 34 AND 35).

#### CLASS 12—VEHICLES

FOR AUTOMOBILES AND THEIR STRUCTURAL PARTS AND FITTINGS; TWO-WHEELED MOTOR VEHICLES AND THEIR STRUCTURAL PARTS AND FITTINGS; BICYCLES AND THEIR STRUCTURAL PARTS AND FITTINGS; WHEELS FOR AUTOMOBILES; EXTERIOR PARTS FOR AUTOMOBILES, NAMELY, AUTOMOTIVE EXTERIOR METAL DECORATIVE AND PROTECTIVE TRIM; PLASTIC PARTS FOR VEHICLES, NAMELY, AUTOMOTIVE EXTERIOR AND INTERIOR PLASTIC EXTRUDED DECORATIVE AND PROTECTIVE TRIM; AUTO AFTERMARKET ACCESSORIES, NAMELY, VEHICLE GRILLS, FENDERS, LICENSE COVER FRAMES AND LAMPS; SPOILERS FOR VEHICLES; BUMPERS FOR AUTOMOBILES; VEHICLE SIDE VIEW MIRROR COVER; SHOCK ABSORBERS FOR AUTOMOBILES; SUSPENSION FOR AUTOMOBILES; INTERIOR PARTS FOR AUTOMOBILES, NAMELY, AUTOMOTIVE INTERIOR PANELING; AUTOMOTIVE INTERIOR TRIM, AUTOMOTIVE INTERIOR PANELING; CUSTOM LEATHER INTERIORS FOR VEHICLES; BRAKE PEDALS, ACCELERATOR PEDALS, REARVIEW MIRRORS, GEAR LEVER KNOBS FOR VEHICLES, DRINK HOLDERS FOR VEHICLES, STEERING WHEEL COVERS, FITTED FABRIC COVERS FOR VEHICLE SEAT BELTS, AUTOMOBILE SEAT CUSHIONS; VEHICLE PARTS, NAMELY, SUN VISORS; FRONT PASSENGER SEAT TABLES SPECIALLY ADAPTED FOR FITTING IN VEHICLES; CENTER CABINETS SPECIALLY ADAPTED FOR FITTING IN VEHICLES; HEAD-RESTS FOR VEHICLES SEATS; NECK PADS SPECIALLY ADAPTED FOR FITTING IN VEHICLES; FITTED DASHBOARD COVERS FOR VEHICLES; CELL PHONE CASES ADAPTED FOR VEHICLES; ASSIST GRIPS FOR USE IN VEHICLES, NAMELY, INTERIOR ROOF HANDLES; AUTOMOTIVE WINDSHIELD SHADE SCREENS; SHEET COVER FOR AUTOMOBILES, NAMELY, FITTED AUTOMOTIVE SEAT COVERS; PARTS AND FITTINGS FOR AUTOMOBILES, NAMELY, AUTOMOBILE STRUCTURAL PARTS (U.S. CLS. 19, 21, 23, 31, 35 AND 44).

#### CLASS 14—JEWELRY

FOR SHOE ORNAMENTS OF PRECIOUS METALS; ORNAMENTS OF PRECIOUS METALS; JEWELRY; UNWROUGHT AND SEMI-WROUGHT PRECIOUS STONES AND THEIR IMITATIONS; WATCHES; KEY RINGS OF PRECIOUS METALS (U.S. CLS. 2, 27, 28 AND 50).

#### CLASS 16—PAPER GOODS AND PRINTED MATTER

FOR INDUSTRIAL PACKAGING CONTAINERS OF PAPER; STATIONERY; CARDS FOR STATIONERY USE; POCKET MEMORANDUM BOOKS; PAPER IDENTIFICATION TAGS; DESK PADS; STICKERS FOR STATIONERY USE; DECORATIVE STICKERS; STICKERS, NAMELY, DECORATIVE STICKERS FOR AUTOMOBILES; DECORATIVE DECALS FOR VEHICLE WINDOWS; PICTURE POSTCARDS, CATALOGUES IN THE FIELDS OF AUTOMOBILES, CLOTHING, BAGS, BELTS AND PERSONAL ORNAMENTS; CALENDARS; MAGAZINES IN THE FIELD OF AUTOMOBILES, PAMPHLETS IN THE FIELDS OF AUTOMOBILES, CLOTHING, BAGS, BELTS AND PERSONAL ORNAMENTS; PHOTOGRAPH STANDS; CAR STICKERS (U.S. CLS. 2, 5, 22, 23, 29, 37, 38 AND 50).

#### CLASS 25—CLOTHING

FOR NON-JAPANESE STYLE OUTER CLOTHING, NAMELY, JACKETS, SHIRTS, AND TROUSERS; SWEATERS, VESTS, WAISTCOATS; HEADWEAR, NAMELY, HATS; UNDERWEAR; COLLAR PROTECTORS; BELTS FOR CLOTHING; FOOTWEAR OTHER THAN BOOTS FOR SPORTS (U.S. CLS. 22 AND 39).

#### CLASS 27—FLOOR COVERINGS

FOR FLOOR COVERINGS (U.S. CLS. 19, 20, 37, 42 AND 50).

**CLASS 34—SMOKERS' ARTICLES**

FOR SMOKER'S ARTICLES NOT OF PRECIOUS METALS, NAMELY, ASHTRAYS AND CIGARETTE CASES; SMOKER'S ARTICLES OF PRECIOUS METALS, NAMELY, ASHTRAYS AND CIGARETTE CASES; CIGARETTE LIGHTER CASES (U.S. CLS. 2, 8, 9 AND 17).

**CLASS 35—ADVERTISING AND BUSINESS**

FOR RETAIL STORE SERVICES AND WHOLESALE STORE SERVICES FEATURING AUTOMOBILES, CLOTHING, BAGS AND POUCHES, PERSONAL ARTICLES, TOBACCOS AND SMOKER'S ARTICLES; ADVERTISING; PROVIDING INFORMATION ON COMMERCIAL SALES BY TELEPHONE, FACSIMILE OR INTERNET; IMPORT-EXPORT AGENCIES (U.S. CLS. 100, 101 AND 102).

TASNEEM HUSSAIN, EXAMINING ATTORNEY

SN 79-082,243. EARLEE PRODUCTS PTY LTD, MURARRIE QLD 4172, AUSTRALIA, FILED 4-8-2010.

# LISTERBLOC

THE MARK CONSISTS OF STANDARD CHARACTERS WITHOUT CLAIM TO ANY PARTICULAR FONT, STYLE, SIZE, OR COLOR.

PRIORITY DATE OF 10-12-2009 IS CLAIMED.

OWNER OF INTERNATIONAL REGISTRATION 1037753 DATED 4-8-2010, EXPIRES 4-8-2020.

THE WORDING "LISTERBLOC" HAS NO MEANING IN A FOREIGN LANGUAGE.

**CLASS 1—CHEMICALS**

FOR FOOD ADDITIVES TO INHIBIT THE GROWTH OF GRAM-POSITIVE MICRO-ORGANISMS IN THE NATURE OF BACTERIA, FUNGI AND YEASTS, NAMELY, SELECTED BIOACTIVE SPICE EXTRACTS AND FOOD EMULSIFIERS BEING CHEMICAL PRODUCTS FOR THE FRESH KEEPING AND PRESERVING OF FOOD; FOOD PRESERVATIVE COMPOSITIONS (U.S. CLS. 1, 5, 6, 10, 26 AND 46).

**CLASS 5—PHARMACEUTICALS**

FOR BIOLOGICAL FOOD PREPARATIONS, NAMELY, MICROBIAL GROWTH INHIBITORS, NAMELY, ANTI-MICROBIAL COATINGS TO TREAT THE GROWTH OF MOLD, MILDEW, BACTERIA AND FUNGUS ON VARIOUS SURFACES; ANTIBACTERIAL PREPARATIONS, NAMELY, ANTIBACTERIAL CLEANSERS FOR USE IN CONJUNCTION WITH FOOD PREPARATION (U.S. CLS. 6, 18, 44, 46, 51 AND 52).

MYRIAH HABEEB, EXAMINING ATTORNEY

SN 79-082,764. MCM MEDIA PTY LTD, AUSTRALIA, FILED 2-25-2010.

# MOVIEO

THE MARK CONSISTS OF STANDARD CHARACTERS WITHOUT CLAIM TO ANY PARTICULAR FONT, STYLE, SIZE, OR COLOR.

OWNER OF INTERNATIONAL REGISTRATION 1039338 DATED 2-25-2010, EXPIRES 2-25-2020.

**CLASS 9—ELECTRICAL AND SCIENTIFIC APPARATUS**

FOR ELECTRONIC PUBLICATIONS, NAMELY, MAGAZINES, BOOKLETS, NEWSLETTERS, AND BROCHURES, FEATURING INFORMATION AND RESOURCES IN THE FIELDS OF MEDIA, MARKETING, NEWS, GENERAL INTEREST, SPORT, ARTS AND ENTERTAINMENT, RECORDED ON COMPUTER MEDIA; DOWNLOADABLE ELECTRONIC PUBLICATIONS, NAMELY, MAGAZINES, BOOKLETS, NEWSLETTERS, AND BROCHURES FEATURING INFORMATION AND RESOURCES IN THE FIELDS OF MEDIA, MARKETING, NEWS, GENERAL INTEREST, SPORT, ARTS AND ENTERTAINMENT; PUBLICATIONS IN ELECTRONICALLY READABLE FORM, NAMELY, DOWNLOADABLE ELECTRONIC PUBLICATIONS IN THE NATURE OF MAGAZINES, BOOKLETS, NEWSLETTERS, AND BROCHURES, FEATURING INFORMATION AND RESOURCES IN THE FIELD OF ELECTRONIC MEDIA; DOWNLOADABLE MUSIC FILES IN THE NATURE OF SOUND RECORDINGS FEATURING MUSIC, NEWS, GENERAL INTEREST, SPORT, ARTS, ENTERTAINMENT, SPOKEN WORD, ACTION, COMEDY AND DRAMA; DOWNLOADABLE VIDEO RECORDINGS FEATURING MUSIC, NEWS, GENERAL INTEREST, SPORT, ARTS, ENTERTAINMENT, SPOKEN WORD, ACTION, COMEDY AND DRAMA; DOWNLOADABLE MULTIMEDIA AUDIO AND VIDEO RECORDINGS FEATURING MUSIC, NEWS, GENERAL INTEREST, SPORT, ARTS, ENTERTAINMENT, SPOKEN WORD, ACTION, COMEDY AND DRAMA; DOWNLOADABLE TELEPHONE RING TONES FOR MOBILE TELEPHONES; DOWNLOADABLE PHOTOGRAPHS; DOWNLOADABLE ELECTRONIC PUBLICATIONS IN THE NATURE OF BOOKS FEATURING ARTICLES AND NEWSLETTERS IN THE FIELDS OF MEDIA, MARKETING, MUSIC, NEWS, GENERAL INTEREST, SPORT, ARTS AND ENTERTAINMENT; CDS, HIGH CAPACITY OPTICAL DISCS AND DVDS FEATURING AUDIO, VIDEO AND MULTI-MEDIA RECORDINGS IN THE NATURE OF MUSIC, NEWS, GENERAL INTEREST, SPORT, ARTS, ENTERTAINMENT, SPOKEN WORD, ACTION, COMEDY AND DRAMA; PRERECORDED COMPACT DISCS FEATURING MUSIC, NEWS, GENERAL INTEREST, SPORT, ARTS, ENTERTAINMENT, SPOKEN WORD, ACTION, COMEDY AND DRAMA; AUDIO RECORDINGS FEATURING MUSIC, NEWS, GENERAL INTEREST, SPORT, ARTS, ENTERTAINMENT, SPOKEN WORD, ACTION, COMEDY AND DRAMA; MUSICAL RECORDINGS; VIDEO RECORDINGS FEATURING MUSIC, NEWS, GENERAL INTEREST IN THE NATURE OF DOCUMENTARIES, SPORT, ARTS, SPOKEN WORD, ACTION, COMEDY AND DRAMA; MULTIMEDIA AUDIO AND VIDEO RECORDINGS FEATURING MUSIC, NEWS, SPORT, ARTS, SPOKEN WORD, ACTION, COMEDY AND DRAMA; MOTION PICTURE FILMS FEATURING MUSIC, NEWS, GENERAL INTEREST IN THE NATURE OF DOCUMENTARIES, SPORT, ARTS, ACTION, COMEDY AND DRAMA; ANIMATED FILMS, NAMELY, VIDEO RECORDINGS FEATURING MUSIC, NEWS, GENERAL INTEREST IN THE NATURE OF DOCUMENTARIES, SPORT, ARTS, ACTION, COMEDY AND DRAMA; ANIMATED CARTOONS IN THE FORM OF MOTION PICTURES AND RECORDED ON OPTICAL DISCS AND DIGITAL VERSATILE DISCS (DVDS); DIGITAL MUSIC IN MP3 FORMAT DOWNLOADABLE FROM WEBSITES ON THE INTERNET FEATURING DOWNLOADABLE MUSIC; MP3 PLAYERS; ELECTRONIC DATABASES IN THE FIELDS OF MEDIA, MARKETING, MUSIC, NEWS, GENERAL INTEREST IN THE NATURE OF DOCUMENTARIES, SPORT, ARTS AND ENTERTAINMENT FEATURING SPOKEN WORD, ACTION, COMEDY AND DRAMA, RECORDED ON COMPUTER MEDIA AND DOWNLOADABLE FROM WEBSITES ON THE INTERNET RECORDED ON COMPUTER MEDIA AND DOWNLOADABLE FROM WEBSITES ON THE INTERNET; DOWNLOADABLE INSTRUCTIONAL MATERIALS SOLD TOGETHER AS A UNIT WITH THE AFORESAID GOODS (U.S. CLS. 21, 23, 26, 36 AND 38).

**CLASS 35—ADVERTISING AND BUSINESS**

FOR ADVERTISING SERVICES; RADIO, TELEVISION AND INTERNET ADVERTISING SERVICES; PROVIDING SPACE AT A WEBSITE FOR THE ADVERTISEMENT OF THE GOODS AND SERVICES OF OTHERS; RENTAL OF ADVERTISING SPACE; PRODUCTION OF ADVERTISING MATTER AND DESIGN OF ADVERTISING MATERIAL; DISSEMINATION OF ADVERTISING MATTER AND MATERIAL; ADVERTISING, NAMELY, PRODUCTION OF RADIO, TELEVISION AND INTERNET ADVERTISEMENTS AND COMMERCIALS; ADVERTISING, NAMELY, PRODUCTION OF SOUND AND VIDEO RECORDINGS FOR ADVERTISING PURPOSES; INFORMATION AND ADVISORY SERVICES RELATING TO ADVERTISING; MARKET RESEARCH FOR ADVERTISING; CONDUCTING BUSINESS AND MARKET RESEARCH RATINGS SURVEYS, NAMELY, ANALYZING AND COMPILING DATA FOR MEASURING OF RADIO, TELEVISION AND INTERNET AUDIENCE NUMBERS; PUBLIC OPINION POLLING; BUSINESS MARKETING SERVICES; PRODUCTION OF SOUND AND VIDEO RECORDINGS FOR MARKETING ADVERTISING PURPOSES; INFORMATION AND ADVISORY SERVICES RELATING TO BUSINESS MARKETING; PROMOTIONAL SERVICES IN THE NATURE OF ADVERTISING; ADVERTISING, NAMELY, PROMOTING THE GOODS AND SERVICES OF ARTISTS AND PROMOTING THE CONCERTS OF OTHERS; ARRANGING OF CONTESTS, NAMELY, ORGANIZING OF PRIZE DRAWS FOR PROMOTIONAL PURPOSES; PROVIDING INFORMATION, INCLUDING BY ELECTRONIC MEANS AND VIA A GLOBAL COMPUTER NETWORK, ABOUT ADVERTISING AND MARKETING SERVICES (U.S. CLS. 100, 101 AND 102).

**CLASS 38—COMMUNICATION**

FOR RADIO BROADCASTING; BROADCASTING OF PROGRAMS BY RADIO; RADIO COMMUNICATION SERVICES; RADIO COMMUNICATION NETWORK SERVICES; BROADCASTING, WEBCASTING, STREAMING, NARROWCASTING, MULTICASTING AND UNICASTING, NAMELY, TRANSMISSION OF RADIO PROGRAMS; BROADCASTING OF RADIO AND TELEVISION PROGRAMS BY SATELLITE; SATELLITE COMMUNICATIONS SERVICES; TRANSMISSION OF RECORDED MESSAGES AND INFORMATION BY AUDIO AND VISUAL BROADCASTING, WEBCASTING, STREAMING, NARROWCASTING, MULTICASTING AND UNICASTING; TELEVISION BROADCASTING; BROADCASTING OF TELEVISION PROGRAMS; BROADCASTING OF INFORMATION BY TELEVISION; BROADCASTING, WEBCASTING, STREAMING, NARROWCASTING, MULTICASTING AND UNICASTING, NAMELY, TRANSMISSION OF TELEVISION PROGRAMS; DELIVERY OF DIGITAL MUSIC BY ELECTRONIC TRANSMISSION, FEATURING TRANSMISSION TO MOBILE TELEPHONES; DIGITAL NETWORK TELECOMMUNICATIONS SERVICES; ELECTRONIC DATA TRANSMISSION, NAMELY, DATA COMMUNICATION SERVICES; STREAMING OF AUDIO, VIDEO AND MULTIMEDIA MATERIAL ON GLOBAL AND LOCAL COMPUTER NETWORKS; MUSIC BROADCASTING, NAMELY, BROADCASTING OF MUSIC BY RADIO, TELEVISION AND ELECTRONIC TRANSMISSION; NETCASTING, NAMELY, ELECTRONIC TRANSMISSION AND STREAMING OF DIGITAL MEDIA CONTENT FOR OTHERS VIA GLOBAL AND LOCAL COMPUTER NETWORKS; WEBCASTING SERVICES; AUDIO COMMUNICATIONS SERVICES, NAMELY, AUDIO BROADCASTING, WEBCASTING, STREAMING, NARROWCASTING, MULTICASTING AND UNICASTING; AUDIOVISUAL COMMUNICATION SERVICES, NAMELY, BROADCASTING, WEBCASTING, STREAMING, NARROWCASTING, MULTICASTING AND UNICASTING OF AUDIOVISUAL MATERIAL; ELECTRONIC COMMUNICATION SERVICES, NAMELY, ELECTRONIC TRANSMISSION OF DATA, DOCUMENTS, AUDIO MATERIAL, VISUAL MATERIAL, AUDIOVISUAL MATERIAL AND MULTIMEDIA MATERIAL AMONG USERS OF COMPUTERS AND MOBILE TELEPHONES; ELECTRONIC NETWORK COMMUNICATIONS, NAMELY, DELIVERY OF MESSAGES, DATA, DOCUMENTS, AUDIO MATERIAL, VISUAL MATERIAL, AUDIOVISUAL MATERIAL AND MULTIMEDIA MATERIAL BY TRANSMISSION OVER AN ELECTRONIC NETWORK; PROVIDING ON-LINE

CHAT ROOMS AND ON-LINE FORUMS FOR TRANSMISSION OF MESSAGES AMONG COMPUTER USERS CONCERNING MUSIC, NEWS, ITEMS OF GENERAL INTEREST, SPORT, ARTS AND ENTERTAINMENT; ELECTRONIC BULLETIN BOARD SERVICES; PROVIDING ACCESS TO DIGITAL MUSIC WEB SITES ON THE INTERNET; PROVIDING INFORMATION BY ELECTRONIC MEANS AND VIA A GLOBAL COMPUTER NETWORK ABOUT RADIO COMMUNICATION SERVICES, SATELLITE COMMUNICATIONS SERVICES, TELEVISION BROADCASTING, TRANSMISSION OF TELEVISION PROGRAMS BY WEBCASTING, STREAMING, NARROWCASTING, MULTICASTING AND UNICASTING, TRANSMISSION OF RECORDED MESSAGES AND INFORMATION BY AUDIO AND VISUAL BROADCASTING, WEBCASTING, STREAMING, NARROWCASTING, MULTICASTING AND UNICASTING, DELIVERY OF DIGITAL MUSIC BY ELECTRONIC TRANSMISSION, INCLUDING TRANSMISSION TO MOBILE TELEPHONES, DIGITAL NETWORK TELECOMMUNICATIONS SERVICES, DATA COMMUNICATION SERVICES IN THE FORM OF ELECTRONIC DATA TRANSMISSION, STREAMING OF AUDIO, VIDEO AND MULTIMEDIA MATERIAL ON GLOBAL AND LOCAL COMPUTER NETWORKS, WEBCASTING SERVICES, AUDIO COMMUNICATIONS SERVICES, NAMELY, BROADCASTING, WEBCASTING, STREAMING, NARROWCASTING, MULTICASTING AND UNICASTING, AUDIOVISUAL COMMUNICATION SERVICES, NAMELY, BROADCASTING, WEBCASTING, STREAMING, NARROWCASTING, MULTICASTING AND UNICASTING OF AUDIOVISUAL MATERIAL, ELECTRONIC COMMUNICATION SERVICES, NAMELY, ELECTRONIC TRANSMISSION OF DATA, DOCUMENTS, AUDIO MATERIAL, VISUAL MATERIAL, AUDIOVISUAL MATERIAL AND MULTIMEDIA MATERIAL AMONG USERS OF COMPUTERS AND MOBILE TELEPHONES, ELECTRONIC NETWORK COMMUNICATIONS, NAMELY, DELIVERY OF MESSAGES, DATA, DOCUMENTS, AUDIO MATERIAL, VISUAL MATERIAL, AUDIOVISUAL MATERIAL AND MULTIMEDIA MATERIAL BY TRANSMISSION OVER AN ELECTRONIC NETWORK, PROVIDING ON-LINE CHAT ROOMS AND ON-LINE FORUMS FOR TRANSMISSION OF MESSAGES AMONG COMPUTER USERS CONCERNING MUSIC, NEWS, ITEMS OF GENERAL INTEREST, SPORT, ARTS AND ENTERTAINMENT, ELECTRONIC BULLETIN BOARD SERVICES, AND PROVIDING ACCESS TO DIGITAL MUSIC WEB SITES ON THE INTERNET (U.S. CLS. 100, 101 AND 104).

**CLASS 41—EDUCATION AND ENTERTAINMENT**

FOR ENTERTAINMENT SERVICES, NAMELY, THE CREATION, DEVELOPMENT AND PRODUCTION OF RADIO PROGRAMS, TELEVISION SHOWS, MOTION PICTURES; ENTERTAINMENT SERVICES, NAMELY, CREATION, DEVELOPMENT, PRODUCTION AND DISTRIBUTION OF VIDEOS IN THE NATURE OF DVDS IN THE FIELD OF MUSIC, NEWS, GENERAL INTEREST IN THE NATURE OF DOCUMENTARIES, SPORTS, ART, SPOKEN WORD, ACTION, COMEDY AND DRAMA; ENTERTAINMENT SERVICES, NAMELY, CREATION, DEVELOPMENT, AND PRODUCTION OF VIDEO AND COMPUTER GAME SOFTWARE, ELECTRONIC GAMES SOFTWARE FOR MOBILE TELEPHONES, SOFTWARE APPLICATIONS FOR MOBILE TELEPHONES, ELECTRONIC MEDIA FILES, MUSIC VIDEO CLIPS, MUSICAL RECORDINGS AND VIDEOS IN THE NATURE OF OPTICAL DISCS; ENTERTAINMENT SERVICES, NAMELY, LIVE PERFORMANCES BY MUSICAL ARTISTS, MUSICAL BANDS, AND DANCERS; PRESENTATION OF LIVE COMEDY SHOWS; DISC JOCKEY SERVICES; RADIO AND TELEVISION PROGRAM SYNDICATION; INTERNET RADIO AND TELEVISION PROGRAMS SYNDICATION SERVICES, NAMELY, SEGMENTS FEATURING MUSIC, NEWS, GENERAL INTEREST IN THE NATURE OF DOCUMENTARIES, SPORTS, ARTS, SPOKEN WORD, ACTION, COMEDY AND DRAMA; PUBLISHING SERVICES, NAMELY, PUBLISHING OF MUSIC, BOOKS, BOOKLETS, POSTERS, MAGAZINES, ARTICLES, NEWSLETTERS, BROCHURES, SONG LISTS, VIDEO LISTS, MEDIA FILE LISTS, INFORMATION SHEETS AND INSTRUCTIONAL MATERIAL; PUBLISHING OF ELECTRONIC PUBLICATIONS; ONLINE PUBLICATION OF MULTIMEDIA MATERIAL, NAMELY, MUSIC, BOOKLETS, POSTERS,

MAGAZINES, ARTICLES, NEWSLETTERS, BROCHURES, SONG LISTS, VIDEO LISTS, MEDIA FILE LISTS, INFORMATION SHEETS AND INSTRUCTIONAL MATERIAL; MUSIC LIBRARY SERVICES; ARCHIVE LIBRARY SERVICES; PROVIDING INFORMATION AND NEWS IN THE FIELD OF ENTERTAINMENT; ORGANIZING EVENTS AND ACTIVITIES FOR ENTERTAINMENT PURPOSES, NAMELY, MUSICAL PERFORMANCES, DANCE PERFORMANCES, COMEDY PERFORMANCES, DISC JOCKEY PERFORMANCES AND FESTIVALS FEATURING MUSIC, DANCING, COMEDY AND DISC JOCKEYS (DJS); ORGANIZING EXHIBITIONS FOR ENTERTAINMENT PURPOSES; ORGANIZING COMPETITIONS FOR ENTERTAINMENT PURPOSES FEATURING PRIZE DRAWINGS AND SCRATCH CARD COMPETITIONS VIA RADIO, TELEVISION, MOBILE TELEPHONE AND THE INTERNET; ORGANIZING COMPETITIONS FOR ENTERTAINMENT PURPOSES IN THE NATURE OF ONLINE COMPETITIONS IN THE FIELD OF ENTERTAINMENT; PROVIDING INFORMATION BY ELECTRONIC MEANS AND VIA A GLOBAL COMPUTER NETWORK ABOUT ENTERTAINMENT SERVICES, SYNDICATION OF RADIO, TELEVISION AND INTERNET PROGRAMS, PUBLISHING SERVICES, ONLINE PUBLICATION OF MULTIMEDIA MATERIAL, MUSIC LIBRARY SERVICES, ARCHIVE LIBRARY SERVICES AND ARRANGING OF CULTURAL AND SPORTING EVENTS, EXHIBITIONS (U.S. CLS. 100, 101 AND 107).

RAMONA ORTIGA, EXAMINING ATTORNEY

#### CLASS 21—HOUSEWARES AND GLASS

FOR GLASSWARE, PORCELAIN WARE AND EARTHENWARE NOT INCLUDED IN OTHER CLASSES, NAMELY, TABLE PLATES NOT OF PRECIOUS METAL, GLASS FLASKS, BUTTER-DISH COVERS, CHEESE-DISH COVERS, BUTTER DISHES, BEER MUGS, JARS, DRINKING VESSELS, BOXES OF GLASS, BOWLS, CANDY BOXES NOT OF PRECIOUS METAL, CANDLESTICKS NOT OF PRECIOUS METAL, GLASS BOWLS, DOOR KNOBS MADE OF PORCELAIN, BUSTS OF PORCELAIN OR GLASS, FLOWER-POT COVERS NOT OF PAPER, DECANTERS, COASTERS NOT OF PAPER AND OTHER THAN TABLE LINEN, CANDELABRA NOT OF PRECIOUS METAL, HOUSEHOLD JUGS, KITCHEN CONTAINERS NOT OF PRECIOUS METAL, TRIVETS, ENAMELED GLASS, SIGNBOARDS OF PORCELAIN OR GLASS, FLASKS NOT OF PRECIOUS METAL, FLOWER POTS, HOLDERS FOR FLOWERS, ICE BUCKETS, MUGS NOT OF PRECIOUS METAL, OPALINE GLASS, TRAYS FOR HOUSEHOLD USE NOT OF PRECIOUS METAL, DISHES NOT OF PRECIOUS METAL, MENU CARD HOLDERS, TOOTHPICK HOLDERS NOT OF PRECIOUS METAL, SOAP HOLDERS, NAPKIN HOLDERS NOT OF PRECIOUS METAL, POTS, POT LIDS, POWDER COMPACTS NOT OF PRECIOUS METAL, PERFUME SPRAYERS SOLD EMPTY, NAPKIN RINGS, SALAD BOWLS NOT OF PRECIOUS METAL, SALT SHAKERS NOT OF PRECIOUS METAL, SOAP BOXES, BUCKETS, SAUCERS NOT OF PRECIOUS METAL, SOUP BOWLS NOT OF PRECIOUS METAL, STATUETTES OF PORCELAIN OR OF GLASS, SUGAR BOWLS NOT OF PRECIOUS METAL, CUPS NOT OF PRECIOUS METAL, TEA CADDIES NOT OF PRECIOUS METAL, TEAPOTS NOT OF PRECIOUS METAL, PIGGY BANKS OF PORCELAIN OR GLASS, CHAMBER POTS, VASES NOT OF PRECIOUS METAL, SACRED VESSELS NOT OF PRECIOUS METAL, ENAMELED GLASS, PAINTED BEVERAGE GLASSWARE, DRINKING GLASSES, OPAL GLASS (U.S. CLS. 2, 13, 23, 29, 30, 33, 40 AND 50).

SN 79-083,224. PARIS WEAR DIFFUSION, FRANCE, FILED 4-29-2010.



OWNER OF INTERNATIONAL REGISTRATION 1040617 DATED 4-29-2010, EXPIRES 4-29-2020.

THE COLOR(S) RED AND BLACK IS/ARE CLAIMED AS A FEATURE OF THE MARK.

THE MARK CONSISTS OF THE WORDING "JE T" IN BLACK TO THE LEFT OF A RED HEART DESIGN.

THE ENGLISH TRANSLATION OF "JE T" + HEART DESIGN IN THE MARK IS I LOVE YOU WHERE "JE" MEANS I AND "T" MEANS YOU.

#### CLASS 14—JEWELRY

FOR PRECIOUS METALS AND THEIR ALLOYS; JEWELRY, PRECIOUS STONES, WATCHES, ALARM CLOCKS, TIMEPIECES AND CHRONOMETRIC INSTRUMENTS; JEWELRY CASES; PENDANTS; EARRINGS; NECKLACES; BRACELETS; FINGER RINGS; RINGS; CASES FOR JEWELRY; BADGES OF PRECIOUS METAL OR IMITATIONS; BROOCHES; PASTE JEWELRY (U.S. CLS. 2, 27, 28 AND 50).

#### CLASS 25—CLOTHING

FOR CLOTHING FOR MEN, WOMEN AND CHILDREN, NAMELY, FOOTWEAR, SHIRTS, DRESSING GOWNS, VESTS, GLOVES; TEE-SHIRTS; SINGLET AND BATHING SUITS; SOCKS, TIGHTS AND STOCKINGS; CAPS, BELTS; NECKTIES; SASHES FOR WEAR AND SCARVES; SLEEPING MASKS; DRESSES; TROUSERS; APRONS; SHAWLS; BLOUSES (U.S. CLS. 22 AND 39).

KRISTIN DAHLING, EXAMINING ATTORNEY

SN 79-083,527. CORMAN S.P.A., ITALY, FILED 3-19-2010.



PRIORITY DATE OF 3-12-2010 IS CLAIMED. OWNER OF INTERNATIONAL REGISTRATION 1041365 DATED 3-19-2010, EXPIRES 3-19-2020.

OWNER OF U.S. REG. NO. 3,807,103.

THE WORDING "CORMAN UNIQUE" DOES NOT IDENTIFY A LIVING INDIVIDUAL.

THE MARK IN QUESTION CONSISTS OF THE COMPLEX NAME "CORMAN UNIQUE". THIS WORDING IS WRITTEN IN SPECIAL FONT, IN PARTICULAR, A CROSS ELEMENT SITS ATOP THE WORD "CORMAN", IN PARTICULAR ATOP THE LETTERS "OR". THE THREE MIDDLE LETTERS OF THE WORD "UNIQUE" ARE ENCLOSED IN PARENTHESES WHICH EXTEND ABOVE AND BELOW SAID WORD.

**CLASS 5—PHARMACEUTICALS**

FOR SANITARY PADS; SANITARY PREPARATIONS FOR MEDICAL USE; DIETETIC SUBSTANCES FOR CHILDREN AND THE SICK FOR MEDICAL USE; PLASTERS FOR MEDICAL PURPOSES; MATERIALS FOR DRESSING FOR WOUNDS, BURNS, SURGERY; BALMS FOR MEDICAL PURPOSES; MATERIAL FOR STOPPING TEETH, DENTAL WAX; DISINFECTANTS FOR HYGIENIC AND MEDICAL PURPOSES; ANTIPARASITIC AGENTS, NAMELY, PARASITICIDES; FUNGICIDES; DEODORANTS, NAMELY, ALL DEODORANTS OTHER THAN FOR PERSONAL USE, NAMELY, AIR DEODORANT, CAR DEODORANT, AND ROOM DEODORANTS; FOOD SUPPLEMENTS; ABSORBENT COTTON SWABS FOR MEDICAL USE; GAUZE; MEDICAL ADHESIVE TAPES; DISSOLVABLE STRIPS TO STOP BLEEDING FROM MINOR CUTS AND GRAZES; DRESSING PRODUCTS FOR WOUNDS, BURNS, AND SURGERY; SANITARY ITEMS OF RUBBER, NAMELY, SANITARY RUBBER GLOVES (U.S. CLS. 6, 18, 44, 46, 51 AND 52).

**CLASS 10—MEDICAL APPARATUS**

FOR SURGICAL, MEDICAL, DENTAL AND VETERINARY INSTRUMENTS AND APPARATUS, NAMELY, ORAL IRRIGATORS AND PROPHY ANGLES; SYRINGES FOR MEDICAL USE AND FOR INJECTION; ARTIFICIAL LIMBS; ARTIFICIAL EYES AND TEETH; PROSTHESES FOR BREAST FOR SURGICAL USE, PROSTHESES FOR HAND FOR SURGICAL USE; IMPLEMENTS FOR SANITARY USE, NAMELY, SANITARY MASKS FOR DUST PREVENTION FOR MEDICAL PURPOSES; ORTHOPEDIC KNEE BANDAGES; SPECIAL FURNITURE FOR SURGICAL USE, FOR DENTISTS AND VETERINARIANS (U.S. CLS. 26, 39 AND 44).

WARREN L. OLANDRIA, EXAMINING ATTORNEY

SN 79-084,408. TEN CATE ADVANCED COMPOSITES B.V., NETHERLANDS, FILED 5-12-2010.



THE MARK CONSISTS OF STANDARD CHARACTERS WITHOUT CLAIM TO ANY PARTICULAR FONT, STYLE, SIZE, OR COLOR.

PRIORITY DATE OF 11-13-2009 IS CLAIMED.

OWNER OF INTERNATIONAL REGISTRATION 1043535 DATED 5-12-2010, EXPIRES 5-12-2020.

OWNER OF U.S. REG. NO. 1,710,036.

THE WORDING "CETEX" HAS NO MEANING IN A FOREIGN LANGUAGE.

**CLASS 17—RUBBER GOODS**

FOR SEMI-FINISHED PLASTICS AND RESINS IN EXTRUDED FORM FOR FURTHER MANUFACTURE, NAMELY, LAMINATES, PANELS AND SANDWICH-PANELS, AND FIBER REINFORCED COMPOSITE MATERIALS, NAMELY, THERMOPLASTIC TAPES, PRE-PREGS, AND UNIDIRECTIONAL TAPE CONSISTING OF CARBON, GLASS, ARAMID, OR COMBINATIONS THEREOF, IMPREGNATED OR LAMINATED WITH THERMOPLASTIC POLYMER RESIN SYSTEMS (PEI, PPS, PA, PEEK), THE FOREGOING TO BE USED AS BASIC MATERIAL FOR MANUFACTURING STRUCTURAL AND INTERIOR PARTS OF AIRCRAFT AND SPACECRAFT, TRAINS, AUTOMOBILES AND RELATED MEANS OF TRANSPORTATION; SEMI-WORKED SYNTHETIC POLYMER RESIN FILM FOR USE IN MANUFACTURE; SEMI-PROCESSED SYNTHETIC RESINS FOR USE IN MANUFACTURING (U.S. CLS. 1, 5, 12, 13, 35 AND 50).

**CLASS 24—FABRICS**

FOR WOVEN FABRICS AND NON-WOVEN FABRICS ACTING AS REINFORCEMENT LAYER(S) IN ADVANCED COMPOSITES, CONSISTING OF CARBON, GLASS, ARAMID OR COMBINATIONS THEREOF; TAPES, NAMELY, NON-ADHESIVE STRIPS OF WOVEN SYNTHETIC FIBER FABRIC AND NON-WOVEN SYNTHETIC FIBER FABRIC COMPOSED OF CARBON, GLASS, OR ARAMID FIBERS, OR COMBINATIONS THEREOF; FABRICS, NAMELY, WOVEN AND NON-WOVEN SYNTHETIC FIBER FABRIC CONSISTING OF CARBON, GLASS, ARAMID OR COMBINATIONS THEREOF, IMPREGNATED WITH ARTIFICIAL RESINS FOR USE IN MANUFACTURE; TAPES, NAMELY, NON-ADHESIVE STRIPS OF SYNTHETIC FIBER FABRIC COMPOSED OF WOVEN AND NON-WOVEN CARBON, GLASS, OR ARAMID FIBERS, OR COMBINATIONS THEREOF, IMPREGNATED WITH ARTIFICIAL RESINS FOR USE IN MANUFACTURE (U.S. CLS. 42 AND 50).

LIEF MARTIN, EXAMINING ATTORNEY

SN 79-084,484. COMEX EUROPE S.R.L., I-42015 CORREGGIO (RE), ITALY, FILED 2-5-2010.



OWNER OF INTERNATIONAL REGISTRATION 1043751 DATED 2-5-2010, EXPIRES 2-5-2020.

NO CLAIM IS MADE TO THE EXCLUSIVE RIGHT TO USE "EUROPE", APART FROM THE MARK AS SHOWN.

THE MARK CONSISTS OF A RECTANGULAR DESIGN SPLIT INTO TWO SECTIONS WITH THE WORD "COMEX" ABOVE THE WORD "EUROPE".

**CLASS 7—MACHINERY**

FOR FANS FOR MOTORS AND ENGINES, ELECTRIC FANS FOR MOTORS AND ENGINES, FANS FOR VEHICLE MOTORS AND ENGINES, ELECTRIC FANS FOR VEHICLE MOTORS AND ENGINES, ALL FOR VEHICLES AND SOLD TO VEHICLE MANUFACTURERS AND VEHICLE REPAIR FACILITIES (U.S. CLS. 13, 19, 21, 23, 31, 34 AND 35).

**CLASS 12—VEHICLES**

FOR ELECTRIC MOTORS AND ENGINES FOR LAND VEHICLES (U.S. CLS. 19, 21, 23, 31, 35 AND 44).

MAUREN DALL, EXAMINING ATTORNEY

SN 79-084,676. EXIV CO., LTD., JAPAN, FILED 3-8-2010.



THE MARK CONSISTS OF STANDARD CHARACTERS WITHOUT CLAIM TO ANY PARTICULAR FONT, STYLE, SIZE, OR COLOR.

OWNER OF INTERNATIONAL REGISTRATION 1044198 DATED 3-8-2010, EXPIRES 3-8-2020.

**CLASS 14—JEWELRY**

FOR KEYRINGS OF PRECIOUS METALS; EARRINGS; INSIGNIAS OF PRECIOUS METAL; BADGES OF PRECIOUS METAL; NECKLACES; BRACELETS; PENDANTS; RINGS; CUFF LINKS (U.S. CLS. 2, 27, 28 AND 50).

**CLASS 18—LEATHER GOODS**

FOR HANDBAG FRAMES BEING COMPONENT PARTS OF HANDBAGS; PURSE FRAMES BEING COMPONENT PARTS OF PURSES; FOLDING BRIEFCASES; SHOULDER BAGS; BRIEFCASES; SUITCASES; CARRY-ON BAGS; TRUNKS; HANDBAGS; BOSTON BAGS; BACKPACKS; NAME CARD CASES; SHOPPING BAGS, NAMELY, CANVAS SHOPPING BAGS, REUSABLE SHOPPING BAGS, TEXTILE SHOPPING BAGS, WHEELED SHOPPING BAGS; PURSES; KEY CASES; WALLETS; COMMUTATION TICKET HOLDERS IN THE NATURE OF TICKET POUCHES; BUSINESS CARD CASES; UNFITTED VANITY CASES; UMBRELLAS AND PARASOLS (U.S. CLS. 1, 2, 3, 22 AND 41).

**CLASS 25—CLOTHING**

FOR CHILDREN'S WEAR, NAMELY, SHIRTS, PANTS AND SKIRTS; JACKETS; SWEATPANTS; SUITS; SKIRTS; SKI JACKETS; SKI PANTS; TROUSERS; SMOCKS; COATS; CARDIGANS; SWEATERS; VESTS AND WAISTCOATS; OPEN-NECKED SHIRTS; CUFFS; COLLARS FOR CLOTHING; SPORT SHIRTS; BLOUSES; POLO SHIRTS; SHIRTS FOR SUITS; NIGHTWEAR; NIGHT GOWNS; NEGLIGEEES; JAPANESE SLEEPING ROBES (NEMAKI); PAJAMAS; BATH ROBES; UNDERWEAR; CAMISOLES; PANTIES, SHORTS AND BRIEFS; SWIMWEAR BEING BATHING SUITS; SWIMMING CAPS IN THE NATURE OF BATHING CAPS; COLLAR PROTECTORS FOR WEAR; SOCKS AND STOCKINGS; GLOVES AND MITTENS; BANDANAS; MUFFLERS; EAR MUFFS; HOODS; SEDGE HATS (SUGE-GASA); HEADGEAR FOR WEAR, NAMELY, HATS AND CAPS; HATS FOR PROTECTION AGAINST HEAT; SUSPENDERS; WAISTBANDS; BELTS FOR CLOTHING; FOOTWEAR; INSOLES FOR SHOES AND BOOTS (U.S. CLS. 22 AND 39).

**CLASS 26—FANCY GOODS**

FOR HAIR ORNAMENTS; BUTTONS, BONNET PINS OF PRECIOUS METAL (U.S. CLS. 37, 39, 40, 42 AND 50).

**CLASS 35—ADVERTISING AND BUSINESS**

FOR RETAIL STORE AND DISTRIBUTORSHIP SERVICES AND WHOLESALE STORE AND DISTRIBUTORSHIP SERVICES FEATURING CLOTHING; RETAIL STORE AND DISTRIBUTORSHIP SERVICES AND WHOLESALE STORE AND DISTRIBUTORSHIP SERVICES FEATURING FOOTWEAR; RETAIL STORE AND DISTRIBUTORSHIP SERVICES AND WHOLESALE STORE AND DISTRIBUTORSHIP SERVICES FEATURING BAGS AND POUCHES; RETAIL STORE AND DISTRIBUTORSHIP SERVICES AND WHOLESALE STORE AND DISTRIBUTORSHIP SERVICES FEATURING PERSONAL ORNAMENTS; RETAIL STORE AND DISTRIBUTORSHIP SERVICES AND WHOLESALE STORE AND DISTRIBUTORSHIP SERVICES FEATURING UMBRELLAS AND THEIR PARTS; RETAIL STORE AND DISTRIBUTORSHIP SERVICES AND WHOLESALE STORE AND DISTRIBUTORSHIP SERVICES FEATURING UNFITTED VANITY CASES; RETAIL STORE AND DISTRIBUTORSHIP SERVICES AND WHOLESALE STORE AND DISTRIBUTORSHIP SERVICES FEATURING SUSPENDERS, WAISTBANDS, AND BELTS FOR CLOTHING; RETAIL STORE AND DISTRIBUTORSHIP SERVICES AND WHOLESALE STORE AND DISTRIBUTORSHIP SERVICES FEATURING HAIR ORNAMENTS AND BUTTONS; RETAIL STORE AND DISTRIBUTORSHIP SERVICES AND WHOLESALE STORE AND DISTRIBUTORSHIP SERVICES FEATURING KEYRINGS, HANDBAG FRAMES, AND PURSE FRAMES (U.S. CLS. 100, 101 AND 102).

LAURA HAMMEL, EXAMINING ATTORNEY

SN 79-084,702. NAIGAI SHISETSU KOGYO CO., LTD. (NAIGAI INDUSTRIES, INC.), JAPAN, FILED 4-20-2010.



OWNER OF INTERNATIONAL REGISTRATION 1044252 DATED 4-20-2010, EXPIRES 4-20-2020.

THE MARK CONSISTS OF A DARK GENERALLY DIAMOND-SHAPED CARRIER WITH JAGGED EDGES, CONTAINING THE LETTERS "NSI" WITH THE "N" SUPERIMPOSED OVER THE "S" SUCH THAT THE MIDDLE OF THE "N" AND THE MIDDLE OF THE "S" APPEAR TO SHARE THE SAME LINE.

**CLASS 6—METAL GOODS**

FOR METAL HIGH PRESSURE GAS CONTAINERS SOLD EMPTY; LIQUEFIED GAS STORAGE TANKS OF METAL; GAS STORAGE TANKS OF METAL; RESERVOIRS OF METAL (U.S. CLS. 2, 12, 13, 14, 23, 25 AND 50).

**CLASS 7—MACHINERY**

FOR CONFECTIONERY MAKING MACHINES; BAKERY MACHINES, NAMELY, MIXERS AND FORMERS FOR BAKERY PRODUCTS; FOOD OR BEVERAGE PROCESSING MACHINES AND APPARATUS, NAMELY, BOTTLE FILLING MACHINES FOR FOODS AND BEVERAGES; AND CAN FILLING MACHINES FOR FOODS AND BEVERAGES (U.S. CLS. 13, 19, 21, 23, 31, 34 AND 35).

**CLASS 11—ENVIRONMENTAL CONTROL APPARATUS**

FOR FREEZERS; CENTRAL AIR-CONDITIONING INSTALLATIONS FOR INDUSTRIAL PURPOSES; AIR-CONDITIONING APPARATUS FOR INDUSTRIAL PURPOSES; COOKING OVENS FOR INDUSTRIAL PURPOSES; COOKING EQUIPMENT FOR INDUSTRIAL PURPOSES, NAMELY, INDUSTRIAL RICE COOKERS, NON-MEDICAL STERILIZING PRESSURIZED RETORTS FOR USE IN ASEPTIC COOKING OR HEAT PROCESSING OF FOODS IN CONTAINERS; STERILIZING MACHINES FOR FOODS AND BEVERAGES; PASTEURIZERS FOR USE IN THE FOOD AND BEVERAGE INDUSTRIES; TEMPERATURE REGULATING UNITS COMPRISING AN ELECTRICAL HEATED TANK OR GAS HEATED BOILER WHICH SUPPLIES HEAT IN FOOD AND BEVERAGE PROCESSING, PARTICULARLY ADAPTED FOR MAINTAINING THE PROCESSED FOOD OR BEVERAGES AT A PRESET TEMPERATURE; GAS WATER HEATERS FOR HOUSEHOLD USE; GAS COOKING OVENS FOR HOUSEHOLD PURPOSES; NON-ELECTRIC COOKING HEATERS FOR HOUSEHOLD PURPOSES, NAMELY, GAS BURNERS FOR HEATING AND BAKING FOODS AND FOR HEATING FOOD CONTAINERS (U.S. CLS. 13, 21, 23, 31 AND 34).

**CLASS 37—CONSTRUCTION AND REPAIR**

FOR MACHINERY INSTALLATION; CONSTRUCTION CONSULTANCY; REPAIR OR MAINTENANCE OF FREEZING MACHINES AND APPARATUS; REPAIR OR MAINTENANCE OF AIR-CONDITIONING APPARATUS FOR INDUSTRIAL PURPOSES; REPAIR OR MAINTENANCE OF MACHINES AND APPARATUS FOR PROCESSING FOODS OR BEVERAGES; REPAIR OR MAINTENANCE OF COOKING APPARATUS FOR INDUSTRIAL PURPOSES; REPAIR OR MAINTENANCE OF STORAGE TANKS; MAINTENANCE OF HIGH PRESSURE GAS MANUFACTURING INSTALLATIONS (U.S. CLS. 100, 103 AND 106).



**CLASS 39—TRANSPORTATION AND STORAGE**

FOR HIGH PRESSURE GAS SUPPLYING; GAS SUPPLYING (U.S. CLS. 100 AND 105).

**CLASS 42—SCIENTIFIC AND COMPUTER SERVICES**

FOR ARCHITECTURE SERVICES, NAMELY, ARCHITECTURAL DESIGN; DESIGNING OF MACHINES, APPARATUS, INSTRUMENTS AND INSTRUMENT PARTS, OR SYSTEMS COMPOSED OF SUCH MACHINES, APPARATUS AND INSTRUMENTS; TECHNICAL ADVICE RELATING TO PERFORMANCE AND OPERATION OF CONFECTIONERY MAKING MACHINES; TECHNICAL ADVICE RELATING TO PERFORMANCE AND OPERATION OF BAKERY MACHINES, NAMELY, MACHINES USED FOR MANUFACTURING BAKED GOODS, AND MIXERS AND FORMERS FOR BAKERY PRODUCTS; TECHNICAL ADVICE RELATING TO PERFORMANCE AND OPERATION OF FOOD OR BEVERAGE PROCESSING MACHINES AND APPARATUS, NAMELY, FILLING MACHINES FOR FOODS AND BEVERAGES; TECHNICAL ADVICE RELATING TO PERFORMANCE AND OPERATION OF FREEZERS; TECHNICAL ADVICE RELATING TO PERFORMANCE AND OPERATION OF CENTRAL AIR-CONDITIONING INSTALLATIONS FOR INDUSTRIAL PURPOSES; TECHNICAL ADVICE RELATING TO PERFORMANCE AND OPERATION OF AIR-CONDITIONING APPARATUS FOR INDUSTRIAL PURPOSES; TECHNICAL ADVICE RELATING TO PERFORMANCE AND OPERATION OF COOKING OVENS FOR INDUSTRIAL PURPOSES; TECHNICAL ADVICE RELATING TO PERFORMANCE AND OPERATION OF COOKING EQUIPMENT FOR INDUSTRIAL PURPOSES, NAMELY, INDUSTRIAL RICE COOKERS, NON-MEDICAL STERILIZER RETORTS FOR USE WITH COOKING EQUIPMENT, STERILIZING MACHINES FOR FOODS AND BEVERAGES, PASTEURIZERS FOR USE IN THE FOOD AND BEVERAGE INDUSTRIES, AND TEMPERATURE REGULATORS FOR PROCESSING OF FOODS AND BEVERAGES; TECHNICAL ADVICE RELATING TO PERFORMANCE AND OPERATION OF GAS WATER HEATERS FOR HOUSEHOLD USE; TECHNICAL ADVICE RELATING TO PERFORMANCE AND OPERATION OF GAS COOKING OVENS FOR HOUSEHOLD PURPOSES; TECHNICAL ADVICE RELATING TO PERFORMANCE AND OPERATION OF NON-ELECTRIC COOKING HEATERS FOR HOUSEHOLD PURPOSES, NAMELY, GAS BURNERS FOR HEATING AND BAKING FOODS AND FOR HEATING FOOD CONTAINERS (U.S. CLS. 100 AND 101).

FRED CARL, EXAMINING ATTORNEY

SN 79-085,383. THYSSENKRUPP STEEL EUROPE AG, FED REP GERMANY, FILED 3-15-2010.

# InnForm T<sup>3</sup>

PRIORITY DATE OF 9-30-2009 IS CLAIMED.  
OWNER OF INTERNATIONAL REGISTRATION 1045898 DATED 3-15-2010, EXPIRES 3-15-2020.  
THE MARK CONSISTS OF THE WORDING "INNFORM T<sup>3</sup>" WITH THE NUMERAL "3" DISPLAYED IN SUPERSCRIPT.

**CLASS 6—METAL GOODS**

FOR SEMI-FINISHED PRODUCTS MADE OF STEEL, NAMELY, PROFILES FOR FURTHER MANUFACTURE AND PIPES (U.S. CLS. 2, 12, 13, 14, 23, 25 AND 50).

**CLASS 12—VEHICLES**

FOR VEHICLE PARTS MADE OF STEEL, NAMELY, EXTERNAL AND INTERNAL COMPONENT STRUCTURAL PARTS FOR THE BODIES OF LAND VEHICLES; COMPONENT PARTS FOR POWER TRAINS OF LAND VEHICLES, NAMELY, POWER TRAIN STRUCTURAL PARTS; STEEL COMPONENT PARTS FOR CHASSIS OF LAND VEHICLES; CAR BODIES MADE OF METAL; LAND VEHICLE PARTS, NAMELY, DRIVE GEARS; DRIVE SHAFTS FOR LAND VEHICLES; COMPONENT PARTS OF DRIVE SHAFTS FOR LAND VEHICLES (U.S. CLS. 19, 21, 23, 31, 35 AND 44).

**CLASS 40—MATERIAL TREATMENT**

FOR TREATMENT OF METALS, NAMELY, FORMING OF STEEL (U.S. CLS. 100, 103 AND 106).

HEATHER THOMPSON, EXAMINING ATTORNEY

SN 79-085,663. VITAMINKA A.D. PRILEP, MACEDONIA, FILED 4-30-2010.



OWNER OF INTERNATIONAL REGISTRATION 0729345 DATED 12-22-1999, EXPIRES 12-22-2019.

OWNER OF U.S. REG. NOS. 3,382,160 AND 3,983,590.

NO CLAIM IS MADE TO THE EXCLUSIVE RIGHT TO USE "VKUS NA KIKIRITKI", APART FROM THE MARK AS SHOWN.

THE COLOR(S) WHITE, RED, ORANGE, YELLOW, GREEN AND BLACK IS/ARE CLAIMED AS A FEATURE OF THE MARK.

THE MARK CONSISTS OF THE WORDING "STOBI FLIPS" IN THE COLOR WHITE OUTLINED IN BLACK, BELOW TO THE RIGHT IS THE WORDING "VKUS NA KIKIRITKI" IN THE COLOR WHITE HOUSED IN A GREEN PARALLELOGRAM OUTLINED IN WHITE, BELOW THAT THE WORDING "VITAMINKA" IN THE COLOR BLACK UNDERLINED IN BLACK WITH A DIAMOND-SHAPED DESIGN TO THE LEFT, ALL HOUSED IN A GREEN PARALLELOGRAM PARTIALLY OUTLINED IN YELLOW; THE ENTIRETY OF THE MARK IS ON A RED RECTANGULAR BACKGROUND WITH A LARGE CHEVRON WITH YELLOW BORDERS AND YELLOW, ORANGE, AND RED PATTERN IN THE CHEVRON.

THE ENGLISH TRANSLATION OF "VKUS NA KIKIRITKI" IN THE MARK IS TASTE OF PEANUTS.

**CLASS 29—MEATS AND PROCESSED FOODS**

FOR VEGETABLE FAT (U.S. CL. 46).

**CLASS 30—STAPLE FOODS**

FOR CEREAL PREPARATIONS, NAMELY, BREAKFAST CEREALS, CEREAL BASED SNACK FOOD; SALT (U.S. CL. 46).

**CLASS 31—NATURAL AGRICULTURAL PRODUCTS**

FOR AGRICULTURAL, MARKET GARDEN AND FORESTRY PRODUCTS, NAMELY, AGRICULTURAL SEEDS (U.S. CLS. 1 AND 46).

ADA HAN, EXAMINING ATTORNEY

SN 79-085,728. ROCKET INDUSTRIES PTY LTD, AUSTRALIA, FILED 3-24-2010.

SN 79-085,852. SKORPIO LIMITED, SWITZERLAND, FILED 5-11-2010.

# AEROFLOW



THE MARK CONSISTS OF STANDARD CHARACTERS WITHOUT CLAIM TO ANY PARTICULAR FONT, STYLE, SIZE, OR COLOR.

OWNER OF INTERNATIONAL REGISTRATION 1046679 DATED 3-24-2010, EXPIRES 3-24-2020.

## CLASS 7—MACHINERY

FOR PARTS AND ACCESSORIES FOR AUTOMOBILE MOTORS AND ENGINES, NAMELY, HOSES, FITTINGS, ADAPTORS, FILTERS, NAMELY, PRO FILTERS WITH STAINLESS STEEL REPLACEABLE ELEMENTS, HIGH PRESSURE NITROUS FILTERS, BILLET FUEL FILTERS WITH BRONZE ELEMENT, INLINE FUEL AND OIL FILTERS, COTTON REPLACEMENT AIR FILTERS, POD FILTERS AND FILTER ASSEMBLIES, CLAMPS, FUEL PUMP BRACKETS, Y-BLOCKS, SHUT OFF VALVES, HOSE SEPARATORS, CHECK VALVES, FUEL LOGS, CARBURETOR ADAPTORS, CARBURETOR INLET RAIL KITS BEING KITS FOR CONSTRUCTING CARBURETOR INLET RAILS FOR DELIVERY OF FUEL FROM THE FUEL LINE TO THE CARBURETOR, FUEL PRESSURE REGULATORS, FUEL PUMPS, SURGE TANKS, CATCH CANS, FUEL CELLS, ROLL OVER VALVES, FUEL PUMP BLOCK OFF PLATES, VELOCITY SPACERS, TRANS BRACKETS, RETURN SPRING ASSEMBLIES, THROTTLE CABLE BRACKETS, OIL BY-PASS ELIMINATOR, GILMER DRIVES, OIL FILTER RELOCATION KITS, NAMELY, KITS FOR MOUNTING OIL FILTERS IN ENGINES, COMPRISED OF SANDWICH BLOCK, REMOTE FILTER MOUNT, HOSE ENDS AND HOSE, RADIATOR FILTERS, THERMOSTAT HOUSINGS, TIMING COVERS, TIMING POINTERS, DISTRIBUTOR HOLD DOWN CLAMPS, PULLEYS, SHIFTER CABLES, ELECTRIC FANS, SHORT SHIFTERS, FLEXPLATES, ALTERNATOR BRACKETS AND FUEL RAILS; INJECTORS FOR AUTOMOBILE ENGINES; AUTOMOBILE FUEL INJECTOR SYSTEMS AND COMPONENTS; FUEL CONVERSION APPARATUS FOR AUTOMOBILE INTERNAL COMBUSTION ENGINES; PUMPS FOR AUTOMOBILE ENGINES AND MOTORS; CONTROL MECHANISMS FOR AUTOMOBILE ENGINES AND MOTORS; CYLINDER HEADS FOR AUTOMOBILE ENGINES; CARBURETORS FOR AUTOMOBILES; CARBURETOR FEEDERS FOR AUTOMOBILES; EXHAUST MANIFOLDS FOR AUTOMOBILE ENGINES; SUPERCHARGERS FOR AUTOMOBILE VEHICLE ENGINES; TURBOCHARGERS FOR AUTOMOBILE VEHICLE ENGINES; SPARK PLUGS FOR AUTOMOBILE INTERNAL COMBUSTION ENGINES; AUTOMOBILE ENGINE VALVES; FLUID PUMPS FOR AUTOMOBILES, NAMELY, ENGINE FUEL PUMPS AND FUEL INJECTION PUMPS; IGNITING DEVICES FOR AUTOMOBILE INTERNAL COMBUSTION ENGINES; CATALYTIC CONVERTERS FOR AUTOMOBILES; NONE OF THE FOREGOING BEING FLUID FLOW CONTROL VALVES (U.S. CLS. 13, 19, 21, 23, 31, 34 AND 35).

## CLASS 17—RUBBER GOODS

FOR FLEXIBLE HOSES, NAMELY, NON-METALLIC HOSES AND CONNECTING HOSES FOR MOTOR LAND VEHICLES; PIPE GASKETS; NON-METALLIC GASKETS FOR MOTOR LAND VEHICLES; RUBBER SEALS, NAMELY, RINGS OF RUBBER FOR USE AS PIPE CONNECTION SEALS; PACKING AND INSULATING MATERIALS; STOPPING MATERIALS, NAMELY, RUBBER STOPPERS, FOAM STOPPERS, PLASTIC STOPPERS, AND STOPPING COMPOUNDS FOR STOPPING LEAKAGE FROM FUEL OR WATER TANKS (U.S. CLS. 1, 5, 12, 13, 35 AND 50).

RON FAIRBANKS, EXAMINING ATTORNEY

OWNER OF INTERNATIONAL REGISTRATION 1026597 DATED 12-30-2009, EXPIRES 12-30-2019.

OWNER OF U.S. REG. NOS. 2,857,230 AND 3,828,467.

THE NAME SHOWN IN THE MARK IDENTIFIES MR. RICHARD SATURNINO "OWENS", A/K/A "RICK OWENS", WHOSE CONSENT TO REGISTER IS MADE OF RECORD.

## CLASS 3—COSMETICS AND CLEANING PREPARATIONS

FOR SOAPS; PERFUMERY, NAMELY, TOILET WATER; AFTER SHAVE LOTIONS; PERSONAL DEODORANTS; EAU DE COLOGNE; ESSENTIAL OILS FOR PERSONAL USE FOR MEN AND WOMEN; COSMETICS; HAIR LOTIONS; DENTIFRICES (U.S. CLS. 1, 4, 6, 50, 51 AND 52).

## CLASS 9—ELECTRICAL AND SCIENTIFIC APPARATUS

FOR EYEGLASSES; MAGNIFYING EYEGLASSES; SUNGLASSES; ANTI-GLARE EYEGLASSES; PROTECTIVE EYEGLASSES; SAFETY GOGGLES; EYEGLASS CASES; EYEGLASS FRAMES; EYEGLASS LENSES (U.S. CLS. 21, 23, 26, 36 AND 38).

## CLASS 14—JEWELRY

FOR PRECIOUS METALS AND THEIR ALLOYS; TIE PINS; CUFFLINKS; PINS BEING JEWELRY; KEY RINGS OF PRECIOUS METALS; JEWELRY; PRECIOUS GEMSTONES; HOROLOGICAL AND CHRONOMETRIC INSTRUMENTS, NAMELY, WATCHES, WRIST WATCHES, CHRONOMETERS, AND CHRONOGRAPHS FOR USE AS WATCHES; CASES FOR TIME PIECES MADE OF PRECIOUS METAL (U.S. CLS. 2, 27, 28 AND 50).

## CLASS 25—CLOTHING

FOR UNITARDS; FOUNDATION GARMENTS; BRASIERES; BUSTIERS; GARTER BELTS; BRIEFS; BOXER SHORTS; THERMAL UNDERWEAR; LINGERIE; NIGHTGOWNS; NIGHT SHIRTS; NEGLIGES; ROBES; PAJAMAS; APRONS; HOSIERY; PANTYHOSE; TIGHTS; KNEE-HIGH STOCKINGS; LEG WARMERS; NECKTIES; BOW TIES; ASCOTS; POCKET SQUARES; NECKERCHIEFS; MITTENS; SASHES; SWIMWEAR; BATHING SUITS; BATHING TRUNKS; BEACH ROBES; BEACHWEAR; SARONGS; THERMAL SOCKS; CREEPERS; SNOW SUITS; BABY BIBS NOT OF PAPER; BIB OVERALLS; PLASTIC BABY BIBS; SKI BIBS; BOOTIES; PLAY SUITS; GOLF SHOES (U.S. CLS. 22 AND 39).

CORY BOONE, EXAMINING ATTORNEY

SN 79-085,854. D.S.H.D. (DESIGN SCREEN HAUTE DEFINITION), FRANCE, FILED 3-31-2010.



PRIORITY DATE OF 2-23-2010 IS CLAIMED.  
OWNER OF INTERNATIONAL REGISTRATION 1047040 DATED 3-31-2010, EXPIRES 3-31-2020.

NO CLAIM IS MADE TO THE EXCLUSIVE RIGHT TO USE "SCREEN" FOR "PROJECTION SCREENS, SCREENS, NAMELY, TELEVISION PROJECTION SCREENS AND FLAT PANEL DISPLAYS, MOVIE PROJECTION SCREENS AND FLAT PANEL DISPLAYS, LAPTOP COMPUTER SCREENS, ROLLING PROJECTION SCREENS, COMPUTER SCREENS, WALL-MOUNTED PROJECTION SCREENS, ROLLING PROJECTION SCREENS AND FURNITURE FOR TELEVISION SCREENS" AND "HD" FOR CLASS 9, APART FROM THE MARK AS SHOWN.

THE MARK CONSISTS OF A QUADRILATERAL CONTAINING THE WORDING "DESIGN SCREEN HD" IN STYLIZED FONT WHERE THE WORD "DESIGN" APPEARS LARGER THAN THE WORD "SCREEN" AND THE LETTERS "HD" APPEAR AS A SUPERScript TO THE RIGHT OF THE WORD "SCREEN".

SN 79-085,893. BLUE TEC GMBH & CO. KG, FED REP GERMANY, FILED 7-5-2010.



PRIORITY DATE OF 4-16-2010 IS CLAIMED.  
OWNER OF INTERNATIONAL REGISTRATION 1047169 DATED 7-5-2010, EXPIRES 7-5-2020.

THE MARK CONSISTS OF A DESIGN OF A SHEET METAL ROLL WITH THE WORDING "R.PLUS" APPEARING IN THE LOWER PART OF THE ROLL.

#### CLASS 9—ELECTRICAL AND SCIENTIFIC APPARATUS

FOR CINEMATOGRAPHIC, OPTICAL AND TEACHING APPARATUS AND INSTRUMENTS, NAMELY, CINEMATOGRAPHIC CAMERAS, BLANK OPTICAL DISKS, CABLES FOR OPTICAL SIGNAL TRANSMISSION; APPARATUS FOR TRANSMITTING AND REPRODUCING IMAGES; APPARATUS FOR PROJECTING IMAGES, NAMELY, CINEMATOGRAPHIC PROJECTORS, MOVIE PROJECTORS, PROJECTION SCREENS; VIDEO PROJECTORS; SCREENS, NAMELY, TELEVISION PROJECTION SCREENS AND FLAT PANEL DISPLAYS, MOVIE PROJECTION SCREENS AND FLAT PANEL DISPLAYS, LAPTOP COMPUTER SCREENS, ROLLING PROJECTION SCREENS, COMPUTER SCREENS, WALL-MOUNTED PROJECTION SCREENS; ACCESSORIES AND COMPONENTS FOR PROJECTION DEVICES, NAMELY, REMOTE CONTROLS FOR RADIOS, TELEVISIONS, STEREOS, ROLLING PROJECTION SCREENS, ADAPTERS, POWER SUPPLY CABLES, AUDIO AND VIDEO CABLES, AND LAMPS FOR PROJECTION DEVICES (U.S. CLS. 21, 23, 26, 36 AND 38).

#### CLASS 17—RUBBER GOODS

FOR PACKING AND INSULATING MATERIALS; PLASTIC AND TEXTILES FOR INSULATION PURPOSES, NAMELY, BUILDING INSULATION COMPOSED OF PLASTIC AND TEXTILES, SHEETS OF PLASTIC FABRIC USED AS AN INSULATING INFILTRATION BARRIER IN BUILDING CONSTRUCTION, INSULATING FABRICS; NOISE-ABATEMENT STRUCTURES OF TEXTILE AND PLASTIC, NAMELY, SOUNDPROOFING MATERIALS FOR BUILDINGS, SOUND CONTROL FLOORING UNDERLAYMENT, THERMALLY BONDED COTTON BATTING USED AS A SOUND DEADENING MATERIAL; SOUND-PROOF WALLS OF TEXTILE AND PLASTIC, NAMELY, SOUNDPROOFING WALL PANELS FOR BUILDINGS, THERMALLY BONDED COTTON BATTING USED AS A SOUND DEADENING WALL PANEL (U.S. CLS. 1, 5, 12, 13, 35 AND 50).

#### CLASS 20—FURNITURE AND ARTICLES NOT OTHERWISE CLASSIFIED

FOR FURNITURE, NAMELY, FURNITURE FOR TELEVISION SCREENS, SIDEBARDS, CHESTS OF DRAWERS, MIRRORS, PICTURE FRAMES AND WORKS OF ART OF WOOD AND PLASTIC (U.S. CLS. 2, 13, 22, 25, 32 AND 50).

TINA BROWN, EXAMINING ATTORNEY

#### CLASS 6—METAL GOODS

FOR METAL BANDS, PLATES, STRIPS AND BLANKS, IN PARTICULAR OF ALUMINUM AND ITS ALLOYS WITH SURFACE COATING ENHANCING THE REFLECTION OF LIGHT AND HEAT RADIATION, ALSO WITH REFLECTION-ENHANCING SURFACE COATING CONTAINING SILVER ALL FOR USE IN THE SOLAR INDUSTRY; METAL DIMMING PARTS, NAMELY, DIMMING CAPS FOR ELECTRICAL LIGHTING MADE OF METAL; METAL LIGHT TUBES; METAL LIGHT LOUVERS FOR DIRECTING LIGHT; METAL BLINDS AND SHUTTERS FOR LIGHTS, LAMPS AND MIRRORS, FOR BOTH INDOORS AND OUTDOORS (U.S. CLS. 2, 12, 13, 14, 23, 25 AND 50).

#### CLASS 11—ENVIRONMENTAL CONTROL APPARATUS

FOR SOLAR RADIATION CONCENTRATORS, NAMELY, MIRRORS DESIGNED FOR THE COLLECTION OF SOLAR ENERGY; REFLECTORS FOR LAMPS; LIGHTING EQUIPMENT, NAMELY, LAMPS AND LED LIGHTING FIXTURES, STRUCTURAL PARTS FOR THE AFOREMENTIONED GOODS (U.S. CLS. 13, 21, 23, 31 AND 34).

#### CLASS 17—RUBBER GOODS

FOR NON-METAL BANDS, STRIPS, AND BLANKS WHICH REFLECT LIGHT AND HEAT RADIATION (U.S. CLS. 1, 5, 12, 13, 35 AND 50).

LEIGH CAROLINE CASE, EXAMINING ATTORNEY

SN 79-086,398. INSTITUTO DE TURISMO DE ESPAÑA (TURESPAÑA), E-28036 MADRID, SPAIN, FILED 8-9-2010.



PRIORITY DATE OF 2-17-2010 IS CLAIMED.  
OWNER OF INTERNATIONAL REGISTRATION 1048522 DATED 8-9-2010, EXPIRES 8-9-2020.

OWNER OF U.S. REG. NO. 1,665,196.

NO CLAIM IS MADE TO THE EXCLUSIVE RIGHT TO USE "SPAIN", APART FROM THE MARK AS SHOWN.

THE MARK CONSISTS OF THE STYLIZED WORDING "I NEED SPAIN" WHERE A STAR DESIGN APPEARS OVER THE LETTER "I".

#### **CLASS 35—ADVERTISING AND BUSINESS**

FOR ADVERTISING SERVICES; BUSINESS MANAGEMENT; BUSINESS ADMINISTRATION; PROVIDING OFFICE FUNCTIONS; ALL THE AFOREMENTIONED SERVICES, NAMELY, BUSINESS MANAGEMENT AND BUSINESS ADMINISTRATION SERVICES PROVIDED ELECTRONICALLY (U.S. CLS. 100, 101 AND 102).

#### **CLASS 39—TRANSPORTATION AND STORAGE**

FOR TRAVEL ARRANGEMENT, NAMELY, ARRANGING TRAVEL TOURS; PROVIDING INFORMATION AND CONSULTING IN RELATION TO FARES, TIMETABLES AND PUBLIC TRANSPORTATION (U.S. CLS. 100 AND 105).

#### **CLASS 41—EDUCATION AND ENTERTAINMENT**

FOR EDUCATION SERVICES, NAMELY, PROVIDING CLASSES, SEMINARS, WORKSHOPS IN THE FIELD OF TOURISM, TRAVEL; PROVIDING OF TRAINING IN THE FIELD OF TRAVEL, TOURISM; ENTERTAINMENT SERVICES IN THE NATURE OF LIVE PERFORMANCES BY MUSICAL GROUPS, TELEVISION COMEDY SERIES, ETHNIC FESTIVAL, LIVE DANCE AND MUSICAL PERFORMANCES, WINE AND FOOD TASTINGS, PLANNING AND CONDUCTING A SERIES OF FILM FESTIVALS, CONDUCTING CARNIVALS; SPORTING AND CULTURAL ACTIVITIES, NAMELY, ORGANIZING COMMUNITY SPORTING AND CULTURAL EVENTS, OPERATION OF SPORTS CAMPS, LIVE THEATRICAL PRODUCTIONS, ORGANIZATION OF EXHIBITIONS FOR CULTURAL AND EDUCATIONAL PURPOSES (U.S. CLS. 100, 101 AND 107).

#### **CLASS 43—HOTEL AND RESTAURANT SERVICES**

FOR PROVIDING OF FOOD AND DRINK; PROVIDING TEMPORARY ACCOMMODATIONS (U.S. CLS. 100 AND 101).

MARIAM MAHMOUDI, EXAMINING ATTORNEY

SN 79-087,185. LIMITED LIABILITY COMPANY "YUNASKO-UKRAINE", UKRAINE, FILED 6-17-2010.

# YUNASKO

THE MARK CONSISTS OF STANDARD CHARACTERS WITHOUT CLAIM TO ANY PARTICULAR FONT, STYLE, SIZE, OR COLOR.

PRIORITY DATE OF 4-14-2010 IS CLAIMED.  
OWNER OF INTERNATIONAL REGISTRATION 1050645 DATED 6-17-2010, EXPIRES 6-17-2020.

THE WORDING "YUNASKO" HAS NO MEANING IN A FOREIGN LANGUAGE.

#### **CLASS 9—ELECTRICAL AND SCIENTIFIC APPARATUS**

FOR ELECTRIC CAPACITORS; ULTRA CAPACITORS, SUPER CAPACITORS, DOUBLELAYER CAPACITORS; RECHARGEABLE ELECTRIC STORAGE BATTERIES; ELECTRIC ACCUMULATORS; ELECTRIC BATTERIES; ELECTRONIC SMART CONTROL SYSTEMS FOR POWER SOURCES COMPRISED OF AMPLIFIERS, CELL SWITCHES, CENTRAL PROCESSING UNITS, ELECTRONIC CHIPS, CIRCUIT BREAKERS, COMMUTATORS, COMPARATORS, ELECTRONIC CONNECTORS, CURRENT RECTIFIERS, ELECTRONIC FUSES, ELECTRONIC INDICATORS, INTERFACES, ELECTRICITY LIMITERS, PRINTED CIRCUITS, ELECTRIC RELAYS, THERMOMETERS, TRANSISTORS; ELECTRONIC LOAD MANAGEMENT SYSTEMS COMPRISED OF SUPER CAPACITOR CELLS' BALANCING CIRCUITS; CHARGERS FOR ELECTRIC STORAGE BATTERIES; ELECTRIC BATTERIES AND ACCUMULATORS FOR VEHICLES; ELECTRODES; SOLAR BATTERIES; BATTERIES FOR LIGHTING; ALTERNATIVE ENERGY SOURCES, NAMELY, PHOTOVOLTAIC SOLAR HYBRID MODULES COMBINED WITH SUPER CAPACITORS; VOLTAGE REGULATORS; ELECTRICAL KINETIC ENERGY RECUPERATION SYSTEMS COMPRISING SUPER CAPACITORS; STARTING DEVICES FOR INTERNAL COMBUSTION ENGINES, NAMELY, SUPER CAPACITOR BATTERY JUMP STARTERS AND HYBRID BATTERY SUPER CAPACITOR JUMP STARTERS; ELECTRIC STORAGE BATTERIES FOR USE IN RELATION TO UNINTERRUPTIBLE POWER SUPPLIES; GRID LOAD LEVELING EQUIPMENT, NAMELY, HYBRID ELECTRICAL STABILIZERS COMPRISED OF BOTH BATTERIES AND SUPER CAPACITORS; APPARATUS AND INSTRUMENTS FOR CONDUCTING, SWITCHING, TRANSFORMING, ACCUMULATING, REGULATING OR CONTROLLING ELECTRICITY, NAMELY, STATIC AND DYNAMIC VOLTAGE REGULATORS; AUTOMATIC VENDING MACHINES AND MECHANISMS FOR COIN AND CASH OPERATED APPARATUS; AUTOMATIC STEERING APPARATUS, NAMELY, ELECTRICAL POWER-ASSISTED STEERING GEAR, START-STOP VEHICLE ELECTRICAL SYSTEMS COMPRISED OF INTEGRATED STARTER, SUPER CAPACITOR BASED POWER UNIT AND CONTROL MODULE THEREFOR, START-STOP VEHICLE ELECTRICAL SYSTEMS COMPRISED OF INTEGRATED ALTERNATOR, SUPER CAPACITOR BASED POWER UNIT AND CONTROL MODULE THEREFOR; REMOTE CONTROLS FOR START-STOP VEHICLE DRIVETRAIN SYSTEMS; ANODES; ELECTRICAL TERMINAL BLOCKS; CURRENT RECTIFIERS; ELECTRIC SENSORS; ELECTRIC IGNITING APPARATUS USED IN CONNECTION WITH BALLASTS TO START DISCHARGE LAMPS; ELECTRONIC INDICATOR PANELS; ELECTRIC CATHODES; ELECTRIC CONTACTS; ACCUMULATOR BOXES; TELECOMMUNICATION EQUIPMENT, NAMELY, HIGH POWER RADIO WAVE SIGNAL EMITTERS; COMMUTATORS; SWITCHBOARDS; AMPLIFIERS AND ELECTRIC CONVERTORS; ELECTRIC CONTROL PANELS; VOLTAGE REGULATORS FOR ELECTRIC POWER; ELECTRICAL PLUGS, SOCKETS AND OTHER ELECTRIC CONTACTS; ELECTRICITY TRANSFORMERS; GAS DETECTORS; VOLTAGE SURGE PROTECTORS; ELECTRICAL INVERTERS; APPARATUS AND INSTRUMENTS FOR PHYSICS, NAMELY, ELECTRICAL PARAMETERS MEASURING DEVICES; COMPONENTS FOR MICRO SCHEMES AND ELECTRONIC EQUIPMENT, NAMELY, ELECTRIC CAPACITORS (U.S. CLS. 21, 23, 26, 36 AND 38).

#### **CLASS 42—SCIENTIFIC AND COMPUTER SERVICES**

FOR SCIENTIFIC RESEARCH; AND TECHNOLOGICAL RESEARCH AND DESIGN SERVICES IN THE FIELD OF ELECTRONICS, ELECTROCHEMISTRY, HYBRID VEHICLE DRIVETRAIN SYSTEMS, ELECTRICAL POWER STORAGE TECHNOLOGIES AND IN THE FIELD OF ELECTRICAL POWER STORAGE DISTRIBUTION, ELECTRICAL POWER DISCHARGE TECHNOLOGIES AND THE FIELD OF ELECTRICAL POWER DISCHARGE DISTRIBUTION; INDUSTRIAL ANALYSIS AND RESEARCH SERVICES IN THE FIELD OF ELECTROCHEMISTRY, ELECTRICAL POWER ELECTRONICS, HYBRID VEHICLE DRIVETRAIN SYSTEMS, ELECTRICAL GRID AND ELECTRICAL DISTRIBUTION.

TION; DESIGN AND DEVELOPMENT OF COMPUTER HARDWARE AND SOFTWARE; TECHNICAL PROJECT STUDIES IN THE NATURE OF TECHNICAL RESEARCH RELATING TO ELECTRICAL POWER ELECTRONICS, ELECTROCHEMISTRY, ELECTRICAL POWER DISTRIBUTION, HYBRID VEHICLE DRIVETRAIN SYSTEMS, ELECTRICAL POWER STORAGE TECHNOLOGIES, AND ELECTRICAL POWER DISCHARGE TECHNOLOGIES; MATERIALS TESTING; DESIGN SERVICES OF ELECTRICAL EQUIPMENT AND ELECTRICAL GRID; TECHNICAL RESEARCH IN THE FIELD OF ELECTRONIC DEVICES, METROLOGY MEASUREMENTS, ELECTROCHEMISTRY, HYBRID VEHICLE DRIVETRAIN SYSTEMS; ENGINEERING; ENGINEERING CONSULTANCY; DRAWING UP OF PLANS AND ENGINEERING DRAWINGS; CALIBRATION; ENGINEERING SERVICES IN THE FIELD OF ENERGY EFFICIENCY; QUALITY CONTROL FOR OTHERS; EXPERT SERVICES IN THE NATURE OF SCIENTIFIC AND ENGINEERING EXPERT SERVICES IN THE FIELD OF PHYSICS, ELECTRONICS, ELECTROCHEMISTRY, HYBRID VEHICLE DRIVETRAIN SYSTEMS; NEW PRODUCTS RESEARCH AND DEVELOPMENT FOR OTHERS; INDUSTRIAL DESIGN; CERTIFIED LABORATORY SERVICES ON TESTING AND MEASURING IN THE FIELD OF PHYSICS, ELECTRONICS, ELECTROCHEMISTRY, HYBRID VEHICLE DRIVETRAIN SYSTEMS; TECHNOLOGY CONSULTING SERVICES IN THE FIELD OF ENERGY STORAGE AND DISTRIBUTION (U.S. CLS. 100 AND 101).

ELIZABETH KAJUBI, EXAMINING ATTORNEY

SN 79-087,332. RODECA GMBH, FED REP GERMANY, FILED 7-2-2010.

# RODECA

THE MARK CONSISTS OF STANDARD CHARACTERS WITHOUT CLAIM TO ANY PARTICULAR FONT, STYLE, SIZE, OR COLOR.

OWNER OF INTERNATIONAL REGISTRATION 1050996 DATED 7-2-2010, EXPIRES 7-2-2020.

THE WORDING "RODECA" HAS NO MEANING IN A FOREIGN LANGUAGE.

## CLASS 6—METAL GOODS

FOR COMMON METALS AND THEIR ALLOYS; METAL BUILDING MATERIALS, NAMELY, COMPOSITE PANELS COMPOSED PRIMARILY OF METAL, METAL COUNTERTOPS FOR FURTHER INSTALLATION, STAIR NOSING OF METAL; CONSTRUCTION ELEMENTS MADE OF METAL, NAMELY, SHORES, SUPPORTS, BRACES; FRAMEWORKS OF METAL; METAL BONDING FASTENERS FOR MOUNTING AND DEMOUNTING OF CEILING AND WALL PANELS; METAL BRACKETS FOR USE IN THE CONSTRUCTION AND ASSEMBLY OF DECKING, SOFFITS, FASCIA, CEILING BOARDS AND FLOOR BOARDS; GOODS OF METAL FOR THE MOUNTING OF TRANSPARENT WALL AND CEILING TILES OF PLASTIC, NAMELY, METAL BOLTS, NAILS, RIVETS, METAL SCREWS, METAL NUTS, SCREW RINGS OF METAL (U.S. CLS. 2, 12, 13, 14, 23, 25 AND 50).

## CLASS 19—NON-METALLIC BUILDING MATERIALS

FOR NON-METAL BUILDING MATERIALS, NAMELY, TRANSPARENT WALL AND CEILING TILES OF PLASTIC (U.S. CLS. 1, 12, 33 AND 50).

## CLASS 42—SCIENTIFIC AND COMPUTER SERVICES

FOR SERVICES IN THE FIELD OF SCIENCE AND TECHNOLOGY, NAMELY, PRODUCT RESEARCH AND DEVELOPMENT, DESIGN OF NEW PRODUCTS FOR OTHERS, ENGINEERING AND TECHNOLOGY CONSULTATION IN THE FIELD OF PLASTIC TECHNOLOGY, RESEARCH AND DEVELOPMENT OF NEW PRODUCTS FOR OTHERS IN THE FIELD OF PLASTIC TECHNOLOGY; INDUSTRIAL ANALYSIS AND RESEARCH IN THE FIELD OF PLASTIC TECHNOLOGY AND BUILDING CONSTRUCTION TECHNOLOGY (U.S. CLS. 100 AND 101).

EVELYN BRADLEY, EXAMINING ATTORNEY

SN 79-087,535. KOSCHNIKE MAGNUS, SWEDEN, FILED 9-15-2010.

# SOYAFILM

THE MARK CONSISTS OF STANDARD CHARACTERS WITHOUT CLAIM TO ANY PARTICULAR FONT, STYLE, SIZE, OR COLOR.

OWNER OF INTERNATIONAL REGISTRATION 1051630 DATED 9-15-2010, EXPIRES 9-15-2020.

THE WORDING "SOYAFILM" HAS NO MEANING IN A FOREIGN LANGUAGE.

## CLASS 12—VEHICLES

FOR SUN-BLINDS ADAPTED FOR AUTOMOBILES (U.S. CLS. 19, 21, 23, 31, 35 AND 44).

## CLASS 17—RUBBER GOODS

FOR ANTI-DAZZLE FILMS FOR WINDOWS (TINTED FILMS) (U.S. CLS. 1, 5, 12, 13, 35 AND 50).

CHARISMA HAMPTON, EXAMINING ATTORNEY

SN 79-087,799. STIFTELSEN WORLD CHILDHOOD FOUNDATION, SWEDEN, FILED 8-30-2010.



PRIORITY DATE OF 6-30-2010 IS CLAIMED.

OWNER OF INTERNATIONAL REGISTRATION 1052343 DATED 8-30-2010, EXPIRES 8-30-2020.

NO CLAIM IS MADE TO THE EXCLUSIVE RIGHT TO USE "WORLD CHILD AND YOUTH FORUM", APART FROM THE MARK AS SHOWN.

THE COLOR(S) BLACK AND GOLD IS/ARE CLAIMED AS A FEATURE OF THE MARK.

THE MARK CONSISTS OF A GOLD BALLOON WITH A BLACK STRING AND THE WORDING "WORLD CHILD & YOUTH FORUM" IN BLACK.

**CLASS 16—PAPER GOODS AND PRINTED MATTER**

FOR PRINTED MATTER, NAMELY, PRINTED PERIODICALS AND PRINTED PAMPHLETS IN THE FIELD OF CHILDREN'S AND YOUNG PEOPLE'S RIGHTS, CONDITIONS AND HEALTH, AND NEWSPAPERS, MAGAZINES, BOOKS, BROCHURES AND HANDBOOKS AND PHOTOGRAPHS, ALL IN THE FIELD OF CHILDREN'S AND YOUNG PEOPLE'S RIGHTS, CONDITIONS AND HEALTH; PRINTED INSTRUCTIONAL AND TEACHING MATERIAL IN THE FIELD OF CHILDREN'S AND YOUNG PEOPLE'S RIGHTS, CONDITIONS AND HEALTH; SEALING WAX FOR STATIONERY PURPOSES; BOOK COVERS; STATIONERY; STICKERS (U.S. CLS. 2, 5, 22, 23, 29, 37, 38 AND 50).

**CLASS 35—ADVERTISING AND BUSINESS**

FOR DISSEMINATION OF ADVERTISING MATTER; PUBLIC RELATIONS; INFLUENCING OF PUBLIC OPINION FOR COMMERCIAL PURPOSES, NAMELY, PROMOTING PUBLIC AWARENESS OF CHILDREN'S AND YOUNG PEOPLE'S RIGHTS, CONDITIONS, AND HEALTH; RETAIL STORE SERVICES FEATURING BOOKS, MAGAZINES, STATIONERY, INSTRUCTIONAL AND TEACHING MATERIAL, PHOTOGRAPHS, POSTCARDS, GREETING CARDS, POSTERS, MAPS, PLASTIC FILES AND PLASTIC MATERIALS FOR PACKING; LOBBYING FOR COMMERCIAL PURPOSES; ORGANIZATION OF TRADE FAIRS FOR COMMERCIAL OR ADVERTISING PURPOSES; ORGANIZATION OF BUSINESS COMPETITIONS FOR COMMERCIAL PURPOSES (U.S. CLS. 100, 101 AND 102).

**CLASS 41—EDUCATION AND ENTERTAINMENT**

FOR ARRANGING AND CONDUCTING OF EDUCATIONAL CONFERENCES IN THE FIELD OF CHILDREN'S AND YOUNG PEOPLE'S RIGHTS, CONDITIONS AND MENTAL HEALTH; ARRANGING AND CONDUCTING OF CONGRESSES, NAMELY, EDUCATIONAL CONFERENCES IN THE FIELD OF CHILDREN'S AND YOUNG PEOPLE'S RIGHTS, CONDITIONS AND HEALTH; EDUCATION INFORMATION; ORGANIZATION OF EXHIBITIONS FOR CULTURAL OR EDUCATIONAL PURPOSES; ARRANGING AND CONDUCTING OF WORKSHOPS IN THE FIELD OF CHILDREN'S AND YOUNG PEOPLE'S RIGHTS, CONDITIONS AND HEALTH; MULTIMEDIA PUBLISHING, NAMELY, PUBLICATION OF ELECTRONIC BOOKS AND JOURNALS ON-LINE; PROVIDING ON-LINE ELECTRONIC PUBLICATIONS, NAMELY, PERIODICALS, PUBLICATIONS, NEWSPAPERS, MAGAZINES, BOOKS, BROCHURES AND HANDBOOKS, ALL IN THE FIELD OF CHILDREN'S AND YOUNG PEOPLE'S RIGHTS, CONDITIONS AND HEALTH; ORGANIZATION OF MUSIC COMPETITIONS; ORGANIZATION OF DANCE COMPETITIONS; ORGANIZATION OF ART COMPETITIONS; ORGANIZATION OF SPORTS COMPETITIONS; NEWSPAPER PUBLICATION; PUBLICATION OF NEWSLETTERS; ON-LINE JOURNALS, NAMELY, BLOGS IN THE FIELD OF CHILDREN'S AND YOUNG PEOPLE'S RIGHTS, CONDITIONS AND HEALTH; PUBLICATION OF TEXTS; TEACHING IN THE FIELD OF CHILDREN'S AND YOUNG PEOPLE'S RIGHTS, CONDITIONS AND HEALTH; EDUCATIONAL SERVICES, NAMELY, CLASSES, SEMINARS, CONFERENCES, WORKSHOPS, ALL IN THE FIELD OF CHILDREN'S AND YOUNG PEOPLE'S RIGHTS, CONDITIONS AND HEALTH; RENTAL OF SOUND RECORDINGS; RENTAL OF MOTION PICTURES; PUBLICATION OF BOOKS; PROVIDING OF TRAINING IN THE FIELD OF CHILDREN'S AND YOUNG PEOPLE'S RIGHTS, CONDITIONS AND HEALTH, AND DISTRIBUTING COURSE MATERIALS IN CONNECTION THEREWITH; PRODUCTION OF EDUCATIONAL TV PROGRAMS; PRODUCTION OF RADIO AND TELEVISION PROGRAMS; ORGANIZING CULTURAL EVENTS (U.S. CLS. 100, 101 AND 107).

**CLASS 45—PERSONAL AND LEGAL SERVICES**

FOR LITIGATION SERVICES; PERSONAL AND SOCIAL SERVICES RENDERED BY OTHERS TO MEET THE NEEDS OF INDIVIDUALS IN THE NATURE OF CASE MANAGEMENT SERVICES, NAMELY, COORDINATING LEGAL, PHYSICAL, SOCIAL AND PSYCHOLOGICAL SERVICES FOR CHILDREN AND YOUNG PEOPLE (U.S. CLS. 100 AND 101).

MICHELE SWAIN, EXAMINING ATTORNEY

SN 79-087.800. CALL CATCH PTY LTD, SYDNEY, AUSTRALIA, FILED 9-17-2010.

# CALL CATCH

THE MARK CONSISTS OF STANDARD CHARACTERS WITHOUT CLAIM TO ANY PARTICULAR FONT, STYLE, SIZE, OR COLOR.

PRIORITY DATE OF 8-24-2010 IS CLAIMED.

OWNER OF INTERNATIONAL REGISTRATION 1052346 DATED 9-17-2010, EXPIRES 9-17-2020.

NO CLAIM IS MADE TO THE EXCLUSIVE RIGHT TO USE "CALL", APART FROM THE MARK AS SHOWN.

**CLASS 9—ELECTRICAL AND SCIENTIFIC APPARATUS**

FOR COMPUTER SOFTWARE FOR USE IN TELECOMMUNICATIONS, NAMELY, SOFTWARE FOR ACCESSING, EXPANDING, ROUTING, MANAGING AND IMPROVING CONNECTIONS FOR COMMUNICATION NETWORK SERVICES TO REMOTE SUBSCRIBERS; COMPUTER HARDWARE FOR USE IN TELECOMMUNICATIONS; DATA COMMUNICATIONS SOFTWARE, NAMELY, SOFTWARE FOR THE TRANSMISSION OF DATA BETWEEN TWO POINTS; DATA PROCESSING SOFTWARE; TELEPHONE CALL MANAGEMENT SYSTEMS CONSISTING OF SOFTWARE FOR CALL STORING, CONTENT ANALYSIS AND COST ACCOUNTING PURPOSES; COMPUTER SOFTWARE FOR TELEPHONE CALL ANALYSIS AND INTERPRETATION; TELEPHONE CALL CENTRE MANAGEMENT SOFTWARE; TELEPHONE CALL RECORDING AND MONITORING SOFTWARE (U.S. CLS. 21, 23, 26, 36 AND 38).

**CLASS 42—SCIENTIFIC AND COMPUTER SERVICES**

FOR DESIGN AND DEVELOPMENT OF COMPUTER SOFTWARE; PROVIDING TECHNICAL ADVICE AND ASSISTANCE FOR THE OPERATION OF DATA PROCESSING EQUIPMENT; COMPUTER DESIGN AND DEVELOPMENT OF A COMPUTERIZED ELECTRONIC INFORMATION DATA BANK; CONSULTANCY AND ADVISORY SERVICES RELATING TO DESIGN, DEVELOPMENT AND MAINTENANCE OF COMPUTER SOFTWARE; COMPUTER SOFTWARE CONSULTANCY; TECHNICAL SUPPORT SERVICES, NAMELY, TROUBLESHOOTING OF COMPUTER SOFTWARE PROBLEMS; COMPUTER SYSTEM DESIGN; COMPUTER SYSTEMS ANALYSIS; REMOTE AND ON-SITE MANAGEMENT OF INFORMATION TECHNOLOGY (IT) SYSTEMS OF OTHERS; RESEARCH RELATING TO TELECOMMUNICATIONS TECHNOLOGY (U.S. CLS. 100 AND 101).

KELLY TRUSILO, EXAMINING ATTORNEY



SN 79-088,356. OCEAN-LED LTD, LEICESTERSHIRE, UNITED KINGDOM, FILED 9-22-2010.

**LIET**

THE MARK CONSISTS OF STANDARD CHARACTERS WITHOUT CLAIM TO ANY PARTICULAR FONT, STYLE, SIZE, OR COLOR.

PRIORITY DATE OF 3-22-2010 IS CLAIMED.  
OWNER OF INTERNATIONAL REGISTRATION 1053942 DATED 9-22-2010, EXPIRES 9-22-2020.

**CLASS 11—ENVIRONMENTAL CONTROL APPARATUS**

FOR DOMESTIC, COMMERCIAL AND INDUSTRIAL LIGHTING APPARATUS AND FITTINGS (U.S. CLS. 13, 21, 23, 31 AND 34).

**CLASS 37—CONSTRUCTION AND REPAIR**

FOR BUILDING CONSTRUCTION AND REPAIR; INSTALLATION SERVICES OF COMMERCIAL AND INDUSTRIAL LIGHTING APPARATUS AND FITTINGS (U.S. CLS. 100, 103 AND 106).  
SCOTT BIBB, EXAMINING ATTORNEY

SN 79-088,484. HUNTSWORTH PLC, UNITED KINGDOM, FILED 3-24-2010.

**CITIGATE DEWE ROGERSON**

THE MARK CONSISTS OF STANDARD CHARACTERS WITHOUT CLAIM TO ANY PARTICULAR FONT, STYLE, SIZE, OR COLOR.

PRIORITY DATE OF 9-24-2009 IS CLAIMED.  
OWNER OF INTERNATIONAL REGISTRATION 1054349 DATED 3-24-2010, EXPIRES 3-24-2020.

THE NAME "CITIGATE DEWE ROGERSON" DOES NOT IDENTIFY A LIVING INDIVIDUAL.

**CLASS 35—ADVERTISING AND BUSINESS**

FOR ADVERTISING AND MARKETING SERVICES; PUBLIC RELATION SERVICES; MARKET RESEARCH; MARKET ANALYSIS; STRATEGIC MARKETING SERVICES, NAMELY, INVESTOR RELATIONS SERVICES FOR OTHERS; PREPARATION OF CUSTOM ADVERTISEMENTS FOR OTHERS; WRITING AND PUBLICATION OF PUBLICITY MATERIALS; PREPARING BUSINESS REPORTS; ADVERTISING AND PROMOTIONAL SERVICES; PUBLIC AGENCY SERVICES, NAMELY, PUBLIC POLICY CONSULTANCY SERVICES, COMMERCIAL LOBBYING SERVICES, GOVERNMENT RELATIONS CONSULTANCY SERVICES; POLITICAL CONSULTANCY, AND INFORMATION AND CONSULTING IN THE FIELD OF GOVERNMENT AFFAIRS; BUSINESS MANAGEMENT CONSULTANCY SERVICES; CONSULTANCY SERVICES RELATING TO BUSINESS OPERATIONS; CONSULTANCY SERVICES RELATING TO THE CREATION AND BRAND ESTABLISHMENT OF TRADEMARKS, TRADE NAMES, AND DOMAIN NAMES (U.S. CLS. 100, 101 AND 102).

**CLASS 42—SCIENTIFIC AND COMPUTER SERVICES**

FOR DESIGN FOR OTHERS IN THE FIELD OF COMMERCIAL PACKAGING, PRINTING, AND GRAPHIC ART; COMMERCIAL OR GRAPHIC ART WORK DESIGN; GRAPHIC DESIGN SERVICES; GRAPHIC ILLUSTRATION SERVICES FOR OTHERS; WEBSITE DESIGN SERVICES; COMPUTER PROGRAMMING SERVICES (U.S. CLS. 100 AND 101).

SUE LAWRENCE, EXAMINING ATTORNEY

SN 79-088,706. HOT SHOTS (AUST) PTY LTD, AUSTRALIA, FILED 6-29-2010.

**FRUIT TAILS**

THE MARK CONSISTS OF STANDARD CHARACTERS WITHOUT CLAIM TO ANY PARTICULAR FONT, STYLE, SIZE, OR COLOR.

OWNER OF INTERNATIONAL REGISTRATION 1054896 DATED 6-29-2010, EXPIRES 6-29-2020.

NO CLAIM IS MADE TO THE EXCLUSIVE RIGHT TO USE "FRUIT", APART FROM THE MARK AS SHOWN.

**CLASS 29—MEATS AND PROCESSED FOODS**

FOR PRESERVED, DRIED OR COOKED FRUITS, ALL CONTAINING FRUIT OR GOODS BEING FRUIT FLAVOURED; FRUIT-BASED OR FRUIT FLAVOURED SNACK FOODS, SNACK BARS AND HEALTH FOODS IN THE NATURE OF FOOD BARS AND FRUIT JELLIES, ALL THE FOREGOING BEING MADE PREDOMINANTLY FROM DRIED AND/OR PRESERVED FRUIT (U.S. CL. 46).

**CLASS 30—STAPLE FOODS**

FOR CANDY, LOLLIES; SWEETS; JELLY BEANS; CONFECTIONERY, NAMELY, FRUIT JELLIES, PASTILLES; FRUIT-BASED AND FRUIT FLAVOURED CONFECTIONERY IN THE NATURE OF FRUIT JELLIES, PASTILLES; FRUIT FLAVOURED SNACK FOODS, NAMELY, FRUIT JELLIES, PASTILLES; FRUIT JELLIES, JELLIES FOR FOOD; SUGAR CONFECTIONERY; BOILED CONFECTIONERY; BOILED SWEETS; BUBBLE GUM; CANDY FOR FOOD, OTHER THAN FOR MEDICAL PURPOSES; CHEWING GUM; LOLLIPOPS; PASTILLES; WINEGUMS (U.S. CL. 46).

LIEF MARTIN, EXAMINING ATTORNEY

SN 79-088,995. RHODIA OPERATIONS, FRANCE, FILED 5-28-2010.

**TECHNYL eXten**

PRIORITY DATE OF 12-11-2009 IS CLAIMED.

OWNER OF INTERNATIONAL REGISTRATION 1055697 DATED 5-28-2010, EXPIRES 5-28-2020.

OWNER OF U.S. REG. NOS. 700,008, 2,806,114 AND OTHERS.

THE WORDING "TECHNYL EXTEN" HAS NO MEANING IN A FOREIGN LANGUAGE.

**CLASS 1—CHEMICALS**

FOR INDUSTRIAL CHEMICALS; POLYAMIDE; PLASTICS, UNPROCESSED; ARTIFICIAL RESINS, UNPROCESSED; POLYAMIDE RESINS USED IN THE MANUFACTURE OF GOODS BY MOLDING OR INJECTION; UNPROCESSED THERMOPLASTIC COMPOUNDS, THERMOPLASTIC ELASTOMER RESINS AND THERMOPLASTIC CONCENTRATES FOR USE IN MANUFACTURING IN A WIDE VARIETY OF INDUSTRIES, THERMOSETTING PLASTIC REFRACTORY MATERIALS; UNPROCESSED PLASTIC AND POLYAMIDE RESINS FOR USE IN ENGINEERED PLASTIC INDUSTRY (U.S. CLS. 1, 5, 6, 10, 26 AND 46).

**CLASS 12—VEHICLES**

FOR PARACHUTES (U.S. CLS. 19, 21, 23, 31, 35 AND 44).

**CLASS 17—RUBBER GOODS**

FOR SEMI-PROCESSED PLASTICS IN POWDER FORM FOR SETTING OBJECTS BY MOLDING, INJECTION, EXTRUSION, BLOWING; SEMI-PROCESSED PLASTIC INSULATING MATERIAL IN THE FORM OF COATING SOLUTIONS TO BE SPRAYED AND APPLIED ON VARIOUS PRODUCTS; SEMI-PROCESSED PLASTICS IN THE FORM OF BARS, TUBES, BOARDS, STRIPS, FILMS AND FILAMENTS; RESINS IN EXTRUDED FORM FOR INSULATION FOR USE IN CONSTRUCTION; GLASS FIBERS FOR INSULATION FOR USE IN CONSTRUCTION (U.S. CLS. 1, 5, 12, 13, 35 AND 50).

**CLASS 28—TOYS AND SPORTING GOODS**

FOR SPORTS GOODS AND EXTREME SPORTS GOODS, NAMELY, SKI BINDINGS, SNOWBOARD BINDINGS AND SNOWSHOE BINDINGS; INLINE SKATES, ICE SKATES, SKIS, ROLLER SKATES; PARAGLIDERS AND PARTS THEREFOR; FISHING REELS; COVERS FOR WINCHES FOR USE IN WATER SPORTS, NAMELY, WAKE BOARDING, WAKE SKATING AND SNOWBOARDING (U.S. CLS. 22, 23, 38 AND 50).  
BARNEY CHARLON, EXAMINING ATTORNEY

SN 79-089,008. CGGVERITAS SERVICES SA, F-91300 MASSY, FRANCE, FILED 9-29-2010.

# BroadSeis

PRIORITY DATE OF 4-20-2010 IS CLAIMED.  
OWNER OF INTERNATIONAL REGISTRATION 1055732 DATED 9-29-2010, EXPIRES 9-29-2020.  
OWNER OF U.S. REG. NO. 3,821,942.

**CLASS 9—ELECTRICAL AND SCIENTIFIC APPARATUS**

FOR COMPUTER SOFTWARE FOR ACQUIRING, PROCESSING, IMAGING AND INTERPRETING GEOPHYSICAL DATA, FOR EXPLORING, EXPLOITING OR MONITORING UNDERGROUND RESOURCES, INCLUDING GAS OR HYDROCARBON DEPOSITS; COMPUTER SOFTWARE FOR ACQUIRING, PROCESSING, IMAGING AND INTERPRETING SEISMIC DATA, FOR EXPLORING, EXPLOITING OR MONITORING UNDERGROUND RESOURCES, INCLUDING GAS OR HYDROCARBON DEPOSITS (U.S. CLS. 21, 23, 26, 36 AND 38).

**CLASS 42—SCIENTIFIC AND COMPUTER SERVICES**

FOR SCIENTIFIC SERVICES, NAMELY, ACQUIRING, PROCESSING, INTERPRETING GEOPHYSICAL DATA FOR UNDERGROUND EXPLORATION AND EXPLOITATION; SCIENTIFIC SERVICES, NAMELY, ACQUIRING, PROCESSING, INTERPRETING SEISMIC DATA FOR SEARCHING OR EXPLOITATION OF HYDROCARBON OR GAS DEPOSITS (U.S. CLS. 100 AND 101).  
FLORENTINA BLANDU, EXAMINING ATTORNEY

SN 79-089,050. CUT LOOSE HELGA HÖLDERLE GMBH, FED REP GERMANY, FILED 10-13-2010.

## LOOSE YOUR MIND

THE MARK CONSISTS OF STANDARD CHARACTERS WITHOUT CLAIM TO ANY PARTICULAR FONT, STYLE, SIZE, OR COLOR.

PRIORITY DATE OF 4-13-2010 IS CLAIMED.  
OWNER OF INTERNATIONAL REGISTRATION 1055904 DATED 10-13-2010, EXPIRES 10-13-2020.

**CLASS 18—LEATHER GOODS**

FOR LEATHER AND IMITATIONS OF LEATHER; TRUNKS AND TRAVELLING BAGS; UMBRELLAS, PARASOLS AND WALKING STICKS (U.S. CLS. 1, 2, 3, 22 AND 41).

**CLASS 25—CLOTHING**

FOR SHOES; FOOTWEAR (U.S. CLS. 22 AND 39).  
TINA BROWN, EXAMINING ATTORNEY

SN 79-089,085. LES ASSURANCES DE PARIS - AVI INTERNATIONAL, F-75009 PARIS, FRANCE, FILED 9-29-2010.



PRIORITY DATE OF 8-25-2010 IS CLAIMED.  
OWNER OF INTERNATIONAL REGISTRATION 1056004 DATED 9-29-2010, EXPIRES 9-29-2020.

NO CLAIM IS MADE TO THE EXCLUSIVE RIGHT TO USE "VOYAGES AND TOUR DU MONDE", APART FROM THE MARK AS SHOWN.

THE COLOR(S) BLUE, WHITE AND RED IS/ARE CLAIMED AS A FEATURE OF THE MARK.

THE MARK CONSISTS OF A GLOBE SUGGESTED BY A RED LINE IN WHICH THE CONTINENTS APPEAR IN BLUE; BENEATH WHICH APPEAR THE WORDS "ASSURANCE" AND "MARCO" IN BLUE AND THE WORDS "POLO" AND "VOYAGES & TOUR DU MONDE" IN RED. THE COLOR WHITE APPEARS IN THE BACKGROUND.

THE ENGLISH TRANSLATION OF "TOUR DE MONDE" IN THE MARK IS "WORLD TOUR".



**CLASS 36—INSURANCE AND FINANCIAL**

FOR INSURANCE SERVICES, NAMELY, UNDERWRITING TRAVEL INSURANCE (U.S. CLS. 100, 101 AND 102).

**CLASS 37—CONSTRUCTION AND REPAIR**

FOR VEHICLE REPAIR (U.S. CLS. 100, 103 AND 106).

**CLASS 39—TRANSPORTATION AND STORAGE**

FOR VEHICLE BREAKDOWN ASSISTANCE, NAMELY, VEHICLE TOWING AND RETURN OF BROKEN DOWN VEHICLE TO OWNER, NON-MEDICAL REPATRIATION OF PERSONS, NAMELY, NON-MEDICAL TRANSPORT OF PERSONS BACK TO THEIR HOME COUNTRY (U.S. CLS. 100 AND 105).

**CLASS 44—MEDICAL, BEAUTY AND AGRICULTURAL SERVICES**

FOR MEDICAL CARE, NAMELY, MEDICAL SERVICES FOR TRAVELERS (U.S. CLS. 100 AND 101).  
FLORENTINA BLANDU, EXAMINING ATTORNEY

**CLASS 38—COMMUNICATION**

FOR PROVIDING ACCESS TO ON-LINE DATA BASES FEATURING ENTERTAINMENT, GAMES AND EDUCATIONAL APPLICATIONS; PROVIDING ACCESS TO ELECTRONIC BULLETIN BOARDS AND CHAT ROOM APPLICATIONS USED FOR TRANSMISSION OF MESSAGES IN PLAYING ON-LINE COMPUTER GAMES; ELECTRONIC TRANSMISSION AND BROADCASTING OF DATA OVER THE INTERNET AND MOBILE NETWORKS; ELECTRONIC MAIL SERVICES; PROVISION OF ELECTRONIC CHAT APPLICATIONS AND BULLETIN BOARD SERVICES USED FOR TRANSMISSION OF MESSAGES WHEN PLAYING ON-LINE COMPUTER GAMES; PROVISION OF ADVICE, CONSULTANCY AND INFORMATION REGARDING ALL OF THE AFORESAID SERVICES (U.S. CLS. 100, 101 AND 104).

**CLASS 41—EDUCATION AND ENTERTAINMENT**

FOR ENTERTAINMENT SERVICES, NAMELY, PROVIDING ON-LINE MULTIPLAYER COMPUTER GAMES BY MEANS OF COMMUNICATIONS NETWORKS; ENTERTAINMENT SERVICES, NAMELY, PROVIDING ON-LINE MULTIPLAYER ELECTRONIC COMPUTER GAMES (U.S. CLS. 100, 101 AND 107).

**CLASS 42—SCIENTIFIC AND COMPUTER SERVICES**

FOR SCIENTIFIC AND TECHNOLOGICAL SERVICES, NAMELY, RESEARCH AND DESIGN IN THE FIELD OF ON-LINE COMPUTER GAMES AND COMPUTER GAMES SOFTWARE; DESIGN AND DEVELOPMENT OF COMPUTER HARDWARE AND SOFTWARE (U.S. CLS. 100 AND 101).

KAREN SEVERSON, EXAMINING ATTORNEY

SN 79-089,236. JUNEHUD AB, SWEDEN, FILED 5-17-2010.

# JUNEHUD

THE MARK CONSISTS OF STANDARD CHARACTERS WITHOUT CLAIM TO ANY PARTICULAR FONT, STYLE, SIZE, OR COLOR.

PRIORITY DATE OF 11-17-2009 IS CLAIMED.  
OWNER OF INTERNATIONAL REGISTRATION 1056366 DATED 5-17-2010, EXPIRES 5-17-2020.

**CLASS 9—ELECTRICAL AND SCIENTIFIC APPARATUS**

FOR DATA PROCESSING EQUIPMENT AND COMPUTERS; COMPUTER GAME SOFTWARE; VIRTUAL REALITY GAME SOFTWARE; COMPUTER AND VIDEO GAME SOFTWARE; ELECTRONIC GAME SOFTWARE AND GAMES SOFTWARE FOR COMPUTERS AND CELLULAR TELEPHONES (U.S. CLS. 21, 23, 26, 36 AND 38).

**CLASS 16—PAPER GOODS AND PRINTED MATTER**

FOR PAPER, CARDBOARD AND GOODS MADE FROM THESE MATERIALS, NOT INCLUDED IN OTHER CLASSES, NAMELY, PAPER BAGS, POSTERS, STICKERS, PAPER BANNERS, POST CARDS, PHOTOGRAPHS, COLLECTOR'S CARDS, TRADING CARDS; GOODS MADE FROM CARDBOARD, NAMELY, BOXES; PRINTED MATTER, NAMELY, BOOKLETS, BROCHURES, FLYERS AND PAMPHLETS IN THE FIELD OF ON-LINE COMPUTER GAMES; BOOK BINDING MATERIAL; PHOTOGRAPHS; STATIONERY; ADHESIVES FOR STATIONERY OR HOUSEHOLD PURPOSES; PAINT BRUSHES; PRINTED INSTRUCTIONAL AND TEACHING MATERIALS IN THE FIELD OF ON-LINE MULTIPLAYER GAMES; PLASTIC MATERIALS FOR PACKAGING, NAMELY, PLASTIC BAGS; PRINTERS' TYPE; PRINTING BLOCKS (U.S. CLS. 2, 5, 22, 23, 29, 37, 38 AND 50).

SN 79-089,483. TANIA E' S.R.L., ITALY, FILED 9-21-2010.



T A N I A E R C O L I

PRIORITY DATE OF 4-2-2010 IS CLAIMED.  
OWNER OF INTERNATIONAL REGISTRATION 1056964 DATED 9-21-2010, EXPIRES 9-21-2020.

THE NAME(S), PORTRAIT(S), AND/OR SIGNATURE(S) SHOWN IN THE MARK IDENTIFIES "TANIA ERCOLI", WHOSE CONSENT(S) TO REGISTER IS MADE OF RECORD.

THE MARK CONSISTS OF THE STYLIZED WORDING "TANIAERCOLI" WRITTEN IN LOWER-CASE LETTERS AND APPEARING BELOW A STYLIZED DESIGN OF MULTIPLE CONCENTRIC CIRCLES WITH AN IRREGULAR CIRCUMFERENCE.

THE ENGLISH TRANSLATION OF "ERCOLI" IN THE MARK IS "HERCULES".

**CLASS 14—JEWELRY**

FOR GOODS OF PRECIOUS METALS, NAMELY, EARRINGS, EAR PENDANTS IN THE NATURE OF EARRINGS, BRACELETS, NECKLACES, PENDANTS, NECK CHAINS, AND RINGS; HOROLOGICAL AND CHRONOMETRIC INSTRUMENTS, NAMELY, CLOCKS, WATCHES, TABLE CLOCKS, STOPWATCHES, ALARM CLOCKS, CHRONOMETERS; PRECIOUS STONES; JEWELRY; BEADS FOR USE IN THE MANUFACTURE OF JEWELRY; BROOCHES (U.S. CLS. 2, 27, 28 AND 50).

**CLASS 18—LEATHER GOODS**

FOR ANIMAL SKINS; ATTACHÉ CASES; BACKPACKS; BEACH BAGS; BELT BAGS; BILLFOLDS; BOSTON BAGS; BRIEFCASES; CARRY-ON BAGS; CLUTCH PURSES; COIN PURSES; DUFFLE BAGS; EVENING HANDBAGS; GLADSTONE BAGS; HANDBAGS; LEATHER AND IMITATION LEATHER BAGS; KEY CASES; PURSES NOT OF PRECIOUS METAL; SHOULDER BAGS; SPORT BAGS; SUITCASES; TOTE BAGS; TRAVELLING BAGS; TRAVELLING CASES OF LEATHER; TRUNKS IN THE NATURE OF LUGGAGE; UMBRELLAS; VALISES; VANITY CASES SOLD EMPTY; WALLETS NOT OF PRECIOUS METAL (U.S. CLS. 1, 2, 3, 22 AND 41).

**CLASS 25—CLOTHING**

FOR HEADGEAR, NAMELY, CAPS, HATS; HEADWEAR; FOOTWEAR, NAMELY, BOOTS, BOOTIES, SANDALS, SHOES, SLIPPERS, AND SNEAKERS; CLOTHING, NAMELY, ANORAKS, BEACHWEAR, BELTS, BLOUSES, BLOUSONS, CARDIGANS, COATS, GLOVES, GYM SUITS, HEADWEAR, JACKETS, JEANS, JERKINS, JERSEYS, JUMPERS, KNICKERS, LEATHER BELTS, LEATHER COATS, LEATHER PANTS, LEGGINGS, LOUNGEWEAR, NECKWEAR, OVERALLS, OVERCOATS, PAJAMAS, PANTS, PULLOVERS, RAINCOATS, SHIRTS, SHORTS, SKIRTS, SLEEPWEAR, SOCKS, STOCKINGS, SUITS, DRESSES, SUSPENDERS, SWEAT PANTS, SWEATERS, SWEAT SHIRTS, TIGHTS, TRACK SUITS, TROUSERS, T-SHIRTS, UNDERWEAR, VESTS, WAISTCOATS (U.S. CLS. 22 AND 39).

MARCIE MILONE, EXAMINING ATTORNEY

SN 79-089,587. BOTSWANA EXPORT DEVELOPMENT AND INVESTMENT AUTHORITY (BEDIA), GABORONE, BOTSWANA, FILED 10-13-2010.



OWNER OF INTERNATIONAL REGISTRATION 1057210 DATED 10-13-2010, EXPIRES 10-13-2020.

NO CLAIM IS MADE TO THE EXCLUSIVE RIGHT TO USE "BOTSWANA", APART FROM THE MARK AS SHOWN.

THE COLOR(S) ORANGE, BROWN, BLUE, GREEN, BLACK, YELLOW AND RED IS/ARE CLAIMED AS A FEATURE OF THE MARK.

THE MARK CONSISTS OF THE STYLIZED WORDING "BOTSWANA" IN BLUE, WITH A DEPICTION OF THE SUN MADE UP OF AN ORANGE CURVE AND VARYING COLORS REPRESENTING THE RAYS OF THE SUN FROM LEFT TO RIGHT: ORANGE, BROWN, ORANGE, RED, BLACK AND BLUE, GREEN, AND YELLOW. BELOW THE WORD MARK IS THE TAGLINE "OUR PRIDE, YOUR DESTINATION" IN BLACK.

**CLASS 1—CHEMICALS**

FOR CHEMICALS USED IN INDUSTRY, SCIENCE AND PHOTOGRAPHY, AND AGRICULTURE, HORTICULTURE AND FORESTRY; UNPROCESSED ARTIFICIAL RESINS, UNPROCESSED PLASTICS; MANURE; FIRE EXTINGUISHING COMPOSITIONS; TEMPERING AND SOLDERING CHEMICALS; CHEMICAL SUBSTANCES FOR PRESERVING FOODSTUFFS; TANNING AGENTS FOR USE IN MANUFACTURE OF LEATHER; ADHESIVES USED IN INDUSTRY; ADHESIVE PREPARATIONS FOR SURGICAL BANDAGES; ADHESIVES FOR COMMERCIAL USE IN POSTING SIGNS; ADHESIVES FOR COMMERCIAL USE IN PAPERHANGING; ADHESIVES FOR WALL TILES (U.S. CLS. 1, 5, 6, 10, 26 AND 46).

**CLASS 2—PAINTS**

FOR PAINTS, VARNISHES, LACQUERS; PRESERVATIVES AGAINST RUST IN THE NATURE OF A COATING AND AGAINST DETERIORATION OF WOOD; COLORANTS; MORDANT DYES; RAW NATURAL RESINS; METALS IN FOIL AND POWDER FORM FOR PAINTERS, DECORATORS, PRINTERS AND ARTISTS (U.S. CLS. 6, 11 AND 16).

**CLASS 3—COSMETICS AND CLEANING PREPARATIONS**

FOR BLEACHING PREPARATIONS FOR LAUNDRY USE; FABRIC SOFTENERS FOR LAUNDRY USE; LAUNDRY BLEACH, LAUNDRY BLUEING; LAUNDRY DETERGENT; LAUNDRY SOAP; LAUNDRY STARCH; WASHING PREPARATIONS AND LAUNDRY BLEACH; CLEANING, POLISHING, SCOURING AND ABRASIVE PREPARATIONS; ANTIBACTERIAL SOAP; BAR SOAP; BATH SOAPS; BATH SOAPS IN LIQUID, SOLID OR GEL FORM; BEAUTY SOAP; COSMETIC SOAPS; DEODORANT SOAP; DETERGENT SOAPS; DISINFECTANT SOAPS; HAND SOAPS; LIQUID SOAPS; MEDICATED SOAPS; NATURAL SOAP BARS; ORGANIC SOAP BARS; PERFUMED SOAPS; SHAVING SOAPS; SKIN SOAP; SOAP POWDER; SOAPS FOR BODY CARE; SOAPS FOR HOUSEHOLD USE; SOAPS FOR PERSONAL USE; TOILET SOAP; WATERLESS SOAP; PERFUMERY, ESSENTIAL OILS, COSMETICS, HAIR LOTIONS; DENTIFRICES (U.S. CLS. 1, 4, 6, 50, 51 AND 52).

**CLASS 4—LUBRICANTS AND FUELS**

FOR INDUSTRIAL OILS; LUBRICATING OILS; INDUSTRIAL GREASES; LUBRICATING GREASES; ALL PURPOSE LUBRICANTS; DUST LAYING AND ABSORBING COMPOSITION FOR USE ON UNPAVED ROADS; PETROLEUM BASED DUST ABSORBING COMPOSITIONS FOR USE IN ROAD BUILDING; DUST-BINDING COMPOSITIONS; FUELS; ILLUMINANTS, NAMELY, LAMP FUEL, LIGHTING FUEL, LIQUID FUELS; MOTOR SPIRITS, NAMELY, MOTOR FUEL, GASOLINE; CANDLES AND WICKS FOR CANDLES FOR LIGHTING; LAMP WICKS (U.S. CLS. 1, 6 AND 15).

**CLASS 5—PHARMACEUTICALS**

FOR PHARMACEUTICAL PREPARATIONS, NAMELY, ANTICOAGULANTS, ANTIDEPRESSANTS, ANTI-INFLAMMATORY MEDICATIONS; APPETITE SUPPRESSANTS; PHARMACEUTICAL PREPARATIONS FOR THE TREATMENT OF GOUT, CARDIOVASCULAR DISORDERS, INFECTIOUS DISEASES, GASTRO-INTESTINAL DISEASES, HORMONAL DISORDERS, ALLERGIES, ALLERGIC RHINITIS AND ASTHMA, DIABETES, SKIN DISORDERS, EYE DISEASES AND CONDITIONS, DAMAGED SKIN AND TISSUES, PAIN, KIDNEY DISEASES, IMMUNE SYSTEM RELATED DISEASES AND DISORDERS, HYPERTENSION, BONE DISEASES, CANCER, RESPIRATORY DISEASES; VETERINARY PREPARATIONS FOR PAIN RELIEF; VETERINARY PREPARATIONS FOR THE TREATMENT OF INTESTINAL BACTERIA, CARDIOVASCULAR DISORDERS, INFECTIOUS DISEASES, GASTRO-INTESTINAL DISEASES, HORMONAL DISORDERS, SKIN

DISORDERS, EYE DISEASES AND CONDITIONS, DAMAGED SKIN AND TISSUES, KIDNEY DISEASES, IMMUNE SYSTEM RELATED DISEASES AND DISORDERS, HYPERTENSION, BONE DISEASES, CANCER, RESPIRATORY DISEASES, PARASITES; SANITARY PREPARATIONS FOR MEDICAL USE; DIETETIC FOODS ADAPTED FOR MEDICAL USE, FOOD FOR BABIES; PLASTERS FOR MEDICAL USE, MEDICAL DRESSINGS; MATERIAL FOR STOPPING TEETH, DENTAL WAX; ALL-PURPOSE DISINFECTANTS; PREPARATIONS FOR DESTROYING VERMIN; FUNGICIDES AND HERBICIDES (U.S. CLS. 6, 18, 44, 46, 51 AND 52).

#### CLASS 6—METAL GOODS

FOR COMMON METALS AND THEIR ALLOYS INCLUDING STAINLESS STEEL; METAL BUILDING MATERIALS, NAMELY, SOFFITS, FASCIA, CEILING BOARDS AND FLOOR BOARDS, STAIR NOSING OF METAL, METAL REINFORCEMENT MATERIALS FOR BUILDING; TRANSPORTABLE BUILDINGS OF METAL; MATERIALS OF METAL FOR RAILWAY TRACKS, NAMELY, METALLIC MATERIALS FOR RAILWAY TRACKS; NON-ELECTRIC CABLES AND WIRES OF COMMON METAL; IRONMONGERY, IN THE NATURE OF SMALL ITEMS OF METAL HARDWARE, NAMELY, BUCKLES OF COMMON METAL, METAL GATE LATCHES, METAL BRACKETS FOR GENERAL USE, METAL PULLS, METAL KEYS AND KEY CYLINDERS, METAL PULLEYS, METAL SPRINGS, METAL NUTS, METAL WASHERS, METAL CARABINEERS, METAL DOUBLE-END SWIVELS, AND METAL CABLE THIMBLES; PIPES AND TUBES OF METAL; METAL SAFES (U.S. CLS. 2, 12, 13, 14, 23, 25 AND 50).

#### CLASS 7—MACHINERY

FOR MACHINES AND MACHINE TOOLS, NAMELY, GEAR CUTTERS, LATHES, ROTARY DIES FOR CUTTING BOXES FOR THE PACKAGING INDUSTRY; VICES, CLAMPS, AND JAWS FOR PRECISION CLAMPING; POWER OPERATED METAL WORKING MACHINE TOOLS, NAMELY, MILLING TOOLS, TURNING TOOLS, BORING TOOLS AND TOOL BITS; MOTORS AND ENGINES, EXCEPT FOR LAND VEHICLES; MACHINE COUPLING AND TRANSMISSION COMPONENTS EXCEPT FOR LAND VEHICLES; AGRICULTURAL IMPLEMENTS OTHER THAN HAND-OPERATED, NAMELY, INCORPORATORS, SEED DRILLS, HAY BALERS, COULTERS, PLOWS, HARROWS, MOWERS, REAPERS, HARVESTERS, HAY RAKES, MANURE SPREADERS, CORN HUSKING MACHINES AND TRACTOR TOWED AGRICULTURAL IMPLEMENTS, NAMELY, FERTILIZER DISTRIBUTORS; INCUBATORS FOR EGGS (U.S. CLS. 13, 19, 21, 23, 31, 34 AND 35).

#### CLASS 8—HAND TOOLS

FOR HAND TOOLS AND IMPLEMENTS, NAMELY, AUGERS, AWLS, CLAMPS, DIES, DRILLS, HAMMERS, HAND JACKS, ICE PICKS, MANUALLY-OPERATED GRINDING WHEELS, MANUALLY-OPERATED GRINDSTONES, MITRE BOXES, MANUALLY-OPERATED SHARPENING WHEELS, PICKS, PINCERS, PLANERS, PLANES, PUNCHES, RASPS, RATCHET WRENCHES, REAMERS, SAWS, SCRAPERS, SCREWDRIVERS, SOCKET SETS, SQUARES, TAPS, TONGS, WRENCHES, CHALK LINE REELS, SANDERS, PUTTY KNIVES, ENGRAVERS, BOLT CUTTERS, WIRE CUTTERS, WIRE STRIPPERS, MAULS, HATCHETS, NAIL SETS, SOCKET WRENCHES, VICES, KNIFE SHARPENERS, PIKES, PRUNERS, PAINT SCRAPERS, RAMMERS, HAND-OPERATED PUMPS, PRUNING SAWS, FRUIT PICKERS, POST HOLE DIGGERS, WEED CUTTERS, TILE CUTTERS, LEVERS, RIVETERS, HAND-OPERATED CUTTING TOOLS; KNIVES; CUTLERY; SIDE ARMS NOT INCLUDING FIREARMS, NAMELY, SWORDS AND HUNTING KNIVES; RAZORS (U.S. CLS. 23, 28 AND 44).

#### CLASS 9—ELECTRICAL AND SCIENTIFIC APPARATUS

FOR SCIENTIFIC, NAUTICAL, SURVEYING, PHOTOGRAPHIC, CINEMATOGRAPHIC, OPTICAL, WEIGHING, MEASURING, SIGNALING, CHECKING, LIFE-SAVING AND TEACHING APPARATUS AND INSTRUMENTS, NAMELY, ACCELEROMETERS, ADDING MACHINES, AERONAUTICAL RADIO COMMUNICATION MACHINES AND APPARATUS, AIR ANALYSIS APPARATUS, AIR TANKS FOR USE IN SCUBA DIVING, ALTIMETERS, AMMETERS, AMPLIFIERS, AMUSEMENT APPARATUS AND GAMES ADAPTED FOR USE WITH TELEVISION RECEIVERS OR WITH VIDEO OR COMPUTER MONITORS, ANODES, ANSWERING MACHINES, ANTENNAS, ANTI-GLARE GLASSES, ANTI-INTRUSION ALARMS, APPARATUS AND INSTRUMENTS FOR WEIGHING, ASTRONOMETRIC MEASURING MACHINES AND INSTRUMENTS, ATTENUATORS, BARCODE SCANNERS, BAROMETERS, BEAKERS, BINOCULARS, BIOLOGICAL MICROSCOPES, BREATHING APPARATUS FOR UNDERWATER SWIMMING, CABLES FOR ELECTRICAL OR OPTICAL SIGNAL TRANSMISSION, CALCULATING MACHINES, CALIBRATED GLASSWARE, CAMCORDERS, CAMERAS, CAPACITORS, CARBON DIOXIDE DETECTORS, CARD READERS FOR MAGNETICALLY ENCODED CARDS, CENTRAL PROCESSING UNITS FOR PROCESSING INFORMATION, DATA, SOUND OR IMAGES, CHROMATOGRAPHY APPARATUS FOR LABORATORY USE, CINEMATOGRAPHIC MACHINES AND APPARATUS, CIRCUIT BOARDS, CIRCUIT BREAKERS, COAXIAL CABLES, COIN COUNTING OR SORTING MACHINES, COMPASSES, COMPUTER CHIPS, COMPUTER DISC DRIVES, COMPUTER GAME SOFTWARE, COMPUTER HARDWARE AND PERIPHERALS, COMPUTER OPERATING SOFTWARE, COMPUTER SERVERS, CONTACT LENSES, CONVERTERS, CORDLESS TELEPHONES, CORRECTIVE GLASSES, DIGITAL MEDIA STREAMING DEVICES, DIODES, DISTANCE MEASURING APPARATUS, DIVING EQUIPMENT, NAMELY, DIVERS MASKS, DIVING HELMETS, PROTECTIVE DIVING SHOES, DIVING GLOVES, DIVING GOGGLES, DIVING SUITS, DOWNLOADABLE COMPUTER GAME PROGRAMS, ELECTRIC SOLDERING APPARATUS, ELECTRONIC GAME SOFTWARE, ELECTRONIC NAVIGATIONAL AND POSITIONING APPARATUS AND INSTRUMENTS, ENCODING AND DECODING APPARATUS AND INSTRUMENTS, EXTENSION CORDS, EYEGLASSES, EYEGLASS CHAINS AND CORDS, EYEGLASS FRAMES, EYEGLASS LENSES, EYEWEAR, FACSIMILE APPARATUS, FIBER OPTICS, FIELD-GLASSES, FIRE AND SMOKE DETECTORS, FLOTATION VESTS, FLOWMETERS, GLASS TUBES FOR SCIENTIFIC PURPOSES, GRAVITY MEASURING INSTRUMENTS, SURVEYING MACHINES AND INSTRUMENTS, OPTICAL FRAMES, OPTICAL GLASSES, OPTICAL INSPECTION APPARATUS, OPTICAL LENSES, OPTICAL READERS, OPTICAL SCANNERS, OPTICAL SENSORS, GYROSCOPES, INSTRUMENTS FOR MEASURING LENGTH, KEYBOARDS, LABORATORY GLASSWARE, LASERS FOR INDUSTRIAL USE, LASERS FOR MEASURING PURPOSES, LASERS FOR NON-MEDICAL PURPOSES, LENSES FOR CAMERAS, MAGNETS, MAGNIFYING GLASSES, MEASURING GLASSWARE, MEASURING TAPES, METEOROLOGICAL INSTRUMENTS, METRONOMES, MICROSCOPES AND PARTS THEREOF, MOBILE PHONES, OPTICAL FIBERS, OPTICAL FRAMES, OPTICAL GLASSES, OPTICAL LENSES, PRINTERS, PROTECTIVE EYEWEAR, PROTECTIVE HELMETS, RADAR, SEISMOLOGICAL INSTRUMENTS, SEMICONDUCTORS, SONAR, SPECTACLES AND SUNGLASSES, SURVEYING MACHINES AND INSTRUMENTS, TELESCOPES, THERMOMETERS, TIMERS; APPARATUS AND INSTRUMENTS FOR CONDUCTING, SWITCHING, TRANSFORMING, ACCUMULATING, REGULATING OR CONTROLLING ELECTRICITY NAMELY, ACCUMULATORS AND BATTERIES, VOLTAGE TESTERS, AMPERAGE TESTERS, ADAPTER PLUGS, ADAPTERS, APPARATUS AND INSTRUMENTS FOR CONVEYING, DISTRIBUTING, TRANSFORMING, STORING, REGULATING OR CONTROLLING ELECTRIC CURRENT, BATTERIES, COVERS FOR ELECTRIC OUTLETS, ELECTRIC AND ELECTRONIC CIRCUITS, ELECTRIC CIRCUIT SWITCHES, ELECTRIC CONNECTIONS AND CONNECTORS, ELECTRIC CONTROL PANELS, ELECTRIC CORDS, ELECTRIC FUSE BOXES, ELECTRIC JUNCTION BOXES, ELECTRIC OUTLET COVERS, ELECTRIC POWER CONVERTERS, ELECTRIC

SWITCH PLATES, ELECTRIC SWITCHES, ELECTRIC TRANSFORMERS, ELECTRIC WIRE AND CABLES, ELECTRICAL FUSES, ELECTRICAL OUTLETS, ELECTRICAL OUTLET PLATES, ELECTRICAL PLUGS AND SOCKETS, ELECTRODES, INSULATED ELECTRICAL CONNECTORS, INTEGRATED CIRCUIT CARDS AND COMPONENTS, POWER ADAPTERS; APPARATUS FOR RECORDING, TRANSMISSION OR REPRODUCTION OF SOUND OR IMAGES NAMELY, ACOUSTIC CONDUITS, ACOUSTIC COUPLERS, ACOUSTIC METERS, APPARATUS FOR BROADCASTING, RECORDING, TRANSMISSION OR REPRODUCTION OF SOUND OR IMAGES, AUDIO AND VIDEO CASSETTE RECORDERS, CASSETTE PLAYERS, CASSETTE RECORDERS, CELL PHONES, DICTATION MACHINES, CAMERAS, DOWN-LOADABLE MUSICAL SOUND RECORDINGS, EARPHONES AND HEADPHONES, HEADSETS FOR CELLULAR OR MOBILE PHONES, MICROPHONES, MUSICAL RECORDINGS, PORTABLE MEDIA PLAYERS, RADIOS, SOUND RECORDING AND SOUND REPRODUCING APPARATUS AND INSTRUMENTS, TELEPHONES, TELEVISIONS, VIDEO RECORDERS; BLANK MAGNETIC DATA CARRIERS AND BLANK RECORDING DISCS, NAMELY, BLANK AUDIO TAPES, BLANK CD-ROMS FOR SOUND OR VIDEO RECORDING, BLANK COMPUTER DISCS, BLANK DIGITAL AUDIO TAPES, BLANK DIGITAL STORAGE MEDIA, BLANK DISCS FOR COMPUTERS, BLANK MAGNETIC DISCS, BLANK OPTICAL DISKS; AUTOMATIC VENDING MACHINES AND MECHANISMS FOR COIN-OPERATED APPARATUS; CASH REGISTERS, CALCULATORS, DATA PROCESSORS AND COMPUTERS; FIRE-EXTINGUISHING APPARATUS (U.S. CLS. 21, 23, 26, 36 AND 38).

#### **CLASS 10—MEDICAL APPARATUS**

FOR SURGICAL APPARATUS AND INSTRUMENTS FOR MEDICAL, DENTAL OR VETERINARY USE; SURGICAL DRAPES, SURGICAL IMPLANTS COMPRISING ARTIFICIAL MATERIALS; MEDICAL APPARATUS AND INSTRUMENTS FOR USE IN POSITRON EMISSION TOMOGRAPHY (PET) IMAGING, MEDICAL APPARATUS AND INSTRUMENTS FOR USE IN ORTHOPEDIC SURGERY, MEDICAL APPARATUS AND INSTRUMENTS FOR TREATING CARDIOVASCULAR DISEASE, MEDICAL APPARATUS AND INSTRUMENTS FOR TREATING OSTEOARTHRITIS AND OSTEOPOROSIS, MEDICAL APPARATUS AND INSTRUMENTS FOR MONITORING VITAL SIGNS, BLOOD PROPERTIES AND RESPIRATORY EVENTS, MEDICAL APPARATUS AND INSTRUMENTS FOR USE IN SURGERY; ELECTRIC DENTAL APPARATUS, NAMELY, MILLING APPARATUS FOR DENTAL PURPOSES, DENTISTS' CHAIRS AND DENTURES; VETERINARY APPARATUS AND INSTRUMENTS FOR SURGICAL USE; ARTIFICIAL LIMBS, EYES AND TEETH; ORTHOPEDIC ARTICLES, NAMELY, ORTHOPEDIC BRACES, ORTHOPEDIC CUSHIONS, ORTHOPEDIC DEVICES FOR DIAGNOSTIC AND THERAPEUTIC USE, ORTHOPEDIC SOLES, ORTHOPEDIC SUPPORTS, ORTHOPEDIC WALKERS; ORTHOPEDIC BELTS; ORTHOPEDIC FOOTWEAR AND ORTHOPEDIC SOLES, PLASTER CASTS FOR ORTHOPEDIC PURPOSES, SUPPORT BANDAGES FOR ORTHOPEDIC PURPOSES; SUTURE MATERIALS (U.S. CLS. 26, 39 AND 44).

#### **CLASS 11—ENVIRONMENTAL CONTROL APPARATUS**

FOR APPARATUS FOR LIGHTING, HEATING, STEAM GENERATING, COOKING, REFRIGERATING, DRYING, VENTILATING, WATER SUPPLY AND SANITARY PURPOSES, NAMELY, AGRICULTURAL IRRIGATION UNITS, AIR CLEANING UNITS, AIR FILTERS FOR DOMESTIC USE, AIR PURIFIERS, AIR-CONDITIONING, AIR COOLING AND VENTILATION APPARATUS AND INSTRUMENTS, APPARATUS AND INSTRUMENTS FOR USE IN THE PURIFICATION, SEPARATION AND STERILIZATION OF LIQUIDS AND GASSES USED IN THE BIOTECHNOLOGY, PHARMACEUTICAL, MEDICAL, BIOPHARMACEUTICAL AND FOOD AND BEVERAGE INDUSTRIES, COOK-TOPS, BAKING OVENS, BARBECUES AND GRILLS, BATHTUBS, BEVERAGES COOLING APPARATUS, BIDDETS, CEILING FANS, CEILING LIGHTS, CHANDELIERS, CLOTHES DRYERS, COAL STOVES,

COMMODOES, COOKING OVENS, COOKING RANGES, DEEP FRYING MACHINES, DEHUMIDIFIERS, DESALINATION UNITS, DISTILLATION APPARATUS, ELECTRIC APPARATUS FOR MAKING COFFEE, ELECTRIC FANS, ELECTRIC LIGHT BULBS, ELECTRIC LIGHTING FIXTURES, ELECTRIC LUMINAIRES, ELECTRIC RADIATORS, ELECTRIC RANGES, ELECTRIC SKILLETS, ELECTRIC SPACE HEATERS, ELECTRIC STOVES, ELECTRIC TOASTERS, FAUCETS, FLASHLIGHTS, FREEZERS, FURNACES, HEAT PUMPS, HOT WATER HEATERS, HUMIDIFIERS, HVAC UNITS, ICE BOXES, ICE MACHINES AND APPARATUS, KITCHEN SINKS, LAMPS, LAMP SHADES, LANTERNS, LIGHT BULBS, LIGHTING FIXTURES, MICROWAVE OVENS, REFRIGERATORS, SHOWERS, SINKS, SOLAR COLLECTORS, TOILETS, URINALS, WATER PURIFICATION AND FILTRATION APPARATUS, WATER FOUNTAINS, WATER HEATERS, AND WATER SOFTENING UNITS (U.S. CLS. 13, 21, 23, 31 AND 34).

#### **CLASS 12—VEHICLES**

FOR VEHICLES, NAMELY, ALL-TERRAIN VEHICLES, AMPHIBIOUS VEHICLES, LAND VEHICLES, LIGHT RAIL VEHICLES, MOTOR VEHICLES, NAMELY, AUTOMOBILES, TRUCKS, VANS SPORT UTILITY VEHICLES AND STRUCTURAL PARTS THEREFOR; APPARATUS FOR LOCOMOTION BY LAND, AIR OR WATER, NAMELY, AIRCRAFT, AIRPLANES AND STRUCTURAL PARTS THEREFOR, AIRSHIPS, AMBULANCES AND STRUCTURAL PARTS THEREFOR, AMPHIBIOUS VEHICLES, ARMORED VEHICLES, AUTOMOBILES AND STRUCTURAL PARTS THEREFOR, BABY CARRIAGES, BABY STROLLERS, BARGES, BICYCLES, BOATS AND STRUCTURAL PARTS THEREFOR, BUSES AND STRUCTURAL PARTS THEREFOR, CAMPERS, CANOES, CARS, CARTS, FORK LIFT TRUCKS, HAND TRUCKS, HELICOPTERS AND STRUCTURAL PARTS THEREFOR, HORSE DRAWN CARRIAGES, HORSE TRAILERS, KAYAKS, LOCOMOTIVES, LORRIES, MOPEDS, MOTOR HOMES AND STRUCTURAL VEHICLE PARTS THEREFOR, MOTOR SCOOTERS, MOTORBIKES, MOTORBOATS, MOTORCYCLES AND STRUCTURAL PARTS THEREFOR, PRAMS, RAILWAY CARS, RICKSHAWS, SAILING VESSELS, SCOOTERS AND STRUCTURAL PARTS THEREFOR, SHIPS, SNOWMOBILES, SPORTS UTILITY VEHICLES, STEAM LOCOMOTIVES, STROLLERS, SUBMARINES, THREE-WHEELED MOTOR VEHICLES, TRACTOR TRAILERS, TRACTORS, TRAILERS, TRAMS, TRICYCLES, TROLLEYS, TRUCKS AND STRUCTURAL PARTS THEREFOR, TWO-WHEELED MOTOR VEHICLES, UNICYCLES AND STRUCTURAL PARTS THEREFOR, VANS AND STRUCTURAL PARTS THEREFOR, VESSELS, WAGONS, WHEELCHAIRS (U.S. CLS. 19, 21, 23, 31, 35 AND 44).

#### **CLASS 13—FIREARMS**

FOR FIREARMS; AMMUNITION AND PROJECTILES FOR FIREARMS; EXPLOSIVES; FIREWORKS (U.S. CLS. 2 AND 9).

#### **CLASS 14—JEWELRY**

FOR PRECIOUS METALS AND THEIR ALLOYS; GOODS IN PRECIOUS METALS OR COATED THEREWITH, NAMELY, BADGES OF PRECIOUS METAL, BOXES OF PRECIOUS METAL, CHARMS IN PRECIOUS METAL OR COATED THEREWITH, CUFF LINKS OF PRECIOUS METAL, FIGURINES OF PRECIOUS METAL, INGOTS OF PRECIOUS METAL, INSIGNIAS OF PRECIOUS METAL, JEWELRY CASES OF PRECIOUS METAL, KEY CHAINS OF PRECIOUS METAL, KEY RINGS OF PRECIOUS METALS, PERSONAL ORNAMENTS OF PRECIOUS METAL, PRECIOUS METAL KNOBS, PRECIOUS METAL PULLS, SCULPTURES MADE OF PRECIOUS METAL, STATUES OF PRECIOUS METAL, WATCHES MADE OF PRECIOUS METALS OR COATED THEREWITH; JEWELLERY, PRECIOUS STONES; HOROLOGICAL AND CHRONOMETRIC INSTRUMENTS (U.S. CLS. 2, 27, 28 AND 50).

**CLASS 15—MUSICAL INSTRUMENTS**

FOR MUSICAL INSTRUMENTS (U.S. CLS. 2, 21 AND 36).

**CLASS 16—PAPER GOODS AND PRINTED MATTER**

FOR PAPER, CARDBOARD AND GOODS MADE FROM THESE MATERIALS, NAMELY, BOXES, CARTONS, STORAGE CONTAINERS, AND PACKING CONTAINERS MADE OF PAPER OR CARDBOARD, CONTAINERS FOR STORAGE AND TRANSPORT MADE OF PAPER OR CARDBOARD, PLACARDS OF PAPER OR CARDBOARD, PRINTED ADVERTISING BOARDS OF PAPER OR CARDBOARD, CARDBOARD MAILING TUBES, CARDBOARD PACKAGING, CORRUGATED CARDBOARD, PAPER BAGS, PAPERBOARD; PRINTED MATTER NAMELY, ACCOUNTING FORMS, ADDRESS BOOKS, AGENDAS, ALMANACS, APPOINTMENT BOOKS, ATLASES, BLANK CARDS, BLANK FORMS, BLANK JOURNALS, BUMPER STICKERS, BUSINESS FORMS, BUSINESS RECORD BOOKS, CALENDARS, CHILDREN'S BOOKS, COLORING BOOKS, COMPOSITION BOOKS, DIARIES, DIRECTORIES OF MANUFACTURERS, GENERAL FEATURE MAGAZINES, GREETING CARDS AND POSTCARDS, LEDGER BOOKS, MAPS, NEWS BULLETINS, NEWSPAPERS, NOTE CARDS, NOTE PAPER, NOTEBOOKS, NOVELS, PAPER, PICTORIAL PRINTS, PICTURE BOOKS, POSTCARDS, POSTERS, PRINTED FORMS, PRINTED PERIODICALS IN THE FIELD OF TOURISM, PRINTS, SKETCHBOOKS, STATIONERY, STICKERS, TRAVEL BOOKS; BOOKBINDING MATERIALS; PHOTOGRAPHS; STATIONERY; ADHESIVES FOR STATIONERY OR HOUSEHOLD PURPOSES; ARTISTS' MATERIALS, NAMELY, ARTISTS' BRUSHES, ARTISTS' PASTELS, ARTISTS' PENCILS, ARTISTS' PENS, CANVAS PANELS FOR ARTISTS, DRAWING INSTRUMENTS, DRAWING PAPER, MARKERS, MODELING CLAY, MOLDS FOR MODELING CLAYS, PAINT APPLICATORS, PAINT BOXES AND BRUSHES, PAINTERS' EASELS; PAINT BRUSHES; TYPEWRITERS; OFFICE REQUISITES, NAMELY, ADHESIVE TAPE DISPENSERS, BINDERS, ENVELOPES, FILE FOLDERS, FOLDERS, OFFICE STATIONERY, PAPER CLIPS, PENCILS, PENS, PUNCHES, RUBBER BANDS, RUBBER STAMPS, STAMP PADS, STAPLES, STAPLERS, WRITING IMPLEMENTS; PRINTED INSTRUCTIONAL, EDUCATIONAL AND TEACHING MATERIAL IN THE FIELDS OF ECONOMIC DEVELOPMENT, TRADE, PRODUCT DEVELOPMENT AND EXPORTS; PLASTIC MATERIALS FOR PACKAGING, NAMELY, PLASTIC BAGS FOR PACKAGING, PLASTIC BUBBLE PACKS FOR WRAPPING OR PACKAGING; PRINTERS' TYPE; PRINTING BLOCKS (U.S. CLS. 2, 5, 22, 23, 29, 37, 38 AND 50).

**CLASS 17—RUBBER GOODS**

FOR RAW OR SEMI-WORKED RUBBER, GUTTA-PERCHA, ASBESTOS, MICA; GOODS MADE FROM RAW OR SEMI-WORKED RUBBER, GUTTA-PERCHA, ASBESTOS, AND MICA, NAMELY, ELECTRICAL INSULATING RUBBER PRODUCTS, FIGURINES MADE OF RUBBER, NON-METAL, PLASTIC AND RUBBER HOSES FOR INDUSTRIAL APPLICATIONS, ORNAMENTS MADE OF RUBBER, PADDING MADE OF RUBBER FOR SHIPPING CONTAINERS, RUBBER BANDS FOR COMMERCIAL AND INDUSTRIAL USES, RUBBER DERIVATIVES, RUBBER SHEETS, ASBESTOS BOARDS, ASBESTOS FABRICS, ELECTRICAL INSULATING MICA PRODUCTS, PLASTICS IN EXTRUDED FORM FOR USE IN MANUFACTURE; PACKING, STOPPING AND INSULATING MATERIALS, NAMELY, ADHESIVE PLASTIC FILM FOR INDUSTRIAL AND COMMERCIAL USE, CUSHIONING OF PLASTIC IN THE NATURE OF STUFFING, EXPANDED PLASTIC PELLETS FOR PACKAGING, EXTRUDED PLASTIC IN THE FORM OF BARS, BLOCKS, PELLETS, RODS, SHEETS AND TUBES FOR USE IN MANUFACTURING, PLASTIC FILM FOR COMMERCIAL AND INDUSTRIAL USE, PLASTIC IN EXTRUDED FORM FOR GENERAL INDUSTRIAL USE; FLEXIBLE PIPES, NOT OF METAL (U.S. CLS. 1, 5, 12, 13, 35 AND 50).

**CLASS 18—LEATHER GOODS**

FOR LEATHER AND IMITATIONS OF LEATHER, AND GOODS MADE OF THESE MATERIALS, NAMELY, ATTACHE CASES MADE OF LEATHER, ATTACHE CASES MADE OF IMITATION LEATHER, BRIEFCASES, CASES OF IMITATION LEATHER, KEY CASES OF LEATHER OR IMITATION LEATHER, LEATHER AND IMITATION LEATHER BAGS, LEATHER BAGS, SUITCASES AND WALLETS, LEATHER CASES, LEATHER LEASHES, LEATHER POUCHES, POUCHES MADE FROM IMITATION LEATHER; ANIMAL SKINS, ANIMAL HIDES; TRUNKS AND TRAVELLING BAGS; UMBRELLAS, PARASOLS AND WALKING STICKS; WHIPS, HARNESSES AND SADDLERY (U.S. CLS. 1, 2, 3, 22 AND 41).

**CLASS 19—NON-METALLIC BUILDING MATERIALS**

FOR NON-METAL BUILDING MATERIALS, NAMELY, FASCIA, SOFFITS, SHUTTERS, SHINGLES, SIDING, TRIM, NON-METAL CLADDING FOR CONSTRUCTION AND BUILDING, NON-METAL DECORATIVE MOLDINGS AND DECORATIVE TRIM USED IN BUILDING CONSTRUCTION, BEAMS NOT OF METAL, BOARDS OF WOOD, BRICKS, BUILDING STONE, CEMENT, CERAMIC TILES, CONCRETE, DRYWALL, FLAGSTONES, FLOORBOARDS, GLASS FOR BUILDING, GRANITE, GYPSUM, HARDWOOD FLOORING, LIMESTONE, LUMBER, MARBLE, MORTAR, NATURAL STONE AND STONE TILE, NON-METAL FLOORS, NON-METAL GATES AND FENCING, NON-METAL POSTS, NON-METAL ROOFING, NON-METAL TILES, PAVERS, PLYWOOD, QUARTZ, SLATE, SPACKLING COMPOUND, STONE FOR BUILDING AND CONSTRUCTION, TIMBER; NON-METALLIC RIGID PIPES FOR BUILDING; ASPHALT, PITCH AND BITUMEN; NON-METALLIC TRANSPORTABLE BUILDINGS; MONUMENTS, NOT OF METAL (U.S. CLS. 1, 12, 33 AND 50).

**CLASS 20—FURNITURE AND ARTICLES NOT OTHERWISE CLASSIFIED**

FOR FURNITURE, MIRRORS, PICTURE FRAMES; GOODS MADE OF WOOD, CORK, REED, CANE, WICKER, HORN, BONE, WHALEBONE, SHELL, AMBER, MOTHER-OF-PEARL, PLASTIC, MEERSCHAUM AND SUBSTITUTES FOR ALL THESE MATERIALS, NAMELY, DECORATIVE BOXES MADE OF WOOD, DECORATIVE CENTERPIECES OF WOOD, CORK, REED, CANE, WICKER, HORN, BONE, WHALEBONE, SHELL, AMBER, MOTHER-OF-PEARL, PLASTIC, MEERSCHAUM, DRAWER PULLS OF WOOD, CORK, REED, CANE, WICKER, HORN, BONE, WHALEBONE, SHELL, AMBER, MOTHER-OF-PEARL, PLASTIC, MEERSCHAUM AND SUBSTITUTES FOR ALL THESE MATERIALS; FIGURINES OF WOOD, CORK, REED, CANE, WICKER, HORN, BONE, WHALEBONE, SHELL, AMBER, MOTHER-OF-PEARL, PLASTIC, MEERSCHAUM; SCULPTURES OF WOOD, CORK, REED, CANE, WICKER, HORN, BONE, WHALEBONE, SHELL, AMBER, MOTHER-OF-PEARL, PLASTIC, MEERSCHAUM; STATUES OF WOOD, CORK, REED, CANE, WICKER, HORN, BONE, WHALEBONE, SHELL, AMBER, MOTHER-OF-PEARL, PLASTIC, MEERSCHAUM, WORKS OF ART OF WOOD, CORK, REED, CANE, WICKER, HORN, BONE, WHALEBONE, SHELL, AMBER, MOTHER-OF-PEARL, PLASTIC, MEERSCHAUM, CORKS, STOPPERS OF CORK OR CORK IMITATIONS, BLINDS OF REED, PLASTIC BINS, PLASTIC BOXES, PLASTIC KEY CHAINS (U.S. CLS. 2, 13, 22, 25, 32 AND 50).

**CLASS 21—HOUSEWARES AND GLASS**

FOR HOUSEHOLD AND KITCHEN CONTAINERS; HOUSEHOLD AND KITCHEN UTENSILS, NAMELY, GRILLS, GRILL COVERS, GRATERS, KITCHEN TONGS, ROLLING PINS, SIEVES, SPATULAS, STRAINERS, WHISKS; COMBS; SPONGES, NAMELY, BATH SPONGES, CLEANING SPONGES, SPONGES USED FOR APPLYING MAKE-UP, SCOURING SPONGES, SPONGES FOR HOUSEHOLD PURPOSES, TOILETRY SPONGES; BRUSHES, EXCEPT PAINT BRUSHES, NAMELY, BATH BRUSHES, BLACKING BRUSHES, BRUSHES FOR FOOTWEAR, BRUSHES FOR PETS, BRUSHES FOR WASHING UP, CLEANING BRUSHES FOR HOUSEHOLD USE, CLOTHES BRUSHES, COSMETIC BRUSHES, HAIR BRUSHES, NAIL BRUSHES, SHAVING BRUSHES, TOILET BRUSHES, TOOTH BRUSHES, WASHING BRUSHES; BRUSH-MAKING MATERIALS, NAMELY, MATERIAL FOR BRUSH-MAKING; ARTICLES FOR CLEANING PURPOSES, NAMELY, CHAMOIS LEATHER FOR CLEANING, CLEANING CLOTHS, CLEANING PADS, CLEANING, DUSTING AND POLISHING CLOTHS, PRE-MOISTENED TOWELETTES FOR CLEANING, STEEL WOOL; UNWORKED OR SEMI-WORKED GLASS, EXCEPT GLASS USED IN BUILDING; BEVERAGE GLASSWARE; GLASS, PORCELAIN AND EARTHENWARE, NAMELY, BUSTS OF GLASS, PORCELAIN AND EARTHENWARE, DECORATIVE CENTERPIECES OF GLASS, PORCELAIN AND EARTHENWARE, DRAWER PULLS OF GLASS, PORCELAIN OR EARTHENWARE, FIGURES OF GLASS, PORCELAIN OR EARTHENWARE, FIGURINES OF GLASS, PORCELAIN OR EARTHENWARE, JARS FOR JAMS AND JELLIES OF GLASS, PORCELAIN KNOBS, PORCELAIN MUGS, SCULPTURES OF GLASS, PORCELAIN OR EARTHENWARE, STATUES OF GLASS, PORCELAIN OR EARTHENWARE, WORKS OF ART OF GLASS, PORCELAIN OR EARTHENWARE; DISHES AND PLATES MADE OF GLASS, PORCELAIN OR EARTHENWARE, BOWLS MADE OF GLASS, PORCELAIN OR EARTHENWARE, VASES MADE OF GLASS, PORCELAIN OR EARTHENWARE (U.S. CLS. 2, 13, 23, 29, 30, 33, 40 AND 50).

**CLASS 22—CORDAGE AND FIBERS**

FOR ROPES, STRING, NETTING, TENTS, AWNINGS, TARPAULINS, SAILS, SACKS AND BAGS, NAMELY, SACKS OR BAGS FOR THE TRANSPORTATION OR STORAGE OF MATERIALS IN BULK, BAGS FOR WASHING HOSIERY, BAGS FOR SECURING VALUABLES, GENERAL UTILITY BAGS FOR COMMERCIAL USE, LAUNDRY BAGS, MAIL BAGS, MESH BAGS FOR STORAGE, MULTI-PURPOSE CLOTH BAGS; PADDING AND STUFFING MATERIALS NOT OF RUBBER OR PLASTICS; RAW FIBROUS TEXTILE MATERIALS (U.S. CLS. 1, 2, 7, 19, 22, 42 AND 50).

**CLASS 23—YARNS AND THREADS**

FOR YARNS AND THREADS, FOR TEXTILE USE (U.S. CL. 43).

**CLASS 24—FABRICS**

FOR TEXTILES AND TEXTILE GOODS, NAMELY, AFGHANS, BABY BLANKETS, BANNERS AND FLAGS OF TEXTILE, BATH LINEN, BEACH TOWELS, BED BLANKETS, BEDSPREADS, BOLTING CLOTH, BROCADE, BUCKRAM, CALICO, CANVAS FOR TAPESTRY OR EMBROIDERY, CHEESE CLOTH, CHIFFON FABRIC, COMFORTERS, COTTON CLOTH, COTTON FABRIC, COVERLETS, CURTAINS AND TOWELS, DAMASK, DENIM FABRIC, DRAPERIES, DUVETS, FABRICS FOR TEXTILE USE, FELTS, FLANNEL, FURNISHING AND UPHOLSTERY FABRICS, HANDKERCHIEFS, HOUSEHOLD LINEN, KITCHEN LINENS, NYLON FABRIC, PILLOW CASES, POLYESTER FABRIC, QUILTS, SILK CLOTH, TAFFETA, TEXTILE FABRICS FOR USE IN MAKING CLOTHING AND HOUSEHOLD FURNISHINGS, TOWELS, TULLE, VELVET; BED AND TABLE LINEN (U.S. CLS. 42 AND 50).

**CLASS 25—CLOTHING**

FOR CLOTHING, NAMELY, APRONS, BANDANAS, BEACHWEAR, BLAZERS, BOTTOMS, BRAS, CAMISOLES, FOUNDATION GARMENTS, INFANTWEAR, LINGERIE, PAJAMAS, SLEEPWEAR, PULLOVERS, RAINWEAR, ROBES, SHAWLS, SHOES, SHIRTS, TOPS, BLOUSES, PANTS, TROUSERS, SLACKS, SHORTS, SKIRTS, SKORTS, SKIWEAR, SWIMWEAR, SWIMSUITS, BATHING SUITS, UNDERGARMENTS, UNDERSHIRTS, UNDERWEAR, UNIFORMS, WETSUITS, SWEATERS, DRESSES, SUITS, JEANS, VESTS, JACKETS, COATS, BATHROBES, HOSIERY, SOCKS, STOCKINGS, SLIPPERS, NECKTIES, NECKWEAR, SCARVES, HATS, CAPS, FOUL WEATHER GEAR, GLOVES, MITTENS, MUFFLERS, BELTS, SUSPENDERS; FOOTWEAR; HEADWEAR (U.S. CLS. 22 AND 39).

**CLASS 26—FANCY GOODS**

FOR LACES AND EMBROIDERY, RIBBONS AND BRAID; BUTTONS, HOOKS AND EYES, SEWING PINS AND NEEDLES; BOBBY PINS; BONNET PINS NOT OF PRECIOUS METAL; HAIR PINS; HAT PINS; ORNAMENTAL NOVELTY PINS; SAFETY PINS; ARTIFICIAL FLOWERS (U.S. CLS. 37, 39, 40, 42 AND 50).

**CLASS 27—FLOOR COVERINGS**

FOR CARPETS, RUGS, MATS AND MATTING, LINOLEUM AND OTHER MATERIALS FOR COVERING EXISTING FLOORS; NON-TEXTILE WALL HANGINGS (U.S. CLS. 19, 20, 37, 42 AND 50).

**CLASS 28—TOYS AND SPORTING GOODS**

FOR GAMES AND PLAYTHINGS, NAMELY, ACTION FIGURES AND ACCESSORIES THEREFOR, ACTION SKILL GAMES, ARCADE GAMES, BABY MULTIPLE ACTIVITY TOYS, BACKGAMMON GAMES, BALLOONS, BATH TOYS, BINGO GAME PLAYING EQUIPMENT, BOARD GAMES, BUILDING GAMES, CARD GAMES, CASES FOR PLAY ACCESSORIES, CHECKER SETS, CHESS SETS, CHILDREN'S MULTIPLE ACTIVITY TOYS, COLLECTABLE TOY FIGURES, COSTUME MASKS, COUNTERS AND MARBLES FOR GAMES, CONSTRUCTION TOYS, CRIB TOYS, CRICKET BALLS, CRICKET BATS, DART BOARDS, DARTS, DICE, DOLLS AND ACCESSORIES THEREFOR, DOLL CLOTHING, DOMINOES, DRAWING TOYS, ELECTRONIC EDUCATIONAL GAME MACHINES FOR CHILDREN, ELECTRONIC LEARNING TOYS, ELECTRONIC TOY VEHICLES, INFANT TOYS, IN-LINE SKATES, JIGSAW AND MANIPULATIVE PUZZLES, JUMP ROPES, KITES, MARBLES, MODEL TOY VEHICLES, MUSICAL TOYS, PLAYING CARDS, PARLOR GAMES, PET TOYS, PIÑATAS, PLAY HOUSES, PLAY SETS FOR ACTION FIGURES, PLUSH TOYS, PUPPETS, PUZZLES, RADIO CONTROLLED TOY VEHICLES, RIDEABLE TOYS AND ACCESSORIES THEREFOR, SANDBOX TOYS, SCALE MODEL VEHICLES, STUFFED AND PLUSH TOYS, TOY VEHICLES AND ACCESSORIES THEREFOR, WATER TOYS, WIND-UP TOYS, YO-YOS; GYMNASTIC AND SPORTING ARTICLES, NAMELY, ARCHERY SETS, BADMINTON GAME PLAYING EQUIPMENT, BALLS FOR GAMES, BALLS FOR SPORTS, BARBELLS, BASEBALL BATS, BASEBALL GLOVES, BASEBALLS, BASKETBALLS, BATS FOR GAMES, BILLIARD EQUIPMENT, BODY-TRAINING APPARATUS, BOWLING APPARATUS AND MACHINERY, BOWLING BALLS, BOXING BAGS, DISCUSSES, DUMBBELLS, EXERCISE BARS, EXERCISE BENCHES, EXERCISE MACHINES, FOOTBALLS, GOLF BALLS, GOLF CLUBS, GOLF TEES, GYMNASTIC APPARATUS, HANDBALLS, HOCKEY PUCKS, HOCKEY STICKS, ICE SKATES, LACROSSE BALLS, LACROSSE STICKS, MARTIAL ARTS TRAINING EQUIPMENT, NETS FOR SPORTS, RACQUET BALL RACKETS, RACQUET BALLS, ROLLER SKATES, RUGBY BALLS, SKATEBOARDS, SKIS, SNOWBOARDS, SOCCER BALLS, SOFTBALLS, SPORT BALLS, SQUASH RACKETS, SURFBOARDS, TABLE TENNIS PADDLES, TENNIS BALLS, TENNIS RACKETS, TRAMPOLINES, VOLLEYBALLS; DECORATIONS FOR CHRISTMAS TREES (U.S. CLS. 22, 23, 38 AND 50).

**CLASS 29—MEATS AND PROCESSED FOODS**

FOR MEAT, FISH, POULTRY AND GAME; MEAT EXTRACTS; PRESERVED, FROZEN, DRIED AND COOKED FRUITS AND VEGETABLES; JELLIES, JAMS, COMPOTES; EGGS, MILK AND MILK PRODUCTS, EXCLUDING ICE CREAM, ICE MILK AND FROZEN YOGURT; EDIBLE OILS AND FATS (U.S. CL. 46).

**CLASS 30—STAPLE FOODS**

FOR COFFEE, TEA, COCOA, SUGAR, RICE, TAPIOCA, SAGO ARTIFICIAL COFFEE; FLOUR AND PREPARATIONS MADE FROM CEREALS, NAMELY, BISCUITS, TARTS, CAKES MADE WITH CEREALS, BREAKFAST CEREALS, CEREAL-BASED SNACK FOODS, PROCESSED CEREALS, PROCESSED CEREAL-BASED FOOD TO BE USED AS A BREAKFAST FOOD, SNACK FOOD OR INGREDIENT FOR MAKING OTHER FOODS, READY-TO-EAT CEREALS, UNPROCESSED CEREALS, CORNMEAL, CORN FLAKES, OATMEAL, OAT FLAKES, PROCESSED GRAINS, ROLLED OATS; BREAD, PASTRY; CONFECTIONERY, NAMELY, CAKE ICING, CAKES, CANDY, CANDY BARS, CHEWING GUM, CHOCOLATE AND CHOCOLATES, CHOCOLATE CONFECTIONS, CHOCOLATE FOR CONFECTIONERY AND BREAD, COCOA-BASED INGREDIENT IN CONFECTIONERY PRODUCTS, CONFECTIONERY CHIPS FOR BAKING, CONFECTIONERY MADE OF SUGAR, PASTILLES, COOKIES, CRYSTAL SUGAR PIECES, CUP CAKES, CUSTARD, DANISH, DONUTS, ÉCLAIRS, FLAVORED AND SWEETENED GELATINS, FONDANTS, FROSTINGS, FROZEN CONFECTIONERY, FROZEN CUSTARDS, FROZEN YOGURT, FRUIT JELLIES AS CONFECTIONERY, FUDGE, GELATO, ICING, MIXES FOR BAKERY GOODS, MUFFINS, PANCAKE MIXES, PARFAITS, PIES, PEPPERMINT FOR CONFECTIONERY, PUDDINGS, SCONES, SHERBET, SORBET, TAFY, TOFFEE, YOGURT-COVERED FRUIT, YOGURT-COVERED NUTS, YOGURT-COVERED PRETZELS, ICE CREAM, EDIBLE ICES; HONEY, TREACLE; YEAST, BAKING-POWDER; SALT, MUSTARD; VINEGAR, CONDIMENT SAUCES; SPICES; ICE (U.S. CL. 46).

**CLASS 31—NATURAL AGRICULTURAL PRODUCTS**

FOR AGRICULTURAL, HORTICULTURAL AND FORESTRY PRODUCTS AND GRAINS, NAMELY, AGRICULTURAL GRAINS FOR PLANTING, AGRICULTURAL SEEDS, BULBS FOR AGRICULTURAL PURPOSES, BULBS FOR HORTICULTURAL PURPOSES, FLOWER BULBS, FLOWER SEEDS, FRUIT SEEDS, LIVING TREES, MULCH, RAW TIMBER, ROUGH CORK; SEEDS AND BULBS, SEEDS FOR HORTICULTURAL PURPOSES, SHRUBS, SOD, UNPROCESSED GRAIN; LIVE ANIMALS; FRESH FRUITS AND VEGETABLES; PLANT SEEDS, NATURAL PLANTS AND FLOWERS; ANIMAL FOODSTUFFS; MALT FOR BREWING AND DISTILLING (U.S. CLS. 1 AND 46).

**CLASS 32—LIGHT BEVERAGES**

FOR BEERS; MINERAL AND AERATED WATERS AND OTHER NON-ALCOHOLIC DRINKS, NAMELY, ALCOHOL FREE APERITIFS, ALCOHOL FREE WINE, ALCOHOL-FREE BEERS, BOTTLED WATER, CARBONATED WATERS, COCONUT-BASED NON-ALCOHOLIC BEVERAGES, COLA, DRINKING WATER, ENERGY DRINKS, FLAVORED WATERS, GINGER ALE, LEMONADE, NON-ALCOHOLIC CIDER, NON-ALCOHOLIC COCKTAIL MIXES, NON-ALCOHOLIC COCKTAILS, NON-ALCOHOLIC CORDIALS, NON-ALCOHOLIC MALT BEVERAGE, NON-ALCOHOLIC PUNCH, SODA POPS, SODA WATER, SOFT DRINKS, SPORTS DRINKS, VEGETABLE DRINKS, VEGETABLE JUICES; FRUIT DRINKS AND FRUIT JUICES; SYRUPS FOR MAKING BEVERAGES; PREPARATIONS FOR MAKING BEVERAGES, NAMELY, CONCENTRATES FOR MAKING FRUIT DRINKS; CONCENTRATES, SYRUPS OR POWDERS USED FOR MAKING SOFT DRINKS OR TEA-FLAVORED BEVERAGES, ESSENCES FOR MAKING NON-ALCOHOLIC BEVERAGES NOT IN THE NATURE OF ESSENTIAL OILS (U.S. CLS. 45, 46 AND 48).

**CLASS 33—WINES AND SPIRITS**

FOR ALCOHOLIC BEVERAGES, EXCEPT BEERS (U.S. CLS. 47 AND 49).

**CLASS 34—SMOKERS' ARTICLES**

FOR TOBACCO; SMOKERS' ARTICLES, NAMELY, ASHTRAYS, CIGAR AND CIGARETTE BOXES, CIGAR CASES, CIGAR CUTTERS, CIGAR HOLDERS, CIGAR LIGHTERS, CIGAR TUBES, CIGAR WRAPS, CIGARETTE ASH RECEPTACLES, CIGARETTE CASES, CIGARETTE FILTERS, CIGARETTE HOLDERS, CIGARETTE LIGHTER HOLDER, CIGARETTE PAPER, CIGARETTE ROLLING PAPER; CIGARETTE TUBES, CIGARETTES, CIGARILLOS, CIGARS, ELECTRONIC CIGARETTES, ELECTRONIC CIGARETTE LIGHTERS, FILTER TIPS, FILTERED CIGARS AND CIGARETTES, FLINTS AND FIRESTONES, HOOKAHS, HUMIDORS, LIGHTERS FOR SMOKERS, MATCH BOXES, POCKET MACHINES FOR ROLLING CIGARETTES, SMOKING PIPE CLEANERS, SMOKING PIPES, SMOKING PIPE RACKS, SMOKING URNS, TOBACCO FILTERS, TOBACCO GRINDERS, TOBACCO JARS, TOBACCO POUCHES, TOBACCO TINS; MATCHES (U.S. CLS. 2, 8, 9 AND 17).

**CLASS 35—ADVERTISING AND BUSINESS**

FOR ADVERTISING SERVICES, NAMELY, ADVERTISING AND MARKETING CONSULTANCY, ADVERTISING, MARKETING AND PROMOTIONAL SERVICES, CREATING CORPORATE AND BRAND IDENTITY FOR OTHERS, PROMOTING THE BRANDS, GOODS AND SERVICES OF OTHERS, ADVERTISING THROUGH ALL PUBLIC COMMUNICATION MEANS, BRAND CONCEPT AND BRAND DEVELOPMENT SERVICES FOR CORPORATE AND INDIVIDUAL CLIENTS, CONDUCTING, ARRANGING AND ORGANIZING TRADE SHOWS AND TRADE FAIRS FOR COMMERCIAL AND ADVERTISING PURPOSES, ORGANIZATION OF EVENTS, EXHIBITIONS, FAIRS AND SHOWS FOR COMMERCIAL, PROMOTIONAL AND ADVERTISING PURPOSES, SPECIAL EVENT PLANNING FOR COMMERCIAL, PROMOTIONAL OR ADVERTISING PURPOSES, PUBLIC RELATIONS, PLANNING AND CONDUCTING OF TRADE FAIRS, EXHIBITIONS AND PRESENTATIONS FOR ECONOMIC AND ADVERTISING PURPOSES, ORGANIZATION OF EXHIBITIONS AND TRADE FAIRS FOR BUSINESS AND PROMOTIONAL PURPOSES, CONSULTING, DEVELOPMENT, MANAGEMENT AND MARKETING OF BRANDS FOR BUSINESSES; BUSINESS ADMINISTRATION AND MANAGEMENT, NAMELY, BUSINESS ADMINISTRATION AND MANAGEMENT, BUSINESS ADVISORY AND CONSULTANCY SERVICES RELATING TO EXPORT, EXPORT SERVICES, EXPORT PROMOTION INFORMATION AND SERVICES, EXPORT AGENCY SERVICES FOR THE GOODS OF OTHERS, EXPORT AND IMPORT AGENCIES, FREIGHT LOGISTICS MANAGEMENT, ECONOMIC RESEARCH AND ANALYSIS, BUSINESS DEVELOPMENT SERVICES, CONDUCTING MARKET SURVEYS, FACILITATING TRANSACTIONS BETWEEN BUYERS AND SELLERS THROUGH PROVIDING BUYERS WITH INFORMATION ABOUT SELLERS, GOODS AND/OR SERVICES; PROVIDING OFFICE FUNCTIONS (U.S. CLS. 100, 101 AND 102).

**CLASS 36—INSURANCE AND FINANCIAL**

FOR INSURANCE AGENCY AND BROKERAGE, DESIGN AND DEVELOPMENT OF INSURANCE POLICIES FOR OTHERS, FINANCIAL CONSULTANCY AND INSURANCE CONSULTANCY, FINANCIAL EVALUATION FOR INSURANCE PURPOSES, INSURANCE ADMINISTRATION, INSURANCE CLAIMS ADMINISTRATION, INSURANCE CLAIMS PROCESSING, INSURANCE INFORMATION AND CONSULTANCY, INSURANCE UNDERWRITING SERVICES FOR ALL TYPES OF INSURANCE, INSURANCE UNDERWRITING CONSULTATION; FINANCIAL AFFAIRS, NAMELY, CREDIT AND FINANCIAL CONSULTATION, FINANCIAL ADVISORY AND CONSULTANCY SERVICES, FINANCIAL AFFAIRS AND MONETARY AFFAIRS, NAMELY, FINANCIAL INFORMATION, MANAGEMENT AND ANALYSIS SERVICES, FINANCIAL PLANNING, FINANCIAL RESEARCH, PROVIDING INFORMATION AND RESEARCH IN THE FIELD OF FINANCE AND FINAN-

CIAL INVESTMENTS; MONETARY AFFAIRS, NAMELY, MONETARY EXCHANGE, MONETARY STRATEGY CONSULTATION AND RESEARCH, CAPITAL INVESTMENT SERVICES; REAL ESTATE AFFAIRS, NAMELY, APPRAISAL OF REAL ESTATE, ASSESSMENT AND MANAGEMENT OF REAL ESTATE, REAL ESTATE AGENCIES, FINANCING OF REAL ESTATE DEVELOPMENT PROJECTS, LEASING OF REAL ESTATE, REAL ESTATE BROKERAGE, REAL ESTATE CONSULTATION, REAL ESTATE FINANCING SERVICES, REAL ESTATE INVESTMENT SERVICES (U.S. CLS. 100, 101 AND 102).

### **CLASS 37—CONSTRUCTION AND REPAIR**

FOR BUILDING CONSTRUCTION; REPAIR OF AIRCRAFT, ALARMS, AUTOMOBILES, BAGS, BICYCLES, BUILDINGS, BURGLAR ALARMS, CAMERAS, VEHICLES, SKIS, CLOCKS AND WATCHES, CLOTHING, COMPUTERS, ELECTRIC APPLIANCES, ELEVATORS, FIRE ALARMS, FURNACES, FURNITURE, GEM AND JEWELRY, HEATING EQUIPMENT, HOUSES, BUSINESS AND OFFICE MACHINERY AND EQUIPMENT, VENTILATING EQUIPMENT, AIR CONDITIONING EQUIPMENT, MACHINERY, RADIOS, REFRIGERATORS, TELEVISIONS, SOUND EQUIPMENT AND PARTS, SPORTS EQUIPMENT, TELECOMMUNICATION MACHINES AND APPARATUS, TOYS, AGRICULTURAL MACHINES AND IMPLEMENTS, CONSTRUCTION MACHINES AND APPARATUS, FIREARMS, LABORATORY APPARATUS AND INSTRUMENTS, MEASURING AND TESTING MACHINES AND INSTRUMENTS, MEDICAL MACHINES AND APPARATUS, METALWORKING MACHINES AND TOOLS, MINING MACHINES AND APPARATUS, PRINTING OR BOOKBINDING MACHINES AND APPARATUS, TELECOMMUNICATION MACHINES AND APPARATUS, TELEPHONE APPARATUS, TEXTILE MACHINES AND APPARATUS, VESSELS, MACHINES AND APPARATUS FOR PROCESSING FOODS, TELEVISIONS, VEHICLES; INSTALLATION SERVICES, NAMELY, COMPUTER INSTALLATION, ELECTRIC APPLIANCE INSTALLATION, ELEVATOR INSTALLATION, FIRE AND BURGLAR ALARM INSTALLATION, FURNACE INSTALLATION, HEATING EQUIPMENT INSTALLATION, AIR CONDITIONING APPARATUS INSTALLATION, INSTALLATION OF BUSINESS AND OFFICE MACHINERY AND EQUIPMENT, INSTALLATION OF HEATING, VENTILATING AND AIR CONDITIONING EQUIPMENT, INSTALLATION OF APPLIANCES, INSTALLATION OF COMPUTER SYSTEMS, INSTALLATION OF DOORS AND WINDOWS, INSTALLATION OF ELECTRICAL AND GENERATING MACHINERY, INSTALLATION OF KITCHEN APPLIANCES, INSTALLATION OF SECURITY SYSTEM, INSTALLATION OF TELEPHONE LINES, MACHINERY INSTALLATION, PLUMBING AND GAS AND WATER INSTALLATION, ROOFING INSTALLATION, TELEPHONE INSTALLATION, TILE INSTALLATION (U.S. CLS. 100, 103 AND 106).

### **CLASS 38—COMMUNICATION**

FOR TELECOMMUNICATIONS, NAMELY, AUDIO AND VIDEO BROADCASTING SERVICES OVER THE INTERNET, TRANSMISSION OF VOICE, AUDIO, VISUAL IMAGES AND DATA BY TELECOMMUNICATION NETWORKS, WIRELESS COMMUNICATIONS NETWORKS, THE INTERNET, INFORMATION SERVICES NETWORKS AND DATA NETWORKS, DATA TRANSMISSION AND RECEPTION SERVICES VIA TELECOMMUNICATION MEANS, DIGITAL NETWORK TELECOMMUNICATIONS SERVICES, LEASING OF TELECOMMUNICATION EQUIPMENT, PROVIDING ACCESS TO TELECOMMUNICATION NETWORKS, PROVIDING TELECOMMUNICATIONS CONNECTIONS TO A GLOBAL COMPUTER NETWORK, RENTAL OF TELECOMMUNICATIONS APPARATUS AND EQUIPMENT, TELECOMMUNICATION ACCESS SERVICES, TELECOMMUNICATION CONSULTATION IN THE NATURE OF TECHNICAL CONSULTING IN THE FIELD OF AUDIO, TEXT AND VISUAL DATA TRANSMISSION AND COMMUNICATION, LOCAL AND LONG DISTANCE TRANSMISSION OF VOICE, DATA, GRAPHICS BY MEANS OF TELEPHONE, TELEGRAPHIC, CABLE AND SATELLITE TRANSMISSIONS, TRANSMISSION OF WEBCASTS, WIRELESS TELEPHONE SERVICES, PROVIDING ADVANCED CALLING FEATURES,

TELECOMMUNICATIONS BY EMAIL, TELECOMMUNICATION CONSULTATION, TELECOMMUNICATION GATEWAY SERVICES, BROADCASTING OF RADIO AND TELEVISION PROGRAMMES, CELLULAR TELEPHONE SERVICES, ELECTRONIC DATA INTERCHANGE, ELECTRONIC MAIL SERVICES, ELECTRONIC MESSAGING, ELECTRONIC, ELECTRIC, AND DIGITAL TRANSMISSION OF VOICE, DATA, IMAGES, SIGNALS AND MESSAGES, FACSIMILE COMMUNICATION, FIXED AND MOBILE TELEPHONE SERVICES, INTERNATIONAL TELEPHONE SERVICES, INTERNET ACCESS PROVIDER SERVICES, INTERNET SERVICE PROVIDER SERVICES, MOBILE TELEPHONY, SATELLITE COMMUNICATION SERVICES, TELECONFERENCING AND VIDEO CONFERENCING SERVICES, TELEGRAM TRANSMISSION, TELEGRAPH SERVICES, TRANSMISSION OF MESSAGES, TRANSMISSION OF NEWS, VOICEMAIL SERVICES (U.S. CLS. 100, 101 AND 104).

### **CLASS 39—TRANSPORTATION AND STORAGE**

FOR TRANSPORT OF PERSONS AND GOODS; PACKAGING AND WAREHOUSING OF GOODS; STORAGE OF GOODS; SUPPLY CHAIN LOGISTICS AND REVERSE LOGISTICS SERVICES, NAMELY, STORAGE, TRANSPORTATION AND DELIVERY OF GOODS FOR OTHERS BY AIR, RAIL, SHIP OR TRUCK; ARRANGING TRAVEL TOURS (U.S. CLS. 100 AND 105).

### **CLASS 40—MATERIAL TREATMENT**

FOR TREATMENT OF MATERIALS, NAMELY, CHEMICAL TREATMENT OF TEXTILE, FUEL TREATMENT SERVICES, METAL TREATMENT, NUCLEAR WASTE TREATMENT, PAPER TREATMENT, PREPARATION AND TREATMENT OF FABRIC, TREATMENT OF MATERIALS, NAMELY, SEMI-PRECIOUS STONES, ARTICLES OF STONE, METALS AND GLASS MATERIALS, TREATMENT OF HAZARDOUS LIQUIDS, TREATMENT OF WASTE WATER, WASTE TREATMENT, WATER TREATMENT SERVICES, DYEING OF CLOTH OR CLOTHING, PROCESSING AND FINISHING OF GLASS, STAINING SERVICES (U.S. CLS. 100, 103 AND 106).

### **CLASS 41—EDUCATION AND ENTERTAINMENT**

FOR EDUCATIONAL SERVICES, NAMELY, CONDUCTING CLASSES, SEMINARS, CONFERENCES, LECTURES, AND WORKSHOPS IN THE FIELDS OF TRADE, BUSINESS, PRODUCT DEVELOPMENT, AND EXPORTS; PROVIDING OF TRAINING IN THE FIELDS OF TRADE, BUSINESS, PRODUCT DEVELOPMENT, AND EXPORTS; BUSINESS TRAINING; ENTERTAINMENT, NAMELY, ENTERTAINMENT INFORMATION, CONDUCTING FAIRS, ORGANIZING AND ARRANGING EXHIBITIONS FOR ENTERTAINMENT PURPOSES, PROVIDING INFORMATION, NEWS AND COMMENTARY IN THE FIELD OF ENTERTAINMENT; ORGANIZING COMMUNITY SPORTING AND CULTURAL EVENTS; ORGANIZATION OF SPORTS COMPETITIONS AND CULTURAL SHOWS; ORGANIZING AND HOSTING OF EVENTS FOR CULTURAL PURPOSES (U.S. CLS. 100, 101 AND 107).



**CLASS 42—SCIENTIFIC AND COMPUTER SERVICES**

FOR SCIENTIFIC, TECHNOLOGICAL, RESEARCH AND DESIGN SERVICES, NAMELY, PRODUCT DEVELOPMENT, PRODUCT DEVELOPMENT CONSULTATION, PRODUCT DEVELOPMENT AND ENGINEERING SERVICES FOR OTHERS, ARCHEOLOGICAL EXPLORATION AND RESEARCH, ARCHITECTURAL AND ENGINEERING SERVICES, AUTOMOTIVE DESIGN SERVICES, BACTERIOLOGICAL CONSULTATION, RESEARCH AND TESTING, BIOCHEMICAL RESEARCH AND DEVELOPMENT, BIOLOGICAL RESEARCH, BIOMEDICAL RESEARCH SERVICES, BUSINESS TECHNOLOGY SOFTWARE CONSULTATION SERVICES, CARTOGRAPHY AND MAPPING, CHEMICAL ENGINEERING, CHEMICAL, BIOCHEMICAL, BIOLOGICAL AND BACTERIOLOGICAL RESEARCH AND ANALYSIS, CIVIL ENGINEERING, COMPUTER AIDED GRAPHIC DESIGN, COMPUTER CONSULTATION, COMPUTER HARDWARE AND SOFTWARE CONSULTING SERVICES, COMPUTER PROGRAMMING, CREATING, MAINTAINING, DESIGNING AND IMPLEMENTING WEB SITES FOR OTHERS, CONSULTING IN THE FIELD OF INFORMATION TECHNOLOGY, DATABASE DESIGN AND DEVELOPMENT, DESIGNING OF MACHINES, APPARATUS, INSTRUMENTS INCLUDING THEIR PARTS OR SYSTEMS COMPOSED OF SUCH MACHINES, APPARATUS AND INSTRUMENTS, DIGITIZATION OF DOCUMENTS, DNA ANALYSIS SERVICES, DRAFTING, DRESS DESIGNING, ENVIRONMENTAL TESTING AND INSPECTION SERVICES, TECHNICAL CONSULTATION IN THE FIELD OF ENVIRONMENTAL SCIENCE, GRADING PRECIOUS STONES, GENOTYPING SERVICES FOR RESEARCH OR ANALYSIS PURPOSES, GEOLOGICAL PROSPECTING, GEOLOGICAL SURVEYS OR RESEARCH, GEOPHYSICAL EXPLORATION FOR THE OIL, GAS AND MINING INDUSTRIES, GRAPHIC DESIGN SERVICES, HOMEPAGE AND WEBPAGE DESIGN, HOSTING OF WEB SITES, HYDRAULIC ENGINEERING AND DESIGN, HYDROLOGICAL RESEARCH, INDUSTRIAL DESIGN, INFORMATION TECHNOLOGY CONSULTATION, INSPECTION, QUANTITY AND QUALITY CONTROL, SUPERVISION AND VERIFICATION OF THE QUALITY AND QUANTITY OF RAW MATERIALS, COMMODITIES, MANUFACTURED, SEMI-MANUFACTURED AND TRANSFORMED GOODS OR GOODS OF ANY OTHER NATURE AND THEIR CONFORMITY WITH NATIONAL AND INTERNATIONAL NORMS, LAWS, RULES, PRACTICE AND STANDARDS AND WITH CLIENTS, CONTRACTUAL REQUIREMENTS, INSTALLATION, MAINTENANCE AND REPAIR OF COMPUTER SOFTWARE, LAND AND ROAD SURVEYING, LAND USE PLANNING SERVICES, MECHANICAL ENGINEERING, MEDICAL RESEARCH, METEOROLOGICAL FORECASTING, MINING EXPLORATION AND MINERAL EXPLORATION SERVICES, OPTICAL LABORATORIES, PACKAGING DESIGN, PHARMACEUTICAL RESEARCH AND DEVELOPMENT, RADIO TOMOGRAPHIC IMAGING SERVICES, RESEARCH AND ANALYSIS IN THE FIELD OF MEDICINE, SCIENTIFIC RESEARCH AND DEVELOPMENT, TESTING OF RAW MATERIALS, TEXTILE TESTING, WATER ANALYSIS; INDUSTRIAL ANALYSIS AND RESEARCH SERVICES, NAMELY, CONDUCTING OF FEASIBILITY STUDIES, PRODUCT RESEARCH AND DEVELOPMENT, RESEARCH AND DEVELOPMENT OF NEW PRODUCTS, DESIGN AND TESTING FOR NEW PRODUCT DEVELOPMENT, AGRICULTURAL RESEARCH, DESIGN OF TEXTILES, DESIGN OF TELECOMMUNICATIONS APPARATUS AND EQUIPMENT, MATERIALS TESTING AND ANALYZING, PRODUCT TESTING, RESEARCH IN THE FIELD OF NATURAL RESOURCES, SURVEYING AND ENGINEERING, TRANSPORTATION AND TRAFFIC PLANNING SERVICES; DESIGN AND DEVELOPMENT OF COMPUTER HARDWARE AND SOFTWARE (U.S. CLS. 100 AND 101).

**CLASS 43—HOTEL AND RESTAURANT SERVICES**

FOR PROVIDING FOOD AND DRINK; PROVIDING TEMPORARY ACCOMMODATION (U.S. CLS. 100 AND 101).

**CLASS 44—MEDICAL, BEAUTY AND AGRICULTURAL SERVICES**

FOR MEDICAL SERVICES; VETERINARY SERVICES; HYGIENIC AND BEAUTY CARE FOR HUMAN BEINGS OR ANIMALS; PEST CONTROL SERVICES FOR AGRICULTURE, HORTICULTURE OR FORESTRY; AGRICULTURAL ADVICE, HORTICULTURAL SERVICES; FORESTRY MANAGEMENT SERVICES; ANIMAL HUSBANDRY, CONDUCTING SURVEYS OF FARMING ACTIVITIES AND CONSULTATION IN CONNECTION THEREWITH (U.S. CLS. 100 AND 101).

**CLASS 45—PERSONAL AND LEGAL SERVICES**

FOR LEGAL SERVICES; SECURITY SERVICES FOR THE PROTECTION OF PROPERTY AND INDIVIDUALS; PERSONAL AND SOCIAL SERVICES RENDERED BY OTHERS TO MEET THE NEEDS OF INDIVIDUALS, NAMELY, ADOPTION AGENCIES, BABYSITTING SERVICES, BEREAVEMENT CONSULTING, CHAPERONING, COMPUTER DATING SERVICES, CONSULTING IN THE FIELD OF PERSONAL RELATIONSHIPS, COUNSELING IN ETIQUETTE AND PROTOCOL, DATING SERVICES, FOSTER CARE, FUNERAL ARRANGEMENT SERVICES, GRIEF COUNSELING, INTERNET-BASED SOCIAL NETWORKING SERVICES, MARRIAGE COUNSELING, MATCHMAKING SERVICES, MINISTERIAL SERVICES, NANNY SERVICES, PERSONAL CONCIERGE SERVICES FOR OTHERS COMPRISING MAKING REQUESTED PERSONAL ARRANGEMENTS AND RESERVATIONS, RUNNING ERRANDS AND PROVIDING CUSTOMER SPECIFIC INFORMATION TO MEET INDIVIDUAL NEEDS, ALL RENDERED IN BUSINESS ESTABLISHMENTS, OFFICE BUILDINGS, HOTELS, RESIDENTIAL COMPLEXES AND HOMES, PERSONAL IMAGE CONSULTING SERVICES, PERSONAL LETTER WRITING, PERSONAL SHOPPING FOR OTHERS, PET SITTING, RUNNING ERRANDS FOR OTHERS, SPIRITUAL COUNSELING (U.S. CLS. 100 AND 101).

LINDA MICKLEBURGH, EXAMINING ATTORNEY

SN 79-089,685. DIRECT WAY S.A., B-1830 MACHELEN, BELGIUM, FILED 11-2-2010.

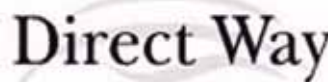

The logo for "Direct Way" features the words "Direct Way" in a serif font, with "Direct" on the top line and "Way" on the bottom line. The text is enclosed within a stylized, swirling graphic that resembles a three-bladed propeller or a swirl design.

OWNER OF INTERNATIONAL REGISTRATION 1057453 DATED 11-2-2010, EXPIRES 11-2-2020.

THE MARK CONSISTS OF THE STYLIZED WORDING "DIRECT WAY" ON TOP OF A SWIRL DESIGN CONSISTING OF THREE SWIRLED LINES.

**CLASS 39—TRANSPORTATION AND STORAGE**

FOR TRANSPORTING PEOPLE BY AUTOMOBILE, NAMELY, LIMOUSINE SERVICES; RENTAL OF LIMOUSINES WITH CHAUFFEURS; CHAUFFEUR SERVICES; ARRANGING OF TOURS (U.S. CLS. 100 AND 105).

**CLASS 41—EDUCATION AND ENTERTAINMENT**

FOR ORGANIZING COMMUNITY SPORTING AND CULTURAL EVENTS (U.S. CLS. 100, 101 AND 107).  
ROBERT STRUCK, EXAMINING ATTORNEY

SN 79-089,716. ORICA AUSTRALIA PTY LTD, AUSTRALIA, FILED 10-12-2010.



PRIORITY DATE OF 4-29-2010 IS CLAIMED.  
OWNER OF INTERNATIONAL REGISTRATION 1057566 DATED 10-12-2010, EXPIRES 10-12-2020.

THE MARK CONSISTS OF THE WORD "OPTEX". TO THE LEFT OF THE WORD IS AN OVAL SHAPED DESIGN WITH THREE CIRCLES, AND UNDER THE WORD IS A LINE.

**CLASS 1—CHEMICALS**

FOR CHEMICALS USED IN MINING, NAMELY, UNPROCESSED POLYMERS, LOW MOLECULAR WEIGHT UNPROCESSED POLYMERS; SURFACTANTS, NAMELY, IONIC SURFACTANTS FOR USE IN THE MANUFACTURE OF INDUSTRIAL PRODUCTS, NAMELY, FOR USE IN THE MANUFACTURE OF EXPLOSIVES AND LUBRICANT ADDITIVES; DETERGENTS FOR INDUSTRIAL USE; AMMONIUM NITRATE AND UREA FERTILIZER USED AS FERTILIZER ADDITIVES; WATER TREATMENT CHEMICALS; ALL OF THE FOREGOING EXCLUDING CHEMICAL ADDITIVES AND ADMIXTURES FOR USE IN OR ON CEMENT, MASONRY, MORTAR, CLAY, CONCRETE AND OTHER CEMENTITIOUS COMPOSITIONS AND STRUCTURES (U.S. CLS. 1, 5, 6, 10, 26 AND 46).

**CLASS 4—LUBRICANTS AND FUELS**

FOR INDUSTRIAL OILS AND GREASES; ALL PURPOSE LUBRICANTS; FUELS (U.S. CLS. 1, 6 AND 15).  
KATHERINE E. HALMEN, EXAMINING ATTORNEY

SN 79-089,896. ARCELORMITTAL-STAINLESS&NICKEL ALLOYS, FRANCE, FILED 11-8-2010.

# PHYNOX

OWNER OF INTERNATIONAL REGISTRATION 0176521 DATED 4-20-1954, EXPIRES 4-20-2014.

THE WORDING "PHYNOX" HAS NO MEANING IN A FOREIGN LANGUAGE.

**CLASS 6—METAL GOODS**

FOR METALS AND METAL ALLOYS; AND METAL HARDWARE, NAMELY, SPRINGS (U.S. CLS. 2, 12, 13, 14, 23, 25 AND 50).

**CLASS 7—MACHINERY**

FOR MACHINE PARTS, NAMELY, SPRINGS (U.S. CLS. 13, 19, 21, 23, 31, 34 AND 35).

**CLASS 12—VEHICLES**

FOR SPRINGS, NAMELY, LAND VEHICLE SUSPENSION PARTS, NAMELY, COIL SPRINGS AND LEAF SPRINGS; AND SPRINGS FOR LAND VEHICLE MOTORS (U.S. CLS. 19, 21, 23, 31, 35 AND 44).

**CLASS 14—JEWELRY**

FOR PRECIOUS METALS AND PRECIOUS METAL ALLOYS, PARTICULARLY FOR TIMEPIECES; AND TIMEPIECES MADE OF PRECIOUS METALS AND THEIR ALLOYS (U.S. CLS. 2, 27, 28 AND 50).  
KELLY TRUSILO, EXAMINING ATTORNEY

SN 79-089,994. ANTIOXIDAIR BV, NL-1017 CA AMSTERDAM, NETHERLANDS, FILED 10-22-2010.



PRIORITY DATE OF 6-8-2010 IS CLAIMED.  
OWNER OF INTERNATIONAL REGISTRATION 1058297 DATED 10-22-2010, EXPIRES 10-22-2020.

THE COLOR(S) GREY, WHITE AND PINK IS/ARE CLAIMED AS A FEATURE OF THE MARK.

THE MARK CONSISTS OF THE STYLIZED WORDING "FLY" IN WHITE, "FIT" IN PINK, AND BUBBLES ABOVE THE WORDING IN PINK AND WHITE ALL ON A PARTIAL OVAL GREY AND WHITE BACKGROUND.

**CLASS 29—MEATS AND PROCESSED FOODS**

FOR MEAT, FISH, POULTRY AND GAME; MEAT EXTRACTS; PRESERVED, DRIED AND COOKED FRUITS AND VEGETABLES; EGGS; DAIRY PRODUCTS, EXCLUDING ICE CREAM, ICE MILK AND FROZEN YOGURT; JELLIES, JAMS, COMPOTES; MILK AND MILK DRINKS CONTAINING FRUITS (U.S. CL. 46).

**CLASS 30—STAPLE FOODS**

FOR COFFEE AND COFFEE SUBSTITUTES; TEA, COCOA, DRINKING CHOCOLATE, NAMELY, CHOCOLATE FOOD BEVERAGES NOT BEING DAIRY-BASED OR VEGETABLE BASED; SUGAR, RICE, TAPIOCA, SAGO; FLOUR AND PREPARATIONS MADE FROM CEREALS, NAMELY, CEREAL BASED SNACK FOOD; CEREAL BASED ENERGY BARS; PASTA; NOODLES; BREAD, BISCUITS, CAKES, PASTRY; CHOCOLATE; CONFECTIONERY MADE OF SUGAR; ICE, ICES AND ICE CREAM; HONEY, TREACLE; SALT, MUSTARD; VINEGAR; SAUCES; PESTO; CONDIMENTS, NAMELY, CHUTNEYS; PROCESSED HERBS, SPICES (U.S. CL. 46).

**CLASS 32—LIGHT BEVERAGES**

FOR BEERS; MINERAL AND AERATED WATERS AND OTHER NON-ALCOHOLIC COCKTAILS; FRUIT DRINKS AND FRUIT JUICES; SYRUPS AND POWDERS USED IN THE PREPARATION OF SOFT DRINKS WITH AND WITHOUT ADDED VITAMINS AND MINERALS (U.S. CLS. 45, 46 AND 48).

TASNEEM HUSSAIN, EXAMINING ATTORNEY

SN 79-090,604. ORICA AUSTRALIA PTY LTD, AUSTRALIA, FILED 10-12-2010.

# OPTEX

THE MARK CONSISTS OF STANDARD CHARACTERS WITHOUT CLAIM TO ANY PARTICULAR FONT, STYLE, SIZE, OR COLOR.

PRIORITY DATE OF 4-29-2010 IS CLAIMED.  
OWNER OF INTERNATIONAL REGISTRATION 1060085 DATED 10-12-2010, EXPIRES 10-12-2020.

**CLASS 1—CHEMICALS**

FOR CHEMICALS USED IN MINING, NAMELY, UNPROCESSED POLYMERS; LOW MOLECULAR WEIGHT UNPROCESSED POLYMERS; SURFACTANTS, NAMELY, IONIC SURFACTANTS FOR USE IN THE MANUFACTURE OF INDUSTRIAL PRODUCTS, NAMELY, FOR USE IN THE MANUFACTURE OF EXPLOSIVES AND LUBRICANT ADDITIVES; DETERGENTS FOR INDUSTRIAL USE; AMMONIUM NITRATE AND UREA FERTILIZER USED AS FERTILIZER ADDITIVES; WATER TREATMENT CHEMICALS; ALL OF THE FOREGOING EXCLUDING CHEMICAL ADDITIVES AND ADMIXTURES FOR USE IN OR ON CEMENT, MASONRY, MORTAR, CLAY, CONCRETE AND OTHER CEMENTITIOUS COMPOSITIONS AND STRUCTURES (U.S. CLS. 1, 5, 6, 10, 26 AND 46).

**CLASS 4—LUBRICANTS AND FUELS**

FOR INDUSTRIAL OILS AND GREASES; ALL PURPOSE LUBRICANTS; FUELS (U.S. CLS. 1, 6 AND 15).

KATHERINE E. HALMEN, EXAMINING ATTORNEY

SN 79-090,627. JOH. RENDENBACH JR. GMBH & CO. KG, FED REP GERMANY, FILED 11-11-2010.



PRIORITY DATE OF 10-11-2010 IS CLAIMED.  
OWNER OF INTERNATIONAL REGISTRATION 1060165 DATED 11-11-2010, EXPIRES 11-11-2020.

THE MARK CONSISTS OF A STYLIZED SHIELD RESEMBLING AN ANIMAL HIDE WITH THREE ACORNS AND THREE OAK LEAVES IN THE CENTER.

**CLASS 18—LEATHER GOODS**

FOR LEATHER, UNWORKED OR SEMI-WORKED; SADDLERY (U.S. CLS. 1, 2, 3, 22 AND 41).

**CLASS 25—CLOTHING**

FOR SHOE SOLES; SHOE HEELS (U.S. CLS. 22 AND 39).

**CLASS 37—CONSTRUCTION AND REPAIR**

FOR SHOE REPAIR (U.S. CLS. 100, 103 AND 106).

TASNEEM HUSSAIN, EXAMINING ATTORNEY

SN 79-090,748. MARTELA OYJ, HELSINKI, FINLAND, FILED 11-19-2010.

# Martela

PRIORITY DATE OF 9-14-2010 IS CLAIMED.  
OWNER OF INTERNATIONAL REGISTRATION 1060483 DATED 11-19-2010, EXPIRES 11-19-2020.  
OWNER OF U.S. REG. NO. 2,938,520.

**CLASS 20—FURNITURE AND ARTICLES NOT OTHERWISE CLASSIFIED**

FOR FURNITURE, FURNITURE FOR OFFICES AND PUBLIC AREAS (U.S. CLS. 2, 13, 22, 25, 32 AND 50).

**CLASS 35—ADVERTISING AND BUSINESS**

FOR RETAIL STORE SERVICES FOR FURNITURE (U.S. CLS. 100, 101 AND 102).

**CLASS 37—CONSTRUCTION AND REPAIR**

FOR REPAIR OF FURNITURE; INSTALLATION OF FURNITURE (U.S. CLS. 100, 103 AND 106).

**CLASS 39—TRANSPORTATION AND STORAGE**

FOR TRANSPORT OF FURNITURE FOR OTHERS (U.S. CLS. 100 AND 105).

BERNICE MIDDLETON, EXAMINING ATTORNEY

SN 79-090,830. MICROSENS BIOPHAGE LIMITED, UNITED KINGDOM, FILED 10-7-2010.

# MICROSENS

THE MARK CONSISTS OF STANDARD CHARACTERS WITHOUT CLAIM TO ANY PARTICULAR FONT, STYLE, SIZE, OR COLOR.

PRIORITY DATE OF 7-15-2010 IS CLAIMED.  
OWNER OF INTERNATIONAL REGISTRATION 1060639 DATED 10-7-2010, EXPIRES 10-7-2020.

**CLASS 1—CHEMICALS**

FOR CHEMICAL PRODUCTS FOR USE IN CHEMICAL ASSAYS AND MICROBIOLOGICAL ASSAYS; ASSAY KITS FOR CONDUCTING CHEMICAL ASSAYS; CULTURES OF MICRO-ORGANISMS; BACTERIA, PHAGE, CELLS OR VIRUSES; CULTURE MEDIA (U.S. CLS. 1, 5, 6, 10, 26 AND 46).

**CLASS 5—PHARMACEUTICALS**

FOR ASSAY KITS FOR MEDICAL DIAGNOSTIC USE; REAGENTS IN KIT FORM FOR CONDUCTING MEDICAL AND VETERINARY ASSAYS; CULTURES OF MICRO-ORGANISMS, BACTERIA, PHAGE, CELLS, AND VIRUSES, ALL BEING MEDICAL OR VETERINARY DIAGNOSTIC REAGENTS FOR USE IN TESTING PATIENT SAMPLES FOR MICRO-ORGANISMS FOR MEDICAL OR VETERINARY PURPOSES; MICROBIOLOGICAL CULTURE MEDIA FOR MEDICAL OR VETERINARY PURPOSES (U.S. CLS. 6, 18, 44, 46, 51 AND 52).

**CLASS 9—ELECTRICAL AND SCIENTIFIC APPARATUS**

FOR LABORATORY APPARATUS, NAMELY, APPARATUS FOR CONTACTING MAGNETIC BEADS WITH SAMPLES FOR ANALYSIS, APPARATUS FOR COLLECTING MAGNETIC BEADS FROM A LIQUID, APPARATUS FOR WASHING MAGNETIC BEADS, AND APPARATUS FOR ELUTING ANALYTE FROM MAGNETIC BEADS, ASSAY WELLS, TEST TUBE HOLDER BLOCKS, MAGNETIC MICROSCOPE SLIDE CARRIERS; FLUORESCENCE MICROSCOPY APPARATUS; DOWNLOADABLE ELECTRONIC DATA IN COMPUTER READABLE FORM RELATING TO CHEMICAL AND MICROBIOLOGICAL ASSAYS; OPTICAL DISCS AND ELECTRONIC MEMORIES, ALL BEARING ENCODED DATA IN COMPUTER READABLE FORM RELATING TO CHEMICAL AND MICROBIOLOGICAL ASSAYS; BIOLOGICAL SAFETY CABINETS FOR LABORATORY USE (U.S. CLS. 21, 23, 26, 36 AND 38).

**CLASS 10—MEDICAL APPARATUS**

FOR APPARATUS AND INSTRUMENTS FOR THE CONDUCT OF ASSAYS RELATING TO MEDICAL DIAGNOSTICS (U.S. CLS. 26, 39 AND 44).  
NAKIA HENRY, EXAMINING ATTORNEY

**CLASS 16—PAPER GOODS AND PRINTED MATTER**

FOR PAPER, CARDBOARD AND GOODS MADE FROM THESE MATERIALS, NAMELY, ADHESIVE PRODUCT LABELS, PRINTED PRODUCT LABELS, PAPER USED IN LAMINATION, LINERS FOR CIGARETTE BOXES, GIFT WRAP PAPER AND PAPER OR CARDBOARD PRINTED WITH HOLOGRAMS; METALIZED, LAMINATED AND COATED PAPER AND CARDBOARD AND GOODS MADE FROM THESE MATERIALS, NAMELY, ADHESIVE PRODUCT LABELS, PRINTED PRODUCT LABELS, LINERS FOR CIGARETTE BOXES, GIFT WRAP PAPER AND PAPER OR CARDBOARD PRINTED WITH HOLOGRAMS; PLASTIC FILM FOR PACKAGING AND WRAPPING FOR HOUSEHOLD, RESIDENTIAL AND STATIONERY PURPOSES; METALIZED PLASTIC FILM FOR HOUSEHOLD, RESIDENTIAL AND STATIONERY PURPOSES; WOVEN, NON-WOVEN AND FIBER-BASED PAPER AND CELLOPHANE PAPER SUBSTRATES; WOVEN, NON-WOVEN AND FIBER-BASED PRINT SUBSTRATES, NAMELY, TRANSPARENT, OPAQUE AND TRANSLUCENT FILMS FOR USE WITH INKJET PRINTERS, INKJET COPIERS AND LASER PRINTERS; PACKAGING MATERIALS MADE OF METALIZED, LAMINATED AND/OR COATED PAPER OR CARDBOARD (U.S. CLS. 2, 5, 22, 23, 29, 37, 38 AND 50).

**CLASS 17—RUBBER GOODS**

FOR PLASTIC FILM FOR COMMERCIAL AND INDUSTRIAL USE; METALIZED PLASTICS IN THE FORM OF SHEETS, FILMS, BLOCKS, RODS AND TUBES; SEMI-FINISHED PLASTICS MATERIAL IN THE FORM OF FILMS FOR COMMERCIAL AND INDUSTRIAL USE AND NOT FOR THE MANUFACTURING OF SHOE STIFFENING MATERIALS; WOVEN, NON-WOVEN AND FIBER-BASED SUBSTRATES PRIMARILY MADE OF SYNTHETIC POLYMERS, PLASTICS OR REGENERATED CELLOPHANE (U.S. CLS. 1, 5, 12, 13, 35 AND 50).

**CLASS 40—MATERIAL TREATMENT**

FOR SERVICES OF COATING OF METAL, PAPER, CARDBOARD, FOIL, PLASTIC, TISSUES, TEXTILES, AND WOVEN, NON-WOVEN AND FIBER-BASED SUBSTRATES; METALIZING AND LAMINATING OF METAL, PAPER, CARDBOARD, FOIL, PLASTIC, TISSUES, TEXTILES, AND WOVEN, NON-WOVEN AND FIBER-BASED SUBSTRATES (U.S. CLS. 100, 103 AND 106).  
STEVEN JACKSON, EXAMINING ATTORNEY

SN 79-090,842. AR METALLIZING, BELGIUM, FILED 11-5-2010.

**ROTOFLEX**

THE MARK CONSISTS OF STANDARD CHARACTERS WITHOUT CLAIM TO ANY PARTICULAR FONT, STYLE, SIZE, OR COLOR.  
PRIORITY DATE OF 5-13-2010 IS CLAIMED.  
OWNER OF INTERNATIONAL REGISTRATION 1060675 DATED 11-5-2010, EXPIRES 11-5-2020.

SN 79-090,877. DIGITAL DARWIN, BESLOTEN VENNootSCHAP MET BEPERKTE AANSPRAKELIJKHEID, BELGIUM, FILED 9-8-2010.

**L2**

THE MARK CONSISTS OF STANDARD CHARACTERS WITHOUT CLAIM TO ANY PARTICULAR FONT, STYLE, SIZE, OR COLOR.  
PRIORITY DATE OF 3-8-2010 IS CLAIMED.  
OWNER OF INTERNATIONAL REGISTRATION 1060754 DATED 9-8-2010, EXPIRES 9-8-2020.

**CLASS 9—ELECTRICAL AND SCIENTIFIC APPARATUS**

FOR COMPUTER SOFTWARE FOR PROCESSING DIGITAL FILES FOR USE IN CONNECTION WITH CONTROLLING PROJECTION AND DISPLAY TECHNOLOGY, LED AND LASER LIGHTS AND CONTROLLING LASER TECHNOLOGY; COMPUTER HARDWARE FOR USE IN CONNECTION WITH CONTROLLING PROJECTION AND DISPLAY TECHNOLOGY, LED AND LASER LIGHTS AND CONTROLLING LASER TECHNOLOGY; BLANK MAGNETIC DATA CARRIERS; BLANK CD-ROMS, CD'S, CASSETTES, DISKETTES, DISCS FOR RECORDING DATA; VIDEO RECORDINGS FEATURING COMPUTER INSTRUCTION ABOUT DIGITAL IMAGING; LASERS FOR INDUSTRIAL PURPOSES; LASER EQUIPMENT FOR NON-MEDICAL PURPOSES; DIGITAL SIGNAL PROCESSORS FOR USE IN TRANSMITTING SIGNALS FOR USE IN CONTROLLING LASER LIGHTS; COMPUTERS FOR USE IN CONNECTION WITH CONTROLLING PROJECTION AND DISPLAY TECHNOLOGY, LED AND LASER LIGHTS AND CONTROLLING LASER TECHNOLOGY; COMPUTER SOFTWARE FOR SECURING ACCESS TO THE INTERNET AND INTRANET COMMUNICATION NETWORKS; DIGITAL IMAGING DEVICES, NAMELY, VIDEO PROJECTORS, LIQUID CRYSTAL DISPLAY (LCD) PROJECTORS AND LCD LARGE SCREEN DISPLAYS; DIGITAL TELECOMMUNICATIONS AND DIGITAL VIDEO DISPLAY UNITS, NAMELY, DIGITAL CELLULAR PHONES, DIGITAL BOOK READERS, DIGITAL CONTENT SERVERS, DIGITAL MEDIA RECEIVERS, MONITORS, PROJECTORS AND DISPLAYS; AND DIGITAL PERSONAL ELECTRONIC DATA ORGANIZERS (U.S. CLS. 21, 23, 26, 36 AND 38).

**CLASS 41—EDUCATION AND ENTERTAINMENT**

FOR EDUCATION, NAMELY, PROVIDING COURSES OF INSTRUCTION IN THE FIELD OF CONTROLLING PROJECTION AND DISPLAY TECHNOLOGY, LED AND LASER LIGHTS AND CONTROLLING LASER TECHNOLOGY; PROVIDING OF TRAINING IN THE FIELD OF CONTROLLING PROJECTION AND DISPLAY TECHNOLOGY, LED AND LASER LIGHTS AND CONTROLLING LASER TECHNOLOGY; ENTERTAINMENT, NAMELY, LASER LIGHT SHOWS, PROJECTING FILM AND OTHER PRESENTATIONS, PROJECTIONS WITH AN ENTERTAINMENT VALUE AMONGST OTHERS FILMS AND VIDEO CONTENTS; ARRANGING OF EVENTS FOR CULTURAL PURPOSES; ARRANGING OF EVENTS FOR EDUCATIONAL OR RECREATIONAL PURPOSES, NAMELY, EDUCATIONAL EXHIBITIONS FEATURING PROJECTION AND DISPLAY TECHNOLOGY, LED AND LASER LIGHTS AND CONTROLLING LASER TECHNOLOGY, LIVE MUSIC CONCERTS, AND LASER LIGHT SHOWS, PROVIDING STREAMS OF IMAGES DURING CONCERT PERFORMANCES AND PROVIDING PRE-RECORDED IMAGES TO BE SHOWN DURING CONCERT PERFORMANCES; PROVIDING DIGITAL IMAGES, DIGITAL FILMS AND OTHER TYPES OF DIGITAL INFORMATION, NAMELY, DIGITAL PUBLISHING SERVICES; DIGITAL POST-PRODUCTION RELATING TO PROJECTION AND DISPLAY TECHNOLOGY AND LED AND LASER LIGHT TECHNOLOGY, NAMELY, DIGITAL MULTIMEDIA PRODUCTION; AND DIGITAL IMAGING SERVICES FOR USE IN THE FIELD OF PROJECTION AND DISPLAY TECHNOLOGY AND LED AND LASER LIGHT TECHNOLOGY (U.S. CLS. 100, 101 AND 107).

**CLASS 42—SCIENTIFIC AND COMPUTER SERVICES**

FOR CREATING AND MAINTAINING WEB SITES FOR OTHERS; WEB HOSTING; INFORMATION TECHNOLOGY SERVICES, NAMELY, INFORMATION TECHNOLOGY CONSULTATION; DESIGN, DEVELOPMENT, WRITING, UPDATING AND IMPLEMENTING OF COMPUTER SOFTWARE FOR USE IN CONNECTION WITH CONTROLLING PROJECTION AND DISPLAY TECHNOLOGY, LED AND LASER TECHNOLOGY; GRAPHIC DESIGN AND COMMERCIAL ART DESIGN; DESIGN AND DEVELOPMENT OF PROJECTION TECHNOLOGY FOR HOME CINEMA, DIGITAL CINEMA AND OTHER FORMS OF ENTERTAINMENT FOR OTHERS (U.S. CLS. 100 AND 101).

PATRICIA EVANKO, EXAMINING ATTORNEY

SN 79-090,889. ADEY HOLDINGS (2008) LIMITED, UNITED KINGDOM, FILED 10-27-2010.

**MAGNACLEANSE**

THE MARK CONSISTS OF STANDARD CHARACTERS WITHOUT CLAIM TO ANY PARTICULAR FONT, STYLE, SIZE, OR COLOR.

OWNER OF INTERNATIONAL REGISTRATION 1060778 DATED 10-27-2010, EXPIRES 10-27-2020.

OWNER OF U.S. REG. NO. 3,892,039.

**CLASS 9—ELECTRICAL AND SCIENTIFIC APPARATUS**

FOR APPARATUS AND INSTRUMENTS FOR CONDITION MONITORING, NAMELY, INDICATORS FOR MONITORING THE LEVEL AND CONTENT OF FLUID CONTAINED IN CENTRAL HEATING AND COOLING SYSTEMS; APPARATUS AND INSTRUMENTS FOR MONITORING FLUID, NAMELY, INDICATORS FOR MONITORING THE LEVEL AND CONTENT OF FLUID CONTAINED IN CENTRAL HEATING AND COOLING SYSTEMS; WATER TESTING APPARATUS AND INSTRUMENTS FOR MONITORING AND DETECTING CONTAMINATION; WATER MONITORING APPARATUS AND INSTRUMENTS FOR MONITORING AND DETECTING CONTAMINATION; APPARATUS AND INSTRUMENTS FOR TESTING CENTRAL HEATING WATER NAMELY, A PLASTIC WATER TESTER DEVICE CONTAINING A MAGNET FOR USE IN TESTING FOR THE EFFECTS OF CORROSION IN THE SYSTEM; APPARATUS AND INSTRUMENTS FOR MONITORING CENTRAL HEATING WATER FOR CONTAMINATION; PARTS AND FITTINGS FOR ALL OF THE AFORESAID GOODS (U.S. CLS. 21, 23, 26, 36 AND 38).

**CLASS 11—ENVIRONMENTAL CONTROL APPARATUS**

FOR APPARATUS AND INSTALLATIONS FOR HEATING AND WATER SUPPLY, NAMELY, LIQUID FILTERS FOR THE CLEANING AND MAINTENANCE OF CENTRAL HEATING AND COOLING SYSTEMS AND FLUID CONTAINED THEREIN; CENTRAL HEATING APPARATUS AND INSTALLATIONS, NAMELY, LIQUID FILTERS FOR THE CLEANING AND MAINTENANCE OF CENTRAL HEATING AND COOLING SYSTEMS AND FLUID CONTAINED THEREIN; MAGNETIC FILTERS BEING PARTS OF HOUSEHOLD OR INDUSTRIAL INSTALLATIONS FOR THE CLEANING AND MAINTENANCE OF CENTRAL HEATING AND COOLING SYSTEMS AND FLUID CONTAINED THEREIN; NON-MAGNETIC FILTERS BEING PARTS OF HOUSEHOLD OR INDUSTRIAL INSTALLATIONS FOR THE CLEANING AND MAINTENANCE OF CENTRAL HEATING AND COOLING SYSTEMS AND FLUID CONTAINED THEREIN; POWER FLUSHING FILTERS BEING PARTS OF HOUSEHOLD OR INDUSTRIAL INSTALLATIONS FOR THE CLEANING AND MAINTENANCE OF CENTRAL HEATING AND COOLING SYSTEMS AND FLUID CONTAINED THEREIN; MAGNETIC FILTERS BEING PARTS OF CENTRAL HEATING APPARATUS AND

INSTALLATIONS FOR THE CLEANING AND MAINTENANCE OF CENTRAL HEATING AND COOLING SYSTEMS AND FLUID CONTAINED THEREIN; NON-MAGNETIC FILTERS BEING PARTS OF CENTRAL HEATING APPARATUS AND INSTALLATIONS FOR THE CLEANING AND MAINTENANCE OF CENTRAL HEATING AND COOLING SYSTEMS AND FLUID CONTAINED THEREIN; POWER FLUSHING FILTERS BEING PARTS OF CENTRAL HEATING APPARATUS AND INSTALLATIONS FOR THE CLEANING AND MAINTENANCE OF CENTRAL HEATING AND COOLING SYSTEMS AND FLUID CONTAINED THEREIN; MAGNETIC FILTERS BEING FOR USE IN CENTRAL HEATING SYSTEMS FOR THE CLEANING AND MAINTENANCE OF CENTRAL HEATING AND COOLING SYSTEMS AND FLUID CONTAINED THEREIN; NON-MAGNETIC FILTERS BEING FOR USE IN CENTRAL HEATING SYSTEMS FOR THE CLEANING AND MAINTENANCE OF CENTRAL HEATING AND COOLING SYSTEMS AND FLUID CONTAINED THEREIN; POWER FLUSHING FILTERS BEING FOR USE IN CENTRAL HEATING SYSTEMS FOR THE CLEANING AND MAINTENANCE OF CENTRAL HEATING AND COOLING SYSTEMS AND FLUID CONTAINED THEREIN; WATER FILTRATION APPARATUS AND INSTALLATIONS FOR THE CLEANING AND MAINTENANCE OF CENTRAL HEATING AND COOLING SYSTEMS AND FLUID CONTAINED THEREIN; WATER FILTRATION APPARATUS AND INSTALLATIONS FOR CENTRAL HEATING APPARATUS AND INSTALLATIONS, NAMELY, LIQUID FILTERS FOR THE CLEANING AND MAINTENANCE OF FLUID CONTAINED THEREIN; PARTS AND FITTINGS FOR ALL OF THE AFORESAID GOODS (U.S. CLS. 13, 21, 23, 31 AND 34).

SN 79-091,008. MARTELA OYJ, HELSINKI, FINLAND, FILED 11-19-2010.



#### CLASS 37—CONSTRUCTION AND REPAIR

FOR CLEANING SERVICES, NAMELY, CENTRAL HEATING AND COOLING SYSTEM FLUSHING; HEATING AND WATER SUPPLY SYSTEM CLEANING SERVICES, NAMELY, POWER FLUSHING SERVICES; CENTRAL HEATING SYSTEM CLEANING SERVICES; INFORMATION, ADVISORY AND CONSULTANCY SERVICES RELATING TO ALL OF AFOREMENTIONED SERVICES (U.S. CLS. 100, 103 AND 106).

MICHAEL WIENER, EXAMINING ATTORNEY

SN 79-090,909. FLUX-GERÄTE GMBH, FED REP GERMANY, FILED 11-26-2010.

# FLUXTRONIC

THE MARK CONSISTS OF STANDARD CHARACTERS WITHOUT CLAIM TO ANY PARTICULAR FONT, STYLE, SIZE, OR COLOR.

PRIORITY DATE OF 6-11-2010 IS CLAIMED.

OWNER OF INTERNATIONAL REGISTRATION 1060836 DATED 11-26-2010, EXPIRES 11-26-2020.

#### CLASS 7—MACHINERY

FOR CONTAINER PUMPS, NAMELY, PUMPS FOR TRANSFERRING LIQUIDS OUT OF BARRELS AND CONTAINERS, CENTRIFUGAL PUMPS (U.S. CLS. 13, 19, 21, 23, 31, 34 AND 35).

#### CLASS 9—ELECTRICAL AND SCIENTIFIC APPARATUS

FOR QUANTITY INDICATORS, NAMELY, LEVEL INDICATORS, FLOW VOLUME MEASURING APPARATUS, NAMELY, FLOW METERS (U.S. CLS. 21, 23, 26, 36 AND 38).

MARLENE BELL, EXAMINING ATTORNEY

PRIORITY DATE OF 9-14-2010 IS CLAIMED.

OWNER OF INTERNATIONAL REGISTRATION 1061129 DATED 11-19-2010, EXPIRES 11-19-2020.

OWNER OF U.S. REG. NO. 2,938,520.

THE MARK CONSISTS OF A RECTANGLE FEATURING THE WORDING "INSPIRING SPACES" IN THE UPPER RIGHT CORNER AND THE WORDING "MARTELA" ACROSS THE BOTTOM OF THE RECTANGLE.

#### CLASS 20—FURNITURE AND ARTICLES NOT OTHERWISE CLASSIFIED

FOR FURNITURE, FURNITURE FOR OFFICES AND PUBLIC AREAS (U.S. CLS. 2, 13, 22, 25, 32 AND 50).

#### CLASS 35—ADVERTISING AND BUSINESS

FOR RETAIL STORE SERVICES FOR FURNITURE (U.S. CLS. 100, 101 AND 102).

#### CLASS 37—CONSTRUCTION AND REPAIR

FOR REPAIR OF FURNITURE; INSTALLATION OF FURNITURE (U.S. CLS. 100, 103 AND 106).

#### CLASS 39—TRANSPORTATION AND STORAGE

FOR TRANSPORT OF FURNITURE FOR OTHERS (U.S. CLS. 100 AND 105).

BERNICE MIDDLETON, EXAMINING ATTORNEY

SN 79-091,009, MARTELA OYJ, HELSINKI, FINLAND,  
FILED 11-19-2010.



PRIORITY DATE OF 9-14-2010 IS CLAIMED.  
OWNER OF INTERNATIONAL REGISTRATION 1061130  
DATED 11-19-2010, EXPIRES 11-19-2020.  
OWNER OF U.S. REG. NO. 2,938,520.  
THE MARK CONSISTS OF A RECTANGLE FEATURING  
THE WORDING "MARTELA" ACROSS THE BOTTOM OF  
THE RECTANGLE.

**CLASS 20—FURNITURE AND ARTICLES NOT  
OTHERWISE CLASSIFIED**

FOR FURNITURE, FURNITURE FOR OFFICES AND  
PUBLIC AREAS (U.S. CLS. 2, 13, 22, 25, 32 AND 50).

**CLASS 35—ADVERTISING AND BUSINESS**

FOR RETAIL STORE SERVICES FOR FURNITURE  
(U.S. CLS. 100, 101 AND 102).

**CLASS 37—CONSTRUCTION AND REPAIR**

FOR REPAIR OF FURNITURE; INSTALLATION OF  
FURNITURE (U.S. CLS. 100, 103 AND 106).

**CLASS 39—TRANSPORTATION AND STO-  
RAGE**

FOR TRANSPORT OF FURNITURE FOR OTHERS  
(U.S. CLS. 100 AND 105).  
BERNICE MIDDLETON, EXAMINING ATTORNEY

**CLASS 9—ELECTRICAL AND SCIENTIFIC  
APPARATUS**

FOR COMPUTER PROGRAMS FOR SMARTPHONES,  
NAMELY, AN APPLICATION FOR DIAGNOSING AN  
INDIVIDUAL'S DRIVING STYLE AND BEHAVIOR BY  
MEASURING ACCELERATING, BRAKING AND  
STEERING MOTIONS; COMPUTER PROGRAMS FOR  
DIAGNOSING AN INDIVIDUAL'S DRIVING STYLE  
AND BEHAVIOR BY MEASURING ACCELERATING,  
BRAKING AND STEERING MOTIONS; COMPUTERS;  
SMARTPHONES (U.S. CLS. 21, 23, 26, 36 AND 38).

**CLASS 42—SCIENTIFIC AND COMPUTER  
SERVICES**

FOR PROVIDING TEMPORARY USE OF ONLINE  
NON-DOWNLOADABLE SOFTWARE FOR SMART-  
PHONES THAT ALLOWS APPLICATION DOWNLOADS;  
COMPUTER PROGRAMMING (U.S. CLS. 100 AND 101).  
CHARLES L. JENKINS, EXAMINING ATTORNEY

SN 79-091,209, KALTENBACH GMBH + CO. KG, FED REP  
GERMANY, FILED 10-12-2010.



SN 79-091,157, DATA TEC CO., LTD., JAPAN, FILED 11-19-  
2010.

s a f e t y r e c

THE MARK CONSISTS OF STANDARD CHARACTERS  
WITHOUT CLAIM TO ANY PARTICULAR FONT, STYLE,  
SIZE, OR COLOR.

PRIORITY DATE OF 10-28-2010 IS CLAIMED.  
OWNER OF INTERNATIONAL REGISTRATION 1061387  
DATED 11-19-2010, EXPIRES 11-19-2020.

PRIORITY DATE OF 4-16-2010 IS CLAIMED.  
OWNER OF INTERNATIONAL REGISTRATION 1061569  
DATED 10-12-2010, EXPIRES 10-12-2020.

THE COLOR(S) TURQUOISE IS/ARE CLAIMED AS A  
FEATURE OF THE MARK.

THE MARK CONSISTS OF THE WORD "KALTENBACH"  
APPEARING IN TURQUOISE BELOW A TURQUOISE  
SQUARE CONTAINING ONE CURVED EDGE TRIANGLE  
AND ONE CHEVRON. THE COLOR WHITE IN THE MARK  
REPRESENTS BACKGROUND AND IS NOT CLAIMED AS  
A FEATURE OF THE MARK.

**CLASS 4—LUBRICANTS AND FUELS**

FOR COOLING LUBRICANTS FOR INDUSTRIAL  
MACHINERY (U.S. CLS. 1, 6 AND 15).



**CLASS 7—MACHINERY**

FOR TRANSPORTING EQUIPMENT, NAMELY, ROLLER CONVEYORS AND CROSS BELT CONVEYORS FOR THE SUPPLY AND CARRYING OF WORK PIECES, MATERIAL WEBS, PROFILES AND SHEETS TO PROCESSING MACHINES AND LENGTH STOPS; INDUSTRIAL ROBOTS FOR THE SUPPLY AND CARRYING OF WORK PIECES, MATERIAL WEBS, PROFILES AND PLATES; MECHANICAL TOOLS, NAMELY, CIRCULAR POWER SAW BLADES, ENDLESS POWER SAW BLADES, SHEARING BLADES FOR SHEARING MACHINES, POWER DRILLS, THREAD MILLING CUTTERS, PUNCHING DIES, CUTTING TORCHES AND PLASMA CUTTING TORCHES, WELDING TORCHES, COOLING LUBRICANT APPARATUS IN THE NATURE OF POWER OPERATED LUBRICANT DISPENSERS FOR MACHINES; MACHINES FOR THE METAL MACHINING AND FINISHING, NAMELY, CIRCULAR COLD SAW CUTTING MACHINES, ENDLESS SAW BLADE CUTTING MACHINES, DRILLING MACHINES FOR THE MACHINING OF STRUCTURAL STEEL PROFILES; GAS-OPERATED BLOW TORCH INDUSTRIAL ROBOTS FOR THE MACHINING OF STRUCTURAL STEEL PROFILES; DRILLING AND GAS OPERATED BLOW TORCH CUTTING MACHINES FOR THE MACHINING OF STEEL SHEETS; PUNCHING/HEAVY INSTALLATIONS, NAMELY, PUNCHING PRESSES FOR THE MACHINING OF STRUCTURAL STEEL PROFILES, IN PARTICULAR FLAT STEEL, CORNER STEELS AND U-BENT PROFILES; PRESERVATION INSTALLATIONS, NAMELY, SHOT BLASTING AND PAINTING MACHINES FOR THE MACHINING OF STRUCTURAL STEEL PROFILES AND SHEETS; INDUSTRIAL ROBOT WELDING MACHINES FOR PRODUCING WELDED CONSTRUCTIONS FOR STEEL CONSTRUCTION WORK; MARKING AND NUMBERING MACHINES, NAMELY, ELECTROMECHANICAL MARKING MACHINES; SHARPENING MACHINES FOR SAW BLADES, ENDLESS POWER SAW BLADES AND POWER DRILLS AS WELL AS SINGLE STRUCTURAL PARTS, WEAR STRUCTURAL PARTS AND REPLACEMENT STRUCTURAL PARTS FOR THE AFORESAID GOODS, AS FAR AS INCLUDED IN THIS CLASS (U.S. CLS. 13, 19, 21, 23, 31, 34 AND 35).

**CLASS 9—ELECTRICAL AND SCIENTIFIC APPARATUS**

FOR LENGTH MEASURING APPARATUS FOR TRANSPORTING EQUIPMENT AND MACHINE TOOLS, NAMELY, LENGTH MEASURING GAUGES; DOWNLOADABLE COMPUTER SOFTWARE FOR THE OPERATION OF MACHINES, FOR THE MANAGEMENT OF ORDER DATA, FOR CUTTING DATA AND MATERIAL DATA AND FOR THE OPTIMIZATION OF PRODUCTION SEQUENCES AND PRODUCTION STEPS, FOR THE COMMUNICATION WITH SUPERIOR CONTROL SYSTEMS SUCH AS CAD SYSTEMS OR ERP SYSTEMS FOR THE VISUALIZATION, SUPERVISION AND CONTROL AND OPERATIONAL PROCESSES (U.S. CLS. 21, 23, 26, 36 AND 38).

KATHERINE E. HALMEN, EXAMINING ATTORNEY

SN 79-091,285. PEAK SCIENTIFIC INSTRUMENTS LIMITED, UNITED KINGDOM, FILED 10-22-2010.



PRIORITY DATE OF 4-29-2010 IS CLAIMED.  
OWNER OF INTERNATIONAL REGISTRATION 1061781 DATED 10-22-2010, EXPIRES 10-22-2020.

NO CLAIM IS MADE TO THE EXCLUSIVE RIGHT TO USE "SCIENTIFIC", APART FROM THE MARK AS SHOWN. THE COLOR(S) GREEN, ORANGE, RED, BLUE, BLACK IS/ARE CLAIMED AS A FEATURE OF THE MARK.

GREEN APPLIES TO THE TEXT "SCIENTIFIC" AND THE TOP PORTION OF THE PYRAMID LOGO; ORANGE APPLIES TO LEFT HAND SIDE OF THE MIDDLE PORTION OF THE PYRAMID LOGO; RED APPLIES TO THE MIDDLE PORTION OF THE PYRAMID LOGO; BLUE APPLIES TO THE BOTTOM PORTION OF THE PYRAMID LOGO; AND BLACK TO THE TEXT "PEAK".

**CLASS 7—MACHINERY**

FOR COMPRESSORS FOR GAS GENERATORS; PUMPS FOR GAS GENERATORS; PARTS AND FITTINGS FOR ALL OF THE AFOREMENTIONED GOODS (U.S. CLS. 13, 19, 21, 23, 31, 34 AND 35).

**CLASS 11—ENVIRONMENTAL CONTROL APPARATUS**

FOR ELECTROCHEMICAL GAS GENERATION EQUIPMENT, NAMELY, ELECTROCHEMICAL GAS GENERATORS; COMPONENT PARTS OF ELECTROCHEMICAL GAS GENERATORS SOLD AS A UNIT THEREWITH, NAMELY, FILTER ELEMENTS, HYDROGEN CELLS, MEMBRANES, CARBON MOLECULAR SIEVES, AIR COMPRESSORS AND CATALYST CHAMBERS; INTEGRAL PARTS OF ELECTROCHEMICAL GAS GENERATORS SOLD AS A UNIT THEREWITH, NAMELY, SOLENOID VALVES, MOTHERBOARDS AND PCBs; ELECTROCHEMICAL GAS GENERATORS; ELECTROCHEMICAL GAS GENERATORS FOR LABORATORY USE; NOZZLES BEING PARTS OF ELECTROCHEMICAL GAS GENERATORS; INERT ELECTROCHEMICAL GAS GENERATORS; PARTS AND FITTINGS FOR INERT ELECTROCHEMICAL GAS GENERATORS; HYDROGEN GENERATORS; NITROGEN GENERATORS; ZERO AIR ELECTROCHEMICAL GENERATORS FOR PRODUCING GAS; DRY AIR ELECTROCHEMICAL GENERATORS FOR PRODUCING GAS; GAS PURIFIERS; GAS CONCENTRATORS; FUEL PROCESSORS; STEAM GENERATORS; STEAM REFORMERS; OXYGEN GENERATORS FOR LABORATORY USE; COMPRESSORS BEING PARTS OF ELECTROCHEMICAL GAS GENERATORS AND SOLD AS A UNIT THEREWITH; PUMPS BEING PART OF ELECTROCHEMICAL GAS GENERATORS AND SOLD AS A UNIT THEREWITH; TOTAL ORGANIC CARBON GENERATORS; PARTS AND FITTINGS FOR ALL OF THE AFOREMENTIONED GOODS (U.S. CLS. 13, 21, 23, 31 AND 34).

**CLASS 37—CONSTRUCTION AND REPAIR**

FOR MAINTENANCE, SERVICING AND REPAIR OF GAS GENERATION EQUIPMENT AND COMPONENTS; INFORMATION, ADVISORY AND CONSULTANCY SERVICES RELATING TO ALL OF THE AFOREMENTIONED SERVICES (U.S. CLS. 100, 103 AND 106).

ALICIA COLLINS, EXAMINING ATTORNEY

SN 79-091,340. CHEMTEX ITALIA SRL, I-15057 TORTONA, ITALY, FILED 12-7-2010.

THE MARK CONSISTS OF STANDARD CHARACTERS WITHOUT CLAIM TO ANY PARTICULAR FONT, STYLE, SIZE, OR COLOR.

PRIORITY DATE OF 11-23-2010 IS CLAIMED.  
OWNER OF INTERNATIONAL REGISTRATION 1061907 DATED 12-7-2010, EXPIRES 12-7-2020.

THE ENGLISH TRANSLATION OF "PROESA" IN THE MARK IS "SKILL", "PROWESS" OR "BRAVERY".



**CLASS 1—CHEMICALS**

FOR INDUSTRIAL CHEMICALS; CHEMICAL FEEDSTOCKS FOR INDUSTRIAL USE (U.S. CLS. 1, 5, 6, 10, 26 AND 46).

**CLASS 4—LUBRICANTS AND FUELS**

FOR FUELS, IN PARTICULAR BIO-FUELS (U.S. CLS. 1, 6 AND 15).

**CLASS 9—ELECTRICAL AND SCIENTIFIC APPARATUS**

FOR APPARATUS AND INSTRUMENTS, NAMELY, AGITATORS, COOLERS, FILTERS, HEAT EXCHANGERS, CYCLONES, PLATES AND FRAMES, CENTRIFUGES, PUMPS, TANKS, GEARS OR LOBES, VESSELS, DRUMS, REACTORS, MIXERS, NOZZLES, CONVEYORS, COMPRESSORS, DISCHARGERS, FEEDERS, STEAMERS, AND DECOMPRESSION DEVICES FOR PROCESSING AND CONVERTING BIOMASS TO CHEMICAL FEEDSTOCK; CHEMISTRY APPARATUS AND INSTRUMENTS, NAMELY, AGITATORS, COOLERS, FILTERS, HEAT EXCHANGERS, CYCLONES, PLATES AND FRAMES, CENTRIFUGES, PUMPS, TANKS, GEARS OR LOBES, VESSELS, DRUMS, REACTORS, MIXERS, NOZZLES, CONVEYORS, COMPRESSORS, DISCHARGERS, FEEDERS, STEAMERS, AND DECOMPRESSION DEVICES FOR PROCESSING AND CONVERTING BIOMASS TO CHEMICAL FEEDSTOCK (U.S. CLS. 21, 23, 26, 36 AND 38).

**CLASS 40—MATERIAL TREATMENT**

FOR PROCESSING AND CONVERSION OF BIOMASS TO CHEMICAL FEEDSTOCKS; CONSULTANCY RELATING TO THE PROCESSING AND CONVERSION OF BIOMASS TO CHEMICAL FEEDSTOCKS (U.S. CLS. 100, 103 AND 106).

FLORENTINA BLANDU, EXAMINING ATTORNEY

SN 79-091,374, HOCER GMBH, FED REP GERMANY, FILED 11-5-2010.



THE MARK CONSISTS OF STANDARD CHARACTERS WITHOUT CLAIM TO ANY PARTICULAR FONT, STYLE, SIZE, OR COLOR.

PRIORITY DATE OF 5-28-2010 IS CLAIMED.  
OWNER OF INTERNATIONAL REGISTRATION 1061989 DATED 11-5-2010, EXPIRES 11-5-2020.

**CLASS 9—ELECTRICAL AND SCIENTIFIC APPARATUS**

FOR RECORDED AND DOWNLOADABLE COMPUTER APPLICATION PROGRAMS, IN PARTICULAR FOR MOBILE TERMINALS FOR ELECTRONIC STORAGE, DISPLAY, CONVERSION AND ENCRYPTION OF DATA; APPARATUS FOR TRANSMISSION OF SOUND, IMAGES OR DATA, IN PARTICULAR MOBILE TERMINALS (U.S. CLS. 21, 23, 26, 36 AND 38).

**CLASS 38—COMMUNICATION**

FOR TELECOMMUNICATIONS, NAMELY, ELECTRONIC TRANSMISSION OF DATA AND DOCUMENTS AND FACILITATING TRANSACTIONS VIA MOBILE AND STATIONARY COMPUTER TERMINALS (U.S. CLS. 100, 101 AND 104).

**CLASS 42—SCIENTIFIC AND COMPUTER SERVICES**

FOR SCIENTIFIC AND TECHNOLOGICAL SERVICES AND RESEARCH AND DESIGN RELATING THERETO, NAMELY, TESTING, DESIGN AND DEVELOPMENT OF MOBILE TELEPHONE AND WEB APPLICATION SOFTWARE; DESIGN AND DEVELOPMENT OF COMPUTER HARDWARE AND SOFTWARE, IN PARTICULAR FOR MOBILE TERMINALS (U.S. CLS. 100 AND 101).

**CLASS 45—PERSONAL AND LEGAL SERVICES**

FOR SECURITY SERVICES FOR THE PROTECTION OF PROPERTY AND INDIVIDUALS, NAMELY, PROVIDING AUTHENTICATION OF PERSONAL IDENTIFICATION INFORMATION VIA SECURE STORAGE AND TRANSMITTING SUCH INFORMATION VIA THE INTERNET; PERSONAL AND SOCIAL SERVICES RENDERED BY OTHERS TO MEET THE NEEDS OF INDIVIDUALS, IN PARTICULAR USING MOBILE TERMINALS, NAMELY, ONLINE SOCIAL NETWORKING, AND COMPUTER SOCIAL MATCHING SERVICES (U.S. CLS. 100 AND 101).

APRIL ROACH, EXAMINING ATTORNEY

SN 79-091,473, OTTO BOCK SCHAUMSYSTEME GMBH, FED REP GERMANY, FILED 11-25-2010.



THE MARK CONSISTS OF STANDARD CHARACTERS WITHOUT CLAIM TO ANY PARTICULAR FONT, STYLE, SIZE, OR COLOR.

PRIORITY DATE OF 9-13-2010 IS CLAIMED.  
OWNER OF INTERNATIONAL REGISTRATION 1062259 DATED 11-25-2010, EXPIRES 11-25-2020.

**CLASS 1—CHEMICALS**

FOR CHEMICALS USED IN INDUSTRY AND SCIENCE, NAMELY, POLYURETHANE FOR USE IN THE MANUFACTURE OF POLYURETHANE FOAM; UNPROCESSED ARTIFICIAL RESINS, UNPROCESSED PLASTICS; ADHESIVES FOR INDUSTRIAL PURPOSES (U.S. CLS. 1, 5, 6, 10, 26 AND 46).

**CLASS 17—RUBBER GOODS**

FOR GOODS OF PLASTICS AS SEMI-FINISHED PRODUCTS, NAMELY, CUSHIONING OF POLYURETHANE IN THE NATURE OF STUFFING; PACKING MATERIALS OF RUBBER OR PLASTICS, NAMELY, STUFFING COMPOSED OF POLYURETHANE FOR USE IN THE FURNITURE INDUSTRY AND IN THE MANUFACTURE OF MATTRESSES, MATTRESS TOPPERS AND CUSHIONS (U.S. CLS. 1, 5, 12, 13, 35 AND 50).

**CLASS 20—FURNITURE AND ARTICLES NOT OTHERWISE CLASSIFIED**

FOR GOODS OF PLASTICS, NAMELY, MATTRESSES, PILLOWS AND CUSHIONS MADE OF POLYURETHANE FOR BEDDING AND SEATING (U.S. CLS. 2, 13, 22, 25, 32 AND 50).

MARK SHINER, EXAMINING ATTORNEY

SN 79-091,476. MIVENION GMBH, 10115 BERLIN, FED REP GERMANY, FILED 6-2-2010.

## RHEUMASCANLITE

THE MARK CONSISTS OF STANDARD CHARACTERS WITHOUT CLAIM TO ANY PARTICULAR FONT, STYLE, SIZE, OR COLOR.

PRIORITY DATE OF 12-2-2009 IS CLAIMED.

OWNER OF INTERNATIONAL REGISTRATION 1062264 DATED 6-2-2010, EXPIRES 6-2-2020.

THE WORDING "RHEUMASCANLITE" HAS NO MEANING IN A FOREIGN LANGUAGE.

### CLASS 9—ELECTRICAL AND SCIENTIFIC APPARATUS

FOR SOFTWARE, FOR USE IN MEDICAL AND MEDICAL TECHNOLOGICAL IMAGING APPARATUS FOR DIAGNOSTIC PURPOSES; APPARATUS FOR RECORDING AND TRANSMISSION OF IMAGES, IN PARTICULAR OPTICAL APPARATUS AND INSTRUMENTS, AND IMAGE RECORDING APPARATUS; REPLACEMENT PARTS OF ALL THE AFOREMENTIONED APPARATUS AND INSTRUMENTS (U.S. CLS. 21, 23, 26, 36 AND 38).

### CLASS 10—MEDICAL APPARATUS

FOR MEDICAL AND TECHNICAL MEDICAL APPARATUS AND EQUIPMENT, NAMELY, ELECTROMAGNETIC MEDICAL DIAGNOSTIC IMAGING APPARATUS FOR DIAGNOSTIC IMAGING; REPLACEMENT PARTS FOR THE AFORESAID APPARATUS (U.S. CLS. 26, 39 AND 44).

### CLASS 44—MEDICAL, BEAUTY AND AGRICULTURAL SERVICES

FOR MEDICAL SERVICES, IN PARTICULAR MEDICAL DIAGNOSTIC PROCESSES AND EVALUATION THEREOF, AND MEDICAL IMAGING DIAGNOSTIC PROCESSES; MEDICAL CONSULTATIONS WITH REGARD TO PROPER DIAGNOSIS FROM MEDICAL AND TECHNICAL MEDICAL APPARATUS RESULTS; MEDICAL CONSULTANCY WITH REGARD TO NON-RESEARCH MEDICAL AND TECHNICAL MEDICAL DIAGNOSTIC PROCESSES (U.S. CLS. 100 AND 101).

FRED CARL, EXAMINING ATTORNEY

SN 79-091,540. ROYER BRANDS INTERNATIONAL SARL, LUXEMBOURG, FILED 11-29-2010.

## VON DUTCH

THE MARK CONSISTS OF STANDARD CHARACTERS WITHOUT CLAIM TO ANY PARTICULAR FONT, STYLE, SIZE, OR COLOR.

PRIORITY DATE OF 6-22-2010 IS CLAIMED.

OWNER OF INTERNATIONAL REGISTRATION 1062295 DATED 11-29-2010, EXPIRES 11-29-2020.

OWNER OF U.S. REG. NOS. 2,380,173, 3,356,955 AND OTHERS.

THE NAME(S), PORTRAIT(S), AND/OR SIGNATURE(S) SHOWN IN THE MARK DOES NOT IDENTIFY A PARTICULAR LIVING INDIVIDUAL.

### CLASS 14—JEWELRY

FOR PRECIOUS METALS AND THEIR ALLOYS; JEWELRY; PRECIOUS STONES; CLOCKS AND CHRONOMETRIC INSTRUMENTS; GOLD AND SILVER WARE OTHER THAN CUTLERY, FORKS AND SPOONS, NAMELY, RINGS, NECKLACES, BRACELETS, EARRINGS, BROOCHES, TIE PINS, ORNAMENTAL PINS; COLLECTIBLE OR COMMEMORATIVE COINS; RINGS BEING JEWELRY; EARRINGS; BRACELETS BEING JEWELRY; BROOCHES BEING JEWELRY; NECKLACES BEING JEWELRY; TIE PINS; ORNAMENTS BEING JEWELRY, NAMELY, ORNAMENTAL PINS, HAT ORNAMENTS OF PRECIOUS METAL, SHOE ORNAMENTS OF PRECIOUS METAL; WORKS OF ART OF PRECIOUS METAL; JEWELRY CASES; WATCHES; CHRONOGRAPHS AS WATCHES; CASES, WRISTBANDS, CHAINS, SPRINGS OR GLASSES FOR WATCHES; NOVELTY KEY RINGS OF PRECIOUS METAL, STATUES OR FIGURINES OR STATUETTES OF PRECIOUS METAL; BOXES AND CASES FOR TIMEPIECES AND JEWELRY; MEDALS (U.S. CLS. 2, 27, 28 AND 50).

### CLASS 18—LEATHER GOODS

FOR LEATHER AND IMITATIONS OF LEATHER; GOODS MADE OF THESE MATERIALS AND NOT INCLUDED IN OTHER CLASSES, NAMELY, LEATHER HANDBAGS, LEATHER PURSES, LEATHER BAGS AND WALLETS; ANIMAL SKINS; TRUNKS AND TRAVELING BAGS; UMBRELLAS, PARASOLS AND WALKING STICKS; CARD CASES AND NOTECASES, NAMELY, BUSINESS CARD CASES, NAME CARD CASES, CREDIT CARD CASES; LEATHER KEY CASES; ATTACHE CASES; BRIEFCASES; ANIMAL SKIN, NAMELY, MOLESKIN AS AN IMITATION OF LEATHER; IMITATION LEATHER; SUNSHADE PARASOLS, BAGS FOR CLIMBERS IN THE NATURE OF ALL-PURPOSE CARRYING BAGS; BAGS FOR CAMPERS IN THE NATURE OF BACKPACKS; TRAVELING BAGS, BEACH BAGS, SCHOOL BAGS; CASES SPECIALLY DESIGNED TO CONTAIN TOILETRY ARTICLES, SOLD EMPTY; LEATHER TRAVELING SETS IN THE NATURE OF KIT BAGS, LUGGAGE; LEATHER AND IMITATION LEATHER BOXES, BUSINESS CASES, CASES FOR MAKE-UP PRODUCTS, SOLD EMPTY; UNFITTED TOILETRY AND MAKE-UP BAGS, SOLD EMPTY; WALLETS, PURSES NOT OF PRECIOUS METAL; COLLARS OR COVERS FOR ANIMALS; SHOPPING NETS OR BAGS, NAMELY, MESH SHOPPING BAGS, TEXTILE SHOPPING BAGS; BAGS OR SMALL BAGS IN THE NATURE OF ENVELOPES AND POUCHES FOR PACKAGING MERCHANDISE, MADE OF LEATHER; BAGS FOR SPORTS (U.S. CLS. 1, 2, 3, 22 AND 41).

### CLASS 25—CLOTHING

FOR CLOTHING, NAMELY, FOOTWEAR, HEADGEAR IN THE NATURE OF HEADWEAR; SHIRTS; LEATHER OR IMITATION LEATHER CLOTHING, NAMELY, PANTS, SHIRTS, TROUSERS, COATS; FEMINE CLOTHING ARTICLES, NAMELY, LINGERIE, SKIRTS AND DRESSES; HOODS AS CLOTHING; BELTS AS CLOTHING; GLOVES AS CLOTHING; SCARVES; NECKTIES, HOŠIERY; SOCKS; SLIPPERS; BEACH, SKI OR SPORTS FOOTWEAR; BABIES' DIAPERS OF TEXTILE; OVERALLS; SHIRTS; CHEMISSETTES; TEE-SHIRTS; COMBINATIONS AS CLOTHING; SLIPS AS UNDERGARMENTS; SUITS; TROUSERS; JACKETS; PULLOVERS; WAISTCOATS; SWEATERS; FROCKS; SHIRT YOKES; SHIRT FRONTS; FINISHED, READY-MADE LININGS AS PARTS OF CLOTHING; COATS; STUFF JACKETS; PELERINES; GABARDINES AS CLOTHING; WATERPROOF CLOTHING, NAMELY, RAINCOATS; FINISHED TEXTILE POCKETS FOR CLOTHING; POCKET SQUARES; JERSEYS AS CLOTHING; KNITWEAR AS CLOTHING, NAMELY, SWEATERS; UNDERWEAR; DRESSING GOWNS; PAJAMAS; CAPS; SASHES FOR WEAR (U.S. CLS. 22 AND 39).

JAMES MACFARLANE, EXAMINING ATTORNEY

SN 79-091,563. THOMAS GEISHAUSER, 84384 WITTIBREUT,  
FED REP GERMANY, FILED 10-28-2010.

# SAMBA

THE MARK CONSISTS OF STANDARD CHARACTERS WITHOUT CLAIM TO ANY PARTICULAR FONT, STYLE, SIZE, OR COLOR.

PRIORITY DATE OF 4-29-2010 IS CLAIMED.  
OWNER OF INTERNATIONAL REGISTRATION 1062346  
DATED 10-28-2010, EXPIRES 10-28-2020.

## CLASS 5—PHARMACEUTICALS

FOR FODDER ADDITIVES FOR MEDICAL PURPOSES; FODDER ADDITIVES FOR PIGS FOR MEDICAL PURPOSES; FODDER ADDITIVES WITH MINERAL NUTRIENTS FOR MEDICAL PURPOSES (U.S. CLS. 6, 18, 44, 46, 51 AND 52).

## CLASS 31—NATURAL AGRICULTURAL PRODUCTS

FOR FOODSTUFF FOR ANIMALS; FOODSTUFF FOR PIGS (U.S. CLS. 1 AND 46).  
TOBY BULLOFF, EXAMINING ATTORNEY

SN 79-091,679. GABBRIELLI FRANCO, ITALY, FILED 10-27-2010.



PRIORITY DATE OF 6-17-2010 IS CLAIMED.  
OWNER OF INTERNATIONAL REGISTRATION 1062657  
DATED 10-27-2010, EXPIRES 10-27-2020.

THE COLOR(S) LIGHT BLUE AND DARK BLUE IS/ARE CLAIMED AS A FEATURE OF THE MARK.

THE MARK CONSISTS OF THE WORDING "DON'T WORRY BE .. GABS" IN FANCY PROFILED DARK BLUE CHARACTERS, WRITTEN IN A CIRCULAR MANNER INSIDE A LIGHT BLUE CIRCLE; BETWEEN THE WORDS "GABS" AND "DON'T" THERE IS A LITTLE PROFILED SIX-POINTED STAR OUTLINED IN DARK BLUE AND BETWEEN THE TERMS "BE" AND "GABS" THERE ARE TWO PROFILED SUSPENSION POINTS OR ELLIPSIS OUTLINED IN DARK BLUE.

## CLASS 18—LEATHER GOODS

FOR HANDBAGS, SHOULDER BAGS, LUGGAGE; GARMENT BAGS FOR TRAVEL, TRAVELLING BAGS, BEACH BAGS, CLUTCH BAGS, ALL PURPOSE SPORTS BAGS, ATTACHE CASES, SCHOOL BAGS, TOTE BAGS, CANVAS SHOPPING BAGS, LEATHER SHOPPING BAGS, DOCUMENT CASES FOR HOLDING NOTES; NAME CARD CASES; UNFITTED VANITY CASES; KEY CASES, KNAPSACKS, RUCKSACKS, BRIEFCASES, PURSES, WALLETS, TRAVELLING TRUNKS, SUIT-CASES; LEATHER AND IMITATION LEATHER; BANDS OF LEATHER (U.S. CLS. 1, 2, 3, 22 AND 41).

## CLASS 26—FANCY GOODS

FOR BUTTONS; SNAP FASTENERS; ZIPPERS; ZIP FASTENERS FOR BAGS; ORNAMENTAL NOVELTY PINS; BROOCHES BEING CLOTHING ACCESSORIES; LACE TRIMMINGS; ORNAMENTAL NOVELTY BUTTONS; TASSELS BEING HABERDASHERY; BUCKLES FOR CLOTHING (U.S. CLS. 37, 39, 40, 42 AND 50).  
GINA FINK, EXAMINING ATTORNEY

SN 79-091,777. DEVIREX AG, SWITZERLAND, FILED 11-25-2010.

# LIPIVIR

THE MARK CONSISTS OF STANDARD CHARACTERS WITHOUT CLAIM TO ANY PARTICULAR FONT, STYLE, SIZE, OR COLOR.

PRIORITY DATE OF 11-18-2010 IS CLAIMED.  
OWNER OF INTERNATIONAL REGISTRATION 1062963  
DATED 11-25-2010, EXPIRES 11-25-2020.

THE WORDING "LIPIVIR" HAS NO MEANING IN A FOREIGN LANGUAGE.

## CLASS 3—COSMETICS AND CLEANING PREPARATIONS

FOR COSMETICS (U.S. CLS. 1, 4, 6, 50, 51 AND 52).

## CLASS 5—PHARMACEUTICALS

FOR PHARMACEUTICAL AND VETERINARY PRODUCTS, NAMELY, DERMATOLOGICAL PRODUCTS FOR TOPICAL USE (U.S. CLS. 6, 18, 44, 46, 51 AND 52).

## CLASS 44—MEDICAL, BEAUTY AND AGRICULTURAL SERVICES

FOR HYGIENIC AND BEAUTY CARE FOR HUMAN BEINGS OR ANIMALS (U.S. CLS. 100 AND 101).  
THOMAS MANOR, EXAMINING ATTORNEY

SN 79-091,778. DEVIREX AG, SWITZERLAND, FILED 11-25-2010.

# DEVIREX

THE MARK CONSISTS OF STANDARD CHARACTERS WITHOUT CLAIM TO ANY PARTICULAR FONT, STYLE, SIZE, OR COLOR.

PRIORITY DATE OF 11-18-2010 IS CLAIMED.  
OWNER OF INTERNATIONAL REGISTRATION 1062964  
DATED 11-25-2010, EXPIRES 11-25-2020.

THE WORDING "DEVIREX" HAS NO MEANING IN A FOREIGN LANGUAGE.

**CLASS 3—COSMETICS AND CLEANING PREPARATIONS**

FOR COSMETICS (U.S. CLS. 1, 4, 6, 50, 51 AND 52).

**CLASS 5—PHARMACEUTICALS**

FOR PHARMACEUTICAL AND VETERINARY PRODUCTS, NAMELY, DERMATOLOGICAL PRODUCTS FOR TOPICAL USE (U.S. CLS. 6, 18, 44, 46, 51 AND 52).

**CLASS 44—MEDICAL, BEAUTY AND AGRICULTURAL SERVICES**

FOR HYGIENIC AND BEAUTY CARE FOR HUMAN BEINGS OR ANIMALS (U.S. CLS. 100 AND 101).  
THOMAS MANOR, EXAMINING ATTORNEY

**CLASS 9—ELECTRICAL AND SCIENTIFIC APPARATUS**

FOR SCIENTIFIC, NAUTICAL, SURVEYING, PHOTOGRAPHIC, CINEMATOGRAPHIC, OPTICAL, WEIGHING, MEASURING, SIGNALING, CHECKING AND SUPERVISING, LIFE-SAVING AND TEACHING APPARATUS AND INSTRUMENTS, IN THE FIELD OF SOLAR ENERGY, NAMELY, SOLAR CONCENTRATORS IN THE NATURE OF LENSES, FRESNEL LENSES, OPTICS FOR CONCENTRATING SOLAR ENERGY, SECONDARY CONCENTRATING RECEIVER OPTICS, LIGHTGUIDES, OPTICAL REFLECTORS, SOLAR RAY REFLECTORS, PHOTOVOLTAIC SOLAR MODULES FOR THE PRODUCTION OF ELECTRICITY, SOLAR CELLS, SOLAR INSTALLATIONS IN THE NATURE OF HIGH CONCENTRATION PHOTOVOLTAIC MODULES, LOW CONCENTRATION PHOTOVOLTAIC MODULES, THIN FILM PHOTOVOLTAIC INSTALLATIONS, CRYSTALLINE PHOTOVOLTAIC INSTALLATIONS, SOLAR HYBRID INSTALLATION SOLAR TRACKERS IN THE NATURE OF SINGLE AXIS SOLAR TRACKERS, TWO-AXIS SOLAR TRACKERS, SOLAR PANELS FOR PRODUCTION OF ELECTRICITY, SOLAR ACCUMULATORS, PHOTO-ELECTRIC TUBES, TROUGH COLLECTOR TUBES, SOLAR PANEL ARRAYS IN THE NATURE OF HIGH CONCENTRATION PHOTOVOLTAIC ARRAYS, LOW CONCENTRATION PHOTOVOLTAIC ARRAYS, THIN FILM PHOTOVOLTAIC ARRAYS, CRYSTALLINE PHOTOVOLTAIC ARRAYS, OPTICAL LENSES, ELECTRONIC SENSORS FOR MEASURING SOLAR RADIATION; APPARATUS AND INSTRUMENTS FOR CONDUCTING, DISTRIBUTING, CONVERTING, STORING, REGULATING OR CONTROLLING ELECTRICITY, NAMELY, SOLAR GENERATORS IN THE NATURE OF PHOTOVOLTAIC SOLAR GENERATORS, SOLAR CONVERTERS, SOLAR INVERTERS, SOLAR POWER INSTALLATIONS IN THE NATURE OF HIGH CONCENTRATION PHOTOVOLTAIC INSTALLATIONS, LOW CONCENTRATION PHOTOVOLTAIC INSTALLATIONS, THIN FILM PHOTOVOLTAIC INSTALLATIONS, CRYSTALLINE PHOTOVOLTAIC INSTALLATIONS, ENERGY STORAGE APPARATUS IN THE NATURE OF PHOTOVOLTAIC ENERGY STORAGE APPARATUS, SOLAR CELL CONNECTORS IN THE NATURE OF PHOTOVOLTAIC CELL CONNECTORS, PHOTOVOLTAIC SOLAR MODULES FOR PRODUCTION OF ELECTRICITY, CURRENT TRANSFORMERS, ELECTRIC CIRCUITS FOR SOLAR CELLS AND SOLAR ELEMENTS, SOLAR BATTERIES, SOLAR WAFERS; SOLAR POWERED APPARATUS FOR RECORDING, TRANSMITTING, REPRODUCING SOUNDS OR IMAGES (U.S. CLS. 21, 23, 26, 36 AND 38).

SN 79-091,818. ABENGOA SOLAR, S.A., SPAIN, FILED 11-2-2010.

**CLASS 37—CONSTRUCTION AND REPAIR**

FOR CONSTRUCTION, REPAIR, INSTALLATION AND MAINTENANCE SERVICES, NAMELY, CONSTRUCTION, REPAIR, INSTALLATION AND MAINTENANCE OF INDUSTRIAL PLANTS FOR THE PRODUCTION OF ENERGY AND SOLAR THERMAL AND PHOTOVOLTAIC INSTALLATIONS (U.S. CLS. 100, 103 AND 106).  
LINDA ORNDORFF, EXAMINING ATTORNEY

**Firefly**

SN 79-091,827. MEDTRON AG, FED REP GERMANY, FILED 10-1-2010.

**Accutron**

THE MARK CONSISTS OF STANDARD CHARACTERS WITHOUT CLAIM TO ANY PARTICULAR FONT, STYLE, SIZE, OR COLOR.

PRIORITY DATE OF 5-5-2010 IS CLAIMED.  
OWNER OF INTERNATIONAL REGISTRATION 1063065 DATED 11-2-2010, EXPIRES 11-2-2020.

THE MARK CONSISTS OF STANDARD CHARACTERS WITHOUT CLAIM TO ANY PARTICULAR FONT, STYLE, SIZE, OR COLOR.

OWNER OF INTERNATIONAL REGISTRATION 1063109 DATED 10-1-2010, EXPIRES 10-1-2020.

**CLASS 10—MEDICAL APPARATUS**

FOR ARTIFICIAL LIMBS, EYES AND TEETH; SUTURE MATERIALS; MEDICAL DISPOSABLES, NAMELY, SYRINGES FOR MEDICAL PURPOSES, CANNULAE, CATHETERS; DRIP CHAMBERS, NEEDLES FOR MEDICAL PURPOSES; INFUSION LINES AND PERFUSION LINES FOR MEDICAL USE; ACTIVE MEDICAL DEVICES, NAMELY, INJECTION SYRINGES FOR INJECTION OF CONTRAST AGENT, HIGH PRESSURE INJECTORS FOR APPLICATION OF LIQUIDS (U.S. CLS. 26, 39 AND 44).

**CLASS 37—CONSTRUCTION AND REPAIR**

FOR INSTALLATION, MAINTENANCE AND REPAIR OF MEDICAL EQUIPMENT (U.S. CLS. 100, 103 AND 106).

NICHOLAS ALTREE, EXAMINING ATTORNEY

**CLASS 41—EDUCATION AND ENTERTAINMENT**

FOR ORGANIZATION OF EXHIBITIONS FOR CULTURAL, EDUCATIONAL, SPORTING AND ENTERTAINMENT PURPOSES; ENTERTAINMENT SERVICES, NAMELY, CONDUCTING FAIRS, NOT FOR COMMERCIAL PURPOSES; ARRANGING AND CONDUCTING OF EDUCATIONAL AND ENTERTAINMENT EVENTS IN THE NATURE OF CONVENTIONS, CONFERENCES, CONGRESSES, SEMINARS, SYMPOSIUMS IN THE FIELD OF COSMETICS, PERFUMERY AND BEAUTY PRODUCTS; ARRANGING AND CONDUCTING OF WORKSHOPS IN THE FIELD OF COSMETICS, PERFUMERY AND BEAUTY PRODUCTS (U.S. CLS. 100, 101 AND 107).

APRIL ROACH, EXAMINING ATTORNEY

SN 79-091,836. PROREALTIME, FRANCE, FILED 12-23-2010.

SN 79-091,829. FIERE INTERNAZIONALI DI BOLOGNA S.P.A. - BOLOGNAFIERE O IN FORMA ABBREVIATA BOLOGNAFIERE S.P.A., ITALY, FILED 11-17-2010.



PRIORITY DATE OF 7-1-2010 IS CLAIMED.  
OWNER OF INTERNATIONAL REGISTRATION 1063116 DATED 11-17-2010, EXPIRES 11-17-2020.

NO CLAIM IS MADE TO THE EXCLUSIVE RIGHT TO USE "HAIR", APART FROM THE MARK AS SHOWN.

THE MARK CONSISTS OF A SIGN DEPICTING THE WORD "ON" IN FANCY CHARACTERS PLACED ABOVE THE WORD "HAIR" OF A SMALLER SIZE AND IT ALSO IN FANCY CHARACTERS, ALL CONTAINED INSIDE A SUBSTANTIALLY RECTANGULAR LABEL WITHOUT A TRIANGULAR PORTION AT THE UPPER LEFT CORNER.

**CLASS 35—ADVERTISING AND BUSINESS**

FOR ORGANIZATION OF EXHIBITIONS FOR COMMERCIAL OR ADVERTISING PURPOSES; ARRANGING AND ORGANIZING TRADE SHOWS AND TRADE FAIRS FOR COMMERCIAL AND ADVERTISING PURPOSES; ADMINISTRATIVE MANAGEMENT OF EXHIBITION, CONVENTION AND FAIR FACILITIES (U.S. CLS. 100, 101 AND 102).

# ProCommunity

THE MARK CONSISTS OF STANDARD CHARACTERS WITHOUT CLAIM TO ANY PARTICULAR FONT, STYLE, SIZE, OR COLOR.

OWNER OF INTERNATIONAL REGISTRATION 1063145 DATED 12-23-2010, EXPIRES 12-23-2020.

**CLASS 36—INSURANCE AND FINANCIAL**

FOR FINANCIAL AND MONETARY SERVICES, NAMELY, FINANCIAL ADVICE AND CONSULTANCY SERVICES, FINANCIAL ANALYSIS AND CONSULTATION, FINANCIAL RESEARCHES AND INFORMATION SERVICES, FINANCIAL INFORMATION IN THE NATURE OF RATES OF EXCHANGES, FINANCIAL INFORMATION PROVIDED BY ELECTRONIC MEANS, FINANCIAL INFORMATION PROCESSING, FINANCIAL PORTFOLIO MANAGEMENT AND ANALYSIS SERVICES, CREATION OF PERSONALIZED STRATEGIES TO ACHIEVE FINANCIAL INDEPENDENCE, PROVIDING ON-LINE STORED VALUE ACCOUNTS IN AN ELECTRONIC ENVIRONMENT, INVESTMENT FUND TRANSFER AND TRANSACTION SERVICES, ASSISTING OTHERS WITH THE COMPLETION OF FINANCIAL TRANSACTIONS OF STOCKS, BONDS, SECURITIES AND EQUITIES, PROVIDING INFORMATION IN THE FIELDS OF FOREIGN CURRENCY, COMMODITIES, FINANCIAL DERIVATIVES, INTERESTS RATES PRODUCTS, AND EQUITIES VIA THE INTERNET AND INTRANET SYSTEMS, INVESTMENT ADVICE, INVESTMENT MANAGEMENT, INVESTMENT CONSULTATION AND INVESTMENT OF FUNDS FOR OTHERS VIA THE INTERNET AND INTRANET SYSTEMS, MONETARY STRATEGY CONSULTATION AND RESEARCH, MONETARY EXCHANGE OPERATIONS (U.S. CLS. 100, 101 AND 102).

**CLASS 38—COMMUNICATION**

FOR TELECOMMUNICATIONS SERVICES, NAMELY, ELECTRONIC, ELECTRIC AND DIGITAL TRANSMISSION OF DATA, INCLUDING FINANCIAL DATA, GRAPHICS, IMAGES, AUDIO AND VIDEO, SIGNALS AND MESSAGES, BY MEANS OF TELECOMMUNICATIONS NETWORKS, WIRELESS TELECOMMUNICATIONS NETWORKS AND THE INTERNET, TELECOMMUNICATIONS GATEWAY SERVICES PROVIDING A GATEWAY LINK FOR FINANCIAL ADVICE, ANALYSIS, INFORMATION AND CONSULTANCY SERVICES (U.S. CLS. 100, 101 AND 104).

**CLASS 42—SCIENTIFIC AND COMPUTER SERVICES**

FOR SCIENTIFIC AND TECHNOLOGICAL SERVICES, NAMELY, RESEARCH, DEVELOPMENT, DESIGN AND UPGRADING OF COMPUTER SOFTWARE; RESEARCH AND DEVELOPMENT OF TECHNOLOGY IN THE FIELD OF FINANCIAL INFORMATION PROCESSING; RESEARCH SERVICES IN THE FIELD OF INFORMATION AND TELECOMMUNICATIONS TECHNOLOGY; DESIGN AND DEVELOPMENT OF COMPUTER HARDWARE AND SOFTWARE (U.S. CLS. 100 AND 101).  
STEVEN PEREZ, EXAMINING ATTORNEY

SN 79-091,845. PALOMBARI EMANUELE, ITALY, FILED 10-20-2010.

**KARMA OF CHARME**

THE MARK CONSISTS OF STANDARD CHARACTERS WITHOUT CLAIM TO ANY PARTICULAR FONT, STYLE, SIZE, OR COLOR.

PRIORITY DATE OF 9-1-2010 IS CLAIMED.  
OWNER OF INTERNATIONAL REGISTRATION 1063156 DATED 10-20-2010, EXPIRES 10-20-2020.  
THE ENGLISH TRANSLATION OF "CHARME" IN THE MARK IS "CHARM".

**CLASS 18—LEATHER GOODS**

FOR LEATHER AND IMITATIONS OF LEATHER, TRUNKS AND SUITCASES, UMBRELLAS, PARASOLS, WALKING STICKS, RUCKSACKS, ALL-PURPOSE SPORT BAGS, TRAVELLING BAGS, GARMENT BAGS FOR TRAVEL, DUFFEL BAGS, BRIEFCASES, PURSES, WALLETS, BAGS AND CLUTCH BAGS, CARRIER BAGS MADE OF FABRIC, NAMELY, CARRY-ALL BAGS, WHEELED CARRIER BAGS, NAMELY, WHEELED DUFFLE BAG, WHEELED SHOPPING BAG, WHEELED TOTE BAG, TOTE BAGS, LEATHER LEASHES, BOOK BAGS, SACHEL CASES, SPORT BAGS, BEACH BAGS, SHOULDER BAGS, WAIST BAGS, COSMETIC BAGS SOLD EMPTY (U.S. CLS. 1, 2, 3, 22 AND 41).

**CLASS 25—CLOTHING**

FOR CLOTHING MADE OF LEATHER, NAMELY, LEATHER COATS, LEATHER JACKETS, LEATHER VESTS, PANT SUITS OF LEATHER, TROUSERS OF LEATHER; CLOTHING ITEMS, NAMELY, SWEATERS, CARDIGANS, WAISTCOATS, SUITS, TROUSERS, SHORTS, JUMPERS, RAINCOATS, STOCKINGS AND SOCKS, STOCKING SUSPENDERS, SOCK SUSPENDERS, WIND RESISTANT JACKETS, SKI TROUSERS, FUR COATS, OVERCOATS, SKIRTS, DRESSES, JACKETS, UNDERSHIRTS, TSHIRTS; SPORT CLOTHING, NAMELY, SPORT JERSEYS AND BREECHES FOR SPORTS, SPORT OVER UNIFORMS, BLOUSES, SHIRTS, FOULARDS, BEACHWEAR, SWIMSUITS, BIKINIS, TRACKSUITS; WEDDING DRESSES; UNDERWEAR, BRAS, BRASSIERE, CORSETS, UNDERPANTS, BRIEFS, VESTS, NIGHTGOWNS, NEGLIGEEES, PYJAMAS, GLOVES, SHAWLS, SCARVES, NECKTIES, BOW TIES, BELTS AS CLOTHING, SUSPENDERS, HATS, CAPS; SHOES, BOOTS, HALF BOOTS, LEATHER SHOES, GALOSHES, RAIN BOOTS, SPORT FOOTWEAR, SANDALS, SLIPPERS, SHOE SOLES, SHOE HEELS, NAMELY, HEEL PIECES FOR SHOES, FOOTWEAR UPPERS (U.S. CLS. 22 AND 39).

**CLASS 35—ADVERTISING AND BUSINESS**

FOR BUSINESS MANAGEMENT ASSISTANCE; COMMERCIAL OR INDUSTRIAL MANAGEMENT ASSISTANCE; COMMERCIAL OR INDUSTRIAL BUSINESS DIRECTION, NAMELY, BUSINESS MANAGEMENT CONSULTANCY, COMMERCIAL CONSULTANCY; THE BRINGING TOGETHER, FOR THE BENEFIT OF OTHERS, OF A VARIETY OF GOODS, NAMELY, LEATHER AND IMITATION OF LEATHER, GOODS MADE FROM THESE MATERIALS, NOT INCLUDED IN OTHER CLASSES, TRUNKS AND SUITCASES, UMBRELLAS, PARASOLS, WALKING STICKS, RUCKSACKS, ALL-PURPOSE SPORT BAGS, TRAVELLING BAGS, GARMENT BAGS, DUFFEL BAGS, BRIEFCASES, PURSES, WALLETS, BAGS AND CLUTCH BAGS, CARRIER BAGS MADE OF FABRIC, WHEELED CARRIER BAGS, TOTE BAGS, LEATHER LEASHES, BOOK BAGS, SACHEL CASES, SPORT BAGS, BEACH BAGS, SHOULDER BAGS, WAIST BAGS, COSMETIC BAGS SOLD EMPTY, CLOTHING ITEMS, NAMELY, SWEATERS, CARDIGANS, WAISTCOATS, SUITS, TROUSERS, SHORTS, JUMPERS, RAINCOATS, CLOTHING MADE OF LEATHER, STOCKINGS AND SOCKS, STOCKING SUSPENDERS, SOCK SUSPENDERS, WIND RESISTANT JACKETS, SKI TROUSERS, FUR COATS, OVERCOATS, SKIRTS, DRESSES, JACKETS, UNDERSHIRTS, TSHIRTS, SPORT CLOTHING, BLOUSES, SHIRT COLLARS, SHIRTS, FOULARDS, BEACHWEAR, SWIMSUITS, BIKINIS, TRACKSUITS, WEDDING DRESSES, UNDERWEAR, BRAS, BRASSIERE, CORSETS, UNDERPANTS, BRIEFS, VESTS, NIGHTGOWNS, NEGLIGEEES, PYJAMAS, GLOVES, SHAWLS, SCARVES, NECKTIES, BOW TIES, BELTS AS CLOTHING, SUSPENDERS, HATS, CAPS, SHOES, BOOTS, HALF BOOTS, LEATHER SHOES, GALOSHES, RAIN BOOTS, SPORT FOOTWEAR, SANDALS, SLIPPERS, SHOE SOLES, SHOE HEELS, FOOTWEAR UPPERS, ENABLING CUSTOMERS TO CONVENIENTLY VIEW AND PURCHASE THOSE GOODS; ORGANIZING EXHIBITIONS FOR COMMERCIAL OR ADVERTISING PURPOSES; ON-LINE RETAIL STORE SERVICES FEATURING FOOTWEAR, CLOTHING AND BAGS; ORGANIZATION OF EXHIBITIONS FOR COMMERCIAL OR ADVERTISING PURPOSES; ORGANIZATION OF EXHIBITIONS AND TRADE FAIRS FOR BUSINESS AND PROMOTIONAL PURPOSE; COMMERCIAL ADMINISTRATION OF THE LICENSING OF THE GOODS AND SERVICES OF OTHERS; ADVERTISING AND ADVERTISEMENT SERVICES; PROVIDING OFFICE FUNCTIONS (U.S. CLS. 100, 101 AND 102).  
DAVID I, EXAMINING ATTORNEY

SN 79-091,865. TKO DI GIACOMO UVA, ITALY, FILED 5-5-2010.



OWNER OF INTERNATIONAL REGISTRATION 1063210 DATED 5-5-2010, EXPIRES 5-5-2020.

THE MARK CONSISTS OF A STYLIZED IMAGE OF AN UPRIGHT HORSESHOE, CROSSED DIAGONALLY BY AN IRREGULAR GEOMETRIC SHAPE WITH ITS CURVED SIDE, SHAPED LIKE A THICK, SHORT HOOK, ENDING IN A TIP AT THE BOTTOM LEFT; THE SAME CURVED SHAPE EXTENDS UPWARDS TO THE RIGHT IN A PROGRESSIVELY THINNER LINE, ENDING IN A TIP; THE NAME "TKO" IS WRITTEN IN UPPER-CASE LETTERING BENEATH THE AFORESAID IMAGE.

**CLASS 9—ELECTRICAL AND SCIENTIFIC APPARATUS**

FOR SPECTACLES; HORSE RIDING HELMETS (U.S. CLS. 21, 23, 26, 36 AND 38).

**CLASS 25—CLOTHING**

FOR TEE-SHIRTS AND JODHPURS FOR HORSE RIDING; RIDING BOOTS; HORSE RIDING HATS (U.S. CLS. 22 AND 39).

JACLYN KIDWELL WALKER, EXAMINING ATTORNEY

SN 79-092,025. TROTEC GMBH & CO. KG, FED REP GERMANY, FILED 10-28-2010.

# Secosan

THE MARK CONSISTS OF STANDARD CHARACTERS WITHOUT CLAIM TO ANY PARTICULAR FONT, STYLE, SIZE, OR COLOR.

OWNER OF INTERNATIONAL REGISTRATION 1063626 DATED 10-28-2010, EXPIRES 10-28-2020.

THE WORDING "SECOSAN" HAS NO MEANING IN A FOREIGN LANGUAGE.

**CLASS 1—CHEMICALS**

FOR CHEMICALS USED IN SOFTENING, PROCESSING, PURIFYING AND STERILIZING WATER; CHEMICALS USED IN INDUSTRY, SCIENCE AND PHOTOGRAPHY, AS WELL AS IN AGRICULTURE, HORTICULTURE AND FORESTRY, EXCEPT FUNGICIDES, HERBICIDES, INSECTICIDES, AND PARASITICIDES; CHEMICAL SUBSTANCES FOR PRESERVING FOODSTUFFS (U.S. CLS. 1, 5, 6, 10, 26 AND 46).

**CLASS 5—PHARMACEUTICALS**

FOR SANITARY PREPARATIONS FOR MEDICAL USE; PLASTERS, MATERIALS FOR MEDICAL DRESSINGS; MATERIAL FOR STOPPING TEETH; DISINFECTANTS; GERMICIDES (U.S. CLS. 6, 18, 44, 46, 51 AND 52).

**CLASS 11—ENVIRONMENTAL CONTROL APPARATUS**

FOR WATER FILTERING APPARATUS; EQUIPMENT, MACHINES AND INSTALLATIONS FOR THE SOFTENING, PROCESSING, PURIFYING AND STERILIZING OF WATER; FILTERS FOR DRINKING WATER; SERVICE WATER FILTERS; WATER SOFTENING APPARATUS AND INSTALLATIONS; WATER STERILIZERS; DISTILLATION APPARATUS; REGULATING AND SAFETY DEVICES FOR WATER APPARATUS, NAMELY, REGULATING ACCESSORIES FOR WATER APPARATUS; COOLING INSTALLATIONS FOR WATER; WATER CONDUITS INSTALLATIONS, NAMELY, REGULATING ACCESSORIES FOR WATER PIPES; WATER SUPPLY INSTALLATIONS, NAMELY, REGULATING ACCESSORIES FOR WATER SUPPLY, NAMELY, METERED VALVES; WATER DISTRIBUTION INSTALLATIONS, NAMELY, REGULATING ACCESSORIES FOR WATER SUPPLY, NAMELY, METERED VALVES; WATER INTAKE APPARATUS, NAMELY, WATER DISTRIBUTION LINES AND WATER DISTRIBUTION MANIFOLDS; DESALINATION PLANTS; AIR FILTERS FOR HEATING APPARATUS, AIR FILTERS FOR DEHUMIDIFYING APPARATUS, AND AIR FILTERS FOR DRYING APPARATUS; AIR HUMIDIFYING APPARATUS, NAMELY, AIR HUMIDIFIERS FOR HUMIDIFYING ROOMS; DEHUMIDIFYING AND DRYING APPARATUS, NAMELY, DEHUMIDIFIERS AND DRYERS FOR HEATING, DEHUMIDIFYING, AND DRYING OF ROOMS, BUILDINGS, PARTS OF BUILDINGS, WAREHOUSES, HALLS, PLANTS, AND INSULA-

TION LAYERS OF FLOORS; FANS, NAMELY, ELECTRIC FANS AND CEILING FANS; HEATING APPARATUS, NAMELY, GAS-FIRED, OIL-POWERED, AND ELECTRIC HEATING APPARATUS FOR HEATING ROOMS, BUILDINGS, PARTS OF BUILDINGS, WAREHOUSES, HALLS, PLANTS, TENTS, OUTDOOR AREAS, AND CONSTRUCTION SITES; ELECTRIC HEATING APPARATUS FOR HEATING; ELECTRIC HEATING APPARATUS FOR INDUSTRIAL PURPOSES; ELECTRIC HEATING APPARATUS, NAMELY, HEATING INSTALLATIONS; ELECTRIC HEATING APPARATUS, NAMELY, HEATING FANS, ELECTRIC BASEBOARD HEATERS, FAN HEATERS, FAN SPACE HEATERS, ELECTRIC SPACE HEATERS, RADIATORS, ELECTRIC RADIATORS; GAS AND OIL BURNING FURNACES; AIR HEATERS IN THE NATURE OF ELECTRIC SPACE HEATERS; HOT-WATER SPACE HEATING APPARATUS; ELECTRIC HEATERS FOR COMMERCIAL USE; ELECTRIC PATIO HEATERS; ELECTRIC RADIANT HEATERS; ELECTRIC SPACE HEATERS; HEATING INSTALLATIONS; HOT-AIR SPACE HEATING APPARATUS; INDOOR RADIANT HEATING SYSTEMS; PORTABLE ELECTRIC HEATERS; STEAM HEATING APPARATUS; STEAM RADIATORS FOR HEATING BUILDINGS; KEROSENE HEATERS; RADIATORS; HEATING APPARATUS FOR CONSTRUCTION SITES, NAMELY, ELECTRIC SPACE HEATERS, PAVEMENT HEATERS, INDIRECT FIRED AIR HEATERS WITH OIL BURNERS, INDIRECT FIRED AIR HEATERS WITH PROPANE BURNERS, INDIRECT FIRED AIR HEATERS WITH NATURAL GAS BURNERS, DIRECT FIRED AIR HEATERS WITH OIL BURNERS, DIRECT FIRED AIR HEATERS WITH NATURAL GAS BURNERS, SURFACE HEATERS WITH ENROLLED HOSES FOR DEFROSTING OF SOIL AND CURING OF CONCRETE; OIL HEATING APPARATUS, ELECTRICAL HEATING APPARATUS, GAS HEATING APPARATUS, AND CENTRAL HEATING APPARATUS, NAMELY, FURNACES; AIR CONDITIONING APPARATUS, REFRIGERATING APPARATUS AND AIR PURIFYING APPARATUS AND REPLACEMENT PARTS THEREFOR, INCLUDED IN THIS CLASS, IN PARTICULAR FILTERS FOR THE AFORESAID GOODS (U.S. CLS. 13, 21, 23, 31 AND 34).

MARK PILARO, EXAMINING ATTORNEY

SN 79-092,095. SIGICOM AB, SE-146 48 TULLINGE, SWEDEN, FILED 11-17-2010.



PRIORITY DATE OF 5-17-2010 IS CLAIMED.

OWNER OF INTERNATIONAL REGISTRATION 1063821 DATED 11-17-2010, EXPIRES 11-17-2020.

THE COLOR(S) DARK BLUE, LIGHT BLUE, WHITE IS/ ARE CLAIMED AS A FEATURE OF THE MARK.

THE MARK CONSISTS OF A LIGHT BLUE SQUARE WITH A WHITE PATTERN RESEMBLING AN ELECTRONIC CIRCUIT, A THIN WHITE VERTICAL RECTANGLE, AND A LONG DARK BLUE HORIZONTAL RECTANGLE CONTAINING THE WORD "SIGICOM" IN WHITE.

**CLASS 9—ELECTRICAL AND SCIENTIFIC APPARATUS**

FOR MEASURING EQUIPMENT, NAMELY, EQUIPMENT FOR MEASURING VIBRATION, NOISE, SHOCK WAVES AND OTHER DISTURBANCES INDOORS AND OUTDOORS; APPARATUSES, DEVICES AND INSTRUMENTS FOR MEASURING VIBRATION, NOISE, SHOCK WAVES AND OTHER DISTURBANCES INDOORS AND OUTDOORS; COMPUTER PROGRAMS AND COMPUTER HARDWARE FOR MEASURING AND FOR USE IN CONJUNCTION WITH MEASURING EQUIPMENT, NAMELY, FOR OPERATING EQUIPMENT FOR MEASURING VIBRATION, NOISE, SHOCK WAVES AND OTHER DISTURBANCES INDOORS AND OUTDOORS (U.S. CLS. 21, 23, 26, 36 AND 38).

**CLASS 42—SCIENTIFIC AND COMPUTER SERVICES**

FOR TECHNICAL MEASURING IN THE FIELD OF VIBRATION, NOISE, SHOCK WAVES AND OTHER DISTURBANCES INDOORS AND OUTDOORS AND CALIBRATION; FUNCTIONAL TESTING OF MEASURING EQUIPMENT; COMPUTER PROGRAMMING AND COMPUTER SYSTEM ANALYSES IN RELATION TO MEASURING SYSTEMS AND MEASURING APPARATUS; RENTAL OF MEASURING EQUIPMENT (U.S. CLS. 100 AND 101).

APRIL ROACH, EXAMINING ATTORNEY

SN 79-092,375. ROLAND GROPP, FED REP GERMANY, FILED 8-17-2010.



PRIORITY DATE OF 5-30-2010 IS CLAIMED.  
OWNER OF INTERNATIONAL REGISTRATION 1064546 DATED 8-17-2010, EXPIRES 8-17-2020.

THE MARK CONSISTS OF THE STYLIZED WORDING "HIPOWDA", WITH THE "H" FORMED BY TWO DANCING FIGURES MADE FROM CURVED LINES AND OVALS. THE TERM "HIPOWDA" IS FORMED BY THE FIRST FEW LETTERS OF EACH OF THE FOLLOWING WORDS: HIGH POWER DANCE.

SN 79-092,164. LIDL STIFTUNG & CO. KG, FED REP GERMANY, FILED 7-22-2010.

# Twinner

THE MARK CONSISTS OF STANDARD CHARACTERS WITHOUT CLAIM TO ANY PARTICULAR FONT, STYLE, SIZE, OR COLOR.

OWNER OF INTERNATIONAL REGISTRATION 0801871 DATED 4-8-2003, EXPIRES 4-8-2013.

**CLASS 29—MEATS AND PROCESSED FOODS**

FOR MEAT, POULTRY, GAME, MEAT PRODUCTS, NAMELY, MEAT PRESERVES, MEAT JELLIES; MEAT PASTE, MEAT JUICES, RING BOLOGNA, BRAUNSCHWEIGER, BOLOGNA AND SMOKED BEEF, FRANKFURTERS, HAMBURGER MEAT, HOT DOGS, MEAT-BASED MOUSSE, MEAT-BASED SPREADS, HAM, BACON, SALAMI, MORTADELLA, BACON RINDS, ROAST BEEF, BEEF PATTIES; VEAL; BEEF MEAT EXTRACTS; CHARCUTERIE SAUSAGE PRODUCTS AND SMALL SAUSAGE PRODUCTS, NAMELY, SAUSAGES, SAUSAGE PRESERVES, SMALL SAUSAGE PRESERVES, SMALL SAUSAGES, BLOOD SAUSAGES, SMOKED SAUSAGE, BRATWURST, POLISH SAUSAGE, ITALIAN SAUSAGE, SUMMER SAUSAGE, LINK SAUSAGE; COMBINATION MEAL CONSISTING PRIMARILY OF A MEAT OR VEGETABLE-BASED ENTREE AND A SOUP OR SALAD FOR CONSUMPTION ON OR OFF THE PREMISES; PREPARED AND PREPACKAGED MEALS AND ENTREES CONSISTING PRIMARILY OF EGG WITH ONE OR MORE OF MEAT, FISH, POULTRY, VEGETABLE, CHEESE OR ONION; PREPARED ENTREES CONSISTING PRIMARILY OF VEGETABLES, SOUPS, FRUIT SALADS AND VEGETABLE SALADS; PRESERVED, DRIED AND COOKED FRUITS AND VEGETABLES; CHEESE; CHEESE SUBSTITUTES (U.S. CL. 46).

**CLASS 30—STAPLE FOODS**

FOR SAUCES INCLUDING SALAD SAUCES, VINEGAR, MUSTARD, SPICES, BREAD, PASTRY INCLUDING WHOLE MEAL PASTRY, CEREAL PREPARATIONS FOR ALIMENTARY PURPOSES, NAMELY, GRANOLA, GRANOLA SNACKS, CEREAL-BASED SNACK FOOD BARS, CEREAL-BASED SNACK FOOD, BREAKFAST CEREALS, PROCESSED CEREALS, PROCESSED CEREALS (U.S. CL. 46).

INGA ERVIN, EXAMINING ATTORNEY

**CLASS 25—CLOTHING**

FOR CLOTHING, NAMELY, APRONS, BABIES' NAPKINS OF TEXTILE, BABIES' PANTS, BANDANAS, BATH ROBES, BATH SANDALS, BATH SLIPPERS, BATHING CAPS, BATHING DRAWERS, BATHING SUITS, BATHING TRUNKS, BEACH CLOTHES, BEACH SHOES, BELTS, BERETS, BIBS NOT OF PAPER, BOAS, BODICES, BOOT UPPERS, HEEL PIECES FOR BOOTS, IRON FITTINGS FOR BOOTS, NON-SLIPPING DEVICES IN THE NATURE OF SOLES FOR BOOTS AND SHOES; SKI BOOTS, WELTS FOR BOOTS, BOOTS, BOOTS FOR SPORTS, BRACES FOR CLOTHING IN THE NATURE OF SUSPENDERS, BRASSIERES, BREECHES, CAMISOLES, CAP PEAKS, CAPS, CHASUBLES, CHEMISETTES, CLOTHING FOR GYMNASTICS, NAMELY, LEOTARDS, TOPS AND BOTTOMS, SPAGHETTI STRAP TOPS, PANTS, CARGO PANTS, CARGO SHORTS, RACER BACK SPORT BRAS, SPORT BRA TOP, TRAINERS IN THE NATURE OF ATHLETIC SHOES, SHORTS, HEADBANDS, GLOVES, SHIRTS, BANDANAS, WRISTBANDS, UNDERWEAR, SOCKS, ELBOW BANDS, HATS, CAPS, BELTS AND LEGGINGS, WARM-UP HOODED SWEATSHIRTS, WARM-UP CAPRIS, V-NECK SHIRT, ROUND-NECK SHIRT, SWEATSHIRT WITH HOOD, SWEATSHIRT, FLIP FLOPS, SHORT PANTS, SHORTS, SHORT LEGGINGS, SLEEVED TOP, TANK TOPS, ATHLETIC SLEEVES, CROPPED TOP, BRA TANK TOP, THONG UNDERWEAR, HALTER TOPS, ONE SHOULDER TOP, LONG-ARM TOP, SKIRTS, HOODED TOP WITH ZIPPER, VESTS, V-NECK TEE-SHIRTS, SWEATBANDS, CARPET GLIDERS IN THE NATURE OF SHOES, FITNESS SHOES, GYMNASTIC SHOES, SLIPS FOR WEAR AT THE GYM, DANCE SHOES, BALLERINA SKIRT, FLAMENCO SKIRT, COMPRESSION SPORTSWEAR FOR ATHLETIC OR OTHER NON-MEDICAL USE, NAMELY, COMPRESSION SOCKS, STOCKINGS, LEGGINGS, JERSEYS, VESTS, TROUSERS, AND RUNNING SHORTS; CLOTHING OF LEATHER, NAMELY, PANTS, SHIRTS, SHOES, TOPS, BOTTOMS AND COATS; COATS, TOP COATS, COLLAR PROTECTORS, COLLARS FOR CLOTHING, COMBINATIONS, CORSELETS, CORSETS, MASQUERADE COSTUMES, CUFFS, CYCLISTS' CLOTHING, NAMELY, TOPS, SHORTS, PANTS, JACKETS AND HEADWEAR; DETACHABLE COLLARS, BABIES' DIAPERS OF TEXTILE, DRAWERS, DRESS SHIELDS, DRESSING GOWNS, EAR MUFFS, SHOES AND SANDALS MADE FROM ESPARTO, FITTINGS OF METAL FOR SHOES AND BOOTS, FOOTBALL SHOES, MUFFS FOR FEET, NOT ELECTRICALLY HEATED, TIPS FOR FOOTWEAR, FOOTWEAR, FOOTWEAR UPPERS, HAT FRAMES IN THE NATURE OF SKELETONS, FROCKS, FUR STOLETS, FURS, GABARDINES, GAITER STRAPS, GAITERS, GALOSHES, GARTERS, GIRDLES, GLOVES, GYMNASTIC SHOES, HALF-BOOTS, HATS, HEADBANDS, HEADGEAR FOR WEAR, NAMELY, HATS AND CAPS, HEEL PIECES FOR BOOTS AND SHOES, HEEL PIECES FOR STOCKINGS, HEELS, HOODS, HOSE, HOSIERY, INNER SOLES, STUFF JACKETS, JACKETS, JERSEYS, JUMPERS, KNITWEAR, NAMELY, SHIRTS, DRESSES, PANTS, SWEATERS, TOPS AND BOTTOMS, LACE BOOTS, LAYETTES, LEGGINGS, BODY LINEN, READY-MADE, FINISHED TEXTILE LININGS FOR CLOTHING, LIVERIES, MANIPLES, MANTILLAS, MITERS IN THE NATURE OF HATS, MITTENS, MOTORISTS' CLOTHING, NAMELY, COATS,



JACKETS, PANTS, SHIRTS; FOOTWEAR AND HEADWEAR; MUFFS, NECKTIES, OUTERCLOTHING, NAMELY, COATS, JACKETS, HEADWEAR, GLOVES AND SCARVES; OVERALLS, OVERCOATS, PAJAMAS, PANTS, CLOTHING MADE FROM PAPER, NAMELY, TOPS, BOTTOMS, PANTS, SHIRTS, AND DRESSES; PARKAS, PELERINES, PELISSES, PETTICOATS, POCKETS FOR CLOTHING, PULLOVERS, READY-MADE CLOTHING, NAMELY, SHIRTS, PANTS, TOPS, BOTTOMS, COATS, JACKETS, AND DRESSES, SANDALS, SARIS, SASHES FOR WEAR, SCARVES, SHAWLS, SHIRT FRONTS, SHIRT YOKES, SHIRTS, WELTS FOR SHOES; SHOES, SHOULDER WRAPS, SINGLETS, SKI BOOTS, SKIRTS, SKULL CAPS, SLIPPERS, SLIPS, SMOCKS, SOCK SUSPENDERS, SOLES FOR FOOTWEAR, SPATS, SPORTS JERSEYS, SPORTS SHOES, STOCKING SUSPENDERS, STOCKINGS, SWEAT-ABSORBENT STOCKINGS, STUDS FOR FOOTBALL BOOTS, SUITS, SUSPENDERS, SWEAT-ABSORBENT UNDERCLOTHING, SWEATERS, SWIMSUITS, TEDDIES, TEE-SHIRTS, TIGHTS, TOGAS, TOP HATS, TROUSER STRAPS, TROUSERS, UNDERCLOTHING, ANTI-SWEAT UNDERCLOTHING, UNDERPANTS, UNDERWEAR, ANTI-SWEAT UNDERWEAR, UNIFORMS, VEILS, VESTS, VISORS FOR HATMAKING, WAISTCOATS, WATER-PROOF CLOTHING, NAMELY, JACKETS, COATS, AND HEADWEAR, WIMPLES, WOODEN SHOES, WRISTBANDS (U.S. CLS. 22 AND 39).

#### **CLASS 39—TRANSPORTATION AND STORAGE**

FOR ARRANGING OF TOURS (U.S. CLS. 100 AND 105).

#### **CLASS 41—EDUCATION AND ENTERTAINMENT**

FOR EDUCATION, NAMELY, ARRANGING AND CONDUCTING CONFERENCES, CONGRESSES, SYMPOSIUMS, CLASSES, WORKSHOPS, COLLOQUIUMS, SYMPOSIUMS AND SEMINARS IN THE FIELD OF FITNESS, DANCE, AND ATHLETIC SPORTS; TRAINING AND INSTRUCTION IN THE FIELD OF FITNESS, DANCE, AND SPORTS; ENTERTAINMENT SERVICES, NAMELY, PROVIDING ENTERTAINMENT EXHIBITIONS IN THE NATURE OF DANCE EVENTS AND ATHLETIC AND FITNESS COMPETITIONS; PROVIDING DANCE AND FITNESS PERFORMANCES AND ORGANIZING AND ARRANGING DANCE AND FITNESS COMPETITIONS; ORGANIZING COMMUNITY SPORTING, FITNESS, DANCE AND CULTURAL EVENTS; ACADEMIES, NAMELY, FITNESS, DANCE AND FINE ARTS SCHOOLS; AMUSEMENT ARCADE SERVICES; AMUSEMENT PARKS; PROVIDING AMUSEMENT FACILITIES; ANIMAL TRAINING; ARRANGING OF BEAUTY CONTESTS; BOARDING SCHOOLS; BOOKING OF SEATS FOR SHOWS; BOOKMOBILE SERVICES; PUBLICATION OF BOOKS; HOLIDAY CAMP SERVICES; SPORT CAMPS; CASINO FACILITIES; RENTAL OF CINE-FILMS; PROVIDING CINEMA FACILITIES; CIRCUSES; PROVIDING DANCE CLUBS, NIGHT CLUBS AND FAN CLUBS; ORGANIZATION OF COMPETITIONS IN THE FIELD OF DANCE, FITNESS, SPORTS AND ATHLETICS; EDUCATION IN THE FIELDS OF DANCE, FITNESS AND ART RENDERED THROUGH CORRESPONDENCE COURSES; DISCOTHEQUE SERVICES; RENTAL OF SKIN DIVING EQUIPMENT; DUBBING AND EDITING OF VIDEOTAPE; PROVIDING INSTRUCTION IN THE FIELD OF RELIGION; EDUCATION INFORMATION; EDUCATIONAL EXAMINATION; ENTERTAINMENT INFORMATION; ORGANIZATION OF EXHIBITIONS FOR CULTURAL OR EDUCATIONAL PURPOSES; FILM PRODUCTION; GAMING SERVICES IN THE NATURE OF CASINO GAMING; PROVIDING GOLF FACILITIES; GYMNASIAC INSTRUCTION; HEALTH CLUB SERVICES, NAMELY, PROVIDING INSTRUCTION AND EQUIPMENT IN THE FIELD OF PHYSICAL EXERCISE; PROVIDING INFORMATION IN THE FIELD OF RECREATION AND LEISURE ACTIVITIES; LENDING LIBRARIES; MOBILE LIBRARY SERVICES; PRESENTATION OF LIVE SHOW PERFORMANCES; LOTTERY SERVICES; MODELLING FOR ARTISTS; RENTAL OF MOTION PICTURES; RENTAL OF MOVIE PROJECTORS AND ACCESSORIES THEREFOR; MOVIE STUDIOS; PROVIDING OF MOVIE THEATRE FACILITIES; BO-

VIDING OF MUSEUM FACILITIES; MUSIC-HALLS; NURSERY SCHOOLS; ORCHESTRA SERVICES; SPECIAL EVENT PLANNING, NAMELY, ORGANIZATION OF BALLS FOR SOCIAL AND ENTERTAINMENT PURPOSES; ORGANIZATION OF EDUCATION AND ENTERTAINMENT COMPETITIONS IN ATHLETICS, FITNESS, MUSIC, DANCE AND FINE ARTS; ORGANIZATION OF SHOWS FOR CULTURAL PURPOSES; ORGANIZATION OF SPORTS AND FITNESS COMPETITIONS; PARTY PLANNING; PHYSICAL EDUCATION; PRACTICAL TRAINING IN THE FIELDS OF ATHLETICS, FITNESS, DANCE, ART AND MUSIC; VIDEOTAPE FILM PRODUCTION; PRODUCTION OF RADIO AND TELEVISION PROGRAMMES; PRODUCTION OF TELEVISION SHOWS; PROVIDING SPORTS FACILITIES; PUBLICATION OF TEXTS OTHER THAN PUBLICITY TEXTS; RENTAL OF RADIO AND TELEVISION SETS; RADIO ENTERTAINMENT PRODUCTION; RENTAL OF VIDEO CASSETTE RECORDERS; RECORDING STUDIO SERVICES; PROVIDING RECREATION FACILITIES; RENTAL OF AUDIO AND LIGHTNING EQUIPMENT; RENTAL OF CAMCORDERS; RENTAL OF LIGHTING APPARATUS FOR THEATRICAL SETS OR TELEVISION STUDIOS; RENTAL OF MOVIE PROJECTORS AND ACCESSORIES; RENTAL OF SHOW SCENERY; RENTAL OF SOUND RECORDINGS; RENTAL OF SPORTS EQUIPMENT EXCEPT VEHICLES; RENTAL OF STADIUM FACILITIES; RENTAL OF STAGE SCENERY; RENTAL OF TENNIS COURTS; RENTAL OF VIDEO CAMERAS; SCRIPT WRITING SERVICES; SPORT CAMP SERVICES; TIMING OF SPORTS EVENTS; ENTERTAINMENT SERVICES IN THE NATURE OF ONGOING TELEVISION PROGRAMS IN THE FIELD OF DANCE, FITNESS, MUSIC, THE FINE ARTS AND ATHLETICS; PRODUCTION OF TELEVISION AND RADIO PROGRAMS; ENTERTAINMENT IN THE NATURE OF THEATRE PRODUCTIONS; VIDEOTAPE EDITING; RENTAL OF VIDEOTAPES; ZOOLOGICAL GARDENS; PHOTOGRAPHY SERVICES; NIGHT CLUB SERVICES WITH KARAOKE SINGING, DANCE AND FITNESS ANIMATION; PUBLICATION OF ELECTRONIC BOOKS, JOURNALS AND VIDEOS VIA A GLOBAL COMPUTER NETWORK; MUSIC PRODUCTION AND PUBLISHING SERVICES (U.S. CLS. 100, 101 AND 107).

AMY HELLA, EXAMINING ATTORNEY

SN 79-092,412. PANDROL LIMITED, UNITED KINGDOM, FILED 11-3-2010.

# PANDROL

PRIORITY DATE OF 9-17-2010 IS CLAIMED.  
OWNER OF INTERNATIONAL REGISTRATION 1064681  
DATED 11-3-2010, EXPIRES 11-3-2020.  
OWNER OF U.S. REG. NOS. 786,285, 2,004,304 AND OTHERS.

**CLASS 6—METAL GOODS**

FOR RAILS OF METAL; RAIL FASTENINGS OF METAL; RAILWAY TRACK FASTENINGS; RAILWAY MATERIALS OF METAL, NAMELY, SLEEPERS, RAILS, BOLTS, TRACKS, INSULATORS, PADS, CLIPS, FEET, LEGS, SHOULDERS, BASE PLATES, JOINTS, FITTINGS, SWITCHES, SPIKES AND SCREWS, CASTINGS, CLAMPS AND CLIPS FOR RAILROAD TRACKS, COUPLINGS FOR RAILROAD TRACKS, FLANGES, RAILWAY POINTS, RAILROAD TIES AND RAILWAY CROSS-OVERS; RAILWAY SWITCHES; RAIL ROAD TIES OF METAL; RAILWAY SLEEPERS OF METAL; TRACKS OF METAL; METALLIC MATERIALS FOR RAILWAY TRACK, NAMELY, METAL TRACKS FOR RAIL VEHICLES, REINFORCING MATERIALS FOR CONCRETE, NON-ELECTRIC CABLES AND WIRES, BARS FOR METAL RAILINGS, BOLTS OF METAL, CASINGS OF METAL, HOUSINGS OF METAL FOR USE WITH CLIPS, LOCKING MECHANISMS AND BUCKLES OF COMMON METAL; METALLIC ASSEMBLIES FOR SUPPORTING OR FASTENING RAILWAY TRACK; PARTS AND FITTINGS OF METAL FOR RAILWAYS AND RAILWAY TRACK; REINFORCING BARS OF METAL; REINFORCEMENT CASINGS OF METAL; STRUCTURAL ELEMENTS OF METAL, NAMELY, REINFORCING BARS OF METAL, REINFORCING CASINGS OF METAL, BASE PLATES, TOP PLATES AND SHOULDER PLATES (U.S. CLS. 2, 12, 13, 14, 23, 25 AND 50).

**CLASS 17—RUBBER GOODS**

FOR INSULATORS FOR RAILWAY TRACK; RAIL PADS; INSULATING MATERIALS, NAMELY, EXPANSION JOINT FILLERS, PLASTIC AND RUBBER PADS, PADS FOR INSULATING AND PREVENTING SHOCK (NOT OF METAL), INSULATORS AND PADS MADE OF RUBBER AND PLASTIC FOR RAILWAY TRACKS, RUBBER ELEMENTS FOR SUPPORTING TRACK, CLAMPING ELEMENTS OF RUBBER, RAIL PADS FOR INSULATING AND PREVENTING SHOCKS; EXPANSION JOINT FILLERS (U.S. CLS. 1, 5, 12, 13, 35 AND 50).

**CLASS 19—NON-METALLIC BUILDING MATERIALS**

FOR RAILROAD TIES NOT OF METAL; NON-METALLIC RAILWAY SLEEPERS; RAIL FASTENINGS NOT OF METAL; BALLAST FOR RAILWAYS; NON-METALLIC STRESS RELIEF MATERIALS; NON-METALLIC STRUCTURAL ELEMENTS, NAMELY, REINFORCING BARS AND CASINGS, BASE PLATES, TOP PLATES AND SHOULDER PLATES (U.S. CLS. 1, 12, 33 AND 50).  
RAUL CORDOVA, EXAMINING ATTORNEY

SN 79-092,490, RENTOKIL INITIAL 1927 PLC, UNITED KINGDOM, FILED 12-21-2010.

**ENTOTHERM**

THE MARK CONSISTS OF STANDARD CHARACTERS WITHOUT CLAIM TO ANY PARTICULAR FONT, STYLE, SIZE, OR COLOR.  
OWNER OF INTERNATIONAL REGISTRATION 1043759 DATED 5-18-2010, EXPIRES 5-18-2020.

**CLASS 9—ELECTRICAL AND SCIENTIFIC APPARATUS**

FOR ELECTRICAL APPARATUS FOR KILLING PESTS (U.S. CLS. 21, 23, 26, 36 AND 38).

**CLASS 11—ENVIRONMENTAL CONTROL APPARATUS**

FOR HEATING APPARATUS, NAMELY, ELECTRIC HEAT CANNONS AND PROPANE HEAT CANNONS USED FOR PEST CONTROL, ELECTRIC HEATERS FOR HEATING A LIQUID SYRUP USED FOR PEST CONTROL, HEAT EXCHANGERS NOT BEING PARTS OF MACHINES (U.S. CLS. 13, 21, 23, 31 AND 34).

**CLASS 37—CONSTRUCTION AND REPAIR**

FOR PEST CONTROL SERVICES; EXTERMINATION OF INSECT PESTS OTHER THAN FOR AGRICULTURAL PURPOSES; RENTAL, INSTALLATION AND MAINTENANCE OF PEST CONTROL APPARATUS (U.S. CLS. 100, 103 AND 106).  
KRISTINA MORRIS, EXAMINING ATTORNEY

SN 79-092,541, RIEMANN TRADING APS, DENMARK, FILED 11-19-2010.

**[RIEMANN] Seriously reliable products**

THE MARK CONSISTS OF STANDARD CHARACTERS WITHOUT CLAIM TO ANY PARTICULAR FONT, STYLE, SIZE, OR COLOR.  
OWNER OF INTERNATIONAL REGISTRATION 1065043 DATED 11-19-2010, EXPIRES 11-19-2020.  
OWNER OF U.S. REG. NOS. 3,784,952, 3,784,953 AND 3,784,954.  
NO CLAIM IS MADE TO THE EXCLUSIVE RIGHT TO USE "RELIABLE PRODUCTS", APART FROM THE MARK AS SHOWN.

**CLASS 3—COSMETICS AND CLEANING PREPARATIONS**

FOR COSMETICS, NAMELY, COSMETIC SUN SCREEN PREPARATIONS AND COSMETIC SUN TANNING PREPARATIONS; DEODORANTS FOR PERSONAL USE; TOILETRIES, NAMELY, ANTIPERSPIRANTS (U.S. CLS. 1, 4, 6, 50, 51 AND 52).

**CLASS 5—PHARMACEUTICALS**

FOR PHARMACEUTICAL PREPARATIONS, NAMELY, MEDICATED SUN SCREEN PREPARATIONS, INSECT REPELLENTS AND PREPARATIONS FOR PREVENTION OR TREATMENT OF INSECT STINGS AND BITES; PHARMACEUTICAL PREPARATIONS FOR USE IN TREATING FOOT PERSPIRATION; PHARMACEUTICAL PREPARATIONS FOR USE IN TREATING HAND PERSPIRATION; INSECT REPELLENTS (U.S. CLS. 6, 18, 44, 46, 51 AND 52).  
COLLEEN DOMBROW, EXAMINING ATTORNEY

SN 79-092,573. GALLETTI JONNY, ITALY, AND GALLETTI GIANLUCA, ITALY, AND GALLETTI TIZIANO, ITALY, FILED 11-9-2010.



PRIORITY DATE OF 8-9-2010 IS CLAIMED.  
OWNER OF INTERNATIONAL REGISTRATION 1065128 DATED 11-9-2010, EXPIRES 11-9-2020.

THE MARK CONSISTS OF THE WORD "GALLETTI" ABOVE A SHIELD WHICH IS DIVIDED INTO TWO AREAS SEPARATED BY AN INCLINED LINE; IN THE UPPER AREA A STYLIZED ROOSTER IS SHOWN, WHILE IN THE LOWER SHADED AREA IT IS REPRESENTED A STYLIZED LILY WITHIN A SQUARE SHAPED FIELD PARTIALLY PROTRUDING FROM THE SHIELD.

#### CLASS 18—LEATHER GOODS

FOR LEATHER AND IMITATIONS OF LEATHER, ANIMAL SKINS, HIDES; TRUNKS AND TRAVELLING BAGS; UMBRELLAS, PARASOLS AND WALKING STICKS; WHIPS, HARNESS AND SADDLERY (U.S. CLS. 1, 2, 3, 22 AND 41).

#### CLASS 25—CLOTHING

FOR CLOTHING, NAMELY, PANTS, SHIRTS, SKIRTS, DRESSES, JACKETS, COATS; FOOTWEAR; HEADWEAR (U.S. CLS. 22 AND 39).

VIVIAN MICZNIK FIRST, EXAMINING ATTORNEY

SN 79-092,643. STEPHEN WALTERS & SONS LIMITED, SUDBURY, SUFFOLK, UNITED KINGDOM, FILED 7-23-2010.

### DAVID WALTERS FABRICS

THE MARK CONSISTS OF STANDARD CHARACTERS WITHOUT CLAIM TO ANY PARTICULAR FONT, STYLE, SIZE, OR COLOR.

PRIORITY DATE OF 7-13-2010 IS CLAIMED.

OWNER OF INTERNATIONAL REGISTRATION 1065345 DATED 7-23-2010, EXPIRES 7-23-2020.

NO CLAIM IS MADE TO THE EXCLUSIVE RIGHT TO USE "FABRICS", APART FROM THE MARK AS SHOWN.

THE NAME(S), PORTRAIT(S), AND/OR SIGNATURE(S) SHOWN IN THE MARK IDENTIFIES "DAVID WALTERS", WHOSE CONSENT(S) TO REGISTER IS MADE OF RECORD.

#### CLASS 18—LEATHER GOODS

FOR LEATHER AND IMITATIONS OF LEATHER, GOODS MADE OF THESE MATERIALS, NAMELY, WALLETS, BRIEFCASES, POUCHES, AND PURSES; TRUNKS AND TRAVELLING BAGS; HOLDALLS; HANDBAGS; SHOULDER BAGS; TOILET BAGS; SUITCASES; UMBRELLAS, PARASOLS AND WALKING STICKS; WHIPS, HARNESSES AND SADDLERY (U.S. CLS. 1, 2, 3, 22 AND 41).

#### CLASS 24—FABRICS

FOR WOVEN AND TEXTILE PRODUCTS, NAMELY, WOVEN FABRICS AND WOVEN FELT; TEXTILE PIECE GOODS, NAMELY, FABRICS FOR TEXTILE USE, CURTAINS OF TEXTILES; FABRICS NAMELY, FABRICS FOR TEXTILE USE, NON-WOVEN FABRICS AND DENIM FABRICS, COTTON FABRICS, CHIFFON FABRICS, CASHMERE FABRICS, GAUGE FABRICS, KNITTED FABRICS, MIXED FIBER FABRICS, NYLON FABRICS, POLYESTER FABRICS, RAMIE FABRICS, RAYON FABRICS, SILK FABRICS AND MESH WOVEN FABRICS; TEXTILES MADE OF SILK; SILK FABRICS; TEXTILES MADE OF COTTON, WOOL, FLAX, LINEN, POLYESTER, SYNTHETICS FIBER FABRICS, CHENILLE OR CASHMERE, PLASTIC SUBSTITUTES FOR FABRICS; BED AND TABLE COVERS; HOUSEHOLD TEXTILE ARTICLES, NAMELY, WASH CLOTHS, TABLE LINEN; UNFITTED FABRIC FURNITURE COVERS NOT OF PAPER; CUSHION COVERS; CLOTHS, NAMELY; JUTE CLOTH, HEMP CLOTH, FACE CLOTH, LINEN CLOTH, DISH CLOTHS, TABLE CLOTHS NOT OF PAPER, BATH LINEN; HOUSEHOLD LINEN; TABLE LINEN; TABLE NAPKINS OF TEXTILE; TEA TOWELS; BED COVERS, BED LINEN, BEDSPREADS; SHEET SETS FOR USE WITH SLEEPING BAGS; PILLOWCASES, DUVET COVERS FOR QUILTS AND EIDERDOWNS, BLINDS OF TEXTILE; COVERLETS; QUILTS, EIDERDOWNS; FACE TOWELS OF TEXTILE; TEXTILE TISSUES FOR REMOVING MAKE UP; FLANNELS; HANDKERCHIEFS OF TEXTILE; TOWELS OF TEXTILE; TABLE MATS NOT MADE OF PAPER; TABLE LINENS, NAMELY, COASTERS; TRAVELLING RUGS; MATTRESS COVERS; BUMPERS FOR COTS; DISH CLOTHS OF TEXTILE FOR DRYING; CURTAINS; TEXTILE WALL COVERINGS; MOSQUITO NETS; FLAGS AND BANNERS MADE OF TEXTILES (U.S. CLS. 42 AND 50).

#### CLASS 25—CLOTHING

FOR CLOTHING, NAMELY, SHIRTS, PANTS, SKIRTS, BELTS, TIES, SUITS; FOOTWEAR, HEADGEAR, NAMELY, HATS AND CAPS; KNITWEAR, NAMELY, KNIT BOTTOMS, KNIT DRESSES, KNIT FACE MASKS, KNIT JACKETS, KNIT SHIRTS, KNIT TOPS; SHIRTS; TROUSERS; SUITS; SKIRTS; JACKETS; TIES; SCARVES; SHAWLS; HOSIERY; SPORTS CLOTHING, NAMELY, BLAZERS, JERSEYS, SPORTS BRAS, SPORTS JACKETS, SPORTS PANTS, SPORTS SHIRTS, SPORTS VESTS, SPORTS CAPS AND HATS, SPORTS OVER UNIFORMS, SPORTS FOOTWEAR; BELTS (U.S. CLS. 22 AND 39).

RICHARD WHITE, EXAMINING ATTORNEY

SN 79-092,679. ODERSUN AKTIENGESSELLSCHAFT, FRANKFURT, FED REP GERMANY, FILED 10-6-2010.

THE MARK CONSISTS OF STANDARD CHARACTERS WITHOUT CLAIM TO ANY PARTICULAR FONT, STYLE, SIZE, OR COLOR.

PRIORITY DATE OF 4-6-2010 IS CLAIMED.

OWNER OF INTERNATIONAL REGISTRATION 1065452 DATED 10-6-2010, EXPIRES 10-6-2020.

#### CLASS 6—METAL GOODS

FOR METAL BUILDING MATERIALS WITH INTEGRATED OR ATTACHED SOLAR CELLS, NAMELY, METAL STRUCTURES FOR MOUNTING SOLAR PANELS FOR FACADES AND ROOFS; EXTERIOR BLINDS OF METAL (U.S. CLS. 2, 12, 13, 14, 23, 25 AND 50).

**CLASS 9—ELECTRICAL AND SCIENTIFIC APPARATUS**

FOR APPARATUS AND INSTRUMENTS FOR CONDUCTING, SWITCHING, FEEDING, TRANSFORMING, ACCUMULATING, REGULATING OR CONTROLLING ELECTRICITY; APPARATUS FOR RECORDING, TRANSMISSION OR REPRODUCTION OF SOUND OR IMAGES; CALCULATING MACHINES, DATA-PROCESSING EQUIPMENT AND COMPUTERS; LAPTOP BAGS; SOLAR CELLS FOR ELECTRICITY GENERATION; SOLAR MODULES FOR ELECTRICITY GENERATION; PHOTOVOLTAIC INSTALLATIONS AND PARTS THEREFOR, IN PARTICULAR PHOTOVOLTAIC SOLAR CELLS, PHOTOVOLTAIC SOLAR MODULES, PHOTOVOLTAIC INVERTERS (U.S. CLS. 21, 23, 26, 36 AND 38).

**CLASS 11—ENVIRONMENTAL CONTROL APPARATUS**

FOR SOLAR COLLECTORS FOR HEATING; SOLAR ENERGY BASED HEATING APPARATUS; SOLAR INSTALLATIONS, NAMELY, SOLAR THERMAL INSTALLATIONS AND PARTS THEREFORE (U.S. CLS. 13, 21, 23, 31 AND 34).

**CLASS 19—NON-METALLIC BUILDING MATERIALS**

FOR NON-METALLIC BUILDING MATERIALS WITH INTEGRATED OR ATTACHED SOLAR CELLS, NAMELY, NON-METAL STRUCTURES FOR MOUNTING SOLAR PANELS FOR FACADES AND ROOFS; JALOUSIES, NOT OF METAL (U.S. CLS. 1, 12, 33 AND 50).

**CLASS 35—ADVERTISING AND BUSINESS**

FOR ADVERTISING; BUSINESS MANAGEMENT SERVICES; BUSINESS ADMINISTRATION; OFFICE FUNCTIONS; BUSINESS CONSULTANCY; PROFESSIONAL BUSINESS PLANNING AND CONSULTANCY WITH REGARD TO THE USE OF SOLAR INSTALLATIONS, SOLAR THERMAL INSTALLATIONS AND PHOTOVOLTAIC INSTALLATIONS; BUSINESS MANAGEMENT OF CONSTRUCTION PROJECTS (U.S. CLS. 100, 101 AND 102).

**CLASS 37—CONSTRUCTION AND REPAIR**

FOR BUILDING CONSTRUCTION; BUILDING CONSTRUCTION SUPERVISION SERVICES FOR BUILDING PROJECTS; CONSTRUCTION AND MAINTENANCE OF PRODUCTION INSTALLATIONS FOR GENERATING ENERGY, IN PARTICULAR SOLAR POWER PRODUCTION INSTALLATIONS (U.S. CLS. 100, 103 AND 106).

**CLASS 42—SCIENTIFIC AND COMPUTER SERVICES**

FOR ARCHITECTURAL CONSULTANCY; ARCHITECTURE, NAMELY, ARCHITECTURAL DESIGN AND ARCHITECTURAL RESEARCH; TECHNICAL PLANNING OF CONSTRUCTION PROJECTS; SCIENTIFIC AND TECHNOLOGICAL SERVICES, NAMELY, RESEARCH AND DESIGN IN THE FIELD OF SOLAR TECHNOLOGY; INDUSTRIAL ANALYSIS AND RESEARCH IN THE FIELD OF SOLAR TECHNOLOGY; SCIENTIFIC AND INDUSTRIAL RESEARCH IN THE FIELD OF PHOTOVOLTAIC AND SOLAR COLLECTORS; DEVELOPMENT OF NEW TECHNOLOGY FOR OTHERS IN THE FIELD OF COMPONENTS, EQUIPMENT AND SYSTEMS FOR PHOTOVOLTAICS; DEVELOPMENT OF NEW TECHNOLOGY FOR OTHERS IN THE FIELD OF COMPONENTS, EQUIPMENT AND SYSTEMS FOR SOLAR COLLECTORS; COMPUTER PROGRAMMING FOR THE CONTROL, REGULATING AND/OR MONITORING OF THERMAL AND PHOTOVOLTAIC SOLAR INSTALLATIONS; TESTING SERVICES FOR THE CERTIFICATION OF QUALITY AND STANDARDS; TECHNICAL MEASURING AND TESTING, NAMELY, MEASUREMENT EVALUATIONS IN THE FIELD OF SOLAR TECHNOLOGY; CONSULTANCY RELATING TO ENERGY MEASUREMENT

FOR THE CONSERVATION OF ENERGY; CHEMIST SERVICES; TECHNICAL TESTS AND CHECKS OF SOLAR TECHNOLOGY; TECHNICAL MEASURING OF SOLAR TECHNOLOGY; DEVELOPMENT OF NEW TECHNOLOGY FOR OTHERS IN THE FIELD OF SOLAR ENERGY; TECHNICAL ANALYSIS FOR THE GENERATION OF SOLAR ENERGY; SURVEYING; PREPARING SCIENTIFIC REPORTS, NAMELY, SCIENTIFIC RESEARCH; MATERIALS TESTING; QUALITY CONTROL; TECHNICAL CONSULTANCY RELATING TO RESEARCH OF PHOTOVOLTAIC AND SOLAR COLLECTORS; TECHNICAL PROJECT STUDIES, NAMELY, CONDUCTING OF FEASIBILITY STUDIES (U.S. CLS. 100 AND 101).

AISHA SALEM, EXAMINING ATTORNEY

SN 79-092,733. SCHLEICH GMBH, 73527 SCHWÄBISCH GMÜND, FED REP GERMANY, FILED 12-9-2010.

# Shansy

THE MARK CONSISTS OF STANDARD CHARACTERS WITHOUT CLAIM TO ANY PARTICULAR FONT, STYLE, SIZE, OR COLOR.

PRIORITY DATE OF 11-5-2010 IS CLAIMED.

OWNER OF INTERNATIONAL REGISTRATION 1065615 DATED 12-9-2010, EXPIRES 12-9-2020.

**CLASS 16—PAPER GOODS AND PRINTED MATTER**

FOR PAPER AND CARDBOARD; PAPER BOXES, PAPER BUNTING, PAPER DOILIES; PRINTED PAPER COLORING SHEETS; CARDBOARD SCORE CARDS FOR USE IN PLAY; PRINTED CARDBOARD COLLECTOR CARDS; CARDBOARD BOXES, CARDBOARD CARTONS; CARDBOARD PACKAGING; PRINTED MATTER, NAMELY, CATALOGUES IN THE FIELD OF TOYS, CHILDREN'S BOOKS, BOOKLETS FOR USE IN EDUCATIONAL CENTERS ON A VARIETY OF EDUCATIONAL DISCIPLINES IN PRE-SCHOOL THROUGH EIGHTH GRADE; BOOKBINDING MATERIALS; BOOKS, NAMELY, PAINTING BOOKS, NOTEBOOKS, AND CHILDREN'S BOOKS; PAPER DIE CUT SHAPES; PHOTOGRAPHS; STATIONERY; PAPER ADHESIVES FOR STATIONERY OR FOR HOUSEHOLD PURPOSES; ARTISTS MATERIALS, NAMELY, PAINT STIRRERS, PAINT ROLLERS, PENCILS, PENS, MARKERS; PAINT BRUSHES; TYPEWRITERS AND OFFICE REQUISITES, NAMELY, RUBBER BANDS, FRANKING MACHINES; PRINTED INSTRUCTIONAL AND TEACHING MATERIAL IN THE FIELD OF TOYS; PACKAGING MATERIALS MADE OF PLASTIC, NAMELY, BAGS, BUBBLE PACKS, PACKAGING MATERIAL MADE OF PLASTIC AND OF PAPER FOR TOYS; PRINTERS' TYPE, PRINTING BLOCKS (U.S. CLS. 2, 5, 22, 23, 29, 37, 38 AND 50).

**CLASS 28—TOYS AND SPORTING GOODS**

FOR GAMES, NAMELY, CARD GAMES; TOYS AND PLAYTHINGS, NAMELY, TOY ACTION FIGURES, TOY FIGURES, TOY FURNITURE, TOY HOUSES, TOY BUILDING BLOCKS CAPABLE OF INTERCONNECTION, TOY CONSTRUCTION SETS, DOLLS FOR PLAYING; TOYS, NAMELY, PLASTIC FIGURINES, PLASTIC ANIMALS AND FLEXIBLE FIGURINES (U.S. CLS. 22, 23, 38 AND 50).

**CLASS 41—EDUCATION AND ENTERTAINMENT**

FOR EDUCATION SERVICES, NAMELY, EDUCATION SERVICES IN THE NATURE OF EARLY CHILDHOOD INSTRUCTION; PUBLICATION OF BOOKS; ONLINE PUBLICATION OF BOOKS; EDUCATIONAL AND ENTERTAINMENT SERVICES FOR CHILDREN, NAMELY, PROVIDING INTERACTIVE PLAY AREAS, INSTRUCTIONAL CLASSES IN THE FIELD OF HISTORY, NATURE, MATH, SCIENCE, LANGUAGE, ART, LOGIC, AND GEOGRAPHY, AND SOCIAL GATHERINGS FOR CHILDREN; PROVIDING OF TRAINING OF CHILDREN IN THE FIELD OF USING ONE'S IMAGINATION AND OF STORYTELLING, MANUAL SKILLS AND DRAWING; ORGANIZING COMMUNITY SPORTING AND CULTURAL EVENTS; PUBLICATION OF MUSICAL TEXTS; PRODUCTION OF FILMS AND VIDEOS, INCLUDING ON THE INTERNET, IN PARTICULAR FOR CHILDREN; ENTERTAINMENT, NAMELY, PRODUCTION OF PLAYS, MUSICALS AND ENTERTAINMENT SHOWS, INCLUDING THE PRESENTATION OF PLAYS, MUSICALS AND ENTERTAINMENT SHOWS FOR CHILDREN (U.S. CLS. 100, 101 AND 107).

PATRICIA EVANKO, EXAMINING ATTORNEY

SN 79-092,811. EPS HOLDING GMBH, 82152 KRALING, FED REP GERMANY, FILED 11-3-2010.



SN 79-092,807. PATRIZIA IMMOBILIEN AG, FED REP GERMANY, FILED 11-30-2010.



THE MARK CONSISTS OF STANDARD CHARACTERS WITHOUT CLAIM TO ANY PARTICULAR FONT, STYLE, SIZE, OR COLOR.

PRIORITY DATE OF 5-31-2010 IS CLAIMED.

OWNER OF INTERNATIONAL REGISTRATION 1065781 DATED 11-30-2010, EXPIRES 11-30-2020.

**CLASS 16—PAPER GOODS AND PRINTED MATTER**

FOR PRINTED MATTER, NAMELY, MAGAZINES, CATALOGUES, BROCHURES AND BOOKS IN THE FIELD OF REAL ESTATE (U.S. CLS. 2, 5, 22, 23, 29, 37, 38 AND 50).

**CLASS 36—INSURANCE AND FINANCIAL**

FOR FINANCIAL AFFAIRS, NAMELY, FINANCIAL CONSULTATION, FINANCIAL ANALYSES, ADMINISTRATION OF FUNDS AND INVESTMENTS, ADVISORY SERVICES RELATING TO FUNDS, CAPITAL INVESTMENT IN REAL ESTATE, MANAGEMENT OF A CAPITAL INVESTMENT FUND; REAL ESTATE AFFAIRS, NAMELY, REAL ESTATE CONSULTATION, REAL ESTATE BROKERAGE, COMMERCIAL REAL ESTATE AGENCY SERVICES, CONSULTANCY IN THE PURCHASING OF REAL ESTATE, ADMINISTRATION OF PROPERTY PORTFOLIOS, PROPERTY MANAGEMENT (U.S. CLS. 100, 101 AND 102).

FLORENTINA BLANDU, EXAMINING ATTORNEY

THE MARK CONSISTS OF STANDARD CHARACTERS WITHOUT CLAIM TO ANY PARTICULAR FONT, STYLE, SIZE, OR COLOR.

PRIORITY DATE OF 7-22-2010 IS CLAIMED.

OWNER OF INTERNATIONAL REGISTRATION 1065787 DATED 11-3-2010, EXPIRES 11-3-2020.

**CLASS 6—METAL GOODS**

FOR METAL DEMARCATION SYSTEMS COMPRISED OF METAL FENCES AND GATES; METAL PARTITIONING GRATINGS; METAL BARRIER SYSTEMS COMPRISED OF METAL FENCES AND GATES; METAL BARRIERS FOR PEDESTRIAN TRAFFIC CONTROL; METAL BARRICADES FOR CROWD CONTROL; METAL STAGE BARRICADES FOR CROWD CONTROL; METAL CROWD FENCES; METAL PASS GATES; METAL FENCING; METAL RAILINGS FOR USE AS FENCING; METAL CROWD CONTROL BARRIERS AND FENCES OF ALL KINDS; METAL MARATHON FENCES; METAL MOBILE FENCES; METALLIC DOORS FOR EMERGENCY EXITS; METAL POLICE BARRIERS FOR CROWD CONTROL AND PEDESTRIAN TRAFFIC CONTROL; METAL GATES; METAL GATE SYSTEMS COMPRISED OF METAL GATES; METAL BARRIER GRATINGS; METAL GATES; METAL FENCES (U.S. CLS. 2, 12, 13, 14, 23, 25 AND 50).

**CLASS 37—CONSTRUCTION AND REPAIR**

FOR RENTAL OF DEMARCATION SYSTEMS COMPRISED OF FENCES AND GATES; RENTAL OF PARTITIONING GRATINGS FOR USE AS FENCING; RENTAL OF BARRIER SYSTEMS AND BARRIERS COMPRISED OF FENCES AND GATES; RENTAL OF BARRICADES, STAGE BARRICADES, CROWD FENCES, PASS GATES, FENCING, RAILINGS FOR USE AS FENCING, CROWD CONTROL BARRIERS AND FENCES OF ALL KINDS, MARATHON FENCES, MOBILE FENCES, POLICE BARRIERS COMPRISED OF FENCES, GATES, GATE SYSTEMS, BARRIER GRATINGS FOR USE AS FENCING, GATES, AND FENCES; RENTAL OF PASS SYSTEMS COMPRISED OF GATES AND FENCES (U.S. CLS. 100, 103 AND 106).

DANNEAN HETZEL, EXAMINING ATTORNEY

SN 79-093,032. VALVITALIA S.P.A., ITALY, FILED 8-13-2010.



PRIORITY DATE OF 7-28-2010 IS CLAIMED.  
OWNER OF INTERNATIONAL REGISTRATION 1066438  
DATED 8-13-2010, EXPIRES 8-13-2020.

THE MARK CONSISTS OF A CIRCLE AROUND A  
STYLIZED LETTER "B" WHICH IS BROKEN IN THE  
UPPER LEFT PORTION OF THE LETTER.

**CLASS 6—METAL GOODS**

FOR VALVES OF METAL NOT BEING PARTS OF  
MACHINES; VALVES OF METAL NOT BEING PARTS  
OF MACHINES FOR WATER PIPES, VALVES OF METAL  
NOT BEING PARTS OF MACHINES FOR DRAINAGE  
PIPES; VALVES OF METAL NOT BEING PARTS  
OF MACHINES FOR GAS, OIL AND STEAM; METAL  
PIPE JUNCTIONS AND FLANGES OF METAL (U.S. CLS.  
2, 12, 13, 14, 23, 25 AND 50).

**CLASS 7—MACHINERY**

FOR MACHINES FOR THE REDUCTION AND REG-  
ULATION OF PRESSURE, NAMELY, PRESSURE REDUCERS  
AS PARTS OF MACHINES AND STRUCTURAL  
PARTS THEREOF, NAMELY, BALL VALVES, SEALANT  
BALL VALVES OF METAL, BUTTERFLY VALVES ALL  
BEING PARTS OF MACHINES; MECHANICAL, HY-  
DRAULIC AND PNEUMATIC VALVE ACTUATORS  
(U.S. CLS. 13, 19, 21, 23, 31, 34 AND 35).

**CLASS 9—ELECTRICAL AND SCIENTIFIC APPARATUS**

FOR TECHNICAL MEASURING, TESTING AND  
CHECKING APPARATUS AND INSTRUMENTS FOR  
MEASURING, TESTING AND CHECKING THE TEM-  
PERATURE, PRESSURE, QUANTITY AND CONCENT-  
RATION OF GAS AND LIQUIDS; ELECTRIC  
OPERATING ACTUATORS, ELECTROMECHANICAL  
ACTUATORS (U.S. CLS. 21, 23, 26, 36 AND 38).

TASNEEM HUSSAIN, EXAMINING ATTORNEY

SN 79-093,039. BIOSILTA OY, FINLAND, FILED 11-23-2010.

THE MARK CONSISTS OF STANDARD CHARACTERS  
WITHOUT CLAIM TO ANY PARTICULAR FONT, STYLE,  
SIZE, OR COLOR.

PRIORITY DATE OF 5-25-2010 IS CLAIMED.  
OWNER OF INTERNATIONAL REGISTRATION 1066475  
DATED 11-23-2010, EXPIRES 11-23-2020.

**CLASS 1—CHEMICALS**

FOR CHEMICAL PREPARATIONS FOR SCIENTIFIC  
PURPOSES, OTHER THAN FOR MEDICAL OR VETER-  
INARY USE (U.S. CLS. 1, 5, 6, 10, 26 AND 46).

**CLASS 5—PHARMACEUTICALS**

FOR NUTRITIVE SUBSTANCES FOR MICROORGAN-  
ISMS (U.S. CLS. 6, 18, 44, 46, 51 AND 52).

**CLASS 9—ELECTRICAL AND SCIENTIFIC APPARATUS**

FOR FLASKS FOR LABORATORY USE (U.S. CLS. 21,  
23, 26, 36 AND 38).  
DANIEL CAPSHAW, EXAMINING ATTORNEY

SN 79-093,206. JOULIA SA, SWITZERLAND, FILED 1-4-2011.

THE MARK CONSISTS OF STANDARD CHARACTERS  
WITHOUT CLAIM TO ANY PARTICULAR FONT, STYLE,  
SIZE, OR COLOR.

PRIORITY DATE OF 7-5-2010 IS CLAIMED.  
OWNER OF INTERNATIONAL REGISTRATION 1066823  
DATED 1-4-2011, EXPIRES 1-4-2021.

**CLASS 3—COSMETICS AND CLEANING PREPARATIONS**

FOR CLEANING, POLISHING, SCOURING AND  
ABRASIVE PREPARATIONS; SOAP; PERFUMERY, ES-  
SENTIAL OILS, COSMETICS, HAIR LOTIONS; DENTI-  
FRICES (U.S. CLS. 1, 4, 6, 50, 51 AND 52).

**CLASS 9—ELECTRICAL AND SCIENTIFIC APPARATUS**

FOR SCIENTIFIC APPARATUS AND INSTRUMENTS  
IN THE NATURE OF FLOW METERS, TEMPERATURE  
AND HUMIDITY SENSORS, ELECTRIC SENSORS,  
MAGNETOMETERS, SOUND SENSORS IN THE NATURE  
OF MICROPHONES, GRAVITY SENSORS IN THE  
NATURE OF GRAVITY MEASURING INSTRUMENTS,  
PRESSURE SENSORS, LIQUID LEVEL SENSORS,  
RADIATION DETECTORS, AND PROXIMITY SENSORS;  
APPARATUS, INSTRUMENTS AND DEVICES FOR  
CONDUCTING, SWITCHING, TRANSFORMING, ACCU-  
MULATING, REGULATING AND CONTROLLING  
ELECTRICITY, NAMELY, ADAPTERS, ELECTRICITY  
CONDUITS, BATTERIES, ELECTRIC SWITCHES AND  
RELAYS, ELECTRICAL CABLES, MAGNETIC DEVICES  
IN THE NATURE OF BLANK MAGNETIC DISKS,  
MAGNETIC CONTACTS AND MAGNETIC WIRE; COM-  
PUTERS WITH AUDIO AND VISUAL PERIPHERALS;  
AND DATA PROCESSING EQUIPMENT, NAMELY,  
DATA AND SIGNAL PROCESSORS (U.S. CLS. 21, 23,  
26, 36 AND 38).

**CLASS 11—ENVIRONMENTAL CONTROL APPARATUS**

FOR APPARATUS FOR LIGHTING, HEATING, STEAM GENERATION, COOKING, DRYING, VENTILATING, WATER SUPPLY AND SANITARY PURPOSES, NAMELY, LIGHTING INSTALLATIONS, HOT WATER HEATERS, HVAC VENTILATOR UNITS, LIGHTING TUBES, HEAT PUMPS, SANITARY FITTINGS, NAMELY, PLUMBING FITTINGS IN THE NATURE OF VALVES, COCKS AND BAFFLES; SHOWER AND BATH INSTALLATIONS; SHOWER AND BATH FITTINGS, NAMELY, PLUMBING FITTINGS IN THE NATURE OF TRAPS, SINK STRAINERS AND FAUCET AERATORS; INLAYS FOR SHOWER INSTALLATIONS IN THE NATURE OF SHOWER TRAYS; HEAT EXCHANGE UNITS FOR USE IN THE PRODUCTION OF STEAM, FOR USE IN COOKING AND FOR USE IN REFRIGERATION (U.S. CLS. 13, 21, 23, 31 AND 34).

**CLASS 37—CONSTRUCTION AND REPAIR**

FOR CONSTRUCTION OF SANITARY INSTALLATIONS, KITCHENS, WATER SUPPLY AND HEAT EXCHANGE INSTALLATIONS; REPAIR OF SANITARY PRODUCTS AND APPARATUSES, NAMELY, SHOWERS AND BATHS FOR USE IN THE PRODUCTION OF STEAM, FOR USE IN COOKING AND FOR USE IN REFRIGERATION; REPAIR OF KITCHEN APPARATUSES AND HEAT EXCHANGE UNITS; INSTALLATION OF SANITARY APPARATUSES, KITCHEN APPLIANCES AND HEAT EXCHANGE UNITS (U.S. CLS. 100, 103 AND 106).

**CLASS 42—SCIENTIFIC AND COMPUTER SERVICES**

FOR SCIENTIFIC AND TECHNOLOGICAL SERVICES, NAMELY, NEW PRODUCT DESIGN AND DEVELOPMENT AND ARCHITECTURE; RESEARCH AND DESIGN FOR OTHERS IN THE FIELD OF ARCHITECTURE; INDUSTRIAL ANALYSIS AND RESEARCH SERVICES IN THE FIELD OF BUILDING UTILITIES, CIVIL ENGINEERING, ARCHITECTURE AND INTERIOR DESIGN (U.S. CLS. 100 AND 101).

KATHERINE CHANG, EXAMINING ATTORNEY

**CLASS 3—COSMETICS AND CLEANING PREPARATIONS**

FOR PERFUMERY, ESSENTIAL OILS, COSMETICS, SKIN CARE PRODUCTS, NAMELY, COSMETIC PREPARATIONS FOR SKIN CARE; COSMETIC CREAMS FOR SKIN CARE; NON-MEDICATED PREPARATIONS FOR THE CARE OF SKIN, HAIR AND SCALP; NON-MEDICATED SKIN CARE PREPARATIONS; NON-MEDICATED SKIN CARE PREPARATIONS, NAMELY, CREAMS, EYE CREAMS, DAY CREAMS, NIGHT CREAMS, LOTIONS, GELS, TONERS, CLEANERS, SKIN MASKS, EXFOLIATORS AND PEELS; NON-MEDICATED SKIN CARE CREAMS AND LOTIONS; SKIN CARE PREPARATIONS, NAMELY, FRUIT ACID PEELS FOR SKIN; SKIN CARE PRODUCTS, NAMELY, NON-MEDICATED SKIN SERUM; WRINKLE REMOVING SKIN CARE PREPARATIONS; COSMETIC PREPARATIONS, NAMELY, FIRMING CREAMS AND LOTIONS, COSMETIC SUNTAN AND SUN PROTECTING PREPARATIONS; COSMETIC AFTER-SUN PREPARATIONS, NAMELY, CREAMS, GELS, LOTIONS, MILKS, OILS, STICKS AND SOLUTIONS; DAY CREAMS WITH SUNSCREEN (U.S. CLS. 1, 4, 6, 50, 51 AND 52).

**CLASS 5—PHARMACEUTICALS**

FOR PHARMACEUTICAL PREPARATIONS FOR THE TREATMENT AND PREVENTION OF ACNE, ROSACEA, PRURITUS AND RASH; SANITARY PREPARATIONS FOR MEDICAL PURPOSES; MEDICATED SKIN CARE PREPARATIONS; PHARMACEUTICAL PREPARATIONS FOR SKIN CARE; MEDICATED CREAMS FOR THE TREATMENT OF ACNE; MEDICATED SUN PROTECTIVE PREPARATIONS, NAMELY, MEDICATED SUNBURN OINTMENTS; MEDICATED SUNBURN PREPARATIONS FOR PHARMACEUTICAL PURPOSES, NAMELY, SUNBURN CREAMS, GELS, LOTIONS, MILKS, OILS, STICKS AND SOLUTIONS (U.S. CLS. 6, 18, 44, 46, 51 AND 52).

ROBIN MITTLER, EXAMINING ATTORNEY

SN 79-093,311. KABUSHIKI KAISHA BLENDS (BLENDS CORPORATION), TOKYO 150-0034, JAPAN, FILED 10-15-2010.

SN 79-093,246. WEIFA AS, NORWAY, FILED 11-25-2010.

**REGENESSE**

THE MARK CONSISTS OF STANDARD CHARACTERS WITHOUT CLAIM TO ANY PARTICULAR FONT, STYLE, SIZE, OR COLOR.

OWNER OF INTERNATIONAL REGISTRATION 1066901 DATED 11-25-2010, EXPIRES 11-25-2020.

THE WORDING "REGENESSE" HAS NO MEANING IN A FOREIGN LANGUAGE.

**HASH BROWNS**

OWNER OF INTERNATIONAL REGISTRATION 1067009 DATED 10-15-2010, EXPIRES 10-15-2020.

THE COLOR(S) LIGHT BLUE, BLACK AND WHITE IS/ARE CLAIMED AS A FEATURE OF THE MARK.

THE MARK CONSISTS OF THE WORDING "HASH BROWNS" IN A LIGHT BLUE STYLIZED FONT, WITH THE "S" FROM THE WORD "BROWNS" APPEARING WITH BLACK AND WHITE STRIPES ON ITS LOWER PORTION.

**CLASS 18—LEATHER GOODS**

FOR ATTACHÉ CASES; BACKPACKS; BAGS IN THE FORM OF ENVELOPES AND POUCHES OF LEATHER, FOR PACKAGING; BAGS FOR CAMPERS IN THE NATURE OF ALL PURPOSE CARRYING BAGS; BAGS FOR CLIMBERS IN THE NATURE OF ALL PURPOSE CARRYING BAGS; BAGS FOR SPORTS; BANDOLIERS; BEACH BAGS; BOXES OF LEATHER OR LEATHERBOARD; BRIEFCASES; CANES; CARD CASES IN THE NATURE OF CREDIT CARD CASES; NOTECASES IN THE NATURE OF BANKNOTE HOLDERS; CARRYING CASES, OF LEATHER OR LEATHERBOARD; CHAIN MESH PURSES; CLOTHING FOR PETS; COLLARS FOR ANIMALS; DOG COLLARS; ENVELOPES, OF LEATHER, FOR PACKAGING; FRAMES FOR UMBRELLAS OR PARASOLS; HUNTERS' GAME BAGS; GARMENT BAGS FOR TRAVEL; HANDBAG FRAMES; HANDBAGS; HAT BOXES OF LEATHER; HAVERSACKS; HORSESHOES; KEY CASES OF LEATHER; LEATHER LEADS; LEATHER LEASHES; LEATHER SHOULDER BELTS; NET BAGS, NAMELY, MESH BAGS, FOR SHOPPING; PARASOLS; POCKET WALLETS; POUCHES, OF LEATHER, FOR PACKAGING; PURSES; RUCKSACKS; SCHOOL BAGS; SCHOOL SATCHELS; SHOPPING BAGS OF TEXTILE; SHOULDER BELTS OF LEATHER; LEATHER SHOULDER STRAPS; SUITCASE HANDLES; SUITCASES; TRAVELING BAGS; TRAVELING SETS OF LEATHER, NAMELY, LUGGAGE; TRAVELING TRUNKS; TRUNKS IN THE NATURE OF LUGGAGE; UMBRELLA COVERS; UMBRELLA HANDLES; UMBRELLA OR PARASOL RIBS, NAMELY, FRAMES FOR UMBRELLAS OR PARASOLS; UMBRELLA RINGS; UMBRELLA STICKS IN THE NATURE OF UMBRELLA HANDLES; UMBRELLAS; VALISES; VANITY CASES, NOT FITTED, SOLD EMPTY; WALKING CANE HANDLES; WALKING STICK HANDLES; WALKING STICK SEATS; WALKING STICKS; AND WHEELED SHOPPING BAGS (U.S. CLS. 1, 2, 3, 22 AND 41).

**CLASS 25—CLOTHING**

FOR APRONS; ASCOTS; BABIES' DIAPERS OF TEXTILE; BABIES' NAPKINS, NAMELY, BIBS, OF TEXTILE; BABIES' PANTS; BANDANAS AND NECKERCHIEFS; BATHROBES; BATH SANDALS; BATH SLIPPERS; BATHING CAPS; BATHING DRAWERS IN THE NATURE OF SHORTS; BATHING SUITS; BATHING TRUNKS; BEACH CLOTHES, NAMELY, BEACHWEAR; BEACH SHOES; BELTS; BERETS; BIBS, NOT OF PAPER; NECKLETS IN THE NATURE OF BOAS; BODICES; BOOT UPPERS IN THE NATURE OF STRUCTURAL PARTS FOR BOOTS; BOOTS; BRACES FOR CLOTHING IN THE NATURE OF SUSPENDERS; BRASSIERES; BREECHES FOR WEAR; CAMISOLES; CAP PEAKS; CAPS; HEADWEAR; CHASUBLES; CHEMISETTES; COATS; COLLAR PROTECTORS; COLLARS; COMBINATIONS; CORSELETS; CORSETS; CUFFS; DETACHABLE COLLARS; DRAWERS IN THE NATURE OF PANTS; DRESS SHIELDS; DRESSING GOWNS; EARMUFFS; ESPARTO SHOES OR SANDALS; FISHING VESTS; FOOT MUFFS, NOT ELECTRICALLY HEATED; FOOTWEAR UPPERS IN THE NATURE OF STRUCTURAL PARTS FOR FOOTWEAR; FROCKS; FUR STOLE; STRAPS SPECIFICALLY DESIGNED FOR GAITERS; GAITERS; GALOSHES; GARTERS; GIRDLES; GLOVES; HALF-BOOTS; HAT FRAMES IN THE NATURE OF STRUCTURAL PARTS FOR HATS AND HAT SKELETONS IN THE NATURE OF STRUCTURAL PARTS FOR HATS; HATS; HEADGEAR FOR WEAR, NAMELY, HEADWEAR; HEELPIECES FOR BOOTS AND SHOES; HEELPIECES FOR STOCKINGS AS PART OF CLOTHING; HEELS; HOODS; HOISERY; INNER SOLES; JACKETS; JUMPERS; LACE BOOTS; LEGGINGS; BODY LINEN; LIVERIES; MANTILLAS; MITERS IN THE NATURE OF HATS; MITRES IN THE NATURE OF HATS; MITTENS; MONEY BELTS; MUFFS; NECKTIES; OUTER CLOTHING, NAMELY, JACKETS; OVERALLS; OVERCOATS; PAJAMAS; PANTS; PAPER HATS FOR USE AS CLOTHING ITEMS; PARKAS; CAP PEAKS; PELERINES; PELISSES; PETTICOATS; POCKET SQUARES; PULLOVERS; PAJAMAS; SANDALS; SARIS; SASHES FOR WEAR; SCARFS; SCARVES; SHAWLS; SHIRT FRONTS; SHIRT YOKES; SHIRTS; SHOES; SHOULDER WRAPS; SHOWER CAPS; SINGLETS; SHIRTS; SKULL CAPS; SLEEP MASKS; SLIPPERS; SLIPS; SMOCKS; SOCK SUSPENDERS; SOCKS; SPORT SHOES; STOCKING SUSPENDERS; STUFF JACKETS; SUITS; SUN VISORS;

SUSPENDERS; SWEAT-ABSORBENT UNDERCLOTHING IN THE NATURE OF UNDERWEAR; SWEATERS; SWIMSUITS; TEDDIES; TEE SHIRTS; TIGHTS; TIPS FOR FOOTWEAR; TOGAS; TOP HATS; TOPCOATS; TROUSER STRAPS IN THE NATURE OF SUSPENDERS; TROUSERS; TURBANS; UNDERCLOTHING; ANTI-SWEAT UNDERCLOTHING; UNDERPANTS; UNDERWEAR; ANTI-SWEAT UNDERWEAR; VEILS; VESTS; VISORS; WAISTCOATS; WELTS FOR BOOTS AND SHOES; WIMPLES; WOODEN SHOES; AND WRISTBANDS (U.S. CLS. 22 AND 39).

JAMES MACFARLANE, EXAMINING ATTORNEY

SN 79-093,855. KGAL GMBH & CO. KG, 82031 GRÜN WALD, FED REP GERMANY, FILED 9-13-2010.

**KGAL REAL INVESTMENTS**

THE MARK CONSISTS OF STANDARD CHARACTERS WITHOUT CLAIM TO ANY PARTICULAR FONT, STYLE, SIZE, OR COLOR.

OWNER OF INTERNATIONAL REGISTRATION 1067901 DATED 9-13-2010, EXPIRES 9-13-2020.

OWNER OF U.S. REG. NOS. 2,560,877 AND 2,590,196.

NO CLAIM IS MADE TO THE EXCLUSIVE RIGHT TO USE "REAL INVESTMENTS", APART FROM THE MARK AS SHOWN.

**CLASS 36—INSURANCE AND FINANCIAL**

FOR FINANCIAL CONSULTANCY RELATING TO CREDIT SERVICES AND INSURANCE SERVICES IN THE FIELD OF CREDIT RISK MANAGEMENT; FACTORING AGENCIES; INSURANCE CONSULTANCY; DEBT COLLECTION AGENCIES; FINANCING SERVICES; CAPITAL INVESTMENT SERVICES; CREDIT CONSULTATION; CREDIT AGENCIES; REAL ESTATE MANAGEMENT AND APARTMENT HOUSE MANAGEMENT; REAL ESTATE AGENCIES; MORTGAGE AGENCIES, NAMELY, MORTGAGE BROKERAGE, MORTGAGE BANKING, MORTGAGE LENDING, MORTGAGE PROCUREMENT FOR OTHERS; LEASING OF REAL ESTATE; EVALUATION OF REAL ESTATE; INSURANCE BROKERAGE; FINANCIAL MANAGEMENT; INSURANCE BUSINESS, NAMELY, INSURANCE ADMINISTRATION, INSURANCE BROKERAGE, INSURANCE CONSULTATION, INSURANCE AGENCIES; RENTING OF APARTMENTS; INVESTMENT SERVICES, NAMELY, CAPITAL INVESTMENT SERVICES, INVESTMENT ADVICE, INVESTMENT OF FUNDS FOR OTHERS, FINANCIAL INVESTMENT BROKERAGE, INVESTMENT MANAGEMENT; RENTAL OF BUILDINGS (U.S. CLS. 100, 101 AND 102).



**CLASS 37—CONSTRUCTION AND REPAIR**

FOR BUILDING DEMOLITION; BUILDING SEALING SERVICES; ROOFING SERVICES; INSTALLATION OF BUILDING INSULATION; INSTALLATION OF ELECTRICITY SYSTEMS; CLEANING OF BUILDING EXTERIORS; CONSTRUCTION OF FIRING INSTALLATIONS, NAMELY, CONSTRUCTION OF INDUSTRIAL FURNACES; REPAIR AND MAINTENANCE OF HEATING, AIR CONDITIONING, REFRIGERATING AND VENTILATING EQUIPMENT; REPAIR AND MAINTENANCE OF MOTOR VEHICLES, AIRCRAFT AND THERMODYNAMIC EQUIPMENT, NAMELY, STEAM GENERATORS, BOILERS; SHIPBUILDING; PLASTERING AND ROUGH CASTING IN THE NATURE OF APPLICATION OF CONVENTIONAL STUCCO; RENTAL OF BUILDING MACHINERY AND HAND AND POWER TOOLS AND CONSTRUCTION APPARATUS; CARPENTRY AND CONSTRUCTION OF WOOD BUILDINGS BY ENGINEERS; LAYING OF TILES; LAYING OF FLOORS, NAMELY, INSTALLING FLOOR TILE, INSTALLING WOOD FLOORING; INSTALLATION OF HOUSE DRAINAGE PIPES; SCAFFOLDING ERECTION; GLAZING; ABOVE OR BELOW GROUND CONSTRUCTION OF BUILDINGS, GARAGES, MASONRY WALLS; CONSTRUCTION BY ENGINEERS OF BUILDINGS, GARAGES, MASONRY WALLS; PLUMBING, GAS AND WATER INSTALLATION; INTERIOR AND EXTERIOR PAINTING; VARNISHING; PAPERING, NAMELY, PAPER HANGING; LAYING OF PARQUET FLOORS; CLEANING OF BUILDINGS, CHIMNEYS AND VEHICLES (U.S. CLS. 100, 103 AND 106).

**CLASS 39—TRANSPORTATION AND STORAGE**

FOR AEROPLANE RENTAL; GARAGE AND PARKING PLACE RENTAL; MOTOR CAR RENTAL; SHIP RENTAL (U.S. CLS. 100 AND 105).  
KRISTIN CARLSON, EXAMINING ATTORNEY

SN 79-093,960. J-PLASMA GMBH, FED REP GERMANY, FILED 1-3-2011.



THE MARK CONSISTS OF STANDARD CHARACTERS WITHOUT CLAIM TO ANY PARTICULAR FONT, STYLE, SIZE, OR COLOR.

OWNER OF INTERNATIONAL REGISTRATION 1068138 DATED 1-3-2011, EXPIRES 1-3-2021.

**CLASS 9—ELECTRICAL AND SCIENTIFIC APPARATUS**

FOR OPTICAL FIBERS AND PREFORMS FOR OPTICAL FIBERS FOR USE IN MANUFACTURING OPTICAL FIBER CABLES; OPTICAL GLASS FIBERS; RADIATION-RESISTANT OPTICAL GLASS FIBERS; SOLARISATION-STABLE OPTICAL GLASS FIBERS; LASER FIBERS, NAMELY, OPTICAL FIBERS FOR TRANSMITTING LASER RADIATION (U.S. CLS. 21, 23, 26, 36 AND 38).

**CLASS 40—MATERIAL TREATMENT**

FOR MATERIAL PROCESSING, NAMELY, GLASS MACHINING, NAMELY, PROCESSING AND FINISHING OF GLASS; MATERIAL PROCESSING, NAMELY DRAWING OF GLASS FIBERS; TREATMENT OF MATERIALS, NAMELY, CHEMICAL OR PHYSICAL COATING OF GLASS OR GLASS FIBERS (U.S. CLS. 100, 103 AND 106).

**CLASS 42—SCIENTIFIC AND COMPUTER SERVICES**

FOR SCIENTIFIC AND TECHNOLOGICAL SERVICES, NAMELY, ANALYSIS, RESEARCH AND TESTING IN THE FIELD OF PRODUCTION OF OPTICAL FIBERS AND GLASS; ENGINEERING SERVICES; RESEARCH AND DEVELOPMENT FOR NEW PRODUCTS FOR OTHERS; QUALITY CONTROL FOR OTHERS AND PRODUCT TESTING; MATERIALS EVALUATION AND TESTING (U.S. CLS. 100 AND 101).

KAELIE KUNG, EXAMINING ATTORNEY

SN 79-093,978. SVEN BRASSAT, FED REP GERMANY, FILED 10-28-2010.



PRIORITY DATE OF 6-15-2010 IS CLAIMED.

OWNER OF INTERNATIONAL REGISTRATION 1068184 DATED 10-28-2010, EXPIRES 10-28-2020.

THE NAME(S), PORTRAIT(S), AND/OR SIGNATURE(S) SHOWN IN THE MARK DOES NOT IDENTIFY A PARTICULAR LIVING INDIVIDUAL.

THE COLOR(S) RED, WHITE AND BLACK IS/ARE CLAIMED AS A FEATURE OF THE MARK.

THE MARK CONSISTS OF THE FANCIFUL LITERAL ELEMENTS "GLEN DOWAN" IN THE COLOR RED WITH WHITE OUTLINE AND THE WHITE IS OUTLINED IN BLACK.

**CLASS 25—CLOTHING**

FOR BERETS; BODICES; CHASUBLES; MITTENS; GLOVES; SHIRTS; JACKETS; CAPS; CAP PEAKS; OUTER-CLOTHING, NAMELY, COATS, VESTS AND JACKETS; COMBINATIONS; PARKAS; PULLOVERS, CYCLISTS' CLOTHING, NAMELY, JERSEYS; WATER-PROOF CLOTHING, NAMELY, JACKETS; COLLAR PROTECTORS; BOOTS; HEADBANDS; SINGLET; T-SHIRTS; WAISTCOATS (U.S. CLS. 22 AND 39).

**CLASS 28—TOYS AND SPORTING GOODS**

FOR BASEBALL GLOVES; BUILDING GAMES; TOY BUILDING BLOCKS; BOXING GLOVES; BOARD GAMES; BOOMERANGS; DRAUGHTS FOR USE WITH DRAUGHTBOARDS; DRAUGHTBOARDS; DOMINOES; KITES; ELECTRONIC TARGETS FOR GAMES AND SPORTS; HAND HELD UNITS FOR PLAYING ELECTRONIC GAMES OTHER THAN THOSE ADAPTED FOR USE WITH AN EXTERNAL DISPLAY SCREEN OR MONITOR; SCALE MODEL VEHICLES; RADIO-CONTROLLED TOY VEHICLES; PARLOUR GAMES; GOLF GLOVES; GOLF CLUBS; GOLF BAGS, WITH OR WITHOUT WHEELS; HOCKEY STICKS; PLAYING CARDS; SPINNING TOPS; PLUSH TOYS; DOLLS; JIGSAW PUZZLES; RING GAMES; TOY SCOOTERS; ROLLER SKATES; IN-LINE ROLLER SKATES; CHESSBOARDS; CHESS GAMES; ELECTRONIC NOVELTY PRACTICAL JOKE TOYS, NAMELY, TOYS THAT ELECTRONICALLY RECORD, PLAY BACK, AND DISTORT OR MANIPULATE VOICES AND SOUNDS; BATTING GLOVES; BOBSLEIGHS; SURF SKIS; FLIPPERS FOR SWIMMING; BUBBLE MAKING WAND AND SOLUTION SETS; SKATEBOARDS, SKIS; BALLS FOR GAMES; BALLS FOR SPORTS; DICE, TOY VEHICLES; RACKETS; TEDDY BEARS; CUPS FOR DICE; DARTS; QUOITS; FLYING DISCS (U.S. CLS. 22, 23, 38 AND 50).

**CLASS 33—WINES AND SPIRITS**

FOR DISTILLED SPIRITS OF RICE; ALCOHOLIC BEVERAGES, EXCEPT BEER; ALCOHOLIC ESSENCES; ALCOHOLIC EXTRACTS; ANISE; ANISETTE; APERITIFS; ARAK; ARRACK; ALCOHOLIC BEVERAGES CONTAINING FRUIT; DISTILLED SPIRITS; ALCOHOLIC BITTERS; BRANDY; HARD CIDER; PREPARED ALCOHOLIC COCKTAILS; CURACAO; ALCOHOLIC BEVERAGES, NAMELY, DIGESTERS; ALCOHOLIC FRUIT EXTRACTS; GIN; HYDROMEL; KIRSCH; LIQUEURS; MEAD IN THE NATURE OF HYDROMEL; PEPPERMINT LIQUEURS; PERRY; WINE-BASED BEVERAGE, NAMELY, PIQUETTE; JAPANESE SWEET RICE-BASED MIXED LIQUOR; RUM; SAKE; VODKA; WHISKY; WINE (U.S. CLS. 47 AND 49).

CHRISIE B. KING, EXAMINING ATTORNEY

SN 79-094,024. MEDICI MOZAIK ÜRETİM İTHALAT İHRAÇAT SANAYİ VE TİCARET LIMITED SİRKETİ, TURKEY, FILED 8-11-2010.



OWNER OF INTERNATIONAL REGISTRATION 1068280 DATED 8-11-2010, EXPIRES 8-11-2020.

NO CLAIM IS MADE TO THE EXCLUSIVE RIGHT TO USE "MOZAICS", APART FROM THE MARK AS SHOWN.

THE COLOR(S) GRAY, BLACK AND WHITE IS/ARE CLAIMED AS A FEATURE OF THE MARK.

THE MARK CONSISTS OF A BACKGROUND DESIGN OF BLACK AND GRAY STRIPES WITH THE WORDS "MEDICI MOZAICS" WRITTEN IN WHITE.

**CLASS 19—NON-METALLIC BUILDING MATERIALS**

FOR NATURAL STONES, NATURAL MARBLES, MOZAICS AND BORDERS MADE OF NATURAL STONES, GLASS TILES (U.S. CLS. 1, 12, 33 AND 50).

**CLASS 21—HOUSEWARES AND GLASS**

FOR MOZAICS OF GLASS AND OF POWDERED GLASS FOR DECORATION, NOT FOR BUILDING (U.S. CLS. 2, 13, 23, 29, 30, 33, 40 AND 50).

PAUL F. GAST, EXAMINING ATTORNEY

**CLASS 38—COMMUNICATION**

FOR SECURE AND NON-SECURE TELECOMMUNICATIONS SERVICES, NAMELY, TRANSMISSION AND DELIVERY OF DIGITAL DATA, PHOTOGRAPHS, AUDIO FILES, DATA, INFORMATION AND IMAGE SIGNALS BY MEANS OF COMPUTERS, CABLE RADIO AND SATELLITE TRANSFER, ALL IN PARTICULAR FOR NAVIGATION SYSTEMS, ROUTE PLANNERS AND THE USE OF ELECTRONIC MAPS; SECURE OR NON-SECURE TELECOMMUNICATIONS SERVICES, NAMELY, TRANSMISSION AND DELIVERY OF DIGITAL DATA, PHOTOGRAPHS, AUDIO FILES, DATA, INFORMATION AND IMAGE SIGNALS FROM AND TO ELECTRONIC STORAGE SITES, ALL IN PARTICULAR FOR NAVIGATION SYSTEMS, ROUTE PLANNERS AND THE USE OF ELECTRONIC MAPS; WIRELESS TRANSFER OF DATA, IN THE FORM OF TELETEXT, THE INTERNET, DIGITAL MOBILE TELEPHONY (GSM) AND WIRELESS APPLICATION PROTOCOLS (WAP); WIRELESS TRANSMISSION OF DIGITAL DATA; ELECTRONIC TRANSMISSION OF DATA AND DOCUMENTS VIA COMPUTER TERMINALS; RENTAL OF TELECOMMUNICATIONS EQUIPMENT AND APPARATUS; TELECOMMUNICATION SERVICES, NAMELY, PROVIDING OF TEMPORARY ACCESS TO NON-DOWNLOADABLE SOFTWARE PROVIDING MAP IMAGES AND GEOGRAPHICAL AND ITINERARY INFORMATION OBTAINED WITH THE AID OF A GLOBAL POSITIONING SYSTEM (GPS) TO ENABLE OTHERS TO DETERMINE LOCATIONS OR DIRECTIONS ACCURATELY; TECHNICAL CONSULTANCY IN CONNECTION WITH THE ABOVE SERVICES CLAIMED (U.S. CLS. 100, 101 AND 104).

**CLASS 39—TRANSPORTATION AND STORAGE**

FOR PROVIDING OF NAVIGATION AND INFORMATION SERVICES, NAMELY, INFORMATION RELATING TO TRAFFIC AND TRAFFIC JAMS; PROVISION OF INFORMATION RELATING TO TRAVEL; PROVIDING OF INFORMATION TO TRAVELLERS REGARDING FARES, TIMETABLES AND PUBLIC TRANSPORT; TRAVEL AGENCY SERVICES, NAMELY, BOOKING THE RENTAL OF CARS, BOATS AND OTHER VEHICLES; ALL THE AFORESAID SERVICES ALSO PROVIDED VIA A COMMUNICATIONS NETWORK OR A CELLULAR TELEPHONE OR WIRELESS NAVIGATION SYSTEM (U.S. CLS. 100 AND 105).

JULIE VEPPUMTHARA, EXAMINING ATTORNEY

SN 79-094,279. KEYSTONE MEDICAL PTY LTD, MORISSET NSW 2264, AUSTRALIA, FILED 11-30-2010.

SN 79-094,160. TOMTOM INTERNATIONAL B.V., NETHERLANDS, FILED 12-1-2010.



PRIORITY DATE OF 8-11-2010 IS CLAIMED. OWNER OF INTERNATIONAL REGISTRATION 1068691 DATED 12-1-2010, EXPIRES 12-1-2020.

THE MARK CONSISTS OF THE WORDING "VIA" IN STYLIZED LETTERING WITH AN ARROW FORMING THE HORIZONTAL PORTION OF THE LETTER "A".

# MOBILIFE

THE MARK CONSISTS OF STANDARD CHARACTERS WITHOUT CLAIM TO ANY PARTICULAR FONT, STYLE, SIZE, OR COLOR.

PRIORITY DATE OF 6-17-2010 IS CLAIMED. OWNER OF INTERNATIONAL REGISTRATION 1068926 DATED 11-30-2010, EXPIRES 11-30-2020.

**CLASS 9—ELECTRICAL AND SCIENTIFIC APPARATUS**

FOR DOSAGE DISPENSERS, NAMELY, MACHINES FOR DISPENSING PRE-DETERMINED DOSAGES OF MEDICATION; MEASURING DEVICES FOR THE PURPOSE OF MEASURING DOSAGES OF LIQUIDS; MEASURING DEVICES IN THE NATURE OF FLUID DISPENSERS THAT MEASURE CONTENTS TO BE DISPENSED; MEASURING APPARATUS, NAMELY, MEASURING CUPS; ELECTRONIC CONTROL APPARATUS FOR MACHINES FOR DISPENSING PRE-DETERMINED DOSAGES OF MEDICATION; ELECTRONIC CONTROL APPARATUS FOR VALVES; ELECTRONIC CONTROLLER FOR USE WITH MACHINES FOR DISPENSING PRE-DETERMINED DOSAGES OF MEDICATION (U.S. CLS. 21, 23, 26, 36 AND 38).

**CLASS 10—MEDICAL APPARATUS**

FOR APPARATUS FOR CONTROLLING MEDICAL INFUSION, NAMELY, INFUSION PUMPS FOR DELIVERING MEASURED AMOUNTS OF SOLUTIONS INTO THE BLOODSTREAM OVER TIME; DIALYSIS MACHINES, APPARATUS FOR MEASURING FLOW RATES IN MEDICAL INFUSION, APPARATUS FOR THE CONTROL AND SUPPLY OF MEDICAL GASES, AND MEDICAL APPARATUS FOR DOSING ANIMALS, INCLUDING HUMANS BY INJECTION, NAMELY, MEDICAL DOSE METERS (U.S. CLS. 26, 39 AND 44).

JILL C. ALT, EXAMINING ATTORNEY

SN 79-094,401. ARTSANA S.P.A, ITALY, FILED 2-1-2011.

**CHICCO PURE.BIO**

THE MARK CONSISTS OF STANDARD CHARACTERS WITHOUT CLAIM TO ANY PARTICULAR FONT, STYLE, SIZE, OR COLOR.

OWNER OF INTERNATIONAL REGISTRATION 1069284 DATED 2-1-2011, EXPIRES 2-1-2021.

OWNER OF U.S. REG. NOS. 1,319,176, 3,830,028 AND OTHERS.

THE ENGLISH TRANSLATION OF "CHICCO" IN THE MARK IS "GRAIN", "COFFEE BEAN", "GRAPESTONE" OR "HAILSTONE" AND IS SOMETIMES THE NICKNAME OF ENRICO.

**CLASS 3—COSMETICS AND CLEANING PREPARATIONS**

FOR SOAPS; PERFUMERY, ESSENTIAL OILS, COSMETICS, HAIR LOTIONS, DENTIFRICES; SOAPS AND DETERGENT PREPARATIONS FOR LAUNDRY USE; FABRIC CONDITIONERS FOR LAUNDRY USE (U.S. CLS. 1, 4, 6, 50, 51 AND 52).

**CLASS 5—PHARMACEUTICALS**

FOR ALL-PURPOSE DISINFECTANTS (U.S. CLS. 6, 18, 44, 46, 51 AND 52).

MARILYN IZZI, EXAMINING ATTORNEY

SN 79-094,815. NICARNICA AS, NORWAY, FILED 12-2-2010.

**NICARNICA**

THE MARK CONSISTS OF STANDARD CHARACTERS WITHOUT CLAIM TO ANY PARTICULAR FONT, STYLE, SIZE, OR COLOR.

PRIORITY DATE OF 6-3-2010 IS CLAIMED.

OWNER OF INTERNATIONAL REGISTRATION 1070311 DATED 12-2-2010, EXPIRES 12-2-2020.

THE WORDING "NICARNICA" HAS NO MEANING IN A FOREIGN LANGUAGE.

**CLASS 9—ELECTRICAL AND SCIENTIFIC APPARATUS**

FOR SCIENTIFIC APPARATUS AND INSTRUMENTS, NAMELY, AIR ANALYSIS APPARATUS AND INSTRUMENTS; NAUTICAL APPARATUS AND INSTRUMENTS, NAMELY, AIR ANALYSIS APPARATUS AND INSTRUMENTS; SURVEYING APPARATUS AND INSTRUMENTS, NAMELY, AIR ANALYSIS APPARATUS AND INSTRUMENTS; PHOTOGRAPHIC APPARATUS AND INSTRUMENTS, NAMELY, AIR ANALYSIS APPARATUS AND INSTRUMENTS; AND OPTICAL APPARATUS AND INSTRUMENTS, NAMELY, AIR ANALYSIS APPARATUS AND INSTRUMENTS; MEASURING APPARATUS AND INSTRUMENTS, NAMELY, AIR ANALYSIS APPARATUS AND INSTRUMENTS; SIGNALLING APPARATUS AND INSTRUMENTS, NAMELY, AIR ANALYSIS APPARATUS AND INSTRUMENTS; CHECKING APPARATUS AND INSTRUMENTS, NAMELY, AIR ANALYSIS APPARATUS AND INSTRUMENTS; SUPERVISION APPARATUS AND INSTRUMENTS, NAMELY, AIR ANALYSIS APPARATUS AND INSTRUMENTS; LIFE-SAVING APPARATUS AND INSTRUMENTS, NAMELY, AIR ANALYSIS APPARATUS AND INSTRUMENTS; AND TEACHING APPARATUS AND INSTRUMENTS, NAMELY, AIR ANALYSIS APPARATUS AND INSTRUMENTS; APPARATUS FOR RECORDING, TRANSMISSION OR REPRODUCTION OF SOUND OR IMAGES; AIR ANALYSIS APPARATUS; APPARATUS FOR RECORDING, TRANSMISSION OR REPRODUCTION OF IMAGES FOR USE IN THE FIELD OF AIRCRAFT SAFETY (U.S. CLS. 21, 23, 26, 36 AND 38).

**CLASS 39—TRANSPORTATION AND STORAGE**

FOR PROVIDING INFORMATION, NEWS AND COMMENTARY IN THE FIELD OF TRAVEL; MANAGEMENT OF AIRFIELD OPERATIONS, NAMELY, MANAGEMENT OF TRAFFIC FLOW THROUGH ADVANCED COMMUNICATIONS NETWORK AND TECHNOLOGY; MANAGEMENT OF AIRCRAFT OPERATIONS, NAMELY, MANAGEMENT OF TRAFFIC FLOW THROUGH ADVANCED COMMUNICATIONS NETWORK AND TECHNOLOGY; PROVISION OF TRANSPORTATION INFORMATION RELATING TO AIRLINE SCHEDULING; PROVISION OF TRANSPORTATION INFORMATION RELATING TO AIRLINE ROUTING (U.S. CLS. 100 AND 105).

**CLASS 42—SCIENTIFIC AND COMPUTER SERVICES**

FOR SCIENTIFIC SERVICES, NAMELY, ANALYSIS OF DATA RELATED TO AIR ANALYSIS, AND RESEARCH AND DESIGN RELATING THERETO; TECHNOLOGICAL SERVICES, NAMELY, AIR ANALYSIS SERVICES, AND RESEARCH AND DESIGN RELATING THERETO; INDUSTRIAL ANALYSIS SERVICES, NAMELY, AIR ANALYSIS SERVICES, AND INDUSTRIAL RESEARCH SERVICES IN THE FIELD OF AIR ANALYSIS; DESIGN AND DEVELOPMENT OF COMPUTER HARDWARE AND SOFTWARE; DESIGN OF COMPUTER PROGRAMS AND SOFTWARE RELATING TO AIRCRAFT; AIRBORNE REMOTE MONITORING RELATING TO ENVIRONMENTAL OR SCIENTIFIC EXPLORATIONS IN THE FIELD OF AIR ANALYSIS; AIRCRAFT DESIGN; CONSULTING SERVICES IN THE FIELD OF ENVIRONMENTAL ASSESSMENT AND PLANNING (U.S. CLS. 100 AND 101).

BRENDAN REGAN, EXAMINING ATTORNEY

SN 79-094,895. STRATPHARMA AG, SWITZERLAND, FILED 2-10-2011.

# STRATAMARK

THE MARK CONSISTS OF STANDARD CHARACTERS WITHOUT CLAIM TO ANY PARTICULAR FONT, STYLE, SIZE, OR COLOR.

PRIORITY DATE OF 8-27-2010 IS CLAIMED.  
OWNER OF INTERNATIONAL REGISTRATION 1070551 DATED 2-10-2011, EXPIRES 2-10-2021.  
OWNER OF U.S. REG. NOS. 3,706,396 AND 3,892,901.

## CLASS 3—COSMETICS AND CLEANING PREPARATIONS

FOR COSMETICS (U.S. CLS. 1, 4, 6, 50, 51 AND 52).

## CLASS 5—PHARMACEUTICALS

FOR PHARMACEUTICAL PREPARATIONS FOR SKIN CARE; MEDICINES FOR TREATING SKIN DISORDERS, PLASTERS FOR MEDICAL PURPOSES, SURGICAL DRESSINGS (U.S. CLS. 6, 18, 44, 46, 51 AND 52).  
KRISTIN CARLSON, EXAMINING ATTORNEY

SN 79-094,968. GOUSSON-CONSULTADORIA E MARKETING S.A.R.L, LUXEMBOURG, FILED 1-25-2011.

# Miss Viv' Roger Vivier

THE MARK CONSISTS OF STANDARD CHARACTERS WITHOUT CLAIM TO ANY PARTICULAR FONT, STYLE, SIZE, OR COLOR.

OWNER OF INTERNATIONAL REGISTRATION 1070727 DATED 1-25-2011, EXPIRES 1-25-2021.  
OWNER OF U.S. REG. NOS. 2,947,572, 2,954,090 AND 3,265,261.

THE NAME "MISS VIV' ROGER VIVIER" DOES NOT IDENTIFY A LIVING INDIVIDUAL.

## CLASS 3—COSMETICS AND CLEANING PREPARATIONS

FOR BLEACHING PREPARATIONS, TOILET SOAPS, SHAVING SOAPS, PERFUMERY, ESSENTIAL OILS, COSMETICS, HAIR LOTIONS (U.S. CLS. 1, 4, 6, 50, 51 AND 52).

## CLASS 18—LEATHER GOODS

FOR LEATHER AND IMITATIONS OF LEATHER, AND GOODS MADE OF THESE MATERIALS, NAMELY, HANDBAGS, HAND LUGGAGE, SUITCASES FOR TRAVEL, BRIEFCASES, LEATHER CREDIT CARD CASES, WALLETS, BRIEFCASE-TYPE PORTFOLIOS MADE OF LEATHER, LEATHER CASES FOR DIARIES, PURSES; TRUNKS AND TRAVELING BAGS; UMBRELLAS, PARASOLS AND WALKING STICKS; WHIPS, HARNESS AND SADDLERY (U.S. CLS. 1, 2, 3, 22 AND 41).

## CLASS 25—CLOTHING

FOR CLOTHING, NAMELY, TOPS, BOTTOMS, SUITS, TROUSERS, DENIM, SKIRTS, DRESSES, COATS, PARKAS, SHIRTS, T-SHIRTS, UNDERWEAR, NIGHT-DRESSES, DRESSING GOWNS FOR THE BATH, GLOVES; FOOTWEAR; HEADGEAR, NAMELY, HEADWEAR, HATS, CAPS, VISORS, AND SCARVES (U.S. CLS. 22 AND 39).

JULIE VEPPUMTHARA, EXAMINING ATTORNEY

SN 79-095,270. OERLIKON SOLAR AG, TRÜBBACH, TRÜBBACH, SWITZERLAND, FILED 3-4-2011.

# ThinFab

THE MARK CONSISTS OF STANDARD CHARACTERS WITHOUT CLAIM TO ANY PARTICULAR FONT, STYLE, SIZE, OR COLOR.

PRIORITY DATE OF 9-7-2010 IS CLAIMED.  
OWNER OF INTERNATIONAL REGISTRATION 1071666 DATED 3-4-2011, EXPIRES 3-4-2021.

## CLASS 7—MACHINERY

FOR INDUSTRIAL MACHINERY IN THE NATURE OF VACUUM PROCESSING INSTALLATIONS FOR MANUFACTURING PHOTOVOLTAIC SOLAR GENERATORS, CELLS, PANELS AND MODULES, NAMELY, VACUUM DEPOSITION MACHINES FOR DEPOSITING FINE FILMS IN THE NATURE OF PVD, PECVD, CVD AND LPCVD; MACHINES FOR ENCAPSULING PHOTOVOLTAIC SOLAR GENERATORS, CELLS, PANELS AND MODULES, THE AFOREMENTIONED FOR PROTECTION AGAINST ENVIRONMENTAL CONDITIONS; MACHINES FOR CABLING AND CONNECTING ELECTRICAL CABLES IN PHOTOVOLTAIC SOLAR GENERATORS, CELLS, PANELS AND MODULES (U.S. CLS. 13, 19, 21, 23, 31, 34 AND 35).

## CLASS 9—ELECTRICAL AND SCIENTIFIC APPARATUS

FOR PHOTOVOLTAIC SOLAR CELLS, PANELS AND MODULES; INSTRUMENTS AND DETECTORS FOR ELECTRICALLY AND OPTICALLY OBSERVING THE PARAMETERS OF PHOTOVOLTAIC SOLAR GENERATORS, CELLS, PANELS AND MODULES, NAMELY, EXPOSURE METERS FOR TRANSMISSION, ABSORPTION AND REFLECTION, AMMETERS, VOLTMETERS AND CURRENT DETECTORS; APPARATUS FOR MONITORING PRODUCTION PROCESSES AND THE QUALITY OF PHOTOVOLTAIC SOLAR GENERATORS, CELLS, PANELS AND MODULES; MEASURING INSTRUMENTS FOR MONITORING AND OBSERVING THE PARAMETERS OF ENVIRONMENTAL FACTORS IN THE NATURE OF SOLAR PENETRATION, SHADING, WIND, SNOW, NAMELY, PHOTOMETER, WIND VELOCITY INDICATOR, RAIN AND SNOW GAUGES; MACHINES FOR QUALITY CONTROL AND MONITORING OF PHOTOVOLTAIC SOLAR GENERATORS, CELLS, PANELS AND MODULES DURING THEIR PRODUCTION, NAMELY, ELECTRICAL METERS AND ELECTRONIC TEST INSTRUMENTS FOR USE IN FUNCTIONAL TESTING OF PHOTOVOLTAIC SOLAR GENERATORS, CELLS, PANELS AND MODULES (U.S. CLS. 21, 23, 26, 36 AND 38).

## CLASS 37—CONSTRUCTION AND REPAIR

FOR INSTALLATION OF MANUFACTURING PLANTS FOR PRODUCING, MAINTAINING AND REPAIRING PHOTOVOLTAIC SOLAR GENERATORS, CELLS, PANELS AND MODULES; MAINTENANCE AND REPAIR OF PHOTOVOLTAIC SOLAR GENERATORS (U.S. CLS. 100, 103 AND 106).

## CLASS 42—SCIENTIFIC AND COMPUTER SERVICES

FOR SCIENTIFIC SERVICES AND RESEARCH SERVICES, NAMELY, DEMONSTRATIONS FOR SCIENTIFIC PURPOSES, DESIGN AND ANALYSIS OF PHOTOVOLTAIC SOLAR GENERATORS, CELLS, PANELS AND MODULES; SCIENTIFIC RESEARCH IN THE FIELD OF FINE FILM DEPOSITING, IN PARTICULAR IN REGARD TO SEMICONDUCTORS AND CONDUCTORS; DEVELOPMENT OF PHOTOVOLTAIC SOLAR GENERATORS, CELLS, PANELS AND MODULES (U.S. CLS. 100 AND 101).

ELI HELLMAN, EXAMINING ATTORNEY

SN 79-095,290. NUGA MEDICAL CO., LTD., REPUBLIC OF KOREA, FILED 12-23-2010.



OWNER OF INTERNATIONAL REGISTRATION 1071740 DATED 12-23-2010, EXPIRES 12-23-2020.

THE MARK CONSISTS OF FLEUR-DE-LIS IN THE FORM OF A CROSS.

### CLASS 3—COSMETICS AND CLEANING PREPARATIONS

FOR ROUGES; LIPSTICKS; MASSAGE GELS OTHER THAN FOR MEDICAL PURPOSES; MASSAGE OIL; MAKE-UP FOUNDATIONS; MAKE-UP; HAIR CREAMS FOR COSMETIC PURPOSES; COLOR-REMOVING PREPARATIONS FOR HAIR; BEAUTY CREAMS; BODY LOTIONS; BODY MILKS; BADIAN ESSENCE OIL FOR PERSONAL USE, BADIAN ESSENCE SKIN LOTION FOR PERSONAL USE; BODY OILS; BODY CREAMS; BATH LOTIONS; BATH OIL COSMETICS; PERFUMED TALCUM POWDER FOR COSMETIC USE; DANDRUFF LOTIONS NOT FOR MEDICAL TREATMENT; SHOWER CREAMS; SHOWER AND BATH FOAM; SUNSCREEN LOTIONS FOR COSMETIC USE; SUNSCREEN CREAMS FOR COSMETIC USE; COSMETIC SUNTAN LOTIONS; SUN TANNING PREPARATIONS; SHAVING FOAM; COSMETIC PREPARATIONS FOR EYELASHES; LOTIONS FOR STRENGTHENING THE NAILS; SKIN LOTIONS; SKIN CLEANSERS; COSMETIC SUN-PROTECTING PREPARATIONS; COLD CREAMS FOR COSMETIC USE; COLD WAVING SOLUTIONS; CLEANSING MILK; PERMANENT WAVE PREPARATIONS; FOUNDATIONS; FOUNDATION CREAMS; FACIAL CREAM; FACE MILK AND LOTIONS; FACE AND BODY LOTIONS; FACE AND BODY MILK; COSMETIC PRODUCTS FOR THE FACE AND BODY, NAMELY, MASSAGE OIL, MAKE-UP, BODY CREAMS, BODY LOTIONS, BEAUTY CREAMS, BADIAN ESSENCE, SHOWER CREAMS, SKIN LOTIONS, BATH SOAP, BEAUTY SOAP, BODY CREAM SOAP, PERFUMED SOAP, COSMETIC SOAPS; LOTIONS FOR FACE AND BODY CARE; FACE AND BODY CREAMS; HAND LOTIONS; PERFUMES; HAIR GEL; HAIR MOUSSE; HAIR STYLING SPRAY; HAIR SPRAY; HAIR CONDITIONERS; HAIR CARE LOTIONS; HAIR CREAMS; COSMETIC GELS; LOTIONS FOR COSMETIC PURPOSES; COSMETIC ROUGES; MASK PACK FOR COSMETIC PURPOSES; COSMETIC HAND CREAMS; MAKE-UP REMOVING LOTIONS; MAKE-UP REMOVING MILKS; MAKE-UP REMOVING PREPARATIONS; COSMETICS; COSMETIC KITS COMPRISING MAKE-UP, BEAUTY CREAMS, BADIAN ESSENCE, SHOWER CREAMS, SKIN LOTIONS, BATH SOAP, BEAUTY SOAP, BODY CREAM SOAP, PERFUMED SOAP, COSMETIC SOAPS, HAIR RINSES AND SHAMPOOS; BATH SOAP; BEAUTY SOAP; BODY CREAM SOAP; SOAP FOR BODY CARE; SHAMPOOS; HAND CLEANSERS; PERFUMED SOAP; HAIR RINSES FOR COSMETIC USE; COSMETIC SOAPS (U.S. CLS. 1, 4, 6, 50, 51 AND 52).

### CLASS 35—ADVERTISING AND BUSINESS

FOR COMMERCIAL INTERMEDIARY SERVICES IN THE FIELDS OF COSMETICS, SOAPS FOR PERSONAL USE, POLISHING PREPARATIONS, PERFUMERY, TOILETRIES, LAUNDRY PREPARATIONS, ESSENTIAL OILS, AND CLEANING, POLISHING, SCOURING AND ABRASIVE PREPARATIONS; ARRANGING THE SALE OF MASSAGE OIL, MAKE-UP, BODY CREAMS, BODY LOTIONS, BEAUTY CREAMS, BADIAN ESSENCE, SHOWER CREAMS, SKIN LOTIONS, BATH SOAP, BEAUTY SOAP, BODY CREAM SOAP, PERFUMED SOAP, COSMETIC SOAPS, HAIR RINSES AND SHAMPOOS IN THE FIELDS OF COSMETICS, SOAPS FOR PERSONAL USE, POLISHING PREPARATIONS, PERFUMERY, TOILETRIES, LAUNDRY PREPARATIONS, ESSENTIAL OILS, AND CLEANING, POLISHING, SCOURING AND ABRASIVE PREPARATIONS; WHOLESALE STORE SERVICES FOR COSMETICS, SOAPS FOR PERSONAL USE, POLISHING PREPARATIONS, PERFUMERY, TOILETRIES, LAUNDRY PREPARATIONS, ESSENTIAL OILS, AND CLEANING, POLISHING, SCOURING AND ABRASIVE PREPARATIONS; RETAIL STORE SERVICES FOR COSMETICS, SOAPS FOR PERSONAL USE, POLISHING PREPARATIONS, PERFUMERY, TOILETRIES, LAUNDRY PREPARATIONS, ESSENTIAL OILS, AND CLEANING, POLISHING, SCOURING AND ABRASIVE PREPARATIONS; SALES PROMOTION SERVICES FOR THIRD PARTIES IN THE FIELD OF COSMETICS, SOAPS FOR PERSONAL USE, POLISHING PREPARATIONS, PERFUMERY, TOILETRIES, LAUNDRY PREPARATIONS, ESSENTIAL OILS, AND CLEANING, POLISHING, SCOURING AND ABRASIVE PREPARATIONS (U.S. CLS. 100, 101 AND 102).

MICHAEL WIENER, EXAMINING ATTORNEY

SN 79-095,328. SK JAPAN CO., LTD., JAPAN, FILED 2-18-2011.



PRIORITY DATE OF 8-19-2010 IS CLAIMED.

OWNER OF INTERNATIONAL REGISTRATION 1071838 DATED 2-18-2011, EXPIRES 2-18-2021.

NO CLAIM IS MADE TO THE EXCLUSIVE RIGHT TO USE "BEAR", APART FROM THE MARK AS SHOWN.

THE COLOR(S) PINK AND BROWN IS/ARE CLAIMED AS A FEATURE OF THE MARK.

THE MARK CONSISTS OF THE STYLIZED WORDING "SWEET BEAR" WITH STYLIZED WINGS APPEARING ON THE LEFT AND RIGHT SIDE OF THE WORDING. THE COLOR PINK APPEARS IN THE WORDING "SWEET BEAR" AND IN THE DESIGN OF A BEAR WHICH REPRESENTS THE LETTER "B" IN THE WORD "BEAR". THE COLOR BROWN APPEARS IN THE DEPICTION OF WINGS WHICH APPEAR ON EITHER SIDE OF THE WORDING "SWEET BEAR" AND IN THE REPRESENTATION OF EYES AND NOSE ON THE BEAR'S FACE. THE COLOR WHITE IS FOR BACKGROUND PURPOSES ONLY.

### CLASS 20—FURNITURE AND ARTICLES NOT OTHERWISE CLASSIFIED

FOR CUSHIONS; PILLOWS; MATTRESSES (U.S. CLS. 2, 13, 22, 25, 32 AND 50).

### CLASS 28—TOYS AND SPORTING GOODS

FOR STUFFED TOYS; TOYS, NAMELY, ACTION FIGURE TOYS AND ACCESSORIES THEREFOR; BATH TOYS; BATHTUB TOYS; BATTERY OPERATED ACTION TOYS; BENDABLE TOYS; CARRYING BAGS SPECIALLY ADAPTED FOR TOY VEHICLES; CASES FOR TOY STRUCTURES; CASES FOR TOY VEHICLES; CHILDREN'S DRESS UP ACCESSORIES, NAMELY, TOY HELMETS FOR PLAY; CHILDREN'S EDUCATIONAL TOYS FOR DEVELOPING FINE MOTOR, ORAL LANGUAGE, NUMBERS, COUNTING, COLORS AND ALPHABET SKILLS SOLD IN A FABRIC BAG WHICH HAS A CLEAR VINYL WINDOW FOR VIEWING SMALL TRINKETS AND TOYS SECURELY CONTAINED WITH-

IN THE BAG ITSELF; CHILDREN'S EDUCATIONAL TOYS FOR DEVELOPING FINE MOTOR, COGNITIVE AND COUNTING SKILLS; CHILDREN'S MULTIPLE ACTIVITY TOYS; CHILDREN'S MULTIPLE ACTIVITY TOYS SOLD AS A UNIT WITH PRINTED BOOKS; CHILDREN'S WIRE CONSTRUCTION AND ART ACTIVITY TOYS; CLOCKWORK TOYS OF METAL; CLOCKWORK TOYS OF PLASTICS; COLLECTABLE TOY FIGURES; CONSTRUCTION TOYS; DECORATIVE TOY MOBILES AND PLUSH TOYS FOR CHILDREN MADE OF FELT; DISC TOSS TOYS; DOLLS AND DOLL ACCESSORIES, NAMELY, CLOTHING FOR DOLLS, DOLL ROOMS, DOLL BEDS, DOLL HOUSES, TOY FABRICS AND LINENS FOR DOLLS AND STROLLERS FOR DOLLS; DRAWING TOYS; ELECTRONIC ACTION TOYS; ELECTRONIC LEARNING TOYS; ELECTRONIC NOVELTY TOYS, NAMELY, TOYS THAT ELECTRONICALLY RECORD, PLAY BACK, AND DISTORT OR MANIPULATE VOICES AND SOUNDS; FANTASY CHARACTER TOYS; FLYING SAUCERS BEING TOYS; GIFT BASKETS COMPRISED PRIMARILY OF TOY IMITATION SPORTING GOODS, NAMELY, TOY GAME BALLS AND ACCESSORIES THEREFOR; GIFT BASKETS CONTAINING PLUSH TOYS; HAND-POWERED NON-MECHANICAL FLYING TOY; INFLATABLE BATH TOYS; INFLATABLE RIDE-ON TOYS; INFLATABLE THIN RUBBER TOYS; INFLATABLE TOYS; INFLATABLE TOYS SHOWING DECORATIVE PICTURES; MECHANICAL ACTION TOYS; MINIATURE TOY HELMETS; MODELED PLASTIC TOY FIGURINES; MOLDED TOY FIGURES; MUSIC BOX TOYS; MUSICAL TOYS; NON-ELECTRONIC TOY VEHICLES; NOVELTY TOY ITEM IN THE NATURE OF A DISPENSER OF STREAM MATERIAL; PARTY FAVORS IN THE NATURE OF SMALL TOYS; PLASTIC CHARACTER TOYS; PLASTIC TOY HOOPS; PLAY HOUSES AND TOY ACCESSORIES THEREFOR; PLAY MATS FOR USE WITH TOY VEHICLES; PLUSH TOYS; POP UP TOYS; POSITIONABLE PRINTED TOY FIGURES FOR USE IN GAMES; POSITIONABLE PRINTED TOY FIGURES FOR USE IN PUZZLES; POSITIONABLE THREE DIMENSIONAL TOYS FOR USE IN GAMES; POSITIONABLE TOY FIGURES; POSITIONABLE TWO DIMENSIONAL TOYS FOR USE IN GAMES; PRINTING TOYS; PULL TOYS; PUNCHING TOYS; PUSH TOYS; REMOTE CONTROL TOYS, NAMELY, CARS, RACE CARS, AIRPLANES, BOATS; RIDEABLE TOY VEHICLES; RIDEABLE TOYS AND ACCESSORIES THEREFOR; RIDE-ON TOYS AND ACCESSORIES THEREFORE; ROLE PLAYING TOYS IN THE NATURE OF PLAY SETS FOR CHILDREN TO IMITATE REAL LIFE OCCUPATIONS; RUBBER CHARACTER TOYS; SAND TOYS; SANDBOX TOYS; SCALE MODEL KITS BEING TOYS; SKETCHING TOYS; SQUEEZABLE SQUEAKING TOYS; STACKING TOYS; STANDS FOR RIDEABLE TOYS; STUFFED AND PLUSH TOYS; TALKING ELECTRONIC PRESS-DOWN TOY; TALKING TOYS; TOSSING DISC TOYS; TOY AIRPLANE; TOY ANIMALS AND ACCESSORIES THEREFOR; TOY ARMOR; TOY ARTIFICIAL FINGERNAILS; TOY BAKEDWARE AND COOKWARE; TOY BALLOONS; TOY BANKS; TOY BOATS; TOY BOXES; TOY BUILDING BLOCKS; TOY BUILDING BLOCKS CAPABLE OF INTERCONNECTION; TOY BUILDING STRUCTURES AND TOY VEHICLE TRACKS; TOY BUILDINGS AND ACCESSORIES THEREFOR; TOY BUTTERFLY NETS; TOY CANDY DISPENSERS; TOY CARS; TOY CHRISTMAS TREES; TOY CLOCKS AND WATCHES; TOY CONSTRUCTION BLOCKS; TOY CONSTRUCTION SETS; TOY FIGURES; TOY FOAM NOVELTY ITEMS, NAMELY, FOAM FINGERS AND HANDS; TOY FURNITURE; TOY GLIDERS; TOY GLOCKENSPIELS; TOY HARMONICAS; TOY HOOP SETS; TOY HOUSES; TOY MAILBOXES; TOY MASKS; TOY MOBILES; TOY NOISEMAKERS; TOY PIANOS; TOY PRISM GLASSES; TOY PUTTY; TOY RECORD PLAYERS; TOY ROBOTS; TOY ROCKETS; TOY SETS OF CARPENTERS' TOOLS; TOY SLING PLANES; TOY STAMPS; TOY SWORDS; TOY TELESCOPES; TOY TOOLS; TOY TRAINS AND PARTS AND ACCESSORIES THEREFOR; TOY VEHICLE TRACK SETS AND ROADWAYS AND ACCESSORIES THEREFOR; TOY VEHICLES AND ACCESSORIES THEREFOR; TOY VEHICLES WITH TRANSFORMING PARTS; TOY VEHICLES, NAMELY, CASTER BOARDS; TOY WHISTLES; TOY XYLOPHONES; TOYS, NAMELY, A DISK TO TOSS IN PLAYING A GAME WHEREIN OTHER DISKS ARE FLIPPED AND COLLECTED; TOYS, NAMELY, BEAN BAG ANIMALS; TOYS, NAMELY, CHILDREN'S DRESS-UP ACCESSORIES; WATER SQUIRTING TOYS;

WATER TOYS; WIND-UP TOYS; WIND-UP WALKING TOYS; DOLLS; TOYS FOR DOMESTIC PETS; GO GAMES; DICE; CUPS FOR DICE; DRAUGHTBOARDS; CHESS GAMES; CHECKERS BEING CHECKER SETS; MAGIC TRICKS; DOMINOES; PLAYING CARDS; MAH-JONG; RUBBER BALLS (U.S. CLS. 22, 23, 38 AND 50).  
EVELYN BRADLEY, EXAMINING ATTORNEY

SN 79-095,679. NUGA MEDICAL CO., LTD., REPUBLIC OF KOREA, FILED 12-22-2010.

# TOURCIA

OWNER OF INTERNATIONAL REGISTRATION 1072781 DATED 12-22-2010, EXPIRES 12-22-2020.

## CLASS 3—COSMETICS AND CLEANING PREPARATIONS

FOR ROUGES; LIPSTICKS; MASSAGE GELS OTHER THAN FOR MEDICAL PURPOSES; MASSAGE OIL; MAKE-UP FOUNDATIONS; MAKE-UP; HAIR CREAMS FOR COSMETIC PURPOSES; COLOR-REMOVING PREPARATIONS FOR HAIR; BEAUTY CREAMS; BODY LOTIONS; BODY MILKS; BADIEN ESSENCE FOR PERSONAL USE; BODY OILS; BODY CREAMS; BATH LOTIONS; BATH OIL COSMETICS; PERFUMED TALCUM POWDER FOR COSMETIC USE; DANDRUFF LOTIONS NOT FOR MEDICAL TREATMENT; SHOWER CREAMS; SHOWER AND BATH FOAM; SUNSCREEN LOTIONS FOR COSMETIC USE; SUNSCREEN CREAMS FOR COSMETIC USE; COSMETIC SUNTAN LOTIONS; SUN TANNING PREPARATIONS; SHAVING FOAM; COSMETIC PREPARATIONS FOR EYELASHES; LOTIONS FOR STRENGTHENING THE NAILS; SKIN LOTIONS; SKIN CLEANSERS; COSMETIC SUN-PROTECTING PREPARATIONS; COLD CREAMS FOR COSMETIC USE; COLD WAVING SOLUTIONS; CLEANSING MILK; PERMANENT WAVE PREPARATIONS; FOUNDATIONS; FOUNDATION CREAMS; FACIAL CREAM; FACE MILK AND LOTIONS; FACE AND BODY LOTIONS; FACE AND BODY MILK; COSMETIC PRODUCTS FOR THE FACE AND BODY, NAMELY, MASSAGE OIL, MAKE-UP, BODY CREAMS, BODY LOTIONS, BEAUTY CREAMS, BADIEN ESSENCE, SHOWER CREAMS, SKIN LOTIONS, BATH SOAP, BEAUTY SOAP, BODY CREAM SOAP, PERFUMED SOAP, COSMETIC SOAPS; LOTIONS FOR FACE AND BODY CARE; FACE AND BODY CREAMS; HAND LOTIONS; PERFUMES; HAIR GEL; HAIR MOUSSE; HAIR STYLING SPRAY; HAIR SPRAY; HAIR CONDITIONERS; HAIR CARE LOTIONS; HAIR CREAMS; COSMETIC GELS; LOTIONS FOR COSMETIC PURPOSES; COSMETIC ROUGES; MASK PACK FOR COSMETIC PURPOSES; COSMETIC HAND CREAMS; MAKE-UP REMOVING LOTIONS; MAKE-UP REMOVING MILKS; MAKE-UP REMOVING PREPARATIONS; COSMETICS; COSMETIC KITS COMPRISING MAKE-UP, BEAUTY CREAMS, BADIEN ESSENCE, SHOWER CREAMS, SKIN LOTIONS, BATH SOAP, BEAUTY SOAP, BODY CREAM SOAP, PERFUMED SOAP, COSMETIC SOAPS, HAIR RINSES AND SHAMPOOS; BATH SOAP; BEAUTY SOAP; BODY CREAM SOAP; SOAP FOR BODY CARE; SHAMPOOS; HAND CLEANSERS; PERFUMED SOAP; HAIR RINSES FOR COSMETIC USE; COSMETIC SOAPS (U.S. CLS. 1, 4, 6, 50, 51 AND 52).



**CLASS 35—ADVERTISING AND BUSINESS**

FOR COMMERCIAL INTERMEDIARY SERVICES IN THE FIELDS OF COSMETICS, SOAPS FOR PERSONAL USE, POLISHING PREPARATIONS, PERFUMERY, TOILETRIES, LAUNDRY PREPARATIONS, ESSENTIAL OILS, AND CLEANING, POLISHING, SCOURING AND ABRASIVE PREPARATIONS; ARRANGING THE SALE OF MASSAGE OIL, MAKE-UP, BODY CREAMS, BODY LOTIONS, BEAUTY CREAMS, BADIAN ESSENCE, SHOWER CREAMS, SKIN LOTIONS, BATH SOAP, BEAUTY SOAP, BODY CREAM SOAP, PERFUMED SOAP, COSMETIC SOAPS, HAIR RINSES AND SHAMPOOS IN THE FIELDS OF COSMETICS, SOAPS FOR PERSONAL USE, POLISHING PREPARATIONS, PERFUMERY, TOILETRIES, LAUNDRY PREPARATIONS, ESSENTIAL OILS, AND CLEANING, POLISHING, SCOURING AND ABRASIVE PREPARATIONS; WHOLESALE STORE SERVICES FOR COSMETICS, SOAPS FOR PERSONAL USE, POLISHING PREPARATIONS, PERFUMERY, TOILETRIES, LAUNDRY PREPARATIONS, ESSENTIAL OILS, AND CLEANING, POLISHING, SCOURING AND ABRASIVE PREPARATIONS; RETAIL STORE SERVICES FOR COSMETICS, SOAPS FOR PERSONAL USE, POLISHING PREPARATIONS, PERFUMERY, TOILETRIES, LAUNDRY PREPARATIONS, ESSENTIAL OILS, AND CLEANING, POLISHING, SCOURING AND ABRASIVE PREPARATIONS; SALES PROMOTION SERVICES FOR THIRD PARTIES IN THE FIELD OF COSMETICS, SOAPS FOR PERSONAL USE, POLISHING PREPARATIONS, PERFUMERY, TOILETRIES, LAUNDRY PREPARATIONS, ESSENTIAL OILS, AND CLEANING, POLISHING, SCOURING AND ABRASIVE PREPARATIONS (U.S. CLS. 100, 101 AND 102).

MICHAEL WIENER, EXAMINING ATTORNEY

**CLASS 9—ELECTRICAL AND SCIENTIFIC APPARATUS**

FOR INSTRUMENTS AND DETECTORS FOR ELECTRICAL, OPTICAL AND SPECIFIC CHARACTERIZATION OF THE MATERIALS OF SEMICONDUCTOR PRODUCTS, PHOTOVOLTAIC DETECTORS, SOLAR CELLS, FLAT PANEL DISPLAYS AND LIGHT EMITTING DEVICES, NAMELY, EXPOSURE METERS FOR TRANSMISSION, ABSORPTION AND REFLECTION, AMMETERS, VOLTMETERS AND CURRENT DETECTORS; APPARATUS FOR MONITORING PRODUCTION PROCESSES AND QUALITY OF SEMICONDUCTOR PRODUCTS, NAMELY, ELECTRICAL METERS AND ELECTRONIC TEST INSTRUMENTS FOR USE IN FUNCTIONAL TESTING OF SEMICONDUCTOR PRODUCTS; PHOTOVOLTAIC DETECTORS, SOLAR CELLS, FLAT PANEL DISPLAY SCREENS; AND LIGHT EMITTING DEVICES, NAMELY, LIGHT EMITTING DIODES, LIGHT EMITTING DIODE DISPLAYS (U.S. CLS. 21, 23, 26, 36 AND 38).

**CLASS 37—CONSTRUCTION AND REPAIR**

FOR INSTALLATION AT FACTORIES OF MACHINES AND EQUIPMENT FOR THE PLASMA ASSISTED MANUFACTURE OR THE PLASMA TREATMENT OF SEMICONDUCTOR DEVICES, PHOTOVOLTAIC DETECTORS, SOLAR CELLS, FLAT PANEL DISPLAYS AND LIGHT EMITTING DEVICES; SERVICING AND REPAIR OF THE AFOREMENTIONED MACHINES AND EQUIPMENT (U.S. CLS. 100, 103 AND 106).

**CLASS 42—SCIENTIFIC AND COMPUTER SERVICES**

FOR SCIENTIFIC SERVICES AND RESEARCH SERVICES, NAMELY, DESIGN, DEVELOPMENT AND ANALYSIS OF PLASMA PROCESSES, SEMICONDUCTOR PRODUCTS, VACUUM TREATMENT INSTALLATIONS FOR PLASMA ASSISTED PRODUCTION AND TREATMENT PROCESSES (U.S. CLS. 100 AND 101).

ELI HELLMAN, EXAMINING ATTORNEY

SN 79-095,843. OERLIKON SOLAR AG, TRÜBBACH, TRÜBBACH, SWITZERLAND, FILED 3-25-2011.

SN 79-096,171. KARACA ZÜCCACIYE TICARET VE SANAYI ANONIM SIRKETI, TURKEY, FILED 10-15-2010.

# Plasmabox

THE MARK CONSISTS OF STANDARD CHARACTERS WITHOUT CLAIM TO ANY PARTICULAR FONT, STYLE, SIZE, OR COLOR.

PRIORITY DATE OF 9-30-2010 IS CLAIMED.

OWNER OF INTERNATIONAL REGISTRATION 1073217 DATED 3-25-2011, EXPIRES 3-25-2021.

THE WORD(S) PLASMAX HAS NO MEANING IN A FOREIGN LANGUAGE.

**CLASS 7—MACHINERY**

FOR MACHINES AND EQUIPMENT FOR THE PLASMA ASSISTED MANUFACTURE OF, AND THE PLASMA TREATMENT OF, SEMICONDUCTOR DEVICES, PHOTOVOLTAIC DETECTORS, SOLAR CELLS, FLAT PANEL DISPLAYS AND LIGHT EMITTING DEVICES, LEDS, OLEDS, NAMELY, VACUUM TREATMENT MACHINES FOR PLASMA ASSISTED DEPOSITION, PLASMA TREATMENT, PLASMA ETCHING, AND VACUUM MACHINES FOR DEPOSITING FINE FILMS, PECVD AND PACVD; VACUUM MACHINES FOR DRY ETCHING; PLASMA TREATMENT MACHINES, AND PARALLEL PLATE PLASMA REACTORS (U.S. CLS. 13, 19, 21, 23, 31, 34 AND 35).



OWNER OF INTERNATIONAL REGISTRATION 1073938 DATED 10-15-2010, EXPIRES 10-15-2020.

THE COLOR(S) ORANGE, BLUE PINK, PURPLE, GREY, BLUE, YELLOW, GREEN, BLACK AND WHITE IS/ARE CLAIMED AS A FEATURE OF THE MARK.

THE MARK CONSISTS OF THE WORD "KARACA" WRITTEN IN WHITE ON A BLACK SQUARE BACKGROUND. BELOW THE SQUARE ARE VARYING STRIPS OF COLORS IN ORANGE, BLUE, PINK, PURPLE, GREY, BLUE, YELLOW AND GREEN. IT LOOKS LIKE A COLORFUL BARCODE.

THE ENGLISH TRANSLATION OF "KARACA" IN THE MARK IS "ROEDEER".

**CLASS 8—HAND TOOLS**

FOR HAND TOOLS AND HAND OPERATED IMPLEMENTS, NAMELY, SCREWDRIVERS, SHOVELS, WRENCHES, HAMMERS, RIVETING TOOLS, DRILLS, PICKS, PINNERS, WIRE CUTTERS, SCISSORS, GARDENING TOOLS, CUTLERY; SIDE ARMS NOT INCLUDING FIREARMS, NAMELY, SWORDS AND HUNTING KNIVES, RAZORS; ELECTRIC RAZORS AND ELECTRIC HAIR CLIPPERS (U.S. CLS. 23, 28 AND 44).

**CLASS 11—ENVIRONMENTAL CONTROL APPARATUS**

FOR APPARATUS FOR LIGHTNING, HEATING, STEAM GENERATING, COOKING, REFRIGERATING, DRYING, VENTILATING, WATER SUPPLY AND SIMILAR SANITARY PURPOSES, NAMELY, LAMPS, ELECTRIC SPACE HEATERS, GAS PATIO HEATERS, HOT WATER HEATERS, ELECTRIC FOOD STEAMERS, STEAM GENERATORS, ELECTRIC STOVES, GAS STOVES, REFRIGERATING MACHINES AND APPLIANCES, CLOTHES DRYERS, HAND-HELD ELECTRIC DRYERS, PORTABLE WARM AIR DRYERS, VENTILATION HOODS FOR STOVES, VENTILATING EXHAUST FANS, ELECTRIC VENTILATING FANS, HOT WATER HEATERS, HOT WATER TANKS, WATER DISTILLING UNITS, WATER CONDITIONING UNITS, AIR CONDITIONING APPARATUS, ELECTRIC KETTLES; GAS AND ELECTRIC FOOD COOKERS; VEHICLE LIGHTS AND VEHICLE AIR CONDITIONING UNITS (U.S. CLS. 13, 21, 23, 31 AND 34).

**CLASS 21—HOUSEWARES AND GLASS**

FOR HOUSEHOLD OR KITCHEN UTENSILS AND CONTAINERS, NAMELY, SPLATTER SCREENS, KITCHEN TONGS, POURING AND STRAINING SPOUTS, GRATER, SIEVES, SPATULAS, TURNERS, SKIMMERS, CONTAINERS FOR HOUSEHOLD AND KITCHEN USE; COMBS AND CLEANING SPONGES; CLEANING BRUSHES, BRUSH-MAKING MACHINES MATERIALS; ARTICLES FOR CLEANING PURPOSES, NAMELY, CLEANING PADS, CLEANING RAGS AND CLEANING MITTS OF FABRIC; STEEL WOOD; ARTICLES MADE OF CERAMICS, GLASS, PORCELAIN OR EARTHENWARE WHICH ARE NOT INCLUDED IN OTHER CLASSES, NAMELY, CANDLESTICKS, CUPS, MUGS, BOWLS, VASES, ELECTRIC AND NON-ELECTRIC TOOTHBRUSHES (U.S. CLS. 2, 13, 23, 29, 30, 33, 40 AND 50).

INGA ERVIN, EXAMINING ATTORNEY

SN 79-096,300. INOMETA GMBH & CO. KG, FED REP GERMANY, FILED 3-25-2011.

# INOMETA

THE MARK CONSISTS OF STANDARD CHARACTERS WITHOUT CLAIM TO ANY PARTICULAR FONT, STYLE, SIZE, OR COLOR.

PRIORITY DATE OF 3-9-2011 IS CLAIMED.

OWNER OF INTERNATIONAL REGISTRATION 1074218 DATED 3-25-2011, EXPIRES 3-25-2021.

**CLASS 6—METAL GOODS**

FOR METAL TUBES, METAL ROLLERS FOR SHEET AND WEB HANDLING MACHINES, METAL CYLINDERS FOR PNEUMATIC AND HYDRAULIC APPLICATIONS, METAL BARS FOR FURTHER MANUFACTURE, METAL WINDING CORES FOR WINDING OF WEB-LIKE MATERIALS LIKE PAPER, BOARD, TISSUE, FILM, FOIL OR TEXTILE PRODUCTS, AND METAL PROFILES, NAMELY, LIGHTWEIGHT PROFILES FROM ALUMINIUM (U.S. CLS. 2, 12, 13, 14, 23, 25 AND 50).

**CLASS 40—MATERIAL TREATMENT**

FOR TREATMENT OF MATERIALS, NAMELY, METALS AND FIBER COMPOSITE MATERIALS; METAL WORKING, NAMELY, LATHING, MILLING AND GRINDING; METAL HARDENING, METAL SURFACE FINISHING; METAL COATING, NOT PAINTING (U.S. CLS. 100, 103 AND 106).

LINDSEY RUBIN, EXAMINING ATTORNEY

SN 79-096,403. XINYUAN COCOON SILK GROUP CO., LTD, HAIAN; JIANGSU, CHINA, FILED 1-4-2011.



OWNER OF INTERNATIONAL REGISTRATION 1074478 DATED 1-4-2011, EXPIRES 1-4-2021.

THE MARK CONSISTS OF THE STYLIZED WORDING "XINYUAN" UNDER THE CHINESE CHARACTER WHICH TRANSLITERATE TO "XIN YUAN" ALL TO THE RIGHT OF A SWIRLED THREE-PART COIL DESIGN.

THE WORDING "XIN" IN CHINESE MEANS "PROSPERITY"; "YUAN" IN CHINESE MEANS "EDGE"; WHEN COMBINED TOGETHER, THE WORDING HAS NO MEANING IN A FOREIGN LANGUAGE.

THE TRANSLITERATION OF THE NON-LATIN CHARACTERS IN THE MARK IS: "XIN YUAN".

**CLASS 22—CORDAGE AND FIBERS**

FOR FIBER MATERIALS, NAMELY, SILK FIBERS FOR TEXTILE USE; SILK COCOON; RAW SILK; SILK FLOSS; CHEMICAL FIBERS FOR TEXTILE USE; RAW WOOL; RAW OR TREATED WOOL; HEMP; KAPOK (U.S. CLS. 1, 2, 7, 19, 22, 42 AND 50).

**CLASS 24—FABRICS**

FOR CLOTHS, NAMELY, HEMP CLOTH, WOOLEN CLOTH AND COTTON FABRICS; NON-WOVEN TEXTILE FABRICS; WALL HANGINGS OF TEXTILE; QUILTS; SILK CARPETS; BED SHEETS; SILK THREADS AND YARN; VELVET; PILLOW COVERS (U.S. CLS. 42 AND 50).

**CLASS 25—CLOTHING**

FOR CLOTHES, NAMELY, UNDERCLOTHES AND PAJAMAS, CAPS; SHOES; GLOVES; CAPES; SCARFS; BABY LAYETTES FOR CLOTHING; SOCKS; BELTS OF TEXTILE; BELTS FOR CLOTHING (U.S. CLS. 22 AND 39).

TASNEEM HUSSAIN, EXAMINING ATTORNEY

SN 79-096,578. HYDROKLEEN INTERNATIONAL PTY LTD, SYDNEY, AUSTRALIA, FILED 1-18-2011.



OWNER OF INTERNATIONAL REGISTRATION 1074909 DATED 1-18-2011, EXPIRES 1-18-2021.



THE MARK CONSISTS OF THE WORDING "HYDROKLEEN" WITH SIX CIRCLES FORMING A TRIANGLE ON THE RIGHT.

#### CLASS 7—MACHINERY

FOR MACHINES BEING APPARATUS FOR CLEANING DOMESTIC AIR CONDITIONING UNITS AND NOT BEING FOR USE ON AIRCRAFT (U.S. CLS. 13, 19, 21, 23, 31, 34 AND 35).

#### CLASS 35—ADVERTISING AND BUSINESS

FOR BUSINESS MANAGEMENT CONSULTANCY; FRANCHISING, NAMELY, CONSULTATION AND ASSISTANCE IN BUSINESS MANAGEMENT, ORGANIZATION AND PROMOTION; ADVERTISING FOR FRANCHISES; PROCUREMENT, NAMELY, PURCHASING AIR CONDITIONERS AND AIR CONDITIONER CLEANING MACHINE APPARATUS FOR FRANCHISES; BUSINESS ADVISORY SERVICES RELATING TO THE BUSINESS MANAGEMENT ASSISTANCE IN THE OPERATION OF AIR CONDITIONER CLEANING MACHINE APPARATUS FRANCHISES; FRANCHISING SERVICES, NAMELY, OFFERING BUSINESS MANAGEMENT ASSISTANCE RELATING TO THE ESTABLISHMENT OF SALES OF AIR CONDITIONER CLEANING MACHINE APPARATUS FRANCHISES; BUSINESS ADMINISTRATION OF THE BUSINESS AFFAIRS IN THE NATURE OF SALES OF AIR CONDITIONER CLEANING MACHINE APPARATUS FRANCHISES; BUSINESS MANAGEMENT (U.S. CLS. 100, 101 AND 102).

#### CLASS 37—CONSTRUCTION AND REPAIR

FOR MAINTENANCE OF AIR CONDITIONING UNITS, NONE OF THE AFOREMENTIONED BEING FOR USE FOR AIRCRAFTS (U.S. CLS. 100, 103 AND 106).  
RAMONA ORTIGA, EXAMINING ATTORNEY

SN 79-096,590. BOC INFORMATION TECHNOLOGIES CONSULTING AG, A-1010 WIEN, AUSTRIA, FILED 2-3-2011.

## ADONIS:COMMUNITY

THE MARK CONSISTS OF STANDARD CHARACTERS WITHOUT CLAIM TO ANY PARTICULAR FONT, STYLE, SIZE, OR COLOR.

PRIORITY DATE OF 2-3-2011 IS CLAIMED.  
OWNER OF INTERNATIONAL REGISTRATION 1074932 DATED 2-3-2011, EXPIRES 2-3-2021.

#### CLASS 9—ELECTRICAL AND SCIENTIFIC APPARATUS

FOR DATA PROCESSING EQUIPMENT AND COMPUTERS (U.S. CLS. 21, 23, 26, 36 AND 38).

#### CLASS 35—ADVERTISING AND BUSINESS

FOR ADVERTISING; BUSINESS MANAGEMENT; BUSINESS ADMINISTRATION; OFFICE FUNCTIONS (U.S. CLS. 100, 101 AND 102).

#### CLASS 42—SCIENTIFIC AND COMPUTER SERVICES

FOR SCIENTIFIC AND TECHNOLOGICAL SERVICES AND RESEARCH AND DESIGN RELATING THERETO IN THE FIELD OF STRATEGY, PERFORMANCE, PROCESS, INFORMATION TECHNOLOGY AND SUPPLY-CHAIN MANAGEMENT; DESIGN AND DEVELOPMENT OF COMPUTER HARDWARE AND SOFTWARE (U.S. CLS. 100 AND 101).  
RAMONA ORTIGA, EXAMINING ATTORNEY

SN 79-096,717. STEP INTO LIFE INTERNATIONAL PTY LTD, MOORABBIN VIC 3189, AUSTRALIA, FILED 2-21-2011.

## STEP INTO LIFE

THE MARK CONSISTS OF STANDARD CHARACTERS WITHOUT CLAIM TO ANY PARTICULAR FONT, STYLE, SIZE, OR COLOR.

OWNER OF INTERNATIONAL REGISTRATION 1075249 DATED 2-21-2011, EXPIRES 2-21-2021.

#### CLASS 10—MEDICAL APPARATUS

FOR APPARATUS FOR PHYSICAL TRAINING FOR MEDICAL USE (U.S. CLS. 26, 39 AND 44).

#### CLASS 25—CLOTHING

FOR CLOTHING, NAMELY, GLOVES, JACKETS, JERSEY CLOTHING, JUMPERS, KNITWEAR, LEGGINGS, OUTER CLOTHING, NAMELY, COATS, PANTS, PARKAS, PULLOVERS, SHIRTS, SINGLETS, SOCKS, SPORTS JERSEYS, SWEAT ABSORBENT UNDER CLOTHING, NAMELY, UNDERSHIRTS, SWEATERS, TEE SHIRTS, TIGHTS, UNDER CLOTHING, NAMELY, UNDERSHIRTS, UNDERWEAR, UNIFORMS, VESTS AND WATERPROOF CLOTHING, NAMELY, RAINCOATS; FOOTWEAR; HEADGEAR, NAMELY, CAPS PEAKS, CAPS, EAR MUFFS, HATS, HEAD BANDS AND SUN VISORS (U.S. CLS. 22 AND 39).

#### CLASS 28—TOYS AND SPORTING GOODS

FOR FITNESS APPARATUS AND FITNESS EXERCISE APPLIANCES IN THE NATURE OF FITNESS EXERCISE MACHINES; APPARATUS FOR GAMES AND APPARATUS FOR BALL GAMES, NAMELY, BALLS, WITCHES HATS, NAMELY, CONES FOR TRAINING PURPOSES, AND FLYING DISCS; APPARATUS FOR USE IN PLAYING GAMES AND BALL GAMES SPECIFICALLY BALLS FOR GAMES; BALLS FOR GYMNASIUM GAMES; BALLS FOR PLAYING GAMES; BATS FOR GAMES; ELECTRONIC GAMES FOR THE TEACHING OF CHILDREN AND ADULTS; INDOOR GAMES SPECIFICALLY BOARD GAMES; NETS FOR BALL GAMES; NETS FOR SPORTING BALL GAMES; RACKETS FOR USE IN BALL GAMES; RACKETS FOR USE IN GAMES; STICKS FOR BALL GAMES; TRAINING APPARATUS FOR BOXING; BOXING GLOVES; BALLS BEING SPORTING ARTICLES; SMALL BALLS FOR GAMES; BALLS FOR PLAYING SPORTS; BALLS MADE OF FOAM; FLOOR-MOUNTED PUNCH BALLS; KICKING BALLS; PLAY BALLS; PLAYGROUND BALLS; PLAYING BALLS; PUMPS ESPECIALLY ADAPTED FOR USE WITH BALLS FOR GAMES; PUNCHING-BALLS; RUGBY BALLS; SOCCER BALLS; SPORTS BALLS; TENNIS BALLS; WEIGHTS FOR PHYSICAL EXERCISE OTHER THAN ADAPTED FOR MEDICAL USE (U.S. CLS. 22, 23, 38 AND 50).

#### CLASS 41—EDUCATION AND ENTERTAINMENT

FOR FITNESS AND EXERCISE FACILITIES, CLUBS AND SALONS; HEALTH CLUB SERVICES, NAMELY, PROVIDING INSTRUCTION AND EQUIPMENT IN THE FIELD OF PHYSICAL EXERCISE; INSTRUCTION IN PHYSICAL FITNESS; OPERATION OF PHYSICAL FITNESS CENTERS; PHYSICAL FITNESS INSTRUCTION; PHYSICAL FITNESS TRAINING SERVICES; PHYSICAL FITNESS TUITION IN THE NATURE OF PERSONAL TRAINING (U.S. CLS. 100, 101 AND 107).

#### CLASS 44—MEDICAL, BEAUTY AND AGRICULTURAL SERVICES

FOR PHYSICAL HEALTH AND FITNESS ASSESSMENTS VIA MEDICAL TESTING SERVICES (U.S. CLS. 100 AND 101).  
KIMBERLY PERRY, EXAMINING ATTORNEY

SN 79-096,768. AKTIEBOLAGET ELECTROLUX, SE-105 45 STOCKHOLM, SWEDEN, FILED 1-17-2011.

**TMIS**

THE MARK CONSISTS OF STANDARD CHARACTERS WITHOUT CLAIM TO ANY PARTICULAR FONT, STYLE, SIZE, OR COLOR.

OWNER OF INTERNATIONAL REGISTRATION 1075352 DATED 1-17-2011, EXPIRES 1-17-2021.

#### CLASS 7—MACHINERY

FOR TEXTILE WASHING MACHINES; DRYING EQUIPMENT, NAMELY, MANGLES AND IRONING MACHINES; IRONING MACHINES IN THE NATURE OF ELECTRIC CLOTHING PRESSING MACHINES FOR COMMERCIAL AND PROFESSIONAL DRY CLEANING AND LAUNDRY PURPOSES; PARTS AND COMPONENTS FOR ALL THE AFORESAID GOODS (U.S. CLS. 13, 19, 21, 23, 31, 34 AND 35).

#### CLASS 9—ELECTRICAL AND SCIENTIFIC APPARATUS

FOR CONTROL SYSTEM FOR THE MANAGEMENT AND OPERATION OF WASHING MACHINES IN PROFESSIONAL LAUNDRIES, COMPRISED OF COMPUTERS, SOFTWARE, ELECTROMECHANICAL CONTROLS, AND VIDEO DISPLAY SCREENS; MICRO-PROCESSORS FOR SELECTION OF WASH PROGRAMS; COMPUTER SOFTWARE PROGRAMMES FOR USE IN PROFESSIONAL DEVELOPMENT AND EDUCATION IN THE FIELD OF COMMERCIAL AND PROFESSIONAL LAUNDRY SYSTEMS; COMPUTER SOFTWARE FOR DISTANT ACCESS OF LAUNDRY EQUIPMENT ACTIVITIES VIA MOBILE DEVICES; PARTS AND COMPONENTS FOR ALL THE AFORESAID GOODS, NAMELY, COMPUTER MONITORS, COMPUTER KEYBOARDS (U.S. CLS. 21, 23, 26, 36 AND 38).

#### CLASS 11—ENVIRONMENTAL CONTROL APPARATUS

FOR CLOTHES DRYERS, NAMELY, TUMBLE DRYERS (U.S. CLS. 13, 21, 23, 31 AND 34).  
KAREN SEVERSON, EXAMINING ATTORNEY

SN 79-097,010. EUROSPITAL S.P.A., ITALY, FILED 3-10-2011.



PRIORITY DATE OF 11-22-2010 IS CLAIMED.  
OWNER OF INTERNATIONAL REGISTRATION 1076073 DATED 3-10-2011, EXPIRES 3-10-2021.

OWNER OF U.S. REG. NO. 3,906,837.  
NO CLAIM IS MADE TO THE EXCLUSIVE RIGHT TO USE "MEDITERRANEAN", APART FROM THE MARK AS SHOWN.

THE COLOR(S) BLUE, YELLOW-ORANGE AND WHITE IS/ARE CLAIMED AS A FEATURE OF THE MARK.

THE MARK CONSISTS OF A DESIGN SUBSTANTIALLY SHAPED AS A QUADRILATERAL WITH THE HORIZONTAL SIDES CURVED AND THE VERTICAL RIGHT SIDE SHORTER THAN THE LEFT ONE, IN BLUE WITH A YELLOW-ORANGE PARTIAL BORDER CONTAINING THE WORDS "MEDITERRANEAN PLEASURES" WRITTEN IN WHITE LETTERS, AND A REVERSED-S SHAPED CURVED LINE IN WHITE; IN THE UPPER LEFT ANGLE THERE IS A REPRESENTATION OF THE SUN IN YELLOW-ORANGE.

#### CLASS 5—PHARMACEUTICALS

FOR DIETETIC FOODS ADAPTED FOR MEDICAL USE; PREPARATIONS MADE FROM CEREALS, NAMELY, CEREAL BASED SNACK-FOODS AND PREPARED DIETARY ITEMS ALL OF WHICH ITEMS ARE GLUTEN-FREE TO ACCOMMODATE SPECIAL MEDICAL AND HEALTH CONDITIONS, EXCLUDING BREAKFAST CEREALS AND CEREAL BARS (U.S. CLS. 6, 18, 44, 46, 51 AND 52).

#### CLASS 30—STAPLE FOODS

FOR BREAD, NAMELY, FRENCH BREAD, BREAD ROLLS, BREAD LOAVES, SLICED BREAD LOAVES, TARTS, COUNTRY BREAD, BREAD-STICKS, BREAD-CRUMBS, CRACKERS, AND CROUTONS; PASTA, NAMELY, SPAGHETTI, PENNE, FUSILLI PASTA, PIPE PASTA, SEDANI PASTA, AND MARGHERITE PASTA; READY-MADE PIZZA TARTS; FLOUR; BAKING POWDERS; BAKING SPICES; BISCUITS, NAMELY, CHOCOLATE DROP BISCUITS, AND MILLET FLOUR BISCUITS; PASTRY AND CONFECTIONERY, NAMELY, APRICOT CAKES, FIG CAKES, ALMOND CAKES, DANISH PASTRIES, FRUIT CAKES, CHOCOLATE OR CREAM SPONGE-CAKE SNACKS; PUDDINGS; ICE CREAM; FROZEN CONFECTIONS (U.S. CL. 46).

MARK PILARO, EXAMINING ATTORNEY

SN 79-097,025. HUEY'S PLANET PTY LTD, AUSTRALIA, FILED 12-3-2010.

**Beachtown**

THE MARK CONSISTS OF STANDARD CHARACTERS WITHOUT CLAIM TO ANY PARTICULAR FONT, STYLE, SIZE, OR COLOR.

PRIORITY DATE OF 6-22-2010 IS CLAIMED.  
OWNER OF INTERNATIONAL REGISTRATION 1076163 DATED 12-3-2010, EXPIRES 12-3-2020.

**CLASS 9—ELECTRICAL AND SCIENTIFIC APPARATUS**

FOR COMPUTER GAME PROGRAMS; COMPUTER GAMES ADAPTED FOR USE WITH AN EXTERNAL DISPLAY SCREEN OR MONITOR; COMPUTER GAMES APPARATUS ADAPTED FOR USE WITH AN EXTERNAL DISPLAY SCREEN OR MONITOR; COMPUTER GAMES APPARATUS ADAPTED FOR USE WITH EXTERNAL MONITORS; COMPUTER GAMES ENTERTAINMENT SOFTWARE; COMPUTER GAMES PROGRAMS; COMPUTER GAMES PROGRAMS DOWNLOADED VIA THE INTERNET; COMPUTER GAMES SOFTWARE; COMPUTER PROGRAMS FOR COMPUTER GAMES; COMPUTER PROGRAMS FOR PLAYING GAMES; COMPUTER PROGRAMS FOR VIDEO GAMES; CONTROLLERS FOR USE WITH ELECTRONIC GAMES; ELECTRIC COMPUTER GAMES ADAPTED FOR USE WITH AN EXTERNAL DISPLAY SCREEN OR MONITOR; ELECTRIC COMPUTER GAMES ADAPTED FOR USE WITH EXTERNAL VISUAL DISPLAY UNITS; GAME PROGRAMS AND SOFTWARE FOR USE WITH ELECTRONIC GAMES OF ALL KINDS; HAND-HELD VIDEO GAMES ADAPTED FOR USE WITH AN EXTERNAL DISPLAY SCREEN OR MONITOR; GAMES SOFTWARE FOR USE WITH AN EXTERNAL DISPLAY SCREEN OR MONITOR; HAND-HELD COMPUTER GAMES FOR USE WITH TELEVISION RECEIVERS ONLY; HAND-HELD ELECTRONIC GAMES FOR USE WITH TELEVISION RECEIVERS ONLY; INTERACTIVE EDUCATIONAL VIDEO OR COMPUTER GAMES FOR USE WITH TELEVISION RECEIVERS; INTERACTIVE EDUCATIONAL VIDEO OR COMPUTER GAMES FOR USE WITH EXTERNAL VIDEO APPARATUS; PERSONAL COMPUTERS FOR USE WITH COIN OPERATED VIDEO GAME DEVICES; PERSONAL COMPUTERS FOR USE WITH VIDEO GAME DEVICES; PROGRAM CARTRIDGES FOR COMPUTER GAMES; PROGRAM DISCS FOR VIDEO GAMES; PROGRAMMED VIDEO GAME SOFTWARE; PROGRAMMED VIDEO GAMES CONTAINED ON CARTRIDGES; PROGRAMS FOR USE WITH COMPUTER GAMES; TELEVISION GAMES, NAMELY, VIDEO GAME MACHINES FOR USE WITH TELEVISIONS; VIDEO GAME APPARATUS FOR USE WITH TELEVISIONS ONLY; VIDEO GAME CARTRIDGES; VIDEO GAME COMPUTER PROGRAMS; VIDEO GAME COMPUTER PROGRAMS FOR USE WITH GAME APPARATUS NOT REQUIRING A SEPARATE MEANS OF DISPLAY; VIDEO GAME PROGRAMS; VIDEO GAME PROGRAMS FOR COIN-OPERATED APPARATUS; VIDEO GAME PROGRAMS FOR USE IN COMPUTERS; VIDEO GAME PROGRAMS FOR USE WITH COMPUTERS; VIDEO GAMES ON DISC; VIDEO GAMES ON TAPE; VIDEO GAMES PROGRAMS (U.S. CLS. 21, 23, 26, 36 AND 38).

**CLASS 28—TOYS AND SPORTING GOODS**

FOR APPARATUS FOR GAMES, NAMELY, EQUIPMENT SOLD AS A UNIT FOR PLAYING BOARD GAMES; BOARD GAMES; CARD GAMES; ELECTRONIC GAMES FOR THE TEACHING OF CHILDREN OTHER THAN THOSE ADAPTED FOR USE WITH AN EXTERNAL DISPLAY SCREEN OR MONITOR; ELECTRONIC GAMES HAVING A WATCH FUNCTION OTHER THAN THOSE ADAPTED FOR USE WITH AN EXTERNAL DISPLAY SCREEN OR MONITOR; ELECTRONIC GAMES IN THE FORM OF A WATCH OTHER THAN THOSE ADAPTED FOR USE WITH AN EXTERNAL DISPLAY SCREEN OR MONITOR; ELECTRONIC GAMES INCORPORATING THEIR OWN VIRTUAL DISPLAY FACILITIES; ELECTRONIC GAMES MACHINES OTHER THAN THOSE ADAPTED FOR USE WITH AN EXTERNAL DISPLAY SCREEN OR MONITOR; ELECTRONIC VIDEO GAME MACHINES, AUTOMATIC AND COIN-OPERATED; BOARD GAMES FOR ADULTS; BOARD GAMES FOR CHILDREN; GAMES IN THE FORM OF QUIZZES; GAMES INCORPORATING TOY CARS; HAND-HELD AUTOMATIC COMPUTER GAMES OTHER THAN THOSE ADAPTED FOR USE WITH AN EXTERNAL DISPLAY SCREEN OR MONITOR; HAND-HELD COIN-OPERATED COMPUTER GAMES OTHER THAN THOSE ADAPTED FOR USE WITH AN EXTERNAL DISPLAY SCREEN OR MONITOR; HAND-HELD AUTOMATIC ELECTRONIC GAME MACHINES OTHER THAN THOSE ADAPTED FOR USE WITH AN EXTERNAL DISPLAY SCREEN OR MONITOR; HAND-HELD COIN-OPERATED ELECTRONIC GAME MACHINES

OTHER THAN THOSE ADAPTED FOR USE WITH AN EXTERNAL DISPLAY SCREEN OR MONITOR; HAND-HELD ELECTRONIC GAME MACHINES OTHER THAN THOSE ADAPTED FOR USE WITH AN EXTERNAL DISPLAY SCREEN OR MONITOR; HAND-HELD AUTOMATIC ELECTRONIC GAMES OTHER THAN THOSE ADAPTED FOR USE WITH AN EXTERNAL DISPLAY SCREEN OR MONITOR; HAND-HELD COIN-OPERATED ELECTRONIC GAMES OTHER THAN THOSE ADAPTED FOR USE WITH AN EXTERNAL DISPLAY SCREEN OR MONITOR; MECHANICALLY OPERATED DART GAMES; MINIATURE ACTION FIGURES FOR USE IN TABLE-TOP BATTLE GAMES; PARTY GAMES; SELF-CONTAINED ELECTRONIC TABLETOP VIDEO GAME APPARATUS OTHER THAN FOR USE WITH TELEVISION RECEIVERS; SPORTS GAMES; TARGET GAMES; TOY CAR GAMES; TRADING CARDS GAME; VIDEO GAME AMUSEMENT MACHINES NOT ADAPTED FOR USE WITH AN EXTERNAL DISPLAY SCREEN OR MONITOR; VIDEO GAME MACHINES INCORPORATING A MEANS OF DISPLAY AND NOT ADAPTED FOR USE WITH AN EXTERNAL DISPLAY SCREEN OR MONITOR (U.S. CLS. 22, 23, 38 AND 50).

**CLASS 41—EDUCATION AND ENTERTAINMENT**

FOR ENTERTAINMENT SERVICES, NAMELY, PROVIDING ONLINE VIDEO GAMES; GAMING, NAMELY, PROVISION OF NON-DOWNLOADABLE INTERNET, VIDEO OR COMPUTER GAMES; PROVISION OF ONLINE VIDEO, INTERNET OR COMPUTER GAMES BY MEANS OF A COMPUTER BASED SYSTEM; ENTERTAINMENT SERVICES, NAMELY, PROVIDING NON-DOWNLOADABLE ELECTRONIC GAME SOFTWARE FOR CELLULAR TELEPHONES (U.S. CLS. 100, 101 AND 107).

MICHAEL WEBSTER, EXAMINING ATTORNEY

SN 79-097,030. ESCANDE SERGE, FRANCE, AND ALQUIER FRANÇOIS-JÉRÔME, FRANCE, AND FRUCHARD RA-  
PHAEL, FRANCE, FILED 2-4-2011.



PRIORITY DATE OF 8-5-2010 IS CLAIMED.  
OWNER OF INTERNATIONAL REGISTRATION 1076181  
DATED 2-4-2011, EXPIRES 2-4-2021.

THE COLOR(S) BEIGE AND BLACK IS/ARE CLAIMED  
AS A FEATURE OF THE MARK.

THE MARK CONSISTS OF THE WORDING "THE" AND  
"FRIDAY, DECEMBER 22, 2006" IN BLACK ON A BEIGE  
COLORED TORN UPPER LEFT CORNER OF A PIECE OF  
PAPER.

**CLASS 35—ADVERTISING AND BUSINESS**

FOR ADVERTISING SERVICES; BUSINESS MANAGEMENT; BUSINESS MANAGEMENT AND ORGANIZATION CONSULTANCY; DOCUMENT REPRODUCTION; COMPUTERIZED FILE MANAGEMENT; ON-LINE ADVERTISING ON A COMPUTER NETWORK; PUBLICATION OF PUBLICITY TEXTS; RENTAL OF ADVERTISING SPACE; REPRESENTATION OF ARTISTS AND WORKS, NAMELY, PROMOTION AND BUSINESS MANAGEMENT OF PERFORMING ARTISTS, ADVICE AND INFORMATION IN THE AFORESAID FIELDS; ADMINISTRATIVE MANAGEMENT OF EDITORIAL CATALOGS (U.S. CLS. 100, 101 AND 102).

**CLASS 41—EDUCATION AND ENTERTAINMENT**

FOR ENTERTAINMENT SERVICES, NAMELY, CONDUCTING PARTIES, MUSICAL PRODUCTION, ORGANIZING CULTURAL AND ARTS EVENTS, PRODUCTION OF MUSICAL SOUND RECORDINGS, RECORDING STUDIOS; VIDEOTAPE FILM PRODUCTION; RENTAL OF SOUND RECORDINGS; VIDEOTAPE EDITING; AUDIOVISUAL PRODUCTION, NAMELY OF DOCUMENTARY FILMS, FICTIONAL FILMS AND TELEVISION PROGRAMS, MUSIC PUBLISHING SERVICES, ORGANIZATION OF SHOWS FOR CULTURAL PURPOSES, ADVICE AND INFORMATION IN THE AFORESAID FIELDS (U.S. CLS. 100, 101 AND 107).

TRACY CROSS, EXAMINING ATTORNEY

SN 79-097,084. MARINOVA PTY LTD, AUSTRALIA, FILED 3-4-2011.

# MARITECH

THE MARK CONSISTS OF STANDARD CHARACTERS WITHOUT CLAIM TO ANY PARTICULAR FONT, STYLE, SIZE, OR COLOR.

OWNER OF INTERNATIONAL REGISTRATION 1076322 DATED 3-4-2011, EXPIRES 3-4-2021.

**CLASS 5—PHARMACEUTICALS**

FOR EXTRACTS OF SEAWEED AND ALGAE PREPARED FOR MEDICAL OR VETERINARY USE; EXTRACTS OF SEAWEED AND ALGAE PREPARED FOR DIETARY OR NUTRITIONAL SUPPLEMENT USE (U.S. CLS. 6, 18, 44, 46, 51 AND 52).

**CLASS 42—SCIENTIFIC AND COMPUTER SERVICES**

FOR LABORATORY RESEARCH SERVICES, NAMELY, PREPARATION OF BIOLOGICAL SAMPLES OF SEAWEED AND MARINE ALGAE FOR ANALYSIS IN MEDICAL OR VETERINARY RESEARCH; LABORATORY RESEARCH SERVICES, NAMELY, PREPARATION OF BIOLOGICAL SAMPLES OF SEAWEED AND MARINE ALGAE FOR DIETARY OR NUTRITIONAL SUPPLEMENT RESEARCH PURPOSES; BIOLOGICAL LABORATORY SERVICES, NAMELY, EXTRACTION OF ACTIVE BIOCHEMICAL SUBSTANCES FROM SEAWEED AND MARINE ALGAE; BIOCHEMICAL RESEARCH, NAMELY, PURIFICATION OF ACTIVE BIOCHEMICAL SUBSTANCES EXTRACTED FROM SEAWEED AND MARINE ALGAE (U.S. CLS. 100 AND 101).

BARBARA RUTLAND, EXAMINING ATTORNEY

SN 79-097,161. CONSEIL INTERPROFESSIONNEL DU VIN DE BORDEAUX, F-33000 BORDEAUX, FRANCE, FILED 2-9-2011.



PRIORITY DATE OF 8-26-2010 IS CLAIMED. OWNER OF INTERNATIONAL REGISTRATION 1076559 DATED 2-9-2011, EXPIRES 2-9-2021.

THE COLOR(S) GRAY AND BLACK IS/ARE CLAIMED AS A FEATURE OF THE MARK.

THE MARK CONSISTS OF THE LARGE LETTER "S" IN GRAY AND THE SMALL WORD "SMART" IN BLACK AND ENTIRELY RESTING IN THE LOWER PART OF THE LETTER "S".

**CLASS 33—WINES AND SPIRITS**

FOR WINES WITH VARIOUS BORDEAUX APPELLATIONS (U.S. CLS. 47 AND 49).

**CLASS 35—ADVERTISING AND BUSINESS**

FOR ADVERTISING; DISSEMINATION OF ADVERTISING MATTER IN THE NATURE OF LEAFLETS, PROSPECTUSES, CATALOGUES AND PRODUCT SAMPLES; CONDUCTING MARKETING STUDIES; MARKETING RESEARCH; ORGANIZATION OF EXHIBITIONS FOR COMMERCIAL OR ADVERTISING PURPOSES; SALES PROMOTION FOR OTHERS; THE BRINGING TOGETHER FOR THE BENEFIT OF OTHERS OF WINES FROM THE DIFFERENT BORDEAUX APPELLATIONS EXCLUDING THE TRANSPORT THEREOF, ENABLING CONSUMERS TO VIEW AND PURCHASE THOSE GOODS FOR PROMOTIONAL PURPOSES; RENTAL OF ADVERTISING SPACE; ON-LINE ADVERTISING ON A COMPUTER NETWORK; DIRECT MAIL ADVERTISING SERVICES; RADIO ADVERTISING AGENCY SERVICES; TELEVISION ADVERTISING AGENCY SERVICES; ALL OF THE AFOREMENTIONED SERVICES ALSO PROVIDED VIA MOBILE TELEPHONY, INTERNET AND INTRANET COMMUNICATIONS NETWORKS, PROVIDED ONLINE AND BY MEANS OF INTERACTIVE COMPUTER SERVICES (U.S. CLS. 100, 101 AND 102).

**CLASS 38—COMMUNICATION**

FOR PROVIDING INTERNET ACCESS, NAMELY, PROVIDING ACCESS TO AN INTERNET SITE; PROVIDING TELECOMMUNICATION ACCESS TO A INTERNET SITE; TRANSMISSION OF INFORMATION ACCESSIBLE VIA ACCESS CODES, DATA PROCESSING SERVERS, COMPUTER DATABASE SERVERS, COMPUTER OR TELEMATIC NETWORKS, INCLUDING THE INTERNET AND THE WORLD WIDE WEB; ELECTRONIC TRANSMISSION OF PERIODICAL PUBLICATIONS AND OTHER PRINTED MATTER FOR OTHERS VIA COMPUTER TERMINALS AND VIA GLOBAL AND LOCAL COMMUNICATION NETWORKS (U.S. CLS. 100, 101 AND 104).

**CLASS 41—EDUCATION AND ENTERTAINMENT**

FOR ENTERTAINMENT IN THE NATURE OF WINE TASTINGS; TEACHING IN THE FIELD OF WINE; ENTERTAINMENT OR EDUCATION CLUB SERVICES, NAMELY, FAN CLUBS, NIGHT CLUBS; HANDS-ON TRAINING IN THE FIELD OF WINEMAKING; INTRODUCTORY WINE TASTING COURSES; TRAINING IN OENOLOGY; ORGANIZATION OF WORKSHOPS AND TRAINING COURSES IN THE FIELD OF WINEMAKING AND WINE TASTING; ARRANGING OF EDUCATIONAL COLLOQUIUMS, CONFERENCES, AND CONGRESSES IN THE FIELD OF WINEMAKING AND WINE TASTING; ORGANIZATION OF EXHIBITIONS FOR CULTURAL OR EDUCATIONAL PURPOSES AND COMPETITIONS FOR CULTURAL OR EDUCATIONAL PURPOSES IN THE NATURE OF WINEMAKING COMPETITIONS; PRODUCTION OF RADIO AND TELEVISION PROGRAMS; FILM PRODUCTION; ALL OF THE AFOREMENTIONED SERVICES ALSO PROVIDED VIA MOBILE TELEPHONY, INTERNET AND INTRANET COMMUNICATIONS NETWORKS, PROVIDED ONLINE AND BY MEANS OF INTERACTIVE COMPUTER SERVICES (U.S. CLS. 100, 101 AND 107).

MICHAEL WIENER, EXAMINING ATTORNEY

SN 79-097,217. FIGHTERS ONLY LIMITED, NEWCASTLE UPON TYNE, NE2 1DJ, UNITED KINGDOM, FILED 4-4-2011.



OWNER OF INTERNATIONAL REGISTRATION 1076711 DATED 4-4-2011, EXPIRES 4-4-2021.

NO CLAIM IS MADE TO THE EXCLUSIVE RIGHT TO USE "FIGHTERS", APART FROM THE MARK AS SHOWN. THE MARK CONSISTS OF THE WORDS "FIGHTERS ONLY" WITH AN OUTLINE ON THE WORDS AND A CRACK IN THE "F" OF "FIGHTERS". ON EITHER SIDE OF THE WORD "ONLY" THERE ARE TRIANGLE SHAPES COMING FROM THE "O" AND THE "Y". THERE IS A SHADOW EFFECT ON THE TRIANGLE SHAPES.

**CLASS 9—ELECTRICAL AND SCIENTIFIC APPARATUS**

FOR DOWNLOADABLE ELECTRONIC PUBLICATIONS, NAMELY, NEWSLETTERS, MAGAZINES, JOURNALS AND BOOKS IN THE FIELD OF MARTIAL ARTS FROM THE INTERNET; COMPUTER GAMES PROGRAMMES; COMPUTER GAMES PROGRAMMES DOWNLOADED VIA THE INTERNET (U.S. CLS. 21, 23, 26, 36 AND 38).

**CLASS 16—PAPER GOODS AND PRINTED MATTER**

FOR PRINTED MATTER, NAMELY, NEWSLETTERS CONCERNED WITH MARTIAL ARTS, TRAINING MANUALS FOR MARTIAL ARTS; PERIODICAL PUBLICATIONS CONCERNED WITH MARTIAL ARTS; BOOKS CONCERNED WITH MARTIAL ARTS; MAGAZINES CONCERNED WITH MARTIAL ARTS; NEWSLETTERS CONCERNED WITH MARTIAL ARTS (U.S. CLS. 2, 5, 22, 23, 29, 37, 38 AND 50).

**CLASS 25—CLOTHING**

FOR SPORTS WEAR AND LEISURE WEAR, NAMELY, SHIRTS, T-SHIRTS, SHORTS, TRUNKS, TOPS, PANTS, JACKETS, HOODED JACKETS, SWEAT SHIRTS, SWEAT PANTS, SOCKS, CAPS, HATS; FOOTWEAR FOR SPORTS; CLOTHING, NAMELY, MARTIAL ARTS UNIFORMS AND FOOTWEAR FOR USE IN MARTIAL ARTS (U.S. CLS. 22 AND 39).

**CLASS 28—TOYS AND SPORTING GOODS**

FOR APPARATUS AND EQUIPMENT FOR USE IN SPORTS, IN GYMNASTICS AND IN MARTIAL ARTS, NAMELY, MARTIAL ARTS TRAINING EQUIPMENT, BOXING GLOVES, PROTECTIVE VESTS FOR USE IN MARTIAL ARTS; FITNESS APPARATUS, NAMELY, DUMB BELLS, WEIGHTS, SKIPPING ROPES; FITNESS EXERCISE MACHINES, NAMELY, STAIR-STEPPING MACHINES, STATIONARY BICYCLES, TREADMILLS, BENCH PRESS MACHINES, ROWING MACHINES (U.S. CLS. 22, 23, 38 AND 50).

**CLASS 41—EDUCATION AND ENTERTAINMENT**

FOR ELECTRONIC GAMES SERVICES PROVIDED BY MEANS OF THE INTERNET; THE PROVISION OF INFORMATION RELATED TO ON-LINE ELECTRONIC PUBLICATIONS; TELEVISION ENTERTAINMENT SERVICES, NAMELY, AN ON GOING TELEVISION PROGRAM IN THE FIELD OF MARTIAL ARTS; RADIO ENTERTAINMENT SERVICES, NAMELY, AN ON GOING RADIO PROGRAM IN THE FIELD OF MARTIAL ARTS; ARRANGING AND HOSTING AWARD CEREMONIES, NAMELY, ARRANGING AND CONDUCTING INCENTIVE AWARD PROGRAMS TO ENCOURAGE THE FREQUENT, CONTINUED AND EFFECTIVE PRACTICE OF PHYSICAL EXERCISE; PROVIDING INFORMATION RELATING TO ENTERTAINMENT PROVIDED ON-LINE VIA THE INTERNET (U.S. CLS. 100, 101 AND 107).

ANNE FARRELL, EXAMINING ATTORNEY

SN 79-097,451. ELEPHANT PARADE.COM PTE. LTD., SINGAPORE, FILED 1-24-2011.

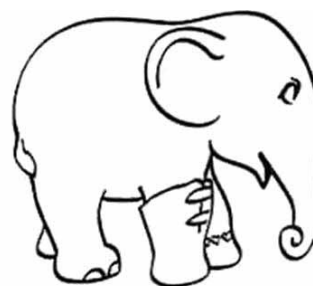

**MOSHA**

PRIORITY DATE OF 8-19-2010 IS CLAIMED. OWNER OF INTERNATIONAL REGISTRATION 1077336 DATED 1-24-2011, EXPIRES 1-24-2021.

THE MARK CONSISTS OF THE WORDING "MOSHA" WITH AN ELEPHANT DESIGN ABOVE.

**CLASS 14—JEWELRY**

FOR NECKLACES; EARRINGS; RINGS; BRACELETS (U.S. CLS. 2, 27, 28 AND 50).

**CLASS 16—PAPER GOODS AND PRINTED MATTER**

FOR ALBUMS FOR PHOTOGRAPHS; ALMANACS; POSTCARDS; PENS; COMIC BOOKS; FIGURINES MACHE MADE OF PAPER; GRAPHIC ART REPRODUCTIONS; GREETING CARDS; STICKERS; HOLOGRAPHIC STICKERS; PICTURES; POSTERS (U.S. CLS. 2, 5, 22, 23, 29, 37, 38 AND 50).

**CLASS 20—FURNITURE AND ARTICLES NOT OTHERWISE CLASSIFIED**

FOR STATUETTES MADE OF WOOD; STATUETTES MADE OF WAX; STATUETTES MADE OF PLASTER; STATUETTES MADE OF PLASTIC (U.S. CLS. 2, 13, 22, 25, 32 AND 50).

**CLASS 30—STAPLE FOODS**

FOR COCOA; BREAD; SAUCES; CAKES; CRACKERS; CONFECTIONARY, NAMELY, PASTILLES, FONDANTS; CHOCOLATE; ICE-CREAM; CANDY; CARAMELS; CHOCOLATE-BASED BEVERAGES; COFFEE-BASED BEVERAGES; BISCUITS; CEREAL-BASED SNACK FOOD; CHEWING GUM, NOT FOR MEDICAL PURPOSES; CHOCOLATE BEVERAGES WITH MILK; COFFEE; COFFEE-BEVERAGES WITH MILK; COOKIES; FRUIT JEL-LIES; PASTA; RICE; TEA; TEA-BASED BEVERAGES (U.S. CL. 46).

**CLASS 32—LIGHT BEVERAGES**

FOR DRINKING WATER; FRUIT JUICES; SOFT DRINKS; NON-ALCOHOLIC FRUIT NECTARS; SODA WATER; BEER; NON-ALCOHOLIC AERATED WATER; CONCENTRATES FOR MAKING FRUIT JUICES; NON-ALCOHOLIC FRUIT EXTRACTS USED IN THE PREPARATION OF BEVERAGES; NON-ALCOHOLIC FRUIT JUICE BEVERAGES; LEMONADES; SYRUPS FOR BEVERAGES; MINERAL WATER (U.S. CLS. 45, 46 AND 48).

**CLASS 41—EDUCATION AND ENTERTAINMENT**

FOR AMUSEMENT PARKS; PUBLICATION OF BOOKS; ORGANIZATION OF SPORT COMPETITIONS; EDUCATION SERVICES, NAMELY, PROVIDING WORKSHOPS IN THE FIELD OF ART; ENTERTAINMENT, NAMELY, LIVE PERFORMANCES OF SCULPTORS AND PAINTERS; ORGANIZATION OF ART EXHIBITIONS FOR CULTURAL OR EDUCATIONAL PURPOSES; FILM PRODUCTION; GAMING SERVICES, NAMELY, PROVIDING AMUSEMENT ARCADE SERVICES; PRESENTATION OF LIVE STAGE THEATRICAL PERFORMANCES; BOOKING OF SEAT FOR ENTERTAINMENT SHOWS; ORGANIZING LOTTERIES; PHOTOGRAPHY; PRODUCTION OF RADIO AND TELEVISION PROGRAMMES; ENTERTAINMENT IN THE NATURE OF ON-GOING TELEVISION PROGRAMS IN THE FIELD OF VARIETY; ARRANGING OF ART EXHIBITIONS OF STATUES AND STATUETTES FOR CULTURAL, EDUCATIONAL AND ENTERTAINMENT PURPOSES; NON-DOWNLOADABLE ELECTRONIC PUBLICATIONS IN THE NATURE OF MAGAZINES IN THE FIELD OF ART (U.S. CLS. 100, 101 AND 107).

ALICE BENMAMAN, EXAMINING ATTORNEY

SN 79-097,495. EDWIN PH. BLAAK, NETHERLANDS, FILED 4-19-2011.

# PITEBA

THE MARK CONSISTS OF STANDARD CHARACTERS WITHOUT CLAIM TO ANY PARTICULAR FONT, STYLE, SIZE, OR COLOR.

OWNER OF INTERNATIONAL REGISTRATION 1077454 DATED 4-19-2011, EXPIRES 4-19-2021.

THE WORD(S) "PITEBA" HAS NO MEANING IN A FOREIGN LANGUAGE.

**CLASS 7—MACHINERY**

FOR MACHINES, PRESSES AND MACHINE TOOLS FOR PROCESSING AGRICULTURAL PRODUCTS (U.S. CLS. 13, 19, 21, 23, 31, 34 AND 35).

**CLASS 8—HAND TOOLS**

FOR HAND-OPERATED PRESSES FOR PROCESSING AGRICULTURAL PRODUCTS (U.S. CLS. 23, 28 AND 44).

SHANNON TWOHIG, EXAMINING ATTORNEY

SN 79-097,701. AMSAFE BRIDPORT LIMITED, BRIDPORT, DORSET, UNITED KINGDOM, FILED 4-18-2011.

# TARIAN

THE MARK CONSISTS OF STANDARD CHARACTERS WITHOUT CLAIM TO ANY PARTICULAR FONT, STYLE, SIZE, OR COLOR.

PRIORITY DATE OF 10-26-2010 IS CLAIMED.

OWNER OF INTERNATIONAL REGISTRATION 1078103 DATED 4-18-2011, EXPIRES 4-18-2021.

**CLASS 22—CORDAGE AND FIBERS**

FOR ARMOUR SYSTEMS MADE WHOLLY OR PRINCIPALLY FROM NON-METAL NET MATERIAL; DEFENSIVE SHIELDS MADE WHOLLY OR PRINCIPALLY FROM NON-METAL NET MATERIAL; RPG (ROCKET PROPELLED GRENADES) COUNTERMEASURES MADE WHOLLY OR PRINCIPALLY FROM NON-METAL NET MATERIAL; VEHICLE MOUNTED DEFENSIVE SHIELDS MADE WHOLLY OR PRINCIPALLY FROM NON-METAL NET MATERIAL; GROUND MOUNTED DEFENSIVE SHIELDS MADE WHOLLY OR PRINCIPALLY FROM NON-METAL NET MATERIAL; NON-METAL NETS BEING STRUCTURAL PARTS AND FITTINGS FOR THE AFORESAID GOODS; STRUCTURAL PARTS AND FITTINGS FOR THE AFORESAID GOODS (U.S. CLS. 1, 2, 7, 19, 22, 42 AND 50).

**CLASS 37—CONSTRUCTION AND REPAIR**

FOR INSTALLATION, MAINTENANCE AND REPAIR OF NETS, ARMOUR SYSTEMS MADE WHOLLY OR PRINCIPALLY FROM NON-METAL NET MATERIAL, DEFENSIVE SHIELDS MADE WHOLLY OR PRINCIPALLY FROM NON-METAL NET MATERIAL, RPG (ROCKET PROPELLED GRENADES) COUNTERMEASURES MADE WHOLLY OR PRINCIPALLY FROM NON-METAL NET MATERIAL, VEHICLE MOUNTED DEFENSIVE SHIELDS MADE WHOLLY OR PRINCIPALLY FROM NON-METAL NET MATERIAL AND GROUND MOUNTED DEFENSIVE SHIELDS MADE WHOLLY OR PRINCIPALLY FROM NON-METAL NET MATERIAL (U.S. CLS. 100, 103 AND 106).

FONG HSU, EXAMINING ATTORNEY



SN 79-097,952. ENPEVITA GMBH, FED REP GERMANY,  
FILED 2-23-2011.



PRIORITY DATE OF 8-23-2010 IS CLAIMED.  
OWNER OF INTERNATIONAL REGISTRATION 1078891  
DATED 2-23-2011, EXPIRES 2-23-2021.

OWNER OF U.S. REG. NO. 3,818,700.  
THE COLOR(S) RED, YELLOW, GREEN AND GREY IS/  
ARE CLAIMED AS A FEATURE OF THE MARK.

THE MARK CONSISTS OF THREE OVERLAPPING CIRCLE DESIGNS AND THE TERM "ENPEVITA"; THE FIRST CIRCLE IS RED THE SECOND CIRCLE IS YELLOW AND THE THIRD CIRCLE IS GREEN; THE FIRST PART "ENPE" OF THE TERM "ENPEVITA" IS GREY, THE SECOND PART "VITA" IS GREEN.

#### **CLASS 9—ELECTRICAL AND SCIENTIFIC APPARATUS**

FOR COMPUTER SOFTWARE FOR THE COLLECTION, EDITING, ORGANIZING, MODIFYING, BOOK MARKING, TRANSMISSION, STORAGE AND SHARING OF DATA AND INFORMATION (U.S. CLS. 21, 23, 26, 36 AND 38).

#### **CLASS 35—ADVERTISING AND BUSINESS**

FOR BUSINESS MARKETING; PUBLIC RELATIONS; ADVERTISING, IN PARTICULAR BY ADVERTISING BROCHURES, BY RENTAL OF ADVERTISING SPACE AND BY PUBLICATION OF PUBLICITY TEXTS; ONLINE MARKETING, PUBLIC RELATIONS AND ADVERTISING SERVICES; COMPILATION AND SYSTEMATIZATION OF INFORMATION IN COMPUTER DATABASES (U.S. CLS. 100, 101 AND 102).

#### **CLASS 38—COMMUNICATION**

FOR TELECOMMUNICATIONS, IN PARTICULAR PROVISION OF E-MAIL OFFERS, CHAT LINES AND FORUMS FOR COMMUNICATIONS ON THE INTERNET, NAMELY, PROVIDING E-MAIL SERVICES, INTERNET CHAT ROOMS AND ONLINE FORUMS FOR TRANSMISSION OF MESSAGES AMONG COMPUTER USERS CONCERNING THE EXCHANGE OF INFORMATION AND EXPERIENCE ON COMPLEX TOPICS; IN PARTICULAR TECHNICAL TOPICS, MEDICAL TOPICS, VETERINARY TOPICS AND SCIENTIFIC TOPICS; SETTING UP AND OPERATING A COMMUNICATIONS NETWORK ON THE INTERNET, NAMELY, PROVIDING REMOTE INTERNET ACCESS; RENTAL OF ACCESS TIME TO DATABASES, NAMELY, RENTAL OF ACCESS TIME TO GLOBAL COMPUTER NETWORKS (U.S. CLS. 100, 101 AND 104).

#### **CLASS 42—SCIENTIFIC AND COMPUTER SERVICES**

FOR DEVELOPMENT AND DESIGN OF COMPUTER SOFTWARE; COMPUTER PROGRAMMING; DESIGN OF INTERNET SITES, NAMELY DESIGN OF HOMEPAGES AND WEBSITES; PROVISION OF DATA ON AN INTERNET WEBSITE, NAMELY, CONFIGURATION AND CUSTOMIZATION OF COMPUTER DATABASES CONTAINING INFORMATION REGARDING COMPLEX TOPICS, IN PARTICULAR MEDICAL TOPICS, TECHNICAL TOPICS, VETERINARY TOPICS, SCIENTIFIC TOPICS (U.S. CLS. 100 AND 101).

#### **CLASS 44—MEDICAL, BEAUTY AND AGRICULTURAL SERVICES**

FOR HYGIENIC AND BEAUTY CARE, NAMELY, PROVIDING HYGIENIC AND BEAUTY CARE INFORMATION, CONSULTANCY AND ADVISORY SERVICES; ADVICE IN MEDICAL QUESTIONS, NAMELY, PROVIDING MEDICAL INFORMATION, CONSULTANCY AND ADVISORY SERVICES (U.S. CLS. 100 AND 101).

DEZMONA MIZELLE, EXAMINING ATTORNEY

SN 79-098,010. BIGPOINT GMBH, FED REP GERMANY,  
FILED 1-27-2011.

# Ponyrama

THE MARK CONSISTS OF STANDARD CHARACTERS WITHOUT CLAIM TO ANY PARTICULAR FONT, STYLE, SIZE, OR COLOR.

PRIORITY DATE OF 8-6-2010 IS CLAIMED.  
OWNER OF INTERNATIONAL REGISTRATION 1079086  
DATED 1-27-2011, EXPIRES 1-27-2021.

#### **CLASS 9—ELECTRICAL AND SCIENTIFIC APPARATUS**

FOR COMPUTERS, RECORDED COMPUTER GAME PROGRAMS; DOWNLOADABLE COMPUTER GAME PROGRAMS AND GAME SOFTWARE, IN PARTICULAR FOR COMPUTER, VIDEO, ONLINE AND BROWSER GAMES; ELECTRONIC GAME SOFTWARE FOR CELLULAR TELEPHONES (U.S. CLS. 21, 23, 26, 36 AND 38).

#### **CLASS 28—TOYS AND SPORTING GOODS**

FOR APPARATUS FOR ELECTRONIC GAMES OTHER THAN THOSE ADAPTED FOR USE WITH AN EXTERNAL DISPLAY SCREEN OR MONITOR; GAMES, NAMELY, ELECTRONIC GAME CONSOLES AS HANDHELD UNITS NOT FOR USE WITH EXTERNAL DISPLAY SCREENS OR MONITORS (U.S. CLS. 22, 23, 38 AND 50).

#### **CLASS 38—COMMUNICATION**

FOR PROVIDING ACCESS TO INFORMATION VIA THE INTERNET, NAMELY, PROVIDING ACCESS TO DATABASES ON THE INTERNET; TRANSMISSION OF INFORMATION AND IMAGES BY ELECTRONIC MEANS; TRANSMISSION OF MESSAGES AND IMAGES VIA COMPUTER NETWORKS (U.S. CLS. 100, 101 AND 104).

#### **CLASS 41—EDUCATION AND ENTERTAINMENT**

FOR ENTERTAINMENT, NAMELY, IN THE FORM OF PROVIDING ONLINE COMPUTER GAMES, ONLINE VIDEO COMPUTER GAMES, ONLINE COMPUTER GAMES AND ONLINE BROWSER COMPUTER GAMES AND COMPUTER GAMES FOR MOBILE TELEPHONES, IN PARTICULAR VIA PORTALS AND PLATFORMS ON THE INTERNET; PROVIDING ONLINE GAMES SERVICES ON COMPUTER NETWORKS (U.S. CLS. 100, 101 AND 107).

KIM SAITO, EXAMINING ATTORNEY

SN 79-098,242. PHADIA AB, SWEDEN, FILED 5-31-2011.

# PrimeA

PRIORITY DATE OF 12-27-2010 IS CLAIMED.  
OWNER OF INTERNATIONAL REGISTRATION 1079622  
DATED 5-31-2011, EXPIRES 5-31-2021.

**CLASS 1—CHEMICALS**

FOR CHEMICAL REAGENTS AND PREPARATIONS FOR IN VITRO USE IN SCIENTIFIC LABORATORIES AND FOR USE IN THE PHARMACEUTICAL INDUSTRY (U.S. CLS. 1, 5, 6, 10, 26 AND 46).

**CLASS 5—PHARMACEUTICALS**

FOR CHEMICAL REAGENTS AND DIAGNOSTIC PREPARATIONS FOR IN VITRO USE IN MEDICAL AND VETERINARY LABORATORIES; CHEMICAL REAGENTS FOR MEDICAL AND VETERINARY PURPOSES; DIAGNOSTIC PREPARATIONS FOR MEDICAL PURPOSES (U.S. CLS. 6, 18, 44, 46, 51 AND 52).  
SEAN CROWLEY, EXAMINING ATTORNEY

SN 79-098,860. DE MARIN DE MONTMARIN EDOUARD, FRANCE, FILED 4-14-2011.

# Being Who

THE MARK CONSISTS OF STANDARD CHARACTERS WITHOUT CLAIM TO ANY PARTICULAR FONT, STYLE, SIZE, OR COLOR.

PRIORITY DATE OF 4-2-2011 IS CLAIMED.  
OWNER OF INTERNATIONAL REGISTRATION 1081276 DATED 4-14-2011, EXPIRES 1-18-2022.

**CLASS 35—ADVERTISING AND BUSINESS**

FOR ADVERTISING FOR SERVICES DEDICATED TO WEBSITES AND TO SOCIAL NETWORKS (U.S. CLS. 100, 101 AND 102).

**CLASS 38—COMMUNICATION**

FOR TELECOMMUNICATIONS ACCESS SERVICES FOR WEBSITES AND SOCIAL NETWORKS (U.S. CLS. 100, 101 AND 104).

**CLASS 41—EDUCATION AND ENTERTAINMENT**

FOR TEACHING AND TRAINING SERVICES IN THE FIELD OF WEBSITES AND SOCIAL NETWORKS; ENTERTAINMENT, NAMELY, PROVIDING A WEBSITE FEATURING ENTERTAINMENT INFORMATION (U.S. CLS. 100, 101 AND 107).

KRISTIN CARLSON, EXAMINING ATTORNEY

SN 79-098,832. MINELAB ELECTRONICS PTY LIMITED, AUSTRALIA, FILED 5-25-2011.

# CTX

THE MARK CONSISTS OF STANDARD CHARACTERS WITHOUT CLAIM TO ANY PARTICULAR FONT, STYLE, SIZE, OR COLOR.

PRIORITY DATE OF 2-15-2011 IS CLAIMED.  
OWNER OF INTERNATIONAL REGISTRATION 1081177 DATED 5-25-2011, EXPIRES 5-9-2022.

**CLASS 9—ELECTRICAL AND SCIENTIFIC APPARATUS**

FOR DETECTORS FOR ELECTRICALLY CONDUCTING MATERIALS, NAMELY, METAL DETECTORS (U.S. CLS. 21, 23, 26, 36 AND 38).

**CLASS 16—PAPER GOODS AND PRINTED MATTER**

FOR PRINTED INSTRUCTIONAL AND TEACHING MATERIALS IN THE FIELD OF METAL DETECTORS; PRINTED MATTER IN THE FIELD OF METAL DETECTORS, NAMELY, PRINTED GUIDES FOR METAL DETECTORS, PRINTED INFORMATION CARDS IN THE FIELD OF METAL DETECTORS, PRINTED INFORMATIONAL FOLDERS IN THE FIELD OF METAL DETECTORS, PRINTED MAGAZINES IN THE FIELD OF METAL DETECTORS, PRINTED BROCHURES IN THE FIELD OF METAL DETECTORS, AND PRINTED BOOKS IN THE FIELD OF METAL DETECTORS (U.S. CLS. 2, 5, 22, 23, 29, 37, 38 AND 50).

**CLASS 37—CONSTRUCTION AND REPAIR**

FOR INSTALLATION, MAINTENANCE AND REPAIR SERVICES RELATING TO ELECTRICAL APPARATUS AND INSTRUMENTS, NAMELY, INSTALLATION, MAINTENANCE AND REPAIR OF METAL DETECTORS AND ELECTRICAL CONDUCTORS (U.S. CLS. 100, 103 AND 106).

STEVEN PEREZ, EXAMINING ATTORNEY

SN 79-099,157. PHADIA AB, SWEDEN, FILED 5-31-2011.

# PlexA

PRIORITY DATE OF 12-17-2010 IS CLAIMED.  
OWNER OF INTERNATIONAL REGISTRATION 1082086 DATED 5-31-2011, EXPIRES 5-15-2022.

**CLASS 1—CHEMICALS**

FOR CHEMICAL REAGENTS AND PREPARATIONS FOR IN VITRO USE IN SCIENTIFIC LABORATORIES AND FOR USE IN THE PHARMACEUTICAL INDUSTRY (U.S. CLS. 1, 5, 6, 10, 26 AND 46).

**CLASS 5—PHARMACEUTICALS**

FOR CHEMICAL REAGENTS AND DIAGNOSTIC PREPARATIONS FOR IN VITRO USE IN MEDICAL AND VETERINARY LABORATORIES; CHEMICAL REAGENTS FOR MEDICAL AND VETERINARY PURPOSES; DIAGNOSTIC PREPARATIONS FOR MEDICAL PURPOSES (U.S. CLS. 6, 18, 44, 46, 51 AND 52).

SEAN CROWLEY, EXAMINING ATTORNEY



SN 79-099,316. TALANX AG, 30659 HANNOVER, FED REP GERMANY, FILED 4-8-2011.

KRISTINA MORRIS, EXAMINING ATTORNEY

# **talánx.**

## Reinsurance Broker

OWNER OF INTERNATIONAL REGISTRATION 1082421 DATED 4-8-2011, EXPIRES 1-12-2022.

NO CLAIM IS MADE TO THE EXCLUSIVE RIGHT TO USE "REINSURANCE BROKER", APART FROM THE MARK AS SHOWN.

THE COLOR(S) RED AND BLACK IS/ARE CLAIMED AS A FEATURE OF THE MARK.

THE MARK CONSISTS OF THE WORD "TALANX" IN BLACK WITH A RED PERIOD AFTER IT, FOLLOWED BY "REINSURANCE BROKER" IN BLACK. THE COLOR WHITE IN THE DRAWING REPRESENTS BACKGROUND AND IS NOT A FEATURE OF THE MARK.

### **CLASS 35—ADVERTISING AND BUSINESS**

FOR ADVERTISING; BUSINESS MANAGEMENT SERVICES; BUSINESS ADMINISTRATION; PROVIDING OFFICE FUNCTIONS (U.S. CLS. 100, 101 AND 102).

### **CLASS 36—INSURANCE AND FINANCIAL**

FOR INSURANCE SERVICES, NAMELY, INSURANCE ACTUARIAL SERVICES, INSURANCE ADMINISTRATION, INSURANCE BROKERAGE, REINSURANCE BROKERAGE, INSURANCE CLAIMS ADJUSTMENT, INSURANCE CLAIMS ADMINISTRATION, INSURANCE CLAIMS PROCESSING, INSURANCE CONSULTATION, REINSURANCE UNDERWRITING, AND INSURANCE UNDERWRITING IN THE FIELDS OF PROPERTY, CASUALTY, ACCIDENT, FIRE, MARINE, CREDIT, HEALTH AND LIFE INSURANCE (U.S. CLS. 100, 101 AND 102).

FRANK LATTUCA, EXAMINING ATTORNEY

SN 79-099,415. SPOOLEX (SOCIÉTÉ PAR ACTIONS SIMPLIFIÉE), FRANCE, FILED 5-30-2011.

# **CALEMARD**

PRIORITY DATE OF 11-30-2010 IS CLAIMED.  
OWNER OF INTERNATIONAL REGISTRATION 1082674 DATED 5-30-2011, EXPIRES 5-14-2022.

### **CLASS 7—MACHINERY**

FOR MACHINES FOR CONTINUOUS SLITTING OF FLEXIBLE MATERIALS SUCH AS TEXTILES, NON-WOVEN FABRICS, PLASTIC FILMS, PAPER (U.S. CLS. 13, 19, 21, 23, 31, 34 AND 35).

### **CLASS 37—CONSTRUCTION AND REPAIR**

FOR CONSTRUCTION AND REPAIR OF MACHINES FOR CONTINUOUS SLITTING OF FLEXIBLE MATERIALS SUCH AS TEXTILES, NONWOVEN FABRICS, PLASTIC FILMS, PAPER (U.S. CLS. 100, 103 AND 106).

### **CLASS 42—SCIENTIFIC AND COMPUTER SERVICES**

FOR DESIGN OF MACHINES FOR CONTINUOUS SLITTING OF FLEXIBLE MATERIALS SUCH AS TEXTILES, NONWOVEN FABRICS, PLASTIC FILMS, PAPER (U.S. CLS. 100 AND 101).

SN 79-099,710. STEELPRESS SP. Z O.O., POLAND, FILED 4-8-2011.



OWNER OF INTERNATIONAL REGISTRATION 1083312 DATED 4-8-2011, EXPIRES 1-12-2022.

THE MARK CONSISTS OF THE LETTERS "SPP" IN AN OVAL.

### **CLASS 6—METAL GOODS**

FOR HINGES OF METAL (U.S. CLS. 2, 12, 13, 14, 23, 25 AND 50).

### **CLASS 12—VEHICLES**

FOR COUPLER LOCKS FOR TRAILERS, COUPLINGS FOR CONTAINER TRAILERS, DRAWBARS FOR TRAILERS, DRAWBAR SUPPORTS FOR TRAILERS, PROTECTIVE CASINGS FOR COUPLER LOCKS USED TO SECURE TRAILERS (U.S. CLS. 19, 21, 23, 31, 35 AND 44).

C. DIONNE CLYBURN, EXAMINING ATTORNEY

SN 79-099,764. POLICHEM S.A., LUXEMBOURG, FILED 5-30-2011.

# **ZELOROSE**

THE MARK CONSISTS OF STANDARD CHARACTERS WITHOUT CLAIM TO ANY PARTICULAR FONT, STYLE, SIZE, OR COLOR.

PRIORITY DATE OF 5-25-2011 IS CLAIMED.

OWNER OF INTERNATIONAL REGISTRATION 1083483 DATED 5-30-2011, EXPIRES 5-14-2022.

### **CLASS 3—COSMETICS AND CLEANING PREPARATIONS**

FOR COSMETICS, NAMELY, NON-MEDICATED CREAM AND OINTMENT PREPARATIONS FOR THE CARE OF SKIN (U.S. CLS. 1, 4, 6, 50, 51 AND 52).

### **CLASS 5—PHARMACEUTICALS**

FOR PHARMACEUTICAL PREPARATIONS, NAMELY, MEDICATED CREAM AND OINTMENT PREPARATIONS FOR THE CARE OF SKIN; SANITARY PREPARATIONS FOR MEDICAL PURPOSES, NAMELY, CREAM AND OINTMENT PREPARATIONS FOR THE CARE OF SKIN (U.S. CLS. 6, 18, 44, 46, 51 AND 52).

KRISTINA MORRIS, EXAMINING ATTORNEY

SN 79-100,619. SPACE DOCTORS LTD., UNITED KINGDOM,  
FILED 6-2-2011.

## SPACE DOCTORS

THE MARK CONSISTS OF STANDARD CHARACTERS WITHOUT CLAIM TO ANY PARTICULAR FONT, STYLE, SIZE, OR COLOR.

OWNER OF INTERNATIONAL REGISTRATION 1085616 DATED 6-2-2011, EXPIRES 7-25-2022.

### CLASS 16—PAPER GOODS AND PRINTED MATTER

FOR PUBLICATIONS AND PRINTED MATTER, NAMELY, BOOKS, BROCHURES, BOOKLETS, JOURNALS, MAGAZINES, TRAINING MANUALS AND WRITTEN ARTICLES ALL IN THE FIELDS OF BUSINESS MANAGEMENT, BRAND CONSULTANCY, MARKET RESEARCH, ADVERTISING AND PUBLIC RELATIONS (U.S. CLS. 2, 5, 22, 23, 29, 37, 38 AND 50).

### CLASS 35—ADVERTISING AND BUSINESS

FOR BUSINESS MANAGEMENT CONSULTANCY; BRAND CONSULTANCY, NAMELY, CONCEPTUALIZATION, CONSULTING, DEVELOPMENT, EVALUATION, MANAGEMENT AND MARKETING OF BRANDS FOR CORPORATE AND INDIVIDUAL CLIENTS; MARKET RESEARCH; ADVERTISING SERVICES; PUBLIC RELATIONS (U.S. CLS. 100, 101 AND 102).

### CLASS 41—EDUCATION AND ENTERTAINMENT

FOR ARRANGING AND CONDUCTING SEMINARS ALL IN THE FIELDS OF BUSINESS MANAGEMENT, BRAND CONSULTANCY, MARKET RESEARCH, ADVERTISING AND PUBLIC RELATIONS; TRAINING SERVICES IN THE FIELDS OF BUSINESS MANAGEMENT, BRAND CONSULTANCY, MARKET RESEARCH, ADVERTISING AND PUBLIC RELATIONS; PUBLISHING SERVICES, NAMELY, DIGITAL VIDEO, AUDIO AND MULTIMEDIA PUBLISHING SERVICES; PUBLISHING SERVICES, NAMELY, PUBLISHING OF BOOKS, MAGAZINES AND REVIEWS, INCLUDING ONLINE ELECTRONIC PUBLICATION OF BOOKS, MAGAZINES AND REVIEWS (U.S. CLS. 100, 101 AND 107).

### CLASS 42—SCIENTIFIC AND COMPUTER SERVICES

FOR DESIGN SERVICES, NAMELY, GRAPHIC DESIGN SERVICES, WEB SITE DESIGN SERVICES, CORPORATE LOGO DESIGN SERVICES; DESIGN SERVICES, NAMELY, PROVIDING GRAPHIC AND MULTIMEDIA DESIGN SERVICES FOR THE PURPOSE OF PROMOTING THE GOODS AND SERVICES OF OTHERS (U.S. CLS. 100 AND 101).

MARILYN IZZI, EXAMINING ATTORNEY

SN 79-100,686. VIMOND MEDIA SOLUTIONS AS, NORWAY,  
FILED 5-25-2011.

## VIMOND

THE MARK CONSISTS OF STANDARD CHARACTERS WITHOUT CLAIM TO ANY PARTICULAR FONT, STYLE, SIZE, OR COLOR.

PRIORITY DATE OF 1-13-2011 IS CLAIMED.  
OWNER OF INTERNATIONAL REGISTRATION 1085745 DATED 5-25-2011, EXPIRES 5-9-2022.

### CLASS 9—ELECTRICAL AND SCIENTIFIC APPARATUS

FOR SOFTWARE FOR PRODUCING, STORING, TAGGING, DISTRIBUTING, PRESENTING, SYNDICATING AND MONETIZING AUDIO VISUAL MEDIA TO CONNECTED SCREENS AND SPEAKERS (U.S. CLS. 21, 23, 26, 36 AND 38).

### CLASS 42—SCIENTIFIC AND COMPUTER SERVICES

FOR DEVELOPMENT OF TECHNOLOGY AND SOFTWARE FOR PRODUCING, STORING, TAGGING, DISTRIBUTING, PRESENTING, SYNDICATING AND MONETIZING AUDIO VISUAL MEDIA TO CONNECTED SCREENS AND SPEAKERS (U.S. CLS. 100 AND 101).

CYNTHIA TRIPI, EXAMINING ATTORNEY

SN 79-100,958. WICOR HOLDING AG, SWITZERLAND,  
FILED 5-30-2011.

## INSULDUR

THE MARK CONSISTS OF STANDARD CHARACTERS WITHOUT CLAIM TO ANY PARTICULAR FONT, STYLE, SIZE, OR COLOR.

PRIORITY DATE OF 12-23-2010 IS CLAIMED.

OWNER OF INTERNATIONAL REGISTRATION 1086515 DATED 5-30-2011, EXPIRES 5-14-2022.

### CLASS 17—RUBBER GOODS

FOR INSULATION FOR ELECTRICAL EQUIPMENT, NAMELY ELECTRICAL INSULATION PAPER AND PRESSBOARD THAT HAS BEEN THERMALLY UPGRADED WITH CHEMICALS TO WITHSTAND HIGHER OPERATING TEMPERATURES, FOR USE IN FLUID FILLED ELECTRIC TRANSFORMERS (U.S. CLS. 1, 5, 12, 13, 35 AND 50).

### CLASS 41—EDUCATION AND ENTERTAINMENT

FOR PROVIDING TRAINING AND ADVANCED TRAINING IN THE FIELD OF MANUFACTURING AND OPERATING TRANSFORMERS, NAMELY TRAINING WITH REGARD TO THE CALCULATION OF TRANSFORMERS FOR THEIR UPGRADING AND RETROFITTING WITH INSULATION MATERIAL IN ORDER TO IMPROVE THE TRANSFORMERS' PERFORMANCE (U.S. CLS. 100, 101 AND 107).

### CLASS 42—SCIENTIFIC AND COMPUTER SERVICES

FOR SCIENTIFIC SERVICES WITH REGARD TO THE CALCULATION OF TRANSFORMERS, NAMELY, CALCULATION OF TRANSFORMERS FOR THEIR UPGRADING AND RETROFITTING WITH INSULATION MATERIAL IN ORDER TO IMPROVE THE TRANSFORMERS' PERFORMANCE (U.S. CLS. 100 AND 101).

KRISTINA MORRIS, EXAMINING ATTORNEY

SN 79-100,993. GABELICA ANNE-MARIE, FRANCE, FILED 5-2-2011.

# Seed to seed

PRIORITY DATE OF 12-10-2010 IS CLAIMED.  
OWNER OF INTERNATIONAL REGISTRATION 1086625  
DATED 5-2-2011, EXPIRES 4-16-2022.  
THE MARK CONSISTS OF THE WORDING "SEED TO SEED" IN A STYLIZED FONT.

### CLASS 3—COSMETICS AND CLEANING PREPARATIONS

FOR BLEACHING PREPARATIONS FOR LAUNDRY USE; LAUNDRY DETERGENT; CLEANING, POLISHING, AND SKIN ABRASIVE PREPARATIONS; DEGREASING PREPARATIONS FOR HOUSEHOLD USE; SOAP; PERFUMES, ESSENTIAL OILS, COSMETICS, HAIR LOTIONS; DENTIFRICES; DEPILETORY PREPARATIONS; MAKE-UP REMOVING PREPARATIONS; LIPSTICKS; BEAUTY MASKS; SHAVING PREPARATIONS; LEATHER PRESERVING POLISHES (U.S. CLS. 1, 4, 6, 50, 51 AND 52).

### CLASS 30—STAPLE FOODS

FOR COFFEE, TEA; COCOA, SUGAR, RICE, TAPIOCA, SAGO, ARTIFICIAL COFFEE; FLOURS; CEREAL PREPARATIONS, NAMELY, OAT FLAKES; BREAD, PASTRY AND CONFECTIONERY MADE OF SUGAR, EDIBLE ICES; HONEY, TREACLE; YEAST, BAKING-POWDER; SALT, MUSTARD; VINEGAR, SAUCES; CONDIMENTS, NAMELY, KETCHUP; SPICES; ICE FOR REFRESHMENT; SANDWICHES, PIZZAS; PANCAKES; COOKIES; CAKES; RUSKS; CHOCOLATE; BEVERAGES MADE WITH COCOA, COFFEE, CHOCOLATE OR TEA (U.S. CL. 46).

### CLASS 32—LIGHT BEVERAGES

FOR BEER; MINERAL AND AERATED WATERS; FRUIT DRINKS AND FRUIT JUICES; SYRUPS AND SYRUP SUBSTITUTES FOR MAKING BEVERAGES; LEMONADES; FRUIT NECTARS, SODA WATER; NON-ALCOHOLIC APERITIFS (U.S. CLS. 45, 46 AND 48).  
KAPIL BHANOT, EXAMINING ATTORNEY

SN 79-101,231. POLICHEM S.A., LUXEMBOURG, FILED 5-30-2011.

# ELASTOLABOR

THE MARK CONSISTS OF STANDARD CHARACTERS WITHOUT CLAIM TO ANY PARTICULAR FONT, STYLE, SIZE, OR COLOR.  
PRIORITY DATE OF 5-25-2011 IS CLAIMED.  
OWNER OF INTERNATIONAL REGISTRATION 1087201  
DATED 5-30-2011, EXPIRES 5-14-2022.

### CLASS 3—COSMETICS AND CLEANING PREPARATIONS

FOR COSMETICS, NAMELY, NON-MEDICATED CREAM AND OINTMENT PREPARATIONS FOR THE CARE OF SKIN (U.S. CLS. 1, 4, 6, 50, 51 AND 52).

### CLASS 5—PHARMACEUTICALS

FOR PHARMACEUTICAL PREPARATIONS, NAMELY, MEDICATED CREAM AND OINTMENT PREPARATIONS FOR THE CARE OF SKIN; SANITARY PREPARATIONS FOR MEDICAL PURPOSES, NAMELY, CREAM AND OINTMENT PREPARATIONS FOR THE CARE OF SKIN (U.S. CLS. 6, 18, 44, 46, 51 AND 52).  
KRISTINA MORRIS, EXAMINING ATTORNEY

SN 79-101,477. DURAVIT AKTIENGESSELLSCHAFT, FED REP GERMANY, FILED 5-11-2011.

# OpenSpace

THE MARK CONSISTS OF STANDARD CHARACTERS WITHOUT CLAIM TO ANY PARTICULAR FONT, STYLE, SIZE, OR COLOR.

PRIORITY DATE OF 11-13-2010 IS CLAIMED.  
OWNER OF INTERNATIONAL REGISTRATION 1087812  
DATED 5-11-2011, EXPIRES 4-25-2022.

### CLASS 11—ENVIRONMENTAL CONTROL APPARATUS

FOR SANITARY INSTALLATIONS IN THE NATURE OF WASH BASINS AND WASH STANDS AND STORAGE TRAYS, ESPECIALLY DESIGNED THEREFOR; BIDETS, TOILETS, URINALS, BATH TUBS, SHOWER TRAYS, SHOWER CUBICLES, SHOWER SCREENS; TAPS AND CONTROL FITTINGS IN THE NATURE OF SHOWER CONTROL VALVES, TUB CONTROL VALVES, FAUCETS FOR WATER SUPPLY APPARATUS AND SANITARY INSTALLATIONS; BATH TUB HANDLES IN THE NATURE OF STRUCTURAL PARTS OF BATH TUBS; TOILET SEATS; LIGHTING APPARATUS, NAMELY, LIGHTING INSTALLATIONS (U.S. CLS. 13, 21, 23, 31 AND 34).

### CLASS 20—FURNITURE AND ARTICLES NOT OTHERWISE CLASSIFIED

FOR FURNITURE FOR BATHROOMS, MIRRORS FOR BATHROOMS; MIRRORING CABINETS FOR BATHROOMS AND WASHROOMS; GOODS MADE OF WOOD OR WOOD SUBSTITUTES FOR BATHROOMS AND WASHROOMS, NAMELY, CURTAIN RAILS, WALL HOOKS, WORKS OF ART, DECORATIVE OBJECTS MADE OF WOOD OR WOOD SUBSTITUTES IN THE NATURE OF WALL PLAQUES, MOBILES, BEAD CURTAINS, WIND CHIMES; BATHROOM ACCESSORIES AND OTHER GOODS FOR DECORATING PURPOSES MADE OF WOOD OR WOOD SUBSTITUTES, NAMELY, FIXED PAPER TOWEL DISPENSERS NOT OF METAL, DOWELS NOT OF METAL, BATH, SHOWER AND TOILET GRAB BARS NOT OF METAL; GOODS MADE OF PLASTIC FOR BATHROOMS AND WASHROOMS, NAMELY, FITTINGS FOR FURNITURE, FOR WINDOWS OR FOR DOORS IN THE NATURE OF INDOOR WINDOW BLINDS AND INDOOR WINDOW BLINDS FOR DOORS, DOOR HANDLES, FURNITURE HANDLES; NON-METAL FITTINGS, FOR USE WITH FURNITURE AND SANITARY INSTALLATIONS FOR BATHROOMS AND WASHROOMS, IN THE NATURE OF LOCKS AND WALL HANDLES FOR GETTING IN AND OUT OF THE BATHTUB, PLASTIC AND WOOD KNOBS AND HANDLES FOR DOORS AND FURNITURE; WALL HOOKS NOT OF METAL FOR BATHROOMS AND WASHROOMS; SHELVES FOR STORAGE FOR WASH-HAND BASINS AND WASHSTANDS; FIXED TOWEL DISPENSERS NOT OF METAL (U.S. CLS. 2, 13, 22, 25, 32 AND 50).

HAI-LY LAM, EXAMINING ATTORNEY

SN 79-101,497. WINHELP LTD., ISRAEL, FILED 5-26-2011.

SN 79-101,812. SADA DAVIDE ALFONSO, ITALY, FILED 4-8-2011.

# HOLIDAYGO

THE MARK CONSISTS OF STANDARD CHARACTERS WITHOUT CLAIM TO ANY PARTICULAR FONT, STYLE, SIZE, OR COLOR.

PRIORITY DATE OF 5-2-2011 IS CLAIMED.

OWNER OF INTERNATIONAL REGISTRATION 1087891 DATED 5-26-2011, EXPIRES 5-10-2022.

## CLASS 35—ADVERTISING AND BUSINESS

FOR ADVERTISING AND BUSINESS SERVICES, NAMELY, PROVIDING AN ONLINE WEBSITE WHERE ADVERTISERS AND MARKETERS CAN INTERACT WITH USERS FOR ADVERTISING AND PROMOTING KNOWLEDGE, PRODUCTS, AND SERVICES ON BEHALF OF THEMSELVES AND OTHERS, AND FOR EVALUATING AND RATING THE SAME, ALL THE FOREGOING RELEVANT TO TRAVEL, LODGING AND ACCOMMODATIONS; ADVERTISING SERVICES FOR OTHERS VIA WEBSITE; PROMOTING AND SHOWCASING THE GOODS AND SERVICES OF OTHERS IN THE FIELD OF TRAVEL AND ACCOMMODATION BY MEANS OF AN ON-LINE SHOPPING SITE WITH LINKS TO THE RETAIL ADVERTISEMENTS OF OTHERS; PROVIDING A SEARCHABLE ONLINE ADVERTISING WEBSITE AND INFORMATIONAL GUIDE FEATURING THE GOODS AND SERVICES OF OTHERS; PROVIDING ON-LINE PRICE COMPARISONS OF TRAVEL AND LODGING SERVICES; MARKETING, ADVERTISING AND PROMOTING THE GOODS AND SERVICES OF OTHERS IN THE FIELD OF TRAVEL AND TOURISM VIA AN ONLINE WEBSITE; PROVIDING A WEB SITE THAT FEATURES AN ON-LINE MARKET FOR USERS TO LIST OFFERED OR WANTED PERSONAL AND BUSINESS ASSETS FOR HIRE OR RENT; AN INTERACTIVE WEB SITE FOR USERS TO REVIEW AND RATE TRAVEL ACCOMMODATIONS; PROMOTING THE GOODS AND SERVICES OF OTHERS BY PROVIDING A COMMUNITY-DRIVEN WEB SITE FEATURING USER-SUBMITTED CONTENT IN THE NATURE OF COUPONS, REBATES, PRICE-COMPARISON INFORMATION, PRODUCT REVIEWS, LINKS TO THE RETAIL WEB SITES OF OTHERS, AND DISCOUNT INFORMATION; PROVIDING A WEB SITE WHERE USERS CAN POST RATINGS, REVIEWS AND RECOMMENDATIONS ON PRODUCTS AND SERVICES (U.S. CLS. 100, 101 AND 102).

## CLASS 42—SCIENTIFIC AND COMPUTER SERVICES

FOR COMPUTER SERVICES, NAMELY, INTERACTIVE HOSTING SERVICES WHICH ALLOW THE USER TO PUBLISH AND SHARE THEIR OWN CONTENT AND IMAGES ON-LINE, PROVIDING AN INTERACTIVE WEB SITE THAT ALLOWS USERS TO SHOWCASE ELECTRONIC AND PAPER-BASED CONTENT, PROVIDING A WEB HOSTING PLATFORM FOR TRAVEL ACCOMMODATIONS PROVIDERS (U.S. CLS. 100 AND 101).

## CLASS 43—HOTEL AND RESTAURANT SERVICES

FOR AGENCY SERVICES FOR THE RESERVATION OF TEMPORARY ACCOMMODATION; TRAVEL AGENCY SERVICES, NAMELY, MAKING RESERVATIONS AND BOOKING FOR TEMPORARY LODGING FOR OTHERS, VIA ON-LINE COMPUTER NETWORKS; PROVIDING INFORMATION ABOUT HOTELS AND TEMPORARY ACCOMMODATIONS FOR TRAVEL VIA THE INTERNET; PROVIDING TRAVEL LODGING INFORMATION SERVICES AND TRAVEL LODGING BOOKING AGENCY SERVICES FOR TRAVELERS; BOOKING OF CAMPGROUND ACCOMMODATION; MAKING RESERVATIONS AND BOOKINGS FOR OTHERS FOR ACCOMMODATIONS (U.S. CLS. 100 AND 101).

LINDA ORNDORFF, EXAMINING ATTORNEY

S A D A

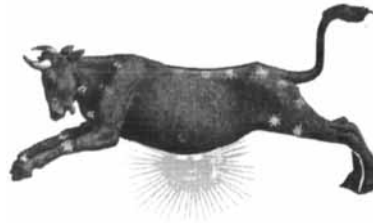

PRIORITY DATE OF 11-10-2010 IS CLAIMED.

OWNER OF INTERNATIONAL REGISTRATION 1088681 DATED 4-8-2011, EXPIRES 1-12-2022.

THE MARK CONSISTS OF THE WORDING SADA AND OF THE STYLIZED FIGURE OF A BULL AND OF THE SUN.

## CLASS 29—MEATS AND PROCESSED FOODS

FOR EDIBLE OILS; ANIMAL OILS AND FATS FOR FOODS; CANOLA OIL; COCONUT OIL; PEPPER OIL; COOKING OIL; FOOD ADDITIVES, NAMELY NATURAL FOOD EXTRACTS DERIVED FROM FISH, FISH OIL, FISH PROTEIN, ALGAE, SEAWEED NOT FOR MEDICAL PURPOSES AND FOR HUMAN CONSUMPTION; MAIZE OIL; MARGARINE; OLIVE OIL FOR FOODS; SALAD OIL; VEGETABLE OIL; OLIVE PASTES; PRESERVED, DRIED AND COOKED OLIVES; TINNED OLIVES; PROCESSED OLIVE PUREE; PROCESSED OLIVES; CANNED PROCESSED OLIVES; CANNED, COOKED, DRIED FRUIT AND VEGETABLES; EDIBLE FATS; MILK (U.S. CL. 46).

## CLASS 33—WINES AND SPIRITS

FOR WINE, SPARKLING WINES, LIQUEURS AND ALCOHOL DISTILLATES IN THE NATURE OF DISTILLED SPIRITS (U.S. CLS. 47 AND 49).

ADA HAN, EXAMINING ATTORNEY

SN 85-001,665. TAS ENERGY INC., HOUSTON, TX. FILED 3-30-2010.

## TAS Renewable Energy Systems

THE MARK CONSISTS OF STANDARD CHARACTERS WITHOUT CLAIM TO ANY PARTICULAR FONT, STYLE, SIZE, OR COLOR.

OWNER OF U.S. REG. NO. 3,179,559.

NO CLAIM IS MADE TO THE EXCLUSIVE RIGHT TO USE "RENEWABLE ENERGY SYSTEMS", APART FROM THE MARK AS SHOWN.

## CLASS 11—ENVIRONMENTAL CONTROL APPARATUS

FOR INDUSTRIAL WATER CHILLING UNITS COMPRISING WATER CHILLER EQUIPMENT AND ASSOCIATED PUMPS, STARTERS, AND CONTROLS, AND WHICH MAY INCLUDE ENGINES, GAS TURBINES, STEAM TURBINES, OR TURBOEXPANDER DRIVEN GENERATORS OR CHILLERS, ALL SOLD AS A UNIT, ALL FOR USE IN POWER PLANTS, LARGE BUILDING HVAC SYSTEMS, AND PROCESS COOLING (U.S. CLS. 13, 21, 23, 31 AND 34).

FIRST USE 11-1-2008; IN COMMERCE 11-1-2008.

**CLASS 40—MATERIAL TREATMENT**

FOR CUSTOM MANUFACTURE OF INDUSTRIAL WATER CHILLING UNITS COMPRISING WATER CHILLER EQUIPMENT AND ASSOCIATED PUMPS, STARTERS, AND CONTROLS, AND WHICH MAY INCLUDE ENGINES, GAS TURBINES, STEAM TURBINES, OR TURBOEXPANDER DRIVEN GENERATORS OR CHILLERS, ALL SOLD AS A UNIT, ALL FOR USE IN POWER PLANTS, LARGE BUILDING HVAC SYSTEMS, AND PROCESS COOLING (U.S. CLS. 100, 103 AND 106).

FIRST USE 11-1-2008; IN COMMERCE 11-1-2008.  
ESTHER BELENKER, EXAMINING ATTORNEY

**CLASS 9—ELECTRICAL AND SCIENTIFIC APPARATUS**

FOR ELECTRIC SWITCHES FOR LAMPS, FANS, POWER TOOLS, MOTORS, VACUUMS AND REFRIGERATORS; CAPACITORS; ELECTRIC SOCKETS; FUSES, INSULATED ELECTRICAL WIRE TERMINALS; ELECTRICAL CONNECTORS; ELECTRIC PLUGS AND ADAPTERS; ELECTRICAL WIRE; ELECTRICAL COILS; MAGNETS; MAGNIFYING GLASSES; AND ELECTRIC POWER EXTENSION CORDS AND ELECTRICAL POWER CORDS FOR VACUUM CLEANERS (U.S. CLS. 21, 23, 26, 36 AND 38).

**CLASS 11—ENVIRONMENTAL CONTROL APPARATUS**

FOR FINIALS FOR LAMPS (U.S. CLS. 13, 21, 23, 31 AND 34).

**CLASS 20—FURNITURE AND ARTICLES NOT OTHERWISE CLASSIFIED**

FOR PLASTIC BOXES; PLASTIC KNOBS; NON-METALLIC CABINETS; CORKS; PLASTIC WINDOW CLIPS; NYLON SLIDE BOLTS; PLASTIC SHELF SUPPORTS; PLASTIC AND NYLON ROLLERS FOR GLASS, SCREEN, WOOD AND SHOWER DOORS AND GARAGE DOORS; BUMPER GUARDS FOR FURNITURE; FURNITURE END PIECE AND CHAIR AND TABLE LEG CAPS; NON-METAL LATCHES, HINGES; NON-METAL PEGS; VINYL CLAMPS; NON-METAL FAUCET HANDLES; NON-METAL KEY TAGS AND KEY RINGS (U.S. CLS. 2, 13, 22, 25, 32 AND 50).

KELLEY WELLS, EXAMINING ATTORNEY

SN 85-009,088. JANDORF LLC, NORTHFIELD, OH. FILED 4-8-2010.



THE MARK CONSISTS OF A STYLIZED LETTER "J" SURROUNDED BY AN INCOMPLETE CIRCLE WHICH IS WIDE ON THE LEFT SIDE AND NARROWS TO A SINGLE LINE ON THE RIGHT SIDE.

**CLASS 6—METAL GOODS**

FOR METAL BOXES; METAL SHIMS; METAL KNOBS; METAL LOCKNUTS, WINGNUTS, SCREWS, COTTER PINS, CLEVIS PINS, SHEAR PINS, LYNCH PINS, DE-TENT RING PINS; METAL CABLE CLIPS SOLD SEPARATELY AND TOGETHER WITH NAILS; BEADED METAL CHAINS; WIRE; METAL FASTENING ANCHORS FOR SECURING PICTURES TO WALLS; METAL WINDOW CRANKS, METAL SASH FASTENERS FOR WINDOWS, METAL HARDWARE FOR MOUNTING WINDOW SHADES ON WINDOW FRAMES; METAL STORM WINDOW CORNER KEYS, METAL DOOR BOLTS, METAL ROLLERS FOR GLASS, SCREEN, AND WOOD SLIDING DOORS AND GARAGE DOORS, METAL HINGES, METAL LATCHES, METAL SPACERS, METAL KEYHOLE PLATES, METAL ESCUTCHEONS FOR KEYHOLES; METAL HOSE FITTINGS; METAL CLAMPS; METAL HOLE PLUGS; METAL SHELF SUPPORTS; METAL KEY BLANKS, METAL KEY RINGS; METAL GASKETS FOR OIL PAN DRAINS; AND METAL SPRINGS (U.S. CLS. 2, 12, 13, 14, 23, 25 AND 50).

**CLASS 8—HAND TOOLS**

FOR HAND TOOLS, NAMELY, WRENCHES, SCREW-DRIVERS, FILES, CLAMPS, PICKS, UTILITY KNIVES, SAWS, SCISSORS, CABLE CUTTERS AND BITS FOR HAND DRILLS (U.S. CLS. 23, 28 AND 44).

SN 85-009,813. WOODBRIDGE ESTATES LIMITED, ALRESFORD, HAMPSHIRE, UNITED KINGDOM, FILED 4-8-2010.

**FORTY SOMETHING**

THE MARK CONSISTS OF STANDARD CHARACTERS WITHOUT CLAIM TO ANY PARTICULAR FONT, STYLE, SIZE, OR COLOR.

OWNER OF UNITED KINGDOM REG. NO. 2346765, DATED 10-23-2003, EXPIRES 10-23-2013.

OWNER OF U.S. REG. NOS. 3,226,339 AND 3,226,340.

**CLASS 9—ELECTRICAL AND SCIENTIFIC APPARATUS**

FOR PRE-RECORDED MAGNETIC DATA CARRIERS, COMPACT DISCS, DVDS, AND PHONOGRAPH RECORDS FEATURING MUSIC, AND VIDEO CASSETTES FEATURING MUSIC VIDEOS, COMEDY TELEVISION PROGRAMS AND HORROR MOVIES, NONE OF THE FOREGOING BEING IN THE FIELD OF ADULT ENTERTAINMENT; COMPUTER GAME SOFTWARE; DOWNLOADABLE MUSIC DISTRIBUTED VIA A GLOBAL COMPUTER NETWORK AND WIRELESS DEVICES; DOWNLOADABLE VIDEO RECORDINGS IN THE FIELD OF POPULAR ENTERTAINMENT TELEVISION SHOWS, MUSIC, AND MOVIES (U.S. CLS. 21, 23, 26, 36 AND 38).

**CLASS 16—PAPER GOODS AND PRINTED MATTER**

FOR PRINTED PUBLICATIONS, NAMELY, BOOKS, MAGAZINES, AND NEWSLETTERS IN THE FIELD OF POPULAR ENTERTAINMENT, NONE OF THE FOREGOING BEING IN THE FIELD OF ADULT ENTERTAINMENT (U.S. CLS. 2, 5, 22, 23, 29, 37, 38 AND 50).

**CLASS 25—CLOTHING**

FOR CLOTHING, NAMELY, JEANS, TROUSERS, SKIRTS, BLOUSES, JUMPERS, SWEATSHIRTS, SOCKS, UNDERWEAR, LINGERIE, PAJAMAS, NIGHTGOWNS, UNDERWEAR, JACKETS, BLAZERS, SUITS, SWEATERS, SCARVES, HATS, T-SHIRTS, DRESS SHIRTS, TUXEDOS, NECKTIES, BOW TIES, PARKAS, GLOVES, MITTENS, BANDANAS, BATHROBES, BATHING SUITS, BIKINIS, SHORTS, SARONGS, BEACHWEAR, VESTS, KNICKERS, BRASSIERES, CAPS, COATS, DRESSING GOWNS, DRESSES, HOSE, STOCKINGS, TIGHTS, PANTYHOSE, PULLOVERS, JERSEYS, JUMPERS, SHIRTS, LEGGINGS, PANTS, OVERALLS, CAPS, COATS AND OVERCOATS; FOOTWEAR, HEADWEAR (U.S. CLS. 22 AND 39).

MARY BOAGNI, EXAMINING ATTORNEY

SN 85-015,062. INDEPENDENT INSURANCE AGENTS & BROKERS OF AMERICA, INC., ALEXANDRIA, VA. FILED 4-15-2010.



OWNER OF U.S. REG. NOS. 1,582,905, 3,200,132 AND OTHERS.

NO CLAIM IS MADE TO THE EXCLUSIVE RIGHT TO USE "INDEPENDENT INSURANCE AGENT", APART FROM THE MARK AS SHOWN.

THE MARK CONSISTS OF A STYLIZED EAGLE WITH A HALF OVAL LINE CURVING DOWNWARD FROM THE TAIL FROM LEFT TO RIGHT WITH A BIG "I" TO THE RIGHT OF THE TAIL AND THE WORDS "INDEPENDENT INSURANCE AGENT" FROM TOP TO BOTTOM TO THE RIGHT OF THE "I".

**CLASS 16—PAPER GOODS AND PRINTED MATTER**

FOR MAGAZINES FEATURING NEWS, ARTICLES, STUDIES, RESEARCH, AND INFORMATION IN THE FIELD OF THE INSURANCE AND FINANCIAL SERVICES INDUSTRIES; NEWSLETTERS FEATURING NEWS, ARTICLES, STUDIES, RESEARCH, AND INFORMATION IN THE FIELD OF INSURANCE AND FINANCIAL SERVICES INDUSTRIES (U.S. CLS. 2, 5, 22, 23, 29, 37, 38 AND 50).

**CLASS 35—ADVERTISING AND BUSINESS**

FOR ASSOCIATION SERVICES, NAMELY, PROMOTING THE INTERESTS OF INSURANCE AND FINANCIAL SERVICES AGENTS AND BROKERS; POLITICAL ACTION COMMITTEE SERVICES, NAMELY, PROMOTING THE INTERESTS OF INSURANCE AND FINANCIAL SERVICES AGENTS AND BROKERS IN THE FIELD OF POLITICS; LOBBYING SERVICES AND GRASSROOTS ADVOCACY, NAMELY, PROMOTING THE INTERESTS OF INSURANCE AND FINANCIAL SERVICES AGENTS AND BROKERS IN THE FIELD OF POLITICS, LEGISLATION, AND REGULATION; PROMOTING AWARENESS OF THE NEED FOR DIVERSITY IN THE INSURANCE AND FINANCIAL SERVICES INDUSTRY; BUSINESS SERVICES IN THE NATURE OF PROMOTING AND PROVIDING ADVICE, STRATEGIES AND BUSINESS PROCEDURES TO ENHANCE WORKFLOW AND EFFICIENCY OF INSURANCE AND FINANCIAL SERVICES AGENTS AND BROKERS; PUBLIC RELATIONS; PROVIDING BUSINESS SERVICES RESOURCES FOR INSURANCE AND FINANCIAL SERVICES AGENTS AND BROKERS, NAMELY, EMPLOYMENT PLACEMENT SERVICES, NAMELY, RESUME MATCHING AND JOB POSTING SERVICES; PROVIDING MARKET INTELLIGENCE BENCHMARKING INFORMATION AND BUSINESS AND MARKETING STRATEGIES THAT GUIDE IN IMPROVING AGENCY AND BROKERAGE PERFORMANCE IN THE INSURANCE AND FINANCIAL SERVICES INDUSTRIES; PROMOTION OF INSURANCE AND FINANCIAL SERVICES ON BEHALF OF THIRD PARTIES; ORGANIZATION OF BUSINESS CONVENTIONS, CONFERENCES, AND TRADE SHOWS IN THE FIELD OF INSURANCE AND FINANCIAL SERVICES; PUBLIC ADVOCACY ON BEHALF OF INSURANCE AND FINANCIAL SERVICES AGENTS AND BROKERS TO PROMOTE AWARENESS OF BUSINESS, LEGAL AND REGULATORY MATTERS THAT AFFECT INSURANCE AND FINANCIAL SERVICES AGENTS AND BROKERS IN THE INSURANCE AND FINANCIAL SERVICES INDUSTRIES; CONSULTING IN THE FIELD OF PUBLIC ADVOCACY SERVICES ON BEHALF OF INSURANCE AND FINANCIAL SERVICES AGENTS AND BROKERS TO PROMOTE AWARENESS OF BUSINESS, LEGAL AND REGULATORY MATTERS THAT AFFECT INSURANCE AND FINANCIAL SERVICES AGENTS AND BROKERS IN THE INSURANCE AND FINANCIAL SERVICES INDUSTRIES; PROVIDING INFORMATION AND NEWS IN THE FIELD OF BUSINESS, NAMELY, INFORMATION AND NEWS ON CURRENT EVENTS AND ON ECONOMIC, LEGISLATIVE, REGULATORY, LEGAL, BUSINESS, AND TECHNOLOGY DEVELOPMENTS AS THEY RELATE TO AND CAN IMPACT BUSINESSES IN THE INSURANCE AND FINANCIAL SERVICES FIELDS; PROVIDING LINKS TO WEBSITES OF OTHERS FEATURING CONSUMER INFORMATION IN THE INSURANCE AND FINANCIAL SERVICES INDUSTRIES; PROVIDING AN ONLINE DATABASE OF CONTACT INFORMATION FOR INDEPENDENT INSURANCE AND FINANCIAL SERVICES AGENTS AND BROKERS FOR USE BY CONSUMERS TO LOCATE AN AGENT OR BROKER; PROVIDING INFORMATION TO PROMOTE AWARENESS OF BUSINESS, LEGAL AND LEGISLATIVE ISSUES FACING THE INSURANCE AND FINANCIAL SERVICES INDUSTRIES; MARKET RESEARCH SERVICES IN THE FIELDS OF INSURANCE AND FINANCIAL SERVICES; BUSINESS RISK MANAGEMENT AND CONSULTING SERVICES RELATED THERETO; BUSINESS RESEARCH IN THE INSURANCE INDUSTRY; ARRANGING AND CONDUCTING BUSINESS CONFERENCES AND SPECIAL EVENTS FOR BUSINESS PURPOSES TO INFORM INSURANCE AGENTS AND BROKERS ABOUT LEGISLATIVE AND BUSINESS ISSUES THAT AFFECT THEIR BUSINESS ENVIRONMENT; PUBLIC ADVOCACY ON BEHALF OF INSURANCE AND FINANCIAL SERVICES AGENTS AND BROKERS TO PROMOTE AWARENESS OF LEGAL AND REGULATORY MATTERS THAT AFFECT INSURANCE AND FINANCIAL SERVICES AGENTS AND BROKERS IN THE INSURANCE AND FINANCIAL SERVICES INDUSTRIES (U.S. CLS. 100, 101 AND 102).

**CLASS 36—INSURANCE AND FINANCIAL**

FOR INSURANCE AGENCY AND BROKERAGE, FINANCIAL PLANNING AND INSURANCE CONSULTATION, AND UNDERWRITING OF ALL KINDS OF INSURANCE; FINANCIAL RISK MANAGEMENT AND CONSULTING SERVICES RELATED THERETO; FINANCIAL SERVICES, NAMELY, PROVIDING FINANCIAL ANALYSIS, CONSULTATION, PLANNING AND MANAGEMENT, AND PORTFOLIO MANAGEMENT OF INVESTMENT VEHICLES; ESTATE PLANNING, AND FINANCIAL PLANNING SERVICES IN THE NATURE OF RETIREMENT, GIFT, AND DISTRIBUTION PLANNING; INVESTMENT CONSULTATION; ADMINISTRATION OF RETIREMENT INVESTMENT AND SAVINGS PLANS AND ACCOUNTS; PROVIDING ONLINE FINANCIAL CALCULATORS; PROVIDING LINKS TO WEBSITES OF OTHERS FEATURING INFORMATION IN THE FIELDS OF INSURANCE AND FINANCIAL SERVICES OF INTEREST TO AND FOR USE BY INSURANCE AND FINANCIAL SERVICES AGENTS AND BROKERS; PROVIDING AN ONLINE DATABASE FEATURING ARTICLES, REPORTS, AND MEMORANDA IN THE FIELDS OF INSURANCE AND FINANCIAL SERVICES OF INTEREST TO INSURANCE AND FINANCIAL SERVICES AGENTS AND BROKERS; PROVIDING INFORMATION IN THE FIELDS OF INSURANCE AND FINANCIAL PLANNING TO YOUNG AND NEW INSURANCE AND FINANCIAL SERVICES AGENTS AND BROKERS; FINANCIAL SERVICES RESEARCH; AND FINANCIAL RESEARCH IN THE INSURANCE INDUSTRY; ALL THE FOREGOING EXCLUDING CREDIT CARD AND DEBIT CARD SERVICES (U.S. CLS. 100, 101 AND 102).

**CLASS 41—EDUCATION AND ENTERTAINMENT**

FOR PROVIDING PROFESSIONAL AND CONTINUING EDUCATION COURSES IN THE FIELD OF INSURANCE AND FINANCIAL SERVICES; PROVIDING ONLINE NEWSLETTERS AND REPORTS FEATURING STUDIES AND RESEARCH IN THE FIELDS OF INSURANCE AND FINANCIAL SERVICES; ARRANGING AND CONDUCTING EDUCATIONAL AND PROFESSIONAL DEVELOPMENT CONVENTIONS AND CONFERENCES IN THE FIELD OF INSURANCE AND FINANCIAL SERVICES; PROVIDING ONLINE PUBLICATIONS IN THE NATURE OF ARTICLES AND MAGAZINE ARTICLES IN THE FIELD OF INSURANCE AND FINANCIAL SERVICES; PROVIDING ON-LINE ELECTRONIC NEWSLETTERS DELIVERED BY E-MAIL IN THE FIELD OF INSURANCE AND FINANCIAL SERVICES; PROVIDING ON-LINE ELECTRONIC NEWSLETTERS AND REPORTS DELIVERED BY E-MAIL FEATURING STUDIES AND RESEARCH IN THE FIELDS OF INSURANCE AND FINANCIAL SERVICES; PROVIDING RECOGNITION AND INCENTIVES BY THE WAY OF AWARDS TO DEMONSTRATE EXCELLENCE IN THE FIELD OF INSURANCE AND FINANCIAL SERVICES; TRAINING SERVICES IN THE FIELD OF INSURANCE AND FINANCIAL SERVICES; ARRANGING AND CONDUCTING EDUCATIONAL CONFERENCES TO INFORM INSURANCE AGENTS AND BROKERS ABOUT LEGISLATIVE AND BUSINESS ISSUES THAT AFFECT THEIR BUSINESS ENVIRONMENT; PROVIDING EDUCATIONAL TRAINING IN THE FIELDS OF INSURANCE AND FINANCIAL PLANNING TO YOUNG AND NEW INSURANCE AND FINANCIAL SERVICES AGENTS AND BROKERS; AND PROVIDING INFORMATION AND NEWS IN THE FIELD OF CURRENT EVENTS RELATING TO THE INSURANCE AND FINANCIAL SERVICES INDUSTRIES (U.S. CLS. 100, 101 AND 107).

**CLASS 42—SCIENTIFIC AND COMPUTER SERVICES**

FOR PROVIDING INFORMATION IN THE FIELD OF TECHNOLOGY IN THE FIELDS OF INSURANCE AND FINANCIAL SERVICES (U.S. CLS. 100 AND 101).

**CLASS 45—PERSONAL AND LEGAL SERVICES**

FOR PROVIDING INFORMATION RELATING TO LEGAL AND REGULATORY AFFAIRS IN THE INSURANCE AND FINANCIAL SERVICES INDUSTRIES; AND LITIGATION SERVICES IN LEGAL MATTERS TO PROTECT THE INTERESTS OF INSURANCE AND FINANCIAL SERVICES AGENTS AND BROKERS IN THE FIELD OF THE INSURANCE AND FINANCIAL SERVICES INDUSTRIES; CONSULTING IN THE FIELD OF LEGAL AND REGULATORY COMPLIANCE MATTERS THAT AFFECT INSURANCE AND FINANCIAL SERVICES AGENTS AND BROKERS IN THE INSURANCE AND FINANCIAL SERVICES INDUSTRIES; PROVIDING LEGAL INFORMATION IN THE FIELDS OF INSURANCE AND FINANCIAL SERVICES INDUSTRIES (U.S. CLS. 100 AND 101).

**CLASS 200—COLLECTIVE MEMBERSHIP**

FOR INDICATING MEMBERSHIP IN AN ORGANIZATION FOR INDEPENDENT INSURANCE AND FINANCIAL SERVICES AGENTS AND BROKERS.

CHRISTINE COOPER, EXAMINING ATTORNEY

SN 85-015,063. INDEPENDENT INSURANCE AGENTS & BROKERS OF AMERICA, INC., ALEXANDRIA, VA. FILED 4-15-2010.



OWNER OF U.S. REG. NOS. 1,582,905, 3,200,132 AND OTHERS.

NO CLAIM IS MADE TO THE EXCLUSIVE RIGHT TO USE "INDEPENDENT INSURANCE AGENT", APART FROM THE MARK AS SHOWN.

THE MARK CONSISTS OF A STYLIZED EAGLE WITH A HALF OVAL LINE CURVING DOWNWARD FROM THE TAIL FROM LEFT TO RIGHT WITH A BIG "I" TO THE RIGHT OF THE TAIL AND THE WORDS "INDEPENDENT INSURANCE AGENT" FROM TOP TO BOTTOM TO THE RIGHT OF THE "I" AND THE WORDS "THE TRUSTED CHOICE" BELOW THE HALF OVAL LINE.

**CLASS 16—PAPER GOODS AND PRINTED MATTER**

FOR MAGAZINES FEATURING NEWS, ARTICLES, STUDIES, RESEARCH, AND INFORMATION IN THE FIELD OF THE INSURANCE AND FINANCIAL SERVICES INDUSTRIES; NEWSLETTERS FEATURING NEWS, ARTICLES, STUDIES, RESEARCH, AND INFORMATION IN THE FIELD OF INSURANCE AND FINANCIAL SERVICES INDUSTRIES (U.S. CLS. 2, 5, 22, 23, 29, 37, 38 AND 50).

**CLASS 35—ADVERTISING AND BUSINESS**

FOR ASSOCIATION SERVICES, NAMELY, PROMOTING THE INTERESTS OF INSURANCE AND FINANCIAL SERVICES AGENTS AND BROKERS; POLITICAL ACTION COMMITTEE SERVICES, NAMELY, PROMOTING THE INTERESTS OF INSURANCE AND FINANCIAL SERVICES AGENTS AND BROKERS IN THE FIELD OF POLITICS; LOBBYING SERVICES AND GRASSROOTS ADVOCACY, NAMELY, PROMOTING THE INTERESTS OF INSURANCE AND FINANCIAL SERVICES AGENTS AND BROKERS IN THE FIELD OF POLITICS, LEGISLATION, AND REGULATION; PROMOTING AWARENESS OF THE NEED FOR DIVERSITY IN THE INSURANCE AND FINANCIAL SERVICES INDUSTRY; BUSINESS SERVICES IN THE NATURE OF PROMOTING AND PROVIDING ADVICE, STRATEGIES AND BUSINESS PROCEDURES TO ENHANCE WORKFLOW AND EFFICIENCY OF INSURANCE AND FINANCIAL SERVICES AGENTS AND BROKERS; PUBLIC RELATIONS; PROVIDING BUSINESS SERVICES RESOURCES FOR INSURANCE AND FINANCIAL SERVICES AGENTS AND BROKERS, NAMELY, EMPLOYMENT PLACEMENT SERVICES, NAMELY, RESUME MATCHING AND JOB POSTING SERVICES; PROVIDING MARKET INTELLIGENCE BENCHMARKING INFORMATION AND BUSINESS AND MARKETING STRATEGIES THAT GUIDE IN IMPROVING AGENCY AND BROKERAGE PERFORMANCE IN THE INSURANCE AND FINANCIAL SERVICES INDUSTRIES; PROMOTION OF INSURANCE AND FINANCIAL SERVICES ON BEHALF OF THIRD PARTIES; ORGANIZATION OF BUSINESS CONVENTIONS, CONFERENCES, AND TRADE SHOWS IN THE FIELD OF INSURANCE AND FINANCIAL SERVICES; PUBLIC ADVOCACY ON BEHALF OF INSURANCE AND FINANCIAL SERVICES AGENTS AND BROKERS TO PROMOTE AWARENESS OF BUSINESS, LEGAL AND REGULATORY MATTERS THAT AFFECT INSURANCE AND FINANCIAL SERVICES AGENTS AND BROKERS IN THE INSURANCE AND FINANCIAL SERVICES INDUSTRIES; CONSULTING IN THE FIELD OF PUBLIC ADVOCACY SERVICES ON BEHALF OF INSURANCE AND FINANCIAL SERVICES AGENTS AND BROKERS TO PROMOTE AWARENESS OF BUSINESS, LEGAL AND REGULATORY MATTERS THAT AFFECT INSURANCE AND FINANCIAL SERVICES AGENTS AND BROKERS IN THE INSURANCE AND FINANCIAL SERVICES INDUSTRIES; PROVIDING INFORMATION AND NEWS IN THE FIELD OF BUSINESS, NAMELY, INFORMATION AND NEWS ON CURRENT EVENTS AND ON ECONOMIC, LEGISLATIVE, REGULATORY, LEGAL, BUSINESS, AND TECHNOLOGY DEVELOPMENTS AS THEY RELATE TO AND CAN IMPACT BUSINESSES IN THE INSURANCE AND FINANCIAL SERVICES FIELDS; PROVIDING LINKS TO WEBSITES OF OTHERS FEATURING CONSUMER INFORMATION IN THE INSURANCE AND FINANCIAL SERVICES INDUSTRIES; PROVIDING AN ONLINE DATABASE OF CONTACT INFORMATION FOR INDEPENDENT INSURANCE AND FINANCIAL SERVICES AGENTS AND BROKERS FOR USE BY CONSUMERS TO LOCATE AN AGENT OR BROKER; PROVIDING INFORMATION TO PROMOTE AWARENESS OF BUSINESS, LEGAL AND LEGISLATIVE ISSUES FACING THE INSURANCE AND FINANCIAL SERVICES INDUSTRIES; MARKET RESEARCH SERVICES IN THE FIELDS OF INSURANCE AND FINANCIAL SERVICES; BUSINESS RISK MANAGEMENT AND CONSULTING SERVICES RELATED THERETO; BUSINESS RESEARCH IN THE INSURANCE INDUSTRY; ARRANGING AND CONDUCTING BUSINESS CONFERENCES AND SPECIAL EVENTS FOR BUSINESS PURPOSES TO INFORM INSURANCE AGENTS AND BROKERS ABOUT LEGISLATIVE AND BUSINESS ISSUES THAT AFFECT THEIR BUSINESS ENVIRONMENT; PUBLIC ADVOCACY ON BEHALF OF INSURANCE AND FINANCIAL SERVICES AGENTS AND BROKERS TO PROMOTE AWARENESS OF LEGAL AND REGULATORY MATTERS THAT AFFECT INSURANCE AND FINANCIAL SERVICES AGENTS AND BROKERS IN THE INSURANCE AND FINANCIAL SERVICES INDUSTRIES (U.S. CLS. 100, 101 AND 102).

**CLASS 36—INSURANCE AND FINANCIAL**

FOR INSURANCE AGENCY AND BROKERAGE, FINANCIAL PLANNING AND INSURANCE CONSULTATION, AND UNDERWRITING OF ALL KINDS OF INSURANCE; FINANCIAL RISK MANAGEMENT AND CONSULTING SERVICES RELATED THERETO; FINANCIAL SERVICES, NAMELY, PROVIDING FINANCIAL ANALYSIS, CONSULTATION, PLANNING AND MANAGEMENT, AND PORTFOLIO MANAGEMENT OF INVESTMENT VEHICLES; ESTATE PLANNING, AND FINANCIAL PLANNING SERVICES IN THE NATURE OF RETIREMENT, GIFT, AND DISTRIBUTION PLANNING; INVESTMENT CONSULTATION; ADMINISTRATION OF RETIREMENT INVESTMENT AND SAVINGS PLANS AND ACCOUNTS; PROVIDING ONLINE FINANCIAL CALCULATORS; PROVIDING LINKS TO WEBSITES OF OTHERS FEATURING INFORMATION IN THE FIELDS OF INSURANCE AND FINANCIAL SERVICES OF INTEREST TO AND FOR USE BY INSURANCE AND FINANCIAL SERVICES AGENTS AND BROKERS; PROVIDING AN ONLINE DATABASE FEATURING ARTICLES, REPORTS, AND MEMORANDA IN THE FIELDS OF INSURANCE AND FINANCIAL SERVICES OF INTEREST TO INSURANCE AND FINANCIAL SERVICES AGENTS AND BROKERS; PROVIDING INFORMATION IN THE FIELDS OF INSURANCE AND FINANCIAL PLANNING TO YOUNG AND NEW INSURANCE AND FINANCIAL SERVICES AGENTS AND BROKERS; FINANCIAL SERVICES RESEARCH; AND FINANCIAL RESEARCH IN THE INSURANCE INDUSTRY; ALL THE FOREGOING EXCLUDING CREDIT CARD AND DEBIT CARD SERVICES (U.S. CLS. 100, 101 AND 102).

**CLASS 41—EDUCATION AND ENTERTAINMENT**

FOR : PROVIDING PROFESSIONAL AND CONTINUING EDUCATION COURSES IN THE FIELD OF INSURANCE AND FINANCIAL SERVICES; PROVIDING ONLINE NEWSLETTERS AND REPORTS FEATURING STUDIES AND RESEARCH IN THE FIELDS OF INSURANCE AND FINANCIAL SERVICES; ARRANGING AND CONDUCTING EDUCATIONAL AND PROFESSIONAL DEVELOPMENT CONVENTIONS AND CONFERENCES IN THE FIELD OF INSURANCE AND FINANCIAL SERVICES; PROVIDING ONLINE PUBLICATIONS IN THE NATURE OF ARTICLES AND MAGAZINE ARTICLES IN THE FIELD OF INSURANCE AND FINANCIAL SERVICES; PROVIDING ON-LINE ELECTRONIC NEWSLETTERS DELIVERED BY E-MAIL IN THE FIELD OF INSURANCE AND FINANCIAL SERVICES; PROVIDING ON-LINE ELECTRONIC NEWSLETTERS AND REPORTS DELIVERED BY E-MAIL FEATURING STUDIES AND RESEARCH IN THE FIELDS OF INSURANCE AND FINANCIAL SERVICES; PROVIDING RECOGNITION AND INCENTIVES BY THE WAY OF AWARDS TO DEMONSTRATE EXCELLENCE IN THE FIELD OF INSURANCE AND FINANCIAL SERVICES; TRAINING SERVICES IN THE FIELD OF INSURANCE AND FINANCIAL SERVICES; ARRANGING AND CONDUCTING EDUCATIONAL CONFERENCES TO INFORM INSURANCE AGENTS AND BROKERS ABOUT LEGISLATIVE AND BUSINESS ISSUES THAT AFFECT THEIR BUSINESS ENVIRONMENT; PROVIDING EDUCATIONAL TRAINING IN THE FIELDS OF INSURANCE AND FINANCIAL PLANNING TO YOUNG AND NEW INSURANCE AND FINANCIAL SERVICES AGENTS AND BROKERS; AND PROVIDING INFORMATION AND NEWS IN THE FIELD OF CURRENT EVENTS RELATING TO THE INSURANCE AND FINANCIAL SERVICES INDUSTRIES (U.S. CLS. 100, 101 AND 107).

**CLASS 42—SCIENTIFIC AND COMPUTER SERVICES**

FOR PROVIDING INFORMATION IN THE FIELD OF TECHNOLOGY IN THE FIELDS OF INSURANCE AND FINANCIAL SERVICES (U.S. CLS. 100 AND 101).



**CLASS 45—PERSONAL AND LEGAL SERVICES**

FOR PROVIDING INFORMATION RELATING TO LEGAL AND REGULATORY AFFAIRS IN THE INSURANCE AND FINANCIAL SERVICES INDUSTRIES; AND LITIGATION SERVICES IN LEGAL MATTERS TO PROTECT THE INTERESTS OF INSURANCE AND FINANCIAL SERVICES AGENTS AND BROKERS IN THE FIELD OF THE INSURANCE AND FINANCIAL SERVICES INDUSTRIES; CONSULTING IN THE FIELD OF LEGAL AND REGULATORY COMPLIANCE MATTERS THAT AFFECT INSURANCE AND FINANCIAL SERVICES AGENTS AND BROKERS IN THE INSURANCE AND FINANCIAL SERVICES INDUSTRIES; PROVIDING LEGAL INFORMATION IN THE FIELDS OF INSURANCE AND FINANCIAL SERVICES INDUSTRIES (U.S. CLS. 100 AND 101).

**CLASS 200—COLLECTIVE MEMBERSHIP**

FOR INDICATING MEMBERSHIP IN AN ORGANIZATION FOR INDEPENDENT INSURANCE AND FINANCIAL SERVICES AGENTS AND BROKERS.

CHRISTINE COOPER, EXAMINING ATTORNEY

SN 85-015.065, INDEPENDENT INSURANCE AGENTS & BROKERS OF AMERICA, INC., ALEXANDRIA, VA. FILED 4-15-2010.



THE MARK CONSISTS OF A STYLIZED EAGLE WITH A HALF OVAL LINE CURVING DOWNWARD FROM THE TAIL FROM LEFT TO RIGHT.

**CLASS 16—PAPER GOODS AND PRINTED MATTER**

FOR MAGAZINES FEATURING NEWS, ARTICLES, STUDIES, RESEARCH, AND INFORMATION IN THE FIELD OF THE INSURANCE AND FINANCIAL SERVICES INDUSTRIES; NEWSLETTERS FEATURING NEWS, ARTICLES, STUDIES, RESEARCH, AND INFORMATION IN THE FIELD OF INSURANCE AND FINANCIAL SERVICES INDUSTRIES (U.S. CLS. 2, 5, 22, 23, 29, 37, 38 AND 50).

**CLASS 35—ADVERTISING AND BUSINESS**

FOR ASSOCIATION SERVICES, NAMELY, PROMOTING THE INTERESTS OF INSURANCE AND FINANCIAL SERVICES AGENTS AND BROKERS; POLITICAL ACTION COMMITTEE SERVICES, NAMELY, PROMOTING THE INTERESTS OF INSURANCE AND FINANCIAL SERVICES AGENTS AND BROKERS IN THE FIELD OF POLITICS; LOBBYING SERVICES AND GRASSROOTS ADVOCACY, NAMELY, PROMOTING THE INTERESTS OF INSURANCE AND FINANCIAL SERVICES AGENTS AND BROKERS IN THE FIELD OF POLITICS, LEGISLATION, AND REGULATION; PROMOTING AWARENESS OF THE NEED FOR DIVERSITY IN THE INSURANCE AND FINANCIAL SERVICES

INDUSTRY; BUSINESS SERVICES IN THE NATURE OF PROMOTING AND PROVIDING ADVICE, STRATEGIES AND BUSINESS PROCEDURES TO ENHANCE WORKFLOW AND EFFICIENCY OF INSURANCE AND FINANCIAL SERVICES AGENTS AND BROKERS; PUBLIC RELATIONS; PROVIDING BUSINESS SERVICES RESOURCES FOR INSURANCE AND FINANCIAL SERVICES AGENTS AND BROKERS, NAMELY, EMPLOYMENT PLACEMENT SERVICES, NAMELY, RESUME MATCHING AND JOB POSTING SERVICES; PROVIDING MARKET INTELLIGENCE BENCHMARKING INFORMATION AND BUSINESS AND MARKETING STRATEGIES THAT GUIDE IN IMPROVING AGENCY AND BROKERAGE PERFORMANCE IN THE INSURANCE AND FINANCIAL SERVICES INDUSTRIES; PROMOTION OF INSURANCE AND FINANCIAL SERVICES ON BEHALF OF THIRD PARTIES; ORGANIZATION OF BUSINESS CONVENTIONS, CONFERENCES, AND TRADE SHOWS IN THE FIELD OF INSURANCE AND FINANCIAL SERVICES; PUBLIC ADVOCACY ON BEHALF OF INSURANCE AND FINANCIAL SERVICES AGENTS AND BROKERS TO PROMOTE AWARENESS OF BUSINESS, LEGAL AND REGULATORY MATTERS THAT AFFECT INSURANCE AND FINANCIAL SERVICES AGENTS AND BROKERS IN THE INSURANCE AND FINANCIAL SERVICES INDUSTRIES; CONSULTING IN THE FIELD OF PUBLIC ADVOCACY SERVICES ON BEHALF OF INSURANCE AND FINANCIAL SERVICES AGENTS AND BROKERS TO PROMOTE AWARENESS OF BUSINESS, LEGAL AND REGULATORY MATTERS THAT AFFECT INSURANCE AND FINANCIAL SERVICES AGENTS AND BROKERS IN THE INSURANCE AND FINANCIAL SERVICES INDUSTRIES; PROVIDING INFORMATION AND NEWS IN THE FIELD OF BUSINESS, NAMELY, INFORMATION AND NEWS ON CURRENT EVENTS AND ON ECONOMIC, LEGISLATIVE, REGULATORY, LEGAL, BUSINESS, AND TECHNOLOGY DEVELOPMENTS AS THEY RELATE TO AND CAN IMPACT BUSINESSES IN THE INSURANCE AND FINANCIAL SERVICES FIELDS; PROVIDING LINKS TO WEBSITES OF OTHERS FEATURING CONSUMER INFORMATION IN THE INSURANCE AND FINANCIAL SERVICES INDUSTRIES; PROVIDING AN ONLINE DATABASE OF CONTACT INFORMATION FOR INDEPENDENT INSURANCE AND FINANCIAL SERVICES AGENTS AND BROKERS FOR USE BY CONSUMERS TO LOCATE AN AGENT OR BROKER; PROVIDING INFORMATION TO PROMOTE AWARENESS OF BUSINESS, LEGAL AND LEGISLATIVE ISSUES FACING THE INSURANCE AND FINANCIAL SERVICES INDUSTRIES; MARKET RESEARCH SERVICES IN THE FIELDS OF INSURANCE AND FINANCIAL SERVICES; BUSINESS RISK MANAGEMENT AND CONSULTING SERVICES RELATED THERETO; BUSINESS RESEARCH IN THE INSURANCE INDUSTRY; ARRANGING AND CONDUCTING BUSINESS CONFERENCES AND SPECIAL EVENTS FOR BUSINESS PURPOSES TO INFORM INSURANCE AGENTS AND BROKERS ABOUT LEGISLATIVE AND BUSINESS ISSUES THAT AFFECT THEIR BUSINESS ENVIRONMENT; PUBLIC ADVOCACY ON BEHALF OF INSURANCE AND FINANCIAL SERVICES AGENTS AND BROKERS TO PROMOTE AWARENESS OF LEGAL AND REGULATORY MATTERS THAT AFFECT INSURANCE AND FINANCIAL SERVICES AGENTS AND BROKERS IN THE INSURANCE AND FINANCIAL SERVICES INDUSTRIES (U.S. CLS. 100, 101 AND 102).

**CLASS 36—INSURANCE AND FINANCIAL**

FOR INSURANCE AGENCY AND BROKERAGE, FINANCIAL PLANNING AND INSURANCE CONSULTATION, AND UNDERWRITING OF ALL KINDS OF INSURANCE; FINANCIAL RISK MANAGEMENT AND CONSULTING SERVICES RELATED THERETO; FINANCIAL SERVICES, NAMELY, PROVIDING FINANCIAL ANALYSIS, CONSULTATION, PLANNING AND MANAGEMENT, AND PORTFOLIO MANAGEMENT OF INVESTMENT VEHICLES; ESTATE PLANNING, AND FINANCIAL PLANNING SERVICES IN THE NATURE OF RETIREMENT, GIFT, AND DISTRIBUTION PLANNING; INVESTMENT CONSULTATION; ADMINISTRATION OF RETIREMENT INVESTMENT AND SAVINGS PLANS AND ACCOUNTS; PROVIDING ONLINE FINANCIAL CALCULATORS; PROVIDING LINKS TO WEBSITES OF OTHERS FEATURING INFORMATION IN THE FIELDS OF INSURANCE AND FINANCIAL SERVICES OF INTEREST TO AND FOR USE BY INSUR-

ANCE AND FINANCIAL SERVICES AGENTS AND BROKERS; PROVIDING AN ONLINE DATABASE FEATURING ARTICLES, REPORTS, AND MEMORANDA IN THE FIELDS OF INSURANCE AND FINANCIAL SERVICES OF INTEREST TO INSURANCE AND FINANCIAL SERVICES AGENTS AND BROKERS; PROVIDING INFORMATION IN THE FIELDS OF INSURANCE AND FINANCIAL PLANNING TO YOUNG AND NEW INSURANCE AND FINANCIAL SERVICES AGENTS AND BROKERS; FINANCIAL SERVICES RESEARCH; AND FINANCIAL RESEARCH IN THE INSURANCE INDUSTRY; ALL THE FOREGOING EXCLUDING CREDIT CARD AND DEBIT CARD SERVICES (U.S. CLS. 100, 101 AND 102).

#### **CLASS 41—EDUCATION AND ENTERTAINMENT**

FOR PROVIDING PROFESSIONAL AND CONTINUING EDUCATION COURSES IN THE FIELD OF INSURANCE AND FINANCIAL SERVICES; PROVIDING ONLINE NEWSLETTERS AND REPORTS FEATURING STUDIES AND RESEARCH IN THE FIELDS OF INSURANCE AND FINANCIAL SERVICES; ARRANGING AND CONDUCTING EDUCATIONAL AND PROFESSIONAL DEVELOPMENT CONVENTIONS AND CONFERENCES IN THE FIELD OF INSURANCE AND FINANCIAL SERVICES; PROVIDING ONLINE PUBLICATIONS IN THE NATURE OF ARTICLES AND MAGAZINE ARTICLES IN THE FIELD OF INSURANCE AND FINANCIAL SERVICES; PROVIDING ON-LINE ELECTRONIC NEWSLETTERS DELIVERED BY E-MAIL IN THE FIELD OF INSURANCE AND FINANCIAL SERVICES; PROVIDING ON-LINE ELECTRONIC NEWSLETTERS AND REPORTS DELIVERED BY E-MAIL FEATURING STUDIES AND RESEARCH IN THE FIELDS OF INSURANCE AND FINANCIAL SERVICES; PROVIDING RECOGNITION AND INCENTIVES BY THE WAY OF AWARDS TO DEMONSTRATE EXCELLENCE IN THE FIELD OF INSURANCE AND FINANCIAL SERVICES; TRAINING SERVICES IN THE FIELD OF INSURANCE AND FINANCIAL SERVICES; ARRANGING AND CONDUCTING EDUCATIONAL CONFERENCES TO INFORM INSURANCE AGENTS AND BROKERS ABOUT LEGISLATIVE AND BUSINESS ISSUES THAT AFFECT THEIR BUSINESS ENVIRONMENT; PROVIDING EDUCATIONAL TRAINING IN THE FIELDS OF INSURANCE AND FINANCIAL PLANNING TO YOUNG AND NEW INSURANCE AND FINANCIAL SERVICES AGENTS AND BROKERS; AND PROVIDING INFORMATION AND NEWS IN THE FIELD OF CURRENT EVENTS RELATING TO THE INSURANCE AND FINANCIAL SERVICES INDUSTRIES (U.S. CLS. 100, 101 AND 107).

#### **CLASS 42—SCIENTIFIC AND COMPUTER SERVICES**

FOR PROVIDING INFORMATION IN THE FIELD OF TECHNOLOGY IN THE FIELDS OF INSURANCE AND FINANCIAL SERVICES (U.S. CLS. 100 AND 101).

#### **CLASS 45—PERSONAL AND LEGAL SERVICES**

FOR PROVIDING INFORMATION RELATING TO LEGAL AND REGULATORY AFFAIRS IN THE INSURANCE AND FINANCIAL SERVICES INDUSTRIES; AND LITIGATION SERVICES IN LEGAL MATTERS TO PROTECT THE INTERESTS OF INSURANCE AND FINANCIAL SERVICES AGENTS AND BROKERS IN THE FIELD OF THE INSURANCE AND FINANCIAL SERVICES INDUSTRIES; CONSULTING IN THE FIELD OF LEGAL AND REGULATORY COMPLIANCE MATTERS THAT AFFECT INSURANCE AND FINANCIAL SERVICES AGENTS AND BROKERS IN THE INSURANCE AND FINANCIAL SERVICES INDUSTRIES; PROVIDING LEGAL INFORMATION IN THE FIELDS OF INSURANCE AND FINANCIAL SERVICES INDUSTRIES (U.S. CLS. 100 AND 101).

#### **CLASS 200—COLLECTIVE MEMBERSHIP**

FOR INDICATING MEMBERSHIP IN AN ORGANIZATION FOR INDEPENDENT INSURANCE AND FINANCIAL SERVICES AGENTS AND BROKERS.  
CHRISTINE COOPER, EXAMINING ATTORNEY

SN 85-017,757. REDBOX AUTOMATED RETAIL, LLC, OAK-BROOK TERRACE, IL. FILED 4-19-2010.

**DON'T JUST RENT IT.  
REDBOX IT.**

THE MARK CONSISTS OF STANDARD CHARACTERS WITHOUT CLAIM TO ANY PARTICULAR FONT, STYLE, SIZE, OR COLOR.  
OWNER OF U.S. REG. NOS. 2,919,854, 3,229,436 AND OTHERS.

#### **CLASS 35—ADVERTISING AND BUSINESS**

FOR AUTOMATED RETAIL SERVICES, NAMELY, PROVIDING AUTOMATED RETAIL VENDING MACHINES FEATURING DVDS, MOVIES, PRERECORDED ELECTRONIC MEDIA FEATURING ENTERTAINMENT CONTENT, AND VIDEO GAME SOFTWARE FOR PURCHASE; AUTOMATED RETAIL SERVICES, NAMELY, ONLINE RETAIL STORE SERVICES FEATURING DVDS, MOVIES, PRERECORDED ELECTRONIC MEDIA FEATURING ENTERTAINMENT CONTENT, AND VIDEO GAME SOFTWARE FOR PURCHASE (U.S. CLS. 100, 101 AND 102).

#### **CLASS 41—EDUCATION AND ENTERTAINMENT**

FOR ENTERTAINMENT RENTAL SERVICES PROVIDED THROUGH AUTOMATED VENDING MACHINES, NAMELY, RENTAL OF DVDS, MOVIES, PRERECORDED ELECTRONIC MEDIA FEATURING ENTERTAINMENT CONTENT, AND VIDEO GAME SOFTWARE; AUTOMATED RENTAL OF DVDS, MOVIES, PRERECORDED ELECTRONIC MEDIA FEATURING ENTERTAINMENT CONTENT, AND VIDEO GAME SOFTWARE (U.S. CLS. 100, 101 AND 107).  
MICHELLE DUBOIS, EXAMINING ATTORNEY

SN 85-017,758. REDBOX AUTOMATED RETAIL, LLC, OAK-BROOK TERRACE, IL. FILED 4-19-2010.

**REDBOX IT.**

THE MARK CONSISTS OF STANDARD CHARACTERS WITHOUT CLAIM TO ANY PARTICULAR FONT, STYLE, SIZE, OR COLOR.  
OWNER OF U.S. REG. NOS. 2,919,854, 3,229,436 AND OTHERS.

**CLASS 35—ADVERTISING AND BUSINESS**

FOR AUTOMATED RETAIL SERVICES, NAMELY, PROVIDING AUTOMATED RETAIL VENDING MACHINES FEATURING DVDS, MOVIES, PRERECORDED ELECTRONIC MEDIA FEATURING ENTERTAINMENT CONTENT, AND VIDEO GAME SOFTWARE FOR PURCHASE; AUTOMATED RETAIL SERVICES, NAMELY, ONLINE RETAIL STORE SERVICES FEATURING DVDS, MOVIES, PRERECORDED ELECTRONIC MEDIA FEATURING ENTERTAINMENT CONTENT, AND VIDEO GAME SOFTWARE FOR PURCHASE (U.S. CLS. 100, 101 AND 102).

SN 85-020,934. CLARLDY SOLUTIONS, INC, HSINCHU, TAIWAN, FILED 4-22-2010.

 The logo for IDS smart features the letters "IDS" in a large, bold, black sans-serif font. To the right of "IDS" is the word "smart" in a smaller, lowercase, black sans-serif font. Below the text is a reflection effect, making it appear as if the logo is sitting on a glossy surface.

THE MARK CONSISTS OF STYLIZED LETTERS "IDS-MART" WITH REFLECTION.

**CLASS 41—EDUCATION AND ENTERTAINMENT**

FOR ENTERTAINMENT RENTAL SERVICES PROVIDED THROUGH AUTOMATED VENDING MACHINES, NAMELY, RENTAL OF DVDS, MOVIES, PRERECORDED ELECTRONIC MEDIA FEATURING ENTERTAINMENT CONTENT, AND VIDEO GAME SOFTWARE; AUTOMATED RENTAL OF DVDS, MOVIES, PRERECORDED ELECTRONIC MEDIA FEATURING ENTERTAINMENT CONTENT, AND VIDEO GAME SOFTWARE (U.S. CLS. 100, 101 AND 107).

MICHELLE DUBOIS, EXAMINING ATTORNEY

**CLASS 9—ELECTRICAL AND SCIENTIFIC APPARATUS**

FOR DATA STORAGE MACHINE, NAMELY, COMPUTER HARDWARE FOR STORAGE OF DATA USING ONE OR MULTIPLE CPUS; DATA PROCESSOR; DATA READER, NAMELY, SMART CARD READER; COMPUTER PROGRAM FOR USE IN DATABASE MANAGEMENT; COMPUTER SOFTWARE FOR USE IN DATABASE MANAGEMENT; CD RECORDED COMPUTER PROGRAMS FEATURING DATABASE MANAGEMENT; CD-ROM DATA CARRIERS RECORDED COMPUTER PROGRAMS FEATURING DATABASE MANAGEMENT; DATA CARRIERS RECORDED COMPUTER PROGRAMS FEATURING DATABASE MANAGEMENT; BARCODE SCANNER; BARCODE READING MACHINE; RFID READING DEVICE; ACCESS CARD MACHINE NAMELY, RANDOM ACCESS MEMORY CARD READER; TAG, NAMELY, ELECTRONIC TAGS AND RFID TAGS FOR GOODS; ANTENNA; MULTIPLEXER; RADIO AND ELECTRONIC SIGNAL TRANSCIEVER; ENCODER, NAMELY, RADIO AND ELECTRONIC SIGNAL DECODER; DECODER, NAMELY, RADIO AND ELECTRONIC SIGNAL DECODER; ELECTRONIC SIGNAL RECEIVER; COMMUNICATIONS DEVICE, NAMELY, RADIO TRANSMITTER AND RECEIVER, WIRELESS TRANSMITTER AND RECEIVER; COMMUNICATIONS EQUIPMENT, NAMELY, ELECTRIC OPERATOR CONTROL PANELS AND INSTRUMENTS IN THE NATURE OF AUTOMATION; COMMUNICATION SERVER; RADIO RELAY TRANSMITTER; RADIO RELAY RECEIVER; WIRELESS TELECOMMUNICATIONS RECEIVER, NAMELY, ADAPTERS FOR COMPUTER, WIRELESS BROADBAND RADIO, WIRELESS IDENTIFICATION TAGS AND LABELS (U.S. CLS. 21, 23, 26, 36 AND 38).

SN 85-020,725. SANTANA ENTERPRISES, LLC, MINNEAPOLIS, MN. FILED 4-22-2010.

JOHAN SANTANA

THE MARK CONSISTS OF STANDARD CHARACTERS WITHOUT CLAIM TO ANY PARTICULAR FONT, STYLE, SIZE, OR COLOR.

THE NAME(S), PORTRAIT(S), AND/OR SIGNATURE(S) SHOWN IN THE MARK IDENTIFIES "JOHAN SANTANA", WHOSE CONSENT(S) TO REGISTER IS MADE OF RECORD.

**CLASS 16—PAPER GOODS AND PRINTED MATTER**

FOR ART PRINTS, POSTERS, BASEBALL CARDS (U.S. CLS. 2, 5, 22, 23, 29, 37, 38 AND 50).

**CLASS 25—CLOTHING**

FOR SHOES AND CLOTHING, NAMELY, PANTS, SHIRTS, JACKETS, HEADWEAR, SWEATSHIRTS AND SHORTS (U.S. CLS. 22 AND 39).

**CLASS 28—TOYS AND SPORTING GOODS**

FOR BASEBALLS; BASEBALL GLOVES (U.S. CLS. 22, 23, 38 AND 50).

**CLASS 41—EDUCATION AND ENTERTAINMENT**

FOR EDUCATIONAL SERVICES, NAMELY, PROVIDING MOTIVATIONAL SPEAKING SERVICES IN THE FIELD OF SPORTS IMPROVEMENT, BUSINESS SUCCESS, AND SETTING AND ACHIEVING GOALS; TRAINING SERVICES IN THE FIELD OF BASEBALL (U.S. CLS. 100, 101 AND 107).

LINDA MICKLEBURGH, EXAMINING ATTORNEY

**CLASS 35—ADVERTISING AND BUSINESS**

FOR DATA PROCESSING SERVICES FEATURING COMPUTER DATA PROCESSING (U.S. CLS. 100, 101 AND 102).

**CLASS 42—SCIENTIFIC AND COMPUTER SERVICES**

FOR COMPUTER PROGRAMMING; DEVELOPMENT OF COMPUTER DATA PROCESSING BY ORDER OF THIRD PARTIES; DESIGN FOR OTHERS IN THE FIELD OF COMPUTER NETWORKS AND ENGINEERING FOR THE FIELD OF AUTOMATIC CONTROL SYSTEMS ENGINEERING PLANNING DESIGN, COMMUNICATIONS SYSTEMS AND EQUIPMENT ENGINEERING PLANNING DESIGN, CENTRAL MONITORING CONTROL SYSTEM PLANNING DESIGN, INSTRUMENT CONTROL SYSTEM DEVELOPMENT PLANNING DESIGN (U.S. CLS. 100 AND 101).

EMILY CHUO, EXAMINING ATTORNEY

SN 85-026,474. PERRIN BERNARD SUPOWITZ, INC., DBA INDIVIDUAL FOODSERVICE, BELL, CA. FILED 4-29-2010.



NO CLAIM IS MADE TO THE EXCLUSIVE RIGHT TO USE "INDIVIDUAL FOODSERVICE" AND "EST. 1926", APART FROM THE MARK AS SHOWN.

THE MARK CONSISTS OF A CUP WITH A SWIRLING RIBBON DESIGN, STYLIZED "IFS" INITIALS APPEAR BESIDE IT; STYLIZED WORDING "INDIVIDUAL FOODSERVICE EST. 1926" APPEARS ON THE RIGHT SIDE OF THE INITIALS WITH RIGHT ALIGNMENT.

### CLASS 3—COSMETICS AND CLEANING PREPARATIONS

FOR JANITORIAL SUPPLIES, NAMELY, FLOOR FINISHING PREPARATION, FLOOR BUFFING COMPOUND, ALL PURPOSE CLEANING PREPARATIONS, AMMONIA FOR CLEANING PURPOSES (U.S. CLS. 1, 4, 6, 50, 51 AND 52).

FIRST USE 4-1-2010; IN COMMERCE 4-1-2010.

### CLASS 16—PAPER GOODS AND PRINTED MATTER

FOR DISPOSABLES FOOD SERVICE PRODUCTS, NAMELY, PAPER NAPKINS, PAPER PLACE MATS, FOOD WRAPPERS (U.S. CLS. 2, 5, 22, 23, 29, 37, 38 AND 50).

FIRST USE 4-1-2010; IN COMMERCE 4-1-2010.

### CLASS 30—STAPLE FOODS

FOR MAYONNAISE, KETCHUP, MUSTARD, RELISH, SWEET AND SOUR SAUCE, SAUCES, FLAVORING SYRUPS, PANCAKE SYRUP (U.S. CL. 46).

FIRST USE 4-1-2010; IN COMMERCE 4-1-2010.

### CLASS 32—LIGHT BEVERAGES

FOR LIGHT BEVERAGES, NAMELY, WATER, FRUIT DRINKS, FRUIT JUICES, SYRUPS FOR BEVERAGES, LEMON JUICE FOR USE IN THE PREPARATION OF BEVERAGES (U.S. CLS. 45, 46 AND 48).

FIRST USE 4-1-2010; IN COMMERCE 4-1-2010.

### CLASS 35—ADVERTISING AND BUSINESS

FOR WHOLESALE FOOD DISTRIBUTORSHIP SERVICES (U.S. CLS. 100, 101 AND 102).

FIRST USE 4-1-2010; IN COMMERCE 4-1-2010.

TRICIA SONNEBORN, EXAMINING ATTORNEY

SN 85-028,899. AGILITAS PARTNERS LLP, LONDON, UNITED KINGDOM, FILED 5-3-2010.

# AGILITAS

THE MARK CONSISTS OF STANDARD CHARACTERS WITHOUT CLAIM TO ANY PARTICULAR FONT, STYLE, SIZE, OR COLOR.

PRIORITY CLAIMED UNDER SEC. 44(D) ON ERPNTY TM OFC APPLICATION NO. 009035262, FILED 4-16-2010, REG. NO. 009035262, DATED 12-9-2010, EXPIRES 4-16-2020.

THE WORDING "AGILITAS" HAS NO MEANING IN A FOREIGN LANGUAGE.

### CLASS 35—ADVERTISING AND BUSINESS

FOR BUSINESS ORGANISATION AND MANAGEMENT CONSULTING SERVICES; BUSINESS PLANNING; BUSINESS ADMINISTRATION; FINANCIAL MANAGEMENT CONSULTANCY; BUSINESS APPRAISALS; ASSISTANCE WITH BUSINESS MANAGEMENT; BUSINESS RESEARCH; COMMERCIAL AND INDUSTRIAL MANAGEMENT ASSISTANCE; ECONOMIC FORECASTING; TAX CONSULTATION; BUSINESS ADVICE AND INFORMATION RELATING TO LOANS, FINANCE AND CAPITAL (U.S. CLS. 100, 101 AND 102).

### CLASS 36—INSURANCE AND FINANCIAL

FOR FINANCIAL CONSULTANCY; INVESTMENT SERVICES, NAMELY, ASSET ACQUISITION; INVESTMENT OF FUNDS FOR OTHERS; FINANCIAL SERVICES, NAMELY, INVESTMENT ADVICE, INVESTMENT MANAGEMENT, INVESTMENT CONSULTATION AND INVESTMENT OF FUNDS FOR OTHERS; FINANCIAL SERVICES, NAMELY, RAISING DEBT AND EQUITY CAPITAL FOR OTHERS; FINANCING SERVICES; CAPITAL INVESTMENT SERVICES; REPAIR COST EVALUATIONS (U.S. CLS. 100, 101 AND 102).

STEVEN JACKSON, EXAMINING ATTORNEY

SN 85-030,577. GREENPHIRE, L.L.C., KING OF PRUSSIA, PA. FILED 5-5-2010.

# CLINCARD

THE MARK CONSISTS OF STANDARD CHARACTERS WITHOUT CLAIM TO ANY PARTICULAR FONT, STYLE, SIZE, OR COLOR.

### CLASS 9—ELECTRICAL AND SCIENTIFIC APPARATUS

FOR MAGNETICALLY ENCODED DEBIT CARDS; COMPUTER SOFTWARE FOR BILLING, INVOICING, PAYMENT, COLLECTION, TRACKING, RECONCILIATION AND DETAILED FINANCIAL REPORTING ON CLINICAL TRIAL ACTIVITY; COMPUTER SOFTWARE FOR ELECTRONIC COLLECTION, STORAGE, DISTRIBUTION AND ANALYSIS OF CLINICAL TRIAL DATA AND PAYMENT, INCLUDING ALL CONTRACTS, BUDGETS AND RELATED DOCUMENTS (U.S. CLS. 21, 23, 26, 36 AND 38).

FIRST USE 5-31-2009; IN COMMERCE 5-31-2009.

### CLASS 36—INSURANCE AND FINANCIAL

FOR PAYMENT PROCESSING SERVICES, NAMELY, DEBIT CARD TRANSACTION PROCESSING SERVICES; PREPAID PURCHASE SERVICES, NAMELY, PROCESSING OF PAYMENTS MADE THROUGH PRE-PAID CARDS ALLOWING USERS TO TRANSFER VALUE VIA AN ELECTRONIC OR OPTICAL COMMUNICATIONS NETWORK, DEBIT CARD SERVICES; ADMINISTRATION AND RECONCILIATION OF TRANSACTIONS INVOLVING FUNDS DRAWN FROM BANK ACCOUNTS ON BEHALF OF OTHERS USING A DEBIT CARD OVER AN ELECTRONIC AND OPTICAL COMMUNICATIONS NETWORK (U.S. CLS. 100, 101 AND 102).

FIRST USE 5-31-2008; IN COMMERCE 5-31-2008.

KIM SAITO, EXAMINING ATTORNEY

SN 85-032,208. ASSISTIVE TECHNOLOGY GROUP, INC.,  
NAPERVILLE, IL. FILED 5-6-2010.

# ATG REHAB

THE MARK CONSISTS OF STANDARD CHARACTERS WITHOUT CLAIM TO ANY PARTICULAR FONT, STYLE, SIZE, OR COLOR.

NO CLAIM IS MADE TO THE EXCLUSIVE RIGHT TO USE "REHAB", APART FROM THE MARK AS SHOWN.

## CLASS 10—MEDICAL APPARATUS

FOR CUSTOMIZED MEDICAL SEATING EQUIPMENT AND POSITIONAL EQUIPMENT FOR DISABLED PERSONS AND MOBILITY IMPAIRED PERSONS, NAMELY, STANDING FRAMES, POSITIONING SEATS, THERAPEUTIC SEATS, THERAPEUTIC SEAT CUSHIONS, ORTHOPEDIC SEATS, ORTHOPEDIC SEAT CUSHIONS, ADAPTIVE SEATS, WALKING FRAMES, AND WALKING AIDS (U.S. CLS. 26, 39 AND 44).

FIRST USE 10-1-2008; IN COMMERCE 10-1-2008.

## CLASS 12—VEHICLES

FOR CUSTOMIZED MOBILITY EQUIPMENT FOR DISABLED PERSONS AND MOBILITY IMPAIRED PERSONS, NAMELY, MOTORIZED WHEELCHAIRS AND MOTORIZED PERSONAL MOBILITY SCOOTERS (U.S. CLS. 19, 21, 23, 31, 35 AND 44).

FIRST USE 10-1-2008; IN COMMERCE 10-1-2008.

## CLASS 36—INSURANCE AND FINANCIAL

FOR FINANCIAL CONSULTING SERVICES, NAMELY, CONSULTING FOR THE PURPOSE OF FINANCING CUSTOMIZED MEDICAL SEATING EQUIPMENT, POSITIONAL EQUIPMENT AND MOBILITY EQUIPMENT FOR DISABLED PERSONS AND MOBILITY IMPAIRED PERSONS, AND INSURANCE AND FINANCIAL CONSULTATION, NAMELY, CONSULTING POTENTIAL CUSTOMERS ON INSURANCE REIMBURSEMENT AND PROVIDING FINANCIAL ANALYSIS CONCERNING COSTS OF CUSTOMIZED MEDICAL SEATING EQUIPMENT, POSITIONAL EQUIPMENT AND MOBILITY EQUIPMENT FOR DISABLED PERSONS AND MOBILITY IMPAIRED PERSONS (U.S. CLS. 100, 101 AND 102).

FIRST USE 10-1-2008; IN COMMERCE 10-1-2008.

## CLASS 37—CONSTRUCTION AND REPAIR

FOR MAINTENANCE, REPAIR AND MODIFICATION OF CUSTOMIZED MEDICAL SEATING EQUIPMENT, POSITIONAL EQUIPMENT, AND MOBILITY EQUIPMENT FOR DISABLED PERSONS AND MOBILITY IMPAIRED PERSONS (U.S. CLS. 100, 103 AND 106).

FIRST USE 10-1-2008; IN COMMERCE 10-1-2008.

## CLASS 39—TRANSPORTATION AND STORAGE

FOR DELIVERY OF CUSTOMIZED MEDICAL SEATING EQUIPMENT, POSITIONAL EQUIPMENT, AND MOBILITY EQUIPMENT FOR DISABLED PERSONS AND MOBILITY IMPAIRED PERSONS (U.S. CLS. 100 AND 105).

FIRST USE 10-1-2008; IN COMMERCE 10-1-2008.

## CLASS 40—MATERIAL TREATMENT

FOR ASSEMBLY OF CUSTOMIZED MEDICAL SEATING EQUIPMENT, POSITIONAL EQUIPMENT, AND MOBILITY EQUIPMENT FOR DISABLED PERSONS AND MOBILITY IMPAIRED PERSONS (U.S. CLS. 100, 103 AND 106).

FIRST USE 10-1-2008; IN COMMERCE 10-1-2008.

## CLASS 41—EDUCATION AND ENTERTAINMENT

FOR EDUCATIONAL SERVICES, NAMELY, PROVIDING CLASSES, WORKSHOPS, SEMINARS AND TRAINING TO DISABLED AND MOBILITY IMPAIRED PERSONS, MEDICAL STAFF, CLINICAL STAFF, CARE GIVERS AND FAMILIES IN THE FIELD OF PROPER CUSTOMIZATION, MODIFICATION, ADJUSTMENT AND USE OF CUSTOMIZED MEDICAL SEATING EQUIPMENT, POSITIONAL EQUIPMENT, AND MOBILITY EQUIPMENT FOR DISABLED PERSONS AND MOBILITY IMPAIRED PERSONS (U.S. CLS. 100, 101 AND 107).

FIRST USE 10-1-2008; IN COMMERCE 10-1-2008.

## CLASS 45—PERSONAL AND LEGAL SERVICES

FOR PROVIDING CASE MANAGEMENT SERVICES, NAMELY, EVALUATING THE SEATING, POSITIONING AND MOBILITY NEEDS OF DISABLED PERSONS AND MOBILITY IMPAIRED PERSONS, COORDINATING THE PROVISION OF AND PROCURING CUSTOMIZED MEDICAL SEATING EQUIPMENT, POSITIONAL EQUIPMENT AND MOBILITY EQUIPMENT FOR DISABLED PERSONS AND MOBILITY IMPAIRED PERSONS (U.S. CLS. 100 AND 101).

FIRST USE 10-1-2008; IN COMMERCE 10-1-2008.

SAMUEL E. SHARPER JR., EXAMINING ATTORNEY

SN 85-032,232. ASSISTIVE TECHNOLOGY GROUP, INC.,  
NAPERVILLE, IL. FILED 5-6-2010.



NO CLAIM IS MADE TO THE EXCLUSIVE RIGHT TO USE "REHAB", APART FROM THE MARK AS SHOWN.

THE MARK CONSISTS OF AN ARC ABOVE THE STYLIZED WORDS "ATG REHAB" WHICH APPEAR TO THE LEFT OF A PERSON ON A WHEELCHAIR.

## CLASS 10—MEDICAL APPARATUS

FOR CUSTOMIZED MEDICAL SEATING EQUIPMENT AND POSITIONAL EQUIPMENT FOR DISABLED PERSONS AND MOBILITY IMPAIRED PERSONS, NAMELY, STANDING FRAMES, POSITIONING SEATS, THERAPEUTIC SEATS, THERAPEUTIC SEAT CUSHIONS, ORTHOPEDIC SEATS, ORTHOPEDIC SEAT CUSHIONS, ADAPTIVE SEATS, WALKING FRAMES, AND WALKING AIDS (U.S. CLS. 26, 39 AND 44).

FIRST USE 10-1-2008; IN COMMERCE 10-1-2008.

## CLASS 12—VEHICLES

FOR CUSTOMIZED MOBILITY EQUIPMENT FOR DISABLED PERSONS AND MOBILITY IMPAIRED PERSONS, NAMELY, MOTORIZED WHEELCHAIRS AND MOTORIZED PERSONAL MOBILITY SCOOTERS (U.S. CLS. 19, 21, 23, 31, 35 AND 44).

FIRST USE 10-1-2008; IN COMMERCE 10-1-2008.

**CLASS 36—INSURANCE AND FINANCIAL**

FOR FINANCIAL CONSULTING SERVICES, NAMELY, CONSULTING FOR THE PURPOSE OF FINANCING CUSTOMIZED MEDICAL SEATING EQUIPMENT, POSITIONAL EQUIPMENT AND MOBILITY EQUIPMENT FOR DISABLED PERSONS AND MOBILITY IMPAIRED PERSONS, AND INSURANCE AND FINANCIAL CONSULTATION, NAMELY, CONSULTING POTENTIAL CUSTOMERS ON INSURANCE REIMBURSEMENT AND PROVIDING FINANCIAL ANALYSIS CONCERNING COSTS OF CUSTOMIZED MEDICAL SEATING EQUIPMENT, POSITIONAL EQUIPMENT AND MOBILITY EQUIPMENT FOR DISABLED PERSONS AND MOBILITY IMPAIRED PERSONS (U.S. CLS. 100, 101 AND 102).

FIRST USE 10-1-2008; IN COMMERCE 10-1-2008.

**CLASS 37—CONSTRUCTION AND REPAIR**

FOR MAINTENANCE, REPAIR AND MODIFICATION OF CUSTOMIZED MEDICAL SEATING EQUIPMENT, POSITIONAL EQUIPMENT, AND MOBILITY EQUIPMENT FOR DISABLED PERSONS AND MOBILITY IMPAIRED PERSONS (U.S. CLS. 100, 103 AND 106).

FIRST USE 10-1-2008; IN COMMERCE 10-1-2008.

**CLASS 39—TRANSPORTATION AND STORAGE**

FOR DELIVERY OF CUSTOMIZED MEDICAL SEATING EQUIPMENT, POSITIONAL EQUIPMENT, AND MOBILITY EQUIPMENT FOR DISABLED PERSONS AND MOBILITY IMPAIRED PERSONS (U.S. CLS. 100 AND 105).

FIRST USE 10-1-2008; IN COMMERCE 10-1-2008.

**CLASS 40—MATERIAL TREATMENT**

FOR ASSEMBLY OF CUSTOMIZED MEDICAL SEATING EQUIPMENT, POSITIONAL EQUIPMENT, AND MOBILITY EQUIPMENT FOR DISABLED PERSONS AND MOBILITY IMPAIRED PERSONS (U.S. CLS. 100, 103 AND 106).

FIRST USE 10-1-2008; IN COMMERCE 10-1-2008.

**CLASS 41—EDUCATION AND ENTERTAINMENT**

FOR EDUCATIONAL SERVICES, NAMELY, PROVIDING CLASSES, WORKSHOPS, SEMINARS AND TRAINING TO DISABLED AND MOBILITY IMPAIRED PERSONS, MEDICAL STAFF, CLINICAL STAFF, CARE GIVERS AND FAMILIES IN THE FIELD OF PROPER CUSTOMIZATION, MODIFICATION, ADJUSTMENT AND USE OF CUSTOMIZED MEDICAL SEATING EQUIPMENT, POSITIONAL EQUIPMENT, AND MOBILITY EQUIPMENT FOR DISABLED PERSONS AND MOBILITY IMPAIRED PERSONS (U.S. CLS. 100, 101 AND 107).

FIRST USE 10-1-2008; IN COMMERCE 10-1-2008.

**CLASS 45—PERSONAL AND LEGAL SERVICES**

FOR PROVIDING CASE MANAGEMENT SERVICES, NAMELY, EVALUATING THE SEATING, POSITIONING AND MOBILITY NEEDS OF DISABLED PERSONS AND MOBILITY IMPAIRED PERSONS, COORDINATING THE PROVISION OF AND PROCURING CUSTOMIZED MEDICAL SEATING EQUIPMENT, POSITIONAL EQUIPMENT AND MOBILITY EQUIPMENT FOR DISABLED PERSONS AND MOBILITY IMPAIRED PERSONS (U.S. CLS. 100 AND 101).

FIRST USE 10-1-2008; IN COMMERCE 10-1-2008.

SAMUEL E. SHARPER JR., EXAMINING ATTORNEY

SN 85-032,244. ASSISTIVE TECHNOLOGY GROUP, INC., NAPERVILLE, IL. FILED 5-6-2010.

**LIFE. IN MOTION.**

THE MARK CONSISTS OF STANDARD CHARACTERS WITHOUT CLAIM TO ANY PARTICULAR FONT, STYLE, SIZE, OR COLOR.

**CLASS 10—MEDICAL APPARATUS**

FOR CUSTOMIZED MEDICAL SEATING EQUIPMENT AND POSITIONAL EQUIPMENT FOR DISABLED PERSONS AND MOBILITY IMPAIRED PERSONS, NAMELY, STANDING FRAMES, POSITIONING SEATS, THERAPEUTIC SEATS, THERAPEUTIC SEAT CUSHIONS, ORTHOPEDIC SEATS, ORTHOPEDIC SEAT CUSHIONS, ADAPTIVE SEATS, WALKING FRAMES, AND WALKING AIDS (U.S. CLS. 26, 39 AND 44).

FIRST USE 10-1-2008; IN COMMERCE 10-1-2008.

**CLASS 12—VEHICLES**

FOR CUSTOMIZED MOBILITY EQUIPMENT FOR DISABLED PERSONS AND MOBILITY IMPAIRED PERSONS, NAMELY, MOTORIZED WHEELCHAIRS AND MOTORIZED PERSONAL MOBILITY SCOOTERS (U.S. CLS. 19, 21, 23, 31, 35 AND 44).

FIRST USE 10-1-2008; IN COMMERCE 10-1-2008.

**CLASS 36—INSURANCE AND FINANCIAL**

FOR FINANCIAL CONSULTING SERVICES, NAMELY, CONSULTING FOR THE PURPOSE OF FINANCING CUSTOMIZED MEDICAL SEATING EQUIPMENT, POSITIONAL EQUIPMENT AND MOBILITY EQUIPMENT FOR DISABLED PERSONS AND MOBILITY IMPAIRED PERSONS, AND INSURANCE AND FINANCIAL CONSULTATION, NAMELY, CONSULTING POTENTIAL CUSTOMERS ON INSURANCE REIMBURSEMENT AND PROVIDING FINANCIAL ANALYSIS CONCERNING COSTS OF CUSTOMIZED MEDICAL SEATING EQUIPMENT, POSITIONAL EQUIPMENT AND MOBILITY EQUIPMENT FOR DISABLED PERSONS AND MOBILITY IMPAIRED PERSONS (U.S. CLS. 100, 101 AND 102).

FIRST USE 10-1-2008; IN COMMERCE 10-1-2008.

**CLASS 37—CONSTRUCTION AND REPAIR**

FOR MAINTENANCE, REPAIR AND MODIFICATION OF CUSTOMIZED MEDICAL SEATING EQUIPMENT, POSITIONAL EQUIPMENT, AND MOBILITY EQUIPMENT FOR DISABLED PERSONS AND MOBILITY IMPAIRED PERSONS (U.S. CLS. 100, 103 AND 106).

FIRST USE 10-1-2008; IN COMMERCE 10-1-2008.

**CLASS 39—TRANSPORTATION AND STORAGE**

FOR DELIVERY OF CUSTOMIZED MEDICAL SEATING EQUIPMENT, POSITIONAL EQUIPMENT, AND MOBILITY EQUIPMENT FOR DISABLED PERSONS AND MOBILITY IMPAIRED PERSONS (U.S. CLS. 100 AND 105).

FIRST USE 10-1-2008; IN COMMERCE 10-1-2008.

**CLASS 40—MATERIAL TREATMENT**

FOR ASSEMBLY OF CUSTOMIZED MEDICAL SEATING EQUIPMENT, POSITIONAL EQUIPMENT, AND MOBILITY EQUIPMENT FOR DISABLED PERSONS AND MOBILITY IMPAIRED PERSONS (U.S. CLS. 100, 103 AND 106).

FIRST USE 10-1-2008; IN COMMERCE 10-1-2008.

**CLASS 41—EDUCATION AND ENTERTAINMENT**

FOR EDUCATIONAL SERVICES, NAMELY, PROVIDING CLASSES, WORKSHOPS, SEMINARS AND TRAINING TO DISABLED AND MOBILITY IMPAIRED PERSONS, MEDICAL STAFF, CLINICAL STAFF, CARE GIVERS AND FAMILIES IN THE FIELD OF PROPER CUSTOMIZATION, MODIFICATION, ADJUSTMENT AND USE OF CUSTOMIZED MEDICAL SEATING EQUIPMENT, POSITIONAL EQUIPMENT, AND MOBILITY EQUIPMENT FOR DISABLED PERSONS AND MOBILITY IMPAIRED PERSONS (U.S. CLS. 100, 101 AND 107).

FIRST USE 10-1-2008; IN COMMERCE 10-1-2008.

**CLASS 45—PERSONAL AND LEGAL SERVICES**

FOR PROVIDING CASE MANAGEMENT SERVICES, NAMELY, EVALUATING THE SEATING, POSITIONING AND MOBILITY NEEDS OF DISABLED PERSONS AND MOBILITY IMPAIRED PERSONS, COORDINATING THE PROVISION OF AND PROCURING CUSTOMIZED MEDICAL SEATING EQUIPMENT, POSITIONAL EQUIPMENT AND MOBILITY EQUIPMENT FOR DISABLED PERSONS AND MOBILITY IMPAIRED PERSONS (U.S. CLS. 100 AND 101).

FIRST USE 10-1-2008; IN COMMERCE 10-1-2008.

SAMUEL E. SHARPER JR., EXAMINING ATTORNEY

SN 85-032,554. SEVEN DEUCE CORPORATION, NEW YORK, NY. FILED 5-7-2010.



NO CLAIM IS MADE TO THE EXCLUSIVE RIGHT TO USE "ARTISANAL KITCHEN" AS TO CLASSES 29 AND 30, APART FROM THE MARK AS SHOWN.

THE MARK CONSISTS OF A FANCIFUL "A" WITH FOUR DOTS FOLLOWED BY "THE" ON ITS SIDE WITH THE WORDS "ARTISANAL KITCHEN" NEXT TO IT, ALL OF WHICH ARE SURROUNDED BY A RECTANGULAR BORDER.

**CLASS 3—COSMETICS AND CLEANING PREPARATIONS**

FOR CLEANING, WASHING, SCOURING, AND POLISHING PREPARATIONS AND SUBSTANCES, FOAM CLEANING PREPARATIONS, FURNITURE POLISH, SOAPS AND DETERGENTS, SOAPS FOR HOUSEHOLD USE (U.S. CLS. 1, 4, 6, 50, 51 AND 52).

**CLASS 16—PAPER GOODS AND PRINTED MATTER**

FOR BATHROOM TISSUE, DISPOSABLE NAPKINS, PAPER HAND TOWELS, PAPER NAPKINS, PAPER TOWELS (U.S. CLS. 2, 5, 22, 23, 29, 37, 38 AND 50).

**CLASS 21—HOUSEWARES AND GLASS**

FOR PAPER PLATES AND PAPER CUPS (U.S. CLS. 2, 13, 23, 29, 30, 33, 40 AND 50).

**CLASS 29—MEATS AND PROCESSED FOODS**

FOR PROCESSED, CANNED, DRIED AND PRESERVED FRUITS; FROZEN AND PREPARED PACKAGED ENTREES CONSISTING PRIMARILY OF MEAT, FISH, POULTRY, OR VEGETABLES; FROZEN, PREPARED AND PACKAGED MEALS CONSISTING PRIMARILY OF MEAT, FISH, POULTRY, OR VEGETABLES; FROZEN, PREPARED AND PACKAGED VEGETABLE-BASED ENTREES; CHICKEN, MEAT AND FISH CROQUETTES; VEGETABLE AND FISH SOUFFLES; ABALONES; ACIDOPHILUS MILK; ALBUMEN FOR USE IN FOOD; ALGAE FOOD BEVERAGES, NAMELY, SEAWEED DRINKS; ANCHOVY PASTE; ANIMAL OILS AND FATS; APPETIZERS, NAMELY, BREADED AND FRIED JALAPEÑO PEPPERS; APPLE PUREE; APPLESAUCE; ARK-SHELLS; ARTICHOKE PASTE; ASPIC; BACON; BACON RINDS; BAKED BEANS; BANANA CHIPS; BEAN DIP; BEEF; BEEF JERKY; BEEF PATTIES; BEEF SLICES; BEEF STEW; BEEF STOCK; BEEF TALLOW; BISQUES; BLACK PUDDING; BLANCHED NUTS; BLENDED OIL; BLOCKS OF BOILED, SMOKED AND THEN DRIED BONITOS; BLOOD SAUSAGE; BLUE MUSSELS; BOLOGNA; BONE OIL; BONELESS SKINLESS CHICKEN TENDERLOIN; BOTTLED COOKED MEAT; BOUILLON, BOUILLON CONCENTRATES; BROTH, SOUP; BRUSCHETTA TOPPINGS; BUTTER; BUTTER SUBSTITUTES; CAFFEINE-COATED NUTS; CANDIED FRUIT; CANDIED FRUIT SNACKS; CANDIED NUTS; CANNED COOKED MEAT; CANNED FISH; CANNED FRUITS; CANNED FRUITS AND VEGETABLES; CANNED OR BOTTLED FRUITS; CANNED OR BOTTLED VEGETABLES; CANNED PORK AND BEANS; CANNED PROCESSED OLIVES; CANNED SNAILS; CANNED TOMATOES; CANNED VEGETABLES; CANNED, COOKED OR OTHERWISE PROCESSED TOMATOES; CANOLA OIL; CAPONATA; CARP; CASEIN FOR FOOD; CAVIAR; CHARCUTERIE; CHEESE; CHEESE AND CRACKER COMBINATIONS; CHEESE FONDUE; CHEESE FOOD; CHEESE POWDER; CHEESE SPREADS; CHEESE SUBSTITUTES; CHEESE, NAMELY, GOUDA, EDAM, CHEDDAR, AND PROCESSED CHEESE; CHICKEN; CHICKEN AND DUMPLINGS; CHICKEN CROQUETTES; CHICKEN MOUSSE; CHICKEN STOCK; CHILE CON QUESO; CHILE RELLENOS; CHILE VERDE; CHILE WITH OR WITHOUT BEANS; CHOCOLATE MILK; CHOCOLATE NUT BUTTER; CHOP SUEY; CHORIZO; CHOW MEIN, MEAT, FISH, AND VEGETABLE BASED; CHOWDER; CLAM JUICE; CLAMS; COCOA BUTTER FOR FOOD PURPOSES; COCONUT OIL; COCONUT OIL AND FAT; COCONUT POWDER; CODS; COFFEE-COATED NUTS; COLE SLAW; COMBINATION MEAL CONSISTING PRIMARILY OF A MEAT OR VEGETABLE-BASED ENTREE AND A SOUP OR SALAD FOR CONSUMPTION ON OR OFF THE PREMISES; COMPOTES; CONDENSED MILK; CONDIMENTS, NAMELY, PEPPER OIL; COOKED FRUITS AND VEGETABLES; COOKED SNAILS; COOKING OIL; CORN DOGS; CORN OIL; CORNED BEEF; CORNED BEEF HASH; COTTAGE CHEESE; CRAB CAKES; CRAB ROE PASTE; CRAB ROE PUREE; CRABS; CRANBERRY SAUCE; CRAYFISH; CRAYFISH; CREAM; CREAM CHEESE; CREAM FRAICHE; CREAM POWDER; CRYSTALLIZED, FROSTED, FROZEN, AND PRESERVED FRUIT; CURD; CUT FRUITS, BAGGED, CANNED AND BOTTLED; CUT VEGETABLES, BAGGED, CANNED AND BOTTLED; DAIRY PRODUCTS EXCLUDING ICE CREAM, ICE MILK, AND FROZEN YOGURT; DAIRY-BASED BEVERAGES; DAIRY-BASED CHOCOLATE FOOD BEVERAGES; DAIRY-BASED DIPS; DAIRY-BASED FOOD BEVERAGES; DAIRY-BASED POWDERS FOR MAKING DAIRY-BASED FOOD, BEVERAGES AND SHAKES; DAIRY-BASED SNACK FOODS EXCLUDING ICE CREAM, ICE MILK, AND FROZEN YOGURT; DEHYDRATED FRUIT SNACKS; DESICCATED COCONUT; DIP MIXES; DIPS; DOLMAS; DRIED BEANS; DRIED BEEF; DRIED EDIBLE ALGAE; DRIED EDIBLE SEAWEED; DRIED EGGS; DRIED FIGS; DRIED FLAKES OF LAVER FOR SPRINKLING ON RICE IN HOT WATER; DRIED FRUIT AND VEGETABLES; DRIED FRUIT MIXES; DRIED FRUITS; DRIED LENTILS; DRIED MEAT; DRIED PIECES OF AGAR JELLY; DRIED

SOYBEANS; DRIED VEGETABLES; DRINKING YOGURTS; DRINKS BASED ON YOGHURT; DRINKS BASED ON YOGURT; DRY OR AROMATIZED FRUIT; DUCK EGGS; EDIBLE BIRD'S NESTS; EDIBLE OILS AND EDIBLE FATS; FISH AND MEAT PRESERVES; EDIBLE PRESERVES AND PICKLES; EDIBLE SHAVINGS OF DRIED KELP; EGG NOG; EGG NOG MIXES; EGG PRODUCT, EGG SUBSTITUTE; EGG WHITES; EGG YOLKS; EGGPLANT PARMIGIANA; EGGS; ESCARGOT; ETOUFFEE; EVAPORATED MILK, EXTRACTS FROM SOUPS; FALAFEL; FERMENTED BAMBOO SHOOTS BOILED AND PRESERVED IN SALT; FERMENTED MILK; FERMENTED SOYBEANS; FERMENTED VEGETABLES; FIG AND DATE ROLL CONSISTING OF DRIED FRUITS, NUTS, AND SPICES; FISH AND CHIPS; FISH AND MEAT PRESERVES; FISH CAKES; FISH CROQUETTES; FISH FILLETS; FISH MOUSSE; FISH PRESERVES; FISH SAUSAGES; FISH STOCK; FISH; FISHMEAL FOR HUMAN CONSUMPTION; FLAKED COCONUT; FLAKES OF DRIED FISH MEAT; FOIE GRAS; FOOD ADDITIVES IN THE NATURE OF FAT ACIDS MADE FROM MEAT, FOOD GLAZING PREPARATIONS COMPRISED PRIMARILY OF FRUIT AND/OR FRUIT PECTIC FOR USE IN COOKING AND BAKING; FOOD PACKAGE COMBINATIONS CONSISTING PRIMARILY OF CHEESE, MEAT AND/OR PROCESSED FRUIT; FORMED TEXTURED VEGETABLE PROTEIN TO BE USED AS AN EXTENDER OR MEAT SUBSTITUTE; FORMED TEXTURED VEGETABLE PROTEIN FOR USE AS A MEAT EXTENDER OR MEAT SUBSTITUTE; FRANKFURTERS; FREEZE-DRIED TOFU PIECES; FRENCH FRIED POTATOES; FRESH UNRIPENED CHEESES; FRIED MEAT; FRIED PLANTAIN; FRIED PLANTANO; FRIED POTATOES; FRIED TOFU PIECES; FROSTED FRUITS; FROZEN APPETIZERS CONSISTING PRIMARILY OF CHICKEN OR SEAFOOD; FROZEN EGGS; FROZEN FRUITS; FROZEN PRE-PACKAGED ENTREES CONSISTING PRIMARILY OF SEAFOOD; FROZEN VEGETABLES; FRUIT AND SOY BASED SNACK FOOD; FRUIT AND VEGETABLE SALADS; FRUIT CHIPS; FRUIT CONCENTRATES AND PUREES USED AS INGREDIENTS OF FOODS; FRUIT CONSERVES; FRUIT LEATHERS; FRUIT PASTE; FRUIT PECTIN; FRUIT PEELS; FRUIT PRESERVES; FRUIT PULPS; FRUIT PUREES; FRUIT RINDS; FRUIT SALADS AND VEGETABLE SALADS; FRUIT TOPPING; FRUITS PRESERVED IN ALCOHOL; FRUITS, NAMELY, PROCESSED, CANNED, DRIED AND PRESERVED; FRUIT-BASED FILLING FOR CAKES AND PIES; FRUIT-BASED FOOD BEVERAGE; FRUIT-BASED ORGANIC FOOD BARS; FRUIT-BASED SNACK FOOD; FRUIT-BASED SPREADS; GAME; GARDEN SALADS; GARLIC-BASED SPREAD; GHEE; GHERKINS; GLAZED FRUITS; GOAT MILK; GROUND ALMONDS; GUACAMOLE; GUAVA PASTE; GUMBO; HALF AND HALF; HAM; HAMBURGER; HARDENED OILS; HAZELNUT SPREAD; HEAD-CHEESE; HEMP MILK USED AS A MILK SUBSTITUTE; HEN EGGS; HERRINGS; HOT DOGS; HUMMUS; HUMMUS CHICK PEA PASTE; INSTANT OR PRE-COOKED MISO SOUP; INSTANT OR PRE-COOKED SOUP; INSTANT OR PRE-COOKED STEW; INSTANT POTATOES; JAMS, MARMALADES AND JELLIES; JELLIES FOR FOOD; JELLY MADE FORM DEVILS' TONGUE ROOT; JERKY; KEFIR; KELP; LACTIC ACID AND BACTERIA DRINKS; LARD; LAVER; LEMON CURD; LIVER; LIVER PASTE; LIVER PATE; LOBSTERS; LOX; LUNCHEON MEATS; MAIZE OIL; MARASCHINO CHERRIES; MARGARINE; MARGARINE SUBSTITUTES; MARINATED MEAT, SEAFOOD, FISH, POULTRY AND VEGETABLES; MASCARPONE; MATZO BALL SOUP; MATZO BALLS IN BROTH; MEAT AND MEAT EXTRACTS; MEAT BOILED DOWN IN SOY SAUCE; MEAT EXTRACTS; MEAT JELLIES; MEAT JUICES; MEAT PASTE; MEAT PRESERVES; MEAT SUBSTITUTES; MEAT, FISH, FRUIT, AND VEGETABLE JELLIES; MEAT, FISH, FRUIT, AND VEGETABLE PRESERVES; MEAT, FISH, POULTRY, AND GAME; MEAT, FISH, POULTRY, AND GAME PRESERVES; FROZEN MEAT; FRUIT AND VEGETABLE JELLIES, JAMS; MEAT, FRUIT AND VEGETABLE JELLIES, MEAT, POULTRY AND GAME MEATBALLS; MEAT-BASED MOUSSE; MEAT-BASED SNACK FOODS; MEAT-BASED SPREADS; MILK; MILK BASED BEVERAGES CONTAINING FRUIT JUICE; MILK BEVERAGES CONTAINING FRUITS; MILK BEVERAGES WITH HIGH MILK CONTENT; MILK CURD; MILK DRINKS CONTAINING FRUITS; MILK POWDER; MILK POWDER FOR NUTRITIONAL PURPOSES; MILK PRODUCTS EXCLUDING ICE CREAM, ICE MILK, AND FROZEN YOGURT; MILK PROTEINS; MILK-BASED

BEVERAGE CONTAINING COFFEE; MILK-BASED BEVERAGES CONTAINING MILK CONCENTRATES, VEGETABLE OIL AND ADDED NUTRIENTS; MILLED FLAX SEEDS; MINCEMEAT; MOLD-RIPENED CHEESE; MORTADELLA; MOULD-RIPENED CHEESE; MOUSSAKA; MOZZARELLA STICKS; NON-DAIRY BASED MIX FOR MAKING WHIPPED ICINGS AND FILLINGS; NON-DAIRY CREAMER; NUT AND SEED-BASED SNACK BARS; NUT BUTTERS; CASHEW BUTTER AND ALMOND BUTTER; NUT CHEESE, NAMELY, CHEESE-TYPE PRODUCT MADE FROM NUTS; NUT FLOURS; NUTMEATS; NUT TOPPING; NUTRITIONAL OILS FOR FOOD PURPOSES; NUT-BASED MILK; NUT-BASED SNACK FOODS, NAMELY, NUT CRISPS; NUT-BASED SNACK FOODS, NAMELY, NUT CLUSTERS; OCTOPUSES; OIL, NAMELY, VEGETABLE OIL, SALAD OIL AND EDIBLE OIL; OILS AND FATS FOR FOOD; OLIVE OIL; OLIVE PASTES; OMELETS; ONION RINGS; ORGANIC NUT AND SEED-BASED SNACK BARS; OYSTERS; PALM OIL; PASTRAMI; PATE; PEANUT BUTTER; PEANUT BUTTER TOPPINGS; PEANUT OIL; PEANUT-BASED FOOD BEVERAGES; PEELED TOMATOES; PEPPERONI; PICCALILLI; PICKLED FISH; PICKLED FRUITS; PICKLED JALAPENOS; PICKLED VEGETABLES; PICKLED WATERMELON RIND; PORK; PORK RINDS; POTATO CRISPS AND CHIPS; POTATO DUMPLINGS; POTATO FRITTERS; POTATO PANCAKES; POTATO SALAD; POTATO STICKS; POTATO-BASED GNOCCHI; POTATO-BASED SNACK FOODS; POULTRY AND GAME; POULTRY SUBSTANCES; POULTRY, NAMELY, CHICKEN, TURKEY AND DUCK; POWDERED MILK; POWDERED MILK FOR FOOD PURPOSES; POWDERED OILS AND FATS; PRAWNS; PREPARATIONS FOR MAKING BOUILLON; PREPARATIONS FOR MAKING BROTHS; PREPARATIONS FOR MAKING SOUPS; PREPARED BEEF; PREPARED COCONUT; PREPARED MEAT; PREPARED NUTS; PREPARED PISTACHIO; PREPARED WALNUTS; PRESERVED FRUIT AND VEGETABLES; PRESERVED MEATS AND SAUSAGES; PRESERVED TRUFFLES; PRESERVED VEGETABLES; PRESERVED, DRIED AND COOKED OLIVES; PRESERVED, DRIED AND COOKED FRUIT AND VEGETABLES; PRESERVED, DRIED, COOKED AND GRILLED VEGETABLES; PRE-CUT VEGETABLE SALAD; PRE-PACKAGED DINNERS CONSISTING OF MEAT, SEAFOOD, OR POULTRY SERVED WITH PASTA, RICE AND VEGETABLES; PROCESSED ALMONDS; PROCESSED ANCHOVIES; PROCESSED APPLES; PROCESSED APRICOTS; PROCESSED ARTICHOKE; PROCESSED ASPARAGUS; PROCESSED AVOCADOS; PROCESSED BEAN SPROUTS; PROCESSED BEANS; PROCESSED BEE-POLLEN FOR FOOD PURPOSES; PROCESSED BEETS; PROCESSED BLUEBERRIES; PROCESSED CABBAGE; PROCESSED CACTUS FOR FOOD PURPOSES; PROCESSED CHERRIES; PROCESSED COCONUT; PROCESSED DATES; PROCESSED EDAMAME; PROCESSED EDIBLE FLOWERS; PROCESSED EDIBLE FLOWERS IN CRYSTALLIZED FORM; PROCESSED EDIBLE SEEDS; PROCESSED EGGS; PROCESSED FISH ROE; PROCESSED FRUITS; PROCESSED FRUIT-AND NUT-BASED FOOD BARS; PROCESSED GARLIC; PROCESSED GINSENG FOR USE AS A VEGETABLE; PROCESSED HEARTS OF PALM; PROCESSED LAMB; PROCESSED LEMON-GRASS; PROCESSED LEMONS; PROCESSED MANGOS; PROCESSED MEAT; PROCESSED MEAT, NAMELY, HAM, TURKEY, LAMB AND VEAL; PROCESSED MUSHROOMS; PROCESSED MUSTARD GREENS; PROCESSED NUTS; PROCESSED OILS AND FATS; PROCESSED OLIVE PUREE; PROCESSED OLIVES WITH PEPPERCORNS; PROCESSED ONIONS; PROCESSED ORANGES; PROCESSED PAPAYAS; PROCESSED PEACHES; PROCESSED PEELS; PROCESSED PEPPERONCINI; PROCESSED PEPPERS; PROCESSED PIGNOLI PINE NUTS; PROCESSES PIMIENTOS; PROCESSES PLANTAIN SEEDS; PROCESSED POTATOES, PROCESSED PUMPKIN SEEDS; PROCESSED QUINCE; PROCESSED ROOTS; PROCESSED SOY BEANS; PROCESSED STUFFED OLIVES; PROCESSED SWEET POTATOES; PROCESSED VEGETABLES AND FRUITS; PROCESSES YAMS; PROCESSED, EDIBLE SEAWEED; PROTEIN BASED, NUTRIENT-DENSE SNACK BARS; PROTEIN FOR USE AS A FOOD ADDITIVE; PROTEIN FOR USE AS A FOOD FILLER; PROTEIN POWDERS FOR HUMAN CONSUMPTION FOR USE AS A FOOD ADDITIVE; PROTEINS BEING FOODSTUFFS FOR HUMAN CONSUMPTION; PULSES, QUAIL EGGS, QUENELLES, RAISINS; RAPE OIL; REFRIED BEANS; REFRIGERATED FOOD PACKAGE COMBINATIONS CONSISTING PRI-



MARILY OF MEAT, CHEESE OR PROCESSED VEGETABLES FOR PURPOSES OF CREATING A SANDWICH; RENNET; RICE BRAN OIL; RICE MILK FOR USE AS A MILK SUBSTITUTE; RIPENED CHEESE; RIPENED CHEESES; ROAST BEEF; ROASTED NUTS; SALAD OIL; SALADS EXCEPT MACARONI, RICE, AND PASTA SALAD; SALAMI; SALMON; SALMON CROQUETTES; SANDWICH SPREADS; SARDINES; SAUERKRAUT; SAUSAGES; SEA BASSES; SEA BREAMS; SEA SALMON OR TROUT ROE; SEA URCHINS; SEAFOOD; SEAFOOD BOILED DOWN IN SOY SAUCE; SEASONED MEAT, SEAFOOD, FISH, POULTRY, AND VEGETABLES; SEASONED NUTS; SESAME OIL; SHEEP CHEESE; SHEEP MILK; SHEETS OF DRIED LAVER; SHELLED NUTS; SHELLFISH, SHRIMP, LOBSTER, CLAMS; SHELLFISH FOR HUMAN CONSUMPTION; SHEPHERDS PIE; SHORTENING, SHORT-NECKED CLAMS; SHRIMP; SHRIMP CHIPS; PRAWNS AND LOBSTERS; SLICED FRUITS BAGGED, CANNED AND BOTTLED; SLICED VEGETABLES, BAGGED, CANNED AND BOTTLED; SMOKED FISH; SNACK DIPS; SNACK MIX CONSISTING PRIMARILY OF PROCESSED FRUITS, PROCESSED NUTS AND/OR RAISINS; SNACK MIX CONSISTING OF DEHYDRATED FRUIT AND PROCESSED NUTS; SNACK MIX CONSISTING PRIMARILY OF DEHYDRATED FRUITS, PROCESSED NUTS AND ALSO INCLUDING SOME SESAME STICKS; SNACK MIX CONSISTING OF WASABI PEAS, PROCESSED NUTS, DEHYDRATED FRUIT AND/OR RAISINS; SNACK MIX CONSISTING PRIMARILY OF PROCESSED NUTS AND SALTED SQUASH SEEDS AND ALSO INCLUDING TOASTED CORN; SNAILS; SOFT CHEESE; SOFT WHITE CHEESE; SOFT-RIPENED CHEESE; SOFT-SHELLED TURTLES; SOUP MIXES; SOUP PASTES; SOUPS AND PREPARATIONS FOR MAKING SOUPS; SOUR CREAM; SOUR CREAM SUBSTITUTES; SOYBEAN OIL; SOY BURGER PATTIES; SOY CHIPS; SOY PROTEIN FOR USE AS A FOOD ADDITIVE; SOYA MILK; SOYBEAN MILK; SOYBEAN OIL FOR COOKING; SOY-BASED FOOD BARS; SOY-BASED FOOD BARS; SOY-BASED FOOD BEVERAGE USED AS A MILK SUBSTITUTE; SOY-BASED SNACK FOODS; SPICY PICKLES; STEAMED CAKES OF SMASHED FISH AND YAM; STEAMED OR TOASTED CAKES OF FISH PASTE; STEWS; STRAINED CHEESE; STRAINED SOFT WHITE CHEESES, STUFFED OLIVES WITH RED PEPPER AND ALMOND, STUFFED OLIVES WITH FETA CHEESE IN SUNFLOWER OIL; STUFFED OLIVES WITH PESTO IN SUNFLOWER OIL; SUNFLOWER OIL; SWEETFISH; TACO SALAD; TAHINI; TAPENADES; TEXTURED VEGETABLE PROTEIN FOR USE AS A MEAT EXTENDER; TEXTURED VEGETABLE PROTEIN BITS HAVING BACON FLAVOR; TINNED MEAT; TINNED OLIVES; TINNED TOMATOES; TOASTED LAVER; TOASTED SHEETS OF LAVER; TOFU; TOMATO EXTRACTS; TOMATO PASTE; TOMATO PUREE; TRIPE; TRUFFLE JUICE; TUBE-SHAPED TOASTED CAKES OF FISH PASTE; TUNA FISH; TURKEY; TURKEY BURGER PATTIES; UNCOOKED HAMBURGER PATTIES; UNFLAVORED AND UNSWEETENED GELATINS; UNFORMED TEXTURED VEGETABLE PROTEIN FOR USE AS A MEAT EXTENDER; VEAL; VEAL STOCK; VEGETABLE CHIPS; VEGETABLE JUICE FOR COOKING; VEGETABLE MOUSSE; VEGETABLE OILS; VEGETABLE OILS AND FATS; VEGETABLE PASTE; VEGETABLE PROTEIN BITS HAVING BACON FLAVOR; VEGETABLE PUREE; VEGETABLE SALADS; VEGETABLES, NAMELY, PROCESSED, FROZEN, CANNED AND PRESERVED; VEGETABLE-BASED CHOCOLATE FOOD BEVERAGES; VEGETABLE-BASED MEAT SUBSTITUTES; VEGETABLE-BASED SNACK FOODS; VEGETABLE-BASED SPREADS; VEGGIE BURGER PATTIES; VERJUS; WHALE OIL AND FAT; WHALES; WHEY; WHIPPED CREAM; WHIPPED TOPPING; WHIPPING CREAM; WHITE CHEESE; YOGURT; YOGURT DRINKS; YOGURT-BASED BEVERAGES; YUCCA CHIPS (U.S. CL. 46).

**CLASS 30—STAPLE FOODS**

FOR FROZEN, PREPARED AND PACKAGED ENTREES CONSISTING PRIMARILY OF PASTA OR RICE; FROZEN, PREPARED AND PACKAGED MEALS CONSISTING PRIMARILY OF PASTA OR RICE; ADOBO; ALIMENTARY PASTA; ALIMENTARY PASTE; ALL-SPICE; ALMOND CAKE; ALMOND PASTE; APPALUM AND PAPADUM; APPLE FRITTERS; APPLE TURNOVERS; ARROWROOT FOR USE AS A FOOD THICKENER; ARTICHOKE SAUCE; ARTIFICIAL COFFEE AND TEA; ARTIFICIAL RICE; ASAFETIDA; BAGEL CHIPS; BAGEL HOLES; BAGELS; BAGUETTES; BAKERY DESSERTS; BAKERY GOODS; BAKERY PRODUCTS; BAKERY PRODUCTS, NAMELY, SWEET BAKERY GOODS; BAKING POWDER; BAKING SODA; BAKING SPICES; BANANA FRITTERS; BARBEQUE DRY RUB; BARBECUE SAUCE; BARLEY FLOUR; BASES FOR MAKING MILK SHAKES; BEAN JAM BUNS; BEAN PASTE; BEAN-JAM FILLED WAFERS; BEAN-STARCH NOODLES; BEVERAGES MADE OF COFFEE; BEVERAGES MADE OF TEA; BICARBONATE OF SODA FOR COOKING PURPOSES; BIRYANI SEASONING PASTE; BISCOTTI; BISCUITS; BISCUITS AND BREAD; BLACK TEA; BLINTZES; BOILED SWEETS; BONBONS; BONBONS MADE OF SUGAR; BREAD; BREAD AND BUNS; BREAD AND PASTRY; BREAD CRUMBS; BREAD DOUGHS; BREAD MIXES; BREAD ROLLS; BREAD WITH SOY BEAN; BREADCRUMBS; BREADSTICKS; BREAKFAST BURRITOS; BREAKFAST CEREALS; BRIOCHES; BROWN SUGAR; BROWNIES; BRUSCHETTE-TOPPED BREAD; BUBBLE GUM; BUCKWHEAT FLOUR; BUNS; BURRITOS; BUTTER BISCUITS; CAFFEINE-FREE DRINKS, NAMELY, CAFFEINE-FREE COFFEE, CAFFEINE-FREE TEA; CAKE DOUGHS; CAKE MIXES; CAKES; CAKES OF SUGAR-BOUNDED MILLET OR POPPED RICE; CALZONES; CANDY; CANDY BARS; CANDY CAKE DECORATIONS; CANDY COATED APPLES; CANDY COATED POPCORN; CANDY CONTAINING ALCOHOLIC BEVERAGE CONTENT AND FLAVOR; CANDY DECORATIONS FOR CAKES; CANDY FOR FOOD; CANDY MINTS; CANDY SPRINKLES; CANDY WITH CARAMEL; CANDY WITH COCOA; CANNELLONI; CAPERS; CAPPUCINO; CARAMEL POPCORN; CARAMELS; CARAO FRUIT SYRUP FOR USE AS FOOD; CATSUP; CELERY SALT; CEREAL BASED ENERGY BARS; CEREAL BASED SNACK FOOD; CEREAL-BASED SNACK FOODS; CHALUPAS; CHEESE FLAVORED PUFFED CORN SNACKS; CHEESE FLAVORED SNACKS, NAMELY, CHEESE CURLS; CHEESE FLAVORED SNACKS, NAMELY, PUFFED CHEESE BALLS; CHEESE SAUCE; CHEESE-CAKE; CHERVIL; CHEWING GUM; CHICKEN WING SAUCE; CHICORY AND CHICORY MIXTURES, ALL FOR USE AS SUBSTITUTES FOR COFFEE; CHICORY BASED COFFEE SUBSTITUTE; CHILI PASTE FOR USE AS SEASONING; CHILI POWDERS; CHILI SAUCE; CHILI SEASONING; CHIMICHANGA; CHINESE NOODLES; CHINESE RICE NOODLES; CHINESE STEAMED DUMPLINGS; CHINESE STUFFED DUMPLINGS; CHOCOLATE AND CHOCOLATES; CHOCOLATE BARS; CHOCOLATE CANDIES; CHOCOLATE CHIPS; CHOCOLATE COVERED COCOA NIBS; CHOCOLATE COVERED FRUIT; CHOCOLATE COVERED NUTS; CHOCOLATE COVERED RAISINS; CHOCOLATE COVERED ROASTED COFFEE BEANS; CHOCOLATE FONDUE; CHOCOLATE FOOD BEVERAGES NOT BEING DAIRY-BASED OR VEGETABLE BASED; CHOCOLATE MOUSSE; CHOCOLATE PASTES; CHOCOLATE POWDER; CHOCOLATE SAUCE; CHOCOLATE SYRUP; CHOCOLATE TOPPING; CHOCOLATE TRUFFLES; CHOCOLATES AND CHOCOLATE BASED READY TO EAT CANDIES AND SNACKS; CHOCOLATE-BASED FILLINGS FOR CAKES AND PIES; CHOCOLATE-BASED READY-TO-EAT FOOD BARS; CHOCOLATE-COVERED POTATO CHIPS; CHOW CHOW; CHOW MEIN NOODLES; CHUTNEY; CINNAMON; CINNAMON POWDER; CLOVES; COCOA; COCOA ROASTED, POWDERED AND GRANULATED; COCOA BEVERAGES WITH MILK; COCOA EXTRACTS FOR HUMAN CONSUMPTION; COCOA MIXES; COCOA POWDER; COCOA SPREADS; COCOA-BASED BEVERAGES; COCOA-BASED CONDIMENTS AND SEASONINGS FOR FOOD AND DRINK; COCOA-BASED INGREDIENT IN CONFECTIONERY PRODUCTS; COFFEE ROASTED, POWDERED AND GRANULATED; COFFEE AND ARTIFICIAL COFFEE; COFFEE AND COFFEE SUBSTITUTES; COFFEE AND TEA, COFFEE BASED BEVERAGES; COFFEE BEANS; COFFEE BEVERAGES WITH MILK; COFFEE ESSENCES; COFFEE

EXTRACTS; COFFEE FLAVORED SYRUP USED IN MAKING FOOD BEVERAGES; COFFEE PODS; COFFEE SUBSTITUTES, NAMELY, GRAIN OR CHICORY BASED; COFFEE-BASED BEVERAGE CONTAINING MILK; COLE SLAW DRESSING; CONDIMENT, NAMELY, PEPPER SAUCE; CONES FOR ICE CREAM; CONFECTIONERY CHIPS FOR BAKING; CONFECTIONERY FOR DECORATING CHRISTMAS TREES; CONFECTIONERY, NAMELY, PASTILLES; COOKIE DOUGH; COOKIE MIXES; COOKIES AND CRACKERS; COOKING SALT; CORN CHIPS; CORN CURLS; CORN FINGERS; CORN FLAKES; CORN FLOUR; CORN FRITTERS; CORN MEAL; CORN STARCH; CORN STARCH BASED DRINK, IN THE NATURE OF A FOOD BEVERAGE CONSISTING PRIMARILY OF MAIZE AND PORRIDGE; CORN STARCH FLOUR; CORN SYRUP; CORNFLOUR; CORNMEAL; CORN-BASED SNACK FOODS; COUSCOUS; CRAB BOIL SEASONING; CRACKER AND CHEESE COMBINATIONS; CRACKER MEAL; CRACKERS; CREAM BUNS; CREAM OF TARTAR FOR FOOD PURPOSES; CREAM OF TARTAR FOR COOKING AND BAKING PURPOSES; CREAM PUFFS; CREPES; CROISSANTS; CROUTONS; CRUMPTS; CRYSTAL SUGAR; CRYSTAL SUGAR PIECES; CRYSTALLIZED GINGER; CUBE SUGAR; CUP CAKES; CURRY; CURRY PASTES; CURRY POWDER; CUSTARD; CUSTARD-BASED FILLINGS FOR CAKES AND PIES; DANISH; DANISH PASTRIES; DESSERT MOUSSE; DESSERT PUDDINGS; DESERT SOUFFLES; DIPPING SAUCES; DISPOSABLE CUPS WITH A TEA-FILLED POUCH ULTRASONICALLY WELDED TO ONE SIDE OF THE BOTTOM OF THE CUP, WHICH ALLOWS THE NATURAL FIBER POUCH TO FLOAT NEAR THE BOTTOM; DIVINITY; DONUTS; DOUGH; DOUGHNUT HOLES; DOUGH-ENROBED FOODS CONSISTING OF A DOUGH BASED WRAPPER WITH FILLINGS CONSISTING PRIMARILY OF MEATS, POULTRY, FISH, FRUITS, VEGETABLES AND CHEESE; DOUGH-ENROBED FOODS CONSISTING OF A DOUGH BASED WRAPPER WITH FILLINGS CONSISTING PRIMARILY OF PASTA OR RICE; DRIED CHILI PEPPERS; DRIED CHIVES; DRIED COOKED-RICE; DRIED CORN HUSKS FOR TAMALES; DRIED PASTA; DRIED PIECES OF WHEAT GLUTEN; DRIED SUGARED CAKES OF RICE FLOUR; DRY SEASONING MIXES FOR GRAVY, SPAGHETTI, STEWS AND SLOPPY JOE; DRY SPICE RUB FOR MEATS AND FISH; DULCE DE LECHE; DUMPLINGS; ECLAIRS; EDIBLE CAKE DECORATIONS; EDIBLE FLOUR; EDIBLE FRUIT ICES; EDIBLE ICES; EDIBLE SALT; EDIBLE SPICES; EDIBLE WAFERS; EGG BARLEY; EGG ROLLS; EGG AND DAIRY FREE MAYONNAISE; EMPANADAS; ENCHILADAS; ENGLISH MUFFINS; ENRICHED RICE; ESPRESSO; EXTRACTS USED AS FLAVORING; EXTRUDED CORN SNACKS; EXTRUDED WHEAT SNACKS; FAJITAS; FARINA; FARINACEOUS FOOD PASTES FOR HUMAN CONSUMPTION; FILLED CHOCOLATE; FILO; FILO DOUGH; FILO LEAVES; FISH DUMPLINGS; FISH SANDWICHES; FISH SAUCE; FLAN; FLAN BASE WAFERS; FLAVOR ENHANCERS USED IN FOOD BEVERAGE PRODUCTS; FLAVORED AND SWEETENED GELATINS; FLAVORED ICES; SWEETENED GELATIN DESSERTS; FLAVORING ADDITIVES FOR NON-NUTRITIONAL PURPOSES; FLAVORING SYRUP; FLAVORINGS; FLAVORINGS FOR BEVERAGES; FLAVORINGS FOR TOBACCO; FLAVORINGS, OTHER THAN ESSENTIAL OILS, FOR CAKES; FLAVOURED VINEGAR; FLAVOURINGS AND SEASONINGS; FLAVOURINGS FOR BUTTER; FLAVOURINGS FOR CAKES OTHER THAN ESSENTIAL OILS; FLAVOURINGS FOR CHEESES; FLAVOURINGS FOR FOODS; FLAVOURINGS FOR SOUPS; FLAVOURINGS OF ALMOND; FLAVOURINGS OF LEMONS; FLAVOURINGS OF TEA; FLOATING ISLANDS; FLOUR; FLOUR FOR FOOD; FLOUR FOR MAKING DUMPLINGS OF GLUTINOUS RICE; FLOUR-BASED CHIPS; FLOUR-BASED GNOCCHI; FONDANTS; FOOD ADDITIVES FOR NON-NUTRITIONAL PURPOSES FOR USE AS A FLAVORING; FOOD LEAVENING AGENTS; FOOD PACKAGE COMBINATIONS CONSISTING PRIMARILY OF BREAD, CRACKERS, AND/OR COOKIES; FOOD SEASONINGS; FOOD STARCH; FRANKFURTER SANDWICHES; FREEZABLE LIQUID FOR USE IN MAKING FROZEN CONFECTIONS; FRENCH TOAST; FRESH PASTA; FRESH PIZZA; FRIED DOUGH COOKIES; FROSTING MIXES; FROSTINGS; FROZEN APPETIZERS CONSISTING PRIMARILY OF CORNMEAL; FROZEN BREADS; FROZEN CONFECTIONERY; FROZEN CONFECTIONS, NAMELY, FREEZER POPS; FROZEN COOKIE DOUGH; FROZEN CUSTARDS; FROZEN DESSERT CONSISTING OF

FRUIT AND CREAM OR CREAM SUBSTITUTES; FROZEN FLAVOURED WATERS; FROZEN PIE CRUSTS; FROZEN SOY-BASED DESSERTS; FROZEN YOGHURT; FROZEN YOGURT; FROZEN YOGURT MIXES; FRUIT CAKES; FRUIT COBBLERS; FRUIT COULI; FRUIT FLAVORINGS, EXCEPT ESSENCES; FRUIT ICE; FRUIT ICE BAR; FRUIT ICES; FRUIT JELLIES; FRUIT PASTE FOR FLAVOURING OF FOOD; FRUIT PIES; FRUIT SAUCES EXCLUDING CRANBERRY SAUCE AND APPLESAUCE; FRUIT TEAS; FRUIT TURNOVERS; FUDGE; GARDEN HERBS, PRESERVED SEASONINGS; GARLIC PASTE FOR USE AS A SEASONING; GARLIC SALT; GELATO; GIFT BASKETS CONTAINING CANDY; GINGER POWDERED SPICE; GINGER PASTE FOR USE AS A SEASONING; GINGERBREAD; GLAZED POPCORN; GLUCOSE FOR FOOD; GLUTEN; GLUTEN FOR FOOD; GLUTINOUS STARCH SYRUP; GRAIN-BASED BEVERAGES; GRAIN-BASED CHIPS; GRAIN-BASED FOOD BARS ALSO CONTAINING SOY, DRIED FRUITS, CHOCOLATE AND NUTS; GRAIN-BASED FOOD BEVERAGES; GRAIN-BASED SNACK FOODS; GRANOLA; GRANOLA SNACKS; GRANOLA BASED SNACK BARS; GRAVY; GRAVY MIXES; GREEN COFFEE; GREEN TEA; GRITS; GROUND COFFEE BEANS; GUM SWEETS; GUMMY CANDIES; HALVAH; HAM GLAZE; HAMBURGER SANDWICHES; HERB TEA; HERBAL FOOD BEVERAGES; HERBAL INFUSIONS; HOAGIES; HOMINY; HOMINY GRITS; HONEY AND TREATLE; HONEY BUNS; HONEY SUBSTITUTES; HOP EXTRACTS USED AS FLAVORING FOR FOODS AND BEVERAGES; HORSERADISH; HOT CHOCOLATE; HOT PEPPER POWDER SPICE; HOT SAUCE; HUEVOS RANCHEROS; HUSHPUPIES; HUSKED BARLEY; HUSKED OATS; HUSKED RICE; ICE; ICE BLOCKS; ICE CANDIES; ICE CREAM; ICE CREAM DRINKS; ICE CREAM FLOATS; ICE CREAM MIXES; ICE CREAM POWDER; ICE CREAM SANDWICHES; ICE CREAM SUBSTITUTE; ICE CREAMS; ICE CUBES; ICE FOR REFRESHMENT; ICE MILK; ICE MILK BARS; ICED CAKES; ICED COFFEE; ICED TEA; ICES; ICE-CREAM CAKES; ICING; ICING MIXES; INSTANT CHINESE NOODLES; INSTANT COFFEE; INSTANT DOUGHNUT MIXES; INSTANT NOODLES; INSTANT PANCAKE MIXES; INSTANT PUDDING MIXES; INSTANT SOBA NOODLES; INSTANT TEA; INSTANT UDON NOODLES; INULIN FOR USE AS A FOOD STARCH; ITALIAN ICE; JAM BUNS; JAPANESE ARROWROOT POWDER; JAPANESE GREEN TEA; JAPANESE HORSERADISH POWDER SPICE, WASABI POWDER; JAPANESE PEPPER POWDER SPICE, SANSHO POWDER; JAPANESE STYLE STEAMED CAKES; KASHA; KETCHUP; LASAGNA; LICORICE; LIME TEA; LIQUORICE; LO MEIN; LOLLIPOPS; MACARONI; MACARONI AND CHEESE; MACARONI SALAD; MACAROONS; MACAROONS PASTRY; MADELEINES; MAIZE-BASED PUDDING DESSERT; MALT BISCUITS; MALT EXTRACTS FOR FOOD; MALT EXTRACTS USED AS FLAVORING; MALT FOR FOOD PURPOSES; MANDLEN; MAPLE SYRUP; MARINADE MIXES; MARINADES; MARSHMALLOW; MARSHMALLOW TOPPING; MARZIPAN; MARZIPAN SUBSTITUTES; MASALA POWDER AND SPICES; MASALA RICE FOR BIRYANI; MATZO; MATZO BALLS; MAYONNAISE; MEAT CURES; MEAT GRAVIES; MEAT PIES; MEAT TENDERIZERS; MEAT TENDERIZERS FOR HOUSEHOLD PURPOSES; MEAT TURNOVERS; MEXICAN CANDY; MICROWAVABLE POPCORN; MILK CHOCOLATE; MILK SHAKES; MINCED GARLIC; MINCEMEAT PIES; MINERAL SALT FOR HUMAN CONSUMPTION; MISO BEAN PASTS; MIX FOR MAKING COMBINED NOODLE AND SAUCE DISH; MIXES FOR BAKERY GOODS; MIXES FOR MAKING BATTERS FOR FRIED FOODS; MIXES FOR MAKING BATTER FOR HUSHPUPIES; MIXES FOR MAKING BREADING; MIXES FOR MAKING MATZO BALLS; MIXES IN THE NATURE OF CONCENTRATES, SYRUPS OR POWDERS USED IN THE PREPARATION OF TEA BASED BEVERAGES; MIXES OF SWEET ADZUKI-BEAN JELLY; MIXTURES OF COFFEE AND CHICORY; MOLASSES; MOLASSES SYRUP; MOON CAKES; MUESLI; MUFFIN MIXES; MUFFINS; MUSTARD; MUSTARD POWDER SPICE; NACHOS; NATURAL BROWN SUGAR; NATURAL SWEETENER; NON-MEDICATED LOZENGES; NOODLES; NOODLES AND SAUCE MIXES COMBINED IN UNITARY PACKAGES; NOODLES AND SEASONING MIXES COMBINED IN UNITARY PACKAGES; NOODLES, SAUCE, AND PROCESSED VEGETABLES COMBINED IN UNITARY PACKAGES; NOODLES, SAUCE, DEHYDRATED VEGETABLES, AND TOPPING COMBINED IN UNITARY

PACKAGES; NOODLES, SEASONINGS, EDIBLE OIL, AND FLAVORINGS COMBINED IN UNITARY PACKAGES; NOODLES, SEASONINGS, EDIBLE OIL, AND DEHYDRATED VEGETABLES COMBINED IN UNITARY PACKAGES; NOUGAT; NUTMEG; OAT FLAKES; OATMEAL; ONION OR CHEESE BISCUITS; ONION SALT; OOLONG TEA, ORGANIC CURRY SAUCES; PACKAGED MEAL KITS CONSISTING PRIMARILY OF PASTA OR RICE; PACKAGED MEAL MIXES CONSISTING PRIMARILY OF PASTA OR RICE; PANCAKE MIXES; PANCAKE SYRUP; PANCAKES; PANELA; PANETTONE; PANINI; PARFAITS; PASTA; PASTA AND NOODLES; PASTA FOR SOUPS; PASTA SALAD; PASTA SAUCE; PASTA SHELLS; PASTA-WRAPINGS FOR GYOZA; PASTIES; PASTRIES; PASTRY SHELLS FOR MONAKA; PEANUT BRITTLE; PEANUT BUTTER CONFECTIONERY CHIPS; PELLET-SHAPED RICE CRACKERS; PEPPER SPICE; PEPPER POWDER; PEPPERMINT CANDY; PEPPERMINT FOR CONFECTIONERY; PESTO; PETITS FOURS; PETIT-BEURRE BISCUITS; PICANTE SAUCE; PICKLE RELISH; PICKLED GINGER; PICO DE GALLO SAUCE; PIE CRUSTS; PIEROGIES; PIES; PIGS-IN-A-BLANKET; PILAF; PIMIENTO USED AS A CONDIMENT; PINEAPPLE FRITTERS; PITA; PITA BREAD; PITA CHIPS; PIZZA; PIZZA CRUST; PIZZA DOUGH; PIZZA SAUCE; POLENTA; POPCORN; POPPED POPCORN; POT PIES; POTATO FLOUR; POTSTICKERS; POUNDED RICE CAKES; POUNDED WHEAT; POWDERED GARLIC; POWDERED STARCH SYRUP; POWDERED SUGAR; PRALINES; PREPARATIONS MADE FROM CEREALS, NAMELY, CEREAL BARS, OATMEAL, CEREAL BASED SNACK FOOD; PREPARED COCOA AND COCOA-BASED BEVERAGES; PREPARED PASTA; PREPARED WASABI; PRESERVED GINGER; PRETZELS; PROCESSED BRAN; PROCESSED CEREALS; PROCESSED CEREAL-BASED FOOD TO BE USED AS A BREAKFAST FOOD, SNACK FOOD OR INGREDIENT FOR MAKING OTHER FOODS; PROCESSED CORN; PROCESSED GARLIC FOR USE AS A SEASONING; PROCESSED GINSENG USED AS AN HERB, SPICE OR FLAVORING; PROCESSED GRAINS; PROCESSED HERBS; PROCESSED OATS; PROCESSED POPCORN; PROCESSED QUINOA; PROCESSED SEMOLINA; PROCESSED UNPOPPED POPCORN; PROCESSED WHEAT; PROPOLIS FOR FOOD PURPOSES; PROTEIN REDUCED AND GLUTEN FREE FLOUR AND BREAD; PUDDINGS; PUFFED CORN SNACKS; PUFFED RICE; QORMA SEASONING PASTE; QUESADILLAS; QUICHE; RAVIOLI; READY TO EAT, CEREAL DERIVED FOOD BARS; READY-MADE SAUCES; READY-TO-EAT CEREALS; RELISH; RICE; RICE AND SEASONING MIX COMBINED IN UNITARY PACKAGES; RICE CAKES; RICE CRACKERS; RICE DUMPLINGS DRESSED WITH SWEET BEAN JAM; RICE FLOUR; RICE NOODLES; RICE PUDDING; RICE SALAD; RICE STARCH FLOUR; RICE, SEASONINGS, AND FLAVORINGS COMBINED IN UNITARY PACKAGES; RICE-BASED PUDDING DESSERT; RICE-BASED SNACK FOODS; RISOTTO; ROASTED AND GROUND SESAME SEEDS; ROASTED COFFEE BEANS; ROLLED OATS; ROLLED OATS AND WHEAT; ROLLS; ROYAL JELLY FOR FOOD PURPOSES; RUSKS; SAFFRON FOR USE AS A FOOD SEASONING; SAGE; SAGE TEA; SAGO; SAGO PALM STARCH; SALAD DRESSING; SALAD SAUCES; SALSA; SALT; SALT FOR PRESERVING FOOD; SANDWICHES; SAUCE MIXES; SAUCES; SAUCES FOR BARBECUED MEAT; SAUSAGE WRAPPED IN DOUGH; SAVARINS; SAVOURY AND SALTED BISCUITS; SCENTED WATER FOR FLAVORING BEVERAGES; SCONES; SEA WATER FOR COOKING; SEAFOOD PIES; SEASONED COATING FOR MEAT, FISH, POULTRY; SEASONED COATING MIXTURES FOR FOODS; SEASONING MIXES; SEASONING PASTES; SEASONINGS; SEASONINGS AND FLAVORINGS FOR DOG FOODS AND CATTLE FEED; SESAME STICKS; SHAKES; SHAVED ICE CONFECTIONS; SHERBET; SHERBET MIXES; SHERBETS; SHRIMP DUMPLINGS; SLOPPY JOE SAUCE; SLOPPY JOE SEASONING MIX; SNACK CAKES; SNACK FOOD CHEWS MADE PRIMARILY FROM BROWN RICE SYRUP; SNACK MIX CONSISTING PRIMARILY OF CRACKERS, PRETZELS, CANDIED NUTS AND/OR POPPED POPCORN; SOBA NOODLES; SOFT PIN-ROLLED CAKES OF POUNDED RICE; SOMEN NOODLES; SOPA-PILLAS; SOPES; SORBET; SORBETS; SOY BEAN PASTE; SOY BURGER SANDWICHES; SOY SAUCE; SOYA BEAN PASTE; SOYA FLOUR; SOY BEAN MOLASSES; SOY-BASED ICE CREAM SUBSTITUTE; SPAGHETTI; SPAGHETTI AND MEATBALLS; SPAGHETTI SAUCE; SPICE BLENDS; SPICE RUBS; SPICES; SPICES AND ICE;

SPICES FOR THE FLAVORING OF PUMPKIN SEEDS; SPONGE CAKES; SPREAD CONTAINING CHOCOLATE AND NUTS; SPRING ROLLS; STABILIZED RICE BRAN; STARCH SYRUP; STARCH-BASED BINDING AGENTS FOR ICE CREAM; STARCH-BASED CANDIES; STARCH-BASED THICKENERS FOR WHIPPED CREAM; STEAK SAUCE; STEAK SEASONING; STEAMED BUNS STUFFED WITH MINCED MEAT; STEAMED CORN KERNELS BITS; STUFFING MIXES CONTAINING BREAD; SUGAR AND SUGAR SUBSTITUTES; SUGAR WAFERS; SUGARED BEANS; SUGAR FREE SWEETS; SUGARLESS CANDIES; SUGARLESS CHEWING GUM; SUGAR-COATED ALMONDS; SUGAR-COATED COFFEE BEANS; SUGAR-COATED HARD CARAMELS; SUHI; SWEET BEAN JAM COATED WITH SUGARED-BEAN BASED SOFT SHELL; SWEET DUMPLINGS; SWEET POUNDED RICE CAKES; SWEETENED YOGURT COVERED RAISINS; SWEETMEAT MADE OF SESAME OIL; SWEETMEATS; SWEETS; SYNTHETIC SUGARCANE MADE FROM CORN FOR FOOD PURPOSES; TABBOULEH; TABLE SALT; TABLE SALT MIXED WITH SESAME SEEDS; TABLE SYRUP; TABOULI; TACO CHIPS; TACO SEASONING; TACO SHELLS; TACOS; TAMALES; TAPIOCA; TAPIOCA FLOUR; TARTAR SAUCE; TARTS; TEA; TEA BAGS; TEA EXTRACTS; TEA FOR INFUSIONS; TEA OF PARCHED POWDER OF BARLEY WITH HUSK; TEA OF SALTY KELP POWDER; TEA PODS; TEA SUBSTITUTES; TEA-BASED BEVERAGES WITH FRUIT FLAVORING; TERIYAKI SAUCE; THEINE-FREE TEA SWEETENED WITH SWEETENERS; THICKENING AGENTS FOR USE IN COOKING; TISANES; TOAST; TOASTED CORN KERNELS; TOASTER PASTRIES; TOFFEE; TOFFEES; TOMATO SAUCE; TOPPING SYRUP; TORTILLA CHIPS; TORTILLA SHELLS; TORTILLAS; TOSTADAS; TREATLE; TURKEY BURGER SANDWICHES; TURMERIC; UDON NOODLES; UNLEAVENED BREAD IN THIN SHEETS; VANILLA; VANILLA BEANS; VEGAN CAKES; VEGAN CHEESECAKE; VEGAN COOKIES; VEGAN CUP CAKES; VEGAN PIES; VEGETABLE CONCENTRATES USED FOR SEASONING; VEGGIE BURGER SANDWICHES; VERMICELLI; VINEGAR; WAFER DOUGHS; WAFERS; WAFFLES; WATER ICE; WHEAT FLOUR; WHEAT GERM; WHEAT STARCH FLOUR; WHEAT-BASED SNACK FOODS; WHITE SUGAR; WHOLEMEAL BREAD; WHOLEMEAL RICE; WINE VINEGAR; WON TON WRAPPERS; WON TONS; WORCESTERSHIRE SAUCE; YEAST; YEAST EXTRACTS; YEAST EXTRACTS FOR FOOD; YEAST EXTRACTS FOR HUMAN CONSUMPTION; YEAST POWDER; YEAST, BAKING POWDER; YEAST, BAKING POWDER AND FLAVOURINGS; YERBA MATE; ZITI; ZWIEBACK (U.S. CL. 46).

### CLASS 31—NATURAL AGRICULTURAL PRODUCTS

FOR FRESH, RAW AND UNPROCESSED CHIVES; FRESH, RAW AND UNPROCESSED HOPS; ABALONES; ANIMAL BEVERAGES; ANIMAL FEED; ANIMAL FEED ADDITIVES FOR NONNUTRITIONAL PURPOSES FOR USE AS INGREDIENT OR FILLER; ANIMAL FOODSTUFFS; APPLE TREE SEEDS; AQUACULTURE FEED; AQUARIUM FISH; ARK-SHELLS; AROMATIC SAND FOR PETS; BEE POLLEN BEING RAW MATERIAL FOR INDUSTRIAL USE; BEVERAGES FOR ANIMALS; BIRD FOOD; BIRD SEED; BIRD TREATS; BULBS FOR AGRICULTURAL PURPOSES; BULBS FOR HORTICULTURAL PURPOSES; CAT FOOD; CAT LITTER; CAT TREATS; CATNIP; COCONUT SHELLS; CONSUMABLE PET CHEWS; CROP SEEDS; CUT CHRISTMAS TREES; CUT FLOWERS; DIGESTIBLE CHEWING BONES FOR DOGS; DISPOSABLE PLASTIC LITTER BOX FOR DOGS SOLD FILLED WITH ARTIFICIAL OR FRESH, LIVE SOD; DOG BISCUITS; DOG FOOD; DOG TREATS; DOGS; DRIED CORN HUSKS; DRIED FLOWER ARRANGEMENTS; DRIED FLOWER WREATHS; DRIED FLOWERS; DRIED HERBS FOR DECORATIVE WREATHS AND SACHETS; DRIED PLANTS; EDIBLE CHEWS FOR ANIMALS; EDIBLE FOOD FOR ANIMALS FOR CHEWING; ELECTROLYTE DRINK MIX FOR PETS; FISH FOOD; FISH MEAL; FLOWER BULBS; FLOWER SEEDS; FLOWERS; FRESH APPLES; FRESH APRICOTS; FRESH ARTICHOKE; FRESH ASPARAGUS; FRESH AVOCADOS; FRESH BANANAS; FRESH BEAN SPROUTS; FRESH BEANS; FRESH BEETS; FRESH BLUEBERRIES; FRESH CABBAGE; FRESH COCONUTS; FRESH CORN; FRESH CUT GARLANDS; FRESH DATES; FRESH FRUITS AND VEGETABLES; FRESH

FRUITS; FRESH GARLIC; FRESH GINGER; FRESH GRAPE CHERRY TOMATOES; FRESH GRAPES FOR WINEMAKING; FRESH HERBS; FRESH LEMONS; FRESH LENTILS; FRESH MANGOS; FRESH MUSHROOMS; FRESH NUTS; FRESH OATS; FRESH OLIVES; FRESH ONIONS; FRESH ORANGES; FRESH PAPAYAS; FRESH PEACHES; FRESH PEAS; FRESH PEPPERS; FRESH POTATOES; FRESH TOMATOES; FRESH TRUFFLES; FRESH VEGETABLES; FRESH WHEAT; FRESH WINE GRAPES; FRESH YAMS; FRESH ZUCCHINI; FRUIT SEEDS; FRUITS, NAMELY, FRESH, RAW AND UNPROCESSED; GRASS SEED; HERB SEEDS FOR PLANTING; LIVE CHRISTMAS TREES; LIVE FLOWERING PLANTS; LIVING PLANTS; LOBSTERS; OYSTERS; PEARS, RAW ANCHOVIES; RAW APPLES; RAW APRICOTS; RAW ARTICHOKE; RAW ASPARAGUS; RAW AVOCADOS; RAW BEAN SPROUTS; RAW BEANS; RAW BEETS; RAW BLUEBERRIES; RAW CABBAGE; RAW COCONUTS; RAW CORN; RAW DATES; RAW FRUITS; RAW GARLIC; RAW GINGER; RAW HERBS; RAW HORSERADISH ROOT; RAW LEMONS; RAW MUSHROOMS; RAW NUTS; RAW OATS; RAW OLIVES; RAW ONIONS; RAW ORANGES; RAW PEACHES; RAW PEPPERS; RAW POPCORN; RAW POTATOES; RAW PULSES; RAW QUINCE; RAW SWEET POTATOES; RAW TOMATOES; RAW VEGETABLES; RAW WHEAT; RAW YAMS; RAW ZUCCHINI; RICE BRAN; RYE SEED; SALT LICKS; SARDINES; SEEDS FOR FRUIT AND VEGETABLES; SEEDS FOR HORTICULTURAL PURPOSES; SHORT-NECKED CLAMS; SOY BEAN MEAL; SOY SAUCE CAKES; WATERMELON (U.S. CLS. 1 AND 46).

#### CLASS 32—LIGHT BEVERAGES

FOR CAFFEINE-FREE DRINKS, NAMELY, FRUIT JUICES, VEGETABLE JUICES, DRINKING WATER, BEER, ENERGY DRINKS, AND CAFFEINE-FREE COLAS (U.S. CLS. 45, 46 AND 48).

PRISCILLA MILTON, EXAMINING ATTORNEY

SN 85-033,795. GALLANTRY LLC, NEW HAVEN, CT. FILED 5-9-2010.

# CO-SIGN

THE MARK CONSISTS OF STANDARD CHARACTERS WITHOUT CLAIM TO ANY PARTICULAR FONT, STYLE, SIZE, OR COLOR.

#### CLASS 35—ADVERTISING AND BUSINESS

FOR MARKETING, ADVERTISING AND PROMOTION SERVICES; MARKET RESEARCH AND MARKET RESEARCH INFORMATION SERVICES; PROMOTING THE GOODS AND SERVICES OF OTHERS VIA COMPUTER AND COMMUNICATION NETWORKS; FACILITATING THE EXCHANGE AND SALE OF SERVICES AND PRODUCTS OF THIRD PARTIES VIA COMPUTER AND COMMUNICATION NETWORKS; CHARITABLE SERVICES, NAMELY, PROMOTING PUBLIC AWARENESS ABOUT CHARITABLE, PHILANTHROPIC, VOLUNTEER, PUBLIC AND COMMUNITY SERVICE AND HUMANITARIAN ACTIVITIES (U.S. CLS. 100, 101 AND 102).

FIRST USE 3-14-2010; IN COMMERCE 2-27-2011.

#### CLASS 38—COMMUNICATION

FOR PROVIDING AN ONLINE NETWORK SERVICE FOR TRANSFERRING OF PERSONAL IDENTITY DATA AND SHARING PERSONAL IDENTITY DATA WITH AND AMONG MULTIPLE WEBSITES; DELIVERY OF DIGITAL MEDIA, NAMELY, VIDEO VIA ELECTRONIC TRANSMISSION (U.S. CLS. 100, 101 AND 104).

FIRST USE 3-14-2010; IN COMMERCE 2-27-2011.

#### CLASS 45—PERSONAL AND LEGAL SERVICES

FOR PROVIDING A SOCIAL NETWORKING WEB SITE THAT ENABLES ONLINE USERS TO CREATE PERSONAL PROFILES FEATURING SOCIAL NETWORKING INFORMATION AND TO TRANSFER AND SHARE SUCH INFORMATION AMONG MULTIPLE WEBSITES (U.S. CLS. 100 AND 101).

FIRST USE 3-14-2010; IN COMMERCE 2-27-2011.

JENNIFER VASQUEZ, EXAMINING ATTORNEY

SN 85-034,125. STANLEY, BRIAN E. AKA KNIGHT FAN STAN, APOPKA, FL. FILED 5-10-2010.

# Knight Fan Stan

THE MARK CONSISTS OF STANDARD CHARACTERS WITHOUT CLAIM TO ANY PARTICULAR FONT, STYLE, SIZE, OR COLOR.

THE NAME "KNIGHT FAN STAN" IDENTIFIES A LIVING INDIVIDUAL WHOSE CONSENT IS OF RECORD.

#### CLASS 25—CLOTHING

FOR (BASED ON USE) T-SHIRTS; (BASED ON INTENT-TO-USE) A-SHIRTS; APPAREL FOR DANCERS, NAMELY, TEE SHIRTS, SWEATSHIRTS, PANTS, LEGGINGS, SHORTS AND JACKETS; ATHLETIC APPAREL, NAMELY, SHIRTS, PANTS, JACKETS, FOOTWEAR, HATS AND CAPS, ATHLETIC UNIFORMS; BASEBALL CAPS AND HATS; BODY SHIRTS; BUTTON-FRONT ALOHA SHIRTS; CAMOUFLAGE SHIRTS; CAMP SHIRTS; CHEF'S HATS; CLOTHING FOR ATHLETIC USE, NAMELY, PADDED SHIRTS; CLOTHING SHIELDS, NAMELY, PADS APPLIED TO THE UNDERARMS OF SHIRTS, BLOUSES AND SWEATERS; DRESS SHIRTS; FISHING SHIRTS; FUR HATS; GOLF PANTS, SHIRTS AND SKIRTS; GOLF SHIRTS; HAT BANDS; HATS; HATS FOR INFANTS, BABIES, TODDLERS AND CHILDREN; HOODED SWEAT SHIRTS; HUNTING SHIRTS; KNIT SHIRTS; LONG-SLEEVED SHIRTS; MOISTURE-WICKING SPORTS SHIRTS; NIGHT SHIRTS; OPEN-NECKED SHIRTS; OVER SHIRTS; PAPER HATS FOR USE AS CLOTHING ITEMS; PARTY HATS; PERSPIRATION ABSORBENT STRAP TO BE USED IN THE BILL OF A HAT; PIQUE SHIRTS; POLO SHIRTS; RAIN HATS; RUGBY SHIRTS; SCIENTIFIC AND TECHNOLOGICAL APPAREL, NAMELY, SHIRTS, PANTS, JACKETS, FOOTWEAR, HATS AND CAPS, UNIFORMS; SEDGE HATS (SUGE-GASA); SHIRT FRONTS; SHIRT YOKES; SHIRTS; SHIRTS AND SHORT-SLEEVED SHIRTS; SHIRTS FOR INFANTS, BABIES, TODDLERS AND CHILDREN; SHIRTS FOR SUITS; SHORT-SLEEVED OR LONG-SLEEVED T-SHIRTS; SHORT-SLEEVED SHIRTS; SLEEP SHIRTS; SMALL HATS; SPORT SHIRTS; SPORTS CAPS AND HATS; SPORTS SHIRTS; SPORTS SHIRTS WITH SHORT SLEEVES; SWEAT SHIRTS; TEE SHIRTS; TOBOGGAN HATS, PANTS AND CAPS; TRIATHLON CLOTHING, NAMELY, TRIATHLON TIGHTS, TRIATHLON SHORTS, TRIATHLON SINGLET, TRIATHLON SHIRTS, TRIATHLON SUITS; TURTLE NECK SHIRTS; WEARABLE GARMENTS AND CLOTHING, NAMELY, SHIRTS; WIND SHIRTS; WOMEN'S HATS AND HOODS; WOOLLY HATS; YOGA SHIRTS (U.S. CLS. 22 AND 39).

**CLASS 35—ADVERTISING AND BUSINESS**

FOR (BASED ON INTENT-TO-USE) AD SERVING, NAMELY, PLACING ADVERTISEMENTS ON WEBSITES FOR OTHERS USING SPECIALIZED COMPUTER SOFTWARE; ADVERTISEMENT AND PUBLICITY SERVICES BY TELEVISION, RADIO, MAIL; ADVERTISEMENT FOR OTHERS ON THE INTERNET; ADVERTISEMENT HOARDING RENTAL; ADVERTISEMENT VIA MOBILE PHONE NETWORKS; ADVERTISING AGENCIES; ADVERTISING AGENCIES PROVIDING THE STRATEGY, DESIGN AND EXECUTION OF PROGRAMS TO PROMOTE BUSINESSES IN THE FOOD AND FOODSERVICE INDUSTRIES; ADVERTISING AGENCIES, NAMELY, PROMOTING THE GOODS AND SERVICES OF OTHERS; ADVERTISING AGENCY SPECIALIZING IN THE DESIGN AND EXECUTION OF WORD OF MOUTH, VIRAL, BUZZ AND EXPERIENTIAL MARKETING PROGRAMS; ADVERTISING AND ADVERTISEMENT SERVICES; ADVERTISING AND BUSINESS ADVICE RELATING TO TELEMATICS' SERVICES; ADVERTISING AND BUSINESS MANAGEMENT CONSULTANCY; ADVERTISING AND BUSINESS SERVICES, NAMELY, PROVIDING AN ONLINE WEBSITE WHERE ADVERTISERS, MARKETERS, AND CONTENT PROVIDERS CAN INTERACT WITH USERS FOR ADVERTISING, BRANDING, AND PROMOTING KNOWLEDGE, PRODUCTS, AND SERVICES, AND TRADESHOWS, ON BEHALF OF THEMSELVES AND OTHERS, AND FOR EVALUATING AND RATING THE SAME, ALL THE FOREGOING RELEVANT TO HUMAN ACTIVITIES AFFECTING CLIMATE CHANGE AND RELATED FIELDS; ADVERTISING AND BUSINESS SERVICES, NAMELY, SECURING AIRTIME ON ALL FORMS OF MEDIA COMMUNICATIONS STATIONS, SYSTEMS, NETWORKS, AND SERVICES FOR THE PURPOSE OF PROMOTING THE GOODS AND SERVICES OF OTHERS; ADVERTISING AND COMMERCIAL INFORMATION SERVICES, VIA THE INTERNET; ADVERTISING AND DIRECTORY SERVICES, NAMELY, PROMOTING THE SERVICES OF OTHERS BY PROVIDING A WEB PAGE FEATURING LINKS TO THE WEBSITES OF OTHERS; ADVERTISING AND MARKETING; ADVERTISING AND MARKETING CONSULTANCY; ADVERTISING AND MARKETING SERVICES, NAMELY, PROMOTING THE GOODS AND SERVICES OF OTHERS; ADVERTISING AND PROMOTING THE GOODS AND SERVICES OF A VISUAL ARTIST; ADVERTISING AND PROMOTION SERVICES AND RELATED CONSULTING; ADVERTISING AND PROMOTIONAL SERVICES; ADVERTISING AND PUBLICITY SERVICES; ADVERTISING AND PUBLICITY SERVICES, NAMELY, PROMOTING THE GOODS, SERVICES, BRAND IDENTITY AND COMMERCIAL INFORMATION AND NEWS OF THIRD PARTIES THROUGH PRINT, AUDIO, VIDEO, DIGITAL AND ON-LINE MEDIUM; ADVERTISING BUSINESS ESPECIALLY IN THE FIELD OF TELEMATIC AND TELEPHONE NETWORKS; ADVERTISING BY TRANSMISSION OF ON-LINE PUBLICITY FOR THIRD PARTIES THROUGH ELECTRONIC COMMUNICATIONS NETWORKS; ADVERTISING CONSULTATION; ADVERTISING COPYWRITING; ADVERTISING FLYER DISTRIBUTION; ADVERTISING IN PERIODICALS, BROCHURES AND NEWSPAPERS; ADVERTISING IN THE POPULAR AND PROFESSIONAL PRESS; ADVERTISING OF COMMERCIAL OR RESIDENTIAL REAL ESTATE; ADVERTISING OF THE PUBLISHED TEXTS OF OTHERS; ADVERTISING ON THE INTERNET FOR OTHERS; ADVERTISING PARTICULARLY SERVICES FOR THE PROMOTION OF GOODS; ADVERTISING RELATING TO PHARMACEUTICAL PRODUCTS AND IN-VIVO IMAGING PRODUCTS; ADVERTISING RELATING TO TRANSPORT AND DELIVERY; ADVERTISING SERVICES; ADVERTISING SERVICES FOR PROMOTING THE BROKERAGE OF STOCKS AND OTHER SECURITIES; ADVERTISING SERVICES OF A RADIO AND TELEVISION ADVERTISING AGENCY; ADVERTISING SERVICES RELATING TO SANDWICHES; ADVERTISING SERVICES, FOR THIRD PARTIES, IN CONNECTION WITH THE COMMERCIALIZATION AND SALE OF PERFUMERY AND COSMETIC ARTICLES, PRODUCTS FOR HOUSEHOLD PURPOSES, OPTICAL PRODUCTS, CLOCKS AND TIMEPIECES, JEWELRY, FURNISHING ARTICLES; ADVERTISING SERVICES, NAMELY, COST-PER-ACTION ON-LINE ADVERTISING; ADVERTISING SERVICES, NAMELY, CREATING CORPORATE AND BRAND IDENTITY FOR OTHERS; ADVERTISING SERVICES, NAMELY, CREATING CORPORATE LOGOS FOR OTHERS; ADVERTISING SERVICES, NAMELY,

PRODUCTION OF SPECIAL EFFECTS INCLUDING MODEL-MAKING SERVICES, COMPUTER-GENERATED IMAGERY AND COMPUTER-GENERATED GRAPHICS FOR THE PRODUCTION OF COMMERCIALS; ADVERTISING SERVICES, NAMELY, PROMOTING AND MARKETING THE GOODS AND SERVICES OF OTHERS IN THE FIELD OF UPSCALE CHOICES SUCH AS CULTURAL EVENTS, RESTAURANTS, SHOPPING, AND TRAVEL VIA PRINT AND ELECTRONIC MEDIA; ADVERTISING SERVICES, NAMELY, PROMOTING AND MARKETING THE GOODS AND SERVICES OF OTHERS THROUGH ALL PUBLIC COMMUNICATION MEANS; ADVERTISING SERVICES, NAMELY, PROMOTING CAR DEALERSHIPS OF OTHERS; ADVERTISING SERVICES, NAMELY, PROMOTING PROPERTIES FOR SALE BY OWNER VIA THE INTERNET; ADVERTISING SERVICES, NAMELY, PROMOTING THE BOOKS OF OTHERS IN THE FIELD OF LAW BY MEANS OF NEWS AND REVIEWS REGARDING SAME; ADVERTISING SERVICES, NAMELY, PROMOTING THE BRANDS, GOODS AND SERVICES OF OTHERS; ADVERTISING SERVICES, NAMELY, PROMOTING THE FOOD AND WINE OF OTHERS; ADVERTISING SERVICES, NAMELY, PROMOTING THE GIFT CARDS OF OTHERS; ADVERTISING SERVICES, NAMELY, PROMOTING THE SANDWICHES OF OTHERS; ADVERTISING SERVICES, NAMELY, PROVIDING A WEBSITE FOR THE PROMOTION OF THE BOOKS OF OTHERS IN THE FIELD OF LAW, INCLUDING NEWS AND REVIEWS REGARDING SAME; ADVERTISING SERVICES, NAMELY, PROVIDING ADVERTISING SPACE IN A PERIODICAL; ADVERTISING SERVICES, PUBLIC RELATIONS AND MARKETING SERVICES, NAMELY, PROMOTING AND MARKETING THE GOODS AND SERVICES OF OTHERS THROUGH ALL PUBLIC COMMUNICATION MEANS; ADVERTISING TEXT PUBLICATION SERVICES; ADVERTISING THROUGH ALL PUBLIC COMMUNICATION MEANS; ADVERTISING VIA ELECTRONIC MEDIA AND SPECIFICALLY THE INTERNET; ADVERTISING, INCLUDING ON-LINE ADVERTISING ON A COMPUTER NETWORK; ADVERTISING, INCLUDING PROMOTION OF PRODUCTS AND SERVICES OF THIRD PARTIES THROUGH SPONSORING ARRANGEMENTS AND LICENSE AGREEMENTS RELATING TO INTERNATIONAL SPORTS EVENTS; ADVERTISING, INCLUDING PROMOTION RELATING TO THE SALE OF ARTICLES AND SERVICES FOR THIRD PARTIES BY THE TRANSMISSION OF ADVERTISING MATERIAL AND THE DISSEMINATION OF ADVERTISING MESSAGES ON COMPUTER NETWORKS; ADVERTISING, MARKETING AND PROMOTING THE GOODS AND SERVICES OF OTHERS USING KIOSKS; ADVERTISING, MARKETING AND PROMOTION SERVICES; ADVERTISING, MARKETING AND PROMOTIONAL SERVICES FOR AUTOMOTIVE DEALERSHIPS; ADVERTISING, MARKETING AND PROMOTIONAL SERVICES FOR LIGHT AND HEAVY EQUIPMENT DEALERSHIPS; ADVERTISING, MARKETING AND PROMOTIONAL SERVICES FOR THE DONATION OF HUMAN BLOOD THAT EXACTLY MATCHES THE BLOOD TYPE OF INDIVIDUALS NEEDING TRANSFUSIONS; ADVERTISING, MARKETING AND PROMOTIONAL SERVICES RELATED TO ALL INDUSTRIES FOR THE PURPOSE OF FACILITATING NETWORKING AND SOCIALIZING OPPORTUNITIES FOR BUSINESS PURPOSES; ADVERTISING, PROMOTION AND MARKETING SERVICES BASED ON CONSUMER CREDIT REPORTS AND SCORES OF OTHERS; ADVERTISING, PROMOTION AND MARKETING SERVICES IN THE NATURE OF E-MAIL BLAST CAMPAIGNS FOR OTHERS; AGENCIES FOR ADVERTISING TIME AND SPACE; ANALYSIS OF ADVERTISING RESPONSE; ARRANGING AND CONDUCTING OF FAIRS AND EXHIBITIONS FOR BUSINESS AND ADVERTISING PURPOSES; BANNER ADVERTISING; BUSINESS MANAGEMENT AND CONSULTING SERVICES FOR THE HEALTH CARE INDUSTRY, NAMELY, CUSTOMER SERVICE, ACCOUNTING SERVICES, AND WEB-BASED ADVERTISING AND MARKETING SERVICES; BUSINESS SERVICES, NAMELY, TRACKING AND MONITORING OF CALLS FOR OTHERS IN RESPONSE TO ADVERTISING ADS; CINEMA ADVERTISING; CLASSIFIED ADVERTISING SERVICES; COMPILATION OF ADVERTISEMENTS FOR USE AS WEB PAGES ON THE INTERNET; COMPILATION, PRODUCTION AND DISSEMINATION OF ADVERTISING MATTER; CONDUCTING, ARRANGING AND ORGANIZING TRADE SHOWS AND TRADE FAIRS FOR COMMERCIAL AND ADVERTISING PUR-

POSES; CONSUMER LOYALTY SERVICES FOR COMMERCIAL, PROMOTIONAL, AND/OR ADVERTISING PURPOSES, NAMELY, ADMINISTRATION OF FREQUENT FLYER PROGRAM THAT ALLOWS MEMBERS TO REDEEM MILES FOR POINTS OR AWARDS OFFERED BY OTHER LOYALTY PROGRAMS; COOPERATIVE ADVERTISING AND MARKETING; COOPERATIVE ADVERTISING AND MARKETING SERVICES BY WAY OF SOLICITATION, CUSTOMER SERVICE AND PROVIDING MARKETING INFORMATION VIA WEB SITES ON A GLOBAL COMPUTER NETWORK; COOPERATIVE ADVERTISING AND MARKETING SERVICES, NAMELY, OFFERING DISCOUNTS TO CLIENTS THROUGH THE JOINT PARTICIPATION OF MEMBER BEAUTY SALONS.; CREATING AND UPDATING ADVERTISING MATERIAL; CREATION OF MARKETING TOOLS DESIGNED TO INCREASE A CLIENT COMPANY'S KNOWLEDGE OF CUSTOMER NEEDS, AND ITS COMPETITORS' PRODUCTS AND SERVICES, PRICING, ADVERTISING STRATEGY AND SALES STRATEGY; CUSTOMER LOYALTY SERVICES AND CUSTOMER CLUB SERVICES, FOR COMMERCIAL, PROMOTIONAL AND/OR ADVERTISING PURPOSES; DESIGN OF ADVERTISING BROCHURES FOR OTHERS; DESIGN OF ADVERTISING FLYERS FOR OTHERS; DESIGN OF ADVERTISING MATERIALS FOR OTHERS; DESIGN OF INTERNET ADVERTISING; DEVELOPING ADVERTISING CAMPAIGNS FOR OTHERS GEARED TOWARD ENVIRONMENTAL ISSUES; DEVELOPMENT, OPERATION AND ADMINISTRATION OF DIGITAL SIGNAGE SYSTEMS AND DIGITAL ADVERTISING SYSTEMS FOR OTHERS, NAMELY, PROVIDING ADVERTISING SPACE BY ELECTRONIC MEANS AND GLOBAL COMPUTER INFORMATION NETWORKS; DIRECT MAIL ADVERTISING SERVICES; DIRECT MARKETING ADVERTISING FOR OTHERS; DISPLAYING ADVERTISEMENTS FOR OTHERS; DISSEMINATION OF ADVERTISEMENTS; DISSEMINATION OF ADVERTISEMENTS AND OF ADVERTISING MATERIAL; DISSEMINATION OF ADVERTISING FOR OTHERS VIA AN ON-LINE COMMUNICATIONS NETWORK ON THE INTERNET; DISSEMINATION OF ADVERTISING FOR OTHERS VIA PUBLIC AND PRIVATE WIRELESS NETWORKS FOR DISPLAY ON MOBILE DEVICES; DISSEMINATION OF ADVERTISING FOR OTHERS VIA THE INTERNET; DISSEMINATION OF ADVERTISING MATERIAL; DISSEMINATION OF ADVERTISING MATTER; DISSEMINATION OF ADVERTISING, SCHEDULING AND MANAGING OF TRAINING COURSES AND PROGRAMS FOR OTHERS VIA A GLOBAL COMPUTER NETWORK; DISSEMINATION SERVICES OF ADVERTISEMENT MATTER; DISTRIBUTION AND DISSEMINATION OF ADVERTISING MATERIALS; DISTRIBUTION OF ADVERTISEMENTS AND COMMERCIAL ANNOUNCEMENTS; DISTRIBUTION OF ADVERTISING MAIL AND OF ADVERTISING SUPPLEMENTS ATTACHED TO REGULAR EDITIONS; DISTRIBUTION OF ADVERTISING MATERIAL; DISTRIBUTION OF ADVERTISING MATERIALS; DISTRIBUTION OF PRODUCTS FOR ADVERTISING PURPOSES; ELECTRONIC BILLBOARD ADVERTISING; ELECTRONIC COMMERCE SERVICES, NAMELY, PROVIDING INFORMATION ABOUT PRODUCTS VIA TELECOMMUNICATION NETWORKS FOR ADVERTISING AND SALES PURPOSES; ENTERTAINMENT MARKETING SERVICES, NAMELY, MARKETING, PROMOTION AND ADVERTISING FOR INDEPENDENT RECORDING ARTISTS; INTERNET ADVERTISING SERVICES; ISSUING AND UPDATING OF ADVERTISING TEXTS; LAYOUT SERVICES FOR ADVERTISING PURPOSES; MANAGEMENT OF ADVERTISING THROUGH A COMMAND AND CONTROL CENTER FOR BOTH MOVIE THEATRE ON-SCREEN ADVERTISING AND OVER THE INTERNET; MARKETING AND ADVERTISING SERVICES FOR AUTOMOBILE DEALERSHIPS; MARKETING, ADVERTISING AND PROMOTING THE GOODS AND SERVICES OF OTHERS IN THE FIELD OF TRAVEL AND TOURISM, NAMELY, PROVIDING INFORMATION VIA MAIL AND ELECTRONIC MAIL; MARKETING, ADVERTISING, AND PROMOTING THE RETAIL GOODS AND SERVICES OF OTHERS TO WIRELESS ELECTRONIC DEVICES; MARKETING, PROMOTIONAL AND ADVERTISING SERVICES PROVIDED BY MOBILE TELEPHONE CONNECTIONS; MEDIA BUYING ADVICE, NAMELY, ADVISING THE CLIENT HOW MUCH MEDIA TIME, AND AT WHAT TIMES THE CLIENT SHOULD BE PURCHASING ADVERTISING; MEDIA PLANNING, NAMELY, ADVISING THE CLIENT ON THE CORRECT TIMES AND STA-

TIONS TO ADVERTISE BASED ON MEDIA ANALYSIS OF THE MARKET FOR THAT MEDIA; MEDIA PRODUCTION LOCATION SCOUTING SERVICES FOR ADVERTISING PURPOSES; MEDIATION OF ADVERTISING; MODELING FOR ADVERTISING OR SALES PROMOTION; MODELING SERVICES FOR ADVERTISING OR SALES PROMOTION; MUSIC SELECTION SERVICES FOR USE IN ADVERTISING; ON-LINE ADVERTISING AND MARKETING SERVICES; ON-LINE ADVERTISING ON COMPUTER COMMUNICATION NETWORKS; ON-LINE ADVERTISING ON COMPUTER NETWORKS; ON-LINE ADVERTISING SERVICES FOR OTHERS; ONLINE ADVERTISING VIA A COMPUTER COMMUNICATIONS NETWORK; ORGANIZATION AND HOLDING OF FAIRS FOR COMMERCIAL OR ADVERTISING PURPOSES; ORGANIZATION OF EXHIBITIONS AND EVENTS FOR COMMERCIAL OR ADVERTISING PURPOSES; ORGANIZATION OF EXHIBITIONS FOR COMMERCIAL OR ADVERTISING PURPOSES; ORGANIZING EXHIBITIONS FOR COMMERCIAL OR ADVERTISING PURPOSES; ORGANIZATION OF EVENTS, EXHIBITIONS, FAIRS AND SHOWS FOR COMMERCIAL, PROMOTIONAL AND ADVERTISING PURPOSES; ORGANIZATION OF EXHIBITIONS FOR COMMERCIAL OR ADVERTISING PURPOSES; ORGANIZATION OF FAIRS AND EXHIBITIONS FOR COMMERCIAL AND ADVERTISING PURPOSES; ORGANIZATION OF FAIRS FOR COMMERCIAL AND ADVERTISING PURPOSES; ORGANIZING EXHIBITIONS FOR COMMERCIAL OR ADVERTISING PURPOSES; OUT-OF-HOME ADVERTISING SERVICES, NAMELY, RENTAL OF ADVERTISING SPACE, AND PREPARING AND PLACING ADVERTISEMENTS FOR OTHERS; PAY PER CLICK (PPC) ADVERTISING MANAGEMENT SERVICES; PLACING ADVERTISEMENTS FOR OTHERS; PLANNING AND CONDUCTING OF TRADE FAIRS, EXHIBITIONS AND PRESENTATIONS FOR ECONOMIC OR ADVERTISING PURPOSES; PREPARATION AND REALIZATION OF MEDIA AND ADVERTISING PLANS AND CONCEPTS; PREPARATION OF CUSTOM ADVERTISEMENTS FOR OTHERS; PREPARATION OF CUSTOM OR NON-CUSTOM ADVERTISING FOR BUSINESSES FOR DISSEMINATION VIA THE WEB, CD OR DVD FOR OPTIONAL UPLOAD OR DOWNLOAD TO A COMPUTER; PREPARING ADVERTISEMENTS FOR OTHERS; PREPARING AND PLACING ADVERTISEMENTS FOR OTHERS; PREPARING AND PLACING OF ADVERTISEMENTS; PREPARING AND PLACING OUTDOOR ADVERTISEMENTS FOR OTHERS; PREPARING AUDIOVISUAL DISPLAYS IN THE FIELD OF ADVERTISING; PREPARING AUDIOVISUAL PRESENTATIONS FOR USE IN ADVERTISING; PREPARING SPEECHES AND ORAL PRESENTATIONS FOR OTHERS FOR USE IN ADVERTISING; PROCESSING TELEPHONE INQUIRIES REGARDING ADVERTISED GOODS AND SERVICES; PRODUCTION OF ADVERTISING MATTER AND COMMERCIALS; PRODUCTION OF FILM AND TELEVISION ADVERTISING; PROMOTING AND SHOWCASING THE GOODS OF OTHERS IN THE FIELD OF COMPUTER MEDIA AND TELEVISIONS BY MEANS OF AN ON-LINE SHOPPING SITE WITH LINKS TO THE RETAIL ADVERTISEMENTS OF OTHERS; PROMOTING THE GOODS AND SERVICES OF OTHERS BY DISTRIBUTING ADVERTISING MATERIALS THROUGH A VARIETY OF METHODS; PROMOTING THE GOODS AND SERVICES OF OTHERS BY MEANS OF DISTRIBUTING ADVERTISING ON THE INTERNET; PROMOTING THE GOODS AND SERVICES OF OTHERS BY PREPARING AND PLACING ADVERTISEMENTS IN AN ELECTRONIC MAGAZINE ACCESSED THROUGH A GLOBAL COMPUTER NETWORK; PROMOTING, ADVERTISING AND MARKETING OF THE ON-LINE WEB SITES OF OTHERS; PROMOTING, ADVERTISING AND MARKETING THE ON-LINE DATABASES AND ELECTRONIC PUBLICATIONS OF OTHERS; PROMOTION, ADVERTISING AND MARKETING OF ON-LINE WEBSITES; PROMOTIONAL SERVICES, NAMELY, DISTRIBUTION OF ADVERTISING FLYERS, COUPONS, CATALOGS AND PROMOTIONAL ITEMS OF OTHERS; PROVIDING A SEARCHABLE ON-LINE ADVERTISING WEBSITE AND GUIDE FEATURING THE GOODS AND SERVICES OF OTHER VENDORS VIA THE INTERNET; PROVIDING A SEARCHABLE ONLINE ADVERTISING GUIDE FEATURING THE GOODS AND SERVICES OF ONLINE VENDORS; PROVIDING A SEARCHABLE ONLINE ADVERTISING GUIDE FEATURING THE GOODS AND SERVICES OF OTHER ON-LINE VENDORS ON THE INTERNET; PROVIDING A SEARCHABLE ONLINE

ADVERTISING WEBSITE AND INFORMATIONAL GUIDE FEATURING THE GOODS AND SERVICES OF OTHER VENDORS VIA THE INTERNET IN THE FIELD OF CLOTHING AND SPORTING GOODS; PROVIDING A WEB SITE AT WHICH FITNESS PROFESSIONALS AND FACILITIES CAN POST PROMOTIONAL PROFILES AND RESPOND TO ADVERTISEMENTS FOR THEIR SERVICES; PROVIDING A WEB SITE WHERE USERS CAN POST ITEMS FOR SALE THROUGH ON-LINE CLASSIFIED ADVERTISEMENTS; PROVIDING A WEB SITE WHICH FEATURES ADVERTISEMENTS FOR THE GOODS AND SERVICES OF OTHERS ON A GLOBAL COMPUTER NETWORK; PROVIDING ADVERTISING AND ADVERTISEMENT SERVICES; PROVIDING ADVERTISING SERVICE TO DISTRIBUTE ADVERTISEMENTS FOR DISPLAY ON INTERNET, NAMELY, IN WEBSITES, SOCIAL CONVERSATIONS OVER THE INTERNET, EMAILS, MICROBLOGS, BLOGS, ELECTRONIC MESSAGES, INSTANT MESSAGES, TEXT MESSAGES, MULTIMEDIA MESSAGES, SOCIAL NETWORKS, STATUS UPDATES, FORUMS, ELECTRONIC BULLETIN BOARDS; PROVIDING ADVERTISING SERVICES; PROVIDING ADVERTISING SERVICES USING 3D AND ANIMATION DESIGNS; PROVIDING ADVERTISING SPACE IN PERIODICALS, NEWSPAPERS AND MAGAZINES; PROVIDING ADVERTISING SPACE ON BILLBOARDS AND IN KIOSKS; PROVIDING ADVERTISING SPACE ON FREE-STANDING VISUAL ADVERTISING SYSTEMS FEATURING THE GOODS AND SERVICES OF OTHERS; PROVIDING ADVERTISING, MARKETING AND PROMOTIONAL SERVICES FOR THE PHARMACEUTICAL AND MEDICAL INDUSTRY; PROVIDING ADVERTISING, MARKETING AND PROMOTIONAL SERVICES FOR THE PHARMACEUTICAL AND MEDICAL PRODUCTS OF OTHERS; PROVIDING ADVERTISING, MARKETING AND PROMOTIONAL SERVICES, NAMELY, DEVELOPMENT OF ADVERTISING CAMPAIGNS FOR TELEVISION, RADIO, PRINT; PROVIDING ADVERTISING, MARKETING AND PROMOTIONAL SERVICES, NAMELY, DEVELOPMENT OF ADVERTISING CAMPAIGNS PROVIDED THROUGH CABLE TELEVISION BROADCAST, WEB CASTS, RADIO BROADCASTS, NEWSPAPERS, MAGAZINES, ONLINE BANNERS, OUTDOOR BILLBOARDS, WILD POSTINGS, BUS AND SUBWAY ADS; PROVIDING AN INTERNET WEB SITE FOR CLASSIFIED ADVERTISING TO BUY AND SELL UKRAINIAN RELATED WARES, ART, ANTIQUES, BOOKS, EMBROIDERY, COSTUMES, COLLECTIBLES, INSTRUMENTS, MEMORABILIA AND OTHER ONE-OF-A-KIND ITEMS; PROVIDING AN INTERNET WEB SITE TO ADVERTISE SERVICES OF INTEREST TO THE UKRAINIAN COMMUNITY IN THE UNITED STATES OF AMERICA AND CANADA AND TO ADVERTISE SERVICES PROVIDED BY INDIVIDUALS OF UKRAINIAN ORIGIN; PROVIDING AN INTERNET WEBSITE PORTAL FEATURING PROMOTION AND ADVERTISING FOR HOME SERVICE PROVIDERS AND PRODUCT MANUFACTURERS; PROVIDING AN ONLINE DIRECTORY INFORMATION SERVICE FEATURING INFORMATION REGARDING VEHICLES IN THE NATURE OF CLASSIFIED ADVERTISEMENTS; PROVIDING AND RENTAL OF ADVERTISING SPACE ON THE INTERNET; PROVIDING SPACE AT A WEB SITE FOR THE ADVERTISEMENT OF THE GOODS AND SERVICES OF OTHERS; PROVIDING TELEVISION ADVERTISING FOR OTHERS; PROVISION OF ADVERTISING SPACE BY ELECTRONIC MEANS AND GLOBAL INFORMATION NETWORKS; PROVISION OF SPACE ON WEBSITES FOR ADVERTISING GOODS AND SERVICES; PUBLIC RELATIONS, ADVERTISING AND MARKETING SERVICES FOR THE TOURISM AND CONVENTION INDUSTRY, NAMELY, ORGANIZING AND HOSTING SITE INSPECTIONS AND FAMILIARIZATION TOURS FOR WHOLESALE, TOUR OPERATORS, TRAVEL AGENTS, MEETING AND INCENTIVE TRAVEL PLANNERS AND TRAVEL MEDIA; PUBLISHING OF ADVERTISING TEXTS; REAL ESTATE ADVERTISING SERVICES; RECRUITMENT ADVERTISEMENT SERVICES, NAMELY, POSTING OF CLINICAL TRIAL NOTICES FOR THE PURPOSE OF RECRUITING PATIENTS FOR PARTICIPATION IN CLINICAL TRIALS FOR THE TESTING OF DRUGS; RENTAL OF ADVERTISEMENT SPACE AND ADVERTISING MATERIAL; RENTAL OF ADVERTISING SPACE; RENTAL OF ADVERTISING SPACE ON WEB SITES; RENTAL OF SIGNS FOR ADVERTISING PURPOSES; RENTING OF ADVERTISING SPACES; SERVICES OF ADVERTISING AGENCIES; SERVICES TO DETERMINE THE AUDIENCE AFFECTED BY AD-

VERTISEMENTS; SPECIALTY MERCHANDISING SERVICES, NAMELY, PROMOTING THE GOODS AND SERVICES OF OTHERS THROUGH THE DISTRIBUTION OF CUSTOMIZED ADVERTISING MATERIALS, NAMELY, KEY CHAINS AND PENS; TELEVISION ADVERTISING AGENCIES; VENDOR-ON-PREMISE SERVICES, NAMELY, THE ADMINISTRATION OF THE EMPLOYMENT PROCESS ON-SITE, INCLUDING RESUME REVIEW AND CHECKING, EMPLOYMENT APPLICATION ACQUISITION, ADVERTISING FOR RECRUITMENT, CONDUCT OF INTERVIEWS, AND REFERENCE CHECKING (U.S. CLS. 100, 101 AND 102).  
FIRST USE 6-10-2009; IN COMMERCE 6-17-2009.  
TRACY FLETCHER, EXAMINING ATTORNEY

SN 85-034,195. AIOLI CO., LTD, SEOUL, REPUBLIC OF KOREA, FILED 5-10-2010.

# PLAMARKET

THE MARK CONSISTS OF STANDARD CHARACTERS WITHOUT CLAIM TO ANY PARTICULAR FONT, STYLE, SIZE, OR COLOR.

## CLASS 18—LEATHER GOODS

FOR COSMETICS BAGS SOLD EMPTY; BAGS OF LEATHER; BAGS OF SYNTHETIC LEATHER; BAGS, NAMELY DUFFEL BAGS, BEACH BAGS, BOOK BAGS, SHOULDER BAGS, SHOPPING BAGS; SUITCASES OF LEATHER; PURSES OF LEATHER; HANDBAGS OF LEATHER; BOSTON BAGS; TRAVELING TRUNKS; HANDBAGS; PARASOLS; SUN UMBRELLAS; UMBRELLAS; VANITY CASES SOLD EMPTY; MULTIPURPOSE PURSES; KEY PURSES OF LEATHER; BRIEFCASES; TRAVELING BAGS; PURSES; UMBRELLA ACCESSORIES, NAMELY UMBRELLA RINGS, UMBRELLA COVERS, UMBRELLA BAGS; LEATHER; CLOTHING FOR PETS; GARMENTS FOR PETS; ANIMALS WRAPS AND COVERS (U.S. CLS. 1, 2, 3, 22 AND 41).

**CLASS 25—CLOTHING**

FOR FOOTWEAR, PARTS AND FITTINGS OF FOOTWEAR, NAMELY, SHOE PEGS, INSOLES, SOLES, FOOTWEAR UPPERS, WELTS, HEELPIECES, TIPS, AND IRON FITTINGS FOR SHOES, NAMELY, PROTECTIVE METAL MEMBERS FOR SHOES; CLOTHING CONSISTING OF LEATHERWEAR, NAMELY, SUITS, TROUSERS AND PANTS, AND SKIRTS; CLOTHING AND APPAREL FOR WOMEN, NAMELY, SUITS, PANTS, SLACKS, DRESS PANTS, DRESSES, SKIRTS, SHIRTS, DRESS SHIRTS, BLOUSES, POLO SHIRTS, PARTY AND CEREMONIAL DRESSES, WEDDING DRESSES, UNDERWEAR, NIGHT GOWNS AND PAJAMAS; CLOTHING FOR MEN, NAMELY, PANTS, DRESS SHIRTS, POLO SHIRTS, SUITS, TUXEDOS, PAJAMAS; CLOTHING FOR CHILDREN, NAMELY, SHIRTS, T-SHIRTS, PANTS, SHORT, SKIRTS, JEANS, AND DRESSES; OUTERWEAR, NAMELY, RAINCOATS, OVERCOATS, HALF-COATS AND PEA COATS, JACKETS FOR PROTECTION AGAINST THE COLD, NAMELY, DOWN JACKETS, THERMAL JACKETS, PARKAS; SPORTSWEAR NAMELY, GOLF TROUSERS, POLO SHIRTS, ANORAKS, SKIWEAR; SAFARI SUITS; HEADGEAR, NAMELY, LEATHER HATS AND CAPS, GOLF CAPS, NIGHT CAPS, KNIT CAPS AND HAT, MANGGON (KOREAN HEADBAND MADE OF HORSEHAIR), FUR HATS, BERETS, BASEBALL CAPS, VISORS, WOOL HATS, SKULL CAPS, CAPS WITH VISORS; CHILDREN'S HEADWEAR, NAMELY, CAPS AND HATS, HOODS, PAPER HATS; SOCKS, EAR MUFFS, GLOVES FOR PROTECTION AGAINST THE COLD, MUFFLERS, MASKS FOR PROTECTION AGAINST THE COLD, NAMELY, SKI MASKS, LEATHER BELTS, GARTERS, GAITER STRAPS, STOCKING SUSPENDERS, SOCK SUSPENDERS, SUSPENDER BELTS, BRACES FOR CLOTHING, BELTS, FABRIC BELTS FOR WEAR (U.S. CLS. 22 AND 39).

RICHARD WHITE, EXAMINING ATTORNEY

**CLASS 16—PAPER GOODS AND PRINTED MATTER**

FOR PRINTED EDUCATIONAL MATERIALS IN THE FORM OF TEXTBOOKS, WORKBOOKS, ANSWER KEYS, READERS, FLASHCARDS, AND TEACHER'S EDITIONS, ALL OF THE FOREGOING IN THE FIELD OF READING AND LANGUAGE ARTS FOR PRE-K THROUGH 6TH GRADE STUDENTS (U.S. CLS. 2, 5, 22, 23, 29, 37, 38 AND 50).

FIRST USE 5-23-2008; IN COMMERCE 5-23-2008.

**CLASS 28—TOYS AND SPORTING GOODS**

FOR MANIPULATIVE GAMES FOR EDUCATIONAL PURPOSES IN THE FIELD OF READING AND LANGUAGE ARTS (U.S. CLS. 22, 23, 38 AND 50).

FIRST USE 5-23-2008; IN COMMERCE 5-23-2008.

**CLASS 41—EDUCATION AND ENTERTAINMENT**

FOR PROVIDING AN EDUCATIONAL WEBSITE THE FIELD OF READING AND LANGUAGE ARTS FOR PRE-K THROUGH 6TH GRADE STUDENTS CONTAINING EDUCATIONAL CONTENT, EDUCATIONAL ASSESSMENTS, ASSIGNMENT MANAGERS, TEST BUILDERS, INSTRUCTION PLANNERS, AND REPORT GENERATORS (U.S. CLS. 100, 101 AND 107).

FIRST USE 5-23-2008; IN COMMERCE 5-23-2008.

MARGARET POWER, EXAMINING ATTORNEY

SN 85-038,030. THE MCGRAW-HILL COMPANIES, INC., NEW YORK, NY. FILED 5-13-2010.

SN 85-037,459. THE MCGRAW-HILL COMPANIES, INC., NEW YORK, NY. FILED 5-13-2010.

**SRA ¡IMAGÍNALO!**

THE MARK CONSISTS OF STANDARD CHARACTERS WITHOUT CLAIM TO ANY PARTICULAR FONT, STYLE, SIZE, OR COLOR.

OWNER OF U.S. REG. NOS. 727,724, 2,049,590 AND OTHERS.

THE ENGLISH TRANSLATION OF "IMAGÍNALO" IN THE MARK IS IMAGINE IT.

**CLASS 9—ELECTRICAL AND SCIENTIFIC APPARATUS**

FOR COMPUTER SOFTWARE AND CD-ROMS THAT CONDUCT EDUCATIONAL ASSESSMENTS, CREATE TESTS, CREATE TEST QUESTION BANKS, CREATE STUDENT REPORTS, CLASS REPORTS, AND ADMINISTRATIVE REPORTS, AND CONTAIN EDUCATIONAL AND INSTRUCTIONAL MATERIALS AND IN THE FIELD OF READING AND LANGUAGE ARTS FOR PRE-K THROUGH 6TH GRADE STUDENTS; DVDS AND AUDIO COMPACT DISCS CONTAINING EDUCATIONAL AND INSTRUCTIONAL MATERIALS IN THE FIELD OF READING AND LANGUAGE ARTS FOR PRE-K THROUGH 6TH GRADE STUDENTS (U.S. CLS. 21, 23, 26, 36 AND 38).

FIRST USE 5-23-2008; IN COMMERCE 5-23-2008.



OWNER OF U.S. REG. NOS. 727,724, 2,049,590 AND OTHERS.

THE COLOR(S) BLUE, PURPLE, RED, AND WHITE IS/ARE CLAIMED AS A FEATURE OF THE MARK.

THE MARK CONSISTS OF THE UPPERCASE WHITE LETTERS "S", "R", AND "A" DISPLAYED IN SMALL SQUARES COLORED BLUE, PURPLE, AND RED RESPECTIVELY; ALL OF THIS IS SHOWN ABOVE THE TERM "¡IMAGÍNALO!" IN WHITE WITH A BLUE OUTLINE. THE INITIAL LETTER "I" IS SHOWN IN UPPERCASE LETTERS AND THE REMAINING LETTERS ARE IN LOWERCASE WITH A WHITE FIVE-POINTED STAR OUTLINED IN BLUE AT THE TOP OF THE FIRST EXCLAMATION MARK AND AT THE BOTTOM OF THE SECOND EXCLAMATION MARK AND A WHITE ACCENT MARK OUTLINED IN BLUE ABOVE THE LOWERCASE LETTER "I".

THE ENGLISH TRANSLATION OF "IMAGÍNALO" IN THE MARK IS IMAGINE IT.

**CLASS 9—ELECTRICAL AND SCIENTIFIC APPARATUS**

FOR COMPUTER SOFTWARE AND CD-ROMS THAT CONDUCT EDUCATIONAL ASSESSMENTS, CREATE TESTS, CREATE TEST QUESTION BANKS, CREATE STUDENT REPORTS, CLASS REPORTS, AND ADMINISTRATIVE REPORTS, AND CONTAIN EDUCATIONAL AND INSTRUCTIONAL MATERIALS AND IN THE FIELD OF READING AND LANGUAGE ARTS FOR PRE-K THROUGH 6TH GRADE STUDENTS; DVDS AND AUDIO COMPACT DISCS CONTAINING EDUCATIONAL AND INSTRUCTIONAL MATERIALS IN THE FIELD OF READING AND LANGUAGE ARTS FOR PRE-K THROUGH 6TH GRADE STUDENTS (U.S. CLS. 21, 23, 26, 36 AND 38).

FIRST USE 5-23-2008; IN COMMERCE 5-23-2008.



**CLASS 16—PAPER GOODS AND PRINTED MATTER**

FOR PRINTED EDUCATIONAL MATERIALS IN THE FORM OF TEXTBOOKS, WORKBOOKS, ANSWER KEYS, READERS, FLASHCARDS, AND TEACHER'S EDITIONS, ALL OF THE FOREGOING IN THE FIELD OF READING AND LANGUAGE ARTS FOR PRE-K THROUGH 6TH GRADE STUDENTS (U.S. CLS. 2, 5, 22, 23, 29, 37, 38 AND 50).

FIRST USE 5-23-2008; IN COMMERCE 5-23-2008.

**CLASS 28—TOYS AND SPORTING GOODS**

FOR MANIPULATIVE GAMES FOR EDUCATIONAL PURPOSES IN THE FIELD OF READING AND LANGUAGE ARTS (U.S. CLS. 22, 23, 38 AND 50).

FIRST USE 5-23-2008; IN COMMERCE 5-23-2008.

**CLASS 41—EDUCATION AND ENTERTAINMENT**

FOR PROVIDING AN EDUCATIONAL WEBSITE THE FIELD OF READING AND LANGUAGE ARTS FOR PRE-K THROUGH 6TH GRADE STUDENTS CONTAINING EDUCATIONAL CONTENT, EDUCATIONAL ASSESSMENTS, ASSIGNMENT MANAGERS, TEST BUILDERS, INSTRUCTION PLANNERS, AND REPORT GENERATORS (U.S. CLS. 100, 101 AND 107).

FIRST USE 5-23-2008; IN COMMERCE 5-23-2008.  
MARGARET POWER, EXAMINING ATTORNEY

SN 85-045,405. FRIKI TIKI HUT, INC., BROKEN ARROW, OK. FILED 5-21-2010.



NO CLAIM IS MADE TO THE EXCLUSIVE RIGHT TO USE "TIKI HUT", APART FROM THE MARK AS SHOWN.

THE MARK CONSISTS OF A CUP RESEMBLING A TRIBAL STATUE BEARING THE WORDS "FRIKI" "TIKI" AND "HUT" ON THE FRONT OF THE CUP ONE ON TOP OF THE OTHER.

**CLASS 21—HOUSEWARES AND GLASS**

FOR PAPER BEVERAGE CUPS AND INSULATED SLEEVE HOLDERS FOR BEVERAGE CUPS (U.S. CLS. 2, 13, 23, 29, 30, 33, 40 AND 50).

**CLASS 43—HOTEL AND RESTAURANT SERVICES**

FOR PROVISION OF FOOD AND DRINKS IN RESTAURANTS (U.S. CLS. 100 AND 101).

NAPOLEON SHARMA, EXAMINING ATTORNEY

SN 85-040,544. DIXON, SCOTT, CAMBY, IN. FILED 5-17-2010.

THE NAME(S), PORTRAIT(S), AND/OR SIGNATURE(S) SHOWN IN THE MARK IDENTIFIES "SCOTT DIXON", WHOSE CONSENT(S) TO REGISTER IS MADE OF RECORD.

THE MARK CONSISTS OF THE WORD MARK "SCOTT DIXON" IN A STYLIZED SIGNATURE FORMAT.

**CLASS 24—FABRICS**

FOR CLOTH PENNANTS (U.S. CLS. 42 AND 50).  
FIRST USE 7-5-2005; IN COMMERCE 7-5-2005.

**CLASS 25—CLOTHING**

FOR CAPS; SHIRTS (U.S. CLS. 22 AND 39).  
FIRST USE 7-5-2005; IN COMMERCE 7-5-2005.  
JEFFREY LOOK, EXAMINING ATTORNEY

SN 85-046,143. PLAYING IN THE DIRT, INC., JACKSON, MO. FILED 5-24-2010.

Playing in the Dirt

THE MARK CONSISTS OF STANDARD CHARACTERS WITHOUT CLAIM TO ANY PARTICULAR FONT, STYLE, SIZE, OR COLOR.

**CLASS 18—LEATHER GOODS**

FOR BAGS FOR CARRYING BABIES' ACCESSORIES; BEACH BAGS; CARRY-ALL BAGS; DIAPER BAGS; OVERNIGHT BAGS; PET PRODUCTS, NAMELY, PET RESTRAINING DEVICES CONSISTING OF LEASHES, COLLARS, HARNESSES, RESTRAINING STRAPS, AND LEASHES WITH LOCKING DEVICES; SHOULDER BAGS; SOUVENIR BAGS; SPORT BAGS; TOTE BAGS (U.S. CLS. 1, 2, 3, 22 AND 41).

**CLASS 21—HOUSEWARES AND GLASS**

FOR BEER MUGS; BOTTLES, SOLD EMPTY; BOWLS; CUPS AND MUGS; INSULATED BAGS FOR FOOD OR BEVERAGE FOR DOMESTIC USE; INSULATED CONTAINERS FOR BEVERAGE CANS FOR DOMESTIC USE; INSULATED CONTAINERS FOR FOOD OR BEVERAGE FOR DOMESTIC USE; PET FEEDING AND DRINKING BOWLS; PET FEEDING DISHES; PET TREAT JARS; PLASTIC WATER BOTTLES SOLD EMPTY; SPORTS BOTTLES SOLD EMPTY (U.S. CLS. 2, 13, 23, 29, 30, 33, 40 AND 50).

**CLASS 24—FABRICS**

FOR BEACH TOWELS (U.S. CLS. 42 AND 50).

**CLASS 25—CLOTHING**

FOR ATHLETIC APPAREL, NAMELY, SHIRTS, PANTS, JACKETS, FOOTWEAR, HATS AND CAPS, ATHLETIC UNIFORMS; BASEBALL CAPS AND HATS; FLIP FLOPS; HATS; HATS FOR INFANTS, BABIES, TODDLERS AND CHILDREN; HOODED SWEAT SHIRTS; LONG-SLEEVED SHIRTS; POLO SHIRTS; SHIRTS; SHIRTS AND SHORT-SLEEVED SHIRTS; SHIRTS FOR INFANTS, BABIES, TODDLERS AND CHILDREN; SHORT-SLEEVED OR LONG-SLEEVED T-SHIRTS; SHORT-SLEEVED SHIRTS; SPORT SHIRTS (U.S. CLS. 22 AND 39).

**CLASS 35—ADVERTISING AND BUSINESS**

FOR ON-LINE WHOLESALE AND RETAIL STORE SERVICES FEATURING CLOTHING AND FASHION ACCESSORIES; RETAIL STORE SERVICES FEATURING CLOTHING AND FASHION ACCESSORIES; WHOLESALE AND RETAIL STORE SERVICES AND ON-LINE RETAIL AND WHOLESALE STORE SERVICES FEATURING CLOTHING AND FASHION ACCESSORIES; WHOLESALE AND RETAIL STORE SERVICES FEATURING CLOTHING AND FASHION ACCESSORIES (U.S. CLS. 100, 101 AND 102).

KATHERINE CHANG, EXAMINING ATTORNEY

SN 85-047,202. PROFESSIONAL MEDICAL SURGICAL SUPPLY, INC., NEW LENNOX, IL. FILED 5-25-2010.

**EMBRACE**

THE MARK CONSISTS OF STANDARD CHARACTERS WITHOUT CLAIM TO ANY PARTICULAR FONT, STYLE, SIZE, OR COLOR.

**CLASS 3—COSMETICS AND CLEANING PREPARATIONS**

FOR SKIN LOTION; SHAMPOOS, SKIN SOAP; ANTI-BACTERIAL SOAP; DISPOSABLE WIPES IMPREGNATED WITH CLEANING COMPOUNDS FOR PERSONAL HYGIENE USE; NON-MEDICATED SKIN CARE PREPARATIONS, NAMELY, PERINEAL CLEANSER (U.S. CLS. 1, 4, 6, 50, 51 AND 52).

**CLASS 5—PHARMACEUTICALS**

FOR HAND SANITIZER, NAMELY, HAND-SANITIZING PREPARATIONS; MEDICATED SKIN CARE PREPARATIONS, NAMELY, BARRIER CREAM AND WASH CREAM (U.S. CLS. 6, 18, 44, 46, 51 AND 52).

KIM MONINGHOFF, EXAMINING ATTORNEY

SN 85-052,648. BASF SE, LUDWIGSHAFEN AM RHEIN, FED REP GERMANY, FILED 6-2-2010.

**AgBalance**

THE MARK CONSISTS OF STANDARD CHARACTERS WITHOUT CLAIM TO ANY PARTICULAR FONT, STYLE, SIZE, OR COLOR.

**CLASS 5—PHARMACEUTICALS**

FOR PREPARATIONS FOR DESTROYING AND COMBATING VERMIN, FUNGICIDES, HERBICIDES, PESTICIDES (U.S. CLS. 6, 18, 44, 46, 51 AND 52).

**CLASS 35—ADVERTISING AND BUSINESS**

FOR ADVERTISING SERVICES; BUSINESS MANAGEMENT; BUSINESS ADMINISTRATION AND OFFICE FUNCTIONS (U.S. CLS. 100, 101 AND 102).

**CLASS 42—SCIENTIFIC AND COMPUTER SERVICES**

FOR SCIENTIFIC AND TECHNOLOGICAL SERVICES, NAMELY, RESEARCH, CERTIFICATION FOR TESTING, ANALYSIS AND EVALUATION OF THE GOODS AND SERVICES, AND DESIGN IN THE FIELD OF AGRICULTURE AND AGRICULTURAL PRODUCTS AND SERVICES; SCIENTIFIC RESEARCH FOR OTHERS IN THE FIELD OF AGRICULTURE; INDUSTRIAL ANALYSIS AND RESEARCH SERVICES IN THE FIELD OF AGRICULTURE AND AGRICULTURAL PRODUCTS (U.S. CLS. 100 AND 101).

**CLASS 44—MEDICAL, BEAUTY AND AGRICULTURAL SERVICES**

FOR AGRICULTURAL ADVICE, HORTICULTURAL SERVICES, AND PEST CONTROL SERVICES FOR AGRICULTURE, HORTICULTURE OR FORESTRY (U.S. CLS. 100 AND 101).

ADA HAN, EXAMINING ATTORNEY

SN 85-056,283. JOHNSON & JOHNSON, NEW BRUNSWICK, NJ. FILED 6-7-2010.



THE MARK CONSISTS OF THE WORDING "ACTIVE NATURALS" WITHIN A LABEL DESIGN HAVING A LINE OF DOTS GOING HORIZONTALLY AND A SHORT PERPENDICULAR LINE OF DOTS BELOW THE LETTER "R".

**CLASS 3—COSMETICS AND CLEANING PREPARATIONS**

FOR NON-MEDICATED SKIN CARE PREPARATIONS, NAMELY, LOTIONS, FACIAL CLEANSER, SKIN CLEANSERS AND SUN CARE PREPARATIONS (U.S. CLS. 1, 4, 6, 50, 51 AND 52).

**CLASS 5—PHARMACEUTICALS**

FOR MEDICATED SKIN CARE PREPARATIONS, NAMELY, LOTIONS, FACIAL CLEANSER, SKIN CLEANSER AND SUN CARE PREPARATIONS; NON-MEDICATED AND MEDICATED THERAPEUTIC SKIN CARE PREPARATIONS FOR THE TREATMENT OF ECZEMA (U.S. CLS. 6, 18, 44, 46, 51 AND 52).  
DOMINIC FATHY, EXAMINING ATTORNEY

SN 85-059,242. SOUTHSIDE TRAINING, EMPLOYMENT AND PLACEMENT SERVICES, INC., FARMVILLE, VA. FILED 6-10-2010.



NO CLAIM IS MADE TO THE EXCLUSIVE RIGHT TO USE "INCORPORATED", APART FROM THE MARK AS SHOWN.

THE MARK CONSISTS OF THE TERM "STEPS" ABOVE THE TERM "INCORPORATED", ALL TO THE LEFT OF A PYRAMID BROKEN INTO THREE SEPARATE PARTS.

SN 85-058,385. HAPPY PRODUCTS, INC., SAINT JUST, PUERTO RICO, FILED 6-9-2010.



NO CLAIM IS MADE TO THE EXCLUSIVE RIGHT TO USE "PRODUCTS, INC.", APART FROM THE MARK AS SHOWN.

THE COLOR(S) RED, YELLOW, BLUE, BLACK, AND GRAY IS/ARE CLAIMED AS A FEATURE OF THE MARK.

THE MARK CONSISTS OF A YELLOW AND RED SUN WITH A SMILING FACE, PLACED OVER A BLUE OVAL WITH "HAPPY" IN YELLOW WITH A BLACK OUTLINE; "HAPPY PRODUCTS, INC." IS IN GRAY.

**CLASS 29—MEATS AND PROCESSED FOODS**

FOR EGGS; EVAPORATED MILK; MILK; POWDERED MILK; SOYBEAN MILK (U.S. CL. 46).

**CLASS 30—STAPLE FOODS**

FOR BREAD; BREAKFAST CEREALS; FARINA; OAT-MEAL; TORTILLAS (U.S. CL. 46).

**CLASS 32—LIGHT BEVERAGES**

FOR BOTTLED DRINKING WATER; CONCENTRATED FRUIT JUICE; FRUIT DRINKS AND FRUIT JUICES (U.S. CLS. 45, 46 AND 48).

**CLASS 35—ADVERTISING AND BUSINESS**

FOR RETAIL DISCOUNT STORE SERVICES IN THE FIELD OF FOOD SALES; WHOLESALE FOOD DISTRIBUTORSHIP SERVICES (U.S. CLS. 100, 101 AND 102).  
PAUL E. FAHRENKOPF, EXAMINING ATTORNEY

**CLASS 35—ADVERTISING AND BUSINESS**

FOR CHARITABLE SERVICES, NAMELY, JOB PLACEMENT AND EMPLOYMENT COUNSELING SERVICES TO INDIVIDUALS WITH DISABILITIES AND INDIVIDUALS FACING ECONOMIC BARRIERS IN THE AREAS OF PREPARING FOR, OBTAINING, MAINTAINING AND ADVANCING IN EMPLOYMENT OPPORTUNITIES IN MANUFACTURING, SPECIFICALLY CLOTHING PRODUCTION, AND OPPORTUNITIES IN RETAIL BUSINESS, SPECIFICALLY CASHIERS, BAGGERS, MAINTENANCE WORKERS (U.S. CLS. 100, 101 AND 102).

FIRST USE 1-2-1991; IN COMMERCE 1-2-1991.

**CLASS 41—EDUCATION AND ENTERTAINMENT**

FOR CHARITABLE SERVICES, NAMELY, PROVIDING JOB TRAINING TO INDIVIDUALS WITH DISABILITIES AND INDIVIDUALS FACING ECONOMIC BARRIERS IN THE FIELDS OF MANUFACTURING, SPECIFICALLY TRAINING IN USING MACHINERY TO MAKE CLOTHING ON A LARGE SCALE, PACKAGING AND SHIPPING; CHARITABLE SERVICES, NAMELY, PROVIDING JOB TRAINING TO INDIVIDUALS WITH DISABILITIES AND INDIVIDUALS FACING ECONOMIC BARRIERS IN THE FIELDS OF RETAIL BUSINESS, SPECIFICALLY, TRAINING TO BECOME STORE CLERKS, BAGGERS, CASHIERS; CHARITABLE SERVICES, NAMELY, PROVIDING JOB TRAINING TO INDIVIDUALS WITH DISABILITIES AND INDIVIDUALS FACING ECONOMIC BARRIERS IN THE FIELDS OF RECYCLING SERVICES, SPECIFICALLY, COLLECTING, SHREDDING AND DISPOSAL OF RECYCLABLE MATERIALS INCLUDING PAPER AND CARDBOARD (U.S. CLS. 100, 101 AND 107).

FIRST USE 1-2-1991; IN COMMERCE 1-2-1991.  
TARA PATE, EXAMINING ATTORNEY

SN 85-060,512. LEDFORD, TIMOTHY G., CHINO, CA. FILED 6-11-2010.

iKUZTOMS

THE MARK CONSISTS OF STANDARD CHARACTERS WITHOUT CLAIM TO ANY PARTICULAR FONT, STYLE, SIZE, OR COLOR.

**CLASS 25—CLOTHING**

FOR CLOTHING, NAMELY, T-SHIRTS, SHORTS, PANTS, HATS, JACKETS, SWEATSHIRTS (U.S. CLS. 22 AND 39).

**CLASS 41—EDUCATION AND ENTERTAINMENT**

FOR ENTERTAINMENT SERVICES IN THE NATURE OF AN ON-GOING NEWS SHOW FEATURING CUSTOMIZED MOTORCYCLES BROADCAST VIDEO MEDIA (U.S. CLS. 100, 101 AND 107).

MAYUR VAGHANI, EXAMINING ATTORNEY

---

SN 85-062,041. OMELICH, INC, DBA COUTURE DOSSIER, CHAPPAQUA, NY. FILED 6-14-2010.

## COUTUREDossier

THE MARK CONSISTS OF STANDARD CHARACTERS WITHOUT CLAIM TO ANY PARTICULAR FONT, STYLE, SIZE, OR COLOR.

**CLASS 25—CLOTHING**

FOR COATS; DRESSES; GLOVES; T-SHIRTS (U.S. CLS. 22 AND 39).

**CLASS 35—ADVERTISING AND BUSINESS**

FOR ON-LINE CONSIGNMENT SERVICES WHEREBY GOODS ARE RECEIVED ON CONSIGNMENT FOR AUCTION ON AN ONLINE AUCTION SITE (U.S. CLS. 100, 101 AND 102).

FIRST USE 9-0-2009; IN COMMERCE 9-0-2009.  
DAVID C. REIHNER, EXAMINING ATTORNEY

---

SN 85-063,484. KPMG INTERNATIONAL COOPERATIVE, AMSTELVEEN, NETHERLANDS, FILED 6-15-2010.

## CUTTING THROUGH COMPLEXITY

THE MARK CONSISTS OF STANDARD CHARACTERS WITHOUT CLAIM TO ANY PARTICULAR FONT, STYLE, SIZE, OR COLOR.

PRIORITY CLAIMED UNDER SEC. 44(D) ON ERPNCMNTY TM OFC APPLICATION NO. 009176215, FILED 6-15-2010, REG. NO. 009176215, DATED 4-14-2011, EXPIRES 6-15-2020.

**CLASS 9—ELECTRICAL AND SCIENTIFIC APPARATUS**

FOR (BASED ON INTENT TO USE) (BASED ON 44(D) PRIORITY APPLICATION) (BASED ON 44(E)) COMPUTER SOFTWARE FOR USE IN THE FIELDS OF ACCOUNTING, AUDITING, TAX AND MANAGEMENT CONSULTING FOR CREATING SOFTWARE SOLUTIONS, SOFTWARE APPLICATIONS AND SOFTWARE TOOLS, GENERATING REPORTS, CONDUCTING SEARCHES, COMPILING DATABASES, ACCESSING DATABASES AND MANAGING DATABASES, FOR CLIENT AND DATA MANAGEMENT, AND MANAGING AND PROMOTING CLIENT INTERACTIONS AND CLIENT RELATIONSHIPS (U.S. CLS. 21, 23, 26, 36 AND 38).

**CLASS 16—PAPER GOODS AND PRINTED MATTER**

FOR (BASED ON INTENT TO USE) (BASED ON 44(D) PRIORITY APPLICATION) (BASED ON 44(E)) PRINTED PUBLICATIONS, NAMELY, BOOKS, MANUALS, MAGAZINES, PRINTED NEWSLETTERS, PRINTED PAMPHLETS, PRINTED BROCHURES AND PRINTED EDUCATIONAL AND INSTRUCTIONAL MATERIALS, DIRECTORIES, REPORTS IN THE FIELDS OF ACCOUNTING, AUDITING, TAX AND MANAGEMENT CONSULTING (U.S. CLS. 2, 5, 22, 23, 29, 37, 38 AND 50).

**CLASS 35—ADVERTISING AND BUSINESS**

FOR (BASED ON INTENT TO USE) (BASED ON 44(D) PRIORITY APPLICATION) ACCOUNTANCY, INTERNAL AND EXTERNAL ACCOUNT AUDITING, INTERNAL AND EXTERNAL BUSINESS AUDITING, BOOK-KEEPING, BUSINESS RESEARCH, THE PROVISION OF COMMERCIAL AND BUSINESS INFORMATION, COST ANALYSIS, AND CONSULTANCY SERVICES RELATING THERETO; BUSINESS MANAGEMENT ASSISTANCE AND ADVICE; PERSONNEL MANAGEMENT, SELECTION AND RECRUITMENT, EMPLOYMENT OUTPLACEMENT SERVICES; BUSINESS ADVISORY SERVICES RELATING TO MERGERS, ACQUISITIONS, FRANCHISING AND BUSINESS LIQUIDATIONS; TAX AND TAXATION ADVISORY, PLANNING, INFORMATION AND CONSULTANCY SERVICES; BUSINESS MANAGEMENT CONSULTANCY SERVICES INCLUDING BUSINESS MANAGEMENT SERVICES, ORGANIZATIONAL PLANNING AND DEVELOPMENT SERVICES, BUSINESS PROJECT ADVICE, BUSINESS RISK MANAGEMENT, AND BUSINESS PROCESS MANAGEMENT SERVICES; BUSINESS INSOLVENCY SERVICES; MARKET RESEARCH AND MARKET STUDIES; PROVIDING ONLINE INFORMATION IN THE FIELD OF BUSINESS MANAGEMENT AND BUSINESS ADMINISTRATION; PROVISION OF BUSINESS INTELLIGENCE SERVICES; BUSINESS ADVICE AND CONSULTANCY SERVICES RELATING TO THE ARRANGEMENT OF JOINT VENTURES; COMPILATION OF INFORMATION INTO COMPUTER DATABASES; PROVIDING BUSINESS ADVICE RELATING TO BUSINESS INVESTIGATIONS; FORENSIC ACCOUNTING SERVICES (U.S. CLS. 100, 101 AND 102).

**CLASS 36—INSURANCE AND FINANCIAL**

FOR (BASED ON INTENT TO USE) (BASED ON 44(D) PRIORITY APPLICATION) ADVISORY SERVICES RELATING TO CREDIT AND DEBIT CONTROL, INVESTMENT, GRANTS AND FINANCING OF LOANS; PENSION SERVICES, NAMELY, FINANCIAL RESEARCH, ANALYSIS, ADVISORY, VALUATION, PLANNING, ADMINISTRATION AND MANAGEMENT SERVICES IN THE FIELD OF PENSION PLANS; TAX ADVICE; REAL ESTATE AND PROPERTY MANAGEMENT; FINANCING OF REAL ESTATE AND OF PROPERTY DEVELOPMENT; CUSTOMS BROKERAGE; CONSULTANCY AND ADVISORY SERVICES RELATING TO FINANCIAL MATTERS; CORPORATE FINANCE SERVICES, NAMELY, ADVISING ON FINANCIAL AFFAIRS, FINANCIAL EVALUATION, AND FINANCIAL CONSULTANCY; CORPORATE FINANCE SERVICES, NAMELY, PROVIDING FINANCIAL ADVICE RELATING TO ASSET AND BUSINESS SALES AND ACQUISITIONS; ACTUARIAL SERVICES; FINANCIAL RISK MANAGEMENT; DEBT COLLECTING; FIS-

CAL ASSESSMENT; MONETARY AFFAIRS, NAMELY, FINANCIAL INFORMATION, MANAGEMENT AND ANALYSIS SERVICES; PROVIDING ONLINE INFORMATION IN THE FIELDS OF INSURANCE, FINANCIAL AFFAIRS, MONETARY AFFAIRS AND REAL ESTATE AFFAIRS; BANKING SERVICES; STOCK EXCHANGE QUOTATIONS; FINANCIAL CONSULTING AND ADVISING IN THE FIELDS OF MERGERS AND ACQUISITIONS, FRANCHISING AND BUSINESS LIQUIDATIONS; PROVIDING INFORMATION ABOUT FINANCIAL RISK MANAGEMENT (U.S. CLS. 100, 101 AND 102).

#### **CLASS 41—EDUCATION AND ENTERTAINMENT**

FOR (BASED ON INTENT TO USE) (BASED ON 44(D) PRIORITY APPLICATION) TRAINING SERVICES IN THE FIELDS OF ACCOUNTING, AUDITING, TAX AND MANAGEMENT CONSULTING; PUBLICATION OF TEXTS IN THE FIELDS OF ACCOUNTING, AUDITING, TAX AND MANAGEMENT CONSULTING; ORGANIZATION OF EDUCATIONAL CONFERENCES, SEMINARS, SYMPOSIA AND MEETINGS IN THE FIELDS OF ACCOUNTING, AUDITING, TAX AND MANAGEMENT CONSULTING MATTERS; PROVISION OF TAX TECHNICAL COURSES; PROVISION OF EDUCATIONAL ACADEMIC RESEARCH PROGRAMMES IN THE FIELDS OF ACCOUNTING, AUDITING, TAX AND MANAGEMENT CONSULTING; PROVISION OF EDUCATIONAL ACADEMIC RESIDENCY PROGRAMS IN THE FIELDS OF ACCOUNTING, AUDITING, TAX AND MANAGEMENT CONSULTING; TRANSLATION OF DEEDS, LEGAL INSTRUMENTS AND LEGAL DOCUMENTS (U.S. CLS. 100, 101 AND 107).

#### **CLASS 42—SCIENTIFIC AND COMPUTER SERVICES**

FOR (BASED ON INTENT TO USE) (BASED ON 44(D) PRIORITY APPLICATION) CONSULTANCY IN THE FIELD OF INFORMATION TECHNOLOGY AND COMPUTERS; COMPUTER SOFTWARE DESIGN; COMPUTER SOFTWARE DESIGN AND PROGRAMMING SERVICES (U.S. CLS. 100 AND 101).

#### **CLASS 45—PERSONAL AND LEGAL SERVICES**

FOR (BASED ON INTENT TO USE) (BASED ON 44(D) PRIORITY APPLICATION) FORENSIC SERVICES, NAMELY, CONDUCTING FRAUD INVESTIGATIONS; EXPERT WITNESS SERVICES IN LEGAL MATTERS IN THE FIELDS OF ACCOUNTING, AUDITING, TAX AND MANAGEMENT CONSULTING; TAX LAW CONSULTANCY; LEGAL SERVICES, NAMELY, LEGAL CONSULTANCY SERVICES; TRIAL ADVOCACY SERVICES; LITIGATION SERVICES; HANDLING LEGAL FORMALITIES IN THE NATURE OF PREPARING AND FILING INCORPORATION PAPERS; DRAFTING OF DEEDS, LEGAL INSTRUMENTS AND LEGAL DOCUMENTS (U.S. CLS. 100 AND 101).

MARY ROSSMAN, EXAMINING ATTORNEY

SN 85-077,010. COHESIVE KNOWLEDGE SOLUTIONS, INC., GUILFORD, CT. FILED 7-2-2010.

# GET CONTROL!

THE MARK CONSISTS OF STANDARD CHARACTERS WITHOUT CLAIM TO ANY PARTICULAR FONT, STYLE, SIZE, OR COLOR.

#### **CLASS 16—PAPER GOODS AND PRINTED MATTER**

FOR PRINTED MATTER, NAMELY, BOOKS, HANDBOOKS, ARTICLES, INSTRUCTIONAL OR TEACHING MATERIALS, MANUALS, WORKSHEETS, WORKBOOKS, AND CHECKLISTS IN THE FIELD OF PERSONAL AND PROFESSIONAL INFORMATION MANAGEMENT TECHNIQUES INCLUDING STRATEGIES FOR IMPROVING PRODUCTIVITY AND EFFICIENCY IN MESSAGING, COMMUNICATION, MEETINGS, INFORMATION STORAGE AND RETRIEVAL, AND WORKFLOW (U.S. CLS. 2, 5, 22, 23, 29, 37, 38 AND 50).

FIRST USE 6-15-2008; IN COMMERCE 9-3-2008.

#### **CLASS 41—EDUCATION AND ENTERTAINMENT**

FOR EDUCATIONAL AND TRAINING SERVICES, NAMELY, CONDUCTING CLASSES, SEMINARS, CONFERENCES, WORKSHOPS AND TUTORIALS PROVIDED IN PERSON AND REMOTELY BY DIGITAL INFORMATION TRANSMISSION TECHNOLOGY, REMOTE COMPUTER ACCESS OR DOWNLOADED TO A PERSONAL COMPUTER, IN THE FIELD OF PERSONAL AND PROFESSIONAL INFORMATION MANAGEMENT TECHNIQUES INCLUDING STRATEGIES FOR IMPROVING PRODUCTIVITY AND EFFICIENCY IN MESSAGING, COMMUNICATION, MEETINGS, INFORMATION STORAGE AND RETRIEVAL, AND WORKFLOW (U.S. CLS. 100, 101 AND 107).

FIRST USE 6-15-2008; IN COMMERCE 9-3-2008.

WILLIAM VERHOSEK, EXAMINING ATTORNEY

SN 85-079,688. KLEAN KANTEEN, INC., CHICO, CA. FILED 7-7-2010.

# BYOS

THE MARK CONSISTS OF STANDARD CHARACTERS WITHOUT CLAIM TO ANY PARTICULAR FONT, STYLE, SIZE, OR COLOR.

#### **CLASS 21—HOUSEWARES AND GLASS**

FOR REUSABLE STAINLESS STEEL BEVERAGE CONTAINERS SOLD EMPTY (U.S. CLS. 2, 13, 23, 29, 30, 33, 40 AND 50).

#### **CLASS 35—ADVERTISING AND BUSINESS**

FOR PROMOTING PUBLIC AWARENESS OF ENVIRONMENTAL ISSUES, ENVIRONMENTAL SUSTAINABILITY AND HEALTH-RELATED ISSUES THROUGH SPONSORSHIP OF ENTERTAINMENT, SPORTING AND CULTURAL EVENTS (U.S. CLS. 100, 101 AND 102).

TEJBIR SINGH, EXAMINING ATTORNEY

SN 85-081,760. SCOTT CONANT MANAGEMENT LLC, NEW YORK, NY. FILED 7-9-2010.

SN 85-081,779. SCOTT CONANT MANAGEMENT LLC, NEW YORK, NY. FILED 7-9-2010.



NO CLAIM IS MADE TO THE EXCLUSIVE RIGHT TO USE "D.O.C.G." AND "ENOTECA" AND "ESPRESSO VINO PIZZA PASTA PANINI DOLCI" FOR INTERNATIONAL CLASSES 35 AND 43, APART FROM THE MARK AS SHOWN.

THE COLOR(S) RED IS/ARE CLAIMED AS A FEATURE OF THE MARK.

THE MARK CONSISTS OF A DEPICTION OF A MAN AND A WOMAN RIDING ON A MOTOR SCOOTER WITH THE LETTERS "D.O.C.G." SEPARATED BY PERIODS OVER THE WORD "ENOTECA" BOTH DEPICTED IN CAPITAL LETTERS IN AN ARC SHAPE AND LOCATED ABOVE THE SCOOTER DESIGN AND THE WORDS "ESPRESSO VINO PIZZA PASTA PANINI DOLCI" DEPICTED WITH THE FIRST LETTER OF EACH WORD CAPITALIZED AND LOCATED BELOW THE SCOOTER DESIGN ALL OF WHICH IS RED.

THE ENGLISH TRANSLATION OF "ENOTECA" IN THE MARK IS "WINE SHOP"; THE ENGLISH TRANSLATION OF "VINO" IS "WINE"; THE ENGLISH TRANSLATION OF "DOLCI" IS "SWEETS".

#### CLASS 8—HAND TOOLS

FOR FLATWARE, NAMELY, FORKS, KNIVES AND SPOONS (U.S. CLS. 23, 28 AND 44).

#### CLASS 21—HOUSEWARES AND GLASS

FOR DINNERWARE, NAMELY, DISHES, CUPS, SAUCERS, BOWLS, COFFEE CUPS, TEA CUPS, MUGS, DEMITASSE CUPS AND SAUCERS, DRINKING GLASSES; BEVERAGeware; BEVERAGE GLASSWARE; STEMWARE; SERVINGWARE FOR SERVING FOOD AND DRINKS; SERVING FORKS AND SERVING SPOONS (U.S. CLS. 2, 13, 23, 29, 30, 33, 40 AND 50).

#### CLASS 35—ADVERTISING AND BUSINESS

FOR RESTAURANT FRANCHISING, NAMELY, OFFERING BUSINESS MANAGEMENT ASSISTANCE IN THE ESTABLISHMENT AND/OR OPERATION OF RESTAURANTS (U.S. CLS. 100, 101 AND 102).

#### CLASS 43—HOTEL AND RESTAURANT SERVICES

FOR RESTAURANT AND WINE BAR SERVICES (U.S. CLS. 100 AND 101).  
MARY CRAWFORD, EXAMINING ATTORNEY

NO CLAIM IS MADE TO THE EXCLUSIVE RIGHT TO USE "D.O.C.G." AND "ENOTECA" AND "ESPRESSO VINO PIZZA PASTA PANINI DOLCI" FOR INTERNATIONAL CLASSES 35 AND 43, APART FROM THE MARK AS SHOWN.

THE COLOR(S) RED AND WHITE IS/ARE CLAIMED AS A FEATURE OF THE MARK.

THE MARK CONSISTS OF A DEPICTION OF MAN WEARING A CAP AND A WOMAN WEARING A LONG SCARF RIDING ON A MOTOR SCOOTER WITH THE LETTERS "D.O.C.G." SEPARATED BY PERIODS OVER THE WORD "ENOTECA" BOTH DEPICTED IN CAPITAL LETTERS AND LOCATED TO THE RIGHT OF THE SCOOTER DESIGN ALL OF WHICH IS RED AND THE WORDS "ESPRESSO VINO PIZZA PASTA PANINI DOLCI" DEPICTED IN WHITE WITH THE FIRST LETTER OF EACH WORD CAPITALIZED AND LOCATED WITHIN THE WOMAN'S SCARF.

THE ENGLISH TRANSLATION OF "ENOTECA" IN THE MARK IS "WINE SHOP"; THE ENGLISH TRANSLATION OF "VINO" IS "WINE"; THE ENGLISH TRANSLATION OF "DOLCI" IS "SWEETS".

#### CLASS 8—HAND TOOLS

FOR FLATWARE, NAMELY, FORKS, KNIVES AND SPOONS (U.S. CLS. 23, 28 AND 44).

#### CLASS 21—HOUSEWARES AND GLASS

FOR DINNERWARE, NAMELY, DISHES, CUPS, SAUCERS, BOWLS, COFFEE CUPS, TEA CUPS, MUGS, DEMITASSE CUPS AND SAUCERS, DRINKING GLASSES; BEVERAGeware; BEVERAGE GLASSWARE; STEMWARE; SERVINGWARE FOR SERVING FOOD AND DRINKS; SERVING FORKS AND SERVING SPOONS (U.S. CLS. 2, 13, 23, 29, 30, 33, 40 AND 50).

#### CLASS 35—ADVERTISING AND BUSINESS

FOR RESTAURANT FRANCHISING, NAMELY, OFFERING BUSINESS MANAGEMENT ASSISTANCE IN THE ESTABLISHMENT AND/OR OPERATION OF RESTAURANTS (U.S. CLS. 100, 101 AND 102).

#### CLASS 43—HOTEL AND RESTAURANT SERVICES

FOR RESTAURANT AND WINE BAR SERVICES (U.S. CLS. 100 AND 101).  
MARY CRAWFORD, EXAMINING ATTORNEY

SN 85-086,954. FRANK RUSSELL COMPANY, SEATTLE, WA. FILED 7-16-2010.

## RUSSELL Investment Discipline ETFs

THE MARK CONSISTS OF STANDARD CHARACTERS WITHOUT CLAIM TO ANY PARTICULAR FONT, STYLE, SIZE, OR COLOR.

OWNER OF U.S. REG. NOS. 1,576,348, 3,792,722 AND OTHERS.

NO CLAIM IS MADE TO THE EXCLUSIVE RIGHT TO USE "INVESTMENT DISCIPLINE ETF'S", APART FROM THE MARK AS SHOWN.

### CLASS 9—ELECTRICAL AND SCIENTIFIC APPARATUS

FOR DOWNLOADABLE ELECTRONIC PUBLICATIONS, NAMELY, PROSPECTUSES, FACTSHEETS, FINANCIAL REPORTS, FINANCIAL BOOKLETS, FINANCIAL NEWSLETTERS, AND FINANCIAL BROCHURES, ALL IN THE FINANCIAL AND INVESTMENT FIELDS; DOWNLOADABLE ELECTRONIC PUBLICATIONS, NAMELY, LISTINGS OF INVESTMENT SECURITIES AND AN INDEX BASED ON SECURITIES VALUES; DOWNLOADABLE ELECTRONIC DATA FILES RELATING TO AN INDEX OF SECURITIES VALUES; DOWNLOADABLE ELECTRONIC PUBLICATIONS, NAMELY, LISTINGS OF SECURITIES WITHIN AN EXCHANGE TRADED FUND AND RELATED METRICS; DOWNLOADABLE ELECTRONIC DATA FILES RELATING TO AN EXCHANGE TRADED FUND AND RELATED METRICS (U.S. CLS. 21, 23, 26, 36 AND 38).

### CLASS 16—PAPER GOODS AND PRINTED MATTER

FOR PRINTED FINANCIAL PUBLICATIONS NAMELY, PROSPECTUSES, FACTSHEETS, FINANCIAL REPORTS, FINANCIAL BOOKLETS, FINANCIAL NEWSLETTERS, FINANCIAL BROCHURES, AND FINANCIAL BOOKS, ALL IN THE FINANCIAL AND INVESTMENT FIELDS; PRINTED MATERIALS, NAMELY, PRINTED LISTINGS OF INVESTMENT SECURITIES AND AN INDEX BASED ON SECURITIES VALUES; PRINTED PUBLICATIONS IN THE NATURE OF LISTINGS OF SECURITIES WITHIN AND EXCHANGE TRADED FUND PORTFOLIOS AND RELATED METRICS (U.S. CLS. 2, 5, 22, 23, 29, 37, 38 AND 50).

### CLASS 36—INSURANCE AND FINANCIAL

FOR FINANCIAL SERVICES IN THE NATURE OF AN INVESTMENT SECURITY; FINANCIAL CONSULTING; TRUST, FIDUCIARY AND INVESTMENT MANAGEMENT SERVICES; INVESTMENT FUND ADMINISTRATION SERVICES; PROVIDING FINANCIAL INFORMATION BY ELECTRONIC MEANS; PROVIDING AND UPDATING INFORMATION RELATING TO AN INDEX OF SECURITIES VALUES FOR OTHERS AND PROVIDING RULES AS TO THE MAKEUP OF THE INDEX; PROVIDING AND UPDATING INFORMATION RELATING TO PORTFOLIOS OF SECURITIES AND RELATED METRICS (U.S. CLS. 100, 101 AND 102).

### CLASS 41—EDUCATION AND ENTERTAINMENT

FOR EDUCATIONAL SERVICES, NAMELY, CONDUCTING CLASSES, CONFERENCES, TELECONFERENCES, SEMINARS, WORKSHOPS AND TUTORIAL SESSIONS, ALL IN THE FINANCIAL AND INVESTMENT FIELDS (U.S. CLS. 100, 101 AND 107).

### CLASS 42—SCIENTIFIC AND COMPUTER SERVICES

FOR PROVIDING ONLINE NON-DOWNLOADABLE SOFTWARE FOR FINANCIAL ANALYSIS AND MEASUREMENT AND FOR GRAPHICAL PRESENTATION, ALL IN THE FINANCIAL AND INVESTMENT FIELD (U.S. CLS. 100 AND 101).

JANICE L. MCMORROW, EXAMINING ATTORNEY

SN 85-087,882. KYOCERA SOLAR, INC., SCOTTSDALE, AZ. FILED 7-19-2010.

## SUNLIGHT TO ELECTRICITY

THE MARK CONSISTS OF STANDARD CHARACTERS WITHOUT CLAIM TO ANY PARTICULAR FONT, STYLE, SIZE, OR COLOR.

NO CLAIM IS MADE TO THE EXCLUSIVE RIGHT TO USE "ELECTRICITY", APART FROM THE MARK AS SHOWN.

### CLASS 7—MACHINERY

FOR SOLAR POWERED ELECTRICITY GENERATORS; SOLAR WATER PUMPS FOR USE IN IRRIGATION; SOLAR POWERED ELECTRIC SYSTEMS COMPRISED OF SOLAR POWERED ELECTRICITY GENERATORS, SOLAR CELLS, SOLAR COLLECTORS, SOLAR HEAT COLLECTION PANELS AND SOLAR POWERED ELECTRICITY GENERATORS (U.S. CLS. 13, 19, 21, 23, 31, 34 AND 35).

### CLASS 9—ELECTRICAL AND SCIENTIFIC APPARATUS

FOR SOLAR CELLS; PHOTOVOLTAIC CELLS (U.S. CLS. 21, 23, 26, 36 AND 38).

### CLASS 11—ENVIRONMENTAL CONTROL APPARATUS

FOR SOLAR WATER HEATERS; SOLAR LIGHT FIXTURES, NAMELY, INDOOR AND OUTDOOR SOLAR POWERED LIGHTING UNITS AND FIXTURES; SOLAR COLLECTORS; SOLAR HEAT COLLECTION PANELS (U.S. CLS. 13, 21, 23, 31 AND 34).

### CLASS 37—CONSTRUCTION AND REPAIR

FOR INSTALLATION SERVICES FOR SOLAR POWERED ELECTRIC SYSTEMS (U.S. CLS. 100, 103 AND 106).

ANTHONY RINKER, EXAMINING ATTORNEY

SN 85-089,882. COFFEE PARTY USA, WASHINGTON, DC.  
FILED 7-21-2010.

## COFFEE PARTY

THE MARK CONSISTS OF STANDARD CHARACTERS WITHOUT CLAIM TO ANY PARTICULAR FONT, STYLE, SIZE, OR COLOR.

OWNER OF U.S. REG. NO. 3,860,031.

NO CLAIM IS MADE TO THE EXCLUSIVE RIGHT TO USE "PARTY", APART FROM THE MARK AS SHOWN.

### CLASS 35—ADVERTISING AND BUSINESS

FOR ARRANGING AND CONDUCTING SPECIAL EVENTS IN THE FIELD OF POLITICS (U.S. CLS. 100, 101 AND 102).

FIRST USE 3-13-2010; IN COMMERCE 3-13-2010.

### CLASS 41—EDUCATION AND ENTERTAINMENT

FOR ONLINE JOURNALS, NAMELY, BLOGS FEATURING NEWS AND INFORMATION IN THE FIELD OF GOVERNMENT AND POLITICS (U.S. CLS. 100, 101 AND 107).

FIRST USE 3-13-2010; IN COMMERCE 3-13-2010.

CHRISTOPHER BUONGIORNO, EXAMINING ATTORNEY

---

SN 85-090,209. PROJECTIONEERING, LLC, FREDERICK, MD. FILED 7-22-2010.

## POISON

THE MARK CONSISTS OF STANDARD CHARACTERS WITHOUT CLAIM TO ANY PARTICULAR FONT, STYLE, SIZE, OR COLOR.

### CLASS 9—ELECTRICAL AND SCIENTIFIC APPARATUS

FOR COMPUTER SOFTWARE FOR USE IN DATABASE MANAGEMENT AND FOR CREATING AND PROVIDING AN ON-LINE DATABASE OF INFORMATION AND DATA IN THE FIELD OF AGRICULTURE; COMPUTER SOFTWARE FOR CREATING SEARCHABLE DATABASES FOR USE BY RISK ASSESSMENT SOFTWARE SOLUTIONS TO DOCUMENT AND USE PAST NEGATIVE EVENTS TO DETECT AND IDENTIFY WARNING SIGNALS ASSOCIATED WITH PAST NEGATIVE EVENTS, PROJECT POSSIBLE FUTURE NEGATIVE EVENTS BASED ON THE DETECTED AND IDENTIFIED WARNING SIGNALS, PREVENT THE OCCURRENCE OF AND/OR MITIGATE THE EFFECTS OF FUTURE NEGATIVE EVENTS, PROVIDE ALERTS OF POSSIBLE OR ACTUAL NEGATIVE EVENTS, AND PROVIDE EVENT-SPECIFIC RESPONSE GUIDELINES; ELECTRONIC DATABASE IN THE FIELD OF AGRICULTURE RECORDED ON COMPUTER MEDIA (U.S. CLS. 21, 23, 26, 36 AND 38).

### CLASS 16—PAPER GOODS AND PRINTED MATTER

FOR PRINTED REPORTS FEATURING EVENT-SPECIFIC RESPONSE GUIDELINES IN THE FIELDS OF AGRICULTURE, TRANSPORTATION, ENERGY, ENVIRONMENT, COMMUNICATIONS, BANKING, FINANCE, PUBLIC SAFETY, GOVERNMENT AND COMMERCIAL PROPERTY, EDUCATION, HEALTHCARE, GOVERNMENT PROCUREMENT, GOVERNMENT INTELLIGENCE, INFORMATION TECHNOLOGY, PHARMACEUTICALS, AND BIOLOGICAL AND MEDICAL RESEARCH INCLUDING INFORMATION REGARDING ACCIDENTS, EQUIPMENT MALFUNCTIONS AND INTENTIONAL ATTACKS (U.S. CLS. 2, 5, 22, 23, 29, 37, 38 AND 50).

### CLASS 35—ADVERTISING AND BUSINESS

FOR COLLECTION, COMPILATION, SYSTEMATIZATION AND UPDATING OF INFORMATION INTO AND MANAGEMENT OF COMPUTER DATABASES (U.S. CLS. 100, 101 AND 102).

### CLASS 42—SCIENTIFIC AND COMPUTER SERVICES

FOR PROVIDING ON-LINE NON-DOWNLOADABLE SOFTWARE FOR USE IN DATABASE MANAGEMENT AND FOR CREATING AND PROVIDING AN ON-LINE DATABASE OF INFORMATION AND DATA IN THE FIELD OF AGRICULTURE; PROVIDING A WEBSITE FEATURING NON-DOWNLOADABLE SOFTWARE FOR USE IN DATABASE MANAGEMENT AND FOR CREATING AND PROVIDING AN ON-LINE DATABASE OF INFORMATION AND DATA IN THE FIELD OF AGRICULTURE; DEVELOPING CUSTOMIZED SOFTWARE FOR OTHERS FOR USE IN RISK ASSESSMENT, MITIGATION AND RESPONSE OPERATIONS TO MONITOR THE PERFORMANCE OF IDENTIFIED CRITICAL OPERATIONS, ANTICIPATE AND PREVENT ACCIDENTS, EQUIPMENT MALFUNCTIONS AND INTENTIONAL ATTACKS, AND PROVIDE EVENT-SPECIFIC RESPONSE GUIDELINES; PROVIDING A WEBSITE FEATURING TEMPORARY USE OF NON-DOWNLOADABLE SOFTWARE FOR GENERATING EVENT-SPECIFIC RESPONSES FOR ANY ACCIDENTS, EQUIPMENT MALFUNCTIONS AND INTENTIONAL ATTACKS (U.S. CLS. 100 AND 101).

### CLASS 44—MEDICAL, BEAUTY AND AGRICULTURAL SERVICES

FOR PROVIDING A SECURED ACCESS DATABASE VIA THE INTERNET IN THE FIELDS OF AGRICULTURE AND AGRICULTURE INFORMATION FOR USE IN IDENTIFYING CRITICAL AGRICULTURE OPERATIONS (U.S. CLS. 100 AND 101).

### CLASS 45—PERSONAL AND LEGAL SERVICES

FOR SECURITY SERVICES, NAMELY, THREAT SIMULATION VULNERABILITY ANALYSIS AND MITIGATION AND EMERGENCY AND CRISIS RESPONSE; PROVIDING CONSULTATION AND INFORMATION IN THE FIELD OF EMERGENCY RESPONSE FOR GOVERNMENT ENTITIES, INDUSTRY AND RESEARCH INSTITUTIONS (U.S. CLS. 100 AND 101).

DEZMONA MIZELLE, EXAMINING ATTORNEY



SN 85-090,216. PROJECTIONEERING, LLC, FREDERICK, MD. FILED 7-22-2010.

# PAT

THE MARK CONSISTS OF STANDARD CHARACTERS WITHOUT CLAIM TO ANY PARTICULAR FONT, STYLE, SIZE, OR COLOR.

## CLASS 9—ELECTRICAL AND SCIENTIFIC APPARATUS

FOR COMPUTER SOFTWARE FOR USE IN DATABASE MANAGEMENT AND FOR CREATING AND PROVIDING AN ON-LINE DATABASE OF INFORMATION AND DATA IN THE FIELD OF AGRICULTURE; COMPUTER SOFTWARE FOR CREATING SEARCHABLE DATABASES FOR USE BY RISK ASSESSMENT SOFTWARE SOLUTIONS TO DOCUMENT AND USE PAST NEGATIVE EVENTS TO DETECT AND IDENTIFY WARNING SIGNALS ASSOCIATED WITH PAST NEGATIVE EVENTS, PROJECT POSSIBLE FUTURE NEGATIVE EVENTS BASED ON THE DETECTED AND IDENTIFIED WARNING SIGNALS, PREVENT THE OCCURRENCE OF AND/OR MITIGATE THE EFFECTS OF FUTURE NEGATIVE EVENTS, PROVIDE ALERTS OF POSSIBLE OR ACTUAL NEGATIVE EVENTS, AND PROVIDE EVENT-SPECIFIC RESPONSE GUIDELINES; ELECTRONIC DATABASE IN THE FIELD OF AGRICULTURE RECORDED ON COMPUTER MEDIA (U.S. CLS. 21, 23, 26, 36 AND 38).

## CLASS 16—PAPER GOODS AND PRINTED MATTER

FOR PRINTED REPORTS FEATURING EVENT-SPECIFIC RESPONSE GUIDELINES IN THE FIELD OF AGRICULTURE INCLUDING INFORMATION REGARDING ACCIDENTS, EQUIPMENT MALFUNCTIONS AND INTENTIONAL ATTACKS (U.S. CLS. 2, 5, 22, 23, 29, 37, 38 AND 50).

## CLASS 35—ADVERTISING AND BUSINESS

FOR COLLECTION, COMPILATION, SYSTEMATIZATION AND UPDATING OF INFORMATION INTO AND MANAGEMENT OF COMPUTER DATABASES (U.S. CLS. 100, 101 AND 102).

## CLASS 42—SCIENTIFIC AND COMPUTER SERVICES

FOR PROVIDING ON-LINE NON-DOWNLOADABLE SOFTWARE FOR USE IN DATABASE MANAGEMENT AND FOR CREATING AND PROVIDING AN ON-LINE DATABASE OF INFORMATION AND DATA IN THE FIELD OF AGRICULTURE; PROVIDING A WEBSITE FEATURING NON-DOWNLOADABLE SOFTWARE FOR USE IN DATABASE MANAGEMENT AND FOR CREATING AND PROVIDING AN ON-LINE DATABASE OF INFORMATION AND DATA IN THE FIELD OF AGRICULTURE; DEVELOPING CUSTOMIZED SOFTWARE FOR OTHERS FOR USE IN RISK ASSESSMENT, MITIGATION AND RESPONSE OPERATIONS TO MONITOR THE PERFORMANCE OF IDENTIFIED CRITICAL OPERATIONS, ANTICIPATE AND PREVENT ACCIDENTS, EQUIPMENT MALFUNCTIONS AND INTENTIONAL ATTACKS, AND PROVIDE EVENT-SPECIFIC RESPONSE GUIDELINES; PROVIDING A WEBSITE FEATURING TEMPORARY USE OF NON-DOWNLOADABLE SOFTWARE FOR GENERATING EVENT-SPECIFIC RESPONSES FOR ANY ACCIDENTS, EQUIPMENT MALFUNCTIONS AND INTENTIONAL ATTACKS (U.S. CLS. 100 AND 101).

## CLASS 44—MEDICAL, BEAUTY AND AGRICULTURAL SERVICES

FOR PROVIDING A SECURED ACCESS DATABASE VIA THE INTERNET IN THE FIELDS OF AGRICULTURE AND AGRICULTURE INFORMATION FOR USE IN IDENTIFYING CRITICAL AGRICULTURE OPERATIONS (U.S. CLS. 100 AND 101).

## CLASS 45—PERSONAL AND LEGAL SERVICES

FOR SECURITY SERVICES, NAMELY, THREAT SIMULATION VULNERABILITY ANALYSIS AND MITIGATION AND EMERGENCY AND CRISIS RESPONSE; PROVIDING CONSULTATION AND INFORMATION IN THE FIELD OF EMERGENCY RESPONSE FOR GOVERNMENT ENTITIES AND INDUSTRY (U.S. CLS. 100 AND 101).

DEZMONA MIZELLE, EXAMINING ATTORNEY

---

SN 85-090,217. PROJECTIONEERING, LLC, FREDERICK, MD. FILED 7-22-2010.

# FDAT

THE MARK CONSISTS OF STANDARD CHARACTERS WITHOUT CLAIM TO ANY PARTICULAR FONT, STYLE, SIZE, OR COLOR.

## CLASS 9—ELECTRICAL AND SCIENTIFIC APPARATUS

FOR COMPUTER SOFTWARE FOR USE IN DATABASE MANAGEMENT AND FOR CREATING AND PROVIDING AN ON-LINE DATABASE OF INFORMATION AND DATA IN THE FIELD OF AGRICULTURE; COMPUTER SOFTWARE FOR CREATING SEARCHABLE DATABASES FOR USE BY RISK ASSESSMENT SOFTWARE SOLUTIONS TO DOCUMENT AND USE PAST NEGATIVE EVENTS TO DETECT AND IDENTIFY WARNING SIGNALS ASSOCIATED WITH PAST NEGATIVE EVENTS, PROJECT POSSIBLE FUTURE NEGATIVE EVENTS BASED ON THE DETECTED AND IDENTIFIED WARNING SIGNALS, PREVENT THE OCCURRENCE OF AND/OR MITIGATE THE EFFECTS OF FUTURE NEGATIVE EVENTS, PROVIDE ALERTS OF POSSIBLE OR ACTUAL NEGATIVE EVENTS, AND PROVIDE EVENT-SPECIFIC RESPONSE GUIDELINES; ELECTRONIC DATABASE IN THE FIELD OF AGRICULTURE RECORDED ON COMPUTER MEDIA (U.S. CLS. 21, 23, 26, 36 AND 38).

## CLASS 16—PAPER GOODS AND PRINTED MATTER

FOR PRINTED REPORTS FEATURING EVENT-SPECIFIC RESPONSE GUIDELINES IN THE FIELD OF AGRICULTURE INCLUDING INFORMATION REGARDING ACCIDENTS, EQUIPMENT MALFUNCTIONS AND INTENTIONAL ATTACKS (U.S. CLS. 2, 5, 22, 23, 29, 37, 38 AND 50).

## CLASS 35—ADVERTISING AND BUSINESS

FOR COLLECTION, COMPILATION, SYSTEMATIZATION AND UPDATING OF INFORMATION INTO AND MANAGEMENT OF COMPUTER DATABASES (U.S. CLS. 100, 101 AND 102).

**CLASS 42—SCIENTIFIC AND COMPUTER SERVICES**

FOR PROVIDING ON-LINE NON-DOWNLOADABLE SOFTWARE FOR USE IN DATABASE MANAGEMENT AND FOR CREATING AND PROVIDING AN ON-LINE DATABASE OF INFORMATION AND DATA IN THE FIELD OF AGRICULTURE; PROVIDING A WEBSITE FEATURING NON-DOWNLOADABLE SOFTWARE FOR USE IN DATABASE MANAGEMENT AND FOR CREATING AND PROVIDING AN ON-LINE DATABASE OF INFORMATION AND DATA IN THE FIELD OF AGRICULTURE; DEVELOPING CUSTOMIZED SOFTWARE FOR OTHERS FOR USE IN RISK ASSESSMENT, MITIGATION AND RESPONSE OPERATIONS TO MONITOR THE PERFORMANCE OF IDENTIFIED CRITICAL OPERATIONS, ANTICIPATE AND PREVENT ACCIDENTS, EQUIPMENT MALFUNCTIONS AND INTENTIONAL ATTACKS, AND PROVIDE EVENT-SPECIFIC RESPONSE GUIDELINES; PROVIDING A WEBSITE FEATURING TEMPORARY USE OF NON-DOWNLOADABLE SOFTWARE FOR GENERATING EVENT-SPECIFIC RESPONSES FOR ANY ACCIDENTS, EQUIPMENT MALFUNCTIONS AND INTENTIONAL ATTACKS (U.S. CLS. 100 AND 101).

**CLASS 44—MEDICAL, BEAUTY AND AGRICULTURAL SERVICES**

FOR PROVIDING A SECURED ACCESS DATABASE VIA THE INTERNET IN THE FIELDS OF AGRICULTURE AND AGRICULTURE INFORMATION FOR USE IN IDENTIFYING CRITICAL AGRICULTURE OPERATIONS (U.S. CLS. 100 AND 101).

**CLASS 45—PERSONAL AND LEGAL SERVICES**

FOR SECURITY SERVICES, NAMELY, THREAT SIMULATION VULNERABILITY ANALYSIS AND MITIGATION AND EMERGENCY AND CRISIS RESPONSE; PROVIDING CONSULTATION AND INFORMATION IN THE FIELD OF EMERGENCY RESPONSE FOR GOVERNMENT ENTITIES AND INDUSTRY (U.S. CLS. 100 AND 101).

DEZMONA MIZELLE, EXAMINING ATTORNEY

---

SN 85-090,220. PROJECTIONEERING, LLC, FREDERICK, MD. FILED 7-22-2010.

**FEAST**

THE MARK CONSISTS OF STANDARD CHARACTERS WITHOUT CLAIM TO ANY PARTICULAR FONT, STYLE, SIZE, OR COLOR.

**CLASS 9—ELECTRICAL AND SCIENTIFIC APPARATUS**

FOR COMPUTER SOFTWARE FOR USE IN DATABASE MANAGEMENT AND FOR CREATING AND PROVIDING AN ON-LINE DATABASE OF INFORMATION AND DATA IN THE FIELD OF AGRICULTURE; COMPUTER SOFTWARE FOR CREATING SEARCHABLE DATABASES FOR USE BY RISK ASSESSMENT SOFTWARE SOLUTIONS TO DOCUMENT AND USE PAST NEGATIVE EVENTS TO DETECT AND IDENTIFY WARNING SIGNALS ASSOCIATED WITH PAST NEGATIVE EVENTS, PROJECT POSSIBLE FUTURE NEGATIVE EVENTS BASED ON THE DETECTED AND IDENTIFIED WARNING SIGNALS, PREVENT THE OCCURRENCE OF AND/OR MITIGATE THE EFFECTS OF FUTURE NEGATIVE EVENTS, PROVIDE ALERTS OF POSSIBLE OR ACTUAL NEGATIVE EVENTS, AND PROVIDE EVENT-SPECIFIC RESPONSE GUIDELINES; ELECTRONIC DATABASE IN THE FIELD OF AGRICULTURE RECORDED ON COMPUTER MEDIA (U.S. CLS. 21, 23, 26, 36 AND 38).

**CLASS 16—PAPER GOODS AND PRINTED MATTER**

FOR PRINTED REPORTS FEATURING EVENT-SPECIFIC RESPONSE GUIDELINES IN THE FIELD OF AGRICULTURE INCLUDING INFORMATION REGARDING ACCIDENTS, EQUIPMENT MALFUNCTIONS AND INTENTIONAL ATTACKS (U.S. CLS. 2, 5, 22, 23, 29, 37, 38 AND 50).

**CLASS 35—ADVERTISING AND BUSINESS**

FOR COLLECTION, COMPILATION, SYSTEMATIZATION AND UPDATING OF INFORMATION INTO AND MANAGEMENT OF COMPUTER DATABASES (U.S. CLS. 100, 101 AND 102).

**CLASS 42—SCIENTIFIC AND COMPUTER SERVICES**

FOR PROVIDING ON-LINE NON-DOWNLOADABLE SOFTWARE FOR USE IN DATABASE MANAGEMENT AND FOR CREATING AND PROVIDING AN ON-LINE DATABASE OF INFORMATION AND DATA IN THE FIELD OF AGRICULTURE; PROVIDING A WEBSITE FEATURING NON-DOWNLOADABLE SOFTWARE FOR USE IN DATABASE MANAGEMENT AND FOR CREATING AND PROVIDING AN ON-LINE DATABASE OF INFORMATION AND DATA IN THE FIELD OF AGRICULTURE; DEVELOPING CUSTOMIZED SOFTWARE FOR OTHERS FOR USE IN RISK ASSESSMENT, MITIGATION AND RESPONSE OPERATIONS TO MONITOR THE PERFORMANCE OF IDENTIFIED CRITICAL OPERATIONS, ANTICIPATE AND PREVENT ACCIDENTS, EQUIPMENT MALFUNCTIONS AND INTENTIONAL ATTACKS, AND PROVIDE EVENT-SPECIFIC RESPONSE GUIDELINES; PROVIDING A WEBSITE FEATURING TEMPORARY USE OF NON-DOWNLOADABLE SOFTWARE FOR GENERATING EVENT-SPECIFIC RESPONSES FOR ANY ACCIDENTS, EQUIPMENT MALFUNCTIONS AND INTENTIONAL ATTACKS (U.S. CLS. 100 AND 101).

**CLASS 44—MEDICAL, BEAUTY AND AGRICULTURAL SERVICES**

FOR PROVIDING A SECURED ACCESS DATABASE VIA THE INTERNET IN THE FIELDS OF AGRICULTURE AND AGRICULTURE INFORMATION FOR USE IN IDENTIFYING CRITICAL AGRICULTURE OPERATIONS (U.S. CLS. 100 AND 101).

**CLASS 45—PERSONAL AND LEGAL SERVICES**

FOR SECURITY SERVICES, NAMELY, THREAT SIMULATION VULNERABILITY ANALYSIS AND MITIGATION AND EMERGENCY AND CRISIS RESPONSE; PROVIDING CONSULTATION AND INFORMATION IN THE FIELD OF EMERGENCY RESPONSE FOR GOVERNMENT ENTITIES AND INDUSTRY (U.S. CLS. 100 AND 101).

DEZMONA MIZELLE, EXAMINING ATTORNEY

---

SN 85-090,222. PROJECTIONEERING, LLC, FREDERICK, MD. FILED 7-22-2010.

**FREE**

THE MARK CONSISTS OF STANDARD CHARACTERS WITHOUT CLAIM TO ANY PARTICULAR FONT, STYLE, SIZE, OR COLOR.

**CLASS 9—ELECTRICAL AND SCIENTIFIC APPARATUS**

FOR COMPUTER SOFTWARE FOR USE IN DATABASE MANAGEMENT AND FOR CREATING AND PROVIDING AN ON-LINE DATABASE OF INFORMATION AND DATA IN THE FIELD OF AGRICULTURE; COMPUTER SOFTWARE FOR CREATING SEARCHABLE DATABASES FOR USE BY RISK ASSESSMENT SOFTWARE SOLUTIONS TO DOCUMENT AND USE PAST NEGATIVE EVENTS TO DETECT AND IDENTIFY WARNING SIGNALS ASSOCIATED WITH PAST NEGATIVE EVENTS, PROJECT POSSIBLE FUTURE NEGATIVE EVENTS BASED ON THE DETECTED AND IDENTIFIED WARNING SIGNALS, PREVENT THE OCCURRENCE OF AND/OR MITIGATE THE EFFECTS OF FUTURE NEGATIVE EVENTS, PROVIDE ALERTS OF POSSIBLE OR ACTUAL NEGATIVE EVENTS, AND PROVIDE EVENT-SPECIFIC RESPONSE GUIDELINES; ELECTRONIC DATABASE IN THE FIELD OF AGRICULTURE RECORDED ON COMPUTER MEDIA (U.S. CLS. 21, 23, 26, 36 AND 38).

**CLASS 16—PAPER GOODS AND PRINTED MATTER**

FOR PRINTED REPORTS FEATURING EVENT-SPECIFIC RESPONSE GUIDELINES IN THE FIELD OF AGRICULTURE INCLUDING INFORMATION REGARDING ACCIDENTS, EQUIPMENT MALFUNCTIONS AND INTENTIONAL ATTACKS (U.S. CLS. 2, 5, 22, 23, 29, 37, 38 AND 50).

**CLASS 35—ADVERTISING AND BUSINESS**

FOR COLLECTION, COMPILATION, SYSTEMATIZATION AND UPDATING OF INFORMATION INTO AND MANAGEMENT OF COMPUTER DATABASES (U.S. CLS. 100, 101 AND 102).

**CLASS 42—SCIENTIFIC AND COMPUTER SERVICES**

FOR PROVIDING ON-LINE NON-DOWNLOADABLE SOFTWARE FOR USE IN DATABASE MANAGEMENT AND FOR CREATING AND PROVIDING AN ON-LINE DATABASE OF INFORMATION AND DATA IN THE FIELD OF AGRICULTURE; PROVIDING A WEBSITE FEATURING NON-DOWNLOADABLE SOFTWARE FOR USE IN DATABASE MANAGEMENT AND FOR CREATING AND PROVIDING AN ON-LINE DATABASE OF INFORMATION AND DATA IN THE FIELD OF AGRICULTURE; DEVELOPING CUSTOMIZED SOFTWARE FOR OTHERS FOR USE IN RISK ASSESSMENT, MITIGATION AND RESPONSE OPERATIONS TO MONITOR THE PERFORMANCE OF IDENTIFIED CRITICAL OPERATIONS, ANTICIPATE AND PREVENT ACCIDENTS, EQUIPMENT MALFUNCTIONS AND INTENTIONAL ATTACKS, AND PROVIDE EVENT-SPECIFIC RESPONSE GUIDELINES; PROVIDING A WEBSITE FEATURING TEMPORARY USE OF NON-DOWNLOADABLE SOFTWARE FOR GENERATING EVENT-SPECIFIC RESPONSES FOR ANY ACCIDENTS, EQUIPMENT MALFUNCTIONS AND INTENTIONAL ATTACKS (U.S. CLS. 100 AND 101).

**CLASS 44—MEDICAL, BEAUTY AND AGRICULTURAL SERVICES**

FOR PROVIDING A SECURED ACCESS DATABASE VIA THE INTERNET IN THE FIELDS OF AGRICULTURE AND AGRICULTURE INFORMATION FOR USE IN IDENTIFYING CRITICAL AGRICULTURE OPERATIONS (U.S. CLS. 100 AND 101).

**CLASS 45—PERSONAL AND LEGAL SERVICES**

FOR SECURITY SERVICES, NAMELY, THREAT SIMULATION VULNERABILITY ANALYSIS AND MITIGATION AND EMERGENCY AND CRISIS RESPONSE; PROVIDING CONSULTATION AND INFORMATION IN THE FIELD OF EMERGENCY RESPONSE FOR GOVERNMENT ENTITIES AND INDUSTRY (U.S. CLS. 100 AND 101).

DEZMONA MIZELLE, EXAMINING ATTORNEY

---

SN 85-097,520. CUSTOM LEATHERCRAFT MANUFACTURING CO., INC., SOUTH GATE, CA. FILED 7-31-2010.

**CLIMATE GEAR**

THE MARK CONSISTS OF STANDARD CHARACTERS WITHOUT CLAIM TO ANY PARTICULAR FONT, STYLE, SIZE, OR COLOR.

NO CLAIM IS MADE TO THE EXCLUSIVE RIGHT TO USE "GEAR", APART FROM THE MARK AS SHOWN.

**CLASS 8—HAND TOOLS**

FOR WEATHER RESISTANT APRONS FOR CARRYING TOOLS, WEATHER RESISTANT UTILITY BELTS FOR CARRYING TOOLS, WEATHER RESISTANT SUSPENDERS FOR HOLDING UTILITY TOOL BELTS, WEATHER RESISTANT TOOL HOLDING POUCHES FOR ATTACHMENT TO UTILITY TOOL BELTS (U.S. CLS. 23, 28 AND 44).

**CLASS 9—ELECTRICAL AND SCIENTIFIC APPARATUS**

FOR WEATHER RESISTANT SAFETY EQUIPMENT, NAMELY, PROTECTIVE WORK GLOVES, PROTECTIVE WORK VESTS, WORK PROTECTIVE JUMPSUITS, PROTECTIVE RAINWEAR AND PROTECTIVE KNEEPADS (U.S. CLS. 21, 23, 26, 36 AND 38).

**CLASS 18—LEATHER GOODS**

FOR WEATHER RESISTANT TOOL BAGS AND TOOL CARRYING BAGS, ALL SOLD EMPTY (U.S. CLS. 1, 2, 3, 22 AND 41).

TINA MAI, EXAMINING ATTORNEY

SN 85-097,658. DANCER FLEET, INC., MARTINEZ, GA. FILED 8-1-2010.



OWNER OF U.S. REG. NOS. 3,653,398 AND 3,662,634.

NO CLAIM IS MADE TO THE EXCLUSIVE RIGHT TO USE "FLEET LIVEABOARD", APART FROM THE MARK AS SHOWN.

THE COLOR(S) PURPLE IS/ARE CLAIMED AS A FEATURE OF THE MARK.

THE MARK CONSISTS OF THE WORDS "DANCER FLEET" IN PURPLE SCRIPT, ASCENDING FROM LEFT TO RIGHT, WITH THE WORDS "LIVEABOARD EXCELLENCE" IN PURPLE, APPEARING IN THE LOWER RIGHT-HAND CORNER OF THE MARK DISPLAYED HORIZONTALLY.

SN 85-097,657. DANCER FLEET, INC., MARTINEZ, GA. FILED 8-1-2010.



OWNER OF U.S. REG. NOS. 3,653,398 AND 3,662,634.

NO CLAIM IS MADE TO THE EXCLUSIVE RIGHT TO USE "FLEET LIVEABOARD", APART FROM THE MARK AS SHOWN.

THE COLOR(S) PURPLE, BLUE, YELLOW, RED AND WHITE IS/ARE CLAIMED AS A FEATURE OF THE MARK.

THE MARK CONSISTS OF A DESIGN COMPRISED OF PURPLE SILHOUETTES OF TWO AQUATIC DIVERS APPEARING ON EITHER SIDE OF A PURPLE AND WHITE CRUISE SHIP WITH A RED AND WHITE FLAG ON A PURPLE FLAG POLE, ALL SUPERIMPOSED UPON A YELLOW AND BLUE OVAL FIELD OF THE EARTH, BORDERED IN PURPLE AND SURROUNDED BY THE PURPLE WORDS "DANCER FLEET LIVE ABOARD EXCELLENCE".

**CLASS 25—CLOTHING**

FOR ATHLETIC APPAREL, NAMELY, SHIRTS, PANTS, JACKETS, FOOTWEAR, HATS AND CAPS, ATHLETIC UNIFORMS (U.S. CLS. 22 AND 39).

FIRST USE 2-1-2010; IN COMMERCE 6-1-2010.

**CLASS 39—TRANSPORTATION AND STORAGE**

FOR CONDUCTING DIVING CHARTERS (U.S. CLS. 100 AND 105).

FIRST USE 2-1-2010; IN COMMERCE 6-1-2010.  
KAELE KUNG, EXAMINING ATTORNEY

**CLASS 25—CLOTHING**

FOR ATHLETIC APPAREL, NAMELY, SHIRTS, PANTS, JACKETS, FOOTWEAR, HATS AND CAPS, ATHLETIC UNIFORMS (U.S. CLS. 22 AND 39).

FIRST USE 2-1-2010; IN COMMERCE 6-1-2010.

**CLASS 39—TRANSPORTATION AND STORAGE**

FOR CONDUCTING DIVING CHARTERS (U.S. CLS. 100 AND 105).

FIRST USE 2-1-2010; IN COMMERCE 6-1-2010.

KAELE KUNG, EXAMINING ATTORNEY

SN 85-098,842. ZENA LICENSES, LLC, LARGO, FL. FILED 8-3-2010.

**JOIN THE HCG DIET REVOLUTION**

THE MARK CONSISTS OF STANDARD CHARACTERS WITHOUT CLAIM TO ANY PARTICULAR FONT, STYLE, SIZE, OR COLOR.

**CLASS 5—PHARMACEUTICALS**

FOR THERAPEUTIC AGENTS CONTAINING HCG OR SPECIFICALLY FOR USE WITH THE HCG DIET FOR WEIGHT CONTROL AND APPETITE SUPPRESSION; HOMEOTHERAPEUTIC AGENTS, NAMELY, HCG (HUMAN CHORIONIC GONADOTROPIN) ORAL SPRAYS FOR WEIGHT LOSS PURPOSES; THERAPEUTIC AGENTS, NAMELY, NUTRITIONAL SUPPLEMENTS AND NUTRITIONAL SUPPLEMENTS FOR ELIMINATING TOXINS FROM THE BODY, FOR TOTAL-BODY WELL-BEING BEFORE, DURING AND AFTER THE HCG DIET (U.S. CLS. 6, 18, 44, 46, 51 AND 52).

FIRST USE 4-1-2010; IN COMMERCE 8-3-2010.

**CLASS 41—EDUCATION AND ENTERTAINMENT**

FOR PROVIDING TRAINING SERVICES IN THE FIELD OF DIETING, WEIGHT LOSS, NUTRITION, HEALTH AND WELLNESS (U.S. CLS. 100, 101 AND 107).

FIRST USE 4-1-2010; IN COMMERCE 8-3-2010.

**CLASS 44—MEDICAL, BEAUTY AND AGRICULTURAL SERVICES**

FOR PROVIDING INFORMATION, NEWS AND COMMENTARY SERVICES IN THE FIELD OF DIETING, WEIGHT LOSS, NUTRITION, HEALTH AND WELLNESS (U.S. CLS. 100 AND 101).

FIRST USE 4-1-2010; IN COMMERCE 8-3-2010.

TARA PATE, EXAMINING ATTORNEY

---

SN 85-099,396. COHERENT, INC., SANTA CLARA, CA. FILED 8-3-2010.

**BEAM DYNAMICS**

THE MARK CONSISTS OF STANDARD CHARACTERS WITHOUT CLAIM TO ANY PARTICULAR FONT, STYLE, SIZE, OR COLOR.

SEC. 2(F) AS TO "BEAM".

**CLASS 7—MACHINERY**

FOR MACHINES AND MACHINE TOOLS FOR THE CUTTING, ETCHING, ENGRAVING AND FORMING OF MATERIALS, AND REPLACEMENT PARTS THEREFOR; LASER MACHINES FOR CUTTING, ETCHING, ENGRAVING AND FORMING OF MATERIALS, AND REPLACEMENT PARTS THEREFOR (U.S. CLS. 13, 19, 21, 23, 31, 34 AND 35).

FIRST USE 0-0-1996; IN COMMERCE 0-0-1996.

**CLASS 9—ELECTRICAL AND SCIENTIFIC APPARATUS**

FOR LASERS FOR INDUSTRIAL USE; COMPUTER CONTROLS FOR THE OPERATION OF MACHINE TOOLS; ELECTRONIC INTERFACE EQUIPMENT FOR MACHINE TOOLS TO INPUT OR OUTPUT CNC (COMPUTER NUMERICAL CONTROL) DATA; INDUSTRIAL PROCESS CONTROL SOFTWARE (U.S. CLS. 21, 23, 26, 36 AND 38).

FIRST USE 0-0-1996; IN COMMERCE 0-0-1996.

GINA FINK, EXAMINING ATTORNEY

---

SN 85-101,258. THE QUILLIAM FOUNDATION LIMITED, LONDON WC1B 4JP, UNITED KINGDOM, FILED 8-5-2010.

**QUILLIAM FOUNDATION**

THE MARK CONSISTS OF STANDARD CHARACTERS WITHOUT CLAIM TO ANY PARTICULAR FONT, STYLE, SIZE, OR COLOR.

OWNER OF ERPN CMNTY TM OFC REG. NO. 007298805, DATED 5-27-2009, EXPIRES 10-8-2018.

NO CLAIM IS MADE TO THE EXCLUSIVE RIGHT TO USE "FOUNDATION", APART FROM THE MARK AS SHOWN.

THE WORDING "QUILLIAM" HAS NO MEANING IN A FOREIGN LANGUAGE.

**CLASS 9—ELECTRICAL AND SCIENTIFIC APPARATUS**

FOR PRE-RECORDED AUDIO-VIDEO RECORDINGS ON THE SUBJECTS OF TOLERANCE, MUSLIM-WESTERN RELATIONS, HUMAN RIGHTS, HISTORICAL, RELIGIOUS AND POLITICAL ISSUES; DOWNLOADABLE ELECTRONIC PUBLICATIONS, NAMELY, BOOKS, MAGAZINES, REPORTS, ARTICLES, SURVEYS, AND NEWSLETTERS IN THE FIELDS OF TOLERANCE, MUSLIM-WESTERN RELATIONS, HUMAN RIGHTS, HISTORICAL, RELIGIOUS AND POLITICAL ISSUES; DOWNLOADABLE TELEVISION PROGRAMS AND FILMS IN THE FIELDS OF TOLERANCE, MUSLIM-WESTERN RELATIONS, HUMAN RIGHTS, HISTORICAL, RELIGIOUS AND POLITICAL ISSUES; DOWNLOADABLE MP3 AND MP4 FILES, MP3 AND MP4 RECORDINGS, ON-LINE DISCUSSION BOARDS, WEBCASTS, WEBINARS AND PODCASTS IN THE FIELDS OF TOLERANCE, MUSLIM-WESTERN RELATIONS, HUMAN RIGHTS, HISTORICAL, RELIGIOUS AND POLITICAL ISSUES; COMPUTER MOUSE PADS; INTERACTIVE GAME PROGRAMS (U.S. CLS. 21, 23, 26, 36 AND 38).

**CLASS 16—PAPER GOODS AND PRINTED MATTER**

FOR BOOKS, JOURNALS, MAGAZINES, BROCHURES, BOOKLETS, REPORTS, NEWSLETTERS, AND STUDY GUIDES IN THE FIELDS OF TOLERANCE, MUSLIM-WESTERN RELATIONS, HUMAN RIGHTS, HISTORICAL, RELIGIOUS AND POLITICAL ISSUES; TRAVEL GUIDES, COLORING BOOKS, ACTIVITY BOOKS FOR CHILDREN, PICTURE BOOKS, SONG BOOKS, PHOTOGRAPH ALBUMS, ADDRESS BOOKS, PHOTOGRAPHS, POSTERS, STICKERS, DECALS, CALENDARS, DIARIES, STATIONERY, WRITING IMPLEMENTS, GIFT WRAPPING PAPER, POST CARDS, GIFT CARDS, GREETING CARDS, ART PRINTS AND REPRODUCTIONS (U.S. CLS. 2, 5, 22, 23, 29, 37, 38 AND 50).

**CLASS 41—EDUCATION AND ENTERTAINMENT**

FOR EDUCATIONAL SERVICES, NAMELY, CONDUCTING SEMINARS, CONFERENCES, SYMPOSIA, WORKSHOPS, COLLOQUIA AND COURSES IN THE FIELDS OF TOLERANCE, MUSLIM-WESTERN RELATIONS, HUMAN RIGHTS, HISTORICAL, RELIGIOUS AND POLITICAL ISSUES, AND DISTRIBUTING EDUCATIONAL MATERIALS THEREWITH; EDUCATIONAL SERVICES, NAMELY, DEVELOPING AND CONDUCTING TRAINING COURSES AND DISTRIBUTING TRAINING MATERIALS IN CONNECTION THEREWITH IN THE FIELDS OF TOLERANCE, MUSLIM-WESTERN RELATIONS, HUMAN RIGHTS, HISTORICAL, RELIGIOUS AND POLITICAL ISSUES; PRODUCTION OF TELEVISION, RADIO, CABLE, AND SATELLITE PROGRAMS AND FILMS; PRODUCTION OF ANIMATED FILMS; PRODUCTION OF VIDEO AND COMPUTER GAME SOFTWARE; PRODUCTION OF AUDIO/VIDEO PRESENTATIONS FOR OTHERS, NAMELY, PRODUCTION OF FILMS, VIDEOS, AND CDS; SCRIPT WRITING; ENTERTAINMENT AND EDUCATION IN THE NATURE OF LIVE PERFORMANCES FEATURING PLAYS, CONCERTS, LECTURES, DRAMATIC READINGS, MUSIC, AND DANCE; ORGANIZING AND ARRANGING EXHIBITIONS FOR CULTURAL OR EDUCATIONAL PURPOSES; BOOK PUBLISHING; ONLINE ELECTRONIC PUBLISHING OF INFORMATION IN THE FIELDS OF TOLERANCE, MUSLIM-WESTERN RELATIONS, HUMAN RIGHTS, HISTORICAL, RELIGIOUS AND POLITICAL ISSUES; ONLINE JOURNALS, NAMELY, BLOGS IN THE FIELDS OF TOLERANCE, MUSLIM-WESTERN RELATIONS, HUMAN RIGHTS, HISTORICAL, RELIGIOUS AND POLITICAL ISSUES (U.S. CLS. 100, 101 AND 107).

STEPHANIE ALI, EXAMINING ATTORNEY

SN 85-112,894. FRANCISCO CADENA GARCIA, SAN LUIS POTOSI, MEXICO, FILED 8-21-2010.

# AMIGO123

THE MARK CONSISTS OF STANDARD CHARACTERS WITHOUT CLAIM TO ANY PARTICULAR FONT, STYLE, SIZE, OR COLOR.

THE ENGLISH TRANSLATION OF "AMIGO" IN THE MARK IS "FRIEND".

## CLASS 35—ADVERTISING AND BUSINESS

FOR BARTER EXCHANGE SERVICES, NAMELY, PROVIDING COMMERCIAL BARTER AND TRADE EXCHANGE OF PRODUCTS AND SERVICES VIA A GLOBAL COMPUTER INFORMATION NETWORK; PROVIDING A USER-SEARCHABLE COMPUTER DATABASE OF GOODS AND SERVICES AVAILABLE FOR EXCHANGE OR BARTER IN AN ONLINE COMMUNITY OF REGISTERED BARTERERS (U.S. CLS. 100, 101 AND 102).

## CLASS 36—INSURANCE AND FINANCIAL

FOR FINANCIAL EXCHANGE SERVICES USED TO PROVIDE A COMMON UNIT OF EXCHANGE FOR ESTABLISHING VALUE OF GOODS AND SERVICES AND FOR TRADING OF GOODS AND SERVICES IN AN ONLINE COMMUNITY OF REGISTERED BARTERERS (U.S. CLS. 100, 101 AND 102).

## CLASS 42—SCIENTIFIC AND COMPUTER SERVICES

FOR COMPUTER SERVICES, NAMELY, CREATING AN ON-LINE COMMUNITY FOR REGISTERED USERS TO ENGAGE IN BARTERING AMONG THEMSELVES FOR GOODS AND SERVICES (U.S. CLS. 100 AND 101).  
ELLEN B. AWRICH, EXAMINING ATTORNEY

SN 85-114,878. ORTIZ, IRMA M., SIERRA MADRE, CA. FILED 8-24-2010.

# VICTORIA ORTIZ "LA MALA"

THE MARK CONSISTS OF STANDARD CHARACTERS WITHOUT CLAIM TO ANY PARTICULAR FONT, STYLE, SIZE, OR COLOR.

THE NAME "VICTORIA ORTIZ" IDENTIFIES A LIVING INDIVIDUAL WHOSE CONSENT IS OF RECORD.

THE ENGLISH TRANSLATION OF "LA MALA" IN THE MARK IS "THE BAD GIRL".

## CLASS 9—ELECTRICAL AND SCIENTIFIC APPARATUS

FOR DIGITAL MATERIALS, NAMELY, CDS, DVDS, DOWNLOADABLE AUDIO FILES AND RING TONES FEATURING MUSIC (U.S. CLS. 21, 23, 26, 36 AND 38).

## CLASS 41—EDUCATION AND ENTERTAINMENT

FOR ENTERTAINMENT SERVICES, NAMELY, LIVE, RADIO, INTERNET, TELEVISED AND MOVIE APPEARANCES BY A PROFESSIONAL ENTERTAINER; ENTERTAINMENT IN THE NATURE OF LIVE PERFORMANCES BY PROFESSIONAL ENTERTAINER; ENTERTAINMENT SERVICES, NAMELY, PROVIDING A WEB SITE FEATURING PHOTOGRAPHIC, AUDIO, VIDEO AND PROSE PRESENTATIONS FEATURING MUSICAL PERFORMANCES (U.S. CLS. 100, 101 AND 107).

\_\_\_\_\_  
NAAKWAMA ANKRAH, EXAMINING ATTORNEY

SN 85-115,697. UCONTROL ACQUISITION, LLC, PALO ALTO, CA. FILED 8-25-2010.



OWNER OF U.S. REG. NO. 3,574,030.

THE MARK CONSISTS OF THE TERM "UCONTROL" TO THE RIGHT OF AN OUTLINE OF A HOME.

## CLASS 35—ADVERTISING AND BUSINESS

FOR MONITORING SERVICES FOR HOME AND OFFICE MONITORING AND CONTROL APPLICATIONS, NAMELY, MONITORING AND CONTROL OF ENERGY CONSUMPTION (U.S. CLS. 100, 101 AND 102).  
FIRST USE 9-0-2006; IN COMMERCE 9-0-2006.

## CLASS 42—SCIENTIFIC AND COMPUTER SERVICES

FOR TECHNICAL MONITORING SERVICES FOR HOME AND OFFICE AUTOMATION SYSTEMS, NAMELY, MONITORING OF LIGHTING, NAMELY, INTERIOR AND EXTERIOR LIGHTS, HVAC SYSTEMS, NAMELY, HEATING AND AIR CONDITIONING SYSTEMS, AND OTHER HOME AND OFFICE MONITORING AND CONTROL APPLICATIONS, NAMELY, VIDEO, HOME AND ENTERTAINMENT MANAGEMENT AND CONTROL OF HOME ENTERTAINMENT CENTERS, NAMELY, CONTROL OF VOLUME, MEDIA SELECTION, NAMELY, SELECTION OF INPUTS FOR HOME ENTERTAINMENT CENTERS, MULTI-ROOM DISTRIBUTION AND SOUND QUALITY (U.S. CLS. 100 AND 101).  
FIRST USE 9-0-2006; IN COMMERCE 9-0-2006.

## CLASS 44—MEDICAL, BEAUTY AND AGRICULTURAL SERVICES

FOR MONITORING SERVICES FOR HOME AND OFFICE AUTOMATION SYSTEMS, NAMELY, REMOTE MONITORING OF HEALTH DIAGNOSTIC LEVELS, NAMELY, HEART RATE, BLOOD PRESSURE AND BLOOD SUGAR/GLUCOSE LEVELS (U.S. CLS. 100 AND 101).  
FIRST USE 9-0-2006; IN COMMERCE 9-0-2006.

## CLASS 45—PERSONAL AND LEGAL SERVICES

FOR MONITORING SERVICES FOR HOME AND OFFICE AUTOMATION SYSTEMS, NAMELY, MONITORING OF SECURITY SYSTEMS, NAMELY HOME AND LIFE SAFETY SYSTEMS THAT PROVIDE DETECTION OF INTRUSION AND FIRE, TOXIC GASES, NAMELY, CARBON MONOXIDE LEVELS, WATER DETECTION, AND IN-HOME TEMPERATURE LEVELS (U.S. CLS. 100 AND 101).  
FIRST USE 9-0-2006; IN COMMERCE 9-0-2006.

BILL DAWE, EXAMINING ATTORNEY

SN 85-115,800. UCONTROL ACQUISITION, LLC, PALO ALTO, CA. FILED 8-25-2010.

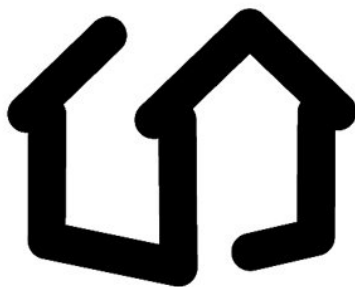

THE MARK CONSISTS OF AN OUTLINE OF A HOME.

#### CLASS 35—ADVERTISING AND BUSINESS

FOR MONITORING SERVICES FOR HOME AND OFFICE MONITORING AND CONTROL APPLICATIONS, NAMELY, MONITORING AND CONTROL OF ENERGY CONSUMPTION (U.S. CLS. 100, 101 AND 102).  
FIRST USE 9-0-2006; IN COMMERCE 9-0-2006.

#### CLASS 42—SCIENTIFIC AND COMPUTER SERVICES

FOR TECHNICAL MONITORING SERVICES FOR HOME AND OFFICE AUTOMATION SYSTEMS, NAMELY, MONITORING OF LIGHTING, NAMELY, INTERIOR AND EXTERIOR LIGHTS, HVAC SYSTEMS, NAMELY, HEATING AND AIR CONDITIONING SYSTEMS, AND OTHER HOME AND OFFICE MONITORING AND CONTROL APPLICATIONS, NAMELY, VIDEO, HOME AND ENTERTAINMENT MANAGEMENT AND CONTROL OF HOME ENTERTAINMENT CENTERS, NAMELY, CONTROL OF VOLUME, MEDIA SELECTION, NAMELY, SELECTION OF INPUTS FOR HOME ENTERTAINMENT CENTERS, MULTI-ROOM DISTRIBUTION AND SOUND QUALITY (U.S. CLS. 100 AND 101).  
FIRST USE 9-0-2006; IN COMMERCE 9-0-2006.

#### CLASS 44—MEDICAL, BEAUTY AND AGRICULTURAL SERVICES

FOR MONITORING SERVICES FOR HOME AND OFFICE AUTOMATION SYSTEMS, NAMELY, REMOTE MONITORING OF HEALTH DIAGNOSTIC LEVELS, NAMELY, HEART RATE, BLOOD PRESSURE AND BLOOD SUGAR/GLUCOSE LEVELS (U.S. CLS. 100 AND 101).  
FIRST USE 9-0-2006; IN COMMERCE 9-0-2006.

#### CLASS 45—PERSONAL AND LEGAL SERVICES

FOR MONITORING SERVICES FOR HOME AND OFFICE AUTOMATION SYSTEMS, NAMELY, MONITORING OF LIGHTING, NAMELY, INTERIOR AND EXTERIOR LIGHTS, HVAC SYSTEMS, NAMELY, HEATING AND AIR CONDITIONING SYSTEMS, SECURITY SYSTEMS, NAMELY, HOME AND LIFE SAFETY SYSTEMS THAT PROVIDE INTRUSION AND FIRE PROTECTION, TOXIC GASES, NAMELY, CARBON MONOXIDE LEVELS, WATER DETECTION, IN-HOME TEMPERATURE LEVELS, AND OTHER HOME AND OFFICE MONITORING AND CONTROL APPLICATIONS, NAMELY, VIDEO AND HOME, AND ENTERTAINMENT MANAGEMENT AND CONTROL, NAMELY, VOLUME, MEDIA SELECTION, MULTI-ROOM DISTRIBUTION, SOUND QUALITY, SCHEDULING AND AUTOMATION (U.S. CLS. 100 AND 101).

FIRST USE 9-0-2006; IN COMMERCE 9-0-2006.  
BILL DAWE, EXAMINING ATTORNEY

SN 85-115,948. WOOF'S! DOG TRAINING CENTER, LLC, ARLINGTON, VA. FILED 8-25-2010.



OWNER OF U.S. REG. NO. 3,624,618.  
THE MARK CONSISTS OF A STYLIZED DEPICTION OF AN INCOMPLETE DOG WITH THE WORD "WOOF'S!" ADJACENT THERETO.

#### CLASS 41—EDUCATION AND ENTERTAINMENT

FOR PET OBEDIENCE TRAINING SERVICES; PET TRAINING SERVICES; PET AGILITY TRAINING SERVICES; PET TRAINING SERVICES IN THE FIELD OF SOCIALIZATION, PROBLEM SOLVING AND AGGRESSION (U.S. CLS. 100, 101 AND 107).  
FIRST USE 5-31-2002; IN COMMERCE 8-6-2002.

#### CLASS 43—HOTEL AND RESTAURANT SERVICES

FOR BOARDING FOR ANIMALS; PET DAY CARE SERVICES (U.S. CLS. 100 AND 101).  
FIRST USE 5-31-2002; IN COMMERCE 8-6-2002.

#### CLASS 44—MEDICAL, BEAUTY AND AGRICULTURAL SERVICES

FOR PET CARE SERVICES, NAMELY, BATHING; PROVIDING INFORMATION PET FEEDING AND NUTRITION; CONSULTATION SERVICES IN THE FIELD OF PET BEHAVIOR (U.S. CLS. 100 AND 101).  
FIRST USE 5-31-2002; IN COMMERCE 8-6-2002.  
JEFFREY LOOK, EXAMINING ATTORNEY

SN 85-119,799. ORIENTAL YEAST CO., LTD., TOKYO 174-8505, JAPAN, FILED 8-31-2010.



NO CLAIM IS MADE TO THE EXCLUSIVE RIGHT TO USE "KOBO KOGYO KABUSHIKI KAISHA", APART FROM THE MARK AS SHOWN.

THE MARK CONSISTS OF A DESIGN CONSISTING OF A CIRCLE INSIDE A CIRCLE DIVIDED INTO THREE PARTS BY A Y-SHAPED DESIGN AND JAPANESE CHARACTERS THAT MEAN ORIENTAL YEAST INDUSTRIES COMPANY.

THE NON-LATIN CHARACTERS IN THE MARK TRANSLITERATE TO ORIENTAL "KOBO KOGYO KABUSHIKI KAISHA" AND THIS MEANS ORIENTAL YEAST INDUSTRIES COMPANY IN ENGLISH.

#### CLASS 1—CHEMICALS

FOR CHEMICALS FOR INDUSTRIAL PURPOSES; CHEMICAL ADDITIVES FOR USE IN THE MANUFACTURE OF FOOD; KANSUI, NAMELY, CHEMICAL ADDITIVES FOR USE IN THE MANUFACTURE OF FOOD; BACTERIOSTATIC AGENTS FOR USE IN THE MANUFACTURE OF FOOD; BIOCHEMICAL REAGENTS USED FOR NON-MEDICAL PURPOSES; ENZYMES FOR USE IN THE FOOD INDUSTRY; ENZYMES AS INGREDIENTS USED IN MANUFACTURE OF BIOCHEMISTRY REAGENTS; BACTERIA FOR USE IN FOOD MANUFACTURE (U.S. CLS. 1, 5, 6, 10, 26 AND 46).

#### CLASS 29—MEATS AND PROCESSED FOODS

FOR FRUIT-BASED FILLING FOR CAKES AND PIE; NON-DAIRY BASED MIX FOR MAKING WHIPPED ICINGS AND FILLINGS; BAKERY CREAMS AND PASTE MADE MAINLY FROM WHEAT FLOUR AND STARCHES; INSTANT OR PRE-COOKED STEW USED AS FILLINGS FOR BREADS, CAKES, AND PIES; PRE-COOKED FILLINGS FOR BREADS, CAKES, AND PIES MAINLY CONSISTING OF BEEF, VEGETABLES, AND VERMICELLI; PRE-COOKED FILLINGS FOR BREADS, CAKES, AND PIES MAINLY CONSISTING OF MEAT, VEGETABLES, AND/OR EGGS; POTATO SALAD USED AS FILLINGS FOR BREADS, CAKES, AND PIES; SWEET POTATO FLAVORED FILLINGS FOR BREADS, CAKES, AND PIES (U.S. CL. 46).

#### CLASS 30—STAPLE FOODS

FOR BUTTERCREAM FILLINGS FOR CAKES; CHOCOLATE-BASED FILLINGS FOR CAKES AND PIES; CUSTARD-BASED FILLINGS FOR CAKES AND PIES; YEAST; CUSTARDS; FLAVOR ENHANCERS USED IN FOOD AND BEVERAGE PRODUCTS; BAKING POWDER; MAYONNAISE; POWDERED MAYONNAISE MIXES; YEAST EXTRACT FOR FOODS; COOKED RICE; PROCESSED GRAINS, NAMELY, RYE; PRE-COOKED SWEET FILLINGS FOR BREADS, CAKES, AND PIES MAINLY CONSISTING OF STICKY RICE; CURRY; CURRY POWDER; CURRY SAUCE; PRE-COOKED OR INSTANT CURRY FOR FILLING (U.S. CL. 46).

#### CLASS 31—NATURAL AGRICULTURAL PRODUCTS

FOR ANIMAL FEED; LIVE LABORATORY ANIMALS (U.S. CLS. 1 AND 46).

JACQUELINE A. LAVINE, EXAMINING ATTORNEY

SN 85-121,927. LATTOUF INTERNATIONAL PTY LTD, VICTORIA, AUSTRALIA, FILED 9-2-2010.



OWNER OF AUSTRALIA REG. NO. 1058085, DATED 6-1-2005. EXPIRES 6-1-2015.

OWNER OF AUSTRALIA REG. NO. 909580, DATED 4-17-2002, EXPIRES 4-17-2012.

THE MARK CONSISTS OF THE LETTERS "H" AND "W" IN LARGE FONT AND WITH THE "H" STACKED VERTICALLY ON TOP OF THE "W", SURROUNDED BY AN INNER CIRCLE AND AN OUTER CIRCLE, WITH THE WORDS "HAIRHOUSE WAREHOUSE" APPEARING IN BETWEEN THE INNER CIRCLE AND THE OUTER CIRCLE.

#### CLASS 3—COSMETICS AND CLEANING PREPARATIONS

FOR HAIR CARE PRODUCTS, NAMELY, SHAMPOO, CONDITIONER AND CREAM; NAIL CARE PREPARATIONS, NAMELY, NAIL GEL, NAIL POLISH, AND NAIL CREAM; COSMETICS; SKIN SOAPS; PERFUMERY; BEAUTY CARE AND SKIN CARE PREPARATIONS, NAMELY, SKIN CLEANSERS, SKIN CLARIFIERS, SKIN CREAMS, AND BODY BALM (U.S. CLS. 1, 4, 6, 50, 51 AND 52).

#### CLASS 14—JEWELRY

FOR JEWELRY (U.S. CLS. 2, 27, 28 AND 50).

#### CLASS 26—FANCY GOODS

FOR WIGS, FALSE HAIR, HAIR PIECES, TOUPEES; HAIR ORNAMENTS AND HAIR ACCESSORIES, NAMELY, HAIR CURLERS, CLIPS, PINS, BOBBY PINS, NEEDLES, GRIPS, ORNAMENTS, FASTENERS, SLIDES, BANDS, TIES, RIBBONS, NETS, BROOCHES, ELASTICS, LACE, EMBROIDERY, BRAID BUTTONS, HOOKS, EYES AND ARTIFICIAL FLOWERS (U.S. CLS. 37, 39, 40, 42 AND 50).

#### CLASS 35—ADVERTISING AND BUSINESS

FOR RETAIL STORE SERVICES AND DISTRIBUTORSHIP SERVICES IN THE FIELD OF HAIR CARE PRODUCTS, BEAUTY CARE PRODUCTS, NAIL CARE PRODUCTS, COSMETICS, SOAPS, PERFUMERY, HAIR ACCESSORIES AND JEWELRY (U.S. CLS. 100, 101 AND 102).



**CLASS 44—MEDICAL, BEAUTY AND AGRICULTURAL SERVICES**

FOR HAIR CARE SERVICES, NAMELY, HAIR CUTTING, COLORING AND STYLING SERVICES; NAIL CARE SERVICES; BEAUTY SALON SERVICES; BODY PIERCING SERVICES; BEAUTY THERAPY SERVICES, NAMELY, FACIALS, MASSAGES, AND COSMETIC BODY CARE; HAIR REPLACEMENT SERVICES AND HAIR CARE AND BEAUTY CARE SERVICES PROVIDED BY THE PROPRIETORS OF HAIR SALONS AND BEAUTY CLINICS TO CUSTOMERS (U.S. CLS. 100 AND 101).

DANNEAN HETZEL, EXAMINING ATTORNEY

SN 85-125,359. PELICAN PRODUCTS, INC., TORRANCE, CA. FILED 9-8-2010.



OWNER OF U.S. REG. NOS. 2,227,063, 3,756,372 AND OTHERS.

NO CLAIM IS MADE TO THE EXCLUSIVE RIGHT TO USE "AUTHENTIC" AND "CASE", APART FROM THE MARK AS SHOWN.

THE MARK CONSISTS OF THE WORDING "ADVANCED CASE SOLUTIONS" INSIDE OF AN OUTER CIRCLE, A DESIGN OF TWO BIRDS AND A SUN INSIDE OF AN INTERIOR CIRCLE ABOVE THE WORDING "PELICAN-HARDIGG", AND A RECTANGLE CONTAINING THE WORDING "AUTHENTIC" WHICH INTERSECTS BOTH CIRCLES.

**CLASS 9—ELECTRICAL AND SCIENTIFIC APPARATUS**

FOR SOFT-SIDED AND HARD-SIDED CASES FOR CARRYING AND STORING PHOTOGRAPHIC AND ELECTRONIC EQUIPMENT AND OTHER SENSITIVE EQUIPMENT, NAMELY, CELL PHONES, PDAS, HAND-HELD ELECTRONIC GAME MACHINES AND GAME CARTRIDGES AND CASSETTES AND SMALL RADIOS, CASSETTES AND CD PLAYERS; COMPUTER CASES; CASES FOR CARRYING AND STORING PERSONAL, MILITARY, SEARCH AND RESCUE AND INDUSTRIAL SPECIALTY ELECTRONIC INSTRUMENTS, NAMELY, ELECTRIC NAVIGATION INSTRUMENTS, SEISMIC SENSORS, DIGITAL DIVING DEPTH AND CHRONOMETER GAUGES, PUBLIC ADDRESS SYSTEMS AND INSTRUMENTS, ELECTRONIC FIRE HOSE CONTROLLERS, PORTABLE AIR COMPRESSOR KITS, ELECTRONIC SURVEILLANCE EQUIPMENT, ELECTRONIC FIELD TESTING EQUIPMENT, MICROCHIPS AND CIRCUIT BOARDS, ELECTRONIC INDICATOR PANELS, RIFLE SCOPES, FIRE FIGHTING COMMUNICATIONS EQUIPMENT, EMERGENCY LIGHTING SYSTEMS, SATELLITE PHONE SYSTEMS, MOBILE CHEMICAL WEAPONS TESTING KITS, MOBILE CHEMICAL DETECTOR SYSTEMS; GADGET BAGS FOR CARRYING VIDEO CAMERAS, BINOCULARS, GAME CARTRIDGES, CDS, ACCESSORIES FOR COMPUTERS, DIGITAL CAMERAS AND ACCESSORIES FOR CAMERAS (U.S. CLS. 21, 23, 26, 36 AND 38).

**CLASS 20—FURNITURE AND ARTICLES NOT OTHERWISE CLASSIFIED**

FOR PLASTIC CASES FOR INDUSTRIAL, COMMERCIAL AND PERSONAL USE, NAMELY, PACKAGING, SHIPPING, TRANSPORTATION, PROTECTION OF CONTENTS AND STORAGE (U.S. CLS. 2, 13, 22, 25, 32 AND 50).

KEVIN CORWIN, EXAMINING ATTORNEY

SN 85-130,204. PURE HOME CORPORATION, KIRKLAND, WA. FILED 9-15-2010.

# PUREHOME

THE MARK CONSISTS OF STANDARD CHARACTERS WITHOUT CLAIM TO ANY PARTICULAR FONT, STYLE, SIZE, OR COLOR.

**CLASS 35—ADVERTISING AND BUSINESS**

FOR PROVIDING A WEBSITE FEATURING INFORMATION FOR CONSUMERS IN THE FIELD OF HOME AND OFFICE IMPROVEMENT, DECORATING AND DÉCOR, AND WHERE USERS CAN POST RATINGS, REVIEWS AND RECOMMENDATIONS REGARDING PRODUCTS, SERVICES AND VENDORS OF HOME AND OFFICE IMPROVEMENT, DECORATING AND DÉCOR PRODUCTS FOR COMMERCIAL PURPOSES; PROVIDING A WEBSITE USED TO PLACE ON-LINE COMMERCIAL ORDERS IN THE FIELD OF HOME AND OFFICE IMPROVEMENT, DECORATING AND DÉCOR; PROVIDING AN INTERNET WEBSITE PORTAL FEATURING PROMOTION AND ADVERTISING FOR HOME SERVICE PROVIDERS AND PRODUCT MANUFACTURERS IN THE FIELD OF HOME AND OFFICE IMPROVEMENT, DECORATING AND DÉCOR; ADVERTISING AND DIRECTORY SERVICES, NAMELY, PROMOTING THE PRODUCTS AND SERVICES OF OTHERS BY PROVIDING A WEB PAGE FEATURING LINKS TO THE WEBSITES OF OTHERS IN THE FIELD OF HOME AND OFFICE IMPROVEMENT, DECORATING AND DÉCOR; PROMOTING THE GOODS AND SERVICES OF OTHERS BY PROVIDING A WEBSITE FEATURING COUPONS, REBATES, PRICE-COMPARISON INFORMATION, PRODUCT REVIEWS, LINKS TO THE RETAIL WEBSITES OF OTHERS, AND DISCOUNT INFORMATION IN THE FIELD OF HOME AND OFFICE IMPROVEMENT, DECORATING AND DÉCOR; ADVERTISING, MARKETING AND PROMOTION SERVICES, NAMELY, PROMOTING THE GOODS AND SERVICES OF OTHERS BY PROVIDING CUSTOMIZED EXHIBITS IN THE FIELD OF HOME AND OFFICE IMPROVEMENT, DECORATING AND DÉCOR; CONDUCTING TRADESHOWS IN THE NATURE OF HOME SHOWS IN THE FIELD OF HOME IMPROVEMENT FEATURING EXHIBITS FOR HOMEOWNERS IN THE PROCESS OF REMODELING, LANDSCAPING AND DECORATING THEIR HOMES (U.S. CLS. 100, 101 AND 102).

**CLASS 41—EDUCATION AND ENTERTAINMENT**

FOR CONDUCTING WORKSHOPS AND SEMINARS IN THE FIELD OF HOME AND OFFICE IMPROVEMENT, DECORATING AND DÉCOR (U.S. CLS. 100, 101 AND 107).

**CLASS 42—SCIENTIFIC AND COMPUTER SERVICES**

FOR PROVIDING A WEBSITE FEATURING INFORMATION IN THE FIELD OF HOME DECORATING; PROVIDING A WEBSITE IN THE FIELD OF INTERIOR DECORATING; COLOR ANALYSIS FOR PURPOSES OF INTERIOR DESIGN, NAMELY, TO ASSIST USERS IN DETERMINING THE PROPER COLOR OR ARRAY OF COLORS FOR HOME AND OFFICE IMPROVEMENT, DECORATING AND DÉCOR, AND INTERIOR DECORATING PURPOSES; INTERIOR DECORATING SERVICES (U.S. CLS. 100 AND 101).

ROBERT C. CLARK JR., EXAMINING ATTORNEY

**CLASS 42—SCIENTIFIC AND COMPUTER SERVICES**

FOR PROVIDING A WEBSITE FEATURING INFORMATION IN THE FIELD OF HOME DECORATING; PROVIDING A WEBSITE IN THE FIELD OF INTERIOR DECORATING; COLOR ANALYSIS FOR PURPOSES OF INTERIOR DESIGN, NAMELY, TO ASSIST USERS IN DETERMINING THE PROPER COLOR OR ARRAY OF COLORS FOR HOME AND OFFICE IMPROVEMENT, DECORATING AND DÉCOR, AND INTERIOR DECORATING PURPOSES; INTERIOR DECORATING SERVICES (U.S. CLS. 100 AND 101).

ROBERT C. CLARK JR., EXAMINING ATTORNEY

SN 85-130,208. PURE HOME CORPORATION, KIRKLAND, WA. FILED 9-15-2010.

# PUREKIDS

THE MARK CONSISTS OF STANDARD CHARACTERS WITHOUT CLAIM TO ANY PARTICULAR FONT, STYLE, SIZE, OR COLOR.

**CLASS 35—ADVERTISING AND BUSINESS**

FOR PROVIDING A WEBSITE FEATURING INFORMATION FOR CONSUMERS IN THE FIELD OF HOME AND OFFICE IMPROVEMENT, DECORATING AND DÉCOR, AND WHERE USERS CAN POST RATINGS, REVIEWS AND RECOMMENDATIONS REGARDING PRODUCTS, SERVICES AND VENDORS OF HOME AND OFFICE IMPROVEMENT, DECORATING AND DÉCOR PRODUCTS FOR COMMERCIAL PURPOSES; PROVIDING A WEBSITE USED TO PLACE ON-LINE COMMERCIAL ORDERS IN THE FIELD OF HOME AND OFFICE IMPROVEMENT, DECORATING AND DÉCOR; PROVIDING AN INTERNET WEBSITE PORTAL FEATURING PROMOTION AND ADVERTISING FOR HOME SERVICE PROVIDERS AND PRODUCT MANUFACTURERS IN THE FIELD OF HOME AND OFFICE IMPROVEMENT, DECORATING AND DÉCOR; ADVERTISING AND DIRECTORY SERVICES, NAMELY, PROMOTING THE PRODUCTS AND SERVICES OF OTHERS BY PROVIDING A WEB PAGE FEATURING LINKS TO THE WEBSITES OF OTHERS IN THE FIELD OF HOME AND OFFICE IMPROVEMENT, DECORATING AND DÉCOR; PROMOTING THE GOODS AND SERVICES OF OTHERS BY PROVIDING A WEBSITE FEATURING COUPONS, REBATES, PRICE-COMPARISON INFORMATION, PRODUCT REVIEWS, LINKS TO THE RETAIL WEBSITES OF OTHERS, AND DISCOUNT INFORMATION IN THE FIELD OF HOME AND OFFICE IMPROVEMENT, DECORATING AND DÉCOR; ADVERTISING, MARKETING AND PROMOTION SERVICES, NAMELY, PROMOTING THE GOODS AND SERVICES OF OTHERS BY PROVIDING CUSTOMIZED EXHIBITS IN THE FIELD OF HOME AND OFFICE IMPROVEMENT, DECORATING AND DÉCOR; CONDUCTING TRADESHOWS IN THE NATURE OF HOME SHOWS IN THE FIELD OF HOME IMPROVEMENT FEATURING EXHIBITS FOR HOMEOWNERS IN THE PROCESS OF REMODELING, LANDSCAPING AND DECORATING THEIR HOMES (U.S. CLS. 100, 101 AND 102).

**CLASS 41—EDUCATION AND ENTERTAINMENT**

FOR CONDUCTING WORKSHOPS AND SEMINARS IN THE FIELD OF HOME AND OFFICE IMPROVEMENT, DECORATING AND DÉCOR (U.S. CLS. 100, 101 AND 107).

SN 85-130,712. SLICK WILLIES LTD, SANTA BARBARA, CA. FILED 9-15-2010.

# SLICK WILLIES

THE MARK CONSISTS OF STANDARD CHARACTERS WITHOUT CLAIM TO ANY PARTICULAR FONT, STYLE, SIZE, OR COLOR.

OWNER OF ERPN CMNTY TM OFC REG. NO. 001073063, DATED 3-22-2000, EXPIRES 2-11-2019.

**CLASS 25—CLOTHING**

FOR (BASED ON 1(B)) CLOTHING, NAMELY, CAPS; SHIRTS, T-SHIRTS, SWEATSHIRTS, TRACK SUITS, TROUSERS, JEANS, SWEAT PANTS, SHORTS, JACKETS, SPORTS JACKETS, SNOWBOARDING JACKETS, PARKAS; JUMPERS, PULLOVERS, VESTS; WETSUITS; SWIMWEAR; HEADWEAR; HATS, CAPS; HEAD BANDS; GLOVES, MITTENS; WRIST BANDS; FOOTWEAR; SNEAKERS, SHOES, BOOTS, SKI BOOTS, FLIP-FLOPS, SANDALS; SOCKS, HOSIERY; BASEBALL CAPS AND HATS; BASEBALL SHOES; BASEBALL UNIFORMS; (BASED ON 44(E)) CLOTHING, NAMELY, ATHLETIC SUITS, NAMELY, JOGGING SUITS, AND BATHING SUITS, BELTS, BIKINIS, BLOUSES, BOTTOMS, BOXER SHORTS, COATS, COVER UPS, CROP TOPS, FLEECE TOPS, FLEECE PULLOVERS, GLOVES, GOLF SHIRTS, GYM SHORTS, HALTER TOPS, HATS, HEADGEAR, NAMELY, VISORS, BASEBALL CAPS, BEANIES, BONNETS, HEADBANDS, AND CAPS, HEADWEAR, JACKETS, JEANS, JERSEYS, JOGGING SUITS, LOUNGEWEAR, MITTENS, MUSCLE TOPS, PAJAMAS, PANTS, PARKAS, POLO SHIRTS, PONCHOS, PULLOVERS, RAIN JACKETS, RAIN SUITS, RASH GUARDS, RASH SHIRTS, RASH VESTS, ROBES, RUGBY TOPS, SHIRTS, SHOES, SHORTS, SKIRTS, SLEEPWEAR, SOCKS, SWEATPANTS, SWEATTOPS, SWEATSHIRTS, SWIMWEAR, TANK TOPS, T-SHIRTS, TOPS, TRACKSUITS, TROUSERS, UNDERWEAR, UNDERGARMENTS, WETSUITS, WETSUIT TOPS, WIND RESISTANT JACKETS AND WINDSHIRTS; FOOTWEAR; SHOES (U.S. CLS. 22 AND 39).

**CLASS 28—TOYS AND SPORTING GOODS**

FOR (BASED ON 1(B)) SPORTING GOODS, NAMELY, SKATEBOARDS, SKATEBOARD DECKS, SKATEBOARD TRUCKS, SKATEBOARD WHEELS; SKATEBOARD GRIP TAPE; WHEELS FOR ROLLER SKATES, IN-LINE SKATES, AND SKATEBOARDS; WHEEL BEARINGS FOR SKATEBOARDS, IN-LINE SKATES, AND ROLLER SKATES; IN-LINE SKATE HARDWARE, NAMELY, NUTS AND BOLTS; ROLLER SKATES, AND PARTS AND ACCESSORIES THEREFOR, NAMELY, WHEELS AND WHEEL BEARINGS, TRUCKS, SKATE FRAMES, TRUCK CUSHIONS; ROLLER SKATE AND IN-LINE SKATE HARDWARE, NAMELY, NUTS AND BOLTS; BALL BEARINGS FOR IN-LINE SKATES; BALL BEARINGS FOR ROLLER SKATES; ELBOW AND KNEE PADS FOR ATHLETIC USE; WRIST GUARDS FOR ATHLETIC

USE; WRIST, ELBOW, AND KNEE GUARDS FOR ATHLETIC USE; HOCKEY STICKS, HOCKEY BALLS, HOCKEY GOALS; BASEBALL AND SOFTBALL TRAINING APPARATUS FOR BATTING AND PITCHING; BASEBALL AND SOFTBALL BAT RACKS; BASEBALL BASES; BASEBALL BAT BAGS; BASEBALL BATS; BASEBALL BATTING GLOVES; BASEBALL GLOVES; BASEBALL MITTS; BASEBALL PITCHING SCREENS; BASEBALLS; GAME APPARATUS, NAMELY, BASES, BATS, AND BALLS FOR PLAYING BASEBALL; GRIP TAPES FOR BASEBALL BATS; TENNIS RACQUETS; CRICKET BATS; GOLF CLUBS; FOOTBALLS, FOOTBALL SHOULDER PADS; BASKETBALLS; BASKETBALL NETS; SURFBOARDS, BODYBOARDS, BODYBOARD LEASHES; FLYING DISCS; TETHERS IN THE NATURE OF STRAPS FOR SURFBOARDS AND BODYBOARDS, BAGS SPECIALLY DESIGNED FOR CARRYING AND PROTECTING SURFBOARDS; EXERCISE AND FITNESS EQUIPMENT AND ACCESSORIES, NAMELY, ANKLE AND WRIST WEIGHTS, EXERCISE BARS, EXERCISE BENCHES, WEIGHT CUFFS, MANUALLY-OPERATED EXERCISE EQUIPMENT, JUMP ROPES, AND PROTECTIVE PADS FOR CYCLING; MARTIAL ARTS EQUIPMENT, NAMELY, BAG GLOVES, AND PADS, NAMELY, KICK PADS, TARGET PADS AND SHIN PADS; TOY SCOOTERS; GOLF GLOVES; GOLF BALL MARKERS; (BASED ON 44(E)) SPORTING GOODS, NAMELY, SKATEBOARDS, SKATEBOARD DECKS, SKATEBOARD TRUCKS, SKATEBOARD WHEELS; SKATEBOARD GRIP TAPE; WHEELS FOR ROLLER SKATES, IN-LINE SKATES; WHEEL BEARINGS FOR SKATEBOARDS, IN-LINE SKATES, AND ROLLER SKATES; IN-LINE SKATE HARDWARE, NAMELY, NUTS AND BOLTS; ROLLER SKATES, AND PARTS AND ACCESSORIES THEREFOR, NAMELY, WHEELS AND WHEEL BEARINGS; ROLLER SKATE AND IN-LINE SKATE HARDWARE, NAMELY, NUTS AND BOLTS; BALL BEARINGS FOR IN-LINE SKATES; BALL BEARINGS FOR ROLLER SKATES; ELBOW AND KNEE PADS FOR ATHLETIC USE; WRIST GUARDS FOR ATHLETIC USE; WRIST, ELBOW, AND KNEE GUARDS FOR ATHLETIC USE; HOCKEY STICKS, HOCKEY BALLS, HOCKEY GOALS; BASEBALL AND SOFTBALL TRAINING APPARATUS FOR BATTING AND PITCHING; BASEBALL AND SOFTBALL BAT RACKS; BASEBALL BASES; BASEBALL BAT BAGS; BASEBALL BATS; BASEBALL BATTING GLOVES; BASEBALL GLOVES; BASEBALL MITTS; BASEBALL PITCHING SCREENS; BASEBALLS; GAME APPARATUS, NAMELY, BASES, BATS, AND BALLS FOR PLAYING BASEBALL; BASKETBALL NETS; BAGS SPECIALLY DESIGNED FOR CARRYING AND PROTECTING SURFBOARDS; MANUALLY-OPERATED EXERCISE EQUIPMENT, JUMP ROPES; MARTIAL ARTS EQUIPMENT, NAMELY, BAG GLOVES, AND PADS, NAMELY, KICK PADS, TARGET PADS AND SHIN PADS; TOY SCOOTERS (U.S. CLS. 22, 23, 38 AND 50).

KARANENDRA S. CHHINA, EXAMINING ATTORNEY

SN 85-130,938. THE RICHARD STOCKTON COLLEGE OF NEW JERSEY, POMONA, NJ. FILED 9-16-2010.

**LLOYD D. LEVENSON  
INSTITUTE OF GAMING,  
HOSPITALITY & TOURISM**

THE MARK CONSISTS OF STANDARD CHARACTERS WITHOUT CLAIM TO ANY PARTICULAR FONT, STYLE, SIZE, OR COLOR.

NO CLAIM IS MADE TO THE EXCLUSIVE RIGHT TO USE "INSTITUTE OF GAMING, HOSPITALITY & TOURISM", APART FROM THE MARK AS SHOWN.

THE NAME(S), PORTRAIT(S), AND/OR SIGNATURE(S) SHOWN IN THE MARK IDENTIFIES "LLOYD D. LEVENSON", WHOSE CONSENT(S) TO REGISTER IS MADE OF RECORD.

**CLASS 35—ADVERTISING AND BUSINESS**

FOR PROVIDING INFORMATION VIA WEB SITES, WRITTEN REPORTS AND PAPERS FEATURING INFORMATION FOR BUSINESSES IN THE FIELD OF PROMOTION AND MARKETING OF REGIONAL TOURISM AND GAMING (U.S. CLS. 100, 101 AND 102).  
FIRST USE 4-23-2010; IN COMMERCE 7-1-2010.

**CLASS 41—EDUCATION AND ENTERTAINMENT**

FOR CONDUCTING SEMINARS, MEETINGS, SYMPOSIA, AND CONFERENCES, AND ISSUING REPORTS AND PAPERS IN CONNECTION THEREWITH, FOR POLICY-MAKERS AND LEADERS IN THE FIELDS OF GAMING, HOSPITALITY AND TOURISM; PROVIDING PROFESSIONAL TRAINING AND EDUCATIONAL OPPORTUNITIES IN THE FIELD OF GAMING, HOSPITALITY MANAGEMENT, PUBLIC POLICY AND TOURISM BY CONDUCTING SEMINARS, MEETINGS, SYMPOSIA, AND CONFERENCES FOR BROADENING THE KNOWLEDGE OF POLICY-MAKERS AND LEADERS IN SUCH FIELDS (U.S. CLS. 100, 101 AND 107).

FIRST USE 4-23-2010; IN COMMERCE 7-1-2010.  
AISHA CLARKE, EXAMINING ATTORNEY

SN 85-130,951. ZEADES MONTE CARLO SARL, MONACO, MONACO, FILED 9-16-2010.

**ZEADES**

THE MARK CONSISTS OF STANDARD CHARACTERS WITHOUT CLAIM TO ANY PARTICULAR FONT, STYLE, SIZE, OR COLOR.

"ZEADES" APPEARING IN THE MARK HAS NO SIGNIFICANCE NOR IS IT A TERM OF ART IN THE RELEVANT TRADE OR INDUSTRY OR AS APPLIED TO THE GOODS/SERVICES LISTED IN THE APPLICATION, OR ANY GEOGRAPHICAL SIGNIFICANCE.

**CLASS 14—JEWELRY**

FOR JEWELRY, COSTUME JEWELRY, PRECIOUS STONES; HOROLOGICAL AND CHRONOMETRIC INSTRUMENTS; PRECIOUS METALS AND ALLOYS THEREOF; WORKS OF ART OF PRECIOUS METAL; JEWELRY CASES AND BOXES MADE OF PRECIOUS METAL; JEWELRY BOXES, BRACELETS AND CHAINS; KEY RINGS, TRINKETS AND FOBS OF PRECIOUS METAL; STATUES, FIGURINES AND STATUETTES OF PRECIOUS METAL; CASES FOR WATCHES; CUFFLINKS AND TIEPINS (U.S. CLS. 2, 27, 28 AND 50).

**CLASS 18—LEATHER GOODS**

FOR ARTICLES OF LEATHER AND IMITATION LEATHER, NAMELY, TRUNKS, TRAVELING BAGS AND SMALL LEATHER GOODS NOT INCLUDED IN OTHER CLASSES, NAMELY, POCKET WALLETS, BUSINESS CARD CASES, POUCHES FOR SMALL OBJECTS AND KEY CASES; UMBRELLAS, PARASOLS, CANES AND WALKING STICKS; HARNESES AND SADDLERY; BAGS AND POUCHES OF LEATHER FOR PACKAGING; HANDBAGS, RUCKSACKS, WHEELED SHOPPING BAGS, TRAVELING BAGS AND BEACH BAGS; TOILETRY CASES AND VANITY CASES SOLD EMPTY; LEATHER AND IMITATION LEATHER COLLARS AND COVERS FOR ANIMALS (U.S. CLS. 1, 2, 3, 22 AND 41).

**CLASS 25—CLOTHING**

FOR CLOTHING, NAMELY, BEACHWEAR, GYMNAS-  
TICS CLOTHING, NAMELY, LEOTARDS; SPORTS-  
WEAR, NAMELY, SWEAT SUITS; AND  
LEISUREWEAR, NAMELY, BATHROBES; CLOTHING  
MADE FROM LEATHER AND IMITATION LEATHER,  
NAMELY, JACKETS; CLOTHING MADE OF FUR AND  
IMITATION FUR, NAMELY, COATS AND HATS;  
CLOTHING ACCESSORIES, NAMELY, ELASTIC WRIST  
STRAPS IN THE NATURE OF WRIST BANDS, GLOVES,  
BELTS, NECKTIES; HEADSCARVES; SASHES; HEAD-  
GEAR, NAMELY, HATS AND CAPS; FOOTWEAR,  
BOOTS, SHOES, SANDALS, SLIPPERS, BEACH SHOES,  
SKI BOOTS AND SPORTS SHOES (U.S. CLS. 22 AND 39).  
BARBARA BROWN, EXAMINING ATTORNEY

SN 85-136,231. REIMAN MEDIA GROUP, LLC, GREEN-  
DALE, WI. FILED 9-23-2010.

**COOKING CARING SHARING**

THE MARK CONSISTS OF STANDARD CHARACTERS  
WITHOUT CLAIM TO ANY PARTICULAR FONT, STYLE,  
SIZE, OR COLOR.

NO CLAIM IS MADE TO THE EXCLUSIVE RIGHT TO  
USE "COOKING", APART FROM THE MARK AS SHOWN.

**CLASS 16—PAPER GOODS AND PRINTED MATTER**

FOR MAGAZINES FEATURING COOKING AND  
FOOD (U.S. CLS. 2, 5, 22, 23, 29, 37, 38 AND 50).  
FIRST USE 3-31-2008; IN COMMERCE 3-31-2008.

**CLASS 35—ADVERTISING AND BUSINESS**

FOR COMPUTERIZED ON-LINE WHOLESALE AND  
RETAIL STORE SERVICES FEATURING COOKING  
PUBLICATIONS, KITCHENWARE, COOKING EQUIP-  
MENT AND ACCESSORIES; PROVIDING PRODUCT  
INFORMATION REGARDING KITCHENWARE, COOK-  
ING EQUIPMENT AND ACCESSORIES (U.S. CLS. 100,  
101 AND 102).

FIRST USE 1-26-2009; IN COMMERCE 1-26-2009.

**CLASS 38—COMMUNICATION**

FOR PROVIDING ON-LINE ELECTRONIC FORUMS  
AND BULLETIN BOARDS FOR THE TRANSMISSION  
OF INFORMATION IN THE FIELD OF FOOD AND  
COOKING (U.S. CLS. 100, 101 AND 104).

FIRST USE 1-26-2009; IN COMMERCE 1-26-2009.

**CLASS 43—HOTEL AND RESTAURANT SERVICES**

FOR PROVIDING INFORMATION ON THE SUBJECT  
OF COOKING, BAKING, FOOD, WINE, BEVERAGES,  
RECIPES, MENUS, REVIEWS, COOKING TIPS, FOOD  
RELATED INFORMATION, AND MEAL PLANNING  
VIA A GLOBAL COMPUTER NETWORK (U.S. CLS. 100  
AND 101).

FIRST USE 1-26-2009; IN COMMERCE 1-26-2009.

**CLASS 44—MEDICAL, BEAUTY AND AGRICULTURAL SERVICES**

FOR PROVIDING INFORMATION ON THE SUBJECT  
OF HEALTH, NUTRITION, DIET, WEIGHT LOSS,  
HEALTHY LIVING AND LIFESTYLE WELLNESS VIA  
A GLOBAL COMPUTER NETWORK (U.S. CLS. 100 AND  
101).

FIRST USE 1-26-2009; IN COMMERCE 1-26-2009.  
TRACY CROSS, EXAMINING ATTORNEY

SN 85-137,436. TRAVELCLICK, INC., SCHAUMBURG, IL.  
FILED 9-24-2010.

**PROFILE360**

THE MARK CONSISTS OF STANDARD CHARACTERS  
WITHOUT CLAIM TO ANY PARTICULAR FONT, STYLE,  
SIZE, OR COLOR.

**CLASS 35—ADVERTISING AND BUSINESS**

FOR PROVIDING STATISTICAL INFORMATION,  
NAMELY, PROVIDING TRAVEL INDUSTRY AND HO-  
TEL-RELATED STATISTICS OF HOTEL CUSTOMERS  
TO THE TRAVEL AND HOTEL INDUSTRIES VIA A  
GLOBAL COMPUTER NETWORK (U.S. CLS. 100, 101  
AND 102).

**CLASS 39—TRANSPORTATION AND STORAGE**

FOR ELECTRONIC STORAGE OF CUSTOMER IN-  
FORMATION AND DATA IN CONNECTION WITH  
HOTELS AND THE HOTEL AND TRAVEL INDUSTRIES  
(U.S. CLS. 100 AND 105).

MICHAEL GAAFAR, EXAMINING ATTORNEY

SN 85-138,261. GUNNARSON ENTERPRISES, LLC, VERDI,  
NV. FILED 9-25-2010.

**ACTION HEROES**

THE MARK CONSISTS OF STANDARD CHARACTERS  
WITHOUT CLAIM TO ANY PARTICULAR FONT, STYLE,  
SIZE, OR COLOR.

NO CLAIM IS MADE TO THE EXCLUSIVE RIGHT TO  
USE "ACTION", APART FROM THE MARK AS SHOWN.

**CLASS 37—CONSTRUCTION AND REPAIR**

FOR CONSTRUCTION CONSULTING IN THE FIELD  
OF CONSTRUCTING ACTION SPORTS FACILITIES,  
NAMELY, FOR SNOWBOARDING, SKATEBOARDING,  
SNOWMOBILING, SKIING, MOTOCROSS, BMX, MOUN-  
TAIN BIKING, ROAD RACING AND ROAD RALLIES  
(U.S. CLS. 100, 103 AND 106).

**CLASS 41—EDUCATION AND ENTERTAINMENT**

FOR ENTERTAINMENT SERVICES IN THE NATURE OF AN ON-GOING REALITY BASED TELEVISION PROGRAM AND A MULTIMEDIA PROGRAM SERIES FEATURING COMEDY, ACTION AND ADVENTURE DISTRIBUTED VIA VARIOUS PLATFORMS ACROSS MULTIPLE FORMS OF TRANSMISSION MEDIA; ENTERTAINMENT SERVICES, NAMELY, A MULTIMEDIA PROGRAM SERIES FEATURING COMEDY, ACTION AND ADVENTURE DISTRIBUTED VIA VARIOUS PLATFORMS ACROSS MULTIPLE FORMS OF TRANSMISSION MEDIA (U.S. CLS. 100, 101 AND 107).

**CLASS 42—SCIENTIFIC AND COMPUTER SERVICES**

FOR CONSULTING SERVICES FOR OTHERS IN THE FIELD OF DESIGN, PLANNING, AND IMPLEMENTATION PROJECT MANAGEMENT OF ACTION SPORTS FACILITIES, NAMELY, FOR SNOWBOARDING, SKATEBOARDING, SNOWMOBILING, SKIING, MOTOCROSS, BMX, MOUNTAIN BIKING, ROAD RACING AND ROAD RALLIES (U.S. CLS. 100 AND 101).  
ADA HAN, EXAMINING ATTORNEY

---

SN 85-143,375. CABRILLO COMMUNITY COLLEGE DISTRICT FINANCING CORPORATION, APTOS, CA. FILED S.R. 10-1-2010; AM. P.R. 10-1-2010.

**ACADEMY FOR COLLEGE EXCELLENCE**

THE MARK CONSISTS OF STANDARD CHARACTERS WITHOUT CLAIM TO ANY PARTICULAR FONT, STYLE, SIZE, OR COLOR.

**CLASS 16—PAPER GOODS AND PRINTED MATTER**

FOR BOOK COVERS, STATIONERY; PAPER PACKING MATERIALS, NAMELY, BOXES, SACKS AND BAGS FOR WRAPPING AND PACKAGING (U.S. CLS. 2, 5, 22, 23, 29, 37, 38 AND 50).

**CLASS 21—HOUSEWARES AND GLASS**

FOR COMBS, HAIR BRUSHES AND HOUSEHOLD CONTAINERS, NAMELY, CUPS, BOWLS AND DRINKING GLASSES; PAPER CONTAINERS, NAMELY, PAPER CUPS AND DRINKING GLASSES (U.S. CLS. 2, 13, 23, 29, 30, 33, 40 AND 50).

**CLASS 25—CLOTHING**

FOR CLOTHING, NAMELY, SHIRTS, SWEATSHIRTS, T-SHIRTS, JACKETS AND CAPS (U.S. CLS. 22 AND 39).  
MICHELLE DUBOIS, EXAMINING ATTORNEY

SN 85-143,417. CABRILLO COMMUNITY COLLEGE DISTRICT FINANCING CORPORATION, APTOS, CA. FILED S.R. 10-1-2010; AM. P.R. 10-1-2010.



THE MARK CONSISTS OF A NETWORK OF INTERSECTING LINES THAT FORM A DOMED SHAPE ABOVE THE WORDS "ACADEMY FOR COLLEGE EXCELLENCE" WHICH IS ABOVE THE WORDS "A TRANSFORMATIVE EDUCATION FOR THE DIGITAL AGE".

**CLASS 16—PAPER GOODS AND PRINTED MATTER**

FOR BOOK COVERS, STATIONERY; PAPER PACKING MATERIALS, NAMELY, BOXES, SACKS AND BAGS FOR WRAPPING AND PACKAGING (U.S. CLS. 2, 5, 22, 23, 29, 37, 38 AND 50).

**CLASS 21—HOUSEWARES AND GLASS**

FOR COMBS, HAIR BRUSHES AND HOUSEHOLD CONTAINERS, NAMELY, CUPS, BOWLS AND DRINKING GLASSES; PAPER CONTAINERS, NAMELY, PAPER CUPS AND DRINKING GLASSES (U.S. CLS. 2, 13, 23, 29, 30, 33, 40 AND 50).

**CLASS 25—CLOTHING**

FOR CLOTHING, NAMELY, SHIRTS, SWEATSHIRTS, T-SHIRTS, JACKETS AND CAPS (U.S. CLS. 22 AND 39).  
MICHELLE DUBOIS, EXAMINING ATTORNEY

---

SN 85-143,510. PELICAN PRODUCTS, INC., TORRANCE, CA. FILED 10-1-2010.

**PELICAN-HARDIGG ADVANCED CASE SOLUTIONS**

THE MARK CONSISTS OF STANDARD CHARACTERS WITHOUT CLAIM TO ANY PARTICULAR FONT, STYLE, SIZE, OR COLOR.

NO CLAIM IS MADE TO THE EXCLUSIVE RIGHT TO USE "CASE", APART FROM THE MARK AS SHOWN.

**CLASS 9—ELECTRICAL AND SCIENTIFIC APPARATUS**

FOR SOFT-SIDED AND HARD-SIDED CASES FOR CARRYING AND STORING PHOTOGRAPHIC AND ELECTRONIC EQUIPMENT AND OTHER SENSITIVE EQUIPMENT, NAMELY, CELL PHONES, PDAS, HAND-HELD ELECTRONIC GAME MACHINES AND GAME CARTRIDGES AND CASSETTES AND SMALL RADIOS, CASSETTES AND CD PLAYERS; COMPUTER CASES; CASES FOR CARRYING AND STORING PERSONAL, MILITARY, SEARCH AND RESCUE AND INDUSTRIAL SPECIALTY ELECTRONIC INSTRUMENTS, NAMELY, ELECTRIC NAVIGATION INSTRUMENTS, SEISMIC SENSORS, DIGITAL DIVING DEPTH AND CHRONOMETER GAUGES, PUBLIC ADDRESS SYSTEMS AND INSTRUMENTS, ELECTRONIC FIRE HOSE CONTROLLERS, PORTABLE AIR COMPRESSOR KITS, ELECTRONIC SURVEILLANCE EQUIPMENT, ELECTRONIC FIELD TESTING EQUIPMENT, MICROCHIPS AND CIRCUIT BOARDS, ELECTRONIC CONTROL PANELS, RIFLE SCOPES, FIRE FIGHTING COMMUNICATIONS EQUIPMENT, EMERGENCY LIGHTING SYSTEMS, SATELLITE PHONE SYSTEMS, MOBILE CHEMICAL WEAPONS TESTING KITS, MOBILE CHEMICAL DETECTOR SYSTEMS; GADGET BAGS FOR CARRYING VIDEO CAMERAS, BINOCULARS, GAME CARTRIDGES, CDS, ACCESSORIES FOR COMPUTERS, DIGITAL CAMERAS AND ACCESSORIES FOR CAMERAS (U.S. CLS. 21, 23, 26, 36 AND 38).

**CLASS 20—FURNITURE AND ARTICLES NOT OTHERWISE CLASSIFIED**

FOR PLASTIC CASES FOR INDUSTRIAL, COMMERCIAL AND PERSONAL USE, NAMELY, PACKAGING, SHIPPING, TRANSPORTATION, PROTECTION OF CONTENTS AND STORAGE (U.S. CLS. 2, 13, 22, 25, 32 AND 50).

**CLASS 40—MATERIAL TREATMENT**

FOR CUSTOM MANUFACTURE OF CASES FOR INDUSTRIAL, COMMERCIAL AND PERSONAL USE, NAMELY, PACKAGING, SHIPPING, TRANSPORTATION, PROTECTION OF CONTENTS AND STORAGE (U.S. CLS. 100, 103 AND 106).

FIRST USE 5-17-2010; IN COMMERCE 5-17-2010.

**CLASS 42—SCIENTIFIC AND COMPUTER SERVICES**

FOR CUSTOM DESIGN OF CASES FOR INDUSTRIAL, COMMERCIAL AND PERSONAL USE, NAMELY, PACKAGING, SHIPPING, TRANSPORTATION, PROTECTION OF CONTENTS AND STORAGE (U.S. CLS. 100 AND 101).

FIRST USE 5-17-2010; IN COMMERCE 5-17-2010.

KEVIN CORWIN, EXAMINING ATTORNEY

SN 85-144,174. VEON, CHRIS, DAVENPORT, IA. FILED 10-4-2010.

**SOCIETY DONT APPLY TO ME**

THE MARK CONSISTS OF STANDARD CHARACTERS WITHOUT CLAIM TO ANY PARTICULAR FONT, STYLE, SIZE, OR COLOR.

**CLASS 25—CLOTHING**

FOR CLOTHING, NAMELY, T-SHIRTS, SHORTS, SWEAT PANTS, SWEAT SHIRTS; MIXED MARTIAL ARTS SUITS (U.S. CLS. 22 AND 39).

**CLASS 28—TOYS AND SPORTING GOODS**

FOR SPORTS EQUIPMENT FOR BOXING AND MARTIAL ARTS, NAMELY, BOXING GLOVES, BOXING BAGS, PUNCHING MITTS, BELLY PROTECTORS, GROIN PROTECTORS AND SHIN GUARDS; KARATE KICK PADS (U.S. CLS. 22, 23, 38 AND 50).

DOUGLAS LEE, EXAMINING ATTORNEY

SN 85-144,826. SYMANTEC CORPORATION, MOUNTAIN VIEW, CA. FILED 10-4-2010.

# SYMANTEC

THE MARK CONSISTS OF STANDARD CHARACTERS WITHOUT CLAIM TO ANY PARTICULAR FONT, STYLE, SIZE, OR COLOR.

OWNER OF U.S. REG. NOS. 3,009,890, 3,274,187 AND OTHERS.

**CLASS 9—ELECTRICAL AND SCIENTIFIC APPARATUS**

FOR COMPUTER SOFTWARE FOR PROVIDING CRYPTOGRAPHIC NETWORK SECURITY AND DATA SECURITY FUNCTIONS; COMPUTER SOFTWARE FOR INTEGRATION OF INFORMATION LOGIC AND DATA BETWEEN COMPUTER NETWORKS; COMPUTER SOFTWARE FOR AUTOMATING A PROCESS FOR AUTHENTICATION OF IDENTITY USING EXISTING DATABASES IN CONNECTION WITH THE ISSUANCE AND MANAGEMENT OF DIGITAL CERTIFICATES USED FOR AUTHENTICATION OR ENCRYPTION OF DIGITAL COMMUNICATIONS, OR AUTHENTICATION OF A DIGITAL SIGNATURE IN AN ELECTRONIC TRANSACTION OR COMMUNICATION, OVER THE INTERNET AND OTHER COMPUTER NETWORKS; COMPUTER SOFTWARE, NAMELY, ENCRYPTION SOFTWARE TO ENABLE SECURE TRANSMISSION OF DIGITAL INFORMATION, NAMELY, CONFIDENTIAL, FINANCIAL AND CREDIT CARD INFORMATION OVER THE INTERNET, AS WELL AS OVER OTHER MODES OF COMMUNICATION BETWEEN COMPUTING DEVICES; COMPUTER SOFTWARE TO INTEGRATE MANAGED SECURITY SERVICES, NAMELY, PUBLIC KEY INFRASTRUCTURE SERVICES, DIGITAL CERTIFICATE ISSUANCE, VERIFICATION, MANAGEMENT AND ENTERPRISE SOFTWARE INTEGRATION, WITH EXISTING COMMUNICATIONS NETWORKS, SOFTWARE AND SERVICES; COMPUTER SOFTWARE FOR USE IN ANALYSIS AND REPORTING OF FIREWALL LOG DATA; COMPUTER PROGRAMS FOR DATA COMMUNICATIONS APPLICATIONS, AND FOR THE ENCRYPTION AND AUTHENTICATION OF ELECTRONIC INFORMATION; COMPUTER SOFTWARE FOR IDENTITY SECURITY; COMPUTER SOFTWARE FOR AUTHENTICATION AND IDENTITY MANAGEMENT INFORMATION SECURITY; COMPUTER SOFTWARE FOR DIGITAL INFORMATION AND DATA ACCESS; COMPUTER SOFTWARE FOR DETECTING IDENTITY FRAUD; COMPUTER SOFTWARE AND FIRMWARE FOR THE MANAGEMENT, TRANSMISSION, AND STORAGE OF DATA AND INFORMATION; COMPUTER SOFTWARE FOR USE IN NETWORKING COMPUTERS; COMPUTER SOFTWARE FOR USE IN OPERATING ELECTRONIC MAIL; COMPUTER SOFTWARE FOR USE IN MONITORING COMPUTERS FOR SECURITY PURPOSES; COMPUTER SOFTWARE FOR USE WITH COMPUTER SERVERS FOR CONTROLLING AND MANAGING SERVER APPLICATIONS; COMPUTER SOFTWARE FOR USE IN ACCESSING DATABASES; DOWNLOADABLE ELECTRONIC PUBLICATIONS IN THE NATURE OF USER MANUALS, WHITE PAPERS, ARTICLES, AND TECHNICAL DOCUMENTATION MANUALS IN THE FIELDS OF COMPUTER HARDWARE AND SOFTWARE, DIGITAL TELECOMMUNICA-

TIONS, CONSUMER ELECTRONICS, AND INFORMATION TECHNOLOGIES (U.S. CLS. 21, 23, 26, 36 AND 38).

#### **CLASS 16—PAPER GOODS AND PRINTED MATTER**

FOR PRINTED MATTER, NAMELY, NEWSLETTERS, INSTRUCTIONAL MATERIALS AND TEACHING MATERIALS IN THE FIELD OF INFORMATION TECHNOLOGY (U.S. CLS. 2, 5, 22, 23, 29, 37, 38 AND 50).

#### **CLASS 35—ADVERTISING AND BUSINESS**

FOR COMMERCIAL INFORMATION AND DIRECTORY AGENCY; PROVIDING COMMERCIAL INFORMATION AND ON-LINE DIRECTORY INFORMATION SERVICES FOR LOCATING INTERNET AND OTHER COMPUTER NETWORK ADDRESSES AND DEMOGRAPHIC INFORMATION FOR ENTITIES, AND PROVIDING A BUSINESS DIRECTORY OF ORGANIZATIONS, INDIVIDUALS, ADDRESSES, AND RESOURCES ACCESSIBLE THROUGH THE USE OF THE INTERNET AND OTHER COMPUTER NETWORKS; BUSINESS MANAGEMENT SERVICES, NAMELY, PROVIDING OUTSOURCE MANAGEMENT SERVICES TO OTHERS IN THE FIELD OF DIGITAL CERTIFICATE AUTHENTICATION; ON-LINE TRADING SERVICES TO FACILITATE THE SALE OF GOODS AND SERVICES BY OTHERS VIA THE INTERNET, OTHER COMPUTER NETWORKS AND AN AFFILIATE PROGRAM, IN WHICH SELLER POSTS PRODUCTS TO BE AUCTIONED AND BIDDING IS DONE VIA THE INTERNET AND OTHER COMPUTER NETWORKS; ON-LINE RETAIL STORE SERVICES FEATURING A VARIETY OF GENERAL MERCHANDISE; ADVANCED COMPUTERIZED DATABASE MANAGEMENT SERVICES AND BILLING SERVICES; BUSINESS INFORMATION RELATING TO SUBSCRIBER ACCOUNT DATA PROVIDED TO LOCAL INTEREXCHANGE AND WIRELESS COMMUNICATIONS COMPANIES; PREPARATION OF CUSTOMIZED BUSINESS REPORTS FOR OTHERS; BUSINESS MANAGEMENT SERVICES, NAMELY, MANAGING THE DISTRIBUTION AND INVENTORY OF GOODS USING THE INTERNET, AND PROVIDING INFORMATION RELATING THERETO; FILE MANAGEMENT RELATING TO DISTRIBUTION AND INVENTORY MANAGEMENT OF GOODS BY COMPUTERS; AGENCIES FOR SEARCHES OF COMPUTER DATABASES RELATING TO DISTRIBUTION AND INVENTORY MANAGEMENT OF GOODS, NAMELY, ONLINE SEARCHING OF INVENTORY DATABASES OF GOODS FOR SCHEDULING DISTRIBUTION AND MANAGEMENT OF THE INVENTORY (U.S. CLS. 100, 101 AND 102).

#### **CLASS 36—INSURANCE AND FINANCIAL**

FOR PROVIDING EXTENDED WARRANTIES FOR AUTHENTICATION, ENCRYPTION AND CERTIFICATION SERVICES USED TO PROVIDE SECURITY IN ELECTRONIC TRANSACTIONS AND COMMUNICATIONS THAT TAKE PLACE OVER THE INTERNET AND OTHER COMPUTER NETWORKS; ADMINISTRATION AND PROCESSING OF CLAIMS UNDER EXTENDED WARRANTIES OF AUTHENTICATION, ENCRYPTION AND CERTIFICATION SERVICES USED TO PROVIDE SECURITY IN ELECTRONIC TRANSACTIONS AND COMMUNICATIONS THAT TAKE PLACE OVER THE INTERNET AND OTHER COMPUTER NETWORKS; FINANCIAL SERVICES, NAMELY, PROVIDING FINANCIAL INFORMATION AND TRANSACTION PROCESSING SERVICES BY ELECTRONIC MEANS VIA THE INTERNET AND OTHER COMPUTER NETWORKS, IN THE FIELD OF ELECTRONIC FUND TRANSFER AND PAYMENT PROCESSING SERVICES (U.S. CLS. 100, 101 AND 102).

#### **CLASS 38—COMMUNICATION**

FOR ELECTRONIC COMMUNICATIONS SERVICES IN THE NATURE OF TRANSPORT, ROUTING AND SWITCHING OF SIGNALING MESSAGES AND INFORMATION TO AND FROM VARIOUS TELECOMMUNICATIONS SWITCHES, NETWORKS AND DATABASES; TELEPHONE VOICE MESSAGING; PROVIDING HOSTED ELECTRONIC MAIL AND INSTANT MESSAGING SERVICES; TRANSPORT, NAMELY, ELECTRONIC TRANSMISSION OF SIGNALING MESSAGES AND INFORMATION FOR BANKING, CREDIT AND FINANCIAL VERIFICATION; TRANSPORT OF SIGNALING MESSAGES AND INFORMATION TO AND FROM CELLULAR SWITCHES, DATABASES AND NETWORKS; TELEPHONE COMMUNICATIONS SERVICES; WIRELESS TELEPHONE SERVICES; PREPAID WIRELESS TELEPHONE SERVICES; WIRELESS, ELECTRONIC, ELECTRIC AND DIGITAL TRANSMISSION OF VOICE, DATA, IMAGES, SIGNALS AND MESSAGES INCLUDING SHORT MESSAGING SERVICE AND MULTIMEDIA MESSAGING SERVICE; ELECTRONIC TRANSMISSION OF MESSAGES AND DATA TO COMMUNICATIONS CARRIERS; VIRTUAL PRIVATE NETWORK SERVICES, NAMELY, PROVIDING REMOTE ACCESS TO LOCAL AREA NETWORKS; PROVIDING ON-LINE FORUMS FOR TRANSMISSION OF MESSAGES AMONG COMPUTER USERS CONCERNING COMPUTERS, COMPUTER HARDWARE, COMPUTER SOFTWARE, COMPUTER PERIPHERALS, COMPUTER SYSTEMS, COMPUTER NETWORKS, COMPUTER-RELATED EQUIPMENT, COMPUTER SECURITY, INFORMATION TECHNOLOGY, ELECTRONIC COMMERCE TECHNOLOGY AND GLOBAL COMPUTER NETWORK TECHNOLOGY, MOBILE COMPUTING, COMMUNICATIONS NETWORKS AND DEVICES, AND TELECOMMUNICATIONS EQUIPMENT AND DEVICES; PROVIDING ON-LINE CHAT ROOMS FOR TRANSMISSION OF MESSAGES AMONG COMPUTER USERS CONCERNING COMPUTERS, COMPUTER HARDWARE, COMPUTER SOFTWARE, COMPUTER PERIPHERALS, COMPUTER SYSTEMS, COMPUTER NETWORKS, COMPUTER-RELATED EQUIPMENT, COMPUTER SECURITY, INFORMATION TECHNOLOGY, ELECTRONIC COMMERCE TECHNOLOGY AND GLOBAL COMPUTER NETWORK TECHNOLOGY, MOBILE COMPUTING, COMMUNICATIONS NETWORKS AND DEVICES, AND TELECOMMUNICATIONS EQUIPMENT AND DEVICES (U.S. CLS. 100, 101 AND 104).

#### **CLASS 41—EDUCATION AND ENTERTAINMENT**

FOR EDUCATIONAL SERVICES, NAMELY, PROVIDING INSTRUCTION AND DEMONSTRATIONS IN THE FIELDS OF USE AND MANAGEMENT OF COMPUTER NETWORKS, CORPORATE LOCAL AREA NETWORKS, THE INTERNET, AND COMPUTER NETWORK ADDRESSES; PROVIDING A NONDOWNLOADABLE ON-LINE NEWSLETTER IN THE FIELD OF INFORMATION TECHNOLOGY; EDUCATIONAL SERVICES, NAMELY, CONDUCTING CLASSES, SEMINARS, CONFERENCES, AND WORKSHOPS IN THE FIELDS OF COMPUTERS, COMPUTER HARDWARE, COMPUTER SOFTWARE, COMPUTER PERIPHERALS, COMPUTER SYSTEMS, COMPUTER NETWORKS, COMPUTER SECURITY, INFORMATION TECHNOLOGY, ELECTRONIC COMMERCE TECHNOLOGY AND GLOBAL COMPUTER NETWORK TECHNOLOGY, MOBILE COMPUTING, COMMUNICATIONS NETWORKS AND DEVICES AND TELECOMMUNICATIONS EQUIPMENT AND DEVICES, AND DISTRIBUTING COURSE MATERIALS IN CONNECTION THEREWITH; TRAINING SERVICES IN THE FIELDS OF COMPUTERS, COMPUTER HARDWARE, COMPUTER SOFTWARE, COMPUTER PERIPHERALS, COMPUTER SYSTEMS, COMPUTER NETWORKS, COMPUTER SECURITY, INFORMATION TECHNOLOGY, ELECTRONIC COMMERCE TECHNOLOGY AND GLOBAL COMPUTER NETWORK TECHNOLOGY, MOBILE COMPUTING, COMMUNICATIONS NETWORKS AND DEVICES, AND TELECOMMUNICATIONS EQUIPMENT AND DEVICES; ENTERTAINMENT SERVICES, NAMELY, PROVIDING PODCASTS, BLOGS, CONTINUING PROGRAMS, SEGMENTS AND SHOWS, ALL FEATURING

TURING NEWS AND COMMENTARY IN THE FORM OF AUDIO, VIDEO, AND PROSE PRESENTATIONS ABOUT COMPUTERS, COMPUTER HARDWARE, COMPUTER SOFTWARE, COMPUTER PERIPHERALS, COMPUTER SYSTEMS, COMPUTER NETWORKS, COMPUTER SECURITY, INFORMATION TECHNOLOGY, ELECTRONIC COMMERCE TECHNOLOGY, GLOBAL COMPUTER NETWORK TECHNOLOGY, MOBILE COMPUTING, COMMUNICATIONS NETWORKS AND DEVICES, AND TELECOMMUNICATIONS EQUIPMENT AND DEVICES, DELIVERED BY THE INTERNET (U.S. CLS. 100, 101 AND 107).

#### **CLASS 42—SCIENTIFIC AND COMPUTER SERVICES**

FOR PROVIDING AUTHENTICATION OF WEBSITE OPERATOR IDENTITY, NAMELY, IP ADDRESS VERIFICATION SERVICES; PROVIDING TECHNICAL AND CUSTOMER SUPPORT SERVICES, NAMELY, ENCRYPTION OF A DIGITAL COMMUNICATION AND TECHNICAL SUPPORT IN THE NATURE OF COMPUTER HELP DESK SERVICES FOR ISSUANCE AND MANAGEMENT OF DIGITAL CERTIFICATES FOR DIGITAL COMMUNICATION AND DIGITAL SIGNATURE AUTHENTICATION AND ENCRYPTION, OVER THE INTERNET AND OTHER COMPUTER NETWORK; DEVELOPMENT, DESIGN, IMPLEMENTATION, TESTING, ANALYSIS, AND CONSULTING SERVICES IN THE FIELD OF SECURITY, ACCESS, AUTHORIZATION, AUTHENTICATION ENCRYPTION, AND IDENTIFICATION SYSTEMS FOR COMPUTERS, COMPUTER HARDWARE AND COMPUTER NETWORKS; DEVELOPMENT, INTEGRATION AND OPERATION OF COMPUTER SYSTEMS TO SUPPORT ISSUANCE AND MANAGEMENT OF DIGITAL CERTIFICATES; CREATING AND IMPLEMENTING SOFTWARE FOR ISSUING AND MANAGING DIGITAL CERTIFICATES; INTEGRATION OF ENTERPRISE SOFTWARE INTO MULTIPLE SYSTEMS AND NETWORKS; ON-LINE TECHNICAL SUPPORT SERVICES, NAMELY, TROUBLESHOOTING IN THE NATURE OF DIAGNOSING COMPUTER HARDWARE AND SOFTWARE PROBLEMS; COMPUTER SERVICES, NAMELY, PROVIDING SEARCH ENGINES FOR OBTAINING DATA ON A GLOBAL COMPUTER NETWORK; COMPUTER CONSULTING SERVICES IN THE FIELD OF SECURITY INTEGRATION, NETWORK SECURITY, NETWORK ARCHITECTURE, ENCRYPTION TECHNOLOGY, AND COMPUTER SECURITY; SECURITY VERIFICATION OF COMPUTER NETWORK FIREWALLS, SERVERS AND OTHER NETWORK DEVICES FROM UNAUTHORIZED ACCESS, NAMELY, ANALYZING GLOBAL COMPUTER INFORMATION NETWORK AND INTERNAL COMPUTER NETWORK VULNERABILITY; WEB HOSTING; COMPUTER SERVICES, NAMELY, PROVIDING TEMPORARY USE OF NON-DOWNLOADABLE SOFTWARE APPLICATIONS FOR CREATING AND OPERATING E-COMMERCE WEBSITES; APPLICATION SERVICE PROVIDER, NAMELY, HOSTING COMPUTER SOFTWARE APPLICATIONS FOR OTHERS; DESIGNING, CREATING OR MAINTAINING OF COMPUTER PROGRAMS FOR COMPUTER NETWORKS USING RADIO FREQUENCY ID AND THE ELECTRONIC PRODUCT CODE; COMPUTER CONSULTATION IN THE FIELD OF COMPUTER SECURITY; COMPUTER SOFTWARE INSTALLATION SERVICES; COMPUTER PROGRAMMING; UPDATING COMPUTER SOFTWARE; TECHNICAL CONSULTATION IN THE FIELD OF COMPUTER SOFTWARE INSTALLATION AND MAINTENANCE; COMPUTER CONSULTING SERVICES RELATED TO COMPUTER PRODUCTS AND SERVICES; COMPUTER SOFTWARE DESIGN FOR OTHERS; APPLICATION SERVICE PROVIDER SERVICES, NAMELY, PROVIDING ON-LINE, NON-DOWNLOADABLE SOFTWARE FOR COMPUTER SECURITY TESTING IN THE FIELDS OF COMPUTER AND INTERNET SECURITY; PROVIDING CONSULTANTS, ON A PROJECT OR HOURLY BASIS, TO HELP CUSTOMERS DEPLOY, SUPERVISE AND MANAGE INFORMATION TECHNOLOGY PROJECTS, NAMELY, INFORMATION TECHNOLOGY PROJECT CONSULTING SERVICES PROVIDED BY HOURLY OR PROJECT BASED CONSULTANTS; PROVIDING INFORMATION IN THE FIELD OF INFORMATION TECHNOLOGY RELATING TO COMMUNICATIONS DEVICES, COMPUTERS, COMPUTER HARDWARE, COMPUTER SOFTWARE, COMPUTER PERIPHERALS, AND COMPUTER NETWORKS; PROTOCOL CONVERSION SERVICES TRANSLATING

MESSAGES AND INFORMATION BETWEEN VARIOUS TELECOMMUNICATIONS PROTOCOLS OR LANGUAGES; PROVIDING INFORMATION IN THE FIELDS OF GLOBAL COMPUTER NETWORK AND LOCAL AREA NETWORK SECURITY, PREVENTING COMPUTER VIRUSES, COMPUTER HARDWARE AND SOFTWARE APPLICATIONS IN SECURITY; ENCRYPTION OF DIGITAL CERTIFICATES AND SIGNATURES IN ELECTRONIC TRANSACTIONS AND COMMUNICATION OVER THE INTERNET AND OTHER COMPUTER NETWORK; PROVIDING A WEB SITE FEATURING NON-DOWNLOADABLE INSTRUCTIONAL VIDEOS IN THE FIELD OF COMPUTERS, COMPUTER HARDWARE, COMPUTER SOFTWARE, COMPUTER PERIPHERALS, COMPUTER SYSTEMS, COMPUTER NETWORKS, COMPUTER SECURITY, INFORMATION TECHNOLOGY, ELECTRONIC COMMERCE TECHNOLOGY, GLOBAL COMPUTER NETWORK TECHNOLOGY, MOBILE COMPUTING, COMMUNICATIONS NETWORKS AND DEVICES, AND TELECOMMUNICATIONS EQUIPMENT AND DEVICES (U.S. CLS. 100 AND 101).

#### **CLASS 45—PERSONAL AND LEGAL SERVICES**

FOR MANAGED PUBLIC KEY INFRASTRUCTURE SERVICES, NAMELY, AUTHENTICATION, ISSUANCE AND VALIDATION OF DIGITAL CERTIFICATES; PROVIDING USER AUTHENTICATION SERVICES IN E-COMMERCE TRANSACTIONS; BUSINESS MANAGEMENT, NAMELY, ISSUANCE OF DIGITAL CERTIFICATES FOR AUTHENTICATION; ISSUANCE OF DIGITAL CERTIFICATES FOR AUTHENTICATION OF A DIGITAL COMMUNICATIONS AND DIGITAL SIGNATURES IN AN ELECTRONIC TRANSACTION OR COMMUNICATION, OVER THE INTERNET AND OTHER COMPUTER NETWORK; MONITORING OF COMPUTER SYSTEMS FOR SECURITY PURPOSES; MONITORING FINANCIAL TRANSACTIONS AND EVALUATING THE LIKELIHOOD OF FRAUD VIA A MULTI-FACTOR SCORING SYSTEM, IN THE FIELD OF ELECTRONIC FUND TRANSFER AND PAYMENT PROCESSING SERVICES; PROVIDING AUTHENTICATION OF IDENTITY IN THE NATURE OF AUTHENTICATION OF PERSONAL IDENTIFICATION INFORMATION; SECURITY CONSULTING ABOUT CREATING AND IMPLEMENTING PROCEDURES AND PRACTICES FOR ISSUING AND MANAGING DIGITAL CERTIFICATES (U.S. CLS. 100 AND 101).

APRIL ROACH, EXAMINING ATTORNEY

SN 85-144,957. BATS GLOBAL MARKETS, INC., LENEXA, KS. FILED 10-5-2010.

# BASES

THE MARK CONSISTS OF STANDARD CHARACTERS WITHOUT CLAIM TO ANY PARTICULAR FONT, STYLE, SIZE, OR COLOR.

#### **CLASS 16—PAPER GOODS AND PRINTED MATTER**

FOR BOOKS AND PAMPHLETS IN THE FIELD OF FINANCIAL CLASSIFICATION OF COMPANIES AND SECURITIES (U.S. CLS. 2, 5, 22, 23, 29, 37, 38 AND 50).  
FIRST USE 7-1-2008; IN COMMERCE 7-1-2009.



**CLASS 36—INSURANCE AND FINANCIAL**

FOR FINANCIAL INFORMATION SERVICES PROVIDED ON-LINE FROM A COMPUTER DATABASE OR A GLOBAL COMPUTER NETWORK, NAMELY, PROVIDING INFORMATION IN THE FIELD OF FINANCIAL CLASSIFICATION OF COMPANIES AND SECURITIES (U.S. CLS. 100, 101 AND 102).

FIRST USE 7-1-2008; IN COMMERCE 7-1-2009.  
JULIE GUTTADAURO, EXAMINING ATTORNEY

SN 85-147,695. NYSE GROUP, INC., NEW YORK, NY. AND EURONEXT N.V., AMSTERDAM, NETHERLANDS, FILED 10-7-2010.

---

## NYSE BondMatch

THE MARK CONSISTS OF STANDARD CHARACTERS WITHOUT CLAIM TO ANY PARTICULAR FONT, STYLE, SIZE, OR COLOR.

PRIORITY CLAIMED UNDER SEC. 44(D) ON ERP CMNTY TM OFC APPLICATION NO. 009408683, FILED 9-29-2010, REG. NO. 009408683, DATED 8-3-2011, EXPIRES 9-29-2020.

OWNER OF U.S. REG. NOS. 3,603,163, 3,915,924 AND OTHERS.

**CLASS 35—ADVERTISING AND BUSINESS**

FOR ADVERTISING; COMPILING OF STATISTICS, COMMERCIAL INFORMATION, MARKET RESEARCH AND MARKET ANALYSIS; PROVIDING THE BUSINESS ADMINISTRATION FOR STOCK EXCHANGES TRADING IN SHARES AND OTHER FINANCIAL SECURITIES; PUBLICITY SERVICES TO PROMOTE TRADING IN SHARES AND OTHER FINANCIAL SECURITIES; MEDIATION IN RESPECT OF DEALING IN SHARES AND OTHER FINANCIAL SECURITIES, NAMELY, MEDIATION AND CONCLUSION OF COMMERCIAL TRANSACTIONS INVOLVING SHARES AND OTHER FINANCIAL SECURITIES FOR OTHERS; COMPILING FINANCIAL, SECURITIES, STOCK EXCHANGE, TRADE AND QUOTE, INDEX VALUE AND OTHER FINANCIAL MARKET INFORMATION FOR BUSINESS PURPOSES (U.S. CLS. 100, 101 AND 102).

**CLASS 36—INSURANCE AND FINANCIAL**

FOR INSURANCE AND FINANCE, NAMELY, PROVIDING AND DISSEMINATING FINANCIAL INFORMATION RELATING TO FINANCIAL SECURITIES, STOCK EXCHANGES, AND OTHER FINANCIAL MARKET INFORMATION; STOCK EXCHANGE QUOTATION AND LISTING SERVICES; SECURITIES BROKERAGE; MEDIATION IN RESPECT OF DEALING IN SHARES AND OTHER FINANCIAL SECURITIES, NAMELY, MEDIATION AND CONCLUSION OF COMMERCIAL TRANSACTIONS INVOLVING SHARES AND OTHER FINANCIAL SECURITIES FOR OTHERS; STOCK EXCHANGES FOR DEALING IN SHARES AND OTHER FINANCIAL SECURITIES; FINANCIAL INFORMATION AND ANALYSIS SERVICES; PROVIDING THE FINANCIAL ADMINISTRATION FOR STOCK EXCHANGES TRADING IN SHARES AND OTHER FINANCIAL SECURITIES; PROVIDING FINANCIAL INFORMATION SERVICES RELATING TO TRADING IN SHARES AND OTHER FINANCIAL SECURITIES (U.S. CLS. 100, 101 AND 102).

**CLASS 38—COMMUNICATION**

FOR TELECOMMUNICATIONS, NAMELY, TRANSFER OF INFORMATION AND DATA VIA ELECTRONIC CHANNELS; FACILITATING TRADING IN SECURITIES AND OTHER STOCKS VIA THE COMPUTER, INTERNET, ON-LINE AND OTHER ELECTRONIC CHANNELS, NAMELY, COMMUNICATING AND ROUTING TRADE INFORMATION INVOLVING ORDERS, ENTRY AND EXECUTION SERVICES, TO OTHERS VIA A GLOBAL COMPUTER NETWORK; PROVIDING ACCESS TIME TO COMPUTER NETWORKS AND INTERNET (U.S. CLS. 100, 101 AND 104).

**CLASS 41—EDUCATION AND ENTERTAINMENT**

FOR PUBLICATION OF STATISTICS, COMMERCIAL INFORMATION, MARKET RESEARCH AND MARKET ANALYSIS (U.S. CLS. 100, 101 AND 107).  
HEATHER BIDDULPH, EXAMINING ATTORNEY

SN 85-148,153. MICHAEL BARBARISI, WESTBURY, NY. FILED 10-8-2010.



THE COLOR(S) PINK, RED, BLUE, BROWN, AND WHITE IS/ARE CLAIMED AS A FEATURE OF THE MARK.

THE MARK CONSISTS OF BROWN STYLIZED LETTERING "LOLLIPOP MOON" OVER ELEVEN SMALL CIRCLES THAT ARE INTERSPERSED IN BLUE AND RED AND BROWN STYLIZED LETTERING "TRENDY APPAREL FOR THE ONE YOU LOVE" UNDERNEATH THE ELEVEN SMALL CIRCLES THAT ARE INTERSPERSED IN BLUE AND RED WITH THE "LOLLI" PORTION OF THE STYLIZED LETTERING SUPERIMPOSED OVER A PINK CIRCLE WITH SMALLER WHITE CIRCLES INSIDE THAT FORM A CIRCLE THAT ARE SUPERIMPOSED OVER AND WITHIN THE PINK CIRCLE WITH ANOTHER SET OF SMALL RED CIRCLES THAT FORM AN ELLIPTICAL CIRCLE THAT IS PARTIALLY SUPERIMPOSED OVER THE PINK CIRCLE.

**CLASS 25—CLOTHING**

FOR CHILDRENS CLOTHING, NAMELY, INFANTWEAR, UNDERWEAR, BODYSUITS, UNDERCLOTHES, UNDERGARMENTS, T-SHIRTS, POLO SHIRTS, HOODED SWEATSHIRTS, TANK TOPS (U.S. CLS. 22 AND 39).

**CLASS 35—ADVERTISING AND BUSINESS**

FOR ONLINE WHOLESALE AND RETAIL STORE SERVICES FEATURING A WIDE RANGE OF WOMEN'S AND CHILDREN'S ITEMS, NAMELY, INFANTWEAR, UNDERWEAR, BODYSUITS, UNDERCLOTHES, UNDERGARMENTS, SOCKS, BIBS, TANK TOPS, T-SHIRTS, HATS, DRESSES, SKIRTS, TUTUS, PANTS, HOODED SWEATSHIRTS, BELTS, LEGGINGS, SHOES, JACKETS, COATS, RAINCOATS, BLANKETS, TOWELS, GIFTS, DIAPER BAGS, TOYS, JEWELRY, HEADBANDS, HAIR CLIPS, PURSES, WALLETS, TRAVEL KITS, CHANGING PADS, BABY BUNTINGS, NURSERY WIPES BOXES, MULTIPURPOSE TRAVEL BAGS AND INFANT CARRIERS WORN ON THE BODY, STROLLERS, LAMPS, WALL ART, FRAMES AND UMBRELLAS (U.S. CLS. 100, 101 AND 102).

DAVID H. STINE, EXAMINING ATTORNEY

**CLASS 35—ADVERTISING AND BUSINESS**

FOR ADVERTISING, PROMOTION AND MARKETING SERVICES; PROVIDING ON-LINE COMPUTER DATABASES AND ON-LINE SEARCHABLE DATABASES FEATURING CLASSIFIED ADVERTISEMENT LISTINGS FOR GOODS AND SERVICES, NAMELY, WANT ADS AND EMPLOYMENT OPPORTUNITIES; PROVIDING CAREER, EMPLOYMENT AND JOB PLACEMENT INFORMATION VIA THE INTERNET; ON-LINE RETAIL STORE SERVICES FEATURING DOWNLOADABLE PRE-RECORDED MUSIC, VIDEO AND COMPUTER GAMES, GAME-RELATED PRODUCTS, COMIC BOOKS, CLOTHING AND BOOKS; PROMOTING THE GOODS OF OTHERS BY MEANS OF OPERATING AN ON-LINE SHOPPING MALL WITH LINKS TO THE RETAIL WEBSITES OF OTHERS; COMPARISON SHOPPING SERVICES; DISSEMINATION OF ADVERTISING FOR OTHERS VIA THE INTERNET; PROVIDING AND RENTAL OF ADVERTISING SPACE ON THE INTERNET; ON-LINE ADVERTISING AND MARKETING SERVICES; PROVIDING ON-LINE AUCTION SERVICES; PROMOTING CONCERTS AND ENTERTAINMENT EVENTS FOR OTHERS (U.S. CLS. 100, 101 AND 102).

SN 85-148,961. MYSPACE, INC., BEVERLY HILLS, CA. FILED 10-9-2010.



OWNER OF U.S. REG. NOS. 3,183,151, 3,629,478 AND OTHERS.

THE MARK CONSISTS OF THE WORD "MY" APPEARING TO THE LEFT OF A BRACKET AND THE WORD "SPACE" APPEARING INSIDE THE BRACKET.

**CLASS 9—ELECTRICAL AND SCIENTIFIC APPARATUS**

FOR COMPUTER SOFTWARE DEVELOPMENT TOOLS; COMPUTER SOFTWARE DEVELOPMENT TOOLS FOR USE IN CREATING SOCIAL NETWORKING INTERFACES, BUILDING SOCIAL NETWORKING APPLICATIONS AND FOR CREATING DATA RETRIEVAL, UPLOAD, ACCESS AND MANAGEMENT SOFTWARE; APPLICATION PROGRAMMING INTERFACE (API) FOR THIRD-PARTY SOFTWARE AND ONLINE SERVICES FOR SOCIAL NETWORKING, BUILDING SOCIAL NETWORKING APPLICATIONS AND FOR ALLOWING DATA RETRIEVAL, UPLOAD, ACCESS AND MANAGEMENT; PRE-RECORDED CDS FEATURING MUSIC, POETRY AND DRAMATIC READINGS AND OTHER AUDIO ENTERTAINMENT; DOWNLOADABLE AUDIO AND VIDEO RECORDINGS FEATURING MUSIC, POETRY, DRAMATIC READINGS, COMPUTER GAMES AND OTHER AUDIO-VISUAL ENTERTAINMENT; DOWNLOADABLE MOTION PICTURES, TELEVISION SHOWS AND VIDEO RECORDINGS FEATURING MUSICAL AND ARTISTIC PERFORMANCES, DRAMAS, DOCUMENTARIES, COMEDIES, REALITY SHOW PROGRAMMING, FASHION SHOWS, TALENT SHOWS, SPORTS, CELEBRITY APPEARANCES AND INTERVIEWS, PROVIDED VIA A VIDEO-ON-DEMAND SERVICE; DOWNLOADABLE RING TONES, RING BACKS, GRAPHICS, WALLPAPER, GAMES AND MUSIC VIA A GLOBAL COMPUTER NETWORK AND WIRELESS DEVICES; COMPUTER SCREEN SAVER SOFTWARE; COMPUTER GAME AND VIDEO GAME SOFTWARE FOR PERSONAL COMPUTERS AND HOME VIDEO GAME CONSOLES (U.S. CLS. 21, 23, 26, 36 AND 38).

**CLASS 38—COMMUNICATION**

FOR PROVIDING ON-LINE CHAT ROOMS AND ELECTRONIC BULLETIN BOARDS FOR TRANSMISSION OF MESSAGES AMONG USERS IN THE FIELD OF GENERAL INTEREST AND MUSIC; PROVIDING EMAIL AND INSTANT MESSAGING SERVICES; TEXT AND NUMERIC WIRELESS DIGITAL MESSAGING SERVICES; PROVIDING MULTIPLE-USER ACCESS TO A GLOBAL COMPUTER INFORMATION NETWORK; COMMUNICATION SERVICES, NAMELY, TRANSMISSION OF VOICE, AUDIO, VISUAL IMAGES AND DATA BY TELECOMMUNICATIONS NETWORKS, WIRELESS COMMUNICATION NETWORKS, THE INTERNET, INFORMATION SERVICES NETWORKS AND DATA NETWORKS; STREAMING AUDIO AND VIDEO MATERIAL ON THE INTERNET; VIDEO-ON-DEMAND TRANSMISSION SERVICES; PROVIDING VOICE COMMUNICATION SERVICES OVER THE INTERNET; PROVIDING ON-LINE FACILITIES FOR REAL-TIME INTERACTION WITH OTHER COMPUTER USERS CONCERNING TOPICS OF GENERAL INTEREST AND GAME-PLAYING TOPICS; PODCASTING SERVICES; WEBCASTING SERVICES (U.S. CLS. 100, 101 AND 104).

**CLASS 41—EDUCATION AND ENTERTAINMENT**

FOR PROVIDING ON-LINE INFORMATION VIA THE INTERNET IN THE FIELDS OF CURRENT EVENTS, CULTURAL EVENTS AND ENTERTAINMENT-RELATED TOPICS; PROVIDING AN ON-LINE COMPUTER DATABASE FEATURING INFORMATION IN THE FIELDS OF CURRENT EVENTS, CULTURAL EVENTS AND ENTERTAINMENT-RELATED TOPICS; ENTERTAINMENT SERVICES IN THE NATURE OF NON-DOWNLOADABLE VIDEOS AND IMAGES TRANSMITTED VIA THE INTERNET AND WIRELESS COMMUNICATION NETWORKS IN THE FIELDS OF LIVE AND RECORDED AUDIO VISUAL PERFORMANCES, MUSIC, FASHION, COMEDY, SPORTS, KARAOKE, PHOTOGRAPHY, COMPUTER GAMES, REALITY SHOW PROGRAMMING, WEBSITE SERIES, CELEBRITY APPEARANCES AND INTERVIEWS, ENTERTAINMENT AND PERFORMANCE REVIEWS, MOTION PICTURE FILMS, THEATER, TELEVISION AND RADIO; PRODUCTION AND DISTRIBUTION OF NON-DOWNLOADABLE VIDEOS AND IMAGES TRANSMITTED VIA THE INTERNET AND WIRELESS COMMUNICATION NETWORKS IN THE FIELDS OF LIVE AND RECORDED AUDIO VISUAL PERFORMANCES, MUSIC, FASHION, COMEDY, SPORTS, KARAOKE, PHOTOGRAPHY, COMPUTER GAMES, REALITY SHOW PROGRAMMING, WEBSITE SERIES, CELEBRITY APPEARANCES AND INTERVIEWS, ENTERTAINMENT AND PERFORMANCE REVIEWS, MOTION PICTURE FILMS, THEATER, TELEVISION AND RADIO; ELECTRONIC PUBLISHING SERVICES, NAMELY, PUBLICATION OF TEXT AND GRAPHIC WORKS OF OTHERS ON-LINE FEATURING CURRENT EVENTS, CULTURAL EVENTS AND ENTERTAINMENT-RELATED TOPICS.

TAINMENT-RELATED TOPICS; ENTERTAINMENT SERVICES, NAMELY, PROVIDING ON-LINE COMPUTER GAMES; ON-LINE JOURNALS, NAMELY, BLOGS FEATURING PERSONAL INFORMATION; MOVIE SCHEDULE AND LOCATION INFORMATION SERVICES; ENTERTAINMENT SERVICES IN THE NATURE OF ORGANIZING, ARRANGING AND CONDUCTING MUSICAL, CULTURAL AND SPORTING EVENTS; ORGANIZING CULTURAL AND COMMUNITY SPORTING EVENTS; ENTERTAINMENT IN THE NATURE OF CONTESTS, COMPETITIONS AND GAMES (U.S. CLS. 100, 101 AND 107).

#### **CLASS 42—SCIENTIFIC AND COMPUTER SERVICES**

FOR COMPUTER SERVICES IN THE NATURE OF CUSTOMIZED WEB PAGES FEATURING USER-DEFINED INFORMATION, PERSONAL PROFILES AND INFORMATION; COMPUTER SERVICES, NAMELY, HOSTING ON-LINE WEB FACILITIES FOR OTHERS FOR ORGANIZING AND CONDUCTING ONLINE MEETINGS, GATHERINGS, AND INTERACTIVE DISCUSSIONS; PROVIDING ON-LINE SEARCH ENGINES FOR OBTAINING DATA ON A WIDE VARIETY OF TOPICS AND FIELDS OF GENERAL INTEREST VIA THE INTERNET; HOSTING OF DIGITAL CONTENT ON THE INTERNET, NAMELY, ON-LINE JOURNALS AND BLOGS; PROVIDING TEMPORARY USE OF NON-DOWNLOADABLE COMPUTER SOFTWARE FOR USE IN THE CREATION AND PUBLICATION OF ON-LINE JOURNALS AND BLOGS; WEBSITE HOSTING SERVICES; COMPUTER SERVICES, NAMELY, PROVIDING SEARCH ENGINES FOR OBTAINING DATA ON A GLOBAL COMPUTER NETWORK; COMPUTER SOFTWARE DEVELOPMENT; APPLICATION SERVICE PROVIDER (ASP) FEATURING SOFTWARE TO ENABLE UPLOADING, POSTING, SHOWING, DISPLAYING, TAGGING, BLOGGING, SHARING OR OTHERWISE PROVIDING ELECTRONIC MEDIA OR INFORMATION OVER THE INTERNET AND OTHER COMMUNICATION NETWORKS (U.S. CLS. 100 AND 101).

#### **CLASS 45—PERSONAL AND LEGAL SERVICES**

FOR INTERNET BASED DATING, INTRODUCTION AND SOCIAL NETWORKING SERVICES; PROVIDING ON-LINE COMPUTER DATABASES AND ON-LINE SEARCHABLE DATABASES FEATURING PERSONALS ADS (U.S. CLS. 100 AND 101).

RONALD AIKENS, EXAMINING ATTORNEY

SN 85-149,459. JELMAR LLC, SKOKIE, IL. FILED 10-11-2010.

## **CHORE WARS**

THE MARK CONSISTS OF STANDARD CHARACTERS WITHOUT CLAIM TO ANY PARTICULAR FONT, STYLE, SIZE, OR COLOR.

#### **CLASS 1—CHEMICALS**

FOR CHEMICAL COMPOSITIONS FOR REMOVING DEPOSITS OF CALCIUM, LIME AND RUST STAINS FROM GLASS, PORCELAIN, CEMENT, STUCCO, CHROME AND METAL SURFACES (U.S. CLS. 1, 5, 6, 10, 26 AND 46).

#### **CLASS 3—COSMETICS AND CLEANING PREPARATIONS**

FOR ALL PURPOSE CLEANING, POLISHING, TARNISH AND STAIN REMOVING PREPARATIONS; AEROSOL DRAIN OPENERS; CLEANING PREPARATIONS FOR REMOVING DEPOSIT BUILDUPS FROM SEPTIC RETAINING TANKS (U.S. CLS. 1, 4, 6, 50, 51 AND 52).

MARY BOAGNI, EXAMINING ATTORNEY

SN 85-150,034. PCMP LLC, SAHUARITA, AZ. FILED 10-11-2010.



NO CLAIM IS MADE TO THE EXCLUSIVE RIGHT TO USE "WORLD HOCKEY ASSOCIATION" FOR GOODS IN CLASS 9 AND CLASS 16 AND SERVICES IN CLASS 41, "HOCKEY ASSOCIATION" FOR GOODS IN CLASS 25 AND CLASS 28, "HALL OF FAME" FOR SERVICES IN CLASS 41, AND "HONORING THE 1972-1979 MAJOR LEAGUE", APART FROM THE MARK AS SHOWN.

THE MARK CONSISTS OF A CIRCLE CONTAINING A HOCKEY PLAYER FIGURE AND THE WORDING: "THE WORLD HOCKEY ASSOCIATION WHA HALL OF FAME HONORING THE 1972-1979 MAJOR LEAGUE".

#### **CLASS 9—ELECTRICAL AND SCIENTIFIC APPARATUS**

FOR DIGITAL MEDIA, NAMELY, DVDS FEATURING CONTENT RELATING TO THE 1972-1979 WORLD HOCKEY ASSOCIATION (U.S. CLS. 21, 23, 26, 36 AND 38).

FIRST USE 6-30-2010; IN COMMERCE 6-30-2010.

#### **CLASS 16—PAPER GOODS AND PRINTED MATTER**

FOR TRADING CARDS AND POSTERS FEATURING CONTENT RELATING TO THE 1972-1979 WORLD HOCKEY ASSOCIATION (U.S. CLS. 2, 5, 22, 23, 29, 37, 38 AND 50).

FIRST USE 6-30-2010; IN COMMERCE 6-30-2010.

#### **CLASS 25—CLOTHING**

FOR SHIRTS FEATURING CONTENT RELATING TO THE 1972-1979 WORLD HOCKEY ASSOCIATION (U.S. CLS. 22 AND 39).

FIRST USE 6-30-2010; IN COMMERCE 6-30-2010.

#### **CLASS 28—TOYS AND SPORTING GOODS**

FOR HOCKEY PUCKS (U.S. CLS. 22, 23, 38 AND 50).

FIRST USE 6-30-2010; IN COMMERCE 6-30-2010.

**CLASS 41—EDUCATION AND ENTERTAINMENT**

FOR EDUCATIONAL AND ENTERTAINMENT MUSEUM SERVICES, NAMELY, ORGANIZING, MAINTAINING AND PROVIDING AN ARCHIVE OF HISTORICAL ARTIFACTS PERTAINING TO THE 1972-1979 WORLD HOCKEY ASSOCIATION; MUSEUM SERVICES, NAMELY, PROVIDING A GALLERY AREA DISPLAYING HISTORICAL ARTIFACTS AND MEMORABILIA RELATING TO THE 1972-1979 WORLD HOCKEY ASSOCIATION; AND CONDUCTING EDUCATIONAL AND ENTERTAINMENT PUBLIC EVENTS, NAMELY, A RECOGNITION CEREMONY, PUBLIC APPEARANCES BY PROFESSIONAL ATHLETES, AND FAN FESTIVALS, ALL IN CONNECTION WITH THE 1972-1979 WORLD HOCKEY ASSOCIATION; PROVIDING A WEBSITE FEATURING NON-DOWNLOADABLE AUDIO AND VIDEO RECORDINGS ABOUT THE 1972-1979 WORLD HOCKEY ASSOCIATION (U.S. CLS. 100, 101 AND 107).

FIRST USE 6-30-2010; IN COMMERCE 6-30-2010.  
REBECCA EISINGER, EXAMINING ATTORNEY

---

SN 85-150,209. ALOK INTERNATIONAL INC., DALLAS, TX.  
FILED 10-12-2010.

# CT1

THE MARK CONSISTS OF STANDARD CHARACTERS WITHOUT CLAIM TO ANY PARTICULAR FONT, STYLE, SIZE, OR COLOR.

**CLASS 23—YARNS AND THREADS**

FOR YARNS AND THREADS FOR TEXTILE USE (U.S. CL. 43).

**CLASS 25—CLOTHING**

FOR CLOTHING, NAMELY, PANTS, SHIRTS, SHORTS, PAJAMAS, DRESSES, JACKETS, SWEAT PANTS, SWEAT SHIRTS, FOOTWEAR, AND HEADWEAR (U.S. CLS. 22 AND 39).

SUNG IN, EXAMINING ATTORNEY

---

SN 85-150,441. ROSS STORES, INC., PLEASANTON, CA.  
FILED 10-12-2010.

# SOHO LOFT

THE MARK CONSISTS OF STANDARD CHARACTERS WITHOUT CLAIM TO ANY PARTICULAR FONT, STYLE, SIZE, OR COLOR.

**CLASS 11—ENVIRONMENTAL CONTROL APPARATUS**

FOR LANTERNS (U.S. CLS. 13, 21, 23, 31 AND 34).

**CLASS 20—FURNITURE AND ARTICLES NOT OTHERWISE CLASSIFIED**

FOR DRAPERY HARDWARE, NAMELY, TRAVERSE RODS, POLES, CURTAIN HOOKS, CURTAIN RODS AND FINIALS; PILLOWS; DECORATIVE BOXES MADE OF WOOD; BOXES THAT ARE MADE OF FABRIC AND BEADS IN THE NATURE OF NON-METAL FABRIC STORAGE BIN ORGANIZERS; FABRIC STORAGE, NAMELY, NON-METAL FABRIC STORAGE BIN ORGANIZER; FLOCKED CLOTHES HANGERS (U.S. CLS. 2, 13, 22, 25, 32 AND 50).

**CLASS 21—HOUSEWARES AND GLASS**

FOR DINNERWARE; SERVEWARE, NAMELY, SERVING TRAYS; DECORATIVE GLASS NOT FOR BUILDING; FABRIC BOXES FOR STORING GREETING CARDS (U.S. CLS. 2, 13, 23, 29, 30, 33, 40 AND 50).

**CLASS 24—FABRICS**

FOR BED THROWS; BED SPREADS; BED SKIRTS; BED SHEETS; PILLOW CASES; PILLOW SHAMS; DUVET COVERS; COMFORTERS; DRAPERIES (U.S. CLS. 42 AND 50).

KATHERINE E. HALMEN, EXAMINING ATTORNEY

---

SN 85-150,562. ROSS STORES, INC., PLEASANTON, CA.  
FILED 10-12-2010.

# BEEKMAN HOME

THE MARK CONSISTS OF STANDARD CHARACTERS WITHOUT CLAIM TO ANY PARTICULAR FONT, STYLE, SIZE, OR COLOR.

NO CLAIM IS MADE TO THE EXCLUSIVE RIGHT TO USE "HOME", APART FROM THE MARK AS SHOWN.

**CLASS 20—FURNITURE AND ARTICLES NOT OTHERWISE CLASSIFIED**

FOR DRAPERY HARDWARE, NAMELY, TRAVERSE RODS, POLES, CURTAIN HOOKS, CURTAIN RODS AND FINIALS; PILLOWS (U.S. CLS. 2, 13, 22, 25, 32 AND 50).

**CLASS 21—HOUSEWARES AND GLASS**

FOR DINNERWARE; SERVEWARE, NAMELY, SERVING TRAYS; DECORATIVE GLASS NOT FOR BUILDING; PORCELAIN AND CERAMIC VASES (U.S. CLS. 2, 13, 23, 29, 30, 33, 40 AND 50).

**CLASS 24—FABRICS**

FOR BED THROWS; BED SPREADS; BED SKIRTS; BED SHEETS; PILLOW CASES; PILLOW SHAMS; DUVET COVERS; COMFORTERS; DRAPERIES (U.S. CLS. 42 AND 50).

KATHERINE E. HALMEN, EXAMINING ATTORNEY

SN 85-151,095. OPENWAVE SYSTEMS INC., REDWOOD CITY, CA. FILED 10-12-2010.

SN 85-155,101. LICE LIFTERS, LLC, PLYMOUTH MEETING, PA. FILED 10-18-2010.

## EASE

THE MARK CONSISTS OF STANDARD CHARACTERS WITHOUT CLAIM TO ANY PARTICULAR FONT, STYLE, SIZE, OR COLOR.

### CLASS 9—ELECTRICAL AND SCIENTIFIC APPARATUS

FOR COMPUTER SOFTWARE FOR COMMUNICATION SERVICE PROVIDERS TO DEVELOP CUSTOMIZED NETWORK BASED APPLICATIONS TO DISTRIBUTE, PROVIDE AND MANAGE SERVICES TO SUBSCRIBERS AND SUBSCRIBER DATA (U.S. CLS. 21, 23, 26, 36 AND 38).

### CLASS 42—SCIENTIFIC AND COMPUTER SERVICES

FOR PROVIDING TEMPORARY USE OF NONDOWN-LOADABLE SOFTWARE FOR COMMUNICATION SERVICE PROVIDERS TO DEVELOP CUSTOMIZED NETWORK BASED APPLICATIONS TO DISTRIBUTE, PROVIDE AND MANAGE SERVICES TO SUBSCRIBERS AND SUBSCRIBER DATA (U.S. CLS. 100 AND 101).  
JOHN SCHUYLER YARD, EXAMINING ATTORNEY

SN 85-154,152. HALL INNOVATIONS, LLC, AKA PILLO1, MALIBU, CA. FILED 10-15-2010.

## Sleep to Health

THE MARK CONSISTS OF STANDARD CHARACTERS WITHOUT CLAIM TO ANY PARTICULAR FONT, STYLE, SIZE, OR COLOR.

### CLASS 10—MEDICAL APPARATUS

FOR CERVICAL PILLOWS FOR MEDICAL USE (U.S. CLS. 26, 39 AND 44).  
FIRST USE 10-15-2010; IN COMMERCE 10-15-2010.

### CLASS 20—FURNITURE AND ARTICLES NOT OTHERWISE CLASSIFIED

FOR BEDS, MATTRESSES, PILLOWS AND BOLSTERS (U.S. CLS. 2, 13, 22, 25, 32 AND 50).  
FIRST USE 10-15-2010; IN COMMERCE 10-15-2010.  
ROBERT STRUCK, EXAMINING ATTORNEY

## THE NIT NANNY

THE MARK CONSISTS OF STANDARD CHARACTERS WITHOUT CLAIM TO ANY PARTICULAR FONT, STYLE, SIZE, OR COLOR.

NO CLAIM IS MADE TO THE EXCLUSIVE RIGHT TO USE "NIT", APART FROM THE MARK AS SHOWN.

### CLASS 5—PHARMACEUTICALS

FOR LICE TREATMENT PREPARATIONS (U.S. CLS. 6, 18, 44, 46, 51 AND 52).

### CLASS 10—MEDICAL APPARATUS

FOR LICE COMBS; KITS USED FOR THE TREATMENT OF LICE IN HUMANS AND ANIMALS (U.S. CLS. 26, 39 AND 44).

MICHAEL ENGEL, EXAMINING ATTORNEY

SN 85-157,580. AUGUST HAT COMPANY, INC., OXNARD, CA. FILED 10-20-2010.

## HEX

THE MARK CONSISTS OF STANDARD CHARACTERS WITHOUT CLAIM TO ANY PARTICULAR FONT, STYLE, SIZE, OR COLOR.

### CLASS 9—ELECTRICAL AND SCIENTIFIC APPARATUS

FOR BANDS WORN ON THE BODY FOR CARRYING PERSONAL ELECTRONIC DEVICES; ARM AND WRIST BANDS FOR CARRYING PERSONAL ELECTRONIC DEVICES; BANDS WORN ON THE BODY FOR CARRYING PORTABLE, DIGITAL ELECTRONIC DEVICES; CASES, STRAPS, WRIST AND ARM BANDS FOR DIGITAL ELECTRONIC DEVICES FOR RECORDING, ORGANIZING, TRANSMITTING, MANIPULATING AND REVIEWING TEXT, DATA AND AUDIO FILES, TIME-KEEPING AND PLAYING MUSIC; WRIST BANDS AND STRAPS FOR HOLDING PERSONAL ELECTRONIC DEVICES (U.S. CLS. 21, 23, 26, 36 AND 38).

### CLASS 14—JEWELRY

FOR WATCH BANDS AND STRAPS; BANDS AND STRAPS FOR CHRONOMETRIC INSTRUMENTS (U.S. CLS. 2, 27, 28 AND 50).

### CLASS 18—LEATHER GOODS

FOR BACK PACKS, TOTE BAGS, SATCHELS, PURSES, WALLETS, WAIST PACKS (U.S. CLS. 1, 2, 3, 22 AND 41).  
DAVID TAYLOR, EXAMINING ATTORNEY

SN 85-158,116. FREEMAN CAPITAL COMPANY, LAS VEGAS, NV. FILED 10-21-2010.

## ImaginAction

THE MARK CONSISTS OF STANDARD CHARACTERS WITHOUT CLAIM TO ANY PARTICULAR FONT, STYLE, SIZE, OR COLOR.

### CLASS 9—ELECTRICAL AND SCIENTIFIC APPARATUS

FOR SOFTWARE AND MULTIMEDIA TECHNOLOGY, NAMELY, COMPUTERS CONNECTED TO VIDEO PROJECTORS AND/OR VIDEO LCD OR PLASMA SCREENS FOR CREATING A WIDE, MULTI-SCREEN DISPLAY BY COMBINING MULTIPLE DISPLAY DEVICES (U.S. CLS. 21, 23, 26, 36 AND 38).

FIRST USE 9-29-2010; IN COMMERCE 9-29-2010.

### CLASS 35—ADVERTISING AND BUSINESS

FOR PREPARING AUDIOVISUAL DISPLAYS IN THE FIELD OF EXHIBITIONS, TRADE SHOWS AND CORPORATE EVENTS (U.S. CLS. 100, 101 AND 102).

FIRST USE 9-29-2010; IN COMMERCE 9-29-2010.

### CLASS 41—EDUCATION AND ENTERTAINMENT

FOR RENTAL OF AUDIOVISUAL EQUIPMENT; OPERATION OF AUDIOVISUAL EQUIPMENT FOR PRODUCTION OF MULTIMEDIA PRESENTATIONS; ENTERTAINMENT SERVICES, NAMELY, MULTIMEDIA PRODUCTION SERVICES; ENTERTAINMENT, NAMELY, PRODUCTION OF MULTIMEDIA PRESENTATIONS (U.S. CLS. 100, 101 AND 107).

FIRST USE 9-29-2010; IN COMMERCE 9-29-2010.  
ANGELA M. MICHELI, EXAMINING ATTORNEY

SN 85-158,781. QUAKER DOG, LLC, NEW YORK, NY. FILED 10-22-2010.

## SILVER TAILS

THE MARK CONSISTS OF STANDARD CHARACTERS WITHOUT CLAIM TO ANY PARTICULAR FONT, STYLE, SIZE, OR COLOR.

### CLASS 10—MEDICAL APPARATUS

FOR PET MASSAGERS IN THE NATURE OF HAND-HELD AND INFRARED MASSAGERS FOR PETS; PET BEDDING, NAMELY, PET BED COVERS FOR THERAPEUTIC USE; PET ACUPRESSURE BANDS IN THE NATURE OF FORM-FITTING BANDS DESIGNED TO APPLY PRESSURE ALONG SPECIFIC ANATOMICAL MERIDIAN LINES (U.S. CLS. 26, 39 AND 44).

### CLASS 18—LEATHER GOODS

FOR PET COLLARS; ANIMAL LEASHES; PET HARNESSES AND LIFTS, NAMELY, HARNESSES FOR USE IN LIFTING AND MOVING OLDER PETS; PET CLOTHING (U.S. CLS. 1, 2, 3, 22 AND 41).

### CLASS 21—HOUSEWARES AND GLASS

FOR HOME DENTAL CARE PRODUCTS FOR PETS, NAMELY, TOOTHBRUSH SYSTEM COMPRISED OF A TOOTHBRUSH HANDLE, DISPOSABLE MICRO-FIBER CLEANING AND POLISHING HEADS, CLEANING SOLUTION AND REUSABLE STORAGE TUBE FOR THE CLEANING AND POLISHING OF PETS' TEETH (U.S. CLS. 2, 13, 23, 29, 30, 33, 40 AND 50).

### CLASS 28—TOYS AND SPORTING GOODS

FOR PET TOYS; PET TOYS MADE OF ROPE (U.S. CLS. 22, 23, 38 AND 50).

### CLASS 31—NATURAL AGRICULTURAL PRODUCTS

FOR PET FOODS; PET TREATS (U.S. CLS. 1 AND 46).  
RONALD DELGIZZI, EXAMINING ATTORNEY

SN 85-162,224. HOMEVESTORS OF AMERICA, INC., DALLAS, TX. FILED 10-27-2010.

## HOMEVESTING

THE MARK CONSISTS OF STANDARD CHARACTERS WITHOUT CLAIM TO ANY PARTICULAR FONT, STYLE, SIZE, OR COLOR.

OWNER OF U.S. REG. NOS. 2,721,129 AND 2,894,974.

### CLASS 35—ADVERTISING AND BUSINESS

FOR FRANCHISING SERVICES, NAMELY, OFFERING TECHNICAL ASSISTANCE IN ESTABLISHING, OPERATING, MARKETING AND DEVELOPING FRANCHISED BUSINESSES THAT PURCHASE, FINANCE AND SELL RESIDENTIAL REAL ESTATE; ORGANIZING AND PROMOTING CONTESTS FOR ADVERTISING PURPOSES; PREPARATION OF ANALYSES AND RELATED WRITTEN REPORTS FOR OTHERS, NAMELY, INVESTORS, REGARDING RESIDENTIAL REAL ESTATE CONDITION AND ESTIMATED REFURBISHMENT EXPENSES UTILIZING A PROPRIETARY ANALYTICAL METHODOLOGY (U.S. CLS. 100, 101 AND 102).

### CLASS 36—INSURANCE AND FINANCIAL

FOR REAL ESTATE SERVICES, NAMELY, REAL ESTATE INVESTMENT SERVICES IN THE NATURE OF PURCHASING OF REAL ESTATE BY FRANCHISEES AND SELLING OF REAL ESTATE TO OTHERS, REAL ESTATE ACQUISITION SERVICES, REAL ESTATE FINANCING, REAL ESTATE BROKERAGE, REAL ESTATE LOAN FINANCING, PROVIDING MORTGAGE, TITLE AND HOME INSURANCE BROKERAGE SERVICES, REAL ESTATE INVESTMENT SERVICES IN THE NATURE OF PURCHASING, FINANCING AND SELLING OF RESIDENTIAL REAL ESTATE RENTAL PROPERTIES (U.S. CLS. 100, 101 AND 102).

### CLASS 37—CONSTRUCTION AND REPAIR

FOR BUILDING REPAIR SERVICES (U.S. CLS. 100, 103 AND 106).  
STEVEN R. FINE, EXAMINING ATTORNEY

SN 85-162,261. FABRICUT, INC., TULSA, OK. FILED 10-27-2010.

SN 85-165,745. IRADIX, LLC, NEW YORK, NY. FILED 10-31-2010.

## EATON SQUARE

THE MARK CONSISTS OF STANDARD CHARACTERS WITHOUT CLAIM TO ANY PARTICULAR FONT, STYLE, SIZE, OR COLOR.

### CLASS 20—FURNITURE AND ARTICLES NOT OTHERWISE CLASSIFIED

FOR DRAPERY HARDWARE, NAMELY, POLES, BRACKETS, FINIALS, HOLDBACKS, AND RINGS (U.S. CLS. 2, 13, 22, 25, 32 AND 50).

### CLASS 24—FABRICS

FOR TEXTILE FABRICS FOR DRAPERY, UPHOLSTERY AND DECORATIVE APPLICATIONS (U.S. CLS. 42 AND 50).

### CLASS 26—FANCY GOODS

FOR TRIMMINGS FOR DRAPERY, UPHOLSTERY AND DECORATIVE APPLICATIONS, NAMELY, BEADS OTHER THAN FOR MAKING JEWELRY, BRAIDS, BORDERS, BANDING, BULLION FRINGE, BUTTONS, FRINGE, CHAIR TIES AND TIE-BACKS, DECORATIVE CORD, FROGS, ROSETTES, TASSELS, GIMP, AND WELT (U.S. CLS. 37, 39, 40, 42 AND 50).

DOMINIC J. FERRAIUOLO, EXAMINING ATTORNEY

SN 85-164,741. EMILY MCBURNETT, SAN ANTONIO, TX. FILED 10-29-2010.

## LENDAS

THE MARK CONSISTS OF STANDARD CHARACTERS WITHOUT CLAIM TO ANY PARTICULAR FONT, STYLE, SIZE, OR COLOR.

THE ENGLISH TRANSLATION OF "LENDAS" IN THE MARK IS "LEGENDS".

### CLASS 16—PAPER GOODS AND PRINTED MATTER

FOR STATIONERY, GREETING CARDS (U.S. CLS. 2, 5, 22, 23, 29, 37, 38 AND 50).

### CLASS 18—LEATHER GOODS

FOR UMBRELLAS (U.S. CLS. 1, 2, 3, 22 AND 41).

### CLASS 25—CLOTHING

FOR CLOTHING, NAMELY, T-SHIRTS, CAPS, SWEATSHIRTS, SWEATPANTS, SHORTS, SPORT SHORTS, UNDERWEAR, SUN VISORS, SCARVES (U.S. CLS. 22 AND 39).

GRETta YAO, EXAMINING ATTORNEY

## HEADED2

THE MARK CONSISTS OF STANDARD CHARACTERS WITHOUT CLAIM TO ANY PARTICULAR FONT, STYLE, SIZE, OR COLOR.

### CLASS 35—ADVERTISING AND BUSINESS

FOR PROVIDING ON-LINE EMPLOYMENT INFORMATION IN THE FIELD OF RECRUITMENT, CAREERS, JOB RESOURCES AND LISTINGS, AND RESUMES (U.S. CLS. 100, 101 AND 102).

FIRST USE 11-25-2009; IN COMMERCE 11-25-2009.

### CLASS 41—EDUCATION AND ENTERTAINMENT

FOR PROVIDING ON-LINE INFORMATION AND NEWS IN THE FIELD OF EMPLOYMENT TRAINING; PROVIDING A WEBSITE FEATURING EDUCATIONAL INFORMATION IN THE FIELD OF CAREER TRAINING (U.S. CLS. 100, 101 AND 107).

FIRST USE 11-25-2009; IN COMMERCE 11-25-2009.

### CLASS 42—SCIENTIFIC AND COMPUTER SERVICES

FOR PROVIDING A WEBSITE THAT GIVES COMPUTER USERS THE ABILITY TO REGISTER FOR AN ACCOUNT, SAVE CAREER-RELATED INFORMATION, PERFORM SEARCHES ON AVAILABLE UNITED STATES JOB OPENINGS AND COLLEGES, CREATE RESUMES, AND BROWSE OCCUPATIONAL PROFILES (U.S. CLS. 100 AND 101).

FIRST USE 11-25-2009; IN COMMERCE 11-25-2009.

### CLASS 45—PERSONAL AND LEGAL SERVICES

FOR PROVIDING A RESOURCE WEBSITE FEATURING INFORMATION IN THE FIELD OF SELF-DEVELOPMENT (U.S. CLS. 100 AND 101).

FIRST USE 11-25-2009; IN COMMERCE 11-25-2009.

TAMARA FRAZIER, EXAMINING ATTORNEY

SN 85-165,970. WIPRO LIMITED, BANGALORE 560 035 K, INDIA, FILED 11-1-2010.

 21st Century Virtual Corporation

NO CLAIM IS MADE TO THE EXCLUSIVE RIGHT TO USE "VIRTUAL CORPORATION", APART FROM THE MARK AS SHOWN.

THE COLOR(S) GREEN, YELLOW, ORANGE, RED, VIOLET, BLUE AND BLACK IS/ARE CLAIMED AS A FEATURE OF THE MARK.

THE MARK CONSISTS OF AN ARC DESIGN DISPLAYED IN GRADIENTS OF THE COLORS GREEN, YELLOW, ORANGE, RED, VIOLET AND BLUE FROM THE UPPER TIP OF THE ARC TO THE LOWER TIP OF THE ARC, PRECEDING THE LITERAL ELEMENT "21ST CENTURY VIRTUAL CORPORATION", WHICH IS DISPLAYED IN BLACK.

**CLASS 9—ELECTRICAL AND SCIENTIFIC APPARATUS**

FOR COMPUTER SOFTWARE AND HARDWARE FOR ENTERPRISE RESOURCE PLANNING, BUSINESS PROCESS MANAGEMENT, PRODUCT LIFE CYCLE MANAGEMENT, CUSTOMER RELATIONSHIP MANAGEMENT, SUPPLY CHAIN MANAGEMENT, ELECTRONIC PROCUREMENT OF GOODS AND SERVICES AND BACK OFFICE TRANSACTION PROCESSING; COMPUTER SOFTWARE AND HARDWARE FOR TIME RECORDAL, BILLING, AUDITING, SUBSCRIPTION MANAGEMENT AND MANAGING BUSINESS PROCESSES AND BUSINESS WORKFLOWS; MAGNETIC DATA CARRIERS SOLD BLANK; COMPUTERS; DATA PROCESSING EQUIPMENT; COMPUTER INTERFACES; COMPUTER HARDWARE; COMPUTER PERIPHERALS; COMPUTER TERMINALS; COMPUTER DISC DRIVES AND DRIVERS, NAMELY, COMPUTER SOFTWARE FOR OPERATING COMPUTER DISC DRIVES; PRINTERS; MODEMS; FLOPPY DISCS SOLD BLANK; DISKETTE HOLDERS; COMPUTER MONITORS; INTEGRATED CIRCUITS; PRINTED CIRCUIT BOARDS; MAGNETIC RECORDING APPARATUS FOR RECORDING SOUND OR IMAGES; VOLTAGE STABILIZERS; VOLTAGE REGULATORS; TRANSFORMERS; INVERTERS; CONVERTERS; UNINTERRUPTED TREATABLE POWER SUPPLIES; APPARATUS FOR RECORDING, TRANSMISSION OR REPRODUCTION OF SOUND OR IMAGES; PHOTOGRAPHIC, CINEMATOGRAPHIC, OPTICAL, WEIGHING, MEASURING, SIGNALING, CHECKING AND TEACHING APPARATUS AND INSTRUMENTS, NAMELY, PHOTOGRAPHIC CAMERAS, CINEMATOGRAPHIC PROJECTORS, OPTICAL CABLES, SCALES AND BALANCES, MEASURING CUPS, SIGNALING BUOYS, MEDICAL TEACHING MANNEQUINS; COIN OR COUNTER FEED APPARATUS, NAMELY, COIN ACCEPTORS FOR SEPARATING COINS FROM COUNTERFEITS, COIN CHANGERS, COIN COUNTING AND SORTING MACHINES; TALKING MACHINES; CASH REGISTERS; CALCULATING MACHINES; FIRE EXTINGUISHING APPARATUS (U.S. CLS. 21, 23, 26, 36 AND 38).

**CLASS 42—SCIENTIFIC AND COMPUTER SERVICES**

FOR CONSULTANCY AND INFORMATION SERVICES RELATING TO INFORMATION TECHNOLOGY, INFORMATION TECHNOLOGY ARCHITECTURE AND INFRASTRUCTURE AND COMPUTER SYSTEM INTEGRATION; CONSULTANCY AND INFORMATION SERVICES RELATING TO INFORMATION TECHNOLOGY FOR USE IN THE FIELDS OF ENTERPRISE RESOURCE PLANNING, BUSINESS PROCESS MANAGEMENT, PRODUCT LIFE CYCLE MANAGEMENT, CUSTOMER RELATIONSHIP MANAGEMENT, SUPPLY CHAIN MANAGEMENT, ELECTRONIC PROCUREMENT OF GOODS AND SERVICES AND BACK OFFICE TRANSACTION PROCESSING; ENGINEERING SERVICES RELATED TO INFORMATION TECHNOLOGY; RESEARCH AND DESIGN IN THE FIELD OF INFORMATION TECHNOLOGY; DESIGN OF COMPUTER SOFTWARE, COMPUTER FIRMWARE, COMPUTER HARDWARE AND COMPUTER SYSTEMS; IMPLEMENTATION OF COMPUTER SOFTWARE, COMPUTER FIRMWARE AND COMPUTER SYSTEMS; MAINTENANCE OF COMPUTER SOFTWARE, COMPUTER FIRMWARE AND COMPUTER SOFTWARE SYSTEMS; INFORMATION TECHNOLOGY TESTING SERVICES; QUALITY CONTROL SERVICES AND QUALITY CONTROL AUDITING IN THE FIELD OF INFORMATION TECHNOLOGY; CONSULTANCY IN THE FIELD OF COMPUTER HARDWARE, COMPUTER PROGRAMMING, MAINTENANCE OF COMPUTER SOFTWARE, UPDATING OF COMPUTER SOFTWARE, COMPUTER SOFTWARE DESIGN, COMPUTER SYSTEMS ANALYSIS AND INTEGRATION, RECOVERING OF COMPUTER DATA (U.S. CLS. 100 AND 101).

KIMBERLY FRYE, EXAMINING ATTORNEY

SN 85-166,797. LAROSE INDUSTRIES, LLC, RANDOLPH, NJ. FILED 11-2-2010.



NO CLAIM IS MADE TO THE EXCLUSIVE RIGHT TO USE "3D", APART FROM THE MARK AS SHOWN.

THE MARK CONSISTS OF THE STYLED TERM "3D" WITHIN THE SHAPE OF A HEART WITH A BUTTERFLY ABOVE THE BORDERED STYLIZED TERMS "SHIMMER 'N SPARKLE".

**CLASS 16—PAPER GOODS AND PRINTED MATTER**

FOR ACTIVITY KITS FOR CREATING TEMPORARY TATTOOS AND BODY ART COMPRISING MARKERS, GLITTER PENS, STENCILS, TEMPORARY TATTOOS, STICKERS, AND PLASTIC GEMS; ACTIVITY KITS COMPRISING COLORING BOOKS, ART PAPER, BLACK AND WHITE POSTERS ON CARDBOARD OR PAPER, CRAYONS, MARKERS, PENCILS, COLORED PENCILS, PAINTS, PAINT BRUSHES, STICKERS, RUBBER STAMPS AND INK STAMPS AND MODELING COMPOUNDS (U.S. CLS. 2, 5, 22, 23, 29, 37, 38 AND 50).

**CLASS 28—TOYS AND SPORTING GOODS**

FOR HOBBY CRAFT KITS FOR DECORATING TOY ARTIFICIAL FINGERNAILS AND TOENAILS, CLOTHING AND FABRICS, MESSENGER BAGS, AND TOTE BAGS; HOBBY CRAFT KITS FOR CREATING AND DECORATING TOY JEWELRY, JEWELRY BOXES, BOTTLE CAPS, TRINKET BOXES, MOSAIC PICTURES, PICTURE FRAMES, TOY MIRROR, DECORATOR TAPE, GREETING CARDS, PARTY INVITATIONS, STUFFED TOYS, PILLOWS, SNEAKERS AND SCARVES; ACTIVITY KITS COMPRISING FIGURES MADE OF PAPER AND CARDBOARD AND PLASTIC GEMS FOR PAPER DOLLS; CHILDREN'S ART ACTIVITY TOYS, NAMELY, DRAWING TOYS (U.S. CLS. 22, 23, 38 AND 50).

ESTHER A. BORSUK, EXAMINING ATTORNEY

SN 85-167,086. BIOLOGICAL SCIENCES CURRICULUM STUDY, AKA BSCS, COLORADO SPRINGS, CO. FILED 11-2-2010.

**BSCS**

THE MARK CONSISTS OF STANDARD CHARACTERS WITHOUT CLAIM TO ANY PARTICULAR FONT, STYLE, SIZE, OR COLOR.



**CLASS 9—ELECTRICAL AND SCIENTIFIC APPARATUS**

FOR DIGITAL MATERIALS, NAMELY, CDS, DVDS, DOWNLOADABLE AUDIO AND VIDEO FILES FEATURING MULTIDISCIPLINARY SCIENCES; DIGITAL MEDIA, NAMELY, PRE-RECORDED VIDEO CASSETTES, DIGITAL VIDEO DISCS, DOWNLOADABLE AUDIO AND VIDEO RECORDINGS, DVDS, CDS FEATURING MULTIDISCIPLINARY SCIENCES; DOWNLOADABLE ELECTRONIC PUBLICATIONS IN THE NATURE OF E-BOOKS, NEWSLETTERS, E-ZINES IN THE FIELD OF MULTIDISCIPLINARY SCIENCES; DVDS FEATURING MULTIDISCIPLINARY SCIENCES; EDUCATIONAL KIT COMPRISING DVDS FEATURING SECONDARY LEVEL CURRICULUM ON ALL SCIENTIFIC DISCIPLINES, ALONG WITH TEACHER GUIDES, SOLD AS A UNIT; ELECTRONIC PUBLICATIONS, NAMELY, E-ZINES FEATURING MULTIDISCIPLINARY SCIENCES RECORDED ON COMPUTER MEDIA; ELECTRONIC PUBLICATIONS, NAMELY, E-BOOKS, NEWSLETTERS, E-ZINES FEATURING MULTIDISCIPLINARY SCIENCES RECORDED ON COMPUTER MEDIA; MULTIMEDIA SOFTWARE RECORDED ON CD-ROM FEATURING MULTIDISCIPLINARY SCIENCES; PRE-RECORDED CDS, VIDEO TAPES, LASER DISKS AND DVDS FEATURING MULTIDISCIPLINARY SCIENCES (U.S. CLS. 21, 23, 26, 36 AND 38).

FIRST USE 3-7-2001; IN COMMERCE 3-7-2001.

**CLASS 16—PAPER GOODS AND PRINTED MATTER**

FOR EDUCATIONAL PUBLICATIONS, NAMELY, TRAINING MANUALS IN THE FIELD OF MULTIDISCIPLINARY SCIENCES; EDUCATIONAL PUBLICATIONS, NAMELY, WORKBOOKS, TEXTBOOKS, ACTIVITY BOOKS, TEACHER GUIDES, MANUALS, POSTERS, EDUCATIONAL BOOKLETS IN THE FIELDS OF MULTIDISCIPLINARY SCIENCES; PUBLICATIONS, NAMELY, BROCHURES, BOOKLETS, AND TEACHING MATERIALS IN THE FIELD OF MULTIDISCIPLINARY SCIENCES; PUBLICATIONS, NAMELY, BOOKS, NEWSLETTERS, AND MAGAZINES IN THE FIELDS OF MULTIDISCIPLINARY SCIENCES (U.S. CLS. 2, 5, 22, 23, 29, 37, 38 AND 50).

FIRST USE 3-7-2001; IN COMMERCE 3-7-2001.

**CLASS 41—EDUCATION AND ENTERTAINMENT**

FOR EDUCATIONAL SERVICES, NAMELY, DEVELOPING CURRICULUM FOR EDUCATORS; PROVIDING ON-LINE E-ZINES IN THE FIELD OF MULTIDISCIPLINARY SCIENCES; PROVIDING ON-LINE PUBLICATIONS IN THE NATURE OF AN E-BOOK IN THE FIELD OF MULTIDISCIPLINARY SCIENCES; PROVIDING ON-LINE PUBLICATIONS IN THE NATURE OF E-BOOKS, NEWSLETTERS, E-ZINES IN THE FIELD OF MULTIDISCIPLINARY SCIENCES; PROVIDING SCIENCE EDUCATIONAL MENTORING SERVICES AND PROGRAMS (U.S. CLS. 100, 101 AND 107).

FIRST USE 3-7-2001; IN COMMERCE 3-7-2001.  
LAKEISHA LEWIS, EXAMINING ATTORNEY

SN 85-167,130. SYLVAN R. SHEMITZ DESIGNS, INC., WEST HAVEN, CT. FILED 11-2-2010.

# FRAQTIR

THE MARK CONSISTS OF STANDARD CHARACTERS WITHOUT CLAIM TO ANY PARTICULAR FONT, STYLE, SIZE, OR COLOR.

**CLASS 9—ELECTRICAL AND SCIENTIFIC APPARATUS**

FOR LIGHT-EMITTING DIODES (LEDs); ELECTRONIC LED SIGNS; LED CIRCUIT BOARDS; LED DISPLAYS (U.S. CLS. 21, 23, 26, 36 AND 38).

**CLASS 10—MEDICAL APPARATUS**

FOR LIGHT-BASED MEDICAL DEVICES, NAMELY, LAMPS AND LED DEVICES FOR TREATMENT OF A VARIETY OF SKIN CONDITIONS; LIGHTING INCORPORATED INTO MEDICAL INSTRUMENTS; LIGHT-EMITTING DIODE (LED) APPARATUS FOR LIGHTING, INCORPORATED INTO MEDICAL INSTRUMENTS (U.S. CLS. 26, 39 AND 44).

**CLASS 11—ENVIRONMENTAL CONTROL APPARATUS**

FOR ELECTRIC LUMINAIRES; LAMP AND LIGHT REFLECTORS; ELECTRIC, INCANDESCENT, FLUORESCENT, HALOGEN, AND GAS DISCHARGE LIGHTS, LAMPS, AND BULBS; LIGHTING FIXTURES; LIGHTING COMPONENTS, NAMELY, EMBEDDED CONTROLS SOLD AS A COMPONENT PART OF ELECTRIC LUMINAIRES, LIGHT REFLECTORS AND LAMP REFLECTORS, BALLASTS, BAFFLES, APERTURE CLOSURE PANELS, FILLER PANELS, LENSES, LOUVERS, HEAT SINKS FOR USE IN ELECTRONIC COMPONENTS, AND REMOTE CONTROLS FOR ELECTRIC LUMINAIRES; LED LIGHTING FIXTURES; LED LIGHT BULBS; LED LIGHT ASSEMBLIES FOR STREET LIGHTS, SIGNS, COMMERCIAL LIGHTING, BUILDINGS AND OTHER ARCHITECTURAL USES, AND AUTOMOBILES; MOTOR VEHICLE LIGHTING, NAMELY, VEHICLE INTERIOR LIGHTS, VEHICLE HEADLIGHTS, TAILLIGHTS AND TURN-SIGNAL LIGHT BULBS (U.S. CLS. 13, 21, 23, 31 AND 34).

**CLASS 16—PAPER GOODS AND PRINTED MATTER**

FOR PRINTED PUBLICATIONS, NAMELY, JOURNALS, PERIODICALS, BOOKS, AND MAGAZINES, IN THE FIELDS OF LIGHTING, LIGHTING PRODUCTS, AND LIGHTING DESIGN (U.S. CLS. 2, 5, 22, 23, 29, 37, 38 AND 50).

**CLASS 35—ADVERTISING AND BUSINESS**

FOR DISTRIBUTORSHIP, WHOLESALE, AND RETAIL STORE SERVICES, INCLUDING ONLINE RETAIL STORE SERVICES, IN THE FIELDS OF LIGHTING, LIGHTING PRODUCTS, AND LIGHTING DESIGN (U.S. CLS. 100, 101 AND 102).

**CLASS 37—CONSTRUCTION AND REPAIR**

FOR INSTALLATION, MAINTENANCE, AND REPAIR SERVICES IN THE FIELDS OF LIGHTING AND LIGHTING PRODUCTS (U.S. CLS. 100, 103 AND 106).

**CLASS 38—COMMUNICATION**

FOR TELECOMMUNICATIONS SERVICES, NAMELY, ELECTRONIC TRANSMISSION OF SOUND, VIDEO, INFORMATION, NEWS, MESSAGES AND DATA; CHAT ROOM SERVICES; TRANSMISSION OF STREAMED AUDIO, VISUAL AND AUDIOVISUAL MATERIAL ON THE INTERNET; ELECTRONIC BULLETIN BOARD SERVICES; ELECTRONIC MAIL AND MESSAGING; PROVIDING ELECTRONIC MESSAGE ALERTS VIA THE INTERNET; ELECTRONIC TRANSMISSION OF INFORMATION POSTED TO USENET NEWSGROUPS AND DISCUSSION GROUPS VIA THE INTERNET; ALL IN THE FIELDS OF LIGHTING, LIGHTING PRODUCTS, AND LIGHTING DESIGN (U.S. CLS. 100, 101 AND 104).

**CLASS 41—EDUCATION AND ENTERTAINMENT**

FOR EDUCATIONAL SERVICES, NAMELY, PROVIDING WORKSHOPS, SEMINARS, CLASSES, SPEECHES, WEBINARS, AND TRAINING SERVICES IN THE FIELDS OF LIGHTING, LIGHTING PRODUCTS, AND LIGHTING DESIGN; ONLINE BLOGS AND JOURNALS IN THE FIELDS OF LIGHTING, LIGHTING PRODUCTS, AND LIGHTING DESIGN (U.S. CLS. 100, 101 AND 107).

**CLASS 42—SCIENTIFIC AND COMPUTER SERVICES**

FOR LIGHTING DESIGN SERVICES; INTERIOR DESIGN SERVICES; PROVIDING A WEBSITE FEATURING INFORMATION AND CONSULTATION IN THE FIELD OF LIGHTING DESIGN (U.S. CLS. 100 AND 101).  
SHAUNIA CARLYLE, EXAMINING ATTORNEY

---

SN 85-167,229. WILMINGTON AUTO GROUP, LLC, WILMINGTON, NC. FILED 11-2-2010.

**PARKWAY OF WILMINGTON**

THE MARK CONSISTS OF STANDARD CHARACTERS WITHOUT CLAIM TO ANY PARTICULAR FONT, STYLE, SIZE, OR COLOR.

NO CLAIM IS MADE TO THE EXCLUSIVE RIGHT TO USE "WILMINGTON", APART FROM THE MARK AS SHOWN.

**CLASS 35—ADVERTISING AND BUSINESS**

FOR AUTOMOTIVE DEALERSHIP FEATURING NEW AND USED PASSENGER VEHICLES AND AUTOMOTIVE PARTS AND ACCESSORIES THEREFOR, EXCLUDING RECREATIONAL VEHICLES (U.S. CLS. 100, 101 AND 102).

FIRST USE 7-17-2007; IN COMMERCE 7-17-2007.

**CLASS 37—CONSTRUCTION AND REPAIR**

FOR REPAIR AND MAINTENANCE OF PASSENGER VEHICLES, EXCLUDING RECREATIONAL VEHICLES (U.S. CLS. 100, 103 AND 106).

FIRST USE 7-17-2007; IN COMMERCE 7-17-2007.  
MARK SHINER, EXAMINING ATTORNEY

---

SN 85-167,246. I12P, LLC, SOUTHLAKE, TX. FILED 11-2-2010.



THE MARK CONSISTS OF AN IMAGE OF A COCOON ATTACHED TO A LIMB WITH SIX PROGRESSIVELY SHARPER IMAGES OF A BUTTERFLY EXTENDING TO THE RIGHT OR THE LEFT.

**CLASS 9—ELECTRICAL AND SCIENTIFIC APPARATUS**

FOR HANDHELD ELECTRONIC DEVICES, NAMELY, ENCODED SMART CARDS AND USB SECURITY TOKEN FOB-LIKE DEVICES CONTAINING AN ENCODED ELECTRONIC CHIP WITH PROGRAMMING USED TO SECURE AND MANAGE PASSWORDS AND END USER ACCESS TO COMPUTERS, DATA, SOFTWARE APPLICATIONS, AND INTERNET HOSTED SITES (U.S. CLS. 21, 23, 26, 36 AND 38).

FIRST USE 10-1-2009; IN COMMERCE 10-1-2009.

**CLASS 42—SCIENTIFIC AND COMPUTER SERVICES**

FOR APPLICATION SERVICE PROVIDER (ASP) FEATURING SOFTWARE FOR USE IN ENABLING OR ASSISTING OTHERS WITH TROUBLESHOOTING BY DIAGNOSING PROBLEMS WITH COMPUTER SYSTEMS OR EQUIPMENT AND IDENTIFYING POSSIBLE CAUSES AND SOLUTIONS; COMPUTER SERVICES IN THE FIELD OF INFORMATION TECHNOLOGY SUPPORT SERVICES, NAMELY, SERVICE DESK SERVICES (U.S. CLS. 100 AND 101).

FIRST USE 10-1-2009; IN COMMERCE 10-1-2009.  
TRACY FLETCHER, EXAMINING ATTORNEY

---

SN 85-168,150. I12P, LLC, SOUTHLAKE, TX. FILED 11-3-2010.



THE MARK CONSISTS OF AN IMAGE OF A BUTTERFLY WITH ITS WINGS SPREAD.

**CLASS 9—ELECTRICAL AND SCIENTIFIC APPARATUS**

FOR HANDHELD ELECTRONIC DEVICES, NAMELY, ENCODED SMART CARDS AND USB SECURITY TOKEN FOB-LIKE DEVICES CONTAINING AN ENCODED ELECTRONIC CHIP WITH PROGRAMMING USED TO SECURE AND MANAGE PASSWORDS AND END USER ACCESS TO COMPUTERS, DATA, SOFTWARE APPLICATIONS, AND INTERNET HOSTED SITES (U.S. CLS. 21, 23, 26, 36 AND 38).

FIRST USE 10-1-2009; IN COMMERCE 10-1-2009.

**CLASS 42—SCIENTIFIC AND COMPUTER SERVICES**

FOR APPLICATION SERVICE PROVIDER (ASP) FEATURING SOFTWARE FOR USE IN ENABLING OR ASSISTING OTHERS WITH TROUBLESHOOTING BY DIAGNOSING PROBLEMS WITH COMPUTER SYSTEMS OR EQUIPMENT AND IDENTIFYING POSSIBLE CAUSES AND SOLUTIONS; COMPUTER SERVICES IN THE FIELD OF INFORMATION TECHNOLOGY SUPPORT SERVICES, NAMELY, SERVICE DESK SERVICES (U.S. CLS. 100 AND 101).

FIRST USE 10-1-2009; IN COMMERCE 10-1-2009.  
TRACY FLETCHER, EXAMINING ATTORNEY

SN 85-168,374. STRINGFELLOW RESTAURANTS LIMITED, LONDON NW 15QT, UNITED KINGDOM, FILED 11-3-2010.

SN 85-170,334. CYWEE GROUP LIMITED, TORTOLA, BR. VIRGIN ISLANDS, FILED 11-5-2010.

## STRINGFELLOWS

THE MARK CONSISTS OF STANDARD CHARACTERS WITHOUT CLAIM TO ANY PARTICULAR FONT, STYLE, SIZE, OR COLOR.

OWNER OF UNITED KINGDOM REG. NO. 2133821, DATED 11-28-1997, EXPIRES 5-23-2017.

OWNER OF U.S. REG. NOS. 1,593,600, 3,789,459 AND OTHERS.  
SEC. 2(F).

### CLASS 9—ELECTRICAL AND SCIENTIFIC APPARATUS

FOR AUDIO TAPES FEATURING RECORDED MUSIC; VIDEO TAPES FEATURING RECORDED MUSICAL PERFORMANCES; COMPACT DISCS FEATURING RECORDED MUSIC (U.S. CLS. 21, 23, 26, 36 AND 38).

### CLASS 14—JEWELRY

FOR JEWELRY; KEY RINGS; CLOCKS AND WATCHES (U.S. CLS. 2, 27, 28 AND 50).

### CLASS 25—CLOTHING

FOR CLOTHING, NAMELY, T-SHIRTS, TANK TOPS AND SWEAT SHIRTS; FOOTWEAR; HEADWEAR; UNDERWEAR; LINGERIE (U.S. CLS. 22 AND 39).

JOHN DALIER, EXAMINING ATTORNEY

SN 85-168,952. PROPARK, INC., HARTFORD, CT. FILED 11-4-2010.

## EV-IQ

THE MARK CONSISTS OF STANDARD CHARACTERS WITHOUT CLAIM TO ANY PARTICULAR FONT, STYLE, SIZE, OR COLOR.

### CLASS 37—CONSTRUCTION AND REPAIR

FOR PROVIDING CHARGING STATION SERVICES FOR ELECTRONIC VEHICLES IN PARKING GARAGES (U.S. CLS. 100, 103 AND 106).

### CLASS 39—TRANSPORTATION AND STORAGE

FOR PARKING GARAGE SERVICES (U.S. CLS. 100 AND 105).  
GISELLE AGOSTO, EXAMINING ATTORNEY

## UPAD

THE MARK CONSISTS OF STANDARD CHARACTERS WITHOUT CLAIM TO ANY PARTICULAR FONT, STYLE, SIZE, OR COLOR.

### CLASS 9—ELECTRICAL AND SCIENTIFIC APPARATUS

FOR VIDEO GAME PROGRAMS; INTERACTIVE ENTERTAINMENT GAME SOFTWARE AND COMPUTER GAME SOFTWARE FOR USE ON MOBILE AND CELLULAR PHONES; GLOBAL POSITIONING SYSTEMS COMPRISING COMPUTERS; MAPPING SOFTWARE; COMPUTER SOFTWARE FOR STORING, MAINTAINING AND DELIVERING MULTI-MEDIA FILES, VIDEOS, AUDIO AND MAPPING FILES AND MANAGING DISTRIBUTION PROCESSES TO END-USERS; PORTABLE ELECTRONIC DEVICES INCORPORATING GLOBAL POSITIONING SYSTEM (GPS) AND MOBILE PHONES; COMPUTER APPLICATION SOFTWARE FOR COLLECTING, EDITING, ORGANIZING, MODIFYING, TRANSMITTING, STORING IMAGE CONTENT TO EXTERNAL DISPLAY SCREEN OR MONITOR FOR DISPLAY; WIRELESS TRANSCEIVERS WITH COLLECTION AND DISPLAY TECHNOLOGY FOR ELECTRONIC TRANSMISSION OF MESSAGES AND DATA; COMPUTER SOFTWARE THAT COLLECTS, STORES, CARRIES DOWNLOADABLE MUSICAL SOUND AND VIDEO RECORDS (U.S. CLS. 21, 23, 26, 36 AND 38).

### CLASS 38—COMMUNICATION

FOR MOBILE MEDIA SERVICES IN THE NATURE OF ELECTRONIC TRANSMISSION OF ENTERTAINMENT MEDIA CONTENT VIA HANDHELD GLOBAL POSITIONING SYSTEM RECEIVERS; ELECTRONIC COMMUNICATIONS NETWORK SERVICES, NAMELY, TRANSMISSION OF AUDIO AND VIDEO VIA ELECTRONIC COMMUNICATIONS NETWORKS; LOCAL AND LONG DISTANCE TRANSMISSION OF VOICE, DATA, GRAPHICS BY MEANS OF TELEPHONE, SATELLITE TRANSMISSIONS AND INTERNET NETWORKS; PROVIDING TELECOMMUNICATIONS CONNECTIONS TO A GLOBAL COMPUTER NETWORK; CONSULTING SERVICES IN THE FIELD OF TELECOMMUNICATIONS; CONSULTING SERVICES RELATING TO ACCESSING COMPUTER NETWORKS AND THE INTERNET; MESSAGING SERVICES, NAMELY, THE RECEIPT AND TRANSMISSION OF DATA, SOUNDS, IMAGES, DOCUMENTS AND MESSAGES VIA COMPUTER NETWORKS, WIRELESS NETWORKS AND GLOBAL COMMUNICATION NETWORKS; TELECOMMUNICATIONS AND INFORMATION TECHNOLOGY SERVICES, NAMELY ELECTRIC, DIGITAL, CELLULAR AND WIRELESS TRANSMISSION OF VOICE, DATA, INFORMATION, IMAGES, SIGNALS AND MESSAGES AND TRANSMISSION OF VOICE, DATA, IMAGES, AUDIO, VIDEO AND INFORMATION VIA TELEPHONE, TELEVISION AND GLOBAL COMMUNICATION NETWORKS; STREAMING OF AUDIO, VISUAL AND AUDIOVISUAL MATERIAL, NAMELY MOVIES, VIA COMPUTER NETWORKS, WIRELESS NETWORKS AND GLOBAL COMMUNICATION NETWORKS; INFORMATION TRANSMISSION VIA ELECTRONIC COMMUNICATIONS NETWORKS (U.S. CLS. 100, 101 AND 104).

**CLASS 41—EDUCATION AND ENTERTAINMENT**

FOR ENTERTAINMENT SERVICES PROVIDED VIA TELEPHONE NETWORKS, NAMELY, ELECTRONIC GAMES AND VIDEO GAMES; PROVIDING ON-LINE COMPUTER GAMES AND NON DOWNLOADABLE PRERECORDED MOVIES VIA COMPUTER NETWORKS, WIRELESS NETWORKS AND GLOBAL COMMUNICATION NETWORKS (U.S. CLS. 100, 101 AND 107).

**CLASS 42—SCIENTIFIC AND COMPUTER SERVICES**

FOR COMPUTER GRAPHICS SERVICES, NAMELY, CREATING AND DISTRIBUTING GRAPHICS FOR USE ON COMPUTER NETWORKS, WIRELESS NETWORKS AND GLOBAL COMMUNICATION NETWORKS; RENTAL OF SOFTWARE AND HARDWARE FOR ONLINE ACCESS; PROVIDING GENERAL INFORMATION BY MEANS OF TELEPHONE OR GENERAL COMPUTER NETWORKS, NAMELY, PROVISION OF INTERNET SEARCH ENGINES; COMPUTER SERVICES, NAMELY, PROVIDING TEMPORARY USE OF A NON-DOWNLOADABLE COMPUTER INTERFACE SOFTWARE IN ORDER TO CREATE ON-LINE PERSONALIZED INFORMATION SERVICES (U.S. CLS. 100 AND 101).  
AISHA SALEM, EXAMINING ATTORNEY

SN 85-170,608. SAN DIEGO GAS & ELECTRIC COMPANY, SAN DIEGO, CA. FILED 11-5-2010.

**BALANCINGACT**

THE MARK CONSISTS OF STANDARD CHARACTERS WITHOUT CLAIM TO ANY PARTICULAR FONT, STYLE, SIZE, OR COLOR.

**CLASS 9—ELECTRICAL AND SCIENTIFIC APPARATUS**

FOR A COMPUTER HARDWARE AND SOFTWARE BASED SYSTEM COMPRISED OF COMPUTER HARDWARE, CENTRAL PROCESSING UNITS, INTEGRATED CIRCUITS, LARGE SCALE INTEGRATED CIRCUITS, PRINTED CIRCUITS, COMPUTER MEMORIES, COMPUTERS FOR DESIGNING THE LAYOUT OF ELECTRONIC CIRCUITS, COMPUTER PERIPHERALS, AND COMPUTER SOFTWARE FOR USE IN ENERGY LOAD MANAGEMENT AND CONTROL APPLICATIONS AND ELECTRICAL ENERGY UTILIZATION AND DISTRIBUTION APPLICATIONS FOR THE PURPOSE OF MONITORING AND CONTROLLING THE DISTRIBUTION OF ELECTRICITY TO MAINTAIN THE BALANCE OF SUPPLY AND DEMAND (U.S. CLS. 21, 23, 26, 36 AND 38).

**CLASS 39—TRANSPORTATION AND STORAGE**

FOR ELECTRICAL UTILITY SERVICES, NAMELY, MONITORING AND CONTROLLING THE DISTRIBUTION OF ELECTRICITY THROUGH THE OPERATION OF A TRANSMISSION GRID THAT MONITORS THE FLOW OF ELECTRICITY TO MAINTAIN THE BALANCE OF SUPPLY AND DEMAND, BY MATCHING LOAD CAPACITY TO RESOURCE LEVELS, BY SHIFTING LOADS TO ENSURE SUFFICIENT GENERATION CAPACITY TO MAINTAIN OPERATING RESERVES, BY SCHEDULING INTERCHANGE BETWEEN CONTROL AREAS, BY MAINTAINING FREQUENCY LIMITS, BY UTILIZING HISTORIC LOAD DATA AND WEATHER AND ECONOMIC FORECASTS TO PROJECT ENERGY NEEDS, CAPACITY AND AVAILABLE RESOURCES (U.S. CLS. 100 AND 105).  
CHRISTINA SOBRAL, EXAMINING ATTORNEY

SN 85-170,682. THIRST, L.C., IOWA CITY, IA. FILED 11-5-2010.

*Rethink how you drink*

THE COLOR(S) BLUE IS/ARE CLAIMED AS A FEATURE OF THE MARK.  
THE MARK CONSISTS OF THE STYLIZED WORDING "RETHINK HOW YOU DRINK" SHOWN IN BLUE.

**CLASS 9—ELECTRICAL AND SCIENTIFIC APPARATUS**

FOR AUTOMATIC VENDING MACHINES; AUTOMATIC VENDING MACHINES AND MECHANISMS FOR COIN OPERATED APPARATUS; AUTOMATIC VENDING MACHINES AND MECHANISMS FOR COIN-OPERATED APPARATUS; COIN-OPERATED VENDING MACHINES; VENDING MACHINES (U.S. CLS. 21, 23, 26, 36 AND 38).  
FIRST USE 10-25-2010; IN COMMERCE 10-25-2010.

**CLASS 32—LIGHT BEVERAGES**

FOR DRINKING WATER; DRINKING WATER WITH VITAMINS; DRINKING WATERS; FLAVORED WATERS (U.S. CLS. 45, 46 AND 48).  
FIRST USE 10-25-2010; IN COMMERCE 10-25-2010.  
VERNA BETH RIRIE, EXAMINING ATTORNEY

SN 85-170,690. THIRST, L.C., IOWA CITY, IA. FILED 11-5-2010.

**Rethink. Refill. Refresh.**

THE MARK CONSISTS OF STANDARD CHARACTERS WITHOUT CLAIM TO ANY PARTICULAR FONT, STYLE, SIZE, OR COLOR.

**CLASS 9—ELECTRICAL AND SCIENTIFIC APPARATUS**

FOR AUTOMATIC VENDING MACHINES; AUTOMATIC VENDING MACHINES AND MECHANISMS FOR COIN OPERATED APPARATUS; AUTOMATIC VENDING MACHINES AND MECHANISMS FOR COIN-OPERATED APPARATUS; COIN-OPERATED VENDING MACHINES; VENDING MACHINES (U.S. CLS. 21, 23, 26, 36 AND 38).

FIRST USE 10-25-2010; IN COMMERCE 10-25-2010.

**CLASS 32—LIGHT BEVERAGES**

FOR DRINKING WATER; DRINKING WATER WITH VITAMINS; DRINKING WATERS; FLAVORED WATERS (U.S. CLS. 45, 46 AND 48).

FIRST USE 10-25-2010; IN COMMERCE 10-25-2010.

VERNA BETH RIRIE, EXAMINING ATTORNEY

**CLASS 9—ELECTRICAL AND SCIENTIFIC APPARATUS**

FOR AUTOMATIC VENDING MACHINES; AUTOMATIC VENDING MACHINES AND MECHANISMS FOR COIN OPERATED APPARATUS; AUTOMATIC VENDING MACHINES AND MECHANISMS FOR COIN-OPERATED APPARATUS; COIN-OPERATED VENDING MACHINES; VENDING MACHINES (U.S. CLS. 21, 23, 26, 36 AND 38).

FIRST USE 10-25-2010; IN COMMERCE 10-25-2010.

**CLASS 32—LIGHT BEVERAGES**

FOR DRINKING WATER; DRINKING WATER WITH VITAMINS; DRINKING WATERS; FLAVORED WATERS (U.S. CLS. 45, 46 AND 48).

FIRST USE 10-25-2010; IN COMMERCE 10-25-2010.

VERNA BETH RIRIE, EXAMINING ATTORNEY

SN 85-170,702. THIRST, L.C., IOWA CITY, IA. FILED 11-5-2010.

Rethink. Refill. Refresh.

THE COLOR(S) BLUE IS/ARE CLAIMED AS A FEATURE OF THE MARK.

THE MARK CONSISTS OF THE STYLIZED WORDING "RETHINK. REFILL. REFRESH." IN THE COLOR BLUE.

**CLASS 9—ELECTRICAL AND SCIENTIFIC APPARATUS**

FOR AUTOMATIC VENDING MACHINES; AUTOMATIC VENDING MACHINES AND MECHANISMS FOR COIN OPERATED APPARATUS; AUTOMATIC VENDING MACHINES AND MECHANISMS FOR COIN-OPERATED APPARATUS; COIN-OPERATED VENDING MACHINES; VENDING MACHINES (U.S. CLS. 21, 23, 26, 36 AND 38).

FIRST USE 10-25-2010; IN COMMERCE 10-25-2010.

**CLASS 32—LIGHT BEVERAGES**

FOR DRINKING WATER; DRINKING WATER WITH VITAMINS; DRINKING WATERS; FLAVORED WATERS (U.S. CLS. 45, 46 AND 48).

FIRST USE 10-25-2010; IN COMMERCE 10-25-2010.

VERNA BETH RIRIE, EXAMINING ATTORNEY

SN 85-171,187. THIRST, L.C., IOWA CITY, IA. FILED 11-8-2010.

thirst station

THE MARK CONSISTS OF STANDARD CHARACTERS WITHOUT CLAIM TO ANY PARTICULAR FONT, STYLE, SIZE, OR COLOR.

SN 85-171,586. ALL YEAR COOLING AND HEATING, INC., PLANTATION, FL. FILED 11-8-2010.

ALL YEAR COOLING & HEATING

THE MARK CONSISTS OF STANDARD CHARACTERS WITHOUT CLAIM TO ANY PARTICULAR FONT, STYLE, SIZE, OR COLOR.

NO CLAIM IS MADE TO THE EXCLUSIVE RIGHT TO USE "COOLING & HEATING", APART FROM THE MARK AS SHOWN.

SEC. 2(F).

**CLASS 35—ADVERTISING AND BUSINESS**

FOR DISTRIBUTORSHIP SERVICES IN THE FIELD OF AIR CONDITIONING (U.S. CLS. 100, 101 AND 102).

FIRST USE 1-0-1974; IN COMMERCE 1-0-1974.

**CLASS 37—CONSTRUCTION AND REPAIR**

FOR AIR CONDITIONING AND HEATING SERVICES, NAMELY, INSTALLATION AND REPAIR OF AIR CONDITIONING AND HEATING EQUIPMENT, INSTALLATION AND REPAIR OF AIR DUCTS, AIR DUCT CLEANING (U.S. CLS. 100, 103 AND 106).

FIRST USE 1-0-1974; IN COMMERCE 1-0-1974.

ADA HAN, EXAMINING ATTORNEY

SN 85-171,618. AMERICAN SUGAR REFINING, INC., YONKERS, NY. FILED 11-8-2010.

HOW DO YOU DO SWEET?

THE MARK CONSISTS OF STANDARD CHARACTERS WITHOUT CLAIM TO ANY PARTICULAR FONT, STYLE, SIZE, OR COLOR.

**CLASS 30—STAPLE FOODS**

FOR NATURAL SWEETENER, NAMELY, AGAVE; SUGAR, SUGAR CUBES, DIRECT COMPACTING SUGAR, DIRECT TABLETING SUGAR, CINNAMON SUGAR, CONFECTIONERS SUGAR, BROWN SUGAR, BROWN FREE-FLOWING SUGAR, FONDANT SUGAR, HARD SUGAR, MOLASSES, MOLASSES GRANULES, HONEY GRANULES, INVERT SUGAR, FLAVORING SYRUP, NAMELY, INVERT SYRUPS; FLAVORING SYRUP, NAMELY, SUGAR SYRUPS; POWDERED SUGAR WITH CORNSTARCH, POWDERED SUGAR WITH MALTODEXTRIN, CO-CRYSTALLIZED SUGAR; NATURAL SWEETENER COMPOSITION, NAMELY, SUGAR THAT ALSO CONTAINS ARTIFICIAL SWEETENER OR NATURAL SWEETENER; COOKIE MIXES, FROSTING, FROSTING MIXES, FROSTING KITS COMPRISING FROSTING AND FROSTING MIXES; READY-TO-USE FROSTINGS; EDIBLE DECORATING KITS FOR BAKERY GOODS COMPRISING EDIBLE CAKE DECORATIONS, CANDY SPRINKLES, FROSTING (U.S. CL. 46).

**CLASS 32—LIGHT BEVERAGES**

FOR FLAVORED DRINK MIXES, NAMELY, CONCENTRATES, SYRUPS OR POWDERS USED IN THE PREPARATION OF SOFT DRINKS, SPORTS AND ENERGY DRINKS, AND FRUIT-FLAVORED BEVERAGES (U.S. CLS. 45, 46 AND 48).

ROBIN MITTLER, EXAMINING ATTORNEY

SN 85-172,358. GREEN WORLD WEAR, LLC, NAPLES, FL. FILED 11-9-2010.

SEED A FOREST THROUGH THE  
TEES

THE MARK CONSISTS OF STANDARD CHARACTERS WITHOUT CLAIM TO ANY PARTICULAR FONT, STYLE, SIZE, OR COLOR.

NO CLAIM IS MADE TO THE EXCLUSIVE RIGHT TO USE "TEES", APART FROM THE MARK AS SHOWN.

**CLASS 25—CLOTHING**

FOR CLOTHING, NAMELY, SHORTS, SHIRTS, BLOUSES, T-SHIRTS, SKIRTS, TIES, BELTS FOR CLOTHING, DRESSES, PANTS, COATS, SCARVES, MITTENS, GLOVES AND SWEATERS, SUITS, JACKETS, HATS, CAPS, BOOTS, SANDALS, HEADWEAR, SHAWLS; VESTS; SLEEPWEAR; SWIMWEAR, FOOTWEAR, INSOLES FOR FOOTWEAR (U.S. CLS. 22 AND 39).

**CLASS 35—ADVERTISING AND BUSINESS**

FOR CHARITABLE SERVICES, NAMELY, PROMOTING EDUCATION RELATING TO ENVIRONMENTAL ISSUES AND ENVIRONMENTAL AWARENESS, AND PROMOTING CHARITABLE DONATIONS TO OTHERS, AND PROVIDING INFORMATION RELATING THERETO BY MEANS OF A GLOBAL COMPUTER INFORMATION NETWORK (U.S. CLS. 100, 101 AND 102).

SUSAN RICHARDS, EXAMINING ATTORNEY

SN 85-172,512. M SQUARED CONSULTING, INC., SAN FRANCISCO, CA. FILED 11-9-2010.

**EXPERTISE AT WORK**

THE MARK CONSISTS OF STANDARD CHARACTERS WITHOUT CLAIM TO ANY PARTICULAR FONT, STYLE, SIZE, OR COLOR.

**CLASS 35—ADVERTISING AND BUSINESS**

FOR BUSINESS MANAGEMENT CONSULTANCY SERVICES; EMPLOYMENT AGENCY SERVICES, NAMELY, FILLING THE TEMPORARY AND PERMANENT STAFFING NEEDS OF BUSINESSES; EMPLOYMENT STAFFING CONSULTATION SERVICES; EXECUTIVE SEARCH AND PLACEMENT SERVICES; HUMAN RESOURCE ANALYSIS AND CONSULTING SERVICES; WORKFORCE MANAGEMENT, NAMELY, MANAGEMENT OF EMPLOYEE AND NON-EMPLOYEE PERSONNEL; SERVING AS A HUMAN RESOURCE DEPARTMENT FOR OTHERS BY PROVIDING A SET OF EMPLOYMENT-RELATED SERVICES, NAMELY, PERSONNEL MANAGEMENT, PAYROLL PREPARATION SERVICES, PAYROLL PROCESSING SERVICES, PAYROLL ADMINISTRATION SERVICES AND PAYROLL MANAGEMENT SERVICES, AND PROFESSIONAL EMPLOYER ORGANIZATION SERVICES IN THE NATURE OF EMPLOYEE LEASING (U.S. CLS. 100, 101 AND 102).

**CLASS 45—PERSONAL AND LEGAL SERVICES**

FOR COMPLIANCE SERVICES, NAMELY, REVIEWING STANDARDS AND PRACTICES TO ASSURE COMPLIANCE WITH EMPLOYMENT LAWS AND REGULATIONS (U.S. CLS. 100 AND 101).

ZACHARY BELLO, EXAMINING ATTORNEY

SN 85-172,720. FRYKMAN, NATASA M, VANCOUVER, CANADA, AND FRYKMAN, HANS B, VANCOUVER, CANADA, FILED 11-9-2010.



THE MARK CONSIST OF THE FOLLOWING: THE WORDING "SPOONK SPACE" APPEARS VERTICALLY ABOVE A ROUNDED RECTANGULAR SHAPE ENCIRCLING A CIRCLE SHAPE. WITHIN THE CIRCLE, THERE IS AN INTERLOCKING DESIGN OF TWO "S" SHAPED LINES.

**CLASS 10—MEDICAL APPARATUS**

FOR ACUPRESSURE MATS; ACUPRESSURE PILLOWS; APPARATUS FOR ACUPRESSURE THERAPY; MASSAGE APPARATUS; MASSAGING APPARATUS FOR PERSONAL USE (U.S. CLS. 26, 39 AND 44).  
FIRST USE 12-1-2009; IN COMMERCE 12-1-2009.

**CLASS 25—CLOTHING**

FOR SPORT COATS; SPORT SHIRTS; SPORT STOCKINGS; SPORTS BRA; SPORTS BRAS; SPORTS CAPS AND HATS; SPORTS JACKETS; SPORTS JERSEYS; SPORTS PANTS; SPORTS SHIRTS; SPORTS SHIRTS WITH SHORT SLEEVES; SPORTS VESTS (U.S. CLS. 22 AND 39).

**CLASS 35—ADVERTISING AND BUSINESS**

FOR RETAIL CLOTHING STORES (U.S. CLS. 100, 101 AND 102).  
JOHN DALIER, EXAMINING ATTORNEY

**CLASS 35—ADVERTISING AND BUSINESS**

FOR PROMOTING PUBLIC AWARENESS OF READING OF THE BIBLE AND ITS APPLICATION TO INDIVIDUAL LIVES AND THE MARKETPLACE, NOT IN THE FIELDS OF HISTORY OR THE SCIENCES; ONLINE RETAIL STORE SERVICES FEATURING BIBLES, BIBLE TEXTS, BOOKS, CHILDREN'S BOOKS, CDS, CD-ROMS, DVDS, SOFTWARE, AND BIBLE-RELATED PRODUCTS (U.S. CLS. 100, 101 AND 102).

**CLASS 45—PERSONAL AND LEGAL SERVICES**

FOR PROVIDING A WEB SITE FEATURING INFORMATION ABOUT RELIGION, NAMELY, PROVIDING INFORMATION REGARDING THE BIBLE AND ITS APPLICATION TO INDIVIDUAL LIVES, THE MARKETPLACE, AND THE BROADER CULTURE, NOT IN THE FIELDS OF HISTORY OR THE SCIENCES (U.S. CLS. 100 AND 101).  
MARC LEIPZIG, EXAMINING ATTORNEY

SN 85-173,158. CONNELLY, A. SCOTT, CORONA DEL MAR, CA. FILED 11-10-2010.

SN 85-173,686. ESTES REALTY SERVICES, INC., GRAND RAPIDS, MI. FILED 11-10-2010.

**INCRAVEABLES**

THE MARK CONSISTS OF STANDARD CHARACTERS WITHOUT CLAIM TO ANY PARTICULAR FONT, STYLE, SIZE, OR COLOR.

**CLASS 29—MEATS AND PROCESSED FOODS**

FOR WHEY PROTEIN FORTIFIED SAVORY SNACK FOODS; WHEY PROTEIN FORTIFIED CONFECTIONERY SNACK FOODS; DAIRY-BASED SNACK FOODS EXCLUDING ICE CREAM, ICE MILK AND FROZEN YOGURT; DAIRY-BASED SNACK FOODS, NAMELY, YOGURT (U.S. CL. 46).

**CLASS 30—STAPLE FOODS**

FOR BAKERY GOODS; DESSERTS, NAMELY, BAKERY DESSERTS AND CHEESECAKE; BAKERY GOODS, NAMELY, PIZZA CRUST; PROCESSED CEREAL-BASED FOOD TO BE USED AS A BREAKFAST FOOD, SNACK FOOD OR INGREDIENTS FOR MAKING OTHER FOODS; PROCESSED CEREALS (U.S. CL. 46).  
NAAKWAMA ANKRAH, EXAMINING ATTORNEY

SN 85-173,668. AMERICAN BIBLE SOCIETY, NEW YORK, NY. FILED 11-10-2010.

**UNCOVER THE WORD**

THE MARK CONSISTS OF STANDARD CHARACTERS WITHOUT CLAIM TO ANY PARTICULAR FONT, STYLE, SIZE, OR COLOR.

**The Estes Group**

THE MARK CONSISTS OF STANDARD CHARACTERS WITHOUT CLAIM TO ANY PARTICULAR FONT, STYLE, SIZE, OR COLOR.

NO CLAIM IS MADE TO THE EXCLUSIVE RIGHT TO USE "GROUP", APART FROM THE MARK AS SHOWN.  
SEC. 2(F).

**CLASS 36—INSURANCE AND FINANCIAL**

FOR LEASING OF REAL ESTATE; REAL ESTATE AGENCIES; REAL ESTATE BROKERAGE; REAL ESTATE INVESTMENT; REAL ESTATE LISTING SERVICES; REAL ESTATE LOAN PACKAGES AND DEBT RESTRUCTURING SERVICES; AND REAL ESTATE PORTFOLIO ANALYSIS AND CONSULTING SERVICES (U.S. CLS. 100, 101 AND 102).

FIRST USE 3-29-1991; IN COMMERCE 3-29-1991.

**CLASS 37—CONSTRUCTION AND REPAIR**

FOR REAL ESTATE DEVELOPMENT (U.S. CLS. 100, 103 AND 106).

FIRST USE 3-29-1991; IN COMMERCE 3-29-1991.

SAIMA MAKHDOOM, EXAMINING ATTORNEY

SN 85-174,445. NATIONPOWER AG, PFÄFFIKON, SWITZERLAND, FILED 11-11-2010.

**NATIONPOWER**

PRIORITY CLAIMED UNDER SEC. 44(D) ON ISRAEL APPLICATION NO. 233289, FILED 10-26-2010.

OWNER OF SWITZERLAND REG. NO. 617141, DATED 7-12-2011, EXPIRES 11-15-2020.

THE MARK CONSISTS OF THE WORDING "NATION-POWER" BELOW A DESIGN OF TWO WINGED LIONS HOLDING A SHIELD WITH THE LETTERS "N" AND "P" APPEARING THEREON AND THE WORDING "NATION-POWER" LOCATED IN A BANNER BELOW THE SHIELD.

**CLASS 9—ELECTRICAL AND SCIENTIFIC APPARATUS**

FOR COMPUTER OPERATING SOFTWARE RUNNING AUTOMATED ENERGY SYSTEMS, NAMELY, FOR MONITORING AND CONTROLLING DISTRIBUTION AND PRODUCTION OF ENERGY, GAS, WATER; COMPUTER OPERATING SOFTWARE FOR RUNNING AUTOMATED ELECTRICITY SYSTEMS; ELECTRIC BATTERIES; BATTERIES FOR LIGHTING; RECHARGEABLE LITHIUM BATTERIES; HIGH TENSION BATTERIES; SOLAR BATTERIES; BATTERY BOXES; BATTERY CHARGERS; BATTERY JARS; BATTERIES FOR GRID SUPPORT; BATTERIES FOR PEAK SHAVING; PEAK LEVELING FOR BATTERIES; ELECTRIC ACCUMULATORS (U.S. CLS. 21, 23, 26, 36 AND 38).

**CLASS 35—ADVERTISING AND BUSINESS**

FOR BUSINESS CONSULTING AND ADVISORY SERVICES IN THE FIELD OF ENERGY EFFICIENCY (U.S. CLS. 100, 101 AND 102).

**CLASS 39—TRANSPORTATION AND STORAGE**

FOR ENERGY DISTRIBUTION AND STORAGE SERVICES, NAMELY, DISTRIBUTION AND STORAGE OF GAS, WATER, ELECTRICITY AND HEATING OIL; PUBLIC UTILITY SERVICES IN THE FIELDS OF GAS, WATER AND ELECTRICITY; DISTRIBUTION OF ENERGY (U.S. CLS. 100 AND 105).

**CLASS 40—MATERIAL TREATMENT**

FOR ENERGY PRODUCTION SERVICES (U.S. CLS. 100, 103 AND 106).

**CLASS 42—SCIENTIFIC AND COMPUTER SERVICES**

FOR COMPUTER SOFTWARE INSTALLATION, MAINTENANCE AND UPGRADING SERVICES; TECHNICAL SUPPORT SERVICES OF COMPUTER SOFTWARE; CONSULTATION AND ADVICE SERVICES RELATING TO COMPUTER SOFTWARE (U.S. CLS. 100 AND 101).

CURTIS FRENCH, EXAMINING ATTORNEY

SN 85-175,294. SEXY HAIR CONCEPTS, LLC, CHATSWORTH, CA. FILED 11-12-2010.

**STRUCTURE IN MOTION**

THE MARK CONSISTS OF STANDARD CHARACTERS WITHOUT CLAIM TO ANY PARTICULAR FONT, STYLE, SIZE, OR COLOR.

**CLASS 16—PAPER GOODS AND PRINTED MATTER**

FOR PUBLICATIONS, NAMELY, BROCHURES, BOOKLETS, AND PRINTED TEACHING MATERIALS IN THE FIELD OF HAIR STYLING AND HAIR CUTTING (U.S. CLS. 2, 5, 22, 23, 29, 37, 38 AND 50).  
FIRST USE 9-12-2001; IN COMMERCE 9-12-2001.

**CLASS 41—EDUCATION AND ENTERTAINMENT**

FOR EDUCATIONAL SERVICES, NAMELY, PROVIDING CLASSES, SEMINARS, CONFERENCES, WORKSHOPS IN THE FIELD OF HAIR STYLING AND HAIR CUTTING (U.S. CLS. 100, 101 AND 107).  
FIRST USE 7-1-2000; IN COMMERCE 7-1-2000.  
COLLEEN DOMBROW, EXAMINING ATTORNEY

SN 85-175,366. FRANKLIN CULVER, PICKERINGTON, OH. FILED 11-12-2010.



THE MARK CONSISTS OF SCRIPTURE VERSES FROM THE BIBLE WHICH FORM A PICTURE OF A CHILD IN THE WOMB ATTACHED TO THE MOTHER'S UMBILICAL CORD. THE WORDING THAT COMPRISES THE UMBILICAL CORD READS "IN THE BEGINNING WAS THE WORD, AND THE WORD WAS WITH GOD AND THE WORD WAS GOD, AND THE WORD BECAME FLESH AND DWELT WITH US AND GOD SAID LET US MAKE HUMAN KIND IN OUR IMAGE". THE WORDING THAT FORMS THE CHILD'S HEAD READS "HE ANOINTS MY HEAD WITH OIL, MY CUP RUNS OVER, SURELY GOODNESS & MERCY SHALL FOLLOW ME ALL THE DAYS OF MY LIFE". THE WORDING THAT FORMS THE CHILD'S EAR READS "HIS EARS ARE OPEN TO MY CRIES". THE WORDING THAT FORMS THE CHILD'S EYE READS "HE SEES ALL MY WAYS". THE WORDING THAT FORMS THE CHILD'S HAND READS "I AM IN YOUR HANDS". THE WORDING THAT FORMS THE CHILD'S NECK READS "YOU LIFT UP MY HEAD". THE WORDING THAT FORMS THE CHILD'S ARM READS "FOR HE STRETCHED FORTH HIS HAND AND HEALED HIM, MY TIMES ARE IN YOUR HANDS". THE WORDING THAT FORMS THE CHILD'S NOSE READS "HE IS THE FRAGRANCE OF LIFE". THE WORDING THAT FORMS THE CHILD'S MOUTH READS "GRACE IS POURED ON HIS LIPS". THE WORDING THAT FORMS THE CHILD'S BACK READS "NO WEAPON FORMED AGAINST ME SHALL PROSPER, I SHALL NOT DIE BUT LIVE AND DECLARE THE WORKS OF THE LORD". THE WORDING THAT FORMS THE CHILD'S FEET AND LEGS READ "I AM MY BELOVED'S & HE IS MINE", "I WILL FOLLOW YOU ALL MY DAYS", AND "I WILL PRAISE YOU, FOR I AM FEARFULLY & WONDERFULLY MADE, MARVELOUS ARE YOU WORKS AND THAT MY SOUL KNOWS WELL". THE VERSE THAT APPEARS IN THE MIDDLE OF THE CHILD'S BODY READS "YOU HAVE A PLAN FOR MY LIFE".



**CLASS 25—CLOTHING**

FOR CLOTHING, NAMELY, SHIRTS, T-SHIRTS, SWEAT SHIRTS, HOODED SWEATSHIRTS, AND TANK TOPS (U.S. CLS. 22 AND 39).

**CLASS 35—ADVERTISING AND BUSINESS**

FOR ON-LINE RETAIL STORE SERVICES AND ON-LINE ORDERING SERVICES FEATURING CLOTHING (U.S. CLS. 100, 101 AND 102).

JEFFERY COWARD, EXAMINING ATTORNEY

---

SN 85-175,571. ENVIRONMENTAL TECHNOLOGY SOLUTIONS LLC, GILBERT, AZ. FILED 11-12-2010.

**ENGINEERING THE PEACE**

THE MARK CONSISTS OF STANDARD CHARACTERS WITHOUT CLAIM TO ANY PARTICULAR FONT, STYLE, SIZE, OR COLOR.

**CLASS 35—ADVERTISING AND BUSINESS**

FOR BUSINESS CONSULTING SERVICES FOR THE PROMOTION OF SOCIAL ENTREPRENEURSHIP, NAMELY, CONSULTING TO IDENTIFY AND CONNECT THE APPROPRIATE CORPORATIONS, FOR PROFIT ENTITIES, GOVERNMENTAL ORGANIZATIONS, INDIVIDUALS, NON-PROFIT ENTITIES, OR NON-GOVERNMENTAL ORGANIZATIONS FOR SUSTAINABLE CONSTRUCTION OF BUILDINGS, SCHOOLS AND ROADS, SUSTAINABLE ENERGY PRODUCTION AND EFFICIENCY, SEWAGE TREATMENT, SUSTAINABLE WATER RECOVERY, WATER TREATMENT AND PURIFICATION, AND SECURITY SYSTEMS (U.S. CLS. 100, 101 AND 102).

**CLASS 42—SCIENTIFIC AND COMPUTER SERVICES**

FOR CONSULTING IN THE FIELD OF ENGINEERING, NAMELY, THE SUSTAINABLE CONSTRUCTION OF BUILDINGS, SCHOOLS AND ROADS, SUSTAINABLE ENERGY PRODUCTION AND EFFICIENCY, SEWAGE TREATMENT, SUSTAINABLE WATER RECOVERY, WATER TREATMENT AND PURIFICATION, AND SECURITY SYSTEMS (U.S. CLS. 100 AND 101).

MARIA-VICTORIA SUAREZ, EXAMINING ATTORNEY

---

SN 85-175,672. W. F. YOUNG, INC., EAST LONGMEADOW, MA. FILED 11-12-2010.

**CANINE AMERICA**

THE MARK CONSISTS OF STANDARD CHARACTERS WITHOUT CLAIM TO ANY PARTICULAR FONT, STYLE, SIZE, OR COLOR.

OWNER OF U.S. REG. NOS. 2,207,710, 3,467,119 AND 3,528,834.

NO CLAIM IS MADE TO THE EXCLUSIVE RIGHT TO USE "CANINE", APART FROM THE MARK AS SHOWN. SEC. 2(F) AS TO "AMERICA".

**CLASS 3—COSMETICS AND CLEANING PREPARATIONS**

FOR NON-MEDICATED ANIMAL HEALTH PRODUCTS FOR DOGS, NAMELY, COAT CARE SHAMPOOS, CONDITIONERS, RINSES, DOG FRAGRANCE SPRAYS, DOG COAT CONDITIONING SPRAYS, TOPICAL HAIRDRESSING SPRAYS FOR DOG COATS, HAIR POLISH FOR DOG COATS, TAIL CLEANERS (U.S. CLS. 1, 4, 6, 50, 51 AND 52).

**CLASS 5—PHARMACEUTICALS**

FOR FEED SUPPLEMENTS FOR DOGS AND MEDICATED ANIMAL HEALTH PRODUCTS, NAMELY, NON-MEDICATED FEED ADDITIVES FOR USE AS NUTRITIONAL DIETARY SUPPLEMENTS; ANIMAL HEALTH FOOD SUPPLEMENTS; LINIMENTS; MEDICATED SHAMPOOS, DOG COAT SPRAYS AND CREAMS; INSECTICIDES AND INSECT REPELLENTS FOR DOGS (U.S. CLS. 6, 18, 44, 46, 51 AND 52).

JESSICA FATHY, EXAMINING ATTORNEY

---

SN 85-175,742. 7598157 CANADA CORP., MONTREAL, QC, CANADA, FILED 11-12-2010.



THE MARK CONSISTS OF THE HEAD, ARMS AND UPPER TORSO OF A SMILING BOY IN A SHORT-SLEEVE SHIRT, BURSTING OUT OF A CIRCLE FRAMED BY SCALLOPED EDGING, HOLDING A HORIZONTAL RECTANGULAR BANNER ABOVE HIS FACE.

**CLASS 35—ADVERTISING AND BUSINESS**

FOR ADVERTISING SERVICES, NAMELY, DISSEMINATION OF ADVERTISING FOR OTHERS CONCERNING GOODS AND SERVICES VIA AN ON-LINE ELECTRONIC COMMUNICATIONS NETWORK; PROVIDING A SEARCHABLE ON-LINE ADVERTISING GUIDE FEATURING THE GOODS AND SERVICES OF OTHER ON-LINE VENDORS; PROVIDING AN ON-LINE INTERACTIVE ADVERTISING DIRECTORY AND ADVERTISEMENTS OVER A GLOBAL COMPUTER NETWORKS; COMPUTERIZED ON-LINE ORDERING FEATURING GENERAL MERCHANDISE AND GENERAL CONSUMER GOODS AND SERVICES; PROVIDING COMPILATIONS OF BUSINESS INFORMATION, NAMELY, RANKINGS, RATINGS, REVIEWS, REFERRALS AND RECOMMENDATIONS RELATING TO BUSINESS ORGANIZATIONS, SERVICE PROVIDERS, USING A GLOBAL COMPUTER NETWORK; ONLINE RETAIL SERVICES IN THE FIELD OF TRAVEL, NAMELY, PROVIDING PRICE COMPARISONS OF TRAVEL AND LODGING SERVICES; ONLINE RETAIL STORE SERVICES FEATURING HOUSEHOLD ELECTRONIC APPLIANCES, APPLIED ELECTRONIC MACHINES AND APPARATUS, PHOTOGRAPHY INSTRUMENTS, MUSICAL INSTRUMENTS AND FITTINGS THEREOF, PHOTOGRAPHY INSTRUMENTS, MUSICAL INSTRUMENTS AND FITTINGS THEREOF, CLOTHING, APPAREL, COSMETICS, SHOES AND BAGS; RESERVING TOURISM PACKAGES IN THE NATURE OF A CITY CARD GIVING ACCESS TO MULTIPLE SPORTS AND ENTERTAINMENT ACTIVITIES FOR ONE PRICE (U.S. CLS. 100, 101 AND 102).

**CLASS 39—TRANSPORTATION AND STORAGE**

FOR AIRLINE, TOUR PACKAGE RESERVATIONS AND TRAVEL INFORMATION SERVICES OVER COMPUTER NETWORKS, GLOBAL COMPUTER COMMUNICATION NETWORKS AND MOBILE NETWORKS; TRAVEL AGENCY SERVICES, NAMELY, MAKING RESERVATIONS AND BOOKINGS FOR TRANSPORTATION AND TRAVEL TOURS; RESERVATIONS AND BOOKINGS FOR RENTAL CARS; MAKING RESERVATIONS AND BOOKINGS FOR SIGHTSEEING CRUISES, SIGHTSEEING GARDEN TOURS AND SIGHTSEEING HISTORICAL TOURS; MAKING RESERVATIONS AND BOOKINGS FOR AIRPORT SHUTTLES, LIMOUSINE RIDES, AND TOWN CAR RIDES; MAKING PARKING ARRANGEMENTS; GIVING ACCESS TO MULTIPLE SIGHTSEEING ACTIVITIES FOR ONE PRICE; TRAVEL CLUBS; GIFT BASKET DELIVERY; PACKAGING OF ARTICLES FOR TRANSPORT FOR OTHERS; PROVIDING INFORMATION CONCERNING TRAVEL, TRAVEL NEWS AND TRAVEL-RELATED TOPICS VIA ELECTRONIC COMMUNICATIONS NETWORKS (U.S. CLS. 100 AND 105).

**CLASS 41—EDUCATION AND ENTERTAINMENT**

FOR TRAVEL AGENCY SERVICES, NAMELY, MAKING RESERVATIONS AND BOOKINGS FOR ENTERTAINMENT EVENTS; MAKING TICKET RESERVATIONS FOR SPORTING EVENTS, PLAYS, MOVIES, CONCERTS, MUSEUMS, AQUARIUMS, ZOOS, AMUSEMENT PARKS, GALLERIES, HISTORICAL EXHIBITS, SKI LIFTS, CARRIAGE RIDES, HELICOPTER RIDES, ANTIQUE BOAT RIDES, WHALE WATCHING, DOLPHIN WATCHING, SWIMMING WITH WHALES, AND SWIMMING WITH DOLPHINS; MAKING ARRANGEMENTS FOR ADVENTURE EXCURSIONS IN THE NATURE OF ALL TERRAIN VEHICLE RIDES; MAKING RESERVATIONS AND BOOKINGS FOR COOKING, TENNIS, GOLF, SURFING, SCUBA DIVING, RACE CAR DRIVING, HANG GLIDING, SAILING, AND SKIING, AS WELL AS LESSONS FOR THESE ACTIVITIES; MAKING RESERVATIONS AND BOOKINGS FOR THE RENTAL OF SPORTING EQUIPMENT; MAKING RESERVATION AND BOOKINGS FOR VARIOUS EVENTS, CONCERTS, SHOWS AND SPORTS RELATED EVENTS, GIVING ACCESS TO MULTIPLE SPORTS AND ENTERTAINMENT ACTIVITIES FOR ONE PRICE; ARRANGING FOR NIGHTCLUB PASSES; ARRANGING FOR HEALTH CLUB PASSES; MAKING RESERVATIONS AND BOOKINGS FOR WINE TASTING TOURS, DIVING TOURS, AND SNORKELING TOURS; MAKING ARRANGEMENTS FOR SHOPPING EXCURSIONS; MAKING ARRANGEMENTS FOR ADVENTURE EXCURSIONS IN THE NATURE OF RACE CAR SIMULATIONS (U.S. CLS. 100, 101 AND 107).

**CLASS 43—HOTEL AND RESTAURANT SERVICES**

FOR TRAVEL AGENCY SERVICES, NAMELY, MAKING RESERVATIONS AND BOOKINGS FOR TEMPORARY LODGINGS, ACCOMMODATIONS, FACILITIES AND SERVICES; TRAVEL AGENCY SERVICES, NAMELY, MAKING RESERVATIONS AND BOOKINGS FOR RESTAURANTS AND MEALS; MAKING RESERVATIONS FOR MEAL PURCHASES DURING FLIGHTS; TRAVEL AGENCY SERVICES, NAMELY, MAKING RESERVATIONS AND BOOKINGS FOR SPA SERVICES, NAMELY, FOR PROVIDING TEMPORARY ACCOMMODATIONS AND MEALS TO CLIENTS OF A HEALTH OR BEAUTY SPA; PROVIDING TEMPORARY ACCOMMODATION INFORMATION OVER COMPUTER NETWORKS, GLOBAL COMPUTER COMMUNICATION NETWORKS AND MOBILE NETWORKS; PROVIDING AN ELECTRONIC DATABASE CONTAINING INFORMATION ABOUT TEMPORARY LODGINGS (U.S. CLS. 100 AND 101).

JOHN WILKE, EXAMINING ATTORNEY

SN 85-175,925. INSIGHT DIRECT USA, INC., TEMPE, AZ. FILED 11-12-2010.

**INSIGHTCLOUD**

THE MARK CONSISTS OF STANDARD CHARACTERS WITHOUT CLAIM TO ANY PARTICULAR FONT, STYLE, SIZE, OR COLOR.

OWNER OF U.S. REG. NOS. 1,940,956, 3,659,763 AND 3,690,982.

**CLASS 35—ADVERTISING AND BUSINESS**

FOR DISTRIBUTORSHIP SERVICES AND COMPUTERIZED ON-LINE RETAIL STORE SERVICES FEATURING COMPUTER HARDWARE AND SOFTWARE, COMPUTER COMPONENTS AND COMPUTER ACCESSORIES AND SUPPLIES; DOMESTIC AND INTERNATIONAL PRICE COMPARISON SERVICES, NAMELY, PRICING COMPUTER HARDWARE AND SOFTWARE, COMPUTER COMPONENTS AND COMPUTER ACCESSORIES AND SUPPLIES FOR OTHERS; DOMESTIC AND INTERNATIONAL PROCUREMENT SERVICES, NAMELY, PURCHASING COMPUTER HARDWARE AND SOFTWARE, COMPUTER COMPONENTS AND COMPUTER ACCESSORIES AND SUPPLIES FOR OTHERS (U.S. CLS. 100, 101 AND 102).

**CLASS 36—INSURANCE AND FINANCIAL**

FOR FINANCIAL SERVICES, NAMELY, FINANCING SERVICES RELATED TO COMPUTER HARDWARE, SOFTWARE, SERVER, NETWORKS, AND WORK STATIONS; UNDERWRITING WARRANTY PROGRAMS IN THE FIELD OF COMPUTER HARDWARE, SOFTWARE, SERVERS, NETWORKS, AND WORK STATIONS; WARRANTY CLAIMS ADMINISTRATION SERVICES, NAMELY, PROCESSING WARRANTY CLAIMS FOR COMPUTER HARDWARE, SOFTWARE, SERVERS, NETWORKS AND WORK STATIONS (U.S. CLS. 100, 101 AND 102).

**CLASS 39—TRANSPORTATION AND STORAGE**

FOR ELECTRONIC STORAGE OF COMPUTER DATA (U.S. CLS. 100 AND 105).

**CLASS 42—SCIENTIFIC AND COMPUTER SERVICES**

FOR COMPUTER PROGRAMMING SERVICES; DESIGN, DEVELOPMENT, DEPLOYMENT, IMPLEMENTATION, ANALYSIS, INTEGRATION, AND MANAGEMENT OF COMPUTER SOFTWARE FOR OTHERS; INSTALLATION, MODIFICATION, MAINTENANCE, AND REPAIR OF COMPUTER SOFTWARE; CUSTOMIZATION AND COMPUTER PROGRAMMING SERVICES FOR OTHERS IN THE FIELD OF COMPUTER SOFTWARE AND HARDWARE CONFIGURATION MANAGEMENT; MANAGED INFORMATION TECHNOLOGY SERVICES AND OPERATIONS FOR OTHERS, NAMELY, REMOTE AND ON-SITE MANAGEMENT OF VIRTUAL INFRASTRUCTURE AND CLOUD COMPUTING SYSTEMS, NETWORKING, APPLICATIONS AND STORAGE SERVICES FOR OTHERS; APPLICATION SERVICE PROVIDER SERVICES, NAMELY, HOSTING COMPUTER SOFTWARE APPLICATIONS OF OTHERS; PROVIDING TEMPORARY USE OF NONDOWNLOADABLE COMPUTER SOFTWARE FOR MANAGING, TESTING, AND USING MULTIPLE OPERATING SYSTEMS; PROVIDING TEMPORARY USE OF NONDOWNLOADABLE COMPUTER SOFTWARE FOR MANAGING VIRTUAL COMPUTING INFRASTRUCTURE, NETWORKING AND STORAGE; PROVIDING TEMPORARY USE OF NONDOWNLOADABLE COMPUTER SOFTWARE FOR CREATING AND MAINTAINING SCAL-

ABLE CLOUD COMPUTING APPLICATIONS; LEASING AND RENTAL OF COMPUTER SOFTWARE; TECHNICAL SUPPORT SERVICES, NAMELY, TROUBLE SHOOTING OF COMPUTER SOFTWARE AND COMPUTER HARDWARE; CONSULTING SERVICES RELATED TO VIRTUAL INFRASTRUCTURE AND THE FIELD OF CLOUD COMPUTING; COMPUTER SYSTEMS INTEGRATION SERVICES; TECHNICAL CONSULTING SERVICES IN THE FIELDS OF DATACENTER ARCHITECTURE, PUBLIC AND PRIVATE CLOUD COMPUTING SOLUTIONS, AND EVALUATION AND IMPLEMENTATION OF INTERNET TECHNOLOGY AND SERVICES; TECHNICAL SUPPORT SERVICES, NAMELY, REMOTE AND ON-SITE INFRASTRUCTURE MANAGEMENT SERVICES FOR MONITORING, ADMINISTRATION AND MANAGEMENT OF PUBLIC AND PRIVATE CLOUD COMPUTING IT AND APPLICATION SYSTEMS; COMPUTER CONSULTATION IN THE FIELD OF COMPUTER HARDWARE, SOFTWARE, SERVER, NETWORK AND WORKSTATION ANALYSES FOR PERFORMANCE, ACCESS, CONFIGURATION, COMPATIBILITY, AND CONNECTIVITY; LEASING OF COMPUTERS, COMPUTER COMPONENTS AND COMPUTER ACCESSORIES; LEASING OF COMPUTERS, COMPUTER COMPONENTS AND COMPUTER ACCESSORIES, AND SUPPLIES, NAMELY, LEASING OF COMPUTERS, SERVERS, BRIDGE/ROUTERS, HUBS, WORKSTATIONS, LAPTOP COMPUTERS, MONITORS, COMPUTER CABINETS AND PERIPHERALS; REMOTE COMPUTER BACK-UP SERVICES; CONSOLIDATION OF COMPUTER DATA, NAMELY, ELECTRONIC MANIPULATION OF DISPERSED DATA TO CENTRALIZED SERVERS TO FACILITATE EFFICIENT DATA BACK-UP AND ARCHIVING (U.S. CLS. 100 AND 101).

#### CLASS 45—PERSONAL AND LEGAL SERVICES

FOR LICENSING OF COMPUTER SOFTWARE (U.S. CLS. 100 AND 101).  
LINDA ORNDORFF, EXAMINING ATTORNEY

SN 85-176,291. SOL REPUBLIC, INC., EL CERRITO, CA. FILED 11-14-2010.

**SOL REPUBLIC**

THE MARK CONSISTS OF STANDARD CHARACTERS WITHOUT CLAIM TO ANY PARTICULAR FONT, STYLE, SIZE, OR COLOR.

THE ENGLISH TRANSLATION OF "SOL" IN THE MARK IS "SUN".

#### CLASS 9—ELECTRICAL AND SCIENTIFIC APPARATUS

FOR AUDIO EQUIPMENT, NAMELY, HEADPHONES, EARPHONES, EAR BUDS; HEADPHONE, EARPHONE AND EAR BUD ACCESSORIES, NAMELY, EARPHONE CUSHIONS, EARPHONE PADS, CORD MANAGEMENT SYSTEMS, EARPHONE CASES, AND EARPHONE EXTENSION CORDS; HEADPHONES, INCLUDING THOSE ATTACHED BY LANYARDS; LOUDSPEAKERS AND MICROPHONES (U.S. CLS. 21, 23, 26, 36 AND 38).

#### CLASS 35—ADVERTISING AND BUSINESS

FOR RETAIL STORE SERVICES, KIOSKS AND ONLINE RETAIL STORE SERVICES FEATURING DEVICES FOR HANDS-FREE USE OF MOBILE PHONES, DIGITAL AUDIO PLAYERS, DIGITAL PHONES, EARPHONES, HEADPHONES, MP3 PLAYERS, PORTABLE LISTENING DEVICES, NAMELY, MP3 PLAYERS, PORTABLE MEDIA PLAYERS, COVERS FOR PORTABLE MEDIA PLAYERS, DIGITAL PHONES, EARPHONES, AND HEADPHONES, CLOTHING AND HEADWEAR, NAMELY, T-SHIRTS, SWEATSHIRTS, HATS AND BANDANAS (U.S. CLS. 100, 101 AND 102).

TRICIA SONNEBORN, EXAMINING ATTORNEY

SN 85-176,299. 7225059 CANADA INC., DBA CLEAN ANYWHERE, MONTREAL, QUEBEC, CANADA, FILED 11-14-2010.

**towel anywhere**

NO CLAIM IS MADE TO THE EXCLUSIVE RIGHT TO USE "TOWEL" FOR INTERNATIONAL CLASS 24, APART FROM THE MARK AS SHOWN.

THE MARK CONSISTS OF THE STYLIZED WORDS "TOWEL" AND "ANYWHERE" SEPARATED BY THE IMAGE OF A DROP OF WATER WITH A SHADOW OF THE DROP APPEARING BELOW.

#### CLASS 3—COSMETICS AND CLEANING PREPARATIONS

FOR SKIN CLEANSERS (U.S. CLS. 1, 4, 6, 50, 51 AND 52).

#### CLASS 5—PHARMACEUTICALS

FOR HAND AND SKIN SANITIZER SOLUTION (U.S. CLS. 6, 18, 44, 46, 51 AND 52).

#### CLASS 21—HOUSEWARES AND GLASS

FOR DISPENSERS FOR CLEANING AND DISINFECTING SOLUTIONS; DISPENSERS FOR LIQUID SOAP; MANUALLY ACTUATED PUMP DISPENSERS FOR ATTACHMENT TO CONTAINERS FOR USE IN DISPENSING LIQUIDS (U.S. CLS. 2, 13, 23, 29, 30, 33, 40 AND 50).

#### CLASS 24—FABRICS

FOR TOWELS (U.S. CLS. 42 AND 50).

#### CLASS 25—CLOTHING

FOR CLOTHING, NAMELY, T-SHIRTS, BATHING SUITS AND INTIMATES, NAMELY, UNDERWEAR (U.S. CLS. 22 AND 39).

JESSICA FATHY, EXAMINING ATTORNEY

SN 85-176,623. ST. MARTIN'S PRESS, LLC, NEW YORK, NY, AND JONES, GARETH JEFFERSON, 12169 BERLIN, FED REP GERMANY, FILED 11-15-2010.

SN 85-176,832. FREEDOMWORKS, INC., WASHINGTON, DC. FILED 11-15-2010.

## GRIMM CITY

THE MARK CONSISTS OF STANDARD CHARACTERS WITHOUT CLAIM TO ANY PARTICULAR FONT, STYLE, SIZE, OR COLOR.

THE WORD(S) "GRIMM" HAS NO MEANING IN A FOREIGN LANGUAGE. "GRIMM" APPEARING IN THE MARK HAS NO SIGNIFICANCE NOR IS IT A TERM OF ART IN THE RELEVANT TRADE OR INDUSTRY OR AS APPLIED TO THE GOODS/SERVICES LISTED IN THE APPLICATION, OR ANY GEOGRAPHICAL SIGNIFICANCE.

### CLASS 9—ELECTRICAL AND SCIENTIFIC APPARATUS

FOR PRE-RECORDED CD-ROMS AND DVD-ROMS FEATURING AUDIOBOOKS AND INTERACTIVE BOOKS IN THE NATURE OF NOVELS; CD-ROMS AND DVD-ROMS FEATURING COMPUTER SOFTWARE FEATURING INTERACTIVE BOOKS IN THE NATURE OF NOVELS; DOWNLOADABLE PODCASTS ON THE TOPIC OF FICTION; DOWNLOADABLE SOFTWARE IN THE NATURE OF COMPUTER GAMES; SOFTWARE IN THE NATURE OF COMPUTER GAMES; DOWNLOADABLE AUDIOBOOKS IN THE NATURE OF FICTION; MOTION PICTURES AND DOWNLOADABLE MOTION PICTURES BASED ON NOVELS (U.S. CLS. 21, 23, 26, 36 AND 38).

### CLASS 16—PAPER GOODS AND PRINTED MATTER

FOR PRINTED PUBLICATIONS, NAMELY, A SERIES OF FICTION BOOKS (U.S. CLS. 2, 5, 22, 23, 29, 37, 38 AND 50).

### CLASS 28—TOYS AND SPORTING GOODS

FOR TOYS AND GAMES, NAMELY, ACTION FIGURES, ELECTRONIC ACTION TOYS, PLUSH TOYS, FANTASY CHARACTER TOYS, AND TOY FIGURES (U.S. CLS. 22, 23, 38 AND 50).

### CLASS 41—EDUCATION AND ENTERTAINMENT

FOR ONGOING TELEVISION SERIES BASED ON NOVELS; PRODUCTION OF TELEVISION SERIES AND MOTION PICTURES; ENTERTAINMENT SERVICES, NAMELY, ONLINE COMPUTER GAMES; ON-LINE JOURNALS, NAMELY, BLOGS IN THE FIELD OF FICTION BOOKS; PRODUCTION AND DISTRIBUTION OF MOTION PICTURES BASED ON NOVELS (U.S. CLS. 100, 101 AND 107).

WILLIAM BRECKENFELD, EXAMINING ATTORNEY

## FREEDOMCONNECT

THE MARK CONSISTS OF STANDARD CHARACTERS WITHOUT CLAIM TO ANY PARTICULAR FONT, STYLE, SIZE, OR COLOR.

### CLASS 35—ADVERTISING AND BUSINESS

FOR PROVIDING A WEB SITE FEATURING INFORMATION ON POLITICAL GRASSROOTS CAMPAIGNING ACTIVITIES AND EVENTS (U.S. CLS. 100, 101 AND 102).

### CLASS 42—SCIENTIFIC AND COMPUTER SERVICES

FOR COMPUTER SERVICES, NAMELY, CREATING AND PROVIDING AN ON-LINE COMMUNITY FOR REGISTERED USERS TO PARTICIPATE IN DISCUSSIONS, GET FEEDBACK FROM THEIR PEERS, FORM VIRTUAL COMMUNITIES, SHARE INFORMATION ON GRASSROOTS CAMPAIGNING ACTIVITIES AND EVENTS AND ENGAGE IN SOCIAL NETWORKING IN THE FIELD OF GRASSROOTS CAMPAIGNING FOR MORE FREEDOM, LOWER TAXES AND LESS GOVERNMENT (U.S. CLS. 100 AND 101).

JANET LEE, EXAMINING ATTORNEY

SN 85-177,112. SCHMIDT, BRIAN M., NAZARETH, PA. FILED 11-15-2010.

## IEXPECT

THE MARK CONSISTS OF STANDARD CHARACTERS WITHOUT CLAIM TO ANY PARTICULAR FONT, STYLE, SIZE, OR COLOR.

### CLASS 25—CLOTHING

FOR CLOTHING, NAMELY, SHIRTS, PANTS AND HEADWEAR (U.S. CLS. 22 AND 39).

### CLASS 35—ADVERTISING AND BUSINESS

FOR ON-LINE RETAIL STORE SERVICES FEATURING CLOTHING, AND GENERAL CONSUMER MERCHANDISE (U.S. CLS. 100, 101 AND 102).

BARBARA A. GOLD, EXAMINING ATTORNEY

SN 85-178,144. HEB GROCERY COMPANY, LP, SAN ANTONIO, TX. FILED 11-16-2010.



THE MARK CONSISTS OF A SHADED RECTANGLE CONTAINING THE WORD "COCINAWARE" IN LIGHT, STYLIZED, CURSIVE LETTERING, UNDERLINED BY A LIGHT CURVED LINE WITH TWO ADDITIONAL UNDERSCORINGS BELOW THE INITIAL LETTER "C".

THE ENGLISH TRANSLATION OF "COCINA" IN THE MARK IS "KITCHEN".

#### CLASS 11—ENVIRONMENTAL CONTROL APPARATUS

FOR COOKWARE, NAMELY, ELECTRIC FOOD STEAMERS (U.S. CLS. 13, 21, 23, 31 AND 34).

#### CLASS 21—HOUSEWARES AND GLASS

FOR COOKWARE, NAMELY, ROASTING PANS, SAUCEPANS, NON-ELECTRIC GRIDDLES, DUTCH OVENS; BROILER COOKING PANS AND BAKING SHEETS; BAKEWARE NOT TOYS; COOKING POTS; SKILLETS; FRYING PANS; BOWLS; DISHES; PLATES NOT OF PRECIOUS METAL; SERVING TRAYS; COOKING UTENSILS, NAMELY, BASTING SPOONS AND BRUSHES FOR BASTING MEAT, MIXING SPOONS, VEGETABLE MASHERS, WHISKS, SLOTTED SPOONS; HOUSEHOLD UTENSILS, NAMELY, SPATULAS, POT SCRAPERS, SERVING TONGS AND COOKING SKEWERS; HOUSEHOLD UTENSILS, NAMELY, GRATERS, CARVING BOARDS, STRAINERS, TEA BALLS, CAKE DECORATING TUBES, COOKING SIFTERS, COFFEE MEASURES, MELON BALLERS, ICE CREAM SCOOPS, JAR OPENERS AND CITRUS JUICERS; SERVING UTENSILS, NAMELY, SERVING FORKS, SERVING SPOONS, KITCHEN LADLES, PIE SERVERS, PASTA SERVING FORKS; TRIVETS; CHEESE GRATERS; KNIFE BOARDS; BOTTLE OPENERS; SALT AND PEPPER MILLS, ROLLING PINS; CUTTING BOARDS; WOOD CHOPPING BOARDS FOR KITCHEN USE; CORK SCREWS; COUNTERTOP HOLDERS FOR PAPER TOWELS; CORN COB HOLDERS; COCKTAIL PICKS; STOVE BURNER COVERS; CLEANING PADS; CLEANING BRUSHES FOR HOUSEHOLD USE (U.S. CLS. 2, 13, 23, 29, 30, 33, 40 AND 50).

STEVEN JACKSON, EXAMINING ATTORNEY

SN 85-178,479. KENTUCKY DERBY FESTIVAL, INC., LOUISVILLE, KY. FILED 11-16-2010.

DERBY FESTIVAL

THE MARK CONSISTS OF STANDARD CHARACTERS WITHOUT CLAIM TO ANY PARTICULAR FONT, STYLE, SIZE, OR COLOR.

OWNER OF U.S. REG. NO. 1,655,056.

#### CLASS 6—METAL GOODS

FOR METAL KEY CHAINS (U.S. CLS. 2, 12, 13, 14, 23, 25 AND 50).  
FIRST USE 1-0-2011; IN COMMERCE 1-0-2011.

#### CLASS 14—JEWELRY

FOR LAPEL PINS (U.S. CLS. 2, 27, 28 AND 50).  
FIRST USE 1-0-2011; IN COMMERCE 1-0-2011.

#### CLASS 16—PAPER GOODS AND PRINTED MATTER

FOR PRINTED MATERIALS, NAMELY, POSTERS, NOTE CARDS AND POSTCARDS; PENS (U.S. CLS. 2, 5, 22, 23, 29, 37, 38 AND 50).

FIRST USE 1-0-2011; IN COMMERCE 1-0-2011.

#### CLASS 18—LEATHER GOODS

FOR TOTE BAGS (U.S. CLS. 1, 2, 3, 22 AND 41).  
FIRST USE 1-0-2011; IN COMMERCE 1-0-2011.

#### CLASS 21—HOUSEWARES AND GLASS

FOR MUGS; DRINKING GLASSES; SHOT GLASSES; JULEP GLASSES (U.S. CLS. 2, 13, 23, 29, 30, 33, 40 AND 50).

FIRST USE 1-0-2011; IN COMMERCE 1-0-2011.

#### CLASS 25—CLOTHING

FOR SHIRTS; T-SHIRTS; JACKETS; HEADWEAR (U.S. CLS. 22 AND 39).

FIRST USE 1-0-2011; IN COMMERCE 1-0-2011.  
DAVID TOOLEY, EXAMINING ATTORNEY

SN 85-178,840. COMPUGROUP MEDICAL A.G., SCOTTSDALE, AZ. FILED 11-17-2010.

CGM

THE MARK CONSISTS OF STANDARD CHARACTERS WITHOUT CLAIM TO ANY PARTICULAR FONT, STYLE, SIZE, OR COLOR.

#### CLASS 9—ELECTRICAL AND SCIENTIFIC APPARATUS

FOR COMPUTER SOFTWARE FOR HEALTHCARE PROFESSIONALS FOR USE IN THE AUTOMATION AND MANAGEMENT OF THE CLINICAL, ADMINISTRATIVE AND COMMUNICATION FUNCTIONS ASSOCIATED WITH PATIENT CARE, BILLING, AND INSURANCE REIMBURSEMENT; COMPUTER SOFTWARE FOR USE BY HEALTHCARE PROFESSIONALS TO AUTOMATE AND MANAGE PHARMACEUTICAL INTERACTIONS AND PROVIDE ADVICE TO HEALTHCARE PROFESSIONAL (U.S. CLS. 21, 23, 26, 36 AND 38).

FIRST USE 6-8-2010; IN COMMERCE 6-8-2010.

**CLASS 35—ADVERTISING AND BUSINESS**

FOR BUSINESS INFORMATION SERVICES FOR HEALTHCARE PROFESSIONALS IN THE FIELD OF AUTOMATION AND MANAGEMENT OF THE CLINICAL, ADMINISTRATIVE AND COMMUNICATION FUNCTIONS ASSOCIATED WITH PATIENT CARE, BILLING, AND INSURANCE (U.S. CLS. 100, 101 AND 102).

FIRST USE 6-8-2010; IN COMMERCE 6-8-2010.

**CLASS 42—SCIENTIFIC AND COMPUTER SERVICES**

FOR DESIGN AND DEVELOPMENT OF COMPUTER HARDWARE AND SOFTWARE FOR USE BY HEALTHCARE PROFESSIONALS TO AUTOMATE AND MANAGE THE CLINICAL, ADMINISTRATIVE AND COMMUNICATION FUNCTIONS ASSOCIATED WITH PATIENT CARE, BILLING, AND INSURANCE; PROVIDING TEMPORARY USE OF NON-DOWNLOADABLE COMPUTER SOFTWARE FOR USE BY HEALTHCARE PROFESSIONALS TO AUTOMATE AND MANAGE PHARMACEUTICAL INTERACTIONS AND PROVIDE ADVICE TO HEALTHCARE PROFESSIONALS (U.S. CLS. 100 AND 101).

FIRST USE 6-8-2010; IN COMMERCE 6-8-2010.  
SANJEEV VOHRA, EXAMINING ATTORNEY

---

SN 85-178,910. KNOWLEDGEBASE MARKETING, INC., RICHARDSON, TX. FILED 11-17-2010.

# KBM GROUP

THE MARK CONSISTS OF STANDARD CHARACTERS WITHOUT CLAIM TO ANY PARTICULAR FONT, STYLE, SIZE, OR COLOR.

OWNER OF U.S. REG. NO. 3,331,997.  
NO CLAIM IS MADE TO THE EXCLUSIVE RIGHT TO USE "GROUP", APART FROM THE MARK AS SHOWN.

**CLASS 35—ADVERTISING AND BUSINESS**

FOR BUSINESS AND MARKETING CONSULTATION SERVICES; DIGITAL AND DIRECT MARKETING SERVICES; DEVELOPMENT, EXECUTION AND MANAGEMENT OF MARKETING CAMPAIGNS, STRATEGIES AND CONCEPTS; OUTSOURCING IN THE FIELD OF MARKETING SERVICES; OPERATION OF TELEPHONE CALL CENTERS FOR OTHERS; COMPILATION AND SYSTEMIZATION OF INFORMATION INTO COMPUTER DATABASES; BUSINESS CONSULTING IN THE FIELD OF DATA INTEGRATION SERVICES, NAMELY, COMPUTER DATABASE LINKAGE AND INTEGRATION, DATA WAREHOUSE CREATION AND MANAGEMENT, INFORMATION MANAGEMENT SYSTEMS INTEGRATION, AND ENHANCEMENT OF INFORMATION MANAGEMENT SYSTEMS OF OTHERS TO INCREASE THE ACCURACY OF USABILITY OF INFORMATION CONCERNING CUSTOMERS AND PROSPECTS; DATA AND INFORMATION PROCESSING SERVICES, NAMELY, DATA SELECTION, DATA ARRANGEMENT, DATA PROCESSING, DATA CLEANING TO REMOVE ERRONEOUS OR UNWANTED INFORMATION, DATA MERGING AND DATA PRESENTATION ALL FOR BUSINESS PURPOSES; BUSINESS CONSULTATION SERVICES, NAMELY, PROVIDING INFORMATION TO OTHERS CONCERNING THE POTENTIAL RETURN-ON-INVESTMENT FOR THE APPLICATION OF DIRECT MARKETING, CUSTOMER RELATIONSHIP MANAGEMENT, CUSTOMER MARKETING DATA, AND CUSTOMER DATA INTEGRATION SERVICES; PROCESSING MANUFACTURERS REBATES; ORDER FULFILLMENT SERVICES; BUSINESS MANAGEMENT CONSULTING WITH RELATION TO STRATEGY, MARKETING, SALES, OPERATIONS, PARTICULARLY SPECIALIZING IN THE USE OF ANALYTIC AND STATISTIC MODELS FOR THE UNDERSTANDING AND PREDICTING OF CONSUMERS, BUSINESSES, AND MARKET TRENDS AND ACTIONS; BUSINESS MONITORING AND CONSULTING SERVICES, NAMELY, TRACKING WEB SITES AND APPLICATIONS OF OTHERS TO PROVIDE STRATEGY, INSIGHT, MARKETING, SALES, OPERATIONS, PARTICULARLY SPECIALIZING IN THE USE OF ANALYTIC AND STATISTIC MODELS FOR THE UNDERSTANDING AND PREDICTING OF CONSUMERS, BUSINESSES, AND MARKET TRENDS AND ACTIONS; SOCIAL MEDIA STRATEGY AND MARKETING CONSULTANCY FOCUSING ON HELPING CLIENTS CREATE AND EXTEND THEIR PRODUCT AND BRAND STRATEGIES BY BUILDING VIRALLY ENGAGING MARKETING SOLUTIONS (U.S. CLS. 100, 101 AND 102).

FIRST USE 10-7-2010; IN COMMERCE 10-7-2010.

**CLASS 36—INSURANCE AND FINANCIAL**

FOR PAYMENT PROCESSING, NAMELY, INCENTIVE PAYMENT PROCESSING FOR LOYALTY, REFERRAL, SWEEPSTAKES AND REBATE PROGRAMS; BANK ACCOUNT MANAGEMENT FOR OTHERS IN THE NATURE OF PROVIDING ACCOUNT INFORMATION REPORTING (U.S. CLS. 100, 101 AND 102).

FIRST USE 10-7-2010; IN COMMERCE 10-7-2010.  
DARRYL SPRUILL, EXAMINING ATTORNEY

---

SN 85-179,077. 4 DYNAMICS INVESTMENTS, LLC, MIAMI, FL. FILED 11-17-2010.

# DYNAMX

THE MARK CONSISTS OF STANDARD CHARACTERS WITHOUT CLAIM TO ANY PARTICULAR FONT, STYLE, SIZE, OR COLOR.

**CLASS 41—EDUCATION AND ENTERTAINMENT**

FOR EDUCATIONAL SERVICES, NAMELY, CONDUCTING CLASSES AND SEMINARS IN THE FIELD OF LIPOSCULPTING, SURGICAL INSTRUMENTS AND DEVICES (U.S. CLS. 100, 101 AND 107).

**CLASS 44—MEDICAL, BEAUTY AND AGRICULTURAL SERVICES**

FOR LIPOSUCTION AND SURGICAL BODY SHAPING SERVICES (U.S. CLS. 100 AND 101).  
LINDA MICKLEBURGH, EXAMINING ATTORNEY

SN 85-180,150. AUGUST HAT COMPANY, INC., OXNARD, CA. FILED 11-18-2010.

**WHAT THE HEX?**

THE MARK CONSISTS OF STANDARD CHARACTERS WITHOUT CLAIM TO ANY PARTICULAR FONT, STYLE, SIZE, OR COLOR.

**CLASS 9—ELECTRICAL AND SCIENTIFIC APPARATUS**

FOR BANDS WORN ON THE BODY FOR CARRYING PERSONAL ELECTRONIC DEVICES; ARM AND WRIST BANDS FOR CARRYING PERSONAL ELECTRONIC DEVICES; BANDS WORN ON THE BODY FOR CARRYING PORTABLE, DIGITAL ELECTRONIC DEVICES; CASES, STRAPS, WRIST AND ARM BANDS FOR DIGITAL ELECTRONIC DEVICES FOR RECORDING, ORGANIZING, TRANSMITTING, MANIPULATING AND REVIEWING TEXT, DATA AND AUDIO FILES, TIME-KEEPING AND PLAYING MUSIC; WRIST BANDS AND STRAPS FOR HOLDING PERSONAL ELECTRONIC DEVICES; HEADPHONES (U.S. CLS. 21, 23, 26, 36 AND 38).

**CLASS 14—JEWELRY**

FOR WATCH BANDS AND STRAPS; BANDS AND STRAPS FOR CHRONOMETRIC INSTRUMENTS (U.S. CLS. 2, 27, 28 AND 50).

**CLASS 18—LEATHER GOODS**

FOR BACK PACKS, TOTE BAGS, SACHELS, PURSES, WALLETS, WAIST PACKS (U.S. CLS. 1, 2, 3, 22 AND 41).  
DAVID TAYLOR, EXAMINING ATTORNEY

SN 85-180,212. TEMASEK HOLDINGS (PRIVATE) LIMITED, SINGAPORE, SINGAPORE, FILED 11-18-2010.

**TEMASEK INTERNATIONAL PANEL**

THE MARK CONSISTS OF STANDARD CHARACTERS WITHOUT CLAIM TO ANY PARTICULAR FONT, STYLE, SIZE, OR COLOR.

OWNER OF U.S. REG. NO. 3,187,580.

NO CLAIM IS MADE TO THE EXCLUSIVE RIGHT TO USE "INTERNATIONAL PANEL", APART FROM THE MARK AS SHOWN.

**CLASS 9—ELECTRICAL AND SCIENTIFIC APPARATUS**

FOR DOWNLOADABLE ELECTRONIC PUBLICATIONS, NAMELY, NEWSLETTERS, JOURNALS, BOOKS, IN THE FIELD OF BUSINESS AND FINANCIAL MATTERS; ELECTRONIC PUBLICATIONS IN COMPUTER READABLE FORM, NAMELY, NEWSLETTERS, JOURNALS, BOOKS IN THE FIELD OF BUSINESS AND FINANCIAL AFFAIRS RECORDED ON COMPUTER MEDIA; ELECTRONIC PUBLICATIONS IN MACHINE READABLE FORM, NAMELY, NEWSLETTERS, JOURNALS, BOOKS IN THE FIELD OF BUSINESS AND FINANCIAL MATTERS RECORDED ON COMPUTER MEDIA (U.S. CLS. 21, 23, 26, 36 AND 38).

**CLASS 16—PAPER GOODS AND PRINTED MATTER**

FOR PRINTED PUBLICATIONS, NAMELY, NEWSLETTERS, JOURNALS AND BOOKS IN THE FIELD OF BUSINESS AND FINANCIAL MATTERS; PERIODIC PUBLICATIONS, NAMELY, PERIODICALS IN THE FIELD OF BUSINESS AND FINANCIAL MATTERS; PRINTED REPORTS FEATURING BUSINESS AND FINANCIAL MATTERS (U.S. CLS. 2, 5, 22, 23, 29, 37, 38 AND 50).

**CLASS 41—EDUCATION AND ENTERTAINMENT**

FOR ENTERTAINMENT IN THE NATURE OF ONGOING VIDEO PROGRAMS IN THE FIELD OF NEWS; PROVISION OF NEWS IN RELATION TO EDUCATION, TRAINING, ENTERTAINMENT OR SPORTING AND CULTURAL ACTIVITIES; NEWS REPORTERS SERVICES; ON-LINE LIBRARY SERVICES, NAMELY, PROVIDING ELECTRONIC LIBRARY SERVICES BY MEANS OF A COMPUTERIZED DATABASE CONTAINING INFORMATION EXTRACTED FROM NEWSPAPERS VIA AN ON-LINE COMPUTER NETWORK; INFORMATION AND ADVISORY SERVICES RELATING TO CURRENT EVENTS IN THE NATURE OF PROVIDING NEWS REPORTER SERVICES ENTAILING NEWS ANALYSIS AND NEWS COMMENTARY ABOUT CURRENT EVENTS; PUBLICATION OF REVIEWS AND CRITIQUES; PUBLICATION OF ELECTRONIC BOOKS AND JOURNALS ON-LINE; PROVIDING NON-DOWNLOADABLE ON-LINE ELECTRONIC PUBLICATIONS IN THE NATURE OF JOURNALS AND BOOKS IN THE FIELD OF BUSINESS AND FINANCE; ELECTRONIC PUBLISHING SERVICES, NAMELY, PUBLICATION OF TEXT AND GRAPHIC WORKS OF OTHERS ON-LINE FEATURING BUSINESS AND FINANCIAL MATTERS; NON-DOWNLOADABLE WEB-BASED PUBLICATION IN THE NATURE OF JOURNALS CONSISTING PRIMARILY OF PERIODIC ARTICLES; PROVIDING NEWS FEEDS AS PART OF NEWS REPORTERS SERVICES; PUBLICATION OF TEXT, AUDIO, VIDEO AND GRAPHIC WORKS ONLINE FEATURING NEWS, DIARIES, COMMENTARY, PHOTOS, POETRY, MINI-ESSAYS, PROJECT UPDATES, NON-FICTION AND FICTION; PRODUCTION OF TELEVISION NEWS PROGRAMS FOR BROADCASTING; ON-LINE JOURNALS, NAMELY, WEBLOGS AND BLOGS FEATURING BUSINESS AND FINANCE; ADVISORY, INFORMATION AND CONSULTANCY SERVICES RELATING TO ALL THE AFORESAID (U.S. CLS. 100, 101 AND 107).

LINDA ESTRADA, EXAMINING ATTORNEY

SN 85-180,297. DR. FREDERICK LUKASH, GREAT NECK, NY. FILED 11-18-2010.

SN 85-180,335. TEMASEK HOLDINGS (PRIVATE) LIMITED, SINGAPORE, SINGAPORE, FILED 11-18-2010.

## SAFE AND SANE

THE MARK CONSISTS OF STANDARD CHARACTERS WITHOUT CLAIM TO ANY PARTICULAR FONT, STYLE, SIZE, OR COLOR.

### CLASS 9—ELECTRICAL AND SCIENTIFIC APPARATUS

FOR PRERECORDED AUDIO CASSETTES AND PRE-RECORDED CDS FEATURING INTERVIEWS AND AUDIO BOOKS IN THE FIELD OF COSMETIC SURGERY; DOWNLOADABLE AUDIO FILES FEATURING PODCASTS, INTERVIEWS, AND AUDIO BOOKS IN THE FIELD OF COSMETIC SURGERY (U.S. CLS. 21, 23, 26, 36 AND 38).

### CLASS 16—PAPER GOODS AND PRINTED MATTER

FOR BOOKS IN THE FIELD OF COSMETIC SURGERY; NEWSLETTERS IN THE FIELD OF COSMETIC SURGERY (U.S. CLS. 2, 5, 22, 23, 29, 37, 38 AND 50).  
SUNG IN, EXAMINING ATTORNEY

---

SN 85-180,308. LINETT, ANDREA, NEW YORK, NY. FILED 11-18-2010.

## I WANT TO BE HER!

THE MARK CONSISTS OF STANDARD CHARACTERS WITHOUT CLAIM TO ANY PARTICULAR FONT, STYLE, SIZE, OR COLOR.

### CLASS 35—ADVERTISING AND BUSINESS

FOR ADVERTISING AND DIRECTORY SERVICES, NAMELY, PROMOTING THE PRODUCTS OF OTHERS BY PROVIDING A WEBSITE WITH PAGES FEATURING LINKS TO THE WEBSITES OF OTHERS (U.S. CLS. 100, 101 AND 102).  
FIRST USE 11-10-2010; IN COMMERCE 11-10-2010.

### CLASS 41—EDUCATION AND ENTERTAINMENT

FOR ONLINE JOURNALS, NAMELY, BLOGS, FEATURING COMMENTARY ABOUT WOMEN'S APPAREL, JEWELRY, ACCESSORIES AND COSMETICS (U.S. CLS. 100, 101 AND 107).  
FIRST USE 11-10-2010; IN COMMERCE 11-10-2010.  
MARGERY A. TIERNEY, EXAMINING ATTORNEY

## TEMASEK EDUCATION FOUNDATION

THE MARK CONSISTS OF STANDARD CHARACTERS WITHOUT CLAIM TO ANY PARTICULAR FONT, STYLE, SIZE, OR COLOR.

OWNER OF U.S. REG. NO. 3,187,580.

NO CLAIM IS MADE TO THE EXCLUSIVE RIGHT TO USE "EDUCATION FOUNDATION", APART FROM THE MARK AS SHOWN.

### CLASS 9—ELECTRICAL AND SCIENTIFIC APPARATUS

FOR DOWNLOADABLE ELECTRONIC PUBLICATIONS, NAMELY, NEWSLETTERS, JOURNALS, BOOKS, IN THE FIELD OF BUSINESS AND FINANCIAL MATTERS; ELECTRONIC PUBLICATIONS IN COMPUTER READABLE FORM, NAMELY, NEWSLETTERS, JOURNALS, BOOKS IN THE FIELD OF BUSINESS AND FINANCIAL AFFAIRS RECORDED ON COMPUTER MEDIA; ELECTRONIC PUBLICATIONS IN MACHINE READABLE FORM, NAMELY, NEWSLETTERS, JOURNALS, BOOKS IN THE FIELD OF BUSINESS AND FINANCIAL MATTERS RECORDED ON COMPUTER MEDIA (U.S. CLS. 21, 23, 26, 36 AND 38).

### CLASS 16—PAPER GOODS AND PRINTED MATTER

FOR PRINTED PUBLICATIONS, NAMELY, NEWSLETTERS, JOURNALS AND BOOKS IN THE FIELD OF BUSINESS AND FINANCIAL MATTERS; PERIODIC PUBLICATIONS, NAMELY, PERIODICALS IN THE FIELD OF BUSINESS AND FINANCIAL MATTERS; PRINTED REPORTS FEATURING BUSINESS AND FINANCIAL MATTERS (U.S. CLS. 2, 5, 22, 23, 29, 37, 38 AND 50).

### CLASS 35—ADVERTISING AND BUSINESS

FOR CHARITABLE SERVICES, NAMELY, PROVIDING BUSINESS MANAGEMENT AND ADMINISTRATION SERVICES, AND ORGANIZING AND CONDUCTING VOLUNTEER PROGRAMS AND COMMUNITY SERVICE PROJECTS (U.S. CLS. 100, 101 AND 102).

### CLASS 36—INSURANCE AND FINANCIAL

FOR CHARITABLE FUNDRAISING; CHARITABLE SERVICES, NAMELY, PROVIDING FINANCIAL AID TO FINANCIALLY DISTRESSED INDIVIDUALS; ORGANIZING OF CHARITABLE COLLECTIONS, NAMELY, ORGANIZING FUNDRAISING SERVICES AND EVENTS TO RAISE FUNDS IN THE FIELD OF COMMUNITY SERVICE PROJECTS (U.S. CLS. 100, 101 AND 102).

### CLASS 41—EDUCATION AND ENTERTAINMENT

FOR ENTERTAINMENT IN THE NATURE OF ONGOING VIDEO PROGRAMS IN THE FIELD OF NEWS; PROVISION OF NEWS IN RELATION TO EDUCATION, TRAINING, ENTERTAINMENT OR SPORTING AND CULTURAL ACTIVITIES; NEWS REPORTERS SERVICES; ON-LINE LIBRARY SERVICES, NAMELY, PROVIDING ELECTRONIC LIBRARY SERVICES BY MEANS OF A COMPUTERIZED DATABASE CONTAINING INFORMATION EXTRACTED FROM NEWSPAPERS VIA AN ON-LINE COMPUTER NETWORK; INFORMATION AND ADVISORY SERVICES RELATING TO CURRENT EVENTS IN THE NATURE OF PROVIDING NEWS



REPORTER SERVICES ENTAILING NEWS ANALYSIS AND NEWS COMMENTARY ABOUT CURRENT EVENTS; PUBLICATION OF REVIEWS AND CRITIQUES; PUBLICATION OF ELECTRONIC BOOKS AND JOURNALS ON-LINE; PROVIDING NON-DOWNLOADABLE ON-LINE ELECTRONIC PUBLICATIONS IN THE NATURE OF JOURNALS AND BOOKS IN THE FIELD OF BUSINESS AND FINANCE; ELECTRONIC PUBLISHING SERVICES, NAMELY, PUBLICATION OF TEXT AND GRAPHIC WORKS OF OTHERS ON-LINE FEATURING BUSINESS AND FINANCIAL MATTERS; NON-DOWNLOADABLE WEB-BASED PUBLICATION IN THE NATURE OF JOURNALS CONSISTING PRIMARILY OF PERIODIC ARTICLES; PROVIDING NEWS FEEDS AS PART OF NEWS REPORTERS SERVICES; PUBLICATION OF TEXT, AUDIO, VIDEO AND GRAPHIC WORKS ONLINE FEATURING NEWS, DIARIES, COMMENTARY, PHOTOS, POETRY, MINI-ESSAYS, PROJECT UPDATES, NON-FICTION AND FICTION; PRODUCTION OF TELEVISION NEWS PROGRAMS FOR BROADCASTING; ON-LINE JOURNALS, NAMELY, WEBLOGS AND BLOGS FEATURING BUSINESS AND FINANCE; ADVISORY, INFORMATION AND CONSULTANCY SERVICES RELATING TO ALL THE AFORESAID; EDUCATIONAL SERVICES, NAMELY, CLASSES AND SEMINARS IN THE FIELD OF FINANCIAL AND BUSINESS MATTERS; TRAINING SERVICES IN THE FIELD OF FINANCIAL AND BUSINESS MATTERS; ARRANGING AND CONDUCTING OF EDUCATIONAL CONFERENCES, CONGRESSES, SEMINARS, SYMPOSIUMS AND TRAINING WORKSHOPS ALL IN THE FIELDS OF BUSINESS AND FINANCE (U.S. CLS. 100, 101 AND 107).

LINDA ESTRADA, EXAMINING ATTORNEY

SN 85-180,404. TEMASEK HOLDINGS (PRIVATE) LIMITED, SINGAPORE, SINGAPORE, FILED 11-18-2010.

## TEMASEK INTERNATIONAL FOUNDATION

THE MARK CONSISTS OF STANDARD CHARACTERS WITHOUT CLAIM TO ANY PARTICULAR FONT, STYLE, SIZE, OR COLOR.

OWNER OF U.S. REG. NO. 3,187,580.

NO CLAIM IS MADE TO THE EXCLUSIVE RIGHT TO USE "INTERNATIONAL FOUNDATION", APART FROM THE MARK AS SHOWN.

### CLASS 9—ELECTRICAL AND SCIENTIFIC APPARATUS

FOR DOWNLOADABLE ELECTRONIC PUBLICATIONS, NAMELY, NEWSLETTERS, JOURNALS, BOOKS, IN THE FIELD OF BUSINESS AND FINANCIAL MATTERS; ELECTRONIC PUBLICATIONS IN COMPUTER READABLE FORM, NAMELY, NEWSLETTERS, JOURNALS, BOOKS IN THE FIELD OF BUSINESS AND FINANCIAL AFFAIRS RECORDED ON COMPUTER MEDIA; ELECTRONIC PUBLICATIONS IN MACHINE READABLE FORM, NAMELY, NEWSLETTERS, JOURNALS, BOOKS IN THE FIELD OF BUSINESS AND FINANCIAL MATTERS RECORDED ON COMPUTER MEDIA (U.S. CLS. 21, 23, 26, 36 AND 38).

### CLASS 16—PAPER GOODS AND PRINTED MATTER

FOR PRINTED PUBLICATIONS, NAMELY, NEWSLETTERS, JOURNALS AND BOOKS IN THE FIELD OF BUSINESS AND FINANCIAL MATTERS; PERIODIC PUBLICATIONS, NAMELY, PERIODICALS IN THE FIELD OF BUSINESS AND FINANCIAL MATTERS; PRINTED REPORTS FEATURING BUSINESS AND FINANCIAL MATTERS (U.S. CLS. 2, 5, 22, 23, 29, 37, 38 AND 50).

### CLASS 35—ADVERTISING AND BUSINESS

FOR CHARITABLE SERVICES, NAMELY, PROVIDING BUSINESS MANAGEMENT AND ADMINISTRATION SERVICES, AND ORGANIZING AND CONDUCTING VOLUNTEER PROGRAMS AND COMMUNITY SERVICE PROJECTS (U.S. CLS. 100, 101 AND 102).

### CLASS 36—INSURANCE AND FINANCIAL

FOR CHARITABLE FUNDRAISING; CHARITABLE SERVICES, NAMELY, PROVIDING FINANCIAL ADVICE TO FINANCIALLY DISTRESSED INDIVIDUALS; ORGANIZING OF CHARITABLE COLLECTIONS, NAMELY, ORGANIZING FUNDRAISING SERVICES AND EVENTS TO RAISE FUNDS IN THE FIELD OF COMMUNITY SERVICE PROJECTS (U.S. CLS. 100, 101 AND 102).

### CLASS 41—EDUCATION AND ENTERTAINMENT

FOR ENTERTAINMENT IN THE NATURE OF ONGOING VIDEO PROGRAMS IN THE FIELD OF NEWS; PROVISION OF NEWS IN RELATION TO EDUCATION, TRAINING, ENTERTAINMENT OR SPORTING AND CULTURAL ACTIVITIES; NEWS REPORTERS SERVICES; ON-LINE LIBRARY SERVICES, NAMELY, PROVIDING ELECTRONIC LIBRARY SERVICES BY MEANS OF A COMPUTERIZED DATABASE CONTAINING INFORMATION EXTRACTED FROM NEWSPAPERS VIA AN ON-LINE COMPUTER NETWORK; INFORMATION AND ADVISORY SERVICES RELATING TO CURRENT EVENTS IN THE NATURE OF PROVIDING NEWS REPORTER SERVICES ENTAILING NEWS ANALYSIS AND NEWS COMMENTARY ABOUT CURRENT EVENTS; PUBLICATION OF REVIEWS AND CRITIQUES; PUBLICATION OF ELECTRONIC BOOKS AND JOURNALS ON-LINE; PROVIDING NON-DOWNLOADABLE ON-LINE ELECTRONIC PUBLICATIONS IN THE NATURE OF JOURNALS AND BOOKS IN THE FIELD OF BUSINESS AND FINANCE; ELECTRONIC PUBLISHING SERVICES, NAMELY, PUBLICATION OF TEXT AND GRAPHIC WORKS OF OTHERS ON-LINE FEATURING BUSINESS AND FINANCIAL MATTERS; NON-DOWNLOADABLE WEB-BASED PUBLICATION IN THE NATURE OF JOURNALS CONSISTING PRIMARILY OF PERIODIC ARTICLES; PROVIDING NEWS FEEDS AS PART OF NEWS REPORTERS SERVICES; PUBLICATION OF TEXT, AUDIO, VIDEO AND GRAPHIC WORKS ONLINE FEATURING NEWS, DIARIES, COMMENTARY, PHOTOS, POETRY, MINI-ESSAYS, PROJECT UPDATES, NON-FICTION AND FICTION; PRODUCTION OF TELEVISION NEWS PROGRAMS FOR BROADCASTING; ON-LINE JOURNALS, NAMELY, WEBLOGS AND BLOGS FEATURING BUSINESS AND FINANCE; ADVISORY, INFORMATION AND CONSULTANCY SERVICES RELATING TO ALL THE AFORESAID; EDUCATIONAL SERVICES, NAMELY, CLASSES AND SEMINARS IN THE FIELD OF FINANCIAL AND BUSINESS MATTERS; TRAINING SERVICES IN THE FIELD OF FINANCIAL AND BUSINESS MATTERS; ARRANGING AND CONDUCTING OF EDUCATIONAL CONFERENCES, CONGRESSES, SEMINARS, SYMPOSIUMS AND TRAINING WORKSHOPS ALL IN THE FIELDS OF BUSINESS AND FINANCE (U.S. CLS. 100, 101 AND 107).

LINDA ESTRADA, EXAMINING ATTORNEY

SN 85-180,446. TEMASEK HOLDINGS (PRIVATE) LIMITED,  
SINGAPORE, SINGAPORE, FILED 11-18-2010.

## TEMASEK TRUST

THE MARK CONSISTS OF STANDARD CHARACTERS WITHOUT CLAIM TO ANY PARTICULAR FONT, STYLE, SIZE, OR COLOR.

OWNER OF U.S. REG. NO. 3,187,580.

NO CLAIM IS MADE TO THE EXCLUSIVE RIGHT TO USE "TRUST", APART FROM THE MARK AS SHOWN.

### CLASS 9—ELECTRICAL AND SCIENTIFIC APPARATUS

FOR DOWNLOADABLE ELECTRONIC PUBLICATIONS, NAMELY, NEWSLETTERS, JOURNALS, BOOKS, IN THE FIELD OF BUSINESS AND FINANCIAL MATTERS; ELECTRONIC PUBLICATIONS IN COMPUTER READABLE FORM, NAMELY, NEWSLETTERS, JOURNALS, BOOKS IN THE FIELD OF BUSINESS AND FINANCIAL AFFAIRS RECORDED ON COMPUTER MEDIA; ELECTRONIC PUBLICATIONS IN MACHINE READABLE FORM, NAMELY, NEWSLETTERS, JOURNALS, BOOKS IN THE FIELD OF BUSINESS AND FINANCIAL MATTERS RECORDED ON COMPUTER MEDIA (U.S. CLS. 21, 23, 26, 36 AND 38).

### CLASS 16—PAPER GOODS AND PRINTED MATTER

FOR PRINTED PUBLICATIONS, NAMELY, NEWSLETTERS, JOURNALS AND BOOKS IN THE FIELD OF BUSINESS AND FINANCIAL MATTERS; PERIODIC PUBLICATIONS, NAMELY, PERIODICALS IN THE FIELD OF BUSINESS AND FINANCIAL MATTERS; PRINTED REPORTS FEATURING BUSINESS AND FINANCIAL MATTERS (U.S. CLS. 2, 5, 22, 23, 29, 37, 38 AND 50).

### CLASS 35—ADVERTISING AND BUSINESS

FOR CHARITABLE SERVICES, NAMELY, PROVIDING BUSINESS MANAGEMENT AND ADMINISTRATION SERVICES, AND ORGANIZING AND CONDUCTING VOLUNTEER PROGRAMS AND COMMUNITY SERVICE PROJECTS (U.S. CLS. 100, 101 AND 102).

### CLASS 36—INSURANCE AND FINANCIAL

FOR CHARITABLE FUNDRAISING; CHARITABLE SERVICES, NAMELY, PROVIDING FINANCIAL ADVICE TO FINANCIALLY DISTRESSED INDIVIDUALS; ORGANIZING OF CHARITABLE COLLECTIONS, NAMELY, ORGANIZING FUNDRAISING SERVICES AND EVENTS TO RAISE FUNDS IN THE FIELD OF COMMUNITY SERVICE PROJECTS (U.S. CLS. 100, 101 AND 102).

### CLASS 41—EDUCATION AND ENTERTAINMENT

FOR ENTERTAINMENT IN THE NATURE OF ON-GOING VIDEO PROGRAMS IN THE FIELD OF NEWS; PROVISION OF NEWS IN RELATION TO EDUCATION, TRAINING, ENTERTAINMENT OR SPORTING AND CULTURAL ACTIVITIES; NEWS REPORTERS SERVICES; ON-LINE LIBRARY SERVICES, NAMELY, PROVIDING ELECTRONIC LIBRARY SERVICES BY MEANS OF A COMPUTERIZED DATABASE CONTAINING INFORMATION EXTRACTED FROM NEWSPAPERS VIA AN ON-LINE COMPUTER NETWORK; INFORMATION AND ADVISORY SERVICES RELATING TO CURRENT EVENTS IN THE NATURE OF PROVIDING NEWS REPORTER SERVICES ENTAILING NEWS ANALYSIS AND NEWS COMMENTARY ABOUT CURRENT EVENTS; PUBLICATION OF REVIEWS AND CRITIQUES; PUBLICATION OF ELECTRONIC BOOKS AND JOURNALS ON-LINE; PROVIDING NON-DOWNLOADABLE ON-LINE ELECTRONIC PUBLICATIONS IN THE NATURE OF JOURNALS AND BOOKS IN THE FIELD OF BUSINESS AND FINANCE; ELECTRONIC PUBLISHING SERVICES, NAMELY, PUBLICATION OF TEXT AND GRAPHIC WORKS OF OTHERS ON-LINE FEATURING BUSINESS AND FINANCIAL MATTERS; NON-DOWNLOADABLE WEB-BASED PUBLICATION IN THE NATURE OF JOURNALS CONSISTING PRIMARILY OF PERIODIC ARTICLES; PROVIDING NEWS FEEDS AS PART OF NEWS REPORTERS SERVICES; PUBLICATION OF TEXT, AUDIO, VIDEO AND GRAPHIC WORKS ONLINE FEATURING NEWS, DIARIES, COMMENTARY, PHOTOS, POETRY, MINI-ESSAYS, PROJECT UPDATES, NON-FICTION AND FICTION; PRODUCTION OF TELEVISION NEWS PROGRAMS FOR BROADCASTING; ON-LINE JOURNALS, NAMELY, WEBLOGS AND BLOGS FEATURING BUSINESS AND FINANCE; ADVISORY, INFORMATION AND CONSULTANCY SERVICES RELATING TO ALL THE AFORESAID (U.S. CLS. 100, 101 AND 107).

LINDA ESTRADA, EXAMINING ATTORNEY

---

SN 85-180,471. TEMASEK HOLDINGS (PRIVATE) LIMITED,  
SINGAPORE, SINGAPORE, FILED 11-18-2010.

## T-TOUCH

THE MARK CONSISTS OF STANDARD CHARACTERS WITHOUT CLAIM TO ANY PARTICULAR FONT, STYLE, SIZE, OR COLOR.

### CLASS 9—ELECTRICAL AND SCIENTIFIC APPARATUS

FOR DOWNLOADABLE ELECTRONIC PUBLICATIONS, NAMELY, NEWSLETTERS, JOURNALS, BOOKS, IN THE FIELD OF BUSINESS AND FINANCIAL MATTERS; ELECTRONIC PUBLICATIONS IN COMPUTER READABLE FORM, NAMELY, NEWSLETTERS, JOURNALS, BOOKS IN THE FIELD OF BUSINESS AND FINANCIAL AFFAIRS RECORDED ON COMPUTER MEDIA; ELECTRONIC PUBLICATIONS IN MACHINE READABLE FORM, NAMELY, NEWSLETTERS, JOURNALS, BOOKS IN THE FIELD OF BUSINESS AND FINANCIAL MATTERS RECORDED ON COMPUTER MEDIA (U.S. CLS. 21, 23, 26, 36 AND 38).

**CLASS 16—PAPER GOODS AND PRINTED MATTER**

FOR PRINTED PUBLICATIONS, NAMELY, NEWSLETTERS, JOURNALS AND BOOKS IN THE FIELD OF BUSINESS AND FINANCIAL MATTERS; PERIODIC PUBLICATIONS, NAMELY, PERIODICALS IN THE FIELD OF BUSINESS AND FINANCIAL MATTERS; PRINTED REPORTS FEATURING BUSINESS AND FINANCIAL MATTERS (U.S. CLS. 2, 5, 22, 23, 29, 37, 38 AND 50).

**CLASS 35—ADVERTISING AND BUSINESS**

FOR CHARITABLE SERVICES, NAMELY, PROVIDING BUSINESS MANAGEMENT AND ADMINISTRATION SERVICES, AND ORGANIZING AND CONDUCTING VOLUNTEER PROGRAMS AND COMMUNITY SERVICE PROJECTS (U.S. CLS. 100, 101 AND 102).

**CLASS 36—INSURANCE AND FINANCIAL**

FOR CHARITABLE FUNDRAISING; CHARITABLE SERVICES, NAMELY, PROVIDING FINANCIAL ADVICE TO FINANCIALLY DISTRESSED INDIVIDUALS; ORGANIZING OF CHARITABLE COLLECTIONS, NAMELY, ORGANIZING FUNDRAISING SERVICES AND EVENTS TO RAISE FUNDS IN THE FIELD OF COMMUNITY SERVICE PROJECTS (U.S. CLS. 100, 101 AND 102).

**CLASS 41—EDUCATION AND ENTERTAINMENT**

FOR ENTERTAINMENT IN THE NATURE OF ONGOING VIDEO PROGRAMS IN THE FIELD OF NEWS; PROVISION OF NEWS IN RELATION TO EDUCATION, TRAINING, ENTERTAINMENT OR SPORTING AND CULTURAL ACTIVITIES; NEWS REPORTERS SERVICES; ON-LINE LIBRARY SERVICES, NAMELY, PROVIDING ELECTRONIC LIBRARY SERVICES BY MEANS OF A COMPUTERIZED DATABASE CONTAINING INFORMATION EXTRACTED FROM NEWSPAPERS VIA AN ON-LINE COMPUTER NETWORK; INFORMATION AND ADVISORY SERVICES RELATING TO CURRENT EVENTS IN THE NATURE OF PROVIDING NEWS REPORTER SERVICES ENTAILING NEWS ANALYSIS AND NEWS COMMENTARY ABOUT CURRENT EVENTS; PUBLICATION OF REVIEWS AND CRITIQUES; PUBLICATION OF ELECTRONIC BOOKS AND JOURNALS ON-LINE; PROVIDING NON-DOWNLOADABLE ON-LINE ELECTRONIC PUBLICATIONS IN THE NATURE OF JOURNALS AND BOOKS IN THE FIELD OF BUSINESS AND FINANCE; ELECTRONIC PUBLISHING SERVICES, NAMELY, PUBLICATION OF TEXT AND GRAPHIC WORKS OF OTHERS ON-LINE FEATURING BUSINESS AND FINANCIAL MATTERS; NON-DOWNLOADABLE WEB-BASED PUBLICATION IN THE NATURE OF JOURNALS CONSISTING PRIMARILY OF PERIODIC ARTICLES IN THE FIELDS OF BUSINESS AND FINANCE; PROVIDING NEWS FEEDS AS PART OF NEWS REPORTERS SERVICES; PUBLICATION OF TEXT, AUDIO, VIDEO AND GRAPHIC WORKS ONLINE FEATURING NEWS, DIARIES, COMMENTARY, PHOTOS, POETRY, MINI-ESSAYS, PROJECT UPDATES, NON-FICTION AND FICTION; PRODUCTION OF TELEVISION NEWS PROGRAMS FOR BROADCASTING; ON-LINE JOURNALS, NAMELY, WEBLOGS AND BLOGS FEATURING BUSINESS AND FINANCE; ADVISORY, INFORMATION AND CONSULTANCY SERVICES RELATING TO ALL THE AFORESAID; CHARITABLE SERVICE, NAMELY, ACADEMIC MENTORING OF SCHOOL AGE CHILDREN; CHARITABLE SERVICES, NAMELY, CONDUCTING CLASSES SEMINARS, AND TRAINING SESSIONS IN THE FIELD OF FINANCIAL ADVICE FOR FINANCIALLY DISTRESSED INDIVIDUALS; EDUCATIONAL SERVICES, NAMELY, CLASSES AND SEMINARS IN THE FIELD OF FINANCIAL AND BUSINESS MATTERS; EDUCATIONAL SERVICES, NAMELY, CLASSES AND SEMINARS IN THE FIELD OF FINANCIAL AND BUSINESS MATTERS; TRAINING SERVICES IN THE FIELD OF FINANCIAL AND BUSINESS MATTERS; ARRANGING AND CONDUCTING OF EDUCATIONAL CONFER-

ENCES, CONGRESSES, SEMINARS, SYMPOSIUMS AND TRAINING WORKSHOPS ALL IN THE FIELDS OF BUSINESS AND FINANCE (U.S. CLS. 100, 101 AND 107).

ALLISON SCHRODY, EXAMINING ATTORNEY

SN 85-180,494. TEMASEK HOLDINGS (PRIVATE) LIMITED, SINGAPORE, SINGAPORE, FILED 11-18-2010.

**TEMASEK ALUMNI**

THE MARK CONSISTS OF STANDARD CHARACTERS WITHOUT CLAIM TO ANY PARTICULAR FONT, STYLE, SIZE, OR COLOR.

OWNER OF U.S. REG. NO. 3,187,580.

NO CLAIM IS MADE TO THE EXCLUSIVE RIGHT TO USE "ALUMNI", APART FROM THE MARK AS SHOWN.

**CLASS 16—PAPER GOODS AND PRINTED MATTER**

FOR STATIONERY; PRINTED TEACHING MATERIALS IN THE FIELD OF BUSINESS AND FINANCIAL MATTERS; PRINTED PUBLICATIONS, PERIODIC PUBLICATIONS AND PRINTED MATTER, NAMELY, PRINTED PERIODICALS, NEWSPAPERS, MAGAZINES, NEWSLETTERS, AND PRINTED REPORTS, ALL IN THE FIELDS OF BUSINESS AND FINANCIAL MATTERS (U.S. CLS. 2, 5, 22, 23, 29, 37, 38 AND 50).

**CLASS 35—ADVERTISING AND BUSINESS**

FOR BUSINESS MANAGEMENT; BUSINESS ADMINISTRATION; PROVIDING OFFICE FUNCTIONS (U.S. CLS. 100, 101 AND 102).

**CLASS 41—EDUCATION AND ENTERTAINMENT**

FOR PROVISION OF SOCIAL CLUB SERVICES, NAMELY, ARRANGING, ORGANIZING, AND HOSTING SOCIAL EVENTS, GET-TOGETHERS, AND PARTIES FOR CLUB MEMBERS; EDUCATIONAL SERVICES, NAMELY, CLASSES AND SEMINARS IN THE FIELD OF FINANCIAL AND BUSINESS MATTERS; TRAINING SERVICES IN THE FIELD OF FINANCIAL AND BUSINESS MATTERS; ARRANGING AND CONDUCTING OF EDUCATIONAL CONFERENCES, CONGRESSES, SEMINARS, SYMPOSIUMS AND TRAINING WORKSHOPS ALL IN THE FIELDS OF BUSINESS AND FINANCE (U.S. CLS. 100, 101 AND 107).

LINDA ESTRADA, EXAMINING ATTORNEY

SN 85-180,557. CALIFORNIA ASSOCIATION OF COMMUNITY MANAGERS, INC., LAGUNA HILLS, CA. FILED 11-18-2010.

**ACMF**

THE MARK CONSISTS OF STANDARD CHARACTERS WITHOUT CLAIM TO ANY PARTICULAR FONT, STYLE, SIZE, OR COLOR.

**CLASS 41—EDUCATION AND ENTERTAINMENT**

FOR EDUCATIONAL SERVICES, NAMELY, CONDUCTING SEMINARS, WORKSHOPS AND EDUCATIONAL TESTING IN THE FIELD OF MANAGEMENT OF HOME OWNER ASSOCIATIONS (U.S. CLS. 100, 101 AND 107).

**CLASS 42—SCIENTIFIC AND COMPUTER SERVICES**

FOR TESTING, ANALYSIS, AND EVALUATION OF THE KNOWLEDGE SKILLS AND ABILITIES OF OTHERS FOR THE PURPOSE OF CERTIFICATION AND RE-CERTIFICATION IN THE FIELD OF MANAGEMENT OF HOMEOWNERS ASSOCIATION; ACCREDITATION SERVICES, NAMELY, DEVELOPING AND ADMINISTERING STANDARDS AND PROCEDURES FOR CERTIFYING PROFESSIONALS IN THE FIELD OF MANAGEMENT OF HOMEOWNERS ASSOCIATIONS (U.S. CLS. 100 AND 101).

SETH A. RAPPAPORT, EXAMINING ATTORNEY

---

SN 85-180,561. SANT'ANGELO, CELESTE MARIE, NEW YORK, NY. FILED 11-18-2010.

**Rosemary & Tyme**

THE MARK CONSISTS OF STANDARD CHARACTERS WITHOUT CLAIM TO ANY PARTICULAR FONT, STYLE, SIZE, OR COLOR.

**CLASS 41—EDUCATION AND ENTERTAINMENT**

FOR CONSULTING SERVICES FOR TEACHING OF FOOD PREPARATION (U.S. CLS. 100, 101 AND 107).  
FIRST USE 11-17-2010; IN COMMERCE 11-18-2010.

**CLASS 43—HOTEL AND RESTAURANT SERVICES**

FOR CONSULTING SERVICES FOR FOOD PREPARATION; CONSULTANCY SERVICES IN THE FIELD OF FOOD AND MEAL PLANNING FOR OTHERS (U.S. CLS. 100 AND 101).

FIRST USE 11-17-2010; IN COMMERCE 11-18-2010.

**CLASS 45—PERSONAL AND LEGAL SERVICES**

FOR ORGANIZATIONAL SERVICES FOR HOME OR PERSONAL PURPOSES, NAMELY, FOR KITCHEN ORGANIZATION, FOR ORGANIZATION, SELECTION, AND ANNOTATION OF BOOKS, MAGAZINES AND OTHER MATERIALS RELATED TO FOOD SELECTION AND PREPARATION AND INFORMATION FOR PERSONAL USE; PERSONAL SHOPPING SERVICES FOR KITCHEN AND HOME ORGANIZATION AND DESIGN, FOR FOOD SELECTION, FOR COOKING AND RECIPE FOOD STOCKS, AND FOR MEAL AND MENU PLANNING; CONSULTING SERVICES ABOUT ORGANIZATIONAL SERVICES FOR HOME OR PERSONAL PURPOSES, NAMELY, HOME AND KITCHEN ORGANIZATION (U.S. CLS. 100 AND 101).

FIRST USE 11-17-2010; IN COMMERCE 11-18-2010.  
HANNO RITTNER, EXAMINING ATTORNEY

SN 85-180,804. QUEST SOFTWARE, INC., ALISO VIEJO, CA. FILED 11-19-2010.

**NETVAULT: TOTALOPS**

THE MARK CONSISTS OF STANDARD CHARACTERS WITHOUT CLAIM TO ANY PARTICULAR FONT, STYLE, SIZE, OR COLOR.

OWNER OF U.S. REG. NO. 2,956,411.

**CLASS 35—ADVERTISING AND BUSINESS**

FOR COMPUTER SERVICES, NAMELY, COMPUTERIZED DATABASE MANAGEMENT (U.S. CLS. 100, 101 AND 102).

**CLASS 39—TRANSPORTATION AND STORAGE**

FOR COMPUTER SERVICES, NAMELY, ELECTRONIC STORAGE OF DATA (U.S. CLS. 100 AND 105).

**CLASS 42—SCIENTIFIC AND COMPUTER SERVICES**

FOR COMPUTER SERVICES, NAMELY, DATA PROTECTION SERVICES IN THE NATURE OF DATA ARCHIVING, REMOTE ONLINE BACKUP OF COMPUTER DATA, AND COMPUTER DATA RECOVERY SERVICES; COMPUTER MONITORING SERVICE WHICH TRACKS HARDWARE AND SOFTWARE PERFORMANCE, PERFORMS PERIODIC MAINTENANCE AND PROVIDES REPORTS AND ALERTS CONCERNING SUCH PERFORMANCE; TECHNICAL CONSULTING SERVICES IN THE FIELD OF COMPUTER DATA BACKUP AND RECOVERY ARCHITECTURE (U.S. CLS. 100 AND 101).

ALICIA COLLINS, EXAMINING ATTORNEY

---

SN 85-180,981. IVAN CHIN, SINGAPORE, SINGAPORE, FILED 11-19-2010.

**TRIMMER**

THE MARK CONSISTS OF THE WORD "TRIMMER" IN STYLIZED FORM.

**CLASS 30—STAPLE FOODS**

FOR GREEN TEA, TEA, BEVERAGES MADE OF TEA, HERB TEA FOR FOOD PURPOSES, TEA EXTRACTS, TEA-BASED BEVERAGES (U.S. CL. 46).

**CLASS 32—LIGHT BEVERAGES**

FOR ENERGY DRINKS; FRUIT-FLAVORED BEVERAGES; NON-ALCOHOLIC BEVERAGES, NAMELY, CARBONATED BEVERAGES; NON-ALCOHOLIC BEVERAGES WITH TEA FLAVOR; OTHER PREPARATIONS FOR MAKING BEVERAGES, NAMELY, FRUIT DRINKS; SPORTS DRINKS; HEALTH DRINKS NOT FOR MEDICINES, NAMELY, SPORTS DRINKS CONTAINING ELECTROLYTES; FRUIT JUICES; FRUIT DRINKS; DRINKING WATER; DRINKING WATER WITH VITAMINS (U.S. CLS. 45, 46 AND 48).

RONALD AIKENS, EXAMINING ATTORNEY

SN 85-181,031. DIMENSION-POLYANT GMBH, KEMPEN, FED REP GERMANY, FILED 11-19-2010.

UVi

THE MARK CONSISTS OF STANDARD CHARACTERS WITHOUT CLAIM TO ANY PARTICULAR FONT, STYLE, SIZE, OR COLOR.

PRIORITY CLAIMED UNDER SEC. 44(D) ON ERPNTY TM OFC APPLICATION NO. 9223629, FILED 7-5-2010, REG. NO. 009223629, DATED 12-24-2010, EXPIRES 7-5-2020.

**CLASS 22—CORDAGE AND FIBERS**

FOR SAILS CONSISTING OF POLYESTER FILM LAMINATES HAVING LAYERS OF POLYESTER, POLYOLEFINE, POLYAMIDE OR CARBON FIBERS; SAILS (U.S. CLS. 1, 2, 7, 19, 22, 42 AND 50).

**CLASS 24—FABRICS**

FOR TEXTILES AND TEXTILE GOODS, NAMELY, SAIL CLOTH (U.S. CLS. 42 AND 50).

MATTHEW KLINE, EXAMINING ATTORNEY

SN 85-181,317. GLOBUS MEDICAL, INC., AUDUBON, PA, FILED 11-19-2010.

**PREEMINENCE IN SPINE**

THE MARK CONSISTS OF STANDARD CHARACTERS WITHOUT CLAIM TO ANY PARTICULAR FONT, STYLE, SIZE, OR COLOR.

**CLASS 5—PHARMACEUTICALS**

FOR BIOLOGICAL SPINAL IMPLANTS COMPRISED OF HUMAN TISSUE (U.S. CLS. 6, 18, 44, 46, 51 AND 52).

**CLASS 10—MEDICAL APPARATUS**

FOR SURGICAL SPINAL IMPLANTS, COMPRISED OF ARTIFICIAL MATERIALS, AND INSTRUMENTS FOR USE IN SPINAL SURGERY (U.S. CLS. 26, 39 AND 44).

**CLASS 16—PAPER GOODS AND PRINTED MATTER**

FOR PRINTED BROCHURES, MANUALS, TECHNIQUE GUIDES, AND POSTCARDS IN THE FIELD OF SPINAL IMPLANTS AND INSTRUMENTS (U.S. CLS. 2, 5, 22, 23, 29, 37, 38 AND 50).

**CLASS 44—MEDICAL, BEAUTY AND AGRICULTURAL SERVICES**

FOR PROVIDING ONLINE INFORMATION REGARDING THE USE OF SPINAL IMPLANTS AND INSTRUMENTS IN SPINE SURGERY (U.S. CLS. 100 AND 101).

MARTHA FROMM, EXAMINING ATTORNEY

SN 85-181,461. CHRIS ORTEGA, GREEN VALLEY, AZ, FILED 11-19-2010.



THE COLOR(S) GREEN, BLACK, WHITE, YELLOW, BLUE AND GRAY IS/ARE CLAIMED AS A FEATURE OF THE MARK.

THE MARK CONSISTS OF THE HEAD AND NECK OF AN ALIEN IN GREEN AND YELLOW WITH YELLOW, BLACK AND WHITE EYES OUTLINED IN GREEN AND GREEN ANTENNAE OUTLINED IN BLACK. THE ANTENNAE SERVE AS THE LETTERS "II" IN THE WORD "OBIS", WITH THE LETTERS "OB" AND "S" IN GREEN OUTLINED IN BLACK, AND WITH AN ALIEN STANDING INSIDE OF THE "O" WITH A GREEN HEAD, BLACK ANTENNAE, GREEN ARMS AND HANDS, A YELLOW SHIRT, BLUE PANTS, AND YELLOW, BLACK AND GRAY SHOES.

**CLASS 18—LEATHER GOODS**

FOR BOOK BAGS (U.S. CLS. 1, 2, 3, 22 AND 41).  
FIRST USE 5-28-2010; IN COMMERCE 5-28-2010.

**CLASS 25—CLOTHING**

FOR WEARING APPAREL, NAMELY, T-SHIRTS, HATS (U.S. CLS. 22 AND 39).  
FIRST USE 5-28-2010; IN COMMERCE 5-28-2010.  
SARA BENJAMIN, EXAMINING ATTORNEY

SN 85-181,492. STROUD CONSULTING LIMITED, BERKSHIRE, UNITED KINGDOM, FILED 11-19-2010.

SN 85-181,575. SCA HYGIENE PRODUCTS AB, GOTEORG, SWEDEN, FILED 11-19-2010.

## STROUD CONSULTING

THE MARK CONSISTS OF STANDARD CHARACTERS WITHOUT CLAIM TO ANY PARTICULAR FONT, STYLE, SIZE, OR COLOR.

PRIORITY CLAIMED UNDER SEC. 44(D) ON ERPN CMNTY TM OFC APPLICATION NO. 009133463, FILED 5-26-2010, REG. NO. 009133463, DATED 11-8-2010, EXPIRES 5-26-2020.

NO CLAIM IS MADE TO THE EXCLUSIVE RIGHT TO USE "CONSULTING", APART FROM THE MARK AS SHOWN.

SEC. 2(F).

### CLASS 16—PAPER GOODS AND PRINTED MATTER

FOR PRINTED NEWSLETTERS AND REPORTS IN THE FIELDS OF BUSINESS MANAGEMENT AND BUSINESS INFORMATION (U.S. CLS. 2, 5, 22, 23, 29, 37, 38 AND 50).

### CLASS 35—ADVERTISING AND BUSINESS

FOR BUSINESS MANAGEMENT ASSISTANCE, INFORMATION AND CONSULTATION SERVICES (U.S. CLS. 100, 101 AND 102).

CHARLES L. JENKINS, EXAMINING ATTORNEY

---

SN 85-181,496. SKYCREPERS LLC, BELLINGHAM, MA. FILED 11-19-2010.

## SKYCREPERS

THE MARK CONSISTS OF STANDARD CHARACTERS WITHOUT CLAIM TO ANY PARTICULAR FONT, STYLE, SIZE, OR COLOR.

### CLASS 30—STAPLE FOODS

FOR CREPES, PANCAKES; FRIED CREPE STRIPS; FRIED DOUGH; CONFECTIONERIES, NAMELY, SNACK FOODS, NAMELY, CHOCOLATE; SNACK FOODS, NAMELY, CHOCOLATE-BASED SNACK FOODS; BAKERY GOODS AND DESSERT ITEMS (U.S. CL. 46).

### CLASS 43—HOTEL AND RESTAURANT SERVICES

FOR RESTAURANT AND CAFÉ SERVICES; RESTAURANT SERVICES FEATURING CREPES; RESTAURANT SERVICES, NAMELY, PROVIDING OF FOOD AND BEVERAGES FOR CONSUMPTION ON AND OFF THE PREMISES (U.S. CLS. 100 AND 101).

LOURDES AYALA, EXAMINING ATTORNEY

## INSTADRI AIR

THE MARK CONSISTS OF STANDARD CHARACTERS WITHOUT CLAIM TO ANY PARTICULAR FONT, STYLE, SIZE, OR COLOR.

### CLASS 5—PHARMACEUTICALS

FOR SANITARY NAPKINS, SANITARY TOWELS, SANITARY PANTIES, SANITARY KNICKERS, SANITARY PANTY LINERS FOR HYGIENE PURPOSES; TISSUES IMPREGNATED WITH PHARMACEUTICAL LOTIONS; ABSORBENT SANITARY ARTICLES, NAMELY, PADS, BRIEFS, DISPOSABLE DIAPERS, NAPKINS, PANTS, PANTIES FOR USE BY PERSONS SUFFERING FROM INCONTINENCE (U.S. CLS. 6, 18, 44, 46, 51 AND 52).

### CLASS 10—MEDICAL APPARATUS

FOR INCONTINENCE BED PADS; INCONTINENCE SHEETS (U.S. CLS. 26, 39 AND 44).

LESLEY LAMOTHE, EXAMINING ATTORNEY

---

SN 85-181,988. PETERSAN, DORON, WASHINGTON, DC. FILED 11-21-2010.



THE MARK CONSISTS OF THREE STARS ABOVE TWO STYLIZED ROLLING PINS.

### CLASS 30—STAPLE FOODS

FOR VEGAN BAKERY GOODS (U.S. CL. 46).  
FIRST USE 9-1-2010; IN COMMERCE 9-1-2010.

### CLASS 35—ADVERTISING AND BUSINESS

FOR VEGAN RETAIL BAKERY SHOPS (U.S. CLS. 100, 101 AND 102).  
FIRST USE 9-1-2010; IN COMMERCE 9-1-2010.  
DAVID TOOLEY, EXAMINING ATTORNEY

SN 85-182,083. MS CURE FUND INC., BOSTON, MA. FILED 11-22-2010.

SN 85-182,097. M.D. ON-LINE, INC., PARSIPPANY, NJ. FILED 11-22-2010.



---

CURE FUND

OWNER OF U.S. REG. NOS. 3,707,109 AND 3,761,618.

NO CLAIM IS MADE TO THE EXCLUSIVE RIGHT TO USE "MS" OR "CURE" FOR INTERNATIONAL CLASSES 35 AND 41, AND "MS" OR "CURE FUND" FOR INTERNATIONAL CLASS 36, APART FROM THE MARK AS SHOWN.

THE MARK CONSISTS OF THE LETTERS "MS" IN AN 11-POINTED GEOMETRIC FIGURE ABOVE A LINE AND THE WORDS "CURE FUND".

#### CLASS 35—ADVERTISING AND BUSINESS

FOR PROMOTING PUBLIC AWARENESS IN THE FIELD OF MULTIPLE SCLEROSIS PREVENTION, DIAGNOSIS AND TREATMENT THROUGH THE DISTRIBUTION OF INFORMATIONAL PUBLICATIONS; ARRANGING AND CONDUCTING BUSINESS PROGRAMS AND CONFERENCES TO THE PUBLIC AND HEALTHCARE PROFESSIONALS ON THE SUBJECTS OF MULTIPLE SCLEROSIS DIAGNOSIS, TREATMENT, MANAGEMENT, PSYCHO-SOCIAL, AND QUALITY OF LIFE ISSUES (U.S. CLS. 100, 101 AND 102).

FIRST USE 1-31-2008; IN COMMERCE 1-31-2008.

#### CLASS 36—INSURANCE AND FINANCIAL

FOR CHARITABLE FUNDRAISING SERVICES, NAMELY, RAISING MONEY FOR MULTIPLE SCLEROSIS RESEARCH AND RAISING MONEY FOR LOCAL COMMUNITY MULTIPLE SCLEROSIS AWARENESS PROGRAMS; CHARITABLE FUNDRAISING THROUGH ORGANIZING AND CONDUCTING SPECIAL EVENTS AND ACTIVITIES RAISE MONEY FOR MULTIPLE SCLEROSIS RESEARCH AND AWARENESS, INCLUDING FUNDRAISING LUNCHEAS AND DINNERS, SPORTING EVENTS, FASHION SHOWS, AND GOLF TOURNAMENTS (U.S. CLS. 100, 101 AND 102).

FIRST USE 1-31-2008; IN COMMERCE 1-31-2008.

#### CLASS 41—EDUCATION AND ENTERTAINMENT

FOR EDUCATIONAL SERVICES, NAMELY, PROVIDING PROGRAMS, CONFERENCES, SEMINARS, CLASSES AND WORKSHOPS, TO THE PUBLIC AND HEALTHCARE PROFESSIONALS ON THE SUBJECTS OF MULTIPLE SCLEROSIS DIAGNOSIS, TREATMENT, MANAGEMENT, PSYCHO-SOCIAL, AND QUALITY OF LIFE ISSUES; ENTERTAINMENT SERVICES, NAMELY, ORGANIZING EXHIBITIONS, DANCE THEATRICAL, AND MUSICAL PERFORMANCES, SOCIAL INTRODUCTION EVENTS, GOLF, RUNNING, WALKING, BICYCLING, EQUESTRIAN AND ROWING EVENTS, AND ART DISPLAYS BY THOSE AFFECTED BY MULTIPLE SCLEROSIS (U.S. CLS. 100, 101 AND 107).

FIRST USE 1-31-2008; IN COMMERCE 1-31-2008.  
ROBIN CHOSID, EXAMINING ATTORNEY

## EHR Edge

THE MARK CONSISTS OF STANDARD CHARACTERS WITHOUT CLAIM TO ANY PARTICULAR FONT, STYLE, SIZE, OR COLOR.

NO CLAIM IS MADE TO THE EXCLUSIVE RIGHT TO USE "EHR", APART FROM THE MARK AS SHOWN.

#### CLASS 9—ELECTRICAL AND SCIENTIFIC APPARATUS

FOR MEDICAL SOFTWARE PRODUCTS, NAMELY, COMPUTER SOFTWARE IN THE FIELD OF HEALTHCARE MANAGEMENT FOR USE BY PHYSICIANS, MEDICAL PRACTITIONERS, AND HOSPITALS IN CONNECTION WITH PATIENT RECORD MANAGEMENT, PATIENT BILLING AND THE PROCESSING AND ORGANIZATION OF INSURANCE AND MEDICAL RECORDS; AND DOCUMENTATION PROVIDED IN CONNECTION THEREWITH (U.S. CLS. 21, 23, 26, 36 AND 38).

#### CLASS 36—INSURANCE AND FINANCIAL

FOR PROVIDING SERVICES TO HEALTHCARE PROVIDERS AND HEALTHCARE PLANS AND INSURERS, NAMELY, ELECTRONIC PROCESSING AND TRANSMISSION OF BILL PAYMENT DATA, BILL PAYMENT SERVICES AND ELECTRONIC PROCESSING OF INSURANCE CLAIMS AND PAYMENT DATA (U.S. CLS. 100, 101 AND 102).

KEVIN DINALLO, EXAMINING ATTORNEY

---

SN 85-182,102. M.D. ON-LINE, INC., PARSIPPANY, NJ. FILED 11-22-2010.

## Total Edge

THE MARK CONSISTS OF STANDARD CHARACTERS WITHOUT CLAIM TO ANY PARTICULAR FONT, STYLE, SIZE, OR COLOR.

#### CLASS 9—ELECTRICAL AND SCIENTIFIC APPARATUS

FOR MEDICAL SOFTWARE PRODUCTS, NAMELY, COMPUTER SOFTWARE IN THE FIELD OF HEALTHCARE MANAGEMENT FOR USE BY PHYSICIANS, MEDICAL PRACTITIONERS, AND HOSPITALS IN CONNECTION WITH PATIENT RECORD MANAGEMENT, PATIENT BILLING AND THE PROCESSING AND ORGANIZATION OF INSURANCE AND MEDICAL RECORDS; AND DOCUMENTATION PROVIDED IN CONNECTION THEREWITH (U.S. CLS. 21, 23, 26, 36 AND 38).

**CLASS 36—INSURANCE AND FINANCIAL**

FOR PROVIDING SERVICES TO HEALTHCARE PROVIDERS AND HEALTH PLANS AND INSURERS, NAMELY, ELECTRONIC PROCESSING AND TRANSMISSION OF BILL PAYMENT DATA, BILL PAYMENT SERVICES AND ELECTRONIC PROCESSING OF INSURANCE CLAIMS AND PAYMENT DATA (U.S. CLS. 100, 101 AND 102).

KEVIN DINALLO, EXAMINING ATTORNEY

---

SN 85-182,326. JA APPAREL CORP., NEW YORK, NY. FILED 11-22-2010.



THE MARK CONSISTS OF THE SHAPE OF A DIAMOND WITH THE LETTER "J" CUT OUT OF THE DIAMOND SHAPE.

**CLASS 18—LEATHER GOODS**

FOR SMALL LEATHER GOODS, NAMELY, TRIFOLD, SLIMFOLD WALLETS, BRIEFCASES, LUGGAGE, TOILETRY CASES SOLD EMPTY (U.S. CLS. 1, 2, 3, 22 AND 41).

**CLASS 25—CLOTHING**

FOR CLOTHING, NAMELY, SLACKS, TROUSERS, TIES, SHIRTS, DRESS SHIRTS, SOCKS; SWIMWEAR; OUTERWEAR, NAMELY, JACKETS, COATS, TOP COATS, WOOL OVERCOATS AND RAINCOATS; HOSIERY; SLEEPWEAR; BELTS; FOOTWEAR; FORMALWEAR, NAMELY, TUXEDOS, SUITS, CUMMERBUNDS, VESTS, AND SUSPENDERS; SPORTSWEAR, NAMELY, SHIRTS, PANTS, SWEATERS, BLAZERS, T-SHIRTS, SHORTS, SWIMWEAR, JEANS, OUTERWEAR, NAMELY, JACKETS, SWEATSHIRTS, HATS, AND CAPS; SUIT SEPARATES, NAMELY, JACKETS AND PANTS MADE OF THE SAME MATERIAL SOLD TOGETHER OR SEPARATELY (U.S. CLS. 22 AND 39).

SIMON TENG, EXAMINING ATTORNEY

---

SN 85-182,666. REBELLION DEVELOPMENTS LIMITED, OXFORD, OXFORDSHIRE, UNITED KINGDOM, FILED 11-22-2010.

**GUNLOK**

THE MARK CONSISTS OF STANDARD CHARACTERS WITHOUT CLAIM TO ANY PARTICULAR FONT, STYLE, SIZE, OR COLOR.

OWNER OF ERPN CMNTY TM OFC REG. NO. 000933200, DATED 2-4-2000, EXPIRES 9-17-2018.

**CLASS 9—ELECTRICAL AND SCIENTIFIC APPARATUS**

FOR COMPUTER PRODUCTS, NAMELY, COMPUTER GAME PROGRAMS; VIDEO GAME CD-ROMS; COMPUTER GAME CD-ROMS; VIDEO GAME PROGRAMS; VIDEO GAME PROGRAMS FOR USE WITH TELEVISION SETS; ELECTRONIC COMPUTER AND VIDEO GAME SOFTWARE (U.S. CLS. 21, 23, 26, 36 AND 38).

**CLASS 28—TOYS AND SPORTING GOODS**

FOR ARCADE-TYPE ELECTRONIC COMPUTER AND VIDEO GAMES; BOARD GAMES AND INSTRUCTIONAL MANUALS SOLD AS A UNIT THEREWITH; CARD GAMES; TOYS, NAMELY, ACTION FIGURES, DOLLS AND PLAYSETS THEREFOR (U.S. CLS. 22, 23, 38 AND 50).

JUDITH HELFMAN, EXAMINING ATTORNEY

---

SN 85-182,726. ALARMFORCE INDUSTRIES INC., TORONTO, ONTARIO, CANADA, FILED 11-22-2010.

**VIDEORELAY**

THE MARK CONSISTS OF STANDARD CHARACTERS WITHOUT CLAIM TO ANY PARTICULAR FONT, STYLE, SIZE, OR COLOR.

PRIORITY CLAIMED UNDER SEC. 44(D) ON CANADA APPLICATION NO. 1502716, FILED 11-5-2010.

**CLASS 9—ELECTRICAL AND SCIENTIFIC APPARATUS**

FOR SECURITY AND FIRE DETECTION MONITORING AND ALARM SYSTEMS FOR RESIDENTIAL AND COMMERCIAL PROPERTIES (U.S. CLS. 21, 23, 26, 36 AND 38).

**CLASS 35—ADVERTISING AND BUSINESS**

FOR WHOLESALE AND RETAIL STORE SERVICES FEATURING SECURITY AND FIRE DETECTION SYSTEMS FOR RESIDENTIAL AND COMMERCIAL PROPERTIES; DISTRIBUTORSHIP SERVICES FEATURING SECURITY AND FIRE DETECTION SYSTEMS FOR RESIDENTIAL AND COMMERCIAL PROPERTIES (U.S. CLS. 100, 101 AND 102).

**CLASS 37—CONSTRUCTION AND REPAIR**

FOR INSTALLING SECURITY AND FIRE DETECTION SYSTEMS FOR RESIDENTIAL AND COMMERCIAL PROPERTIES (U.S. CLS. 100, 103 AND 106).

**CLASS 45—PERSONAL AND LEGAL SERVICES**

FOR MONITORING SECURITY AND FIRE DETECTION SYSTEMS FOR RESIDENTIAL AND COMMERCIAL PROPERTIES; PROVIDING SECURITY AND FIRE DETECTION SYSTEMS FOR RESIDENTIAL AND COMMERCIAL PROPERTIES (U.S. CLS. 100 AND 101).

KAREN K. BUSH, EXAMINING ATTORNEY



SN 85-182,739. CATO RESEARCH LTD., DURHAM, NC.  
FILED 11-22-2010.

**BRINGING YOUR PROJECTS TO  
A HIGHER LEVEL**

THE MARK CONSISTS OF STANDARD CHARACTERS WITHOUT CLAIM TO ANY PARTICULAR FONT, STYLE, SIZE, OR COLOR.

**CLASS 35—ADVERTISING AND BUSINESS**

FOR PROVIDING STATISTICAL INFORMATION, STATISTICAL ANALYSIS FOR BUSINESS PURPOSES AND COST MANAGEMENT ALL IN THE FIELD OF PHARMACEUTICALS (U.S. CLS. 100, 101 AND 102).  
FIRST USE 12-31-2007; IN COMMERCE 12-31-2007.

**CLASS 42—SCIENTIFIC AND COMPUTER SERVICES**

FOR CONTRACT RESEARCH AND DEVELOPMENT SERVICES IN THE FIELD OF PHARMACEUTICALS, NAMELY, PHARMACEUTICAL PRODUCT EVALUATION SERVICES THAT INVOLVE CREATING AND EXECUTING DRUG, BIOLOGIC AND MEDICAL DEVICE DEVELOPMENT STRATEGIES FOR OTHERS; DESIGNING LABORATORY RESEARCH, NAMELY, MANAGING AND MONITORING PRECLINICAL AND CLINICAL TRIALS; DATA MANAGEMENT, NAMELY, ABSTRACTION AND COLLECTION OF MEDICAL DATA FROM CLINICAL TESTS FOR PHARMACEUTICAL RESEARCH AND DEVELOPMENT PURPOSES; TECHNICAL WRITING SERVICES FOR OTHERS; AND CONSULTATION RELATING TO ALL OF THE FORGOING; PROJECT PLANNING IN THE FIELD OF CLINICAL TRIALS FOR PHARMACEUTICAL PRODUCTS AND MEDICAL DEVICES (U.S. CLS. 100 AND 101).  
FIRST USE 12-31-2007; IN COMMERCE 12-31-2007.

**CLASS 45—PERSONAL AND LEGAL SERVICES**

FOR DEVELOPMENT OF REGULATORY COMPLIANCE STRATEGIES TO ASSURE COMPLIANCE WITH REGULATIONS IN THE FIELD OF MEDICAL RESEARCH (U.S. CLS. 100 AND 101).  
FIRST USE 12-31-2007; IN COMMERCE 12-31-2007.  
ELIZABETH KAJUBI, EXAMINING ATTORNEY

SN 85-182,978. HALELUK, ROBERT, NEW YORK, NY.  
FILED 11-22-2010.

**TUNED**

THE MARK CONSISTS OF STANDARD CHARACTERS WITHOUT CLAIM TO ANY PARTICULAR FONT, STYLE, SIZE, OR COLOR.

**CLASS 42—SCIENTIFIC AND COMPUTER SERVICES**

FOR COMPUTER SERVICES, NAMELY, CREATING AN ON-LINE COMMUNITY FOR REGISTERED USERS TO PARTICIPATE IN DISCUSSIONS, GET FEEDBACK FROM THEIR PEERS, FORM VIRTUAL COMMUNITIES, AND ENGAGE IN SOCIAL NETWORKING FEATURING SOCIAL MEDIA AND TOPICS ON AND RELATING TO AUTOMOBILES AND THE AUTOMOTIVE INDUSTRY (U.S. CLS. 100 AND 101).

**CLASS 45—PERSONAL AND LEGAL SERVICES**

FOR ONLINE SOCIAL NETWORKING SERVICES; INTERNET BASED INTRODUCTION AND SOCIAL NETWORKING SERVICES; PROVIDING ONLINE COMPUTER DATABASES AND ONLINE SEARCHABLE DATABASES IN THE FIELD OF SOCIAL NETWORKING (U.S. CLS. 100 AND 101).

NAPOLEON SHARMA, EXAMINING ATTORNEY

SN 85-183,369. SUSSMAN-AUTOMATIC CORPORATION,  
LONG ISLAND CITY, NY. FILED 11-23-2010.

**A LIFETIME OF PLEASURE**

THE MARK CONSISTS OF STANDARD CHARACTERS WITHOUT CLAIM TO ANY PARTICULAR FONT, STYLE, SIZE, OR COLOR.

**CLASS 9—ELECTRICAL AND SCIENTIFIC APPARATUS**

FOR ELECTRONIC CONTROLS FOR COMMERCIAL AND RESIDENTIAL STEAMBATHS, STEAM GENERATORS AND SAUNAS (U.S. CLS. 21, 23, 26, 36 AND 38).

**CLASS 11—ENVIRONMENTAL CONTROL APPARATUS**

FOR COMMERCIAL AND RESIDENTIAL STEAMBATHS, STEAM GENERATORS AND SAUNAS (U.S. CLS. 13, 21, 23, 31 AND 34).  
DAYNA BROWNE, EXAMINING ATTORNEY

SN 85-183,708. NEW WORLD HOME LLC, ROSWELL, GA.  
FILED 11-23-2010.

**THE OLD WORLD IS READY FOR  
A NEW WORLD HOUSING  
SOLUTION**

THE MARK CONSISTS OF STANDARD CHARACTERS WITHOUT CLAIM TO ANY PARTICULAR FONT, STYLE, SIZE, OR COLOR.

**CLASS 19—NON-METALLIC BUILDING MATERIALS**

FOR MODULAR HOMES (U.S. CLS. 1, 12, 33 AND 50).  
FIRST USE 2-12-2009; IN COMMERCE 2-12-2009.

**CLASS 37—CONSTRUCTION AND REPAIR**

FOR RESIDENTIAL AND COMMERCIAL BUILDING CONSTRUCTION (U.S. CLS. 100, 103 AND 106).  
FIRST USE 2-12-2009; IN COMMERCE 2-12-2009.  
JENNY PARK, EXAMINING ATTORNEY

SN 85-184,215. CLEAR HOPE ASSOCIATION, SANTA ANA, CA. FILED 11-23-2010.

**CLEAR HOPE ASSOCIATION**

THE MARK CONSISTS OF STANDARD CHARACTERS WITHOUT CLAIM TO ANY PARTICULAR FONT, STYLE, SIZE, OR COLOR.

NO CLAIM IS MADE TO THE EXCLUSIVE RIGHT TO USE "ASSOCIATION", APART FROM THE MARK AS SHOWN.

**CLASS 41—EDUCATION AND ENTERTAINMENT**

FOR EDUCATION SERVICES, NAMELY, PROVIDING CLASSES, CONFERENCES, MENTORING SERVICES, NETWORKING SEMINARS, REGIONAL LEARNING AND INNOVATION CENTERS, RETREATS, SEMINARS, TRAININGS, AND WORKSHOPS IN THE FIELD OF MINISTERING TO WOMEN'S ISSUES AND DISTRIBUTION OF COURSE MATERIAL IN CONNECTION THEREWITH (U.S. CLS. 100, 101 AND 107).

FIRST USE 9-1-2004; IN COMMERCE 9-1-2004.

**CLASS 45—PERSONAL AND LEGAL SERVICES**

FOR CHRISTIAN MINISTRY SERVICES; CHARITABLE OUTREACH SERVICES, NAMELY, PROVIDING SERVICES THAT SPEAK TO WOMEN'S EMOTIONAL AND SPIRITUAL CONCERNS INCLUDING SPIRITUAL COUNSEL (U.S. CLS. 100 AND 101).

FIRST USE 9-1-2004; IN COMMERCE 9-1-2004.  
INGA ERVIN, EXAMINING ATTORNEY

SN 85-184,217. CLEAR HOPE ASSOCIATION, SANTA ANA, CA. FILED 11-23-2010.

**THE WOMAN IMPACT**

THE MARK CONSISTS OF STANDARD CHARACTERS WITHOUT CLAIM TO ANY PARTICULAR FONT, STYLE, SIZE, OR COLOR.

NO CLAIM IS MADE TO THE EXCLUSIVE RIGHT TO USE "WOMAN", APART FROM THE MARK AS SHOWN.

**CLASS 41—EDUCATION AND ENTERTAINMENT**

FOR EDUCATION SERVICES, NAMELY, PROVIDING CLASSES, CONFERENCES, MENTORING SERVICES, NETWORKING, REGIONAL CENTERS, RETREATS, SEMINARS, TRAININGS, AND WORKSHOPS IN THE FIELD OF MINISTERING TO WOMEN'S ISSUES AND DISTRIBUTION OF COURSE MATERIAL IN CONNECTION THEREWITH (U.S. CLS. 100, 101 AND 107).

FIRST USE 2-0-2011; IN COMMERCE 2-0-2011.

**CLASS 45—PERSONAL AND LEGAL SERVICES**

FOR CHRISTIAN MINISTRY SERVICES; CHARITABLE OUTREACH SERVICES, NAMELY, PROVIDING COUNSELING SERVICES THAT SPEAK TO WOMEN'S EMOTIONAL AND SPIRITUAL CONCERNS INCLUDING SPIRITUAL COUNSEL (U.S. CLS. 100 AND 101).

FIRST USE 2-0-2011; IN COMMERCE 2-0-2011.  
INGA ERVIN, EXAMINING ATTORNEY

SN 85-184,219. CLEAR HOPE ASSOCIATION, SANTA ANA, CA. FILED 11-23-2010.



NO CLAIM IS MADE TO THE EXCLUSIVE RIGHT TO USE "ASSOCIATION", APART FROM THE MARK AS SHOWN.

THE MARK CONSISTS OF THE WORDS "CLEAR HOPE ASSOCIATION" OVER A BAR STRIPE WITH A TILTED CROSS INTERSECTING THROUGH THE WORDS "HOPE" AND "ASSOCIATION" AND THE BAR STRIPE.

**CLASS 41—EDUCATION AND ENTERTAINMENT**

FOR EDUCATION SERVICES, NAMELY, PROVIDING CLASSES, CONFERENCES, MENTORING SERVICES, NETWORKING, REGIONAL CENTERS, RETREATS, SEMINARS, TRAININGS, AND WORKSHOPS IN THE FIELD OF MINISTERING TO WOMEN'S ISSUES AND DISTRIBUTION OF COURSE MATERIAL IN CONNECTION THEREWITH (U.S. CLS. 100, 101 AND 107).

FIRST USE 11-5-2010; IN COMMERCE 11-5-2010.

**CLASS 45—PERSONAL AND LEGAL SERVICES**

FOR CHRISTIAN MINISTRY SERVICES; CHARITABLE OUTREACH SERVICES, NAMELY, PROVIDING COUNSELING SERVICES THAT SPEAK TO WOMEN'S EMOTIONAL AND SPIRITUAL CONCERNS INCLUDING SPIRITUAL COUNSEL (U.S. CLS. 100 AND 101).

FIRST USE 11-5-2010; IN COMMERCE 11-5-2010.  
INGA ERVIN, EXAMINING ATTORNEY

SN 85-184,350. THE MCGRAW-HILL COMPANIES, INC.,  
NEW YORK, NY. FILED 11-24-2010.

# LANGE

THE MARK CONSISTS OF STANDARD CHARACTERS  
WITHOUT CLAIM TO ANY PARTICULAR FONT, STYLE,  
SIZE, OR COLOR.

OWNER OF U.S. REG. NO. 3,341,044.  
SEC. 2(F).

## CLASS 9—ELECTRICAL AND SCIENTIFIC APPARATUS

FOR MULTIMEDIA SOFTWARE RECORDED ON CD-  
ROMS, COMPUTER SOFTWARE, AND DOWNLOAD-  
ABLE E-BOOKS CONTAINING EDUCATIONAL MATE-  
RIALS IN THE FIELDS OF MEDICINE, PSYCHIATRY,  
PEDIATRICS, PATHOLOGY, PHARMACOLOGY,  
RADIOGRAPHY, MAMMOGRAPHY, ORTHOPEDICS,  
SPORTS MEDICINE, ACID-BASE, FLUIDS, AND ELEC-  
TROLYTES, SURGERY, INTERNAL MEDICINE, HOSPI-  
TAL ADMISSIONS, EMT-PARAMEDICS, WARDS,  
OBSTETRICS AND GYNECOLOGY, MICROBIOLOGY,  
INFECTIOUS DISEASES, BIOCHEMISTRY, GENETICS,  
CHEMISTRY, ULTRASONOGRAPHY, SURGICAL  
TECHNOLOGY, PHYSIOLOGY, CLINICAL CHEMIS-  
TRY, EKGS, AND CARDIAC STUDIES (U.S. CLS. 21,  
23, 26, 36 AND 38).

FIRST USE 0-0-2001; IN COMMERCE 0-0-2001.

## CLASS 16—PAPER GOODS AND PRINTED MATTER

FOR TEXTBOOKS, FLASHCARDS, AND TEST  
GUIDES, BOOKLETS, AND PRINTED ANSWER  
SHEETS, ALL IN THE FIELDS OF MEDICINE, PSY-  
CHIATRY, PEDIATRICS, PATHOLOGY, PHARMACOL-  
OGY, RADIOGRAPHY, MAMMOGRAPHY,  
ORTHOPEDICS, SPORTS MEDICINE, ACID-BASE,  
FLUIDS, AND ELECTROLYTES, SURGERY, INTERNAL  
MEDICINE, HOSPITAL ADMISSIONS, EMT-PARAME-  
DICS, WARDS, OBSTETRICS AND GYNECOLOGY, MI-  
CROBIOLOGY, INFECTIOUS DISEASES,  
BIOCHEMISTRY, GENETICS, CHEMISTRY, ULTRASO-  
NOGRAPHY, SURGICAL TECHNOLOGY, PHYSIOL-  
OGY, CLINICAL CHEMISTRY, EKGS, AND CARDIAC  
STUDIES (U.S. CLS. 2, 5, 22, 23, 29, 37, 38 AND 50).

FIRST USE 0-0-1999; IN COMMERCE 0-0-1999.  
SOPHIA S. KIM, EXAMINING ATTORNEY

SN 85-184,483. NEWKIRK PRODUCTS, INC., ALBANY, NY.  
FILED 11-24-2010.

# TWEE(K)

THE MARK CONSISTS OF STANDARD CHARACTERS  
WITHOUT CLAIM TO ANY PARTICULAR FONT, STYLE,  
SIZE, OR COLOR.

## CLASS 36—INSURANCE AND FINANCIAL

FOR ON-LINE FINANCIAL PLANNING SERVICES;  
ON-LINE NEWS REPORTING SERVICES IN THE FIELD  
OF FINANCIAL NEWS (U.S. CLS. 100, 101 AND 102).

## CLASS 41—EDUCATION AND ENTERTAIN- MENT

FOR EDUCATIONAL SERVICES, NAMELY, PROVID-  
ING ON-LINE CLASSES AND SEMINARS IN THE FIELD  
OF FINANCIAL PLANNING, RETIREMENT FINAN-  
CIAL PLANNING, AND FINANCIAL PLANNING VIA  
TAX DEFERRED ANNUITIES (U.S. CLS. 100, 101 AND  
107).

JIM RINGLE, EXAMINING ATTORNEY

SN 85-184,509. NEWKIRK PRODUCTS, INC., ALBANY, NY.  
FILED 11-24-2010.

# TWEE-K

THE MARK CONSISTS OF STANDARD CHARACTERS  
WITHOUT CLAIM TO ANY PARTICULAR FONT, STYLE,  
SIZE, OR COLOR.

## CLASS 36—INSURANCE AND FINANCIAL

FOR ON-LINE FINANCIAL PLANNING SERVICES;  
ON-LINE NEWS REPORTING SERVICES IN THE FIELD  
OF FINANCIAL NEWS (U.S. CLS. 100, 101 AND 102).

## CLASS 41—EDUCATION AND ENTERTAIN- MENT

FOR EDUCATIONAL SERVICES, NAMELY, PROVID-  
ING ON-LINE CLASSES AND SEMINARS IN THE FIELD  
OF FINANCIAL PLANNING, RETIREMENT FINAN-  
CIAL PLANNING, AND FINANCIAL PLANNING VIA  
TAX DEFERRED ANNUITIES (U.S. CLS. 100, 101 AND  
107).

JIM RINGLE, EXAMINING ATTORNEY

SN 85-184,650. NOVUS, INC., GUAYNABO, PUERTO RICO,  
FILED 11-24-2010.

# BKS

THE MARK CONSISTS OF STANDARD CHARACTERS  
WITHOUT CLAIM TO ANY PARTICULAR FONT, STYLE,  
SIZE, OR COLOR.

## CLASS 3—COSMETICS AND CLEANING PRE- PARATIONS

FOR SHOE CARE CREAMS AND CONDITIONERS  
(U.S. CLS. 1, 4, 6, 50, 51 AND 52).

## CLASS 14—JEWELRY

FOR WATCHES (U.S. CLS. 2, 27, 28 AND 50).

## CLASS 18—LEATHER GOODS

FOR HANDBAGS; BACKPACKS (U.S. CLS. 1, 2, 3, 22  
AND 41).

**CLASS 25—CLOTHING**

FOR SOCKS (U.S. CLS. 22 AND 39).  
PAUL E. FAHRENKOPF, EXAMINING ATTORNEY

SN 85-184,682. TINTRI, INC., MOUNTAIN VIEW, CA. FILED  
11-24-2010.

**TINTRI**

THE MARK CONSISTS OF STANDARD CHARACTERS WITHOUT CLAIM TO ANY PARTICULAR FONT, STYLE, SIZE, OR COLOR.

THE ENGLISH TRANSLATION OF THE WORD "TINTRI" IN THE MARK IS "OF LIGHTNING".

**CLASS 9—ELECTRICAL AND SCIENTIFIC APPARATUS**

FOR COMPUTER HARDWARE AND SOFTWARE FOR THE PURPOSE OF VIRTUAL STORAGE OF DATA (U.S. CLS. 21, 23, 26, 36 AND 38).

**CLASS 39—TRANSPORTATION AND STORAGE**

FOR VIRTUAL STORAGE SERVICES FOR ARCHIVING DATABASES, IMAGES AND OTHER ELECTRONIC DATA (U.S. CLS. 100 AND 105).

**CLASS 42—SCIENTIFIC AND COMPUTER SERVICES**

FOR COMPUTER SERVICES, NAMELY, PROVIDING VIRTUAL SERVERS OF VARIABLE CAPACITY TO THIRD PARTY DATA STORAGE FACILITIES (U.S. CLS. 100 AND 101).

AMY HELLA, EXAMINING ATTORNEY

SN 85-184,831. LARSON, APRIL, LOS ANGELES, CA. FILED  
11-24-2010.

**THE QUESTIONEERS**

THE MARK CONSISTS OF STANDARD CHARACTERS WITHOUT CLAIM TO ANY PARTICULAR FONT, STYLE, SIZE, OR COLOR.

**CLASS 35—ADVERTISING AND BUSINESS**

FOR PROMOTING PUBLIC AWARENESS OF ENVIRONMENTAL ISSUES AND INITIATIVES TO CHILDREN; CHARITABLE SERVICES, NAMELY, ORGANIZING AND DEVELOPING PROJECTS TO PROMOTE AWARENESS OF ENVIRONMENTAL CONSERVATION; CHARITABLE SERVICES, NAMELY, ORGANIZING AND CONDUCTING VOLUNTEER PROGRAMS AND COMMUNITY SERVICE PROJECTS AIMED AT INCREASING SUPPORT FOR ENVIRONMENTAL CONSERVATION INITIATIVES (U.S. CLS. 100, 101 AND 102).

FIRST USE 3-1-2010; IN COMMERCE 3-1-2010.

**CLASS 41—EDUCATION AND ENTERTAINMENT**

FOR EDUCATIONAL AND ENTERTAINMENT SERVICES FOR CHILDREN, NAMELY, PROVIDING A VOLUNTEER PROGRAM FEATURING RECREATIONAL ACTIVITIES TO SUPPORT ENVIRONMENTAL CONSERVATION (U.S. CLS. 100, 101 AND 107).

FIRST USE 3-1-2010; IN COMMERCE 3-1-2010.  
RONALD AIKENS, EXAMINING ATTORNEY

SN 85-184,933. STELLA & DOT LLC, BURLINGAME, CA.  
FILED 11-24-2010.

**STELLA & DOT INDEPENDENT  
STYLIST**

THE MARK CONSISTS OF STANDARD CHARACTERS WITHOUT CLAIM TO ANY PARTICULAR FONT, STYLE, SIZE, OR COLOR.

OWNER OF U.S. REG. NO. 3,797,557.

NO CLAIM IS MADE TO THE EXCLUSIVE RIGHT TO USE "INDEPENDENT STYLIST", APART FROM THE MARK AS SHOWN.

**CLASS 14—JEWELRY**

FOR JEWELRY (U.S. CLS. 2, 27, 28 AND 50).

**CLASS 40—MATERIAL TREATMENT**

FOR PROVIDING ON-LINE INFORMATION IN THE FIELD OF JEWELRY-MAKING (U.S. CLS. 100, 103 AND 106).

BERYL GARDNER, EXAMINING ATTORNEY

SN 85-185,376. M.A.S. TEXTILES LIMITED, HONG KONG,  
HONG KONG, FILED 11-26-2010.

**SUITE 16**

THE MARK CONSISTS OF STANDARD CHARACTERS WITHOUT CLAIM TO ANY PARTICULAR FONT, STYLE, SIZE, OR COLOR.

PRIORITY CLAIMED UNDER SEC. 44(D) ON HONG KONG APPLICATION NO. 301773379, FILED 11-26-2010.

**CLASS 18—LEATHER GOODS**

FOR LEATHER GOODS AND IMITATION LEATHER GOODS, NAMELY, COSMETIC BAGS SOLD EMPTY, KNAPSACKS, TOTE BAG, ATHLETIC BAGS, PURSES, HANDBAGS, WALLETS, TRUNKS FOR TRAVELING AND SUITCASES; UMBRELLAS; PARASOLS; AND WALKING STICKS (U.S. CLS. 1, 2, 3, 22 AND 41).

**CLASS 25—CLOTHING**

FOR CLOTHING FOR MEN, WOMEN AND CHILDREN, NAMELY, SOCKS, STOCKINGS, LINGERIE, BRASSIERES, PANTIES, OVERALLS, TOPS, VESTS, UNDERSHIRTS, UNDERPANTS, PAJAMAS, SWIM WEAR, TROUSERS, SKIRTS, SLACKS, BLOUSES, SHIRTS, T-SHIRTS, SWEATERS, WAISTCOATS, SHAWLS, PULL-OVERS, CARDIGANS, JERSEYS, JACKETS, SUITS, TIES, CRAVATS, OVERCOATS, COATS, HUNTING JACKETS, TRACK SUITS, RAINCOATS, GLOVES, SUSPENDERS, BELTS, STOLES AND PONCHOS, FOOTWEAR, HEADGEAR, NAMELY, HATS, SCARVES, CAPS AND HEADBANDS (U.S. CLS. 22 AND 39).

**CLASS 35—ADVERTISING AND BUSINESS**

FOR ADVERTISING AND MARKETING; BUSINESS MANAGEMENT; BUSINESS ADMINISTRATION; PROVIDING OFFICE FUNCTIONS; RETAIL STORE SERVICES FEATURING CLOTHING, FOOTWEAR, HEADGEAR, LEATHER GOODS, BAGS AND LUGGAGE (U.S. CLS. 100, 101 AND 102).

CHRIS DONINGER, EXAMINING ATTORNEY

**CLASS 35—ADVERTISING AND BUSINESS**

FOR ADVICE IN THE FIELD OF BUSINESS MANAGEMENT AND MARKETING; BUSINESS ADVISORY SERVICES, CONSULTANCY AND INFORMATION; PROVIDING A WEB SITE FEATURING BUSINESS INFORMATION IN THE FORM OF AUDIO AND VIDEO INTERVIEWS, TRANSCRIPTS AND OTHER EDUCATIONAL MATERIALS (U.S. CLS. 100, 101 AND 102).

FIRST USE 9-1-2008; IN COMMERCE 10-21-2008.  
MARGARET POWER, EXAMINING ATTORNEY

SN 85-185,576. M.A.S. TEXTILES LIMITED, HONG KONG, HONG KONG, FILED 11-26-2010.

SN 85-185,515. MARKETING REBEL LLC, RENO, NV. FILED 11-26-2010.

**LET'S MEET AT SUITE 16****Simple Writing System**

THE MARK CONSISTS OF STANDARD CHARACTERS WITHOUT CLAIM TO ANY PARTICULAR FONT, STYLE, SIZE, OR COLOR.

NO CLAIM IS MADE TO THE EXCLUSIVE RIGHT TO USE "WRITING SYSTEM", APART FROM THE MARK AS SHOWN.

THE MARK CONSISTS OF STANDARD CHARACTERS WITHOUT CLAIM TO ANY PARTICULAR FONT, STYLE, SIZE, OR COLOR.

PRIORITY CLAIMED UNDER SEC. 44(D) ON HONG KONG APPLICATION NO. 301773379, FILED 11-26-2010.

**CLASS 9—ELECTRICAL AND SCIENTIFIC APPARATUS**

FOR AUDIO DISCS FEATURING COPYWRITING, MARKETING, BUSINESS, AND TECHNOLOGY INSTRUCTION; DOWNLOADABLE MULTIMEDIA FILE CONTAINING ARTWORK, TEXT, AUDIO, VIDEO, GAMES, AND INTERNET WEB LINKS RELATING TO COPYWRITING, MARKETING, BUSINESS, AND TECHNOLOGY INSTRUCTION; DOWNLOADABLE VIDEO RECORDINGS FEATURING COPYWRITING, MARKETING, BUSINESS, AND TECHNOLOGY INSTRUCTION; ELECTRONIC PUBLICATIONS, NAMELY, ARTICLES AND BOOKS FEATURING COPYWRITING, MARKETING, BUSINESS, AND TECHNOLOGY INSTRUCTION RECORDED ON COMPUTER MEDIA; VIDEO DISCS FEATURING COPYWRITING, MARKETING, BUSINESS, AND TECHNOLOGY INSTRUCTION (U.S. CLS. 21, 23, 26, 36 AND 38).

FIRST USE 6-1-2008; IN COMMERCE 9-20-2008.

**CLASS 18—LEATHER GOODS**

FOR LEATHER GOODS AND IMITATION LEATHER GOODS, NAMELY, COSMETIC BAGS SOLD EMPTY, KNAPSACKS, TOTE BAG, ATHLETIC BAGS, PURSES, HANDBAGS, WALLETS, TRUNKS FOR TRAVELING AND SUITCASES; UMBRELLAS; PARASOLS; AND WALKING STICKS (U.S. CLS. 1, 2, 3, 22 AND 41).

**CLASS 25—CLOTHING**

FOR CLOTHING FOR MEN, WOMEN AND CHILDREN, NAMELY, SOCKS, STOCKINGS, LINGERIE, BRASSIERES, PANTIES, OVERALLS, TOPS, VESTS, UNDERSHIRTS, UNDERPANTS, PAJAMAS, SWIM WEAR, TROUSERS, SKIRTS, SLACKS, BLOUSES, SHIRTS, T-SHIRTS, SWEATERS, WAISTCOATS, SHAWLS, PULL-OVERS, CARDIGANS, JERSEYS, JACKETS, SUITS, TIES, CRAVATS, OVERCOATS, COATS, HUNTING JACKETS, TRACK SUITS, RAINCOATS, GLOVES, SUSPENDERS, BELTS, STOLES AND PONCHOS, FOOTWEAR, HEADGEAR, NAMELY, HATS, SCARVES, CAPS AND HEADBANDS (U.S. CLS. 22 AND 39).

**CLASS 16—PAPER GOODS AND PRINTED MATTER**

FOR A SERIES OF BOOKS AND WRITTEN ARTICLES IN THE FIELD OF BUSINESS, NAMELY, COPYWRITING, MARKETING, BUSINESS GROWTH, AND TECHNOLOGY; BOOKS IN THE FIELD OF BUSINESS, NAMELY, COPYWRITING, MARKETING, BUSINESS GROWTH, AND TECHNOLOGY (U.S. CLS. 2, 5, 22, 23, 29, 37, 38 AND 50).

FIRST USE 2-28-2008; IN COMMERCE 9-20-2008.

**CLASS 35—ADVERTISING AND BUSINESS**

FOR ADVERTISING AND MARKETING; BUSINESS MANAGEMENT; BUSINESS ADMINISTRATION; PROVIDING OFFICE FUNCTIONS; RETAIL STORE SERVICES FEATURING CLOTHING, FOOTWEAR, HEADGEAR, LEATHER GOODS, BAGS AND LUGGAGE (U.S. CLS. 100, 101 AND 102).

CHRIS DONINGER, EXAMINING ATTORNEY

SN 85-185,676. CAI GLOBAL GROUP LTD., KOWLOON, HONG KONG, FILED 11-27-2010.

SN 85-186,141. 163972 CANADA INC., MONTRÉAL, QUÉBEC, CANADA, FILED 11-29-2010.

# REPET

THE MARK CONSISTS OF STANDARD CHARACTERS WITHOUT CLAIM TO ANY PARTICULAR FONT, STYLE, SIZE, OR COLOR.

OWNER OF U.S. REG. NOS. 3,632,495 AND 3,778,791.

## CLASS 9—ELECTRICAL AND SCIENTIFIC APPARATUS

FOR COMPUTER BAGS (U.S. CLS. 21, 23, 26, 36 AND 38).

## CLASS 16—PAPER GOODS AND PRINTED MATTER

FOR GROCERY BAGS (U.S. CLS. 2, 5, 22, 23, 29, 37, 38 AND 50).

## CLASS 18—LEATHER GOODS

FOR ALL PURPOSE SPORT BAGS; ALL-PURPOSE ATHLETIC BAGS; ALL-PURPOSE CARRYING BAGS; ALL-PURPOSE REUSABLE CARRYING BAGS; BACKPACKS, BOOK BAGS, SPORTS BAGS, BUM BAGS, WALLETS AND HANDBAGS; BAGS FOR SPORTS; BOOK BAGS; CARRY-ALL BAGS; CARRY-ON BAGS; DUFFEL BAGS; DUFFEL BAGS FOR TRAVEL; DUFFLE BAGS; FLEXIBLE BAGS FOR GARMENTS; FLIGHT BAGS; GARMENT BAGS FOR TRAVEL; GENERAL PURPOSE BAGS FOR CARRYING YOGA EQUIPMENT; GYM BAGS; HIKING BAGS; HUNTING BAGS; KNITTED BAGS, NOT OF PRECIOUS METALS; MESH SHOPPING BAGS; MILITARY DUFFLE BAGS, GARMENT BAGS FOR TRAVEL, TOTE BAGS, SHOULDER BAGS AND BACKPACKS; REUSABLE SHOPPING BAGS; REUSABLE TEXTILE PRODUCE BAGS TO CARRY PRODUCE FROM GROCERY STORES AND FARMER'S MARKETS; ROLL BAGS; SACK PACKS, NAMELY, DRAWSTRING BAGS USED AS BACKPACKS; SCHOOL BAGS; SHOULDER BAGS; SLING BAGS; SMALL BAGS FOR MEN; SOUVENIR BAGS; SPORT BAGS; SPORTS BAGS; SPORTSMAN'S HUNTING BAGS; STRING BAGS FOR SHOPPING; TEXTILE SHOPPING BAGS; TOOL BAGS SOLD EMPTY; TOTE BAGS; TRAVEL BAGS; WAIST BAGS; WHEELED BAGS; WHEELED SHOPPING BAGS; WHEELED TOTE BAGS (U.S. CLS. 1, 2, 3, 22 AND 41).

## CLASS 20—FURNITURE AND ARTICLES NOT OTHERWISE CLASSIFIED

FOR SLEEPING BAGS (U.S. CLS. 2, 13, 22, 25, 32 AND 50).  
ANN E. SAPPENFIELD, EXAMINING ATTORNEY

## JUDITH & CHARLES

THE MARK CONSISTS OF STANDARD CHARACTERS WITHOUT CLAIM TO ANY PARTICULAR FONT, STYLE, SIZE, OR COLOR.

## CLASS 18—LEATHER GOODS

FOR HANDBAGS (U.S. CLS. 1, 2, 3, 22 AND 41).

## CLASS 25—CLOTHING

FOR WOMEN'S CLOTHING, NAMELY, DRESSES, SKIRTS, BLOUSES, SWEATERS, PANTS, TEE-SHIRTS, SHORTS, BLAZERS, VESTS, JACKETS, SCARVES, STOCKINGS, SHIRTS (U.S. CLS. 22 AND 39).

BENJAMIN OKEKE, EXAMINING ATTORNEY

SN 85-186,168. AMERICAN PANTRY, LLC, ST. LOUIS PARK, MN. FILED 11-29-2010.

## AMERICAN PANTRY FOOD, EQUIPMENT & KNOWLEDGE FOR THE UNEXPECTED

THE MARK CONSISTS OF STANDARD CHARACTERS WITHOUT CLAIM TO ANY PARTICULAR FONT, STYLE, SIZE, OR COLOR.

NO CLAIM IS MADE TO THE EXCLUSIVE RIGHT TO USE "AMERICAN", APART FROM THE MARK AS SHOWN.

## CLASS 35—ADVERTISING AND BUSINESS

FOR ONLINE RETAIL STORE SERVICES FEATURING SUPPLIES FOR EMERGENCY AND DISASTER PREPAREDNESS (U.S. CLS. 100, 101 AND 102).

## CLASS 45—PERSONAL AND LEGAL SERVICES

FOR PROVIDING A WEBSITE FEATURING INFORMATION IN THE FIELD OF EMERGENCY AND DISASTER PREPAREDNESS (U.S. CLS. 100 AND 101).

MARK SPARACINO, EXAMINING ATTORNEY

SN 85-186,465. SARAH ARIZONA, LLC, MANHASSET, NY. FILED 11-29-2010.

## SARAHARIZONA

THE MARK CONSISTS OF STANDARD CHARACTERS WITHOUT CLAIM TO ANY PARTICULAR FONT, STYLE, SIZE, OR COLOR.

**CLASS 18—LEATHER GOODS**

FOR EVENING HANDBAGS; FASHION HANDBAGS (U.S. CLS. 1, 2, 3, 22 AND 41).

**CLASS 25—CLOTHING**

FOR APPAREL FOR DANCERS, NAMELY, TEE SHIRTS, SWEATSHIRTS, PANTS, LEGGINGS, SHORTS AND JACKETS; ATHLETIC APPAREL, NAMELY, SHIRTS, PANTS, JACKETS, FOOTWEAR, HATS AND CAPS, ATHLETIC UNIFORMS; CHILDREN'S AND INFANTS APPAREL, NAMELY, JUMPERS, OVERALL SLEEPWEAR, PAJAMAS, ROMPERS AND ONE-PIECE GARMENTS; CHILDREN'S AND INFANTS' APPAREL TREATED WITH FIRE AND HEAT RETARDANTS, NAMELY, JUMPERS, OVERALL SLEEPWEAR, PAJAMAS, ROMPERS AND ONE-PIECE GARMENTS; GLOVES FOR APPAREL (U.S. CLS. 22 AND 39).

**CLASS 35—ADVERTISING AND BUSINESS**

FOR RETAIL APPAREL STORES (U.S. CLS. 100, 101 AND 102).  
KIM SAITO, EXAMINING ATTORNEY

SN 85-186,730. TATHAM, WILLIAM, FRESNO, CA. FILED 11-29-2010.

## FREEDOM FOOTBALL LEAGUE

THE MARK CONSISTS OF STANDARD CHARACTERS WITHOUT CLAIM TO ANY PARTICULAR FONT, STYLE, SIZE, OR COLOR.

NO CLAIM IS MADE TO THE EXCLUSIVE RIGHT TO USE "FOOTBALL LEAGUE", APART FROM THE MARK AS SHOWN.

**CLASS 38—COMMUNICATION**

FOR BROADCAST OF TELEVISION AND CABLE TELEVISION PROGRAMS FEATURING FOOTBALL GAMES AND TOURNAMENTS; SIMULCASTING BROADCAST OF TELEVISION PROGRAMS FEATURING FOOTBALL GAMES AND TOURNAMENTS OVER THE INTERNET (U.S. CLS. 100, 101 AND 104).

**CLASS 41—EDUCATION AND ENTERTAINMENT**

FOR ENTERTAINMENT IN THE NATURE OF FOOTBALL GAMES AND TOURNAMENTS (U.S. CLS. 100, 101 AND 107).

BARBARA A. GOLD, EXAMINING ATTORNEY

SN 85-186,744. TATHAM, WILLIAM, FRESNO, CA. FILED 11-29-2010.

## FREEDOM BASKETBALL LEAGUE

THE MARK CONSISTS OF STANDARD CHARACTERS WITHOUT CLAIM TO ANY PARTICULAR FONT, STYLE, SIZE, OR COLOR.

NO CLAIM IS MADE TO THE EXCLUSIVE RIGHT TO USE "BASKETBALL LEAGUE", APART FROM THE MARK AS SHOWN.

**CLASS 38—COMMUNICATION**

FOR BROADCAST OF TELEVISION AND CABLE TELEVISION PROGRAMS FEATURING BASKETBALL GAMES AND TOURNAMENTS; SIMULCASTING BROADCAST OF TELEVISION PROGRAMS FEATURING BASKETBALL GAMES AND TOURNAMENTS OVER THE INTERNET (U.S. CLS. 100, 101 AND 104).

**CLASS 41—EDUCATION AND ENTERTAINMENT**

FOR ENTERTAINMENT IN THE NATURE OF BASKETBALL GAMES AND TOURNAMENTS (U.S. CLS. 100, 101 AND 107).

BARBARA A. GOLD, EXAMINING ATTORNEY

SN 85-186,795. WILLOW GARAGE, INC., MENLO PARK, CA. FILED 11-29-2010.

## WILLOW GARAGE

THE MARK CONSISTS OF STANDARD CHARACTERS WITHOUT CLAIM TO ANY PARTICULAR FONT, STYLE, SIZE, OR COLOR.

**CLASS 7—MACHINERY**

FOR ROBOTS FOR INDUSTRIAL USE; STRUCTURAL PARTS THEREFOR (U.S. CLS. 13, 19, 21, 23, 31, 34 AND 35).

**CLASS 9—ELECTRICAL AND SCIENTIFIC APPARATUS**

FOR ROBOTS FOR PERSONAL, EDUCATIONAL OR HOBBY USE AND STRUCTURAL PARTS THEREFOR; COMPUTER HARDWARE AND COMPUTERS FOR ROBOTIC SYSTEMS AND APPLICATIONS; SOFTWARE FOR USE IN CONTROLLING ROBOTIC SYSTEMS AND APPLICATIONS (U.S. CLS. 21, 23, 26, 36 AND 38).

**CLASS 37—CONSTRUCTION AND REPAIR**

FOR REPAIR AND MAINTENANCE OF ROBOTS; REPAIR AND MAINTENANCE OF HARDWARE AND COMPUTERS FOR ROBOTIC SYSTEMS AND APPLICATIONS (U.S. CLS. 100, 103 AND 106).

**CLASS 41—EDUCATION AND ENTERTAINMENT**

FOR TRAINING IN THE USE OF ROBOTS; TRAINING IN THE USE OF SOFTWARE, HARDWARE AND COMPUTERS FOR ROBOTIC SYSTEMS AND APPLICATIONS (U.S. CLS. 100, 101 AND 107).

**CLASS 42—SCIENTIFIC AND COMPUTER SERVICES**

FOR RESEARCH, CONSULTATION AND ADVISORY SERVICES IN THE FIELD OF SOFTWARE, HARDWARE AND COMPUTERS FOR ROBOTIC SYSTEMS AND APPLICATIONS; DESIGN, TESTING AND DEVELOPMENT OF ROBOTS AND PARTS, HARDWARE AND SOFTWARE FOR ROBOTS; UPDATING SOFTWARE OF ROBOTS; PROVIDING INFORMATION CONCERNING ROBOTS, SOFTWARE, HARDWARE AND COMPUTERS FOR USE WITH ROBOTIC SYSTEMS AND APPLICATIONS; LEASING ROBOTS, SOFTWARE, HARDWARE AND COMPUTERS FOR ROBOTIC SYSTEMS AND APPLICATIONS; REPAIR AND MAINTENANCE OF SOFTWARE FOR ROBOTIC SYSTEMS AND APPLICATIONS (U.S. CLS. 100 AND 101).

HOWARD B. LEVINE, EXAMINING ATTORNEY

SN 85-186,799. WILLOW GARAGE, INC., MENLO PARK, CA.  
FILED 11-29-2010.

PR2

THE MARK CONSISTS OF STANDARD CHARACTERS WITHOUT CLAIM TO ANY PARTICULAR FONT, STYLE, SIZE, OR COLOR.

**CLASS 7—MACHINERY**

FOR ROBOTS FOR INDUSTRIAL USE; STRUCTURAL PARTS THEREFOR (U.S. CLS. 13, 19, 21, 23, 31, 34 AND 35).

**CLASS 9—ELECTRICAL AND SCIENTIFIC APPARATUS**

FOR ROBOTS FOR PERSONAL, EDUCATIONAL OR HOBBY USE AND STRUCTURAL PARTS THEREFOR; COMPUTER HARDWARE AND COMPUTERS FOR ROBOTIC SYSTEMS AND APPLICATIONS; SOFTWARE FOR USE IN CONTROLLING ROBOTIC SYSTEMS AND APPLICATIONS (U.S. CLS. 21, 23, 26, 36 AND 38).

**CLASS 10—MEDICAL APPARATUS**

FOR ROBOTS FOR SURGICAL, MEDICAL AND THERAPEUTIC USE, NAMELY, ROBOTS USED FOR ASSISTING OR PERFORMING SURGERY ON PATIENTS, ROBOTS USED FOR CONDUCTING PHYSICAL EXAMINATIONS OF PATIENTS, ROBOTS USED FOR ADMINISTERING TREATMENTS OR MEDICATIONS TO PATIENTS (U.S. CLS. 26, 39 AND 44).

HOWARD B. LEVINE, EXAMINING ATTORNEY

SN 85-187,019. BRITT ALLCROFT PRODUCTIONS, LLC,  
SANTA MONICA, CA. FILED 11-30-2010.

CUBLEY AND THE CITY KIDS

THE MARK CONSISTS OF STANDARD CHARACTERS WITHOUT CLAIM TO ANY PARTICULAR FONT, STYLE, SIZE, OR COLOR.

**CLASS 9—ELECTRICAL AND SCIENTIFIC APPARATUS**

FOR COMPUTER SOFTWARE PROGRAMS AND PRE-RECORDED CDS, DVDS, VIDEO RECORDINGS, VIDEO DISC RECORDINGS, CD-ROMS, AUDIO RECORDINGS, AUDIO CASSETTES, PHONOGRAPH RECORDS AND VIDEOTAPES ALL FEATURING ENTERTAINMENT FOR CHILDREN (U.S. CLS. 21, 23, 26, 36 AND 38).

**CLASS 16—PAPER GOODS AND PRINTED MATTER**

FOR PRINTED PUBLICATIONS, NAMELY, BOOKS, MAGAZINES, NEWSLETTERS, BROCHURES AND POSTERS IN THE FIELD OF ENTERTAINMENT (U.S. CLS. 2, 5, 22, 23, 29, 37, 38 AND 50).

**CLASS 25—CLOTHING**

FOR APPAREL, NAMELY, HEADWEAR, FOOTWEAR, RAINWEAR, LOUNGEWEAR, TOPS AND BOTTOMS, TANK TOPS, CROP-TOPS, T-SHIRTS, SHIRTS, NECKTIES, ASCOTS, SWEATSHIRTS, SWEAT PANTS, SWEAT SUITS, CARDIGANS, SWEATERS, JACKETS, COATS, BLAZERS, SPORT COATS, SLACKS, BLOUSES, JERSEYS, TIES, VESTS, PULLOVERS, PANTS, WORKOUT SUITS, UNDERSHIRTS, JEANS, LEGGINGS, LONG JOHN'S, SKORTS, SHORTS, SLEEP SHORTS, ROMPERS, TROUSERS, JUMPSUITS, OVERALLS, SKIRTS, DRESSES, JUMPERS, SWIMWEAR, UNITARDS, LEOTARDS, TIGHTS, SLEEPWEAR, PAJAMAS, NIGHTSHIRTS, ROBES, BATH ROBES, NIGHTGOWNS, SLEEP SHORTS, PONCHOS, SLIPPERS, SLIPPER SOCKS, SOCKS, HOSIERY, BANDANNAS, SCARVES, SHAWLS, NECKERCHIEFS, SUSPENDERS, DRESSING GOWNS, APRONS, MUFFLERS, HATS, CAPS, VISORS, HEADBANDS, GLOVES, BELTS, LEGGINGS, LINGERIE; WOMEN'S UNDERWEAR, NAMELY, BRAS, PANTIES AND THONGS; MEN'S UNDERWEAR, NAMELY, BOXER SHORTS AND BRIEFS; CLOTH BIBS; AND MASQUERADE COSTUMES AND MASKS SOLD IN CONNECTION THEREWITH (U.S. CLS. 22 AND 39).

**CLASS 28—TOYS AND SPORTING GOODS**

FOR PLUSH TOYS (U.S. CLS. 22, 23, 38 AND 50).

**CLASS 41—EDUCATION AND ENTERTAINMENT**

FOR ENTERTAINMENT SERVICES, NAMELY, TELEVISION PROGRAMS AND MOTION PICTURE FILM PRODUCTION FEATURING ANIMATION; PROVIDING A WEBSITE FEATURING INFORMATION IN THE FIELD OF ANIMATED TELEVISION AND MOTION PICTURE ENTERTAINMENT (U.S. CLS. 100, 101 AND 107).

H. M. FISHER, EXAMINING ATTORNEY

SN 85-187,096. MILLENNIUM WEAVERS, LC, DALTON, GA.  
FILED 11-30-2010.

MILLENNIUM WEAVERS

THE MARK CONSISTS OF STANDARD CHARACTERS WITHOUT CLAIM TO ANY PARTICULAR FONT, STYLE, SIZE, OR COLOR.

NO CLAIM IS MADE TO THE EXCLUSIVE RIGHT TO USE "WEAVERS", APART FROM THE MARK AS SHOWN.



**CLASS 27—FLOOR COVERINGS**

FOR SOFT FLOORING, NAMELY, CARPETS AND RUGS (U.S. CLS. 19, 20, 37, 42 AND 50).  
FIRST USE 8-2-2011; IN COMMERCE 8-2-2011.

**CLASS 40—MATERIAL TREATMENT**

FOR MANUFACTURE OF SOFT FLOORING, NAMELY, CARPETS AND RUGS TO ORDER AND/OR SPECIFICATION OF OTHERS (U.S. CLS. 100, 103 AND 106).  
FIRST USE 8-2-2011; IN COMMERCE 8-2-2011.  
WARREN L. OLANDRIA, EXAMINING ATTORNEY

**CLASS 44—MEDICAL, BEAUTY AND AGRICULTURAL SERVICES**

FOR MEDICAL IMAGING SERVICES, NAMELY, PROVIDING ANALYSIS, DATA, AND IMAGERY FOR VASCULATURE (U.S. CLS. 100 AND 101).  
TARA PATE, EXAMINING ATTORNEY

SN 85-187,298. BIO-TREE SYSTEMS, INC., FRAMINGHAM, MA. FILED 11-30-2010.

SN 85-187,245. BIO-TREE SYSTEMS, INC., FRAMINGHAM, MA. FILED 11-30-2010.

**BIO-TREE**

THE MARK CONSISTS OF STANDARD CHARACTERS WITHOUT CLAIM TO ANY PARTICULAR FONT, STYLE, SIZE, OR COLOR.

**CLASS 9—ELECTRICAL AND SCIENTIFIC APPARATUS**

FOR COMPUTER SOFTWARE FOR PROVIDING ANALYSIS, COLLECTING DATA AND PROCESSING DIGITAL IMAGES OF VASCULATURE FOR USE IN DIAGNOSIS AND TREATMENT (U.S. CLS. 21, 23, 26, 36 AND 38).

**CLASS 44—MEDICAL, BEAUTY AND AGRICULTURAL SERVICES**

FOR MEDICAL IMAGING SERVICES, NAMELY, PROVIDING ANALYSIS, DATA, AND IMAGERY FOR VASCULATURE (U.S. CLS. 100 AND 101).  
TARA PATE, EXAMINING ATTORNEY

SN 85-187,270. BIO-TREE SYSTEMS, INC., FRAMINGHAM, MA. FILED 11-30-2010.

**ANGIOTREE**

THE MARK CONSISTS OF STANDARD CHARACTERS WITHOUT CLAIM TO ANY PARTICULAR FONT, STYLE, SIZE, OR COLOR.

**CLASS 9—ELECTRICAL AND SCIENTIFIC APPARATUS**

FOR COMPUTER SOFTWARE FOR PROVIDING ANALYSIS, COLLECTING DATA AND PROCESSING DIGITAL IMAGES OF VASCULATURE FOR USE IN DIAGNOSIS AND TREATMENT (U.S. CLS. 21, 23, 26, 36 AND 38).

**ANGIOTRACK**

THE MARK CONSISTS OF STANDARD CHARACTERS WITHOUT CLAIM TO ANY PARTICULAR FONT, STYLE, SIZE, OR COLOR.

**CLASS 9—ELECTRICAL AND SCIENTIFIC APPARATUS**

FOR COMPUTER SOFTWARE FOR PROVIDING ANALYSIS, COLLECTING DATA AND PROCESSING DIGITAL IMAGES OF VASCULATURE FOR USE IN DIAGNOSIS AND TREATMENT (U.S. CLS. 21, 23, 26, 36 AND 38).

**CLASS 44—MEDICAL, BEAUTY AND AGRICULTURAL SERVICES**

FOR MEDICAL IMAGING SERVICES, NAMELY, PROVIDING ANALYSIS, DATA, AND IMAGERY FOR VASCULATURE (U.S. CLS. 100 AND 101).  
TARA PATE, EXAMINING ATTORNEY

SN 85-187,997. VERISIGN, INC., DULLES, VA. FILED 12-1-2010.



THE COLOR(S) BLUE AND WHITE IS/ARE CLAIMED AS A FEATURE OF THE MARK.

THE MARK CONSISTS OF A STYLIZED "V" IN THE COLOR WHITE CENTERED WITHIN A CENTRAL BLUE CIRCLE WHICH IS SURROUNDED BY A WHITE RING IN THE STYLE OF A BUTTON.

**CLASS 9—ELECTRICAL AND SCIENTIFIC APPARATUS**

FOR DOMAIN NAME RESOLUTION SOFTWARE FOR RESOLVING DOMAIN NAMES; DOMAIN NAME CONVERSION SOFTWARE FOR CONVERTING DOMAIN NAMES BETWEEN DISTINCT DOMAIN NAME SYSTEMS; COMPUTER HARDWARE AND SOFTWARE FOR USE IN CREATING, TRANSLATING, AND ADAPTING WEBSITES, CONTENT, APPLICATIONS, DATA, DATABASES, AND INFORMATION FOR DELIVERY TO AND USE WITH WIRELESS COMMUNICATION DEVICES AND OTHER DEVICES; COMPUTER SOFTWARE IN THE FIELD OF CRYPTOGRAPHIC NETWORK SECURITY AND DATA SECURITY FUNCTIONS; COMPUTER SOFTWARE FOR INTEGRATION OF INFORMATION LOGIC AND DATA BETWEEN COMPUTER NETWORKS; DOWNLOADABLE ELECTRONIC PUBLICATIONS IN THE NATURE OF A NEWSLETTER IN THE FIELD OF DOMAIN NAMES AND INFORMATION TECHNOLOGY (U.S. CLS. 21, 23, 26, 36 AND 38).

**CLASS 16—PAPER GOODS AND PRINTED MATTER**

FOR PRINTED MATTER, NAMELY, NEWSLETTERS, INSTRUCTIONAL MATERIALS AND TEACHING MATERIALS IN THE FIELD OF DOMAIN NAMES AND INFORMATION TECHNOLOGY (U.S. CLS. 2, 5, 22, 23, 29, 37, 38 AND 50).

**CLASS 35—ADVERTISING AND BUSINESS**

FOR COMMERCIAL INFORMATION AND DIRECTORY SERVICES; PROVIDING COMMERCIAL INFORMATION AND ON-LINE DIRECTORY INFORMATION SERVICES FOR LOCATING INTERNET AND OTHER COMPUTER NETWORK ADDRESSES AND DEMOGRAPHIC INFORMATION FOR ENTITIES, AND PROVIDING A DIRECTORY OF ORGANIZATIONS, INDIVIDUALS, ADDRESSES, AND RESOURCES ACCESSIBLE THROUGH THE USE OF THE INTERNET AND OTHER COMPUTER NETWORKS (U.S. CLS. 100, 101 AND 102).

**CLASS 41—EDUCATION AND ENTERTAINMENT**

FOR EDUCATIONAL SERVICES, NAMELY, PROVIDING INSTRUCTION IN THE FIELD OF THE INTERNET, COMPUTER NETWORK ADDRESSES, AND INTERNET DOMAIN NAME ISSUES; PROVIDING A NON-DOWNLOADABLE ON-LINE NEWSLETTER IN THE FIELD OF DOMAIN NAMES AND INFORMATION TECHNOLOGY (U.S. CLS. 100, 101 AND 107).

**CLASS 42—SCIENTIFIC AND COMPUTER SERVICES**

FOR DEVELOPMENT, DESIGN, IMPLEMENTATION, TESTING, ANALYSIS, AND CONSULTING SERVICES IN THE FIELD OF SECURITY, ACCESS, AUTHORIZATION, AUTHENTICATION ENCRYPTION, AND IDENTIFICATION SYSTEMS FOR COMPUTERS, COMPUTER HARDWARE AND COMPUTER NETWORKS; COMPUTER SERVICES, NAMELY, ENABLING USERS OF THE INTERNET TO DELIVER INFORMATION ABOUT THEMSELVES AND, IF APPLICABLE, THEIR BUSINESSES, PRODUCTS OR SERVICES, AND TO REGISTER THEIR UNIVERSAL RESOURCE LOCATORS, WITH ON-LINE CATALOGUES, DIRECTORIES, SEARCH ENGINES AND WEB SITES, VIA THE INTERNET AND OTHER COMPUTER NETWORKS; REGISTRATION AND TRACKING OF DOMAIN NAMES FOR IDENTIFICATION OF USERS ON A GLOBAL COMPUTER NETWORK AND OTHER COMPUTER NETWORKS; PROVIDING INFORMATION IN THE FIELD OF SERVICES RELATING TO THE OWNERSHIP RIGHTS OF DOMAIN NAMES; DOMAIN NAME MANAGEMENT SERVICES, NAMELY, DOMAIN NAME SYSTEM ("DNS") MANAGEMENT AND MAINTENANCE, DOMAIN NAME DIRECTORY MANAGEMENT AND MAINTENANCE, DOMAIN NAME SYSTEM ("DNS") INFRASTRUCTURE SERVICES, DOMAIN NAME AND

DOMAIN NAME SYSTEM ("DNS") INFORMATION PROPAGATION, AND RESOLUTION OF DOMAIN NAME SYSTEM ("DNS") REQUESTS; DATA CONVERSION OF COMPUTER PROGRAM DATA OR INFORMATION, NAMELY, NETWORK, COMPUTER, DATABASE AND DIRECTORY SERVICES THAT CONVERT AN ASSIGNED NUMBER SEQUENCE INTO AN INTERNET PROTOCOL ("IP") ADDRESS OR UNIFORM RESOURCE LOCATOR ("URL") FOR THE PURPOSE OF ENABLING ACCESS, SELECTION AND DISPLAY OF ONLINE CONTENT VIA A WIRELESS NETWORK; COMPUTER SERVICES, NAMELY, MONITORING DOMAIN NAMES FOR CHANGE IN STATUS AND AFTER-MARKET AVAILABILITY; PROVIDING INFORMATION IN THE FIELD OF SERVICES RELATING TO THE OWNERSHIP RIGHTS OF DOMAIN NAMES; PROVIDING ONLINE NON-DOWNLOADABLE SOFTWARE FOR CREATING, TRANSLATING, AND ADAPTING WEBSITES, CONTENT, APPLICATIONS, DATA, DATABASES, AND INFORMATION FOR DELIVERY TO AND USE WITH WIRELESS COMMUNICATION DEVICES AND OTHER DEVICES (U.S. CLS. 100 AND 101).

**CLASS 45—PERSONAL AND LEGAL SERVICES**

FOR COMPUTER SERVICES, NAMELY, PROVIDING ON-LINE LEGAL INFORMATION IN THE FIELD OF DOMAIN NAME DISPUTES; REGISTRATION OF DOMAIN NAMES FOR IDENTIFICATION OF USERS ON A GLOBAL COMPUTER NETWORK; DOMAIN NAME REGISTRATION SERVICES; SECURITY SERVICES, NAMELY, SECURITY RISK AND THREAT MANAGEMENT IN THE FIELD OF THE SECURITY OF, AND VULNERABILITY TO BREACHES AND HACKING OF, COMPUTER AND ELECTRONIC INFORMATION INFRASTRUCTURE; AND PROVIDING INFORMATION IN THE FIELD OF THE SECURITY OF, AND VULNERABILITY TO BREACHES AND HACKING OF, COMPUTER AND ELECTRONIC INFORMATION INFRASTRUCTURE IN THE NATURE OF ELECTRONIC REPORTS AND THREAT ALERT NOTICES VIA A GLOBAL COMPUTER NETWORK (U.S. CLS. 100 AND 101).

DAVID I. EXAMINING ATTORNEY

SN 85-188,119. ZWIG, ADAM, PORTLAND, OR. FILED 12-1-2010.

# First Mind

THE MARK CONSISTS OF STANDARD CHARACTERS WITHOUT CLAIM TO ANY PARTICULAR FONT, STYLE, SIZE, OR COLOR.

**CLASS 9—ELECTRICAL AND SCIENTIFIC APPARATUS**

FOR DIGITAL MATERIALS, NAMELY, CDS, DVDS, DOWNLOADABLE AUDIO FILES FEATURING PERSONAL TRANSFORMATION, OVERCOMING DEPRESSION AND LOW SELF ESTEEM, IMPROVING RELATIONSHIPS, MIND AND BODY CONNECTION, SPIRITUALITY AND PSYCHOLOGY; DOWNLOADABLE MOTION PICTURES AND TELEVISION SHOWS ABOUT PERSONAL TRANSFORMATION, OVERCOMING DEPRESSION AND LOW SELF ESTEEM, IMPROVING RELATIONSHIPS, MIND AND BODY CONNECTION, SPIRITUALITY AND PSYCHOLOGY (U.S. CLS. 21, 23, 26, 36 AND 38).

**CLASS 16—PAPER GOODS AND PRINTED MATTER**

FOR A SERIES OF BOOKS AND WRITTEN ARTICLES IN THE FIELD OF PERSONAL TRANSFORMATION, OVERCOMING DEPRESSION AND LOW SELF ESTEEM, IMPROVING RELATIONSHIPS, MIND AND BODY CONNECTION, SPIRITUALITY AND PSYCHOLOGY; BOOKS IN THE FIELD OF PERSONAL TRANSFORMATION, OVERCOMING DEPRESSION AND LOW SELF ESTEEM, IMPROVING RELATIONSHIPS, MIND AND BODY CONNECTION, SPIRITUALITY AND PSYCHOLOGY; SCHOLARLY BOOKS ON VARIOUS TOPICS, NAMELY, PERSONAL TRANSFORMATION, OVERCOMING DEPRESSION AND LOW SELF ESTEEM, IMPROVING RELATIONSHIPS, MIND AND BODY CONNECTION, SPIRITUALITY AND PSYCHOLOGY (U.S. CLS. 2, 5, 22, 23, 29, 37, 38 AND 50).

**CLASS 35—ADVERTISING AND BUSINESS**

FOR PROVIDING CONSUMER INFORMATION IN THE FIELD OF PERSONAL TRANSFORMATION, OVERCOMING DEPRESSION AND LOW SELF ESTEEM, IMPROVING RELATIONSHIPS, MIND AND BODY CONNECTION, SPIRITUALITY AND PSYCHOLOGY VIA THE INTERNET (U.S. CLS. 100, 101 AND 102).

**CLASS 41—EDUCATION AND ENTERTAINMENT**

FOR CONDUCTING WORKSHOPS AND SEMINARS IN PERSONAL TRANSFORMATION, OVERCOMING DEPRESSION AND LOW SELF ESTEEM, IMPROVING RELATIONSHIPS, MIND AND BODY CONNECTION, SPIRITUALITY AND PSYCHOLOGY; ENTERTAINMENT SERVICES IN THE NATURE OF AN ONGOING IPTV (INTERNET PROTOCOL TELEVISION), TELEVISION PROGRAMMING SEGMENTS IN THE FIELD OF POSITIVE PSYCHOLOGY, PERSONAL RELATIONSHIPS, THE ART AND SCIENCE OF HAPPINESS; WORKSHOPS AND SEMINARS IN THE FIELD OF PERSONAL TRANSFORMATION, OVERCOMING DEPRESSION AND LOW SELF ESTEEM, IMPROVING RELATIONSHIPS, MIND AND BODY CONNECTION, SPIRITUALITY AND PSYCHOLOGY (U.S. CLS. 100, 101 AND 107).

KEVIN DINALLO, EXAMINING ATTORNEY

SN 85-188,130. ZWIG, ADAM, PORTLAND, OR. FILED 12-1-2010.

## Second Mind

THE MARK CONSISTS OF STANDARD CHARACTERS WITHOUT CLAIM TO ANY PARTICULAR FONT, STYLE, SIZE, OR COLOR.

**CLASS 9—ELECTRICAL AND SCIENTIFIC APPARATUS**

FOR DIGITAL MATERIALS, NAMELY, CDS, DVDS, DOWNLOADABLE AUDIO FILES FEATURING PERSONAL TRANSFORMATION, OVERCOMING DEPRESSION AND LOW SELF ESTEEM, IMPROVING RELATIONSHIPS, MIND AND BODY CONNECTION, SPIRITUALITY AND PSYCHOLOGY; DOWNLOADABLE MOTION PICTURES AND TELEVISION SHOWS ABOUT PERSONAL TRANSFORMATION, OVERCOMING DEPRESSION AND LOW SELF ESTEEM, IMPROVING RELATIONSHIPS, MIND AND BODY CONNECTION, SPIRITUALITY AND PSYCHOLOGY (U.S. CLS. 21, 23, 26, 36 AND 38).

**CLASS 16—PAPER GOODS AND PRINTED MATTER**

FOR A SERIES OF BOOKS AND WRITTEN ARTICLES IN THE FIELD OF PERSONAL TRANSFORMATION, OVERCOMING DEPRESSION AND LOW SELF ESTEEM, IMPROVING RELATIONSHIPS, MIND AND BODY CONNECTION, SPIRITUALITY AND PSYCHOLOGY; A SERIES OF BOOKS, WRITTEN ARTICLES, HANDOUTS AND WORKSHEETS IN THE FIELD OF PERSONAL TRANSFORMATION, OVERCOMING DEPRESSION AND LOW SELF ESTEEM, IMPROVING RELATIONSHIPS, MIND AND BODY CONNECTION, SPIRITUALITY AND PSYCHOLOGY; BOOKS IN THE FIELD OF PERSONAL TRANSFORMATION, OVERCOMING DEPRESSION AND LOW SELF ESTEEM, IMPROVING RELATIONSHIPS, MIND AND BODY CONNECTION, SPIRITUALITY AND PSYCHOLOGY; SCHOLARLY BOOKS ON VARIOUS TOPICS, NAMELY, PERSONAL TRANSFORMATION, OVERCOMING DEPRESSION AND LOW SELF ESTEEM, IMPROVING RELATIONSHIPS, MIND AND BODY CONNECTION, SPIRITUALITY AND PSYCHOLOGY (U.S. CLS. 2, 5, 22, 23, 29, 37, 38 AND 50).

**CLASS 35—ADVERTISING AND BUSINESS**

FOR PROVIDING CONSUMER INFORMATION IN THE FIELD OF PERSONAL TRANSFORMATION, OVERCOMING DEPRESSION AND LOW SELF ESTEEM, IMPROVING RELATIONSHIPS, MIND AND BODY CONNECTION, SPIRITUALITY AND PSYCHOLOGY VIA THE INTERNET (U.S. CLS. 100, 101 AND 102).

**CLASS 41—EDUCATION AND ENTERTAINMENT**

FOR CONDUCTING WORKSHOPS AND SEMINARS IN PERSONAL TRANSFORMATION, OVERCOMING DEPRESSION AND LOW SELF ESTEEM, IMPROVING RELATIONSHIPS, MIND AND BODY CONNECTION, SPIRITUALITY AND PSYCHOLOGY; ENTERTAINMENT SERVICES IN THE NATURE OF AN ONGOING IPTV (INTERNET PROTOCOL TELEVISION), TELEVISION PROGRAMMING SEGMENTS IN THE FIELD OF POSITIVE PSYCHOLOGY, PERSONAL RELATIONSHIPS, THE ART AND SCIENCE OF HAPPINESS; WORKSHOPS AND SEMINARS IN THE FIELD OF PERSONAL TRANSFORMATION, OVERCOMING DEPRESSION AND LOW SELF ESTEEM, IMPROVING RELATIONSHIPS, MIND AND BODY CONNECTION, SPIRITUALITY AND PSYCHOLOGY (U.S. CLS. 100, 101 AND 107).

KEVIN DINALLO, EXAMINING ATTORNEY

SN 85-188,142. ZWIG, ADAM, PORTLAND, OR. FILED 12-1-2010.

## Rock n Roll Meditation

THE MARK CONSISTS OF STANDARD CHARACTERS WITHOUT CLAIM TO ANY PARTICULAR FONT, STYLE, SIZE, OR COLOR.

NO CLAIM IS MADE TO THE EXCLUSIVE RIGHT TO USE "MEDITATION", APART FROM THE MARK AS SHOWN.

**CLASS 9—ELECTRICAL AND SCIENTIFIC APPARATUS**

FOR DIGITAL MATERIALS, NAMELY, CDS, DVDS, DOWNLOADABLE AUDIO FILES FEATURING MATERIAL IN THE FIELD OF PERSONAL TRANSFORMATION, DEPRESSION, SELF ESTEEM, RELATIONSHIPS, MIND/BODY CONNECTION, SPIRITUALITY, PSYCHOLOGY, PSYCHOTHERAPY, PERSONAL DEVELOPMENT, AND FAMILY THERAPY (U.S. CLS. 21, 23, 26, 36 AND 38).

**CLASS 16—PAPER GOODS AND PRINTED MATTER**

FOR BOOKS IN THE FIELD OF PERSONAL TRANSFORMATION, OVERCOMING DEPRESSION AND LOW SELF ESTEEM, IMPROVING RELATIONSHIPS, SPIRITUALITY, MIND AND BODY CONNECTION AND PSYCHOLOGY (U.S. CLS. 2, 5, 22, 23, 29, 37, 38 AND 50).

**CLASS 35—ADVERTISING AND BUSINESS**

FOR PROVIDING CONSUMER INFORMATION IN THE FIELD OF PERSONAL TRANSFORMATION, OVERCOMING DEPRESSION AND LOW SELF ESTEEM, IMPROVING RELATIONSHIPS, SPIRITUALITY, MIND AND BODY CONNECTION AND PSYCHOLOGY VIA THE INTERNET (U.S. CLS. 100, 101 AND 102).

**CLASS 41—EDUCATION AND ENTERTAINMENT**

FOR CONDUCTING WORKSHOPS AND SEMINARS IN THE FIELD OF PERSONAL TRANSFORMATION, OVERCOMING DEPRESSION AND LOW SELF ESTEEM, IMPROVING RELATIONSHIPS, SPIRITUALITY, MIND AND BODY CONNECTION AND PSYCHOLOGY; ENTERTAINMENT SERVICES IN THE NATURE OF AN ONGOING IPTV (INTERNET PROTOCOL TELEVISION), TELEVISION PROGRAMMING SEGMENTS IN THE FIELD OF POSITIVE PSYCHOLOGY, PERSONAL RELATIONSHIPS, THE ART AND SCIENCE OF HAPPINESS (U.S. CLS. 100, 101 AND 107).

**CLASS 44—MEDICAL, BEAUTY AND AGRICULTURAL SERVICES**

FOR MENTAL HEALTH COUNSELING AND PSYCHOTHERAPY AS IT RELATES TO RELATIONSHIPS; PSYCHOLOGICAL COUNSELING; PSYCHOTHERAPY AND PSYCHOTHERAPY COUNSELING FOR CHILDREN AND ADULTS IN INDIVIDUAL AND FAMILY SESSIONS; PSYCHOTHERAPY SERVICES (U.S. CLS. 100 AND 101).

KEVIN DINALLO, EXAMINING ATTORNEY

**CLASS 9—ELECTRICAL AND SCIENTIFIC APPARATUS**

FOR DIGITAL MATERIALS, NAMELY, CDS, DVDS, DOWNLOADABLE AUDIO FILES FEATURING MATERIAL IN THE FIELD OF PERSONAL TRANSFORMATION, DEPRESSION, SELF ESTEEM, RELATIONSHIPS, MIND/BODY CONNECTION, SPIRITUALITY, PSYCHOLOGY, PSYCHOTHERAPY, PERSONAL DEVELOPMENT, AND FAMILY THERAPY (U.S. CLS. 21, 23, 26, 36 AND 38).

**CLASS 16—PAPER GOODS AND PRINTED MATTER**

FOR BOOKS IN THE FIELD OF PERSONAL TRANSFORMATION, OVERCOMING DEPRESSION AND LOW SELF ESTEEM, IMPROVING RELATIONSHIPS, SPIRITUALITY, MIND AND BODY CONNECTION AND PSYCHOLOGY (U.S. CLS. 2, 5, 22, 23, 29, 37, 38 AND 50).

**CLASS 35—ADVERTISING AND BUSINESS**

FOR PROVIDING CONSUMER INFORMATION IN THE FIELD OF PERSONAL TRANSFORMATION, OVERCOMING DEPRESSION AND LOW SELF ESTEEM, IMPROVING RELATIONSHIPS, SPIRITUALITY, MIND AND BODY CONNECTION AND PSYCHOLOGY VIA THE INTERNET (U.S. CLS. 100, 101 AND 102).

**CLASS 41—EDUCATION AND ENTERTAINMENT**

FOR CONDUCTING WORKSHOPS AND SEMINARS IN THE FIELD OF PERSONAL TRANSFORMATION, OVERCOMING DEPRESSION AND LOW SELF ESTEEM, IMPROVING RELATIONSHIPS, SPIRITUALITY, MIND AND BODY CONNECTION AND PSYCHOLOGY; ENTERTAINMENT SERVICES IN THE NATURE OF AN ONGOING IPTV (INTERNET PROTOCOL TELEVISION), TELEVISION PROGRAMMING SEGMENTS IN THE FIELD OF POSITIVE PSYCHOLOGY, PERSONAL RELATIONSHIPS, THE ART AND SCIENCE OF HAPPINESS (U.S. CLS. 100, 101 AND 107).

**CLASS 44—MEDICAL, BEAUTY AND AGRICULTURAL SERVICES**

FOR MENTAL HEALTH COUNSELING AND PSYCHOTHERAPY AS IT RELATES TO RELATIONSHIPS; PSYCHOLOGICAL COUNSELING; PSYCHOTHERAPY AND PSYCHOTHERAPY COUNSELING FOR CHILDREN AND ADULTS IN INDIVIDUAL AND FAMILY SESSIONS; PSYCHOTHERAPY SERVICES (U.S. CLS. 100 AND 101).

KEVIN DINALLO, EXAMINING ATTORNEY

SN 85-188,163. ZWIG, ADAM, PORTLAND, OR. FILED 12-1-2010.

Zwigology

THE MARK CONSISTS OF STANDARD CHARACTERS WITHOUT CLAIM TO ANY PARTICULAR FONT, STYLE, SIZE, OR COLOR.

SN 85-188,198. VERISIGN, INC., DULLES, VA. FILED 12-1-2010.



OWNER OF U.S. REG. NOS. 3,307,778, 3,651,523 AND 3,671,294.

THE MARK CONSISTS OF A STYLIZED "V" CENTERED WITHIN A CENTRAL CIRCLE AND EXTERIOR CIRCLE IN THE STYLE OF A BUTTON ADJACENT TO THE HORIZONTAL WORD "VERISIGN".

**CLASS 9—ELECTRICAL AND SCIENTIFIC APPARATUS**

FOR DOMAIN NAME RESOLUTION SOFTWARE FOR RESOLVING DOMAIN NAMES; DOMAIN NAME CONVERSION SOFTWARE FOR CONVERTING DOMAIN NAMES BETWEEN DISTINCT DOMAIN NAME SYSTEMS; COMPUTER HARDWARE AND SOFTWARE FOR USE IN CREATING, TRANSLATING, AND ADAPTING WEBSITES, CONTENT, APPLICATIONS, DATA, DATABASES, AND INFORMATION FOR DELIVERY TO AND USE WITH WIRELESS COMMUNICATION DEVICES AND OTHER DEVICES; COMPUTER SOFTWARE IN THE FIELD OF CRYPTOGRAPHIC NETWORK SECURITY AND DATA SECURITY FUNCTIONS; COMPUTER SOFTWARE FOR INTEGRATION OF INFORMATION LOGIC AND DATA BETWEEN COMPUTER NETWORKS; DOWNLOADABLE ELECTRONIC PUBLICATIONS IN THE NATURE OF A NEWSLETTER IN THE FIELD OF DOMAIN NAMES AND INFORMATION TECHNOLOGY (U.S. CLS. 21, 23, 26, 36 AND 38).

**CLASS 16—PAPER GOODS AND PRINTED MATTER**

FOR PRINTED MATTER, NAMELY, NEWSLETTERS, INSTRUCTIONAL MATERIALS AND TEACHING MATERIALS IN THE FIELD OF DOMAIN NAMES AND INFORMATION TECHNOLOGY (U.S. CLS. 2, 5, 22, 23, 29, 37, 38 AND 50).

**CLASS 35—ADVERTISING AND BUSINESS**

FOR COMMERCIAL INFORMATION AND DIRECTORY SERVICES; PROVIDING COMMERCIAL INFORMATION AND ON-LINE DIRECTORY INFORMATION SERVICES FOR LOCATING INTERNET AND OTHER COMPUTER NETWORK ADDRESSES AND DEMOGRAPHIC INFORMATION FOR ENTITIES, AND PROVIDING A DIRECTORY OF ORGANIZATIONS, INDIVIDUALS, ADDRESSES, AND RESOURCES ACCESSIBLE THROUGH THE USE OF THE INTERNET AND OTHER COMPUTER NETWORKS (U.S. CLS. 100, 101 AND 102).

**CLASS 41—EDUCATION AND ENTERTAINMENT**

FOR EDUCATIONAL SERVICES, NAMELY, PROVIDING INSTRUCTION IN THE FIELD OF THE INTERNET, COMPUTER NETWORK ADDRESSES, AND INTERNET DOMAIN NAME ISSUES; PROVIDING A NON-DOWNLOADABLE ON-LINE NEWSLETTER IN THE FIELD OF DOMAIN NAMES AND INFORMATION TECHNOLOGY (U.S. CLS. 100, 101 AND 107).

**CLASS 42—SCIENTIFIC AND COMPUTER SERVICES**

FOR DEVELOPMENT, DESIGN, IMPLEMENTATION, TESTING, ANALYSIS, AND CONSULTING SERVICES IN THE FIELD OF SECURITY, ACCESS, AUTHORIZATION, AUTHENTICATION ENCRYPTION, AND IDENTIFICATION SYSTEMS FOR COMPUTERS, COMPUTER HARDWARE AND COMPUTER NETWORKS; COMPUTER SERVICES, NAMELY, ENABLING USERS OF THE INTERNET TO DELIVER INFORMATION ABOUT THEMSELVES AND, IF APPLICABLE, THEIR BUSINESSES, PRODUCTS OR SERVICES, AND TO REGISTER THEIR UNIVERSAL RESOURCE LOCATORS, WITH ON-LINE CATALOGUES, DIRECTORIES, SEARCH ENGINES AND WEB SITES, VIA THE INTERNET AND OTHER COMPUTER NETWORKS; REGISTRATION AND TRACKING OF DOMAIN NAMES FOR IDENTIFICATION OF USERS ON A GLOBAL COMPUTER NETWORK AND OTHER COMPUTER NETWORKS; PROVIDING INFORMATION IN THE FIELD OF SERVICES RELATING TO THE OWNERSHIP RIGHTS OF DOMAIN NAMES; DOMAIN NAME MANAGEMENT SERVICES, NAMELY, DOMAIN NAME SYSTEM ("DNS") MANAGEMENT AND MAINTENANCE, DOMAIN NAME DIRECTORY MANAGEMENT AND MAINTENANCE, DOMAIN NAME SYSTEM ("DNS") INFRASTRUCTURE SERVICES, DOMAIN NAME AND

DOMAIN NAME SYSTEM ("DNS") INFORMATION PROPAGATION, AND RESOLUTION OF DOMAIN NAME SYSTEM ("DNS") REQUESTS; DATA CONVERSION OF COMPUTER PROGRAM DATA OR INFORMATION, NAMELY, NETWORK, COMPUTER, DATABASE AND DIRECTORY SERVICES THAT CONVERT AN ASSIGNED NUMBER SEQUENCE INTO AN INTERNET PROTOCOL ("IP") ADDRESS OR UNIFORM RESOURCE LOCATOR ("URL") FOR THE PURPOSE OF ENABLING ACCESS, SELECTION AND DISPLAY OF ONLINE CONTENT VIA A WIRELESS NETWORK; COMPUTER SERVICES, NAMELY, MONITORING DOMAIN NAMES FOR CHANGE IN STATUS AND AFTER-MARKET AVAILABILITY; PROVIDING INFORMATION IN THE FIELD OF SERVICES RELATING TO THE OWNERSHIP RIGHTS OF DOMAIN NAMES; PROVIDING ONLINE NON-DOWNLOADABLE SOFTWARE FOR CREATING, TRANSLATING, AND ADAPTING WEBSITES, CONTENT, APPLICATIONS, DATA, DATABASES, AND INFORMATION FOR DELIVERY TO AND USE WITH WIRELESS COMMUNICATION DEVICES AND OTHER DEVICES (U.S. CLS. 100 AND 101).

**CLASS 45—PERSONAL AND LEGAL SERVICES**

FOR COMPUTER SERVICES, NAMELY, PROVIDING ON-LINE LEGAL INFORMATION IN THE FIELD OF DOMAIN NAME DISPUTES; REGISTRATION OF DOMAIN NAMES FOR IDENTIFICATION OF USERS ON A GLOBAL COMPUTER NETWORK; DOMAIN NAME REGISTRATION SERVICES; SECURITY SERVICES, NAMELY, SECURITY RISK AND THREAT MANAGEMENT IN THE FIELD OF THE SECURITY OF, AND VULNERABILITY TO BREACHES AND HACKING OF, COMPUTER AND ELECTRONIC INFORMATION INFRASTRUCTURE; AND PROVIDING INFORMATION IN THE FIELD OF THE SECURITY OF, AND VULNERABILITY TO BREACHES AND HACKING OF, COMPUTER AND ELECTRONIC INFORMATION INFRASTRUCTURE IN THE NATURE OF ELECTRONIC REPORTS AND THREAT ALERT NOTICES VIA A GLOBAL COMPUTER NETWORK (U.S. CLS. 100 AND 101).

DAVID I. EXAMINING ATTORNEY

SN 85-188,208. VERISIGN, INC., DULLES, VA. FILED 12-1-2010.



THE MARK CONSISTS OF A STYLIZED "V" CENTERED WITHIN A CENTRAL CIRCLE AND EXTERIOR CIRCLE IN THE STYLE OF A BUTTON.

**CLASS 9—ELECTRICAL AND SCIENTIFIC APPARATUS**

FOR DOMAIN NAME RESOLUTION SOFTWARE FOR RESOLVING DOMAIN NAMES; DOMAIN NAME CONVERSION SOFTWARE FOR CONVERTING DOMAIN NAMES BETWEEN DISTINCT DOMAIN NAME SYSTEMS; COMPUTER HARDWARE AND SOFTWARE FOR USE IN CREATING, TRANSLATING, AND ADAPTING WEBSITES, CONTENT, APPLICATIONS, DATA, DATABASES, AND INFORMATION FOR DELIVERY TO AND USE WITH WIRELESS COMMUNICATION DEVICES AND OTHER DEVICES; COMPUTER SOFTWARE IN THE FIELD OF CRYPTOGRAPHIC NETWORK SECURITY AND DATA SECURITY FUNCTIONS; COMPUTER SOFTWARE FOR INTEGRATION OF INFORMATION LOGIC AND DATA BETWEEN COMPUTER NETWORKS; DOWNLOADABLE ELECTRONIC PUBLICATIONS IN THE NATURE OF A NEWSLETTER IN THE FIELD OF DOMAIN NAMES AND INFORMATION TECHNOLOGY (U.S. CLS. 21, 23, 26, 36 AND 38).

**CLASS 16—PAPER GOODS AND PRINTED MATTER**

FOR PRINTED MATTER, NAMELY, NEWSLETTERS, INSTRUCTIONAL MATERIALS AND TEACHING MATERIALS IN THE FIELD OF DOMAIN NAMES AND INFORMATION TECHNOLOGY (U.S. CLS. 2, 5, 22, 23, 29, 37, 38 AND 50).

**CLASS 35—ADVERTISING AND BUSINESS**

FOR COMMERCIAL INFORMATION AND DIRECTORY SERVICES; PROVIDING COMMERCIAL INFORMATION AND ON-LINE DIRECTORY INFORMATION SERVICES FOR LOCATING INTERNET AND OTHER COMPUTER NETWORK ADDRESSES AND DEMOGRAPHIC INFORMATION FOR ENTITIES, AND PROVIDING A DIRECTORY OF ORGANIZATIONS, INDIVIDUALS, ADDRESSES, AND RESOURCES ACCESSIBLE THROUGH THE USE OF THE INTERNET AND OTHER COMPUTER NETWORKS (U.S. CLS. 100, 101 AND 102).

**CLASS 41—EDUCATION AND ENTERTAINMENT**

FOR EDUCATIONAL SERVICES, NAMELY, PROVIDING INSTRUCTION IN THE FIELD OF THE INTERNET, COMPUTER NETWORK ADDRESSES, AND INTERNET DOMAIN NAME ISSUES; PROVIDING A NON-DOWNLOADABLE ON-LINE NEWSLETTER IN THE FIELD OF DOMAIN NAMES AND INFORMATION TECHNOLOGY (U.S. CLS. 100, 101 AND 107).

**CLASS 42—SCIENTIFIC AND COMPUTER SERVICES**

FOR DEVELOPMENT, DESIGN, IMPLEMENTATION, TESTING, ANALYSIS, AND CONSULTING SERVICES IN THE FIELD OF SECURITY, ACCESS, AUTHORIZATION, AUTHENTICATION ENCRYPTION, AND IDENTIFICATION SYSTEMS FOR COMPUTERS, COMPUTER HARDWARE AND COMPUTER NETWORKS; COMPUTER SERVICES, NAMELY, ENABLING USERS OF THE INTERNET TO DELIVER INFORMATION ABOUT THEMSELVES AND, IF APPLICABLE, THEIR BUSINESSES, PRODUCTS OR SERVICES, AND TO REGISTER THEIR UNIVERSAL RESOURCE LOCATORS, WITH ON-LINE CATALOGUES, DIRECTORIES, SEARCH ENGINES AND WEB SITES, VIA THE INTERNET AND OTHER COMPUTER NETWORKS; REGISTRATION AND TRACKING OF DOMAIN NAMES FOR IDENTIFICATION OF USERS ON A GLOBAL COMPUTER NETWORK AND OTHER COMPUTER NETWORKS; PROVIDING INFORMATION IN THE FIELD OF SERVICES RELATING TO THE OWNERSHIP RIGHTS OF DOMAIN NAMES; DOMAIN NAME MANAGEMENT SERVICES, NAMELY, DOMAIN NAME SYSTEM ("DNS") MANAGEMENT AND MAINTENANCE, DOMAIN NAME DIRECTORY MANAGEMENT AND MAINTENANCE, DOMAIN NAME SYSTEM ("DNS") INFRASTRUCTURE SERVICES, DOMAIN NAME AND

DOMAIN NAME SYSTEM ("DNS") INFORMATION PROPAGATION, AND RESOLUTION OF DOMAIN NAME SYSTEM ("DNS") REQUESTS; DATA CONVERSION OF COMPUTER PROGRAM DATA OR INFORMATION, NAMELY, NETWORK, COMPUTER, DATABASE AND DIRECTORY SERVICES THAT CONVERT AN ASSIGNED NUMBER SEQUENCE INTO AN INTERNET PROTOCOL ("IP") ADDRESS OR UNIFORM RESOURCE LOCATOR ("URL") FOR THE PURPOSE OF ENABLING ACCESS, SELECTION AND DISPLAY OF ONLINE CONTENT VIA A WIRELESS NETWORK; COMPUTER SERVICES, NAMELY, MONITORING DOMAIN NAMES FOR CHANGE IN STATUS AND AFTER-MARKET AVAILABILITY; PROVIDING INFORMATION IN THE FIELD OF SERVICES RELATING TO THE OWNERSHIP RIGHTS OF DOMAIN NAMES; PROVIDING ONLINE NON-DOWNLOADABLE SOFTWARE FOR CREATING, TRANSLATING, AND ADAPTING WEBSITES, CONTENT, APPLICATIONS, DATA, DATABASES, AND INFORMATION FOR DELIVERY TO AND USE WITH WIRELESS COMMUNICATION DEVICES AND OTHER DEVICES (U.S. CLS. 100 AND 101).

**CLASS 45—PERSONAL AND LEGAL SERVICES**

FOR COMPUTER SERVICES, NAMELY, PROVIDING ON-LINE LEGAL INFORMATION IN THE FIELD OF DOMAIN NAME DISPUTES; REGISTRATION OF DOMAIN NAMES FOR IDENTIFICATION OF USERS ON A GLOBAL COMPUTER NETWORK; DOMAIN NAME REGISTRATION SERVICES; SECURITY SERVICES, NAMELY, SECURITY RISK AND THREAT MANAGEMENT IN THE FIELD OF THE SECURITY OF, AND VULNERABILITY TO BREACHES AND HACKING OF, COMPUTER AND ELECTRONIC INFORMATION INFRASTRUCTURE; AND PROVIDING INFORMATION IN THE FIELD OF THE SECURITY OF, AND VULNERABILITY TO BREACHES AND HACKING OF, COMPUTER AND ELECTRONIC INFORMATION INFRASTRUCTURE IN THE NATURE OF ELECTRONIC REPORTS AND THREAT ALERT NOTICES VIA A GLOBAL COMPUTER NETWORK (U.S. CLS. 100 AND 101).

DAVID I. EXAMINING ATTORNEY

---

SN 85-188,320. TRITON LEO GROUP (PROPRIETARY) LIMITED, ISANDO 1600, SOUTH AFRICA, FILED 12-1-2010.

Q20

THE MARK CONSISTS OF STANDARD CHARACTERS WITHOUT CLAIM TO ANY PARTICULAR FONT, STYLE, SIZE, OR COLOR.

**CLASS 1—CHEMICALS**

FOR CHEMICAL PREPARATIONS, NAMELY, CLEANING SOLVENTS FOR REMOVING INCrustATION; CHEMICAL PRODUCTS USED FOR RUST PREVENTION AND REMOVAL BY SURFACE APPLICATION TO ANY EXPOSED METAL SURFACE; DEWATERING CHEMICALS AND COMPOSITIONS, NAMELY, CHEMICALS IN THE NATURE OF WATER DISPLACING CHEMICAL COMPOSITIONS AND WATERPROOFING CHEMICAL COMPOSITIONS (U.S. CLS. 1, 5, 6, 10, 26 AND 46).

FIRST USE 6-8-2011; IN COMMERCE 6-8-2011.

**CLASS 2—PAINTS**

FOR ANTI-RUST COMPOSITIONS, NAMELY, ANTI-RUST GREASES, ANTI-RUST OILS, RUST PRESERVATIVES IN THE NATURE OF A COATING, RUST PREVENTATIVES IN THE NATURE OF A COATING (U.S. CLS. 6, 11 AND 16).

FIRST USE 6-8-2011; IN COMMERCE 6-8-2011.

**CLASS 4—LUBRICANTS AND FUELS**

FOR MULTI-PURPOSE LUBRICANTS AND PENETRANTS FOR INDUSTRIAL AND HOUSEHOLD USE, NAMELY, ALL PURPOSE LUBRICANTS AND ALL PURPOSE PENETRATING OIL (U.S. CLS. 1, 6 AND 15).

FIRST USE 6-8-2011; IN COMMERCE 6-8-2011.

APRIL HESIK, EXAMINING ATTORNEY

**CLASS 42—SCIENTIFIC AND COMPUTER SERVICES**

FOR COMPUTER SERVICE, ACTING AS AN APPLICATION SERVICE PROVIDER IN THE FIELD OF KNOWLEDGE MANAGEMENT TO HOST COMPUTER APPLICATION SOFTWARE FOR CREATING SEARCHABLE DATABASES OF INFORMATION AND DATA TO ALLOW USERS TO PERFORM, ON-LINE, THE COLLECTING AND ANALYZING OF DIFFERENT TYPES OF OPINION SURVEYS; SURVEY DESIGN AND RESEARCH; WORKPLACE CERTIFICATION SERVICES, NAMELY, CONDUCTING SURVEYS AND TESTING FOR WORKPLACE EXCELLENCE (U.S. CLS. 100 AND 101).

JOHN E. MICHOS, EXAMINING ATTORNEY

SN 85-188,564. HAPPYORNOT LTD, TAMPERE, FINLAND,  
FILED 12-1-2010.

# HAPPYORNOT

THE MARK CONSISTS OF STANDARD CHARACTERS WITHOUT CLAIM TO ANY PARTICULAR FONT, STYLE, SIZE, OR COLOR.

OWNER OF FINLAND REG. NO. 250197, DATED 10-29-2010, EXPIRES 10-29-2020.

**CLASS 9—ELECTRICAL AND SCIENTIFIC APPARATUS**

FOR COMPUTER SOFTWARE THAT ALLOWS PEOPLE OR ORGANIZATIONS TO CREATE A VOTING EVENT, VOTE ON THE ISSUE, CHANGE THEIR VOTE AT WILL AND TRACK THE INPUT AND DISPLAY IT IN A UNIQUE GRAPHICAL WAY; VOTING MACHINES; COMPUTER SOFTWARE THAT PROVIDES REAL-TIME, INTEGRATED BUSINESS MANAGEMENT INTELLIGENCE BY COMBINING INFORMATION FROM VARIOUS DATABASES AND PRESENTING IT IN AN EASY-TO-UNDERSTAND USER INTERFACE (U.S. CLS. 21, 23, 26, 36 AND 38).

**CLASS 35—ADVERTISING AND BUSINESS**

FOR BUSINESS CONSULTING SERVICES, NAMELY, PROVIDING A TURNKEY BUSINESS SOLUTION FOR REVIEWING PRODUCTS AND SERVICES, PLANNING DOCUMENTATION AND WORKFLOW, HIRING TECHNICAL WRITERS, MANAGING PROJECTS FOR BUSINESS PURPOSES, TRACKING USER SATISFACTION, AND RUNNING USABILITY STUDIES FOR BUSINESS PURPOSES; BUSINESS CONSULTING SERVICES, NAMELY, PROVIDING A TURNKEY SOLUTION FOR REVIEWING PRODUCT AND SERVICE DOCUMENTATION AND WORKFLOW, MANAGING PROJECTS FOR BUSINESS PURPOSES, TRACKING USER SATISFACTION, AND RUNNING USABILITY STUDIES FOR BUSINESS PURPOSES; PROVIDING INFORMATION ON THE TOPIC OF PROMOTING PATIENT, PHYSICIAN AND EMPLOYEE SATISFACTION VIA A GLOBAL COMPUTER NETWORK; PROVIDING INFORMATION ON THE TOPIC OF DETERMINING JOB SATISFACTION; TOTAL QUALITY MANAGEMENT SERVICES, NAMELY, BUSINESS MANAGEMENT SERVICES FOR ESTABLISHING BUSINESS QUALITY POLICY AND DETERMINING BUSINESS MEANS FOR IMPLEMENTING THOSE POLICIES TO IMPROVE CUSTOMER SATISFACTION; PROFIT SURVEY AND ANALYSIS; PUBLIC OPINION SURVEYS; RENTAL OF ELECTRONIC VOTING SYSTEMS AND PROVIDING OPERATORS THEREFOR; VOTING SERVICES, NAMELY, SERVICES ALLOWING USERS TO CAST VOTES IN CONTESTS USING TELEPHONES (U.S. CLS. 100, 101 AND 102).

SN 85-189,290. HAPPYORNOT LTD, TAMPERE, FINLAND,  
FILED 12-2-2010.



OWNER OF FINLAND REG. NO. 250198, DATED 10-29-2010, EXPIRES 10-29-2020.

THE MARK CONSISTS OF THE TEXT "HAPPYORNOT" WITH CAPITALIZED LETTERS, BLACK AND WHITE. WORD "OR" IS INSIDE THE BLACK AND WHITE ELLIPSE.

**CLASS 9—ELECTRICAL AND SCIENTIFIC APPARATUS**

FOR COMPUTER SOFTWARE THAT ALLOWS PEOPLE OR ORGANIZATIONS TO CREATE A VOTING EVENT, VOTE ON THE ISSUE, CHANGE THEIR VOTE AT WILL AND TRACK THE INPUT AND DISPLAY IT IN A UNIQUE GRAPHICAL WAY; VOTING MACHINES; COMPUTER SOFTWARE THAT PROVIDES REAL-TIME, INTEGRATED BUSINESS MANAGEMENT INTELLIGENCE BY COMBINING INFORMATION FROM VARIOUS DATABASES AND PRESENTING IT IN AN EASY-TO-UNDERSTAND USER INTERFACE (U.S. CLS. 21, 23, 26, 36 AND 38).

**CLASS 35—ADVERTISING AND BUSINESS**

FOR BUSINESS CONSULTING SERVICES, NAMELY, PROVIDING A TURNKEY BUSINESS SOLUTION FOR REVIEWING PRODUCTS AND SERVICES, PLANNING DOCUMENTATION AND WORKFLOW, HIRING TECHNICAL WRITERS, MANAGING PROJECTS FOR BUSINESS PURPOSES, TRACKING USER SATISFACTION, AND RUNNING USABILITY STUDIES FOR BUSINESS PURPOSES; BUSINESS CONSULTING SERVICES, NAMELY, PROVIDING A TURNKEY SOLUTION FOR REVIEWING PRODUCT AND SERVICE DOCUMENTATION AND WORKFLOW, MANAGING PROJECTS FOR BUSINESS PURPOSES, TRACKING USER SATISFACTION, AND RUNNING USABILITY STUDIES FOR BUSINESS PURPOSES; PROVIDING INFORMATION ON THE TOPIC OF PROMOTING PATIENT, PHYSICIAN AND EMPLOYEE SATISFACTION VIA A GLOBAL COMPUTER NETWORK; PROVIDING INFORMATION ON THE TOPIC OF DETERMINING JOB SATISFACTION; TOTAL QUALITY MANAGEMENT SERVICES, NAMELY, BUSINESS MANAGEMENT SERVICES FOR ESTABLISHING BUSINESS QUALITY POLICY AND DETERMINING BUSINESS MEANS FOR IMPLEMENTING THOSE POLICIES TO IMPROVE CUSTOMER SATISFACTION; PROFIT SURVEY AND ANALYSIS; PUBLIC OPINION SURVEYS; RENTAL OF ELECTRONIC VOTING SYSTEMS AND PROVIDING OPERATORS THEREFOR; VOTING SERVICES, NAMELY, SERVICES ALLOWING USERS TO CAST VOTES IN CONTESTS USING TELEPHONES (U.S. CLS. 100, 101 AND 102).

**CLASS 42—SCIENTIFIC AND COMPUTER SERVICES**

FOR COMPUTER SERVICE, ACTING AS AN APPLICATION SERVICE PROVIDER IN THE FIELD OF KNOWLEDGE MANAGEMENT TO HOST COMPUTER APPLICATION SOFTWARE FOR CREATING SEARCHABLE DATABASES OF INFORMATION AND DATA TO ALLOW USERS TO PERFORM, ON-LINE, THE COLLECTING AND ANALYZING OF DIFFERENT TYPES OF OPINION SURVEYS; SURVEY DESIGN AND RESEARCH; WORKPLACE CERTIFICATION SERVICES, NAMELY, CONDUCTING SURVEYS AND TESTING FOR WORKPLACE EXCELLENCE (U.S. CLS. 100 AND 101).

JOHN E. MICHOS, EXAMINING ATTORNEY

SN 85-189,474. GALLAGHER, NEIL, ST. ALBANS, HERTS, UNITED KINGDOM, FILED 12-2-2010.

# PORAORA

THE MARK CONSISTS OF STANDARD CHARACTERS WITHOUT CLAIM TO ANY PARTICULAR FONT, STYLE, SIZE, OR COLOR.

PRIORITY CLAIMED UNDER SEC. 44(D) ON ERP CMNTY TM OFC APPLICATION NO. 009568429, FILED 12-2-2010, REG. NO. 009568429, DATED 5-10-2011, EXPIRES 12-2-2020.

THE WORDING "PORAORA" HAS NO MEANING IN A FOREIGN LANGUAGE.

**CLASS 9—ELECTRICAL AND SCIENTIFIC APPARATUS**

FOR VIDEO AND COMPUTER GAME PROGRAMS; COMPUTER AND VIDEO GAMES SOFTWARE AND PROGRAMS; ELECTRONIC GAMES PROGRAMS AND SOFTWARE; INTERACTIVE GAMES PROGRAMS AND SOFTWARE; MULTIMEDIA SOFTWARE RECORDED ON CD-ROM FEATURING GAMES; AMUSEMENT APPARATUS AND GAMES ADAPTED FOR USE WITH TELEVISION RECEIVERS OR WITH VIDEO OR COMPUTER MONITORS; DISC MEMORIES, GAME CONTROLLERS FOR COMPUTER GAMES, COMPUTER MONITORS, KEYBOARDS, PRESSURE AND MOTION SENSORS, COMPUTER JOYSTICKS; DOWNLOADABLE ELECTRONIC PUBLICATIONS IN THE NATURE OF WORKSHEETS, MANUALS AND BOOKS IN THE FIELD OF EDUCATION AND ENTERTAINMENT; DOWNLOADABLE COMPUTER GAME PROGRAMS AND COMPUTER GAME SOFTWARE; DOWNLOADABLE COMPUTER GAME PROGRAMS FOR MOBILE PHONES; COMPUTER SOFTWARE THAT PROVIDES WEB-BASED ACCESS TO APPLICATIONS AND SERVICES THROUGH A WEB OPERATING SYSTEM OR PORTAL INTERFACE; APPARATUS FOR RECORDING, TRANSMISSION OR REPRODUCTION OF DIGITAL INFORMATION, SOUND OR IMAGES; PRE-RECORDED DIGITAL MEDIA FEATURING GAMES; BLANK MAGNETIC DIGITAL DATA CARRIERS; BLANK MAGNETIC RECORDING DISCS AND COMPACT DISCS; DOWNLOADABLE RING TONES AND GRAPHICS FOR MOBILE PHONES; NOVELTY MAGNETS; MOUSE PADS (U.S. CLS. 21, 23, 26, 36 AND 38).

**CLASS 28—TOYS AND SPORTING GOODS**

FOR GAMES AND PLAYTHINGS, NAMELY, BOARD GAMES, ACTION FIGURES, PLUSH ANIMALS, CARD GAMES, PLAYING CARDS, FLYING DISCS, BALLS FOR SPORTS, BALLS FOR GAMES; HAND HELD UNITS FOR PLAYING ELECTRONIC GAMES OTHER THAN THOSE ADAPTED FOR USE WITH AN EXTERNAL DISPLAY SCREEN OR MONITOR; ELECTRONIC GAMES OTHER THAN THOSE ADAPTED FOR USE WITH TELEVISION RECEIVERS ONLY; HAND-HELD GAMES WITH LIQUID CRYSTAL DISPLAYS; ARCADE TYPE VIDEO GAME MACHINES (U.S. CLS. 22, 23, 38 AND 50).

**CLASS 41—EDUCATION AND ENTERTAINMENT**

FOR EDUCATION SERVICES, NAMELY, PROVIDING ONLINE COMPUTER GAMES IN THE FIELDS OF CHILDREN'S DEVELOPMENT AND EDUCATION; ENTERTAINMENT SERVICES, NAMELY, PROVIDING ONLINE COMPUTER GAMES; ENTERTAINMENT SERVICES, NAMELY, PROVIDING TEMPORARY USE OF NON-DOWNLOADABLE COMPUTER GAMES; ELECTRONIC GAMES SERVICES PROVIDED BY MEANS OF THE INTERNET; ENTERTAINMENT SERVICES, NAMELY, PROVIDING ONLINE VIDEO GAMES; PROVISION OF COMPUTER GAMES ON-LINE OR BY MEANS OF A GLOBAL COMPUTER NETWORK; PROVISION OF INTERACTIVE GAMES PROVIDED ON-LINE OR BY MEANS OF A GLOBAL COMPUTER NETWORK; ONLINE ENTERTAINMENT IN THE NATURE OF COMPUTER GAME TOURNAMENTS AND CONTESTS; PROVIDING INFORMATION ON-LINE RELATING TO COMPUTER GAMES AND COMPUTER ENHANCEMENTS FOR GAMES; PUBLISHING OF BOOKS AND MAGAZINES; ELECTRONIC PUBLISHING SERVICES, NAMELY, PUBLICATION OF TEXT AND GRAPHIC WORKS OF OTHERS ON-LINE OR ON CD OR DVD FEATURING MATERIAL FOR CHILDREN'S EDUCATION AND ENTERTAINMENT; LIBRARY SERVICES; ADVISORY, CONSULTANCY AND INFORMATION SERVICES RELATING TO THE AFORESAID SERVICES (U.S. CLS. 100, 101 AND 107).

MARK T. MULLEN, EXAMINING ATTORNEY



SN 85-190,132. GENESYS HEALTH SYSTEM, GRAND BLANC, MI. FILED 12-3-2010.

SN 85-190,613. JENNY LIVITS, SOLANA BEACH, CA. FILED 12-3-2010.



NO CLAIM IS MADE TO THE EXCLUSIVE RIGHT TO USE "COMMUNITY" AND "PHYSICIANS", APART FROM THE MARK AS SHOWN.

THE MARK CONSISTS OF A TELESCOPE ON A TRIPOD TO THE LEFT OF THE TEXT AND A CURVED LINE THAT BEGINS FROM THE TELESCOPE AND PARTIALLY SURROUNDS THE WORD "VISIONSCAPE".

#### CLASS 35—ADVERTISING AND BUSINESS

FOR CHARITABLE SERVICES, NAMELY, ORGANIZING AND DEVELOPING PROJECTS THAT AIM TO IMPROVE THE LIVES OF UNDERPRIVILEGED AND IMPOVERISHED PEOPLE; PROMOTING THE EXCHANGE OF INFORMATION AND RESOURCES WITHIN THE SCIENTIFIC RESEARCH AND MEDICAL COMMUNITIES TO ACHIEVE ADVANCES IN THE FIELD OF HEALTHCARE; PROMOTING THE INTERESTS OF PEOPLE CONCERNED WITH HEALTH, COMMUNITY AND ENVIRONMENTAL SUSTAINABILITY ISSUES; DEVELOPING AND COORDINATING VOLUNTEER PROJECTS IN THE FIELDS OF IMPROVING HEALTHCARE AND HEALTHCARE POLICY; CHARITABLE SERVICES THROUGH THE PROMOTION OF COMMUNITY REVITALIZATION AND JOB CREATION PROJECTS; PROMOTING HOSPITAL SAFETY AND ELIMINATION OF MEDICAL ERRORS (U.S. CLS. 100, 101 AND 102).

FIRST USE 9-29-2009; IN COMMERCE 9-29-2009.

#### CLASS 41—EDUCATION AND ENTERTAINMENT

FOR EDUCATIONAL SERVICES, NAMELY, ARRANGING AND CONDUCTING CLASSES, SEMINARS, TRAINING PROGRAMS, MEETINGS, PRESENTATIONS AND EDUCATIONAL RESEARCH IN THE FIELDS OF IMPROVING HEALTHCARE DELIVERY AND HEALTHCARE POLICY, COMMUNITY REVITALIZATION AND DEVELOPMENT OF SUSTAINABLE COMMUNITIES; EXPANDING MEDICAL EDUCATION OPPORTUNITIES IN THE COMMUNITY BY OFFERING MEDICAL EDUCATIONAL CLASSES; DEVELOPING EDUCATION PROGRAMS, INCLUDING EXCHANGE PROGRAMS GEARED TOWARD A NEW GENERATION OF PHYSICIANS, NURSES AND HEALTHCARE PROFESSIONALS; ARRANGING AND OFFERING TEAM-BASED EDUCATIONAL HEALTHCARE CLASSES FOR HEALTHCARE PROFESSIONALS; CHARITABLE SERVICES, NAMELY, PROVIDING TRAINING AND PROGRAMS IN THE FIELD OF MEDICAL TREATMENT FOR UNDERSERVED MEMBERS OF THE COMMUNITY (U.S. CLS. 100, 101 AND 107).

FIRST USE 9-29-2009; IN COMMERCE 9-29-2009.

#### CLASS 44—MEDICAL, BEAUTY AND AGRICULTURAL SERVICES

FOR HOSPITAL AND HEALTH CARE SERVICES, NAMELY, THE DEVELOPMENT AND PROVISION OF INTEGRATED HEALTH DELIVERY SERVICES; DEVELOPING CLINICAL PROTOCOLS; CONSULTING SERVICES IN THE FIELD OF HEALTH, NAMELY, DEVELOPING SERVICES, MATERIALS AND PROCEDURES TO CONTAIN AND REDUCE THE COSTS OF HEALTHCARE DELIVERY; PROVIDING INFORMATION IN THE FIELD OF IMPROVING HEALTHCARE (U.S. CLS. 100 AND 101).

FIRST USE 9-29-2009; IN COMMERCE 9-29-2009.  
KAREN K. BUSH, EXAMINING ATTORNEY



THE COLOR(S) LIGHT PINK, DARK PINK AND TAN IS/ARE CLAIMED AS A FEATURE OF THE MARK.

THE MARK CONSISTS OF STYLIZED LETTERING OF THE WORDS "PINK LAGOON" IN FRONT OF A PINK SHADED CIRCLE. THE WORD "PINK" IS IN THE COLOR PINK AND THE WORD "LAGOON" IS IN THE COLOR TAN.

#### CLASS 25—CLOTHING

FOR BOUTIQUE CLOTHING, NAMELY, SHIRTS, BLOUSES, SWEATERS, PANTS, SKIRTS, DRESSES, SUITS, JACKETS AND COATS (U.S. CLS. 22 AND 39).

#### CLASS 45—PERSONAL AND LEGAL SERVICES

FOR PERSONAL SHOPPING SERVICES FOR OTHERS (U.S. CLS. 100 AND 101).

MIDGE BUTLER, EXAMINING ATTORNEY

SN 85-190,674. VISM KABUSHIKI KAISHA, TOKYO, JAPAN, FILED 12-3-2010.



THE MARK CONSISTS OF THE LETTERS "BCA" INSIDE A HEXAGON DESIGN. AT THE TOP OF THE HEXAGON, AND AT THE BOTTOM 3 POINTS OF THE HEXAGON ARE LINES RADIATING FROM THE CORNERS OF THE HEXAGON, OUTSIDE THE UPPER RIGHT CORNER OF THE HEXAGON ARE TWO SETS OF LINES THAT APPEAR AS CHEVRONS.

THE WORD(S) "BCA" HAS NO MEANING IN A FOREIGN LANGUAGE.

**CLASS 3—COSMETICS AND CLEANING PREPARATIONS**

FOR COSMETIC PREPARATIONS FOR THE HAIR AND SCALP, HAIR CARE PREPARATIONS, PERMANENT WAVE PREPARATIONS, HAIR COLORING PREPARATIONS, HAIR CONDITIONERS, HAIR DYES, HAIR LOTION, HAIR RELAXING PREPARATIONS, HAIR RINSES, HAIR STRAIGHTENING PREPARATIONS, HAIR WAVING PREPARATIONS, NON-MEDICATED HAIR TREATMENT PREPARATIONS FOR COSMETIC PURPOSE, COSMETIC PREPARATIONS FOR SKIN CARE (U.S. CLS. 1, 4, 6, 50, 51 AND 52).

**CLASS 26—FANCY GOODS**

FOR PERM RODS; HAIR RODS (U.S. CLS. 37, 39, 40, 42 AND 50).

DAWN FELDMAN, EXAMINING ATTORNEY

SN 85-190,794. THOMAS DIPALMA, ELKTON, MD. FILED 12-4-2010.

# Paleogenics

THE MARK CONSISTS OF STANDARD CHARACTERS WITHOUT CLAIM TO ANY PARTICULAR FONT, STYLE, SIZE, OR COLOR.

**CLASS 16—PAPER GOODS AND PRINTED MATTER**

FOR EDUCATIONAL BOOKS FEATURING DIET AND FITNESS PROGRAM INFORMATION; EXERCISE BOOKS; PAMPHLETS IN THE FIELD OF DIET AND FITNESS PROGRAM INFORMATION; PRINTED MATTER, NAMELY, PAPER SIGNS, BOOKS, MANUALS, CURRICULUM, NEWSLETTERS, INFORMATIONAL CARDS AND BROCHURES IN THE FIELD OF DIET AND FITNESS PROGRAM INFORMATION (U.S. CLS. 2, 5, 22, 23, 29, 37, 38 AND 50).

**CLASS 41—EDUCATION AND ENTERTAINMENT**

FOR EDUCATIONAL SERVICES, NAMELY, PROVIDING INSTRUCTION IN THE FIELDS OF DIET AND FITNESS; PROVIDING INFORMATION IN THE FIELD OF PHYSICAL FITNESS TRAINING AND EXERCISE (U.S. CLS. 100, 101 AND 107).

**CLASS 44—MEDICAL, BEAUTY AND AGRICULTURAL SERVICES**

FOR PROVIDING DIETARY AND NUTRITIONAL INFORMATION; PROVIDING INFORMATION IN THE FIELD OF MENTAL FITNESS (U.S. CLS. 100 AND 101).

REBECCA EISINGER, EXAMINING ATTORNEY

SN 85-191,011. SOCIÉTÉ DES PRODUITS NESTLÉ S.A., 1800 VEVEY, SWITZERLAND, FILED 12-6-2010.



THE MARK CONSISTS OF THE WORD "PARENTALK" WITH THE LETTER "EN" CONTAINED WITHIN A SPEECH BUBBLE.

**CLASS 9—ELECTRICAL AND SCIENTIFIC APPARATUS**

FOR INSTRUCTIONAL DVDS ON THE SUBJECT OF ENTERAL FEEDING (U.S. CLS. 21, 23, 26, 36 AND 38).

**CLASS 16—PAPER GOODS AND PRINTED MATTER**

FOR EDUCATIONAL PUBLICATIONS, NAMELY, BOOKS, NEWSLETTERS, PAMPHLETS, HAND-OUTS, WORKBOOKS, MAGAZINES, JOURNALS, AND PERIODICALS ON THE SUBJECT OF ENTERAL FEEDING (U.S. CLS. 2, 5, 22, 23, 29, 37, 38 AND 50).

**CLASS 41—EDUCATION AND ENTERTAINMENT**

FOR PROVIDING EDUCATIONAL SERVICES, NAMELY, PROVIDING CLASSES, COURSES, SEMINARS, WORKSHOPS, CONFERENCES, AND EXHIBITIONS, TO PARENTS AND OTHER CAREGIVERS ON THE SUBJECT OF ENTERAL FEEDING (U.S. CLS. 100, 101 AND 107).

**CLASS 44—MEDICAL, BEAUTY AND AGRICULTURAL SERVICES**

FOR PROVIDING HEALTHCARE INFORMATION TO PARENTS AND OTHER CAREGIVERS REGARDING ENTERAL FEEDING (U.S. CLS. 100 AND 101).

THOMAS MANOR, EXAMINING ATTORNEY

SN 85-191,316. SEKISUI HOUSE, LTD., OSAKA, JAPAN, FILED 12-6-2010.



THE MARK CONSISTS OF A STYLIZED REPRESENTATION OF PEOPLE FORMING THE WORDING "NASH" AND A TREE ALL WITHIN A SQUARE FRAME.

**CLASS 6—METAL GOODS**

FOR BUILD-ON-SITE HOMES CONSTRUCTED FROM PRE-FABRICATED CONSTRUCTION MATERIALS THAT ARE ASSEMBLED INTO HOMES AT THE CONSTRUCTION SITE, PRIMARILY OF METAL (U.S. CLS. 2, 12, 13, 14, 23, 25 AND 50).

**CLASS 19—NON-METALLIC BUILDING MATERIALS**

FOR MODULAR HOMES; MANUFACTURED HOMES; PRE-FABRICATED HOMES; BUILD-ON-SITE HOMES CONSTRUCTED FROM PRE-FABRICATED CONSTRUCTION MATERIALS THAT ARE ASSEMBLED INTO HOMES AT THE CONSTRUCTION SITE, NOT PRIMARILY OF METAL (U.S. CLS. 1, 12, 33 AND 50).

**CLASS 35—ADVERTISING AND BUSINESS**

FOR RETAIL STORE SERVICES FEATURING PREFABRICATED AND MODULAR BUILDINGS; MAIL ORDER SERVICES FEATURING PREFABRICATED AND MODULAR BUILDINGS; ON-LINE RETAIL STORE SERVICES FEATURING PREFABRICATED AND MODULAR BUILDINGS; REAL ESTATE MARKETING SERVICES FEATURING BUILDINGS AND LAND; MAIL ORDER REAL ESTATE MARKETING SERVICES FEATURING BUILDINGS AND LAND; ONLINE REAL ESTATE MARKETING SERVICES FEATURING BUILDINGS AND LAND (U.S. CLS. 100, 101 AND 102).

**CLASS 36—INSURANCE AND FINANCIAL**

FOR APPRAISAL AND EVALUATION OF REAL ESTATE; ASSESSMENT AND MANAGEMENT OF REAL ESTATE; COMMERCIAL AND RESIDENTIAL REAL ESTATE AGENCY SERVICES; MANAGEMENT OF BUILDINGS; AGENCIES OR BROKERAGE FOR RENTING OF BUILDINGS; BROKERAGE IN THE FIELD OF BUILDINGS AND LAND (U.S. CLS. 100, 101 AND 102).

**CLASS 37—CONSTRUCTION AND REPAIR**

FOR BUILDING CONSTRUCTION AND REPAIR; CONSTRUCTION PLANNING; CUSTOM CONSTRUCTION AND REPAIR OF RESIDENTIAL HOUSES AND APARTMENT HOUSES; CUSTOM CONSTRUCTION AND REPAIR OF COMMERCIAL COMMUNITIES; RESIDENTIAL AND BUILDING CONSTRUCTION CONSULTING (U.S. CLS. 100, 103 AND 106).

TRACY FLETCHER, EXAMINING ATTORNEY

SN 85-191,321. ADVANCED SEMICONDUCTOR ENGINEERING, INC., KAOHSIUNG, TAIWAN, FILED 12-6-2010.

a-EASI

THE MARK CONSISTS OF STANDARD CHARACTERS WITHOUT CLAIM TO ANY PARTICULAR FONT, STYLE, SIZE, OR COLOR.

**CLASS 9—ELECTRICAL AND SCIENTIFIC APPARATUS**

FOR SEMICONDUCTOR DEVICE, PRODUCT FEATURING SEMICONDUCTOR PACKAGE, NAMELY, COMPUTER HARDWARE IN THE NATURE OF WIRELESS ACCESS POINT DEVICES; WAFER LEVEL PACKAGE COMPRISING SILICON WAFERS, STRUCTURED SEMICONDUCTOR WAFERS, INTEGRATED CIRCUITS; INTEGRATED CIRCUITS THAT CONTAIN METAL BUMPS; SEMICONDUCTOR SUBSTRATE (U.S. CLS. 21, 23, 26, 36 AND 38).

**CLASS 40—MATERIAL TREATMENT**

FOR ETCHING PROCESSING IN THE SEMICONDUCTOR WAFER; MANUFACTURE OF SEMICONDUCTOR, INTEGRATED CIRCUIT, INTEGRATED CIRCUIT BOARD AND WAFER SPECIFIED IN THE STANDARD FROM CUSTOMERS; SEMICONDUCTOR PACKAGING PROCESSING IN THE NATURE OF MANUFACTURING SERVICES FOR OTHERS; ETCHING PROCESSING IN INTEGRATED CIRCUITS; SEMICONDUCTOR WAFER-LEVEL PROCESSING; WAFER FOUNDRY, NAMELY, MANUFACTURING OF SEMICONDUCTOR WAFERS FOR OTHERS; INTEGRATED CIRCUIT PACKAGING PROCESSING IN THE NATURE OF MANUFACTURING SERVICES FOR OTHERS; SEMICONDUCTOR SUBSTRATE PROCESSING AND MANUFACTURING; SUBSTRATE FOUNDRY, NAMELY, MANUFACTURING OF SEMICONDUCTOR SUBSTRATES FOR OTHERS; MANUFACTURE OF SEMICONDUCTOR SUBSTRATE (U.S. CLS. 100, 103 AND 106).

**CLASS 42—SCIENTIFIC AND COMPUTER SERVICES**

FOR SEMICONDUCTOR RELATED PRODUCTS TECHNOLOGY RESEARCH AND DEVELOPMENT FOR OTHERS; SEMICONDUCTOR PACKAGING DESIGN; INTEGRATED CIRCUIT DESIGN; SEMICONDUCTOR SUBSTRATE DESIGN; QUALITY INSPECTION FOR SEMICONDUCTORS AND RELATED PRODUCTS; TESTING FOR SEMICONDUCTORS AND RELATED PRODUCTS; QUALITY IDENTIFICATION FOR SEMICONDUCTORS AND RELATED PRODUCTS, NAMELY, QUALITY CONTROL FOR OTHERS (U.S. CLS. 100 AND 101).

JESSICA A. POWERS, EXAMINING ATTORNEY

SN 85-191,330. FLIPBOARD, INC., PALO ALTO, CA. FILED 12-6-2010.

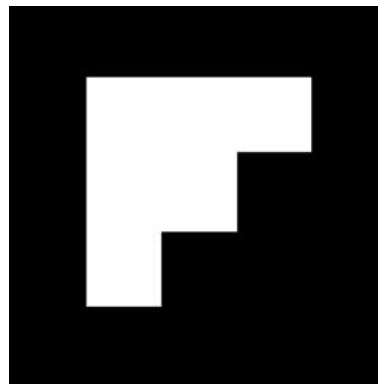

THE MARK CONSISTS OF A SQUARE WITH A STYLIZED LETTER "F" INSIDE THAT ALSO CREATES A DESIGN WITH AN OVERALL TRIANGULAR SHAPE WITH ONE SIDE BEING CUT OUT TO FORM A STEP PATTERN.

**CLASS 9—ELECTRICAL AND SCIENTIFIC APPARATUS**

FOR COMPUTER SOFTWARE, NAMELY, SOFTWARE FOR CREATING OR FACILITATING AN ON-LINE PRESENCE WHERE USERS CAN SHARE INFORMATION, PARTICIPATE IN DISCUSSIONS, GET FEEDBACK FROM THEIR PEERS, FORM VIRTUAL COMMUNITIES, AND ENGAGE IN SOCIAL NETWORKING FEATURING SOCIAL MEDIA, PHOTOS, IMAGES, AND TOPICS OF GENERAL INTEREST TO SUCH USERS; COMPUTER SOFTWARE FOR AGGREGATING AND INTEGRATING INFORMATION, IMAGES AND CONTENT FROM SOCIAL NETWORKS, PUBLICLY AVAILABLE SOURCES AND PERSONAL WEBSITES AND COMMUNICATIONS TO PROVIDE AND ENABLE USERS TO INTERACT WITH INFORMATION, IMAGES AND CONTENT OF GREATEST INTEREST TO THEM; COMPUTER SOFTWARE, NAMELY, SOFTWARE THAT ENABLES USERS OF COMPUTERS AND MOBILE DEVICES TO ACCESS, AGGREGATE, ORGANIZE AND INTERACT WITH CONTENT, INFORMATION AND IMAGES FROM SOCIAL MEDIA WEBSITES, PUBLICLY AVAILABLE SOURCES, AND PERSONAL WEBSITES AND COMMUNICATIONS, AND PROVIDES DATA, INFORMATION AND UPDATES ON TOPICS OF GENERAL INTEREST TO MEMBERS OF AN ON-LINE COMMUNITY (U.S. CLS. 21, 23, 26, 36 AND 38).

**CLASS 35—ADVERTISING AND BUSINESS**

FOR ONLINE ADVERTISING SERVICES FOR OTHERS; PROMOTING THE GOODS AND SERVICES OF OTHERS VIA A WEBSITE FEATURING COUPONS AND PRODUCT REVIEWS FOR SHOPPING; ADVERTISING AND DIRECTORY SERVICES, NAMELY, PROMOTING THE GOODS AND SERVICES OF OTHERS BY PROVIDING A WEB PAGE FEATURING IMAGERY, ADS AND CONTENT WITH LINKS TO THE WEBSITES OF OTHERS; PROMOTING THE GOODS AND SERVICES OF OTHERS BY PROVIDING A COMMUNITY-DRIVEN WEB SITE FEATURING CONSUMER INFORMATION IN THE FIELDS OF BUSINESS, COMMERCE, AND SHOPPING, NAMELY, CONSUMER PRODUCT INFORMATION, INFORMATION ON RESTAURANTS, INFORMATION ON RETAIL STORES, INFORMATION ON BUSINESS ORGANIZATIONS, INFORMATION ON SERVICE PROVIDERS (U.S. CLS. 100, 101 AND 102).

**CLASS 41—EDUCATION AND ENTERTAINMENT**

FOR ENTERTAINMENT AND EDUCATIONAL SERVICES, NAMELY, ONLINE MAGAZINE FEATURING ARTICLES, IMAGES, AND PHOTOS ABOUT NEWS, ENTERTAINMENT, AND CURRENT EVENTS; PROVIDING A VIRTUAL ENVIRONMENT WHERE USERS CAN FIND AND EXCHANGE ARTICLES, IMAGES, AND PHOTOS ABOUT TOPICS, PEOPLE, AND CURRENT EVENTS, AND WHERE USERS CAN INTERACT FOR ENTERTAINMENT PURPOSES AND TO EXPRESS OPINIONS ABOUT TOPICS, PEOPLE, AND CURRENT EVENTS; COMPUTER SERVICES, NAMELY, PROVIDING DATA, INFORMATION AND UPDATES ON TOPICS OF INTEREST TO USERS OF AN ON-LINE COMMUNITY, NAMELY, ENTERTAINMENT INFORMATION (U.S. CLS. 100, 101 AND 107).

**CLASS 42—SCIENTIFIC AND COMPUTER SERVICES**

FOR COMPUTER SERVICES, NAMELY, PROVIDING AN ON-LINE SITE FEATURING NON-DOWNLOADABLE SOFTWARE FOR USERS TO SHARE INFORMATION, PARTICIPATE IN DISCUSSIONS, GET FEEDBACK FROM THEIR PEERS, FORM VIRTUAL COMMUNITIES, AND ENGAGE IN SOCIAL NETWORKING FEATURING SOCIAL MEDIA, PHOTOS, IMAGES, AND TOPICS OF GENERAL INTEREST TO SUCH USERS; PROVIDING AN INTERACTIVE WEBSITE FEATURING TECHNOLOGY THAT AGGREGATES AND INTEGRATES INFORMATION, IMAGES AND CONTENT FROM SOCIAL NETWORKS, PUBLICLY AVAILABLE SOURCES AND PERSONAL WEBSITES AND COMMUNICATIONS AND ENABLES USERS TO INTERACT WITH INFORMATION AND CONTENT OF

GREATEST INTEREST TO THEM; COMPUTER SERVICES, NAMELY, PROVIDING A WEB-BASED SYSTEM AND ONLINE PORTAL FEATURING ON-LINE NON-DOWNLOADABLE SOFTWARE THAT ENABLES USERS OF COMPUTERS AND MOBILE DEVICES TO ACCESS, AGGREGATE AND INTERACT WITH CONTENT, INFORMATION AND IMAGES FROM SOCIAL MEDIA WEBSITES, PUBLICLY AVAILABLE SOURCES, AND PERSONAL WEBSITES AND COMMUNICATIONS; PROVIDING A WEBSITE FEATURING A MEDIA AGGREGATOR AND SEARCH ENGINE FOR INTERNET AND SOCIAL CONTENT; APPLICATION SERVICE PROVIDER, NAMELY, PROVIDING, HOSTING, MANAGING, DEVELOPING, AND MAINTAINING APPLICATIONS, SOFTWARE, WEB SITES, AND DATABASES OF OTHERS IN THE FIELDS OF PERSONAL MEDIA AND COMMUNICATIONS CONTENT; APPLICATION SERVICE PROVIDER (ASP) FEATURING SOFTWARE FOR USE IN THE COLLECTION, DISSEMINATION, AND ASSIMILATION OF DATA, INFORMATION, PHOTOS AND IMAGES FOR SOCIAL NETWORKING PURPOSES (U.S. CLS. 100 AND 101).

**CLASS 45—PERSONAL AND LEGAL SERVICES**

FOR ONLINE SOCIAL NETWORKING SERVICES; PROVIDING A SOCIAL NETWORKING WEBSITE FOR ENTERTAINMENT AND SOCIAL COMMUNICATIONS PURPOSES; COMPUTER SERVICES, NAMELY, PROVIDING DATA, INFORMATION AND UPDATES ON TOPICS OF INTEREST TO USERS OF AN ON-LINE COMMUNITY, NAMELY, SOCIAL NETWORKING INFORMATION (U.S. CLS. 100 AND 101).

LINDSEY RUBIN, EXAMINING ATTORNEY

---

SN 85-191,367. CAMPUS CREST COMMUNITIES, INC., CHARLOTTE, NC. FILED 12-6-2010.



NO CLAIM IS MADE TO THE EXCLUSIVE RIGHT TO USE "CAMPUS" AND "COMMUNITIES", APART FROM THE MARK AS SHOWN.

THE MARK CONSISTS OF THE WORDING "CAMPUS CREST" UNDERLINED WITH A DESIGN OF AN OVAL WITHIN A CIRCLE BETWEEN THEM AND THE TERM "COMMUNITIES" BELOW THE TERM "CREST".

**CLASS 36—INSURANCE AND FINANCIAL**

FOR REAL ESTATE MANAGEMENT (U.S. CLS. 100, 101 AND 102).  
FIRST USE 12-31-2006; IN COMMERCE 12-31-2006.

**CLASS 37—CONSTRUCTION AND REPAIR**

FOR REAL ESTATE DEVELOPMENT; BUILDING CONSTRUCTION (U.S. CLS. 100, 103 AND 106).  
FIRST USE 12-31-2006; IN COMMERCE 12-31-2006.  
SALLY SHIH, EXAMINING ATTORNEY

SN 85-191,518. NEWTEK BUSINESS SERVICES, INC., NEW YORK, NY. FILED 12-6-2010.



OWNER OF U.S. REG. NOS. 3,318,058, 3,454,308 AND 3,547,273.

NO CLAIM IS MADE TO THE EXCLUSIVE RIGHT TO USE "SMALL BUSINESS", APART FROM THE MARK AS SHOWN.

THE MARK CONSISTS OF THE IMAGE OF A CITYSCAPE FLANKED BY EXTENDED SOLID LINES TO THE LEFT AND THE RIGHT OF THE CITYSCAPE IMAGE AND WITH THE WORDING "THESBA.COM" APPEARING TO THE RIGHT OF THE CITYSCAPE WITH "THE SMALL BUSINESS" UNDERNEATH AND ABOVE "AUTHORITY" IN A SHADED RECTANGULAR BOX ALL ABOVE "POWERED BY NEWTEK" AT THE BOTTOM RIGHT.

#### **CLASS 9—ELECTRICAL AND SCIENTIFIC APPARATUS**

FOR DOWNLOADABLE ELECTRONIC PUBLICATIONS IN THE NATURE OF NEWSLETTERS FEATURING ARTICLES IN THE FIELD OF BUSINESS AND OF INTEREST TO BUSINESS OWNERS (U.S. CLS. 21, 23, 26, 36 AND 38).

#### **CLASS 16—PAPER GOODS AND PRINTED MATTER**

FOR PRINTED PUBLICATIONS IN THE NATURE OF NEWSLETTERS FEATURING ARTICLES IN THE FIELD OF BUSINESS AND OF INTEREST TO BUSINESS OWNERS (U.S. CLS. 2, 5, 22, 23, 29, 37, 38 AND 50).

#### **CLASS 35—ADVERTISING AND BUSINESS**

FOR ACCOUNTING SERVICES; ONLINE ACCOUNTING SERVICES; COMPUTERIZED ACCOUNTING SERVICES; ACCOUNTING SERVICES FOR ELECTRONIC FUNDS SERVICES; ADMINISTRATION OF BUSINESS PAYROLL FOR OTHERS; PAYROLL PREPARATION; FINANCIAL STATEMENT PREPARATION AND ANALYSIS FOR BUSINESS; INTEGRATED TRACKING AND MANAGEMENT OF COMMERCIAL TRANSACTIONS ON A GLOBAL COMPUTER NETWORK; COMPUTER SERVICES, NAMELY, NOTIFICATION SERVICES TO BUSINESSES IN THE NATURE OF PROVIDING INFORMATION REGARDING BUSINESS FILING REQUIREMENTS AND FILING DATES VIA THE INTERNET AND EMAIL; INCOME TAX CONSULTATION AND PREPARATION SERVICES; BUSINESS ACQUISITION AND MERGER CONSULTATION; BUSINESS APPRAISALS; BUSINESS AUDITING; BUSINESS CONSULTATION; BUSINESS DEVELOPMENT SERVICES, NAMELY, PROVIDING START-UP SUPPORT FOR BUSINESSES OF OTHERS; BUSINESS INVOICING SERVICES; CONDUCTING BUSINESS AND MARKET RESEARCH SURVEYS; BUSINESS MANAGEMENT PLANNING; BUSINESS MANAGEMENT INFORMATION ON A WIDE VARIETY OF TOPICS TO BUSINESS PROFESSIONALS; BUSINESS MARKETING; BUSINESS MARKETING CONSULTING SERVICES; BUSINESS ORGANIZATIONAL CONSULTATION; BUSINESS PLANNING; BUSINESS RESEARCH AND SURVEYS; BUSINESS SUCCESSION PLANNING; BUSINESS SUPERVISION; PREPARING BUSINESS REPORTS; PROVIDING STATISTICAL INFORMATION FOR BUSINESSES; BUSINESS MANAGEMENT CONSULTATION AND MANAGEMENT CONSULTATION SERVICES IN THE FIELD OF BUSINESS MANAGEMENT CONSULTING; CONSULTING SERVICES IN THE FIELD OF BUSINESS MANAGEMENT, CONSULTING SERVICES IN THE FIELD OF BUSINESS MANAGEMENT, AND HUMAN RESOURCES; FINANCIAL RECORD KEEPING AND FINANCIAL RECORDS MANAGEMENT SERVICES; BOOKKEEPING SERVICES; FINANCIAL STATEMENT

PREPARATION AND ANALYSIS FOR BUSINESSES; PREPARING FINANCIAL REPORTS FOR OTHERS; ADMINISTRATION, BILLING AND RECONCILIATION OF ACCOUNTS ON BEHALF OF OTHERS; ACCOUNTS RECEIVABLE SERVICES; PAYROLL PREPARATION AND PROCESSING SERVICES (U.S. CLS. 100, 101 AND 102).

#### **CLASS 36—INSURANCE AND FINANCIAL**

FOR FINANCIAL ANALYSIS FOR BUSINESS; FINANCIAL ANALYSIS AND CONSULTATION SERVICES; FINANCIAL MANAGEMENT SERVICES; BUSINESS FINANCE PROCUREMENT SERVICES; LOAN FINANCING AND LOAN PROGRAMS IN THE NATURE OF BUSINESS LOANS AND TEMPORARY LOANS; PROVIDING FINANCIAL AND BANK ACCOUNT INFORMATION BY TELEPHONE AND THE INTERNET; PROVIDING ON-LINE FINANCIAL SERVICES IN THE NATURE OF BANKING AND BANKING SERVICES; BILL PAYMENT SERVICES; ELECTRONIC PAYMENT, NAMELY, ELECTRONIC PROCESSING AND TRANSMISSION OF BILL PAYMENT DATA; FINANCIAL INFORMATION PROVIDED BY ELECTRONIC MEANS; TAX PAYMENT PROCESSING SERVICES; BUSINESS BROKERAGE; FINANCIAL INFORMATION PROCESSING AND FINANCIAL ANALYSIS AND RESEARCH SERVICES, ALL FOR OTHERS; PROVIDING AN ON-LINE COMPUTER DATABASE FEATURING THE FINANCIAL INFORMATION OF OTHERS; ACCOUNTS PAYABLE SERVICES (U.S. CLS. 100, 101 AND 102).

#### **CLASS 38—COMMUNICATION**

FOR PROVIDING HIGH SPEED ACCESS TO AREA NETWORKS AND A GLOBAL COMPUTER INFORMATION NETWORKS; PROVIDING ELECTRONIC MAIL SERVICES FOR OTHERS (U.S. CLS. 100, 101 AND 104).

#### **CLASS 42—SCIENTIFIC AND COMPUTER SERVICES**

FOR PROVIDING TEMPORARY USE OF ON-LINE NON-DOWNLOADABLE SOFTWARE FOR USE IN PROVIDING REFERRAL, FINANCIAL, SALES, PLANNING, FORECASTING, AND BUDGETING MODULES; PROVIDING TEMPORARY USE OF ON-LINE NON-DOWNLOADABLE SOFTWARE TO ALLOW CUSTOMERS TO ACCESS ACCOUNT INFORMATION, REVIEW REFERRAL INFORMATION, AND INITIATE CONTACT REQUESTS; APPLICATION SERVICE PROVIDER (ASP), NAMELY, PROVIDING, HOSTING, MANAGING, DEVELOPING, AND MAINTAINING APPLICATIONS, SOFTWARE, WEBSITES, AND DATABASES FEATURING SOFTWARE FOR USE IN DOCUMENT STORAGE AND MANAGEMENT, FINANCIAL RECORD KEEPING AND MANAGEMENT SERVICES, BOOKKEEPING SERVICES, AND FACILITATING COMMUNICATIONS BETWEEN FINANCIAL PROFESSIONALS; COMPUTER AND BUSINESS SERVICES, NAMELY, HOSTING OF THE WEB SITES OF OTHERS ON A COMPUTER SERVER FOR A GLOBAL COMPUTER NETWORK; PROVIDING INFORMATION ABOUT WEB SITE DEVELOPMENT; WEB SITE HOSTING SERVICES; DESIGNING, DEVELOPING, AND HOSTING WEB SITES FOR OTHERS; COMPUTER NETWORK ADDRESS MANAGEMENT SERVICES, NAMELY, PROVIDING SERVICES ENABLING ENTITIES TO RESERVE, MANAGE AND SECURE DOMAIN NAMES FOR USE ON A GLOBAL COMPUTER NETWORK AND TO ACCESS, ADD, MODIFY, OR DELETE THEIR DOMAIN NAME INFORMATION (U.S. CLS. 100 AND 101).

ELIZABETH KAJUBI, EXAMINING ATTORNEY

SN 85-191,534. NEWTEK BUSINESS SERVICES, INC., NEW YORK, NY. FILED 12-6-2010.



NO CLAIM IS MADE TO THE EXCLUSIVE RIGHT TO USE "SMALL BUSINESS", APART FROM THE MARK AS SHOWN.

THE MARK CONSISTS OF THE IMAGE OF A CITYSCAPE FLANKED BY EXTENDED SOLID LINES TO THE LEFT AND THE RIGHT OF THE CITYSCAPE IMAGE AND WITH THE WORDING THESBA.COM APPEARING TO THE RIGHT OF THE CITYSCAPE WITH "THE SMALL BUSINESS" UNDERNEATH AND ABOVE "AUTHORITY" IN A SHADED RECTANGULAR BOX.

#### **CLASS 9—ELECTRICAL AND SCIENTIFIC APPARATUS**

FOR DOWNLOADABLE ELECTRONIC PUBLICATIONS IN THE NATURE OF NEWSLETTERS FEATURING ARTICLES IN THE FIELD OF BUSINESS AND OF INTEREST TO BUSINESS OWNERS (U.S. CLS. 21, 23, 26, 36 AND 38).

#### **CLASS 16—PAPER GOODS AND PRINTED MATTER**

FOR PRINTED PUBLICATIONS IN THE NATURE OF NEWSLETTERS FEATURING ARTICLES IN THE FIELD OF BUSINESS AND OF INTEREST TO BUSINESS OWNERS (U.S. CLS. 2, 5, 22, 23, 29, 37, 38 AND 50).

#### **CLASS 35—ADVERTISING AND BUSINESS**

FOR ACCOUNTING SERVICES; ONLINE ACCOUNTING SERVICES; COMPUTERIZED ACCOUNTING SERVICES; ACCOUNTING SERVICES FOR ELECTRONIC FUNDS SERVICES; ADMINISTRATION OF BUSINESS PAYROLL FOR OTHERS; PAYROLL PREPARATION; FINANCIAL STATEMENT PREPARATION AND ANALYSIS FOR BUSINESS; INTEGRATED TRACKING AND MANAGEMENT OF COMMERCIAL TRANSACTIONS ON A GLOBAL COMPUTER NETWORK; COMPUTER SERVICES, NAMELY, NOTIFICATION SERVICES TO BUSINESSES IN THE NATURE OF PROVIDING INFORMATION REGARDING BUSINESS FILING REQUIREMENTS AND FILING DATES VIA THE INTERNET AND EMAIL; INCOME TAX CONSULTATION AND PREPARATION SERVICES; BUSINESS ACQUISITION AND MERGER CONSULTATION; BUSINESS APPRAISALS; BUSINESS AUDITING; BUSINESS CONSULTATION; BUSINESS DEVELOPMENT SERVICES, NAMELY, PROVIDING START-UP SUPPORT FOR BUSINESSES OF OTHERS; BUSINESS INVOICING SERVICES; CONDUCTING BUSINESS AND MARKET RESEARCH SURVEYS; BUSINESS MANAGEMENT PLANNING; BUSINESS MANAGEMENT INFORMATION ON A WIDE VARIETY OF TOPICS TO BUSINESS PROFESSIONALS; BUSINESS MARKETING; BUSINESS MARKETING CONSULTING SERVICES; BUSINESS ORGANIZATIONAL CONSULTATION; BUSINESS PLANNING; BUSINESS RESEARCH AND SURVEYS; BUSINESS SUCCESSION PLANNING; BUSINESS SUPERVISION; PREPARING BUSINESS REPORTS; PROVIDING STATISTICAL INFORMATION FOR BUSINESSES; BUSINESS MANAGEMENT CONSULTATION AND MANAGEMENT CONSULTATION SERVICES IN THE FIELD OF BUSINESS MANAGEMENT CONSULTING; CONSULTING SERVICES IN THE FIELD OF BUSINESS MANAGEMENT, CONSULTING SERVICES IN THE FIELD OF BUSINESS MANAGEMENT, AND HUMAN RESOURCES; FINANCIAL RECORD KEEPING AND FINANCIAL RECORDS MANAGEMENT SERVICES; BOOKKEEPING SERVICES; FINANCIAL STATEMENT PREPARATION AND ANALYSIS FOR BUSINESSES; PREPARING FINANCIAL REPORTS FOR OTHERS; ADMINISTRATION, BILLING AND RECONCILIATION

OF ACCOUNTS ON BEHALF OF OTHERS; ACCOUNTS RECEIVABLE SERVICES; PAYROLL PREPARATION AND PROCESSING SERVICES (U.S. CLS. 100, 101 AND 102).

#### **CLASS 36—INSURANCE AND FINANCIAL**

FOR FINANCIAL ANALYSIS FOR BUSINESS; FINANCIAL ANALYSIS AND CONSULTATION SERVICES; FINANCIAL MANAGEMENT SERVICES; BUSINESS FINANCE PROCUREMENT SERVICES; LOAN FINANCING AND LOAN PROGRAMS IN THE NATURE OF BUSINESS LOANS AND TEMPORARY LOANS; PROVIDING FINANCIAL AND BANK ACCOUNT INFORMATION BY TELEPHONE AND THE INTERNET; PROVIDING ON-LINE FINANCIAL SERVICES IN THE NATURE OF BANKING AND BANKING SERVICES; BILL PAYMENT SERVICES; ELECTRONIC PAYMENT, NAMELY, ELECTRONIC PROCESSING AND TRANSMISSION OF BILL PAYMENT DATA; FINANCIAL INFORMATION PROVIDED BY ELECTRONIC MEANS; TAX PAYMENT PROCESSING SERVICES; BUSINESS BROKERAGE; FINANCIAL INFORMATION PROCESSING AND FINANCIAL ANALYSIS AND RESEARCH SERVICES, ALL FOR OTHERS; PROVIDING AN ON-LINE COMPUTER DATABASE FEATURING THE FINANCIAL INFORMATION OF OTHERS; ACCOUNTS PAYABLE SERVICES (U.S. CLS. 100, 101 AND 102).

#### **CLASS 38—COMMUNICATION**

FOR PROVIDING HIGH SPEED ACCESS TO AREA NETWORKS AND A GLOBAL COMPUTER INFORMATION NETWORKS; PROVIDING ELECTRONIC MAIL SERVICES FOR OTHERS (U.S. CLS. 100, 101 AND 104).

#### **CLASS 42—SCIENTIFIC AND COMPUTER SERVICES**

FOR PROVIDING TEMPORARY USE OF ON-LINE NON-DOWNLOADABLE SOFTWARE FOR USE IN PROVIDING REFERRAL, FINANCIAL, SALES, PLANNING, FORECASTING, AND BUDGETING MODULES; PROVIDING TEMPORARY USE OF ON-LINE NON-DOWNLOADABLE SOFTWARE TO ALLOW CUSTOMERS TO ACCESS ACCOUNT INFORMATION, REVIEW REFERRAL INFORMATION, AND INITIATE CONTACT REQUESTS; APPLICATION SERVICE PROVIDER (ASP), NAMELY, PROVIDING, HOSTING, MANAGING, DEVELOPING, AND MAINTAINING APPLICATIONS, SOFTWARE, WEBSITES, AND DATABASES FEATURING SOFTWARE FOR USE IN DOCUMENT STORAGE AND MANAGEMENT, FINANCIAL RECORD KEEPING AND MANAGEMENT SERVICES, BOOKKEEPING SERVICES, AND FACILITATING COMMUNICATIONS BETWEEN FINANCIAL PROFESSIONALS; COMPUTER AND BUSINESS SERVICES, NAMELY, HOSTING OF THE WEB SITES OF OTHERS ON A COMPUTER SERVER FOR A GLOBAL COMPUTER NETWORK; PROVIDING INFORMATION ABOUT WEB SITE DEVELOPMENT; WEB SITE HOSTING SERVICES; DESIGNING, DEVELOPING, AND HOSTING WEB SITES FOR OTHERS; COMPUTER NETWORK ADDRESS MANAGEMENT SERVICES, NAMELY, PROVIDING SERVICES ENABLING ENTITIES TO RESERVE, MANAGE AND SECURE DOMAIN NAMES FOR USE ON A GLOBAL COMPUTER NETWORK AND TO ACCESS, ADD, MODIFY, OR DELETE THEIR DOMAIN NAME INFORMATION (U.S. CLS. 100 AND 101).

ELIZABETH KAJUBI, EXAMINING ATTORNEY

SN 85-191,594. GLOBAL ACCESS TO TECHNOLOGY FOR DEVELOPMENT FOUNDATION, BERKELEY, CA. FILED 12-6-2010.

## GLOBAL ACCESS IN ACTION

THE MARK CONSISTS OF STANDARD CHARACTERS WITHOUT CLAIM TO ANY PARTICULAR FONT, STYLE, SIZE, OR COLOR.

### CLASS 16—PAPER GOODS AND PRINTED MATTER

FOR PRINTED PUBLICATIONS, NAMELY, BOOKS, BROCHURES, REPORTS, HAND-OUTS, MAGAZINES, WORKBOOKS IN THE FIELD OF BUSINESS DEVELOPMENT, COMMERCIALIZATION, AND INTELLECTUAL PROPERTY ISSUES FOR TECHNOLOGIES RELATING TO GLOBAL POVERTY; PRINTED EDUCATION MATERIAL IN THE FIELD OF BUSINESS DEVELOPMENT, COMMERCIALIZATION, AND INTELLECTUAL PROPERTY ISSUES FOR TECHNOLOGIES RELATING TO GLOBAL POVERTY (U.S. CLS. 2, 5, 22, 23, 29, 37, 38 AND 50).

### CLASS 35—ADVERTISING AND BUSINESS

FOR BUSINESS CONSULTATION SERVICES FOR THE BUSINESS DEVELOPMENT AND COMMERCIALIZATION ISSUES FOR TECHNOLOGIES RELATING TO GLOBAL POVERTY; BUSINESS RESEARCH AND BUSINESS DATA ANALYSIS RELATING TO THE BUSINESS DEVELOPMENT AND COMMERCIALIZATION ISSUES FOR TECHNOLOGIES RELATING TO GLOBAL POVERTY; PROVIDING PUBLIC POLICY CONSULTING AND STRATEGIC BUSINESS CONSULTING ADVICE RELATING TO THE BUSINESS DEVELOPMENT AND COMMERCIALIZATION ISSUES FOR TECHNOLOGIES RELATING TO GLOBAL POVERTY; PUBLIC ADVOCACY SERVICES TO PROMOTE AWARENESS OF THE BUSINESS DEVELOPMENT, COMMERCIALIZATION, AND INTELLECTUAL PROPERTY ISSUES FOR TECHNOLOGIES RELATING TO GLOBAL POVERTY; PROVIDING ONLINE COMPUTER DATABASES FEATURING TRADE INFORMATION IN THE FIELD OF BUSINESS DEVELOPMENT, COMMERCIALIZATION, AND INTELLECTUAL PROPERTY ISSUES FOR TECHNOLOGIES RELATING TO GLOBAL POVERTY; PROVIDING A WEBSITE FEATURING BUSINESS INFORMATION REGARDING BUSINESS DEVELOPMENT AND COMMERCIALIZATION ISSUES FOR TECHNOLOGIES RELATING TO GLOBAL POVERTY; PROVIDING BUSINESS ADMINISTRATION AND BUSINESS MANAGEMENT OF DEVELOPMENT PROJECTS (U.S. CLS. 100, 101 AND 102).

### CLASS 41—EDUCATION AND ENTERTAINMENT

FOR EDUCATIONAL SERVICES, NAMELY, PROVIDING WORKSHOPS AND SEMINARS IN THE FIELD OF BUSINESS DEVELOPMENT, COMMERCIALIZATION, AND INTELLECTUAL PROPERTY ISSUES FOR TECHNOLOGIES RELATING TO GLOBAL POVERTY AND THE DISTRIBUTION OF PRINTED EDUCATIONAL MATERIALS THEREWITH; EDUCATIONAL SERVICES, NAMELY, PROVIDING ONLINE WORKSHOPS AND SEMINARS IN THE FIELD OF BUSINESS DEVELOPMENT, COMMERCIALIZATION, AND INTELLECTUAL PROPERTY ISSUES FOR TECHNOLOGIES RELATING TO GLOBAL POVERTY; PROVIDING ONLINE WORKBOOKS IN THE FIELD OF BUSINESS DEVELOPMENT, COMMERCIALIZATION AND INTELLECTUAL PROPERTY ISSUES FOR TECHNOLOGIES RELATING TO GLOBAL POVERTY, WHICH ARE USED IN CONNECTION WITH ONLINE WORKSHOPS AND SEMINARS; PROVIDING ONLINE PUBLICATIONS, NAMELY, BOOKS, BROCHURES, REPORTS, HAND-OUTS, MAGAZINES, WORKBOOKS IN THE FIELD OF BUSINESS DEVELOPMENT, COMMERCIALIZATION, AND INTELLECTUAL PROPERTY ISSUES FOR TECHNOLOGIES RELATING TO GLOBAL POVERTY (U.S. CLS. 100, 101 AND 107).

### CLASS 45—PERSONAL AND LEGAL SERVICES

FOR INTELLECTUAL PROPERTY CONSULTING SERVICES IN THE FIELD OF TECHNOLOGIES RELATING TO GLOBAL PROPERTY; PROVIDING A WEBSITE FEATURING INFORMATION IN THE FIELD OF INTELLECTUAL PROPERTY ISSUES FOR TECHNOLOGIES RELATING TO GLOBAL POVERTY (U.S. CLS. 100 AND 101).

MARK SPARACINO, EXAMINING ATTORNEY

---

SN 85-192,653. DISTRIBUTION MARKETING SERVICES, L.P., HOUSTON, TX. FILED 12-7-2010.

## PROPAK

THE MARK CONSISTS OF STANDARD CHARACTERS WITHOUT CLAIM TO ANY PARTICULAR FONT, STYLE, SIZE, OR COLOR.

### CLASS 5—PHARMACEUTICALS

FOR SANITARY TOWELS, NAMELY, TOWELS IMPREGNATED WITH ANTIMICROBIAL TREATMENT (U.S. CLS. 6, 18, 44, 46, 51 AND 52).

FIRST USE 7-31-2007; IN COMMERCE 7-31-2007.

### CLASS 8—HAND TOOLS

FOR PLASTIC UTENSILS FOR USE IN THE CONSUMPTION OF FOOD, NAMELY, KNIVES, FORKS AND SPOONS (U.S. CLS. 23, 28 AND 44).

FIRST USE 9-30-2003; IN COMMERCE 9-30-2003.

**CLASS 16—PAPER GOODS AND PRINTED MATTER**

FOR GOODS OF PAPER, NAMELY, PAPER TAKE-OUT CARTONS FOR FOOD, NAPKINS, TOWELS, TABLE CLOTHS, PLACE MATS, AND FOOD WRAPS; PLASTIC GARBAGE BAGS, TRASH CAN LINERS, PLASTIC GENERAL PURPOSE STORAGE BAGS; CASH REGISTER PAPER ROLLS; PAPER RESTAURANT GUEST CHECKS (U.S. CLS. 2, 5, 22, 23, 29, 37, 38 AND 50).

FIRST USE 9-30-2010; IN COMMERCE 9-30-2010.

**CLASS 20—FURNITURE AND ARTICLES NOT OTHERWISE CLASSIFIED**

FOR PLASTIC DRINKING STRAWS, PLASTIC LIDS (U.S. CLS. 2, 13, 22, 25, 32 AND 50).

FIRST USE 9-30-2003; IN COMMERCE 9-30-2003.

**CLASS 21—HOUSEWARES AND GLASS**

FOR PLASTIC ACCESSORIES FOR USE IN THE CONSUMPTION OF FOOD, NAMELY, PLASTIC CUPS, BOWLS; FOAM CUPS, PLATES, BOWLS; PAPER CUPS; PLASTIC BEVERAGE STIRRERS; DISPOSABLE GLOVES FOR GENERAL USE, NAMELY, LATEX GLOVES, POLY GLOVES AND VINYL GLOVES; CLEANING PADS (U.S. CLS. 2, 13, 23, 29, 30, 33, 40 AND 50).

FIRST USE 2-28-2007; IN COMMERCE 2-28-2007.

**CLASS 25—CLOTHING**

FOR CHEF HATS (U.S. CLS. 22 AND 39).  
FIRST USE 9-30-2007; IN COMMERCE 9-30-2007.  
JORDAN BAKER, EXAMINING ATTORNEY

SN 85-192,857. ESSENTA COMPANY LIMITED, DUBLIN 2, IRELAND, FILED 12-8-2010.

## ESSENTA FOODS

THE MARK CONSISTS OF STANDARD CHARACTERS WITHOUT CLAIM TO ANY PARTICULAR FONT, STYLE, SIZE, OR COLOR.

PRIORITY CLAIMED UNDER SEC. 44(D) ON ERP CMNTY TM OFC APPLICATION NO. 009528068, FILED 11-17-2010, REG. NO. 009528068, DATED 5-3-2011, EXPIRES 11-17-2020.

NO CLAIM IS MADE TO THE EXCLUSIVE RIGHT TO USE "FOODS", APART FROM THE MARK AS SHOWN.

**CLASS 29—MEATS AND PROCESSED FOODS**

FOR MEAT, FISH, POULTRY AND GAME; MEAT EXTRACTS; PRESERVED AND TINNED MEAT; CANNED, PRESERVED, DRIED AND COOKED FRUIT AND VEGETABLES; JELLIES, JAMS; EGGS, MILK AND MILK PRODUCTS EXCLUDING ICE CREAM, ICE MILK AND FROZEN YOGURT; EDIBLE OILS AND FATS; MEAT SPREADS, PASTES AND PATE; PICKLES AND SALADS, NAMELY, GARDEN SALADS AND SALADS CONSISTING PRIMARILY OF MEAT; SOUP AND SOUP PREPARATIONS; PREPARED CHILLED MEALS CONSISTING PRIMARILY OF MEAT, FISH, POULTRY OR VEGETABLES; PREPARED FOODS, NAMELY, PREPARED MEALS CONSISTING PRIMARILY OF MEAT, FISH, POULTRY OR VEGETABLES; CHILLED, FROZEN AND AMBIENT FOOD PRODUCTS, NAMELY, MEALS CONSISTING PRIMARILY OF MEAT, FISH, POULTRY OR VEGETABLES, SOUPS, STEWS, CHOWDERS, DIPS, SNACK DIPS, YORKSHIRE PUDDING, POTATO SALAD, MEAT-BASED SPREADS; FRUIT SAUCES, NAMELY, CRANBERRY SAUCE (U.S. CL. 46).

**CLASS 30—STAPLE FOODS**

FOR FLOUR, PASTRY; CONFECTIONARY, NAMELY, CHOCOLATE CONFECTIONS, CONFECTIONERY MADE OF SUGAR; COFFEE, TEA AND COCOA; BREAD, BISCUITS, CAKES, PASTRIES, PUDDINGS AND DESSERTS, NAMELY, BAKERY DESSERTS, CHEESECAKE, PIES, DESSERT PUDDINGS; CUSTARD; YEAST, BAKING POWDER; SEASONINGS, SPICES, SALT, MUSTARD, VINEGAR; DRESSINGS FOR SALAD; SAUCES, RELISH, CHUTNEYS; SUGAR; HONEY, TREA-CLE, MOLASSES; RICE, PASTA, PASTA MEALS, NAMELY, PACKAGED MEAL KITS CONSISTING PRIMARILY OF PASTA; MEAT GRAVIES, MEAT PIES AND PASTIES; FLANS, QUICHES, PIZZA; SANDWICHES, PREPARED MEALS AND SNACKS, NAMELY, PREPARED MEALS CONSISTING PRIMARILY OF PASTA OR RICE; FRUIT SAUCES EXCLUDING CRANBERRY SAUCES AND APPLESAUCE; CHILLED, FROZEN AND AMBIENT FOOD PRODUCTS, NAMELY, FROZEN CONFECTIONERY, NON-DAIRY FROZEN CONFECTIONS, CHILLED GRAVIES, POT PIES, SUSHI; SALADS, NAMELY, MACARONI SALADS, PASTA SALAD; COOKING SAUCES; PASTA SAUCES; CHILLED SAUCES; MALT FOR FOOD PURPOSES (U.S. CL. 46).

**CLASS 31—NATURAL AGRICULTURAL PRODUCTS**

FOR FRESH FRUIT AND VEGETABLES (U.S. CLS. 1 AND 46).

**CLASS 32—LIGHT BEVERAGES**

FOR NON ALCOHOLIC BEVERAGES, NAMELY, SOFT DRINKS; MINERAL WATER; CARBONATED BEVERAGES; FRUIT JUICES AND VEGETABLE JUICES (U.S. CLS. 45, 46 AND 48).

**CLASS 39—TRANSPORTATION AND STORAGE**

FOR DELIVERY AND WAREHOUSING SERVICES FOR FOOD PRODUCTS (U.S. CLS. 100 AND 105).  
ALLISON SCHRODY, EXAMINING ATTORNEY

SN 85-192,910. HARMONY HEALTH & BEAUTY, INC., PURCHASE, NY, FILED 12-8-2010.

## HARMONY HEALTH & BEAUTY

THE MARK CONSISTS OF STANDARD CHARACTERS WITHOUT CLAIM TO ANY PARTICULAR FONT, STYLE, SIZE, OR COLOR.

NO CLAIM IS MADE TO THE EXCLUSIVE RIGHT TO USE "HEALTH & BEAUTY", APART FROM THE MARK AS SHOWN.

**CLASS 3—COSMETICS AND CLEANING PREPARATIONS**

FOR COSMETIC FACIAL BLOTTER PAPERS; COSMETIC SOAPS; COSMETICS; EYE MAKE-UP REMOVER; FACE AND BODY CREAMS; FACE AND BODY LOTIONS; FACIAL BEAUTY MASKS; FACIAL MAKE-UP; FRAGRANCES; NAIL POLISH; NON-MEDICATED CLEANSERS FOR PERSONAL USE, NAMELY, SKIN CLEANSERS AND FACIAL CLEANSERS (U.S. CLS. 1, 4, 6, 50, 51 AND 52).

**CLASS 4—LUBRICANTS AND FUELS**

FOR CANDLES (U.S. CLS. 1, 6 AND 15).



**CLASS 18—LEATHER GOODS**

FOR COSMETIC BAGS SOLD EMPTY (U.S. CLS. 1, 2, 3, 22 AND 41).

**CLASS 21—HOUSEWARES AND GLASS**

FOR COSMETIC BRUSHES; FACIAL CLEANSING SPONGES; HAIRBRUSHES; SPONGES USED FOR APPLYING MAKEUP (U.S. CLS. 2, 13, 23, 29, 30, 33, 40 AND 50).

**CLASS 35—ADVERTISING AND BUSINESS**

FOR RETAIL STORE AND ON-LINE RETAIL STORE SERVICES FEATURING HEALTH AND BEAUTY PRODUCTS (U.S. CLS. 100, 101 AND 102).

FIRST USE 10-0-2010; IN COMMERCE 12-1-2010.  
JACQUELINE A. LAVINE, EXAMINING ATTORNEY

SN 85-192,981. CRODA, INC., EDISON, NJ. FILED 12-8-2010.

**VIBRANCE FACTOR**

THE MARK CONSISTS OF STANDARD CHARACTERS WITHOUT CLAIM TO ANY PARTICULAR FONT, STYLE, SIZE, OR COLOR.

**CLASS 1—CHEMICALS**

FOR CHEMICALS FOR USE IN INDUSTRY AND SCIENCE (U.S. CLS. 1, 5, 6, 10, 26 AND 46).

**CLASS 3—COSMETICS AND CLEANING PREPARATIONS**

FOR COSMETIC PREPARATIONS; TOILET SOAPS AND TOILET WATER; SOAPS FOR PERSONAL USE; PERFUMERY; AND ESSENTIAL OILS (U.S. CLS. 1, 4, 6, 50, 51 AND 52).

**CLASS 42—SCIENTIFIC AND COMPUTER SERVICES**

FOR SCIENTIFIC AND INDUSTRIAL ANALYSIS AND RESEARCH SERVICES; MATERIAL TESTING; AND CHEMICAL TESTING (U.S. CLS. 100 AND 101).  
DARRYL SPRUILL, EXAMINING ATTORNEY

SN 85-193,178. INTUIT INC., MOUNTAIN VIEW, CA. FILED 12-8-2010.

**INTUIT PAYTRENDS**

THE MARK CONSISTS OF STANDARD CHARACTERS WITHOUT CLAIM TO ANY PARTICULAR FONT, STYLE, SIZE, OR COLOR.

OWNER OF U.S. REG. NOS. 1,821,148, 3,850,588 AND OTHERS.

NO CLAIM IS MADE TO THE EXCLUSIVE RIGHT TO USE "PAYTRENDS", APART FROM THE MARK AS SHOWN.

**CLASS 35—ADVERTISING AND BUSINESS**

FOR PROVIDING ONLINE BUSINESS INFORMATION AND STATISTICS TO COMPARE WAGES AND BENEFITS; PROVIDING ONLINE BUSINESS INFORMATION IN THE FIELD OF WAGES AND BENEFITS; PROVIDING ONLINE INFORMATION IN THE NATURE OF PERCENTILE DISTRIBUTIONS OF HOURLY WAGES AND ANNUAL WAGES FOR JOBS AT GIVEN GEOGRAPHICAL LOCATIONS; PROVIDING ONLINE BUSINESS INFORMATION IN THE FIELD OF WAGES AND BENEFITS FOR EMPLOYERS TO MAKE INFORMED PAY DECISIONS (U.S. CLS. 100, 101 AND 102).

**CLASS 36—INSURANCE AND FINANCIAL**

FOR PROVIDING ONLINE INFORMATION AND STATISTICS TO COMPARE HEALTHCARE AND INSURANCE BENEFITS; PROVIDING ONLINE FINANCIAL INFORMATION AND STATISTICS TO COMPARE WAGES AND BENEFITS; PROVIDING ONLINE INFORMATION IN THE FIELD OF INSURANCE BENEFITS; PROVIDING ONLINE FINANCIAL INFORMATION IN THE FIELD OF WAGES AND BENEFITS; PROVIDING ONLINE INFORMATION IN THE FIELD OF INSURANCE BENEFITS FOR EMPLOYERS TO MAKE INFORMED PAY DECISIONS; PROVIDING ONLINE FINANCIAL INFORMATION IN THE FIELD OF WAGES AND BENEFITS FOR EMPLOYERS TO MAKE INFORMED PAY DECISIONS (U.S. CLS. 100, 101 AND 102).

**CLASS 42—SCIENTIFIC AND COMPUTER SERVICES**

FOR PROVIDING TEMPORARY USE OF AN ONLINE NON-DOWNLOADABLE SOFTWARE TOOL FOR USE IN COMPARING WAGES AND BENEFITS; PROVIDING TEMPORARY USE OF AN ONLINE NON-DOWNLOADABLE SOFTWARE TOOL FOR USE IN OBTAINING INFORMATION ON WAGES AND BENEFITS; PROVIDING TEMPORARY USE OF AN ONLINE NON-DOWNLOADABLE SOFTWARE TOOL TO COMPARE PERCENTILE DISTRIBUTIONS OF HOURLY WAGES AND ANNUAL WAGES FOR JOBS AT GIVEN GEOGRAPHICAL LOCATIONS; PROVIDING TEMPORARY USE OF AN ONLINE NON-DOWNLOADABLE SOFTWARE TOOL FOR USE BY EMPLOYERS TO MAKE INFORMED PAY DECISIONS (U.S. CLS. 100 AND 101).  
APRIL ROACH, EXAMINING ATTORNEY

SN 85-194,445. GOAL ZERO LLC, BLUFFDALE, UT. FILED 12-9-2010.

**ESCAPE**

THE MARK CONSISTS OF STANDARD CHARACTERS WITHOUT CLAIM TO ANY PARTICULAR FONT, STYLE, SIZE, OR COLOR.

**CLASS 9—ELECTRICAL AND SCIENTIFIC APPARATUS**

FOR BATTERIES; SOLAR PANELS FOR PRODUCTION OF ELECTRICITY (U.S. CLS. 21, 23, 26, 36 AND 38).

FIRST USE 10-0-2009; IN COMMERCE 2-0-2010.

**CLASS 11—ENVIRONMENTAL CONTROL APPARATUS**

FOR LAMPS (U.S. CLS. 13, 21, 23, 31 AND 34).

FIRST USE 10-0-2009; IN COMMERCE 2-0-2010.  
KELLY TRUSILO, EXAMINING ATTORNEY

SN 85-194,607. CLEAN ENERGY, SEAL BEACH, CA. FILED 12-9-2010.

SN 85-195,259. AMERICAN SAIL TRAINING ASSOCIATION, NEWPORT, RI. FILED 12-10-2010.

## SAFE FILL

THE MARK CONSISTS OF STANDARD CHARACTERS WITHOUT CLAIM TO ANY PARTICULAR FONT, STYLE, SIZE, OR COLOR.

### CLASS 35—ADVERTISING AND BUSINESS

FOR RETAIL GASOLINE SUPPLY SERVICES FEATURING ALTERNATIVE FUELS (U.S. CLS. 100, 101 AND 102).

### CLASS 37—CONSTRUCTION AND REPAIR

FOR AUTOMOBILE SERVICE STATION SERVICES (U.S. CLS. 100, 103 AND 106).  
REBECCA SMITH, EXAMINING ATTORNEY

---

SN 85-194,890. CHEMETALL GMBH, FRANKFURT, FED REP GERMANY, FILED 12-10-2010.

## GARDOMER

THE MARK CONSISTS OF STANDARD CHARACTERS WITHOUT CLAIM TO ANY PARTICULAR FONT, STYLE, SIZE, OR COLOR.

OWNER OF FED REP GERMANY REG. NO. 30720275, DATED 5-11-2007, EXPIRES 3-31-2017.

### CLASS 1—CHEMICALS

FOR CHEMICALS FOR USE IN THE MANUFACTURE OF METAL, NAMELY, POLYMER EMULSIONS AND NON-COLORANT DISPERSIONS BASED ON POLYMERS OR POLYAMIDES, POLYIMIDES, POLYURETHANES AND POLYOLEFINS, NAMELY, POLYETHYLENE AND POLYPROPYLENE (U.S. CLS. 1, 5, 6, 10, 26 AND 46).

### CLASS 2—PAINTS

FOR PAINTS, VARNISHES, LACQUERS, CORROSION INHIBITANTS IN THE NATURE OF A COATING, ALL WITH A POLYMER BASE CONSISTING OF POLYAMIDES, POLYIMIDES, POLYURETHANES AND POLYOLEFINS, NAMELY, POLYETHYLENE AND POLYPROPYLENE FOR METALS (U.S. CLS. 6, 11 AND 16).

### CLASS 4—LUBRICANTS AND FUELS

FOR INDUSTRIAL LUBRICANTS, NAMELY, EMULSIONS AND DISPERSIONS BOTH WITH A POLYMER BASE CONSISTING OF POLYAMIDES, POLYIMIDES, POLYURETHANES AND POLYOLEFINS, NAMELY, POLYETHYLENE AND POLYPROPYLENE FOR METAL FORMING (U.S. CLS. 1, 6 AND 15).  
YAT SYE, LEE, EXAMINING ATTORNEY

## TALL SHIPS

THE MARK CONSISTS OF STANDARD CHARACTERS WITHOUT CLAIM TO ANY PARTICULAR FONT, STYLE, SIZE, OR COLOR.

OWNER OF U.S. REG. NOS. 1,053,408, 2,413,069 AND OTHERS.

### CLASS 16—PAPER GOODS AND PRINTED MATTER

FOR POSTERS, SERIES OF BOOKS AND PAMPHLETS ON THE SUBJECT OF SAILING (U.S. CLS. 2, 5, 22, 23, 29, 37, 38 AND 50).

### CLASS 21—HOUSEWARES AND GLASS

FOR MUGS, PLATES, DRINKING GLASSES (U.S. CLS. 2, 13, 23, 29, 30, 33, 40 AND 50).

### CLASS 25—CLOTHING

FOR CLOTHING, NAMELY, CAPS, SHIRTS, T-SHIRTS, SWEAT SHIRTS, AND HATS (U.S. CLS. 22 AND 39).

### CLASS 35—ADVERTISING AND BUSINESS

FOR RETAIL AND ONLINE RETAIL STORE SERVICES FEATURING DVDS, JEWELRY, POSTERS, BOOKS, CALENDARS, PAMPHLETS, MUGS, PLATES, DRINKING GLASSES, CLOTHING, MAGNETS, PENS, KEY CHAINS, STUFFED ANIMALS, BLANKETS, FLAGS, LAP THROWS, TOYS, MODEL SHIPS, TOTE BAGS, BAGS, AND LAPEL PINS (U.S. CLS. 100, 101 AND 102).

GIANCARLO CASTRO, EXAMINING ATTORNEY

---

SN 85-195,405. THE PRUDENTIAL INSURANCE COMPANY OF AMERICA, NEWARK, NJ. FILED 12-10-2010.

## BORROWERCONNECT

THE MARK CONSISTS OF STANDARD CHARACTERS WITHOUT CLAIM TO ANY PARTICULAR FONT, STYLE, SIZE, OR COLOR.

### CLASS 36—INSURANCE AND FINANCIAL

FOR MORTGAGE BANKING SERVICES, NAMELY, ELECTRONIC LOAN ORIGINATION SERVICES AND SERVICING OF MORTGAGE LOANS; ASSET MANAGEMENT SERVICES, NAMELY, FINANCIAL ASSET AND INVESTMENT MANAGEMENT SERVICES; PAYMENT MANAGEMENT, NAMELY, BILL PAYMENT SERVICES PROVIDED THROUGH A WEBSITE (U.S. CLS. 100, 101 AND 102).  
FIRST USE 10-0-2004; IN COMMERCE 10-0-2004.

**CLASS 41—EDUCATION AND ENTERTAINMENT**

FOR DOCUMENT MANAGEMENT, NAMELY, PROVIDING ON-LINE DOCUMENTS FOR APPLICATIONS CONCERNING LOANS (U.S. CLS. 100, 101 AND 107).  
FIRST USE 10-0-2004; IN COMMERCE 10-0-2001.

**CLASS 42—SCIENTIFIC AND COMPUTER SERVICES**

FOR DOCUMENT MANAGEMENT, NAMELY, ON-LINE, NON-DOWNLOADABLE SOFTWARE FOR DOCUMENT MANAGEMENT OF LOANS (U.S. CLS. 100 AND 101).  
FIRST USE 10-0-2004; IN COMMERCE 10-0-2004.  
MARK SHINER, EXAMINING ATTORNEY

---

SN 85-195,796. EYELEVEL INTERACTIVE, LLC, GREENSBORO, GA. FILED 12-11-2010.

**MADE BANK**

THE MARK CONSISTS OF STANDARD CHARACTERS WITHOUT CLAIM TO ANY PARTICULAR FONT, STYLE, SIZE, OR COLOR.

NO CLAIM IS MADE TO THE EXCLUSIVE RIGHT TO USE "BANK", APART FROM THE MARK AS SHOWN.

**CLASS 9—ELECTRICAL AND SCIENTIFIC APPARATUS**

FOR WIRELESS COMMUNICATION SOFTWARE TO ALLOW CUSTOMERS TO ACCESS BANK AND BUSINESS ACCOUNT INFORMATION AND TRANSACT BANK BUSINESS AND ELECTRONIC TRANSACTIONS (U.S. CLS. 21, 23, 26, 36 AND 38).

**CLASS 38—COMMUNICATION**

FOR WIRELESS ELECTRONIC TRANSMISSION OF VOICE SIGNALS, DATA, FACSIMILES, IMAGES AND INFORMATION, NAMELY, PROVIDING WIRELESS INTERACTION BETWEEN MOBILE ACTION CODES (MAC'S), HANDHELD MOBILE DEVICES AND AN INTERNET BASED WEB PAGE (U.S. CLS. 100, 101 AND 104).

SKYE YOUNG, EXAMINING ATTORNEY

---

SN 85-196,365. CAMPERO INTERNATIONAL LIMITED, BARBADOS, BARBADOS, FILED 12-13-2010.



OWNER OF U.S. REG. NOS. 1,783,043, 3,508,553 AND OTHERS.

NO CLAIM IS MADE TO THE EXCLUSIVE RIGHT TO USE "POLLO" FOR INTERNATIONAL CLASSES 29, 35 AND 43, APART FROM THE MARK AS SHOWN.

THE COLOR(S) BROWN AND GOLD IS/ARE CLAIMED AS A FEATURE OF THE MARK.

THE MARK CONSISTS OF THE WORD "POLLO" IN GOLD AND OUTLINED IN BROWN WITH THE WORD "CAMPERO" IN BROWN OUTLINED IN GOLD.

THE ENGLISH TRANSLATION OF "POLLO CAMPERO" IN THE MARK IS "COUNTRY CHICKEN".

**CLASS 29—MEATS AND PROCESSED FOODS**

FOR COOKED POULTRY, COLE SLAW, PROCESSED POTATOES, SALADS, NAMELY, VEGETABLE SALADS, GARDEN SALADS, PROCESSED BEANS, COOKED VEGETABLES, FRENCH FRIED POTATOES, AND PREPARED ENTREES CONSISTING OF POULTRY OR VEGETABLES (U.S. CL. 46).

**CLASS 30—STAPLE FOODS**

FOR BREADS, PASTRIES, SALSA, GRAIN-BASED BEVERAGES, AND BAKERY DESSERTS (U.S. CL. 46).

**CLASS 32—LIGHT BEVERAGES**

FOR BEVERAGES, NAMELY, FRUIT DRINKS, FRUIT PUNCH, LEMONADE AND DRINKING WATER (U.S. CLS. 45, 46 AND 48).

**CLASS 35—ADVERTISING AND BUSINESS**

FOR RESTAURANT FRANCHISING, NAMELY, OFFERING BUSINESS MANAGEMENT ASSISTANCE IN THE ESTABLISHMENT AND/OR OPERATION OF RESTAURANTS (U.S. CLS. 100, 101 AND 102).

**CLASS 43—HOTEL AND RESTAURANT SERVICES**

FOR RESTAURANT SERVICES (U.S. CLS. 100 AND 101).

SARA BENJAMIN, EXAMINING ATTORNEY

---

SN 85-196,423. BETHANY HAMILTON, PRINCEVILLE, HI. FILED 12-13-2010.

**SOUL SURFER**

THE MARK CONSISTS OF STANDARD CHARACTERS WITHOUT CLAIM TO ANY PARTICULAR FONT, STYLE, SIZE, OR COLOR.

**CLASS 9—ELECTRICAL AND SCIENTIFIC APPARATUS**

FOR DVDS FEATURING FICTION AND NON-FICTION STORIES AND ADVICE CONCERNING OVERCOMING ADVERSITY AND FAITH, DIGITAL MEDIA, NAMELY, CDS FEATURING FICTION AND NON-FICTION STORIES AND ADVICE CONCERNING OVERCOMING ADVERSITY AND FAITH, AUDIO CASSETTES FEATURING FICTION AND NON-FICTION STORIES AND ADVICE CONCERNING OVERCOMING ADVERSITY AND FAITH, DOWNLOADABLE MP3 FILES AND MP3 RECORDINGS FEATURING FICTION AND NON-FICTION STORIES AND ADVICE CONCERNING OVERCOMING ADVERSITY AND FAITH (U.S. CLS. 21, 23, 26 AND 38).

**CLASS 16—PAPER GOODS AND PRINTED MATTER**

FOR POSTERS, SURFBOARD LAMINATED DECALS, BUMPER STICKERS, APPLIQUES IN THE NATURE OF IRON-ON TRANSFERS (U.S. CLS. 2, 5, 22, 23, 29, 37, 38 AND 50).

ANNE E. GUSTASON, EXAMINING ATTORNEY

SN 85-196,605. CAMPERO INTERNATIONAL LIMITED, BARBADOS, BARBADOS, FILED 12-13-2010.



SN 85-196,482. CAMPERO INTERNATIONAL LIMITED, BARBADOS, BARBADOS, FILED 12-13-2010.



OWNER OF U.S. REG. NOS. 1,783,043, 3,508,553 AND OTHERS.

NO CLAIM IS MADE TO THE EXCLUSIVE RIGHT TO USE "POLLO" FOR INTERNATIONAL CLASSES 29, 35 AND 43, APART FROM THE MARK AS SHOWN.

THE MARK CONSISTS OF A RECTANGLE WITH LINES INSIDE OF IT FORMING THE LETTERS "PC" AND A CHICKEN, WITH OTHER LINES FORMING ABSTRACT DESIGNS WITHIN THE RECTANGLE. TO THE LEFT AND BELOW THE RECTANGLE DESIGN ARE THE WORDS "POLLO CAMPERO".

THE ENGLISH TRANSLATION OF "POLLO CAMPERO" IN THE MARK IS "COUNTRY CHICKEN".

**CLASS 29—MEATS AND PROCESSED FOODS**

FOR COOKED POULTRY, COLE SLAW, PROCESSED POTATOES, SALADS, NAMELY, VEGETABLE SALADS, GARDEN SALADS, PROCESSED BEANS, COOKED VEGETABLES, FRENCH FRIED POTATOES, AND PREPARED ENTREES CONSISTING OF POULTRY OR VEGETABLES (U.S. CL. 46).

**CLASS 30—STAPLE FOODS**

FOR BREADS, PASTRIES, SALSA, GRAIN-BASED BEVERAGES, AND BAKERY DESSERTS (U.S. CL. 46).

**CLASS 32—LIGHT BEVERAGES**

FOR BEVERAGES, NAMELY, FRUIT DRINKS, FRUIT PUNCH, LEMONADE AND DRINKING WATER (U.S. CLS. 45, 46 AND 48).

**CLASS 35—ADVERTISING AND BUSINESS**

FOR RESTAURANT FRANCHISING, NAMELY, OFFERING BUSINESS MANAGEMENT ASSISTANCE IN THE ESTABLISHMENT AND/OR OPERATION OF RESTAURANTS (U.S. CLS. 100, 101 AND 102).

**CLASS 43—HOTEL AND RESTAURANT SERVICES**

FOR RESTAURANT SERVICES (U.S. CLS. 100 AND 101).

SARA BENJAMIN, EXAMINING ATTORNEY

OWNER OF U.S. REG. NOS. 1,783,043, 3,508,553 AND OTHERS.

NO CLAIM IS MADE TO THE EXCLUSIVE RIGHT TO USE "POLLO" FOR INTERNATIONAL CLASSES 29, 35 AND 43, APART FROM THE MARK AS SHOWN.

THE MARK CONSISTS OF A RECTANGLE WITH LINES INSIDE OF IT FORMING THE LETTERS "PC" AND A CHICKEN, WITH OTHER LINES FORMING ABSTRACT DESIGNS WITHIN THE RECTANGLE. TO THE RIGHT OF THE RECTANGLE DESIGN ARE THE WORDS "POLLO CAMPERO".

THE ENGLISH TRANSLATION OF "POLLO CAMPERO" IN THE MARK IS "COUNTRY CHICKEN".

**CLASS 29—MEATS AND PROCESSED FOODS**

FOR COOKED POULTRY, COLE SLAW, PROCESSED POTATOES, SALADS, NAMELY, VEGETABLE SALADS, GARDEN SALADS, PROCESSED BEANS, COOKED VEGETABLES, FRENCH FRIED POTATOES, AND PREPARED ENTREES CONSISTING OF POULTRY OR VEGETABLES (U.S. CL. 46).

**CLASS 30—STAPLE FOODS**

FOR BREADS, PASTRIES, SALSA, GRAIN-BASED BEVERAGES, AND BAKERY DESSERTS (U.S. CL. 46).

**CLASS 32—LIGHT BEVERAGES**

FOR BEVERAGES, NAMELY, FRUIT DRINKS, FRUIT PUNCH, LEMONADE AND DRINKING WATER (U.S. CLS. 45, 46 AND 48).

**CLASS 35—ADVERTISING AND BUSINESS**

FOR RESTAURANT FRANCHISING, NAMELY, OFFERING BUSINESS MANAGEMENT ASSISTANCE IN THE ESTABLISHMENT AND/OR OPERATION OF RESTAURANTS (U.S. CLS. 100, 101 AND 102).

**CLASS 43—HOTEL AND RESTAURANT SERVICES**

FOR RESTAURANT SERVICES (U.S. CLS. 100 AND 101).

SARA BENJAMIN, EXAMINING ATTORNEY

SN 85-196,617. DMG EVENTS (USA) INC., STAMFORD, CT. FILED 12-13-2010.

**DMG :: EVENTS**

THE MARK CONSISTS OF STANDARD CHARACTERS WITHOUT CLAIM TO ANY PARTICULAR FONT, STYLE, SIZE, OR COLOR.

NO CLAIM IS MADE TO THE EXCLUSIVE RIGHT TO USE "EVENTS", APART FROM THE MARK AS SHOWN.

**CLASS 35—ADVERTISING AND BUSINESS**

FOR ORGANIZING EXHIBITIONS AND TRADE FAIRS FOR COMMERCIAL AND ADVERTISING PURPOSES IN THE FIELDS OF HOME DESIGN, HOME DECORATING, FURNITURE, GIFTS, ART, ANTIQUES, SPORTS AND LEISURE, BUILDING AND CONSTRUCTION, NATURAL RESOURCES AND ENERGY, TRAVEL, HOSPITALITY SERVICES, HOUSEWARES, OFFICE SOLUTIONS, INFORMATION TECHNOLOGY, FINANCE, HUMAN RESOURCES, INTERACTIVE MEDIA AND MARKETING, ADVERTISING, MEDIA AND ENTERTAINMENT; PROMOTING THE GOODS AND SERVICES OF OTHERS BY PROVIDING HYPERTEXT LINKS TO THE WEBSITES OF OTHERS (U.S. CLS. 100, 101 AND 102).

FIRST USE 4-0-2010; IN COMMERCE 4-0-2010.

**CLASS 41—EDUCATION AND ENTERTAINMENT**

FOR EDUCATIONAL SERVICES, NAMELY, ARRANGING AND CONDUCTING OF COLLOQUIUMS, CONFERENCES CONGRESSES, SEMINARS, SYMPOSIUMS AND WORKSHOPS IN THE FIELDS OF HOME DESIGN, HOME DECORATING, FURNITURE, GIFTS, ART, ANTIQUES, SPORTS AND LEISURE, BUILDING AND CONSTRUCTION, NATURAL RESOURCES AND ENERGY, TRAVEL, HOSPITALITY SERVICES, HOUSEWARES, OFFICE SOLUTIONS, INFORMATION TECHNOLOGY, FINANCE, HUMAN RESOURCES, INTERACTIVE MEDIA AND MARKETING, ADVERTISING, MEDIA AND ENTERTAINMENT; ENTERTAINMENT SERVICES, NAMELY, ORGANIZING EXHIBITIONS FOR CULTURAL AND EDUCATIONAL PURPOSES IN THE FIELDS OF HOME DESIGN, HOME DECORATING, FURNITURE, GIFTS, ART, ANTIQUES, SPORTS AND LEISURE, BUILDING AND CONSTRUCTION, NATURAL RESOURCES AND ENERGY, TRAVEL, HOSPITALITY SERVICES, HOUSEWARES, OFFICE SOLUTIONS, INFORMATION TECHNOLOGY, FINANCE, HUMAN RESOURCES, INTERACTIVE MEDIA AND MARKETING, ADVERTISING, MEDIA AND ENTERTAINMENT (U.S. CLS. 100, 101 AND 107).

FIRST USE 4-0-2010; IN COMMERCE 4-0-2010.  
ALLISON HOLTZ, EXAMINING ATTORNEY

SN 85-196,710. CAMPERO INTERNATIONAL LIMITED, BARBADOS, BARBADOS, FILED 12-13-2010.



FRESH LATIN FLAVORS

OWNER OF U.S. REG. NOS. 1,783,043, 3,508,553 AND OTHERS.

NO CLAIM IS MADE TO THE EXCLUSIVE RIGHT TO USE "POLLO" AND "FRESH LATIN FLAVORS" FOR INTERNATIONAL CLASS 43, APART FROM THE MARK AS SHOWN.

THE MARK CONSISTS OF A RECTANGLE WITH LINES INSIDE OF IT FORMING THE LETTERS "PC" AND A CHICKEN, WITH OTHER LINES FORMING ABSTRACT DESIGNS WITHIN THE RECTANGLE. TO THE RIGHT OF THE RECTANGLE DESIGN ARE THE WORDS "POLLO CAMPERO" OVER THE WORDS "FRESH LATIN FLAVORS".

THE ENGLISH TRANSLATION OF "POLLO CAMPERO" IN THE MARK IS "COUNTRY CHICKEN".

**CLASS 25—CLOTHING**

FOR MEN'S AND WOMEN'S SPORTSWEAR AND ACTIVE WEAR; NAMELY, JACKETS, HATS, KNIT SHIRTS, DRESS SHIRTS, SPORT SHIRTS, T-SHIRTS, SHORTS AND PANTS (U.S. CLS. 22 AND 39).

**CLASS 43—HOTEL AND RESTAURANT SERVICES**

FOR RESTAURANT SERVICES (U.S. CLS. 100 AND 101).

SARA BENJAMIN, EXAMINING ATTORNEY

SN 85-196,726. BETHANY HAMILTON, PRINCEVILLE, HI. FILED 12-13-2010.

**SOUL SURFER**

THE MARK CONSISTS OF STANDARD CHARACTERS WITHOUT CLAIM TO ANY PARTICULAR FONT, STYLE, SIZE, OR COLOR.

**CLASS 16—PAPER GOODS AND PRINTED MATTER**

FOR SERIES OF NON-FICTION AND FICTION BOOKS IN THE FIELD OF LIFE, EXPERIENCE AND ADVICE, DEVOTIONALS IN THE FIELD OF LIFE, EXPERIENCE AND ADVICE (U.S. CLS. 2, 5, 22, 23, 29, 37, 38 AND 50).

FIRST USE 10-31-2005; IN COMMERCE 10-31-2005.

**CLASS 41—EDUCATION AND ENTERTAINMENT**

FOR EDUCATIONAL AND ENTERTAINMENT SERVICES, NAMELY, PROVIDING MOTIVATIONAL AND EDUCATIONAL SPEAKERS IN THE FIELD OF OVERCOMING ADVERSITY AND FAITH (U.S. CLS. 100, 101 AND 107).

FIRST USE 10-31-2005; IN COMMERCE 10-31-2005.  
ANNE E. GUSTASON, EXAMINING ATTORNEY

SN 85-196,967. CUBILLO, ENRIQUE G., NEW YORK, NY. FILED 12-13-2010.

**Stand Up Spike**

THE MARK CONSISTS OF STANDARD CHARACTERS WITHOUT CLAIM TO ANY PARTICULAR FONT, STYLE, SIZE, OR COLOR.

**CLASS 28—TOYS AND SPORTING GOODS**

FOR SKATEBOARDS (U.S. CLS. 22, 23, 38 AND 50).

**CLASS 41—EDUCATION AND ENTERTAINMENT**

FOR ARRANGING AND CONDUCTING ATHLETIC COMPETITIONS (U.S. CLS. 100, 101 AND 107).

JERI J. FICKES, EXAMINING ATTORNEY

SN 85-198,040. ESTORA PRODUCTS COMPANY, LLC, INDIANAPOLIS, IN. FILED 12-15-2010.

# ESTORA

THE MARK CONSISTS OF STANDARD CHARACTERS WITHOUT CLAIM TO ANY PARTICULAR FONT, STYLE, SIZE, OR COLOR.

## CLASS 11—ENVIRONMENTAL CONTROL APPARATUS

FOR BATHROOM LIGHTING FIXTURES AND PARTS AND FITTINGS THEREFOR (U.S. CLS. 13, 21, 23, 31 AND 34).

## CLASS 20—FURNITURE AND ARTICLES NOT OTHERWISE CLASSIFIED

FOR MIRRORS; NON-METAL CABINETS AND PARTS THEREFOR; NON-METAL CABINET TOPS; NON-METAL DOORS FOR CABINETS (U.S. CLS. 2, 13, 22, 25, 32 AND 50).

## CLASS 21—HOUSEWARES AND GLASS

FOR SHOWER CADDIES (U.S. CLS. 2, 13, 23, 29, 30, 33, 40 AND 50).  
SUSAN RICHARDS, EXAMINING ATTORNEY

SN 85-198,951. ADVANCED INGREDIENTS, INC., CAPITOLA, CA. FILED 12-15-2010.



## ADVANCED INGREDIENTS

NO CLAIM IS MADE TO THE EXCLUSIVE RIGHT TO USE "INGREDIENTS", APART FROM THE MARK AS SHOWN.

THE MARK CONSISTS OF THE LETTERS "AI" INSIDE AN OVAL WITH A BORDER ALONGSIDE THE WORDS "ADVANCED INGREDIENTS".

## CLASS 1—CHEMICALS

FOR FOOD PRESERVATIVE COMPOSITION USED AS AN INGREDIENT IN BAKERY GOODS TO ENHANCE MOISTURE RETENTION AND EXTEND SHELF LIFE; CHEMICAL COMPOUND, NAMELY, CARBOHYDRATE-BASED SYRUPS AND SOLIDS USED AS AN INGREDIENT IN BAKERY GOODS TO ENHANCE MOISTURE AND EXTEND SHELF LIFE; FOOD PRESERVATIVE COMPOSITION USED IN THE TREATMENT OF FRUIT TO ENHANCE FLAVOR AND EXTEND SHELF LIFE; FOOD PRESERVATIVE COMPOSITION USED IN THE TREATMENT OF MEAT AND MEAT PRODUCTS TO ENHANCE MOISTURE RETENTION AND EXTEND SHELF LIFE; DOUGH CONDITIONERS; DOUGH TEXTURIZERS; FOOD PRESERVATIVE COMPOSITION USED TO PREVENT SYNERESIS IN MEAT; FOOD PRESERVATIVE COMPOSITION USED AS AN INGREDIENT IN EXTRUDED BARS AND ENERGY BARS TO ENHANCE MOISTURE AND EXTEND SHELF LIFE; CHEMICAL PRODUCTS FOR THE FRESH-KEEPING AND PRESERVING OF FOOD; EMULSIFIERS FOR USE IN THE MANUFACTURE OF FOOD; FOOD PRESERVATIVE COMPOSITIONS; PRODUCE STABILIZER USED FOR PRESERVING FOODS (U.S. CLS. 1, 5, 6, 10, 26 AND 46).

FIRST USE 1-27-1997; IN COMMERCE 1-27-1997.

## CLASS 3—COSMETICS AND CLEANING PREPARATIONS

FOR COSMETICS; SKIN MOISTURIZER USED AS AN INGREDIENT IN COSMETICS (U.S. CLS. 1, 4, 6, 50, 51 AND 52).

FIRST USE 3-1-2007; IN COMMERCE 3-1-2007.

## CLASS 5—PHARMACEUTICALS

FOR DIETARY SUPPLEMENTS; NUTRACEUTICALS FOR USE AS A DIETARY SUPPLEMENT; NUTRIENT SUPPLEMENTS; ADDITIVE USED AS A BINDER AND EXCIPIENT IN DIETARY SUPPLEMENTS; INSECTICIDES FOR DOMESTIC AND AGRICULTURAL USE; CHEMICAL COMPOUND, NAMELY, CARBOHYDRATE-BASED MIXTURES DERIVED FROM SELECT FRUIT AND GRAIN OR SELECT FRUIT, GRAIN AND VEGETABLE SOURCES USED AS AN INGREDIENT IN INSECTICIDES (U.S. CLS. 6, 18, 44, 46, 51 AND 52).

FIRST USE 1-27-1997; IN COMMERCE 1-27-1997.

## CLASS 29—MEATS AND PROCESSED FOODS

FOR FAT SUBSTITUTE, NAMELY, A CARBOHYDRATE-BASED MIXTURE FOR USE AS AN INGREDIENT IN BAKED GOODS, COOKIES, CANDIES, COATINGS, FRUIT-BASED SNACKS, GRAIN-BASED SNACKS, ENERGY FOODS, AND BEVERAGES; EXTENDER IN THE NATURE OF A CARBOHYDRATE-BASED MIXTURE DERIVED FROM SELECT FRUIT AND GRAIN OR SELECT FRUIT, GRAIN AND VEGETABLE SOURCES USED IN MEAT, BAKERY GOODS AND FRUIT-BASED PRODUCTS TO REDUCE MOISTURE LOSS DURING PROCESSING OR BAKING TO INCREASE THE YIELDS OF FINISHED GOODS AND TO INCREASE YIELD AND CONTROL COSTS FOR MEAT, BAKERY GOODS AND FRUIT-BASED PRODUCTS; ADDITIVE IN THE NATURE OF A CARBOHYDRATE-BASED MIXTURE USED AS A BINDER IN MEAT AND MEAT PRODUCTS; EMULSIFIER FOR USE AS AN INGREDIENT IN THE MANUFACTURE OF BAKED GOODS, COOKIES, CANDIES, COATINGS, FRUIT-BASED SNACKS, GRAIN-BASED SNACKS, ENERGY FOODS, AND BEVERAGES; ADDITIVE IN THE NATURE OF A CARBOHYDRATE-BASED MIXTURE USED TO PREVENT RANCIDITY IN NUTS; ADDITIVE IN THE

NATURE OF A CARBOHYDRATE BASED MIXTURE OR EMULSIFIER USED TO PREVENT SYNERESIS IN SALAD DRESSINGS AND SAUCES; NON-MEDICATED INGREDIENTS OR ADDITIVES FOR USE IN FOOD, NAMELY, EXTRACTS OF FRUIT, VEGETABLES OR GRAINS AND ESSENCES OF FRUIT, VEGETABLES OR GRAINS; NON-MEDICATED INGREDIENTS OR ADDITIVES FOR USE AS INGREDIENTS IN NUTRITIONAL SUPPLEMENTS, NAMELY, EXTRACTS OF FRUIT, VEGETABLES OR GRAINS AND ESSENCES OF FRUIT, VEGETABLES OR GRAINS AND JUICES OF FRUITS AND VEGETABLES (U.S. CL. 46).

FIRST USE 1-27-1997; IN COMMERCE 1-27-1997.

**CLASS 30—STAPLE FOODS**

FOR NATURAL SWEETENERS; NATURAL SWEETENER FOR USE AS AN INGREDIENT IN BAKED GOODS, COOKIES, CANDIES, COATINGS, FRUIT BASED SNACKS, GRAIN BASED SNACKS, ENERGY FOODS, AND BEVERAGES; FRUIT BASED NATURAL SWEETENERS; INGREDIENT, NAMELY, FRUIT AND GRAIN-BASED NATURAL SWEETENER USED IN CHOCOLATE, CHOCOLATE SYRUP, CHOCOLATE PUD- DING, CHOCOLATE TOPPING, AND CHOCOLATE SPREAD; FOOD ADDITIVES FOR NON-NUTRITIONAL PURPOSES FOR USE AS A FLAVORING, INGREDIENT OR FILLER (U.S. CL. 46).

FIRST USE 1-27-1997; IN COMMERCE 1-27-1997.

**CLASS 40—MATERIAL TREATMENT**

FOR CUSTOM MANUFACTURE OF INGREDIENTS FOR FOOD PRODUCTS, NAMELY, BAKED GOODS, FROZEN FOODS AND PROCESSED FOOD PRODUCTS, DIETARY SUPPLEMENTS AND COSMETICS (U.S. CLS. 100, 103 AND 106).

FIRST USE 1-27-1997; IN COMMERCE 1-27-1997.

**CLASS 42—SCIENTIFIC AND COMPUTER SERVICES**

FOR PRODUCT RESEARCH AND DEVELOPMENT SERVICES FOR OTHERS IN THE FIELDS OF FOOD PRODUCTS; RESEARCH ON FOOD; SCIENTIFIC CON- SULTING AND RESEARCH SERVICES RELATING TO FOODS AND DIETARY SUPPLEMENTS; TECHNICAL CONSULTANCY IN RELATION TO RESEARCH SER- VICES RELATING TO FOODS AND DIETARY SUPPLE- MENTS; TECHNICAL CONSULTANCY IN RELATION TO THE TECHNICAL RESEARCH IN THE FIELD OF FOOD AND BEVERAGES; DESIGN, DEVELOPMENT, AND TESTING SERVICES FOR OTHERS IN THE FIELDS OF NEW FOOD PRODUCTS; PRODUCT RE- SEARCH AND DEVELOPMENT SERVICES FOR OTHERS IN THE FIELDS OF FOOD PRODUCTS; TECH- NICAL CONSULTANCY IN RELATION TO THE DEVEL- OPMENT OF TECHNOLOGIES AND TECHNICAL COMPONENTS FOR FOOD (U.S. CLS. 100 AND 101).

FIRST USE 1-27-1997; IN COMMERCE 1-27-1997.

GIANCARLO CASTRO, EXAMINING ATTORNEY

SN 85-199,000. BOTTOM LINE FOOD PROCESSORS, INC., DBA MICHAEL ANGELO'S GOURMET FOODS, INC., AUSTIN, TX. FILED 12-15-2010.

THE WAY WE'VE ALWAYS DONE  
IT

THE MARK CONSISTS OF STANDARD CHARACTERS WITHOUT CLAIM TO ANY PARTICULAR FONT, STYLE, SIZE, OR COLOR.

**CLASS 29—MEATS AND PROCESSED FOODS**

FOR PREPARED FROZEN ENTREES CONSISTING PRIMARILY OF POULTRY, MEATS OR COOKED VE- GETABLES WITH ONE OR MORE OF PASTAS, LASAG- NAS, SPAGHETTIS, NOODLES, RICE, TOMATO SAUCE, PIZZA SAUCE OR SPAGHETTI SAUCE (U.S. CL. 46).

FIRST USE 3-0-2011; IN COMMERCE 3-0-2011.

**CLASS 30—STAPLE FOODS**

FOR PREPARED FROZEN ENTREES CONSISTING PRIMARILY OF PASTAS, LASAGNAS, SPAGHETTIS, NOODLES, AND RICES WITH ONE OR MORE OF TOMATO SAUCE, PIZZA SAUCE, SPAGHETTI SAUCE, POULTRY, MEATS OR COOKED VEGETABLES (U.S. CL. 46).

FIRST USE 3-0-2011; IN COMMERCE 3-0-2011.

AMY C. KEAN, EXAMINING ATTORNEY

SN 85-199,109. C.O.R.E.X. S.P.A. S.S., SALERNO, ITALY, FILED 12-16-2010.

EMIDIO DI NOLA

THE MARK CONSISTS OF STANDARD CHARACTERS WITHOUT CLAIM TO ANY PARTICULAR FONT, STYLE, SIZE, OR COLOR.

THE NAME(S), PORTRAIT(S), AND/OR SIGNATURE(S) SHOWN IN THE MARK DOES NOT IDENTIFY A PARTI- CULAR LIVING INDIVIDUAL.

THE WORDING "EMIDIO DI NOLA" HAS NO MEANING IN A FOREIGN LANGUAGE.

**CLASS 29—MEATS AND PROCESSED FOODS**

FOR CANNED TOMATOES, OLIVE OIL, ANTIPASTO (U.S. CL. 46).

FIRST USE 1-1-2005; IN COMMERCE 1-1-2005.

**CLASS 30—STAPLE FOODS**

FOR PASTA SAUCES, PESTO, PASTAS, BALSAMIC VINEGAR (U.S. CL. 46).

FIRST USE 1-1-2005; IN COMMERCE 1-1-2005.

LINDA POWELL, EXAMINING ATTORNEY

SN 85-199,798. WORLD TRIATHLON CORPORATION, TAMPA, FL. FILED 12-16-2010.



OWNER OF U.S. REG. NOS. 2,908,850 AND 2,945,327.  
THE MARK CONSISTS OF A GRAPHICAL ELEMENT DEPICTING A FANCIFUL BUTTERFLY THAT MIGHT EVOKE A HUMAN FIGURE DOING A JUMPING JACK.

#### CLASS 5—PHARMACEUTICALS

FOR NUTRITIONAL FOOD BARS FOR USE AS A MEAL SUBSTITUTE; NUTRITIONAL SUPPLEMENTS IN GEL, BAR, POWDER AND LIQUID FORM; VITAMIN PREPARATIONS (U.S. CLS. 6, 18, 44, 46, 51 AND 52).

#### CLASS 29—MEATS AND PROCESSED FOODS

FOR PROTEIN BASED, NUTRIENT-DENSE SNACK BARS (U.S. CL. 46).

#### CLASS 30—STAPLE FOODS

FOR READY TO EAT CEREAL BASED FOOD BARS; GRAIN-BASED SNACK FOODS; SHAKES (U.S. CL. 46).

#### CLASS 32—LIGHT BEVERAGES

FOR SPORTS DRINKS IN LIQUID, POWDER OR CONCENTRATE FORM; FRUIT AND VEGETABLE JUICES AND ENERGY DRINKS; DRINKING WATER WITH VITAMINS, STILL WATER, SPRING WATER, MINERAL WATER, FLAVORED WATER, PROCESSED WATER, NAMELY, AERATED WATER, SPARKLING WATER; SOFT DRINKS; PROTEIN AND CARBOHYDRATE DRINKS FOR USE AS FOOD FILLERS AND NOT FOR USE AS MEAL REPLACEMENTS (U.S. CLS. 45, 46 AND 48).

RONALD DELGIZZI, EXAMINING ATTORNEY

SN 85-200,615. BOOKS FOR AFRICA, ST. PAUL, MN. FILED 12-17-2010.

#### LAW & DEMOCRACY INITIATIVE

THE MARK CONSISTS OF STANDARD CHARACTERS WITHOUT CLAIM TO ANY PARTICULAR FONT, STYLE, SIZE, OR COLOR.

NO CLAIM IS MADE TO THE EXCLUSIVE RIGHT TO USE "LAW" AND "INITIATIVE", APART FROM THE MARK AS SHOWN.

#### CLASS 35—ADVERTISING AND BUSINESS

FOR CHARITABLE SERVICES, NAMELY, COORDINATING THE PROCUREMENT AND DISTRIBUTION OF BOOKS AND OTHER EDUCATIONAL MATERIALS (U.S. CLS. 100, 101 AND 102).

FIRST USE 9-1-2008; IN COMMERCE 9-1-2008.

#### CLASS 36—INSURANCE AND FINANCIAL

FOR CHARITABLE FUNDRAISING SERVICES (U.S. CLS. 100, 101 AND 102).

FIRST USE 9-1-2008; IN COMMERCE 9-1-2008.

SUZANNE BLANE, EXAMINING ATTORNEY

SN 85-200,726. VOITH PATENT GMBH, HEIDENHEIM, FED REP GERMANY, FILED 12-17-2010.

# QuatConn

THE MARK CONSISTS OF STANDARD CHARACTERS WITHOUT CLAIM TO ANY PARTICULAR FONT, STYLE, SIZE, OR COLOR.

PRIORITY CLAIMED UNDER SEC. 44(D) ON ERPN CMNTY TM OFC APPLICATION NO. 009342478, FILED 8-31-2010, REG. NO. 009342478, DATED 2-10-2011, EXPIRES 8-31-2020.

#### CLASS 12—VEHICLES

FOR VEHICLES, IN PARTICULAR RAIL-MOUNTED VEHICLES, NAMELY, RAILCARS AND SUPERSTRUCTURES THEREFOR, NAMELY, UNDERCARRIAGES OF RAILWAY CARS, RAIL STANCHIONS; APPARATUS FOR LOCOMOTION BY LAND, AIR OR WATER, NAMELY, LOCOMOTIVES, RAILCARS, BOATS, AUTOMOBILES, TRUCKS, TRAILERS, BUSES, BOATS AND AIRPLANES; VEHICLE PARTS, NAMELY, JOINTS, NAMELY, CONSTANT VELOCITY JOINTS, KNUCKLE JOINTS, COUPLINGS FOR LAND VEHICLES, NAMELY, LOCOMOTIVES, RAILCARS, AUTOMOBILES, TRUCKS, TRAILERS AND BUSES IN PARTICULAR COUPLINGS FOR TENSION AND COMPRESSION STRESS, INCLUDING FOR AIR, STEAM, WATER AND POWER CONDUITS FOR LINKING TWO VEHICLES; COMPONENTS FOR RAIL-MOUNTED AND NON-RAIL-MOUNTED LAND VEHICLES, NAMELY, LOCOMOTIVES, RAILCARS, AUTOMOBILES, TRUCKS, TRAILERS AND BUSES IN PARTICULAR COUPLING DEVICES, NAMELY, COUPLINGS FOR POWER, ENERGY, MATERIAL, DATA AND ELECTRICITY TRANSFER, AND FOR AIR, STEAM, WATER AND FIBRE OPTIC CONDUITS BETWEEN LAND VEHICLES; STRUCTURAL PARTS FOR LOCOMOTIVES, RAILCARS, BOATS, AUTOMOBILES, TRUCKS, TRAILERS, AIRPLANES AND OTHER MOTOR VEHICLES (U.S. CLS. 19, 21, 23, 31, 35 AND 44).



**CLASS 37—CONSTRUCTION AND REPAIR**

FOR REPAIR AND MAINTENANCE OF COUPLINGS, IN PARTICULAR AUTOMATIC COUPLINGS FOR THE MECHANICAL ENGAGING AND DISENGAGING OF OBJECTS COMPELLED IN OPPOSITE DIRECTIONS, INCLUDING CRANES, PIPES OR PONTOONS, FOR FORMING A RIGID CONNECTION, INCLUDING FOR AIR, STEAM, WATER AND POWER CONDUITS BETWEEN THESE OBJECTS; REPAIR AND MAINTENANCE OF VEHICLES, IN PARTICULAR RAIL-MOUNTED VEHICLES AND SUPERSTRUCTURES THEREFOR; REPAIR AND MAINTENANCE OF APPARATUS FOR LOCOMOTION BY LAND, AIR OR WATER; REPAIR AND MAINTENANCE OF JOINTS, KNUCKLE JOINTS, SHOCK ABSORBERS, ENERGY DISSIPATION LINKS AND COUPLINGS FOR LAND VEHICLES, IN PARTICULAR COUPLINGS FOR TENSION AND COMPRESSION STRESS, INCLUDING FOR AIR, STEAM, WATER AND POWER CONDUITS FOR LINKING TWO VEHICLES; REPAIR AND MAINTENANCE OF PARTS FOR THE AFORESAID GOODS (U.S. CLS. 100, 103 AND 106).

**CLASS 42—SCIENTIFIC AND COMPUTER SERVICES**

FOR CONSULTANCY WITH REGARD TO RAILWAY ENGINEERING (U.S. CLS. 100 AND 101).  
RICHARD WHITE, EXAMINING ATTORNEY

SN 85-201,535. T-CETRA, LLC, DUBLIN, OH. FILED 12-20-2010.

# T CETRA

THE MARK CONSISTS OF STANDARD CHARACTERS WITHOUT CLAIM TO ANY PARTICULAR FONT, STYLE, SIZE, OR COLOR.

**CLASS 35—ADVERTISING AND BUSINESS**

FOR ONLINE WHOLESALE STORE SERVICES FEATURING PREPAID TELEPHONE CARDS, CELLULAR TELEPHONE HANDSETS, GIFT CARDS, AND PREPAID DEBIT CARDS (U.S. CLS. 100, 101 AND 102).

**CLASS 36—INSURANCE AND FINANCIAL**

FOR CREDIT CARD TRANSACTION PROCESSING SERVICES (U.S. CLS. 100, 101 AND 102).  
MORGAN WYNNE, EXAMINING ATTORNEY

SN 85-201,845. COMMSCOPE, INC. OF NORTH CAROLINA, HICKORY, NC. FILED 12-20-2010.

# SYSTEMAX

THE MARK CONSISTS OF STANDARD CHARACTERS WITHOUT CLAIM TO ANY PARTICULAR FONT, STYLE, SIZE, OR COLOR.  
OWNER OF U.S. REG. NOS. 1,605,354, 3,983,006 AND OTHERS.

**CLASS 6—METAL GOODS**

FOR METAL TELECOMMUNICATION BRACKETS, CLIPS AND CLAMPS TO HOUSE AND SUPPORT CABLE AND TELECOMMUNICATIONS EQUIPMENT ALL DISTRIBUTED AS A UNIT (U.S. CLS. 2, 12, 13, 14, 23, 25 AND 50).

FIRST USE 12-31-1989; IN COMMERCE 12-31-1989.

**CLASS 9—ELECTRICAL AND SCIENTIFIC APPARATUS**

FOR TELECOMMUNICATIONS CABLES, NAMELY, COAXIAL CABLES, TWISTED PAIR CABLES, FIBER OPTIC CABLES AND HYBRIDS THEREOF; ELECTRIC WIRES IN THE NATURE OF PATCH TELECOMMUNICATION CABLES; FIBER OPTIC INTERCONNECTION AND CROSS CONNECTION CABLES; TRUNK CABLES IN THE NATURE OF TELECOMMUNICATION CABLES; TELECOMMUNICATIONS ADAPTORS; TELECOMMUNICATIONS CABLE CONNECTORS FOR COAXIAL CABLES, TWISTED PAIR CABLES, FIBER OPTIC CABLES AND HYBRIDS THEREOF; ELECTRICAL AND FIBER OPTIC CONNECTOR PLUGS; TELECOMMUNICATIONS JACKS; TELECOMMUNICATION CABLE CONNECTING BLOCKS; POWER STRIPS; HARDWARE TO HOUSE AND SUPPORT ELECTRICAL AND OPTICAL CABLE AND TELECOMMUNICATIONS EQUIPMENT, NAMELY, CABLE PATHWAY CONDUITS FOR HOLDING COAXIAL CABLES, FIBER OPTIC CABLES, TWISTED PAIR CABLES AND HYBRIDS THEREOF, SHELVING MOUNTING RACKS FOR TELECOMMUNICATIONS HARDWARE AND METAL CABINETS SPECIALLY ADAPTED TO PROTECT TELECOMMUNICATIONS EQUIPMENT IN THE NATURE OF TELECOMMUNICATION CABLES AND HORIZONTAL AND VERTICAL CABLE MANAGER HOUSINGS FOR SUPPORTING, ORGANIZING AND PROTECTING MULTIPLE TELECOMMUNICATION CABLES; METAL GROUNDING CLAMPS FOR USE ONLY AS PARTS AND FITTINGS FOR COAXIAL CABLE AND NOT FOR NON-ELECTRIC CABLE OR MACHINERY OR MACHINE PARTS; CABLE AND WIRING FACE PLATES IN THE NATURE OF PROTECTIVE COVERS FOR ELECTRICAL AND FIBER OPTIC TELECOMMUNICATION CABLE AND WIRING; TELECOMMUNICATION CONTROL PATCH PANELS FOR HOUSING PATCH TELECOMMUNICATION CABLES; ELECTRICAL ZONE WIRING CONNECTION BOXES; SOFTWARE ASSOCIATED WITH OPERATION OF THE FOREGOING, NAMELY, COMPUTER SOFTWARE TO MANAGE, MONITOR AND CONTROL TELECOMMUNICATION NETWORK INFRASTRUCTURE CONNECTIVITY (U.S. CLS. 21, 23, 26, 36 AND 38).

FIRST USE 12-31-1989; IN COMMERCE 12-31-1989.

**CLASS 41—EDUCATION AND ENTERTAINMENT**

FOR TRAINING SERVICES IN THE FIELD OF DESIGNING, REPAIRING AND INSTALLING TELECOMMUNICATIONS AND RADIO FREQUENCY TELECOMMUNICATIONS SYSTEMS AND NETWORKS (U.S. CLS. 100, 101 AND 107).

FIRST USE 1-31-2005; IN COMMERCE 1-31-2005.  
DAVID YONTEF, EXAMINING ATTORNEY

SN 85-201,868. INDABA MEDIA, LLC, NEW YORK, NY. FILED 12-20-2010.

# INDABAMUSIC

THE MARK CONSISTS OF STANDARD CHARACTERS WITHOUT CLAIM TO ANY PARTICULAR FONT, STYLE, SIZE, OR COLOR.  
OWNER OF U.S. REG. NO. 3,928,783.

**CLASS 38—COMMUNICATION**

FOR PROVIDING ON-LINE CHAT ROOMS, ELECTRONIC BULLETIN BOARDS, ELECTRONIC MESSAGE BOARDS AND ON-LINE COMMUNITY FORUMS FOR THE TRANSMISSION OF MESSAGES AMONG COMPUTER USERS CONCERNING ENTERTAINMENT, MUSIC, CONCERTS, VIDEOS, MUSICAL PERFORMANCES, AND OTHER RELATED INFORMATION (U.S. CLS. 100, 101 AND 104).

FIRST USE 10-6-2010; IN COMMERCE 10-6-2010.

**CLASS 41—EDUCATION AND ENTERTAINMENT**

FOR PROVIDING A WEBSITE FEATURING INFORMATION IN THE FIELD OF MUSIC AND ENTERTAINMENT; PROVIDING ONLINE INSTRUCTION IN THE FIELD OF MUSIC AND MUSICAL INSTRUMENTS; PROVISION OF INFORMATION RELATING TO LIVE PERFORMANCES, LIVE STAGE EVENTS, AND LIVE MUSIC CONCERTS; ENTERTAINMENT SERVICES, NAMELY, PROVIDING INFORMATION ABOUT A RECORDING ARTIST VIA AN ONLINE NETWORK; ARRANGING OF CONTESTS (U.S. CLS. 100, 101 AND 107).

FIRST USE 10-6-2010; IN COMMERCE 10-6-2010.

**CLASS 42—SCIENTIFIC AND COMPUTER SERVICES**

FOR PROVIDING A WEB SITE FEATURING TECHNOLOGY THAT ENABLES USERS TO CREATE, EDIT, RECORD, REMIX, POST, UPLOAD, DOWNLOAD, PURCHASE, AND PLAY MUSICAL SOUND RECORDINGS; COMPUTER SERVICES, NAMELY, PROVIDING ONLINE NON-DOWNLOADABLE SOFTWARE FEATURING A VIRTUAL ONLINE RECORDING STUDIO WHERE INDIVIDUALS CAN CREATE MUSIC, INTERACT, AND COLLABORATE VIA A WEBSITE FOR THE PRODUCTION OF MUSICAL SOUND RECORDINGS (U.S. CLS. 100 AND 101).

FIRST USE 10-6-2010; IN COMMERCE 10-6-2010.

ALICE BENMAMAN, EXAMINING ATTORNEY

SN 85-201,878. TEQUILAS DEL SEÑOR, S.A. DE C.V., GUADALAJARA, JALISCO, MEXICO, FILED 12-20-2010.

# SOMBRERAZO

THE MARK CONSISTS OF STANDARD CHARACTERS WITHOUT CLAIM TO ANY PARTICULAR FONT, STYLE, SIZE, OR COLOR.

OWNER OF MEXICO REG. NO. 1185937, DATED 9-24-2010, EXPIRES 10-15-2020.

OWNER OF MEXICO REG. NO. 1191216, DATED 10-15-2010, EXPIRES 10-15-2020.

OWNER OF U.S. REG. NOS. 2,874,896 AND 3,866,775.

THE ENGLISH TRANSLATION OF "SOMBRERAZO" IN THE MARK IS GIANT HAT.

**CLASS 32—LIGHT BEVERAGES**

FOR NON-ALCOHOLIC BEVERAGES, NAMELY, BEER, CARBONATED WATER, MINERAL WATER; NON-ALCOHOLIC FRUIT JUICE BEVERAGES, FRUIT JUICES (U.S. CLS. 45, 46 AND 48).

**CLASS 33—WINES AND SPIRITS**

FOR ALCOHOLIC BEVERAGES, NAMELY, TEQUILA, COCKTAILS, AND LIQUORS (U.S. CLS. 47 AND 49).

JOHN E. MICHOS, EXAMINING ATTORNEY

SN 85-202,169. THE NPD GROUP, INC., PORT WASHINGTON, NY. FILED 12-20-2010.

# myDigiStuff

THE MARK CONSISTS OF STANDARD CHARACTERS WITHOUT CLAIM TO ANY PARTICULAR FONT, STYLE, SIZE, OR COLOR.

**CLASS 35—ADVERTISING AND BUSINESS**

FOR MARKET RESEARCH SERVICES (U.S. CLS. 100, 101 AND 102).

**CLASS 42—SCIENTIFIC AND COMPUTER SERVICES**

FOR PROVIDING AN INTERACTIVE WEBSITE FEATURING NON-DOWNLOADABLE SOFTWARE FOR USE BY CONSUMERS TO ORGANIZE, REVIEW AND UPLOAD SALES AND PRODUCT INFORMATION (U.S. CLS. 100 AND 101).

CARYN GLASSER, EXAMINING ATTORNEY

SN 85-202,473. ADVANCE MAGAZINE PUBLISHERS INC., NEW YORK, NY. FILED 12-21-2010.

# WIRED

THE MARK CONSISTS OF STANDARD CHARACTERS WITHOUT CLAIM TO ANY PARTICULAR FONT, STYLE, SIZE, OR COLOR.

OWNER OF U.S. REG. NOS. 2,781,551, 3,342,456 AND OTHERS.

**CLASS 35—ADVERTISING AND BUSINESS**

FOR ARRANGING AND CONDUCTING TRADE SHOWS IN THE FIELDS OF TECHNOLOGY, ENTERTAINMENT AND PUBLISHING (U.S. CLS. 100, 101 AND 102).

**CLASS 41—EDUCATION AND ENTERTAINMENT**

FOR ARRANGING AND CONDUCTING EDUCATIONAL CONFERENCES; ORGANIZING EXHIBITIONS FOR EDUCATIONAL PURPOSES IN THE FIELD OF TECHNOLOGY (U.S. CLS. 100, 101 AND 107).

DAWN FELDMAN, EXAMINING ATTORNEY

SN 85-202,989. RMO, INC., DENVER, CO. FILED 12-21-2010.

**SYNERGISTIC SOLUTIONS FOR  
PROGRESSIVE ORTHODONTICS**

THE MARK CONSISTS OF STANDARD CHARACTERS WITHOUT CLAIM TO ANY PARTICULAR FONT, STYLE, SIZE, OR COLOR.

OWNER OF U.S. REG. NOS. 3,364,950, 3,521,552 AND OTHERS.

**CLASS 10—MEDICAL APPARATUS**

FOR ORTHODONTIC APPLIANCES (U.S. CLS. 26, 39 AND 44).

**CLASS 16—PAPER GOODS AND PRINTED MATTER**

FOR PRINTED MATTER, NAMELY, PRINTED INSTRUCTIONS IN THE FIELD OF ORTHODONTICS, PEDIATRIC DENTISTRY AND GENERAL DENTISTRY; PRINTED GUIDES, PRINTED INSTRUCTIONAL AND EDUCATIONAL MATERIALS, INFORMATIONAL FLYERS, NEWSLETTERS, BOOKLETS, POSTERS, PAMPHLETS, PRINTED INFORMATION SHEETS, PRODUCT GUIDES, CATALOGS, REPORTS, BROCHURES, BOOKS, LEAFLETS, BULLETINS AND JOURNALS ALL IN THE FIELD OF ORTHODONTICS, PEDIATRIC DENTISTRY AND GENERAL DENTISTRY (U.S. CLS. 2, 5, 22, 23, 29, 37, 38 AND 50).

**CLASS 44—MEDICAL, BEAUTY AND AGRICULTURAL SERVICES**

FOR PROVIDING A WEBSITE IN THE FIELD OF ORTHODONTICS (U.S. CLS. 100 AND 101).

TOBY BULLOFF, EXAMINING ATTORNEY

SN 85-203,961. WISERG, SEATTLE, WA. FILED 12-22-2010.

**WISERG**

THE MARK CONSISTS OF STANDARD CHARACTERS WITHOUT CLAIM TO ANY PARTICULAR FONT, STYLE, SIZE, OR COLOR.

**CLASS 1—CHEMICALS**

FOR PRODUCTS MADE FROM LEACHATE AND REDUCED COMPOSTABLE SOLID, NAMELY, FERTILIZER (U.S. CLS. 1, 5, 6, 10, 26 AND 46).

**CLASS 4—LUBRICANTS AND FUELS**

FOR PRODUCTS MADE FROM LEACHATE AND REDUCED COMPOSTABLE SOLID, NAMELY, BIOGAS (U.S. CLS. 1, 6 AND 15).

**CLASS 7—MACHINERY**

FOR MACHINES FOR CONVERTING ORGANIC WASTE INTO A LEACHATE AND A REDUCED COMPOSTABLE SOLID THROUGH HYDROLYSIS (U.S. CLS. 13, 19, 21, 23, 31, 34 AND 35).

**CLASS 40—MATERIAL TREATMENT**

FOR ORGANIC WASTE REDUCTION VIA HYDROLYSIS FOR OTHERS (U.S. CLS. 100, 103 AND 106).  
HENRY S. ZAK, EXAMINING ATTORNEY

SN 85-204,266. SONATYPE, INC., MOUNTAIN VIEW, CA. FILED 12-22-2010.

**SONATYPE**

THE MARK CONSISTS OF STANDARD CHARACTERS WITHOUT CLAIM TO ANY PARTICULAR FONT, STYLE, SIZE, OR COLOR.

**CLASS 9—ELECTRICAL AND SCIENTIFIC APPARATUS**

FOR COMPUTER SOFTWARE DEVELOPMENT PROGRAMS; COMPUTER SOFTWARE DEVELOPMENT TOOLS; COMPUTER SOFTWARE FOR THE DEVELOPMENT AND OPERATING OF CLOUD COMPUTER APPLICATIONS AND NETWORKS; ELECTRONIC PUBLICATIONS AND DOWNLOADABLE ELECTRONIC PUBLICATIONS, NAMELY, GUIDES AND TRAINING MANUALS IN THE FIELD OF COMPUTERS, SOFTWARE, COMPUTER SYSTEM AND SOFTWARE DEVELOPMENT, AND CLOUD COMPUTING (U.S. CLS. 21, 23, 26, 36 AND 38).

FIRST USE 3-0-2007; IN COMMERCE 3-0-2007.

**CLASS 42—SCIENTIFIC AND COMPUTER SERVICES**

FOR PROVIDING A COMPUTER SOFTWARE REPOSITORY FOR OTHERS, NAMELY, PROVIDING AN ON-LINE COMPUTER DATABASE IN THE FIELD OF COMPUTER ENGINEERING AND SOFTWARE DEVELOPMENT; DESIGN, DEVELOPMENT, INSTALLATION AND MAINTENANCE OF COMPUTER SOFTWARE; COMPUTER SOFTWARE CONSULTING; PROVIDING CUSTOMIZED ON-LINE WEB PAGES AND DATA FEEDS FEATURING USER-DEFINED INFORMATION, WHICH INCLUDES BLOG POSTS, NEW MEDIA CONTENT, OTHER ON-LINE CONTENT, AND ON-LINE WEB LINKS TO OTHER WEBSITES (U.S. CLS. 100 AND 101).

FIRST USE 3-0-2007; IN COMMERCE 3-0-2007.

TRACY FLETCHER, EXAMINING ATTORNEY

SN 85-204,276. SONATYPE, INC., MOUNTAIN VIEW, CA. FILED 12-22-2010.

**SONATYPE NEXUS**

THE MARK CONSISTS OF STANDARD CHARACTERS WITHOUT CLAIM TO ANY PARTICULAR FONT, STYLE, SIZE, OR COLOR.

**CLASS 9—ELECTRICAL AND SCIENTIFIC APPARATUS**

FOR COMPUTER SOFTWARE DEVELOPMENT PROGRAMS; COMPUTER SOFTWARE DEVELOPMENT TOOLS; COMPUTER SOFTWARE FOR THE DEVELOPMENT AND OPERATING OF CLOUD COMPUTER APPLICATIONS AND NETWORKS; ELECTRONIC PUBLICATIONS AND DOWNLOADABLE ELECTRONIC COMPUTER SERVICES, NAMELY, PROVIDING A COMPUTER SOFTWARE REPOSITORY FOR OTHERS; DESIGN, DEVELOPMENT, INSTALLATION AND MAINTENANCE OF COMPUTER SOFTWARE; COMPUTER SOFTWARE CONSULTING; PROVIDING CUSTOMIZED ON-LINE WEB PAGES AND DATA FEEDS FEATURING USER-DEFINED INFORMATION, WHICH INCLUDES BLOG POSTS, NEW MEDIA CONTENT, OTHER ON-LINE CONTENT, AND ON-LINE WEB LINKS TO OTHER WEBSITE PUBLICATIONS, NAMELY, GUIDES AND TRAINING MANUALS IN THE FIELD OF COMPUTERS, SOFTWARE, COMPUTER SYSTEM AND SOFTWARE DEVELOPMENT, AND CLOUD COMPUTING (U.S. CLS. 21, 23, 26, 36 AND 38).

**CLASS 42—SCIENTIFIC AND COMPUTER SERVICES**

FOR PROVIDING A COMPUTER SOFTWARE REPOSITORY FOR OTHERS, NAMELY, PROVIDING AN ON-LINE COMPUTER DATABASE IN THE FIELD OF COMPUTER ENGINEERING AND SOFTWARE DEVELOPMENT; DESIGN, DEVELOPMENT, INSTALLATION AND MAINTENANCE OF COMPUTER SOFTWARE; COMPUTER SOFTWARE CONSULTING; PROVIDING CUSTOMIZED ON-LINE WEB PAGES AND DATA FEEDS FEATURING USER-DEFINED INFORMATION, WHICH INCLUDES BLOG POSTS, NEW MEDIA CONTENT, AND ON-LINE WEB LINKS TO OTHER WEBSITES (U.S. CLS. 100 AND 101).

TRACY FLETCHER, EXAMINING ATTORNEY

SN 85-204,296. SONATYPE, INC., MOUNTAIN VIEW, CA. FILED 12-22-2010.

**TRANSFORMING SOFTWARE DEVELOPMENT**

THE MARK CONSISTS OF STANDARD CHARACTERS WITHOUT CLAIM TO ANY PARTICULAR FONT, STYLE, SIZE, OR COLOR.

NO CLAIM IS MADE TO THE EXCLUSIVE RIGHT TO USE "SOFTWARE DEVELOPMENT", APART FROM THE MARK AS SHOWN.

**CLASS 9—ELECTRICAL AND SCIENTIFIC APPARATUS**

FOR COMPUTER SOFTWARE DEVELOPMENT PROGRAMS; COMPUTER SOFTWARE DEVELOPMENT TOOLS; COMPUTER SOFTWARE FOR THE DEVELOPMENT AND OPERATING OF CLOUD COMPUTER APPLICATIONS AND NETWORKS; ELECTRONIC PUBLICATIONS AND DOWNLOADABLE ELECTRONIC PUBLICATIONS, NAMELY, GUIDES AND TRAINING MANUALS IN THE FIELD OF COMPUTERS, SOFTWARE, COMPUTER SYSTEM AND SOFTWARE DEVELOPMENT, AND CLOUD COMPUTING (U.S. CLS. 21, 23, 26, 36 AND 38).

FIRST USE 5-0-2010; IN COMMERCE 5-0-2010.

**CLASS 42—SCIENTIFIC AND COMPUTER SERVICES**

FOR PROVIDING A COMPUTER SOFTWARE REPOSITORY FOR OTHERS, NAMELY, PROVIDING AN ON-LINE COMPUTER DATABASE IN THE FIELD OF COMPUTER ENGINEERING AND SOFTWARE DEVELOPMENT; DESIGN, DEVELOPMENT, INSTALLATION AND MAINTENANCE OF COMPUTER SOFTWARE; COMPUTER SOFTWARE CONSULTING; PROVIDING CUSTOMIZED ON-LINE WEB PAGES AND DATA FEEDS FEATURING USER-DEFINED INFORMATION, WHICH INCLUDES BLOG POSTS, NEW MEDIA CONTENT, OTHER ON-LINE CONTENT, AND ON-LINE WEB LINKS TO OTHER WEBSITES (U.S. CLS. 100 AND 101).

FIRST USE 5-0-2010; IN COMMERCE 5-0-2010.  
TRACY FLETCHER, EXAMINING ATTORNEY

SN 85-204,742. NEW LIFE INDUSTRIES, INC., SOMERSET, KY. FILED 12-23-2010.

**HAVE A BETTER LIFE**

THE MARK CONSISTS OF STANDARD CHARACTERS WITHOUT CLAIM TO ANY PARTICULAR FONT, STYLE, SIZE, OR COLOR.

OWNER OF U.S. REG. NO. 3,586,781.

**CLASS 25—CLOTHING**

FOR T-SHIRTS (U.S. CLS. 22 AND 39).  
FIRST USE 10-31-2008; IN COMMERCE 10-31-2008.

**CLASS 35—ADVERTISING AND BUSINESS**

FOR ONLINE RETAIL STORE SERVICES FEATURING IMPRINTED T-SHIRTS (U.S. CLS. 100, 101 AND 102).

FIRST USE 10-31-2008; IN COMMERCE 10-31-2008.  
AMY HELLA, EXAMINING ATTORNEY

SN 85-204,901. HALLVARD LERØY A/S, BERGEN, NORWAY, FILED 12-23-2010.

**LERØY**

THE MARK CONSISTS OF STANDARD CHARACTERS WITHOUT CLAIM TO ANY PARTICULAR FONT, STYLE, SIZE, OR COLOR.

OWNER OF NORWAY REG. NO. 257692, DATED 11-29-2010, EXPIRES 11-29-2020.

OWNER OF U.S. REG. NO. 1,699,663.

**CLASS 29—MEATS AND PROCESSED FOODS**

FOR FISH, NOT LIVE; SHELLFISH, NOT LIVE; CRUSTACEANS, NOT LIVE; AND OTHER EDIBLE AQUATIC ANIMALS, NOT LIVE; FOOD PRODUCTS MADE FROM FISH, SHELLFISH, CRUSTACEANS AND OTHER EDIBLE AQUATIC ANIMALS, NAMELY, FISH FILLETS, SMOKED, CURED AND MARINATED FISH, FISH GRATINS, FISHBURGERS, READY TO COOK OVEN DISHES, PRAWN SALADS, SHELLFISH SALADS AND CAVIAR; PRESERVED FISH, SHELLFISH, CRUSTACEANS AND OTHER EDIBLE AQUATIC ANIMALS; TINNED FISH, SHELLFISH, CRUSTACEANS AND OTHER EDIBLE AQUATIC ANIMALS; FISHMEAL FOR HUMAN CONSUMPTION; EDIBLE OILS AND FATS (U.S. CL. 46).

**CLASS 31—NATURAL AGRICULTURAL PRODUCTS**

FOR FISH, LIVE; SHELLFISH, LIVE; CRUSTACEANS, LIVE; AND OTHER EDIBLE AQUATIC ANIMALS, LIVE; FISHMEAL FOR ANIMAL CONSUMPTION (U.S. CLS. 1 AND 46).

**CLASS 40—MATERIAL TREATMENT**

FOR FISH PROCESSING; AND OTHER FOOD PROCESSING; CONSULTANCY AND PROVIDING INFORMATION RELATING TO FOOD PROCESSING; RENTAL OF MACHINES AND APPARATUS FOR PROCESSING FOOD (U.S. CLS. 100, 103 AND 106).

REBECCA EISINGER, EXAMINING ATTORNEY

SN 85-205,083. INDIANA WESLEYAN UNIVERSITY, MARION, IN. FILED 12-23-2010.



THE MARK CONSISTS OF STYLIZED INTERLOCKING LETTERS "I", "W" AND "U".

**CLASS 16—PAPER GOODS AND PRINTED MATTER**

FOR PRINTED MATTER, NAMELY, DECALS, NOTEBOOKS, WRITING PADS, STATIONERY, FOLDERS, POSTCARDS, WRITING PAPER, ENVELOPES, BINDERS, CALENDARS, AND ACADEMIC AND ENTERTAINMENT PUBLICATIONS, NAMELY, PRINTED EVENT PROGRAMS AND BROCHURES ABOUT STUDENT RECRUITMENT AND STUDENT EXPERIENCE, FUNDRAISING, ALUMNI AND CHURCH RELATIONS; PRINTED UNIVERSITY ACADEMIC CATALOG; PAMPHLETS IN THE FIELD OF TRADITIONAL AND ADULT STUDENT RECRUITMENT AND STUDENT EXPERIENCE; NEWS RELEASES ABOUT UNIVERSITY ACTIVITIES; ALUMNI MAGAZINE; SCHOOL YEARBOOKS (U.S. CLS. 2, 5, 22, 23, 29, 37, 38 AND 50).

FIRST USE 6-1-2010; IN COMMERCE 6-1-2010.

**CLASS 25—CLOTHING**

FOR CLOTHING, NAMELY, T-SHIRTS, SHIRTS, SWEATSHIRTS, SWEATPANTS, JACKETS, COATS, SHORTS, TIES, CAPS, HATS, VISORS, SOCKS AND SLEEPWEAR (U.S. CLS. 22 AND 39).

FIRST USE 6-1-2010; IN COMMERCE 6-1-2010.

**CLASS 41—EDUCATION AND ENTERTAINMENT**

FOR EDUCATIONAL SERVICES, NAMELY, PROVIDING INSTRUCTIONAL COURSES, PUBLIC LECTURES, WORKSHOPS, SEMINARS, AND CONFERENCES AT THE UNDERGRADUATE AND GRADUATE LEVELS; ENTERTAINMENT SERVICES, NAMELY, CONDUCTING INTERCOLLEGIATE ATHLETIC COMPETITIONS AND INTERCOLLEGIATE ATHLETIC PROGRAMS AND ARRANGING, ORGANIZING, CONDUCTING AND HOSTING SOCIAL EVENTS IN THE NATURE OF PARTIES FOR UNDERGRADUATE AND ALUMNI (U.S. CLS. 100, 101 AND 107).

FIRST USE 6-1-2010; IN COMMERCE 6-1-2010.

ROBIN CHOSID, EXAMINING ATTORNEY

SN 85-205,386. ONE STOP MOVING, COLORADO SPRINGS, CO. FILED 12-23-2010.

# MOVINGAL

THE MARK CONSISTS OF STANDARD CHARACTERS WITHOUT CLAIM TO ANY PARTICULAR FONT, STYLE, SIZE, OR COLOR.

**CLASS 35—ADVERTISING AND BUSINESS**

FOR PROVIDING A WEBSITE WHEREBY USERS CAN FIND INFORMATION ABOUT AND MAKING REFERRALS IN THE FIELD OF CONSUMER PRODUCTS AND SERVICES FOR RETAIL SERVICES CONCERNING PRODUCTS, SERVICES, EVENTS, ACTIVITIES, ATTRACTIONS AND FACILITIES IN PARTICULAR GEOGRAPHIC LOCATIONS; PROVIDING A SEARCHABLE WEBSITE FEATURING THE GOODS AND SERVICES OF OTHER VENDORS IN PARTICULAR GEOGRAPHIC LOCATIONS; PROVIDING A WEBSITE WITH INFORMATION ABOUT THE GOODS AND SERVICES OF OTHERS IN PARTICULAR GEOGRAPHIC LOCATIONS (U.S. CLS. 100, 101 AND 102).

**CLASS 41—EDUCATION AND ENTERTAINMENT**

FOR PROVIDING A WEBSITE FEATURING ON-LINE JOURNALS, NAMELY, BLOGS ABOUT GOODS AND SERVICES OFFERED IN A GEOGRAPHIC AREA WHERE SOMEONE HAS RELOCATED TO A PROPERTY IN THE GEOGRAPHIC AREA (U.S. CLS. 100, 101 AND 107).

GINA FINK, EXAMINING ATTORNEY

SN 85-205,803. HIGH PERFORMANCE SPORTS LIMITED, TSIMSHATSUI, KOWLOON, HONG KONG, FILED 12-27-2010.



OWNER OF HONG KONG REG. NO. 1999B12214, DATED 2-26-1998, EXPIRES 2-26-2015.

OWNER OF HONG KONG REG. NO. 1999B12213, DATED 2-26-1998, EXPIRES 2-26-2015.

NO CLAIM IS MADE TO THE EXCLUSIVE RIGHT TO USE "THE OUTDOOR SHOP", APART FROM THE MARK AS SHOWN.

THE MARK CONSISTS OF THE STYLIZED WORDS "THE OUTDOOR SHOP" IN FRONT OF AN OUTLINE OF MOUNTAINS IN THE BACKGROUND.

#### CLASS 35—ADVERTISING AND BUSINESS

FOR RETAIL STORE SERVICES FEATURING CLOTHING, FOOTWEAR, HEADGEAR, SPORTS AND RECREATIONAL EQUIPMENT; RETAIL SHOP-AT-HOME PARTY SERVICES IN THE FIELD OF CLOTHING, FOOTWEAR, HEADGEAR, SPORTS AND RECREATIONAL EQUIPMENT; WHOLESALE STORES FEATURING CLOTHING, FOOTWEAR, HEADGEAR, SPORTS AND RECREATIONAL EQUIPMENT; ADVERTISING SERVICES; DEMONSTRATION OF GOODS; DIRECT MAIL ADVERTISING SERVICES; DISPLAY SERVICES FOR MERCHANDISE, NAMELY, BUSINESS MERCHANDISING DISPLAY SERVICES; ARRANGING AND CONDUCTING EXHIBITIONS FOR BUSINESS ADVERTISING OR COMMERCIAL PURPOSES; MARKETING ANALYSIS SERVICES; MARKET RESEARCH; MARKETING SERVICES, NAMELY, DIRECT MARKETING CONSULTING SERVICES, CREATIVE MARKETING DESIGN SERVICES, MARKETING RESEARCH SERVICES; PROMOTIONAL SERVICES, NAMELY, DEVELOPING PROMOTIONAL CAMPAIGNS FOR BUSINESSES, ONLINE ADVERTISING AND PROMOTIONAL SERVICES; BUSINESS ADMINISTRATION SERVICES, BUSINESS ADVICE, BUSINESS RESEARCH; ALL RELATING TO CLOTHING, FOOTWEAR, HEADGEAR, SPORTS AND RECREATIONAL EQUIPMENT (U.S. CLS. 100, 101 AND 102).

#### CLASS 42—SCIENTIFIC AND COMPUTER SERVICES

FOR NEW PRODUCT DESIGN SERVICES; COMMERCIAL DESIGN SERVICES, NAMELY, COMMERCIAL ART DESIGN; INDUSTRIAL DESIGN SERVICES; PACKAGING DESIGN SERVICES; ART WORK DESIGN, NAMELY, COMMERCIAL ART DESIGN, GRAPHIC ART DESIGN, INDUSTRIAL AND GRAPHIC ART DESIGN; ART WORK REPRODUCTION, NAMELY, COMMERCIAL ART DESIGN, GRAPHIC ART DESIGN, INDUSTRIAL AND GRAPHIC ART DESIGN; GRAPHIC ART SERVICES, NAMELY, GRAPHIC ART DESIGN SERVICES AND GRAPHIC DESIGN SERVICES; GRAPHIC ILLUSTRATION SERVICES FOR OTHERS, NAMELY, PROVIDING GRAPHIC ILLUSTRATIONS OF DESIGNS FOR CLOTHING, FOOTWEAR, HEADGEAR, SPORTS AND RECREATIONAL EQUIPMENT; ALL RELATING TO CLOTHING, FOOTWEAR, HEADGEAR, SPORTS AND RECREATIONAL EQUIPMENT (U.S. CLS. 100 AND 101).

KATHERINE E. HALMEN, EXAMINING ATTORNEY

SN 85-205,878. ELDER, MARC, WINTER HAVEN, FL. FILED 12-27-2010.



THE MARK CONSISTS OF THE STYLIZED TEXT "TRAIL LIFE".

#### CLASS 16—PAPER GOODS AND PRINTED MATTER

FOR BUMPER STICKERS; DECALS; DECORATIVE DECALS FOR VEHICLE WINDOWS; MAGNETIC BUMPER STICKERS; STICKERS (U.S. CLS. 2, 5, 22, 23, 29, 37, 38 AND 50).

#### CLASS 25—CLOTHING

FOR HATS; JACKETS; PANTS; SHIRTS; SHOES (U.S. CLS. 22 AND 39).

#### CLASS 35—ADVERTISING AND BUSINESS

FOR WHOLESALE AND RETAIL STORE SERVICES AND ON-LINE RETAIL AND WHOLESALE STORE SERVICES FEATURING STICKERS, BUMPER STICKERS, CLOTHING AND ACCESSORIES (U.S. CLS. 100, 101 AND 102).

JENNY PARK, EXAMINING ATTORNEY

SN 85-206,371. MARTINEZ, JR., MARIANO A., DALLAS, TX. FILED 12-28-2010.



OWNER OF U.S. REG. NOS. 1,001,671 AND 1,145,216. THE PORTRAIT AND THE NAME IN THE MARK IDENTIFY MARIANO A. MARTINEZ, JR., A LIVING INDIVIDUAL WHOSE CONSENT IS OF RECORD.

THE MARK CONSISTS OF THE TERM "MARIANO'S" WITH THE IMAGE OF A MAN DRESSED IN BANDITO ATTIRE FRAMED IN A BORDER.

#### CLASS 32—LIGHT BEVERAGES

FOR NON ALCOHOLIC COCKTAIL MIXES (U.S. CLS. 45, 46 AND 48).

**CLASS 33—WINES AND SPIRITS**

FOR ALCOHOLIC COCKTAIL MIXES; DISTILLED SPIRITS, LIQUEURS AND DISTILLED LIQUORS (U.S. CLS. 47 AND 49).

DAVID TAYLOR, EXAMINING ATTORNEY

**CLASS 42—SCIENTIFIC AND COMPUTER SERVICES**

FOR WEBSITE DESIGN, PROGRAMMING AND MAINTENANCE SERVICES (U.S. CLS. 100 AND 101).

MARTHA FROMM, EXAMINING ATTORNEY

SN 85-206,375. MARTINEZ, JR., MARIANO A., DALLAS, TX. FILED 12-28-2010.



OWNER OF U.S. REG. NOS. 1,001,671 AND 1,145,216. THE PORTRAIT AND THE NAME IN THE MARK IDENTIFY MARIANO A. MARTINEZ, JR., A LIVING INDIVIDUAL WHOSE CONSENT IS OF RECORD.

THE MARK CONSISTS OF THE TERM "MARIANO'S" WITH A PARTIAL IMAGE OF A MAN'S FACE.

SN 85-208,777. CRYSTAL VISION LTD, NEWPORT BEACH, CA. FILED 1-1-2011.

## SKINNY LIFE

THE MARK CONSISTS OF STANDARD CHARACTERS WITHOUT CLAIM TO ANY PARTICULAR FONT, STYLE, SIZE, OR COLOR.

**CLASS 32—LIGHT BEVERAGES**

FOR NON ALCOHOLIC COCKTAIL MIXES (U.S. CLS. 45, 46 AND 48).

**CLASS 33—WINES AND SPIRITS**

FOR ALCOHOLIC COCKTAIL MIXES; DISTILLED SPIRITS, LIQUEURS AND DISTILLED LIQUORS (U.S. CLS. 47 AND 49).

DAVID TAYLOR, EXAMINING ATTORNEY

**CLASS 9—ELECTRICAL AND SCIENTIFIC APPARATUS**

FOR PRE-RECORDED AUDIO AND VIDEO TAPES AND DOWNLOADABLE AUDIO AND VIDEO FILES, NAMELY, LECTURES, COACHING, HYPNOSIS, GUIDED IMAGERY, DIRECTION, DEMONSTRATION, AND INSTRUCTION IN THE FIELD OF WEIGHT LOSS, FITNESS, AND SUBCONSCIOUS IMAGE INTERVENTION (U.S. CLS. 21, 23, 26, 36 AND 38).

**CLASS 16—PAPER GOODS AND PRINTED MATTER**

FOR COOKBOOKS, TRAINING MANUALS, AND BROCHURES IN THE FIELD OF OBESITY, WEIGHT LOSS, WEIGHT MANAGEMENT PROGRAMS, NUTRITION AND EXERCISE (U.S. CLS. 2, 5, 22, 23, 29, 37, 38 AND 50).

APRIL ROACH, EXAMINING ATTORNEY

SN 85-207,332. CASIO KEISANKI KABUSHIKI KAISHA, DBA CASIO COMPUTER CO., LTD., SHIBUYA-KU, TOKYO, JAPAN, FILED 12-29-2010.

## MY ATELIER

SN 85-208,855. TELEHOUSE INTERNATIONAL CORPORATION OF AMERICA, STATEN ISLAND, NY. FILED 1-2-2011.

THE MARK CONSISTS OF STANDARD CHARACTERS WITHOUT CLAIM TO ANY PARTICULAR FONT, STYLE, SIZE, OR COLOR.

## Telehouse Wevsentinel

**CLASS 9—ELECTRICAL AND SCIENTIFIC APPARATUS**

FOR COMPUTER SOFTWARE TO ENHANCE THE AUDIO-VISUAL CAPABILITIES OF COMPUTER AND MULTIMEDIA APPLICATIONS, NAMELY, FOR THE INTEGRATION OF TEXT, AUDIO, GRAPHICS, STILL IMAGES AND MOVING PICTURES; COMPUTER SOFTWARE FOR EXCHANGING DATA BETWEEN A PERSONAL COMPUTER AND A DIGITAL CAMERA; DIGITAL CAMERAS; APPARATUS FOR RECORDING, SCANNING, PROCESSING, TRANSMITTING OR REPRODUCING SOUND OR IMAGES (U.S. CLS. 21, 23, 26, 36 AND 38).

THE MARK CONSISTS OF STANDARD CHARACTERS WITHOUT CLAIM TO ANY PARTICULAR FONT, STYLE, SIZE, OR COLOR.

OWNER OF U.S. REG. NOS. 1,491,520 AND 1,492,597.

**CLASS 38—COMMUNICATION**

FOR TELECOMMUNICATIONS CONSULTATION (U.S. CLS. 100, 101 AND 104).

**CLASS 42—SCIENTIFIC AND COMPUTER SERVICES**

FOR COMPUTER CONSULTATION IN THE FIELD OF COMPUTER SECURITY; INFORMATION TECHNOLOGY CONSULTATION; INFORMATION TECHNOLOGY SERVICES, NAMELY, CONSULTATION IN THE FIELD OF ASSESSING, CORRECTING AND MANAGING COMPUTER NETWORK VULNERABILITIES; COMPUTER SERVICES, NAMELY, COMPUTER SYSTEM ADMINISTRATION OF FIREWALLS FOR OTHERS (U.S. CLS. 100 AND 101).

RONALD DELGIZZI, EXAMINING ATTORNEY

SN 85-208,890. GINA L. TAGLIENTE, DBA THUNDERBOX, BAY SHORE, NY, AND NATALIE R COURVILLE, DBA THUNDERBOX, BAY SHORE, NY. FILED 1-2-2011.



NO CLAIM IS MADE TO THE EXCLUSIVE RIGHT TO USE "ALL-GIRL ALL-METAL", APART FROM THE MARK AS SHOWN.

THE COLOR(S) RED, BLACK, AND WHITE IS/ARE CLAIMED AS A FEATURE OF THE MARK.

THE MARK CONSISTS OF THE WORDING "THUNDERBOX" IN WHITE WITH BLACK OUTLINE AND RED SHADOWING. THE WORDING "THE ALL-GIRL ALL-METAL SUPERGROUP" APPEARS UNDERNEATH "THUNDERBOX" IN RED WITH WHITE OUTLINE. THESE WORDS APPEAR AGAINST A BLACK BACKGROUND.

**CLASS 9—ELECTRICAL AND SCIENTIFIC APPARATUS**

FOR AUDIO AND VIDEO RECORDINGS FEATURING MUSIC AND ARTISTIC PERFORMANCES; AUDIO TAPES FEATURING MUSIC; COMPACT DISCS FEATURING MUSIC; DIGITAL MUSIC DOWNLOADABLE FROM THE INTERNET; DOWNLOADABLE MP3 FILES, MP3 RECORDINGS, ON-LINE DISCUSSION BOARDS, WEBCASTS, WEBINARS AND PODCASTS FEATURING MUSIC, AUDIO BOOKS IN THE FIELD OF MUSIC, AND NEWS BROADCASTS; DOWNLOADABLE MUSICAL SOUND RECORDINGS; DOWNLOADABLE RING TONES, GRAPHICS AND MUSIC VIA A GLOBAL COMPUTER NETWORK AND WIRELESS DEVICES; DOWNLOADABLE VIDEO RECORDINGS FEATURING MUSIC; DOWNLOADABLE MUSIC AND VIDEOS VIA THE INTERNET AND WIRELESS DEVICES; ELECTRICAL PICKUPS FOR USE WITH MUSICAL INSTRUMENTS; MOTION PICTURE FILMS AND FILMS FOR TELEVISION FEATURING CHILDREN'S ENTERTAINMENT; MOTION PICTURE FILMS FEATURING CHILDREN'S ENTERTAINMENT; MUSICAL INSTRUMENT AMPLIFIERS; MUSICAL INSTRUMENT CONNECTORS; MUSICAL VIDEO RECORDINGS; PHONOGRAPH RECORDS FEATURING MUSIC; PRERECORDED AUDIO TAPES FEATURING MUSIC; PRERECORDED VIDEO CASSETTES FEATURING MUSIC; PRERECORDED VIDEO TAPES FEATURING MUSIC; PROTECTIVE CARRYING CASES FOR PORTABLE MUSIC PLAYERS, NAMELY, MP3 PLAYERS; SERIES OF MUSICAL SOUND RECORDINGS; VIDEO RECORDINGS FEATURING MUSIC; VISUAL RECORDINGS AND AUDIOVISUAL RECORDINGS FEATURING MUSIC AND ANIMATION (U.S. CLS. 21, 23, 26, 36 AND 38).

FIRST USE 8-22-2009; IN COMMERCE 8-22-2009.

**CLASS 41—EDUCATION AND ENTERTAINMENT**

FOR ENTERTAINMENT IN THE NATURE OF LIVE PERFORMANCES BY A MUSICAL GROUP; ENTERTAINMENT IN THE NATURE OF VISUAL AND AUDIO PERFORMANCES BY A MUSICAL GROUP; ENTERTAINMENT IN THE NATURE OF VISUAL AND AUDIO PERFORMANCES, NAMELY, MUSICAL BAND, ROCK GROUP, GYMNASTIC, DANCE, AND BALLET PERFORMANCES; ENTERTAINMENT SERVICES IN THE NATURE OF LIVE MUSICAL PERFORMANCES; ENTERTAINMENT SERVICES IN THE NATURE OF PRESENTING LIVE MUSICAL PERFORMANCES; ENTERTAINMENT SERVICES IN THE NATURE OF RECORDING, PRODUCTION AND POST-PRODUCTION SERVICES IN THE FIELD OF MUSIC; ENTERTAINMENT SERVICES, NAMELY, PROVIDING A WEB SITE FEATURING PHOTOGRAPHIC, VIDEO AND PROSE PRESENTATIONS FEATURING MUSIC; ENTERTAINMENT SERVICES, NAMELY, PROVIDING NON-DOWNLOADABLE PLAYBACK OF MUSIC VIA GLOBAL COMMUNICATIONS NETWORKS; ENTERTAINMENT, NAMELY, LIVE MUSIC CONCERTS; ENTERTAINMENT, NAMELY, LIVE PERFORMANCES BY A MUSICAL BAND; ENTERTAINMENT, NAMELY, LIVE PERFORMANCES BY MUSICAL BANDS; ENTERTAINMENT, NAMELY, LIVE PERFORMANCES BY ROCK GROUPS; LIVE PERFORMANCES BY A MUSICAL GROUP; PRESENTATION OF MUSICAL PERFORMANCE; PRODUCTION OF MUSICAL SOUND RECORDING; PRODUCTION OF SOUND AND MUSIC VIDEO RECORDINGS; PROVIDING A WEBSITE FEATURING INFORMATION IN THE FIELD OF MUSIC AND ENTERTAINMENT; MUSICAL EVENT BOOKING AGENCIES; PRODUCTION OF MUSICAL VIDEOS (U.S. CLS. 100, 101 AND 107).

FIRST USE 8-22-2009; IN COMMERCE 8-22-2009.

JANICE KIM, EXAMINING ATTORNEY

SN 85-209,704. AVENUES IN LEATHER, INC., TINTON FALLS, NJ. FILED 1-4-2011.

# ALLANT

THE MARK CONSISTS OF STANDARD CHARACTERS WITHOUT CLAIM TO ANY PARTICULAR FONT, STYLE, SIZE, OR COLOR.

**CLASS 9—ELECTRICAL AND SCIENTIFIC APPARATUS**

FOR CELL PHONE CASES, CELL PHONE SLEEVES FOR HOLDING CELL PHONES, BAGS SPECIALLY ADAPTED FOR CARRYING HANDHELD COMPUTER GAME UNITS, CAMERA CASES, CAMCORDER CASES, CAMERA BAGS, CAMERA SLEEVES; CARRYING BAGS FOR MP3 PLAYERS, PERSONAL DIGITAL ASSISTANTS, GLOBAL POSITIONING APPARATUS AND DVD PLAYERS; COMPUTER CARRYING CASES, BACKPACKS SPECIALLY ADAPTED FOR HOLDING NOTEBOOK COMPUTERS, COMPUTER SLEEVES, ELECTRONIC AGENDAS (U.S. CLS. 21, 23, 26, 36 AND 38).



**CLASS 16—PAPER GOODS AND PRINTED MATTER**

FOR BINDERS, CARD FILES, CLIP BOARDS, UNDER-ARM ENVELOPES, SMALL SPIRAL BOUND NOTEBOOKS SOLD WITH PENS OR PENCILS, TRAVEL DOCUMENT ORGANIZERS FOR STATIONERY USE, NOTEPADS AND LOOSE LEAF PAPERS, AGENDAS, BLANK JOURNALS, APPOINTMENT BOOKS, DATE BOOKS, ADDRESS BOOKS, CALENDARS, DIARIES, INDEX DIVIDERS AND NOTEBOOK DIVIDERS, CALENDAR REFILLS AND PEN INK REFILLS; DAILY PLANNERS, DAY PLANNERS AND DESKTOP PLANNERS; TIME MANAGEMENT ORGANIZER BOOKS, PAPER WEIGHTS, LETTER ENVELOPE OPENERS; DESKTOP ORGANIZERS, NAMELY, BLOTTERS, BOOK-ENDS; DESKTOP TRAYS, HOLDERS, RACKS AND STANDS FOR HOLDING FILES, LETTERS, AND/OR DOCUMENTS; CUPS, BOXES, HOLDERS, STANDS AND TRAYS FOR HOLDING PENS AND/OR PENCILS; DESKTOP BUSINESS CARD HOLDERS, PASSPORT HOLDERS, STATIONERY-TYPE PORTFOLIOS (U.S. CLS. 2, 5, 22, 23, 29, 37, 38 AND 50).

**CLASS 18—LEATHER GOODS**

FOR LUGGAGE, SUITCASES, GARMENT BAGS FOR TRAVEL, DUFFEL BAGS, SUIT BAGS, TOTE BAGS, SHOE BAGS FOR TRAVEL, LUGGAGE INSERTS, NAMELY, PACKING CUBES, BACKPACKS, MESSENGER BAGS, COURIER BAGS, CATALOG CASES, SLING BAGS; PERSONAL LEATHER GOODS, NAMELY, WALLET, CREDIT CARD HOLDERS, UMBRELLAS, TRUNKS, BRIEFCASE-TYPE PORTFOLIOS, BUSINESS CARD CASES, CREDIT CARD CASES AND CAMERA POUCHES MADE OF TEXTILE (U.S. CLS. 1, 2, 3, 22 AND 41).

JENNIFER VASQUEZ, EXAMINING ATTORNEY

**CLASS 9—ELECTRICAL AND SCIENTIFIC APPARATUS**

FOR DOWNLOADABLE COMPUTER SOFTWARE IN THE FORM OF AN INTERNET VIRTUAL SIMULATION APPLICATION FOR CREATING CLOTHING, FOOTWEAR, HEADGEAR AND ACCESSORIES OUTFITS; COMPUTER GRAPHICS AND VIRTUAL SIMULATION SOFTWARE FOR ASSISTING IN THE DESIGN OF CLOTHING, FOOTWEAR, HEADGEAR; COMPUTER ANALYSIS AND GRAPHICS PROGRAMS RELATING TO COMPUTER AIDED HUMAN BODY SIZING; VIRTUAL SIMULATION COMPUTER PROGRAMS RELATING TO COMPUTER AIDED SIZING OF THE HUMAN BODY; COMPUTER PROGRAMS FOR IMAGE PROCESSING; COMPUTER DATABASE PROGRAMS FEATURING PHYSICAL REPRESENTATIONS OF IMAGES STORED ELECTRONICALLY FOR ELECTRONIC MANIPULATION; DOWNLOADABLE IMAGE FILES CONTAINING PHYSICAL REPRESENTATIONS OF IMAGES STORED ELECTRONICALLY FOR ELECTRONIC MANIPULATION; COMPUTER GRAPHICS PROGRAMS RELATING TO COMPUTER AIDED THREE DIMENSIONAL CLOTHES AND BODY VISUALIZATION; DOWNLOADABLE IMAGE AND AUDIO FILES CONTAINING AUDIO, VIDEO, STILL AND MOVING IMAGES AND DATA RECORDINGS IN COMPRESSED AND UNCOMPRESSED FORM; DOWNLOADABLE COMPUTER SOFTWARE, NAMELY, SOFTWARE FOR USE IN DOWNLOADING AUDIO, VIDEO, STILL AND MOVING IMAGES AND DATA IN COMPRESSED AND UNCOMPRESSED FORM FROM A COMPUTER OR COMMUNICATION NETWORK; COMPUTER DATABASE SOFTWARE FOR ORGANIZATION OF DATA; COMPUTER SOFTWARE, NAMELY, DATA SYNCHRONIZATION PROGRAMS AND PROGRAMS FOR APPLICATION DEVELOPMENT (U.S. CLS. 21, 23, 26, 36 AND 38).

**CLASS 35—ADVERTISING AND BUSINESS**

FOR ADVERTISING SERVICES; ADVERTISING AND PROMOTIONAL SERVICES OF THE GOODS AND SERVICES OF OTHERS; PROVIDING AN ON-LINE COMPUTER DATABASE IN THE FIELD OF LOCATING PRODUCTS, DESCRIBING PRODUCTS, RATING PRODUCTS, PRICING PRODUCTS AND COMPARING PRICES OF PRODUCTS; DISSEMINATION OF ADVERTISING FOR OTHERS VIA THE INTERNET; ADVERTISING ON COMPUTER NETWORKS; ADVERTISING SERVICES, NAMELY, PRODUCTION OF SPECIAL EFFECTS, NAMELY, MODEL-MAKING SERVICES FOR USE IN ADVERTISEMENTS; PROVISION OF SPACE ON WEBSITES FOR ADVERTISING GOODS AND SERVICES; ONLINE RETAIL STORE AND RETAIL STORE SERVICES FEATURING CLOTHING, CLOTHING ACCESSORIES, FOOTWEAR, HEADWEAR, BAGS, JEWELRY; SALES PROMOTION SERVICES; COMPUTER FILE MANAGEMENT; COMPUTERIZED FILE MANAGEMENT; DATABASE MANAGEMENT (U.S. CLS. 100, 101 AND 102).

**CLASS 42—SCIENTIFIC AND COMPUTER SERVICES**

FOR RENTAL OF COMPUTER SOFTWARE; MAINTENANCE OF COMPUTER SOFTWARE; COMMERCIAL GRAPHIC DESIGN SERVICES FOR OTHERS RELATING TO HUMAN BODY-SIZING; COMPUTER AIDED VIRTUAL SIMULATION DESIGN SERVICES FOR OTHERS IN THE FIELD OF CLOTHING; DESIGN SERVICES FOR OTHERS IN THE FIELD OF CLOTHING; FASHION AND CLOTHING DESIGN CONSULTING SERVICES; COMPUTER GRAPHIC DESIGN AND VIRTUAL SIMULATION DESIGN FOR OTHERS, NAMELY, PREPARATION OF DESIGN PARAMETERS FOR VISUAL IMAGES; DESIGN SERVICES FOR OTHERS IN THE FIELD OF FASHION ARTICLES, NAMELY, CLOTHING, ACCESSORIES, FOOTWEAR, HEADWEAR; PROVIDING A WEB HOSTING PLATFORM FOR UPLOADING, DOWNLOADING AND PROCESSING OF IMAGES AND DATA; PLATFORM AS A SERVICE (PAAS) FEATURING COMPUTER SOFTWARE PLATFORMS FOR UPLOADING, DOWNLOADING AND PROCESSING OF IMAGES AND DATA; PROVIDING TEMPORARY USE OF NON-DOWNLOADABLE GRAPHICS AND VIRTUAL SIMULATION SOFTWARE FOR DESIGN OF CLOTHING; PRO-

SN 85-210,151, METAIL LIMITED, LONDON E2 6PG, UNITED KINGDOM, FILED 1-4-2011.

**METAIL**

THE MARK CONSISTS OF STANDARD CHARACTERS WITHOUT CLAIM TO ANY PARTICULAR FONT, STYLE, SIZE, OR COLOR.

OWNER OF UNITED KINGDOM REG. NO. 2554132, DATED 5-13-2011, EXPIRES 7-27-2020.

VIDING A WEB HOSTING PLATFORM FOR ORDERING FASHION PRODUCTS THAT ARE CREATED BASED ON CUSTOMERS' IMAGE DATA; PLATFORM AS A SERVICE (PAAS) COMPUTER SOFTWARE PLATFORMS FOR ORDERING FASHION PRODUCTS THAT ARE CREATED BASED ON CUSTOMERS' IMAGE DATA; COMPUTER PROGRAMMING SERVICES, NAMELY, CONTENT CREATION FOR VIRTUAL WORLD AND THREE DIMENSIONAL PLATFORMS RELATING TO FASHION; PROGRAMMING OF MULTIMEDIA APPLICATIONS; DATA ENCRYPTION AND DECODING SERVICES; PROVIDING ON-LINE, NON-DOWNLOADABLE INTERNET-BASED COMPUTER SOFTWARE, NAMELY, SOFTWARE FOR USE IN DOWNLOADING AUDIO, VIDEO, STILL AND MOVING IMAGES AND DATA IN COMPRESSED AND UNCOMPRESSED FORM FROM A COMPUTER OR COMMUNICATION NETWORK; PROVIDING ONLINE, NON-DOWNLOADABLE INTERNET BASED SOFTWARE APPLICATIONS IN THE FORM OF VIRTUAL SIMULATION APPLICATIONS FOR CREATING CLOTHING, FOOTWEAR, HEADGEAR AND ACCESSORIES OUTFITS (U.S. CLS. 100 AND 101).

**CLASS 45—PERSONAL AND LEGAL SERVICES**

FOR PROVIDING ONLINE PERSONALIZED FASHION INFORMATION (U.S. CLS. 100 AND 101).  
JERI J. FICKES, EXAMINING ATTORNEY

SN 85-211,977. BOARD OF REGENTS OF THE UNIVERSITY SYSTEM OF GEORGIA, ATLANTA, GA. FILED 1-6-2011.

**ATLANTA METROPOLITAN COLLEGE**

THE MARK CONSISTS OF STANDARD CHARACTERS WITHOUT CLAIM TO ANY PARTICULAR FONT, STYLE, SIZE, OR COLOR.

NO CLAIM IS MADE TO THE EXCLUSIVE RIGHT TO USE "METROPOLITAN COLLEGE", APART FROM THE MARK AS SHOWN.

SEC. 2(F).

**CLASS 16—PAPER GOODS AND PRINTED MATTER**

FOR NOTEBOOKS; PENCILS; PENS; STATIONERY (U.S. CLS. 2, 5, 22, 23, 29, 37, 38 AND 50).

FIRST USE 7-1-1988; IN COMMERCE 7-1-1988.

**CLASS 18—LEATHER GOODS**

FOR BACKPACKS; BOOK BAGS; UMBRELLAS (U.S. CLS. 1, 2, 3, 22 AND 41).

FIRST USE 7-1-1988; IN COMMERCE 7-1-1988.

**CLASS 25—CLOTHING**

FOR HEADGEAR, NAMELY, HATS AND CAPS; HOODED SWEATSHIRTS; POLO SHIRTS; SHIRTS; SHORTS; T-SHIRTS (U.S. CLS. 22 AND 39).

FIRST USE 7-1-1988; IN COMMERCE 7-1-1988.

**CLASS 41—EDUCATION AND ENTERTAINMENT**

FOR EDUCATIONAL SERVICES, NAMELY, PROVIDING COURSES OF INSTRUCTION AT THE COLLEGE LEVEL AND DISTRIBUTION OF COURSE MATERIAL IN CONNECTION THEREWITH; ENTERTAINMENT IN THE NATURE OF COMPETITIONS IN THE FIELD OF ATHLETIC EVENTS (U.S. CLS. 100, 101 AND 107).

FIRST USE 7-1-1988; IN COMMERCE 7-1-1988.

SUSAN RICHARDS, EXAMINING ATTORNEY

SN 85-212,154. CHANDOO, ARIF, LONDON, UNITED KINGDOM, FILED 1-6-2011.



PRIORITY CLAIMED UNDER SEC. 44(D) ON ERPN CMNTY TM OFC APPLICATION NO. 009458274, FILED 10-19-2010, REG. NO. 009458274, DATED 4-1-2011, EXPIRES 10-19-2020.

NO CLAIM IS MADE TO THE EXCLUSIVE RIGHT TO USE "WORLD SIM", APART FROM THE MARK AS SHOWN. THE COLOR(S) BLUE, YELLOW, GREEN AND WHITE IS/ARE CLAIMED AS A FEATURE OF THE MARK.

THE MARK CONSISTS OF A GLOBE IN SHADES OF BLUE AROUND WHICH IS WRAPPED A GREEN AND YELLOW BANNER WITH A WHITE SHADOW CUTTING THROUGH THE GLOBE, THE END OF WHICH IS IN THE DESIGN OF A WHITE CELLULAR SIM CARD. ADJACENT IS THE WORD "WORLD" IN ALL CAPITAL BLUE LETTERS AND "SIM" IN ALL CAPITAL GREEN LETTERS.

**CLASS 9—ELECTRICAL AND SCIENTIFIC APPARATUS**

FOR MOBILE PHONE SIM CARDS (U.S. CLS. 21, 23, 26, 36 AND 38).

**CLASS 35—ADVERTISING AND BUSINESS**

FOR RETAIL STORES FEATURING MOBILE SIM CARDS; ONLINE RETAIL STORES FEATURING MOBILE SIM CARDS (U.S. CLS. 100, 101 AND 102).

**CLASS 38—COMMUNICATION**

FOR TELECOMMUNICATIONS SERVICES FOR MOBILE PHONES, NAMELY, PROVIDING MOBILE TELEPHONE COMMUNICATIONS, ELECTRONIC MESSAGE TRANSMISSION (U.S. CLS. 100, 101 AND 104).

APRIL ROACH, EXAMINING ATTORNEY

SN 85-212,692. DAVIS, GEOFF, PRINCETON, NJ. FILED 1-7-2011.

**Story Lite**

THE MARK CONSISTS OF STANDARD CHARACTERS WITHOUT CLAIM TO ANY PARTICULAR FONT, STYLE, SIZE, OR COLOR.

NO CLAIM IS MADE TO THE EXCLUSIVE RIGHT TO USE "STORY", APART FROM THE MARK AS SHOWN.

**CLASS 9—ELECTRICAL AND SCIENTIFIC APPARATUS**

FOR COMPUTER PROGRAMS FOR CREATING, EDITING AND PRINTING DOCUMENTS COMPRISED OF TEXT AND GRAPHICS AND UTILITY PROGRAMS FOR USE THEREWITH; COMPUTER PROGRAMS FOR EXPORTING, PUBLISHING, DATA AND TEXT PROCESSING, FEATURING A ZOOMABLE INTERFACE, A PORTABLE DESKTOP PROGRAM, AND TWO DIMENSIONAL LAYOUT OF FILES; COMPUTER SOFTWARE FOR TEMPLATES FOR WRITING AND USER MANUALS IN PRINTED AND ELECTRONIC FORM SOLD AS A UNIT (U.S. CLS. 21, 23, 26, 36 AND 38).

FIRST USE 12-8-2010; IN COMMERCE 12-8-2010.

**CLASS 42—SCIENTIFIC AND COMPUTER SERVICES**

FOR COMPUTER SERVICES, NAMELY, CREATING AN ON-LINE COMMUNITY FOR REGISTERED USERS TO PARTICIPATE IN DISCUSSIONS IN THE FIELDS OF WRITING, GRAPHICS, PUBLISHING AND RELATED COMPUTER APPLICATIONS; PROVIDING TEMPORARY USE OF ON-LINE NON-DOWNLOADABLE SOFTWARE AND APPLICATIONS FOR CREATING, EDITING AND PRINTING DOCUMENTS COMPRISED OF TEXT AND GRAPHICS AND UTILITY PROGRAMS FOR USE THEREWITH; PROVIDING TEMPORARY USE OF ON-LINE NON-DOWNLOADABLE SOFTWARE AND APPLICATIONS FOR EXPORTING, PUBLISHING, DATA AND TEXT PROCESSING, FEATURING A ZOOMABLE INTERFACE, A PORTABLE DESKTOP PROGRAM, AND TWO DIMENSIONAL LAYOUT OF FILES; PROVIDING TEMPORARY USE OF ON-LINE NONDOWNLOADABLE SOFTWARE AND APPLICATIONS FOR TEMPLATES FOR WRITING (U.S. CLS. 100 AND 101).

FIRST USE 12-8-2010; IN COMMERCE 12-8-2010.

PAULA MAHONEY, EXAMINING ATTORNEY

SN 85-212,704. DAVIS, GEOFF, PRINCETON, NJ. FILED 1-7-2011.

# Story Turbo

THE MARK CONSISTS OF STANDARD CHARACTERS WITHOUT CLAIM TO ANY PARTICULAR FONT, STYLE, SIZE, OR COLOR.

NO CLAIM IS MADE TO THE EXCLUSIVE RIGHT TO USE "STORY", APART FROM THE MARK AS SHOWN.

**CLASS 9—ELECTRICAL AND SCIENTIFIC APPARATUS**

FOR COMPUTER PROGRAMS FOR CREATING, EDITING AND PRINTING DOCUMENTS COMPRISED OF TEXT AND GRAPHICS AND UTILITY PROGRAMS FOR USE THEREWITH; COMPUTER PROGRAMS FOR EXPORTING, PUBLISHING, DATA AND TEXT PROCESSING, FEATURING A ZOOMABLE INTERFACE, A PORTABLE DESKTOP PROGRAM, AND TWO DIMENSIONAL LAYOUT OF FILES; COMPUTER SOFTWARE FOR TEMPLATES FOR WRITING AND USER MANUALS IN PRINTED AND ELECTRONIC FORM SOLD AS A UNIT (U.S. CLS. 21, 23, 26, 36 AND 38).

**CLASS 42—SCIENTIFIC AND COMPUTER SERVICES**

FOR COMPUTER SERVICES, NAMELY, CREATING AN ON-LINE COMMUNITY FOR REGISTERED USERS TO PARTICIPATE IN DISCUSSIONS IN THE FIELDS OF WRITING, GRAPHICS, PUBLISHING AND RELATED COMPUTER APPLICATIONS; PROVIDING TEMPORARY USE OF ON-LINE NON-DOWNLOADABLE SOFTWARE AND APPLICATIONS FOR CREATING, EDITING AND PRINTING DOCUMENTS COMPRISED OF TEXT AND GRAPHICS AND UTILITY PROGRAMS FOR USE THEREWITH; PROVIDING TEMPORARY USE OF ON-LINE NON-DOWNLOADABLE SOFTWARE AND APPLICATIONS FOR EXPORTING, PUBLISHING, DATA AND TEXT PROCESSING, FEATURING A ZOOMABLE INTERFACE, A PORTABLE DESKTOP PROGRAM, AND TWO DIMENSIONAL LAYOUT OF FILES; PROVIDING TEMPORARY USE OF ON-LINE NONDOWNLOADABLE SOFTWARE AND APPLICATIONS FOR TEMPLATES FOR WRITING (U.S. CLS. 100 AND 101).

PAULA MAHONEY, EXAMINING ATTORNEY

SN 85-212,993. HAPA AG, VOLKETSUIL, SWITZERLAND, FILED 1-7-2011.



THE COLOR(S) RED AND WHITE IS/ARE CLAIMED AS A FEATURE OF THE MARK.

THE MARK CONSISTS OF THE WORDS "REDCUBE" IN STYLIZED LETTERS IN WHITE WITHIN A RED SQUARE AND A WHITE CROSS APPEARING IN THE RIGHT HAND CORNER.

**CLASS 2—PAINTS**

FOR PRINTING INK AND INK TONER FOR PRINTING MACHINES; FILLED COLOR INK CARTRIDGES AND FILLED PRINTING INK CARTRIDGES FOR PRINTING MACHINES (U.S. CLS. 6, 11 AND 16).

**CLASS 7—MACHINERY**

FOR PRINTING MACHINES AND AUTOMATIC INDUSTRIAL LABELING MACHINES FOR APPLYING LABELS TO CONTAINERS AND BOTTLES (U.S. CLS. 13, 19, 21, 23, 31, 34 AND 35).

**CLASS 9—ELECTRICAL AND SCIENTIFIC APPARATUS**

FOR PRINTERS FOR USE WITH COMPUTERS AND COMPUTER SOFTWARE FOR OPERATING PRINTERS; APPARATUS FOR DATA PROCESSING, COMPUTER HARDWARE AND SOFTWARE FOR THE MARKING AND CODING OF PACKAGES (U.S. CLS. 21, 23, 26, 36 AND 38).

JULIE VEPPUMTHARA, EXAMINING ATTORNEY

SN 85-213,743. WORD OF FAITH INTERNATIONAL CHRISTIAN CENTER, SOUTHFIELD, MI. FILED 1-10-2011.



NO CLAIM IS MADE TO THE EXCLUSIVE RIGHT TO USE "WOMEN'S MINISTRY", APART FROM THE MARK AS SHOWN.

THE MARK CONSISTS OF THE WORD "DIAMONDS" WITH THE "O" REPRESENTING A FACETED DIAMOND RADIATING A LIGHT THAT FORMS A CHRISTIAN CROSS, AND THE WORDS "WOMEN'S MINISTRY ABOVE AND "LIVE WHAT YOU'RE WORTH" BELOW.

#### CLASS 25—CLOTHING

FOR CLOTHING, NAMELY, T-SHIRTS, JACKETS, SWEATSHIRTS AND HATS (U.S. CLS. 22 AND 39).

#### CLASS 45—PERSONAL AND LEGAL SERVICES

FOR EVANGELICAL AND MINISTERIAL SERVICES IN THE NATURE OF CONDUCTING CHURCH SERVICES AND PROMOTING CHRISTIAN BELIEFS THROUGH A RELIGIOUS ORGANIZATION; RELIGIOUS SERVICES, NAMELY, MINISTERIAL SERVICES, EVANGELICAL SERVICES, PREACHING SERVICES, CONDUCTING RELIGIOUS SERVICES, AND PERSONAL RELIGIOUS COUNSELING (U.S. CLS. 100 AND 101).

PAUL MORENO, EXAMINING ATTORNEY

SN 85-214,295. SITU, YUAN XI, TEMPLE CITY, CA. FILED 1-10-2011.

**GSW**

THE MARK CONSISTS OF STANDARD CHARACTERS WITHOUT CLAIM TO ANY PARTICULAR FONT, STYLE, SIZE, OR COLOR.

#### CLASS 6—METAL GOODS

FOR METAL CASTERS, NAMELY, STEM CASTERS, INDUSTRIAL CASTERS, THREADED CASTERS, AND ADJUSTIBLE CASTERS (U.S. CLS. 2, 12, 13, 14, 23, 25 AND 50).

FIRST USE 1-16-1998; IN COMMERCE 1-16-1998.

#### CLASS 9—ELECTRICAL AND SCIENTIFIC APPARATUS

FOR SCALES, NAMELY, FOOD SCALES (U.S. CLS. 21, 23, 26, 36 AND 38).

FIRST USE 1-16-1998; IN COMMERCE 1-16-1998.

#### CLASS 11—ENVIRONMENTAL CONTROL APPARATUS

FOR SINKS, NAMELY, COMPARTMENT SINKS, HAND SINKS, DIPPER WELL SINKS, MOP SINKS, AND SINK-RELATED ACCESSORIES, NAMELY, SINK DRAIN TRAPS; OVENS, NAMELY, BAKING OVENS, BARBECUE OVENS, COMMERCIAL COOKING OVENS, CONVENTION OVENS, AND COOKING OVENS; COOKING RANGES FOR WOKS; GAS BURNERS FOR WOKS (U.S. CLS. 13, 21, 23, 31 AND 34).

FIRST USE 1-16-1998; IN COMMERCE 1-16-1998.

#### CLASS 12—VEHICLES

FOR CARTS, NAMELY, UTILITY CARTS, INCLUDING DOLLIES, TUBULAR CATS, BUSSING CARTS, AND DIM SUM CARTS (U.S. CLS. 19, 21, 23, 31, 35 AND 44).

FIRST USE 1-16-1998; IN COMMERCE 1-16-1998.

#### CLASS 20—FURNITURE AND ARTICLES NOT OTHERWISE CLASSIFIED

FOR CABINETS, NAMELY, DISH CABINETS AND WALL CABINETS; RACKS, NAMELY, BAKER'S RACKS, DISPLAY RACKS, PAN RACKS, AND STORAGE RACKS; NON-METAL CASTERS, NAMELY, PU CASTERS, PVC CASTERS, HARD RUBBER CASTERS, AND SOFT RUBBER CASTERS; SHELVES, NAMELY, OVER-SHELVES, WALL-MOUNTED SHELVES, WIRE SHELVING, AND SOLID SHELVES; TABLES, NAMELY, DONUT TABLES, WORK TABLES, DISH TABLES, AND TABLE-RELATED ACCESSORIES, NAMELY, DRAWERS; LOCKERS (U.S. CLS. 2, 13, 22, 25, 32 AND 50).

FIRST USE 1-16-1998; IN COMMERCE 1-16-1998.

#### CLASS 21—HOUSEWARES AND GLASS

FOR FRY BASKETS, NAMELY, WIRE COOKING BASKETS, VEGETABLE BASKETS, LADLES FOR KITCHEN USE; HOUSEHOLD UTENSILS, NAMELY, SKIMMERS, SPATULAS, AND TURNERS; COOKWARE, NAMELY, WOKS, FRYING PANS, SKILLETTS, STEAMERS, AND STEAMER-RELATED ACCESSORIES, NAMELY, STEAMER BASKETS, STEAMER COVERS, STEAMER BASKETS IN THE NATURE OF GRATES, STEAMER SHEETS IN THE NATURE OF COOKIE SHEETS; WASTE BINS; TRASH CANS; DRAIN BOARDS, NAMELY, DISH RACKS IN THE FORM OF BOARDS THAT ATTACH TO THE TOP OF SINKS; SINK DISH RACKS (U.S. CLS. 2, 13, 23, 29, 30, 33, 40 AND 50).

FIRST USE 1-16-1998; IN COMMERCE 1-16-1998.

SUNG IN, EXAMINING ATTORNEY

SN 85-216,059. REVEL MATCH LLC, DBA RAVE SPORTS, ST. PAUL, MN. FILED 1-12-2011.

**RAVE**

THE MARK CONSISTS OF STANDARD CHARACTERS WITHOUT CLAIM TO ANY PARTICULAR FONT, STYLE, SIZE, OR COLOR.

OWNER OF U.S. REG. NOS. 2,562,357 AND 3,629,832.

#### CLASS 6—METAL GOODS

FOR ACCESSORIES, NAMELY, MARINE ANCHORS FOR USE WITH RAFTS; BAGS FOR MARINE ANCHORS; ACCESSORIES, NAMELY, METAL LADDERS (U.S. CLS. 2, 12, 13, 14, 23, 25 AND 50).

**CLASS 9—ELECTRICAL AND SCIENTIFIC APPARATUS**

FOR WATER RECREATIONAL PRODUCTS, NAMELY, LIFE JACKETS (U.S. CLS. 21, 23, 26, 36 AND 38).

SN 85-217,546. DENNIS J. SPRONG AND ERIN S. SPRONG, RAMONA, CA. FILED 1-13-2011.

**CLASS 12—VEHICLES**

FOR INFLATABLE WATER PRODUCTS, NAMELY, INFLATABLE RAFTS, INFLATABLE BOATS AND INFLATABLE KAYAKS, AND REPAIR PATCHES FOR THE FOREGOING (U.S. CLS. 19, 21, 23, 31, 35 AND 44).

**Hidden Gem Vineyards**

THE MARK CONSISTS OF STANDARD CHARACTERS WITHOUT CLAIM TO ANY PARTICULAR FONT, STYLE, SIZE, OR COLOR.

NO CLAIM IS MADE TO THE EXCLUSIVE RIGHT TO USE "VINEYARDS", APART FROM THE MARK AS SHOWN.

**CLASS 22—CORDAGE AND FIBERS**

FOR CLOTH AND MESH BAGS FOR STORAGE OF WATER RECREATIONAL PRODUCTS (U.S. CLS. 1, 2, 7, 19, 22, 42 AND 50).

**CLASS 31—NATURAL AGRICULTURAL PRODUCTS**

FOR FRESH WINE GRAPES (U.S. CLS. 1 AND 46).

**CLASS 25—CLOTHING**

FOR CLOTHING, NAMELY, SWIMWEAR; SHIRTS, T-SHIRTS, TANK TOPS, SHORTS (U.S. CLS. 22 AND 39).

**CLASS 33—WINES AND SPIRITS**

FOR WINE (U.S. CLS. 47 AND 49).  
STEVEN R. FINE, EXAMINING ATTORNEY

**CLASS 28—TOYS AND SPORTING GOODS**

FOR WATER RECREATIONAL PRODUCTS, NAMELY, WATER SKIS, WAKEBOARDS, WATER MATS IN THE NATURE OF A FOAM FLAT MAT WITH HANDLES TO SLIDE DOWN WATER PARK SLIDES, AND REPAIR PATCHES FOR THE FOREGOING; INFLATABLE WATER RECREATIONAL PRODUCTS, NAMELY, TRAMPOLINES, BOUNCE PLATFORMS, WATER SLIDES, FLOAT TUBES USED TO TOW BEHIND A BOAT, PONTOON WATER SLIDES, AND INFLATABLE PLAYGROUNDS IN THE NATURE OF OUTDOOR PLAY STRUCTURES, VOLLEYBALL SETS CONSISTING PRIMARILY OF A VOLLEYBALL AND AN INFLATABLE STRUCTURE SUPPORTING A NET, SWIMMING POOL FLOATS, SWIMMING POOL LOUNGERS IN THE NATURE OF FLOATING LOUNGE CHAIRS, AND REPAIR PATCHES FOR THE FOREGOING; WATER SKI TRAINERS IN THE NATURE OF A CATAMARAN-STYLE INFLATABLE DEVICE WHICH ALLOWS NEW SKIERS TO SIT ON THE DEVICE WHILE THEY GET PULLED BY A BOAT, AND REPAIR PATCHES THEREFOR; WAKEBOARD TRAINERS IN THE NATURE OF A CATAMARAN-STYLE INFLATABLE DEVICE WHICH ALLOWS NEW WAKE-BOARDERS TO SIT ON THE DEVICE WHILE THEY GET PULLED BY A BOAT, ALL FOR RECREATIONAL USE, AND REPAIR PATCHES THEREFOR; SNOW SLEDS FOR RECREATIONAL USE; ACCESSORIES, NAMELY, WATER-SKI TOW ROPES, SKI ROPES, ROPE SWING ATTACHMENT IN THE NATURE OF AN INFLATABLE STRUCTURE SUPPORTING A ROPE SWING FOR WATER TRAMPOLINES, AND REPAIR PATCHES THEREFOR; PUMPS FOR INFLATING WATER RECREATIONAL SPORTING EQUIPMENT; RECREATIONAL EQUIPMENT IN THE NATURE OF AN INFLATABLE FLOAT WHICH MARKS THE LOCATION OF THE ANCHOR USED TO TETHER THE INFLATABLE RECREATIONAL WATER PRODUCTS, TO BE USED WITH A TETHER LINE AND A SNAP HOOK, AN ANCHOR LINE WITH BULL SNAP, AN ELASTIC SHOCK CORD, AND A SECTION OF CHAIN (U.S. CLS. 22, 23, 38 AND 50).

DAWN HAN, EXAMINING ATTORNEY

SN 85-218,514. LEADER TECHNOLOGIES INCORPORATED, LEWIS CENTER, OH. FILED 1-14-2011.

**LEADER2LEADER**

THE MARK CONSISTS OF STANDARD CHARACTERS WITHOUT CLAIM TO ANY PARTICULAR FONT, STYLE, SIZE, OR COLOR.

OWNER OF U.S. REG. NOS. 2,743,661, 2,867,183 AND OTHERS.

**CLASS 35—ADVERTISING AND BUSINESS**

FOR ADVERTISING SERVICES, NAMELY, PLACING ADVERTISEMENTS FOR OTHERS FOR PROMOTING COMPUTER CONSULTATION SERVICES AND COMMUNICATIONS GOODS OF OTHERS; RETAIL STORE SERVICES FEATURING COMMUNICATIONS GOODS; ON-LINE TRADING SERVICES IN WHICH SELLERS POST COMPUTER CONSULTATION SERVICES AND COMMUNICATIONS GOODS TO BE AUCTIONED AND BIDDING IS DONE VIA THE INTERNET; DISSEMINATION OF ADVERTISING FOR OTHERS AND PROMOTING THE GOODS AND SERVICES OF OTHERS BY MEANS OF OPERATING AN ONLINE SHOPPING MALL WITH LINKS TO THE RETAIL WEB SITES OF OTHERS (U.S. CLS. 100, 101 AND 102).

**CLASS 42—SCIENTIFIC AND COMPUTER SERVICES**

FOR COMPUTER SERVICES, NAMELY, PROVIDING AN ONLINE NON-DOWNLOADABLE SUITE OF COMPUTER SOFTWARE FOR USE IN TELECOMMUNICATIONS THAT ENABLES COLLABORATION THROUGH TRACKING, CONTEXT, AND STORAGE COMPONENTS OF TECHNOLOGY WITHIN A WEB-BASED SYSTEM; ENABLES MANAGEMENT OF TASKS; ENABLE MANAGEMENT OF COMMUNICATIONS, NAMELY, TRACKING OF INCOMING AND OUTGOING WRITTEN, ELECTRONIC, AND TELEPHONIC COMMUNICATIONS; ENABLES FILE TRANSFERS; ENABLES USE OF USER-DEFINED TOOLS, NAMELY, NEWS INTERFACES, AND ESCALATIONS OF ALERT NOTIFICATION THAT ENHANCE THE PRODUCTIVITY OF THE USER, ENABLE TEAMWORK AMONG THE USERS, ENABLE ACCESS TO USER-GENERATED DATA, AND ENABLE THE USER TO LEVERAGE ENTERPRISE KNOWLEDGE; APPLICATION SERVICE PROVIDER (ASP) FEATURING SOFTWARE TO ENABLE OR FACILITATE THE UPLOADING, DOWNLOADING, STREAMING, POSTING, DISPLAYING, BLOGGING, LINKING, SHARING OR OTHERWISE PROVIDING ELECTRONIC MEDIA OR INFORMATION OVER COMMUNICATION NETWORKS; PROVIDING A WEB SITE FEATURING NON-DOWNLOADABLE SOFTWARE TECHNOLOGY THAT ENABLES ONLINE USERS TO CREATE PERSONAL PROFILES FEATURING SOCIAL NETWORKING INFORMATION AND TO TRANSFER AND SHARE SUCH INFORMATION AMONG MULTIPLE WEBSITES (U.S. CLS. 100 AND 101).

CARYN GLASSER, EXAMINING ATTORNEY

**CLASS 16—PAPER GOODS AND PRINTED MATTER**

FOR BALL POINT PENS; COLOURED PENS; DESK FILE TRAYS; DESK STANDS AND HOLDERS FOR PENS, PENCILS, AND INK; DESKTOP STATIONERY CABINETS; DOCUMENT FILE TRAYS; ENVELOPES FOR STATIONERY USE; FILE TRAYS; FOOD WRAPPING PLASTIC FILM FOR HOUSEHOLD USE; GEL ROLLER PENS; GLUE PENS FOR STATIONERY PURPOSES; HIGHLIGHTER PENS; INK PENS; LETTER TRAYS; MARKING PENS; OFFICE PAPER STATIONERY; OFFICE STATIONERY; ORGANIZATIONAL KITS CONTAINING CALENDARS, STATIONERY, PLANNING FOLDERS, TEMPLATES AND PRINTED GUIDELINES FOR PLANNING SOCIAL EVENTS; PAINT TRAYS; PAPER STATIONERY; PAPER TRAY COVERS; PEN AND PENCIL CASES; PEN AND PENCIL CASES AND BOXES; PEN AND PENCIL HOLDERS; PEN AND PENCIL TRAYS; PLASTIC FOOD STORAGE BAGS FOR HOUSEHOLD USE; PROTRACTORS; STATIONERY; STATIONERY BOXES; STATIONERY FOLDERS; STATIONERY WRITING PAPER AND ENVELOPES; STATIONERY-TYPE PORTFOLIOS; WRITING UTENSILS (U.S. CLS. 2, 5, 22, 23, 29, 37, 38 AND 50).

**CLASS 20—FURNITURE AND ARTICLES NOT OTHERWISE CLASSIFIED**

FOR COMMERCIAL PACKAGING MATERIALS, NAMELY, THERMOFORMED PLASTIC TRAYS; PACKAGING MATERIALS, NAMELY, RIGID PLASTIC TRAYS; PLASTIC CONTAINERS AND COVERS FOR THE FOOD INDUSTRY; PLASTIC CONTAINERS AND COVERS SOLD AS A UNIT TO THE FAST FOOD INDUSTRY FOR MADE TO ORDER FOOD PRODUCTS (U.S. CLS. 2, 13, 22, 25, 32 AND 50).

**CLASS 21—HOUSEWARES AND GLASS**

FOR HOUSEHOLD CONTAINERS FOR FOODS; HOUSEHOLD UTENSILS, NAMELY, STRAINERS; INSULATED BAGS FOR FOOD OR BEVERAGE FOR DOMESTIC USE; KITCHEN UTENSILS, NAMELY, POURING AND STRAINING SPOUTS; KITCHEN UTENSILS, NAMELY, SPLATTER SCREENS; MEAL TRAYS; NON-METALLIC TRAYS; SERVING TRAYS; SERVINGWARE FOR SERVING FOOD; TRAYS (U.S. CLS. 2, 13, 23, 29, 30, 33, 40 AND 50).

ANN E. SAPPENFIELD, EXAMINING ATTORNEY

SN 85-218,581. CAI GLOBAL GROUP LTD., KOWLOON, HONG KONG, FILED 1-15-2011.

SN 85-218,793. CRUCCELL HOLLAND B.V., LEIDEN, NETHERLANDS, FILED 1-16-2011.

# REPET

THE MARK CONSISTS OF STANDARD CHARACTERS WITHOUT CLAIM TO ANY PARTICULAR FONT, STYLE, SIZE, OR COLOR.

OWNER OF U.S. REG. NOS. 3,632,495 AND 3,778,791.

**CLASS 8—HAND TOOLS**

FOR COOKING SPOONS; FLATWARE, NAMELY, FORKS, KNIVES, AND SPOONS; KNIVES, FORKS AND SPOONS; SPREADER IN THE NATURE OF A SMALL KNIFE FOR BUTTER OR CHEESE; TABLEWARE, NAMELY, KNIVES, FORKS AND SPOONS (U.S. CLS. 23, 28 AND 44).

# PERCIVIA

THE MARK CONSISTS OF STANDARD CHARACTERS WITHOUT CLAIM TO ANY PARTICULAR FONT, STYLE, SIZE, OR COLOR.

OWNER OF BENELUX REG. NO. 0827342, DATED 10-5-2007, EXPIRES 7-20-2017.

**CLASS 5—PHARMACEUTICALS**

FOR LIVE CELLS AND CELL-LINES FOR MEDICAL OR CLINICAL USE; PHARMACEUTICAL PRODUCTS AS BIO-ENGINEERED COMPONENT FOR THERAPEUTIC MATERIAL, NAMELY, THERAPEUTIC PROTEINS FOR THE PREVENTION AND TREATMENT OF VIRAL, INFECTIOUS AND GENETIC DISEASES (U.S. CLS. 6, 18, 44, 46, 51 AND 52).

**CLASS 42—SCIENTIFIC AND COMPUTER SERVICES**

FOR SCIENTIFIC AND PHARMACEUTICAL RESEARCH; SCIENTIFIC RESEARCH SERVICES IN THE MEDICAL AND BIOCHEMICAL FIELD, NAMELY, EXPRESSING PROTEINS; PHARMACEUTICAL RESEARCH AND DEVELOPMENT, NAMELY, DEVELOPMENT, EXAMINATION AND TESTING OF PHARMACEUTICAL AND BIOCHEMICAL SEMI-FINISHED PRODUCTS FOR USE IN MEDICINES (U.S. CLS. 100 AND 101).

**CLASS 45—PERSONAL AND LEGAL SERVICES**

FOR LICENSING OF INTELLECTUAL PROPERTY (U.S. CLS. 100 AND 101).  
JENNIFER MARTIN, EXAMINING ATTORNEY

SN 85-219,153. BIOPET LTD., 40230, ISRAEL, FILED 1-17-2011.

**NOVIPET**

THE MARK CONSISTS OF STANDARD CHARACTERS WITHOUT CLAIM TO ANY PARTICULAR FONT, STYLE, SIZE, OR COLOR.

**CLASS 5—PHARMACEUTICALS**

FOR DIETARY SUPPLEMENTS FOR PETS; FEED SUPPLEMENTS FOR PETS (U.S. CLS. 6, 18, 44, 46, 51 AND 52).

**CLASS 31—NATURAL AGRICULTURAL PRODUCTS**

FOR PET TREATS (U.S. CLS. 1 AND 46).  
AMEEN IMAM, EXAMINING ATTORNEY

SN 85-221,209. HELMER INC., NOBLESVILLE, IN. FILED 1-19-2011.

**TRUEBLUE VISION**

THE MARK CONSISTS OF STANDARD CHARACTERS WITHOUT CLAIM TO ANY PARTICULAR FONT, STYLE, SIZE, OR COLOR.

**CLASS 9—ELECTRICAL AND SCIENTIFIC APPARATUS**

FOR INCUBATORS FOR MEDICAL LABORATORY USE, AND COMPONENTS SOLD AS A UNIT THEREWITH, NAMELY, COMPUTER HARDWARE AND SOFTWARE TO MONITOR AND COLLECT DATA AND PROVIDE NOTIFICATION AND ACCESS OVER A NETWORK, MICROPROCESSOR BASED CONTROL BOARDS, LCD TOUCHSCREEN DISPLAYS, AND TEMPERATURE MEASURING DEVICES, MONITORS, AND ALARM SYSTEMS (U.S. CLS. 21, 23, 26, 36 AND 38).

**CLASS 11—ENVIRONMENTAL CONTROL APPARATUS**

FOR MEDICAL REFRIGERATORS AND FREEZERS, AND COMPONENTS SOLD AS A UNIT THEREWITH, NAMELY, COMPUTER HARDWARE AND SOFTWARE TO MONITOR AND COLLECT DATA AND PROVIDE NOTIFICATION AND ACCESS OVER A NETWORK, MICROPROCESSOR BASED CONTROL BOARDS, LCD TOUCHSCREEN DISPLAYS, AND TEMPERATURE MEASURING DEVICES, MONITORS, AND ALARM SYSTEMS (U.S. CLS. 13, 21, 23, 31 AND 34).  
FONG HSU, EXAMINING ATTORNEY

SN 85-221,257. HELMER INC., NOBLESVILLE, IN. FILED 1-19-2011.

**i.C<sup>3</sup>**

THE MARK CONSISTS OF THE LETTERS "I", ".", "C", AND "3" IN SUPERSCRIPIT FONT.

**CLASS 9—ELECTRICAL AND SCIENTIFIC APPARATUS**

FOR INCUBATORS FOR MEDICAL LABORATORY USE, AND COMPONENTS SOLD AS A UNIT THEREWITH, NAMELY, COMPUTER HARDWARE AND SOFTWARE TO MONITOR AND COLLECT DATA AND PROVIDE NOTIFICATION AND ACCESS OVER A NETWORK, MICROPROCESSOR BASED CONTROL BOARDS, LCD TOUCHSCREEN DISPLAYS, AND TEMPERATURE MEASURING DEVICES, MONITORS, AND ALARM SYSTEMS (U.S. CLS. 21, 23, 26, 36 AND 38).

**CLASS 11—ENVIRONMENTAL CONTROL APPARATUS**

FOR MEDICAL REFRIGERATORS AND FREEZERS, AND COMPONENTS SOLD AS A UNIT THEREWITH, NAMELY, COMPUTER HARDWARE AND SOFTWARE TO MONITOR AND COLLECT DATA AND PROVIDE NOTIFICATION AND ACCESS OVER A NETWORK, MICROPROCESSOR BASED CONTROL BOARDS, LCD TOUCHSCREEN DISPLAYS, AND TEMPERATURE MEASURING DEVICES, MONITORS, AND ALARM SYSTEMS (U.S. CLS. 13, 21, 23, 31 AND 34).  
FONG HSU, EXAMINING ATTORNEY

SN 85-221,308. EPONA SOFTWARE PRODUCTIONS B.V., ROTTERDAM, NETHERLANDS, FILED 1-19-2011.

**EPONA**

THE MARK CONSISTS OF STANDARD CHARACTERS WITHOUT CLAIM TO ANY PARTICULAR FONT, STYLE, SIZE, OR COLOR.

OWNER OF ERPN CMNTY TM OFC REG. NO. 007438674, DATED 8-22-2009, EXPIRES 8-22-2019.

THE WORDING "EPONA" HAS NO MEANING IN A FOREIGN LANGUAGE.

### CLASS 9—ELECTRICAL AND SCIENTIFIC APPARATUS

FOR COMPUTER SOFTWARE FOR CONTACT MANAGEMENT, DOCUMENT MANAGEMENT, RECORDS MANAGEMENT, WORKFLOW MANAGEMENT, INTELLECTUAL PROPERTY RECORDS MANAGEMENT, E-MAIL MANAGEMENT, CREATING MEDICAL DISEASE SIMULATIONS, REWARD PLAN ADMINISTRATION, TAX FINANCE, FINANCIAL PRACTICE MANAGEMENT, KNOWLEDGE MANAGEMENT AND CREATING DIGITAL DASHBOARDS (U.S. CLS. 21, 23, 26, 36 AND 38).

### CLASS 42—SCIENTIFIC AND COMPUTER SERVICES

FOR COMPUTER SOFTWARE CONSULTANCY; DESIGN, DEVELOPMENT, INSTALLATION AND MAINTENANCE OF COMPUTER SOFTWARE; PROVIDING TEMPORARY USE OF ON-LINE NON-DOWNLOADABLE SOFTWARE AND APPLICATIONS FOR CONTACT MANAGEMENT, DOCUMENT MANAGEMENT, RECORDS MANAGEMENT, WORKFLOW MANAGEMENT, INTELLECTUAL PROPERTY RECORDS MANAGEMENT, E-MAIL MANAGEMENT, CREATING MEDICAL DISEASE SIMULATIONS, REWARD PLAN ADMINISTRATION, TAX FINANCE, FINANCIAL PRACTICE MANAGEMENT, KNOWLEDGE MANAGEMENT AND CREATING DIGITAL DASHBOARDS (U.S. CLS. 100 AND 101).

HANNO RITTRER, EXAMINING ATTORNEY

SN 85-221,832, WEBB, ARTHUR W., CAMBRIDGE, MD. FILED 1-20-2011.

SUBJECT TO CONCURRENT USE PROCEEDING WITH REGISTRATION NO. 1674276 AND 2780945 AND B&L MANAGEMENT, INC., P.O. BOX 238, DALESVILLE, VA, 24083. APPLICANT CLAIMS THE EXCLUSIVE RIGHT TO USE THE MARK IN THE AREA COMPRISING THE STATES OF MAINE, NEW HAMPSHIRE, VERMONT, MASSACHUSETTS, RHODE ISLAND, CONNECTICUT, TEXAS, LOUISIANA, MISSISSIPPI, ALABAMA AND FLORIDA.

NO CLAIM IS MADE TO THE EXCLUSIVE RIGHT TO USE "SEAFOOD COMPANY", APART FROM THE MARK AS SHOWN.

THE MARK CONSISTS OF THE WORDS "AWFUL ARTHUR'S" ABOVE THE WORDS "SEAFOOD COMPANY" WHERE THE WORDS "SEAFOOD COMPANY" ARE SANDWICHED BETWEEN A PAIR OF HORIZONTAL LINES ABOVE AND BELOW THE WORDS WITH A CARICATURE FISH SKELETAL DESIGN BETWEEN THE WORDS "SEAFOOD" AND "COMPANY".

### CLASS 25—CLOTHING

FOR CLOTHING, NAMELY, SHIRTS, CAPS AND JACKETS (U.S. CLS. 22 AND 39).

FIRST USE 4-1-1994; IN COMMERCE 4-1-1994.

### CLASS 43—HOTEL AND RESTAURANT SERVICES

FOR RESTAURANT SERVICES, CATERING SERVICES, TAKE-OUT FOOD SERVICES (U.S. CLS. 100 AND 101).

FIRST USE 4-1-1994; IN COMMERCE 4-1-1994.  
KIMBERLY FRYE, EXAMINING ATTORNEY

SN 85-222,160. TECACE SOFTWARE LTD., BELLEVUE, WA. FILED 1-20-2011.

# TECACE

THE MARK CONSISTS OF STANDARD CHARACTERS WITHOUT CLAIM TO ANY PARTICULAR FONT, STYLE, SIZE, OR COLOR.

### CLASS 9—ELECTRICAL AND SCIENTIFIC APPARATUS

FOR COMPUTER SOFTWARE DEVELOPMENT AND TESTING TOOLS; COMPUTER SOFTWARE FOR COMPUTER SYSTEM AND APPLICATION DEVELOPMENT, TESTING, DEPLOYMENT AND MANAGEMENT IN INTERNATIONAL; COMPUTER SOFTWARE FOR ADMINISTRATION OF COMPUTER NETWORKS. SMARTPHONES; COMPUTER HARDWARE FOR USE WITH MOBILE DEVICES; COMPUTER HARDWARE AND SOFTWARE USED FOR THE CONTROL OF VOICE CONTROLLED INFORMATION AND COMMUNICATION DEVICES. COMPUTER OPERATING SYSTEM SOFTWARE FOR USE WITH MOBILE COMPUTING DEVICE HARDWARE AND SMARTPHONES. COMPUTER SOFTWARE FOR WIRELESS CONTENT DELIVERY; COMPUTER SOFTWARE PLATFORMS FOR MOBILE DEVICE HARDWARE AND SMARTPHONES. COMPUTER SOFTWARE FOR USE IN DEVELOPING, EXECUTING, AND RUNNING OTHER SOFTWARE ON MOBILE COMPUTING DEVICES, COMPUTERS, COMPUTER NETWORKS, AND GLOBAL COMMUNICATION NETWORKS (U.S. CLS. 21, 23, 26, 36 AND 38).

### CLASS 42—SCIENTIFIC AND COMPUTER SERVICES

FOR COMPUTER HARDWARE AND SOFTWARE CONSULTING SERVICES; DESIGN AND DEVELOPMENT OF COMPUTER SOFTWARE; COMPUTER SOFTWARE DESIGN AND DEVELOPMENT SERVICES FOR OTHERS; COMPUTER SOFTWARE DEVELOPMENT SERVICES, NAMELY, CREATING, DESIGNING, ANALYZING, AND MODIFYING SOFTWARE FOR COMPUTERS, MOBILE DEVICES, AND SMARTPHONES; CUSTOM DESIGN OF COMPUTER SOFTWARE FOR MOBILE DEVICES, HANDHELD COMPUTERS, AND SMARTPHONES. DESIGN AND DEVELOPMENT OF COMPUTER HARDWARE, NAMELY, HANDHELD COMPUTERS AND SMARTPHONES (U.S. CLS. 100 AND 101).

LAKEISHA LEWIS, EXAMINING ATTORNEY



SN 85-222,869. COMMSCOPE, INC. OF NORTH CAROLINA, HICKORY, NC. FILED 1-21-2011.



THE MARK CONSISTS OF A STYLIZED SPHERE CONTAINING A CURVED BAR AND PARTIALLY FADED OVAL SHOWN THEREIN.

#### CLASS 6—METAL GOODS

FOR METAL HANGERS FOR HOLDING TELECOMMUNICATION CABLES; METAL TELECOMMUNICATION BRACKETS, CLIPS AND CLAMPS TO HOUSE AND SUPPORT CABLE AND TELECOMMUNICATIONS EQUIPMENT ALL DISTRIBUTED AS A UNIT; METAL BRACKETS AND CLAMPS FOR SUPPORTING ANTENNAS; METAL LADDER FOR INSTALLING TELECOMMUNICATION CABLES (U.S. CLS. 2, 12, 13, 14, 23, 25 AND 50).

#### CLASS 9—ELECTRICAL AND SCIENTIFIC APPARATUS

FOR COMMUNICATIONS CABLES, NAMELY, COAXIAL CABLES, FIBER OPTIC CABLES, TWISTED PAIR CABLES AND HYBRIDS THEREOF, PATCH TELECOMMUNICATION CABLES, JUMPER CABLES AND TRUNK CABLES IN THE NATURE OF TELECOMMUNICATION CABLES; COMMUNICATIONS CABLE CONNECTORS FOR COAXIAL, FIBER OPTIC AND TWISTED PAIR CABLES AND HYBRIDS THEREOF; ELECTRICAL AND FIBER OPTIC CONNECTOR PLUGS; TELECOMMUNICATIONS JACKS; TELECOMMUNICATION CABLE CONNECTING BLOCKS; CABLE AND WIRING FACE PLATES IN THE NATURE OF PROTECTIVE COVERS FOR TELECOMMUNICATION CABLE AND WIRING; ADAPTORS; COAXIAL AND FIBER OPTIC CABLE TAPS; SHELVING MOUNTING RACKS FOR TELECOMMUNICATIONS HARDWARE; TELECOMMUNICATION CONTROL PATCH PANELS FOR HOUSING PATCH TELECOMMUNICATION CABLES; COMMUNICATIONS CABLE ACCESSORIES, NAMELY, SURGE PROTECTORS AND CABLE PATHWAY CONDUITS FOR HOLDING COAXIAL CABLES, FIBER OPTIC CABLES, TWISTED PAIR CABLES AND HYBRIDS THEREOF; METAL CABINETS SPECIALLY ADAPTED TO PROTECT TELECOMMUNICATIONS EQUIPMENT IN THE NATURE OF TELECOMMUNICATION CABLES AND RUNWAY AND HORIZONTAL AND VERTICAL CABLE MANAGER HOUSINGS FOR SUPPORTING, ORGANIZING AND PROTECTING MULTIPLE TELECOMMUNICATION CABLES; BATTERY CASES FOR HOUSING BACK-UP BATTERIES; METAL CABINETS SPECIALLY ADAPTED TO PROTECT TELECOMMUNICATIONS EQUIPMENT IN THE NATURE OF POWER SUPPLIES AND ELECTRONIC EQUIPMENT FOR TELECOMMUNICATIONS SYSTEMS; ANTENNAS AND STRUCTURAL COMPONENTS THEREFOR, NAMELY, SUPPORT BRACKETS AND CLAMPS SPECIALLY ADAPTED FOR INSTALLING AND SUPPORTING ANTENNAS; BASE STATION ANTENNAS; DUAL-POLARIZED ANTENNAS; REMOTE ELECTRICAL TILT ANTENNAS; POINT TO POINT ANTENNAS; MICROWAVE ANTENNAS; RADIO FREQUENCY ANTENNAS; RADIATING RADIO FREQUENCY TELECOMMUNICATION CABLES; BROADBAND ANTENNAS; BASE STATION AND IN-

BUILDING WIRELESS EQUIPMENT, NAMELY, INDOOR ANTENNAS, DISTRIBUTED ANTENNAS, FIBER-BASED DISTRIBUTED ANTENNAS, RADIO-OVER-FIBER DISTRIBUTED ANTENNAS, WIRELESS TRANSMITTERS AND RECEIVERS, TRANSCEIVERS, AMPLIFIERS AND SIGNAL PROCESSORS FOR REPEATING, RESHAPING AND REFORMATTING DATA SIGNALS; WIRELESS DISTRIBUTION SYSTEM COMPRISING WAVEGUIDES, ELLIPTICAL WAVEGUIDES, RIGID AND FLEXIBLE WAVEGUIDES AND STRUCTURAL PARTS THEREFOR, NAMELY, WAVEGUIDE BRIDGES; SECTOR FRAMES AND MONOPOLE T-FRAMES FOR MOUNTING ANTENNAS TO TELECOMMUNICATION TOWERS; ELECTRICAL GROUND WIRES; ELECTRONIC EQUIPMENT AND SYSTEMS COMPRISED OF SIGNAL PROCESSORS, TRANSCEIVERS, ELECTRONIC CONTROLLERS AND COMPUTER SYSTEMS SOFTWARE FOR PROCESSING COMMUNICATIONS SIGNALS ASSOCIATED WITH GEOLOCATION DEVICES, MANAGING AND CONTROLLING TELECOMMUNICATIONS EQUIPMENT AND SYSTEMS FROM REMOTE LOCATIONS AND EVALUATING WIRELESS VOICE AND DATA TRANSMISSIONS (U.S. CLS. 21, 23, 26, 36 AND 38).

#### CLASS 11—ENVIRONMENTAL CONTROL APPARATUS

FOR PRESSURIZATION EQUIPMENT FOR USE IN PRESSURIZING RADIO FREQUENCY TRANSMISSION LINES AND ANTENNAS, NAMELY, DEHUMIDIFIERS AND ELECTRIC DEHYDRATORS (U.S. CLS. 13, 21, 23, 31 AND 34).

DAVID YONTEF, EXAMINING ATTORNEY

SN 85-223,926. CRUCCELL HOLLAND B.V., LEIDEN, NETHERLANDS, FILED 1-23-2011.

# CRUCCELL

THE MARK CONSISTS OF STANDARD CHARACTERS WITHOUT CLAIM TO ANY PARTICULAR FONT, STYLE, SIZE, OR COLOR.

OWNER OF ERPN CMNTY TM OFC REG. NO. 000712299, DATED 5-17-1999, EXPIRES 12-24-2017.

OWNER OF U.S. REG. NOS. 3,084,039 AND 3,627,121.

#### CLASS 1—CHEMICALS

FOR BIOCHEMICALS IN THE FIELD OF GENETIC PHARMACOLOGY, NAMELY, GENETIC MATERIALS FOR THE MANUFACTURE, RESEARCH AND DEVELOPMENT OF GENE THERAPY AND VACCINE PRODUCTS (U.S. CLS. 1, 5, 6, 10, 26 AND 46).

#### CLASS 5—PHARMACEUTICALS

FOR PHARMACEUTICAL PREPARATIONS FOR THE TREATMENT AND PREVENTION OF INFECTIOUS DISEASES; VACCINES (U.S. CLS. 6, 18, 44, 46, 51 AND 52).

#### CLASS 45—PERSONAL AND LEGAL SERVICES

FOR LICENSING OF INTELLECTUAL PROPERTY IN THE FIELD OF GENETIC PHARMACOLOGY (U.S. CLS. 100 AND 101).

JENNIFER MARTIN, EXAMINING ATTORNEY

SN 85-224,207. FRAMED.COM LLC, FAIRFIELD, CT. FILED 1-24-2011.

## FRAMED

THE MARK CONSISTS OF STANDARD CHARACTERS WITHOUT CLAIM TO ANY PARTICULAR FONT, STYLE, SIZE, OR COLOR.

### CLASS 9—ELECTRICAL AND SCIENTIFIC APPARATUS

FOR EYEWEAR, GLASSES, SUNGLASSES (U.S. CLS. 21, 23, 26, 36 AND 38).

### CLASS 14—JEWELRY

FOR WATCHES AND JEWELRY (U.S. CLS. 2, 27, 28 AND 50).

### CLASS 25—CLOTHING

FOR CLOTHING, NAMELY, TOPS, PANTS, JACKETS, SWEATPANTS, SWEATSHIRTS, SWEATERS, T-SHIRTS, SHORTS AND FOOTWEAR (U.S. CLS. 22 AND 39).

### CLASS 35—ADVERTISING AND BUSINESS

FOR RETAIL STORE SERVICES AND ONLINE RETAIL STORE SERVICES FEATURING EYEWEAR, GLASSES, SUNGLASSES, WATCHES AND JEWELRY, AND CLOTHING (U.S. CLS. 100, 101 AND 102).  
JOHN DWYER, EXAMINING ATTORNEY

SN 85-224,579. NICKELS AND DIMES INCORPORATED, CARROLLTON, TX. FILED 1-24-2011.

## TILT STUDIO

THE MARK CONSISTS OF STANDARD CHARACTERS WITHOUT CLAIM TO ANY PARTICULAR FONT, STYLE, SIZE, OR COLOR.

### CLASS 35—ADVERTISING AND BUSINESS

FOR CONCESSION STANDS FEATURING FOOD AND SOUVENIRS (U.S. CLS. 100, 101 AND 102).  
FIRST USE 4-15-2010; IN COMMERCE 4-15-2010.

### CLASS 41—EDUCATION AND ENTERTAINMENT

FOR ENTERTAINMENT SERVICES IN THE NATURE OF AMUSEMENT ARCADE GAME FACILITIES; ENTERTAINMENT SERVICES IN THE NATURE OF INDOOR AMUSEMENT COMPLEXES; ENTERTAINMENT IN THE NATURE OF AMUSEMENT PARK RIDES; ENTERTAINMENT SERVICES, NAMELY, ARRANGING AND PROVIDING RIDES AND THEME PARK ATTRACTIONS FOR CHILDREN, MINIATURE GOLF FACILITIES, AND BOWLING ALLEYS (U.S. CLS. 100, 101 AND 107).  
FIRST USE 4-15-2010; IN COMMERCE 4-15-2010.

### CLASS 43—HOTEL AND RESTAURANT SERVICES

FOR PROVIDING FOOD AT AMUSEMENT PARKS (U.S. CLS. 100 AND 101).  
FIRST USE 12-31-2010; IN COMMERCE 12-31-2010.  
DAVID C. REIHNER, EXAMINING ATTORNEY

SN 85-225,133. BAYER AKTIENGESELLSCHAFT, 51373 LEVERKUSEN, FED REP GERMANY, FILED 1-25-2011.

## BAYFOL REFLEX

THE MARK CONSISTS OF STANDARD CHARACTERS WITHOUT CLAIM TO ANY PARTICULAR FONT, STYLE, SIZE, OR COLOR.  
OWNER OF U.S. REG. NO. 1,450,786.

### CLASS 7—MACHINERY

FOR LINEAR ACTUATORS (U.S. CLS. 13, 19, 21, 23, 31, 34 AND 35).

### CLASS 9—ELECTRICAL AND SCIENTIFIC APPARATUS

FOR ELECTRIC ACTUATORS FOR USE IN MOTION CONTROL; ELECTRIC ACTUATORS FEATURING HAPTIC TECHNOLOGY; ELECTRIC ACTUATORS FOR SIMULATING TACTILE FEEDBACK; ELECTRIC LINEAR TRANSDUCERS; ELECTRICAL TRANSDUCERS FOR USE IN MOTION CONTROL (U.S. CLS. 21, 23, 26, 36 AND 38).  
JULIE VEPPUMTHARA, EXAMINING ATTORNEY

SN 85-225,140. CARSON PIRIE SCOTT II, INC., YORK, PA. FILED 1-25-2011.

## KENNETH ROBERTS

THE MARK CONSISTS OF STANDARD CHARACTERS WITHOUT CLAIM TO ANY PARTICULAR FONT, STYLE, SIZE, OR COLOR.

OWNER OF U.S. REG. NOS. 3,436,925 AND 3,881,265.  
THE NAME(S), PORTRAIT(S), AND/OR SIGNATURE(S) SHOWN IN THE MARK DOES NOT IDENTIFY A PARTICULAR LIVING INDIVIDUAL.

### CLASS 14—JEWELRY

FOR CUFF LINKS, TIE BARS, TIE TACKS, AND TIE CHAINS (U.S. CLS. 2, 27, 28 AND 50).

### CLASS 16—PAPER GOODS AND PRINTED MATTER

FOR MONEY CLIPS (U.S. CLS. 2, 5, 22, 23, 29, 37, 38 AND 50).

**CLASS 26—FANCY GOODS**

FOR COLLAR STAYS (U.S. CLS. 37, 39, 40, 42 AND 50).  
MIDGE BUTLER, EXAMINING ATTORNEY

SN 85-226,247. WORLDWIDE INTERACTIVE NETWORK,  
INC., KINGSTON, TN. FILED 1-26-2011.

WORLDWIDE INTERACTIVE  
NETWORK

THE MARK CONSISTS OF STANDARD CHARACTERS WITHOUT CLAIM TO ANY PARTICULAR FONT, STYLE, SIZE, OR COLOR.

NO CLAIM IS MADE TO THE EXCLUSIVE RIGHT TO USE "INTERACTIVE NETWORK", APART FROM THE MARK AS SHOWN.

SEC. 2(F).

**CLASS 9—ELECTRICAL AND SCIENTIFIC APPARATUS**

FOR COMPUTER SOFTWARE, NAMELY, EDUCATIONAL SOFTWARE FEATURING INSTRUCTION AND RELATED SOFTWARE TEACHING MATERIALS IN THE FIELDS OF CAREER AND COLLEGE READINESS SKILLS TRAINING (U.S. CLS. 21, 23, 26, 36 AND 38).

FIRST USE 5-31-1996; IN COMMERCE 5-31-1996.

**CLASS 41—EDUCATION AND ENTERTAINMENT**

FOR EDUCATIONAL SERVICES, NAMELY, PROVIDING WEB BASED TRAINING AND CLASSES IN THE FIELDS OF CAREER AND COLLEGE READINESS (U.S. CLS. 100, 101 AND 107).

FIRST USE 5-31-1996; IN COMMERCE 5-31-1996.

JOHN WILKE, EXAMINING ATTORNEY

SN 85-226,746. COMMSCOPE, INC. OF NORTH CAROLINA,  
HICKORY, NC. FILED 1-26-2011.

COMMSCOPE

OWNER OF U.S. REG. NOS. 898,651, 3,418,814 AND OTHERS.

THE STIPPLING IS A FEATURE OF THE MARK.

THE MARK CONSISTS OF THE WORD "COMMSCOPE" IN STYLIZED FONT WHEREBY THE LAST LETTER "O" IS REPRESENTED BY A STYLIZED SPHERE CONTAINING A CURVED BAR AND PARTIALLY FADED OVAL SHOWN THEREIN AND STIPPLING BELOW THE SAME THAT REPRESENTS SHADOWING.

**CLASS 6—METAL GOODS**

FOR METAL HANGERS FOR HOLDING TELECOMMUNICATION CABLES; METAL TELECOMMUNICATION BRACKETS, CLIPS AND CLAMPS TO HOUSE AND SUPPORT CABLE AND TELECOMMUNICATIONS EQUIPMENT ALL DISTRIBUTED AS A UNIT; METAL BRACKETS AND CLAMPS FOR SUPPORTING ANTENNAS; METAL LADDER FOR INSTALLING TELECOMMUNICATION CABLES (U.S. CLS. 2, 12, 13, 14, 23, 25 AND 50).

**CLASS 9—ELECTRICAL AND SCIENTIFIC APPARATUS**

FOR COMMUNICATIONS CABLES, NAMELY, COAXIAL CABLES, FIBER OPTIC CABLES, TWISTED PAIR CABLES AND HYBRIDS THEREOF, PATCH TELECOMMUNICATION CABLES, JUMPER CABLES AND TRUNK CABLES IN THE NATURE OF TELECOMMUNICATION CABLES; COMMUNICATIONS CABLE CONNECTORS FOR COAXIAL, FIBER OPTIC AND TWISTED PAIR CABLES AND HYBRIDS THEREOF; ELECTRICAL AND FIBER OPTIC CONNECTOR PLUGS; TELECOMMUNICATIONS JACKS; TELECOMMUNICATION CABLE CONNECTING BLOCKS; CABLE AND WIRING FACE PLATES IN THE NATURE OF PROTECTIVE COVERS FOR TELECOMMUNICATION CABLE AND WIRING; ADAPTORS; COAXIAL AND FIBER OPTIC CABLE TAPS; SHELVING MOUNTING RACKS FOR TELECOMMUNICATIONS HARDWARE; TELECOMMUNICATION CONTROL PATCH PANELS FOR HOUSING PATCH TELECOMMUNICATION CABLES; COMMUNICATIONS CABLE ACCESSORIES, NAMELY, SURGE PROTECTORS AND CABLE PATHWAY CONDUITS FOR HOLDING COAXIAL CABLES, FIBER OPTIC CABLES, TWISTED PAIR CABLES AND HYBRIDS THEREOF; METAL CABINETS SPECIALLY ADAPTED TO PROTECT TELECOMMUNICATIONS EQUIPMENT IN THE NATURE OF TELECOMMUNICATION CABLES AND RUNWAY AND HORIZONTAL AND VERTICAL CABLE MANAGER HOUSINGS FOR SUPPORTING, ORGANIZING AND PROTECTING MULTIPLE TELECOMMUNICATION CABLES; BATTERY CASES FOR HOUSING BACK-UP BATTERIES; METAL CABINETS SPECIALLY ADAPTED TO PROTECT TELECOMMUNICATIONS EQUIPMENT IN THE NATURE OF POWER SUPPLIES AND ELECTRONIC EQUIPMENT FOR TELECOMMUNICATIONS SYSTEMS; ANTENNAS AND STRUCTURAL COMPONENTS THEREFOR, NAMELY, SUPPORT BRACKETS AND CLAMPS SPECIALLY ADAPTED FOR INSTALLING AND SUPPORTING ANTENNAS; BASE STATION ANTENNAS; DUAL-POLARIZED ANTENNAS; REMOTE ELECTRICAL TILT ANTENNAS; POINT TO POINT ANTENNAS; MICROWAVE ANTENNAS; RADIO FREQUENCY ANTENNAS; RADIATING RADIO FREQUENCY TELECOMMUNICATION CABLES; BROAD-BAND ANTENNAS; BASE STATION AND IN-BUILDING WIRELESS EQUIPMENT, NAMELY, IN-DOOR ANTENNAS, DISTRIBUTED ANTENNAS, FIBER-BASED DISTRIBUTED ANTENNAS, RADIO-OVER-FIBER DISTRIBUTED ANTENNAS, WIRELESS TRANSMITTERS AND RECEIVERS, TRANSCEIVERS, AMPLIFIERS AND SIGNAL PROCESSORS FOR REPEATING, RESHAPING AND REFORMATTING DATA SIGNALS; WIRELESS DISTRIBUTION SYSTEM COMPRISING WAVEGUIDES, ELLIPTICAL WAVEGUIDES, RIGID AND FLEXIBLE WAVEGUIDES AND STRUCTURAL PARTS THEREFOR, NAMELY, WAVEGUIDE BRIDGES; SECTOR FRAMES AND MONOPOLE T-FRAMES FOR MOUNTING ANTENNAS TO TELECOMMUNICATION TOWERS; ELECTRICAL GROUND WIRES; ELECTRONIC EQUIPMENT AND SYSTEMS COMPRISED OF SIGNAL PROCESSORS, TRANSCEIVERS, ELECTRONIC CONTROLLERS AND COMPUTER SYSTEMS SOFTWARE FOR PROCESSING COMMUNICATIONS SIGNALS ASSOCIATED WITH GEOLOCATION DEVICES, MANAGING AND CONTROLLING TELECOMMUNICATIONS EQUIPMENT AND SYSTEMS

FROM REMOTE LOCATIONS AND EVALUATING WIRELESS VOICE AND DATA TRANSMISSIONS (U.S. CLS. 21, 23, 26, 36 AND 38).

**CLASS 11—ENVIRONMENTAL CONTROL APPARATUS**

FOR PRESSURIZATION EQUIPMENT FOR USE IN PRESSURIZING RADIO FREQUENCY TRANSMISSION LINES AND ANTENNAS, NAMELY, DEHUMIDIFIERS AND ELECTRIC DEHYDRATORS (U.S. CLS. 13, 21, 23, 31 AND 34).

DAVID YONTEF, EXAMINING ATTORNEY

SN 85-227,213. COLLABORATIVE MEDIA, LLC, HOLLYWOOD, CA. FILED 1-26-2011.

## Collaborative Media

THE MARK CONSISTS OF STANDARD CHARACTERS WITHOUT CLAIM TO ANY PARTICULAR FONT, STYLE, SIZE, OR COLOR.

NO CLAIM IS MADE TO THE EXCLUSIVE RIGHT TO USE "MEDIA", APART FROM THE MARK AS SHOWN.

**CLASS 35—ADVERTISING AND BUSINESS**

FOR CONSULTING SERVICES RELATING TO PUBLICITY (U.S. CLS. 100, 101 AND 102).

FIRST USE 1-0-2006; IN COMMERCE 1-0-2006.

**CLASS 41—EDUCATION AND ENTERTAINMENT**

FOR ARRANGING AND CONDUCTING SPECIAL EVENTS FOR SOCIAL ENTERTAINMENT PURPOSES; CONCERT BOOKING; ENTERTAINMENT IN THE NATURE OF ORGANIZING AND PRODUCING LIVE MUSICAL EVENTS, ART SHOWS, FASHION SHOWS AND TECHNOLOGY SHOWS; FILM AND VIDEO PRODUCTION CONSULTING SERVICES; PHOTOGRAPHY SERVICES; VIDEO PRODUCTION SERVICES; VIDEOGRAPHY SERVICES (U.S. CLS. 100, 101 AND 107).

FIRST USE 1-0-2006; IN COMMERCE 1-0-2006.

**CLASS 42—SCIENTIFIC AND COMPUTER SERVICES**

FOR WEBSITE DESIGN AND DEVELOPMENT FOR OTHERS (U.S. CLS. 100 AND 101).

FIRST USE 1-0-2006; IN COMMERCE 1-0-2006.

SHAUNIA CARLYLE, EXAMINING ATTORNEY

SN 85-227,328. FORD MOTOR COMPANY, DEARBORN, MI. FILED 1-27-2011.

## FORD FIESTA

THE MARK CONSISTS OF STANDARD CHARACTERS WITHOUT CLAIM TO ANY PARTICULAR FONT, STYLE, SIZE, OR COLOR.

**CLASS 14—JEWELRY**

FOR RINGS, BRACELETS, EARRINGS, NECKLACES, CUFFLINKS, WATCHES (U.S. CLS. 2, 27, 28 AND 50).

**CLASS 16—PAPER GOODS AND PRINTED MATTER**

FOR MONEY CLIPS (U.S. CLS. 2, 5, 22, 23, 29, 37, 38 AND 50).

**CLASS 26—FANCY GOODS**

FOR BELT BUCKLES (U.S. CLS. 37, 39, 40, 42 AND 50). KEVON CHISOLM, EXAMINING ATTORNEY

SN 85-229,735. LA VOZ DE LINARES S.A., MONTERREY N.L., MEXICO, FILED 1-31-2011.



NO CLAIM IS MADE TO THE EXCLUSIVE RIGHT TO USE "107.1 FM", APART FROM THE MARK AS SHOWN.

THE COLOR(S) RED, YELLOW, ORANGE WHITE AND BLACK IS/ARE CLAIMED AS A FEATURE OF THE MARK.

THE MARK CONSISTS OF THE WORD "LA" IN YELLOW AND OUTLINED IN BLACK OVER THE WORD "MAS" IN RED OUTLINED IN BLACK NEXT TO THE WORD "BUENA" IN YELLOW OUTLINED IN BLACK OVER "107.1" IN WHITE OUTLINED IN BLACK AND "FM" IN WHITE OUTLINED IN BLACK ALL ON TOP OF A BLACK OVAL WITH AN ORANGE BORDER ON THE BOTTOM AND A YELLOW AND BLACK STAR IN THE LOWER RIGHT HAND CORNER. THE WORDS "MAS" AND "BUENA" ARE BOTH BORDERED IN YELLOW AT THE TOP AND ORANGE ON THE SIDE AND BOTTOM.

THE ENGLISH TRANSLATION OF "LA MAS BUENA" IN THE MARK IS THE GOOD MORE.

**CLASS 38—COMMUNICATION**

FOR RADIO BROADCASTING OF INFORMATION AND OTHER PROGRAMS (U.S. CLS. 100, 101 AND 104).

FIRST USE 3-0-2007; IN COMMERCE 3-0-2007.

**CLASS 41—EDUCATION AND ENTERTAINMENT**

FOR PRODUCTION AND DISTRIBUTION OF RADIO PROGRAMMES (U.S. CLS. 100, 101 AND 107).

FIRST USE 3-0-2007; IN COMMERCE 3-0-2007.

ZHALEH DELANEY, EXAMINING ATTORNEY

SN 85-230,339. AUTHENTEC, INC., MELBOURNE, FL.  
FILED 1-31-2011.

# AUTHENTEC

THE MARK CONSISTS OF STANDARD CHARACTERS WITHOUT CLAIM TO ANY PARTICULAR FONT, STYLE, SIZE, OR COLOR.

## CLASS 9—ELECTRICAL AND SCIENTIFIC APPARATUS

FOR COMPUTER HARDWARE; COMPUTER SOFTWARE FOR PREVENTING UNAUTHORIZED ACCESS TO COMPUTER NETWORKS AND FOR PROVIDING SECURE CONNECTIONS WITHIN AND TO COMPUTER NETWORKS IN THE FIELD OF ENCRYPTED AND SECURE COMMUNICATION FOR PUBLIC OR PRIVATE NETWORKS AS WELL AS IN THE FIELD OF IDENTIFICATION AND AUTHENTICATION, FOR PROTECTING THE EXCHANGE OF INFORMATION AND CONTENT, DIGITAL RIGHTS MANAGEMENT, AND IN THE FIELD OF CONTROL OF COMPUTER SYSTEMS USED FOR ENCRYPTED COMMUNICATION AND SECURE CONTENT DELIVERY, AND TOOLKITS FOR CREATING EMBEDDED HARDWARE AND SOFTWARE FOR USE IN COMPUTER OR COMMUNICATION NETWORKS; COMPUTER HARDWARE AND SOFTWARE FOR SECURING DATA COMMUNICATIONS, DATA LINES, DIGITAL RIGHTS MANAGEMENT, PUBLIC OR PRIVATE NETWORKS, AND USER ACCESS FOR GLOBAL ONLINE NETWORKS, ENCRYPTION AND AUTHENTICATION PRODUCTS, AND FOR PROVIDING SECURE TELECOMMUNICATIONS CONNECTIONS TO A GLOBAL COMPUTER NETWORK AND COMMUNICATION NETWORKS IN THE FIELD OF ENCRYPTED AND SECURE COMMUNICATIONS (U.S. CLS. 21, 23, 26, 36 AND 38).

FIRST USE 9-0-2010; IN COMMERCE 9-0-2010.

## CLASS 38—COMMUNICATION

FOR ENABLING PRIVATE AND SECURE REAL TIME ELECTRONIC COMMUNICATION OVER A COMPUTER NETWORK; SECURE E-MAIL SERVICES (U.S. CLS. 100, 101 AND 104).

FIRST USE 9-0-2010; IN COMMERCE 9-0-2010.  
INGA ERVIN, EXAMINING ATTORNEY

SN 85-230,351. ARTISTS & INSTIGATORS, LLC, WEST CONSHOHOCKEN, PA. FILED 1-31-2011.

# ARTISTS & INSTIGATORS

THE MARK CONSISTS OF STANDARD CHARACTERS WITHOUT CLAIM TO ANY PARTICULAR FONT, STYLE, SIZE, OR COLOR.

NO CLAIM IS MADE TO THE EXCLUSIVE RIGHT TO USE "ARTISTS", APART FROM THE MARK AS SHOWN.

## CLASS 35—ADVERTISING AND BUSINESS

FOR INTERNSHIP PLACEMENT SERVICES; BRANDING SERVICES, NAMELY, CONSULTING, DEVELOPMENT, MANAGEMENT AND MARKETING OF BRANDS FOR BUSINESSES; BUSINESS DEVELOPMENT SERVICES, NAMELY, PROVIDING START-UP SUPPORT FOR BUSINESSES OF OTHERS (U.S. CLS. 100, 101 AND 102).

## CLASS 36—INSURANCE AND FINANCIAL

FOR VENTURE CAPITAL FUNDING SERVICES TO EMERGING AND START-UP COMPANIES; VENTURE CAPITAL SERVICES, NAMELY, PROVIDING FINANCING TO EMERGING AND START-UP COMPANIES; INCUBATION SERVICES, NAMELY, PROVIDING FINANCING TO FREELANCERS, START-UPS, EXISTING BUSINESSES AND NON-PROFITS (U.S. CLS. 100, 101 AND 102).

## CLASS 41—EDUCATION AND ENTERTAINMENT

FOR EDUCATIONAL SERVICES, NAMELY, PROVIDING INTERNSHIPS AND APPRENTICESHIP PROGRAMS IN THE FIELDS OF BUSINESS, SCIENCE, RESEARCH, AND HUMANITIES; FACILITATING THE PROVISION OF INTERNSHIPS AND APPRENTICESHIPS IN THE FIELDS OF BUSINESS, SCIENCE, RESEARCH, AND HUMANITIES (U.S. CLS. 100, 101 AND 107).

MELISSA VALLILLO, EXAMINING ATTORNEY

SN 85-230,440. ARTISTS & INSTIGATORS, LLC, WEST CONSHOHOCKEN, PA. FILED 1-31-2011.

# ARTISTS & INSTIGATORS PRACTICUM

THE MARK CONSISTS OF STANDARD CHARACTERS WITHOUT CLAIM TO ANY PARTICULAR FONT, STYLE, SIZE, OR COLOR.

NO CLAIM IS MADE TO THE EXCLUSIVE RIGHT TO USE "ARTISTS" AND "PRACTICUM", APART FROM THE MARK AS SHOWN.

## CLASS 35—ADVERTISING AND BUSINESS

FOR INTERNSHIP PLACEMENT SERVICES (U.S. CLS. 100, 101 AND 102).

## CLASS 36—INSURANCE AND FINANCIAL

FOR VENTURE CAPITAL FUNDING SERVICES TO EMERGING AND START-UP COMPANIES; VENTURE CAPITAL SERVICES, NAMELY, PROVIDING FINANCING TO EMERGING AND START-UP COMPANIES; INCUBATION SERVICES, NAMELY, PROVIDING FINANCING TO FREELANCERS, START-UPS, EXISTING BUSINESSES AND NON-PROFITS (U.S. CLS. 100, 101 AND 102).

## CLASS 41—EDUCATION AND ENTERTAINMENT

FOR EDUCATIONAL SERVICES, NAMELY, PROVIDING INTERNSHIPS AND APPRENTICESHIP PROGRAMS IN THE FIELDS OF BUSINESS, SCIENCE, RESEARCH, AND HUMANITIES; FACILITATING THE PROVISION OF INTERNSHIPS AND APPRENTICESHIPS IN THE FIELDS OF BUSINESS, SCIENCE, RESEARCH, AND HUMANITIES (U.S. CLS. 100, 101 AND 107).

MELISSA VALLILLO, EXAMINING ATTORNEY

SN 85-230,451. ARTISTS & INSTIGATORS, LLC, WEST CONSHOHOCKEN, PA. FILED 1-31-2011.

## A&I PRACTICUM

THE MARK CONSISTS OF STANDARD CHARACTERS WITHOUT CLAIM TO ANY PARTICULAR FONT, STYLE, SIZE, OR COLOR.

NO CLAIM IS MADE TO THE EXCLUSIVE RIGHT TO USE "PRACTICUM", APART FROM THE MARK AS SHOWN.

### CLASS 35—ADVERTISING AND BUSINESS

FOR INTERNSHIP PLACEMENT SERVICES (U.S. CLS. 100, 101 AND 102).

### CLASS 36—INSURANCE AND FINANCIAL

FOR VENTURE CAPITAL FUNDING SERVICES TO EMERGING AND START-UP COMPANIES; VENTURE CAPITAL SERVICES, NAMELY, PROVIDING FINANCING TO EMERGING AND START-UP COMPANIES; INCUBATION SERVICES, NAMELY, PROVIDING FINANCING TO FREELANCERS, START-UPS, EXISTING BUSINESSES AND NON-PROFITS (U.S. CLS. 100, 101 AND 102).

### CLASS 41—EDUCATION AND ENTERTAINMENT

FOR EDUCATIONAL SERVICES, NAMELY, PROVIDING INTERNSHIPS AND APPRENTICESHIP PROGRAMS IN THE FIELDS OF BUSINESS, SCIENCE, RESEARCH, AND HUMANITIES; FACILITATING THE PROVISION OF INTERNSHIPS AND APPRENTICESHIPS IN THE FIELDS OF BUSINESS, SCIENCE, RESEARCH, AND HUMANITIES (U.S. CLS. 100, 101 AND 107).  
MELISSA VALLILLO, EXAMINING ATTORNEY

SN 85-230,618. LEADER TECHNOLOGIES INCORPORATED, LEWIS CENTER, OH. FILED 1-31-2011.



OWNER OF U.S. REG. NOS. 2,743,662, 2,807,278 AND OTHERS.

THE COLOR(S) ORANGE AND BLACK IS/ARE CLAIMED AS A FEATURE OF THE MARK.

THE MARK CONSISTS OF FIVE LINES SEPARATED BY SPACES ALONG A DIAGONAL AXIS WITH GEOMETRIC SHAPES APPEARING TO BE CUT OUT FROM THE CENTER OF THE LINES AND THE TERM "LEADER" TO THE RIGHT OF THE GRAPHIC DESIGN WITH A CAPITAL "L" AND LOWERCASE LETTERS THEREAFTER. THE COLOR ORANGE APPEARS IN THE DESIGN OF THE LINES AND THE COLOR BLACK APPEARS IN THE WORD "LEADER".

### CLASS 9—ELECTRICAL AND SCIENTIFIC APPARATUS

FOR COMPUTER SOFTWARE FOR INTERACTIVE AUDIO, IMAGE, VIDEO, GRAPHICS, AND DATA TRANSFER FOR USE IN TELECOMMUNICATIONS; COMPUTER SOFTWARE FOR USE IN PREPAID LICENSURES (U.S. CLS. 21, 23, 26, 36 AND 38).

### CLASS 38—COMMUNICATION

FOR TELECOMMUNICATIONS SERVICES, NAMELY, ELECTRONIC TRANSMISSION OF VOICE, DATA, INFORMATION AND IMAGES (U.S. CLS. 100, 101 AND 104).

### CLASS 42—SCIENTIFIC AND COMPUTER SERVICES

FOR COMPUTER SERVICES, NAMELY, PROVIDING AN ONLINE NON-DOWNLOADABLE SUITE OF COMPUTER SOFTWARE FOR USE IN TELECOMMUNICATIONS THAT ENABLES COLLABORATION THROUGH TRACKING, CONTEXT, AND STORAGE COMPONENTS OF TECHNOLOGY WITHIN A WEB-BASED SYSTEM; ENABLES MANAGEMENT OF TASKS; ENABLES MANAGEMENT OF COMMUNICATIONS, NAMELY, TRACKING OF INCOMING AND OUTGOING WRITTEN, ELECTRONIC, AND TELEPHONIC COMMUNICATIONS; ENABLES FILE TRANSFERS; ENABLES USE OF USER-DEFINED TOOLS, NAMELY, NEWS INTERFACES, AND ESCALATIONS OF ALERT NOTIFICATION THAT ENHANCE THE PRODUCTIVITY OF THE USER, ENABLES TEAMWORK AMONG THE USERS, ENABLES ACCESS TO USER-GENERATED DATA, AND ENABLES THE USER TO LEVERAGE ENTERPRISE KNOWLEDGE; APPLICATION SERVICE PROVIDER (ASP) FEATURING SOFTWARE TO ENABLE OR FACILITATE THE UPLOADING, DOWNLOADING, STREAMING, POSTING, DISPLAYING, BLOGGING, LINKING, SHARING OR OTHERWISE PROVIDING ELECTRONIC MEDIA OR INFORMATION OVER COMMUNICATION NETWORKS; PROVIDING A WEB SITE FEATURING TECHNOLOGY THAT ENABLES ONLINE USERS TO CREATE PERSONAL PROFILES FEATURING SOCIAL NETWORKING INFORMATION AND TO TRANSFER AND SHARE SUCH INFORMATION AMONG MULTIPLE WEBSITES (U.S. CLS. 100 AND 101).

CARYN GLASSER, EXAMINING ATTORNEY

SN 85-231,292. CREATIVE KIDS FAR EAST INC., MONSEY, NY. FILED 2-1-2011.



THE COLOR(S) PINK, BLACK, WHITE AND GRAY IS/ARE CLAIMED AS A FEATURE OF THE MARK.

THE MARK CONSISTS OF A FIGURAL FACE OF A GIRL OVERLYING A PAIR OF CROSSED WHITE BONES OUTLINED IN BLACK. THE GIRL WEARS A PAIR OF PINK

BOWS IN HER HAIR AND HAS ONE EYE IN THE FORM OF A BLACK SHADED CIRCLE WITH A PINK HEART. THE GIRL'S FACE IS IN WHITE, THE CHEEKS AND FACIAL SHADING ARE IN PINK. HER NOSE IS IN THE SHAPE OF AN UPSIDE DOWN BLACK HEART, HER LIPS ARE PINK AND OUTLINED IN BLACK, AND HER OTHER EYE AND EYEBROWS ARE BLACK. THE REMAINDER OF THE MARK IS IN GRAY AND BLACK SHADING. THE LITERAL WORDING "PINKY SKULL" APPEARS BELOW THE FIGURAL PORTION OUTLINED IN BLACK.

**CLASS 3—COSMETICS AND CLEANING PREPARATIONS**

FOR CHILDREN'S COSMETICS (U.S. CLS. 1, 4, 6, 50, 51 AND 52).

**CLASS 28—TOYS AND SPORTING GOODS**

FOR CHILDREN'S ACTIVITY SETS, NAMELY, CRAFT SETS FOR MAKING TEMPORARY TATTOOS, CRAFT SETS FOR MAKING TOY JEWELRY, HOBBY CRAFT SETS CONSISTING OF BEADS, SEQUINS AND STRINGING THREAD (U.S. CLS. 22, 23, 38 AND 50).  
DARRYL SPRUILL, EXAMINING ATTORNEY

---

SN 85-231,735. JACKSON GUTHY, BEVERLY HILLS, CA. FILED 2-1-2011.

THE NAME(S), PORTRAIT(S), AND/OR SIGNATURE(S) SHOWN IN THE MARK IDENTIFIES "JACKSON GUTHY", WHOSE CONSENT(S) TO REGISTER IS MADE OF RECORD.

THE MARK CONSISTS OF STYLIZED LETTERING WITH "GUTHY" APPEARING UNDERNEATH "JACKSON", AND THE LETTER "K" HAVING A STARBURST AT ITS LOWEST END.

**CLASS 9—ELECTRICAL AND SCIENTIFIC APPARATUS**

FOR PRE-RECORDED CDS AND DVDS OF MUSICAL AND THEATRICAL PERFORMANCES (U.S. CLS. 21, 23, 26, 36 AND 38).

**CLASS 41—EDUCATION AND ENTERTAINMENT**

FOR ENTERTAINMENT, NAMELY, LIVE MUSICAL AND THEATRICAL PERFORMANCES (U.S. CLS. 100, 101 AND 107).  
IRA J. GOODSAD, EXAMINING ATTORNEY

SN 85-232,120. STEUP, MIKE, ISERLOHN, FED REP GERMANY, FILED 2-2-2011.

# BLU-MOTE

THE MARK CONSISTS OF STANDARD CHARACTERS WITHOUT CLAIM TO ANY PARTICULAR FONT, STYLE, SIZE, OR COLOR.

PRIORITY CLAIMED UNDER SEC. 44(D) ON ERPN CMNTY TM OFC APPLICATION NO. 009703083, FILED 2-1-2011, REG. NO. 009703083, DATED 7-21-2011, EXPIRES 2-1-2021.

**CLASS 9—ELECTRICAL AND SCIENTIFIC APPARATUS**

FOR REMOTE CONTROLS FOR RADIOS, TELEVISION, STEREOS, APPLIANCES AND TOYS; VIDEO GAME INTERACTIVE REMOTE CONTROL UNITS; SYSTEM MANAGEMENT SOFTWARE, NAMELY, COMPUTER SOFTWARE THAT ALLOWS USERS TO REMOTELY CONTROL AND VIEW LARGE AND SMALL APPLIANCES, ELECTRICAL SYSTEMS, AND SECURITY SYSTEMS IN HOMES, OFFICES AND VEHICLES; REMOTE CONTROL TRANSMITTERS AND REMOTE CONTROL RECEIVERS FOR RADIO-CONTROLLED DEVICES; VIDEO GAME INTERACTIVE HAND HELD REMOTE CONTROLS INCORPORATING LIQUID CRYSTAL DISPLAYS FOR PLAYING ELECTRONIC GAMES (U.S. CLS. 21, 23, 26, 36 AND 38).

**CLASS 28—TOYS AND SPORTING GOODS**

FOR REMOTE CONTROL TOYS AND PLAYTHINGS, NAMELY, CARS, RACE CARS, AIRPLANES, AND BOATS (U.S. CLS. 22, 23, 38 AND 50).  
KIM MONINGHOFF, EXAMINING ATTORNEY

---

SN 85-233,753. INTUIT INC., MOUNTAIN VIEW, CA. FILED 2-3-2011.

# TOTAL ASSURANCE

THE MARK CONSISTS OF STANDARD CHARACTERS WITHOUT CLAIM TO ANY PARTICULAR FONT, STYLE, SIZE, OR COLOR.

NO CLAIM IS MADE TO THE EXCLUSIVE RIGHT TO USE "ASSURANCE", APART FROM THE MARK AS SHOWN.

**CLASS 35—ADVERTISING AND BUSINESS**

FOR PROVIDING TAX AND TAX PREPARATION MANAGEMENT INFORMATION VIA COMPUTER AND COMMUNICATIONS NETWORKS; TAX CONSULTATION AND ADVISORY SERVICES; PROVIDING TAX ANALYSIS AND CALCULATION IN THE NATURE OF ACCOUNTING AND ASSESSMENT, PLANNING, PREPARATION, AND FILING SERVICES; ELECTRONIC TAX FILING SERVICES; PROVISION OF INFORMATION CONCERNING TAXES, TAX RETURNS, TAX PLANNING, TAX PREPARATION MANAGEMENT, PREPARATION OF TAX FORMS, AND ELECTRONIC FILING OF TAX FORMS (U.S. CLS. 100, 101 AND 102).  
FIRST USE 1-18-2011; IN COMMERCE 1-18-2011.

**CLASS 36—INSURANCE AND FINANCIAL**

FOR PROVIDING TAX PAYMENT MANAGEMENT INFORMATION VIA COMPUTER AND COMMUNICATIONS NETWORKS; ELECTRONIC FUNDS TRANSFER OF TAX REFUNDS; PROVIDING TAX ANALYSIS AND CALCULATION, NAMELY, PROVIDING ANALYSIS AND CALCULATION OF TAX PAYMENTS; PROVISION OF INFORMATION CONCERNING TAX PAYMENT MANAGEMENT (U.S. CLS. 100, 101 AND 102).

FIRST USE 1-18-2011; IN COMMERCE 1-18-2011.

**CLASS 42—SCIENTIFIC AND COMPUTER SERVICES**

FOR PROVIDING TEMPORARY USE OF ON-LINE NON-DOWNLOADABLE SOFTWARE FOR TAX PLANNING, TAX CALCULATION, AND TAX RETURN PREPARATION AND FILING; PROVISION OF ONLINE ACCESS TO AND USE OF HOSTED COMPUTER SOFTWARE FOR PREPARING AND FILING TAX RETURNS, NAMELY, SOFTWARE AS A SERVICES (SAAS) SERVICES FEATURING SOFTWARE FOR PREPARING AND FILING OF TAX RETURNS; TRANSACTION PROCESSING SOFTWARE, NAMELY, PROVIDING TEMPORARY USE OF ON-LINE NON-DOWNLOADABLE SOFTWARE FOR PROCESSING TAX PAYMENTS; PROVIDING TEMPORARY USE OF ONLINE NON-DOWNLOADABLE COMPUTER SOFTWARE FOR ORGANIZING, TRACKING AND REPORTING TAX-DEDUCTIBLE EXPENSES (U.S. CLS. 100 AND 101).

FIRST USE 1-18-2011; IN COMMERCE 1-18-2011.  
APRIL ROACH, EXAMINING ATTORNEY

SN 85-233,755. INTUIT INC., MOUNTAIN VIEW, CA. FILED 2-3-2011.

**TURBOTAX TOTAL ASSURANCE**

THE MARK CONSISTS OF STANDARD CHARACTERS WITHOUT CLAIM TO ANY PARTICULAR FONT, STYLE, SIZE, OR COLOR.

OWNER OF U.S. REG. NOS. 1,369,883, 3,833,983 AND OTHERS.

NO CLAIM IS MADE TO THE EXCLUSIVE RIGHT TO USE "ASSURANCE", APART FROM THE MARK AS SHOWN.

**CLASS 35—ADVERTISING AND BUSINESS**

FOR PROVIDING TAX AND TAX PREPARATION MANAGEMENT INFORMATION VIA COMPUTER AND COMMUNICATIONS NETWORKS; TAX CONSULTATION AND ADVISORY SERVICES; PROVIDING TAX ANALYSIS AND CALCULATION IN THE NATURE OF ACCOUNTING AND ASSESSMENT, PLANNING, PREPARATION, AND FILING SERVICES; ELECTRONIC TAX FILING SERVICES; PROVISION OF INFORMATION CONCERNING TAXES, TAX RETURNS, TAX PLANNING, TAX PREPARATION MANAGEMENT, PREPARATION OF TAX FORMS, AND ELECTRONIC FILING OF TAX FORMS (U.S. CLS. 100, 101 AND 102).

FIRST USE 1-18-2011; IN COMMERCE 1-18-2011.

**CLASS 36—INSURANCE AND FINANCIAL**

FOR PROVIDING TAX PAYMENT MANAGEMENT INFORMATION VIA COMPUTER AND COMMUNICATIONS NETWORKS; ELECTRONIC FUNDS TRANSFER OF TAX REFUNDS; PROVIDING TAX ANALYSIS AND CALCULATION, NAMELY, PROVIDING ANALYSIS AND CALCULATION OF TAX PAYMENTS; PROVISION OF INFORMATION CONCERNING TAX PAYMENT MANAGEMENT (U.S. CLS. 100, 101 AND 102).

FIRST USE 1-18-2011; IN COMMERCE 1-18-2011.

**CLASS 42—SCIENTIFIC AND COMPUTER SERVICES**

FOR PROVIDING TEMPORARY USE OF ON-LINE NON-DOWNLOADABLE SOFTWARE FOR TAX PLANNING, TAX CALCULATION, AND TAX RETURN PREPARATION AND FILING; PROVISION OF ONLINE ACCESS TO AND USE OF HOSTED COMPUTER SOFTWARE FOR PREPARING AND FILING TAX RETURNS, NAMELY, SOFTWARE AS A SERVICES (SAAS) SERVICES FEATURING SOFTWARE FOR PREPARING AND FILING OF TAX RETURNS; TRANSACTION PROCESSING SOFTWARE, NAMELY, PROVIDING TEMPORARY USE OF ON-LINE NON-DOWNLOADABLE SOFTWARE FOR PROCESSING TAX PAYMENTS; PROVIDING TEMPORARY USE OF ONLINE NON-DOWNLOADABLE COMPUTER SOFTWARE FOR ORGANIZING, TRACKING AND REPORTING TAX-DEDUCTIBLE EXPENSES (U.S. CLS. 100 AND 101).

FIRST USE 1-18-2011; IN COMMERCE 1-18-2011.  
APRIL ROACH, EXAMINING ATTORNEY

SN 85-234,034. BROADCASTING BOARD OF GOVERNORS, WASHINGTON, DC. FILED 2-4-2011.

**PARAZIT**

THE MARK CONSISTS OF STANDARD CHARACTERS WITHOUT CLAIM TO ANY PARTICULAR FONT, STYLE, SIZE, OR COLOR.

THE ENGLISH TRANSLATION OF "PARAZIT" IN THE MARK IS "STATIC".

**CLASS 38—COMMUNICATION**

FOR STREAMING OF AUDIO AND VIDEO MATERIAL ON THE INTERNET (U.S. CLS. 100, 101 AND 104).

FIRST USE 11-28-2009; IN COMMERCE 11-28-2009.

**CLASS 41—EDUCATION AND ENTERTAINMENT**

FOR ENTERTAINMENT SERVICES, NAMELY, PROVIDING ON-GOING TELEVISION PROGRAMS IN THE FIELD OF NEWS COMMENTARY AND SATIRE VIA A GLOBAL COMPUTER NETWORK; ENTERTAINMENT SERVICES, NAMELY, PROVIDING PODCASTS IN THE FIELD OF NEWS COMMENTARY AND SATIRE; ENTERTAINMENT, NAMELY, A CONTINUING NEWS COMMENTARY AND SATIRE SHOW BROADCAST OVER SATELLITE, AUDIO, AND VIDEO MEDIA; ONLINE JOURNALS, NAMELY, BLOGS FEATURING NEWS COMMENTARY AND SATIRE (U.S. CLS. 100, 101 AND 107).

FIRST USE 5-31-2009; IN COMMERCE 5-31-2009.  
JANICE L. MCMORROW, EXAMINING ATTORNEY



SN 85-234,451. SPIELO INTERNATIONAL CANADA ULC, MONCTON, NEW BRUNSWICK, CANADA, FILED 2-4-2011.

## SPIELO INTERNATIONAL

THE MARK CONSISTS OF STANDARD CHARACTERS WITHOUT CLAIM TO ANY PARTICULAR FONT, STYLE, SIZE, OR COLOR.

PRIORITY CLAIMED UNDER SEC. 44(D) ON CANADA APPLICATION NO. 1513637, FILED 2-2-2011.

OWNER OF U.S. REG. NO. 2,008,795.

NO CLAIM IS MADE TO THE EXCLUSIVE RIGHT TO USE "INTERNATIONAL", APART FROM THE MARK AS SHOWN.

### CLASS 9—ELECTRICAL AND SCIENTIFIC APPARATUS

FOR WAGERING SYSTEMS, NAMELY, COMPUTER HARDWARE AND SOFTWARE FOR PROCESSING AND REPORTING ON VIDEO LOTTERY AND SLOT TRANSACTIONS AND PERFORMING RELATED MANAGEMENT AND ACCOUNTING FUNCTIONS; SOFTWARE FOR VIDEO LOTTERY AND SLOT SYSTEMS FOR OPERATING VIDEO LOTTERY AND SLOT SYSTEMS; GAMING MACHINES, NAMELY, SLOT MACHINES AND VIDEO LOTTERY TERMINALS; COMPUTER GAME SOFTWARE FOR GAMING MACHINES, NAMELY, SLOT MACHINES AND VIDEO LOTTERY TERMINALS (U.S. CLS. 21, 23, 26, 36 AND 38).

### CLASS 35—ADVERTISING AND BUSINESS

FOR OPERATION OF GAMING EQUIPMENT AND GAMING SYSTEMS FOR OTHERS (U.S. CLS. 100, 101 AND 102).

### CLASS 37—CONSTRUCTION AND REPAIR

FOR MAINTENANCE AND INSTALLATION OF GAMING EQUIPMENT AND GAMING SYSTEMS FOR OTHERS (U.S. CLS. 100, 103 AND 106).

### CLASS 42—SCIENTIFIC AND COMPUTER SERVICES

FOR GAMING EQUIPMENT, GAMING SOFTWARE AND GAMING OPERATIONS TECHNOLOGY SUPPORT SERVICES, NAMELY, EMAIL, PHONE AND ON-SITE SOFTWARE MAINTENANCE AND REPAIR SERVICES, ALL RELATING TO CASINO AND LOTTERY GAMING EQUIPMENT AND GAMING SYSTEMS; CUSTOM DESIGN AND TECHNOLOGY CONSULTING SERVICES FOR GAMING EQUIPMENT AND GAMING SYSTEMS (U.S. CLS. 100 AND 101).

JENNIFER MARTIN, EXAMINING ATTORNEY

SN 85-236,391. DANIEL ADLER, CHARLEVOIX, MI. FILED 2-8-2011.

## DANNY ADLER THE ROOGALATOR

THE MARK CONSISTS OF STANDARD CHARACTERS WITHOUT CLAIM TO ANY PARTICULAR FONT, STYLE, SIZE, OR COLOR.

THE NAME(S), PORTRAIT(S), AND/OR SIGNATURE(S) SHOWN IN THE MARK IDENTIFIES "DANNY ADLER", WHOSE CONSENT(S) TO REGISTER IS MADE OF RECORD.

### CLASS 9—ELECTRICAL AND SCIENTIFIC APPARATUS

FOR DIGITAL MEDIA, NAMELY, PRE-RECORDED DVDS, DOWNLOADABLE AUDIO AND VIDEO RECORDINGS, CDS, RECORDS AND ALBUMS FEATURING MUSICAL ENTERTAINMENT (U.S. CLS. 21, 23, 26, 36 AND 38).

FIRST USE 11-0-1972; IN COMMERCE 11-0-1972.

### CLASS 41—EDUCATION AND ENTERTAINMENT

FOR ENTERTAINMENT IN THE NATURE OF LIVE MUSICAL PERFORMANCES; EDUCATIONAL SERVICES, NAMELY, PROVIDING LIVE AND ONLINE MUSICAL PRESENTATIONS IN TRADITIONAL MUSIC GENRES SUCH AS JAZZ, BLUES, FOLK AND POPULAR MUSIC IN THE FIELD OF MUSIC APPRECIATION (U.S. CLS. 100, 101 AND 107).

FIRST USE 11-0-1972; IN COMMERCE 11-0-1972.

MICHAEL ENGEL, EXAMINING ATTORNEY

SN 85-237,932. RÖHREN- UND PUMPENWERK BAUER GMBH, VOITSBERG, AUSTRIA, FILED 2-9-2011.



PRIORITY CLAIMED UNDER SEC. 44(D) ON ERPNTY TM OFC APPLICATION NO. 009593195, FILED 12-13-2010, REG. NO. 009593195, DATED 5-27-2011, EXPIRES 12-13-2020.

THE COLOR(S) BLUE, GREY AND WHITE IS/ARE CLAIMED AS A FEATURE OF THE MARK.

THE MARK CONSISTS OF THE LETTERS "BRU" IN WHITE WITH THE LETTER "R" WITHIN A GREY BROKEN CIRCLE, AND WITH THE LETTERS "BRU" AND THE BROKEN CIRCLE ON A BLUE BACKGROUND. THE WHITE BACKGROUND SURROUNDING THE BLUE BACKGROUND IN THE DRAWING IS NOT CLAIMED AS A FEATURE OF THE MARK.

### CLASS 7—MACHINERY

FOR SUBMERSIBLE PUMPS WITH MIXING DEVICE; FEEDING AUGERS, NAMELY, EARTH AUGERS; CONVEYOR BELTS; SEPARATORS FOR SOLID/LIQUID PHASES, NAMELY, SCREW PRESSES AND ROLL PRESSES IN THE NATURE OF INDUSTRIAL MACHINE PRESSES; HYDRO-CENTRIFUGES; PUMPS FOR MACHINES, DEFOAMING CENTRIFUGES; DEVICES FOR PROCESSING OF SOLID MATTER REMOVED, NAMELY, COMPOSTERS, BRIQUETTING PRESSES AND SOLIDS GASIFIERS; FEED UNITS, NAMELY, MECHANIZED LIVESTOCK FEEDERS (U.S. CLS. 13, 19, 21, 23, 31, 34 AND 35).

**CLASS 9—ELECTRICAL AND SCIENTIFIC APPARATUS**

FOR DOSING APPARATUS, NAMELY, DISPENSERS OF PRESET PORTIONS OF FLUIDS FOR DOSING PURPOSES NOT FOR MEDICAL USE; DEVICES FOR HOMOGENIZATION, NAMELY, HOMOGENIZERS; FLOTATION APPARATUS INCLUDING ACCESSORY UNITS, NAMELY, INFLATABLE FLOTATION DEVICES AS A PROTECTION APPARATUS (U.S. CLS. 21, 23, 26, 36 AND 38).

**CLASS 11—ENVIRONMENTAL CONTROL APPARATUS**

FOR EXHAUST AIR FANS; GAS INJECTORS FOR DISBURSING SOLIDS AND/OR LIQUIDS FOR PURIFICATION AND STERILIZATION PURPOSES; DEVICES FOR PROCESSING OF SOLID MATTER REMOVED, NAMELY, DRYERS USED FOR THE REMOVAL OF SOLID, LIQUID AND VAPOR CONTAMINANTS FROM COMPRESSED AIR AND GASES (U.S. CLS. 13, 21, 23, 31 AND 34).

**CLASS 37—CONSTRUCTION AND REPAIR**

FOR INSTALLATION, REPAIR, AND MAINTENANCE OF SUBMERSIBLE PUMPS WITH MIXING DEVICE, EXHAUST AIR FANS, FEEDING AUGERS, DOSING APPARATUS, CONVEYOR BELTS, SEPARATORS FOR SOLID/LIQUID PHASES, PARTICULARLY SCREW PRESSES AND ROLL PRESSES, HYDRO-CENTRIFUGES, SIEVING AND FLOTATION APPARATUS INCLUDING ACCESSORY UNITS, NAMELY, PUMPS, DEVICES FOR TRANSPORTATION, HOMOGENIZATION, GAS INJECTORS, AND DEFOAMING CENTRIFUGES, DEVICES FOR PROCESSING OF SOLID MATTER REMOVED, PARTICULARLY COMPOSTERS, BRIQUETTING PRESSES, AND SOLIDS GASIFIERS, FEED UNITS, AND DEVICES FOR PROCESSING OF SOLID MATTER REMOVED, NAMELY, DRYERS; INSTALLATION, REPAIR AND MAINTENANCE OF MACHINERY (U.S. CLS. 100, 103 AND 106).

EMILY CHUO, EXAMINING ATTORNEY

---

SN 85-238,564. MURATA MACHINERY, LTD., KYOTO-SHI, KYOTO, JAPAN, FILED 2-10-2011.

**Uni-SHUTTLE<sup>HP</sup>**

THE MARK CONSISTS OF THE STYLIZED LETTERING "UNI-SHUTTLE HP".

**CLASS 7—MACHINERY**

FOR AUTOMATED WAREHOUSING SYSTEMS COMPRISED PRIMARILY OF CRANES AND RACKS (U.S. CLS. 13, 19, 21, 23, 31, 34 AND 35).

**CLASS 9—ELECTRICAL AND SCIENTIFIC APPARATUS**

FOR EQUIPMENT FOR AUTOMATION OF WAREHOUSES, NAMELY, CONTROLLERS AND ELECTRONIC CONTROL PANELS WITH DIGITAL DISPLAYS FOR OPERATING AUTOMATED WAREHOUSING SYSTEMS (U.S. CLS. 21, 23, 26, 36 AND 38).

MICHAEL KEATING, EXAMINING ATTORNEY

SN 85-239,338. MEDIAVISION, INC., FOXBORO, MA. FILED 2-10-2011.



NO CLAIM IS MADE TO THE EXCLUSIVE RIGHT TO USE "PATIENT EXPERIENCE MANAGEMENT", APART FROM THE MARK AS SHOWN.

THE MARK CONSISTS OF THE WORDING "MEDIATION PATIENT EXPERIENCE MANAGEMENT" TO THE RIGHT OF DESIGNS. THE DESIGN FEATURES A WAVY WIRE WINDING UP AN ANTENNA WITH ENERGY WAVES EMANATING FROM IT, WITH THE TOTAL EFFECT OF THE DESIGN RESEMBLING THE MEDICAL SYMBOL OF A SERPENT AND STAFF.

**CLASS 38—COMMUNICATION**

FOR PROVIDING ACCESS TO THE INTERNET; INTERNET TELEPHONY SERVICES; BROADCASTING SERVICES AND PROVISION OF TELECOMMUNICATIONS ACCESS TO AUDIO AND VIDEO CONTENT VIA A VIDEO-ON-DEMAND SERVICE; VIDEO CONFERENCING SERVICES; ALL SERVICES PROVIDED TO HOSPITAL PATIENTS (U.S. CLS. 100, 101 AND 104).

**CLASS 41—EDUCATION AND ENTERTAINMENT**

FOR PROVISION OF NON-DOWNLOADABLE FILMS AND TELEVISION PROGRAMS VIA A VIDEO-ON-DEMAND SERVICE; ENTERTAINMENT SERVICES, NAMELY, PROVIDING ONLINE ELECTRONIC GAMES (U.S. CLS. 100, 101 AND 107).

CORY BOONE, EXAMINING ATTORNEY

---

SN 85-240,430. HILLERICH & BRADSBY CO., LOUISVILLE, KY. FILED 2-11-2011.

**RELIEFGRIP**

THE MARK CONSISTS OF STANDARD CHARACTERS WITHOUT CLAIM TO ANY PARTICULAR FONT, STYLE, SIZE, OR COLOR.

**CLASS 9—ELECTRICAL AND SCIENTIFIC APPARATUS**

FOR PROTECTIVE GLOVES NOT FOR INDUSTRIAL PURPOSES (U.S. CLS. 21, 23, 26, 36 AND 38).

**CLASS 21—HOUSEWARES AND GLASS**

FOR HOUSEHOLD AND DOMESTIC PURPOSES; GLOVES FOR GARDENING AND LANDSCAPING PURPOSES (U.S. CLS. 2, 13, 23, 29, 30, 33, 40 AND 50).

**CLASS 25—CLOTHING**

FOR GLOVES; EQUESTRIAN GLOVES; DRIVING GLOVES; DRESS GLOVES; MOTORCYCLE GLOVES (U.S. CLS. 22 AND 39).

**CLASS 28—TOYS AND SPORTING GOODS**

FOR BATTING GLOVES; BASEBALL GLOVES; SOFTBALL GLOVES; GLOVES, NAMELY, FIELDERS GLOVES AND MITTS; GLOVES, NAMELY, BASEBALL AND SOFTBALL MITTS; HOCKEY GLOVES; GOLF GLOVES; FOOTBALL GLOVES; FITNESS GLOVES; TENNIS GLOVES; RACQUETBALL GLOVES; CYCLING GLOVES; EQUESTRIAN GLOVES (U.S. CLS. 22, 23, 38 AND 50).  
CHRISTINA SOBRAL, EXAMINING ATTORNEY

---

SN 85-240,574. IBC-HEARTHWARE, INC., LIBERTYVILLE, IL. FILED 2-11-2011.



THE MARK CONSISTS OF THE STYLIZED WORDING "PERFECTGREEN" WITH A LEAF DESIGN APPEARING BEHIND THE WORD "GREEN".

**CLASS 11—ENVIRONMENTAL CONTROL APPARATUS**

FOR ELECTRIC COOKERS, NAMELY, ELECTRIC PRESSURE COOKERS; ELECTRIC RICE COOKERS; ELECTRIC SLOW COOKERS; ELECTRIC COFFEE MAKERS; ELECTRIC YOGURT MAKERS; ELECTRIC POP-CORN MAKERS; ELECTRIC WAFFLE MAKERS; FONDUE POTS WITH HEAT SOURCE; ELECTRIC COOKTOPS (U.S. CLS. 13, 21, 23, 31 AND 34).

**CLASS 21—HOUSEWARES AND GLASS**

FOR COOKWARE, NAMELY, POTS, PANS, PAN LIDS, POT LIDS, SKILLETS, NON-ELECTRIC PRESSURE COOKERS, GRIDDLES, DUTCH OVENS, WOKS, TEAKETTLES; FONDUE POTS WITHOUT HEAT SOURCE; FONDUE POT LIDS; FONDUE POT INSERTS; STEAMER BASKETS USED AS INSERTS FOR POTS (U.S. CLS. 2, 13, 23, 29, 30, 33, 40 AND 50).  
AMY KERTGATE, EXAMINING ATTORNEY

---

SN 85-241,396. AUDI AG, INGOLSTADT, FED REP GERMANY, FILED 2-14-2011.



THE MARK CONSISTS OF STANDARD CHARACTERS WITHOUT CLAIM TO ANY PARTICULAR FONT, STYLE, SIZE, OR COLOR.  
OWNER OF FED REP GERMANY REG. NO. 302009030628, DATED 7-3-2009, EXPIRES 5-31-2019.  
OWNER OF U.S. REG. NOS. 708,352, 2,083,439 AND OTHERS.

**CLASS 9—ELECTRICAL AND SCIENTIFIC APPARATUS**

FOR AUTOMOTIVE PREVENTATIVE OCCUPANT PROTECTION SYSTEM CONSISTING OF RADAR OBJECT DETECTORS FOR USE ON VEHICLES, VIDEO CAMERAS FOR MONITORING ROAD AND TRAFFIC, ADAPTIVE CRUISE CONTROL FOR MOTOR VEHICLES AND BRAKE CONTROLLERS (U.S. CLS. 21, 23, 26, 36 AND 38).

**CLASS 12—VEHICLES**

FOR LAND VEHICLES AND THEIR STRUCTURAL PARTS (U.S. CLS. 19, 21, 23, 31, 35 AND 44).  
KYLE PEETE, EXAMINING ATTORNEY

---

SN 85-241,754. SCHOLTEN NICHOLAS DEAN, SEATTLE, WA. FILED 2-14-2011.



THE MARK CONSISTS OF STANDARD CHARACTERS WITHOUT CLAIM TO ANY PARTICULAR FONT, STYLE, SIZE, OR COLOR.

NO CLAIM IS MADE TO THE EXCLUSIVE RIGHT TO USE "ENERGY", APART FROM THE MARK AS SHOWN.  
THE ENGLISH TRANSLATION OF THE WORD "VERO" IN THE MARK IS "REAL" OR "GENUINE".

**CLASS 5—PHARMACEUTICALS**

FOR DIETARY SUPPLEMENTAL DRINKS IN THE NATURE OF VITAMIN AND MINERAL BEVERAGES; NUTRITIONALLY FORTIFIED BEVERAGES; VITAMIN FORTIFIED BEVERAGES (U.S. CLS. 6, 18, 44, 46, 51 AND 52).

**CLASS 30—STAPLE FOODS**

FOR TEA-BASED BEVERAGES; TEA-BASED BEVERAGES WITH FRUIT FLAVORING (U.S. CL. 46).

**CLASS 32—LIGHT BEVERAGES**

FOR FRUIT CONCENTRATES AND PUREES USED AS INGREDIENTS OF BEVERAGES; FRUIT-FLAVORED BEVERAGES; NON-ALCOHOLIC BEVERAGES WITH TEA FLAVOR; NON-ALCOHOLIC BEVERAGES, NAMELY, CARBONATED BEVERAGES; NON-ALCOHOLIC FRUIT EXTRACTS USED IN THE PREPARATION OF BEVERAGES; WATER BEVERAGES (U.S. CLS. 45, 46 AND 48).  
FONG HSU, EXAMINING ATTORNEY

SN 85-241,857. BEN AUGUST, DBA AUGUST GROUP, LLC,  
CONROE, TX. FILED 2-14-2011.

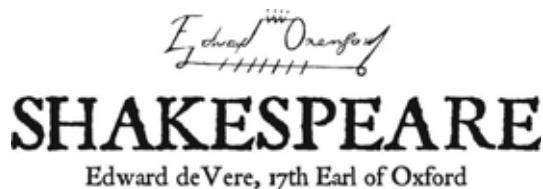

THE NAMES "EDWARD OXFENFORD" AND "EDWARD DE VERE, 17TH EARL OF OXFORD" DO NOT IDENTIFY LIVING INDIVIDUALS.

THE MARK CONSISTS OF THE SIGNATURE OF "EDWARD OXFENFORD" WITH CROWN AND UNDERLYING MARKS WITH THE WORD "SHAKESPEARE" IN LARGE STYLIZED LETTERS AND THE WORDS "EDWARD DE VERE, 17TH EARL OF OXFORD" IN SMALLER STYLIZED LETTERS BELOW.

#### CLASS 6—METAL GOODS

FOR BUSTS OF NON-PRECIOUS METAL (U.S. CLS. 2, 12, 13, 14, 23, 25 AND 50).

#### CLASS 19—NON-METALLIC BUILDING MATERIALS

FOR BUSTS OF STONE AND MARBLE (U.S. CLS. 1, 12, 33 AND 50).

#### CLASS 20—FURNITURE AND ARTICLES NOT OTHERWISE CLASSIFIED

FOR BUSTS OF PLASTER (U.S. CLS. 2, 13, 22, 25, 32 AND 50).

KATHY DE JONGE, EXAMINING ATTORNEY

SN 85-242,904. BEND RESEARCH, INC., BEND, OR. FILED 2-15-2011.



THE MARK CONSISTS OF A DESIGN FORMED BY A COMBINATION OF THE LETTERS "B" AND "R" APPEARING INSIDE OF A CIRCLE.

#### CLASS 40—MATERIAL TREATMENT

FOR MANUFACTURING FOR OTHERS IN THE PHARMACEUTICAL AND HEALTH SCIENCES INDUSTRIES (U.S. CLS. 100, 103 AND 106).

FIRST USE 8-1-2010; IN COMMERCE 8-1-2010.

#### CLASS 42—SCIENTIFIC AND COMPUTER SERVICES

FOR RESEARCH AND DEVELOPMENT OF PHARMACEUTICAL FORMULATIONS; SCIENTIFIC ANALYSIS IN THE FIELDS OF MEDICINE, PHARMACOLOGY, CHEMISTRY, AND BIOCHEMISTRY; ENGINEERING SERVICES FOR THE PHARMACEUTICAL AND HEALTH SCIENCE INDUSTRIES (U.S. CLS. 100 AND 101).

FIRST USE 8-1-2010; IN COMMERCE 8-1-2010.  
DEBRA LEE, EXAMINING ATTORNEY

SN 85-243,728. ENVIRONMENTALISM THROUGH INSPIRATION AND NON-VIOLENT ACTION, VENICE, CA. FILED 2-16-2011.

### REBUILD THE DREAM

THE MARK CONSISTS OF STANDARD CHARACTERS WITHOUT CLAIM TO ANY PARTICULAR FONT, STYLE, SIZE, OR COLOR.

#### CLASS 35—ADVERTISING AND BUSINESS

FOR ASSOCIATION SERVICES, NAMELY, PROMOTING PUBLIC AWARENESS OF THE NEED FOR PARTICIPATION AS BRIDGE-BUILDING LEADERS AND ORGANIZERS AT COMMUNITY, LOCAL, STATE AND NATIONAL LEVELS IN SOCIAL, CIVIL RIGHTS, ENVIRONMENTAL AND POLITICAL ISSUES (U.S. CLS. 100, 101 AND 102).

#### CLASS 41—EDUCATION AND ENTERTAINMENT

FOR EDUCATIONAL SERVICES, NAMELY, CONDUCTING LECTURES, SEMINARS, TRAINING COURSES, AND WORKSHOPS IN THE FIELDS OF SOCIAL ISSUES, CIVIL RIGHTS, ENVIRONMENTAL ISSUES AND POLITICAL ISSUES (U.S. CLS. 100, 101 AND 107).

GINA FINK, EXAMINING ATTORNEY

SN 85-244,542. COUCH, SHEILA MORAN, SARATOGA, CA. FILED 2-17-2011.



THE COLOR(S) YELLOW, GOLD, WHITE, GREEN, BURGUNDY, GRAY, AND BLUE IS/ARE CLAIMED AS A FEATURE OF THE MARK.

THE MARK CONSISTS OF A STYLIZED SHIELD DIVIDED INTO FOUR SECTIONS. THE UPPER LEFT-HAND SECTION OF THE SHIELD APPEARS IN YELLOW WITH A GOLD OUTLINE AND CONTAINS THE LETTER "B" IN GOLD AND THE WORD "BEAUTIFULLY" IN GOLD, WITH TWO WHITE FLOWERS WITH GREEN LEAVES AND GOLD CENTERS. THE UPPER RIGHT-HAND SECTION OF THE SHIELD APPEARS IN BURGUNDY WITH A GOLD OUTLINE AND CONTAINS AN ELEPHANT IN GRAY, OUTLINED IN GOLD WITH WHITE TUSKS. THE LOWER LEFT-HAND SECTION OF THE SHIELD APPEARS IN BURGUNDY WITH A GOLD OUTLINE AND CONTAINS A PEACOCK IN BLUE, GREEN AND GOLD. THE LOWER RIGHT-HAND SECTION OF THE SHIELD APPEARS IN YELLOW WITH A GOLD OUTLINE AND CONTAINS THE WORD "USEFUL" IN GOLD AND THE LETTER "U" IN GOLD, WITH TWO WHITE FLOWERS WITH GREEN LEAVES AND GOLD CENTERS. AT THE BOTTOM OF THE SHIELD IS A BANNER APPEARING IN BURGUNDY, YELLOW AND OUTLINED IN GOLD CONTAINING THE WORDS "BE YOU - BEAUTIFULLY USEFUL" IN GOLD.

#### CLASS 18—LEATHER GOODS

FOR HANDBAGS; MULTI-PURPOSE PURSES; PURSES AND WALLETS (U.S. CLS. 1, 2, 3, 22 AND 41).

#### CLASS 25—CLOTHING

FOR APRONS (U.S. CLS. 22 AND 39).  
KHANH LE, EXAMINING ATTORNEY

#### CLASS 42—SCIENTIFIC AND COMPUTER SERVICES

FOR DEVELOPING AND MANAGING APPLICATION SOFTWARE AND DATABASES FOR DELIVERY OF MULTI-MEDIA CONTENT PROVIDED BY BRAND-OWNERS AND BUSINESSES FOR USE ON MULTIPLE TYPES OF WIRELESS MOBILE DEVICES; COMPUTER SERVICES, NAMELY, HOSTING, MANAGING, DEVELOPING, ANALYZING, AND MAINTAINING APPLICATIONS, SOFTWARE, AND WEB SITES FOR THE PURPOSE OF ADVERTISING, MARKETING AND PROMOTING THE GOODS AND SERVICES OF OTHERS; COMPUTER SERVICES, NAMELY OPERATING APPLICATIONS, SOFTWARE, AND WEB SITES FOR THE PURPOSE OF ADVERTISING, MARKETING AND PROMOTING THE GOODS AND SERVICES OF OTHERS, NAMELY OPERATION OF A COMPUTER INFRASTRUCTURE FOR DISSEMINATION OF ADVERTISING FOR OTHERS VIA WIRELESS TELECOMMUNICATIONS NETWORKS (U.S. CLS. 100 AND 101).  
SUZANNE BLANE, EXAMINING ATTORNEY

SN 85-245,396. CISCO TECHNOLOGY, INC., SAN JOSE, CA.  
FILED 2-17-2011.

SN 85-245,333. FUNCTION (X) INC., NEW YORK, NY. FILED  
2-17-2011.

# FUNCTION(X)

THE MARK CONSISTS OF STANDARD CHARACTERS WITHOUT CLAIM TO ANY PARTICULAR FONT, STYLE, SIZE, OR COLOR.

#### CLASS 35—ADVERTISING AND BUSINESS

FOR ADVERTISING, MARKETING AND PROMOTIONAL SERVICES; ADVERTISING VIA ELECTRONIC MEDIA AND SPECIFICALLY VIA DIGITAL COMMUNICATIONS NETWORKS; ADVERTISING AND COMMERCIAL INFORMATION SERVICES VIA MOBILE PHONES AND OTHER HANDHELD TELECOMMUNICATIONS DEVICES; ADVERTISING AND PROMOTION SERVICES AND RELATED CONSULTING; ADVERTISING SERVICES FOR THE PROMOTION OF GOODS AND SERVICES; DISSEMINATION OF ADVERTISING FOR OTHERS VIA WIRELESS TELECOMMUNICATIONS NETWORKS; ELECTRONIC COMMERCE SERVICES, NAMELY, PROVIDING INFORMATION ABOUT PRODUCTS AND SERVICES OF OTHERS VIA DIGITAL COMMUNICATIONS NETWORKS FOR ADVERTISING AND SALES PURPOSES; MARKETING, ADVERTISING, AND PROMOTING THE RETAIL GOODS AND SERVICES OF OTHERS TO WIRELESS ELECTRONIC DEVICES (U.S. CLS. 100, 101 AND 102).

# CISCO JABBER

THE MARK CONSISTS OF STANDARD CHARACTERS WITHOUT CLAIM TO ANY PARTICULAR FONT, STYLE, SIZE, OR COLOR.

OWNER OF U.S. REG. NOS. 3,709,076, 3,759,451 AND OTHERS.

#### CLASS 9—ELECTRICAL AND SCIENTIFIC APPARATUS

FOR COMPUTER SOFTWARE FOR ENABLING REAL-TIME COMMUNICATION OVER THE INTERNET; COMPUTER SOFTWARE FOR FACILITATING INSTANT MESSAGING, VOICE OVER INTERNET PROTOCOL (VOIP), VIDEO CONFERENCING, AUDIO CONFERENCING, APPLICATION SHARING, COMPUTER DESKTOP SHARING, FILE TRANSFER, SENSING AND PROVIDING USER PRESENCE INFORMATION, AND TELEPHONY; COMPUTER SOFTWARE FOR MOBILE DEVICES TO SECURE REMOTE ACCESS VIA THE INTERNET TO PRIVATE COMPUTER NETWORKS; COMPUTER SOFTWARE FOR FACILITATING THE INTEROPERABILITY OF MULTIPLE SOFTWARE APPLICATIONS; COMPUTER SOFTWARE FOR ENABLING USERS TO IDENTIFY AVAILABILITY OF OTHER USERS AND INTEGRATE ELECTRONIC ADDRESS BOOKS AND CALENDARS; COMPUTER SOFTWARE FOR USE IN TRANSMITTING INFORMATION, VIDEO, VOICE, AUDIO, AND CONTENT OVER A GLOBAL COMPUTER INFORMATION NETWORK; COMPUTER SOFTWARE FOR ENABLING USERS TO COMMUNICATE, COLLABORATE, AND SHARE COMPUTER SCREENS, DESKTOPS, DATA, ELECTRONIC DOCUMENTS, VIDEO AND APPLICATIONS VIA THE INTERNET; COMPUTER SOFTWARE FOR VIEWING, MANAGING, EDITING AND STORING DOCUMENTS VIA COMPUTER NETWORKS; COMPUTER SOFTWARE FOR SCHEDULING AND MANAGING CALENDARS, CONTACTS, ONLINE MEETINGS, TELEPHONE CONFERENCING, AND VIDEO CONFERENCING (U.S. CLS. 21, 23, 26, 36 AND 38).

**CLASS 42—SCIENTIFIC AND COMPUTER SERVICES**

FOR COMPUTER SOFTWARE CONSULTATION RELATED TO ENABLING REAL-TIME COMMUNICATION OVER THE INTERNET; TECHNICAL SUPPORT SERVICES, NAMELY, TROUBLESHOOTING OF COMPUTER SOFTWARE PROBLEMS; COMPUTER SERVICES, NAMELY, CREATING AN ON-LINE COMMUNITY FOR REGISTERED USERS TO PARTICIPATE IN DISCUSSIONS, FORM VIRTUAL COMMUNITIES, ENGAGE IN SOCIAL NETWORKING, AND EXCHANGE DOCUMENTS; TECHNOLOGY ADVICE PROVIDED TO INTERNET USERS BY MEANS OF A SUPPORT HOTLINE; TECHNICAL CONSULTATION REGARDING COMPUTER HARDWARE, COMPUTER SOFTWARE, COMPUTER SYSTEMS, COMPUTER NETWORKS, INTRANETS, AND THE INTERNET (U.S. CLS. 100 AND 101).

TRICIA SONNEBORN, EXAMINING ATTORNEY

SN 85-246,634. TEXTRON INC., PROVIDENCE, RI. FILED 2-18-2011.

# PRO-FIT

THE MARK CONSISTS OF STANDARD CHARACTERS WITHOUT CLAIM TO ANY PARTICULAR FONT, STYLE, SIZE, OR COLOR.

**CLASS 7—MACHINERY**

FOR AFTER MARKET PARTS AND ACCESSORIES FOR LAND VEHICLES, NAMELY, ENGINE PARTS, NAMELY, AIR FILTERS, OIL FILTERS, SPARK PLUGS, HEAD GASKETS, INTAKE AND EXHAUST VALVES, PISTONS, SPARK PLUG WIRES, CRANKSHAFTS, PISTON RINGS, CAMS, CARBURETORS, FUEL PUMPS, FUEL FILTERS AND TIMING BELTS (U.S. CLS. 13, 19, 21, 23, 31, 34 AND 35).

**CLASS 9—ELECTRICAL AND SCIENTIFIC APPARATUS**

FOR AFTER MARKET PARTS AND ACCESSORIES FOR VEHICLES, NAMELY, RADIOS FOR LAND VEHICLES, MP3 PLAYERS FOR LAND VEHICLES, GLOBAL POSITIONING SYSTEMS (GPS) FOR LAND VEHICLES, AND ELECTRONIC SPEED CONTROLLERS (U.S. CLS. 21, 23, 26, 36 AND 38).

**CLASS 12—VEHICLES**

FOR AFTER MARKET PARTS AND ACCESSORIES FOR LAND VEHICLES, NAMELY, WHEELS, TIRES, BRAKE PADS, BRAKE SHOES, STEERING WHEELS, CABS, ENCLOSURES, NAMELY, SOFT FABRIC TOPS WITH METAL FRAMES FOR VEHICLES, AXLES, DIFFERENTIALS AND SUSPENSION COMPONENTS, NAMELY, SHOCK ABSORBERS, SPRINGS AND LIFT KITS PRIMARILY CONSISTING OF LEAF SPRINGS, SHACKLE MOUNTS, AXLES AND SPINDLES, ALL FOR INCREASING VEHICLE GROUND CLEARANCE, BRUSH GUARDS, STEP BARS FOR FACILITATING VEHICLE ACCESS, AND LIGHT KITS PRIMARILY CONSISTING OF HEADLIGHTS, TAILLIGHTS, AUXILIARY DECORATIVE LIGHTING AND WIRE HARNESSES, AND MOTORS; ALL FOR GASOLINE AND ELECTRIC-POWERED ON-ROAD AND OFF-ROAD LAND VEHICLES, LIGHT-TRANSPORTATION VEHICLES AND LOW-SPEED VEHICLES USED AS PERSONAL RESIDENTIAL AND NEIGHBORHOOD VEHICLES, PLANT PERSONNEL CARRIERS, GENERAL UTILITY AND MAINTENANCE CARS, MOTEL AND RESORT CARS, BAGGAGE CARRIERS, GOLF CARS, TURF MAINTENANCE VEHICLES, TRAILERS; STRUCTURAL PARTS FOR GASOLINE AND ELECTRIC-POWERED AUTOMOBILES (U.S. CLS. 19, 21, 23, 31, 35 AND 44).

EDWARD FENNESSY, EXAMINING ATTORNEY

SN 85-246,225. RESMED LIMITED, BELLA VISTA NSW, AUSTRALIA, FILED 2-18-2011.

# GEO

THE MARK CONSISTS OF STANDARD CHARACTERS WITHOUT CLAIM TO ANY PARTICULAR FONT, STYLE, SIZE, OR COLOR.

PRIORITY CLAIMED UNDER SEC. 44(D) ON AUSTRALIA APPLICATION NO. 1382532, FILED 9-9-2010, REG. NO. 1382532, DATED 5-5-2011, EXPIRES 9-9-2020.

**CLASS 9—ELECTRICAL AND SCIENTIFIC APPARATUS**

FOR DIAGNOSTIC ELECTRIC SENSORS FOR MASKS; ELECTRONIC CONTROLLERS FOR MEDICAL RESPIRATORS AND VENTILATORS (U.S. CLS. 21, 23, 26, 36 AND 38).

**CLASS 10—MEDICAL APPARATUS**

FOR MEDICAL APPARATUS AND INSTRUMENTS, NAMELY, RESPIRATORY APPARATUS; MEDICAL NOSE MASKS AND FULL FACE MASKS FOR RESPIRATORY APPARATUS; PUMPS FOR MEDICAL RESPIRATORS OR VENTILATORS; DIAGNOSTIC SENSORS FOR MASKS AS PART OF MEDICAL VENTILATORS; COMPONENT CONTROLLERS AS PART OF MEDICAL RESPIRATORS OR VENTILATORS; MECHANICAL VENTILATORS OR RESPIRATORS; NON-INVASIVE POSITIVE PRESSURE MEDICAL VENTILATORS; VALVES, TUBING, HEADGEAR AND POWER SUPPLIES FOR USE WITH MEDICAL VENTILATORS; AND COMPONENT PARTS OF MEDICAL RESPIRATORS OR VENTILATORS (U.S. CLS. 26, 39 AND 44).

COLLEEN KEARNEY, EXAMINING ATTORNEY

SN 85-247,591. RUCHITA PARAT, PALO ALTO, CA. FILED 2-21-2011.

# Jano India

THE MARK CONSISTS OF STANDARD CHARACTERS WITHOUT CLAIM TO ANY PARTICULAR FONT, STYLE, SIZE, OR COLOR.

NO CLAIM IS MADE TO THE EXCLUSIVE RIGHT TO USE "INDIA", APART FROM THE MARK AS SHOWN. THE ENGLISH TRANSLATION OF "JANO" IN THE MARK IS "KNOW".

#### **CLASS 9—ELECTRICAL AND SCIENTIFIC APPARATUS**

FOR EDUCATIONAL SOFTWARE FEATURING INSTRUCTION IN INDIAN CULTURE AND INDIAN LANGUAGES (U.S. CLS. 21, 23, 26, 36 AND 38).

#### **CLASS 16—PAPER GOODS AND PRINTED MATTER**

FOR CHILDREN'S ACTIVITY BOOKS; CHILDREN'S BOOKS; CHILDREN'S INTERACTIVE EDUCATIONAL BOOKS; CHILDREN'S STORYBOOKS; EDUCATIONAL PUBLICATIONS, NAMELY, EDUCATIONAL LEARNING CARDS, FLASH CARDS, ACTIVITY CARDS, WORKBOOKS, TEXTBOOKS, ACTIVITY BOOKS, STORY BOOKS, PUZZLE BOOKS, PRINTED PUZZLES, TEACHER GUIDES, MANUALS, POSTERS AND EDUCATIONAL BOOKLETS IN THE FIELD OF INDIAN CULTURE AND INDIAN LANGUAGES; PRINTED INSTRUCTIONAL, EDUCATIONAL, AND TEACHING MATERIALS IN THE FIELD OF INDIAN CULTURE AND INDIAN LANGUAGE (U.S. CLS. 2, 5, 22, 23, 29, 37, 38 AND 50).

#### **CLASS 41—EDUCATION AND ENTERTAINMENT**

FOR CHILDREN'S EDUCATIONAL SERVICES, NAMELY, PROVIDING ACADEMIC PERFORMANCE EVALUATION, GUIDANCE AND MONITORING FOR CHILDREN PRE-KINDERGARTEN THROUGH GRADE 12 VIA THE INTERNET; EDUCATION IN THE FIELD OF INDIAN CULTURE AND INDIAN LANGUAGES RENDERED THROUGH CORRESPONDENCE COURSES; EDUCATION IN THE FIELD OF INDIAN CULTURE AND INDIAN LANGUAGE RENDERED THROUGH VIDEO CONFERENCE; EDUCATION SERVICES IN THE NATURE OF EARLY CHILDHOOD INSTRUCTION; EDUCATIONAL AND ENTERTAINMENT SERVICES, NAMELY, A CONTINUING PROGRAM ABOUT INDIAN CULTURE AND INDIAN LANGUAGE ACCESSIBLE BY RADIO, TELEVISION, SATELLITE, AUDIO, VIDEO AND COMPUTER NETWORKS; EDUCATIONAL AND ENTERTAINMENT SERVICES, NAMELY, PROVIDING ON-LINE INTERACTIVE CHILDREN'S STORIES; EDUCATIONAL SERVICES, NAMELY, PROVIDING COURSES OF INSTRUCTION AT THE PRESCHOOL, ELEMENTARY, SECONDARY, UNIVERSITY LEVEL; ENTERTAINMENT AND EDUCATION SERVICES IN THE NATURE OF A SERIES OF SHORT SHOWS FEATURING INDIAN CULTURE AND INDIAN LANGUAGE DISTRIBUTED TO MOBILE HANDSETS, WHICH MAY INCLUDE VIDEO, TEXT, PHOTOS, ILLUSTRATIONS OR HYPERTEXT; PROVIDING COURSES OF INSTRUCTION AT THE PRESCHOOL, ELEMENTARY, SECONDARY AND ADULT LEVEL; EDUCATION SERVICES, NAMELY, PROVIDING KINDERGARTEN THROUGH 12TH GRADE (K-12) CLASSROOM INSTRUCTION; EDUCATION SERVICES, NAMELY, PROVIDING LIVE AND ON-LINE CLASSES, SEMINARS AND WORKSHOPS, IN THE FIELD OF INDIAN CULTURE AND INDIAN LANGUAGE; EDUCATION SERVICES, NAMELY, PROVIDING MENTORING, TUTORING, CLASSES, SEMINARS AND WORKSHOPS IN THE FIELD OF INDIAN CULTURE AND INDIAN LANGUAGE; EDUCATIONAL AND ENTERTAINMENT SERVICES FOR CHILDREN, NAMELY, PROVIDING INTERACTIVE PLAY AREAS, INSTRUCTIONAL CLASSES IN THE FIELD OF INDIAN CULTURE AND INDIAN LANGUAGE AND SOCIAL GATHERINGS FOR CHILDREN; EDUCATIONAL AND ENTERTAINMENT SERVICES, NAMELY, CONDUCTING WORKSHOPS, CLASSES AND CAMPS IN THE FIELD OF INDIAN CULTURE AND INDIAN LANGUAGE AND DISTRIBUTION OF COURSE MATERIALS IN CONNECTION THEREWITH, AND EDUCATION CONSULTING RELATED THERETO; EDUCATIONAL SERVICES, NAMELY, DEVELOPING CURRICULUM FOR OTHERS IN THE FIELD OF INDIAN CULTURE AND INDIAN LANGUAGE; EDUCATIONAL SERVICES,

NAMELY, DEVELOPING CURRICULUM FOR TEACHERS; EDUCATIONAL SERVICES, NAMELY, DEVELOPING, ARRANGING, AND CONDUCTING EDUCATIONAL CONFERENCES AND PROGRAMS AND PROVIDING COURSES OF INSTRUCTION IN THE FIELD OF INDIAN CULTURE AND INDIAN LANGUAGE; EDUCATIONAL SERVICES, NAMELY, PROVIDING INTERNSHIPS AND APPRENTICESHIPS IN THE FIELD OF INDIAN CULTURE AND INDIAN LANGUAGE; PROVIDING AFTER SCHOOL EDUCATIONAL PROGRAMS IN THE FIELD OF INDIAN CULTURE AND INDIAN LANGUAGE AND PLAY FACILITIES FOR CHILDREN; ENTERTAINMENT SERVICES, NAMELY, PROVIDING A WEBSITE FEATURING NON-DOWNLOADABLE MUSICAL PERFORMANCES, MUSICAL VIDEOS, RELATED FILM CLIPS, PHOTOGRAPHS, AND OTHER MULTIMEDIA MATERIALS FEATURING EDUCATIONAL INFORMATION IN THE FIELD OF INDIAN CULTURE AND INDIAN LANGUAGES (U.S. CLS. 100, 101 AND 107).

KATHERINE M. DUBRAY, EXAMINING ATTORNEY

SN 85-249,238. THE HERTZ CORPORATION, PARK RIDGE, NJ. FILED 2-23-2011.

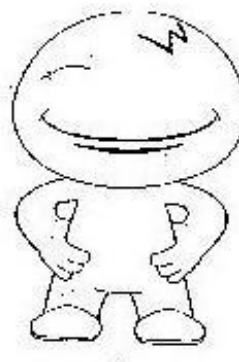

THE MARK CONSISTS OF A CARTOON CHARACTER.

#### **CLASS 35—ADVERTISING AND BUSINESS**

FOR DEALERSHIP SERVICES IN THE FIELD OF USED MOTOR VEHICLES (U.S. CLS. 100, 101 AND 102).

#### **CLASS 37—CONSTRUCTION AND REPAIR**

FOR RENTAL OF CONSTRUCTION EQUIPMENT, MATERIAL HANDLING EQUIPMENT AND INDUSTRIAL EQUIPMENT (U.S. CLS. 100, 103 AND 106).

#### **CLASS 39—TRANSPORTATION AND STORAGE**

FOR VEHICLE RENTAL SERVICES (U.S. CLS. 100 AND 105).

BARBARA GAYNOR, EXAMINING ATTORNEY

SN 85-249,312. THE HERTZ CORPORATION, PARK RIDGE, NJ. FILED 2-23-2011.



THE MARK CONSISTS OF A CARTOON CHARACTER WITH A LOWER CASE "H" ON HIS SHIRT.

**CLASS 35—ADVERTISING AND BUSINESS**

FOR DEALERSHIP SERVICES IN THE FIELD OF USED MOTOR VEHICLES (U.S. CLS. 100, 101 AND 102).

**CLASS 37—CONSTRUCTION AND REPAIR**

FOR RENTAL OF CONSTRUCTION EQUIPMENT, MATERIAL HANDLING EQUIPMENT AND INDUSTRIAL EQUIPMENT (U.S. CLS. 100, 103 AND 106).

**CLASS 39—TRANSPORTATION AND STORAGE**

FOR VEHICLE RENTAL SERVICES (U.S. CLS. 100 AND 105).  
BARBARA GAYNOR, EXAMINING ATTORNEY

SN 85-249,337. THE HERTZ CORPORATION, PARK RIDGE, NJ. FILED 2-23-2011.

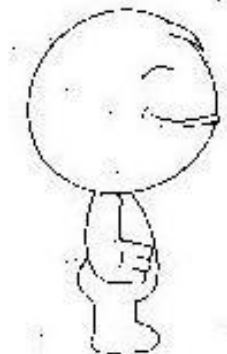

THE MARK CONSISTS OF A CARTOON CHARACTER.

**CLASS 35—ADVERTISING AND BUSINESS**

FOR DEALERSHIP SERVICES IN THE FIELD OF USED MOTOR VEHICLES (U.S. CLS. 100, 101 AND 102).

**CLASS 37—CONSTRUCTION AND REPAIR**

FOR RENTAL OF CONSTRUCTION EQUIPMENT, MATERIAL HANDLING EQUIPMENT AND INDUSTRIAL EQUIPMENT (U.S. CLS. 100, 103 AND 106).

**CLASS 39—TRANSPORTATION AND STORAGE**

FOR VEHICLE RENTAL SERVICES (U.S. CLS. 100 AND 105).  
BARBARA GAYNOR, EXAMINING ATTORNEY

SN 85-249,359. THE HERTZ CORPORATION, PARK RIDGE, NJ. FILED 2-23-2011.

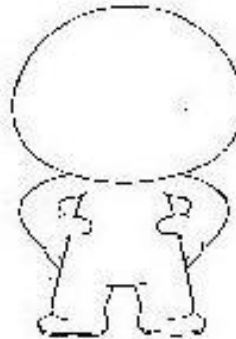

THE MARK CONSISTS OF A CARTOON CHARACTER.

**CLASS 35—ADVERTISING AND BUSINESS**

FOR DEALERSHIP SERVICES IN THE FIELD OF USED MOTOR VEHICLES (U.S. CLS. 100, 101 AND 102).

**CLASS 37—CONSTRUCTION AND REPAIR**

FOR RENTAL OF CONSTRUCTION EQUIPMENT, MATERIAL HANDLING EQUIPMENT AND INDUSTRIAL EQUIPMENT (U.S. CLS. 100, 103 AND 106).

**CLASS 39—TRANSPORTATION AND STORAGE**

FOR VEHICLE RENTAL SERVICES (U.S. CLS. 100 AND 105).  
BARBARA GAYNOR, EXAMINING ATTORNEY

SN 85-249,474. AEP, LLC, WESTFIELD, NJ. FILED 2-23-2011.

**USENTREPRENEURTODAY**

THE MARK CONSISTS OF STANDARD CHARACTERS WITHOUT CLAIM TO ANY PARTICULAR FONT, STYLE, SIZE, OR COLOR.



**CLASS 35—ADVERTISING AND BUSINESS**

FOR PROVIDING MARKETING SERVICES AND MARKETING CONSULTING SERVICES IN THE FIELD OF ENTREPRENEURSHIP (U.S. CLS. 100, 101 AND 102).

**CLASS 36—INSURANCE AND FINANCIAL**

FOR PROVIDING FINANCING SERVICES FOR ENTREPRENEURSHIP (U.S. CLS. 100, 101 AND 102).

**CLASS 41—EDUCATION AND ENTERTAINMENT**

FOR PROVIDING A WEBSITE FEATURING RESOURCES, NAMELY, NON-DOWNLOADABLE PUBLICATIONS IN THE NATURE OF NEWSLETTERS REGARDING ENTREPRENEURSHIP, FINANCING, MARKETING, GOVERNMENT PROGRAMS, UNIVERSITY TECHNOLOGY AND COMMERCIALIZATION AND A RANGE OF OTHER SUBJECTS THAT IS INFORMATIVE AND HELPFUL TO ENTREPRENEURS AND SMALL BUSINESSES, INCLUDING EDUCATING INDIVIDUALS ABOUT RESOURCES AVAILABLE WITHIN A NATIONAL OR STATE BOUNDARIES; EDUCATIONAL SERVICES, NAMELY, CONDUCTING WEBINARS, CONFERENCES, SEMINARS AND EDUCATIONAL MEETINGS REGARDING SUBJECTS SUCH AS ENTREPRENEURSHIP, FINANCING, MARKETING, GOVERNMENT PROGRAMS, UNIVERSITY TECHNOLOGY AND COMMERCIALIZATION AND A RANGE OF OTHER SUBJECTS THAT IS INFORMATIVE AND HELPFUL TO ENTREPRENEURS AND SMALL BUSINESSES, INCLUDING EDUCATING INDIVIDUALS ABOUT RESOURCES AVAILABLE WITHIN A NATIONAL OR STATE BOUNDARIES (U.S. CLS. 100, 101 AND 107).

ALICE BENMAMAN, EXAMINING ATTORNEY

SN 85-249,496. CYTOSPORT, INC., BENICIA, CA. FILED 2-23-2011.

IT'S POWERFUL PROTEIN

THE MARK CONSISTS OF STANDARD CHARACTERS WITHOUT CLAIM TO ANY PARTICULAR FONT, STYLE, SIZE, OR COLOR.

NO CLAIM IS MADE TO THE EXCLUSIVE RIGHT TO USE "PROTEIN", APART FROM THE MARK AS SHOWN.

**CLASS 5—PHARMACEUTICALS**

FOR NUTRITIONAL SUPPLEMENTS; DIETARY SUPPLEMENTS; MEAL REPLACEMENT DRINKS; NUTRITIONALLY FORTIFIED BEVERAGES; MEAL REPLACEMENT AND DIETARY SUPPLEMENT DRINK MIXES; NUTRITIONALLY FORTIFIED MEAL REPLACEMENT BARS; ALL OF THE FOREGOING CONTAINING PROTEIN (U.S. CLS. 6, 18, 44, 46, 51 AND 52).

**CLASS 29—MEATS AND PROCESSED FOODS**

FOR NUTRITIONALLY FORTIFIED SNACK BARS, NAMELY, PROTEIN BASED, NUTRIENT-DENSE SNACK BARS (U.S. CL. 46).

ANDREW RHIM, EXAMINING ATTORNEY

SN 85-250,338. PARADIGM SPINE, LLC, NEW YORK, NY. FILED 2-24-2011.

LUMBAR INTERBODY DYNAMIC STABILIZATION (LIDS)

THE MARK CONSISTS OF STANDARD CHARACTERS WITHOUT CLAIM TO ANY PARTICULAR FONT, STYLE, SIZE, OR COLOR.

NO CLAIM IS MADE TO THE EXCLUSIVE RIGHT TO USE "LUMBAR INTERBODY DYNAMIC STABILIZATION", APART FROM THE MARK AS SHOWN.

**CLASS 5—PHARMACEUTICALS**

FOR SURGICAL IMPLANTS MADE OF BIOLOGICAL MATERIALS (U.S. CLS. 6, 18, 44, 46, 51 AND 52).

**CLASS 10—MEDICAL APPARATUS**

FOR SURGICAL IMPLANTS MADE OF ARTIFICIAL MATERIALS; MEDICAL AND SURGICAL INSTRUMENTS FOR USE IN SPINAL SURGERY; SURGICAL ACCESS DEVICES, NAMELY, CANNULAE, SURGICAL RETRACTORS AND ENDOSCOPES; MEDICAL AND SURGICAL KITS CONTAINING THE FOREGOING (U.S. CLS. 26, 39 AND 44).

TASNEEM HUSSAIN, EXAMINING ATTORNEY

SN 85-250,506. SPRINTPAK, INC., HOMERVILLE, OH. FILED 2-24-2011.

SPRINTPAK

THE MARK CONSISTS OF STANDARD CHARACTERS WITHOUT CLAIM TO ANY PARTICULAR FONT, STYLE, SIZE, OR COLOR.

**CLASS 35—ADVERTISING AND BUSINESS**

FOR ORDER FULFILLMENT SERVICES; INVENTORY MANAGEMENT (U.S. CLS. 100, 101 AND 102).  
FIRST USE 11-0-2006; IN COMMERCE 11-0-2006.

**CLASS 39—TRANSPORTATION AND STORAGE**

FOR PACKAGING ARTICLES TO THE ORDER AND SPECIFICATION OF OTHERS (U.S. CLS. 100 AND 105).  
FIRST USE 11-0-2006; IN COMMERCE 11-0-2006.

**CLASS 40—MATERIAL TREATMENT**

FOR ASSEMBLY OF PRODUCTS FOR OTHERS; CUSTOM MANUFACTURE OF PALLETS AND CRATES TO THE ORDER AND SPECIFICATION OF OTHERS (U.S. CLS. 100, 103 AND 106).

FIRST USE 11-0-2006; IN COMMERCE 11-0-2006.  
PAULA MAHONEY, EXAMINING ATTORNEY

SN 85-251,114. BARRY D. SEARS, PH.D., MARBLEHEAD, MA. FILED 2-24-2011.

## ZONE DIET

THE MARK CONSISTS OF STANDARD CHARACTERS WITHOUT CLAIM TO ANY PARTICULAR FONT, STYLE, SIZE, OR COLOR.

NO CLAIM IS MADE TO THE EXCLUSIVE RIGHT TO USE "DIET", APART FROM THE MARK AS SHOWN.

### CLASS 41—EDUCATION AND ENTERTAINMENT

FOR PROVIDING SEMINARS, LECTURES AND PROGRAMS CONCERNING WEIGHT REDUCTION, NUTRITION AND HEALTHY LIFESTYLES (U.S. CLS. 100, 101 AND 107).

FIRST USE 0-0-1990; IN COMMERCE 0-0-1990.

### CLASS 44—MEDICAL, BEAUTY AND AGRICULTURAL SERVICES

FOR PROVIDING INFORMATION IN THE FIELD OF WEIGHT REDUCTION AND HEALTHY LIFESTYLES FOR EDUCATIONAL PURPOSES; PROVIDING AN EDUCATIONAL WEBSITE IN THE FIELD OF WEIGHT REDUCTION, WEIGHT MAINTENANCE, DIET PLANNING, NUTRITION AND HEALTHY LIFESTYLES; COUNSELING IN THE FIELDS OF NUTRITION AND WELLNESS, MEAL PLANNING SERVICES; PERSONAL ASSESSMENTS IN THE FIELD OF DIET AND NUTRITION (U.S. CLS. 100 AND 101).

FIRST USE 0-0-1990; IN COMMERCE 0-0-1990.

SHAUNIA CARLYLE, EXAMINING ATTORNEY

SN 85-251,696. AMERICAN SOCIETY FOR RADIATION ONCOLOGY, FAIRFAX, VA. FILED 2-25-2011.



OWNER OF U.S. REG. NOS. 3,156,384, 3,317,131 AND 3,480,598.

THE MARK CONSISTS OF THE LITERAL ELEMENT "ASTRO" IN WHICH AN ORBITING CIRCLE SURROUNDS THE LETTER "A" AND THE LETTER "T" APPEARS IN A LIGHTER SHADE THAN THE REMAINING LETTERS.

### CLASS 16—PAPER GOODS AND PRINTED MATTER

FOR PRINTED EDUCATIONAL MATERIALS IN THE FIELD OF RADIATION ONCOLOGY (U.S. CLS. 2, 5, 22, 23, 29, 37, 38 AND 50).

FIRST USE 1-0-2009; IN COMMERCE 1-0-2009.

### CLASS 35—ADVERTISING AND BUSINESS

FOR ASSOCIATION SERVICES, NAMELY, PROMOTING THE INTERESTS OF PERSONS IN THE FIELD OF RADIATION ONCOLOGY; PROMOTING PUBLIC AWARENESS ABOUT RADIATION ONCOLOGY; CONDUCTING PUBLIC RELATIONS/MEDIA CAMPAIGNS TO PROMOTE PUBLIC AWARENESS ABOUT RADIATION ONCOLOGY; CONDUCTING ADVOCACY PROGRAMS TO PROMOTE PUBLIC AWARENESS RELATING TO RADIATION ONCOLOGY (U.S. CLS. 100, 101 AND 102).

FIRST USE 1-0-2009; IN COMMERCE 1-0-2009.

### CLASS 41—EDUCATION AND ENTERTAINMENT

FOR EDUCATIONAL SERVICES, NAMELY, CONDUCTING EDUCATIONAL CONFERENCES, LECTURES, SYMPOSIUMS, AND SEMINARS IN THE FIELD OF RADIATION ONCOLOGY; EDUCATIONAL SERVICES, NAMELY, PROVIDING PUBLIC EDUCATION PROGRAMS IN THE FIELD OF RADIATION ONCOLOGY (U.S. CLS. 100, 101 AND 107).

FIRST USE 1-0-2009; IN COMMERCE 1-0-2009.

### CLASS 42—SCIENTIFIC AND COMPUTER SERVICES

FOR PROVIDING INFORMATION REGARDING MEDICAL RESEARCH IN THE FIELD OF RADIATION ONCOLOGY (U.S. CLS. 100 AND 101).

FIRST USE 1-0-2009; IN COMMERCE 1-0-2009.

MARGARET POWER, EXAMINING ATTORNEY

SN 85-252,575. SUPER STAR LEARNING COMPANY, SAN CLEMENTE, CA. FILED 2-26-2011.

## Room 21

THE MARK CONSISTS OF STANDARD CHARACTERS WITHOUT CLAIM TO ANY PARTICULAR FONT, STYLE, SIZE, OR COLOR.

### CLASS 35—ADVERTISING AND BUSINESS

FOR ONLINE SUBSCRIPTION SERVICES FEATURING ONLINE WEB FACILITIES, NAMELY, CLASSES, BLOGS, AND MESSAGING FOR TEACHERS, STUDENTS, AND PARENTS (U.S. CLS. 100, 101 AND 102).

FIRST USE 9-17-2009; IN COMMERCE 9-17-2009.

### CLASS 41—EDUCATION AND ENTERTAINMENT

FOR EDUCATIONAL SERVICES, NAMELY, PROVIDING ONLINE CURRICULA, COURSES, CLASSES, SEMINARS, WORKSHOPS, FORUMS, MENTORING, LECTURES, AND LEARNING PROJECTS IN THE FIELDS OF ADVISORY, CAREER AND TECHNOLOGY EDUCATION, COMPUTER TECHNOLOGY, FOREIGN LANGUAGES, GOVERNMENT, ECONOMICS, LANGUAGE ARTS, ENGLISH, MATHEMATICS, PHILOSOPHY, RELIGION, PHYSICAL EDUCATION AND SPORTS, READING, SCIENCE, SOCIAL STUDIES, HISTORY, TEST PREPARATION, FINE ARTS, MUSIC, GOAL SETTING, COLLEGE READINESS, CAREER READINESS, TECHNOLOGY INTEGRATION, SPECIAL EDUCATION, INTEGRATED INSTRUCTION, HUMAN RESOURCES, PARENT RELATIONS, ENGLISH LANGUAGE DEVELOPMENT STRATEGIES, ASSESSMENT (U.S. CLS. 100, 101 AND 107).

FIRST USE 9-17-2009; IN COMMERCE 9-17-2009.

**CLASS 42—SCIENTIFIC AND COMPUTER SERVICES**

FOR COMPUTER SERVICES, NAMELY, HOSTING ONLINE WEB FACILITIES FOR OTHERS BY PROVIDING RELEVANT TOOLS, NAMELY, COMMENTING, THREADED DISCUSSIONS, MESSAGING, EMAIL, BLOGGING, VIDEO, MUSIC COMPOSITION, AND GOAL SETTING (U.S. CLS. 100 AND 101).

FIRST USE 9-17-2009; IN COMMERCE 9-17-2009.

**CLASS 45—PERSONAL AND LEGAL SERVICES**

FOR ONLINE SOCIAL NETWORKING CONCERNING TOPICS OF EDUCATION IN THE FIELDS OF ADVISORY, CAREER AND TECHNOLOGY EDUCATION, COMPUTER TECHNOLOGY, FOREIGN LANGUAGES, GOVERNMENT, ECONOMICS, LANGUAGE ARTS, ENGLISH, MATHEMATICS, PHILOSOPHY, RELIGION, PHYSICAL EDUCATION AND SPORTS, READING, SCIENCE, SOCIAL STUDIES, HISTORY, TEST PREPARATION, FINE ARTS, MUSIC, GOAL SETTING, COLLEGE READINESS, CAREER READINESS, TECHNOLOGY INTEGRATION, SPECIAL EDUCATION, HUMAN RESOURCES, PARENT RELATIONS, ENGLISH LANGUAGE DEVELOPMENT STRATEGIES, ASSESSMENT (U.S. CLS. 100 AND 101).

FIRST USE 9-17-2009; IN COMMERCE 9-17-2009.

JILL C. ALT, EXAMINING ATTORNEY

SN 85-252,851. MOLKEREI WEIHENSTEPHAN GMBH & CO. KG, FREISING, FED REP GERMANY, FILED 2-27-2011.

WEIHENSTEPHAN

THE MARK CONSISTS OF STANDARD CHARACTERS WITHOUT CLAIM TO ANY PARTICULAR FONT, STYLE, SIZE, OR COLOR.

THE ENGLISH TRANSLATION OF "WEIHENSTEPHAN" IN THE MARK IS CONSECRATED STEPHAN.

**CLASS 29—MEATS AND PROCESSED FOODS**

FOR MILK, BUTTERMILK, SOUR MILK AND MILK PRODUCTS, NAMELY, BUTTER, CHEESE, CREAM, YOGURT, KEFIR MADE FROM MILK WITH SPECIFIC KEFIR CULTURES CONSISTING OF KEFIR BULBS, BUTTERMILK, POWDERED MILK, DAIRY-BASED FOOD BEVERAGES; PROCESSED BEAN CURD (U.S. CL. 46).

**CLASS 30—STAPLE FOODS**

FOR MILKSHAKES, FROZEN YOGURT, FROZEN CONFECTIONS CONTAINING YOGURT, BEAN CURD AND CREAM; ICE CREAM (U.S. CL. 46).

MEGHAN REINHART, EXAMINING ATTORNEY

SN 85-253,596. GLOBAL SYSTEM INTERNATIONAL, S.P.A., SCANZOROSCIATE (BG), ITALY, FILED 2-28-2011.

GSI

THE MARK CONSISTS OF STANDARD CHARACTERS WITHOUT CLAIM TO ANY PARTICULAR FONT, STYLE, SIZE, OR COLOR.

**CLASS 40—MATERIAL TREATMENT**

FOR MANUFACTURING PRODUCTS, PARTS AND ASSEMBLED SYSTEMS MADE OF THERMOPLASTIC AND THERMOSET COMPOSITE MATERIALS, NAMELY, SHEET MOLDED COMPOSITE, GLASS-MAT THERMOPLASTIC, AND LONG FIBER THERMOPLASTIC MATERIALS FOR USE IN FURTHER MANUFACTURING OF INDUSTRIAL, AUTOMOTIVE, AGRICULTURAL, AND ELECTRONIC COMPONENT PRODUCTS; MANUFACTURING PRODUCTS, PARTS AND ASSEMBLED SYSTEMS MADE OF THERMOPLASTIC AND THERMOSET COMPOSITE MATERIALS, NAMELY, SHEET MOLDED COMPOSITE, GLASS-MAT THERMOPLASTIC, AND LONG FIBER THERMOPLASTIC MATERIALS FOR USE IN INDUSTRIAL, AUTOMOTIVE, AGRICULTURAL, AND ELECTRONIC COMPONENT PRODUCTS (U.S. CLS. 100, 103 AND 106).

**CLASS 42—SCIENTIFIC AND COMPUTER SERVICES**

FOR DEVELOPING PRODUCTS, PARTS AND ASSEMBLED SYSTEMS MADE OF THERMOPLASTIC AND THERMOSET COMPOSITE MATERIALS, NAMELY, SHEET MOLDED COMPOSITE, GLASS-MAT THERMOPLASTIC, AND LONG FIBER THERMOPLASTIC MATERIALS (U.S. CLS. 100 AND 101).

JUDITH HELFMAN, EXAMINING ATTORNEY

SN 85-255,805. NORTH AMERICAN PUBLISHING COMPANY, PHILADELPHIA, PA. FILED 3-2-2011.

CE WEEK

NO CLAIM IS MADE TO THE EXCLUSIVE RIGHT TO USE "CE WEEK", APART FROM THE MARK AS SHOWN.

THE MARK CONSISTS OF THE STYLIZED WORDING "CE WEEK" WITH EACH LETTER WITHIN A CIRCLE.

**CLASS 35—ADVERTISING AND BUSINESS**

FOR ARRANGING AND CONDUCTING TRADE SHOWS AND TRADE SHOW EXHIBITIONS IN THE FIELD OF CONSUMER ELECTRONICS (U.S. CLS. 100, 101 AND 102).

**CLASS 41—EDUCATION AND ENTERTAINMENT**

FOR EDUCATIONAL SERVICES, NAMELY, CONDUCTING SEMINARS, CONFERENCES, AND WORKSHOPS IN THE FIELD OF CONSUMER ELECTRONICS AND DISTRIBUTION OF PRINTED MATERIALS IN CONNECTION THEREWITH IN HARD COPY OR ELECTRONIC FORMAT ON THE SAME TOPICS; EDUCATIONAL FORUMS RELATING TO CONSUMER ELECTRONICS (U.S. CLS. 100, 101 AND 107).

BRIAN PINO, EXAMINING ATTORNEY

SN 85-255,869. THE COLOMER GROUP SPAIN, S.L., BARCELONA, SPAIN, FILED 3-2-2011.

## BEAUTIGE

THE MARK CONSISTS OF STANDARD CHARACTERS WITHOUT CLAIM TO ANY PARTICULAR FONT, STYLE, SIZE, OR COLOR.

### CLASS 3—COSMETICS AND CLEANING PREPARATIONS

FOR COSMETICS; HAIR CARE PREPARATIONS; HAIR CARE LOTIONS; HAIR SHAMPOO; HAIR CONDITIONERS; HAIR STYLING PREPARATIONS; HAIR STYLING SPRAYS; HAIR MOUSSES; HAIR WAX; HAIR GELS; HAIR OILS; HAIR COLORING PREPARATIONS; HAIR DYES; NAIL CARE PREPARATIONS; NAIL ENAMELS; NAIL ENAMEL REMOVERS; NAIL POLISH; NAIL POLISH BASE COAT; NAIL POLISH REMOVERS; AND NAIL GELS (U.S. CLS. 1, 4, 6, 50, 51 AND 52).

### CLASS 41—EDUCATION AND ENTERTAINMENT

FOR EDUCATIONAL SERVICES, NAMELY, CONDUCTING CLASSES IN THE FIELD OF HAIRDRESSING, MANICURES AND PEDICURES; TRAINING IN THE FIELD OF HAIRDRESSING, MANICURES AND PEDICURES (U.S. CLS. 100, 101 AND 107).

### CLASS 44—MEDICAL, BEAUTY AND AGRICULTURAL SERVICES

FOR BEAUTY SALON SERVICES; HAIRDRESSING SERVICES; MANICURE SERVICES; AND PEDICURE SERVICES (U.S. CLS. 100 AND 101).  
SUSAN RICHARDS, EXAMINING ATTORNEY

SN 85-256,507. EXECUTIVE HEALTH RESOURCES, INC., NEWTOWN SQUARE, PA. FILED 3-3-2011.



OWNER OF U.S. REG. NO. 2,649,080.  
NO CLAIM IS MADE TO THE EXCLUSIVE RIGHT TO USE "HEALTH RESOURCES" AND "COMPANY", APART FROM THE MARK AS SHOWN.

THE MARK CONSISTS OF THE STYLIZED LETTERS "EHR" DIRECTLY ABOVE THE WORDS "EXECUTIVE HEALTH RESOURCES" IN A RECTANGULAR BOX, AND THE WORDS "THE PHYSICIAN ADVISOR COMPANY" DIRECTLY BENEATH THE RECTANGULAR BOX.  
SEC. 2(F) AS TO "PHYSICIAN ADVISOR".

### CLASS 35—ADVERTISING AND BUSINESS

FOR MEDICAL COST MANAGEMENT; HEALTH CARE COST REVIEW (U.S. CLS. 100, 101 AND 102).  
FIRST USE 6-18-2006; IN COMMERCE 6-18-2006.

### CLASS 41—EDUCATION AND ENTERTAINMENT

FOR EDUCATIONAL SERVICES, NAMELY, PROVIDING CLINICAL EDUCATION AND TRAINING TO PHYSICIANS AND HOSPITAL MANAGED CARE PERSONNEL IN THE FIELDS OF UTILIZATION REVIEW, CASE MANAGEMENT, MEDICAL COST MANAGEMENT, AND QUALITY ASSURANCE (U.S. CLS. 100, 101 AND 107).

FIRST USE 6-18-2006; IN COMMERCE 6-18-2006.

### CLASS 45—PERSONAL AND LEGAL SERVICES

FOR REVIEWING STANDARDS AND PRACTICES TO ASSURE COMPLIANCE WITH MEDICARE AND MEDICAID MEDICAL NECESSITY LAWS AND REGULATIONS; BUSINESS COMPLIANCE CONSULTATION, NAMELY, REGULATORY COMPLIANCE CONSULTING IN THE FIELD OF HEALTH CARE MANAGEMENT (U.S. CLS. 100 AND 101).

FIRST USE 6-18-2006; IN COMMERCE 6-18-2006.

FLORENTINA BLANDU, EXAMINING ATTORNEY

SN 85-257,227. SUMMIT ELECTRIC SUPPLY COMPANY, INC., ALBUQUERQUE, NM. FILED 3-3-2011.

## SUMMIT

THE MARK CONSISTS OF STANDARD CHARACTERS WITHOUT CLAIM TO ANY PARTICULAR FONT, STYLE, SIZE, OR COLOR.

OWNER OF U.S. REG. NOS. 2,440,973, 3,208,048 AND OTHERS.

### CLASS 37—CONSTRUCTION AND REPAIR

FOR CUSTOM MODIFICATION SERVICES FOR ELECTRICAL CONTROLS, MOTOR CONTROLS, LIGHTING CONTROLS AND ELECTRICAL CABLE ASSEMBLIES (U.S. CLS. 100, 103 AND 106).

FIRST USE 8-10-1979; IN COMMERCE 8-10-1979.

### CLASS 40—MATERIAL TREATMENT

FOR CUSTOM FABRICATION SERVICES FOR ELECTRICAL CONTROLS, MOTOR CONTROLS, LIGHTING CONTROLS AND ELECTRICAL CABLE ASSEMBLIES (U.S. CLS. 100, 103 AND 106).

FIRST USE 8-10-1979; IN COMMERCE 8-10-1979.

BRIAN PINO, EXAMINING ATTORNEY

SN 85-257,309. ACES AND EIGHTS CORPORATION, FAIRMONT, WV. FILED 3-3-2011.

SN 85-257,530. J CAVANAUGH GROUP, INC., BONNY DOON, CA. FILED 3-3-2011.

# LIDDS



THE MARK CONSISTS OF A DECORATIVE SPADE, WITH THE LETTER "A" AND THE NUMBER "8" INTERTWINED.

## CLASS 9—ELECTRICAL AND SCIENTIFIC APPARATUS

FOR (BASED ON INTENT TO USE) MULTI-MODAL HANDHELD BIOMETRIC COLLECTION, ENROLLMENT AND TRANSMISSION DEVICES FOR DETECTING, COLLECTING AND ENROLLING FINGER PRINTS, FACIAL PHOTOGRAPHS, IRISES, AND/OR VOICES; SOFTWARE FOR USE IN ASSOCIATION WITH THE COLLECTION, VERIFICATION AND PROCESSING OF BIOMETRIC INFORMATION, FORENSIC DATA OR OTHER INTELLIGENCE INFORMATION; SOFTWARE FOR USE IN CONDUCTING AND PROCESSING ANALYTICS AND TECHNICAL EXPLOITATION (U.S. CLS. 21, 23, 26, 36 AND 38).

## CLASS 42—SCIENTIFIC AND COMPUTER SERVICES

FOR (BASED ON USE IN COMMERCE) PRODUCT AND HARDWARE DESIGN AND DEVELOPMENT IN BIOMETRIC COLLECTION AND VERIFICATION, FORENSIC COLLECTION AND ANALYSIS, INTELLIGENCE, AND TECHNICAL EXPLOITATION; CLOUD COMPUTING FEATURING SOFTWARE FOR USE IN ASSOCIATION WITH THE COLLECTION, VERIFICATION AND PROCESSING OF BIOMETRIC INFORMATION, FORENSIC DATA OR OTHER INTELLIGENCE INFORMATION, AND SOFTWARE FOR USE IN CONDUCTING AND PROCESSING ANALYTICS AND TECHNICAL EXPLOITATION; SOFTWARE DEVELOPMENT FOR OTHERS FOR USE IN ASSOCIATION WITH THE COLLECTION, VERIFICATION AND PROCESSING OF BIOMETRICS INFORMATION, FORENSIC DATA, OR OTHER INTELLIGENCE INFORMATION; SOFTWARE DEVELOPMENT FOR OTHERS FOR USE IN ASSOCIATION WITH CONDUCTING AND PROCESSING ANALYTICS AND TECHNICAL EXPLOITATION (U.S. CLS. 100 AND 101).

FIRST USE 5-17-2011; IN COMMERCE 5-17-2011.  
SEAN CROWLEY, EXAMINING ATTORNEY

THE MARK CONSISTS OF STANDARD CHARACTERS WITHOUT CLAIM TO ANY PARTICULAR FONT, STYLE, SIZE, OR COLOR.

## CLASS 16—PAPER GOODS AND PRINTED MATTER

FOR PRINTED DOCUMENTS IN THE FIELD OF LEADERSHIP DEVELOPMENT, NAMELY, WORKBOOKS, CARDS, MANUALS AND INSTRUCTIONAL GUIDES (U.S. CLS. 2, 5, 22, 23, 29, 37, 38 AND 50).

## CLASS 35—ADVERTISING AND BUSINESS

FOR PROVIDING A WEBSITE FEATURING INFORMATION IN THE FIELD OF BUSINESS AND PROFESSIONAL LEADERSHIP DEVELOPMENT (U.S. CLS. 100, 101 AND 102).

## CLASS 41—EDUCATION AND ENTERTAINMENT

FOR PROVIDING A WEBSITE FEATURING BLOG ENTRIES IN THE FIELD OF LEADERSHIP DEVELOPMENT (U.S. CLS. 100, 101 AND 107).

WANDA KAY PRICE, EXAMINING ATTORNEY

SN 85-258,247. PATRAFICO AG, ZUG, SWITZERLAND, FILED 3-4-2011.



OWNER OF U.S. REG. NOS. 559,256, 3,561,080 AND OTHERS.

THE MARK CONSISTS OF A CLOWN HEAD WEARING A HAT WITH THE TERM "PEZ" ON THE HAT.

## CLASS 16—PAPER GOODS AND PRINTED MATTER

FOR PRINTED MATTER, NAMELY, STATIONERY, CALENDARS, STICKERS; PACKAGING CONTAINERS OF PAPER (U.S. CLS. 2, 5, 22, 23, 29, 37, 38 AND 50).

FIRST USE 8-31-2004; IN COMMERCE 8-31-2004.

**CLASS 28—TOYS AND SPORTING GOODS**

FOR TOYS AND NOVELTY ITEMS, NAMELY, PLASTIC CANDY DISPENSERS DESIGNED AS TOYS, PLUSH TOYS, JIGSAW PUZZLES, CHRISTMAS TREE ORNAMENTS, INTERACTIVE MULTIMEDIA STAND ALONE VIDEO GAME MACHINES (U.S. CLS. 22, 23, 38 AND 50).  
FIRST USE 8-31-2004; IN COMMERCE 8-31-2004.

SN 85-258,808. BIOMATRIX, LLC, EDINA, MN. FILED 3-5-2011.

**CLASS 30—STAPLE FOODS**

FOR CONFECTIONERY, NAMELY, CRYSTAL SUGAR PIECES AND SWEETMEATS, NAMELY, COMPRESSED SUGAR; DEXTROSE AND COMPRESSED DEXTROSE FOR PURPOSES OF NOURISHMENT; GUMMY PRODUCTS, NAMELY, FRUIT AND FRUIT TYPE GUMMY CANDIES AND FRUIT AND YOGHURT GUMMY CANDIES; REFRESHMENT PASTILLES AND CANDY; BUBBLE GUM AND CHEWING GUM; CONFECTIONERY, NAMELY, PASTILLES AND DRAGEES, INCLUDING SUGAR-FREE PASTILLES AND DRAGEES, NOT FOR MEDICAL PURPOSES (U.S. CL. 46).

FIRST USE 8-31-2004; IN COMMERCE 8-31-2004.  
STEVEN JACKSON, EXAMINING ATTORNEY

# REGENDO

THE MARK CONSISTS OF STANDARD CHARACTERS WITHOUT CLAIM TO ANY PARTICULAR FONT, STYLE, SIZE, OR COLOR.

**CLASS 5—PHARMACEUTICALS**

FOR BIOLOGICAL PREPARATIONS FOR THE TREATMENT OF ROOT CANAL PROCEDURES; BLOOD FOR MEDICAL PURPOSES (U.S. CLS. 6, 18, 44, 46, 51 AND 52).

**CLASS 10—MEDICAL APPARATUS**

FOR MEDICAL APPARATUS AND INSTRUMENTS FOR DENTAL USE; NEEDLES FOR MEDICAL PURPOSES; SYRINGES FOR MEDICAL PURPOSES AND FOR INJECTIONS (U.S. CLS. 26, 39 AND 44).  
INGA ERVIN, EXAMINING ATTORNEY

SN 85-258,366. SHAREDBOOK LTD., GEORGE TOWN, CAYMAN ISLANDS, FILED 3-4-2011.

# ACADEMICPUB

THE MARK CONSISTS OF STANDARD CHARACTERS WITHOUT CLAIM TO ANY PARTICULAR FONT, STYLE, SIZE, OR COLOR.

**CLASS 16—PAPER GOODS AND PRINTED MATTER**

FOR PRINTED MATERIALS PRODUCED BY A PUBLISHING HOUSE, NAMELY, SERIES OF FICTION BOOKS, NON-FICTION BOOKS, AND BOOKLETS ON A VARIETY OF TOPICS (U.S. CLS. 2, 5, 22, 23, 29, 37, 38 AND 50).

FIRST USE 7-13-2010; IN COMMERCE 1-24-2011.

**CLASS 41—EDUCATION AND ENTERTAINMENT**

FOR ELECTRONIC PUBLISHING OF BOOKS, DOCUMENTS, TEXT, IMAGES, AUDIO RECORDINGS, VIDEO RECORDINGS AND SOUND RECORDINGS OF OTHERS; EDUCATIONAL SERVICES, NAMELY, PROVIDING AN INTERACTIVE WEBSITE FEATURING EDUCATIONAL INFORMATION FOR THE ANNOTATION OF EDUCATIONAL DOCUMENTS, BOOKS AND MATERIALS (U.S. CLS. 100, 101 AND 107).

FIRST USE 7-13-2010; IN COMMERCE 1-24-2011.  
CORY BOONE, EXAMINING ATTORNEY

SN 85-259,694. ART PORTER MUSIC EDUCATION INC, LITTLE ROCK, AR. FILED 3-7-2011.

# ART PORTER

THE MARK CONSISTS OF STANDARD CHARACTERS WITHOUT CLAIM TO ANY PARTICULAR FONT, STYLE, SIZE, OR COLOR.

THE NAME "ART PORTER" DOES NOT IDENTIFY A LIVING INDIVIDUAL.

**CLASS 36—INSURANCE AND FINANCIAL**

FOR CHARITABLE FUNDRAISING TO RAISE MONEY TO PROVIDE EDUCATIONAL SCHOLARSHIPS FOR MUSICIANS AND TO FUND MUSIC EDUCATION FOR MUSICALLY TALENTED STUDENTS (U.S. CLS. 100, 101 AND 102).

**CLASS 41—EDUCATION AND ENTERTAINMENT**

FOR MUSIC EDUCATION SERVICES, NAMELY, CONDUCTING WORKSHOPS AND SEMINARS IN THE FIELD OF MUSIC FOR MUSICALLY TALENTED STUDENTS (U.S. CLS. 100, 101 AND 107).

ELISSA GARBER KON, EXAMINING ATTORNEY

SN 85-260,888. SOLAR SOLEIL LLC, AVONDALE, PA. FILED 3-8-2011.

**SOLAR SOLEIL**  
The Solar Power Professionals

NO CLAIM IS MADE TO THE EXCLUSIVE RIGHT TO USE "SOLAR" AND "THE SOLAR POWER PROFESSIONALS", APART FROM THE MARK AS SHOWN.

THE COLOR(S) GREEN, YELLOW AND WHITE IS/ARE CLAIMED AS A FEATURE OF THE MARK.

THE MARK CONSISTS OF THE WORD "SOLAR" WITH GREEN UPPER CASE LETTERS "SLAR" AND YELLOW UPPER CASE LETTER "O" WITH WHITE LINES DEPICTING RAYS OF LIGHT PASSING THROUGH THE WORD "SOLAR" AND THE WORD "SOLEIL" IN GREEN UPPER CASE LETTERS. THE WORDING "THE SOLAR POWER PROFESSIONALS" IN GREEN LETTERS APPEARS BELOW THE WORDING "SOLAR SOLEIL".

THE ENGLISH TRANSLATION OF THE WORD "SOLEIL" IN THE MARK IS "SUN".

#### CLASS 35—ADVERTISING AND BUSINESS

FOR CONDUCTING ENERGY AUDITS AND PROVIDING REPORTS FOR THE PURPOSE OF IDENTIFYING ENERGY COST SAVINGS FOR HOME OWNERS (U.S. CLS. 100, 101 AND 102).

#### CLASS 37—CONSTRUCTION AND REPAIR

FOR INSTALLATION, MAINTENANCE AND REPAIR OF SOLAR PHOTOVOLTAIC AND SOLAR THERMAL EQUIPMENT; ELECTRIC CONTRACTING SERVICES, NAMELY, INSTALLATION AND MAINTENANCE OF ELECTRIC GENERATORS (U.S. CLS. 100, 103 AND 106).  
CURTIS FRENCH, EXAMINING ATTORNEY

SN 85-261,183. WAGLET WORKS, LLC, MIAMI, FL. FILED 3-8-2011.

**WAGLETWORKS**

THE MARK CONSISTS OF STANDARD CHARACTERS WITHOUT CLAIM TO ANY PARTICULAR FONT, STYLE, SIZE, OR COLOR.

#### CLASS 11—ENVIRONMENTAL CONTROL APPARATUS

FOR FLASHLIGHT FOR LOCATING PET WASTE (U.S. CLS. 13, 21, 23, 31 AND 34).

#### CLASS 12—VEHICLES

FOR VEHICLE SEAT COVER FOR PETS (U.S. CLS. 19, 21, 23, 31, 35 AND 44).

#### CLASS 18—LEATHER GOODS

FOR PET WASTE BELT BAG SYSTEM COMPRISING CLIP ON OR LOOP ON SUPPORT FOR HOLDING PET ACCESSORIES; AND PET ACCESSORIES, NAMELY, CARRY BAG FOR DISPENSING DISPOSABLE SOLID ANIMAL WASTE PLASTIC BAGS AND FOR CARRYING USED DISPOSABLE SOLID ANIMAL WASTE PLASTIC BAGS, TOTE BAGS FOR PET TOYS (U.S. CLS. 1, 2, 3, 22 AND 41).

#### CLASS 20—FURNITURE AND ARTICLES NOT OTHERWISE CLASSIFIED

FOR COMBINATION TRAVEL BED (U.S. CLS. 2, 13, 22, 25, 32 AND 50).

#### CLASS 21—HOUSEWARES AND GLASS

FOR WATER BOTTLE HOLDER, FOLDING WATER BOWL, WET WIPES HOLDER AND DISPENSER, PET SNACK BOWL (U.S. CLS. 2, 13, 23, 29, 30, 33, 40 AND 50).

#### CLASS 24—FABRICS

FOR PET TOWEL; UNFITTED SEAT COVERS OF TEXTILE FOR PETS (U.S. CLS. 42 AND 50).

NAAKWAMA ANKRAH, EXAMINING ATTORNEY

SN 85-261,526. PINNACLE ENTERTAINMENT, INC., LAS VEGAS, NV. FILED 3-8-2011.

RIVER DOWNS  
**RACEBOOK**

NO CLAIM IS MADE TO THE EXCLUSIVE RIGHT TO USE "DOWNS" AND "RACEBOOK", APART FROM THE MARK AS SHOWN.

THE MARK CONSISTS OF THE WORDS "RIVER DOWNS" IN STYLIZED FORM CENTERED OVER A SOLID LINE WHICH IS CENTERED OVER THE STYLIZED WORD "RACEBOOK" WHICH IS CENTERED OVER A SOLID LINE.

#### CLASS 41—EDUCATION AND ENTERTAINMENT

FOR ENTERTAINMENT SERVICES, NAMELY, PROVIDING LIVE AND SIMULCAST HORSE RACES; PROVISION OF HORSE TRACK FACILITIES; BETTING SERVICES (U.S. CLS. 100, 101 AND 107).

FIRST USE 1-28-2011; IN COMMERCE 1-28-2011.

#### CLASS 43—HOTEL AND RESTAURANT SERVICES

FOR RESTAURANT, BAR AND CATERING SERVICES; PROVIDING BANQUET AND SOCIAL FUNCTION FACILITIES FOR SPECIAL OCCASIONS (U.S. CLS. 100 AND 101).

FIRST USE 1-28-2011; IN COMMERCE 1-28-2011.  
JULIE GUTTADAURO, EXAMINING ATTORNEY

SN 85-262,075. INTUIT INC., MOUNTAIN VIEW, CA. FILED 3-9-2011.

### INTUIT FULL SERVICE PAYROLL

THE MARK CONSISTS OF STANDARD CHARACTERS WITHOUT CLAIM TO ANY PARTICULAR FONT, STYLE, SIZE, OR COLOR.

OWNER OF U.S. REG. NOS. 1,821,148, 3,039,919 AND OTHERS.

NO CLAIM IS MADE TO THE EXCLUSIVE RIGHT TO USE "FULL SERVICE PAYROLL", APART FROM THE MARK AS SHOWN.

### CLASS 35—ADVERTISING AND BUSINESS

FOR PAYROLL ADMINISTRATION, PREPARATION, PROCESSING, AND MANAGEMENT SERVICES; PAYROLL SERVICES, NAMELY, VERIFICATION OF EMPLOYEE SOCIAL SECURITY NUMBERS AND COMPANY IDENTIFICATION NUMBERS WITH FEDERAL AND STATE AGENCIES; PAYROLL SERVICES, NAMELY, SETTING UP COMPANY DIRECT DEPOSIT ACCOUNTS AND EMPLOYEE DIRECT DEPOSIT ACCOUNTS FOR PAYROLL PAYMENTS; PAYROLL PLANNING, ADVICE, INFORMATION AND CONSULTANCY SERVICES; CREATING AND DISTRIBUTING FORM W-2 WAGE AND TAX STATEMENTS (U.S. CLS. 100, 101 AND 102).

FIRST USE 11-8-2010; IN COMMERCE 11-8-2010.

### CLASS 36—INSURANCE AND FINANCIAL

FOR PAYROLL TAX NOTIFICATION, PREPARATION, PAYMENT, AND DEBITING SERVICES; PAYROLL TAX PAYMENT PROCESSING, PAYROLL TAX PAYMENT MANAGEMENT, AND PAYROLL TAX PAYMENT ANALYSIS SERVICES (U.S. CLS. 100, 101 AND 102).

FIRST USE 11-8-2010; IN COMMERCE 11-8-2010.

### CLASS 42—SCIENTIFIC AND COMPUTER SERVICES

FOR SOFTWARE AS A SERVICE (SAAS) SERVICES FEATURING SOFTWARE FOR PAYROLL ADMINISTRATION, PREPARATION, PROCESSING, AND MANAGEMENT; SOFTWARE AS A SERVICE (SAAS) SERVICES FEATURING SOFTWARE FOR PAYROLL TAX PAYMENT PROCESSING, PAYROLL TAX PAYMENT MANAGEMENT, AND PAYROLL TAX PAYMENT ANALYSIS (U.S. CLS. 100 AND 101).

FIRST USE 11-8-2010; IN COMMERCE 11-8-2010.

JOHN DALIER, EXAMINING ATTORNEY

SN 85-262,327. LIFE CARE COMPANIES LLC, DES MOINES, IA. FILED 3-9-2011.

# CRSA

THE MARK CONSISTS OF STANDARD CHARACTERS WITHOUT CLAIM TO ANY PARTICULAR FONT, STYLE, SIZE, OR COLOR.

### CLASS 35—ADVERTISING AND BUSINESS

FOR BUSINESS MANAGEMENT OF RESIDENTIAL COMMUNITIES, CONTINUING CARE COMMUNITIES, ASSISTED LIVING COMMUNITIES AND RETIREMENT COMMUNITIES; BUSINESS DEVELOPMENT OF RESIDENTIAL, CONTINUING CARE, ASSISTED LIVING COMMUNITIES AND RETIREMENT COMMUNITIES; BUSINESS MANAGEMENT AND OPERATION OF CONTINUING CARE RETIREMENT COMMUNITIES (U.S. CLS. 100, 101 AND 102).

### CLASS 36—INSURANCE AND FINANCIAL

FOR FINANCIAL MANAGEMENT OF RESIDENTIAL COMMUNITIES, CONTINUING CARE COMMUNITIES, ASSISTED LIVING COMMUNITIES AND RETIREMENT COMMUNITIES; REAL ESTATE MANAGEMENT OF CONTINUING CARE RETIREMENT COMMUNITIES (U.S. CLS. 100, 101 AND 102).

BRENDAN MCCAULEY, EXAMINING ATTORNEY

SN 85-262,479. INTERNATIONAL CODE COUNCIL, INC., WHITTIER, CA. FILED 3-9-2011.

### INTERNATIONAL WILDLAND-URBAN INTERFACE CODE

THE MARK CONSISTS OF STANDARD CHARACTERS WITHOUT CLAIM TO ANY PARTICULAR FONT, STYLE, SIZE, OR COLOR.

OWNER OF U.S. REG. NO. 2,927,328.

NO CLAIM IS MADE TO THE EXCLUSIVE RIGHT TO USE "CODE", APART FROM THE MARK AS SHOWN.

SEC. 2(F).

### CLASS 9—ELECTRICAL AND SCIENTIFIC APPARATUS

FOR DOWNLOADABLE ELECTRONIC PUBLICATIONS, NAMELY, BOOKS, MAGAZINES, PAMPHLETS, NEWSLETTERS, WRITTEN ARTICLES, WRITTEN ANNOUNCEMENTS AND INFORMATIONAL BROCHURES AND MANUALS, ALL DEALING WITH URBAN WILDLAND INTERFACE CODES, STANDARDS, REGULATIONS AND RULES, AND DIRECTED TO GOVERNMENT OFFICIALS, ARCHITECTS, PLANNERS, ENGINEERS AND OTHERS CONCERNED WITH SUCH CODES, STANDARDS, REGULATIONS AND RULES (U.S. CLS. 21, 23, 26, 36 AND 38).

FIRST USE 12-31-2005; IN COMMERCE 12-31-2005.

### CLASS 41—EDUCATION AND ENTERTAINMENT

FOR PROVIDING ON-LINE NON-DOWNLOADABLE ELECTRONIC PUBLICATIONS IN THE NATURE OF BOOKS, MAGAZINES, PAMPHLETS, NEWSLETTERS, WRITTEN ARTICLES, WRITTEN ANNOUNCEMENTS AND INFORMATIONAL BROCHURES AND MANUALS, ALL DEALING WITH RECOMMENDED AND ENACTED CODES, STANDARDS, REGULATIONS AND RULES IN THE FIELD OF URBAN WILDLAND INTERFACE, AND DIRECTED TO GOVERNMENT OFFICIALS, ARCHITECTS, PLANNERS, ENGINEERS AND OTHERS CONCERNED WITH SUCH CODES, STANDARDS, REGULATIONS AND RULES (U.S. CLS. 100, 101 AND 107).

FIRST USE 12-31-2005; IN COMMERCE 12-31-2005.

EVELYN BRADLEY, EXAMINING ATTORNEY



SN 85-262,697. SPIRITED BUSINESS LLC, WEST HOLLYWOOD, CA. FILED 3-9-2011.

# The Upgrade

THE MARK CONSISTS OF STANDARD CHARACTERS WITHOUT CLAIM TO ANY PARTICULAR FONT, STYLE, SIZE, OR COLOR.

## CLASS 9—ELECTRICAL AND SCIENTIFIC APPARATUS

FOR DIGITAL MEDIA, NAMELY, CDS, DVDS, DOWNLOADABLE AUDIO FILES FEATURING BUSINESS AND HEALING (U.S. CLS. 21, 23, 26, 36 AND 38).

## CLASS 41—EDUCATION AND ENTERTAINMENT

FOR EDUCATION SERVICES, NAMELY, PROVIDING LIVE AND ON-LINE CLASSES, SEMINARS, WORKSHOPS IN THE FIELD OF BUSINESS, HEALING, AND LIFE TRANSFORMATIONAL TOPICS; ENTERTAINMENT SERVICES, NAMELY, THE PROVISION OF INDIVIDUAL AND CONTINUING PROGRAMS ON LIFE TRANSFORMATION TOPICS, HEALING AND BUSINESS TO BE DELIVERED BY TELEVISION, RADIO, SATELLITE, THE INTERNET (U.S. CLS. 100, 101 AND 107).

CHARLES L. JENKINS, EXAMINING ATTORNEY

SN 85-263,114. PEER39 INC., NEW YORK, NY. FILED 3-10-2011.

# PEER39

THE MARK CONSISTS OF STANDARD CHARACTERS WITHOUT CLAIM TO ANY PARTICULAR FONT, STYLE, SIZE, OR COLOR.

## CLASS 35—ADVERTISING AND BUSINESS

FOR PROVIDING ADVERTISING CONSULTATION TO COMPANIES, INCLUDING ADVERTISERS, PUBLISHERS AND EMERGING PLATFORMS, FEATURING SEMANTIC ADVERTISING TECHNOLOGY THAT ANALYZES THE MEANING OF WEBSITE CONTENT IN ORDER TO OPTIMIZE AND PROVIDE TARGETED ADVERTISING TO CONSUMERS WHILE PROTECTING ADVERTISER BRANDS IN REAL-TIME (U.S. CLS. 100, 101 AND 102).

FIRST USE 7-16-2006; IN COMMERCE 12-10-2006.

## CLASS 42—SCIENTIFIC AND COMPUTER SERVICES

FOR PROVIDE SEMANTIC ADVERTISING TECHNOLOGY TO COMPANIES, INCLUDING ADVERTISERS, PUBLISHERS AND EMERGING PLATFORMS; NAMELY, ONLINE NON-DOWNLOADABLE SOFTWARE THAT ANALYZES THE MEANING OF WEBSITE CONTENT IN ORDER TO OPTIMIZE AND PROVIDE TARGETED ADVERTISING TO CONSUMERS WHILE PROTECTING ADVERTISER BRANDS IN REAL-TIME (U.S. CLS. 100 AND 101).

FIRST USE 7-16-2006; IN COMMERCE 12-10-2006.

MICHELLE DUBOIS, EXAMINING ATTORNEY

SN 85-263,271. SARTORIUS STEDIM BIOTECH GMBH, GOETTINGEN, FED REP GERMANY, FILED 3-10-2011.

# TUFLUX

THE MARK CONSISTS OF STANDARD CHARACTERS WITHOUT CLAIM TO ANY PARTICULAR FONT, STYLE, SIZE, OR COLOR.

PRIORITY CLAIMED UNDER SEC. 44(D) ON ERPNCMNTY TM OFC APPLICATION NO. 009797796, FILED 3-9-2011, REG. NO. 009797796, DATED 8-30-2011, EXPIRES 3-9-2021.

## CLASS 7—MACHINERY

FOR EQUIPMENT FOR WELDING AND SEPARATING PLASTICS, NAMELY, ELECTRIC WELDING MACHINES FOR THE STERILE CONNECTION OF PLASTIC VESSELS, NAMELY, PLASTIC HOSES, TUBES, BAGS AND CONTAINERS (U.S. CLS. 13, 19, 21, 23, 31, 34 AND 35).

## CLASS 9—ELECTRICAL AND SCIENTIFIC APPARATUS

FOR LABORATORY FILTERS; FILTERS FOR USE IN LABORATORY EQUIPMENT IN THE BIOPHARMACEUTICAL INDUSTRY; DISPOSABLE PLASTIC BIOREACTORS FOR CELL CULTURING; CELL CULTURE APPARATUS FOR LABORATORY USE, NAMELY, CELL CULTURE VESSELS AND CELL CULTURE BAG AND TUBE ASSEMBLIES SOLD AS A UNIT (U.S. CLS. 21, 23, 26, 36 AND 38).

## CLASS 11—ENVIRONMENTAL CONTROL APPARATUS

FOR FILTERS, NAMELY, MEMBRANE FILTER CARTRIDGES FOR THE SEPARATION OF BIOMOLECULES IN BIOPHARMACEUTICAL PRODUCTION; APPARATUS FOR USE IN THE PURIFICATION, SEPARATION AND STERILIZATION OF LIQUIDS AND GASES USED IN THE BIOTECHNOLOGY, PHARMACEUTICAL AND BIOPHARMACEUTICAL INDUSTRIES (U.S. CLS. 13, 21, 23, 31 AND 34).

## CLASS 17—RUBBER GOODS

FOR FLEXIBLE PIPES, NOT OF METAL (U.S. CLS. 1, 5, 12, 13, 35 AND 50).

JIM RINGLE, EXAMINING ATTORNEY

SN 85-263,520. MEXICAN TABLE, LLC, BETHESDA, MD. FILED 3-10-2011.

## WHERE YOU'LL FIND THE HEART OF MEXICAN CUISINE

THE MARK CONSISTS OF STANDARD CHARACTERS WITHOUT CLAIM TO ANY PARTICULAR FONT, STYLE, SIZE, OR COLOR.

NO CLAIM IS MADE TO THE EXCLUSIVE RIGHT TO USE "MEXICAN CUISINE", APART FROM THE MARK AS SHOWN.

SN 85-263,968. SD BIOSENSOR, INC., SUWON-SI, GYEONG-GI-DO, REPUBLIC OF KOREA, FILED 3-10-2011.

#### **CLASS 16—PAPER GOODS AND PRINTED MATTER**

FOR BOOKS IN THE FIELD OF HUMAN CULTURES, CUISINE, CUISINE TECHNIQUES, MEXICO, AND GENERAL TOPICS RELATING TO CUISINE AND CUISINE CULTURE (U.S. CLS. 2, 5, 22, 23, 29, 37, 38 AND 50).

#### **CLASS 35—ADVERTISING AND BUSINESS**

FOR ENDORSEMENT SERVICES, NAMELY, PROMOTING THE GOODS AND SERVICES OF OTHERS (U.S. CLS. 100, 101 AND 102).

#### **CLASS 41—EDUCATION AND ENTERTAINMENT**

FOR ENTERTAINMENT IN THE NATURE OF ONGOING TELEVISION PROGRAMS IN THE FIELD OF COOKING, CUISINE, CUISINE TECHNIQUES, MEXICO AND GENERAL TOPICS RELATING TO CUISINE AND CUISINE CULTURE; ONLINE JOURNALS, NAMELY, BLOGS FEATURING INFORMATION IN THE FIELDS OF HUMAN CULTURES, CUISINE, CUISINE TECHNIQUES AND GENERAL TOPICS RELATING TO CUISINE AND CUISINE CULTURE (U.S. CLS. 100, 101 AND 107).  
DAWN HAN, EXAMINING ATTORNEY

## SD LipidoCare

THE MARK CONSISTS OF STANDARD CHARACTERS WITHOUT CLAIM TO ANY PARTICULAR FONT, STYLE, SIZE, OR COLOR.

PRIORITY CLAIMED UNDER SEC. 44(D) ON REPUBLIC OF KOREA APPLICATION NO. 40-2010-0050, FILED 10-4-2010.

#### **CLASS 5—PHARMACEUTICALS**

FOR REAGENTS FOR TESTING CHOLESTEROL LEVEL; REAGENTS FOR MEDICAL USE (U.S. CLS. 6, 18, 44, 46, 51 AND 52).

#### **CLASS 10—MEDICAL APPARATUS**

FOR APPARATUS AND INSTRUMENTS FOR USE IN MONITORING AND ANALYZING BLOOD CHOLESTEROL LEVEL (U.S. CLS. 26, 39 AND 44).

WILLIAM BRECKENFELD, EXAMINING ATTORNEY

SN 85-263,560. ZO SKIN HEALTH, INC., DEL MAR, CA. FILED 3-10-2011.

SN 85-264,263. STARDOLL AB, STOCKHOLM, SWEDEN, FILED 3-11-2011.

## ZO M.D.

THE MARK CONSISTS OF STANDARD CHARACTERS WITHOUT CLAIM TO ANY PARTICULAR FONT, STYLE, SIZE, OR COLOR.

OWNER OF U.S. REG. NOS. 3,443,711 AND 3,443,712.

NO CLAIM IS MADE TO THE EXCLUSIVE RIGHT TO USE "M.D.", APART FROM THE MARK AS SHOWN.

#### **CLASS 3—COSMETICS AND CLEANING PREPARATIONS**

FOR ANTI-AGING CREAMS; ANTI-WRINKLE CREAMS; COSMETIC CREAMS FOR SKIN CARE; SKIN TONERS; SKIN WHITENING CREAMS (U.S. CLS. 1, 4, 6, 50, 51 AND 52).

#### **CLASS 5—PHARMACEUTICALS**

FOR ACNE MEDICATIONS; MEDICATED CREAMS FOR TREATING DERMATOLOGICAL CONDITIONS (U.S. CLS. 6, 18, 44, 46, 51 AND 52).

ELLEN PERKINS, EXAMINING ATTORNEY

## BONJOUR BIZOU

THE MARK CONSISTS OF STANDARD CHARACTERS WITHOUT CLAIM TO ANY PARTICULAR FONT, STYLE, SIZE, OR COLOR.

#### **CLASS 25—CLOTHING**

FOR CLOTHING FOR TEENAGERS AND WOMEN, NAMELY, COATS, BATH ROBES, BEACH CLOTHES AND BEACHWEAR, SWIMWEAR, BRASSIERES, BOTTOMS, DRESSES, DENIMS, JACKETS, JERSEYS, JUMPERS, GIRDLES, OVERALLS, PAJAMAS, PARKAS, PETTICOATS, SCARVES, SHIRTS, SOCKS, STOCKINGS, T-SHIRTS, TIGHTS, TROUSERS, UNDERCLOTHING AND UNDERWEAR; FOOTWEAR (U.S. CLS. 22 AND 39).

#### **CLASS 28—TOYS AND SPORTING GOODS**

FOR DOLLS; DOLL CLOTHING; DOLL CLOTHING ACCESSORIES; FOOTWEAR FOR DOLLS; COLLECTIBLE DOLLS (U.S. CLS. 22, 23, 38 AND 50).

**CLASS 35—ADVERTISING AND BUSINESS**

FOR ONLINE RETAIL STORE SERVICES, NAMELY, AN INTERACTIVE WEB SITE FOR PURCHASING VIRTUAL CLOTHING AND VIRTUAL ACCESSORIES ONLINE FOR USE ON VIRTUAL DOLLS DEPICTED ON THE WEB SITE; ONLINE RETAIL STORE SERVICES, NAMELY, AN INTERACTIVE WEB SITE FOR PURCHASING DOLLS, DOLL CLOTHING, DOLL CLOTHING ACCESSORIES, FOOTWEAR FOR DOLLS; MEMBERSHIP CLUB SERVICES PROVIDING DISCOUNTS TO MEMBERS ON VIRTUAL CLOTHING AND VIRTUAL DOLLS ONLINE FOR USE ON VIRTUAL DOLLS ALL DEPICTED ON A WEB SITE; MEMBERSHIP CLUB SERVICES PROVIDING DISCOUNTS TO MEMBERS ON DOLLS, DOLL CLOTHING, DOLL CLOTHING ACCESSORIES AND DOLL FOOTWEAR; MEMBERSHIP CLUB SERVICES PROVIDING DISCOUNTS TO MEMBERS ON CLOTHING FOR TEENAGERS, NAMELY, COATS, BATH ROBES, BEACH CLOTHES, BRASSIERES, BOTTOMS, DRESSES, DENIM, JACKETS, JERSEYS, JUMPERS, GIRDLES, OVERALLS, PAJAMAS, PARKAS, PETTICOATS, SCARVES, SHIRTS, SOCKS, STOCKINGS, T-SHIRTS, TIGHTS, TROUSERS, UNDERCLOTHING AND FOOTWEAR (U.S. CLS. 100, 101 AND 102).

**CLASS 41—EDUCATION AND ENTERTAINMENT**

FOR ENTERTAINMENT GAMING SERVICES, NAMELY, PROVIDING AN INTERACTIVE WEB SITE FOR CREATING VIRTUAL CLOTHING AND VIRTUAL ACCESSORIES ONLINE FOR USE ON VIRTUAL DOLLS DEPICTED ON THE WEB SITE; PROVIDING ONLINE FAN-CLUB SERVICES FOR USERS OF VIRTUAL CLOTHING AND VIRTUAL DOLLS VIA THE INTERNET (U.S. CLS. 100, 101 AND 107).

RONALD AIKENS, EXAMINING ATTORNEY

SN 85-264,293. I.S.T. CORPORATION, SHIGA, JAPAN, FILED 3-11-2011.

**TORMED**

THE MARK CONSISTS OF STANDARD CHARACTERS WITHOUT CLAIM TO ANY PARTICULAR FONT, STYLE, SIZE, OR COLOR.

**CLASS 1—CHEMICALS**

FOR ARTIFICIAL RESINS, NAMELY, POLYAMIC ACID RESINS AND POLYIMIDE RESINS; UNPROCESSED PLASTICS; POLYMER COATING AGENTS FOR MEDICAL DEVICES, NAMELY, MEDICAL GRADE ARTIFICIAL RESINS FOR USE IN THE MANUFACTURE OF MEDICAL TUBING, FILMS, SPRAYS AND MEMBRANES; ADHESIVES FOR INDUSTRIAL USE (U.S. CLS. 1, 5, 6, 10, 26 AND 46).

**CLASS 2—PAINTS**

FOR VARNISHES; ENAMELS, NAMELY, ENAMEL PAINTS; PAINTS; COATING COMPOSITIONS IN THE NATURE OF PAINT FOR INDUSTRIAL APPLICATIONS (U.S. CLS. 6, 11 AND 16).

GINA FINK, EXAMINING ATTORNEY

SN 85-264,412. TEYMA USA INC., PHOENIX, AZ. FILED 3-11-2011.

**TEYMA USA**

NO CLAIM IS MADE TO THE EXCLUSIVE RIGHT TO USE "USA", APART FROM THE MARK AS SHOWN.

THE COLOR(S) THE COLOR PANTONE RED 172 IS/ARE CLAIMED AS A FEATURE OF THE MARK.

THE MARK CONSISTS OF THE WORDS "TEYMA USA" IN ALL CAPS; HANDELGOTHIC BT FONT IN PANTONE RED 172.

**CLASS 37—CONSTRUCTION AND REPAIR**

FOR INSTALLATION AND MAINTENANCE OF SOLAR ENERGY BASED POWER PLANTS; PLANT CONSTRUCTION, MAINTENANCE AND CONSTRUCTION PROJECT MANAGEMENT SERVICES FOR BUSINESSES IN THE ENERGY PRODUCTION AND TRANSMISSION SECTOR (U.S. CLS. 100, 103 AND 106).

FIRST USE 8-27-2009; IN COMMERCE 8-27-2009.

**CLASS 42—SCIENTIFIC AND COMPUTER SERVICES**

FOR ARCHITECTURAL AND ENGINEERING SERVICES; CIVIL ENGINEERING FOR THE DESIGN OF SOLAR POWER PLANTS; ENGINEERING SERVICES, NAMELY, ENGINEERING FOR THE CONSTRUCTION OF SOLAR POWER PLANTS; MECHANICAL ENGINEERING; TECHNICAL PLANNING OF SOLAR ENERGY BASED POWER PLANTS (U.S. CLS. 100 AND 101).

FIRST USE 8-27-2009; IN COMMERCE 8-27-2009.

CAROLINE WOOD, EXAMINING ATTORNEY

SN 85-264,514. DATA RESEARCH NETWORK, INC., DBA HIRESAFE, ELK GROVE, CA. FILED 3-11-2011.

 **HireSafe**

THE COLOR(S) BLACK AND MAROON IS/ARE CLAIMED AS A FEATURE OF THE MARK.

THE MARK CONSISTS OF A BLACK CIRCLE WITH AN INTERSECTING OVERLAID BLACK LETTER "V" SHAPE WITH A MAROON DOT IN THE TOP OPENING OF THE LETTER "V" AND THE WORD "HIRSAFE" IN MAROON LETTERS.

**CLASS 35—ADVERTISING AND BUSINESS**

FOR BUSINESS SERVICES, NAMELY, REGISTERING, SCREENING, CREDENTIALING, AND ORGANIZING THIRD-PARTY VENDORS, SUPPLIERS, AND CONTRACTORS, AND DOCUMENTATION AND INFORMATION ON BEHALF OF OTHERS (U.S. CLS. 100, 101 AND 102).

FIRST USE 7-2-1999; IN COMMERCE 7-2-1999.

**CLASS 44—MEDICAL, BEAUTY AND AGRICULTURAL SERVICES**

FOR PRE-EMPLOYMENT DRUG SCREENING (U.S. CLS. 100 AND 101).

FIRST USE 7-2-1999; IN COMMERCE 7-2-1999.

**CLASS 45—PERSONAL AND LEGAL SERVICES**

FOR BACKGROUND INVESTIGATION AND RESEARCH SERVICES; BACKGROUND INVESTIGATION SERVICES; DRUG, ALCOHOL AND DNA SCREENING FOR SECURITY AND EMPLOYMENT PURPOSES; EMPLOYMENT BACKGROUND SCREENING, NAMELY, BACKGROUND SCREENING OF CURRENT EMPLOYEES OF OTHERS; INVESTIGATION OR SURVEILLANCE ON BACKGROUND PROFILES; PERSONAL BACKGROUND INVESTIGATIONS; PRE-EMPLOYMENT BACKGROUND INVESTIGATION SERVICES; PRE-EMPLOYMENT BACKGROUND SCREENING; PROVIDING AN INTERACTIVE WEB SITE THAT FACILITATES THE VERIFICATION OF A PERSON'S BACKGROUND CREDENTIALS (U.S. CLS. 100 AND 101).

FIRST USE 7-2-1999; IN COMMERCE 7-2-1999.  
PAULA MAHONEY, EXAMINING ATTORNEY

**CLASS 41—EDUCATION AND ENTERTAINMENT**

FOR (BASED ON USE IN COMMERCE) PROVIDING ON-LINE PUBLICATIONS IN THE NATURE OF E-BOOKS IN THE FIELD OF CHILDREN'S ENTERTAINMENT (U.S. CLS. 100, 101 AND 107).

FIRST USE 10-20-2009; IN COMMERCE 10-20-2009.  
SUSAN RICHARDS, EXAMINING ATTORNEY

SN 85-266,370. R & B MARKETING CORPORATION, GAFFNEY, SC. FILED 3-14-2011.

SN 85-264,696. BFTV, LLC, LOS ANGELES, CA. FILED 3-11-2011.

**BABYFIRST**

THE MARK CONSISTS OF STANDARD CHARACTERS WITHOUT CLAIM TO ANY PARTICULAR FONT, STYLE, SIZE, OR COLOR.

OWNER OF U.S. REG. NOS. 3,314,403, 3,586,906 AND OTHERS.

**CLASS 9—ELECTRICAL AND SCIENTIFIC APPARATUS**

FOR (BASED ON USE IN COMMERCE) ELECTRONIC PUBLICATIONS, NAMELY, BOOKS IN THE FIELD OF CHILDREN'S ENTERTAINMENT; ELECTRONIC DOWNLOADABLE MULTIMEDIA PUBLICATIONS IN THE NATURE OF EBOOKS, AND E-READER FILES ALL FEATURING EDUCATIONAL THEMES AND ENTERTAINMENT DIRECTED TO CHILDREN, PARENTS AND FAMILIES; ELECTRONIC GAME SOFTWARE FOR USE WITH MOBILE DEVICES, PERSONAL COMPUTERS, CONSOLES, TABLETS; ELECTRONIC GAME PROGRAMS, DOWNLOADABLE COMPUTER GAME PROGRAMS; INTERACTIVE GAME PROGRAMS; INTERACTIVE GAME SOFTWARE FEATURING EDUCATIONAL THEMES AND ENTERTAINMENT DIRECTED TO CHILDREN, PARENTS AND FAMILIES; (BASED ON INTENT TO USE) ELECTRONIC DOWNLOADABLE MULTIMEDIA PUBLICATIONS IN THE NATURE OF BOOKS, MAGAZINES, E-MAGAZINES, CATALOGS, E-CATALOGS, BROCHURES, AND E-BROCHURES, ALL FEATURING EDUCATIONAL THEMES AND ENTERTAINMENT DIRECTED TO CHILDREN, PARENTS AND FAMILIES; HAND HELD ELECTRONIC PLATFORMS FOR RECEIVING AND STORING DOWNLOADED INFORMATION, NAMELY, A HANDHELD ELECTRONIC BOOK READER; COMPUTER SOFTWARE APPLICATIONS FOR USE IN CONNECTION WITH SMART PHONES, PDA DEVICES, TABLET COMPUTERS AND PORTABLE AND HANDHELD DIGITAL ELECTRONIC DEVICES FEATURING EDUCATIONAL THEMES AND ENTERTAINMENT DIRECTED TO CHILDREN, PARENTS AND FAMILIES; HAND HELD UNITS FOR PLAYING ELECTRONIC GAMES FOR USE WITH EXTERNAL DISPLAY SCREEN OR MONITOR (U.S. CLS. 21, 23, 26, 36 AND 38).

FIRST USE 10-20-2009; IN COMMERCE 10-20-2009.

**DECKWISE**

THE MARK CONSISTS OF STANDARD CHARACTERS WITHOUT CLAIM TO ANY PARTICULAR FONT, STYLE, SIZE, OR COLOR.

**CLASS 1—CHEMICALS**

FOR WOOD GLUES FOR USE IN THE CONSTRUCTION INDUSTRY (U.S. CLS. 1, 5, 6, 10, 26 AND 46).

**CLASS 2—PAINTS**

FOR WOOD PRESERVING OILS; WOOD SEALER COATINGS IN THE NATURE OF PAINTS; PENETRATING SEALER COATINGS FOR USE ON WOOD (U.S. CLS. 6, 11 AND 16).

**CLASS 6—METAL GOODS**

FOR METAL SCREWS (U.S. CLS. 2, 12, 13, 14, 23, 25 AND 50).

FIRST USE 3-3-2011; IN COMMERCE 3-3-2011.

**CLASS 7—MACHINERY**

FOR DRILL BITS FOR POWER DRILLS; SCREW DRIVER BITS FOR POWER OPERATED SCREW GUNS (U.S. CLS. 13, 19, 21, 23, 31, 34 AND 35).

**CLASS 8—HAND TOOLS**

FOR HAND TOOLS, NAMELY, HAND-OPERATED TOOLS FOR STRAIGHTENING DECK BOARDS (U.S. CLS. 23, 28 AND 44).

**CLASS 20—FURNITURE AND ARTICLES NOT OTHERWISE CLASSIFIED**

FOR NON-METAL FASTENERS IN THE NATURE OF EDGE MOUNT FASTENERS FOR HOLDING DECKING AND SIDING IN PLACE; FASTENERS IN THE NATURE OF EDGE MOUNT FASTENERS FOR HOLDING DECKING AND SIDING IN PLACE THAT ARE PRIMARILY NON-METAL BUT WITH METALLIC COMPONENTS; WOOD PLUGS FOR COVERING HOLES IN NON-METALLIC PLANKING OR WOODWORK (U.S. CLS. 2, 13, 22, 25, 32 AND 50).

STEVEN PEREZ, EXAMINING ATTORNEY

SN 85-266,377. R & B MARKETING CORPORATION, GAFFNEY, SC. FILED 3-14-2011.



THE MARK CONSISTS OF THE STYLIZED WORD "DECKWISE" WITH AN OWL'S HEAD ABOVE THE LETTERS "S" AND "E".

**CLASS 1—CHEMICALS**

FOR WOOD GLUES FOR USE IN THE CONSTRUCTION INDUSTRY (U.S. CLS. 1, 5, 6, 10, 26 AND 46).

**CLASS 2—PAINTS**

FOR WOOD PRESERVING OILS; WOOD SEALER COATINGS IN THE NATURE OF PAINTS; PENETRATING SEALER COATINGS FOR USE ON WOOD (U.S. CLS. 6, 11 AND 16).

**CLASS 6—METAL GOODS**

FOR METAL SCREWS (U.S. CLS. 2, 12, 13, 14, 23, 25 AND 50).  
FIRST USE 3-3-2011; IN COMMERCE 3-3-2011.

**CLASS 7—MACHINERY**

FOR DRILL BITS FOR POWER DRILLS; SCREW DRIVER BITS FOR POWER OPERATED SCREW GUNS (U.S. CLS. 13, 19, 21, 23, 31, 34 AND 35).

**CLASS 8—HAND TOOLS**

FOR HAND TOOLS, NAMELY, HAND-OPERATED TOOLS FOR STRAIGHTENING DECK BOARDS (U.S. CLS. 23, 28 AND 44).

**CLASS 20—FURNITURE AND ARTICLES NOT OTHERWISE CLASSIFIED**

FOR NON-METAL FASTENERS IN THE NATURE OF EDGE MOUNT FASTENERS FOR HOLDING DECKING AND SIDING IN PLACE; FASTENERS IN THE NATURE OF EDGE MOUNT FASTENERS FOR HOLDING DECKING AND SIDING IN PLACE THAT ARE PRIMARILY NON-METAL BUT WITH METALLIC COMPONENTS; WOOD PLUGS FOR COVERING HOLES IN NON-METALLIC PLANKING OR WOODWORK (U.S. CLS. 2, 13, 22, 25, 32 AND 50).  
STEVEN PEREZ, EXAMINING ATTORNEY

SN 85-266,565. HARRISONG PRODUCTIONS, LLC, GUALALA, CA. FILED 3-14-2011.

...& MUSIC WAS KING

THE MARK CONSISTS OF STANDARD CHARACTERS WITHOUT CLAIM TO ANY PARTICULAR FONT, STYLE, SIZE, OR COLOR.

**CLASS 9—ELECTRICAL AND SCIENTIFIC APPARATUS**

FOR INTERACTIVE COMPUTER GAME PROGRAMS (U.S. CLS. 21, 23, 26, 36 AND 38).

**CLASS 41—EDUCATION AND ENTERTAINMENT**

FOR ENTERTAINMENT AND EDUCATIONAL SERVICES, NAMELY, AN ON-GOING TELEVISION PROGRAM IN THE FIELD OF MUSIC; PROVIDING TEMPORARY USE OF A NON-DOWNLOADABLE INTERACTIVE COMPUTER GAME; AND PRODUCTION OF INTERACTIVE DVDS (U.S. CLS. 100, 101 AND 107).  
LINDA ESTRADA, EXAMINING ATTORNEY

SN 85-266,809. MARC NELSON, LLC, KNOXVILLE, TN. FILED 3-14-2011.

Marc Nelson

THE MARK CONSISTS OF STANDARD CHARACTERS WITHOUT CLAIM TO ANY PARTICULAR FONT, STYLE, SIZE, OR COLOR.  
THE NAME "MARC NELSON" DOES NOT IDENTIFY A LIVING INDIVIDUAL.

**CLASS 18—LEATHER GOODS**

FOR ALL-PURPOSE ATHLETIC BAGS; ALL-PURPOSE CARRYING BAGS; ATHLETIC BAGS; BAGS FOR SPORTS; CARRY-ON BAGS; DRAWSTRING BAGS; DUFFEL BAGS; DUFFEL BAGS FOR TRAVEL; DUFFLE BAGS; GYM BAGS; HANDBAGS FOR MEN; LEATHER AND IMITATION LEATHER SPORT BAGS AND GENERAL PURPOSE TROLLEY BAGS; MEN'S CLUTCH BAGS; MESSENGER BAGS; MILITARY DUFFLE BAGS, GARMENT BAGS FOR TRAVEL, TOTE BAGS, SHOULDER BAGS AND BACKPACKS; OVERNIGHT BAGS; SMALL BAGS FOR MEN; SPORT BAGS (U.S. CLS. 1, 2, 3, 22 AND 41).

**CLASS 25—CLOTHING**

FOR CAPRI PANTS; COLLARED SHIRTS; DENIMS; DRESS PANTS; DRESS SHIRTS; FOOTWEAR FOR MEN; GOLF SHIRTS; GYM PANTS; HOODED SWEAT SHIRTS; JOGGING PANTS; LEATHER PANTS; LOUNGE PANTS; MEN'S DRESS SOCKS; MEN'S SOCKS; NIGHT SHIRTS; OPEN-NECKED SHIRTS; OVER SHIRTS; PANTS; POLO SHIRTS; RUGBY SHIRTS; SHIRT INSERTS, NAMELY, DICKIES; SHIRTS; SHIRTS AND SHORT-SLEEVED SHIRTS; SHIRTS FOR SUITS; SHORT-SLEEVED OR LONG-SLEEVED T-SHIRTS; SHORT-SLEEVED SHIRTS; SLEEP PANTS; SWEAT PANTS; SWEAT SHIRTS; T-SHIRTS; TEE SHIRTS; TURTLE NECK SHIRTS (U.S. CLS. 22 AND 39).  
CHARLOTTE CORWIN, EXAMINING ATTORNEY

SN 85-266,856. LIVE WELL MARKETING, LLC., MIDDLEBURG, FL. FILED 3-15-2011.

SN 85-269,402. TELSCO INDUSTRIES, INC., DBA WEATHERMATIC, GARLAND, TX. FILED 3-17-2011.

## LIVE WELL RESEARCH

THE MARK CONSISTS OF STANDARD CHARACTERS WITHOUT CLAIM TO ANY PARTICULAR FONT, STYLE, SIZE, OR COLOR.

### CLASS 3—COSMETICS AND CLEANING PREPARATIONS

FOR NON-MEDICATED SKIN CARE PREPARATIONS (U.S. CLS. 1, 4, 6, 50, 51 AND 52).

### CLASS 5—PHARMACEUTICALS

FOR NUTRITIONAL SUPPLEMENTS; VITAMINS (U.S. CLS. 6, 18, 44, 46, 51 AND 52).  
BARBARA RUTLAND, EXAMINING ATTORNEY

SN 85-266,891. THE ROBERT & AUDREY TALBOTT FOUNDATION, CARMEL, CA. FILED 3-15-2011.



OWNER OF U.S. REG. NOS. 1,786,829 AND 2,883,622.  
THE MARK CONSISTS OF A SHADED HERALDIC LION ON A BAR ALL ABOVE A STYLIZED SHIELD FEATURING THREE HERALDIC LIONS AND A BANNER BELOW THE SHIELD.

### CLASS 35—ADVERTISING AND BUSINESS

FOR PROMOTING PUBLIC AWARENESS OF CULTURAL AND SOCIAL ENRICHMENT PROGRAMS FOR YOUTH COMMUNITY FACILITIES (U.S. CLS. 100, 101 AND 102).

FIRST USE 9-1-2008; IN COMMERCE 9-1-2008.

### CLASS 36—INSURANCE AND FINANCIAL

FOR CHARITABLE FOUNDATION SERVICES, NAMELY, PROVIDING FUNDING AND FUND RAISING ACTIVITIES TO SUPPORT NEW CONSTRUCTION, UPGRADES AND OPERATIONAL EXPENSES FOR EDUCATIONAL FACILITIES; CHARITABLE FOUNDATION SERVICES, NAMELY, PROVIDING FUNDING AND FUND RAISING ACTIVITIES TO SUPPORT EDUCATIONAL SCHOLARSHIP PROGRAMS FOR GIFTED AND SPECIAL NEEDS STUDENTS (U.S. CLS. 100, 101 AND 102).

FIRST USE 9-1-2008; IN COMMERCE 9-1-2008.  
BERYL GARDNER, EXAMINING ATTORNEY

## SMARTLINK

THE MARK CONSISTS OF STANDARD CHARACTERS WITHOUT CLAIM TO ANY PARTICULAR FONT, STYLE, SIZE, OR COLOR.

### CLASS 9—ELECTRICAL AND SCIENTIFIC APPARATUS

FOR DEVICE IN THE NATURE OF ELECTRONIC CONTROLLER, TRANSCEIVER AND MODEM; COMPUTER SOFTWARE AND GRAPHICAL USER INTERFACE SOFTWARE FOR WIRELESSLY CONNECTING AN AGRICULTURAL, EXTERIOR LAWN, AND GARDEN IRRIGATION CONTROLLER TO AN INFORMATION NETWORK, NAMELY, A LAN, PSTN, CELLULAR, WAN OR INTERNET, FOR ENABLING BI-DIRECTIONS COMMUNICATION BETWEEN THE IRRIGATION CONTROLLER AND A USER/OPERATOR ON THE NETWORK (U.S. CLS. 21, 23, 26, 36 AND 38).

### CLASS 38—COMMUNICATION

FOR IRRIGATION CONTROLLER COMMUNICATION SERVICE VIA COMPUTER TERMINALS BY TERRESTRIAL OR SATELLITE TRANSMISSIONS, EITHER ANALOG OR DIGITAL, ENABLING BI-DIRECTIONS COMMUNICATION BETWEEN A USER/OPERATOR AND AN ELECTRONIC IRRIGATION CONTROLLER, THROUGH AN INTERFACE SOFTWARE HOSTED ON AN INFORMATION NETWORK, NAMELY, A LAN, PSTN, CELLULAR, WAN OR INTERNET (U.S. CLS. 100, 101 AND 104).

SOPHIA S. KIM, EXAMINING ATTORNEY

SN 85-269,645. EZ TEAR MEDIA, HUNTERSVILLE, NC. FILED 3-17-2011.



NO CLAIM IS MADE TO THE EXCLUSIVE RIGHT TO USE THE UNIVERSAL RECYCLING SYMBOL AS TO THE GOODS IN CLASS 16 OR TO "EASY TEAR COUPONS.COM" AS TO ALL OF THE GOODS AND SERVICES, APART FROM THE MARK AS SHOWN.

THE STIPPLING IS FOR SHADING PURPOSES ONLY.  
THE MARK CONSISTS OF THE STYLIZED WORDING "EZ TEAR COUPONS.COM" WITH A DESIGN OF A GLOBE SURROUNDED BY THE RECYCLE SYMBOL AND OUTLINED IN DOTTED LINES, WHICH ARE A FEATURE OF THE MARK.

**CLASS 16—PAPER GOODS AND PRINTED MATTER**

FOR COUPON MAGAZINES (U.S. CLS. 2, 5, 22, 23, 29, 37, 38 AND 50).  
FIRST USE 3-22-2010; IN COMMERCE 7-15-2010.

**CLASS 35—ADVERTISING AND BUSINESS**

FOR PROMOTING THE GOODS AND SERVICES OF OTHERS BY PROVIDING A WEB SITE FEATURING COUPONS, REBATES, PRICE-COMPARISON INFORMATION, PRODUCT REVIEWS, LINKS TO THE RETAIL WEB SITES OF OTHERS, AND DISCOUNT INFORMATION (U.S. CLS. 100, 101 AND 102).  
FIRST USE 3-22-2010; IN COMMERCE 7-15-2010.

LINDA M. KING, EXAMINING ATTORNEY

---

SN 85-271,190. AXIOM FOODS, INC., LOS ANGELES, CA. FILED 3-18-2011.

**GROWING CRACKER**

THE MARK CONSISTS OF STANDARD CHARACTERS WITHOUT CLAIM TO ANY PARTICULAR FONT, STYLE, SIZE, OR COLOR.

NO CLAIM IS MADE TO THE EXCLUSIVE RIGHT TO USE "CRACKER", APART FROM THE MARK AS SHOWN.

**CLASS 5—PHARMACEUTICALS**

FOR NUTRITIONAL SUPPLEMENTS IN THE FORM OF CRACKERS (U.S. CLS. 6, 18, 44, 46, 51 AND 52).

**CLASS 30—STAPLE FOODS**

FOR CRACKERS (U.S. CL. 46).  
PAULA MAHONEY, EXAMINING ATTORNEY

---

SN 85-273,141. GROUPON, INC., CHICAGO, IL. FILED 3-22-2011.

**GROUPON NOW**

THE MARK CONSISTS OF STANDARD CHARACTERS WITHOUT CLAIM TO ANY PARTICULAR FONT, STYLE, SIZE, OR COLOR.

OWNER OF U.S. REG. NOS. 3,513,882 AND 3,685,954.

**CLASS 9—ELECTRICAL AND SCIENTIFIC APPARATUS**

FOR COMPUTER APPLICATION SOFTWARE FOR MOBILE DIGITAL DEVICES, NAMELY, SOFTWARE THAT ALLOWS USERS TO ACCESS COUPONS, REBATES, PRICE-COMPARISON INFORMATION, PRODUCT REVIEWS, LINKS TO THE RETAIL WEBSITES OF OTHERS, AND DISCOUNT INFORMATION (U.S. CLS. 21, 23, 26, 36 AND 38).

**CLASS 35—ADVERTISING AND BUSINESS**

FOR PROMOTING THE GOODS AND SERVICES OF OTHERS BY PROVIDING A WEBSITE FEATURING COUPONS, REBATES, PRICE-COMPARISON INFORMATION, PRODUCT REVIEWS, LINKS TO THE RETAIL WEBSITES OF OTHERS, AND DISCOUNT INFORMATION; ADVERTISING AND MARKETING SERVICES, NAMELY, PROMOTING THE BRANDS, GOODS AND SERVICES OF OTHERS; ARRANGING ONLINE SALES CAMPAIGNS FOR BUSINESS AND ADVERTISING PURPOSES OF OTHERS; PLANNING AND MANAGEMENT FOR MARKETING, PROMOTING OR ADVERTISING THE GOODS AND SERVICES OF OTHERS (U.S. CLS. 100, 101 AND 102).

**CLASS 41—EDUCATION AND ENTERTAINMENT**

FOR ELECTRONIC PUBLICATION OF INFORMATION RELATING TO THE PRODUCTS AND SERVICES OF OTHERS, NAMELY, PRICE-COMPARISON INFORMATION, PRODUCT REVIEWS AND DISCOUNT INFORMATION (U.S. CLS. 100, 101 AND 107).

CHERYL CLAYTON, EXAMINING ATTORNEY

---

SN 85-273,149. SPORTSBLOGS, INC., DBA SB NATION, WASHINGTON, DC. FILED 3-22-2011.

**BASEBALL NATION**

THE MARK CONSISTS OF STANDARD CHARACTERS WITHOUT CLAIM TO ANY PARTICULAR FONT, STYLE, SIZE, OR COLOR.

NO CLAIM IS MADE TO THE EXCLUSIVE RIGHT TO USE "BASEBALL", APART FROM THE MARK AS SHOWN.

**CLASS 38—COMMUNICATION**

FOR PROVIDING ON-LINE ELECTRONIC BULLETIN BOARDS FOR TRANSMISSION OF MESSAGES AND INFORMATION AMONG USERS IN THE FIELD OF SPORTS (U.S. CLS. 100, 101 AND 104).

**CLASS 41—EDUCATION AND ENTERTAINMENT**

FOR ONLINE JOURNALS, NAMELY, BLOGS, IN THE FIELD OF SPORTS; PROVIDING A WIDE RANGE OF INFORMATION IN THE FIELDS OF SPORTS; PROVIDING INFORMATION VIA COMPUTER AND DIGITAL NETWORKS IN THE FIELD OF SPORTS; PROVIDING A WEBSITE FEATURING INFORMATION RELATED TO THE SPORT OF BASEBALL; EDUCATION AND ENTERTAINMENT SERVICES, NAMELY, PROVIDING NETWORK OF WEBSITES FEATURING INFORMATION, DATA, OPINIONS, COMMENTS AND IMAGES ON THE SPORT OF BASEBALL (U.S. CLS. 100, 101 AND 107).

LAURA KOVALSKY, EXAMINING ATTORNEY

SN 85-273,188. KYLE BUSCH, MOORESVILLE, NC. FILED 3-22-2011.



OWNER OF U.S. REG. NOS. 3,083,303, 3,175,522 AND OTHERS.

NO CLAIM IS MADE TO THE EXCLUSIVE RIGHT TO USE "MOTORSPORTS", APART FROM THE MARK AS SHOWN.

THE NAME "KYLE BUSCH" IDENTIFIES A LIVING INDIVIDUAL WHOSE CONSENT IS OF RECORD.

THE COLOR(S) RED, WHITE, BLUE AND SILVER IS/ARE CLAIMED AS A FEATURE OF THE MARK.

THE MARK CONSISTS OF THE INITIALS "KBM" IN RED WITH WHITE OUTLINING AND BLUE SHADOWING SUPERIMPOSED OVER BLUE AND WHITE MOUNTAINS AND A CIRCULAR, SILVER DESIGN DENOTING FORWARD MOVEMENT, BENEATH WHICH ARE THE WORDS "KYLE BUSCH MOTORSPORTS" IN WHITE WITH BLUE OUTLINING.

#### CLASS 25—CLOTHING

FOR CLOTHING, NAMELY, T-SHIRTS, SHIRTS, SWEATSHIRTS, SWEATPANTS, SHORTS, JACKETS; FOOTWEAR; HEADGEAR, NAMELY, HATS, CAPS AND VISORS (U.S. CLS. 22 AND 39).

FIRST USE 1-1-2011; IN COMMERCE 1-1-2011.

#### CLASS 41—EDUCATION AND ENTERTAINMENT

FOR ENTERTAINMENT SERVICES IN THE FORM OF PROFESSIONAL AUTOMOBILE RACING (U.S. CLS. 100, 101 AND 107).

FIRST USE 1-1-2011; IN COMMERCE 1-1-2011.

HEATHER THOMPSON, EXAMINING ATTORNEY

SN 85-273,584. PANTS, INC., PACIFIC PALISADES, CA. FILED 3-22-2011.



NO CLAIM IS MADE TO THE EXCLUSIVE RIGHT TO USE "KIDS", APART FROM THE MARK AS SHOWN.

THE COLOR(S) BLACK AND RED IS/ARE CLAIMED AS A FEATURE OF THE MARK.

THE MARK CONSISTS OF THE WORDING "KIDS" IN BLACK AND A RED HEART.

#### CLASS 16—PAPER GOODS AND PRINTED MATTER

FOR COFFEE TABLE BOOKS FEATURING A COLLECTION OF CHILDREN'S DRAWINGS AND WRITINGS ON TOPICS WITH EDUCATIONAL OR ENTERTAINMENT VALUE TO CHILDREN, NAMELY, POLITICS, NATURE, HEALTH, FOOD AND NUTRITION, GROWING UP AND RELATIONSHIPS (U.S. CLS. 2, 5, 22, 23, 29, 37, 38 AND 50).

FIRST USE 11-3-2008; IN COMMERCE 4-13-2009.

#### CLASS 25—CLOTHING

FOR T-SHIRTS FOR BABIES, CHILDREN AND ADULTS (U.S. CLS. 22 AND 39).

FIRST USE 11-3-2008; IN COMMERCE 4-13-2009.

MARY CRAWFORD, EXAMINING ATTORNEY

SN 85-274,132. SEQUEL NATURALS, INC., PORT COQUITLAM, CANADA, FILED 3-23-2011.

# SAVISEED

THE MARK CONSISTS OF STANDARD CHARACTERS WITHOUT CLAIM TO ANY PARTICULAR FONT, STYLE, SIZE, OR COLOR.

OWNER OF U.S. REG. NOS. 3,982,639 AND 3,982,640.

#### CLASS 29—MEATS AND PROCESSED FOODS

FOR (BASED ON INTENT TO USE) BUTTER AND FLAVORED BUTTERS CONTAINING SACHA INCHI; MILK PRODUCTS, EXCLUDING ICE CREAM, ICE MILK AND FROZEN YOGURT, CONTAINING SACHA INCHI; OIL CONTAINING SACHA INCHI; PROTEIN POWDER CONTAINING SACHA INCHI FOR HUMAN CONSUMPTION FOR USE AS A FOOD ADDITIVE (U.S. CL. 46).

#### CLASS 30—STAPLE FOODS

FOR (BASED ON USE IN COMMERCE) SNACK FOODS CONTAINING SACHA INCHI SEEDS, NAMELY, CHOCOLATES-BASED SNACK FOODS; (BASED ON INTENT-TO-USE) SNACK FOODS CONTAINING SACHA INCHI SEEDS, NAMELY, SNACK BARS, CRACKERS, COOKIES AND CANDIES (U.S. CL. 46).

FIRST USE 0-0-2010; IN COMMERCE 0-0-2010.

ALICE BENMAMAN, EXAMINING ATTORNEY

SN 85-275,862. OAKSTONE PUBLISHING, LLC, DBA PERSONAL BEST, BIRMINGHAM, AL. FILED 3-24-2011.



OWNER OF U.S. REG. NOS. 2,180,185, 3,514,998 AND OTHERS.

THE MARK CONSISTS OF THE WORDS "PERSONAL BEST", AND BEHIND THE LETTERS "PE" IN THE WORD "PERSONAL" IS MODERN DESIGN OF PERSON WITH ARMS UPLIFTED ENCASED IN A BOX. THE NUMBER "4" FOLLOWED BY A PERIOD AND A SMALL LETTER "U" APPEARS OVER THE LETTERS "ES" IN THE WORD "BEST".

#### CLASS 9—ELECTRICAL AND SCIENTIFIC APPARATUS

FOR ELECTRONIC DOWNLOADABLE PUBLICATIONS, NAMELY, NEWSLETTERS FEATURING HEALTH AND WELLNESS AND SAFETY AND PRODUCTIVITY INFORMATION (U.S. CLS. 21, 23, 26, 36 AND 38).

FIRST USE 1-31-2011; IN COMMERCE 1-31-2011.



**CLASS 16—PAPER GOODS AND PRINTED MATTER**

FOR PUBLICATIONS, NAMELY, PRINTED NEWSLETTERS FEATURING HEALTH AND WELLNESS AND SAFETY AND PRODUCTIVITY INFORMATION (U.S. CLS. 2, 5, 22, 23, 29, 37, 38 AND 50).

FIRST USE 1-31-2011; IN COMMERCE 1-31-2011.

**CLASS 41—EDUCATION AND ENTERTAINMENT**

FOR ELECTRONIC NON-DOWNLOADABLE PUBLICATIONS, IN THE NATURE OF NEWSLETTERS FEATURING HEALTH AND WELLNESS AND SAFETY AND PRODUCTIVITY INFORMATION (U.S. CLS. 100, 101 AND 107).

FIRST USE 1-31-2011; IN COMMERCE 1-31-2011.  
ELLEN PERKINS, EXAMINING ATTORNEY

SN 85-276,157. DANKANYIN, THEODORE R., HAILEY, ID.  
FILED 3-24-2011.

# TUIT

THE MARK CONSISTS OF STANDARD CHARACTERS WITHOUT CLAIM TO ANY PARTICULAR FONT, STYLE, SIZE, OR COLOR.

**CLASS 6—METAL GOODS**

FOR METAL KEY CHAINS AND METAL KEY RINGS (U.S. CLS. 2, 12, 13, 14, 23, 25 AND 50).

**CLASS 14—JEWELRY**

FOR NON MONETARY COINS, MEDALS, ORNAMENTAL PINS (U.S. CLS. 2, 27, 28 AND 50).

**CLASS 21—HOUSEWARES AND GLASS**

FOR CORKSCREWS, WINE OPENERS, BOTTLE OPENERS, COASTERS MADE OF PLASTIC (U.S. CLS. 2, 13, 23, 29, 30, 33, 40 AND 50).

SCOTT BIBB, EXAMINING ATTORNEY

SN 85-276,046. BRETT SICILIANO, IRVINE, CA. FILED 3-24-2011.



THE MARK CONSISTS OF THE WORDS "WRAP WRENCH" WITH A TORNADO.

**CLASS 7—MACHINERY**

FOR POWER OPERATED HAND HELD TOOL FOR THE PURPOSE OF ROLLING UP CLOTH OR ELASTIC WRAPS, RIBBON, STRING, ROPE, WIRE OR OTHER MATERIAL BY POSITIONING THE MATERIAL INSIDE THE BIT (U.S. CLS. 13, 19, 21, 23, 31, 34 AND 35).

**CLASS 8—HAND TOOLS**

FOR BITS FOR HAND DRILLS; HAND TOOLS, NAMELY, HAND-OPERATED REACHING DEVICES FOR PICKING UP AND REMOVING TRASH, LITTER AND OBJECTS; HAND TOOLS, NAMELY, TOOLS FOR PLACING A ROPE OR OTHER FLEXIBLE MEMBER THROUGH AN EYE OR AROUND A TARGET OBJECT; HAND TOOLS, NAMELY, MANUALLY OPERATED HAND HELD TOOL FOR THE PURPOSE OF ROLLING UP CLOTH OR ELASTIC WRAPS, RIBBON, STRING, ROPE, WIRE OR OTHER MATERIAL BY POSITIONING THE MATERIAL INSIDE THE BIT (U.S. CLS. 23, 28 AND 44).

CHERYL CLAYTON, EXAMINING ATTORNEY

SN 85-276,522. NXSTAGE MEDICAL, INC., LAWRENCE, MA. FILED 3-25-2011.

# NXSTEPS

THE MARK CONSISTS OF STANDARD CHARACTERS WITHOUT CLAIM TO ANY PARTICULAR FONT, STYLE, SIZE, OR COLOR.

**CLASS 16—PAPER GOODS AND PRINTED MATTER**

FOR PRINTED EDUCATIONAL MATERIALS IN THE FIELD OF DIALYSIS FOR NURSES AND PATIENTS (U.S. CLS. 2, 5, 22, 23, 29, 37, 38 AND 50).

FIRST USE 2-21-2011; IN COMMERCE 2-21-2011.

**CLASS 41—EDUCATION AND ENTERTAINMENT**

FOR ONLINE EDUCATIONAL SERVICES, NAMELY, TUTORIALS AND MODULES FOR SELF STUDY, AND TRAINING SERVICES IN THE FIELD OF DIALYSIS FOR NURSES AND PATIENTS AND PROVIDING ONLINE EDUCATIONAL MATERIALS IN THE FIELD OF DIALYSIS FOR NURSES AND PATIENTS IN CONNECTION THEREWITH (U.S. CLS. 100, 101 AND 107).

FIRST USE 2-21-2011; IN COMMERCE 2-21-2011.  
ZACHARY BELLO, EXAMINING ATTORNEY

SN 85-276,524. NXSTAGE MEDICAL, INC., LAWRENCE, MA. FILED 3-25-2011.

SN 85-276,736. FABBRICADIGITALE S.R.L., CASALMAGGIORE (CR), ITALY, FILED 3-25-2011.

**SIMPLE STEPS FOR SUCCESS  
AT HOME**



THE MARK CONSISTS OF STANDARD CHARACTERS WITHOUT CLAIM TO ANY PARTICULAR FONT, STYLE, SIZE, OR COLOR.

PRIORITY CLAIMED UNDER SEC. 44(D) ON ERPN CMNTY TM OFC APPLICATION NO. 9812711, FILED 3-15-2011, REG. NO. 9812711, DATED 3-15-2011, EXPIRES 3-15-2021.

THE MARK CONSISTS OF A CIRCLE WHICH APPEARS TO BE A ROUND TABLE WITH PEOPLE FOLLOWING THIS DESIGN IS THE WORD "BOXED UC" IN STYLIZED LETTERS AND BELOW IT APPEAR THE WORDS "UNIFIED COMMUNICATIONS IN A BOX" IN LETTER OF SMALLER SIZE.

**CLASS 16—PAPER GOODS AND PRINTED MATTER**

FOR PRINTED EDUCATIONAL MATERIALS IN THE FIELD OF DIALYSIS FOR NURSES AND PATIENTS (U.S. CLS. 2, 5, 22, 23, 29, 37, 38 AND 50).

FIRST USE 2-21-2011; IN COMMERCE 2-21-2011.

**CLASS 9—ELECTRICAL AND SCIENTIFIC APPARATUS**

FOR SOFTWARE FOR COLLECTING, ORGANIZING, DISTRIBUTING AND PRESENTING CROSS MEDIA CONTENT; COMPUTER PROGRAMS FOR COLLECTING, ORGANIZING, DISTRIBUTING AND PRESENTING CROSS MEDIA CONTENT; SOFTWARE PLATFORM THAT ALLOWS THE INTEGRATED MANAGEMENT OF DIFFERENT MULTIMEDIA COMMUNICATION CHANNELS (U.S. CLS. 21, 23, 26, 36 AND 38).

**CLASS 41—EDUCATION AND ENTERTAINMENT**

FOR ONLINE EDUCATIONAL SERVICES, NAMELY, TUTORIALS AND MODULES FOR SELF STUDY, AND TRAINING SERVICES IN THE FIELD OF DIALYSIS FOR NURSES AND PATIENTS AND PROVIDING ONLINE EDUCATIONAL MATERIALS IN THE FIELD OF DIALYSIS FOR NURSES AND PATIENTS IN CONNECTION THEREWITH (U.S. CLS. 100, 101 AND 107).

FIRST USE 2-21-2011; IN COMMERCE 2-21-2011.

ZACHARY BELLO, EXAMINING ATTORNEY

**CLASS 42—SCIENTIFIC AND COMPUTER SERVICES**

FOR DESIGN AND DEVELOPMENT OF COMPUTER SOFTWARE (U.S. CLS. 100 AND 101).

DOMINICK J. SALEMI, EXAMINING ATTORNEY

SN 85-276,626. THEOCHEM LABORATORIES, INC., TAMPA, FL. FILED 3-25-2011.



NO CLAIM IS MADE TO THE EXCLUSIVE RIGHT TO USE "COST CONTROL SYSTEM", APART FROM THE MARK AS SHOWN.

THE MARK CONSISTS OF THE TERM "PRO" FOLLOWED BY TWO HORIZONTAL ARROWS AND THE TERM "FLO" WITH ARROW DESIGNS WITHIN, AND THE PHRASE "COST CONTROL SYSTEM" BELOW.

SN 85-276,868. A & J WASHROOM ACCESSORIES INC., NEW WINDSOR, NY. FILED 3-25-2011.



**CLASS 3—COSMETICS AND CLEANING PREPARATIONS**

FOR CONCENTRATED CHEMICAL CLEANERS FOR USE WITH DILUTION CONTROL DISPENSERS FOR, BUT NOT LIMITED TO, THE JANITORIAL/SANITATION AND FOOD SERVICE INDUSTRIES (U.S. CLS. 1, 4, 6, 50, 51 AND 52).

FIRST USE 3-1-2011; IN COMMERCE 3-1-2011.

OWNER OF U.S. REG. NO. 1,644,425.

NO CLAIM IS MADE TO THE EXCLUSIVE RIGHT TO USE "WASHROOM ACCESSORIES", APART FROM THE MARK AS SHOWN.

THE MARK CONSISTS OF THE LETTERS "AJW" WRITTEN HORIZONTALLY, WHICH ARE LOCATED ABOVE A HORIZONTAL SERIES OF THIRTEEN SOLID SQUARES, WHICH ARE LOCATED ABOVE "A&J WASHROOM ACCESSORIES" WRITTEN HORIZONTALLY.

**CLASS 20—FURNITURE AND ARTICLES NOT OTHERWISE CLASSIFIED**

FOR NON-METAL DISPENSERS FOR USE WITH CHEMICAL CLEANERS FOR USE IN THE JANITORIAL, SANITATION AND FOOD SERVICE INDUSTRIES (U.S. CLS. 2, 13, 22, 25, 32 AND 50).

FIRST USE 3-1-2011; IN COMMERCE 3-1-2011.

MICHELE SWAIN, EXAMINING ATTORNEY

**CLASS 6—METAL GOODS**

FOR METAL HOOKS; METAL BATHTUB AND SHOWER GRAB BARS; WALL PROTECTION PRODUCTS, NAMELY, METAL CORNER GUARDS; DOOR KICK PLATES OF METAL (U.S. CLS. 2, 12, 13, 14, 23, 25 AND 50).

FIRST USE 3-0-2009; IN COMMERCE 3-0-2009.

**CLASS 20—FURNITURE AND ARTICLES NOT OTHERWISE CLASSIFIED**

FOR SHELVES; MEDICINE CABINETS; SHOWER SEATS; SHOWER RODS; DIAPER CHANGING STATIONS; SPECIMEN CABINETS, NAMELY, MEDICAL SPECIMEN PASS THROUGH BOXES; BED PAN CABINETS; BED PAN RACKS; SHOWER CURTAIN HOOKS (U.S. CLS. 2, 13, 22, 25, 32 AND 50).

FIRST USE 3-0-2009; IN COMMERCE 3-0-2009.

**CLASS 21—HOUSEWARES AND GLASS**

FOR SOAP DISPENSERS; PAPER CUP DISPENSERS; DISPENSERS FOR PAPER TOWELS; DISPENSERS FOR FACIAL TISSUES; TOOTHBRUSH HOLDERS; TOWEL RAILS AND RINGS; WASTE RECEPTACLES, NAMELY, WASTE BASKETS; SOAP DISHES; TOILET PAPER HOLDERS; TOILET PAPER DISPENSERS; TOILET SEAT COVER DISPENSERS; SANITARY NAPKIN DISPOSAL RECEPTACLES; BATHROOM STALL COMBINATION UNITS CONSISTING OF TOILET PAPER DISPENSERS, TOILET SEAT COVER DISPENSERS, AND SANITARY NAPKIN DISPOSAL RECEPTACLES (U.S. CLS. 2, 13, 23, 29, 30, 33, 40 AND 50).

FIRST USE 3-0-2009; IN COMMERCE 3-0-2009.

DAVID ELTON, EXAMINING ATTORNEY

SN 85-276,967. RACKSPACE US, INC., DBA RACKSPACE HOSTING, SAN ANTONIO, TX. FILED 3-25-2011.

**FANATICAL SUPPORT**

THE MARK CONSISTS OF STANDARD CHARACTERS WITHOUT CLAIM TO ANY PARTICULAR FONT, STYLE, SIZE, OR COLOR.

OWNER OF U.S. REG. NOS. 3,246,427, 3,339,387 AND 3,620,467.

**CLASS 35—ADVERTISING AND BUSINESS**

FOR (BASED ON USE IN COMMERCE) CUSTOMER SERVICE IN THE NATURE OF PROVIDING ASSISTANCE TO CUSTOMERS WHEN THEY HAVE A BUSINESS PROBLEM OR CONCERN IN THE FIELD OF CLOUD COMPUTING, NAMELY, CLOUD HOSTING IN THE NATURE OF SCALABLE HOSTING OF COMPUTER SOFTWARE, INTERNET WEBSITES, INTERNET WEB SOFTWARE APPLICATIONS, ELECTRONIC DATABASES, DIGITAL CONTENT, AND BUSINESS COMPUTER SOFTWARE APPLICATIONS OF OTHERS THAT ARE ACCESSIBLE VIA THE INTERNET; PROMOTING PUBLIC AWARENESS OF THE NEED FOR TECHNOLOGY STANDARDS AND INTEROPERABILITY IN THE FIELD OF CLOUD COMPUTING INFRASTRUCTURE (U.S. CLS. 100, 101 AND 102).

FIRST USE 3-0-2009; IN COMMERCE 3-0-2009.

**CLASS 41—EDUCATION AND ENTERTAINMENT**

FOR (BASED ON INTENT TO USE) TRAINING OTHERS TO USE COMPUTER SOFTWARE PLATFORMS FOR CREATING, MANAGING, AND DEPLOYING CLOUD COMPUTING INFRASTRUCTURE SERVICES; TRAINING GOVERNMENT ENTITIES AND LARGE COMPANIES TO USE COMPUTER SOFTWARE PLATFORMS FOR CREATING, MANAGING, AND DEPLOYING CLOUD COMPUTING INFRASTRUCTURE SERVICES, SUCH INFRASTRUCTURE SERVICES TO BE PROVIDED IN THE DATA CENTERS OF THE GOVERNMENT ENTITIES AND LARGE COMPANIES (U.S. CLS. 100, 101 AND 107).

**CLASS 42—SCIENTIFIC AND COMPUTER SERVICES**

FOR (BASED ON USE IN COMMERCE) CLOUD COMPUTING SERVICES, NAMELY, CLOUD HOSTING IN THE NATURE OF SCALABLE HOSTING OF COMPUTER SOFTWARE, INTERNET WEBSITES, INTERNET WEB SOFTWARE APPLICATIONS, ELECTRONIC DATABASES, DIGITAL CONTENT, AND BUSINESS COMPUTER SOFTWARE APPLICATIONS OF OTHERS THAT ARE ACCESSIBLE VIA THE INTERNET; TECHNICAL SUPPORT SERVICES, NAMELY, ADMINISTRATION, MANAGEMENT AND TROUBLESHOOTING IN THE NATURE OF SERVICE DESK/HELP DESK SERVICES, PROVIDING DEDICATED SERVICE DESK/HELP DESK PERSONNEL, TROUBLESHOOTING OF COMPUTER SOFTWARE AND NETWORK PROBLEMS, AND DIAGNOSING OF COMPUTER HARDWARE PROBLEMS IN THE FIELD OF CLOUD COMPUTING SERVICES, NAMELY, CLOUD HOSTING IN THE NATURE OF SCALABLE HOSTING OF COMPUTER SOFTWARE, INTERNET WEBSITES, INTERNET WEB SOFTWARE APPLICATIONS, ELECTRONIC DATABASES, DIGITAL CONTENT, AND BUSINESS COMPUTER SOFTWARE APPLICATIONS OF OTHERS THAT ARE ACCESSIBLE VIA THE INTERNET; INFRASTRUCTURE AS A SERVICE (IAAS) FEATURING COMPUTER SOFTWARE PLATFORMS FOR CREATING, MANAGING, AND DEPLOYING CLOUD COMPUTING INFRASTRUCTURE SERVICES; INSTALLATION, CONFIGURATION, AND OPERATION OF COMPUTER SOFTWARE PLATFORMS FOR CREATING, MANAGING, AND DEPLOYING CLOUD COMPUTING INFRASTRUCTURE SERVICES; AND RESEARCH, DESIGN, AND OPTIMIZATION OF COMPUTER HARDWARE AND SOFTWARE TO RUN COMPUTER SOFTWARE PLATFORMS FOR CREATING, MANAGING, AND DEPLOYING CLOUD COMPUTING INFRASTRUCTURE SERVICES; AND DESIGN, DEPLOYMENT, SUPPORT, MANAGEMENT, AND MAINTENANCE OF CLOUD COMPUTING INFRASTRUCTURE SOFTWARE FOR OTHERS; DESIGN, DEPLOYMENT, SUPPORT, MANAGEMENT, AND MAINTENANCE OF CLOUD COMPUTING INFRASTRUCTURE SOFTWARE FOR GOVERNMENT ENTITIES AND LARGE COMPANIES WHO WISH TO USE SUCH SOFTWARE IN THEIR DATA CENTERS (U.S. CLS. 100 AND 101).

FIRST USE 3-0-2009; IN COMMERCE 3-0-2009.

FLORENTINA BLANDU, EXAMINING ATTORNEY

SN 85-277,130. APJET, INC., SANTA FE, NM. FILED S.R. 3-25-2011; AM. P.R. 8-5-2011.

**APTEX**

THE MARK CONSISTS OF STANDARD CHARACTERS WITHOUT CLAIM TO ANY PARTICULAR FONT, STYLE, SIZE, OR COLOR.

**CLASS 7—MACHINERY**

FOR INDUSTRIAL SURFACE TREATMENT EQUIPMENT, NAMELY, CORONA TREATMENT SYSTEMS COMPRISED OF A HIGH FREQUENCY, HIGH VOLTAGE GENERATOR, TRANSFORMERS, ELECTRODES, OZONE FILTER AND TREATMENT STATION AND STRUCTURAL PARTS THEREFOR; INDUSTRIAL SURFACE TREATMENT EQUIPMENT, NAMELY, PLASMA TREATMENT SYSTEMS COMPRISED OF A HIGH FREQUENCY, HIGH VOLTAGE GENERATOR, TREATING HEADS AND NOZZLES AND STRUCTURAL PARTS THEREFOR (U.S. CLS. 13, 19, 21, 23, 31, 34 AND 35).

FIRST USE 9-29-2008; IN COMMERCE 3-2-2009.

**CLASS 40—MATERIAL TREATMENT**

FOR APPLYING FINISHES TO TEXTILES; FINISHING AND COATING OF TEXTILES; WATERPROOFING TEXTILES; WOOL TREATMENT AND FINISHING (U.S. CLS. 100, 103 AND 106).

FIRST USE 3-2-2009; IN COMMERCE 3-3-2009.  
HEATHER BIDDULPH, EXAMINING ATTORNEY

**CLASS 16—PAPER GOODS AND PRINTED MATTER**

FOR PRINTED BOOKS, BROCHURES, PAMPHLETS, FEATURING CONTENT IN THE FIELD OF PERSONAL IMPROVEMENT AND EMPOWERMENT, SPIRITUALITY, AND/OR SELF-HELP; DIARIES, CALENDARS, STATIONERY (U.S. CLS. 2, 5, 22, 23, 29, 37, 38 AND 50).  
KATHLEEN M. VANSTON, EXAMINING ATTORNEY

SN 85-277,179. KUNGSANGEN PRODUKTION AB, ENKOPING, SWEDEN, FILED 3-25-2011.

SN 85-277,944. FIRST SHOWING, LLC, COLORADO SPRINGS, CO. FILED 3-26-2011.

**PASS OF SWEDEN**

THE MARK CONSISTS OF STANDARD CHARACTERS WITHOUT CLAIM TO ANY PARTICULAR FONT, STYLE, SIZE, OR COLOR.

NO CLAIM IS MADE TO THE EXCLUSIVE RIGHT TO USE "SWEDEN", APART FROM THE MARK AS SHOWN.

**CLASS 6—METAL GOODS**

FOR METAL HARDWARE, NAMELY, SPRINGS (U.S. CLS. 2, 12, 13, 14, 23, 25 AND 50).

**CLASS 20—FURNITURE AND ARTICLES NOT OTHERWISE CLASSIFIED**

FOR BEDS, PILLOWS, SPRING MATTRESSES, MATTRESSES, MATTRESS CUSHIONS, BED SLATS, SOFAS, ARMCHAIRS, OFFICE FURNITURE (U.S. CLS. 2, 13, 22, 25, 32 AND 50).

**CLASS 24—FABRICS**

FOR BEDDING, NAMELY, DUVET COVERS AND QUILTS (U.S. CLS. 42 AND 50).  
PATRICIA EVANKO, EXAMINING ATTORNEY

SN 85-277,451. ART & SOUL PRODUCTIONS, LLC, BOULDER, CO. FILED 3-25-2011.

**THE WHEEL OF CREATIVITY**

THE MARK CONSISTS OF STANDARD CHARACTERS WITHOUT CLAIM TO ANY PARTICULAR FONT, STYLE, SIZE, OR COLOR.

NO CLAIM IS MADE TO THE EXCLUSIVE RIGHT TO USE "CREATIVITY", APART FROM THE MARK AS SHOWN.

**CLASS 9—ELECTRICAL AND SCIENTIFIC APPARATUS**

FOR ELECTRONIC BOOKS FEATURING CONTENT IN THE FIELD OF PERSONAL IMPROVEMENT AND EMPOWERMENT, SPIRITUALITY, AND/OR SELF HELP RECORDED ON COMPUTER MEDIA (U.S. CLS. 21, 23, 26, 36 AND 38).

**FIRSTSHOWING**

THE MARK CONSISTS OF STANDARD CHARACTERS WITHOUT CLAIM TO ANY PARTICULAR FONT, STYLE, SIZE, OR COLOR.

**CLASS 35—ADVERTISING AND BUSINESS**

FOR PROVIDING CONSUMER INFORMATION AND RELATED NEWS IN THE FIELD OF FILM, AUDIO AND VIDEO ENTERTAINMENT; PROVIDING CONSUMER INFORMATION SERVICES AND MAKING REFERRALS IN THE FIELD OF ENTERTAINMENT SERVICES FOR PRODUCTS, SERVICES, EVENTS, ACTIVITIES, FACILITIES AND LOCATIONS (U.S. CLS. 100, 101 AND 102).  
FIRST USE 7-1-2006; IN COMMERCE 7-1-2006.

**CLASS 41—EDUCATION AND ENTERTAINMENT**

FOR ARRANGING, ORGANIZING, CONDUCTING, AND HOSTING SOCIAL ENTERTAINMENT EVENTS; CONSULTATION IN THE FIELD OF SPECIAL EVENT PLANNING FOR SOCIAL ENTERTAINMENT PURPOSES; ENTERTAINMENT AND EDUCATIONAL SERVICES, NAMELY, PROVIDING A WEBSITE THAT DISPLAYS VARIOUS REQUESTS, REVIEWS, RECOMMENDATIONS, RANKINGS, TRACKINGS, VOTES, AND INFORMATION RELATING TO UNCREATED, UNRELEASED, NEW, SPECIAL, POPULAR, AND RARE PRODUCTS, SERVICES, AND EVENTS IN THE FIELDS OF POP CULTURE, ENTERTAINMENT, EDUCATION, AND SPORTS, ALL EXCLUSIVELY FOR NON-BUSINESS AND NON-COMMERCIAL TRANSACTIONS AND PURPOSES; ENTERTAINMENT IN THE NATURE OF THEATER PRODUCTIONS; ENTERTAINMENT INFORMATION; ENTERTAINMENT MEDIA PRODUCTION SERVICES FOR MOTION PICTURES, TELEVISION AND INTERNET; ENTERTAINMENT SERVICES, NAMELY, PLANNING AND CONDUCTING A SERIES OF FILM FESTIVALS; ENTERTAINMENT SERVICES, NAMELY, PROVIDING A WEB SITE FEATURING NON-DOWNLOADABLE MUSICAL PERFORMANCES, MUSICAL VIDEOS, RELATED FILM CLIPS, PHOTOGRAPHS, AND OTHER MULTIMEDIA MATERIALS FEATURING MOTION PICTURE AND TELEVISION MATERIALS; ENTERTAINMENT SERVICES, NAMELY, PROVIDING PODCASTS IN THE FIELD OF MOTION PICTURE AND VIDEO REVIEWS AND COMMENTARY; ENTERTAINMENT SERVICES, NAMELY, PROVIDING VIDEO PODCASTS IN THE FIELD OF MOTION PICTURE AND VIDEO REVIEWS AND COMMENTARY; INFORMATION RELATING TO ENTERTAINMENT AND EDUCATION, PROVIDED ON-LINE FROM A COMPUTER DATABASE OR THE INTERNET; NEWS AGENCIES, NAMELY, GATHERING AND DISSEMINATION OF NEWS; PROVIDING A WEBSITE FEATURING ENTERTAINMENT INFORMATION; PROVIDING A WEBSITE FEATURING INFORMATION IN THE FIELD OF MUSIC AND ENTERTAINMENT; PROVIDING AN INTERNET WEBSITE PORTAL IN THE FIELD OF ENTERTAINMENT, CULTURAL AND SPORTING EVENTS; PROVIDING INFORMATION AND ARTICLES IN THE FIELD OF

FILM, FILMMAKING, AND ENTERTAINMENT VIA A GLOBAL COMPUTER NETWORK; PROVIDING INFORMATION, NEWS AND COMMENTARY IN THE FIELD OF ENTERTAINMENT; PROVIDING ON-LINE ENTERTAINMENT INFORMATION, NAMELY, INFORMATION ABOUT TELEVISION PROGRAMMING; PROVIDING ONLINE INTERVIEWS FEATURING MOTION PICTURE DIRECTORS, PRODUCERS AND ACTORS IN THE FIELD OF MOTION PICTURES AND TELEVISION FOR ENTERTAINMENT PURPOSES; PROVISION OF INFORMATION RELATING TO CHILDREN'S ENTERTAINMENT; SPECIAL EVENT PLANNING FOR SOCIAL ENTERTAINMENT PURPOSES (U.S. CLS. 100, 101 AND 107).

FIRST USE 7-1-2006; IN COMMERCE 7-1-2006.

#### **CLASS 45—PERSONAL AND LEGAL SERVICES**

FOR INTERNET-BASED SOCIAL NETWORKING SERVICES; ON-LINE SOCIAL NETWORKING SERVICES; ONLINE SOCIAL NETWORKING SERVICES PROVIDED THROUGH A COMMUNITY WEBSITE; ONLINE SOCIAL NETWORKING SERVICES IN THE FIELD OF MULTIMEDIA CONSUMPTION; ONLINE SOCIAL NETWORKING SERVICES IN THE FIELD OF MULTIMEDIA CONSUMPTION PROVIDED VIA A WEBSITE; PROVIDING A SOCIAL NETWORKING WEBSITE FOR ENTERTAINMENT PURPOSES; SOCIAL NETWORKING SERVICES IN THE FIELD OF MULTIMEDIA CONSUMPTION PROVIDED VIA A WEBSITE (U.S. CLS. 100 AND 101).

MARK SHINER, EXAMINING ATTORNEY

---

SN 85-278,166. HOWAT, ED, EAGAN, MN. AND KURITZ, MARTIN, SAN DIEGO, CA. FILED 3-28-2011.

### **THE GIFT OF ANSWERS**

THE MARK CONSISTS OF STANDARD CHARACTERS WITHOUT CLAIM TO ANY PARTICULAR FONT, STYLE, SIZE, OR COLOR.

#### **CLASS 16—PAPER GOODS AND PRINTED MATTER**

FOR PRINTED PUBLICATIONS, NAMELY, WORKBOOKS AND OTHER MATERIALS, NAMELY, BROCHURES, PAMPHLETS, BOOKS, NOTE CARDS, BUSINESS CARDS, ENVELOPES, POSTCARDS, NAME-TAGS AND BINDERS IN THE FIELD OF ORGANIZING ONE'S WISHES, HOPES, DREAMS AND FINAL REQUESTS FOR THEIR FAMILIES PRIOR TO DEATH FOR USE IN CONNECTION WITH SEMINARS AND WORKSHOPS FOR FINANCIAL ADVISORS AND FINANCIAL PLANNERS (U.S. CLS. 2, 5, 22, 23, 29, 37, 38 AND 50).

FIRST USE 9-0-2007; IN COMMERCE 9-0-2007.

#### **CLASS 41—EDUCATION AND ENTERTAINMENT**

FOR EDUCATIONAL SERVICES, NAMELY, PROVIDING SEMINARS AND WORKSHOPS FOR FINANCIAL ADVISORS AND FINANCIAL PLANNERS IN THE FIELD OF ORGANIZING ONE'S WISHES, HOPES, DREAMS AND FINAL REQUESTS FOR THEIR FAMILIES PRIOR TO DEATH (U.S. CLS. 100, 101 AND 107).

FIRST USE 9-0-2007; IN COMMERCE 9-0-2007.  
HOWARD SMIGA, EXAMINING ATTORNEY

SN 85-279,879. SIRIUS XM RADIO INC., NEW YORK, NY. FILED 3-29-2011.



OWNER OF U.S. REG. NOS. 3,071,291, 3,818,003 AND OTHERS.

NO CLAIM IS MADE TO THE EXCLUSIVE RIGHT TO USE "SATELLITE RADIO", APART FROM THE MARK AS SHOWN.

THE MARK CONSISTS OF THE WORD "SIRIUSXM" WITH THREE CURVED LINES ON EACH SIDE ABOVE THE WORDS "SATELLITE RADIO".

#### **CLASS 35—ADVERTISING AND BUSINESS**

FOR ONLINE RETAIL STORE SERVICES IN THE FIELD OF MUSIC AND CONSUMER ELECTRONICS (U.S. CLS. 100, 101 AND 102).

FIRST USE 2-0-2011; IN COMMERCE 2-0-2011.

#### **CLASS 38—COMMUNICATION**

FOR RADIO BROADCASTING SERVICES; WEBCASTING SERVICES; STREAMING OF AUDIO, VISUAL AND DATA INFORMATION VIA A GLOBAL COMPUTER NETWORK, MOBILE TELEPHONE OR OTHER ELECTRONIC OR DIGITAL COMMUNICATIONS NETWORK OR DIGITAL COMMUNICATIONS DEVICE; ELECTRONIC AND DIGITAL TRANSMISSION AND DELIVERY OF VOICE, DATA, TEXT, IMAGES, GRAPHICS, SIGNALS AND MESSAGES VIA SATELLITE, A GLOBAL COMPUTER NETWORK, MOBILE TELEPHONE OR OTHER ELECTRONIC OR DIGITAL COMMUNICATIONS NETWORK OR DEVICE; TRANSMISSION OF AUDIO, VISUAL AND DATA INFORMATION AVAILABLE FOR DOWNLOAD VIA A GLOBAL COMPUTER NETWORK, MOBILE TELEPHONE OR OTHER ELECTRONIC OR DIGITAL COMMUNICATIONS NETWORK OR DIGITAL COMMUNICATIONS DEVICE (U.S. CLS. 100, 101 AND 104).

FIRST USE 11-24-2010; IN COMMERCE 11-24-2010.

#### **CLASS 41—EDUCATION AND ENTERTAINMENT**

FOR ENTERTAINMENT SERVICES, NAMELY, PROVIDING AUDIO PROGRAMS FEATURING MUSIC, SPORTS, TALK, NEWS AND DATA VIA SATELLITE, GLOBAL COMPUTER NETWORK, TELECOMMUNICATION NETWORK, WIRELESS COMMUNICATION NETWORK, OR OTHER ELECTRONIC OR DIGITAL COMMUNICATIONS NETWORK OR DIGITAL COMMUNICATIONS DEVICE (U.S. CLS. 100, 101 AND 107).

FIRST USE 11-24-2010; IN COMMERCE 11-24-2010.  
ANGELA M. MICHELI, EXAMINING ATTORNEY

---

SN 85-279,954. THE NEWS FUNNEL, LLC, NEW YORK, NY. FILED 3-29-2011.

### **THE REAL ESTATE FUNNEL**

THE MARK CONSISTS OF STANDARD CHARACTERS WITHOUT CLAIM TO ANY PARTICULAR FONT, STYLE, SIZE, OR COLOR.

NO CLAIM IS MADE TO THE EXCLUSIVE RIGHT TO USE "REAL ESTATE", APART FROM THE MARK AS SHOWN.

SN 85-280,729. CUNSA S.A., SANTIAGO, CHILE, FILED 3-30-2011.

#### CLASS 35—ADVERTISING AND BUSINESS

FOR PRESS RELEASE DISTRIBUTION SERVICES, NAMELY, DISTRIBUTION OF PRESS RELEASES ON BEHALF OF CORPORATIONS TO THE MEDIA, INVESTMENT COMMUNITY, INVESTORS AND THE GENERAL PUBLIC; PRESS RELEASE DISTRIBUTION VIA A GLOBAL COMPUTER NETWORK (U.S. CLS. 100, 101 AND 102).



#### CLASS 36—INSURANCE AND FINANCIAL

FOR PROVIDING A WEBSITE THAT AGGREGATES AND DELIVERS NEWS AND OTHER INFORMATION IN THE FIELDS OF FINANCE AND REAL ESTATE; PROVIDING AN ON-LINE NEWS PORTAL FEATURING ORIGINAL NEWS STORIES AND ARTICLES, PRESS RELEASES, AND LINKS TO NEWS STORIES AND ARTICLES IN THE FIELDS OF FINANCE AND REAL ESTATE (U.S. CLS. 100, 101 AND 102).

GINA FINK, EXAMINING ATTORNEY

NO CLAIM IS MADE TO THE EXCLUSIVE RIGHT TO USE "PERFORMANCE NUTRITION", APART FROM THE MARK AS SHOWN.

THE COLOR(S) ORANGE, WHITE AND BLACK IS/ARE CLAIMED AS A FEATURE OF THE MARK.

THE MARK CONSISTS OF THE WORD "SPORT" IN STYLIZED SPACKLED WHITE AND BLACK LETTERING; NEXT TO THE WORD "LAB" IN ORANGE LETTERING; BOTH ABOVE THE WORDS "ADVANCED PERFORMANCE NUTRITION" IN WHITE LETTERING; ALL TO THE LEFT OF A LARGE, BIO-CYCLE SYMBOL IN ORANGE AND BLACK; ALL SET AGAINST A BLACK BACKGROUND.

SN 85-280,144. SUN, TEH-SAN, SHANDONG, CHINA, FILED 3-29-2011.



THE MARK CONSISTS OF AN OUTLINED SOLID OVAL CONTAINING CHINESE PINYINS ALL CENTERED ABOVE THE WORD "SHINHO".

"SHINHO" AND THE CHARACTERS THAT TRANSLITERATE TO "SHIN HO" HAVE NO MEANING IN A FOREIGN LANGUAGE.

THE NON-LATIN CHARACTERS IN THE MARK TRANSLITERATE TO "SHIN HO" AND THIS HAS NO MEANING IN A FOREIGN LANGUAGE.

#### CLASS 29—MEATS AND PROCESSED FOODS

FOR BEAN CURD; BUTTER; EDIBLE OILS; FISH; FROZEN VEGETABLES; PEANUT BUTTER; PREPARATIONS FOR MAKING BROTHS; PREPARED NUTS; PROCESSED MUSHROOMS; PROCESSED, EDIBLE SEAWEED; SALADS EXCEPT MACARONI, RICE, AND PASTA SALAD; SEA CUCUMBERS; SOUPS (U.S. CL. 46).  
FIRST USE 10-1-1996; IN COMMERCE 10-1-1996.

#### CLASS 30—STAPLE FOODS

FOR FLOUR; FLOUR FOR FOOD; FOOD SEASONINGS; MEAT PIES; PROCESSED CEREALS; RICE; SALAD DRESSINGS; SAUCES; SOY BEAN PASTE; SOY SAUCE; SUGAR; TOMATO SAUCE; VINEGAR; YEAST (U.S. CL. 46).

FIRST USE 10-1-1996; IN COMMERCE 10-1-1996.  
CHRISIE B. KING, EXAMINING ATTORNEY

#### CLASS 5—PHARMACEUTICALS

FOR AMINO ACIDS FOR NUTRITIONAL PURPOSES; DIETARY AND NUTRITIONAL SUPPLEMENTS CONTAINING WHEY PROTEIN; WHEY PROTEIN SUPPLEMENTS (U.S. CLS. 6, 18, 44, 46, 51 AND 52).  
FIRST USE 1-1-2009; IN COMMERCE 1-1-2009.

#### CLASS 29—MEATS AND PROCESSED FOODS

FOR TEXTURED WHEY PROTEIN (U.S. CL. 46).  
FIRST USE 1-1-2009; IN COMMERCE 1-1-2009.  
DAWN HAN, EXAMINING ATTORNEY

SN 85-281,438. RED ROBIN INTERNATIONAL, INC., GREENWOOD VILLAGE, CO. FILED 3-30-2011.

#### RED ROBIN GOURMET BURGERS

THE MARK CONSISTS OF STANDARD CHARACTERS WITHOUT CLAIM TO ANY PARTICULAR FONT, STYLE, SIZE, OR COLOR.

OWNER OF U.S. REG. NOS. 1,133,872, 3,874,071 AND OTHERS.

NO CLAIM IS MADE TO THE EXCLUSIVE RIGHT TO USE "GOURMET BURGERS" FOR INTERNATIONAL CLASS 43, APART FROM THE MARK AS SHOWN.

#### CLASS 25—CLOTHING

FOR CLOTHING, NAMELY, HEADWEAR, JACKETS, SHIRTS, VESTS, LAB COATS AND APRONS (U.S. CLS. 22 AND 39).

FIRST USE 3-0-2009; IN COMMERCE 3-0-2009.

**CLASS 43—HOTEL AND RESTAURANT SERVICES**

FOR RESTAURANT SERVICES; TAKE-OUT RESTAURANT SERVICES; BAR SERVICES, NAMELY, PREPARING AND SERVING ALCOHOLIC AND NON-ALCOHOLIC BEVERAGES, FROZEN DRINKS, MALTS, SHAKES, SMOOTHIES AND SPECIALTY DRINKS; ALCOHOLIC BEVERAGE PREPARATION SERVICES, NAMELY, PREPARING ALCOHOLIC BEVERAGES TO ORDER (U.S. CLS. 100 AND 101).

FIRST USE 3-0-2009; IN COMMERCE 3-0-2009.  
MATTHEW PAPPAS, EXAMINING ATTORNEY

---

**BEAUTIFICAL**

THE MARK CONSISTS OF STANDARD CHARACTERS WITHOUT CLAIM TO ANY PARTICULAR FONT, STYLE, SIZE, OR COLOR.

**CLASS 14—JEWELRY**

FOR PERSONAL ORNAMENTS OF PRECIOUS METALS; JEWELRY AND IMITATION JEWELRY; UNWROUGHT AND SEMI-WROUGHT PRECIOUS STONES AND THEIR IMITATIONS; KEY RINGS OF PRECIOUS METALS; CLOCKS AND WATCHES; JEWEL CASES OF PRECIOUS METAL (U.S. CLS. 2, 27, 28 AND 50).

**CLASS 18—LEATHER GOODS**

FOR BAGS, NAMELY, SPORTS BAGS, BABY CARRYING BAGS, BEACH BAGS, BELT BAGS, BOOK BAGS, BOSTON BAGS, ALL-PURPOSE CARRYING BAGS, COSMETIC BAGS SOLD EMPTY, DIAPER BAGS, DUFFEL BAGS, HIKING BAGS, GARMENT BAGS FOR TRAVEL, LEATHER AND IMITATION LEATHER BAGS; POUCHES, NAMELY, FELT POUCHES, POUCHES MADE OF COTTON, POUCHES OF LEATHER AND DRAWSTRING POUCHES; UNFITTED VANITY CASES; SLING BAGS FOR CARRYING INFANTS; CLOTHING FOR DOMESTIC PETS; UMBRELLAS; WALKING STICKS; CANES (U.S. CLS. 1, 2, 3, 22 AND 41).

**CLASS 25—CLOTHING**

FOR CLOTHING, NAMELY, SHIRTS, T-SHIRTS, PANTS, JEANS, JACKETS, COATS, DRESSES, SKIRTS, SOCKS, TIGHTS, GLOVES, VESTS, UNDERWEAR, ANORAKS, RAINWEAR, WIND RESISTANT JACKETS, SWEATSHIRTS, TANK TOPS, PULLOVERS, SWEATERS, KNIT SHIRTS, CARDIGANS, PARKAS, MUFFLERS, FLEECE PULLOVERS, HEADWEAR, CAPS, HATS AND VISORS; GARTER BELTS; SOCK SUSPENDERS; SUSPENDERS; WAISTBANDS; BELTS FOR CLOTHING; SHOES AND BOOTS OTHER THAN SHOE DOWELS, SHOE PEGS, SHOE HANDLES, HOBNAILED AND SHOE PROTECTIVE METAL MEMBERS (U.S. CLS. 22 AND 39).  
SCOTT BIBB, EXAMINING ATTORNEY

SN 85-282,158. BOLLYDOLL, LLC, LOS ANGELES, CA.  
FILED 3-31-2011.

**BOLLYDOLL**

THE MARK CONSISTS OF STANDARD CHARACTERS WITHOUT CLAIM TO ANY PARTICULAR FONT, STYLE, SIZE, OR COLOR.

**CLASS 9—ELECTRICAL AND SCIENTIFIC APPARATUS**

FOR CARRYING BAGS AND CASES FOR PERSONAL ELECTRONICS AND SMALL ELECTRONIC DEVICES (U.S. CLS. 21, 23, 26, 36 AND 38).

**CLASS 18—LEATHER GOODS**

FOR BAGS, NAMELY, LEATHER BAGS, ALL PURPOSE SPORTS BAGS, BAGS FOR SPORTS CLOTHING, MESSENGER BAGS, FLIGHT BAGS, TOILETRY BAGS SOLD EMPTY, AND TOTES; CARRYING BAGS, TOTE BAGS, REUSABLE SHOPPING BAGS, TEXTILE SHOPPING BAGS, ALL-PURPOSE CARRYING BAGS, BOOK BAGS, SCHOOL BAGS, SCHOOL BOOK BAGS, OVERNIGHT BAGS, DIAPER BAGS, BEACH BAGS, ATHLETIC BAGS, GYM BAGS, DUFFEL BAGS, PURSES, HANDBAGS, LUGGAGE, TRAVEL BAGS, COSMETIC BAGS SOLD EMPTY, BACKPACKS, WALLETS, SMALL LEATHER BAGS, GENERAL PURPOSE BAGS FOR CARRYING YOGA EQUIPMENT, SACK PACKS, NAMELY, DRAWSTRING BAGS USED AS BACKPACKS, DRAWSTRING BAGS, DRAWSTRING POUCHES; SMALL LEATHER ACCESSORIES, NAMELY, COIN PURSES, WRISTLETS, LEATHER POUCHES, LEATHER CASES, TRAVEL CASES, KEY CASES, LUGGAGE TAGS, BUSINESS CARD CASES, COSMETIC CASES SOLD EMPTY, AND CREDIT CARD CASES (U.S. CLS. 1, 2, 3, 22 AND 41).

REGINA DRUMMOND, EXAMINING ATTORNEY

---

SN 85-282,842. UNIVERSITY OF MIAMI, CORAL GABLES, FL. FILED 3-31-2011.

**UMBRELLA**

THE MARK CONSISTS OF STANDARD CHARACTERS WITHOUT CLAIM TO ANY PARTICULAR FONT, STYLE, SIZE, OR COLOR.

**CLASS 3—COSMETICS AND CLEANING PREPARATIONS**

FOR NON-MEDICATED SUN CREAMS, SUN CARE LOTIONS, SUNBLOCK, AND BODY LOTIONS (U.S. CLS. 1, 4, 6, 50, 51 AND 52).

**CLASS 12—VEHICLES**

FOR CAR WINDOW SHADES (U.S. CLS. 19, 21, 23, 31, 35 AND 44).

**CLASS 24—FABRICS**

FOR TOWELS (U.S. CLS. 42 AND 50).

MICHELE SWAIN, EXAMINING ATTORNEY

OWNER OF U.S. REG. NO. 3,731,021.

SN 85-283,781. OMNI FINANCIAL GROUP, INC., DBA THE OMNI GROUP, ROCHESTER, NY. FILED 4-1-2011.

**OMNI**

THE MARK CONSISTS OF STANDARD CHARACTERS WITHOUT CLAIM TO ANY PARTICULAR FONT, STYLE, SIZE, OR COLOR.

OWNER OF U.S. REG. NOS. 2,310,866 AND 3,296,033.

**CLASS 9—ELECTRICAL AND SCIENTIFIC APPARATUS**

FOR PRE-RECORDED DVDS FOR EDUCATIONAL PURPOSES IN THE FIELD OF EMPLOYER-SPONSORED RETIREMENT PLANS; AND DOWNLOADABLE WEBINARS FOR EDUCATIONAL PURPOSES IN THE FIELD OF EMPLOYER-SPONSORED RETIREMENT PLANS; DOWNLOADABLE ELECTRONIC NEWSLETTERS IN THE FIELD OF EMPLOYER-SPONSORED RETIREMENT PLANS (U.S. CLS. 21, 23, 26, 36 AND 38).  
FIRST USE 4-7-2009; IN COMMERCE 4-7-2009.

**CLASS 36—INSURANCE AND FINANCIAL**

FOR ADMINISTRATION OF EMPLOYER-SPONSORED FINANCIAL RETIREMENT PLANS (U.S. CLS. 100, 101 AND 102).

FIRST USE 9-0-1997; IN COMMERCE 9-0-1997.

**CLASS 41—EDUCATION AND ENTERTAINMENT**

FOR EDUCATIONAL SERVICES, NAMELY, CONDUCTING SEMINARS IN THE FIELD OF EMPLOYER-SPONSORED RETIREMENT PLANS AND DISTRIBUTION OF PRINTED MATERIALS IN CONNECTION THEREWITH IN HARD COPY OR ELECTRONIC FORMAT ON THE SAME TOPIC (U.S. CLS. 100, 101 AND 107).

FIRST USE 4-7-2009; IN COMMERCE 4-7-2009.

**CLASS 45—PERSONAL AND LEGAL SERVICES**

FOR REVIEWING STANDARDS AND PRACTICES TO ASSURE COMPLIANCE WITH LAWS AND REGULATIONS IN THE FIELD OF EMPLOYER-SPONSORED RETIREMENT PLANS (U.S. CLS. 100 AND 101).

FIRST USE 9-0-1997; IN COMMERCE 9-0-1997.

JOHN SCHUYLER YARD, EXAMINING ATTORNEY

SN 85-283,810. OMNI FINANCIAL GROUP, INC., DBA THE OMNI GROUP, ROCHESTER, NY. FILED 4-1-2011.

**LISTENS. LEADS. DELIVERS.**

THE MARK CONSISTS OF STANDARD CHARACTERS WITHOUT CLAIM TO ANY PARTICULAR FONT, STYLE, SIZE, OR COLOR.

**CLASS 9—ELECTRICAL AND SCIENTIFIC APPARATUS**

FOR PRE-RECORDED DVDS FOR EDUCATIONAL PURPOSES IN THE FIELD OF EMPLOYER-SPONSORED RETIREMENT PLANS; AND DOWNLOADABLE WEBINARS FOR EDUCATIONAL PURPOSES IN THE FIELD OF EMPLOYER-SPONSORED RETIREMENT PLANS; DOWNLOADABLE ELECTRONIC NEWSLETTERS IN THE FIELD OF EMPLOYER-SPONSORED RETIREMENT PLANS (U.S. CLS. 21, 23, 26, 36 AND 38).

FIRST USE 4-7-2009; IN COMMERCE 4-7-2009.

**CLASS 36—INSURANCE AND FINANCIAL**

FOR ADMINISTRATION OF EMPLOYER-SPONSORED FINANCIAL RETIREMENT PLANS (U.S. CLS. 100, 101 AND 102).

FIRST USE 1-0-2008; IN COMMERCE 1-0-2008.

**CLASS 41—EDUCATION AND ENTERTAINMENT**

FOR EDUCATIONAL SERVICES, NAMELY, CONDUCTING SEMINARS IN THE FIELD OF EMPLOYER-SPONSORED RETIREMENT PLANS AND DISTRIBUTION OF PRINTED MATERIALS IN CONNECTION THEREWITH IN HARD COPY OR ELECTRONIC FORMAT ON THE SAME TOPIC (U.S. CLS. 100, 101 AND 107).

FIRST USE 4-7-2009; IN COMMERCE 4-7-2009.

**CLASS 45—PERSONAL AND LEGAL SERVICES**

FOR REVIEWING STANDARDS AND PRACTICES TO ASSURE COMPLIANCE WITH LAWS AND REGULATIONS IN THE FIELD OF EMPLOYER-SPONSORED RETIREMENT PLANS (U.S. CLS. 100 AND 101).

FIRST USE 1-0-2008; IN COMMERCE 1-0-2008.

JOHN SCHUYLER YARD, EXAMINING ATTORNEY

SN 85-283,832. OMNI FINANCIAL GROUP, INC., DBA THE OMNI GROUP, ROCHESTER, NY. FILED 4-1-2011.

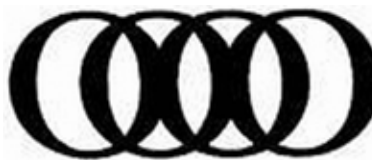

OWNER OF U.S. REG. NO. 2,361,311.

THE MARK CONSISTS OF FOUR STYLIZED, INTERLOCKING CIRCLES.

**CLASS 9—ELECTRICAL AND SCIENTIFIC APPARATUS**

FOR PRE-RECORDED DVDS FOR EDUCATIONAL PURPOSES IN THE FIELD OF EMPLOYER-SPONSORED RETIREMENT PLANS; AND DOWNLOADABLE WEBINARS FOR EDUCATIONAL PURPOSES IN THE FIELD OF EMPLOYER-SPONSORED RETIREMENT PLANS; DOWNLOADABLE ELECTRONIC NEWSLETTERS IN THE FIELD OF EMPLOYER-SPONSORED RETIREMENT PLANS (U.S. CLS. 21, 23, 26, 36 AND 38).

FIRST USE 4-7-2009; IN COMMERCE 4-7-2009.



**CLASS 36—INSURANCE AND FINANCIAL**

FOR ADMINISTRATION OF EMPLOYER-SPONSORED FINANCIAL RETIREMENT PLANS (U.S. CLS. 100, 101 AND 102).

FIRST USE 0-0-1999; IN COMMERCE 0-0-1999.

**CLASS 41—EDUCATION AND ENTERTAINMENT**

FOR EDUCATIONAL SERVICES, NAMELY, CONDUCTING SEMINARS IN THE FIELD OF EMPLOYER-SPONSORED RETIREMENT PLANS AND DISTRIBUTION OF PRINTED MATERIALS IN CONNECTION THEREWITH IN HARD COPY OR ELECTRONIC FORMAT ON THE SAME TOPIC (U.S. CLS. 100, 101 AND 107).

FIRST USE 4-7-2009; IN COMMERCE 4-7-2009.

**CLASS 45—PERSONAL AND LEGAL SERVICES**

FOR REVIEWING STANDARDS AND PRACTICES TO ASSURE COMPLIANCE WITH LAWS AND REGULATIONS IN THE FIELD OF EMPLOYER-SPONSORED RETIREMENT PLANS (U.S. CLS. 100 AND 101).

FIRST USE 0-0-1999; IN COMMERCE 0-0-1999.

JOHN SCHUYLER YARD, EXAMINING ATTORNEY

SN 85-283,850. NATIONAL OVARIAN CANCER COALITION, INC., PLEASANTON, CA. FILED 4-1-2011.



OWNER OF U.S. REG. NOS. 3,939,443, 3,939,444 AND 3,939,445.

NO CLAIM IS MADE TO THE EXCLUSIVE RIGHT TO USE "COALITION", APART FROM THE MARK AS SHOWN.

THE MARK CONSISTS OF THE LETTERS "NOCC" IN LARGE FONT WITH A SUNBURST IMAGE FOR THE LETTER "O"; THE WORDING "NATIONAL OVARIAN CANCER COALITION" IS WRITTEN BELOW THE WORDING "NOCC".

SEC. 2(F) AS TO "NATIONAL OVARIAN CANCER COALITION".

**CLASS 35—ADVERTISING AND BUSINESS**

FOR ASSOCIATION SERVICES, NAMELY, PROMOTING THE INTERESTS OF THOSE WITH OVARIAN CANCER (U.S. CLS. 100, 101 AND 102).

FIRST USE 3-20-2011; IN COMMERCE 3-20-2011.

**CLASS 44—MEDICAL, BEAUTY AND AGRICULTURAL SERVICES**

FOR PROVIDING MEDICAL INFORMATION REGARDING OVARIAN CANCER TREATMENT AND THE DETECTION AND MANAGEMENT OF RELATED SYMPTOMS IN ORDER TO IMPROVE THE SURVIVAL RATE AND QUALITY OF LIFE FOR WOMEN WITH OVARIAN CANCER (U.S. CLS. 100 AND 101).

FIRST USE 3-20-2011; IN COMMERCE 3-20-2011.

**CLASS 45—PERSONAL AND LEGAL SERVICES**

FOR PROVIDING INFORMATION ABOUT HOW TO DEAL WITH AND PROCESS PERSONAL EMOTIONS RELATED TO OVARIAN CANCER TREATMENT IN ORDER TO IMPROVE THE SURVIVAL RATE AND QUALITY OF LIFE FOR WOMEN WITH OVARIAN CANCER (U.S. CLS. 100 AND 101).

FIRST USE 3-20-2011; IN COMMERCE 3-20-2011.

H. M. FISHER, EXAMINING ATTORNEY

SN 85-284,156. NORTH AMERICAN FUNERAL AND CREMATION SERVICES, INC., MISSISSAUGA, ON, CANADA, FILED 4-1-2011.

**BASIC FUNERALS AND CREMATION CHOICES**

THE MARK CONSISTS OF STANDARD CHARACTERS WITHOUT CLAIM TO ANY PARTICULAR FONT, STYLE, SIZE, OR COLOR.

NO CLAIM IS MADE TO THE EXCLUSIVE RIGHT TO USE "BASIC FUNERALS AND CREMATION", APART FROM THE MARK AS SHOWN.

**CLASS 40—MATERIAL TREATMENT**

FOR CREMATION SERVICES (U.S. CLS. 100, 103 AND 106).

**CLASS 45—PERSONAL AND LEGAL SERVICES**

FOR INTERMENT SERVICES; MEMORIAL AND FUNERAL SERVICES, NAMELY, FUNERAL HOME SERVICES; PROVIDING FUNERAL HOME SERVICES, NAMELY, PROVIDING DEATH ANNOUNCEMENT INFORMATION; FUNERAL ARRANGEMENT SERVICES, NAMELY, FUNERAL, CREMATION AND BURIAL PLANNING SERVICES (U.S. CLS. 100 AND 101).

MARK SPARACINO, EXAMINING ATTORNEY

SN 85-284,539. SAE INTERNATIONAL, WARRENDALE, PA. FILED 4-2-2011.

**ENGINEERXCHANGE**

THE MARK CONSISTS OF STANDARD CHARACTERS WITHOUT CLAIM TO ANY PARTICULAR FONT, STYLE, SIZE, OR COLOR.

**CLASS 35—ADVERTISING AND BUSINESS**

FOR ONLINE BUSINESS NETWORKING SERVICES; PROVIDING AN ONLINE DIRECTORY INFORMATION SERVICE FEATURING INFORMATION REGARDING SCIENCE, ENGINEERING, TECHNOLOGY AND MATH (U.S. CLS. 100, 101 AND 102).

FIRST USE 7-27-2010; IN COMMERCE 7-27-2010.

**CLASS 38—COMMUNICATION**

FOR TELECOMMUNICATIONS SERVICES, NAMELY, ENABLING USERS TO ELECTRONICALLY TRANSMIT MESSAGES, TEXT, DATA, MULTIMEDIA CONTENT, VIDEOS, PHOTOS, AUDIO, ANIMATION AND IMAGES VIA THE INTERNET; PROVIDING ONLINE CHAT ROOMS AND ELECTRONIC BULLETIN BOARDS FOR TRANSMISSION OF MESSAGES AMONG USERS IN THE FIELDS OF SCIENCE, ENGINEERING, TECHNOLOGY, MATH, GENERAL INTEREST, CLASSIFIEDS, VIRTUAL COMMUNITY, BUSINESS NETWORKING AND SOCIAL NETWORKING; PROVIDING ACCESS TO COMPUTER, ELECTRONIC AND ONLINE DATABASES; AUDIO AND VIDEO BROADCASTING SERVICES OVER THE INTERNET, NAMELY, ELECTRONICALLY TRANSMITTING VIDEO (U.S. CLS. 100, 101 AND 104).  
FIRST USE 7-27-2010; IN COMMERCE 7-27-2010.

**CLASS 42—SCIENTIFIC AND COMPUTER SERVICES**

FOR COMPUTER SERVICES, NAMELY, CREATING ONLINE COMMUNITIES FOR REGISTERED USERS TO ORGANIZE GROUPS, EVENTS, PARTICIPATE IN DISCUSSIONS, SHARE INFORMATION AND RESOURCES, AND ENGAGE IN SOCIAL, BUSINESS AND COMMUNITY NETWORKING; PROVIDING TEMPORARY USE OF ONLINE NON-DOWNLOADABLE SOFTWARE FOR ALLOWING USERS TO COMMUNICATE INFORMATION FOR PURPOSES OF SOCIAL, BUSINESS AND COMMUNITY NETWORKING, MARKETING, RECRUITMENT AND EMPLOYMENT; PROVIDING A WEBSITE FEATURING TEMPORARY USE OF NON-DOWNLOADABLE SOFTWARE ENABLING USERS TO SEARCH, LOCATE AND COMMUNICATE WITH OTHERS VIA ELECTRONIC COMMUNICATIONS NETWORK TO NETWORK, CONDUCT SURVEYS, TRACK ONLINE REFERENCE TO JOB OPPORTUNITIES AND BUSINESS TOPICS; APPLICATION SERVICE PROVIDER (ASP) SERVICES, NAMELY, HOSTING COMPUTER SOFTWARE APPLICATIONS OF OTHERS; APPLICATION SERVICE PROVIDER (ASP) FEATURING SOFTWARE TO ENABLE OR FACILITATE THE UPLOADING, DOWNLOADING, STREAMING, POSTING, DISPLAYING, BLOGGING, LINKING, SHARING OR OTHERWISE PROVIDING ELECTRONIC MEDIA OR INFORMATION OVER COMMUNICATION NETWORKS; COMPUTER SERVICES IN THE NATURE OF CUSTOMIZED WEB PAGES FEATURING USER DEFINED INFORMATION, NAMELY, PERSONAL PROFILES, INFORMATION, AUDIO, VIDEO, PHOTOGRAPHIC IMAGES, TEXT, GRAPHICS AND DATA; CREATING AND MAINTAINING BLOGS FOR OTHERS IN THE FIELDS OF SCIENCE, ENGINEERING, TECHNOLOGY, MATH, GENERAL INTEREST, CLASSIFIEDS, VIRTUAL COMMUNITY, BUSINESS NETWORKING AND SOCIAL NETWORKING (U.S. CLS. 100 AND 101).

FIRST USE 7-27-2010; IN COMMERCE 7-27-2010.  
TAMARA FRAZIER, EXAMINING ATTORNEY

SN 85-284,943. NURISE SALES & MARKETING, OAKVILLE, ON, CANADA, FILED 4-4-2011.

**Ultimate Gardener Series**

THE MARK CONSISTS OF STANDARD CHARACTERS WITHOUT CLAIM TO ANY PARTICULAR FONT, STYLE, SIZE, OR COLOR.

NO CLAIM IS MADE TO THE EXCLUSIVE RIGHT TO USE "GARDENER SERIES", APART FROM THE MARK AS SHOWN.

**CLASS 11—ENVIRONMENTAL CONTROL APPARATUS**

FOR FAUCET SPRAYERS; HAND HELD SHOWER HEADS; HAND SHOWERS, HAND HELD SHOWERS; IRRIGATION SPRAY NOZZLES; IRRIGATION SPRINKLERS; KITCHEN SINK SPRAYERS; WATER SPRINKLERS FOR THE IRRIGATION OF LAWNS; OXYGEN GENERATOR FOR PROCESSING WATER BY INCREASING OXYGEN CONTENT IN THE WATER; PLUMBING FITTINGS, NAMELY, AERATORS FOR FAUCETS; PLUMBING FITTINGS, NAMELY, SHOWER CONTROL VALVES; PLUMBING FIXTURES, NAMELY, SHOWER MIXERS; PLUMBING FIXTURES, NAMELY, SHOWER SPRAYERS; PLUMBING FIXTURES, NAMELY, SINK SPRAYERS; SHOWER FAUCET EXTENSIONS; SHOWER HEAD SPRAYERS; TAP WATER FAUCETS; VALVES BEING PARTS OF SPRINKLER SYSTEMS; WATER FAUCET SPOUT (U.S. CLS. 13, 21, 23, 31 AND 34).

**CLASS 21—HOUSEWARES AND GLASS**

FOR GARDEN HOSE SPRAYERS; GRASS SPRINKLERS; LAWN SPRINKLERS, PET GROOMING DEVICE COMPRISING A BUILT IN BRUSH HEAD AND AN ATTACHMENT THAT CONNECTS TO A WATER SOURCE; SHUT-OFF VALVES FOR WATER SPRINKLER NOZZLES; SPRAYER NOZZLES FOR GARDEN HOSES; SPRAYER WANDS FOR GARDEN HOSES; SPRAYERS ATTACHED TO GARDEN HOSES; STREAM DEFLECTOR NOZZLES FOR GARDEN HOSES (U.S. CLS. 2, 13, 23, 29, 30, 33, 40 AND 50).

JOHN E. MICHOS, EXAMINING ATTORNEY

SN 85-285,221. C/HCA, INC., NASHVILLE, TN. FILED 4-4-2011.



THE COLOR(S) BLACK, WHITE, BLUE, LIGHT BLUE, BLUE-GREEN, RED, GREY AND YELLOW ARE CLAIMED AS A FEATURE OF THE MARK IS/ARE CLAIMED AS A FEATURE OF THE MARK.

THE MARK CONSISTS OF THE DESIGN OF FIVE RECTANGULAR SHAPED WASTECANS DEPICTED IN THE COLORS BLACK, BLUE, RED, GREY AND YELLOW, RESPECTIVELY, AND EACH HAVING THE REPRESENTATION OF REFUSE IN THE COLOR WHITE AT THE TOP OF THE WASTECAN. THE DESIGN OF A LIGHT BLUE WATER DROP IS SITUATED IN FRONT OF THE WASTECANS. ALL OF THE AFOREMENTIONED DESIGNS ARE RESTING ON A BLUE-GREEN CIRCULAR MAT.

**CLASS 37—CONSTRUCTION AND REPAIR**

FOR PROVIDING INFORMATION AND INSTRUCTIONS IN THE FIELD OF PHARMACEUTICAL WASTE DISPOSAL; DISPOSAL OF PHARMACEUTICAL WASTE; CONSULTATION IN THE FIELD OF PHARMACEUTICAL WASTE DISPOSAL (U.S. CLS. 100, 103 AND 106).

**CLASS 39—TRANSPORTATION AND STORAGE**

SN 85-285,630. JOHN T. ZIEMBA, EDISON, NJ. FILED 4-4-2011.

FOR PROVIDING INFORMATION AND INSTRUCTIONS IN THE FIELD OF TRANSPORTATION OF PHARMACEUTICAL WASTE; CONSULTATION IN THE FIELD OF TRANSPORTATION OF PHARMACEUTICAL WASTE (U.S. CLS. 100 AND 105).

**CLASS 40—MATERIAL TREATMENT**

FOR PROVIDING INFORMATION AND INSTRUCTIONS IN THE FIELD OF DESTRUCTION, TREATMENT, MANAGEMENT, AND RECYCLING OF PHARMACEUTICAL WASTE; PROVIDING TECHNICAL INFORMATION IN THE FIELD OF PHARMACEUTICAL WASTE MANAGEMENT; PHARMACEUTICAL WASTE MANAGEMENT; CONSULTATION IN THE FIELD OF DESTRUCTION, TREATMENT, MANAGEMENT, AND RECYCLING OF PHARMACEUTICAL WASTE (U.S. CLS. 100, 103 AND 106).

**CLASS 41—EDUCATION AND ENTERTAINMENT**

FOR EDUCATIONAL SERVICES, NAMELY, PROVIDING CLASSES, SEMINARS, AND TUTORING IN THE FIELD OF PHARMACEUTICAL WASTE AND UTILIZATION OF VISUAL AIDS IN CONNECTION THEREWITH; INSTRUCTION IN THE FIELD OF PHARMACEUTICAL WASTE (U.S. CLS. 100, 101 AND 107).

**CLASS 45—PERSONAL AND LEGAL SERVICES**

FOR REGULATORY COMPLIANCE CONSULTING IN THE FIELD OF PHARMACEUTICAL WASTE (U.S. CLS. 100 AND 101).

JAY BESCH, EXAMINING ATTORNEY

---

SN 85-285,404. STONE GROUP HOLDINGS, LLC, NIXA, MO. FILED 4-4-2011.

**ZURI STONE**

THE MARK CONSISTS OF STANDARD CHARACTERS WITHOUT CLAIM TO ANY PARTICULAR FONT, STYLE, SIZE, OR COLOR.

NO CLAIM IS MADE TO THE EXCLUSIVE RIGHT TO USE "STONE", APART FROM THE MARK AS SHOWN.

THE ENGLISH TRANSLATION OF "ZURI" IN THE MARK IS "BEAUTIFUL".

**CLASS 11—ENVIRONMENTAL CONTROL APPARATUS**

FOR DECORATIVE SINKS, NAMELY, SINKS MADE OF CEMENTITIOUS MATERIALS DESIGNED TO SIMULATE STONE OR MARBLE (U.S. CLS. 13, 21, 23, 31 AND 34).

FIRST USE 4-2-2011; IN COMMERCE 4-2-2011.

**CLASS 19—NON-METALLIC BUILDING MATERIALS**

FOR CEMENTITIOUS BUILDING MATERIALS, NAMELY, FIREPLACE SURROUNDS AND CEMENT TILE BACK SPLASHES DESIGNED TO SIMULATE STONE OR MARBLE; CEMENTITIOUS BUILDING MATERIAL MIXES (U.S. CLS. 1, 12, 33 AND 50).

FIRST USE 4-2-2011; IN COMMERCE 4-2-2011.

WILLIAM VERHOSEK, EXAMINING ATTORNEY

**INYER CASE**

THE MARK CONSISTS OF STANDARD CHARACTERS WITHOUT CLAIM TO ANY PARTICULAR FONT, STYLE, SIZE, OR COLOR.

NO CLAIM IS MADE TO THE EXCLUSIVE RIGHT TO USE "CASE", APART FROM THE MARK AS SHOWN.

**CLASS 9—ELECTRICAL AND SCIENTIFIC APPARATUS**

FOR CARRYING CASES, SOLD EMPTY, SPECIFICALLY DESIGNED FOR THE STORAGE, PROTECTION, AND TRANSPORTATION OF HANDHELD ELECTRONICS, NAMELY, PORTABLE COMPUTERS, TABLETS, PORTABLE AUDIO DEVICES, WIRELESS TELEPHONES, DIGITAL CAMERAS AND PERSONAL DIGITAL ASSISTANTS (U.S. CLS. 21, 23, 26, 36 AND 38).

**CLASS 28—TOYS AND SPORTING GOODS**

FOR CARRYING CASES, SOLD EMPTY, SPECIFICALLY DESIGNED FOR THE STORAGE, PROTECTION, AND TRANSPORTATION OF HANDHELD VIDEO GAMES (U.S. CLS. 22, 23, 38 AND 50).

NICHOLAS ALTREE, EXAMINING ATTORNEY

---

SN 85-286,411. FERGUSON ENTERPRISES, INC., NEWPORT NEWS, VA. FILED 4-5-2011.

**SOPHISTISPA**

THE MARK CONSISTS OF STANDARD CHARACTERS WITHOUT CLAIM TO ANY PARTICULAR FONT, STYLE, SIZE, OR COLOR.

**CLASS 11—ENVIRONMENTAL CONTROL APPARATUS**

FOR SHOWERS AND SHOWER INSTALLATIONS, NAMELY, SHOWER RECEPTORS, SHOWER AND BATH CUBICLES, SHOWER HEADS, SHOWER DOORS; PLUMBING FITTINGS, NAMELY, WATER DIVERTERS FOR SHOWERS, HAND SHOWERS, SHOWER HEAD SPRAYERS, SHOWER ARMS, AND SHOWER SLIDE BARS; PLUMBING FITTINGS IN THE NATURE OF SHOWER VALVES, NAMELY, PRESSURE BALANCED VALVES, THERMOSTATIC VALVES, VOLUME CONTROL VALVES, AND DIVERTER VALVES (U.S. CLS. 13, 21, 23, 31 AND 34).

**CLASS 17—RUBBER GOODS**

FOR SHOWER HOSES (U.S. CLS. 1, 5, 12, 13, 35 AND 50).

Laurie Mayes, Examining Attorney

SN 85-286,783. ANGELSOFT LLC, NEW YORK, NY. FILED 4-5-2011.

**Gust**

THE MARK CONSISTS OF STANDARD CHARACTERS WITHOUT CLAIM TO ANY PARTICULAR FONT, STYLE, SIZE, OR COLOR.

**CLASS 9—ELECTRICAL AND SCIENTIFIC APPARATUS**

FOR COMPUTER COMMUNICATIONS SOFTWARE TO ALLOW USERS TO COLLABORATE WITH OTHER USERS AND PERFORM ELECTRONIC BUSINESS TRANSACTIONS VIA A GLOBAL COMPUTER NETWORK IN SUPPORT OF PRIVATE EQUITY INVESTMENTS (U.S. CLS. 21, 23, 26, 36 AND 38).

**CLASS 35—ADVERTISING AND BUSINESS**

FOR BUSINESS SERVICES, NAMELY, MATCHING POTENTIAL PRIVATE INVESTORS WITH ENTREPRENEURS NEEDING FUNDING (U.S. CLS. 100, 101 AND 102).

**CLASS 38—COMMUNICATION**

FOR PROVIDING TELECOMMUNICATIONS SERVICES TO OTHERS, NAMELY, FACILITATING COMMUNICATION AND COLLABORATION BETWEEN ALL PARTIES IN PRIVATE EQUITY INVESTMENT DEALS BY PROVIDING E-MAIL SERVICES, ONLINE FORUMS AND PRIVATE INTRANET ACCESS (U.S. CLS. 100, 101 AND 104).

**CLASS 42—SCIENTIFIC AND COMPUTER SERVICES**

FOR APPLICATION SERVICE PROVIDER (ASP) FEATURING SOFTWARE FOR USE IN DATABASE MANAGEMENT, WEB SITE HOSTING, VIDEO DELIVERY, FILE STORAGE, ELECTRONIC MAIL, FINANCIAL REPORTING, CUSTOMER RELATIONSHIP MANAGEMENT AND DEAL FLOW PROCESSING IN THE FIELD OF INVESTMENT MARKETING, ANALYSIS, COLLABORATION, TRACKING AND FINANCING (U.S. CLS. 100 AND 101).

MAYUR VAGHANI, EXAMINING ATTORNEY

SN 85-287,051. BRUIN GROUP LLC, NEW YORK, NY. FILED 4-5-2011.

**BRUIN 360**

THE MARK CONSISTS OF STANDARD CHARACTERS WITHOUT CLAIM TO ANY PARTICULAR FONT, STYLE, SIZE, OR COLOR.

**CLASS 9—ELECTRICAL AND SCIENTIFIC APPARATUS**

FOR COMPUTER SOFTWARE FOR MANAGING, CONTROLLING, MONITORING, TRACKING, REPORTING AND ANALYZING TELECOMMUNICATION AND OTHER UTILITY SERVICES AND ASSETS (U.S. CLS. 21, 23, 26, 36 AND 38).

FIRST USE 3-0-2010; IN COMMERCE 7-0-2010.

**CLASS 35—ADVERTISING AND BUSINESS**

FOR BUSINESS CONSULTING AND BUSINESS PROCESS OUTSOURCING IN THE FIELD OF TELECOMMUNICATION AND OTHER UTILITY SERVICES, NAMELY, EXPENSE MANAGEMENT, INVENTORY MANAGEMENT AND COST OPTIMIZATION BUSINESS AUDITS, ORDER FULFILLMENT MANAGEMENT, ADMINISTRATIVE PROCESSING OF SERVICE TICKETS AND PURCHASE ORDERS, ASSISTING WITH THE MANAGEMENT OF CONTRACTS WITH BUSINESS ENTITIES, VENDOR MANAGEMENT OF TELECOMMUNICATIONS AND PUBLIC UTILITY FACILITIES, DISPUTE MANAGEMENT IN THE NATURE OF ASSISTING OTHERS IN RESOLVING DISPUTES RELATING TO COMMERCIAL TRANSACTIONS AND CENTRALIZED DATABASE MANAGEMENT OF NETWORK/TELECOM INVENTORY AND CONTRACTED SERVICES APPLICATIONS (U.S. CLS. 100, 101 AND 102).

FIRST USE 3-0-2010; IN COMMERCE 7-0-2010.

**CLASS 38—COMMUNICATION**

FOR TELECOMMUNICATIONS CONSULTING (U.S. CLS. 100, 101 AND 104).

FIRST USE 8-3-2011; IN COMMERCE 8-3-2011.

WILLIAM VERHOSEK, EXAMINING ATTORNEY

SN 85-287,053. THE EDWIN M. KNOWLES CHINA COMPANY, NILES, IL. FILED 4-5-2011.

**DAVENPORT STUDIOS**

THE MARK CONSISTS OF STANDARD CHARACTERS WITHOUT CLAIM TO ANY PARTICULAR FONT, STYLE, SIZE, OR COLOR.

NO CLAIM IS MADE TO THE EXCLUSIVE RIGHT TO USE "STUDIOS", APART FROM THE MARK AS SHOWN.

**CLASS 15—MUSICAL INSTRUMENTS**

FOR MUSICAL BOXES (U.S. CLS. 2, 21 AND 36).

**CLASS 21—HOUSEWARES AND GLASS**

FOR PORCELAIN SCULPTURES, VASES, VESSELS, BOWLS, PLATES AND POTS; FIGURINES OF PORCELAIN (U.S. CLS. 2, 13, 23, 29, 30, 33, 40 AND 50).

TINA BROWN, EXAMINING ATTORNEY

SN 85-287,295. BURWELL INDUSTRIES, INC., CENTENNIAL, CO. FILED S.R. 4-6-2011; AM. P.R. 9-8-2011.

# TOKYOMILK

THE MARK CONSISTS OF STANDARD CHARACTERS WITHOUT CLAIM TO ANY PARTICULAR FONT, STYLE, SIZE, OR COLOR.

### CLASS 3—COSMETICS AND CLEANING PREPARATIONS

FOR BAR SOAP; BATH SOAPS; BEAUTY SOAP; BUBBLE BATH; HAND CREAM; LIP BALM; LIPSTICK; PERFUME (U.S. CLS. 1, 4, 6, 50, 51 AND 52).  
FIRST USE 6-20-2008; IN COMMERCE 6-20-2008.

### CLASS 4—LUBRICANTS AND FUELS

FOR CANDLES (U.S. CLS. 1, 6 AND 15).  
FIRST USE 6-16-2009; IN COMMERCE 6-16-2009.

### CLASS 16—PAPER GOODS AND PRINTED MATTER

FOR GREETING CARDS (U.S. CLS. 2, 5, 22, 23, 29, 37, 38 AND 50).  
FIRST USE 11-13-2008; IN COMMERCE 11-13-2008.

### CLASS 18—LEATHER GOODS

FOR COSMETIC BAGS SOLD EMPTY (U.S. CLS. 1, 2, 3, 22 AND 41).  
FIRST USE 3-21-2011; IN COMMERCE 3-21-2011.

### CLASS 20—FURNITURE AND ARTICLES NOT OTHERWISE CLASSIFIED

FOR PERSONAL COMPACT MIRRORS (U.S. CLS. 2, 13, 22, 25, 32 AND 50).  
FIRST USE 12-9-2008; IN COMMERCE 12-9-2008.  
LAURA KOVALSKY, EXAMINING ATTORNEY

SN 85-287,981. MORALES, GRETCHEN DEL CARMEN, DBA CIRQUE ETIENNE, SAN JUAN, PUERTO RICO, FILED 4-6-2011.



CIRQUE ETIENNE

THE COLOR(S) NAVY BLUE IS/ARE CLAIMED AS A FEATURE OF THE MARK.

THE MARK CONSISTS OF THE WORDS "CIRQUE ETIENNE" IN STYLIZED NAVY BLUE LETTERING, BETWEEN WHICH IS THE SILHOUETTED IMAGE IN NAVY BLUE OF A BOY STANDING, JUGGLING THREE BALLS, WITH THE LETTER "Q" IN THE WORD "CIRQUE" HAVING A MAGNIFIED DOT INSTEAD OF A TAIL.

### CLASS 25—CLOTHING

FOR ATHLETIC APPAREL, NAMELY, SHIRTS, PANTS, JACKETS, FOOTWEAR, HATS AND CAPS, ATHLETIC UNIFORMS; CHILDREN'S AND INFANT'S APPAREL, NAMELY, JUMPERS, OVERALL SLEEPWEAR, PAJAMAS, ROMPERS AND ONE-PIECE GARMENTS; CHILDREN'S AND INFANTS' APPAREL TREATED WITH FIRE AND HEAT RETARDANTS, NAMELY, JUMPERS, OVERALL SLEEPWEAR, PAJAMAS, ROMPERS AND ONE-PIECE GARMENTS; CHILDREN'S AND INFANTS' CLOTH BIBS; CHILDREN'S CLOTH EATING BIBS; CHILDREN'S HEADWEAR; CLOTHING FOR BABIES, TODDLERS AND CHILDREN, TREATED WITH FIRE AND HEAT RETARDANTS, NAMELY, PAJAMAS, JACKETS, SHIRTS, PANTS, JUMPERS; COSTUMES FOR USE IN CHILDREN'S DRESS UP PLAY; HATS FOR INFANTS, BABIES, TODDLERS AND CHILDREN; HOODED SWEATSHIRTS FOR CASUAL WEAR; ONE-PIECE GARMENTS FOR CHILDREN; SHIRTS FOR INFANTS, BABIES, TODDLERS AND CHILDREN; T-SHIRTS FOR DAILY USE (U.S. CLS. 22 AND 39).

### CLASS 35—ADVERTISING AND BUSINESS

FOR RETAIL APPAREL STORES (U.S. CLS. 100, 101 AND 102).  
HEATHER THOMPSON, EXAMINING ATTORNEY

SN 85-288,611. BALLET MAKERS, INC., TOTOWA, NJ. FILED 4-7-2011.

# CAPEZIO NEW YORK

THE MARK CONSISTS OF STANDARD CHARACTERS WITHOUT CLAIM TO ANY PARTICULAR FONT, STYLE, SIZE, OR COLOR.

OWNER OF U.S. REG. NOS. 546,042, 1,826,413 AND OTHERS.

NO CLAIM IS MADE TO THE EXCLUSIVE RIGHT TO USE "NEW YORK", APART FROM THE MARK AS SHOWN.

### CLASS 25—CLOTHING

FOR ACROBAT SHOES; AEROBIC WEAR, NAMELY, LEGGINGS AND LEOTARDS; BLOUSES; BRIEFS; COTTON TOPS; DANCE BELTS; DANCEWEAR, NAMELY, LEOTARDS, LEGGINGS, TIGHTS, SHIRTS, PANTS, SKIRTS, VESTS AND SWEATERS; DOUBLE TRUNKS; EXERCISE SHOES; JACKETS; JEANS; KNITWEAR, NAMELY, SWEATERS, SWEATSHIRTS, SHIRTS, SKIRTS, PANTS, LEGGINGS, AND LEOTARDS; LEGGINGS; LEOTARDS; OPERA HOSE IN THE NATURE OF STOCKINGS; RAINWEAR; SANDALS; SCARVES; SHOES FOR MEN, WOMEN AND CHILDREN, MADE OF LEATHER, FABRIC, AND COMBINATION OF LEATHER AND FABRIC; SHORTS; SLIPPERS FOR MEN, WOMEN AND CHILDREN; SOCKS; SOFT BALLET SHOES; STAGE CHARACTER SHOES; STREET SHOES; STIRRUP PANTS; SWEATERS; SWEATSHIRTS; TAP SHOES; TAPS FOR AFFIXING TO DANCE SHOES; TIGHTS; TOE PADS MADE OF FUR, LAMBS WOOL OR FOAM RUBBER FOR FOOTWEAR; TOE SHOE COVERS; TOE SHOES; TRUNKS; T-SHIRTS; TUNICS; TURTLE-NECKS; AND VESTS (U.S. CLS. 22 AND 39).

### CLASS 26—FANCY GOODS

FOR LACES IN THE FORM OF RIBBONS FOR FOOTWEAR (U.S. CLS. 37, 39, 40, 42 AND 50).  
TINA MAI, EXAMINING ATTORNEY

SN 85-288,992. HICKENBOTTOM, MICHAEL, CARLSBAD, CA. FILED 4-7-2011.

SN 85-289,440. LRK PARTNERS, L.L.C., FRISCO, TX. FILED 4-7-2011.

# MR. HOF

THE MARK CONSISTS OF STANDARD CHARACTERS WITHOUT CLAIM TO ANY PARTICULAR FONT, STYLE, SIZE, OR COLOR.

"MR. HOF" IDENTIFIES THE PSEUDONYM/STAGE NAME/NICKNAME OF MICHAEL HICKENBOTTOM, A LIVING INDIVIDUAL WHOSE CONSENT IS OF RECORD.

## CLASS 9—ELECTRICAL AND SCIENTIFIC APPARATUS

FOR DIGITAL VIDEO DISCS AND DIGITAL VERSATILE DISCS ALL FEATURING SPORTS AND ENTERTAINMENT IN THE NATURE OF WRESTLING; VIDEO GAME CARTRIDGES AND DISCS; COMPUTER GAME CARTRIDGES AND DISCS; HAND HELD UNITS FOR PLAYING ELECTRONIC VIDEO GAMES FOR USE WITH AN EXTERNAL DISPLAY SCREEN OR MONITOR (U.S. CLS. 21, 23, 26, 36 AND 38).

## CLASS 16—PAPER GOODS AND PRINTED MATTER

FOR POSTERS; EVENT AND COMPETITION PROGRAMS; PHOTOGRAPHS; POSTCARDS; TRADING CARDS; STICKERS, SCRAPBOOK ALBUMS, ADDRESS BOOKS, AUTOGRAPH BOOKS, LOOSE LEAF BINDERS, COMPUTER GAME INSTRUCTION MANUALS, DECALS, NOTEBOOKS, FOLDERS, MAGAZINES FEATURING WRESTLING, TRIVIA CARDS, PAPER LUNCH SACKS (U.S. CLS. 2, 5, 22, 23, 29, 37, 38 AND 50).

## CLASS 25—CLOTHING

FOR WEARING APPAREL, NAMELY, WARM-UP SUITS, SWEATSHIRTS, TEE-SHIRTS; MUSCLE SHIRTS; SPORTS SHIRTS; TANK TOPS; BATHING SUITS; BEACH WEAR; JOGGING SUITS; SHORTS; SHIRTS; GLOVES; UNDERWEAR; JERSEYS; HEADWEAR; FOOTWEAR, BELTS, SOCKS, HATS; CAPS; WORKOUT AND SPORTS APPAREL, NAMELY, SHORTS AND SHIRTS (U.S. CLS. 22 AND 39).

## CLASS 28—TOYS AND SPORTING GOODS

FOR WRESTLING GLOVES; BOXING GLOVES, TOY ACTION FIGURES, BOARD GAMES, CARD GAMES, TRADING CARD GAMES, TOY VEHICLES, TOY CARS, TOY TRUCKS, MODELED PLASTIC TOY FIGURINES, ORNAMENTAL TOY MASKS, AND SPORTS FACE MASKS FOR FOOTBALL; PLAYING CARDS AND HAND-HELD UNITS FOR PLAYING ELECTRONIC VIDEO GAMES OTHER THAN THOSE ADAPTED FOR USE WITH AN EXTERNAL DISPLAY SCREEN OR MONITOR (U.S. CLS. 22, 23, 38 AND 50).

## CLASS 41—EDUCATION AND ENTERTAINMENT

FOR ENTERTAINMENT SERVICES RENDERED BY A PROFESSIONAL WRESTLER IN THE NATURE OF PERSONAL APPEARANCES; ENTERTAINMENT SERVICES, NAMELY, WRESTLING PERFORMANCES BY A PROFESSIONAL WRESTLER AND ENTERTAINER; LIVE STAGE SHOWS AND PERFORMANCES FEATURING WRESTLING (U.S. CLS. 100, 101 AND 107).

COLLEEN DOMBROW, EXAMINING ATTORNEY

# TIMBERHORN IT SOLUTIONS

THE MARK CONSISTS OF STANDARD CHARACTERS WITHOUT CLAIM TO ANY PARTICULAR FONT, STYLE, SIZE, OR COLOR.

NO CLAIM IS MADE TO THE EXCLUSIVE RIGHT TO USE "IT SOLUTIONS", APART FROM THE MARK AS SHOWN.

## CLASS 35—ADVERTISING AND BUSINESS

FOR EMPLOYMENT STAFFING IN THE FIELD OF INFORMATION TECHNOLOGY AND INFORMATION SERVICES; EMPLOYMENT AGENCY SERVICES, NAMELY, FILLING THE TEMPORARY AND PERMANENT STAFFING NEEDS OF BUSINESSES; EMPLOYMENT STAFFING CONSULTATION SERVICES; EMPLOYMENT HIRING, RECRUITING, PLACEMENT, STAFFING AND CAREER NETWORKING SERVICES; PROFESSIONAL STAFFING AND RECRUITING SERVICES; OUTSOURCING IN THE FIELD OF INFORMATION TECHNOLOGY, INFORMATION SERVICES, AND THE SALES AND MARKETING OF COMPUTER HARDWARE AND SOFTWARE; OUTSOURCING SERVICES FOR BUSINESSES (U.S. CLS. 100, 101 AND 102).

FIRST USE 5-1-2010; IN COMMERCE 5-1-2010.

## CLASS 42—SCIENTIFIC AND COMPUTER SERVICES

FOR COMPUTER CONSULTATION AND COMPUTER SYSTEMS DESIGN SERVICES FOR OTHERS; TECHNICAL SUPPORT SERVICES, NAMELY, TROUBLESHOOTING OF COMPUTER SOFTWARE PROBLEMS; TECHNICAL SUPPORT SERVICES, NAMELY, TROUBLESHOOTING IN THE NATURE OF DIAGNOSING COMPUTER HARDWARE PROBLEMS; COMPUTER SOFTWARE AND HARDWARE DESIGN FOR OTHERS; INTEGRATION OF COMPUTER SYSTEMS AND NETWORKS; INSTALLATION, UPDATING AND MAINTENANCE OF COMPUTER SOFTWARE FOR OTHERS; COMPUTER PROGRAMMING FOR OTHERS; CONSULTING SERVICES IN THE FIELD OF COMPUTER HARDWARE AND SOFTWARE; COMPUTER SYSTEMS ANALYSIS (U.S. CLS. 100 AND 101).

FIRST USE 5-1-2010; IN COMMERCE 5-1-2010.

MARK SPARACINO, EXAMINING ATTORNEY

SN 85-289,965. JPP, LLC, RALEIGH, NC. FILED 4-8-2011.

# CRAZY COUNTRY GALS

THE MARK CONSISTS OF STANDARD CHARACTERS WITHOUT CLAIM TO ANY PARTICULAR FONT, STYLE, SIZE, OR COLOR.

NO CLAIM IS MADE TO THE EXCLUSIVE RIGHT TO USE "GALS", APART FROM THE MARK AS SHOWN.

**CLASS 9—ELECTRICAL AND SCIENTIFIC APPARATUS**

FOR DOWNLOADABLE AUDIO VISUAL FILES FEATURING ADULT ENTERTAINMENT (U.S. CLS. 21, 23, 26, 36 AND 38).

FIRST USE 12-17-2010; IN COMMERCE 12-17-2010.

**CLASS 41—EDUCATION AND ENTERTAINMENT**

FOR ENTERTAINMENT SERVICES, NAMELY, PROVIDING A WEB SITE FEATURING NON-DOWNLOADABLE ADULT ENTERTAINMENT AND MULTIMEDIA MATERIALS FEATURING ADULT ENTERTAINMENT (U.S. CLS. 100, 101 AND 107).

FIRST USE 12-17-2010; IN COMMERCE 12-17-2010.

CHRIS WELLS, EXAMINING ATTORNEY

SN 85-290,312. BIOMETRIC SECURITY LIMITED, LONDON, UNITED KINGDOM, FILED 4-8-2011.

# VOICEAUTH

THE MARK CONSISTS OF STANDARD CHARACTERS WITHOUT CLAIM TO ANY PARTICULAR FONT, STYLE, SIZE, OR COLOR.

PRIORITY CLAIMED UNDER SEC. 44(D) ON UNITED KINGDOM APPLICATION NO. 2574852, FILED 3-11-2011, REG. NO. 2574852, DATED 3-11-2011, EXPIRES 3-11-2021.

OWNER OF U.S. REG. NO. 3,587,537.

**CLASS 9—ELECTRICAL AND SCIENTIFIC APPARATUS**

FOR COMPUTER SOFTWARE FOR DATABASE MANAGEMENT AND VOICE VERIFICATION (U.S. CLS. 21, 23, 26, 36 AND 38).

**CLASS 42—SCIENTIFIC AND COMPUTER SERVICES**

FOR COMPUTER NETWORK DESIGN AND COMPUTER SOFTWARE DESIGN FOR THE PROVISION OF VOICE IDENTITY VERIFICATION SYSTEMS; COMPUTER SERVICE, NAMELY, ACTING AS AN APPLICATION SERVICE PROVIDER IN THE FIELD OF INFORMATION MANAGEMENT TO HOST COMPUTER APPLICATION SOFTWARE FOR THE PURPOSE OF VOICE IDENTIFICATION VERIFICATION SERVICES (U.S. CLS. 100 AND 101).

DAWN HAN, EXAMINING ATTORNEY

SN 85-290,316. BIOMETRIC SECURITY LIMITED, LONDON, UNITED KINGDOM, FILED 4-8-2011.

# VOICERESET

THE MARK CONSISTS OF STANDARD CHARACTERS WITHOUT CLAIM TO ANY PARTICULAR FONT, STYLE, SIZE, OR COLOR.

PRIORITY CLAIMED UNDER SEC. 44(D) ON UNITED KINGDOM APPLICATION NO. 257854, FILED 3-11-2011, REG. NO. 2574854, DATED 3-11-2011, EXPIRES 3-11-2021.

OWNER OF U.S. REG. NO. 3,587,537.

**CLASS 9—ELECTRICAL AND SCIENTIFIC APPARATUS**

FOR COMPUTER SOFTWARE FOR DATABASE MANAGEMENT AND VOICE VERIFICATION (U.S. CLS. 21, 23, 26, 36 AND 38).

**CLASS 42—SCIENTIFIC AND COMPUTER SERVICES**

FOR COMPUTER NETWORK DESIGN AND COMPUTER SOFTWARE DESIGN FOR THE PROVISION OF VOICE IDENTITY VERIFICATION SYSTEMS; COMPUTER SERVICE, NAMELY, ACTING AS AN APPLICATION SERVICE PROVIDER IN THE FIELD OF INFORMATION MANAGEMENT TO HOST COMPUTER APPLICATION SOFTWARE FOR THE PURPOSE OF VOICE IDENTIFICATION VERIFICATION SERVICES (U.S. CLS. 100 AND 101).

DAWN HAN, EXAMINING ATTORNEY

SN 85-290,317. AMERICAN URBAN RADIO NETWORKS, PITTSBURGH, PA. FILED 4-8-2011.



OWNER OF U.S. REG. NOS. 2,657,822, 3,092,578 AND OTHERS.

NO CLAIM IS MADE TO THE EXCLUSIVE RIGHT TO USE "AMERICAN URBAN" OR "NETWORK", APART FROM THE MARK AS SHOWN.

THE MARK CONSISTS OF THE WORDS "AMERICAN URBAN ELITE NETWORK" AND AN OVAL HAVING LEFT AND RIGHT HALVES FORMED BY A SERIES OF SPACED APART LINES.

**CLASS 38—COMMUNICATION**

FOR RADIO BROADCASTING SERVICES (U.S. CLS. 100, 101 AND 104).

FIRST USE 12-1-2010; IN COMMERCE 12-1-2010.

**CLASS 41—EDUCATION AND ENTERTAINMENT**

FOR ENTERTAINMENT SERVICES IN THE NATURE OF RADIO PROGRAMS IN THE FIELD OF MUSIC, NEWS, SPORTS, BUSINESS, ENTERTAINMENT AND PUBLIC AFFAIRS (U.S. CLS. 100, 101 AND 107).

FIRST USE 12-1-2010; IN COMMERCE 12-1-2010.

DAWN HAN, EXAMINING ATTORNEY

SN 85-290,535. BASF AGRO TRADEMARKS GMBH, LUDWIGSHAFEN AM RHEIN, FED REP GERMANY, FILED 4-8-2011.

# MUNDIAL

THE MARK CONSISTS OF STANDARD CHARACTERS WITHOUT CLAIM TO ANY PARTICULAR FONT, STYLE, SIZE, OR COLOR.

OWNER OF U.S. REG. NO. 3,030,976.  
THE ENGLISH TRANSLATION OF "MUNDIAL" IN THE MARK IS "WORLDWIDE".

## CLASS 1—CHEMICALS

FOR CHEMICALS USED IN AGRICULTURE, HORTICULTURE AND FORESTRY, NAMELY, PLANT FORTIFYING PREPARATIONS, PLANT GROWTH REGULATING PREPARATIONS, CHEMICAL PREPARATIONS FOR THE TREATMENT OF SEEDS, SURFACTANTS, NATURAL OR ARTIFICIAL CHEMICALS TO BE USED AS SEXUAL BAITS OR AGENTS TO CONFUSE INSECTS (U.S. CLS. 1, 5, 6, 10, 26 AND 46).

## CLASS 31—NATURAL AGRICULTURAL PRODUCTS

FOR AGRICULTURAL, HORTICULTURAL AND FORESTRY PRODUCTS, NAMELY, SEEDS FOR AGRICULTURAL, HORTICULTURAL AND FORESTRY PURPOSES, AGRICULTURAL, HORTICULTURAL AND FORESTRY GRAINS FOR PLANTING, UNPROCESSED GRAINS AND UNPROCESSED CEREALS; SEEDS FOR AGRICULTURAL PURPOSES; HYBRID AGRICULTURAL SEEDS; SOWING SEEDS; PLANT SEEDS; SEEDS FOR HORTICULTURAL PURPOSES; FOODSTUFFS FOR ANIMALS (U.S. CLS. 1 AND 46).

ALLISON SCHRODY, EXAMINING ATTORNEY

SN 85-291,334. 21ST CENTURY INSURANCE AND FINANCIAL SERVICES, INC., WILMINGTON, DE. FILED 4-11-2011.

# 21ST PERKS

THE MARK CONSISTS OF STANDARD CHARACTERS WITHOUT CLAIM TO ANY PARTICULAR FONT, STYLE, SIZE, OR COLOR.

NO CLAIM IS MADE TO THE EXCLUSIVE RIGHT TO USE "PERKS", APART FROM THE MARK AS SHOWN.

## CLASS 35—ADVERTISING AND BUSINESS

FOR PROMOTING THE GOODS AND SERVICES OF OTHERS THROUGH THE ADMINISTRATION OF AN INCENTIVE AWARD PROGRAM ENABLING PARTICIPANTS TO OBTAIN DISCOUNTS ON PRODUCTS AND SERVICES (U.S. CLS. 100, 101 AND 102).

## CLASS 36—INSURANCE AND FINANCIAL

FOR INSURANCE UNDERWRITING SERVICES IN THE FIELD OF PROPERTY AND CASUALTY AND AUTOMOBILE; INSURANCE CLAIMS PROCESSING, INSURANCE CLAIMS ADMINISTRATION, AND INSURANCE AGENCY SERVICES; PROVIDING INFORMATION IN INSURANCE MATTERS (U.S. CLS. 100, 101 AND 102).

ELI HELLMAN, EXAMINING ATTORNEY

SN 85-291,449. LEVINE, LORRAINE, PACIFIC PALISADES, CA. FILED 4-11-2011.

# Fashion Foodies

THE MARK CONSISTS OF STANDARD CHARACTERS WITHOUT CLAIM TO ANY PARTICULAR FONT, STYLE, SIZE, OR COLOR.

NO CLAIM IS MADE TO THE EXCLUSIVE RIGHT TO USE "FASHION", APART FROM THE MARK AS SHOWN.

## CLASS 24—FABRICS

FOR TOWELS; OVEN MITTS; POT HOLDERS; PLACE MATS OF TEXTILE MATERIAL; FABRIC TABLE RUNNERS; CLOTH NAPKINS (U.S. CLS. 42 AND 50).

## CLASS 25—CLOTHING

FOR APRONS; CHEF'S COATS; CHEF'S HATS; PANTS; TEE-SHIRTS (U.S. CLS. 22 AND 39).

MATTHEW PAPPAS, EXAMINING ATTORNEY

SN 85-291,612. MANNING, JOHN, CATHEDRAL CITY, CA. FILED 4-11-2011.

# Restroom Lounger

THE MARK CONSISTS OF STANDARD CHARACTERS WITHOUT CLAIM TO ANY PARTICULAR FONT, STYLE, SIZE, OR COLOR.

NO CLAIM IS MADE TO THE EXCLUSIVE RIGHT TO USE "RESTROOM", APART FROM THE MARK AS SHOWN.

## CLASS 10—MEDICAL APPARATUS

FOR TOILET AID FOR MEDICAL PURPOSES FOR THE ELDERLY AND DISABLED IN THE NATURE OF A TOILET SEAT ADAPTOR FOR THE PURPOSE OF PROVIDING LEISURE AND RELAXATION WHEN SITTING ON THE TOILET (U.S. CLS. 26, 39 AND 44).

## CLASS 11—ENVIRONMENTAL CONTROL APPARATUS

FOR TOILET AID NOT FOR MEDICAL PURPOSES FOR THE ELDERLY AND DISABLED IN THE NATURE OF PLASTIC DEVICE SPECIALLY ADAPTED TO REST ON A TOILET SEAT FOR THE PURPOSE OF PROVIDING LEISURE AND RELAXATION WHEN SITTING ON THE TOILET (U.S. CLS. 13, 21, 23, 31 AND 34).



ANDREW LEASER, EXAMINING ATTORNEY

SN 85-291,725. PARKSBYNATURE NETWORK, LLC, NEW YORK, NY. FILED 4-11-2011.

## ParksByNature Network

THE MARK CONSISTS OF STANDARD CHARACTERS WITHOUT CLAIM TO ANY PARTICULAR FONT, STYLE, SIZE, OR COLOR.

NO CLAIM IS MADE TO THE EXCLUSIVE RIGHT TO USE "NETWORK", APART FROM THE MARK AS SHOWN.

### CLASS 9—ELECTRICAL AND SCIENTIFIC APPARATUS

FOR (BASED ON USE IN COMMERCE) COMPUTER APPLICATION SOFTWARE FOR MOBILE PHONES, NAMELY, SOFTWARE FOR SOCIAL NETWORKING FOR THE OUTDOOR ENTHUSIAST (U.S. CLS. 21, 23, 26, 36 AND 38).

FIRST USE 9-2-2010; IN COMMERCE 9-2-2010.

### CLASS 16—PAPER GOODS AND PRINTED MATTER

FOR (BASED ON INTENT TO USE) PRINTED PUBLICATIONS, NAMELY, TOUR GUIDE BOOKS, BOOKLETS AND PAMPHLETS (U.S. CLS. 2, 5, 22, 23, 29, 37, 38 AND 50).

### CLASS 35—ADVERTISING AND BUSINESS

FOR (BASED ON INTENT TO USE) ONLINE RETAIL STORE SERVICES FEATURING PRODUCTS RELATED TO THE OUTDOORS, NAMELY, HIKING AND CAMPING EQUIPMENT, FISHING AND SPORTS EQUIPMENT, NAVIGATION EQUIPMENT, CLOTHING, SHOES, AND HATS (U.S. CLS. 100, 101 AND 102).

### CLASS 42—SCIENTIFIC AND COMPUTER SERVICES

FOR (BASED ON INTENT TO USE) COMPUTER SERVICES, NAMELY, CREATING AN ON-LINE COMMUNITY FOR REGISTERED USERS TO PARTICIPATE IN DISCUSSIONS, GET FEEDBACK FROM THEIR PEERS, FORM VIRTUAL COMMUNITIES, AND ENGAGE IN SOCIAL NETWORKING (U.S. CLS. 100 AND 101).

KAREN K. BUSH, EXAMINING ATTORNEY

SN 85-292,173. LEIJDEKKERS, PETER, CREMORNE, AUSTRALIA, FILED 4-11-2011.

## MYFITNESSCOMPANION

THE MARK CONSISTS OF STANDARD CHARACTERS WITHOUT CLAIM TO ANY PARTICULAR FONT, STYLE, SIZE, OR COLOR.

### CLASS 9—ELECTRICAL AND SCIENTIFIC APPARATUS

FOR COMPUTER APPLICATION SOFTWARE FOR MOBILE PHONES, HANDHELD COMPUTER, COMPUTERS, AND TABLET COMPUTERS, NAMELY, SOFTWARE PROVIDING PERSONALIZED HEALTH MONITORING OF YOUR WEIGHT, BLOOD PRESSURE, BLOOD GLUCOSE, BODY TEMPERATURE, RESPIRATION, OXYGEN AND HEART RATE USING BLUETOOTH SENSORS OR MANUAL INPUT (U.S. CLS. 21, 23, 26, 36 AND 38).

FIRST USE 2-1-2011; IN COMMERCE 2-17-2011.

### CLASS 42—SCIENTIFIC AND COMPUTER SERVICES

FOR PROVIDING A WEBSITE FEATURING ON-LINE NON-DOWNLOADABLE SOFTWARE THAT ENABLES USERS TO VIEW, MODIFY OR DELETE THEIR VITAL SIGNS DATA, ALLOWS USERS TO SHARE THEIR DATA WITH OTHER USERS AND HEALTH CARE PROFESSIONALS (U.S. CLS. 100 AND 101).

FIRST USE 2-1-2011; IN COMMERCE 2-17-2011.

WILLIAM BRECKENFELD, EXAMINING ATTORNEY

SN 85-292,184. LT OVERSEAS NORTH AMERICA, INC., IRVINE, CA. FILED 4-11-2011.

## ROYAL

THE MARK CONSISTS OF STANDARD CHARACTERS WITHOUT CLAIM TO ANY PARTICULAR FONT, STYLE, SIZE, OR COLOR.

OWNER OF U.S. REG. NOS. 1,683,914, 2,066,393 AND OTHERS.

### CLASS 29—MEATS AND PROCESSED FOODS

FOR MEAT, FISH, POULTRY, AND GAME; MEAT EXTRACTS; PRESERVED, FROZEN, DRIED AND COOKED FRUITS AND VEGETABLES; JELLIES, JAMS, COMPOTES; EGGS, MILK; MILK PRODUCTS, NAMELY, MILK POWDER, EVAPORATED MILK, STERILIZED MILK, WHIPPING CREAM, FERMENTED MILK BEVERAGES, CULTURED MILK DRINKS CONTAINING LACTIC ACID, YOGURT, FERMENTED MILK; EDIBLE OILS AND FATS (U.S. CL. 46).

### CLASS 30—STAPLE FOODS

FOR COFFEE, TEA, COCOA, SUGAR, RICE, TAPIOCA, SAGO, ARTIFICIAL COFFEE; FLOUR; PREPARATIONS MADE FROM CEREALS, NAMELY, CORN FLOUR, WHOLE GRAIN OAT, CORN BRAN, RICE; BREAD, PASTRY; CONFECTIONERY, NAMELY, CHOCOLATES, CANDIES, GUMDROPS, MINTS, CARAMELS, TOFFEES, CHEWING GUM, FROZEN CONFECTIONERY; ICES, HONEY, TREACLE; YEAST, BAKING POWDER; SALT, MUSTARD; VINEGAR, CONDIMENTS, NAMELY, SAUCES; SPICES; ICE (U.S. CL. 46).

WANDA KAY PRICE, EXAMINING ATTORNEY

SN 85-292,662. WYLIE WAGG FOR PETS, LLC, MIDDLEBURG, VA. FILED 4-12-2011.

## GIVE-ABLES

THE MARK CONSISTS OF STANDARD CHARACTERS WITHOUT CLAIM TO ANY PARTICULAR FONT, STYLE, SIZE, OR COLOR.

### CLASS 18—LEATHER GOODS

FOR (BASED ON INTENT TO USE) PET COLLARS; PET LEASHES; PET CLOTHING, INCLUDING CAPS (U.S. CLS. 1, 2, 3, 22 AND 41).

### CLASS 28—TOYS AND SPORTING GOODS

FOR (BASED ON INTENT TO USE) PET TOYS (U.S. CLS. 22, 23, 38 AND 50).

### CLASS 31—NATURAL AGRICULTURAL PRODUCTS

FOR (BASED ON USE IN COMMERCE) HEALTHY DOG TREATS (U.S. CLS. 1 AND 46).  
FIRST USE 4-9-2011; IN COMMERCE 4-9-2011.  
JOHN GARTNER, EXAMINING ATTORNEY

SN 85-293,132. CREMONAFIERE S.P.A., CREMONA, ITALY, AND FONDAZIONE ANTONIO STRADIVARI, AKA FONDAZIONE ANTONIO STRADIVARI CREMONA - LA TRIENNALE, CREMONA, ITALY, FILED 4-12-2011.

## MONDOMUSICA

THE MARK CONSISTS OF STANDARD CHARACTERS WITHOUT CLAIM TO ANY PARTICULAR FONT, STYLE, SIZE, OR COLOR.

### CLASS 35—ADVERTISING AND BUSINESS

FOR BUSINESS CONSULTING, BUSINESS MANAGEMENT AND PROVIDING INFORMATION IN THE MUSIC BUSINESS FIELD; CONSULTATION AND ADVICE FOR THE PURCHASE OF MUSICAL INSTRUMENTS AND SOUND RECORDING DEVICES; CONVENTION AND VISITORS BUREAU SERVICES, NAMELY, PROMOTING TOURISM, BUSINESS AND CONVENTIONS IN AND AROUND THE AREA OF CREMONA, ITALY AREA; ORGANIZATION OF BUSINESS CONVENTIONS; PROVIDING A LIVE FORUM FOR COMPANIES TO SHOWCASE, DISPLAY, DEMONSTRATE AND PROMOTE NEW AND INNOVATIVE IDEAS, PRODUCTS AND SERVICES IN THE CONVENTION/MEETING MANAGEMENT ARENA (U.S. CLS. 100, 101 AND 102).  
FIRST USE 10-1-1995; IN COMMERCE 10-1-1995.

### CLASS 41—EDUCATION AND ENTERTAINMENT

FOR EDUCATIONAL AND ENTERTAINMENT SERVICES, NAMELY, CONDUCTING CONVENTIONS AND FAIRS IN THE FIELD OF MUSICAL INSTRUMENTS AND DISTRIBUTION OF COURSE MATERIALS IN CONNECTION THEREWITH, AND EDUCATION CONSULTING RELATED THERETO; ENTERTAINMENT, NAMELY, LIVE MUSIC CONCERTS; ENTERTAINMENT, NAMELY, LIVE PERFORMANCES BY MUSICAL BANDS; LIVE PERFORMANCES BY A MUSICAL GROUP; MULTIMEDIA PUBLISHING OF BOOKS, MAGAZINES, JOURNALS, SOFTWARE, GAMES, MUSIC, AND ELECTRONIC PUBLICATIONS; MUSICAL EVENT BOOKING AGENCIES; ORGANIZATION OF EXHIBITIONS FOR MUSICAL ENTERTAINMENT; PLANNING ARRANGEMENT OF SHOWING MOVIES, SHOWS, PLAYS OR MUSICAL PERFORMANCES; PROVIDING FACILITIES FOR MOVIES, SHOWS, PLAYS, MUSIC OR EDUCATIONAL TRAINING; PROVISION OF INFORMATION RELATING TO MUSIC (U.S. CLS. 100, 101 AND 107).

FIRST USE 10-1-1995; IN COMMERCE 10-1-1995.

### CLASS 43—HOTEL AND RESTAURANT SERVICES

FOR PROVISION OF FACILITIES FOR CONVENTIONS (U.S. CLS. 100 AND 101).  
FIRST USE 10-1-1995; IN COMMERCE 10-1-1995.  
LIEF MARTIN, EXAMINING ATTORNEY

SN 85-293,148. GOLF GALAXY, LLC, CORAOPOLIS, PA. FILED 4-12-2011.



THE MARK CONSISTS OF A STYLIZED HALF OF A GOLF BALL TO THE LEFT OF A STYLIZED HALF OF A HUMAN BRAIN.

### CLASS 35—ADVERTISING AND BUSINESS

FOR RETAIL STORE SERVICES FEATURING GOLF EQUIPMENT, GOLF ACCESSORIES, GOLF APPAREL AND GOLF FOOTWEAR AND ON-LINE RETAIL STORE SERVICES FEATURING GOLF EQUIPMENT, GOLF ACCESSORIES, GOLF APPAREL AND GOLF FOOTWEAR; TELEPHONE ORDERING SERVICES IN THE FIELDS OF GOLF EQUIPMENT, GOLF ACCESSORIES, GOLF APPAREL AND GOLF FOOTWEAR (U.S. CLS. 100, 101 AND 102).

### CLASS 41—EDUCATION AND ENTERTAINMENT

FOR GOLF INSTRUCTION SERVICES (U.S. CLS. 100, 101 AND 107).  
LIEF MARTIN, EXAMINING ATTORNEY

SN 85-293,160. COMMODITY AND INGREDIENT HEDGING, LLC, CHICAGO, IL. FILED 4-12-2011.



THE MARK CONSISTS OF THE FOLLOWING: A GLOBE WITH THE CAPITALIZED LETTERS "CIH" UNDERNEATH, AND A SHADED BLOCK BEHIND ALL OF THE LETTER "C" AND HALF OF THE LETTER "I", AND A LIGHTER SHADED BLOCK BEHIND HALF OF THE LETTER "I" AND ALL OF THE LETTER "H", WITH THE GLOBE FORMING THE DOT OVER THE LETTER "I". THE BLACK REPRESENTS SHADING AND THE WHITE LETTERS REPRESENT TRANSPARENT AREAS AND ARE NOT CLAIMED AS FEATURES OF THE MARK.

#### CLASS 36—INSURANCE AND FINANCIAL

FOR COMMODITY INVESTMENT ADVICE; FINANCIAL CONSULTING AND ADVISORY SERVICES IN THE FIELD OF COMMODITY PURCHASING AND SELLING FOR INDIVIDUALS AND BUSINESSES, NAMELY, ADVISING INDIVIDUALS AND BUSINESSES ON ISSUES OF ESTABLISHING A COMMODITY HEDGE PROGRAM, HEDGE STRATEGIES, EVALUATION OF COMMODITY MARKET EXPOSURE, AND COMMODITY RISK ANALYSIS (U.S. CLS. 100, 101 AND 102).

FIRST USE 12-31-2000; IN COMMERCE 12-31-2000.

#### CLASS 41—EDUCATION AND ENTERTAINMENT

FOR NON-DOWNLOADABLE ELECTRONIC NEWSLETTERS DELIVERED BY E-MAIL IN THE FIELD OF COMMODITY PURCHASING AND SELLING, NAMELY, EDUCATING BUSINESSES AND INDIVIDUALS ON ISSUES OF ESTABLISHING A COMMODITY HEDGE PROGRAM, HEDGE STRATEGIES, EVALUATION OF COMMODITY MARKET EXPOSURE, AND COMMODITY RISK ANALYSIS; EDUCATIONAL SERVICES, NAMELY, CONDUCTING SEMINARS AND CONFERENCES IN THE FIELD OF COMMODITY PURCHASING AND SELLING, NAMELY, EDUCATING BUSINESSES AND INDIVIDUALS ON ISSUES OF ESTABLISHING A COMMODITY HEDGE PROGRAM, HEDGE STRATEGIES, AND EVALUATION OF COMMODITY MARKET EXPOSURE, COMMODITY RISK ANALYSIS AND DISTRIBUTION OF PRINTED MATERIALS IN CONNECTION THEREWITH IN HARD COPY OR ELECTRONIC FORMAT ON THE SAME TOPICS; PROVIDING LIVE AND ON-LINE SEMINARS AND CONFERENCES IN THE FIELD OF COMMODITY PURCHASING AND SELLING, NAMELY, EDUCATING BUSINESSES AND INDIVIDUALS ON ISSUES OF ESTABLISHING A COMMODITY HEDGE PROGRAM, HEDGE STRATEGIES, EVALUATION OF COMMODITY MARKET EXPOSURE, AND COMMODITY RISK ANALYSIS; PROVIDING ON-LINE NON-DOWNLOADABLE REPORTS VIA E-MAIL IN THE FIELD OF COMMODITY PURCHASING AND SELLING, NAMELY, EDUCATING BUSINESSES AND INDIVIDUALS ON ISSUES OF ESTABLISHING A COMMODITY HEDGE PROGRAM, HEDGE STRATEGIES, EVALUATION OF COMMODITY MARKET EXPOSURE, AND COMMODITY RISK (U.S. CLS. 100, 101 AND 107).

FIRST USE 12-31-2000; IN COMMERCE 12-31-2000.

#### CLASS 42—SCIENTIFIC AND COMPUTER SERVICES

FOR PROVIDING A WEBSITE TO SUBSCRIBING USERS FEATURING TEMPORARY USE OF NON-DOWNLOADABLE SOFTWARE FOR COMMODITY MARGIN MANAGEMENT, TRACKING OF COMMODITY PURCHASES, AND COMMODITY AND INGREDIENT HEDGING SERVICES; PROVIDING TEMPORARY USE OF ON-LINE NON-DOWNLOADABLE SOFTWARE FOR THE MANAGEMENT OF COMMODITY MARGIN MANAGEMENT, TRACKING OF COMMODITY PURCHASES AND COMMODITY AND INGREDIENT HEDGING SERVICES (U.S. CLS. 100 AND 101).

FIRST USE 12-31-2000; IN COMMERCE 12-31-2000.

JASON TURNER, EXAMINING ATTORNEY

SN 85-293,568. HERRERA, MISHEL, BROOKLYN, NY. FILED 4-13-2011.



THE MARK CONSISTS OF A SKETCH OF A CURVY WOMAN IN A ONE-PIECE BATHING SUIT FACING LEFT (IF TAKING THE WOMAN'S PERSPECTIVE), EXTENDING HER KNEES TO THE LEFT, FLEXING HER HIPS TO THE LEFT, SWINGING HER ARMS BACK TO THE RIGHT (THOUGH ONE ONLY SEES HER RIGHT ARM), AND TUCKING HER CHIN AGAINST HER UPPER CHEST - WITH THE STYLIZED WORDS "LA DEA VITA" IN ALL CAPITALS BELOW THE SKETCH OF THE WOMAN.

THE ENGLISH TRANSLATION OF THE WORDS "LA DEA VITA" IN THE MARK IS "THE GODDESS LIFE".

#### CLASS 25—CLOTHING

FOR FASHIONABLE ATHLETIC APPAREL FOR WOMEN, NAMELY, T-SHIRTS, SWEATSHIRTS, SHORT-SLEEVE SHIRTS, LONG-SLEEVE SHIRTS, TIGHTS, LEOTARDS, UNITARDS, YOGA PANTS, SHORTS, RUNNING PANTS, TANK-TOPS, SPORTS BRAS, BATHING SUITS, BIKINIS, WRIST BANDS, HEAD BANDS, SWEATSHIRTS, ATHLETIC SOCKS, AND DANCE SLIPPERS (U.S. CLS. 22 AND 39).

FIRST USE 2-2-2011; IN COMMERCE 2-2-2011.

#### CLASS 35—ADVERTISING AND BUSINESS

FOR ONLINE RETAIL STORE SERVICES FEATURING FASHIONABLE ATHLETIC APPAREL FOR WOMEN (U.S. CLS. 100, 101 AND 102).

FIRST USE 2-2-2011; IN COMMERCE 2-2-2011.

KEVIN DINALLO, EXAMINING ATTORNEY

SN 85-294,475. MED PRIDE HEALTH CORP., NEW YORK, NY. FILED 4-13-2011.

SN 85-295,293. TEDESCHI FOOD SHOPS, INC., ROCKLAND, MA. FILED 4-14-2011.



NO CLAIM IS MADE TO THE EXCLUSIVE RIGHT TO USE "MED", APART FROM THE MARK AS SHOWN. THE MARK CONSISTS OF THE WORD "MEDPRIDE" WITH THE "I" IN THE SHAPE OF A CADUCEUS.

#### CLASS 10—MEDICAL APPARATUS

FOR SURGICAL GLOVES, SURGICAL SCRUB SUITS, SURGICAL SCRUB TOPS, SURGICAL MASKS, SURGICAL CAPS, SURGICAL GOWNS, AND SURGICAL SHOE COVERS (U.S. CLS. 26, 39 AND 44).  
FIRST USE 12-31-2002; IN COMMERCE 12-31-2002.

#### CLASS 16—PAPER GOODS AND PRINTED MATTER

FOR FACIAL TISSUES (U.S. CLS. 2, 5, 22, 23, 29, 37, 38 AND 50).  
FIRST USE 12-31-2002; IN COMMERCE 12-31-2002.  
MARK T. MULLEN, EXAMINING ATTORNEY

SN 85-294,543. SUPREME BIOTECHNOLOGIES LIMITED, LONDON NW3 2TB, UNITED KINGDOM, FILED 4-13-2011.

# AstaSupreme

THE MARK CONSISTS OF STANDARD CHARACTERS WITHOUT CLAIM TO ANY PARTICULAR FONT, STYLE, SIZE, OR COLOR.  
OWNER OF NEW ZEALAND REG. NO. 820538, DATED 3-5-2010, EXPIRES 3-5-2020.

#### CLASS 5—PHARMACEUTICALS

FOR DIETARY SUPPLEMENTS; INGREDIENTS FOR DIETARY SUPPLEMENTS SOLD AS AN INTEGRAL INGREDIENT OF DIETARY SUPPLEMENTS (U.S. CLS. 6, 18, 44, 46, 51 AND 52).

#### CLASS 29—MEATS AND PROCESSED FOODS

FOR ALGAE FOR HUMAN CONSUMPTION; DRIED EDIBLE ALGAE (U.S. CL. 46).

#### CLASS 40—MATERIAL TREATMENT

FOR CUSTOM MANUFACTURE OF DIETARY SUPPLEMENTS AND INGREDIENTS FOR THESE (U.S. CLS. 100, 103 AND 106).  
HANNO RITTNER, EXAMINING ATTORNEY

## TD'S FARMER'S MARKET

THE MARK CONSISTS OF STANDARD CHARACTERS WITHOUT CLAIM TO ANY PARTICULAR FONT, STYLE, SIZE, OR COLOR.

NO CLAIM IS MADE TO THE EXCLUSIVE RIGHT TO USE "FARMER'S MARKET", APART FROM THE MARK AS SHOWN.

#### CLASS 31—NATURAL AGRICULTURAL PRODUCTS

FOR FRESH FRUIT AND VEGETABLES (U.S. CLS. 1 AND 46).

#### CLASS 35—ADVERTISING AND BUSINESS

FOR RETAIL FRUIT AND VEGETABLE STANDS; RETAIL CONVENIENCE STORES FEATURING FRESH PRODUCE AND FRESH PRODUCE STANDS; FRANCHISE SERVICES, NAMELY, OFFERING BUSINESS MANAGEMENT ASSISTANCE IN THE ESTABLISHMENT AND OPERATION OF RETAIL FRUIT AND VEGETABLE STANDS WITHIN RETAIL CONVENIENCE STORES (U.S. CLS. 100, 101 AND 102).  
WON TEAK OH, EXAMINING ATTORNEY

SN 85-295,736. INNOCENTIVE, INC., WALTHAM, MA. FILED 4-14-2011.

## CHALLENGE DRIVEN INNOVATION

THE MARK CONSISTS OF STANDARD CHARACTERS WITHOUT CLAIM TO ANY PARTICULAR FONT, STYLE, SIZE, OR COLOR.

#### CLASS 35—ADVERTISING AND BUSINESS

FOR BUSINESS CONSULTING AND ADVISORY SERVICES; PROVIDING A SECURE WEBSITE FOR BUSINESS PURPOSES FOR REGISTERED USERS WITHIN A CLIENT ORGANIZATION TO POST SCIENTIFIC, TECHNICAL AND BUSINESS CHALLENGES, COLLABORATE AND PROPOSE SOLUTIONS, AND PROVIDE FEEDBACK AND RECOMMENDATIONS FOR SOLUTIONS FOR OTHERS (U.S. CLS. 100, 101 AND 102).

**CLASS 42—SCIENTIFIC AND COMPUTER SERVICES**

FOR DESIGNING, CREATING, MAINTAINING AND HOSTING A SECURE WEB SITE FOR REGISTERED USERS WITHIN A CLIENT ORGANIZATION TO POST SCIENTIFIC, TECHNICAL AND BUSINESS CHALLENGES, COLLABORATE AND PROPOSE SOLUTIONS, AND PROVIDE FEEDBACK AND RECOMMENDATIONS FOR SOLUTIONS FOR OTHERS; PROVIDING DATA MIGRATION SERVICES FOR CLIENT CHALLENGES IN THE NATURE OF PROVIDING TECHNICAL ADVICE TO USERS REGARDING THE POSTING OF SCIENTIFIC, TECHNICAL AND BUSINESS CHALLENGES ON AN ONLINE INTERACTIVE EXCHANGE THAT IS ACCESSIBLE TO A NETWORK OF USERS (U.S. CLS. 100 AND 101).

GRETTA YAO, EXAMINING ATTORNEY

SN 85-296,637. FAVORHOOD, INC., SAN DIEGO, CA. FILED 4-15-2011.

**FAVORHOOD**

THE MARK CONSISTS OF STANDARD CHARACTERS WITHOUT CLAIM TO ANY PARTICULAR FONT, STYLE, SIZE, OR COLOR.

**CLASS 35—ADVERTISING AND BUSINESS**

FOR PROVIDING A WEBSITE FEATURING AN ONLINE MARKETPLACE FOR SERVICES WITH OTHER REGISTERED USERS, FOR WHICH A USER CAN REQUEST AND PERFORM FAVORS FOR OTHERS IN THE NATURE OF EXCHANGING GOODS AND SERVICES WITH OTHER USERS (U.S. CLS. 100, 101 AND 102).

**CLASS 45—PERSONAL AND LEGAL SERVICES**

FOR PROVIDING AN INTERNET BASED SOCIAL NETWORKING WEBSITE (U.S. CLS. 100 AND 101).

EMILY CARLSEN, EXAMINING ATTORNEY

SN 85-296,517. TOOLSELECT.COM, GRAND RAPIDS, MI. FILED 4-15-2011.



THE MARK CONSISTS OF A RIGHT HAND, PARTICULARLY THE RIGHT INDEX FINGER, CLICKING A BUTTON TO MAKE A SELECTION. TO THE RIGHT THERE IS THE STYLIZED TEXT "TOOLSELECT.COM REAL STATS. REAL PEOPLE. REAL EASY."

**CLASS 35—ADVERTISING AND BUSINESS**

FOR BUSINESS INFORMATION AND COMMERCIAL BUSINESS INFORMATION ON GLOBAL AND LOCAL NETWORKS FOR PRICE AND PRODUCT COMPARISONS; COMPILATION AND SYSTEMATISATION OF INFORMATION ABOUT PRODUCTS AND SERVICES ON-LINE AND IN DATABASES; PROVIDING PRICE AND PRODUCT INFORMATION, PRICE COMPARISONS AND OTHER INFORMATION RELEVANT TO CONSUMERS OR COMPANIES WHEN MAKING PURCHASE DECISIONS; PROVIDING AN ON-LINE ADVERTISING SPACE FOR THE ADVERTISING OF PRODUCTS AND SERVICES; BUSINESS RESEARCH AND MARKET RESEARCH; CARRYING OUT BUSINESS AND MARKET REPORTS AND STATISTICS; CARRYING OUT BUSINESS INQUIRIES ON-LINE AND COLLECTION OF STATISTICS FOR THE COMPILATION OF REPORTS AND ARTICLES; PROVIDING AN ON-LINE MARKETPLACE TO CONTRIBUTE TO COMMERCIAL TRANSACTIONS BETWEEN DIFFERENT OPERATORS IN THE SALE OF PRODUCTS AND SERVICES (U.S. CLS. 100, 101 AND 102).

**CLASS 38—COMMUNICATION**

FOR PROVIDING AN ON-LINE FORUM FOR COMPARING AND OBTAINING PRICE AND PRODUCT INFORMATION, PRICE COMPARISONS AND OTHER INFORMATION RELEVANT TO CONSUMERS OR COMPANIES WHEN MAKING PURCHASE DECISIONS (U.S. CLS. 100, 101 AND 104).

PAM WILLIS, EXAMINING ATTORNEY

SN 85-296,710. SONIA KASHUK, INC., NEW YORK, NY. FILED 4-15-2011.

**SONIA KASHUK**

THE MARK CONSISTS OF STANDARD CHARACTERS WITHOUT CLAIM TO ANY PARTICULAR FONT, STYLE, SIZE, OR COLOR.

OWNER OF U.S. REG. NO. 3,019,102.

THE NAME(S), PORTRAIT(S), AND/OR SIGNATURE(S) SHOWN IN THE MARK IDENTIFIES "SONIA KASHUK", WHOSE CONSENT(S) TO REGISTER IS MADE OF RECORD.

**CLASS 3—COSMETICS AND CLEANING PREPARATIONS**

FOR MAKE-UP POWDER; BLUSH; COSMETICS; COSMETICS, NAMELY, CONCEALERS, COMPACTS, FOUNDATION, EYEBROW PENCILS; EYE CREAM; EYE MAKEUP; EYE MAKEUP REMOVER; EYE PENCILS; EYE SHADOW; FACE CREAMS; FACE POWDER; FACIAL MAKEUP; FOUNDATION MAKEUP; LIP BALM; LIP CREAM; LIP GLOSS; LIP GLOSS PALETTE; LIP LINER; MAKEUP; MAKEUP KITS COMPRISED OF FACIAL MAKEUP; MAKEUP KITS COMPRISED OF EYE MAKEUP; MAKEUP KITS COMPRISED OF LIP MAKEUP; MASCARA; NAIL ENAMELS; NAIL POLISH; POWDER; NON-MEDICATED LIP CARE PREPARATIONS; NON-MEDICATED LIP PROTECTOR; POMADES FOR LIPS; SKIN MOISTURIZER; MAKEUP BLOTTER PAPERS (U.S. CLS. 1, 4, 6, 50, 51 AND 52).

FIRST USE 12-31-1999; IN COMMERCE 12-31-1999.

**CLASS 8—HAND TOOLS**

FOR EYELASH CURLERS; EYELASH SEPARATORS; TWEEZERS (U.S. CLS. 23, 28 AND 44).

FIRST USE 12-31-1999; IN COMMERCE 12-31-1999.

**CLASS 18—LEATHER GOODS**

FOR COSMETIC CASES SOLD EMPTY; COSMETIC BAGS SOLD EMPTY (U.S. CLS. 1, 2, 3, 22 AND 41).  
FIRST USE 12-31-1999; IN COMMERCE 12-31-1999.

**CLASS 21—HOUSEWARES AND GLASS**

FOR APPLICATOR STICKS FOR APPLYING MAKEUP; COSMETIC BRUSHES; EYEBROW BRUSHES (U.S. CLS. 2, 13, 23, 29, 30, 33, 40 AND 50).  
FIRST USE 12-31-1999; IN COMMERCE 12-31-1999.

**CLASS 24—FABRICS**

FOR CLOTH NAPKINS FOR REMOVING MAKEUP; TEXTILE NAPKINS FOR REMOVING MAKEUP (U.S. CLS. 42 AND 50).  
FIRST USE 12-31-1999; IN COMMERCE 12-31-1999.

**CLASS 44—MEDICAL, BEAUTY AND AGRICULTURAL SERVICES**

FOR COSMETICIAN AND MAKEUP ARTIST SERVICES; PROVIDING INFORMATION IN THE FIELD OF COSMETICS ANALYSIS; PROVIDING INFORMATION IN THE FIELD OF MAKE-UP APPLICATION AND ARTISTRY (U.S. CLS. 100 AND 101).  
FIRST USE 12-31-1982; IN COMMERCE 12-31-1982.  
CHRISTINE COOPER, EXAMINING ATTORNEY

---

SN 85-296,715. AUTHENTEC, INC., MELBOURNE, FL.  
FILED 4-15-2011.

**FIDO**

THE MARK CONSISTS OF STANDARD CHARACTERS WITHOUT CLAIM TO ANY PARTICULAR FONT, STYLE, SIZE, OR COLOR.

**CLASS 42—SCIENTIFIC AND COMPUTER SERVICES**

FOR DESIGNING AND DEVELOPING FOR OTHERS SECURE SOFTWARE APPLICATIONS, NAMELY, DESIGNING COMPUTER SOFTWARE WITH SECURITY FEATURES; CONSULTING PROVIDED TO BUSINESSES, GOVERNMENTS AND OTHER ORGANIZATIONS IN THE AREA OF TECHNICAL SOFTWARE AND NETWORK SECURITY REQUIREMENTS AND PROVIDING SECURITY ASSURANCE IN THE FORM OF TESTING TO DETERMINE WHETHER SOFTWARE APPLICATIONS MEET TECHNICAL SECURITY OBJECTIVES; PROVIDING MAINTENANCE AND SUPPORT FOR COMPUTER SOFTWARE SECURITY PRODUCTS, NAMELY, MAINTENANCE AND UPDATING OF COMPUTER SOFTWARE RELATING TO COMPUTER SECURITY AND PREVENTION OF COMPUTER RISKS (U.S. CLS. 100 AND 101).

**CLASS 45—PERSONAL AND LEGAL SERVICES**

FOR PROVIDING USER AUTHENTICATION SERVICES IN E-COMMERCE TRANSACTIONS, NAMELY, PROVIDING A SECURE BINDING PROCESS FROM A USER DEVICE TO A SERVER BACKEND FOR ASSURED USER AUTHENTICATION (U.S. CLS. 100 AND 101).  
ANDREA HACK, EXAMINING ATTORNEY

SN 85-297,595. THE MINNESOTA ELK BREEDERS ASSOCIATION, INC., HOWARD LAKE, MN. FILED 4-18-2011.



NO CLAIM IS MADE TO THE EXCLUSIVE RIGHT TO USE "MNElk", APART FROM THE MARK AS SHOWN.

THE MARK CONSISTS OF AN IMAGE OF AN ELK, A PORTION OF WHICH IS WHITE WITH A BLACK BACKGROUND AND A PORTION IS BLACK WITH A WHITE BACKGROUND. THE WORDS "MNElk" WITH "MN" IN A BOLD FONT AND "ELK" BEING IN DIFFERENT LESS BOLD FONT.

**CLASS 5—PHARMACEUTICALS**

FOR DIETARY SUPPLEMENTS FOR ANIMALS AND HUMANS CONTAINING VELVET ANTLER, NAMELY, ELK VELVET ANTLER; DIETARY SUPPLEMENTS FOR ANIMALS AND HUMANS FOR TREATING PAIN ASSOCIATED WITH ARTHRITIS, JOINT PAIN AND JOINT STIFFNESS CONTAINING VELVET ANTLER, NAMELY, ELK VELVET ANTLER (U.S. CLS. 6, 18, 44, 46, 51 AND 52).  
FIRST USE 5-19-2010; IN COMMERCE 3-25-2011.

**CLASS 29—MEATS AND PROCESSED FOODS**

FOR ELK MEAT; MEAT FROM HUMANELY TREATED ELK (U.S. CL. 46).  
FIRST USE 5-19-2010; IN COMMERCE 12-14-2010.  
ALLISON HOLTZ, EXAMINING ATTORNEY

---

SN 85-298,607. T-MOBILE USA, INC., BELLEVUE, WA.  
FILED 4-19-2011.



THE COLOR(S) MAGENTA AND CHARCOAL GRAY IS/ ARE CLAIMED AS A FEATURE OF THE MARK.

THE MARK CONSISTS OF A BOBSLEDDER, PRESENTED PREDOMINANTLY IN MAGENTA WITH A HELMET VISOR PRESENTED IN CHARCOAL GRAY, IN SLIGHTLY CROUCHED POSITION TO THE LEFT OF THE DESIGN, WHO IS GRASPING A SLIGHTLY ITALICIZED LOWER CASE LETTER "b" PRESENTED IN CHARCOAL GRAY.

**CLASS 9—ELECTRICAL AND SCIENTIFIC APPARATUS**

FOR DOWNLOADABLE SOFTWARE THAT ENABLES IP-BASED VOICE COMMUNICATIONS AMONG COMPUTERS; DOWNLOADABLE SOFTWARE THAT ENABLES THE CREATION, TRANSMISSION AND RECEIPT OF TEXT MESSAGES AND AUDIO MESSAGES AMONG COMPUTERS; DOWNLOADABLE SOFTWARE THAT SYNCHRONIZES TEXT MESSAGES AND ADDRESS BOOK INFORMATION AMONG COMPUTERS, MOBILE COMMUNICATIONS DEVICES AND CLOUD-BASED DATABASES (U.S. CLS. 21, 23, 26, 36 AND 38).

**CLASS 38—COMMUNICATION**

FOR TELECOMMUNICATIONS SERVICES, NAMELY, ELECTRONIC TRANSMISSION OF IP-BASED AUDIO COMMUNICATIONS AMONG COMPUTERS; ELECTRONIC TRANSMISSION OF DATA CONSISTING OF TEXT AND AUDIO CONTENT; IP-BASED TEXT AND VOICE COMMUNICATIONS SERVICES, NAMELY, WIRELESS DIGITAL TEXT MESSAGING AND AUDIO MESSAGING SERVICES AMONG COMPUTERS (U.S. CLS. 100, 101 AND 104).

**CLASS 42—SCIENTIFIC AND COMPUTER SERVICES**

FOR PROVIDING TEMPORARY USE OF ONLINE, NON-DOWNLOADABLE SOFTWARE THAT ALLOWS USERS TO UTILIZE IP-BASED VOICE COMMUNICATIONS SERVICES AMONG COMPUTERS; PROVIDING TEMPORARY USE OF ONLINE, NON-DOWNLOADABLE SOFTWARE THAT ENABLES THE CREATION, TRANSMISSION AND RECEIPT OF TEXT MESSAGES AND AUDIO MESSAGES AMONG COMPUTERS; ASP SERVICES IN THE NATURE OF HOSTING, MAINTAINING AND SYNCHRONIZING DATABASES CONSISTING OF TEXT MESSAGES ADDRESS BOOK INFORMATION AMONG COMPUTERS AND MOBILE COMMUNICATIONS DEVICES (U.S. CLS. 100 AND 101).  
TRACY FLETCHER, EXAMINING ATTORNEY

SN 85-298,711. PREFCO CORP., HOUSTON, TX. FILED 4-19-2011.



OWNER OF U.S. REG. NOS. 2,064,470 AND 2,459,977.  
NO CLAIM IS MADE TO THE EXCLUSIVE RIGHT TO USE "BRAND" "SINCE 1946" AND THE PICTORIAL REPRESENTATION OF THE STATE OF TEXAS, APART FROM THE MARK AS SHOWN.

THE MARK CONSISTS OF A STYLIZED REPRESENTATION OF A RIBBON WITH THE WORDS "BLUE RIBBON" APPEARING IN THE MIDDLE OF THE RIBBON; TO THE RIGHT OF THE WORD "RIBBON" APPEARS THE WORD "BRAND" IN SMALLER FONT; A CURVY BAR APPEARS BELOW THE WORDING "RIBBON" AND TO THE RIGHT OF THE WORDS "BLUE RIBBON" APPEARS A DESIGN IN THE SHAPE OF THE STATE OF TEXAS WITH THE WORDS "SINCE 1946" IN THE MIDDLE OF THE DESIGN.

**CLASS 29—MEATS AND PROCESSED FOODS**

FOR SAUSAGE, BACON AND SALT PORK (U.S. CL. 46).  
FIRST USE 0-0-2008; IN COMMERCE 0-0-2008.

**CLASS 30—STAPLE FOODS**

FOR PRE-PACKAGED MEALS CONSISTING PRIMARILY OF BREAKFAST SANDWICHES WITH BACON OR SAUSAGE; SAUSAGE KOLACHES (U.S. CL. 46).  
FIRST USE 0-0-2008; IN COMMERCE 0-0-2008.  
JENNY PARK, EXAMINING ATTORNEY

SN 85-298,863. BACARDI & COMPANY LIMITED, VADUZ, LIECHTENSTEIN, FILED 4-19-2011.

**TRUE ORIGINALS**

THE MARK CONSISTS OF STANDARD CHARACTERS WITHOUT CLAIM TO ANY PARTICULAR FONT, STYLE, SIZE, OR COLOR.

NO CLAIM IS MADE TO THE EXCLUSIVE RIGHT TO USE "ORIGINALS", APART FROM THE MARK AS SHOWN.

**CLASS 33—WINES AND SPIRITS**

FOR RUM, RUM-BASED BEVERAGES, FLAVORED RUMS, COCKTAILS FLAVORED WITH RUM (U.S. CLS. 47 AND 49).

**CLASS 38—COMMUNICATION**

FOR EDUCATION SERVICES, NAMELY, PROVIDING ON-LINE FORUMS IN THE FIELD OF BARTENDING, BARTENDING TRENDS, BARTENDING TECHNIQUES, COCKTAIL RECIPES, AND BARTENDING AND ALCOHOL BEVERAGE HISTORY (U.S. CLS. 100, 101 AND 104).

**CLASS 42—SCIENTIFIC AND COMPUTER SERVICES**

FOR COMPUTER SERVICES, NAMELY, CREATING AN ON-LINE COMMUNITY FOR REGISTERED USERS TO PARTICIPATE IN DISCUSSIONS, GET FEEDBACK FROM THEIR PEERS, FORM VIRTUAL COMMUNITIES, UPLOAD CONTENT IN THE FORM OF DEMONSTRATIONS AND ADVICE, AND ENGAGE IN SOCIAL NETWORKING, ALL FEATURING BARTENDING (U.S. CLS. 100 AND 101).  
KEVIN DINALLO, EXAMINING ATTORNEY

SN 85-299,238. PULSAR INVESTMENT HOLDINGS LIMITED, GENEVA, SWITZERLAND, FILED 4-19-2011.

**ICONICAL**

THE MARK CONSISTS OF STANDARD CHARACTERS WITHOUT CLAIM TO ANY PARTICULAR FONT, STYLE, SIZE, OR COLOR.

**CLASS 35—ADVERTISING AND BUSINESS**

FOR BUSINESS MANAGEMENT SERVICES; BUSINESS MANAGEMENT CONSULTANCY SERVICES; BUSINESS ADMINISTRATION CONSULTANCY; BUSINESS OFFICE FUNCTIONS; ADVICE RELATING TO THE ORGANIZATION AND MANAGEMENT OF BUSINESS; ADMINISTRATION OF BUSINESS AFFAIRS, NAMELY, HELP IN THE MANAGEMENT OF BUSINESS AFFAIRS OR COMMERCIAL FUNCTIONS OF AN INDUSTRIAL OR COMMERCIAL ENTERPRISE; ADVISORY SERVICES RELATING TO BUSINESS MANAGEMENT AND ORGANIZATION; ADVISORY SERVICES RELATING TO THE ACQUISITION OF BUSINESSES; BUSINESS ADVICE; BUSINESS ASSISTANCE RELATING TO THE FORMATION OF COMMERCIAL UNDERTAKINGS; BUSINESS CONSULTING AND INFORMATION SERVICES; BUSINESS RESEARCH AND LEADERSHIP DEVELOPMENT SERVICES; MARKETING SERVICES, NAMELY, PROMOTING THE GOODS AND SERVICES OF OTHERS; MARKETING CONSULTANCY SERVICES; ADVERTISING SERVICES; ADVERTISING CONSULTANCY SERVICES; EMPLOYMENT RECRUITMENT SERVICES; EMPLOYMENT AGENCY SERVICES; BUSINESS INFORMATION, ADVISORY AND CONSULTANCY SERVICES, ALL RELATING TO THE AFORESAID SERVICES (U.S. CLS. 100, 101 AND 102).

**CLASS 36—INSURANCE AND FINANCIAL**

FOR FINANCIAL SERVICES, NAMELY, BANKING, INVESTMENTS IN SECURITIES AND FINANCING SERVICES; FINANCIAL ANALYSIS AND RESEARCH SERVICES; BUSINESS FINANCE PROCUREMENT SERVICES; CORPORATE FINANCE SERVICES, NAMELY, CONSULTATION IN THE FIELDS OF ASSET SALES AND CAPITAL STRUCTURE; FINANCIAL SERVICES, NAMELY, ASSISTING OTHERS WITH THE COMPLETION OF FINANCIAL TRANSACTIONS FOR STOCKS, BONDS, SECURITIES AND EQUITIES; CAPITAL INVESTMENT SERVICES; FINANCIAL ADVICE; MONETARY AFFAIRS, NAMELY, ACQUISITION AND TRANSFER OF MONETARY CLAIMS; ASSESSMENT AND MANAGEMENT OF REAL ESTATE; VENTURE CAPITAL SERVICES, NAMELY, PROVIDING FINANCING TO EMERGING AND START-UP COMPANIES; VENTURE CAPITAL MANAGEMENT SERVICES, NAMELY, MANAGEMENT OF A VENTURE CAPITAL INVESTMENT FUND; INVESTMENT MANAGEMENT SERVICES IN THE FIELD OF ACQUIRING JOINT VENTURES; PROVIDING WORKING CAPITAL FINANCING TO SMALL BUSINESSES AND SMALL BUSINESS OWNERS; PROJECT CAPITAL INVESTMENT SERVICES; ADMINISTRATION OF FINANCIAL AFFAIRS, NAMELY, ADMINISTRATION OF TRANSACTIONS INVOLVING FUNDS DRAWN FROM SECURITIES, STOCKS, FUNDS, EQUITIES, BONDS, CASH, OR OTHER TYPES OF FINANCIAL INVESTMENTS IN RETIREMENT PLANS USING A CHECK OR NEGOTIABLE ORDER OF WITHDRAWAL OVER A GLOBAL DATA NETWORK; FINANCIAL CONSULTING SERVICES; FINANCIAL ADVISORY AND CONSULTANCY SERVICES; FINANCIAL ASSET MANAGEMENT SERVICES, INVESTMENT MANAGEMENT SERVICES AND INVESTMENT ADVISORY SERVICES; PRIVATE EQUITY FUND SERVICES, NAMELY, MANAGEMENT OF PRIVATE EQUITY FUNDS AND PRIVATE EQUITY FUND INVESTMENT SERVICES; HEDGE FUND INVESTMENT SERVICES; REAL ESTATE INVESTMENT SERVICES; OPERATION AND MANAGEMENT OF INVESTMENT FUNDS; FINANCIAL INVESTMENT ADVISORY SERVICES IN THE FIELD OF VENTURE CAPITAL, CROSS-OVER FUNDS, MUTUAL FUNDS, PRIVATE EQUITY FUNDS; FINANCIAL ANALYSIS AND CONSULTATION; FINANCIAL INVESTMENT SERVICES IN THE FIELD OF DERIVATIVES, INVESTMENT BANKING AND FUNDS; INFORMATION, ADVISORY AND CONSULTANCY SERVICES, ALL RELATING TO THE AFORESAID SERVICES (U.S. CLS. 100, 101 AND 102).

JENNY PARK, EXAMINING ATTORNEY

SN 85-299,761. NGL ENERGY PARTNERS LP, TULSA, OK. FILED 4-20-2011.



NO CLAIM IS MADE TO THE EXCLUSIVE RIGHT TO USE "ENERGY PARTNERS LP", APART FROM THE MARK AS SHOWN.

THE MARK CONSISTS OF THE LETTER "G" BETWEEN THE LETTERS "N" AND "L" WITH THE LETTER "G" HAVING LATITUDE AND LONGITUDE LINES, AND WITH "ENERGY PARTNERS LP" BENEATH THE "NGL".

**CLASS 4—LUBRICANTS AND FUELS**

FOR NATURAL GAS LIQUIDS, NAMELY, PROPANE, BUTANE, ISO BUTANE AND NATURAL GASOLINE (U.S. CLS. 1, 6 AND 15).

**CLASS 39—TRANSPORTATION AND STORAGE**

FOR STORAGE, DISTRIBUTION AND TRANSPORTATION OF NATURAL GAS LIQUIDS, NAMELY, PROPANE, BUTANE, ISO BUTANE AND NATURAL GASOLINE (U.S. CLS. 100 AND 105).

CHRISTOPHER BUONGIORNO, EXAMINING ATTORNEY

SN 85-300,100. KARDIN SYSTEMS, INC., BENICIA, CA. FILED 4-20-2011.

**Kardin**

THE MARK CONSISTS OF STANDARD CHARACTERS WITHOUT CLAIM TO ANY PARTICULAR FONT, STYLE, SIZE, OR COLOR.

**CLASS 9—ELECTRICAL AND SCIENTIFIC APPARATUS**

FOR DOWNLOADABLE COMPUTER SOFTWARE FOR FINANCIAL ANALYSIS, BUDGETING, FORECASTING, AND FOR CONTROLLING AND MANAGING INFORMATION IN THE FIELDS OF LEASE ADMINISTRATION, PROPERTY MANAGEMENT AND ASSET MANAGEMENT (U.S. CLS. 21, 23, 26, 36 AND 38).

FIRST USE 10-3-1996; IN COMMERCE 10-3-1996.

**CLASS 42—SCIENTIFIC AND COMPUTER SERVICES**

FOR CONSULTING IN THE FIELD OF SOFTWARE AND PRODUCT DEVELOPMENT IN THE FIELD OF DATABASE DEVELOPMENT, ASSET MANAGEMENT AND PROPERTY MANAGEMENT (U.S. CLS. 100 AND 101).

FIRST USE 10-3-1996; IN COMMERCE 10-3-1996.



TARA PATE, EXAMINING ATTORNEY

SN 85-300,464. BENTLEY 3 TECHNOLOGIES, INC., ENCINITAS, CA. FILED 4-20-2011.

SN 85-300,105. ASAHI KASEI E-MATERIALS CORPORATION, TOKYO 101-8101, JAPAN, FILED 4-20-2011.

# AFP

THE MARK CONSISTS OF STANDARD CHARACTERS WITHOUT CLAIM TO ANY PARTICULAR FONT, STYLE, SIZE, OR COLOR.

## CLASS 1—CHEMICALS

FOR PHOTSENSITIVE SYNTHETIC RESIN FOR PRINTING, PHOTOGRAPHIC CHEMICALS, PHOTOGRAPHIC DRY PLATES, PHOTOGRAPHIC SENSITIZERS, PHOTOGRAPHIC DEVELOPERS, UNEXPOSED PHOTOGRAPHIC FILM (U.S. CLS. 1, 5, 6, 10, 26 AND 46). FIRST USE 8-1-1986; IN COMMERCE 1-1-2000.

## CLASS 7—MACHINERY

FOR EQUIPMENT FOR MAKING PRINTING PLATE OF PHOTOPOLYMER, TYPOGRAPHIC PRINTING PRESSES, FLEXOGRAPHIC PRINTING PRESSES, INTALIO PRINTING MACHINES, PHOTOPOLYMER PLATE FOR PRINTING (U.S. CLS. 13, 19, 21, 23, 31, 34 AND 35). FIRST USE 8-1-1986; IN COMMERCE 1-1-2000. WILLIAM VERHOSEK, EXAMINING ATTORNEY

SN 85-300,144. EAST MEADOW CORP., DBA UNCLE GIUSEPPE'S, FARMINGDALE, NY. FILED 4-20-2011.

# UNCLE GIUSEPPE'S

THE MARK CONSISTS OF STANDARD CHARACTERS WITHOUT CLAIM TO ANY PARTICULAR FONT, STYLE, SIZE, OR COLOR.  
OWNER OF U.S. REG. NO. 2,970,582.

## CLASS 35—ADVERTISING AND BUSINESS

FOR RETAIL BAKE SHOPS; TAKE-OUT BAKERY SERVICES (U.S. CLS. 100, 101 AND 102). FIRST USE 10-0-1999; IN COMMERCE 10-0-1999.

## CLASS 43—HOTEL AND RESTAURANT SERVICES

FOR RESTAURANT SERVICES FEATURING DELICATESSEN SANDWICHES, HOT AND COLD ENTREES, PREPARED FOODS AND PIZZA FOR CONSUMPTION ON OR OFF THE PREMISES (U.S. CLS. 100 AND 101). FIRST USE 10-0-1999; IN COMMERCE 10-0-1999. DAWN HAN, EXAMINING ATTORNEY

# BLAST NUMBER

THE MARK CONSISTS OF STANDARD CHARACTERS WITHOUT CLAIM TO ANY PARTICULAR FONT, STYLE, SIZE, OR COLOR.

## CLASS 35—ADVERTISING AND BUSINESS

FOR COLLECTION AND COMPILATION OF INFORMATION INTO COMPUTER DATABASES IN THE FIELD OF MOTION TRACKING, POSITION AND ORIENTATION SENSING; PROVIDING INFORMATION IN THE FIELD OF THE MOTION TRACKING, POSITION AND ORIENTATION SENSING INDUSTRY (U.S. CLS. 100, 101 AND 102).

## CLASS 41—EDUCATION AND ENTERTAINMENT

FOR COACHING AND INSTRUCTION SERVICES IN THE FIELD OF THE BIOMECHANICS OF GOLF (U.S. CLS. 100, 101 AND 107).  
WON TEAK OH, EXAMINING ATTORNEY

SN 85-300,490. BENTLEY 3 TECHNOLOGIES, INC., ENCINITAS, CA. FILED 4-20-2011.

# BLAST FACTOR

THE MARK CONSISTS OF STANDARD CHARACTERS WITHOUT CLAIM TO ANY PARTICULAR FONT, STYLE, SIZE, OR COLOR.

## CLASS 35—ADVERTISING AND BUSINESS

FOR COLLECTION AND COMPILATION OF INFORMATION INTO COMPUTER DATABASES IN THE FIELD OF MOTION TRACKING, POSITION AND ORIENTATION SENSING; PROVIDING INFORMATION IN THE FIELD OF THE MOTION TRACKING, POSITION AND ORIENTATION SENSING INDUSTRY (U.S. CLS. 100, 101 AND 102).

## CLASS 41—EDUCATION AND ENTERTAINMENT

FOR COACHING AND INSTRUCTION SERVICES IN THE FIELD OF THE BIOMECHANICS OF GOLF (U.S. CLS. 100, 101 AND 107).  
WON TEAK OH, EXAMINING ATTORNEY

SN 85-300,584. GOOGIE GAMES, LLC, SAN FRANCISCO, CA. FILED 4-20-2011.

## GOOGIE GAMES

THE MARK CONSISTS OF STANDARD CHARACTERS WITHOUT CLAIM TO ANY PARTICULAR FONT, STYLE, SIZE, OR COLOR.

NO CLAIM IS MADE TO THE EXCLUSIVE RIGHT TO USE "GAMES", APART FROM THE MARK AS SHOWN.

### CLASS 9—ELECTRICAL AND SCIENTIFIC APPARATUS

FOR DOWNLOADABLE COMPUTER GAMES, EDUCATIONAL SOFTWARE FEATURING INSTRUCTION IN K-12 EDUCATIONAL SUBJECTS AND MOBILE APPLICATIONS, NAMELY, COMPUTER EDUCATIONAL SOFTWARE FOR K-12 INSTRUCTION VIA A GLOBAL COMPUTER NETWORK, WIRELESS DEVICES, DVD AND CD (U.S. CLS. 21, 23, 26, 36 AND 38).

### CLASS 41—EDUCATION AND ENTERTAINMENT

FOR PROVIDING NONDOWNLOADABLE COMPUTER GAMES AND MOBILE APPLICATION GAMES VIA A GLOBAL COMPUTER NETWORK OR WIRELESS DEVICES (U.S. CLS. 100, 101 AND 107).

### CLASS 42—SCIENTIFIC AND COMPUTER SERVICES

FOR PROVIDING NONDOWNLOADABLE EDUCATIONAL SOFTWARE FEATURING INSTRUCTION IN K-12 EDUCATIONAL SUBJECT MATTER VIA A GLOBAL COMPUTER NETWORK OR WIRELESS DEVICES; PROVIDING NONDOWNLOADABLE MOBILE APPLICATIONS, NAMELY COMPUTER EDUCATIONAL SOFTWARE FOR K-12 LEARNING VIA A GLOBAL COMPUTER NETWORK OR WIRELESS DEVICES (U.S. CLS. 100 AND 101).

MATTHEW EINSTEIN, EXAMINING ATTORNEY

SN 85-300,593. ZO SKIN HEALTH, INC., DEL MAR, CA. FILED 4-20-2011.

## ZO RX

THE MARK CONSISTS OF STANDARD CHARACTERS WITHOUT CLAIM TO ANY PARTICULAR FONT, STYLE, SIZE, OR COLOR.

OWNER OF U.S. REG. NOS. 3,443,711 AND 3,443,712.

NO CLAIM IS MADE TO THE EXCLUSIVE RIGHT TO USE "RX", APART FROM THE MARK AS SHOWN.

### CLASS 3—COSMETICS AND CLEANING PREPARATIONS

FOR ANTI-AGING CREAMS; ANTI-WRINKLE CREAMS; COSMETIC CREAMS FOR SKIN CARE; SKIN TONERS; SKIN WHITENING CREAMS (U.S. CLS. 1, 4, 6, 50, 51 AND 52).

### CLASS 5—PHARMACEUTICALS

FOR ACNE MEDICATIONS; MEDICATED CREAMS FOR TREATING DERMATOLOGICAL CONDITIONS (U.S. CLS. 6, 18, 44, 46, 51 AND 52).

ELLEN PERKINS, EXAMINING ATTORNEY

SN 85-301,172. NEXON CORPORATION, SEOUL, REPUBLIC OF KOREA, FILED 4-21-2011.

## WISEKIDS

THE MARK CONSISTS OF STANDARD CHARACTERS WITHOUT CLAIM TO ANY PARTICULAR FONT, STYLE, SIZE, OR COLOR.

### CLASS 9—ELECTRICAL AND SCIENTIFIC APPARATUS

FOR ELECTRONIC DOWNLOADABLE GAME SOFTWARE FOR WIRELESS COMMUNICATION DEVICES, NAMELY, CELLULAR AND MOBILE TELEPHONES, AND HANDHELD ELECTRONIC DEVICES (U.S. CLS. 21, 23, 26, 36 AND 38).

### CLASS 28—TOYS AND SPORTING GOODS

FOR TOYS, NAMELY, HAND HELD UNITS FOR PLAYING VIDEO GAMES OTHER THAN THOSE ADAPTED FOR USE WITH AN EXTERNAL DISPLAY SCREEN OR MONITOR (U.S. CLS. 22, 23, 38 AND 50).

### CLASS 38—COMMUNICATION

FOR MOBILE MEDIA SERVICES IN THE NATURE OF ELECTRONIC TRANSMISSION OF ENTERTAINMENT MEDIA CONTENT TO MOBILE TELEPHONES (U.S. CLS. 100, 101 AND 104).

### CLASS 41—EDUCATION AND ENTERTAINMENT

FOR ENTERTAINMENT SERVICES, NAMELY, PRODUCTION OF ELECTRONIC GAME SOFTWARE FOR WIRELESS COMMUNICATION DEVICES, CELLULAR AND MOBILE TELEPHONES, AND HANDHELD ELECTRONIC DEVICES; ENTERTAINMENT SERVICES, NAMELY, PROVIDING ONLINE ELECTRONIC GAMES TO WIRELESS COMMUNICATION DEVICES, CELLULAR AND MOBILE TELEPHONES, AND HANDHELD ELECTRONIC DEVICES; ENTERTAINMENT SERVICES, NAMELY, PROVIDING ONLINE COMPUTER GAMES (U.S. CLS. 100, 101 AND 107).

TARA PATE, EXAMINING ATTORNEY

SN 85-301,291. JACKSON, ALICE BEST. EVERETT, WA. AND JACKSON, DENNIS ALAN, EVERETT, WA. FILED 4-21-2011.

SN 85-301,410. FBI NATIONAL CITIZENS' ACADEMY ALUMNI ASSOCIATION, INC., KANSAS CITY, MO. FILED 4-21-2011.

## MESSAGES FROM BEYOND

THE MARK CONSISTS OF STANDARD CHARACTERS WITHOUT CLAIM TO ANY PARTICULAR FONT, STYLE, SIZE, OR COLOR.

### CLASS 41—EDUCATION AND ENTERTAINMENT

FOR ARRANGING PROFESSIONAL WORKSHOP AND TRAINING COURSES; CONDUCTING ENTERTAINMENT EXHIBITIONS IN THE NATURE OF PRESENTING PSYCHIC AND MEDIUM READINGS FOR AUDIENCE MEMBERS; CONDUCTING WORKSHOPS AND SEMINARS IN PERSONAL SELF-AWARENESS AND PSYCHIC DEVELOPMENT; EDUCATIONAL AND ENTERTAINMENT SERVICES, NAMELY, CONDUCTING SEMINARS, LECTURES, TELESEMINARS, TELECLASSES, AND WORKSHOPS IN THE FIELD OF PERSONAL AWARENESS AND PSYCHIC DEVELOPMENT AND DISTRIBUTION OF COURSE MATERIALS IN CONNECTION THEREWITH, AND EDUCATION CONSULTING RELATED THERETO; EDUCATIONAL SERVICES, NAMELY, CONDUCTING SEMINARS, LECTURES, TELESEMINARS, TELECLASSES, AND WORKSHOPS IN PERSONAL AWARENESS; ENTERTAINMENT AND EDUCATIONAL SERVICES, NAMELY, THE PRESENTATION OF SEMINARS, LECTURES, WORKSHOPS AND PANEL DISCUSSIONS, AND ONGOING TELEVISION AND RADIO TALK SHOWS ALL IN THE FIELD OF PUBLIC INTEREST CONCERNING THE ASSISTANCE OF INDIVIDUALS WHO ARE GOING THROUGH THE GRIEF PROCESS AFTER LOSING A LOVED ONE; ENTERTAINMENT IN THE NATURE OF LIVE STAGE PERFORMANCES IN THE NATURE OF GIVING PSYCHIC READINGS, ASSISTING GRIEVING INDIVIDUALS, AND LECTURE FOR HIRE IN THE FIELD OF PSYCHIC AND MEDIUM READINGS BY AN INDIVIDUAL; ENTERTAINMENT SERVICES, NAMELY, AN ON-GOING SERIES FEATURING INFORMATION IN THE FIELD OF SPIRITUALITY, SELF-HELP, AND PERSONAL EMPOWERMENT SUBJECT MATTERS, PROVIDED THROUGH THE INTERNET AND BROADCAST MEDIA; ENTERTAINMENT SERVICES, NAMELY, THE PROVISION OF CONTINUING PROGRAMS, SEGMENTS, AND SHOWS PROVIDING INFORMATION IN THE FIELD OF SPIRITUALITY, SELF-HELP, AND PERSONAL EMPOWERMENT SUBJECT MATTERS FEATURING DISCUSSIONS, OPINIONS, PHILOSOPHY, AND DIALOGUE WITH PARTICIPANTS DELIVERED BY THE INTERNET AND BROADCAST MEDIA; ENTERTAINMENT, NAMELY, A CONTINUING TALK SHOW BROADCAST OVER THE INTERNET AND BROADCAST MEDIA; PROVISION OF INFORMATION RELATING TO LIVE PERFORMANCES, ROAD SHOWS, LIVE STAGE EVENTS, THEATRICAL PERFORMANCES, LIVE MUSIC CONCERTS AND AUDIENCE PARTICIPATION IN SUCH EVENTS (U.S. CLS. 100, 101 AND 107).

FIRST USE 4-5-2002; IN COMMERCE 4-5-2002.

### CLASS 45—PERSONAL AND LEGAL SERVICES

FOR PROVIDING BOTH IN-PERSON AND ON-LINE HOLISTIC SPIRITUAL COUNSELING SERVICES; PROVIDING ON-LINE INFORMATION IN THE FIELD OF SPIRITUALITY, SELF-HELP, AND PERSONAL EMPOWERMENT SUBJECT MATTERS; SPIRITUAL COUNSELING (U.S. CLS. 100 AND 101).

FIRST USE 4-5-2002; IN COMMERCE 4-5-2002.  
FRANK LATTUCA, EXAMINING ATTORNEY



NO CLAIM IS MADE TO THE EXCLUSIVE RIGHT TO USE "FBI" AND "ALUMNI ASSOCIATION", APART FROM THE MARK AS SHOWN.

THE COLOR(S) GOLD, RED, WHITE, ROYAL BLUE, SKY BLUE, AND BLACK IS/ARE CLAIMED AS A FEATURE OF THE MARK.

THE MARK CONSISTS OF A CIRCLE MEDALLION CREST WITH A GOLD SUNBURST BACKGROUND AROUND THE CIRCLE AND A GOLD CIRCULAR LINE INSIDE THE CIRCLE CREATING AN OUTER RING AND AN INNER CIRCLE; THE OUTER RING IS ROYAL BLUE WITH WHITE LETTERING OF THE WORDS "FBI CITIZENS' ACADEMY" IN THE TOP AND "ALUMNI ASSOCIATION" IN THE BOTTOM, WITH ONE WHITE STAR BEFORE "ALUMNI" AND ONE WHITE STAR AFTER "ASSOCIATION"; THE INNER CIRCLE HAS A SKY-BLUE BACKGROUND WITH A DEPICTION OF A GOLD-TRIMMED, WHITE-HEADED BLACK-BODIED/-WINGED EAGLE HOLDING A STYLIZED VERSION OF THE AMERICAN FLAG WITH RED AND WHITE ALTERNATING HORIZONTAL STRIPES AND WHITE STARS AGAINST A ROYAL-BLUE BACKGROUND.

SEC. 2(F) AS TO "CITIZENS ACADEMY".

### CLASS 25—CLOTHING

FOR CLOTHING, NAMELY, CAPS, JACKETS, SHIRTS AND SWEATSHIRTS (U.S. CLS. 22 AND 39).

FIRST USE 0-0-2008; IN COMMERCE 0-0-2008.

### CLASS 35—ADVERTISING AND BUSINESS

FOR ASSOCIATION SERVICES, NAMELY, ORGANIZING CHAPTERS OF MEMBERSHIP, AND PROMOTING THE MISSION OF THE FEDERAL BUREAU OF INVESTIGATION AND COMMUNITY OUTREACH AND COOPERATION BETWEEN THE FEDERAL BUREAU OF INVESTIGATION AND CIVILIANS (U.S. CLS. 100, 101 AND 102).

FIRST USE 0-0-2008; IN COMMERCE 0-0-2008.

BRENDAN REGAN, EXAMINING ATTORNEY

SN 85-301,957. DALMATIAN CORPORATION, BALTIMORE, MD. FILED 4-22-2011.

## DUTCH OVEN

THE MARK CONSISTS OF STANDARD CHARACTERS WITHOUT CLAIM TO ANY PARTICULAR FONT, STYLE, SIZE, OR COLOR.

**CLASS 24—FABRICS**

FOR FLEECE BLANKETS AND BLANKET THROWS FOR INDOOR AND OUTDOOR USE IN THE NATURE OF BLANKETS AND THROWS MADE FROM SYNTHETIC MATERIALS (U.S. CLS. 42 AND 50).  
FIRST USE 8-1-2011; IN COMMERCE 8-1-2011.

**CLASS 25—CLOTHING**

FOR WEARABLE BLANKETS FOR INDOOR AND OUTDOOR USE IN THE NATURE OF BLANKETS WITH SLEEVES (U.S. CLS. 22 AND 39).  
FIRST USE 8-1-2011; IN COMMERCE 8-1-2011.  
NICHOLAS COLEMAN, EXAMINING ATTORNEY

---

SN 85-302,739. SKYCAST SOLUTIONS INC., KAPAA, HI. FILED 4-22-2011.

TRAYVU

THE MARK CONSISTS OF STANDARD CHARACTERS WITHOUT CLAIM TO ANY PARTICULAR FONT, STYLE, SIZE, OR COLOR.

**CLASS 9—ELECTRICAL AND SCIENTIFIC APPARATUS**

FOR IN-FLIGHT ENTERTAINMENT PLAYERS FOR PLAYING MOVIES, VIDEO PROGRAMS, MUSIC, VOICE MESSAGES, DATA FILES AND TEXT FILES, FOR INTERNET ACCESS, ELECTRONIC COMMUNICATIONS AND ELECTRONIC MAIL, FOR TELEPHONE COMMUNICATIONS, AND FOR USING COMPUTER PROGRAMS, ALL BY AIRLINE PASSENGERS WHILE IN THEIR SEATS DURING FLIGHTS; IN-FLIGHT ENTERTAINMENT PLAYERS INCORPORATED INTO TRAY TABLES FOR AIRPLANES; IN-FLIGHT ENTERTAINMENT PLAYER AND TRAY TABLE SEPARATELY ATTACHABLE TO A TRAY TABLE SUPPORT FRAME FOR USE TOGETHER IN AIRPLANES (U.S. CLS. 21, 23, 26, 36 AND 38).

**CLASS 20—FURNITURE AND ARTICLES NOT OTHERWISE CLASSIFIED**

FOR TRAY TABLES FOR AIRPLANES (U.S. CLS. 2, 13, 22, 25, 32 AND 50).  
HENRY S. ZAK, EXAMINING ATTORNEY

---

SN 85-302,744. SKYCAST SOLUTIONS INC., KAPAA, HI. FILED 4-22-2011.

SKYCAST SOLUTIONS

THE MARK CONSISTS OF STANDARD CHARACTERS WITHOUT CLAIM TO ANY PARTICULAR FONT, STYLE, SIZE, OR COLOR.

**CLASS 9—ELECTRICAL AND SCIENTIFIC APPARATUS**

FOR IN-FLIGHT ENTERTAINMENT PLAYERS FOR PLAYING MOVIES, VIDEO PROGRAMS, MUSIC, VOICE MESSAGES, DATA FILES AND TEXT FILES, FOR INTERNET ACCESS, ELECTRONIC COMMUNICATIONS AND ELECTRONIC MAIL, FOR TELEPHONE COMMUNICATIONS, AND FOR USING COMPUTER PROGRAMS, ALL BY AIRLINE PASSENGERS WHILE IN THEIR SEATS DURING FLIGHTS; HEAD PHONES FOR USE WITH IN-FLIGHT ENTERTAINMENT PLAYERS; COMPUTERS; COMPUTER SERVERS; CARD READERS FOR CREDIT CARDS (U.S. CLS. 21, 23, 26, 36 AND 38).

**CLASS 12—VEHICLES**

FOR TRAY TABLES FOR AIRPLANES (U.S. CLS. 19, 21, 23, 31, 35 AND 44).

**CLASS 35—ADVERTISING AND BUSINESS**

FOR ADVERTISING AND MARKETING; PROVIDING SHOPPING SERVICES IN THE FIELD OF GENERAL MERCHANDISE TO AIRLINE PASSENGERS BY MEANS OF IN-FLIGHT ENTERTAINMENT PLAYERS (U.S. CLS. 100, 101 AND 102).

**CLASS 37—CONSTRUCTION AND REPAIR**

FOR REPAIR AND MAINTENANCE OF COMPUTERS AND IN-FLIGHT ENTERTAINMENT PLAYERS (U.S. CLS. 100, 103 AND 106).

**CLASS 41—EDUCATION AND ENTERTAINMENT**

FOR ENTERTAINMENT SERVICES, NAMELY, PROVIDING MOVIES, VIDEO PROGRAMS AND MUSIC FOR PLAYING BY AIRLINE PASSENGERS BY MEANS OF IN-FLIGHT ENTERTAINMENT PLAYERS; REFORMATTING MOVIES, VIDEO PROGRAMS AND MUSIC FOR PLAYING BY AIRLINE PASSENGERS BY MEANS OF IN-FLIGHT ENTERTAINMENT PLAYERS; LOADING MOVIES, VIDEO PROGRAMS AND MUSIC ON IN-FLIGHT ENTERTAINMENT PLAYERS AND COMPUTER SERVERS COMMUNICATING WITH IN-FLIGHT ENTERTAINMENT PLAYERS FOR PLAYING BY AIRLINE PASSENGERS BY MEANS OF IN-FLIGHT ENTERTAINMENT PLAYERS (U.S. CLS. 100, 101 AND 107).  
HENRY S. ZAK, EXAMINING ATTORNEY

---

SN 85-302,751. SKYCAST SOLUTIONS INC., KAPAA, HI. FILED 4-22-2011.

SKYCAST

THE MARK CONSISTS OF STANDARD CHARACTERS WITHOUT CLAIM TO ANY PARTICULAR FONT, STYLE, SIZE, OR COLOR.

**CLASS 9—ELECTRICAL AND SCIENTIFIC APPARATUS**

FOR IN-FLIGHT ENTERTAINMENT PLAYERS FOR PLAYING MOVIES, VIDEO PROGRAMS, MUSIC, VOICE MESSAGES, DATA FILES AND TEXT FILES, FOR INTERNET ACCESS, ELECTRONIC COMMUNICATIONS AND ELECTRONIC MAIL, FOR TELEPHONE COMMUNICATIONS, AND FOR USING COMPUTER PROGRAMS, ALL BY AIRLINE PASSENGERS WHILE IN THEIR SEATS DURING FLIGHTS; HEAD PHONES FOR USE WITH IN-FLIGHT ENTERTAINMENT PLAYERS; COMPUTERS; COMPUTER SERVERS; CARD READERS FOR CREDIT CARDS (U.S. CLS. 21, 23, 26, 36 AND 38).

**CLASS 12—VEHICLES**

FOR TRAY TABLES FOR AIRPLANES (U.S. CLS. 19, 21, 23, 31, 35 AND 44).

**CLASS 35—ADVERTISING AND BUSINESS**

FOR ADVERTISING AND MARKETING; PROVIDING SHOPPING SERVICES IN THE FIELD OF GENERAL MERCHANDISE TO AIRLINE PASSENGERS BY MEANS OF IN-FLIGHT ENTERTAINMENT PLAYERS (U.S. CLS. 100, 101 AND 102).

**CLASS 37—CONSTRUCTION AND REPAIR**

FOR REPAIR AND MAINTENANCE OF COMPUTERS AND IN-FLIGHT ENTERTAINMENT PLAYERS (U.S. CLS. 100, 103 AND 106).

**CLASS 41—EDUCATION AND ENTERTAINMENT**

FOR ENTERTAINMENT SERVICES, NAMELY, PROVIDING MOVIES, VIDEO PROGRAMS AND MUSIC FOR PLAYING BY AIRLINE PASSENGERS BY MEANS OF IN-FLIGHT ENTERTAINMENT PLAYERS; REFORMATTING MOVIES, VIDEO PROGRAMS AND MUSIC FOR PLAYING BY AIRLINE PASSENGERS BY MEANS OF IN-FLIGHT ENTERTAINMENT PLAYERS; LOADING MOVIES, VIDEO PROGRAMS AND MUSIC ON IN-FLIGHT ENTERTAINMENT PLAYERS AND COMPUTER SERVERS COMMUNICATING WITH IN-FLIGHT ENTERTAINMENT PLAYERS FOR PLAYING BY AIRLINE PASSENGERS BY MEANS OF IN-FLIGHT ENTERTAINMENT PLAYERS (U.S. CLS. 100, 101 AND 107).

HENRY S. ZAK, EXAMINING ATTORNEY

SN 85-303,698. THE COMPASSIONATE FRIENDS, OAK BROOK, IL. FILED 4-25-2011.

**Los Amigos Compasivos**

THE MARK CONSISTS OF STANDARD CHARACTERS WITHOUT CLAIM TO ANY PARTICULAR FONT, STYLE, SIZE, OR COLOR.

OWNER OF U.S. REG. NOS. 1,522,187 AND 2,698,380.  
THE ENGLISH TRANSLATION OF "LOS AMIGOS COMPASIVOS" IN THE MARK IS "THE COMPASSIONATE FRIENDS".

**CLASS 16—PAPER GOODS AND PRINTED MATTER**

FOR PRINTED MATTER, NAMELY, BROCHURES FEATURING THE TOPIC OF GRIEF SUPPORT FOR FAMILIES WHO HAVE EXPERIENCED THE DEATH OF A CHILD (U.S. CLS. 2, 5, 22, 23, 29, 37, 38 AND 50).

FIRST USE 12-0-2002; IN COMMERCE 12-0-2002.

**CLASS 45—PERSONAL AND LEGAL SERVICES**

FOR ORGANIZING MEETINGS FOR BEREAVED PARENTS AND SIBLINGS TO AID IN THE POSITIVE RESOLUTION OF GRIEF UPON THE DEATH OF A CHILD (U.S. CLS. 100 AND 101).

FIRST USE 2-0-2001; IN COMMERCE 2-0-2001.

HANNO RITTNER, EXAMINING ATTORNEY

SN 85-303,994. EXALT EDUCATION, INC., LITTLE ROCK, AR. FILED 4-25-2011.

**Exalt Education**

THE MARK CONSISTS OF STANDARD CHARACTERS WITHOUT CLAIM TO ANY PARTICULAR FONT, STYLE, SIZE, OR COLOR.

NO CLAIM IS MADE TO THE EXCLUSIVE RIGHT TO USE "EDUCATION", APART FROM THE MARK AS SHOWN.

**CLASS 35—ADVERTISING AND BUSINESS**

FOR EMPLOYMENT RECRUITING SERVICES FOR OTHERS, NAMELY, IDENTIFYING AND RECRUITING EDUCATIONAL LEADERS TO OPERATE AND TEACH IN SCHOOLS SERVING EDUCATIONALLY UNDERSERVED STUDENTS IN GRADES PRESCHOOL THROUGH TWELFTH GRADE, PROVIDED ON A NON-PROFIT BASIS (U.S. CLS. 100, 101 AND 102).

**CLASS 41—EDUCATION AND ENTERTAINMENT**

FOR TRAINING EDUCATIONAL LEADERS TO OPERATE AND TEACH IN SCHOOLS SERVING EDUCATIONALLY UNDERSERVED STUDENTS IN GRADES PRESCHOOL THROUGH TWELFTH GRADE, PROVIDED ON A NON-PROFIT BASIS; DEVELOPING EDUCATIONAL MATERIALS AND CURRICULUM FOR OTHERS IN THE FIELD OF EDUCATION FOR EDUCATIONALLY UNDERSERVED STUDENTS IN GRADES PRESCHOOL THROUGH TWELFTH GRADE, PROVIDED ON A NON-PROFIT BASIS; ANALYZING EDUCATIONAL TESTS SCORES AND DATA FOR OTHERS OF EDUCATIONALLY UNDERSERVED STUDENTS IN GRADES PRESCHOOL THROUGH TWELFTH GRADE, PROVIDED ON A NON-PROFIT BASIS; PROVIDING COURSES OF INSTRUCTION FOR EDUCATIONALLY UNDERSERVED STUDENTS IN GRADES PRESCHOOL THROUGH TWELFTH GRADE, AND DISTRIBUTING COURSE MATERIALS IN CONNECTION THEREWITH, ALL PROVIDED ON A NON-PROFIT BASIS (U.S. CLS. 100, 101 AND 107).

AISHA CLARKE, EXAMINING ATTORNEY

SN 85-304,018. EXALT EDUCATION, INC., LITTLE ROCK, AR. FILED 4-25-2011.

## Exalt Academies

THE MARK CONSISTS OF STANDARD CHARACTERS WITHOUT CLAIM TO ANY PARTICULAR FONT, STYLE, SIZE, OR COLOR.

NO CLAIM IS MADE TO THE EXCLUSIVE RIGHT TO USE "ACADEMIES", APART FROM THE MARK AS SHOWN.

### CLASS 35—ADVERTISING AND BUSINESS

FOR EMPLOYMENT RECRUITING SERVICES FOR OTHERS, NAMELY, IDENTIFYING AND RECRUITING EDUCATIONAL LEADERS TO OPERATE AND TEACH IN SCHOOLS SERVING EDUCATIONALLY UNDERSERVED STUDENTS IN GRADES PRESCHOOL THROUGH TWELFTH GRADE, PROVIDED ON A NON-PROFIT BASIS (U.S. CLS. 100, 101 AND 102).

### CLASS 41—EDUCATION AND ENTERTAINMENT

FOR TRAINING EDUCATIONAL LEADERS TO OPERATE AND TEACH IN SCHOOLS SERVING EDUCATIONALLY UNDERSERVED STUDENTS IN GRADES PRESCHOOL THROUGH TWELFTH GRADE, PROVIDED ON A NON-PROFIT BASIS; DEVELOPING EDUCATIONAL MATERIALS AND CURRICULUM FOR OTHERS IN THE FIELD OF EDUCATION FOR EDUCATIONALLY UNDERSERVED STUDENTS IN GRADES PRESCHOOL THROUGH TWELFTH GRADE, PROVIDED ON A NON-PROFIT BASIS; ANALYZING EDUCATIONAL TESTS SCORES AND DATA FOR OTHERS OF EDUCATIONALLY UNDERSERVED STUDENTS IN GRADES PRESCHOOL THROUGH TWELFTH GRADE, PROVIDED ON A NON-PROFIT BASIS; PROVIDING COURSES OF INSTRUCTION FOR EDUCATIONALLY UNDERSERVED STUDENTS IN GRADES PRESCHOOL THROUGH TWELFTH GRADE, AND DISTRIBUTING COURSE MATERIALS IN CONNECTION THEREWITH, ALL PROVIDED ON A NON-PROFIT BASIS (U.S. CLS. 100, 101 AND 107).

AISHA CLARKE, EXAMINING ATTORNEY

SN 85-304,601. PARADYSZ INC., NEW YORK, NY. FILED 4-26-2011.

## HELIX

THE MARK CONSISTS OF STANDARD CHARACTERS WITHOUT CLAIM TO ANY PARTICULAR FONT, STYLE, SIZE, OR COLOR.

### CLASS 35—ADVERTISING AND BUSINESS

FOR PREPARING AND UPDATING MAILING LISTS TO ENSURE ACCURACY (U.S. CLS. 100, 101 AND 102).

### CLASS 42—SCIENTIFIC AND COMPUTER SERVICES

FOR COMPUTER SERVICES, NAMELY, HOSTING AN ON-LINE WEB SITE FOR OTHERS FOR MAINTAINING ELECTRONIC DATABASES OF MAILING LISTS (U.S. CLS. 100 AND 101).

VERNA BETH RIRIE, EXAMINING ATTORNEY

SN 85-304,619. LEADERSHIP LIVES PARTNERS, LLC, ATLANTA, GA. FILED 4-26-2011.

## LEADERSHIP LIVES

THE MARK CONSISTS OF STANDARD CHARACTERS WITHOUT CLAIM TO ANY PARTICULAR FONT, STYLE, SIZE, OR COLOR.

NO CLAIM IS MADE TO THE EXCLUSIVE RIGHT TO USE "LEADERSHIP", APART FROM THE MARK AS SHOWN.

### CLASS 35—ADVERTISING AND BUSINESS

FOR PROFESSIONAL BUSINESS CONSULTING TO HELP BUSINESSES DEVELOP EMPLOYEE SELF-IMPROVEMENT, SELF-FULFILLMENT AND INTERPERSONAL COMMUNICATION SKILLS (U.S. CLS. 100, 101 AND 102).

### CLASS 41—EDUCATION AND ENTERTAINMENT

FOR TRAINING SERVICES IN THE FIELD OF BUSINESS DEVELOPMENT OF EMPLOYEE SELF-IMPROVEMENT, SELF-FULFILLMENT AND INTERPERSONAL COMMUNICATION SKILLS (U.S. CLS. 100, 101 AND 107).

CAROLYN CATALDO, EXAMINING ATTORNEY

SN 85-304,682. THE PARRIS FOUNDATION, INC., YONKERS, NY. FILED 4-26-2011.



NO CLAIM IS MADE TO THE EXCLUSIVE RIGHT TO USE "FOUNDATION", APART FROM THE MARK AS SHOWN.

THE MARK CONSISTS OF THE TERM "THE PARRIS FOUNDATION" IN TWO ROWS ON TOP OF THE PHRASE "S.T.E.M.ULATING MINDS AND MAGNIFYING DREAMS". THE WORD "THE" IS IN ALL CAPS AND DISPLAYED VERTICALLY NEXT TO THE WORD "PARRIS" WHICH IS IN RED AND IN ALL CAPS. BINARY NUMBERS SHAPE THE LETTER "P" IN "PARRIS" AND

THE "A" IN "PARRIS" IS TOPPED OFF WITH A BLACK, SQUARE GRADUATION CAP. THE WORD "FOUNDATION" IN BLACK COMPRISES THE SECOND ROW SEPARATED FROM THE FIRST ROW BY A BLACK LINE WHICH UNDERLINES THE WORD "PARRIS". THE WORDS "S.T.E.M.ULATING MINDS AND MAGNIFYING DREAMS" IN BLACK COMPRISE THE THIRD ROW. A MAGNIFYING GLASS OUTLINED IN GRAY WITH A BLACK HANDLE MAGNIFIES OR DISTORTS THE WORDS "ATI" IN "FOUNDATION" AND "MAGNIFYING".

#### CLASS 36—INSURANCE AND FINANCIAL

FOR CHARITABLE FOUNDATION SERVICES, NAMELY, PROVIDING FUNDRAISING ACTIVITIES, FUNDING, SCHOLARSHIPS AND/OR FINANCIAL ASSISTANCE FOR UNDERREPRESENTED STUDENTS SEEKING HIGHER EDUCATION IN THE SCIENCE, TECHNOLOGY, ENGINEERING AND MATH DISCIPLINES (U.S. CLS. 100, 101 AND 102).

FIRST USE 12-28-2009; IN COMMERCE 2-25-2010.

#### CLASS 41—EDUCATION AND ENTERTAINMENT

FOR EDUCATION SERVICES, NAMELY, PROVIDING MENTORING, TUTORING, CLASSES, SEMINARS AND WORKSHOPS IN THE FIELD OF SCIENCE, TECHNOLOGY, ENGINEERING AND MATH (U.S. CLS. 100, 101 AND 107).

FIRST USE 12-28-2009; IN COMMERCE 2-25-2010.  
MARK SPARACINO, EXAMINING ATTORNEY

#### CLASS 42—SCIENTIFIC AND COMPUTER SERVICES

FOR PROVIDING ADVISORY AND CONSULTING SERVICES IN THE FIELD OF FOOD RESEARCH RELATING TO NEW SOYBEAN TRAIT INFORMATION; PROVIDING INFORMATION ABOUT FOOD RESEARCH CONCERNING SOYBEANS AND THE SOYBEAN INDUSTRY; SCIENTIFIC CONSULTING, RESEARCH AND PRODUCT DEVELOPMENT SERVICES, NAMELY, FACILITATING THE CREATION, DEVELOPMENT AND COMMERCIALIZATION OF SOYBEANS WITH ENHANCED TRAITS; FOOD RESEARCH, NAMELY, IDENTIFYING AND PRIORITIZING RESEARCH AND KNOWLEDGE NEEDS OF THE SOYBEAN INDUSTRY; PROVIDING INFORMATION REGARDING SCIENTIFIC RESEARCH AND INVESTIGATION IN THE SOYBEAN INDUSTRY (U.S. CLS. 100 AND 101).

FIRST USE 12-31-2004; IN COMMERCE 12-31-2004.  
CAROLINE WOOD, EXAMINING ATTORNEY

SN 85-304,746. THOMPSON, LINDA, GULF BREEZE, FL. FILED 4-26-2011.

# SUP'N GIRLS

THE MARK CONSISTS OF STANDARD CHARACTERS WITHOUT CLAIM TO ANY PARTICULAR FONT, STYLE, SIZE, OR COLOR.

NO CLAIM IS MADE TO THE EXCLUSIVE RIGHT TO USE "GIRLS", APART FROM THE MARK AS SHOWN.

SN 85-304,699. QUALISOY, INCORPORATED, CHESTERFIELD, MO. FILED 4-26-2011.

# QUALISOY

THE MARK CONSISTS OF STANDARD CHARACTERS WITHOUT CLAIM TO ANY PARTICULAR FONT, STYLE, SIZE, OR COLOR.

#### CLASS 35—ADVERTISING AND BUSINESS

FOR ASSOCIATION AND MARKETING SERVICES, NAMELY, PROMOTING THE INTERESTS OF THE U.S. SOYBEAN INDUSTRY; PROMOTING PUBLIC AWARENESS OF NEW SOYBEAN VARIETIES; PROVIDING CONSUMER INFORMATION CONCERNING SOYBEANS AND THE SOYBEAN INDUSTRY; PREPARATION OF PROMOTIONAL AND MERCHANDISING MATERIALS FOR OTHERS FEATURING INFORMATION ABOUT TRAIT-ENHANCED U.S. SOYBEANS; PROMOTING INDUSTRY-WIDE COOPERATION AND COLLABORATION IN THE DEVELOPMENT OF TECHNOLOGY IN THE FIELD OF TRAIT-ENHANCED U.S. SOYBEANS (U.S. CLS. 100, 101 AND 102).

FIRST USE 3-3-2004; IN COMMERCE 3-3-2004.

#### CLASS 25—CLOTHING

FOR CLOTHING, NAMELY, T-SHIRTS, SHORTS AND HATS (U.S. CLS. 22 AND 39).

#### CLASS 41—EDUCATION AND ENTERTAINMENT

FOR ORGANIZING, ARRANGING, AND CONDUCTING GATHERINGS, EXHIBITIONS AND RACE EVENTS FOR ENTHUSIASTS OF STAND UP PADDLE SURFING (U.S. CLS. 100, 101 AND 107).

JEFF DEFORD, EXAMINING ATTORNEY

SN 85-304,774. HOLLY SEED, LLC, SHERIDAN, WY. FILED 4-26-2011.



THE MARK CONSISTS OF A STYLIZED LOWERCASE LETTER "H".

**CLASS 42—SCIENTIFIC AND COMPUTER SERVICES**

FOR RESEARCH AND CONSULTING SERVICES IN THE FIELD OF SEEDS; AGRICULTURAL SERVICES, NAMELY, DEVELOPMENT, BREEDING, AND GENETIC ENGINEERING OF SEED (U.S. CLS. 100 AND 101).

**CLASS 44—MEDICAL, BEAUTY AND AGRICULTURAL SERVICES**

FOR PROVIDING INFORMATION IN THE FIELD OF AGRICULTURE, NAMELY, INFORMATION ON INSECTS, CROP DISEASE, PLANT BREEDING, SEED PROCESSING AND TREATMENT, SEED SELECTION, FARMING, AND CROP CULTIVATION; AGRICULTURAL ADVICE (U.S. CLS. 100 AND 101).

NAPOLEON SHARMA, EXAMINING ATTORNEY

SN 85-304,865. QUALISOY, INCORPORATED, CHESTERFIELD, MO. FILED 4-26-2011.



THE COLOR(S) BLACK AND GREEN IS/ARE CLAIMED AS A FEATURE OF THE MARK.

THE MARK CONSISTS OF THE BLACK CAPITAL LETTERS "QUALISOY", WITH A GREEN SEMI-CIRCLE SURROUNDING THE LEFT SIDE OF THE LETTER "Q" AND A GREEN LEAF AND STEM SERVING AS THE TAIL OF THE "Q".

**CLASS 35—ADVERTISING AND BUSINESS**

FOR ASSOCIATION AND MARKETING SERVICES, NAMELY, PROMOTING THE INTERESTS OF THE U.S. SOYBEAN INDUSTRY; PROMOTING PUBLIC AWARENESS OF NEW SOYBEAN VARIETIES; PROVIDING CONSUMER INFORMATION CONCERNING SOYBEANS AND THE SOYBEAN INDUSTRY; PREPARATION OF PROMOTIONAL AND MERCHANDISING MATERIALS FOR OTHERS FEATURING INFORMATION ABOUT TRAIT-ENHANCED U.S. SOYBEANS; PROMOTING INDUSTRY-WIDE COOPERATION AND COLLABORATION IN THE DEVELOPMENT OF TECHNOLOGY IN THE FIELD OF TRAIT-ENHANCED U.S. SOYBEANS (U.S. CLS. 100, 101 AND 102).

FIRST USE 3-3-2004; IN COMMERCE 3-3-2004.

**CLASS 42—SCIENTIFIC AND COMPUTER SERVICES**

FOR PROVIDING ADVISORY AND CONSULTING SERVICES IN THE FIELD OF FOOD RESEARCH RELATING TO NEW SOYBEAN TRAIT INFORMATION; PROVIDING INFORMATION ABOUT FOOD RESEARCH CONCERNING SOYBEANS AND THE SOYBEAN INDUSTRY; SCIENTIFIC CONSULTING, RESEARCH AND PRODUCT DEVELOPMENT SERVICES, NAMELY, FACILITATING THE CREATION, DEVELOPMENT AND COMMERCIALIZATION OF SOYBEANS WITH ENHANCED TRAITS; FOOD RESEARCH, NAMELY, IDENTIFYING AND PRIORITIZING RESEARCH AND KNOWLEDGE NEEDS OF THE SOYBEAN INDUSTRY; PROVIDING INFORMATION REGARDING SCIENTIFIC RESEARCH AND INVESTIGATION IN THE SOYBEAN INDUSTRY (U.S. CLS. 100 AND 101).

FIRST USE 3-3-2004; IN COMMERCE 3-3-2004.  
CAROLINE WOOD, EXAMINING ATTORNEY

SN 85-305,892. SEATTLE GOURMET FOODS, INC., KENT, WA. FILED 4-27-2011.

**MERRY CHERRY**

THE MARK CONSISTS OF STANDARD CHARACTERS WITHOUT CLAIM TO ANY PARTICULAR FONT, STYLE, SIZE, OR COLOR.

NO CLAIM IS MADE TO THE EXCLUSIVE RIGHT TO USE "CHERRY", APART FROM THE MARK AS SHOWN.

**CLASS 30—STAPLE FOODS**

FOR COFFEE-BASED BEVERAGES, HOT CHOCOLATE, CHOCOLATES AND PASTRIES (U.S. CL. 46).

**CLASS 33—WINES AND SPIRITS**

FOR PREPARED ALCOHOLIC COCKTAILS (U.S. CLS. 47 AND 49).

JIM RINGLE, EXAMINING ATTORNEY

SN 85-306,252. ECOGLATT, INC., PUEBLO, CO. FILED 4-27-2011.

**ECOGLATT**

THE MARK CONSISTS OF STANDARD CHARACTERS WITHOUT CLAIM TO ANY PARTICULAR FONT, STYLE, SIZE, OR COLOR.

THE ENGLISH TRANSLATION OF "GLATT" IN THE MARK IS A TERM APPLIED TO MEAT THAT HAS PASSED A STRICT LEVEL OF KOSHER INSPECTION.

**CLASS 29—MEATS AND PROCESSED FOODS**

FOR (BASED ON USE IN COMMERCE) FRESH AND FROZEN KOSHER MEAT, WHOLE, IN PARTS, GROUND, AND OTHERWISE PROCESSED (U.S. CL. 46).

FIRST USE 1-0-2011; IN COMMERCE 2-0-2011.

**CLASS 42—SCIENTIFIC AND COMPUTER SERVICES**

FOR (BASED ON INTENT TO USE) CONSULTATION, SUPERVISION, AND INSPECTION IN THE FIELD OF FOOD QUALITY CONTROL, NAMELY, REVIEWING AND OVERSEEING STANDARDS AND PRACTICES FOR FOOD MANUFACTURERS AND PRODUCERS TO ASSURE COMPLIANCE WITH KOSHER LAWS AND REGULATIONS AND ECO-FRIENDLY AND SUSTAINABLE PRACTICES (U.S. CLS. 100 AND 101).

LINDA POWELL, EXAMINING ATTORNEY



SN 85-306,718. ADOBE KITCHEN, DANA POINT, CA. FILED 4-27-2011.



NO CLAIM IS MADE TO THE EXCLUSIVE RIGHT TO USE "KITCHEN", APART FROM THE MARK AS SHOWN. THE MARK CONSISTS OF THE WORDING "ADOBE KITCHEN" IN BLOCK LETTERING AND A LINE DRAWING OF AN ADOBE STYLE BRICK BUILDING WITH A PITCHED ROOF WITH PICKET FENCES IN THE FORE-FRONT AND BACKGROUND, INTERSPERSED ACCENTS OF GRASS, STALKS OF CORN IN THE BACKGROUND, A STONE WALKWAY TO THE BUILDING, AND A MAILBOX AT THE END OF THE BACK FENCE. A STYLIZED SUN APPEARS ABOVE THE HOUSE. THE ENTIRE DESIGN IS SURROUNDED BY A SINGLE LINE SQUARE WITH ROUNDED CORNERS. THE WORDING APPEARS IN THE TOP LINE OF THE SQUARE.

#### CLASS 29—MEATS AND PROCESSED FOODS

FOR CURD; DIP MIXES; DIPS; EDIBLE OILS AND FATS, PRESERVES AND PICKLES; EDIBLE OILS AND FATS, PRESERVES, PICKLES; FRUIT JELLIES; JAMS; JAMS AND MARMALADES; JELLIES; JELLIES AND JAMS; JELLIES FOR FOOD; JELLIES, JAMS; LEMON CURD; MARMALADES AND JAMS; PICKLED CUCUMBERS; PICKLED FRUITS; PICKLED JALAPENOS; PICKLED RADISHES; PICKLED VEGETABLES; PICKLED VEGETABLES IN SOY SAUCE, SOYBEAN PASTE OR VINEGAR; PICKLED WATERMELON RIND; PICKLES; SPICY PICKLES (U.S. CL. 46).

FIRST USE 9-1-1996; IN COMMERCE 9-1-1996.

#### CLASS 30—STAPLE FOODS

FOR BARBECUE DRY RUB; BARBECUE SAUCE; CHILI SAUCE; CHIMICHURRI SAUCE; CONDIMENT, NAMELY, PEPPER SAUCE; COOKING SAUCES; DRY SPICE RUB FOR MEATS AND FISH; FOOD CONDIMENT CONSISTING PRIMARILY OF KETCHUP AND SALSA; FRUIT JELLIES; HOT SAUCE; PASTA SAUCE; PICKLE RELISH; READY-MADE SAUCES; SALAD SAUCES; SALSA; SAUCES; SAUCES FOR BARBECUED MEAT; SPAGHETTI SAUCE; SPICE RUBS; TOMATO SAUCE; TOMATO-BASED SALSA (U.S. CL. 46).

FIRST USE 9-1-1996; IN COMMERCE 9-1-1996.

JEFFREY LOOK, EXAMINING ATTORNEY

SN 85-307,186. STAR OF TEXAS FAIR & RODEO, AUSTIN, TX. FILED 4-28-2011.

TAKING LEGENDARY TO A NEW  
LEVEL

THE MARK CONSISTS OF STANDARD CHARACTERS WITHOUT CLAIM TO ANY PARTICULAR FONT, STYLE, SIZE, OR COLOR.

#### CLASS 16—PAPER GOODS AND PRINTED MATTER

FOR PRINTED MATERIALS, NAMELY, PRINTED TICKETS, PRINTED PAPER SIGNS, BUMPER STICKERS, STICKERS, POSTCARDS, DECALS, GREETING CARDS, NOTE BOOKS; PRINTED LITERATURE, NAMELY, BOOKS, MAGAZINES, BROCHURES AND NEWSLETTERS ALL OF THE FOREGOING LITERATURE IN THE FIELD OF RODEO COMPETITIONS AND ANIMAL EXHIBITIONS (U.S. CLS. 2, 5, 22, 23, 29, 37, 38 AND 50).

#### CLASS 25—CLOTHING

FOR CLOTHING, NAMELY, T-SHIRTS, GOLF SHIRTS, SWEAT SHIRTS, SHIRTS, JERSEYS, JACKETS, PANTS, SHORTS, SWEAT PANTS, HEADBANDS, SUN VISORS, CAPS, BASEBALL CAPS, HATS (U.S. CLS. 22 AND 39).

#### CLASS 41—EDUCATION AND ENTERTAINMENT

FOR ORGANIZING AND CONDUCTING EXHIBITIONS AND SPORTING EVENTS FOR ENTERTAINMENT, NAMELY, RODEOS, ANIMAL EXHIBITIONS, LIVESTOCK SHOWS, HORSE SHOWINGS, STEER ROPING, TIE-DOWN ROPING, TEAM ROPING, BULL RIDING, SADDLE BRONC RIDING, BAREBACK RIDING, BARREL RACING, PIG RACING, SHEEP RIDING, MILKING SHOWS, CHUCK WAGON SHOWS, PONY RIDES, AND ROPING SHOWS, ENTERTAINMENT IN THE NATURE OF LIVE MUSICAL CONCERTS, AMUSEMENT PARK RIDES, CULINARY COMPETITIONS, PETTING ZOOS, GOLF TOURNAMENTS, ORGANIZING COMMUNITY FESTIVALS FEATURING PRIMARILY RODEO-RELATED SPORTING EVENTS, ART EXHIBITIONS, DANCING, AND ALSO PROVIDING GALA DINNERS (U.S. CLS. 100, 101 AND 107).

MARK SPARACINO, EXAMINING ATTORNEY

SN 85-307,886. SWEET ORANGE, LLC, MILLBURN, NJ. FILED 4-28-2011.

THE MARK CONSISTS OF THE STYLIZED TEXT "SWEETORANGE" WITH THE "O" IN A YOGURT SWIRL SHAPE WITH A LEAF.

#### CLASS 30—STAPLE FOODS

FOR FROZEN YOGURT; FROZEN YOGURT CONFECTIONS (U.S. CL. 46).

FIRST USE 3-1-2011; IN COMMERCE 3-1-2011.

#### CLASS 43—HOTEL AND RESTAURANT SERVICES

FOR RESTAURANT SERVICES FEATURING FROZEN YOGURT AND FROZEN YOGURT CONFECTIONS FOR CONSUMPTION ON AND OFF THE PREMISES (U.S. CLS. 100 AND 101).

FIRST USE 3-1-2011; IN COMMERCE 3-1-2011.

MICHELE SWAIN, EXAMINING ATTORNEY

SN 85-308,757. ECOGLATT, INC., PUEBLO, CO. FILED 4-29-2011.



NO CLAIM IS MADE TO THE EXCLUSIVE RIGHT TO USE "GLATT", APART FROM THE MARK AS SHOWN.

THE MARK CONSISTS OF THREE CURVED ARROWS TOGETHER CREATING THE APPEARANCE OF A FIRST TRIANGLE, AND A SECOND TRIANGLE POINTING OPPOSITE THE FIRST TRIANGLE AND HAVING THE WORD "ECOGLATT" WRITTEN THEREIN, WITH THE FIRST TRIANGLE SUPERIMPOSED ON THE SECOND TRIANGLE TO CREATE THE OVERALL APPEARANCE OF A JEWISH STAR.

THE ENGLISH TRANSLATION OF "GLATT" IN THE MARK IS A TERM APPLIED TO MEAT THAT HAS PASSED A STRICT LEVEL OF KOSHER INSPECTION.

#### CLASS 29—MEATS AND PROCESSED FOODS

FOR (BASED ON USE IN COMMERCE) FRESH AND FROZEN KOSHER MEAT, WHOLE, IN PARTS, GROUND, AND OTHERWISE PROCESSED (U.S. CL. 46). FIRST USE 3-3-2011; IN COMMERCE 3-3-2011.

#### CLASS 42—SCIENTIFIC AND COMPUTER SERVICES

FOR (BASED ON INTENT TO USE) CONSULTATION, SUPERVISION, AND INSPECTION IN THE FIELD OF FOOD QUALITY CONTROL, NAMELY, REVIEWING AND OVERSEEING STANDARDS AND PRACTICES FOR FOOD MANUFACTURERS AND PRODUCERS TO ASSURE COMPLIANCE WITH KOSHER LAWS AND REGULATIONS AND ECO-FRIENDLY AND SUSTAINABLE PRACTICES (U.S. CLS. 100 AND 101).

LINDA POWELL, EXAMINING ATTORNEY

SN 85-308,825. AMERICAS COMMITTEE FOR TREATMENT AND RESEARCH IN MULTIPLE SCLEROSIS, INC., NEW YORK, NY. FILED 4-29-2011.



NO CLAIM IS MADE TO THE EXCLUSIVE RIGHT TO USE "AMERICAS COMMITTEE FOR TREATMENT AND RESEARCH IN MULTIPLE SCLEROSIS", APART FROM THE MARK AS SHOWN.

THE COLOR(S) ORANGE AND DARK GRAY IS/ARE CLAIMED AS A FEATURE OF THE MARK.

THE MARK CONSISTS OF "ACTRIMS" IN STYLIZED LOWER-CASE TYPE ABOVE "AMERICAS COMMITTEE FOR TREATMENT AND RESEARCH IN MULTIPLE SCLEROSIS" IN BLOCK UPPER-CASE TYPE, WITH THE LETTERS "MS" AND THE DOT ABOVE THE "I" IN "ACTRIMS" IN ORANGE AND THE REMAINDER OF THE LETTERS IN THE MARK IN DARK GRAY.

#### CLASS 41—EDUCATION AND ENTERTAINMENT

FOR EDUCATIONAL SERVICES, NAMELY, CONDUCTING CLASSES, SEMINARS, CONFERENCES, AND WORKSHOPS IN THE FIELD OF MULTIPLE SCLEROSIS AND DISTRIBUTION OF COURSE MATERIAL IN CONNECTION THEREWITH (U.S. CLS. 100, 101 AND 107).

#### CLASS 42—SCIENTIFIC AND COMPUTER SERVICES

FOR PROVIDING MEDICAL AND SCIENTIFIC RESEARCH INFORMATION IN THE FIELD OF MULTIPLE SCLEROSIS TO PHYSICIANS AND RESEARCHERS (U.S. CLS. 100 AND 101).

DAVID I, EXAMINING ATTORNEY

SN 85-308,964. NEWPORT HARBOR NAUTICAL MUSEUM, AKA EXPLOROCEAN, NEWPORT BEACH, CA. FILED 4-29-2011.

## EXPLOROCEAN

THE MARK CONSISTS OF STANDARD CHARACTERS WITHOUT CLAIM TO ANY PARTICULAR FONT, STYLE, SIZE, OR COLOR.

#### CLASS 9—ELECTRICAL AND SCIENTIFIC APPARATUS

FOR NAUTICAL AND PHOTOGRAPHIC APPARATUS AND INSTRUMENTS, NAMELY, UNDERWATER HOUSINGS FOR CAMERAS, UNDERWATER ENCLOSURES FOR CAMERAS AND UNDERWATER ENCLOSURES FOR PHOTOGRAPHIC LENSES; SCUBA EQUIPMENT, NAMELY, GOGGLES (U.S. CLS. 21, 23, 26, 36 AND 38).

#### CLASS 14—JEWELRY

FOR CHRONOGRAPHS AS WATCHES; CLOCKS AND WATCHES; DIVING WATCHES; JEWELLERY AND WATCHES; JEWELLERY, CLOCKS AND WATCHES; MECHANICAL AND AUTOMATIC WATCHES; SPORTS WATCHES; STOP WATCHES; WATCH BANDS; WATCH CASES; WATCH CHAINS; WATCHES AND CLOCKS; WATCHES AND STRAPS FOR WATCHES; WATCHES FOR OUTDOOR USE; WATCHES FOR SPORTING USE; WOMEN'S WATCHES; WRIST WATCHES (U.S. CLS. 2, 27, 28 AND 50).

**CLASS 25—CLOTHING**

FOR ATHLETIC APPAREL, NAMELY, SHIRTS, PANTS, JACKETS, FOOTWEAR, HATS AND CAPS, ATHLETIC UNIFORMS; ATHLETIC SHOES; BASEBALL CAPS AND HATS; BEACH SHOES; BELTS FOR CLOTHING; BOAT SHOES; CANVAS SHOES; DECK-SHOES; FISHING SHIRTS; HOODED SWEAT SHIRTS; HOODS; JERSEYS; KNIT SHIRTS; LEISURE SHOES; LONG-SLEEVED SHIRTS; OPEN-NECKED SHIRTS; OVER SHIRTS; RUNNING SHOES; SANDALS AND BEACH SHOES; SHIRTS AND SHORT-SLEEVED SHIRTS; SHOES; SHORT-SLEEVED OR LONG-SLEEVED T-SHIRTS; SPORT SHIRTS; SPORTS CAPS AND HATS; SPORTS JERSEYS; SWEAT SHIRTS; T-SHIRTS; TENNIS SHOES; TRAINING SHOES; WATER REPELLING LEATHER SHOES AND BOOTS; WATERPROOF LEATHER SHOES AND BOOTS; WIND SHIRTS; WOMEN'S CLOTHING, NAMELY, SHIRTS, DRESSES, SKIRTS, BLOUSES; WOMEN'S HATS AND HOODS; WOMEN'S SHOES (U.S. CLS. 22 AND 39).

**CLASS 28—TOYS AND SPORTING GOODS**

FOR ELECTRONIC LEARNING TOYS; MODEL TOY VEHICLES; SCALE MODEL KITS; TOY BOATS; TOY MODEL HOBBYCRAFT KITS; WATER SQUIRTING TOYS; WATER TOYS (U.S. CLS. 22, 23, 38 AND 50).

**CLASS 41—EDUCATION AND ENTERTAINMENT**

FOR ARRANGING, ORGANIZING, CONDUCTING, AND HOSTING SOCIAL ENTERTAINMENT EVENTS; BOOKING OF ENTERTAINMENT HALLS; CHILDREN'S ENTERTAINMENT AND AMUSEMENT CENTERS, NAMELY, INTERACTIVE PLAY AREAS; CONDUCTING ENTERTAINMENT EXHIBITIONS IN THE NATURE OF CULTURAL EXHIBITIONS, SPORTS COMPETITIONS, MARINE BIOLOGY EXHIBITS, AND ECOLOGICAL SUBJECT EXHIBITIONS; EDUCATIONAL AND ENTERTAINMENT SERVICES FOR CHILDREN, NAMELY, PROVIDING INTERACTIVE PLAY AREAS, INSTRUCTIONAL CLASSES IN THE FIELD OF WATER ACTIVITIES, NAMELY, BOATING, MARINE BIOLOGY AND ECOLOGY, AND SOCIAL GATHERINGS FOR CHILDREN; ENTERTAINMENT AND EDUCATION SERVICES IN THE NATURE OF LIVE DANCE AND MUSICAL PERFORMANCES; ENTERTAINMENT AND EDUCATIONAL SERVICES IN THE NATURE OF ONLINE COMPETITIONS IN THE FIELD OF ENTERTAINMENT, EDUCATION, CULTURE, SPORTS, AND OTHER NON-BUSINESS AND NON-COMMERCIAL FIELDS; ENTERTAINMENT AND EDUCATIONAL SERVICES, NAMELY, PROVIDING A WEBSITE THAT DISPLAYS VARIOUS REQUESTS, REVIEWS, RECOMMENDATIONS, RANKINGS, TRACKINGS, VOTES, AND INFORMATION RELATING TO UNCREATED, UNRELEASED, NEW, SPECIAL, POPULAR, AND RARE PRODUCTS, SERVICES, AND EVENTS IN THE FIELDS OF POP CULTURE, ENTERTAINMENT, EDUCATION, AND SPORTS, ALL EXCLUSIVELY FOR NON-BUSINESS AND NON-COMMERCIAL TRANSACTIONS AND PURPOSES; ENTERTAINMENT IN THE NATURE OF A WATER PARK AND AMUSEMENT CENTER; ENTERTAINMENT IN THE NATURE OF AN AMUSEMENT PARK RIDE; ENTERTAINMENT IN THE NATURE OF YACHT RACES; ENTERTAINMENT SERVICES IN THE NATURE OF AN AMUSEMENT PARK ATTRACTION, NAMELY, A THEMED AREA; ENTERTAINMENT SERVICES IN THE NATURE OF LIVE MUSICAL PERFORMANCES; ENTERTAINMENT SERVICES IN THE NATURE OF PRESENTING LIVE MUSICAL PERFORMANCES; ENTERTAINMENT SERVICES, NAMELY, A MULTIMEDIA PROGRAM SERIES FEATURING COMEDY, ACTION AND ADVENTURE DISTRIBUTED VIA VARIOUS PLATFORMS ACROSS MULTIPLE FORMS OF TRANSMISSION MEDIA; ENTERTAINMENT SERVICES, NAMELY, CONDUCTING CONTESTS; ENTERTAINMENT SERVICES, NAMELY, CONDUCTING FAIRS; ENTERTAINMENT SERVICES, NAMELY, CONDUCTING PARTIES; ENTERTAINMENT SERVICES, NAMELY, DISPLAYING A SERIES OF FILMS; ENTERTAINMENT SERVICES, NAMELY, MULTIMEDIA PRODUCTION SERVICES; ENTERTAINMENT SERVICES, NAMELY, ORGANIZING AND CONDUCTING AN ARRAY OF ATHLETIC EVENTS RENDERED LIVE AND

RECORDED FOR THE PURPOSE OF DISTRIBUTION THROUGH BROADCAST MEDIA; ENTERTAINMENT SERVICES, NAMELY, PLANNING AND CONDUCTING A SERIES OF FILM FESTIVALS; ENTERTAINMENT SERVICES, NAMELY, PROVIDING AN ON-LINE COMPUTER GAME; MULTIMEDIA ENTERTAINMENT SOFTWARE PRODUCTION SERVICES; ORGANIZING AND ARRANGING EXHIBITIONS FOR ENTERTAINMENT PURPOSES; ORGANIZING EXHIBITIONS FOR BOATING, ECOLOGY, GEOGRAPHY, AND MARINE BIOLOGY; ORGANIZING LIVE EXHIBITIONS AND CONFERENCES IN THE FIELDS OF EDUCATION, CULTURE, SPORTS AND ENTERTAINMENT FOR NON-BUSINESS AND NON-COMMERCIAL PURPOSES; ORGANIZING ON-LINE EXHIBITIONS AND CONFERENCES IN THE FIELDS OF EDUCATION, CULTURE, SPORTS AND ENTERTAINMENT FOR NON-BUSINESS AND NON-COMMERCIAL PURPOSES; PROVISION OF INFORMATION RELATING TO THE ORGANIZING OF EDUCATIONAL, CULTURAL, SPORTING, OR ENTERTAINMENT EXHIBITIONS (U.S. CLS. 100, 101 AND 107).  
HOWARD B. LEVINE, EXAMINING ATTORNEY

SN 85-309,349. MURPHY, KIMBERLY M, RENTON, WA.  
FILED 5-1-2011.

# Kim Kare

THE MARK CONSISTS OF STANDARD CHARACTERS WITHOUT CLAIM TO ANY PARTICULAR FONT, STYLE, SIZE, OR COLOR.

THE NAME "KIM KARE" DOES NOT IDENTIFY A LIVING INDIVIDUAL.

**CLASS 36—INSURANCE AND FINANCIAL**

FOR PROVIDING A WEBSITE FEATURING COMMENTARY AND ADVICE IN THE FIELD OF SAVING MONEY (U.S. CLS. 100, 101 AND 102).

FIRST USE 11-20-2010; IN COMMERCE 11-20-2010.

**CLASS 41—EDUCATION AND ENTERTAINMENT**

FOR ENTERTAINMENT AND EDUCATIONAL SERVICES, NAMELY, PROVIDING INSTRUCTION IN THE FIELDS OF INTERIOR DECORATING, CULINARY ARTS, PSYCHOLOGICAL HEALTH, PHYSICAL HEALTH, NUTRITION, HUMAN DETOXIFICATION, NUTRITIONAL SUPPLEMENTS, DIET, EXERCISE, HUMAN LONGEVITY, HEALTHCARE, PERSONAL RELATIONSHIPS, ETIQUETTE, AND PERSONAL ORGANIZATION (U.S. CLS. 100, 101 AND 107).

FIRST USE 11-20-2010; IN COMMERCE 11-20-2010.

**CLASS 44—MEDICAL, BEAUTY AND AGRICULTURAL SERVICES**

FOR PROVIDING A WEBSITE FEATURING COMMENTARY AND ADVICE IN THE FIELD OF PSYCHOLOGICAL HEALTH, PHYSICAL HEALTH, NUTRITION, HUMAN DETOXIFICATION, NUTRITIONAL SUPPLEMENTS, DIET, EXERCISE, HUMAN LONGEVITY, AND HEALTHCARE (U.S. CLS. 100 AND 101).

FIRST USE 11-20-2010; IN COMMERCE 11-20-2010.  
DAVID TOOLEY, EXAMINING ATTORNEY

SN 85-309,527. M&M ASSET HOLDINGS, LTD., CARSON CITY, NV. FILED 5-2-2011.



NO CLAIM IS MADE TO THE EXCLUSIVE RIGHT TO USE "GRAPHICS", APART FROM THE MARK AS SHOWN. THE MARK CONSISTS OF AN ELONGATED OVAL WITH THE TERM "EGRX" INSIDE, WITH THE TERM "GRAPHICS" BELOW "EGR" AND OVERLYING THE BOTTOM OF THE LETTERS "R" AND "X".

#### CLASS 40—MATERIAL TREATMENT

FOR CUSTOM PRINTING SERVICES FOR OTHERS (U.S. CLS. 100, 103 AND 106).  
FIRST USE 6-1-2010; IN COMMERCE 6-1-2010.

#### CLASS 42—SCIENTIFIC AND COMPUTER SERVICES

FOR CUSTOM GRAPHIC DESIGN SERVICES FOR OTHERS (U.S. CLS. 100 AND 101).  
FIRST USE 6-1-2010; IN COMMERCE 6-1-2010.  
JASON BLAIR, EXAMINING ATTORNEY

---

SN 85-309,652. GWIN, CORY S, DBA CORY GWIN, ALISO VIEJO, CA. FILED 5-2-2011.

America...  
WINNING

THE MARK CONSISTS OF STANDARD CHARACTERS WITHOUT CLAIM TO ANY PARTICULAR FONT, STYLE, SIZE, OR COLOR.

#### CLASS 25—CLOTHING

FOR T-SHIRTS (U.S. CLS. 22 AND 39).

#### CLASS 35—ADVERTISING AND BUSINESS

FOR POLITICAL ACTION COMMITTEE SERVICES, NAMELY, PROMOTING THE INTERESTS OF THE LIBERTARIAN PARTY IN THE FIELD OF POLITICS (U.S. CLS. 100, 101 AND 102).  
SOPHIA S. KIM, EXAMINING ATTORNEY

---

SN 85-310,071. MARTY COOPER PRODUCTIONS, INC., MALIBU, CA. FILED 5-2-2011.

A LITTLE BIT COUNTRY, A  
LITTLE BIT ROCK'N ROLL

THE MARK CONSISTS OF STANDARD CHARACTERS WITHOUT CLAIM TO ANY PARTICULAR FONT, STYLE, SIZE, OR COLOR.

#### CLASS 9—ELECTRICAL AND SCIENTIFIC APPARATUS

FOR AUDIO AND VISUAL MUSICAL SOUND RECORDINGS; COMPUTER PRODUCTS, NAMELY, PRE-RECORDED CD-ROMS AND DISCS, ALL FEATURING MUSIC; AUDIO AND VIDEO TAPES AND PHONOGRAPH RECORDS, ALL FEATURING MUSIC (U.S. CLS. 21, 23, 26, 36 AND 38).

#### CLASS 16—PAPER GOODS AND PRINTED MATTER

FOR PRINTED MATTER, NAMELY, POSTERS, STATIONERY (U.S. CLS. 2, 5, 22, 23, 29, 37, 38 AND 50).

#### CLASS 21—HOUSEWARES AND GLASS

FOR MUGS (U.S. CLS. 2, 13, 23, 29, 30, 33, 40 AND 50).

#### CLASS 25—CLOTHING

FOR SPORTS AND CASUAL WEAR FOR MEN, WOMEN AND CHILDREN, NAMELY, TOPS, BOTTOMS, OUTER WEAR BEING JACKETS, COATS, SWEATSHIRTS AND SWEATERS, AND HEADWEAR (U.S. CLS. 22 AND 39).

#### CLASS 28—TOYS AND SPORTING GOODS

FOR TOYS, NAMELY, PLUSH TOY ANIMALS (U.S. CLS. 22, 23, 38 AND 50).

#### CLASS 35—ADVERTISING AND BUSINESS

FOR ONLINE RETAIL STORE FEATURING AUDIO AND VISUAL RECORDINGS, PRINTED MATTER AND PUBLICATIONS, TOYS, MUGS AND CLOTHING (U.S. CLS. 100, 101 AND 102).  
RUDY R. SINGLETON, EXAMINING ATTORNEY

---

SN 85-310,669. DORMA DOOR CONTROLS, INC., REAMSTOWN, PA. FILED 5-3-2011.

#### FUSION OFFICE FRONTS

THE MARK CONSISTS OF STANDARD CHARACTERS WITHOUT CLAIM TO ANY PARTICULAR FONT, STYLE, SIZE, OR COLOR.

OWNER OF U.S. REG. NO. 3,868,432.  
NO CLAIM IS MADE TO THE EXCLUSIVE RIGHT TO USE "OFFICE FRONTS", APART FROM THE MARK AS SHOWN.

#### CLASS 6—METAL GOODS

FOR METAL ACCESSORIES FOR PARTITIONING WALLS, NAMELY, LOCKS EXCLUDING ELECTRICAL LOCKS, AND LOCK BOXES, STRIKE PLATES, KICK PLATES, HANDLES, DOOR KNOBS, CLAMPING AND CONNECTING JOINERY FITTINGS, GUIDE RAILS AND GUIDE RAIL SYSTEMS COMPRISING SLIDES AND SLIDE RAILS (U.S. CLS. 2, 12, 13, 14, 23, 25 AND 50).

**CLASS 19—NON-METALLIC BUILDING MATERIALS**

FOR NON-METAL PARTITIONING WALLS, PARTICULARLY FEATURING STATIONARY AND MOVABLE INDIVIDUAL PANELS, SLIDING DOORS, SLIDING DOORS WITH SWING DOORS, FOLDING DOORS, ALL MADE PRIMARILY OF GLASS; SOUND INSULATED PARTITIONING WALLS, PARTICULARLY FEATURING STATIONARY AND MOVABLE INDIVIDUAL PANELS, SLIDING DOORS, SLIDING DOORS WITH SWING DOORS, FOLDING DOORS, ALL MADE PRIMARILY OF GLASS (U.S. CLS. 1, 12, 33 AND 50).

PAUL MORENO, EXAMINING ATTORNEY

SN 85-310,952. MAZIN G. SAMONA, BIRMINGHAM, MI. FILED 5-3-2011.

# WILD BILL'S

THE MARK CONSISTS OF STANDARD CHARACTERS WITHOUT CLAIM TO ANY PARTICULAR FONT, STYLE, SIZE, OR COLOR.

**CLASS 34—SMOKERS' ARTICLES**

FOR SMOKERS' ARTICLES, NAMELY, ASHTRAYS, CHEWING TOBACCO, CIGARETTES, CIGARETTE CASES, CIGARETTE-ROLLING MACHINES, MACHINES ALLOWING INDIVIDUALS TO MAKE CIGARETTES FOR AND BY THEMSELVES, CIGARETTE PAPERS, CIGARETTE TUBES, CIGARS, ELECTRONIC CIGARETTES, HOOKAHS, HOOKAH TOBACCO, LIGHTERS FOR SMOKERS, PIPE TOBACCO, SMOKELESS CIGARETTE VAPORIZER PIPES, SMOKING AND TOBACCO PIPES, AND TOBACCO (U.S. CLS. 2, 8, 9 AND 17).

**CLASS 35—ADVERTISING AND BUSINESS**

FOR RETAIL STORE SERVICES FEATURING SMOKERS' ARTICLES (U.S. CLS. 100, 101 AND 102).  
JUDITH HELFMAN, EXAMINING ATTORNEY

SN 85-310,947. ZETEC, INC., SNOQUALMIE, WA. FILED 5-3-2011.

# ZETEC

THE MARK CONSISTS OF STANDARD CHARACTERS WITHOUT CLAIM TO ANY PARTICULAR FONT, STYLE, SIZE, OR COLOR.

**CLASS 9—ELECTRICAL AND SCIENTIFIC APPARATUS**

FOR TEST INSTRUMENTS FOR ACQUIRING AND PROCESSING ULTRASOUND AND/OR EDDY CURRENT SIGNALS IN NON-DESTRUCTIVE TESTING OF PHYSICAL MATERIALS; COMPUTER SOFTWARE FOR THE ACQUISITION OF ULTRASOUND AND/OR EDDY CURRENT SIGNALS IN NON-DESTRUCTIVE TESTING OF PHYSICAL MATERIALS; AND, COMPUTER SOFTWARE FOR DISPLAYING AND ANALYZING ULTRASOUND AND/OR EDDY CURRENT SIGNALS IN NON-DESTRUCTIVE TESTING OF PHYSICAL MATERIALS (U.S. CLS. 21, 23, 26, 36 AND 38).

FIRST USE 0-0-1968; IN COMMERCE 0-0-1968.

**CLASS 37—CONSTRUCTION AND REPAIR**

FOR EQUIPMENT REPAIR OF EDDY CURRENT EQUIPMENT AND ULTRASONIC EQUIPMENT (U.S. CLS. 100, 103 AND 106).

FIRST USE 0-0-1968; IN COMMERCE 0-0-1968.

**CLASS 42—SCIENTIFIC AND COMPUTER SERVICES**

FOR DATA ACQUISITION, DATA ANALYSIS AND REPORTING OF EDDY CURRENT AND ULTRASONIC EXAMINATIONS FOR TEST AND MEASUREMENT PURPOSES; CALIBRATION OF EDDY CURRENT AND ULTRASONIC TESTING EQUIPMENT; TECHNICAL SUPPORT SERVICES, NAMELY, TROUBLESHOOTING OF EDDY CURRENT EQUIPMENT AND ULTRASONIC EQUIPMENT (U.S. CLS. 100 AND 101).

FIRST USE 0-0-1968; IN COMMERCE 0-0-1968.  
ODESSA BIBBINS, EXAMINING ATTORNEY

SN 85-310,965. MAZIN G. SAMONA, BIRMINGHAM, MI. FILED 5-3-2011.

# WILD BILL'S TOBACCO

THE MARK CONSISTS OF STANDARD CHARACTERS WITHOUT CLAIM TO ANY PARTICULAR FONT, STYLE, SIZE, OR COLOR.

NO CLAIM IS MADE TO THE EXCLUSIVE RIGHT TO USE "TOBACCO", APART FROM THE MARK AS SHOWN.

**CLASS 34—SMOKERS' ARTICLES**

FOR SMOKERS' ARTICLES, NAMELY, ASHTRAYS, CHEWING TOBACCO, CIGARETTES, CIGARETTE CASES, CIGARETTE-ROLLING MACHINES, MACHINES ALLOWING INDIVIDUALS TO MAKE CIGARETTES FOR AND BY THEMSELVES, CIGARETTE PAPERS, CIGARETTE TUBES, CIGARS, ELECTRONIC CIGARETTES, HOOKAHS, HOOKAH TOBACCO, LIGHTERS FOR SMOKERS, PIPE TOBACCO, SMOKELESS CIGARETTE VAPORIZER PIPES, SMOKING AND TOBACCO PIPES, AND TOBACCO (U.S. CLS. 2, 8, 9 AND 17).

**CLASS 35—ADVERTISING AND BUSINESS**

FOR RETAIL STORE SERVICES FEATURING SMOKERS' ARTICLES (U.S. CLS. 100, 101 AND 102).  
JUDITH HELFMAN, EXAMINING ATTORNEY

SN 85-311,194. AMERICAN AUTOMOBILE ASSOCIATION, INC., HEATHROW, FL. FILED 5-3-2011.



OWNER OF U.S. REG. NOS. 2,622,099 AND 3,084,767.  
THE MARK CONSISTS OF THE WORD "RESPONSE" WITH A STYLIZED STROBE LIGHT ABOVE AND BELOW THE LETTER "N".

#### CLASS 37—CONSTRUCTION AND REPAIR

FOR PROVIDING ROADSIDE EMERGENCY ASSISTANCE SERVICES, NAMELY, PROVIDING FLAT TIRE CHANGING, FUEL SUPPLYING AND BATTERY JUMP STARTING SERVICES (U.S. CLS. 100, 103 AND 106).

#### CLASS 39—TRANSPORTATION AND STORAGE

FOR PROVIDING ROADSIDE EMERGENCY ASSISTANCE SERVICES, NAMELY, TOWING, WINCH-OUT AND KEY DELIVERY SERVICES (U.S. CLS. 100 AND 105).

#### CLASS 45—PERSONAL AND LEGAL SERVICES

FOR PROVIDING ROADSIDE EMERGENCY ASSISTANCE SERVICES, NAMELY, LOCK OPENING SERVICES (U.S. CLS. 100 AND 101).

CHRISTOPHER BUONGIORNO, EXAMINING ATTORNEY

SN 85-311,216. DIGITAL PATIENT, INC., ROANOKE, TX. FILED 5-3-2011.

THE MARK CONSISTS OF THE WORDING "SAFE HARBOR" WITH THE LETTER "A" WITHIN THE WORD "SAFE" DESIGNED AS A PADLOCK.

#### CLASS 9—ELECTRICAL AND SCIENTIFIC APPARATUS

FOR DOWNLOADABLE COMPUTER SOFTWARE FOR ONLINE, AND LOCAL, BACKUP AND STORAGE OF COMPUTER OR SERVER CONTENT (U.S. CLS. 21, 23, 26, 36 AND 38).

#### CLASS 39—TRANSPORTATION AND STORAGE

FOR ENCRYPTED STORAGE SERVICES FOR ARCHIVING DATABASES, IMAGES AND OTHER ELECTRONIC DATA (U.S. CLS. 100 AND 105).

#### CLASS 42—SCIENTIFIC AND COMPUTER SERVICES

FOR ELECTRONIC STORAGE OF DATA, NAMELY, REMOTE ONLINE BACKUP OF ELECTRONIC DATA; SOFTWARE AS A SERVICE (SAAS) SERVICES FEATURING SOFTWARE FOR BACKING UP, ENCRYPTING AND ARCHIVING ELECTRONIC DATA; REMOTE AND LOCAL COMPUTER BACKUP SERVICES; ONLINE COMPUTER BACKUP SERVICES (U.S. CLS. 100 AND 101).

CAROLINE WOOD, EXAMINING ATTORNEY

SN 85-311,392. BECKMAN COULTER, INC., BREA, CA. FILED 5-3-2011.



THE COLOR(S) BLACK, RED, GREEN, AND WHITE IS/ ARE CLAIMED AS A FEATURE OF THE MARK.

THE MARK CONSISTS OF THE WORDS "WE'RE BETTER" APPEARING IN BLACK WITH THE WORD "TOGETHER" APPEARING IN RED BELOW AND SLIGHTLY TO THE RIGHT OF THE WORDS "WE'RE BETTER" AND A GREEN LEAF DESIGN APPEARING TO THE RIGHT OF THE WORDS "WE'RE BETTER TOGETHER" WITH THE WORDS "QUALITY FOR ECO" APPEARING IN WHITE WITHIN THE GREEN LEAF DESIGN. THE COLOR WHITE IN THE BACKGROUND OF THE MARK REPRESENTS TRANSPARENT AREAS AND THEREFORE IS NOT CLAIMED AS PART OF THE MARK.

#### CLASS 1—CHEMICALS

FOR DIAGNOSTIC REAGENTS AND ASSAYS AND CHEMICAL PREPARATIONS ALL FOR SCIENTIFIC, BIORESEARCH, BIOMEDICAL AND LABORATORY PURPOSES AND ANALYSIS; DIAGNOSTIC REAGENTS AND ASSAYS AND CHEMICAL PREPARATIONS ALL FOR SCIENTIFIC AND RESEARCH PURPOSES IN THE FIELD OF BIOTECHNOLOGY; DIAGNOSTIC CHEMICALS AND REAGENTS FOR IN VITRO CLINICAL OR MEDICAL LABORATORY USE; ANTIBODY BASED CHEMICALS AND REAGENTS FOR SCIENTIFIC AND RESEARCH USE, NAMELY, MONOCLONAL ANTIBODIES; IMMUNOASSAY TEST KITS CONSISTING PRIMARILY OF IN VITRO REAGENTS FOR THE DIAGNOSIS AND MONITORING OF CONDITIONS OF PHYSIOLOGICAL SIGNIFICANCE, ALL FOR LABORATORY, BIOTECHNOLOGY, AND BIORESEARCH USE (U.S. CLS. 1, 5, 6, 10, 26 AND 46).

#### CLASS 5—PHARMACEUTICALS

FOR REAGENTS FOR MEDICAL USE; MEDICAL ASSAYS FOR TESTING OF BODY FLUIDS; CHEMICAL PREPARATIONS, NAMELY, CHEMICAL REAGENTS FOR MEDICAL PURPOSES; MEDICAL DIAGNOSTIC REAGENTS AND ASSAYS FOR TESTING OF BODY FLUIDS; DIAGNOSTIC PREPARATIONS FOR MEDICAL PURPOSES; DIAGNOSTIC CHEMICALS AND DIAGNOSTIC REAGENTS FOR IN VITRO MEDICAL DIAGNOSTIC USE; DIAGNOSTIC CHEMICALS AND DIAGNOSTIC REAGENTS FOR MEDICAL USE; ANTI-BODY-BASED CHEMICALS AND REAGENTS FOR MEDICAL USE, NAMELY, MONOCLONAL ANTIBODIES; DIAGNOSTIC ASSAY TEST KITS FOR MEDICAL USE CONSISTING OF MEDICAL DIAGNOSTIC CHEMICALS AND REAGENTS; IMMUNOASSAY TEST KITS FOR MEDICAL USE CONSISTING PRIMARILY OF IN VITRO REAGENTS FOR THE DIAGNOSIS AND MONITORING OF PHYSIOLOGICAL SIGNIFICANCE (U.S. CLS. 6, 18, 44, 46, 51 AND 52).

**CLASS 9—ELECTRICAL AND SCIENTIFIC APPARATUS**

FOR INSTRUMENTS, SYSTEMS, EQUIPMENT AND DEVICES FOR LABORATORY, BIOTECHNOLOGY, BIORESEARCH, BIOMEDICAL AND CLINICAL DIAGNOSIS RESEARCH, NAMELY, HEMATOLOGY AND BLOOD ANALYZERS; AUTOMATED MICROBIOLOGY ANALYZERS FOR CLINICAL LABORATORY USE; AUTOMATED HEMATOLOGY CHEMISTRY ANALYZERS FOR CLINICAL LABORATORY USE; DNA ANALYZERS FOR CLINICAL LABORATORY USE; PARTICLE AND CELL SIZE ANALYZERS FOR SCIENTIFIC, LABORATORY, AND GENERAL RESEARCH USES; GAS ABSORPTION ANALYZERS FOR SCIENTIFIC, LABORATORY, AND GENERAL RESEARCH USES; SCIENTIFIC APPARATUS, NAMELY, UV/VISIBLE SPECTROPHOTOMETERS FOR SCIENTIFIC, LABORATORY, AND GENERAL RESEARCH USES; SCIENTIFIC APPARATUS, NAMELY, GAMMA SCINTILLATION COUNTERS AND ANALYZERS; PH METERS FOR SCIENTIFIC RESEARCH AND LABORATORY USE; LIQUID CHROMATOGRAPHY CELL SORTERS FOR SCIENTIFIC LABORATORY USE; REPLACEMENT PARTS FOR THE FOREGOING GOODS, NAMELY, CENTRIFUGE ROTORS AND CANISTER ASSEMBLIES; LABORATORY EQUIPMENT AND SUPPLIES, NAMELY, PIPETTE TIPS, TEST TUBES, TEST TUBE RACKS, CENTRIFUGE TUBE RACKS, AND LABORATORY WETTING TRAYS; INSTRUMENTS, SYSTEMS AND DEVICES FOR CLINICAL RESEARCH AND LABORATORY USE, NAMELY, AUTOMATED MICROBIOLOGY ANALYZERS, AUTOMATED HEMATOLOGY CHEMISTRY ANALYZERS, DNA ANALYZERS, PARTICLE AND CELL SIZE ANALYZERS, GAS ABSORPTION ANALYZERS, UV/VISIBLE SPECTROPHOTOMETERS, GAMMA SCINTILLATION COUNTERS AND ANALYZERS, PH METERS, LIQUID CHROMATOGRAPHY CELL SORTERS, CENTRIFUGES (U.S. CLS. 21, 23, 26, 36 AND 38).

**CLASS 10—MEDICAL APPARATUS**

FOR MEDICAL DIAGNOSTIC DEVICES, INSTRUMENTS AND APPARATUS USED IN CONNECTION WITH PATIENTS FOR SEPARATING, DETECTING, ANALYZING, TRANSPORTING, MONITORING, AND MEASURING MATERIALS IN FLUID AND SOLID PATIENT MATERIALS, NAMELY, AUTOMATED MICROBIOLOGY ANALYZERS, AUTOMATED HEMATOLOGY CHEMISTRY ANALYZERS, DNA ANALYZERS, PARTICLE AND CELL SIZE ANALYZERS, GAS ABSORPTION ANALYZERS, UV/VISIBLE SPECTROPHOTOMETERS, GAMMA SCINTILLATION COUNTERS AND ANALYZERS, PH METERS, LIQUID CHROMATOGRAPHY CELL SORTERS, CENTRIFUGES AND REPLACEMENT PARTS THEREFOR; INSTRUMENTS, SYSTEMS AND DEVICES FOR CLINICAL DIAGNOSTIC USE, NAMELY, AUTOMATED MICROBIOLOGY ANALYZERS, AUTOMATED HEMATOLOGY CHEMISTRY ANALYZERS, DNA ANALYZERS, PARTICLE AND CELL SIZE ANALYZERS, GAS ABSORPTION ANALYZERS, UV/VISIBLE SPECTROPHOTOMETERS, GAMMA SCINTILLATION COUNTERS AND ANALYZERS, PH METERS, LIQUID CHROMATOGRAPHY CELL SORTERS, CENTRIFUGES (U.S. CLS. 26, 39 AND 44).  
KIMBERLY FRYE, EXAMINING ATTORNEY

SN 85-311,413. RED MANGO, INC., DALLAS, TX. FILED 5-3-2011.

OWNER OF U.S. REG. NO. 3,583,814.  
THE COLOR(S) RED AND BLACK IS/ARE CLAIMED AS A FEATURE OF THE MARK.

THE MARK CONSISTS OF THE WORD "LOVE" WHEREIN THE LETTERS "L", "V" AND "E" ARE REPRESENTED BY A BLACK OUTLINE AND A RED LETTER "O" THAT CONTAINS A STYLIZED MANGO SHAPE. THE COLOR WHITE REPRESENTS BACKGROUND.

**CLASS 16—PAPER GOODS AND PRINTED MATTER**

FOR DISPOSABLE NAPKINS; PAPER CONTAINERS; PAPER FOOD AND BEVERAGE CONTAINERS (U.S. CLS. 2, 5, 22, 23, 29, 37, 38 AND 50).

**CLASS 25—CLOTHING**

FOR CLOTHING, NAMELY, SHIRTS, SWEATSHIRTS, JACKETS, APRONS, HEADWEAR AND UNIFORMS (U.S. CLS. 22 AND 39).

**CLASS 43—HOTEL AND RESTAURANT SERVICES**

FOR SERVING OF FOOD AND DRINK/BEVERAGES AT RESTAURANTS, CAFES AND DRINK BARS; RESTAURANT, CAFE, DRINK BAR SERVICES; AND PROVIDING INFORMATION IN THE FIELD OF THE PROVISION OF FOOD AND BEVERAGES (U.S. CLS. 100 AND 101).

NAKWAMA ANKRAH, EXAMINING ATTORNEY

SN 85-311,559. HUB JUICE LLC, DBA HUB JUICE, LLC, DALLAS, TX. FILED 5-3-2011.

THE MARK CONSISTS OF STANDARD CHARACTERS WITHOUT CLAIM TO ANY PARTICULAR FONT, STYLE, SIZE, OR COLOR.

NO CLAIM IS MADE TO THE EXCLUSIVE RIGHT TO USE "HUB", APART FROM THE MARK AS SHOWN.

**CLASS 35—ADVERTISING AND BUSINESS**

FOR ADVERTISING AND MARKETING SERVICES PROVIDED BY MEANS OF INDIRECT METHODS OF MARKETING COMMUNICATIONS, NAMELY, SOCIAL MEDIA, SEARCH ENGINE MARKETING, INQUIRY MARKETING, INTERNET MARKETING, MOBILE MARKETING, BLOGGING AND OTHER FORMS OF PASSIVE, SHARABLE OR VIRAL COMMUNICATIONS CHANNELS (U.S. CLS. 100, 101 AND 102).

FIRST USE 4-1-2011; IN COMMERCE 4-1-2011.

**CLASS 38—COMMUNICATION**

FOR ELECTRONIC TRANSMISSION AND STREAMING OF DIGITAL MEDIA CONTENT FOR OTHERS VIA GLOBAL AND LOCAL COMPUTER NETWORKS (U.S. CLS. 100, 101 AND 104).

FIRST USE 4-1-2011; IN COMMERCE 4-1-2011.

**CLASS 42—SCIENTIFIC AND COMPUTER SERVICES**

FOR APPLICATION SERVICE PROVIDER, NAMELY, HOSTING, MANAGING, DEVELOPING, ANALYZING, AND MAINTAINING APPLICATIONS, SOFTWARE, AND WEB SITES, OF OTHERS IN THE FIELDS OF ADVERTISING AND MARKETING; PROVIDING CUSTOMER-DEFINED GENERATED CONTENT AND CONTENT OF OTHERS AUTOMATICALLY SELECTED AND CUSTOMIZED BASED ON THE KNOWN OR ESTIMATED GEOGRAPHICAL LOCATION OF AN INTERNET, MOBILE TELEPHONE OR OTHER WIRED OR WIRELESS DIGITAL NETWORK BASED CUSTOMER; PROVIDING CUSTOMIZED ON-LINE WEB PAGES AND DATA FEEDS FEATURING USER-DEFINED INFORMATION, WHICH INCLUDES BLOG POSTS, NEW MEDIA CONTENT, OTHER ON-LINE CONTENT, AND ON-LINE WEB LINKS TO OTHER WEBSITES (U.S. CLS. 100 AND 101).

FIRST USE 4-1-2011; IN COMMERCE 4-1-2011.  
ANGELA DUONG, EXAMINING ATTORNEY

SN 85-311,746. PROVIDENT LABEL GROUP, LLC, NEW YORK, NY. FILED 5-4-2011.



OWNER OF U.S. REG. NOS. 3,012,993 AND 3,012,995.  
NO CLAIM IS MADE TO THE EXCLUSIVE RIGHT TO USE "SOUNDTRACKS", APART FROM THE MARK AS SHOWN.

THE MARK CONSISTS OF THE LOWERCASE RENDERINGS OF THE LETTERS "PH" WITHIN A CIRCLE, AND AN UPWARD POINTING ARROW ENCLOSED IN A CONTRASTING CIRCLE WITHIN THE ARC OF THE "H". THE WORD ELEMENT "SOUNDTRACKS" CROSSES VERTICALLY BELOW.

**CLASS 9—ELECTRICAL AND SCIENTIFIC APPARATUS**

FOR MUSICAL SOUND RECORDINGS; AUDIOVISUAL RECORDINGS FEATURING MUSIC AND MUSICAL BASED ENTERTAINMENT; DOWNLOADABLE MUSICAL SOUND AND DOWNLOADABLE AUDIOVISUAL RECORDINGS FEATURING MUSIC AND MUSICAL BASED ENTERTAINMENT; DOWNLOADABLE RINGTONES, GRAPHICS AND MUSIC VIA A GLOBAL COMPUTER NETWORK AND WIRELESS DEVICES (U.S. CLS. 21, 23, 26, 36 AND 38).

**CLASS 38—COMMUNICATION**

FOR STREAMING OF AUDIO MATERIAL, NAMELY, MUSICAL RECORDINGS, ON THE INTERNET; STREAMING OF AUDIOVISUAL MATERIAL, NAMELY, MUSICAL AUDIOVISUAL RECORDINGS, ON THE INTERNET; AUDIO-ON-DEMAND AND VIDEO-ON-DEMAND TRANSMISSION SERVICES FEATURING MUSIC AND MUSIC VIDEO; WEBCASTING SERVICES FEATURING MUSIC AND MUSIC VIDEO (U.S. CLS. 100, 101 AND 104).

JORDAN BAKER, EXAMINING ATTORNEY

SN 85-311,766. PROVIDENT LABEL GROUP, LLC, NEW YORK, NY. FILED 5-4-2011.



**PRAISEHYMN**  
SOUNDTRACKS

OWNER OF U.S. REG. NOS. 3,012,993 AND 3,012,995.  
NO CLAIM IS MADE TO THE EXCLUSIVE RIGHT TO USE "PRAISE HYMN" AND "SOUNDTRACKS", APART FROM THE MARK AS SHOWN.

THE MARK CONSISTS OF A SOLID OUTLINED CIRCLE ENCLOSING THE LITERAL ELEMENTS "PH", WHEREIN AN UPWARD POINTING ARROW IS ENCLOSED IN A CONTRASTING, SMALLER CIRCLE BELOW THE ARC IN THE "H". BELOW THE CIRCLE ARE THE WORD ELEMENTS "PRAISEHYMN". BELOW THESE ELEMENTS IS THE WORD "SOUNDTRACKS".

**CLASS 9—ELECTRICAL AND SCIENTIFIC APPARATUS**

FOR MUSICAL SOUND RECORDINGS; AUDIOVISUAL RECORDINGS FEATURING MUSIC AND MUSICAL BASED ENTERTAINMENT; DOWNLOADABLE MUSICAL SOUND AND DOWNLOADABLE AUDIOVISUAL RECORDINGS FEATURING MUSIC AND MUSICAL BASED ENTERTAINMENT; DOWNLOADABLE RINGTONES, GRAPHICS AND MUSIC VIA A GLOBAL COMPUTER NETWORK AND WIRELESS DEVICES (U.S. CLS. 21, 23, 26, 36 AND 38).

**CLASS 38—COMMUNICATION**

FOR MUSICAL SOUND RECORDINGS; AUDIOVISUAL RECORDINGS FEATURING MUSIC AND MUSICAL BASED ENTERTAINMENT; DOWNLOADABLE MUSICAL SOUND AND DOWNLOADABLE AUDIOVISUAL RECORDINGS FEATURING MUSIC AND MUSICAL BASED ENTERTAINMENT; DOWNLOADABLE RINGTONES, GRAPHICS AND MUSIC VIA A GLOBAL COMPUTER NETWORK AND WIRELESS DEVICES (U.S. CLS. 100, 101 AND 104).

JORDAN BAKER, EXAMINING ATTORNEY



SN 85-311,797. PROVIDENT LABEL GROUP, LLC, NEW YORK, NY. FILED 5-4-2011.



OWNER OF U.S. REG. NOS. 2,923,344, 3,012,995 AND OTHERS.

NO CLAIM IS MADE TO THE EXCLUSIVE RIGHT TO USE "SOUNDTRACKS" AND "PRAISE HYMN", APART FROM THE MARK AS SHOWN.

THE MARK CONSISTS OF A SOLID OUTLINED CIRCLE ENCLOSING THE LITERAL ELEMENTS "PH", WHEREIN AN UPWARD POINTING ARROW IS ENCLOSED IN A CONTRASTING, SMALLER CIRCLE BELOW THE ARC IN THE "H". BELOW THE CIRCLE ARE THE WORD ELEMENTS "PRAISEHYMN". BELOW THESE ELEMENTS IS "SOUNDTRACKS". TO THE RIGHT OF "SOUNDTRACKS" IS THE WORDING "HI MEDIUM LOW" APPEARING WITHIN A RECTANGLE DESIGN. A SMALL DOT APPEARS BETWEEN "HI" AND "MEDIUM", AND BETWEEN "MEDIUM" AND "LOW".

#### **CLASS 9—ELECTRICAL AND SCIENTIFIC APPARATUS**

FOR MUSICAL SOUND RECORDINGS; AUDIOVISUAL RECORDINGS FEATURING MUSIC AND MUSICAL BASED ENTERTAINMENT; DOWNLOADABLE MUSICAL SOUND AND DOWNLOADABLE AUDIOVISUAL RECORDINGS FEATURING MUSIC AND MUSICAL BASED ENTERTAINMENT; DOWNLOADABLE RINGTONES, GRAPHICS AND MUSIC VIA A GLOBAL COMPUTER NETWORK AND WIRELESS DEVICES (U.S. CLS. 21, 23, 26, 36 AND 38).

#### **CLASS 38—COMMUNICATION**

FOR STREAMING OF AUDIO MATERIAL, NAMELY, MUSICAL RECORDINGS, ON THE INTERNET; STREAMING OF AUDIOVISUAL MATERIAL, NAMELY, MUSICAL AUDIOVISUAL RECORDINGS, ON THE INTERNET; AUDIO-ON-DEMAND AND VIDEO-ON-DEMAND TRANSMISSION SERVICES FEATURING MUSIC AND MUSIC VIDEO; WEBCASTING SERVICES FEATURING MUSIC AND MUSIC VIDEO (U.S. CLS. 100, 101 AND 104).

JORDAN BAKER, EXAMINING ATTORNEY

SN 85-311,849. RED CARPET DATABASE LLC, LAS VEGAS, NV. FILED 5-4-2011.

# THE RCDB

THE MARK CONSISTS OF STANDARD CHARACTERS WITHOUT CLAIM TO ANY PARTICULAR FONT, STYLE, SIZE, OR COLOR.

#### **CLASS 35—ADVERTISING AND BUSINESS**

FOR BUSINESS SERVICES, NAMELY, MANAGEMENT AND COMPILATION OF AN ARCHIVAL AND HISTORICAL DATABASE FEATURING FASHION, CELEBRITIES AND AWARD SHOWS; PROVIDING A WEBSITE ADVERTISING PRODUCTS AND SERVICES FOR OTHERS (U.S. CLS. 100, 101 AND 102).

#### **CLASS 41—EDUCATION AND ENTERTAINMENT**

FOR ENTERTAINMENT, NAMELY, PROVIDING A WEBSITE FEATURING INFORMATION ABOUT AWARD SHOWS AND CELEBRITIES; PROVIDING A DATABASE IN THE FIELD OF ENTERTAINMENT CELEBRITIES AND AWARD SHOWS (U.S. CLS. 100, 101 AND 107).

DAVID I, EXAMINING ATTORNEY

SN 85-312,009. QUIRKY, INC., NEW YORK, NY. FILED 5-4-2011.

# QUIRKY

THE MARK CONSISTS OF STANDARD CHARACTERS WITHOUT CLAIM TO ANY PARTICULAR FONT, STYLE, SIZE, OR COLOR.

OWNER OF U.S. REG. NO. 3,960,507.

#### **CLASS 8—HAND TOOLS**

FOR KNIVES; UTILITY KNIVES; KNIVES FOR HOBBY USE (U.S. CLS. 23, 28 AND 44).

#### **CLASS 9—ELECTRICAL AND SCIENTIFIC APPARATUS**

FOR CORD AND CABLE MANAGEMENT DEVICES, NAMELY, WEIGHTED HOLDERS FOR CONTAINING AND ORGANIZING AUDIO, COMPUTER, CONNECTION, ELECTRICAL, ELECTRONIC, POWER, PRINTER, STEREO AND VIDEO CABLES, ALL FOR CONSUMER ELECTRONICS AND HOUSEHOLD ELECTRIC APPLIANCES; CARRYING CASES FOR ELECTRONIC EQUIPMENT, NAMELY, COMPUTERS AND HANDHELD ELECTRONIC AUDIO SPEAKERS, CELL PHONES, CAMERAS, PERSONAL DIGITAL ASSISTANTS (PDAS) AND MEDIA PLAYERS; USB HUBS; USB HARDWARE; MOUSE PADS; ELECTRONIC WRITING TABLETS; MULTIPLE OUTLET ELECTRICAL POWER STRIP; BATTERY CHARGERS; CONDUCTIVE FIBERS, NAMELY, FIBERS FOR CONDUCTING ELECTRICAL CHARGES AND STATIC ELECTRICAL CHARGES; LIGHT EMITTING DIODES (LEDS) (U.S. CLS. 21, 23, 26, 36 AND 38).

#### **CLASS 11—ENVIRONMENTAL CONTROL APPARATUS**

FOR FLASHLIGHTS; LED (LIGHT EMITTING DIODE) LIGHTING FIXTURES; LED LIGHT MACHINES; LED LIGHT BULBS (U.S. CLS. 13, 21, 23, 31 AND 34).

#### **CLASS 12—VEHICLES**

FOR CARTS (U.S. CLS. 19, 21, 23, 31, 35 AND 44).

#### **CLASS 16—PAPER GOODS AND PRINTED MATTER**

FOR ADHESIVE TAPE DISPENSERS FOR HOUSEHOLD OR STATIONERY USE; ADHESIVE TAPE DISPENSERS (U.S. CLS. 2, 5, 22, 23, 29, 37, 38 AND 50).

#### **CLASS 18—LEATHER GOODS**

FOR BACKPACKS (U.S. CLS. 1, 2, 3, 22 AND 41).

**CLASS 20—FURNITURE AND ARTICLES NOT OTHERWISE CLASSIFIED**

FOR STORAGE AND ORGANIZATION SYSTEMS COMPRISING SHELVES, DRAWERS, CUPBOARDS, BASKETS AND CLOTHES RODS, SOLD AS A UNIT; CLOTHES HANGERS (U.S. CLS. 2, 13, 22, 25, 32 AND 50).

**CLASS 21—HOUSEWARES AND GLASS**

FOR DUST PANS; PLASTIC STORAGE CONTAINERS FOR HOUSEHOLD OR DOMESTIC USE; TOOTHBRUSH HOLDERS; STORAGE AND ORGANIZATION SYSTEMS COMPRISED OF PORTABLE CONTAINERS FOR STORING HOUSEHOLD UTENSILS; HOUSEHOLD UTENSILS, NAMELY, SPATULAS, MIXING SPOONS AND SLOTTED SPOONS; SHOWER CADDIES; SHOWER RACKS; LAUNDRY BASKETS; TRASH CANS; TRASH CONTAINERS FOR HOUSEHOLD USE (U.S. CLS. 2, 13, 23, 29, 30, 33, 40 AND 50).

**CLASS 27—FLOOR COVERINGS**

FOR FLOOR MATS; BATH MATS; RUBBER MATS (U.S. CLS. 19, 20, 37, 42 AND 50).  
DAVID YONTEF, EXAMINING ATTORNEY

**CLASS 11—ENVIRONMENTAL CONTROL APPARATUS**

FOR FLASHLIGHTS; LED (LIGHT EMITTING DIODE) LIGHTING FIXTURES; LED LIGHT MACHINES; LED LIGHT BULBS (U.S. CLS. 13, 21, 23, 31 AND 34).

**CLASS 12—VEHICLES**

FOR CARTS (U.S. CLS. 19, 21, 23, 31, 35 AND 44).

**CLASS 16—PAPER GOODS AND PRINTED MATTER**

FOR ADHESIVE TAPE DISPENSERS FOR HOUSEHOLD OR STATIONERY USE; ADHESIVE TAPE DISPENSERS (U.S. CLS. 2, 5, 22, 23, 29, 37, 38 AND 50).

**CLASS 18—LEATHER GOODS**

FOR ANIMAL LEASHES; BACKPACKS (U.S. CLS. 1, 2, 3, 22 AND 41).

**CLASS 20—FURNITURE AND ARTICLES NOT OTHERWISE CLASSIFIED**

FOR STORAGE AND ORGANIZATION SYSTEMS COMPRISING SHELVES, DRAWERS, CUPBOARDS, BASKETS AND CLOTHES RODS, SOLD AS A UNIT; CLOTHES HANGERS (U.S. CLS. 2, 13, 22, 25, 32 AND 50).

SN 85-312,017. QUIRKY, INC., NEW YORK, NY. FILED 5-4-2011.



THE MARK CONSISTS OF A STYLIZED LETTER "Q".

**CLASS 21—HOUSEWARES AND GLASS**

FOR DUST PANS; PLASTIC STORAGE CONTAINERS FOR HOUSEHOLD OR DOMESTIC USE; TOOTHBRUSH HOLDERS; STORAGE AND ORGANIZATION SYSTEMS COMPRISED OF PORTABLE CONTAINERS FOR STORING HOUSEHOLD UTENSILS; HOUSEHOLD UTENSILS, NAMELY, SPATULAS, MIXING SPOONS AND SLOTTED SPOONS; SHOWER CADDIES; SHOWER RACKS; LAUNDRY BASKETS; TRASH CANS; TRASH CONTAINERS FOR HOUSEHOLD USE (U.S. CLS. 2, 13, 23, 29, 30, 33, 40 AND 50).

**CLASS 27—FLOOR COVERINGS**

FOR FLOOR MATS; BATH MATS; RUBBER MATS (U.S. CLS. 19, 20, 37, 42 AND 50).  
DAVID YONTEF, EXAMINING ATTORNEY

SN 85-312,145. RICHNOW LIFESTYLE TRANSITIONS, LLC, WEST CHESTER, PA. FILED 5-4-2011.

**CLASS 8—HAND TOOLS**

FOR KNIVES; UTILITY KNIVES; KNIVES FOR HOBBY USE (U.S. CLS. 23, 28 AND 44).

**RICHNOW ENTERPRISES****CLASS 9—ELECTRICAL AND SCIENTIFIC APPARATUS**

FOR CORD AND CABLE MANAGEMENT DEVICES, NAMELY, WEIGHTED HOLDERS FOR CONTAINING AND ORGANIZING AUDIO, COMPUTER, CONNECTION, ELECTRICAL, ELECTRONIC, POWER, PRINTER, STEREO AND VIDEO CABLES, ALL FOR CONSUMER ELECTRONICS AND HOUSEHOLD ELECTRIC APPLIANCES; CARRYING CASES FOR ELECTRONIC EQUIPMENT, NAMELY, COMPUTERS AND HANDHELD ELECTRONIC AUDIO SPEAKERS, CELL PHONES, CAMERAS, PERSONAL DIGITAL ASSISTANTS (PDAS) AND MEDIA PLAYERS; USB HUBS; USB HARDWARE; MOUSE PADS; ELECTRONIC WRITING TABLETS; MULTIPLE OUTLET ELECTRICAL POWER STRIP; BATTERY CHARGERS; CONDUCTIVE FIBERS, NAMELY, FIBERS FOR CONDUCTING ELECTRICAL CHARGES AND STATIC ELECTRICAL CHARGES; LIGHT EMITTING DIODES (LEDS) (U.S. CLS. 21, 23, 26, 36 AND 38).

THE MARK CONSISTS OF STANDARD CHARACTERS WITHOUT CLAIM TO ANY PARTICULAR FONT, STYLE, SIZE, OR COLOR.

NO CLAIM IS MADE TO THE EXCLUSIVE RIGHT TO USE "ENTERPRISES", APART FROM THE MARK AS SHOWN.

**CLASS 35—ADVERTISING AND BUSINESS**

FOR HOME RELOCATION CONSULTING SERVICES, NAMELY, CONSULTING RELATED TO PLANNING AND IMPLEMENTING MOVES OF HOMES; BUSINESS RELOCATION CONSULTING; AND ARRANGING SALES FOR OTHERS OF PERSONAL POSSESSIONS (U.S. CLS. 100, 101 AND 102).

FIRST USE 3-0-2010; IN COMMERCE 3-1-2011.

**CLASS 42—SCIENTIFIC AND COMPUTER SERVICES**

FOR HOME STAGING CONSULTATION, NAMELY, TEMPORARY INTERIOR AND EXTERIOR HOME DECORATION CONSULTATION FOR THE PURPOSE OF MAKING HOMES MORE APPEALING TO PROSPECTIVE BUYERS (U.S. CLS. 100 AND 101).

FIRST USE 3-0-2010; IN COMMERCE 3-1-2011.

**CLASS 45—PERSONAL AND LEGAL SERVICES**

FOR ORGANIZATIONAL SERVICES FOR HOME OR PERSONAL PURPOSES, NAMELY, ORGANIZING ATTIC STORAGE SPACE, CLOSET SPACE, DOCUMENTS, GARAGE STORAGE SPACE, HOME STORAGE SPACE, AND PERSONAL POSSESSIONS (U.S. CLS. 100 AND 101).

FIRST USE 3-0-2010; IN COMMERCE 3-1-2011.  
JAMES LOVELACE, EXAMINING ATTORNEY

**CLASS 9—ELECTRICAL AND SCIENTIFIC APPARATUS**

FOR CONTROL VALVES FOR REGULATING THE FLOW OF GASES AND LIQUIDS; SAFETY VALVES FOR FLOW SHUTOFF IN WELL CONSTRUCTION; SAFETY RESTRAINTS OTHER THAN FOR VEHICLE SEATS AND SPORTS EQUIPMENT; SAFETY EQUIPMENT, NAMELY, RESTRAINT SYSTEMS FOR WELL SERVICE FLOW LINES; MONITORING DEVICES FOR MONITORING THE OPERATION AND PERFORMANCE OF PUMPS; CONTROL PANELS FOR REGULATING PRESSURE RELIEF VALVES (U.S. CLS. 21, 23, 26, 36 AND 38).

**CLASS 12—VEHICLES**

FOR TRAILERS (U.S. CLS. 19, 21, 23, 31, 35 AND 44).

**CLASS 37—CONSTRUCTION AND REPAIR**

FOR RENTAL OF SAFETY RESTRAINTS OTHER THAN FOR VEHICLE SEATS AND SPORTS EQUIPMENT; RENTAL OF SAFETY EQUIPMENT, NAMELY, RESTRAINT SYSTEMS FOR WELL SERVICE FLOW LINES; PUMP REPAIR; REPAIR OF PUMPS PARTS; REFURBISHMENT OF PIPES, VALVES AND MANIFOLDS FOR USE IN WELL SERVICE APPLICATIONS; RENTAL OF PIPES, VALVES, MANIFOLDS AND EQUIPMENT FOR USE IN WELL SERVICE APPLICATIONS (U.S. CLS. 100, 103 AND 106).

**CLASS 39—TRANSPORTATION AND STORAGE**

FOR RENTAL OF TRAILERS (U.S. CLS. 100 AND 105).

**CLASS 42—SCIENTIFIC AND COMPUTER SERVICES**

FOR TESTING, ANALYSIS AND EVALUATION OF THE GOODS OF OTHERS FOR THE PURPOSE OF CERTIFICATION (U.S. CLS. 100 AND 101).

EDWARD NELSON, EXAMINING ATTORNEY

SN 85-312,884. S.P.M. FLOW CONTROL, INC., FORT WORTH, TX. FILED 5-5-2011.

SPM

THE MARK CONSISTS OF STANDARD CHARACTERS WITHOUT CLAIM TO ANY PARTICULAR FONT, STYLE, SIZE, OR COLOR.

OWNER OF U.S. REG. NOS. 1,760,988 AND 2,512,027.

**CLASS 6—METAL GOODS**

FOR METAL PIPES AND METAL FITTINGS THEREFOR; METAL VALVES NOT BEING PARTS OF MACHINES; MANUALLY OPERATED METAL VALVES; ELBOWS OF METAL FOR PIPES; METAL SEALS FOR METAL PIPE CONNECTIONS; METAL CLAMPS; METAL PIPE CONNECTORS; METAL PLUGS; METAL FRACTURING HEADS AND METAL CEMENT HEADS ALL DESIGNED FOR USE IN THE GAS AND OIL FIELD INDUSTRY (U.S. CLS. 2, 12, 13, 14, 23, 25 AND 50).

**CLASS 7—MACHINERY**

FOR VALVES BEING PARTS OF MACHINES; VALVES FOR PUMPS; HYDRAULIC VALVE ACTUATORS; PNEUMATIC VALVE ACTUATORS; BALL INJECTOR FOR INSERTING BALLS INTO A WELL DURING FRACTURING TREATMENT; PNEUMATIC DEVICES FOR INSTALLING METAL PIPE CONNECTIONS AND PUMPS ALL FOR USE IN THE GAS AND OIL FIELD INDUSTRY; PLUNGER PUMP PARTS, NAMELY, PLUNGERS, PLUNGER PACKING AND SEATS; PARTS OF OIL FIELD WELLHEAD MACHINES, NAMELY, GATE VALVES, BALL VALVES, CHECK VALVES, PLUG VALVES, GLOBE VALVES, CHOKE AND MANIFOLD INDUSTRIAL PUMPS, PUMP AND VALVE PARTS, PIPE FITTINGS AND FLANGES (U.S. CLS. 13, 19, 21, 23, 31, 34 AND 35).

SN 85-313,037. THE ENERGY STUDIO, INC., OMAHA, NE. FILED 5-5-2011.

THE ENERGY STUDIO  
FOSTERING ENERGY EFFICIENCY

NO CLAIM IS MADE TO THE EXCLUSIVE RIGHT TO USE "ENERGY", APART FROM THE MARK AS SHOWN.

THE MARK CONSISTS FOUR SYMBOLS TO THE LEFT OF THE WORDS "ENERGY STUDIO". THE SYMBOLS CONSIST OF TWO SQUARES AND TWO CIRCLES. THE SQUARES ARE ON THE FAR LEFT, AND SIT ATOP OF EACH OTHER, WITH THE CIRCLES, SITTING ATOP OF EACH OTHER BETWEEN THE TWO SQUARES AND THE WORD "ENERGY". THE WORD "THE" SITS ATOP OF THE WORD "ENERGY" AND THE WORDS "FOSTERING ENERGY EFFICIENCY" SIT BELOW THE WORDS "ENERGY STUDIO". THE "I" IN THE WORD "STUDIO" IS DOTTED WITH A CIRCLE.

**CLASS 35—ADVERTISING AND BUSINESS**

FOR CONSULTATION IN THE FIELD OF ENERGY EFFICIENCY, NAMELY, CONSULTATION WITH MEMBERS OF THE BUILDING INDUSTRY ON WAY TO IMPROVE ENERGY EFFICIENCY (U.S. CLS. 100, 101 AND 102).

FIRST USE 11-1-2010; IN COMMERCE 11-1-2010.

**CLASS 41—EDUCATION AND ENTERTAINMENT**

FOR TRAINING SERVICES, NAMELY, PROVIDING TRAINING IN THE FIELDS OF ENERGY MODELING AND SUSTAINABILITY (U.S. CLS. 100, 101 AND 107).  
FIRST USE 11-1-2010; IN COMMERCE 11-1-2010.  
ROBIN CHOSID, EXAMINING ATTORNEY

SN 85-313,599, CODA LEADERSHIP CONSULTING LLC, NEW YORK, NY. FILED 5-5-2011.

**OUT ON THE STREET**

THE MARK CONSISTS OF STANDARD CHARACTERS WITHOUT CLAIM TO ANY PARTICULAR FONT, STYLE, SIZE, OR COLOR.

**CLASS 35—ADVERTISING AND BUSINESS**

FOR ARRANGING AND CONDUCTING BUSINESS PROGRAMS IN THE NATURE OF BUSINESS CONFERENCES, BUSINESS RESEARCH AND ANALYSIS, AND BUSINESS NETWORKING, ALL DESIGNED TO ENHANCE OPPORTUNITIES FOR THE LESBIAN, GAY, BISEXUAL AND TRANSGENDER COMMUNITY THROUGH THE COLLABORATION OF COMPANIES IN THE FINANCIAL SERVICES INDUSTRY; PROMOTING THE INTERESTS OF THE LESBIAN, GAY, BISEXUAL AND TRANSGENDER COMMUNITY IN THE FINANCIAL SERVICES INDUSTRY (U.S. CLS. 100, 101 AND 102).  
FIRST USE 3-20-2011; IN COMMERCE 3-20-2011.

**CLASS 41—EDUCATION AND ENTERTAINMENT**

FOR ARRANGING AND CONDUCTING BUSINESS SEMINARS IN THE FIELD OF ENHANCING OPPORTUNITIES FOR THE LESBIAN, GAY, BISEXUAL AND TRANSGENDER COMMUNITY IN THE FINANCIAL SERVICES INDUSTRY (U.S. CLS. 100, 101 AND 107).  
FIRST USE 3-30-2011; IN COMMERCE 3-30-2011.  
NICHOLAS ALTREE, EXAMINING ATTORNEY

SN 85-313,749, LIQUIDMETAL TECHNOLOGIES, INC., RANCHO SANTA MARGARITA, CA. FILED 5-5-2011.

**LIQUIDMETAL**

THE MARK CONSISTS OF STANDARD CHARACTERS WITHOUT CLAIM TO ANY PARTICULAR FONT, STYLE, SIZE, OR COLOR.

**CLASS 7—MACHINERY**

FOR PUMP IMPELLERS (U.S. CLS. 13, 19, 21, 23, 31, 34 AND 35).

**CLASS 9—ELECTRICAL AND SCIENTIFIC APPARATUS**

FOR MRI DIAGNOSTIC APPARATUS, NUCLEAR MEDICINE IMAGING APPARATUS FOR RESEARCH PURPOSES; NUCLEAR MEDICINE IMAGING APPARATUS; ULTRASONIC SENSORS AND DEVICES, NAMELY, MEDICAL IMAGING; APPARATUS AND INSTRUMENTS FOR ELECTROPHORESIS AND MASS SPECTROMETRY; METERING DEVICES FOR METERING LIQUIDS, NAMELY, METERING DEVICES FOR LABORATORY REQUIREMENTS, NAMELY, VOLUMETRIC FLASKS, MEASURING CYLINDERS, PIPETTES, BURETTES (U.S. CLS. 21, 23, 26, 36 AND 38).

**CLASS 10—MEDICAL APPARATUS**

FOR ORTHOPEDIC JOINT IMPLANTS, NAMELY, KNEE AND HIP IMPLANTS; SURGICAL SCREWS; COATING SOLD AS AN INTEGRAL COMPONENT OF MEDICAL STENTS AND OTHER IMPLANTABLE MEDICAL DEVICES, NAMELY, CARDIAC PACEMAKERS AND HEART PACEMAKERS; VACUUM PUMPS FOR MEDICAL PURPOSES; MEDICAL APPARATUS FOR DIAGNOSING OR TREATING RESPIRATORY CONDITIONS, NAMELY, RESPIRATORY ASPIRATORS; MEDICAL CUTTING DEVICES, MEDICAL APPARATUS AND UNITS FOR DOSAGE, MEASURING AND MONITORING, NAMELY, DRUG DELIVERY DEVICES AND SYSTEMS; HYDROPHILIC GUIDE WIRE TO TRACK CATHETERS; LAPAROSCOPIC TOOLS AND DEVICES, NAMELY, SCISSORS, FORCEPS; MEDICAL SYRINGES; DRUG DELIVERY SYSTEMS; PHACO TIPS FOR CATARACT REMOVAL; SURGICAL TOOLS, NAMELY, SCALPELS, STAPLING DEVICES AND STAPLES, PLIERS, TROCARS, ENDOSCOPY MICRO-NANO SCALE TOOLS AND MACHINES; FIXATION IMPLANTS COMPRISED OF ARTIFICIAL MATERIAL USED IN THE BONE AND NECK; MEDICAL AND SURGICAL APPARATUS AND INSTRUMENTS, NAMELY, ORTHOPEDIC FIXATION DEVICE USED IN ORTHOPEDIC TRANSPLANT AND/OR IMPLANT SURGERY; OPHTHALMIC TOOLS DEVICES AND EQUIPMENT, NAMELY, TOOLS, DEVICES AND EQUIPMENT FOR LOCATING GROOVES, ENGRAVINGS AND OTHER INDICIA ON OPHTHALMIC LENSES; OPHTHALMIC INSTRUMENTS, NAMELY, INSTRUMENTS FOR MEASURING THE DIAMETER OF OPHTHALMIC LENSES; OPHTHALMIC INSTRUMENTS, NAMELY, INSTRUMENTS FOR LOCATING THE OPTICAL CENTER OF OPHTHALMIC LENSES; DENTAL DEVICES AND EQUIPMENT, NAMELY, DENTAL BRIDGES, INLAYS; DENTAL IMPLANTS; BRACHYTHERAPY DEVICES, NAMELY, RADIATION SHIELDS (U.S. CLS. 26, 39 AND 44).

**CLASS 17—RUBBER GOODS**

FOR RUBBER HERMETIC SEALS FOR MACHINE USE (U.S. CLS. 1, 5, 12, 13, 35 AND 50).  
INGA ERVIN, EXAMINING ATTORNEY

SN 85-313,855, CLINICAL TRIALS OF TEXAS, INC., SAN ANTONIO, TX. FILED 5-5-2011.

**ADAPTIX CLINICAL SOLUTIONS**

THE MARK CONSISTS OF STANDARD CHARACTERS WITHOUT CLAIM TO ANY PARTICULAR FONT, STYLE, SIZE, OR COLOR.

NO CLAIM IS MADE TO THE EXCLUSIVE RIGHT TO USE "CLINICAL SOLUTIONS", APART FROM THE MARK AS SHOWN.

**CLASS 35—ADVERTISING AND BUSINESS**

FOR BUSINESS MANAGEMENT IN THE FIELD OF CLINICAL TRIALS, NAMELY, CLINICAL DATA AND REGULATORY SUBMISSION MANAGEMENT ON BEHALF OF MEDICAL, BIOPHARMACEUTICAL AND BIOTECHNOLOGY COMPANIES TO ASSIST THEM WITH CLINICAL RESEARCH, CLINICAL TRIALS AND APPLICATIONS FOR DRUG APPROVAL (U.S. CLS. 100, 101 AND 102).

**CLASS 42—SCIENTIFIC AND COMPUTER SERVICES**

FOR CLINICAL RESEARCH PROGRAM DEVELOPMENT SERVICES (U.S. CLS. 100 AND 101).  
CHERYL CLAYTON, EXAMINING ATTORNEY

**CLASS 9—ELECTRICAL AND SCIENTIFIC APPARATUS**

FOR INSTRUCTIONAL AUDIO AND VIDEO RECORDINGS CONTAINING TRAINING PROGRAMS CONCERNING SAFETY AND SAFE WORK HABITS (U.S. CLS. 21, 23, 26, 36 AND 38).

FIRST USE 5-1-1997; IN COMMERCE 5-1-1997.

**CLASS 16—PAPER GOODS AND PRINTED MATTER**

FOR PAPER TAGS, PRINTED FORMS, PRINTED INSTRUCTIONAL SAFETY MANUALS, DECALS, PRINTED PAPER LABELS, AND PRINTED PAPER SIGNS CONCERNING SAFETY, SAFE WORK HABITS AND SAFETY CAUTION NOTICES (U.S. CLS. 2, 5, 22, 23, 29, 37, 38 AND 50).

FIRST USE 5-1-1997; IN COMMERCE 5-1-1997.  
DAVID HOFFMAN, EXAMINING ATTORNEY

SN 85-313,896. ZIEGLER, BRANDON, R., DBA ZIGGY BUILT, SANTA ROSA, CA. FILED 5-5-2011.



NO CLAIM IS MADE TO THE EXCLUSIVE RIGHT TO USE "PERFORMANCE", APART FROM THE MARK AS SHOWN.

THE MARK CONSISTS OF "ZIGGY" BUILT IN TWO TONE LETTERING WITH THE "Z" BEING A DIFFERENT COLOR THEN THE REST OF THE LOGO, ENCLOSED BY A SOLID COLOR BOX WITH THE WORD "PERFORMANCE" PLACED IMMEDIATELY BELOW THE FRAMED BOX AND THE SAME SIZE FROM SIDE TO SIDE AS THE BOX. "ZIGGY BUILT" IN BLOCK LETTERING WITH "PERFORMANCE" IN A STANDARD FONT.

**CLASS 35—ADVERTISING AND BUSINESS**

FOR DISTRIBUTORSHIP SERVICES IN THE FIELD OF AUTOMOTIVE AFTERMARKET PERFORMANCE PARTS (U.S. CLS. 100, 101 AND 102).

**CLASS 37—CONSTRUCTION AND REPAIR**

FOR AUTOMOTIVE CONVERSION SERVICES, NAMELY, INSTALLING SPECIALTY AUTOMOTIVE EQUIPMENT; AUTOMOTIVE MAINTENANCE SERVICES, NAMELY, AUTOMOTIVE UPGRADING; AUTOMOTIVE UPGRADE SERVICES, NAMELY, SUPERCHARGING, TURBOCHARGING AND PERFORMANCE UPGRADES OF AUTOMOBILES (U.S. CLS. 100, 103 AND 106).

DAVID HOFFMAN, EXAMINING ATTORNEY

SN 85-313,900. KEEPSAFE INCORPORATED, BAKER, LA. FILED 5-5-2011.

**KEEPSAFE**

THE MARK CONSISTS OF STANDARD CHARACTERS WITHOUT CLAIM TO ANY PARTICULAR FONT, STYLE, SIZE, OR COLOR.

SN 85-313,980. DIGITAL PATIENT, INC., ROANOKE, TX. FILED 5-6-2011.



NO CLAIM IS MADE TO THE EXCLUSIVE RIGHT TO USE "DIGITAL PATIENT", APART FROM THE MARK AS SHOWN.

THE MARK CONSISTS OF THE ITALICIZED WORDS "DIGITAL PATIENT", WITH A SWEEPING BRUSH STROKE BEGINNING TO THE LEFT OF THE WORD "DIGITAL", THEN WIDENING AND ARCING OVER THE WORD "DIGITAL", THEN TAPERING AND ENDING OVER THE LETTER "T" IN THE WORD "PATIENT".

**CLASS 9—ELECTRICAL AND SCIENTIFIC APPARATUS**

FOR DOWNLOADABLE COMPUTER SOFTWARE FOR SECURE ENCRYPTED STORAGE AND RETRIEVAL OF ELECTRONIC DATA AND IMAGES, SUCH SOFTWARE TO BE REMOTE AND LOCALLY DOWNLOADABLE (U.S. CLS. 21, 23, 26, 36 AND 38).

**CLASS 42—SCIENTIFIC AND COMPUTER SERVICES**

FOR APPLICATION SERVICE PROVIDER (ASP) FEATURING SOFTWARE FOR USE FOR HOSPITAL, MEDICAL PRACTICE, FINANCIAL, SERVICE AND PROFESSIONAL RECORD KEEPING AND MANAGING CUSTOMER AND PATIENT RECORDS AND DIGITIZING PAPER BASED REGISTRATION AND INTAKE FORMS VIA END-USER AND PATIENT DIRECT DATA ACQUISITION VIA COMPUTERS, TABLET AND MOBILE DEVICES UTILIZING ALL MODALITIES OF CONNECTIVITY FOR DIRECT INTEGRATION INTO EXISTING HEALTHCARE AND BUSINESS PRACTICE MANAGEMENT SOFTWARE APPLICATIONS (U.S. CLS. 100 AND 101).

**CLASS 45—PERSONAL AND LEGAL SERVICES**

FOR COMPLIANCE CONSULTING IN THE FIELD OF PRIVACY AND SECURITY LAWS, REGULATIONS, AND REQUIREMENTS (U.S. CLS. 100 AND 101).  
CAROLINE WOOD, EXAMINING ATTORNEY

SN 85-314,269. LABORATORIOS PISA, S.A. DE CV, GUADAJARA, MEXICO, FILED 5-6-2011.



OWNER OF U.S. REG. NOS. 3,490,329 AND 3,743,382. THE COLOR(S) WHITE, BLUE, RED, YELLOW, ORANGE, GREEN AND PURPLE IS/ARE CLAIMED AS A FEATURE OF THE MARK.

THE MARK CONSISTS OF THE WORD "ELECTROLIT" AND DESIGN. THE TERM "ELECTROLIT" IS BLUE AND FOUR LIQUID DROPS VARYING IN LENGTHS EMANATE FROM THE LETTER "I" IN "ELECTROLIT". THE FIRST DROPLET EXTENDS TO THE SECOND LETTER "E" IN "ELECTROLIT" AND IS GREEN IN COLOR. THE NEXT DROPLET IS ORANGE WHICH FADES TO YELLOW AND THEN TO ORANGE. THE THIRD DROPLET IS RED AND THE FOURTH IS PURPLE. EACH DROP ALSO HAS SPECKS OF WHITE.

**CLASS 5—PHARMACEUTICALS**

FOR ELECTROLYTE REPLACEMENT SOLUTION FOR ORAL REHYDRATION (U.S. CLS. 6, 18, 44, 46, 51 AND 52).

**CLASS 32—LIGHT BEVERAGES**

FOR ORAL REHYDRATION BEVERAGES, NAMELY, SPORTS DRINKS (U.S. CLS. 45, 46 AND 48). MARLENE BELL, EXAMINING ATTORNEY

SN 85-314,356. QUIDEL CORPORATION, SAN DIEGO, CA. FILED 5-6-2011.



THE MARK CONSISTS OF STANDARD CHARACTERS WITHOUT CLAIM TO ANY PARTICULAR FONT, STYLE, SIZE, OR COLOR.

**CLASS 9—ELECTRICAL AND SCIENTIFIC APPARATUS**

FOR CLINICAL LABORATORY ANALYZERS FOR MEASURING, TESTING AND ANALYZING BLOOD AND OTHER BODILY FLUIDS (U.S. CLS. 21, 23, 26, 36 AND 38).

**CLASS 10—MEDICAL APPARATUS**

FOR MEDICAL DIAGNOSTIC ANALYZERS FOR MEASURING, TESTING AND ANALYZING BLOOD AND OTHER BODILY FLUIDS (U.S. CLS. 26, 39 AND 44). TRACY CROSS, EXAMINING ATTORNEY

SN 85-315,592. JOHNSON, JOHN W, SANTA ANA, CA. AND JOHNSON, LUCINDA M, SANTA ANA, CA. FILED 5-9-2011.



OWNER OF U.S. REG. NOS. 3,034,489 AND 3,053,261. THE MARK CONSISTS OF THE WORD "SAFER" WRITTEN OVER THE NUMERAL "3" WITH A SCRIBBLE PATTERN IN THE BACKGROUND. THIS IMAGE IS SURROUNDED BY A TRIANGLE, AND ON THE INSIDE OF EACH ARM OF THE TRIANGLE APPEARS THE PHRASES: "SAFER KIDS," "SAFER WATER," "SAFER RESPONSE," RESPECTIVELY. OUTSIDE OF EACH ARM OF THE TRIANGLE APPEARS A TADPOLE AND THE NAME "TIMMY TADPOLE" BELOW IT, A STARFISH AND THE NAME "SAMMY STARFISH" BELOW THE STARFISH, AND A GUPPY AND THE NAME "GILBERT GUPPY" BELOW IT.

**CLASS 9—ELECTRICAL AND SCIENTIFIC APPARATUS**

FOR AUDIO DISCS FEATURING POOL SAFETY AND DROWNING PREVENTION (U.S. CLS. 21, 23, 26, 36 AND 38). FIRST USE 10-23-2003; IN COMMERCE 10-23-2003.

**CLASS 16—PAPER GOODS AND PRINTED MATTER**

FOR EDUCATIONAL PUBLICATIONS, NAMELY, CHILDREN'S ACTIVITY BOOKS, PRINTED TEACHING ACTIVITY GUIDES, POSTERS, BROCHURES, AND PAPER BANNERS IN THE FIELDS OF POOL SAFETY AND DROWNING PREVENTION (U.S. CLS. 2, 5, 22, 23, 29, 37, 38 AND 50). FIRST USE 10-23-2003; IN COMMERCE 10-23-2003. MARGARET POWER, EXAMINING ATTORNEY

SN 85-315,634. PRO FOOTBALL WEEKLY LLC, RIVERWOODS, IL. FILED 5-9-2011.



THE MARK CONSISTS OF STANDARD CHARACTERS WITHOUT CLAIM TO ANY PARTICULAR FONT, STYLE, SIZE, OR COLOR. OWNER OF U.S. REG. NOS. 1,549,119 AND 2,450,576.

**CLASS 9—ELECTRICAL AND SCIENTIFIC APPARATUS**

FOR DOWNLOADABLE COMPUTER SOFTWARE FOR DELIVERING ARTICLES, EDITORIAL CONTENT, AUDIO AND VIDEO CLIPS AND FOR STORING, MANAGING, TRACKING, ANALYZING AND REPORTING DATA IN THE FIELD OF SPORTS FOR USE ON WIRELESS DEVICES AND COMPUTERS (U.S. CLS. 21, 23, 26, 36 AND 38).

FIRST USE 12-0-1998; IN COMMERCE 12-0-1998.

**CLASS 16—PAPER GOODS AND PRINTED MATTER**

FOR PRINTED MATTER, NAMELY, MAGAZINES IN THE FIELD OF PROFESSIONAL FOOTBALL; PRINTED MATTER, NAMELY, MAGAZINES IN THE FIELD OF SPORTS; PRINTED NEWSPAPER SECTIONS, PAGES, INSERTS AND NEWSLETTERS IN THE FIELD OF PROFESSIONAL FOOTBALL; PRINTED NEWSPAPER SECTIONS, PAGES, INSERTS AND NEWSLETTERS IN THE FIELD OF SPORTS (U.S. CLS. 2, 5, 22, 23, 29, 37, 38 AND 50).

FIRST USE 9-17-1967; IN COMMERCE 9-17-1967.

**CLASS 41—EDUCATION AND ENTERTAINMENT**

FOR PROVIDING SPORTS INFORMATION BY MEANS OF A GLOBAL COMPUTER INFORMATION NETWORK; PROVIDING AN ONLINE MAGAZINE ABOUT FOOTBALL VIA A GLOBAL COMMUNICATIONS NETWORK; PROVIDING AN ONLINE MAGAZINE ABOUT SPORTS VIA A GLOBAL COMMUNICATIONS NETWORK (U.S. CLS. 100, 101 AND 107).

FIRST USE 12-0-1998; IN COMMERCE 12-0-1998.  
CHARLES L. JENKINS, EXAMINING ATTORNEY

SN 85-315,684. VANCE PUBLISHING CORPORATION, LINCOLNSHIRE, IL. FILED 5-9-2011.



OWNER OF U.S. REG. NOS. 2,646,862, 2,965,835 AND 3,424,950.

NO CLAIM IS MADE TO THE EXCLUSIVE RIGHT TO USE "CATTLE NETWORK", APART FROM THE MARK AS SHOWN.

THE MARK CONSISTS OF THE TEXT "DROVERS CATTLENETWORK" WITH A SET OF HORNS COMPRISING THE "V".

**CLASS 16—PAPER GOODS AND PRINTED MATTER**

FOR TRADE PUBLICATIONS, NAMELY, MAGAZINES FEATURING INFORMATION REGARDING THE BEEF INDUSTRY (U.S. CLS. 2, 5, 22, 23, 29, 37, 38 AND 50).

FIRST USE 3-31-2010; IN COMMERCE 3-31-2010.

**CLASS 35—ADVERTISING AND BUSINESS**

FOR PROVIDING A WEBSITE FEATURING TRADE INFORMATION REGARDING THE BEEF INDUSTRY (U.S. CLS. 100, 101 AND 102).

FIRST USE 3-31-2010; IN COMMERCE 3-31-2010.

**CLASS 41—EDUCATION AND ENTERTAINMENT**

FOR ELECTRONIC PUBLICATIONS, NAMELY, ONLINE MAGAZINES AND NEWSLETTERS FEATURING INFORMATION REGARDING THE BEEF INDUSTRY (U.S. CLS. 100, 101 AND 107).

FIRST USE 3-31-2010; IN COMMERCE 3-31-2010.  
ANDREW LEASER, EXAMINING ATTORNEY

SN 85-315,742. THE STONEBRIDGE GROUP, LLC, PEWEE VALLEY, KY. FILED 5-9-2011.



THE COLOR(S) BLUE, BLACK AND GRAY IS/ARE CLAIMED AS A FEATURE OF THE MARK.

THE MARK CONSISTS OF THE WORD "VISO" WHERE THE "I" IS DEPICTED AS A CAMERA LENSE ABOVE A CAMERA TRIPOD STAND COMPRISING LEGS DEPICTED BY ELONGATED CURVED MEMBERS. THE LETTERS "V", "S", AND "O" ARE IN BLACK. THE CAMERA LENSE AND TRIPOD ARE BLUE, GRAY, AND BLACK.

THE ENGLISH TRANSLATION OF "VISO" IN THE MARK IS "FACE".

**CLASS 9—ELECTRICAL AND SCIENTIFIC APPARATUS**

FOR COMPUTER SOFTWARE AND PROGRAMS TO USED TO GENERATE CONTENT AND ACHIEVE INTERACTION, NAMELY, TELECONFERENCING AND PRESENTATIONS BETWEEN TWO OR MORE USERS FOR SENDING AND RECEIVING INFORMATION UTILIZING ON-LINE COMMUNICATION USING A COMPUTER, PHONE, TABLET, PDA, LAPTOP, MOBILE PHONES AND/OR OTHER ELECTRONIC MEDIA UTILIZING AUDIO AND VIDEO INFORMATION (U.S. CLS. 21, 23, 26, 36 AND 38).

**CLASS 42—SCIENTIFIC AND COMPUTER SERVICES**

FOR COMPUTER SERVICES, NAMELY, CREATING, DESIGNING, IMPLEMENTING AND HOSTING AUDIO CONFERENCING AND PRESENTATION SOFTWARE TO ACHIEVE ON-LINE INTERACTION BETWEEN TWO OR MORE USERS IN TELECONFERENCING APPLICATIONS (U.S. CLS. 100 AND 101).

EDWARD NELSON, EXAMINING ATTORNEY

SN 85-315,930. QUIRKY, INC., NEW YORK, NY. FILED 5-9-2011.

**INVENTED TOGETHER**

THE MARK CONSISTS OF STANDARD CHARACTERS WITHOUT CLAIM TO ANY PARTICULAR FONT, STYLE, SIZE, OR COLOR.

**CLASS 9—ELECTRICAL AND SCIENTIFIC APPARATUS**

FOR CORD AND CABLE MANAGEMENT DEVICES, NAMELY, WEIGHTED HOLDERS FOR CONTAINING AND ORGANIZING AUDIO, COMPUTER, CONNECTION, ELECTRICAL, ELECTRONIC, POWER, PRINTER, STEREO AND VIDEO CABLES, ALL FOR CONSUMER ELECTRONICS AND HOUSEHOLD ELECTRIC APPLIANCES; CARRYING CASES FOR ELECTRONIC EQUIPMENT, NAMELY, COMPUTERS AND HANDHELD ELECTRONIC AUDIO SPEAKERS, CELL PHONES, CAMERAS, PERSONAL DIGITAL ASSISTANTS (PDAS) AND MEDIA PLAYERS; USB HUBS; USB HARDWARE; MOUSE PADS; ELECTRONIC WRITING TABLETS; MULTIPLE OUTLET ELECTRICAL POWER STRIP; BATTERY CHARGERS; CONDUCTIVE FIBERS, NAMELY, FIBERS FOR CONDUCTING ELECTRICAL CHARGES AND STATIC ELECTRICAL CHARGES; LIGHT EMITTING DIODES (LEDS) (U.S. CLS. 21, 23, 26, 36 AND 38).

**CLASS 21—HOUSEWARES AND GLASS**

FOR DUST PANS; PLASTIC STORAGE CONTAINERS FOR HOUSEHOLD OR DOMESTIC USE; TOOTHBRUSH HOLDERS; STORAGE AND ORGANIZATION SYSTEMS COMPRISED OF PORTABLE CONTAINERS FOR STORING HOUSEHOLD UTENSILS; HOUSEHOLD UTENSILS, NAMELY, SPATULAS, MIXING SPOONS AND SLOTTED SPOONS; SHOWER CADDIES; SHOWER RACKS; LAUNDRY BASKETS; TRASH CANS; TRASH CONTAINERS FOR HOUSEHOLD USE (U.S. CLS. 2, 13, 23, 29, 30, 33, 40 AND 50).

DAVID YONTEF, EXAMINING ATTORNEY

SN 85-315,970. MUNDER, NICOLE R., WEST PALM BEACH, FL. FILED 5-9-2011.

**JUST IN CASE**

THE MARK CONSISTS OF STANDARD CHARACTERS WITHOUT CLAIM TO ANY PARTICULAR FONT, STYLE, SIZE, OR COLOR.

**CLASS 10—MEDICAL APPARATUS**

FOR BLISTER KIT COMPOSED OF ADHESIVE TAPE AND PADS FOR USE IN THE PROTECTION OF SKIN AND PREVENTION AND RELIEF FROM BLISTERS (U.S. CLS. 26, 39 AND 44).

**CLASS 14—JEWELRY**

FOR EARRING CLIP PADS; NECKLACE EXTENDERS; NECKLACE SHORTENING ADJUSTERS; EARRING STABILIZERS; PIN TO PENDANT JEWELRY ACCESSORY (U.S. CLS. 2, 27, 28 AND 50).

**CLASS 21—HOUSEWARES AND GLASS**

FOR LINT REMOVER IN THE FORM OF A LINT ROLLER (U.S. CLS. 2, 13, 23, 29, 30, 33, 40 AND 50).

**CLASS 25—CLOTHING**

FOR SHOE PARTS, NAMELY, REPLACEMENT HEEL TIPS (U.S. CLS. 22 AND 39).

**CLASS 26—FANCY GOODS**

FOR PERSONAL VALET DRESSING AND TRAVEL KIT PRIMARILY COMPRISED OF, DOUBLE-SIDED APPAREL TAPE AND TAPE FOR KEEPING CLOTHING STRAPS IN PLACE, POP-ON BUTTONS AND HEM SNAPS, SAFETY PINS, CLIPS USED TO ALIGN BRA STRAPS WITH GARMENT STRAPS, CLEAR GARMENT STRAPS, ADHESIVE TAPE AND PADS FOR PROTECTION OF SKIN AND BLISTER PREVENTION, EARRING CLIP PADS, NECKLACE EXTENDERS, NECKLACE SHORTENING ADJUSTERS, EARRING STABILIZERS, LINT ROLLERS, SHOE HEEL TIPS, HEM TAPE, GARMENT CLIPS, ALL FOR TEMPORARY REPAIRS AND ALTERATIONS TO CLOTHING, ALL SOLD AS A UNIT (U.S. CLS. 37, 39, 40, 42 AND 50).

FONG HSU, EXAMINING ATTORNEY

SN 85-316,098. UNITED SOCIAL SPORTS INC., WASHINGTON, DC. FILED 5-9-2011.

NO CLAIM IS MADE TO THE EXCLUSIVE RIGHT TO USE "SOCIAL SPORTS", APART FROM THE MARK AS SHOWN.

THE COLOR(S) BLUE AND RED IS/ARE CLAIMED AS A FEATURE OF THE MARK.

THE MARK CONSISTS OF THE STYLIZED WORDING "UNITED" IN LOWERCASE BLUE TEXT ABOVE THE WORDING "SOCIAL" IN RED TEXT AND "SPORTS" IN BLUE TEXT IN CAPITAL LETTERS.

**CLASS 35—ADVERTISING AND BUSINESS**

FOR ADMINISTRATION OF COMMUNITY RECREATIONAL SPORTS LEAGUES; COORDINATION OF RECREATIONAL SPORTING OPPORTUNITIES FOR INDIVIDUALS WHO WISH TO PARTICIPATE IN TEAM LEAGUE SPORTS; PROVIDING A WEB SITE THAT PROVIDES SPORTS LEAGUE MANAGEMENT (U.S. CLS. 100, 101 AND 102).

FIRST USE 1-1-2010; IN COMMERCE 1-1-2010.

**CLASS 41—EDUCATION AND ENTERTAINMENT**

FOR ARRANGING AND CONDUCTING SPECIAL EVENTS FOR SOCIAL ENTERTAINMENT PURPOSES; ARRANGING, ORGANIZING, CONDUCTING, AND HOSTING SOCIAL ENTERTAINMENT EVENTS; ENTERTAINMENT SERVICES, NAMELY, CONDUCTING PARTIES FOR THE PURPOSE OF DATING AND SOCIAL INTRODUCTION FOR ADULTS; SOCIAL CLUB SERVICES, NAMELY, ARRANGING, ORGANIZING, AND HOSTING SOCIAL EVENTS, GET-TOGETHERS, AND PARTIES FOR CLUB MEMBERS; SPECIAL EVENT PLANNING FOR SOCIAL ENTERTAINMENT PURPOSES (U.S. CLS. 100, 101 AND 107).

FIRST USE 1-1-2010; IN COMMERCE 1-1-2010.  
KATINA MISTER, EXAMINING ATTORNEY



SN 85-316,195. SK TELECOM AMERICAS, INC., SUNNYVALE, CA. FILED 5-9-2011.

# YESWELL

THE MARK CONSISTS OF STANDARD CHARACTERS WITHOUT CLAIM TO ANY PARTICULAR FONT, STYLE, SIZE, OR COLOR.

## CLASS 38—COMMUNICATION

FOR PROVIDING ON-LINE CHAT ROOMS, INTERACTIVE DISCUSSION FORUMS AND ELECTRONIC BULLETIN BOARDS FOR TRANSMISSION OF MESSAGES AMONG USERS IN THE AREA OF WELLNESS, DIET, NUTRITION, WEIGHT LOSS, HEALTH, PHYSICAL FITNESS, MENTAL HEALTH, STRENGTH, CONDITIONING, EXERCISE, AND WELL-BEING (U.S. CLS. 100, 101 AND 104).

## CLASS 41—EDUCATION AND ENTERTAINMENT

FOR PROVIDING A WEBSITE FEATURING INFORMATION IN THE FIELDS OF PHYSICAL FITNESS, STRENGTH, PHYSICAL CONDITIONING AND EXERCISE; CONSULTATION IN THE FIELDS OF PHYSICAL FITNESS, STRENGTH, CONDITIONING AND EXERCISE; INFORMATION SERVICES CONCERNING PHYSICAL FITNESS, STRENGTH, CONDITIONING AND EXERCISE FOR WIRELESS AND MOBILE DEVICES; PROVIDING INFORMATION VIA A GLOBAL COMPUTER NETWORK IN THE FIELDS OF PHYSICAL FITNESS, STRENGTH, CONDITIONING AND EXERCISE; PROVIDING INTERACTIVE ON-LINE DATABASES VIA A GLOBAL COMPUTER NETWORK FOR CREATING PERSONALIZED AND CUSTOMIZED PHYSICAL FITNESS, STRENGTH, CONDITIONING AND EXERCISE PROGRAMS; PROVIDING CONSULTATION AND INFORMATION VIA A GLOBAL COMPUTER NETWORK IN THE FIELDS OF PHYSICAL FITNESS, STRENGTH, CONDITIONING AND EXERCISE; PROVIDING ONLINE INFORMATION RELATED TO THE PLANNING AND SUPERVISION OF PHYSICAL FITNESS, CONDITIONING AND EXERCISE PROGRAMS; EDUCATIONAL SERVICES, NAMELY, CONDUCTING ONLINE SEMINARS, CLASSES AND WORKSHOPS IN THE FIELDS OF WELLNESS, DIET, NUTRITION, WEIGHT LOSS, HEALTH, PHYSICAL FITNESS, MENTAL HEALTH, STRENGTH, CONDITIONING, EXERCISE, AND WELL-BEING; ELECTRONIC PUBLISHING SERVICES, NAMELY, ELECTRONIC PUBLICATION OF DOWNLOADABLE TEXT, PHOTOS, VIDEO, AND AUDIO CONTENT OF OTHERS ON THE INTERNET IN THE FIELD OF WELLNESS, DIET, NUTRITION, WEIGHT LOSS, HEALTH, PHYSICAL FITNESS, MENTAL HEALTH, STRENGTH, CONDITIONING, EXERCISE, AND WELL-BEING; PROVIDING NON-DOWNLOADABLE ELECTRONIC NEWSLETTERS VIA WEBSITE AND ELECTRONIC MAIL CONCERNING WELLNESS, DIET, NUTRITION, WEIGHT LOSS, HEALTH, PHYSICAL FITNESS, MENTAL HEALTH, STRENGTH, CONDITIONING, EXERCISE, AND WELL-BEING; ON-LINE JOURNALS, NAMELY, BLOGS IN THE FIELDS OF WELLNESS, DIET, NUTRITION, WEIGHT LOSS, HEALTH, PHYSICAL FITNESS, MENTAL HEALTH, STRENGTH, CONDITIONING, EXERCISE, AND WELL-BEING; INSTRUCTION AND TRAINING IN THE FIELDS OF WELLNESS, DIET, NUTRITION, WEIGHT LOSS, HEALTH, PHYSICAL FITNESS, MENTAL HEALTH, STRENGTH, CONDITIONING, EXERCISE, AND WELL-BEING; PHYSICAL FITNESS TRAINING AND CONSULTATION SERVICES, NAMELY, PERSONALIZED FITNESS PLANS, STRENGTH AND CONDITIONING TRAINING AND WEIGHT LOSS INSTRUCTION; INSTRUCTION IN MENTAL AND PHYSICAL HEALTH AND WELLNESS, PHYSICAL FITNESS AND HOLISTIC HEALTHCARE (U.S. CLS. 100, 101 AND 107).

## CLASS 42—SCIENTIFIC AND COMPUTER SERVICES

FOR PROVIDING ON-LINE NON-DOWNLOADABLE SOFTWARE THAT ENABLES USERS TO UPLOAD, DOWNLOAD, MANIPULATE, STORE, AND VIEW TEXT, PHOTOS, VIDEO, AND AUDIO CONTENT IN THE FIELDS OF WELLNESS, DIET, NUTRITION, WEIGHT LOSS, HEALTH, PHYSICAL FITNESS, MENTAL HEALTH, STRENGTH, CONDITIONING, EXERCISE, AND WELL-BEING; COMPUTER SERVICES IN THE NATURE OF CUSTOMIZED WEB PAGES FEATURING USER-DEFINED INFORMATION AND PERSONAL PROFILES; PROVIDING TEMPORARY USE OF ON-LINE NON-DOWNLOADABLE SOFTWARE FOR CREATING PERSONALIZED AND CUSTOMIZED WELLNESS, DIET, NUTRITION, WEIGHT LOSS, HEALTH, PHYSICAL FITNESS, MENTAL HEALTH, STRENGTH, CONDITIONING, EXERCISE, AND WELL-BEING PROGRAMS (U.S. CLS. 100 AND 101).

## CLASS 44—MEDICAL, BEAUTY AND AGRICULTURAL SERVICES

FOR CONSULTATION IN THE FIELDS OF WELLNESS, DIET, NUTRITION, WEIGHT LOSS, HEALTH, MENTAL HEALTH AND WELL-BEING; PROVIDING A WEBSITE FEATURING INFORMATION IN THE FIELDS OF WELLNESS, DIET, NUTRITION, WEIGHT LOSS, HEALTH, MENTAL HEALTH, AND WELL-BEING; INFORMATION SERVICES CONCERNING WELLNESS, DIET, NUTRITION, WEIGHT LOSS, HEALTH, MENTAL HEALTH AND WELL-BEING FOR WIRELESS AND MOBILE DEVICES; PROVIDING INFORMATION VIA A GLOBAL COMPUTER NETWORK IN THE FIELDS OF WELLNESS, DIET, NUTRITION, WEIGHT LOSS, HEALTH, MENTAL HEALTH AND WELL-BEING; PROVIDING INTERACTIVE ON-LINE DATABASES VIA A GLOBAL COMPUTER NETWORK FOR CREATING PERSONALIZED AND CUSTOMIZED WELLNESS, DIET, NUTRITION, WEIGHT LOSS, HEALTH, MENTAL HEALTH AND WELL-BEING PROGRAMS; PROVIDING CONSULTATION AND INFORMATION VIA A GLOBAL COMPUTER NETWORK IN THE FIELDS OF WELLNESS, DIET, NUTRITION, WEIGHT LOSS, HEALTH, MENTAL HEALTH AND WELL-BEING; PROVIDING ONLINE INFORMATION RELATED TO THE PLANNING AND SUPERVISION OF DIET, NUTRITION, WEIGHT LOSS AND MENTAL HEALTH PROGRAMS; PREVENTATIVE HEALTH CARE INFORMATION AND CONSULTATION (U.S. CLS. 100 AND 101).

DOMINIC J. FERRAIUOLO, EXAMINING ATTORNEY

SN 85-316,283. SHAMBHALA PUBLICATIONS, INC., BOSTON, MA. FILED 5-9-2011.



NO CLAIM IS MADE TO THE EXCLUSIVE RIGHT TO USE "BOOKS", APART FROM THE MARK AS SHOWN. THE MARK CONSISTS OF A STYLIZED BIRD AND BRANCH WITH LEAVES ABOVE THE WORDS "ROOST BOOKS" WITH THE WORD "ROOST" ABOVE THE WORD "BOOKS".

**CLASS 16—PAPER GOODS AND PRINTED MATTER**

FOR FICTION AND NON-FICTION BOOKS ON A VARIETY OF TOPICS (U.S. CLS. 2, 5, 22, 23, 29, 37, 38 AND 50).

**CLASS 35—ADVERTISING AND BUSINESS**

FOR ONLINE RETAIL STORE SERVICES FEATURING FICTION AND NON-FICTION BOOKS ON A VARIETY OF TOPICS (U.S. CLS. 100, 101 AND 102).  
JIM RINGLE, EXAMINING ATTORNEY

---

SN 85-316,303. SHAMBHALA PUBLICATIONS, INC., BOSTON, MA. FILED 5-9-2011.

**ROOST BOOKS**

THE MARK CONSISTS OF STANDARD CHARACTERS WITHOUT CLAIM TO ANY PARTICULAR FONT, STYLE, SIZE, OR COLOR.

NO CLAIM IS MADE TO THE EXCLUSIVE RIGHT TO USE "BOOKS", APART FROM THE MARK AS SHOWN.

**CLASS 16—PAPER GOODS AND PRINTED MATTER**

FOR FICTION AND NON-FICTION BOOKS ON A VARIETY OF TOPICS (U.S. CLS. 2, 5, 22, 23, 29, 37, 38 AND 50).

**CLASS 35—ADVERTISING AND BUSINESS**

FOR ONLINE RETAIL STORE SERVICES FEATURING FICTION AND NON-FICTION BOOKS ON A VARIETY OF TOPICS (U.S. CLS. 100, 101 AND 102).  
JIM RINGLE, EXAMINING ATTORNEY

---

SN 85-316,762. LUCAS, ERIC G., MINNETONKA, MN. FILED 5-10-2011.

**STUFF MY BOSS SAYS**

THE MARK CONSISTS OF STANDARD CHARACTERS WITHOUT CLAIM TO ANY PARTICULAR FONT, STYLE, SIZE, OR COLOR.

**CLASS 9—ELECTRICAL AND SCIENTIFIC APPARATUS**

FOR DOWNLOADABLE ELECTRONIC NEWSLETTERS FEATURING GUIDANCE AND INSTRUCTION IN STRESS REDUCTION TECHNIQUES AND IMPLEMENTATION TECHNIQUES (U.S. CLS. 21, 23, 26, 36 AND 38).

**CLASS 41—EDUCATION AND ENTERTAINMENT**

FOR PERSONAL COACHING SERVICES IN THE FIELD OF WELLNESS AND STRESS REDUCTION; EDUCATIONAL SERVICES, NAMELY, PROVIDING COURSES OF INSTRUCTION AND SEMINARS IN THE FIELD OF WELLNESS AND STRESS REDUCTION AND DISTRIBUTING INSTRUCTIONAL MATERIALS AND UPDATABLE DOCUMENTATION FOR USE IN IDENTIFYING, CATEGORIZING, ORGANIZING AND MANAGING STRESSORS IN CONNECTION THEREWITH; ONLINE JOURNALS, NAMELY, BLOGS FEATURING DISCUSSIONS IN THE FIELD OF WELLNESS AND STRESS REDUCTION; PROVIDING ELECTRONIC ONLINE NEWSLETTERS FEATURING GUIDANCE AND INSTRUCTION IN STRESS REDUCTION TECHNIQUES AND IMPLEMENTATION TECHNIQUES; PROVIDING ELECTRONIC NEWSLETTERS FEATURING GUIDANCE AND INSTRUCTION IN STRESS REDUCTION TECHNIQUES AND IMPLEMENTATION TECHNIQUES VIA EMAIL (U.S. CLS. 100, 101 AND 107).

**CLASS 42—SCIENTIFIC AND COMPUTER SERVICES**

FOR APPLICATION SERVICE PROVIDER (ASP) SERVICES, NAMELY, HOSTING, MANAGING, DEVELOPING AND MAINTAINING APPLICATIONS, SOFTWARE, WEBSITES AND DATABASES FOR USE IN THE FIELD OF STRESS REDUCTION BY ENABLING INDIVIDUALS, GROUPS, ORGANIZATIONS, COMPANIES AND EMPLOYEES TO IDENTIFY, CATEGORIZE AND ORGANIZE ACTIVITIES (U.S. CLS. 100 AND 101).

**CLASS 44—MEDICAL, BEAUTY AND AGRICULTURAL SERVICES**

FOR CONSULTING SERVICES IN THE FIELD OF WELLNESS AND STRESS REDUCTION, NAMELY, PROVIDING PERSONAL ASSESSMENT SERVICES AND COUNSELING SERVICES (U.S. CLS. 100 AND 101).  
HELENE LIWINSKI, EXAMINING ATTORNEY

---

SN 85-316,858. AMAZON TECHNOLOGIES, INC., RENO, NV. FILED 5-10-2011.

**MONTLAKE ROMANCE**

THE MARK CONSISTS OF STANDARD CHARACTERS WITHOUT CLAIM TO ANY PARTICULAR FONT, STYLE, SIZE, OR COLOR.

NO CLAIM IS MADE TO THE EXCLUSIVE RIGHT TO USE "ROMANCE", APART FROM THE MARK AS SHOWN.

**CLASS 16—PAPER GOODS AND PRINTED MATTER**

FOR SERIES OF FICTION AND NON-FICTION BOOKS IN THE FIELD OF ROMANCE (U.S. CLS. 2, 5, 22, 23, 29, 37, 38 AND 50).

**CLASS 40—MATERIAL TREATMENT**

FOR PRINTING OF PRINTED MATTER AND BOOKS; DIGITAL ON-DEMAND PRINTING SERVICES OF PRINTED MATTER AND BOOKS (U.S. CLS. 100, 103 AND 106).

**CLASS 41—EDUCATION AND ENTERTAINMENT**

FOR PUBLISHING OF PRINTED MATTER AND BOOKS; PROVIDING INFORMATION IN THE FIELD OF PUBLISHING; ENTERTAINMENT SERVICES, NAMELY, PROVIDING INFORMATION AND COMMENTARY IN THE FIELDS OF AUTHORS, BOOKS, LITERARY WORKS AND RECOMMENDATIONS AS TO THE SAME; PUBLISHING OF REVIEWS OF LITERARY WORKS; PROVIDING A WEB SITE WHERE USERS CAN POST RATINGS, REVIEWS AND RECOMMENDATIONS ON LITERARY WORKS, BOOKS AND PRINTED MATTER (U.S. CLS. 100, 101 AND 107).

ANGELA M. MICHELI, EXAMINING ATTORNEY

SN 85-317,307. WILTURNER, DERRICK P., PEARLAND, TX. FILED 5-10-2011.

**COTTON GENIUS**

THE MARK CONSISTS OF STANDARD CHARACTERS WITHOUT CLAIM TO ANY PARTICULAR FONT, STYLE, SIZE, OR COLOR.

NO CLAIM IS MADE TO THE EXCLUSIVE RIGHT TO USE "COTTON", APART FROM THE MARK AS SHOWN.

**CLASS 8—HAND TOOLS**

FOR HAND TOOLS, NAMELY, CLAMPS (U.S. CLS. 23, 28 AND 44).

**CLASS 25—CLOTHING**

FOR T-SHIRTS MADE OF COTTON (U.S. CLS. 22 AND 39).

KELLY TRUSILO, EXAMINING ATTORNEY

SN 85-317,597. NATIONAL ARTS TREASURE INITIATIVE, WASHINGTON, DC. FILED 5-10-2011.

**NATIONAL ARTS TREASURE INITIATIVE**

THE MARK CONSISTS OF STANDARD CHARACTERS WITHOUT CLAIM TO ANY PARTICULAR FONT, STYLE, SIZE, OR COLOR.

NO CLAIM IS MADE TO THE EXCLUSIVE RIGHT TO USE "NATIONAL ARTS" AND "INITIATIVE", APART FROM THE MARK AS SHOWN.

**CLASS 36—INSURANCE AND FINANCIAL**

FOR CHARITABLE FUNDRAISING (U.S. CLS. 100, 101 AND 102).

**CLASS 41—EDUCATION AND ENTERTAINMENT**

FOR FILM AND VIDEO PRODUCTION (U.S. CLS. 100, 101 AND 107).

LAURA HAMMEL, EXAMINING ATTORNEY

SN 85-317,689. BEACHBODY, LLC, SANTA MONICA, CA. FILED 5-11-2011.

**DYNAMIC SET TRAINING**

THE MARK CONSISTS OF STANDARD CHARACTERS WITHOUT CLAIM TO ANY PARTICULAR FONT, STYLE, SIZE, OR COLOR.

NO CLAIM IS MADE TO THE EXCLUSIVE RIGHT TO USE "SET TRAINING", APART FROM THE MARK AS SHOWN.

**CLASS 9—ELECTRICAL AND SCIENTIFIC APPARATUS**

FOR PRE-RECORDED VIDEO TAPES, AUDIO AND VIDEO CASSETTES, DVDS, AND CDS, FEATURING EXERCISE, FITNESS, DIETARY INFORMATION AND INSTRUCTION, AND INSTRUCTIONAL MATERIALS DISTRIBUTED IN CONNECTION THEREWITH (U.S. CLS. 21, 23, 26, 36 AND 38).

**CLASS 41—EDUCATION AND ENTERTAINMENT**

FOR PROVIDING A WEB SITE FEATURING ON-LINE INSTRUCTION IN THE FIELD OF PHYSICAL EXERCISE AND NUTRITION AND TRACKING PROGRESS OF WORKOUTS; EDUCATIONAL SERVICES AND ON-LINE EDUCATIONAL SERVICES, NAMELY, PROVIDING INSTRUCTION IN THE FIELDS OF EXERCISE EQUIPMENT, PHYSICAL EXERCISE AND NUTRITION, AND INSTRUCTIONAL MATERIALS DISTRIBUTED IN CONNECTION THEREWITH; PHYSICAL FITNESS TRAINING SERVICES, NAMELY, TRACKING PROGRESS OF WORKOUTS FOR OTHERS; ENTERTAINMENT SERVICES, NAMELY, CONDUCTING CONTESTS; EDUCATION AND ENTERTAINMENT SERVICES, NAMELY, PROVIDING A WEBSITE FEATURING NON-DOWNLOADABLE AUDIO CLIPS, VIDEO CLIPS, MUSICAL PERFORMANCES, MUSICAL VIDEOS, FILM CLIPS, PHOTOGRAPHS, AND INFORMATION IN THE FIELD OF EXERCISE (U.S. CLS. 100, 101 AND 107).

ELIZABETH KAJUBI, EXAMINING ATTORNEY

SN 85-317,701. BEACHBODY, LLC, SANTA MONICA, CA. FILED 5-11-2011.

**BEACHBODY DYNAMIC SET TRAINING**

THE MARK CONSISTS OF STANDARD CHARACTERS WITHOUT CLAIM TO ANY PARTICULAR FONT, STYLE, SIZE, OR COLOR.

OWNER OF U.S. REG. NOS. 2,862,904, 3,664,668 AND OTHERS.

NO CLAIM IS MADE TO THE EXCLUSIVE RIGHT TO USE "SET TRAINING", APART FROM THE MARK AS SHOWN.

**CLASS 9—ELECTRICAL AND SCIENTIFIC APPARATUS**

FOR PRE-RECORDED VIDEO TAPES, AUDIO AND VIDEO CASSETTES, DVDS, AND CDS, FEATURING EXERCISE, FITNESS, DIETARY INFORMATION AND INSTRUCTION, AND INSTRUCTIONAL MATERIALS DISTRIBUTED IN CONNECTION THEREWITH (U.S. CLS. 21, 23, 26, 36 AND 38).

**CLASS 41—EDUCATION AND ENTERTAINMENT**

FOR PROVIDING A WEB SITE FEATURING ON-LINE INSTRUCTION IN THE FIELD OF PHYSICAL EXERCISE AND NUTRITION AND TRACKING PROGRESS OF WORKOUTS; EDUCATIONAL SERVICES AND ON-LINE EDUCATIONAL SERVICES, NAMELY, PROVIDING INSTRUCTION IN THE FIELDS OF EXERCISE EQUIPMENT, PHYSICAL EXERCISE AND NUTRITION, AND INSTRUCTIONAL MATERIALS DISTRIBUTED IN CONNECTION THEREWITH; PHYSICAL FITNESS TRAINING SERVICES, NAMELY, TRACKING PROGRESS OF WORKOUTS FOR OTHERS; ENTERTAINMENT SERVICES, NAMELY, CONDUCTING CONTESTS; EDUCATION AND ENTERTAINMENT SERVICES, NAMELY, PROVIDING A WEBSITE FEATURING NON-DOWNLOADABLE AUDIO CLIPS, VIDEO CLIPS, MUSICAL PERFORMANCES, MUSICAL VIDEOS, FILM CLIPS, PHOTOGRAPHS, AND INFORMATION IN THE FIELD OF EXERCISE (U.S. CLS. 100, 101 AND 107).  
ELIZABETH KAJUBI, EXAMINING ATTORNEY

SN 85-317,943. LONE STAR ATTITUDE, INC., FLOWER MOUND, TX. FILED 5-11-2011.



THE MARK CONSISTS OF THE WORDS "PURPLE FIGHTERS" IN A BANNER SUPERIMPOSED OVER A HEART, WITH A GUITAR ABOVE THE HEART, AND WITH TWO WINGS AND MULTIPLE LINES RADIATING FROM THE HEART.

**CLASS 25—CLOTHING**

FOR CLOTHING, NAMELY, SHIRTS, PANTS, COATS, DRESSES, JERSEYS, JACKETS, HEADBANDS FOR CLOTHING, TIES, TOPS, FOOTWEAR, HATS AND CAPS, ATHLETIC UNIFORMS, ATHLETIC FOOTWEAR, ATHLETIC SHOES, BASEBALL CAPS AND HATS, GLOVES, PULLOVERS, SLEEPWEAR, SWIM WEAR, TANK TOPS, T-SHIRTS, AND ATHLETIC APPAREL, NAMELY, SHIRTS, PANTS, AND JACKETS (U.S. CLS. 22 AND 39).

SN 85-317,902. GREEN EXCHANGE LLC, NEW YORK, NY. FILED 5-11-2011.

**GREENX**

THE MARK CONSISTS OF STANDARD CHARACTERS WITHOUT CLAIM TO ANY PARTICULAR FONT, STYLE, SIZE, OR COLOR.

OWNER OF U.S. REG. NO. 3,970,873.

**CLASS 35—ADVERTISING AND BUSINESS**

FOR ARRANGING AND CONDUCTING BUSINESS CONFERENCES (U.S. CLS. 100, 101 AND 102).

**CLASS 36—INSURANCE AND FINANCIAL**

FOR FINANCIAL SERVICES IN THE NATURE OF TRADING COMMODITIES; PROVIDING FINANCIAL INFORMATION (U.S. CLS. 100, 101 AND 102).  
FIRST USE 1-24-2011; IN COMMERCE 1-24-2011.

**CLASS 41—EDUCATION AND ENTERTAINMENT**

FOR ARRANGING AND CONDUCTING EDUCATIONAL CONFERENCES; CONDUCTING SEMINARS AND WORKSHOPS IN THE FIELD OF ENVIRONMENTAL MARKETS (U.S. CLS. 100, 101 AND 107).  
BRENDAN REGAN, EXAMINING ATTORNEY

**CLASS 41—EDUCATION AND ENTERTAINMENT**

FOR ENTERTAINMENT SERVICES IN THE NATURE OF LIVE PERFORMANCES BY A MUSICAL SOLOIST OR BAND, LIVE MUSIC CONCERTS, SERVICES BY A MUSICAL ARTIST AND PRODUCER, NAMELY, MUSICAL COMPOSITION FOR OTHERS AND PRODUCTION OF MUSICAL SOUND RECORDINGS (U.S. CLS. 100, 101 AND 107).

BRENDAN REGAN, EXAMINING ATTORNEY

SN 85-317,948. NEW ORLEANS FEDERAL ALLIANCE, NEW ORLEANS, LA. FILED 5-11-2011.



NO CLAIM IS MADE TO THE EXCLUSIVE RIGHT TO USE "NEW ORLEANS LOUISIANA", APART FROM THE MARK AS SHOWN.

THE MARK CONSISTS OF THE STYLIZED WORDING "FEDERAL CITY NEW ORLEANS LOUISIANA", WITH A SMALL SQUARE BETWEEN "NEW ORLEANS" AND "LOUISIANA", FOUND IN THE CENTER OF A RECTANGULAR SHAPED FIGURE COMPRISED OF TRIANGLES AND POLYGONS WITH A POLYGON IN THE UPPER LEFT CONTAINING FIVE STARS.

**CLASS 36—INSURANCE AND FINANCIAL**

FOR REAL ESTATE AND PROPERTY MANAGEMENT SERVICES; REAL ESTATE SERVICES, NAMELY, RENTAL, BROKERAGE, LEASING AND MANAGEMENT OF APARTMENTS, CONDOMINIUMS, COMMERCIAL PROPERTY, OFFICES AND OFFICE SPACE; SHOPPING CENTER SERVICES, NAMELY, LEASING AND MANAGEMENT OF RETAIL SPACE (U.S. CLS. 100, 101 AND 102).

**CLASS 37—CONSTRUCTION AND REPAIR**

FOR REAL ESTATE AND LAND DEVELOPMENT SERVICES, NAMELY, PLANNING AND LAYING OUT OF RESIDENTIAL COMMUNITIES AND COMMERCIAL COMMUNITIES; CONSTRUCTION SERVICES, NAMELY, PLANNING, LAYING OUT AND CONSTRUCTION OF RESIDENTIAL COMMUNITIES AND COMMERCIAL COMMUNITIES; CONSTRUCTION OF HOMES, RESIDENTIAL BUILDINGS AND COMMERCIAL BUILDINGS; CONSTRUCTION PLANNING, MANAGEMENT AND SUPERVISION SERVICES (U.S. CLS. 100, 103 AND 106).

KELLY BOULTON, EXAMINING ATTORNEY

SN 85-317,955. NEW ORLEANS FEDERAL ALLIANCE, NEW ORLEANS, LA. FILED 5-11-2011.



NO CLAIM IS MADE TO THE EXCLUSIVE RIGHT TO USE "NEW ORLEANS", APART FROM THE MARK AS SHOWN.

THE MARK CONSISTS OF A RECTANGULAR SHAPED CARRIER COMPRISED OF TRIANGLES AND POLYGONS WITH A POLYGON ON THE LEFT SIDE CONTAINING FIVE STARS AND THE STYLIZED WORD "FEDERAL" ABOVE THE DESIGN, THE STYLIZED WORD "CITY" IN THE UPPER RIGHT PORTION OF THE DESIGN AND THE STYLIZED WORD "NEW ORLEANS" UNDERNEATH THE DESIGN.

**CLASS 36—INSURANCE AND FINANCIAL**

FOR REAL ESTATE AND PROPERTY MANAGEMENT SERVICES; REAL ESTATE SERVICES, NAMELY, RENTAL, BROKERAGE, LEASING AND MANAGEMENT OF APARTMENTS, CONDOMINIUMS, COMMERCIAL PROPERTY, OFFICES AND OFFICE SPACE; SHOPPING CENTER SERVICES, NAMELY, LEASING AND MANAGEMENT OF RETAIL SPACE (U.S. CLS. 100, 101 AND 102).

**CLASS 37—CONSTRUCTION AND REPAIR**

FOR REAL ESTATE AND LAND DEVELOPMENT SERVICES, NAMELY, PLANNING AND LAYING OUT OF RESIDENTIAL COMMUNITIES AND COMMERCIAL COMMUNITIES; CONSTRUCTION SERVICES, NAMELY, PLANNING, LAYING OUT AND CONSTRUCTION OF RESIDENTIAL COMMUNITIES AND COMMERCIAL COMMUNITIES; CONSTRUCTION OF HOMES, RESIDENTIAL BUILDINGS AND COMMERCIAL BUILDINGS; CONSTRUCTION PLANNING, MANAGEMENT AND SUPERVISION SERVICES (U.S. CLS. 100, 103 AND 106).

KELLY BOULTON, EXAMINING ATTORNEY

SN 85-317,960. NEW ORLEANS FEDERAL ALLIANCE, NEW ORLEANS, LA. FILED 5-11-2011.



NO CLAIM IS MADE TO THE EXCLUSIVE RIGHT TO USE "NEW ORLEANS LOUISIANA", APART FROM THE MARK AS SHOWN.

THE MARK CONSISTS OF THE STYLIZED WORDING "FEDERAL CITY NEW ORLEANS LOUISIANA", WITH A SMALL SQUARE BETWEEN "NEW ORLEANS" AND "LOUISIANA", BELOW A RECTANGULAR DESIGN COMPRISED OF TRIANGLES AND POLYGONS WITH A POLYGON ON THE LEFT SIDE CONTAINING FIVE STARS.

**CLASS 36—INSURANCE AND FINANCIAL**

FOR REAL ESTATE AND PROPERTY MANAGEMENT SERVICES; REAL ESTATE SERVICES, NAMELY, RENTAL, BROKERAGE, LEASING AND MANAGEMENT OF APARTMENTS, CONDOMINIUMS, COMMERCIAL PROPERTY, OFFICES AND OFFICE SPACE; SHOPPING CENTER SERVICES, NAMELY, LEASING AND MANAGEMENT OF RETAIL SPACE (U.S. CLS. 100, 101 AND 102).

**CLASS 37—CONSTRUCTION AND REPAIR**

FOR REAL ESTATE AND LAND DEVELOPMENT SERVICES, NAMELY, PLANNING AND LAYING OUT OF RESIDENTIAL COMMUNITIES AND COMMERCIAL COMMUNITIES; CONSTRUCTION SERVICES, NAMELY, PLANNING, LAYING OUT AND CONSTRUCTION OF RESIDENTIAL COMMUNITIES AND COMMERCIAL COMMUNITIES; CONSTRUCTION OF HOMES, RESIDENTIAL BUILDINGS AND COMMERCIAL BUILDINGS; CONSTRUCTION PLANNING, MANAGEMENT AND SUPERVISION SERVICES (U.S. CLS. 100, 103 AND 106).

KELLY BOULTON, EXAMINING ATTORNEY

SN 85-318,209. TAYLOR, DANA BIANCA, ACCOKEEK, MD.  
FILED 5-11-2011.

SN 85-318,890. SEALEY, ANDREA P., NIAGARA FALLS, NY.  
FILED 5-12-2011.



THE COLOR(S) GRAY AND TURQUOISE BLUE IS/ARE CLAIMED AS A FEATURE OF THE MARK.

THE MARK CONSISTS OF THE TERMS "MORE SURPRISES" WITH A GRAY BUTTERFLY LOCATED ATOP OF "MORE" WHICH IS TURQUOISE BLUE; AT THE BOTTOM IS "SURPRISES" IN GRAY.

#### **CLASS 16—PAPER GOODS AND PRINTED MATTER**

FOR A SERIES OF BOOKS AND WRITTEN ARTICLES IN THE FIELD OF ASTROLOGY, ART, MATERNITY, FASHION, SELF-HELP; ADDRESS BOOKS; ADDRESS BOOKS AND DIARIES; ANNIVERSARY BOOKS; BABY BOOKS; BIRTHDAY BOOKS; BLACKBOARDS AND SCRAP BOOKS; BLANK JOURNAL BOOKS; BOOK COVERS; BOOK ENDS; BOOK MARKERS; BOOK MARKS; BOOKS IN THE FIELD OF ASTROLOGY, ART, MATERNITY, FASHION, SELF-HELP; BRAG BOOKS; CARDS BEARING UNIVERSAL GREETINGS; CHECK BOOKS; CHILDREN'S ACTIVITY BOOKS; CHILDREN'S BOOKS; CHILDREN'S INTERACTIVE EDUCATIONAL BOOKS; CHRISTMAS CARDS; COFFEE TABLE BOOKS FEATURING ASTROLOGY, ART, FASHION, MATERNITY, SELF-HELP; COMIC BOOKS; COOK BOOKS; CUSTOMIZABLE JOURNAL BOOKS; DATE BOOKS; ENGAGEMENT BOOKS; EXERCISE BOOKS; GIFT BOOKS FEATURING ASTROLOGY, ART, MATERNITY, FASHION, SELF-HELP; GIFT BOXES CONTAINING NOTE CARDS; GREETING CARDS; GREETINGS CARDS AND POSTCARDS; GUEST BOOKS; HOLIDAY CARDS; INVITATION CARDS; MEMORANDUM BOOKS; MOTIVATIONAL CARDS; MUSICAL GREETING CARDS; OCCASION CARDS; PAPER BOXES FOR STORING GREETING CARDS; PICTURE BOOKS; PICTURE CARDS; POST CARDS; POSTCARDS AND GREETING CARDS; PRINTED GREETING CARDS WITH ELECTRONIC INFORMATION STORED THEREIN; PRINTED INFORMATIONAL CARDS IN THE FIELD OF ASTROLOGY, ART, MATERNITY, FASHION, SELF-HELP; PRINTED INVITATIONS; PRINTED MATTER, NAMELY, PAPER SIGNS, BOOKS, MANUALS, CURRICULUM, NEWSLETTERS, INFORMATIONAL CARDS AND BROCHURES IN THE FIELD OF MATERNITY, FASHION, SELF-HELP, ASTROLOGY; RECIPE BOOKS; SCHOOL WRITING BOOKS; SCRAP BOOKS; SERIES OF FICTION WORKS, NAMELY, NOVELS AND BOOKS; SERIES OF NON-FICTION BOOKS IN THE FIELD OF ASTROLOGY, ART, MATERNITY, FASHION, SELF-HELP; SKETCH BOOKS; SOCIAL NOTE CARDS; STORY BOOKS; TAROT CARDS; TRAVEL BOOKS; VISITING CARDS (U.S. CLS. 2, 5, 22, 23, 29, 37, 38 AND 50).

#### **CLASS 28—TOYS AND SPORTING GOODS**

FOR BALLOONS (U.S. CLS. 22, 23, 38 AND 50).  
LINDA MICKLEBURGH, EXAMINING ATTORNEY

## Andrea Sealey

THE MARK CONSISTS OF STANDARD CHARACTERS WITHOUT CLAIM TO ANY PARTICULAR FONT, STYLE, SIZE, OR COLOR.

THE NAME "ANDREA SEALEY" IDENTIFIES A LIVING INDIVIDUAL WHOSE CONSENT IS OF RECORD.

#### **CLASS 9—ELECTRICAL AND SCIENTIFIC APPARATUS**

FOR DIGITAL MATERIALS, NAMELY, CDS, DVDS, AND TAPES FEATURING GOSPEL MESSAGES (U.S. CLS. 21, 23, 26, 36 AND 38).

FIRST USE 10-9-1967; IN COMMERCE 10-9-1967.

#### **CLASS 16—PAPER GOODS AND PRINTED MATTER**

FOR A SERIES OF BOOKS, WRITTEN ARTICLES, HANDOUTS AND WORKSHEETS IN THE FIELD OF GOSPEL MESSAGES (U.S. CLS. 2, 5, 22, 23, 29, 37, 38 AND 50).

FIRST USE 10-9-1967; IN COMMERCE 10-9-1967.

#### **CLASS 41—EDUCATION AND ENTERTAINMENT**

FOR ON-LINE JOURNALS, NAMELY, BLOGS FEATURING GOSPEL MESSAGES (U.S. CLS. 100, 101 AND 107).

FIRST USE 10-9-1967; IN COMMERCE 10-9-1967.

CHRIS WELLS, EXAMINING ATTORNEY

SN 85-318,954. WEBASTO PRODUCT NORTH AMERICA, INC., FENTON, MI. FILED 5-12-2011.

## FCF SERIES FEEL COOL FAST

THE MARK CONSISTS OF STANDARD CHARACTERS WITHOUT CLAIM TO ANY PARTICULAR FONT, STYLE, SIZE, OR COLOR.

OWNER OF U.S. REG. NOS. 3,175,333, 3,302,321 AND 3,307,075.

NO CLAIM IS MADE TO THE EXCLUSIVE RIGHT TO USE "SERIES", APART FROM THE MARK AS SHOWN.

#### **CLASS 9—ELECTRICAL AND SCIENTIFIC APPARATUS**

FOR ELECTRONIC AND ELECTRICAL CONTROLLERS FOR AIR CONDITIONING UNITS FOR MARINE APPLICATIONS (U.S. CLS. 21, 23, 26, 36 AND 38).

#### **CLASS 11—ENVIRONMENTAL CONTROL APPARATUS**

FOR AIR CONDITIONING UNITS FOR MARINE APPLICATIONS (U.S. CLS. 13, 21, 23, 31 AND 34).  
JUSTINE D. PARKER, EXAMINING ATTORNEY

SN 85-319,037. S. C. JOHNSON & SON, INC., RACINE, WI. FILED 5-12-2011.

SN 85-319,055. S. C. JOHNSON & SON, INC., RACINE, WI. FILED 5-12-2011.



THE MARK CONSISTS OF MONSTER EATING WASTE FROM A CAN, ALL INSIDE A CIRCLE WITH A LINE THROUGH IT (THE UNIVERSAL PROHIBITION SYMBOL).

**CLASS 9—ELECTRICAL AND SCIENTIFIC APPARATUS**

FOR MAGNETS (U.S. CLS. 21, 23, 26, 36 AND 38).

**CLASS 16—PAPER GOODS AND PRINTED MATTER**

FOR POSTERS, PLASTIC BAGS FOR HOUSEHOLD USE (U.S. CLS. 2, 5, 22, 23, 29, 37, 38 AND 50).

**CLASS 21—HOUSEWARES AND GLASS**

FOR PLASTIC STORAGE CONTAINERS FOR HOUSEHOLD USE (U.S. CLS. 2, 13, 23, 29, 30, 33, 40 AND 50).

**CLASS 28—TOYS AND SPORTING GOODS**

FOR TOY FOAM NOVELTY ITEMS, NAMELY, SQUISHY FOAM TOYS (U.S. CLS. 22, 23, 38 AND 50).

**CLASS 42—SCIENTIFIC AND COMPUTER SERVICES**

FOR PROVIDING A WEBSITE FEATURING ENVIRONMENTAL PROTECTION INFORMATION AS IT CONCERNS RECYCLING (U.S. CLS. 100 AND 101).  
BRENDAN REGAN, EXAMINING ATTORNEY

THE MARK CONSISTS OF MONSTER EATING WASTE FROM A CAN.

**CLASS 9—ELECTRICAL AND SCIENTIFIC APPARATUS**

FOR MAGNETS (U.S. CLS. 21, 23, 26, 36 AND 38).

**CLASS 16—PAPER GOODS AND PRINTED MATTER**

FOR POSTERS, PLASTIC BAGS FOR HOUSEHOLD USE (U.S. CLS. 2, 5, 22, 23, 29, 37, 38 AND 50).

**CLASS 21—HOUSEWARES AND GLASS**

FOR PLASTIC STORAGE CONTAINERS FOR HOUSEHOLD USE (U.S. CLS. 2, 13, 23, 29, 30, 33, 40 AND 50).

**CLASS 28—TOYS AND SPORTING GOODS**

FOR TOY FOAM NOVELTY ITEMS, NAMELY, SQUISHY FOAM TOYS (U.S. CLS. 22, 23, 38 AND 50).

**CLASS 42—SCIENTIFIC AND COMPUTER SERVICES**

FOR PROVIDING A WEBSITE FEATURING ENVIRONMENTAL PROTECTION INFORMATION AS IT CONCERNS RECYCLING (U.S. CLS. 100 AND 101).  
BRENDAN REGAN, EXAMINING ATTORNEY

SN 85-319,486. PROPPER MANUFACTURING COMPANY, INC., LONG ISLAND CITY, NY. FILED 5-12-2011.

**EMU-CHEX**

THE MARK CONSISTS OF STANDARD CHARACTERS WITHOUT CLAIM TO ANY PARTICULAR FONT, STYLE, SIZE, OR COLOR.

**CLASS 1—CHEMICALS**

FOR CHEMICALLY TREATED STERILIZATION TEST INDICATORS FOR USE IN CONNECTION WITH LABORATORY INSTRUMENTS AND EQUIPMENT (U.S. CLS. 1, 5, 6, 10, 26 AND 46).

**CLASS 10—MEDICAL APPARATUS**

FOR STERILIZATION TEST UNITS FOR USE IN CONNECTION WITH MEDICAL INSTRUMENTS AND EQUIPMENT (U.S. CLS. 26, 39 AND 44).  
WILLIAM P. SHANAHAN, EXAMINING ATTORNEY

SN 85-319,680. MESA STATE COLLEGE BOARD OF TRUSTEES, GRAND JUNCTION, CO. FILED 5-12-2011.

SN 85-319,503. THE INDEPENDENT TRAVELER, INC., PENNINGTON, NJ. FILED 5-12-2011.

COLORADO MESA UNIVERSITY

REAL TRAVELERS. PRACTICAL  
TRAVEL ADVICE.

THE MARK CONSISTS OF STANDARD CHARACTERS WITHOUT CLAIM TO ANY PARTICULAR FONT, STYLE, SIZE, OR COLOR.

THE MARK CONSISTS OF STANDARD CHARACTERS WITHOUT CLAIM TO ANY PARTICULAR FONT, STYLE, SIZE, OR COLOR.

OWNER OF U.S. REG. NO. 3,156,813.

NO CLAIM IS MADE TO THE EXCLUSIVE RIGHT TO USE "COLORADO" AND "UNIVERSITY", APART FROM THE MARK AS SHOWN.

**CLASS 38—COMMUNICATION**

FOR PROVIDING ONLINE ELECTRONIC BULLETIN BOARDS, CHAT ROOMS AND FORUMS FOR TRANSMISSION OF MESSAGES AND IMAGES AMONG USERS IN THE FIELD OF CRUISE PROFILES, REVIEWS, NEWS AND TRAVEL (U.S. CLS. 100, 101 AND 104).

**CLASS 16—PAPER GOODS AND PRINTED MATTER**

FOR PAPER PRODUCTS, NAMELY, NOTEBOOKS, DOCUMENT PORTFOLIOS, CALENDARS, STATIONERY, NOTE CARDS, NAPKINS, BALLPOINT PENS, CHECKBOOK HOLDERS, SEALS, DECALS (U.S. CLS. 2, 5, 22, 23, 29, 37, 38 AND 50).

**CLASS 39—TRANSPORTATION AND STORAGE**

FOR TRAVEL INFORMATION SERVICES; PROVIDING AN INTERACTIVE ON-LINE COMPUTER DATABASE IN THE FIELD OF TRAVEL; PROVIDING REVIEWS OF TRAVEL SERVICE PROVIDERS VIA A GLOBAL COMPUTER NETWORK; PROVIDING ONLINE INFORMATION IN THE FIELD OF CRUISE SHIP SERVICES, TRAVEL REVIEWS, AND TRAVEL NEWS; PROVIDING SEARCH ENGINES FOR OBTAINING TRAVEL AND TRANSPORTATION DATA, INFORMATION, AND REVIEWS VIA COMPUTER NETWORKS AND GLOBAL INFORMATION NETWORKS (U.S. CLS. 100 AND 105).

**CLASS 18—LEATHER GOODS**

FOR BACKPACKS, BRIEFCASES, SATCHELS, BRIEFCASE-TYPE PORTFOLIOS, BILLFOLDS, COIN PURSES, EQUIPMENT CARRIERS, NAMELY, ALL PURPOSE CARRYING BAGS (U.S. CLS. 1, 2, 3, 22 AND 41).

**CLASS 25—CLOTHING**

FOR CLOTHING, NAMELY, SHIRTS, T-SHIRTS, SWEATSHIRTS, SHORTS, SWEATPANTS, SWEATERS, JACKETS, SCARVES, MITTENS, SOCKS, SLIPPERS, CLOTH BIBS, AND HEADWEAR, NAMELY, CAPS, HATS, HEADBANDS AND VISORS (U.S. CLS. 22 AND 39).

**CLASS 41—EDUCATION AND ENTERTAINMENT**

FOR ONLINE PUBLICATION OF TEXT, GRAPHICS AND PHOTOGRAPHS OF OTHERS ON CRUISES AND CRUISE PROFILES, REVIEWS AND NEWS (U.S. CLS. 100, 101 AND 107).

**CLASS 41—EDUCATION AND ENTERTAINMENT**

FOR EDUCATIONAL SERVICES, NAMELY, PROVIDING COURSES OF INSTRUCTION AT THE DOCTORAL, MASTER'S, BACCALAUREATE, ASSOCIATE DEGREE, AND POST SECONDARY CERTIFICATE LEVELS; AND ENTERTAINMENT SERVICES, NAMELY, PROVIDING FINE ARTS EVENTS, DANCE RECITALS, LIVE MUSICAL CONCERTS AND SPORTING EVENTS, NAMELY, BASEBALL, BASKETBALL, CROSS COUNTRY, FOOTBALL, INDOOR TRACK AND FIELD, LACROSSE, OUTDOOR TRACK AND FIELD, SOCCER, SWIMMING, TENNIS, WRESTLING, GOLF, SOFTBALL, VOLLEYBALL, CHEERLEADING, CYCLING, HOCKEY, RODEO, RUGBY AND SKIING (U.S. CLS. 100, 101 AND 107).

**CLASS 42—SCIENTIFIC AND COMPUTER SERVICES**

FOR COMPUTER SERVICES, NAMELY, PROVIDING AN INTERACTIVE COMPUTER DATABASE IN THE FIELD OF CRUISE REVIEWS, NEWS AND TRAVEL (U.S. CLS. 100 AND 101).  
JACLYN KIDWELL WALKER, EXAMINING ATTORNEY

TRICIA SONNEBORN, EXAMINING ATTORNEY



SN 85-319,741. BOTICA COMERCIAL FARMACEUTICA LTDA, S. JOSE DOS PINHAIS PR, BRAZIL, FILED 5-12-2011.



THE MARK CONSISTS OF A STYLIZED LETTER "B" SURROUNDED BY CURVED LINES.

### CLASS 3—COSMETICS AND CLEANING PREPARATIONS

FOR SHAVING FOAM; AFTER SHAVE BALM, AFTER SHAVE GEL; SHAMPOO, CONDITIONER, HAIR MASK, NO RINSE HAIR CREAM, BODY MOISTURIZING CREAM AND LOTION; BODY EXFOLIATING CREAM, BODY MOISTURIZING OIL, BODY MOISTURIZING TREATMENTS PREPARATIONS; FACIAL LIQUID SOAP, FACIAL MOISTURIZING CREAM AND LOTION, AEROSOL DEODORANT FOR PERSONAL USE, DEODORANT SPRAY FOR PERSONAL USE; EAU DE TOILETTE; LIQUID SOAPS, EXFOLIATING SOAPS, BAR SOAP (U.S. CLS. 1, 4, 6, 50, 51 AND 52).

### CLASS 35—ADVERTISING AND BUSINESS

FOR RETAIL AND WHOLESALE STORE SERVICES IN THE FIELD OF SHAVING FOAM, AFTER SHAVE BALM, AFTER SHAVE GEL, SHAMPOO, CONDITIONER, HAIR MASK, NO RINSE HAIR CREAM, BODY MOISTURIZING CREAM AND LOTION, BODY EXFOLIATING CREAM, BODY MOISTURIZING OIL, BODY MOISTURIZING TREATMENTS, FACIAL LIQUID SOAP, FACIAL MOISTURIZING CREAM AND LOTION, AEROSOL DEODORANT, DEODORANT SPRAY, EAU DE TOILETTE, LIQUID SOAPS, EXFOLIATING SOAPS, BAR SOAP (U.S. CLS. 100, 101 AND 102).

ANGELA DUONG, EXAMINING ATTORNEY

SN 85-319,958. INTELLIGENT BUSINESS ENTERTAINMENT INC., LINCOLN, MA. FILED 5-13-2011.

## TRUE OFFICE

THE MARK CONSISTS OF STANDARD CHARACTERS WITHOUT CLAIM TO ANY PARTICULAR FONT, STYLE, SIZE, OR COLOR.

NO CLAIM IS MADE TO THE EXCLUSIVE RIGHT TO USE "OFFICE", APART FROM THE MARK AS SHOWN.

### CLASS 9—ELECTRICAL AND SCIENTIFIC APPARATUS

FOR DOWNLOADABLE SOFTWARE APPLICATIONS IN THE FIELD OF BUSINESS EDUCATIONAL TRAINING (U.S. CLS. 21, 23, 26, 36 AND 38).

### CLASS 42—SCIENTIFIC AND COMPUTER SERVICES

FOR SOFTWARE AS A SERVICE (SAAS) SERVICES, NAMELY, HOSTING SOFTWARE FOR USE BY OTHERS FOR USE IN BUSINESS EDUCATIONAL TRAINING (U.S. CLS. 100 AND 101).

MATTHEW PAPPAS, EXAMINING ATTORNEY

SN 85-320,004. NEW WORLD PRODUCTS INTERNATIONAL LLC, CORAL GABLES, FL. FILED 5-13-2011.

## KAPTIVE

THE MARK CONSISTS OF STANDARD CHARACTERS WITHOUT CLAIM TO ANY PARTICULAR FONT, STYLE, SIZE, OR COLOR.

### CLASS 30—STAPLE FOODS

FOR TEAS (U.S. CL. 46).

### CLASS 32—LIGHT BEVERAGES

FOR FLAVORED WATER, STILL WATER, SPARKLING WATER; ENERGY DRINKS; AND SPORTS DRINKS, NAMELY, STIMULATION AND PERFORMANCE DRINKS (U.S. CLS. 45, 46 AND 48).

ALEXANDER L. POWERS, EXAMINING ATTORNEY

SN 85-320,152. CIENSKI, NICK, BALTIMORE, MD. FILED 5-13-2011.

## MISSION 14

THE MARK CONSISTS OF STANDARD CHARACTERS WITHOUT CLAIM TO ANY PARTICULAR FONT, STYLE, SIZE, OR COLOR.

### CLASS 25—CLOTHING

FOR CLOTHING, NAMELY, PANTS, FLEECE PANTS, HATS, SHIRTS, T-SHIRTS, SWEATSHIRTS, JACKETS, FLEECE JACKETS, TRACK PANTS, TRACK SUITS, SWEAT SUITS; MEN'S CLOTHING, NAMELY, PANTS, FLEECE PANTS, HATS, SHIRTS, T-SHIRTS, SWEATSHIRTS, JACKETS, FLEECE JACKETS, TRACK PANTS, TRACK SUITS, SWEAT SUITS; WOMEN'S CLOTHING, NAMELY, PANTS, FLEECE PANTS, HATS, SHIRTS, T-SHIRTS, SWEATSHIRTS, JACKETS, FLEECE JACKETS, TRACK PANTS, TRACK SUITS, SWEAT SUITS; CLOTHING FOR YOUTH, NAMELY, PANTS, FLEECE PANTS, HATS, SHIRTS, T-SHIRTS, SWEATSHIRTS, JACKETS, FLEECE JACKETS, TRACK PANTS, TRACK SUITS, SWEAT SUITS (U.S. CLS. 22 AND 39).

### CLASS 36—INSURANCE AND FINANCIAL

FOR CHARITABLE FUNDRAISING SERVICES (U.S. CLS. 100, 101 AND 102).

MATTHEW PAPPAS, EXAMINING ATTORNEY

SN 85-320,185. HOEGEMEYER HYBRIDS, INC., HOOPER, NE. FILED 5-13-2011.

## RightStand

THE MARK CONSISTS OF STANDARD CHARACTERS WITHOUT CLAIM TO ANY PARTICULAR FONT, STYLE, SIZE, OR COLOR.

### CLASS 31—NATURAL AGRICULTURAL PRODUCTS

FOR AGRICULTURAL SEED (U.S. CLS. 1 AND 46).

### CLASS 40—MATERIAL TREATMENT

FOR AGRICULTURAL SERVICES, NAMELY, SEED TREATMENT (U.S. CLS. 100, 103 AND 106).  
VERNA BETH RIRIE, EXAMINING ATTORNEY

SN 85-320,581. POLYJOHN ENTERPRISES CORPORATION, WHITING, IN. FILED 5-13-2011.

## SINKSNMORE

THE MARK CONSISTS OF STANDARD CHARACTERS WITHOUT CLAIM TO ANY PARTICULAR FONT, STYLE, SIZE, OR COLOR.

### CLASS 3—COSMETICS AND CLEANING PREPARATIONS

FOR LIQUID/FOAM HAND SOAPS; CLEANING PREPARATIONS AND SOLUTIONS FOR USE WITH PORTABLE CABANA TOILETS AND PORTABLE HAND-WASH STATIONS (U.S. CLS. 1, 4, 6, 50, 51 AND 52).  
FIRST USE 11-1-2007; IN COMMERCE 11-1-2007.

### CLASS 5—PHARMACEUTICALS

FOR DEODORIZING AND DISINFECTING PREPARATIONS AND SOLUTIONS FOR USE WITH PORTABLE CABANA TOILETS AND PORTABLE HAND-WASH STATIONS (U.S. CLS. 6, 18, 44, 46, 51 AND 52).  
FIRST USE 11-1-2007; IN COMMERCE 11-1-2007.

### CLASS 11—ENVIRONMENTAL CONTROL APPARATUS

FOR PORTABLE CABANA TOILETS; PORTABLE HAND-WASH STATIONS; HAND SANITIZER DISPENSERS FOR BEING MOUNTED WITHIN PORTABLE CABANA TOILETS; PORTABLE SHOWERS; PORTABLE DRESSING ROOMS; PORTABLE WORK STATION SHELTERS; PORTABLE SIGN HOLDERS, PORTABLE BARRIERS AND STANDALONE WASTE WATER HOLDING TANKS FOR USE WITH PORTABLE CABANA TOILETS, PORTABLE HAND-WASH STATIONS AND PORTABLE SHOWERS (U.S. CLS. 13, 21, 23, 31 AND 34).  
FIRST USE 11-1-2007; IN COMMERCE 11-1-2007.

### CLASS 12—VEHICLES

FOR TRANSPORT TRAILERS FOR USE WITH PORTABLE CABANA TOILETS (U.S. CLS. 19, 21, 23, 31, 35 AND 44).

FIRST USE 11-1-2007; IN COMMERCE 11-1-2007.  
CAROLYN CATALDO, EXAMINING ATTORNEY

SN 85-320,684. PORSHA MARIE DAVIS, DBA SHINING LIGHT INDUSTRY, EAST ORANGE, NJ. FILED 5-13-2011.

## Shining Light Industry

THE MARK CONSISTS OF STANDARD CHARACTERS WITHOUT CLAIM TO ANY PARTICULAR FONT, STYLE, SIZE, OR COLOR.

### CLASS 35—ADVERTISING AND BUSINESS

FOR PROMOTING PUBLIC AWARENESS OF THE DIVERSITY OF HUMANITY (U.S. CLS. 100, 101 AND 102).

### CLASS 41—EDUCATION AND ENTERTAINMENT

FOR CONDUCTING WORKSHOPS AND SEMINARS IN SELF AWARENESS (U.S. CLS. 100, 101 AND 107).  
WENDY GOODMAN, EXAMINING ATTORNEY

SN 85-320,688. MASI, KIMBERLY A., FREEHOLD, NJ. FILED 5-13-2011.

## Confections of a RockStar

THE MARK CONSISTS OF STANDARD CHARACTERS WITHOUT CLAIM TO ANY PARTICULAR FONT, STYLE, SIZE, OR COLOR.

### CLASS 35—ADVERTISING AND BUSINESS

FOR RETAIL BAKERY SHOPS (U.S. CLS. 100, 101 AND 102).  
FIRST USE 11-19-2010; IN COMMERCE 11-19-2010.

### CLASS 40—MATERIAL TREATMENT

FOR BAKERY SERVICES, NAMELY, THE MANUFACTURE OF BAKERY PRODUCTS TO ORDER AND/OR SPECIFICATION OF OTHERS (U.S. CLS. 100, 103 AND 106).  
FIRST USE 11-19-2010; IN COMMERCE 11-19-2010.  
KAREN K. BUSH, EXAMINING ATTORNEY

SN 85-321,134. ROBERT LORENZ ELZ, SUWANEE, GA.  
FILED 5-14-2011.

Rethinking how to Think.  
ReTHINKing how to Think.  
Rethinking how to think.  
Rethinking Thinking.  
Rethinking thinking.

THE MARK CONSISTS OF STANDARD CHARACTERS WITHOUT CLAIM TO ANY PARTICULAR FONT, STYLE, SIZE, OR COLOR.

#### **CLASS 9—ELECTRICAL AND SCIENTIFIC APPARATUS**

FOR AUDIO BOOKS IN THE FIELD OF EDUCATION REFORM, CORPORATE TRAINING AND DEVELOPMENT, CORPORATE LEARNING, K-12 EDUCATION, HIGHER EDUCATION; COMPUTER SOFTWARE FOR THE COLLECTION, EDITING, ORGANIZING, MODIFYING, BOOK MARKING, TRANSMISSION, STORAGE AND SHARING OF DATA AND INFORMATION; DOWNLOADABLE MP3 FILES, MP3 RECORDINGS, ON-LINE DISCUSSION BOARDS, WEBCASTS, WEBINARS AND PODCASTS FEATURING MUSIC, AUDIO BOOKS IN THE FIELD OF EDUCATION REFORM, CORPORATE TRAINING AND DEVELOPMENT, CORPORATE LEARNING, K-12 EDUCATION, HIGHER EDUCATION, AND NEWS BROADCASTS; ELECTRONIC PUBLICATIONS, NAMELY, BOOKS AND MAGAZINES FEATURING EDUCATION REFORM, CORPORATE TRAINING AND DEVELOPMENT, CORPORATE LEARNING, K-12 EDUCATION, HIGHER EDUCATION RECORDED ON COMPUTER MEDIA; NON-FICTION AUDIO BOOKS ON A VARIETY OF TOPICS (U.S. CLS. 21, 23, 26, 36 AND 38).

#### **CLASS 16—PAPER GOODS AND PRINTED MATTER**

FOR A SERIES OF BOOKS AND WRITTEN ARTICLES IN THE FIELD OF EDUCATION REFORM, CORPORATE TRAINING AND DEVELOPMENT, CORPORATE LEARNING, K-12 EDUCATION, HIGHER EDUCATION; A SERIES OF BOOKS, WRITTEN ARTICLES, HANDOUTS AND WORKSHEETS IN THE FIELD OF EDUCATION REFORM, CORPORATE TRAINING AND DEVELOPMENT, CORPORATE LEARNING, K-12 EDUCATION, HIGHER EDUCATION; BOOK COVERS; BOOKS IN THE FIELD OF EDUCATION REFORM, CORPORATE TRAINING AND DEVELOPMENT, CORPORATE LEARNING, K-12 EDUCATION, HIGHER EDUCATION; CUSTOMIZABLE JOURNAL BOOKS (U.S. CLS. 2, 5, 22, 23, 29, 37, 38 AND 50).

#### **CLASS 35—ADVERTISING AND BUSINESS**

FOR ADVERTISING AND BUSINESS MANAGEMENT CONSULTANCY; ADVERTISING AND MARKETING CONSULTANCY; ADVERTISING AND PROMOTION SERVICES AND RELATED CONSULTING; ADVERTISING CONSULTATION; ADVERTISING SERVICES, NAMELY, CREATING CORPORATE AND BRAND IDENTITY FOR OTHERS; ASSISTANCE AND CONSULTANCY SERVICES IN THE FIELD OF BUSINESS MANAGEMENT OF COMPANIES IN THE ENERGY SECTOR; ASSISTANCE, ADVICE AND CONSULTANCY WITH REGARD TO BUSINESS PLANNING, BUSINESS ANALYSIS, BUSINESS MANAGEMENT AND BUSINESS ORGANIZATION RELATING TO PURCHASING FUNCTIONS; ASSISTANCE, ADVISORY SERVICES AND CONSULTANCY WITH REGARD TO BUSINESS PLANNING, BUSINESS ANALYSIS, BUSINESS MANAGEMENT, AND BUSINESS ORGANIZATION RELATING TO MICRO CREDITS, MICRO FINANCE AND ENERGY PRODUCTS; ASSISTANCE, ADVISORY SERVICES AND CONSULTANCY WITH REGARD TO BUSINESS PLANNING, BUSINESS

ANALYSIS, BUSINESS MANAGEMENT, BUSINESS ORGANIZATION, MARKETING AND CUSTOMER ANALYSIS; BRAND CONCEPT AND BRAND DEVELOPMENT SERVICES FOR CORPORATE AND INDIVIDUAL CLIENTS; BRAND CONCEPT AND BRAND DEVELOPMENT SERVICES FOR CORPORATE CLIENTS; BRAND IMAGERY CONSULTING SERVICES; BRANDING SERVICES, NAMELY, CONSULTING, DEVELOPMENT, MANAGEMENT AND MARKETING OF BRANDS FOR BUSINESSES; BUSINESS ACQUISITION AND MERGER CONSULTATION; BUSINESS ACQUISITIONS CONSULTATION; BUSINESS ADMINISTRATION CONSULTANCY; BUSINESS ADVISORY AND CONSULTANCY SERVICES RELATING TO EXPORT, EXPORT SERVICES, EXPORT PROMOTION INFORMATION AND SERVICES; BUSINESS ADVISORY SERVICES, CONSULTANCY AND INFORMATION; BUSINESS AND MANAGEMENT CONSULTING FOR HEALTHCARE PROVIDERS AND RELATED BUSINESSES; BUSINESS APPRAISAL CONSULTATION; BUSINESS CONSULTATION; BUSINESS CONSULTATION AND MANAGEMENT REGARDING MARKETING ACTIVITIES AND LAUNCHING OF NEW PRODUCTS; BUSINESS CONSULTATION IN THE FIELD OF BUSINESS LEADERSHIP DEVELOPMENT; BUSINESS CONSULTATION SERVICES; BUSINESS CONSULTATION SERVICES IN THE FIELDS OF SUPPLY CHAIN ANALYSIS, REGULATION COMPLIANCE AND COUNTERFEIT DETECTION; BUSINESS CONSULTATION SERVICES TO ASSIST NON-PROFIT ORGANIZATIONS IN PLANNING, MANAGING, AND CONDUCTING FUNDRAISING ACTIVITIES VIA A GLOBAL COMPUTER NETWORK; BUSINESS CONSULTATION SERVICES, NAMELY, BUSINESS PROCESS IMPROVEMENT AND ENTERPRISE ARCHITECTURE DESIGN; BUSINESS CONSULTING AND BUSINESS INFORMATION FOR ENTERPRISES; BUSINESS CONSULTING AND INFORMATION SERVICES; BUSINESS CONSULTING IN THE CONSUMER PRODUCTS INDUSTRY; BUSINESS CONSULTING SERVICE THAT PROVIDES TRANSFORMATIONAL STRATEGIES TO COMPANIES WISHING TO MOVE TOWARDS SUSTAINABILITY AND SOCIALLY RESPONSIBLE BUSINESS PRACTICES, PROVIDED MAINLY TO THE CONSUMER PRODUCTS INDUSTRY; BUSINESS CONSULTING SERVICES IN THE FIELD OF BUSINESS KNOWLEDGE TRANSFER THROUGH AUDIO TOOLS, NAMELY, RECORDING INTERVIEWS WITH SUBJECT MATTER EXPERTS FOR AN ORGANIZATION'S CAPTURE AND FUTURE USE; BUSINESS CONSULTING SERVICES RELATING TO THE INTEGRATION OF THE AREAS OF BUSINESS PROCESS TECHNOLOGY, ORGANIZATIONAL LEARNING, CHANGE MANAGEMENT, AND OPERATIONAL SUSTAINABILITY; BUSINESS MANAGEMENT AND CONSULTING SERVICES FOR THE HEALTH CARE INDUSTRY, NAMELY, CUSTOMER SERVICE, ACCOUNTING SERVICES, AND WEB-BASED ADVERTISING AND MARKETING SERVICES; BUSINESS MANAGEMENT AND CONSULTING SERVICES FOR THE HEALTH CARE INDUSTRY, NAMELY, PROVIDING INDUSTRY EXPERTISE AND SUPPLIER PARTNERSHIPS; BUSINESS MANAGEMENT AND ENTERPRISE ORGANIZATION CONSULTANCY; BUSINESS MANAGEMENT CONSULTANCY AND ADVISORY SERVICES; BUSINESS MANAGEMENT CONSULTANCY AS WELL AS DEVELOPMENT OF PROCESSES FOR THE ANALYSIS AND THE IMPLEMENTATION OF STRATEGY PLANS AND MANAGEMENT PROJECTS; BUSINESS MANAGEMENT CONSULTANCY SERVICES; BUSINESS MANAGEMENT CONSULTANCY, ALSO VIA THE INTERNET; BUSINESS MANAGEMENT CONSULTATION IN THE FIELD OF EXECUTIVE AND LEADERSHIP DEVELOPMENT; BUSINESS MANAGEMENT CONSULTING WITH RELATION TO STRATEGY, MARKETING, PRODUCTION, PERSONNEL AND RETAIL SALE MATTERS; BUSINESS MANAGEMENT CONSULTING WITH RELATION TO STRATEGY, MARKETING, SALES, OPERATION, PRODUCT DESIGN PARTICULARLY SPECIALIZING IN THE USE OF ANALYTIC AND STATISTIC MODELS FOR THE UNDERSTANDING AND PREDICTING OF CONSUMERS, BUSINESSES, AND MARKET TRENDS AND ACTIONS; BUSINESS MANAGEMENT CONSULTING, STRATEGIC PLANNING AND BUSINESS ADVISORY SERVICES PROVIDED TO THE VETERINARY MEDICAL PROFESSION; BUSINESS SERVICES, NAMELY, CONSUMER RESEARCH AND CONSULTING RELATED THERETO; BUSINESS SERVICES, NAMELY, STRUCTURING, OPTIMIZING AND CHANGE MAN-

AGEMENT CONSULTING RELATED TO CORPORATE IN-HOUSE INTELLECTUAL PROPERTY DEPARTMENTS AND INTELLECTUAL PROPERTY ASSET MANAGEMENT PROGRAMS; CONSULTANCY AND ADVISORY SERVICES IN THE FIELD OF BUSINESS STRATEGY; CONSULTANCY SERVICES REGARDING BUSINESS STRATEGIES; CONSULTING IN SALES TECHNIQUES AND SALES PROGRAMMES; CONSULTING IN THE FIELD OF SALES METHODS, SALES MANAGEMENT, AND SALES IMPROVEMENT; CONSULTING SERVICES IN THE FIELD OF HUMAN RESOURCES DEVELOPMENT, NAMELY, UTILIZING TECHNOLOGY FOR THE PROMOTION OF EMPLOYEE RETENTION, CAREER GROWTH AND INCREASED PRODUCTIVITY FOR EMPLOYEES AND EMPLOYERS; CONSULTING SERVICES IN THE FIELD OF INTERNET MARKETING; CONSULTING SERVICES IN THE FIELD OF MARKETING OF EDUCATIONAL TRAINING; CONSULTING SERVICES IN THE FIELDS OF BUSINESS MANAGEMENT, HUMAN RESOURCES, AND BUSINESS ORGANIZATIONAL DESIGN; CONSUMER STRATEGY BUSINESS CONSULTING IN THE FIELDS OF MARKETING, SALES, OPERATION, AND PRODUCT DESIGN PARTICULARLY SPECIALIZING IN THE USE OF ANALYTIC MODELS FOR THE UNDERSTANDING AND PREDICTING OF CONSUMER, BUSINESS, AND RETAIL MARKET TRENDS AND ACTIONS; CORPORATE IMAGE CONSULTING SERVICES; EDUCATION LEADERSHIP DEVELOPMENT; PROVIDING INFORMATION ABOUT THE CORPORATE WORLD, CORPORATE CULTURE, AND THE CORPORATE SECTOR (U.S. CLS. 100, 101 AND 102).

#### **CLASS 41—EDUCATION AND ENTERTAINMENT**

FOR CONSULTATION IN THE FIELD OF K-12 EDUCATIONAL SYSTEMS; EDUCATION INFORMATION (U.S. CLS. 100, 101 AND 107).

#### **CLASS 42—SCIENTIFIC AND COMPUTER SERVICES**

FOR THINK TANK SERVICES, NAMELY, PROVIDING NEW IDEAS AND CONCEPTS FOR WEB-BASED APPLICATIONS FOR OTHERS (U.S. CLS. 100 AND 101).  
MAYUR VAGHANI, EXAMINING ATTORNEY

---

SN 85-321,455. FIGUEROA, PATRICIO R., LAS CONDES, SANTIAGO, CHILE, FILED 5-16-2011.

# Pepuva

THE MARK CONSISTS OF STANDARD CHARACTERS WITHOUT CLAIM TO ANY PARTICULAR FONT, STYLE, SIZE, OR COLOR.

THE WORDING "PEPUVA" HAS NO MEANING IN A FOREIGN LANGUAGE.

#### **CLASS 3—COSMETICS AND CLEANING PREPARATIONS**

FOR COSMETIC CREAMS; COSMETIC CREAMS FOR SKIN CARE; COSMETIC PREPARATIONS; COSMETIC PREPARATIONS AGAINST SUNBURN; COSMETIC PREPARATIONS FOR PROTECTING THE SKIN FROM THE SUN'S RAYS (U.S. CLS. 1, 4, 6, 50, 51 AND 52).

#### **CLASS 5—PHARMACEUTICALS**

FOR MEDICATED LOTIONS FOR TREATING DERMATOLOGICAL CONDITIONS; MEDICINAL CREAMS FOR SKIN CARE; NUTRACEUTICALS FOR THE TREATMENT OF SKIN CONDITIONS, CANCER, CARDIOVASCULAR CONDITIONS, GASTROINTESTINAL CONDITIONS, UROLOGICAL CONDITIONS, METABOLIC CONDITIONS, AND OCULAR CONDITIONS (U.S. CLS. 6, 18, 44, 46, 51 AND 52).

CARYN GLASSER, EXAMINING ATTORNEY

---

SN 85-321,479. NEEL PRODUCTS LLC, STAMPING GROUND, KY. FILED 5-16-2011.

# Avapta

THE MARK CONSISTS OF STANDARD CHARACTERS WITHOUT CLAIM TO ANY PARTICULAR FONT, STYLE, SIZE, OR COLOR.

#### **CLASS 3—COSMETICS AND CLEANING PREPARATIONS**

FOR ALL NATURAL COSMETICS (U.S. CLS. 1, 4, 6, 50, 51 AND 52).

#### **CLASS 5—PHARMACEUTICALS**

FOR ANTIMICROBIAL PRESERVATIVES FOR COSMETICS (U.S. CLS. 6, 18, 44, 46, 51 AND 52).

MARC LEIPZIG, EXAMINING ATTORNEY

---

SN 85-321,628. CORAL NETWORKS, INC., RESTON, VA. FILED 5-16-2011.

# CORAL NETWORKS

THE MARK CONSISTS OF STANDARD CHARACTERS WITHOUT CLAIM TO ANY PARTICULAR FONT, STYLE, SIZE, OR COLOR.

NO CLAIM IS MADE TO THE EXCLUSIVE RIGHT TO USE "NETWORKS", APART FROM THE MARK AS SHOWN.

**CLASS 9—ELECTRICAL AND SCIENTIFIC APPARATUS**

FOR COMMUNICATIONS SOFTWARE FOR CONNECTING GLOBAL COMPUTER NETWORKS AND USERS; COMPUTER NETWORK SERVER; COMPUTER PROGRAMS FOR CONNECTING REMOTELY TO COMPUTERS OR COMPUTER NETWORKS; COMPUTER PROGRAMS FOR SEARCHING REMOTELY FOR CONTENT ON COMPUTERS AND COMPUTER NETWORKS; COMPUTER PROGRAMS FOR SEARCHING THE CONTENTS OF COMPUTERS AND COMPUTER NETWORKS BY REMOTE CONTROL; COMPUTER SOFTWARE FOR ACCESSING INFORMATION DIRECTORIES THAT MAY BE DOWNLOADED FROM THE GLOBAL COMPUTER NETWORK; COMPUTER SOFTWARE FOR CONTROLLING AND MANAGING ACCESS SERVER APPLICATIONS; COMPUTER SOFTWARE FOR THE COLLECTION, EDITING, ORGANIZING, MODIFYING, BOOK MARKING, TRANSMISSION, STORAGE AND SHARING OF DATA AND INFORMATION (U.S. CLS. 21, 23, 26, 36 AND 38).

**CLASS 38—COMMUNICATION**

FOR COMMUNICATION SERVICES, NAMELY, ELECTRONIC TRANSMISSION OF DATA AND DOCUMENTS AMONG USERS OF COMPUTERS; ON-LINE DOCUMENT DELIVERY VIA A GLOBAL COMPUTER NETWORK; PROVIDING USER ACCESS TO A GLOBAL COMPUTER NETWORK; PROVIDING USER ACCESS TO COMPUTER PROGRAMMES IN DATA NETWORKS; TRANSMISSION OF INFORMATION BY ELECTRONIC COMMUNICATIONS NETWORKS (U.S. CLS. 100, 101 AND 104).

**CLASS 42—SCIENTIFIC AND COMPUTER SERVICES**

FOR COMPUTER SERVICES, NAMELY, PROVIDING AN INTERACTIVE WEB SITE FEATURING TECHNOLOGY THAT ALLOWS USERS TO CONSOLIDATE AND MANAGE SOCIAL NETWORKS, ACCOUNTS, AND CONNECTIONS TO EXISTING AND EMERGING APPLICATION PROGRAMMING INTERFACES (APIS); DEVELOPMENT OF SOFTWARE FOR SECURE NETWORK OPERATIONS; FILE SHARING SERVICES, NAMELY, PROVIDING A WEBSITE FEATURING TECHNOLOGY ENABLING USERS TO UPLOAD AND DOWNLOAD ELECTRONIC FILES; PROVIDING A WEB SITE FEATURING TECHNOLOGY THAT ENABLES INTERNET USERS TO SHARE DOCUMENTS, IMAGES AND VIDEOS; PROVIDING AN ON-LINE NETWORK ENVIRONMENT THAT FEATURES TECHNOLOGY THAT ENABLES USERS TO SHARE DATA (U.S. CLS. 100 AND 101).

ANGELA DUONG, EXAMINING ATTORNEY

SN 85-321,680. HIPSTER, INC., LOS ANGELES, CA. FILED 5-16-2011.

# HIPSTER

THE MARK CONSISTS OF STANDARD CHARACTERS WITHOUT CLAIM TO ANY PARTICULAR FONT, STYLE, SIZE, OR COLOR.

**CLASS 9—ELECTRICAL AND SCIENTIFIC APPARATUS**

FOR COMPUTER SOFTWARE FOR USE IN FACILITATING AND MANAGING SOCIAL NETWORKING; COMPUTER SOFTWARE FOR USE IN POSTING, UPLOADING, DOWNLOADING, TRANSMITTING, RETRIEVING, RECEIVING, REVIEWING, TAGGING, ORGANIZING, SEARCHING, PROVIDING AND MANAGING TEXT, AUDIO, VISUAL AND MULTIMEDIA DATA AND CONTENT VIA COMPUTERS, MOBILE PHONES, WIRED AND WIRELESS COMMUNICATION DEVICES, AND OPTICAL AND ELECTRONIC COMMUNICATIONS NETWORKS; COMPUTER SOFTWARE FOR USE IN MANAGING, CONTROLLING AND SECURING PERSONAL INFORMATION; COMPUTER SOFTWARE FOR CALCULATING, MAPPING, MANAGING, TRANSMITTING, CONTROLLING AND SECURING LOCATION INFORMATION; COMPUTER SOFTWARE FOR PROVIDING A USER WITH INFORMATION ON GOODS AND SERVICES FOR SALE, AND FOR SHARING INFORMATION ABOUT ITEM LOCATION AND GOODS AND SERVICES FOR SALE WITH OTHERS, PROVIDED VIA COMPUTERS, MOBILE PHONES, WIRED AND WIRELESS COMMUNICATION DEVICES, AND OPTICAL AND ELECTRONIC COMMUNICATIONS NETWORKS; COMPUTER SOFTWARE FOR CALCULATING, MAPPING, TRANSMITTING AND REPORTING POINT-OF-INTEREST INFORMATION AND LOCATION-INFORMED ADVERTISEMENTS AND PROMOTIONS VIA COMPUTERS, MOBILE PHONES, WIRED AND WIRELESS COMMUNICATION DEVICES, AND OPTICAL AND ELECTRONIC COMMUNICATIONS NETWORKS (U.S. CLS. 21, 23, 26, 36 AND 38).

**CLASS 35—ADVERTISING AND BUSINESS**

FOR MARKETING AND ADVERTISING SERVICES; PROVIDING SPECIAL OFFERS, COUPONS, AND SALES PROMOTIONS FOR THE GOODS AND SERVICES OF OTHERS VIA COMPUTERS, MOBILE PHONES, WIRED AND WIRELESS COMMUNICATION DEVICES, AND OPTICAL AND ELECTRONIC COMMUNICATIONS NETWORKS (U.S. CLS. 100, 101 AND 102).

**CLASS 38—COMMUNICATION**

FOR COMMUNICATIONS SERVICES, NAMELY, PROVIDING ONLINE AND ELECTRONIC FACILITIES AND FORUMS FOR REAL TIME INTERACTION AMONG USERS OF COMPUTERS, MOBILE PHONES AND WIRED AND WIRELESS COMMUNICATION DEVICES TO POST, TRANSMIT, RETRIEVE, RECEIVE, REVIEW, ORGANIZE, SEARCH, MANAGE AND REPORT TEXT, AUDIO, VISUAL AND MULTIMEDIA DATA AND CONTENT VIA OPTICAL AND ELECTRONIC COMMUNICATIONS NETWORKS IN THE NATURE OF ELECTRONIC BULLETIN BOARDS AND CHAT ROOMS IN THE FIELD OF TOPICS OF GENERAL INTEREST; COMMUNICATIONS SERVICES, NAMELY, TRANSMISSION OF TEXT, AUDIO, VISUAL AND MULTIMEDIA DATA AND CONTENT VIA OPTICAL AND ELECTRONIC COMMUNICATIONS NETWORKS INCLUDING THE TRANSMISSION OF POINT-OF-INTEREST INFORMATION AND LOCATION-INFORMED ADVERTISEMENTS AND PROMOTIONS VIA OPTICAL AND ELECTRONIC COMMUNICATIONS NETWORKS (U.S. CLS. 100, 101 AND 104).

**CLASS 42—SCIENTIFIC AND COMPUTER SERVICES**

FOR COMPUTER SERVICES, NAMELY, PROVIDING A WEB PAGE FOR USERS TO ASK AND ANSWER QUESTIONS ON A VARIETY OF TOPICS OF GENERAL INTEREST, INCLUDING POINTS OF INTEREST AND LOCATIONS OF INTEREST; PROVIDING TEMPORARY USE OF NON DOWNLOADABLE COMPUTER SOFTWARE FOR USE IN FACILITATING AND MANAGING SOCIAL NETWORKING; PROVIDING TEMPORARY USE OF NON DOWNLOADABLE COMPUTER SOFTWARE FOR USE IN POSTING, UPLOADING, DOWNLOADING, TRANSMITTING, RETRIEVING, RECEIVING, REVIEWING, TAGGING, ORGANIZING, SEARCHING, PROVIDING AND MANAGING TEXT, AUDIO, VISUAL AND MULTIMEDIA DATA AND CON-

TENT VIA COMPUTERS, MOBILE PHONES, WIRED AND WIRELESS COMMUNICATION DEVICES, AND OPTICAL AND ELECTRONIC COMMUNICATIONS NETWORKS; PROVIDING TEMPORARY USE OF NON DOWNLOADABLE COMPUTER SOFTWARE FOR USE IN MANAGING, CONTROLLING AND SECURING PERSONAL INFORMATION; PROVIDING TEMPORARY USE OF NON DOWNLOADABLE COMPUTER SOFTWARE FOR CALCULATING, MAPPING, MANAGING, TRANSMITTING, CONTROLLING AND SECURING LOCATION INFORMATION; PROVIDING TEMPORARY USE OF NON DOWNLOADABLE COMPUTER SOFTWARE FOR PROVIDING A USER WITH INFORMATION ON GOODS AND SERVICES FOR SALE, AND FOR SHARING INFORMATION ABOUT ITEM LOCATION AND GOODS AND SERVICES FOR SALE WITH OTHERS, PROVIDED VIA COMPUTERS, MOBILE PHONES, WIRED AND WIRELESS COMMUNICATION DEVICES, AND OPTICAL AND ELECTRONIC COMMUNICATIONS NETWORKS; PROVIDING TEMPORARY USE OF NON DOWNLOADABLE COMPUTER SOFTWARE FOR CALCULATING, MAPPING, TRANSMITTING AND REPORTING POINT-OF-INTEREST INFORMATION AND LOCATION-INFORMED ADVERTISEMENTS AND PROMOTIONS VIA COMPUTERS, MOBILE PHONES, WIRED AND WIRELESS COMMUNICATION DEVICES, AND OPTICAL AND ELECTRONIC COMMUNICATIONS NETWORKS; COMPUTER SERVICES, NAMELY, PROVIDING SEARCH ENGINES FOR LOCATING INFORMATION, RESOURCES, AND THE WEBSITES OF OTHERS VIA ELECTRONIC AND OPTICAL COMMUNICATIONS NETWORKS; APPLICATION SERVICE PROVIDER FEATURING APPLICATION PROGRAMMING INTERFACE (API) SOFTWARE FOR USE IN BUILDING SOFTWARE APPLICATIONS; COMPUTER SERVICES, NAMELY, PROVIDING CUSTOMIZED ONLINE WEB PAGES FEATURING USER-DEFINED INFORMATION (U.S. CLS. 100 AND 101).

#### **CLASS 45—PERSONAL AND LEGAL SERVICES**

FOR ONLINE SOCIAL NETWORKING SERVICES; ONLINE SOCIAL NETWORKING SERVICES CONDUCTED VIA WIRELESS TELECOMMUNICATIONS NETWORKS AND VIA ELECTRONIC AND OPTICAL COMMUNICATION NETWORKS (U.S. CLS. 100 AND 101).

ANGELA DUONG, EXAMINING ATTORNEY

SN 85-321,960. GRAEALYN GOURMET FOODS, LLC, DBA A TASTE OF OLIVE, WEST CHESTER, PA. FILED 5-16-2011.

## A Taste of Olive

THE MARK CONSISTS OF STANDARD CHARACTERS WITHOUT CLAIM TO ANY PARTICULAR FONT, STYLE, SIZE, OR COLOR.

NO CLAIM IS MADE TO THE EXCLUSIVE RIGHT TO USE "OLIVE", APART FROM THE MARK AS SHOWN.

#### **CLASS 29—MEATS AND PROCESSED FOODS**

FOR GRAPESEED OIL; INFUSED OILS FOR COOKING; OLIVE OIL; OLIVE OILS; PROCESSED STUFFED OLIVES; SESAME OIL; TAPENADES (U.S. CL. 46).

FIRST USE 3-30-2008; IN COMMERCE 6-30-2008.

#### **CLASS 30—STAPLE FOODS**

FOR PASTA SAUCE; PESTO SAUCE; VINEGAR; WINE VINEGAR (U.S. CL. 46).

FIRST USE 3-30-2008; IN COMMERCE 6-30-2008.

#### **CLASS 35—ADVERTISING AND BUSINESS**

FOR RETAIL STORE AND ON-LINE RETAIL STORE SERVICES FEATURING OLIVE OIL, BALSAMIC VINEGAR, SPECIALTY OILS AND VINEGARS, GOURMET FOODS (U.S. CLS. 100, 101 AND 102).

FIRST USE 3-30-2008; IN COMMERCE 6-30-2008.

MAYUR VAGHANI, EXAMINING ATTORNEY

SN 85-322,369. NICHOLS, SUSAN, VENICE, CA. FILED 5-16-2011.

## HUMANOCRACY

THE MARK CONSISTS OF STANDARD CHARACTERS WITHOUT CLAIM TO ANY PARTICULAR FONT, STYLE, SIZE, OR COLOR.

#### **CLASS 25—CLOTHING**

FOR CLOTHING, NAMELY, T SHIRTS, SHIRTS, AND JACKETS (U.S. CLS. 22 AND 39).

#### **CLASS 41—EDUCATION AND ENTERTAINMENT**

FOR PROVIDING ON-LINE JOURNALS IN THE FIELDS OF SUSTAINABILITY, HEALTH AND WELLNESS, POLITICAL AND SOCIAL ISSUES; PROVIDING ON-LINE NON-DOWNLOADABLE GENERAL FEATURE MAGAZINES; PROVIDING AN INTERNET NEWS PORTAL FEATURING MULTIMEDIA, NEWS STORIES, AND BLOGS IN THE FIELDS OF SUSTAINABILITY, HEALTH AND WELLNESS, POLITICAL AND SOCIAL ISSUES; PROVIDING A WEBSITE FEATURING NON-DOWNLOADABLE VIDEOS IN THE FIELD OF CURRENT EVENT NEWS; PROVIDING CURRENT EVENT NEWS AND INFORMATION VIA A GLOBAL COMPUTER NETWORK (U.S. CLS. 100, 101 AND 107).

BRIAN NEVILLE, EXAMINING ATTORNEY

SN 85-322,598. HALL, JOHN THOMAS, BEVERLY HILLS, CA. FILED 5-17-2011.

## TEAM WALK ON

THE MARK CONSISTS OF STANDARD CHARACTERS WITHOUT CLAIM TO ANY PARTICULAR FONT, STYLE, SIZE, OR COLOR.

#### **CLASS 25—CLOTHING**

FOR ATHLETIC CLOTHING, NAMELY, SHORTS AND TOPS (U.S. CLS. 22 AND 39).

#### **CLASS 35—ADVERTISING AND BUSINESS**

FOR PRODUCTION OF TELEVISION COMMERCIALS (U.S. CLS. 100, 101 AND 102).

**CLASS 41—EDUCATION AND ENTERTAINMENT**

FOR EDUCATIONAL AND ENTERTAINMENT SERVICES, NAMELY, PROVIDING MOTIVATIONAL AND EDUCATIONAL SPEECHES IN THE FIELD OF ATHLETICS (U.S. CLS. 100, 101 AND 107).

CIMMERIAN COLEMAN, EXAMINING ATTORNEY

SN 85-322,640. LEARN OUR HISTORY LLC, DANBURY, CT. FILED 5-17-2011.



NO CLAIM IS MADE TO THE EXCLUSIVE RIGHT TO USE "HISTORY", APART FROM THE MARK AS SHOWN.

THE MARK CONSISTS OF THE WORDS "LEARN OUR HISTORY", IN WHICH THE LETTER "O" OF THE TERM "OUR" IS FORMED BY A STYLIZED SHAPE OF THE EARTH DEPICTING A CONTINENT, SURROUNDED BY A SERIES OF STRIPES, WITH THE LETTER, "U" CONTAINING SIX UN-SHADED STARS, AND THE LETTER "R" CONTAINING FOUR UN-SHADED STARS, IN THE TERM "OUR".

**CLASS 9—ELECTRICAL AND SCIENTIFIC APPARATUS**

FOR PRE-RECORDED CDS, VIDEO TAPES, AND DVDS FEATURING HISTORY, SOCIAL STUDIES, AND CURRENT EVENTS (U.S. CLS. 21, 23, 26, 36 AND 38).

**CLASS 16—PAPER GOODS AND PRINTED MATTER**

FOR EDUCATIONAL PUBLICATIONS, NAMELY, NEWSLETTERS, BOOKS, COMIC BOOKS, GUIDES, AND STUDY TOOLS IN NATURE OF TIMELINES, MAPS, AND LISTS OF DISCUSSION TOPICS, IN THE FIELDS OF HISTORY, SOCIAL STUDIES, AND CURRENT EVENTS (U.S. CLS. 2, 5, 22, 23, 29, 37, 38 AND 50).

**CLASS 42—SCIENTIFIC AND COMPUTER SERVICES**

FOR PROVIDING A WEB SITE FEATURING TEMPORARY USE OF NON-DOWNLOADABLE SOFTWARE FOR TRANSMISSION AND DISPLAY OF ANIMATED PROGRAMS OF AN EDUCATIONAL AND ENTERTAINMENT NATURE, FOR USE IN EDUCATION IN THE FIELDS OF HISTORY, SOCIAL STUDIES, AND CURRENT EVENTS (U.S. CLS. 100 AND 101).

ODESSA BIBBINS, EXAMINING ATTORNEY

SN 85-322,685. J&R CREATIVE MEDIA LLC, BROOKLYN, NY. FILED 5-17-2011.

THE MARK CONSISTS OF STANDARD CHARACTERS WITHOUT CLAIM TO ANY PARTICULAR FONT, STYLE, SIZE, OR COLOR.

**CLASS 9—ELECTRICAL AND SCIENTIFIC APPARATUS**

FOR (BASED ON INTENT TO USE) AUDIO AND VIDEO RECORDINGS FEATURING DATING AND RELATIONSHIP ADVICE; COMPUTER APPLICATION SOFTWARE FOR MOBILE PHONES, NAMELY, SOFTWARE FEATURING ADVICE ON INTERPERSONAL RELATIONSHIPS AND SELF IMPROVEMENT; PERSONAL NETWORKING AND SOCIAL ACTIVITY ORGANIZATION; COMPUTER GAME PROGRAMS; COMPUTER GAME SOFTWARE; DOWNLOADABLE VIRTUAL GOODS, NAMELY, COMPUTER PROGRAMS FEATURING DATING AND RELATIONSHIP ADVICE FOR USE IN ONLINE VIRTUAL WORLDS; GAME SOFTWARE; VIDEO AND COMPUTER GAME PROGRAMS (U.S. CLS. 21, 23, 26, 36 AND 38).

**CLASS 16—PAPER GOODS AND PRINTED MATTER**

FOR (BASED ON INTENT TO USE) A SERIES OF BOOKS AND WRITTEN ARTICLES IN THE FIELD OF DATING, INTERPERSONAL RELATIONSHIPS, ROMANCE, ROMANTIC ADVICE AND SELF-IMPROVEMENT; A SERIES OF BOOKS, WRITTEN ARTICLES, HANDOUTS AND WORKSHEETS IN THE FIELD OF DATING, INTERPERSONAL RELATIONSHIPS, ROMANCE, ROMANTIC ADVICE AND SELF-IMPROVEMENT; EDUCATIONAL PUBLICATIONS, NAMELY, A SERIES OF BOOKS IN THE FIELDS OF DATING, INTERPERSONAL RELATIONSHIPS, ROMANCE, ROMANTIC ADVICE AND SELF-IMPROVEMENT; SERIES OF FICTION WORKS, NAMELY, NOVELS AND BOOKS (U.S. CLS. 2, 5, 22, 23, 29, 37, 38 AND 50).

**CLASS 25—CLOTHING**

FOR (BASED ON INTENT TO USE) BATHING SUITS; BELTS FOR CLOTHING; CAPS; COATS; COVER UPS; DRESSES; HATS; HEADBANDS; NECKTIES; PAJAMAS; PANTS; SCARVES; SHIRTS; SHORTS; SKIRTS; SPORTS CAPS AND HATS; SPORTS JERSEYS; SWEATSHIRTS; T-SHIRTS; UNDERWEAR (U.S. CLS. 22 AND 39).

**CLASS 28—TOYS AND SPORTING GOODS**

FOR (BASED ON INTENT TO USE) BOARD GAMES; CARD GAMES; DOLLS; PLAYING CARDS (U.S. CLS. 22, 23, 38 AND 50).

**CLASS 41—EDUCATION AND ENTERTAINMENT**

FOR (BASED ON USE IN COMMERCE) EDUCATIONAL SERVICES, NAMELY, PROVIDING ONLINE INSTRUCTION IN THE FIELD OF DATING, INTERPERSONAL RELATIONSHIPS, ROMANCE, ROMANTIC ADVICE AND SELF-IMPROVEMENT VIA AN ONLINE WEBSITE; EDUCATIONAL SERVICES, NAMELY, PROVIDING AND CONDUCTING WORKSHOPS AND SEMINARS IN THE FIELDS OF DATING, INTERPERSONAL RELATIONSHIPS, ROMANCE, ROMANTIC ADVICE AND SELF-IMPROVEMENT; ENTERTAINMENT IN THE NATURE OF ON-GOING TELEVISION PROGRAMS IN THE FIELD OF DATING, INTERPERSONAL RELATIONSHIPS, ROMANCE, ROMANTIC ADVICE AND SELF-IMPROVEMENT; ENTERTAINMENT SERVICES, NAMELY, PARTICIPATION IN MOTION PICTURE FILM IN THE FIELD OF ROMANTIC COMEDY; ENTERTAINMENT SERVICES, NAMELY, PROVIDING A WEB SITE FEATURING PHOTOGRAPHIC, AUDIO, VIDEO AND PROSE PRESENTATIONS FEATURING THE FIELDS OF DATING, INTERPERSONAL RELATIONSHIPS, ROMANCE, ROMANTIC ADVICE AND SELF-IMPROVEMENT; ENTERTAINMENT SERVICES, NAMELY, PROVIDING A WEBSITE AT WHICH THE GENERAL PUBLIC CAN RECEIVE ADVICE FROM AN INDIVIDUAL CONCERNING RELATIONSHIPS, SUCH ADVICE BEING FOR ENTERTAINMENT PURPOSES ONLY (U.S. CLS. 100, 101 AND 107).

FIRST USE 5-3-2010; IN COMMERCE 5-3-2010.

**CLASS 45—PERSONAL AND LEGAL SERVICES**

FOR (BASED ON INTENT TO USE) COMPUTER DATING SERVICES; DATING SERVICES; INTERNET BASED SOCIAL NETWORKING, INTRODUCTION, AND DATING SERVICES; MATCHMAKING SERVICES (U.S. CLS. 100 AND 101).

KEVIN DINALLO, EXAMINING ATTORNEY

---

SN 85-322,692. UNIVERSITY OF IDAHO, MOSCOW, ID. FILED 5-17-2011.



OWNER OF U.S. REG. NO. 3,992,385.  
THE MARK CONSISTS OF THE LETTER "V".

**CLASS 25—CLOTHING**

FOR HEADWEAR; POLO SHIRTS; TEE SHIRTS (U.S. CLS. 22 AND 39).

FIRST USE 5-1-2011; IN COMMERCE 5-1-2011.

**CLASS 41—EDUCATION AND ENTERTAINMENT**

FOR ENTERTAINMENT IN THE NATURE OF COMPETITIONS IN THE FIELD OF ATHLETICS (U.S. CLS. 100, 101 AND 107).

FIRST USE 5-1-2011; IN COMMERCE 5-1-2011.  
KIM MONINGHOFF, EXAMINING ATTORNEY

---

SN 85-322,735. LUCAS, ERIC G., MINNETONKA, MN. FILED 5-17-2011.

**Stuff The Boss Says**

THE MARK CONSISTS OF STANDARD CHARACTERS WITHOUT CLAIM TO ANY PARTICULAR FONT, STYLE, SIZE, OR COLOR.

**CLASS 9—ELECTRICAL AND SCIENTIFIC APPARATUS**

FOR DOWNLOADABLE ELECTRONIC NEWSLETTERS FEATURING GUIDANCE AND INSTRUCTION IN STRESS REDUCTION TECHNIQUES AND IMPLEMENTATION TECHNIQUES (U.S. CLS. 21, 23, 26, 36 AND 38).

**CLASS 41—EDUCATION AND ENTERTAINMENT**

FOR PERSONAL COACHING SERVICES IN THE FIELD OF WELLNESS AND STRESS REDUCTION; EDUCATIONAL SERVICES, NAMELY, PROVIDING COURSES OF INSTRUCTION AND SEMINARS IN THE FIELD OF WELLNESS AND STRESS REDUCTION AND DISTRIBUTING INSTRUCTIONAL MATERIALS AND UPDATABLE DOCUMENTATION FOR USE IN IDENTIFYING, CATEGORIZING, ORGANIZING AND MANAGING STRESSORS IN CONNECTION THEREWITH; ONLINE JOURNALS, NAMELY, BLOGS FEATURING DISCUSSIONS IN THE FIELD OF WELLNESS AND STRESS REDUCTION; PROVIDING ELECTRONIC ONLINE NEWSLETTERS FEATURING GUIDANCE AND INSTRUCTION IN STRESS REDUCTION TECHNIQUES AND IMPLEMENTATION TECHNIQUES; PROVIDING ELECTRONIC NEWSLETTERS FEATURING GUIDANCE AND INSTRUCTION IN STRESS REDUCTION TECHNIQUES AND IMPLEMENTATION TECHNIQUES VIA EMAIL (U.S. CLS. 100, 101 AND 107).

**CLASS 42—SCIENTIFIC AND COMPUTER SERVICES**

FOR APPLICATION SERVICE PROVIDER (ASP) SERVICES, NAMELY, HOSTING, MANAGING, DEVELOPING AND MAINTAINING APPLICATIONS, SOFTWARE, WEBSITES AND DATABASES FOR USE IN THE FIELD OF STRESS REDUCTION BY ENABLING INDIVIDUALS, GROUPS, ORGANIZATIONS, COMPANIES AND EMPLOYEES TO IDENTIFY, CATEGORIZE AND ORGANIZE ACTIVITIES (U.S. CLS. 100 AND 101).

**CLASS 44—MEDICAL, BEAUTY AND AGRICULTURAL SERVICES**

FOR CONSULTING SERVICES IN THE FIELD OF WELLNESS AND STRESS REDUCTION, NAMELY, PROVIDING PERSONAL ASSESSMENT SERVICES AND COUNSELING SERVICES (U.S. CLS. 100 AND 101).

HELENE LIWINSKI, EXAMINING ATTORNEY

---

SN 85-322,805. RULE STEEL TANKS, INC., CALDWELL, ID. FILED 5-17-2011.

**RULE STEEL**

THE MARK CONSISTS OF STANDARD CHARACTERS WITHOUT CLAIM TO ANY PARTICULAR FONT, STYLE, SIZE, OR COLOR.

NO CLAIM IS MADE TO THE EXCLUSIVE RIGHT TO USE "STEEL", APART FROM THE MARK AS SHOWN.

**CLASS 6—METAL GOODS**

FOR METAL JOISTS, DECKS, STAIRS, RAILING FOR WALKWAYS; METAL TRASH CONTAINERS, METAL SEED BOXES; METAL RAMPS, LOCKS AND VALVES (U.S. CLS. 2, 12, 13, 14, 23, 25 AND 50).

FIRST USE 1-2-1992; IN COMMERCE 1-2-1992.

**CLASS 40—MATERIAL TREATMENT**

FOR METAL FABRICATION, GRINDER AND GRINDER PART FABRICATION AND METAL FINISHING SERVICES (U.S. CLS. 100, 103 AND 106).

FIRST USE 1-2-1992; IN COMMERCE 1-2-1992.  
ALLISON SCHRODY, EXAMINING ATTORNEY



SN 85-322,846. CAMBRIDGE INVESTMENTS, INC., LA JOLLA, CA. FILED 5-17-2011.

SN 85-323,088. OLDEMARK LLC, DUBLIN, OH. FILED 5-17-2011.

## Magnifico Giornata

THE MARK CONSISTS OF STANDARD CHARACTERS WITHOUT CLAIM TO ANY PARTICULAR FONT, STYLE, SIZE, OR COLOR.

THE ENGLISH TRANSLATION OF "MAGNIFICO GIORNATA" IN THE MARK IS "MAGNIFICENT DAY".

### CLASS 21—HOUSEWARES AND GLASS

FOR CHAMPAGNE FLUTES (U.S. CLS. 2, 13, 23, 29, 30, 33, 40 AND 50).

### CLASS 25—CLOTHING

FOR A-SHIRTS; ATHLETIC APPAREL, NAMELY, SHIRTS, PANTS, JACKETS, FOOTWEAR, HATS AND CAPS, ATHLETIC UNIFORMS; BASEBALL CAPS AND HATS; HATS; LOUNGE PANTS; SHIRTS; SHIRTS AND SHORT-SLEEVED SHIRTS; SHORT-SLEEVED OR LONG-SLEEVED T-SHIRTS; SHORT-SLEEVED SHIRTS; T-SHIRTS; TEE SHIRTS; TOPS; WEARABLE GARMENTS AND CLOTHING, NAMELY, SHIRTS (U.S. CLS. 22 AND 39).

NAAKWAMA ANKRAH, EXAMINING ATTORNEY

SN 85-322,984. TICKETS.COM, INC., COSTA MESA, CA. FILED 5-17-2011.



THE MARK CONSISTS OF A BOX ON THE LEFT WITH AN ANGLED LETTER "U" NEXT TO THE WORD "RAVE" WITH THREE LINES ABOVE THE LETTER "V".

### CLASS 9—ELECTRICAL AND SCIENTIFIC APPARATUS

FOR (BASED ON INTENT TO USE) DOWNLOADABLE ELECTRONIC PUBLICATIONS IN THE NATURE OF WHITE PAPERS IN THE FIELD OF MARKETING (U.S. CLS. 21, 23, 26, 36 AND 38).

### CLASS 41—EDUCATION AND ENTERTAINMENT

FOR (BASED ON USE IN COMMERCE) ON-LINE ELECTRONIC NEWSLETTERS DELIVERED BY E-MAIL IN THE FIELD OF BOX OFFICE MARKETING; PROVIDING ON-LINE TRAINING COURSES AND SEMINARS IN THE FIELD OF MARKETING; NONDOWNLOADABLE ELECTRONIC PUBLICATIONS IN THE NATURE OF WHITE PAPERS IN THE FIELD OF MARKETING (U.S. CLS. 100, 101 AND 107).

FIRST USE 3-16-2011; IN COMMERCE 3-16-2011.  
JACLYN KIDWELL WALKER, EXAMINING ATTORNEY

## Redhead Roasters

THE MARK CONSISTS OF STANDARD CHARACTERS WITHOUT CLAIM TO ANY PARTICULAR FONT, STYLE, SIZE, OR COLOR.

NO CLAIM IS MADE TO THE EXCLUSIVE RIGHT TO USE "ROASTERS", APART FROM THE MARK AS SHOWN.

### CLASS 30—STAPLE FOODS

FOR BAKERY GOODS; PREPARED COFFEE AND COFFEE-BASED BEVERAGES (U.S. CL. 46).

### CLASS 43—HOTEL AND RESTAURANT SERVICES

FOR RESTAURANT SERVICES, NAMELY, PROVIDING OF FOOD AND BEVERAGES FOR CONSUMPTION ON AND OFF THE PREMISES (U.S. CLS. 100 AND 101).  
KEVIN DINALLO, EXAMINING ATTORNEY

SN 85-323,096. DISCOVER KALAMAZOO, KALAMAZOO, MI. FILED 5-17-2011.

KALAMAZOO YOU'LL BE BACK  
WE PROMISE

THE MARK CONSISTS OF STANDARD CHARACTERS WITHOUT CLAIM TO ANY PARTICULAR FONT, STYLE, SIZE, OR COLOR.

NO CLAIM IS MADE TO THE EXCLUSIVE RIGHT TO USE "KALAMAZOO", APART FROM THE MARK AS SHOWN.

### CLASS 6—METAL GOODS

FOR METAL KEY CHAINS (U.S. CLS. 2, 12, 13, 14, 23, 25 AND 50).

FIRST USE 7-1-2009; IN COMMERCE 7-1-2009.

### CLASS 16—PAPER GOODS AND PRINTED MATTER

FOR PAPER STATIONERY; ENVELOPES; NOTE-CARDS; NOTEPADS; PADFOLIOS; PENS; PENCILS; POSTCARDS; PICTURE POSTCARDS; BUMPER STICKERS; PLASTIC SHOPPING BAGS (U.S. CLS. 2, 5, 22, 23, 29, 37, 38 AND 50).

FIRST USE 7-1-2009; IN COMMERCE 7-1-2009.

### CLASS 18—LEATHER GOODS

FOR BUSINESS CASES; DUFFEL BAGS; REUSABLE SHOPPING BAGS (U.S. CLS. 1, 2, 3, 22 AND 41).

FIRST USE 7-1-2009; IN COMMERCE 7-1-2009.

**CLASS 21—HOUSEWARES AND GLASS**

FOR CUPS AND MUGS; THERMAL INSULATED CONTAINER FOR FOOD OR BEVERAGES; THERMAL INSULATED BAGS FOR FOOD OR BEVERAGES; CORK-SCREWS; BOTTLE OPENERS (U.S. CLS. 2, 13, 23, 29, 30, 33, 40 AND 50).

FIRST USE 7-1-2009; IN COMMERCE 7-1-2009.

**CLASS 25—CLOTHING**

FOR CLOTHING, NAMELY, SHIRTS, T-SHIRTS, SWEATSHIRTS, SWEATERS, POLO SHIRTS, VESTS, FLEECE TOPS (U.S. CLS. 22 AND 39).

FIRST USE 7-1-2009; IN COMMERCE 7-1-2009.

**CLASS 35—ADVERTISING AND BUSINESS**

FOR CONVENTION AND VISITORS BUREAU SERVICES, NAMELY, PROMOTING TOURISM, BUSINESS AND CONVENTIONS IN AND AROUND THE KALAMAZOO, MICHIGAN AREA; PROMOTING RECREATION AND TOURISM IN AND AROUND THE KALAMAZOO, MICHIGAN AREA (U.S. CLS. 100, 101 AND 102).

FIRST USE 7-1-2009; IN COMMERCE 7-1-2009.  
EMILY CARLSEN, EXAMINING ATTORNEY

SN 85-323,136. ABRAHAM, THOMAS G., MIAMI, FL. FILED 5-17-2011.

"I GUARANTEE IT"

THE MARK CONSISTS OF STANDARD CHARACTERS WITHOUT CLAIM TO ANY PARTICULAR FONT, STYLE, SIZE, OR COLOR.

**CLASS 20—FURNITURE AND ARTICLES NOT OTHERWISE CLASSIFIED**

FOR SPORTS-THEMED STATUES MADE OF COLD CAST RESIN; THREE-DIMENSIONAL FIGURINES MADE OF COLD CAST RESIN (U.S. CLS. 2, 13, 22, 25, 32 AND 50).

**CLASS 28—TOYS AND SPORTING GOODS**

FOR SPORTS-THEMED MODELED PLASTIC TOY FIGURINES (U.S. CLS. 22, 23, 38 AND 50).

JAMES LOVELACE, EXAMINING ATTORNEY

SN 85-323,162. BOWERS, JUDITH B, LOS ANGELES, CA. AND GOTTEN III, NICHOLAS, GLENDALE, CA. FILED 5-17-2011.

D20

THE MARK CONSISTS OF STANDARD CHARACTERS WITHOUT CLAIM TO ANY PARTICULAR FONT, STYLE, SIZE, OR COLOR.

**CLASS 5—PHARMACEUTICALS**

FOR BITTER TASTING PET TRAINING AID IN THE FORM OF A SPRAY TO PREVENT PETS FROM LICKING, CHEWING AND BITING ON OBJECTS; DEODORIZERS FOR HOUSEHOLD PET LITTER BOXES; DEODORIZING PREPARATIONS FOR PET LITTER BOXES; DIAGNOSTIC RADIOPHARMACEUTICAL AGENT FOR USE IN PET IMAGING; DIETARY PET SUPPLEMENTS IN THE FORM OF PET TREATS; DIETARY SUPPLEMENTS FOR PETS; DIETARY SUPPLEMENTS FOR PETS IN THE NATURE OF A POWDERED DRINK MIX; FEED SUPPLEMENTS FOR PETS; HERBAL ANTI-ITCH AND SORE SKIN OINTMENT FOR PETS; PHARMACEUTICAL PREPARATIONS FOR THE TREATMENT OF WORMS IN PETS; SORE SKIN OINTMENT FOR PETS; VITAMINS FOR PETS (U.S. CLS. 6, 18, 44, 46, 51 AND 52).

**CLASS 31—NATURAL AGRICULTURAL PRODUCTS**

FOR AROMATIC SAND FOR PETS; CONSUMABLE PET CHEWS; ELECTROLYTE DRINK MIX FOR PETS; LIVE BIRDS, NAMELY, PET BIRDS; PET BEVERAGES; PET FOOD; PET TREATS; PET TREATS IN THE NATURE OF BULLY STICKS; SANDED PAPER FOR PETS (U.S. CLS. 1 AND 46).

ROBIN MITTLER, EXAMINING ATTORNEY

SN 85-323,179. DISCOVER KALAMAZOO, KALAMAZOO, MI. FILED 5-17-2011.

**Kalamazoo**  
You'll be back We promise

NO CLAIM IS MADE TO THE EXCLUSIVE RIGHT TO USE "KALAMAZOO", APART FROM THE MARK AS SHOWN.

THE MARK CONSISTS OF THE WORDS "KALAMAZOO" AND "YOU'LL BE BACK WE PROMISE" SEPARATED BY A WAVY LINE.

**CLASS 6—METAL GOODS**

FOR METAL KEY CHAINS (U.S. CLS. 2, 12, 13, 14, 23, 25 AND 50).

FIRST USE 7-1-2009; IN COMMERCE 7-1-2009.

**CLASS 16—PAPER GOODS AND PRINTED MATTER**

FOR PAPER STATIONERY; ENVELOPES; NOTE-CARDS; NOTEPADS; PADFOLIOS; PENS; PENCILS; POSTCARDS; PICTURE POSTCARDS; BUMPER STICKERS; PLASTIC SHOPPING BAGS (U.S. CLS. 2, 5, 22, 23, 29, 37, 38 AND 50).

FIRST USE 7-1-2009; IN COMMERCE 7-1-2009.

**CLASS 18—LEATHER GOODS**

FOR BUSINESS CASES; DUFFEL BAGS; REUSABLE SHOPPING BAGS (U.S. CLS. 1, 2, 3, 22 AND 41).

FIRST USE 7-1-2009; IN COMMERCE 7-1-2009.

**CLASS 21—HOUSEWARES AND GLASS**

FOR CUPS AND MUGS; THERMAL INSULATED CONTAINER FOR FOOD OR BEVERAGES; THERMAL INSULATED BAGS FOR FOOD OR BEVERAGES; CORK-SCREWS; BOTTLE OPENERS (U.S. CLS. 2, 13, 23, 29, 30, 33, 40 AND 50).

FIRST USE 7-1-2009; IN COMMERCE 7-1-2009.

**CLASS 25—CLOTHING**

FOR CLOTHING, NAMELY, SHIRTS, T-SHIRTS, SWEATSHIRTS, SWEATERS, POLO SHIRTS, VESTS, FLEECE TOPS (U.S. CLS. 22 AND 39).

FIRST USE 7-1-2009; IN COMMERCE 7-1-2009.

**CLASS 35—ADVERTISING AND BUSINESS**

FOR CONVENTION AND VISITORS BUREAU SERVICES, NAMELY, PROMOTING TOURISM, BUSINESS AND CONVENTIONS IN AND AROUND THE KALAMAZOO, MICHIGAN AREA; PROMOTING RECREATION AND TOURISM IN AND AROUND THE KALAMAZOO, MICHIGAN AREA (U.S. CLS. 100, 101 AND 102).

FIRST USE 7-1-2009; IN COMMERCE 7-1-2009.  
EMILY CARLSEN, EXAMINING ATTORNEY

---

SN 85-323,328. TREVISI, MATTEO, NÜRNBERG, FED REP GERMANY, FILED 5-17-2011.

# LINMIO

THE MARK CONSISTS OF STANDARD CHARACTERS WITHOUT CLAIM TO ANY PARTICULAR FONT, STYLE, SIZE, OR COLOR.

THE WORDING "LINMIO" HAS NO MEANING IN A FOREIGN LANGUAGE.

**CLASS 3—COSMETICS AND CLEANING PREPARATIONS**

FOR SOAPS FOR PERSONAL USE (U.S. CLS. 1, 4, 6, 50, 51 AND 52).

**CLASS 31—NATURAL AGRICULTURAL PRODUCTS**

FOR AGRICULTURAL PRODUCTS, NAMELY, FRESH FRUITS AND VEGETABLES (U.S. CLS. 1 AND 46).

**CLASS 33—WINES AND SPIRITS**

FOR WINES (U.S. CLS. 47 AND 49).  
JEAN IM, EXAMINING ATTORNEY

SN 85-323,357. FOTOWATIO RENEWABLE VENTURES, INC., SAN FRANCISCO, CA. FILED 5-17-2011.

# ORO VERDE

THE MARK CONSISTS OF STANDARD CHARACTERS WITHOUT CLAIM TO ANY PARTICULAR FONT, STYLE, SIZE, OR COLOR.

THE ENGLISH TRANSLATION OF "ORO VERDE" IN THE MARK IS "GREEN GOLD".

**CLASS 7—MACHINERY**

FOR ELECTRICITY GENERATORS; GENERATORS OF ELECTRICITY; SOLAR-POWERED ELECTRICITY GENERATORS (U.S. CLS. 13, 19, 21, 23, 31, 34 AND 35).

**CLASS 9—ELECTRICAL AND SCIENTIFIC APPARATUS**

FOR POWER-LINE TRANSMISSION MACHINES AND APPARATUS (U.S. CLS. 21, 23, 26, 36 AND 38).

**CLASS 39—TRANSPORTATION AND STORAGE**

FOR DISTRIBUTION AND TRANSMISSION OF ELECTRICITY; LEASING THE USE OF POWER LINES TO THIRD PARTIES FOR THE TRANSMISSION OF ELECTRICITY; UTILITY SERVICES, NAMELY, TRANSMISSION OF ELECTRICITY (U.S. CLS. 100 AND 105).

**CLASS 40—MATERIAL TREATMENT**

FOR ELECTRICITY GENERATION; GENERATING OF ELECTRICITY; GENERATION OF ELECTRICITY FROM SOLAR ENERGY (U.S. CLS. 100, 103 AND 106).  
MATTHEW KLINE, EXAMINING ATTORNEY

---

SN 85-323,360. BEATS AT SEA, LLC, BOCA RATON, FL. FILED 5-17-2011.

# HOLY SHIP!

THE MARK CONSISTS OF STANDARD CHARACTERS WITHOUT CLAIM TO ANY PARTICULAR FONT, STYLE, SIZE, OR COLOR.

NO CLAIM IS MADE TO THE EXCLUSIVE RIGHT TO USE "SHIP", APART FROM THE MARK AS SHOWN.

**CLASS 25—CLOTHING**

FOR FOOTWEAR; HATS; HEADBANDS; JACKETS; SCARVES; SHORTS; SOCKS; SWEAT SHIRTS; SWEATERS; T-SHIRTS; TANK TOPS; VISORS (U.S. CLS. 22 AND 39).

**CLASS 39—TRANSPORTATION AND STORAGE**

FOR CRUISE SHIP SERVICES (U.S. CLS. 100 AND 105).

**CLASS 41—EDUCATION AND ENTERTAINMENT**

FOR ARRANGING AND CONDUCTING OF CONCERTS; ENTERTAINMENT IN THE NATURE OF LIVE PERFORMANCES BY VARIOUS MUSIC GROUPS ON CRUISE SHIPS; ENTERTAINMENT, NAMELY, LIVE MUSIC CONCERTS (U.S. CLS. 100, 101 AND 107).

EDWARD FENNESSY, EXAMINING ATTORNEY

**CLASS 41—EDUCATION AND ENTERTAINMENT**

FOR EDUCATIONAL AND ENTERTAINMENT SERVICES, NAMELY, A CONTINUING PROGRAM ABOUT CHRISTIAN RELIGION AND CHRISTIAN LIVING AND LIFESTYLES ACCESSIBLE BY RADIO, TELEVISION, SATELLITE, AUDIO, VIDEO AND COMPUTER NETWORKS; PRODUCTION OF RADIO PROGRAMS (U.S. CLS. 100, 101 AND 107).

FIRST USE 1-1-1979; IN COMMERCE 1-1-1979.

EDWARD NELSON, EXAMINING ATTORNEY

SN 85-323,540. TITLE RESOURCE GROUP LLC, MT. LAUREL, NJ. FILED 5-18-2011.



NO CLAIM IS MADE TO THE EXCLUSIVE RIGHT TO USE "TITLE SERVICES", APART FROM THE MARK AS SHOWN.

THE MARK CONSISTS OF A STYLIZED LETTER "K" IN A BLOCK TO THE LEFT OF THE WORDS "KEYSTONE TITLE SERVICES" DISPLAYED IN ALL-CAPS AND STACKED ON TOP OF EACH OTHER.

SN 85-323,773. CALAYAN, INC., W. HOLLYWOOD, CA. FILED 5-18-2011.

**CLASS 36—INSURANCE AND FINANCIAL**

FOR INSURANCE SERVICES RELATED TO REAL ESTATE TRANSACTIONS, NAMELY, TITLE INSURANCE UNDERWRITING, TITLE INSURANCE CONSULTATION AND TITLE INSURANCE CLAIMS PROCESSING; REAL ESTATE ESCROW SERVICES (U.S. CLS. 100, 101 AND 102).

FIRST USE 9-2-2010; IN COMMERCE 9-2-2010.

**CLASS 45—PERSONAL AND LEGAL SERVICES**

FOR REAL ESTATE SETTLEMENT SERVICES; REAL ESTATE CLOSING SERVICES (U.S. CLS. 100 AND 101).

FIRST USE 9-2-2010; IN COMMERCE 9-2-2010.

RON FAIRBANKS, EXAMINING ATTORNEY

SN 85-323,630. FAMILY WORSHIP CENTER CHURCH, INC., DBA JIMMY SWAGGART MINISTRIES, BATON ROUGE, LA. FILED 5-18-2011.

**Sonlife Radio Network**

THE MARK CONSISTS OF STANDARD CHARACTERS WITHOUT CLAIM TO ANY PARTICULAR FONT, STYLE, SIZE, OR COLOR.

OWNER OF U.S. REG. NOS. 3,853,033 AND 3,853,998.

NO CLAIM IS MADE TO THE EXCLUSIVE RIGHT TO USE "RADIO NETWORK", APART FROM THE MARK AS SHOWN.

**CLASS 38—COMMUNICATION**

FOR RADIO BROADCASTING (U.S. CLS. 100, 101 AND 104).

FIRST USE 1-1-1979; IN COMMERCE 1-1-1979.

THE MARK CONSISTS OF THE MARK CONSISTS OF TWO ELEMENTS. THE FIRST ELEMENT IS AN ISOSCELES TRIANGLE WITH THE PROFILE OF A WOMAN WITHIN IT BOUNDARIES CREATED BY THE OUTLINE OF NEGATIVE SPACE WITHIN THE TRIANGLE. THE SECOND ELEMENT IS THE WORD "CALAYAN" IN CAPITAL LETTERS. THE INITIAL LETTER "C" PARTIALLY ENCIRCLES THE TRIANGULAR ELEMENT.

**CLASS 3—COSMETICS AND CLEANING PREPARATIONS**

FOR BODY CARE PRODUCTS, NAMELY, NON-MEDICATED SOAP, LOTIONS, DEODORANT, ASTRINGENT, MOISTURIZER (U.S. CLS. 1, 4, 6, 50, 51 AND 52).

FIRST USE 3-1-2000; IN COMMERCE 4-1-2000.

**CLASS 44—MEDICAL, BEAUTY AND AGRICULTURAL SERVICES**

FOR AESTHETIC AND COSMETIC SURGERY SERVICES, NAMELY, PROVIDING SKIN WHITENING, BODY SCRUBS, LASER, FACIAL AND BODY TREATMENTS (U.S. CLS. 100 AND 101).

FIRST USE 3-1-2000; IN COMMERCE 4-1-2000.

FLORENTINA BLANDU, EXAMINING ATTORNEY

SN 85-324,167. NOT IN GOOD TASTE, INC., SPRINGFIELD, IL. FILED 5-18-2011.



NO CLAIM IS MADE TO THE EXCLUSIVE RIGHT TO USE "5K" AND "STREET PARTY FOR CHARITY", APART FROM THE MARK AS SHOWN.

THE MARK CONSISTS OF A PIG RUNNING IN A WARM-UP SUIT, SUNGLASSES AND HEADBAND, CARRYING A LIT CIGAR IN HIS RIGHT HAND AND A MUG FULL OF BEVERAGE IN HIS LEFT HAND, WITH THE WORD "FAT ASS 5K" APPEARING LARGE AND CENTERED OVER THE IMAGE OF THE PIG, AND THE WORDING "& STREET PARTY FOR CHARITY" APPEARING SMALLER AND BENEATH THE WORDING "5K".

#### CLASS 25—CLOTHING

FOR CLOTHING, NAMELY, T-SHIRTS, SWEATSHIRTS, SHORTS, HATS AND SOCKS (U.S. CLS. 22 AND 39).

FIRST USE 2-0-2008; IN COMMERCE 2-0-2008.

#### CLASS 36—INSURANCE AND FINANCIAL

FOR CHARITABLE FUNDRAISING SERVICES (U.S. CLS. 100, 101 AND 102).

FIRST USE 2-0-2008; IN COMMERCE 2-0-2008.

#### CLASS 41—EDUCATION AND ENTERTAINMENT

FOR ATHLETIC AND SPORTS EVENT SERVICES, NAMELY, ARRANGING, ORGANIZING AND CONDUCTING ATHLETIC COMPETITIONS (U.S. CLS. 100, 101 AND 107).

FIRST USE 2-0-2008; IN COMMERCE 2-0-2008.  
RON FAIRBANKS, EXAMINING ATTORNEY

SN 85-324,172. NOT IN GOOD TASTE, INC., SPRINGFIELD, IL. FILED 5-18-2011.

## Fat Ass 5K and Street Party for Charity

THE MARK CONSISTS OF STANDARD CHARACTERS WITHOUT CLAIM TO ANY PARTICULAR FONT, STYLE, SIZE, OR COLOR.

NO CLAIM IS MADE TO THE EXCLUSIVE RIGHT TO USE "5K" AND "STREET PARTY FOR CHARITY", APART FROM THE MARK AS SHOWN.

#### CLASS 36—INSURANCE AND FINANCIAL

FOR CHARITABLE FUNDRAISING SERVICES (U.S. CLS. 100, 101 AND 102).

FIRST USE 2-0-2008; IN COMMERCE 2-0-2008.

#### CLASS 41—EDUCATION AND ENTERTAINMENT

FOR ATHLETIC AND SPORTS EVENT SERVICES, NAMELY, ARRANGING, ORGANIZING AND CONDUCTING ATHLETIC COMPETITIONS (U.S. CLS. 100, 101 AND 107).

FIRST USE 2-0-2008; IN COMMERCE 2-0-2008.  
RON FAIRBANKS, EXAMINING ATTORNEY

SN 85-324,421. HEINRICH-STEINBERG, KATRINA B., RANCHO MIRAGE, CA. FILED 5-18-2011.

## VALLEY CENTER

THE MARK CONSISTS OF STANDARD CHARACTERS WITHOUT CLAIM TO ANY PARTICULAR FONT, STYLE, SIZE, OR COLOR.

NO CLAIM IS MADE TO THE EXCLUSIVE RIGHT TO USE "CENTER", APART FROM THE MARK AS SHOWN.

#### CLASS 36—INSURANCE AND FINANCIAL

FOR REAL ESTATE INVESTMENT SERVICES (U.S. CLS. 100, 101 AND 102).

#### CLASS 37—CONSTRUCTION AND REPAIR

FOR LAND DEVELOPMENT SERVICES, NAMELY, PLANNING AND LAYING OUT OF RESIDENTIAL AND/OR COMMERCIAL COMMUNITIES; REAL ESTATE DEVELOPMENT (U.S. CLS. 100, 103 AND 106).

RON FAIRBANKS, EXAMINING ATTORNEY

SN 85-324,469. SEACOR RESPONSE LTD., AJELTAKE ISLAND, MARSHALL ISLANDS, FILED 5-18-2011.



NO CLAIM IS MADE TO THE EXCLUSIVE RIGHT TO USE "RESPONSE", APART FROM THE MARK AS SHOWN.

THE MARK CONSISTS OF A LITERAL AND A DESIGN COMPONENT. THE LITERAL COMPONENT CONSISTS OF THE TWO WORDS "SEACOR RESPONSE" IN STYLIZED CAPITAL LETTERS WITH "SEACOR" LOCATED ABOVE IN LARGER, BOLDER LETTERS, AND "RESPONSE" FITTED IN BELOW IT. THE DESIGN COMPONENT IS A SHADED CIRCLE, TO THE LEFT OF THE TWO WORDS, CONTAINING A HIGHLY STYLIZED CAPITAL "S" IN A LIGHT SHADE.

**CLASS 35—ADVERTISING AND BUSINESS**

FOR BUSINESS MANAGEMENT CONSULTATION SERVICES IN THE FIELD OF CRISIS MANAGEMENT IN CONNECTION WITH HEALTH, SAFETY OR ENVIRONMENTAL PROBLEMS, INCIDENTS AND HAZARDS (U.S. CLS. 100, 101 AND 102).

FIRST USE 5-24-2011; IN COMMERCE 5-24-2011.

**CLASS 37—CONSTRUCTION AND REPAIR**

FOR LEASING OF OIL SPILL CONTAINMENT, CLEAN-UP AND COLLECTION EQUIPMENT, NAMELY, PUMPS, CONTAINMENT BOOMS AND SKIMMERS; OIL SPILL CONTAINMENT, CLEAN-UP AND COLLECTION SERVICES; CLEAN-UP OF HAZARDOUS MATERIAL SPILLS; ENVIRONMENTAL REMEDIATION SERVICES, NAMELY, EMERGENCY SPILL CLEAN-UP, CONTAINMENT, AND COLLECTION; CONSULTING SERVICES IN THE FIELD OF CLEAN-UP OF HAZARDOUS MATERIAL SPILLS; CONSULTING SERVICES IN THE FIELD OF ENVIRONMENTAL REMEDIATION, NAMELY, EMERGENCY SPILL CLEAN-UP, CONTAINMENT, AND COLLECTION (U.S. CLS. 100, 103 AND 106).

FIRST USE 5-24-2011; IN COMMERCE 5-24-2011.

**CLASS 40—MATERIAL TREATMENT**

FOR DECONTAMINATION OF HAZARDOUS MATERIAL SPILLS; CONSULTING IN THE FIELD OF DECONTAMINATION OF HAZARDOUS MATERIAL SPILLS; ENVIRONMENTAL REMEDIATION SERVICES; CONSULTING SERVICES IN THE FIELD OF ENVIRONMENTAL REMEDIATION; FIRE FIGHTING RESCUE AND RESPONSE (U.S. CLS. 100, 103 AND 106).

FIRST USE 5-24-2011; IN COMMERCE 5-24-2011.

**CLASS 41—EDUCATION AND ENTERTAINMENT**

FOR TRAINING OF OTHERS IN THE FIELD OF ENVIRONMENTAL DISASTER PREPAREDNESS AND RESPONSE (U.S. CLS. 100, 101 AND 107).

FIRST USE 5-24-2011; IN COMMERCE 5-24-2011.

**CLASS 45—PERSONAL AND LEGAL SERVICES**

FOR CONSULTING SERVICES IN THE FIELD OF NATURAL DISASTER PREPAREDNESS AND RESPONSE; NATURAL DISASTER RESPONSE SERVICES, NAMELY, OIL SPILL CONTAINMENT, CLEAN-UP AND COLLECTION SERVICES, CLEAN-UP OF HAZARDOUS MATERIAL SPILLS, ENVIRONMENTAL REMEDIATION SERVICES, NAMELY, EMERGENCY SPILL CLEAN-UP, CONTAINMENT, AND COLLECTION AND REMOVAL OF OIL FROM THE WATER, AND DECONTAMINATION OF HAZARDOUS MATERIAL SPILLS; SECURITY SERVICES, NAMELY, PROVIDING SECURITY FOR WATERFRONT FACILITIES AND MARINE VESSELS (U.S. CLS. 100 AND 101).

FIRST USE 5-24-2011; IN COMMERCE 5-24-2011.

JILL C. ALT, EXAMINING ATTORNEY

SN 85-324,644. MALLON, CAROLYN ANN, SADDLE RIVER, NJ. FILED 5-19-2011.

**Spanky the Seaturtle**

THE MARK CONSISTS OF STANDARD CHARACTERS WITHOUT CLAIM TO ANY PARTICULAR FONT, STYLE, SIZE, OR COLOR.

NO CLAIM IS MADE TO THE EXCLUSIVE RIGHT TO USE "SEA TURTLE", APART FROM THE MARK AS SHOWN.

**CLASS 16—PAPER GOODS AND PRINTED MATTER**

FOR CHILDREN'S STORYBOOKS (U.S. CLS. 2, 5, 22, 23, 29, 37, 38 AND 50).

**CLASS 28—TOYS AND SPORTING GOODS**

FOR CHILDREN'S MULTIPLE ACTIVITY TOYS (U.S. CLS. 22, 23, 38 AND 50).

TRICIA SONNEBORN, EXAMINING ATTORNEY

SN 85-324,851. ROBOFUSION, INC., AWENDAW, SC. FILED 5-19-2011.

**ROBOFUSION**

THE MARK CONSISTS OF STANDARD CHARACTERS WITHOUT CLAIM TO ANY PARTICULAR FONT, STYLE, SIZE, OR COLOR.

**CLASS 7—MACHINERY**

FOR ROBOTIC MACHINES FOR CREATING TREATS FROM FROZEN CONFECTIONERIES (U.S. CLS. 13, 19, 21, 23, 31, 34 AND 35).

**CLASS 30—STAPLE FOODS**

FOR ICE CREAM AND FROZEN CONFECTIONERIES (U.S. CL. 46).

MELISSA VALLILLO, EXAMINING ATTORNEY

SN 85-325,117. MINNESOTA INDEPENDENT OIL COMPANY, LITTLE CANADA, MN. FILED 5-19-2011.

**minnoco**

THE MARK CONSISTS OF THE WORD "MINNOCO" HAVING TWO WAVY LINES UNDERNEATH.

**CLASS 4—LUBRICANTS AND FUELS**

FOR FUELS AND LUBRICANTS, NAMELY, AUTOMOTIVE LUBRICANTS AND ALL PURPOSE LUBRICANTS (U.S. CLS. 1, 6 AND 15).

**CLASS 35—ADVERTISING AND BUSINESS**

FOR RETAIL CONVENIENCE STORES (U.S. CLS. 100, 101 AND 102).

PATRICIA EVANKO, EXAMINING ATTORNEY

SN 85-325,264. PETROTECHNICAL DATA SYSTEMS AMERICAN HOLDING LLC, RIJSWIJK, ZUID HOLLAND, NETHERLANDS, FILED 5-19-2011.

**PRODUCTION ENTERPRISE**

THE MARK CONSISTS OF STANDARD CHARACTERS WITHOUT CLAIM TO ANY PARTICULAR FONT, STYLE, SIZE, OR COLOR.  
OWNER OF U.S. REG. NO. 3,990,724.

**CLASS 9—ELECTRICAL AND SCIENTIFIC APPARATUS**

FOR COMPUTER SOFTWARE FOR ACCESSING INFORMATION DIRECTORIES THAT MAY BE DOWNLOADED FROM THE GLOBAL COMPUTER NETWORK; COMPUTER SOFTWARE FOR DATA MANAGEMENT IN THE OIL AND GAS PRODUCTION SECTOR THAT MAY BE DOWNLOADED FROM A GLOBAL COMPUTER NETWORK; DOWNLOADABLE SOFTWARE FOR DATA MANAGEMENT IN THE OIL AND GAS PRODUCTION SECTOR; ELECTRONIC SOFTWARE UPDATES, NAMELY, DOWNLOADABLE COMPUTER SOFTWARE AND ASSOCIATED DATA FILES FOR UPDATING COMPUTER SOFTWARE IN THE FIELDS OF DATA MANAGEMENT IN THE OIL AND GAS PRODUCTION SECTOR, PROVIDED VIA COMPUTER AND COMMUNICATION NETWORKS (U.S. CLS. 21, 23, 26, 36 AND 38).  
FIRST USE 5-12-2011; IN COMMERCE 5-12-2011.

**CLASS 42—SCIENTIFIC AND COMPUTER SERVICES**

FOR PROVIDING NON-DOWNLOADABLE ONLINE COMPUTER SOFTWARE FOR CREATING WORKFLOW SOLUTIONS FOR THE OIL AND GAS PRODUCTION SECTOR; PROVIDING NON-DOWNLOADABLE ONLINE COMPUTER SOFTWARE FOR ACCESSING INFORMATION DIRECTORIES; PROVIDING NON-DOWNLOADABLE ONLINE COMPUTER SOFTWARE FOR DATA MANAGEMENT IN THE OIL AND GAS PRODUCTION SECTOR (U.S. CLS. 100 AND 101).  
FIRST USE 3-23-2010; IN COMMERCE 3-23-2010.  
FRANK LATTUCA, EXAMINING ATTORNEY

SN 85-325,277. THE HAROLD P. FREEMAN INSTITUTE, NEW YORK, NY. FILED 5-19-2011.



NO CLAIM IS MADE TO THE EXCLUSIVE RIGHT TO USE "PATIENT NAVIGATION INSTITUTE", APART FROM THE MARK AS SHOWN.

THE NAME(S), PORTRAIT(S), AND/OR SIGNATURE(S) SHOWN IN THE MARK IDENTIFIES "HAROLD P. FREEMAN", WHOSE CONSENT(S) TO REGISTER IS MADE OF RECORD.

THE COLOR(S) BLACK, BLUE AND YELLOW IS/ARE CLAIMED AS A FEATURE OF THE MARK.

THE MARK CONSISTS OF A BLUE CIRCLE THAT SURROUNDS A YELLOW COMPASS ROSE, WHICH FACES NORTHWEST AND IS EVENLY DIVIDED IN FOUR PARTS BY A YELLOW CROSS. THE BLUE CIRCLE IS ENCIRCLED BY THE WORDING "HAROLD P. FREEMAN PATIENT NAVIGATION INSTITUTE" IN BLACK.

**CLASS 16—PAPER GOODS AND PRINTED MATTER**

FOR PRINTED EDUCATIONAL TEACHING MATERIALS IN THE FIELD OF PATIENT NAVIGATION (U.S. CLS. 2, 5, 22, 23, 29, 37, 38 AND 50).  
FIRST USE 1-0-2009; IN COMMERCE 1-0-2009.

**CLASS 41—EDUCATION AND ENTERTAINMENT**

FOR EDUCATIONAL SERVICES, NAMELY, PROVIDING CLASSES, SEMINARS AND TRAINING IN THE HEALTH CARE INDUSTRY (U.S. CLS. 100, 101 AND 107).  
FIRST USE 1-0-2009; IN COMMERCE 1-0-2009.  
PAUL F. GAST, EXAMINING ATTORNEY

SN 85-325,439. TDG-TREGNY, LLC, NEW YORK, NY. FILED 5-19-2011.

**REAL IMPACT REAL ESTATE**

THE MARK CONSISTS OF STANDARD CHARACTERS WITHOUT CLAIM TO ANY PARTICULAR FONT, STYLE, SIZE, OR COLOR.

NO CLAIM IS MADE TO THE EXCLUSIVE RIGHT TO USE "REAL ESTATE", APART FROM THE MARK AS SHOWN.

**CLASS 35—ADVERTISING AND BUSINESS**

FOR ADVERTISING AND ADVERTISEMENT SERVICES; ADVERTISING AND MARKETING; ADVERTISING AND MARKETING CONSULTANCY; ADVERTISING AND MARKETING SERVICES PROVIDED BY MEANS OF INDIRECT METHODS OF MARKETING COMMUNICATIONS, NAMELY, SOCIAL MEDIA, SEARCH ENGINE MARKETING, INQUIRY MARKETING, INTERNET MARKETING, MOBILE MARKETING, BLOGGING AND OTHER FORMS OF PASSIVE, SHARABLE OR VIRAL COMMUNICATIONS CHANNELS; ADVERTISING AND MARKETING SERVICES, NAMELY, PROMOTING THE GOODS AND SERVICES OF OTHERS; ADVERTISING OF COMMERCIAL OR RESIDENTIAL REAL ESTATE; ADVERTISING SERVICES; ADVERTISING SERVICES, NAMELY, CREATING CORPORATE LOGOS FOR OTHERS; ADVERTISING SERVICES, NAMELY, PROMOTING AND MARKETING THE GOODS AND SERVICES OF OTHERS THROUGH ALL PUBLIC COMMUNICATION MEANS; ADVERTISING SERVICES, NAMELY, PROMOTING PROPERTIES FOR SALE BY OWNER VIA THE INTERNET; ADVERTISING SERVICES, NAMELY, PROVIDING INFORMATION AS TO THE AVAILABILITY OF REAL ESTATE FOR RENT OR PURCHASE; ADVERTISING SERVICES, PUBLIC RELATIONS AND MARKETING SERVICES, NAMELY, PROMOTING AND MARKETING THE GOODS AND SERVICES OF OTHERS THROUGH ALL PUBLIC COMMUNICATION MEANS; ADVERTISING, MARKETING AND PROMOTING THE GOODS AND SERVICES OF OTHERS USING KIOSKS; ADVERTISING, MARKETING AND PROMOTION SERVICES; ADVERTISING, MARKETING AND PROMOTION SERVICES, NAMELY, PROMOTING THE GOODS AND SERVICES OF OTHERS BY PROVIDING CUSTOMIZED EXHIBITS; MATCHING CONSUMERS WITH REAL ESTATE PROFESSIONALS IN THE FIELD OF REAL ESTATE SERVICES VIA COMPUTER NETWORK; NEGOTIATION AND RENEGOTIATION FOR OTHERS OF LEASES AND SUBLEASES AND REAL ESTATE PURCHASE AGREEMENTS; PROVIDING AN INTERACTIVE REAL ESTATE WEBSITE WHICH PROMOTES HOUSING AND APARTMENT PROPERTIES THROUGH OFFERING PROSPECTIVE TENANTS VIDEO WALK THROUGH, PROPERTY DESCRIPTIONS, TEXT, PRICE, LOCATION, MAPS AND OTHER INFORMATION THAT WOULD BE INFLUENTIAL TO A PROSPECTIVE TENANT IN MAKING A RENTAL DECISION; PROVIDING BUSINESS PLANNING AND MARKETING SOLUTIONS FOR REAL ESTATE PROFESSIONALS; PROVIDING MARKETING SOLUTIONS FOR THE SALE, LEASE OR TRANSFER OF REAL ESTATE THROUGH ALL PUBLIC COMMUNICATION MEANS.; PROVIDING REAL ESTATE LEADS FOR PROSPECTIVE PURCHASERS; PROVIDING REAL ESTATE VIDEO TOURS FOR MARKETING PURPOSES; REAL ESTATE ADVERTISING SERVICES; REAL ESTATE MARKETING ANALYSIS; REAL ESTATE MARKETING SERVICES IN THE FIELD OF NEW DEVELOPMENT; REAL ESTATE MARKETING SERVICES, NAMELY, ON-LINE SERVICES FEATURING THE PROMOTION OF RESIDENTIAL NEW CONSTRUCTION, WHICH ALSO CONTAINS BACK OFFICE SOLUTIONS FOR BUILDERS; REAL ESTATE MARKETING SERVICES, NAMELY, ON-LINE SERVICES FEATURING TOURS OF RESIDENTIAL AND COMMERCIAL REAL ESTATE; REAL ESTATE SALES MANAGEMENT (U.S. CLS. 100, 101 AND 102).  
FIRST USE 5-4-2011; IN COMMERCE 5-4-2011.

**CLASS 36—INSURANCE AND FINANCIAL**

FOR EVALUATING REAL ESTATE TO ASSESS FEASIBILITY FOR USE AS A PROPERTY SELF-STORAGE FACILITY; PROVIDING A DATABASE OF INFORMATION ABOUT RESIDENTIAL REAL ESTATE LISTINGS IN DIFFERENT NEIGHBORHOODS AND COMMUNITIES; PROVIDING A DATABASE OF RESIDENTIAL REAL ESTATE LISTINGS WITHIN NEIGHBORHOODS AND COMMUNITIES SPECIFICALLY IDENTIFIED BY USERS; PROVIDING AN INTERNET WEBSITE PORTAL OFFERING INFORMATION IN THE FIELDS OF REAL ESTATE CONCERNING THE PURCHASE AND SALE OF NEW AND RESALE HOMES AND CONDOS; PROVIDING INFORMATION IN THE FIELD OF REAL ESTATE BY MEANS OF LINKING THE WEB SITE TO OTHER WEB SITES FEATURING REAL ESTATE INFORMATION; PROVIDING INFORMATION IN THE FIELD OF

REAL ESTATE VIA THE INTERNET; PROVIDING REAL ESTATE LISTINGS AND REAL ESTATE INFORMATION VIA THE INTERNET; PROVIDING REAL ESTATE LISTINGS VIA THE INTERNET; REAL ESTATE ACQUISITION SERVICES; REAL ESTATE AGENCIES; REAL ESTATE BROKERAGE; REAL ESTATE CONSULTANCY; REAL ESTATE CONSULTATION; REAL ESTATE LISTING; REAL ESTATE LISTING SERVICES FOR HOUSING RENTALS AND APARTMENT RENTALS; REAL ESTATE MANAGEMENT CONSULTATION; REAL ESTATE MULTIPLE LISTING SERVICES; REAL ESTATE PROCUREMENT FOR OTHERS; REAL ESTATE RENTAL SERVICES, NAMELY, RENTAL OF RESIDENTIAL HOUSING; REAL ESTATE SERVICES, NAMELY, LEASING AND MANAGEMENT FOR OTHERS OF RESIDENTIAL CONDOMINIUMS LOCATED WITHIN HOTEL DEVELOPMENTS; REAL ESTATE SERVICES, NAMELY, PROVIDING ONLINE QUESTIONS TO HELP USERS DETERMINE THE BEST NEIGHBORHOODS AND COMMUNITIES SUITED TO THEIR INDIVIDUAL NEEDS AND PREFERENCES; REAL ESTATE SERVICES, NAMELY, RENTAL OF SHORT-TERM FURNISHED APARTMENTS; REAL ESTATE SERVICES, NAMELY, RENTAL OF VACATION HOMES; REAL ESTATE SERVICES, NAMELY, RENTAL OF VACATION HOMES, CONDOMINIUMS, CABINS, AND VILLAS USING PAY PER CLICK ADVERTISING ON A GLOBAL COMPUTER NETWORK; RESIDENTIAL REAL ESTATE AGENCY SERVICES (U.S. CLS. 100, 101 AND 102).  
FIRST USE 5-4-2011; IN COMMERCE 5-4-2011.  
LINDA M. KING, EXAMINING ATTORNEY

SN 85-325,596. ONTEL PRODUCTS CORPORATION, FAIRFIELD, NJ. FILED 5-20-2011.

**DREAM LITES**

THE MARK CONSISTS OF STANDARD CHARACTERS WITHOUT CLAIM TO ANY PARTICULAR FONT, STYLE, SIZE, OR COLOR.  
NO CLAIM IS MADE TO THE EXCLUSIVE RIGHT TO USE "LIGHTS", APART FROM THE MARK AS SHOWN.

**CLASS 11—ENVIRONMENTAL CONTROL APPARATUS**

FOR ELECTRIC NIGHT LIGHTS (U.S. CLS. 13, 21, 23, 31 AND 34).

**CLASS 28—TOYS AND SPORTING GOODS**

FOR PLUSH TOYS; PLUSH TOYS WITH BUILT IN ELECTRIC NIGHT LIGHTS (U.S. CLS. 22, 23, 38 AND 50).  
LEIGH LOWRY, EXAMINING ATTORNEY

SN 85-325,688. KEMIN INDUSTRIES, INC., DES MOINES, IA. FILED 5-20-2011.

**ASSURITEA**

THE MARK CONSISTS OF STANDARD CHARACTERS WITHOUT CLAIM TO ANY PARTICULAR FONT, STYLE, SIZE, OR COLOR.



**CLASS 5—PHARMACEUTICALS**

FOR DIETARY AND NUTRITIONAL SUPPLEMENTS CONTAINING TEA; FOOD SUPPLEMENTS, NAMELY, ANTIOXIDANTS CONTAINING TEA (U.S. CLS. 6, 18, 44, 46, 51 AND 52).

**CLASS 30—STAPLE FOODS**

FOR TEA EXTRACTS (U.S. CL. 46).  
KARANENDRA S. CHHINA, EXAMINING ATTORNEY

SN 85-326,035. CANA-VAC SYSTEMS INC., OWEN SOUND, CANADA, FILED 5-20-2011.

# DOC IT ALL

THE MARK CONSISTS OF STANDARD CHARACTERS WITHOUT CLAIM TO ANY PARTICULAR FONT, STYLE, SIZE, OR COLOR.

**CLASS 7—MACHINERY**

FOR VACUUM CLEANER HOSE MANAGEMENT SYSTEM FOR HOSES, ATTACHMENTS AND TOOLS USED IN CONJUNCTION WITH A CENTRAL VACUUM SYSTEM AND/OR VACUUM, NAMELY A HOSE CONTAINER INSTALLED INSIDE TYPICAL WALL CONSTRUCTION, A RETRACTOR MECHANISM, VACUUM AND VACUUM CLEANER ATTACHMENTS (U.S. CLS. 13, 19, 21, 23, 31, 34 AND 35).

**CLASS 37—CONSTRUCTION AND REPAIR**

FOR INSTALLATION, REPAIR AND MAINTENANCE SERVICES FOR VACUUM AND HOSE MANAGEMENT SYSTEMS (U.S. CLS. 100, 103 AND 106).  
MARIA-VICTORIA SUAREZ, EXAMINING ATTORNEY

SN 85-326,073. OTIS ELEVATOR COMPANY, FARMINGTON, CT. FILED 5-20-2011.

# SKYRISE

THE MARK CONSISTS OF STANDARD CHARACTERS WITHOUT CLAIM TO ANY PARTICULAR FONT, STYLE, SIZE, OR COLOR.

**CLASS 7—MACHINERY**

FOR ELEVATORS, ESCALATORS AND MOVING WALKWAYS (U.S. CLS. 13, 19, 21, 23, 31, 34 AND 35).

**CLASS 37—CONSTRUCTION AND REPAIR**

FOR INSTALLATION, MAINTENANCE AND REPAIR OF ELEVATORS, ESCALATORS AND MOVING WALKWAYS (U.S. CLS. 100, 103 AND 106).  
RONALD AIKENS, EXAMINING ATTORNEY

SN 85-326,208. POOLSIDE CREATIVE, LLC, MENLO PARK, CA. FILED 5-20-2011.

# Schlurple the Turtle

THE MARK CONSISTS OF STANDARD CHARACTERS WITHOUT CLAIM TO ANY PARTICULAR FONT, STYLE, SIZE, OR COLOR.

**CLASS 9—ELECTRICAL AND SCIENTIFIC APPARATUS**

FOR ELECTRONIC BOOK PUBLICATIONS WHICH CAN BE DOWNLOADED TO COMPUTER DESKTOPS, LAPTOPS, WIRELESS HANDHELD DEVICES AND ELECTRONIC BOOK READERS, NAMELY, IN THE FIELD OF CHILDREN'S ACTIVITY BOOKS, CHILDREN'S ANIMATED ACTIVITY BOOKS, CHILDREN'S ANIMATED BOOKS, CHILDREN'S ANIMATED MAGAZINES, CHILDREN'S BOOKS, CHILDREN'S MAGAZINES, CHILDREN'S INTERACTIVE EDUCATIONAL BOOKS, CHILDREN'S STORYBOOKS, COLORING BOOKS, COMIC BOOKS; COMPACT DISCS CONTAINING DIGITAL PUBLICATIONS FEATURING CHILDREN'S ACTIVITY BOOKS, CHILDREN'S ANIMATED ACTIVITY BOOKS, CHILDREN'S ANIMATED BOOKS, CHILDREN'S ANIMATED MAGAZINES, CHILDREN'S BOOKS, CHILDREN'S INTERACTIVE EDUCATIONAL BOOKS, CHILDREN'S STORYBOOKS, COLORING BOOKS, COMIC BOOKS (U.S. CLS. 21, 23, 26, 36 AND 38).

**CLASS 16—PAPER GOODS AND PRINTED MATTER**

FOR CHILDREN'S ACTIVITY BOOKS; CHILDREN'S BOOKS; CHILDREN'S MAGAZINES; CHILDREN'S INTERACTIVE EDUCATIONAL BOOKS; CHILDREN'S STORYBOOKS; COLORING BOOKS; COMIC BOOKS (U.S. CLS. 2, 5, 22, 23, 29, 37, 38 AND 50).  
MARK SPARACINO, EXAMINING ATTORNEY

SN 85-326,532. WATSON, JASPER, APEX, NC. FILED 5-20-2011.



The logo for "haloHeads" features the word "halo" in a lowercase, sans-serif font, followed by "Heads" in a larger, bold, uppercase, sans-serif font. A white halo ring is positioned above the letter "H" in "Heads".

THE MARK CONSISTS OF THE WORDING "HALO-HEADS" IN STYLIZED FONT WITH A HALO DESIGN AROUND THE SECOND LETTER "H".

**CLASS 16—PAPER GOODS AND PRINTED MATTER**

FOR DECORATIVE DECALS FOR VEHICLE WINDOWS; PRINTED MATTER, NAMELY, VINYL STATIC CLING SHEETS ON WHICH PRAYERS ARE PRINTED FOR AFFIXATION IN WINDOWS AND WINDSHIELDS (U.S. CLS. 2, 5, 22, 23, 29, 37, 38 AND 50).  
FIRST USE 1-1-2009; IN COMMERCE 2-1-2010.

**CLASS 25—CLOTHING**

FOR SWEATSHIRTS; T-SHIRTS (U.S. CLS. 22 AND 39).  
FIRST USE 1-1-2009; IN COMMERCE 2-1-2010.

STEVEN PEREZ, EXAMINING ATTORNEY

---

SN 85-326,716. ESSEX & ORANGE, INC., SOMONAUK, IL.  
FILED 5-21-2011.

## Essex & Orange

---

THE MARK CONSISTS OF STANDARD CHARACTERS WITHOUT CLAIM TO ANY PARTICULAR FONT, STYLE, SIZE, OR COLOR.

### CLASS 28—TOYS AND SPORTING GOODS

FOR EDUCATIONAL TOYS FOR TEACHING AND TESTING KNOWLEDGE RELATING TO THE POLITICS, POLITICAL PROCESS, AND POLITICAL HISTORY OF THE UNITED STATES (U.S. CLS. 22, 23, 38 AND 50).

### CLASS 42—SCIENTIFIC AND COMPUTER SERVICES

FOR CREATING AN ON-LINE COMMUNITY FOR TEA PARTY MEMBERS OR POLITICAL CONSERVATIVES FOR THE PURPOSE OF EDUCATION, ENTERTAINMENT AND ACTIVISM OF THE CONSERVATIVE AGENDA (U.S. CLS. 100 AND 101).

ESTHER BELENKER, EXAMINING ATTORNEY

---

SN 85-326,910. WHATSAPP INC., SANTA CLARA, CA. FILED  
5-22-2011.

## WHATSAPP

THE MARK CONSISTS OF STANDARD CHARACTERS WITHOUT CLAIM TO ANY PARTICULAR FONT, STYLE, SIZE, OR COLOR.

### CLASS 9—ELECTRICAL AND SCIENTIFIC APPARATUS

FOR DOWNLOADABLE SOFTWARE, NAMELY, INSTANT MESSAGING SOFTWARE, FILE SHARING SOFTWARE, COMMUNICATIONS SOFTWARE FOR ELECTRONICALLY EXCHANGING DATA, AUDIO, VIDEO IMAGES AND GRAPHICS VIA COMPUTER, MOBILE, WIRELESS, TELECOMMUNICATIONS NETWORKS AND DOWNLOADABLE COMPUTER SOFTWARE FOR PROCESSING IMAGES, GRAPHICS, AUDIO, VIDEO, AND TEXT (U.S. CLS. 21, 23, 26, 36 AND 38).

FIRST USE 9-10-2009; IN COMMERCE 9-10-2009.

### CLASS 38—COMMUNICATION

FOR TELECOMMUNICATION SERVICES, NAMELY, DATA TRANSMISSION AND RECEPTION SERVICES VIA TELECOMMUNICATION NETWORKS; ELECTRONIC EXCHANGE OF VOICE, DATA, AUDIO, VIDEO, TEXT AND GRAPHICS ACCESSIBLE VIA COMPUTER AND TELECOMMUNICATIONS NETWORKS; INSTANT MESSAGING SERVICES; MOBILE PHONE COMMUNICATION SERVICES (U.S. CLS. 100, 101 AND 104).

FIRST USE 9-10-2009; IN COMMERCE 9-10-2009.  
LINDA ORNDORFF, EXAMINING ATTORNEY

---

SN 85-326,998. UNITED SEATING & MOBILITY LLC,  
HAZELWOOD, MO. FILED 5-23-2011.

## United Seating & Mobility

THE MARK CONSISTS OF STANDARD CHARACTERS WITHOUT CLAIM TO ANY PARTICULAR FONT, STYLE, SIZE, OR COLOR.

NO CLAIM IS MADE TO THE EXCLUSIVE RIGHT TO USE "SEATING & MOBILITY", APART FROM THE MARK AS SHOWN.

### CLASS 7—MACHINERY

FOR STAIR LIFTS; WHEEL CHAIR LIFTS FOR USE IN THE HOME (U.S. CLS. 13, 19, 21, 23, 31, 34 AND 35).  
FIRST USE 9-1-2001; IN COMMERCE 9-1-2001.

### CLASS 10—MEDICAL APPARATUS

FOR WALKERS FOR USE BY MOBILITY-IMPAIRED INDIVIDUALS; WALKERS TO AID IN MOBILITY; WALKING AIDS FOR HANDICAPPED PERSONS, NAMELY, WALKING FRAMES (U.S. CLS. 26, 39 AND 44).

FIRST USE 9-1-2001; IN COMMERCE 9-1-2001.

### CLASS 12—VEHICLES

FOR CHAIR LIFTS; MOTORISED WHEELCHAIRS FOR THE DISABLED AND THOSE WITH MOBILITY DIFFICULTIES; MOTORIZED PERSONAL MOBILITY SCOOTERS; MOTORIZED, ELECTRIC-POWERED, SELF-PROPELLED, SELF-BALANCING, WHEELED PERSONAL MOBILITY, TRANSPORTATION DEVICE; MOTORIZED, SELF-PROPELLED, WHEELED PERSONAL MOBILITY DEVICE, NAMELY, SCOOTERS; POWER TRANSFER SEATS FOR VEHICLES TO PROVIDE EASIER INGRESS TO AND EGRESS FROM A VEHICLE FOR DISABLED OR MOBILITY IMPAIRED PEOPLE; VEHICLES FOR THE PHYSICALLY HANDICAPPED AND THOSE OF REDUCED MOBILITY; WHEELCHAIRS (U.S. CLS. 19, 21, 23, 31, 35 AND 44).

FIRST USE 9-1-2001; IN COMMERCE 9-1-2001.  
LINDA ORNDORFF, EXAMINING ATTORNEY

SN 85-327,024. RUTH BARNES, BOCA RATON, FL. FILED 5-23-2011.

SN 85-327,510. GREENS & GILLS, LLC, HIGHLAND PARK, IL. FILED 5-23-2011.

## MOROCCO IN A DAY

THE MARK CONSISTS OF STANDARD CHARACTERS WITHOUT CLAIM TO ANY PARTICULAR FONT, STYLE, SIZE, OR COLOR.

### **CLASS 16—PAPER GOODS AND PRINTED MATTER**

FOR COOK BOOKS (U.S. CLS. 2, 5, 22, 23, 29, 37, 38 AND 50).

### **CLASS 29—MEATS AND PROCESSED FOODS**

FOR PREPARED FOOD KITS COMPOSED OF MEAT, POULTRY, FISH, SEAFOOD, AND/OR VEGETABLES AND ALSO INCLUDING SAUCES OR SEASONINGS, READY FOR COOKING AND ASSEMBLY AS A MEAL (U.S. CL. 46).

KELLY TRUSILO, EXAMINING ATTORNEY

---

SN 85-327,043. BBL CONSTRUCTION SERVICES, LLC, ALBANY, NY. FILED 5-23-2011.

## BBL CAMPUS FACILITIES

THE MARK CONSISTS OF STANDARD CHARACTERS WITHOUT CLAIM TO ANY PARTICULAR FONT, STYLE, SIZE, OR COLOR.

OWNER OF U.S. REG. NOS. 3,141,021, 3,141,022 AND 3,711,252.

NO CLAIM IS MADE TO THE EXCLUSIVE RIGHT TO USE "CAMPUS FACILITIES", APART FROM THE MARK AS SHOWN.

### **CLASS 37—CONSTRUCTION AND REPAIR**

FOR CONSTRUCTION PLANNING SERVICES AND CONSTRUCTION IN THE FIELD OF CAMPUS FACILITIES (U.S. CLS. 100, 103 AND 106).

FIRST USE 5-20-2011; IN COMMERCE 5-20-2011.

### **CLASS 42—SCIENTIFIC AND COMPUTER SERVICES**

FOR DESIGN FOR OTHERS IN THE FIELD OF CAMPUS FACILITIES; CONDUCTING FEASIBILITY STUDIES; CONSULTATION IN THE FIELD OF OBTAINING GOVERNMENT AND REGULATORY APPROVAL FOR CAMPUS FACILITIES (U.S. CLS. 100 AND 101).

FIRST USE 5-20-2011; IN COMMERCE 5-20-2011.  
CAROLYN CATALDO, EXAMINING ATTORNEY

## GREENS & GILLS

THE MARK CONSISTS OF STANDARD CHARACTERS WITHOUT CLAIM TO ANY PARTICULAR FONT, STYLE, SIZE, OR COLOR.

NO CLAIM IS MADE TO THE EXCLUSIVE RIGHT TO USE "GREENS" AS TO INTERNATIONAL CLASS 31, APART FROM THE MARK AS SHOWN.

### **CLASS 29—MEATS AND PROCESSED FOODS**

FOR FISH (U.S. CL. 46).

### **CLASS 31—NATURAL AGRICULTURAL PRODUCTS**

FOR UNPROCESSED VEGETABLES (U.S. CLS. 1 AND 46).

FLORENTINA BLANDU, EXAMINING ATTORNEY

---

SN 85-327,628. TBC TRADEMARKS, LLC, LAS VEGAS, NV. FILED 5-23-2011.

## TREADMASTERS

THE MARK CONSISTS OF STANDARD CHARACTERS WITHOUT CLAIM TO ANY PARTICULAR FONT, STYLE, SIZE, OR COLOR.

### **CLASS 35—ADVERTISING AND BUSINESS**

FOR WHOLESALE AND RETAIL STORE SERVICES AND ON-LINE WHOLESALE AND RETAIL STORE SERVICES FEATURING VEHICLE TIRES (U.S. CLS. 100, 101 AND 102).

### **CLASS 37—CONSTRUCTION AND REPAIR**

FOR EMERGENCY ROADSIDE ASSISTANCE SERVICES, NAMELY, RESPONDING TO CALLS FOR ROADSIDE ASSISTANCE, FLAT TIRE CHANGING (U.S. CLS. 100, 103 AND 106).

SCOTT BIBB, EXAMINING ATTORNEY

SN 85-328,066. MEGAN RACING, INC., CITY OF INDUSTRY, CA. FILED 5-23-2011.



OWNER OF U.S. REG. NOS. 3,608,390 AND 3,863,439.  
 NO CLAIM IS MADE TO THE EXCLUSIVE RIGHT TO USE "RACING", APART FROM THE MARK AS SHOWN.  
 THE MARK CONSISTS OF GEOMETRIC SHAPED SYMBOL ABOVE THE WORDS "MEGAN RACING".

**CLASS 7—MACHINERY**

FOR AUTOMOTIVE EXHAUST PIPE (U.S. CLS. 13, 19, 21, 23, 31, 34 AND 35).  
 FIRST USE 4-9-2010; IN COMMERCE 4-9-2010.

**CLASS 12—VEHICLES**

FOR RACING MOTOR CARS; WHEEL SUSPENSIONS (U.S. CLS. 19, 21, 23, 31, 35 AND 44).  
 FIRST USE 4-9-2010; IN COMMERCE 4-9-2010.  
 KHANH LE, EXAMINING ATTORNEY

SN 85-328,105. THE FORWARD GROUP, LLC, CHICAGO, IL. FILED 5-23-2011.

**PLAYBOARD**

THE MARK CONSISTS OF STANDARD CHARACTERS WITHOUT CLAIM TO ANY PARTICULAR FONT, STYLE, SIZE, OR COLOR.

**CLASS 16—PAPER GOODS AND PRINTED MATTER**

FOR DRY ERASE WRITING BOARDS AND WRITING SURFACES; MAGNETIC BOARDS; PACKAGED KITS SOLD AS A UNIT CONSISTING OF AN A ERASABLE PLANNING BOARD, INSTRUCTIONAL MANUAL/BOOK, NOTEPAD AND MARKER (U.S. CLS. 2, 5, 22, 23, 29, 37, 38 AND 50).

**CLASS 35—ADVERTISING AND BUSINESS**

FOR BUSINESS CONSULTING; ON-LINE RETAIL STORE SERVICES FEATURING PERSONAL AND PROFESSIONAL DEVELOPMENT THEMED MERCHANDISE (U.S. CLS. 100, 101 AND 102).

**CLASS 41—EDUCATION AND ENTERTAINMENT**

FOR PROVIDING EDUCATION, TRAINING, AND COACHING SERVICES IN THE FIELD OF LEADERSHIP AND PERSONAL AND PROFESSIONAL DEVELOPMENT (U.S. CLS. 100, 101 AND 107).  
 MORGAN WYNNE, EXAMINING ATTORNEY

SN 85-328,360. GARCIA, JOSELITO, STATEN ISLAND, NY. FILED 5-24-2011.



NO CLAIM IS MADE TO THE EXCLUSIVE RIGHT TO USE "LLC", APART FROM THE MARK AS SHOWN.  
 THE MARK CONSISTS OF AN ABSTRACT, ROUND DESIGN CONSISTING OF A CIRCLE WITH A GRID DESIGN IN THE MIDDLE, SUNRAYS COMING OUT OF THE RIGHT CORNER AND A LEAF COVERING THE BOTTOM. THIS DESIGN IS ABOVE THE TEXT, "LLC" ABOVE THE "Y" IN "SOLARGREENENERGY", AND "SAVE MONEY BEING ENVIRONMENTALLY CONSCIOUS" AT THE BOTTOM.

**CLASS 35—ADVERTISING AND BUSINESS**

FOR RETAIL STORE SERVICES FEATURING SOLAR PANELS AND ACCESSORIES (U.S. CLS. 100, 101 AND 102).

**CLASS 37—CONSTRUCTION AND REPAIR**

FOR INSTALLATION OF SOLAR PANELS (U.S. CLS. 100, 103 AND 106).  
 MORGAN WYNNE, EXAMINING ATTORNEY

SN 85-328,475. CAFFREY, ANN MARIE, CONCORD, CA. FILED 5-24-2011.

**A TINY YES**

THE MARK CONSISTS OF STANDARD CHARACTERS WITHOUT CLAIM TO ANY PARTICULAR FONT, STYLE, SIZE, OR COLOR.

**CLASS 16—PAPER GOODS AND PRINTED MATTER**

FOR BOOKS IN THE FIELD OF HUMAN INTEREST, MOTIVATION AND POTENTIAL (U.S. CLS. 2, 5, 22, 23, 29, 37, 38 AND 50).

**CLASS 41—EDUCATION AND ENTERTAINMENT**

FOR ON-LINE JOURNALS, NAMELY, BLOGS FEATURING WORKS REGARDING HUMAN INTEREST, MOTIVATION AND POTENTIAL (U.S. CLS. 100, 101 AND 107).

MEGHAN REINHART, EXAMINING ATTORNEY

SN 85-328,976. GOTHAM LICENSING GROUP, LLC, NEW YORK, NY. FILED 5-24-2011.

SN 85-328,825. YALE UNIVERSITY, NEW HAVEN, CT. FILED 5-24-2011.

**MINDING THE BABY**

THE MARK CONSISTS OF STANDARD CHARACTERS WITHOUT CLAIM TO ANY PARTICULAR FONT, STYLE, SIZE, OR COLOR.

**CLASS 16—PAPER GOODS AND PRINTED MATTER**

FOR MANUALS AND QUICK REFERENCE GUIDES FOR REFLECTIVE PARENTING PROGRAMS FOR NEW MOTHERS, INFANTS, TODDLERS AND THEIR FAMILIES (U.S. CLS. 2, 5, 22, 23, 29, 37, 38 AND 50).  
FIRST USE 0-0-2010; IN COMMERCE 0-0-2010.

**CLASS 41—EDUCATION AND ENTERTAINMENT**

FOR EDUCATIONAL TRAINING, NAMELY, COURSES IN THE FIELD OF NURSING AND SOCIAL WORK; EDUCATIONAL SERVICES, NAMELY, CONDUCTING TRAINING SESSIONS ON ENHANCING REFLECTIVE PARENTING THROUGH COUNSELING, CLINICAL INTERVENTION AND HOME VISITATION TO TREAT, GUIDE AND SUPPORT NEW MOTHERS AND THEIR FAMILIES (U.S. CLS. 100, 101 AND 107).  
FIRST USE 0-0-2010; IN COMMERCE 0-0-2010.

**CLASS 44—MEDICAL, BEAUTY AND AGRICULTURAL SERVICES**

FOR NURSING SERVICES; NURSING CARE; HOME VISITATION HEALTH CARE SERVICES TO INFANTS, TODDLERS, AND PARENTS; INFORMATION IN THE FIELD OF REFLECTIVE PARENTING CONCERNING THE HEALTH OF CHILDREN; COUNSELING AND SOCIAL SERVICES, NAMELY, PROVIDING MENTAL HEALTH, PSYCHOLOGICAL AND MEDICAL COUNSELING THROUGH CLINICAL INTERVENTION AND HOME VISITATION TO TREAT, GUIDE AND SUPPORT NEW MOTHERS AND THEIR FAMILIES (U.S. CLS. 100 AND 101).  
FIRST USE 0-0-2002; IN COMMERCE 0-0-2002.

**CLASS 45—PERSONAL AND LEGAL SERVICES**

FOR COUNSELING AND SOCIAL SERVICES, NAMELY, PROVIDING EMOTIONAL COUNSELING AND SUPPORT THROUGH CLINICAL INTERVENTION AND HOME VISITATION TO TREAT, GUIDE AND SUPPORT NEW MOTHERS AND THEIR FAMILIES; INFORMATION IN THE FIELD OF REFLECTIVE PARENTING CONCERNING INTRAFAMILY RELATIONSHIPS (U.S. CLS. 100 AND 101).  
FIRST USE 0-0-2002; IN COMMERCE 0-0-2002.  
JUDITH HELFMAN, EXAMINING ATTORNEY

**D by DOLLHOUSE**

THE MARK CONSISTS OF STANDARD CHARACTERS WITHOUT CLAIM TO ANY PARTICULAR FONT, STYLE, SIZE, OR COLOR.  
OWNER OF U.S. REG. NOS. 2,201,406, 2,648,406 AND 3,079,142.

**CLASS 9—ELECTRICAL AND SCIENTIFIC APPARATUS**

FOR EYEGLASS CASES; EYEGLASSES; SUNGLASSES (U.S. CLS. 21, 23, 26, 36 AND 38).

**CLASS 25—CLOTHING**

FOR BOTTOMS; DENIM JACKETS; DENIMS; JEANS; JEGGINGS, NAMELY, PANTS THAT ARE PARTIALLY JEANS AND PARTIALLY LEGGINGS; T-SHIRTS; TOPS (U.S. CLS. 22 AND 39).  
MARY BOAGNI, EXAMINING ATTORNEY

SN 85-329,013. NORTHLAND CAPITAL FINANCIAL SERVICES, LLC, ST. CLOUD, MN. FILED 5-24-2011.



NO CLAIM IS MADE TO THE EXCLUSIVE RIGHT TO USE "FINANCIAL SERVICES LLC", APART FROM THE MARK AS SHOWN.

THE COLOR(S) BLACK, GREEN AND LIGHT GREEN IS/ARE CLAIMED AS A FEATURE OF THE MARK.

THE MARK CONSISTS OF TWO GREEN EVERGREEN TREES LOCATED IN THE FOREGROUND OF A LANDSCAPE WITH GREEN MOUNTAINS. TO THE RIGHT OF THE TREES AND MOUNTAINS ARE THE WORDS "NORTHLAND CAPITAL" WHICH ARE BLACK IN COLOR. UNDERNEATH THE WORDS "NORTHLAND CAPITAL" IS THE PHRASE "FINANCIAL SERVICES LLC" IN CAPITAL LETTERS IN THE COLOR BLACK. ON THE LOWER RIGHT HAND PORTION OF THE MARK, UNDERNEATH THE WORDS "FINANCIAL SERVICES LLC" IS THE PHRASE "YOU'RE WORTH MORE" WHICH IS COLORED LIGHT GREEN.

**CLASS 37—CONSTRUCTION AND REPAIR**

FOR LEASING OF BUILDING MACHINERY (U.S. CLS. 100, 103 AND 106).  
FIRST USE 3-1-2001; IN COMMERCE 3-1-2001.

**CLASS 39—TRANSPORTATION AND STORAGE**

FOR LEASING OF MOTOR VEHICLES (U.S. CLS. 100 AND 105).  
FIRST USE 3-1-2001; IN COMMERCE 3-1-2001.

**CLASS 44—MEDICAL, BEAUTY AND AGRICULTURAL SERVICES**

FOR LEASING OF AGRICULTURAL EQUIPMENT (U.S. CLS. 100 AND 101).  
FIRST USE 3-1-2001; IN COMMERCE 3-1-2001.  
EVELYN BRADLEY, EXAMINING ATTORNEY

SN 85-329,702. PASIÓN MEXICANA, S.A. DE C.V., TLALNEPANTLA DE BAZ, MEXICO, FILED 5-25-2011.

**BABATOCHI**

THE MARK CONSISTS OF STANDARD CHARACTERS WITHOUT CLAIM TO ANY PARTICULAR FONT, STYLE, SIZE, OR COLOR.

OWNER OF MEXICO REG. NO. 1122858, DATED 9-25-2009, EXPIRES 9-10-2019.

OWNER OF MEXICO REG. NO. 1122857, DATED 9-25-2009, EXPIRES 9-10-2019.

THE WORDING "BABATOCHI" HAS NO MEANING IN A FOREIGN LANGUAGE.

SN 85-329,017. LOGICAL CHOICE TECHNOLOGIES, INC., LAWRENCEVILLE, GA. FILED 5-24-2011.

**Logical Choice Alive**

THE MARK CONSISTS OF STANDARD CHARACTERS WITHOUT CLAIM TO ANY PARTICULAR FONT, STYLE, SIZE, OR COLOR.

**CLASS 9—ELECTRICAL AND SCIENTIFIC APPARATUS**

FOR EDUCATIONAL SOFTWARE FEATURING INTERACTIVE AUGMENTED REALITY PLATFORMS TO PROVIDE INSTRUCTION IN READING (U.S. CLS. 21, 23, 26, 36 AND 38).

**CLASS 29—MEATS AND PROCESSED FOODS**

FOR GUACAMOLE (U.S. CL. 46).

**CLASS 30—STAPLE FOODS**

FOR SALSA (U.S. CL. 46).  
PAM WILLIS, EXAMINING ATTORNEY

**CLASS 28—TOYS AND SPORTING GOODS**

FOR ELECTRONIC GAMES FOR THE TEACHING OF CHILDREN (U.S. CLS. 22, 23, 38 AND 50).  
INGA ERVIN, EXAMINING ATTORNEY

SN 85-329,738. GLOBAL ORANGE, L.L.C., EAST LANSING, MI. FILED 5-25-2011.

SN 85-329,117. DR. JOHN C. KOIS, SEATTLE, WA. FILED 5-24-2011.

**JKAD**

THE MARK CONSISTS OF STANDARD CHARACTERS WITHOUT CLAIM TO ANY PARTICULAR FONT, STYLE, SIZE, OR COLOR.

**CLASS 9—ELECTRICAL AND SCIENTIFIC APPARATUS**

FOR CAD (COMPUTER AIDED DESIGN) COMPUTER PROGRAMS IN PARTICULAR FOR DENTAL USE; COMPUTER PROGRAMS FOR PLANNING AND ADMINISTERING MEDICAL AND DENTAL TREATMENTS; COMPUTER PROGRAMS FOR PLANNING AND PRODUCTION OF MEDICAL AND DENTAL CONSTRUCTION UNITS AND IMPLANTS (U.S. CLS. 21, 23, 26, 36 AND 38).

**CLASS 16—PAPER GOODS AND PRINTED MATTER**

FOR PRINTED MATTER, NAMELY, INSTRUCTION MANUALS IN THE FIELD OF DENTISTRY (U.S. CLS. 2, 5, 22, 23, 29, 37, 38 AND 50).  
MICHAEL WIENER, EXAMINING ATTORNEY



OWNER OF U.S. REG. NOS. 3,171,628, 3,205,543 AND 3,838,278.

NO CLAIM IS MADE TO THE EXCLUSIVE RIGHT TO USE "COFFEE", APART FROM THE MARK AS SHOWN.

THE MARK CONSISTS OF A VERTICALLY-ORIENTED RECTANGLE OUTLINED WITH A THICK LINE. INSIDE THIS RECTANGLE IS A STYLIZED LETTER "B". UNDER THE RECTANGLE IS THE NAME "BIGGBY". UNDER "BIGGBY" IS A LINE. UNDER THE LINE IS THE WORD "COFFEE".

**CLASS 30—STAPLE FOODS**

FOR GROUND AND WHOLE BEAN COFFEE; HERBAL AND NON-HERBAL TEAS; COFFEE, TEA, COCOA, AND ESPRESSO BEVERAGES, AND BEVERAGES MADE WITH A BASE OF COFFEE, TEA AND ESPRESSO, INSTANT COFFEE AND COFFEE SUBSTITUTES; READY-TO-DRINK COFFEE AND TEA BEVERAGES; BAKED GOODS, NAMELY, MUFFINS, SCONES, COOKIES, PASTRIES, CAKES AND BREADS; CHOCOLATE; CANDY; SANDWICHES (U.S. CL. 46).  
FIRST USE 1-1-2008; IN COMMERCE 1-1-2008.

**CLASS 43—HOTEL AND RESTAURANT SERVICES**

FOR RESTAURANT FEATURING COFFEE DRINKS (U.S. CLS. 100 AND 101).  
FIRST USE 1-1-2008; IN COMMERCE 1-1-2008.  
WILLIAM VERHOSEK, EXAMINING ATTORNEY

SN 85-330,135. QUENTUS TECHNOLOGIES, INC., SEATTLE, WA. FILED 5-25-2011.

# QUENTUS

THE MARK CONSISTS OF STANDARD CHARACTERS WITHOUT CLAIM TO ANY PARTICULAR FONT, STYLE, SIZE, OR COLOR.

THE ENGLISH TRANSLATION OF "QUENTUS" IN THE MARK IS "FIFTH".

**CLASS 38—COMMUNICATION**

FOR VOICE OVER INTERNET PROTOCOL (VOIP) SERVICES (U.S. CLS. 100, 101 AND 104).  
FIRST USE 1-1-2009; IN COMMERCE 1-1-2009.

**CLASS 42—SCIENTIFIC AND COMPUTER SERVICES**

FOR APPLICATION SERVICE PROVIDER (ASP), NAMELY, HOSTING COMPUTER SOFTWARE APPLICATIONS OF OTHERS; CUSTOMIZED SOFTWARE DEVELOPMENT SERVICES (U.S. CLS. 100 AND 101).  
FIRST USE 1-1-2009; IN COMMERCE 1-1-2009.  
CHRIS WELLS, EXAMINING ATTORNEY

SN 85-330,348. THE FRS COMPANY, FOSTER CITY, CA. FILED 5-25-2011.

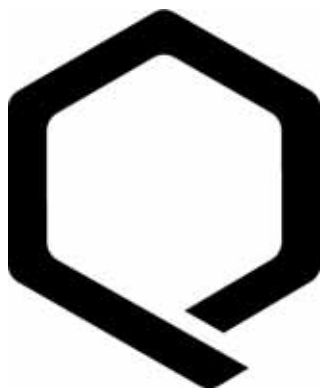

OWNER OF U.S. REG. NOS. 3,800,533 AND 3,871,075.  
THE MARK CONSISTS OF A STYLIZED "Q".

**CLASS 5—PHARMACEUTICALS**

FOR NUTRITIONAL SUPPLEMENTS; NUTRITIONALLY FORTIFIED BEVERAGES; POWDERED NUTRITIONAL SUPPLEMENT DRINK MIX AND CONCENTRATE; NUTRITIONALLY FORTIFIED SOFT CHEWS (U.S. CLS. 6, 18, 44, 46, 51 AND 52).

**CLASS 32—LIGHT BEVERAGES**

FOR ENERGY DRINKS, FRUIT-FLAVORED BEVERAGES, SPORTS DRINKS, NON-ALCOHOLIC BEVERAGES CONTAINING FRUIT JUICES, AND FRUIT-BASED BEVERAGES; CONCENTRATES AND POWDERS USED IN THE PREPARATION OF ENERGY DRINKS, FRUIT-FLAVORED BEVERAGES, SPORTS DRINKS, NON-ALCOHOLIC BEVERAGES CONTAINING FRUIT JUICES, AND FRUIT-BASED BEVERAGES (U.S. CLS. 45, 46 AND 48).

KAELIE KUNG, EXAMINING ATTORNEY

SN 85-330,525. LIFEBOUND, INC., SAN DIEGO, CA. FILED 5-26-2011.

# Yearbound

THE MARK CONSISTS OF STANDARD CHARACTERS WITHOUT CLAIM TO ANY PARTICULAR FONT, STYLE, SIZE, OR COLOR.

**CLASS 40—MATERIAL TREATMENT**

FOR DIGITAL ON-DEMAND PRINTING SERVICES OF BOOKS AND OTHER DOCUMENTS (U.S. CLS. 100, 103 AND 106).  
FIRST USE 5-23-2011; IN COMMERCE 5-25-2011.

**CLASS 42—SCIENTIFIC AND COMPUTER SERVICES**

FOR COMPUTER SERVICES, NAMELY, ELECTRONIC IMAGING OF SOCIAL MEDIA POSTS AND PHOTOS (U.S. CLS. 100 AND 101).  
FIRST USE 5-23-2011; IN COMMERCE 5-25-2011.

**CLASS 45—PERSONAL AND LEGAL SERVICES**

FOR PREPARATION OF CUSTOM MEMORY BOOKS, SCRAPBOOKS, PERSONAL ARCHIVES, FAMILY ARCHIVES, WEDDING ALBUMS, DIARIES, VACATION ALBUMS, FAMILY ALBUMS, FAMILY HISTORIES, PHOTOGRAPH ALBUMS, BIRTHDAY ALBUMS, AND SPECIAL EVENT ALBUMS FOR OTHERS (U.S. CLS. 100 AND 101).

FIRST USE 5-23-2011; IN COMMERCE 5-25-2011.  
MICHELE SWAIN, EXAMINING ATTORNEY

SN 85-330,595. ALEXA LOVES LLC, ATLANTA, GA. FILED 5-26-2011.

# MERCHANT SOCIETY

THE MARK CONSISTS OF STANDARD CHARACTERS WITHOUT CLAIM TO ANY PARTICULAR FONT, STYLE, SIZE, OR COLOR.

**CLASS 14—JEWELRY**

FOR JEWELRY (U.S. CLS. 2, 27, 28 AND 50).

**CLASS 18—LEATHER GOODS**

FOR HANDBAGS (U.S. CLS. 1, 2, 3, 22 AND 41).

SN 85-330,668. JAVA PURA, LLC, HOUSTON, TX. FILED 5-26-2011.

**CLASS 25—CLOTHING**

FOR SCARVES; TOPS; WOMEN'S CLOTHING, NAMELY, SHIRTS, DRESSES, SKIRTS, BLOUSES (U.S. CLS. 22 AND 39).

MARCIE MILONE, EXAMINING ATTORNEY



THE MARK CONSISTS OF A DRAWING OF A HORSE REARING UP WITH A ROOSTER, OR COCK, RIDING ON ITS BACK.

SN 85-330,650. SYNERGENT CORP., DBA SYNERGENT CORPORATION MAINE, WESTBROOK, ME. FILED 5-26-2011.

**SYNERGENT**

THE MARK CONSISTS OF STANDARD CHARACTERS WITHOUT CLAIM TO ANY PARTICULAR FONT, STYLE, SIZE, OR COLOR.

OWNER OF U.S. REG. NO. 2,737,369.

**CLASS 30—STAPLE FOODS**

FOR ROASTED COFFEE BEANS; ROASTED GROUND COFFEE; COFFEE; COFFEE BASED BEVERAGES; ESPRESSO; ESPRESSO DRINKS (U.S. CL. 46).

FIRST USE 10-31-2008; IN COMMERCE 10-31-2008.

**CLASS 35—ADVERTISING AND BUSINESS**

FOR ONLINE RETAIL AND WHOLESALE STORE SERVICES FEATURING ROASTED COFFEE BEANS (U.S. CLS. 100, 101 AND 102).

FIRST USE 8-31-2009; IN COMMERCE 8-31-2009.

**CLASS 43—HOTEL AND RESTAURANT SERVICES**

FOR COFFEE SUPPLY SERVICES FOR OFFICES; CATERING SERVICES FEATURING COFFEE, COFFEE BASED BEVERAGES, ESPRESSO, ESPRESSO DRINKS, SMOOTHIES AND SODAS; COFFEE AND ESPRESSO BARS (U.S. CLS. 100 AND 101).

FIRST USE 7-31-2008; IN COMMERCE 7-31-2008.  
ELLEN BURNS, EXAMINING ATTORNEY

**CLASS 35—ADVERTISING AND BUSINESS**

FOR PROVIDING BACK OFFICE OPERATIONS TO CREDIT UNIONS, NAMELY, DATA PROCESSING, PREPARING ADVERTISEMENTS FOR OTHERS, NAMELY, PROMOTING THE SERVICES OF CREDIT UNIONS THROUGH THE DISTRIBUTION OF PRINTED AND AUDIO PROMOTIONAL MATERIALS AND BY RENDERING SALES PROMOTION ADVICE, PREPARING ADVERTISEMENTS FOR OTHERS, NAMELY, CREATING ADVERTISEMENTS THROUGH BROCHURES (U.S. CLS. 100, 101 AND 102).

FIRST USE 9-18-2000; IN COMMERCE 9-18-2000.

SN 85-330,800. NEWBLUE, INC., LA JOLLA, CA. FILED 5-26-2011.

SHOOT IT SHINE IT SHARE IT

**CLASS 36—INSURANCE AND FINANCIAL**

FOR PROVIDING SERVICE SOLUTIONS FOR CREDIT UNIONS, NAMELY, CREDIT CARD SERVICES, CHECK PROCESSING AND DEBIT CARD SERVICES (U.S. CLS. 100, 101 AND 102).

FIRST USE 9-18-2000; IN COMMERCE 9-18-2000.

THE MARK CONSISTS OF STANDARD CHARACTERS WITHOUT CLAIM TO ANY PARTICULAR FONT, STYLE, SIZE, OR COLOR.

**CLASS 40—MATERIAL TREATMENT**

FOR PRINTING SERVICES (U.S. CLS. 100, 103 AND 106).

FIRST USE 9-18-2000; IN COMMERCE 9-18-2000.

**CLASS 9—ELECTRICAL AND SCIENTIFIC APPARATUS**

FOR COMPUTER PROGRAMS FOR EDITING IMAGES, SOUND AND VIDEO (U.S. CLS. 21, 23, 26, 36 AND 38).

**CLASS 42—SCIENTIFIC AND COMPUTER SERVICES**

FOR CREATIVE GRAPHIC ART DESIGN SERVICES (U.S. CLS. 100 AND 101).

FIRST USE 9-18-2000; IN COMMERCE 9-18-2000.  
JEFF DEFORD, EXAMINING ATTORNEY

**CLASS 42—SCIENTIFIC AND COMPUTER SERVICES**

FOR SOFTWARE AS A SERVICE (SAAS) SERVICES FEATURING SOFTWARE FOR EDITING IMAGES, SOUND, AND VIDEO (U.S. CLS. 100 AND 101).  
GEORGE LORENZO, EXAMINING ATTORNEY



SN 85-330,945. ILLEN PRODUCTS LTD., DBA IMPRINT PLUS, RICHMOND, CANADA, FILED 5-26-2011.

# BADGEPLAY

THE MARK CONSISTS OF STANDARD CHARACTERS WITHOUT CLAIM TO ANY PARTICULAR FONT, STYLE, SIZE, OR COLOR.

### CLASS 6—METAL GOODS

FOR METAL NAME TAGS AND BADGES; NAME TAG COMPONENTS OF METAL, NAMELY, TAG HOLDERS, PLATES, BACKERS AND FASTENERS OF METAL, NAMELY, CLIPS AND PINS (U.S. CLS. 2, 12, 13, 14, 23, 25 AND 50).

### CLASS 9—ELECTRICAL AND SCIENTIFIC APPARATUS

FOR COMPUTER SOFTWARE FOR THE PRODUCTION OF IDENTIFICATION TAGS; FASTENERS FOR METAL NAME TAGS, NAMELY, MAGNETS (U.S. CLS. 21, 23, 26, 36 AND 38).

### CLASS 16—PAPER GOODS AND PRINTED MATTER

FOR PAPER BACKERS, NAMELY, PRINTABLE PAPER INSERTS FOR NAME TAGS (U.S. CLS. 2, 5, 22, 23, 29, 37, 38 AND 50).

### CLASS 20—FURNITURE AND ARTICLES NOT OTHERWISE CLASSIFIED

FOR PLASTIC COVERS FOR NAME TAGS; AND BACKERS OF PLASTIC, NAMELY, PRINTABLE INSERTS FOR NAME TAGS (U.S. CLS. 2, 13, 22, 25, 32 AND 50).

### CLASS 40—MATERIAL TREATMENT

FOR CUSTOM MANUFACTURING OF NAME TAGS, NAME PLATES, DESK PLATES, PLAQUES AND SIGNS FOR OTHERS (U.S. CLS. 100, 103 AND 106).  
DOUGLAS LEE, EXAMINING ATTORNEY

SN 85-331,023. SYNERGENT CORP., DBA SYNERGENT CORPORATION MAINE, WESTBROOK, ME. FILED 5-26-2011.



OWNER OF U.S. REG. NO. 2,737,369.  
THE MARK CONSISTS OF TWO SHAPES FORMING AN INCOMPLETE CIRCLE FOLLOWED BY THE WORD "SYNERGENT".

### CLASS 35—ADVERTISING AND BUSINESS

FOR PROVIDING BACK OFFICE OPERATIONS TO CREDIT UNIONS, NAMELY, DATA PROCESSING, PREPARING ADVERTISEMENTS FOR OTHERS, NAMELY, PROMOTING THE SERVICES OF CREDIT UNIONS THROUGH THE DISTRIBUTION OF PRINTED AND AUDIO PROMOTIONAL MATERIALS AND BY RENDERING SALES PROMOTION ADVICE, PREPARING ADVERTISEMENTS FOR OTHERS, NAMELY, CREATING ADVERTISEMENTS THROUGH BROCHURES (U.S. CLS. 100, 101 AND 102).

FIRST USE 4-1-2011, THE MARK WAS FIRST USED ANYWHERE IN A DIFFERENT FORM OTHER THAN THAT SOUGHT TO BE REGISTERED AT LEAST AS EARLY AS 09/18/2000.; IN COMMERCE 5-15-2011, THE MARK WAS FIRST USED IN COMMERCE IN A DIFFERENT FORM OTHER THAN THAT SOUGHT TO BE REGISTERED AT LEAST AS EARLY AS 09/18/2000. .

### CLASS 36—INSURANCE AND FINANCIAL

FOR PROVIDING SERVICE SOLUTIONS FOR CREDIT UNIONS, NAMELY, CREDIT CARD SERVICES, CHECK PROCESSING AND DEBIT CARD SERVICES (U.S. CLS. 100, 101 AND 102).

FIRST USE 4-1-2011, THE MARK WAS FIRST USED ANYWHERE IN A DIFFERENT FORM OTHER THAN THAT SOUGHT TO BE REGISTERED AT LEAST AS EARLY AS 09/18/2000.; IN COMMERCE 5-15-2011, THE MARK WAS FIRST USED IN COMMERCE IN A DIFFERENT FORM OTHER THAN THAT SOUGHT TO BE REGISTERED AT LEAST AS EARLY AS 09/18/2000. .

### CLASS 40—MATERIAL TREATMENT

FOR PRINTING SERVICES (U.S. CLS. 100, 103 AND 106).

FIRST USE 4-1-2011; IN COMMERCE 5-15-2011.

### CLASS 42—SCIENTIFIC AND COMPUTER SERVICES

FOR CREATIVE GRAPHIC ART DESIGN SERVICES (U.S. CLS. 100 AND 101).

FIRST USE 4-1-2011, THE MARK WAS FIRST USED ANYWHERE IN A DIFFERENT FORM OTHER THAN THAT SOUGHT TO BE REGISTERED AT LEAST AS EARLY AS 09/18/2000.; IN COMMERCE 5-15-2011, THE MARK WAS FIRST USED IN COMMERCE IN A DIFFERENT FORM OTHER THAN THAT SOUGHT TO BE REGISTERED AT LEAST AS EARLY AS 09/18/2000..

JEFF DEFORD, EXAMINING ATTORNEY

SN 85-331,077. BARSUM FASHION GROUP, INC., BEVERLY HILLS, CA. FILED 5-26-2011.



THE NAME "FARBOD BARSUM" IDENTIFIES A LIVING INDIVIDUAL WHOSE CONSENT IS OF RECORD.  
THE MARK CONSISTS OF THE STYLIZED WORDS "FARBOD BARSUM" INSIDE A CIRCULAR SHAPE DESIGN.

**CLASS 18—LEATHER GOODS**

FOR DUFFEL BAGS; HANDBAGS; WALLETS (U.S. CLS. 1, 2, 3, 22 AND 41).

**CLASS 25—CLOTHING**

FOR BELTS; DRESSES; JACKETS; PANTS; SHOES; SHORTS; SKIRTS; SWEAT SHIRTS; T-SHIRTS; TANK TOPS (U.S. CLS. 22 AND 39).  
STEVEN R. FINE, EXAMINING ATTORNEY

SN 85-331,527. THE MUSEUM OF WESTERN COLORADO, GRAND JUNCTION, CO. FILED 5-26-2011.



THE MARK CONSISTS OF PICTORIAL REPRESENTATION OF AN ALLOSAURUS SKELETON STANDING ON ITS HIND LEGS WEARING A SCOTTISH TAM ON ITS HEAD AND HOLDING A GOLF CLUB.

SN 85-331,206. B.T.T.R. VENTURESE, LLC, AKA BACK TO THE ROOTS, OAKLAND, CA. FILED 5-26-2011.

**Back to the Roots**

THE MARK CONSISTS OF STANDARD CHARACTERS WITHOUT CLAIM TO ANY PARTICULAR FONT, STYLE, SIZE, OR COLOR.

**CLASS 1—CHEMICALS**

FOR (BASED ON USE IN COMMERCE) SOIL AMENDMENTS (BASED ON INTENT TO USE) NUTRITIVE ADDITIVE TO ENHANCE THE BIOLOGICAL ACTIVITY OF WATER, SOIL, SEEDS AND PLANTS FOR PURPOSES OF FERTILIZATION AND BIOREMEDIATION OF POLLUTANTS (U.S. CLS. 1, 5, 6, 10, 26 AND 46).  
FIRST USE 4-22-2009; IN COMMERCE 10-1-2010.

**CLASS 31—NATURAL AGRICULTURAL PRODUCTS**

FOR (BASED ON USE IN COMMERCE) FRESH MUSHROOMS; ORGANIC GARDENING KIT FOR INDOOR AND OUTDOOR PLANTING COMPOSED PRIMARILY OF ORGANIC AGRICULTURAL SEEDS, MUSHROOM SPAWN, HERB SEEDS, FRUIT SEEDS, VEGETABLE SEEDS, MYCHORRHIZAL ROOT INNOCULUM AND ALSO INCLUDING EDUCATIONAL MATERIALS, AS WELL AS, THOUGH NOT LIMITED TO, SUSTAINABLE SOILS SUCH AS COFFEE GROUNDS, SPENT GRAINS AND HOPS, SPENT OKARA, SPENT TEA WASTE, AND COMPOST; SPORES AND SPAWN (U.S. CLS. 1 AND 46).  
FIRST USE 4-22-2009; IN COMMERCE 10-9-2009.  
SHARON MEIER, EXAMINING ATTORNEY

**CLASS 25—CLOTHING**

FOR SHIRTS, T-SHIRTS, GOLF SHIRTS, POLO SHIRTS, TANK TOPS, WARM-UP SUITS, SWEATSHIRTS, SWEATPANTS, SWEATSHORTS, SHORTS, NON-MEDICAL COMPRESSION SHORTS, TRUNKS, JACKETS, REVERSIBLE JACKETS, COATS, RAINWEAR, SWEATERS, TURTLENECK SHIRTS AND SWEATERS, VESTS, FLEECE VESTS, RUNNER'S VEST WITH REFLECTIVE STRIPES AND ADJUSTABLE STRAPS, TIGHTS, BRIEFS, UNDERWEAR, BRAS, SPORTS BRAS, SINGLETS, HATS, CAPS, HEADBANDS, GLOVES, SCARVES, LOUNGEWEAR, SLEEPWEAR, SOCKS, SLIPPERS AND FOOTWEAR (U.S. CLS. 22 AND 39).

**CLASS 41—EDUCATION AND ENTERTAINMENT**

FOR ENTERTAINMENT SERVICES, NAMELY, ORGANIZING, CONDUCTING AND STAGING ATHLETIC CONTESTS, NAMELY, GOLF TOURNAMENTS, AND ATHLETIC BIKING AND RUNNING RACES; AND EDUCATIONAL SERVICES, NAMELY, HOSTING SEMINARS, COORDINATING LECTURES AND ARRANGING HISTORICAL EXHIBITS IN THE FIELD OF SOCIAL SCIENCE (U.S. CLS. 100, 101 AND 107).  
LAURIE MAYES, EXAMINING ATTORNEY

SN 85-331,630. BUNCH AND ASSOCIATES, LLC, LAKE-LAND, FL. FILED 5-26-2011.

**NFR**

THE MARK CONSISTS OF STANDARD CHARACTERS WITHOUT CLAIM TO ANY PARTICULAR FONT, STYLE, SIZE, OR COLOR.

**CLASS 35—ADVERTISING AND BUSINESS**

FOR WORKERS' COMPENSATION CLAIMS MANAGEMENT SERVICES, NAMELY, ELECTRONIC DATA COLLECTION AND DATA ENTERING IN THE FIELD OF WORKERS' COMPENSATION; AND COLLECTING AND ANALYZING WORKERS' COMPENSATION CLAIMS DATA FOR BUSINESS PURPOSES (U.S. CLS. 100, 101 AND 102).

**CLASS 36—INSURANCE AND FINANCIAL**

FOR CLAIMS ADMINISTRATION IN THE FIELD OF WORKERS' COMPENSATION; CONSULTATION AND CLAIMS PROCESSING IN THE FIELD OF WORKERS' COMPENSATION INSURANCE (U.S. CLS. 100, 101 AND 102).

ALEXANDER L. POWERS, EXAMINING ATTORNEY

SN 85-331,640. BUNCH AND ASSOCIATES, LLC, LAKE-  
LAND, FL. FILED 5-26-2011.

CIA

THE MARK CONSISTS OF STANDARD CHARACTERS WITHOUT CLAIM TO ANY PARTICULAR FONT, STYLE, SIZE, OR COLOR.

**CLASS 35—ADVERTISING AND BUSINESS**

FOR WORKERS' COMPENSATION CLAIMS MANAGEMENT SERVICES, NAMELY, ELECTRONIC DATA COLLECTION AND DATA ENTERING IN THE FIELD OF WORKERS' COMPENSATION; AND COLLECTING AND ANALYZING WORKERS' COMPENSATION CLAIMS DATA FOR BUSINESS PURPOSES (U.S. CLS. 100, 101 AND 102).

**CLASS 36—INSURANCE AND FINANCIAL**

FOR CLAIMS ADMINISTRATION IN THE FIELD OF WORKERS' COMPENSATION; CONSULTATION AND CLAIMS PROCESSING IN THE FIELD OF WORKERS' COMPENSATION INSURANCE (U.S. CLS. 100, 101 AND 102).

ALEXANDER L. POWERS, EXAMINING ATTORNEY

SN 85-331,649. NISOURCE CORPORATE SERVICES COM-  
PANY, MERRILLVILLE, IN. FILED 5-26-2011.

ADVANCING ENERGY THROUGH  
TRANSPARENCY

THE MARK CONSISTS OF STANDARD CHARACTERS WITHOUT CLAIM TO ANY PARTICULAR FONT, STYLE, SIZE, OR COLOR.

**CLASS 35—ADVERTISING AND BUSINESS**

FOR ENERGY MANAGEMENT SERVICES, NAMELY PROVIDING AN INTERSTATE NATURAL GAS TRADING HUB (U.S. CLS. 100, 101 AND 102).

**CLASS 39—TRANSPORTATION AND STORAGE**

FOR TRANSMISSION OF OIL OR GAS THROUGH PIPELINES (U.S. CLS. 100 AND 105).

JESSICA FATHY, EXAMINING ATTORNEY

SN 85-331,861. PROSKAUER ROSE LLP, NEW YORK, NY.  
FILED 5-26-2011.

PROSKAUER

THE MARK CONSISTS OF STANDARD CHARACTERS WITHOUT CLAIM TO ANY PARTICULAR FONT, STYLE, SIZE, OR COLOR.

OWNER OF U.S. REG. NOS. 2,521,420, 3,862,025 AND OTHERS.

SEC. 2(F).

**CLASS 41—EDUCATION AND ENTERTAINMENT**

FOR EDUCATIONAL SERVICES, NAMELY, PROVIDING SEMINARS ON LEGAL ISSUES (U.S. CLS. 100, 101 AND 107).

FIRST USE 9-1-2000; IN COMMERCE 9-1-2000.

**CLASS 45—PERSONAL AND LEGAL SERVICES**

FOR LEGAL SERVICES (U.S. CLS. 100 AND 101).

FIRST USE 9-1-2000; IN COMMERCE 9-1-2000.  
STEVEN JACKSON, EXAMINING ATTORNEY

SN 85-331,981. FINDING MY MUCHNESS, L.L.C., TEA-  
NECK, NJ. FILED 5-27-2011.

MUCHNESS

THE MARK CONSISTS OF STANDARD CHARACTERS WITHOUT CLAIM TO ANY PARTICULAR FONT, STYLE, SIZE, OR COLOR.

**CLASS 14—JEWELRY**

FOR JEWELRY (U.S. CLS. 2, 27, 28 AND 50).

**CLASS 45—PERSONAL AND LEGAL SERVICES**

FOR PROVIDING ON-LINE INFORMATION IN THE FIELD OF SPIRITUALITY, SELF-HELP, AND PERSONAL EMPOWERMENT SUBJECT MATTERS (U.S. CLS. 100 AND 101).

JOHN HWANG, EXAMINING ATTORNEY

SN 85-332,047. WALKER, ROBIN ANN, GALVESTON, TX. FILED 5-27-2011.

SN 85-332,086. SPEEDWAY PROPERTIES COMPANY, LLC, RENO, NV. FILED 5-27-2011.

## MillionDollarRedhead

THE MARK CONSISTS OF STANDARD CHARACTERS WITHOUT CLAIM TO ANY PARTICULAR FONT, STYLE, SIZE, OR COLOR.

### CLASS 21—HOUSEWARES AND GLASS

FOR MUGS (U.S. CLS. 2, 13, 23, 29, 30, 33, 40 AND 50).

### CLASS 25—CLOTHING

FOR CAPS; EYESHADES; GLOVES; HATS; JACKETS; SCARVES; SWEATSHIRTS; T-SHIRTS (U.S. CLS. 22 AND 39).

SUNG IN, EXAMINING ATTORNEY

---

SN 85-332,077. RECKITT BENCKISER HEALTHCARE (UK) LIMITED, HULL, UNITED KINGDOM, FILED 5-27-2011.



THE COLOR(S) BLUE, BLACK, TAN IS/ARE CLAIMED AS A FEATURE OF THE MARK.

THE MARK CONSISTS OF A STYLIZED BLUE BIRD WITH A CURVING THREAD TRAILING FROM ITS TAIL IN WITH THE UPPER PORTION OF THE THREAD IN BLUE WITH A RECTANGULAR TAN SHAPE WHICH SEPARATES THE BOTTOM PORTION IN BLACK WITH A LARGE KNOT AT THE END.

### CLASS 16—PAPER GOODS AND PRINTED MATTER

FOR PRINTED MATTER, NAMELY INFORMATION CARDS, LEAFLETS AND PAMPHLETS IN THE FIELD OF OPIOID DEPENDENCE AND ITS TREATMENT (U.S. CLS. 2, 5, 22, 23, 29, 37, 38 AND 50).

FIRST USE 9-15-2010; IN COMMERCE 9-15-2010.

### CLASS 44—MEDICAL, BEAUTY AND AGRICULTURAL SERVICES

FOR PROVISION OF HEALTH CARE ADVICE; PROVIDING INFORMATION RELATING TO OPIOID DEPENDENCE (U.S. CLS. 100 AND 101).

FIRST USE 9-3-2010; IN COMMERCE 9-3-2010. JOHN WILKE, EXAMINING ATTORNEY

## MILES OF COURAGE

THE MARK CONSISTS OF STANDARD CHARACTERS WITHOUT CLAIM TO ANY PARTICULAR FONT, STYLE, SIZE, OR COLOR.

### CLASS 6—METAL GOODS

FOR METAL KEY RINGS, METAL LICENSE PLATES AND METAL IDENTIFICATION TAGS (U.S. CLS. 2, 12, 13, 14, 23, 25 AND 50).

### CLASS 16—PAPER GOODS AND PRINTED MATTER

FOR PAPER GOODS AND PRINTED MATERIALS, NAMELY POSTERS, BUMPER STICKERS, DECALS, WALL CALENDARS, WINDOW STICKERS, COLLECTIBLE TRADING CARD SETS AND COLLECTIBLE TRIVIA CARD SETS, BROCHURES AND BOOKS ABOUT AUTOMOBILE RACING (U.S. CLS. 2, 5, 22, 23, 29, 37, 38 AND 50).

### CLASS 25—CLOTHING

FOR CLOTHING, NAMELY SWEATSHIRTS, WARM-UP SUITS, SHORTS, SHIRTS, SPORT SHIRTS, GOLF SHIRTS, T-SHIRTS, SUSPENDERS, SWEATERS, JACKETS, HEADBANDS, CAPS, VISORS, STRAW HATS, SOCKS AND INFANT WEAR (U.S. CLS. 22 AND 39).

### CLASS 36—INSURANCE AND FINANCIAL

FOR CHARITABLE FUNDRAISING SERVICES (U.S. CLS. 100, 101 AND 102).

### CLASS 41—EDUCATION AND ENTERTAINMENT

FOR ENTERTAINMENT SERVICES IN THE NATURE OF ORGANIZING AND CONDUCTING RACES AND EXHIBITIONS (U.S. CLS. 100, 101 AND 107).

JOHN WILKE, EXAMINING ATTORNEY

---

SN 85-332,114. HOLLANDER HOME FASHIONS, LLC, BOCA RATON, FL. FILED 5-27-2011.

## HEALTHY LIVING

THE MARK CONSISTS OF STANDARD CHARACTERS WITHOUT CLAIM TO ANY PARTICULAR FONT, STYLE, SIZE, OR COLOR.

### CLASS 20—FURNITURE AND ARTICLES NOT OTHERWISE CLASSIFIED

FOR PILLOWS AND FIBER BEDS (U.S. CLS. 2, 13, 22, 25, 32 AND 50).

**CLASS 24—FABRICS**

FOR MATTRESS PADS AND COMFORTERS (U.S. CLS. 42 AND 50).  
JOHN GARTNER, EXAMINING ATTORNEY

SN 85-332,116. INNOVATION VENTURE, LLC, FARMINGTON HILLS, MI. FILED 5-27-2011.

**BEAT THE 2:30 BLUES**

THE MARK CONSISTS OF STANDARD CHARACTERS WITHOUT CLAIM TO ANY PARTICULAR FONT, STYLE, SIZE, OR COLOR.

**CLASS 5—PHARMACEUTICALS**

FOR DIETARY SUPPLEMENTS (U.S. CLS. 6, 18, 44, 46, 51 AND 52).

**CLASS 32—LIGHT BEVERAGES**

FOR NON-ALCOHOLIC LIQUIDS, NAMELY ENERGY SHOTS (U.S. CLS. 45, 46 AND 48).  
JENNIFER VASQUEZ, EXAMINING ATTORNEY

SN 85-332,121. DM PAYROLL SERVICES, LLC, TROY, MI. FILED 5-27-2011.



OWNER OF U.S. REG. NOS. 1,847,846, 2,480,658 AND 3,576,648.

THE MARK CONSISTS OF THE LETTERS "DM" IN STYLIZED FORM.

**CLASS 16—PAPER GOODS AND PRINTED MATTER**

FOR PRINTED MATTER, NAMELY, MANUALS AND USER GUIDES IN THE FIELD OF EMPLOYER PAYROLL AND BENEFITS ADMINISTRATION MANAGEMENT; BULLETINS, CHECK LISTS, PERIODICALS AND NEWSLETTERS IN THE FIELD OF PAYROLL ADMINISTRATION AND HUMAN RESOURCE AND BENEFITS ADMINISTRATION (U.S. CLS. 2, 5, 22, 23, 29, 37, 38 AND 50).

FIRST USE 7-29-1999; IN COMMERCE 7-29-1999.

**CLASS 35—ADVERTISING AND BUSINESS**

FOR PAYROLL PROCESSING SERVICES; PROVIDING COMPUTING, DATA, AND PROFESSIONAL SERVICES TO EMPLOYERS, NAMELY, PAYROLL PROCESSING, TAX DEPOSIT FILING AND REPORTING, HUMAN RESOURCES MANAGEMENT, EMPLOYEE TIME AND ATTENDANCE RECORD KEEPING, PENSION RECORD KEEPING, EMPLOYEE LEASING, AND BUSINESS MANAGEMENT CONSULTING; BUSINESS MANAGEMENT IN THE FIELD OF EMPLOYMENT COMPENSATION (U.S. CLS. 100, 101 AND 102).

FIRST USE 7-29-1999; IN COMMERCE 7-29-1999.

**CLASS 36—INSURANCE AND FINANCIAL**

FOR PROVIDING PROFESSIONAL SERVICES TO EMPLOYERS, NAMELY, PROCESSING, ADMINISTERING AND MANAGING EMPLOYEE BENEFIT PLANS, ADMINISTRATION OF EMPLOYEE PENSION PLANS (U.S. CLS. 100, 101 AND 102).

FIRST USE 7-29-1999; IN COMMERCE 7-29-1999.

**CLASS 42—SCIENTIFIC AND COMPUTER SERVICES**

FOR ONLINE SERVICES PROVIDED TO CLIENTS VIA THE GLOBAL COMPUTER NETWORK (INTERNET), NAMELY, PROVIDING ON-LINE NON-DOWNLOADABLE SOFTWARE FOR PROVIDING AN INTEGRATED PAYROLL/HUMAN RESOURCE SERVICES FOR PROCESSING PAYROLLS, EMPLOYEE EARNINGS RECORDS, PAYROLL CHECKS AND CALCULATIONS, GENERAL LEDGER REPORTS, WORKER'S COMPENSATION REPORTS, AUDITS AND REPORTS, AND PROCESSING PAYROLL TAX FILINGS FOR CLIENTS INCLUDING COLLECTION OF FEDERAL DEPOSITORY TAXES THROUGH AN ELECTRONIC FUND TRANSFER SYSTEM WHICH GIVES CLIENT'S THE ABILITY TO ACCESS INFORMATION AND TO PRINT REPORTS, PAYROLL, CHECKS, AND VOUCHERS (U.S. CLS. 100 AND 101).

FIRST USE 7-29-1999; IN COMMERCE 7-29-1999.

JOHN E. MICHOS, EXAMINING ATTORNEY

SN 85-332,131. GRUPO PROEZA, S.A.P.I. DE C.V., MONTERREY, NUEVO LEON, MEXICO, FILED 5-27-2011.



THE MARK CONSISTS OF OVAL ABOVE TWO VARIEGATED LEAF SHAPED SWOOSHES ON THE LEFT AND THREE VARIEGATED LEAF SHAPED SWOOSHES ON THE RIGHT.

**CLASS 29—MEATS AND PROCESSED FOODS**

FOR CANDIED FRUIT; CANDIED FRUIT SNACKS; CANNED FRUITS; DRIED FRUIT MIXES; DRIED FRUIT-BASED SNACKS; DRIED FRUITS; FROZEN FRUITS; FRUIT CHIPS; FRUIT JUICES FOR COOKING; FRUIT PEELS; FRUIT PULPS; FRUIT PUREES; FRUIT-BASED FOOD BEVERAGE; FRUIT-BASED SNACK FOOD; PRESERVED FRUITS; PROCESSED FRUITS (U.S. CL. 46).

FIRST USE 5-25-2011; IN COMMERCE 5-25-2011.

**CLASS 30—STAPLE FOODS**

FOR FRUIT JELLIES; FRUIT PASTE FOR FLAVOURING OF FOOD; HONEY (U.S. CL. 46).  
FIRST USE 5-25-2011; IN COMMERCE 5-25-2011.

SN 85-332,142. E&J STARZ, INC., STATEN ISLAND, NY.  
FILED 5-27-2011.

**CLASS 31—NATURAL AGRICULTURAL PRODUCTS**

FOR FRESH FRUITS; LIVING TREES; UNPROCESSED FRUITS (U.S. CLS. 1 AND 46).  
FIRST USE 5-25-2011; IN COMMERCE 5-25-2011.

**CLASS 32—LIGHT BEVERAGES**

FOR FRUIT BEVERAGES; FRUIT DRINKS AND JUICES; FRUIT JUICE CONCENTRATES (U.S. CLS. 45, 46 AND 48).  
FIRST USE 5-25-2011; IN COMMERCE 5-25-2011.  
KHANH LE, EXAMINING ATTORNEY

NO CLAIM IS MADE TO THE EXCLUSIVE RIGHT TO USE "ENERGY", APART FROM THE MARK AS SHOWN. THE COLOR(S) BLACK AND RED IS/ARE CLAIMED AS A FEATURE OF THE MARK.

THE MARK CONSISTS OF THE WORDING "STARZ" IN BLACK AND "ENERGY" IN RED WITH SPIKE LIKE PROJECTIONS COMING OUT OF THE LETTERS "S", "Z" AND "N". THE LETTER "A" IN "STARZ" IS A TRIANGLE. THE LETTERS "R" ARE NOT FULLY CLOSED AT THE HEAD OF THE LETTER.

SN 85-332,141. EGGE MACHINE COMPANY, INC., SANTA FE SPRINGS, CA. FILED 5-27-2011.



OWNER OF U.S. REG. NO. 2,992,538.  
THE MARK CONSISTS OF AN OVAL WITH THE STYLIZED LETTERS "EGGE".

**CLASS 5—PHARMACEUTICALS**

FOR DIETARY SUPPLEMENTAL DRINKS (U.S. CLS. 6, 18, 44, 46, 51 AND 52).  
FIRST USE 0-0-2010; IN COMMERCE 0-0-2011.

**CLASS 32—LIGHT BEVERAGES**

FOR ENERGY DRINKS (U.S. CLS. 45, 46 AND 48).  
FIRST USE 0-0-2010; IN COMMERCE 0-0-2011.  
KEVON CHISOLM, EXAMINING ATTORNEY

**CLASS 7—MACHINERY**

FOR INTERNAL COMPONENTS FOR LAND-VEHICLE COMBUSTION ENGINES IN THE NATURE OF PISTONS, CYLINDER VALVES, GASKETS, BEARINGS, RODS, MAIN BEARING BOLTS, VALVE SPRINGS, OIL PANS, ROCKER ARMS, OIL PUMPS, CRANKSHAFTS, CAMSHAFTS, DISTRIBUTORS (U.S. CLS. 13, 19, 21, 23, 31, 34 AND 35).  
FIRST USE 7-4-1915; IN COMMERCE 7-4-1915.

SN 85-332,235. AVECIA BIOTECHNOLOGY, INC, MILFORD, MA. FILED 5-27-2011.

OLIGO FASTER SMARTER BETTER

**CLASS 35—ADVERTISING AND BUSINESS**

FOR RETAIL STORE SERVICES, DISTRIBUTORSHIP SERVICES, AND ON-LINE ORDERING SERVICES, ALL FEATURING ENGINES FOR LAND VEHICLES AND INTERNAL COMPONENTS FOR LAND-VEHICLE COMBUSTION ENGINES (U.S. CLS. 100, 101 AND 102).  
FIRST USE 7-4-1915; IN COMMERCE 7-4-1915.

THE MARK CONSISTS OF STANDARD CHARACTERS WITHOUT CLAIM TO ANY PARTICULAR FONT, STYLE, SIZE, OR COLOR.

**CLASS 37—CONSTRUCTION AND REPAIR**

FOR RECONDITIONING SERVICES FOR ENGINES AND INTERNAL COMBUSTION ENGINE COMPONENTS FOR LAND VEHICLES (U.S. CLS. 100, 103 AND 106).  
FIRST USE 7-4-1915; IN COMMERCE 7-4-1915.

**CLASS 40—MATERIAL TREATMENT**

FOR BIOCHEMICAL CONTRACT MANUFACTURING SERVICES (U.S. CLS. 100, 103 AND 106).  
FIRST USE 5-23-2011; IN COMMERCE 5-23-2011.

**CLASS 40—MATERIAL TREATMENT**

FOR CUSTOM MANUFACTURE OF INTERNAL COMPONENTS FOR LAND-VEHICLE COMBUSTION ENGINES (U.S. CLS. 100, 103 AND 106).  
FIRST USE 7-4-1915; IN COMMERCE 7-4-1915.  
KEVON CHISOLM, EXAMINING ATTORNEY

**CLASS 42—SCIENTIFIC AND COMPUTER SERVICES**

FOR SCIENTIFIC DEVELOPMENT SERVICES IN THE FIELD OF BIOCHEMISTRY (U.S. CLS. 100 AND 101).  
FIRST USE 5-23-2011; IN COMMERCE 5-23-2011.  
BRIAN NEVILLE, EXAMINING ATTORNEY

SN 85-332,296. OLYMPUS CORPORATION, TOKYO, JAPAN,  
FILED 5-27-2011.

## FOCUS ON LIFE

THE MARK CONSISTS OF STANDARD CHARACTERS WITHOUT CLAIM TO ANY PARTICULAR FONT, STYLE, SIZE, OR COLOR.

### CLASS 9—ELECTRICAL AND SCIENTIFIC APPARATUS

FOR PHOTOGRAPHIC CAMERAS, DIGITAL CAMERAS, VIDEO AND AUDIO TAPE RECORDERS AND BLANK VIDEO AND AUDIO TAPES, IC RECORDERS, OPTICAL, ACOUSTIC AND SCANNING MICROSCOPES, MEASURING EQUIPMENT, NAMELY, MEASURING MICROSCOPES, BINOCULARS, BATTERIES, MAGNETO-OPTICAL DISC DRIVERS, DIGITAL PHOTO PRINTERS, BAR CODE SCANNERS, DOT-CODE READERS AND WRITERS, PHOTOCOPYING MACHINES, ENDOSCOPES FOR INDUSTRIAL USE, AND REPLACEMENTS PARTS THEREFOR (U.S. CLS. 21, 23, 26, 36 AND 38).

### CLASS 10—MEDICAL APPARATUS

FOR MEDICAL AND SURGICAL ENDOSCOPES, ULTRASONIC DIAGNOSTIC APPARATUS, SURGICAL MICROSCOPES, CLINICAL ANALYZERS FOR TESTING AND ANALYZING BLOOD AND REPLACEMENT PARTS THEREFOR; MEDICAL FURNITURE, NAMELY, LAMPS, TABLES, STOOLS AND BEDS FOR ENDOSCOPIC EXAMINATION PURPOSES, ARTIFICIAL LIMBS, EYES AND TEETH; ORTHOPEDIC ARTICLES, NAMELY, ORTHOPEDIC SHOE INSERTS, ORTHOPEDIC IMPLANTS, SURGICAL INSTRUMENTS USED FOR ORTHOPEDIC IMPLANTATION AND SUTURES (U.S. CLS. 26, 39 AND 44).

DAVID TOOLEY, EXAMINING ATTORNEY

SN 85-332,411. HACHICK DISTRIBUTORS, INC., ASTON,  
PA. FILED 5-27-2011.

## Sunburst

THE MARK CONSISTS OF STANDARD CHARACTERS WITHOUT CLAIM TO ANY PARTICULAR FONT, STYLE, SIZE, OR COLOR.

### CLASS 1—CHEMICALS

FOR WATER PURIFYING AND TREATMENT CHEMICALS FOR SWIMMING POOLS, SPAS, AND HOT TUBS, NAMELY, CHLORINE, LITHIUM AND BROMINE WATER CHEMICALS, SLIME REMOVERS FOR WATER, BALANCERS FOR ADJUSTING AND BUFFERING PH, TOTAL ALKALINITY AND HARDNESS OF WATER, CHLORINE AND NON-CHLORINE SHOCK TREATMENTS FOR OXIDIZING WATER CONTAMINATES, CLARIFIERS FOR AGGLOMERATING PARTICLES SUSPENDED IN WATER TO FACILITATE FILTERING, REACTING WITH ORGANIC CONTAMINATES IN WATER, PREVENTING SCUM LINES, FILTER CLOGGING AND CLOUDINESS IN WATER, AND PREVENTING FLOATING AND DIVING INSECTS FROM GATHERING ON A WATER SURFACE, COAGULATING AGENTS FOR PRECIPITATING FLOATING DEBRIS AND UNFILTERABLE MATERIAL IN WATER, FOAM REDUCER FOR WATER, STABILIZERS FOR STABILIZING CHLORINATED WATER AGAINST ATTACK BY SUNLIGHT, STAIN CONTROLLERS, NAMELY SEQUESTERING AGENTS FOR PREVENTING STAINING, SCALE AND RUST IN WATER FROM DEPOSITING ON POOL EQUIPMENT, PIPES AND FITTINGS, CHEMICALLY TREATED NON-MEDICAL TEST STRIPS FOR TESTING THE PH, ALKALINITY, CHLORINE, LITHIUM OR BROMINE CONCENTRATION IN WATER, WATER TREATMENT KITS COMPRISING WATER PURIFYING AND TREATMENT CHEMICALS AND TEST STRIPS FOR CONTROLLING AND TESTING THE PH, ALKALINITY, CHLORINE, LITHIUM OR BROMINE IN SWIMMING POOLS, SPAS AND HOT TUBS, AND TEST KITS COMPRISING WATER PURIFYING AND TREATMENT CHEMICALS AND TEST STRIPS FOR CONTROLLING AND TESTING THE PH, ALKALINITY, CHLORINE, LITHIUM OR BROMINE IN SWIMMING POOLS, SPAS AND HOT TUBS (U.S. CLS. 1, 5, 6, 10, 26 AND 46).

### CLASS 5—PHARMACEUTICALS

FOR ALGAECIDES FOR SWIMMING POOLS, SPAS AND HOT TUBS (U.S. CLS. 6, 18, 44, 46, 51 AND 52).  
SHAUNIA CARLYLE, EXAMINING ATTORNEY

SN 85-332,530. GRN COMMUNITY SERVICE BOARD, LAWRENCEVILLE, GA. FILED 5-27-2011.



NO CLAIM IS MADE TO THE EXCLUSIVE RIGHT TO USE "HEALTH", APART FROM THE MARK AS SHOWN.

THE MARK CONSISTS OF ALTERNATING CIRCULAR STRIPES WHICH APPEAR DIRECTLY ABOVE THREE STYLIZED WORDS; THE FIRST WORD CONSISTS OF THE STYLIZED LETTERS "V", "I", "E", "W"; THE SECOND WORD CONSISTS OF THE STYLIZED LETTERS "P", "O", "I", "N", "T"; THE WORDS "VIEW" AND "POINT" APPEAR IN THE SAME HORIZONTAL PLANE CENTERED DIRECTLY BELOW THE CIRCULAR STRIPES; THE THIRD WORD CONSISTS OF THE STYLIZED LETTERS "H", "E", "A", "L", "T", "H"; THE WORD "HEALTH" IS CENTERED DIRECTLY BELOW THE WORDS "VIEW" AND "POINT" AND PARTIALLY OVERLAPS THE SAME WORDS.

**CLASS 41—EDUCATION AND ENTERTAINMENT**

FOR EDUCATION SERVICES, NAMELY, PROVIDING DAY PROGRAMS IN THE FIELD OF DAILY LIVING AND EMPLOYMENT SKILLS FOR DEVELOPMENTALLY DISABLED ADULTS AND/OR MENTALLY ILL ADULTS (U.S. CLS. 100, 101 AND 107).

**CLASS 43—HOTEL AND RESTAURANT SERVICES**

FOR PUBLIC HOUSING SERVICES (U.S. CLS. 100 AND 101).

**CLASS 44—MEDICAL, BEAUTY AND AGRICULTURAL SERVICES**

FOR ADDICTION TREATMENT SERVICES; BEHAVIORAL HEALTH SERVICES; CHEMICAL DEPENDENCY AND SUBSTANCE ABUSE TREATMENT SERVICES; CLINICAL MENTAL HEALTH COUNSELING SERVICES; CONSULTING SERVICES IN THE FIELD OF MENTAL HEALTH AND WELLNESS; HEALTH CARE SERVICES, NAMELY, WELLNESS PROGRAMS; MENTAL HEALTH COUNSELING AND PSYCHOTHERAPY AS IT RELATES TO RELATIONSHIPS; MENTAL HEALTH SERVICES; MENTAL HEALTH THERAPY SERVICES; REHABILITATION OF ALCOHOL ADDICTED PATIENTS; REHABILITATION OF DRUG ADDICTED PATIENTS; REHABILITATION OF NARCOTIC ADDICTED PATIENTS; REHABILITATION PATIENT CARE SERVICES WHICH INCLUDES INPATIENT AND OUTPATIENT CARE (U.S. CLS. 100 AND 101).

**CLASS 45—PERSONAL AND LEGAL SERVICES**

FOR PROVIDING CASE MANAGEMENT SERVICES, NAMELY, COORDINATING LEGAL, PHYSICAL, SOCIAL AND PSYCHOLOGICAL SERVICES FOR DISABLED PERSONS (U.S. CLS. 100 AND 101).  
MICHAEL ENGEL, EXAMINING ATTORNEY

---

SN 85-332,611. RIGHTSCUBE, INC., AKA BOOKLR, NEW YORK, NY. FILED 5-27-2011.

# BOOKLR

THE MARK CONSISTS OF STANDARD CHARACTERS WITHOUT CLAIM TO ANY PARTICULAR FONT, STYLE, SIZE, OR COLOR.

**CLASS 35—ADVERTISING AND BUSINESS**

FOR PROMOTIONAL SERVICES, NAMELY, PROMOTING THE GOODS OF OTHERS BY OFFERING EXCLUSIVE CONTENT AND PRODUCTS DIRECT TO CONSUMERS THROUGH AN E-COMMERCE WEBSITE (U.S. CLS. 100, 101 AND 102).  
FIRST USE 5-12-2011; IN COMMERCE 5-12-2011.

**CLASS 42—SCIENTIFIC AND COMPUTER SERVICES**

FOR PROVIDING CUSTOMIZED ON-LINE WEB PAGES AND DATA FEEDS FEATURING USER-DEFINED INFORMATION, WHICH INCLUDES BLOG POSTS, NEW MEDIA CONTENT, OTHER ON-LINE CONTENT, AND ON-LINE WEB LINKS TO OTHER WEBSITES (U.S. CLS. 100 AND 101).  
FIRST USE 5-12-2011; IN COMMERCE 5-12-2011.  
JUSTINE D. PARKER, EXAMINING ATTORNEY

---

SN 85-332,716. SHIMMER & SHINE PRODUCTIONS, INC., ALPHARETTA, GA. FILED 5-27-2011.

# KBDB

THE MARK CONSISTS OF STANDARD CHARACTERS WITHOUT CLAIM TO ANY PARTICULAR FONT, STYLE, SIZE, OR COLOR.

**CLASS 14—JEWELRY**

FOR BRACELETS (U.S. CLS. 2, 27, 28 AND 50).  
FIRST USE 1-24-2011; IN COMMERCE 1-24-2011.

**CLASS 25—CLOTHING**

FOR T-SHIRTS (U.S. CLS. 22 AND 39).  
FIRST USE 11-22-2010; IN COMMERCE 1-24-2011.

**CLASS 35—ADVERTISING AND BUSINESS**

FOR ADMINISTRATION OF A PROGRAM TO PROMOTE COMMUNITY SERVICE; CHARITABLE SERVICES, NAMELY, ORGANIZING YOUTH GROUPS TO UNDERTAKE PROJECTS TO BENEFIT THE NEEDY AND THE COMMUNITY TO ENCOURAGE LEADERSHIP, CHARACTER, COMPASSION, AND GOOD CITIZENSHIP (U.S. CLS. 100, 101 AND 102).  
JASON BLAIR, EXAMINING ATTORNEY

---

SN 85-332,891. EZ AS A DRINK PRODUCTIONS, INC., SAN JOSE, CA. FILED 5-27-2011.

# BLUE ESTATE

THE MARK CONSISTS OF THE WORDS "BLUE ESTATE" WRITTEN IN STYLIZED LETTERS WITH THE WORD "BLUE" PLACED ABOVE THE WORD "ESTATE".



**CLASS 9—ELECTRICAL AND SCIENTIFIC APPARATUS**

FOR DOWNLOADABLE ELECTRONIC PUBLICATIONS IN THE NATURE OF GRAPHIC NOVELS AND COMIC BOOKS FOR ADULTS; ELECTRONIC PUBLICATIONS, NAMELY E-ZINES FEATURING ONGOING FICTITIOUS CRIME-DRAMA STORIES FOR ADULTS; MOTION PICTURE FILMS FEATURING FICTITIOUS ADVENTURE STORIES FOR ADULT AUDIENCES; VIDEO GAME SOFTWARE; ELECTRONIC GAME SOFTWARE FOR CELLULAR TELEPHONES; ELECTRONIC GAME SOFTWARE FOR WIRELESS DEVICES; ELECTRONIC GAME SOFTWARE FOR HANDHELD ELECTRONIC DEVICES (U.S. CLS. 21, 23, 26, 36 AND 38).

**CLASS 16—PAPER GOODS AND PRINTED MATTER**

FOR PUBLICATIONS, NAMELY GRAPHIC NOVELS, COMIC MAGAZINES AND COMIC BOOKS FEATURING ONGOING FICTITIOUS CRIME-DRAMA STORIES FOR ADULTS (U.S. CLS. 2, 5, 22, 23, 29, 37, 38 AND 50).

**CLASS 41—EDUCATION AND ENTERTAINMENT**

FOR ONLINE COMPUTER GAMES FOR ADULTS; PROVIDING AN INTERACTIVE WEBSITE WHERE USERS CAN COMMENT ON STORY LINES AND DOWNLOAD GRAPHICS (U.S. CLS. 100, 101 AND 107).  
ALLISON HOLTZ, EXAMINING ATTORNEY

SN 85-333,097. GMB CORPORATION, NARA, JAPAN, FILED 5-28-2011.



OWNER OF U.S. REG. NOS. 2,174,837 AND 3,034,636.  
THE MARK CONSISTS OF THE LETTERING "GMB" APPEARING WITHIN A STYLIZED OVAL DESIGN.

**CLASS 7—MACHINERY**

FOR ENGINE TIMING COMPONENTS, NAMELY, TIMING TENSIONERS AND IDLER BEARINGS; WATER PUMPS FOR USE IN MOTORS AND ENGINES, ALL FOR USE WITH LAND VEHICLES (U.S. CLS. 13, 19, 21, 23, 31, 34 AND 35).  
FIRST USE 0-0-1990; IN COMMERCE 0-0-1990.

**CLASS 12—VEHICLES**

FOR LAND VEHICLE ENGINE PARTS, NAMELY, WHEEL HUB ASSEMBLIES; UNIVERSAL JOINTS FOR LAND VEHICLES (U.S. CLS. 19, 21, 23, 31, 35 AND 44).  
FIRST USE 0-0-1990; IN COMMERCE 0-0-1990.  
MARGERY A. TIERNEY, EXAMINING ATTORNEY

SN 85-333,096. GMB CORPORATION, NARA, JAPAN, FILED 5-28-2011.

OWNER OF U.S. REG. NOS. 2,174,837 AND 3,034,636.  
THE COLOR(S) RED IS/ARE CLAIMED AS A FEATURE OF THE MARK.  
THE MARK CONSISTS OF THE STYLIZED LETTERING "GMB" APPEARING IN THE COLOR RED.

**CLASS 7—MACHINERY**

FOR ENGINE TIMING COMPONENTS, NAMELY, TIMING TENSIONERS AND IDLER BEARINGS; WATER PUMPS FOR USE IN MOTORS AND ENGINES, ALL FOR USE WITH LAND VEHICLES; AND FUEL PUMPS FOR LAND VEHICLES (U.S. CLS. 13, 19, 21, 23, 31, 34 AND 35).  
FIRST USE 0-0-1976; IN COMMERCE 0-0-1976.

**CLASS 12—VEHICLES**

FOR LAND VEHICLE ENGINE PARTS, NAMELY, WHEEL HUB ASSEMBLIES; AND UNIVERSAL JOINTS FOR LAND VEHICLES (U.S. CLS. 19, 21, 23, 31, 35 AND 44).  
FIRST USE 0-0-1976; IN COMMERCE 0-0-1976.  
MARGERY A. TIERNEY, EXAMINING ATTORNEY

SN 85-333,116. BERZACK, ANTONY, NEW YORK, NY. FILED 5-28-2011.

## Calendar Ware

THE MARK CONSISTS OF STANDARD CHARACTERS WITHOUT CLAIM TO ANY PARTICULAR FONT, STYLE, SIZE, OR COLOR.

**CLASS 20—FURNITURE AND ARTICLES NOT OTHERWISE CLASSIFIED**

FOR PLASTIC CONTAINERS AND COVERS FOR THE FOOD INDUSTRY (U.S. CLS. 2, 13, 22, 25, 32 AND 50).  
FIRST USE 5-27-2011; IN COMMERCE 5-27-2011.

**CLASS 21—HOUSEWARES AND GLASS**

FOR HOUSEHOLD CONTAINERS FOR FOODS (U.S. CLS. 2, 13, 23, 29, 30, 33, 40 AND 50).  
FIRST USE 5-27-2011; IN COMMERCE 5-27-2011.  
SOPHIA S. KIM, EXAMINING ATTORNEY

SN 85-333,131. MARCO, PETER, R, DBA MARCOART, NEW YORK, NY. FILED 5-28-2011.



THE COLOR(S) PINK, YELLOW, LIGHT BLUE, ORANGE, LIGHT GREEN, BLACK IS/ARE CLAIMED AS A FEATURE OF THE MARK.

THE MARK CONSISTS OF A GREEN EYED ORANGE DONUT OUTLINED IN BLACK WITH PINK FROSTING AND LIGHT BLUE SPRINKLES STANDING INSIDE A BLACK OUTLINED YELLOW CIRCLE. THE WORDS "BY" IN BLACK AND "MARCO" IN BLACK WRITTEN AS A SIGNATURE APPEARS BENEATH THE DONUT. A BAND OF PINK WITH YELLOW POLKA DOTS RINGS THE BLACK OUTLINED YELLOW CIRCLE IN WHICH LIGHT BLUE TEXT READS "FOODTOPIA FOOD THAT'S FUN".

#### CLASS 29—MEATS AND PROCESSED FOODS

FOR BANANA CHIPS; CANDIED FRUIT SNACKS; CANNED BEANS; CANNED PROCESSED OLIVES; CANNED TOMATOES; CANNED VEGETABLES; CANNED, COOKED OR OTHERWISE PROCESSED TOMATOES; CHOCOLATE NUT BUTTER; COFFEE-COATED NUTS; CUT FRUITS; CUT VEGETABLES; DEHYDRATED FRUIT SNACKS; DRIED DATES; DRIED FIGS; DRIED FRUIT MIXES; DRIED FRUIT-BASED SNACKS; DRIED FRUITS; DRIED VEGETABLES; DRIED VEGETABLES IN POWDER FORM; EDIBLE SHAVINGS OF DRIED KELP (TORORO-KOMBU); FIG AND DATE ROLL CONSISTING OF DRIED FRUITS, NUTS, AND SPICES; FRUIT JELLIES; JAMS; JAMS AND MARMALADES; JELLIES; JELLIES AND JAMS; JELLIES FOR FOOD; JELLIES, JAMS; MARMALADES AND JAMS; MEAT JELLIES; NUT AND SEED-BASED SNACK BARS; NUT BUTTERS; NUT-BASED SNACK FOODS; NUT-BASED SNACK FOODS, NAMELY, NUT CLUSTERS; NUT-BASED SNACK FOODS, NAMELY, NUT CRISPS; OLIVE OIL; OLIVE OILS; OLIVE PASTES; ORGANIC NUT AND SEED-BASED SNACK BARS; PEANUT BUTTER; PEANUT BUTTER TOPPING; PEANUT BUTTER PASTE; PEANUT SPREAD; POTATO STICKS; POTATO-BASED GNOCCHI; POTATO-BASED SNACK FOODS; PROCESSED OLIVE PUREE; PROCESSED OLIVES; PROCESSED OLIVES WITH PEPPERCORNS; PROCESSED PEANUTS; PROCESSED STUFFED OLIVES; PROTEIN BASED, NUTRIENT-DENSE SNACK BARS; PROTEIN BASED, NUTRIENT-DENSE SNACK FOODS; SLICED FRUITS; SNACK DIPS; SNACK FOOD DIPS; SNACK MIX CONSISTING OF DEHYDRATED FRUIT AND PROCESSED NUTS; SNACK MIX CONSISTING OF PRIMARILY OF PROCESSED NUTS, SEEDS, DRIED FRUIT AND ALSO INCLUDING CHOCOLATE; SNACK MIX CONSISTING OF WASABI PEAS, PROCESSED NUTS, DEHYDRATED FRUIT AND/OR RAISINS; SNACK MIX CONSISTING PRIMARILY OF DEHYDRATED FRUITS, PROCESSED NUTS AND ALSO INCLUDING SESAME STICKS; SNACK MIX CONSISTING PRIMARILY OF PROCESSED FRUITS, PROCESSED NUTS AND/OR RAISINS; SNACK MIX CONSISTING PRIMARILY OF PROCESSED NUTS AND SALTED SQUASH SEEDS AND ALSO INCLUDING TOASTED CORN; SOY CHIPS; SOY-BASED SNACK FOODS; TINNED OLIVES; TOFU-BASED SNACKS; TRAIL MIX CONSISTING PRIMARILY OF PROCESSED NUTS, SEEDS, DRIED FRUIT AND ALSO INCLUDING CHOCOLATE; VEGETABLE CHIPS; VEGETABLE-BASED SNACK FOODS; YUCCA CHIPS (U.S. CL. 46).

#### CLASS 30—STAPLE FOODS

FOR ARTICHOKE SAUCE; ARTIFICIAL COFFEE AND TEA; BAGEL CHIPS; BARBECUE SAUCE; BARBECUE SAUCE; BEVERAGES MADE OF COFFEE; BEVERAGES MADE OF TEA; BEVERAGES WITH A COFFEE BASE; BEVERAGES WITH A TEA BASE; BLACK TEA; BUTTERSCOTCH CHIPS; CEREAL BASED SNACK FOOD; CEREAL-BASED SNACK FOODS; CHAI TEA; CHEESE FLAVORED PUFFED CORN SNACKS; CHEESE FLAVORED SNACKS, NAMELY, CHEESE CURLS; CHEESE FLAVORED SNACKS, NAMELY, PUFFED CHEESE BALLS; CHEESE SAUCE; CHEESE-FLAVORED CORN SNACKS; CHILI OIL FOR USE AS A SEASONING OR CONDIMENT; CHILI SAUCE; CHIMICHURRI SAUCE; CHOCOLATE; CHOCOLATE AND CHOCOLATES; CHOCOLATE BARK CONTAINING GROUND COFFEE BEANS; CHOCOLATE BARS; CHOCOLATE CANDIES; CHOCOLATE CHIPS; CHOCOLATE CONFECTIONS; CHOCOLATE COVERED COCOA NIBS; CHOCOLATE COVERED COOKIES; CHOCOLATE COVERED NUTS; CHOCOLATE COVERED POPCORN; CHOCOLATE COVERED PRETZELS; CHOCOLATE COVERED RAISINS; CHOCOLATE COVERED ROASTED COFFEE BEANS; CHOCOLATE FOR TOPPING; CHOCOLATE PASTES; CHOCOLATE POWDER; CHOCOLATE SAUCE; CHOCOLATE SYRUP; CHOCOLATE TOPPED PRETZELS; CHOCOLATE TOPPING; CHOCOLATE TRUFFLES; CHOCOLATE-BASED READY-TO-EAT FOOD BARS; CHOCOLATE-COVERED POTATO CHIPS; CHOCOLATES AND CHOCOLATE BASED READY TO EAT CANDIES AND SNACKS; CHOCOLATES CONTAINING NUTRIENTS; CHUTNEYS; COCOA-BASED CONDIMENTS AND SEASONINGS FOR FOOD AND DRINK; COFFEE; COFFEE; COFFEE AND ARTIFICIAL COFFEE; COFFEE AND TEA; COFFEE BASED BEVERAGES; COFFEE BEANS; COFFEE ESSENCES; COFFEE EXTRACTS; COFFEE-BASED BEVERAGES; CONDIMENT, NAMELY, PEPPER SAUCE; CONFECTIONERIES, NAMELY, SNACK FOODS, NAMELY, CHOCOLATE; CONFECTIONERY CHIPS FOR BAKING; CORN CHIPS; CORN-BASED SNACK FOODS; CRACKERS; CURRY SAUCE; DIPPING SAUCES; DRIED HERBS; DRIED PASTA; EXTRUDED CORN SNACKS; EXTRUDED WHEAT SNACKS; FILLED CHOCOLATE; FLOUR-BASED CHIPS; FOOD CONDIMENT CONSISTING PRIMARILY OF KETCHUP AND SALSA; FRESH PASTA; FRUIT TEAS; GINSENG TEA; GRAIN-BASED CHIPS; GRAIN-BASED SNACK FOODS; GRANOLA SNACKS; GRANOLA-BASED SNACK BARS; GREEN TEA; HERB TEA; HERBAL TEA; HOT CHILI PEPPER SAUCE; HOT CHOCOLATE; HOT SAUCE; ICED TEA; JAPANESE GREEN TEA; KETCHUP; LIME TEA; MULTIGRAIN-BASED SNACK FOODS; MUSTARD; OOLONG TEA; PASTA; PASTA AND NOODLES; PASTA FOR SOUPS; PASTA SAUCE; PASTA SHELLS; PEANUT BRITTLE; PEANUT BUTTER CONFECTIONERY CHIPS; PELLET-SHAPED RICE CRACKERS (ARARE); PESTO SAUCE; PICKLED GINGER; PITA CHIPS; PREPARED HORSE-RADISH; PROCESSED CEREAL-BASED FOOD TO BE USED AS A BREAKFAST FOOD, SNACK FOOD OR INGREDIENT FOR MAKING OTHER FOODS; PUFFED CORN SNACKS; RICE-BASED SNACK FOODS; ROASTED COFFEE BEANS; SAGE TEA; SAUCES; SEA SALT FOR COOKING; SNACK CAKES; SNACK FOODS, NAMELY, CHOCOLATE-BASED SNACK FOODS; SPAGHETTI SAUCE; TABLE SALT; TACO CHIPS; TEA; TEA EXTRACTS; TEA FOR INFUSIONS; TEA OF PARCHED POWDER OF BARLEY WITH HUSK (MUGI-CHA); TEA OF SALTY KELP POWDER (KOMBU-CHA); TEA-BASED BEVERAGES; TEA-BASED BEVERAGES WITH FRUIT FLAVORING; TOMATO SAUCE; TORTILLA CHIPS; UNPOPPED POPCORN; WORCESTERSHIRE SAUCE (U.S. CL. 46).

GIANCARLO CASTRO, EXAMINING ATTORNEY

SN 85-333,272. REBECCA KLEMM CHARITABLE FOUNDATION, WASHINGTON, DC. FILED 5-29-2011.

SN 85-333,390. MESAN KILIT VE YEDEK PARCA SANAYI TICARET LIMITED SIRKETI, IKITELLI, ISTANBUL, TURKEY, FILED 5-30-2011.

# NumbersAlive!



THE MARK CONSISTS OF STANDARD CHARACTERS WITHOUT CLAIM TO ANY PARTICULAR FONT, STYLE, SIZE, OR COLOR.  
OWNER OF U.S. REG. NO. 3,925,630.

THE MARK CONSISTS OF THE WORD "MESAN" ENCLOSED IN AN ELLIPTICAL SHAPE DEVICE.

## CLASS 16—PAPER GOODS AND PRINTED MATTER

FOR CHILDREN'S BOOKS; CHILDREN'S ACTIVITY BOOKS; CHILDREN'S INTERACTIVE EDUCATIONAL BOOKS; BOOKS IN THE FIELD OF ADVENTURE STORIES (U.S. CLS. 2, 5, 22, 23, 29, 37, 38 AND 50).

## CLASS 6—METAL GOODS

FOR METAL HANDLES FOR DRAWERS; METAL HANDLES FOR FURNITURE; METAL HINGES; METAL LOCKS (U.S. CLS. 2, 12, 13, 14, 23, 25 AND 50).  
FIRST USE 12-31-1979; IN COMMERCE 7-24-2009.

## CLASS 28—TOYS AND SPORTING GOODS

FOR STUFFED TOYS; PLUSH TOYS; PLASTIC TOY NUMBERS (U.S. CLS. 22, 23, 38 AND 50).  
KAREN K. BUSH, EXAMINING ATTORNEY

## CLASS 17—RUBBER GOODS

FOR NON-METAL GASKETS FOR INSULATION AND MAINTENANCE OF LEAKAGE MADE OF PLASTIC (U.S. CLS. 1, 5, 12, 13, 35 AND 50).  
FIRST USE 12-31-1979; IN COMMERCE 7-24-2009.  
JAY FLOWERS, EXAMINING ATTORNEY

SN 85-333,374. E. LEET WOODWORKING, L.L.C., PLAINWELL, MI. FILED 5-30-2011.

SN 85-333,600. INGERSOLL-RAND COMPANY, PISCATAWAY, NJ. FILED 5-31-2011.

# BOARD STALL

# SPEXTRA

THE MARK CONSISTS OF STANDARD CHARACTERS WITHOUT CLAIM TO ANY PARTICULAR FONT, STYLE, SIZE, OR COLOR.

THE MARK CONSISTS OF STANDARD CHARACTERS WITHOUT CLAIM TO ANY PARTICULAR FONT, STYLE, SIZE, OR COLOR.

## CLASS 9—ELECTRICAL AND SCIENTIFIC APPARATUS

FOR COMPUTER SOFTWARE THAT CREATES HARDWARE, MECHANICAL AND ELECTRICAL SPECIFICATIONS, ELECTRICAL DIAGRAMS, DOOR ELEVATION DRAWINGS, BIDS, QUOTES, RECEIVES AND TRACKS CUSTOMER ORDERS AND PROJECTS IN THE FIELDS OF SECURITY AND SAFETY (U.S. CLS. 21, 23, 26, 36 AND 38).

## CLASS 25—CLOTHING

FOR SWEATSHIRTS; T-SHIRTS; TOPS (U.S. CLS. 22 AND 39).

## CLASS 42—SCIENTIFIC AND COMPUTER SERVICES

FOR CUSTOM DESIGN OF COMPUTER SOFTWARE THAT CREATES HARDWARE, MECHANICAL AND ELECTRICAL SPECIFICATIONS, ELECTRICAL DIAGRAMS, DOOR ELEVATION DRAWINGS, BIDS, QUOTES, RECEIVES AND TRACKS CUSTOMER ORDERS AND PROJECTS IN THE FIELDS OF SECURITY AND SAFETY (U.S. CLS. 100 AND 101).

## CLASS 28—TOYS AND SPORTING GOODS

FOR STORAGE RACKS FOR ATHLETIC EQUIPMENT (U.S. CLS. 22, 23, 38 AND 50).  
MARILYN IZZI, EXAMINING ATTORNEY

HOWARD SMIGA, EXAMINING ATTORNEY

SN 85-333,886. ITEM CREATIVE GROUP, PUTNAM, CT.  
FILED 5-31-2011.

SN 85-333,744. AG GLOBAL PRODUCTS, LLC, LOS AN-  
GELES, CA. FILED 5-31-2011.

# RAVEN

THE MARK CONSISTS OF STANDARD CHARACTERS  
WITHOUT CLAIM TO ANY PARTICULAR FONT, STYLE,  
SIZE, OR COLOR.

## CLASS 9—ELECTRICAL AND SCIENTIFIC APPARATUS

FOR ELECTRIC HAIR CURLING IRONS; ELECTRIC  
HAND-HELD HAIR STYLING IRONS; ELECTRIC IR-  
ONS FOR STYLING HAIR (U.S. CLS. 21, 23, 26, 36 AND  
38).

## CLASS 11—ENVIRONMENTAL CONTROL AP- PARATUS

FOR HAND-HELD ELECTRIC HAIR DRYERS (U.S.  
CLS. 13, 21, 23, 31 AND 34).  
GINA FINK, EXAMINING ATTORNEY

SN 85-333,776. KAPPBOOM INC., SUNNYVALE, CA. FILED  
5-31-2011.

# KAPPBOOM

THE MARK CONSISTS OF STANDARD CHARACTERS  
WITHOUT CLAIM TO ANY PARTICULAR FONT, STYLE,  
SIZE, OR COLOR.

## CLASS 9—ELECTRICAL AND SCIENTIFIC APPARATUS

FOR COMPUTER SOFTWARE APPLICATIONS FOR  
MOBILE PHONE AND HANDHELD DEVICE DEVEL-  
OPERS, ADVERTISERS AND USERS FOR USE IN DE-  
SIGNING MOBILE GAME PLATFORMS AND  
SOFTWARE APPLICATIONS THAT CAN BE USED ON  
VARIOUS MOBILE TELEPHONES AND HAND-HELD  
COMPUTER DEVICES (U.S. CLS. 21, 23, 26, 36 AND 38).

## CLASS 42—SCIENTIFIC AND COMPUTER SERVICES

FOR COMPUTER SOFTWARE DESIGN, COMPUTER  
PROGRAMMING, AND MAINTENANCE OF COMPU-  
TER SOFTWARE FOR MOBILE PHONE AND HAND-  
HELD DEVICE APPLICATIONS (U.S. CLS. 100 AND 101).  
TRACY FLETCHER, EXAMINING ATTORNEY

## THE WORLD AT YOUR DESK

THE MARK CONSISTS OF STANDARD CHARACTERS  
WITHOUT CLAIM TO ANY PARTICULAR FONT, STYLE,  
SIZE, OR COLOR.

## CLASS 30—STAPLE FOODS

FOR TEA (U.S. CL. 46).

## CLASS 35—ADVERTISING AND BUSINESS

FOR RETAIL STORE AND ONLINE RETAIL STORE  
SERVICES FEATURING TEA, OFFICE FURNITURE,  
OFFICE SUPPLIES AND WORKSPACE RELATED  
ITEMS (U.S. CLS. 100, 101 AND 102).

LINDA M. KING, EXAMINING ATTORNEY

SN 85-333,887. RED ROCK VALLEY LIMITED, LASVEGAS,  
NV. FILED 5-31-2011.

# MetaSpa

THE MARK CONSISTS OF STANDARD CHARACTERS  
WITHOUT CLAIM TO ANY PARTICULAR FONT, STYLE,  
SIZE, OR COLOR.

## CLASS 44—MEDICAL, BEAUTY AND AGRI- CULTURAL SERVICES

FOR HEALTH SPA SERVICES FOR HEALTH AND  
WELLNESS OF THE BODY AND SPIRIT; HEALTH SPA  
SERVICES FOR HEALTH AND WELLNESS OF THE  
MIND, BODY AND SPIRIT OFFERED IN OR FROM A  
REMOTE, MOBILE OR TEMPORARY ON-SITE LOCA-  
TION (U.S. CLS. 100 AND 101).

## CLASS 45—PERSONAL AND LEGAL SER- VICES

FOR PSYCHIC READING SERVICES (U.S. CLS. 100  
AND 101).

LINDA M. KING, EXAMINING ATTORNEY

SN 85-333,935. SCOOP MONKEY LLC, MIDLOTHIAN, VA.  
FILED 5-31-2011.

# SCOOP MONKEY

THE MARK CONSISTS OF STANDARD CHARACTERS  
WITHOUT CLAIM TO ANY PARTICULAR FONT, STYLE,  
SIZE, OR COLOR.

**CLASS 35—ADVERTISING AND BUSINESS**

FOR PROVIDING A WEB SITE FEATURING PRODUCT RATINGS OF THE CONSUMER GOODS AND SERVICES OF OTHERS IN THE FIELD OF FREIGHT TRANSPORTATION; PROVIDING A WEB SITE WHERE USERS CAN POST RATINGS, REVIEWS AND RECOMMENDATIONS ON PRODUCTS AND SERVICES, AND RELAY INFORMATION ABOUT THEIR EXPERIENCES WITH SUCH PRODUCTS AND SERVICES, ALL FOR COMMERCIAL PURPOSES; PROVIDING INDEPENDENT RATINGS AND REVIEWS OF OTHER BUSINESSES FOR COMMERCIAL PURPOSES (U.S. CLS. 100, 101 AND 102).

**CLASS 36—INSURANCE AND FINANCIAL**

FOR CREDIT RATING SERVICES (U.S. CLS. 100, 101 AND 102).

NICHOLAS ALTREE, EXAMINING ATTORNEY

SN 85-333,979. CATAPULT SYSTEMS, INC., AUSTIN, TX. FILED 5-31-2011.



THE MARK CONSISTS OF THE WORDING "SLINGROCK" BENEATH AN AMORPHOUS SHAPE CONSISTING OF THICK, INTERSECTING BANDS.

**CLASS 35—ADVERTISING AND BUSINESS**

FOR ADVERTISING AND MARKETING; ADVERTISING AGENCY; INTERNET MARKETING SERVICES, NAMELY, MARKETING CONSULTATION IN THE FIELDS OF SEARCH ENGINE OPTIMIZATION, SEARCH ENGINE MARKETING, AND SOCIAL MEDIA (U.S. CLS. 100, 101 AND 102).

FIRST USE 1-18-2011; IN COMMERCE 1-18-2011.

**CLASS 42—SCIENTIFIC AND COMPUTER SERVICES**

FOR IT CONSULTING SERVICES; WEBSITE DEVELOPMENT AND DESIGN FOR OTHERS; COMPUTER SOFTWARE DEVELOPMENT AND COMPUTER PROGRAMMING DEVELOPMENT FOR OTHERS; GRAPHIC DESIGN SERVICES (U.S. CLS. 100 AND 101).

FIRST USE 1-18-2011; IN COMMERCE 1-18-2011.

ODESSA BIBBINS, EXAMINING ATTORNEY

SN 85-333,958. CATAPULT SYSTEMS, INC., AUSTIN, TX. FILED 5-31-2011.

SLINGROCK

SN 85-334,019. ARISTOTLE CIRCLE, INC., NEW YORK, NY. FILED 5-31-2011.

THE MARK CONSISTS OF STANDARD CHARACTERS WITHOUT CLAIM TO ANY PARTICULAR FONT, STYLE, SIZE, OR COLOR.

**CLASS 35—ADVERTISING AND BUSINESS**

FOR ADVERTISING AND MARKETING; ADVERTISING AGENCY; INTERNET MARKETING SERVICES, NAMELY, MARKETING CONSULTATION IN THE FIELDS OF SEARCH ENGINE OPTIMIZATION, SEARCH ENGINE MARKETING, AND SOCIAL MEDIA (U.S. CLS. 100, 101 AND 102).

FIRST USE 1-18-2011; IN COMMERCE 1-18-2011.

**CLASS 42—SCIENTIFIC AND COMPUTER SERVICES**

FOR IT CONSULTING SERVICES; WEBSITE DEVELOPMENT AND DESIGN FOR OTHERS; COMPUTER SOFTWARE DEVELOPMENT AND COMPUTER PROGRAMMING DEVELOPMENT FOR OTHERS; GRAPHIC DESIGN SERVICES (U.S. CLS. 100 AND 101).

FIRST USE 1-18-2011; IN COMMERCE 1-18-2011.

ODESSA BIBBINS, EXAMINING ATTORNEY

Expert Advice. Brighter  
Future.

THE MARK CONSISTS OF STANDARD CHARACTERS WITHOUT CLAIM TO ANY PARTICULAR FONT, STYLE, SIZE, OR COLOR.

**CLASS 16—PAPER GOODS AND PRINTED MATTER**

FOR PACKAGED KITS COMPRISING PRINTED INSTRUCTIONAL, EDUCATIONAL, AND TEACHING MATERIALS FOR EDUCATIONAL ACTIVITIES IN THE FIELD OF EARLY CHILDHOOD DEVELOPMENTAL, INTELLIGENCE, AND ABILITY TESTING (U.S. CLS. 2, 5, 22, 23, 29, 37, 38 AND 50).

FIRST USE 3-1-2011; IN COMMERCE 4-1-2011.

**CLASS 41—EDUCATION AND ENTERTAINMENT**

FOR ADMISSION CONSULTING SERVICES, NAMELY, CONSULTING IN THE FIELD OF SCHOOL ADMISSIONS FOR ANY AGE RANGE INCLUDING PRE-KINDERGARTEN, KINDERGARTEN, ELEMENTARY, MIDDLE, SECONDARY, POST-SECONDARY, HIGH SCHOOL, COLLEGE, BOARDING SCHOOL, AND GRADUATE SCHOOL SPECIFICALLY, SCHOOL SELECTION, COMPLETING ADMISSIONS APPLICATIONS, AND PREPARATION FOR ADMISSION INTERVIEWS (U.S. CLS. 100, 101 AND 107).

FIRST USE 3-1-2011; IN COMMERCE 4-1-2011.  
TAMARA FRAZIER, EXAMINING ATTORNEY

SN 85-334,076. GLOW INTERACTIVE, INC., NEW YORK, NY. FILED 5-31-2011.

# Picma

THE MARK CONSISTS OF STANDARD CHARACTERS WITHOUT CLAIM TO ANY PARTICULAR FONT, STYLE, SIZE, OR COLOR.

**CLASS 9—ELECTRICAL AND SCIENTIFIC APPARATUS**

FOR COMPUTER APPLICATION SOFTWARE FOR MOBILE PHONES, NAMELY, SOFTWARE FOR PHOTO SHARING (U.S. CLS. 21, 23, 26, 36 AND 38).

**CLASS 45—PERSONAL AND LEGAL SERVICES**

FOR ON-LINE SOCIAL NETWORKING SERVICES (U.S. CLS. 100 AND 101).

DAVID H. STINE, EXAMINING ATTORNEY

SN 85-334,113. MASTER LOCK COMAPNY LLC, OAK CREEK, WI. FILED 5-31-2011.

# MASTER

THE MARK CONSISTS OF STANDARD CHARACTERS WITHOUT CLAIM TO ANY PARTICULAR FONT, STYLE, SIZE, OR COLOR.

**CLASS 6—METAL GOODS**

FOR METAL SAFES (U.S. CLS. 2, 12, 13, 14, 23, 25 AND 50).

**CLASS 9—ELECTRICAL AND SCIENTIFIC APPARATUS**

FOR ELECTRONIC SAFES; ELECTRONIC STORAGE CONTAINERS (U.S. CLS. 21, 23, 26, 36 AND 38).

**CLASS 20—FURNITURE AND ARTICLES NOT OTHERWISE CLASSIFIED**

FOR NON-METAL CASH BOXES; NON-METAL CABINETS (U.S. CLS. 2, 13, 22, 25, 32 AND 50).

KELLY TRUSILO, EXAMINING ATTORNEY

SN 85-334,308. GOLD, KAREN, HUNTINGTON BEACH, CA. FILED 5-31-2011.

KeepDoggieSafe.com



THE MARK CONSISTS OF THE TEXT "KEEPDOGGIE-SAFE.COM" AND A DOG WITH A LIGHTED LEASH BELOW.

**CLASS 18—LEATHER GOODS**

FOR PET PRODUCTS, NAMELY, PET RESTRAINING DEVICES CONSISTING OF LEASHES, COLLARS, AND HARNESSES ; PET COLLAR ACCESSORIES, NAMELY, BELLS, SILENCERS, SAFETY LIGHTS, AND BLINKERS (U.S. CLS. 1, 2, 3, 22 AND 41).

FIRST USE 4-12-2006; IN COMMERCE 4-12-2006.

**CLASS 35—ADVERTISING AND BUSINESS**

FOR ON-LINE RETAIL STORE SERVICES FEATURING A WIDE VARIETY OF PET PRODUCTS OF OTHERS (U.S. CLS. 100, 101 AND 102).

FIRST USE 4-12-2006; IN COMMERCE 4-12-2006.  
DEZMONA MIZELLE, EXAMINING ATTORNEY

SN 85-334,310. ISKIN INC., TORONTO, ONTARIO, CANADA, FILED 5-31-2011.

# TECHNOISTA

THE MARK CONSISTS OF STANDARD CHARACTERS WITHOUT CLAIM TO ANY PARTICULAR FONT, STYLE, SIZE, OR COLOR.

**CLASS 9—ELECTRICAL AND SCIENTIFIC APPARATUS**

FOR COMPUTER SOFTWARE FOR USE IN ORGANIZING, TRANSMITTING, MANIPULATING AND REVIEWING AUDIO FILES ON PORTABLE AND HANDHELD DIGITAL AND ELECTRONIC DEVICES, MESSENGER BAGS ADAPTED FOR CARRYING LAPTOP COMPUTERS; COVERS SPECIALLY ADAPTED FOR PERSONAL HANDHELD MUSIC PLAYERS; HEADSETS FOR PERSONAL HANDHELD MUSIC PLAYERS, MEDIA PLAYERS, TELEPHONES, VIDEOGAME PLAYERS, RADIOS AND TELEVISION, EARPHONES, WIRELESS STEREO TRANSMITTERS, WIRELESS STEREO RECEIVERS; PORTABLE AUDIO SPEAKERS (U.S. CLS. 21, 23, 26, 36 AND 38).

**CLASS 18—LEATHER GOODS**

FOR BAGS OF TEXTILE, LEATHER OR ARTIFICIAL LEATHER, NAMELY, ALL PURPOSE SORTS BAGS, ALL PURPOSE CARRYING BAGS, ALL PURPOSE ATHLETIC BAGS, BACKPACKS, BELT BAGS, GARMENT BAGS FOR TRAVEL, MESSENGER BAGS, SHOPPING BAGS, TRAVEL BAGS, WALLETS, TOILETRY BAGS SOLD EMPTY, SHAVING BAGS SOLD EMPTY (U.S. CLS. 1, 2, 3, 22 AND 41).

**CLASS 25—CLOTHING**

FOR CLOTHING FOR MEN, WOMEN AND CHILDREN, NAMELY, JACKETS, COATS, TROUSERS, SUITS, VESTS, RAIN JACKETS, PANTS, BATHING SUITS, PULLOVERS, HOODS, JERSEYS, SHIRTS, UNDERWEAR, CAPS, HATS, GLOVES, SOCKS, FOOTWEAR FOR MEN WOMEN AND CHILDREN, NAMELY, ATHLETIC SHOES, BEACH SHOES, SANDALS, SLIPPERS, BOOTS AND SHOES (U.S. CLS. 22 AND 39).

**CLASS 35—ADVERTISING AND BUSINESS**

FOR ONLINE RETAIL STORE SERVICES FEATURING CASES AND COVERS FOR HANDHELD MUSIC PLAYERS, MEDIA PLAYERS, TELEPHONES, VIDEO-GAME PLAYERS, RADIOS AND TELEVISIONS; HEADSETS, EARPHONES, PORTABLE SPEAKERS, ELECTRONIC EQUIPMENT, AUDIO EQUIPMENT, COMPUTER SOFTWARE, BAGS, CLOTHING AND FOOTWEAR (U.S. CLS. 100, 101 AND 102).

DEZMONA MIZELLE, EXAMINING ATTORNEY

SN 85-334,434. BELL HELICOPTER TEXTRON INC., FORTH WORTH, TX. FILED 5-31-2011.

**MXLINK**

THE MARK CONSISTS OF STANDARD CHARACTERS WITHOUT CLAIM TO ANY PARTICULAR FONT, STYLE, SIZE, OR COLOR.

**CLASS 9—ELECTRICAL AND SCIENTIFIC APPARATUS**

FOR COMPUTER SOFTWARE FOR USE ON PORTABLE COMPUTER DEVICES, THAT INCLUDES BIOMETRIC IDENTIFICATION, USED FOR INTERFACING, TRAINING, SIMULATING, IDENTIFYING AND ORDERING PARTS, AND TRACKING MAINTENANCE ACTIONS AND REPAIRS OF FLYING VEHICLES, NAMELY, AIRCRAFT, HELICOPTERS AND RELATED STRUCTURAL PARTS (U.S. CLS. 21, 23, 26, 36 AND 38).

**CLASS 38—COMMUNICATION**

FOR PROVIDING ELECTRONIC TRANSMISSIONS OF MESSAGES, GRAPHICS, AND DATA FOR USERS BY MEANS OF A GLOBAL COMPUTER NETWORK AND WIRELESS DEVICES (U.S. CLS. 100, 101 AND 104).

KYLE PEETE, EXAMINING ATTORNEY

SN 85-334,417. SOCIETE DES PRODUITS NESTLE S.A., 1800 VEVEY, SWITZERLAND, FILED 5-31-2011.

**SIMPLE FAVORITES**

THE MARK CONSISTS OF STANDARD CHARACTERS WITHOUT CLAIM TO ANY PARTICULAR FONT, STYLE, SIZE, OR COLOR.

**CLASS 29—MEATS AND PROCESSED FOODS**

FOR FROZEN PREPARED ENTREES CONSISTING PRIMARILY OF MEAT, FISH, POULTRY, OR VEGETABLES (U.S. CL. 46).

FIRST USE 1-30-2010; IN COMMERCE 1-30-2010.

**CLASS 30—STAPLE FOODS**

FOR FROZEN PREPARED ENTREES CONSISTING PRIMARILY OF PASTA OR RICE (U.S. CL. 46).

FIRST USE 1-30-2010; IN COMMERCE 1-30-2010.  
VIVIAN MICZNIK FIRST, EXAMINING ATTORNEY

SN 85-334,451. YULONG COMPUTER TELECOMMUNICATION SCIENTIFIC (SHENZHEN) CO., LTD., SHENZHEN, CHINA, FILED 5-31-2011.

**Coolpad**

OWNER OF U.S. REG. NO. 3,527,661.  
THE MARK CONSISTS OF "COOLPAD" IN STYLIZED LETTERS.

**CLASS 35—ADVERTISING AND BUSINESS**

FOR ASSISTANCE AND ADVICE REGARDING BUSINESS ORGANIZATION AND MANAGEMENT; COMPILATION AND SYSTEMIZATION OF INFORMATION INTO COMPUTER DATABASES; COMPILATION OF BUSINESS DIRECTORIES; CONFERENCE CALL TRANSCRIPTION SERVICES; MARKET RESEARCH BY MEANS OF A COMPUTER DATABASE; MESSAGE TRANSCRIPTION; ON-LINE ADVERTISING ON COMPUTER NETWORKS; PROMOTION, ADVERTISING AND MARKETING OF ON-LINE WEBSITES; PROVIDING AN ON-LINE SEARCHABLE DATABASE FEATURING BUSINESS INFORMATION AND BUSINESS CONTACTS; PROVIDING AN ON-LINE SEARCHABLE DATABASE FEATURING USED BOOKS BEING OFFERED FOR SALE AND BUYER/SELLER CONTACT INFORMATION; PROVIDING AND RENTAL OF ADVERTISING SPACE ON THE INTERNET (U.S. CLS. 100, 101 AND 102).

**CLASS 38—COMMUNICATION**

FOR BROADCASTING OF VIDEO AND AUDIO PROGRAMMING OVER THE INTERNET; BROADCASTING SERVICES AND PROVISION OF TELECOMMUNICATION ACCESS TO VIDEO AND AUDIO CONTENT PROVIDED VIA A VIDEO-ON-DEMAND SERVICE VIA THE INTERNET; COMMUNICATION SERVICES, NAMELY, TRANSMISSION OF VOICE, AUDIO, VISUAL IMAGES AND DATA BY TELECOMMUNICATIONS NETWORKS, WIRELESS COMMUNICATION NETWORKS, THE INTERNET, INFORMATION SERVICES NETWORKS AND DATA NETWORKS; COMMUNICATION VIA COMPUTER TERMINALS, BY DIGITAL TRANSMISSION OR BY SATELLITE; COMMUNICATION VIA RADIO, TELEGRAPH, TELEPHONE AND TELEVISION TRANSMISSIONS; DELIVERY OF MESSAGES BY ELECTRONIC TRANSMISSION; E-MAIL FORWARDING SERVICES; ELECTRONIC MAIL AND MESSAGING SERVICES; ELECTRONIC MAIL SERVICES FOR DATA AND VOICE; ELECTRONIC MESSAGE TRANSMISSION; ELECTRONIC TRANSMISSION OF DATA AND DOCUMENTS VIA COMPUTER TERMINALS AND ELECTRONIC DEVICES; ELECTRONIC, ELECTRIC, AND DIGITAL TRANSMISSION OF VOICE, DATA, IMAGES, SIGNALS, AND MESSAGES; INFORMATION TRANSMISSION SERVICES VIA DIGITAL NETWORKS; MESSAGE SENDING, RECEIVING AND FORWARDING; MOBILE MEDIA SERVICES IN THE NATURE OF ELECTRONIC TRANSMISSION OF ENTERTAINMENT MEDIA CONTENT; PAY-PER-VIEW TELEVISION TRANSMISSION SERVICES; SATELLITE TRANSMISSION SERVICES; TELEVISION AND RADIO BROADCASTING SERVICES; VIDEO BROADCASTING SERVICES VIA THE INTERNET; VOICE MAIL SERVICES; WIRELESS ELECTRONIC TRANSMISSION OF VOICE SIGNALS, DATA, FACSIMILES, IMAGES AND INFORMATIONS (U.S. CLS. 100, 101 AND 104).

**CLASS 41—EDUCATION AND ENTERTAINMENT**

FOR ELECTRONIC GAMES SERVICES PROVIDED BY MEANS OF THE INTERNET; ENTERTAINMENT SERVICES, NAMELY, PROVIDING AN ON-LINE BOARD GAME; ENTERTAINMENT SERVICES, NAMELY, PROVIDING GAMES OF CHANCE VIA THE INTERNET; ENTERTAINMENT SERVICES, NAMELY, PROVIDING ON-LINE COMPUTER GAMES; ENTERTAINMENT SERVICES, NAMELY, PROVIDING ONLINE COMPUTER GAMES THAT HELP MAINTAIN AN ACTIVE BRAIN AND THUS IMPROVE MEMORY, SPEED OF PROCESSING, AND THAT PROVIDE A VARIETY OF COGNITIVE BENEFITS THAT POSITIVELY IMPACT QUALITY OF LIFE; ENTERTAINMENT SERVICES, NAMELY, PROVIDING TEMPORARY USE OF NON-DOWNLOADABLE ELECTRONIC GAMES; ON-LINE ACADEMIC LIBRARY SERVICES; PROVIDING CURRENT EVENT NEWS AND INFORMATION VIA A GLOBAL COMPUTER NETWORK; PROVISION OF INFORMATION RELATING TO ELECTRONIC COMPUTER GAMES PROVIDED VIA THE INTERNET; PROVISION OF INFORMATION RELATING TO MULTIMEDIA PUBLISHING; PROVISION OF INFORMATION RELATING TO PUBLISHING OF ELECTRONIC PUBLICATIONS (U.S. CLS. 100, 101 AND 107).

**CLASS 42—SCIENTIFIC AND COMPUTER SERVICES**

FOR CLOUD COMPUTING FEATURING SOFTWARE FOR USE IN DATABASE MANAGEMENT; COMPUTER HARDWARE AND SOFTWARE DESIGN; COMPUTER PROGRAMMING AND MAINTENANCE OF COMPUTER PROGRAMS; COMPUTER SERVICES, NAMELY, DATA RECOVERY SERVICES; COMPUTER SERVICES, NAMELY, ENCRYPTED DATA RECOVERY SERVICES; COMPUTER SERVICES, NAMELY, PROVIDING SEARCH ENGINES FOR OBTAINING DATA ON A GLOBAL COMPUTER NETWORK; COMPUTER SERVICES, NAMELY, SEARCH ENGINE OPTIMIZATION; COMPUTER SOFTWARE DESIGN AND UPDATING; COMPUTER SOFTWARE DESIGN, COMPUTER PROGRAMMING, OR MAINTENANCE OF COMPUTER

SOFTWARE; CONVERSION OF DATA OR DOCUMENTS FROM PHYSICAL TO ELECTRONIC MEDIA; COPYING OF COMPUTER SOFTWARE; DATA CONVERSION OF COMPUTER PROGRAMS AND DATA, NOT PHYSICAL CONVERSION; PROVIDING INFORMATION IN THE FIELDS OF TECHNOLOGY AND SOFTWARE DEVELOPMENT VIA AN ON-LINE WEBSITE; PROVIDING INFORMATION RELATING TO ON-LINE NON-DOWNLOADABLE SOFTWARE TO FACILITATE ELECTRONIC COMMUNICATION BETWEEN INDIVIDUALS PROVIDED VIA THE INTERNET; PROVIDING WEATHER INFORMATION (U.S. CLS. 100 AND 101).

BILL DAWE, EXAMINING ATTORNEY

SN 85-334,467. PAINT A PIECE, LLC, MEMPHIS, TN. FILED 5-31-2011.

**PAINT A PIECE**

THE MARK CONSISTS OF STANDARD CHARACTERS WITHOUT CLAIM TO ANY PARTICULAR FONT, STYLE, SIZE, OR COLOR.  
SEC. 2(F).

**CLASS 40—MATERIAL TREATMENT**

FOR POTTERY FIRING; KILN FIRING OF SILVER CLAY AND GLASS (U.S. CLS. 100, 103 AND 106).  
FIRST USE 11-16-1998; IN COMMERCE 11-16-1998.

**CLASS 41—EDUCATION AND ENTERTAINMENT**

FOR ENTERTAINMENT SERVICES, NAMELY, CONDUCTING POTTERY PAINTING PARTIES FOR ADULTS; PROVIDING CHILDREN'S PARTY CENTERS FOR THE PURPOSE OF ENTERTAINING CHILDREN AND CELEBRATING BIRTHDAYS; DAY CAMP SERVICES (U.S. CLS. 100, 101 AND 107).  
FIRST USE 11-16-1998; IN COMMERCE 11-16-1998.  
HANNO RITTNER, EXAMINING ATTORNEY

SN 85-334,479. NAFICY, AZAD, SANTA MONICA, CA. FILED 5-31-2011.

**Azad Right**

THE MARK CONSISTS OF STANDARD CHARACTERS WITHOUT CLAIM TO ANY PARTICULAR FONT, STYLE, SIZE, OR COLOR.



**CLASS 9—ELECTRICAL AND SCIENTIFIC APPARATUS**

FOR AUDIO AND VIDEO RECORDINGS FEATURING MUSIC AND ARTISTIC PERFORMANCES; AUDIO RECORDINGS FEATURING MUSIC.; DIGITAL MEDIA, NAMELY, PRE-RECORDED DVDS, DOWNLOADABLE AUDIO AND VIDEO RECORDINGS, AND CDS FEATURING AND PROMOTING MUSIC; DIGITAL MEDIA, NAMELY, PRE-RECORDED VIDEO CASSETTES, DIGITAL VIDEO DISCS, DIGITAL VERSATILE DISCS, DOWNLOADABLE AUDIO AND VIDEO RECORDINGS, DVDS, AND HIGH DEFINITION DIGITAL DISCS FEATURING MUSIC; DOWNLOADABLE MP3 FILES AND MP3 RECORDINGS FEATURING MUSIC; DOWNLOADABLE MUSICAL SOUND RECORDINGS; DOWNLOADABLE VIDEO RECORDINGS FEATURING MUSIC; ELECTRONIC PUBLICATIONS, NAMELY, E-ZINES FEATURING MUSIC RECORDED ON COMPUTER MEDIA; MULTIMEDIA SOFTWARE RECORDED ON CD-ROM FEATURING MUSIC; MUSICAL RECORDINGS; MUSICAL SOUND RECORDINGS; MUSICAL VIDEO RECORDINGS; PHONOGRAPH RECORDS FEATURING MUSIC; PRE-RECORDED CDS FEATURING MUSIC; PRE-RECORDED CDS, VIDEO TAPES, LASER DISKS AND DVDS FEATURING MUSIC; PRE-RECORDED DIGITAL MEDIA FEATURING MUSIC; PRE-RECORDED DIGITAL VIDEO DISCS FEATURING MUSIC; PRE-RECORDED DVDS FEATURING MUSIC; PRE-RECORDED ELECTRONIC AND DIGITAL MEDIA FEATURING MUSIC; PRE-RECORDED ELECTRONIC MEDIA FEATURING MUSIC; PRE-RECORDED FLASH DRIVES FEATURING MUSIC; PRE-RECORDED VIDEO DISCS, VIDEO RECORDING AND VIDEO TAPES FEATURING MUSIC; SERIES OF MUSICAL SOUND RECORDINGS; SOUND RECORDINGS FEATURING MUSIC; VIDEO RECORDINGS FEATURING MUSIC; VISUAL AND AUDIO RECORDINGS FEATURING MUSIC (U.S. CLS. 21, 23, 26, 36 AND 38).

**CLASS 41—EDUCATION AND ENTERTAINMENT**

FOR ARRANGING AND CONDUCTING NIGHTCLUB ENTERTAINMENT EVENTS; ARRANGING AND CONDUCTING SPECIAL EVENTS FOR SOCIAL ENTERTAINMENT PURPOSES; ARRANGING FOR TICKET RESERVATIONS FOR SHOWS AND OTHER ENTERTAINMENT EVENTS; ARRANGING, ORGANIZING, CONDUCTING, AND HOSTING SOCIAL ENTERTAINMENT EVENTS; BOOKING OF ENTERTAINMENT HALLS; CONDUCTING ENTERTAINMENT EXHIBITIONS IN THE NATURE OF MUSIC; ENTERTAINMENT IN THE NATURE OF LIVE PERFORMANCES BY A MUSICIAN; ENTERTAINMENT IN THE NATURE OF VISUAL AND AUDIO PERFORMANCES BY A MUSICIAN; ENTERTAINMENT IN THE NATURE OF VISUAL AND AUDIO PERFORMANCES, AND MUSICAL, VARIETY, NEWS AND COMEDY SHOWS; ENTERTAINMENT IN THE NATURE OF VISUAL AND AUDIO PERFORMANCES, NAMELY, MUSICAL BAND, ROCK GROUP, GYMNASTIC, DANCE, AND BALLET PERFORMANCES; ENTERTAINMENT IN THE NATURE OF MUSIC; ENTERTAINMENT SERVICES BY A MUSICAL ARTIST AND PRODUCER, NAMELY, MUSICAL COMPOSITION FOR OTHERS AND PRODUCTION OF MUSICAL SOUND RECORDINGS; ENTERTAINMENT SERVICES IN THE NATURE OF LIVE MUSICAL PERFORMANCES; ENTERTAINMENT SERVICES IN THE NATURE OF PRESENTING LIVE MUSICAL PERFORMANCES; ENTERTAINMENT SERVICES IN THE NATURE OF RECORDING, PRODUCTION AND POST-PRODUCTION SERVICES IN THE FIELD OF MUSIC; ENTERTAINMENT SERVICES, NAMELY, NON-DOWNLOADABLE RINGTONES, PRE-RECORDED MUSIC, AND GRAPHICS PRESENTED TO MOBILE COMMUNICATIONS DEVICES VIA A GLOBAL COMPUTER NETWORK AND WIRELESS NETWORKS; ENTERTAINMENT SERVICES, NAMELY, PERSONAL APPEARANCES BY A MUSICIAN; ENTERTAINMENT SERVICES, NAMELY, PROVIDING A WEB SITE FEATURING NON-DOWNLOADABLE MUSICAL PERFORMANCES, MUSICAL VIDEOS, RELATED FILM CLIPS, PHOTOGRAPHS, AND OTHER MULTIMEDIA MATERIALS FEATURING A MUSICIAN; ENTERTAINMENT SERVICES, NAMELY, PROVIDING A WEB SITE FEATURING PHOTOGRAPHIC AND PROSE PRESENTATIONS FEATURING A MUSICIAN; ENTERTAINMENT SERVICES, NAMELY,

PROVIDING A WEB SITE FEATURING PHOTOGRAPHIC, AUDIO, VIDEO AND PROSE PRESENTATIONS FEATURING A MUSICIAN; ENTERTAINMENT SERVICES, NAMELY, PROVIDING A WEB SITE FEATURING PHOTOGRAPHIC, VIDEO AND PROSE PRESENTATIONS FEATURING A MUSICIAN; ENTERTAINMENT SERVICES, NAMELY, PROVIDING INFORMATION ABOUT A RECORDING ARTIST VIA AN ONLINE NETWORK; ENTERTAINMENT SERVICES, NAMELY, PROVIDING NON-DOWNLOADABLE PLAYBACK OF MUSIC VIA GLOBAL COMMUNICATIONS NETWORKS; ENTERTAINMENT SERVICES, NAMELY, PROVIDING NONDOWNLOADABLE PRERECORDED MUSIC, INFORMATION IN THE FIELD OF MUSIC, AND COMMENTARY AND ARTICLES ABOUT MUSIC, ALL ON-LINE VIA A GLOBAL COMPUTER NETWORK; ENTERTAINMENT SERVICES, NAMELY, PROVIDING WEBCASTS IN THE FIELD OF MUSIC; ENTERTAINMENT, NAMELY, LIVE MUSIC CONCERTS; ENTERTAINMENT, NAMELY, LIVE PERFORMANCES BY A MUSICAL BAND; MULTIMEDIA ENTERTAINMENT SERVICES IN THE NATURE OF RECORDING, PRODUCTION AND POST-PRODUCTION SERVICES IN THE FIELDS OF MUSIC, VIDEO, AND FILMS (U.S. CLS. 100, 101 AND 107).

HANNO RITTNER, EXAMINING ATTORNEY

SN 85-334,594. ART.SY, INC., NEW YORK, NY. FILED 5-31-2011.

# ART.SY

THE MARK CONSISTS OF STANDARD CHARACTERS WITHOUT CLAIM TO ANY PARTICULAR FONT, STYLE, SIZE, OR COLOR.

**CLASS 35—ADVERTISING AND BUSINESS**

FOR ART GALLERY SERVICES; ON-LINE ART GALLERIES; PROVIDING AN ON-LINE SEARCHABLE DATABASE FEATURING ARTISTIC WORKS AND BUSINESS CONTACTS AT MUSEUMS AND GALLERIES; MAINTAINING A REGISTRY OF WORKS OF ART; INVENTORY MANAGEMENT FOR OTHERS IN THE FIELD OF ART; PROVIDING AN ON-LINE MARKETPLACE FEATURING ARTWORK; PROVIDING AN ON-LINE SEARCHABLE DATABASE FEATURING ARTISTIC WORKS AND BUSINESS CONTACTS AT MUSEUMS AND GALLERIES (U.S. CLS. 100, 101 AND 102).  
FIRST USE 7-9-2010; IN COMMERCE 7-9-2010.

**CLASS 41—EDUCATION AND ENTERTAINMENT**

FOR PROVIDING A WEBSITE IN THE FIELD OF ART; PROVIDING AN ON-LINE SEARCHABLE DATABASE FEATURING INFORMATION ABOUT ART, ARTISTS, ARTISTIC WORKS, ARTISTIC STYLES, AND RELATIONSHIPS BETWEEN ARTISTS, ARTISTIC WORKS, AND ARTISTIC STYLES VIA GLOBAL COMMUNICATIONS NETWORKS; ENTERTAINMENT SERVICES, NAMELY, PROVIDING A WEBSITE FEATURING IMAGES OF ARTISTIC WORKS, INFORMATION IN THE FIELD OF ART, AND INFORMATION CONCERNING RELATIONSHIPS BETWEEN ARTISTS, ARTISTIC WORKS AND ARTISTIC STYLES, ALL ON-LINE VIA A GLOBAL COMPUTER NETWORK; PROVIDING AN INTERNET WEBSITE PORTAL IN THE FIELD OF ART; PROVIDING A WEBSITE FEATURING INFORMATION ABOUT ARTISTIC STYLES (U.S. CLS. 100, 101 AND 107).  
FIRST USE 7-9-2010; IN COMMERCE 7-9-2010.

LEIGH CAROLINE CASE, EXAMINING ATTORNEY

SN 85-334,596. ASHKAN GHANDEHARI, DBA TRIBLISS, IRVINE, CA. FILED 5-31-2011.

tribliss

THE MARK CONSISTS OF STANDARD CHARACTERS WITHOUT CLAIM TO ANY PARTICULAR FONT, STYLE, SIZE, OR COLOR.

**CLASS 5—PHARMACEUTICALS**

FOR DIETARY AND NUTRITIONAL SUPPLEMENTS FOR ENDURANCE SPORTS (U.S. CLS. 6, 18, 44, 46, 51 AND 52).

**CLASS 25—CLOTHING**

FOR ATHLETIC APPAREL, NAMELY, SHIRTS, PANTS, JACKETS, FOOTWEAR, HATS AND CAPS, ATHLETIC UNIFORMS; SCIENTIFIC AND TECHNOLOGICAL APPAREL, NAMELY, SHIRTS, PANTS, JACKETS, FOOTWEAR, HATS AND CAPS, UNIFORMS (U.S. CLS. 22 AND 39).

**CLASS 41—EDUCATION AND ENTERTAINMENT**

FOR MEMBERSHIP CLUB SERVICES, NAMELY, PROVIDING TRAINING TO MEMBERS IN THE FIELD OF PHYSICAL, MENTAL, AND EMOTIONAL FITNESS INCLUDING YOGA, MEDITATION, AND CONCENTRATION; PHYSICAL FITNESS TRAINING OF INDIVIDUALS AND GROUPS (U.S. CLS. 100, 101 AND 107).

ANNE E. GUSTASON, EXAMINING ATTORNEY

SN 85-334,678. MARLEY WILLIAMS, SANTA BARBARA, CA. FILED 6-1-2011.

HILL KID

THE MARK CONSISTS OF STANDARD CHARACTERS WITHOUT CLAIM TO ANY PARTICULAR FONT, STYLE, SIZE, OR COLOR.

**CLASS 9—ELECTRICAL AND SCIENTIFIC APPARATUS**

FOR AUDIO RECORDINGS FEATURING MUSIC; DIGITAL MUSIC DOWNLOADABLE FROM THE INTERNET; DOWNLOADABLE MUSICAL SOUND RECORDINGS; MUSICAL SOUND RECORDINGS; PRE-RECORDED CDS FEATURING MUSIC; PRE-RECORDED DIGITAL MEDIA FEATURING MUSIC (U.S. CLS. 21, 23, 26, 36 AND 38).

FIRST USE 9-7-2001; IN COMMERCE 6-15-2007.

**CLASS 25—CLOTHING**

FOR T-SHIRTS (U.S. CLS. 22 AND 39).  
FIRST USE 9-7-2001; IN COMMERCE 1-0-2008.

**CLASS 41—EDUCATION AND ENTERTAINMENT**

FOR ENTERTAINMENT SERVICES IN THE NATURE OF LIVE MUSICAL PERFORMANCES; ENTERTAINMENT SERVICES IN THE NATURE OF PRESENTING LIVE MUSICAL PERFORMANCES; ENTERTAINMENT, NAMELY, LIVE MUSIC CONCERTS; ENTERTAINMENT, NAMELY, LIVE PERFORMANCES BY A MUSICAL BAND (U.S. CLS. 100, 101 AND 107).

FIRST USE 9-7-2001; IN COMMERCE 1-0-2007.

MARGARET POWER, EXAMINING ATTORNEY

SN 85-334,719. WORLD FINER FOODS, INC., BLOOMFIELD, NJ. FILED 6-1-2011.

Fattoma

THE MARK CONSISTS OF STANDARD CHARACTERS WITHOUT CLAIM TO ANY PARTICULAR FONT, STYLE, SIZE, OR COLOR.

**CLASS 29—MEATS AND PROCESSED FOODS**

FOR OLIVE OILS; PROCESSED VEGETABLES; VEGETABLE-BASED SPREADS (U.S. CL. 46).

**CLASS 30—STAPLE FOODS**

FOR COUSCOUS (U.S. CL. 46).  
GRETTA YAO, EXAMINING ATTORNEY

SN 85-334,721. GUILLORY FAMILY, LLC, SANTA ROSA BEACH, FL. FILED 6-1-2011.

LIFE IS 30A

THE MARK CONSISTS OF STANDARD CHARACTERS WITHOUT CLAIM TO ANY PARTICULAR FONT, STYLE, SIZE, OR COLOR.

**CLASS 25—CLOTHING**

FOR HATS; JACKETS; PANTS; SHIRTS; SHORTS; SWEATSHIRTS; UNDERWEAR (U.S. CLS. 22 AND 39).

**CLASS 35—ADVERTISING AND BUSINESS**

FOR ON-LINE RETAIL STORE SERVICES FEATURING CLOTHING; RETAIL CLOTHING STORES (U.S. CLS. 100, 101 AND 102).

GRETTA YAO, EXAMINING ATTORNEY

SN 85-334,722. DIEHL, ELIZABETH LAYNE, MARTINSBURG, WV. FILED 6-1-2011.

NORA BUCHANAN WILL, EXAMINING ATTORNEY

## Pointing Business Forward

THE MARK CONSISTS OF STANDARD CHARACTERS WITHOUT CLAIM TO ANY PARTICULAR FONT, STYLE, SIZE, OR COLOR.

### CLASS 35—ADVERTISING AND BUSINESS

FOR BRANDING SERVICES, NAMELY, CONSULTING, DEVELOPMENT, MANAGEMENT AND MARKETING OF BRANDS FOR BUSINESSES; BUSINESS CONSULTATION SERVICES; BUSINESS CONSULTING SERVICES, NAMELY, PROVIDING ASSISTANCE IN DEVELOPMENT OF BUSINESS STRATEGIES AND CREATIVE IDEATION; BUSINESS DEVELOPMENT CONSULTING SERVICES; BUSINESS DEVELOPMENT SERVICES; BUSINESS DEVELOPMENT SERVICES, NAMELY, PROVIDING START-UP SUPPORT FOR BUSINESSES OF OTHERS; BUSINESS MANAGEMENT CONSULTANCY SERVICES; BUSINESS MANAGEMENT CONSULTING AND ADVISORY SERVICES; BUSINESS MANAGEMENT INFORMATION ON A WIDE VARIETY OF TOPICS TO SERVICE PROVIDING PROFESSIONALS; BUSINESS MARKETING SERVICES; BUSINESS ORGANISATION AND MANAGEMENT CONSULTING SERVICES; BUSINESS RISK ASSESSMENT SERVICES; BUSINESS STRATEGIC PLANNING SERVICES; BUSINESS STRATEGY DEVELOPMENT SERVICES; BUSINESS SUPPORT SERVICES, NAMELY, BUSINESS CONSULTING TO FREELANCERS, START-UPS, EXISTING BUSINESSES AND NON-PROFIT ORGANIZATIONS (U.S. CLS. 100, 101 AND 102).

FIRST USE 7-1-2011; IN COMMERCE 7-1-2011.

### CLASS 45—PERSONAL AND LEGAL SERVICES

FOR LEGAL CONSULTATION SERVICES; LEGAL RESEARCH; LEGAL SERVICES (U.S. CLS. 100 AND 101).  
FIRST USE 7-1-2011; IN COMMERCE 7-1-2011.  
GRETTA YAO, EXAMINING ATTORNEY

SN 85-334,850. SMITH, MELISSA M., KATY, TX. FILED 6-1-2011.

## Thai & Fly

THE MARK CONSISTS OF STANDARD CHARACTERS WITHOUT CLAIM TO ANY PARTICULAR FONT, STYLE, SIZE, OR COLOR.

### CLASS 41—EDUCATION AND ENTERTAINMENT

FOR YOGA INSTRUCTION (U.S. CLS. 100, 101 AND 107).  
FIRST USE 1-30-2010; IN COMMERCE 10-27-2010.

### CLASS 44—MEDICAL, BEAUTY AND AGRICULTURAL SERVICES

FOR MESSAGES (U.S. CLS. 100 AND 101).  
FIRST USE 1-30-2010; IN COMMERCE 10-27-2010.

SN 85-335,102. SHAREAHOLIC, INC., CAMBRIDGE, MA. FILED 6-1-2011.

## Shareaholic

THE MARK CONSISTS OF STANDARD CHARACTERS WITHOUT CLAIM TO ANY PARTICULAR FONT, STYLE, SIZE, OR COLOR.

### CLASS 9—ELECTRICAL AND SCIENTIFIC APPARATUS

FOR SOFTWARE USED FOR SHARING INFORMATION; NAMELY SOFTWARE FOR SHARING LINKS VIA SOCIAL NETWORKS, EMAIL, BLOGS, AND INSTANT MESSAGING (U.S. CLS. 21, 23, 26, 36 AND 38).

FIRST USE 8-5-2007; IN COMMERCE 8-5-2007.

### CLASS 35—ADVERTISING AND BUSINESS

FOR BUSINESS INFORMATION MANAGEMENT; NAMELY, ELECTRONIC REPORTING OF BUSINESS ANALYTICS (U.S. CLS. 100, 101 AND 102).

FIRST USE 8-5-2007; IN COMMERCE 8-5-2007.

KEVON CHISOLM, EXAMINING ATTORNEY

SN 85-335,108. AXCER, LAS VEGAS, NV. FILED 6-1-2011.

## BOOKENDS

THE MARK CONSISTS OF STANDARD CHARACTERS WITHOUT CLAIM TO ANY PARTICULAR FONT, STYLE, SIZE, OR COLOR.

### CLASS 35—ADVERTISING AND BUSINESS

FOR BRAND EVALUATION SERVICES; BRAND IMAGERY CONSULTING SERVICES; BRAND POSITIONING SERVICES; MARKETING CONSULTING (U.S. CLS. 100, 101 AND 102).

FIRST USE 8-18-2009; IN COMMERCE 8-18-2009.

### CLASS 41—EDUCATION AND ENTERTAINMENT

FOR CONDUCTING WORKSHOPS AND SEMINARS IN MARKETING, BRAND EVALUATION, BRAND IMAGERY, AND BRAND POSITIONING (U.S. CLS. 100, 101 AND 107).

FIRST USE 8-18-2009; IN COMMERCE 8-18-2009.

KEVON CHISOLM, EXAMINING ATTORNEY

SN 85-335,139. PINK STONE CAPITAL GROUP, NEW YORK, NY. FILED 6-1-2011.

## PINK STONE

THE MARK CONSISTS OF STANDARD CHARACTERS WITHOUT CLAIM TO ANY PARTICULAR FONT, STYLE, SIZE, OR COLOR.

### CLASS 36—INSURANCE AND FINANCIAL

FOR REAL ESTATE ACQUISITION SERVICES; REAL ESTATE BROKERAGE; REAL ESTATE FINANCING SERVICES; REAL ESTATE INVESTMENT SERVICES; REAL ESTATE MANAGEMENT SERVICES (U.S. CLS. 100, 101 AND 102).

### CLASS 37—CONSTRUCTION AND REPAIR

FOR REAL ESTATE DEVELOPMENT (U.S. CLS. 100, 103 AND 106).  
IRA J. GOODSAD, EXAMINING ATTORNEY

SN 85-335,172. MARY REES, HOUSTON, TX. FILED 6-1-2011.

## TRANSFORMING CONSCIOUSNESS

THE MARK CONSISTS OF STANDARD CHARACTERS WITHOUT CLAIM TO ANY PARTICULAR FONT, STYLE, SIZE, OR COLOR.

### CLASS 9—ELECTRICAL AND SCIENTIFIC APPARATUS

FOR DIGITAL MATERIALS, NAMELY, CDS, DVDS, AND DOWNLOADABLE AUDIO FILES FEATURING KNOWLEDGE AND EXPERIENTIAL PRACTICES FOR ESTABLISHING INSIGHT AND MINDFULNESS WITHIN ALL RELATIONSHIPS, PERSONAL AND PROFESSIONAL, INTRAPERSONAL, INTERPERSONAL AND TRANSPERSONAL (U.S. CLS. 21, 23, 26, 36 AND 38).  
FIRST USE 11-15-2007; IN COMMERCE 11-15-2007.

### CLASS 16—PAPER GOODS AND PRINTED MATTER

FOR A SERIES OF BOOKS, WRITTEN ARTICLES, HANDOUTS AND WORKSHEETS IN THE FIELD OF KNOWLEDGE AND EXPERIENTIAL PRACTICES FOR ESTABLISHING INSIGHT AND MINDFULNESS WITHIN ALL RELATIONSHIPS, PERSONAL AND PROFESSIONAL, INTRAPERSONAL, INTERPERSONAL AND TRANSPERSONAL (U.S. CLS. 2, 5, 22, 23, 29, 37, 38 AND 50).  
FIRST USE 2-24-2006; IN COMMERCE 4-18-2006.

### CLASS 41—EDUCATION AND ENTERTAINMENT

FOR EDUCATION SERVICES, NAMELY, PROVIDING LIVE AND ON-LINE CLASSES, SEMINARS, AND WORKSHOPS FOR GROUPS, ORGANIZATIONS, OR INDIVIDUALS IN THE FIELD OF KNOWLEDGE AND EXPERIENTIAL PRACTICES FOR ESTABLISHING INSIGHT AND MINDFULNESS WITHIN ALL RELATIONSHIPS, PERSONAL AND PROFESSIONAL, INTRAPERSONAL, INTERPERSONAL AND TRANSPERSONAL; PROVIDING ON-LINE PUBLICATIONS IN THE NATURE OF AN E-BOOK IN THE FIELD OF KNOWLEDGE AND EXPERIENTIAL PRACTICES FOR ESTABLISHING INSIGHT AND MINDFULNESS WITHIN ALL RELATIONSHIPS, PERSONAL AND PROFESSIONAL, INTRAPERSONAL, INTERPERSONAL AND TRANSPERSONAL (U.S. CLS. 100, 101 AND 107).

FIRST USE 4-16-2004; IN COMMERCE 4-16-2004.  
JUSTINE D. PARKER, EXAMINING ATTORNEY

SN 85-335,195. GOOD HEALTH COOKING TECHNOLOGIES, LLC, COLUMBUS, OH. FILED 6-1-2011.

## GOOD HEALTH

THE MARK CONSISTS OF STANDARD CHARACTERS WITHOUT CLAIM TO ANY PARTICULAR FONT, STYLE, SIZE, OR COLOR.

### CLASS 7—MACHINERY

FOR ELECTRIC FOOD PROCESSORS AND ELECTRIC FOOD BLENDERS (U.S. CLS. 13, 19, 21, 23, 31, 34 AND 35).

### CLASS 11—ENVIRONMENTAL CONTROL APPARATUS

FOR ELECTRIC COFFEE POTS; ELECTRIC CASSEROLES; ELECTRIC GRILLS; ELECTRIC DEEP FRYERS; ELECTRIC DEEP FRYERS FOR MANUFACTURE OF POTATO CHIPS; COOKING OVENS; COOKING RANGES; ELECTRIC COOKING POTS FOR COMMERCIAL USE; ELECTRIC COOKING POTS; MULTI-PURPOSE, ELECTRIC COUNTERTOP FOOD PREPARATION APPARATUS FOR COOKING, BAKING, BROILING, ROASTING, TOASTING, SEARING, BROWNING, BARBECUING AND/OR GRILLING FOOD; TEMPERATURE CONTROLLED, REFRIGERATED OR HEATED MOBILE OR STORAGE UNITS FOR THE STORAGE AND DELIVERY OF FOOD PRODUCTS; REFRIGERATED MOBILE AND STORAGE UNITS FOR THE STORAGE AND DELIVERY OF FLOWERS; PET FOOD MANUFACTURING AND COOKING EQUIPMENT (U.S. CLS. 13, 21, 23, 31 AND 34).

### CLASS 21—HOUSEWARES AND GLASS

FOR COOKWARE, NAMELY POTS, PANS, STEAMERS AND ROASTING OVENS (U.S. CLS. 2, 13, 23, 29, 30, 33, 40 AND 50).  
HEATHER SAPP, EXAMINING ATTORNEY

SN 85-335,241. FONTIUS, DANIEL, SAN DIEGO, CA. FILED 6-1-2011.

SN 85-335,292. GE MEDICAL SYSTEMS INFORMATION TECHNOLOGIES, INC., MILWAUKEE, WI. FILED 6-1-2011.

# DECO

THE MARK CONSISTS OF STANDARD CHARACTERS WITHOUT CLAIM TO ANY PARTICULAR FONT, STYLE, SIZE, OR COLOR.

## CLASS 25—CLOTHING

FOR SHIRTS; TOPS (U.S. CLS. 22 AND 39).

## CLASS 28—TOYS AND SPORTING GOODS

FOR BODY SURF HAND PLANES; STAND-UP PADDLE BOARD CARRYING STRAPS (U.S. CLS. 22, 23, 38 AND 50).

JESSICA A. POWERS, EXAMINING ATTORNEY

SN 85-335,259. CAMARA, ANNA, NEW YORK, NY. FILED 6-1-2011.

# SAMMY AND THE CITY

THE MARK CONSISTS OF STANDARD CHARACTERS WITHOUT CLAIM TO ANY PARTICULAR FONT, STYLE, SIZE, OR COLOR.

## CLASS 16—PAPER GOODS AND PRINTED MATTER

FOR CHILDREN'S BOOKS (U.S. CLS. 2, 5, 22, 23, 29, 37, 38 AND 50).

## CLASS 25—CLOTHING

FOR T-SHIRTS FOR CHILDREN AND ADULTS (U.S. CLS. 22 AND 39).

## CLASS 41—EDUCATION AND ENTERTAINMENT

FOR ON-LINE JOURNALS, NAMELY, BLOGS FEATURING INFORMATION RELATING TO TOURISM (U.S. CLS. 100, 101 AND 107).

FIRST USE 4-2-2011; IN COMMERCE 4-2-2011.  
STEVEN PEREZ, EXAMINING ATTORNEY

# PICOMAC

THE MARK CONSISTS OF STANDARD CHARACTERS WITHOUT CLAIM TO ANY PARTICULAR FONT, STYLE, SIZE, OR COLOR.

## CLASS 9—ELECTRICAL AND SCIENTIFIC APPARATUS

FOR COMPUTER HARDWARE AND SOFTWARE, FOR USE WITH MEDICAL PATIENT MONITORING EQUIPMENT, FOR RECEIVING, PROCESSING, TRANSMITTING AND DISPLAYING DATA (U.S. CLS. 21, 23, 26, 36 AND 38).

## CLASS 10—MEDICAL APPARATUS

FOR ELECTROCARDIOGRAPHS (U.S. CLS. 26, 39 AND 44).

PATRICIA EVANKO, EXAMINING ATTORNEY

SN 85-335,308. DILLARD'S INC., LITTLE ROCK, AR. FILED 6-1-2011.

# Summer Oasis

THE MARK CONSISTS OF STANDARD CHARACTERS WITHOUT CLAIM TO ANY PARTICULAR FONT, STYLE, SIZE, OR COLOR.

## CLASS 4—LUBRICANTS AND FUELS

FOR PATIO TORCHES (U.S. CLS. 1, 6 AND 15).  
FIRST USE 3-1-2011; IN COMMERCE 3-1-2011.

## CLASS 11—ENVIRONMENTAL CONTROL APPARATUS

FOR LIGHTED PARTY-THEMED DECORATIONS, ELECTRIC LIGHT DECORATIVE STRINGS (U.S. CLS. 13, 21, 23, 31 AND 34).

FIRST USE 3-1-2011; IN COMMERCE 3-1-2011.

## CLASS 24—FABRICS

FOR BEACH TOWELS (U.S. CLS. 42 AND 50).  
FIRST USE 3-1-2011; IN COMMERCE 3-1-2011.  
EUGENIA MARTIN, EXAMINING ATTORNEY

SN 85-335,341. WEREADIA, INC., PACIFIC PALISADES, CA.  
FILED 6-1-2011.

# SUBTEXT

THE MARK CONSISTS OF STANDARD CHARACTERS WITHOUT CLAIM TO ANY PARTICULAR FONT, STYLE, SIZE, OR COLOR.

## CLASS 9—ELECTRICAL AND SCIENTIFIC APPARATUS

FOR COMPUTER SOFTWARE AND DOWNLOADABLE MOBILE APPLICATIONS THAT ALLOW USERS TO PARTICIPATE IN DISCUSSIONS, GET FEEDBACK FROM THEIR PEERS, CREATE PERSONAL PROFILES, ADD BLOG POSTS, FORM VIRTUAL COMMUNITIES, AND ENGAGE IN SOCIAL NETWORKING; COMPUTER SOFTWARE AND DOWNLOADABLE MOBILE APPLICATIONS FOR RECEIPT, DOWNLOAD AND DISPLAY OF ELECTRONIC PUBLICATIONS IN THE NATURE OF BOOKS, NEWSPAPERS, MAGAZINES, JOURNALS, PERIODICALS, ESSAYS AND OTHER FORMS OF LITERATURE, WHICH ALLOWS USERS, AUTHORS, EXPERTS AND PUBLISHERS TO POST COMMENTS, QUESTIONS, POLLS, QUIZZES AND LINKS TO WEB CONTENT REFERRING TO SPECIFIC PORTIONS OF TEXT, TO VIEW COMMENTS AND QUESTIONS CONTRIBUTED BY OTHER USERS, AND TO ENGAGE IN CONVERSATIONS WITH EACH OTHER ABOUT THE PUBLICATIONS; COMPUTER SOFTWARE FOR TRANSMITTING, SHARING, RECEIVING, DOWNLOADING, DISPLAYING AND TRANSFERRING CONTENT, TEXT, VISUAL WORKS, AUDIO WORKS, AUDIOVISUAL WORKS, LITERARY WORKS, DATA, FILES, DOCUMENTS AND ELECTRONIC WORKS VIA PORTABLE ELECTRONIC DEVICES AND COMPUTERS; DOWNLOADABLE SOFTWARE IN THE NATURE OF A MOBILE APPLICATION THAT ALLOWS USERS TO RETRIEVE AND SHARE RATINGS, REVIEWS, RECOMMENDATIONS, PHOTOGRAPHS, VIDEOS, READ-ALONGS, LIVE QUESTION-AND-ANSWER SESSIONS WITH AUTHORS, LINKS TO WEB ARTICLES, AND INFORMATION, ALL IN THE FIELD OF BOOKS, LITERATURE, NEWSPAPERS, MAGAZINES, JOURNALS, PERIODICALS, ESSAYS, MOVIES, TELEVISION SHOWS, AUTHORS AND BOOK SIGNINGS; APPLICATION PROGRAMMING INTERFACE (API) SOFTWARE FOR SOCIAL NETWORKING, ACCESSING ADDITIVE CONTENT, GAMES, AND OTHER FEATURES; ELECTRONIC BOOK READERS (U.S. CLS. 21, 23, 26, 36 AND 38).

## CLASS 41—EDUCATION AND ENTERTAINMENT

FOR PROVIDING INFORMATION VIA AN ONLINE WEBSITE ABOUT ELECTRONIC PUBLICATIONS, INCLUDING BOOKS, NEWSPAPERS, MAGAZINES, JOURNALS, PERIODICALS, ESSAYS, MOVIES, TELEVISION SHOWS, AND ABOUT AUTHORS AND BOOK SIGNINGS; ENTERTAINMENT SERVICES, NAMELY, PROVIDING A WEB SITE WHERE USERS CAN POST AND OBTAIN INFORMATION, RATINGS, REVIEWS, RECOMMENDATIONS, PHOTOGRAPHS, VIDEOS AND LINKS TO WEB ARTICLES ABOUT LITERATURE, BOOKS, NEWSPAPERS, MAGAZINES, JOURNALS, PERIODICALS, ESSAYS, MOVIES, TELEVISION SHOWS, AUTHORS AND BOOK SIGNINGS; ORGANIZING LITERARY EVENTS IN THE NATURE OF AUTHOR READ-ALONGS, VIRTUAL BOOK SIGNINGS, LIVE QUESTION-AND-ANSWER SESSIONS WITH AUTHORS, AND READING COMPETITIONS; ENTERTAINMENT AND EDUCATIONAL SERVICES, NAMELY, PROVIDING AN INTERNET WEBSITE FEATURING ON-LINE REVIEWS

RELATING TO BOOKS, MUSIC, MOVIES, PERIODICALS AND PUBLICATIONS, AND ENTERTAINMENT AND EDUCATIONAL INFORMATION RELATING TO BOOKS, MUSIC, MOVIES, REVIEWS, PERIODICALS AND PUBLICATIONS; PROVIDING INFORMATION IN THE FIELD OF ELECTRONIC PUBLISHING IN ALL FORMS, VIA A GLOBAL COMPUTER INFORMATION NETWORK; PROVIDING ONLINE VIDEOS IN THE FIELD OF LITERATURE, BOOKS, NEWSPAPERS, MAGAZINES, JOURNALS, PERIODICALS, ESSAYS, MOVIES AND TELEVISION SHOWS (U.S. CLS. 100, 101 AND 107).

## CLASS 42—SCIENTIFIC AND COMPUTER SERVICES

FOR PROVIDING AN INTERACTIVE WEBSITE FOR READERS, AUTHORS, EXPERTS, AND PUBLISHERS FEATURING TECHNOLOGY THAT ALLOWS USERS TO RECEIVE, DOWNLOAD AND DISPLAY ELECTRONIC PUBLICATIONS IN THE NATURE OF BOOKS, NEWSPAPERS, MAGAZINES, JOURNALS, PERIODICALS, ESSAYS AND OTHER FORMS OF LITERATURE, TO POST COMMENTS AND QUESTIONS REFERRING TO SPECIFIC PORTIONS OF TEXT, TO VIEW COMMENTS AND QUESTIONS CONTRIBUTED BY OTHER USERS, AND TO ENGAGE IN CONVERSATIONS WITH EACH OTHER ABOUT THE PUBLICATIONS AND ABOUT MOVIES, TELEVISION SHOWS, AUTHORS AND BOOK SIGNINGS AND OTHER RELEVANT CONTENT; COMPUTER SERVICES, NAMELY, CREATING AN ON-LINE COMMUNITY FOR REGISTERED USERS TO PARTICIPATE IN DISCUSSIONS, GET FEEDBACK FROM THEIR PEERS, FORM VIRTUAL COMMUNITIES, AND ENGAGE IN SOCIAL NETWORKING; PROVIDING A WEBSITE FEATURING TECHNOLOGY THAT ENABLES USERS TO LINK TO, UPLOAD AND SHARE COMMENTS, PHOTOGRAPHS AND VIDEOS ABOUT LITERATURE, ELECTRONIC PUBLICATIONS AND AUTHORS; COMPUTER SERVICES IN THE NATURE OF CUSTOMIZED WEB PAGES AND DATA FEEDS FEATURING USER-DEFINED INFORMATION, WHICH INCLUDES PERSONAL PROFILES, BLOG POSTS, NEW MEDIA CONTENT, OTHER ON-LINE CONTENT, AND ON-LINE WEB LINKS TO OTHER WEBSITES; PROVIDING A WEBSITE FEATURING A SEARCH ENGINE FOR OBTAINING DATA; PROVIDING A WEBSITE THAT ALLOWS USERS TO UPLOAD AND SHARE USER-GENERATED WRITINGS, STORIES, PHOTOGRAPHS AND VIDEOS ON A WIDE VARIETY OF TOPICS AND SUBJECTS; APPLICATION SERVICE PROVIDER FEATURING APPLICATION PROGRAMMING INTERFACE (API) SOFTWARE FOR SOCIAL NETWORKING, ACCESSING ADDITIVE CONTENT, GAMES, AND OTHER FEATURES; PROVIDING ONLINE NONDOWNLOADABLE SOFTWARE, ONLINE TOOLS AND CONTENT FOR USE IN ALLOWING USERS TO EMBED CONTENT INTO THEIR BLOGS, WEBSITES, ONLINE SERVICES, AND OTHER APPLICATIONS AND DEVICES; HOSTING OF DIGITAL CONTENT ON GLOBAL COMPUTER NETWORKS, WIRELESS NETWORKS, AND ELECTRONIC COMMUNICATIONS NETWORKS (U.S. CLS. 100 AND 101).

## CLASS 45—PERSONAL AND LEGAL SERVICES

FOR ON-LINE SOCIAL NETWORKING SERVICES; PROVIDING A WEBSITE FOR THE PURPOSES OF SOCIAL NETWORKING; PROVIDING ONLINE COMPUTER DATABASES AND ONLINE SEARCHABLE DATABASES IN THE FIELD OF SOCIAL NETWORKING (U.S. CLS. 100 AND 101).

MICHAEL ENGEL, EXAMINING ATTORNEY

SN 85-335,348. DAVID A. WIRTH INC., HOLLYWOOD, FL.  
FILED 6-1-2011.

SN 85-335,436. DENNIS' SEVEN DEES LANDSCAPING, INC.,  
PORTLAND, OR. FILED 6-1-2011.



THE MARK CONSISTS OF A STYLIZED HOOK DESIGN WITH THE POINT OF THE HOOK CURLING INWARD.

**CLASS 14—JEWELRY**

FOR JEWELRY (U.S. CLS. 2, 27, 28 AND 50).

**CLASS 24—FABRICS**

FOR FABRIC FLAGS (U.S. CLS. 42 AND 50).  
FIRST USE 2-17-2011; IN COMMERCE 3-28-2011.

**CLASS 25—CLOTHING**

FOR DRESSES; HATS; SHIRTS (U.S. CLS. 22 AND 39).  
FIRST USE 2-17-2011; IN COMMERCE 3-28-2011.  
PRISCILLA MILTON, EXAMINING ATTORNEY

## TAKE ROOT

THE MARK CONSISTS OF STANDARD CHARACTERS WITHOUT CLAIM TO ANY PARTICULAR FONT, STYLE, SIZE, OR COLOR.

**CLASS 35—ADVERTISING AND BUSINESS**

FOR RETAIL LAWN, GARDEN AND NURSERY STORES (U.S. CLS. 100, 101 AND 102).  
FIRST USE 4-29-2011; IN COMMERCE 4-29-2011.

**CLASS 44—MEDICAL, BEAUTY AND AGRICULTURAL SERVICES**

FOR LANDSCAPE AND GARDEN DESIGN, INSTALLATION AND MAINTENANCE SERVICES (U.S. CLS. 100 AND 101).  
FIRST USE 4-29-2011; IN COMMERCE 4-29-2011.  
GISELLE AGOSTO, EXAMINING ATTORNEY

SN 85-335,456. PUSHYOURSELF.COM LLC, ROCHESTER, NY. FILED 6-1-2011.

SN 85-335,362. INVISTA NORTH AMERICA S.A R.L., WICHITA, KS. FILED 6-1-2011.

## SOLARMAX

THE MARK CONSISTS OF STANDARD CHARACTERS WITHOUT CLAIM TO ANY PARTICULAR FONT, STYLE, SIZE, OR COLOR.  
OWNER OF U.S. REG. NO. 3,122,129.

**CLASS 22—CORDAGE AND FIBERS**

FOR SYNTHETIC FIBERS USED IN THE MANUFACTURE OF CARPETS AND RUGS (U.S. CLS. 1, 2, 7, 19, 22, 42 AND 50).

**CLASS 27—FLOOR COVERINGS**

FOR CARPETS AND RUGS (U.S. CLS. 19, 20, 37, 42 AND 50).  
NAAKWAMA ANKRAH, EXAMINING ATTORNEY

## PUSH YOURSELF

THE MARK CONSISTS OF STANDARD CHARACTERS WITHOUT CLAIM TO ANY PARTICULAR FONT, STYLE, SIZE, OR COLOR.

**CLASS 25—CLOTHING**

FOR ATHLETIC APPAREL, NAMELY, SHIRTS, PANTS, JACKETS, FOOTWEAR, HATS AND CAPS, ATHLETIC UNIFORMS; TOPS; WEARABLE GARMENTS AND CLOTHING, NAMELY, SHIRTS (U.S. CLS. 22 AND 39).  
FIRST USE 6-1-2007; IN COMMERCE 6-1-2007.

**CLASS 45—PERSONAL AND LEGAL SERVICES**

FOR PROVIDING A MOTIVATIONAL WEBSITE THE PRIMARY MISSION OF WHICH IS TO INCREASE PERSONAL HAPPINESS IN TERMS OF PERSONAL RELATIONSHIPS, PERSONAL GROWTH AND MOTIVATION, AND SELF-FULFILLMENT (U.S. CLS. 100 AND 101).  
FIRST USE 6-1-2007; IN COMMERCE 6-1-2007.  
GISELLE AGOSTO, EXAMINING ATTORNEY

SN 85-335,483. LEDTRONICS, INC., TORRANCE, CA. FILED 6-1-2011.

SN 85-335,548. JONES, TIMOTHY, LOS ANGELES, CA. FILED 6-1-2011.

LEDTRONICS THE FUTURE OF  
LIGHT

THE MARK CONSISTS OF STANDARD CHARACTERS WITHOUT CLAIM TO ANY PARTICULAR FONT, STYLE, SIZE, OR COLOR.

OWNER OF U.S. REG. NOS. 1,914,678, 2,472,746 AND 3,356,292.

**CLASS 40—MATERIAL TREATMENT**

FOR CUSTOM MANUFACTURE OF LIGHT EMITTING DIODE (LED) DEVICES (U.S. CLS. 100, 103 AND 106).

FIRST USE 8-0-1997; IN COMMERCE 8-0-1997.

**CLASS 42—SCIENTIFIC AND COMPUTER SERVICES**

FOR DESIGN FOR OTHERS IN THE FIELD OF LIGHT EMITTING DIODE (LED) DEVICES (U.S. CLS. 100 AND 101).

FIRST USE 8-0-1997; IN COMMERCE 8-0-1997.

C. DIONNE CLYBURN, EXAMINING ATTORNEY

SN 85-335,537. PACIFIC CHEESE CO., INC., HAYWARD, CA. FILED 6-1-2011.

JARED'S CHOICE

THE MARK CONSISTS OF STANDARD CHARACTERS WITHOUT CLAIM TO ANY PARTICULAR FONT, STYLE, SIZE, OR COLOR.

**CLASS 29—MEATS AND PROCESSED FOODS**

FOR DAIRY PRODUCTS, NAMELY CHEESE (U.S. CL. 46).

**CLASS 30—STAPLE FOODS**

FOR CEREAL BASED SNACK BAR (U.S. CL. 46).  
MARK SPARACINO, EXAMINING ATTORNEY



THE COLOR(S) BLUE, YELLOW, GREEN IS/ARE CLAIMED AS A FEATURE OF THE MARK.

THE MARK CONSISTS OF THE LITERAL ELEMENTS "DONE", "WWW.WHATDOESDONELOOKLIKE.COM" WHEREIN THE IMAGE CONSISTS OF A SUN IN YELLOW COLOR WITH RAYS AND A GREEN COLOR FIGURE ABOVE WHICH THE WORDS "DONE" ARE WRITTEN IN BLUE COLOR, BELOW THE IMAGE THERE IS A TAG LINE "WWW.WHATDOESDONELOOKLIKE.COM" IN BLUE AND GREEN ALTERNATE COLORS IS PLACED AS SHOWN IN THE MARK.

**CLASS 16—PAPER GOODS AND PRINTED MATTER**

FOR A SERIES OF BOOKS IN THE FIELD OF SELF DEVELOPMENT (U.S. CLS. 2, 5, 22, 23, 29, 37, 38 AND 50).

**CLASS 41—EDUCATION AND ENTERTAINMENT**

FOR EDUCATIONAL SERVICES, NAMELY, CONDUCTING CLASSES, SEMINARS, AND WORKSHOPS IN THE FIELD OF SELF DEVELOPMENT AND DISTRIBUTION OF COURSE MATERIAL IN CONNECTION THEREWITH (U.S. CLS. 100, 101 AND 107).

MARK SPARACINO, EXAMINING ATTORNEY

SN 85-335,565. MJ BIG APPLE NY IMPORT INC., YONKERS, NY. FILED 6-1-2011.



THE MARK CONSISTS OF THREE WORDS "MY BIG APPLE", WHICH FORMS THE SHAPE OF AN APPLE, WITH A STEM AND A LEAF ON THE TOP OF THE APPLE. LETTER "I" IN THE WORD "BIG" HAS A HEART INSTEAD OF A DOT ON THE TOP.



**CLASS 6—METAL GOODS**

FOR METAL LICENSE PLATES; METAL NAMEPLATES AND DOOR NAMEPLATES; METAL NOVELTY LICENSE PLATES; METAL RINGS AND CHAINS FOR KEYS; PIGGY BANKS OF METAL; SOUVENIR LICENSE PLATES OF METAL (U.S. CLS. 2, 12, 13, 14, 23, 25 AND 50).

**CLASS 8—HAND TOOLS**

FOR NAIL FILES; SPOONS (U.S. CLS. 23, 28 AND 44).

**CLASS 9—ELECTRICAL AND SCIENTIFIC APPARATUS**

FOR DECORATIVE REFRIGERATOR MAGNETS; MOUSE PADS; MOUSEPADS; SUNGLASSES (U.S. CLS. 21, 23, 26, 36 AND 38).

**CLASS 14—JEWELRY**

FOR CLOCKS; WATCHES (U.S. CLS. 2, 27, 28 AND 50).

**CLASS 16—PAPER GOODS AND PRINTED MATTER**

FOR BALL PENS; COASTERS MADE OF CARDBOARD; COASTERS MADE OF PAPER; EVENTS ALBUMS; MEMORY BOOKS; MINI PHOTO ALBUMS; NOTE PADS; PAPER BABY BIBS; PENCILS (U.S. CLS. 2, 5, 22, 23, 29, 37, 38 AND 50).

**CLASS 18—LEATHER GOODS**

FOR BACKPACKS; COIN PURSES; HANDBAGS; LUGGAGE; SCHOOLBAGS; UMBRELLAS (U.S. CLS. 1, 2, 3, 22 AND 41).

**CLASS 20—FURNITURE AND ARTICLES NOT OTHERWISE CLASSIFIED**

FOR NAMEPLATES, NOT OF METAL; NON-METAL AND NON-LEATHER KEY CHAINS; PICTURE FRAMES (U.S. CLS. 2, 13, 22, 25, 32 AND 50).

**CLASS 21—HOUSEWARES AND GLASS**

FOR BEER MUGS; COASTERS, NOT OF PAPER AND OTHER THAN TABLE LINEN; COFFEE CUPS, TEA CUPS AND MUGS; COFFEE MUGS; FLASKS; GLASS BEVERAGeware; JAPANESE STYLE SOUP SERVING BOWLS (WAN); NON-METAL COIN BANKS; NON-METAL PIGGY BANKS; SCULPTURES OF CRYSTAL; SOUVENIR PLATES; SPORTS BOTTLES SOLD EMPTY; STATUES OF EARTHENWARE; WINE OPENERS (U.S. CLS. 2, 13, 23, 29, 30, 33, 40 AND 50).

**CLASS 25—CLOTHING**

FOR BABY BIBS NOT OF PAPER; BABY BODYSUITS; BASEBALL CAPS; CHILDREN'S AND INFANTS' CLOTH BIBS; CLOTH BIBS FOR ADULT DINERS; FLIP FLOPS; HOODED SWEATSHIRTS; INFANT WEAR; INFANTS' TROUSERS; ONE PIECE GARMENT FOR INFANTS AND TODDLERS; PAJAMAS; SHIRTS FOR INFANTS, BABIES, TODDLERS AND CHILDREN; SNEAKERS; SOCKS; SWEATSHIRTS; T-SHIRTS; UNDERWEAR; UNDERWEAR, NAMELY, BOY SHORTS (U.S. CLS. 22 AND 39).

**CLASS 28—TOYS AND SPORTING GOODS**

FOR CHILDREN'S MULTIPLE ACTIVITY TOYS; GOLF BALLS; INFANT TOYS; PLAYING CARDS; RUBBER CHARACTER TOYS; STUFFED TOY ANIMALS; STUFFED TOY BEARS; STUFFED TOYS; WATER GLOBES (U.S. CLS. 22, 23, 38 AND 50).

**CLASS 34—SMOKERS' ARTICLES**

FOR ASHTRAYS; LIGHTERS FOR SMOKERS (U.S. CLS. 2, 8, 9 AND 17).  
REGINA DRUMMOND, EXAMINING ATTORNEY

SN 85-335,643. CAVANAUGH MARKETING NETWORK, INC., DBA THE CRONS BRAND, PITTSBURGH, PA. FILED 6-1-2011.

---

# COME READY

THE MARK CONSISTS OF STANDARD CHARACTERS WITHOUT CLAIM TO ANY PARTICULAR FONT, STYLE, SIZE, OR COLOR.

**CLASS 16—PAPER GOODS AND PRINTED MATTER**

FOR POSTERS (U.S. CLS. 2, 5, 22, 23, 29, 37, 38 AND 50).

**CLASS 25—CLOTHING**

FOR SANDALS, SOCKS, GYM SHORTS, SHORTS, JERSEYS, SWEAT BANDS, SWEAT SHORTS, SWEAT PANTS, WARM-UP PANTS, T-SHIRTS, POLO SHIRTS; HOODED SWEAT SHIRTS, WRIST BANDS, HEAD BANDS, WARM-UP JACKETS, HATS, BASEBALL CAPS, VISORS AND KNIT HATS (U.S. CLS. 22 AND 39).  
EUGENIA MARTIN, EXAMINING ATTORNEY

SN 85-335,680. CREXENDO, INC., OREM, UT. FILED 6-1-2011.

---

# CREXENDO

THE MARK CONSISTS OF STANDARD CHARACTERS WITHOUT CLAIM TO ANY PARTICULAR FONT, STYLE, SIZE, OR COLOR.  
OWNER OF U.S. REG. NOS. 3,938,051 AND 3,963,203.

**CLASS 9—ELECTRICAL AND SCIENTIFIC APPARATUS**

FOR TELEPHONES; VOICE OVER INTERNET PROTOCOL (VOIP) PHONE ADAPTER (U.S. CLS. 21, 23, 26, 36 AND 38).

**CLASS 38—COMMUNICATION**

FOR VOICE OVER INTERNET PROTOCOL (VOIP) SERVICES (U.S. CLS. 100, 101 AND 104).

**CLASS 42—SCIENTIFIC AND COMPUTER SERVICES**

FOR SOFTWARE AS A SERVICE (SAAS) SERVICES, NAMELY, HOSTING SOFTWARE FOR USE BY OTHERS FOR USE TO MANAGE COMMUNICATIONS AND TO CREATE, OPERATE AND MAINTAIN AN ELECTRONIC COMMERCE WEBSITE (U.S. CLS. 100 AND 101).

PAUL MORENO, EXAMINING ATTORNEY

SN 85-335,687. CREXENDO, INC., OREM, UT. FILED 6-1-2011.



OWNER OF U.S. REG. NOS. 3,938,051 AND 3,963,203.  
THE MARK CONSISTS OF A VERTICAL LINE DESIGN ELEMENT POSITIONED ADJACENT TO THE TERM "CREXENDO".

**CLASS 9—ELECTRICAL AND SCIENTIFIC APPARATUS**

FOR TELEPHONES; VOICE OVER INTERNET PROTOCOL (VOIP) PHONE ADAPTER (U.S. CLS. 21, 23, 26, 36 AND 38).

**CLASS 38—COMMUNICATION**

FOR VOICE OVER INTERNET PROTOCOL (VOIP) SERVICES (U.S. CLS. 100, 101 AND 104).

PAUL MORENO, EXAMINING ATTORNEY

SN 85-335,689. LOCASTIC, INC., CAMBRIDGE, MA. FILED 6-1-2011.



THE MARK CONSISTS OF STANDARD CHARACTERS WITHOUT CLAIM TO ANY PARTICULAR FONT, STYLE, SIZE, OR COLOR.

**CLASS 9—ELECTRICAL AND SCIENTIFIC APPARATUS**

FOR DOWNLOADABLE SOFTWARE FOR MANAGING INCENTIVE AWARD POINTS AND REWARDS; COMPUTER SOFTWARE FOR THE COLLECTION, EDITING, ORGANIZING, MODIFYING, BOOKMARKING, TRANSMISSION, STORAGE AND SHARING OF DATA AND INFORMATION IN THE FIELDS OF BUSINESS AND SOCIAL NETWORKING (U.S. CLS. 21, 23, 26, 36 AND 38).

**CLASS 35—ADVERTISING AND BUSINESS**

FOR ADMINISTRATION OF A PROGRAM FOR ENABLING PARTICIPANTS TO OBTAIN DISCOUNTS ON PRODUCTS AND SERVICES; INCENTIVE AWARD PROGRAMS TO PROMOTE THE SALE OF PRODUCTS AND SERVICES OF OTHERS; PROMOTING THE GOODS AND SERVICES OF OTHERS BY PROVIDING A WEBSITE FEATURING DISCOUNT VOUCHERS, REBATES, PRICE-COMPARISON INFORMATION, PRODUCT REVIEWS, LINKS TO THE RETAIL WEBSITES OF OTHERS, AND DISCOUNT INFORMATION (U.S. CLS. 100, 101 AND 102).

**CLASS 42—SCIENTIFIC AND COMPUTER SERVICES**

FOR PROVIDING A WEB SITE FEATURING TEMPORARY USE OF NON-DOWNLOADABLE SOFTWARE ALLOWING WEB SITE USERS TO MANAGE INCENTIVE AWARD POINTS AND REWARDS; PROVIDING A WEB SITE FEATURING TEMPORARY USE OF NON-DOWNLOADABLE COMPUTER SOFTWARE FOR THE COLLECTION, EDITING, ORGANIZING, MODIFYING, BOOKMARKING, TRANSMISSION, STORAGE AND SHARING OF DATA AND INFORMATION IN THE FIELDS OF BUSINESS AND SOCIAL NETWORKING (U.S. CLS. 100 AND 101).

PAUL MORENO, EXAMINING ATTORNEY

SN 85-335,706. INPHONEX.COM, LLC, MIAMI, FL. FILED 6-1-2011.



THE MARK CONSISTS OF STANDARD CHARACTERS WITHOUT CLAIM TO ANY PARTICULAR FONT, STYLE, SIZE, OR COLOR.

**CLASS 35—ADVERTISING AND BUSINESS**

FOR TELECOMMUNICATIONS NETWORK MANAGEMENT SERVICES, NAMELY, THE OPERATION AND ADMINISTRATION OF TELECOMMUNICATION SYSTEMS (U.S. CLS. 100, 101 AND 102).

**CLASS 42—SCIENTIFIC AND COMPUTER SERVICES**

FOR APPLICATION SERVICE PROVIDER FEATURING SOFTWARE FOR USE IN PROVIDING TELECOMMUNICATION SERVICES (U.S. CLS. 100 AND 101).

DAVID HOFFMAN, EXAMINING ATTORNEY

SN 85-335,797. PHOENIX MEDIA NETWORK, INC., BOCA RATON, FL. FILED 6-1-2011.



THE MARK CONSISTS OF STANDARD CHARACTERS WITHOUT CLAIM TO ANY PARTICULAR FONT, STYLE, SIZE, OR COLOR.

SEC. 2(F).

**CLASS 16—PAPER GOODS AND PRINTED MATTER**

FOR MAGAZINES IN THE FIELD OF RETAIL FOOD SERVICE (U.S. CLS. 2, 5, 22, 23, 29, 37, 38 AND 50).  
FIRST USE 6-1-1996; IN COMMERCE 6-1-1996.

**CLASS 41—EDUCATION AND ENTERTAINMENT**

FOR PROVIDING ON-LINE MAGAZINES IN THE FIELD OF RETAIL FOOD SERVICE (U.S. CLS. 100, 101 AND 107).  
FIRST USE 9-26-1997; IN COMMERCE 9-26-1997.  
TINA BROWN, EXAMINING ATTORNEY

SN 85-335,964. NYLAND, JULIE, RAMONA, CA. FILED 6-2-2011.



THE MARK CONSISTS OF A CUSTOMIZED FONT DESIGN CONSISTING OF AN UPPER CASE "J" FOLLOWED IMMEDIATELY BY A LOWER CASE "S". THE STYLE RESEMBLES SCRIPT.

**CLASS 18—LEATHER GOODS**

FOR LUGGAGE; PURSES (U.S. CLS. 1, 2, 3, 22 AND 41).

**CLASS 24—FABRICS**

FOR BATH TOWELS; BED BLANKETS; BED LINEN; FABRIC TABLE RUNNERS; HANDKERCHIEFS; QUILTS; TEXTILE NAPKINS (U.S. CLS. 42 AND 50).  
IRA J. GOODSAD, EXAMINING ATTORNEY

SN 85-336,021. BASS & BASS, LLC, SHREVEPORT, LA. FILED 6-2-2011.



THE COLOR(S) RED, WHITE AND BLACK IS/ARE CLAIMED AS A FEATURE OF THE MARK.

THE MARK CONSISTS OF THE FACE OF MAN WEARING A BLACK COWBOY HAT WITH A WHITE STRIPE AND WHITE SPOT ON THE TOP OF THE HAT. THE FACE OF THE MAN IS WHITE WITH A BLACK OUTLINE AROUND HIS EYE. THE EYE ALSO HAS A RED DOT IN THE MIDDLE. THE MAN IS ALSO WEARING A RED HANDKERCHIEF BELOW HIS NOSE AND OVER HIS MOUTH. TO THE RIGHT OF MAN IN A BLACK STYLIZED FONT IN ALL CAPITAL LETTERS ARE THE WORDS "BANDIT BUSTER".

**CLASS 9—ELECTRICAL AND SCIENTIFIC APPARATUS**

FOR CLOSED CIRCUIT TV SYSTEMS FOR SECURITY AND SURVEILLANCE, NAMELY, CAMERAS, SWITCHERS, MONITORS, MICROPHONES, AND RECORDERS (U.S. CLS. 21, 23, 26, 36 AND 38).

**CLASS 45—PERSONAL AND LEGAL SERVICES**

FOR SECURITY SERVICES, NAMELY, PROVIDING A WEBSITE NOTIFYING INDIVIDUALS OF A CHANGED STATUS OR CONDITION OF A SENSING DEVICE IN A SECURITY SYSTEM VIA ELECTRONIC MESSAGE ALERTS (U.S. CLS. 100 AND 101).  
HENRY S. ZAK, EXAMINING ATTORNEY

SN 85-336,101. ANYTIME FITNESS, LLC, HASTINGS, MN. FILED 6-2-2011.

**THE CLUB FOR BUSY PEOPLE**

THE MARK CONSISTS OF STANDARD CHARACTERS WITHOUT CLAIM TO ANY PARTICULAR FONT, STYLE, SIZE, OR COLOR.

**CLASS 6—METAL GOODS**

FOR KEY CHAIN FOBS MADE OF COMMON METAL (U.S. CLS. 2, 12, 13, 14, 23, 25 AND 50).

**CLASS 9—ELECTRICAL AND SCIENTIFIC APPARATUS**

FOR MOTION PICTURE FILMS ABOUT HEALTH AND FITNESS; DIGITAL MEDIA, NAMELY, PRE-RECORDED DVDS, DOWNLOADABLE AUDIO AND VIDEO RECORDINGS, AND CDS FEATURING AND PROMOTING HEALTH AND FITNESS; DOWNLOADABLE ELECTRONIC NEWSLETTERS IN THE FIELD OF HEALTH AND FITNESS (U.S. CLS. 21, 23, 26, 36 AND 38).

**CLASS 16—PAPER GOODS AND PRINTED MATTER**

FOR BOOKS IN THE FIELD OF HEALTH AND FITNESS; NEWSLETTERS IN THE FIELD OF HEALTH AND FITNESS; PENCILS; PENS; STATIONERY; NOTE CARDS; POSTERS; BUMPER STICKERS; POSTCARDS (U.S. CLS. 2, 5, 22, 23, 29, 37, 38 AND 50).

**CLASS 18—LEATHER GOODS**

FOR TOTE BAGS; LUGGAGE TAGS (U.S. CLS. 1, 2, 3, 22 AND 41).

**CLASS 20—FURNITURE AND ARTICLES NOT OTHERWISE CLASSIFIED**

FOR KEY CHAIN FOBS NOT MADE OF METAL (U.S. CLS. 2, 13, 22, 25, 32 AND 50).

**CLASS 21—HOUSEWARES AND GLASS**

FOR PLASTIC WATER BOTTLES SOLD EMPTY; MUGS; PLASTIC CUPS (U.S. CLS. 2, 13, 23, 29, 30, 33, 40 AND 50).

**CLASS 25—CLOTHING**

FOR CLOTHING, NAMELY, T-SHIRTS, TANK TOPS, SPORT BRAS, SHIRTS, SWEAT SHIRTS, SWEATERS, JERSEYS, JACKETS, COATS, HATS, CAPS, PANTS, SHORTS, GLOVES, SLEEPWEAR, BOXER SHORTS, SOCKS, PLASTIC BABY BIBS, HOODED SHIRTS, HEADBANDS, VISORS, SCARVES (U.S. CLS. 22 AND 39).

**CLASS 41—EDUCATION AND ENTERTAINMENT**

FOR HEALTH AND FITNESS CLUB SERVICES, NAMELY PROVIDING FACILITIES, INSTRUCTION, AND EQUIPMENT IN THE FIELD OF PHYSICAL EXERCISE AND FITNESS; EDUCATIONAL AND ENTERTAINMENT SERVICES, NAMELY, PROVIDING MOTIVATIONAL SPEAKING SERVICES IN THE FIELD OF HEALTH AND FITNESS (U.S. CLS. 100, 101 AND 107).

THEODORE MCBRIDE, EXAMINING ATTORNEY

SN 85-336,111. LOKO INDUSTRIES, LLC, SAN RAMON, CA. FILED 6-2-2011.

Peel.Stick.Play.

THE MARK CONSISTS OF STANDARD CHARACTERS WITHOUT CLAIM TO ANY PARTICULAR FONT, STYLE, SIZE, OR COLOR.

**CLASS 9—ELECTRICAL AND SCIENTIFIC APPARATUS**

FOR HAND GRIPS FOR HAND-HELD VIDEO GAME CONTROLLERS; HAND GRIPS FOR MOBILE PHONES AND PERSONAL DIGITAL ASSISTANTS (PDAS) (U.S. CLS. 21, 23, 26, 36 AND 38).

**CLASS 25—CLOTHING**

FOR CLOTHING, NAMELY, SHIRTS, HATS, SWEAT SHIRTS, SWEATBANDS, JACKETS, BEANIES AND GLOVES (U.S. CLS. 22 AND 39).

INGRID C. EULIN, EXAMINING ATTORNEY

SN 85-336,144. THE CRAIG GROUP, LLC, VIRGINIA BEACH, VA. FILED 6-2-2011.

GO2GEAR

THE MARK CONSISTS OF STANDARD CHARACTERS WITHOUT CLAIM TO ANY PARTICULAR FONT, STYLE, SIZE, OR COLOR.

**CLASS 14—JEWELRY**

FOR BRACELETS (U.S. CLS. 2, 27, 28 AND 50). FIRST USE 7-1-2010; IN COMMERCÉ 7-1-2010.

**CLASS 22—CORDAGE AND FIBERS**

FOR BUNGEE CORDS, CABLE TIES AND LANYARDS (U.S. CLS. 1, 2, 7, 19, 22, 42 AND 50). FIRST USE 7-1-2010; IN COMMERCÉ 7-1-2010.

FLORENTINA BLANDU, EXAMINING ATTORNEY

SN 85-336,152. ANYTIME FITNESS, LLC, HASTINGS, MN. FILED 6-2-2011.

WORKING OUT SUCKS

THE MARK CONSISTS OF STANDARD CHARACTERS WITHOUT CLAIM TO ANY PARTICULAR FONT, STYLE, SIZE, OR COLOR.

**CLASS 6—METAL GOODS**

FOR KEY CHAIN FOBS MADE OF COMMON METAL (U.S. CLS. 2, 12, 13, 14, 23, 25 AND 50).

**CLASS 9—ELECTRICAL AND SCIENTIFIC APPARATUS**

FOR MOTION PICTURE FILMS ABOUT HEALTH AND FITNESS; DIGITAL MEDIA, NAMELY, PRE-RECORDED DVDS, DOWNLOADABLE AUDIO AND VIDEO RECORDINGS, AND CDS FEATURING AND PROMOTING HEALTH AND FITNESS; DOWNLOADABLE ELECTRONIC NEWSLETTERS IN THE FIELD OF HEALTH AND FITNESS (U.S. CLS. 21, 23, 26, 36 AND 38).

**CLASS 16—PAPER GOODS AND PRINTED MATTER**

FOR BOOKS IN THE FIELD OF HEALTH AND FITNESS; NEWSLETTERS IN THE FIELD OF HEALTH AND FITNESS; PENCILS; PENS; STATIONERY; NOTE CARDS; POSTERS; BUMPER STICKERS; POSTCARDS (U.S. CLS. 2, 5, 22, 23, 29, 37, 38 AND 50).

**CLASS 18—LEATHER GOODS**

FOR TOTE BAGS; LUGGAGE TAGS (U.S. CLS. 1, 2, 3, 22 AND 41).

**CLASS 20—FURNITURE AND ARTICLES NOT OTHERWISE CLASSIFIED**

FOR KEY CHAIN FOBS NOT MADE OF METAL (U.S. CLS. 2, 13, 22, 25, 32 AND 50).

**CLASS 21—HOUSEWARES AND GLASS**

FOR PLASTIC WATER BOTTLES SOLD EMPTY; MUGS; PLASTIC CUPS (U.S. CLS. 2, 13, 23, 29, 30, 33, 40 AND 50).

**CLASS 25—CLOTHING**

FOR CLOTHING, NAMELY, T-SHIRTS, TANK TOPS, SPORT BRAS, SHIRTS, SWEAT SHIRTS, SWEATERS, JERSEYS, JACKETS, COATS, HATS, CAPS, PANTS, SHORTS, GLOVES, SLEEPWEAR, BOXER SHORTS, SOCKS, PLASTIC BABY BIBS, HOODED SHIRTS, HEADBANDS, VISORS, SCARVES (U.S. CLS. 22 AND 39).

**CLASS 41—EDUCATION AND ENTERTAINMENT**

FOR HEALTH AND FITNESS CLUB SERVICES, NAMELY PROVIDING FACILITIES, INSTRUCTION, AND EQUIPMENT IN THE FIELD OF PHYSICAL EXERCISE AND FITNESS; EDUCATIONAL AND ENTERTAINMENT SERVICES, NAMELY, PROVIDING MOTIVATIONAL SPEAKING SERVICES IN THE FIELD OF HEALTH AND FITNESS (U.S. CLS. 100, 101 AND 107).

THEODORE MCBRIDE, EXAMINING ATTORNEY

SN 85-336,171. DEBAUN DEVELOPMENT INC., NEW YORK, NY. FILED 6-2-2011.

AIO

THE MARK CONSISTS OF STANDARD CHARACTERS WITHOUT CLAIM TO ANY PARTICULAR FONT, STYLE, SIZE, OR COLOR.

**CLASS 3—COSMETICS AND CLEANING PREPARATIONS**

FOR ANTIBACTERIAL SKIN SOAPS; BEAUTY CREAMS FOR BODY CARE; BODY AND BEAUTY CARE COSMETICS; COSMETIC CREAMS FOR SKIN CARE; COSMETIC PREPARATIONS FOR BODY CARE; COSMETIC PREPARATIONS FOR SKIN RENEWAL; LOTIONS FOR FACE AND BODY CARE; SKIN AND BODY TOPICAL LOTIONS, CREAMS AND OILS FOR COSMETIC USE; SKIN CARE PRODUCTS, NAMELY, NON-MEDICATED SKIN SERUM; SKIN CLARIFIERS; SKIN CREAMS IN LIQUID AND IN SOLID FORM; SKIN MOISTURIZER (U.S. CLS. 1, 4, 6, 50, 51 AND 52).

**CLASS 5—PHARMACEUTICALS**

FOR DIETARY AND NUTRITIONAL SUPPLEMENTS; DIETARY SUPPLEMENTS FOR HUMAN CONSUMPTION; FOOD SUPPLEMENTS; NUTRACEUTICALS FOR USE AS A DIETARY SUPPLEMENT (U.S. CLS. 6, 18, 44, 46, 51 AND 52).

BENJAMIN OKEKE, EXAMINING ATTORNEY

SN 85-336,214. DC SHOES, INC., HUNTINGTON BEACH, CA. FILED 6-2-2011.



THE MARK CONSISTS OF A RECTANGLE WITH A SEVEN POINT STAR AND TWO ADJACENT RECTANGLES, ONE WITH THE LETTERS "DC" AND A SEVEN POINT STAR.

**CLASS 18—LEATHER GOODS**

FOR ALL PURPOSE SPORT BAGS; ATHLETIC BAGS; BACKPACKS; DUFFEL BAGS; FANNY PACKS; GYM BAGS; KEY CASES; KNAPSACKS (U.S. CLS. 1, 2, 3, 22 AND 41).

**CLASS 25—CLOTHING**

FOR BELTS; CAPS; COATS; FOOTWEAR; GLOVES; HATS; JACKETS; PANTS; SHIRTS; SHORTS; SOCKS; SWEATERS; SWEATSHIRTS; SWIMWEAR; UNDERGARMENTS; VESTS; VISORS; WETSUITS (U.S. CLS. 22 AND 39).

MARGERY A. TIERNEY, EXAMINING ATTORNEY

SN 85-336,305. M2P2, LLC, AMES, IA. FILED 6-2-2011.

M2P2

THE MARK CONSISTS OF STANDARD CHARACTERS WITHOUT CLAIM TO ANY PARTICULAR FONT, STYLE, SIZE, OR COLOR.

**CLASS 35—ADVERTISING AND BUSINESS**

FOR BUSINESS MANAGEMENT OF SWINE BREEDING AND SWINE FARMING FACILITIES (U.S. CLS. 100, 101 AND 102).

**CLASS 42—SCIENTIFIC AND COMPUTER SERVICES**

FOR SCIENTIFIC RESEARCH IN THE FIELD OF SWINE BREEDING AND SWINE FARMING (U.S. CLS. 100 AND 101).

**CLASS 44—MEDICAL, BEAUTY AND AGRICULTURAL SERVICES**

FOR SWINE BREEDING AND SWINE FARMING; CONSULTING IN THE FIELD OF SWINE BREEDING AND SWINE FARMING (U.S. CLS. 100 AND 101).

AMY KERTGATE, EXAMINING ATTORNEY

SN 85-336,551. KUTCHINS, ROBBINS & DIAMOND, LTD.,  
SCHAUMBURG, IL. FILED 6-2-2011.

Helping our clients  
achieve financial success  
through sound advice

THE MARK CONSISTS OF STANDARD CHARACTERS WITHOUT CLAIM TO ANY PARTICULAR FONT, STYLE, SIZE, OR COLOR.

#### CLASS 35—ADVERTISING AND BUSINESS

FOR ACCOUNT AUDITING; ACCOUNTANCY SERVICES; ACCOUNTING CONSULTATION; ACCOUNTING FOR THIRD PARTIES; ACCOUNTING SERVICES; ADMINISTRATIVE ACCOUNTING; BUSINESS AUDITING; BUSINESS INFORMATION AND ACCOUNTING ADVISORY SERVICES; CONSULTING AND INFORMATION CONCERNING ACCOUNTING; CONSULTING SERVICES, NAMELY, EXPERT ANALYSIS AND MANAGEMENT CONSULTING IN ECONOMICS AND ACCOUNTING; COST ACCOUNTING; FORENSIC ACCOUNTING SERVICES; TAX ADVISORY SERVICES; TAX AND TAXATION PLANNING, ADVICE, INFORMATION AND CONSULTANCY SERVICES; TAX FILING SERVICES (U.S. CLS. 100, 101 AND 102).

FIRST USE 9-30-2000; IN COMMERCE 9-30-2000.

#### CLASS 36—INSURANCE AND FINANCIAL

FOR CHARITABLE FUNDRAISING SERVICES FOR SENDING UNDERPRIVILEGED CHILDREN TO ONE OF SEVERAL CAMPS AROUND THE UNITED STATES WHICH ACCEPT THESE CHILDREN AT DISCOUNTED RATES FOR ONE OR MORE WEEKS; FIDUCIARY SERVICES, NAMELY, FIDUCIARY REPRESENTATIVE SERVICES; FIDUCIARY TAX PAYMENT PROCESSING SERVICES; FINANCIAL ADMINISTRATION OF RETIREMENT PLANS; FINANCIAL ADVICE; FINANCIAL ADVICE AND CONSULTANCY SERVICES; FINANCIAL ADVICE, NAMELY, BUDGET PLANNING; FINANCIAL CONSULTATION; FINANCIAL CONSULTATION IN THE FIELD OF ELDER CARE; FINANCIAL COUNSELING SERVICES, NAMELY, HELPING OTHERS BUILD A BETTER WORKING RELATIONSHIP WITH THEIR MONEY; FINANCIAL PLANNING; FINANCIAL PLANNING AND INVESTMENT ADVISORY SERVICES; FINANCIAL PLANNING CONSULTATION; FINANCIAL PLANNING FOR RETIREMENT; FINANCIAL PLANNING, NAMELY, PERSONALIZED STRATEGY FOR ACHIEVING FINANCIAL INDEPENDENCE FOR THE ELDERLY; FINANCIAL TRUST PLANNING; INVESTMENT CONSULTANCY; INVESTMENT CONSULTATION; INVESTMENT MANAGEMENT; ON-LINE CASH ACCOUNT SERVICES; ON-LINE FINANCIAL PLANNING SERVICES; ONLINE, REAL-TIME TAX PAYMENT PROCESSING, TAX PAYMENT MANAGEMENT, AND TAX PAYMENT ANALYSIS SERVICES; PAYROLL TAX DEBITING SERVICES; PROVIDING ON-LINE INFORMATION IN THE FIELD OF CHARITABLE MONETARY GIVING THROUGH FINANCIAL AND ESTATE PLANNING; TAX PAYMENT PROCESSING SERVICES (U.S. CLS. 100, 101 AND 102).

FIRST USE 9-30-2000; IN COMMERCE 9-30-2000.

#### CLASS 41—EDUCATION AND ENTERTAINMENT

FOR EDUCATIONAL SERVICES, NAMELY, CONDUCTING CLASSES, SEMINARS, CONFERENCES AND WORKSHOPS IN THE FIELD OF TAX PREPARATION, ACCOUNTING, AUDITING, BUSINESS SERVICES, FINANCIAL PLANNING, INVESTMENT ADVERTISING, FORENSIC ACCOUNTING, BUSINESS VALUATION, FAMILY OFFICE SERVICES, AND ELDER CARE PLANNING AND DISTRIBUTION OF PRINTED MATERIALS IN CONNECTION THEREWITH IN HARD COPY OR ELECTRONIC FORMAT ON THE SAME TOPICS; EDUCATIONAL SERVICES, NAMELY, CONDUCTING CLASSES, SEMINARS, CONFERENCES AND WORKSHOPS IN THE FIELD OF TAX PREPARATION, ACCOUNTING, AUDITING, BUSINESS SERVICES, FINANCIAL PLANNING, INVESTMENT ADVERTISING, FORENSIC ACCOUNTING, BUSINESS VALUATION, FAMILY OFFICE SERVICES AND ELDER CARE PLANNING AND DISTRIBUTION OF COURSE MATERIAL IN CONNECTION THEREWITH; EDUCATIONAL SERVICES, NAMELY, CONDUCTING CLASSES, SEMINARS, CONFERENCES AND WORKSHOPS IN THE FIELD OF TAX PREPARATION, ACCOUNTING, AUDITING, BUSINESS SERVICES, FINANCIAL PLANNING, INVESTMENT ADVERTISING, FORENSIC ACCOUNTING, BUSINESS VALUATION, FAMILY OFFICE SERVICES, AND ELDER CARE PLANNING AND DISTRIBUTION OF TRAINING MATERIAL IN CONNECTION THEREWITH (U.S. CLS. 100, 101 AND 107).

FIRST USE 9-30-2000; IN COMMERCE 9-30-2000.

JILL C. ALT, EXAMINING ATTORNEY

SN 85-336,826. TRIPLINGO, LLC, ATLANTA, GA. FILED 6-2-2011.



THE COLOR(S) ORANGE FOR THE SPEECH BUBBLE AND WHITE FOR THE SUITCASE IS/ARE CLAIMED AS A FEATURE OF THE MARK.

THE MARK CONSISTS OF CONSISTS OF A SOLID ORANGE SPEECH BUBBLE FORMED BY A CIRCLE WITH A RIGHT POINTING TAIL THAT DROPS OFF THE CIRCLE, IN WHICH AN WHITE IMAGE OF A SUITCASE WITH A TOP HANDLE IS CONTAINED.

#### CLASS 9—ELECTRICAL AND SCIENTIFIC APPARATUS

FOR COMPUTER APPLICATION SOFTWARE FOR MOBILE PHONES, NAMELY, SOFTWARE FOR FOREIGN LANGUAGE LEARNING (U.S. CLS. 21, 23, 26, 36 AND 38).

FIRST USE 1-31-2011; IN COMMERCE 2-22-2011.

**CLASS 41—EDUCATION AND ENTERTAINMENT**

FOR EDUCATION SERVICES, NAMELY, PROVIDING LIVE AND ON-LINE INSTRUCTION IN THE FIELD OF FOREIGN LANGUAGES VIA AN ONLINE WEBSITE (U.S. CLS. 100, 101 AND 107).

FIRST USE 1-31-2011; IN COMMERCE 2-22-2011.  
AISHA CLARKE, EXAMINING ATTORNEY

**CLASS 25—CLOTHING**

FOR HATS; SHORT-SLEEVED OR LONG-SLEEVED T-SHIRTS (U.S. CLS. 22 AND 39).

**CLASS 26—FANCY GOODS**

FOR BELT BUCKLES (U.S. CLS. 37, 39, 40, 42 AND 50).  
CAROLINE WOOD, EXAMINING ATTORNEY

---

SN 85-336,877. ROBERT J. BURNETT, WESTON, FL. FILED 6-2-2011.

---

SN 85-337,043. TURNER, DARLYN, NAPERVILLE, IL. FILED 6-3-2011.

**LIMB REAPER**

THE MARK CONSISTS OF STANDARD CHARACTERS WITHOUT CLAIM TO ANY PARTICULAR FONT, STYLE, SIZE, OR COLOR.

**CLASS 25—CLOTHING**

FOR CLOTHING, NAMELY, SHIRTS, HATS, PANTS, SHORTS, SWEAT PANTS, HEAD BANDS, AND ROBES (U.S. CLS. 22 AND 39).

**CLASS 28—TOYS AND SPORTING GOODS**

FOR ATHLETIC EQUIPMENT, NAMELY, MOUTH GUARDS; SPORTS EQUIPMENT FOR BOXING AND MARTIAL ARTS, NAMELY, BOXING GLOVES AND MIXED MARTIAL ARTS (MMA) GLOVES (U.S. CLS. 22, 23, 38 AND 50).  
STEPHANIE ALI, EXAMINING ATTORNEY

---

SN 85-336,984. DEBBIE'S DREAM FOUNDATION, INC., DAVIE, FL. FILED 6-2-2011.

**CAN'T STOMACH CANCER**

THE MARK CONSISTS OF STANDARD CHARACTERS WITHOUT CLAIM TO ANY PARTICULAR FONT, STYLE, SIZE, OR COLOR.

**CLASS 14—JEWELRY**

FOR JEWELRY; ORNAMENTAL PINS; KEY CHAINS AS JEWELRY (U.S. CLS. 2, 27, 28 AND 50).

**CLASS 16—PAPER GOODS AND PRINTED MATTER**

FOR WRITING UTENSILS (U.S. CLS. 2, 5, 22, 23, 29, 37, 38 AND 50).

**CLASS 18—LEATHER GOODS**

FOR FANNY PACKS (U.S. CLS. 1, 2, 3, 22 AND 41).

**RUN THE WORLD!**

THE MARK CONSISTS OF STANDARD CHARACTERS WITHOUT CLAIM TO ANY PARTICULAR FONT, STYLE, SIZE, OR COLOR.

**CLASS 14—JEWELRY**

FOR BRACELETS, NECKLACES (U.S. CLS. 2, 27, 28 AND 50).

**CLASS 25—CLOTHING**

FOR T-SHIRTS, HATS, SHOES (U.S. CLS. 22 AND 39).  
SHARON MEIER, EXAMINING ATTORNEY

---

SN 85-337,258. THE CORPORATE EXECUTIVE BOARD COMPANY, ARLINGTON, VA. FILED 6-3-2011.

**CHALLENGER**

THE MARK CONSISTS OF STANDARD CHARACTERS WITHOUT CLAIM TO ANY PARTICULAR FONT, STYLE, SIZE, OR COLOR.

**CLASS 35—ADVERTISING AND BUSINESS**

FOR ANALYSIS OF MARKET RESEARCH DATA AND STATISTICS; BUSINESS ADVISORY SERVICES IN THE FIELD OF CORPORATE BEST PRACTICES, SALES PROFESSIONAL DEVELOPMENT, SUPPORT AND MANAGEMENT; BUSINESS ADVISORY SERVICES, CONSULTANCY AND INFORMATION; BUSINESS DATA ANALYSIS; CONDUCTING BUSINESS AND MARKET RESEARCH SURVEYS (U.S. CLS. 100, 101 AND 102).

FIRST USE 4-30-2009; IN COMMERCE 5-31-2009.

**CLASS 41—EDUCATION AND ENTERTAINMENT**

FOR EDUCATIONAL SERVICES, NAMELY, CONDUCTING CLASSES, SEMINARS, LECTURES, WORKSHOPS, IN THE FIELD OF CORPORATE BEST PRACTICES, SALES PROFESSIONAL DEVELOPMENT, SUPPORT AND MANAGEMENT AND DISTRIBUTION OF COURSE MATERIAL IN CONNECTION THEREWITH; EDUCATIONAL SERVICES, NAMELY, DEVELOPING CURRICULUM FOR OTHERS IN THE FIELD OF CORPORATE BEST PRACTICES, SALES PROFESSIONAL DEVELOPMENT, SUPPORT AND MANAGEMENT; EDUCATIONAL SERVICES, NAMELY, DEVELOPING, ARRANGING, AND CONDUCTING EDUCATIONAL CONFERENCES AND PROGRAMS AND PROVIDING COURSES OF INSTRUCTION IN THE FIELD OF CORPORATE BEST PRACTICES, SALES PROFESSIONAL DEVELOPMENT, SUPPORT AND MANAGEMENT; EDUCATIONAL SERVICES, NAMELY, PROVIDING ON-LINE CLASSES, SEMINARS, LECTURES, WORKSHOPS IN THE FIELD OF CORPORATE BEST PRACTICES, SALES PROFESSIONAL DEVELOPMENT, SUPPORT AND MANAGEMENT (U.S. CLS. 100, 101 AND 107).

FIRST USE 4-30-2009; IN COMMERCE 5-31-2009.  
THOMAS MANOR, EXAMINING ATTORNEY

SN 85-337,351. CARSOPH INTERNATIONAL GROUP, LLC, DBA CARSOPH INTERNATIONAL GROUP, LLC, MIAMI, FL. FILED 6-3-2011.



THE COLOR(S) PURPLE AND PINK IS/ARE CLAIMED AS A FEATURE OF THE MARK.

THE MARK CONSISTS OF THE WORD "BODY" IN PURPLE AND THE WORD "SIGNER" IN PINK.

**CLASS 3—COSMETICS AND CLEANING PREPARATIONS**

FOR CLEANING PREPARATIONS; COSMETICS; NON-MEDICATED BODY, FACE, FOOT, HAIR, SKIN AND NAIL CARE PREPARATIONS; PERFUMERY (U.S. CLS. 1, 4, 6, 50, 51 AND 52).

**CLASS 25—CLOTHING**

FOR BODY SHIRTS; DRESSES; FOOTWEAR; GIRDLES; HEADWEAR; JERSEYS; PAJAMAS; SHAPEWEAR, NAMELY, JEANS WITH ABDOMINAL CONTROL, SKIRTS WITH ABDOMINAL CONTROL, PANTS WITH ABDOMINAL CONTROL AND GLUTEUS PUSH UP; SWIMSUITS; UNDERCLOTHES; UNDERGARMENTS; UNDERWEAR (U.S. CLS. 22 AND 39).

LINDSEY RUBIN, EXAMINING ATTORNEY

SN 85-337,302. CORPORATE SUITES, LLC, NEW YORK, NY. FILED 6-3-2011.



SN 85-337,395. THE LITTLE PARLOUR, LLC, SHERMAN OAKS, CA. FILED 6-3-2011.

**QUEEN OF THE NIGHT**

OWNER OF U.S. REG. NO. 2,775,868.  
THE MARK CONSISTS OF A DESIGN OF TWO SQUARES, ONE OVERLAPPING THE OTHER.

**CLASS 35—ADVERTISING AND BUSINESS**

FOR TELEPHONE ANSWERING SERVICES AND MAIL SORTING, HANDLING AND RECEIVING SERVICES (U.S. CLS. 100, 101 AND 102).

FIRST USE 5-27-2011; IN COMMERCE 5-27-2011.

**CLASS 36—INSURANCE AND FINANCIAL**

FOR RENTAL AND LEASING OF OFFICE SPACE, EXECUTIVE OFFICE SUITES, AND CONFERENCE ROOMS (U.S. CLS. 100, 101 AND 102).

FIRST USE 5-27-2011; IN COMMERCE 5-27-2011.  
DANIEL CAPSHAW, EXAMINING ATTORNEY

THE MARK CONSISTS OF STANDARD CHARACTERS WITHOUT CLAIM TO ANY PARTICULAR FONT, STYLE, SIZE, OR COLOR.

**CLASS 3—COSMETICS AND CLEANING PREPARATIONS**

FOR FRAGRANCES; ROOM FRAGRANCES (U.S. CLS. 1, 4, 6, 50, 51 AND 52).

**CLASS 4—LUBRICANTS AND FUELS**

FOR CANDLES (U.S. CLS. 1, 6 AND 15).  
DAVID TOOLEY, EXAMINING ATTORNEY



SN 85-337,399. THE LITTLE PARLOUR, LLC, SHERMAN OAKS, CA. FILED 6-3-2011.

SN 85-337,550. THOUSAND EYES, INC., SAN FRANCISCO, CA. FILED 6-3-2011.

## REINA DE LA NOCHE

THE MARK CONSISTS OF STANDARD CHARACTERS WITHOUT CLAIM TO ANY PARTICULAR FONT, STYLE, SIZE, OR COLOR.

THE ENGLISH TRANSLATION OF REINA DE LA NOCHE IN THE MARK IS QUEEN OF THE NIGHT.

### CLASS 3—COSMETICS AND CLEANING PREPARATIONS

FOR FRAGRANCES; ROOM FRAGRANCES (U.S. CLS. 1, 4, 6, 50, 51 AND 52).

### CLASS 4—LUBRICANTS AND FUELS

FOR CANDLES (U.S. CLS. 1, 6 AND 15).  
DAVID TOOLEY, EXAMINING ATTORNEY

---

SN 85-337,525. DIAMOND WIPES, CHINO, CA. FILED 6-3-2011.

## Pretty Touch

THE MARK CONSISTS OF STANDARD CHARACTERS WITHOUT CLAIM TO ANY PARTICULAR FONT, STYLE, SIZE, OR COLOR.

### CLASS 3—COSMETICS AND CLEANING PREPARATIONS

FOR BEAUTY MASKS; COSMETIC PADS; DISPOSABLE WIPES IMPREGNATED WITH CLEANSING CHEMICALS OR COMPOUNDS FOR REMOVAL OF MAKEUP, NAIL POLISH, ACNE TREATMENT, SKIN MOISTURIZERS, AND NAIL CONDITIONERS; EXFOLIATING PAD CONTAINING A GLYCOLIC INGREDIENT NOT FOR MEDICAL PURPOSES; FACIAL BEAUTY MASKS; FACIAL MASKS; IMPREGNATED CLEANING PADS IMPREGNATED WITH COSMETICS; IMPREGNATED CLEANING PADS IMPREGNATED WITH TOILET PREPARATIONS; NON-MEDICATED SUN CARE PREPARATIONS; PRE-MOISTENED COSMETIC WIPES; SKIN MASKS; SKIN MOISTURIZER MASKS; WIPES IMPREGNATED WITH A SKIN CLEANSER (U.S. CLS. 1, 4, 6, 50, 51 AND 52).

### CLASS 5—PHARMACEUTICALS

FOR ACNE TREATMENT PREPARATIONS; ANTISEPTIC WIPES; MEDICATED PRE-MOISTENED WIPES; PRE-MOISTENED MEDICATED WIPES (U.S. CLS. 6, 18, 44, 46, 51 AND 52).  
PAUL MORENO, EXAMINING ATTORNEY

## ThousandEyes

THE MARK CONSISTS OF STANDARD CHARACTERS WITHOUT CLAIM TO ANY PARTICULAR FONT, STYLE, SIZE, OR COLOR.

### CLASS 9—ELECTRICAL AND SCIENTIFIC APPARATUS

FOR COMPUTER APPLICATION SOFTWARE FOR COMPUTERS, HANDHELDS AND MOBILE DEVICES, NAMELY, SOFTWARE FOR MONITORING, DIAGNOSING AND OPTIMIZING WEB APPLICATION AND NETWORK PERFORMANCE (U.S. CLS. 21, 23, 26, 36 AND 38).

FIRST USE 8-4-2009; IN COMMERCE 4-1-2010.

### CLASS 42—SCIENTIFIC AND COMPUTER SERVICES

FOR SOFTWARE AS A SERVICE (SAAS) SERVICES FEATURING SOFTWARE FOR MONITORING, DIAGNOSING AND OPTIMIZING WEB APPLICATION AND NETWORK PERFORMANCE (U.S. CLS. 100 AND 101).

FIRST USE 8-4-2009; IN COMMERCE 4-1-2010.

ANNE MADDEN, EXAMINING ATTORNEY

---

SN 85-337,618. DIAMOND WIPES, CHINO, CA. FILED 6-3-2011.

## *pretty touch*

THE MARK CONSISTS OF THE WORDING "PRETTY TOUCH" IN A STYLIZED FONT.

### CLASS 3—COSMETICS AND CLEANING PREPARATIONS

FOR BEAUTY MASKS; COSMETIC PADS; DISPOSABLE WIPES IMPREGNATED WITH CLEANSING CHEMICALS OR COMPOUNDS FOR REMOVAL OF MAKEUP, NAIL POLISH, ACNE TREATMENT, SKIN MOISTURIZERS, AND NAIL CONDITIONERS; EXFOLIATING PAD CONTAINING A GLYCOLIC INGREDIENT NOT FOR MEDICAL PURPOSES; FACIAL BEAUTY MASKS; FACIAL MASKS; IMPREGNATED CLEANING PADS IMPREGNATED WITH COSMETICS; IMPREGNATED CLEANING PADS IMPREGNATED WITH TOILET PREPARATIONS; NON-MEDICATED SUN CARE PREPARATIONS; PRE-MOISTENED COSMETIC WIPES; SKIN MASKS; SKIN MOISTURIZER MASKS; WIPES IMPREGNATED WITH A SKIN CLEANSER (U.S. CLS. 1, 4, 6, 50, 51 AND 52).

### CLASS 5—PHARMACEUTICALS

FOR ACNE TREATMENT PREPARATIONS; ANTISEPTIC WIPES; MEDICATED PRE-MOISTENED WIPES; PRE-MOISTENED MEDICATED WIPES (U.S. CLS. 6, 18, 44, 46, 51 AND 52).  
PAUL MORENO, EXAMINING ATTORNEY

SN 85-337,726. DATAPIPE, INC., JERSEY CITY, NJ. FILED 6-3-2011.

### YOUR ENTERPRISE VIRTUALIZED

THE MARK CONSISTS OF STANDARD CHARACTERS WITHOUT CLAIM TO ANY PARTICULAR FONT, STYLE, SIZE, OR COLOR.

### CLASS 39—TRANSPORTATION AND STORAGE

FOR ELECTRONIC DATA STORAGE SERVICES, NAMELY, STORING ELECTRONIC DATA AT DATA CENTERS; COMPUTER SERVICES IN THE NATURE OF PROVIDING AN INTEGRATED SUITE OF DATA AND COMPUTER RELATED SERVICES, NAMELY, ELECTRONIC DATA STORAGE (U.S. CLS. 100 AND 105).

FIRST USE 11-17-2010; IN COMMERCE 11-17-2010.

### CLASS 42—SCIENTIFIC AND COMPUTER SERVICES

FOR COMPUTER SERVICES IN THE NATURE OF PROVIDING AN INTEGRATED SUITE OF DATA AND COMPUTER RELATED SERVICES, NAMELY, PROVIDING COMPUTER SECURITY CONSULTING IN THE AREA OF DATA STORAGE, ONLINE SECURITY AND INFORMATION SECURITY VULNERABILITY; PROVIDING A SECURE AND SAFE ENVIRONMENT FOR THE INFORMATION TECHNOLOGY SYSTEMS OF OTHERS, NAMELY, PROVIDING COMPUTER CO-LOCATION SERVICES IN THE NATURE OF PROVIDING FACILITIES FOR THE LOCATION OF COMPUTER SERVERS AND EQUIPMENT OF OTHERS; COMPUTER SERVICES IN THE NATURE OF MONITORING AND MANAGING COMPUTER NETWORK SYSTEMS; NETWORK SECURITY SERVICES IN THE NATURE OF COMPUTER NETWORK SECURITY SERVICES, NAMELY, RESTRICTING ACCESS TO AND BY COMPUTER NETWORKS TO AND OF UNDESIREED WEB SITES, MEDIA AND INDIVIDUALS AND FACILITIES; SECURITY MANAGEMENT SERVICES, NAMELY, COMPUTER CONSULTATION IN THE FIELD OF COMPUTER SECURITY; DISASTER RECOVERY SERVICES, NAMELY, COMPUTER DISASTER RECOVERY PLANNING AND RECOVERY OF COMPUTER DATA; SERVER MANAGEMENT SERVICES, NAMELY, HOSTING THE WEB SITES OF OTHERS ON A COMPUTER SERVER FOR A GLOBAL COMPUTER NETWORK; DATA BACKUP SERVICES, NAMELY, BACK-UP SERVICES FOR COMPUTER HARD DRIVE DATA; WEB SITE HOSTING SERVICES; COMPUTER SERVICES, NAMELY, REMOTE AND ON-SITE MANAGEMENT OF THE INFORMATION TECHNOLOGY CLOUD COMPUTING SYSTEMS OF OTHERS; TECHNICAL SUPPORT SERVICES, NAMELY, REMOTE AND ON-SITE INFRASTRUCTURE MANAGEMENT SERVICES FOR MONITORING, ADMINISTRATION AND MANAGEMENT OF PUBLIC AND PRIVATE CLOUD COMPUTING AND APPLICATION SYSTEMS; CONSULTING SERVICES IN THE FIELD OF CLOUD COMPUTING, NAMELY, CONSULTING IN CONNECTION WITH CLOUD COMPUTING APPLICATIONS AND NETWORKS; TECHNICAL CONSULTING SERVICES IN THE FIELDS OF PUBLIC AND PRIVATE CLOUD COMPUTING, NAMELY, CONSULTING SERVICES IN THE FIELD OF DESIGN, SELECTION, IMPLEMENTATION AND USE OF COMPUTER HARDWARE AND SOFTWARE SYSTEMS FOR OTHERS; TECHNICAL SUPPORT SERVICES, NAMELY, MONITORING OF NETWORK SYSTEMS, SERVERS AND WEB AND DATABASE APPLICATIONS AND NOTIFICATION OF RELATED EVENTS AND ALERTS; PROVIDING ON-DEMAND RESOURCE ALLOCATION FOR COMPUTER SYSTEMS INCLUDING ACCESS TO VIRTUAL SERVERS AND VIRTUAL MACHINES; HOSTING THE SOFTWARE AND OTHER COMPUTER APPLICATIONS OF OTHERS ON A VIRTUAL PRIVATE AND PUBLIC SERVER; TECHNICAL SUPPORT SERVICES

FOR HARDWARE, SOFTWARE AND OPERATING SYSTEMS IN THE NATURE OF MONITORING, DIAGNOSING AND PROBLEM RESOLUTION RELATED TO SOFTWARE APPLICATIONS; COMPUTER SERVICES, NAMELY, REMOTE AND ON-SITE MANAGEMENT OF ELECTRONIC MESSAGING SYSTEMS OF OTHERS INCLUDING TROUBLESHOOTING, OPTIMIZING, PATCHING, HARDENING, STORAGE MANAGEMENT, MAILBOX MOVEMENT, INSTALLATION AND CONFIGURATION AND MIGRATION OF ELECTRONIC MESSAGES AND MESSAGE SYSTEMS, SUCH AS E-MAIL (U.S. CLS. 100 AND 101).

FIRST USE 11-17-2010; IN COMMERCE 11-17-2010.

KIMBERLY PERRY, EXAMINING ATTORNEY

SN 85-337,740. BRANDIUM LLC, KETCHUM, ID. FILED 6-3-2011.

# QWYRK

THE MARK CONSISTS OF STANDARD CHARACTERS WITHOUT CLAIM TO ANY PARTICULAR FONT, STYLE, SIZE, OR COLOR.

### CLASS 9—ELECTRICAL AND SCIENTIFIC APPARATUS

FOR COMPUTER SOFTWARE FOR ASSOCIATING MUSIC CLIPS, AUDIO CLIPS, VIDEO CLIPS AND IMAGE CLIPS WITH A USER'S PROFILE AND FOR SHARING THE CLIPS WITH OTHERS VIA LOCAL AND GLOBAL COMMUNICATIONS NETWORKS; COMPUTER SOFTWARE FOR USE IN THE DELIVERY, DISTRIBUTION AND TRANSMISSION OF DIGITAL MUSIC AND ENTERTAINMENT-RELATED AUDIO, VIDEO, TEXT, VISUAL AND MULTIMEDIA CONTENT; COMPUTER SOFTWARE THAT ENABLES USERS TO SELECT AND SAMPLE MUSIC AND ENTERTAINMENT-RELATED AUDIO, VIDEO, TEXT, VISUAL AND MULTIMEDIA CONTENT (U.S. CLS. 21, 23, 26, 36 AND 38).

### CLASS 35—ADVERTISING AND BUSINESS

FOR ADVERTISING AND PROMOTIONAL SERVICES; DISSEMINATION OF ADVERTISING FOR OTHERS VIA THE INTERNET AND LOCAL AND GLOBAL COMMUNICATIONS NETWORKS (U.S. CLS. 100, 101 AND 102).

### CLASS 41—EDUCATION AND ENTERTAINMENT

FOR ENTERTAINMENT SERVICES, NAMELY, PROVIDING NONDOWNLOADABLE PRERECORDED AUDIO, VIDEO, TEXTUAL, VISUAL AND MULTIMEDIA CONTENT IN THE FIELD OF MUSIC, VIDEO AND ENTERTAINMENT, VIA LOCAL AND GLOBAL COMMUNICATIONS NETWORKS; PROVIDING ONLINE DATABASES IN THE FIELD OF MUSIC AND VIDEO ENTERTAINMENT (U.S. CLS. 100, 101 AND 107).

**CLASS 42—SCIENTIFIC AND COMPUTER SERVICES**

FOR SOFTWARE AS A SERVICE (SAAS) SERVICES FEATURING SOFTWARE FOR USE IN DISSEMINATING ADVERTISING FOR OTHERS; SOFTWARE AS A SERVICE (SAAS) SERVICES FEATURING SOFTWARE FOR ASSOCIATING MUSIC CLIPS, AUDIO CLIPS, VIDEO CLIPS AND IMAGE CLIPS WITH A USER'S PROFILE AND FOR SHARING THE CLIPS WITH OTHERS VIA LOCAL AND GLOBAL COMMUNICATIONS NETWORKS; SOFTWARE AS A SERVICE (SAAS) SERVICES FEATURING SOFTWARE THAT ENABLES USERS TO SELECT AND SAMPLE MUSIC AND ENTERTAINMENT-RELATED AUDIO, VIDEO, TEXT, VISUAL AND MULTIMEDIA CONTENT IN THE FIELD OF MUSIC, VIDEO AND ENTERTAINMENT; PROVIDING A WEBSITE FEATURING NON-DOWNLOADABLE SOFTWARE TO ENABLE USERS TO SELECT AND SAMPLE MUSIC AND ENTERTAINMENT-RELATED AUDIO, VIDEO, TEXT, VISUAL AND MULTIMEDIA CONTENT IN THE FIELD OF MUSIC, VIDEO AND ENTERTAINMENT (U.S. CLS. 100 AND 101).

ESTHER BELENKER, EXAMINING ATTORNEY

SN 85-337,878. PIERRE-LOUIS, MONA, NEW YORK, NY. FILED 6-3-2011.

**Triumph Begins With U**

THE MARK CONSISTS OF STANDARD CHARACTERS WITHOUT CLAIM TO ANY PARTICULAR FONT, STYLE, SIZE, OR COLOR.

**CLASS 14—JEWELRY**

FOR BRACELETS; JEWELRY; RINGS; RINGS BEING JEWELRY; STAINLESS STEEL JEWELRY BRACELETS (U.S. CLS. 2, 27, 28 AND 50).

FIRST USE 5-25-2011; IN COMMERCE 5-25-2011.

**CLASS 25—CLOTHING**

FOR SHORT-SLEEVED OR LONG-SLEEVED T-SHIRTS; T-SHIRTS; T-SHIRTS FOR BABIES, CHILDREN, ADULTS, WOMEN, MEN (U.S. CLS. 22 AND 39).

CHARLES L. JENKINS, EXAMINING ATTORNEY

SN 85-337,756. ZURVITA HOLDINGS, INC., HOUSTON, TX. FILED 6-3-2011.

**ZLINKED**

THE MARK CONSISTS OF STANDARD CHARACTERS WITHOUT CLAIM TO ANY PARTICULAR FONT, STYLE, SIZE, OR COLOR.

**CLASS 35—ADVERTISING AND BUSINESS**

FOR ONLINE ADVERTISING AND PROMOTIONAL SERVICES FOR OTHERS; PROVIDING A SEARCHABLE ON-LINE ADVERTISING WEBSITE AND GUIDE FEATURING THE GOODS AND SERVICES OF OTHER VENDORS VIA THE INTERNET; ADVERTISING SERVICES, NAMELY, COST-PER-ACTION ON-LINE ADVERTISING; ADVERTISING AND DIRECTORY SERVICES, NAMELY, PROMOTING THE SERVICES OF OTHERS BY PROVIDING A WEB PAGE FEATURING LINKS TO THE WEBSITES OF OTHERS; ADVERTISING AND MARKETING SERVICES PROVIDED BY MEANS OF INDIRECT METHODS OF MARKETING COMMUNICATIONS, NAMELY, SEARCH ENGINE MARKETING, INQUIRY MARKETING, INTERNET MARKETING, MOBILE MARKETING, BLOGGING AND OTHER FORMS OF PASSIVE, SHARABLE OR VIRAL COMMUNICATIONS CHANNELS (U.S. CLS. 100, 101 AND 102).

**CLASS 38—COMMUNICATION**

FOR PROVIDING ON-LINE ELECTRONIC BULLETIN BOARDS FOR TRANSMISSION OF MESSAGES AMONG COMPUTER USERS CONCERNING REVIEWS, PROFILES, RATINGS, REFERRALS AND RECOMMENDATIONS RELATING TO THE GOODS AND SERVICES OF OTHERS (U.S. CLS. 100, 101 AND 104).

STEVEN PEREZ, EXAMINING ATTORNEY

SN 85-337,920. ARCHIE KAO, LOS ANGELES, CA. FILED 6-3-2011.

**VIBRALARM**

THE MARK CONSISTS OF STANDARD CHARACTERS WITHOUT CLAIM TO ANY PARTICULAR FONT, STYLE, SIZE, OR COLOR.

**CLASS 9—ELECTRICAL AND SCIENTIFIC APPARATUS**

FOR COUNTDOWN TIMER(S) AND ALARMS TO REMIND A PERSON TO TAKE OR GIVE A MEDICATION(S) AND/OR TO REMIND A PERSON TO DO A DAILY ROUTINE(S) INCORPORATED INTO A WRISTBAND (U.S. CLS. 21, 23, 26, 36 AND 38).

**CLASS 38—COMMUNICATION**

FOR PROVIDING ELECTRONIC TRANSMISSION OF INFORMATION TO PERSONS WHO ARE DEAF OR HEARING IMPAIRED VIA THE INTERNET, TELEPHONES AND WIRELESS DEVICES (U.S. CLS. 100, 101 AND 104).

SUSAN RICHARDS, EXAMINING ATTORNEY

SN 85-337,944. GONZALEZ, JACK, CHICAGO, IL. FILED 6-3-2011.

## It's AmeriCAN! not AmeriCAN'T

THE MARK CONSISTS OF STANDARD CHARACTERS WITHOUT CLAIM TO ANY PARTICULAR FONT, STYLE, SIZE, OR COLOR.

### CLASS 16—PAPER GOODS AND PRINTED MATTER

FOR 3D DECALS FOR USE ON ANY SURFACE; ADHESIVE LABELS; ADVERTISING SIGNS OF PAPER OR CARDBOARD; BANNERS OF PAPER; BUMPER STICKERS; CALENDARS; COLOR PRINTS; EVENT ALBUMS; GENERAL PURPOSE PLASTIC BAGS; MAGNETIC BUMPER STICKERS; PAPER BAGS AND SACKS; PRINTED PAPER SIGNS; STAMP PADS; STICKERS AND TRANSFERS; IRON-ON AND PLASTIC TRANSFERS (U.S. CLS. 2, 5, 22, 23, 29, 37, 38 AND 50).

### CLASS 25—CLOTHING

FOR ATHLETIC APPAREL, NAMELY, SHIRTS, PANTS, JACKETS, FOOTWEAR, HATS AND CAPS, ATHLETIC UNIFORMS; BANDANAS; BASEBALL CAPS AND HATS; BERETS; CAPS WITH VISORS; HEAD SWEATBANDS; HEADGEAR, NAMELY, HATS, CAPS; POLO SHIRTS; SHORT-SLEEVED OR LONG-SLEEVED T-SHIRTS; SWEATBANDS; T-SHIRTS; TANK TOPS (U.S. CLS. 22 AND 39).

### CLASS 35—ADVERTISING AND BUSINESS

FOR ADVERTISING AND MARKETING SERVICES PROVIDED BY MEANS OF INDIRECT METHODS OF MARKETING COMMUNICATIONS, NAMELY, SOCIAL MEDIA, SEARCH ENGINE MARKETING, INQUIRY MARKETING, INTERNET MARKETING, MOBILE MARKETING, BLOGGING AND OTHER FORMS OF PASSIVE, SHARABLE OR VIRAL COMMUNICATIONS CHANNELS; ADVERTISING SERVICES, NAMELY, PROMOTING AND MARKETING THE GOODS AND SERVICES OF OTHERS THROUGH ALL PUBLIC COMMUNICATION MEANS; ADVERTISING, MARKETING AND PROMOTION SERVICES, NAMELY, PROMOTING THE GOODS AND SERVICES OF OTHERS BY PROVIDING CUSTOMIZED EXHIBITS; MARKETING SERVICES, NAMELY, PROMOTING OR ADVERTISING THE GOODS AND SERVICES OF OTHERS; ORGANIZING, PROMOTING AND CONDUCTING EXHIBITIONS, TRADESHOWS AND EVENTS FOR BUSINESS PURPOSES; PUBLIC RELATIONS (U.S. CLS. 100, 101 AND 102).

LEIGH CAROLINE CASE, EXAMINING ATTORNEY

SN 85-337,969. TIBCO SOFTWARE INC., PALO ALTO, CA. FILED 6-3-2011.

# TIBCAST

THE MARK CONSISTS OF STANDARD CHARACTERS WITHOUT CLAIM TO ANY PARTICULAR FONT, STYLE, SIZE, OR COLOR.

OWNER OF U.S. REG. NOS. 1,659,536, 2,770,804 AND OTHERS.

### CLASS 38—COMMUNICATION

FOR COMMUNICATION AND TELECOMMUNICATION SERVICES, NAMELY, TRANSMISSION OF VOICE, DATA, GRAPHICS, IMAGES, AUDIO AND VIDEO BY MEANS OF TELECOMMUNICATIONS NETWORKS, WIRELESS COMMUNICATION NETWORKS, AND THE INTERNET (U.S. CLS. 100, 101 AND 104).

### CLASS 42—SCIENTIFIC AND COMPUTER SERVICES

FOR APPLICATION SERVICE PROVIDER (ASP) SERVICES FEATURING COMPUTER SOFTWARE FOR TRANSMISSION OF VOICE, DATA, GRAPHICS, IMAGES, AUDIO AND VIDEO BY MEANS OF TELECOMMUNICATIONS NETWORKS, WIRELESS COMMUNICATION NETWORKS, AND THE INTERNET; COMPUTER PROGRAMMING; INFORMATION RELATING TO COMPUTER HARDWARE OR SOFTWARE PROVIDED ON-LINE FROM A GLOBAL COMPUTER NETWORK OR THE INTERNET; INFORMATION, ADVISORY AND CONSULTANCY SERVICES RELATING TO ALL THE AFORESAID (U.S. CLS. 100 AND 101).

JEFFREY LOOK, EXAMINING ATTORNEY

SN 85-338,014. SCHURMAN FINE PAPERS, FAIRFIELD, CA. FILED 6-3-2011.



# NIQUEA.D

THE MARK CONSISTS OF THE WORDS "NIQUEA.D" IN SPECIAL FORM WITH A REPRESENTATION OF THE PROFILE OF A UNICORN.

### CLASS 14—JEWELRY

FOR JEWELRY (U.S. CLS. 2, 27, 28 AND 50).  
FIRST USE 3-25-2011; IN COMMERCE 3-25-2011.

### CLASS 16—PAPER GOODS AND PRINTED MATTER

FOR ART PICTURES (U.S. CLS. 2, 5, 22, 23, 29, 37, 38 AND 50).

### CLASS 18—LEATHER GOODS

FOR PURSES (U.S. CLS. 1, 2, 3, 22 AND 41).  
FIRST USE 3-0-2011; IN COMMERCE 3-0-2011.

### CLASS 20—FURNITURE AND ARTICLES NOT OTHERWISE CLASSIFIED

FOR (BASED ON USE IN COMMERCE) PILLOWS(-BASED ON INTENT TO USE) FURNITURE (U.S. CLS. 2, 13, 22, 25, 32 AND 50).  
FIRST USE 3-0-2011; IN COMMERCE 3-0-2011.

### CLASS 25—CLOTHING

FOR HATS (U.S. CLS. 22 AND 39).  
FIRST USE 3-0-2011; IN COMMERCE 3-0-2011.  
MARK T. MULLEN, EXAMINING ATTORNEY

SN 85-338,026. SCHURMAN FINE PAPERS, FAIRFIELD, CA.  
FILED 6-3-2011.

# NIQUEA.D

THE MARK CONSISTS OF STANDARD CHARACTERS WITHOUT CLAIM TO ANY PARTICULAR FONT, STYLE, SIZE, OR COLOR.

## CLASS 14—JEWELRY

FOR JEWELRY (U.S. CLS. 2, 27, 28 AND 50).  
FIRST USE 3-25-2011; IN COMMERCE 3-25-2011.

## CLASS 16—PAPER GOODS AND PRINTED MATTER

FOR ART PICTURES (U.S. CLS. 2, 5, 22, 23, 29, 37, 38 AND 50).

## CLASS 18—LEATHER GOODS

FOR PURSES (U.S. CLS. 1, 2, 3, 22 AND 41).  
FIRST USE 3-0-2011; IN COMMERCE 3-0-2011.

## CLASS 20—FURNITURE AND ARTICLES NOT OTHERWISE CLASSIFIED

FOR (BASED ON USE IN COMMERCE) PILLOWS-(BASED ON INTENT TO USE) FURNITURE (U.S. CLS. 2, 13, 22, 25, 32 AND 50).  
FIRST USE 3-0-2011; IN COMMERCE 3-0-2011.

## CLASS 25—CLOTHING

FOR HATS (U.S. CLS. 22 AND 39).  
FIRST USE 3-0-2011; IN COMMERCE 3-0-2011.  
MARK T. MULLEN, EXAMINING ATTORNEY

---

SN 85-338,033. LIFE TECHNOLOGIES CORPORATION,  
CARLSBAD, CA. FILED 6-3-2011.

# ION ONETOUCH

THE MARK CONSISTS OF STANDARD CHARACTERS WITHOUT CLAIM TO ANY PARTICULAR FONT, STYLE, SIZE, OR COLOR.

## CLASS 1—CHEMICALS

FOR CHEMICAL REAGENTS FOR NON-MEDICAL PURPOSE; DIAGNOSTIC REAGENTS AND KITS COMPRISED OF DIAGNOSTIC REAGENTS FOR CLINICAL OR MEDICAL LABORATORY USE (U.S. CLS. 1, 5, 6, 10, 26 AND 46).

## CLASS 9—ELECTRICAL AND SCIENTIFIC APPARATUS

FOR COMPUTER SOFTWARE USED FOR THE COLLECTION, ORGANIZATION, ANALYSIS, INTEGRATION AND COMMUNICATION OF SCIENTIFIC DATA; COMPUTER SOFTWARE USED TO OPERATE LABORATORY INSTRUMENTS; LABORATORY INSTRUMENTS, NAMELY, NUCLEIC ACID SEQUENCERS AND SYNTHESIZERS, GENETIC ANALYZERS, INSTRUMENTS FOR PREPARATION OF NUCLEIC ACID SAMPLES; LABORATORY SUPPLIES, NAMELY, RACK, VIALS, CAPS, SEPTA, NEEDLES, BOTTLES, FLASK, LABORATORY FILTER, TUBES, AND SEALS, PLASTIC TRAY COVER, MICRO PLATE, PIPETTE TIPS, REAGENT RESERVOIR, OPTICAL HEAT FIELD COVERS, AND PLASTIC CAPILLARY ARRAYS; ALL FOR SCIENTIFIC AND RESEARCH USE AND DIAGNOSTICS (U.S. CLS. 21, 23, 26, 36 AND 38).

SOPHIA S. KIM, EXAMINING ATTORNEY

---

SN 85-338,039. J BEVERLY HILLS, INC., CHATSWORTH, CA.  
FILED 6-3-2011.

# JUAN JUAN

THE MARK CONSISTS OF STANDARD CHARACTERS WITHOUT CLAIM TO ANY PARTICULAR FONT, STYLE, SIZE, OR COLOR.

## CLASS 3—COSMETICS AND CLEANING PREPARATIONS

FOR HAIR GEL AND HAIR MOUSSE; HAIR MASKS; HAIR POMADES; HAIR SHAMPOOS AND CONDITIONERS; HAIR STRAIGHTENING PREPARATIONS; HAIR WAX; HAIRSPRAY; NON-MEDICATED HAIR SERUMS (U.S. CLS. 1, 4, 6, 50, 51 AND 52).  
FIRST USE 7-1-1995; IN COMMERCE 7-1-1995.

## CLASS 44—MEDICAL, BEAUTY AND AGRICULTURAL SERVICES

FOR BEAUTY SALONS (U.S. CLS. 100 AND 101).  
FIRST USE 1-15-1986; IN COMMERCE 1-15-1986.  
SOPHIA S. KIM, EXAMINING ATTORNEY

---

SN 85-338,043. OTIS MCALLISTER INC., SAN FRANCISCO,  
CA. FILED 6-3-2011.

# ANGELITA

THE MARK CONSISTS OF STANDARD CHARACTERS WITHOUT CLAIM TO ANY PARTICULAR FONT, STYLE, SIZE, OR COLOR.

## CLASS 29—MEATS AND PROCESSED FOODS

FOR OLIVE OIL; CANNED TOMATOES (U.S. CL. 46).

**CLASS 30—STAPLE FOODS**

FOR RICE (U.S. CL. 46).  
SOPHIA S. KIM, EXAMINING ATTORNEY

SN 85-338,277. ACCURENCE, INC., WESTMINSTER, CO.  
FILED 6-5-2011.

accurrence

THE MARK CONSISTS OF STANDARD CHARACTERS WITHOUT CLAIM TO ANY PARTICULAR FONT, STYLE, SIZE, OR COLOR.

SN 85-338,088. BAKER, WILLIAM, LOS ANGELES, CA.  
FILED 6-4-2011.

NETFORCE

THE MARK CONSISTS OF STANDARD CHARACTERS WITHOUT CLAIM TO ANY PARTICULAR FONT, STYLE, SIZE, OR COLOR.

**CLASS 9—ELECTRICAL AND SCIENTIFIC APPARATUS**

FOR COMPUTER SOFTWARE, NAMELY, SOFTWARE DEVELOPMENT TOOLS FOR THE CREATION OF MOBILE INTERNET APPLICATIONS AND CLIENT INTERFACES (U.S. CLS. 21, 23, 26, 36 AND 38).

**CLASS 42—SCIENTIFIC AND COMPUTER SERVICES**

FOR SOFTWARE AS A SERVICE (SAAS) SERVICES FEATURING SOFTWARE FOR DATABASE MANAGEMENT (U.S. CLS. 100 AND 101).  
ALICE BENMAMAN, EXAMINING ATTORNEY

**CLASS 35—ADVERTISING AND BUSINESS**

FOR DATA COMPILING AND ANALYZING IN THE FIELD OF INSURANCE; INSURANCE CLAIMS AUDITING SERVICES; PROVIDING A PRICING PROGRAM IN THE FIELD OF PROPERTY AND CASUALTY INSURANCE THROUGH WHICH MEMBERS OF DESIGNATED ASSOCIATIONS, ORGANIZATIONS, AND GROUPS MAY BE OFFERED OR GRANTED DOWNWARD ADJUSTMENTS IN THE PREMIUMS FOR SUCH INSURANCE; PROVIDING STATISTICAL EVALUATION OF INSURANCE CLAIMS PERFORMANCE MEASURES FOR OTHERS; TRACKING AND MONITORING INSURANCE COMPLIANCE (U.S. CLS. 100, 101 AND 102).  
FIRST USE 11-18-2010; IN COMMERCE 11-18-2010.

**CLASS 36—INSURANCE AND FINANCIAL**

FOR APPRAISALS FOR INSURANCE CLAIMS OF REAL ESTATE; ASSESSING INSURANCE CLAIMS; CLAIMS ADJUSTMENT IN THE FIELD OF INSURANCE; CONSULTING AND INFORMATION CONCERNING INSURANCE (U.S. CLS. 100, 101 AND 102).  
FIRST USE 11-18-2010; IN COMMERCE 11-18-2010.  
JOHN E. MICHOS, EXAMINING ATTORNEY

SN 85-338,276. ALBARDA, VALERIE L.S., STAMFORD, CT.  
FILED 6-5-2011.

F.O.O.D. (Food Ocular  
Obsessive Disorder)

THE MARK CONSISTS OF STANDARD CHARACTERS WITHOUT CLAIM TO ANY PARTICULAR FONT, STYLE, SIZE, OR COLOR.

**CLASS 21—HOUSEWARES AND GLASS**

FOR COFFEE CUPS, TEA CUPS AND MUGS (U.S. CLS. 2, 13, 23, 29, 30, 33, 40 AND 50).

**CLASS 25—CLOTHING**

FOR APRONS; HOODED SWEATSHIRTS; SHORT-SLEEVED OR LONG-SLEEVED T-SHIRTS; SWEATSHIRTS; T-SHIRTS; BASEBALL CAPS AND HATS (U.S. CLS. 22 AND 39).  
LINDA ORNDORFF, EXAMINING ATTORNEY

SN 85-338,498. COVERED 6 L.L.C., SIMI VALLEY, CA. FILED 6-6-2011.



THE STIPPLING IS FOR SHADING PURPOSES ONLY.  
THE MARK CONSISTS OF A SHIELD DESIGN WITH TWO SWORDS CROSSING IN FRONT OF IT. CONTAINED WITHIN THE SHIELD IS A STYLIZED NUMBER "6" AND THE STYLIZED TEXT "COVERED SIX" WHICH CURVES BELOW THE "6".

**CLASS 25—CLOTHING**

FOR HATS; PANTS; SHIRTS (U.S. CLS. 22 AND 39).  
FIRST USE 11-6-2010; IN COMMERCE 11-6-2010.

**CLASS 41—EDUCATION AND ENTERTAINMENT**

FOR TRAINING SERVICES IN THE FIELD OF FIREARM OPERATION, FIREARM SAFETY, AND SELF DEFENSE (U.S. CLS. 100, 101 AND 107).

FIRST USE 11-6-2010; IN COMMERCE 11-6-2010.  
EDWARD FENNESSY, EXAMINING ATTORNEY

SN 85-338,602. LEPRINO FOODS COMPANY, DENVER, CO.  
FILED 6-6-2011.

# EXSALT

THE MARK CONSISTS OF STANDARD CHARACTERS WITHOUT CLAIM TO ANY PARTICULAR FONT, STYLE, SIZE, OR COLOR.

**CLASS 29—MEATS AND PROCESSED FOODS**

FOR CHEESE (U.S. CL. 46).

**CLASS 30—STAPLE FOODS**

FOR FOOD ADDITIVE FOR NON-NUTRITIONAL PURPOSES FOR USE AS A FLAVORING (U.S. CL. 46).  
JASON BLAIR, EXAMINING ATTORNEY

SN 85-338,641. CLEANPATH VENTURES, LLC, SAN FRANCISCO, CA. FILED 6-6-2011.

# CleanPath

THE MARK CONSISTS OF STANDARD CHARACTERS WITHOUT CLAIM TO ANY PARTICULAR FONT, STYLE, SIZE, OR COLOR.

**CLASS 35—ADVERTISING AND BUSINESS**

FOR ACQUISITION AND MERGER CONSULTATION; ASSISTANCE AND CONSULTANCY SERVICES IN THE FIELD OF BUSINESS MANAGEMENT OF COMPANIES IN THE ENERGY SECTOR; ASSISTING WITH THE FORMATION, NEGOTIATION, AND MANAGEMENT OF CONTRACTS WITH PUBLIC SECTOR ENTITIES; BUSINESS ADVICE AND INFORMATION RELATING TO LOANS, FINANCE AND CAPITAL; BUSINESS CONSULTING AND ADVISORY SERVICES IN THE FIELD OF ENERGY EFFICIENCY; BUSINESS CONSULTING SERVICES FOR THE ELECTRIC ENERGY INDUSTRY; BUSINESS MANAGEMENT; BUSINESS MANAGEMENT AND CONSULTATION IN THE FIELD OF RENEWABLE ENERGY; BUSINESS SERVICES, NAMELY, OPERATION OF POWER GENERATION EQUIPMENT AND FACILITIES FOR OTHERS; BUSINESS VENTURE DEVELOPMENT AND FORMATION CONSULTING SERVICES FOR THE RENEWABLE ENERGY INDUSTRY; PROCUREMENT SERVICES, NAMELY, PROCUREMENT OF CONTRACTS FOR OTHERS FOR THE PURCHASE OF ENERGY; PROCUREMENT, NAMELY, PURCHASING SOLAR PANELS AND EQUIPMENT FOR OTHERS (U.S. CLS. 100, 101 AND 102).

FIRST USE 6-14-2010; IN COMMERCE 6-14-2010.

**CLASS 36—INSURANCE AND FINANCIAL**

FOR CAPITAL INVESTMENT SERVICES; FINANCIAL ADVISORY AND CONSULTANCY SERVICES, NAMELY, IN THE FIELD OF RENEWABLE ENERGY; FINANCIAL ASSET MANAGEMENT; FINANCIAL DUE DILIGENCE; FINANCIAL PORTFOLIO MANAGEMENT; FINANCIAL SERVICES, NAMELY, INVESTMENT ADVICE, INVESTMENT MANAGEMENT, INVESTMENT CONSULTATION AND INVESTMENT OF FUNDS FOR OTHERS, INCLUDING PRIVATE AND PUBLIC EQUITY AND DEBT INVESTMENT SERVICES; FINANCIAL VALUATIONS; FISCAL ASSESSMENT AND EVALUATION; FUNDS INVESTMENT; INVESTMENT SERVICES, NAMELY, ASSET ACQUISITION, CONSULTATION, DEVELOPMENT AND MANAGEMENT SERVICES; LEASING OF LAND; MANAGEMENT OF A CAPITAL INVESTMENT FUND; MANAGEMENT OF PRIVATE EQUITY FUNDS; PROVIDING FINANCIAL INFORMATION; PROVIDING INVESTORS WITH FINANCIAL INFORMATION; PROVIDING WORKING CAPITAL (U.S. CLS. 100, 101 AND 102).

FIRST USE 6-14-2010; IN COMMERCE 6-14-2010.

**CLASS 37—CONSTRUCTION AND REPAIR**

FOR CONSTRUCTION PROJECT MANAGEMENT SERVICES; INSTALLATION AND MAINTENANCE OF PHOTOVOLTAIC INSTALLATIONS; INSTALLATION AND MAINTENANCE OF SOLAR ENERGY BASED POWER PLANTS; INSTALLATION OF ELECTRICAL AND GENERATING MACHINERY; INSTALLATION OF GEOTHERMAL ENERGY BASED POWER PLANTS; INSTALLATION OF RENEWABLE ENERGY GENERATION EQUIPMENT; INSTALLATION OF SOLAR ENERGY SYSTEMS AND ALTERNATIVE ENERGY PRODUCTS FOR RESIDENTIAL AND COMMERCIAL USE; PLANT CONSTRUCTION, MAINTENANCE AND CONSTRUCTION PROJECT MANAGEMENT SERVICES FOR BUSINESSES IN THE ENERGY PRODUCTION AND TRANSMISSION SECTOR; REPAIR OR MAINTENANCE OF POWER GENERATORS (U.S. CLS. 100, 103 AND 106).

FIRST USE 6-14-2010; IN COMMERCE 6-14-2010.  
DOUGLAS LEE, EXAMINING ATTORNEY

SN 85-338,656. RAZOR INSIGHTS, LLC, KENNESAW, GA.  
FILED 6-6-2011.

# RAZORINSIGHTS

THE MARK CONSISTS OF STANDARD CHARACTERS WITHOUT CLAIM TO ANY PARTICULAR FONT, STYLE, SIZE, OR COLOR.

**CLASS 9—ELECTRICAL AND SCIENTIFIC APPARATUS**

FOR SOFTWARE FOR USE IN THE MEDICAL FIELD FOR SECURING, TRANSCRIBING, AND MAINTAINING MEDICAL RECORDS OF PATIENTS BY PHYSICIANS, CLINICS, AND HOSPITALS (U.S. CLS. 21, 23, 26, 36 AND 38).

FIRST USE 5-12-2011; IN COMMERCE 5-12-2011.

**CLASS 42—SCIENTIFIC AND COMPUTER SERVICES**

FOR SOFTWARE AS A SERVICE (SAAS) SERVICES FEATURING NONDOWNLOADABLE SOFTWARE IN THE MEDICAL FIELD FOR SECURING, TRANSCRIBING, AND MAINTAINING MEDICAL RECORDS OF PATIENTS BY PHYSICIANS, CLINICS, AND HOSPITALS (U.S. CLS. 100 AND 101).

FIRST USE 7-31-2010; IN COMMERCE 7-31-2010.

DORITT L. CARROLL, EXAMINING ATTORNEY

SN 85-338,778. THE STANDARD REGISTER COMPANY,  
DAYTON, OH. FILED 6-6-2011.SN 85-338,667. RAZOR INSIGHTS, LLC, KENNESAW, GA.  
FILED 6-6-2011.

THE MARK CONSISTS OF THE LETTERS "RI" IN A STYLIZED FONT. THE LEFT SIDE OF THE LETTER "R" IS DEPICTED AS A PLUS SIGN. THE ENTIRE DESIGN IS CUT IN HALF FROM THE BOTTOM LEFT TO TOP RIGHT.

**CLASS 9—ELECTRICAL AND SCIENTIFIC APPARATUS**

FOR SOFTWARE FOR USE IN THE MEDICAL FIELD FOR SECURING, TRANSCRIBING, AND MAINTAINING MEDICAL RECORDS OF PATIENTS BY PHYSICIANS, CLINICS, AND HOSPITALS (U.S. CLS. 21, 23, 26, 36 AND 38).

FIRST USE 5-12-2011; IN COMMERCE 5-12-2011.

**CLASS 42—SCIENTIFIC AND COMPUTER SERVICES**

FOR SOFTWARE AS A SERVICE (SAAS) SERVICES FEATURING NONDOWNLOADABLE SOFTWARE IN THE MEDICAL FIELD FOR SECURING, TRANSCRIBING, AND MAINTAINING MEDICAL RECORDS OF PATIENTS BY PHYSICIANS, CLINICS, AND HOSPITALS (U.S. CLS. 100 AND 101).

FIRST USE 7-31-2010; IN COMMERCE 7-31-2010.  
DORITT L. CARROLL, EXAMINING ATTORNEY

SN 85-338,775. LUND FOOD HOLDINGS, INC., EDINA, MN.  
FILED 6-6-2011.**RESPONSIBLY SOURCED**

THE MARK CONSISTS OF STANDARD CHARACTERS WITHOUT CLAIM TO ANY PARTICULAR FONT, STYLE, SIZE, OR COLOR.

**CLASS 29—MEATS AND PROCESSED FOODS**

FOR SEAFOOD (U.S. CL. 46).  
FIRST USE 3-24-2011; IN COMMERCE 3-24-2011.

**CLASS 35—ADVERTISING AND BUSINESS**

FOR RETAIL GROCERY STORE SERVICES (U.S. CLS. 100, 101 AND 102).  
FIRST USE 3-24-2011; IN COMMERCE 3-24-2011.  
KEVON CHISOLM, EXAMINING ATTORNEY

**CELEBRATE HEALTH**

THE MARK CONSISTS OF STANDARD CHARACTERS WITHOUT CLAIM TO ANY PARTICULAR FONT, STYLE, SIZE, OR COLOR.

**CLASS 35—ADVERTISING AND BUSINESS**

FOR ADVERTISING SERVICES, NAMELY, CREATING AND PRINTING PROMOTIONAL BANNERS, POSTERS AND SIGNS ADVERTISING THE GOODS AND SERVICES OF OTHERS; BUSINESS CARD DESIGN SERVICES; BUSINESS SERVICES FOR FUNDRAISING PROGRAMS, NAMELY, DEVELOPING FUNDRAISING PROGRAM CATALOGS, BROCHURES, PRICE SHEETS, ORDER FORMS, AND OTHER DOCUMENTS FOR NOT-FOR-PROFIT ORGANIZATIONS; COMPILATION OF PHYSICIAN DIRECTORIES; CREATIVE MARKETING DESIGN SERVICES; CUSTOM WRITING SERVICES COMPRISING PUBLIC RELATIONS AND MARKETING MATERIALS FOR THE HEALTHCARE INDUSTRY; DESIGN OF ADVERTISING BROCHURES FOR OTHERS; DEVELOPMENT OF CUSTOMIZED PERSONNEL MANAGEMENT MATERIALS FOR OTHERS, NAMELY, DEVELOPMENT OF CUSTOMIZED EMPLOYEE AND VOLUNTEER MANUALS AND HANDBOOKS; DIRECT MAIL ADVERTISING SERVICES; PREPARING PROMOTIONAL AND MERCHANDISING MATERIAL FOR OTHERS (U.S. CLS. 100, 101 AND 102).

**CLASS 40—MATERIAL TREATMENT**

FOR ASSEMBLY OF ADVERTISING AND FUNDRAISING MATERIALS INTO KITS; CUSTOMIZED IMPRINTING OF COMPANY NAMES AND LOGOS ON THE GOODS OF OTHERS, NAMELY, ON PROMOTIONAL MERCHANDISE, APPAREL AND CORPORATE GIFTS; DIGITAL ON-DEMAND PRINTING SERVICES OF BADGES, BROCHURES, BUSINESS CARDS, FUNDRAISING MATERIALS, MARKETING MATERIALS, NEWSLETTERS AND STATIONERY; PRINTING (U.S. CLS. 100, 103 AND 106).

KEVON CHISOLM, EXAMINING ATTORNEY

SN 85-338,788. LUND FOOD HOLDINGS, INC., EDINA, MN.  
FILED 6-6-2011.

THE COLOR(S) GREEN, BLUE AND WHITE IS/ARE CLAIMED AS A FEATURE OF THE MARK.



THE MARK CONSISTS OF A CIRCLE DESIGN WITH THE WORD "RESPONSIBLY" IN WHITE LETTERS INSIDE A BLUE HALF CIRCLE ABOVE THE LETTER "S" IN WHITE AND THE WORD "SOURCED" IN WHITE LETTERS INSIDE A GREEN HALF CIRCLE.

**CLASS 29—MEATS AND PROCESSED FOODS**

FOR SEAFOOD (U.S. CL. 46).  
FIRST USE 3-24-2011; IN COMMERCE 3-24-2011.

**CLASS 35—ADVERTISING AND BUSINESS**

FOR RETAIL GROCERY STORE SERVICES (U.S. CLS. 100, 101 AND 102).  
FIRST USE 3-24-2011; IN COMMERCE 3-24-2011.  
KEVON CHISOLM, EXAMINING ATTORNEY

---

SN 85-338,805. FOREST LABORATORIES, INC., NEW YORK, NY. FILED 6-6-2011.

**FAST**

THE MARK CONSISTS OF STANDARD CHARACTERS WITHOUT CLAIM TO ANY PARTICULAR FONT, STYLE, SIZE, OR COLOR.

**CLASS 16—PAPER GOODS AND PRINTED MATTER**

FOR PRINTED MATTER, NAMELY, BROCHURES, PAMPHLETS, POSTERS, NEWSLETTERS, VISUALS IN THE NATURE OF PROMOTIONAL MATERIALS, AND PATIENT EDUCATIONAL MATERIALS, ALL CONCERNING THE TREATMENT OF BACTERIAL INFECTIONS (U.S. CLS. 2, 5, 22, 23, 29, 37, 38 AND 50).

**CLASS 44—MEDICAL, BEAUTY AND AGRICULTURAL SERVICES**

FOR MEDICAL TESTING SERVICES, NAMELY, TESTING REGARDING THE IN VITRO ACTIVITY OF PHARMACEUTICAL PREPARATIONS AGAINST BACTERIAL PATHOGENS (U.S. CLS. 100 AND 101).  
KEVIN CORWIN, EXAMINING ATTORNEY

---

SN 85-338,816. STATSLICE SYSTEMS, INC., DALLAS, TX. FILED 6-6-2011.

**STATSLICE**

THE MARK CONSISTS OF STANDARD CHARACTERS WITHOUT CLAIM TO ANY PARTICULAR FONT, STYLE, SIZE, OR COLOR.

**CLASS 35—ADVERTISING AND BUSINESS**

FOR BUSINESS CONSULTING SERVICES IN THE FIELDS OF CORPORATE PERFORMANCE MANAGEMENT, BUSINESS DATA ANALYTICS, BUSINESS DATA COLLECTION, BUSINESS DATA INTEGRATION; BUSINESS INTELLIGENCE SERVICES (U.S. CLS. 100, 101 AND 102).

FIRST USE 10-1-2006; IN COMMERCE 10-1-2006.

**CLASS 42—SCIENTIFIC AND COMPUTER SERVICES**

FOR COMPUTER SERVICES, NAMELY, DESIGN AND DEVELOPMENT OF SOFTWARE FOR CORPORATE PERFORMANCE MANAGEMENT, BUSINESS DATA ANALYTICS, BUSINESS DATA COLLECTION, BUSINESS DATA INTEGRATION, AND APPLICATION DASHBOARD CAPABILITIES OF COLLABORATION TECHNOLOGIES; DESIGN OF SOFTWARE FOR USE IN PROVIDING CORRELATIVE AND PREDICTIVE DATA ANALYSIS; COMPUTER SERVICES, NAMELY, PROVIDING CONSULTATION RELATED TO DATA WAREHOUSE DESIGN, DASHBOARD DESIGN AND DATA MINING (U.S. CLS. 100 AND 101).

FIRST USE 10-1-2006; IN COMMERCE 10-1-2006.

KAPIL BHANOT, EXAMINING ATTORNEY

---

SN 85-338,819. FOREST LABORATORIES, INC., NEW YORK, NY. FILED 6-6-2011.

**PATCH**

THE MARK CONSISTS OF STANDARD CHARACTERS WITHOUT CLAIM TO ANY PARTICULAR FONT, STYLE, SIZE, OR COLOR.

**CLASS 16—PAPER GOODS AND PRINTED MATTER**

FOR PRINTED MATTER, NAMELY, BROCHURES, PAMPHLETS, POSTERS, NEWSLETTERS, VISUALS IN THE NATURE OF PROMOTIONAL MATERIALS, AND PATIENT EDUCATIONAL MATERIALS, ALL CONCERNING THE TREATMENT OF BACTERIAL INFECTIONS (U.S. CLS. 2, 5, 22, 23, 29, 37, 38 AND 50).

**CLASS 42—SCIENTIFIC AND COMPUTER SERVICES**

FOR MEDICAL AND SCIENTIFIC RESEARCH, NAMELY, CONDUCTING CLINICAL TRIALS AND STUDIES FOR PHARMACEUTICAL PREPARATIONS RELATED TO THE TREATMENT OF BACTERIAL INFECTIONS AND PROVIDING SCIENTIFIC INFORMATION ON THE EFFICACY OF PHARMACEUTICAL PREPARATIONS FOR THE TREATMENT OF BACTERIAL INFECTIONS (U.S. CLS. 100 AND 101).  
KEVIN CORWIN, EXAMINING ATTORNEY

SN 85-338,885. COLLINS, MATTHEW, WEST HAVEN, CT.  
FILED 6-6-2011.

SN 85-339,105. INSURANCE DATA PROCESSING, INC.,  
WYNCOTE, PA. FILED 6-6-2011.

Dogs are happier on  
Nantucket

THE MARK CONSISTS OF STANDARD CHARACTERS WITHOUT CLAIM TO ANY PARTICULAR FONT, STYLE, SIZE, OR COLOR.

**CLASS 16—PAPER GOODS AND PRINTED MATTER**

FOR BUMPER STICKERS; STICKERS (U.S. CLS. 2, 5, 22, 23, 29, 37, 38 AND 50).

**CLASS 25—CLOTHING**

FOR T-SHIRTS (U.S. CLS. 22 AND 39).  
LAURA HAMMEL, EXAMINING ATTORNEY

SN 85-338,960. SOLTA MEDICAL, INC., HAYWARD, CA.  
FILED 6-6-2011.

clear +  
brilliant 

THE MARK CONSISTS OF THE WORDS "CLEAR + BRILLIANT" IN A STACKED FORMAT ADJACENT TO THREE CONCENTRIC CIRCLES OF DOTS.

**CLASS 3—COSMETICS AND CLEANING PREPARATIONS**

FOR COSMETIC AND NON-MEDICATED COSMETIC SKIN CARE PREPARATIONS (U.S. CLS. 1, 4, 6, 50, 51 AND 52).

**CLASS 10—MEDICAL APPARATUS**

FOR MEDICAL DEVICES FOR NON-SURGICAL COSMETIC SKIN TREATMENTS (U.S. CLS. 26, 39 AND 44).

**CLASS 44—MEDICAL, BEAUTY AND AGRICULTURAL SERVICES**

FOR DERMATOLOGY SERVICES; NON-INVASIVE COSMETIC MEDICAL SERVICES (U.S. CLS. 100 AND 101).  
KEVIN CORWIN, EXAMINING ATTORNEY

IDP

THE MARK CONSISTS OF STANDARD CHARACTERS WITHOUT CLAIM TO ANY PARTICULAR FONT, STYLE, SIZE, OR COLOR.

OWNER OF U.S. REG. NOS. 3,238,094, 3,238,095 AND 3,240,490.

**CLASS 9—ELECTRICAL AND SCIENTIFIC APPARATUS**

FOR COMPUTER SOFTWARE FOR USE BY INSURANCE CARRIERS, MANAGING GENERAL AGENTS AND INSURANCE AGENTS, NAMELY, SOFTWARE USED FOR DATABASE MANAGEMENT, INSURANCE POLICY ADMINISTRATION, INSURANCE CLAIMS PROCESSING AND SERVICES, INSURANCE POLICY BILLING, ACCOUNTING AND PAYMENT FUNCTIONS, INSURANCE AND REINSURANCE SALES BY AGENTS AND MANAGING GENERAL AGENTS, AND FOR CUSTOMER RELATIONSHIP MANAGEMENT AND CUSTOMER COMMUNICATIONS (U.S. CLS. 21, 23, 26, 36 AND 38).

FIRST USE 10-31-2005; IN COMMERCE 10-31-2005.

**CLASS 35—ADVERTISING AND BUSINESS**

FOR BUSINESS MANAGEMENT CONSULTING AND ADVISORY SERVICES FOR THE INSURANCE AND REINSURANCE INDUSTRY; DATA PROCESSING SERVICES; BUSINESS SERVICES PROVIDED TO THE INSURANCE INDUSTRY, NAMELY, THE COLLECTION, REPORTING, AND ANALYSIS OF DATA FOR BUSINESS PURPOSES AND FOR COMPLIANCE WITH INSURANCE BUREAU LAWS AND REGULATIONS (U.S. CLS. 100, 101 AND 102).

FIRST USE 10-31-2005; IN COMMERCE 10-31-2005.

**CLASS 42—SCIENTIFIC AND COMPUTER SERVICES**

FOR COMPUTER SERVICES, NAMELY, REMOTE AND ON-SITE MANAGEMENT OF THE INFORMATION TECHNOLOGY (IT) SYSTEMS AND THE SOFTWARE APPLICATIONS OF OTHERS; COMPUTER SERVICES, NAMELY, CREATING AND MAINTAINING WEB SITES FOR OTHERS; SOFTWARE AS A SERVICE (SAAS) SERVICES FOR INSURANCE CARRIERS, NAMELY, HOSTING SOFTWARE FOR USE BY OTHERS FOR DATABASE MANAGEMENT, INSURANCE POLICY ADMINISTRATION, INSURANCE CLAIMS PROCESSING AND SERVICES, INSURANCE POLICY BILLING, ACCOUNTING AND PAYMENT FUNCTIONS, CUSTOMER RELATIONSHIP MANAGEMENT AND CUSTOMER COMMUNICATIONS; COMPUTER TECHNICAL SUPPORT SERVICES, NAMELY, 24/7 SERVICE DESK/HELP DESK SERVICES FOR IT INFRASTRUCTURE, OPERATING SYSTEMS, DATABASE SYSTEMS, AND WEB APPLICATIONS; COMPUTER SYSTEMS INTEGRATION SERVICES; DATA CONVERSION SERVICES; COMPUTER PROJECT MANAGEMENT; CONSULTING SERVICES IN THE DESIGN AND IMPLEMENTATION OF COMPUTER-BASED INFORMATION SYSTEMS FOR BUSINESSES IN THE INSURANCE INDUSTRY (U.S. CLS. 100 AND 101).

FIRST USE 10-31-2005; IN COMMERCE 10-31-2005.  
JOHN WILKE, EXAMINING ATTORNEY

SN 85-339,131. INSURANCE DATA PROCESSING, INC., WYNCOTE, PA. FILED 6-6-2011.

JOHN WILKE, EXAMINING ATTORNEY



OWNER OF U.S. REG. NOS. 3,238,094, 3,238,095 AND 3,240,490.

THE MARK CONSISTS OF THE LETTERS "IDP" WITH THE LETTER "I" TOPPED BY A TRIANGLE.

#### CLASS 9—ELECTRICAL AND SCIENTIFIC APPARATUS

FOR COMPUTER SOFTWARE FOR USE BY INSURANCE CARRIERS, MANAGING GENERAL AGENTS AND INSURANCE AGENTS, NAMELY, SOFTWARE USED FOR DATABASE MANAGEMENT, INSURANCE POLICY ADMINISTRATION, INSURANCE CLAIMS PROCESSING AND SERVICES, INSURANCE POLICY BILLING, ACCOUNTING AND PAYMENT FUNCTIONS, INSURANCE AND REINSURANCE SALES BY AGENTS AND MANAGING GENERAL AGENTS, AND FOR CUSTOMER RELATIONSHIP MANAGEMENT AND CUSTOMER COMMUNICATIONS (U.S. CLS. 21, 23, 26, 36 AND 38).

FIRST USE 6-1-2008; IN COMMERCE 6-1-2008.

#### CLASS 35—ADVERTISING AND BUSINESS

FOR BUSINESS MANAGEMENT CONSULTING AND ADVISORY SERVICES FOR THE INSURANCE AND REINSURANCE INDUSTRY; DATA PROCESSING SERVICES; BUSINESS SERVICES PROVIDED TO THE INSURANCE INDUSTRY, NAMELY, THE COLLECTION, REPORTING, AND ANALYSIS OF DATA FOR BUSINESS PURPOSES AND FOR COMPLIANCE WITH INSURANCE BUREAU LAWS AND REGULATIONS (U.S. CLS. 100, 101 AND 102).

FIRST USE 6-1-2008; IN COMMERCE 6-1-2008.

#### CLASS 42—SCIENTIFIC AND COMPUTER SERVICES

FOR COMPUTER SERVICES, NAMELY, REMOTE AND ON-SITE MANAGEMENT OF THE INFORMATION TECHNOLOGY (IT) SYSTEMS AND THE SOFTWARE APPLICATIONS OF OTHERS; COMPUTER SERVICES, NAMELY, CREATING AND MAINTAINING WEB SITES FOR OTHERS; SOFTWARE AS A SERVICE (SAAS) SERVICES FOR INSURANCE CARRIERS, NAMELY, HOSTING SOFTWARE FOR USE BY OTHERS FOR DATABASE MANAGEMENT, INSURANCE POLICY ADMINISTRATION, INSURANCE CLAIMS PROCESSING AND SERVICES, INSURANCE POLICY BILLING, ACCOUNTING AND PAYMENT FUNCTIONS, CUSTOMER RELATIONSHIP MANAGEMENT AND CUSTOMER COMMUNICATIONS; COMPUTER TECHNICAL SUPPORT SERVICES, NAMELY, 24/7 SERVICE DESK HELP DESK SERVICES FOR IT INFRASTRUCTURE, OPERATING SYSTEMS, DATABASE SYSTEMS, AND WEB APPLICATIONS; COMPUTER SYSTEMS INTEGRATION SERVICES; DATA CONVERSION SERVICES; COMPUTER PROJECT MANAGEMENT; CONSULTING SERVICES IN THE DESIGN AND IMPLEMENTATION OF COMPUTER-BASED INFORMATION SYSTEMS FOR BUSINESSES IN THE INSURANCE INDUSTRY (U.S. CLS. 100 AND 101).

FIRST USE 6-1-2010; IN COMMERCE 6-1-2010.

SN 85-339,147. KNORR-NÄHRMITTEL AKTIENGESELLSCHAFT, THAYNGEN CH-8240, SWITZERLAND, FILED 6-6-2011.

## WE LIVE FOOD

THE MARK CONSISTS OF STANDARD CHARACTERS WITHOUT CLAIM TO ANY PARTICULAR FONT, STYLE, SIZE, OR COLOR.

#### CLASS 29—MEATS AND PROCESSED FOODS

FOR BOUILLON; SOUPS AND SOUP MIXES; DIP AND DIP MIXES (U.S. CL. 46).

#### CLASS 30—STAPLE FOODS

FOR PREPARED MEALS CONSISTING PRIMARILY OF PASTA OR RICE; GRAVY AND GRAVY MIXES; SAUCE AND SAUCE MIXES, EXCLUDING APPLE AND CRANBERRY; SEASONINGS AND SEASONED COATING FOR MEAT, FISH AND POULTRY (U.S. CL. 46).

KELLY TRUSILO, EXAMINING ATTORNEY

SN 85-339,183. BRITISH SWIM CENTERS, LLC, SUNRISE, FL. FILED 6-6-2011.



NO CLAIM IS MADE TO THE EXCLUSIVE RIGHT TO USE "SWIM SCHOOL" AND "SINCE 1981", APART FROM THE MARK AS SHOWN.

THE COLOR(S) RED, WHITE, BLUE, BLACK, YELLOW, GREY, AND TAN IS/ARE CLAIMED AS A FEATURE OF THE MARK.

THE MARK CONSISTS OF THE WORD "BRITISH" OUTLINED IN BLACK WITH A BLUE AND RED BACKGROUND, ABOVE THE WORDS "SWIM SCHOOL" IN BLACK LETTERING. BENEATH THE WORDS "BRITISH SWIM SCHOOL" APPEAR TWO CHILDREN. THE GIRL IS DEPICTED FROM THE WAIST UP, WITH YELLOW HAIR, RED HAIR TIES, AND A RED SWIMSUIT. HER SKIN IS DEPICTED IN TAN AND HER MOUTH IN WHITE, AND HER EYES IN BLACK AND WHITE. TO HER RIGHT IS A BOY, DEPICTED FROM THE WAIST UP WITH BLACK HAIR, BLACK AND WHITE EYES, A BLACK SMILING MOUTH AND TAN SKIN. GREY IS USED TO DEFINE THE CHILDREN'S FEATURES AND THEY BOTH ARE SET AGAINST BLACK AND GREY SHADOWING. THE CHILDREN ARE SHOWN FLOATING IN CIRCULAR RED AND WHITE FLOTATION DEVICES SURROUNDED BY BLUE

WATER. ABOVE THE WORDS "BRITISH SWIM SCHOOL" IS A CURVED BANNER APPEARING IN RED, WHITE, AND BLUE, OUTLINED IN BLACK. BENEATH THE CHILDREN AND THE WATER IS ANOTHER CURVED RED, WHITE AND BLUE BANNER WITH BLACK OUTLINING. ALSO BENEATH THE CHILDREN AND THE LOWER BANNER IS A RED RIBBON INSIDE OF WHICH APPEARS THE WORDS "SURVIVAL OF THE LITTLEST" IN YELLOW LETTERING. AROUND THE SIDES AND TOP OF THE CHILDREN AND THE WORDS "BRITISH SWIM SCHOOL" IS AN OUTLINE OF A PARTIAL RED CIRCLE, THE TOP LEFT OF WHICH IS FORMED BY THE WORDS "SAVING LIVES SINCE 1981" IN RED LETTERING. AROUND THE OUTSIDE OF THE ENTIRE MARK IS A FULL OUTLINE OF A RED CIRCLE. THE ENTIRE MARK APPEARS ON A WHITE BACKGROUND.

#### CLASS 35—ADVERTISING AND BUSINESS

FOR FRANCHISING, NAMELY, OFFERING BUSINESS MANAGEMENT ASSISTANCE IN THE ESTABLISHMENT AND/OR OPERATION OF LOCAL SWIMMING INSTRUCTION BUSINESSES (U.S. CLS. 100, 101 AND 102).  
FIRST USE 1-31-2011; IN COMMERCE 1-31-2011.

#### CLASS 41—EDUCATION AND ENTERTAINMENT

FOR SWIMMING INSTRUCTION (U.S. CLS. 100, 101 AND 107).  
FIRST USE 1-31-2011; IN COMMERCE 1-31-2011.  
EMILY CARLSEN, EXAMINING ATTORNEY

---

SN 85-339,408. LESCHISIN, GREG, LAFAYETTE, CO. FILED 6-6-2011.

# Hoi Polloi

THE MARK CONSISTS OF STANDARD CHARACTERS WITHOUT CLAIM TO ANY PARTICULAR FONT, STYLE, SIZE, OR COLOR.

#### CLASS 35—ADVERTISING AND BUSINESS

FOR ADVERTISING SERVICES, NAMELY, PROMOTING AND MARKETING THE GOODS AND SERVICES OF OTHERS THROUGH ALL PUBLIC COMMUNICATION MEANS (U.S. CLS. 100, 101 AND 102).

#### CLASS 42—SCIENTIFIC AND COMPUTER SERVICES

FOR INTERIOR DESIGN SERVICES; NEW PRODUCT DESIGN SERVICES (U.S. CLS. 100 AND 101).  
KHANH LE, EXAMINING ATTORNEY

SN 85-339,410. FRY, MARY CONSTANCE, ANAHEIM HILLS, CA. FILED 6-6-2011.

# CRAZY MARY

THE MARK CONSISTS OF STANDARD CHARACTERS WITHOUT CLAIM TO ANY PARTICULAR FONT, STYLE, SIZE, OR COLOR.

#### CLASS 14—JEWELRY

FOR CLOCKS; WATCHES; JEWELRY; BRACELETS COMPOSED OF MATERIAL OTHER THAN PRECIOUS METAL (U.S. CLS. 2, 27, 28 AND 50).

#### CLASS 18—LEATHER GOODS

FOR HANDBAGS; BEACH BAGS; TOTE BAGS; BACKPACKS; ALL PURPOSE CARRYING BAGS; ATHLETIC BAGS; SPORTS BAGS, PURSES; WALLETS (U.S. CLS. 1, 2, 3, 22 AND 41).

#### CLASS 25—CLOTHING

FOR DRESSES, SKIRTS, SHORTS, SHIRTS, T-SHIRTS, TANK TOPS, BLOUSES, KNIT TOPS, PANTS, TROUSERS, JEANS, VESTS, LEGGINGS, SWEATSHIRTS, SWEATPANTS, AND SWEATERS; OUTERWEAR, NAMELY, COATS, JACKETS; BATHING SUITS, LINGERIE, PAJAMAS, ROBES, BELTS, GLOVES, MITTENS, BANDANAS, SCARVES, SOCKS; HEADWEAR, NAMELY HATS, CAPS, BEANIES, VISORS; AND FOOTWEAR, NAMELY, SHOES, BOOTS, SANDALS, SLIPPERS (U.S. CLS. 22 AND 39).

CHARLES L. JENKINS, EXAMINING ATTORNEY

---

SN 85-339,477. UNITED STATES FUND FOR UNICEF, NEW YORK, NY. FILED 6-7-2011.

# BELIEVE IN ZERO

THE MARK CONSISTS OF STANDARD CHARACTERS WITHOUT CLAIM TO ANY PARTICULAR FONT, STYLE, SIZE, OR COLOR.

OWNER OF U.S. REG. NO. 3,687,210.

#### CLASS 35—ADVERTISING AND BUSINESS

FOR PROMOTING PUBLIC AWARENESS ABOUT CHILDREN IN DEVELOPING COUNTRIES AND THE CONDITIONS IN WHICH THEY LIVE (U.S. CLS. 100, 101 AND 102).

FIRST USE 11-11-2008; IN COMMERCE 11-11-2008.

#### CLASS 36—INSURANCE AND FINANCIAL

FOR CHARITABLE FUNDRAISING SERVICES (U.S. CLS. 100, 101 AND 102).

FIRST USE 11-11-2008; IN COMMERCE 11-11-2008.  
KATHERINE STOIDES, EXAMINING ATTORNEY

SN 85-339,488. PIVOTSPAN, LLC, MAHWAH, NJ. FILED 6-7-2011.

SN 85-339,564. TEACH FOR AMERICA, INC., NEW YORK, NY. FILED 6-7-2011.

# IWEDO

THE MARK CONSISTS OF STANDARD CHARACTERS WITHOUT CLAIM TO ANY PARTICULAR FONT, STYLE, SIZE, OR COLOR.

## CLASS 35—ADVERTISING AND BUSINESS

FOR PROMOTING THE GOODS AND SERVICES OF OTHERS VIA A GLOBAL COMPUTER NETWORK (U.S. CLS. 100, 101 AND 102).

## CLASS 42—SCIENTIFIC AND COMPUTER SERVICES

FOR PROVIDING ON-LINE NON-DOWNLOADABLE SOFTWARE WHICH ALLOWS USERS TO SCHEDULE ACTIVITIES, EVENTS AND TASKS AND INTERACT WITH OTHER USERS AND PLACES (U.S. CLS. 100 AND 101).

LINDA MICKLEBURGH, EXAMINING ATTORNEY

## LEADERSHIP FOR EDUCATIONAL EQUITY

THE MARK CONSISTS OF STANDARD CHARACTERS WITHOUT CLAIM TO ANY PARTICULAR FONT, STYLE, SIZE, OR COLOR.

NO CLAIM IS MADE TO THE EXCLUSIVE RIGHT TO USE "LEADERSHIP", APART FROM THE MARK AS SHOWN.

## CLASS 35—ADVERTISING AND BUSINESS

FOR EDUCATIONAL LEADERSHIP DEVELOPMENT; BUSINESS NETWORKING OF GROUPS OF PEOPLE INTERESTED IN PUBLIC LEADERSHIP AS CANDIDATES FOR ELECTED OFFICE, POLICY EXPERTS AND ADVOCATES FOR EDUCATION REFORM (U.S. CLS. 100, 101 AND 102).

FIRST USE 8-0-2007; IN COMMERCE 8-0-2007.

## CLASS 41—EDUCATION AND ENTERTAINMENT

FOR PROVIDING GROUP COACHING AND LEARNING FORUMS IN THE FIELD OF LEADERSHIP DEVELOPMENT; MEMBERSHIP CLUB SERVICES, NAMELY, PROVIDING TRAINING TO MEMBERS IN THE FIELD OF PUBLIC LEADERSHIP, PUBLIC POLICY AND EDUCATIONAL REFORM (U.S. CLS. 100, 101 AND 107).

FIRST USE 3-0-2010; IN COMMERCE 3-0-2010.

CHRISTINA SOBRAL, EXAMINING ATTORNEY

SN 85-339,546. ARCH UK BIOCIDES LIMITED, WEST YORKSHIRE, UNITED KINGDOM, FILED 6-7-2011.

# BAQUACIL

THE MARK CONSISTS OF STANDARD CHARACTERS WITHOUT CLAIM TO ANY PARTICULAR FONT, STYLE, SIZE, OR COLOR.

OWNER OF U.S. REG. NOS. 1,058,905 AND 2,921,462.

## CLASS 1—CHEMICALS

FOR CHEMICALS USED TO TREAT SWIMMING POOL WATER; REAGENT BEARING TEST STRIPS FOR TESTING SWIMMING POOL WATER (U.S. CLS. 1, 5, 6, 10, 26 AND 46).

FIRST USE 12-31-1995; IN COMMERCE 12-31-1995.

## CLASS 3—COSMETICS AND CLEANING PREPARATIONS

FOR CLEANERS FOR USE ON POOL FILTERS, POOL SURFACES, AND POOL LINES (U.S. CLS. 1, 4, 6, 50, 51 AND 52).

FIRST USE 12-31-1995; IN COMMERCE 12-31-1995.  
MIDGE BUTLER, EXAMINING ATTORNEY

SN 85-339,579. JAMES OTIS JOHNSON, JR., SOUTH HOLLAND, IL. FILED 6-7-2011.

THE MARK CONSISTS OF THE STYLIZED LETTERS "F2F", WHERE THE SECOND "F" IS REVERSED.

## CLASS 35—ADVERTISING AND BUSINESS

FOR BUSINESS NETWORKING; GENERAL BUSINESS NETWORKING REFERRAL SERVICES, NAMELY, PROMOTING THE GOODS AND SERVICES OF OTHERS BY PASSING BUSINESS LEADS AND REFERRALS AMONG GROUP MEMBERS; ON-LINE ADVERTISING ON COMPUTER COMMUNICATION NETWORKS; ON-LINE ADVERTISING ON COMPUTER NETWORKS; ON-LINE BUSINESS NETWORKING SERVICES; ON-LINE PROFESSIONAL NETWORKING SERVICES; ONLINE ADVERTISING VIA A COMPUTER COMMUNICATIONS NETWORK; PROMOTING THE GOODS AND SERVICES OF OTHERS VIA A GLOBAL COMPUTER NETWORK; PROVIDING BUSINESS INFORMATION, ALSO VIA INTERNET, THE CABLE NETWORK OR OTHER FORMS OF DATA TRANSFER; PROVIDING INFORMATION ABOUT THE GOODS AND SERVICES OF OTHERS VIA THE GLOBAL COMPUTER NETWORK (U.S. CLS. 100, 101 AND 102).

FIRST USE 4-1-2010; IN COMMERCE 4-1-2010.

**CLASS 45—PERSONAL AND LEGAL SERVICES**

FOR INTERNET-BASED SOCIAL NETWORKING SERVICES; ON-LINE SOCIAL NETWORKING SERVICES; ONLINE SOCIAL NETWORKING SERVICES IN THE FIELD OF BUSINESS; ONLINE SOCIAL NETWORKING SERVICES IN THE FIELD OF BUSINESS PROVIDED VIA A WEBSITE; SOCIAL NETWORKING SERVICES IN THE FIELD OF BUSINESS PROVIDED VIA A WEBSITE (U.S. CLS. 100 AND 101).

FIRST USE 4-1-2010; IN COMMERCE 4-1-2010.  
TINA BROWN, EXAMINING ATTORNEY

**CLASS 42—SCIENTIFIC AND COMPUTER SERVICES**

FOR PLATFORM AS A SERVICE (PAAS) FEATURING COMPUTER SOFTWARE PLATFORMS FOR USE IN INGESTING, STORING, ACCESSING, MANAGING AND DISTRIBUTING, DIGITAL VIDEO AND OTHER MEDIA AND FOR USE IN MAINTAINING A DATABASE OF INDEXED VIDEO OF TELEVISION, FILM, CREATIVE, AND USER-GENERATED CONTENT MEDIA; VIDEO MANAGEMENT SERVICES AND PRODUCTION OFFERINGS FOR CREATION, DISTRIBUTION AND PRODUCTION OF PROGRAMMING OR MEDIA IN THE AREAS OF ENTERTAINMENT, SPORTS, NEWS AND DIGITAL MEDIA (U.S. CLS. 100 AND 101).

FIRST USE 9-30-2010; IN COMMERCE 9-30-2010.  
ALLISON HOLTZ, EXAMINING ATTORNEY

SN 85-339,706. THOUGHT EQUITY MOTION, INC., DENVER, CO. FILED 6-7-2011.

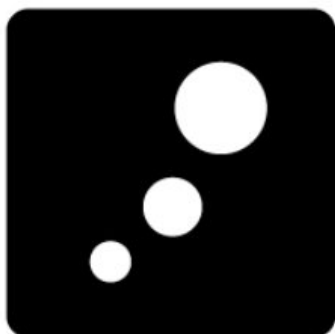

OWNER OF U.S. REG. NO. 3,548,634.  
THE MARK CONSISTS OF THREE SOLID BUBBLES OF INCREASING SIZE.

**CLASS 9—ELECTRICAL AND SCIENTIFIC APPARATUS**

FOR DIGITAL AUDIO AND VISUAL MATERIALS, NAMELY, CD'S, DVD'S, DOWNLOADABLE VIDEO FILES FEATURING IMAGES, PHOTOGRAPHS, AND MOTION CONTENT, NAMELY, VIDEO FOOTAGE, CLIPS, ANIMATION, AND GRAPHICS FOR USE IN THE ADVERTISING AND MARKETING MATERIALS OF OTHERS AND IN THE MOVIE, TELEVISION, AND SPORTS INDUSTRIES (U.S. CLS. 21, 23, 26, 36 AND 38).

FIRST USE 9-30-2010; IN COMMERCE 9-30-2010.

**CLASS 35—ADVERTISING AND BUSINESS**

FOR COMMERCIAL ADMINISTRATION OF THE LICENSING OF DIGITAL AUDIO AND VISUAL MATERIALS OF OTHERS, NAMELY, IMAGES, PHOTOGRAPHS, AUDIO CLIPS AND MOTION CONTENT, NAMELY, VIDEO FOOTAGE, CLIPS, ANIMATION, AND GRAPHICS FOR USE IN ADVERTISING AND MARKETING MATERIALS OF OTHERS AND IN THE MOVIE, TELEVISION, AND SPORTS INDUSTRIES (U.S. CLS. 100, 101 AND 102).

FIRST USE 9-30-2010; IN COMMERCE 9-30-2010.

SN 85-339,742. JEFF LEATHAM, INC., NEW YORK, NY. FILED 6-7-2011.

**JEFF LEATHAM**

THE MARK CONSISTS OF STANDARD CHARACTERS WITHOUT CLAIM TO ANY PARTICULAR FONT, STYLE, SIZE, OR COLOR.

THE NAME(S), PORTRAIT(S), AND/OR SIGNATURE(S) SHOWN IN THE MARK IDENTIFIES JEFF LEATHAM, WHOSE CONSENT(S) TO REGISTER IS MADE OF RECORD.

**CLASS 3—COSMETICS AND CLEANING PREPARATIONS**

FOR FRAGRANCES FOR PERSONAL USE; PERFUMES AND COLOGNES; ROOM FRAGRANCES; SCENTED ROOM SPRAYS (U.S. CLS. 1, 4, 6, 50, 51 AND 52).

**CLASS 4—LUBRICANTS AND FUELS**

FOR CANDLES (U.S. CLS. 1, 6 AND 15).  
ESTHER BELENKER, EXAMINING ATTORNEY

SN 85-339,766. CUMULUS BROADCASTING LLC, ATLANTA, GA. FILED 6-7-2011.



OWNER OF U.S. REG. NO. 3,900,235.  
THE MARK CONSISTS OF A CIRCLE DIVIDED BY CURVED LINES.

**CLASS 9—ELECTRICAL AND SCIENTIFIC APPARATUS**

FOR DOWNLOADABLE ELECTRONIC PUBLICATIONS, NAMELY, MAGAZINES IN THE FIELDS OF GENERAL INTEREST AND MUSIC (U.S. CLS. 21, 23, 26, 36 AND 38).

**CLASS 16—PAPER GOODS AND PRINTED MATTER**

FOR MAGAZINES IN THE FIELDS OF GENERAL INTEREST AND MUSIC (U.S. CLS. 2, 5, 22, 23, 29, 37, 38 AND 50).

**CLASS 41—EDUCATION AND ENTERTAINMENT**

FOR PROVIDING ONLINE MAGAZINES IN THE FIELDS OF GENERAL INTEREST AND MUSIC (U.S. CLS. 100, 101 AND 107).

DANIEL CAPSHAW, EXAMINING ATTORNEY

SN 85-339,774. BRICKSTIX LLC, HARTLAND, WI. FILED 6-7-2011.

# BRICKSTIX

THE MARK CONSISTS OF STANDARD CHARACTERS WITHOUT CLAIM TO ANY PARTICULAR FONT, STYLE, SIZE, OR COLOR.

**CLASS 16—PAPER GOODS AND PRINTED MATTER**

FOR STICKERS AND DECALCOMANIAS (U.S. CLS. 2, 5, 22, 23, 29, 37, 38 AND 50).

FIRST USE 9-13-2010; IN COMMERCE 9-13-2010.

**CLASS 28—TOYS AND SPORTING GOODS**

FOR CONSTRUCTION TOYS (U.S. CLS. 22, 23, 38 AND 50).

FIRST USE 9-13-2010; IN COMMERCE 9-13-2010.  
PAM WILLIS, EXAMINING ATTORNEY

SN 85-339,803. ZEETOGROUP, LLC, SAN DIEGO, CA. FILED 6-7-2011.

# ZEETO

THE MARK CONSISTS OF STANDARD CHARACTERS WITHOUT CLAIM TO ANY PARTICULAR FONT, STYLE, SIZE, OR COLOR.

**CLASS 35—ADVERTISING AND BUSINESS**

FOR PROVIDING DEMAND CREATION AND LEAD GENERATION ACTIVITIES AND SERVICES. DISSEMINATION OF ADVERTISING FOR OTHERS VIA THE INTERNET. DISSEMINATION OF ADVERTISING FOR OTHERS VIA AN ON-LINE COMMUNICATIONS NETWORK USING A NETWORK OF AFFILIATES (U.S. CLS. 100, 101 AND 102).

FIRST USE 8-5-2007; IN COMMERCE 8-5-2007.

**CLASS 42—SCIENTIFIC AND COMPUTER SERVICES**

FOR PROVIDING ON-LINE NON-DOWNLOADABLE SOFTWARE FOR CONDUCTING AND MANAGING ONLINE MARKETING CAMPAIGNS (U.S. CLS. 100 AND 101).

FIRST USE 8-5-2007; IN COMMERCE 8-5-2007.  
DAWN FELDMAN, EXAMINING ATTORNEY

SN 85-340,054. IHEARTGAMERS, SANTA ANA, CA. FILED 6-7-2011.

# iheartgamers

THE MARK CONSISTS OF STANDARD CHARACTERS WITHOUT CLAIM TO ANY PARTICULAR FONT, STYLE, SIZE, OR COLOR.

**CLASS 16—PAPER GOODS AND PRINTED MATTER**

FOR STICKERS (U.S. CLS. 2, 5, 22, 23, 29, 37, 38 AND 50).

**CLASS 25—CLOTHING**

FOR SHIRTS (U.S. CLS. 22 AND 39).

JANICE KIM, EXAMINING ATTORNEY

SN 85-340,115. SCHMIDT, MICHAEL B, CAMBRIDGE, MA. FILED 6-7-2011.

# The Bearded Pig

THE MARK CONSISTS OF STANDARD CHARACTERS WITHOUT CLAIM TO ANY PARTICULAR FONT, STYLE, SIZE, OR COLOR.

**CLASS 30—STAPLE FOODS**

FOR BARBECUE SAUCE (U.S. CL. 46).

**CLASS 43—HOTEL AND RESTAURANT SERVICES**

FOR CATERING SERVICES (U.S. CLS. 100 AND 101).

FLORENTINA BLANDU, EXAMINING ATTORNEY

SN 85-340,200. EAGLE NEW MEDIA INVESTMENTS, LLC,  
CHICAGO, IL. FILED 6-7-2011.

SN 85-340,344. TECNOQUIMICAS S.A., CALI, COLOMBIA,  
FILED 6-7-2011.

EAT.LEARN.SHOP.FIND.WE ARE  
CHICAGO

TECNOQUIMICAS

THE MARK CONSISTS OF STANDARD CHARACTERS  
WITHOUT CLAIM TO ANY PARTICULAR FONT, STYLE,  
SIZE, OR COLOR.

OWNER OF U.S. REG. NOS. 1,319,357, 1,367,605 AND  
2,742,591.

SEC. 2(F) AS TO "CHICAGO".

#### **CLASS 16—PAPER GOODS AND PRINTED MATTER**

FOR GENERAL FEATURE MAGAZINES (U.S. CLS. 2,  
5, 22, 23, 29, 37, 38 AND 50).

#### **CLASS 41—EDUCATION AND ENTERTAIN- MENT**

FOR PROVIDING ON-LINE PUBLICATIONS IN THE  
NATURE OF A MAGAZINE ABOUT CHICAGO AND  
TOPICS OF INTEREST TO CHICAGOANS (U.S. CLS. 100,  
101 AND 107).

DAWN HAN, EXAMINING ATTORNEY

---

SN 85-340,335. PUKLICH BICYCLES, INC., DBA EXCEL-  
CYCLE, EXCELSIOR, MN. FILED 6-7-2011.

Excelcycle

THE MARK CONSISTS OF STANDARD CHARACTERS  
WITHOUT CLAIM TO ANY PARTICULAR FONT, STYLE,  
SIZE, OR COLOR.

#### **CLASS 35—ADVERTISING AND BUSINESS**

FOR RETAIL STORE AND ON-LINE RETAIL STORE  
SERVICES FEATURING BICYCLES AND BICYCLE RE-  
LATED PRODUCTS AND ACCESSORIES (U.S. CLS. 100,  
101 AND 102).

FIRST USE 9-19-2005; IN COMMERCE 5-13-2006.

#### **CLASS 37—CONSTRUCTION AND REPAIR**

FOR REPAIR OF BICYCLES (U.S. CLS. 100, 103 AND  
106).

FIRST USE 9-19-2005; IN COMMERCE 5-13-2006.  
ALICIA COLLINS, EXAMINING ATTORNEY

THE MARK CONSISTS OF STANDARD CHARACTERS  
WITHOUT CLAIM TO ANY PARTICULAR FONT, STYLE,  
SIZE, OR COLOR.

OWNER OF COLOMBIA REG. NO. 08024616, DATED 9-29-  
2008, EXPIRES 9-29-2018.

OWNER OF COLOMBIA REG. NO. 08024627, DATED 9-29-  
2008, EXPIRES 9-29-2018.

THE WORDING "TECNOQUIMICAS" HAS NO MEAN-  
ING IN A FOREIGN LANGUAGE.

#### **CLASS 3—COSMETICS AND CLEANING PRE- PARATIONS**

FOR BLEACHING PREPARATIONS FOR LAUNDRY  
USE; CLEANING, WASHING AND POLISHING PRE-  
PARATIONS; COSMETICS; DE-GREASING PREPARA-  
TIONS FOR HOUSEHOLD PURPOSES; DENTIFRICES;  
ESSENTIAL OILS; HAIR LOTIONS; PERFUMERY; POL-  
ISHING, SCOURING AND ABRASIVE PREPARATIONS;  
SOAPS (U.S. CLS. 1, 4, 6, 50, 51 AND 52).

#### **CLASS 5—PHARMACEUTICALS**

FOR ANALGESIC AND MUSCLE RELAXANT PHAR-  
MACEUTICAL PREPARATIONS; ANALGESICS; ANTI-  
DIABETIC PREPARATIONS; ANTI-INFECTIVES; ANTI-  
INFLAMMATORIES; ANTIBIOTICS; ANTIFUNGAL  
PREPARATIONS; ANTIPARASITIC PREPARATIONS;  
ANTIPARASITICS; BABY FOODS; CARDIOVASCULAR  
PHARMACEUTICALS; COUGH EXPECTORANTS; DEN-  
TAL VARNISH FOR USE BY DENTISTS; DERMATOLO-  
GICALS; DIETETIC BEVERAGES ADAPTED FOR  
MEDICAL PURPOSES; DIETETIC FOODS ADAPTED  
FOR MEDICAL USE; DISINFECTANTS FOR HYGIENIC  
PURPOSES; DRESSINGS FOR DENTAL PURPOSES;  
FISSURE SEALANT FOR DENTAL AND DENTAL  
TECHNICAL PURPOSES; FIXING MATERIALS FOR  
DENTAL PURPOSES; FUNGICIDES; HERBICIDES;  
MEDICINES FOR THE TREATMENT OF GASTROIN-  
TESTINAL DISEASES; MINERAL SUPPLEMENTS;  
PHARMACEUTICAL PREPARATIONS FOR USE IN  
UROLOGY; PHARMACEUTICAL PREPARATIONS FOR  
WOUNDS; PHARMACEUTICAL PREPARATIONS FOR  
THE TREATMENT OF GYNECOLOGICAL DISEASES,  
SENSE ORGANS, PARASITOLOGICAL DISEASES, SYS-  
TEMATIC HORMONAL DISEASES, MUCOLYTIC DIS-  
EASES, BLOOD AND HEMATOLOGICAL DISEASES,  
CARDIOVASCULAR SYSTEM DISEASES, GENITOUR-  
INARY SYSTEM DISEASES, MUSCULOSKELETAL SYS-  
TEM DISEASES, CENTRAL NERVOUS SYSTEM  
DISEASES, RESPIRATORY SYSTEM DISEASES, ALI-  
MENTARY TRACT AND METABOLISM DISEASES,  
BLOOD VESSELS, MUSCLE PAIN AND INFLAMMA-  
TIONS, PAIN AND FEVER, STOMACH FLU, COUGH  
AND THROAT, AND SKIN DISEASES; PHARMACEUTI-  
CAL PRODUCTS FOR TREATING RESPIRATORY DIS-  
EASES; PREPARATIONS FOR DESTROYING VERMIN;  
PREPARATIONS FOR KILLING WEEDS AND DE-  
STROYING VERMIN; VACCINES; VETERINARY PRE-  
PARATIONS FOR THE TREATMENT OF PARASITES;  
VETERINARY PREPARATIONS, NAMELY, ANTI-MI-  
CROBIALS, ANTI-PARASITICS, ANTI-INFLAMMATORY  
PREPARATIONS AND ORGANIC MINERALS; VETER-  
INARY PREPARATIONS, NAMELY, PAIN RELIEF  
MEDICATION; VITAMINS; VITAMINS AND DIETARY  
FOOD SUPPLEMENTS FOR ANIMALS (U.S. CLS. 6, 18,  
44, 46, 51 AND 52).

RAMONA ORTIGA, EXAMINING ATTORNEY



SN 85-340,357. TECNOQUIMICAS S.A., CALI, COLOMBIA,  
FILED 6-7-2011.

SN 85-340,382. WILLIAMS, SAMMIE, NEW ORLEANS, LA.  
FILED 6-7-2011.

TQ

THE MARK CONSISTS OF STANDARD CHARACTERS WITHOUT CLAIM TO ANY PARTICULAR FONT, STYLE, SIZE, OR COLOR.

THE WORDING "TQ" HAS NO MEANING IN A FOREIGN LANGUAGE.

### CLASS 3—COSMETICS AND CLEANING PREPARATIONS

FOR BLEACHING PREPARATIONS FOR LAUNDRY USE; CLEANING, WASHING AND POLISHING PREPARATIONS; COSMETICS; DE-GREASING PREPARATIONS FOR HOUSEHOLD PURPOSES; DENTIFRICES; ESSENTIAL OILS; HAIR LOTIONS; PERFUMERY; POLISHING, SCOURING AND ABRASIVE PREPARATIONS; SOAPS (U.S. CLS. 1, 4, 6, 50, 51 AND 52).

### CLASS 5—PHARMACEUTICALS

FOR ANALGESIC AND MUSCLE RELAXANT PHARMACEUTICAL PREPARATIONS; ANALGESICS; ANTI-DIABETIC PREPARATIONS; ANTI-INFECTIVES; ANTI-INFLAMMATORIES; ANTIBIOTICS; ANTIFUNGAL PREPARATIONS; ANTIPARASITIC PREPARATIONS; ANTIPARASITICS; BABY FOODS; CARDIOVASCULAR PHARMACEUTICALS; COUGH EXPECTORANTS; DENTAL VARNISH FOR USE BY DENTISTS; DERMATOLOGICALS; DIETETIC BEVERAGES ADAPTED FOR MEDICAL PURPOSES; DIETETIC FOODS ADAPTED FOR MEDICAL USE; DISINFECTANTS FOR HYGIENIC PURPOSES; DRESSINGS FOR DENTAL PURPOSES; FISSURE SEALANT FOR DENTAL AND DENTAL TECHNICAL PURPOSES; FIXING MATERIALS FOR DENTAL PURPOSES; FUNGICIDES; HERBICIDES; MEDICINES FOR THE TREATMENT OF GASTROINTESTINAL DISEASES; MINERAL SUPPLEMENTS; PHARMACEUTICAL PREPARATIONS FOR USE IN UROLOGY; PHARMACEUTICAL PREPARATIONS FOR WOUNDS; PHARMACEUTICAL PREPARATIONS FOR THE TREATMENT OF GYNECOLOGICAL DISEASES, SENSE ORGANS, PARASITOLOGICAL DISEASES, SYSTEMIC HORMONAL DISEASES, MUCOLYTIC DISEASES, BLOOD AND HEMATOLOGICAL DISEASES, CARDIOVASCULAR SYSTEM DISEASES, GENITOURINARY SYSTEM DISEASES, MUSCULOSKELETAL SYSTEM DISEASES, CENTRAL NERVOUS SYSTEM DISEASES, RESPIRATORY SYSTEM DISEASES, ALIMENTARY TRACT AND METABOLISM DISEASES, BLOOD VESSELS, MUSCLE PAIN AND INFLAMMATIONS, PAIN AND FEVER, STOMACH FLU, COUGH AND THROAT, AND SKIN DISEASES; PHARMACEUTICAL PRODUCTS FOR TREATING RESPIRATORY DISEASES; PREPARATIONS FOR DESTROYING VERMIN; PREPARATIONS FOR KILLING WEEDS AND DESTROYING VERMIN; VACCINES; VETERINARY PREPARATIONS FOR THE TREATMENT OF PARASITES; VETERINARY PREPARATIONS, NAMELY, ANTI-MICROBIALS, ANTI-PARASITICS, ANTI-INFLAMMATORY PREPARATIONS AND ORGANIC MINERALS; VETERINARY PREPARATIONS, NAMELY, PAIN RELIEF MEDICATION; VITAMINS; VITAMINS AND DIETARY FOOD SUPPLEMENTS FOR ANIMALS (U.S. CLS. 6, 18, 44, 46, 51 AND 52).

RAMONA ORTIGA, EXAMINING ATTORNEY

Big Sam's Funky Nation

THE MARK CONSISTS OF STANDARD CHARACTERS WITHOUT CLAIM TO ANY PARTICULAR FONT, STYLE, SIZE, OR COLOR.

THE NAME SHOWN IN THE MARK IDENTIFIES SAMMIE WILLIAMS, A LIVING INDIVIDUAL WHOSE CONSENT TO REGISTER IS MADE OF RECORD

### CLASS 9—ELECTRICAL AND SCIENTIFIC APPARATUS

FOR DIGITAL MEDIA, NAMELY, CDS FEATURING MUSIC (U.S. CLS. 21, 23, 26, 36 AND 38).

FIRST USE 1-1-2001; IN COMMERCE 1-1-2002.

### CLASS 41—EDUCATION AND ENTERTAINMENT

FOR ENTERTAINMENT IN THE NATURE OF LIVE MUSICAL PERFORMANCES (U.S. CLS. 100, 101 AND 107).

FIRST USE 1-1-2001; IN COMMERCE 1-1-2002.

THEODORE MCBRIDE, EXAMINING ATTORNEY

SN 85-340,507. BALIUS, LLC, DENISON, TX. FILED 6-7-2011.

GOCORE

THE MARK CONSISTS OF STANDARD CHARACTERS WITHOUT CLAIM TO ANY PARTICULAR FONT, STYLE, SIZE, OR COLOR.

### CLASS 25—CLOTHING

FOR CLOTHING, NAMELY, HATS, SHIRTS, SHORTS, PANTS, WARM UP SUITS, SWEAT SHIRTS, SWEATERS, JACKETS, GLOVES, FOOTWEAR, RAIN WEAR, UNDER GARMENTS (U.S. CLS. 22 AND 39).

### CLASS 28—TOYS AND SPORTING GOODS

FOR MANUALLY-OPERATED EXERCISE EQUIPMENT (U.S. CLS. 22, 23, 38 AND 50).

NORA BUCHANAN WILL, EXAMINING ATTORNEY

SN 85-340,549. YOASIS, OCEAN CITY, NJ. FILED 6-7-2011.

# Yoasis

THE MARK CONSISTS OF STANDARD CHARACTERS WITHOUT CLAIM TO ANY PARTICULAR FONT, STYLE, SIZE, OR COLOR.

## CLASS 30—STAPLE FOODS

FOR FROZEN YOGURT (U.S. CL. 46).

## CLASS 35—ADVERTISING AND BUSINESS

FOR SELF-SERVE YOGURT SHOP SERVICES (U.S. CLS. 100, 101 AND 102).  
ALICIA COLLINS, EXAMINING ATTORNEY

---

SN 85-340,812. MILE DEVELOPMENT CORP., JERICHO, NY.  
FILED 6-8-2011.

THE BEECHWOOD ORGANIZATION

THE MARK CONSISTS OF STANDARD CHARACTERS WITHOUT CLAIM TO ANY PARTICULAR FONT, STYLE, SIZE, OR COLOR.

NO CLAIM IS MADE TO THE EXCLUSIVE RIGHT TO USE "ORGANIZATION", APART FROM THE MARK AS SHOWN.

## CLASS 36—INSURANCE AND FINANCIAL

FOR REAL ESTATE SERVICES, NAMELY, REAL ESTATE BROKERAGE SERVICES, LEASING OF REAL ESTATE, REAL ESTATE INVESTMENT SERVICES; REAL ESTATE EQUITY SHARING, NAMELY, MANAGING AND ARRANGING FOR CO-OWNERSHIP OF REAL ESTATE (U.S. CLS. 100, 101 AND 102).  
FIRST USE 4-21-1988; IN COMMERCE 4-21-1988.

## CLASS 37—CONSTRUCTION AND REPAIR

FOR REAL ESTATE DEVELOPMENT SERVICES (U.S. CLS. 100, 103 AND 106).  
FIRST USE 4-21-1988; IN COMMERCE 4-21-1988.  
ANGELA M. MICHELI, EXAMINING ATTORNEY

---

SN 85-340,867. LEE, GRACE SUNMIE, POKFULAM, HONG KONG, FILED 6-8-2011.

# BlockBury

THE MARK CONSISTS OF STANDARD CHARACTERS WITHOUT CLAIM TO ANY PARTICULAR FONT, STYLE, SIZE, OR COLOR.

## CLASS 9—ELECTRICAL AND SCIENTIFIC APPARATUS

FOR COMPUTER SOFTWARE FOR COMMUNICATING WITH USERS OF HAND-HELD COMPUTERS; COMPUTER SOFTWARE FOR COMPUTER SYSTEM AND APPLICATION DEVELOPMENT, DEPLOYMENT AND MANAGEMENT; COMPUTER SOFTWARE FOR CONTROLLING AND MANAGING ACCESS SERVER APPLICATIONS; COMPUTER SOFTWARE FOR THE COLLECTION, EDITING, ORGANIZING, MODIFYING, BOOK MARKING, TRANSMISSION, STORAGE AND SHARING OF DATA AND INFORMATION; COMPUTER SOFTWARE THAT PROVIDES WEB-BASED ACCESS TO APPLICATIONS AND SERVICES THROUGH A WEB OPERATING SYSTEM OR PORTAL INTERFACE; COMPUTER SOFTWARE TO MAINTAIN AND OPERATE COMPUTER SYSTEM; COMPUTER SOFTWARE, NAMELY, SOFTWARE DEVELOPMENT TOOLS FOR THE CREATION OF MOBILE INTERNET APPLICATIONS AND CLIENT INTERFACES (U.S. CLS. 21, 23, 26, 36 AND 38).

## CLASS 42—SCIENTIFIC AND COMPUTER SERVICES

FOR COMPUTER SOFTWARE DEVELOPMENT IN THE FIELD OF MOBILE APPLICATIONS; CREATING, MAINTAINING, AND MODERNIZING COMPUTER SOFTWARE; DESIGN AND DEVELOPMENT OF COMPUTER SOFTWARE (U.S. CLS. 100 AND 101).  
KIM MONINGHOFF, EXAMINING ATTORNEY

---

SN 85-341,067. VIKING TECHNOLOGIES INC, DBA VIKING TECHNOLOGIES, MADISON HEIGHTS, MI. FILED 6-8-2011.

# pour-tech

THE MARK CONSISTS OF STANDARD CHARACTERS WITHOUT CLAIM TO ANY PARTICULAR FONT, STYLE, SIZE, OR COLOR.

## CLASS 9—ELECTRICAL AND SCIENTIFIC APPARATUS

FOR LASER MEASURING SYSTEMS (U.S. CLS. 21, 23, 26, 36 AND 38).

## CLASS 37—CONSTRUCTION AND REPAIR

FOR INSTALLATION OF FOUNDRY PRODUCTS (U.S. CLS. 100, 103 AND 106).

## CLASS 42—SCIENTIFIC AND COMPUTER SERVICES

FOR COMPUTER SOFTWARE DESIGN, COMPUTER PROGRAMMING, OR MAINTENANCE OF COMPUTER SOFTWARE (U.S. CLS. 100 AND 101).  
THEODORE MCBRIDE, EXAMINING ATTORNEY

SN 85-341,237. METDAQ, LLC, NORTH MIAMI BEACH, FL.  
FILED 6-8-2011.



THE MARK CONSISTS OF THE STYLIZED IMAGE OF A BODYBUILDER IN A PARTIAL KNEELING POSITION TO THE LEFT OF THE WORD "METDAQ".

#### CLASS 35—ADVERTISING AND BUSINESS

FOR ON-LINE TRADING SERVICES IN WHICH SELLER POSTS PRODUCTS TO BE AUCTIONED AND BIDDING IS DONE VIA THE INTERNET (U.S. CLS. 100, 101 AND 102).

#### CLASS 36—INSURANCE AND FINANCIAL

FOR ELECTRONIC FINANCIAL TRADING SERVICES; ON-LINE REAL-TIME CURRENCY TRADING; ON-LINE TRADING OF FINANCIAL INSTRUMENTS, SHARES, OPTIONS AND OTHER DERIVATIVE PRODUCTS; ON-LINE TRADING OF OPTIONS ON THE OPTIONS EXCHANGE MARKET; SECURITIES TRADING AND INVESTING SERVICES FOR OTHERS VIA THE INTERNET (U.S. CLS. 100, 101 AND 102).

#### CLASS 42—SCIENTIFIC AND COMPUTER SERVICES

FOR PLATFORM AS A SERVICE (PAAS) FEATURING COMPUTER SOFTWARE PLATFORMS FOR THE TRADING OF METALS (U.S. CLS. 100 AND 101).

DOMINICK J. SALEMI, EXAMINING ATTORNEY

SN 85-341,361. BELL FLAVORS & FRAGRANCES, INC.,  
NORTHBROOK, IL. FILED 6-8-2011.

# PRINTSCENT

THE MARK CONSISTS OF STANDARD CHARACTERS WITHOUT CLAIM TO ANY PARTICULAR FONT, STYLE, SIZE, OR COLOR.

#### CLASS 1—CHEMICALS

FOR ARTIFICIAL SWEETENERS; CHEMICALS FOR USE IN THE MANUFACTURE OF FLAVORS AND FRAGRANCES; CHEMICALS FOR USE IN THE MANUFACTURE OF FRAGRANCES, NAMELY, ESTERS, ACIDS, AND ALDEHYDES; EMULSIFIERS FOR USE IN THE MANUFACTURE OF FOODS; FRAGRANCES FOR USE IN MANUFACTURING TOILETRIES AND COSMETICS; SYNTHETIC RESINS FOR USE IN MANUFACTURING COSMETICS (U.S. CLS. 1, 5, 6, 10, 26 AND 46).

#### CLASS 3—COSMETICS AND CLEANING PREPARATIONS

FOR COLOGNE; ESSENTIAL OILS; ESSENTIAL OILS FOR FLAVORING BEVERAGES; ESSENTIAL OILS FOR FOOD FLAVORINGS; ESSENTIAL OILS FOR USE IN MANUFACTURING OF MEDICINES, PHARMACEUTICAL PREPARATIONS, PERFUMES, SCENTS, COSMETICS, DETERGENTS, CLEANING PREPARATIONS, AND PERSONAL CARE PRODUCTS; ESSENTIAL OILS FOR USE IN THE MANUFACTURE OF SCENTED PRODUCTS; INCENSE; PERFUMES (U.S. CLS. 1, 4, 6, 50, 51 AND 52).

MARK SHINER, EXAMINING ATTORNEY

SN 85-341,560. QVM GROUP LLC, SOUTH GLASTONBURY,  
CT. FILED 6-8-2011.

# StopAlerts

THE MARK CONSISTS OF STANDARD CHARACTERS WITHOUT CLAIM TO ANY PARTICULAR FONT, STYLE, SIZE, OR COLOR.

#### CLASS 35—ADVERTISING AND BUSINESS

FOR PREPARATION OF REPORTS RELATING TO FINANCE AND INVESTMENTS (U.S. CLS. 100, 101 AND 102).

FIRST USE 10-26-2010; IN COMMERCE 6-8-2011.

#### CLASS 36—INSURANCE AND FINANCIAL

FOR ADVICE RELATING TO INVESTMENTS (U.S. CLS. 100, 101 AND 102).

FIRST USE 10-26-2010; IN COMMERCE 6-8-2011.  
JANET LEE, EXAMINING ATTORNEY

SN 85-342,999. CLEAN ENERGY VENTURE GROUP, LLC,  
BROOKLINE, MA. FILED 6-10-2011.

# cevg

THE MARK CONSISTS OF STANDARD CHARACTERS WITHOUT CLAIM TO ANY PARTICULAR FONT, STYLE, SIZE, OR COLOR.

#### CLASS 35—ADVERTISING AND BUSINESS

FOR BUSINESS VENTURE DEVELOPMENT AND FORMATION CONSULTING SERVICES FOR THE RENEWABLE ENERGY INDUSTRY (U.S. CLS. 100, 101 AND 102).

FIRST USE 1-3-2008; IN COMMERCE 1-3-2008.

#### CLASS 36—INSURANCE AND FINANCIAL

FOR VENTURE CAPITAL FINANCING; VENTURE CAPITAL FUNDING SERVICES TO EMERGING AND START-UP COMPANIES (U.S. CLS. 100, 101 AND 102).

FIRST USE 1-3-2008; IN COMMERCE 1-3-2008.  
ODESSA BIBBINS, EXAMINING ATTORNEY

SN 85-343,774. CELLCO PARTNERSHIP, DBA VERIZON WIRELESS, BASKING RIDGE, NJ. FILED 6-10-2011.

## HELPASSURE

THE MARK CONSISTS OF STANDARD CHARACTERS WITHOUT CLAIM TO ANY PARTICULAR FONT, STYLE, SIZE, OR COLOR.

### CLASS 9—ELECTRICAL AND SCIENTIFIC APPARATUS

FOR ELECTRONIC PERSONAL EMERGENCY RESPONSE SYSTEM CONSISTING OF A WIRELESS DEVICE WORN ON THE BODY WITH A BUTTON THAT USERS PUSH TO NOTIFY OTHERS IN THE EVENT OF AN EMERGENCY, AND A REMOTE UNIT THAT DIALS OUT ON THE TELEPHONE FOR HELP (U.S. CLS. 21, 23, 26, 36 AND 38).

### CLASS 45—PERSONAL AND LEGAL SERVICES

FOR EMERGENCY RESPONSE ALARM MONITORING SERVICES, NAMELY, MONITORING OF ALERT DEVICES BY A REMOTE MONITORING CENTER FOR THE DISPATCH OF EMERGENCY PUBLIC HEALTH AND SECURITY SERVICES AND NOTIFICATION TO THIRD PARTIES, NAMELY, PREFERRED FAMILY CONTACTS, EMERGENCY RESPONDERS, A NURSE OR THEIR FAMILY (U.S. CLS. 100 AND 101).  
KEVIN CORWIN, EXAMINING ATTORNEY

SN 85-344,202. HEALTH TO YOU, LLC, NASHVILLE, TN. FILED 6-13-2011.



OWNER OF U.S. REG. NOS. 2,944,994, 3,171,050 AND OTHERS.

THE MARK CONSISTS OF THE TERM "H2U" POSITIONED ABOVE THE WORDS "SALUD PARA USTED".

THE ENGLISH TRANSLATION OF "SALUD PARA USTED" IS "HEALTH TO YOU".

### CLASS 9—ELECTRICAL AND SCIENTIFIC APPARATUS

FOR DOWNLOADABLE ELECTRONIC PUBLICATIONS, NAMELY, BOOKS, BOOKLETS, FLYERS, BROCHURES, HEALTH RISK ASSESSMENT FORMS, MAGAZINES, NEWSLETTERS, AND PAMPHLETS, ALL IN THE FIELD OF LIFESTYLE, HEALTH AND WELLNESS (U.S. CLS. 21, 23, 26, 36 AND 38).

### CLASS 16—PAPER GOODS AND PRINTED MATTER

FOR PRINTED PUBLICATIONS, NAMELY, BOOKS, BOOKLETS, FLYERS, BROCHURES, POSTERS, INFORMATION CARDS, TABLE TENTS, HEALTH RISK ASSESSMENT FORMS, MAGAZINES, NEWSLETTERS, AND PAMPHLETS, ALL IN THE FIELD OF LIFESTYLE, HEALTH AND WELLNESS (U.S. CLS. 2, 5, 22, 23, 29, 37, 38 AND 50).

### CLASS 41—EDUCATION AND ENTERTAINMENT

FOR PROVIDING ONLINE NON-DOWNLOADABLE ELECTRONIC PUBLICATIONS, NAMELY, BOOKS, BOOKLETS, FLYERS, BROCHURES, MAGAZINES, NEWSLETTERS, AND PAMPHLETS, ALL IN THE FIELD OF LIFESTYLE, HEALTH AND WELLNESS (U.S. CLS. 100, 101 AND 107).

### CLASS 44—MEDICAL, BEAUTY AND AGRICULTURAL SERVICES

FOR PROVIDING LIFESTYLE AND HEALTH INFORMATION; HEALTHCARE SERVICES; WELLNESS PROGRAMS; MEDICAL SERVICES; HEALTH CONSULTATION SERVICES; PROVIDING INFORMATION ABOUT MAINTAINING A HEALTHY LIFESTYLE (U.S. CLS. 100 AND 101).

JESSICA A. POWERS, EXAMINING ATTORNEY

SN 85-345,272. TLV CO., LTD., HYOGO-KEN, JAPAN, FILED 6-14-2011.

## BPSSM

THE MARK CONSISTS OF STANDARD CHARACTERS WITHOUT CLAIM TO ANY PARTICULAR FONT, STYLE, SIZE, OR COLOR.

### CLASS 37—CONSTRUCTION AND REPAIR

FOR MAINTENANCE AND REPAIR OF STEAM SYSTEMS FOR HEATING AND COOLING AND PARTS THEREFOR (U.S. CLS. 100, 103 AND 106).

### CLASS 42—SCIENTIFIC AND COMPUTER SERVICES

FOR TECHNICAL SUPPORT SERVICES, NAMELY, MONITORING, INSPECTION, SURVEY AND DIAGNOSTIC SERVICES FOR STEAM SYSTEMS FOR HEATING AND COOLING; PLANNING, ENGINEERING AND DESIGN FOR OTHERS OF STEAM SYSTEMS FOR HEATING AND COOLING; TECHNOLOGICAL CONSULTATION AND ADVICE IN THE FIELD OF STEAM SYSTEMS FOR HEATING AND COOLING (U.S. CLS. 100 AND 101).

KATHERINE E. HALMEN, EXAMINING ATTORNEY

SN 85-346,713. RAM GLOBAL LLC, FAIRFIELD, OH. FILED 6-15-2011.

# Love the Lite

THE MARK CONSISTS OF STANDARD CHARACTERS WITHOUT CLAIM TO ANY PARTICULAR FONT, STYLE, SIZE, OR COLOR.

## CLASS 25—CLOTHING

FOR HATS; HOODED SWEAT SHIRTS; HOODED SWEATSHIRTS; PANTS; SHIRTS; SHORT-SLEEVED OR LONG-SLEEVED T-SHIRTS; SHORTS; SWEAT SHIRTS; SWEATERS; SWEATSHIRTS; T-SHIRTS (U.S. CLS. 22 AND 39).

## CLASS 32—LIGHT BEVERAGES

FOR BEER (U.S. CLS. 45, 46 AND 48).  
PAM WILLIS, EXAMINING ATTORNEY

SN 85-347,333. PANDORA MEDIA, INC., OAKLAND, CA. FILED 6-15-2011.



THE MARK CONSISTS OF "P" IN A STYLIZED FONT SURROUNDED BY A SQUARE BORDER HAVING ROUNDED CORNERS.

## CLASS 9—ELECTRICAL AND SCIENTIFIC APPARATUS

FOR COMPUTER SOFTWARE FOR STREAMING, BROADCASTING, TRANSMITTING AND REPRODUCING MUSIC; DOWNLOADABLE COMPUTER SOFTWARE FOR STREAMING, BROADCASTING, TRANSMITTING AND REPRODUCING MUSIC (U.S. CLS. 21, 23, 26, 36 AND 38).

## CLASS 38—COMMUNICATION

FOR BROADCASTING SERVICES, NAMELY DIGITAL AUDIO BROADCASTING SERVICES PROVIDED VIA A GLOBAL COMMUNICATIONS NETWORK (U.S. CLS. 100, 101 AND 104).

## CLASS 41—EDUCATION AND ENTERTAINMENT

FOR ENTERTAINMENT SERVICES, NAMELY PROVIDING PRERECORDED MUSIC VIA A GLOBAL COMMUNICATIONS NETWORK AND PROVIDING PRERECORDED MUSIC ACCORDING TO CONSUMER PREFERENCES VIA A GLOBAL COMMUNICATIONS NETWORK (U.S. CLS. 100, 101 AND 107).  
KIM SAITO, EXAMINING ATTORNEY

SN 85-347,337. PANDORA MEDIA, INC., OAKLAND, CA. FILED 6-15-2011.



THE COLOR(S) BLUE AND WHITE IS/ARE CLAIMED AS A FEATURE OF THE MARK.

THE MARK CONSISTS OF "P" IN A BLUE STYLIZED FONT SURROUNDED BY A WHITE BACKGROUND AND A BLUE SQUARE BORDER HAVING ROUNDED CORNERS.

## CLASS 9—ELECTRICAL AND SCIENTIFIC APPARATUS

FOR COMPUTER SOFTWARE FOR STREAMING, BROADCASTING, TRANSMITTING AND REPRODUCING MUSIC; DOWNLOADABLE COMPUTER SOFTWARE FOR STREAMING, BROADCASTING, TRANSMITTING AND REPRODUCING MUSIC (U.S. CLS. 21, 23, 26, 36 AND 38).

## CLASS 38—COMMUNICATION

FOR BROADCASTING SERVICES, NAMELY DIGITAL AUDIO BROADCASTING SERVICES PROVIDED VIA A GLOBAL COMMUNICATIONS NETWORK (U.S. CLS. 100, 101 AND 104).

## CLASS 41—EDUCATION AND ENTERTAINMENT

FOR ENTERTAINMENT SERVICES, NAMELY PROVIDING PRERECORDED MUSIC VIA A GLOBAL COMMUNICATIONS NETWORK AND PROVIDING PRERECORDED MUSIC ACCORDING TO CONSUMER PREFERENCES VIA A GLOBAL COMMUNICATIONS NETWORK (U.S. CLS. 100, 101 AND 107).  
KIM SAITO, EXAMINING ATTORNEY

SN 85-349,138. PENTON BUSINESS MEDIA, INC., NEW YORK, NY. FILED 6-17-2011.

## Grove and Vegetable

THE MARK CONSISTS OF STANDARD CHARACTERS WITHOUT CLAIM TO ANY PARTICULAR FONT, STYLE, SIZE, OR COLOR.

### CLASS 16—PAPER GOODS AND PRINTED MATTER

FOR MAGAZINE SECTIONS IN THE FIELD OF AGRICULTURE, CROPS AND CROP GROWING, FARM MANAGEMENT, FARM EQUIPMENT, AGRICULTURAL TECHNOLOGY AND MARKETING, AND ENVIRONMENTAL AND REGULATORY ISSUES RELATED TO AGRICULTURE; MAGAZINES IN THE FIELD OF AGRICULTURE, CROPS AND CROP GROWING, FARM MANAGEMENT, FARM EQUIPMENT, AGRICULTURAL TECHNOLOGY AND MARKETING, AND ENVIRONMENTAL AND REGULATORY ISSUES RELATED TO AGRICULTURE (U.S. CLS. 2, 5, 22, 23, 29, 37, 38 AND 50).

### CLASS 41—EDUCATION AND ENTERTAINMENT

FOR EDUCATIONAL SERVICES, NAMELY, CONDUCTING CLASSES, SEMINARS, WORKSHOPS AND CONFERENCES IN THE FIELDS OF AGRICULTURE, CROPS AND CROP GROWING, FARM MANAGEMENT, FARM EQUIPMENT, AGRICULTURAL TECHNOLOGY AND MARKETING, AND ENVIRONMENTAL AND REGULATORY ISSUES RELATED TO AGRICULTURE AND DISTRIBUTION OF TRAINING MATERIALS IN CONNECTION THEREWITH; EDUCATIONAL SERVICES, NAMELY, DEVELOPING, ARRANGING, AND CONDUCTING EDUCATIONAL CONFERENCES AND PROGRAMS AND PROVIDING COURSES OF INSTRUCTION IN THE FIELD OF AGRICULTURE, CROPS AND CROP GROWING, FARM MANAGEMENT, FARM EQUIPMENT, AGRICULTURAL TECHNOLOGY AND MARKETING, AND ENVIRONMENTAL AND REGULATORY ISSUES RELATED TO AGRICULTURE; ENTERTAINMENT SERVICES, NAMELY, PROVIDING WEBCASTS IN THE FIELD OF AGRICULTURE, CROPS AND CROP GROWING, FARM MANAGEMENT, FARM EQUIPMENT, AGRICULTURAL TECHNOLOGY AND MARKETING, AND ENVIRONMENTAL AND REGULATORY ISSUES RELATED TO AGRICULTURE; PROVIDING A WEBSITE FEATURING BLOGS AND NON-DOWNLOADABLE PUBLICATIONS IN THE NATURE OF ARTICLES IN THE FIELD(S) OF AGRICULTURE, CROPS AND CROP GROWING, FARM MANAGEMENT, FARM EQUIPMENT, AGRICULTURAL TECHNOLOGY AND MARKETING, AND ENVIRONMENTAL AND REGULATORY ISSUES RELATED TO AGRICULTURE; PROVIDING A WEBSITE FEATURING NON-DOWNLOADABLE PUBLICATIONS IN THE NATURE OF MAGAZINES, NEWSPAPERS, NEWSLETTER AND RESOURCE GUIDES IN THE FIELD OF AGRICULTURE, CROPS AND CROP GROWING, FARM MANAGEMENT, FARM EQUIPMENT, AGRICULTURAL TECHNOLOGY AND MARKETING, AND ENVIRONMENTAL AND REGULATORY ISSUES RELATED TO AGRICULTURE; PROVIDING A WEBSITE FEATURING RESOURCES, NAMELY, NON-DOWNLOADABLE PUBLICATIONS IN THE NATURE OF MAGAZINES, NEWSPAPERS, NEWSLETTER AND RESOURCE GUIDES IN THE FIELD OF AGRICULTURE, CROPS AND CROP GROWING, FARM MANAGEMENT, FARM EQUIPMENT, AGRICULTURAL TECHNOLOGY AND MARKETING, AND ENVIRONMENTAL AND REGULATORY

ISSUES RELATED TO AGRICULTURE; PROVIDING NEWSLETTERS IN THE FIELD OF AGRICULTURE, CROPS AND CROP GROWING, FARM MANAGEMENT, FARM EQUIPMENT, AGRICULTURAL TECHNOLOGY AND MARKETING, AND ENVIRONMENTAL AND REGULATORY ISSUES RELATED TO AGRICULTURE VIA E-MAIL; PROVIDING ON-LINE MAGAZINES IN THE FIELD OF AGRICULTURE, CROPS AND CROP GROWING, FARM MANAGEMENT, FARM EQUIPMENT, AGRICULTURAL TECHNOLOGY AND MARKETING, AND ENVIRONMENTAL AND REGULATORY ISSUES RELATED TO AGRICULTURE (U.S. CLS. 100, 101 AND 107).

ALEXANDER L. POWERS, EXAMINING ATTORNEY

SN 85-349,662. STANOJEVIC, DEJAN, DOWNEY, CA. FILED 6-17-2011.



THE MARK CONSISTS OF THE STYLIZED TEXT "RIDONKULOUS!".

### CLASS 25—CLOTHING

FOR HATS; JACKETS; JEANS; LONG-SLEEVED SHIRTS; SHORTS; SWEATERS; SWIMWEAR; T-SHIRTS; UNDERGARMENTS (U.S. CLS. 22 AND 39).

### CLASS 41—EDUCATION AND ENTERTAINMENT

FOR ENTERTAINMENT IN THE NATURE OF A SCRIPTED ONGOING SITCOM FOR TELEVISION, INTERNET, SATELLITE AND RADIO (U.S. CLS. 100, 101 AND 107).

KEVON CHISOLM, EXAMINING ATTORNEY

SN 85-351,888. MILLERCOORS LLC, CHICAGO, IL. FILED 6-21-2011.



OWNER OF U.S. REG. NOS. 3,842,638 AND 3,842,639.

THE MARK CONSISTS OF THE WORDS "GREAT BEER GREAT RESPONSIBILITY" NEXT TO AN OUTLINE OF A CAN.

### CLASS 32—LIGHT BEVERAGES

FOR BEER (U.S. CLS. 45, 46 AND 48).  
FIRST USE 3-1-2010; IN COMMERCE 3-1-2010.

### CLASS 35—ADVERTISING AND BUSINESS

FOR PROMOTING PUBLIC AWARENESS OF THE NEED FOR ALCOHOL AWARENESS AND MODERATION AND RESPONSIBILITY IN DRINKING ALCOHOLIC BEVERAGES (U.S. CLS. 100, 101 AND 102).

FIRST USE 10-1-2010; IN COMMERCE 10-1-2010.  
SUSAN RICHARDS, EXAMINING ATTORNEY

SN 85-352,714. PRECISION FOODS, INC., ST. LOUIS, MO.  
FILED 6-22-2011.

# Flavorwise

THE MARK CONSISTS OF STANDARD CHARACTERS WITHOUT CLAIM TO ANY PARTICULAR FONT, STYLE, SIZE, OR COLOR.

## CLASS 29—MEATS AND PROCESSED FOODS

FOR SALAD DRESSING MIXES (U.S. CL. 46).

## CLASS 30—STAPLE FOODS

FOR FOOD SEASONINGS; SAUCE, SALSA AND GRAVY MIXES (U.S. CL. 46).  
MEGHAN REINHART, EXAMINING ATTORNEY

SN 85-354,160. GILI RITZ, BEVERLY HILLS, CA. FILED 6-23-2011.

# SMUSH

THE MARK CONSISTS OF STANDARD CHARACTERS WITHOUT CLAIM TO ANY PARTICULAR FONT, STYLE, SIZE, OR COLOR.

OWNER OF U.S. REG. NOS. 3,159,499, 3,537,537 AND 3,591,042.

## CLASS 10—MEDICAL APPARATUS

FOR CONDOMS (U.S. CLS. 26, 39 AND 44).  
FIRST USE 5-2-2011; IN COMMERCE 5-2-2011.

## CLASS 33—WINES AND SPIRITS

FOR ALCOHOLIC BEVERAGES OF FRUIT; ALCOHOLIC PUNCH; PREPARED ALCOHOLIC COCKTAIL (U.S. CLS. 47 AND 49).

FIRST USE 6-23-2011; IN COMMERCE 6-23-2011.  
STEVEN R. FINE, EXAMINING ATTORNEY

SN 85-354,841. ZYNGA INC., SAN FRANCISCO, CA. FILED 6-23-2011.



THE MARK CONSISTS OF THE LETTERS "HANG" FOLLOWED BY A SHADOW IMAGE OF A PERSON HOLDING FOUR BALLOONS FOLLOWED BY THE LETTERS "NG" FOLLOWED BY THE WORD "WITH" OVER THE WORD "FRIENDS" WITHIN A THOUGHT BUBBLE.

## CLASS 9—ELECTRICAL AND SCIENTIFIC APPARATUS

FOR COMPUTER GAME SOFTWARE; COMPUTER GAME PROGRAMS; ELECTRONIC GAME PROGRAMS; INTERACTIVE VIDEO GAME PROGRAMS; COMPUTER SOFTWARE PLATFORMS FOR SOCIAL NETWORKING; COMPUTER SOFTWARE TO ENABLE UPLOADING, POSTING, SHOWING, DISPLAYING, TAGGING, BLOGGING, SHARING OR OTHERWISE PROVIDING ELECTRONIC MEDIA OR INFORMATION IN THE FIELDS OF VIRTUAL COMMUNITIES, ELECTRONIC GAMING, ENTERTAINMENT, AND GENERAL INTEREST VIA THE INTERNET OR OTHER COMMUNICATIONS NETWORKS WITH THIRD PARTIES; MAGNETIC ENCODED GIFT CARDS (U.S. CLS. 21, 23, 26, 36 AND 38).

## CLASS 41—EDUCATION AND ENTERTAINMENT

FOR COMPUTER AND ELECTRONIC GAMES PROVIDED ONLINE, ENHANCEMENTS WITHIN ONLINE COMPUTER AND ELECTRONIC GAMES; INFORMATION RELATING TO COMPUTER GAMES PROVIDED ONLINE; VIRTUAL ENVIRONMENTS IN WHICH USERS CAN INTERACT THROUGH SOCIAL GAMES FOR RECREATIONAL, LEISURE OR ENTERTAINMENT PURPOSES (U.S. CLS. 100, 101 AND 107).  
PAUL E. FAHRENKOPF, EXAMINING ATTORNEY

SN 85-355,271. AMERICAN ACADEMY OF FAMILY PHYSICIANS, LEAWOOD, KS. FILED 6-24-2011.

## TRANSLATION TO PRACTICE

THE MARK CONSISTS OF STANDARD CHARACTERS WITHOUT CLAIM TO ANY PARTICULAR FONT, STYLE, SIZE, OR COLOR.

## CLASS 9—ELECTRICAL AND SCIENTIFIC APPARATUS

FOR PRE-RECORDED ELECTRONIC AND DIGITAL MEDIA FEATURING CONTINUING MEDICAL EDUCATIONAL PROGRAMS; AUDIO AND VIDEO RECORDINGS FEATURING CONTINUING MEDICAL EDUCATION PROGRAMS DOWNLOADABLE FROM A COMPUTER DATABASE OR THE INTERNET (U.S. CLS. 21, 23, 26, 36 AND 38).

## CLASS 16—PAPER GOODS AND PRINTED MATTER

FOR PRINTED EDUCATIONAL MATERIALS DIRECTED TO CONTINUING MEDICAL EDUCATION (U.S. CLS. 2, 5, 22, 23, 29, 37, 38 AND 50).

**CLASS 41—EDUCATION AND ENTERTAINMENT**

FOR EDUCATIONAL SERVICES, NAMELY, PROVIDING LIVE AND ON-LINE COURSES, SEMINARS, CONFERENCES AND WORKSHOPS IN THE FIELD OF CONTINUING MEDICAL EDUCATION AND DISTRIBUTION OF COURSE MATERIALS IN CONNECTION THEREWITH; EDUCATIONAL SERVICES, NAMELY PROVIDING CONTINUING MEDICAL EDUCATION MATERIALS IN AN ELECTRONIC AND ONLINE FORM; EDUCATIONAL SERVICES, NAMELY, PROVIDING A WEB-BASED PRACTICE IMPROVEMENT PROGRAM PROVIDING CONTINUING MEDICAL EDUCATION COURSES TO FAMILY PHYSICIANS, MEDICAL PRACTITIONERS AND OTHER HEALTH-CARE PROVIDERS FOR MAINTAINING MEDICAL SPECIALTY CERTIFICATION (U.S. CLS. 100, 101 AND 107).

MICHAEL ENGEL, EXAMINING ATTORNEY

**CLASS 41—EDUCATION AND ENTERTAINMENT**

FOR EDUCATIONAL SERVICES, NAMELY, PROVIDING LIVE AND ON-LINE COURSES, SEMINARS, CONFERENCES AND WORKSHOPS IN THE FIELD OF CONTINUING MEDICAL EDUCATION AND DISTRIBUTION OF COURSE MATERIALS IN CONNECTION THEREWITH; EDUCATIONAL SERVICES, NAMELY PROVIDING CONTINUING MEDICAL EDUCATION MATERIALS IN AN ELECTRONIC AND ONLINE FORM; EDUCATIONAL SERVICES, NAMELY, PROVIDING A WEB-BASED PRACTICE IMPROVEMENT PROGRAM PROVIDING CONTINUING MEDICAL EDUCATION COURSES TO FAMILY PHYSICIANS, MEDICAL PRACTITIONERS AND OTHER HEALTH-CARE PROVIDERS FOR MAINTAINING MEDICAL SPECIALTY CERTIFICATION (U.S. CLS. 100, 101 AND 107).

MICHAEL ENGEL, EXAMINING ATTORNEY

---

SN 85-357,545. AVECIA BIOTECHNOLOGY, INC., MILFORD, MA. FILED 6-27-2011.

SN 85-355,288. AMERICAN ACADEMY OF FAMILY PHYSICIANS, LEAWOOD, KS. FILED 6-24-2011.



THE MARK CONSISTS OF THE LETTERS "OLI" FOLLOWED BY THE STYLIZED CAPITAL LETTERS "GO".

**CLASS 40—MATERIAL TREATMENT**

FOR BIOCHEMICAL CONTRACT MANUFACTURING SERVICES (U.S. CLS. 100, 103 AND 106).  
FIRST USE 5-23-2011; IN COMMERCE 5-23-2011.

**CLASS 42—SCIENTIFIC AND COMPUTER SERVICES**

FOR SCIENTIFIC DEVELOPMENT SERVICES IN THE FIELD OF BIOCHEMISTRY (U.S. CLS. 100 AND 101).  
FIRST USE 5-23-2011; IN COMMERCE 5-23-2011.  
BRIAN NEVILLE, EXAMINING ATTORNEY

---

SN 85-357,718. SIEMENS INDUSTRY, INC., ALPHARETTA, GA. FILED 6-28-2011.

THE MARK CONSISTS OF THE STYLIZED LETTERS "T2P".

**CLASS 9—ELECTRICAL AND SCIENTIFIC APPARATUS**

FOR PRE-RECORDED ELECTRONIC AND DIGITAL MEDIA FEATURING CONTINUING MEDICAL EDUCATIONAL PROGRAMS; AUDIO AND VIDEO RECORDINGS FEATURING CONTINUING MEDICAL EDUCATION PROGRAMS DOWNLOADABLE FROM A COMPUTER DATABASE OR THE INTERNET (U.S. CLS. 21, 23, 26, 36 AND 38).

**CLASS 16—PAPER GOODS AND PRINTED MATTER**

FOR PRINTED EDUCATIONAL MATERIALS DIRECTED TO CONTINUING MEDICAL EDUCATION (U.S. CLS. 2, 5, 22, 23, 29, 37, 38 AND 50).



THE MARK CONSISTS OF STANDARD CHARACTERS WITHOUT CLAIM TO ANY PARTICULAR FONT, STYLE, SIZE, OR COLOR.

**CLASS 9—ELECTRICAL AND SCIENTIFIC APPARATUS**

FOR ELECTRICAL APPARATUS, NAMELY, CHARGING STATIONS FOR CHARGING ELECTRIC VEHICLES (U.S. CLS. 21, 23, 26, 36 AND 38).



**CLASS 37—CONSTRUCTION AND REPAIR**

FOR CHARGING STATION SERVICES FOR ELECTRIC VEHICLES (U.S. CLS. 100, 103 AND 106).  
MICHAEL TANNER, EXAMINING ATTORNEY

**CLASS 43—HOTEL AND RESTAURANT SERVICES**

FOR RESTAURANT AND BAR SERVICES (U.S. CLS. 100 AND 101).  
FIRST USE 6-0-2003; IN COMMERCE 6-0-2003.  
GRETCHEN ULRICH, EXAMINING ATTORNEY

SN 85-358,849. AMERICAN INSTITUTE OF CERTIFIED PUBLIC ACCOUNTANTS, NEW YORK, NY. FILED 6-28-2011.

SN 85-360,998. BELL FLAVORS & FRAGRANCES, INC., NORTHBROOK, IL. FILED 6-30-2011.



NO CLAIM IS MADE TO THE EXCLUSIVE RIGHT TO USE "QUALIFICATION EXAMINATION", APART FROM THE MARK AS SHOWN.

THE MARK CONSISTS OF A STYLIZED DEPICTION OF THE LETTERS "IQEX" ADJACENT TO A CURVED DESIGN AND ALSO TO THE WORDS "INTERNATIONAL QUALIFICATION EXAMINATION".

SEC. 2(F) AS TO "INTERNATIONAL QUALIFICATION EXAMINATION".

**CLASS 16—PAPER GOODS AND PRINTED MATTER**

FOR PRINTED MATTER, NAMELY, PRACTICE ACCOUNTING EXAMINATIONS, ACCOUNTING EXAMS, ACCOUNTING EXAM INFORMATION BOOKLETS, AND PRIOR ACCOUNTING EXAMINATION QUESTIONS AND ANSWERS (U.S. CLS. 2, 5, 22, 23, 29, 37, 38 AND 50).

**CLASS 41—EDUCATION AND ENTERTAINMENT**

FOR EDUCATIONAL TESTING SERVICES, NAMELY, PREPARING, DISSEMINATING AND GRADING COMPUTER BASED ACCOUNTING EXAMINATIONS; ADMINISTERING COMPUTER BASED ACCOUNTING EXAMINATIONS VIA THE INTERNET; PROVIDING PRACTICE ACCOUNTING EXAMINATIONS VIA THE INTERNET (U.S. CLS. 100, 101 AND 107).  
MIDGE BUTLER, EXAMINING ATTORNEY

SN 85-359,893. UINTA BREWING COMPANY, SALT LAKE CITY, UT. FILED 6-29-2011.

**EARTH, WIND AND BEER**

THE MARK CONSISTS OF STANDARD CHARACTERS WITHOUT CLAIM TO ANY PARTICULAR FONT, STYLE, SIZE, OR COLOR.

**CLASS 32—LIGHT BEVERAGES**

FOR BEER (U.S. CLS. 45, 46 AND 48).  
FIRST USE 6-0-2002; IN COMMERCE 6-0-2002.

**SEAL-AROMES**

THE MARK CONSISTS OF STANDARD CHARACTERS WITHOUT CLAIM TO ANY PARTICULAR FONT, STYLE, SIZE, OR COLOR.

THE ENGLISH TRANSLATION OF "AROMES" IN THE MARK IS "AROMAS".

**CLASS 1—CHEMICALS**

FOR ARTIFICIAL SWEETENERS; CHEMICALS FOR USE IN THE MANUFACTURE OF FLAVORS AND FRAGRANCES; CHEMICALS FOR USE IN THE MANUFACTURE OF FRAGRANCES, NAMELY, ESTERS, ACIDS, AND ALDEHYDES; EMULSIFIERS FOR USE IN THE MANUFACTURE OF FOODS; FRAGRANCES FOR USE IN MANUFACTURING TOILETRIES AND COSMETICS; SYNTHETIC RESINS FOR USE IN MANUFACTURING COSMETICS (U.S. CLS. 1, 5, 6, 10, 26 AND 46).

**CLASS 3—COSMETICS AND CLEANING PREPARATIONS**

FOR COLOGNE; ESSENTIAL OILS; ESSENTIAL OILS FOR FLAVORING BEVERAGES; ESSENTIAL OILS FOR FOOD FLAVORINGS; ESSENTIAL OILS FOR USE IN MANUFACTURING OF MEDICINES, PHARMACEUTICAL PREPARATIONS, PERFUMES, SCENTS, COSMETICS, DETERGENTS, CLEANING PREPARATIONS, AND PERSONAL CARE PRODUCTS; ESSENTIAL OILS FOR USE IN THE MANUFACTURE OF SCENTED PRODUCTS; INCENSE; PERFUMES (U.S. CLS. 1, 4, 6, 50, 51 AND 52).

**CLASS 30—STAPLE FOODS**

FOR EXTRACTS USED AS FLAVORING; FLAVORING ADDITIVES FOR NON-NUTRITIONAL PURPOSES; FLAVORING SYRUP; FLAVORINGS FOR TOBACCO; SAUCES; SEASONINGS (U.S. CL. 46).  
MARK SHINER, EXAMINING ATTORNEY

SN 85-361,145. MONAVIE LLC, SOUTH JORDAN, UT. FILED 6-30-2011.

**MONAVIERVL**

THE MARK CONSISTS OF STANDARD CHARACTERS WITHOUT CLAIM TO ANY PARTICULAR FONT, STYLE, SIZE, OR COLOR.

OWNER OF U.S. REG. NOS. 3,111,333, 3,770,346 AND OTHERS.

SN 85-365,830. LAS VEGAS CONVENTION AND VISITORS AUTHORITY, LAS VEGAS, NV. FILED 7-7-2011.

### CLASS 5—PHARMACEUTICALS

FOR DIETARY AND NUTRITIONAL SUPPLEMENTS; DIETARY AND NUTRITIONAL SUPPLEMENTS CONTAINING ACAI; DIETARY DRINK MIX FOR USE AS A MEAL REPLACEMENT; DIETARY SUPPLEMENTS IN THE NATURE OF WEIGHT LOSS POWDERS; ENERGY BOOSTING BARS FOR USE AS A MEAL SUBSTITUTE; MEAL REPLACEMENT AND DIETARY SUPPLEMENT DRINK MIXES; MEAL REPLACEMENT BARS; MEAL REPLACEMENT DRINKS; MEAL REPLACEMENT POWDERS; MEAL REPLACEMENT SHAKES; MEAL REPLACEMENT SNACKS; NUTRITIONAL AND DIETARY SUPPLEMENTS FORMED AND PACKAGED AS BARS; NUTRITIONAL DRINK MIX FOR USE AS A MEAL REPLACEMENT; NUTRITIONAL DRINKS USED FOR MEAL REPLACEMENT; NUTRITIONAL ENERGY BARS FOR USE AS A MEAL SUBSTITUTE; NUTRITIONAL FOOD BARS FOR USE AS A MEAL REPLACEMENT; NUTRITIONAL SHAKES FOR USE AS A MEAL SUBSTITUTE; NUTRITIONAL SUPPLEMENT IN THE NATURE OF A NUTRIENT-DENSE, PROTEIN-BASED DRINK MIX; POWDERED FRUIT-FLAVORED DIETARY SUPPLEMENT DRINK MIX; POWDERED NUTRITIONAL SUPPLEMENT DRINK MIX; WEIGHT MANAGEMENT SUPPLEMENTS (U.S. CLS. 6, 18, 44, 46, 51 AND 52).

FIRST USE 12-24-2010; IN COMMERCE 12-24-2010.

### CLASS 29—MEATS AND PROCESSED FOODS

FOR PROTEIN BASED, NUTRIENT-DENSE SNACK BARS (U.S. CL. 46).

FIRST USE 12-24-2010; IN COMMERCE 12-24-2010.

FRED CARL, EXAMINING ATTORNEY

SN 85-365,082. TITLE RESOURCE GROUP LLC, MT. LAUREL, NJ. FILED 7-7-2011.

### MAKING HOUSES INTO HOMES COAST TO COAST

THE MARK CONSISTS OF STANDARD CHARACTERS WITHOUT CLAIM TO ANY PARTICULAR FONT, STYLE, SIZE, OR COLOR.

OWNER OF U.S. REG. NO. 3,288,623.

### CLASS 36—INSURANCE AND FINANCIAL

FOR REAL ESTATE TITLE INSURANCE AGENCY SERVICES; REAL ESTATE ESCROW SERVICES (U.S. CLS. 100, 101 AND 102).

FIRST USE 5-0-2006; IN COMMERCE 5-0-2006.

### CLASS 45—PERSONAL AND LEGAL SERVICES

FOR REAL ESTATE SETTLEMENT SERVICES (U.S. CLS. 100 AND 101).

FIRST USE 5-0-2006; IN COMMERCE 5-0-2006.  
RON FAIRBANKS, EXAMINING ATTORNEY

### LAS VEGAS NEWS BUREAU

THE MARK CONSISTS OF STANDARD CHARACTERS WITHOUT CLAIM TO ANY PARTICULAR FONT, STYLE, SIZE, OR COLOR.

NO CLAIM IS MADE TO THE EXCLUSIVE RIGHT TO USE "NEWS BUREAU", APART FROM THE MARK AS SHOWN.

SEC. 2(F) AS TO "LAS VEGAS".

### CLASS 38—COMMUNICATION

FOR NEWS AGENCIES, NAMELY, THE TRANSMISSION OF NEWS ITEMS TO NEWS REPORTING ORGANIZATIONS (U.S. CLS. 100, 101 AND 104).

FIRST USE 12-30-1949; IN COMMERCE 12-30-1949.

### CLASS 41—EDUCATION AND ENTERTAINMENT

FOR PHOTOGRAPHY (U.S. CLS. 100, 101 AND 107).

FIRST USE 12-30-1949; IN COMMERCE 12-30-1949.

EMILY CHUO, EXAMINING ATTORNEY

SN 85-366,839. HEARST COMMUNICATIONS, INC., NEW YORK, NY. FILED 7-8-2011.

### BUY NOW KEEP FOREVER

THE MARK CONSISTS OF STANDARD CHARACTERS WITHOUT CLAIM TO ANY PARTICULAR FONT, STYLE, SIZE, OR COLOR.

### CLASS 9—ELECTRICAL AND SCIENTIFIC APPARATUS

FOR EYEGLASSES AND EYEGLASS FRAMES, SUNGLASSES (U.S. CLS. 21, 23, 26, 36 AND 38).

### CLASS 14—JEWELRY

FOR WATCHES, IMITATION JEWELRY INCLUDING, ORNAMENTAL PINS, BRACELETS, NECKLACES (U.S. CLS. 2, 27, 28 AND 50).

### CLASS 18—LEATHER GOODS

FOR TOTE BAGS, HAND BAGS, WALLETS, COSMETIC CASES SOLD EMPTY (U.S. CLS. 1, 2, 3, 22 AND 41).

### CLASS 25—CLOTHING

FOR ATHLETIC APPAREL, NAMELY, SHIRTS, PANTS, JACKETS, FOOTWEAR, HATS AND CAPS; SHIRTS, BLOUSES, DRESSES, SKIRTS, CAPS, HATS, GLOVES, HOSE, TIGHTS, UNDERWEAR, COATS, JACKETS, JEANS, PANTS, SHORTS, LINGERIE, PAJAMAS, ROBES, SHOES, SANDALS, SLIPPERS, SCARVES, BELTS FOR CLOTHING AND SWIMWEAR (U.S. CLS. 22 AND 39).

KELLY TRUSILO, EXAMINING ATTORNEY

---

SN 85-366,851. THE COCA-COLA COMPANY, ATLANTA, GA. FILED 7-8-2011.

# IGNITOR

---

THE MARK CONSISTS OF STANDARD CHARACTERS WITHOUT CLAIM TO ANY PARTICULAR FONT, STYLE, SIZE, OR COLOR.

## CLASS 35—ADVERTISING AND BUSINESS

FOR BUSINESS MANAGEMENT CONSULTING WITH RELATION TO STRATEGY, MARKETING, SALES, OPERATION, PRODUCT DESIGN PARTICULARLY SPECIALIZING IN THE USE OF VARIOUS MODELS FOR THE UNDERSTANDING AND PREDICTING OF CONSUMERS, BUSINESSES, AND MARKET TRENDS AND ACTIONS (U.S. CLS. 100, 101 AND 102).

## CLASS 42—SCIENTIFIC AND COMPUTER SERVICES

FOR RESEARCH AND DESIGN SERVICES RELATING TO INDUSTRIAL ANALYSIS AND RESEARCH SERVICES (U.S. CLS. 100 AND 101).

GEOFFREY FOSDICK, EXAMINING ATTORNEY

---

SN 85-366,855. HEARST COMMUNICATIONS, INC., NEW YORK, NY. FILED 7-8-2011.

# FABULOUS AT EVERY AGE

THE MARK CONSISTS OF STANDARD CHARACTERS WITHOUT CLAIM TO ANY PARTICULAR FONT, STYLE, SIZE, OR COLOR.

## CLASS 9—ELECTRICAL AND SCIENTIFIC APPARATUS

FOR EYEGLASSES AND EYEGLASS FRAMES, SUNGLASSES (U.S. CLS. 21, 23, 26, 36 AND 38).

## CLASS 14—JEWELRY

FOR WATCHES, IMITATION JEWELRY INCLUDING, ORNAMENTAL PINS, BRACELETS, NECKLACES (U.S. CLS. 2, 27, 28 AND 50).

## CLASS 18—LEATHER GOODS

FOR TOTE BAGS, HAND BAGS, WALLETS, COSMETIC CASES SOLD EMPTY (U.S. CLS. 1, 2, 3, 22 AND 41).

## CLASS 25—CLOTHING

FOR ATHLETIC APPAREL, NAMELY, SHIRTS, PANTS, JACKETS, FOOTWEAR, HATS AND CAPS; SHIRTS, BLOUSES, DRESSES, SKIRTS, CAPS, HATS, GLOVES, HOSIERY, TIGHTS, UNDERWEAR, COATS, JACKETS, JEANS, PANTS, SHORTS, LINGERIE, PAJAMAS, ROBES, SHOES, SANDALS, SLIPPERS, SCARVES, BELTS FOR CLOTHING AND SWIMWEAR (U.S. CLS. 22 AND 39).

KELLY TRUSILO, EXAMINING ATTORNEY

---

SN 85-369,140. AON CORPORATION, CHICAGO, IL. FILED 7-12-2011.

# Possibility, Empowered.

THE MARK CONSISTS OF STANDARD CHARACTERS WITHOUT CLAIM TO ANY PARTICULAR FONT, STYLE, SIZE, OR COLOR.

## CLASS 35—ADVERTISING AND BUSINESS

FOR BUSINESS CONSULTATION; BUSINESS RESEARCH AND SURVEYS; BUSINESS RISK MANAGEMENT; COMPILATION AND PROVISION OF TRADE AND BUSINESS PRICE AND STATISTICAL INFORMATION; CONSULTING SERVICES IN THE FIELD OF HUMAN RESOURCES DEVELOPMENT, NAMELY, FOR THE PROMOTION OF EMPLOYEE RETENTION, CAREER GROWTH, AND INCREASED PRODUCTIVITY FOR EMPLOYEES AND EMPLOYERS; COST CONTAINMENT IN THE FIELD OF INSURANCE; COST MANAGEMENT FOR THE HEALTH BENEFIT PLANS OF OTHERS; DATA COMPILING AND ANALYZING IN THE FIELD OF INSURANCE; HUMAN RESOURCE ANALYSIS AND CONSULTING SERVICES; WORK ANALYSIS TO DETERMINE WORKER SKILL SETS AND OTHER WORKER REQUIREMENTS (U.S. CLS. 100, 101 AND 102).

## CLASS 36—INSURANCE AND FINANCIAL

FOR ACTUARIAL SERVICES; ADMINISTRATION OF EMPLOYEE BENEFIT PLANS CONCERNING INSURANCE AND FINANCE; CONSULTING SERVICES IN THE FIELD OF RETIREMENT PLAN ADMINISTRATION AND FIDUCIARY COMPLIANCE; FINANCIAL RISK MANAGEMENT; INSURANCE ADMINISTRATION; INSURANCE BROKERAGE; INSURANCE CLAIMS PROCESSING; INSURANCE INFORMATION AND CONSULTANCY; INSURANCE SERVICES IN THE NATURE OF LOSS CONTROL MANAGEMENT FOR OTHERS; INSURANCE UNDERWRITING CONSULTATION; PROVIDING INFORMATION IN THE FIELD OF EMPLOYEE FINANCIAL BENEFIT PLANS (U.S. CLS. 100, 101 AND 102).

RONALD AIKENS, EXAMINING ATTORNEY

SN 85-369,145. AON CORPORATION, CHICAGO, IL. FILED 7-12-2011.

GISELLE AGOSTO, EXAMINING ATTORNEY

## Empower Results

THE MARK CONSISTS OF STANDARD CHARACTERS WITHOUT CLAIM TO ANY PARTICULAR FONT, STYLE, SIZE, OR COLOR.

### CLASS 35—ADVERTISING AND BUSINESS

FOR BUSINESS CONSULTATION; BUSINESS RESEARCH AND SURVEYS; BUSINESS RISK MANAGEMENT; COMPILATION AND PROVISION OF TRADE AND BUSINESS PRICE AND STATISTICAL INFORMATION; CONSULTING SERVICES IN THE FIELD OF HUMAN RESOURCES DEVELOPMENT, NAMELY, FOR THE PROMOTION OF EMPLOYEE RETENTION, CAREER GROWTH, AND INCREASED PRODUCTIVITY FOR EMPLOYEES AND EMPLOYERS; COST CONTAINMENT IN THE FIELD OF INSURANCE; COST MANAGEMENT FOR THE HEALTH BENEFIT PLANS OF OTHERS; DATA COMPILING AND ANALYZING IN THE FIELD OF INSURANCE; HUMAN RESOURCE ANALYSIS AND CONSULTING SERVICES; WORK ANALYSIS TO DETERMINE WORKER SKILL SETS AND OTHER WORKER REQUIREMENTS (U.S. CLS. 100, 101 AND 102).

### CLASS 36—INSURANCE AND FINANCIAL

FOR ACTUARIAL SERVICES; ADMINISTRATION OF EMPLOYEE BENEFIT PLANS CONCERNING INSURANCE AND FINANCE; CONSULTING SERVICES IN THE FIELD OF RETIREMENT PLAN ADMINISTRATION AND FIDUCIARY COMPLIANCE; FINANCIAL RISK MANAGEMENT; INSURANCE ADMINISTRATION; INSURANCE BROKERAGE; INSURANCE CLAIMS PROCESSING; INSURANCE INFORMATION AND CONSULTANCY; INSURANCE SERVICES IN THE NATURE OF LOSS CONTROL MANAGEMENT FOR OTHERS; INSURANCE UNDERWRITING CONSULTATION; PROVIDING INFORMATION IN THE FIELD OF EMPLOYEE FINANCIAL BENEFIT PLANS (U.S. CLS. 100, 101 AND 102).

RONALD AIKENS, EXAMINING ATTORNEY

SN 85-373,161. MONTAUK U.S.A., LLC, NEW YORK, NY. FILED 7-16-2011.

## GET YOUR SLOPPY ON

THE MARK CONSISTS OF STANDARD CHARACTERS WITHOUT CLAIM TO ANY PARTICULAR FONT, STYLE, SIZE, OR COLOR.

### CLASS 25—CLOTHING

FOR WEARABLE GARMENTS AND CLOTHING, NAMELY, SHIRTS (U.S. CLS. 22 AND 39).

### CLASS 43—HOTEL AND RESTAURANT SERVICES

FOR RESTAURANT AND BAR SERVICES (U.S. CLS. 100 AND 101).

SN 85-373,168. MONTAUK U.S.A., LLC, NEW YORK, NY. FILED 7-16-2011.

## MONTUNA

THE MARK CONSISTS OF STANDARD CHARACTERS WITHOUT CLAIM TO ANY PARTICULAR FONT, STYLE, SIZE, OR COLOR.

### CLASS 25—CLOTHING

FOR WEARABLE GARMENTS AND CLOTHING, NAMELY, SHIRTS (U.S. CLS. 22 AND 39).

### CLASS 43—HOTEL AND RESTAURANT SERVICES

FOR RESTAURANT AND BAR SERVICES (U.S. CLS. 100 AND 101).  
GISELLE AGOSTO, EXAMINING ATTORNEY

SN 85-373,948. SONY MUSIC ENTERTAINMENT, NEW YORK, NY. FILED 7-18-2011.

## MW

THE MARK CONSISTS OF STANDARD CHARACTERS WITHOUT CLAIM TO ANY PARTICULAR FONT, STYLE, SIZE, OR COLOR.

### CLASS 9—ELECTRICAL AND SCIENTIFIC APPARATUS

FOR MUSICAL SOUND RECORDINGS, NAMELY, COMPACT DISCS; DOWNLOADABLE RING TONES, GRAPHICS AND MUSIC VIA A GLOBAL COMPUTER NETWORK AND WIRELESS DEVICES (U.S. CLS. 21, 23, 26, 36 AND 38).

### CLASS 35—ADVERTISING AND BUSINESS

FOR ON-LINE RETAIL STORE SERVICES FEATURING MUSICAL SOUND RECORDINGS, NAMELY, COMPACT DISCS, DOWNLOADABLE RING TONES, GRAPHICS AND MUSIC VIA A GLOBAL COMPUTER NETWORK AND WIRELESS DEVICES (U.S. CLS. 100, 101 AND 102).

NORA BUCHANAN WILL, EXAMINING ATTORNEY

SN 85-374,058. SONY MUSIC ENTERTAINMENT, NEW YORK, NY. FILED 7-18-2011.

## METAL WRECKAGE

THE MARK CONSISTS OF STANDARD CHARACTERS WITHOUT CLAIM TO ANY PARTICULAR FONT, STYLE, SIZE, OR COLOR.

### CLASS 9—ELECTRICAL AND SCIENTIFIC APPARATUS

FOR MUSICAL SOUND RECORDINGS, NAMELY, COMPACT DISCS; DOWNLOADABLE RING TONES, GRAPHICS AND MUSIC VIA A GLOBAL COMPUTER NETWORK AND WIRELESS DEVICES (U.S. CLS. 21, 23, 26, 36 AND 38).

### CLASS 35—ADVERTISING AND BUSINESS

FOR ON-LINE RETAIL STORE SERVICES FEATURING MUSICAL SOUND RECORDINGS, NAMELY, COMPACT DISCS, DOWNLOADABLE RING TONES, GRAPHICS AND MUSIC VIA A GLOBAL COMPUTER NETWORK AND WIRELESS DEVICES (U.S. CLS. 100, 101 AND 102).

NORA BUCHANAN WILL, EXAMINING ATTORNEY

SN 85-374,712. SONY MUSIC ENTERTAINMENT, NEW YORK, NY. FILED 7-19-2011.

## ARCADE PRODUCTIONS

THE MARK CONSISTS OF STANDARD CHARACTERS WITHOUT CLAIM TO ANY PARTICULAR FONT, STYLE, SIZE, OR COLOR.

OWNER OF U.S. REG. NO. 3,640,402.

NO CLAIM IS MADE TO THE EXCLUSIVE RIGHT TO USE "PRODUCTIONS", APART FROM THE MARK AS SHOWN.

### CLASS 35—ADVERTISING AND BUSINESS

FOR POST-PRODUCTION EDITING SERVICES FOR VIDEO AND AUDIO COMMERCIALS (U.S. CLS. 100, 101 AND 102).

### CLASS 41—EDUCATION AND ENTERTAINMENT

FOR PRODUCTION OF SOUND AND MUSIC VIDEO RECORDINGS; PROVIDING FACILITIES FOR PRODUCING VIDEO, CINEMA AND PHOTOGRAPHY PRODUCTIONS; POST-PRODUCTION EDITING SERVICES IN THE FIELD OF MUSIC, VIDEOS AND FILMS; ENTERTAINMENT MEDIA PRODUCTION SERVICES FOR MOTION PICTURES, TELEVISION AND INTERNET; MULTIMEDIA ENTERTAINMENT SERVICES IN THE NATURE OF DEVELOPMENT, PRODUCTION AND POST-PRODUCTION SERVICES IN THE FIELDS OF MUSIC, VIDEO AND MOTION PICTURES (U.S. CLS. 100, 101 AND 107).

### CLASS 42—SCIENTIFIC AND COMPUTER SERVICES

FOR VISUAL DESIGN SERVICES IN THE NATURE OF DESIGNING VISUAL ELEMENTS FOR LIVE MUSICAL AND THEATRICAL PERFORMANCES (U.S. CLS. 100 AND 101).

NORA BUCHANAN WILL, EXAMINING ATTORNEY

SN 85-377,039. CELLCO PARTNERSHIP, DBA VERIZON WIRELESS, BASKING RIDGE, NJ. FILED 7-21-2011.

## HELPWEAR

THE MARK CONSISTS OF STANDARD CHARACTERS WITHOUT CLAIM TO ANY PARTICULAR FONT, STYLE, SIZE, OR COLOR.

### CLASS 9—ELECTRICAL AND SCIENTIFIC APPARATUS

FOR ELECTRONIC PERSONAL EMERGENCY RESPONSE SYSTEM CONSISTING OF A WIRELESS DEVICE WORN ON THE BODY WITH A BUTTON THAT USERS PUSH TO NOTIFY OTHERS IN THE EVENT OF AN EMERGENCY, AND A REMOTE UNIT THAT DIALS OUT ON THE TELEPHONE FOR HELP (U.S. CLS. 21, 23, 26, 36 AND 38).

### CLASS 45—PERSONAL AND LEGAL SERVICES

FOR EMERGENCY RESPONSE ALARM MONITORING SERVICES, NAMELY, MONITORING OF ALERT DEVICES BY A REMOTE MONITORING CENTER FOR THE DISPATCH OF EMERGENCY PUBLIC HEALTH AND SECURITY SERVICES AND NOTIFICATION TO THIRD PARTIES, NAMELY, PREFERRED FAMILY CONTACTS, EMERGENCY RESPONDERS, A NURSE OR THEIR FAMILY (U.S. CLS. 100 AND 101).

KEVIN CORWIN, EXAMINING ATTORNEY

SN 85-377,361. DANNY ZELISKO PRESENTS, LLC, PHOENIX, AZ. FILED 7-21-2011.



THE MARK CONSISTS OF THE LETTERS "D" AND "P" AGAINST A CIRCULAR BACKGROUND, WITH THE LETTER "D" IN THE UPPER-LEFT QUADRANT OF THE MARK, AND THE LETTER "P" IN THE LOWER-RIGHT QUADRANT OF THE MARK, AND THE LETTER "Z" SUPERIMPOSED OVER THE LOWER PORTION OF THE LETTER "D" AND OVER THE UPPER PORTION OF THE LETTER "P" CENTRALLY WITHIN THE MARK.

#### CLASS 35—ADVERTISING AND BUSINESS

FOR PROMOTING THE CONCERTS OF OTHERS (U.S. CLS. 100, 101 AND 102).  
FIRST USE 6-1-2011; IN COMMERCE 6-1-2011.

#### CLASS 41—EDUCATION AND ENTERTAINMENT

FOR ARRANGING AND CONDUCTING OF CONCERTS; CONCERT BOOKING; ENTERTAINMENT, NAMELY, LIVE MUSIC CONCERTS, VISUAL AND AUDIO PERFORMANCES, MUSICAL, THEATRICAL, VARIETY AND COMEDY SHOWS (U.S. CLS. 100, 101 AND 107).

FIRST USE 5-13-2011; IN COMMERCE 5-13-2011.  
STEVEN PEREZ, EXAMINING ATTORNEY

SN 85-382,003. JONES, RUSSEL SCOTT, YORKTOWN HEIGHTS, NY. FILED 7-27-2011.

## HOW TO IN GREEN

THE MARK CONSISTS OF STANDARD CHARACTERS WITHOUT CLAIM TO ANY PARTICULAR FONT, STYLE, SIZE, OR COLOR.

#### CLASS 35—ADVERTISING AND BUSINESS

FOR BUSINESS ADVICE AND COMMERCIAL INFORMATION; BUSINESS ADVICE AND INFORMATION; BUSINESS ADVICE AND INFORMATION ABOUT A CORPORATE EXECUTIVE WHOSE WEALTH AMOUNTS TO AT LEAST A MILLION DOLLARS, POUNDS, OR THE EQUIVALENT IN OTHER CURRENCY; BUSINESS ADVICE, INQUIRIES OR INFORMATION; BUSINESS RELOCATION CONSULTING; BUSINESS RELOCATION SERVICES; MOVING AND RELOCATION SERVICES, NAMELY, PLANNING AND IMPLEMENTING MOVES OF HOMES AND OFFICES; PROVIDING BUSINESS INFORMATION, ALSO VIA INTERNET, THE CABLE NETWORK OR OTHER FORMS OF DATA TRANSFER; PROVIDING COMMERCIAL INFORMATION UPDATES ONLINE AND OVER A GLOBAL COMPUTER NETWORK IN THE FIELDS OF BUSINESS, COMMERCE, AND INDUSTRY; PROVIDING INFORMATION AND NEWS IN THE FIELD OF BUSINESS, NAMELY, INFORMATION AND NEWS ON CURRENT EVENTS AND ON ECONOMIC, LEGISLATIVE, AND REGULATORY DEVELOPMENTS AS IT RELATES TO AND CAN IMPACT BUSINESSES; RELOCATION SERVICES FOR BUSINESS; TAX ADVISORY SERVICES; TAX AND TAXATION PLANNING, ADVICE, INFORMATION AND CONSULTANCY SERVICES (U.S. CLS. 100, 101 AND 102).

#### CLASS 39—TRANSPORTATION AND STORAGE

FOR COORDINATING TRAVEL ARRANGEMENTS FOR INDIVIDUALS AND FOR GROUPS; PROVIDING A WEBSITE FEATURING INFORMATION ON TRAVEL; TRAVEL INFORMATION SERVICES (U.S. CLS. 100 AND 105).

#### CLASS 45—PERSONAL AND LEGAL SERVICES

FOR LEGAL SERVICES; LEGAL SERVICES, NAMELY, PROVIDING CUSTOMIZED INFORMATION, COUNSELING, ADVICE AND LITIGATION SERVICES IN ALL AREAS OF IMMIGRATION LAW (U.S. CLS. 100 AND 101).

FONG HSU, EXAMINING ATTORNEY

SN 85-383,375. RENESSENZ LLC, JACKSONVILLE, FL. FILED 7-28-2011.

**RENESENZ**

THE COLOR(S) BLUE AND GREEN IS/ARE CLAIMED AS A FEATURE OF THE MARK.

THE MARK CONSISTS OF THE WORD "RENESENZ" IN STYLIZED FORM IN BLUE AND GREEN.

#### CLASS 1—CHEMICALS

FOR CHEMICAL ADDITIVES PRODUCED FROM NATURALLY OCCURRING RENEWABLE AND SUSTAINABLE FEEDSTOCKS USED AS FRAGRANCES AND FLAVORINGS IN THE MANUFACTURE OF HOUSEHOLD AND PERSONAL CARE PRODUCTS, ORAL-CARE PRODUCTS, CONFECTIONERY AND BEVERAGES; INDUSTRIAL INTERMEDIATES USED AS INITIATORS IN RUBBER INDUSTRY AND IN OTHER INDUSTRIAL APPLICATIONS (U.S. CLS. 1, 5, 6, 10, 26 AND 46).

FIRST USE 12-22-2010; IN COMMERCE 12-22-2010.

**CLASS 4—LUBRICANTS AND FUELS**

FOR FUELS AND BIOFUELS BLENDED WITH CHEMICALS AND/OR BIOLOGICAL PRODUCTS; FUELS FROM BIOLOGICAL SOURCES; TERPENE-BASED FUEL (U.S. CLS. 1, 6 AND 15);

FIRST USE 12-22-2010; IN COMMERCE 12-22-2010.

JAY FLOWERS, EXAMINING ATTORNEY

BILL DAWE, EXAMINING ATTORNEY

SN 85-384,507. HUNTER DOUGLAS INC., UPPER SADDLE RIVER, NJ. FILED 7-29-2011.

SN 85-384,800. WELSPUN GLOBAL BRANDS LIMITED, MUMBAI, INDIA, FILED 7-29-2011.

# AMULETTE

THE MARK CONSISTS OF STANDARD CHARACTERS WITHOUT CLAIM TO ANY PARTICULAR FONT, STYLE, SIZE, OR COLOR.

**CLASS 20—FURNITURE AND ARTICLES NOT OTHERWISE CLASSIFIED**

FOR INTERIOR WINDOW AND DOOR BLINDS; INTERIOR WINDOW AND DOOR SHADES; ROOM DIVIDERS AND SCREENS; FABRIC WINDOW AND DOOR COVERINGS, NAMELY, FABRIC WINDOW AND DOOR BLINDS AND SHADES AND STRUCTURAL PARTS THEREFOR (U.S. CLS. 2, 13, 22, 25, 32 AND 50).

**CLASS 24—FABRICS**

FOR FABRIC WINDOW AND DOOR COVERINGS, NAMELY, CURTAINS, DRAPERIES, SHEERS, AND SWAGS; WINDOW AND DOOR TREATMENTS IN THE NATURE OF WINDOW AND DOOR COVERING PANELS MADE OF POLYESTER, COTTON, WOOL, LINEN, AND POLYESTER-BLEND FABRICS; FABRICS FOR USE IN WINDOW AND DOOR COVERINGS, NAMELY, POLYESTER, COTTON, WOOL, LINEN AND POLYESTER-BLEND FABRICS; WOVEN AND NON-WOVEN FABRIC FOR USE IN THE MANUFACTURE OF INTERIOR WINDOW AND DOOR COVERINGS AND DOOR BLINDS AND WINDOW AND DOOR SHADES; FABRIC VALANCES (U.S. CLS. 42 AND 50).

JOHN SCHUYLER YARD, EXAMINING ATTORNEY

SN 85-384,639. HEB GROCERY COMPANY, LP, SAN ANTONIO, TX. FILED 7-29-2011.

# LA DESPENSA

THE MARK CONSISTS OF STANDARD CHARACTERS WITHOUT CLAIM TO ANY PARTICULAR FONT, STYLE, SIZE, OR COLOR.

THE ENGLISH TRANSLATION OF "LA DESPENSA" IN THE MARK IS "THE PANTRY".

**CLASS 29—MEATS AND PROCESSED FOODS**

FOR REFRIED BEANS (U.S. CL. 46).

**CLASS 30—STAPLE FOODS**

FOR COOKING SAUCES (U.S. CL. 46).

# PERFECT TOUCH

THE MARK CONSISTS OF STANDARD CHARACTERS WITHOUT CLAIM TO ANY PARTICULAR FONT, STYLE, SIZE, OR COLOR.

**CLASS 24—FABRICS**

FOR BED BLANKETS; BED SHEETS; COMFORTERS; DISH CLOTHS; DUVETS; FITTED BED SHEETS; FLAT BED SHEETS; KITCHEN TOWELS; MATTRESS COVERS; MATTRESS PADS; PILLOW CASES; PILLOW SHAMS; SHEET SETS; TOWELS; WASHCLOTHS (U.S. CLS. 42 AND 50).

**CLASS 27—FLOOR COVERINGS**

FOR BATH MATS (U.S. CLS. 19, 20, 37, 42 AND 50).  
SHAILA SETTLES, EXAMINING ATTORNEY

SN 85-385,118. ZINUS INC., HAYWARD, CA. FILED 7-29-2011.

# Clean First

THE MARK CONSISTS OF STANDARD CHARACTERS WITHOUT CLAIM TO ANY PARTICULAR FONT, STYLE, SIZE, OR COLOR.

**CLASS 20—FURNITURE AND ARTICLES NOT OTHERWISE CLASSIFIED**

FOR BEDS, MATTRESSES, PILLOWS AND BOLSTERS; BUNK BEDS (U.S. CLS. 2, 13, 22, 25, 32 AND 50).

**CLASS 24—FABRICS**

FOR MATTRESS COVERS (U.S. CLS. 42 AND 50).  
JEFFREY LOOK, EXAMINING ATTORNEY

SN 85-385,748. SONY MUSIC ENTERTAINMENT, NEW YORK, NY. FILED 8-1-2011.

# ARCADE

THE MARK CONSISTS OF STANDARD CHARACTERS WITHOUT CLAIM TO ANY PARTICULAR FONT, STYLE, SIZE, OR COLOR.

OWNER OF U.S. REG. NO. 3,640,402.

## CLASS 35—ADVERTISING AND BUSINESS

FOR POST-PRODUCTION EDITING SERVICES FOR VIDEO AND AUDIO COMMERCIALS; ADVERTISING AGENCY SERVICES, NAMELY, PROMOTING THE GOODS AND SERVICES OF OTHERS; ADVERTISING, MARKETING AND PROMOTION SERVICES; POST-PRODUCTION EDITING SERVICES FOR VIDEO AND AUDIO COMMERCIALS; PROVIDING CONSULTING SERVICES IN THE FIELD OF FACILITATING THE PLANNING, BUYING, AND SELLING OF MEDIA; MARKETING DESIGN SERVICES AND TALENT AGENCIES (U.S. CLS. 100, 101 AND 102).

## CLASS 41—EDUCATION AND ENTERTAINMENT

FOR PRODUCTION OF SOUND AND MUSIC VIDEO RECORDINGS; PROVIDING FACILITIES FOR PRODUCING VIDEO, CINEMA AND PHOTOGRAPHY PRODUCTIONS; POST-PRODUCTION EDITING SERVICES IN THE FIELD OF MUSIC, VIDEOS AND FILMS; ENTERTAINMENT MEDIA PRODUCTION SERVICES FOR MOTION PICTURES, TELEVISION AND INTERNET; MULTIMEDIA ENTERTAINMENT SERVICES IN THE NATURE OF DEVELOPMENT, PRODUCTION AND POST-PRODUCTION SERVICES IN THE FIELDS OF MUSIC, VIDEO AND MOTION PICTURES; PRODUCTION OF SOUND AND MUSIC VIDEO RECORDINGS; PROVIDING FACILITIES FOR PRODUCING VIDEO, CINEMA AND PHOTOGRAPHY PRODUCTIONS; POST-PRODUCTION EDITING SERVICES IN THE FIELD OF MUSIC, VIDEOS AND FILMS; ENTERTAINMENT IN NATURE OF THEATER PRODUCTIONS (U.S. CLS. 100, 101 AND 107).

## CLASS 42—SCIENTIFIC AND COMPUTER SERVICES

FOR VISUAL DESIGN SERVICES IN THE NATURE OF DESIGNING VISUAL ELEMENTS FOR LIVE MUSICAL AND THEATRICAL PERFORMANCES (U.S. CLS. 100 AND 101).

NORA BUCHANAN WILL, EXAMINING ATTORNEY

SN 85-387,650. FIREDUP ENTERPRISES, LLC, CULVER CITY, CA. FILED 8-2-2011.

# PRINCESS PLACE

THE MARK CONSISTS OF STANDARD CHARACTERS WITHOUT CLAIM TO ANY PARTICULAR FONT, STYLE, SIZE, OR COLOR.

## CLASS 3—COSMETICS AND CLEANING PREPARATIONS

FOR NON-MEDICATED TOILETRIES, NAMELY, HAIR SHAMPOO, HAIR CONDITIONER, HAIR MOUSSE, SCALP CONDITIONER, HAIR CREAM RINSE, SKIN CLEANSING CREME, FACIAL, HAND AND BODY CRÈMES, LOTIONS AND MOISTURIZERS, BUBBLE BATH, BATH OIL, BATH AND BODY GELS, BATH AND BODY POWDER, NAIL POLISH, NAIL HARDENER, NAIL CONDITIONER, NAIL POLISH REMOVER, CUTICLE CRÈMES AND CONDITIONERS, FACIAL SCRUBS, FACIAL MASKS, TALCUM POWDER, SHAVING CREAM AND FOAM, BAR SOAP, LIQUID SOAP, BEAUTY PREPARATIONS, NAMELY, FOUNDATION, FACE POWDER, MASCARA, LIP STICK, LIP GLOSS, EYELINER, BLUSH, ROUGE, EYE SHADOW, EYEBROW PENCIL, DEODORANTS AND ANTI-PERSPIRANTS, COSMETICS; COSMETIC PENCILS, COSMETIC PADS, PRE-MOISTENED COSMETIC TISSUES; NON-MEDICATED HAIR, SKIN AND NAIL CARE PREPARATIONS; FRAGRANCES FOR PERSONAL USE, NAMELY, PERFUME, COLOGNE, EAU DE TOILETTE, AFTER SHAVE GEL AND AFTER SHAVE LOTION; BEAUTY CARE COSMETICS; ESSENTIAL OILS; BODY AND HAIR LOTIONS AND OILS (U.S. CLS. 1, 4, 6, 50, 51 AND 52).

## CLASS 9—ELECTRICAL AND SCIENTIFIC APPARATUS

FOR EYEWEAR, NAMELY, SPORTS, PROTECTIVE, SUNGLASSES, SPECTACLES, EYEGLASSES; ELECTRONIC DEVICES, NAMELY, RADIOS, STEREO EQUIPMENT, NAMELY, CD AND DVD PLAYERS, TELEVISIONS AND AUDIOVISUAL RECEIVERS; ELECTRONIC GAMES, NAMELY, ELECTRONIC GAME PROGRAMS; COMPUTER GAMES, NAMELY, COMPUTER GAME PROGRAMS, COMPUTER GAME SOFTWARE, COMPUTER GAME DISCS; COMPUTER SOFTWARE FOR USE IN DATABASE MANAGEMENT, USE AS A SPREADSHEET, WORD PROCESSING, GAMES; PRERECORDED MAGNETIC DATA CARRIERS FEATURING MUSIC, DRAMA, THEATRICAL AND COMEDY PERFORMANCES; BLANK RECORDING DISCS; AUDIO AND VISUAL RECORDINGS FEATURING MUSIC, DRAMA, THEATRICAL AND COMEDY PERFORMANCES; PREPAID MAGNETICALLY ENCODED CALLING CARDS; GRADUATED RULERS; DOWNLOADABLE ELECTRONIC GAMES VIA THE INTERNET AND WIRELESS DEVICES (U.S. CLS. 21, 23, 26, 36 AND 38).

## CLASS 14—JEWELRY

FOR JEWELRY; KEY CHAINS OF PRECIOUS METAL; WATCHES; JEWELRY BOXES NOT OF METAL (U.S. CLS. 2, 27, 28 AND 50).

## CLASS 16—PAPER GOODS AND PRINTED MATTER

FOR PAPER GOODS, NAMELY, ART PAPER, CRAFT PAPER, BOND PAPER, COMPUTER PAPER, COLLAPSIBLE BOXES MADE OF PAPER; PRINTED MATERIALS, NAMELY, BLANK AND PARTIALLY PRINTED POSTCARDS, PRINTED INVITATIONS; STATIONERY; PUBLISHED PAPER GOODS, NAMELY, CHILDREN'S BOOKS, AND GENERAL FEATURE MAGAZINES; ADDRESS BOOKS, BLANK JOURNAL BOOKS, COLORING BOOKS, STORY BOOKS, TALKING CHILDREN'S BOOKS, NOTE BOOKS; RUBBER STAMPS; DECALS; ART, NAMELY, ART PICTURES, ART PRINTS; ART SUPPLIES, NAMELY, PENS, PENCILS, MECHANICAL PENCILS, MARKERS, CRAYONS, HIGHLIGHTERS, PAPER, GLUE, PAINT BRUSHES; TEMPORARY TATTOOS; TRADING CARDS; CHECKBOOK COVERS; PENS; PENCILS; PENCIL SHARPENERS; ERASERS; COASTERS MADE OF PAPER; POSTCARDS; AUTOGRAPH BOOKS; BINDERS; SCHOOL AND OFFICE SUPPLIES, NAMELY, WRITING INSTRUMENTS, PENS, PENCILS, MECHANICAL PENCILS, ERASERS, MARKERS, CRAYONS, HIGHLIGHTERS, FOLDERS, NOTEBOOKS, PAPER, PROTRACTORS, PAPER CLIPS, PENCIL SHARPENERS, WRITING GRIPS, GLUE AND BOOK MARKS; PAPER PARTY DECORATIONS (U.S. CLS. 2, 5, 22, 23, 29, 37, 38 AND 50).



**CLASS 18—LEATHER GOODS**

FOR LEATHER AND IMITATION LEATHER GOODS, NAMELY, LEATHER PURSES, LEATHER HANDBAGS, LEATHER CASES FOR KEYS, LEATHER AND IMITATION LEATHER BAGS; FURS, NAMELY, FUR PELTS AND FURS SOLD IN BULK; BAGS, NAMELY, CARRY-ON BAGS, DUFFEL BAGS, GYM BAGS; WALLETTS; PURSES; HANDBAGS; BACKPACKS; UMBRELLAS (U.S. CLS. 1, 2, 3, 22 AND 41).

**CLASS 20—FURNITURE AND ARTICLES NOT OTHERWISE CLASSIFIED**

FOR FURNITURE; PICTURE FRAMES NOT OF PRECIOUS METAL; MIRRORS; NAME BADGES OF PLASTIC; PILLOWS (U.S. CLS. 2, 13, 22, 25, 32 AND 50).

**CLASS 21—HOUSEWARES AND GLASS**

FOR HOUSEHOLD OR KITCHEN UTENSILS, NAMELY, LADLES, ROLLING PINS, SPATULAS, STRAINERS; KITCHEN ACCESSORIES, NAMELY, PAPER TOWEL HOLDERS, SALAD SPINNERS, CUTTING BOARDS, MIXING BOWLS; HOUSEHOLD OR KITCHEN CONTAINERS NOT OF PRECIOUS METAL; HOME FURNISHINGS AND HOME WARES, NAMELY, SOAP DISHES SOLD EMPTY, DISH SOAP DISPENSERS, LOTION BOTTLES SOLD EMPTY, TOOTHBRUSH HOLDERS, DRINKING GLASSES, NAMELY, TUMBLERS, TISSUE BOXES SOLD EMPTY, WASTEBASKETS AND PLASTIC COASTERS; BEVERAGE GLASSWARE; DISHES; COOKWARE, NAMELY, POTS, PANS, ROASTING PANS, STEAMERS, PLATES; CUPS; MUGS; SHOT GLASSES; COMBS; BRUSHES, NAMELY, HAIR BRUSHES, NAIL BRUSHES; LUNCH BOXES; PARTY GOODS, NAMELY, VEGETABLE DISHES; CHIP AND DIP BOWLS, CAKE PLATES WITH OR WITHOUT DOMES, RELISH DISHES, PUNCH BOWLS (U.S. CLS. 2, 13, 23, 29, 30, 33, 40 AND 50).

**CLASS 24—FABRICS**

FOR TOWELS; BEDDING, NAMELY, SHEETS, BLANKETS; CURTAINS (U.S. CLS. 42 AND 50).

**CLASS 25—CLOTHING**

FOR CLOTHING, FOOTWEAR AND HEADWEAR, NAMELY, T-SHIRTS, SWEAT SHIRTS, FUR JACKETS, LEATHER JACKETS, CLOTH JACKETS, JERSEYS, SHORTS, SWEAT PANTS, HATS, CAPS, SCARVES, GLOVES, HOSIERY, NECKTIES, PAJAMAS, BATHROBES, NIGHT SHIRTS, NIGHT GOWNS, UNDERWEAR, HEAD BANDS, WRIST BANDS, SWIM SUITS, SKIRTS, SHIRTS, TANK TOPS, PANTS, FUR COATS, LEATHER COATS, RAINCOATS, SPORT COATS, SUIT COATS, TOPCOATS, OVERCOATS, SWEATERS, LEOTARDS, LEG WARMERS, STOCKINGS, SOCKS, PANTY HOSE, TIGHTS, BELTS, SHOES, SLIPPERS, BOOTS, SANDALS; RAINWEAR; ATHLETIC SHOES, CASUAL FOOTWEAR, SANDALS; BANDANNAS, NECKERCHIEFS; SWIMWEAR, NAMELY, BATHING SUITS AND TRUNKS, BEACHWEAR, BEACH AND BATHING COVERUPS, AND BIKINIS; BERMUDA SHORTS, GYM SHORTS, JEANS, PLAY SUITS, POLO SHIRTS, PULL-OVERS, SWEATSHORTS, TOPS, SUITS, JOGGING SUITS, WARMUP SUITS, SWEAT SUITS, SHORTS, KNIT SHIRTS (U.S. CLS. 22 AND 39).

**CLASS 26—FANCY GOODS**

FOR BUTTONS, NAMELY, SHIRT BUTTONS, BUTTONS FOR CLOTHING, ORNAMENTAL BUTTONS; PINS, NAMELY, HAIR PINS, SAFETY PINS, HAT PINS, SEWING PINS; SHOELACES; PATCHES OF CLOTH AND EMBROIDERED PATCHES FOR CLOTHING; ARTIFICIAL FLOWERS; HAIR ORNAMENTS AND ACCESSORY KITS CONTAINING HAIR ORNAMENTS; ORNAMENTAL NOVELTY PINS; ORNAMENTAL NOVELTY BUTTONS; HAIR GROOMING ACCESSORIES, NAMELY, HAIR BANDS, BARRETTES, HAIR PINS (U.S. CLS. 37, 39, 40, 42 AND 50).

**CLASS 28—TOYS AND SPORTING GOODS**

FOR GAMES, NAMELY, BOARD GAMES, CARD GAMES, ACTION SKILL GAMES; PUZZLES; PARTY SUPPLIES, NAMELY, CHRISTMAS TREE DECORATIONS; PLAYTHINGS, NAMELY, PLAY HOUSES, PLAY TENTS, PLAY TUNNELS; GYMNASIAC AND SPORTING ARTICLES NAMELY, GYMNASIAC VAULTING HORSES, PARALLEL BARS, TENNIS RACKETS, RACKET BALLS; TOYS, NAMELY, PORCELAIN DOLLS, FASHION DOLLS, RAG DOLLS, PAPER DOLLS, DOLL HOUSES, DOLL ACCESSORIES, DOLL CLOTHING, DOLL CASES, DOLLS COSTUMES, COLLECTABLE TOY FIGURINES; DOLLS; DOLL PLAY SETS; DOLL FURNITURE; TOY STUFFED ANIMALS; TOY SLIDE VIEWERS; EDUCATIONAL TOYS, NAMELY, ELECTRONIC LEARNING TOYS AND CHILDREN'S MULTIPLE ACTIVITY TOYS (U.S. CLS. 22, 23, 38 AND 50).

**CLASS 30—STAPLE FOODS**

FOR FOOD, NAMELY, CEREAL BASED SNACK FOOD, HONEY, PROCESSED GRAINS, READY TO EAT, CEREAL DERIVED BREAKFAST BARS, BREAKFAST CEREAL, CRACKERS, COOKIES; CANDY CAKE DECORATIONS (U.S. CL. 46).

**CLASS 32—LIGHT BEVERAGES**

FOR NON-ALCOHOLIC BEVERAGES, NAMELY, FRUIT BEVERAGES, SMOOTHIES, SOY BASED BEVERAGE NOT BEING MILK SUBSTITUTES (U.S. CLS. 45, 46 AND 48).

**CLASS 35—ADVERTISING AND BUSINESS**

FOR RETAIL DEPARTMENT STORES; ADVERTISING VIA ELECTRONIC MEDIA AND SPECIFICALLY THE INTERNET; ON-LINE RETAIL STORE SERVICES FEATURING MULTIMEDIA SOFTWARE RECORDED ON CD-ROM, DIGITAL MEDIA, TOYS, CLOTHING, FOOD, KITCHEN ACCESSORIES, BEAUTY PRODUCTS, EYEWEAR, JEWELRY AND PAPER GOODS (U.S. CLS. 100, 101 AND 102).

**CLASS 41—EDUCATION AND ENTERTAINMENT**

FOR PUBLICATION OF BOOKS, MAGAZINES; ENTERTAINMENT IN THE NATURE OF LIVE PERFORMANCES BY MUSICAL GROUPS, TELEVISION SERIES FOR CHILDREN AND YOUTH, CULTURAL FESTIVALS FOR YOUTH, ONGOING ANIMATED AND NON-ANIMATED PROGRAMS PRESENTED ONLINE FOR CHILDREN, AND ON-LINE MOTION PICTURES FEATURING CHILDREN'S ENTERTAINMENT; PROVIDING INTERACTIVE WEBSITES FEATURING CHILDREN'S ENTERTAINMENT; TELEVISION PRODUCTION; MOVIE PRODUCTION; PRODUCTION OF AUDIO AND/OR VIDEO RECORDINGS; ENTERTAINMENT SERVICES, NAMELY, PROVIDING AN ON-LINE COMPUTER GAME; ENTERTAINMENT SERVICES, NAMELY, PROVIDING ON-LINE VIDEO GAMES (U.S. CLS. 100, 101 AND 107).

Laurie Kaufman, Examining Attorney

SN 85-387,825. KILWIN'S CHOCOLATES FRANCHISE, INC., PETOSKEY, MI. FILED 8-3-2011.

# Kilwins

THE MARK CONSISTS OF STANDARD CHARACTERS WITHOUT CLAIM TO ANY PARTICULAR FONT, STYLE, SIZE, OR COLOR.

OWNER OF U.S. REG. NOS. 3,870,465, 3,870,466 AND 3,870,468.

**CLASS 35—ADVERTISING AND BUSINESS**

FOR RETAIL STORE SERVICES FEATURING CANDY, CONFECTIONS AND ICE CREAM (U.S. CLS. 100, 101 AND 102).

FIRST USE 1-1-1967; IN COMMERCE 5-23-1978.

**CLASS 43—HOTEL AND RESTAURANT SERVICES**

FOR ICE CREAM SHOP SERVICES IN THE NATURE OF A RESTAURANT (U.S. CLS. 100 AND 101).

FIRST USE 1-1-1967; IN COMMERCE 5-23-1978.  
KATHY DE JONGE, EXAMINING ATTORNEY

---

SN 85-388,645. THE SPORTSMAN'S GUIDE, INC., SOUTH ST. PAUL, MN. FILED 8-3-2011.

**THE SPORTSMAN'S GUIDE**

THE MARK CONSISTS OF STANDARD CHARACTERS WITHOUT CLAIM TO ANY PARTICULAR FONT, STYLE, SIZE, OR COLOR.

OWNER OF U.S. REG. NOS. 1,430,664, 2,624,677 AND OTHERS.

**CLASS 35—ADVERTISING AND BUSINESS**

FOR RETAIL STORE SERVICES IN THE FIELD OF SPORTING GOODS AND EQUIPMENT FEATURING A BONUS INCENTIVE PROGRAM FOR CUSTOMERS (U.S. CLS. 100, 101 AND 102).

FIRST USE 7-25-2011; IN COMMERCE 7-25-2011.

**CLASS 36—INSURANCE AND FINANCIAL**

FOR CREDIT CARD SERVICES (U.S. CLS. 100, 101 AND 102).

FIRST USE 7-25-2011; IN COMMERCE 7-25-2011.  
MAYUR VAGHANI, EXAMINING ATTORNEY

---

SN 85-389,371. MILLERCOORS LLC, CHICAGO, IL. FILED 8-4-2011.

**COUNTDOWN TO GREATNESS**

THE MARK CONSISTS OF STANDARD CHARACTERS WITHOUT CLAIM TO ANY PARTICULAR FONT, STYLE, SIZE, OR COLOR.

**CLASS 30—STAPLE FOODS**

FOR PIZZA (U.S. CL. 46).

**CLASS 32—LIGHT BEVERAGES**

FOR BEER (U.S. CLS. 45, 46 AND 48).  
SUSAN RICHARDS, EXAMINING ATTORNEY

SN 85-394,224. KNORR-NÄHRMITTEL AKTIENGESELLSCHAFT, THAYNGEN CH-8240, SWITZERLAND, FILED 8-10-2011.

**LIVE FOR FLAVOR**

THE MARK CONSISTS OF STANDARD CHARACTERS WITHOUT CLAIM TO ANY PARTICULAR FONT, STYLE, SIZE, OR COLOR.

**CLASS 29—MEATS AND PROCESSED FOODS**

FOR BOUILLON; SOUPS AND SOUP MIXES; DIP AND DIP MIXES (U.S. CL. 46).

**CLASS 30—STAPLE FOODS**

FOR PREPARED MEALS CONSISTING PRIMARILY OF PASTA OR RICE; GRAVY AND GRAVY MIXES; SAUCE AND SAUCE MIXES, EXCLUDING APPLE AND CRANBERRY; SEASONINGS AND SEASONED COATING FOR MEAT, FISH AND POULTRY (U.S. CL. 46).

KELLY TRUSILO, EXAMINING ATTORNEY

---

SN 85-394,517. LEDTRONICS, INC., TORRANCE, CA. FILED 8-10-2011.

**LEDTRONICS**

OWNER OF U.S. REG. NOS. 1,914,678, 2,472,746 AND 3,356,292.

THE COLOR(S) GREEN AND RED IS/ARE CLAIMED AS A FEATURE OF THE MARK.

THE MARK CONSISTS OF THE STYLIZED LETTERS "LEDTRONICS" WHERE THE LETTERS "LED" ARE IN RED AND THE LETTERS "TRONICS" ARE IN GREEN.

**CLASS 6—METAL GOODS**

FOR METAL KEY CHAINS (U.S. CLS. 2, 12, 13, 14, 23, 25 AND 50).

FIRST USE 7-26-2011; IN COMMERCE 8-6-2011.

**CLASS 9—ELECTRICAL AND SCIENTIFIC APPARATUS**

FOR ELECTRONIC LED SIGNS; LED CIRCUIT BOARDS; LED VEHICLE TRAFFIC SIGNALS; LIGHT EMITTING DIODE (LED) DISPLAYS; LIGHT EMITTING DIODES (LEDS); PORTABLE LED SAFETY LIGHTING DEVICES FOR PERSONAL USE FOR SAFETY PURPOSES (U.S. CLS. 21, 23, 26, 36 AND 38).

FIRST USE 7-26-2011; IN COMMERCE 8-6-2011.

**CLASS 11—ENVIRONMENTAL CONTROL APPARATUS**

FOR LED (LIGHT EMITTING DIODE) LIGHTING FIXTURES; LED (LIGHT EMITTING DIODES) LIGHTING FIXTURES FOR USE IN DISPLAY, COMMERCIAL, INDUSTRIAL, RESIDENTIAL, AND ARCHITECTURAL ACCENT LIGHTING APPLICATIONS; LED LANDSCAPE LIGHTS; LED LIGHT APPARATUS THAT CLIPS ON TO A HANDBAG, USED TO ILLUMINATE A HANDBAG; LED LIGHT ASSEMBLIES FOR STREET LIGHTS, SIGNS, COMMERCIAL LIGHTING, AUTOMOBILES, BUILDINGS, AND OTHER ARCHITECTURAL USES; LED LIGHT BULBS; LED LIGHT MACHINES; LED LIGHTING FIXTURES FOR INDOOR AND OUTDOOR LIGHTING APPLICATIONS; LED LIGHTING SYSTEMS, NAMELY, LED MODULES, POWER SUPPLIES, AND WIRING; LED LIGHTS FOR LIGHTING PURPOSES INCORPORATED INTO KEY CHAINS, SMALL TOYS OR OTHER SIMILAR PERSONAL ITEMS; LED LIGHTS FOR STRINGS, FLOWERS, BRANCHES AND OTHER ORNAMENTAL DECORATIONS; LED LUMINAIRES; LIGHT EMITTING DIODE (LED) PLANT GROW LIGHT; LIGHTS FOR USE IN ILLUMINATING SIGNS AND DISPLAYS; LUMINAIRES, USING LIGHT EMITTING DIODES (LEDS) AS A LIGHT SOURCE, FOR STREET OR ROADWAY LIGHTING; OPTICAL LENS COVERS THAT IMPROVE LIGHT OUTPUT AND UNIFORMITY AND PROTECT THE LED, SOLD AS A FEATURE OF AN LED LIGHTING SYSTEM; TOOLS, COMPONENTS AND SUPPLIES FOR USE IN MAKING SIGNS, NAMELY, LED BULBS, LAMPS AND FIXTURES; LED STREET LIGHTS; LED STREET LIGHT BULBS; LED TUBE LIGHTS; LED TUBE LIGHT BULBS; LED TUBE LIGHT FIXTURES (U.S. CLS. 13, 21, 23, 31 AND 34).

FIRST USE 7-26-2011; IN COMMERCE 8-6-2011.

**CLASS 40—MATERIAL TREATMENT**

FOR CUSTOM MANUFACTURE OF LIGHT EMITTING DIODE (LED) DEVICES; MANUFACTURE OF LIGHT EMITTING DIODE (LED) DEVICES, NAMELY, ARRAYS, CLUSTERS AND DISPLAYS OF LED DEVICES FOR INSTRUMENTATION, INDICATION AND ILLUMINATION WITHIN THE VISIBLE LIGHT AND INFRARED SPECTRUM TO ORDER AND/OR SPECIFICATION OF OTHERS (U.S. CLS. 100, 103 AND 106).

FIRST USE 7-26-2011; IN COMMERCE 8-6-2011.

**CLASS 42—SCIENTIFIC AND COMPUTER SERVICES**

FOR DESIGN FOR OTHERS IN THE FIELD OF LIGHT EMITTING DIODE (LED) DEVICES, LIGHTS, DISPLAYS, ARRAYS, CLUSTERS AND FIXTURES (U.S. CLS. 100 AND 101).

FIRST USE 7-26-2011; IN COMMERCE 8-6-2011.

C. DIONNE CLYBURN, EXAMINING ATTORNEY

SN 85-395,777. STRIKE KING LURE COMPANY, COLLIERVILLE, TN. FILED 8-11-2011.

# STRIKE KING

THE MARK CONSISTS OF STANDARD CHARACTERS WITHOUT CLAIM TO ANY PARTICULAR FONT, STYLE, SIZE, OR COLOR.

OWNER OF U.S. REG. NOS. 1,327,249 AND 2,960,530.

**CLASS 9—ELECTRICAL AND SCIENTIFIC APPARATUS**

FOR CASES FOR EYEGLASSES AND SUNGLASSES; SUNGLASS CHAINS AND CORDS; PROTECTIVE COVERS AND CASES FOR CELL PHONES, LAPTOPS AND PORTABLE MEDIA PLAYERS; COMPUTER APPLICATIONS FOR MOBILE PHONES, NAMELY, SOFTWARE FOR LOGGING FISHING DATA (U.S. CLS. 21, 23, 26, 36 AND 38).

**CLASS 25—CLOTHING**

FOR SHIRTS; FISHING SHIRTS; T-SHIRTS; SWEAT SHIRTS; JACKETS; FISHERMEN'S JACKETS; VESTS; FISHING VESTS; PULLOVERS; HEADWEAR; RAINWEAR (U.S. CLS. 22 AND 39).

**CLASS 28—TOYS AND SPORTING GOODS**

FOR FISHING ACCESSORIES, NAMELY, FISHING TACKLE BAGS; FISHING ROD AND REEL COVERS; FISHING ROD WRAPS; WEIGH-IN BAGS; PLAYING CARDS; POKER SETS (U.S. CLS. 22, 23, 38 AND 50).

ANNE MADDEN, EXAMINING ATTORNEY

SN 85-396,314. ALM MEDIA PROPERTIES, LLC, NEW YORK, NY. FILED 8-12-2011.

# Better Buildings

THE MARK CONSISTS OF STANDARD CHARACTERS WITHOUT CLAIM TO ANY PARTICULAR FONT, STYLE, SIZE, OR COLOR.

NO CLAIM IS MADE TO THE EXCLUSIVE RIGHT TO USE "BUILDINGS", APART FROM THE MARK AS SHOWN.

**CLASS 16—PAPER GOODS AND PRINTED MATTER**

FOR MAGAZINE SECTIONS IN THE FIELD OF BUILDING OPERATIONS AND REAL ESTATE; MAGAZINES IN THE FIELD OF BUILDING OPERATIONS AND REAL ESTATE; NEWSLETTERS IN THE FIELD OF BUILDING OPERATIONS AND REAL ESTATE (U.S. CLS. 2, 5, 22, 23, 29, 37, 38 AND 50).

**CLASS 41—EDUCATION AND ENTERTAINMENT**

FOR ENTERTAINMENT SERVICES, NAMELY, PROVIDING WEBCASTS IN THE FIELD OF BUILDING OPERATIONS AND REAL ESTATE; ON-LINE JOURNALS, NAMELY, BLOGS FEATURING NEWS, INFORMATION AND COMMENTARY IN THE FIELD OF BUILDING OPERATIONS AND REAL ESTATE; PROVIDING NEWSLETTERS IN THE FIELD OF BUILDING OPERATIONS AND REAL ESTATE VIA E-MAIL; PROVIDING ON-LINE PUBLICATIONS IN THE NATURE OF NEWSLETTERS, GUIDES, MAGAZINES, NEWSPAPERS IN THE FIELD OF BUILDING OPERATIONS AND REAL ESTATE (U.S. CLS. 100, 101 AND 107).

WILLIAM ROSSMAN, EXAMINING ATTORNEY

SN 85-407,437. BROOKSTONE COMPANY, INC., MERRIMACK, NH. FILED 8-25-2011.



NO CLAIM IS MADE TO THE EXCLUSIVE RIGHT TO USE "AUDIO", APART FROM THE MARK AS SHOWN.

THE MARK CONSISTS OF THE WORDS "BIG BLUE AUDIO" IN A STACKED, LEFT-JUSTIFIED CONFIGURATION WHEREIN THE LETTER "L" IN THE WORD BLUE AND THE "I" IN THE WORD BIG ARE PLACED WITH A SINGLE ANTENNAE WITH SOUND WAVES EMANATING UPWARDS.

**CLASS 9—ELECTRICAL AND SCIENTIFIC APPARATUS**

FOR AUDIO SPEAKERS; DIGITAL AUDIO PLAYERS; EARPHONES AND HEADPHONES; PERSONAL STEREO; PORTABLE LISTENING DEVICES, NAMELY, MP3 PLAYERS (U.S. CLS. 21, 23, 26, 36 AND 38).

**CLASS 35—ADVERTISING AND BUSINESS**

FOR ON-LINE RETAIL GIFT SHOPS (U.S. CLS. 100, 101 AND 102).  
CAROLYN CATALDO, EXAMINING ATTORNEY

SN 85-407,476. BROOKSTONE COMPANY, INC., MERRIMACK, NH. FILED 8-25-2011.



NO CLAIM IS MADE TO THE EXCLUSIVE RIGHT TO USE "AUDIO", APART FROM THE MARK AS SHOWN.

THE COLOR(S) BLUE IS/ARE CLAIMED AS A FEATURE OF THE MARK.

THE MARK CONSISTS OF THE WORDS "BIG BLUE AUDIO" IN A BLUE STYLIZED FONT AND STACKED IN A LEFT-JUSTIFIED CONFIGURATION WHEREIN THE LETTER "L" IN THE WORD BLUE AND THE "I" IN THE WORD BIG ARE PLACED WITH A SINGLE ANTENNAE WITH SOUND WAVES EMANATING UPWARDS.

**CLASS 9—ELECTRICAL AND SCIENTIFIC APPARATUS**

FOR AUDIO SPEAKERS; DIGITAL AUDIO PLAYERS; EARPHONES AND HEADPHONES; PERSONAL STEREO; PORTABLE LISTENING DEVICES, NAMELY, MP3 PLAYERS (U.S. CLS. 21, 23, 26, 36 AND 38).

**CLASS 35—ADVERTISING AND BUSINESS**

FOR ON-LINE RETAIL GIFT SHOPS (U.S. CLS. 100, 101 AND 102).  
CAROLYN CATALDO, EXAMINING ATTORNEY

SN 85-408,418. MILLERCOORS LLC, CHICAGO, IL. FILED 8-26-2011.



OWNER OF U.S. REG. NO. 3,842,638.

THE MARK CONSISTS OF THE WORDS "GREAT BEER" APPEARING TO THE LEFT OF TWO CROSSED CHECKERED FLAGS; THE WORDS "GREAT RESPONSIBILITY" APPEAR BELOW THE WORDS "GREAT BEER" AND THE BOTTOM OF THE FLAGPOLES TOUCH THE TOP OF THE LETTERS "BI" IN THE WORD "RESPONSIBILITY".

**CLASS 32—LIGHT BEVERAGES**

FOR BEER (U.S. CLS. 45, 46 AND 48).

**CLASS 35—ADVERTISING AND BUSINESS**

FOR PROMOTING PUBLIC AWARENESS OF THE NEED FOR ALCOHOL AWARENESS AND MODERATION AND RESPONSIBILITY IN DRINKING ALCOHOLIC BEVERAGES (U.S. CLS. 100, 101 AND 102).  
SUSAN RICHARDS, EXAMINING ATTORNEY

SN 85-415,866. THE CHICKASAW NATION, ADA, OK. FILED 9-6-2011.



THE COLOR(S) BLUE, RED AND YELLOW IS/ARE CLAIMED AS A FEATURE OF THE MARK.

THE MARK CONSISTS OF THE STYLIZED WORDS "CHICKASAW" IN RED, "COUNTRY" IN BLUE AND "A MILLION WAYS TO PLAY" IN RED UNDER A MAP OF THE CHICKASAW NATION IN BLUE WITH A COMPOSITE LETTER "C" SUPERIMPOSED OVER THE MAP CONSISTING OF A TRADITIONAL BEAD WORK PATTERN IN RED, YELLOW AND SEVERAL SHADES OF BLUE.

#### **CLASS 16—PAPER GOODS AND PRINTED MATTER**

FOR PRINTED PERIODICALS IN THE FIELD OF TOURISM (U.S. CLS. 2, 5, 22, 23, 29, 37, 38 AND 50).

#### **CLASS 35—ADVERTISING AND BUSINESS**

FOR ADMINISTRATION OF CULTURAL AND EDUCATIONAL EXCHANGE PROGRAMS; CONVENTION AND VISITORS BUREAU SERVICES, NAMELY, PROMOTING TOURISM, BUSINESS AND CONVENTIONS IN AND AROUND THE JURISDICTIONAL AREA OF THE CHICKASAW NATION, CONSISTING OF ALL OR PORTIONS OF THIRTEEN COUNTIES IN THE SOUTH CENTRAL OKLAHOMA AREA, AS WELL AS IN THE STATES OF OKLAHOMA AND TEXAS; INFORMATION IN THE FIELD OF GOVERNMENT AFFAIRS; MARKETING, ADVERTISING AND PROMOTING THE GOODS AND SERVICES OF OTHERS IN THE FIELD OF TRAVEL AND TOURISM, NAMELY, PROVIDING INFORMATION VIA MAIL, ELECTRONIC MAIL AND ALL OTHER MEANS OF MARKETING AND ADVERTISING; ON-LINE RETAIL GIFT SHOPS; PROMOTING RECREATION AND TOURISM IN THE JURISDICTIONAL AREA OF THE CHICKASAW NATION, CONSISTING OF ALL OR PORTIONS OF THIRTEEN COUNTIES IN SOUTH CENTRAL OKLAHOMA, AS WELL AS IN THE STATES OF OKLAHOMA AND TEXAS; RETAIL GIFT SHOPS; CHAMBER OF COMMERCE SERVICES, NAMELY, PROMOTING BUSINESS AND TOURISM IN THE JURISDICTIONAL AREA OF THE CHICKASAW NATION, CONSISTING OF ALL OR PORTIONS OF THIRTEEN COUNTIES IN SOUTH CENTRAL OKLAHOMA, AS WELL AS IN THE STATES OF OKLAHOMA AND TEXAS (U.S. CLS. 100, 101 AND 102).

#### **CLASS 39—TRANSPORTATION AND STORAGE**

FOR ARRANGING EXCURSIONS FOR TOURISTS; TOURIST OFFICE SERVICES; OPERATION OF TOURIST WELCOME/VISITOR CENTERS FOR PROVIDING TRAVEL AND TOUR INFORMATION (U.S. CLS. 100 AND 105).

#### **CLASS 41—EDUCATION AND ENTERTAINMENT**

FOR GUIDED TOURS OF MUSEUMS AND HISTORICAL SITES WITHIN THE JURISDICTIONAL AREA OF THE CHICKASAW NATION, CONSISTING OF ALL OR PORTIONS OF THIRTEEN COUNTIES IN SOUTH CENTRAL OKLAHOMA, AS WELL AS IN THE STATES OF OKLAHOMA AND TEXAS; MUSEUM SERVICES; MUSEUM SERVICES, NAMELY, EXHIBITING TO THE PUBLIC A HISTORICAL SITE; ORGANIZATION OF CULTURAL SHOWS; ORGANIZATION OF EVENTS FOR CULTURAL PURPOSES; ORGANIZATION OF EXHIBITIONS FOR CULTURAL OR EDUCATIONAL PURPOSES; ORGANIZATION OF SHOWS FOR CULTURAL PURPOSES; ORGANIZING AND HOSTING OF EVENTS FOR CULTURAL PURPOSES; ORGANIZING CULTURAL AND ARTS EVENTS (U.S. CLS. 100, 101 AND 107).

#### **CLASS 43—HOTEL AND RESTAURANT SERVICES**

FOR PROVIDING ADVICE TO TOURISTS AND BUSINESS TRAVELERS ON HOTEL AND RESTAURANT DESTINATIONS; TOURIST HOSTELS; TOURIST INNS; HOTEL AND MOTEL SERVICES (U.S. CLS. 100 AND 101).

#### **CLASS 45—PERSONAL AND LEGAL SERVICES**

FOR PROVIDING INFORMATION RELATING TO DIVERSE HUMAN CULTURES, BELIEFS, AND LIFESTYLES (U.S. CLS. 100 AND 101).

KATHLEEN M. VANSTON, EXAMINING ATTORNEY

---

SN 85-975,053. GARDEN FRESH SALSA COMPANY, INC., FERNDALE, MI. FILED 7-9-2010.

### **GARDEN FRESH BRANDS**

THE MARK CONSISTS OF STANDARD CHARACTERS WITHOUT CLAIM TO ANY PARTICULAR FONT, STYLE, SIZE, OR COLOR.

OWNER OF U.S. REG. NOS. 2,692,792, 2,916,050 AND 3,307,250.

NO CLAIM IS MADE TO THE EXCLUSIVE RIGHT TO USE "FRESH" OR "BRANDS", APART FROM THE MARK AS SHOWN.

#### **CLASS 29—MEATS AND PROCESSED FOODS**

FOR SNACK GOODS, NAMELY, VEGETABLE-BASED SNACK FOODS AND FRUIT-BASED SNACK FOODS; HUMMUS (U.S. CL. 46).

#### **CLASS 30—STAPLE FOODS**

FOR PREPARED FOODS, NAMELY, NOODLES, PASTA, PASTA SAUCE, PESTO SAUCE, SALAD DRESSINGS, SPAGHETTI, SPAGHETTI SAUCE, TOMATO SALSA, TOMATO SAUCE, AND TORTILLA CHIPS (U.S. CL. 46).  
DOUGLAS LEE, EXAMINING ATTORNEY

---

SN 85-975,364. TOUCHSTONES DISCUSSION PROJECT, ANNAPOLIS, MD. FILED 11-5-2010.

### **TOUCHSTONES**

THE MARK CONSISTS OF STANDARD CHARACTERS WITHOUT CLAIM TO ANY PARTICULAR FONT, STYLE, SIZE, OR COLOR.

#### **CLASS 16—PAPER GOODS AND PRINTED MATTER**

FOR EDUCATIONAL PUBLICATIONS, NAMELY, WORKBOOKS, TEXTBOOKS, STORY BOOKS, TEACHER GUIDES AND MANUAL, IN THE FIELD OF THE HUMANITIES, MATH, SCIENCE, AND THE LIBERAL ARTS IN CONJUNCTION WITH WORKSHOPS, SEMINARS AND DISCUSSION GROUPS (U.S. CLS. 2, 5, 22, 23, 29, 37, 38 AND 50).

FIRST USE 1-1-1984; IN COMMERCE 6-1-1984.

**CLASS 41—EDUCATION AND ENTERTAINMENT**

FOR EDUCATIONAL SERVICES, NAMELY, COORDINATING WORKSHOPS, SEMINARS AND DISCUSSION GROUPS IN THE FIELD OF THE HUMANITIES, MATH, SCIENCE, AND THE LIBERAL ARTS (U.S. CLS. 100, 101 AND 107).

FIRST USE 6-1-1984; IN COMMERCE 6-1-1984.  
DANNEAN HETZEL, EXAMINING ATTORNEY

**CLASS 30—STAPLE FOODS**

FOR PREPARED FOOD PRODUCTS, NAMELY, FROZEN ENTREES, MICROWAVEABLE MEAL KITS, AND APPETIZERS CONSISTING PRIMARILY OF PASTA AND/OR RICE; DUMPLINGS; NOODLES (U.S. CL. 46).

JENNIFER VASQUEZ, EXAMINING ATTORNEY

SN 85-975,563. CANOPY MANAGEMENT, LLC, NAPA, CA. FILED 5-4-2010.

SN 85-975,624. T-MOBILE USA, INC., BELLEVUE, WA. FILED 4-19-2011.

**WINE SISTERHOOD**

THE MARK CONSISTS OF STANDARD CHARACTERS WITHOUT CLAIM TO ANY PARTICULAR FONT, STYLE, SIZE, OR COLOR.

NO CLAIM IS MADE TO THE EXCLUSIVE RIGHT TO USE "WINE", APART FROM THE MARK AS SHOWN.

**CLASS 35—ADVERTISING AND BUSINESS**

FOR ONLINE RETAIL STORE SERVICES FEATURING WINE, CLOTHING, POSTERS, APRONS AND TOTE BAGS; MARKETING SERVICES; CONDUCTING BUSINESS AND MARKET RESEARCH SURVEYS; BUSINESS NETWORKING (U.S. CLS. 100, 101 AND 102).

FIRST USE 9-1-2009; IN COMMERCE 9-1-2009.

**CLASS 42—SCIENTIFIC AND COMPUTER SERVICES**

FOR COMPUTER SERVICES, NAMELY, CREATING AN ON-LINE COMMUNITY FOR REGISTERED USERS TO PARTICIPATE IN DISCUSSIONS, GET FEEDBACK FROM THEIR PEERS, FORM VIRTUAL COMMUNITIES, AND ENGAGE IN SOCIAL NETWORKING (U.S. CLS. 100 AND 101).

FIRST USE 9-1-2009; IN COMMERCE 9-1-2009.  
DEBRA LEE, EXAMINING ATTORNEY

SN 85-975,605. CADENCE GOURMET, LLC, CULVER CITY, CA. FILED 9-29-2010.

**CADENCE GOURMET**

THE MARK CONSISTS OF STANDARD CHARACTERS WITHOUT CLAIM TO ANY PARTICULAR FONT, STYLE, SIZE, OR COLOR.

NO CLAIM IS MADE TO THE EXCLUSIVE RIGHT TO USE "GOURMET", APART FROM THE MARK AS SHOWN.

**CLASS 29—MEATS AND PROCESSED FOODS**

FOR PREPARED FOOD PRODUCTS, NAMELY, FROZEN ENTREES, MICROWAVEABLE MEAL KITS, AND APPETIZERS CONSISTING PRIMARILY OF FISH, SHRIMP, OTHER SHELLFISH AND SEAFOOD, POULTRY, MEAT AND VEGETABLES; SOUPS; BREADED SHRIMP (U.S. CL. 46).



THE COLOR(S) MAGENTA AND CHARCOAL GRAY IS/ ARE CLAIMED AS A FEATURE OF THE MARK.

THE MARK CONSISTS OF A BOBSLEDDER, PRESENTED PREDOMINANTLY IN MAGENTA WITH A HELMET VISOR THAT IS SHAPED LIKE A SPEECH BUBBLE PRESENTED IN CHARCOAL GRAY, IN SLIGHTLY CROUCHED POSITION TO THE LEFT OF THE DESIGN, WHO IS GRASPING A SLIGHTLY ITALICIZED LOWER CASE LETTER "B" PRESENTED IN CHARCOAL GRAY.

**CLASS 38—COMMUNICATION**

FOR TELECOMMUNICATIONS SERVICES, NAMELY, ELECTRONIC TRANSMISSION OF IP-BASED AUDIO COMMUNICATIONS AMONG COMPUTERS; ELECTRONIC TRANSMISSION OF DATA CONSISTING OF TEXT AND AUDIO CONTENT; IP-BASED TEXT AND VOICE COMMUNICATIONS SERVICES, NAMELY, WIRELESS DIGITAL TEXT MESSAGING AND AUDIO MESSAGING SERVICES AMONG COMPUTERS (U.S. CLS. 100, 101 AND 104).

FIRST USE 4-19-2011; IN COMMERCE 4-19-2011.

**CLASS 42—SCIENTIFIC AND COMPUTER SERVICES**

FOR PROVIDING TEMPORARY USE OF ONLINE, NON-DOWNLOADABLE SOFTWARE THAT ALLOWS USERS TO UTILIZE IP-BASED VOICE COMMUNICATIONS SERVICES AMONG COMPUTERS; PROVIDING TEMPORARY USE OF ONLINE, NON-DOWNLOADABLE SOFTWARE THAT ENABLES THE CREATION, TRANSMISSION AND RECEIPT OF TEXT MESSAGES AND AUDIO MESSAGES AMONG COMPUTERS; ASP SERVICES IN THE NATURE OF HOSTING, MAINTAINING AND SYNCHRONIZING DATABASES CONSISTING OF TEXT MESSAGES ADDRESS BOOK INFORMATION AMONG COMPUTERS AND MOBILE COMMUNICATIONS DEVICES (U.S. CLS. 100 AND 101).

FIRST USE 4-19-2011; IN COMMERCE 4-19-2011.  
TRACY FLETCHER, EXAMINING ATTORNEY

SN 85-975,635. MILLY LLC, NEW YORK, NY. FILED 12-13-2010.

SN 85-975,644. SOUNDEARTH STRATEGIES, INC., SEATTLE, WA. FILED 11-18-2010.



THE MARK CONSISTS OF A SCRIPTED LETTER "M".

**CLASS 18—LEATHER GOODS**

FOR HOBO BAGS, SPORTS BAGS, HANDBAGS, CLUTCHES, PURSES, OVERNIGHT BAGS, TOTE BAGS, GYM BAGS, BEACH BAGS, CARRY-ON BAGS, COSMETIC BAGS SOLD EMPTY (U.S. CLS. 1, 2, 3, 22 AND 41).

FIRST USE 2-28-2002; IN COMMERCE 2-28-2002.

**CLASS 25—CLOTHING**

FOR WOMEN'S CLOTHING, NAMELY, JACKETS, COATS, SHIRTS, BLOUSES, SWEATERS, SWEAT PANTS, SWEAT SHIRTS, SWEAT SUITS, SWIM WEAR, DRESSES, PANTS, UNDERWEAR, LINGERIE, SHOES, BELTS, GLOVES, SHORTS, VESTS, SOCKS, SLEEPWEAR, SCARVES, SKIRTS, COVER-UPS AND TIGHTS; HEADWEAR AND FOOTWEAR (U.S. CLS. 22 AND 39).

FIRST USE 2-28-2002; IN COMMERCE 2-28-2002.  
BERYL GARDNER, EXAMINING ATTORNEY

**SAFE WATER FOR ALL**

THE MARK CONSISTS OF STANDARD CHARACTERS WITHOUT CLAIM TO ANY PARTICULAR FONT, STYLE, SIZE, OR COLOR.

**CLASS 40—MATERIAL TREATMENT**

FOR CONSULTING IN THE FIELD OF ENVIRONMENTAL REMEDIATION SERVICES, NAMELY, IN THE FIELD OF TREATMENT OF WATER AND SEDIMENT (U.S. CLS. 100, 103 AND 106).

FIRST USE 10-0-2006; IN COMMERCE 10-0-2006.

**CLASS 42—SCIENTIFIC AND COMPUTER SERVICES**

FOR ENGINEERING AND CONSULTING IN THE FIELDS OF HYDROLOGIC ENGINEERING, GROUND-WATER HYDROLOGY AND CHEMISTRY, AQUIFER GEOLOGY, WATER RESOURCES SUPPLY PLANNING, GROUNDWATER WELL FIELD DESIGN, AQUIFER TESTING AND ANALYSIS; ENGINEERING AND CONSULTING IN THE FIELD OF SEDIMENT TRANSPORT (U.S. CLS. 100 AND 101).

FIRST USE 10-0-2006; IN COMMERCE 10-0-2006.

**CLASS 44—MEDICAL, BEAUTY AND AGRICULTURAL SERVICES**

FOR CONSULTING IN THE FIELD OF AQUATIC HABITAT RESTORATION (U.S. CLS. 100 AND 101).

FIRST USE 11-0-2006; IN COMMERCE 11-0-2006.  
JAMES MACFARLANE, EXAMINING ATTORNEY

\* \* \* \* \*

## SECTION 2.— INTERNATIONAL CLASSIFICATION

The short titles associated below with the international class numbers are terms designed merely for quick identification and are not an official part of the international classification. The full names of international classes are given in section 6.1 of the trademark rules of practice.

The designation "U.S. Cl." appearing in this section refers to the U.S. class in effect prior to Sep. 1, 1973 rather than the international class which applies to applications filed on or after that date. For adoption of international classification see notice in the OFFICIAL GAZETTE of Jun. 26, 1973 (911 O.G. TM 210).

### Application in one class

#### CLASS 1—CHEMICALS

SN 77-845,592. KOLON PLASTICS, INC., GYUNGSANGBUK-DO, REPUBLIC OF KOREA, FILED S.R. 10-9-2009; AM. P.R. 8-22-2011.

#### CLASS 1—(Continued).

SN 79-083,055. KUREHA CORPORATION, JAPAN, FILED 4-27-2010.



# KOPEL

THE MARK CONSISTS OF STANDARD CHARACTERS WITHOUT CLAIM TO ANY PARTICULAR FONT, STYLE, SIZE, OR COLOR.

THE WORDING "KOPEL" HAS NO MEANING IN A FOREIGN LANGUAGE.

SEC. 2(F).

FOR POLYESTER RESINS (U.S. CLS. 1, 5, 6, 10, 26 AND 46).

FIRST USE 9-0-2000; IN COMMERCE 9-0-2000.

AMEEN IMAM, EXAMINING ATTORNEY

PRIORITY DATE OF 4-14-2010 IS CLAIMED.  
OWNER OF INTERNATIONAL REGISTRATION 1040088 DATED 4-27-2010, EXPIRES 4-27-2020.

OWNER OF U.S. REG. NOS. 3,033,202 AND 3,697,653.

THE COLOR(S) BLUE, GRAY AND WHITE IS/ARE CLAIMED AS A FEATURE OF THE MARK.

THE MARK CONSISTS OF THE WORDING "BAC" IN WHITE ABOVE NON-LATIN CHARACTERS IN WHITE ALL WITHIN A BLUE OVAL OUTLINED IN GRAY.

THE NON-LATIN CHARACTERS IN THE MARK TRANSLITERATE TO "BAKKU" AND THIS MEANS "BAC" IN ENGLISH.

SEC. 2(F).

FOR ADSORBENT CARBONS FOR GENERAL INDUSTRIAL USE; CHEMICALS, NAMELY ACTIVATED CARBONS FOR GAS ABSORPTION, SOLVENT RECOVERY, ODOR ELIMINATION AND WATER TREATMENT; ACTIVATED CARBONS IN THE FORM OF POWDER FOR ELECTROCHEMICAL DEVICES; ACTIVATED CARBONS IN THE FORM OF GRAIN FOR ELECTROCHEMICAL DEVICES; ACTIVATED CARBONS FORMED IN THE SHAPE OF A CYLINDRICAL COLUMN OR RECTANGULAR PARALLEL PIPED FOR ELECTROCHEMICAL DEVICES; ACTIVATED CARBONS FOR ELECTROCHEMICAL DEVICES; BEAD SHAPED ACTIVATED CARBONS FOR WATER PURIFICATION AND SEWAGE WATER TREATMENT; BEAD SHAPED ACTIVATED CARBONS FOR GAS ABSORPTION AND RECOVERY OF SOLVENTS; BEAD SHAPED ACTIVATED CARBONS FOR FOOD ADDITIVES; BEAD SHAPED ACTIVATED CARBONS FOR AIR PURIFICATION; BEAD SHAPED ACTIVATED CARBONS FOR FILTERS; INDUSTRIAL CHEMICALS (U.S. CLS. 1, 5, 6, 10, 26 AND 46).

TRACY FLETCHER, EXAMINING ATTORNEY



**CLASS 1—(Continued).**

SN 85-130,546. THE FAIRFAX COMPANIES, LLC, TA TANK'S GREEN STUFF, TUCSON, AZ. FILED 9-15-2010.

**TANK'S GREEN STUFF**

THE MARK CONSISTS OF STANDARD CHARACTERS WITHOUT CLAIM TO ANY PARTICULAR FONT, STYLE, SIZE, OR COLOR.

NO CLAIM IS MADE TO THE EXCLUSIVE RIGHT TO USE "GREEN", APART FROM THE MARK AS SHOWN.

FOR COMPOST MADE FROM RECYCLED LANDSCAPE WASTE (U.S. CLS. 1, 5, 6, 10, 26 AND 46).

KATHLEEN LORENZO, EXAMINING ATTORNEY

**CLASS 1—(Continued).**

SN 85-206,698. CAPITAL ADHESIVES & PACKAGING CORP., MOORESVILLE, IN. FILED 12-28-2010.



NO CLAIM IS MADE TO THE EXCLUSIVE RIGHT TO USE "ADHESIVES", APART FROM THE MARK AS SHOWN.

THE MARK CONSISTS OF THE STYLIZED WORDING "CAPITAL ADHESIVES", WITH A DOMED BUILDING FORMING THE LETTER "A", AND A THICK LINE BELOW THE WORD "ADHESIVES".

FOR ADHESIVES AND GLUES FOR INDUSTRIAL AND COMMERCIAL USE, NOT FOR USE IN THE FLOORING INDUSTRY (U.S. CLS. 1, 5, 6, 10, 26 AND 46).

FIRST USE 0-0-1992; IN COMMERCE 0-0-1992.

IRA J. GOODSAD, EXAMINING ATTORNEY

SN 85-169,192. MERCK KGAA, 64293 DARMSTADT, FED REP GERMANY, FILED 11-4-2010.

**SECCOSOLV**

THE MARK CONSISTS OF STANDARD CHARACTERS WITHOUT CLAIM TO ANY PARTICULAR FONT, STYLE, SIZE, OR COLOR.

FOR CHEMICALS FOR USE IN INDUSTRY AND SCIENCE; PHOTOGRAPHIC CHEMICALS; CHEMICALS FOR USE IN AGRICULTURE, HORTICULTURE AND FORESTRY EXCEPT FUNGICIDES, HERBICIDES, INSECTICIDES AND PARASITICIDES; CHEMICAL SOLVENTS FOR USE IN INDUSTRY AND SCIENCE (U.S. CLS. 1, 5, 6, 10, 26 AND 46).

DAVID ELTON, EXAMINING ATTORNEY

SN 85-241,935. LIFE TECHNOLOGIES CORPORATION, CARLSBAD, CA. FILED 2-14-2011.

**TROPIX**

SN 85-200,235. MULTISORB TECHNOLOGIES, INC., BUFFALO, NY. FILED 12-17-2010.

**FROSTSORB**

THE MARK CONSISTS OF STANDARD CHARACTERS WITHOUT CLAIM TO ANY PARTICULAR FONT, STYLE, SIZE, OR COLOR.

FOR DESICCANTS; HUMECTANTS (U.S. CLS. 1, 5, 6, 10, 26 AND 46).

TARA PATE, EXAMINING ATTORNEY

THE MARK CONSISTS OF STANDARD CHARACTERS WITHOUT CLAIM TO ANY PARTICULAR FONT, STYLE, SIZE, OR COLOR.

OWNER OF U.S. REG. NO. 1,583,186.

FOR CHEMICALS FOR USE AS LUMINESCENT SUBSTRATES FOR INDUSTRIAL AND COMMERCIAL USES (U.S. CLS. 1, 5, 6, 10, 26 AND 46).

FIRST USE 3-9-1989; IN COMMERCE 3-9-1989.

NAKWAMA ANKRAH, EXAMINING ATTORNEY

**CLASS 1—(Continued).**

SN 85-251,994. XYNYTH MANUFACTURING CORP., BURNABY, BC, CANADA, FILED 2-25-2011.

ARCTIC ECO GREEN

THE MARK CONSISTS OF STANDARD CHARACTERS WITHOUT CLAIM TO ANY PARTICULAR FONT, STYLE, SIZE, OR COLOR.

PRIORITY CLAIMED UNDER SEC. 44(D) ON CANADA APPLICATION NO. 1494078, FILED 8-30-2010, REG. NO. TMA802,922, DATED 7-26-2011, EXPIRES 7-26-2026.

NO CLAIM IS MADE TO THE EXCLUSIVE RIGHT TO USE "ECO GREEN", APART FROM THE MARK AS SHOWN.

FOR ENVIRONMENTALLY FRIENDLY CHEMICAL PREPARATIONS FOR MELTING SNOW AND ICE (U.S. CLS. 1, 5, 6, 10, 26 AND 46).

RON FAIRBANKS, EXAMINING ATTORNEY

SN 85-252,559. GREEN FOOT GLOBAL, L.L.C., HENDERSON, NV, FILED 2-26-2011.

GREENFOOT GLOBAL

THE MARK CONSISTS OF STANDARD CHARACTERS WITHOUT CLAIM TO ANY PARTICULAR FONT, STYLE, SIZE, OR COLOR.

OWNER OF U.S. REG. NO. 3,802,188.

NO CLAIM IS MADE TO THE EXCLUSIVE RIGHT TO USE "GLOBAL", APART FROM THE MARK AS SHOWN.

FOR CHEMICAL ADDITIVES FOR USE WITH INTERNAL COMBUSTION ENGINE FUELS; CHEMICAL ADDITIVES FOR ENHANCING THE PERFORMANCE OF INTERNAL COMBUSTION ENGINE FUELS; CHEMICAL ENGINE TREATMENTS AND ADDITIVES FOR USE WITH INTERNAL COMBUSTION ENGINE FUELS INCLUDING BUT NOT LIMITED TO GASOLINE AND DIESEL FUELS (U.S. CLS. 1, 5, 6, 10, 26 AND 46).

TINA BROWN, EXAMINING ATTORNEY

**CLASS 1—(Continued).**

SN 85-264,051. CONSORCIO COMEX, S.A. DE C.V., MEXICO, D.F., MEXICO, FILED 3-10-2011.

COMEX

THE MARK CONSISTS OF STANDARD CHARACTERS WITHOUT CLAIM TO ANY PARTICULAR FONT, STYLE, SIZE, OR COLOR.

OWNER OF MEXICO REG. NO. 808975, DATED 10-9-2003, EXPIRES 8-13-2013.

OWNER OF U.S. REG. NOS. 1,958,222, 2,909,357 AND OTHERS.

FOR CHEMICALS FOR INDUSTRIAL, SCIENCE, PHOTOGRAPHY, AGRICULTURE, HORTICULTURE AND FORESTRY USES EXCEPT FUNGICIDES, HERBICIDES, INSECTICIDES AND PARASITICIDES; UNPROCESSED ARTIFICIAL RESINS, UNPROCESSED PLASTICS; MANURE FOR AGRICULTURE; FIRE EXTINGUISHING COMPOSITIONS; CHEMICAL PREPARATIONS FOR SOFTENING AND SOLDERING METALS; CHEMICALS FOR PRESERVING FOODSTUFFS; TANNING AGENTS FOR USE IN THE MANUFACTURE OF LEATHER; ADHESIVES FOR INDUSTRIAL USE (U.S. CLS. 1, 5, 6, 10, 26 AND 46).

MARK T. MULLEN, EXAMINING ATTORNEY

SN 85-270,789. TAKARA HOLDINGS INC., KYOTO, JAPAN, FILED 3-18-2011.

TaKaRa Ex Taq

THE MARK CONSISTS OF STANDARD CHARACTERS WITHOUT CLAIM TO ANY PARTICULAR FONT, STYLE, SIZE, OR COLOR.

OWNER OF U.S. REG. NO. 1,548,788.

NO CLAIM IS MADE TO THE EXCLUSIVE RIGHT TO USE "TAQ", APART FROM THE MARK AS SHOWN.

THE ENGLISH TRANSLATION OF "TAKARA" IS "TREASURE".

FOR REAGENTS FOR SCIENTIFIC RESEARCH USE (U.S. CLS. 1, 5, 6, 10, 26 AND 46).

FIRST USE 8-31-1994; IN COMMERCE 8-31-1994.

KIMBERLY FRYE, EXAMINING ATTORNEY

**CLASS 1—(Continued).**

SN 85-271,195. WARREN DISTRIBUTION, INC., OMAHA, NE. FILED 3-18-2011.



NO CLAIM IS MADE TO THE EXCLUSIVE RIGHT TO USE "PURE", APART FROM THE MARK AS SHOWN.

THE COLOR(S) GRAY AND BLACK IS/ARE CLAIMED AS A FEATURE OF THE MARK.

THE MARK CONSISTS OF THE WORD "PURE" IN GRAY STYLIZED FONT OUTLINED IN BLACK WITH A NUMBER "4" APPEARING IN GRAY WITH BLACK OUTLINING AS A SUBSCRIPT TO THE RIGHT OF THE WORD "PURE". THE WORDING "PURE PERFORMANCE. PURE VALUE." APPEARS IN BLACK STYLIZED FONT CENTERED BELOW THE WORD "PURE" AND THE NUMBER "4".

FOR TRANSMISSION FLUID (U.S. CLS. 1, 5, 6, 10, 26 AND 46).

TINA BROWN, EXAMINING ATTORNEY

SN 85-285,098. SEACHEM LABORATORIES, INC., MADISON, GA. FILED 4-4-2011.

## Neutral Regulator

THE MARK CONSISTS OF STANDARD CHARACTERS WITHOUT CLAIM TO ANY PARTICULAR FONT, STYLE, SIZE, OR COLOR.

FOR WATER CONDITIONER FOR USE IN AQUARIUMS (U.S. CLS. 1, 5, 6, 10, 26 AND 46).

FIRST USE 10-1-1981; IN COMMERCE 10-1-1981.

ALICE BENMAMAN, EXAMINING ATTORNEY

SN 85-285,116. SEACHEM LABORATORIES, INC., MADISON, GA. FILED 4-4-2011.

## Marine Buffer

THE MARK CONSISTS OF STANDARD CHARACTERS WITHOUT CLAIM TO ANY PARTICULAR FONT, STYLE, SIZE, OR COLOR.

NO CLAIM IS MADE TO THE EXCLUSIVE RIGHT TO USE "BUFFER", APART FROM THE MARK AS SHOWN.

FOR CHEMICAL BLEND USED TO CONTROL PH (U.S. CLS. 1, 5, 6, 10, 26 AND 46).

FIRST USE 9-1-1981; IN COMMERCE 9-1-1981.

ALICE BENMAMAN, EXAMINING ATTORNEY

**CLASS 1—(Continued).**

SN 85-289,814. DIAMOND T AG, REEDSBURG, WI. FILED 4-8-2011.



Diamond t Ag

NO CLAIM IS MADE TO THE EXCLUSIVE RIGHT TO USE "AG", APART FROM THE MARK AS SHOWN.

THE COLOR(S) LIGHT BLUE, DARK BLUE, GREEN, BLACK AND WHITE IS/ARE CLAIMED AS A FEATURE OF THE MARK.

THE MARK CONSISTS OF AN IMAGE OF A SQUARE SO AS THE CORNERS OF THE SQUARE ARE ORIENTATED VERTICALLY AND HORIZONTALLY FORMING A SQUARE DIAMOND SHAPE WITH A BLACK BORDER AROUND THE OUTSIDE EDGE, A WHITE BORDER INTERIOR AND ADJACENT TO THE OUTER BLACK BORDER, A THIN BLACK BORDER INTERIOR AND ADJACENT TO THE WHITE BORDER. THE BACKGROUND WITHIN THE BORDERED DIAMOND SHAPE GRADIATES FROM A DARK BLUE ON THE UPPER SIDE OF THE BACKGROUND TO A LIGHT BLUE ON THE LOWER PORTION OF THE BACKGROUND WITH A TAPERED FACETED DIAMOND IN THE FOREGROUND AND A REFLECTION OF THE DIAMOND APPEARING ON THE BACKGROUND AS THE TAPERED DIAMOND IS POSITIONED ON ITS TIP WHILE PROJECTING BEYOND THE WHITE PORTION OF THE BORDER OF THE OUTLINED SQUARE DIAMOND FORM WITH THE LETTER "T" PROMINENTLY POSITIONED IN FRONT OF THE DIAMOND AND THE WORDS "DIAMOND T AG" UNDERLINED WITH A GREEN LINE ADJACENT TO THE RIGHT POINT OF THE SQUARE DIAMOND SHAPE.

FOR FERTILIZERS FOR AGRICULTURAL USE (U.S. CLS. 1, 5, 6, 10, 26 AND 46).

FIRST USE 6-22-2010; IN COMMERCE 6-22-2010.

GISELLE AGOSTO, EXAMINING ATTORNEY

SN 85-302,006. THE ANDERSONS, INC., MAUMEE, OH. FILED 4-22-2011.

## ENVIRO-GREEN

THE MARK CONSISTS OF STANDARD CHARACTERS WITHOUT CLAIM TO ANY PARTICULAR FONT, STYLE, SIZE, OR COLOR.

FOR FERTILIZERS (U.S. CLS. 1, 5, 6, 10, 26 AND 46).

FIRST USE 4-30-2006; IN COMMERCE 4-30-2006.

CIMMERIAN COLEMAN, EXAMINING ATTORNEY

**CLASS 1—(Continued).**

SN 85-306,893. ATOTECH DEUTSCHLAND GMBH, 10553 BERLIN, FED REP GERMANY, FILED 4-28-2011.

**SPHEROLYTE**

THE MARK CONSISTS OF STANDARD CHARACTERS WITHOUT CLAIM TO ANY PARTICULAR FONT, STYLE, SIZE, OR COLOR.

OWNER OF FED REP GERMANY REG. NO. 30675242, DATED 3-15-2007, EXPIRES 3-15-2017.

FOR CHEMICALS USED IN THE SURFACE TREATMENT OF METALS, SEMICONDUCTORS AND POLYMERS, PARTICULARLY FOR GALVANO PLATING, GALVANIZING BATHS, GALVANIZING PREPARATIONS, TEMPERING AND SOLDERING PREPARATIONS (U.S. CLS. 1, 5, 6, 10, 26 AND 46).

FIRST USE 7-12-2005; IN COMMERCE 7-12-2005.  
TAMARA FRAZIER, EXAMINING ATTORNEY

**CLASS 1—(Continued).**

SN 85-329,521. PMC BIOGENIX, INC., MT. LAUREL, NJ, FILED 5-25-2011.

**KEMLUBE**

THE MARK CONSISTS OF STANDARD CHARACTERS WITHOUT CLAIM TO ANY PARTICULAR FONT, STYLE, SIZE, OR COLOR.

FOR CHEMICAL PREPARATIONS FOR GENERAL INDUSTRIAL MANUFACTURING (U.S. CLS. 1, 5, 6, 10, 26 AND 46).

FIRST USE 2-28-2008; IN COMMERCE 2-28-2008.  
CIMMERIAN COLEMAN, EXAMINING ATTORNEY

SN 85-324,352. TRACTOR SUPPLY CO. OF TEXAS, LP, BRENTWOOD, TN, FILED 5-18-2011.



OWNER OF U.S. REG. NOS. 3,319,816 AND 3,420,720.

THE MARK CONSISTS OF THE WORD "GROUNDWORK" IN A STYLIZED FONT APPEARING WITHIN A SLIGHTLY ARCHED RECTANGLE BANNER WITH A SEMI CIRCLE PROTRUSION AT THE TOP CENTER, CENTERED ABOVE THE WORD "GROUNDWORK" AND WITHIN THE SEMI CIRCLE PROTRUSION APPEARS THE IMAGE OF THREE LEAVES.

FOR FERTILIZERS FOR AGRICULTURAL USE; FERTILIZERS FOR DOMESTIC USE (U.S. CLS. 1, 5, 6, 10, 26 AND 46).

REGINA DRUMMOND, EXAMINING ATTORNEY

SN 85-330,842. GANTEC INC, MIDLAND, MI, FILED 5-26-2011.

**Pure Bloom**

THE MARK CONSISTS OF STANDARD CHARACTERS WITHOUT CLAIM TO ANY PARTICULAR FONT, STYLE, SIZE, OR COLOR.

FOR PLANT GROWTH NUTRIENTS (U.S. CLS. 1, 5, 6, 10, 26 AND 46).

LAURA KOVALSKY, EXAMINING ATTORNEY

SN 85-328,844. HI-MAR SPECIALTY CHEMICALS, LLC, MILWAUKEE, WI, FILED 5-24-2011.

**HI-MAR**

THE MARK CONSISTS OF STANDARD CHARACTERS WITHOUT CLAIM TO ANY PARTICULAR FONT, STYLE, SIZE, OR COLOR.

FOR INDUSTRIAL CHEMICALS (U.S. CLS. 1, 5, 6, 10, 26 AND 46).

FIRST USE 1-0-2006; IN COMMERCE 1-0-2006.  
THOMAS MANOR, EXAMINING ATTORNEY

SN 85-331,896. ADVANCE AUTO INNOVATIONS, LLC, ROANOKE, VA, FILED 5-26-2011.

**TOUGH ONE**

THE MARK CONSISTS OF STANDARD CHARACTERS WITHOUT CLAIM TO ANY PARTICULAR FONT, STYLE, SIZE, OR COLOR.

OWNER OF U.S. REG. NOS. 1,715,139 AND 3,071,896.  
FOR REFRIGERANT CHEMICAL PREPARATIONS FOR USE IN AUTOMOTIVE AIR CONDITIONERS (U.S. CLS. 1, 5, 6, 10, 26 AND 46).

PAUL E. FAHRENKOPF, EXAMINING ATTORNEY

**CLASS 1—(Continued).**

SN 85-332,299. BIOCONVERSION, INC., ELLIJAY, GA.  
FILED 5-27-2011.

# BCT-OX

THE MARK CONSISTS OF STANDARD CHARACTERS WITHOUT CLAIM TO ANY PARTICULAR FONT, STYLE, SIZE, OR COLOR.

FOR CHEMICALS FOR THE TREATMENT OF WATER AND WASTEWATER (U.S. CLS. 1, 5, 6, 10, 26 AND 46).  
FIRST USE 5-12-2011; IN COMMERCE 5-12-2011.  
WENDY JUN, EXAMINING ATTORNEY

**CLASS 1—(Continued).**

SN 85-333,142. PROSEEDS MARKETING, INC., JEFFERSON, OR. FILED 5-28-2011.

# StormGuard

THE MARK CONSISTS OF STANDARD CHARACTERS WITHOUT CLAIM TO ANY PARTICULAR FONT, STYLE, SIZE, OR COLOR.

FOR ANTI-FREEZING AND DE-ICING PREPARATIONS (U.S. CLS. 1, 5, 6, 10, 26 AND 46).  
NORA BUCHANAN WILL, EXAMINING ATTORNEY

SN 85-332,347. CHEMTREAT, INC., GLEN ALLEN, VA.  
FILED 5-27-2011.

# AQUASAVE

THE MARK CONSISTS OF STANDARD CHARACTERS WITHOUT CLAIM TO ANY PARTICULAR FONT, STYLE, SIZE, OR COLOR.

FOR CHEMICAL ADDITIVES FOR INDUSTRIAL WATER TREATMENT SYSTEMS (U.S. CLS. 1, 5, 6, 10, 26 AND 46).  
HAI-LY LAM, EXAMINING ATTORNEY

SN 85-333,544. CASITE INTRACO, L.L.C., TROY, MI. FILED 5-31-2011.



THE MARK CONSISTS OF FANCIFUL DESIGN OF A BEE.

FOR CHEMICAL ADDITIVES FOR USE IN CONNECTION WITH INTERNAL COMBUSTION ENGINE FLUIDS (U.S. CLS. 1, 5, 6, 10, 26 AND 46).  
MELISSA VALLILLO, EXAMINING ATTORNEY

SN 85-333,035. RESINS ENHANCEMENTS LLC, CELEBRATION, FL. FILED 5-28-2011.

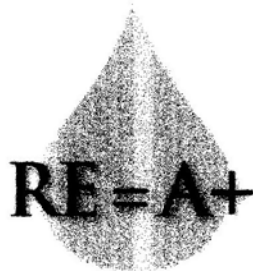

SN 85-333,679. MECS, INC., CHESTERFIELD, MO. FILED 5-31-2011.

# GEAR

THE STIPPLING IS FOR SHADING PURPOSES ONLY. THE MARK CONSISTS OF A TEAR DROP IMAGE OVERLAPPED BY THE STYLIZED TEXT "RE=A+".

FOR CHEMICAL ADDITIVES FOR USE IN CEMENT AND PAINT PRODUCTS (U.S. CLS. 1, 5, 6, 10, 26 AND 46).

STEVEN JACKSON, EXAMINING ATTORNEY

THE MARK CONSISTS OF STANDARD CHARACTERS WITHOUT CLAIM TO ANY PARTICULAR FONT, STYLE, SIZE, OR COLOR.

FOR CATALYSTS FOR USE IN THE MANUFACTURE OF INDUSTRIAL CHEMICALS AND FOR USE IN THE OIL REFINING INDUSTRY (U.S. CLS. 1, 5, 6, 10, 26 AND 46).

KARANENDRA S. CHHINA, EXAMINING ATTORNEY

**CLASS 1—(Continued).**

SN 85-333,690. KALO, INC., OVERLAND PARK, KS. FILED 5-31-2011.

# MEDALIST

THE MARK CONSISTS OF STANDARD CHARACTERS WITHOUT CLAIM TO ANY PARTICULAR FONT, STYLE, SIZE, OR COLOR.

FOR SURFACTANT BLEND THAT ALTERS PROPERTY OF WATER FOR THE PURPOSE OF ENHANCING WATER INFILTRATION IN TURF AND SOIL MEDIA THROUGH INCREASED AVAILABILITY OF SURFACE WATER TO THE SOIL AND SOIL MEDIA PROFILE (U.S. CLS. 1, 5, 6, 10, 26 AND 46).  
MARK RADEMACHER, EXAMINING ATTORNEY

---

SN 85-334,092. SEASOURCE, INC., SALT LAKE CITY, UT. FILED 5-31-2011.

# SEASOURCE

THE MARK CONSISTS OF STANDARD CHARACTERS WITHOUT CLAIM TO ANY PARTICULAR FONT, STYLE, SIZE, OR COLOR.

FOR FERTILIZER (U.S. CLS. 1, 5, 6, 10, 26 AND 46).  
FIRST USE 6-15-1991; IN COMMERCE 11-30-1991.  
ELLEN B. AWRICH, EXAMINING ATTORNEY

---

SN 85-334,199. GORDON R. WYBO, KYLE, TX. FILED 5-31-2011.

# SUSTAINACYCLE

THE MARK CONSISTS OF STANDARD CHARACTERS WITHOUT CLAIM TO ANY PARTICULAR FONT, STYLE, SIZE, OR COLOR.

FOR SOIL CONDITIONERS FOR AGRICULTURAL, DOMESTIC OR HORTICULTURAL USE (U.S. CLS. 1, 5, 6, 10, 26 AND 46).  
ZACHARY BELLO, EXAMINING ATTORNEY

**CLASS 1—(Continued).**

SN 85-334,312. CYTERIX PHARMACEUTICALS, INC., SAN FRANCISCO, CA. FILED 5-31-2011.

# OncoCYP

THE MARK CONSISTS OF THE WORD "ONCOCYP" IN A STYLIZED FONT WITH THE LETTER "O" IN UPPERCASE, THE LETTERS "NCO" IN LOWER CASE AND THE LETTERS "CYP" IN UPPER CASE.

FOR ENZYMES FOR DRUG DISCOVERY RESEARCH AND LABORATORY SCREENING (U.S. CLS. 1, 5, 6, 10, 26 AND 46).  
NICHOLAS ALTREE, EXAMINING ATTORNEY

---

SN 85-334,531. WISE, PHILLIP, SPRING, TX. FILED 5-31-2011.



THE MARK CONSISTS OF A TREE OF ROCKS WITH THE STYLIZED TEXT "GREEN LIME".

FOR RECLAIMED CALCIUM HYDROXIDE WITHOUT CARBON DIOXIDE (U.S. CLS. 1, 5, 6, 10, 26 AND 46).  
NAAKWAMA ANKRAH, EXAMINING ATTORNEY

**CLASS 1—(Continued).**

SN 85-335,597. SOUTHERN BIOTECHNOLOGY ASSOCIATES, INC., BIRMINGHAM, AL. FILED 6-1-2011.

**APOSCREEN**

THE MARK CONSISTS OF STANDARD CHARACTERS WITHOUT CLAIM TO ANY PARTICULAR FONT, STYLE, SIZE, OR COLOR.

FOR DYES AND BUFFER SOLUTIONS FOR SCIENTIFIC OR MEDICAL RESEARCH USE IN THE FIELD OF APOPTOSIS; REAGENTS FOR SCIENTIFIC OR MEDICAL RESEARCH USE IN THE FIELD OF APOPTOSIS; LABELED CELLULAR PROTEINS FOR SCIENTIFIC OR MEDICAL RESEARCH USE IN THE FIELD OF APOPTOSIS; KITS COMPRISING REAGENTS AND INSTRUCTIONS FOR PERFORMING APOPTOSIS ASSAYS BASED ON LABELED CELLULAR PROTEINS (U.S. CLS. 1, 5, 6, 10, 26 AND 46).

FIRST USE 11-6-1996; IN COMMERCE 11-6-1996.  
DAVID TAYLOR, EXAMINING ATTORNEY

**CLASS 1—(Continued).**

SN 85-337,372. FUTURE TRANSFER CO. INC., AYLMER, ONTARIO, CANADA, FILED 6-3-2011.

**BARE PAW**

THE MARK CONSISTS OF STANDARD CHARACTERS WITHOUT CLAIM TO ANY PARTICULAR FONT, STYLE, SIZE, OR COLOR.

FOR CHEMICAL PREPARATIONS FOR MELTING SNOW AND ICE (U.S. CLS. 1, 5, 6, 10, 26 AND 46).  
SUSAN RICHARDS, EXAMINING ATTORNEY

SN 85-337,562. DAINICHISEIKA COLOR & CHEMICALS MFG. CO., LTD., CHUO-KU, TOKYO, JAPAN, FILED 6-3-2011.

SN 85-336,364. INNOPHOS, INC., CRANBURY, NJ. FILED 6-2-2011.

**OSTEOFIT**

THE MARK CONSISTS OF STANDARD CHARACTERS WITHOUT CLAIM TO ANY PARTICULAR FONT, STYLE, SIZE, OR COLOR.

FOR CHEMICALS USED IN INDUSTRY, NAMELY, TRICALCIUM PHOSPHATE (U.S. CLS. 1, 5, 6, 10, 26 AND 46).

SHAILA SETTLES, EXAMINING ATTORNEY

**DAISOLBOND**

THE MARK CONSISTS OF STANDARD CHARACTERS WITHOUT CLAIM TO ANY PARTICULAR FONT, STYLE, SIZE, OR COLOR.

FOR ADHESIVES FOR INDUSTRIAL PURPOSES; ADHESIVES FOR PAPERHANGING; ADHESIVES FOR WALL TILES; ADHESIVES FOR LAMINATING PLASTIC FILMS; ADHESIVES FOR USE IN MANUFACTURING TEXTILES; ADHESIVES FOR USE IN THE MANUFACTURE OF CORRUGATED PAPER; ADHESIVES PREPARATIONS FOR USE IN MANUFACTURING SURGICAL BANDAGES; ADHESIVES FOR LAMINATING METAL SHEETS; INDUSTRIAL CHEMICALS; CHEMICAL PREPARATIONS FOR SCIENTIFIC PURPOSES OTHER THAN FOR MEDICAL OR VETERINARY USE (U.S. CLS. 1, 5, 6, 10, 26 AND 46).

APRIL ROACH, EXAMINING ATTORNEY

SN 85-337,164. INNOVATIVE POLYMER SOLUTIONS, INC., VALRICO, FL. FILED 6-3-2011.

**LeviTech**

THE MARK CONSISTS OF STANDARD CHARACTERS WITHOUT CLAIM TO ANY PARTICULAR FONT, STYLE, SIZE, OR COLOR.

FOR CHEMICAL ADDITIVES FOR OILS (U.S. CLS. 1, 5, 6, 10, 26 AND 46).

FIRST USE 4-16-2011; IN COMMERCE 4-25-2011.  
LINDA ESTRADA, EXAMINING ATTORNEY

SN 85-338,304. HAPPY WIRE DOG, LLC, SCOTTSDALE, AZ. FILED 6-5-2011.

**InstaMorph**

THE MARK CONSISTS OF STANDARD CHARACTERS WITHOUT CLAIM TO ANY PARTICULAR FONT, STYLE, SIZE, OR COLOR.

FOR PLASTIC MOLDING COMPOUNDS FOR USE IN THE MANUFACTURE OF MOLDED PLASTIC ARTICLES (U.S. CLS. 1, 5, 6, 10, 26 AND 46).

FIRST USE 6-10-2010; IN COMMERCE 6-14-2010.  
NICHOLAS ALTREE, EXAMINING ATTORNEY

**CLASS 1—(Continued).**

SN 85-339,024. NATURAL ENRICHMENT INDUSTRIES, LLC, HERRIN, IL. FILED 6-6-2011.

# AEROCAL

THE MARK CONSISTS OF STANDARD CHARACTERS WITHOUT CLAIM TO ANY PARTICULAR FONT, STYLE, SIZE, OR COLOR.

FOR CALCIUM PHOSPHATE (U.S. CLS. 1, 5, 6, 10, 26 AND 46).

ALLISON HOLTZ, EXAMINING ATTORNEY

---

SN 85-339,450. CHEN CHENGKAI, BAIYUN AREA, GUANGZHOU, CHINA, FILED 6-7-2011.



THE MARK CONSISTS OF THE STYLIZED WORD "BS" ABOVE TWO CHINESE CHARACTERS WHICH TRANSLITERATE INTO "BAO"; "SHEN" AND THE STYLIZED WORD "BAOSHEN", ALL ABOVE THE STYLIZED WORD "BIODRY".

THE WORDING "BS" AND "BIODRY" HAS NO MEANING IN A FOREIGN LANGUAGE.

THE NON-LATIN CHARACTERS IN THE MARK TRANSLITERATE TO "BAO"; "SHEN" AND THIS MEANS "TREASURE"; "GENTLEMAN" IN ENGLISH.

FOR ADHESIVES FOR INDUSTRIAL PURPOSES; BIO-CHEMICAL CATALYSTS; CHEMICAL PREPARATIONS TO PREVENT MILDEW; DESICCANTS; FATTY-ACID BASED GASOLINE FUEL CONDITIONERS; FOOD PRESERVING CHEMICALS; INDUSTRIAL CHEMICALS; SILICON; WATERPROOFING CHEMICAL COMPOSITIONS FOR ARTICLES OF LEATHER (U.S. CLS. 1, 5, 6, 10, 26 AND 46).

FIRST USE 1-1-2009; IN COMMERCE 12-10-2009.  
DORITT L. CARROLL, EXAMINING ATTORNEY

---

SN 85-339,842. HEART OF NATURE, LLC., BAKERSFIELD, CA. FILED 6-7-2011.

# SSK

THE MARK CONSISTS OF STANDARD CHARACTERS WITHOUT CLAIM TO ANY PARTICULAR FONT, STYLE, SIZE, OR COLOR.

FOR ORGANIC SOIL AMENDMENTS; ORGANIC SOIL IMPROVING AGENTS; ORGANIC SOIL CONDITIONING PREPARATIONS (U.S. CLS. 1, 5, 6, 10, 26 AND 46).

KIMBERLY PERRY, EXAMINING ATTORNEY

**CLASS 1—(Continued).**

SN 85-340,144. HEART OF NATURE, LLC., BAKERSFIELD, CA. FILED 6-7-2011.

# BANANAMITE

THE MARK CONSISTS OF STANDARD CHARACTERS WITHOUT CLAIM TO ANY PARTICULAR FONT, STYLE, SIZE, OR COLOR.

FOR ORGANIC SOIL AMENDMENTS; ORGANIC SOIL IMPROVING AGENTS; ORGANIC SOIL CONDITIONING PREPARATIONS (U.S. CLS. 1, 5, 6, 10, 26 AND 46).

KIMBERLY PERRY, EXAMINING ATTORNEY

---

SN 85-354,989. AGILENT TECHNOLOGIES, INC., SANTA CLARA, CA. FILED 6-24-2011.

# SureTag

THE MARK CONSISTS OF STANDARD CHARACTERS WITHOUT CLAIM TO ANY PARTICULAR FONT, STYLE, SIZE, OR COLOR.

FOR LABORATORY REAGENTS FOR USE IN SCIENTIFIC RESEARCH, MOLECULAR BIOLOGY AND DNA LABELING (U.S. CLS. 1, 5, 6, 10, 26 AND 46).

JOHN E. MICHOS, EXAMINING ATTORNEY

---

SN 85-361,650. STOLLER ENTERPRISES, INC., HOUSTON, TX. FILED 7-1-2011.

# ROMANCING YOUR PLANTS

THE MARK CONSISTS OF STANDARD CHARACTERS WITHOUT CLAIM TO ANY PARTICULAR FONT, STYLE, SIZE, OR COLOR.

FOR FERTILIZER (U.S. CLS. 1, 5, 6, 10, 26 AND 46).

DAWN FELDMAN, EXAMINING ATTORNEY



**CLASS 1—(Continued).**

SN 85-364,885. AGILENT TECHNOLOGIES, INC., SANTA CLARA, CA. FILED 7-7-2011.

# SureFISH

THE MARK CONSISTS OF STANDARD CHARACTERS WITHOUT CLAIM TO ANY PARTICULAR FONT, STYLE, SIZE, OR COLOR.

FOR LABORATORY REAGENTS FOR USE IN SCIENTIFIC RESEARCH, MOLECULAR BIOLOGY AND DNA LABELING (U.S. CLS. 1, 5, 6, 10, 26 AND 46).

JOHN E. MICHOS, EXAMINING ATTORNEY

SN 85-372,968. AGILENT TECHNOLOGIES, INC., SANTA CLARA, CA. FILED 7-15-2011.

# EASIVIAL

THE MARK CONSISTS OF STANDARD CHARACTERS WITHOUT CLAIM TO ANY PARTICULAR FONT, STYLE, SIZE, OR COLOR.

FOR POLYMERS OF DEFINED PROPERTIES FOR USE AS CALIBRATION STANDARDS IN THE FIELD OF CHROMATOGRAPHY (U.S. CLS. 1, 5, 6, 10, 26 AND 46).

FIRST USE 0-0-2004; IN COMMERCE 0-0-2004.  
JOHN E. MICHOS, EXAMINING ATTORNEY

SN 85-380,861. RALCO NUTRITION, INC., MARSHALL, MN. FILED 7-26-2011.

# Generate

THE MARK CONSISTS OF STANDARD CHARACTERS WITHOUT CLAIM TO ANY PARTICULAR FONT, STYLE, SIZE, OR COLOR.

FOR PLANT GROWTH NUTRIENTS (U.S. CLS. 1, 5, 6, 10, 26 AND 46).

FIRST USE 1-1-2011; IN COMMERCE 1-1-2011.  
MEGHAN REINHART, EXAMINING ATTORNEY

**CLASS 1—(Continued).**

SN 85-381,013. Z CORPORATION, BURLINGTON, MA. FILED 7-26-2011.



OWNER OF U.S. REG. NOS. 2,709,321, 3,205,811 AND 3,290,883.

NO CLAIM IS MADE TO THE EXCLUSIVE RIGHT TO USE "CORPORATION", APART FROM THE MARK AS SHOWN.

THE MARK CONSISTS OF AN IMAGE CONSISTING OF A PYRAMID INSIDE A THREE-DIMENSIONAL CUBE INSIDE A CIRCLE FOLLOWED BY THE "Z CORPORATION" MARK.

FOR CHEMICALS IN POWDER FORM FOR THE PRODUCTION OF DIRECT-POUR METAL CASTING MOLDS USING RAPID PROTOTYPING SYSTEMS, COMPRISING OF A COMPUTER CONTROLLED APPARATUS, BASED ON INK-JET TECHNOLOGY, FOR THE PRODUCTION OF THREE-DIMENSIONAL MODELS; CHEMICALS IN LIQUID FORM USED AS A BINDING AGENT IN THE MANUFACTURE OF THREE-DIMENSIONAL MODELS; CHEMICALS IN POWDER FORM USED IN THE MANUFACTURE OF THREE-DIMENSIONAL MODELS; CHEMICAL PREPARATIONS IN LIQUID FORM FOR USE AS A BINDING AGENT IN THE MANUFACTURE OF MOLDS USED TO PRODUCE THREE-DIMENSIONAL MODELS, AND CHEMICAL PREPARATIONS IN POWDER FORM FOR USE AS A BINDING AGENT IN THE MANUFACTURE OF MOLDS WHICH ARE USED TO PRODUCE THREE-DIMENSIONAL MODELS (U.S. CLS. 1, 5, 6, 10, 26 AND 46).

FIRST USE 12-20-1997; IN COMMERCE 12-20-1997.  
TRACY FLETCHER, EXAMINING ATTORNEY

SN 85-386,741. PPG INDUSTRIES OHIO, INC., CLEVELAND, OH. FILED 8-2-2011.

# AMERITABS

THE MARK CONSISTS OF STANDARD CHARACTERS WITHOUT CLAIM TO ANY PARTICULAR FONT, STYLE, SIZE, OR COLOR.

FOR SOLID SANITIZING CHEMICALS, NAMELY, CHLORINE TABLETS, FOR CHLORINATION AND SANITATION OF WATER FOR SWIMMING POOLS, POTABLE WATER, WASTE WATER AND INDUSTRIAL USE (U.S. CLS. 1, 5, 6, 10, 26 AND 46).

CHARLES L. JENKINS, EXAMINING ATTORNEY

**CLASS 1—(Continued).**

SN 85-388,901. NORTHWEST AGRICULTURAL PRODUCTS, INC., PASCO, WA. FILED 8-3-2011.

YEOMAN ORGANIC

THE MARK CONSISTS OF STANDARD CHARACTERS WITHOUT CLAIM TO ANY PARTICULAR FONT, STYLE, SIZE, OR COLOR.

NO CLAIM IS MADE TO THE EXCLUSIVE RIGHT TO USE "ORGANIC", APART FROM THE MARK AS SHOWN. FOR ORGANIC FERTILIZERS FOR AGRICULTURAL USE (U.S. CLS. 1, 5, 6, 10, 26 AND 46).

MIDGE BUTLER, EXAMINING ATTORNEY

SN 85-391,061. RALCO NUTRITION, INC., MARSHALL, MN. FILED 8-5-2011.

AgNition

THE MARK CONSISTS OF STANDARD CHARACTERS WITHOUT CLAIM TO ANY PARTICULAR FONT, STYLE, SIZE, OR COLOR.

FOR SOIL CONDITIONERS FOR AGRICULTURAL USE (U.S. CLS. 1, 5, 6, 10, 26 AND 46).

FIRST USE 1-1-2011; IN COMMERCE 1-1-2011.

MEGHAN REINHART, EXAMINING ATTORNEY

**CLASS 2—PAINTS**

SN 77-709,343. SWIMC, INC., NEWARK, DE. FILED 4-8-2009.



OWNER OF U.S. REG. NOS. 3,241,200 AND 3,283,775. NO CLAIM IS MADE TO THE EXCLUSIVE RIGHT TO USE "GREEN", APART FROM THE MARK AS SHOWN.

THE MARK CONSISTS OF THE STYLIZED WORDING "GREEN SURE" AND A DESIGN OF TWO LEAVES FORMING A CIRCLE.

FOR PAINTS, INCLUDING PAINTS MANUFACTURED TO REDUCE ENVIRONMENTAL IMPACT OR TO MEET REGULATORY REQUIREMENTS (U.S. CLS. 6, 11 AND 16).

FIRST USE 4-8-2010; IN COMMERCE 4-8-2010.

TIMOTHY FINNEGAN, EXAMINING ATTORNEY

SN 79-096,552. MANKIEWICZ GEBR. & CO. GMBH & CO. KG, FED REP GERMANY, FILED 3-10-2011.

Blade-Rep

THE MARK CONSISTS OF STANDARD CHARACTERS WITHOUT CLAIM TO ANY PARTICULAR FONT, STYLE, SIZE, OR COLOR.

OWNER OF INTERNATIONAL REGISTRATION 1074851 DATED 3-10-2011, EXPIRES 3-10-2021.

FOR PAINTS, VARNISHES, LACQUERS, PRESERVATIVES AGAINST RUST IN THE NATURE OF COATING AND PRESERVATIVES AGAINST THE DETERIORATION OF WOOD; COLORANTS; MORDANTS FOR USE IN THE ROTOR BLADE COATINGS AND COATING SYSTEMS; RAW NATURAL RESINS, METALS IN FOIL AND POWDER FORM FOR PAINTERS, DECORATORS, PRINTERS AND ARTISTS (U.S. CLS. 6, 11 AND 16).

JESSICA FATHY, EXAMINING ATTORNEY

**CLASS 2—(Continued).**

SN 79-096,553. MANKIEWICZ GEBR. & CO. GMBH & CO. KG, FED REP GERMANY, FILED 3-10-2011.

**ALEXIT Blade-Rep**

THE MARK CONSISTS OF STANDARD CHARACTERS WITHOUT CLAIM TO ANY PARTICULAR FONT, STYLE, SIZE, OR COLOR.

OWNER OF INTERNATIONAL REGISTRATION 1074852 DATED 3-10-2011, EXPIRES 3-10-2021.

OWNER OF U.S. REG. NOS. 1,900,263 AND 3,352,790.

FOR PAINTS, VARNISHES, LACQUERS, PRESERVATIVES AGAINST RUST IN THE NATURE OF COATING AND PRESERVATIVES AGAINST THE DETERIORATION OF WOOD; COLORANTS; MORDANTS FOR USE IN THE ROTOR BLADE COATINGS AND COATING SYSTEMS; RAW NATURAL RESINS, METALS IN FOIL AND POWDER FORM FOR PAINTERS, DECORATORS, PRINTERS AND ARTISTS (U.S. CLS. 6, 11 AND 16).

JESSICA FATHY, EXAMINING ATTORNEY

SN 85-139,759. AKZO NOBEL COATINGS INTERNATIONAL B.V., ARNHEM, NETHERLANDS, FILED 9-28-2010.

**AWLCOAT**

THE MARK CONSISTS OF STANDARD CHARACTERS WITHOUT CLAIM TO ANY PARTICULAR FONT, STYLE, SIZE, OR COLOR.

PRIORITY CLAIMED UNDER SEC. 44(D) ON ERP CMNTY TM OFC APPLICATION NO. 9403601, FILED 9-27-2010, REG. NO. 9403601, DATED 3-6-2011, EXPIRES 9-27-2020.

OWNER OF U.S. REG. NO. 3,005,385.

FOR PAINTS; COATINGS IN THE NATURE OF PAINTS AND ENAMEL PAINTS; VARNISHES; COLORANTS; DISTEMPERS; LACQUERS; WOOD PRESERVATIVES; PAINT AND VARNISH DRYING AGENTS; WOOD STAINS; ANTI-CORROSIVE COATINGS; ANTI-FOULING PAINTS; PAINT THINNERS; PRIMERS (U.S. CLS. 6, 11 AND 16).

DOMINIC FATHY, EXAMINING ATTORNEY

SN 85-196,291. HUF, GERALD, D., DBA NORTHWEST, MEADVILLE, PA. FILED 12-13-2010.

**THERMA ALL-WEATHER**

THE MARK CONSISTS OF STANDARD CHARACTERS WITHOUT CLAIM TO ANY PARTICULAR FONT, STYLE, SIZE, OR COLOR.

NO CLAIM IS MADE TO THE EXCLUSIVE RIGHT TO USE "ALL WEATHER", APART FROM THE MARK AS SHOWN.

FOR CERAMIC PAINTS; EXTERIOR PAINT; INTERIOR PAINT (U.S. CLS. 6, 11 AND 16).

KATINA MISTER, EXAMINING ATTORNEY

**CLASS 2—(Continued).**

SN 85-203,227. ELIZABETH KIEHNLE NANNE DE BURKBALLIER, COL. TLACOPAC 01040, MEXICO, FILED 12-21-2010.



OWNER OF MEXICO REG. NO. 360575, DATED 2-29-1988, EXPIRES 2-28-2013.

THE MARK CONSISTS OF "CITOCOL" IN STYLIZED FORM.

FOR DYESTUFFS FOR USE IN THE MANUFACTURE OF CLOTHING AND FABRICS (U.S. CLS. 6, 11 AND 16).

KYLE PEETE, EXAMINING ATTORNEY

SN 85-264,053. CONSORCIO COMEX, S.A. DE C.V., MEXICO, D.F., MEXICO, FILED 3-10-2011.

**COMEX**

THE MARK CONSISTS OF STANDARD CHARACTERS WITHOUT CLAIM TO ANY PARTICULAR FONT, STYLE, SIZE, OR COLOR.

OWNER OF MEXICO REG. NO. 808974, DATED 10-9-2003, EXPIRES 8-13-2013.

OWNER OF U.S. REG. NOS. 1,958,222, 2,909,357 AND OTHERS.

FOR PAINTS, VARNISHES, LACQUERS; RUST PRESERVATIVES IN THE NATURE OF A COATING; WOOD TREATMENT PREPARATIONS FOR PRESERVING; MORDANT DYES; RAW NATURAL RESINS; METAL FOIL AND POWDER FOR PAINTERS, DECORATORS, PRINTERS AND ARTISTS (U.S. CLS. 6, 11 AND 16).

MARK T. MULLEN, EXAMINING ATTORNEY

SN 85-265,584. CONSORCIO COMEX, S.A. DE C.V., MEXICO, D.F., MEXICO, FILED 3-13-2011.



OWNER OF MEXICO REG. NO. 1013692, DATED 11-27-2007, EXPIRES 9-19-2017.

OWNER OF U.S. REG. NOS. 1,958,222, 2,909,357 AND OTHERS.

THE COLOR(S) LIGHT BLUE IS/ARE CLAIMED AS A FEATURE OF THE MARK.

THE MARK CONSISTS OF A STYLIZED AND LIGHT BLUE VERSION OF THE WORD "COMEX".

FOR PAINTS, VARNISHES, LACQUERS; RUST PRESERVATIVES IN THE NATURE OF A COATING; WOOD TREATMENT PREPARATIONS FOR PRESERVING; MORDANT DYES; RAW NATURAL RESINS; METAL FOIL AND POWDER FOR PAINTERS, DECORATORS, PRINTERS AND ARTISTS (U.S. CLS. 6, 11 AND 16).

MARK T. MULLEN, EXAMINING ATTORNEY

**CLASS 2—(Continued).**

SN 85-293,330. BONA AB, SE-200 21 MALMÖ, SWEDEN, FILED 4-12-2011.

**BONA TRAFFIC HD**

THE MARK CONSISTS OF STANDARD CHARACTERS WITHOUT CLAIM TO ANY PARTICULAR FONT, STYLE, SIZE, OR COLOR.

OWNER OF U.S. REG. NOS. 1,640,991, 3,925,024 AND OTHERS.

FOR COATINGS IN THE NATURE OF WOOD FLOOR FINISHES (U.S. CLS. 6, 11 AND 16).

FIRST USE 6-30-2011; IN COMMERCE 6-30-2011.  
ELIZABETH KAJUBI, EXAMINING ATTORNEY

**CLASS 2—(Continued).**

SN 85-329,936. GREENFIELD MANUFACTURING, INC., SARATOGA SPRINGS, NY. FILED 5-25-2011.

**HULLSPEED**

THE MARK CONSISTS OF STANDARD CHARACTERS WITHOUT CLAIM TO ANY PARTICULAR FONT, STYLE, SIZE, OR COLOR.

SEC. 2(F).

FOR DRAG REDUCTION AND LOW SURFACE ENERGY COATING FOR MOTOR VEHICLES; DRAG REDUCTION AND LOW SURFACE ENERGY COATING FOR MARINE VEHICLES (U.S. CLS. 6, 11 AND 16).

FIRST USE 3-1-2004; IN COMMERCE 3-1-2004.  
MICHELLE DUBOIS, EXAMINING ATTORNEY

---

SN 85-308,024. EPIC METALS CORPORATION, RANKIN, PA. FILED 4-29-2011.

**EPISHIELD**

THE MARK CONSISTS OF STANDARD CHARACTERS WITHOUT CLAIM TO ANY PARTICULAR FONT, STYLE, SIZE, OR COLOR.

FOR PROTECTIVE AND DECORATIVE FINISH COATINGS SOLD AS AN INTEGRAL COMPONENT OF METAL ROOF DECKING AND EXTERIOR ARCHITECTURAL BUILDING PANELS FOR CONTROLLING SUN EXPOSURE, HEAT LOADING AND GLARE (U.S. CLS. 6, 11 AND 16).

MICHAEL WIENER, EXAMINING ATTORNEY

---

SN 85-332,227. REITECH CORPORATION, LAURELDALE, PA. FILED 5-27-2011.

**ROFLEX**

THE MARK CONSISTS OF STANDARD CHARACTERS WITHOUT CLAIM TO ANY PARTICULAR FONT, STYLE, SIZE, OR COLOR.

OWNER OF U.S. REG. NO. 1,155,568.

FOR PRINTING INKS (U.S. CLS. 6, 11 AND 16).

FIRST USE 3-12-1973; IN COMMERCE 3-12-1973.  
LESLIE RICHARDS, EXAMINING ATTORNEY

---

SN 85-329,567. RED SPOT PAINT & VARNISH CO., INC., EVANSVILLE, IN. FILED 5-25-2011.

**IN-GEL**

THE MARK CONSISTS OF STANDARD CHARACTERS WITHOUT CLAIM TO ANY PARTICULAR FONT, STYLE, SIZE, OR COLOR.

FOR CLEAR AND PIGMENTED COATINGS USED IN THE NATURE OF PAINT; PAINTS (U.S. CLS. 6, 11 AND 16).

BENJAMIN OKEKE, EXAMINING ATTORNEY

---

SN 85-332,248. REITECH CORPORATION, LAURELDALE, PA. FILED 5-27-2011.

**REISPERSE**

THE MARK CONSISTS OF STANDARD CHARACTERS WITHOUT CLAIM TO ANY PARTICULAR FONT, STYLE, SIZE, OR COLOR.

FOR WATER-BASED PIGMENT DISPERSIONS (U.S. CLS. 6, 11 AND 16).

FIRST USE 8-0-1993; IN COMMERCE 8-0-1993.  
LESLIE RICHARDS, EXAMINING ATTORNEY

**CLASS 2—(Continued).**

SN 85-332,263. CARBOLINE INTERNATIONAL CORPORATION, ST. LOUIS, MO. FILED 5-27-2011.

**PYROCLAD**

THE MARK CONSISTS OF STANDARD CHARACTERS WITHOUT CLAIM TO ANY PARTICULAR FONT, STYLE, SIZE, OR COLOR.

FOR EPOXY INTUMESCENT FIREPROOFING COATING FOR THE PROTECTION OF STRUCTURAL STEEL (U.S. CLS. 6, 11 AND 16).

ZACHARY BELLO, EXAMINING ATTORNEY

SN 85-332,281. CARBOLINE INTERNATIONAL CORPORATION, ST. LOUIS, MO. FILED 5-27-2011.

**THERMALINE**

THE MARK CONSISTS OF STANDARD CHARACTERS WITHOUT CLAIM TO ANY PARTICULAR FONT, STYLE, SIZE, OR COLOR.

FOR TEMPERATURE RESISTANT COATINGS IN THE NATURE OF PAINT FOR THE PROTECTION OF STEEL AND OTHER SURFACES (U.S. CLS. 6, 11 AND 16).

FIRST USE 9-27-1990; IN COMMERCE 9-27-1990.

ZACHARY BELLO, EXAMINING ATTORNEY

SN 85-332,289. CARBOLINE INTERNATIONAL CORPORATION, ST. LOUIS, MO. FILED 5-27-2011.

**CARBOTHERM**

THE MARK CONSISTS OF STANDARD CHARACTERS WITHOUT CLAIM TO ANY PARTICULAR FONT, STYLE, SIZE, OR COLOR.

FOR PAINT-LIKE COATINGS FOR INSULATING PIPES, TANKS, BUILDINGS OR OPERATING EQUIPMENT (U.S. CLS. 6, 11 AND 16).

FIRST USE 5-1-2011; IN COMMERCE 5-1-2011.

ZACHARY BELLO, EXAMINING ATTORNEY

**CLASS 2—(Continued).**

SN 85-334,894. THE VALSPAR CORPORATION, MINNEAPOLIS, MN. FILED 6-1-2011.



THE MARK CONSISTS OF A STYLIZED "X" AND THE WORD "MAX".

FOR AEROSOL SPRAY PAINTS (U.S. CLS. 6, 11 AND 16).

NAKIA HENRY, EXAMINING ATTORNEY

SN 85-335,062. DUNCAN ENTERPRISES, DBA ILOVE-TOCREATE, CLOVIS, CA. FILED 6-1-2011.

**TULIP FABRIC SPRAY PAINT**

THE MARK CONSISTS OF STANDARD CHARACTERS WITHOUT CLAIM TO ANY PARTICULAR FONT, STYLE, SIZE, OR COLOR.

OWNER OF U.S. REG. NOS. 2,475,771, 3,913,374 AND OTHERS.

NO CLAIM IS MADE TO THE EXCLUSIVE RIGHT TO USE "FABRIC SPRAY PAINT", APART FROM THE MARK AS SHOWN.

FOR FABRIC PAINTS; PAINTS FOR ARTS AND CRAFTS (U.S. CLS. 6, 11 AND 16).

FIRST USE 4-1-2009; IN COMMERCE 4-1-2009.

WENDY JUN, EXAMINING ATTORNEY

**CLASS 2—(Continued).**

SN 85-335,981. ANNIE SLOAN INTERIORS LTD., OXFORD, UNITED KINGDOM. FILED 6-2-2011.



THE NAME(S), PORTRAIT(S), AND/OR SIGNATURE(S) SHOWN IN THE MARK IDENTIFIES "ANNIE SLOAN", WHOSE CONSENT TO REGISTER IS MADE OF RECORD. THE MARK CONSISTS OF THE STYLIZED TERMS "ANNIE SLOAN".

FOR HOUSE PAINT; INTERIOR PAINT; PAINTS FOR ARTS AND CRAFTS (U.S. CLS. 6, 11 AND 16).  
FIRST USE 12-0-2010; IN COMMERCE 12-0-2010.  
MEGHAN REINHART, EXAMINING ATTORNEY

SN 85-341,554. INSTANT ASPHALT, INC., DBA ME-TACRYLICS, SAN JOSE, CA. FILED 6-8-2011.

## Extreme Weather

THE MARK CONSISTS OF STANDARD CHARACTERS WITHOUT CLAIM TO ANY PARTICULAR FONT, STYLE, SIZE, OR COLOR.

FOR ELASTOMERIC-BASED COATINGS FOR USE ON ROOFS, WALLS AND BUILDING FOUNDATIONS; RESIN-BASED COATINGS FOR USE ON ROOFS, WALLS AND PAVEMENTS; WATER-BASED ROOF COATINGS (U.S. CLS. 6, 11 AND 16).

FIRST USE 9-15-2009; IN COMMERCE 9-15-2009.  
WARREN L. OLANDRIA, EXAMINING ATTORNEY

SN 85-342,947. GREENFIELD MANUFACTURING, INC., SARATOGA SPRINGS, NY. FILED 6-10-2011.

## WET-GRIP

THE MARK CONSISTS OF STANDARD CHARACTERS WITHOUT CLAIM TO ANY PARTICULAR FONT, STYLE, SIZE, OR COLOR.

FOR PROTECTIVE COATING FOR METAL, WOOD, MASONRY AND CEMENT (U.S. CLS. 6, 11 AND 16).  
MICHELLE DUBOIS, EXAMINING ATTORNEY

**CLASS 2—(Continued).**

SN 85-342,956. GREENFIELD MANUFACTURING, INC., SARATOGA SPRINGS, NY. FILED 6-10-2011.

## WET-GLIDE

THE MARK CONSISTS OF STANDARD CHARACTERS WITHOUT CLAIM TO ANY PARTICULAR FONT, STYLE, SIZE, OR COLOR.

FOR NON-STICK COATING FOR METAL, WOOD, MASONRY AND CEMENT (U.S. CLS. 6, 11 AND 16).  
MICHELLE DUBOIS, EXAMINING ATTORNEY

SN 85-360,649. THE VALSPAR CORPORATION, MINNEAPOLIS, MN. FILED 6-30-2011.

## TIMBERJACK

THE MARK CONSISTS OF STANDARD CHARACTERS WITHOUT CLAIM TO ANY PARTICULAR FONT, STYLE, SIZE, OR COLOR.

FOR EXTERIOR AND INTERIOR PAINTS AND WOOD STAINS, VARNISHES, PRIMERS AND SEALERS (U.S. CLS. 6, 11 AND 16).

NAKIA HENRY, EXAMINING ATTORNEY

SN 85-378,463. HEARST COMMUNICATIONS, INC., NEW YORK, NY. FILED 7-22-2011.

## HOUSE BEAUTIFUL

THE MARK CONSISTS OF STANDARD CHARACTERS WITHOUT CLAIM TO ANY PARTICULAR FONT, STYLE, SIZE, OR COLOR.

OWNER OF U.S. REG. NOS. 273,427, 3,021,426 AND 3,051,304.

FOR EXTERIOR PAINT; INTERIOR PAINT; PAINTS (U.S. CLS. 6, 11 AND 16).

KELLY TRUSILO, EXAMINING ATTORNEY

**CLASS 3—COSMETICS AND CLEANING PREPARATIONS**

SN 76-707,833. GLIPTONE MANUFACTURING, INC., ROKKONKOMA, NY. FILED 6-3-2011.

**GLIPSTIK**

FOR PRODUCT FOR USE IN CONNECTION WITH CLEANING AND MAINTAINING AUTOMOBILES, NAMELY, AN INK AND PEN MARK REMOVER FOR VEHICLE INTERIORS (U.S. CLS. 1, 4, 6, 50, 51 AND 52). FIRST USE 12-7-2002; IN COMMERCE 12-7-2002. ROSELLE HERRERA, EXAMINING ATTORNEY

---

SN 77-185,826. VIE SALON AND SPA, LLC, CHANDLER, AZ. FILED 5-21-2007.

**Miss Maya**

THE MARK CONSISTS OF STANDARD CHARACTERS WITHOUT CLAIM TO ANY PARTICULAR FONT, STYLE, SIZE, OR COLOR. THE NAME "MISS MAYA" DOES NOT IDENTIFY A LIVING INDIVIDUAL. FOR BODY AND BEAUTY CARE COSMETICS (U.S. CLS. 1, 4, 6, 50, 51 AND 52). MAUREEN DALL, EXAMINING ATTORNEY

---

SN 77-195,414. SEATTLE SOAPWORKS INC., SEATTLE, WA. FILED 6-1-2007.

**VIOZENA**

THE MARK CONSISTS OF STANDARD CHARACTERS WITHOUT CLAIM TO ANY PARTICULAR FONT, STYLE, SIZE, OR COLOR. FOR HAND AND BODY LOTIONS, FACE CREAMS, BAR SOAPS, AND MOISTURIZING REPAIR BEAUTY SERUMS (U.S. CLS. 1, 4, 6, 50, 51 AND 52). FIRST USE 4-1-2007; IN COMMERCE 4-1-2007. ALEXANDER L. POWERS, EXAMINING ATTORNEY

**CLASS 3—(Continued).**

SN 77-490,266. SOAP & GLORY LIMITED, LONDON, UNITED KINGDOM, FILED 6-4-2008.

**supercolorfabulipstick**

THE MARK CONSISTS OF STANDARD CHARACTERS WITHOUT CLAIM TO ANY PARTICULAR FONT, STYLE, SIZE, OR COLOR.

OWNER OF UNITED KINGDOM REG. NO. 2489250, DATED 6-4-2008, EXPIRES 6-4-2018.

FOR LIPSTICK, LIP GLOSS, LIP CREAM, LIP LINER, NON-MEDICATED LIP BALM, LIP PENCILS (U.S. CLS. 1, 4, 6, 50, 51 AND 52).

MICHAEL ENGEL, EXAMINING ATTORNEY

---

SN 77-658,588. REVOLUTION DISTRIBUTORS, LLC, EDISON, NJ. FILED 1-28-2009.

*Ron Marone's*



NO CLAIM IS MADE TO THE EXCLUSIVE RIGHT TO USE "POUR FEMME", APART FROM THE MARK AS SHOWN.

THE NAME(S), PORTRAIT(S), AND/OR SIGNATURE(S) SHOWN IN THE MARK DOES NOT IDENTIFY A PARTICULAR LIVING INDIVIDUAL.

THE MARK CONSISTS OF THE NAME "RON MARONE'S" ABOVE A RECTANGULAR BOX, THE RECTANGULAR BOX COMPRISING THE WORD "JUICY" ABOVE THE WORDS "POUR FEMME".

THE ENGLISH TRANSLATION OF "POUR FEMME" IN THE MARK IS "FOR WOMEN".

FOR AFTERSHAVE; BATH GELS; BODY LOTION; DEODORANT FOR PERSONAL USE; EAU DE PERFUME; EAU DE TOILETTE; SHOWER GELS (U.S. CLS. 1, 4, 6, 50, 51 AND 52).

MATTHEW PAPPAS, EXAMINING ATTORNEY

**CLASS 3—(Continued).**

SN 77-926,884. TON SAVON, INC, MANHATTAN BEACH, CA. FILED 2-3-2010.

Pure Provence

THE MARK CONSISTS OF STANDARD CHARACTERS WITHOUT CLAIM TO ANY PARTICULAR FONT, STYLE, SIZE, OR COLOR.

NO CLAIM IS MADE TO THE EXCLUSIVE RIGHT TO USE "PROVENCE", APART FROM THE MARK AS SHOWN. FOR BAR SOAP (U.S. CLS. 1, 4, 6, 50, 51 AND 52). FIRST USE 2-26-2007; IN COMMERCE 2-26-2007. BARBARA A. GOLD, EXAMINING ATTORNEY

**CLASS 3—(Continued).**

SN 77-966,524. PAN PARAG INDIA LIMITED, KANPUR, INDIA, FILED 3-23-2010.



THE MARK CONSISTS OF THE WORDS "PAN PARAG" ACROSS AN ARCHED BANNER.

THE WORD "PAN" TRANSLATED FROM HINDI MEANS "BY COMING", "TO ARRIVE (AT)"; "TO DEPART"; "OF A REVERED PERSON" OR "AN IDOL OF GOD HAVE BEEN WASHED"; "OF GOD HAVE BEEN WASHED"; "BETEL", "BETEL-LEAF"; OR "(THE ACT OR PROCESS OF) DRINKING (WATER OR ANY LIQUID)". THE WORD "PARAG" TRANSLATED FROM HINDI MEANS "THE POLLEN (OF A FLOWER)".

SEC. 2(F).

FOR BREATH FRESHENER, NAMELY, PAN MASALA (U.S. CLS. 1, 4, 6, 50, 51 AND 52).

FIRST USE 5-12-1986; IN COMMERCE 5-12-1986.

HEATHER THOMPSON, EXAMINING ATTORNEY

SN 77-937,319. L'OREAL, PARIS, FRANCE, FILED 2-17-2010.

VITAMINO COLOR CAPTIV

THE MARK CONSISTS OF STANDARD CHARACTERS WITHOUT CLAIM TO ANY PARTICULAR FONT, STYLE, SIZE, OR COLOR.

PRIORITY CLAIMED UNDER SEC. 44(D) ON FRANCE APPLICATION NO. 103712376, FILED 2-11-2010, REG. NO. 103712376, DATED 2-11-2010, EXPIRES 2-11-2020.

OWNER OF U.S. REG. NO. 2,857,756.

NO CLAIM IS MADE TO THE EXCLUSIVE RIGHT TO USE "COLOR", APART FROM THE MARK AS SHOWN.

THE ENGLISH TRANSLATION OF "VITAMINO" IN THE MARK IS "VITAMIN".

FOR SHAMPOOS; PRODUCTS FOR HAIR STYLING AND HAIR CARE, NAMELY, GELS, MOUSSES, BALMS, CREAM, WAX, SERUMS, LOTIONS AND MASKS; HAIR LACQUERS; HAIR COLORING AND HAIR DECOLORANT PREPARATIONS; PERMANENT WAVING AND CURLING PREPARATIONS; ESSENTIAL OILS FOR PERSONAL USE (U.S. CLS. 1, 4, 6, 50, 51 AND 52).

GINA HAYES, EXAMINING ATTORNEY

SN 79-088,694. SCARLETT & GREENE PTY LTD, MOSSMAN, SYDNEY NSW 2088, AUSTRALIA, FILED 10-8-2010.



PRIORITY DATE OF 7-9-2010 IS CLAIMED.

OWNER OF INTERNATIONAL REGISTRATION 1054864 DATED 10-8-2010, EXPIRES 10-8-2020.

THE MARK CONSISTS OF THE WORDING "SCARLETT & GREENE" WITH THE "L" EXTENDING ABOVE THE OTHER LETTERS, AND A SERIES OF HORIZONTAL LINES BENEATH THE WORDING, SOME OF WHICH TERMINATE IN PARTIAL CIRCLES.

FOR NON-MEDICATED SKIN CREAMS; NON-MEDICATED SKIN LOTIONS; NON-MEDICATED SKIN CARE PREPARATIONS; COSMETICS (U.S. CLS. 1, 4, 6, 50, 51 AND 52).

FRED CARL, EXAMINING ATTORNEY



**CLASS 3—(Continued).**

SN 79-090,777. BARTEL, BORIS, FED REP GERMANY, FILED 10-28-2010.

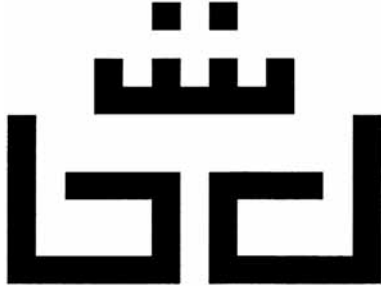

PRIORITY DATE OF 5-20-2010 IS CLAIMED.  
OWNER OF INTERNATIONAL REGISTRATION 1060585 DATED 10-28-2010, EXPIRES 10-28-2020.

THE MARK CONSISTS OF THE HIGHLY STYLIZED LETTERS "BB" WHEREIN THE LETTERS ARE MIRROR IMAGES AND ABOVE THE LETTERS IS A DESIGN COMPRISED OF TWO SQUARE DOTS ABOVE A HORIZONTAL LINE WITH FOUR SQUARE DOT JUTTING UPWARD.

THE WORDING "BB" HAS NO MEANING IN A FOREIGN LANGUAGE.

FOR LAUNDRY PREPARATIONS, NAMELY, LAUNDRY DETERGENTS, LAUNDRY SOAP; LAUNDRY BLEACH; FURBISHING PREPARATIONS, NAMELY, GENERAL PURPOSE POLISHING LIQUIDS; POLISHING PREPARATIONS; DEGREASING PREPARATIONS NOT USED IN MANUFACTURING PROCESSES FOR HOUSEHOLD PURPOSES; SOAP, NAMELY, BATH SOAP, BODY SOAP; PERFUMERY; ETHEREAL OILS; COSMETICS; HAIR LOTIONS; DENTIFRICES, MAKE-UP REMOVING PREPARATIONS; ASTRINGENTS FOR COSMETIC PURPOSES; AMBER BEING PERFUME; BREATH FRESHENING SPRAYS; ETHEREAL ESSENCES; EYEBROW COSMETICS; EYEBROW PENCILS; SOAP FOR BRIGHTENING TEXTILE; BATH SALTS, NOT FOR MEDICAL PURPOSES; COSMETIC PREPARATIONS FOR BATHS; SKIN WHITENING CREAMS; BLEACHING PREPARATIONS BEING DECOLORANTS FOR COSMETIC PURPOSES; DEODORANTS FOR PERSONAL USE; DEODORANT SOAP; SCENTED LINEN WATER; COLORANTS FOR TOILET PURPOSES FOR HAIR; COSMETIC HAIR DYES; GREASES FOR COSMETIC PURPOSES; HAIR DYES; HAIR SPRAY; SHAMPOOS; SUN-TANNING PREPARATIONS BEING COSMETICS; COSMETICS; COSMETIC PENCILS; COSMETIC CREAMS; COSMETIC PREPARATIONS FOR SKIN CARE; DECORATIVE TRANSFERS FOR COSMETIC PURPOSES; FALSE NAILS; FALSE EYELASHES; LIPSTICKS; LOTIONS FOR COSMETIC PURPOSES; MAKE-UP; MOISTURIZING ALMOND MILK FOR COSMETIC PURPOSES; COSMETIC ALMOND OIL; ALMOND SOAP; MASSAGE GEL, OTHER THAN FOR MEDICAL PURPOSES; MOUTH WASHES, NOT FOR MEDICAL PURPOSES; NAIL VARNISH; NAIL CARE PREPARATIONS; OILS FOR TOILET PURPOSES; OILS FOR COSMETIC PURPOSES; OILS FOR PERFUMES AND SCENTS; PERFUMES; AFTER-SHAVE LOTIONS; CLEANSING MILK FOR TOILET PURPOSES; COSMETIC PREPARATIONS FOR SLIMMING PURPOSES; MAKE-UP PREPARATIONS; MAKE-UP POWDER; BEAUTY MASKS; ANTIPERSPIRANT SOAP; SUN-TANNING PREPARATIONS FOR NATURAL SUN; SUN-TANNING PREPARATIONS FOR ARTIFICIAL SUN, ESPECIALLY FOR SOLARIUMS; NON-MEDICATED TOILETRIES; CAKES OF TOILET SOAP; TOILET WATER; TISSUES IMPREGNATED WITH COSMETIC LOTIONS; PETROLEUM JELLY FOR COSMETIC PURPOSES; HYDROGEN PEROXIDE FOR COSMETIC PURPOSES, NAMELY, FOR USE ON THE HAIR; COTTON WOOL FOR COSMETIC PURPOSES; COTTON SWABS BEING TOILETRIES FOR COSMETIC PURPOSES; COSMETIC PREPARATIONS FOR EYELASHES; MASCARA (U.S. CLS. 1, 4, 6, 50, 51 AND 52).

MYRIAH HABEEB, EXAMINING ATTORNEY

**CLASS 3—(Continued).**

SN 79-091,504. LIDL STIFTUNG & CO. KG, FED REP GERMANY, FILED 11-12-2010.

G. Bellini

THE MARK CONSISTS OF STANDARD CHARACTERS WITHOUT CLAIM TO ANY PARTICULAR FONT, STYLE, SIZE, OR COLOR.

OWNER OF INTERNATIONAL REGISTRATION 0655396 DATED 4-26-1996, EXPIRES 4-26-2016.

OWNER OF U.S. REG. NO. 2,914,021.

FOR COSMETICS, INCLUDING AFTERSHAVE MOISTURIZING CREAM FOR MEN; SCENTED LINEN WATER AND SCENTED WATERS IN THE NATURE OF PERFUMERY, MEN'S COLOGNE, AFTERSHAVE, AND EAU DE TOILET, PERSONAL DEODORANTS INCLUDING DEODORANT SOAP AND BODY WASHES FOR MEN AND DECORATIVE COSMETICS, NAMELY, CONCEALERS, EYE SHADOW, COSMETIC PENCILS, ROUGE, HENNA FOR COSMETIC PURPOSES, LIPSTICK, LIP GLOSS, TONERS, NAIL ENAMEL, NAIL GLITTER, NAIL POLISH, NAIL VARNISH FOR COSMETIC PURPOSES, EYE LINER, EYE MAKEUP, EYE PENCILS, UNDER-EYE ENHANCERS, CHALK FOR MAKE-UP, COMPACTS CONTAINING MAKE-UP, MAKE UP FOUNDATIONS, MAKE-UP PENCILS, MAKE-UP POWDER, MAKE-UP PRODUCTS FOR THE FACE AND BODY, MASCARA, COSMETIC PREPARATIONS FOR EYE LASHES, LIP LINER, LIP CREAM, FACE POWDER, SKIN LIGHTENERS, SKIN WHITENING CREAMS, SKIN WHITENING PREPARATIONS, SKIN GELS FOR ACCELERATING, ENHANCING OR EXTENDING TANS, SUNTAN CREAMS, AND SELF TANNING CREAMS (U.S. CLS. 1, 4, 6, 50, 51 AND 52).

INGA ERVIN, EXAMINING ATTORNEY

**CLASS 3—(Continued).**

SN 79-093,551. KWH MIRKA LTD, FINLAND, FILED 5-19-2010.

# Q.SILVER

THE MARK CONSISTS OF STANDARD CHARACTERS WITHOUT CLAIM TO ANY PARTICULAR FONT, STYLE, SIZE, OR COLOR.

OWNER OF INTERNATIONAL REGISTRATION 0800300 DATED 3-26-2003, EXPIRES 3-26-2013.

OWNER OF U.S. REG. NO. 2,927,796.

FOR ABRASIVES, NAMELY, COATED ABRASIVES IN THE NATURE OF ABRASIVE FILM TO WHICH ABRASIVE GRAINS ARE ATTACHED, FLEXIBLE ABRASIVES IN THE NATURE OF ABRASIVE FILM TO WHICH ABRASIVE GRAINS ARE ATTACHED, ABRASIVE FILM TO WHICH ABRASIVE GRAINS ARE ATTACHED, COATED ABRASIVES IN THE NATURE OF ABRASIVE NET TO WHICH ABRASIVE GRAINS ARE ATTACHED, FLEXIBLE ABRASIVES IN THE NATURE OF ABRASIVE NET TO WHICH ABRASIVE GRAINS ARE ATTACHED, ABRASIVE NET TO WHICH ABRASIVE GRAINS ARE ATTACHED, COATED ABRASIVES IN THE NATURE OF ABRASIVE CLOTH TO WHICH ABRASIVE GRAINS ARE ATTACHED, FLEXIBLE ABRASIVES IN THE NATURE OF ABRASIVE CLOTH TO WHICH ABRASIVE GRAINS ARE ATTACHED, ABRASIVE CLOTH TO WHICH ABRASIVE GRAINS ARE ATTACHED, ABRASIVE PAPER DISCS, ABRASIVE PAPER BELTS, ABRASIVE PAPER WHEELS, ABRASIVE ROLLS, ABRASIVE SHEETS, AND ABRASIVE STRIPS; ALL THE AFORESAID GOODS FOR GRINDING, SANDING, POLISHING, CLEANING AND FINISHING WOOD, PLASTIC, METAL, PAINTED AND LACQUERED SURFACES, AND COMPOSITES OF THE FOREGOING MATERIALS (U.S. CLS. 1, 4, 6, 50, 51 AND 52).

ALEXANDER L. POWERS, EXAMINING ATTORNEY

**CLASS 3—(Continued).**

SN 79-100,402. GABELICA ANNE-MARIE, FRANCE, FILED 6-7-2011.

# Oolution

PRIORITY DATE OF 12-10-2010 IS CLAIMED. OWNER OF INTERNATIONAL REGISTRATION 1085058 DATED 6-7-2011, EXPIRES 7-30-2022.

THE MARK CONSISTS OF THE WORDING "OOLUTION" IN A STYLIZED FONT.

FOR SOAP FOR PERSONAL USE DESIGNED EXCLUSIVELY FOR INDIVIDUALS; PERFUMES, ESSENTIAL OILS; COSMETICS, HAIR LOTIONS; DENTIFRICES; DEPILATORY PREPARATIONS; MAKE-UP REMOVING PREPARATIONS; LIPSTICKS; BEAUTY MASKS; SHAVING PREPARATIONS; LEATHER PRESERVING POLISHES (U.S. CLS. 1, 4, 6, 50, 51 AND 52).

KAPIL BHANOT, EXAMINING ATTORNEY

SN 85-059,478. AMOREPACIFIC CORPORATION, YONGSAN-KU, SEOUL, REPUBLIC OF KOREA, FILED 6-10-2010.

明禕眞  
명의진

SN 79-099,227. ATTI-LA DAHLGREN C/O IME INTERMED ENTERPRISES SA, SWITZERLAND, FILED 3-31-2011.

# EDELWHITE

THE MARK CONSISTS OF STANDARD CHARACTERS WITHOUT CLAIM TO ANY PARTICULAR FONT, STYLE, SIZE, OR COLOR.

OWNER OF INTERNATIONAL REGISTRATION 0796171 DATED 12-16-2002, EXPIRES 8-3-2012.

FOR CLEANING, POLISHING, SCOURING AND ABRASIVE PREPARATIONS; SOAPS; PERFUMERY, ESSENTIAL OILS, COSMETICS, HAIR LOTIONS; DENTIFRICES (U.S. CLS. 1, 4, 6, 50, 51 AND 52).

TRACY FLETCHER, EXAMINING ATTORNEY

OWNER OF SINGAPORE REG. NO. T1007785Z, DATED 6-23-2010, EXPIRES 6-23-2020.

THE MARK CONSISTS OF THREE STYLIZED CHINESE CHARACTERS DIRECTLY ABOVE THREE STYLIZED KOREAN CHARACTERS.

THE CHINESE CHARACTERS IN THE MARK TRANSLITERATE TO "MYUNG, EUI, JIN" IN ENGLISH AND THESE MEAN "BRIGHT, BEAUTIFUL, TRUTH" RESPECTIVELY IN ENGLISH; THE KOREAN CHARACTERS IN THE MARK TRANSLITERATE TO "MYUNG, EUI, JIN" IN ENGLISH AND THIS HAS NO MEANING IN KOREAN OR A FOREIGN LANGUAGE.

FOR SKIN LOTIONS; COSMETIC MILKS, NAMELY, MOISTURIZING ESSENCE IN THE NATURE OF MILKY LOTION; BEAUTY SERUM; NON-MEDICAL COSMETIC SKIN CARE PREPARATIONS; HAIR SHAMPOOS; CLEANING PREPARATIONS; POLISHING WAX; POLISHING, SCOURING AND ABRASIVE PREPARATIONS; FUMIGATION INCENSES; DENTIFRICES; POTPOURRI; COSMETICS FOR ANIMALS (U.S. CLS. 1, 4, 6, 50, 51 AND 52).

LEIGH LOWRY, EXAMINING ATTORNEY

**CLASS 3—(Continued).**

SN 85-074,080. CELLCEUTICALS SKIN CARE, INC., BEVERLY HILLS, CA. FILED 6-29-2010.

**INTERACTIVE MOISTURE**

THE MARK CONSISTS OF STANDARD CHARACTERS WITHOUT CLAIM TO ANY PARTICULAR FONT, STYLE, SIZE, OR COLOR.

NO CLAIM IS MADE TO THE EXCLUSIVE RIGHT TO USE "MOISTURE", APART FROM THE MARK AS SHOWN. FOR ANTI-AGING FACIAL MOISTURIZER (U.S. CLS. 1, 4, 6, 50, 51 AND 52).

TRACY CROSS, EXAMINING ATTORNEY

**CLASS 3—(Continued).**

SN 85-077,631. GOLDEN MARKS, INC., BEVERLY HILLS, CA. FILED 7-2-2010.



THE MARK CONSISTS OF A TWO-DIMENSIONAL OUTLINE OF A PERFUME OR COLOGNE BOTTLE AND CAP THEREFOR.

FOR PERFUMES AND FRAGRANCES (U.S. CLS. 1, 4, 6, 50, 51 AND 52).

FIRST USE 3-31-1994; IN COMMERCE 1-31-1995.

MICHELE SWAIN, EXAMINING ATTORNEY

SN 85-077,628. GOLDEN MARKS, INC., BEVERLY HILLS, CA. FILED 7-2-2010.



SN 85-125,643. PURE & NATURAL COMPANY, SCOTTSDALE, AZ. FILED 9-9-2010.

**FRESH MORNING BURST PUREX**

THE MARK CONSISTS OF A TWO-DIMENSIONAL OUTLINE OF A PERFUME OR COLOGNE BOTTLE AND CAP THEREFOR.

FOR PERFUMES AND FRAGRANCES (U.S. CLS. 1, 4, 6, 50, 51 AND 52).

FIRST USE 3-31-1994; IN COMMERCE 1-31-1995.

MICHELE SWAIN, EXAMINING ATTORNEY

THE MARK CONSISTS OF STANDARD CHARACTERS WITHOUT CLAIM TO ANY PARTICULAR FONT, STYLE, SIZE, OR COLOR.

OWNER OF U.S. REG. NOS. 312,493, 3,094,059 AND OTHERS.

FOR FABRIC SOFTENERS; LAUNDRY DETERGENTS (U.S. CLS. 1, 4, 6, 50, 51 AND 52).

VIVIAN MICZNIK FIRST, EXAMINING ATTORNEY

**CLASS 3—(Continued).**

SN 85-154,617. NATURALLY SUSAN'S LLC, NEW YORK, NY. FILED 10-18-2010.



THE COLOR(S) GREEN AND WHITE IS/ARE CLAIMED AS A FEATURE OF THE MARK.

THE MARK CONSISTS OF A GREEN LEAF IN AN OVAL SHAPE ORIENTED FROM THE UPPER LEFT TO THE LOWER RIGHT. WITHIN THE LEAF APPEAR THE LETTERS "NS". THESE LETTERS ARE WHITE IN COLOR.

FOR BATH FIZZIES; BATH SOAPS; BATH SOAPS IN SOLID OR GEL FORM; COSMETIC PREPARATIONS FOR SKIN CARE; EXFOLIANTS FOR FACE; FRAGRANCED SKIN CARE PREPARATIONS, NAMELY, FACE AND BODY SCRUBS FEATURING NATURAL LAVENDER, EUCALYPTUS, GINGER, HONEY, PEPPERMINT, LEMONGRASS, AND SWEET ORANGE; LIQUID BATH SOAPS; MOISTURIZING PREPARATIONS FOR THE SKIN; MOISTURIZING SOLUTIONS FOR THE SKIN; NON-MEDICATED SKIN CARE PREPARATIONS; SKIN CLEANSERS; SKIN CONDITIONERS; SKIN MASKS; SKIN MOISTURIZER; SKIN MOISTURIZER MASKS (U.S. CLS. 1, 4, 6, 50, 51 AND 52).

FIRST USE 4-14-2010; IN COMMERCE 4-14-2010.

WARREN L. OLANDRIA, EXAMINING ATTORNEY

SN 85-155,127. OCCY LABORATOIRE INC., LAVAL (QUEBEC), CANADA, FILED 10-18-2010.

## AQUAUNDE

THE MARK CONSISTS OF STANDARD CHARACTERS WITHOUT CLAIM TO ANY PARTICULAR FONT, STYLE, SIZE, OR COLOR.

PRIORITY CLAIMED UNDER SEC. 44(D) ON CANADA APPLICATION NO. 1497144, FILED 9-24-2010.

THE WORDING "AQUAUNDE" HAS NO MEANING IN A FOREIGN LANGUAGE.

FOR NON-MEDICATED SKIN CARE PREPARATIONS, BODY CREAMS, SHOWER GELS, BEAUTY MASKS, CREAMS FOR THE VISIBLE REDUCTION OF CELLULITE, GELS FOR THE VISIBLE REDUCTION OF CELLULITE, ANTI-WRINKLE AND SKIN BRIGHTENING GELS, SKIN MOISTURIZING AND CALMING GELS (U.S. CLS. 1, 4, 6, 50, 51 AND 52).

LINDSEY RUBIN, EXAMINING ATTORNEY

**CLASS 3—(Continued).**

SN 85-157,400. TRISH MCEVOY, LTD., NEW YORK, NY. FILED 10-20-2010.

## Trish McEvoy Intense Coverage Concealer

THE MARK CONSISTS OF STANDARD CHARACTERS WITHOUT CLAIM TO ANY PARTICULAR FONT, STYLE, SIZE, OR COLOR.

NO CLAIM IS MADE TO THE EXCLUSIVE RIGHT TO USE "COVERAGE CONCEALER", APART FROM THE MARK AS SHOWN.

THE NAME(S), PORTRAIT(S), AND/OR SIGNATURE(S) SHOWN IN THE MARK IDENTIFIES "TRISH MCEVOY", WHOSE CONSENT(S) TO REGISTER IS MADE OF RECORD.

FOR COSMETIC GOODS, NAMELY, SKIN CONCEALER (U.S. CLS. 1, 4, 6, 50, 51 AND 52).

BARBARA A. GOLD, EXAMINING ATTORNEY

SN 85-162,830. BHE, GP, LLC, HOUSTON, TX. FILED 10-27-2010.

## FINITO

THE MARK CONSISTS OF STANDARD CHARACTERS WITHOUT CLAIM TO ANY PARTICULAR FONT, STYLE, SIZE, OR COLOR.

FOR HAIR STYLING SPRAY (U.S. CLS. 1, 4, 6, 50, 51 AND 52).

FIRST USE 6-1-2010; IN COMMERCE 7-10-2010.

RONALD MCMORROW, EXAMINING ATTORNEY

**CLASS 3—(Continued).**

SN 85-171,984. ORIGINAL ADDITIONS (BEAUTY PRODUCTS) LTD, HAYES, MIDDLESEX, UNITED KINGDOM, FILED 11-8-2010.



THE MARK CONSISTS OF THE WORD "EYLURE" IN STYLIZED FORM WITH THE FIRST LETTER "E" WITHIN A STYLIZED OVAL.

FOR FALSE EYELASHES AND ADHESIVES FOR FIXING SUCH EYELASHES; LASH EXTENSIONS, NAMELY, ARTIFICIAL EYELASHES; LASH PERMING PREPARATIONS, NAMELY, COSMETIC PREPARATIONS FOR CURLING AND SEPARATING EYELASHES; EYELASH TINT; EYEBROW TINT; COSMETICS; COSMETIC PREPARATIONS FOR EYELASHES; HAIR WAX AND DEPILATORY PREPARATIONS FOR EYEBROWS; FACE JEWELLERY, NAMELY, FACE GLITTER, DECORATIVE TRANSFERS AND SKIN JEWELS FOR COSMETIC PURPOSES (U.S. CLS. 1, 4, 6, 50, 51 AND 52).  
CARYN GLASSER, EXAMINING ATTORNEY

**CLASS 3—(Continued).**

SN 85-173,692. ZIMU HOLDINGS, LLC, DBA VINCENT LONGO COSMETICS, NEW YORK, NY. FILED 11-10-2010.

WAKE UP YOUR MAKEUP!

THE MARK CONSISTS OF STANDARD CHARACTERS WITHOUT CLAIM TO ANY PARTICULAR FONT, STYLE, SIZE, OR COLOR.

FOR COSMETICS, NAMELY, LIPSTICK, LIPLINER, LIP GLOSS, FOUNDATION MAKEUP, PRESSED POWDER COMPACTS, LOOSE FACE POWDER, EYE SHADOW, EYE LINERS, EYEBROW AND LIP TINTS, MASCARA, CONCEALERS, BLUSH, BRONZERS, FACIAL HIGHLIGHTERS, EYEBROW DEFINERS, NAMELY, EYEBROW PENCILS AND POMADES; MAKEUP REMOVER; SKINCARE PRODUCTS, NAMELY, MOISTURIZERS, EYE CREAMS, FACIAL CLEANSERS; NAIL ENAMEL, NAIL POLISH, NAIL POLISH REMOVER (U.S. CLS. 1, 4, 6, 50, 51 AND 52).

SAIMA MAKHDOOM, EXAMINING ATTORNEY

SN 85-175,811. PARFUMS ROCHAS S.A.S., PARIS, FRANCE, FILED 11-12-2010.

EAU DE ROCHAS

Rock Shine

SN 85-172,377. COLLE PRODUCTS LLC, MOUNTAIN LAKES, NJ. FILED 11-9-2010.

THE MARK CONSISTS OF STANDARD CHARACTERS WITHOUT CLAIM TO ANY PARTICULAR FONT, STYLE, SIZE, OR COLOR.

NO CLAIM IS MADE TO THE EXCLUSIVE RIGHT TO USE "SHINE", APART FROM THE MARK AS SHOWN.

FOR CLEANER FOR USE ON JEWELRY (U.S. CLS. 1, 4, 6, 50, 51 AND 52).

DAVID TAYLOR, EXAMINING ATTORNEY

THE MARK CONSISTS OF STANDARD CHARACTERS WITHOUT CLAIM TO ANY PARTICULAR FONT, STYLE, SIZE, OR COLOR.

OWNER OF U.S. REG. NOS. 734,683 AND 3,110,929.

NO CLAIM IS MADE TO THE EXCLUSIVE RIGHT TO USE "EAU", APART FROM THE MARK AS SHOWN.

THE ENGLISH TRANSLATION OF "EAU DE ROCHAS" IN THE MARK IS "WATER OF ROCHAS".

FOR PERFUMERIES, BATH GEL, SHOWER GEL, FOAM BATH AND PERSONAL DEODORANTS; TOILET SOAPS (U.S. CLS. 1, 4, 6, 50, 51 AND 52).

PAUL MORENO, EXAMINING ATTORNEY

**CLASS 3—(Continued).**

SN 85-177,615. CALEEL + HAYDEN LLC, DENVER, CO. FILED 11-16-2010.



OWNER OF U.S. REG. NOS. 3,411,273, 3,468,456 AND 3,798,184.

THE MARK CONSISTS OF THE WORD "GLOPROFESSIONAL", WITH "GLO" STYLIZED WITHIN A SHADED CIRCLE.

FOR SKIN CARE PRODUCTS, NAMELY, CLEANSING CREAMS, CLEANSING BARS, FACIAL SOAPS, FACIAL MOISTURIZER, FACIAL SCRUBS, REVITALIZING FACIAL MASKS, TONERS, LIGHTENERS, MOISTURIZERS, AND SKIN CREAMS, GLAMOUR AND BEAUTY PRODUCTS, NAMELY, EYE COLORS IN THE NATURE OF EYE DEFINING PENCILS, EYEBROW PENCILS, MASCARA, LIPSTICKS, LIP GLOSS, LIP LINER PENCILS, CHEEK COLORS IN THE NATURE OF ROUGE, LOOSE FACE POWDER, PRESSED FACE POWDER, FACIAL HIGHLIGHTER IN THE NATURE OF CONCEALERS AND ILLUMINATORS, CREAM AND LIQUID FOUNDATIONS, BLEMISH CONCEALERS, SKIN CONCEALERS AND CAMOUFLAGE SKIN CONCEALERS (U.S. CLS. 1, 4, 6, 50, 51 AND 52).

FIRST USE 4-21-2006; IN COMMERCE 7-1-2010.  
TAMARA FRAZIER, EXAMINING ATTORNEY

SN 85-180,641. HEINZ, JEFFREY T., DBA INFINITÉ NATURAL COLLAGEN, CORONA, CA. FILED 11-19-2010.

## Infinité Natural Collagen

THE MARK CONSISTS OF STANDARD CHARACTERS WITHOUT CLAIM TO ANY PARTICULAR FONT, STYLE, SIZE, OR COLOR.

NO CLAIM IS MADE TO THE EXCLUSIVE RIGHT TO USE "NATURAL COLLAGEN", APART FROM THE MARK AS SHOWN.

THE ENGLISH TRANSLATION OF "INFINITÉ" IN THE MARK IS "INFINITY".

FOR EXFOLIANTS FOR SKIN CONTAINING COLLAGEN; FACIAL CLEANSERS CONTAINING COLLAGEN; FACIAL CREAMS CONTAINING COLLAGEN (U.S. CLS. 1, 4, 6, 50, 51 AND 52).

FIRST USE 11-1-2009; IN COMMERCE 9-1-2010.  
MATTHEW EINSTEIN, EXAMINING ATTORNEY

**CLASS 3—(Continued).**

SN 85-181,348. THOMAS C. FORD, LOS ANGELES, CA. FILED 11-19-2010.

## TOM FORD VIOLET BLONDE

THE MARK CONSISTS OF STANDARD CHARACTERS WITHOUT CLAIM TO ANY PARTICULAR FONT, STYLE, SIZE, OR COLOR.

OWNER OF U.S. REG. NOS. 3,076,975, 3,544,448 AND OTHERS.

NO CLAIM IS MADE TO THE EXCLUSIVE RIGHT TO USE "VIOLET", APART FROM THE MARK AS SHOWN.

THE NAME "TOM FORD" IN THE MARK IDENTIFIES THOMAS C. FORD, A LIVING INDIVIDUAL WHOSE CONSENT IS OF RECORD.

FOR FRAGRANCES FOR PERSONAL USE; NON-MEDICATED SKIN CARE PREPARATIONS (U.S. CLS. 1, 4, 6, 50, 51 AND 52).

DAVID H. STINE, EXAMINING ATTORNEY

SN 85-181,594. ANDUJAR, HECTOR, CHICAGO, IL. FILED 11-19-2010.



NO CLAIM IS MADE TO THE EXCLUSIVE RIGHT TO USE "SPA AT HOME", APART FROM THE MARK AS SHOWN.

THE NAME(S), PORTRAIT(S), AND/OR SIGNATURE(S) SHOWN IN THE MARK DOES NOT IDENTIFY A PARTICULAR LIVING INDIVIDUAL.

THE COLOR(S) BLACK, WHITE, BEIGE, MAGENTA, PINK, BLUE AND GOLD IS/ARE CLAIMED AS A FEATURE OF THE MARK.

THE MARK CONSISTS OF A BLACK RECTANGLE CONTAINING A GENIE WITH A STREAM OF SMOKE EMERGING FROM A BOTTLE. THE WORDING "ICKY FEEL GOOD SPA AT HOME" IS IN MAGENTA AT THE TOP OF THE RECTANGLE. THE WORDING "POTION" IS IN WHITE NEAR THE BOTTOM RIGHT OF THE SMOKE. THE GENIE HAS BEIGE SKIN, BLACK HAIR, BLACK EYEBROWS AND EYELASHES, AND EYES WITH BLUE IRISES,

**CLASS 3—(Continued).**

BLACK AND WHITE PUPILS, AND WHITE OUTSIDE THE IRIS OF THE EYE. THE GENIE'S COSTUME IS MAGENTA WITH PINK TRIM ON THE TOP OF THE COSTUME. THE CIRCLE BEHIND THE GENIE, THE SMOKE, AND THE WORDING "NICKY ICKY" ARE IN BLUE. THE WORDING "NICKY" IS ON THE LEFT SIDE OF THE BOTTLE AND "ICKY" IS ON THE RIGHT SIDE OF THE BOTTLE. THERE ARE WHITE SPARKLES AMONG THE BLUE SMOKE. THE BOTTLE, WHICH IS BLUE WITH A GOLD BASE, HAS DETAILING IN GOLD, BLUE AND WHITE.

FOR AFTER-SUN LOTIONS; BEAUTY LOTIONS; BODY MASK LOTION; COSMETIC PREPARATIONS FOR SKIN CARE; FACE AND BODY LOTIONS; FACIAL BEAUTY MASKS; SKIN LOTION (U.S. CLS. 1, 4, 6, 50, 51 AND 52).

ELLEN B. AWRICH, EXAMINING ATTORNEY

SN 85-188,908. GHC SYSTEMS INC., SASKATOON SASKATCHEWAN, CANADA, FILED 12-2-2010.

# ONE SHOT

THE MARK CONSISTS OF STANDARD CHARACTERS WITHOUT CLAIM TO ANY PARTICULAR FONT, STYLE, SIZE, OR COLOR.

OWNER OF CANADA REG. NO. TMA801845, DATED 7-8-2011, EXPIRES 7-8-2026.

FOR NON-MEDICATED PROTEIN HAIR TREATMENT; HAIR SHAMPOO, HAIR CONDITIONER; HAIR STYLING PRODUCTS, NAMELY, HAIR GEL, HAIR MOUSSE AND HAIR SPRAY; HAIR WAX, HAIR POMADES, HAIR CREAMS; HAIR COLOR; HAIR CURLING PREPARATIONS; HAIR STRAIGHTENING PREPARATIONS (U.S. CLS. 1, 4, 6, 50, 51 AND 52).

BERYL GARDNER, EXAMINING ATTORNEY

SN 85-190,167. BON VITAL INCORPORATED, HARTLAND, WI. FILED 12-3-2010.

# PT PRO

THE MARK CONSISTS OF STANDARD CHARACTERS WITHOUT CLAIM TO ANY PARTICULAR FONT, STYLE, SIZE, OR COLOR.

NO CLAIM IS MADE TO THE EXCLUSIVE RIGHT TO USE "PT", APART FROM THE MARK AS SHOWN.

FOR SKIN CARE PREPARATIONS, NAMELY, SKIN CREAMS, OILS, BALMS, NON-MEDICATED OINTMENTS, LOTIONS, GELS, AND BODY POLISH (U.S. CLS. 1, 4, 6, 50, 51 AND 52).

AMY HELLA, EXAMINING ATTORNEY

**CLASS 3—(Continued).**

SN 85-193,478. ESTREA USA, LLC, RINCON, ID. FILED 12-8-2010.



THE MARK CONSISTS OF A STYLIZED LETTER "E" FACING BACKWARD FOLLOWING BY A STYLIZED LETTER "E" FACING FORWARD ABOVE THE WORD "ESTREA".

FOR COSMETIC CREAMS FOR SKIN CARE (U.S. CLS. 1, 4, 6, 50, 51 AND 52).

FIRST USE 2-8-2010; IN COMMERCE 2-8-2010.

JOHN GARTNER, EXAMINING ATTORNEY

SN 85-194,295. JOSEPH'S FLOORING, INC., WINSLOW, ME. FILED 12-9-2010.



NO CLAIM IS MADE TO THE EXCLUSIVE RIGHT TO USE "ECO CLEAN", APART FROM THE MARK AS SHOWN.

THE COLOR(S) GREEN IS/ARE CLAIMED AS A FEATURE OF THE MARK.

THE MARK CONSISTS OF 3 LEAVES AND THE WORD "ECOCLEAN". THE FIRST LEAF IS A DARK GREEN, THE SECOND LEAF IS A MEDIUM GREEN, AND THE THIRD LEAF IS A LIGHTER GREEN. THE WORD "ECOCLEAN", IS LOCATED UNDER THE 3 LEAVES. THE FIRST 3 LETTERS "E","C","O" ARE GREEN, CONSISTENT IN COLOR WITH THE FIRST LEAF. THE LAST FIVE LETTERS "C","L","E","A","N" ARE A DARKER GREEN AND THE FONT IS BOLD.

FOR ALL-PURPOSE CLEANERS (U.S. CLS. 1, 4, 6, 50, 51 AND 52).

FIRST USE 6-0-2010; IN COMMERCE 11-0-2010.

ANNE MADDEN, EXAMINING ATTORNEY

**CLASS 3—(Continued).**

SN 85-195,840. GINGER CLEAN, INC., RAPID CITY, MI.  
FILED 12-11-2010.

**GINGER CLEAN**

THE MARK CONSISTS OF STANDARD CHARACTERS WITHOUT CLAIM TO ANY PARTICULAR FONT, STYLE, SIZE, OR COLOR.

FOR CLEANING PREPARATIONS FOR CLEANING SURFACES (U.S. CLS. 1, 4, 6, 50, 51 AND 52).

FIRST USE 1-1-2010; IN COMMERCE 1-1-2010.

JOHN DALIER, EXAMINING ATTORNEY

SN 85-198,282. JENNIFER COSMETICS, INC., NEW YORK, NY. FILED 12-15-2010.



THE MARK CONSISTS OF THE WORD "JENNIFER" WITH A FLOWER AND LONG STEM ABOVE THE LETTERS "ENN".

FOR BABY LOTION; COSMETIC PENCILS; COSMETIC PREPARATIONS FOR EYE LASHES; EYE CREAM; EYE LINER; EYE MAKE-UP; EYE MAKE-UP REMOVER; EYE PENCILS; EYE SHADOWS; EYEBROW PENCILS; GEL EYE MASKS; HAIR DYES; LIP GLOSS; LIP GLOSS PALATTE; LIP LINER; LIPSTICK CASES; LIPSTICKS; MAKE-UP KITS COMPRISED OF LIPSTICK, PERFUME, EYE AND LIP PENCIL, MAKEUP, NAIL ENAMEL, AND MASCARA; MASCARA; MASCARAS; NAIL ENAMEL; NAIL POLISH; NAIL POLISH REMOVERS; OILS FOR PERFUMES AND SCENTS; PERFUME (U.S. CLS. 1, 4, 6, 50, 51 AND 52).

FIRST USE 9-19-1995; IN COMMERCE 12-2-1995.

LEIGH CAROLINE CASE, EXAMINING ATTORNEY

SN 85-200,262. COTY GERMANY GMBH, MAINZ, FED REP GERMANY, FILED 12-17-2010.

**RIMMEL VOLUME ACCELERATOR**

THE MARK CONSISTS OF STANDARD CHARACTERS WITHOUT CLAIM TO ANY PARTICULAR FONT, STYLE, SIZE, OR COLOR.

OWNER OF U.S. REG. NOS. 3,019,608, 3,658,299 AND OTHERS.

NO CLAIM IS MADE TO THE EXCLUSIVE RIGHT TO USE "VOLUME", APART FROM THE MARK AS SHOWN.

FOR COSMETICS (U.S. CLS. 1, 4, 6, 50, 51 AND 52).

DOUGLAS LEE, EXAMINING ATTORNEY

**CLASS 3—(Continued).**

SN 85-200,307. THE PROCTER & GAMBLE COMPANY, CINCINNATI, OH. FILED 12-17-2010.

**RICH CLEAN**

THE MARK CONSISTS OF STANDARD CHARACTERS WITHOUT CLAIM TO ANY PARTICULAR FONT, STYLE, SIZE, OR COLOR.

NO CLAIM IS MADE TO THE EXCLUSIVE RIGHT TO USE "CLEAN", APART FROM THE MARK AS SHOWN.

FOR HAIR CARE PREPARATIONS, NAMELY, SHAMPOOS AND HAIR CONDITIONERS; NON-MEDICATED HAIR SCALP TREATMENTS, NAMELY, RESTRUCTURIZERS AND SCALP CONDITIONERS, HAIR STYLING PRODUCTS, IN THE FORM OF SPRAYS, SPRAY GELS, GELS, MOUSSES, CREAMS, LOTIONS, POMADES AND WAXES (U.S. CLS. 1, 4, 6, 50, 51 AND 52).

JOHN KELLY, EXAMINING ATTORNEY

SN 85-204,117. NAMASTE LABORATORIES, L.L.C., BLUE ISLAND, IL. FILED S.R. 12-22-2010; AM. P.R. 8-31-2011.



OWNER OF U.S. REG. NOS. 3,795,594, 3,809,734 AND 3,913,142.

NO CLAIM IS MADE TO THE EXCLUSIVE RIGHT TO USE "ANTI-FRIZZ OLIVE OIL GLOSSING POLISHER", APART FROM THE MARK AS SHOWN.

THE MARK CONSISTS OF THE WORDS "ANTI-FRIZZ" IN A BANNER ABOVE THE WORDS "OLIVE OIL" WITH A RECTANGLE UNDERNEATH THE WORDS WITH OLIVES ON AN OLIVE BRANCH INSIDE THE RECTANGLE BOX, UNDERNEATH THE BOX ARE THE WORDS "GLOSSING POLISHER".

FOR HAIR CARE PREPARATIONS (U.S. CLS. 1, 4, 6, 50, 51 AND 52).

FIRST USE 7-31-2006; IN COMMERCE 7-31-2006.

KATHRYN COWARD, EXAMINING ATTORNEY



**CLASS 3—(Continued).**

SN 85-204,254. NAMASTE LABORATORIES, L.L.C., BLUE ISLAND, IL. FILED 12-22-2010.



OWNER OF U.S. REG. NOS. 3,795,594, 3,809,734 AND 3,913,142.

NO CLAIM IS MADE TO THE EXCLUSIVE RIGHT TO USE "OLIVE OIL PROFESSIONAL", APART FROM THE MARK AS SHOWN.

THE MARK CONSISTS OF THE WORDS "OLIVE OIL" WITH THE WORD "PROFESSIONAL" UNDERNEATH "OLIVE OIL", WITH AN OLIVE BRANCH WITH THREE OLIVES UNDERNEATH THE WORD "PROFESSIONAL".

FOR HAIR CARE PREPARATIONS (U.S. CLS. 1, 4, 6, 50, 51 AND 52).

FIRST USE 10-31-2006; IN COMMERCE 10-31-2006.  
KATHRYN COWARD, EXAMINING ATTORNEY

SN 85-212,391. DISNEY ENTERPRISES, INC., BURBANK, CA. FILED 1-6-2011.

## D23

THE MARK CONSISTS OF STANDARD CHARACTERS WITHOUT CLAIM TO ANY PARTICULAR FONT, STYLE, SIZE, OR COLOR.

OWNER OF U.S. REG. NOS. 3,825,617, 3,912,333 AND OTHERS.

FOR COSMETICS; DENTIFRICES; NON-MEDICATED TOILETRIES; FRAGRANCES; PERFUMES (U.S. CLS. 1, 4, 6, 50, 51 AND 52).

SOPHIA S. KIM, EXAMINING ATTORNEY

SN 85-216,845. COSMOS CORPORATION, WENTZVILLE, MO. FILED 1-13-2011.

## TROPICLEAN FRESH BREEZE NATURE'S SOLUTION

THE MARK CONSISTS OF STANDARD CHARACTERS WITHOUT CLAIM TO ANY PARTICULAR FONT, STYLE, SIZE, OR COLOR.

OWNER OF U.S. REG. NOS. 2,959,292, 3,834,668 AND 3,834,669.

FOR CARPET CLEANING PREPARATIONS; CARPET CLEANING PREPARATIONS WITH DEODORIZERS; STAIN REMOVING PREPARATIONS; STAIN REMOVING PREPARATIONS WITH DEODORIZERS; PET STAIN REMOVERS (U.S. CLS. 1, 4, 6, 50, 51 AND 52).

DANNEAN HETZEL, EXAMINING ATTORNEY

**CLASS 3—(Continued).**

SN 85-224,375. CAMBRA LLC, DBA ORAL BIOTECH, ALBANY, OR. FILED 1-24-2011.

## HA NANO

THE MARK CONSISTS OF STANDARD CHARACTERS WITHOUT CLAIM TO ANY PARTICULAR FONT, STYLE, SIZE, OR COLOR.

NO CLAIM IS MADE TO THE EXCLUSIVE RIGHT TO USE "HA", APART FROM THE MARK AS SHOWN.

FOR TOOTHPASTE AND MOUTHWASHES (U.S. CLS. 1, 4, 6, 50, 51 AND 52).

FIRST USE 1-21-2011; IN COMMERCE 1-21-2011.

TARA PATE, EXAMINING ATTORNEY

SN 85-225,272. LANCOME PARFUMS ET BEAUTE & CIE, PARIS, FRANCE, FILED 1-25-2011.

## ROUGE IN LOVE

THE MARK CONSISTS OF STANDARD CHARACTERS WITHOUT CLAIM TO ANY PARTICULAR FONT, STYLE, SIZE, OR COLOR.

PRIORITY CLAIMED UNDER SEC. 44(D) ON FRANCE APPLICATION NO. 10/3770814, FILED 10-1-2010, REG. NO. 10/3770814, DATED 10-1-2010, EXPIRES 10-1-2020.

NO CLAIM IS MADE TO THE EXCLUSIVE RIGHT TO USE "ROUGE", APART FROM THE MARK AS SHOWN.

FOR COSMETICS AND MAKEUP (U.S. CLS. 1, 4, 6, 50, 51 AND 52).

BARBARA BROWN, EXAMINING ATTORNEY

SN 85-229,271. DC LABS, CARLSBAD, CA. FILED 1-28-2011.

## OVATION CELL THERAPY

THE MARK CONSISTS OF STANDARD CHARACTERS WITHOUT CLAIM TO ANY PARTICULAR FONT, STYLE, SIZE, OR COLOR.

NO CLAIM IS MADE TO THE EXCLUSIVE RIGHT TO USE "CELL THERAPY", APART FROM THE MARK AS SHOWN.

FOR HAIR CARE PRODUCTS, NAMELY, SHAMPOOS, CONDITIONERS, AND STYLING PREPARATIONS, STYLING SPRAY, STYLING LOTION, STYLING GEL AND STYLING MOUSSE (U.S. CLS. 1, 4, 6, 50, 51 AND 52).

FIRST USE 9-0-2007; IN COMMERCE 9-0-2007.

PAUL F. GAST, EXAMINING ATTORNEY

**CLASS 3—(Continued).**

SN 85-229,327. DC LABS, CARLSBAD, CA. FILED 1-28-2011.



THE COLOR(S) BLUE, BROWN AND WHITE IS/ARE CLAIMED AS A FEATURE OF THE MARK.

THE MARK CONSISTS OF A BLUE OUTER CIRCLE AROUND A BROWN INNER CIRCLE WITH AN INTERIOR WHITE DESIGN OF CURVED LINES ABOVE THE WORD "OVATION" IN BLUE.

FOR HAIR CARE PRODUCTS, NAMELY, SHAMPOOS, CONDITIONERS, AND STYLING PREPARATIONS, STYLING SPRAY, STYLING LOTION, STYLING GEL AND STYLING MOUSSE (U.S. CLS. 1, 4, 6, 50, 51 AND 52).

FIRST USE 11-0-2007; IN COMMERCE 12-0-2007.  
PAUL F. GAST, EXAMINING ATTORNEY

---

SN 85-231,561. BOTICA COMERCIAL FARMACEUTICA LTDA, S. JOSE DOS PINHAIS PR, BRAZIL, FILED 2-1-2011.

# EUDORA

THE MARK CONSISTS OF STANDARD CHARACTERS WITHOUT CLAIM TO ANY PARTICULAR FONT, STYLE, SIZE, OR COLOR.

FOR ESSENTIAL OILS; COSMETICS, NAMELY, FACE MAKE-UP; EYE PENCILS, EYE SHADOWS, EYE LINER, MASCARA, LIPSTICK, LIP GLOSS, BLUSH; CREAMS, NAMELY, COSMETIC CREAMS, SKIN MOISTURIZING CREAMS, SUN TANNING CREAMS, SKIN CLEARING CREAMS; DENTIFRICES; DEODORANTS FOR PERSONAL USE; MAKE-UP PREPARATIONS; OILS FOR TOILET PURPOSES, NAMELY, BATH OILS, LAVENDER WATER, TOILET WATER; PERFUMERY; PERFUMES; SOAPS; SHAMPOOS; COSMETIC KITS, COMPRISED OF MAKE-UP; BEAUTY MASKS; COSMETIC MASKS; COSMETIC PENCILS; WIPES IMPREGNATED WITH COSMETIC LOTIONS (U.S. CLS. 1, 4, 6, 50, 51 AND 52).

CAROLINE WOOD, EXAMINING ATTORNEY

**CLASS 3—(Continued).**

SN 85-243,136. KATE SOMERVILLE SKIN CARE LLC, WEST HOLLYWOOD, CA. FILED 2-15-2011.

# CLINIC-TO-GO

THE MARK CONSISTS OF STANDARD CHARACTERS WITHOUT CLAIM TO ANY PARTICULAR FONT, STYLE, SIZE, OR COLOR.

NO CLAIM IS MADE TO THE EXCLUSIVE RIGHT TO USE "CLINIC", APART FROM THE MARK AS SHOWN.

FOR NON-MEDICATED COSMETIC SKIN CARE PRODUCTS, NAMELY, RESURFACING PEEL PADS TO BE APPLIED TO THE SKIN (U.S. CLS. 1, 4, 6, 50, 51 AND 52).  
NAPOLEON SHARMA, EXAMINING ATTORNEY

---

SN 85-243,490. IT'S A 10, INC., DEERFIELD BEACH, FL. FILED 2-16-2011.

# MIRACLE VOLUME SHAMPOO

THE MARK CONSISTS OF STANDARD CHARACTERS WITHOUT CLAIM TO ANY PARTICULAR FONT, STYLE, SIZE, OR COLOR.

OWNER OF U.S. REG. NOS. 3,760,933, 3,760,956 AND 3,761,012.

NO CLAIM IS MADE TO THE EXCLUSIVE RIGHT TO USE "VOLUME SHAMPOO", APART FROM THE MARK AS SHOWN.

FOR HAIR CARE PRODUCTS, NAMELY, SHAMPOOS (U.S. CLS. 1, 4, 6, 50, 51 AND 52).

INGA ERVIN, EXAMINING ATTORNEY

---

SN 85-243,502. IT'S A 10, INC., DEERFIELD BEACH, FL. FILED 2-16-2011.

# MIRACLE LEAVE-IN PLUS KERATIN

THE MARK CONSISTS OF STANDARD CHARACTERS WITHOUT CLAIM TO ANY PARTICULAR FONT, STYLE, SIZE, OR COLOR.

OWNER OF U.S. REG. NOS. 3,760,933, 3,760,956 AND 3,761,012.

NO CLAIM IS MADE TO THE EXCLUSIVE RIGHT TO USE "LEAVE-IN PLUS KERATIN", APART FROM THE MARK AS SHOWN.

FOR HAIR CARE PRODUCTS, NAMELY, STYLING, NOURISHING AND PROTECTIVE SPRAYS (U.S. CLS. 1, 4, 6, 50, 51 AND 52).

FIRST USE 2-1-2011; IN COMMERCE 2-1-2011.

INGA ERVIN, EXAMINING ATTORNEY

**CLASS 3—(Continued).**

SN 85-243,515. IT'S A 10, INC., DEERFIELD BEACH, FL.  
FILED 2-16-2011.

**MIRACLE SHAMPOO PLUS  
KERATIN**

THE MARK CONSISTS OF STANDARD CHARACTERS  
WITHOUT CLAIM TO ANY PARTICULAR FONT, STYLE,  
SIZE, OR COLOR.

OWNER OF U.S. REG. NOS. 3,760,933, 3,760,956 AND  
3,761,012.

NO CLAIM IS MADE TO THE EXCLUSIVE RIGHT TO  
USE "SHAMPOO PLUS KERATIN", APART FROM THE  
MARK AS SHOWN.

FOR HAIR CARE PRODUCTS, NAMELY, SHAMPOOS  
(U.S. CLS. 1, 4, 6, 50, 51 AND 52).

INGA ERVIN, EXAMINING ATTORNEY

**CLASS 3—(Continued).**

SN 85-251,430. AZTEC FINANCE CORPORATION LIMITED,  
PORT LOUIS, MAURITIUS, FILED 2-25-2011.

**BUENAVISTA ACE**

THE MARK CONSISTS OF STANDARD CHARACTERS  
WITHOUT CLAIM TO ANY PARTICULAR FONT, STYLE,  
SIZE, OR COLOR.

PRIORITY CLAIMED UNDER SEC. 44(D) ON ERPN  
CMNTY TM OFC APPLICATION NO. 9651506, FILED 1-11-  
2011, REG. NO. 9651506, DATED 6-17-2011, EXPIRES 1-11-  
2021.

FOR PERFUMES; TOILET WATERS; EAU DE CO-  
LOGNE; ESSENTIAL OILS; COSMETICS; TOILET PRE-  
PARATIONS, NAMELY, AFTERSHAVE LOTIONS;  
SOAPS; ANTIPERSPIRANTS; DEODORANTS FOR PER-  
SONAL BODY CARE USE; NON-MEDICATED PRE-  
PARATIONS FOR THE HAIR, THE SCALP, THE SKIN  
AND THE NAILS; SHAMPOOS; CONDITIONERS; HAND  
LOTIONS AND BODY LOTIONS; DENTIFRICES; SHAV-  
ING PREPARATIONS; DYES FOR THE HAIR (U.S. CLS.  
1, 4, 6, 50, 51 AND 52).

FLORENTINA BLANDU, EXAMINING ATTORNEY

SN 85-273,762. EXCEPTIONAL PARFUMS, LLC, DEER  
PARK, NY. FILED 3-22-2011.

**PRESCRIPTION: YOUTH  
SKINLABS**

THE MARK CONSISTS OF STANDARD CHARACTERS  
WITHOUT CLAIM TO ANY PARTICULAR FONT, STYLE,  
SIZE, OR COLOR.

NO CLAIM IS MADE TO THE EXCLUSIVE RIGHT TO  
USE "SKINLABS", APART FROM THE MARK AS SHOWN.

FOR SKINCARE PRODUCTS, NAMELY, CREAMS,  
GELS AND LOTIONS FOR THE FACE, EYES AND  
BODY; FACIAL CLEANSERS, WASHES AND MOISTUR-  
IZERS; NON-MEDICATED ANTI-AGING CREAMS AND  
SERUMS (U.S. CLS. 1, 4, 6, 50, 51 AND 52).

JEAN IM, EXAMINING ATTORNEY

SN 85-245,671. COTY GERMANY GMBH, MAINZ, FED REP  
GERMANY, FILED 2-18-2011.

**RIMMEL LASH ACCELERATOR**

THE MARK CONSISTS OF STANDARD CHARACTERS  
WITHOUT CLAIM TO ANY PARTICULAR FONT, STYLE,  
SIZE, OR COLOR.

OWNER OF U.S. REG. NOS. 2,976,346, 3,722,596 AND  
OTHERS.

NO CLAIM IS MADE TO THE EXCLUSIVE RIGHT TO  
USE "LASH ACCELERATOR", APART FROM THE MARK  
AS SHOWN.

FOR COSMETICS (U.S. CLS. 1, 4, 6, 50, 51 AND 52).

FIRST USE 9-30-2010; IN COMMERCE 9-30-2010.

DOUGLAS LEE, EXAMINING ATTORNEY

SN 85-278,851. ACME SPECIALTY PRODUCTS, LLC, TAM-  
PA, FL. FILED 3-28-2011.

**SEXUAL FLAVORS**

THE MARK CONSISTS OF STANDARD CHARACTERS  
WITHOUT CLAIM TO ANY PARTICULAR FONT, STYLE,  
SIZE, OR COLOR.

FOR NON-MEDICATED BREATH FRESHENING  
STRIPS, NAMELY, TASTE MASKING DISSOLVING  
STRIPS FOR ORAL CONSUMPTION (U.S. CLS. 1, 4, 6,  
50, 51 AND 52).

FIRST USE 5-29-2011; IN COMMERCE 6-7-2011.

ASMAT KHAN, EXAMINING ATTORNEY

**CLASS 3—(Continued).**

SN 85-286,636. REVLON CONSUMER PRODUCTS CORPORATION, NEW YORK, NY. FILED 4-5-2011.

**ALMAY INTENSE I-COLOR  
SHIMMER-I**

THE MARK CONSISTS OF STANDARD CHARACTERS WITHOUT CLAIM TO ANY PARTICULAR FONT, STYLE, SIZE, OR COLOR.

OWNER OF U.S. REG. NOS. 980,494, 3,261,921 AND OTHERS.

NO CLAIM IS MADE TO THE EXCLUSIVE RIGHT TO USE "EYE COLOR", APART FROM THE MARK AS SHOWN.

FOR COSMETICS; MAKE-UP (U.S. CLS. 1, 4, 6, 50, 51 AND 52).

DAWN HAN, EXAMINING ATTORNEY

**CLASS 3—(Continued).**

SN 85-287,865. REVLON CONSUMER PRODUCTS CORPORATION, NEW YORK, NY. FILED 4-6-2011.

**ALMAY INTENSE I-COLOR  
ESSENTIAL-I**

THE MARK CONSISTS OF STANDARD CHARACTERS WITHOUT CLAIM TO ANY PARTICULAR FONT, STYLE, SIZE, OR COLOR.

OWNER OF U.S. REG. NOS. 980,494, 3,261,921 AND OTHERS.

NO CLAIM IS MADE TO THE EXCLUSIVE RIGHT TO USE "EYE COLOR", APART FROM THE MARK AS SHOWN.

FOR COSMETICS; MAKE-UP (U.S. CLS. 1, 4, 6, 50, 51 AND 52).

DAWN HAN, EXAMINING ATTORNEY

SN 85-287,592. SENSPA, LLC, SAN FRANCISCO, CA. FILED 4-6-2011.



SN 85-296,244. WAHIBA, BEN MOKDAD, AKA VALERIE BORDEAUX, MCKINNEY, TX. FILED 4-15-2011.

**VALERIE BORDEAUX**

OWNER OF U.S. REG. NOS. 3,958,744, 3,979,089 AND OTHERS.

THE MARK CONSISTS OF THE LETTERS "SEN" VERTICALLY AND THE LETTERS "ZEN" HORIZONTALLY AND INTERLOCKING IN STYLIZED FONT WITHIN A CIRCULAR BORDER.

FOR PERSONAL CARE PRODUCTS, NAMELY, NON-MEDICATED SKIN SERUMS, SKIN CLEANSERS, SKIN MOISTURIZERS, EYE CREAMS, HAIR AND SCALP TREATMENT, BODY LOTIONS, AND FACIAL SCRUBS (U.S. CLS. 1, 4, 6, 50, 51 AND 52).

FIRST USE 4-1-2010; IN COMMERCE 4-1-2010.

KYLE PEETE, EXAMINING ATTORNEY

THE MARK CONSISTS OF STANDARD CHARACTERS WITHOUT CLAIM TO ANY PARTICULAR FONT, STYLE, SIZE, OR COLOR.

THE NAME "VALERIE BORDEAUX" DOES NOT IDENTIFY A LIVING INDIVIDUAL.

FOR COSMETICS (U.S. CLS. 1, 4, 6, 50, 51 AND 52).

FIRST USE 1-1-2006; IN COMMERCE 1-1-2006.

ASMAT KHAN, EXAMINING ATTORNEY

**CLASS 3—(Continued).**

SN 85-297,259. SHIRAN PTY LTD, HALLAM, AUSTRALIA, FILED 4-17-2011.



PRIORITY CLAIMED UNDER SEC. 44(D) ON AUSTRALIA APPLICATION NO. 1408880, FILED 2-24-2011.

THE MARK CONSISTS OF THE WORDING "ISTAR" AND AN IMAGE OF A STAR.

THE WORDING "ISTAR" HAS NO MEANING IN A FOREIGN LANGUAGE.

FOR BEAUTY CREAMS FOR BODY CARE; BEAUTY GELS, LOTIONS, MILKS, SERUMS AND SOAP; BODY AND BEAUTY CARE COSMETICS; HAIR CARE PRODUCTS AND PREPARATIONS BEING LOTIONS, CONDITIONERS, CREAMS AND SHAMPOOS; NON-MEDICATED HAIR CARE PREPARATIONS; NON-MEDICATED PREPARATIONS FOR THE CARE OF SKIN, HAIR AND SCALP; HAIR WAX; COSMETIC CREAMS FOR SKIN CARE; COSMETIC HAIR DRESSING PREPARATIONS; COSMETIC HAND CREAMS; COSMETIC MILKS; COSMETIC NOURISHING CREAMS; COSMETIC OILS; LOTIONS FOR COSMETIC PURPOSES; SKIN AND BODY TOPICAL LOTIONS, CREAMS AND OILS FOR COSMETIC USE; MASSAGE OILS; ESSENTIAL OILS; FRAGRANCES AND PERFUMERY; SHAVING CREAMS; SHAVING FOAM; SHAVING GEL; SHAVING LOTIONS; NON-MEDICATED TOILETRIES; SOAPS FOR PERSONAL USE; SHOWER AND BATH GEL; DISPOSABLE WIPES IMPREGNATED WITH CLEANSING CHEMICALS OR COMPOUNDS FOR PERSONAL HYGIENE; FACIAL CLEANING PREPARATION, NAMELY, SALICYLIC ACNE CLEANSER NOT FOR MEDICAL PURPOSES; NON-MEDICATED ACNE TREATMENT PREPARATIONS; NON-MEDICATED SKIN CREAMS; NON-MEDICATED COSMETIC CREAMS FOR SKIN AND HAIR CARE (U.S. CLS. 1, 4, 6, 50, 51 AND 52).

SANJEEV VOHRA, EXAMINING ATTORNEY

**CLASS 3—(Continued).**

SN 85-299,503. AMERICAN REALTY PUBLISHING GROUP, INC., FORT LAUDERDALE, FL. FILED 4-20-2011.

LA VIE FABULEUX

THE MARK CONSISTS OF STANDARD CHARACTERS WITHOUT CLAIM TO ANY PARTICULAR FONT, STYLE, SIZE, OR COLOR.

THE ENGLISH TRANSLATION OF "LA VIE FABULEUX" IN THE MARK IS "THE FABULOUS LIFE".

FOR PERFUMES (U.S. CLS. 1, 4, 6, 50, 51 AND 52).

FIRST USE 2-28-2011; IN COMMERCE 2-28-2011.

DAVID HOFFMAN, EXAMINING ATTORNEY

SN 85-298,437. REVLOX CONSUMER PRODUCTS CORPORATION, NEW YORK, NY. FILED 4-19-2011.



THE MARK CONSISTS OF THE DESIGN OF AN UMBRELLA AND RAINDROPS.

FOR DEODORANTS AND ANTIPERSPIRANTS (U.S. CLS. 1, 4, 6, 50, 51 AND 52).

DAWN HAN, EXAMINING ATTORNEY



THE MARK CONSISTS OF THE DESIGN OF AN ALARM CLOCK WITH THE NUMERALS "48" ON ITS FACE.

FOR DEODORANTS AND ANTIPERSPIRANTS (U.S. CLS. 1, 4, 6, 50, 51 AND 52).

DAWN HAN, EXAMINING ATTORNEY

**CLASS 3—(Continued).**

SN 85-299,755. REVLON CONSUMER PRODUCTS CORPORATION, NEW YORK, NY. FILED 4-20-2011.



THE MARK CONSISTS OF THE DESIGN OF A DUMB-BELL.  
FOR DEODORANTS AND ANTIPERSPIRANTS (U.S. CLS. 1, 4, 6, 50, 51 AND 52).  
DAWN HAN, EXAMINING ATTORNEY

SN 85-299,765. CARPRECIATE, LLC, BROWN DEER, WI. FILED 4-20-2011.



THE MARK CONSISTS OF THE WORD "CARPRECIATE" SURROUNDED BY AN OUTLINE OF A CAR.  
FOR AUTOMOTIVE CLEANING PREPARATIONS (U.S. CLS. 1, 4, 6, 50, 51 AND 52).  
ASMAT KHAN, EXAMINING ATTORNEY

**CLASS 3—(Continued).**

SN 85-300,179. ANDERSON, KATHY L., D.O., CLEAR-WATER, FL. FILED 4-20-2011.



OWNER OF U.S. REG. NO. 3,910,521.  
NO CLAIM IS MADE TO THE EXCLUSIVE RIGHT TO USE "NOBURN", APART FROM THE MARK AS SHOWN.  
THE COLOR(S) YELLOW, WHITE, LIGHT YELLOW, BLUE, LIGHT BLUE IS/ARE CLAIMED AS A FEATURE OF THE MARK.  
THE MARK CONSISTS OF A YELLOW SUN WITH LIGHT YELLOW RAYS WITH THE WORDING "NOBURN" IN BLUE WITH A WHITE OUTLINE IN THE CENTER OF THE SUN AND BELOW IS THE WORDING "SPORTSCREEN" IN LIGHT BLUE WITH WHITE OUTLINE.  
FOR SUN SCREEN (U.S. CLS. 1, 4, 6, 50, 51 AND 52).  
FIRST USE 3-29-2010; IN COMMERCE 3-29-2010.  
JENNY PARK, EXAMINING ATTORNEY

SN 85-300,590. ZO SKIN HEALTH, INC., DEL MAR, CA. FILED 4-20-2011.

**ZO RADICAL PEEL**

THE MARK CONSISTS OF STANDARD CHARACTERS WITHOUT CLAIM TO ANY PARTICULAR FONT, STYLE, SIZE, OR COLOR.  
OWNER OF U.S. REG. NOS. 3,443,711 AND 3,443,712.  
NO CLAIM IS MADE TO THE EXCLUSIVE RIGHT TO USE "PEEL", APART FROM THE MARK AS SHOWN.  
FOR ANTI-AGING CREAMS; ANTI-WRINKLE CREAMS; COSMETIC CREAMS FOR SKIN CARE; SKIN TONERS; SKIN WHITENING CREAMS (U.S. CLS. 1, 4, 6, 50, 51 AND 52).  
ELLEN PERKINS, EXAMINING ATTORNEY

**CLASS 3—(Continued).**

SN 85-304,482. REVLON CONSUMER PRODUCTS CORPORATION, NEW YORK, NY. FILED 4-26-2011.

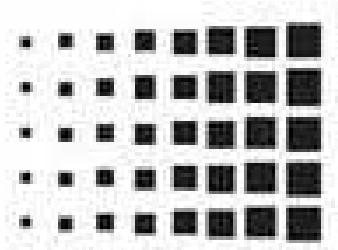

OWNER OF U.S. REG. NO. 3,880,036.  
THE MARK CONSISTS OF A STYLIZED DESIGN RESEMBLING LIGHT, CONSISTING OF FIVE ROWS OF SQUARES WITH EIGHT SQUARES IN EACH ROW, WITH THE SQUARES INCREASING IN SIZE FROM LEFT TO RIGHT.  
FOR COSMETICS AND MAKE-UP (U.S. CLS. 1, 4, 6, 50, 51 AND 52).

DAWN HAN, EXAMINING ATTORNEY

SN 85-305,078. TELEBRANDS CORP., FAIRFIELD, NJ. FILED 4-26-2011.

**DR. GEORGE'S PLAQUE BLAST**

THE MARK CONSISTS OF STANDARD CHARACTERS WITHOUT CLAIM TO ANY PARTICULAR FONT, STYLE, SIZE, OR COLOR.

NO CLAIM IS MADE TO THE EXCLUSIVE RIGHT TO USE "PLAQUE", APART FROM THE MARK AS SHOWN.

THE NAME(S), PORTRAIT(S), AND/OR SIGNATURE(S) SHOWN IN THE MARK IDENTIFIES GEORGE MADRAY, WHOSE CONSENT(S) TO REGISTER IS MADE OF RECORD.

FOR NON-MEDIATED PLAQUE REMOVAL SPRAY FOR PETS (U.S. CLS. 1, 4, 6, 50, 51 AND 52).  
CHRISTINA SOBRAL, EXAMINING ATTORNEY

SN 85-305,525. GADDE AND CHIRRA INC, WILMINGTON, DE. FILED 4-27-2011.

**SHAI**

THE MARK CONSISTS OF STANDARD CHARACTERS WITHOUT CLAIM TO ANY PARTICULAR FONT, STYLE, SIZE, OR COLOR.

FOR SOAP FOR FACE, BODY AND REMOVING MAKEUP; COSMETICS; COSMETIC PREPARATIONS FOR SKIN CARE (U.S. CLS. 1, 4, 6, 50, 51 AND 52).

JAMES GRIFFIN, EXAMINING ATTORNEY

**CLASS 3—(Continued).**

SN 85-306,449. LIMINOVA, INC., RANCHO SANTA FE, CA. FILED 4-27-2011.



THE COLOR(S) YELLOW, BLACK, GRAY, AND LIGHT GRAY IS/ARE CLAIMED AS A FEATURE OF THE MARK.  
THE MARK CONSISTS OF THE BLACK STYLIZED LETTERS "TC" WITH THE SMALLER BLACK STYLIZED WORD "PLUS" WITHIN THE "C" WITH FIVE SPRAY MARKS EXPANDING FROM THE "S" CHANGING COLOR FROM BLACK TO GRAY TO LIGHT GRAY ALL IN ON A YELLOW, IRREGULARLY SHAPED RECTANGLE.

FOR HAIR CARE PREPARATION, NAMELY, HAIR TINTING SPRAY FEATURING SPRAY ON, WASH OUT HAIR TINTING AND THICKENING SPRAY IN A VARIETY OF HAIR COLORS (U.S. CLS. 1, 4, 6, 50, 51 AND 52).

FIRST USE 12-9-2010; IN COMMERCE 1-14-2011.  
DAVID TOOLEY, EXAMINING ATTORNEY

SN 85-307,185. VELOUR LASHES INC., WILMINGTON, DE. FILED 4-28-2011.



NO CLAIM IS MADE TO THE EXCLUSIVE RIGHT TO USE "LASHES", APART FROM THE MARK AS SHOWN.

THE MARK CONSISTS OF THE STYLIZED TEXT "VELOUR LASHES".

FOR FALSE EYELASHES (U.S. CLS. 1, 4, 6, 50, 51 AND 52).

MARK SPARACINO, EXAMINING ATTORNEY

SN 85-307,285. ROMO, JOSE ISMAEL, TONALA JALISCO, MEXICO, FILED 4-28-2011.



THE COLOR(S) GRAY, WHITE, RED AND BLACK IS/ARE CLAIMED AS A FEATURE OF THE MARK.

THE MARK CONSISTS OF THE FOLLOWING: GRAY RECTANGLE WITH THE LETTERS "REL" IN BLACK, THE LETTER "O" IN WHITE INSIDE A BLACK SQUARE ABOVE THE WORD INNOVATION IN GRAY AND A RED RIBBON.

FOR ANTI-AGING CREAM; BODY CREAMS; CLEANSING CREAMS; HAIR CONDITIONER; HAIR SHAMPOO (U.S. CLS. 1, 4, 6, 50, 51 AND 52).

WON TEAK OH, EXAMINING ATTORNEY

**CLASS 3—(Continued).**

SN 85-311,217. PEAK ENTERPRISES, INC., SARASOTA, FL. FILED 5-3-2011.

**PEAK ESSENTIALS THE  
ORIGINAL TUNG GEL**

THE MARK CONSISTS OF STANDARD CHARACTERS WITHOUT CLAIM TO ANY PARTICULAR FONT, STYLE, SIZE, OR COLOR.

NO CLAIM IS MADE TO THE EXCLUSIVE RIGHT TO USE "THE ORIGINAL TONGUE GEL", APART FROM THE MARK AS SHOWN.

FOR GEL COMPOUND FOR CLEANSING THE TONGUE (U.S. CLS. 1, 4, 6, 50, 51 AND 52).  
APRIL ROACH, EXAMINING ATTORNEY

---

SN 85-311,365. PHILOSOPHY, INC., PHOENIX, AZ. FILED 5-3-2011.

**CHARMING CITRUS FLOWER**

THE MARK CONSISTS OF STANDARD CHARACTERS WITHOUT CLAIM TO ANY PARTICULAR FONT, STYLE, SIZE, OR COLOR.

NO CLAIM IS MADE TO THE EXCLUSIVE RIGHT TO USE "CITRUS FLOWER", APART FROM THE MARK AS SHOWN.

FOR NON-MEDICATED BATH PREPARATIONS (U.S. CLS. 1, 4, 6, 50, 51 AND 52).  
ALICIA COLLINS, EXAMINING ATTORNEY

---

SN 85-312,582. TRACTOR SUPPLY CO. OF TEXAS, LP, BRENTWOOD, TN. FILED 5-4-2011.

**4HEALTH**

THE MARK CONSISTS OF STANDARD CHARACTERS WITHOUT CLAIM TO ANY PARTICULAR FONT, STYLE, SIZE, OR COLOR.

OWNER OF U.S. REG. NOS. 3,846,317 AND 3,846,326.  
FOR PET CARE PRODUCTS, NAMELY, TOOTH PASTE AND TOOTH GEL (U.S. CLS. 1, 4, 6, 50, 51 AND 52).  
ROBERT C. CLARK JR., EXAMINING ATTORNEY

**CLASS 3—(Continued).**

SN 85-313,223. A. L. WILSON CHEMICAL COMPANY, KEARNY, NJ. FILED 5-5-2011.

**"G"GO**

THE MARK CONSISTS OF STANDARD CHARACTERS WITHOUT CLAIM TO ANY PARTICULAR FONT, STYLE, SIZE, OR COLOR.

OWNER OF U.S. REG. NOS. 314,336, 576,649 AND OTHERS.

FOR CLEANING COMPOUND AND STAIN REMOVER FOR USE ON TEXTILES, FABRICS AND CLOTHING (U.S. CLS. 1, 4, 6, 50, 51 AND 52).

FIRST USE 4-28-2011; IN COMMERCE 4-28-2011.  
BILL DAWE, EXAMINING ATTORNEY

---

SN 85-316,432. CADENCE DISTRIBUTORS, LLC, NEW YORK, NY. FILED 5-10-2011.

**PARFUMS PARISIENNE'S SEXY  
CITY**

THE MARK CONSISTS OF STANDARD CHARACTERS WITHOUT CLAIM TO ANY PARTICULAR FONT, STYLE, SIZE, OR COLOR.

NO CLAIM IS MADE TO THE EXCLUSIVE RIGHT TO USE "PARFUMS", APART FROM THE MARK AS SHOWN.

THE ENGLISH TRANSLATION OF "PARFUMS PARISIENNE'S" IN THE MARK IS PERFUME PARISIAN'S.

FOR COSMETIC PREPARATIONS; COSMETICS; EAU DE PARFUM; FRAGRANCES; PERFUMES (U.S. CLS. 1, 4, 6, 50, 51 AND 52).  
ARETHA SOMERVILLE, EXAMINING ATTORNEY



**CLASS 3—(Continued).**

SN 85-317,684. BOMBER BETTY CUSTOM COSMETICS INC.,  
ISLAND LAKE, IL. FILED 5-11-2011.

**BOMBER BETTY**

THE MARK CONSISTS OF STANDARD CHARACTERS WITHOUT CLAIM TO ANY PARTICULAR FONT, STYLE, SIZE, OR COLOR.

FOR COMPACTS CONTAINING MAKE-UP; CONCEALERS FOR UNDER EYE CIRCLES/BLEMISHES; COSMETICS AND MAKE-UP; EYE MAKE-UP; EYES MAKE-UP; FACIAL MAKE-UP; MAKE-UP; MAKE-YOUR-OWN LIP GLOSS KITS; MAKE-UP FOR THE FACE AND BODY; MAKE-UP KITS CONTAINING EYE SHADOWS AND BLUSH; MAKE-UP KITS CONTAINING EYE SHADOWS; MAKE-UP POWDER; MAKE-UP PREPARATIONS; MAKE-UP PREPARATIONS FOR THE FACE AND BODY; NATURAL MINERAL MAKE-UP; NON-MEDICATED SKIN CARE PREPARATIONS; NON-MEDICATED SKIN CARE PREPARATIONS, NAMELY, CREAMS; POWDER FOR MAKE-UP; LOOSE AND PRESSED POWDER MINERAL FOUNDATIONS; LOOSE AND PRESSED POWDER MINERAL BLUSH; LOOSE AND PRESSED POWDER MINERAL EYE SHADOW; PRESSED EYE SHADOW PALETTES; PRESSED POWDER FOUNDATION AND BLUSH; PRESSED POWDER EYE SHADOWS AND EYE LINERS; RE-FILLABLE SHAKE COSMETIC BRUSHES FILLED WITH LOOSE FACE POWDER; CREAM BLUSH; CREAM EYE SHADOW; LIP AND CHEEK STAINS; LIPSTICK; LIP GLOSS; CONCEALER AND EYE SHADOW PRIMER; EYEBROW TINT; BROW TINTS; LIQUID FOUNDATION; FOUNDATION PRIMER; TINTED FACIAL MOISTURIZER; LOOSE POWDER FOUNDATION; LOOSE POWDER BLUSH AND SHADOWS (U.S. CLS. 1, 4, 6, 50, 51 AND 52).

FIRST USE 9-30-2006; IN COMMERCE 5-29-2010.  
BARBARA RUTLAND, EXAMINING ATTORNEY

SN 85-317,755. BOMBER BETTY CUSTOM COSMETICS INC.,  
ISLAND LAKE, IL. FILED 5-11-2011.



THE COLOR(S) BROWN, GOLD, PINK, BLACK, OLIVE GREEN, CAUCASIAN SKIN COLOR, WHITE, SILVER, AND RED IS/ARE CLAIMED AS A FEATURE OF THE MARK.

THE MARK CONSISTS OF A BUXOM WOMAN, WITH DARK BROWN OR BRUNETTE HAIR AND WHITE HIGHLIGHTS, SITTING ON AN AERIAL BOMB; THE BOMB SLANTED AT AN ANGLE AND UPWARDS FROM LEFT TO RIGHT AS THE IMAGE IS VIEWED; THE BOMB HAVING TAIL FINS ON ITS AFT END TOWARD AT ITS LOWERED SIDE AND A SILVER STAR AT ITS FORWARD END AT ITS RAISED, SIDE; THE BOMB HAVING A PRINCIPAL OLIVE GREEN COLOR WITH DARK HIGHLIGHTS AND SILVER

**CLASS 3—(Continued).**

DETAILS INCLUDING A RING AT THE AFT END, A STAR TOWARD ITS FORWARD END, AND A FORWARD TIP; THE WOMAN WEARING A WHITE SAILOR UNIFORM; THE WOMAN WEARING A WHITE SAILOR CAP; THE WOMAN WEARING A TANK TOP STYLE SAILOR MIDDY WITH BLACK STRIPING AND BLACK CUFFS; THE MIDDY HAVING RANK INSIGNIA ON THE RIGHT SLEEVE INCLUDING A BLACK EAGLE ATOP TWO RED CHEVRON STRIPES; THE MIDDY TIED BELOW THE BOSOM OF THE WOMAN; THE WOMAN WEARING A SHORT WHITE SKIRT WITH MID RIFT SHOWING INCLUDING VISIBLE BELLY BUTTON; THE WOMAN WEARING BLACK STOCKINGS CUFFED AT THE THIGH; THE WOMAN WEARING BLACK HIGH HEELED SHOES; THE WOMAN HAVING HER HEAD TURNED PARTIALLY TOWARD HER RIGHT AND THE LEFT OF THE IMAGE; THE WOMAN HAVING BOTH HANDS AND FOREARMS RAISED AND TO HER SIDES; THE WOMAN HAVING RED FINGERNAILS; THE WOMAN HOLDING A GOLD COLORED COMPACT WITH PINK CONTENTS IN HER RIGHT HAND; THE WOMAN HOLDING A GOLD COLORED LIPSTICK APPLICATOR CONTAINING RED LIPSTICK IN HER LEFT HAND; THE WOMAN SEATED ON THE BOMB WITH SKIRT DRAPED ON THE BOMB; THE WOMAN'S LEFT LEG BENT AND RESTING ON THE SIDE OF THE BOMB; THE WOMAN'S RIGHT LEG PARTIALLY BENT AND RESTING ON THE ANKLE OF HER LEFT FOOT; A PINK CIRCLE WITH WHITE OUTLINING IN THE BACKGROUND OF THE WOMAN AND BOMB; THE PINK CIRCLE WITH WHITE OUTLINING PARTIALLY ENCOMPASSING THE WOMAN AND BOMB; THE PINK CIRCLE WITH WHITE OUTLINING PARTIALLY ENCOMPASSING THE WOMAN AND BOMB; "BOMBER BETTY" IN PINK SCRIPT LETTERING WITH WHITE OUTLINING; "BOMBER" OVERLAPPING AND EXTENDING TO THE RIGHT OF THE IMAGE FROM THE WOMAN'S RIGHT LOWER LEG; "BETTY" APPEARING BELOW "BOMBER;" THE "B" IN "BETTY" LOCATED BELOW THE "MB" IN "BOMBER;" "BETTY" OVERLAPPING WITH THE PINK CIRCLE WITH ALL ELEMENTS OF THE MARK SUPERIMPOSED OVER A BLACK BACKGROUND.

FOR COMPACTS CONTAINING MAKE-UP; CONCEALERS FOR UNDER EYE CIRCLES AND BLEMISHES; COSMETICS AND MAKE-UP; EYE MAKE-UP; EYES MAKE-UP; FACIAL MAKE-UP; EYEBROW TINTS; MAKE-UP; MAKE-UP FOR THE FACE AND BODY; MAKE-UP KITS CONTAINING EYE SHADOWS AND BLUSH; MAKE-UP KITS CONTAINING EYE SHADOWS; MAKE-UP POWDER; MAKE-UP PREPARATIONS; MAKE-UP PREPARATIONS FOR THE FACE AND BODY; NATURAL MINERAL MAKE-UP; NON-MEDICATED SKIN CARE PREPARATIONS; POWDER FOR MAKE-UP; LOOSE AND PRESSED POWDER MINERAL FOUNDATIONS; LOOSE AND PRESSED POWDER MINERAL BLUSH; LOOSE AND PRESSED POWDER MINERAL EYE SHADOW; PRESSED EYE SHADOW PALETTES; PRESSED POWDER FOUNDATION AND BLUSH; PRESSED POWDER SHADOWS AND LINERS; CREAM BLUSH; CREAM EYE SHADOW; LIP AND CHEEK STAINS; LOOSE POWDER FOUNDATION; LOOSE POWDER BLUSH AND SHADOWS (U.S. CLS. 1, 4, 6, 50, 51 AND 52).

FIRST USE 6-1-2010; IN COMMERCE 6-1-2010.  
BARBARA RUTLAND, EXAMINING ATTORNEY

**CLASS 3—(Continued).**

SN 85-318,038. A.V.W. INC., DBA MAX PROFESSIONAL, FT LAUDERDALE, FL. FILED 5-11-2011.

## Super Wax

THE MARK CONSISTS OF STANDARD CHARACTERS WITHOUT CLAIM TO ANY PARTICULAR FONT, STYLE, SIZE, OR COLOR.

NO CLAIM IS MADE TO THE EXCLUSIVE RIGHT TO USE "WAX", APART FROM THE MARK AS SHOWN, FOR AUTOMOBILE WAX (U.S. CLS. 1, 4, 6, 50, 51 AND 52).

FIRST USE 5-10-2001; IN COMMERCE 5-15-2008.  
SKYE YOUNG, EXAMINING ATTORNEY

SN 85-319,410. FIBROELL TECHNOLOGIES, INC., EXTON, PA. FILED 5-12-2011.

## LE MATRAIRE DAILY MOISTURIZING CRÈME

THE MARK CONSISTS OF STANDARD CHARACTERS WITHOUT CLAIM TO ANY PARTICULAR FONT, STYLE, SIZE, OR COLOR.

NO CLAIM IS MADE TO THE EXCLUSIVE RIGHT TO USE "DAILY MOISTURIZING CRÈME", APART FROM THE MARK AS SHOWN.

THE ENGLISH TRANSLATION OF THE WORD "LE" AND "CRÈME" IN THE MARK IS "THE" AND "CREAM". THE WORDING "MATRAIRE" HAS NO MEANING IN A FOREIGN LANGUAGE.

FOR NON-MEDICATED SKIN CARE PREPARATIONS; MOISTURIZING CREAMS FOR SKIN (U.S. CLS. 1, 4, 6, 50, 51 AND 52).

TRACY FLETCHER, EXAMINING ATTORNEY

SN 85-321,512. GARCIA, SOPHY, GUYTON, GA. FILED 5-16-2011.

## M.O.B.E. Miami's Own Beauty Essentials

THE MARK CONSISTS OF STANDARD CHARACTERS WITHOUT CLAIM TO ANY PARTICULAR FONT, STYLE, SIZE, OR COLOR.

NO CLAIM IS MADE TO THE EXCLUSIVE RIGHT TO USE "BEAUTY ESSENTIALS", APART FROM THE MARK AS SHOWN.

FOR BLUSH; EYE SHADOW; LIPSTICK (U.S. CLS. 1, 4, 6, 50, 51 AND 52).

DORITT L. CARROLL, EXAMINING ATTORNEY

**CLASS 3—(Continued).**

SN 85-321,669. INTELLIGENT NUTRIENTS, LLC, MINNEAPOLIS, MN. FILED 5-16-2011.

## Intelligent Nutrients Plant Stem Cell Science Renewal Complex

THE MARK CONSISTS OF STANDARD CHARACTERS WITHOUT CLAIM TO ANY PARTICULAR FONT, STYLE, SIZE, OR COLOR.

OWNER OF U.S. REG. NOS. 3,549,184, 3,767,379 AND OTHERS.

NO CLAIM IS MADE TO THE EXCLUSIVE RIGHT TO USE "NUTRIENTS PLANT STEM CELL SCIENCE RENEWAL COMPLEX", APART FROM THE MARK AS SHOWN.

FOR BEAUTY SERUMS; NON-MEDICATED ANTI-AGING SERUM; SKIN CARE PRODUCTS, NAMELY, NON-MEDICATED SKIN SERUM; SKIN CREAM (U.S. CLS. 1, 4, 6, 50, 51 AND 52).

BENJAMIN OKEKE, EXAMINING ATTORNEY

SN 85-321,874. SMITH, TAKISHA, TORRANCE, CA. FILED 5-16-2011.

## Heavenly Bottoms

THE MARK CONSISTS OF STANDARD CHARACTERS WITHOUT CLAIM TO ANY PARTICULAR FONT, STYLE, SIZE, OR COLOR.

FOR COSMETIC PREPARATIONS FOR BODY CARE, BODY FRAGRANCES, DEODORANTS FOR PERSONAL USE, AND DEODORANT TOWELETTES FOR PERSONAL USE (U.S. CLS. 1, 4, 6, 50, 51 AND 52).

CAROLINE WOOD, EXAMINING ATTORNEY

SN 85-321,903. CLEMENTS, MAYLING WOO, LAGUNA NIGUEL, CA. FILED 5-16-2011.

## O.C. Fenix

THE MARK CONSISTS OF STANDARD CHARACTERS WITHOUT CLAIM TO ANY PARTICULAR FONT, STYLE, SIZE, OR COLOR.

NO CLAIM IS MADE TO THE EXCLUSIVE RIGHT TO USE "O.C.", APART FROM THE MARK AS SHOWN.

FOR BEAUTY SERUMS; BODY LOTION; COSMETICS AND MAKE-UP; EYE CREAM; FACIAL CLEANSERS; FACIAL LOTION; FACIAL MOISTURIZER WITH SPF; HAND LOTIONS; SKIN CLEANSERS; SKIN MOISTURIZER; SKIN TONERS; SUN SCREEN (U.S. CLS. 1, 4, 6, 50, 51 AND 52).

WILLIAM VERHOSEK, EXAMINING ATTORNEY

**CLASS 3—(Continued).**

SN 85-322,461. JOHNSTON, JAMES, SANTA PAULA, CA. AND HARRIS, MICHAEL, SANTA PAULA, CA. FILED 5-17-2011.



NO CLAIM IS MADE TO THE EXCLUSIVE RIGHT TO USE "BUG", APART FROM THE MARK AS SHOWN.

THE COLOR(S) YELLOW, BLACK AND PURPLE IS/ARE CLAIMED AS A FEATURE OF THE MARK.

THE MARK CONSISTS OF THE WORDING "BUG SPLAT" AND DESIGN. THE WORDS "BUG SPLAT" ARE YELLOW IN COLOR AND ARE OUTLINED IN BLACK. THE TERM "BUG" APPEARS ABOVE THE TERM "SPLAT". TO THE RIGHT OF THE WORD "BUG" IS A BLACK WINGED BUG AND PURPLE LIQUID SURROUNDS THE BUG AND IS ALSO SPLATTERED OVER SEVERAL LETTERS.

FOR CHEMICAL PREPARATIONS IN SPRAY PUMP USED FOR CLEANING AND REMOVING INSECTS FROM VEHICLE SURFACES (U.S. CLS. 1, 4, 6, 50, 51 AND 52).

MARLENE BELL, EXAMINING ATTORNEY

SN 85-322,792. MILANO HAIR PRODUCTS INC., PLAINVIEW, NY. FILED 5-17-2011.



OWNER OF U.S. REG. NO. 3,660,068.

THE MARK CONSISTS OF SIDE VIEW OF BUTTERFLY WITH THE WORD "KISMERIA" ACROSS THE BUTTERFLY'S WING.

THE WORDING "KISMERIA" HAS NO MEANING IN A FOREIGN LANGUAGE.

FOR HAIR CARE PREPARATIONS, NAMELY, SHAMPOOS, CONDITIONERS, STYLING PREPARATIONS, AND HAIR DYING PREPARATIONS (U.S. CLS. 1, 4, 6, 50, 51 AND 52).

EDWARD NELSON, EXAMINING ATTORNEY

**CLASS 3—(Continued).**

SN 85-323,045. PHILOSOPHY, INC., PHOENIX, AZ. FILED 5-17-2011.

**PLAYFUL PEACH TINI**

THE MARK CONSISTS OF STANDARD CHARACTERS WITHOUT CLAIM TO ANY PARTICULAR FONT, STYLE, SIZE, OR COLOR.

NO CLAIM IS MADE TO THE EXCLUSIVE RIGHT TO USE "PEACH", APART FROM THE MARK AS SHOWN.

FOR LIP GLOSS; NON-MEDICATED BATH PREPARATIONS (U.S. CLS. 1, 4, 6, 50, 51 AND 52).

LINDSEY RUBIN, EXAMINING ATTORNEY

SN 85-323,449. SLEEK SENSATION, LTD., BROOKLYN, NY. FILED 5-17-2011.

**SHABBOS WIPES**

THE MARK CONSISTS OF STANDARD CHARACTERS WITHOUT CLAIM TO ANY PARTICULAR FONT, STYLE, SIZE, OR COLOR.

NO CLAIM IS MADE TO THE EXCLUSIVE RIGHT TO USE "WIPES", APART FROM THE MARK AS SHOWN.

THE ENGLISH TRANSLATION OF THE WORD "SHABBOS" IN THE MARK IS "SABBATH".

FOR BABY WIPES, SHAMPOO, COSMETICS, PRE-MOISTENED MAKEUP REMOVAL WIPES (U.S. CLS. 1, 4, 6, 50, 51 AND 52).

TRACY WHITTAKER-BROWN, EXAMINING ATTORNEY

**CLASS 3—(Continued).**

SN 85-323,459. BARON, STACY MARIE, TUJUNGA, CA. FILED 5-18-2011.



THE COLOR(S) RED, BROWN, GREEN, WHITE, BLACK, PINK AND LIGHT PINK IS/ARE CLAIMED AS A FEATURE OF THE MARK.

THE MARK CONSISTS OF THE WORDING "SOAPME" IN THE COLOR RED AND THE WORDING "WITH NATURE" IN THE COLOR BROWN. THERE IS A DESIGN OF A CLAWFOOT BATHTUB IN THE COLORS PINK, WHITE, BROWN AND BLACK, WITH GREEN LEAVES AND BLACK-OUTLINE OF BUBBLES; ALL ON TOP OF CIRCULAR RUG IN THE COLORS RED, PINK AND LIGHT PINK.

FOR 3-IN-1 ORGANIC SOAP BARS FOR USE AS SOAP, SHAMPOO AND CONDITIONER; AROMATIC BODY CARE PRODUCTS, NAMELY, BODY LOTION, SHOWER GEL, CUTICLE CREAM, SHAMPOO, CONDITIONER, NON-MEDICATED LIP BALM, SOAP, BODY POLISH, BODY AND FOOT SCRUB AND NON-MEDICATED FOOT CREAM (U.S. CLS. 1, 4, 6, 50, 51 AND 52).

FIRST USE 2-15-2011; IN COMMERCE 2-15-2011.  
LINDA E. BLOHM, EXAMINING ATTORNEY

**CLASS 3—(Continued).**

SN 85-324,178. FIBROCELL TECHNOLOGIES, INC., EXTON, PA. FILED 5-18-2011.

**LA CRÈME NATRILLAIRE DAILY MOISTURIZER**

THE MARK CONSISTS OF STANDARD CHARACTERS WITHOUT CLAIM TO ANY PARTICULAR FONT, STYLE, SIZE, OR COLOR.

NO CLAIM IS MADE TO THE EXCLUSIVE RIGHT TO USE "CREME" OR "DAILY MOISTURIZER", APART FROM THE MARK AS SHOWN.

FOR NON-MEDICATED SKIN CARE PREPARATIONS; MOISTURIZING CREAMS FOR SKIN (U.S. CLS. 1, 4, 6, 50, 51 AND 52).

JAMES A. RAUEN, EXAMINING ATTORNEY

SN 85-324,541. KYPKE, CAMIE, DBA WILD ABOUT SKIN, ABILENE, TX. FILED 5-19-2011.

**WILD ABOUT SKIN**

THE MARK CONSISTS OF STANDARD CHARACTERS WITHOUT CLAIM TO ANY PARTICULAR FONT, STYLE, SIZE, OR COLOR.

NO CLAIM IS MADE TO THE EXCLUSIVE RIGHT TO USE "SKIN", APART FROM THE MARK AS SHOWN.

FOR COSMETICS FOR SKIN AND BODY REJUVENATION, NAMELY, LOTIONS FOR SKIN AND BODY, TONERS, BODY SCRUBS, BEAUTY SERUMS, SKIN MOISTURIZERS, FACE AND BODY CREAMS, BODY BALMS, OILS FOR COSMETIC PURPOSES, BODY AND FACE POWDERS, FOUNDATIONS, BEAUTY GELS, BODY BUTTERS, NON-MEDICATED OINTMENT FOR TREATMENT OF SUNBURN, MOISTURIZING SOLUTIONS FOR THE SKIN, BODY AND FACIAL MASKS, BLUSH, EYE SHADOWS, LIP STICK, BODY POLISH, SOAPS, BODY SPRAYS, SHAMPOOS, NAIL CARE PREPARATIONS, CONDITIONER, HAIR MOUSSE, NON-MEDICATED LIP CARE PREPARATIONS, EXFOLIANT CREAMS, BATH SALTS, BUBBLE BATH, OIL BATHS FOR HAIR CARE, LIP GLOSSES, NAIL POLISH REMOVERS, SKIN CLEANSERS, EYE LINERS, LIP LINERS, MASCARA, MAKE-UP MINERAL POWDERS, SKIN BRONZERS, LIP PRIMERS, FACIAL CONCEALERS, EYELASH TINTS, BODY SPRAYS, POMADES, SEALS, FOAMS, COSMETIC SUNSCREEN PREPARATIONS, SUN BLOCK, BODY WASH, HAIR RINSES, NAIL LACQUERS, PRE-MOISTENED COSMETIC TOWELLETTES, COSMETIC PADS, COSMETIC PREPARATIONS FOR SKIN CARE (U.S. CLS. 1, 4, 6, 50, 51 AND 52).

KAPIL BHANOT, EXAMINING ATTORNEY

SN 85-324,169. FIBROCELL TECHNOLOGIES, INC., EXTON, PA. FILED 5-18-2011.

**LA CRÈME MATRILLAIRE DAILY MOISTURIZER**

THE MARK CONSISTS OF STANDARD CHARACTERS WITHOUT CLAIM TO ANY PARTICULAR FONT, STYLE, SIZE, OR COLOR.

NO CLAIM IS MADE TO THE EXCLUSIVE RIGHT TO USE "CREME" OR "DAILY MOISTURIZER", APART FROM THE MARK AS SHOWN.

FOR NON-MEDICATED SKIN CARE PREPARATIONS; MOISTURIZING CREAMS FOR SKIN (U.S. CLS. 1, 4, 6, 50, 51 AND 52).

JAMES A. RAUEN, EXAMINING ATTORNEY

**CLASS 3—(Continued).**

SN 85-327,926. USA LEASE INC., WEST COLUMBIA, SC. FILED 5-23-2011.

# OXY SUDS

THE MARK CONSISTS OF STANDARD CHARACTERS WITHOUT CLAIM TO ANY PARTICULAR FONT, STYLE, SIZE, OR COLOR.

NO CLAIM IS MADE TO THE EXCLUSIVE RIGHT TO USE "SUDS", APART FROM THE MARK AS SHOWN.

FOR LAUNDRY DETERGENTS (U.S. CLS. 1, 4, 6, 50, 51 AND 52).

FIRST USE 11-1-2008; IN COMMERCE 11-1-2008.  
RON FAIRBANKS, EXAMINING ATTORNEY

SN 85-328,436. JACOBS, AIMEE, HUNTINGTON BEACH, CA. FILED 5-24-2011.



NO CLAIM IS MADE TO THE EXCLUSIVE RIGHT TO USE "WINE" AND "BRIGHTENER", APART FROM THE MARK AS SHOWN.

THE MARK CONSISTS OF A GIRL HOLDING A GLASS OF WINE ONE FLOWER LIKE SYMBOL AND 6 OTHER BULLSEYE TYPE CIRCLES OVER THE STYLIZED TEXT "WINE AND SHINE SMILE BRIGHTENER".

FOR TEETH WHITENING PREPARATIONS USED TO REMOVE RED WINE STAINS (U.S. CLS. 1, 4, 6, 50, 51 AND 52).

FIRST USE 7-1-2008; IN COMMERCE 3-17-2009.  
FLORENTINA BLANDU, EXAMINING ATTORNEY

**CLASS 3—(Continued).**

SN 85-328,512. SUSAN POSNICK COSMETICS, INC., DALLAS, TX. FILED 5-24-2011.

## Susan Posnick Family

THE MARK CONSISTS OF STANDARD CHARACTERS WITHOUT CLAIM TO ANY PARTICULAR FONT, STYLE, SIZE, OR COLOR.

THE NAME(S), PORTRAIT(S), AND/OR SIGNATURE(S) SHOWN IN THE MARK IDENTIFIES "SUSAN POSNICK", WHOSE CONSENT(S) TO REGISTER IS MADE OF RECORD.

FOR COSMETIC SUNSCREEN PREPARATIONS; LIP BALM; LOOSE FACE POWDER; SKIN BRONZER (U.S. CLS. 1, 4, 6, 50, 51 AND 52).

CHERYL CLAYTON, EXAMINING ATTORNEY

SN 85-329,562. REVLON CONSUMER PRODUCTS CORPORATION, NEW YORK, NY. FILED 5-25-2011.

## ALMAY INTENSE I-COLOR SATIN-I

THE MARK CONSISTS OF STANDARD CHARACTERS WITHOUT CLAIM TO ANY PARTICULAR FONT, STYLE, SIZE, OR COLOR.

OWNER OF U.S. REG. NOS. 980,494, 3,261,921 AND OTHERS.

NO CLAIM IS MADE TO THE EXCLUSIVE RIGHT TO USE "EYE COLOR", APART FROM THE MARK AS SHOWN.

FOR COSMETICS; MAKE-UP (U.S. CLS. 1, 4, 6, 50, 51 AND 52).

DAWN HAN, EXAMINING ATTORNEY

SN 85-329,632. SYNCHRONICITY MARKETING LLC, COPLEY, OH. FILED 5-25-2011.

## Aura Sensory

THE MARK CONSISTS OF STANDARD CHARACTERS WITHOUT CLAIM TO ANY PARTICULAR FONT, STYLE, SIZE, OR COLOR.

FOR BODY AND BEAUTY CARE COSMETICS (U.S. CLS. 1, 4, 6, 50, 51 AND 52).

FIRST USE 10-22-2010; IN COMMERCE 4-20-2011.

BILL DAWE, EXAMINING ATTORNEY

**CLASS 3—(Continued).**

SN 85-330,554. SOAP & GLORY LIMITED, LONDON, UNITED KINGDOM, FILED 5-26-2011.

# kick ass

THE MARK CONSISTS OF STANDARD CHARACTERS WITHOUT CLAIM TO ANY PARTICULAR FONT, STYLE, SIZE, OR COLOR.

FOR COSMETICS; SKIN HIGHLIGHTER FOR THE FACE, BLEMISH CONCEALER, UNDER EYE CONCEALER (U.S. CLS. 1, 4, 6, 50, 51 AND 52).

STEVEN JACKSON, EXAMINING ATTORNEY

SN 85-330,866. GRIFFIN MOORE, SUSAN, COCOA, FL. FILED 5-26-2011.

# SASANI Skin as soft as nature intended

THE MARK CONSISTS OF STANDARD CHARACTERS WITHOUT CLAIM TO ANY PARTICULAR FONT, STYLE, SIZE, OR COLOR.

FOR DEODORANTS FOR BODY CARE; LOTIONS FOR FACE AND BODY CARE; SHAMPOO-CONDITIONERS; SOAPS FOR BODY CARE (U.S. CLS. 1, 4, 6, 50, 51 AND 52).

FIRST USE 6-30-2008; IN COMMERCE 6-30-2008.

JOHN WILKE, EXAMINING ATTORNEY

SN 85-331,317. MEDIA NOCHE PRODUCTIONS, INC., NEW YORK, NY. FILED 5-26-2011.

# HAPPY HEAD

THE MARK CONSISTS OF STANDARD CHARACTERS WITHOUT CLAIM TO ANY PARTICULAR FONT, STYLE, SIZE, OR COLOR.

FOR COSMETIC PREPARATIONS FOR THE HAIR AND SCALP; HAIR LOTIONS; HAIR RINSES; HAIR SHAMPOOS AND CONDITIONERS (U.S. CLS. 1, 4, 6, 50, 51 AND 52).

LEIGH CAROLINE CASE, EXAMINING ATTORNEY

**CLASS 3—(Continued).**

SN 85-331,811. GREEN LIFE DEVELOPMENT INC., LAS VEGAS, NV. FILED 5-26-2011.

# HAVE A NICE GREEN DAY

THE MARK CONSISTS OF STANDARD CHARACTERS WITHOUT CLAIM TO ANY PARTICULAR FONT, STYLE, SIZE, OR COLOR.

FOR ALL-PURPOSE CLEANERS; BIOTECHNOLOGICAL CHEMICAL AND SPRAY CLEANERS FOR INDUSTRIAL AND HOUSEHOLD APPLICATIONS SUCH AS STAIN REMOVAL, ODOR ELIMINATION, AND BIOREMEDIATION OF MANY TYPES OF ORGANIC AND HYDROCARBON-BASED MATERIALS; ALL PURPOSE CLEANING PREPARATIONS; BIOTECHNOLOGICAL CLEANING SOLUTION FOR ELIMINATING ODORS, BREAKING DOWN ORGANICS, AND REMOVING STAINS; CLEANING PREPARATIONS; GUN-CLEANING PREPARATIONS; MARINE, BOAT AND SHIP CLEANING PREPARATIONS; JEWELRY CLEANING PREPARATIONS; GLASS CLEANERS (U.S. CLS. 1, 4, 6, 50, 51 AND 52).

AMY HELLA, EXAMINING ATTORNEY

SN 85-331,958. MARCO POLO HUB, LLC, DIAMOND BAR, CA. FILED 5-27-2011.

# CENTERSTAGE

THE MARK CONSISTS OF STANDARD CHARACTERS WITHOUT CLAIM TO ANY PARTICULAR FONT, STYLE, SIZE, OR COLOR.

FOR TEETH WHITENING KITS INCLUDING TOOTH WHITENING GELS AND PENS (U.S. CLS. 1, 4, 6, 50, 51 AND 52).

COURTNEY ALVAREZ, EXAMINING ATTORNEY

SN 85-332,922. THE FRAGRANCE HOUSE, INC., COMMERCE, CA. FILED 5-27-2011.

# 300 Men Eau De Parfum

THE MARK CONSISTS OF STANDARD CHARACTERS WITHOUT CLAIM TO ANY PARTICULAR FONT, STYLE, SIZE, OR COLOR.

NO CLAIM IS MADE TO THE EXCLUSIVE RIGHT TO USE "MEN EAU DE PARFUM", APART FROM THE MARK AS SHOWN.

FOR PERFUMES (U.S. CLS. 1, 4, 6, 50, 51 AND 52).

FIRST USE 12-10-2010; IN COMMERCE 12-10-2010.

COLLEEN DOMBROW, EXAMINING ATTORNEY

**CLASS 3—(Continued).**

SN 85-333,494. SAVELEV, IRINA V, DBA POWCLEAN LTD., HIGHLANDS RANCH, CO. FILED 5-31-2011.

# POWGLASS

THE MARK CONSISTS OF STANDARD CHARACTERS WITHOUT CLAIM TO ANY PARTICULAR FONT, STYLE, SIZE, OR COLOR.

FOR GLASS CLEANERS (U.S. CLS. 1, 4, 6, 50, 51 AND 52).

FIRST USE 5-1-2011; IN COMMERCE 5-1-2011.  
KAPIL BHANOT, EXAMINING ATTORNEY

**CLASS 3—(Continued).**

SN 85-333,666. JOHN JOSEPH MANZIONE, ISLIP, NY. FILED 5-31-2011.

# MAGNETIX

THE MARK CONSISTS OF STANDARD CHARACTERS WITHOUT CLAIM TO ANY PARTICULAR FONT, STYLE, SIZE, OR COLOR.

FOR NAIL POLISH (U.S. CLS. 1, 4, 6, 50, 51 AND 52).  
WANDA KAY PRICE, EXAMINING ATTORNEY

SN 85-333,535. L'OREAL USA CREATIVE, INC., NEW YORK, NY. FILED 5-31-2011.

# THE DIRT TRAPPER

THE MARK CONSISTS OF STANDARD CHARACTERS WITHOUT CLAIM TO ANY PARTICULAR FONT, STYLE, SIZE, OR COLOR.

FOR FACIAL CLEANSER (U.S. CLS. 1, 4, 6, 50, 51 AND 52).

KIM MONINGHOFF, EXAMINING ATTORNEY

SN 85-333,699. UROWSKY, MICHAEL S., WYNANTSKILL, NY. FILED 5-31-2011.

# Hand It Over

THE MARK CONSISTS OF STANDARD CHARACTERS WITHOUT CLAIM TO ANY PARTICULAR FONT, STYLE, SIZE, OR COLOR.

FOR HAND CLEANERS (U.S. CLS. 1, 4, 6, 50, 51 AND 52).

HEATHER THOMPSON, EXAMINING ATTORNEY

SN 85-333,550. CASITE INTRACO, L.L.C., TROY, MI. FILED 5-31-2011.



THE MARK CONSISTS OF FANCIFUL DESIGN OF A BEE.

FOR ALL PURPOSE CLEANERS, CLEANING PREPARATIONS FOR ELIMINATING OIL AND GREASE AND PREPARATIONS FOR CLEANING, POLISHING AND PROTECTING SURFACES (U.S. CLS. 1, 4, 6, 50, 51 AND 52).

MELISSA VALLILLO, EXAMINING ATTORNEY

SN 85-333,715. WILLIAMS, ANITA, PLANO, TX. FILED 5-31-2011.

# Legit

THE MARK CONSISTS OF THE STYLIZED TEXT "LEGIT".

FOR BODY LOTION; BODY WASH; COLOGNE; DEODORANT FOR PERSONAL USE; FACIAL SCRUBS; FACIAL WASHES; HAIR SHAMPOOS AND CONDITIONERS; LOTIONS FOR KNEES, HANDS, ELBOWS; NON-MEDICATED ACNE TREATMENT PREPARATIONS; SKIN MOISTURIZER; SUNSCREEN CREAM (U.S. CLS. 1, 4, 6, 50, 51 AND 52).

TRACY FLETCHER, EXAMINING ATTORNEY

**CLASS 3—(Continued).**

SN 85-333,731. WILLIAMS, ANITA, PLANO, TX. FILED 5-31-2011.

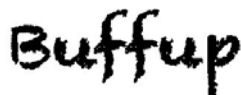

THE MARK CONSISTS OF THE STYLIZED TEXT "BUFFUP".

FOR BODY LOTION; BODY WASH; COLOGNE; DEODORANT FOR PERSONAL USE; FACIAL SCRUBS; FACIAL WASHES; HAIR SHAMPOOS AND CONDITIONERS; LOTIONS FOR KNEES, HANDS, ELBOWS; NON-MEDICATED ACNE TREATMENT PREPARATIONS; SKIN MOISTURIZER; SUNSCREEN CREAM (U.S. CLS. 1, 4, 6, 50, 51 AND 52).

TRACY FLETCHER, EXAMINING ATTORNEY

**CLASS 3—(Continued).**

SN 85-334,014. THE OUTER EDGE INC., DENVER, CO. FILED 5-31-2011.



THE MARK CONSISTS OF STANDARD CHARACTERS WITHOUT CLAIM TO ANY PARTICULAR FONT, STYLE, SIZE, OR COLOR.

FOR INCENSE; INCENSE STICKS; POTPOURRI (U.S. CLS. 1, 4, 6, 50, 51 AND 52).

FIRST USE 8-1-2010; IN COMMERCE 8-1-2010.  
MICHELE SWAIN, EXAMINING ATTORNEY

SN 85-334,223. KISS NAIL PRODUCTS, INC., PORT WASHINGTON, NY. FILED 5-31-2011.



THE MARK CONSISTS OF STANDARD CHARACTERS WITHOUT CLAIM TO ANY PARTICULAR FONT, STYLE, SIZE, OR COLOR.

NO CLAIM IS MADE TO THE EXCLUSIVE RIGHT TO USE "FACE", APART FROM THE MARK AS SHOWN.

FOR COSMETICS, NAMELY, BLUSHER, BRONZER, FOUNDATION MAKEUP (U.S. CLS. 1, 4, 6, 50, 51 AND 52).

PAUL F. GAST, EXAMINING ATTORNEY

SN 85-333,848. SHOWLINE SOAPS, INC., RALEIGH, NC. FILED 5-31-2011.



THE MARK CONSISTS OF THE WORDS "QUICK STUFF" SUPERIMPOSED ON A TRIANGLE.

FOR ALL-PURPOSE CLEANERS; AUTOMOBILE CLEANERS; CLEANER FOR USE ON INDUSTRIAL SURFACES; DEGREASING PREPARATIONS FOR HOUSEHOLD, AUTOMOTIVE, AND INDUSTRIAL SURFACES (U.S. CLS. 1, 4, 6, 50, 51 AND 52).

JAMES LOVELACE, EXAMINING ATTORNEY

SN 85-334,243. KISS NAIL PRODUCTS, INC., PORT WASHINGTON, NY. FILED 5-31-2011.



THE MARK CONSISTS OF STANDARD CHARACTERS WITHOUT CLAIM TO ANY PARTICULAR FONT, STYLE, SIZE, OR COLOR.

NO CLAIM IS MADE TO THE EXCLUSIVE RIGHT TO USE "LIP", APART FROM THE MARK AS SHOWN.

FOR COSMETIC PRODUCTS, NAMELY, LIP BALM, LIP GLOSS, AND LIP PLUMPERS (U.S. CLS. 1, 4, 6, 50, 51 AND 52).

PAUL F. GAST, EXAMINING ATTORNEY



**CLASS 3—(Continued).**

SN 85-334,253. KISS NAIL PRODUCTS, INC., PORT WASHINGTON, NY. FILED 5-31-2011.

**EYE STORIES**

THE MARK CONSISTS OF STANDARD CHARACTERS WITHOUT CLAIM TO ANY PARTICULAR FONT, STYLE, SIZE, OR COLOR.

NO CLAIM IS MADE TO THE EXCLUSIVE RIGHT TO USE "EYE", APART FROM THE MARK AS SHOWN.

FOR COSMETICS, NAMELY, EYE SHADOW, EYE-LINER, MASCARA, FALSE EYELASHES (U.S. CLS. 1, 4, 6, 50, 51 AND 52).

PAUL F. GAST, EXAMINING ATTORNEY

SN 85-334,423. NRCOMMUNICATION, CO. LTD., SEOUL, REPUBLIC OF KOREA, FILED 5-31-2011.



THE MARK CONSISTS OF THE WORD "RENDREVIE" ON THE RIGHT SIDE OF A STYLIZED FLOWER DESIGN.

FOR AFTER SUN CREAMS; AFTER-SHAVE CREAMS; AFTER-SHAVE EMULSIONS; AFTER-SHAVE LOTIONS; AFTER-SUN LOTIONS; BABY OIL; BABY POWDER; BEAUTY LOTIONS; BLEACHING PREPARATIONS FOR THE HAIR; BLUSH; BODY LOTIONS; BODY MILKS; COMMON TOILET WATER; COSMETIC CREAMS FOR SKIN CARE; COSMETIC PREPARATIONS; COSMETIC PREPARATIONS FOR BATH AND SHOWER; COSMETIC PREPARATIONS FOR SKIN CARE; COSMETIC PREPARATIONS FOR SLIMMING PURPOSES; COSMETIC PREPARATIONS, NAMELY, FIRING CREAMS; COSMETIC SKIN FRESHENERS; COSMETIC SUN MILK LOTIONS; COSMETIC SUN-PROTECTING PREPARATIONS; COSMETIC SUN-TANNING PREPARATIONS; COSMETIC SUNSCREEN PREPARATIONS; COSMETIC WHITE FACE POWDER; COSMETICS IN THE FORM OF MILKS, LOTIONS AND EMULSIONS; DENTIFRICES; EYE CREAM; EYE LOTIONS; EYE MAKE-UP REMOVER; EYE SHADOWS; EYEBROW COSMETICS; EYES PENCILS; FACE AND BODY LOTIONS; FOUNDATIONS; HAIR BLEACHING PREPARATIONS; HAIR CARE LOTIONS; HAIR COLORANTS; HAIR COLOURING AND DYES; HAIR DYE; HAIR DYES; HAIR GEL AND HAIR MOUSSE; HAIR GELS; HAIR LOTIONS; HAIR RINSES; HAIR STYLING SPRAY; HAND CLEANERS; LIP LINER; LIPSTICKS; LOOSE FACE POWDER; LOTIONS FOR FACE AND BODY CARE; MAKE-UP; MAKE-UP FOUNDATIONS; MAKE-UP POWDER; MAKE-UP REMOVER; MASCARA; MASK PACK FOR COSMETIC PURPOSES; MASSAGE OIL; MOISTURIZING SOLUTIONS FOR THE SKIN; POWDER FOR MAKE-UP; PRESSED FACE POWDER; SHAMPOOS; SHAVING LOTIONS; SHOWER GELS; SKIN CREAMS; SKIN LOTIONS; SOLID POWDER FOR COMPACTS; SUN-BLOCK LOTIONS; SUNSCREEN CREAMS; TOILET WATER (U.S. CLS. 1, 4, 6, 50, 51 AND 52).

ELI HELLMAN, EXAMINING ATTORNEY

**CLASS 3—(Continued).**

SN 85-334,445. NRCOMMUNICATION, CO. LTD., SEOUL, REPUBLIC OF KOREA, FILED 5-31-2011.

**THE CELLIN**

THE MARK CONSISTS OF STANDARD CHARACTERS WITHOUT CLAIM TO ANY PARTICULAR FONT, STYLE, SIZE, OR COLOR.

FOR AFTER-SUN LOTIONS; BEAUTY LOTIONS; BODY LOTIONS; BODY OILS; CLEANSING CREAMS; COMMON TOILET WATER; COSMETIC CREAMS; COSMETIC CREAMS FOR SKIN CARE; COSMETIC PREPARATIONS; COSMETIC PREPARATIONS FOR SKIN CARE; COSMETIC SUN MILK LOTIONS; COSMETIC SUN-PROTECTING PREPARATIONS; COSMETIC SUN-TANNING PREPARATIONS; COSMETIC SUNSCREEN PREPARATIONS; COSMETICS IN THE FORM OF MILKS, LOTIONS AND EMULSIONS; FACE AND BODY LOTIONS; HAND LOTIONS; LIP LINER; LIPSTICKS; LOOSE FACE POWDER; LOTIONS FOR FACE AND BODY CARE; MAKE-UP; MAKE-UP FOUNDATIONS; MASCARA; MASK PACK FOR COSMETIC PURPOSES; MASSAGE GELS OTHER THAN FOR MEDICAL PURPOSES; MASSAGE LOTIONS; MASSAGE OILS; SKIN CREAMS; SKIN LOTIONS; SUN CARE LOTIONS; SUN-BLOCK LOTIONS; SUN-TANNING OILS AND LOTIONS; SUNSCREEN CREAMS; TOILET WATER (U.S. CLS. 1, 4, 6, 50, 51 AND 52).

ELI HELLMAN, EXAMINING ATTORNEY

SN 85-334,772. MERCURY RETAIL SERVICES LLC, SAN ANTONIO, TX. FILED 6-1-2011.

**KYLA & CARLOS**

THE MARK CONSISTS OF STANDARD CHARACTERS WITHOUT CLAIM TO ANY PARTICULAR FONT, STYLE, SIZE, OR COLOR.

THE NAME(S), PORTRAIT(S), AND/OR SIGNATURE(S) SHOWN IN THE MARK IDENTIFIES "KYLA" HOLDER, MINOR DAUGHTER OF LOUIE LEE HOLDER III, WHOSE CONSENT(S) TO REGISTER IS MADE OF RECORD.

FOR LIP BALM (U.S. CLS. 1, 4, 6, 50, 51 AND 52).

FIRST USE 6-3-2011; IN COMMERCE 6-3-2011.

FLORENTINA BLANDU, EXAMINING ATTORNEY

**CLASS 3—(Continued).**

SN 85-334,875. HENKEL AG & CO. KGAA, DUESSELDORF, FED REP GERMANY, FILED 6-1-2011.

**PROFESSION**

THE MARK CONSISTS OF STANDARD CHARACTERS WITHOUT CLAIM TO ANY PARTICULAR FONT, STYLE, SIZE, OR COLOR.

FOR HAIR CARE PREPARATIONS; HAIR COLORING PREPARATIONS; HAIR STYLING PREPARATIONS (U.S. CLS. 1, 4, 6, 50, 51 AND 52).

SAIMA MAKHDOOM, EXAMINING ATTORNEY

**CLASS 3—(Continued).**

SN 85-335,277. VERABELLA, INC., BEVERLY HILLS, CA. FILED 6-1-2011.

**Kiss Zit Goodbye**

THE MARK CONSISTS OF STANDARD CHARACTERS WITHOUT CLAIM TO ANY PARTICULAR FONT, STYLE, SIZE, OR COLOR.

FOR NON-MEDICATED ACNE TREATMENT PREPARATIONS (U.S. CLS. 1, 4, 6, 50, 51 AND 52). FIRST USE 6-1-2000; IN COMMERCE 7-15-2004.

WILLIAM P. SHANAHAN, EXAMINING ATTORNEY

SN 85-334,888. CONCEPT AMENITIES PTY LTD, BRAESIDE, VICTORIA, AUSTRALIA, FILED 6-1-2011.

**E&W**

THE MARK CONSISTS OF STANDARD CHARACTERS WITHOUT CLAIM TO ANY PARTICULAR FONT, STYLE, SIZE, OR COLOR.

FOR NON-MEDICATED TOILETRIES, PERFUMERY, COSMETICS, HAIR CARE PREPARATIONS; SHAMPOOS, HAIR CONDITIONERS AND HAIR CLEANSERS, SKIN AND BODY LOTIONS, CREAMS, POWDERS AND MOISTURISERS, CLEANSERS FOR SKIN, SKIN MOISTURISERS, EXFOLIANTS FOR SKIN, NON-MEDICATED SKIN CARE PREPARATIONS; SHAVING PREPARATIONS; SOAP INCLUDING LIQUID AND HAND SOAPS; BATH AND SHOWER GELS; ESSENTIAL OILS FOR USE IN AROMATHERAPY (U.S. CLS. 1, 4, 6, 50, 51 AND 52).

RONALD MCMORROW, EXAMINING ATTORNEY

SN 85-335,437. SERGENT, DANNIELLE, SAN FRANCISCO, CA. FILED 6-1-2011.

**COGNOSCENTI**

THE MARK CONSISTS OF STANDARD CHARACTERS WITHOUT CLAIM TO ANY PARTICULAR FONT, STYLE, SIZE, OR COLOR.

FOR BATH OILS; BATH SALTS; BEAUTY LOTIONS; ESSENTIAL OILS; PERFUMES AND COLOGNES; PERFUMES IN SOLID FORM; POTPOURRI; SCENTED ROOM SPRAYS (U.S. CLS. 1, 4, 6, 50, 51 AND 52). FIRST USE 10-10-2010; IN COMMERCE 12-10-2010.

GISELLE AGOSTO, EXAMINING ATTORNEY

SN 85-335,066. INTENSIVE NUTRITION INCORPORATED, SAN LEANDRO, CA. FILED 6-1-2011.

**Tanoral**

THE MARK CONSISTS OF STANDARD CHARACTERS WITHOUT CLAIM TO ANY PARTICULAR FONT, STYLE, SIZE, OR COLOR.

FOR TOOTH POWDER (U.S. CLS. 1, 4, 6, 50, 51 AND 52).

FIRST USE 3-0-1985; IN COMMERCE 3-0-1985.

EMILY CHUO, EXAMINING ATTORNEY

SN 85-336,010. CAROL'S DAUGHTER HOLDINGS, LLC, NEW YORK, NY. FILED 6-2-2011.

**JUST FINE**

THE MARK CONSISTS OF STANDARD CHARACTERS WITHOUT CLAIM TO ANY PARTICULAR FONT, STYLE, SIZE, OR COLOR.

FOR BODY AND BEAUTY CARE COSMETICS; PERFUME; SKIN SOAP; BODY LOTION; BEAUTY LOTIONS; BEAUTY CREAMS; BEAUTY CREAMS FOR BODY CARE; FACE AND BODY BEAUTY CREAMS; BODY CREAMS; BODY POWDER; PERFUMED CREAMS; EYE CREAM; EYE LOTIONS; BODY SCRUB; BODY SPRAYS; COSMETIC SOAPS; HAND LOTIONS; NON-MEDICATED TOILETRIES (U.S. CLS. 1, 4, 6, 50, 51 AND 52).

HENRY S. ZAK, EXAMINING ATTORNEY

**CLASS 3—(Continued).**

SN 85-336,016. BECK, ANN, REDDING, CA. AND BECK, STEVEN, REDDING, CA. FILED 6-2-2011.

# Tou-shea

THE MARK CONSISTS OF STANDARD CHARACTERS WITHOUT CLAIM TO ANY PARTICULAR FONT, STYLE, SIZE, OR COLOR.

FOR NON-MEDICATED SKIN CARE PREPARATIONS (U.S. CLS. 1, 4, 6, 50, 51 AND 52).  
IRA J. GOODSAD, EXAMINING ATTORNEY

SN 85-336,353. ROUX LABORATORIES, INC., JACKSONVILLE, FL. FILED 6-2-2011.

## STRAIGHT FROM EDEN

THE MARK CONSISTS OF STANDARD CHARACTERS WITHOUT CLAIM TO ANY PARTICULAR FONT, STYLE, SIZE, OR COLOR.

FOR CONDITIONER; SHAMPOO; AND HAIR RELAXERS (U.S. CLS. 1, 4, 6, 50, 51 AND 52).  
LINDA E. BLOHM, EXAMINING ATTORNEY

SN 85-336,473. JABU STONE PRODUCTS (PROPRIETARY) LIMITED, GAUTENG, SOUTH AFRICA, FILED 6-2-2011.



NO CLAIM IS MADE TO THE EXCLUSIVE RIGHT TO USE "NATURAL HEALTH CARE", APART FROM THE MARK AS SHOWN.

THE MARK CONSISTS OF THE NAME "JABU STONE", THE WORDS "NATURAL HAIR CARE", AND THE FANCIFUL DESIGN OF A WOMAN'S HEAD ALL LOCATED INSIDE A SQUARE.

FOR HAIR CARE, HAIR STYLING AND HAIR TREATMENT PRODUCTS, NAMELY, HAIR SHAMPOOS, HAIR CONDITIONERS, HAIR MOISTURIZERS, HAIR SPRAYS, HAIR GELS, HAIR WAXES AND HAIR CREAMS (U.S. CLS. 1, 4, 6, 50, 51 AND 52).

SANI KHOURI, EXAMINING ATTORNEY

**CLASS 3—(Continued).**

SN 85-336,882. RICH HIPPIE INC, LOS ANGELES, CA. FILED 6-2-2011.

# Abbey Road

THE MARK CONSISTS OF STANDARD CHARACTERS WITHOUT CLAIM TO ANY PARTICULAR FONT, STYLE, SIZE, OR COLOR.

FOR COLOGNES, PERFUMES AND COSMETICS; EAU DE PERFUME; OILS FOR PERFUMES AND SCENTS (U.S. CLS. 1, 4, 6, 50, 51 AND 52).

FIRST USE 1-1-2002; IN COMMERCE 1-1-2002.  
STEPHANIE ALI, EXAMINING ATTORNEY

SN 85-337,097. SANCHEZ, NICOLE, CANOGA PARK, CA. FILED 6-3-2011.

# SWIPEZ

THE MARK CONSISTS OF STANDARD CHARACTERS WITHOUT CLAIM TO ANY PARTICULAR FONT, STYLE, SIZE, OR COLOR.

FOR DISPOSABLE WIPES IMPREGNATED WITH CLEANSING COMPOUNDS FOR USE ON SHOES (U.S. CLS. 1, 4, 6, 50, 51 AND 52).

CHARLOTTE CORWIN, EXAMINING ATTORNEY

SN 85-337,274. UNITED BEAUTY PRODUCTS, INC., ALPHARETTA, GA. FILED 6-3-2011.

# NAIL IT!

THE MARK CONSISTS OF STANDARD CHARACTERS WITHOUT CLAIM TO ANY PARTICULAR FONT, STYLE, SIZE, OR COLOR.

FOR ADHESIVES FOR ATTACHING ARTIFICIAL FINGERNAILS AND/OR EYELASHES; ARTIFICIAL FINGERNAILS; FINGERNAIL DECALS; FINGERNAIL EMBELLISHMENTS; FINGERNAIL JEWELRY (U.S. CLS. 1, 4, 6, 50, 51 AND 52).

KYLE PEETE, EXAMINING ATTORNEY

**CLASS 3—(Continued).**

SN 85-337,288. UNITED BEAUTY PRODUCTS, INC., ALPHARETTA, GA. FILED 6-3-2011.

**CRACK IT!**

THE MARK CONSISTS OF STANDARD CHARACTERS WITHOUT CLAIM TO ANY PARTICULAR FONT, STYLE, SIZE, OR COLOR.

FOR ADHESIVES FOR ATTACHING ARTIFICIAL FINGERNAILS AND/OR EYELASHES; ARTIFICIAL FINGERNAILS; FINGERNAIL DECALS; FINGERNAIL EMBELLISHMENTS; FINGERNAIL JEWELRY (U.S. CLS. 1, 4, 6, 50, 51 AND 52).

KYLE PEETE, EXAMINING ATTORNEY

SN 85-337,296. UNITED BEAUTY PRODUCTS, INC., ALPHARETTA, GA. FILED 6-3-2011.

**TOP IT!**

THE MARK CONSISTS OF STANDARD CHARACTERS WITHOUT CLAIM TO ANY PARTICULAR FONT, STYLE, SIZE, OR COLOR.

FOR ADHESIVES FOR ATTACHING ARTIFICIAL FINGERNAILS AND/OR EYELASHES; ARTIFICIAL FINGERNAILS; FINGERNAIL DECALS; FINGERNAIL EMBELLISHMENTS; FINGERNAIL JEWELRY (U.S. CLS. 1, 4, 6, 50, 51 AND 52).

KYLE PEETE, EXAMINING ATTORNEY

SN 85-337,305. UNITED BEAUTY PRODUCTS, INC., ALPHARETTA, GA. FILED 6-3-2011.

**WRAP IT!**

THE MARK CONSISTS OF STANDARD CHARACTERS WITHOUT CLAIM TO ANY PARTICULAR FONT, STYLE, SIZE, OR COLOR.

FOR ADHESIVES FOR ATTACHING ARTIFICIAL FINGERNAILS AND/OR EYELASHES; ARTIFICIAL FINGERNAILS; FINGERNAIL DECALS; FINGERNAIL EMBELLISHMENTS; FINGERNAIL JEWELRY (U.S. CLS. 1, 4, 6, 50, 51 AND 52).

KYLE PEETE, EXAMINING ATTORNEY

**CLASS 3—(Continued).**

SN 85-337,324. UNITED BEAUTY PRODUCTS, INC., ALPHARETTA, GA. FILED 6-3-2011.

**WINK IT!**

THE MARK CONSISTS OF STANDARD CHARACTERS WITHOUT CLAIM TO ANY PARTICULAR FONT, STYLE, SIZE, OR COLOR.

FOR ADHESIVES FOR AFFIXING FALSE EYELASHES; ARTIFICIAL EYELASHES; FALSE EYELASHES (U.S. CLS. 1, 4, 6, 50, 51 AND 52).

KYLE PEETE, EXAMINING ATTORNEY

SN 85-337,383. INTERNATIONAL PERFUME PALACE INCORPORATED, PLAINVIEW, NY. FILED 6-3-2011.

**TR TONY RAKANA**

THE MARK CONSISTS OF STANDARD CHARACTERS WITHOUT CLAIM TO ANY PARTICULAR FONT, STYLE, SIZE, OR COLOR.

THE NAME "TONY RAKANA" DOES NOT IDENTIFY A LIVING INDIVIDUAL.

FOR AFTERSHAVE; BAR SOAP; BATH POWDER; BATH SOAPS; BATH SOAPS IN LIQUID, SOLID OR GEL FORM; BEAUTY CREAMS; BODY CREAM; BODY DEODORANTS; BODY LOTIONS; BODY POWDER; BODY SPRAY USED AS A PERSONAL DEODORANT AND AS FRAGRANCE; COLOGNE; COLOGNE WATER; COSMETICS; DEODORANTS AND ANTIPERSPIRANTS; EAU DE COLOGNE; FACIAL LOTION; FRAGRANCES; HAIR SHAMPOOS AND CONDITIONERS; NON-MEDICATED SKIN CARE PREPARATION, NAMELY, BODY MIST; PERFUMED SOAP; PERFUMES AND COLOGNES; PERFUMES, AFTERSHAVES AND COLOGNES; POWDER FOR MAKE-UP; SHOWER AND BATH GEL; SHOWER GEL; TOILET WATER (U.S. CLS. 1, 4, 6, 50, 51 AND 52).

JENNIFER MARTIN, EXAMINING ATTORNEY

SN 85-337,557. LA COMÉDIE DES PARFUMS - PARIS - LLC, DBA THE PERFUMES COMEDY, SEATTLE, WA. FILED 6-3-2011.

**MOLIÈRE**

THE MARK CONSISTS OF STANDARD CHARACTERS WITHOUT CLAIM TO ANY PARTICULAR FONT, STYLE, SIZE, OR COLOR.

FOR COLOGNE; FRAGRANCES; PERFUME; PERFUMERIES (U.S. CLS. 1, 4, 6, 50, 51 AND 52).

FIRST USE 4-15-2011; IN COMMERCE 4-15-2011.

MARK SHINER, EXAMINING ATTORNEY

**CLASS 3—(Continued).**

SN 85-337,601. LA COMÉDIE DES PARFUMS - PARIS - LLC, DBA THE PERFUMES COMEDY, SEATTLE, WA. FILED 6-3-2011.

# MOLIÈRE-ROYAL

THE MARK CONSISTS OF STANDARD CHARACTERS WITHOUT CLAIM TO ANY PARTICULAR FONT, STYLE, SIZE, OR COLOR.

FOR COLOGNE; FRAGRANCES; PERFUME; PERFUMERIES (U.S. CLS. 1, 4, 6, 50, 51 AND 52).  
MARK SHINER, EXAMINING ATTORNEY

**CLASS 3—(Continued).**

SN 85-338,219. INTERNATIONAL PERFUME PALACE INCORPORATED, PLAINVIEW, NY. FILED 6-4-2011.

# HAMPTON GIRLS

THE MARK CONSISTS OF STANDARD CHARACTERS WITHOUT CLAIM TO ANY PARTICULAR FONT, STYLE, SIZE, OR COLOR.

FOR AFTERSHAVE; BAR SOAP; BATH POWDER; BATH SOAPS; BATH SOAPS IN LIQUID, SOLID OR GEL FORM; BEAUTY CREAMS; BODY CREAM; BODY DEODORANTS; BODY LOTIONS; BODY POWDER; BODY SPRAY USED AS A PERSONAL DEODORANT AND AS FRAGRANCE; COLOGNE; COLOGNE WATER; COSMETICS; DEODORANTS AND ANTIPERSPIRANTS; EAU DE COLOGNE; FACIAL LOTION; FRAGRANCES; HAIR SHAMPOOS AND CONDITIONERS; NON-MEDICATED SKIN CARE PREPARATION, NAMELY, BODY MIST; PERFUMED SOAP; PERFUMES AND COLOGNES; PERFUMES, AFTERSHAVES AND COLOGNES; POWDER FOR MAKE-UP; SHOWER AND BATH GEL; SHOWER GEL; TOILET WATER (U.S. CLS. 1, 4, 6, 50, 51 AND 52).

JENNIFER MARTIN, EXAMINING ATTORNEY

SN 85-338,218. INTERNATIONAL PERFUME PALACE INCORPORATED, PLAINVIEW, NY. FILED 6-4-2011.

# TONY RAKANA

THE MARK CONSISTS OF STANDARD CHARACTERS WITHOUT CLAIM TO ANY PARTICULAR FONT, STYLE, SIZE, OR COLOR.

THE NAME "TONY RAKANA" DOES NOT IDENTIFY A LIVING INDIVIDUAL.

FOR AFTERSHAVE; BAR SOAP; BATH POWDER; BATH SOAPS; BATH SOAPS IN LIQUID, SOLID OR GEL FORM; BEAUTY CREAMS; BODY CREAM; BODY DEODORANTS; BODY LOTIONS; BODY POWDER; BODY SPRAY USED AS A PERSONAL DEODORANT AND AS FRAGRANCE; COLOGNE; COLOGNE WATER; COSMETICS; DEODORANTS AND ANTIPERSPIRANTS; EAU DE COLOGNE; FACIAL LOTION; FRAGRANCES; HAIR SHAMPOOS AND CONDITIONERS; NON-MEDICATED SKIN CARE PREPARATION, NAMELY, BODY MIST; PERFUMED SOAP; PERFUMES AND COLOGNES; PERFUMES, AFTERSHAVES AND COLOGNES; POWDER FOR MAKE-UP; SHOWER AND BATH GEL; SHOWER GEL; TOILET WATER (U.S. CLS. 1, 4, 6, 50, 51 AND 52).

JENNIFER MARTIN, EXAMINING ATTORNEY

SN 85-338,220. INTERNATIONAL PERFUME PALACE INCORPORATED, PLAINVIEW, NY. FILED 6-4-2011.

# TR LUSCIOUS

THE MARK CONSISTS OF STANDARD CHARACTERS WITHOUT CLAIM TO ANY PARTICULAR FONT, STYLE, SIZE, OR COLOR.

FOR AFTERSHAVE; BAR SOAP; BATH POWDER; BATH SOAPS; BATH SOAPS IN LIQUID, SOLID OR GEL FORM; BEAUTY CREAMS; BODY CREAM; BODY DEODORANTS; BODY LOTIONS; BODY POWDER; BODY SPRAY USED AS A PERSONAL DEODORANT AND AS FRAGRANCE; COLOGNE; COLOGNE WATER; COSMETICS; DEODORANTS AND ANTIPERSPIRANTS; EAU DE COLOGNE; FACIAL LOTION; FRAGRANCES; HAIR SHAMPOOS AND CONDITIONERS; NON-MEDICATED SKIN CARE PREPARATION, NAMELY, BODY MIST; PERFUMED SOAP; PERFUMES AND COLOGNES; PERFUMES, AFTERSHAVES AND COLOGNES; POWDER FOR MAKE-UP; SHOWER AND BATH GEL; SHOWER GEL; TOILET WATER (U.S. CLS. 1, 4, 6, 50, 51 AND 52).

JENNIFER MARTIN, EXAMINING ATTORNEY

**CLASS 3—(Continued).**

SN 85-338,222. INTERNATIONAL PERFUME PALACE INCORPORATED, PLAINVIEW, NY. FILED 6-4-2011.

**HAMPTON BOYS**

THE MARK CONSISTS OF STANDARD CHARACTERS WITHOUT CLAIM TO ANY PARTICULAR FONT, STYLE, SIZE, OR COLOR.

FOR AFTERSHAVE; BAR SOAP; BATH POWDER; BATH SOAPS; BATH SOAPS IN LIQUID, SOLID OR GEL FORM; BEAUTY CREAMS; BODY CREAM; BODY DEODORANTS; BODY LOTIONS; BODY POWDER; BODY SPRAY USED AS A PERSONAL DEODORANT AND AS FRAGRANCE; COLOGNE; COLOGNE WATER; COSMETICS; DEODORANTS AND ANTIPERSPIRANTS; EAU DE COLOGNE; FACIAL LOTION; FRAGRANCES; HAIR SHAMPOOS AND CONDITIONERS; NON-MEDICATED SKIN CARE PREPARATION, NAMELY, BODY MIST; PERFUMED SOAP; PERFUMES AND COLOGNES; PERFUMES, AFTERSHAVES AND COLOGNES; POWDER FOR MAKE-UP; SHOWER AND BATH GEL; SHOWER GEL; TOILET WATER (U.S. CLS. 1, 4, 6, 50, 51 AND 52).

JENNIFER MARTIN, EXAMINING ATTORNEY

SN 85-338,223. INTERNATIONAL PERFUME PALACE INCORPORATED, PLAINVIEW, NY. FILED 6-4-2011.

**TONY RAKANA DYNAMIC**

THE MARK CONSISTS OF STANDARD CHARACTERS WITHOUT CLAIM TO ANY PARTICULAR FONT, STYLE, SIZE, OR COLOR.

THE NAME "TONY RAKANA" DOES NOT IDENTIFY A LIVING INDIVIDUAL.

FOR AFTERSHAVE; BAR SOAP; BATH POWDER; BATH SOAPS; BATH SOAPS IN LIQUID, SOLID OR GEL FORM; BEAUTY CREAMS; BODY CREAM; BODY DEODORANTS; BODY LOTIONS; BODY POWDER; BODY SPRAY USED AS A PERSONAL DEODORANT AND AS FRAGRANCE; COLOGNE; COLOGNE WATER; COSMETICS; DEODORANTS AND ANTIPERSPIRANTS; EAU DE COLOGNE; FACIAL LOTION; FRAGRANCES; HAIR SHAMPOOS AND CONDITIONERS; NON-MEDICATED SKIN CARE PREPARATION, NAMELY, BODY MIST; PERFUMED SOAP; PERFUMES AND COLOGNES; PERFUMES, AFTERSHAVES AND COLOGNES; POWDER FOR MAKE-UP; SHOWER AND BATH GEL; SHOWER GEL; TOILET WATER (U.S. CLS. 1, 4, 6, 50, 51 AND 52).

JENNIFER MARTIN, EXAMINING ATTORNEY

**CLASS 3—(Continued).**

SN 85-338,781. COLGATE-PALMOLIVE COMPANY, NEW YORK, NY. FILED 6-6-2011.

**HANDLE IT**

THE MARK CONSISTS OF STANDARD CHARACTERS WITHOUT CLAIM TO ANY PARTICULAR FONT, STYLE, SIZE, OR COLOR.

FOR DEODORANTS AND ANTIPERSPIRANTS FOR PERSONAL USE (U.S. CLS. 1, 4, 6, 50, 51 AND 52).  
JAY FLOWERS, EXAMINING ATTORNEY

SN 85-339,022. STEVEN CAMPS, DBA RKG CAMPS, HUNTINGTON BEACH, CA. FILED 6-6-2011.

**GlassBlast**

THE MARK CONSISTS OF STANDARD CHARACTERS WITHOUT CLAIM TO ANY PARTICULAR FONT, STYLE, SIZE, OR COLOR.

FOR GLASS GRANULES USED AS ABRASIVES IN BLASTING SERVICES (U.S. CLS. 1, 4, 6, 50, 51 AND 52).  
SHANNON TWOHIG, EXAMINING ATTORNEY

SN 85-339,175. BOLTINGHOUSE, PATRICK, DBA VG COSMETICS, DES MOINES, IA. FILED 6-6-2011.

**VGCosmetics**

THE MARK CONSISTS OF STANDARD CHARACTERS WITHOUT CLAIM TO ANY PARTICULAR FONT, STYLE, SIZE, OR COLOR.

FOR COSMETICS (U.S. CLS. 1, 4, 6, 50, 51 AND 52).  
FIRST USE 2-1-2008; IN COMMERCE 2-1-2008.  
RONALD DELGIZZI, EXAMINING ATTORNEY

**CLASS 3—(Continued).**

SN 85-339,861. INGENUE, LLC, MINNEAPOLIS, MN. FILED 6-7-2011.

**THE NEW FACE OF HOLLYWOOD**

THE MARK CONSISTS OF STANDARD CHARACTERS WITHOUT CLAIM TO ANY PARTICULAR FONT, STYLE, SIZE, OR COLOR.

FOR AFTER-SUN GELS; BODY AND BEAUTY CARE COSMETICS; CLEANSING CREAMS; COLOGNES, PERFUMES AND COSMETICS; COSMETIC CREAMS; COSMETIC CREAMS FOR SKIN CARE; COSMETIC HAND CREAMS; COSMETIC PREPARATIONS FOR BODY CARE; COSMETIC PREPARATIONS FOR PROTECTING THE SKIN FROM THE SUN'S RAYS; COSMETIC PREPARATIONS FOR SKIN CARE; COSMETIC PREPARATIONS FOR SKIN RENEWAL; COSMETIC SUN-PROTECTING PREPARATIONS; COSMETIC SUNSCREEN PREPARATIONS; COSMETICS AND MAKE-UP; FACE CREAMS FOR COSMETIC USE; WRINKLE-MINIMIZING COSMETIC PREPARATIONS FOR TOPICAL FACIAL USE (U.S. CLS. 1, 4, 6, 50, 51 AND 52).

RUSS HERMAN, EXAMINING ATTORNEY

SN 85-340,056. VICTORIA'S SECRET STORES BRAND MANAGEMENT, INC., REYNOLDSBURG, OH. FILED 6-7-2011.

**TEASE FOR TWO**

THE MARK CONSISTS OF STANDARD CHARACTERS WITHOUT CLAIM TO ANY PARTICULAR FONT, STYLE, SIZE, OR COLOR.

OWNER OF U.S. REG. NO. 3,832,857.  
FOR BODY ART PENS; BODY CREAM; FRAGRANCED BODY CARE PREPARATIONS, NAMELY, EDIBLE BODY ICING; LIP GLOSS; NON-MEDICATED SKIN CARE PREPARATION, NAMELY, BODY MIST (U.S. CLS. 1, 4, 6, 50, 51 AND 52).

ALICE BENMAMAN, EXAMINING ATTORNEY

SN 85-340,104. GREYSON INTERNATIONAL, INC., BOCA RATON, FL. FILED 6-7-2011.

**DAMAGE CONTROL**

THE MARK CONSISTS OF STANDARD CHARACTERS WITHOUT CLAIM TO ANY PARTICULAR FONT, STYLE, SIZE, OR COLOR.

OWNER OF U.S. REG. NO. 2,443,588.  
FOR COSMETICS, NAMELY, SKIN CREAMS, MOISTURIZERS, CLEANSERS AND LOTIONS (U.S. CLS. 1, 4, 6, 50, 51 AND 52).  
FIRST USE 7-15-1998; IN COMMERCE 7-15-1998.  
KELLEY WELLS, EXAMINING ATTORNEY

**CLASS 3—(Continued).**

SN 85-340,220. EC RESEARCH CORP., CHADDS FORD, PA. FILED 6-7-2011.

**CALM-CLEANSE**

THE MARK CONSISTS OF STANDARD CHARACTERS WITHOUT CLAIM TO ANY PARTICULAR FONT, STYLE, SIZE, OR COLOR.

FOR SKIN CLEANSING LOTION (U.S. CLS. 1, 4, 6, 50, 51 AND 52).

FIRST USE 4-1-2010; IN COMMERCE 4-1-2010.

FRED CARL, EXAMINING ATTORNEY

SN 85-340,422. LORINDA GRAHAM-VAN NEWKIRK, WEATHERFORD, TX. FILED 6-7-2011.

**GYPSY SOULE**

THE MARK CONSISTS OF STANDARD CHARACTERS WITHOUT CLAIM TO ANY PARTICULAR FONT, STYLE, SIZE, OR COLOR.

FOR PERFUME, COLOGNE, EAU DE TOILETTE (U.S. CLS. 1, 4, 6, 50, 51 AND 52).

SHAUNIA CARLYLE, EXAMINING ATTORNEY

SN 85-340,456. DR. RYAMOND LABORATORIES, INC., RUMSON, NJ. FILED 6-7-2011.

**PSORIAPALM**

THE MARK CONSISTS OF STANDARD CHARACTERS WITHOUT CLAIM TO ANY PARTICULAR FONT, STYLE, SIZE, OR COLOR.

FOR SKIN CREAMS, SKIN LOTIONS, SHAMPOOS (U.S. CLS. 1, 4, 6, 50, 51 AND 52).

CHERYL CLAYTON, EXAMINING ATTORNEY

**CLASS 3—(Continued).**

SN 85-340,533. AVOCADO DREAMIN LLC, DBA AVOCADO DREAMIN LLC, FALLBROOK, CA. FILED 6-7-2011.

# Avocology

THE MARK CONSISTS OF STANDARD CHARACTERS WITHOUT CLAIM TO ANY PARTICULAR FONT, STYLE, SIZE, OR COLOR.

FOR ANTI-WRINKLE CREAM; ANTI-WRINKLE CREAMS; BEAUTY CREAMS; BEAUTY CREAMS FOR BODY CARE; BEAUTY LOTIONS; BEAUTY SERUMS; BODY AND BEAUTY CARE COSMETICS; BODY CREAM; BODY CREAMS; BODY LOTION; BODY LOTIONS; BODY SCRUB; COSMETIC CREAMS; COSMETIC CREAMS FOR SKIN CARE; COSMETIC HAND CREAMS; EYE CREAM; EYE LOTIONS; FACE AND BODY BEAUTY CREAMS; FACE AND BODY CREAMS; FACE AND BODY LOTIONS; FACE CREAMS; FACE CREAMS FOR COSMETIC USE; FACIAL CREAM; FACIAL CREAMS; FACIAL LOTION; FACIAL SCRUBS; HAND CREAM; HAND CREAMS; HAND LOTIONS; HAND SCRUBS; LIP BALM; LIP BALM; LOTIONS FOR COSMETIC PURPOSES; LOTIONS FOR FACE AND BODY CARE; MOISTURIZING CREAMS; NIGHT CREAM; NON-MEDICATED FOOT CREAM; NON-MEDICATED FOOT LOTIONS; NON-MEDICATED LIP BALM THAT DOES NOT CONTAIN BEESWAX; NON-MEDICATED SKIN CARE CREAMS AND LOTIONS; NON-MEDICATED SKIN CARE PREPARATIONS, NAMELY, CREAMS, LOTIONS, GELS, TONERS, CLEANSERS AND PEELS; NON-MEDICATED SKIN CREAMS; NON-MEDICATED SKIN CREAMS WITH ESSENTIAL OILS FOR USE IN AROMATHERAPY; SCENTED BODY LOTIONS AND CREAMS; SKIN AND BODY TOPICAL LOTIONS, CREAMS AND OILS FOR COSMETIC USE; SKIN CONDITIONING CREAMS FOR COSMETIC PURPOSES; SKIN CREAM; SKIN CREAMS; SKIN CREAMS IN LIQUID AND IN SOLID FORM; SKIN CREAMS IN LIQUID AND SOLID; SKIN CREAMS IN LIQUID AND SOLID FORM; SKIN LOTION; SKIN LOTIONS (U.S. CLS. 1, 4, 6, 50, 51 AND 52).

FIRST USE 5-1-2010; IN COMMERCE 5-1-2010.  
THOMAS MANOR, EXAMINING ATTORNEY

SN 85-341,000. MARC FRASER, PALM SPRINGS, CA. FILED 6-8-2011.



THE MARK CONSISTS OF A STYLIZED LETTER "S" SUPERIMPOSED ON A STYLIZED LETTER "E".

FOR NON-MEDICATED BALMS FOR USE ON SKIN (U.S. CLS. 1, 4, 6, 50, 51 AND 52).

FIRST USE 1-31-2011; IN COMMERCE 3-10-2011.  
LINDA MICKLEBURGH, EXAMINING ATTORNEY

**CLASS 3—(Continued).**

SN 85-341,088. COLGATE-PALMOLIVE COMPANY, NEW YORK, NY. FILED 6-8-2011.

# COLGATE 360

THE MARK CONSISTS OF STANDARD CHARACTERS WITHOUT CLAIM TO ANY PARTICULAR FONT, STYLE, SIZE, OR COLOR.

OWNER OF U.S. REG. NOS. 1,695,708, 3,677,181 AND OTHERS.

FOR TOOTHPASTE AND MOUTHWASH (U.S. CLS. 1, 4, 6, 50, 51 AND 52).

JAY FLOWERS, EXAMINING ATTORNEY

SN 85-341,191. INTELLIGENT NUTRIENTS, LLC, MINNEAPOLIS, MN. FILED 6-8-2011.

# IN

THE MARK CONSISTS OF STANDARD CHARACTERS WITHOUT CLAIM TO ANY PARTICULAR FONT, STYLE, SIZE, OR COLOR.

OWNER OF U.S. REG. NOS. 3,546,036, 4,002,706 AND OTHERS.

FOR HAIR CARE PRODUCTS, NAMELY, HAIR COLOR AND WAVING LOTIONS; COSMETICS, NAMELY, EYE SHADOW, FOUNDATION, BLUSH, FACE POWDER, CONCEALER, EYE PENCILS, LIP PENCILS AND MASCARA; HAIR CARE AND SKIN CARE PREPARATIONS FOR PETS, NAMELY, SHAMPOO, CONDITIONER, DETANGLING SPRAYS AND CONDITIONERS, CLEANSERS, EMULSIONS FOR USE ON PAWS AND SKIN, BODY SPRAYS AND POWDERS; HOUSEHOLD CLEANING PREPARATIONS, NAMELY, ALL PURPOSE CLEANERS, CLEANERS FOR USE ON DISHES, CLEANERS FOR USE ON FABRIC AND CLEANERS FOR USE ON FLOORS, WALLS, WINDOWS AND TOILETS; AND INCENSE (U.S. CLS. 1, 4, 6, 50, 51 AND 52).

BENJAMIN OKEKE, EXAMINING ATTORNEY

SN 85-341,623. SPARTAN BRANDS, INC., NEW YORK, NY. FILED 6-8-2011.

# NEUTREASY

THE MARK CONSISTS OF STANDARD CHARACTERS WITHOUT CLAIM TO ANY PARTICULAR FONT, STYLE, SIZE, OR COLOR.

FOR HAIR RELAXERS (U.S. CLS. 1, 4, 6, 50, 51 AND 52).

DAVID C. REIHNER, EXAMINING ATTORNEY



**CLASS 3—(Continued).**

SN 85-342,025. MYBODY, L.L.C., PHOENIX, AZ. FILED 6-9-2011.

**MYFACE IS BRIGHT**

THE MARK CONSISTS OF STANDARD CHARACTERS WITHOUT CLAIM TO ANY PARTICULAR FONT, STYLE, SIZE, OR COLOR.

FOR FACIAL CREAMS; NON-MEDICATED SKIN CREAMS; SKIN LIGHTENING CREAMS (U.S. CLS. 1, 4, 6, 50, 51 AND 52).

DEBRA LEE, EXAMINING ATTORNEY

**CLASS 3—(Continued).**

SN 85-343,148. L'OREAL USA CREATIVE, INC., NEW YORK, NY. FILED 6-10-2011.

**LITE SHIELD**

THE MARK CONSISTS OF STANDARD CHARACTERS WITHOUT CLAIM TO ANY PARTICULAR FONT, STYLE, SIZE, OR COLOR.

FOR HAIR CARE PREPARATION (U.S. CLS. 1, 4, 6, 50, 51 AND 52).

KIM MONINGHOFF, EXAMINING ATTORNEY

SN 85-342,413. TEVA ANIMAL HEALTH, INC., ST. JOSEPH, MO. FILED 6-9-2011.

**AVENALYT**

THE MARK CONSISTS OF STANDARD CHARACTERS WITHOUT CLAIM TO ANY PARTICULAR FONT, STYLE, SIZE, OR COLOR.

FOR NON-MEDICATED GROOMING PREPARATIONS FOR COMPANION ANIMALS, NAMELY, SHAMPOO, CONDITIONER, SKIN CARE PREPARATIONS (U.S. CLS. 1, 4, 6, 50, 51 AND 52).

JEFFERY COWARD, EXAMINING ATTORNEY

SN 85-343,340. LA SENZA CORPORATION, DORVAL, QUEBEC, CANADA, FILED 6-10-2011.

**SEXY CANDY**

THE MARK CONSISTS OF STANDARD CHARACTERS WITHOUT CLAIM TO ANY PARTICULAR FONT, STYLE, SIZE, OR COLOR.

FOR PERSONAL CARE PRODUCTS AND PERFUMERY PRODUCTS, NAMELY, PERFUME, EAU DE PARFUM, EAU DE COLOGNE, EAU DE TOILETTE, BODY SPLASH, BODY MIST, BODY SCRUB, BUBBLE BATH, SHOWER GEL, BODY WASH, BODY SOAP, HAND SOAP, BODY BUTTER, BODY CREAM, HAND CREAM, BODY LOTION, HAND LOTION, BODY POWDER (U.S. CLS. 1, 4, 6, 50, 51 AND 52).

KATHLEEN LORENZO, EXAMINING ATTORNEY

SN 85-342,636. SPARTAN BRANDS, INC., NEW YORK, NY. FILED 6-9-2011.

**NEUTRLIFE**

THE MARK CONSISTS OF STANDARD CHARACTERS WITHOUT CLAIM TO ANY PARTICULAR FONT, STYLE, SIZE, OR COLOR.

FOR HAIR RELAXERS (U.S. CLS. 1, 4, 6, 50, 51 AND 52).

DAVID C. REIHNER, EXAMINING ATTORNEY

SN 85-344,288. L'OREAL USA CREATIVE, INC., NEW YORK, NY. FILED 6-13-2011.

**MAKE AN IMPRESSION**

THE MARK CONSISTS OF STANDARD CHARACTERS WITHOUT CLAIM TO ANY PARTICULAR FONT, STYLE, SIZE, OR COLOR.

FOR NAIL COLOR AND NAIL COLOR PENS (U.S. CLS. 1, 4, 6, 50, 51 AND 52).

KIM MONINGHOFF, EXAMINING ATTORNEY

**CLASS 3—(Continued).**

SN 85-345,578. INTERNATIONAL PERFUME PALACE INCORPORATED, PLAINVIEW, NY. FILED 6-14-2011.

**TONY RAKANA BLACK**

THE MARK CONSISTS OF STANDARD CHARACTERS WITHOUT CLAIM TO ANY PARTICULAR FONT, STYLE, SIZE, OR COLOR.

THE NAME "TONY RAKANA" DOES NOT IDENTIFY A LIVING INDIVIDUAL.

FOR AFTERSHAVE; BAR SOAP; BATH POWDER; BATH SOAPS; BATH SOAPS IN LIQUID, SOLID OR GEL FORM; BEAUTY CREAMS; BODY CREAM; BODY DEODORANTS; BODY LOTIONS; BODY POWDER; BODY SPRAY USED AS A PERSONAL DEODORANT AND AS FRAGRANCE; COLOGNE; COLOGNE WATER; COSMETICS; DEODORANTS AND ANTIPERSPIRANTS; EAU DE COLOGNE; FACIAL LOTION; FRAGRANCES; HAIR SHAMPOOS AND CONDITIONERS; NON-MEDICATED SKIN CARE PREPARATION, NAMELY, BODY MIST; PERFUMED SOAP; PERFUMES AND COLOGNES; PERFUMES, AFTERSHAVES AND COLOGNES; POWDER FOR MAKE-UP; SHOWER AND BATH GEL; SHOWER GEL; TOILET WATER (U.S. CLS. 1, 4, 6, 50, 51 AND 52).

JENNIFER MARTIN, EXAMINING ATTORNEY

SN 85-345,582. INTERNATIONAL PERFUME PALACE INCORPORATED, PLAINVIEW, NY. FILED 6-14-2011.

**TONY RAKANA PINK**

THE MARK CONSISTS OF STANDARD CHARACTERS WITHOUT CLAIM TO ANY PARTICULAR FONT, STYLE, SIZE, OR COLOR.

THE NAME "TONY RAKANA" DOES NOT IDENTIFY A LIVING INDIVIDUAL.

FOR AFTERSHAVE; BAR SOAP; BATH POWDER; BATH SOAPS; BATH SOAPS IN LIQUID, SOLID OR GEL FORM; BEAUTY CREAMS; BODY CREAM; BODY DEODORANTS; BODY LOTIONS; BODY POWDER; BODY SPRAY USED AS A PERSONAL DEODORANT AND AS FRAGRANCE; COLOGNE; COLOGNE WATER; COSMETICS; DEODORANTS AND ANTIPERSPIRANTS; EAU DE COLOGNE; FACIAL LOTION; FRAGRANCES; HAIR SHAMPOOS AND CONDITIONERS; NON-MEDICATED SKIN CARE PREPARATION, NAMELY, BODY MIST; PERFUMED SOAP; PERFUMES AND COLOGNES; PERFUMES, AFTERSHAVES AND COLOGNES; POWDER FOR MAKE-UP; SHOWER AND BATH GEL; SHOWER GEL; TOILET WATER (U.S. CLS. 1, 4, 6, 50, 51 AND 52).

JENNIFER MARTIN, EXAMINING ATTORNEY

**CLASS 3—(Continued).**

SN 85-346,014. HENKEL AG & CO. KGAA, DUESSELDORF, FED REP GERMANY, FILED 6-14-2011.

**OIL-LICIOUS**

THE MARK CONSISTS OF STANDARD CHARACTERS WITHOUT CLAIM TO ANY PARTICULAR FONT, STYLE, SIZE, OR COLOR.

FOR HAIR STYLING PREPARATIONS (U.S. CLS. 1, 4, 6, 50, 51 AND 52).

SAIMA MAKHDOOM, EXAMINING ATTORNEY

SN 85-349,907. TRIPLE M GLOBAL SOLUTIONS, LLC, INCLINE VILLAGE, NV. FILED 6-18-2011.

**NO NAME**

THE MARK CONSISTS OF STANDARD CHARACTERS WITHOUT CLAIM TO ANY PARTICULAR FONT, STYLE, SIZE, OR COLOR.

FOR ALL-PURPOSE CLEANING PREPARATIONS; FLOOR CLEANING PREPARATIONS; FLOOR FINISHING PREPARATIONS; FLOOR STRIPPING PREPARATIONS; WINDOW CLEANING PREPARATIONS; TILE CLEANING PREPARATIONS; AND CARPET CLEANING PREPARATIONS (U.S. CLS. 1, 4, 6, 50, 51 AND 52).

FIRST USE 4-26-2011; IN COMMERCE 4-26-2011.

RAMONA ORTIGA, EXAMINING ATTORNEY

SN 85-350,618. L'OREAL USA CREATIVE, INC., NEW YORK, NY. FILED 6-20-2011.

**ESSIE**

THE MARK CONSISTS OF STANDARD CHARACTERS WITHOUT CLAIM TO ANY PARTICULAR FONT, STYLE, SIZE, OR COLOR.

OWNER OF U.S. REG. NOS. 1,712,921, 3,080,530 AND OTHERS.

FOR NAIL POLISH (U.S. CLS. 1, 4, 6, 50, 51 AND 52).

FIRST USE 0-0-1982; IN COMMERCE 0-0-1982.

KIM MONINGHOFF, EXAMINING ATTORNEY

**CLASS 3—(Continued).**

SN 85-350,898. TNG WORLDWIDE, INC., FARMINGTON HILLS, MI. FILED 6-20-2011.



THE MARK CONSISTS OF THE LITERAL ELEMENTS OF THE MARK, "TWICE A WEEK", ADJACENT A DESIGN COMPRISING A PLURALITY OF HEXAGONS.

FOR HAIR CARE PREPARATIONS; NON-MEDICATED LEAVE-IN TREATMENT FOR HAIR; CONDITIONERS; HAIR CONDITIONERS; HAIR MASKS; HAIR SPRAY; HAIR SPRAYS; HAIRSPRAY; SHAMPOO-CONDITIONERS; SHAMPOOS (U.S. CLS. 1, 4, 6, 50, 51 AND 52).

ANNE MADDEN, EXAMINING ATTORNEY

**CLASS 3—(Continued).**

SN 85-353,519. SILLAGE, LLC, LAGUNA BEACH, CA. FILED 6-22-2011.

# Haute Bijoux

THE MARK CONSISTS OF STANDARD CHARACTERS WITHOUT CLAIM TO ANY PARTICULAR FONT, STYLE, SIZE, OR COLOR.

THE ENGLISH TRANSLATION OF "HAUTE BIJOUX" IN THE MARK IS "HIGH JEWELRY".

FOR PERFUMES AND COGNES (U.S. CLS. 1, 4, 6, 50, 51 AND 52).

SANJEEV VOHRA, EXAMINING ATTORNEY

SN 85-352,571. DJF ENTERPRISES, NEW YORK, NY. FILED 6-22-2011.

# BLUSH RUSH

THE MARK CONSISTS OF STANDARD CHARACTERS WITHOUT CLAIM TO ANY PARTICULAR FONT, STYLE, SIZE, OR COLOR.

FOR COSMETICS (U.S. CLS. 1, 4, 6, 50, 51 AND 52).

FIRST USE 8-15-2008; IN COMMERCE 8-15-2008.

DAVID ELTON, EXAMINING ATTORNEY

SN 85-354,079. L'OREAL USA CREATIVE, INC., NEW YORK, NY. FILED 6-23-2011.

# LEAVE NO TRACE

THE MARK CONSISTS OF STANDARD CHARACTERS WITHOUT CLAIM TO ANY PARTICULAR FONT, STYLE, SIZE, OR COLOR.

FOR NAIL POLISH REMOVER (U.S. CLS. 1, 4, 6, 50, 51 AND 52).

KIM MONINGHOFF, EXAMINING ATTORNEY

SN 85-352,786. COLGATE-PALMOLIVE COMPANY, NEW YORK, NY. FILED 6-22-2011.



THE MARK CONSISTS OF SHIELD DESIGN. FOR TOOTHPASTE (U.S. CLS. 1, 4, 6, 50, 51 AND 52). JAY FLOWERS, EXAMINING ATTORNEY

SN 85-355,070. L'OREAL USA CREATIVE, INC., NEW YORK, NY. FILED 6-24-2011.

# TAKE COVER

THE MARK CONSISTS OF STANDARD CHARACTERS WITHOUT CLAIM TO ANY PARTICULAR FONT, STYLE, SIZE, OR COLOR.

FOR HAIR CARE PREPARATION (U.S. CLS. 1, 4, 6, 50, 51 AND 52).

KIM MONINGHOFF, EXAMINING ATTORNEY

**CLASS 3—(Continued).**

SN 85-355,893. UNILEVER SUPPLY CHAIN, INC., CLINTON, CT. FILED 6-24-2011.

**PASSIONATE SPELL**

THE MARK CONSISTS OF STANDARD CHARACTERS WITHOUT CLAIM TO ANY PARTICULAR FONT, STYLE, SIZE, OR COLOR.

FOR BODY CLEANSING WASH AND SOAP BARS (U.S. CLS. 1, 4, 6, 50, 51 AND 52).  
PRISCILLA MILTON, EXAMINING ATTORNEY

**CLASS 3—(Continued).**

SN 85-357,197. UNILEVER SUPPLY CHAIN, INC., CLINTON, CT. FILED 6-27-2011.

**LOVING KISS**

THE MARK CONSISTS OF STANDARD CHARACTERS WITHOUT CLAIM TO ANY PARTICULAR FONT, STYLE, SIZE, OR COLOR.

FOR BODY CLEANSING WASH, SOAP (U.S. CLS. 1, 4, 6, 50, 51 AND 52).  
PRISCILLA MILTON, EXAMINING ATTORNEY

SN 85-356,738. COLGATE-PALMOLIVE COMPANY, NEW YORK, NY. FILED 6-27-2011.

**TROPICAL SUN SPLASH**

THE MARK CONSISTS OF STANDARD CHARACTERS WITHOUT CLAIM TO ANY PARTICULAR FONT, STYLE, SIZE, OR COLOR.

OWNER OF U.S. REG. NOS. 2,735,643, 3,648,093 AND OTHERS.  
FOR DISH WASHING DETERGENT (U.S. CLS. 1, 4, 6, 50, 51 AND 52).  
JAY FLOWERS, EXAMINING ATTORNEY

SN 85-359,001. L'OREAL USA CREATIVE, INC., NEW YORK, NY. FILED 6-29-2011.

**SMOOTH LOCK**

THE MARK CONSISTS OF STANDARD CHARACTERS WITHOUT CLAIM TO ANY PARTICULAR FONT, STYLE, SIZE, OR COLOR.

FOR HAIR CARE PREPARATIONS, HAIR STRAIGHTENING PREPARATIONS, AND NON-MEDICATED HAIR TREATMENT PREPARATIONS (U.S. CLS. 1, 4, 6, 50, 51 AND 52).  
KIM MONINGHOFF, EXAMINING ATTORNEY

SN 85-356,769. COLGATE-PALMOLIVE COMPANY, NEW YORK, NY. FILED 6-27-2011.

**CRISP ORCHARD BURST**

THE MARK CONSISTS OF STANDARD CHARACTERS WITHOUT CLAIM TO ANY PARTICULAR FONT, STYLE, SIZE, OR COLOR.

OWNER OF U.S. REG. NOS. 2,673,294, 3,223,916 AND 3,309,964.  
FOR DISH WASHING DETERGENT (U.S. CLS. 1, 4, 6, 50, 51 AND 52).  
JAY FLOWERS, EXAMINING ATTORNEY

SN 85-359,491. UNITED BEAUTY PRODUCTS, INC., ALPHARETTA, GA. FILED 6-29-2011.

**GLAM REPUBLIC**

THE MARK CONSISTS OF STANDARD CHARACTERS WITHOUT CLAIM TO ANY PARTICULAR FONT, STYLE, SIZE, OR COLOR.

FOR COSMETICS AND MAKE-UP (U.S. CLS. 1, 4, 6, 50, 51 AND 52).  
KYLE PEETE, EXAMINING ATTORNEY

**CLASS 3—(Continued).**

SN 85-359,527. UNITED BEAUTY PRODUCTS, INC., ALPHARETTA, GA. FILED 6-29-2011.

# SMACK IT!

THE MARK CONSISTS OF STANDARD CHARACTERS WITHOUT CLAIM TO ANY PARTICULAR FONT, STYLE, SIZE, OR COLOR.

FOR LIPSTICKS; MAKE-UP KITS COMPRISED OF LIP ADORNMENTS, TEMPORARY LIP TATTOOS AND TRANSFERS (U.S. CLS. 1, 4, 6, 50, 51 AND 52).  
KYLE PEETE, EXAMINING ATTORNEY

SN 85-360,165. THE PROCTER & GAMBLE COMPANY, CINCINNATI, OH. FILED 6-30-2011.

# FEBREZE

THE MARK CONSISTS OF STANDARD CHARACTERS WITHOUT CLAIM TO ANY PARTICULAR FONT, STYLE, SIZE, OR COLOR.

OWNER OF U.S. REG. NOS. 2,924,317, 3,106,916 AND 3,670,114.

FOR UPHOLSTERY CLEANERS AND CARPET CLEANERS (U.S. CLS. 1, 4, 6, 50, 51 AND 52).  
FIRST USE 8-20-2010; IN COMMERCE 8-20-2010.  
DANIEL CAPSHAW, EXAMINING ATTORNEY

SN 85-360,224. LOTTA LUV, LLC, NEW YORK, NY. FILED 6-30-2011.

# LOUD MOUTH

THE MARK CONSISTS OF STANDARD CHARACTERS WITHOUT CLAIM TO ANY PARTICULAR FONT, STYLE, SIZE, OR COLOR.

FOR LIP GLOSS (U.S. CLS. 1, 4, 6, 50, 51 AND 52).  
MARGARET POWER, EXAMINING ATTORNEY

**CLASS 3—(Continued).**

SN 85-360,228. LOTTA LUV, LLC, NEW YORK, NY. FILED 6-30-2011.

# MOUTH OFF

THE MARK CONSISTS OF STANDARD CHARACTERS WITHOUT CLAIM TO ANY PARTICULAR FONT, STYLE, SIZE, OR COLOR.

FOR LIP GLOSS (U.S. CLS. 1, 4, 6, 50, 51 AND 52).  
MARGARET POWER, EXAMINING ATTORNEY

SN 85-362,396. ARIZONA INVESTMENT & TRADING, LLC, SCOTTSDALE, AZ. FILED 7-2-2011.

# ASTRA

THE MARK CONSISTS OF STANDARD CHARACTERS WITHOUT CLAIM TO ANY PARTICULAR FONT, STYLE, SIZE, OR COLOR.

FOR PERFUME (U.S. CLS. 1, 4, 6, 50, 51 AND 52).  
SOPHIA S. KIM, EXAMINING ATTORNEY

SN 85-365,031. DEBAUN DEVELOPMENT INC., NEW YORK, NY. FILED 7-7-2011.

# ROGANIC

THE MARK CONSISTS OF STANDARD CHARACTERS WITHOUT CLAIM TO ANY PARTICULAR FONT, STYLE, SIZE, OR COLOR.

FOR BEAUTY CREAMS FOR BODY CARE; BODY AND BEAUTY CARE COSMETICS; COSMETIC CREAMS FOR SKIN CARE; COSMETIC PREPARATIONS FOR BATH AND SHOWER; COSMETIC PREPARATIONS FOR BODY CARE; ESSENTIAL OILS FOR PERSONAL USE; FACIAL CLEANSERS; FACIAL MAKE-UP; FACIAL MASKS; FRAGRANCES AND PERFUMERY; LOTIONS FOR FACE AND BODY CARE; NON-MEDICATED TOILETRIES; SKIN CARE PRODUCTS, NAMELY, NON-MEDICATED SKIN SERUM; SKIN CREAMS IN LIQUID AND IN SOLID FORM; SKIN MOISTURIZER; SOAPS FOR PERSONAL USE; SUN SCREEN PREPARATIONS (U.S. CLS. 1, 4, 6, 50, 51 AND 52).

BENJAMIN OKEKE, EXAMINING ATTORNEY

**CLASS 3—(Continued).**

SN 85-365,817. ARIZONA INVESTMENT & TRADING, LLC, SCOTTSDALE, AZ. FILED 7-7-2011.

# BRAMA

THE MARK CONSISTS OF STANDARD CHARACTERS WITHOUT CLAIM TO ANY PARTICULAR FONT, STYLE, SIZE, OR COLOR.

FOR PERFUME (U.S. CLS. 1, 4, 6, 50, 51 AND 52).  
SOPHIA S. KIM, EXAMINING ATTORNEY

SN 85-370,922. ARIZONA INVESTMENT & TRADING, LLC, SCOTTSDALE, AZ. FILED 7-13-2011.



THE MARK CONSISTS OF A STYLIZED "H" NEXT TO AND PARTIALLY OVERLAPPED WITH A STYLIZED "&" NEXT TO AND PARTIALLY OVERLAPPING A STYLIZED "G".

FOR PERFUME (U.S. CLS. 1, 4, 6, 50, 51 AND 52).  
SOPHIA S. KIM, EXAMINING ATTORNEY

SN 85-371,824. KISS NAIL PRODUCTS, INC., PORT WASHINGTON, NY. FILED 7-14-2011.

# IMPRESS

THE MARK CONSISTS OF STANDARD CHARACTERS WITHOUT CLAIM TO ANY PARTICULAR FONT, STYLE, SIZE, OR COLOR.

OWNER OF U.S. REG. NO. 2,437,263.  
FOR ARTIFICIAL FINGER NAILS AND TOE NAILS (U.S. CLS. 1, 4, 6, 50, 51 AND 52).  
PAUL F. GAST, EXAMINING ATTORNEY

**CLASS 3—(Continued).**

SN 85-379,109. INTERNATIONAL PERFUME PALACE INCORPORATED, PLAINVIEW, NY. FILED 7-22-2011.

## TONY RAKANA ELECTRIC NIGHT

THE MARK CONSISTS OF STANDARD CHARACTERS WITHOUT CLAIM TO ANY PARTICULAR FONT, STYLE, SIZE, OR COLOR.

THE NAME "TONY RAKANA" DOES NOT IDENTIFY A LIVING INDIVIDUAL.

FOR AFTERSHAVE; BAR SOAP; BATH POWDER; BATH SOAPS; BATH SOAPS IN LIQUID, SOLID OR GEL FORM; BEAUTY CREAMS; BODY CREAM; BODY DEODORANTS; BODY LOTIONS; BODY POWDER; BODY SPRAY USED AS A PERSONAL DEODORANT AND AS FRAGRANCE; COLOGNE; COLOGNE WATER; COSMETICS; DEODORANTS AND ANTIPERSPIRANTS; EAU DE COLOGNE; FACIAL LOTION; FRAGRANCES; HAIR SHAMPOOS AND CONDITIONERS; NON-MEDICATED SKIN CARE PREPARATION, NAMELY, BODY MIST; PERFUMED SOAP; PERFUMES AND COLOGNES; PERFUMES, AFTERSHAVES AND COLOGNES; POWDER FOR MAKE-UP; SHOWER AND BATH GEL; SHOWER GEL; TOILET WATER (U.S. CLS. 1, 4, 6, 50, 51 AND 52).

JENNIFER MARTIN, EXAMINING ATTORNEY

SN 85-379,421. TRIPLE M GLOBAL SOLUTIONS, LLC, INCLINE VILLAGE, NV. FILED 7-24-2011.

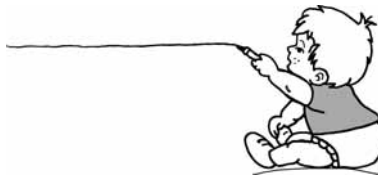

THE MARK CONSISTS OF A SEATED BABY HOLDING A CRAYON AND DRAWING A LINE ON A WALL.

FOR ALL-PURPOSE CLEANING PREPARATIONS; FLOOR CLEANING PREPARATIONS; FLOOR FINISHING PREPARATIONS; FLOOR STRIPPING PREPARATIONS; WINDOW CLEANING PREPARATIONS; TILE CLEANING PREPARATIONS; AND CARPET CLEANING PREPARATIONS (U.S. CLS. 1, 4, 6, 50, 51 AND 52).

FIRST USE 4-26-2011; IN COMMERCE 4-26-2011.

RAMONA ORTIGA, EXAMINING ATTORNEY

SN 85-380,927. DJF ENTERPRISES, NEW YORK, NY. FILED 7-26-2011.

## BE LEGENDARY

THE MARK CONSISTS OF STANDARD CHARACTERS WITHOUT CLAIM TO ANY PARTICULAR FONT, STYLE, SIZE, OR COLOR.

FOR COSMETICS (U.S. CLS. 1, 4, 6, 50, 51 AND 52).  
DAVID ELTON, EXAMINING ATTORNEY

**CLASS 3—(Continued).**

SN 85-389,735. CAROL'S DAUGHTER HOLDINGS, LLC, NEW YORK, NY. FILED 8-4-2011.

**MY LIFE BLOSSOM**

THE MARK CONSISTS OF STANDARD CHARACTERS WITHOUT CLAIM TO ANY PARTICULAR FONT, STYLE, SIZE, OR COLOR.

OWNER OF U.S. REG. NO. 3,865,908.  
FOR COSMETICS; PERFUMERY; NON-MEDICATED TOILETRIES; BODY LOTION; BODY CREAM; SOAP (U.S. CLS. 1, 4, 6, 50, 51 AND 52).  
HENRY S. ZAK, EXAMINING ATTORNEY

SN 85-390,197. AG GLOBAL PRODUCTS, LLC, LOS ANGELES, CA. FILED 8-4-2011.

**KORE BY FHI HEAT**

THE MARK CONSISTS OF STANDARD CHARACTERS WITHOUT CLAIM TO ANY PARTICULAR FONT, STYLE, SIZE, OR COLOR.

OWNER OF U.S. REG. NOS. 3,730,432, 3,731,453 AND 3,733,134.  
FOR HAIR CARE PREPARATIONS; HAIR CONDITIONER; HAIR STYLING PREPARATIONS; SHAMPOOS (U.S. CLS. 1, 4, 6, 50, 51 AND 52).  
GINA FINK, EXAMINING ATTORNEY

SN 85-392,431. KISS NAIL PRODUCTS, INC., PORT WASHINGTON, NY. FILED 8-8-2011.

**NAIL DRESS**

THE MARK CONSISTS OF STANDARD CHARACTERS WITHOUT CLAIM TO ANY PARTICULAR FONT, STYLE, SIZE, OR COLOR.

NO CLAIM IS MADE TO THE EXCLUSIVE RIGHT TO USE "NAIL", APART FROM THE MARK AS SHOWN.  
FOR NAIL ART STICKERS (U.S. CLS. 1, 4, 6, 50, 51 AND 52).  
FIRST USE 11-30-2010; IN COMMERCE 11-30-2010.  
PAUL F. GAST, EXAMINING ATTORNEY

**CLASS 3—(Continued).**

SN 85-393,099. SOPHIA LA BELLE, COLUMBIA, MD. FILED 8-9-2011.



THE MARK CONSISTS OF A DESIGN OF A WOMAN LOOKING OVER HER RIGHT SHOULDER.

FOR BODY AND BEAUTY CARE COSMETICS; BODY LOTION; COSMETIC CREAMS FOR SKIN CARE; COSMETIC PREPARATIONS FOR SKIN CARE; COSMETIC SKIN FRESHENERS; HAIR CONDITIONER; HAIR SHAMPOOS AND CONDITIONERS; HAIR STRAIGHTENING PREPARATIONS; NON-MEDICATED HAIR SERUMS; SHAMPOOS (U.S. CLS. 1, 4, 6, 50, 51 AND 52).  
FIRST USE 1-19-2011; IN COMMERCE 6-1-2011.  
HANNO RITTNER, EXAMINING ATTORNEY

**CLASS 4—LUBRICANTS AND FUELS**

SN 85-172,491. BLAKE, WALTER, APEX, NC. FILED 11-9-2010.

**bore-kote**

THE MARK CONSISTS OF STANDARD CHARACTERS WITHOUT CLAIM TO ANY PARTICULAR FONT, STYLE, SIZE, OR COLOR.

FOR GUN BARREL ANTI-FRICTION POWDER COATING FOR USE AS A LUBRICANT (U.S. CLS. 1, 6 AND 15).  
KATHERINE E. HALMEN, EXAMINING ATTORNEY

**CLASS 4—(Continued).**

SN 85-301,193. MVP GROUP INTERNATIONAL, INC., CHARLESTON, SC. FILED 4-21-2011.

# WonderfulWick

OWNER OF U.S. REG. NO. 3,244,185.  
NO CLAIM IS MADE TO THE EXCLUSIVE RIGHT TO USE "WICK", APART FROM THE MARK AS SHOWN.  
THE MARK CONSISTS OF STYLIZED LETTERING OF THE WORDS "WONDERFUL WICK".  
FOR CANDLES; SCENTED CANDLES (U.S. CLS. 1, 6 AND 15).  
FIRST USE 7-27-2011; IN COMMERCE 7-27-2011.  
GEORGE LORENZO, EXAMINING ATTORNEY

---

SN 85-326,272. ROYAL OAK ENTERPRISES, LLC, ROSWELL, GA. FILED 5-20-2011.

# RIDGE

THE MARK CONSISTS OF STANDARD CHARACTERS WITHOUT CLAIM TO ANY PARTICULAR FONT, STYLE, SIZE, OR COLOR.  
FOR CHARCOAL BRIQUETTES (U.S. CLS. 1, 6 AND 15).  
LAKEISHA LEWIS, EXAMINING ATTORNEY

---

SN 85-330,826. C&G FUELS, LLC, ST. AUGUSTINE, FL. FILED 5-26-2011.



THE MARK CONSISTS OF THE LETTER "G" INSIDE THE LETTER "C".  
FOR FUEL; BIOFUEL; FOSSIL FUEL SUBSTITUTES, NAMELY, BIOMASS AND BIOFUELS; URBAN WOOD WASTE FOR USE AS FUEL; WOOD CHIPS FOR USE AS FUEL (U.S. CLS. 1, 6 AND 15).  
LINDA POWELL, EXAMINING ATTORNEY

**CLASS 4—(Continued).**

SN 85-334,378. DURAFLAME, INC., STOCKTON, CA. FILED 5-31-2011.

# BIO-GLO

THE MARK CONSISTS OF STANDARD CHARACTERS WITHOUT CLAIM TO ANY PARTICULAR FONT, STYLE, SIZE, OR COLOR.  
FOR FUELS AND BIOFUELS; FUELS AND BIOFUELS FOR FIREPLACES AND TORCHES (U.S. CLS. 1, 6 AND 15).  
VERNA BETH RIRIE, EXAMINING ATTORNEY

---

SN 85-334,584. STRIPES LLC, CORPUS CHRISTI, TX. FILED 5-31-2011.



THE COLOR(S) RED IS/ARE CLAIMED AS A FEATURE OF THE MARK.  
THE MARK CONSISTS OF THE COLOR RED APPEARING IN THE FOUR DIAGONAL BARS FORMING A DIAMOND SHAPE.  
FOR FUELS (U.S. CLS. 1, 6 AND 15).  
FIRST USE 3-0-2008; IN COMMERCE 3-0-2008.  
ANNE E. GUSTASON, EXAMINING ATTORNEY



**CLASS 4—(Continued).**

SN 85-334,598. STRIPES LLC, CORPUS CHRISTI, TX. FILED 5-31-2011.



THE MARK CONSISTS OF A DESIGN COMPRISING FOUR DIAGONAL BARS FORMING A DIAMOND SHAPE. FOR FUELS (U.S. CLS. 1, 6 AND 15). FIRST USE 3-0-2008; IN COMMERCE 3-0-2008. ANNE E. GUSTASON, EXAMINING ATTORNEY

SN 85-334,679. PRINCELUBE (ASIA) PTE LIMITED, KL, HONG KONG, FILED 6-1-2011.

**PRINCE**

FOR DIESEL OIL; DUST-BINDING COMPOSITIONS; FIRELIGHTERS; FUELS; GEAR OILS; LAMP WICKS; LIQUEFIED PETROLEUM GAS; LUBRICATING OILS; MOTOR OILS; PARAFFIN (U.S. CLS. 1, 6 AND 15). FIRST USE 3-17-2008; IN COMMERCE 3-17-2008. REBECCA POVARCHUK, EXAMINING ATTORNEY

**CLASS 4—(Continued).**

SN 85-335,101. GOLD GRENADE, LLC, SANTA MONICA, CA. FILED 6-1-2011.

**THE DARKNESS**

THE MARK CONSISTS OF STANDARD CHARACTERS WITHOUT CLAIM TO ANY PARTICULAR FONT, STYLE, SIZE, OR COLOR.

FOR AROMATHERAPY FRAGRANCE CANDLES; CANDLES; PERFUMED CANDLES; SCENTED CANDLES (U.S. CLS. 1, 6 AND 15).

KEVON CHISOLM, EXAMINING ATTORNEY

SN 85-335,885. CHIRATECH CO,LTD, BANGKOK, THAILAND, FILED 6-2-2011.

**CHIRATECH**

THE MARK CONSISTS OF STANDARD CHARACTERS WITHOUT CLAIM TO ANY PARTICULAR FONT, STYLE, SIZE, OR COLOR.

FOR FUELS, NAMELY, A FUEL CONTAINING ONLY BIO ETHANOL FUEL, SPECIAL LUBRICANTS AND ADDITIVES FOR RADIO CONTROL ENGINES (U.S. CLS. 1, 6 AND 15).

JOHN E. MICHOS, EXAMINING ATTORNEY

SN 85-337,290. MULTYMELTY, LLC, NORTH HOLLYWOOD, CA. FILED 6-3-2011.

**MULTYMELTY**

THE MARK CONSISTS OF STANDARD CHARACTERS WITHOUT CLAIM TO ANY PARTICULAR FONT, STYLE, SIZE, OR COLOR.

FOR SCENTED WAX CHIPS TO MELT IN A WARMER (U.S. CLS. 1, 6 AND 15).

DAVID HOFFMAN, EXAMINING ATTORNEY

**CLASS 4—(Continued).**

SN 85-338,342. PERESS, SASS M., ILE PERROT, CANADA, FILED 6-5-2011.

# ISASS

THE MARK CONSISTS OF STANDARD CHARACTERS WITHOUT CLAIM TO ANY PARTICULAR FONT, STYLE, SIZE, OR COLOR.

FOR RENEWABLE ENERGY, NAMELY, SOLAR ENERGY, WIND ENERGY AND GEOTHERMAL ENERGY (U.S. CLS. 1, 6 AND 15).

JENNY PARK, EXAMINING ATTORNEY

**CLASS 4—(Continued).**

SN 85-341,400. WOODS INTERNATIONAL, INC., HIGH POINT, NC. FILED 6-8-2011.

# FIREFLY

THE MARK CONSISTS OF STANDARD CHARACTERS WITHOUT CLAIM TO ANY PARTICULAR FONT, STYLE, SIZE, OR COLOR.

FOR DECORATIVE TABLETOP TORCHES; FUEL FOR DECORATIVE TABLETOP TORCHES; FUEL CONTAINING INSECT REPELLANT FOR DECORATIVE TABLETOP TORCHES (U.S. CLS. 1, 6 AND 15).

JANET LEE, EXAMINING ATTORNEY

SN 85-339,795. DFHS, LLC, PELHAM, AL. FILED 6-7-2011.

# BLO

THE MARK CONSISTS OF STANDARD CHARACTERS WITHOUT CLAIM TO ANY PARTICULAR FONT, STYLE, SIZE, OR COLOR.

FOR ALL PURPOSE LUBRICANTS; INDUSTRIAL AND VEHICULAR LUBRICANTS (U.S. CLS. 1, 6 AND 15).

SUNG IN, EXAMINING ATTORNEY

**CLASS 5—PHARMACEUTICALS**

SN 76-707,632. MOREY, KEITH B., IRVINE, CA. FILED 5-16-2011.

# NATURALLY PERFECT

THE MARK CONSISTS OF STANDARD CHARACTERS WITHOUT CLAIM TO ANY PARTICULAR FONT, STYLE, SIZE, OR COLOR.

FOR DIETARY SUPPLEMENTS AND HORMONES, ALL COMPOSED PRIMARILY OF NATURAL INGREDIENTS (U.S. CLS. 6, 18, 44, 46, 51 AND 52).

DAVID H. STINE, EXAMINING ATTORNEY

SN 85-339,936. RENESSENZ LLC, JACKSONVILLE, FL. FILED 6-7-2011.

# GLIDFUEL

THE MARK CONSISTS OF STANDARD CHARACTERS WITHOUT CLAIM TO ANY PARTICULAR FONT, STYLE, SIZE, OR COLOR.

FOR FUELS AND BIOFUELS BLENDED WITH CHEMICALS AND/OR BIOLOGICAL PRODUCTS; FUELS FROM BIOLOGICAL SOURCES; TERPENE-BASED FUEL (U.S. CLS. 1, 6 AND 15).

FIRST USE 7-1-1991; IN COMMERCE 7-1-1991.

JAY FLOWERS, EXAMINING ATTORNEY

SN 77-449,926. NATURAL HEALTH CORPORATION, MIAMI, FL. FILED 4-16-2008.

# THE HEALTHY WAY TO LIVE

THE MARK CONSISTS OF STANDARD CHARACTERS WITHOUT CLAIM TO ANY PARTICULAR FONT, STYLE, SIZE, OR COLOR.

FOR DIETARY SUPPLEMENT (U.S. CLS. 6, 18, 44, 46, 51 AND 52).

FIRST USE 4-1-2008; IN COMMERCE 4-1-2008.

CYNTHIA TRIPI, EXAMINING ATTORNEY

**CLASS 5—(Continued).**

SN 77-848,672. VITASPORT, INC., CHINO HILLS, CA. FILED 10-14-2009.

**HYDRO PRO**

THE MARK CONSISTS OF STANDARD CHARACTERS WITHOUT CLAIM TO ANY PARTICULAR FONT, STYLE, SIZE, OR COLOR.

FOR DIETARY AND NUTRITIONAL SUPPLEMENTS; NUTRITIONAL SUPPLEMENTS IN THE NATURE OF POWDERED PROTEIN DRINK MIXES (U.S. CLS. 6, 18, 44, 46, 51 AND 52).

STEVEN PEREZ, EXAMINING ATTORNEY

**CLASS 5—(Continued).**

SN 77-946,439. CYBERWIZE.COM, INC., SARASOTA, FL. FILED 2-26-2010.

**LiveSmart 360**

THE MARK CONSISTS OF STANDARD CHARACTERS WITHOUT CLAIM TO ANY PARTICULAR FONT, STYLE, SIZE, OR COLOR.

FOR APPETITE SUPPRESSANTS; DIETARY AND NUTRITIONAL SUPPLEMENTS; DIETARY BEVERAGE SUPPLEMENTS FOR HUMAN CONSUMPTION IN LIQUID AND DRY MIX FORM FOR THERAPEUTIC PURPOSES; DIETARY DRINK MIX FOR USE AS A MEAL REPLACEMENT; DIETARY SUPPLEMENTAL DRINKS; DIETARY SUPPLEMENTS FOR PETS; DISSOLVING NUTRITIONAL SUPPLEMENT STRIPS; FEED SUPPLEMENTS FOR PETS; HERBAL SUPPLEMENTS; LIQUID NUTRITIONAL SUPPLEMENT; MEAL REPLACEMENT AND DIETARY SUPPLEMENT DRINK MIXES; MEAL REPLACEMENT DRINKS; MEAL REPLACEMENT POWDERS; MEAL REPLACEMENT SHAKES; NATURAL HERBAL SUPPLEMENTS; NUTRITIONAL DRINK MIX FOR USE AS A MEAL REPLACEMENT; NUTRITIONAL DRINKS USED FOR MEAL REPLACEMENT; NUTRITIONAL SUPPLEMENT CHEWING GUMS; ORAL NUTRITIONAL SUPPLEMENT SPRAYS; POWDERED NUTRITIONAL SUPPLEMENT DRINK MIX; THERAPEUTIC AGENTS FOR WEIGHT CONTROL AND APPETITE SUPPRESSION; VITAMIN AND MINERAL SUPPLEMENTS; WEIGHT MANAGEMENT SUPPLEMENTS (U.S. CLS. 6, 18, 44, 46, 51 AND 52).

KEVIN CORWIN, EXAMINING ATTORNEY

SN 77-852,303. GREENLIGHT SPORTS NUTRITION, LLC, LOUISVILLE, KY. FILED 10-19-2009.



SN 79-088,210. ERNST MÜHLBAUER GMBH & CO. KG, FED REP GERMANY, FILED 9-7-2010.

**Honigum Pro**

NO CLAIM IS MADE TO THE EXCLUSIVE RIGHT TO USE "SPORTS NUTRITION" OR "ESSENTIALS", APART FROM THE MARK AS SHOWN.

THE COLOR(S) GREEN, GRAY AND BLACK IS/ARE CLAIMED AS A FEATURE OF THE MARK.

THE MARK CONSISTS OF THE WORDING "GREENLIGHT SPORTS NUTRITION APE AMINIO PROCESS ESSENTIALS" IN GREEN AND AN APE FACE ABOVE A BACKGROUND COMPRISING A DIAMOND PATTERN, EACH IN VARYING SHADES OF GRAY, ALL ON A BLACK BACKGROUND.

FOR POWDER, TABLET, LIQUID AND ENCAPSULATED DIETARY SUPPLEMENTS, NAMELY, FOOD SUPPLEMENTS; HERBAL SUPPLEMENTS; MINERAL SUPPLEMENTS; NUTRITIONAL SUPPLEMENTS; VITAMIN SUPPLEMENTS; MULTI-VITAMIN SUPPLEMENTS (U.S. CLS. 6, 18, 44, 46, 51 AND 52).

HANNO RITTNER, EXAMINING ATTORNEY

THE MARK CONSISTS OF STANDARD CHARACTERS WITHOUT CLAIM TO ANY PARTICULAR FONT, STYLE, SIZE, OR COLOR.

PRIORITY DATE OF 8-4-2010 IS CLAIMED.

OWNER OF INTERNATIONAL REGISTRATION 1053507 DATED 9-7-2010, EXPIRES 9-7-2020.

OWNER OF U.S. REG. NO. 2,192,011.

FOR DENTAL MATERIAL FOR STOPPING TEETH; FASTENING AND MOULDING MATERIALS USED FOR DENTAL IMPRESSIONS; PROFESSIONAL DENTAL PREPARATIONS, NAMELY, DENTAL IMPRESSION MATERIALS (U.S. CLS. 6, 18, 44, 46, 51 AND 52).

BERNICE MIDDLETON, EXAMINING ATTORNEY

**CLASS 5—(Continued).**

SN 79-089,752. ZHEJIANG CHIMIN PHARMACEUTICAL CO., LTD., CHINA, FILED 11-9-2010.



OWNER OF INTERNATIONAL REGISTRATION 1057670 DATED 11-9-2010, EXPIRES 11-9-2020.

THE MARK CONSISTS OF THE WORDING "CHIMIN" INTERSECTED BY FIVE HORIZONTAL LINES FEATURED BELOW THE DESIGN OF A CIRCLE ENCASING A GEOMETRIC OBLONG REPRESENTING A PILL, ALSO INTERSECTED BY FIVE HORIZONTAL LINES.

THE WORDING "CHIMIN" HAS NO MEANING IN A FOREIGN LANGUAGE.

FOR MEDICINES FOR HUMAN PURPOSES IN THE TREATMENT OF RESPIRATORY SYSTEMS DISEASES, DIGESTIVE SYSTEM DISEASES, SKIN DISEASES, GYNECOLOGICAL DISEASES, NERVOUS SYSTEM DISEASES, UROGENITAL SYSTEM DISEASES, CARDIOVASCULAR DISEASES AND DISORDERS; PHARMACEUTICAL PREPARATIONS FOR THE TREATMENT OF RESPIRATORY SYSTEMS DISEASES, DIGESTIVE SYSTEM DISEASES, SKIN DISEASES, GYNECOLOGICAL DISEASES, NERVOUS SYSTEM DISEASES, UROGENITAL SYSTEM DISEASES, CARDIOVASCULAR DISEASES AND DISORDERS; CHEMICO-PHARMACEUTICAL PREPARATIONS FOR THE TREATMENT OF RESPIRATORY SYSTEMS DISEASES, DIGESTIVE SYSTEM DISEASES, SKIN DISEASES, GYNECOLOGICAL DISEASES, NERVOUS SYSTEM DISEASES, UROGENITAL SYSTEM DISEASES, CARDIOVASCULAR DISEASES AND DISORDERS; DIETIC BEVERAGES ADAPTED FOR MEDICAL PURPOSES; AIR FRESHENING PREPARATIONS; MEDICINES FOR VETERINARY PURPOSES, NAMELY, ENZYMES FOR USE IN ANIMAL FEEDS TO ASSIST IN DIGESTION, ANIMAL REPELLENTS; INSECTICIDES; PESTICIDES; MEDICAL KITS, NAMELY, FIRST AID KITS, PREGNANCY TEST KITS FOR HOME USE, DRUG TESTING KITS COMPRISED OF MEDICAL DIAGNOSTIC REAGENTS AND ASSAYS FOR TESTING BODY FLUIDS; MEDICINES FOR DENTAL PURPOSES, NAMELY, MEDICATED TOOTHPASTE, BONDING AND PRIMER MATERIALS FOR DENTAL PURPOSES, MEDICATED DENTAL RINSES (U.S. CLS. 6, 18, 44, 46, 51 AND 52).

CHARISMA HAMPTON, EXAMINING ATTORNEY

**CLASS 5—(Continued).**

SN 79-092,813. DEFIANTE FARMACÉUTICA, S.A., PORTUGAL, FILED 12-15-2010.

# KIMVAS

THE MARK CONSISTS OF STANDARD CHARACTERS WITHOUT CLAIM TO ANY PARTICULAR FONT, STYLE, SIZE, OR COLOR.

OWNER OF INTERNATIONAL REGISTRATION 1065791 DATED 12-15-2010, EXPIRES 12-15-2020.

THE WORDING "KIMVAS" HAS NO MEANING IN A FOREIGN LANGUAGE.

FOR PHARMACEUTICAL PREPARATIONS, NAMELY, PHARMACEUTICAL PREPARATIONS FOR THE TREATMENT OF CARDIOVASCULAR DISEASES AND DISORDERS (U.S. CLS. 6, 18, 44, 46, 51 AND 52).

JAMES STEIN, EXAMINING ATTORNEY

SN 79-093,497. ZAKRYTOE AKTSIONERNOE OBSHESTVO "PHARM-SINTEZ", RUSSIAN FED., FILED 9-28-2010.

# TSELLEX

# ЦЕЛЛЕКС

OWNER OF INTERNATIONAL REGISTRATION 1067338 DATED 9-28-2010, EXPIRES 9-28-2020.

THE NON-LATIN CHARACTERS IN THE MARK TRANSLITERATE TO "TSELLEX" AND THIS HAS NO MEANING IN A FOREIGN LANGUAGE.

FOR PHARMACEUTICAL PREPARATIONS IN THE FIELD OF NEUROLOGY FOR THE TREATMENT OF ACUTE STROKES OF THE ISCHEMIC AND HAEMORRHAGIC TYPE IN THE ACUITY AND EARLY REHABILITATION PERIOD, ENCEPHALITIS AND ENCEPHALOMYELITIS, INFANTILE CEREBRAL PARALYSIS (ICP), ENCEPHALOPATHY OF THE VASCULAR, TRAUMATIC, TOXIC, AND PERINATAL TYPES, NEUROPSYCHIC DISORDERS, AND PERINATAL ENCEPHALOPATHY; PHARMACEUTICAL PREPARATIONS IN THE FIELD OF NEUROSURGERY FOR THE TREATMENT OF TRAUMATIC AFFECTION OF THE CENTRAL NERVOUS SYSTEM; PHARMACEUTICAL PREPARATIONS IN THE FIELD OF OBSTETRICS AND NEONATOLOGY FOR THE TREATMENT OF CEREBRAL BIRTH INJURY, HYPOXEMIA AND ASPHYXIA, AND FOR IMPROVEMENT OF THE PRE-NATAL CONDITION OF THE FETUS; PHARMACEUTICAL PREPARATIONS IN THE FIELD OF REANIMATOLOGY FOR THE TREATMENT OF EXPRESSED IMPAIRMENT OF CONSCIOUSNESS; PHARMACEUTICAL PREPARATIONS IN THE FIELD OF REHABILITATOLOGY FOR THE TREATMENT OF THE CONSEQUENCES OF TRAUMATIC, VASCULAR, TOXIC, AND INFECTIOUS AFFECTION OF THE CENTRAL NERVOUS SYSTEM; PHARMACEUTICAL PREPARATIONS FOR PSYCHOSTIMULATION FOR USE AS AN ADAPTOGENE, AND IN ANESTHESIOLOGY, FOR ACTIVATION OF THE CENTRAL NERVOUS SYSTEM IN THE POSTANESTHETIC RECOVERY PERIOD; VETERINARY PREPARATIONS IN THE FIELD OF NEUROLOGY FOR THE TREATMENT OF ACUTE STROKES OF THE ISCHEMIC AND HAEMORRHAGIC TYPE IN THE ACUITY AND EARLY REHABILITATION PERIOD, ENCEPHALITIS AND ENCEPHALOMYELITIS, INFANTILE CEREBRAL PARALYSIS (ICP), ENCEPHALOPATHY OF THE VASCULAR, TRAUMATIC, TOXIC, AND PERINATAL TYPES, NEUROPSYCHIC DISORDERS, AND PERINATAL ENCEPHALOPATHY; VETERINARY PREPARATIONS IN

**CLASS 5—(Continued).**

THE FIELD OF NEUROSURGERY FOR THE TREATMENT OF TRAUMATIC AFFECTION OF THE CENTRAL NERVOUS SYSTEM; VETERINARY PREPARATIONS IN THE FIELD OF OBSTETRICS AND NEONATOLOGY FOR THE TREATMENT OF CEREBRAL BIRTH INJURY, HYPOXEMIA AND ASPHYXIA, AND FOR IMPROVEMENT OF THE PRE-NATAL CONDITION OF THE FETUS; VETERINARY PREPARATIONS IN THE FIELD OF REANIMATOLOGY FOR THE TREATMENT OF EXPRESSED IMPAIRMENT OF CONSCIOUSNESS; VETERINARY PREPARATIONS IN THE FIELD OF REHABILITATION FOR THE TREATMENT OF THE CONSEQUENCES OF TRAUMATIC, VASCULAR, TOXIC, AND INFECTIOUS AFFECTION OF THE CENTRAL NERVOUS SYSTEM; VETERINARY PREPARATIONS FOR PSYCHO STIMULATION FOR USE AS AN ADAPTOGENE, AND IN ANESTHESIOLOGY, FOR ACTIVATION OF THE CENTRAL NERVOUS SYSTEM IN THE POSTANESTHETIC RECOVERY PERIOD; HYGIENIC PREPARATIONS FOR MEDICAL PURPOSES, NAMELY, FOR REPARATION OF MUCOUS MEMBRANES AFTER DAMAGE (U.S. CLS. 6, 18, 44, 46, 51 AND 52).

DAVID I, EXAMINING ATTORNEY

SN 79-094,005. MERIDEN ANIMAL HEALTH LIMITED, UNITED KINGDOM, FILED 11-22-2010.



OWNER OF INTERNATIONAL REGISTRATION 1068243 DATED 11-22-2010, EXPIRES 11-22-2020.

OWNER OF U.S. REG. NOS. 2,708,005 AND 2,783,152. THE COLOR(S) BLACK, GREY, LIGHT GREEN AND OLIVE GREEN IS/ARE CLAIMED AS A FEATURE OF THE MARK.

THE MARK CONSISTS OF THE WORDS "MERIDEN FUSION OREGO-STIM". THE WORDS "MERIDEN FUSION OREGO" ARE IN BLACK AND "-STIM" IS IN GRAY. THERE IS A BLACK LINED GLOBE APPEARING AS THE DOT ON THE "I" IN "FUSION" AND A PLUS SYMBOL IN OLIVE GREEN BELOW THE "I" IN "FUSION" WITH A LIGHT GREEN CURVED LINE BEHIND THE PLUS SYMBOL.

FOR NATURAL PHARMACEUTICAL PRODUCTS, NAMELY, ANIMAL FEED AND WATER ADDITIVE FOR IMPROVING FEED AND WATER INTAKE, IMPROVING APPETITE AND CONTROLLING AND PREVENTING BACTERIAL PATHOGENS WHICH OTHERWISE COULD CAUSE REDUCED PRODUCTION PERFORMANCE (U.S. CLS. 6, 18, 44, 46, 51 AND 52).

ANNE FARRELL, EXAMINING ATTORNEY

**CLASS 5—(Continued).**

SN 79-098,517. CELLTRION, INC., REPUBLIC OF KOREA, FILED 2-18-2011.

# SIMABTRA

THE MARK CONSISTS OF STANDARD CHARACTERS WITHOUT CLAIM TO ANY PARTICULAR FONT, STYLE, SIZE, OR COLOR.

PRIORITY DATE OF 1-31-2011 IS CLAIMED.

OWNER OF INTERNATIONAL REGISTRATION 1080251 DATED 2-18-2011, EXPIRES 7-6-2021.

THE WORDING "SIMABTRA" HAS NO MEANING IN A FOREIGN LANGUAGE.

FOR PHARMACEUTICAL PREPARATIONS FOR THE TREATMENT OF CANCER (U.S. CLS. 6, 18, 44, 46, 51 AND 52).

SUSAN STIGLITZ, EXAMINING ATTORNEY

SN 79-098,539. CELLTRION, INC., REPUBLIC OF KOREA, FILED 2-18-2011.

# HERTUZU

THE MARK CONSISTS OF STANDARD CHARACTERS WITHOUT CLAIM TO ANY PARTICULAR FONT, STYLE, SIZE, OR COLOR.

PRIORITY DATE OF 1-31-2011 IS CLAIMED.

OWNER OF INTERNATIONAL REGISTRATION 1080312 DATED 2-18-2011, EXPIRES 7-6-2021.

THE WORDING "HERTUZU" HAS NO MEANING IN A FOREIGN LANGUAGE.

FOR PHARMACEUTICAL PREPARATIONS FOR THE TREATMENT OF CANCER (U.S. CLS. 6, 18, 44, 46, 51 AND 52).

SUSAN STIGLITZ, EXAMINING ATTORNEY

SN 79-098,540. CELLTRION, INC., REPUBLIC OF KOREA, FILED 2-18-2011.

# HERZUMA

THE MARK CONSISTS OF STANDARD CHARACTERS WITHOUT CLAIM TO ANY PARTICULAR FONT, STYLE, SIZE, OR COLOR.

PRIORITY DATE OF 1-31-2011 IS CLAIMED.

OWNER OF INTERNATIONAL REGISTRATION 1080313 DATED 2-18-2011, EXPIRES 7-6-2021.

THE WORDING "HERZUMA" HAS NO MEANING IN A FOREIGN LANGUAGE.

FOR PHARMACEUTICAL PREPARATIONS FOR THE TREATMENT OF CANCER (U.S. CLS. 6, 18, 44, 46, 51 AND 52).

SUSAN STIGLITZ, EXAMINING ATTORNEY

**CLASS 5—(Continued).**

SN 79-098,840. BOEHRINGER INGELHEIM VETMEDICA GMBH, FED REP GERMANY, FILED 5-24-2011.

# MYCOMAX

THE MARK CONSISTS OF STANDARD CHARACTERS WITHOUT CLAIM TO ANY PARTICULAR FONT, STYLE, SIZE, OR COLOR.

PRIORITY DATE OF 3-3-2011 IS CLAIMED.  
OWNER OF INTERNATIONAL REGISTRATION 1081228 DATED 5-24-2011, EXPIRES 5-8-2022.  
FOR VETERINARY VACCINES (U.S. CLS. 6, 18, 44, 46, 51 AND 52).  
RUDY R. SINGLETON, EXAMINING ATTORNEY

---

SN 79-098,993. PHADIA AB, SWEDEN, FILED 5-31-2011.

# GENECA

PRIORITY DATE OF 12-17-2010 IS CLAIMED.  
OWNER OF INTERNATIONAL REGISTRATION 1081627 DATED 5-31-2011, EXPIRES 5-15-2022.  
FOR CHEMICAL REAGENTS AND DIAGNOSTIC PREPARATIONS FOR IN VITRO USE IN MEDICAL AND VETERINARY LABORATORIES; CHEMICAL REAGENTS FOR MEDICAL AND VETERINARY PURPOSES; DIAGNOSTIC PREPARATIONS FOR MEDICAL PURPOSES (U.S. CLS. 6, 18, 44, 46, 51 AND 52).  
SEAN CROWLEY, EXAMINING ATTORNEY

---

SN 79-099,345. DANISCO A/S, COPENHAGEN K, DENMARK, FILED 5-9-2011.

# ActivK

THE MARK CONSISTS OF STANDARD CHARACTERS WITHOUT CLAIM TO ANY PARTICULAR FONT, STYLE, SIZE, OR COLOR.

PRIORITY DATE OF 12-1-2010 IS CLAIMED.  
OWNER OF INTERNATIONAL REGISTRATION 1082503 DATED 5-9-2011, EXPIRES 4-23-2022.  
FOR VITAMINS, NAMELY, VITAMIN K, USED IN ANIMAL FEED, PET FOOD AND INFANT CHILD NUTRITION, OTC (OVER THE COUNTER) MEDICINE, PRESCRIPTION MEDICINE; DIETARY SUPPLEMENTS, NAMELY, VITAMIN K FOR MEDICAL USE (U.S. CLS. 6, 18, 44, 46, 51 AND 52).  
KRISTINA MORRIS, EXAMINING ATTORNEY

**CLASS 5—(Continued).**

SN 85-008,244. ENZYMOTEC LTD., KFAR BARUCH, ISRAEL, FILED 4-7-2010.

# VAYACOG

THE MARK CONSISTS OF STANDARD CHARACTERS WITHOUT CLAIM TO ANY PARTICULAR FONT, STYLE, SIZE, OR COLOR.

PRIORITY CLAIMED UNDER SEC. 44(D) ON ISRAEL APPLICATION NO. 224488, FILED 10-12-2009, REG. NO. 224488, DATED 5-17-2011, EXPIRES 5-17-2021.  
FOR DIETARY SUPPLEMENTS; PHARMACEUTICALS, NAMELY, PHARMACEUTICAL PREPARATIONS FOR THE TREATMENT OR PREVENTION OF AGE-ASSOCIATED MEMORY IMPAIRMENT, LEARNING DISORDERS, MILD COGNITIVE IMPAIRMENT, PRE-ALZHEIMER'S DISEASE, ALZHEIMER'S DISEASE, PRE-DEMENTIA SYNDROME, DEMENTIA, AGE RELATED COGNITIVE DECLINE, ANXIETY, CONCENTRATION AND ATTENTION IMPAIRMENT AND MOOD DETERIORATION (U.S. CLS. 6, 18, 44, 46, 51 AND 52).  
MARIAM MAHMOUDI, EXAMINING ATTORNEY

---

SN 85-028,329. WITH IMPRESSIONS, INC., WEST GROVE, PA. FILED 5-3-2010.



THE COLOR(S) PINK, GOLD, GREEN, BLACK, AND WHITE IS/ARE CLAIMED AS A FEATURE OF THE MARK.

THE MARK CONSISTS OF A STYLIZED WHITE HANDBAG OUTLINED IN BLACK WITH THE WORDING "JUST" IN PINK STYLIZED LETTERING, THE LETTER "N" IN GOLD STYLIZED LETTERING, AND THE WORDING "CASE" IN GREEN STYLIZED LETTERING, WITH A BLACK OUTLINED LEAF-LIKE POLYGON DESIGN IN THE LOWER RIGHT CORNER OF THE HANDBAG FLAP.

FOR CARRYING KIT MADE OF CLOTH CONSISTING OF PERSONAL CARE ITEMS, NAMELY, SANITARY NAPKINS, LINERS, IMPREGNATED CLEANING CLOTHS, PLASTIC TRASH BAG, AND PANTIES (U.S. CLS. 6, 18, 44, 46, 51 AND 52).

FIRST USE 4-1-2010; IN COMMERCE 4-1-2010.  
JULIE VEPPUMTHARA, EXAMINING ATTORNEY

**CLASS 5—(Continued).**

SN 85-074,948. NHY INTERNATIONAL INC., RANCHO PALOS VERDES, CA. FILED 6-30-2010.



NO CLAIM IS MADE TO THE EXCLUSIVE RIGHT TO USE "NATURALS", APART FROM THE MARK AS SHOWN. THE COLOR(S) GREEN AND BLACK IS/ARE CLAIMED AS A FEATURE OF THE MARK.

THE MARK CONSISTS OF TWO GREEN BUTTERFLIES ABOVE THE WORD "AVAIL", ALSO IN GREEN. THE TERM "NATURALS" IN BLACK IS TO THE RIGHT OF THE TERM "AVAIL".

FOR NUTRITIONAL SUPPLEMENTS MADE WITH ALL-NATURAL INGREDIENTS (U.S. CLS. 6, 18, 44, 46, 51 AND 52).

FIRST USE 12-20-2009; IN COMMERCE 1-1-2010.  
JAMES STEIN, EXAMINING ATTORNEY

SN 85-087,641. MARLYN NUTRACEUTICALS, INC., DBA NATURALLY VITAMINS, PHOENIX, AZ. FILED 7-19-2010.

## URGEN-C

THE MARK CONSISTS OF STANDARD CHARACTERS WITHOUT CLAIM TO ANY PARTICULAR FONT, STYLE, SIZE, OR COLOR.

FOR DIETARY AND NUTRITIONAL SUPPLEMENTS; VITAMIN AND MINERAL SUPPLEMENTS; VITAMIN SUPPLEMENT IN TABLET FORM FOR USE IN MAKING AN EFFERVESCENT BEVERAGE WHEN ADDED TO WATER; ALL OF THE FOREGOING CONTAINING VITAMIN C (U.S. CLS. 6, 18, 44, 46, 51 AND 52).

SANI KHOURI, EXAMINING ATTORNEY

SN 85-103,398. ALIFT BEVERAGES, LLC, NEW YORK, NY. FILED 8-9-2010.

## Change your energy, not your drink

THE MARK CONSISTS OF STANDARD CHARACTERS WITHOUT CLAIM TO ANY PARTICULAR FONT, STYLE, SIZE, OR COLOR.

FOR DIETARY SUPPLEMENT; VITAMIN, MINERAL AND ELECTROLYTE ENERGY ENHANCED CONCENTRATE USED IN THE PREPARATION OF CARBONATED AND NON-CARBONATED BEVERAGES (U.S. CLS. 6, 18, 44, 46, 51 AND 52).

ERIN FALK, EXAMINING ATTORNEY

**CLASS 5—(Continued).**

SN 85-125,717. MUSCLEBASIX, LLC, AKRON, OH. FILED 9-9-2010.

## MUSCLEBASIX

THE MARK CONSISTS OF STANDARD CHARACTERS WITHOUT CLAIM TO ANY PARTICULAR FONT, STYLE, SIZE, OR COLOR.

FOR NUTRITIONAL SUPPLEMENTS FOR SPORTS AND FITNESS PERFORMANCE (U.S. CLS. 6, 18, 44, 46, 51 AND 52).

FIRST USE 1-3-2009; IN COMMERCE 1-3-2009.

HOWARD B. LEVINE, EXAMINING ATTORNEY

SN 85-127,739. BACON HOT SAUCE LLC, AKA BACON HOT SAUCE, MOUNTAIN VIEW, CA. FILED 9-13-2010.



NO CLAIM IS MADE TO THE EXCLUSIVE RIGHT TO USE "BACON HOT SAUCE" "WWW.BACONHOTSAUCE.COM", APART FROM THE MARK AS SHOWN.

THE COLOR(S) BLACK, WHITE, RED, PINK, ORANGE, YELLOW, GRAY IS/ARE CLAIMED AS A FEATURE OF THE MARK.

THE MARK CONSISTS OF A DESIGN OF A FIRE BREATHING PIG WITH STEAM COMING OUT OF HIS EARS AND DROPS OF SWEAT ABOUT HIS FACE WITHIN A SHADED CIRCLE. ABOVE AND BELOW THE CIRCLE ARE BANNER DESIGNS, WITH CIRCLE AND BANNERS HAVING OUTLINES. THE TOP BANNER CONTAINS THE WORD "BACON" AND THE BOTTOM BANNER CONTAINS THE WORDS "HOT SAUCE". THE WORDING "WWW.BACONHOTSAUCE.COM" APPEARS IN THE LOWER RIGHT-HAND CIRCLE OUTLINE. THE COLOR BLACK APPEARS IN THE BORDERS AND THE BANNERS. THE COLOR WHITE APPEARS IN THE STEAM, THE SHADING, THE MIDDLE BORDER, THE EYES, AND THE WORDING "WWW.BACONHOTSAUCE.COM". THE COLOR RED APPEARS IN THE INNER BORDERS, THE SHADING ON THE PIG, AND THE FIRE. THE COLOR PINK APPEARS IN THE PIG. THE COLOR ORANGE APPEARS IN THE FIRE. THE COLOR GRAY APPEARS IN THE DROPS OF SWEAT AND THE OUTLINE OF THE STEAM. THE WORDING "BACON HOT SAUCE" IS SHADED FROM RED, THROUGH ORANGE, TO YELLOW.

FOR BISCUITS, BREAD, BREAD ROLLS, CAKES, CEREAL PRODUCTS, CONFECTIONERY, CRACKERS, NOODLES, FISH SAUCE, RELISH, SAUCES, CEREAL-BASED SNACK-FOODS AND PREPARED DIETARY ITEMS ALL OF WHICH ARE GLUTEN-FREE TO ACCOMMODATE SPECIAL MEDICAL AND HEALTH CONDITIONS (U.S. CLS. 6, 18, 44, 46, 51 AND 52).

FIRST USE 9-5-2009; IN COMMERCE 1-1-2010.

ALLISON HOLTZ, EXAMINING ATTORNEY

**CLASS 5—(Continued).**

SN 85-159,354. VIAMARKET CONSUMER PRODUCTS, INC., TULSA, OK. FILED 10-22-2010.

**EVOLVE**

THE MARK CONSISTS OF STANDARD CHARACTERS WITHOUT CLAIM TO ANY PARTICULAR FONT, STYLE, SIZE, OR COLOR.

FOR ALL-NATURAL BIOTECHNOLOGICAL BASED, NON-DETERGENT, CHEMICAL COMPOUNDS EXHIBITING ANTI-VIRAL, ANTI-BACTERIAL, AND/OR ANTI-MICROBIAL PROPERTIES FOR INDUSTRIAL AND HOUSEHOLD APPLICATIONS (U.S. CLS. 6, 18, 44, 46, 51 AND 52).

RONALD AIKENS, EXAMINING ATTORNEY

SN 85-174,835. PENTRON CLINICAL TECHNOLOGIES, LLC, ORANGE, CA. FILED 11-11-2010.

**BUILD-IT TOTAL CORE**

THE MARK CONSISTS OF STANDARD CHARACTERS WITHOUT CLAIM TO ANY PARTICULAR FONT, STYLE, SIZE, OR COLOR.

OWNER OF U.S. REG. NOS. 2,001,528 AND 3,302,220. FOR COMPOSITE, BONDING, CEMENTING AND LUTING ADHESIVES FOR DENTAL USE, DENTAL COMPOSITES FOR RESTORING OR RE-BUILDING TEETH (U.S. CLS. 6, 18, 44, 46, 51 AND 52).

JAY FLOWERS, EXAMINING ATTORNEY

SN 85-176,010. MARZ, KEITH, VAN NUYS, CA. FILED 11-12-2010.

**REBOOT**

THE MARK CONSISTS OF STANDARD CHARACTERS WITHOUT CLAIM TO ANY PARTICULAR FONT, STYLE, SIZE, OR COLOR.

FOR ORAL SPRAY FOR BOOSTING ENERGY (U.S. CLS. 6, 18, 44, 46, 51 AND 52).

FIRST USE 4-1-2010; IN COMMERCE 4-1-2010.  
KAREN SEVERSON, EXAMINING ATTORNEY

**CLASS 5—(Continued).**

SN 85-178,986. MEDTRONIC XOMED, INC., JACKSONVILLE, FL. FILED 11-17-2010.

**NOVOGEN**

THE MARK CONSISTS OF STANDARD CHARACTERS WITHOUT CLAIM TO ANY PARTICULAR FONT, STYLE, SIZE, OR COLOR.

FOR MEDICAL DRESSINGS, NAMELY, NASAL DRESSINGS AND PACKING (U.S. CLS. 6, 18, 44, 46, 51 AND 52).

MARK SPARACINO, EXAMINING ATTORNEY

SN 85-181,248. HARRIS PUBLICATIONS, INC., NEW YORK, NY. FILED 11-19-2010.

**MUSCLE PRESS**

THE MARK CONSISTS OF STANDARD CHARACTERS WITHOUT CLAIM TO ANY PARTICULAR FONT, STYLE, SIZE, OR COLOR.

NO CLAIM IS MADE TO THE EXCLUSIVE RIGHT TO USE "MUSCLE", APART FROM THE MARK AS SHOWN.

FOR DIETARY AND NUTRITIONAL SUPPLEMENTS; MULTI-VITAMIN PREPARATIONS; NUTRITIONAL ENERGY BARS FOR USE AS A MEAL SUBSTITUTE; NUTRITIONAL SHAKES FOR USE AS A MEAL SUBSTITUTE; NUTRITIONAL SUPPLEMENTS; VITAMIN AND MINERAL SUPPLEMENTS; VITAMIN FORTIFIED BEVERAGES; VITAMIN SUPPLEMENTS (U.S. CLS. 6, 18, 44, 46, 51 AND 52).

ELI HELLMAN, EXAMINING ATTORNEY

SN 85-181,362. 4 LIFE TM HOLDINGS, LLC, SCOTTSDALE, AZ. FILED 11-19-2010.

**S4L Release**

THE MARK CONSISTS OF STANDARD CHARACTERS WITHOUT CLAIM TO ANY PARTICULAR FONT, STYLE, SIZE, OR COLOR.

FOR DIETARY AND NUTRITIONAL SUPPLEMENTS (U.S. CLS. 6, 18, 44, 46, 51 AND 52).

LINDA MICKLEBURGH, EXAMINING ATTORNEY



**CLASS 5—(Continued).**

SN 85-182,788. TITAN PHARMACEUTICALS, INC., SOUTH SAN FRANCISCO, CA. FILED 11-22-2010.

**TITAN PHARMACEUTICALS**

THE MARK CONSISTS OF STANDARD CHARACTERS WITHOUT CLAIM TO ANY PARTICULAR FONT, STYLE, SIZE, OR COLOR.

NO CLAIM IS MADE TO THE EXCLUSIVE RIGHT TO USE "PHARMACEUTICALS", APART FROM THE MARK AS SHOWN.

FOR PHARMACEUTICALS, NAMELY, TREATMENT FOR CENTRAL NERVOUS DISORDERS, CANCER, HEMATOLOGICAL DISORDERS, ENDOCRINE DISORDERS, METABOLIC DISORDERS, INFLAMMATORY DISORDERS, GASTROINTESTINAL DISORDERS, LIVER DISEASE, HEART DISORDERS, LUNG AND BRONCHIAL DISEASE, BLOOD CARDIOVASCULAR DISEASE, CIRCULATORY SYSTEM DISEASE, INTESTINAL DISORDERS, BONE DISEASE, AUTOIMMUNE DISORDERS AND DISORDERS OF THE IMMUNE SYSTEMS, INFECTIOUS DISEASE AND ENZYME DEFICIENCY DISEASE; IMPLANTABLE DELIVERY SYSTEMS COMPRISED OF SUSTAINABLE RELEASE DRUGS FOR TREATMENT FOR CENTRAL NERVOUS DISORDERS AND OTHER SERIOUS AND LIFE-THREATENING DISEASES, CANCER, HEMATOLOGICAL DISORDERS, ENDOCRINE DISORDERS, METABOLIC DISORDERS, INFLAMMATORY DISORDERS, GASTROINTESTINAL DISORDERS, LIVER DISEASE, HEART DISORDERS, LUNG AND BRONCHIAL DISEASE, BLOOD CARDIOVASCULAR DISEASE, CIRCULATORY SYSTEM DISEASE, INTESTINAL DISORDERS, BONE DISEASE, AUTOIMMUNE DISORDERS AND DISORDERS OF THE IMMUNE SYSTEMS, INFECTIOUS DISEASE AND ENZYME DEFICIENCY DISEASE (U.S. CLS. 6, 18, 44, 46, 51 AND 52).

JAY FLOWERS, EXAMINING ATTORNEY

SN 85-185,034. ONYX PHARMACEUTICALS, INC., SOUTH SAN FRANCISCO, CA. FILED 11-24-2010.



OWNER OF U.S. REG. NOS. 2,791,902, 3,063,997 AND OTHERS.

NO CLAIM IS MADE TO THE EXCLUSIVE RIGHT TO USE "PHARMACEUTICALS", APART FROM THE MARK AS SHOWN.

THE MARK CONSISTS OF TWO CURVED LINES THAT PARTIALLY INTERSECT AT ONE POINT WITH THE WORDS "ONYX PHARMACEUTICALS" TO THE RIGHT OF THE CURVED LINES.

FOR HUMAN AND VETERINARY PHARMACEUTICALS FOR USE IN THE PREVENTION AND TREATMENT OF CANCER, ONCOLOGY, TUMORS, SOLID AND HEMATOLOGICAL TUMORS AND GROWTHS, HEMATOLOGICAL AND HEMOLYTIC DISEASES AND DISORDERS, AMYLOIDOSIS, METABOLIC DISEASES AND DISORDERS, LUPUS, AND INFLAMMATION AND AUTOIMMUNE DISEASES AND DISORDERS (U.S. CLS. 6, 18, 44, 46, 51 AND 52).

ELI HELLMAN, EXAMINING ATTORNEY

**CLASS 5—(Continued).**

SN 85-187,578. CARE CHIEF INTERNATIONAL CO., LTD., TAICHUNG CITY, TAIWAN, FILED 11-30-2010.

**funaicare**

THE MARK CONSISTS OF STANDARD CHARACTERS WITHOUT CLAIM TO ANY PARTICULAR FONT, STYLE, SIZE, OR COLOR.

THE WORDING "FUNAICARE" HAS NO MEANING IN A FOREIGN LANGUAGE.

FOR NUTRITIONAL SUPPLEMENTS, DIETARY AND NUTRITIONAL SUPPLEMENTS USED FOR WEIGHT LOSS, HEALTH FOOD SUPPLEMENTS, POWDERED NUTRITIONAL SUPPLEMENT DRINK MIX, ENZYME NUTRITIONAL SUPPLEMENTS, ENZYME FOOD SUPPLEMENTS, ENZYMES FOR MEDICAL PURPOSES, LECITHIN NUTRITIONAL SUPPLEMENTS, LECITHIN FOR USE AS A DIETARY SUPPLEMENT, MINERAL NUTRITIONAL SUPPLEMENTS, VITAMIN NUTRITIONAL SUPPLEMENTS, DIETARY FIBER AS AN ADDITIVE FOR FOOD PRODUCTS, THERAPEUTIC AGENTS FOR WEIGHT CONTROL AND APPETITE SUPPRESSION, DIETING PILLS AND POWDER PREPARATIONS TO PROMOTE FAT BURNING, DIET CAPSULES, DIET PILLS, DIETARY SUPPLEMENTAL DRINKS, MEAL REPLACEMENT POWDERS, MEAL REPLACEMENT DRINKS, NUTRITIONAL DRINKS USED FOR MEAL REPLACEMENT, WEIGHT MANAGEMENT SUPPLEMENTS, HERBAL DRINKS USED TO AID IN SLEEP AND RELAXATION, TRANSDERMAL PATCH FOR APPETITE SUPPRESSION, TRANSDERMAL PATCHES FOR DIET PURPOSE AND WEIGHT LOSS (U.S. CLS. 6, 18, 44, 46, 51 AND 52).

BARNEY CHARLON, EXAMINING ATTORNEY

SN 85-189,801. AIM STAR NETWORK CO., LTD., WATTANA BANGKOK 10110, THAILAND, FILED 12-2-2010.



OWNER OF THAILAND REG. NO. 290582, DATED 12-15-2008, EXPIRES 12-15-2018.

THE COLOR(S) YELLOW IS/ARE CLAIMED AS A FEATURE OF THE MARK.

THE MARK CONSISTS OF THE WORDS "VITAL STAR" WITH A TAIL CURVING DOWNWARD UNDER THE WORDS, ALL IN YELLOW, WITH AN EIGHT-POINTED STAR AT THE END OF THE CURVED TAIL. THE COLOR WHITE REPRESENTS BACKGROUND OR TRANSPARENT AREAS AND IS NOT PART OF THE MARK.

FOR DIETARY SUPPLEMENTS (U.S. CLS. 6, 18, 44, 46, 51 AND 52).

AISHA SALEM, EXAMINING ATTORNEY

**CLASS 5—(Continued).**

SN 85-191,870. IVAN CHIN, SINGAPORE, SINGAPORE, FILED 12-7-2010.

**TRIMMER**

THE MARK CONSISTS OF STANDARD CHARACTERS WITHOUT CLAIM TO ANY PARTICULAR FONT, STYLE, SIZE, OR COLOR.

FOR DIETARY AND NUTRITIONAL SUPPLEMENTS; DIETARY BEVERAGES SUPPLEMENTS FOR HUMAN CONSUMPTION IN LIQUID AND DRY MIX FORM FOR THERAPEUTIC PURPOSES; DIETARY DRINK MIX FOR USE AS A MEAL REPLACEMENT; DIETARY SUPPLEMENTAL DRINKS; DIETARY SUPPLEMENTS FOR HUMAN CONSUMPTION; NUTRITIONAL SUPPLEMENTS; LIQUID NUTRITIONAL SUPPLEMENT; MINERAL NUTRITIONAL SUPPLEMENT; POWDERED NUTRITIONAL SUPPLEMENT DRINK MIX (U.S. CLS. 6, 18, 44, 46, 51 AND 52).

RONALD AIKENS, EXAMINING ATTORNEY

SN 85-195,359. BE CLEAN PRODUCTS, LLC, OLD BRIDGE, NJ. FILED 12-10-2010.



THE MARK CONSISTS OF THE WORD "DR" WITH THE "R" HAVING A LINE THROUGH IT SO IT APPEARS AS "RX" AND THE WORD "DEFEND" BEGINNING UNDERNEATH THE "R" OF "DR", WITH A FANCIFUL PLANT STEM AND LEAF DESIGN IN THE BACKGROUND.

FOR ANTIMICROBIAL AND DISINFECTANT SPRAYS AND CREAMS FOR ADULT HYGIENE APPLICATIONS (U.S. CLS. 6, 18, 44, 46, 51 AND 52).

JOHN SCHUYLER YARD, EXAMINING ATTORNEY

SN 85-212,967. FAMILY DOLLAR STORES OF MICHIGAN, INC., MATTHEWS, NC. FILED 1-7-2011.

**FAMILY WELLNESS**

THE MARK CONSISTS OF STANDARD CHARACTERS WITHOUT CLAIM TO ANY PARTICULAR FONT, STYLE, SIZE, OR COLOR.

NO CLAIM IS MADE TO THE EXCLUSIVE RIGHT TO USE "WELLNESS", APART FROM THE MARK AS SHOWN.

FOR DIETARY DRINK MIX FOR USE AS MEAL REPLACEMENT; HERBAL SUPPLEMENTS; FIBER AS DIETARY SUPPLEMENTS; VITAMINS; DIETARY OR NUTRITIONAL SUPPLEMENTS; MINERAL SUPPLEMENTS (U.S. CLS. 6, 18, 44, 46, 51 AND 52).

SUSAN LESLIE DUBOIS, EXAMINING ATTORNEY

**CLASS 5—(Continued).**

SN 85-217,115. PUREBRANDS, LLC, BOCA RATON, FL. FILED 1-13-2011.

**SHEETS**

THE MARK CONSISTS OF STANDARD CHARACTERS WITHOUT CLAIM TO ANY PARTICULAR FONT, STYLE, SIZE, OR COLOR.

FOR DISSOLVABLE ORAL STRIPS CONTAINING NUTRIENTS SUPPLEMENTS, DIETARY SUPPLEMENTS, VITAMINS, ANALGESICS, AND CENTRAL NERVOUS SYSTEMS' STIMULANTS (U.S. CLS. 6, 18, 44, 46, 51 AND 52).

FLORENTINA BLANDU, EXAMINING ATTORNEY

SN 85-219,181. ANDUJAR, HECTOR, CHICAGO, IL. FILED 1-17-2011.



NO CLAIM IS MADE TO THE EXCLUSIVE RIGHT TO USE "SPA AT HOME", APART FROM THE MARK AS SHOWN.

THE NAME(S), PORTRAIT(S), AND/OR SIGNATURE(S) SHOWN IN THE MARK DOES NOT IDENTIFY A PARTICULAR LIVING INDIVIDUAL.

THE COLOR(S) BLACK, WHITE, BEIGE, MAGENTA, PINK, BLUE AND GOLD IS/ARE CLAIMED AS A FEATURE OF THE MARK.

THE MARK CONSISTS OF A BLACK RECTANGLE CONTAINING A GENIE WITH A STREAM OF SMOKE EMERGING FROM A BOTTLE. THE WORDING "ICKY FEEL GOOD SPA AT HOME" IS IN MAGENTA AT THE TOP OF THE RECTANGLE. THE WORDING "POTION" IS IN WHITE NEAR THE BOTTOM RIGHT OF THE SMOKE. THE GENIE HAS BEIGE SKIN, BLACK HAIR, BLACK EYEBROWS AND EYELASHES, AND EYES WITH BLUE IRISES, BLACK AND WHITE PUPILS, AND WHITE OUTSIDE THE IRIS OF THE EYE. THE GENIE'S COSTUME IS MAGENTA WITH PINK TRIM ON THE TOP OF THE COSTUME. THE CIRCLE BEHIND THE GENIE, THE SMOKE, AND THE WORDING "NICKY ICKY" ARE IN BLUE. THE WORDING "NICKY" IS ON THE LEFT SIDE OF THE BOTTLE AND "ICKY" IS ON THE RIGHT SIDE OF THE BOTTLE. THERE ARE WHITE SPARKLES AMONG THE BLUE SMOKE. THE BOTTLE, WHICH IS BLUE WITH A GOLD BASE, HAS DETAILING IN GOLD, BLUE AND WHITE.

FOR PERSONAL LUBRICANTS (U.S. CLS. 6, 18, 44, 46, 51 AND 52).

ELLEN B. AWRICH, EXAMINING ATTORNEY

**CLASS 5—(Continued).**

SN 85-226,662. PRIMARY INVESTMENTS GROUP LIMITED, ROAD TOWN, TORTOLA, BR. VIRGIN ISLANDS, FILED 1-26-2011.

**TRIPLE-BOOST CAFFEINE-FREE  
ENERGY**

THE MARK CONSISTS OF STANDARD CHARACTERS WITHOUT CLAIM TO ANY PARTICULAR FONT, STYLE, SIZE, OR COLOR.

OWNER OF U.S. REG. NO. 2,899,300.

NO CLAIM IS MADE TO THE EXCLUSIVE RIGHT TO USE "CAFFEINE-FREE ENERGY", APART FROM THE MARK AS SHOWN.

FOR DIETARY SUPPLEMENTS; FOOD SUPPLEMENTS; HERBAL SUPPLEMENTS; NUTRITIONAL SUPPLEMENTS; VITAMIN SUPPLEMENTS; MINERAL SUPPLEMENTS; MULTI-VITAMIN AND MINERAL SUPPLEMENTS (U.S. CLS. 6, 18, 44, 46, 51 AND 52).

FIRST USE 9-28-2007; IN COMMERCE 9-28-2007.

KYLE PEETE, EXAMINING ATTORNEY

---

SN 85-232,118. NIKKEN, INC., IRVINE, CA. FILED 2-2-2011.

**KENZEN BERGISTEROL**

THE MARK CONSISTS OF STANDARD CHARACTERS WITHOUT CLAIM TO ANY PARTICULAR FONT, STYLE, SIZE, OR COLOR.

OWNER OF U.S. REG. NOS. 2,918,726 AND 3,531,369.

FOR DIETARY SUPPLEMENT BEVERAGES, NAMELY, NUTRITIONALLY FORTIFIED BEVERAGES (U.S. CLS. 6, 18, 44, 46, 51 AND 52).

TARA PATE, EXAMINING ATTORNEY

**CLASS 5—(Continued).**

SN 85-237,429. BEGOVIC, BINAIS, TA OWNER, WEST HOLLYWOOD, CA. FILED 2-9-2011.

**BMR Sports Nutrition**

THE MARK CONSISTS OF STANDARD CHARACTERS WITHOUT CLAIM TO ANY PARTICULAR FONT, STYLE, SIZE, OR COLOR.

NO CLAIM IS MADE TO THE EXCLUSIVE RIGHT TO USE "SPORTS NUTRITION", APART FROM THE MARK AS SHOWN.

FOR AMINO ACIDS FOR NUTRITIONAL PURPOSES; AROMATIZED BEVERAGES BASED ON FRUIT, PROTEIN, CORDIAL, SUGAR AND OTHER FLUID NUTRIENTS, NAMELY, WEIGHT MANAGEMENT POWDERS FOR USE AS A FOOD FILLERS; DIET CAPSULES; DIET PILLS; DIETARY AND NUTRITIONAL SUPPLEMENTS; DIETARY AND NUTRITIONAL SUPPLEMENTS FOR ENDURANCE SPORTS; DIETARY AND NUTRITIONAL SUPPLEMENTS USED FOR WEIGHT LOSS; DIETARY FOOD SUPPLEMENTS; DIETARY SUPPLEMENTAL DRINKS; DIETARY SUPPLEMENTAL DRINKS IN THE NATURE OF VITAMIN AND MINERAL BEVERAGES; DIETARY SUPPLEMENTS; DIETARY SUPPLEMENTS FOR HUMAN CONSUMPTION; DIETARY SUPPLEMENTS FOR PETS IN THE NATURE OF A POWDERED DRINK MIX; DIETARY SUPPLEMENTS IN THE NATURE OF WEIGHT LOSS POWDERS; DIETING PILLS AND POWDER PREPARATIONS TO PROMOTE FAT BURNING; ENERGY BOOSTING BARS FOR USE AS A MEAL SUBSTITUTE; ENERGY BOOSTING MOUTH DISSOLVABLE FLAVORED EDIBLE FILMS; ENERGY BOOSTING SERUM FOR INJECTION; FOOD FOR MEDICALLY RESTRICTED DIETS; FOOD SUPPLEMENTS; FOOD SUPPLEMENTS, NAMELY, ANTI-OXIDANTS; GROUND FLAXSEED FIBER FOR USE AS A DIETARY SUPPLEMENT; HEALTH FOOD SUPPLEMENTS; HIGHLY CAFFEINATED ENERGY PILLS; HOMEOPATHIC-STYLE HCG (HUMAN CHORIONIC GONADOTROPIN) ORAL SPRAYS FOR WEIGHT LOSS PURPOSES; HOMEOTHERAPEUTIC HCG (HUMAN CHORIONIC GONADOTROPIN) ORAL SPRAYS FOR WEIGHT LOSS PURPOSES; LIQUID NUTRITIONAL SUPPLEMENT; LIQUID PROTEIN SUPPLEMENTS; LIQUID VITAMIN SUPPLEMENTS; MINERAL NUTRITIONAL SUPPLEMENTS; MIXED VITAMIN PREPARATIONS; MULTI-VITAMIN PREPARATIONS; NUTRITIONAL AND DIETARY SUPPLEMENTS FORMED AND PACKAGED AS BARS; NUTRITIONAL DRINK MIX FOR USE AS A MEAL REPLACEMENT; NUTRITIONAL DRINKS USED FOR MEAL REPLACEMENT; NUTRITIONAL ENERGY BARS FOR USE AS A MEAL SUBSTITUTE; NUTRITIONAL FOOD BARS FOR USE AS A MEAL REPLACEMENT; NUTRITIONAL MEAL REPLACEMENT BARS FOR INDIVIDUALS UNDERGOING MEDICAL TREATMENTS; NUTRITIONAL OILS NOT FOR FOOD OR COSMETIC PURPOSES; NUTRITIONAL SHAKES FOR USE AS A MEAL SUBSTITUTE; NUTRITIONAL SUPPLEMENT IN THE NATURE OF A NUTRIENT-DENSE, PROTEIN-BASED DRINK MIX; NUTRITIONAL SUPPLEMENTS; NUTRITIONAL SUPPLEMENTS IN LOTION FORM SOLD AS A COMPONENT OF NUTRITIONAL SKIN CARE PRODUCTS; NUTRITIONAL SUPPLEMENTS, NAMELY, CARBOHYDRATES IN POWDERED FORM; ORAL SPRAY FOR BOOSTING ENERGY; ORALLY INGESTED GEL FOR BOOSTING ENERGY; PRENATAL VITAMINS; PROTEIN SUPPLEMENTS; RECTALLY ADMINISTERED AGENTS FOR WEIGHT CONTROL AND APPETITE SUPPRESSION; SOY PROTEIN FOR USE AS A NUTRITIONAL SUPPLEMENT IN VARIOUS POWDERED AND READY-TO-DRINK BEVERAGES; STIMULATORY MEDICATIONS FOR USE IN WEIGHT REDUCTION PROGRAMS; THERAPEUTIC AGENTS FOR WEIGHT CONTROL AND APPETITE SUPPRESSION; VEGAN LIQUID PROTEIN SUPPLEMENTS; VEGAN PROTEIN FOR USE AS A NUTRITIONAL SUPPLEMENT IN READY-TO-DRINK BEVERAGES; VITAMIN AND MINERAL FORMED AND PACKAGED AS BARS; VITA-

**CLASS 5—(Continued).**

MIN AND MINERAL PREPARATIONS FOR MEDICAL USE; VITAMIN AND MINERAL PREPARATIONS FOR USE AS INGREDIENTS IN THE FOOD AND PHARMACEUTICAL INDUSTRY; VITAMIN AND MINERAL SUPPLEMENTS; VITAMIN B PREPARATIONS; VITAMIN C PREPARATIONS; VITAMIN D PREPARATIONS; VITAMIN DROPS; VITAMIN ENRICHED BREAD FOR THERAPEUTIC PURPOSES; VITAMIN ENRICHED CHEWING GUM; VITAMIN ENRICHED WATER; VITAMIN OILS FOR HUMAN CONSUMPTION; VITAMIN SUPPLEMENTS; VITAMINS; VITAMINS AND VITAMIN PREPARATIONS; WEIGHT MANAGEMENT SUPPLEMENTS; WHEY PROTEIN SUPPLEMENTS (U.S. CLS. 6, 18, 44, 46, 51 AND 52).

FIRST USE 2-20-2009; IN COMMERCE 2-20-2009.  
MATTHEW PAPPAS, EXAMINING ATTORNEY

SN 85-238,291. ARCHIE COMIC PUBLICATIONS, INC.,  
MAMARONECK, NY. FILED 2-9-2011.

# ARCHIE

THE MARK CONSISTS OF STANDARD CHARACTERS WITHOUT CLAIM TO ANY PARTICULAR FONT, STYLE, SIZE, OR COLOR.

FOR VITAMINS FOR CHILDREN (U.S. CLS. 6, 18, 44, 46, 51 AND 52).  
SKYE YOUNG, EXAMINING ATTORNEY

SN 85-238,301. ARCHIE COMIC PUBLICATIONS, INC.,  
MAMARONECK, NY. FILED 2-9-2011.

# BETTY

THE MARK CONSISTS OF STANDARD CHARACTERS WITHOUT CLAIM TO ANY PARTICULAR FONT, STYLE, SIZE, OR COLOR.

FOR VITAMINS FOR CHILDREN (U.S. CLS. 6, 18, 44, 46, 51 AND 52).  
SKYE YOUNG, EXAMINING ATTORNEY

SN 85-238,310. ARCHIE COMIC PUBLICATIONS, INC.,  
MAMARONECK, NY. FILED 2-9-2011.

# VERONICA

THE MARK CONSISTS OF STANDARD CHARACTERS WITHOUT CLAIM TO ANY PARTICULAR FONT, STYLE, SIZE, OR COLOR.

FOR VITAMINS FOR CHILDREN (U.S. CLS. 6, 18, 44, 46, 51 AND 52).  
SKYE YOUNG, EXAMINING ATTORNEY

**CLASS 5—(Continued).**

SN 85-238,322. ARCHIE COMIC PUBLICATIONS, INC.,  
MAMARONECK, NY. FILED 2-9-2011.

# JUGHEAD

THE MARK CONSISTS OF STANDARD CHARACTERS WITHOUT CLAIM TO ANY PARTICULAR FONT, STYLE, SIZE, OR COLOR.

FOR VITAMINS FOR CHILDREN (U.S. CLS. 6, 18, 44, 46, 51 AND 52).  
SKYE YOUNG, EXAMINING ATTORNEY

SN 85-238,823. ROTAM AGROCHEM INTERNATIONAL CO.  
LTD., CHAIWAN, HONG KONG, FILED 2-10-2011.

# ALTITUDE

THE MARK CONSISTS OF STANDARD CHARACTERS WITHOUT CLAIM TO ANY PARTICULAR FONT, STYLE, SIZE, OR COLOR.

FOR AGRICULTURAL HERBICIDES, INSECTICIDES AND FUNGICIDES (U.S. CLS. 6, 18, 44, 46, 51 AND 52).  
DORITT L. CARROLL, EXAMINING ATTORNEY

SN 85-242,323. THE HARTZ MOUNTAIN CORPORATION,  
SECAUCUS, NJ. FILED 2-15-2011.

# REVO ADVANCED

THE MARK CONSISTS OF STANDARD CHARACTERS WITHOUT CLAIM TO ANY PARTICULAR FONT, STYLE, SIZE, OR COLOR.

NO CLAIM IS MADE TO THE EXCLUSIVE RIGHT TO USE "ADVANCED", APART FROM THE MARK AS SHOWN.

FOR FLEA AND TICK KILLER CARPET POWDER FOR USE IN THE HOME; FLEA AND TICK KILLER SPRAY FOGGER FOR USE IN THE HOME; FLEA AND TICK KILLER SPRAY FOR USE ON THE DOG OR CAT, IN THE HOME AND IN THE YARD; MEDICATED FLEA AND TICK ERADICATION PRODUCTS FOR CATS AND DOGS, NAMELY, SHAMPOOS AND CONDITIONERS, DIPS, SPRAYS, COLLARS AND TOPICAL LIQUID DROPS, EXCLUDING PHARMACEUTICALS (U.S. CLS. 6, 18, 44, 46, 51 AND 52).

DAVID COLLIER, EXAMINING ATTORNEY

**CLASS 5—(Continued).**

SN 85-242,465. BRILLMAN'S BEST, INC. RINGOES, NJ. FILED 2-15-2011.



NO CLAIM IS MADE TO THE EXCLUSIVE RIGHT TO USE "BEST", APART FROM THE MARK AS SHOWN.

THE STIPPLING IS A FEATURE OF THE MARK AND DOES NOT INDICATE COLOR; THE STIPPLING IS FOR SHADING PURPOSES ONLY.

THE MARK CONSISTS OF A CIRCULARLY LINED CIRCLE WITH A RECTANGULARLY LINED BAR RUNNING HORIZONTALLY THROUGH THE CIRCULAR IMAGE, APPROXIMATELY DISSECTING THE CIRCLE IN HALF; CONTAINS A FIGURE IN THE UPPER SECTION HOLDING TOOLS WITH FAN RAYS OF ALTERNATING SHADE IN THE BACKGROUND; THE COMPANY NAME "BRILLMAN'S BEST" IS INSCRIBED IN THE CENTER OF THE BAR; THE PHRASE "BEST FROM THE GROUND UP" IS INSCRIBED IN THE LOWER SECTION OF THE CIRCLE INTERIOR ON A SHADE BACKGROUND. THE GRAY IN THE MARK IS FOR SHADING PURPOSES ONLY AND DOES NOT INDICATE COLOR.

FOR HERBICIDES, INSECTICIDES, PESTICIDES AND FUNGICIDES FOR HOME, GARDEN AND LAWN USE AND FOR PROFESSIONAL USE (U.S. CLS. 6, 18, 44, 46, 51 AND 52).

FIRST USE 1-3-2011; IN COMMERCE 1-3-2011.  
REBECCA SMITH, EXAMINING ATTORNEY

SN 85-247,666. HUGHES, LOU ANN, SAN ANTONIO, TX. FILED 2-21-2011.



NO CLAIM IS MADE TO THE EXCLUSIVE RIGHT TO USE "PROBIOTICS", APART FROM THE MARK AS SHOWN.

THE COLOR(S) RED, BLUE, GRAY AND BLACK IS/ARE CLAIMED AS A FEATURE OF THE MARK.

INSIDE THE LETTER "P" IS A GLOBE OF THE EARTH. THE CONTINENTS ARE IN GRAY, THE LONGITUDE AND LATITUDE LINES ARE IN GRAY AND THE OCEANS ARE IN BLUE. THE WORD "PERFORMANCE" IS IN BLUE. THE LINE BELOW "PERFORMANCE" IS IN BLACK AS IS THE WORD "PROBIOTICS" APPEARING BELOW THE LINE WHICH IS ALSO IN THE COLOR BLACK. THE GEOMETRIC SHAPES FORMING THE OVALS AROUND THE LETTER "P" AND THE GLOBE OF THE EARTH ARE IN BLUE AND RED.

FOR ANIMAL FEED SUPPLEMENTS COMPOSED WHOLLY OR IN PART OF PROBIOTICS (U.S. CLS. 6, 18, 44, 46, 51 AND 52).

FIRST USE 1-1-2011; IN COMMERCE 1-1-2011.  
EDWARD NELSON, EXAMINING ATTORNEY

**CLASS 5—(Continued).**

SN 85-253,616. NEXGEN PHARMA, INC., IRVINE, CA. FILED 2-28-2011.

## GLUCOSAMINE CHONDROITIN COMPLETE

THE MARK CONSISTS OF STANDARD CHARACTERS WITHOUT CLAIM TO ANY PARTICULAR FONT, STYLE, SIZE, OR COLOR.

OWNER OF U.S. REG. NO. 2,932,084.

NO CLAIM IS MADE TO THE EXCLUSIVE RIGHT TO USE "GLUCOSAMINE CHONDROITIN", APART FROM THE MARK AS SHOWN.

SEC. 2(F).

FOR NUTRITIONAL AND DIETARY SUPPLEMENTS CONTAINING GLUCOSAMINE AND CHONDROITIN (U.S. CLS. 6, 18, 44, 46, 51 AND 52).

FIRST USE 3-17-2003; IN COMMERCE 3-17-2003.

ELLEN PERKINS, EXAMINING ATTORNEY

SN 85-258,217. ESSENTIAL PHARMACEUTICALS, LLC, NEWTOWN, PA. FILED 3-4-2011.

## CRYO-ESS

THE MARK CONSISTS OF STANDARD CHARACTERS WITHOUT CLAIM TO ANY PARTICULAR FONT, STYLE, SIZE, OR COLOR.

FOR CULTURE MEDIA USED FOR PHARMACEUTICAL, MEDICAL, VETERINARY OR SCIENTIFIC PURPOSES, SPECIFICALLY USED IN PRESERVING CELLS AND TISSUE (U.S. CLS. 6, 18, 44, 46, 51 AND 52).

FIRST USE 12-21-2010; IN COMMERCE 12-21-2010.

ZACHARY BELLO, EXAMINING ATTORNEY

SN 85-265,162. BURT'S BEES, INC., DURHAM, NC. FILED 3-11-2011.

## BURT'S BEES

THE MARK CONSISTS OF STANDARD CHARACTERS WITHOUT CLAIM TO ANY PARTICULAR FONT, STYLE, SIZE, OR COLOR.

OWNER OF U.S. REG. NOS. 2,171,302 AND 3,356,042.

THE NAME(S), PORTRAIT(S), AND/OR SIGNATURE(S) SHOWN IN THE MARK IDENTIFIES INGRAM BURT SHAVITZ, WHOSE CONSENT(S) TO REGISTER IS MADE OF RECORD.

FOR MEDICATED SKIN CARE PREPARATIONS (U.S. CLS. 6, 18, 44, 46, 51 AND 52).

FIRST USE 12-31-2006; IN COMMERCE 12-31-2006.

ZACHARY BELLO, EXAMINING ATTORNEY

**CLASS 5—(Continued).**

SN 85-268,427. ECOLAB USA INC., SAINT PAUL, MN. FILED 3-16-2011.

**FINITO**

THE MARK CONSISTS OF STANDARD CHARACTERS WITHOUT CLAIM TO ANY PARTICULAR FONT, STYLE, SIZE, OR COLOR.  
FOR PESTICIDES (U.S. CLS. 6, 18, 44, 46, 51 AND 52).  
BILL DAWE, EXAMINING ATTORNEY

---

SN 85-279,748. GUTHY-RENKER LLC, PALM DESERT, CA. FILED 3-29-2011.

**SHEER COVER**

THE MARK CONSISTS OF STANDARD CHARACTERS WITHOUT CLAIM TO ANY PARTICULAR FONT, STYLE, SIZE, OR COLOR.  
OWNER OF U.S. REG. NOS. 2,729,563 AND 2,823,868.  
FOR PHARMACEUTICAL PREPARATIONS, NAMELY, VITAMINS, MINERAL SUPPLEMENTS, DIETARY SUPPLEMENTS, NUTRITIONAL SUPPLEMENTS (U.S. CLS. 6, 18, 44, 46, 51 AND 52).  
MORGAN WYNNE, EXAMINING ATTORNEY

---

SN 85-281,735. ZWIRN, LAURENCE, LOS ANGELES, CA. FILED 3-30-2011.

**OCULAR FACTORS**

THE MARK CONSISTS OF STANDARD CHARACTERS WITHOUT CLAIM TO ANY PARTICULAR FONT, STYLE, SIZE, OR COLOR.  
NO CLAIM IS MADE TO THE EXCLUSIVE RIGHT TO USE "FACTORS", APART FROM THE MARK AS SHOWN. SEC. 2(F).  
FOR DIETARY AND NUTRITIONAL SUPPLEMENTS (U.S. CLS. 6, 18, 44, 46, 51 AND 52).  
FIRST USE 1-1-2000; IN COMMERCE 1-1-2000.  
TINA BROWN, EXAMINING ATTORNEY

**CLASS 5—(Continued).**

SN 85-290,815. ORGANIKA HEALTH PRODUCTS INC., RICHMOND, BC, CANADA, FILED 4-8-2011.

**ORGANIKA PLANT ENZYMES**

THE MARK CONSISTS OF STANDARD CHARACTERS WITHOUT CLAIM TO ANY PARTICULAR FONT, STYLE, SIZE, OR COLOR.  
OWNER OF U.S. REG. NO. 2,611,037.  
NO CLAIM IS MADE TO THE EXCLUSIVE RIGHT TO USE "PLANT ENZYMES", APART FROM THE MARK AS SHOWN.  
FOR HERBAL SUPPLEMENTS CONTAINING ORGANIC PLANT ENZYMES TO AID IN DIGESTION; ENZYME FOOD SUPPLEMENTS CONTAINING ORGANIC PLANT ENZYMES (U.S. CLS. 6, 18, 44, 46, 51 AND 52).  
JAY FLOWERS, EXAMINING ATTORNEY

---

SN 85-301,265. ASPEN GLOBAL INCORPORATED, GRAND BAY, MAURITIUS, FILED 4-21-2011.

**ELTROXIN**

THE MARK CONSISTS OF STANDARD CHARACTERS WITHOUT CLAIM TO ANY PARTICULAR FONT, STYLE, SIZE, OR COLOR.  
FOR PHARMACEUTICAL AND VETERINARY PREPARATIONS FOR TREATING HYPOTHYROIDISM; SANITARY PREPARATIONS FOR MEDICAL PURPOSES; MEDICAL PLASTERS, MEDICAL DRESSINGS; MATERIALS FOR STOPPING TEETH, DENTAL WAX; DISINFECTANTS FOR MEDICAL PURPOSES (U.S. CLS. 6, 18, 44, 46, 51 AND 52).  
JAMES GRIFFIN, EXAMINING ATTORNEY

---

SN 85-302,629. SYNEDGEN, INC., CLAREMONT, CA. FILED 4-22-2011.

**CATASYN**

THE MARK CONSISTS OF STANDARD CHARACTERS WITHOUT CLAIM TO ANY PARTICULAR FONT, STYLE, SIZE, OR COLOR.  
FOR WOUND RINSE, NAMELY, ANTIMICROBIALS; WOUND TREATMENTS, NAMELY, ANTIBIOTIC GELS; WOUND DRESSINGS (U.S. CLS. 6, 18, 44, 46, 51 AND 52).  
INGRID C. EULIN, EXAMINING ATTORNEY

**CLASS 5—(Continued).**

SN 85-303,423. LAM, MICHAEL, AKA DR. MICHAEL LAM, MONTEREY PARK, CA. FILED 4-25-2011.

**Michael Lam, MD**

THE MARK CONSISTS OF STANDARD CHARACTERS WITHOUT CLAIM TO ANY PARTICULAR FONT, STYLE, SIZE, OR COLOR.

NO CLAIM IS MADE TO THE EXCLUSIVE RIGHT TO USE "MD", APART FROM THE MARK AS SHOWN.

THE NAME "MICHAEL LAM" IDENTIFIES A LIVING INDIVIDUAL WHOSE CONSENT IS OF RECORD.

FOR DIETARY AND NUTRITIONAL SUPPLEMENTS; HEALTH FOOD SUPPLEMENTS; LIQUID NUTRITIONAL SUPPLEMENT; LIQUID VITAMIN SUPPLEMENTS; NATURAL HERBAL SUPPLEMENTS; NUTRITIONAL SUPPLEMENTS; VITAMIN AND MINERAL SUPPLEMENTS (U.S. CLS. 6, 18, 44, 46, 51 AND 52).

FIRST USE 4-13-2011; IN COMMERCE 4-13-2011.  
JAMES STEIN, EXAMINING ATTORNEY

SN 85-307,371. RAMIREZ MORELES, SELOMITH, IRAPUATO, MEXICO, FILED 4-28-2011.

**MAX CLEAN FIBER**

THE MARK CONSISTS OF STANDARD CHARACTERS WITHOUT CLAIM TO ANY PARTICULAR FONT, STYLE, SIZE, OR COLOR.

OWNER OF U.S. REG. NO. 3,905,426.

NO CLAIM IS MADE TO THE EXCLUSIVE RIGHT TO USE "CLEAN FIBER", APART FROM THE MARK AS SHOWN.

FOR DIETARY AND NUTRITIONAL SUPPLEMENTS CONTAINING FIBER (U.S. CLS. 6, 18, 44, 46, 51 AND 52).

FIRST USE 1-2-2006; IN COMMERCE 10-5-2008.

JULIE VEPPUMTHARA, EXAMINING ATTORNEY

SN 85-312,723. PAUL C. KRUGER, OREM, UT. FILED 5-4-2011.



THE COLOR(S) BLACK, WHITE, AND RED IS/ARE CLAIMED AS A FEATURE OF THE MARK.

THE COLORS WHITE, BLACK, AND RED ARE CLAIMED AS A FEATURE OF THE MARK. THE MARK CONSISTS OF THE WORDING "MAN FEED" IN WHITE BLOCK LETTERS. IN THE SPACE BETWEEN THE WORDS IS THE BLACK SILHOUETTE OF A BODY BUILDER WITH A RED CAPE. THE BLACK RECTANGLE BEHIND THE MARK REPRESENTS BACKGROUND AND IS NOT CLAIMED AS A FEATURE OF THE MARK.

FOR DIETARY AND NUTRITIONAL SUPPLEMENTS (U.S. CLS. 6, 18, 44, 46, 51 AND 52).

KIMBERLY FRYE, EXAMINING ATTORNEY

**CLASS 5—(Continued).**

SN 85-315,777. MEDTRADE PRODUCTS LIMITED, CREWE, CHESHIRE, UNITED KINGDOM, FILED 5-9-2011.

**CHITO-R**

THE MARK CONSISTS OF STANDARD CHARACTERS WITHOUT CLAIM TO ANY PARTICULAR FONT, STYLE, SIZE, OR COLOR.

PRIORITY CLAIMED UNDER SEC. 44(D) ON UNITED KINGDOM APPLICATION NO. 2579961, FILED 5-4-2011.

FOR PHARMACEUTICAL AND VETERINARY PREPARATIONS CONTAINING CHITOSAN FOR TREATING WOUNDS; HAEMOSTATIC AGENTS CONTAINING CHITOSAN FOR USE IN CONTROLLING BLEEDING (U.S. CLS. 6, 18, 44, 46, 51 AND 52).

APRIL HESIK, EXAMINING ATTORNEY

SN 85-316,585. THIN CENTERS MD, LLC, DALLAS, TX. FILED 5-10-2011.



NO CLAIM IS MADE TO THE EXCLUSIVE RIGHT TO USE "MD" OR THE CADUCEUS DESIGN, APART FROM THE MARK AS SHOWN.

THE MARK CONSISTS OF THE WORDS "THIN CENTERS MD" IN STYLIZED LETTERING WITH A STYLIZED REPRESENTATION OF A CADUCEUS PLACED BETWEEN THE LETTERS "M" AND "D".

FOR VITAMINS; DIETARY AND NUTRITIONAL SUPPLEMENTS; DIETARY AND NUTRITIONAL SUPPLEMENTS USED FOR WEIGHT LOSS; FOOD FOR MEDICALLY RESTRICTED DIETS; DIETARY SUPPLEMENTAL DRINKS (U.S. CLS. 6, 18, 44, 46, 51 AND 52).

FIRST USE 12-4-2010; IN COMMERCE 12-4-2010.

IRA J. GOODSAD, EXAMINING ATTORNEY

SN 85-316,877. HEALTH PRODUCTS EXPRESS, INC., WINTHROP, MA. FILED 5-10-2011.

**MEMORY FOCUS**

THE MARK CONSISTS OF STANDARD CHARACTERS WITHOUT CLAIM TO ANY PARTICULAR FONT, STYLE, SIZE, OR COLOR.

NO CLAIM IS MADE TO THE EXCLUSIVE RIGHT TO USE "MEMORY", APART FROM THE MARK AS SHOWN.

FOR VITAMINS AND DIETARY SUPPLEMENTS (U.S. CLS. 6, 18, 44, 46, 51 AND 52).

MARY BOAGNI, EXAMINING ATTORNEY



**CLASS 5—(Continued).**

SN 85-318,154. BLISTEX INC., OAK BROOK, IL. FILED 5-11-2011.

**MOISTURE ADVANCE**

THE MARK CONSISTS OF STANDARD CHARACTERS WITHOUT CLAIM TO ANY PARTICULAR FONT, STYLE, SIZE, OR COLOR.

OWNER OF U.S. REG. NOS. 1,831,866, 3,178,654 AND OTHERS.

NO CLAIM IS MADE TO THE EXCLUSIVE RIGHT TO USE "MOISTURE", APART FROM THE MARK AS SHOWN.

FOR MEDICATED LIP CARE PREPARATIONS, MEDICATED TOPICAL CREAMS, LOTIONS, GELS, BALMS, AND OINTMENTS FOR HUMAN USE FOR LIP AND SKIN DRYNESS, COLD SORES, AND FOR LIP AND SKIN CARE (U.S. CLS. 6, 18, 44, 46, 51 AND 52).

INGRID C. EULIN, EXAMINING ATTORNEY

SN 85-320,615. DENNIS F. HOLT, LOS ANGELES, CA. FILED 5-13-2011.

**AQUA D-KULA**

THE MARK CONSISTS OF STANDARD CHARACTERS WITHOUT CLAIM TO ANY PARTICULAR FONT, STYLE, SIZE, OR COLOR.

NO CLAIM IS MADE TO THE EXCLUSIVE RIGHT TO USE "AQUA", APART FROM THE MARK AS SHOWN.

FOR NUTRITIONALLY FORTIFIED WATER; NUTRITIONALLY FORTIFIED BEVERAGES (U.S. CLS. 6, 18, 44, 46, 51 AND 52).

JEFF DEFORD, EXAMINING ATTORNEY

SN 85-321,449. TRIM NUTRITION, INC., CLEARWATER, FL. FILED 5-16-2011.



OWNER OF U.S. REG. NO. 3,474,607.

THE COLOR(S) BLACK AND GREEN IS/ARE CLAIMED AS A FEATURE OF THE MARK.

THE MARK CONSISTS OF THE WORD "TRIM" IN BLACK, WITH A GREEN DOT OVER THE LETTER "I".

FOR DIETARY AND NUTRITIONAL SUPPLEMENTS; HOMEOPATHIC-STYLE HCG (HUMAN CHORIONIC GONADOTROPIN) IN THE FORM OF INJECTIONS FOR WEIGHT LOSS PURPOSES; NUTRITIONAL AND DIETARY SUPPLEMENTS FORMED AND PACKAGED AS BARS; NUTRITIONAL SHAKES FOR USE AS A MEAL SUBSTITUTE; VITAMIN AND MINERAL SUPPLEMENTS; WEIGHT MANAGEMENT SUPPLEMENTS (U.S. CLS. 6, 18, 44, 46, 51 AND 52).

FIRST USE 10-1-2008; IN COMMERCE 10-1-2008.

JORDAN BAKER, EXAMINING ATTORNEY

**CLASS 5—(Continued).**

SN 85-322,500. TRIARCO INDUSTRIES, INC., WAYNE, NJ. FILED 5-17-2011.

**GRAB-A-MATÉ**

THE MARK CONSISTS OF STANDARD CHARACTERS WITHOUT CLAIM TO ANY PARTICULAR FONT, STYLE, SIZE, OR COLOR.

FOR VITAMINS, MINERAL SUPPLEMENTS, NUTRITIONAL AND DIETARY SUPPLEMENTS, ALL CONTAINING MATÉ (U.S. CLS. 6, 18, 44, 46, 51 AND 52).

TOBY BULLOFF, EXAMINING ATTORNEY

SN 85-322,870. ROCKTAPE, INC., LOS GATOS, CA. FILED 5-17-2011.

**ROCK SAUCE**

THE MARK CONSISTS OF STANDARD CHARACTERS WITHOUT CLAIM TO ANY PARTICULAR FONT, STYLE, SIZE, OR COLOR.

FOR TOPICAL GEL FOR MEDICAL AND THERAPEUTIC TREATMENT OF MUSCLE PAIN AND TENSION (U.S. CLS. 6, 18, 44, 46, 51 AND 52).

FIRST USE 1-0-2011; IN COMMERCE 1-0-2011.

MICHAEL WIENER, EXAMINING ATTORNEY

SN 85-323,177. INNERGENESIS LLC, NAHSUA, NH. FILED 5-17-2011.

**EZAging**

THE MARK CONSISTS OF STANDARD CHARACTERS WITHOUT CLAIM TO ANY PARTICULAR FONT, STYLE, SIZE, OR COLOR.

FOR DIETARY SUPPLEMENTS; DIETARY SUPPLEMENTS FOR HUMAN CONSUMPTION; DIETARY SUPPLEMENTS FOR RELIEVING ANTI-AGING SYMPTOMS; NUTRACEUTICALS FOR USE AS A DIETARY SUPPLEMENT; NUTRACEUTICALS FOR USE AS A DIETARY SUPPLEMENT FOR RELIEVING ANTI-AGING SYMPTOMS; NUTRITIONAL SUPPLEMENTS; NUTRITIONAL SUPPLEMENTS FOR RELIEVING ANTI-AGING SYMPTOMS (U.S. CLS. 6, 18, 44, 46, 51 AND 52).

KATHERINE E. HALMEN, EXAMINING ATTORNEY



**CLASS 5—(Continued).**

SN 85-323,448. VIM VIDA CORPORATION, LA JOLLA, CA. FILED 5-17-2011.

**VIMVIDA**

THE MARK CONSISTS OF STANDARD CHARACTERS WITHOUT CLAIM TO ANY PARTICULAR FONT, STYLE, SIZE, OR COLOR.

THE WORDING "VIMVIDA" HAS NO MEANING IN A FOREIGN LANGUAGE.

FOR VITAMIN FOOD PRODUCTS, NAMELY, VITAMINS CONTAINING MINT (U.S. CLS. 6, 18, 44, 46, 51 AND 52).

BRIAN PINO, EXAMINING ATTORNEY

SN 85-323,747. FIRSTSTREET FOR BOOMERS AND BEYOND, INC., COLONIAL HEIGHTS, VA. FILED 5-18-2011.

**NIGHT PROOFS**

THE MARK CONSISTS OF STANDARD CHARACTERS WITHOUT CLAIM TO ANY PARTICULAR FONT, STYLE, SIZE, OR COLOR.

NO CLAIM IS MADE TO THE EXCLUSIVE RIGHT TO USE "NIGHT", APART FROM THE MARK AS SHOWN.

FOR DISPOSABLE ADULT DIAPERS (U.S. CLS. 6, 18, 44, 46, 51 AND 52).

MARGARET POWER, EXAMINING ATTORNEY

SN 85-323,753. COMPOUND SOLUTIONS, VISTA, CA. FILED 5-18-2011.

**Aminoade**

THE MARK CONSISTS OF STANDARD CHARACTERS WITHOUT CLAIM TO ANY PARTICULAR FONT, STYLE, SIZE, OR COLOR.

FOR NUTRITIONAL SUPPLEMENTS CONTAINING AMINO ACIDS FOR SPORTS NUTRITION (U.S. CLS. 6, 18, 44, 46, 51 AND 52).

MAYUR VAGHANI, EXAMINING ATTORNEY

**CLASS 5—(Continued).**

SN 85-323,754. FIRSTSTREET FOR BOOMERS AND BEYOND, INC., COLONIAL HEIGHTS, VA. FILED 5-18-2011.

**DAY PROOFS**

THE MARK CONSISTS OF STANDARD CHARACTERS WITHOUT CLAIM TO ANY PARTICULAR FONT, STYLE, SIZE, OR COLOR.

NO CLAIM IS MADE TO THE EXCLUSIVE RIGHT TO USE "DAY", APART FROM THE MARK AS SHOWN.

FOR DISPOSABLE ADULT DIAPERS (U.S. CLS. 6, 18, 44, 46, 51 AND 52).

MARGARET POWER, EXAMINING ATTORNEY

SN 85-323,763. NOVARTIS CORPORATION, SUMMIT, NJ. FILED 5-18-2011.



OWNER OF U.S. REG. NOS. 2,177,116, 2,182,834 AND 3,819,018.

THE MARK CONSISTS OF THE WORD "DIOVANHCT" PRECEDED BY A SQUARE; THE SQUARE IS BIASECTED BY A CURVING LINE EXTENDING FROM THE UPPER LEFT CORNER THROUGH THE LOWER RIGHT CORNER AND UNDER AND TO A POINT EVEN WITH THE "T" IN "DIOVANHCT"; THE COLOR GRAY IS INTENDED TO SHOW SHADING OR CONTRAST ONLY.

FOR PHARMACEUTICAL PREPARATIONS FOR THE PREVENTION AND TREATMENT OF DISORDERS OF THE CARDIOVASCULAR SYSTEM (U.S. CLS. 6, 18, 44, 46, 51 AND 52).

FIRST USE 5-1-2011; IN COMMERCE 5-1-2011.

FLORENTINA BLANDU, EXAMINING ATTORNEY

SN 85-324,355. TRACTOR SUPPLY CO. OF TEXAS, LP, BRENTWOOD, TN. FILED 5-18-2011.



OWNER OF U.S. REG. NOS. 3,319,816 AND 3,420,720.

THE MARK CONSISTS OF THE WORD GROUNDWORK IN A STYLIZED FONT APPEARING WITHIN A SLIGHTLY ARCHED RECTANGLE BANNER WITH A SEMI CIRCLE PROTRUSION AT THE TOP CENTER. CENTERED ABOVE THE WORD GROUNDWORK AND WITHIN THE SEMI CIRCLE PROTRUSION APPEARS THE IMAGE OF THREE LEAVES.

FOR HERBICIDES FOR AGRICULTURAL USE; HERBICIDES FOR DOMESTIC USE; INSECTICIDES FOR AGRICULTURAL USE; INSECTICIDES FOR DOMESTIC USE (U.S. CLS. 6, 18, 44, 46, 51 AND 52).

REGINA DRUMMOND, EXAMINING ATTORNEY

**CLASS 5—(Continued).**

SN 85-324,858. NATURAL CHEMISTRY, INC., DBA CORPORATION, STAMFORD, CT. FILED 5-19-2011.

**ALGAE Break90**

THE MARK CONSISTS OF STANDARD CHARACTERS WITHOUT CLAIM TO ANY PARTICULAR FONT, STYLE, SIZE, OR COLOR.

NO CLAIM IS MADE TO THE EXCLUSIVE RIGHT TO USE "ALGAE", APART FROM THE MARK AS SHOWN.

FOR ALGAECIDE CHEMICALS FOR SWIMMING POOLS (U.S. CLS. 6, 18, 44, 46, 51 AND 52).

FIRST USE 1-1-2011; IN COMMERCE 1-1-2011.

KATHLEEN LORENZO, EXAMINING ATTORNEY

SN 85-325,322. CHEMTURA CORPORATION, MIDDLEBURY, CT. FILED 5-19-2011.

**PERCUTIO**

THE MARK CONSISTS OF STANDARD CHARACTERS WITHOUT CLAIM TO ANY PARTICULAR FONT, STYLE, SIZE, OR COLOR.

THE WORDING "PERCUTIO" HAS NO MEANING IN A FOREIGN LANGUAGE.

FOR HERBICIDES (U.S. CLS. 6, 18, 44, 46, 51 AND 52).

ALEX KEAM, EXAMINING ATTORNEY

SN 85-326,318. CHEMTURA CORPORATION, MIDDLEBURY, CT. FILED 5-20-2011.

**EMENDO**

THE MARK CONSISTS OF STANDARD CHARACTERS WITHOUT CLAIM TO ANY PARTICULAR FONT, STYLE, SIZE, OR COLOR.

THE WORDING "EMENDO" HAS NO MEANING IN A FOREIGN LANGUAGE.

FOR FUNGICIDES (U.S. CLS. 6, 18, 44, 46, 51 AND 52).

ALEX KEAM, EXAMINING ATTORNEY

**CLASS 5—(Continued).**

SN 85-326,556. BIONUTRITIONAL RESEARCH GROUP, INC., IRVINE, CA. FILED 5-20-2011.

**SOFTPSIL**

THE MARK CONSISTS OF STANDARD CHARACTERS WITHOUT CLAIM TO ANY PARTICULAR FONT, STYLE, SIZE, OR COLOR.

FOR DIETARY FIBER FOR USE AS A DIETARY AND NUTRITIONAL SUPPLEMENT, WITH SAID FIBER BEING SOLD AS AN INTEGRAL COMPONENT OF DIETARY FOOD SUPPLEMENT (U.S. CLS. 6, 18, 44, 46, 51 AND 52).

FIRST USE 4-28-1996; IN COMMERCE 4-28-1996.

TRACY WHITTAKER-BROWN, EXAMINING ATTORNEY

SN 85-326,720. TRITON TECHNOLOGY GROUP, LLC, GROSSE POINTE FARMS, MI. FILED 5-21-2011.

**AMUNITY**

THE MARK CONSISTS OF STANDARD CHARACTERS WITHOUT CLAIM TO ANY PARTICULAR FONT, STYLE, SIZE, OR COLOR.

FOR ANTIBACTERIAL ALCOHOL SKIN SANITIZER GEL; ANTIBACTERIAL HAND LOTIONS; DISPOSABLE SANITIZING WIPES; HAND-SANITIZING PREPARATIONS; KITS COMPRISING SANITIZER GEL, DISINFECTING WIPES, SANITARY MASKS, PLASTIC GLOVES AND HAND CREAM USED FOR GERM PREVENTION; LAUNDRY SANITIZER TABLETS; MEDICAL PREPARATIONS, NAMELY, FOOT, HAND AND SKIN CREAMS FOR DIABETICS; MEDICATED HAND WASH; NAIL SANITIZING PREPARATIONS; SANITIZING PREPARATIONS FOR HOSPITAL USE; SANITIZING PREPARATIONS FOR HOUSEHOLD USE; SANITIZING PREPARATIONS FOR USE IN INSTITUTIONAL AND INDUSTRIAL AREAS; SANITIZING WIPES; SPRAY SANITIZER FOR PERSONAL USE (U.S. CLS. 6, 18, 44, 46, 51 AND 52).

FIRST USE 3-3-2011; IN COMMERCE 4-16-2011.

TRACY CROSS, EXAMINING ATTORNEY

SN 85-327,098. AIR LIQUIDE HEALTHCARE AMERICA CORPORATION, HOUSTON, TX. FILED 5-23-2011.

**VASONOX**

THE MARK CONSISTS OF STANDARD CHARACTERS WITHOUT CLAIM TO ANY PARTICULAR FONT, STYLE, SIZE, OR COLOR.

FOR MEDICAL GASES (U.S. CLS. 6, 18, 44, 46, 51 AND 52).

TRICIA SONNEBORN, EXAMINING ATTORNEY

**CLASS 5—(Continued).**

SN 85-327,464. BEACHBODY, LLC, SANTA MONICA, CA. FILED 5-23-2011.

## RESULTS & RECOVERY FORMULA

THE MARK CONSISTS OF STANDARD CHARACTERS WITHOUT CLAIM TO ANY PARTICULAR FONT, STYLE, SIZE, OR COLOR.

OWNER OF U.S. REG. NOS. 3,817,380 AND 3,817,386.

NO CLAIM IS MADE TO THE EXCLUSIVE RIGHT TO USE "RECOVERY FORMULA", APART FROM THE MARK AS SHOWN.

FOR MEAL REPLACEMENT AND DIETARY SUPPLEMENT DRINKS, POWDERED NUTRITIONAL SUPPLEMENT DRINKS; NUTRITIONAL AND DIETARY SUPPLEMENTS; MEAL REPLACEMENT SHAKES; MEAL REPLACEMENT BARS (U.S. CLS. 6, 18, 44, 46, 51 AND 52).

ELIZABETH KAJUBI, EXAMINING ATTORNEY

SN 85-328,541. I'M A LITTLE TEACUP, DBA ANGELS' EYES, SUNRISE, FL. FILED 5-24-2011.

## SUGARS' COAT

THE MARK CONSISTS OF STANDARD CHARACTERS WITHOUT CLAIM TO ANY PARTICULAR FONT, STYLE, SIZE, OR COLOR.

NO CLAIM IS MADE TO THE EXCLUSIVE RIGHT TO USE "COAT", APART FROM THE MARK AS SHOWN.

FOR EDIBLE MEDICATED ANIMAL FOOD ADDITIVE FOR TREATING COAT STAINING (U.S. CLS. 6, 18, 44, 46, 51 AND 52).

PAUL E. FAHRENKOPF, EXAMINING ATTORNEY

SN 85-328,543. ALTICOR INC., ADA, MI. FILED 5-24-2011.

## NUTRILITE OSTEO KEEPER

THE MARK CONSISTS OF STANDARD CHARACTERS WITHOUT CLAIM TO ANY PARTICULAR FONT, STYLE, SIZE, OR COLOR.

OWNER OF U.S. REG. NOS. 1,303,954, 2,145,912 AND OTHERS.

NO CLAIM IS MADE TO THE EXCLUSIVE RIGHT TO USE "OSTEO", APART FROM THE MARK AS SHOWN.

FOR DIETARY AND NUTRITIONAL SUPPLEMENTS (U.S. CLS. 6, 18, 44, 46, 51 AND 52).

JUSTINE D. PARKER, EXAMINING ATTORNEY

**CLASS 5—(Continued).**

SN 85-329,436. SHENZHEN UPCERA CO., LTD., NANSHAN, SHENZHEN, CHINA, FILED 5-25-2011.

## UPCERA

FOR ADHESIVES FOR DENTAL AND DENTISTRY USE; CERAMIC MATERIALS FOR DENTAL USE FOR FILLINGS; CONDUCTIVE LACQUER FOR DENTAL PURPOSES; DENTAL ABRASIVES; DENTAL CEMENTS; DENTAL IMPRESSION MATERIALS; DENTAL MASTICS; DENTAL RESIN CEMENT; FILLINGS FOR TEETH; MOLDING WAX FOR DENTAL USE; PORCELAIN FOR DENTAL PROSTHESES; SEALING AGENTS FOR DENTAL PURPOSES (U.S. CLS. 6, 18, 44, 46, 51 AND 52).

FIRST USE 2-14-2010; IN COMMERCE 2-14-2010.  
TRICIA SONNEBORN, EXAMINING ATTORNEY

SN 85-329,560. DO FOR WOMEN, LLC, SANTA MONICA, CA. FILED 5-25-2011.

## D3FY

THE MARK CONSISTS OF STANDARD CHARACTERS WITHOUT CLAIM TO ANY PARTICULAR FONT, STYLE, SIZE, OR COLOR.

FOR MIXED VITAMIN PREPARATIONS; MULTI-VITAMIN PREPARATIONS; PRENATAL VITAMINS; VITAMINS AND VITAMIN PREPARATIONS (U.S. CLS. 6, 18, 44, 46, 51 AND 52).

BENJAMIN OKEKE, EXAMINING ATTORNEY

SN 85-329,947. AMYLIN PHARMACEUTICALS, INC., SAN DIEGO, CA. FILED 5-25-2011.

## BYDUREON

THE MARK CONSISTS OF STANDARD CHARACTERS WITHOUT CLAIM TO ANY PARTICULAR FONT, STYLE, SIZE, OR COLOR.

FOR PHARMACEUTICAL PREPARATIONS, NAMELY PHARMACEUTICAL PREPARATIONS FOR USE IN THE TREATMENT AND PREVENTION OF METABOLIC DISORDERS, ENDOCRINE CONDITIONS AND DISORDERS, DIABETES, DIABETIC COMPLICATIONS AND HORMONAL DISEASES AND DISORDERS (U.S. CLS. 6, 18, 44, 46, 51 AND 52).

GISELLE AGOSTO, EXAMINING ATTORNEY

**CLASS 5—(Continued).**

SN 85-329,950. AMYLIN PHARMACEUTICALS, INC., SAN DIEGO, CA. FILED 5-25-2011.

# BYPERSTA

THE MARK CONSISTS OF STANDARD CHARACTERS WITHOUT CLAIM TO ANY PARTICULAR FONT, STYLE, SIZE, OR COLOR.

FOR PHARMACEUTICAL PREPARATIONS, NAMELY PHARMACEUTICAL PREPARATIONS FOR USE IN THE TREATMENT AND PREVENTION OF METABOLIC DISORDERS, ENDOCRINE CONDITIONS AND DISORDERS, DIABETES, DIABETIC COMPLICATIONS AND HORMONAL DISEASES AND DISORDERS (U.S. CLS. 6, 18, 44, 46, 51 AND 52).

GISELLE AGOSTO, EXAMINING ATTORNEY

SN 85-330,032. GENE ME LLC, LEXINGTON, KY. FILED 5-25-2011.

# LÉNEME

THE MARK CONSISTS OF STANDARD CHARACTERS WITHOUT CLAIM TO ANY PARTICULAR FONT, STYLE, SIZE, OR COLOR.

FOR WEIGHT MANAGEMENT SUPPLEMENTS (U.S. CLS. 6, 18, 44, 46, 51 AND 52).

KELLY BOULTON, EXAMINING ATTORNEY

SN 85-330,813. PEARSON DENTAL SUPPLIES, INC., SYLMAR, CA. FILED 5-26-2011.

# ORA-FLUOR

THE MARK CONSISTS OF STANDARD CHARACTERS WITHOUT CLAIM TO ANY PARTICULAR FONT, STYLE, SIZE, OR COLOR.

FOR ANTI-CAVITY FLUORIDE GELS FOR USE BY DENTISTS (U.S. CLS. 6, 18, 44, 46, 51 AND 52). FIRST USE 4-2-2011; IN COMMERCE 4-2-2011.

JENNIFER MARTIN, EXAMINING ATTORNEY

**CLASS 5—(Continued).**

SN 85-331,081. AVN GLOBAL SCIENCE, INC., TEMECULA, CA. FILED 5-26-2011.

# ArthraPro

THE MARK CONSISTS OF STANDARD CHARACTERS WITHOUT CLAIM TO ANY PARTICULAR FONT, STYLE, SIZE, OR COLOR.

FOR DIETARY SUPPLEMENTS FOR ANIMALS (U.S. CLS. 6, 18, 44, 46, 51 AND 52).

STEVEN R. FINE, EXAMINING ATTORNEY

SN 85-331,933. BRAINTREE LABORATORIES, INC., BRAINTREE, MA. FILED 5-26-2011.

# KINDERPEG

THE MARK CONSISTS OF STANDARD CHARACTERS WITHOUT CLAIM TO ANY PARTICULAR FONT, STYLE, SIZE, OR COLOR.

FOR LAXATIVES (U.S. CLS. 6, 18, 44, 46, 51 AND 52).

HEATHER THOMPSON, EXAMINING ATTORNEY

SN 85-331,998. BLOCK DRUG COMPANY INC., WEST TRENTON, NJ. FILED 5-27-2011.

# FASTGELS

THE MARK CONSISTS OF STANDARD CHARACTERS WITHOUT CLAIM TO ANY PARTICULAR FONT, STYLE, SIZE, OR COLOR.

FOR PHARMACEUTICAL PREPARATIONS FOR ABDOMINAL DISTRESS (U.S. CLS. 6, 18, 44, 46, 51 AND 52).

ANNE MADDEN, EXAMINING ATTORNEY

**CLASS 5—(Continued).**

SN 85-332,279. ESSENTIAL SKINCARE SOLUTIONS, LLC,  
DBA ESS, DUNEDIN, FL. FILED 5-27-2011.

# Safe'N Soft

THE MARK CONSISTS OF STANDARD CHARACTERS  
WITHOUT CLAIM TO ANY PARTICULAR FONT, STYLE,  
SIZE, OR COLOR.  
FOR HAND-SANITIZING PREPARATIONS (U.S. CLS.  
6, 18, 44, 46, 51 AND 52).  
JOHN SCHUYLER YARD, EXAMINING ATTORNEY

SN 85-332,352. LANG NATURALS, INC., MIDDLETOWN, RI.  
FILED 5-27-2011.

# THRIVE! for life

THE MARK CONSISTS OF STANDARD CHARACTERS  
WITHOUT CLAIM TO ANY PARTICULAR FONT, STYLE,  
SIZE, OR COLOR.  
FOR DIETARY AND NUTRITIONAL SUPPLEMENTS  
(U.S. CLS. 6, 18, 44, 46, 51 AND 52).  
HAI-LY LAM, EXAMINING ATTORNEY

SN 85-332,662. STRAIT, JAMES, MARIETTA, GA. FILED 5-  
27-2011.

# GINSATIN

THE MARK CONSISTS OF STANDARD CHARACTERS  
WITHOUT CLAIM TO ANY PARTICULAR FONT, STYLE,  
SIZE, OR COLOR.  
FOR DENTAL RINSE (U.S. CLS. 6, 18, 44, 46, 51 AND  
52).  
BENJAMIN OKEKE, EXAMINING ATTORNEY

**CLASS 5—(Continued).**

SN 85-332,910. RESEARCH AND DIAGNOSTIC ANTIBO-  
DIES, SACRAMENTO, CA. FILED 5-27-2011.

# PLINOSA

THE MARK CONSISTS OF STANDARD CHARACTERS  
WITHOUT CLAIM TO ANY PARTICULAR FONT, STYLE,  
SIZE, OR COLOR.  
FOR DIAGNOSTIC PREPARATIONS FOR MEDICAL  
OR VETERINARY PURPOSES (U.S. CLS. 6, 18, 44, 46, 51  
AND 52).  
REBECCA EISINGER, EXAMINING ATTORNEY

SN 85-333,109. WATKINS, DAVID, WEST SUSSEX, UNITED  
KINGDOM, FILED 5-28-2011.



OWNER OF UNITED KINGDOM REG. NO. 2563388,  
DATED 11-4-2010, EXPIRES 11-4-2020.

THE COLOR(S) GREEN, WHITE AND BLACK IS/ARE  
CLAIMED AS A FEATURE OF THE MARK.

THE MARK CONSISTS OF THE STYLIZED WORD  
"TONVARA" IN BLACK APPEARING ON TOP OF A  
GREEN SHADED BACKGROUND. THE ARTISTIC REN-  
DERING OF THE PLANET EARTH IN GREEN, WHITE  
AND BLACK APPEARS BEHIND THE "T" IN "TONVARA".

FOR FOOD SUPPLEMENTS; NUTRITIONAL SUPPLE-  
MENTS; VITAMIN SUPPLEMENTS (U.S. CLS. 6, 18, 44,  
46, 51 AND 52).

CHERYL CLAYTON, EXAMINING ATTORNEY

SN 85-333,562. TAMBRANDS INC., CINCINNATI, OH.  
FILED 5-31-2011.

# CLEANGRIP

THE MARK CONSISTS OF STANDARD CHARACTERS  
WITHOUT CLAIM TO ANY PARTICULAR FONT, STYLE,  
SIZE, OR COLOR.  
FOR TAMPONS (U.S. CLS. 6, 18, 44, 46, 51 AND 52).  
WENDY GOODMAN, EXAMINING ATTORNEY

**CLASS 5—(Continued).**

SN 85-333,581. BAYER AKTIENGESELLSCHAFT, 51373 LEVERKUSEN, FED REP GERMANY, FILED 5-31-2011.

**PURNATE**

THE MARK CONSISTS OF STANDARD CHARACTERS WITHOUT CLAIM TO ANY PARTICULAR FONT, STYLE, SIZE, OR COLOR.

OWNER OF FED REP GERMANY REG. NO. 30261038, DATED 2-26-2003, EXPIRES 12-31-2012.

FOR PREPARATIONS FOR DESTROYING VERMIN; FUNGICIDES, HERBICIDES (U.S. CLS. 6, 18, 44, 46, 51 AND 52).

JULIE VEPPUMTHARA, EXAMINING ATTORNEY

**CLASS 5—(Continued).**

SN 85-333,859. GENESIS LABORATORIES, LLC, CLARKSVILLE, TN. FILED 5-31-2011.

**PURE BLU**

THE MARK CONSISTS OF STANDARD CHARACTERS WITHOUT CLAIM TO ANY PARTICULAR FONT, STYLE, SIZE, OR COLOR.

NO CLAIM IS MADE TO THE EXCLUSIVE RIGHT TO USE "BLUE", APART FROM THE MARK AS SHOWN.

FOR ALL PURPOSE DISINFECTANT WITH ANTI-BACTERIAL AND ANTI-MICROBIAL PROPERTIES; ANTI-BACTERIAL AND ANTI-MICROBIAL ALCOHOL SKIN SANITIZER (U.S. CLS. 6, 18, 44, 46, 51 AND 52).

MARGARET POWER, EXAMINING ATTORNEY

SN 85-333,599. TAMBRANDS INC., CINCINNATI, OH. FILED 5-31-2011.

**CLEANSEAL**

THE MARK CONSISTS OF STANDARD CHARACTERS WITHOUT CLAIM TO ANY PARTICULAR FONT, STYLE, SIZE, OR COLOR.

FOR TAMPONS (U.S. CLS. 6, 18, 44, 46, 51 AND 52).

WENDY GOODMAN, EXAMINING ATTORNEY

SN 85-333,888. CHEN, CHAOYING, FREEHOLD, NJ. FILED 5-31-2011.

**Valericalm**

THE MARK CONSISTS OF STANDARD CHARACTERS WITHOUT CLAIM TO ANY PARTICULAR FONT, STYLE, SIZE, OR COLOR.

FOR DIETARY AND NUTRITIONAL SUPPLEMENTS (U.S. CLS. 6, 18, 44, 46, 51 AND 52).

FIRST USE 12-1-2009; IN COMMERCE 12-1-2009.

MATTHEW KLINE, EXAMINING ATTORNEY

SN 85-333,624. CREATIVE INNOVATIONS, CINCINNATI, OH. FILED 5-31-2011.

**AquaLax**

THE MARK CONSISTS OF STANDARD CHARACTERS WITHOUT CLAIM TO ANY PARTICULAR FONT, STYLE, SIZE, OR COLOR.

FOR LAXATIVES; MINERAL, VITAMIN, OR NUTRITIONALLY ENHANCED WATER (U.S. CLS. 6, 18, 44, 46, 51 AND 52).

JOHN GARTNER, EXAMINING ATTORNEY

SN 85-334,099. ROBERT BISORDI, KENT, WA. FILED 5-31-2011.

**Lady Be Good**

THE MARK CONSISTS OF STANDARD CHARACTERS WITHOUT CLAIM TO ANY PARTICULAR FONT, STYLE, SIZE, OR COLOR.

FOR FOOD SUPPLEMENTS, NAMELY, ANTI-OXIDANTS; FOODS AND SNACKS WHICH ARE FREE OF WHEAT OR MILK TO ACCOMMODATE SPECIAL MEDICAL AND HEALTH CONDITIONS; MEAL REPLACEMENT SNACKS (U.S. CLS. 6, 18, 44, 46, 51 AND 52).

EMILY CARLSEN, EXAMINING ATTORNEY

**CLASS 5—(Continued).**

SN 85-334,232. FERNDALE IP, INC., FERNDALE, MI. FILED 5-31-2011.

# PRAM

THE MARK CONSISTS OF STANDARD CHARACTERS WITHOUT CLAIM TO ANY PARTICULAR FONT, STYLE, SIZE, OR COLOR.

FOR PHARMACEUTICAL PREPARATION, NAMELY, TOPICAL SKIN CARE PREPARATIONS FOR THE TREATMENT OF SKIN DISORDERS (U.S. CLS. 6, 18, 44, 46, 51 AND 52).

HEATHER SAPP, EXAMINING ATTORNEY

---

SN 85-334,315. CYTERIX PHARMACEUTICALS, INC., SAN FRANCISCO, CA. FILED 5-31-2011.

# OncoCYP

THE MARK CONSISTS OF THE WORD "ONCOCYP" IN A STYLIZED FONT WITH THE LETTER "O" IN UPPERCASE, THE LETTERS "NCO" IN LOWER CASE AND THE LETTERS "CYP" IN UPPER CASE.

FOR ENZYMES FOR MEDICAL PURPOSES; DIAGNOSTIC PREPARATIONS FOR MEDICAL PURPOSES RELATING TO CANCER DETECTION AND TREATMENT (U.S. CLS. 6, 18, 44, 46, 51 AND 52).

NICHOLAS ALTREE, EXAMINING ATTORNEY

---

SN 85-334,439. CHEN, CHAOYING, FREEHOLD, NJ. FILED 5-31-2011.

# Cardiatrin

THE MARK CONSISTS OF STANDARD CHARACTERS WITHOUT CLAIM TO ANY PARTICULAR FONT, STYLE, SIZE, OR COLOR.

FOR DIETARY AND NUTRITIONAL SUPPLEMENTS (U.S. CLS. 6, 18, 44, 46, 51 AND 52).

FIRST USE 12-1-2009; IN COMMERCE 12-1-2009.

MATTHEW KLINE, EXAMINING ATTORNEY

**CLASS 5—(Continued).**

SN 85-334,494. CHEN, CHAOYING, FREEHOLD, NJ. FILED 5-31-2011.

# DiabetiRX

THE MARK CONSISTS OF STANDARD CHARACTERS WITHOUT CLAIM TO ANY PARTICULAR FONT, STYLE, SIZE, OR COLOR.

FOR DIETARY AND NUTRITIONAL SUPPLEMENTS (U.S. CLS. 6, 18, 44, 46, 51 AND 52).

FIRST USE 12-1-2009; IN COMMERCE 12-1-2009.

MATTHEW KLINE, EXAMINING ATTORNEY

---

SN 85-334,549. GENENTECH, INC., SOUTH SAN FRANCISCO, CA. FILED 5-31-2011.

# PERJETA

THE MARK CONSISTS OF STANDARD CHARACTERS WITHOUT CLAIM TO ANY PARTICULAR FONT, STYLE, SIZE, OR COLOR.

FOR PHARMACEUTICAL ONCOLOGY PREPARATIONS (U.S. CLS. 6, 18, 44, 46, 51 AND 52).

ASMAT KHAN, EXAMINING ATTORNEY

---

SN 85-334,569. UNIVERSAL BACTERIA SPECIALIST INC., RICHMOND, TX. FILED 5-31-2011.

# ENVIROLYTE O&G

THE MARK CONSISTS OF STANDARD CHARACTERS WITHOUT CLAIM TO ANY PARTICULAR FONT, STYLE, SIZE, OR COLOR.

FOR BIOCIDES USED TO CONTROL MICROBIAL INDUCED CORROSION IN OIL AND GAS FIELD APPLICATIONS, NAMELY, OIL AND GAS FIELD DRILLING, PRODUCTION, PROCESSING, DISTRIBUTION AND STORAGE SYSTEMS (U.S. CLS. 6, 18, 44, 46, 51 AND 52).

TINA MAI, EXAMINING ATTORNEY

**CLASS 5—(Continued).**

SN 85-334,640. APPLIED LIFESCIENCE RESEARCH INDUSTRIES, INC., LAS VEGAS, NV. FILED 5-31-2011.

This changes everything!

THE MARK CONSISTS OF STANDARD CHARACTERS WITHOUT CLAIM TO ANY PARTICULAR FONT, STYLE, SIZE, OR COLOR.

FOR DIETARY AND NUTRITIONAL SUPPLEMENTS (U.S. CLS. 6, 18, 44, 46, 51 AND 52).  
DAVID HOFFMAN, EXAMINING ATTORNEY

SN 85-334,784. LEVEL ENTERPRISES, LLC, BOYNTON BEACH, FL. FILED 6-1-2011.

THE SCIENCE OF WEIGHT  
LOSS, SIMPLIFIED

THE MARK CONSISTS OF STANDARD CHARACTERS WITHOUT CLAIM TO ANY PARTICULAR FONT, STYLE, SIZE, OR COLOR.

FOR NUTRITIONAL SUPPLEMENTS (U.S. CLS. 6, 18, 44, 46, 51 AND 52).  
FLORENTINA BLANDU, EXAMINING ATTORNEY

SN 85-334,818. BAYER AKTIENGESELLSCHAFT, 51373 LEVERKUSEN, FED REP GERMANY, FILED 6-1-2011.

CORALZOR

THE MARK CONSISTS OF STANDARD CHARACTERS WITHOUT CLAIM TO ANY PARTICULAR FONT, STYLE, SIZE, OR COLOR.

FOR PHARMACEUTICAL PREPARATIONS FOR VETERINARY USE TO TREAT CHRONIC DISEASES, NAMELY, CHRONIC RENAL FAILURE AND CONGESTIVE HEART FAILURE, IN DOGS AND CATS (U.S. CLS. 6, 18, 44, 46, 51 AND 52).  
JULIE VEPPUMTHARA, EXAMINING ATTORNEY

**CLASS 5—(Continued).**

SN 85-334,821. ENVINCIO, LLC, CARY, NC. FILED 6-1-2011.

ESSENTRIA

THE MARK CONSISTS OF STANDARD CHARACTERS WITHOUT CLAIM TO ANY PARTICULAR FONT, STYLE, SIZE, OR COLOR.

FOR PESTICIDE AND INSECTICIDE FOR COMMERCIAL AND RESIDENTIAL USE AS INSECT CONTROL AND REPELLANT (U.S. CLS. 6, 18, 44, 46, 51 AND 52).  
MARGARET POWER, EXAMINING ATTORNEY

SN 85-334,870. LEVEL ENTERPRISES, LLC, BOYNTON BEACH, FL. FILED 6-1-2011.

LEVEL

THE MARK CONSISTS OF THE WORD "LEVEL" ENDING WITH THE LETTER "L" WHICH IS A MIRRORED IMAGE OF THE FIRST LETTER "L", THE LETTERS "E" HAVING NO VERTICAL LINE AND THE LETTER "V" HAVING HORIZONTAL LINES EXTENDING BOTH DIRECTIONS OVER THE "L"'S AND "E"'S.

FOR NUTRITIONAL SUPPLEMENTS (U.S. CLS. 6, 18, 44, 46, 51 AND 52).  
FLORENTINA BLANDU, EXAMINING ATTORNEY

SN 85-335,347. DYAX CORP., CAMBRIDGE, MA. FILED 6-1-2011.

DYAX

THE MARK CONSISTS OF STANDARD CHARACTERS WITHOUT CLAIM TO ANY PARTICULAR FONT, STYLE, SIZE, OR COLOR.

OWNER OF U.S. REG. NOS. 2,186,240 AND 2,710,452.  
FOR A FULL LINE OF PHARMACEUTICALS (U.S. CLS. 6, 18, 44, 46, 51 AND 52).  
PRISCILLA MILTON, EXAMINING ATTORNEY



**CLASS 5—(Continued).**

SN 85-335,378. MAKHTESHIM CHEMICAL WORKS LTD.,  
BEER SHEVA, ISRAEL, FILED 6-1-2011.

# PITCH

THE MARK CONSISTS OF STANDARD CHARACTERS  
WITHOUT CLAIM TO ANY PARTICULAR FONT, STYLE,  
SIZE, OR COLOR.

FOR FUNGICIDES AND HERBICIDES; INSECTI-  
CIDES; PESTICIDES (U.S. CLS. 6, 18, 44, 46, 51 AND 52).  
JAY BESCH, EXAMINING ATTORNEY

---

SN 85-335,504. OPMX LLC, CHICAGO, IL, FILED 6-1-2011.

# PTX

THE MARK CONSISTS OF STANDARD CHARACTERS  
WITHOUT CLAIM TO ANY PARTICULAR FONT, STYLE,  
SIZE, OR COLOR.

FOR FOOD SUPPLEMENTS (U.S. CLS. 6, 18, 44, 46, 51  
AND 52).

FIRST USE 5-20-2011; IN COMMERCE 5-20-2011.  
KAREN BRACEY, EXAMINING ATTORNEY

---

SN 85-335,575. RRB CLEVELAND, LLC, NORMAN, OK.  
FILED 6-1-2011.

# SooneRelief

THE MARK CONSISTS OF STANDARD CHARACTERS  
WITHOUT CLAIM TO ANY PARTICULAR FONT, STYLE,  
SIZE, OR COLOR.

FOR HERBAL TOPICAL CREAMS, GELS, SALVES,  
SPRAYS, POWDER, BALMS, LINIMENT AND OINT-  
MENTS FOR THE RELIEF OF ACHES AND PAIN; PAIN  
RELIEF MEDICATION; SPORTS CREAM FOR RELIEF  
OF PAIN (U.S. CLS. 6, 18, 44, 46, 51 AND 52).

FIRST USE 5-1-2011; IN COMMERCE 5-1-2011.  
JUDITH HELFMAN, EXAMINING ATTORNEY

**CLASS 5—(Continued).**

SN 85-335,641. RRB CLEVELAND, LLC, NORMAN, OK.  
FILED 6-1-2011.

# Get pain relief Sooner than later

THE MARK CONSISTS OF STANDARD CHARACTERS  
WITHOUT CLAIM TO ANY PARTICULAR FONT, STYLE,  
SIZE, OR COLOR.

FOR HERBAL TOPICAL CREAMS, GELS, SALVES,  
SPRAYS, POWDER, BALMS, LINIMENT AND OINT-  
MENTS FOR THE RELIEF OF ACHES AND PAIN; PAIN  
RELIEF MEDICATION; SPORTS CREAM FOR RELIEF  
OF PAIN (U.S. CLS. 6, 18, 44, 46, 51 AND 52).

FIRST USE 5-1-2011; IN COMMERCE 5-1-2011.  
JUDITH HELFMAN, EXAMINING ATTORNEY

---

SN 85-335,847. GREGORY G. PLUMMER, PORTLAND, OR.  
FILED 6-1-2011.

# VITATAK

THE MARK CONSISTS OF STANDARD CHARACTERS  
WITHOUT CLAIM TO ANY PARTICULAR FONT, STYLE,  
SIZE, OR COLOR.

FOR DIETARY SUPPLEMENTS; NUTRITIONAL SUP-  
PLEMENTS; NUTRITIONALLY FORTIFIED BEV-  
ERAGES; VITAMIN AND MINERAL SUPPLEMENTS;  
VITAMIN PREPARATIONS; VITAMIN SUPPLEMENTS;  
VITAMIN TABLETS; VITAMINS (U.S. CLS. 6, 18, 44, 46,  
51 AND 52).

SUNG IN, EXAMINING ATTORNEY

---

SN 85-335,977. RALCO NUTRITION, INC., MARSHALL, MN.  
FILED 6-2-2011.

# Ecodiar

THE MARK CONSISTS OF STANDARD CHARACTERS  
WITHOUT CLAIM TO ANY PARTICULAR FONT, STYLE,  
SIZE, OR COLOR.

FOR ANIMAL FEED SUPPLEMENTS (U.S. CLS. 6, 18,  
44, 46, 51 AND 52).

FIRST USE 6-1-2011; IN COMMERCE 6-1-2011.

MEGHAN REINHART, EXAMINING ATTORNEY

**CLASS 5—(Continued).**

SN 85-336,009. KOKOBERNA & CO., WILMINGTON, DE.  
FILED 6-2-2011.

# KOKOBERNA

THE MARK CONSISTS OF STANDARD CHARACTERS WITHOUT CLAIM TO ANY PARTICULAR FONT, STYLE, SIZE, OR COLOR.  
FOR NON-MEDICATED SKIN CARE PREPARATIONS (U.S. CLS. 6, 18, 44, 46, 51 AND 52).  
FIRST USE 1-1-2009; IN COMMERCE 7-7-2010.  
HENRY S. ZAK, EXAMINING ATTORNEY

---

SN 85-336,078. FORGIVEN BOTTLING GROUP, INC., LAS VEGAS, NV. FILED 6-2-2011.



THE MARK CONSISTS OF THE WORD "FORGIVEN" WITH WINGS EXTENDING FROM BOTH ENDS OF THE MARK, SPECIFICALLY THE LETTERS "F" AND "N", AND A HALO ABOVE THE LETTER "I".  
FOR DIETARY SUPPLEMENTS (U.S. CLS. 6, 18, 44, 46, 51 AND 52).  
FIRST USE 9-1-2010; IN COMMERCE 10-1-2010.  
MARGERY A. TIERNEY, EXAMINING ATTORNEY

---

SN 85-336,162. FORGIVEN BOTTLING GROUP, INC., LAS VEGAS, NV. FILED 6-2-2011.



THE MARK CONSISTS OF THE LETTER "F" WITH A WING EXTENDING THEREFROM AND HALO ABOVE.  
FOR DIETARY SUPPLEMENTS (U.S. CLS. 6, 18, 44, 46, 51 AND 52).  
FIRST USE 9-1-2010; IN COMMERCE 10-1-2010.  
MARGERY A. TIERNEY, EXAMINING ATTORNEY

**CLASS 5—(Continued).**

SN 85-336,266. TRACEY MCCALLUM, STEVENSVILLE, MD.  
FILED 6-2-2011.

# Skin Water

THE MARK CONSISTS OF STANDARD CHARACTERS WITHOUT CLAIM TO ANY PARTICULAR FONT, STYLE, SIZE, OR COLOR.  
FOR MINERAL, VITAMIN, OR NUTRITIONALLY ENHANCED WATER (U.S. CLS. 6, 18, 44, 46, 51 AND 52).  
KAREN K. BUSH, EXAMINING ATTORNEY

---

SN 85-336,395. ISTA PHARMACEUTICALS, INC., IRVINE, CA. FILED 6-2-2011.

# PROLENSA

THE MARK CONSISTS OF STANDARD CHARACTERS WITHOUT CLAIM TO ANY PARTICULAR FONT, STYLE, SIZE, OR COLOR.  
FOR PHARMACEUTICAL PREPARATIONS FOR THE TREATMENT OF OPHTHALMIC DISEASES AND CONDITIONS (U.S. CLS. 6, 18, 44, 46, 51 AND 52).  
CHARLES L. JENKINS, EXAMINING ATTORNEY

---

SN 85-336,403. ISTA PHARMACEUTICALS, INC., IRVINE, CA. FILED 6-2-2011.

# XILENSA

THE MARK CONSISTS OF STANDARD CHARACTERS WITHOUT CLAIM TO ANY PARTICULAR FONT, STYLE, SIZE, OR COLOR.  
FOR PHARMACEUTICAL PREPARATIONS FOR THE TREATMENT OF OPHTHALMIC DISEASES AND CONDITIONS (U.S. CLS. 6, 18, 44, 46, 51 AND 52).  
CHARLES L. JENKINS, EXAMINING ATTORNEY

**CLASS 5—(Continued).**

SN 85-336,408. ISTA PHARMACEUTICALS, INC., IRVINE, CA. FILED 6-2-2011.

**BROLEXA**

THE MARK CONSISTS OF STANDARD CHARACTERS WITHOUT CLAIM TO ANY PARTICULAR FONT, STYLE, SIZE, OR COLOR.

FOR PHARMACEUTICAL PREPARATIONS FOR THE TREATMENT OF OPHTHALMIC DISEASES AND CONDITIONS (U.S. CLS. 6, 18, 44, 46, 51 AND 52).

CHARLES L. JENKINS, EXAMINING ATTORNEY

**CLASS 5—(Continued).**

SN 85-337,356. BIOORIGYN, LLC, SPOKANE, WA. FILED 6-3-2011.

**JATO**

THE MARK CONSISTS OF STANDARD CHARACTERS WITHOUT CLAIM TO ANY PARTICULAR FONT, STYLE, SIZE, OR COLOR.

FOR PERSONAL LUBRICANT (U.S. CLS. 6, 18, 44, 46, 51 AND 52).

SHAUNIA CARLYLE, EXAMINING ATTORNEY

SN 85-336,611. PIC CORPORATION, LINDEN, NJ. FILED 6-2-2011.

**TWIST-IT**

THE MARK CONSISTS OF STANDARD CHARACTERS WITHOUT CLAIM TO ANY PARTICULAR FONT, STYLE, SIZE, OR COLOR.

FOR INSECT AND RODENT REPELLENTS (U.S. CLS. 6, 18, 44, 46, 51 AND 52).

SKYE YOUNG, EXAMINING ATTORNEY

SN 85-337,540. DEN-MAT HOLDINGS, LLC, SANTA MARIA, CA. FILED 6-3-2011.

**LUMINEERS EXPRESS**

THE MARK CONSISTS OF STANDARD CHARACTERS WITHOUT CLAIM TO ANY PARTICULAR FONT, STYLE, SIZE, OR COLOR.

OWNER OF U.S. REG. NO. 3,000,428.

FOR DENTAL RESTORATIVES, NAMELY, PORCELAIN LAMINATES AND PORCELAIN VENEERS (U.S. CLS. 6, 18, 44, 46, 51 AND 52).

ALICE BENMAMAN, EXAMINING ATTORNEY

SN 85-336,771. ACETO AGRICULTURAL CHEMICALS CORPORATION, PORT WASHINGTON, NY. FILED 6-2-2011.

**ELAST**

THE MARK CONSISTS OF STANDARD CHARACTERS WITHOUT CLAIM TO ANY PARTICULAR FONT, STYLE, SIZE, OR COLOR.

FOR FUNGICIDES (U.S. CLS. 6, 18, 44, 46, 51 AND 52). FIRST USE 0-0-2003; IN COMMERCE 0-0-2003.

RENEE MCCRAY, EXAMINING ATTORNEY

SN 85-337,647. PHARMEKAL HEALTH PRODUCTS, LLC, DBA QN LABS, CERRITOS, CA. FILED 6-3-2011.

**SUNSHINE VALLEY**

THE MARK CONSISTS OF STANDARD CHARACTERS WITHOUT CLAIM TO ANY PARTICULAR FONT, STYLE, SIZE, OR COLOR.

FOR DIETARY AND NUTRITIONAL SUPPLEMENTS (U.S. CLS. 6, 18, 44, 46, 51 AND 52).

FIRST USE 5-1-2011; IN COMMERCE 5-1-2011.

APRIL ROACH, EXAMINING ATTORNEY

**CLASS 5—(Continued).**

SN 85-337,859. MEETGAIN INTERNATIONAL GROUP (USA), INC., SOUTH EL MONTE, CA. FILED 6-3-2011.

# Meetgain

THE MARK CONSISTS OF STANDARD CHARACTERS WITHOUT CLAIM TO ANY PARTICULAR FONT, STYLE, SIZE, OR COLOR.

FOR DIETARY AND NUTRITIONAL SUPPLEMENTS; DIETARY AND NUTRITIONAL SUPPLEMENTS FOR ENDURANCE SPORTS; DIETARY AND NUTRITIONAL SUPPLEMENTS USED FOR WEIGHT LOSS; DIETARY BEVERAGE SUPPLEMENTS FOR HUMAN CONSUMPTION IN LIQUID AND DRY MIX FORM FOR THERAPEUTIC PURPOSES; DIETARY DRINK MIX FOR USE AS A MEAL REPLACEMENT; DIETARY FOOD SUPPLEMENTS; DIETARY SUPPLEMENT FOR ELIMINATING TOXINS FROM THE INTESTINAL TRACT; DIETARY SUPPLEMENTAL DRINKS; DIETARY SUPPLEMENTAL DRINKS IN THE NATURE OF VITAMIN AND MINERAL BEVERAGES; DIETARY SUPPLEMENTS; DIETARY SUPPLEMENTS FOR CONTROLLING CHOLESTEROL; DIETARY SUPPLEMENTS FOR HUMAN CONSUMPTION; DIETARY SUPPLEMENTS FOR URINARY HEALTH; DIETARY SUPPLEMENTS IN THE NATURE OF WEIGHT LOSS POWDERS; FOOD SUPPLEMENTS; FOOD SUPPLEMENTS, NAMELY, ANTI-OXIDANTS; HEALTH FOOD SUPPLEMENTS; HERBAL SUPPLEMENTS; HERBAL SUPPLEMENTS FOR SLEEPING PROBLEMS; HOMEOPATHIC SUPPLEMENTS; MINERAL NUTRITIONAL SUPPLEMENTS; MINERAL SUPPLEMENTS; NATURAL HERBAL SUPPLEMENTS; NATURAL SUPPLEMENTS FOR TREATING ERECTILE DYSFUNCTION; NUTRITIONAL AND DIETARY SUPPLEMENTS FORMED AND PACKAGED AS BARS; NUTRITIONAL DRINK MIX FOR USE AS A MEAL REPLACEMENT; NUTRITIONAL SUPPLEMENT FOR ELIMINATING TOXINS FROM THE BODY; NUTRITIONAL SUPPLEMENT FOR ELIMINATING TOXINS FROM THE INTESTINAL TRACT; NUTRITIONAL SUPPLEMENTS; NUTRITIONAL SUPPLEMENTS, NAMELY, PROBIOTIC COMPOSITIONS (U.S. CLS. 6, 18, 44, 46, 51 AND 52).

BARBARA RUTLAND, EXAMINING ATTORNEY

SN 85-337,893. DEN-MAT HOLDINGS, LLC, SANTA MARIA, CA. FILED 6-3-2011.

# CERINATE EXPRESS

THE MARK CONSISTS OF STANDARD CHARACTERS WITHOUT CLAIM TO ANY PARTICULAR FONT, STYLE, SIZE, OR COLOR.

OWNER OF U.S. REG. NO. 1,362,864.  
FOR DENTAL RESTORATIVES, NAMELY, PORCELAIN LAMINATES AND PORCELAIN VENEERS (U.S. CLS. 6, 18, 44, 46, 51 AND 52).

ALICE BENMAMAN, EXAMINING ATTORNEY

**CLASS 5—(Continued).**

SN 85-337,973. MASHOUF, KARIM, WALNUT CREEK, CA. FILED 6-3-2011.

# WADDA BLAST

THE MARK CONSISTS OF STANDARD CHARACTERS WITHOUT CLAIM TO ANY PARTICULAR FONT, STYLE, SIZE, OR COLOR.

FOR VITAMIN-FORTIFIED BEVERAGES AND NUTRITIONALLY FORTIFIED BEVERAGES (U.S. CLS. 6, 18, 44, 46, 51 AND 52).

JEFFREY LOOK, EXAMINING ATTORNEY

SN 85-338,101. HYMAN, ANDREW, BALTIMORE, MD. FILED 6-4-2011.

# Pain Punch

THE MARK CONSISTS OF STANDARD CHARACTERS WITHOUT CLAIM TO ANY PARTICULAR FONT, STYLE, SIZE, OR COLOR.

FOR DIETARY SUPPLEMENTAL DRINKS IN THE NATURE OF VITAMIN AND MINERAL BEVERAGES; MEDICINAL DRINKS; PREPARATION FOR THE RELIEF OF PAIN (U.S. CLS. 6, 18, 44, 46, 51 AND 52).

DAVID C. REIHNER, EXAMINING ATTORNEY

SN 85-338,621. BIOREST LTD., TEL AVIV, ISRAEL, FILED 6-6-2011.

# BIOREST

THE MARK CONSISTS OF STANDARD CHARACTERS WITHOUT CLAIM TO ANY PARTICULAR FONT, STYLE, SIZE, OR COLOR.

FOR PHARMACEUTICAL PREPARATIONS FOR THE PREVENTION OF DISEASES OF THE CARDIOVASCULAR SYSTEM (U.S. CLS. 6, 18, 44, 46, 51 AND 52).

INGRID C. EULIN, EXAMINING ATTORNEY

**CLASS 5—(Continued).**

SN 85-338,784. BIOORIGYN, LLC, SPOKANE, WA. FILED 6-6-2011.

# ISOLOVE

THE MARK CONSISTS OF STANDARD CHARACTERS WITHOUT CLAIM TO ANY PARTICULAR FONT, STYLE, SIZE, OR COLOR.

FOR NON-IRRITATING, ISOTONIC TRANSMISSION GEL FOR USE IN ULTRASOUND PROCEDURES; PERSONAL LUBRICANTS (U.S. CLS. 6, 18, 44, 46, 51 AND 52).

SHAUNIA CARLYLE, EXAMINING ATTORNEY

SN 85-339,776. AZUR PHARMA INTERNATIONAL III LIMITED, HAMILTON, BERMUDA, FILED 6-7-2011.

# Oracloz

THE MARK CONSISTS OF STANDARD CHARACTERS WITHOUT CLAIM TO ANY PARTICULAR FONT, STYLE, SIZE, OR COLOR.

FOR PHARMACEUTICAL PREPARATIONS FOR THE TREATMENT OF SCHIZOPHRENIA (U.S. CLS. 6, 18, 44, 46, 51 AND 52).

PAM WILLIS, EXAMINING ATTORNEY

SN 85-339,911. AGRI LABORATORIES, LTD., ST. JOSEPH, MO. FILED 6-7-2011.

# DI-METHOX

THE MARK CONSISTS OF STANDARD CHARACTERS WITHOUT CLAIM TO ANY PARTICULAR FONT, STYLE, SIZE, OR COLOR.

FOR ANTIBIOTIC FOR CATTLE, HORSES, SWINE AND POULTRY (U.S. CLS. 6, 18, 44, 46, 51 AND 52). FIRST USE 9-8-1992; IN COMMERCE 9-8-1992.

DOMINIC J. FERRAIUOLO, EXAMINING ATTORNEY

**CLASS 5—(Continued).**

SN 85-340,030. DYNAMIC SPORTS NUTRITION, LLC, HOUSTON, TX. FILED 6-7-2011.

# OMNADREN

THE MARK CONSISTS OF STANDARD CHARACTERS WITHOUT CLAIM TO ANY PARTICULAR FONT, STYLE, SIZE, OR COLOR.

FOR DIETARY AND NUTRITIONAL SUPPLEMENTS (U.S. CLS. 6, 18, 44, 46, 51 AND 52).

JANICE KIM, EXAMINING ATTORNEY

SN 85-340,039. DYNAMIC SPORTS NUTRITION, LLC, HOUSTON, TX. FILED 6-7-2011.

# TRENBOLONE

THE MARK CONSISTS OF STANDARD CHARACTERS WITHOUT CLAIM TO ANY PARTICULAR FONT, STYLE, SIZE, OR COLOR.

FOR DIETARY AND NUTRITIONAL SUPPLEMENTS (U.S. CLS. 6, 18, 44, 46, 51 AND 52).

JANICE KIM, EXAMINING ATTORNEY

SN 85-340,078. PIPING ROCK HEALTH PRODUCTS, LLC, BOHEMIA, NY. FILED 6-7-2011.

# PIPING ROCK

THE MARK CONSISTS OF STANDARD CHARACTERS WITHOUT CLAIM TO ANY PARTICULAR FONT, STYLE, SIZE, OR COLOR.

FOR VITAMINS AND VITAMIN PREPARATIONS; VITAMIN SUPPLEMENTS; MINERAL SUPPLEMENTS; NUTRITIONAL SUPPLEMENTS; DIETARY SUPPLEMENTS; FOOD SUPPLEMENTS; HERBAL SUPPLEMENTS (U.S. CLS. 6, 18, 44, 46, 51 AND 52).

EMILY CARLSEN, EXAMINING ATTORNEY

**CLASS 5—(Continued).**

SN 85-340,230. BOCK VETPHARMA, LLC, ST. LOUIS, MO. FILED 6-7-2011.

# DIPHENEX

THE MARK CONSISTS OF STANDARD CHARACTERS WITHOUT CLAIM TO ANY PARTICULAR FONT, STYLE, SIZE, OR COLOR.

FOR VETERINARY PHARMACEUTICAL PREPARATIONS FOR THE CONTROL AND TREATMENT OF ALLERGIES (U.S. CLS. 6, 18, 44, 46, 51 AND 52).

JOHN GARTNER, EXAMINING ATTORNEY

**CLASS 5—(Continued).**

SN 85-340,381. VITONOMY, LLC, PHOENIX, AZ. FILED 6-7-2011.

# V-COMPLETE

THE MARK CONSISTS OF STANDARD CHARACTERS WITHOUT CLAIM TO ANY PARTICULAR FONT, STYLE, SIZE, OR COLOR.

FOR DIETARY AND NUTRITIONAL SUPPLEMENTS (U.S. CLS. 6, 18, 44, 46, 51 AND 52).

LAURIE MAYES, EXAMINING ATTORNEY

SN 85-340,369. VITONOMY, LLC, PHOENIX, AZ. FILED 6-7-2011.

# TIMELESS VITALITY

THE MARK CONSISTS OF STANDARD CHARACTERS WITHOUT CLAIM TO ANY PARTICULAR FONT, STYLE, SIZE, OR COLOR.

FOR DIETARY AND NUTRITIONAL SUPPLEMENTS (U.S. CLS. 6, 18, 44, 46, 51 AND 52).

LAURIE MAYES, EXAMINING ATTORNEY

SN 85-340,406. ZOGENIX, INC., SAN DIEGO, CA. FILED 6-7-2011.

# ZYCONTA

THE MARK CONSISTS OF STANDARD CHARACTERS WITHOUT CLAIM TO ANY PARTICULAR FONT, STYLE, SIZE, OR COLOR.

FOR PHARMACEUTICAL PREPARATIONS AND PRODUCTS FOR THE TREATMENT OF PAIN (U.S. CLS. 6, 18, 44, 46, 51 AND 52).

ALICIA COLLINS, EXAMINING ATTORNEY

SN 85-340,372. VITONOMY, LLC, PHOENIX, AZ. FILED 6-7-2011.

# ELITE EIGHT

THE MARK CONSISTS OF STANDARD CHARACTERS WITHOUT CLAIM TO ANY PARTICULAR FONT, STYLE, SIZE, OR COLOR.

FOR DIETARY AND NUTRITIONAL SUPPLEMENTS (U.S. CLS. 6, 18, 44, 46, 51 AND 52).

LAURIE MAYES, EXAMINING ATTORNEY

SN 85-340,407. GENERAL NUTRITION INVESTMENT COMPANY, PHOENIX, AZ. FILED 6-7-2011.

# RESTACK

THE MARK CONSISTS OF STANDARD CHARACTERS WITHOUT CLAIM TO ANY PARTICULAR FONT, STYLE, SIZE, OR COLOR.

FOR DIETARY SUPPLEMENTS (U.S. CLS. 6, 18, 44, 46, 51 AND 52).

HEATHER THOMPSON, EXAMINING ATTORNEY

**CLASS 5—(Continued).**

SN 85-340,408. ZOGENIX, INC., SAN DIEGO, CA. FILED 6-7-2011.

**ZOHYDRO**

THE MARK CONSISTS OF STANDARD CHARACTERS WITHOUT CLAIM TO ANY PARTICULAR FONT, STYLE, SIZE, OR COLOR.

FOR PHARMACEUTICAL PREPARATIONS AND PRODUCTS FOR THE TREATMENT OF PAIN (U.S. CLS. 6, 18, 44, 46, 51 AND 52).

ALICIA COLLINS, EXAMINING ATTORNEY

**CLASS 5—(Continued).**

SN 85-341,045. BAYER AKTIENGESELLSCHAFT, LEVERKUSEN, FED REP GERMANY, FILED 6-8-2011.

**LUCENLO**

THE MARK CONSISTS OF STANDARD CHARACTERS WITHOUT CLAIM TO ANY PARTICULAR FONT, STYLE, SIZE, OR COLOR.

FOR PHARMACEUTICAL PREPARATIONS, NAMELY HORMONAL PREPARATIONS (U.S. CLS. 6, 18, 44, 46, 51 AND 52).

JULIE VEPPUMTHARA, EXAMINING ATTORNEY

SN 85-340,410. ZOGENIX, INC., SAN DIEGO, CA. FILED 6-7-2011.

**ZOLIVATE**

THE MARK CONSISTS OF STANDARD CHARACTERS WITHOUT CLAIM TO ANY PARTICULAR FONT, STYLE, SIZE, OR COLOR.

FOR PHARMACEUTICAL PREPARATIONS AND PRODUCTS FOR THE TREATMENT OF PAIN (U.S. CLS. 6, 18, 44, 46, 51 AND 52).

ALICIA COLLINS, EXAMINING ATTORNEY

SN 85-341,050. BAYER AKTIENGESELLSCHAFT, LEVERKUSEN, FED REP GERMANY, FILED 6-8-2011.

**VELAPATCH**

THE MARK CONSISTS OF STANDARD CHARACTERS WITHOUT CLAIM TO ANY PARTICULAR FONT, STYLE, SIZE, OR COLOR.

FOR PHARMACEUTICAL PREPARATIONS, NAMELY HORMONAL PREPARATIONS (U.S. CLS. 6, 18, 44, 46, 51 AND 52).

JULIE VEPPUMTHARA, EXAMINING ATTORNEY

SN 85-340,540. POWER BRAIN INC., NORTHBROOK, IL. FILED 6-7-2011.

**MNEMOSYNE**

THE MARK CONSISTS OF STANDARD CHARACTERS WITHOUT CLAIM TO ANY PARTICULAR FONT, STYLE, SIZE, OR COLOR.

FOR DIETARY AND NUTRITIONAL SUPPLEMENTS; DIETARY SUPPLEMENTS FOR PROMOTING BRAIN ALERTNESS AND HEALTH; NUTRITIONAL SUPPLEMENTS; NUTRITIONAL SUPPLEMENTS FOR PROMOTING BRAIN ALERTNESS AND HEALTH (U.S. CLS. 6, 18, 44, 46, 51 AND 52).

ELIZABETH KAJUBI, EXAMINING ATTORNEY

SN 85-341,161. BRAIN PHARMA, LLC, HOLLYWOOD, FL. FILED 6-8-2011.

**ONE MORE REP**

THE MARK CONSISTS OF STANDARD CHARACTERS WITHOUT CLAIM TO ANY PARTICULAR FONT, STYLE, SIZE, OR COLOR.

FOR DIETARY SUPPLEMENTS (U.S. CLS. 6, 18, 44, 46, 51 AND 52).

FIRST USE 10-28-2009; IN COMMERCE 10-28-2009. DAVID ELTON, EXAMINING ATTORNEY

**CLASS 5—(Continued).**

SN 85-341,638. HARRIS, DAVID JAMES JR., REDDING, CA.  
FILED 6-8-2011.

gotX

THE MARK CONSISTS OF STANDARD CHARACTERS WITHOUT CLAIM TO ANY PARTICULAR FONT, STYLE, SIZE, OR COLOR.

FOR DIETARY AND NUTRITIONAL SUPPLEMENTS; DIETARY AND NUTRITIONAL SUPPLEMENTS FOR ENDURANCE SPORTS; DIETARY AND NUTRITIONAL SUPPLEMENTS USED FOR WEIGHT LOSS; DIETARY BEVERAGE SUPPLEMENTS FOR HUMAN CONSUMPTION IN LIQUID AND DRY MIX FORM FOR THERAPEUTIC PURPOSES (U.S. CLS. 6, 18, 44, 46, 51 AND 52).  
FIRST USE 8-8-2008; IN COMMERCE 8-30-2008.  
ARETHA SOMERVILLE, EXAMINING ATTORNEY

SN 85-341,680. ASTUTE MEDICAL, INC., SAN DIEGO, CA.  
FILED 6-8-2011.

NephroCheck

THE MARK CONSISTS OF STANDARD CHARACTERS WITHOUT CLAIM TO ANY PARTICULAR FONT, STYLE, SIZE, OR COLOR.

FOR MEDICAL DIAGNOSTIC TESTING APPARATUS, NAMELY, IMMUNOASSAY KITS CONTAINING IMMUNOLOGICAL REAGENTS FOR THE DETECTION OF MARKERS RELATED TO A WIDE VARIETY OF ILLNESSES AND DISEASES (U.S. CLS. 6, 18, 44, 46, 51 AND 52).  
JEFFREY LOOK, EXAMINING ATTORNEY

SN 85-342,167. APPLIED LIFESCIENCE RESEARCH INDUSTRIES, INC., LAS VEGAS, NV. FILED 6-9-2011.

Myoslin

THE MARK CONSISTS OF STANDARD CHARACTERS WITHOUT CLAIM TO ANY PARTICULAR FONT, STYLE, SIZE, OR COLOR.

FOR DIETARY SUPPLEMENTS (U.S. CLS. 6, 18, 44, 46, 51 AND 52).  
DAVID HOFFMAN, EXAMINING ATTORNEY

**CLASS 5—(Continued).**

SN 85-343,088. TEVA ANIMAL HEALTH, INC., ST. JOSEPH, MO. FILED 6-10-2011.

DUAL-CARE

THE MARK CONSISTS OF STANDARD CHARACTERS WITHOUT CLAIM TO ANY PARTICULAR FONT, STYLE, SIZE, OR COLOR.

FOR PARASITICIDAL PREPARATION FOR USE ON ANIMALS (U.S. CLS. 6, 18, 44, 46, 51 AND 52).  
JEFFERY COWARD, EXAMINING ATTORNEY

SN 85-344,207. COUNTRY LIFE, LLC, HAUPPAUGE, NY.  
FILED 6-13-2011.

TARGET-MINS

THE MARK CONSISTS OF STANDARD CHARACTERS WITHOUT CLAIM TO ANY PARTICULAR FONT, STYLE, SIZE, OR COLOR.

FOR DIETARY AND NUTRITIONAL SUPPLEMENTS (U.S. CLS. 6, 18, 44, 46, 51 AND 52).  
FIRST USE 10-9-1997; IN COMMERCE 10-9-1997.  
KIM MONINGHOFF, EXAMINING ATTORNEY

SN 85-347,198. CELGENE CORPORATION, SUMMIT, NJ.  
FILED 6-15-2011.

POML

THE MARK CONSISTS OF STANDARD CHARACTERS WITHOUT CLAIM TO ANY PARTICULAR FONT, STYLE, SIZE, OR COLOR.

PRIORITY CLAIMED UNDER SEC. 44(D) ON SWITZERLAND APPLICATION NO. 56838/2011, FILED 6-8-2011, REG. NO. 56838/2011, DATED 6-8-2011, EXPIRES 6-8-2021.

FOR PHARMACEUTICAL PREPARATIONS, NAMELY, CYTOKINE INHIBITORY DRUGS; PHARMACEUTICAL PREPARATIONS THAT MODULATE THE IMMUNE SYSTEM; PHARMACEUTICAL PREPARATIONS FOR THE TREATMENT OF CERTAIN CANCERS AND BLOOD DISEASES AND PRINTED DOSAGE INSTRUCTIONAL MANUALS SOLD TOGETHER AS A UNIT (U.S. CLS. 6, 18, 44, 46, 51 AND 52).  
CARYN GLASSER, EXAMINING ATTORNEY



**CLASS 5—(Continued).**

SN 85-347,212. CELGENE CORPORATION, SUMMIT, NJ. FILED 6-15-2011.

# POMD

THE MARK CONSISTS OF STANDARD CHARACTERS WITHOUT CLAIM TO ANY PARTICULAR FONT, STYLE, SIZE, OR COLOR.

PRIORITY CLAIMED UNDER SEC. 44(D) ON SWITZERLAND APPLICATION NO. 56839/2011, FILED 6-8-2011, REG. NO. 56839/2011, DATED 6-8-2011, EXPIRES 6-8-2021.

FOR PHARMACEUTICAL PREPARATIONS, NAMELY, CYTOKINE INHIBITORY DRUGS; PHARMACEUTICAL PREPARATIONS THAT MODULATE THE IMMUNE SYSTEM; PHARMACEUTICAL PREPARATIONS FOR THE TREATMENT OF CERTAIN CANCERS AND BLOOD DISEASES AND PRINTED DOSAGE INSTRUCTIONAL MANUALS SOLD TOGETHER AS A UNIT (U.S. CLS. 6, 18, 44, 46, 51 AND 52).

CARYN GLASSER, EXAMINING ATTORNEY

---

SN 85-349,105. DYNAMIC SPORTS NUTRITION, LLC, HOUSTON, TX. FILED 6-17-2011.

# LAURABOLIN

THE MARK CONSISTS OF STANDARD CHARACTERS WITHOUT CLAIM TO ANY PARTICULAR FONT, STYLE, SIZE, OR COLOR.

FOR DIETARY AND NUTRITIONAL SUPPLEMENTS (U.S. CLS. 6, 18, 44, 46, 51 AND 52).

JANICE KIM, EXAMINING ATTORNEY

---

SN 85-349,222. DYNAMIC SPORTS NUTRITION, LLC, HOUSTON, TX. FILED 6-17-2011.

# PRIMOBOLAN

THE MARK CONSISTS OF STANDARD CHARACTERS WITHOUT CLAIM TO ANY PARTICULAR FONT, STYLE, SIZE, OR COLOR.

FOR DIETARY AND NUTRITIONAL SUPPLEMENTS (U.S. CLS. 6, 18, 44, 46, 51 AND 52).

JANICE KIM, EXAMINING ATTORNEY

**CLASS 5—(Continued).**

SN 85-351,912. LUPIN LTD., MUMBAI, INDIA, FILED 6-21-2011.

# DELNOVU

THE MARK CONSISTS OF STANDARD CHARACTERS WITHOUT CLAIM TO ANY PARTICULAR FONT, STYLE, SIZE, OR COLOR.

FOR PHARMACEUTICALS, NAMELY, CONTRACEPTIVES; ORAL CONTRACEPTIVES; ORAL HORMONAL CONTRACEPTIVES; CONTRACEPTIVE PREPARATIONS AND SUBSTANCES; HORMONE REPLACEMENT THERAPIES; HORMONAL AGENTS FOR TREATING DISORDERS AND CONDITIONS RELATED TO WOMEN'S HEALTH, NAMELY, SYMPTOMS AND CONDITIONS ASSOCIATED WITH MENOPAUSE, PREMENSTRUATION SYNDROME AND OTHER SYMPTOMS AND CONDITIONS ASSOCIATED WITH MENSTRUATION; TRANSDERMAL PATCHES USED FOR CONTRACEPTIVE PURPOSES (U.S. CLS. 6, 18, 44, 46, 51 AND 52).

KATHERINE M. DUBRAY, EXAMINING ATTORNEY

---

SN 85-351,933. LUPIN LTD., MUMBAI, INDIA, FILED 6-21-2011.

# EDRIENA

THE MARK CONSISTS OF STANDARD CHARACTERS WITHOUT CLAIM TO ANY PARTICULAR FONT, STYLE, SIZE, OR COLOR.

FOR PHARMACEUTICALS, NAMELY, CONTRACEPTIVES; ORAL CONTRACEPTIVES; ORAL HORMONAL CONTRACEPTIVES; CONTRACEPTIVE PREPARATIONS AND SUBSTANCES; HORMONE REPLACEMENT THERAPIES; HORMONAL AGENTS FOR TREATING DISORDERS AND CONDITIONS RELATED TO WOMEN'S HEALTH, NAMELY, SYMPTOMS AND CONDITIONS ASSOCIATED WITH MENOPAUSE, PREMENSTRUATION SYNDROME AND OTHER SYMPTOMS AND CONDITIONS ASSOCIATED WITH MENSTRUATION; TRANSDERMAL PATCHES USED FOR CONTRACEPTIVE PURPOSES (U.S. CLS. 6, 18, 44, 46, 51 AND 52).

KATHERINE M. DUBRAY, EXAMINING ATTORNEY

**CLASS 5—(Continued).**

SN 85-351,941. LUPIN LTD., MUMBAI, INDIA, FILED 6-21-2011.

**ENSKYCE**

THE MARK CONSISTS OF STANDARD CHARACTERS WITHOUT CLAIM TO ANY PARTICULAR FONT, STYLE, SIZE, OR COLOR.

FOR PHARMACEUTICALS, NAMELY, CONTRACEPTIVES; ORAL CONTRACEPTIVES; ORAL HORMONAL CONTRACEPTIVES; CONTRACEPTIVE PREPARATIONS AND SUBSTANCES; HORMONE REPLACEMENT THERAPIES; HORMONAL AGENTS FOR TREATING DISORDERS AND CONDITIONS RELATED TO WOMEN'S HEALTH, NAMELY, SYMPTOMS AND CONDITIONS ASSOCIATED WITH MENOPAUSE, PREMENSTRUATION SYNDROME AND OTHER SYMPTOMS AND CONDITIONS ASSOCIATED WITH MENSTRUATION; TRANSDERMAL PATCHES USED FOR CONTRACEPTIVE PURPOSES (U.S. CLS. 6, 18, 44, 46, 51 AND 52).

KATHERINE M. DUBRAY, EXAMINING ATTORNEY

**CLASS 5—(Continued).**

SN 85-351,970. LUPIN LTD., MUMBAI, INDIA, FILED 6-21-2011.

**IBELNIA**

THE MARK CONSISTS OF STANDARD CHARACTERS WITHOUT CLAIM TO ANY PARTICULAR FONT, STYLE, SIZE, OR COLOR.

FOR PHARMACEUTICALS, NAMELY, CONTRACEPTIVES; ORAL CONTRACEPTIVES; ORAL HORMONAL CONTRACEPTIVES; CONTRACEPTIVE PREPARATIONS AND SUBSTANCES; HORMONE REPLACEMENT THERAPIES; HORMONAL AGENTS FOR TREATING DISORDERS AND CONDITIONS RELATED TO WOMEN'S HEALTH, NAMELY, SYMPTOMS AND CONDITIONS ASSOCIATED WITH MENOPAUSE, PREMENSTRUATION SYNDROME AND OTHER SYMPTOMS AND CONDITIONS ASSOCIATED WITH MENSTRUATION; TRANSDERMAL PATCHES USED FOR CONTRACEPTIVE PURPOSES (U.S. CLS. 6, 18, 44, 46, 51 AND 52).

KATHERINE M. DUBRAY, EXAMINING ATTORNEY

---

SN 85-351,954. LUPIN LTD., MUMBAI, INDIA, FILED 6-21-2011.

**GLEZRA**

THE MARK CONSISTS OF STANDARD CHARACTERS WITHOUT CLAIM TO ANY PARTICULAR FONT, STYLE, SIZE, OR COLOR.

FOR PHARMACEUTICALS, NAMELY, CONTRACEPTIVES; ORAL CONTRACEPTIVES; ORAL HORMONAL CONTRACEPTIVES; CONTRACEPTIVE PREPARATIONS AND SUBSTANCES; HORMONE REPLACEMENT THERAPIES; HORMONAL AGENTS FOR TREATING DISORDERS AND CONDITIONS RELATED TO WOMEN'S HEALTH, NAMELY, SYMPTOMS AND CONDITIONS ASSOCIATED WITH MENOPAUSE, PREMENSTRUATION SYNDROME AND OTHER SYMPTOMS AND CONDITIONS ASSOCIATED WITH MENSTRUATION; TRANSDERMAL PATCHES USED FOR CONTRACEPTIVE PURPOSES (U.S. CLS. 6, 18, 44, 46, 51 AND 52).

KATHERINE M. DUBRAY, EXAMINING ATTORNEY

---

SN 85-351,989. LUPIN LTD., MUMBAI, INDIA, FILED 6-21-2011.

**KACENYA**

THE MARK CONSISTS OF STANDARD CHARACTERS WITHOUT CLAIM TO ANY PARTICULAR FONT, STYLE, SIZE, OR COLOR.

FOR PHARMACEUTICALS, NAMELY, CONTRACEPTIVES; ORAL CONTRACEPTIVES; ORAL HORMONAL CONTRACEPTIVES; CONTRACEPTIVE PREPARATIONS AND SUBSTANCES; HORMONE REPLACEMENT THERAPIES; HORMONAL AGENTS FOR TREATING DISORDERS AND CONDITIONS RELATED TO WOMEN'S HEALTH, NAMELY, SYMPTOMS AND CONDITIONS ASSOCIATED WITH MENOPAUSE, PREMENSTRUATION SYNDROME AND OTHER SYMPTOMS AND CONDITIONS ASSOCIATED WITH MENSTRUATION; TRANSDERMAL PATCHES USED FOR CONTRACEPTIVE PURPOSES (U.S. CLS. 6, 18, 44, 46, 51 AND 52).

KATHERINE M. DUBRAY, EXAMINING ATTORNEY

**CLASS 5—(Continued).**

SN 85-352,007. LUPIN LTD., MUMBAI, INDIA, FILED 6-21-2011.

**KAITLIB**

THE MARK CONSISTS OF STANDARD CHARACTERS WITHOUT CLAIM TO ANY PARTICULAR FONT, STYLE, SIZE, OR COLOR.

FOR PHARMACEUTICALS, NAMELY, CONTRACEPTIVES; ORAL CONTRACEPTIVES; ORAL HORMONAL CONTRACEPTIVES; CONTRACEPTIVE PREPARATIONS AND SUBSTANCES; HORMONE REPLACEMENT THERAPIES; HORMONAL AGENTS FOR TREATING DISORDERS AND CONDITIONS RELATED TO WOMEN'S HEALTH, NAMELY, SYMPTOMS AND CONDITIONS ASSOCIATED WITH MENOPAUSE, PREMENSTRUATION SYNDROME AND OTHER SYMPTOMS AND CONDITIONS ASSOCIATED WITH MENSTRUATION; TRANSDERMAL PATCHES USED FOR CONTRACEPTIVE PURPOSES (U.S. CLS. 6, 18, 44, 46, 51 AND 52).

KATHERINE M. DUBRAY, EXAMINING ATTORNEY

**CLASS 5—(Continued).**

SN 85-352,034. LUPIN LTD., MUMBAI, INDIA, FILED 6-21-2011.

**LACENYA**

THE MARK CONSISTS OF STANDARD CHARACTERS WITHOUT CLAIM TO ANY PARTICULAR FONT, STYLE, SIZE, OR COLOR.

FOR PHARMACEUTICALS, NAMELY, CONTRACEPTIVES; ORAL CONTRACEPTIVES; ORAL HORMONAL CONTRACEPTIVES; CONTRACEPTIVE PREPARATIONS AND SUBSTANCES; HORMONE REPLACEMENT THERAPIES; HORMONAL AGENTS FOR TREATING DISORDERS AND CONDITIONS RELATED TO WOMEN'S HEALTH, NAMELY, SYMPTOMS AND CONDITIONS ASSOCIATED WITH MENOPAUSE, PREMENSTRUATION SYNDROME AND OTHER SYMPTOMS AND CONDITIONS ASSOCIATED WITH MENSTRUATION; TRANSDERMAL PATCHES USED FOR CONTRACEPTIVE PURPOSES (U.S. CLS. 6, 18, 44, 46, 51 AND 52).

KATHERINE M. DUBRAY, EXAMINING ATTORNEY

SN 85-352,024. LUPIN LTD., MUMBAI, INDIA, FILED 6-21-2011.

**KIZMEK**

THE MARK CONSISTS OF STANDARD CHARACTERS WITHOUT CLAIM TO ANY PARTICULAR FONT, STYLE, SIZE, OR COLOR.

FOR PHARMACEUTICALS, NAMELY, CONTRACEPTIVES; ORAL CONTRACEPTIVES; ORAL HORMONAL CONTRACEPTIVES; CONTRACEPTIVE PREPARATIONS AND SUBSTANCES; HORMONE REPLACEMENT THERAPIES; HORMONAL AGENTS FOR TREATING DISORDERS AND CONDITIONS RELATED TO WOMEN'S HEALTH, NAMELY, SYMPTOMS AND CONDITIONS ASSOCIATED WITH MENOPAUSE, PREMENSTRUATION SYNDROME AND OTHER SYMPTOMS AND CONDITIONS ASSOCIATED WITH MENSTRUATION; TRANSDERMAL PATCHES USED FOR CONTRACEPTIVE PURPOSES (U.S. CLS. 6, 18, 44, 46, 51 AND 52).

KATHERINE M. DUBRAY, EXAMINING ATTORNEY

SN 85-355,642. ALLMAX NUTRITION INC., ONTARIO, M2N 6N4, CANADA, FILED 6-24-2011.

**NUTRA  FORME**

THE MARK CONSISTS OF THE WORD "NUTRAFORME" BIFURCATED BY THE STYLIZED LETTERS "NF".

FOR DIETARY AND NUTRITIONAL SUPPLEMENTS; DIETARY AND NUTRITIONAL SUPPLEMENTS CONTAINING ANTIOXIDANTS, OMEGA-3 FATTY ACIDS AND ENZYMES; HERBAL SUPPLEMENTS; NUTRITIONAL SUPPLEMENT FOR ELIMINATING TOXINS FROM THE BODY; POWDERED NUTRITIONAL SUPPLEMENT DRINK MIX (U.S. CLS. 6, 18, 44, 46, 51 AND 52).

FIRST USE 4-28-2011; IN COMMERCE 5-12-2011.  
MARK SHINER, EXAMINING ATTORNEY

**CLASS 5—(Continued).**

SN 85-355,701. ALLMAX NUTRITION INC., ONTARIO, M2N 6N4, CANADA, FILED 6-24-2011.

**NUTRAFORME**

THE MARK CONSISTS OF STANDARD CHARACTERS WITHOUT CLAIM TO ANY PARTICULAR FONT, STYLE, SIZE, OR COLOR.

FOR DIETARY AND NUTRITIONAL SUPPLEMENTS; DIETARY AND NUTRITIONAL SUPPLEMENTS CONTAINING ANTIOXIDANTS, OMEGA-3 FATTY ACIDS AND ENZYMES; HERBAL SUPPLEMENTS; NUTRITIONAL SUPPLEMENT FOR ELIMINATING TOXINS FROM THE BODY; POWDERED NUTRITIONAL SUPPLEMENT DRINK MIX (U.S. CLS. 6, 18, 44, 46, 51 AND 52).

FIRST USE 4-28-2011; IN COMMERCE 5-12-2011.  
MARK SHINER, EXAMINING ATTORNEY

SN 85-361,595. FIRST QUALITY PRODUCTS, INC., GREAT NECK, NY. FILED 7-1-2011.

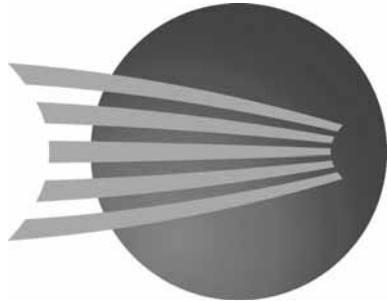

THE MARK CONSISTS OF A CIRCLE WITH FIVE LINES FOR INCONTINENCE BRIEFS (U.S. CLS. 6, 18, 44, 46, 51 AND 52).

NAKIA HENRY, EXAMINING ATTORNEY

SN 85-363,418. MERCURY RETAIL SERVICES LLC, SAN ANTONIO, TX. FILED 7-5-2011.

**RIKA TIKA**

THE MARK CONSISTS OF STANDARD CHARACTERS WITHOUT CLAIM TO ANY PARTICULAR FONT, STYLE, SIZE, OR COLOR.

FOR NUTRITIONAL SUPPLEMENTS; VITAMINS (U.S. CLS. 6, 18, 44, 46, 51 AND 52).

FLORENTINA BLANDU, EXAMINING ATTORNEY

**CLASS 5—(Continued).**

SN 85-368,783. FOUR ON THE FLOOR PET PRODUCTS, INC., INDIANAPOLIS, IN. FILED 7-12-2011.

**OMNISEPT**

THE MARK CONSISTS OF STANDARD CHARACTERS WITHOUT CLAIM TO ANY PARTICULAR FONT, STYLE, SIZE, OR COLOR.

FOR MOLD INHIBITORS FOR TREATING MOLD GROWTH IN AND AROUND BUILDINGS (U.S. CLS. 6, 18, 44, 46, 51 AND 52).

JOHN E. MICHOS, EXAMINING ATTORNEY

SN 85-369,451. GENENTECH, INC., SOUTH SAN FRANCISCO, CA. FILED 7-12-2011.

**HEDGESMO**

THE MARK CONSISTS OF STANDARD CHARACTERS WITHOUT CLAIM TO ANY PARTICULAR FONT, STYLE, SIZE, OR COLOR.

FOR PHARMACEUTICAL ONCOLOGY PREPARATIONS (U.S. CLS. 6, 18, 44, 46, 51 AND 52).

ASMAT KHAN, EXAMINING ATTORNEY

SN 85-369,465. GENENTECH, INC., SOUTH SAN FRANCISCO, CA. FILED 7-12-2011.

**ERIVEDGE**

THE MARK CONSISTS OF STANDARD CHARACTERS WITHOUT CLAIM TO ANY PARTICULAR FONT, STYLE, SIZE, OR COLOR.

FOR PHARMACEUTICAL ONCOLOGY PREPARATIONS (U.S. CLS. 6, 18, 44, 46, 51 AND 52).

ASMAT KHAN, EXAMINING ATTORNEY

**CLASS 5—(Continued).**

SN 85-369,473. GENENTECH, INC., SOUTH SAN FRANCISCO, CA. FILED 7-12-2011.

# INVISEEDGE

THE MARK CONSISTS OF STANDARD CHARACTERS WITHOUT CLAIM TO ANY PARTICULAR FONT, STYLE, SIZE, OR COLOR.  
FOR PHARMACEUTICAL ONCOLOGY PREPARATIONS (U.S. CLS. 6, 18, 44, 46, 51 AND 52).  
ASMAT KHAN, EXAMINING ATTORNEY

SN 85-369,480. GENENTECH, INC., SOUTH SAN FRANCISCO, CA. FILED 7-12-2011.

# VYZMIO

THE MARK CONSISTS OF STANDARD CHARACTERS WITHOUT CLAIM TO ANY PARTICULAR FONT, STYLE, SIZE, OR COLOR.  
FOR PHARMACEUTICAL ONCOLOGY PREPARATIONS (U.S. CLS. 6, 18, 44, 46, 51 AND 52).  
ASMAT KHAN, EXAMINING ATTORNEY

SN 85-369,576. TRANSDERMAL CORP., BIRMINGHAM, MI. FILED 7-12-2011.

# UTILIZING TRANSDERMAL CORP.'S INPART/SMDS

THE MARK CONSISTS OF STANDARD CHARACTERS WITHOUT CLAIM TO ANY PARTICULAR FONT, STYLE, SIZE, OR COLOR.  
FOR DRUG DELIVERY AGENTS CONSISTING OF COMPOUNDS THAT FACILITATE DELIVERY OF A WIDE RANGE OF PHARMACEUTICALS (U.S. CLS. 6, 18, 44, 46, 51 AND 52).  
EMILY CARLSEN, EXAMINING ATTORNEY

**CLASS 5—(Continued).**

SN 85-371,489. PIC CORPORATION, LINDEN, NJ. FILED 7-14-2011.

# FEEL BETTER!

THE MARK CONSISTS OF STANDARD CHARACTERS WITHOUT CLAIM TO ANY PARTICULAR FONT, STYLE, SIZE, OR COLOR.  
FOR TOPICAL DERMATOLOGICAL PREPARATIONS THAT TREAT INSECT BITES AND STINGS; ADHESIVE BANDAGES (U.S. CLS. 6, 18, 44, 46, 51 AND 52).  
SKYE YOUNG, EXAMINING ATTORNEY

SN 85-375,199. FIRST QUALITY PRODUCTS, INC., GREAT NECK, NY. FILED 7-19-2011.

# PROCARE

THE MARK CONSISTS OF STANDARD CHARACTERS WITHOUT CLAIM TO ANY PARTICULAR FONT, STYLE, SIZE, OR COLOR.  
FOR INCONTINENCE PRODUCTS, NAMELY, WIPES, DIAPERS, UNDERWEAR, UNDERPADS, BRIEFS, PADS AND GUARDS (U.S. CLS. 6, 18, 44, 46, 51 AND 52).  
NAKIA HENRY, EXAMINING ATTORNEY

SN 85-377,259. MAKHTESHIM CHEMICAL WORKS LTD., BEER SHEVA, ISRAEL, FILED 7-21-2011.

# MANDREL

THE MARK CONSISTS OF STANDARD CHARACTERS WITHOUT CLAIM TO ANY PARTICULAR FONT, STYLE, SIZE, OR COLOR.  
FOR FUNGICIDES AND HERBICIDES; INSECTICIDES; PESTICIDES (U.S. CLS. 6, 18, 44, 46, 51 AND 52).  
JAY BESCH, EXAMINING ATTORNEY

**CLASS 5—(Continued).**

SN 85-377,453. BOEHRINGER INGELHEIM INTERNATIONAL GMBH, INGELHEIM, FED REP GERMANY, FILED 7-21-2011.

# CONJENTA

THE MARK CONSISTS OF STANDARD CHARACTERS WITHOUT CLAIM TO ANY PARTICULAR FONT, STYLE, SIZE, OR COLOR.

FOR PHARMACEUTICAL PREPARATIONS, NAMELY, PHARMACEUTICAL PREPARATIONS FOR THE TREATMENT OF DIABETES (U.S. CLS. 6, 18, 44, 46, 51 AND 52).

CARYN GLASSER, EXAMINING ATTORNEY

SN 85-378,123. BOEHRINGER INGELHEIM INTERNATIONAL GMBH, INGELHEIM, FED REP GERMANY, FILED 7-22-2011.

# TRAMETFO

THE MARK CONSISTS OF STANDARD CHARACTERS WITHOUT CLAIM TO ANY PARTICULAR FONT, STYLE, SIZE, OR COLOR.

FOR PHARMACEUTICAL PREPARATIONS, NAMELY, PHARMACEUTICAL PREPARATIONS FOR THE TREATMENT OF DIABETES (U.S. CLS. 6, 18, 44, 46, 51 AND 52).

CARYN GLASSER, EXAMINING ATTORNEY

**CLASS 5—(Continued).**

SN 85-378,766. ALTICOR INC., ADA, MI. FILED 7-22-2011.

# AMWAY

THE MARK CONSISTS OF STANDARD CHARACTERS WITHOUT CLAIM TO ANY PARTICULAR FONT, STYLE, SIZE, OR COLOR.

OWNER OF U.S. REG. NOS. 707,656, 727,367 AND OTHERS.

FOR PROTEIN SUPPLEMENTS IN POWDER FORM; VITAMIN AND MINERAL SUPPLEMENTS FOR ANIMALS; NUTRITIONALLY FORTIFIED SNACK FOODS, NAMELY, PROCESSED FRUIT AND/OR NUT-BASED SNACK BARS FORTIFIED WITH VITAMINS AND/OR MINERALS FOR USE AS DIETARY OR NUTRITIONAL SUPPLEMENTS; MEAL REPLACEMENT BARS, DRINKS, DRINK MIXES, AND SNACKS; POWDERED NUTRITIONAL SUPPLEMENT DRINK MIX AND CONCENTRATE; NUTRITIONALLY FORTIFIED BEVERAGES, FIBER POWDER FOR USE AS A NUTRITIONAL SUPPLEMENT; DISINFECTANT TOILET BOWL CLEANER; AEROSOL ANTI-ITCH OINTMENTS, CARPET DEODORIZER, MEDICATED PRE-MOISTENED TOWELETTES, SANITARY NAPKINS, ANTI-DANDRUFF HAIR SHAMPOOS AND CREAM RINSES, ALL-PURPOSE DISINFECTANTS, ANTI-BACTERIAL HAND WASH (U.S. CLS. 6, 18, 44, 46, 51 AND 52).

JUSTINE D. PARKER, EXAMINING ATTORNEY

SN 85-379,365. SCG POWER RANGERS LLC, LOS ANGELES, CA. FILED 7-24-2011.

# POWER RIDER

THE MARK CONSISTS OF STANDARD CHARACTERS WITHOUT CLAIM TO ANY PARTICULAR FONT, STYLE, SIZE, OR COLOR.

FOR VITAMIN SUPPLEMENTS (U.S. CLS. 6, 18, 44, 46, 51 AND 52).

THOMAS MANOR, EXAMINING ATTORNEY

**CLASS 5—(Continued).**

SN 85-383,080. VITACOST.COM, INC., BOCA RATON, FL. FILED 7-28-2011.



The logo for Walker Diet features the word "Walker" in a blue, sans-serif font, followed by "Diet" in a red, cursive script font. A stylized red figure of a person with arms raised is positioned above the "D" in "Diet".

OWNER OF U.S. REG. NOS. 2,900,479, 2,919,590 AND 3,102,630.

NO CLAIM IS MADE TO THE EXCLUSIVE RIGHT TO USE "DIET", APART FROM THE MARK AS SHOWN.

THE COLOR(S) RED AND BLUE IS/ARE CLAIMED AS A FEATURE OF THE MARK.

THE MARK CONSISTS OF THE WORD "WALKER" IN BLUE FOLLOWED BY THE STYLIZED WORD "DIET" IN RED WITH A BLUE PERIOD OVER THE "D". THE BLUE PERIOD OVER THE LETTER "D" CREATES A STYLIZED REPRESENTATION OF A STICK FIGURE.

FOR NUTRITIONAL DRINK MIX FOR USE AS A MEAL REPLACEMENT (U.S. CLS. 6, 18, 44, 46, 51 AND 52).

FIRST USE 7-17-2009; IN COMMERCE 7-17-2009.  
WILLIAM VERHOSEK, EXAMINING ATTORNEY

SN 85-384,684. PROFESSIONAL DISPOSABLES INTERNATIONAL, INC., ORANGEBURG, NY. FILED 7-29-2011.

## PREVANTICS

THE MARK CONSISTS OF STANDARD CHARACTERS WITHOUT CLAIM TO ANY PARTICULAR FONT, STYLE, SIZE, OR COLOR.

FOR ANTISEPTIC WIPES; ANTISEPTICS; DISPOSABLE WIPES IMPREGNATED WITH DISINFECTING CHEMICALS OR COMPOUNDS THEREFOR FOR USE IN HOSPITALS, CLINICS, MEDICAL OFFICES, MEDICAL FACILITIES, AND PATIENT CARE FACILITIES; DISPOSABLE WIPES IMPREGNATED WITH DISINFECTING CHEMICALS OR COMPOUNDS THEREFOR FOR USE ON HANDS OR SKIN, OR ON SOLID SURFACES, NAMELY, BATHROOMS, FURNITURE, WHEELCHAIRS; MICROFIBER TOWEL IMPREGNATED WITH AN ANTIMICROBIAL TREATMENT; SANITIZING WIPES (U.S. CLS. 6, 18, 44, 46, 51 AND 52).

ODESSA BIBBINS, EXAMINING ATTORNEY

SN 85-390,477. BOCK VETPHARMA, LLC, ST. LOUIS, MO. FILED 8-5-2011.

## SERENEX

THE MARK CONSISTS OF STANDARD CHARACTERS WITHOUT CLAIM TO ANY PARTICULAR FONT, STYLE, SIZE, OR COLOR.

FOR NUTRITIONAL SUPPLEMENT FOR THE CONTROL OF BEHAVIORAL DISORDERS IN CANINES (U.S. CLS. 6, 18, 44, 46, 51 AND 52).

JOHN GARTNER, EXAMINING ATTORNEY

**CLASS 5—(Continued).**

SN 85-393,023. DR. LAUREN ROSECAN, WEST PALM BEACH, FL. FILED 8-9-2011.

EYES DRY? DON'T CRY!  
CROCODILE TEARS SOOTHE  
YOUR EYES. THEY DON'T  
STING AND THEY DON'T BITE.

THE MARK CONSISTS OF STANDARD CHARACTERS WITHOUT CLAIM TO ANY PARTICULAR FONT, STYLE, SIZE, OR COLOR.

FOR ARTIFICIAL TEARS; EYE DROPS (U.S. CLS. 6, 18, 44, 46, 51 AND 52).

SEAN CROWLEY, EXAMINING ATTORNEY

**CLASS 6—METAL GOODS**

SN 77-803,704. LUVATA ESPOO OY, ESPOO, FINLAND, FILED 8-13-2009.

## SEAWIRE

THE MARK CONSISTS OF STANDARD CHARACTERS WITHOUT CLAIM TO ANY PARTICULAR FONT, STYLE, SIZE, OR COLOR.

FOR WIRE, WIRE FENCES, FISH PEN FENCES, METAL SUBMERSIBLE FISH FARM CAGES, NAMELY, FISH PENS FOR MARINE AQUACULTURE; FISH CAGES FOR COMMERCIAL USE, LOBSTER CAGES, CRAB CAGES, EEL CAGES, AND CLAM TRAYS IN THE NATURE OF TRAYS USED FOR FISHING AND FARMING, ALL OF METAL ALLOYS AND COMPOSITE METALS (U.S. CLS. 2, 12, 13, 14, 23, 25 AND 50).

DEZMONA MIZELLE, EXAMINING ATTORNEY

SN 77-875,014. YAU, PAK SUM, NEW TERRITORIES, HONG KONG, FILED 11-18-2009.

## CALIBRE CHANNEL

THE MARK CONSISTS OF STANDARD CHARACTERS WITHOUT CLAIM TO ANY PARTICULAR FONT, STYLE, SIZE, OR COLOR.

PRIORITY CLAIMED UNDER SEC. 44(D) ON HONG KONG APPLICATION NO. 301478142, FILED 11-17-2009.

NO CLAIM IS MADE TO THE EXCLUSIVE RIGHT TO USE "CHANNEL", APART FROM THE MARK AS SHOWN.

FOR METALLIC BUILDING MATERIALS, NAMELY, A CONSTRUCTION ELEMENT USED TO AFFIX WALLS IN BUILDING SUCH AS FOR SECURING THE EXTERIOR WALL OF THE BUILDING TO THE FLOOR OR FOR SECURING THE WALL TO THE CEILING (U.S. CLS. 2, 12, 13, 14, 23, 25 AND 50).

KEVIN CORWIN, EXAMINING ATTORNEY

**CLASS 6—(Continued).**

SN 77-913,873. AUTORE, PATRICK THOMAS, WADMALAW ISLAND, SC. FILED 1-18-2010.



NO CLAIM IS MADE TO THE EXCLUSIVE RIGHT TO USE "HIDE" AND "SAFE", APART FROM THE MARK AS SHOWN.

THE MARK CONSISTS OF A LINE OF THREE WORDS, "HIDE", "A" AND "SAFE" ALL IN CAPITAL LETTERS WITH THE "A" BEING SLIGHTLY BIGGER/TALLER IN MIDDLE AND WITH THE WORDS "HIDE" AND "SAFE" LETTERS ON EACH SIDE CANTED OR SLANTED IN SAME ANGLE AS "A" SIDES INWARD.

FOR METAL SAFES, METAL GUN SAFES, SAFES, PORTABLE SECURITY CONTAINERS AND FIRE RESISTANT SAFES AND WATERPROOF SAFES MADE PRIMARILY OF METAL (U.S. CLS. 2, 12, 13, 14, 23, 25 AND 50).

FIRST USE 4-1-2010; IN COMMERCE 4-1-2010.  
ERIN FALK, EXAMINING ATTORNEY

**CLASS 6—(Continued).**

SN 79-096,798. MOUNTING SYSTEMS GMBH, FED REP GERMANY, FILED 3-17-2011.

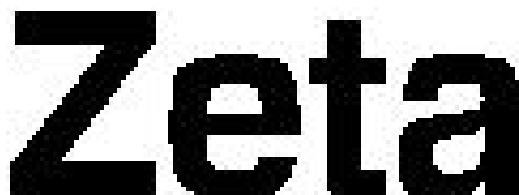

SN 79-095,099. MOUNTING SYSTEMS GMBH, FED REP GERMANY, FILED 10-1-2010.



THE MARK CONSISTS OF STANDARD CHARACTERS WITHOUT CLAIM TO ANY PARTICULAR FONT, STYLE, SIZE, OR COLOR.

OWNER OF INTERNATIONAL REGISTRATION 1071086 DATED 10-1-2010, EXPIRES 10-1-2020.

FOR METAL BUILDINGS AND BUILDING MATERIALS FOR USE ONLY WITH PHOTOVOLTAIC AND THERMAL SOLAR PLANTS USED IN OPEN-AIR MOUNTING SYSTEMS, NAMELY, TRANSPORTABLE BUILDINGS, SUPPORT FRAMES, FRAMING, POSTS, PILES, MASTS, PROFILES, AND METAL FASTENERS, NAMELY, BOLTS, NAILS, RIVETS, AND SCREWS (U.S. CLS. 2, 12, 13, 14, 23, 25 AND 50).

STEVEN JACKSON, EXAMINING ATTORNEY

THE MARK CONSISTS OF STANDARD CHARACTERS WITHOUT CLAIM TO ANY PARTICULAR FONT, STYLE, SIZE, OR COLOR.

PRIORITY DATE OF 10-1-2010 IS CLAIMED.

OWNER OF INTERNATIONAL REGISTRATION 1075455 DATED 3-17-2011, EXPIRES 3-17-2021.

FOR BUILDING AND FASTENING MATERIALS OF METAL, NAMELY, SOFFITS AND FASCIA FOR BUILDING PURPOSES; METAL SCAFFOLDING, METAL STANDS FOR PHOTOVOLTAIC AND THERMAL SOLAR INSTALLATIONS; METAL POSTS, METAL PILES AND METAL MASTS, PROFILES AND FRAMES FOR MOUNTING PHOTOVOLTAIC AND THERMAL SOLAR ARRAYS, ALL OF METAL, TRANSPORTABLE BUILDINGS OF METAL; ALL THE AFORESAID BUILDING MATERIALS IN PARTICULAR FOR PHOTOVOLTAIC AND THERMAL SOLAR INSTALLATIONS, BEING ON-ROOF MOUNTING SYSTEMS, IN-ROOF MOUNTING SYSTEMS, FLAT-ROOF OR OPEN-LAND MOUNTING SYSTEMS (U.S. CLS. 2, 12, 13, 14, 23, 25 AND 50).

JESSICA FATHY, EXAMINING ATTORNEY



**CLASS 6—(Continued).**

SN 79-098,014. SHANDONG HUAMIN STEEL BALL JOINT-STOCK CO., LTD., CHINA, FILED 4-11-2011.



OWNER OF INTERNATIONAL REGISTRATION 1079095 DATED 4-11-2011, EXPIRES 4-11-2021.

THE MARK CONSISTS OF THE ENGLISH WORDING "H", "M" AND THE SHADOW OF A HUMAN FIGURE WITH A HAMMERHEAD.

FOR STEEL, UNWROUGHT OR SEMI-WROUGHT; CAST STEEL; ANTI-FRICTION METAL ALLOYS OF COMMON METAL; ALLOYED IRON, UNWROUGHT OR SEMI-WROUGHT; COMMON METALS, UNWROUGHT OR SEMI-WROUGHT, FOR FURTHER MANUFACTURE; COMMON METAL ALLOYS; STEEL IN THE FORM OF STEEL GRIT; STAIRCASES OF METAL; GRATINGS OF METAL; FENCES OF METAL WIRE; BUILDING MATERIALS OF METAL, NAMELY, METAL REINFORCEMENT MATERIALS FOR BUILDING; FITTINGS OF METAL FOR FURNITURE, NAMELY, METAL HINGES; IRONMONGERY, NAMELY, NAILS; FLANGES OF METAL; STEEL BALLS; FOUNDRY CHILL-MOULDLS; UPRIGHT SIGNBOARDS OF COMMON METAL; WORKS OF ART OF COMMON METAL (U.S. CLS. 2, 12, 13, 14, 23, 25 AND 50).

ROBIN MITTLER, EXAMINING ATTORNEY

SN 85-080,187. SUNMARK ENVIRONMENTAL SERVICES, LLC, PORTLAND, OR. FILED 7-8-2010.



NO CLAIM IS MADE TO THE EXCLUSIVE RIGHT TO USE "FISHWAYRX", APART FROM THE MARK AS SHOWN.

THE MARK CONSISTS OF THE NAME "FISHWAY RX" PRINTED IN SOLID LETTERING AND RESTS ON TOP OF A THICK, DASHED LINE REPRESENTING A BRIDGE CROSSING OVER A WATERWAY. THE "RX" AT THE END OF "FISHWAY" IS INSIDE A CIRCLE APPROXIMATELY HALF THE FONT SIZE OF "FISHWAY" AND RAISED ABOVE THE DASHED LINE. BELOW THE BRIDGE CROSSING ARE IMAGES OF A WATERWAY WITH A SOLID IMAGE OF A FISH AND SOLID ROUND ROCKS ON THE BOTTOM OF THE WATERWAY. THE SIDES OF THE WATERWAY LEVEL WITH AND UNDER THE

**CLASS 6—(Continued).**

BRIDGE CROSSING ARE IMAGES OF STACKED PARALLELOGRAM BAGS WITH CRISSCROSSED LINE RUNNING THROUGH THEM REPRESENTING ROOTS OF PLANTS. THE TWO SIDES ARE ANGLED OUTWARD AND UPWARD FROM THE BED OF THE WATERWAY WITH IMAGES OF GRASS AND LEAVED PLANTS ON THEM REPRESENTING PLANTS GROWING ON THE BANK OF A WATERWAY. THESE PLANT IMAGES START JUST UNDER THE WATER LINE AND CONTINUE UP THE SIDES UNTIL THEY REACH THE BRIDGE CROSSING ABOVE.

THE WORDING "FISHWAYRX" HAS NO MEANING IN A FOREIGN LANGUAGE.

FOR PREFABRICATED METAL BRIDGES (U.S. CLS. 2, 12, 13, 14, 23, 25 AND 50).

FIRST USE 11-15-2009; IN COMMERCE 2-1-2010.

JENNIFER MARTIN, EXAMINING ATTORNEY

SN 85-155,732. CAMPBELL-ERS L.L.C., HARRISON, NJ. FILED 10-19-2010.

**GRATE WALL**

THE MARK CONSISTS OF STANDARD CHARACTERS WITHOUT CLAIM TO ANY PARTICULAR FONT, STYLE, SIZE, OR COLOR.

FOR GRATINGS, FENCES, FENCE POSTS, GUARDRAILS, BARRICADES, ALL OF THE ABOVE MADE OF METAL; METAL VERTICAL STRUCTURES IN THE NATURE OF GRATINGS, FENCES, FENCE POSTS, GUARDRAILS AND BARRICADES (U.S. CLS. 2, 12, 13, 14, 23, 25 AND 50).

SUZANNE BLANE, EXAMINING ATTORNEY

SN 85-178,658. HIGHLANDS CORPORATION, WILMINGTON, DE. FILED 11-17-2010.

**WISCONSIN NIPPLE**

THE MARK CONSISTS OF STANDARD CHARACTERS WITHOUT CLAIM TO ANY PARTICULAR FONT, STYLE, SIZE, OR COLOR.

NO CLAIM IS MADE TO THE EXCLUSIVE RIGHT TO USE "NIPPLE", APART FROM THE MARK AS SHOWN.

SEC. 2(F).

FOR METAL PIPE COUPLINGS AND METAL PIPE NIPPLES (U.S. CLS. 2, 12, 13, 14, 23, 25 AND 50).

FIRST USE 0-0-1990; IN COMMERCE 0-0-1990.

TEJBIR SINGH, EXAMINING ATTORNEY

**CLASS 6—(Continued).**

SN 85-213,895. SOUTHERN MARKETING AFFILIATES, INC., AKA SMA, JONESBORO, AR. FILED 1-10-2011.



THE COLOR(S) BLUE, RED, AND WHITE IS/ARE CLAIMED AS A FEATURE OF THE MARK.

THE MARK CONSISTS OF THE DESIGN OF A WHITE, ROUND EDGED RECTANGLE WITH A RED BORDER, AND THE TERM "STORSMART" INSIDE; THE FIRST LETTERS "STOR" ARE IN THE COLOR BLUE, AND THE LAST LETTERS "SMART" ARE IN THE COLOR RED.

FOR METAL TOOL BOXES; TOOL AND TOOL ACCESSORY BOXES MADE OF METAL SOLD EMPTY AND PARTS AND FITTINGS THEREFOR; TOOL AND TOOL ACCESSORY TRAYS MADE OF METAL SOLD EMPTY AND PARTS AND FITTINGS THEREFOR; TOOL BOXES OF METAL; TOOLS CHESTS OF METAL SOLD EMPTY; TOOLS, COMPONENTS AND SUPPLIES FOR USE IN MAKING SIGNS, NAMELY, METAL SUBSTRATES, PANELS, SIGN BLANKS AND WIRE (U.S. CLS. 2, 12, 13, 14, 23, 25 AND 50).

FIRST USE 5-1-2010; IN COMMERCE 5-1-2010.  
BARBARA A. GOLD, EXAMINING ATTORNEY

**CLASS 6—(Continued).**

SN 85-257,075. KOOLSHADE UK LTD, HAVANT, HAMPSHIRE, UNITED KINGDOM, FILED 3-3-2011.

# KOOLSHADE

THE MARK CONSISTS OF STANDARD CHARACTERS WITHOUT CLAIM TO ANY PARTICULAR FONT, STYLE, SIZE, OR COLOR.

OWNER OF UNITED KINGDOM REG. NO. 2336932, DATED 6-10-2003, EXPIRES 6-10-2020.

FOR EXTERIOR BLINDS MADE OF METAL, WIRE, WIRE FABRIC MATERIAL AND WOVEN WIRE MATERIAL; WINDOW SCREENS MADE OF METAL, WIRE, WIRE FABRIC MATERIAL AND WOVEN WIRE MATERIAL (U.S. CLS. 2, 12, 13, 14, 23, 25 AND 50).

JAMES GRIFFIN, EXAMINING ATTORNEY

SN 85-259,523. FOR LIFE PRODUCTS, INC., MIRAMAR, FL. FILED 3-7-2011.

SN 85-237,923. STEWART HARDISON, ONEONTA, NY. FILED 2-9-2011.



NO CLAIM IS MADE TO THE EXCLUSIVE RIGHT TO USE "MOORING SYSTEMS", APART FROM THE MARK AS SHOWN.

THE MARK CONSISTS OF A MOORING BLOCK NEXT TO "HABITAT" WITH THE WORDS "MOORING SYSTEMS" UNDERNEATH THE WORD "HABITAT".

FOR ANCHORS FOR THE MOORING OF VESSELS, RAFTS, FLOATING WIND TURBINES AND POWER GENERATORS, AND OTHER FLOATING OR SEMI-FLOATING STRUCTURES (U.S. CLS. 2, 12, 13, 14, 23, 25 AND 50).

FIRST USE 10-22-2010; IN COMMERCE 10-22-2010.  
PAM WILLIS, EXAMINING ATTORNEY



NO CLAIM IS MADE TO THE EXCLUSIVE RIGHT TO USE "STOP" AND "HINGE PIN DOOR STOP", APART FROM THE MARK AS SHOWN.

THE MARK CONSISTS OF AN OCTAGON SHAPE WITH THE WORD "SMART" ON THE FIRST LINE; THE WORD "STOP" WITH AN IMAGE OF A HINGE PIN DOOR STOP IN PLACE OF THE LETTER "O" ON THE SECOND LINE; THE WORDS "HINGE PIN" ON THE THIRD LINE; AND THE WORDS "DOOR STOP" ON THE FOURTH LINE.

FOR METAL DOOR STOPS (U.S. CLS. 2, 12, 13, 14, 23, 25 AND 50).

FONG HSU, EXAMINING ATTORNEY

**CLASS 6—(Continued).**

SN 85-272,041. JULIE HSU, DBA ACE METAL PRODUCT, CHINO, CA. FILED 3-21-2011.



NO CLAIM IS MADE TO THE EXCLUSIVE RIGHT TO USE "METAL PRODUCTS" AND THE REPRESENTATION OF A CARABINER, APART FROM THE MARK AS SHOWN. THE COLOR(S) BLUE, GRAY AND BLACK IS/ARE CLAIMED AS A FEATURE OF THE MARK.

THE MARK CONSISTS OF GREY METAL PIECES JOINED TOGETHER WITH RIVETS TO FORM THE WORD "AMP." A BLUE CARABINER WITH A GRAY CLOSURE SLANTED AT A SIXTY DEGREE ANGLE PLACED IN FRONT TO THE LEFT OF THE "AMP." THE WORDS "ACE METAL PRODUCTS" IN BLACK SPELLED OUT AND PLACED UNDER THE CARABINEER AND "AMP." THE "A" AND "E" IN "ACE" ARE CAPITAL AND THE "C" IS LOWER CASE. THE "E" AND "A" IN "METAL" ARE CAPITAL AND THE "M", "T", AND "L" ARE LOWER CASE AND ALL THE LETTERS IN "PRODUCTS" ARE LOWER CASE.

FOR METAL HARDWARE FOR USE IN DESCENDING ROPES, NAMELY, BELAY DEVICES; METAL HARDWARE FOR USE IN DESCENDING ROPES, NAMELY, DESCENDERS; METAL HARDWARE, NAMELY, CARABINERS OF METAL; METAL HARDWARE, NAMELY, DOUBLE-END SWIVELS; METAL SHACKLES AND HOOKS FOR LIFTING AND RIGGING (U.S. CLS. 2, 12, 13, 14, 23, 25 AND 50).

FIRST USE 1-1-2002; IN COMMERCE 1-1-2002.  
CAROLINE WOOD, EXAMINING ATTORNEY

SN 85-300,140. AGENCIE GROUP LLC, NEW YORK, NY. FILED 4-20-2011.

**URBAN UMBRELLA**

THE MARK CONSISTS OF STANDARD CHARACTERS WITHOUT CLAIM TO ANY PARTICULAR FONT, STYLE, SIZE, OR COLOR.

NO CLAIM IS MADE TO THE EXCLUSIVE RIGHT TO USE "UMBRELLA", APART FROM THE MARK AS SHOWN.

FOR SIDEWALK SHED, NAMELY, METAL SHELTER STRUCTURE WITH CURVED BEAMS SUPPORTING A ROOF TO PROTECT SIDEWALKS, PEDESTRIANS AND PROPERTY FROM DEBRIS FALLING FROM OVERHEAD (U.S. CLS. 2, 12, 13, 14, 23, 25 AND 50).

FIRST USE 11-0-2009; IN COMMERCE 11-0-2009.  
JENNY PARK, EXAMINING ATTORNEY

**CLASS 6—(Continued).**

SN 85-318,112. TAPHANDLES LLC, SEATTLE, WA. FILED 5-11-2011.

**SELL MORE BEER**

THE MARK CONSISTS OF STANDARD CHARACTERS WITHOUT CLAIM TO ANY PARTICULAR FONT, STYLE, SIZE, OR COLOR.

OWNER OF U.S. REG. NO. 4,008,953.

FOR NON-LUMINOUS AND NON-MECHANICAL METAL SIGNS AND METAL TOOL BOXES, METAL HANDLES FOR TAPS FOR KEGS (U.S. CLS. 2, 12, 13, 14, 23, 25 AND 50).

TAMARA FRAZIER, EXAMINING ATTORNEY

SN 85-321,071. DURHAM, TAMIKA S, DBA THE DURHAM COMPANY, UNION, NJ. FILED 5-14-2011.

**Climate Seal**

THE MARK CONSISTS OF STANDARD CHARACTERS WITHOUT CLAIM TO ANY PARTICULAR FONT, STYLE, SIZE, OR COLOR.

NO CLAIM IS MADE TO THE EXCLUSIVE RIGHT TO USE "SEAL", APART FROM THE MARK AS SHOWN.

FOR METAL INTERIOR STORM WINDOWS (U.S. CLS. 2, 12, 13, 14, 23, 25 AND 50).

EDWARD FENNESSY, EXAMINING ATTORNEY

SN 85-321,528. BASILE, VINCENT M., EASTHAMPTON, MA. AND BASILE, JENNIFER A., EASTHAMPTON, MA. FILED 5-16-2011.

**TRAIL RAIL**

THE MARK CONSISTS OF STANDARD CHARACTERS WITHOUT CLAIM TO ANY PARTICULAR FONT, STYLE, SIZE, OR COLOR.

FOR METAL COMPONENTS, NAMELY, BRACKETS, SUPPORT RINGS AND SCREWS FOR MOUNTING ACCESSORIES TO OUTDOOR RECREATIONAL VEHICLES (U.S. CLS. 2, 12, 13, 14, 23, 25 AND 50).

SAMUEL E. SHARPER JR., EXAMINING ATTORNEY

**CLASS 6—(Continued).**

SN 85-323,130. SOUTHEASTERN METALS MANUFACTURING COMPANY, INC., BUFFALO, NY. FILED 5-17-2011.

# Clean Mesh

THE MARK CONSISTS OF STANDARD CHARACTERS WITHOUT CLAIM TO ANY PARTICULAR FONT, STYLE, SIZE, OR COLOR.

NO CLAIM IS MADE TO THE EXCLUSIVE RIGHT TO USE "MESH", APART FROM THE MARK AS SHOWN.

FOR METAL DEBRIS GUARDS FOR GUTTERS (U.S. CLS. 2, 12, 13, 14, 23, 25 AND 50).

LINDSEY RUBIN, EXAMINING ATTORNEY

**CLASS 6—(Continued).**

SN 85-331,646. WALLHIT INTERNATIONAL INC, STE ANNE DES PLAINES, CANADA, FILED 5-26-2011.

# WALLHIT

THE MARK CONSISTS OF STANDARD CHARACTERS WITHOUT CLAIM TO ANY PARTICULAR FONT, STYLE, SIZE, OR COLOR.

FOR ANCHORS (U.S. CLS. 2, 12, 13, 14, 23, 25 AND 50).  
ALEXANDER L. POWERS, EXAMINING ATTORNEY

SN 85-326,246. VARCO I/P, INC., HOUSTON, TX. FILED 5-20-2011.

# THRU-KOTE

THE MARK CONSISTS OF STANDARD CHARACTERS WITHOUT CLAIM TO ANY PARTICULAR FONT, STYLE, SIZE, OR COLOR.

OWNER OF U.S. REG. NO. 2,050,081.

FOR METAL TUBULAR GOODS, NAMELY, TUBING AND LINE PIPE CONNECTIONS, INSERTS, AND FITTINGS (U.S. CLS. 2, 12, 13, 14, 23, 25 AND 50).

JOHN WILKE, EXAMINING ATTORNEY

SN 85-332,029. ASC PROFILES, INC., WEST SACRAMENTO, CA. FILED 5-27-2011.

# N-32

THE MARK CONSISTS OF STANDARD CHARACTERS WITHOUT CLAIM TO ANY PARTICULAR FONT, STYLE, SIZE, OR COLOR.

FOR METAL ROOF DECK PANELS WITH CORRUGATED RIBS (U.S. CLS. 2, 12, 13, 14, 23, 25 AND 50).  
FIRST USE 7-0-2010; IN COMMERCE 7-0-2010.

REBECCA POVARCHUK, EXAMINING ATTORNEY

SN 85-331,361. GRASCHE U.S.A., INC., HICKORY, NC. FILED 5-26-2011.

# GRASCHE

THE MARK CONSISTS OF STANDARD CHARACTERS WITHOUT CLAIM TO ANY PARTICULAR FONT, STYLE, SIZE, OR COLOR.

FOR SEMI FINISHED METAL PLATES FOR USE IN THE FURTHER MANUFACTURE OF CUTTING BLADES FOR USE IN THE WOOD AND METAL CUTTING INDUSTRIES (U.S. CLS. 2, 12, 13, 14, 23, 25 AND 50).

FIRST USE 0-0-1979; IN COMMERCE 0-0-1979.

MICHAEL TANNER, EXAMINING ATTORNEY

SN 85-333,123. L & W FASTENERS COMPANY, TAINAN, TAIWAN, FILED 5-28-2011.

# LWFC

THE MARK CONSISTS OF STANDARD CHARACTERS WITHOUT CLAIM TO ANY PARTICULAR FONT, STYLE, SIZE, OR COLOR.

FOR METAL HARDWARE, NAMELY NUTS, SCREWS AND BOLTS (U.S. CLS. 2, 12, 13, 14, 23, 25 AND 50).

FIRST USE 4-20-2011; IN COMMERCE 4-20-2011.

SOPHIA S. KIM, EXAMINING ATTORNEY

**CLASS 6—(Continued).**

SN 85-334,872. PECK & HALE, L.L.C., WEST SAYVILLE, NY.  
FILED 6-1-2011.

# UCLS

THE MARK CONSISTS OF STANDARD CHARACTERS WITHOUT CLAIM TO ANY PARTICULAR FONT, STYLE, SIZE, OR COLOR.

FOR CONTAINERS OF METAL FOR TRANSPORT (U.S. CLS. 2, 12, 13, 14, 23, 25 AND 50).  
FLORENTINA BLANDU, EXAMINING ATTORNEY

---

SN 85-335,878. CHONGQING BAJIE JINGCHANG STAINLESS STEEL TUBE MANUFACTURE CO., LTD, BANAN, CHONGQING, CHINA. FILED 6-2-2011.

**CLASS 6—(Continued).**

SN 85-339,055. BENJAMIN STROYER, EAST ROCHESTER, NY. FILED 6-6-2011.

# STELCOR

THE MARK CONSISTS OF STANDARD CHARACTERS WITHOUT CLAIM TO ANY PARTICULAR FONT, STYLE, SIZE, OR COLOR.

FOR CONSTRUCTION MATERIALS, NAMELY, METAL PILES (U.S. CLS. 2, 12, 13, 14, 23, 25 AND 50).  
FIRST USE 6-22-2009; IN COMMERCE 6-22-2009.  
DAVID TAYLOR, EXAMINING ATTORNEY

---

SN 85-341,148. PLATT, GREG, WINDBER, PA. FILED 6-8-2011.



# HUNTAM

THE MARK CONSISTS OF THE STYLIZED LETTERS "B" AND "J" ORBITED BY A LITTLE DOT.

FOR BRANCHING TUBES OF METAL FOR PIPELINES; DRAIN PIPES MADE OF METAL; METAL GUTTER PIPES; METAL JUNCTIONS FOR PIPES; METAL MANIFOLDS FOR USE WITH HYDRAULIC AND PNEUMATIC SYSTEMS; METAL PIPE COLLARS; METAL PIPE MUFFS; METAL WATER PIPES; METALLIC DRAIN TRAPS; TUBES OF STAINLESS STEEL (U.S. CLS. 2, 12, 13, 14, 23, 25 AND 50).

FIRST USE 6-1-2000; IN COMMERCE 12-22-2003.  
JOHN E. MICHOS, EXAMINING ATTORNEY

THE MARK CONSISTS OF STANDARD CHARACTERS WITHOUT CLAIM TO ANY PARTICULAR FONT, STYLE, SIZE, OR COLOR.

FOR METAL HOOKS FOR HANGING HUNTING EQUIPMENT (U.S. CLS. 2, 12, 13, 14, 23, 25 AND 50).  
MATTHEW EINSTEIN, EXAMINING ATTORNEY

---

SN 85-366,608. ASC PROFILES, INC., WEST SACRAMENTO, CA. FILED 7-8-2011.

SN 85-337,169. STAXXON LLC, MONTCLAIR, NJ. FILED 6-3-2011.

# STAXXON

THE MARK CONSISTS OF STANDARD CHARACTERS WITHOUT CLAIM TO ANY PARTICULAR FONT, STYLE, SIZE, OR COLOR.

FOR VERTICAL FOLDING METAL CARGO CONTAINERS (U.S. CLS. 2, 12, 13, 14, 23, 25 AND 50).  
TINA BROWN, EXAMINING ATTORNEY

# KLONDIKE

THE MARK CONSISTS OF STANDARD CHARACTERS WITHOUT CLAIM TO ANY PARTICULAR FONT, STYLE, SIZE, OR COLOR.

FOR METAL SIDING (U.S. CLS. 2, 12, 13, 14, 23, 25 AND 50).  
REBECCA POVARCHUK, EXAMINING ATTORNEY

**CLASS 6—(Continued).**

SN 85-383,716. HANDI-FOIL CORPORATION, WHEELING, IL. FILED 7-28-2011.

**CHANGING TRENDS**

THE MARK CONSISTS OF STANDARD CHARACTERS WITHOUT CLAIM TO ANY PARTICULAR FONT, STYLE, SIZE, OR COLOR.

FOR ALUMINUM FOIL AND ALUMINUM FOIL PAPER (U.S. CLS. 2, 12, 13, 14, 23, 25 AND 50).  
JASON BLAIR, EXAMINING ATTORNEY

SN 85-399,144. HANDI-FOIL CORPORATION, WHEELING, IL. FILED 8-16-2011.

**CHOICES FOR CHANGING TRENDS**

THE MARK CONSISTS OF STANDARD CHARACTERS WITHOUT CLAIM TO ANY PARTICULAR FONT, STYLE, SIZE, OR COLOR.

FOR ALUMINUM FOIL AND ALUMINUM FOIL PAPER (U.S. CLS. 2, 12, 13, 14, 23, 25 AND 50).  
JASON BLAIR, EXAMINING ATTORNEY

**CLASS 7—MACHINERY**

SN 76-704,270. SUPERIOR INDUSTRIAL PRODUCTS, NASHVILLE, TN. FILED 8-26-2010.



THE MARK CONSISTS OF A DESIGN OF TWO LINES IN AN OVAL FRAME.

FOR USED AND RECONDITIONED MATERIAL HANDLING MACHINERY AND EQUIPMENT, NAMELY, FORKLIFTS, AND SPECIFICALLY GAS FORKLIFTS, LP-GAS FORKLIFTS, DIESEL FORKLIFTS, ELECTRIC FORKLIFTS, MECHANICAL FORKLIFTS, HYDRAULIC LIFTS, DOCK EQUIPMENT, NAMELY, HYDRAULIC PALLET JACKS (U.S. CLS. 13, 19, 21, 23, 31, 34 AND 35).

FIRST USE 12-31-2002; IN COMMERCE 12-31-2002.  
MATTHEW EINSTEIN, EXAMINING ATTORNEY

**CLASS 7—(Continued).**

SN 76-705,324. COLD AIR INDUCTIONS INC., MEMPHIS, MI. FILED 11-12-2010.



THE COLOR(S) BLUE AND BLACK IS/ARE CLAIMED AS A FEATURE OF THE MARK.

THE MARK CONSISTS OF THREE HORIZONTAL LINES, EACH SHORTER THAN THE ONE ABOVE, WITH THE TOP LINE IN BLACK AND THE BOTTOM TWO IN BLUE, AND THE BLUE STYLIZED LETTERING "CAI" FORMING A QUADRILATERAL SHAPE.

FOR AIR-INTAKE TUBES AND FILTERS FOR AFTER-MARKET INSTALLATION OF AUTOMOTIVE ENGINES (U.S. CLS. 13, 19, 21, 23, 31, 34 AND 35).

FIRST USE 10-18-2009; IN COMMERCE 10-18-2009.  
KRISTIN CARLSON, EXAMINING ATTORNEY

SN 76-707,246. GFG INNOVATIONS, INC., WILDWOOD, MO. FILED 4-13-2011.

**SECOND SUN POWER SYSTEMS**

THE MARK CONSISTS OF STANDARD CHARACTERS WITHOUT CLAIM TO ANY PARTICULAR FONT, STYLE, SIZE, OR COLOR.

NO CLAIM IS MADE TO THE EXCLUSIVE RIGHT TO USE "POWER SYSTEMS", APART FROM THE MARK AS SHOWN.

FOR ELECTRICAL GENERATORS (U.S. CLS. 13, 19, 21, 23, 31, 34 AND 35).

FIRST USE 9-25-2010; IN COMMERCE 9-25-2010.  
ANNE MADDEN, EXAMINING ATTORNEY

SN 76-708,150. ASSEMBLED PRODUCTS CORPORATION, ROGERS, AR. FILED 6-27-2011.

**SMTVACKING**

THE MARK CONSISTS OF STANDARD CHARACTERS WITHOUT CLAIM TO ANY PARTICULAR FONT, STYLE, SIZE, OR COLOR.

FOR PORTABLE AND CENTRAL VACUUM CLEANERS FOR COMMERCIAL AND INDUSTRIAL USE; VACUUM CLEANER ATTACHMENTS, NAMELY, HOSES, ADAPTORS, COUPLINGS AND SUCTION NOZZLES FOR VACUUM CLEANERS (U.S. CLS. 13, 19, 21, 23, 31, 34 AND 35).

DANIEL CAPSHAW, EXAMINING ATTORNEY

**CLASS 7—(Continued).**

SN 76-708,378. SMARTPOOL, INC., LAKEWOOD, NJ. FILED 7-15-2011.

# CLIMBER

THE MARK CONSISTS OF STANDARD CHARACTERS WITHOUT CLAIM TO ANY PARTICULAR FONT, STYLE, SIZE, OR COLOR.

OWNER OF U.S. REG. NO. 3,640,037.  
FOR ROBOTIC POOL CLEANERS (U.S. CLS. 13, 19, 21, 23, 31, 34 AND 35).  
FIRST USE 1-12-2011; IN COMMERCE 1-12-2011.  
SAMUEL E. SHARPER JR., EXAMINING ATTORNEY

SN 77-756,291. 537397 ONTARIO INC., DBA TECH SALES CO., RICHMOND HILL, ONTARIO, CANADA, FILED 6-10-2009.

# STREAM VAC

THE MARK CONSISTS OF STANDARD CHARACTERS WITHOUT CLAIM TO ANY PARTICULAR FONT, STYLE, SIZE, OR COLOR.

PRIORITY CLAIMED UNDER SEC. 44(D) ON CANADA APPLICATION NO. 1426220, FILED 1-30-2009, REG. NO. TMA799646, DATED 6-9-2011, EXPIRES 6-9-2026.

NO CLAIM IS MADE TO THE EXCLUSIVE RIGHT TO USE "VAC", APART FROM THE MARK AS SHOWN.

FOR IN-LINE AIR VACUUM CONVEYORS FOR INDUSTRIAL APPLICATIONS (U.S. CLS. 13, 19, 21, 23, 31, 34 AND 35).

RONALD DELGIZZI, EXAMINING ATTORNEY

**CLASS 7—(Continued).**

SN 77-848,131. MANNTECH GEVELINSTALLATIES B.V., ZEVENBERGEN, NETHERLANDS, FILED 10-14-2009.

# MANNTTECH

THE MARK CONSISTS OF STANDARD CHARACTERS WITHOUT CLAIM TO ANY PARTICULAR FONT, STYLE, SIZE, OR COLOR.

OWNER OF ERPN CMNTY TM OFC REG. NO. 008345225, DATED 2-22-2010, EXPIRES 2-22-2020.

FOR LIFTING AND CONVEYANCE APPARATUS, NAMELY, POWER OPERATED LIFTS AND CRANES FOR BUILDING MAINTENANCE SYSTEMS; POWER-OPERATED FACADE LIFTS FOR BUILDING MAINTENANCE AND FACADE CLEANING; LIFTING APPLIANCES, NAMELY, CRANES, POWER-OPERATED WORK PLATFORMS, MAST ELEVATORS AND TRAVELING LADDER AFFIXED TO THE PLATFORM BUT STILL HAVING MOBILITY, ALL SOLD TOGETHER AS A UNIT; HYDRAULIC MACHINES AND APPARATUS, NAMELY, CRANES, ELEVATING WORK PLATFORMS, MAST ELEVATORS AND TRAVELING LADDER AFFIXED TO THE PLATFORM BUT STILL HAVING MOBILITY, ALL SOLD TOGETHER AS A UNIT; ELECTRIC MACHINES AND APPARATUS, NAMELY, CRANES, ELEVATING WORK PLATFORMS FOR BUILDING MAINTENANCE AND FACADE CLEANING, ELECTRIC TRACKS, MAST ELEVATORS, TRAVELING LADDER AFFIXED TO THE PLATFORM BUT STILL HAVING MOBILITY, ALL SOLD TOGETHER AS A UNIT, AND BUILDING FACADE CLEANING MACHINES; MECHANICAL MACHINES AND APPARATUS, NAMELY, CRANES, ELEVATING WORK PLATFORMS FOR BUILDING FACADE CLEANING AND MAINTENANCE, TRACKS, MAST ELEVATORS, TRAVELING LADDER AFFIXED TO THE PLATFORM BUT STILL HAVING MOBILITY, ALL SOLD TOGETHER AS A UNIT, AND BUILDING FACADE CLEANING MACHINES; PNEUMATIC LIFTING BEAMS IN THE NATURE OF LIFTING WORK PLATFORMS, CRANES, ELEVATING FACADE LIFTS FOR BUILDING MAINTENANCE AND FACADE CLEANING, MAST ELEVATORS, AND TRAVELING LADDER AFFIXED TO THE PLATFORM BUT STILL HAVING MOBILITY, ALL SOLD TOGETHER AS A UNIT; CLEANING APPARATUS FOR BUILDING FACADES, NAMELY, FACADE ELEVATING LIFTS, ROBOTS AND MACHINES FOR CLEANING BUILDING FACADES (U.S. CLS. 13, 19, 21, 23, 31, 34 AND 35).

Laurie Mayes, EXAMINING ATTORNEY

**CLASS 7—(Continued).**

SN 77-876,609. BAR MAID CORPORATION, POMPANO BEACH, FL. FILED 11-19-2009.



NO CLAIM IS MADE TO THE EXCLUSIVE RIGHT TO USE "BAR", APART FROM THE MARK AS SHOWN.

THE MARK CONSISTS OF THE WORDS "BEST" ABOVE THE WORDING "IN THE", BELOW WHICH IS LOCATED THE WORDING "BAR" AND ALL THE WORDS "BEST IN THE BAR" BEING INSIDE A CIRCULAR DESIGN ELEMENT WHICH IS BROKEN BY TWO STAR DESIGN ELEMENTS AT THE 10 O'CLOCK AND 4 O'CLOCK POSITIONS.

FOR SMALL BAR APPLIANCES, NAMELY, PORTABLE ELECTRIC WASHERS USED FOR WASHING GLASSWARE (U.S. CLS. 13, 19, 21, 23, 31, 34 AND 35).

FIRST USE 7-31-2007; IN COMMERCE 7-31-2007.  
 NAPOLEON SHARMA, EXAMINING ATTORNEY

SN 77-959,059. PROVENTIA EMISSION CONTROL OY, OULUNSAALO, FINLAND, FILED 3-15-2010.

# PROAIR

THE MARK CONSISTS OF STANDARD CHARACTERS WITHOUT CLAIM TO ANY PARTICULAR FONT, STYLE, SIZE, OR COLOR.

OWNER OF ERPN CMNTY TM OFC REG. NO. 8952012, DATED 2-17-2011, EXPIRES 3-15-2020.

FOR ENGINE EXHAUST PURIFICATION SYSTEMS COMPRISING FILTERS AND CATALYSTS; EMISSION FILTERING APPARATUS FOR ENGINES; EMISSION FILTERS; VEHICLE ENGINE EMISSION CONTROL APPARATUS AND SYSTEMS COMPRISING FILTERS AND CATALYSTS (U.S. CLS. 13, 19, 21, 23, 31, 34 AND 35).

KEVON CHISOLM, EXAMINING ATTORNEY

**CLASS 7—(Continued).**

SN 79-092,876. HENGST GMBH & CO. KG, 48147 MÜNSTER, FED REP GERMANY, FILED 10-14-2010.

# Blue.jet

THE MARK CONSISTS OF STANDARD CHARACTERS WITHOUT CLAIM TO ANY PARTICULAR FONT, STYLE, SIZE, OR COLOR.

PRIORITY DATE OF 4-15-2010 IS CLAIMED.

OWNER OF INTERNATIONAL REGISTRATION 1065932 DATED 10-14-2010, EXPIRES 10-14-2020.

FOR CENTRIFUGES AND PARTS THEREFOR FOR USE IN MOTORS AND ENGINES EXCEPT FOR LAND VEHICLES; CENTRIFUGES AND PARTS THEREFOR, FOR USE IN MOTORS AND ENGINES FOR LAND VEHICLES AND FOR USE IN APPARATUS FOR LOCOMOTION BY LAND, AIR OR WATER (U.S. CLS. 13, 19, 21, 23, 31, 34 AND 35).

MAYUR VAGHANI, EXAMINING ATTORNEY

SN 79-093,377. ZHEJIANG OUYAO MACHINERY CO., LTD, TAIZHOU CITY ZHEJIANG, CHINA, FILED 6-29-2010.



OWNER OF INTERNATIONAL REGISTRATION 1067119 DATED 6-29-2010, EXPIRES 6-29-2020.

THE MARK CONSISTS OF THE TERM "OUYAO" WITH A DESIGN OF A CURVED LINE WITH A CIRCLE AT THE TOP END OF THE LINE.

THE WORDING "OUYAO" HAS NO MEANING IN A FOREIGN LANGUAGE.

FOR AGRICULTURAL MACHINES, NAMELY, CULTIVATORS, DISK HARROWS, SEEDERS; SPRAYING MACHINES; PUMPS AS PARTS OF MACHINES; GASOLINE ENGINES NOT FOR LAND VEHICLES; ELECTRIC WASHING MACHINES FOR INDUSTRIAL PURPOSE; SAWS MACHINES; PAPERMAKING MACHINES; POWER WEAVING LOOMS; DIP-DYEING MACHINES; TEA MANUFACTURING MACHINES; LEATHERWORKING MACHINES; BICYCLE ASSEMBLING MACHINES; STRAW ROPE FINISHING MACHINE; ELECTRIC FRUIT SQUEEZERS FOR HOUSEHOLD PURPOSES; ELECTRIC SPIN DRYERS FOR FOOD; MACHINES USED FOR PROCESS FILTRATION IN THE PHARMACEUTICAL INDUSTRY; ELECTROMECHANICAL MARKING MACHINES FOR CHEMICAL INDUSTRY; SLURRY PUMP FOR PETROLEUM; MIXERS; ELEVATORS LIFTS; PUNCHING PRESS FOR METALWORKING INDUSTRIAL PURPOSE; FOUNDRY MACHINES; STEAM ENGINES; HAND- HELD POWER TOOLS, OTHER THAN HAND-OPERATED, NAMELY, DRILLS, ROUTERS, CIRCULAR SAWS; DRIVING MOTORS OTHER THAN FOR LAND VEHICLES; COMPRESSED AIR MACHINES; PROPELLERS FOR WIND-POWERED ELECTRICITY GENERATORS; GAS-OPERATED SOLDERING IRONS; VEHICLE WASHING MACHINES; ELECTRICITY GENERATORS (U.S. CLS. 13, 19, 21, 23, 31, 34 AND 35).

BARBARA RUTLAND, EXAMINING ATTORNEY



**CLASS 7—(Continued).**

SN 79-094,167. DAIFUKU CO., LTD., JAPAN, FILED 2-3-2011.

**U-SPIN**

OWNER OF INTERNATIONAL REGISTRATION 1068716 DATED 2-3-2011, EXPIRES 2-3-2021.

THE MARK CONSISTS OF THE WORDING "U-SPIN" IN STYLIZED LETTERING.

FOR METALWORKING MACHINES; CONSTRUCTION MACHINES AND APPARATUS, NAMELY, CONCRETE CONSTRUCTION MACHINES, CONCRETE MIXERS, POWER DRILLS, HYDRAULIC EXCAVATORS; LOADING AND UNLOADING MACHINES; CONVEYORS; RAIL TYPE CONVEYORS; POWER OPERATED LIFTING EQUIPMENT NAMELY, LIFTING MECHANISM/LIFTS, NAMELY, MECHANICAL RAILED LIFTING CONVEYORS, FORK LIFTS, HYDRAULIC LIFTS AND CAR LIFTS; PAINTING MACHINES; PACKAGING AND WRAPPING MACHINES; SEMICONDUCTOR MANUFACTURING MACHINES; VEHICLE WASHING INSTALLATIONS; INTEGRATED CIRCUIT MANUFACTURING MACHINES (U.S. CLS. 13, 19, 21, 23, 31, 34 AND 35).

DEBRA LEE, EXAMINING ATTORNEY

SN 79-096,842. WENLING HUANYU BEARING CO., LTD., ZHEJIANG PROVINCE, CHINA, FILED 4-11-2011.

**FKG**

OWNER OF INTERNATIONAL REGISTRATION 1075598 DATED 4-11-2011, EXPIRES 4-11-2021.

THE MARK CONSISTS OF THE LETTERS "F", "K" AND "G", WITH A ITALIC DOT ON THE RIGHT SIDE ABOVE THE LETTER "k".

FOR SELF-OILING BEARINGS AS PARTS OF MACHINES; BALL-BEARINGS AS PARTS OF MACHINES; BEARINGS AS PARTS OF MACHINES; BEARINGS FOR TRANSMISSION SHAFTS, BEING PARTS OF MACHINES; ROLLER BEARINGS FOR MACHINES; BALL RINGS FOR BEARINGS FOR MACHINES, NAMELY, AUTOMOBILE, DYNAMO; ANTI-FRICTION BEARINGS FOR MACHINES; VEHICLE BEARINGS, NAMELY, ENGINE BEARINGS (U.S. CLS. 13, 19, 21, 23, 31, 34 AND 35).

MATTHEW EINSTEIN, EXAMINING ATTORNEY

**CLASS 7—(Continued).**

SN 79-098,688. ULVAC, INC., JAPAN, FILED 5-30-2011.

**ULGLAZE**

THE MARK CONSISTS OF STANDARD CHARACTERS WITHOUT CLAIM TO ANY PARTICULAR FONT, STYLE, SIZE, OR COLOR.

PRIORITY DATE OF 4-15-2011 IS CLAIMED.

OWNER OF INTERNATIONAL REGISTRATION 1080827 DATED 5-30-2011, EXPIRES 5-14-2022.

FOR CHEMICAL VAPOR DEPOSITION APPARATUS FOR USE IN THE MANUFACTURE OF SEMICONDUCTORS; VACUUM DEPOSITION APPARATUS FOR USE IN THE MANUFACTURE OF SEMICONDUCTORS; SPUTTERING APPARATUS FOR USE IN THE MANUFACTURE OF SEMICONDUCTORS (U.S. CLS. 13, 19, 21, 23, 31, 34 AND 35).

LAURA HAMMEL, EXAMINING ATTORNEY

SN 85-058,701. SCHRADER-BRIDGEPORT INTERNATIONAL, INC., ALTAVISTA, VA. FILED 6-9-2010.

**MAXFLOW**

THE MARK CONSISTS OF STANDARD CHARACTERS WITHOUT CLAIM TO ANY PARTICULAR FONT, STYLE, SIZE, OR COLOR.

FOR PNEUMATIC, HYDRAULIC AND HYDRO-PNEUMATIC CYLINDERS, ACTUATORS AND POSITIONERS FOR MECHANICAL PURPOSES; FLUID PRESSURE INTENSIFIERS FOR MECHANICAL PURPOSES; DIRECTIONAL CONTROL VALVES FOR MECHANICAL PURPOSES; EXHAUST VALVES, TWO-WAY DIRECT ACTING VALVES, DIAPHRAGM VALVES, AXIAL AND PISTON OPERATED VALVES FOR MECHANICAL PURPOSES; AIR LINE ACCESSORIES NAMELY COUPLINGS, BLOW GUNS AND SILENCERS, TUBING AND FITTINGS ALL FOR USE IN COMPRESSED AIR LINES AND AS PARTS OF MACHINES AND INTEGRATION OF ELECTRO-PNEUMATIC PANELS CONSISTING OF THE ABOVE COMPONENTS; AIR FILTRATION UNITS, AIR REGULATION UNITS, AIR LUBRICATION UNITS, AIR OPERATED ACTUATORS AND AIR CONTROL VALVES, ALL FOR USE IN COMPRESSED AIR LINES (U.S. CLS. 13, 19, 21, 23, 31, 34 AND 35).

JULIE GUTTADAURO, EXAMINING ATTORNEY

SN 85-122,474. ANEST IWATA CORPORATION, KANAGAWA-KEN, JAPAN, FILED 9-3-2010.

**maxxJet**

THE MARK CONSISTS OF THE WORDING "MAXX JET" IN STYLIZED FORMAT.

FOR AIR COMPRESSORS (U.S. CLS. 13, 19, 21, 23, 31, 34 AND 35).

CAROLINE WOOD, EXAMINING ATTORNEY

**CLASS 7—(Continued).**

SN 85-123,594. EASTERN WIND POWER, INC., CAMBRIDGE, MA. FILED 9-6-2010.

## Eastern Wind Power

THE MARK CONSISTS OF STANDARD CHARACTERS WITHOUT CLAIM TO ANY PARTICULAR FONT, STYLE, SIZE, OR COLOR.

NO CLAIM IS MADE TO THE EXCLUSIVE RIGHT TO USE "WIND POWER", APART FROM THE MARK AS SHOWN.

FOR PARTS OF WIND TURBINE MOTORS, NAMELY, COMPACT DRIVE SYSTEMS; WIND TURBINES; WIND-POWERED ELECTRICITY GENERATORS (U.S. CLS. 13, 19, 21, 23, 31, 34 AND 35).

FIRST USE 8-8-2008; IN COMMERCE 9-10-2009.  
DAVID C. REIHNER, EXAMINING ATTORNEY

---

SN 85-175,769. GOODMAN, JAMES A., HIGHLAND PARK, IL. FILED 11-12-2010.

## PEDDLEVISION

THE MARK CONSISTS OF STANDARD CHARACTERS WITHOUT CLAIM TO ANY PARTICULAR FONT, STYLE, SIZE, OR COLOR.

FOR ELECTRICAL AND ELECTRONIC APPARATUS AND EQUIPMENT, NAMELY, ELECTROMECHANICAL GENERATORS, BICYCLE CRANKSETS, PEDALS AND FRAMES FOR HOUSING THE APPARATUS AND EQUIPMENT, SOLD TOGETHER AS A UNIT, ALL FOR USE IN CONVERTING ENERGY OBTAINED FROM ALTERNATIVE ENERGY SOURCES, NAMELY, TURNING A CRANKSET, INTO ELECTRICITY (U.S. CLS. 13, 19, 21, 23, 31, 34 AND 35).

LAURA KOVALSKY, EXAMINING ATTORNEY

**CLASS 7—(Continued).**

SN 85-190,834. GRAND STRONG PRECISION MACHINES CO., LTD., QINGDAO CITY SHANDONG, CHINA, FILED 12-5-2010.



THE MARK CONSISTS OF ENGLISH LETTERS "LIJIAN" AND TWO OVERLAPPING ARROW HEADS SHOWN ABOVE THE ENGLISH LETTERS, THE TWO ARROW HEADS POINT TO OPPOSITE DIRECTIONS.

THE WORDING "LIJIAN" HAS NO MEANING IN A FOREIGN LANGUAGE.

FOR SEWING MACHINE PARTS, NAMELY, NEEDLE PLATE, GAUGE SET, NEEDLE PLATE ASSEMBLY, KNIVES; CUTTING CLOTH MACHINES; SEWING MACHINES; NAMELY, STITCHING MACHINES; CLOTH SLITTING KNIVESPARTS OF MACHINES; OVERLOCK SEWING MACHINES; ELECTRIC KNIVES FOR INDUSTRY USE; THREAD TRIMMER ATTACHMENT FOR SEWING MACHINES; SEWING MACHINES (U.S. CLS. 13, 19, 21, 23, 31, 34 AND 35).

REBECCA SMITH, EXAMINING ATTORNEY

---

SN 85-192,477. AYLWARD ENTERPRISES, LLC, NEW BERN, NC. FILED 12-7-2010.

## AYLMACH

THE MARK CONSISTS OF STANDARD CHARACTERS WITHOUT CLAIM TO ANY PARTICULAR FONT, STYLE, SIZE, OR COLOR.

FOR PACKAGING MACHINES AND PARTS THEREFOR (U.S. CLS. 13, 19, 21, 23, 31, 34 AND 35).

DANIEL CAPSHAW, EXAMINING ATTORNEY

**CLASS 7—(Continued).**

SN 85-193,575. WORLD DIAMOND SOURCE, INC., DBA WORLD DIAMOND SOURCE, POMPANO BEACH, FL. FILED 12-8-2010.



OWNER OF U.S. REG. NO. 3,495,716.  
NO CLAIM IS MADE TO THE EXCLUSIVE RIGHT TO USE "DIAMOND", APART FROM THE MARK AS SHOWN.  
THE MARK CONSISTS OF A DESIGN OF THE EARTH BEING CUT BY A DIAMOND BLADE WITH "WORLD DIAMOND SOURCE" THROUGH THE CENTER, AND "SERVING THE WORLD'S DIAMOND BLADE NEEDS" UNDERNEATH.

SEC. 2(F) AS TO "WORLD DIAMOND SOURCE".  
FOR BLADES FOR POWER SAWS (U.S. CLS. 13, 19, 21, 23, 31, 34 AND 35).  
FIRST USE 4-3-1996; IN COMMERCE 4-3-1996.  
REBECCA POVARCHUK, EXAMINING ATTORNEY

SN 85-200,766. CONN-WELD INDUSTRIES, INC., PRINCETON, WV. FILED 12-17-2010.

# TUFFLOK

THE MARK CONSISTS OF STANDARD CHARACTERS WITHOUT CLAIM TO ANY PARTICULAR FONT, STYLE, SIZE, OR COLOR.  
OWNER OF U.S. REG. NOS. 1,293,918, 3,175,828 AND OTHERS.  
FOR SCREEN PANELS FOR VIBRATING MACHINES (U.S. CLS. 13, 19, 21, 23, 31, 34 AND 35).  
WARREN L. OLANDRIA, EXAMINING ATTORNEY

**CLASS 7—(Continued).**

SN 85-208,516. TRIPPOINT, L.L.C., LAFAYETTE, LA. FILED S.R. 12-31-2010; AM. P.R. 9-12-2011.



THE MARK CONSISTS OF THE TERM "STIMPACT" WITH A STYLIZED DESIGN OF A SECTION OF HORIZONTAL WELL DRILLING EQUIPMENT EXTENDING FROM BELOW THE LETTER "I" AND UNDERLINING THE LETTERS "MP".

FOR OIL AND GAS WELL DOWNHOLE SERVICE TOOLS, NAMELY, WELL PACKERS AND PRODUCTION PACKERS (U.S. CLS. 13, 19, 21, 23, 31, 34 AND 35).  
FIRST USE 4-15-2010; IN COMMERCE 4-15-2010.  
ANTHONY RINKER, EXAMINING ATTORNEY

SN 85-260,733. BE AEROSPACE, INC., WELLINGTON, FL. FILED 3-8-2011.

# ICE SHIELD

THE MARK CONSISTS OF STANDARD CHARACTERS WITHOUT CLAIM TO ANY PARTICULAR FONT, STYLE, SIZE, OR COLOR.

OWNER OF U.S. REG. NO. 2,551,227.  
SEC. 2(F).  
FOR POWER OPERATED ELECTROTHERMAL AND PNEUMATIC DEICERS FOR ATTACHMENT TO AIRCRAFT TO PREVENT ICING (U.S. CLS. 13, 19, 21, 23, 31, 34 AND 35).  
FIRST USE 9-29-1997; IN COMMERCE 9-29-1997.  
CHRISTOPHER BUONGIORNO, EXAMINING ATTORNEY

SN 85-264,332. VEECO INSTRUMENTS INC., PLAINVIEW, NY. FILED 3-11-2011.

# MAXBRIGHT

THE MARK CONSISTS OF STANDARD CHARACTERS WITHOUT CLAIM TO ANY PARTICULAR FONT, STYLE, SIZE, OR COLOR.  
FOR CHEMICAL VAPOR DEPOSITION TOOLS, NAMELY, WAFER PROCESS MACHINES (U.S. CLS. 13, 19, 21, 23, 31, 34 AND 35).  
FIRST USE 2-7-2011; IN COMMERCE 2-22-2011.  
JACQUELINE A. LAVINE, EXAMINING ATTORNEY

**CLASS 7—(Continued).**

SN 85-268,461. TSUBAKI EMERSON CO., KYOTO, JAPAN,  
FILED 3-16-2011.

# ECHT-FLEX

THE MARK CONSISTS OF STANDARD CHARACTERS WITHOUT CLAIM TO ANY PARTICULAR FONT, STYLE, SIZE, OR COLOR.

OWNER OF JAPAN REG. NO. 5395515, DATED 3-4-2011, EXPIRES 3-4-2021.

FOR COUPLINGS FOR MACHINES; SHAFT COUPLINGS AS PARTS OF MACHINES; CLUTCHES FOR MACHINES; TORQUE CONVERTERS, NOT FOR LAND VEHICLES; LIMITING DEVICES, NAMELY, OVERLOAD CLUTCHES; AXLES FOR MACHINES; KEY-LESS SHAFTS FOR MACHINES; HUB COUPLING DEVICES, NOT FOR LAND VEHICLES; ENGINES NOT FOR LAND VEHICLES; ELECTRIC MOTORS, NOT FOR LAND VEHICLES; MOTORS FOR FORCE TRANSMISSION IN MACHINES; STARTERS FOR MOTORS AND ENGINES; SHOCK ABSORBERS FOR MACHINES; LINEAR ACTUATORS; INDEXING TRANSMISSIONS FOR MACHINES; INDUSTRIAL ROBOTS; TRANSMISSIONS FOR MACHINES, ENGINES, AND MOTORS; REDUCTION GEARS FOR MACHINES, ENGINES, AND MOTORS; SPEED CHANGERS FOR MACHINES, ENGINES, AND MOTORS; GEARS FOR MACHINES; GEAR BOXES, NOT FOR LAND VEHICLES; MACHINE PARTS, NAMELY, BEARINGS; CYLINDERS FOR MOTORS AND ENGINES (U.S. CLS. 13, 19, 21, 23, 31, 34 AND 35).  
SCOTT BIBB, EXAMINING ATTORNEY

---

SN 85-293,653. STAPLES THE OFFICE SUPERSTORE, LLC., FRAMINGHAM, MA. FILED 4-13-2011.



NO CLAIM IS MADE TO THE EXCLUSIVE RIGHT TO USE "PROFESSIONAL", APART FROM THE MARK AS SHOWN.

THE MARK CONSISTS OF A CIRCLE COMPRISED OF 4 CRESCENTS OVER THE WORDS "BRIGHTON PROFESSIONAL".

FOR FLOOR CLEANING MACHINES; VACUUM CLEANERS, VACUUM CLEANER REPLACEMENT BAGS (U.S. CLS. 13, 19, 21, 23, 31, 34 AND 35).

GIANCARLO CASTRO, EXAMINING ATTORNEY

**CLASS 7—(Continued).**

SN 85-296,210. GRAPHIC ARTS SYSTEMS, INC., OCEAN, NJ,  
FILED 4-15-2011.



NO CLAIM IS MADE TO THE EXCLUSIVE RIGHT TO USE "SYSTEMS", APART FROM THE MARK AS SHOWN.

THE MARK CONSISTS OF A CIRCLE CONTAINING AN EAGLE. BELOW THE CIRCLE ARE THE STYLIZED WORDS "EAGLE SYSTEMS".

FOR FOILING MACHINES, NAMELY, FOIL STAMPING MACHINES AND OFFSET FOIL TRANSFER MACHINES AND PARTS THEREFOR (U.S. CLS. 13, 19, 21, 23, 31, 34 AND 35).

FIRST USE 0-0-1990; IN COMMERCE 0-0-1990.  
JENNY PARK, EXAMINING ATTORNEY

---

SN 85-297,941. BREVILLE PTY. LIMITED, BOTANY, NEW SOUTH WALE, AUSTRALIA, FILED 4-18-2011.

# BREVILLE SOUS CHEF

THE MARK CONSISTS OF STANDARD CHARACTERS WITHOUT CLAIM TO ANY PARTICULAR FONT, STYLE, SIZE, OR COLOR.

OWNER OF U.S. REG. NOS. 1,935,749, 3,711,097 AND 3,711,098.

NO CLAIM IS MADE TO THE EXCLUSIVE RIGHT TO USE "SOUS CHEF", APART FROM THE MARK AS SHOWN. FOR ELECTRIC FOOD PROCESSORS (U.S. CLS. 13, 19, 21, 23, 31, 34 AND 35).

LIEF MARTIN, EXAMINING ATTORNEY

---

SN 85-299,659. MAGNUM PRODUCTS, LLC, BERLIN, WI,  
FILED 4-20-2011.

# POWER ZONE

THE MARK CONSISTS OF STANDARD CHARACTERS WITHOUT CLAIM TO ANY PARTICULAR FONT, STYLE, SIZE, OR COLOR.

OWNER OF U.S. REG. NO. 2,498,342.

NO CLAIM IS MADE TO THE EXCLUSIVE RIGHT TO USE "POWER", APART FROM THE MARK AS SHOWN.

FOR ELECTRICAL GENERATORS (U.S. CLS. 13, 19, 21, 23, 31, 34 AND 35).

SUE LAWRENCE, EXAMINING ATTORNEY

**CLASS 7—(Continued).**

SN 85-311,879. WUHAN GOLDENLASER CO., LTD., HUBEI, 430012, CHINA, FILED 5-4-2011.

**GOLDEN LASER**

NO CLAIM IS MADE TO THE EXCLUSIVE RIGHT TO USE "LASER", APART FROM THE MARK AS SHOWN.

THE MARK CONSISTS OF THE WORDING "GOLDEN LASER" IN STYLIZED FONT.

FOR PRINTING MACHINES FOR COMMERCIAL OR INDUSTRIAL USE; LEATHER TANNING MACHINES; INDUSTRIAL PAPER CUTTING MACHINES; STONE WORKING MACHINES; COMPUTER CONTROLLED WOOD, STONE, METAL, PLASTIC AND CERAMIC CARVING MACHINES; COMPUTER CONTROLLED WOOD, STONE, METAL, PLASTIC AND CERAMIC CARVING MACHINES FOR CARVING PRESET CHARACTERS; COMPUTER CONTROLLED CHARACTER CUTTING MACHINES; ELECTRON RUSH PLASTIC MACHINE, NAMELY, MACHINES FOR PLASTICS WORKING; PROCESSING PLASTIC MOULD, NAMELY, EXTRUSION MOULDING MACHINES AND PLASTIC JET MOULDING MACHINES; POLISHING MACHINES FOR USE IN GRINDING AND POLISHING METAL, WOOD, CERAMICS AND PLASTICS (U.S. CLS. 13, 19, 21, 23, 31, 34 AND 35).

FIRST USE 3-10-2009; IN COMMERCE 5-20-2010.  
ELLEN PERKINS, EXAMINING ATTORNEY

SN 85-315,991. DIVERSIFIED DYNAMICS CORPORATION, MINNEAPOLIS, MN. FILED 5-9-2011.

**FINISH MAX**

THE MARK CONSISTS OF STANDARD CHARACTERS WITHOUT CLAIM TO ANY PARTICULAR FONT, STYLE, SIZE, OR COLOR.

NO CLAIM IS MADE TO THE EXCLUSIVE RIGHT TO USE "FINISH", APART FROM THE MARK AS SHOWN.

FOR HIGH VOLUME, LOW PRESSURE HAND HELD PAINT SPRAYER WITH A HOSE CONNECTED TO A BASE UNIT WITH A MOTOR (U.S. CLS. 13, 19, 21, 23, 31, 34 AND 35).

WILLIAM ROSSMAN, EXAMINING ATTORNEY

**CLASS 7—(Continued).**

SN 85-316,406. WHEELLESS, JUSTIN, J, DBA THE SPRAY BOX, TALLAHASSEE, FL. FILED 5-9-2011.



NO CLAIM IS MADE TO THE EXCLUSIVE RIGHT TO USE "SPRAY", APART FROM THE MARK AS SHOWN.

THE COLOR(S) BLACK, YELLOW, WHITE IS/ARE CLAIMED AS A FEATURE OF THE MARK.

THE MARK CONSISTS OF A BLACK BACKGROUND WITH THE STYLIZED WORDS "THE SPRAY BOX" WITH THE LETTERING FADING FROM YELLOW TO WHITE STARTING WITH THE LETTERS "AY" IN THE WORD "SPRAY", AND GOING BACK TO YELLOW WITHIN THE WORD "BOX".

FOR MACHINES FOR CLEANING SURFACES USING HIGH PRESSURE WATER; MULTI-PURPOSE HIGH PRESSURE WASHERS (U.S. CLS. 13, 19, 21, 23, 31, 34 AND 35).

FIRST USE 8-1-2010; IN COMMERCE 8-1-2010.  
MARY CRAWFORD, EXAMINING ATTORNEY

SN 85-317,898. ACCURATE TECHNOLOGIES COMPANY LIMITED, SAMUTPRAKARN, THAILAND, FILED 5-11-2011.



OWNER OF U.S. REG. NO. 3,979,162.

NO CLAIM IS MADE TO THE EXCLUSIVE RIGHT TO USE "INTERNATIONAL", APART FROM THE MARK AS SHOWN.

THE MARK CONSISTS OF GLOBE ON THE LEFT EDGE OF AN OUTLINE OF AN OVAL. THE WORD "INTERNATIONAL IMAGE" IS WITHIN THE OVAL. THE WORD "INTERNATIONAL" IS WRITTEN ALONG THE LEFT EDGE OF THE LETTER "I" IN "IMAGE".

FOR COMMERCIAL AND INDUSTRIAL LAUNDRY EQUIPMENT, NAMELY, WASHER EXTRACTORS, NAMELY, ELECTRIC CLOTHING PRESSING MACHINES, AND FLATWORK FOLDERS, NAMELY, CLOTHES FOLDING MACHINES (U.S. CLS. 13, 19, 21, 23, 31, 34 AND 35).

KATHY DE JONGE, EXAMINING ATTORNEY

**CLASS 7—(Continued).**

SN 85-320,946. EVOLUTION ROBOTICS, INC., PASADENA, CA. FILED 5-13-2011.

**MINT PLUS**

THE MARK CONSISTS OF STANDARD CHARACTERS WITHOUT CLAIM TO ANY PARTICULAR FONT, STYLE, SIZE, OR COLOR.

OWNER OF U.S. REG. NOS. 3,945,514, 3,945,547 AND 3,945,548.

FOR AUTOMATIC FLOOR CLEANING MACHINES FOR CONSUMER USE (U.S. CLS. 13, 19, 21, 23, 31, 34 AND 35).

FRANK LATTUCA, EXAMINING ATTORNEY

**CLASS 7—(Continued).**

SN 85-329,445. SUZHOU POWERGREEN EMISSION SOLUTION SYSTEM CO., LTD., JIANGSU PROVINCE, CHINA, FILED 5-25-2011.



NO CLAIM IS MADE TO THE EXCLUSIVE RIGHT TO USE "EMISSION SOLUTION SYSTEM", APART FROM THE MARK AS SHOWN.

THE MARK CONSISTS OF A CIRCULAR DESIGN FORMED BY SEVEN BROAD CURVING BANDS ON THE LEFT, THE STYLIZED WORD POWERGREEN ABOVE THE STYLIZED WORDS EMISSION SOLUTION SYSTEM ON THE RIGHT.

FOR CATALYTIC CONVERTER UNITS FOR VEHICLE EXHAUSTS; CATALYTIC CONVERTERS; ENGINE EXHAUST SYSTEMS COMPRISED OF PIPES, COLLECTOR AND MUFFLER; ENGINE INJECTORS; EXHAUST GAS TREATMENT SYSTEMS FOR DIESEL ENGINES; MACHINE PARTS THAT HEAT AND MAINTAIN TEMPERATURE IN MACHINE PIPING SYSTEMS, NAMELY, STEAM JACKETING, ELECTRICAL TRACING, AND INSULATION SOLD AS INTEGRAL COMPONENTS OF FINISHED MACHINES; MUFFLERS FOR MOTORS AND ENGINES; PUMP DIAPHRAGMS; PUMPS FOR MACHINES; WATER PUMPS FOR USE IN MOTORS AND ENGINES (U.S. CLS. 13, 19, 21, 23, 31, 34 AND 35).

LEIGH LOWRY, EXAMINING ATTORNEY

SN 85-325,641. HUBBELL INCORPORATED, SHELTON, CT. FILED 5-20-2011.

**MINUTEMAN**

THE MARK CONSISTS OF STANDARD CHARACTERS WITHOUT CLAIM TO ANY PARTICULAR FONT, STYLE, SIZE, OR COLOR.

FOR HAND-HELD BATTERY ACTUATED HYDRAULIC CRIMPING TOOL (U.S. CLS. 13, 19, 21, 23, 31, 34 AND 35).

TRACY WHITTAKER-BROWN, EXAMINING ATTORNEY

SN 85-330,827. PTS SALES COMPANY, WARREN, MI. FILED 5-26-2011.

**RAPID TRU**

THE MARK CONSISTS OF STANDARD CHARACTERS WITHOUT CLAIM TO ANY PARTICULAR FONT, STYLE, SIZE, OR COLOR.

FOR MACHINE PARTS, NAMELY, WORK HOLDING FIXTURES FOR PRECISION MACHINING APPLICATIONS; MACHINE TOOLS, NAMELY CLAMPS FOR USE IN THE PRECISION CLAMPING OF WORK PIECES; MACHINE TOOLS, NAMELY VICES FOR USE IN THE PRECISION CLAMPING OF WORK PIECES (U.S. CLS. 13, 19, 21, 23, 31, 34 AND 35).

LINDA POWELL, EXAMINING ATTORNEY

**CLASS 7—(Continued).**

SN 85-332,031. PRODUCTION DESIGN PRODUCTS, INC.,  
RAMSEY, MN. FILED 5-27-2011.

# MATMASTER

THE MARK CONSISTS OF STANDARD CHARACTERS  
WITHOUT CLAIM TO ANY PARTICULAR FONT, STYLE,  
SIZE, OR COLOR.

FOR FLOOR MAT ROLLING MACHINES FOR COM-  
MERCIAL USE (U.S. CLS. 13, 19, 21, 23, 31, 34 AND 35).  
YAT SYE, LEE, EXAMINING ATTORNEY

---

SN 85-332,046. INTEGRADIGM CORPORATION, FORT  
WAYNE, IN. FILED 5-27-2011.

# MUFLERCO

THE MARK CONSISTS OF STANDARD CHARACTERS  
WITHOUT CLAIM TO ANY PARTICULAR FONT, STYLE,  
SIZE, OR COLOR.

FOR RECEIVERS FOR EXHAUST AND EMISSION  
SYSTEMS, NAMELY, MUFFLERS AND SOUND DEAD-  
ENING DEVICES (U.S. CLS. 13, 19, 21, 23, 31, 34 AND 35).  
KHANH LE, EXAMINING ATTORNEY

---

SN 85-332,396. UNITED RENTALS, INC., GREENWICH, CT.  
FILED 5-27-2011.

# TRUE CAST

THE MARK CONSISTS OF STANDARD CHARACTERS  
WITHOUT CLAIM TO ANY PARTICULAR FONT, STYLE,  
SIZE, OR COLOR.

FOR BLADES FOR POWER SAWS (U.S. CLS. 13, 19, 21,  
23, 31, 34 AND 35).  
KAREN SEVERSON, EXAMINING ATTORNEY

**CLASS 7—(Continued).**

SN 85-334,200. AIR-O FASTENERS, KAYSVILLE, UT. FILED  
5-31-2011.

THE MARK CONSISTS OF AN OVER SIZED LETTER "A",  
THE "A" HAS ITS CROSS MEMBER FORMING AN ARROW  
THAT UNDERLINES THE REST OF THE WORD, ALL  
LETTERS ARE IN CAPITAL LETTERS, THE ARROW JOINS  
THE LETTER "R" WITH AN ARROWHEAD JOINING THE  
FURTHEST MOST LEG OF THE LETTER "R".

FOR AIR POWERED TOOLS, NAMELY, POWER  
STAPLERS, POWER OPERATED NAILING GUNS AND  
ACCESSORIES THEREFOR, NAMELY, AIR COMPRES-  
SORS, AIR HOSE COUPLERS, POWER OPERATED  
SCREW GUNS AND ACCESSORIES (U.S. CLS. 13, 19,  
21, 23, 31, 34 AND 35).

FIRST USE 2-1-2011; IN COMMERCE 2-1-2011.  
ZACHARY BELLO, EXAMINING ATTORNEY

---

SN 85-334,460. HAMPTON PRODUCTS INTERNATIONAL  
CORPORATION, FOOTHILL RANCH, CA. FILED 5-31-  
2011.

OWNER OF U.S. REG. NOS. 2,497,135, 2,613,811 AND  
OTHERS.

NO CLAIM IS MADE TO THE EXCLUSIVE RIGHT TO  
USE "PRODUCTS", APART FROM THE MARK AS SHOWN.

THE MARK CONSISTS OF THE STYLIZED WORD  
"WRIGHT" UNDERSCORED BY A HORIZONTAL LINE,  
BELOW WHICH IS THE WORD "PRODUCTS" IN CAPITA-  
LIZED BLOCK LETTERS.

SEC. 2(F).

FOR HYDRAULIC AND PNEUMATIC DOOR CLO-  
SERS FOR STORM, SCREEN, AND PATIO DOORS (U.S.  
CLS. 13, 19, 21, 23, 31, 34 AND 35).

FIRST USE 9-2-2010; IN COMMERCE 9-2-2010.

WARREN L. OLANDRIA, EXAMINING ATTORNEY

**CLASS 7—(Continued).**

SN 85-334,484. JAIR TREJO, LLC., SOUTH EL MONTE, CA. FILED 5-31-2011.

# dicermatic

THE MARK CONSISTS OF STANDARD CHARACTERS WITHOUT CLAIM TO ANY PARTICULAR FONT, STYLE, SIZE, OR COLOR.

FOR ELECTRIC FOOD CHOPPERS (U.S. CLS. 13, 19, 21, 23, 31, 34 AND 35).  
H. M. FISHER, EXAMINING ATTORNEY

**CLASS 7—(Continued).**

SN 85-336,618. DEERE & COMPANY, MOLINE, IL. FILED 6-2-2011.

# TANGO

THE MARK CONSISTS OF STANDARD CHARACTERS WITHOUT CLAIM TO ANY PARTICULAR FONT, STYLE, SIZE, OR COLOR.

FOR LAWNMOWERS (U.S. CLS. 13, 19, 21, 23, 31, 34 AND 35).  
SKYE YOUNG, EXAMINING ATTORNEY

SN 85-335,161. SSP FITTINGS CORP., TWINSBURG, OH. FILED 6-1-2011.

# TURNPRO

THE MARK CONSISTS OF STANDARD CHARACTERS WITHOUT CLAIM TO ANY PARTICULAR FONT, STYLE, SIZE, OR COLOR.

FOR POWER TOOLS FOR BENDING, CUTTING, DEBURRING, TURNING, TWISTING AND PHYSICALLY MANIPULATING TUBING, TUBE FITTINGS, AND FITTINGS FOR VALVES AND GAUGES (U.S. CLS. 13, 19, 21, 23, 31, 34 AND 35).

FIRST USE 5-1-2011; IN COMMERCE 5-1-2011.  
MARK T. MULLEN, EXAMINING ATTORNEY

SN 85-337,728. POSITEC GROUP LIMITED, HONG KONG ADM. REGION, CHINA, FILED 6-3-2011.

# VERSACUT

THE MARK CONSISTS OF STANDARD CHARACTERS WITHOUT CLAIM TO ANY PARTICULAR FONT, STYLE, SIZE, OR COLOR.

FOR POWER OPERATED TOOLS, NAMELY, SAWS (U.S. CLS. 13, 19, 21, 23, 31, 34 AND 35).

FIRST USE 6-1-2011; IN COMMERCE 6-1-2011.  
LESLEY LAMOTHE, EXAMINING ATTORNEY

SN 85-336,332. NEW WIND, LLC, NASHVILLE, TN. FILED 6-2-2011.

ENERGY SAVINGS IS A BREEZE

THE MARK CONSISTS OF STANDARD CHARACTERS WITHOUT CLAIM TO ANY PARTICULAR FONT, STYLE, SIZE, OR COLOR.

FOR WIND TURBINES (U.S. CLS. 13, 19, 21, 23, 31, 34 AND 35).  
CHRISTINE COOPER, EXAMINING ATTORNEY

SN 85-341,147. PYROTEK INCORPORATED, SPOKANE VALLEY, WA. FILED 6-8-2011.

# SNIF

THE MARK CONSISTS OF CAPITALIZED AND SLIGHTLY ITALICIZED LETTERS "SNIF" IN BLACK.

FOR MACHINE TOOLS FOR REMOVING IMPURITIES FROM ALUMINUM DURING REFINING (U.S. CLS. 13, 19, 21, 23, 31, 34 AND 35).

FIRST USE 1-1-1974; IN COMMERCE 10-18-1976.  
JILL C. ALT, EXAMINING ATTORNEY



**CLASS 7—(Continued).**

SN 85-356,570. BETCO CORPORATION, TOLEDO, OH.  
FILED 6-27-2011.

# GENIE

THE MARK CONSISTS OF STANDARD CHARACTERS WITHOUT CLAIM TO ANY PARTICULAR FONT, STYLE, SIZE, OR COLOR.

FOR FLOOR CLEANING MACHINES (U.S. CLS. 13, 19, 21, 23, 31, 34 AND 35).

FIRST USE 7-1-2007; IN COMMERCE 7-1-2007.  
MATTHEW KLINE, EXAMINING ATTORNEY

**CLASS 7—(Continued).**

SN 85-380,129. THE TORO COMPANY, BLOOMINGTON, MN. FILED 7-25-2011.

# HOVERPRO

THE MARK CONSISTS OF STANDARD CHARACTERS WITHOUT CLAIM TO ANY PARTICULAR FONT, STYLE, SIZE, OR COLOR.

FOR OUTDOOR POWER EQUIPMENT, NAMELY, LAWN MOWERS (U.S. CLS. 13, 19, 21, 23, 31, 34 AND 35).  
ANTHONY RINKER, EXAMINING ATTORNEY

SN 85-362,852. PULSAFEEDER, INC., ROCHESTER, NY.  
FILED 7-5-2011.

# OBL

THE MARK CONSISTS OF STANDARD CHARACTERS WITHOUT CLAIM TO ANY PARTICULAR FONT, STYLE, SIZE, OR COLOR.

FOR CENTRIFUGAL PUMPS; HYDRAULIC PUMPS; POSITIVE DISPLACEMENT PUMPS; PUMP DIAPHRAGMS (U.S. CLS. 13, 19, 21, 23, 31, 34 AND 35).

FIRST USE 7-30-1975; IN COMMERCE 7-30-1975.  
HELENE LIWINSKI, EXAMINING ATTORNEY

SN 85-374,136. FASTENAL IP COMPANY, WINONA, MN.  
FILED 7-18-2011.

# FMT

THE MARK CONSISTS OF STANDARD CHARACTERS WITHOUT CLAIM TO ANY PARTICULAR FONT, STYLE, SIZE, OR COLOR.

FOR DRILL BITS FOR POWER DRILLS; TAPS AND DIES FOR USE WITH MACHINE TOOLS; BLADES FOR POWER SAWS, ANNULAR CUTTERS (U.S. CLS. 13, 19, 21, 23, 31, 34 AND 35).

FIRST USE 5-0-2007; IN COMMERCE 5-0-2007.  
NAAKWAMA ANKRAH, EXAMINING ATTORNEY

SN 85-380,151. SCHLUMBERGER TECHNOLOGY CORPORATION, ROSHARON, TX. FILED 7-25-2011.

# MANARA

THE MARK CONSISTS OF STANDARD CHARACTERS WITHOUT CLAIM TO ANY PARTICULAR FONT, STYLE, SIZE, OR COLOR.

THE ENGLISH TRANSLATION OF "MANARA" IN THE MARK IS "LIGHTHOUSE".

FOR A MULTIPLE SEGMENT PRODUCTION ASSEMBLY FOR SUBSURFACE WELLS NAMELY FLOW CONTROL VALVES, PACKERS, MONITORING AND TELEMETRY EQUIPMENT FOR SEGMENTING A DOWNHOLE WELL AND ENABLING CONTROL AND MONITORING OF EACH INDIVIDUAL SEGMENT WHILE PRODUCING THE WELL (U.S. CLS. 13, 19, 21, 23, 31, 34 AND 35).

SKYE YOUNG, EXAMINING ATTORNEY

SN 85-380,949. JOHNSON ELECTRIC HOLDINGS LIMITED, SHATIN, N.T., HONG KONG, FILED 7-26-2011.

# POSI-PINION

THE MARK CONSISTS OF STANDARD CHARACTERS WITHOUT CLAIM TO ANY PARTICULAR FONT, STYLE, SIZE, OR COLOR.

FOR ELECTRIC STARTER MOTORS (U.S. CLS. 13, 19, 21, 23, 31, 34 AND 35).

KELLY BOULTON, EXAMINING ATTORNEY

**CLASS 7—(Continued).**

SN 85-394,323. INVISTA NORTH AMERICA S.A R.L., WICHITA, KS. FILED 8-10-2011.



THE MARK CONSISTS OF DIFFERENT SIZE BALLS APPEARING IN A PINWHEEL FASHION, AND THE WORDS "PRECISION" AND "CONCEPTS" SEPARATED BY A LINE.

FOR MACHINE PARTS (U.S. CLS. 13, 19, 21, 23, 31, 34 AND 35).  
 NAAKWAMA ANKRAH, EXAMINING ATTORNEY

SN 85-398,162. PANASONIC CORPORATION OF NORTH AMERICA, SECAUCUS, NJ. FILED 8-15-2011.

**JETFORCE**

THE MARK CONSISTS OF STANDARD CHARACTERS WITHOUT CLAIM TO ANY PARTICULAR FONT, STYLE, SIZE, OR COLOR.

FOR VACUUM CLEANERS (U.S. CLS. 13, 19, 21, 23, 31, 34 AND 35).  
 KATHERINE CHANG, EXAMINING ATTORNEY

SN 85-403,423. DEERE & COMPANY, MOLINE, IL. FILED 8-22-2011.



OWNER OF U.S. REG. NOS. 1,254,339, 3,132,124 AND OTHERS.

THE COLOR(S) GREEN AND YELLOW IS/ARE CLAIMED AS A FEATURE OF THE MARK.

THE MARK CONSISTS OF THE COLOR COMBINATION GREEN AND YELLOW IN WHICH GREEN IS APPLIED TO AN EXTERIOR SURFACE OF THE MACHINE AND YELLOW IS APPLIED TO THE WHEELS. THE BROKEN-LINE OUTLINING IS TO SHOW THE POSITION OR PLACEMENT OF THE MARK ON THE GOODS. THE OUTLINING AND THE SHAPE OF THE MACHINE ARE NOT CLAIMED AS PART OF THE MARK.

SEC. 2(F).  
 FOR FORESTRY MACHINES, NAMELY, FELLER BUNCHERS, SKIDDERS, HARVESTERS AND FORWARDERS, KNUCKLEBOOM LOADERS (U.S. CLS. 13, 19, 21, 23, 31, 34 AND 35).

FIRST USE 6-1-2005; IN COMMERCE 6-1-2005.  
 LINDA ESTRADA, EXAMINING ATTORNEY

**CLASS 7—(Continued).**

SN 85-403,459. DEERE & COMPANY, MOLINE, IL. FILED 8-22-2011.



OWNER OF U.S. REG. NOS. 1,254,339, 3,132,124 AND OTHERS.

THE COLOR(S) GREEN AND YELLOW IS/ARE CLAIMED AS A FEATURE OF THE MARK.

THE MARK CONSISTS OF THE COLOR COMBINATION GREEN AND YELLOW IN WHICH GREEN IS APPLIED TO AN EXTERIOR SURFACE OF THE MACHINE AND A YELLOW STRIPE IS APPLIED TO A PORTION OF THE EXTERIOR SURFACE. WHEN VIEWED FROM A DISTANCE, THE STRIPE APPEARS SOLID YELLOW. BROKEN-LINE OUTLINING IS TO SHOW THE POSITION OR PLACEMENT OF THE MARK ON THE GOODS. THE OUTLINING AND THE SHAPE OF THE MACHINE ARE NOT CLAIMED AS PART OF THE MARK.

SEC. 2(F).  
 FOR FORESTRY MACHINES, NAMELY, FELLER BUNCHERS, SKIDDERS, HARVESTERS AND FORWARDERS, KNUCKLEBOOM LOADERS, FORESTRY SWING MACHINES (U.S. CLS. 13, 19, 21, 23, 31, 34 AND 35).

FIRST USE 6-1-2005; IN COMMERCE 6-1-2005.  
 LINDA ESTRADA, EXAMINING ATTORNEY

SN 85-403,506. DEERE & COMPANY, MOLINE, IL. FILED 8-22-2011.



OWNER OF U.S. REG. NOS. 1,254,339, 1,503,576 AND 3,132,124.

THE COLOR(S) GREEN AND YELLOW IS/ARE CLAIMED AS A FEATURE OF THE MARK.

THE MARK CONSISTS OF THE COLOR COMBINATION GREEN AND YELLOW IN WHICH GREEN IS APPLIED TO AN EXTERIOR SURFACE OF THE MACHINE AND YELLOW IS APPLIED TO THE WHEELS. THE BROKEN-LINE OUTLINING IS TO SHOW THE POSITION OR PLACEMENT OF THE MARK ON THE GOODS. THE OUTLINING AND THE SHAPE OF THE MACHINE ARE NOT CLAIMED AS PART OF THE MARK.

SEC. 2(F).  
 FOR FORESTRY MACHINES, NAMELY, FELLER BUNCHERS, SKIDDERS, HARVESTERS AND FORWARDERS, KNUCKLEBOOM LOADERS (U.S. CLS. 13, 19, 21, 23, 31, 34 AND 35).

FIRST USE 12-31-2005; IN COMMERCE 12-31-2005.  
 LINDA ESTRADA, EXAMINING ATTORNEY

**CLASS 7—(Continued).**

SN 85-404,464. DEERE & COMPANY, MOLINE, IL. FILED 8-23-2011.

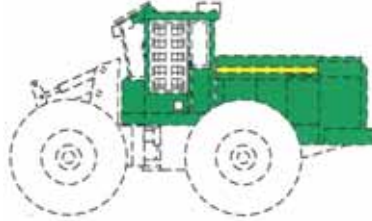

OWNER OF U.S. REG. NOS. 1,254,339, 3,132,124 AND OTHERS.

THE COLOR(S) GREEN AND YELLOW IS/ARE CLAIMED AS A FEATURE OF THE MARK.

THE MARK CONSISTS OF THE COLOR COMBINATION GREEN AND YELLOW IN WHICH GREEN IS APPLIED TO AN EXTERIOR SURFACE OF THE MACHINE AND A YELLOW STRIPE IS APPLIED TO A PORTION OF THE EXTERIOR SURFACE. WHEN VIEWED FROM A DISTANCE, THE STRIPE APPEARS SOLID YELLOW. BROKEN-LINE OUTLINING IS TO SHOW THE POSITION OR PLACEMENT OF THE MARK ON THE GOODS. THE OUTLINING AND THE SHAPE OF THE MACHINE ARE NOT CLAIMED AS PART OF THE MARK.

SEC. 2(F).

FOR FORESTRY MACHINES, NAMELY, FELLER BUNCHERS, SKIDDERS, HARVESTERS AND FORWARDERS, KNUCKLEBOOM LOADERS, FORESTRY SWING MACHINES (U.S. CLS. 13, 19, 21, 23, 31, 34 AND 35).

FIRST USE 6-30-2004; IN COMMERCE 6-30-2004.

LINDA ESTRADA, EXAMINING ATTORNEY

**CLASS 8—HAND TOOLS**

SN 77-712,194. NGHIA NIPPERS CORPORATION, HO CHI MINH, VIETNAM, FILED 4-12-2009.



SN 85-404,554. DEERE & COMPANY, MOLINE, IL. FILED 8-23-2011.

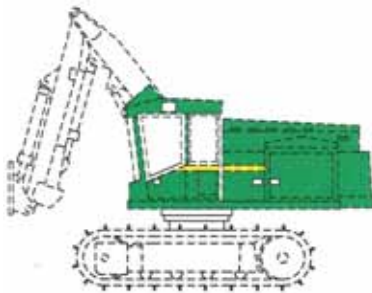

OWNER OF U.S. REG. NOS. 1,254,339, 3,132,124 AND OTHERS.

THE COLOR(S) GREEN AND YELLOW IS/ARE CLAIMED AS A FEATURE OF THE MARK.

THE MARK CONSISTS OF THE COLOR COMBINATION GREEN AND YELLOW IN WHICH GREEN IS APPLIED TO AN EXTERIOR SURFACE OF THE MACHINE AND A YELLOW STRIPE IS APPLIED TO A PORTION OF THE EXTERIOR SURFACE. WHEN VIEWED FROM A DISTANCE, THE STRIPE APPEARS SOLID YELLOW. BROKEN-LINE OUTLINING IS TO SHOW THE POSITION OR PLACEMENT OF THE MARK ON THE GOODS. THE OUTLINING AND THE SHAPE OF THE MACHINE ARE NOT CLAIMED AS PART OF THE MARK.

SEC. 2(F).

FOR FORESTRY MACHINES, NAMELY, FELLER BUNCHERS, SKIDDERS, HARVESTERS AND FORWARDERS, KNUCKLEBOOM LOADERS, FORESTRY SWING MACHINES (U.S. CLS. 13, 19, 21, 23, 31, 34 AND 35).

FIRST USE 6-30-2004; IN COMMERCE 6-30-2004.

LINDA ESTRADA, EXAMINING ATTORNEY

PRIORITY CLAIMED UNDER SEC. 44(D) ON VIETNAM APPLICATION NO. 4-2009-04171, FILED 3-12-2009, REG. NO. 146771, DATED 5-20-2010, EXPIRES 3-12-2019.

OWNER OF U.S. REG. NOS. 3,546,083 AND 3,549,186.

THE COLOR(S) BLACK, WHITE, GREEN, YELLOW AND GREY IS/ARE CLAIMED AS A FEATURE OF THE MARK.

THE MARK CONSISTS OF A RECTANGLE IN BLACK AND GREEN WHICH CONTAINS A SMALL RECTANGLE IN GREY, TWO OBLIQUE BANDS, ONE IN GREY AND OTHER IN YELLOW, AND WORD "NGHIA" IN WHITE. THE ROUNDED OUTLINE OF THE RECTANGLE IS NOT CLAIMED AS A FEATURE OF THE MARK.

THE WORDING "NGHIA" HAS NO MEANING IN A FOREIGN LANGUAGE.

FOR NAIL NIPPERS, TOENAIL NIPPERS, NAIL FILES, TWEEZERS, HAIR CUTTING SCISSORS (U.S. CLS. 23, 28 AND 44).

ANGELA DUONG, EXAMINING ATTORNEY

**CLASS 8—(Continued).**

SN 79-090,921. DA LIAN YA TU TOU ZI ZI XUN YOU XIAN GONG SI, LIAONING PROVINCE, CHINA, FILED 11-25-2010.

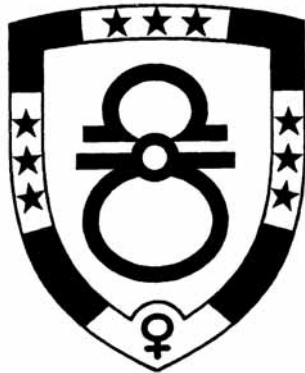

OWNER OF INTERNATIONAL REGISTRATION 1060930 DATED 11-25-2010, EXPIRES 11-25-2020.

THE MARK CONSISTS OF A STYLIZED SHIELD, WITH THREE STARS WITHIN THE TOP, LOWER LEFT AND LOWER RIGHT BORDERS OF THE SHIELD, A MALE GENDER SYMBOL WITHIN THE BOTTOM BORDER, WITHIN THE SHIELD AT THE TOP IS THE OMEGA SYMBOL ATOP AN UPSIDE DOWN OMEGA SYMBOL WITH AN OVAL IN THE MIDDLE OF THE DESIGN SEPARATING THE TWO SYMBOLS.

FOR HAND OPERATED AGRICULTURAL IMPLEMENTS, NAMELY, BROADFORKS, CIDER PRESSES, RAKES; GARDEN TOOLS, HAND-OPERATED, NAMELY, TROWELS, WEEDING FORKS, SPADES, HOES; HARPOONS FOR COMMERCIAL FISHING; ELECTRIC BEARD CLIPPERS; MANICURE SETS; HAND-OPERATED SCRAPING TOOL FOR CLEANING CLEATS FOR ATTACHMENT TO SPORTS SHOES; HAND TOOLS, NAMELY, GRAVING TOOLS; KNIVES; SWORDS; TABLEWARE, NAMELY, KNIVES, FORKS AND SPOONS (U.S. CLS. 23, 28 AND 44).

SCOTT BIBB, EXAMINING ATTORNEY

**CLASS 8—(Continued).**

SN 79-090,922. DA LIAN YA TU TOU ZI ZI XUN YOU XIAN GONG SI, LIAONING PROVINCE, CHINA, FILED 11-25-2010.



OWNER OF INTERNATIONAL REGISTRATION 1060931 DATED 11-25-2010, EXPIRES 11-25-2020.

THE MARK CONSISTS OF A STYLIZED SHIELD, WITH THREE STARS WITHIN THE TOP, LOWER LEFT AND LOWER RIGHT BORDERS OF THE SHIELD, A MALE GENDER SYMBOL WITHIN THE BOTTOM BORDER, WITHIN THE SHIELD AT THE TOP IS THE SCORPIO ZODIAC SYMBOL ATOP A STYLIZED "A" WITH AN OVAL IN THE MIDDLE OF THE DESIGN SEPARATING THE TWO SYMBOLS.

FOR HAND OPERATED AGRICULTURAL IMPLEMENTS, NAMELY, BROADFORKS, CIDER PRESSES, RAKES; GARDEN TOOLS, HAND-OPERATED, NAMELY, TROWELS, WEEDING FORKS, SPADES, HOES; HARPOONS FOR COMMERCIAL FISHING; ELECTRIC BEARD CLIPPERS; MANICURE SETS; HAND-OPERATED SCRAPING TOOL FOR CLEANING CLEATS FOR ATTACHMENT TO SPORTS SHOES; HAND TOOLS, NAMELY, GRAVING TOOLS; KNIVES; SWORDS; TABLEWARE, NAMELY, KNIVES, FORKS AND SPOONS (U.S. CLS. 23, 28 AND 44).

SCOTT BIBB, EXAMINING ATTORNEY

**CLASS 8—(Continued).**

SN 79-090,923. DA LIAN YA TU TOU ZI ZI XUN YOU XIAN GONG SI, LIAONING PROVINCE, CHINA, FILED 11-25-2010.

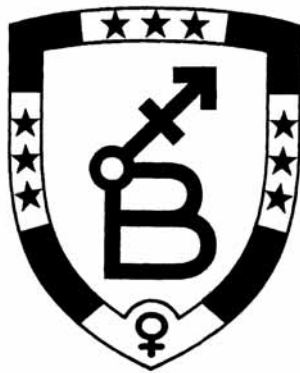

OWNER OF INTERNATIONAL REGISTRATION 1060932 DATED 11-25-2010, EXPIRES 11-25-2020.

THE MARK CONSISTS OF A STYLIZED SHIELD, WITH THREE STARS WITHIN THE TOP, LOWER LEFT AND LOWER RIGHT BORDERS OF THE SHIELD, A FEMALE GENDER SYMBOL WITHIN THE BOTTOM BORDER, WITHIN THE SHIELD AT THE TOP IS THE SAGITTARIUS ZODIAC SYMBOL WITH AN OVAL AT THE END, ATOP A STYLIZED LETTER "B".

FOR HAND OPERATED AGRICULTURAL IMPLEMENTS, NAMELY, BROADFORKS, CIDER PRESSES, RAKES; GARDEN TOOLS, HAND-OPERATED, NAMELY, TROWELS, WEEDING FORKS, SPADES, HOES; HARPOONS FOR COMMERCIAL FISHING; ELECTRIC BEARD CLIPPERS; MANICURE SETS; HAND-OPERATED SCRAPING TOOL FOR CLEANING CLEATS FOR ATTACHMENT TO SPORTS SHOES; HAND TOOLS, NAMELY, GRAVING TOOLS; KNIVES; SWORDS; TABLEWARE, NAMELY, KNIVES, FORKS AND SPOONS (U.S. CLS. 23, 28 AND 44).

SCOTT BIBB, EXAMINING ATTORNEY

**CLASS 8—(Continued).**

SN 79-090,924. DA LIAN YA TU TOU ZI ZI XUN YOU XIAN GONG SI, LIAONING PROVINCE, CHINA, FILED 11-25-2010.



OWNER OF INTERNATIONAL REGISTRATION 1060933 DATED 11-25-2010, EXPIRES 11-25-2020.

THE MARK CONSISTS OF A STYLIZED SHIELD, WITH THREE STARS WITHIN THE TOP, LOWER LEFT AND LOWER RIGHT BORDERS OF THE SHIELD, A FEMALE GENDER SYMBOL WITHIN THE BOTTOM BORDER, WITHIN THE SHIELD AT THE TOP ARE THE COMBINED ZODIAC SYMBOLS ARIES AND CAPRICORN, ATOP THE STYLIZED LETTERS "AB" FORMED AS ONE LETTER, WITH AN OVAL AT THE TOP SEPARATING THE SYMBOLS.

FOR HAND OPERATED AGRICULTURAL IMPLEMENTS, NAMELY, BROADFORKS, CIDER PRESSES, RAKES; GARDEN TOOLS, HAND-OPERATED, NAMELY, TROWELS, WEEDING FORKS, SPADES, HOES; HARPOONS FOR COMMERCIAL FISHING; ELECTRIC BEARD CLIPPERS; MANICURE SETS; HAND-OPERATED SCRAPING TOOL FOR CLEANING CLEATS FOR ATTACHMENT TO SPORTS SHOES; HAND TOOLS, NAMELY, GRAVING TOOLS; KNIVES; SWORDS; TABLEWARE, NAMELY, KNIVES, FORKS AND SPOONS (U.S. CLS. 23, 28 AND 44).

SCOTT BIBB, EXAMINING ATTORNEY

**CLASS 8—(Continued).**

SN 79-090,933. DA LIAN YA TU TOU ZI ZI XUN YOU XIAN GONG SI, LIAONING PROVINCE, CHINA, FILED 12-1-2010.



OWNER OF INTERNATIONAL REGISTRATION 1060947 DATED 12-1-2010, EXPIRES 12-1-2020.

THE MARK CONSISTS OF A STYLIZED SHIELD WITH THREE STARS WITHIN THE TOP, LEFT AND RIGHT BORDERS OF THE SHIELD, AND A MALE GENDER SYMBOL WITHIN THE BOTTOM BORDER, WITHIN THE SHIELD AT THE TOP IS THE ZODIAC SYMBOL FOR ARIES ATOP THE LETTER "B" WITH A STYLIZED ARROWHEAD WITHIN AN OVAL CONNECTING THE TWO SYMBOLS.

FOR HAND OPERATED AGRICULTURAL IMPLEMENTS, NAMELY, BROADFORKS, CIDER PRESSES, RAKES; GARDEN TOOLS, HAND-OPERATED NAMELY, TROWELS, WEEDING FORKS, SPADES, HOES; HARPOONS FOR COMMERCIAL FISHING; ELECTRIC BEARD CLIPPERS; MANICURE SETS; HAND-OPERATED SCRAPING TOOL FOR CLEANING CLEATS FOR ATTACHMENT TO SPORTS SHOES; HAND TOOLS, NAMELY, GRAVING TOOLS; KNIVES; SWORDS; TABLEWARE NAMELY KNIVES, FORKS AND SPOONS (U.S. CLS. 23, 28 AND 44).

SCOTT BIBB, EXAMINING ATTORNEY

**CLASS 8—(Continued).**

SN 79-090,947. DA LIAN YA TU TOU ZI ZI XUN YOU XIAN GONG SI, LIAONING PROVINCE, CHINA, FILED 11-25-2010.



OWNER OF INTERNATIONAL REGISTRATION 1060963 DATED 11-25-2010, EXPIRES 11-25-2020.

THE MARK CONSISTS OF A STYLIZED SHIELD WITH THREE STARS WITHIN THE TOP, LEFT AND RIGHT BORDERS OF THE SHIELD, AND A MALE GENDER SYMBOL WITHIN THE BOTTOM BORDER, WITHIN THE SHIELD AT THE TOP IS THE CANCER ZODIAC SYMBOL SUPERIMPOSED OVER A STYLIZED LETTER "A" WITH AN ARROWHEAD INSIDE AN OVAL SEPARATING THE SYMBOLS.

FOR HAND OPERATED AGRICULTURAL IMPLEMENTS, NAMELY, BROADFORKS, CIDER PRESSES, RAKES; GARDEN TOOLS, HAND-OPERATED, NAMELY, TROWELS, WEEDING FORKS, SPADES, HOES; HARPOONS FOR COMMERCIAL FISHING; ELECTRIC BEARD CLIPPERS; MANICURE SETS; HAND-OPERATED SCRAPING TOOL FOR CLEANING CLEATS FOR ATTACHMENT TO SPORTS SHOES; HAND TOOLS, NAMELY, GRAVING TOOLS; KNIVES; SWORDS; TABLEWARE, NAMELY, KNIVES, FORKS AND SPOONS (U.S. CLS. 23, 28 AND 44).

SCOTT BIBB, EXAMINING ATTORNEY

**CLASS 8—(Continued).**

SN 79-093,694. LOBTEX CO., LTD., JAPAN, FILED 1-7-2011.



PRIORITY DATE OF 7-9-2010 IS CLAIMED.  
 OWNER OF INTERNATIONAL REGISTRATION 1067420 DATED 1-7-2011, EXPIRES 1-7-2021.  
 THE COLOR(S) RED AND BLACK IS/ARE CLAIMED AS A FEATURE OF THE MARK.  
 THE INNER CIRCLE ELEMENT AND THE AFTER "G" IS RED.

THE MARK CONSISTS OF THE WORDING "GG G.-LESS" WITH A HIGHLY STYLIZED LETTER "G" IN THE COLOR RED INSIDE A HIGHLY STYLIZED LETTER "G" IN THE COLOR BLACK RESEMBLING A WRENCH. THE WORDING "G-LESS" APPEARS IN THE COLOR BLACK BENEATH THE HIGHLY STYLIZED LETTERING "GG". THE PERIOD NEXT TO THE LETTER "G" IN "G-LESS" APPEARS IN THE COLOR RED.

FOR MONKEY WRENCHES; HAND TOOLS AND IMPLEMENTS HAND OPERATED, NAMELY, ADJUSTABLE WRENCHES AND WRENCHES (U.S. CLS. 23, 28 AND 44).

COLLEEN DOMBROW, EXAMINING ATTORNEY

**CLASS 8—(Continued).**

SN 85-199,888. FROST CUTLERY COMPANY LLC, OOLTEWAH, TN. FILED 12-16-2010.



NO CLAIM IS MADE TO THE EXCLUSIVE RIGHT TO USE "CUTLERY", APART FROM THE MARK AS SHOWN.  
 THE COLOR(S) GREEN, BLUE, GRAY, WHITE, GOLD, BLACK, TAN, BEIGE, BROWN IS/ARE CLAIMED AS A FEATURE OF THE MARK.

THE MARK CONSISTS OF THE WORDS "OCOEE RIVER" IN GREEN STACKED TO THE LEFT OF A SQUARE CONTAINING A FISHING LURE WITH A WHITE TIP, A BLACK RING BENEATH THE TIP, A BLUE SECTION BELOW THE BLACK RING WITH A WHITE AND GRAY FEATHER, A GOLD SECTION APPEARING BELOW THE BLUE SECTION WITH A BLACK RING AND A GOLD FEATHER WITH A WHITE HOOK ON THE END. A LARGER FEATHER APPEARS WITH GREEN AT THE TOP AND GOLD, BEIGE, TAN AND BROWN COMPRISING THE REMAINING COLORS. THE LURE APPEARS IN FRONT OF GRAY ROCKS AND A BLUE STREAM. THE WORD "CUTLERY" APPEARS IN BLACK CURSIVE FONT BENEATH THE DESIGN.

THE WORDING "OCOEE" HAS NO MEANING IN A FOREIGN LANGUAGE.

FOR KNIVES, NAMELY, HUNTING, FOLDING, FIXED, FISHING, SPORT AND COLLECTORS' KNIVES (U.S. CLS. 23, 28 AND 44).

FIRST USE 2-28-2010; IN COMMERCE 2-28-2010.  
 TAMARA FRAZIER, EXAMINING ATTORNEY

SN 85-073,558. ROCKLER COMPANIES, INC., MEDINA, MN. FILED 6-29-2010.

**BENCH DOG**



THE MARK CONSISTS OF STANDARD CHARACTERS WITHOUT CLAIM TO ANY PARTICULAR FONT, STYLE, SIZE, OR COLOR.

FOR HAND OPERATED TOOLS FOR WOODWORKING; ROUTER TABLES AND ACCESSORIES THEREFOR, NAMELY, FENCES, BIT GUARDS, ROUTER TABLE INSERTS, ROUTER TABLE PLATES, FENCE RISERS, MITER GAUGE TRACKS, TRIM GAUGE, CUTTING GUIDES, FEATHERBOARDS, ROUTER LIFTS, ROUTER TABLE EXTENSIONS (U.S. CLS. 23, 28 AND 44).

FIRST USE 6-0-1995; IN COMMERCE 6-0-1995.  
 INGA ERVIN, EXAMINING ATTORNEY

SN 85-210,886. FROST CUTLERY COMPANY LLC, OOLTEWAH, TN. FILED 1-5-2011.

THE MARK CONSISTS OF THE WORDS "BEAR & BULL" IN THE CENTER OF A CIRCULAR SHAPE WITH THE IMAGE OF A BEAR TO THE LEFT OF THE CENTER IN A TRIANGULAR SHAPE AND THE IMAGE OF A BULL TO THE RIGHT OF THE CENTER IN A TRIANGULAR SHAPE.

FOR KNIVES, NAMELY, HUNTING, FOLDING, FIXED, FISHING, KITCHEN, SPORT, COLLECTORS, COMBAT AND SURVIVOR (U.S. CLS. 23, 28 AND 44).

FIRST USE 2-22-2010; IN COMMERCE 2-22-2010.  
 TAMARA FRAZIER, EXAMINING ATTORNEY

**CLASS 8—(Continued).**

SN 85-211,706. FROST CUTLERY COMPANY LLC, OOLTEWAH, TN. FILED 1-6-2011.



THE MARK CONSISTS OF THE STACKED WORDS "FLYING FALCON" APPEARING WITHIN A DESIGN ELEMENT RESEMBLING A WING.

FOR KNIVES, NAMELY, HUNTING, FOLDING, FIXED, FISHING, SPORT AND COLLECTORS' KNIVES (U.S. CLS. 23, 28 AND 44).

FIRST USE 1-31-1993; IN COMMERCE 1-31-1993.  
TAMARA FRAZIER, EXAMINING ATTORNEY

SN 85-260,689. JORDAN DREW CORPORATION, TARRYTOWN, NY. FILED 3-8-2011.

## Jewel Dazzler

THE MARK CONSISTS OF STANDARD CHARACTERS WITHOUT CLAIM TO ANY PARTICULAR FONT, STYLE, SIZE, OR COLOR.

NO CLAIM IS MADE TO THE EXCLUSIVE RIGHT TO USE "JEWEL", APART FROM THE MARK AS SHOWN.

FOR HAND-OPERATED MACHINE FOR ASSEMBLING LONG STRANDS OF BEADS FOR NECKLACES, BRACELETS, BELTS, BEADED CURTAINS, CHANDELIERS, AND OTHER DECORATIVE BEADWORK (U.S. CLS. 23, 28 AND 44).

EDWARD FENNESSY, EXAMINING ATTORNEY

SN 85-273,956. TOY MATES, INCORPORATED, FRENCHTOWN, MT. FILED 3-22-2011.

## Little Johnny Popper

THE MARK CONSISTS OF STANDARD CHARACTERS WITHOUT CLAIM TO ANY PARTICULAR FONT, STYLE, SIZE, OR COLOR.

FOR HAND OPERATED APPARATUS FOR CUTTING STONE AND BRICK (U.S. CLS. 23, 28 AND 44).

MARTHA FROMM, EXAMINING ATTORNEY

**CLASS 8—(Continued).**

SN 85-278,591. BOHRMANN, BRUCE W., DBA BOHRMANN KNIVES, YARMOUTH, ME. FILED 3-28-2011.



NO CLAIM IS MADE TO THE EXCLUSIVE RIGHT TO USE "YARMOUTH MAINE", APART FROM THE MARK AS SHOWN.

THE MARK CONSISTS OF STYLIZED ANTLERS WITH THE BASE OF THE ANTLERS FORMING THE LETTER "B". "BOHRMANN" APPEARS CENTERED BETWEEN THE TIPS OF THE ANTLERS AND "YARMOUTH" AND "MAINE" APPEAR ON EITHER SIDE OF THE BASE OF THE ANTLERS.

FOR HUNTING KNIVES (U.S. CLS. 23, 28 AND 44).

FIRST USE 3-14-2010; IN COMMERCE 7-8-2010.  
ANDREA BUTLER, EXAMINING ATTORNEY

SN 85-279,398. PRIMESOURCE BUILDING PRODUCTS, INC., IRVING, TX. FILED 3-29-2011.



OWNER OF U.S. REG. NOS. 2,953,644, 3,032,141 AND OTHERS.

THE MARK CONSISTS OF THE WORDS "GRIP RITE" INSIDE A QUADRILATERAL.

FOR HAND TOOLS, NAMELY, KNIVES (U.S. CLS. 23, 28 AND 44).

NORA BUCHANAN WILL, EXAMINING ATTORNEY

SN 85-293,661. THE TRAVEL CHANNEL, L.L.C., CHEVY CHASE, MD. FILED 4-13-2011.

## SAND MASTERS

THE MARK CONSISTS OF STANDARD CHARACTERS WITHOUT CLAIM TO ANY PARTICULAR FONT, STYLE, SIZE, OR COLOR.

NO CLAIM IS MADE TO THE EXCLUSIVE RIGHT TO USE "SAND", APART FROM THE MARK AS SHOWN.

FOR TOOLS FOR SCULPTING SAND, NAMELY, SHOVELS, CHISELS, RAKES, CARVING KNIVES AND TROWELS (U.S. CLS. 23, 28 AND 44).

DAVID I, EXAMINING ATTORNEY



**CLASS 8—(Continued).**

SN 85-307,182. JPY INVESTMENT HOLDING CO., CARSON CITY, NV. FILED 4-28-2011.

# iHome

THE MARK CONSISTS OF STANDARD CHARACTERS WITHOUT CLAIM TO ANY PARTICULAR FONT, STYLE, SIZE, OR COLOR.

FOR HAND TOOLS, NAMELY, HAMMERS, SCREWDRIVERS, WRENCHES, PLIERS, SCREWDRIVER BITS, NUT DRIVERS, SOCKETS, SOLID BLADE KNIVES, UTILITY KNIVES, UTILITY BLADES, PRY BARS, FILES, CHISELS, DRILL BITS FOR HAND HELD TOOLS (U.S. CLS. 23, 28 AND 44).

GRETTA YAO, EXAMINING ATTORNEY

SN 85-310,908. LAUB, MAURICIO C., DBA CORTA KNIVES, LONG BEACH, CA. FILED 5-3-2011.

# Corta Knives

THE MARK CONSISTS OF STANDARD CHARACTERS WITHOUT CLAIM TO ANY PARTICULAR FONT, STYLE, SIZE, OR COLOR.

NO CLAIM IS MADE TO THE EXCLUSIVE RIGHT TO USE "KNIVES", APART FROM THE MARK AS SHOWN.

THE ENGLISH TRANSLATION OF "CORTA" IN THE MARK IS "CUT".

FOR CHEF KNIVES; CUTLERY, NAMELY, KNIVES (U.S. CLS. 23, 28 AND 44).

JESSICA A. POWERS, EXAMINING ATTORNEY

SN 85-316,715. VAZQUEZ, ALEJANDRO, LEBANON, PA. FILED 5-10-2011.

# Vazquez Tattoo Wizard

THE MARK CONSISTS OF STANDARD CHARACTERS WITHOUT CLAIM TO ANY PARTICULAR FONT, STYLE, SIZE, OR COLOR.

NO CLAIM IS MADE TO THE EXCLUSIVE RIGHT TO USE "TATTOO", APART FROM THE MARK AS SHOWN.

FOR APPARATUS FOR TATTOOING (U.S. CLS. 23, 28 AND 44).

CHRIS WELLS, EXAMINING ATTORNEY

**CLASS 8—(Continued).**

SN 85-321,527. LO BUE, DANIELE, SUWANEE, GA. FILED 5-16-2011.

smart blades   
swiss quality since 1932

NO CLAIM IS MADE TO THE EXCLUSIVE RIGHT TO USE "BLADES" AND "SWISS QUALITY SINCE 1932", APART FROM THE MARK AS SHOWN.

THE COLOR(S) WHITE, BLACK, GRAY, RED AND LIGHT RED IS/ARE CLAIMED AS A FEATURE OF THE MARK.

THE MARK CONSISTS OF THE WORDING "SMART" WITH LETTERS APPEARS IN THE COLOR BLACK, THE WORDING "BLADES" APPEARING IN THE COLOR GRAY ABOVE A LINE WHICH APPEARS IN LIGHT RED TO RED COLOR FROM LEFT TO RIGHT WITH A RED OVAL AMOEBA-LIKE SHAPE AT THE RIGHT END OF THE LINE WHICH CONTAINS A LIGHT RED CROSS WITH TWO WHITE CIRCLES ON THE BOTTOM OF THE LEFT BAR OF THE CROSS, AND BELOW THE LINE AND OVAL AMOEBA-LIKE SHAPE APPEARS THE WORDING "SWISS QUALITY SINCE 1932" WHICH APPEARS IN THE COLOR BLACK, ALL APPEARING ON A WHITE BACKGROUND.

FOR BLADES FOR SHEARS; BLADES FOR BARBER SHEARS, BLADES FOR SHEARS, HOLDERS FOR SHEARS AND SHEAR BLADES, BARBER RAZORS AND STRAIGHT RAZORS, HAIR CLIPPERS, THINNING SHEARS, HAIR STYLING SHEARS, HAIR CUTTING SCISSORS AND SCISSORS BLADES, NAIL CLIPPERS, NAIL SCISSORS, CUTICLE CLIPPERS, CUTICLE PUSHERS, CUTICLE SCISSORS, ACRYLIC CLIPPERS FOR CUTTING AND TRIMMING ACRYLIC NAILS, NAIL BUFFERS, CUSHION BOARDS FOR NAIL CARE, MANICURE STICKS, NAMELY, STICKS THAT FUNCTION AS CUTICLE REMOVERS AND PUSHERS, NAIL FILES, NIPPERS, HAND TOOLS, NAMELY, PLANERS, RASPS, TWEEZERS, SCISSORS, COME DO BLACKHEAD AND WHITEHEAD EXTRACTORS, EYELASH CURLERS, NOSE HAIR TRIMMERS, THINNING AND TEXTURIZING SHEARS, HAIR SHAPERS, INDUSTRIAL SHEARS AND HAIR CLIPPERS, TEXTILE SHEARS AND JAPANESE THREAD CLIPPERS; HAND TOOLS AND BLADES FOR HOME AND INDUSTRY, NAMELY, UTILITY KNIVES AND BLADES THEREFOR, SCRAPERS AND BLADES THEREFOR, RAZOR KNIVES AND BLADES THEREFOR, CARTON CUTTERS AND BLADES THEREFOR; AND MULTI-PURPOSE HAND TOOLS COMPRISED OF SAFETY CUTTERS AND KNIVES WHICH TOOLS FUNCTION AS CAN OPENERS, SCRAPERS, SAFETY CUTTERS, HAIR TRIMMERS AND DISPOSABLE RAZOR BLADES; FIXED BLADE KNIVES; HAND TOOLS, NAMELY, DICING BLADES, SLITTING BLADES, OPTICALLY TRANSPARENT BLADES, OPTICALLY TRANSMITTING BLADES (U.S. CLS. 23, 28 AND 44).

FIRST USE 2-1-2011; IN COMMERCE 3-15-2011.

SAMUEL E. SHARPER JR., EXAMINING ATTORNEY

SN 85-329,989. GARY BUCHHOLZ, DBA BUCHHOLZ WRAP BUSTER, LLC, HARBOR BEACH, MI. FILED 5-25-2011.

# WRAP BUSTER

THE MARK CONSISTS OF STANDARD CHARACTERS WITHOUT CLAIM TO ANY PARTICULAR FONT, STYLE, SIZE, OR COLOR.

NO CLAIM IS MADE TO THE EXCLUSIVE RIGHT TO USE "WRAP", APART FROM THE MARK AS SHOWN.

FOR HAND OPERATED TOOLS FOR CUTTING WRAPPINGS ON FEET OF LIVESTOCK (U.S. CLS. 23, 28 AND 44).

FIRST USE 2-28-2010; IN COMMERCE 2-28-2010.

KAREN K. BUSH, EXAMINING ATTORNEY

**CLASS 8—(Continued).**

SN 85-331,305. ECOSPAN, LLC, GREENBRAE, CA. FILED 5-26-2011.



THE MARK CONSISTS OF THE WORD "ECOSPAN" IN A STYLIZED FORMAT PLUS PARTIAL CONCENTRIC OVAL SHAPES.

FOR PLASTIC FLATWARE, NAMELY, SPOONS, FORKS, AND KNIVES (U.S. CLS. 23, 28 AND 44).  
ALLISON SCHRODY, EXAMINING ATTORNEY

---

SN 85-383,423. FISH TALES, LLC, TUCSON, AZ. FILED 7-28-2011.

ONE CUT AND YOU'RE THROUGH

THE MARK CONSISTS OF STANDARD CHARACTERS WITHOUT CLAIM TO ANY PARTICULAR FONT, STYLE, SIZE, OR COLOR.

FOR KNIFE (U.S. CLS. 23, 28 AND 44).  
SOPHIA S. KIM, EXAMINING ATTORNEY

**CLASS 9—ELECTRICAL AND SCIENTIFIC APPARATUS**

SN 76-180,250. FUGRO FINANCE AG, ZUG, SWITZERLAND, FILED 12-13-2000.

**FALCON**

PRIORITY CLAIMED UNDER SEC. 44(D) ON AUSTRALIA APPLICATION NO. 838728, FILED 6-14-2000, REG. NO. 838728, DATED 6-14-2000, EXPIRES 6-14-2010.

FOR COMPUTER SOFTWARE FOR USE IN GEOLOGICAL EXPLORATION, OIL EXPLORATION AND GEOLOGICAL RESEARCH, NAMELY, IN THE ANALYSIS OF AERIAL SURVEY DATA; GRAVITY GRADIOMETERS; MAGNETOMETERS; PRECISE MEASURING APPARATUS, NAMELY FOR USE IN OBTAINING SURVEY DATA DURING AERIAL SURVEYING OVER LANDSCAPES AND SEASCAPES (U.S. CLS. 21, 23, 26, 36 AND 38).

ELIZABETH HUGHITT, EXAMINING ATTORNEY

**CLASS 9—(Continued).**

SN 76-702,611. KIDZ BY DESIGN, INC., LAWRENCEVILLE, GA. FILED 4-23-2010.

**SOPHISTACHICS**

THE MARK CONSISTS OF STANDARD CHARACTERS WITHOUT CLAIM TO ANY PARTICULAR FONT, STYLE, SIZE, OR COLOR.

FOR PRE-RECORDED AUDIO TAPES, DISCS AND CASSETTES, VIDEO TAPES, DISCS AND CASSETTES, DIGITAL AUDIO AND AUDIO VIDEO TAPES AND DISCS, CDS, DVDS, LASER DISCS, PHONOGRAPH RECORDS, AND THEATRICAL AND SOUND AND VIDEO RECORDINGS FEATURING STORIES, MUSIC OR CHARACTERS FOR CHILDREN AND ADOLESCENT GIRLS; DOWNLOADABLE RING TONES, MUSIC, MP3 FILES FEATURING STORIES FOR STORIES FOR CHILDREN AND ADOLESCENT GIRLS, IMAGES AND VIDEOS FEATURING STORIES FOR CHILDREN AND ADOLESCENT GIRLS FOR WIRELESS COMMUNICATION DEVICES; VIRTUAL REALITY GAME PROGRAMS; DOWNLOADABLE COMPUTER GAME PROGRAMS; COMPUTER AND VIDEO GAME EQUIPMENT, NAMELY, COMPUTER AND VIDEO GAME PROGRAMS, TAPES, CARTRIDGES, CASSETTES, JOYSTICKS AND REMOTE CONTROL UNITS; MOUSE PADS; VIDEO GAME INTERACTIVE CONTROL FLOOR PADS; LIGHT SWITCHES; DECORATIVE MAGNETS; SAFETY HELMETS; SUNGLASSES; EYEGLASSES; PHOTOGRAPHIC CAMERAS; MOBILE PHONE CASES; COMPACT DISC HOLDERS; SWIM MASKS; SWIM GOGGLES; DIGITAL PHOTO FRAMES FOR DISPLAYING DIGITAL PICTURES AND MUSIC; AND PROTECTIVE CARRYING CASES FOR PORTABLE MUSIC PLAYERS, NAMELY, MP3 PLAYERS (U.S. CLS. 21, 23, 26, 36 AND 38).

SAIMA MAKHDOOM, EXAMINING ATTORNEY

---

SN 76-703,850. RICOH COMPANY, LTD., TOKYO, JAPAN, FILED 7-21-2010.

**Toy Color**

THE MARK CONSISTS OF STANDARD CHARACTERS WITHOUT CLAIM TO ANY PARTICULAR FONT, STYLE, SIZE, OR COLOR.

NO CLAIM IS MADE TO THE EXCLUSIVE RIGHT TO USE "COLOR", APART FROM THE MARK AS SHOWN.

FOR FIRMWARE MODE FEATURE FOR MODIFYING THE COLOR OF DIGITAL IMAGES SOLD AS AN INTEGRAL COMPONENT OF DIGITAL CAMERAS (U.S. CLS. 21, 23, 26, 36 AND 38).

CHARLOTTE CORWIN, EXAMINING ATTORNEY

**CLASS 9—(Continued).**

SN 76-707,511. GROUP DEKKO, INC., GARRETT, IN. FILED 5-5-2011.

**Energy  Sense**

NO CLAIM IS MADE TO THE EXCLUSIVE RIGHT TO USE "ENERGY", APART FROM THE MARK AS SHOWN.

THE MARK CONSISTS OF THE STYLIZED WORDING "ENERGY SENSE" WITH A DESIGN OF AN ELECTRICAL PLUG AND CORD WITH A STYLIZED LEAF AT THE END OF THE CORD IN BETWEEN THE WORDS.

FOR ELECTRICAL DISTRIBUTION SYSTEMS AND PARTS, THEREFOR, CONSISTING OF ELECTRICAL DISTRIBUTION HARNESES, ELECTRICAL RECEPTACLES, ELECTRICAL POWER FEEDS AND JUMPER CABLES (U.S. CLS. 21, 23, 26, 36 AND 38).

SCOTT BIBB, EXAMINING ATTORNEY

**CLASS 9—(Continued).**

SN 77-367,532. THALES COMMUNICATIONS, INC., CLARKSBURG, MD. FILED 1-9-2008.

**LIBERTY**

THE MARK CONSISTS OF STANDARD CHARACTERS WITHOUT CLAIM TO ANY PARTICULAR FONT, STYLE, SIZE, OR COLOR.

OWNER OF U.S. REG. NO. 2,815,366.

FOR GOVERNMENT AND MILITARY HAND HELD RADIO TRANSCEIVERS FOR COMMUNICATION OF VOICE AND DATA, AND STRUCTURAL PARTS THEREFOR (U.S. CLS. 21, 23, 26, 36 AND 38).

DAWN HAN, EXAMINING ATTORNEY

SN 76-707,568. KIM, TOM B., LONG BEACH, CA. FILED 5-10-2011.

**TWINKLE**

THE MARK CONSISTS OF STANDARD CHARACTERS WITHOUT CLAIM TO ANY PARTICULAR FONT, STYLE, SIZE, OR COLOR.

FOR CONTACT LENSES, CONTACT LENS CASES AND CONTACT LENS CONTAINERS (U.S. CLS. 21, 23, 26, 36 AND 38).

FIRST USE 4-15-2011; IN COMMERCE 4-15-2011.

JULIE VEPPUMTHARA, EXAMINING ATTORNEY

SN 77-450,865. BTI SYSTEMS, INC., OTTAWA, ONTARIO, CANADA, FILED 4-17-2008.

**BTI SYSTEMS**

THE MARK CONSISTS OF STANDARD CHARACTERS WITHOUT CLAIM TO ANY PARTICULAR FONT, STYLE, SIZE, OR COLOR.

PRIORITY CLAIMED UNDER SEC. 44(D) ON CANADA APPLICATION NO. 1370027, FILED 10-31-2007, REG. NO. TMA782,188, DATED 11-10-2010, EXPIRES 11-10-2025.

NO CLAIM IS MADE TO THE EXCLUSIVE RIGHT TO USE "SYSTEMS", APART FROM THE MARK AS SHOWN.

FOR OPTICAL COMMUNICATIONS EQUIPMENT FOR OPTICAL SIGNAL MANAGEMENT, SIGNAL PROCESSING, INTEGRATED PACKET PROCESSING, FIBER OPTIC SIGNAL CONDITIONING AND MANAGEMENT, NAMELY, OPTICAL TRANSMITTERS, OPTICAL RECEIVERS, OPTICAL DISPERSION CONDITIONERS, OPTICAL MULTIPLEXORS, OPTICAL AMPLIFIERS, OPTICAL TRANSLATORS, OPTICAL LINE CARDS, OPTICAL TRANSPONDERS, MULTIPLEXING TRANSPONDERS, ETHERNET SERVICES MODULES FOR ETHERNET SWITCHING AND NETWORKING, MODULES FOR DISPERSION COMPENSATION, COURSE WAVELENGTH DIVISION MULTIPLEXING (CWDM) TRANSMITTERS AND DENSE WAVELENGTH DIVISION MULTIPLEXING (DWDM) TRANSMITTERS; OPTICAL NETWORKING SYSTEMS, NAMELY, OPTICAL TRANSMITTERS AND OPTICAL RECEIVERS FOR COMMUNICATING DIGITAL AND ANALOG SIGNALS OVER A FIBER OPTIC LINK; OPTICAL NETWORK MANAGEMENT AND ADMINISTRATION EQUIPMENT, NAMELY, COMPUTERS, COMPUTER SOFTWARE FOR OPTICAL AND PACKET NETWORK MANAGEMENT AND ADMINISTRATION, FAULT MANAGEMENT, NETWORK COMPONENT CONFIGURATION MANAGEMENT, SERVICE ACTIVATION, NETWORK MONITORING AND CONTROL OF NETWORK SOFTWARE PARAMETERS (U.S. CLS. 21, 23, 26, 36 AND 38).

CHRISTOPHER BUONGIORNO, EXAMINING ATTORNEY

SN 76-708,637. ESSILOR OF AMERICA, INC., DALLAS, TX. FILED 8-8-2011.

**TREXA**

THE MARK CONSISTS OF STANDARD CHARACTERS WITHOUT CLAIM TO ANY PARTICULAR FONT, STYLE, SIZE, OR COLOR.

FOR OPTICAL LENSES (U.S. CLS. 21, 23, 26, 36 AND 38).

KATHERINE STOIDES, EXAMINING ATTORNEY

**CLASS 9—(Continued).**

SN 77-601,099. LAIPAC TECHNOLOGY INC., RICHMOND HILL, CANADA, FILED 10-27-2008.

 The logo for LAIPAC TECH features a large, stylized letter 'L' on the left. To the right of the 'L', the word 'LAIPAC' is written in a bold, sans-serif font, and the word 'TECH' is written below it in the same style.

PRIORITY CLAIMED UNDER SEC. 44(D) ON CANADA APPLICATION NO. 1407371, FILED 8-14-2008, REG. NO. TMA802689, DATED 7-21-2011, EXPIRES 7-21-2026.

NO CLAIM IS MADE TO THE EXCLUSIVE RIGHT TO USE "TECH", APART FROM THE MARK AS SHOWN.

FOR (BASED ON USE IN COMMERCE) GPS PRODUCTS, NAMELY, GPS ENGINE BOARDS, GPS RECEIVERS, GPS EVALUATION UNITS CONNECTABLE TO A GPS ENGINE FOR EVALUATING THE GPS ENGINE, AND GPS ANTENNAS; PASSIVE TRACKING SYSTEMS, NAMELY, A GPS MOUNTABLE ON A VEHICLE OR OTHER SUPPORT FOR PROVIDING LOCATION INFORMATION, AND A DATA LOGGER FOR STORING SUCH LOCATION INFORMATION FOR LATER USE; PORTABLE GPS TRACKING DEVICE HAVING A GPS, AND A DATA LOGGER AND A CELL PHONE TO REPORT LOCATION AND MOVEMENT INFORMATION OF A PERSON TO A PRE-SELECTED BASE LOCATION; RADIO FREQUENCY (RF) MODULES, NAMELY, RF TRANSMITTER MODULES, RF RECEIVER MODULES, RF DATA AND VOICE TRANSCEIVERS, AND RE REMOTE CONTROL TRANSMITTER MODULES; TRACKING SYSTEMS, NAMELY, REAL TIME TRACKING DEVICES HAVING A GPS AND A DATA LOGGER FOR DETERMINING AND STORING LOCATION INFORMATION AND A CELL PHONE FOR COMMUNICATING SUCH INFORMATION TO A RECEIVER; WIRELESS PRODUCTS, NAMELY, WIRELESS GSM/GPRS MODEMS FOR ACCESSING THE INTERNET, AND WIRELESS ALARMS ADAPTED TO BE INTEGRATED WITH CELL PHONE NETWORKS TO PROVIDE SECURITY ALARMS ON DETECTION OF A PRE-PROGRAMMED EVENT; (BASED ON INTENT TO USE) WRIST WEARABLE LOCATOR HAVING A CELL PHONE, A GPS, A DATA LOGGER, AND AN ACCELERATION SENSOR FOR USE AS A CELL PHONE, A GPS, A LOCATOR, AND FOR SENDING AND RECEIVING EMAIL AND TEXT MESSAGES, AND FOR REPORTING IMPACTS, ACCIDENTS AND FALLING (U.S. CLS. 21, 23, 26, 36 AND 38).

FIRST USE 1-31-2000; IN COMMERCE 1-31-2000.  
DANNEAN HETZEL, EXAMINING ATTORNEY

**CLASS 9—(Continued).**

SN 77-667,570. TECHNOLOGY RESEARCH CORPORATION, CLEARWATER, FL. FILED 2-10-2009.

## SURGE GUARD

THE MARK CONSISTS OF STANDARD CHARACTERS WITHOUT CLAIM TO ANY PARTICULAR FONT, STYLE, SIZE, OR COLOR.

NO CLAIM IS MADE TO THE EXCLUSIVE RIGHT TO USE "SURGE", APART FROM THE MARK AS SHOWN.

FOR VOLTAGE SURGE PROTECTORS TO BE PLUGGED INTO SHOREPOWER, POWER PEDESTALS OR GENERATORS AND SOLD IN RECREATIONAL VEHICLE, CAMPING, MARINE, SPECIALTY VEHICLE, AIRCRAFT AND MILITARY CHANNELS OF TRADE (U.S. CLS. 21, 23, 26, 36 AND 38).

FIRST USE 11-28-1995; IN COMMERCE 11-28-1995.  
ANNE FARRELL, EXAMINING ATTORNEY

SN 77-667,675. TECOM INDUSTRIES, INC., THOUSAND OAKS, CA. FILED 2-10-2009.

 The logo for KuSTREAM features a stylized globe on the left, composed of a circle with several small ovals around its perimeter, suggesting motion or a sphere. To the right of the globe, the word 'KuSTREAM' is written in a bold, sans-serif font.

NO CLAIM IS MADE TO THE EXCLUSIVE RIGHT TO USE "KUSTREAM", APART FROM THE MARK AS SHOWN.

THE MARK CONSISTS OF THE WORD "KUSTREAM". A CIRCLE WITH SMALL OVALS MOVING IN A SPHERICAL MANNER APPEARS TO THE LEFT OF THE WORD "KUSTREAM".

FOR BROADBAND ANTENNA SYSTEM CONSISTING OF KU BAND TRANSMIT/RECEIVE ANTENNA ASSEMBLY, HIGH POWER TRANSCEIVER, ANTENNA CONTROL UNIT, AND INTERCONNECT AND POWER CABLES, FOR USE WITH AIRPLANES, TRAINS, SHIPS, AND VEHICLES (U.S. CLS. 21, 23, 26, 36 AND 38).

ANDREW RHIM, EXAMINING ATTORNEY

**CLASS 9—(Continued).**

SN 77-720,248. ADSCAPTCHA LTD., TEL AVIV, ISRAEL, FILED 4-23-2009.

## PPT – Pay Per Type

THE MARK CONSISTS OF STANDARD CHARACTERS WITHOUT CLAIM TO ANY PARTICULAR FONT, STYLE, SIZE, OR COLOR.

NO CLAIM IS MADE TO THE EXCLUSIVE RIGHT TO USE "PAY PER TYPE", APART FROM THE MARK AS SHOWN.

FOR COMPUTER SOFTWARE, COMPUTER OPERATING SYSTEMS AND COMPUTER PROGRAMS AND DATABASE MANAGEMENT SOFTWARE, ALL USED FOR ADVERTISING AND ADVERTISEMENT SERVICES, NAMELY, FOR THE CREATION, PLACING AND MANAGEMENT OF ON-LINE ADVERTISEMENTS, ADVERTISING CAMPAIGNS, AND ADVERTISING ACCOUNTS, WHERE THE PAYMENT MODEL IS BASED ON THE NUMBER OF ADVERTISING MESSAGES TYPED BY CAPTCHA OR OTHER INVENTORY USERS (U.S. CLS. 21, 23, 26, 36 AND 38).

MARK PILARO, EXAMINING ATTORNEY

---

SN 77-806,349. TRIUMPH INTERNATIONAL, INC., ATLANTA, GA. FILED 8-17-2009.

## MICHAEL JACKSON

THE MARK CONSISTS OF STANDARD CHARACTERS WITHOUT CLAIM TO ANY PARTICULAR FONT, STYLE, SIZE, OR COLOR.

OWNER OF U.S. REG. NO. 1,908,209.

THE NAME "MICHAEL JACKSON" DOES NOT IDENTIFY A LIVING INDIVIDUAL.

FOR MUSICAL SOUND RECORDINGS; AUDIOVISUAL RECORDINGS FEATURING MUSIC AND MUSICAL ENTERTAINMENT; MOTION PICTURE FILMS FEATURING MUSIC AND MUSICAL ENTERTAINMENT; COMPUTER APPLICATION SOFTWARE FOR MOBILE PHONES; DOWNLOADABLE RING TONES AND GRAPHICS FOR MOBILE PHONES; DOWNLOADABLE IMAGE AND GRAPHICS FILES FEATURING DISPLAY SCREEN BACKGROUNDS OR WALLPAPERS, WIDGETS, ICONS AND PHOTOGRAPHS; DOWNLOADABLE PODCASTS IN THE FIELD OF MUSIC; DOWNLOADABLE ELECTRONIC PUBLICATIONS IN THE NATURE OF BOOKS, MAGAZINES, NEWSLETTERS, PAMPHLETS, BOOKLETS AND BROCHURES IN THE FIELD OF MUSIC AND ENTERTAINMENT; ELECTRONIC GAME PROGRAMS; VIDEO GAME SOFTWARE; STORAGE CASES FOR COMPACT DISCS AND DVDS; CELL PHONE CASES AND COVERS; DECORATIVE LIGHT SWITCH PLATES; ELECTRIC SIGNS; COMPUTER MOUSE PADS; EYEWEAR, EYEWEAR ACCESSORIES, NAMELY, STRAPS, NECK CORDS AND HEAD STRAPS WHICH RESTRAIN EYEWEAR FROM MOVEMENT ON A WEARER; MAGNETS (U.S. CLS. 21, 23, 26, 36 AND 38).

HEATHER THOMPSON, EXAMINING ATTORNEY

**CLASS 9—(Continued).**

SN 77-806,392. TRIUMPH INTERNATIONAL, INC., ATLANTA, GA. FILED 8-17-2009.



OWNER OF U.S. REG. NO. 1,908,209.

THE NAME "MICHAEL JACKSON" DOES NOT IDENTIFY A LIVING INDIVIDUAL.

THE MARK CONSISTS OF THE NAME "MICHAEL JACKSON" WRITTEN IN STYLIZED FORM WHEN THE END OF THE LETTER "N" HAS A VERTICAL LINE UP AND AT THE PEAK HAS A SLIGHTLY CURVED LINE DOWN ENDING WITH A STYLIZED STARBURST.

FOR MUSICAL SOUND RECORDINGS; AUDIOVISUAL RECORDINGS FEATURING MUSIC AND MUSICAL ENTERTAINMENT; MOTION PICTURE FILMS FEATURING MUSIC AND MUSICAL ENTERTAINMENT; COMPUTER APPLICATION SOFTWARE FOR MOBILE PHONES; DOWNLOADABLE RING TONES AND GRAPHICS FOR MOBILE PHONES; DOWNLOADABLE IMAGE AND GRAPHICS FILES FEATURING DISPLAY SCREEN BACKGROUNDS OR WALLPAPERS, WIDGETS, ICONS AND PHOTOGRAPHS; DOWNLOADABLE PODCASTS IN THE FIELD OF MUSIC; DOWNLOADABLE ELECTRONIC PUBLICATIONS IN THE NATURE OF BOOKS, MAGAZINES, NEWSLETTERS, PAMPHLETS, BOOKLETS AND BROCHURES IN THE FIELD OF MUSIC AND ENTERTAINMENT; ELECTRONIC GAME PROGRAMS; VIDEO GAME SOFTWARE; STORAGE CASES FOR COMPACT DISCS AND DVDS; CELL PHONE CASES AND COVERS; DECORATIVE LIGHT SWITCH PLATES; ELECTRIC SIGNS; COMPUTER MOUSE PADS; EYEWEAR, EYEWEAR ACCESSORIES, NAMELY, STRAPS, NECK CORDS AND HEAD STRAPS WHICH RESTRAIN EYEWEAR FROM MOVEMENT ON A WEARER; MAGNETS (U.S. CLS. 21, 23, 26, 36 AND 38).

HEATHER THOMPSON, EXAMINING ATTORNEY

---

SN 77-825,946. POWER DISTRIBUTION, INC., RICHMOND, VA. FILED 9-14-2009.

## ToughRail Technology

THE MARK CONSISTS OF STANDARD CHARACTERS WITHOUT CLAIM TO ANY PARTICULAR FONT, STYLE, SIZE, OR COLOR.

NO CLAIM IS MADE TO THE EXCLUSIVE RIGHT TO USE "TECHNOLOGY", APART FROM THE MARK AS SHOWN.

FOR ELECTRIC POWER EQUIPMENT, NAMELY, ELECTRIC CONDUCTOR RAILS FOR USE WITH ELECTRIC POWER EQUIPMENT, AND STRUCTURED ELECTRICAL BUSES COMPRISING ELECTRICAL POWER CONNECTORS, ELECTRICAL POWER DISTRIBUTION UNITS, ELECTRIC POWER SUPPLIES, AND ELECTRIC CONDUCTOR RAILS FOR USE WITH ELECTRIC POWER EQUIPMENT (U.S. CLS. 21, 23, 26, 36 AND 38).

JOHN KELLY, EXAMINING ATTORNEY

**CLASS 9—(Continued).**

SN 77-833,865. CHARACTER TALES, LLC, DBA CHARACTER TALES, EDMOND, OK. FILED S.R. 9-24-2009; AM. P.R. 8-11-2010.

# Character Tales

THE MARK CONSISTS OF STANDARD CHARACTERS WITHOUT CLAIM TO ANY PARTICULAR FONT, STYLE, SIZE, OR COLOR.

NO CLAIM IS MADE TO THE EXCLUSIVE RIGHT TO USE "TALES", APART FROM THE MARK AS SHOWN.

FOR MOTION PICTURE FILMS FEATURING CHILDREN'S ENTERTAINMENT (U.S. CLS. 21, 23, 26, 36 AND 38).

FIRST USE 11-30-2009; IN COMMERCE 1-27-2010.  
BRIAN CALLAGHAN, EXAMINING ATTORNEY

**CLASS 9—(Continued).**

SN 77-863,854. LG ELECTRONICS INC., SEOUL, REPUBLIC OF KOREA, FILED 11-3-2009.



PRIORITY CLAIMED UNDER SEC. 44(D) ON REPUBLIC OF KOREA APPLICATION NO. 40-2009-0045, FILED 9-15-2009, REG. NO. 0845986, DATED 12-10-2010, EXPIRES 12-10-2020.

NO CLAIM IS MADE TO THE EXCLUSIVE RIGHT TO USE "AV", APART FROM THE MARK AS SHOWN.

THE MARK CONSISTS OF "AV" WITHIN A WHITE SQUARE. THREE WHITE LINES EXTEND FROM THE SQUARE WITH HOLLOW CIRCLES AT THE END OF EACH LINE. THIS DESIGN IS ALL WITHIN ANOTHER SQUARE.

FOR COMPUTER MONITORS; TELEVISION RECEIVERS (U.S. CLS. 21, 23, 26, 36 AND 38).  
ADA HAN, EXAMINING ATTORNEY

SN 77-839,155. LG ELECTRONICS INC., SEOUL, REPUBLIC OF KOREA, FILED 10-1-2009.

# EZ control

THE MARK CONSISTS OF STANDARD CHARACTERS WITHOUT CLAIM TO ANY PARTICULAR FONT, STYLE, SIZE, OR COLOR.

OWNER OF REPUBLIC OF KOREA REG. NO. 0832681, DATED 8-11-2010, EXPIRES 8-11-2020.

NO CLAIM IS MADE TO THE EXCLUSIVE RIGHT TO USE "EASY", APART FROM THE MARK AS SHOWN.

FOR COMPUTER MONITORS (U.S. CLS. 21, 23, 26, 36 AND 38).  
BERNICE MIDDLETON, EXAMINING ATTORNEY

SN 77-863,924. LG ELECTRONICS INC., SEOUL, REPUBLIC OF KOREA, FILED 11-3-2009.



PRIORITY CLAIMED UNDER SEC. 44(D) ON REPUBLIC OF KOREA APPLICATION NO. 40-2009-0045, FILED 9-15-2009, REG. NO. 0845979, DATED 12-10-2010, EXPIRES 12-10-2020.

NO CLAIM IS MADE TO THE EXCLUSIVE RIGHT TO USE "2MS" AND "FAST RESPONSE TIME", APART FROM THE MARK AS SHOWN.

THE MARK CONSISTS OF "2MS LIGHTNING FAST RESPONSE TIME" WITH LINES EXTENDING FROM THE "2".

FOR COMPUTER MONITORS; TELEVISION RECEIVERS (U.S. CLS. 21, 23, 26, 36 AND 38).  
ADA HAN, EXAMINING ATTORNEY

**CLASS 9—(Continued).**

SN 77-864,003. LG ELECTRONICS INC., SEOUL, REPUBLIC OF KOREA, FILED 11-3-2009.



**Invisible Speaker**

OWNER OF ERPN CMNTY TM OFC REG. NO. 008661548, DATED 4-5-2010, EXPIRES 11-4-2019.

NO CLAIM IS MADE TO THE EXCLUSIVE RIGHT TO USE "SPEAKER", APART FROM THE MARK AS SHOWN.

THE MARK CONSISTS OF THE STYLIZED WORDING "INVISIBLE SPEAKER" UNDERNEATH A RECTANGLE WITH A STYLIZED SPEAKER WITH SOUND WAVES IN THE UPPER LEFT CORNER.

FOR COMPUTER MONITORS; TELEVISION RECEIVERS (U.S. CLS. 21, 23, 26, 36 AND 38).  
ADA HAN, EXAMINING ATTORNEY

**CLASS 9—(Continued).**

SN 77-873,771. LINCOLN GLOBAL, INC., CITY OF INDUSTRY, CA. FILED 11-16-2009.

**FLEXTEC**

THE MARK CONSISTS OF STANDARD CHARACTERS WITHOUT CLAIM TO ANY PARTICULAR FONT, STYLE, SIZE, OR COLOR.

FOR ELECTRIC ARC WELDERS (U.S. CLS. 21, 23, 26, 36 AND 38).

KATHERINE CONNOLLY, EXAMINING ATTORNEY

SN 77-864,114. LG ELECTRONICS INC., SEOUL, REPUBLIC OF KOREA, FILED 11-3-2009.



**Glare Panel**

PRIORITY CLAIMED UNDER SEC. 44(D) ON REPUBLIC OF KOREA APPLICATION NO. 40-2009-0045, FILED 9-15-2009, REG. NO. 0845987, DATED 12-10-2010, EXPIRES 12-10-2020.

NO CLAIM IS MADE TO THE EXCLUSIVE RIGHT TO USE "GLARE PANEL", APART FROM THE MARK AS SHOWN.

THE MARK CONSISTS OF THE STYLIZED WORDING "GLARE PANEL" UNDER A RECTANGLE DESIGN THAT CONTAINS TWO FOUR-POINTED STARS IN THE UPPER RIGHT CORNER, AND A TRAPEZOID WITH A CURVED SIDE FILLING THE LEFT HALF OF THE RECTANGLE.

FOR COMPUTER MONITORS; TELEVISION RECEIVERS (U.S. CLS. 21, 23, 26, 36 AND 38).  
ADA HAN, EXAMINING ATTORNEY

SN 77-899,151. NOKIA CORPORATION, FI-02150 ESPOO, FINLAND, FILED 12-22-2009.

**MODE**

THE MARK CONSISTS OF STANDARD CHARACTERS WITHOUT CLAIM TO ANY PARTICULAR FONT, STYLE, SIZE, OR COLOR.

FOR MOBILE TELEPHONES; ACCESSORIES AND REPLACEMENT PARTS FOR MOBILE TELEPHONES, NAMELY, BATTERIES, BATTERY CHARGERS, CAR CHARGERS FOR MOBILE TELEPHONES, CARRYING CASES FOR MOBILE TELEPHONES, DATA CABLES, HEADSETS, AND MEMORY CARDS SOLD AS A UNIT WITH MOBILE TELEPHONES; COMPONENT PARTS OF MOBILE TELEPHONES, NAMELY, ALARM CLOCKS, CALCULATORS, DIGITAL CAMERAS, ELECTRONIC ADDRESS BOOKS AND CALENDARS, FM RADIO TUNERS, ELECTRONIC FOREIGN CURRENCY CONVERTERS, GLOBAL POSITIONING SYSTEMS, MUSIC AND VIDEO PLAYERS, AND SOUND AND VIDEO RECORDERS (U.S. CLS. 21, 23, 26, 36 AND 38).

FIRST USE 6-16-2010; IN COMMERCE 6-16-2010.  
ANGELA DUONG, EXAMINING ATTORNEY

**CLASS 9—(Continued).**

SN 77-902,208. FLIR SYSTEMS, INC., WILSONVILLE, OR.  
FILED 12-29-2009.

**CLASS 9—(Continued).**

SN 77-952,995. VISHAY INTERTECHNOLOGY, INC., MALVERN, PA. FILED 3-8-2010.



**FLIR CDMQ 3-D ARMAMENT  
SYSTEM**

THE MARK CONSISTS OF STANDARD CHARACTERS WITHOUT CLAIM TO ANY PARTICULAR FONT, STYLE, SIZE, OR COLOR.

OWNER OF U.S. REG. NOS. 2,975,668, 3,313,758 AND OTHERS.

NO CLAIM IS MADE TO THE EXCLUSIVE RIGHT TO USE "3-D ARMAMENT SYSTEM", APART FROM THE MARK AS SHOWN.

SEC. 2(F) AS TO "FLIR".

FOR AN ARMAMENT SYSTEM IN THE NATURE OF AN ELECTROMAGNETIC WEAPONS TRACKING AND SIGHTING SYSTEM COMPRISED OF A LASER DESIGNATOR DEVICE, A GIMBAL, AND AN ELECTRONIC WEAPON FIRE CONTROL UNIT USED IN COMBINATION WITH WEAPON SYSTEMS, INCLUDING DOOR MOUNTED MINI-GUNS COUPLED WITH A GATLING GUN AND A LASER GUIDED ROCKET SYSTEM, USED IN CONJUNCTION WITH A VIDEO DISPLAY UNIT WITH EITHER A HEADS UP DISPLAY OR A HEADS DOWN DISPLAY ALONG WITH A RECORDING DEVICE, NAMELY, A DIGITAL VIDEO RECORDER, AND A MOVING MAP SYSTEM (U.S. CLS. 21, 23, 26, 36 AND 38).

JEFFERY COWARD, EXAMINING ATTORNEY

OWNER OF U.S. REG. NOS. 837,476, 1,790,212 AND OTHERS.

NO CLAIM IS MADE TO THE EXCLUSIVE RIGHT TO USE "PRECISION" AND "GROUP", APART FROM THE MARK AS SHOWN.

THE COLOR(S) BLUE, BLACK AND WHITE IS/ARE CLAIMED AS A FEATURE OF THE MARK.

THE MARK CONSISTS OF A SQUARE ROOT SYMBOL WITH THE CHECK MARK PORTION IN WHITE INSIDE A BLUE CIRCLE. THE WORD "VISHAY" IN BLACK ON TOP OF THE BLUE LINE, THE WORDS "PRECISION GROUP" IN BLACK BELOW THE BLUE LINE. A BLUE HORIZONTAL LINE APPEARS AT THE TOP AND THE BOTTOM OF THE DRAWING.

FOR ELECTRIC COMPONENTS, NAMELY, RESISTORS AND RESISTOR NETWORKS, LOW VALUE RESISTORS, SHUNT RESISTORS, CURRENT SENSORS, POTENTIOMETERS, TRIMMER POTENTIOMETERS, CAPACITY SENSORS, INDUCTOR SENSORS, VOLUME CONTROL SENSORS, INCLINOMETER SENSORS, MEMS (MICROELECTROMECHANICAL SYSTEM) SENSORS, VIBRATING WIRE SENSORS, ELECTRICAL RESISTANCE STRAIN GAUGES, STRAIN GAUGE TRANSDUCERS, LOAD CELLS, PRESSURE SENSORS, ACCELERATORS, STRESS ANALYSIS SYSTEMS, STRAIN GAUGE INSTRUMENTATIONS, COMPUTER SOFTWARE FOR USE IN WEIGHING SYSTEMS AND PROCESSES CONTROL, COMPUTER SOFTWARE FOR USE IN STRESS ANALYSIS; LOAD CELL MODULES THAT INCLUDE ELECTRONIC INSTRUMENTATION AND SYSTEMS USED FOR PROCESS CONTROL, FOR WEIGHING AND SORTING, AND FOR PROCESS CONTROL USING TRANSDUCERS; STRAIN GAUGE INSTRUMENTATION, REFLECTION POLARISCOPEs AND PHOTOELASTIC PLASTICS IN THE NATURE OF STRAIN SENSITIVE PLASTICS FOR MEASURING STRAINS ON SURFACES OF MATERIALS FOR OPTICAL MEASUREMENT AND ANALYSIS OF STRESSES AND STRAINS; STRAIN GAUGE CALIBRATION EQUIPMENT; STRAIN GAUGE INSTALLATION TESTERS; ACCESSORIES USED FOR SURFACE PREPARATION AND INSTALLATION OF ELECTRICAL RESISTANCE STRAIN GAUGES AND BONDABLE RESISTORS, NAMELY, SOLDERING AND WELDING EQUIPMENT, NAMELY, PORTABLE ELECTRIC POWERED STRAIN GAUGE WELDING AND SOLDERING APPARATUS, BONDABLE ELECTRONIC TERMINALS, ELECTRIC BRIDGE COMPLETION MODULES, NAMELY, GAUGE INSTALLATION TESTERS, FOR VERIFYING THE ELECTRICAL QUALITY OF STRAIN GAUGE INSTALLATION (U.S. CLS. 21, 23, 26, 36 AND 38).

LINDA POWELL, EXAMINING ATTORNEY



**CLASS 9—(Continued).**

SN 77-953,022. GRID NET, INC., SAN FRANCISCO, CA. FILED 3-8-2010.

**CLASS 9—(Continued).**

SN 77-953,395. VISHAY INTERTECHNOLOGY, INC., MALVERN, PA. FILED 3-8-2010.



# POLICYNET

THE MARK CONSISTS OF STANDARD CHARACTERS WITHOUT CLAIM TO ANY PARTICULAR FONT, STYLE, SIZE, OR COLOR.

FOR COMPUTER SOFTWARE FOR THE DEPLOYMENT, OPERATION, CONFIGURATION, ADMINISTRATION, MANAGEMENT AND SECURITY OF GRID NETWORKS, SMART ENERGY GRID NETWORKS, BROADBAND NETWORKS AND BROADBAND COMMUNICATIONS RELATING TO THE FOREGOING; RULES-BASED COMPUTER SOFTWARE AGENTS FOR USE WITH GRID NETWORKS, SMART ENERGY GRID NETWORKS, BROADBAND NETWORKS AND BROADBAND COMMUNICATIONS RELATING TO THE FOREGOING; NETWORK OPERATING SOFTWARE FOR GRID NETWORKS, SMART ENERGY GRID NETWORKS, BROADBAND NETWORKS AND BROADBAND COMMUNICATIONS RELATING TO THE FOREGOING; COMPUTER SOFTWARE USED IN ROUTERS AND METERS FOR ADMINISTERING AND MANAGING GRID NETWORKS, SMART ENERGY GRID NETWORKS, BROADBAND NETWORKS AND BROADBAND COMMUNICATIONS RELATING TO THE FOREGOING; HOME AREA NETWORKS AND UTILITY DEVICES; COMPUTER SOFTWARE FOR MEASURING AND MANAGING ENERGY USAGE AND FOR CONTROLLING AND MONITORING THE STATUS OF INDUSTRIAL PROCESSES; COMPUTER SOFTWARE FOR MONITORING ENVIRONMENTAL CONDITIONS AND CONTROLLING DEVICES WITHIN A BUILDING, FACILITY, GROUNDS OR DESIGNATED SPATIAL AREA (U.S. CLS. 21, 23, 26, 36 AND 38).

YAT SYE, LEE, EXAMINING ATTORNEY

OWNER OF U.S. REG. NOS. 837,476, 1,790,212 AND OTHERS.

NO CLAIM IS MADE TO THE EXCLUSIVE RIGHT TO USE "PRECISION" AND "GROUP", APART FROM THE MARK AS SHOWN.

THE MARK CONSISTS OF A SQUARE ROOT SYMBOL WITH THE CHECK MARK PORTION INSIDE A CIRCLE, THE WORD "VISHAY" ON TOP OF THE LINE, THE WORDS "PRECISION GROUP" BELOW THE LINE, A HORIZONTAL LINE APPEARS AT THE TOP AND THE BOTTOM OF THE DRAWING.

FOR ELECTRIC COMPONENTS, NAMELY, RESISTORS AND RESISTOR NETWORKS, LOW VALUE RESISTORS, SHUNT RESISTORS, CURRENT SENSORS, POTENTIOMETERS, TRIMMER POTENTIOMETERS, CAPACITY SENSORS, INDUCTOR SENSORS, VOLUME CONTROL SENSORS, INCLINOMETER SENSORS, MEMS (MICROELECTROMECHANICAL SYSTEM) SENSORS, VIBRATING WIRE SENSORS, ELECTRICAL RESISTANCE STRAIN GAUGES, STRAIN GAUGE TRANSDUCERS, LOAD CELLS, PRESSURE SENSORS, ACCELERATORS, STRESS ANALYSIS SYSTEMS, STRAIN GAUGE INSTRUMENTATIONS, COMPUTER SOFTWARE FOR USE IN WEIGHING SYSTEMS AND PROCESSES CONTROL, COMPUTER SOFTWARE FOR USE IN STRESS ANALYSIS; LOAD CELL MODULES THAT INCLUDE ELECTRONIC INSTRUMENTATION AND SYSTEMS USED FOR PROCESS CONTROL, FOR WEIGHING AND SORTING, AND FOR PROCESS CONTROL USING TRANSDUCERS; STRAIN GAUGE INSTRUMENTATION, REFLECTION POLARISCOPE AND PHOTOELASTIC PLASTICS IN THE NATURE OF STRAIN SENSITIVE PLASTICS FOR MEASURING STRAINS ON SURFACES OF MATERIALS FOR OPTICAL MEASUREMENT AND ANALYSIS OF STRESSES AND STRAINS; STRAIN GAUGE CALIBRATION EQUIPMENT; STRAIN GAUGE INSTALLATION TESTERS; ACCESSORIES USED FOR SURFACE PREPARATION AND INSTALLATION OF ELECTRICAL RESISTANCE STRAIN GAUGES AND BONDABLE RESISTORS, NAMELY, SOLDERING AND WELDING EQUIPMENT, NAMELY, PORTABLE ELECTRIC POWERED STRAIN GAUGE WELDING AND SOLDERING APPARATUS, BONDABLE ELECTRONIC TERMINALS, ELECTRIC BRIDGE COMPLETION MODULES, NAMELY, GAUGE INSTALLATION TESTERS, FOR VERIFYING THE ELECTRICAL QUALITY OF STRAIN GAUGE INSTALLATION (U.S. CLS. 21, 23, 26, 36 AND 38).

LINDA POWELL, EXAMINING ATTORNEY

**CLASS 9—(Continued).**

SN 77-968,505. EZ DISTRIBUTION INC., ANN ARBOR, MI. FILED 3-25-2010.

# PREMIER

THE MARK CONSISTS OF STANDARD CHARACTERS WITHOUT CLAIM TO ANY PARTICULAR FONT, STYLE, SIZE, OR COLOR.

FOR BLANK CD-ROMS FOR SOUND OR VIDEO RECORDING; BLANK RECORDABLE CD-RS AND DVD-RS; BLANK RECORDABLE DVDS; CD CASES; CD SLEEVES; DVD CASES; DVD SLEEVES; BLANK BD-R, BD-RE, AND BD-RW DISCS FOR SOUND OR VIDEO RECORDING (U.S. CLS. 21, 23, 26, 36 AND 38).

FIRST USE 11-30-2008; IN COMMERCE 11-30-2008.

DAVID TAYLOR, EXAMINING ATTORNEY

---

SN 79-087,331. ASELSAN ELEKTRONIK SANAYI VE TICARET ANONIM SIRKETI, YENIMAHALLE ANKARA, TURKEY, FILED 8-3-2010.



The logo for SONEC-IR features the word "SONEC" in a bold, black, sans-serif font. The letter "O" is stylized as a square with a circle inside, and the "N" has a similar square-and-circle design. To the right of "SONEC" is a dot, followed by "IR" in a purple, sans-serif font.

OWNER OF INTERNATIONAL REGISTRATION 1050991 DATED 8-3-2010, EXPIRES 8-3-2020.

THE COLOR(S) PURPLE AND DARK NAVY BLUE IS/ARE CLAIMED AS A FEATURE OF THE MARK.

THE MARK CONSISTS OF THE WORD "SONEC" FOLLOWED BY A DOT AND "IR"; "SONEC" APPEARING IN STYLIZED FONT AND IN DARK NAVY BLUE; THE LETTER "O" IS FORMED BY A STYLIZED ELECTRONIC INSTRUMENT, COMPOSED OF AN INCOMPLETE SQUARE CONSISTING OF FOUR CORNERS, AND CONCENTRIC CIRCLES WITHIN THE SQUARE DESIGN, SUGGESTIVE OF THE FRONT VIEW OF A CAMERA WITH A LENS, AND THE LETTER "IR" ARE IN PURPLE. THE WHITE IN THE DRAWING REPRESENTS BACKGROUND OR TRANSPARENT AREAS AND IS NOT PART OF THE MARK.

FOR ELECTRO-OPTICAL APPARATUS FOR RECORDING, TRANSMISSION OR REPRODUCTION OF VIDEO STREAMS, IMAGES AND SOUND WITH INTEGRATED COMPUTER HARDWARE, SOFTWARE AND PERIPHERALS FOR PROCESSING OF DATA, DATA COMMUNICATION AND DATA REPRODUCTION FOR SECURITY, SURVEILLANCE, MANUFACTURING QUALITY CONTROL, VEHICLE GUIDANCE AND NAVIGATION PURPOSES; ALARM INSTALLATIONS EXCEPT VEHICLE ALARMS COMPRISED OF SENSORS, CAMERAS, POWER SOURCES, COMMUNICATION DEVICES, STORAGE DEVICES, MONITORS, CONTROL EQUIPMENT AND OPERATING AND APPLICATION SOFTWARE; NIGHT VISION PROVIDING AND INCREASING DEVICES AND APPARATUS, NAMELY, NIGHT VISION ELECTRO-OPTICAL CAMERAS (U.S. CLS. 21, 23, 26, 36 AND 38).

HENRY S. ZAK, EXAMINING ATTORNEY

**CLASS 9—(Continued).**

SN 79-090,665. SALTO SYSTEMS, S.L., SPAIN, FILED 10-28-2010.

# SALTOGEO

THE MARK CONSISTS OF STANDARD CHARACTERS WITHOUT CLAIM TO ANY PARTICULAR FONT, STYLE, SIZE, OR COLOR.

PRIORITY DATE OF 7-22-2010 IS CLAIMED.

OWNER OF INTERNATIONAL REGISTRATION 1060241 DATED 10-28-2010, EXPIRES 10-28-2020.

OWNER OF U.S. REG. NO. 2,825,133.

THE WORDING "SALTOGEO" HAS NO MEANING IN A FOREIGN LANGUAGE.

FOR ELECTRONIC LOCKS; ELECTRONIC DOOR CLOSING SYSTEMS COMPRISED OF ENCODED MAGNETIC KEY CARDS, MAGNETIC ENCODED CARD READERS, ELECTRONIC DOOR OPENERS, ELECTRONIC ENCRYPTION UNITS, AND ELECTRONIC CLOSING DEVICES, NAMELY, ELECTRONIC DOOR CLOSERS AND ELECTRONIC LOCK CYLINDERS (U.S. CLS. 21, 23, 26, 36 AND 38).

MYRIAH HABEEB, EXAMINING ATTORNEY

---

SN 79-090,872. BIOHIT OYJ, FINLAND, FILED 11-9-2010.

# BIOHIT ROBOLINE

THE MARK CONSISTS OF STANDARD CHARACTERS WITHOUT CLAIM TO ANY PARTICULAR FONT, STYLE, SIZE, OR COLOR.

PRIORITY DATE OF 5-12-2010 IS CLAIMED.

OWNER OF INTERNATIONAL REGISTRATION 1060733 DATED 11-9-2010, EXPIRES 11-9-2020.

OWNER OF U.S. REG. NOS. 2,600,098 AND 3,136,067.

THE WORD(S) "BIOHIT ROBOLINE" HAS NO MEANING IN A FOREIGN LANGUAGE.

FOR LABORATORY EQUIPMENT, NAMELY, DISPENSERS FOR LIQUIDS AND REAGENTS, FOR LABORATORY USE; LABORATORY DISPENSING ROBOTS FOR LABORATORY USE (U.S. CLS. 21, 23, 26, 36 AND 38).

RONALD DELGIZZI, EXAMINING ATTORNEY

**CLASS 9—(Continued).**

SN 79-090,903. COLEBROOK BOSSON SAUNDERS PRODUCTS LTD, UNITED KINGDOM, FILED 11-17-2010.

**FLO**

THE MARK CONSISTS OF STANDARD CHARACTERS WITHOUT CLAIM TO ANY PARTICULAR FONT, STYLE, SIZE, OR COLOR.

PRIORITY DATE OF 5-20-2010 IS CLAIMED.

OWNER OF INTERNATIONAL REGISTRATION 1060818 DATED 11-17-2010, EXPIRES 11-17-2020.

FOR COMPUTER MONITOR SUPPORTS, ARMS, MOUNTS AND STANDS; TV AND FLAT PANEL DISPLAY SCREEN SUPPORTS, ARMS, MOUNTS AND STANDS; LAPTOP SUPPORTS AND STANDS; COMPUTER AND CPU HOLDERS, STANDS AND SUPPORTS; AND PARTS, FITTINGS AND COMPONENTS FOR ALL THE AFORESAID GOODS (U.S. CLS. 21, 23, 26, 36 AND 38).

MICHELE SWAIN, EXAMINING ATTORNEY

**CLASS 9—(Continued).**

SN 79-092,362. TYCO ELECTRONICS AMP GMBH, FED REP GERMANY, FILED 12-21-2010.

**MQS**

THE MARK CONSISTS OF STANDARD CHARACTERS WITHOUT CLAIM TO ANY PARTICULAR FONT, STYLE, SIZE, OR COLOR.

PRIORITY DATE OF 7-21-2010 IS CLAIMED.

OWNER OF INTERNATIONAL REGISTRATION 1064513 DATED 12-21-2010, EXPIRES 12-21-2020.

FOR ELECTRICAL CONNECTORS, TERMINALS IN THE NATURE OF ELECTRICAL CONNECTIONS, PLUG CONNECTORS AND HEADERS IN THE NATURE OF ELECTRICAL CONNECTIONS (U.S. CLS. 21, 23, 26, 36 AND 38).

KRISTINA MORRIS, EXAMINING ATTORNEY

SN 79-092,195. KRAUSS-MAFFEI WEGMANN GMBH & CO. KG, FED REP GERMANY, FILED 11-12-2010.

**TAS**

THE MARK CONSISTS OF STANDARD CHARACTERS WITHOUT CLAIM TO ANY PARTICULAR FONT, STYLE, SIZE, OR COLOR.

PRIORITY DATE OF 6-18-2010 IS CLAIMED.

OWNER OF INTERNATIONAL REGISTRATION 1064062 DATED 11-12-2010, EXPIRES 11-12-2020.

FOR VIRTUAL REALITY SOFTWARE FOR GENERATING AND CONTROLLING TERRAIN, ENVIRONMENT, WEAPONS AND LAND-BASED VEHICLES OF A VIRTUAL REALITY FOR MILITARY USE; VIRTUAL REALITY SOFTWARE FOR INTERACTION WITH TERRAIN, ENVIRONMENT, WEAPONS AND LAND-BASED VEHICLES OF A VIRTUAL REALITY FOR MILITARY USE; SOFTWARE FOR OPERATING SIMULATORS OF WEAPONS AND LAND-BASED VEHICLES FOR MILITARY USE; SOFTWARE FOR DATA MANAGEMENT AND DATA DISTRIBUTION IN SERVER/CLIENT-BASED SIMULATION SYSTEMS FOR MILITARY USE; GRAPHICS GENERATION SOFTWARE FOR MILITARY USE; SIMULATORS OF WEAPONS AND LAND-BASED VEHICLES, IN PARTICULAR TRAINING SIMULATORS FOR TANKS AND WEAPON SYSTEMS (U.S. CLS. 21, 23, 26, 36 AND 38).

MARY BOAGNI, EXAMINING ATTORNEY

SN 79-093,404. ALEADER VISION TECHNOLOGY CO., LTD., GUANGDONG PROVINCE, CHINA, FILED 11-24-2010.

**ALeader**

OWNER OF INTERNATIONAL REGISTRATION 1067169 DATED 11-24-2010, EXPIRES 11-24-2020.

THE MARK CONSISTS OF THE WORD "ALEADER" IN STYLIZED UNDERLINED CHARACTERS AND SHADOWS FOLLOWING THE LETTER "R" SHOWN AS SEVEN LEDGEMENTS.

FOR AUTOMATIC OPTICAL TESTING INSTRUMENT FOR TESTING DEFECTS OF PCB (PRINTED CIRCUIT BOARD) (U.S. CLS. 21, 23, 26, 36 AND 38).

CARYN GLASSER, EXAMINING ATTORNEY

**CLASS 9—(Continued).**

SN 79-094,249. NINGBO WEIFENG IMAGE EQUIPMENT GROUP CO., LTD, CHINA, FILED 1-4-2011.

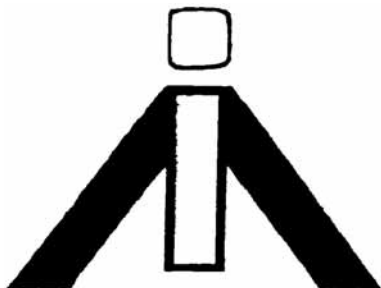

OWNER OF INTERNATIONAL REGISTRATION 1068877 DATED 1-4-2011, EXPIRES 1-4-2021.

THE MARK CONSISTS OF THE STYLIZED LETTERS "IA".

FOR TRIPODS FOR CAMERAS; CASES ESPECIALLY MADE FOR PHOTOGRAPHIC APPARATUS AND INSTRUMENTS; STANDS FOR PHOTOGRAPHIC APPARATUS; BAGS ESPECIALLY MADE FOR PHOTOGRAPHIC INSTRUMENTS; LENSE OBJECTIVES FOR OPTICS, NAMELY, OPTICAL LENSES, ANTI-REFLECTIVE LENSES; ELECTRICAL APPARATUS, NAMELY, HEAT SEALING MACHINES FOR SEALING PLASTICS FOR PACKAGING; APPARATUS AND INSTRUMENTS FOR ASTRONOMY, NAMELY, ASTRONOMETRIC MEASURING MACHINES AND INSTRUMENTS, ASTRONOMICAL SPECTROGRAPHS; BATTERY CHARGERS; GALVANIC CELL BATTERIES; ELECTRIC WIRES; WEIGHING APPARATUS AND INSTRUMENTS (U.S. CLS. 21, 23, 26, 36 AND 38).

BARBARA RUTLAND, EXAMINING ATTORNEY

SN 79-094,798. PHARMATRON AG, SWITZERLAND, FILED 1-21-2011.

# PHARMATRON

THE MARK CONSISTS OF STANDARD CHARACTERS WITHOUT CLAIM TO ANY PARTICULAR FONT, STYLE, SIZE, OR COLOR.

PRIORITY DATE OF 7-21-2010 IS CLAIMED.

OWNER OF INTERNATIONAL REGISTRATION 1070261 DATED 1-21-2011, EXPIRES 1-21-2021.

FOR INSTRUMENTS FOR MEASURING TORQUE IN PARTICULAR FOR BOTTLE CLOSURES; MEASURING APPARATUS FOR THE PHARMACEUTICAL INDUSTRY, IN PARTICULAR FOR PRODUCTS SOLD IN SOLID, LIQUID AND PASTE DOSAGE FORMS, AND FOR PACKAGING MATERIALS AND PACKAGING TO MEASURE HARDNESS, CONTENT UNIFORMITY, DISINTEGRATION, FRIABILITY, DENSITY AND DISSOLUTION, MEASURING APPARATUS FOR THE MEASUREMENT OF THE COMPRESSION DENSITY OF POWDERS, GRANULATES OR SIMILAR PRODUCTS; PHARMACEUTICAL TABLET MEASURING, TESTING AND WEIGHING APPARATUS, IN PARTICULAR FOR MEASURING TABLET HARDNESS; MEASURING APPARATUS FOR THICKNESS AND DIAMETER OF PHARMACEUTICAL TABLETS; MEASURING APPARATUS FOR PHARMACEUTICAL TABLET DECAY TIME AND TABLET ABRASION (U.S. CLS. 21, 23, 26, 36 AND 38).

MICHELLE DUBOIS, EXAMINING ATTORNEY

**CLASS 9—(Continued).**

SN 79-095,704. JEAN GABES, F-33720 LANDIRAS, FRANCE, FILED 2-22-2011.

# SHINKEN

THE MARK CONSISTS OF STANDARD CHARACTERS WITHOUT CLAIM TO ANY PARTICULAR FONT, STYLE, SIZE, OR COLOR.

OWNER OF INTERNATIONAL REGISTRATION 1072861 DATED 2-22-2011, EXPIRES 2-22-2021.

FOR COMPUTER SOFTWARE FOR MONITORING AND REPORTING THE AVAILABILITY AND OPERATIONAL STATE OF COMPUTER SYSTEMS AND COMPUTER SOFTWARE; COMPUTER SOFTWARE FOR USE IN MONITORING AND REPORTING THE AVAILABILITY AND OPERATIONAL STATE OF COMPUTER SYSTEMS, COMPUTER SOFTWARE, NETWORK OPERATING SYSTEMS, AND NETWORK SERVICES (U.S. CLS. 21, 23, 26, 36 AND 38).

ELI HELLMAN, EXAMINING ATTORNEY

SN 79-096,801. NED. DECK MARINE B.V., NETHERLANDS, FILED 3-21-2011.

# NED-DECK

THE MARK CONSISTS OF STANDARD CHARACTERS WITHOUT CLAIM TO ANY PARTICULAR FONT, STYLE, SIZE, OR COLOR.

PRIORITY DATE OF 10-18-2010 IS CLAIMED.

OWNER OF INTERNATIONAL REGISTRATION 1075488 DATED 3-21-2011, EXPIRES 3-21-2021.

FOR LIFE BOATS (U.S. CLS. 21, 23, 26, 36 AND 38).

SKYE YOUNG, EXAMINING ATTORNEY

SN 79-096,963. LOGOSAPIENCE, F-49070 SAINT JEAN DE LINIERES, FRANCE, FILED 4-8-2011.

# WIZZBE

THE MARK CONSISTS OF STANDARD CHARACTERS WITHOUT CLAIM TO ANY PARTICULAR FONT, STYLE, SIZE, OR COLOR.

PRIORITY DATE OF 12-10-2010 IS CLAIMED.

OWNER OF INTERNATIONAL REGISTRATION 1076000 DATED 4-8-2011, EXPIRES 4-8-2021.

THE WORDING "WIZZBE" HAS NO MEANING IN A FOREIGN LANGUAGE.

FOR COMPUTER SOFTWARE FOR MANAGING MULTIMEDIA DATA FOR EDUCATIONAL AND OTHER USES; LANGUAGE LEARNING AND TRAINING SOFTWARE; COMPUTER PROGRAMS FOR DIGITIZING AUDIO, VIDEO, IMAGE, PHOTOGRAPHIC AND TEXT DOCUMENTS (U.S. CLS. 21, 23, 26, 36 AND 38).

RICHARD WHITE, EXAMINING ATTORNEY

**CLASS 9—(Continued).**

SN 79-097,144. NED. DECK MARINE B.V., NETHERLANDS,  
FILED 3-21-2011.

# NDM

THE MARK CONSISTS OF STANDARD CHARACTERS  
WITHOUT CLAIM TO ANY PARTICULAR FONT, STYLE,  
SIZE, OR COLOR.

PRIORITY DATE OF 10-18-2010 IS CLAIMED.  
OWNER OF INTERNATIONAL REGISTRATION 1076511  
DATED 3-21-2011, EXPIRES 3-21-2021.

FOR LIFE BOATS (U.S. CLS. 21, 23, 26, 36 AND 38).  
SKYE YOUNG, EXAMINING ATTORNEY

**CLASS 9—(Continued).**

SN 85-009,598. AXEDE S.A., BOGOTÁ D.C., COLOMBIA,  
FILED 4-8-2010.



OWNER OF COLOMBIA REG. NO. 389740, DATED 9-30-  
2009, EXPIRES 9-30-2019.

THE COLOR(S) ORANGE, YELLOW AND PURPLE IS/  
ARE CLAIMED AS A FEATURE OF THE MARK.

THE MARK CONSISTS OF TWO STYLIZED HUMANOID  
FORMS STANDING SIDE BY SIDE, EACH FORMING  
HALF OF THE LETTER "X" WITH TWO CIRCLES FLOAT-  
ING ABOVE EACH OF THE HUMANOID FORM AND THE  
LETTERS "YNTHESIS" IN STYLIZED LETTERING THE  
RIGHT OF THE HUMANOID FORMS; THE COLOR OR-  
ANGE APPEARS IN THE LEFT HUMANOID FORM; THE  
COLOR YELLOW APPEARS IN THE RIGHT HUMANOID  
FORM; THE COLOR PURPLE APPEARS IN THE TERM  
"YNTHESIS".

THE WORDING "XYNTHESIS" HAS NO MEANING IN A  
FOREIGN LANGUAGE.

FOR TECHNOLOGICAL EQUIPMENT FOR VOICE,  
DATA AND VIDEO TRANSMISSION AS WELL AS FOR  
INFORMATION PROCESSING AND COMPUTERS,  
NAMELY, COMPUTER NETWORK INTERFACE DE-  
VICES USED FOR MEASURING THE CONSUMPTION  
OF TELECOMMUNICATIONS DEVICES; WEB STRUC-  
TURE EQUIPMENT FOR VOICE IP, VOICE, DATA,  
VIDEOCONFERENCES, SECURITY, AUDIOVISUAL  
EQUIPMENT, RECORDING SYSTEMS, TRADING  
DESKS SYSTEMS AND MANAGEMENT PLATFORMS,  
NAMELY, TELECOMMUNICATIONS AND DATA NET-  
WORKING HARDWARE, NAMELY, COMPUTER NET-  
WORK INTERFACE DEVICES FOR TRANSPORTING  
AND AGGREGATING VOICE, DATA, AND VIDEO  
COMMUNICATIONS ACROSS MULTIPLE NETWORK  
INFRASTRUCTURES AND COMMUNICATIONS PRO-  
TOCOLS (U.S. CLS. 21, 23, 26, 36 AND 38).

MYRIAH HABEEB, EXAMINING ATTORNEY

SN 79-101,412. BEIJING NUFRONT MOBILE COMMUNICA-  
TIONS TECHNOLOGY CO., LTD., CHINA, FILED 5-30-  
2011.

# TeLink

PRIORITY DATE OF 4-21-2011 IS CLAIMED.  
OWNER OF INTERNATIONAL REGISTRATION 1087699  
DATED 5-30-2011, EXPIRES 5-14-2022.

THE MARK CONSISTS OF AN INVENTED WORD  
"TELINK" IN STYLIZED FORM.

FOR SEMICONDUCTORS; PRINTED CIRCUITS; IN-  
TEGRATED CIRCUITS; MODEMS; PORTABLE TELE-  
PHONES; MONEY COUNTING AND SORTING  
MACHINES (U.S. CLS. 21, 23, 26, 36 AND 38).

SHAILA SETTLES, EXAMINING ATTORNEY

**CLASS 9—(Continued).**

SN 85-009,618. AXEDE S.A., BOGOTÁ D.C., COLOMBIA, FILED 4-8-2010.



OWNER OF COLOMBIA REG. NO. 380426, DATED 5-22-2009, EXPIRES 5-22-2019.

THE COLOR(S) ORANGE, YELLOW AND PURPLE IS/ARE CLAIMED AS A FEATURE OF THE MARK.

THE MARK CONSISTS OF THE STYLIZED TERM "INTERAXION" WHEREIN THE LETTER "X" IS COMPRISED OF TWO STYLIZED HUMANOID FORMS STANDING SIDE BY SIDE, EACH FORMING HALF OF THE LETTER "X" WITH TWO CIRCLES FLOATING ABOVE EACH OF THE HUMANOID FORMS REPRESENTING HEADS; THE COLOR ORANGE APPEARS IN THE LEFT HUMANOID FORM; THE COLOR YELLOW APPEARS IN THE RIGHT HUMANOID FORM; THE COLOR PURPLE APPEARS IN THE LETTERS "INTERA" AND "ION".

THE WORDING "INTERAXION" HAS NO MEANING IN A FOREIGN LANGUAGE.

FOR TECHNOLOGICAL EQUIPMENT FOR VOICE, DATA AND VIDEO TRANSMISSION AS WELL AS FOR INFORMATION PROCESSING AND COMPUTERS, NAMELY, COMPUTER NETWORK INTERFACE DEVICES USED FOR EXTRACTING AND PROCESSING DATA THROUGH TELECOMMUNICATIONS AND COMPUTER NETWORKS TO ANALYZE, CONTROL AND PLAN ALLOCATION AND CONSUMPTION OF TELECOMMUNICATIONS RESOURCES AND TO MANAGE, ADMINSTRATE AND AUTOMATE VIDEO CONFERENCE ROOMS; WEB STRUCTURE EQUIPMENT FOR VOICE IP, VOICE, DATA, VIDEOCONFERENCES, SECURITY, AUDIOVISUAL EQUIPMENT, RECORDING SYSTEMS, TRADING DESKS SYSTEMS AND MANAGEMENT PLATFORMS, NAMELY, TELECOMMUNICATIONS AND DATA NETWORKING HARDWARE, NAMELY, COMPUTER NETWORK INTERFACE DEVICES FOR TRANSPORTING AND AGGREGATING VOICE, DATA, AND VIDEO COMMUNICATIONS ACROSS MULTIPLE NETWORK INFRASTRUCTURES AND COMMUNICATIONS PROTOCOLS TO ANALYZE, CONTROL AND PLAN ALLOCATION AND CONSUMPTION OF TELECOMMUNICATIONS RESOURCES AND TO MANAGE, ADMINSTRATE, AND AUTOMATE VIDEO CONFERENCE ROOMS (U.S. CLS. 21, 23, 26, 36 AND 38).

MYRIAH HABEEB, EXAMINING ATTORNEY

**CLASS 9—(Continued).**

SN 85-022,709. EMC CORPORATION, HOPKINTON, MA, FILED 4-26-2010.

## SMARTPOOLS

THE MARK CONSISTS OF STANDARD CHARACTERS WITHOUT CLAIM TO ANY PARTICULAR FONT, STYLE, SIZE, OR COLOR.

FOR COMPUTER SOFTWARE, NAMELY, INTELLIGENT STORAGE SYSTEMS CAPABLE OF NETWORK COMMUNICATION, NAMELY, NETWORK ACCESS SERVER OPERATING SOFTWARE; COMPUTER SOFTWARE FOR USE IN MANAGING, ANALYZING, REPORTING, AND AUTOMATION IN CONJUNCTION WITH CUSTOMER WORKFLOWS, STORAGE PATTERNS, AND FILE CONTENT FOR DATA STORAGE SYSTEMS (U.S. CLS. 21, 23, 26, 36 AND 38).

JAMES MACFARLANE, EXAMINING ATTORNEY

SN 85-029,537. SKM INDUSTRIES INC., OLYPHANT, PA, FILED 5-4-2010.

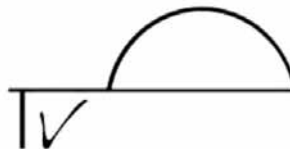

THE MARK CONSISTS OF LETTERS "TV" WITH A CAP DESIGN WHERE THE HORIZONTAL PART OF THE LETTER "T" FORMS PART OF THE CAP BILL.

FOR HEADGEAR, NAMELY, HATS HAVING AN OPTICAL DEVICE AND A VIEWING ENCLOSURE FOR STORING AND VIEWING A SCREEN OF AN ELECTRONIC DEVICE (U.S. CLS. 21, 23, 26, 36 AND 38).

FIRST USE 11-16-2009; IN COMMERCE 11-16-2009.

CHRISTOPHER BUONGIORNO, EXAMINING ATTORNEY

SN 85-033,591. ULTIHOME, DBA ULTIMACHINE, SOUTH PITTSBURG, TN, FILED 5-8-2010.

## UltiMachine

THE MARK CONSISTS OF STANDARD CHARACTERS WITHOUT CLAIM TO ANY PARTICULAR FONT, STYLE, SIZE, OR COLOR.

FOR ROBOTS FOR PERSONAL, EDUCATIONAL AND HOBBY USE AND STRUCTURAL PARTS THEREFOR (U.S. CLS. 21, 23, 26, 36 AND 38).

DAWN HAN, EXAMINING ATTORNEY

**CLASS 9—(Continued).**

SN 85-036,583. D-LINK SYSTEMS, INC., FOUNTAIN VALLEY, CA. FILED 5-12-2010.

# Shadow

THE MARK CONSISTS OF STANDARD CHARACTERS WITHOUT CLAIM TO ANY PARTICULAR FONT, STYLE, SIZE, OR COLOR.

FOR COMPUTER NETWORKING HARDWARE FOR USE IN DATA STORAGE, OPERATION OF COMPUTER APPLICATIONS AND NETWORKS, RECOVERY OF DATA, DATA PROTECTION, DATA BACK-UP, DATA ENCRYPTION, DATA CONSOLIDATION AND DATA DUPLICATION/REDUNDANCY AND NETWORK DATA MANAGEMENT (U.S. CLS. 21, 23, 26, 36 AND 38).

MARCIE MILONE, EXAMINING ATTORNEY

SN 85-039,204. VISISONICS CORPORATION, HIGHLAND, MD. FILED 5-14-2010.

# VisiSonics

THE MARK CONSISTS OF STANDARD CHARACTERS WITHOUT CLAIM TO ANY PARTICULAR FONT, STYLE, SIZE, OR COLOR.

FOR AUDIO HEADPHONES; AUDIO RECORDERS FOR USE IN THE FIELDS OF AUDIO SURVEILLANCE, ACOUSTIC RESEARCH, ARCHITECTURAL ACOUSTICS, TELEPRESENCE APPLICATIONS, AND SOUND ANALYSIS AND DIAGNOSTICS; BOXES SPECIALLY ADAPTED FOR HOUSING AUDIO EQUIPMENT; APPARATUS FOR RECORDING, TRANSMISSION, PROCESSING AND REPRODUCTION OF SOUND, IMAGES OR DATA, NAMELY, MULTI-CHANNEL AUDIO-VISUAL ARRAYS SOLD AS A UNIT, COMPRISED OF CAMERAS AND MICROPHONES, AND A COMBINATION OF CENTRAL PROCESSING UNITS FOR PROCESSING INFORMATION, DATA, SOUND OR IMAGES, COMPUTER HARDWARE FOR COMMUNICATING AUDIO, VIDEO AND DATA BETWEEN COMPUTERS VIA A GLOBAL COMPUTER NETWORK, WIDE-AREA COMPUTER NETWORKS, AND PEER-TO-PEER COMPUTER NETWORKS, COMPUTER SOFTWARE TO ENHANCE THE AUDIO-VISUAL CAPABILITIES OF MULTIMEDIA APPLICATIONS, NAMELY, FOR THE INTEGRATION OF TEXT, AUDIO, GRAPHICS, STILL IMAGES AND MOVING PICTURES, AND DIGITAL AUDIO AND VIDEO RECORDERS AND PLAYERS, ALL OF THE FOREGOING FOR USE IN THE FIELDS OF AUDIO SURVEILLANCE, ACOUSTIC RESEARCH, ARCHITECTURAL ACOUSTICS, TELEPRESENCE APPLICATIONS, AND SOUND ANALYSIS AND DIAGNOSTICS; COMPUTER GRAPHICS SOFTWARE; COMPUTER HARDWARE AND COMPUTER SOFTWARE PROGRAMS FOR THE INTEGRATION OF TEXT, AUDIO, GRAPHICS, STILL IMAGES AND MOVING PICTURES INTO AN INTERACTIVE DELIVERY FOR MULTIMEDIA APPLICATIONS; COMPUTER SOFTWARE FOR MANIPULATING DIGITAL AUDIO INFORMATION FOR USE IN AUDIO MEDIA APPLICATIONS AND FOR PROCESSING DIGITAL IMAGES, ALL OF THE FOREGOING FOR USE IN THE FIELDS OF AUDIO SURVEILLANCE, ACOUSTIC RESEARCH, ARCHITECTURAL ACOUSTICS, TELEPRESENCE APPLICATIONS, AND SOUND ANALYSIS AND DIAGNOSTICS; COMPUTER SOFTWARE FOR THE DATABASING, VISUALIZATION, MANIPULATION, VIRTUAL REALITY

**CLASS 9—(Continued).**

IMMERSION AND INTEGRATION OF GEOGRAPHIC INFORMATION WITH ON-LINE MEMBER COMMUNITIES; COMPUTER SOFTWARE THAT ASSISTS COMPUTERS IN DEPLOYING PARALLEL APPLICATIONS AND PERFORMING PARALLEL COMPUTATIONS; COMPUTER SOFTWARE TO CONTROL AND IMPROVE COMPUTER AND AUDIO EQUIPMENT SOUND QUALITY; ELECTRONIC PRODUCTS FOR THE GENERATION, MEASUREMENT, AND ANALYSIS OF AUDIO SIGNALS, NAMELY, AUDIO ANALYZERS; ELECTRONIC SOUND MIXING, PROCESSING AND SYNTHESIZING APPARATUS; GRAPHICAL USER INTERFACE SOFTWARE; PORTABLE AND HANDHELD DIGITAL ELECTRONIC DEVICES FOR RECORDING, ORGANIZING, TRANSMITTING, MANIPULATING, AND REVIEWING TEXT, DATA, IMAGE, AND AUDIO FILES FOR USE IN THE FIELDS OF AUDIO SURVEILLANCE, ACOUSTIC RESEARCH, ARCHITECTURAL ACOUSTICS, TELEPRESENCE APPLICATIONS, AND SOUND ANALYSIS AND DIAGNOSTICS; OPERATING SYSTEM AND APPLICATION SOFTWARE TO DETECT VEHICLE LOCATION USING A MULTI-CHANNEL AUDIO-VISUAL ARRAY HAVING MULTIPLE MICROPHONES; VIDEO GAME SOFTWARE; VIRTUAL REALITY GAME SOFTWARE (U.S. CLS. 21, 23, 26, 36 AND 38).

STEVEN PEREZ, EXAMINING ATTORNEY

SN 85-041,820. WITZ SPORT CASES, INC., GOLD RIVER, CA. FILED 5-18-2010.

# SMARTPHONE LOCKER

THE MARK CONSISTS OF STANDARD CHARACTERS WITHOUT CLAIM TO ANY PARTICULAR FONT, STYLE, SIZE, OR COLOR.

OWNER OF U.S. REG. NO. 2,552,097.

NO CLAIM IS MADE TO THE EXCLUSIVE RIGHT TO USE "SMARTPHONE", APART FROM THE MARK AS SHOWN.

FOR PLASTIC BUOYANT WATERPROOF CASES FOR SMARTPHONES AND VALUABLES IN THE NATURE OF CAMERAS AND PORTABLE AUDIO PLAYERS (U.S. CLS. 21, 23, 26, 36 AND 38).

MICHAEL KEATING, EXAMINING ATTORNEY

**CLASS 9—(Continued).**

SN 85-042,478. SKYCAM, DBA LUXOR DIRECT, STAFFORD, TX. FILED 5-19-2010.

**CLASS 9—(Continued).**

SN 85-045,289. ENTERPRISE DATABASE CORPORATION, MANASSAS, VA. FILED 5-21-2010.

## EDC-CONTACT



NO CLAIM IS MADE TO THE EXCLUSIVE RIGHT TO USE "SMART", APART FROM THE MARK AS SHOWN.

THE COLOR(S) ORANGE, GREY, AND WHITE IS/ARE CLAIMED AS A FEATURE OF THE MARK.

THE MARK CONSISTS OF A STYLIZED DEPICTION OF AN ORANGE FOX RUNNING WITH A WHITE EYE AND WHITE HIGHLIGHTS ABOVE THE TERM "SMART" IN ORANGE AND "FOX" IN GREY; THE BACKGROUND OF THE ENTIRE MARK IS TRANSLUCENT.

FOR ELECTRIC AND ELECTRONIC VIDEO SURVEILLANCE INSTALLATIONS; ELECTRONIC VIDEO SURVEILLANCE PRODUCTS, NAMELY, ELECTRONIC COMPONENTS OF SECURITY SYSTEMS; VIDEO CAMERAS (U.S. CLS. 21, 23, 26, 36 AND 38).

FIRST USE 10-15-2008; IN COMMERCE 10-15-2008.

JIM RINGLE, EXAMINING ATTORNEY

THE MARK CONSISTS OF STANDARD CHARACTERS WITHOUT CLAIM TO ANY PARTICULAR FONT, STYLE, SIZE, OR COLOR.

FOR COMPUTER AND DATA NETWORKING HARDWARE IN THE NATURE OF DEVICES FOR TRANSPORTING AND AGGREGATING DATA, VOICE OR WIRELESS COMMUNICATIONS ACROSS MULTIPLE NETWORK INFRASTRUCTURES AND COMMUNICATIONS PROTOCOLS; COMPUTER HARDWARE AND SOFTWARE AND DATA NETWORKING HARDWARE AND SOFTWARE IN THE NATURE OF DEVICES, FOR USE WITH PERSONAL COMPUTERS, FOR TRANSMITTING, RECEIVING, RECORDING AND MONITORING VOICE, DATA, INFORMATION, IMAGES, SIGNALS, AND MESSAGES; ELECTRONIC COMMUNICATIONS SYSTEMS COMPRISED OF COMPUTER HARDWARE AND SOFTWARE FOR THE TRANSMISSION OF DATA BETWEEN TWO POINTS; COMPUTER SOFTWARE TO MANAGE, ANALYZE, RETRIEVE, MONITOR, MAINTAIN, REPORT ON, STRUCTURE, MODEL, FORECAST, PRESENT AND DISPLAY DATA AND INFORMATION FROM VARIOUS DATABASES; COMPUTER SOFTWARE THAT PROVIDES WEB-BASED ACCESS TO APPLICATIONS AND SERVICES THROUGH A WEB OPERATING SYSTEM OR PORTAL INTERFACE; COMPUTER SOFTWARE THAT PROVIDES REAL-TIME, INTEGRATED BUSINESS MANAGEMENT INTELLIGENCE BY COMBINING INFORMATION FROM VARIOUS DATABASES AND PRESENTING IT IN AN EASY-TO-UNDERSTAND USER INTERFACE; COMPUTER SOFTWARE FOR CREATING SEARCHABLE DATABASES OF INFORMATION AND DATA; COMPUTER SOFTWARE TO AUTOMATE DATA WAREHOUSING; COMPUTER SOFTWARE FOR USE IN DATABASE MANAGEMENT; COMPUTER SOFTWARE FOR COMPUTER SYSTEMS AND APPLICATION DEVELOPMENT, DEPLOYMENT AND MANAGEMENT; AND INSTRUCTIONAL MANUALS SOLD AS A UNIT THEREWITH (U.S. CLS. 21, 23, 26, 36 AND 38).

JILL C. ALT, EXAMINING ATTORNEY



**CLASS 9—(Continued).**

SN 85-049,629. ENTERPRISE DATABASE CORPORATION, MANASSAS, VA. FILED 5-27-2010.

EASYDPS

THE MARK CONSISTS OF STANDARD CHARACTERS WITHOUT CLAIM TO ANY PARTICULAR FONT, STYLE, SIZE, OR COLOR.

FOR COMPUTER AND DATA NETWORKING HARDWARE IN THE NATURE OF DEVICES FOR TRANSPORTING AND AGGREGATING DATA, VOICE OR WIRELESS COMMUNICATIONS ACROSS MULTIPLE NETWORK INFRASTRUCTURES AND COMMUNICATIONS PROTOCOLS; COMPUTER HARDWARE AND SOFTWARE AND DATA NETWORKING HARDWARE AND SOFTWARE IN THE NATURE OF DEVICES, FOR USE WITH PERSONAL COMPUTERS, FOR TRANSMITTING, RECEIVING, RECORDING AND MONITORING VOICE, DATA, INFORMATION, IMAGES, SIGNALS, AND MESSAGES; ELECTRONIC COMMUNICATIONS SYSTEMS COMPRISED OF COMPUTER HARDWARE AND SOFTWARE FOR THE TRANSMISSION OF DATA BETWEEN TWO POINTS; COMPUTER SOFTWARE TO MANAGE, ANALYZE, RETRIEVE, MONITOR, MAINTAIN, REPORT ON, STRUCTURE, MODEL, FORECAST, PRESENT AND DISPLAY DATA AND INFORMATION FROM VARIOUS DATABASES; COMPUTER SOFTWARE THAT PROVIDES WEB-BASED ACCESS TO APPLICATIONS AND SERVICES THROUGH A WEB OPERATING SYSTEM OR PORTAL INTERFACE; COMPUTER SOFTWARE THAT PROVIDES REAL-TIME, INTEGRATED BUSINESS MANAGEMENT INTELLIGENCE BY COMBINING INFORMATION FROM VARIOUS DATABASES AND PRESENTING IT IN AN EASY-TO-UNDERSTAND USER INTERFACE; COMPUTER SOFTWARE FOR CREATING SEARCHABLE DATABASES OF INFORMATION AND DATA; COMPUTER SOFTWARE TO AUTOMATE DATA WAREHOUSING; COMPUTER SOFTWARE FOR USE IN DATABASE MANAGEMENT; COMPUTER SOFTWARE FOR COMPUTER SYSTEMS AND APPLICATION DEVELOPMENT, DEPLOYMENT AND MANAGEMENT; AND INSTRUCTIONAL MANUALS SOLD AS A UNIT THEREWITH (U.S. CLS. 21, 23, 26, 36 AND 38).

JILL C. ALT, EXAMINING ATTORNEY

**CLASS 9—(Continued).**

SN 85-049,644. ENTERPRISE DATABASE CORPORATION, MANASSAS, VA. FILED 5-27-2010.



THE MARK CONSISTS OF THE TEXT "EASYDPS" WITHIN A GEOMETRIC BORDER IN THE GENERAL SHAPE OF A ROUNDED RECTANGLE.

FOR COMPUTER AND DATA NETWORKING HARDWARE IN THE NATURE OF DEVICES FOR TRANSPORTING AND AGGREGATING DATA, VOICE OR WIRELESS COMMUNICATIONS ACROSS MULTIPLE NETWORK INFRASTRUCTURES AND COMMUNICATIONS PROTOCOLS; COMPUTER HARDWARE AND SOFTWARE AND DATA NETWORKING HARDWARE AND SOFTWARE IN THE NATURE OF DEVICES, FOR USE WITH PERSONAL COMPUTERS, FOR TRANSMITTING, RECEIVING, RECORDING AND MONITORING VOICE, DATA, INFORMATION, IMAGES, SIGNALS, AND MESSAGES; ELECTRONIC COMMUNICATIONS SYSTEMS COMPRISED OF COMPUTER HARDWARE AND SOFTWARE FOR THE TRANSMISSION OF DATA BETWEEN TWO POINTS; COMPUTER SOFTWARE TO MANAGE, ANALYZE, RETRIEVE, MONITOR, MAINTAIN, REPORT ON, STRUCTURE, MODEL, FORECAST, PRESENT AND DISPLAY DATA AND INFORMATION FROM VARIOUS DATABASES; COMPUTER SOFTWARE THAT PROVIDES WEB-BASED ACCESS TO APPLICATIONS AND SERVICES THROUGH A WEB OPERATING SYSTEM OR PORTAL INTERFACE; COMPUTER SOFTWARE THAT PROVIDES REAL-TIME, INTEGRATED BUSINESS MANAGEMENT INTELLIGENCE BY COMBINING INFORMATION FROM VARIOUS DATABASES AND PRESENTING IT IN AN EASY-TO-UNDERSTAND USER INTERFACE; COMPUTER SOFTWARE FOR CREATING SEARCHABLE DATABASES OF INFORMATION AND DATA; COMPUTER SOFTWARE TO AUTOMATE DATA WAREHOUSING; COMPUTER SOFTWARE FOR USE IN DATABASE MANAGEMENT; COMPUTER SOFTWARE FOR COMPUTER SYSTEMS AND APPLICATION DEVELOPMENT, DEPLOYMENT AND MANAGEMENT; AND INSTRUCTIONAL MANUALS SOLD AS A UNIT THEREWITH (U.S. CLS. 21, 23, 26, 36 AND 38).

JILL C. ALT, EXAMINING ATTORNEY

**CLASS 9—(Continued).**

SN 85-049,652. ENTERPRISE DATABASE CORPORATION, MANASSAS, VA. FILED 5-27-2010.



THE MARK CONSISTS OF THE WORDS "EDC AGENT LINK" IN STYLIZED LETTERING ON TWO LINES WITH "EDC" ONE THIRD THE SIZE OF "AGENTLINK" AND TO THE LEFT. A CABLE RUNS FROM THE TOP OF THE "G" IN "AGENT" TO THE TOP OF THE "L" IN "LINK" WITH A CONNECTION RECEIVER MIDWAY DOWN THE "L".

FOR COMPUTER AND DATA NETWORKING HARDWARE IN THE NATURE OF DEVICES FOR TRANSPORTING AND AGGREGATING DATA, VOICE OR WIRELESS COMMUNICATIONS ACROSS MULTIPLE NETWORK INFRASTRUCTURES AND COMMUNICATIONS PROTOCOLS; COMPUTER HARDWARE AND SOFTWARE AND DATA NETWORKING HARDWARE AND SOFTWARE IN THE NATURE OF DEVICES, FOR USE WITH PERSONAL COMPUTERS, FOR TRANSMITTING, RECEIVING, RECORDING AND MONITORING VOICE, DATA, INFORMATION, IMAGES, SIGNALS, AND MESSAGES; ELECTRONIC COMMUNICATIONS SYSTEMS COMPRISED OF COMPUTER HARDWARE AND SOFTWARE FOR THE TRANSMISSION OF DATA BETWEEN TWO POINTS; COMPUTER SOFTWARE TO MANAGE, ANALYZE, RETRIEVE, MONITOR, MAINTAIN, REPORT ON, STRUCTURE, MODEL, FORECAST, PRESENT AND DISPLAY DATA AND INFORMATION FROM VARIOUS DATABASES; COMPUTER SOFTWARE THAT PROVIDES WEB-BASED ACCESS TO APPLICATIONS AND SERVICES THROUGH A WEB OPERATING SYSTEM OR PORTAL INTERFACE; COMPUTER SOFTWARE THAT PROVIDES REAL-TIME, INTEGRATED BUSINESS MANAGEMENT INTELLIGENCE BY COMBINING INFORMATION FROM VARIOUS DATABASES AND PRESENTING IT IN AN EASY-TO-UNDERSTAND USER INTERFACE; COMPUTER SOFTWARE FOR CREATING SEARCHABLE DATABASES OF INFORMATION AND DATA; COMPUTER SOFTWARE TO AUTOMATE DATA WAREHOUSING; COMPUTER SOFTWARE FOR USE IN DATABASE MANAGEMENT; COMPUTER SOFTWARE FOR COMPUTER SYSTEMS AND APPLICATION DEVELOPMENT, DEPLOYMENT AND MANAGEMENT; AND INSTRUCTIONAL MANUALS SOLD AS A UNIT THEREWITH (U.S. CLS. 21, 23, 26, 36 AND 38).

JILL C. ALT, EXAMINING ATTORNEY

**CLASS 9—(Continued).**

SN 85-049,661. ENTERPRISE DATABASE CORPORATION, MANASSAS, VA. FILED 5-27-2010.



THE MARK CONSISTS OF A SQUARE WITH ROUNDED CORNERS WITHIN WHICH IS LOCATED A STYLIZED CAPITAL "A" FROM WHICH A CABLE ASCENDS UP THE LEFT SIDE OF THE SQUARE AROUND THE CORNER AND OVER BEYOND THE "A" TO A TERMINUS LOCATED JUST OUTSIDE THE CROSSBAR OF THE "A".

FOR COMPUTER AND DATA NETWORKING HARDWARE IN THE NATURE OF DEVICES FOR TRANSPORTING AND AGGREGATING DATA, VOICE OR WIRELESS COMMUNICATIONS ACROSS MULTIPLE NETWORK INFRASTRUCTURES AND COMMUNICATIONS PROTOCOLS; COMPUTER HARDWARE AND SOFTWARE AND DATA NETWORKING HARDWARE AND SOFTWARE IN THE NATURE OF DEVICES, FOR USE WITH PERSONAL COMPUTERS, FOR TRANSMITTING, RECEIVING, RECORDING AND MONITORING VOICE, DATA, INFORMATION, IMAGES, SIGNALS, AND MESSAGES; ELECTRONIC COMMUNICATIONS SYSTEMS COMPRISED OF COMPUTER HARDWARE AND SOFTWARE FOR THE TRANSMISSION OF DATA BETWEEN TWO POINTS; COMPUTER SOFTWARE TO MANAGE, ANALYZE, RETRIEVE, MONITOR, MAINTAIN, REPORT ON, STRUCTURE, MODEL, FORECAST, PRESENT AND DISPLAY DATA AND INFORMATION FROM VARIOUS DATABASES; COMPUTER SOFTWARE THAT PROVIDES WEB-BASED ACCESS TO APPLICATIONS AND SERVICES THROUGH A WEB OPERATING SYSTEM OR PORTAL INTERFACE; COMPUTER SOFTWARE THAT PROVIDES REAL-TIME, INTEGRATED BUSINESS MANAGEMENT INTELLIGENCE BY COMBINING INFORMATION FROM VARIOUS DATABASES AND PRESENTING IT IN AN EASY-TO-UNDERSTAND USER INTERFACE; COMPUTER SOFTWARE FOR CREATING SEARCHABLE DATABASES OF INFORMATION AND DATA; COMPUTER SOFTWARE TO AUTOMATE DATA WAREHOUSING; COMPUTER SOFTWARE FOR USE IN DATABASE MANAGEMENT; COMPUTER SOFTWARE FOR COMPUTER SYSTEMS AND APPLICATION DEVELOPMENT, DEPLOYMENT AND MANAGEMENT; AND INSTRUCTIONAL MANUALS SOLD AS A UNIT THEREWITH (U.S. CLS. 21, 23, 26, 36 AND 38).

JILL C. ALT, EXAMINING ATTORNEY

**CLASS 9—(Continued).**

SN 85-053,611. FUJITSU LIMITED, KANAGAWA 211-8588, JAPAN, FILED 6-3-2010.

**CLASS 9—(Continued).**

SN 85-062,585. TERAPHYSICS CORPORATION, CLEVELAND, OH. FILED 6-14-2010.

# TERAPHYSICS

## ETERNUS SF Express

THE MARK CONSISTS OF STANDARD CHARACTERS WITHOUT CLAIM TO ANY PARTICULAR FONT, STYLE, SIZE, OR COLOR.

PRIORITY CLAIMED UNDER SEC. 44(D) ON JAPAN APPLICATION NO. 2009-092612, FILED 12-8-2009, REG. NO. 5330626, DATED 6-18-2010, EXPIRES 6-18-2020.

OWNER OF U.S. REG. NO. 2,793,871.

FOR COMPUTERS SOFTWARE FOR STORAGE RESOURCE MANAGEMENT AND STORAGE CONFIGURATION MANAGEMENT; COMPUTER SOFTWARE FOR USE IN COMPREHENSIVE DATA PROTECTION SOLUTIONS, SUCH AS DATA BACK-UP AND RESTORE, AUTOMATIC REMOTE DATA STORAGE OVER INTERNET NETWORKS, AND NETWORK ATTACHED STORAGE (U.S. CLS. 21, 23, 26, 36 AND 38).

KIM MONINGHOFF, EXAMINING ATTORNEY

THE MARK CONSISTS OF STANDARD CHARACTERS WITHOUT CLAIM TO ANY PARTICULAR FONT, STYLE, SIZE, OR COLOR.

OWNER OF U.S. REG. NO. 3,316,713.

FOR VACUUM ELECTRON DEVICES, NAMELY, BACKWARD WAVE OSCILLATORS AND TRAVELING WAVE TUBES; COMPONENTS OF VACUUM ELECTRON DEVICES, NAMELY, CATHODES, ELECTRON GUNS, SLOW WAVE STRUCTURES, ELECTRON COLLECTORS, MAGNETS, MAGNETIC CIRCUITS, AND VACUUM ENVELOPES; MILLIMETER WAVE ELECTRONIC SYSTEMS, CONSISTING PRIMARILY OF SIGNAL SOURCES, AMPLIFIERS, DETECTORS, MODULATORS, DEMODULATORS, POWER SUPPLIES, PHASE SHIFTERS, AND ATTENUATORS FOR WIRELESS COMMUNICATIONS; AND TERAHERTZ ELECTRONIC SYSTEMS, CONSISTING PRIMARILY OF SIGNAL SOURCES, AMPLIFIERS, SPECTROMETERS, POWER SUPPLIES, MIRRORS, LENSES, AND DETECTORS FOR DETECTION OF CANCEROUS TISSUE, TOXIC SOLIDS, GASES AND LIQUIDS, CONCEALED EXPLOSIVES AND CONTRABAND, BIOMARKERS, CHEMICAL/BIOLOGICAL THREATS, AND PATHOGENS (U.S. CLS. 21, 23, 26, 36 AND 38).

LINDA ORNDORFF, EXAMINING ATTORNEY

SN 85-062,589. TERAPHYSICS CORPORATION, CLEVELAND, OH. FILED 6-14-2010.

SN 85-057,884. GUINANE GEORGE THOMAS, MANCHESTER, MA. FILED 6-8-2010.

## ILLUMINATING A SPECTRUM OF NEW POSSIBILITIES

# PayAdTV

THE MARK CONSISTS OF STANDARD CHARACTERS WITHOUT CLAIM TO ANY PARTICULAR FONT, STYLE, SIZE, OR COLOR.

FOR COMPUTER CONTROLLED TELEVISIONS OPERATED OVER TELEPHONE LINES, OR CABLE LINES, OR WIRELESS DEVICES. PRINCIPALLY ADVERTISING DIFFERENT PRODUCTS FOR PAY (U.S. CLS. 21, 23, 26, 36 AND 38).

KYLE PEETE, EXAMINING ATTORNEY

THE MARK CONSISTS OF STANDARD CHARACTERS WITHOUT CLAIM TO ANY PARTICULAR FONT, STYLE, SIZE, OR COLOR.

FOR VACUUM ELECTRON DEVICES, NAMELY, BACKWARD WAVE OSCILLATORS AND TRAVELING WAVE TUBES; COMPONENTS OF VACUUM ELECTRON DEVICES, NAMELY, CATHODES, ELECTRON GUNS, SLOW WAVE STRUCTURES, ELECTRON COLLECTORS, MAGNETS, MAGNETIC CIRCUITS, AND VACUUM ENVELOPES; MILLIMETER WAVE ELECTRONIC SYSTEMS, CONSISTING PRIMARILY OF SIGNAL SOURCES, AMPLIFIERS, DETECTORS, MODULATORS, DEMODULATORS, POWER SUPPLIES, PHASE SHIFTERS, AND ATTENUATORS FOR WIRELESS COMMUNICATIONS; AND TERAHERTZ ELECTRONIC SYSTEMS, CONSISTING PRIMARILY OF SIGNAL SOURCES, AMPLIFIERS, SPECTROMETERS, POWER SUPPLIES, MIRRORS, LENSES, AND DETECTORS FOR DETECTION OF CANCEROUS TISSUE, TOXIC SOLIDS, GASES AND LIQUIDS, CONCEALED EXPLOSIVES AND CONTRABAND, BIOMARKERS, CHEMICAL/BIOLOGICAL THREATS, AND PATHOGENS (U.S. CLS. 21, 23, 26, 36 AND 38).

LINDA ORNDORFF, EXAMINING ATTORNEY

**CLASS 9—(Continued).**

SN 85-062,598. TERAPHYSICS CORPORATION, CLEVELAND, OH. FILED 6-14-2010.

**POWERED BY TERAPHYSICS**

THE MARK CONSISTS OF STANDARD CHARACTERS WITHOUT CLAIM TO ANY PARTICULAR FONT, STYLE, SIZE, OR COLOR.

OWNER OF U.S. REG. NO. 3,316,713.

FOR VACUUM ELECTRON DEVICES, NAMELY, BACKWARD WAVE OSCILLATORS AND TRAVELING WAVE TUBES; COMPONENTS OF VACUUM ELECTRON DEVICES, NAMELY, CATHODES, ELECTRON GUNS, SLOW WAVE STRUCTURES, ELECTRON COLLECTORS, MAGNETS, MAGNETIC CIRCUITS, AND VACUUM ENVELOPES; MILLIMETER WAVE ELECTRONIC SYSTEMS, CONSISTING PRIMARILY OF SIGNAL SOURCES, AMPLIFIERS, DETECTORS, MODULATORS, DEMODULATORS, POWER SUPPLIES, PHASE SHIFTERS, AND ATTENUATORS FOR WIRELESS COMMUNICATIONS; AND TERAHERTZ ELECTRONIC SYSTEMS, CONSISTING PRIMARILY OF SIGNAL SOURCES, AMPLIFIERS, SPECTROMETERS, POWER SUPPLIES, MIRRORS, LENSES, AND DETECTORS FOR DETECTION OF CANCEROUS TISSUE, TOXIC SOLIDS, GASES AND LIQUIDS, CONCEALED EXPLOSIVES AND CONTRABAND, BIOMARKERS, CHEMICAL/BIOLOGICAL THREATS, AND PATHOGENS (U.S. CLS. 21, 23, 26, 36 AND 38).

LINDA ORNDORFF, EXAMINING ATTORNEY

SN 85-062,603. TERAPHYSICS CORPORATION, CLEVELAND, OH. FILED 6-14-2010.



THE MARK CONSISTS OF A DIAMOND SHAPE FORMED BY ALTERNATING SOLID HORIZONTAL LINES.

FOR VACUUM ELECTRON DEVICES, NAMELY, BACKWARD WAVE OSCILLATORS AND TRAVELING WAVE TUBES; COMPONENTS OF VACUUM ELECTRON DEVICES, NAMELY, CATHODES, ELECTRON GUNS, SLOW WAVE STRUCTURES, ELECTRON COLLECTORS, MAGNETS, MAGNETIC CIRCUITS, AND VACUUM ENVELOPES; MILLIMETER WAVE ELECTRONIC SYSTEMS, CONSISTING PRIMARILY OF SIGNAL SOURCES, AMPLIFIERS, DETECTORS, MODULATORS, DEMODULATORS, POWER SUPPLIES, PHASE SHIFTERS, AND ATTENUATORS FOR WIRELESS COMMUNICATIONS; AND TERAHERTZ ELECTRONIC SYSTEMS, CONSISTING PRIMARILY OF SIGNAL SOURCES, AMPLIFIERS, SPECTROMETERS, POWER SUPPLIES, MIRRORS, LENSES, AND DETECTORS FOR USE IN DETECTION OF CANCEROUS TISSUE, TOXIC SOLIDS, GASES AND LIQUIDS, CONCEALED EXPLOSIVES AND CONTRABAND, BIOMARKERS, CHEMICAL/BIOLOGICAL THREATS, AND PATHOGENS (U.S. CLS. 21, 23, 26, 36 AND 38).

LINDA ORNDORFF, EXAMINING ATTORNEY

**CLASS 9—(Continued).**

SN 85-088,179. SYSTEMS AND ELECTRONIC DEVELOPMENT FZCO, DUBAI, UNITED ARAB EMIR., FILED 7-20-2010.



PRIORITY CLAIMED UNDER SEC. 44(D) ON NETHERLANDS APPLICATION NO. 009183146, FILED 6-17-2010, REG. NO. 009183146, DATED 11-30-2010, EXPIRES 6-17-2020.

NO CLAIM IS MADE TO THE EXCLUSIVE RIGHT TO USE "CUSTOMER VISIT MANAGEMENT", APART FROM THE MARK AS SHOWN.

THE MARK CONSISTS OF A HORIZONTALLY SITUATED RECTANGLE WITH ROUNDED EDGES. SITUATED WITHIN AND TO THE RIGHT SIDE OF THIS RECTANGLE IS ANOTHER RECTANGLE. THE WORDING "CUSTOMER VISIT MANAGEMENT" APPEARS IN STYLIZED FONT WITHIN THE INNER RECTANGLE WITH "MANAGEMENT" STACKED UNDER "CUSTOMER VISIT". TO THE LEFT OF THE INNER RECTANGLE ARE THE SILHOUETTES OF SEVEN PEOPLE.

FOR COMPUTER SOFTWARE AND HARDWARE FOR GATHERING INFORMATION RELATED TO CUSTOMER VISITS IN RETAIL SPACES, EVALUATING AND ALLEVIATING CUSTOMER LINES AND CONGESTION IN TRANSPORTATION HUBS, CONTROLLING INFORMATION ON DIGITAL SIGNAGE, OPERATING SELF SERVICE KIOSKS, MANAGING CONTENT DELIVERED TO DIGITAL SIGNAGE, RELAYING INFORMATION TO NEWS AND MEDIA OUTLETS, DETERMINING SOLUTIONS FOR TRAFFIC ISSUES AT AIRPORTS, AUTOMATION OF BUSINESS FUNCTIONS FOR RETAILERS (U.S. CLS. 21, 23, 26, 36 AND 38).

GRETCHEN ULRICH, EXAMINING ATTORNEY

SN 85-103,150. RONNICHOLS.COM, INC., GRAND LEDGE, MI. FILED 8-9-2010.

**Retouching Palette**

THE MARK CONSISTS OF STANDARD CHARACTERS WITHOUT CLAIM TO ANY PARTICULAR FONT, STYLE, SIZE, OR COLOR.

NO CLAIM IS MADE TO THE EXCLUSIVE RIGHT TO USE "RETOUCHING", APART FROM THE MARK AS SHOWN.

FOR COMPUTER SOFTWARE FOR PROCESSING DIGITAL IMAGES (U.S. CLS. 21, 23, 26, 36 AND 38).

FIRST USE 7-1-2005; IN COMMERCE 7-1-2005.

ESTHER A. BORSUK, EXAMINING ATTORNEY

**CLASS 9—(Continued).**

SN 85-104,891. POWER GLEANER, INC., LAPEER, MI. FILED 8-11-2010.

**POWER GLEANER**

THE MARK CONSISTS OF STANDARD CHARACTERS WITHOUT CLAIM TO ANY PARTICULAR FONT, STYLE, SIZE, OR COLOR.

NO CLAIM IS MADE TO THE EXCLUSIVE RIGHT TO USE "POWER", APART FROM THE MARK AS SHOWN.

FOR TRANSIENT VOLTAGE SURGE SUPPRESSOR, SURGE PROTECTION DEVICE (U.S. CLS. 21, 23, 26, 36 AND 38).

FIRST USE 4-30-2004; IN COMMERCE 6-25-2004.

WARREN L. OLANDRIA, EXAMINING ATTORNEY

SN 85-106,170. AUTOMATE CORP., SKOKIE, IL. FILED 8-12-2010.



OWNER OF U.S. REG. NO. 2,504,605.

NO CLAIM IS MADE TO THE EXCLUSIVE RIGHT TO USE "TOTAL PROJECT MANAGEMENT", APART FROM THE MARK AS SHOWN.

THE COLOR(S) YELLOW, PINK, TEAL, BLUE, BLACK, WHITE, GRAY IS/ARE CLAIMED AS A FEATURE OF THE MARK.

THE MARK CONSISTS OF RECTANGLES THAT ARE COMPLETELY OR PARTIALLY SHADED, ANGLES [GEOMETRIC] CHEVRONS INSIDE ONE ANOTHER, A SMALL YELLOW GEOMETRIC SHAPE, A MEDIUM PINK GEOMETRIC SHAPE, A MEDIUM TEAL GEOMETRIC SHAPE, A PROGRESSIVE VERTICAL COLOR CHANGE FROM BLACK, GRAY AND TO BLUE, "CADMANDU" IN WHITE AND "TOTAL PROJECT MANAGEMENT" IN WHITE WITH A BLACK BORDER.

FOR COMPUTER PROGRAMMES FOR DOCUMENT MANAGEMENT (U.S. CLS. 21, 23, 26, 36 AND 38).

FIRST USE 1-1-1987; IN COMMERCE 1-1-1987.

PAUL E. FAHRENKOPF, EXAMINING ATTORNEY

**CLASS 9—(Continued).**

SN 85-110,507. CARL ZEISS MEDITEC AG, JENA, FED REP GERMANY, FILED 8-18-2010.

**Z CALC**

THE MARK CONSISTS OF STANDARD CHARACTERS WITHOUT CLAIM TO ANY PARTICULAR FONT, STYLE, SIZE, OR COLOR.

PRIORITY CLAIMED UNDER SEC. 44(D) ON FED REP GERMANY APPLICATION NO. 302010040790, FILED 7-2-2010, REG. NO. 302010040790, DATED 9-20-2010, EXPIRES 7-31-2020.

NO CLAIM IS MADE TO THE EXCLUSIVE RIGHT TO USE "CALC", APART FROM THE MARK AS SHOWN.

FOR SOFTWARE USED IN OPHTHALMIC SURGERY TO PROVIDE POST-OPERATIVE REFRACTION DATA (U.S. CLS. 21, 23, 26, 36 AND 38).

DEIRDRE ROBERTSON, EXAMINING ATTORNEY

SN 85-112,137. ISPA, INC., ATLANTA, GA. FILED 8-20-2010.

**INFOLINKER**

THE MARK CONSISTS OF STANDARD CHARACTERS WITHOUT CLAIM TO ANY PARTICULAR FONT, STYLE, SIZE, OR COLOR.

FOR DOWNLOADABLE COMPUTER SOFTWARE FOR GENERATING HYPERLINKS, BOOKMARKS AND ADD-INS WITHIN PDF DOCUMENTS FOR CUSTOMIZATION OF THOSE DOCUMENTS (U.S. CLS. 21, 23, 26, 36 AND 38).

FIRST USE 9-1-1994; IN COMMERCE 9-1-1994.

LESLEY LAMOTHE, EXAMINING ATTORNEY

SN 85-117,570. BURLINGAME INDUSTRIES, INC., RIALTO, CA. FILED 8-27-2010.



OWNER OF U.S. REG. NOS. 1,635,497 AND 1,985,582.

NO CLAIM IS MADE TO THE EXCLUSIVE RIGHT TO USE "SOLAR", APART FROM THE MARK AS SHOWN.

THE MARK CONSISTS OF THE WORDS "EAGLE SOLAR" ACCOMPANIED BY THE DESIGN OF A BIRD AND THE SUN.

FOR SOLAR PHOTOVOLTAIC PANELS AND TILES (U.S. CLS. 21, 23, 26, 36 AND 38).

TINA L. SNAPP, EXAMINING ATTORNEY

**CLASS 9—(Continued).**

SN 85-120,823. THE TRUSTEES OF THE RODNEY A HAMILTON LIVING TRUST, LOS ANGELES, CA. FILED 9-1-2010.

# Gtab

THE MARK CONSISTS OF STANDARD CHARACTERS WITHOUT CLAIM TO ANY PARTICULAR FONT, STYLE, SIZE, OR COLOR.

FOR CONSUMER ELECTRONIC PRODUCTS, NAMELY, CALCULATORS; ELECTROMECHANICAL PERIMETER SIGNALING DEVICE FOR MEASURING DISTANCE AND DIRECTION OF PARTICLES IN THE FIELD OF COMMERCE, SCIENCE AND MEDICINE; COMPUTER HARDWARE; GAMING MACHINES, NAMELY, ELECTRONIC SLOT, BINGO, ARCADE, LOTTERY, POKER, RAFFLE AND SPORTS BETTING MACHINES; COMPUTER COMPONENTS AND ACCESSORIES, NAMELY, MICROPROCESSORS, MEMORY BOARDS, MONITORS, DISPLAY SCREENS, KEYBOARDS, CABLES, MODEMS, PRINTERS, DISK DRIVES, POWER ADAPTERS, ADAPTER CARDS, CABLE CONNECTORS AND DRIVER SOFTWARE, NAMELY, FOR USE IN DATABASE MANAGEMENT, SPREAD SHEETS, WORD PROCESSING, PROCESSING DIGITAL MUSIC FILES, PROCESSING AND REPRODUCING 3 DIMENSIONAL IMAGES IN THE FIELD OF COMMERCE, SCIENCE, MEDICINE, ENTERTAINMENT AND RELIGION, PROCESSING DATA RELATING TO THE UNKNOWN STATE OF A PHOTON OF LIGHT PROJECTED ONTO ANOTHER PHOTON IN THE FIELD OF SCIENCE; BLANK DIGITAL COMPUTER STORAGE MEDIA; BLANK MAGNETIC DATA CARRIERS; COMPUTER SOFTWARE AND FIRMWARE, NAMELY, FOR OPERATING SYSTEM PROGRAMS, DATA SYNCHRONIZATION PROGRAMS, AND APPLICATION DEVELOPMENT TOOL PROGRAMS FOR PERSONAL AND HANDHELD COMPUTERS; PRE-RECORDED COMPUTER PROGRAMS, NAMELY, PRE-RECORDED DIGITAL MEDIA FEATURING PERSONAL INFORMATION MANAGEMENT SOFTWARE, DATABASE MANAGEMENT SOFTWARE, CHARACTER RECOGNITION SOFTWARE, TELEPHONY MANAGEMENT SOFTWARE, ELECTRONIC MAIL AND MESSAGING SOFTWARE, PAGING SOFTWARE, MOBILE TELEPHONE SOFTWARE; DATABASE SYNCHRONIZATION SOFTWARE, COMPUTER PROGRAMS FOR ACCESSING, BROWSING AND SEARCHING ONLINE DATABASES, COMPUTER HARDWARE AND SOFTWARE FOR PROVIDING INTEGRATED TELEPHONE COMMUNICATION WITH COMPUTERIZED GLOBAL INFORMATION NETWORKS; HANDHELD DIGITAL ELECTRONIC DEVICES FOR RECORDING, ORGANIZING, TRANSMITTING, MANIPULATING, AND REVIEWING TEXT, DATA, IMAGE, AND AUDIO FILES AND OPERATING SOFTWARE RELATED THERETO; MP3 AND OTHER DIGITAL FORMAT AUDIO PLAYERS; HAND HELD COMPUTERS, TOUCH SCREEN COMPUTERS, PERSONAL DIGITAL ASSISTANTS, ELECTRONIC PERSONAL ORGANIZERS, ELECTRONIC NOTEPADS, NAMELY, ELECTRONIC TOUCH NOTEBOOK COMPUTERS; MOBILE DIGITAL ELECTRONIC DEVICES FOR RECORDING, ORGANIZING, TRANSMITTING, MANIPULATING, AND REVIEWING TEXT, DATA, IMAGE, AND AUDIO FILES; GLOBAL POSITIONING SYSTEM (GPS) DEVICES, TELEPHONES; HANDHELD AND MOBILE DIGITAL ELECTRONIC DEVICES FOR THE SENDING AND RECEIVING OF TELEPHONE CALLS, FAXES, ELECTRONIC MAIL, AND OTHER DIGITAL DATA, NAMELY, TELEPHONES; CORDLESS TELEPHONES; MOBILE TELEPHONES; PARTS AND ACCESSORIES FOR MOBILE TELEPHONES, NAMELY, MEMORY CARDS, CAR BATTERY CHARGERS, BATTERIES, TRAVEL BATTERY CHARGERS, SOLAR BATTERY CHARGERS, LEATHER CASES, SPECIALTY HOLSTERS, HANDS FREE DEVICES, ELECTRONIC DATA CABLES, SNAP ON COVERS, SILICONE SKINS IN THE NATURE OF COVERS, COMPUTER STYLUS, LCD PROTECTORS IN THE NATURE OF COVERS,

**CLASS 9—(Continued).**

ANTENNAS, PHONE HOLDERS, PHONE STRAPS, HANDS FREE CAR KITS, MP3 PLAYERS, FACEPLATES; FACSIMILE MACHINES, ANSWERING MACHINES, CAMERAS, VIDEOPHONES, COMPUTER SOFTWARE AND HARDWARE FOR RETRIEVING INFORMATION TRANSMITTED VIA TELEPHONE; ELECTRONIC HANDHELD UNITS FOR THE WIRELESS RECEIPT, STORAGE AND/OR TRANSMISSION OF DATA AND MESSAGES, NAMELY, WIRELESS TELEPHONES, AND ELECTRONIC DEVICES THAT ENABLE THE USER TO KEEP TRACK OF OR MANAGE PERSONAL INFORMATION, NAMELY, PERSONAL DIGITAL ASSISTANTS; TELECOMMUNICATIONS APPARATUS AND INSTRUMENTS, NAMELY, SOUND ALARMS; COMPUTER SOFTWARE FOR THE REDIRECTION OF MESSAGES, INTERNET E-MAIL, AND/OR OTHER DATA TO ONE OR MORE ELECTRONIC HANDHELD DEVICES FROM A DATA STORE ON OR ASSOCIATED WITH A PERSONAL COMPUTER OR A SERVER; COMPUTER SOFTWARE FOR THE SYNCHRONIZATION OF DATA BETWEEN A REMOTE STATION OR DEVICE AND A FIXED OR REMOTE STATION OR DEVICE; DOWNLOADABLE PRINTING FONTS, DOWNLOADABLE PRINTING TYPEFACES, DOWNLOADABLE PRINTING TYPE DESIGNS AND DOWNLOADABLE PRINTING SYMBOLS; COMPUTER CHIPS, DISCS AND TAPES FEATURING SOFTWARE FOR USE IN DATABASE MANAGEMENT, USE AS A SPREAD SHEET, WORD PROCESSING, NUMBER PROCESSING IN THE FIELDS OF MANAGEMENT, SCIENCE AND EDUCATION; RANDOM ACCESS MEMORY CARDS, READ ONLY DISC MEMORIES; SOLID STATE MEMORY APPARATUS, NAMELY, COMPUTER MEMORIES; COMPUTER GAME AND ELECTRONIC GAME PROGRAMS; COMPUTER EQUIPMENT FOR USE WITH ANY OF THE AFORESAID GOODS, NAMELY, COMPUTER HARDWARE, PERIPHERAL EQUIPMENT, BLANK COMPUTER DISCS, WIRELESS CARDS; ELECTRONIC APPARATUS WITH MULTIMEDIA FUNCTIONS FOR USE WITH ANY OF THE AFORESAID GOODS, NAMELY, THIN FILM SWITCHES, TRANSISTOR LIQUID CRYSTAL DISPLAY PANELS; ELECTRONIC APPARATUS WITH INTERACTIVE FUNCTIONS FOR USE WITH ANY OF THE AFORESAID GOODS, NAMELY, SURFACE ACOUSTIC WAVE SYSTEMS AND RESISTIVE SYSTEMS IN THE NATURE OF AN APPARATUS FOR WIRELESS TRANSMISSION OF ACOUSTIC INFORMATION; ACCESSORIES, PARTS, FITTINGS FOR ALL THE AFOREMENTIONED GOODS, NAMELY, LITHIUM ION CELLS IN THE NATURE OF BATTERIES, NANOCRYSTALLINE SILICON, SUBWOOFERS, TWEETERS, SOUND CROSSOVERS, ELECTRICAL WIRES, CONVERTERS, ELECTRO ACOUSTIC TRANSDUCERS, ACOUSTIC CONDUITS, ACOUSTIC COUPLERS, ACOUSTIC MEMBRANES, ACOUSTIC METERS, PHOTOVOLTAIC MODULES, FITTED PLASTIC FILMS KNOWN AS SKINS FOR COVERING AND PROVIDING A SCRATCH PROOF BARRIER OR PROTECTION FOR ELECTRONIC DEVICES, DUST CAPS IN THE NATURE OF COVERS FOR COMPUTERS, ELECTRIC VOICE COILS, MAGNETS, ELECTRIC SWITCHES, SOLID STATE DEVICES IN THE NATURE OF DRIVES, HIGH-PRESSURE PUMPS FOR PROPORTIONING AND TESTING PURPOSES, CENTRAL PROCESSING UNIT FANS, ELECTRIC LOCKS, LIGHT EMITTING DIODES, ULTRAVIOLET LIGHT EMITTING DIODES, SCANNERS, AUTOMATIC SENSOR VALVES, GENERAL PURPOSE DATA PROCESSORS, DIGITAL SIGNAL PROCESSORS, APPLICATION SPECIFIC INTEGRATED CIRCUITS, AUTOMATIC PIXEL VALVES, INPUT DEVICES FOR COMPUTER HARDWARE AND ELECTRONIC INSTRUMENTS, NAMELY, JOG WHEELS, AUTOMATED TELLER MACHINES, EYE TRACKING DEVICES IN THE NATURE OF SCANNERS, ELECTRICAL POSITIONING CONTROLLERS, ELECTRICAL COMMUNICATION CONTROLLERS, PERSONAL EMERGENCY LOCATOR TRANSMITTERS OF ELECTRONIC SIGNALS, ELECTRONIC KEY CARDS, ELECTRONIC SECURITY TOKEN IN THE NATURE OF A FOB-LIKE DEVICE USED BY AN AUTHORIZED USER OF A COMPUTER SYSTEM FACILITATE AUTHENTICATION, ELECTRIC MICROBE CONDUCTORS, ELECTROLYTIC CAPACITORS, RECTIFIER DIODES, OSCILLOSCOPE, HEAT SINK FOR USE IN COMPUTERS AND ELECTRONIC COMPONENTS, AMPLIFIERS, VOLTAGE METER IN THE NATURE OF A REGULATOR, ELECTRIC TRANSFORMERS, THERMISTOR, ELECTRIC FILTER COILS, ELECTRIC RELAY

**CLASS 9—(Continued).**

COILS, CAPACITORS, ELECTRIC MOVING COILS, ELECTRIC WIREROUND RESISTORS, MICROCHIPS, MICROCONTROLLERS, PSEUDO DYNAMIC TESTING DEVICE FOR EARTHQUAKES AND VARIOUS MOTIONS, INSPECTION MIRRORS, LEVEL GAUGES, AUTOMATIC VALVES, BIPOLAR TRANSISTORS, FUSES, COMPUTER NETWORK RECTIFIER BRIDGES, NON TANGLE ELECTRICAL CABLES, RECTIFIER TUBES, EARBUDS, IN EAR HEADPHONE, SEMICONDUCTORS, RIGID AND FLEXIBLE ENDOSCOPE FOR NON-MEDICAL USE, ACCELEROMETER, GYROSCOPE, FUEL CELL, IONIZATION DETECTORS, AMERICIUM DETECTORS FOR DETECTING THE PRESENCE OF AMERICIUM, PHOTOIONIZATION DETECTORS, IONIZATION DEVICES IN THE NATURE OF SMOKE DETECTORS, RCC FOILS ELEMENTS, NAMELY, CIRCUITS FOR HEATING OR ELECTRICAL CONDUCTION, EXPOSED CAMERA FILM, NAMELY, PHOTO DRY FILMS, MICROWAVE ANTENNAE, LASER NOT FOR MEDICAL USE, FOIL ELEMENTS, NAMELY, CIRCUITS FOR HEATING OR ELECTRICAL CONDUCTION, DECOUPLING CAPACITORS, DISCRETE CAPACITORS, DIELECTRICS CAPACITOR, ELECTRIC SUPERCONDUCTORS, MICROCHIPS, RADIO FREQUENCY IDENTIFICATION TAGS, NEUROHEADSET FOR TELEPHONES OR COMPUTERS, SPINTRONIC TRANSISTORS, PAPERLESS TACTILE ELECTROPHORETIC DISPLAY, CARBON NANOTUBES, NAMELY, TUBULAR CARBON MOLECULES USED IN EXTREMELY SMALL SCALE ELECTRONIC AND MECHANICAL APPLICATIONS; BAGS AND CASES ADAPTED; USER MANUALS IN ELECTRONICALLY READABLE, MACHINE READABLE OR COMPUTER READABLE FORM FOR USE WITH, AND SOLD AS A UNIT WITH, ALL THE AFOREMENTIONED GOODS; APPARATUS FOR DATA STORAGE, NAMELY, BLANK INTERNAL COMPUTER FLASH DRIVES, WIRELESS MULTI MEDIA CARDS AND SECURE-DIGITAL CARDS FOR COMPUTERS, BLANK USB COMPUTER FLASH DRIVES AND COMPUTER HARDWARE; HARD DISK DRIVES; MINIATURE HARD DISK DRIVES FOR DATA STORAGE; PRE-RECORDED AUDIO VIDEO DISCS FEATURING RELIGIOUS, MEDICAL, HISTORICAL, CURRENT EVENT NEWS, RELATING TO ENTERTAINMENT LIVE AND RECORDED PERFORMANCE, EVENTS AND VENUES, SCIENCE RESEARCH AND MEDICAL DATA, EDUCATION RELATING TO SCIENCE, BUSINESS AND RELIGION, SOCIAL RELATING TO CIVIL GOVERNMENT, PUBLIC POLICY MATTERS, WEATHER AND COMMERCE, ELECTRONICS RELATING TO TECHNOLOGICAL ADVANCEMENTS AND ENHANCEMENTS, GLOBAL RELATING TO SOCIAL ECONOMICS, POLITICAL AND EDUCATIONAL, COMMERCE RELATING TO MARKET ANALYSIS AND FORECAST, ADVERTISING MERCHANDISE IN THE ENTERTAINMENT, RELIGIOUS, SCIENTIFIC, EDUCATIONAL, ELECTRONICS, AND MEDICAL FIELDS; BLANK CD-ROMS FOR SOUND OR VIDEO RECORDING; BLANK DIGITAL VERSATILE DISCS; MOUSE PADS; BATTERIES; RECHARGEABLE BATTERIES; BATTERY CHARGERS; CHARGERS FOR ELECTRIC BATTERIES; HEADPHONES; STEREO HEADPHONES; IN-EAR HEADPHONES; STEREO AUDIO SPEAKERS; AUDIO SPEAKERS; AUDIO SPEAKERS FOR HOME; AUDIO SPEAKERS FOR COMPUTER MONITORS; AUDIO SPEAKERS FOR COMPUTERS; PERSONAL STEREO AUDIO SPEAKERS; RADIO RECEIVERS, AMPLIFIERS, SOUND RECORDING AND REPRODUCING APPARATUS, LOUDSPEAKERS FOR HIGH FIDELITY STEREO APPARATUS, SPEAKER UNITS COMPRISED OF MULTIPLE AUDIO SPEAKERS, MICROPHONES; DIGITAL AUDIO AND VIDEO DEVICES, NAMELY, CD AND DVD PLAYERS; COMPACT DISC PLAYERS, DIGITAL VERSATILE DISC RECORDERS AND PLAYERS; DIGITAL AUDIO TAPE RECORDERS AND PLAYERS; DIGITAL AUDIO MUSIC AND/OR VIDEO PLAYERS; RADIOS; VIDEO CAMERAS; AUDIO, VIDEO, AND DIGITAL SOUND MIXERS; RADIO TRANSMITTERS; CAR AUDIO APPARATUS, NAMELY, CD AND DVD PLAYERS; PARTS AND FITTINGS FOR ALL THE AFORESAID GOODS, NAMELY, SUBWOOFERS, TWEETERS, SOUND CROSSOVERS, ELECTRICAL WIRES, CONVERTERS, ELECTRO ACOUSTIC TRANSDUCERS, ACOUSTIC CONDUITS, ACOUSTIC COUPLERS, ACOUSTIC MEMBRANES, ACOUSTIC METERS, PHOTOVOLTAIC MODULES, FITTED PLASTIC FILMS KNOWN AS SKINS FOR COVERING AND PROVIDING

**CLASS 9—(Continued).**

A SCRATCH PROOF BARRIER OR PROTECTION FOR ELECTRONIC DEVICES, DUST CAPS IN THE NATURE OF COVERS FOR COMPUTERS, ELECTRIC VOICE COILS, MAGNETS, ELECTRIC SWITCHES, SOLID STATE DEVICES IN THE NATURE OF DRIVES, HIGH-PRESSURE PUMPS FOR PROPORTIONING AND TESTING PURPOSES, CENTRAL PROCESSING UNIT FANS, ELECTRIC LOCKS, LIGHT EMITTING DIODES, ULTRAVIOLET LIGHT EMITTING DIODES, SCANNERS, AUTOMATIC SENSOR VALVES, GENERAL PURPOSE DATA PROCESSORS, DIGITAL SIGNAL PROCESSORS, APPLICATION SPECIFIC INTEGRATED CIRCUITS, AUTOMATIC PIXEL VALVES, INPUT DEVICES FOR COMPUTER HARDWARE AND ELECTRONIC INSTRUMENTS, NAMELY, JOG WHEELS, AUTOMATED TELLER MACHINES, EYE TRACKING DEVICES IN THE NATURE OF SCANNERS, ELECTRICAL POSITIONING CONTROLLERS, ELECTRICAL COMMUNICATION CONTROLLERS, PERSONAL EMERGENCY LOCATOR TRANSMITTERS OF ELECTRONIC SIGNALS, ELECTRONIC KEY CARDS, ELECTRONIC SECURITY TOKEN IN THE NATURE OF A FOB-LIKE DEVICE USED BY AN AUTHORIZED USER OF A COMPUTER SYSTEM TO FACILITATE AUTHENTICATION, ELECTRIC MICROBE CONDUCTORS, ELECTROLYTIC CAPACITORS, RECTIFIER DIODES, OSCILLOSCOPE, HEATSINK FOR USE IN COMPUTERS AND ELECTRONIC COMPONENTS, AMPLIFIERS, VOLTAGE METER IN THE NATURE OF A REGULATOR, ELECTRIC TRANSFORMERS, THERMISTOR, ELECTRIC FILTER COILS, ELECTRIC RELAY COILS, CAPACITORS, ELECTRIC MOVING COILS, ELECTRIC WIREROUND RESISTORS, MICROCHIPS, MICROCONTROLLERS, PSEUDO DYNAMIC TESTING DEVICE FOR EARTHQUAKES AND VARIOUS MOTIONS, INSPECTION MIRRORS, LEVEL GAUGES, AUTOMATIC VALVES, BIPOLAR TRANSISTORS, FUSES, COMPUTER NETWORK RECTIFIER BRIDGES, NON TANGLE ELECTRICAL CABLES, RECTIFIER TUBES, EARBUDS, IN EAR HEADPHONE, SEMICONDUCTORS, RIGID AND FLEXIBLE ENDOSCOPE FOR NON-MEDICAL USE, ACCELEROMETER, GYROSCOPE, FUEL CELL, IONIZATION DETECTORS, AMERICIUM DETECTORS FOR DETECTING THE PRESENCE OF AMERICIUM, PHOTOIONIZATION DETECTORS, IONIZATION DEVICES IN THE NATURE OF SMOKE DETECTORS, RCC FOILS ELEMENTS, NAMELY, CIRCUITS FOR HEATING OR ELECTRICAL CONDUCTION, EXPOSED CAMERA FILM, NAMELY, PHOTO DRY FILMS, MICROWAVE ANTENNAE, LASER NOT FOR MEDICAL USE, FOIL ELEMENTS, NAMELY, CIRCUITS FOR HEATING OR ELECTRICAL CONDUCTION, DECOUPLING CAPACITORS, DISCRETE CAPACITORS, DIELECTRICS CAPACITOR, ELECTRIC SUPERCONDUCTORS, MICROCHIPS, RADIO FREQUENCY IDENTIFICATION TAGS, NEUROHEADSET FOR TELEPHONES OR COMPUTERS, SPINTRONIC TRANSISTORS, PAPERLESS TACTILE ELECTROPHORETIC DISPLAY, CARBON NANOTUBES NAMELY, TUBULAR CARBON MOLECULES USED IN EXTREMELY SMALL SCALE ELECTRONIC AND MECHANICAL APPLICATIONS; BAGS AND CASES ADAPTED OR SHAPED TO CONTAIN CAMERAS AND/OR VIDEO CAMERAS; MOBILE TELEPHONE COVERS NOT MADE OF PAPER; MOBILE TELEPHONE CASES; MOBILE TELEPHONE CASES MADE OF LEATHER OR IMITATIONS OF LEATHER; MOBILE TELEPHONE COVERS MADE OF CLOTH OR TEXTILE MATERIALS; BAGS AND CASES ADAPTED OR SHAPED TO CONTAIN MP3 PLAYERS, HAND HELD COMPUTERS, TABLET COMPUTERS, PERSONAL DIGITAL ASSISTANTS, GLOBAL POSITIONING SYSTEM (GPS) DEVICES, ELECTRONIC ORGANIZERS AND ELECTRONIC NOTEPADS (U.S. CLS. 21, 23, 26, 36 AND 38).

FIRST USE 5-4-2010; IN COMMERCE 5-4-2010.

TARA PATE, EXAMINING ATTORNEY

**CLASS 9—(Continued).**

SN 85-122,723. THERMALTAKE TECHNOLOGY CO., LTD.,  
TAIPEI COUNTY, TAIWAN, FILED 9-3-2010.

**FACECLOUD**

THE MARK CONSISTS OF STANDARD CHARACTERS WITHOUT CLAIM TO ANY PARTICULAR FONT, STYLE, SIZE, OR COLOR.

PRIORITY CLAIMED UNDER SEC. 44(D) ON TAIWAN APPLICATION NO. 99041798, FILED 8-24-2010, REG. NO. 01465389, DATED 7-16-2011, EXPIRES 7-15-2021.

FOR DATA STORING DEVICES, NAMELY, BLANK TAPES FOR STORAGE OF COMPUTER DATA; COMPUTER DISC DRIVES; COMPUTERS; INTERNET EQUIPMENT, NAMELY, INTERNET SERVERS; NETWORK SERVERS; COMPUTER HARDWARE; NETWORK STORING SERVERS, NAMELY, NETWORK ACCESS SERVER HARDWARE; PLASTIC AND CARDBOARD CASES FOR STORING COMPUTER DISCS; BLANK DIGITAL STORAGE MEDIA; COMPUTER SERVERS, NAMELY, IMAGE SERVERS; NETWORK AUDIO SERVERS; COMPUTER SERVERS, NAMELY, MAIL SERVERS; COMPUTER SOFTWARE FOR THE CREATION OF FIREWALLS; INTERFACES FOR COMPUTERS; INTEGRATED CIRCUIT CHIPS FOR COMPUTERS; SEMI-CONDUCTORS; INTEGRATED CIRCUITS (U.S. CLS. 21, 23, 26, 36 AND 38).

PAUL MORENO, EXAMINING ATTORNEY

SN 85-125,140. MITSUBISHI ELECTRIC CORPORATION,  
CHIYODA-KU, TOKYO, JAPAN, FILED 9-8-2010.

**CW Workbench**

THE MARK CONSISTS OF STANDARD CHARACTERS WITHOUT CLAIM TO ANY PARTICULAR FONT, STYLE, SIZE, OR COLOR.

NO CLAIM IS MADE TO THE EXCLUSIVE RIGHT TO USE "WORKBENCH", APART FROM THE MARK AS SHOWN.

FOR COMPUTER SOFTWARE FOR DEVELOPING CONTROLLERS FOR USE IN MANUFACTURING MACHINES, NAMELY, MACHINES FOR MANUFACTURING SEMI-CONDUCTORS, LIQUID CRYSTAL DISPLAY MODULES, SOLAR BATTERIES, CARS, TRAINS, BEVERAGES, FOODS, AND PRINTING GLASS; SOFTWARE FOR DEVELOPING MACHINE CONTROLLERS, NAMELY, FOR PROCESSING MACHINES FOR MACHINE PARTS, FOR TRANSPORTATION MACHINES FOR USE IN FACTORIES, AND FOR MACHINES FOR STRUCTURING OR SUPERVISING SOCIETY'S INFRASTRUCTURE (U.S. CLS. 21, 23, 26, 36 AND 38).

LIEF MARTIN, EXAMINING ATTORNEY

**CLASS 9—(Continued).**

SN 85-127,343. ROADSTAR MANAGEMENT S.A., CH-6863  
NOVAZZANO, SWITZERLAND, FILED 9-10-2010.



OWNER OF SWITZERLAND REG. NO. 380991, DATED 9-26-1990, RENEWED AS REG. NO. 380991, DATED 9-26-2010, EXPIRES 9-26-2020.

OWNER OF U.S. REG. NO. 3,016,492.

THE MARK CONSISTS OF THE WORD "ROADSTAR" WITH A STYLIZED CIRCLE DESIGN TO THE LEFT AND BENEATH THE FIRST LETTER "R" WITH STYLIZED CIRCUITRY. THE STYLIZED CIRCUITRY IS IN WHITE, THE CIRCLE IS GRAY AND THE WORD PORTION OF THE MARK IS IN BLACK.

FOR RADIO RECEIVERS FOR CAR, HOME, PORTABLE AND OTHER USES; RADIO WITH AUDIO CASSETTE PLAYER AND RECORDER FOR CAR, HOME, PORTABLE AND OTHER USES; RADIO WITH COMPACT DISC PLAYER AND RECORDER FOR CAR, HOME, PORTABLE AND OTHER USES; RADIO WITH COMPACT DISC AND AUDIO CASSETTE PLAYER AND RECORDER FOR CAR, HOME, PORTABLE AND OTHER USES; RADIO WITH ELECTRONIC AUDIO DECODER AND ENCODER FOR CAR, HOME, PORTABLE AND OTHER USES; RADIO WITH ELECTRONIC VIDEO DECODER AND ENCODER FOR CAR, HOME, PORTABLE AND OTHER USES; AUDIO CASSETTE PLAYER AND RECORDER FOR CAR, HOME, PORTABLE AND OTHER USES; COMPACT DISC PLAYER, SINGLE OR MULTICHANGER, FOR CAR, HOME, PORTABLE AND OTHER USES; POWER AMPLIFIER FOR CAR, HOME, PORTABLE AND OTHER USES; SOUND EQUALIZER FOR CAR, HOME, PORTABLE AND OTHER USES; LOUD SPEAKER SYSTEM, SINGLE OR MULTIPLE WAY, FOR CAR, HOME, PORTABLE AND OTHER USES; AUDIO SUPPORTS, NAMELY, BRACKETS SPECIALLY ADAPTED FOR MOUNTING CAR RADIOS; ANTENNAS, RECEIVING AND TRANSMITTING FOR CAR, HOME, PORTABLE AND OTHER USES; CITIZENS' BAND RADIO TRANSCEIVERS FOR CAR, HOME, PORTABLE AND OTHER USES; TELEPHONES FOR CAR, PORTABLE, HOME AND OTHER USES; FAX MACHINES FOR CAR, HOME, PORTABLE AND OTHER USES; RADAR DETECTOR FOR CAR, PORTABLE AND OTHER USES; BLACK AND WHITE AND COLOR TV RECEIVERS FOR CAR, HOME, PORTABLE AND OTHER USES; VIDEO CASSETTE PLAYER AND RECORDER FOR CAR, HOME, PORTABLE AND OTHER USES; VIDEO DISC PLAYER AND RECORDER FOR CAR, HOME, PORTABLE AND OTHER USES; DIGITAL VERSATILE DISC (DVD), VIDEO COMPACT DISC (VCD) PLAYERS; MP3 PLAYERS AND RECORDERS; VIDEO CAMERAS FOR CAR, HOME, PORTABLE AND OTHER USES; BLACK AND WHITE AND COLOR COMPUTER MONITORS FOR CAR, HOME, PORTABLE AND OTHER USES; BLANK MAGNETIC TAPES FOR



**CLASS 9—(Continued).**

AUDIO AND VIDEO TAPE RECORDERS; HEADPHONES; SATELLITE RECEIVERS WITH AND WITHOUT HARD-DISC, CONNECTION CABLES AND DISH ANTENNAS; ELECTRONIC PRODUCTS FOR THE GENERATION, MEASUREMENT, AND ANALYSIS OF AUDIO SIGNALS, NAMELY, AUDIO ANALYZERS; BATTERIES, ALKALINE BATTERIES AND RECHARGEABLE BATTERIES; CAR BATTERIES; ACCESSORIES TO BE USED IN CONNECTION WITH ALL OF THE ABOVE ITEMS, NAMELY, ELECTRIC POWER SUPPLY ADAPTERS FOR USE IN AUTOMOBILES AND OTHER VEHICLES, BATTERY CHARGERS, AC/DC ELECTRIC POWER ADAPTERS, EXTENSION CABLES, BATTERY PACKS, ANTENNAS, ELECTRONIC DOCKING STATIONS, KEYBOARDS, AND REMOTE CONTROLS FOR RADIOS, COMPACT DISC PLAYERS, TV RECEIVERS, VIDEOCASSETTE PLAYERS AND RECORDERS, VIDEO DISC PLAYERS AND RECORDERS, DIGITAL VERSATILE DISC (DVD) AND VIDEO COMPACT DISC (VCD) PLAYERS, MP3 PLAYERS AND RECORDERS, AND VIDEO CAMERAS (U.S. CLS. 21, 23, 26, 36 AND 38).

ROBERT C. CLARK JR., EXAMINING ATTORNEY

---

SN 85-136,709. SPENCER, CLINT W., DBA SPENCER, CLINT W., OKLAHOMA CITY, OK. FILED 9-23-2010.

vyne

THE MARK CONSISTS OF STANDARD CHARACTERS WITHOUT CLAIM TO ANY PARTICULAR FONT, STYLE, SIZE, OR COLOR.

FOR PORTABLE ELECTRONIC DEVICE APPARATUS FOR HANDS FREE MOBILE MEDIA VIEWING (U.S. CLS. 21, 23, 26, 36 AND 38).

LINDA MICKLEBURGH, EXAMINING ATTORNEY

---

SN 85-141,582. NASTEL TECHNOLOGIES, INC., MELVILLE, NY. FILED 9-29-2010.

Driving Business  
Transaction Performance

THE MARK CONSISTS OF STANDARD CHARACTERS WITHOUT CLAIM TO ANY PARTICULAR FONT, STYLE, SIZE, OR COLOR.

FOR COMPUTER SOFTWARE THAT PROVIDES REAL-TIME, INTEGRATED BUSINESS MANAGEMENT INTELLIGENCE BY COMBINING INFORMATION FROM DISCOVERED BUSINESS TRANSACTIONS AND PRESENTING THEM IN AN EASY-TO-UNDERSTAND USER INTERFACE (U.S. CLS. 21, 23, 26, 36 AND 38).

FIRST USE 4-9-2009; IN COMMERCE 4-9-2009.

KATHRYN COWARD, EXAMINING ATTORNEY

**CLASS 9—(Continued).**

SN 85-143,630. PLANET PIGSKIN PICTURES LLC, BATON ROUGE, LA. FILED 10-1-2010.

TRY US

THE MARK CONSISTS OF STANDARD CHARACTERS WITHOUT CLAIM TO ANY PARTICULAR FONT, STYLE, SIZE, OR COLOR.

FOR PRE-RECORDED CDS, VIDEO TAPES, LASER DISKS, AND DVDS FEATURING MUSIC, MUSIC VIDEOS, ENTERTAINMENT MOTION PICTURE FILMS, INDEPENDENT MOTION PICTURE FILMS, TELEVISION SHOWS, AND DOCUMENTARY MOTION PICTURE FILMS IN THE FIELDS OF DRAMA AND SPORTS; DOWNLOADABLE COMPUTER SOFTWARE FOR THE COLLECTION, EDITING, ORGANIZING, SEARCHING, BOOKMARKING, TRANSMISSION, STORAGE, AND SHARING OF GENERAL INTEREST NEWS, ENTERTAINMENT, SPORTS AND EDUCATIONAL INFORMATION; SOFTWARE APPLICATION FOR MOBILE PHONES, HANDHELD DEVICES, AND COMPUTERS FOR THE COLLECTION, EDITING, ORGANIZING, SEARCHING, BOOKMARKING, TRANSMISSION, STORAGE, AND SHARING OF GENERAL INTEREST NEWS, ENTERTAINMENT, SPORTS AND EDUCATIONAL INFORMATION (U.S. CLS. 21, 23, 26, 36 AND 38).

BERNICE MIDDLETON, EXAMINING ATTORNEY

---

SN 85-148,946. VALENTINE, JARED M., AKA GHOST OF MUTINY, ANCHORAGE, AK. AND VALENTINE, JAYSON P., AKA GHOST OF MUTINY, ANCHORAGE, AK. AND VALENTINE, JONATHAN E., AKA GHOST OF MUTINY, ANCHORAGE, AK. FILED 10-8-2010.

Ghost of Mutiny

THE MARK CONSISTS OF STANDARD CHARACTERS WITHOUT CLAIM TO ANY PARTICULAR FONT, STYLE, SIZE, OR COLOR.

FOR AUDIO AND VIDEO RECORDINGS FEATURING MUSIC AND ARTISTIC PERFORMANCES; COMPACT DISCS FEATURING MUSIC; DIGITAL MUSIC DOWNLOADABLE FROM THE INTERNET; DOWNLOADABLE MP3 FILES, MP3 RECORDINGS, ON-LINE DISCUSSION BOARDS, WEBCASTS, WEBINARS AND PODCASTS FEATURING MUSIC AND NEWS BROADCASTS; DOWNLOADABLE MUSICAL SOUND RECORDINGS; DOWNLOADABLE RING TONES, GRAPHICS AND MUSIC VIA A GLOBAL COMPUTER NETWORK AND WIRELESS DEVICES; MUSICAL SOUND RECORDINGS; MUSICAL VIDEO RECORDINGS (U.S. CLS. 21, 23, 26, 36 AND 38).

ALLISON SCHRODY, EXAMINING ATTORNEY

**CLASS 9—(Continued).**

SN 85-153,649. PAXERAMED CORP, IRVINE, CA. FILED 10-15-2010.



THE COLOR(S) ORANGE, BLACK AND GRAY IS/ARE CLAIMED AS A FEATURE OF THE MARK.

THE MARK CONSISTS OF THE STYLIZED WORDING "PAXERAMED", WHERE THE LETTERS "PAXERA" AND "E" ARE IN THE COLOR ORANGE, AND THE LETTERS "M" AND "D" ARE IN THE COLOR GRAY. THE MARK ALSO CONSISTS OF THE DESIGN OF AN UNDERLINE FORMED BY GRAY AND BLACK SQUARES BELOW THE WORDING "PAXERAMED", AND A CIRCULAR DESIGN FORMED BY THE GRAY OUTLINE OF A CIRCLE, AN ORANGE LETTER "E" FORMED BY THREE HORIZONTAL LINES, AND A GRAY CIRCLE OVERLAPPING A GENERALLY OVAL REPRESENTATION OF A PILL, ALL TO THE LEFT OF ALL OTHER ELEMENTS OF THE MARK. THE STYLIZED WORDING "NEW ERA IN PACS" APPEARS IN THE COLOR GRAY BELOW THE UNDERLINE DESIGN. THE COLOR WHITE REPRESENTS TRANSPARENT AREAS AND IS NOT PART OF THE MARK.

FOR MEDICAL SOFTWARE FOR PROCESSING AND DISPLAYING BREAST IMAGES ON MEDICAL RESONANCE IMAGING MACHINES (MRI'S); MEDICAL SOFTWARE FOR PROCESSING AND DISPLAYING IMAGES ON ULTRASOUND MEDICAL IMAGING MACHINES; MEDICAL SOFTWARE FOR DISPLAYING AND PROCESSING RADIOLOGICAL IMAGES (U.S. CLS. 21, 23, 26, 36 AND 38).

FIRST USE 5-1-2009; IN COMMERCE 9-1-2009.  
JAY BESCH, EXAMINING ATTORNEY

SN 85-158,287. BOSS PACKAGING INC., CALGARY, ALBERTA, CANADA, FILED 10-21-2010.



OWNER OF U.S. REG. NO. 3,869,023.

THE MARK CONSISTS OF THE STYLIZED WORD "BOSSPAC" WITH THE STYLIZED WORD "WASP" DIRECTLY BENEATH AND TO THE LEFT OF THREE QUARTER MOONS WITHIN A SOLID SQUARE.

FOR AN INSTRUMENT, NAMELY, A SENSORY DEVICE FOR REMOTELY MEASURING VELOCITY, ACCELERATION AND TEMPERATURE (U.S. CLS. 21, 23, 26, 36 AND 38).

DOMINICK J. SALEMI, EXAMINING ATTORNEY

**CLASS 9—(Continued).**

SN 85-159,286. VDA MULTIMEDIA SPA, PORDENONE, ITALY, FILED 10-22-2010.

## Bed TV

THE MARK CONSISTS OF STANDARD CHARACTERS WITHOUT CLAIM TO ANY PARTICULAR FONT, STYLE, SIZE, OR COLOR.

NO CLAIM IS MADE TO THE EXCLUSIVE RIGHT TO USE "TV", APART FROM THE MARK AS SHOWN.

FOR SCIENTIFIC, ELECTRIC CINEMATOGRAPHIC, OPTICAL, CHECKING AND SUPERVISION APPARATUS AND INSTRUMENTS, NAMELY, TELEVISIONS, REMOTE CONTROLS FOR TELEVISIONS, ELECTRONIC APPARATUS AND DEVICES FOR CONTROLLING ACCESS TO PAY-TELEVISION SERVICES, CABLE TELEVISION CONVERTERS, CABLE TELEVISION TRANSMITTERS, RECEIVERS FOR RECEIVING CABLE TELEVISION, AMUSEMENT APPARATUS FOR USE WITH A TELEVISION; HAND-HELD UNITS FOR PLAYING ELECTRONIC GAMES FOR USE WITH EXTERNAL DISPLAY SCREENS OR MONITORS, CONTROL DEVICES FOR ELECTRIC AND ELECTRONIC APPARATUS FOR USAGE IN HOTEL ROOMS; APPARATUS FOR RECORDING, TRANSMISSION OR REPRODUCTION OF SOUND OR IMAGES; MAGNETIC DATA CARRIERS; BLANK CD-ROMS FOR SOUND OR VIDEO RECORDING; BLANK DISCS FOR COMPUTERS; BLANK RECORDABLE OPTICAL DISCS; AUTOMATIC VENDING MACHINES AND MECHANISMS FOR COIN-OPERATED APPARATUS; CASH REGISTERS, CALCULATING MACHINES, DATA PROCESSING EQUIPMENT AND COMPUTERS; REMOTE CONTROLS FOR AUDIOVISUAL SYSTEMS; COMPUTER HARDWARE; COMPUTER SOFTWARE AND HARDWARE FOR MANAGING AUDIO-VISUAL CONTENT ON COMPUTER NETWORKS; COMPUTER SOFTWARE FOR ADMINISTRATION OF COMPUTER NETWORKS; COMPUTER HARDWARE AND SOFTWARE FOR SETTING UP AND CONFIGURING LOCAL AREA NETWORKS; PC TABLETS; HAND-HELD COMPUTERS; COMPUTER SOFTWARE FOR COMMUNICATING WITH USERS OF HAND-HELD COMPUTERS; COMPUTER SOFTWARE FOR DATABASE MANAGEMENT, SPREADSHEET APPLICATIONS, AND WORD PROCESSING (U.S. CLS. 21, 23, 26, 36 AND 38).

RAUL CORDOVA, EXAMINING ATTORNEY

**CLASS 9—(Continued).**

SN 85-160,096. COOPER TECHNOLOGIES COMPANY, HOUSTON, TX. FILED S.R. 10-25-2010; AM. P.R. 6-20-2011.

**CLASS 9—(Continued).**

SN 85-161,278. TWO BROTHERS RACING, INC., SANTA ANA, CA. FILED 10-26-2010.

**SURGE PROTECTION MADE  
SIMPLE**



THE COLOR(S) GREY AND BLACK IS/ARE CLAIMED AS A FEATURE OF THE MARK.

THE MARK CONSISTS OF THE WORD "ROKFORM" IN STYLIZED FONT WITH A STYLIZED LINE BENEATH THE WORD AND A CIRCLE ABOVE THE WORD WITH 12 SMALLER, SOLID CIRCLES INSIDE THE CIRCLE AND A SINGLE SOLID CIRCLE INSIDE THE 12 SMALLER, SOLID CIRCLES, THE ENTIRE MARK BEING GREY WITH BLACK SHADING.

FOR CASES AND HOLDERS FOR PERSONAL ELECTRONIC DEVICES (U.S. CLS. 21, 23, 26, 36 AND 38).  
GIANCARLO CASTRO, EXAMINING ATTORNEY

THE MARK CONSISTS OF STANDARD CHARACTERS WITHOUT CLAIM TO ANY PARTICULAR FONT, STYLE, SIZE, OR COLOR.

NO CLAIM IS MADE TO THE EXCLUSIVE RIGHT TO USE "SURGE PROTECTION", APART FROM THE MARK AS SHOWN.

FOR VOLTAGE SURGE PROTECTORS, VOLTAGE SURGE PROTECTION, NAMELY, ELECTRICAL ARC DETECTION AND SUPPRESSING DEVICE USED IN LOW VOLTAGE SWITCHGEAR, LIGHTNING ARRESTERS, CIRCUIT PROTECTIVE EQUIPMENT, DEVICES TO PROTECT ELECTRICAL EQUIPMENT FROM IRREGULAR POWER, ELECTRICAL SURGE PROTECTOR DEVICE, OVERVOLTAGE SURGE PROTECTIVE DEVICE, SURGE SUPPRESSION EQUIPMENT, TRANSIENT ARRESTER VOLTAGE REGULATORS, TRANSIENT VOLTAGE ARRESTERS, TRANSIENT VOLTAGE SURGE SUPPRESSORS, VOLTAGE OVERLOAD AND SURGE PROTECTORS, VOLTAGE SURGE PROTECTORS, ELECTROSTATIC DISCHARGE PROTECTIVE DEVICE, OVERVOLTAGE SURGE SUPPRESSING DEVICE USED IN LOW VOLTAGE SWITCHGEAR; VOLTAGE SURGE PROTECTIVE DEVICES, NAMELY, ELECTRICAL ARC DETECTION AND SUPPRESSING DEVICE USED IN LOW VOLTAGE SWITCHGEAR, LIGHTNING ARRESTERS, CIRCUIT PROTECTIVE EQUIPMENT, DEVICES TO PROTECT ELECTRICAL EQUIPMENT FROM IRREGULAR POWER, ELECTRICAL SURGE PROTECTOR DEVICE, OVERVOLTAGE SURGE PROTECTIVE DEVICE, SURGE SUPPRESSION EQUIPMENT, TRANSIENT ARRESTER VOLTAGE REGULATORS, TRANSIENT VOLTAGE ARRESTERS, TRANSIENT VOLTAGE SURGE SUPPRESSORS, VOLTAGE OVERLOAD AND SURGE PROTECTORS, VOLTAGE SURGE PROTECTORS, ELECTROSTATIC DISCHARGE PROTECTIVE DEVICE, OVERVOLTAGE SURGE SUPPRESSING DEVICE USED IN LOW VOLTAGE SWITCHGEAR; VOLTAGE SURGE SUPPRESSORS (U.S. CLS. 21, 23, 26, 36 AND 38).

FIRST USE 10-12-2010; IN COMMERCE 10-12-2010.  
KEVIN CORWIN, EXAMINING ATTORNEY

SN 85-163,207. SHENZHEN OVERSEAWIN TECHNOLOGY CO., LTD., SHENZHEN, GUANGDONG, CHINA, FILED 10-28-2010.



THE MARK CONSISTS OF A RECTANGLE DIVIDED INTO TWO SECTIONS. THE TERM "OWP" APPEARS ON THE LEFT SECTION AND THREE UNDERLINED ASIAN CHARACTERS APPEAR ON THE RIGHT SECTION.

THE ENGLISH TRANSLATION OF "YUE YANG DA" IN THE MARK IS "OVERSEAS ACHIEVE".

THE NON-LATIN CHARACTERS IN THE MARK TRANSLITERATE TO YUE YANG DA AND THIS MEANS OVERSEAS ACHIEVE IN ENGLISH.

FOR ACOUSTIC COUPLERS; DATA PROCESSORS; ELECTRIC CONNECTIONS; FIBRE OPTIC COUPLINGS (U.S. CLS. 21, 23, 26, 36 AND 38).

FIRST USE 1-4-2007; IN COMMERCE 1-4-2007.  
GISELLE AGOSTO, EXAMINING ATTORNEY

**CLASS 9—(Continued).**

SN 85-163,934. BIO-KEY INTERNATIONAL, INC., WALL, NJ. FILED 10-28-2010.

**TRUE USER IDENTIFICATION**

THE MARK CONSISTS OF STANDARD CHARACTERS WITHOUT CLAIM TO ANY PARTICULAR FONT, STYLE, SIZE, OR COLOR.

OWNER OF U.S. REG. NO. 2,993,467.  
NO CLAIM IS MADE TO THE EXCLUSIVE RIGHT TO USE "USER IDENTIFICATION", APART FROM THE MARK AS SHOWN.

SEC. 2(F).  
FOR SOFTWARE FEATURING BIOMETRIC IDENTIFICATION TECHNOLOGY AND PROCESSES FOR SECURITY AND ACCURACY OF USER AUTHENTIFICATIONS (U.S. CLS. 21, 23, 26, 36 AND 38).  
FIRST USE 9-1-2001; IN COMMERCE 9-1-2001.  
ELI HELLMAN, EXAMINING ATTORNEY

---

SN 85-164,547. SOLIDDD CORPORATION, BROOKLYN, NY. FILED 10-29-2010.

**SOLIDDD**

THE MARK CONSISTS OF STANDARD CHARACTERS WITHOUT CLAIM TO ANY PARTICULAR FONT, STYLE, SIZE, OR COLOR.

FOR THREE-DIMENSIONAL PRINTING SYSTEMS, COMPRISED PRIMARILY OF A COMBINATION OF OPTICAL ELEMENTS, NAMELY, LENSES AND SPECIFIC SPACING BETWEEN LENSES AND UNDERLYING IMAGES, MIRRORS AND PRISMS AND OTHER OPTICAL ELEMENTS, POLARIZERS, AND SPECIFICALLY FORMATTED PRINTING OF TEXT, ART AND/OR PHOTOGRAPHS WHICH ALLOW FOR THREE-DIMENSIONAL GRAPHICS; THREE-DIMENSIONAL CAMERA SYSTEMS, NAMELY, ADAPTERS FOR ALLOWING THREE-DIMENSIONAL SHOOTING; AND COMPUTER HARDWARE AND SOFTWARE FOR CONVERTING EXISTING TWO-DIMENSIONAL DISPLAYS TO THREE-DIMENSIONAL DISPLAYS AND FOR COMBINING, SYNTHESIZING AND CORRECTING IMAGERY IN BOTH TWO-DIMENSIONAL AND THREE-DIMENSIONAL FORMS (U.S. CLS. 21, 23, 26, 36 AND 38).  
LINDA E. BLOHM, EXAMINING ATTORNEY

**CLASS 9—(Continued).**

SN 85-169,335. BRAILLE BATTERY, INC., SARASOTA, FL. FILED 11-4-2010.



THE MARK CONSISTS OF AN INCOMPLETE CIRCLE THAT CONTAINS THE LETTER "B" INSIDE. THE RIGHT SIDE OF THE CIRCLE CONTAINS A SMALLER COMPLETE CIRCLE CONTAINING A PLUS SIGN. TO THE LEFT OF THE CIRCLE THERE ARE SEVERAL SMALL SHADED CIRCLES THAT FORM AN ARROWHEAD THAT POINTS TO THE LEFT.

FOR BATTERIES AND BATTERY CHARGERS (U.S. CLS. 21, 23, 26, 36 AND 38).  
FIRST USE 10-31-2009; IN COMMERCE 10-31-2009.  
TRACY WHITTAKER-BROWN, EXAMINING ATTORNEY

---

SN 85-169,458. COURTROOM TELEVISION NETWORK LLC, NEW YORK, NY. FILED 11-4-2010.

**TRUTV PRESENTS: WORLD'S DUMBEST...**

THE MARK CONSISTS OF STANDARD CHARACTERS WITHOUT CLAIM TO ANY PARTICULAR FONT, STYLE, SIZE, OR COLOR.

OWNER OF U.S. REG. NOS. 3,493,740, 3,664,198 AND 3,669,937.  
FOR DOWNLOADABLE TELEVISION PROGRAMS FEATURING COMEDY, DRAMA, ACTION, ADVENTURE AND/OR REALITY PROVIDED VIA THE INTERNET AND WIRELESS COMMUNICATIONS NETWORKS (U.S. CLS. 21, 23, 26, 36 AND 38).  
TAMARA FRAZIER, EXAMINING ATTORNEY

**CLASS 9—(Continued).**

SN 85-170,583. SOUTHWEST AIRLINES CO., DALLAS, TX. FILED 11-5-2010.

**International Connect**

THE MARK CONSISTS OF STANDARD CHARACTERS WITHOUT CLAIM TO ANY PARTICULAR FONT, STYLE, SIZE, OR COLOR.

NO CLAIM IS MADE TO THE EXCLUSIVE RIGHT TO USE "INTERNATIONAL", APART FROM THE MARK AS SHOWN.

FOR COMPUTER SOFTWARE FOR DELIVERING PERSONALIZED TRAVEL INFORMATION VIA THE INTERNET (U.S. CLS. 21, 23, 26, 36 AND 38).

JAY BESCH, EXAMINING ATTORNEY

SN 85-171,955. CASHEDGE, INC., NEW YORK, NY. FILED 11-8-2010.



OWNER OF U.S. REG. NOS. 3,848,688 AND 3,867,315. THE MARK CONSISTS OF THE WORD "POP" WITH CIRCULAR ARROWS ABOVE AND BELOW.

FOR DOWNLOADABLE COMPUTER SOFTWARE FOR USE BY BANKS AND ONLINE BANKING CUSTOMERS IN BANKING TRANSACTIONS, NAMELY, FOR ELECTRONIC FUNDS TRANSFER AND ELECTRONIC PAYMENT PROCESSING NOT INCLUDING PAPER CHECK CONVERSIONS; DOWNLOADABLE COMPUTER SOFTWARE FOR USE BY BANKS AND ONLINE BANKING CUSTOMERS IN BANKING TRANSACTIONS, NAMELY, DIRECT ELECTRONIC DEBIT TRANSACTIONS, PEER TO PEER ELECTRONIC PAYMENTS, AND PEER-TO-PEER MONEY TRANSFERS; DOWNLOADABLE COMPUTER SOFTWARE FOR USE IN BANKING AND FINANCIAL TRANSACTIONS, NAMELY, FOR PEER TO PEER ELECTRONIC PAYMENTS AND PEER-TO-PEER MONEY TRANSFERS (U.S. CLS. 21, 23, 26, 36 AND 38).

FIRST USE 6-8-2010; IN COMMERCE 6-8-2010. HANNO RITTNER, EXAMINING ATTORNEY

**CLASS 9—(Continued).**

SN 85-172,012. BLASTER COMMUNICATIONS, ALTA LOMA, CA. FILED 11-8-2010.

**EyeKnow, "NARCOTICS & EMS"**

THE MARK CONSISTS OF STANDARD CHARACTERS WITHOUT CLAIM TO ANY PARTICULAR FONT, STYLE, SIZE, OR COLOR.

NO CLAIM IS MADE TO THE EXCLUSIVE RIGHT TO USE "NARCOTICS & EMS", APART FROM THE MARK AS SHOWN.

FOR DOWNLOADABLE COMPUTER SOFTWARE FOR TRACKING NARCOTICS (U.S. CLS. 21, 23, 26, 36 AND 38).

WENDY JUN, EXAMINING ATTORNEY

SN 85-172,099. HEALEY, ROBERT, WILLIAMSBURG, OH. FILED 11-9-2010.

**SOLAR WAVE**

THE MARK CONSISTS OF STANDARD CHARACTERS WITHOUT CLAIM TO ANY PARTICULAR FONT, STYLE, SIZE, OR COLOR.

NO CLAIM IS MADE TO THE EXCLUSIVE RIGHT TO USE "SOLAR", APART FROM THE MARK AS SHOWN.

FOR ELECTRICAL APPARATUS, NAMELY, SOLAR-POWERED BATTERY CHARGERS FOR HANDHELD ELECTRONICS, GAMING DEVICES, LAPTOP COMPUTERS, WIRELESS COMMUNICATION DEVICES, AND OTHER BATTERY OPERATED HANDHELD DEVICES (U.S. CLS. 21, 23, 26, 36 AND 38).

MARK SPARACINO, EXAMINING ATTORNEY

SN 85-173,011. TRUE FREEDOM ENTERPRISES LLC, NORTH HOLLYWOOD, CA. FILED 11-9-2010.

**Her Success Blueprint**

THE MARK CONSISTS OF STANDARD CHARACTERS WITHOUT CLAIM TO ANY PARTICULAR FONT, STYLE, SIZE, OR COLOR.

FOR DOWNLOADABLE AUDIO FILES, MULTIMEDIA FILES, TEXT FILES, E-MAILS, WRITTEN DOCUMENTS, AUDIO MATERIAL, VIDEO MATERIAL AND GAMES FEATURING INFORMATION IN THE FORM OF DOWNLOADABLE SHORT EDUCATIONAL/TRAINING COMMUNICATIONS IN THE FIELD OF HUMAN RESOURCE DEVELOPMENT FOR THE PROMOTION OF EMPLOYEE RETENTION, CAREER GROWTH AND INCREASED PRODUCTIVITY FOR EMPLOYEES AND EMPLOYERS (U.S. CLS. 21, 23, 26, 36 AND 38).

FIRST USE 2-24-2010; IN COMMERCE 2-24-2010. KATHLEEN LORENZO, EXAMINING ATTORNEY

**CLASS 9—(Continued).**

SN 85-173,650. AMERICAN BIBLE SOCIETY, NEW YORK, NY. FILED 11-10-2010.

**CLASS 9—(Continued).**

SN 85-174,825. VXI CORPORATION, DOVER, NH. FILED 11-11-2010.

**UNCOVER THE WORD**

THE MARK CONSISTS OF STANDARD CHARACTERS WITHOUT CLAIM TO ANY PARTICULAR FONT, STYLE, SIZE, OR COLOR.

FOR PRE-RECORDED CDS, DVDS, AND CD-ROMS IN THE FIELDS OF THE BIBLE, CHRISTIANITY, RELIGION, THEOLOGY, SPIRITUALITY, ETHICS, VALUES, AND APPLICATION OF THE BIBLE TO INDIVIDUAL LIVES AND THE MARKETPLACE, NOT RELATING TO HISTORY OR THE SCIENCES; DOWNLOADABLE MULTIMEDIA FILES CONTAINING TEXT, VIDEO AND INTERNET WEB LINKS RELATING TO THE BIBLE, CHRISTIANITY, RELIGION, THEOLOGY, SPIRITUALITY, ETHICS, VALUES, AND APPLICATION OF THE BIBLE TO INDIVIDUAL LIVES AND THE MARKETPLACE, NOT RELATING TO HISTORY OR THE SCIENCES; DOWNLOADABLE ELECTRONIC PUBLICATIONS, NAMELY, ELECTRONIC BOOKLETS, BROCHURES, STUDY GUIDES, NEWSLETTERS, AND INFORMATIONAL FLYERS, ALL IN THE FIELDS OF THE BIBLE, CHRISTIANITY, RELIGION, THEOLOGY, SPIRITUALITY, ETHICS, VALUES, AND APPLICATION OF THE BIBLE TO INDIVIDUAL LIVES AND THE MARKETPLACE, NOT RELATING TO HISTORY OR THE SCIENCES; COMPUTER APPLICATION SOFTWARE FOR MOBILE PHONES, PORTABLE MEDIA PLAYERS, AND HANDHELD COMPUTERS, NAMELY, SOFTWARE FOR PROVIDING ACCESS TO THE INTERNET TO ACCESS MULTI-MEDIA CONTENT, COMMUNICATION SERVICES, AND SOCIAL NETWORKING VIA A GLOBAL COMMUNICATIONS NETWORKS IN THE FIELDS OF THE BIBLE, CHRISTIANITY, RELIGION, THEOLOGY, SPIRITUALITY, ETHICS, VALUES, AND APPLICATION OF THE BIBLE TO INDIVIDUAL LIVES AND THE MARKETPLACE, NOT RELATING TO HISTORY OR THE SCIENCES (U.S. CLS. 21, 23, 26, 36 AND 38).

MARC LEIPZIG, EXAMINING ATTORNEY

SN 85-173,872. ION AUDIO, LLC, CUMBERLAND, RI. FILED 11-10-2010.

OWNER OF U.S. REG. NOS. 2,398,354, 3,439,329 AND OTHERS.

THE MARK CONSISTS OF THE WORD "BLUEPARROTT" IN LOWER CASE LETTERS WITH A PARROTT ON THE CROSS OF THE SECOND "T" AND WITH THE LETTERS VXI ABOVE THE LETTERS "U" AND "E" IN THE WORD "BLUEPARROTT", THE "VXI" HAVING AN ARC STARTING AT THE DOT ON THE LETTER "I" AND GOING PAST THE LETTER "V" TO THE BEGINNING OF THE LETTER "L" IN "BLUEPARROTT", AND THE WORD "XPRESSWAY" WITH A CAPITAL "X" AND WITH TWO LINES INTERSECTING THE FIRST HALF OF THE LETTER "X" AND DASHED LINES UNDER THE WORD "XPRESSWAY".

FOR WIRELESS HEADSETS FOR TELEPHONES (U.S. CLS. 21, 23, 26, 36 AND 38).

FIRST USE 11-30-2009; IN COMMERCE 11-30-2009.

DANIEL CAPSHAW, EXAMINING ATTORNEY

SN 85-178,797. OGMENTO, INC., NEW YORK, NY. FILED 11-17-2010.

**KING OF THE COURT****HEAR NO EVIL**

THE MARK CONSISTS OF STANDARD CHARACTERS WITHOUT CLAIM TO ANY PARTICULAR FONT, STYLE, SIZE, OR COLOR.

FOR AUDIO EQUIPMENT, NAMELY, HEADPHONES, WIRELESS HEADPHONES, DIGITAL WIRELESS HEADPHONES, HEADPHONE AMPLIFIERS AND SURROUND PROCESSOR IN THE NATURE OF AN AUDIO SIGNAL PROCESSOR FOR USE WITH COMPUTERS, HEADSETS, MUSIC PLAYERS AND PORTABLE MUSIC PLAYERS (U.S. CLS. 21, 23, 26, 36 AND 38).

MAUREEN DALL, EXAMINING ATTORNEY

THE MARK CONSISTS OF STANDARD CHARACTERS WITHOUT CLAIM TO ANY PARTICULAR FONT, STYLE, SIZE, OR COLOR.

FOR COMPUTER GAME DISCS; COMPUTER GAME SOFTWARE; DOWNLOADABLE COMPUTER GAME SOFTWARE VIA A GLOBAL COMPUTER NETWORK; INTERACTIVE MULTIMEDIA COMPUTER GAME PROGRAMS; INTERACTIVE VIDEO GAME PROGRAMS; VIDEO GAME DISCS; VIDEO GAME SOFTWARE; VIRTUAL REALITY GAME SOFTWARE (U.S. CLS. 21, 23, 26, 36 AND 38).

ROBERT C. CLARK JR., EXAMINING ATTORNEY

**CLASS 9—(Continued).**

SN 85-179,084. LOVED ONE LOCATOR, LLC, CHICAGO, IL. FILED 11-17-2010.

**LOVED ONE LOCATOR**

THE MARK CONSISTS OF STANDARD CHARACTERS WITHOUT CLAIM TO ANY PARTICULAR FONT, STYLE, SIZE, OR COLOR.

NO CLAIM IS MADE TO THE EXCLUSIVE RIGHT TO USE "LOCATOR", APART FROM THE MARK AS SHOWN.

FOR HANDHELD ELECTRONIC DEVICE USED IN LOCATING BURIAL OR INURNMENT SITES (U.S. CLS. 21, 23, 26, 36 AND 38).

MICHAEL WIENER, EXAMINING ATTORNEY

SN 85-179,484. MOPHIE, INC., SANTA ANA, CA. FILED 11-17-2010.

**MOPHIE JUICE PACK SLIM**

THE MARK CONSISTS OF STANDARD CHARACTERS WITHOUT CLAIM TO ANY PARTICULAR FONT, STYLE, SIZE, OR COLOR.

OWNER OF U.S. REG. NOS. 3,227,723, 3,227,725 AND 3,949,983.

NO CLAIM IS MADE TO THE EXCLUSIVE RIGHT TO USE "SLIM", APART FROM THE MARK AS SHOWN.

FOR RECHARGEABLE BATTERIES INTEGRATED INTO A PROTECTIVE CASE OR HOUSING WITH AN ELECTRICAL CONNECTOR FOR USE WITH MOBILE ELECTRONIC DEVICES, NAMELY, MOBILE PHONES, DIGITAL AUDIO AND VIDEO PLAYERS, HANDHELD COMPUTERS, PERSONAL DIGITAL ASSISTANTS, ELECTRONIC ORGANIZERS, ELECTRONIC NOTEPADS, AND CAMERAS; BATTERY CHARGERS (U.S. CLS. 21, 23, 26, 36 AND 38).

MARY CRAWFORD, EXAMINING ATTORNEY

**CLASS 9—(Continued).**

SN 85-182,105. KOLLMORGEN CORPORATION, NORTH-AMPTON, MA. FILED 11-22-2010.

**O · N · E 360**

THE MARK CONSISTS OF STANDARD CHARACTERS WITHOUT CLAIM TO ANY PARTICULAR FONT, STYLE, SIZE, OR COLOR.

NO CLAIM IS MADE TO THE EXCLUSIVE RIGHT TO USE "360", APART FROM THE MARK AS SHOWN.

FOR THERMAL IMAGING SYSTEMS, NOT FOR MEDICAL USE; ELECTRO-OPTICAL IMAGING APPARATUS COMPRISED OF A SENSOR SYSTEM WITH VISUAL AND INFRARED CAMERAS; A HIGH BANDWIDTH, HIGH CAPACITY, LOW LATENCY VIDEO PROCESSOR; AND DISPLAY FOR DETECTING, RECOGNIZING, IDENTIFYING, AND TRACKING MOVEMENT (U.S. CLS. 21, 23, 26, 36 AND 38).

H. M. FISHER, EXAMINING ATTORNEY

SN 85-183,652. ASTRIUM GMBH, OTTOBRUNN, FED REP GERMANY, FILED 11-23-2010.



OWNER OF FED REP GERMANY REG. NO. 302009040059, DATED 9-21-2009, EXPIRES 7-31-2019.

OWNER OF U.S. REG. NO. 3,776,756.

NO CLAIM IS MADE TO THE EXCLUSIVE RIGHT TO USE "SECURE SYSTEM", APART FROM THE MARK AS SHOWN.

THE MARK CONSISTS OF FIVE CURVED HORIZONTAL LINES AND TWO CURVED VERTICAL LINES POSITIONED TO FORM SUBSTANTIALLY A GRID ABOVE THE PHRASE "SECURESYSTEM".

FOR MEASUREMENT APPARATUS, NAMELY, CONTAINER MOUNTED GPS SENSOR FOR DETERMINING THE RATE OF MOTION FOR A CONTAINER; SATELLITE NAVIGATIONAL SYSTEM, NAMELY, A GLOBAL POSITIONING SYSTEM (GPS); ENCODED MICRO PARTICULATES, TAGS AND TAGGANTS OF PLASTIC, METAL OR SILICATE FOR USE IN THE FIELD OF PASSIVE LABELING; WIRELESS TRANSCIEVERS WITH COLLECTION AND DISPLAY TECHNOLOGY FOR THE STATUS AND TRACKING OF ALL CONTAINER TYPES IN LOCAL ENVIRONMENTS; WIRELESS TRANSCIEVERS WITH COLLECTION AND DISPLAY TECHNOLOGY FOR THE STATUS AND TRACKING OF RETAIL GOODS FROM THE BACKDOOR TO THE SHELF; COMPUTER HARDWARE AND SOFTWARE SYSTEM FOR TRACKING PEOPLE, OBJECTS AND PETS USING GPS DATA ON A DEVICE ON THE TRACKED PEOPLE, OBJECTS AND PETS; GLOBAL POSITIONING SYSTEM (GPS) CONSISTING OF COMPUTERS, COMPUTER SOFTWARE, TRANSMITTERS, RECEIVERS, AND NETWORK INTERFACE DEVICES; GLOBAL POSITIONING SYSTEM (GPS); SATELLITE NAVIGATIONAL SYSTEM, NAMELY, A GLOBAL POSITIONING SYSTEM (GPS); SIGNAL APPARATUS, NAMELY, SATELLITE AERIALS; SATELLITE AND MICROWAVE COMMUNICATIONS APPARATUS TO TRANSMIT COMMUNICATIONS FROM A VEHICLE TO ANOTHER VEHICLE, OR FROM A VEHICLE TO A SATELLITE; SATELLITE DISHES; SATELLITE DISHES FOR SATELLITE TRANSMISSIONS;

**CLASS 9—(Continued).**

SATELLITE NAVIGATIONAL SYSTEM, NAMELY, A GLOBAL POSITIONING SYSTEM (GPS); SATELLITE PROCESSORS; SATELLITE TELEPHONES; SATELLITE TRANSMITTERS AND RECEIVERS; SATELLITES; SATELLITE AND MICROWAVE COMMUNICATIONS APPARATUS TO TRANSMIT COMMUNICATIONS FROM A CONTAINER TO A SATELLITE; CONTROL APPARATUS, NAMELY, WIRELESS TRANSCEIVERS WITH COLLECTION AND DISPLAY TECHNOLOGY FOR THE STATUS AND TRACKING OF ALL CONTAINER TYPES IN LOCAL ENVIRONMENTS; ELECTRICAL AND ELECTRONIC SECURITY MONITORING APPARATUS, NAMELY, SATELLITE AND MICROWAVE COMMUNICATIONS APPARATUS TO TRANSMIT COMMUNICATIONS FROM A CONTAINER TO ANOTHER STATION, OR FROM A CONTAINER TO A SATELLITE; RADIO, TELEPHONE, SATELLITE, MICROWAVE, TELECOMMUNICATIONS, DATA, DIGITAL, AND ELECTRONIC TRANSMITTERS; ELECTRONIC AND OPTICAL COMMUNICATIONS INSTRUMENTS AND COMPONENTS, NAMELY, DIGITAL TRANSMITTERS; TRANSMITTERS OF ELECTRONIC SIGNALS; BUILDING SECURITY SYSTEMS COMPRISING SOFTWARE AND HARDWARE FOR PROVIDING PICTURE, VIDEO, ALARM STATUS, BUILDING PLANS, AND OTHER INFORMATION TO A REMOTE STATION; ELECTRONIC SECURITY TOKEN IN THE NATURE OF A FOB-LIKE DEVICE USED BY AN AUTHORIZED USER OF A COMPUTER SYSTEM TO FACILITATE AUTHENTICATION; VEHICLE LOCATING, TRACKING AND SECURITY SYSTEM COMPRISED OF AN ANTENNA AND RADIO TRANSMITTER TO BE PLACED IN A CONTAINER; TELECOMMUNICATIONS HARDWARE AND SOFTWARE FOR MONITORING AND ALERTING REMOTE SENSOR STATUS VIA THE INTERNET; ELECTRONIC APPARATUS, NAMELY, MOTION DETECTORS; INFRARED DETECTORS FOR USE IN MILITARY, LAW ENFORCEMENT, CIVIL, SCIENTIFIC AND INDUSTRIAL APPLICATIONS; ELECTRICAL AND ELECTRONIC SECURITY MONITORS, NAMELY, SATELLITE AND MICROWAVE COMMUNICATIONS APPARATUS TO TRANSMIT COMMUNICATIONS FROM A VEHICLE TO ANOTHER VEHICLE, OR FROM A CONTAINER TO A SATELLITE; MODEMS; ELECTRONIC TRANSMITTERS FOR JAMMING SIGNALS; TRANSMITTERS OF ELECTRONIC SIGNALS; RECEIVERS FOR ELECTRONIC SIGNALS (U.S. CLS. 21, 23, 26, 36 AND 38).

AMY KERTGATE, EXAMINING ATTORNEY

---

SN 85-184,297. SMITH, DOUGLAS, SAN ANTONIO, TX. FILED 11-24-2010.

**HITECH CLOUD ACCUMULATION**

THE MARK CONSISTS OF STANDARD CHARACTERS WITHOUT CLAIM TO ANY PARTICULAR FONT, STYLE, SIZE, OR COLOR.

OWNER OF U.S. REG. NO. 3,977,225.  
NO CLAIM IS MADE TO THE EXCLUSIVE RIGHT TO USE "CLOUD", APART FROM THE MARK AS SHOWN.

FOR COMPUTER SOFTWARE, NAMELY, PROPRIETARY COMPUTER PROGRAM FOR ACQUIRING CONFIDENTIAL ELECTRONIC HEALTH RECORDS FROM MULTIPLE ELECTRONIC MEDICAL RECORDS AND COMBINING THE RECORDS WITH REQUIRED MONITORING AND REPORTING IN COMPLIANCE WITH REGULATORY REQUIREMENTS FOR MEDICAL PRACTITIONERS AND MEDICAL CARE FACILITIES (U.S. CLS. 21, 23, 26, 36 AND 38).

JAMES LOVELACE, EXAMINING ATTORNEY

**CLASS 9—(Continued).**

SN 85-184,318. FREDERICKSON, DAVID, VICTORIA, CANADA, FILED 11-24-2010.

**RAINBOW BINGO**

THE MARK CONSISTS OF STANDARD CHARACTERS WITHOUT CLAIM TO ANY PARTICULAR FONT, STYLE, SIZE, OR COLOR.

NO CLAIM IS MADE TO THE EXCLUSIVE RIGHT TO USE "BINGO", APART FROM THE MARK AS SHOWN.

FOR GAMING DEVICES, NAMELY, VIDEO BINGO MACHINE KIOSKS; COMPUTER GAME SOFTWARE FOR MOBILE PHONES FEATURING BINGO GAMES (U.S. CLS. 21, 23, 26, 36 AND 38).

JORDAN BAKER, EXAMINING ATTORNEY

---

SN 85-184,378. KABA ILCO CORP., ROCKY MOUNT, NC. FILED 11-24-2010.

**TKO**

THE MARK CONSISTS OF STANDARD CHARACTERS WITHOUT CLAIM TO ANY PARTICULAR FONT, STYLE, SIZE, OR COLOR.

FOR ELECTRONIC DEVICES FOR PROGRAMMING, READING, RESETTING AND CANCELLING TRANSPONDER KEYS AND REMOTE KEYLESS ENTRY FOBs AND OPERATING SOFTWARE THEREFOR; ELECTRONIC DEVICES FOR READING AND RESETTING VEHICLE IMMOBILIZER CODES AND OPERATING SOFTWARE THEREFOR (U.S. CLS. 21, 23, 26, 36 AND 38).

FIRST USE 9-15-2006; IN COMMERCE 9-15-2006.  
JEFFREY LOOK, EXAMINING ATTORNEY

---

SN 85-185,276. FRANKE, ALBERT, MILFORD, CT. FILED 11-25-2010.

**MEVICE**

THE MARK CONSISTS OF STANDARD CHARACTERS WITHOUT CLAIM TO ANY PARTICULAR FONT, STYLE, SIZE, OR COLOR.

FOR TELECOMMUNICATION PRODUCTS, NAMELY, PERSONAL DIGITAL ASSISTANTS AND SMART PHONES ALL WITH WIRELESS AND MOBILE PHONE FEATURES (U.S. CLS. 21, 23, 26, 36 AND 38).

BERYL GARDNER, EXAMINING ATTORNEY



**CLASS 9—(Continued).**

SN 85-186,503. TICKETHOUND LLC, AUSTIN, TX. FILED 11-29-2010.

# TKTHOUND

THE MARK CONSISTS OF STANDARD CHARACTERS WITHOUT CLAIM TO ANY PARTICULAR FONT, STYLE, SIZE, OR COLOR.

FOR SOFTWARE FOR IDENTIFYING INFORMATION ABOUT TICKET PRICING, AVAILABILITY, AND VENUE INFORMATION ABOUT ENTERTAINMENT, SPORTING AND CULTURAL EVENT TICKETS; SOFTWARE TO ALLOW PROSPECTIVE BUYERS OF ENTERTAINMENT, SPORTING AND CULTURAL EVENT TICKETS TO LOCATE VENUE INFORMATION ABOUT ENTERTAINMENT, SPORTING AND CULTURAL EVENT TICKETS; SOFTWARE TO ALLOW PROSPECTIVE BUYERS OF ENTERTAINMENT, SPORTING AND CULTURAL EVENT TICKETS TO IDENTIFY THE GEOGRAPHIC LOCATION OF SELLERS OF ENTERTAINMENT, SPORTING AND CULTURAL EVENT TICKETS (U.S. CLS. 21, 23, 26, 36 AND 38).

ANTHONY RINKER, EXAMINING ATTORNEY

---

SN 85-186,630. COLOR OF BEAUTY INC., OLD BRIDGE, NJ. FILED 11-29-2010.

# SUCK MY FAT

THE MARK CONSISTS OF STANDARD CHARACTERS WITHOUT CLAIM TO ANY PARTICULAR FONT, STYLE, SIZE, OR COLOR.

FOR DIGITAL MEDIA, NAMELY, DVDS AND DOWNLOADABLE AUDIO AND AUDIO VISUAL FILES, MOTION PICTURE FILMS, WEBISODES AND SHORT FILMS FEATURING INFORMATION REGARDING COSMETIC AND CORRECTIVE SURGERY (U.S. CLS. 21, 23, 26, 36 AND 38).

ARETHA SOMERVILLE, EXAMINING ATTORNEY

**CLASS 9—(Continued).**

SN 85-187,678. PELICAN PRODUCTS, INC., TORRANCE, CA. FILED 11-30-2010.

# HARDIGG

THE MARK CONSISTS OF STANDARD CHARACTERS WITHOUT CLAIM TO ANY PARTICULAR FONT, STYLE, SIZE, OR COLOR.

FOR SOFT-SIDED AND HARD-SIDED CASES FOR CARRYING AND STORING PHOTOGRAPHIC AND ELECTRONIC EQUIPMENT AND OTHER SENSITIVE EQUIPMENT IN THE NATURE OF CELL PHONES, PDAS, HAND-HELD ELECTRONIC GAME MACHINES AND GAME CARTRIDGES AND CASSETTES, SMALL RADIOS, CASSETTES, CD PLAYERS AND/OR COMPUTERS; CASES FOR CARRYING AND STORING PERSONAL, MILITARY, SEARCH AND RESCUE AND/OR INDUSTRIAL SPECIALTY ELECTRONIC INSTRUMENTS IN THE NATURE OF ELECTRIC NAVIGATION INSTRUMENTS, SEISMIC SENSORS, DIGITAL DIVING DEPTH AND CHRONOMETER GAUGES, PUBLIC ADDRESS SYSTEMS AND INSTRUMENTS, ELECTRONIC FIRE HOSE CONTROLLERS, PORTABLE AIR COMPRESSOR KITS, ELECTRONIC SURVEILLANCE EQUIPMENT, ELECTRONIC FIELD TESTING EQUIPMENT, MICROCHIPS AND CIRCUIT BOARDS, ELECTRONIC INDICATOR PANELS, RIFLE SCOPES, FIRE FIGHTING COMMUNICATIONS EQUIPMENT, EMERGENCY LIGHTING SYSTEMS, SATELLITE PHONE SYSTEMS, MOBILE CHEMICAL WEAPONS TESTING KITS, MOBILE CHEMICAL DETECTOR SYSTEMS; GADGET BAGS FOR CARRYING VIDEO CAMERAS, BINOCULARS, GAME CARTRIDGES, CDS, ACCESSORIES FOR COMPUTERS, DIGITAL CAMERAS AND/OR ACCESSORIES FOR CAMERAS (U.S. CLS. 21, 23, 26, 36 AND 38).

FIRST USE 5-31-1960; IN COMMERCE 5-31-1960.  
MICHAEL KEATING, EXAMINING ATTORNEY

---

SN 85-188,349. RAWLINGS SPORTING GOODS COMPANY, INC., ST. LOUIS, MO. FILED 12-1-2010.

# RAWLINGS

THE MARK CONSISTS OF STANDARD CHARACTERS WITHOUT CLAIM TO ANY PARTICULAR FONT, STYLE, SIZE, OR COLOR.

OWNER OF U.S. REG. NOS. 412,343 AND 1,337,914.  
SEC. 2(F).

FOR SPORT WHISTLES; ANTENNAS; SUNGLASSES AND SUNGLASS ACCESSORIES, NAMELY, SUNGLASS STORAGE CASES AND SPECIALLY ADAPTED BAGS, SUNGLASS HOLDERS IN THE NATURE OF CLIPS TO ATTACH SUNGLASSES TO OTHER OBJECTS, RESTRAINING STRAPS AND CORDS TO ATTACH SUNGLASSES AROUND ONE'S NECK, IN EACH CASE SPECIFICALLY DESIGNED AND MARKED AS SUNGLASS ACCESSORIES (U.S. CLS. 21, 23, 26, 36 AND 38).

LEIGH LOWRY, EXAMINING ATTORNEY

**CLASS 9—(Continued).**

SN 85-188,388. RAWLINGS SPORTING GOODS COMPANY, INC., ST. LOUIS, MO. FILED 12-1-2010.



OWNER OF U.S. REG. NOS. 412,343 AND 1,337,914.  
THE MARK CONSISTS OF THE STYLIZED WORD "RAWLINGS" OUTLINED BY A SINGLE LINE.  
SEC. 2(F).

FOR SPORT WHISTLES; ANTENNAS; SUNGLASSES AND SUNGLASS ACCESSORIES, NAMELY, SUNGLASS STORAGE CASES AND SPECIALLY ADAPTED BAGS, SUNGLASS HOLDERS IN THE NATURE OF CLIPS TO ATTACH SUNGLASSES TO OTHER OBJECTS, RESTRAINING STRAPS AND CORDS TO ATTACH SUNGLASSES AROUND ONE'S NECK, IN EACH CASE SPECIFICALLY DESIGNED AND MARKED AS SUNGLASS ACCESSORIES (U.S. CLS. 21, 23, 26, 36 AND 38).  
LEIGH LOWRY, EXAMINING ATTORNEY

---

SN 85-189,387. KASAWORKS, LLC, COLUMBUS, OH. FILED 12-2-2010.



THE MARK CONSISTS OF STANDARD CHARACTERS WITHOUT CLAIM TO ANY PARTICULAR FONT, STYLE, SIZE, OR COLOR.

FOR ELECTRONIC CONTROL SYSTEMS FOR MACHINES (U.S. CLS. 21, 23, 26, 36 AND 38).

FIRST USE 1-11-2006; IN COMMERCE 1-11-2006.  
SCOTT BIBB, EXAMINING ATTORNEY

---

SN 85-189,415. KASAWORKS, LLC, COLUMBUS, OH. FILED 12-2-2010.



THE MARK CONSISTS OF STANDARD CHARACTERS WITHOUT CLAIM TO ANY PARTICULAR FONT, STYLE, SIZE, OR COLOR.

FOR ELECTRONIC CONTROLLERS FOR TEXTILE PROCESSING MACHINES (U.S. CLS. 21, 23, 26, 36 AND 38).

FIRST USE 10-22-1998; IN COMMERCE 10-22-1998.  
SCOTT BIBB, EXAMINING ATTORNEY

**CLASS 9—(Continued).**

SN 85-190,775. VECTOR GENIUS, INCORPORATED, BRADENTON, FL. FILED 12-4-2010.



THE MARK CONSISTS OF A STYLIZED DRAWING OF THE WORDING "VECTOR GENIUS", WITH THE BOTTOM PART OF THE LETTER "T" IN "VECTOR" ALSO USED IN THE "I" IN "GENIUS". THE BOTTOM PART OF THE LETTER "T" IN "VECTOR" RESEMBLES A BOLT OF ELECTRICITY. THE LETTERS FORMING THE WORDING, EXCEPT FOR THE LETTERS "T", "O", "E" IN "GENIUS" AND "S", INCLUDE DESIGNS RESEMBLING PLANTS, FEATHERS, AND THE LIKE.

FOR DOWNLOADABLE COMPUTER GRAPHICS (U.S. CLS. 21, 23, 26, 36 AND 38).

FIRST USE 1-10-2008; IN COMMERCE 3-29-2010.  
NANCY CLARKE, EXAMINING ATTORNEY

---

SN 85-191,068. PROFICIENCY TESTING SERVICES, BROWNSVILLE, TX. FILED 12-6-2010.



NO CLAIM IS MADE TO THE EXCLUSIVE RIGHT TO USE "DIGITAL SCOPE", APART FROM THE MARK AS SHOWN.

THE COLOR(S) BLACK, BLUE, AND RED IS/ARE CLAIMED AS A FEATURE OF THE MARK.

THE MARK CONSISTS OF A BLACK MICROSCOPE AND THE WORD "DIGITALSCOPE" WITH "DIGITAL" IN BLUE, AND "SCOPE" IN RED. THE COLOR WHITE IN THE MARK REPRESENTS BACKGROUND, OUTLINING, SHADING AND/OR TRANSPARENT AREAS AND IS NOT PART OF THE MARK.

FOR COMPUTER SOFTWARE PROGRAMS FOR THE INTEGRATION OF TEXT, AUDIO, GRAPHICS, STILL IMAGES AND MOVING PICTURES INTO AN INTERACTIVE DELIVERY FOR MULTIMEDIA APPLICATIONS FOR PROFICIENCY TESTING AND COMPETENCY ASSESSMENT OF LABORATORY PERSONNEL; COMPUTER PROCESSING SOFTWARE TO PROCESS THE IMAGE COLORS WITH THE COLOR AND INTENSITY AND INTERPRET THE RESULTS AS TENDENCIES OF THE ORGANS, GLANDS AND TISSUES ACCORDING TO THE IRIDODOLOGY CHARTS FOR PROFICIENCY TESTING AND COMPETENCY ASSESSMENT OF LABORATORY PERSONNEL; AND COMPUTER SOFTWARE FOR PROCESSING DIGITAL IMAGES FOR PROFICIENCY TESTING AND COMPETENCY ASSESSMENT OF LABORATORY PERSONNEL (U.S. CLS. 21, 23, 26, 36 AND 38).

FIRST USE 10-6-2009; IN COMMERCE 10-6-2009.  
STEVEN PEREZ, EXAMINING ATTORNEY

**CLASS 9—(Continued).**

SN 85-191,161. FLAT SCREEN BLING, LLC, DENVER, CO. FILED 12-6-2010.

# Flat Screen Bling

THE MARK CONSISTS OF STANDARD CHARACTERS WITHOUT CLAIM TO ANY PARTICULAR FONT, STYLE, SIZE, OR COLOR.

NO CLAIM IS MADE TO THE EXCLUSIVE RIGHT TO USE "FLAT SCREEN", APART FROM THE MARK AS SHOWN.

FOR DECORATIVE TELEVISION COVERS AND FRAMES (U.S. CLS. 21, 23, 26, 36 AND 38).  
STEPHANIE ALI, EXAMINING ATTORNEY

**CLASS 9—(Continued).**

SN 85-194,696. CLEAR-MEDIA, LLC, EL SEGUNDO, CA. FILED 12-9-2010.

# APPETITES

THE MARK CONSISTS OF STANDARD CHARACTERS WITHOUT CLAIM TO ANY PARTICULAR FONT, STYLE, SIZE, OR COLOR.

FOR DOWNLOADABLE SOFTWARE IN THE NATURE OF A MOBILE APPLICATION, NAMELY, SOFTWARE COMPRISING COOKING RECIPES WITH INTEGRATED VIDEO CLIPS SHOWING HOW TO PERFORM STEPS WITHIN THE RECIPES (U.S. CLS. 21, 23, 26, 36 AND 38).  
FIRST USE 11-15-2010; IN COMMERCE 11-15-2010.

KIM MONINGHOFF, EXAMINING ATTORNEY

SN 85-192,536. BRAVADO INTERNATIONAL GROUP LIMITED, LONDON, UNITED KINGDOM, FILED 12-7-2010.

# BRAVADO

THE MARK CONSISTS OF STANDARD CHARACTERS WITHOUT CLAIM TO ANY PARTICULAR FONT, STYLE, SIZE, OR COLOR.

FOR PRE-RECORDED AUDIO DISCS, DISCS, CDS, DVDS, AND PHONOGRAPH RECORDS FEATURING MUSIC AND MUSIC-RELATED ENTERTAINMENT; THEATRICAL AND MUSICAL SOUND AND VIDEO RECORDINGS; VIRTUAL REALITY GAME SOFTWARE; DOWNLOADABLE RING TONES, MUSIC, GRAPHICS, AND GAMES, AND DOWNLOADABLE MP3 FILES, IMAGES AND VIDEOS FEATURING MUSIC AND MUSIC-RELATED ENTERTAINMENT, ALL FOR WIRELESS COMMUNICATION DEVICES; DOWNLOADABLE DIGITAL MUSIC FROM THE INTERNET, DOWNLOADABLE MP3 FILES FEATURING MUSIC AND MUSIC-RELATED ENTERTAINMENT, DOWNLOADABLE COMPUTER GRAPHICS, COMPUTER GAME SOFTWARE DOWNLOADABLE FROM A GLOBAL COMPUTER NETWORK, DOWNLOADABLE IMAGES AND VIDEO RECORDINGS FEATURING MUSIC AND MUSIC-RELATED ENTERTAINMENT; COMPUTER GAME SOFTWARE; VIDEO GAME SOFTWARE; AND MOUSE PADS (U.S. CLS. 21, 23, 26, 36 AND 38).  
SUE LAWRENCE, EXAMINING ATTORNEY

SN 85-194,777. AMERICAN MEDICAL ASSOCIATION, CHICAGO, IL. FILED 12-10-2010.

# AMA HEALTHIER LIFE STEPS

THE MARK CONSISTS OF STANDARD CHARACTERS WITHOUT CLAIM TO ANY PARTICULAR FONT, STYLE, SIZE, OR COLOR.

OWNER OF U.S. REG. NOS. 3,207,140, 3,212,075 AND 3,871,150.

FOR DOWNLOADABLE ELECTRONIC PUBLICATIONS, NAMELY, GUIDES, QUESTIONNAIRES, ACTION PLANS, AND CALENDARS IN THE FIELD OF HEALTH CARE FOR PHYSICIANS AND PATIENTS (U.S. CLS. 21, 23, 26, 36 AND 38).  
FIRST USE 3-31-2008; IN COMMERCE 5-31-2008.

AISHA CLARKE, EXAMINING ATTORNEY

**CLASS 9—(Continued).**

SN 85-196,882. DISNEY ENTERPRISES, INC., BURBANK, CA. FILED 12-13-2010.

# IRIDESSA

THE MARK CONSISTS OF STANDARD CHARACTERS WITHOUT CLAIM TO ANY PARTICULAR FONT, STYLE, SIZE, OR COLOR.

FOR APPARATUS FOR RECORDING, TRANSMISSION OR REPRODUCTION OF SOUND OR IMAGES; AUDIO BOOKS FEATURING FICTION; AUDIO BOOKS FEATURING NON-FICTION; AUDIO RECORDINGS FEATURING MUSIC, STORIES, DRAMATIC PERFORMANCES, NON-DRAMATIC PERFORMANCES, LEARNING ACTIVITIES FOR CHILDREN, AND GAMES; DOWNLOADABLE RINGTONES AND SOUND RECORDINGS FEATURING MUSIC AND OTHER SOUNDS, ALL FOR WIRELESS COMMUNICATIONS DEVICES; AUDIO AND VISUAL RECORDINGS FEATURING LIVE-ACTION ENTERTAINMENT, ANIMATED ENTERTAINMENT, MUSIC, STORIES, AND GAMES FOR CHILDREN; MUSICAL RECORDINGS; VIDEO GAME SOFTWARE; COMPUTER GAME SOFTWARE; COMPUTER SOFTWARE FEATURING LEARNING ACTIVITIES FOR CHILDREN; CHIPS CONTAINING MUSICAL RECORDINGS; COMPUTER HARDWARE AND PERIPHERAL DEVICES; MOUSE PADS; WRIST AND ARM RESTS FOR USE WITH COMPUTERS; CALCULATORS; ELECTRONIC PERSONAL ORGANIZERS; PERSONAL DIGITAL ASSISTANTS; CAMCORDERS; CAMERAS; DIGITAL CAMERAS; RADIOS; TELEVISION SETS; AUDIO SPEAKERS; HEADPHONES; EARPHONES; WALKIE-TALKIES; PAGERS; TELEPHONES; VIDEOPHONES; HEAD SETS FOR CELLULAR TELEPHONES; ADAPTERS FOR CELLULAR TELEPHONES; BATTERIES FOR CELLULAR TELEPHONES; CELLULAR TELEPHONE CASES; FACE PLATES FOR CELLULAR TELEPHONES; HAND-HELD UNITS FOR PLAYING ELECTRONIC GAMES FOR USE WITH AN EXTERNAL DISPLAY SCREEN OR MONITOR; EYEGLASSES; SUNGLASSES; EYEGLOSS AND SUNGLASS CASES; BINOCULARS; DECORATIVE REFRIGERATOR MAGNETS; GRADUATED RULERS FOR OFFICE AND STATIONERY (U.S. CLS. 21, 23, 26, 36 AND 38).

WILLIAM ROSSMAN, EXAMINING ATTORNEY

SN 85-197,125. PROMANTEK, INC., PARKER, CO. FILED 12-14-2010.

# TrakStar

THE MARK CONSISTS OF STANDARD CHARACTERS WITHOUT CLAIM TO ANY PARTICULAR FONT, STYLE, SIZE, OR COLOR.

FOR COMPUTER SOFTWARE FOR EMPLOYEE PERFORMANCE EVALUATION (U.S. CLS. 21, 23, 26, 36 AND 38).

FIRST USE 10-4-2001; IN COMMERCE 10-4-2001.  
CHARLES L. JENKINS, EXAMINING ATTORNEY

**CLASS 9—(Continued).**

SN 85-198,615. TIMES FIBER COMMUNICATIONS, INC., WALLINGFORD, CT. FILED 12-15-2010.

# QuickShield

THE MARK CONSISTS OF STANDARD CHARACTERS WITHOUT CLAIM TO ANY PARTICULAR FONT, STYLE, SIZE, OR COLOR.

FOR ELECTRICAL CONNECTORS (U.S. CLS. 21, 23, 26, 36 AND 38).

ANNE E. GUSTASON, EXAMINING ATTORNEY

SN 85-201,091. INTELLIGENT SOFTWARE SOLUTIONS, INC., COLORADO SPRINGS, CO. FILED 12-17-2010.

# WEBTASFX

THE MARK CONSISTS OF STANDARD CHARACTERS WITHOUT CLAIM TO ANY PARTICULAR FONT, STYLE, SIZE, OR COLOR.

SEC. 2(F).

FOR COMPUTER SOFTWARE FOR A WEB 2.0 BASED SOFTWARE TOOLKIT PROVIDING VISUALIZATION, INTEGRATION AND ANALYSIS OF DISPARATE DATA, EXCLUDING FINANCIAL EXCHANGE DATA, IN A SERVICE ORIENTED ARCHITECTURE (SOA) COMPLIANT PLATFORM (U.S. CLS. 21, 23, 26, 36 AND 38).

FIRST USE 9-0-2009; IN COMMERCE 9-0-2009.

JAMES MACFARLANE, EXAMINING ATTORNEY

SN 85-202,862. REDSTONE HANDELSBOLAG, SE-652 24 KARLSTAD, SWEDEN, FILED 12-21-2010.

# PROJIFY

THE MARK CONSISTS OF STANDARD CHARACTERS WITHOUT CLAIM TO ANY PARTICULAR FONT, STYLE, SIZE, OR COLOR.

PRIORITY CLAIMED UNDER SEC. 44(D) ON ERP/CMNTY TM OFC APPLICATION NO. 009215419, FILED 7-1-2010, REG. NO. 009215419, DATED 12-13-2010, EXPIRES 12-13-2020.

FOR COMPUTER SOFTWARE FOR USING THE INTERNET AND THE WORLDWIDE WEB, WEB PAGE DESIGN, CREATING DYNAMIC WEBSITES, WEBSITE DEVELOPMENT, PROJECT MANAGEMENT, SHARING DOCUMENTS, AND FOR HANDLING MESSAGES AND CALENDAR NOTICES; DOWNLOADABLE COMPUTER SOFTWARE FOR USING THE INTERNET AND THE WORLDWIDE WEB, WEB PAGE DESIGN, CREATING DYNAMIC WEBSITES, WEBSITE DEVELOPMENT, PROJECT MANAGEMENT, SHARING DOCUMENTS, AND FOR HANDLING MESSAGES AND CALENDAR NOTICES; COMPUTER SERVERS FOR WEB HOSTING (U.S. CLS. 21, 23, 26, 36 AND 38).

NANCY CLARKE, EXAMINING ATTORNEY

**CLASS 9—(Continued).**

SN 85-204,404. BOREGYDE, INC., SIMI VALLEY, CA. FILED 12-22-2010.

# BOREGYDE

THE MARK CONSISTS OF STANDARD CHARACTERS WITHOUT CLAIM TO ANY PARTICULAR FONT, STYLE, SIZE, OR COLOR.

OWNER OF U.S. REG. NO. 2,442,063.

FOR OIL AND GAS FIELD BOREHOLE DIRECTIONAL DRILLING AND TESTING SYSTEMS, NAMELY, DOWNHOLE AND UPHOLE SONDES, DRILL-STRING ANTENNAE, MICRO-CONTROLLERS AND SENSORS TO PROVIDE DATA TO RIG OPERATOR FOR USE IN STEERING, RECEIVER-PROCESSORS, COMPUTERS, CUSTOMIZED SOFTWARE PROGRAMS FOR CONTROLLING AND MONITORING PHYSICAL ENVIRONMENT DRILLING DATA, SAFETY-BARRIER BOXES, PRINTERS, AND VIDEO MONITORS, UTILIZING ELECTROMAGNETIC (EM) CABLELESS COMMUNICATIONS (U.S. CLS. 21, 23, 26, 36 AND 38).

FIRST USE 12-0-1992; IN COMMERCE 12-0-1992.  
WILLIAM ROSSMAN, EXAMINING ATTORNEY

**CLASS 9—(Continued).**

SN 85-204,705. PELICAN PRODUCTS, INC., TORRANCE, CA. FILED 12-23-2010.

# STORM CASE

SN 85-204,694. PELICAN PRODUCTS, INC., TORRANCE, CA. FILED 12-23-2010.



THE MARK CONSISTS OF A SWIRL DESIGN.

FOR SOFT-SIDED AND HARD-SIDED CASES FOR CARRYING AND STORING PHOTOGRAPHIC AND ELECTRONIC EQUIPMENT AND OTHER SENSITIVE EQUIPMENT IN THE NATURE OF CELL PHONES, PDAS, HAND-HELD ELECTRONIC GAME MACHINES AND GAME CARTRIDGES AND CASSETTES AND SMALL RADIOS, CASSETTES, CD PLAYERS AND/OR COMPUTERS; CASES FOR CARRYING AND STORING PERSONAL, MILITARY, SEARCH AND RESCUE AND/OR INDUSTRIAL SPECIALTY ELECTRONIC INSTRUMENTS IN THE NATURE OF ELECTRIC NAVIGATION INSTRUMENTS, SEISMIC SENSORS, DIGITAL DIVING DEPTH AND CHRONOMETER GAUGES, PUBLIC ADDRESS SYSTEMS AND INSTRUMENTS, ELECTRONIC FIRE HOSE CONTROLLERS, PORTABLE AIR COMPRESSOR KITS, ELECTRONIC SURVEILLANCE EQUIPMENT, ELECTRONIC FIELD TESTING EQUIPMENT, MICROCHIPS AND CIRCUIT BOARDS, ELECTRONIC INDICATOR PANELS, RIFLE SCOPES, FIRE FIGHTING COMMUNICATIONS EQUIPMENT, EMERGENCY LIGHTING SYSTEMS, SATELLITE PHONE SYSTEMS, MOBILE CHEMICAL WEAPONS TESTING KITS, MOBILE CHEMICAL DETECTOR SYSTEMS; GADGET BAGS FOR CARRYING VIDEO CAMERAS, BINOCULARS, GAME CARTRIDGES, CDS, ACCESSORIES FOR COMPUTERS, DIGITAL CAMERAS AND/OR ACCESSORIES FOR CAMERAS (U.S. CLS. 21, 23, 26, 36 AND 38).

FIRST USE 1-4-2002; IN COMMERCE 1-4-2002.  
MICHAEL KEATING, EXAMINING ATTORNEY

THE MARK CONSISTS OF STANDARD CHARACTERS WITHOUT CLAIM TO ANY PARTICULAR FONT, STYLE, SIZE, OR COLOR.

NO CLAIM IS MADE TO THE EXCLUSIVE RIGHT TO USE "CASE", APART FROM THE MARK AS SHOWN.

FOR SOFT-SIDED AND HARD-SIDED CASES FOR CARRYING AND STORING PHOTOGRAPHIC AND ELECTRONIC EQUIPMENT AND OTHER SENSITIVE EQUIPMENT IN THE NATURE OF CELL PHONES, PDAS, HAND-HELD ELECTRONIC GAME MACHINES AND GAME CARTRIDGES AND CASSETTES AND SMALL RADIOS, CASSETTES, CD PLAYERS AND/OR COMPUTERS; CASES FOR CARRYING AND STORING PERSONAL, MILITARY, SEARCH AND RESCUE AND/OR INDUSTRIAL SPECIALTY ELECTRONIC INSTRUMENTS IN THE NATURE OF ELECTRIC NAVIGATION INSTRUMENTS, SEISMIC SENSORS, DIGITAL DIVING DEPTH AND CHRONOMETER GAUGES, PUBLIC ADDRESS SYSTEMS AND INSTRUMENTS, ELECTRONIC FIRE HOSE CONTROLLERS, PORTABLE AIR COMPRESSOR KITS, ELECTRONIC SURVEILLANCE EQUIPMENT, ELECTRONIC FIELD TESTING EQUIPMENT, MICROCHIPS AND CIRCUIT BOARDS, ELECTRONIC INDICATOR PANELS, RIFLE SCOPES, FIRE FIGHTING COMMUNICATIONS EQUIPMENT, EMERGENCY LIGHTING SYSTEMS, SATELLITE PHONE SYSTEMS, MOBILE CHEMICAL WEAPONS TESTING KITS, MOBILE CHEMICAL DETECTOR SYSTEMS; GADGET BAGS FOR CARRYING VIDEO CAMERAS, BINOCULARS, GAME CARTRIDGES, CDS, ACCESSORIES FOR COMPUTERS, DIGITAL CAMERAS AND/OR ACCESSORIES FOR CAMERAS (U.S. CLS. 21, 23, 26, 36 AND 38).

FIRST USE 5-11-2001; IN COMMERCE 12-31-2001.  
MICHAEL KEATING, EXAMINING ATTORNEY

**CLASS 9—(Continued).**

SN 85-204,884. CENTRANCE, INC., MORTON GROVE, IL.  
FILED 12-23-2010.

**MASTERCLASS**

THE MARK CONSISTS OF STANDARD CHARACTERS WITHOUT CLAIM TO ANY PARTICULAR FONT, STYLE, SIZE, OR COLOR.

FOR APPARATUS FOR THE TRANSMISSION OR REPRODUCTION OF SOUND FOR PROFESSIONAL, HOME, VEHICLE, INDOOR AND OUTDOOR USE; CONSUMER ELECTRONIC PRODUCTS, NAMELY, AUDIO AMPLIFIERS WITH INTEGRATED SPEAKERS, AUDIO SPEAKERS, ELECTRICAL AUDIO AND SPEAKER CABLES AND CONNECTORS, HOME THEATER SYSTEMS COMPRISING DVD PLAYERS, BLU-RAY PLAYER, SURROUND-SOUND SPEAKERS, THEATER PRE-AMPLIFIERS AND AMPLIFIERS, AUDIO PROCESSORS AND RECEIVERS, AND AUDIO AND VIDEO CONNECTORS; AUDIO DECODERS, AUDIO SPEAKERS; PROFESSIONAL AND STUDIO ELECTRONICS PRODUCTS, NAMELY, AUDIO AMPLIFIERS WITH INTEGRATED SPEAKERS, AUDIO SPEAKERS, ELECTRICAL AUDIO AND SPEAKER CABLES AND CONNECTORS, AUDIO DECODERS, AUDIO SPEAKERS; DIGITAL AUDIO RECORDERS AND PLAYERS; COMPUTER HARDWARE AND SOFTWARE FOR CREATING AND EDITING MUSIC AND SOUNDS; COMPUTER HARDWARE AND SOFTWARE TO CONTROL AND IMPROVE COMPUTER AND AUDIO EQUIPMENT SOUND QUALITY; AUDIO CIRCUIT BOARDS; AUDIO ELECTRONIC COMPONENTS, NAMELY, SURROUND SOUND SYSTEMS; COMPUTER MONITORS; STUDIO MONITORS, HOME THEATER SPEAKERS; HI-FI SPEAKERS; AUDIO EQUIPMENT FOR VEHICLES, NAMELY, STEREOS, SPEAKERS, AMPLIFIERS, EQUALIZERS, CROSSOVERS AND SPEAKER HOUSINGS, SUBWOOFERS, LOUD SPEAKERS FOR AUTOMOTIVE AUDIO SYSTEMS; AUDIO CABLES AND CONNECTORS FOR PROFESSIONAL, HOME, VEHICLE, INDOOR AND OUTDOOR USE; WIRELESS INDOOR AND OUTDOOR SPEAKERS (U.S. CLS. 21, 23, 26, 36 AND 38).

EMILY CHUO, EXAMINING ATTORNEY

SN 85-207,809. TRYNEX, INC., WARREN, MI. FILED 12-30-2010.

**SALT TRAXX**

THE MARK CONSISTS OF STANDARD CHARACTERS WITHOUT CLAIM TO ANY PARTICULAR FONT, STYLE, SIZE, OR COLOR.

NO CLAIM IS MADE TO THE EXCLUSIVE RIGHT TO USE "SALT", APART FROM THE MARK AS SHOWN.

FOR ELECTRONIC DEVICES FOR USE IN CONNECTION WITH SALT SPREADERS AS A DIGITAL JOB TRACKER TO MONITOR THE AMOUNT OF SALT USED ON EACH JOB (U.S. CLS. 21, 23, 26, 36 AND 38).

PATRICIA EVANKO, EXAMINING ATTORNEY

**CLASS 9—(Continued).**

SN 85-208,305. 2715 SCOTT STREET, SAN FRANCISCO, CA.  
FILED 12-30-2010.

**Right Shift**

THE MARK CONSISTS OF STANDARD CHARACTERS WITHOUT CLAIM TO ANY PARTICULAR FONT, STYLE, SIZE, OR COLOR.

FOR PROTECTIVE PC TABLET CASES (U.S. CLS. 21, 23, 26, 36 AND 38).

FIRST USE 1-10-2011; IN COMMERCE 1-10-2011.  
JENNIFER MARTIN, EXAMINING ATTORNEY

SN 85-211,125. ARISTOCRAT TECHNOLOGIES AUSTRALIA PTY LTD., NORTH RYDE, NSW, AUSTRALIA, FILED 1-5-2011.

**MOUNT EVER RICH**

THE MARK CONSISTS OF STANDARD CHARACTERS WITHOUT CLAIM TO ANY PARTICULAR FONT, STYLE, SIZE, OR COLOR.

PRIORITY CLAIMED UNDER SEC. 44(D) ON AUSTRALIA APPLICATION NO. 1398485, FILED 12-15-2010.

OWNER OF AUSTRALIA REG. NO. 1398485, DATED 12-15-2010, EXPIRES 12-15-2020.

FOR ELECTRONIC GAMING MACHINES, NAMELY, DEVICES WHICH ACCEPT A WAGER (U.S. CLS. 21, 23, 26, 36 AND 38).

GINA FINK, EXAMINING ATTORNEY

SN 85-212,280. ECHANNEL NETWORKS, DBA ECHANNEL NETWORKS, TORONTO, CANADA, FILED 1-6-2011.

**eChannel Networks**

THE MARK CONSISTS OF STANDARD CHARACTERS WITHOUT CLAIM TO ANY PARTICULAR FONT, STYLE, SIZE, OR COLOR.

NO CLAIM IS MADE TO THE EXCLUSIVE RIGHT TO USE "NETWORKS", APART FROM THE MARK AS SHOWN.

FOR COMPUTER MULTIPLAYER SOCIAL GAME PROGRAMS; COMPUTER MULTIPLAYER SOCIAL GAME PROGRAMS DOWNLOADABLE VIA THE INTERNET; COMPUTER APPLICATION SOFTWARE FOR MOBILE PHONES, ONLINE PORTALS, AND SOCIAL NETWORKING SITES, NAMELY, MULTIPLAYER SOCIAL GAME SOFTWARE (U.S. CLS. 21, 23, 26, 36 AND 38).

MARIA-VICTORIA SUAREZ, EXAMINING ATTORNEY

**CLASS 9—(Continued).**

SN 85-216,404. MESA LABORATORIES, INC., LAKEWOOD, CO. FILED 1-12-2011.

## DATATRACE

THE MARK CONSISTS OF STANDARD CHARACTERS WITHOUT CLAIM TO ANY PARTICULAR FONT, STYLE, SIZE, OR COLOR.

FOR ELECTRONIC DATA LOGGERS (U.S. CLS. 21, 23, 26, 36 AND 38).

FIRST USE 11-0-1985; IN COMMERCE 11-0-1985.  
KIMBERLY FRYE, EXAMINING ATTORNEY

SN 85-217,749. HEWLETT-PACKARD DEVELOPMENT COMPANY, L.P., HOUSTON, TX. FILED 1-14-2011.

## HP TOUCHPAD

THE MARK CONSISTS OF STANDARD CHARACTERS WITHOUT CLAIM TO ANY PARTICULAR FONT, STYLE, SIZE, OR COLOR.

OWNER OF U.S. REG. NOS. 2,540,854, 3,412,631 AND OTHERS.

NO CLAIM IS MADE TO THE EXCLUSIVE RIGHT TO USE "TOUCHPAD", APART FROM THE MARK AS SHOWN.

FOR COMPUTERS; COMPUTER HARDWARE; COMPUTER AND COMMUNICATIONS NETWORKING HARDWARE AND SOFTWARE; COMPUTER HARDWARE, NAMELY, MEMORY CARDS; COMPUTER HARDWARE FOR TELECOMMUNICATIONS; COMPUTER MONITORS; MOBILE COMPUTERS; HANDHELD COMPUTERS; PORTABLE COMPUTERS; TABLET COMPUTERS; PERSONAL DIGITAL ASSISTANTS; ELECTRONIC ORGANIZERS; COMPUTER MEMORIES; TELEPHONES; MOBILE TELEPHONES; PAGERS; SMARTPHONES; VIDEOPHONES; MOBILE AND HANDHELD COMMUNICATIONS DEVICES FOR SENDING AND RECEIVING DATA, INFORMATION AND OTHER DIGITAL CONTENT, INCLUDING AUDIO AND VIDEO CONTENT, NAMELY, HANDHELD COMPUTERS, MOBILE PHONES AND SMARTPHONES; PHOTOGRAPHIC AND VIDEO CAMERAS; AUDIO PLAYERS; VIDEO PLAYERS; COMPUTER COMMUNICATIONS SOFTWARE; COMPUTER SOFTWARE, NAMELY, PRERECORDED COMPUTER PROGRAMS FOR PERSONAL INFORMATION MANAGEMENT, DATABASE MANAGEMENT SOFTWARE, CHARACTER RECOGNITION SOFTWARE, TELECOMMUNICATIONS SOFTWARE,

**CLASS 9—(Continued).**

TELEPHONY MANAGEMENT SOFTWARE, ELECTRONIC MAIL AND MESSAGING SOFTWARE, PAGING SOFTWARE, DATABASE SYNCHRONIZATION SOFTWARE, COMPUTER PROGRAMS FOR ACCESSING, BROWSING AND SEARCHING ONLINE DATABASES; COMPUTER GAME PROGRAMS; VIDEO GAME SOFTWARE; DOWNLOADABLE COMPUTER AND VIDEO GAMES; DOWNLOADABLE MUSIC, AUDIO, VIDEO AND ENTERTAINMENT RELATED CONTENT; COMPUTER CARRYING CASES; ACCESSORIES, PARTS AND CASES FOR ALL THE FOREGOING SOLD AS A UNIT; INSTRUCTION MANUALS IN ELECTRONIC FORM SUPPLIED WITH THE FOREGOING SOLD AS A UNIT; APPARATUS FOR RECORDING, TRANSMISSION OR REPRODUCTION OF DATA, TEXT, GRAPHICS, SOUND OR IMAGES; BLANK MAGNETIC DATA CARRIERS; PRERECORDED MAGNETIC DATA CARRIERS FEATURING SOFTWARE FOR USE IN CONNECTION WITH HANDHELD COMMUNICATIONS DEVICES, NAMELY, MOBILE PHONES AND SMARTPHONES (U.S. CLS. 21, 23, 26, 36 AND 38).

JOHN WILKE, EXAMINING ATTORNEY

SN 85-219,941. THINKLABS, LLC, AKA THINKLABS INTERACTIVE, NEW YORK, NY. FILED 1-18-2011.

## Crowdstream

THE MARK CONSISTS OF STANDARD CHARACTERS WITHOUT CLAIM TO ANY PARTICULAR FONT, STYLE, SIZE, OR COLOR.

FOR COMPUTER APPLICATION SOFTWARE FOR MOBILE PHONES, NAMELY, SOFTWARE FOR STORAGE, CONSUMPTION AND DISTRIBUTION OF PHOTOS, VIDEOS AND TEXT (U.S. CLS. 21, 23, 26, 36 AND 38).

FIRST USE 1-12-2011; IN COMMERCE 1-18-2011.  
SEAN CROWLEY, EXAMINING ATTORNEY

SN 85-224,290. HUAWEI TECHNOLOGIES CO., LTD., SHENZHEN, CHINA, FILED 1-24-2011.

## Hi4G

THE MARK CONSISTS OF STANDARD CHARACTERS WITHOUT CLAIM TO ANY PARTICULAR FONT, STYLE, SIZE, OR COLOR.

FOR MOBILE PHONES; USB MODEMS; GATEWAY IN THE NATURE OF TELECOMMUNICATIONS AND DATA NETWORKING HARDWARE, NAMELY, GATEWAY ROUTERS IN THE NATURE OF COMPUTER CONTROL HARDWARE; VIDEO TELEPHONES; MODEMS; COMPUTERS; SET-TOP BOXES; COMPUTER TERMINALS, NAMELY, TABLE MULTI-FUNCTIONAL VIDEO TERMINALS WITH ACCESSING INTERNET, MAKING PHONE CALLS, VIEWING VIDEOS AND PLAYING GAMES FUNCTIONS; ELECTRONIC BOOK READERS; ADSL BROADBAND ACCESSING TERMINAL DEVICES AND EQUIPMENTS, NAMELY, MODEMS FOR ADSL BROADBAND; NETWORK AND TELEPHONE CALL ROUTERS; COMMUNICATION MODULES, NAMELY, INTEGRATED CIRCUIT MODULES; PERSONAL DIGITAL ASSISTANT (PDA); TELEPHONES FOR REMOTE TELEPHONE CONFERENCING;

**CLASS 9—(Continued).**

DIGITAL PHOTO FRAMES; APPARATUS FOR REMOTE VIDEO CONFERENCE, APPARATUS FOR NETWORK VIDEO CONFERENCE AND INTELLIGENT CONTROL APPARATUS FOR VIDEO CONFERENCE, NAMELY, VIDEO MONITORS, CAMERAS, VIDEO TERMINALS, CONFERENCING HARDWARE AND SOFTWARE AND CONFERENCE ROOM FURNITURE, ALL SOLD AS INTEGRAL COMPONENTS BEING PART OF AN INTEGRAL UNIT; BATTERIES; BATTERY CHARGERS; COMPUTER MOUSE; EARPHONES AND HEADPHONES; SOFTWARE IN THE COMMUNICATION FIELD, NAMELY, COMPUTER SOFTWARE FOR MANAGING, OPERATING AND MAINTAINING VIDEO CONFERENCING, COMPUTER SOFTWARE FOR DATA COMMUNICATIONS, COMPUTER SOFTWARE FOR USE IN DATABASE MANAGEMENT AND NETWORK MANAGEMENT, COMPUTER SOFTWARE FOR USE AS A SPREADSHEET AND WORD PROCESSING; MICROPHONE; LAN (LOCAL AREA NETWORK) COMPUTER CARDS FOR CONNECTING PORTABLE COMPUTER DEVICES TO COMPUTER NETWORKS; COMPUTER EQUIPMENT, NAMELY, WIRELESS CARDS; WIRELESS ADAPTERS USED TO LINK COMPUTERS TO A TELECOMMUNICATIONS NETWORK; COMPUTER NETWORK ADAPTERS (U.S. CLS. 21, 23, 26, 36 AND 38).

DARRYL SPRULL, EXAMINING ATTORNEY

**CLASS 9—(Continued).**

SN 85-226,834. HUAWEI TECHNOLOGIES CO., LTD., SHENZHEN, CHINA, FILED 1-26-2011.



THE COLOR(S) RED AND GRAY IS/ARE CLAIMED AS A FEATURE OF THE MARK.

THE MARK CONSISTS OF THE WORD "HI" IN GRAY, WITH THE "DOT" OVER THE LETTER "I" COMPRISED OF THREE RED ARCS IN A TRIANGULAR SHAPE, AND THE STYLIZED WORDING "4G" IN RED.

FOR MOBILE PHONES; USB MODEMS; GATEWAY IN THE NATURE OF TELECOMMUNICATIONS AND DATA NETWORKING HARDWARE, NAMELY, GATEWAY ROUTERS IN THE NATURE OF COMPUTER CONTROL HARDWARE; VIDEO TELEPHONES; MODEMS; COMPUTERS; SET-TOP BOXES; COMPUTER TERMINALS, NAMELY, TABLE MULTI-FUNCTIONAL VIDEO TERMINALS WITH ACCESSING INTERNET, MAKING PHONE CALLS, VIEWING VIDEOS AND PLAYING GAMES FUNCTIONS; ELECTRONIC BOOK READERS; ADSL BROADBAND ACCESSING TERMINAL DEVICES AND EQUIPMENTS, NAMELY, MODEMS FOR ADSL BROADBAND; NETWORK AND TELEPHONE CALL ROUTERS; COMMUNICATION MODULES, NAMELY, INTEGRATED CIRCUIT MODULES; PERSONAL DIGITAL ASSISTANT (PDA); TELEPHONES FOR REMOTE TELEPHONE CONFERENCING; DIGITAL PHOTO FRAMES; APPARATUS FOR REMOTE VIDEO CONFERENCE, APPARATUS FOR NETWORK VIDEO CONFERENCE AND INTELLIGENT CONTROL APPARATUS FOR VIDEO CONFERENCE, NAMELY, VIDEO MONITORS, CAMERAS, VIDEO TERMINALS, CONFERENCING HARDWARE AND SOFTWARE AND CONFERENCE ROOM FURNITURE, ALL SOLD AS INTEGRAL COMPONENTS BEING PART OF AN INTEGRAL UNIT; BATTERIES; BATTERY CHARGERS; COMPUTER MOUSE; EARPHONES AND HEADPHONES; SOFTWARE IN THE COMMUNICATION FIELD, NAMELY, COMPUTER SOFTWARE FOR MANAGING, OPERATING AND MAINTAINING VIDEO CONFERENCING, COMPUTER SOFTWARE FOR DATA COMMUNICATIONS, COMPUTER SOFTWARE FOR USE IN DATABASE MANAGEMENT AND NETWORK MANAGEMENT, COMPUTER SOFTWARE FOR USE AS A SPREADSHEET AND WORD PROCESSING; MICROPHONE; LAN (LOCAL AREA NETWORK) COMPUTER CARDS FOR CONNECTING PORTABLE COMPUTER DEVICES TO COMPUTER NETWORKS; COMPUTER EQUIPMENT, NAMELY, WIRELESS CARDS; WIRELESS ADAPTERS USED TO LINK COMPUTERS TO A TELECOMMUNICATIONS NETWORK; COMPUTER NETWORK ADAPTERS (U.S. CLS. 21, 23, 26, 36 AND 38).

DARRYL SPRULL, EXAMINING ATTORNEY

SN 85-225,654. EYELEVEL INTERACTIVE, LLC, GREENSBORO, GA. FILED 1-25-2011.

IPOPS INTERACTIVE POINT OF  
PURCHASE SYSTEM

THE MARK CONSISTS OF STANDARD CHARACTERS WITHOUT CLAIM TO ANY PARTICULAR FONT, STYLE, SIZE, OR COLOR.

NO CLAIM IS MADE TO THE EXCLUSIVE RIGHT TO USE "INTERACTIVE POINT OF PURCHASE SYSTEM", APART FROM THE MARK AS SHOWN.

FOR COMPUTER HARDWARE AND COMPUTER SOFTWARE PROGRAMS FOR THE INTEGRATION OF TEXT, AUDIO, GRAPHICS, STILL IMAGES AND MOVING PICTURES INTO AN INTERACTIVE DELIVERY FOR MULTIMEDIA APPLICATIONS; CONTINGENCY RESPONSE COMMUNICATION SYSTEM DESIGNED TO PROVIDE RADIO INTEROPERABILITY, STREAMING VIDEO, WIRELESS INTERNET, AND VOIP PHONE; DOWNLOADABLE COMPUTER GAME SOFTWARE VIA A GLOBAL COMPUTER NETWORK AND WIRELESS DEVICES; ELECTRONIC GAME SOFTWARE FOR WIRELESS DEVICES (U.S. CLS. 21, 23, 26, 36 AND 38).

SKYE YOUNG, EXAMINING ATTORNEY



**CLASS 9—(Continued).**

SN 85-227,357. EPIC STONE GROUP, CORAL GABLES, FL. FILED 1-27-2011.

# GRACHIO

THE MARK CONSISTS OF STANDARD CHARACTERS WITHOUT CLAIM TO ANY PARTICULAR FONT, STYLE, SIZE, OR COLOR.

FOR AUDIO AND VIDEO RECORDINGS FEATURING MUSIC AND ARTISTIC PERFORMANCES; AUDIO AND VIDEO RECORDINGS FEATURING MUSICALS; COMMUNICATION SOFTWARE FOR PROVIDING ACCESS TO THE INTERNET; COMPUTER GAME CARTRIDGES; COMPUTER GAME CARTRIDGES AND DISCS; COMPUTER GAME CASSETTES; COMPUTER GAME CONSOLES FOR USE WITH AN EXTERNAL DISPLAY SCREEN OR MONITOR; COMPUTER GAME DISCS; COMPUTER GAME PROGRAMMES; COMPUTER GAME PROGRAMMES DOWNLOADABLE VIA THE INTERNET; COMPUTER GAME PROGRAMS; COMPUTER GAME PROGRAMS, CARTRIDGES, AND CASSETTES; COMPUTER GAME SOFTWARE; COMPUTER GAME SOFTWARE DOWNLOADABLE FROM A GLOBAL COMPUTER NETWORK; COMPUTER GAME SOFTWARE FOCUSING ON ACHIEVING A SET OF GOALS, POSITIONS, OWNERSHIP, AND CREDENTIALS, AND PROFESSIONAL AND SOCIAL STATUS, AND GOOD FORTUNE NECESSARY TO SUCCEED PROFESSIONALLY AND PERSONALLY, AND NOT REFERRING EITHER TO A GROUP OF SOFTWARE FOR USE IN COMMERCE OR TO A GROUP OF OFFICES; COMPUTER GAME SOFTWARE FOR USE ON MOBILE AND CELLULAR PHONES; COMPUTER GAME SOFTWARE FOR USE WITH PERSONAL COMPUTERS, HOME VIDEO GAME CONSOLES USED WITH TELEVISIONS AND ARCADE-BASED VIDEO GAME CONSOLES; COMPUTER PROGRAMS FOR USING THE INTERNET AND THE WORLD WIDE WEB; COMPUTER PROGRAMS FOR USING THE INTERNET AND THE WORLDWIDE WEB; COMPUTER SOFTWARE FOR CONTROLLING THE OPERATION OF AUDIO AND VIDEO DEVICES; COMPUTER SOFTWARE, NAMELY, SOFTWARE DEVELOPMENT TOOLS FOR THE CREATION OF MOBILE INTERNET APPLICATIONS AND CLIENT INTERFACES; CONTINGENCY RESPONSE COMMUNICATION SYSTEM DESIGNED TO PROVIDE RADIO INTEROPERABILITY, STREAMING VIDEO, WIRELESS INTERNET, AND VOIP PHONE; DIGITAL MUSIC DOWNLOADABLE FROM THE INTERNET; DIGITAL MUSIC SYSTEMS THAT SYNCHRONIZES DIGITAL RADIO FILES STORED ON A HOME UNIT, A CAR UNIT, OR PORTABLE UNIT AND THAT MAY BE BACKED UP TO AN INTERNET DEPOSITORY; DOWNLOADABLE AUDIO FILES, MULTIMEDIA FILES, TEXT FILES, E-MAILS, WRITTEN DOCUMENTS, AUDIO MATERIAL, VIDEO MATERIAL AND GAMES FEATURING INFORMATION IN THE FORM OF DOWNLOADABLE SHORT EDUCATIONAL/TRAINING COMMUNICATIONS IN THE FIELD OF HUMAN RESOURCE DEVELOPMENT FOR THE PROMOTION OF EMPLOYEE RETENTION, CAREER GROWTH AND INCREASED PRODUCTIVITY FOR EMPLOYEES AND EMPLOYERS; DOWNLOADABLE COMPUTER GAME PROGRAMS; DOWNLOADABLE COMPUTER PROGRAMS FEATURING POSITIONABLE GAME PIECE FIGURES FOR USE IN THE FIELD OF COMPUTER GAMES; DOWNLOADABLE ELECTRONIC GAME PROGRAMS; DOWNLOADABLE FILMS AND MOVIES FEATURING MUSICALS PROVIDED VIA A VIDEO-ON-DEMAND SERVICE; DOWNLOADABLE FILMS AND TELEVISION PROGRAMS FEATURING MUSICALS PROVIDED VIA A VIDEO-ON-DEMAND SERVICE; DOWNLOADABLE IMAGE FILE CONTAINING ARTWORK, TEXT, AUDIO, VIDEO, GAMES AND INTERNET WEB LINKS RELATING TO SPORTING AND CULTURAL ACTIVITIES; DOWNLOADABLE MULTIMEDIA FILE CONTAINING ARTWORK, TEXT, AUDIO, VIDEO, GAMES, AND INTERNET WEB LINKS RELATING TO MUSICALS; DOWNLOADABLE SCIENTIFIC

**CLASS 9—(Continued).**

AND MEDICAL DATA VIA THE INTERNET; DOWNLOADABLE ELECTRONIC GAMES VIA THE INTERNET AND WIRELESS DEVICES; INTERNET PHONES; INTERNET SERVERS; INTEROPERABLE COMMUNICATION SYSTEM DESIGNED TO PROVIDE RADIO, STREAMING VIDEO, WIRELESS INTERNET, AND VOIP PHONE; IP (INTERNET PROTOCOL) CAMERAS; SOFTWARE UTILIZING BIDIRECTIONAL COMMUNICATION VIA ETHERNET AND INTERNET TO MONITOR AND/OR CONFIGURE PROGRAMMABLE LOGIC CONTROLS FOR WINE CELLARS; TELECOMMUNICATIONS HARDWARE AND SOFTWARE FOR MONITORING AND ALERTING REMOTE SENSOR STATUS VIA THE INTERNET; TELEPHONE CALL ROUTER, FOR HOME AND OFFICE TOUCHTONE PHONES, FOR INTERNATIONAL AND LONG DISTANCE CALLS MADE FROM VARIOUS TELEPHONY PLATFORMS INCLUDING VOIP PLATFORM WITHOUT THE REQUIREMENT FOR INTERNET (U.S. CLS. 21, 23, 26, 36 AND 38).

WILLIAM P. SHANAHAN, EXAMINING ATTORNEY

SN 85-227,993. BULLY! COMMERCIAL AND ENTERTAINMENT MEDIA, DBA BULLY! ENTERTAINMENT, BALTIMORE, MD. FILED 1-27-2011.



THE MARK CONSISTS OF PIXELATED HANDS FRAMING THE WORD "FLICKABLE"; ONE HAND IS ON THE LOWER LEFT, THE OTHER IS ON THE UPPER RIGHT.

FOR ELECTRONIC GAME PROGRAMS (U.S. CLS. 21, 23, 26, 36 AND 38).

SAIMA MAKHDOOM, EXAMINING ATTORNEY

**CLASS 9—(Continued).**

SN 85-228,349. CHERIAN, AVARACHAN V, AMHERST, NY.  
FILED 1-27-2011.



THE MARK CONSISTS OF A LINE DRAWING REPRESENTING TWO WINGS AND BODY LINE OF A BUTTERFLY. THE BODY LINE EXTENDS TO THE LEFT AS A TAIL. IT ALSO CONTAINS LETTERS 'PUPA' NEXT TO THE LINE DRAWING. THE LETTER U HAS AN ACUTE (´) SIGN ABOVE IT.

FOR COMPUTER HARDWARE; COMPUTER HARDWARE AND COMPUTER PERIPHERAL DEVICES; COMPUTER HARDWARE AND COMPUTER PERIPHERALS; COMPUTER HARDWARE AND COMPUTER SOFTWARE FOR RETAIL INVENTORY MANAGEMENT, SOLD AS A UNIT; COMPUTER HARDWARE AND COMPUTER SOFTWARE PROGRAMS FOR THE INTEGRATION OF TEXT, AUDIO, GRAPHICS, STILL IMAGES AND MOVING PICTURES INTO AN INTERACTIVE DELIVERY FOR MULTIMEDIA APPLICATIONS; COMPUTER HARDWARE AND PERIPHERAL DEVICES; COMPUTER HARDWARE AND PERIPHERALS; COMPUTER HARDWARE AND PERIPHERALS THEREFOR; COMPUTER HARDWARE AND SOFTWARE FOR PROCESSING DIGITAL MUSIC FILES; COMPUTER HARDWARE AND SOFTWARE FOR SETTING UP AND CONFIGURING LOCAL AREA NETWORKS; COMPUTER HARDWARE AND SOFTWARE FOR SETTING UP AND CONFIGURING WIDE AREA NETWORKS; COMPUTER HARDWARE AND SOFTWARE SOLD AS A UNIT FOR TESTING OF EMBEDDED COMPUTER SYSTEMS; COMPUTER HARDWARE FOR COMMUNICATING AUDIO, VIDEO AND DATA BETWEEN COMPUTERS VIA A GLOBAL COMPUTER NETWORK, WIDE-AREA COMPUTER NETWORKS, AND PEER-TO-PEER COMPUTER NETWORKS; COMPUTER HARDWARE FOR HIGH-SPEED PROCESSING AND STORAGE OF DATA USING MULTIPLE CPUs; COMPUTER HARDWARE FOR UPLOAD, STORAGE, RETRIEVAL, DOWNLOAD, TRANSMISSION AND DELIVERY OF DIGITAL CONTENT; COMPUTER HARDWARE FOR WIRELESS CONTENT DELIVERY; COMPUTER KEYBOARD CONTROLLERS; COMPUTER KEYBOARDS; COMPUTER KEYPADS; COMPUTER MICE; COMPUTER MONITOR FRAMES; COMPUTER MONITORS; COMPUTER MOTHERBOARDS AND

**CLASS 9—(Continued).**

DAUGHTERBOARDS; COMPUTER MOUSE; COMPUTER MOUSE IN THE NATURE OF A TRACKPAD; COMPUTER MOUSE, NAMELY, TOUCHPADS; COMPUTER MOUSE, NAMELY, TRACKBALLS; COMPUTER NETWORKING HARDWARE; COMPUTER PERIPHERAL APPARATUS; COMPUTER PERIPHERAL DEVICES; COMPUTER PERIPHERAL EQUIPMENT; COMPUTER PERIPHERALS; COMPUTER PERIPHERALS AND PARTS THEREOF; COMPUTER SCREENS; COMPUTER TERMINALS; COMPUTER TERMINALS, KEYBOARDS AND PRINTERS; COMPUTER TOUCHSCREENS; COMPUTER WORKSTATIONS COMPRISING DISPLAY MONITOR, CPU, HARD DISK DRIVE, KEYBOARD, MOUSE AND POWER SUPPLY; COMPUTERS; COMPUTERS AND COMPUTER HARDWARE; COMPUTERS AND COMPUTER PERIPHERALS; COMPUTERS AND INSTRUCTIONAL MANUALS SOLD AS A UNIT; COMPUTERS FOR NETWORK MANAGEMENT; COMPUTERS FOR USE IN DATA MANAGEMENT; COMPUTERS, NAMELY, NETBOOKS (U.S. CLS. 21, 23, 26, 36 AND 38).

FRANK LATTUCA, EXAMINING ATTORNEY

SN 85-229,080. CITYHYPE INC., DBA CITYHYPE INC., SAN FRANCISCO, CA. FILED 1-28-2011.



THE MARK CONSISTS OF A SKEWED BUILDING, IN WHICH THE WINDOWS, DOORS AND TOWER ARE TILTED, AND WHICH RESEMBLES AN EXCLAMATION POINT.

FOR COMPUTER APPLICATION SOFTWARE FOR MOBILE PHONES, NAMELY, SOFTWARE FOR THE BAR, NIGHTCLUB, DRINKING ESTABLISHMENT INDUSTRY, AS WELL AS THE FOOD AND BEVERAGE INDUSTRY, TO ALLOW PATRONS TO COMMUNICATE WITH ONE ANOTHER AND BUSINESSES TO ADVERTISE, PROMOTE, AND DISTRIBUTE PRODUCTS (U.S. CLS. 21, 23, 26, 36 AND 38).

ANGELA M. MICHELI, EXAMINING ATTORNEY

**CLASS 9—(Continued).**

SN 85-230,850. THE BAMBOO TREE MEDIA GROUP LLC, NEWARK, NJ. FILED 2-1-2011.

## THE BAMBOO TREE MEDIA GROUP

THE MARK CONSISTS OF STANDARD CHARACTERS WITHOUT CLAIM TO ANY PARTICULAR FONT, STYLE, SIZE, OR COLOR.

NO CLAIM IS MADE TO THE EXCLUSIVE RIGHT TO USE "MEDIA GROUP", APART FROM THE MARK AS SHOWN.

FOR SERIES OF SOUND RECORDINGS FEATURING MUSIC AND ARTISTIC PERFORMANCES; PRE-RECORDED COMPACT DISCS AND DVDS FEATURING MUSIC AND ARTISTIC PERFORMANCES; DIGITAL MEDIA, NAMELY, DOWNLOADABLE AND STREAMABLE AUDIO FILES, AUDIO RECORDINGS, AND VIDEO RECORDINGS FEATURING MUSIC AND ARTISTIC PERFORMANCES (U.S. CLS. 21, 23, 26, 36 AND 38).

PAULA MAHONEY, EXAMINING ATTORNEY

SN 85-234,001. ZYGOR GUIDES, LLC, BEAVERCREEK, OH. FILED 2-4-2011.

## ZYGOR GUIDES

THE MARK CONSISTS OF STANDARD CHARACTERS WITHOUT CLAIM TO ANY PARTICULAR FONT, STYLE, SIZE, OR COLOR.

NO CLAIM IS MADE TO THE EXCLUSIVE RIGHT TO USE "GUIDES", APART FROM THE MARK AS SHOWN.

FOR SOFTWARE, NAMELY, INTERACTIVE VIDEO AND COMPUTER GAME STRATEGY GUIDES AND PLAY GUIDANCE SOFTWARE (U.S. CLS. 21, 23, 26, 36 AND 38).

FIRST USE 4-15-2007; IN COMMERCE 4-15-2007.  
JULIE WATSON, EXAMINING ATTORNEY

SN 85-236,869. ADENUS GROUP, LLC, SMYRNA, TN. FILED 2-8-2011.

## HAWK

THE MARK CONSISTS OF STANDARD CHARACTERS WITHOUT CLAIM TO ANY PARTICULAR FONT, STYLE, SIZE, OR COLOR.

FOR SUPERVISORY CONTROL AND DATA ACQUISITION (SCADA) COMPUTER SOFTWARE AND HARDWARE FOR USE IN THE FIELDS OF WASTEWATER PROCESSING, PURIFICATION, TREATMENT AND DISPOSAL, FOR THE PURPOSE OF MONITORING AND AUTOMATING WASTEWATER SYSTEM CONTROL PANELS (U.S. CLS. 21, 23, 26, 36 AND 38).

PAUL MORENO, EXAMINING ATTORNEY

**CLASS 9—(Continued).**

SN 85-237,901. INTERNATIONAL ASSOCIATION OF LIGHTING DESIGNERS, LTD., AKA IALD, CHICAGO, IL. FILED 2-9-2011.

## LightMap

THE MARK CONSISTS OF STANDARD CHARACTERS WITHOUT CLAIM TO ANY PARTICULAR FONT, STYLE, SIZE, OR COLOR.

FOR DOWNLOADABLE INTERFACE FOR USE AS A MAPS INTERFACE FOR COMPUTER AND MOBILE INTERNET APPLICATIONS (U.S. CLS. 21, 23, 26, 36 AND 38).

FIRST USE 10-11-2010; IN COMMERCE 10-11-2010.  
PATRICIA EVANKO, EXAMINING ATTORNEY

SN 85-239,179. E. MISHAN & SONS, INC., NEW YORK, NY. FILED 2-10-2011.

## RIBBZ

THE MARK CONSISTS OF STANDARD CHARACTERS WITHOUT CLAIM TO ANY PARTICULAR FONT, STYLE, SIZE, OR COLOR.

FOR ACCESSORIES FOR USE WITH PORTABLE PHONES, SMART PHONES, MOBILE PHONES, PERSONAL ELECTRONIC DEVICES AND HANDHELD PERSONAL ELECTRONIC DEVICES, NAMELY, CASES AND COVERS FOR THE FOREGOING (U.S. CLS. 21, 23, 26, 36 AND 38).

FIRST USE 8-18-2011; IN COMMERCE 8-18-2011.  
MELISSA VALLILLO, EXAMINING ATTORNEY

SN 85-239,632. ODER, HARRY, CHAMBLEE, GA. FILED 2-11-2011.



THE MARK CONSISTS OF LETTERS "SEFAC" ENCLOSED IN ELLIPSE WITH THREE SMALLER ELLIPSES INTERLOCKING IN CENTER AS SHOWN IN THE MARK.

FOR ELECTRONIC DISPLAY PANELS FOR USE WITH PAGING EQUIPMENT (U.S. CLS. 21, 23, 26, 36 AND 38).

FIRST USE 5-1-1985; IN COMMERCE 5-1-1985.  
KRISTINA MORRIS, EXAMINING ATTORNEY

**CLASS 9—(Continued).**

SN 85-239,926. ULLUCUS HEAVEN, INC., OSAKA 564-0063, JAPAN, FILED 2-11-2011.

**SPEED CLUSTER**

PRIORITY CLAIMED UNDER SEC. 44(D) ON JAPAN APPLICATION NO. 2010-65103, FILED 8-18-2010, REG. NO. 5390266, DATED 2-10-2011, EXPIRES 2-10-2021.

THE MARK CONSISTS OF THE WORDS "SPEED CLUSTER" IN BLOCK LETTERS WITH THE WORD "CLUSTER" IN WIDER PRINT AND THE BOTTOM HALVES OF BOTH WORDS SLIGHTLY FADED.

FOR COMPUTER GAME PROGRAMS, ELECTRONIC GAME PROGRAMS, VIDEO GAME PROGRAMS DOWNLOADABLE COMPUTER GAME PROGRAMS, DOWNLOADABLE ELECTRONIC GAME PROGRAMS, DOWNLOADABLE VIDEO GAME PROGRAMS (U.S. CLS. 21, 23, 26, 36 AND 38).

FIRST USE 9-3-2010; IN COMMERCE 9-3-2010.  
DAVID I, EXAMINING ATTORNEY

---

SN 85-239,977. SA'QUON DEESE LLC, LAHAINA, HI. FILED 2-11-2011.

**Sa'quon Deese**

THE MARK CONSISTS OF STANDARD CHARACTERS WITHOUT CLAIM TO ANY PARTICULAR FONT, STYLE, SIZE, OR COLOR.

THE WORDING "SA'QUON DEESE" HAS NO MEANING IN A FOREIGN LANGUAGE.

FOR DOWNLOADABLE ELECTRONIC BOOKS FEATURING WORKS OF FICTION INCLUDING THRILLERS AND NOVELS OF SUSPENSE (U.S. CLS. 21, 23, 26, 36 AND 38).

DEBRA LEE, EXAMINING ATTORNEY

---

SN 85-241,712. VALDEZ, FRANK M, DBA TIZIT.COM, GILBERT, AZ. FILED 2-14-2011.

**Tizit**

THE MARK CONSISTS OF STANDARD CHARACTERS WITHOUT CLAIM TO ANY PARTICULAR FONT, STYLE, SIZE, OR COLOR.

FOR COMMUNICATION SOFTWARE FOR PROVIDING ACCESS TO THE INTERNET; COMPUTER PROGRAMS FOR USING THE INTERNET AND THE WORLD WIDE WEB; COMPUTER PROGRAMS FOR USING THE INTERNET AND THE WORLDWIDE WEB (U.S. CLS. 21, 23, 26, 36 AND 38).

FIRST USE 2-13-2011; IN COMMERCE 2-13-2011.  
SALLY SHIH, EXAMINING ATTORNEY

**CLASS 9—(Continued).**

SN 85-242,430. VIOLIN MEMORY, INC., MOUNTAIN VIEW, CA. FILED 2-15-2011.

**FLASH FORWARD**

THE MARK CONSISTS OF STANDARD CHARACTERS WITHOUT CLAIM TO ANY PARTICULAR FONT, STYLE, SIZE, OR COLOR.

NO CLAIM IS MADE TO THE EXCLUSIVE RIGHT TO USE "FLASH", APART FROM THE MARK AS SHOWN.

FOR SOLID STATE MEMORY ARRAYS, NAMELY, FLASH MEMORY CARDS AND FLASH MEMORY HARDWARE (U.S. CLS. 21, 23, 26, 36 AND 38).

JORDAN BAKER, EXAMINING ATTORNEY

---

SN 85-242,674. LAB PARTNERS ASSOCIATES, INC., SOUTH BURLINGTON, VT. FILED 2-15-2011.

**HYPERSYNC**

THE MARK CONSISTS OF STANDARD CHARACTERS WITHOUT CLAIM TO ANY PARTICULAR FONT, STYLE, SIZE, OR COLOR.

FOR FEATURE OF ELECTRONIC WIRELESS COMMUNICATION APPARATUS, NAMELY, TRANSMITTERS, RECEIVERS, AND TRANSCEIVERS FOR WIRELESS COMMUNICATION AND CONTROL BETWEEN EQUIPMENT USED IN THE FIELDS OF PHOTOGRAPHY AND LIGHTING (U.S. CLS. 21, 23, 26, 36 AND 38).

FIRST USE 2-27-2009; IN COMMERCE 2-27-2009.  
DOMINIC J. FERRAIUOLO, EXAMINING ATTORNEY

**CLASS 9—(Continued).**

SN 85-243,729. MARVEL CHARACTERS, INC., MANHATTAN BEACH, CA. FILED 2-16-2011.

# KA-ZAR

THE MARK CONSISTS OF STANDARD CHARACTERS WITHOUT CLAIM TO ANY PARTICULAR FONT, STYLE, SIZE, OR COLOR.

OWNER OF U.S. REG. NO. 3,944,780.

FOR BICYCLE HELMETS; COMPUTER GAME CARTRIDGES; COMPUTER GAME DISCS; COMPUTER GAME PROGRAMS DOWNLOADABLE VIA THE INTERNET; COMPUTER GAME PROGRAMS; COMPUTER GAME SOFTWARE; COMPUTER GAME SOFTWARE DOWNLOADABLE FROM A GLOBAL COMPUTER NETWORK; DOWNLOADABLE COMPUTER GAME PROGRAMS; DOWNLOADABLE COMPUTER GAME SOFTWARE VIA A GLOBAL COMPUTER NETWORK AND WIRELESS DEVICES; DOWNLOADABLE COMPUTER PROGRAMS FEATURING POSITIONABLE GAME PIECE FIGURES FOR USE IN THE FIELD OF COMPUTER GAMES; INTERACTIVE MULTIMEDIA COMPUTER GAME PROGRAM; INTERACTIVE VIDEO GAME PROGRAMS; INTERACTIVE VIDEO GAMES OF VIRTUAL REALITY COMPRISED OF COMPUTER HARDWARE FOR USE WITH AN EXTERNAL MONITOR AND SOFTWARE; PRE-RECORDED CDS, VIDEO TAPES, LASER DISKS AND DVDS FEATURING MUSIC AND/OR LIVE ACTION PROGRAMS OR MOTION PICTURES OR ANIMATED CARTOONS OR ANIMATED FEATURE LENGTH FILMS; SUNGLASSES; VIDEO GAME CARTRIDGES; VIDEO GAME DISCS; VIDEO GAME SOFTWARE (U.S. CLS. 21, 23, 26, 36 AND 38).

ROSELLE HERRERA, EXAMINING ATTORNEY

SN 85-244,889. SPECTORSOFT CORPORATION, VERO BEACH, FL. FILED 2-17-2011.

# viziSafe

THE MARK CONSISTS OF STANDARD CHARACTERS WITHOUT CLAIM TO ANY PARTICULAR FONT, STYLE, SIZE, OR COLOR.

FOR DOWNLOADABLE IT ANALYTICS SOFTWARE FOR IT ADMINISTRATORS AND NETWORK OWNERS, NAMELY, SOFTWARE THAT CAPTURES AND RECORDS ALL USER ELECTRONIC ACTIVITY SO IT ADMINISTRATORS CAN DETECT TRENDS AND IDENTIFY PROBLEMS (U.S. CLS. 21, 23, 26, 36 AND 38).

FIRST USE 1-3-2011; IN COMMERCE 1-3-2011.

RONALD MCMORROW, EXAMINING ATTORNEY

**CLASS 9—(Continued).**

SN 85-244,989. HANSON ROBOTICS INCORPORATED, PLANO, TX. FILED 2-17-2011.

# RoboKind

THE MARK CONSISTS OF STANDARD CHARACTERS WITHOUT CLAIM TO ANY PARTICULAR FONT, STYLE, SIZE, OR COLOR.

FOR ROBOTS FOR PERSONAL, EDUCATIONAL AND HOBBY USE AND STRUCTURAL PARTS THEREFOR (U.S. CLS. 21, 23, 26, 36 AND 38).

FIRST USE 1-6-2005; IN COMMERCE 3-1-2007.

LINDA ESTRADA, EXAMINING ATTORNEY

SN 85-248,739. BENSON, MARK, HOUSTON, TX. FILED 2-22-2011.

# DIGIDRILL

THE MARK CONSISTS OF STANDARD CHARACTERS WITHOUT CLAIM TO ANY PARTICULAR FONT, STYLE, SIZE, OR COLOR.

FOR COMPUTER HARDWARE AND SOFTWARE FOR USE IN CONNECTION WITH DRILLING OPERATIONS (U.S. CLS. 21, 23, 26, 36 AND 38).

FIRST USE 5-1-2004; IN COMMERCE 11-1-2004.

LAKEISHA LEWIS, EXAMINING ATTORNEY

SN 85-249,008. TRIPTYCH GAMES, LLC, RICHARDSON, TX. FILED 2-22-2011.



NO CLAIM IS MADE TO THE EXCLUSIVE RIGHT TO USE "GAMES", APART FROM THE MARK AS SHOWN.

THE MARK CONSISTS OF THREE VERTICAL BARS OVER THE WORDS "TRIPTYCH GAMES".

FOR COMPUTER SOFTWARE, NAMELY, COMPUTER GAME DEVELOPMENT AND CREATIONS OF COMPUTER GAME SOFTWARE (U.S. CLS. 21, 23, 26, 36 AND 38).

FIRST USE 9-3-2010; IN COMMERCE 9-3-2010.

RICHARD WHITE, EXAMINING ATTORNEY

**CLASS 9—(Continued).**

SN 85-250,508. JUST PROGRAM, LLC, ORLANDO, FL. FILED 2-24-2011.



OWNER OF U.S. REG. NO. 3,328,406.  
THE COLOR(S) RED AND BLACK IS/ARE CLAIMED AS A FEATURE OF THE MARK.

THE MARK CONSISTS OF THE WORDING "SOLODEV" IN BLACK TO THE RIGHT OF A RED STYLIZED STAR.

FOR COMPUTER APPLICATION SOFTWARE FOR CONTENT MANAGEMENT ON SERVERS AND DATABASES FOR MANIPULATING IMAGES AND DOCUMENTS, NAMELY, SOFTWARE FOR WEBSITE MANAGEMENT; COMPUTER CURSOR CONTROL DEVICES, NAMELY, LIGHT PENS; COMPUTER DATABASE MANAGEMENT SOFTWARE FOR USE IN PERSONALIZING THE CONTENT OF E-MAIL COMMUNICATIONS; COMPUTER E-COMMERCE SOFTWARE TO ALLOW USERS TO PERFORM ELECTRONIC BUSINESS TRANSACTIONS VIA A GLOBAL COMPUTER NETWORK; COMPUTER SOFTWARE DEVELOPMENT TOOLS (U.S. CLS. 21, 23, 26, 36 AND 38).

FIRST USE 1-1-2002; IN COMMERCE 1-1-2002.  
PAULA MAHONEY, EXAMINING ATTORNEY

**CLASS 9—(Continued).**

SN 85-251,668. NORTHWEST KINEMATICS LLC, DBA MOBILE EDUCATION STORE, SALEM, OR. FILED 2-25-2011.

**CONVERSATIONBUILDER**

THE MARK CONSISTS OF STANDARD CHARACTERS WITHOUT CLAIM TO ANY PARTICULAR FONT, STYLE, SIZE, OR COLOR.

FOR CHILDREN'S EDUCATIONAL SOFTWARE; COMPUTER APPLICATION SOFTWARE FOR MOBILE PHONES, NAMELY, SOFTWARE FOR INDIVIDUALS, MAINLY CHILDREN, TO LEARN AND DEVELOP COMMUNICATION TECHNIQUES; COMPUTER APPLICATION SOFTWARE FOR TABLET COMPUTER, NAMELY, SOFTWARE FOR INDIVIDUALS, MAINLY CHILDREN, TO LEARN AND DEVELOP COMMUNICATION TECHNIQUES; DOWNLOADABLE SOFTWARE FOR LAPTOP COMPUTER OR WIRELESS HAND-HELD COMPUTING DEVICES FOR INDIVIDUALS, MAINLY CHILDREN, TO LEARN AND DEVELOP COMMUNICATION TECHNIQUES; DOWNLOADABLE SOFTWARE IN THE NATURE OF A MOBILE APPLICATION FOR ELEMENTARY AGE CHILDREN FEATURING LANGUAGE LEARNING TOOLS FOR LEARNING AND DEVELOPING COMMUNICATION TECHNIQUES; EDUCATIONAL SOFTWARE FEATURING INSTRUCTION IN ENGLISH LANGUAGE SYNTAX DEVELOPMENT (U.S. CLS. 21, 23, 26, 36 AND 38).

KATHERINE E. HALMEN, EXAMINING ATTORNEY

SN 85-250,908. SELMAN AND ASSOCIATES, LTD., MIDLAND, TX. FILED 2-24-2011.

**LOGIT**

THE MARK CONSISTS OF STANDARD CHARACTERS WITHOUT CLAIM TO ANY PARTICULAR FONT, STYLE, SIZE, OR COLOR.

OWNER OF U.S. REG. NO. 2,944,497.

FOR SOFTWARE IN THE FIELD OF GEOLOGY FOR USE TO CAPTURE, CATEGORIZE, AND DISPLAY SURFACE LOG INFORMATION FOR WELLS (U.S. CLS. 21, 23, 26, 36 AND 38).

FIRST USE 1-26-2004; IN COMMERCE 1-26-2004.  
GIANCARLO CASTRO, EXAMINING ATTORNEY

SN 85-260,874. DAVID MARK AGLOW, CHERRY HILL, NJ. FILED 3-8-2011.

**The Vital Record**

THE MARK CONSISTS OF STANDARD CHARACTERS WITHOUT CLAIM TO ANY PARTICULAR FONT, STYLE, SIZE, OR COLOR.

NO CLAIM IS MADE TO THE EXCLUSIVE RIGHT TO USE "RECORD", APART FROM THE MARK AS SHOWN.

FOR DIGITAL MEDIA, NAMELY, CDS AND DVDS FEATURING MUSICAL RECORDINGS (U.S. CLS. 21, 23, 26, 36 AND 38).

SIMON TENG, EXAMINING ATTORNEY

**CLASS 9—(Continued).**

SN 85-264,221. MARTHA STEWART LIVING OMNIMEDIA, INC., NEW YORK, NY. FILED 3-11-2011.

**MARTHA STEWART LIVING**

THE MARK CONSISTS OF STANDARD CHARACTERS WITHOUT CLAIM TO ANY PARTICULAR FONT, STYLE, SIZE, OR COLOR.

OWNER OF U.S. REG. NOS. 1,709,962, 3,313,881 AND OTHERS.

THE NAME(S), PORTRAIT(S), AND/OR SIGNATURE(S) SHOWN IN THE MARK IDENTIFIES "MARTHA STEWART", WHOSE CONSENT(S) TO REGISTER IS MADE OF RECORD.

FOR DOWNLOADABLE ELECTRONIC PUBLICATIONS IN THE NATURE OF MAGAZINES IN THE FIELDS OF HOMEMAKING, HOME CARE, COOKING, HOUSEKEEPING, DECORATING, GARDENING, ENTERTAINING, WEDDINGS, CRAFTS, ANTIQUE COLLECTING, HOLIDAY PLANNING, HEALTH AND FITNESS; DOWNLOADABLE SOFTWARE IN THE NATURE OF A MOBILE APPLICATION FOR PROVIDING INFORMATION IN THE FIELDS OF HOMEMAKING, HOME CARE, COOKING, HOUSEKEEPING, DECORATING, GARDENING, ENTERTAINING, WEDDINGS, CRAFTS, ANTIQUE COLLECTING, HOLIDAY PLANNING, HEALTH AND FITNESS; DOWNLOADABLE DIGITAL AND MULTIMEDIA SOFTWARE APPLICATIONS VIA THE INTERNET AND WIRELESS DEVICES FOR PROVIDING INFORMATION IN THE FIELDS OF HOMEMAKING, HOME CARE, COOKING, HOUSEKEEPING, DECORATING, GARDENING, ENTERTAINING, WEDDINGS, CRAFTS, ANTIQUE COLLECTING, HOLIDAY PLANNING, HEALTH AND FITNESS (U.S. CLS. 21, 23, 26, 36 AND 38).

FIRST USE 11-0-2010; IN COMMERCE 11-0-2010.  
LINDA MICKLEBURGH, EXAMINING ATTORNEY

SN 85-265,520. IMMUNO CONCEPTS N.A., LTD, DALLAS, TX. FILED 3-12-2011.

**IMAGE NAVIGATOR**

THE MARK CONSISTS OF STANDARD CHARACTERS WITHOUT CLAIM TO ANY PARTICULAR FONT, STYLE, SIZE, OR COLOR.

NO CLAIM IS MADE TO THE EXCLUSIVE RIGHT TO USE "IMAGE", APART FROM THE MARK AS SHOWN.

FOR MICROSCOPES; AUTOMATED ACCESSORIES IN THE NATURE OF COMPUTER HARDWARE AND COMPUTER MONITORS, BAR CODE READERS AND SCANNERS; DIGITAL CAMERAS AND AUTOMATED MOTION CONTROL SYSTEMS FOR USE WITH MICROSCOPES, NAMELY, MOTORIZED STAGES AND AUTO-FOCUS SYSTEMS; MEDICAL SOFTWARE FOR GENERATING, PROCESSING, ANALYZING, STORING AND ARCHIVING IMAGES AND DIAGNOSTIC LABORATORY INFORMATION (U.S. CLS. 21, 23, 26, 36 AND 38).  
JULIE VEPPUMTHARA, EXAMINING ATTORNEY

**CLASS 9—(Continued).**

SN 85-265,884. MLOGIC, LLC, LOS ANGELES, CA. FILED 3-14-2011.

**mDock**

THE MARK CONSISTS OF STANDARD CHARACTERS WITHOUT CLAIM TO ANY PARTICULAR FONT, STYLE, SIZE, OR COLOR.

FOR COMPUTER DOCKING STATION AND BACKUP SOLUTION FOR LAPTOPS, NAMELY, A PORT REPLICATION SYSTEM IN THE NATURE OF AN ELECTRONIC DOCKING STATION, HARD DISK DRIVE, AND SOLID STATE DRIVE (U.S. CLS. 21, 23, 26, 36 AND 38).  
SAIMA MAKHDOOM, EXAMINING ATTORNEY

SN 85-265,897. MLOGIC, LLC, LOS ANGELES, CA. FILED 3-14-2011.

**mLogic**

THE MARK CONSISTS OF STANDARD CHARACTERS WITHOUT CLAIM TO ANY PARTICULAR FONT, STYLE, SIZE, OR COLOR.

FOR STORAGE SOLUTIONS AND ACCESSORIES FOR COMPUTERS, NAMELY, HARD DISK DRIVES, BACKUP HARD DRIVES, SOLID STATE DRIVES, TAPE DRIVES, AND PORT REPLICATION SYSTEM IN THE NATURE OF AN ELECTRONIC DOCKING STATION (U.S. CLS. 21, 23, 26, 36 AND 38).

SAIMA MAKHDOOM, EXAMINING ATTORNEY

SN 85-266,154. CRUMRINE, STACEY L., SAN DIEGO, CA. FILED 3-14-2011.

**Captain Positive**

THE MARK CONSISTS OF STANDARD CHARACTERS WITHOUT CLAIM TO ANY PARTICULAR FONT, STYLE, SIZE, OR COLOR.

FOR CHILD DEVELOPMENT MATERIALS, NAMELY, RECORDED CDS AND DVDS FEATURING TRAINING MATERIALS TO DEVELOP CONFIDENCE AND SELF-ESTEEM IN CHILDREN AGES 2 - 10 (U.S. CLS. 21, 23, 26, 36 AND 38).

LINDA ESTRADA, EXAMINING ATTORNEY

**CLASS 9—(Continued).**

SN 85-266,164. MIAMI TRIBE OF OKLAHOMA BUSINESS DEVELOPMENT AUTHORITY, A TRIBAL ENTERPRISE OF THE MIAMI TRIBE OF OKLAHOMA, MIAMI, OK. FILED 3-14-2011.

## TAKE THE CANNOLI

THE MARK CONSISTS OF STANDARD CHARACTERS WITHOUT CLAIM TO ANY PARTICULAR FONT, STYLE, SIZE, OR COLOR.

FOR GAMING MACHINES, NAMELY, BINGO-RELATED GAMES AND SLOT MACHINES (U.S. CLS. 21, 23, 26, 36 AND 38).

KATHLEEN M. VANSTON, EXAMINING ATTORNEY

---

SN 85-266,206. CRUMRINE, STACEY L., SAN DIEGO, CA. FILED 3-14-2011.



THE COLOR(S) BLACK, RED, ORANGE, YELLOW IS/ ARE CLAIMED AS A FEATURE OF THE MARK.

THE MARK CONSISTS OF A RED STAR INSIDE ORANGE CIRCLE, EACH OUTLINED IN BLACK, WORDS "CAPTAIN POSITIVE" IN YELLOW WITH BLACK OUTLINE OVERLAYING THE CENTER AND RIGHT SIDE OF STAR-CIRCLE; THREE YELLOW STARS IN BLACK-OUTLINE BELOW WORD "POSITIVE" AND A STAR FORMING THE DOT IN THE LETTER "I" IN "CAPTAIN".

FOR CHILD DEVELOPMENT MATERIALS, NAMELY, RECORDED CDS AND DVDS FEATURING TRAINING MATERIALS TO DEVELOP CONFIDENCE AND SELF-ESTEEM IN CHILDREN AGES 2 - 10 (U.S. CLS. 21, 23, 26, 36 AND 38).

LINDA ESTRADA, EXAMINING ATTORNEY

**CLASS 9—(Continued).**

SN 85-270,617. MARVEL CHARACTERS, INC., MANHATTAN BEACH, CA. FILED 3-18-2011.

## MARVEL ARCADE

THE MARK CONSISTS OF STANDARD CHARACTERS WITHOUT CLAIM TO ANY PARTICULAR FONT, STYLE, SIZE, OR COLOR.

OWNER OF U.S. REG. NOS. 1,741,813, 3,602,028 AND OTHERS.

NO CLAIM IS MADE TO THE EXCLUSIVE RIGHT TO USE "ARCADE", APART FROM THE MARK AS SHOWN.

FOR COMPUTER GAME CARTRIDGES; COMPUTER GAME DISCS; COMPUTER GAME PROGRAMMES DOWNLOADABLE VIA THE INTERNET; COMPUTER GAME PROGRAMS; COMPUTER GAME SOFTWARE; COMPUTER GAME SOFTWARE DOWNLOADABLE FROM A GLOBAL COMPUTER NETWORK; DOWNLOADABLE COMPUTER GAME PROGRAMS; DOWNLOADABLE COMPUTER GAME SOFTWARE VIA A GLOBAL COMPUTER NETWORK AND WIRELESS DEVICES; DOWNLOADABLE COMPUTER PROGRAMS FEATURING POSITIONABLE GAME PIECE FIGURES FOR USE IN THE FIELD OF COMPUTER GAMES; INTERACTIVE MULTIMEDIA COMPUTER GAME PROGRAM; INTERACTIVE VIDEO GAME PROGRAMS; INTERACTIVE VIDEO GAMES OF VIRTUAL REALITY COMPRISED OF COMPUTER HARDWARE FOR USE WITH AN EXTERNAL MONITOR AND SOFTWARE; PRE-RECORDED CDS, VIDEO TAPES, LASER DISKS AND DVDS FEATURING MUSIC AND/OR LIVE ACTION PROGRAMS OR MOTION PICTURES OR ANIMATED CARTOONS OR ANIMATED FEATURE LENGTH FILMS; VIDEO GAME CARTRIDGES; VIDEO GAME DISCS; VIDEO GAME SOFTWARE (U.S. CLS. 21, 23, 26, 36 AND 38).

WILLIAM VERHOSEK, EXAMINING ATTORNEY

---

SN 85-271,496. DATA STRATEGIES, INC., POWAY, CA. FILED 3-19-2011.

## Connect2Us

THE MARK CONSISTS OF STANDARD CHARACTERS WITHOUT CLAIM TO ANY PARTICULAR FONT, STYLE, SIZE, OR COLOR.

FOR COMPUTER SOFTWARE FOR USE IN THE HEALTHCARE FIELD TO PROVIDE PATIENTS WITH WEB-BASED ACCESS TO APPLICATIONS CONTAINING THEIR OWN MEDICAL INFORMATION AND THAT ALLOW PATIENTS TO CONTACT THE PRACTICE AND MAKE PAYMENTS VIA A WEB PORTAL INTERFACE (U.S. CLS. 21, 23, 26, 36 AND 38).

MICHAEL WEBSTER, EXAMINING ATTORNEY



**CLASS 9—(Continued).**

SN 85-273,263. DIXON, MARTIN, HONOLULU, HI. FILED 3-22-2011.

# Illis It

THE MARK CONSISTS OF STANDARD CHARACTERS WITHOUT CLAIM TO ANY PARTICULAR FONT, STYLE, SIZE, OR COLOR.

THE NAME "ILLIS IT" IDENTIFIES A LIVING INDIVIDUAL WHOSE CONSENT IS OF RECORD.

FOR DIGITAL MEDIA, NAMELY, AUDIO FILES, DOWNLOADABLE AUDIO FILES, MUSIC VIDEOS, AND COMPACT DISC ALBUMS ALL FEATURING MUSIC, SPOKEN MUSIC AND COMEDIC SKITS (U.S. CLS. 21, 23, 26, 36 AND 38).

JOHN KELLY, EXAMINING ATTORNEY

---

SN 85-273,855. MAUI JIM, INC., PEORIA, IL. FILED 3-22-2011.

# MAUIGRADIENT

THE MARK CONSISTS OF STANDARD CHARACTERS WITHOUT CLAIM TO ANY PARTICULAR FONT, STYLE, SIZE, OR COLOR.

OWNER OF U.S. REG. NOS. 1,404,711, 3,573,259 AND OTHERS.

FOR SUNGLASSES AND SUNGLASS LENSES (U.S. CLS. 21, 23, 26, 36 AND 38).

HENRY S. ZAK, EXAMINING ATTORNEY

---

SN 85-274,078. CASEY RESEARCH, LLC, ASPEN, CO. FILED 3-23-2011.

# CASEY RESEARCH

THE MARK CONSISTS OF STANDARD CHARACTERS WITHOUT CLAIM TO ANY PARTICULAR FONT, STYLE, SIZE, OR COLOR.

NO CLAIM IS MADE TO THE EXCLUSIVE RIGHT TO USE "RESEARCH", APART FROM THE MARK AS SHOWN.

FOR DOWNLOADABLE ELECTRONIC NEWSLETTERS IN THE FIELD OF FINANCIAL INVESTMENT, FINANCIAL ANALYSIS, GLOBAL FINANCIAL TRENDS, GEOPOLITICAL ISSUES, NATURAL RESOURCES AND EMERGING INVESTMENT OPPORTUNITIES (U.S. CLS. 21, 23, 26, 36 AND 38).

FIRST USE 4-1-2004; IN COMMERCE 4-1-2004.

JOSETTE BEVERLY, EXAMINING ATTORNEY

**CLASS 9—(Continued).**

SN 85-276,063. OAKSTONE PUBLISHING, LLC, DBA PERSONAL BEST, BIRMINGHAM, AL. FILED 3-24-2011.

# Practical Reviews)))

NO CLAIM IS MADE TO THE EXCLUSIVE RIGHT TO USE "PRACTICAL REVIEWS", APART FROM THE MARK AS SHOWN.

THE MARK CONSISTS OF WORDS, "PRACTICAL REVIEWS", FOLLOWED BY THREE GRADUATING VERTICAL CURVED LINES.

FOR AUDIO RECORDINGS OF MEDICAL AND DENTAL JOURNALS EVALUATIONS AND ANALYSIS (U.S. CLS. 21, 23, 26, 36 AND 38).

FIRST USE 7-31-2010; IN COMMERCE 7-31-2010.

ELLEN PERKINS, EXAMINING ATTORNEY

---

SN 85-277,146. SIMPLEXION LLC, PRESCOTT VALLEY, AZ. FILED 3-25-2011.

# myWorm

THE MARK CONSISTS OF STANDARD CHARACTERS WITHOUT CLAIM TO ANY PARTICULAR FONT, STYLE, SIZE, OR COLOR.

FOR CARRYING CASES FOR ELECTRONIC EQUIPMENT, NAMELY, TABLET COMPUTERS, ELECTRONIC WRITING TABLETS, PERSONAL COMPUTERS, CELL PHONES; CELL PHONE CASES; CELL PHONE COVERS; HARNESSES FOR HOLDING ELECTRONIC DEVICES, NAMELY, TABLET COMPUTERS, ELECTRONIC WRITING TABLETS, PERSONAL COMPUTERS, CELL PHONES; LEATHER PROTECTIVE COVERS SPECIALLY ADAPTED FOR PERSONAL ELECTRONIC DEVICES; PROTECTIVE CARRYING CASES SPECIALLY ADAPTED FOR PERSONAL DIGITAL ASSISTANTS (PDA); PROTECTIVE COVERS AND CASES FOR CELL PHONES, LAPTOPS AND PORTABLE MEDIA PLAYERS; SPECIALTY HOLSTER FOR CARRYING TABLET COMPUTERS, ELECTRONIC WRITING TABLETS, PERSONAL COMPUTERS, CELL PHONES; STANDS FOR HANDHELD DIGITAL ELECTRONIC DEVICES; STANDS FOR PERSONAL DIGITAL ELECTRONIC DEVICES (U.S. CLS. 21, 23, 26, 36 AND 38).

CARYN GLASSER, EXAMINING ATTORNEY

**CLASS 9—(Continued).**

SN 85-277,238. STREAMVOICE WIRELESS CORP, JERSEY CITY, NJ. FILED S.R. 3-25-2011; AM. P.R. 6-23-2011.



NO CLAIM IS MADE TO THE EXCLUSIVE RIGHT TO USE "THEPHONE", APART FROM THE MARK AS SHOWN. THE MARK CONSISTS OF THE WORDS "THEPHONESTORE". THE LETTER "S" WITHIN THE WORDING IS DEPICTED ON THE FRONT OF A SHOPPING BAG WITH TWO HANDLES ON TOP OF THE BAG.

FOR BROADBAND WIRELESS EQUIPMENT, NAMELY, TELECOMMUNICATIONS BASE STATION EQUIPMENT FOR CELLULAR AND FIXED NETWORKING AND COMMUNICATIONS APPLICATIONS (U.S. CLS. 21, 23, 26, 36 AND 38).

FIRST USE 4-2-2010; IN COMMERCE 4-2-2010.  
NAKIA HENRY, EXAMINING ATTORNEY

SN 85-278,357. HUAWEI TECHNOLOGIES CO., LTD., SHENZHEN, CHINA, FILED 3-28-2011.

**Hi HUAWEI**

THE MARK CONSISTS OF STANDARD CHARACTERS WITHOUT CLAIM TO ANY PARTICULAR FONT, STYLE, SIZE, OR COLOR.

OWNER OF U.S. REG. NOS. 2,750,650, 3,313,908 AND 3,854,515.

THE WORDING "HUAWEI" HAS NO MEANING IN A FOREIGN LANGUAGE.

FOR MOBILE TELEPHONES; MODEMS; USB MODEMS; WIRELESS MODEMS; COMPUTERS; DIGITAL PHOTO FRAMES FOR DISPLAYING DIGITAL PICTURES, VIDEO CLIPS AND MUSIC; TABLET COMPUTERS; DIGITAL BOOK READERS; PERSONAL DIGITAL ASSISTANTS (PDA); NETWORK ROUTERS; GATEWAY ROUTERS IN THE NATURE OF COMPUTER CONTROL HARDWARE; COMPUTER HARDWARE AND PERIPHERAL DEVICES AND COMPUTER SOFTWARE FOR DATA COMMUNICATION AND TRANSLATING AND TRANSMITTING DATA SOLD THEREWITH; ELECTRONIC COMMUNICATIONS SYSTEMS COMPRISED OF COMPUTER HARDWARE AND SOFTWARE FOR THE TRANSMISSION OF DATA BETWEEN TWO POINTS (U.S. CLS. 21, 23, 26, 36 AND 38).

MELISSA VALLILLO, EXAMINING ATTORNEY

**CLASS 9—(Continued).**

SN 85-278,430. HUAWEI TECHNOLOGIES CO., LTD., SHENZHEN, CHINA, FILED 3-28-2011.

**HUAWEI VISION**

THE MARK CONSISTS OF STANDARD CHARACTERS WITHOUT CLAIM TO ANY PARTICULAR FONT, STYLE, SIZE, OR COLOR.

OWNER OF U.S. REG. NOS. 2,750,650, 3,313,908 AND 3,854,515.

THE WORDING "HUAWEI" HAS NO MEANING IN A FOREIGN LANGUAGE.

FOR MOBILE TELEPHONES; COMPUTERS; DIGITAL PHOTO FRAMES FOR DISPLAYING DIGITAL PICTURES, VIDEO CLIPS AND MUSIC; TABLET COMPUTERS; DIGITAL BOOK READERS; PERSONAL DIGITAL ASSISTANTS (PDA) (U.S. CLS. 21, 23, 26, 36 AND 38).

MELISSA VALLILLO, EXAMINING ATTORNEY

SN 85-279,162. KAUFMANN GROUP, INC., LOS ANGELES, CA. FILED 3-28-2011.



THE COLOR(S) GOLD AND SHADES OF BROWN ON WHITE BACKGROUND IS/ARE CLAIMED AS A FEATURE OF THE MARK.

THE MARK CONSISTS OF A CIRCULAR SEAL WITH AN OUTER BORDER OF BROWN WITH AN INNER BORDER OF GOLD CONCENTRIC WITH THE OUTER BAND BUT HALF ITS SIZE IN WIDTH. FURTHER, A SECOND SET OF CONCENTRIC CIRCLES MATCHING THE COLORS AND DIMENSIONAL WIDTH OF THE OUTER CONCENTRIC BANDS, THESE INNER CONCENTRIC CIRCLES ARE LOCATED CLOSER TO THE CENTER OF THE SEAL LEAVING AMPLE SPACING BETWEEN THE TWO SETS OF CONCENTRIC BANDS AS TO ALLOW SPACE TO ACCOMMODATE THE WORDING ON THE MARK. ADDITIONALLY, THERE ARE A SET OF SCALES LOCATED IN THE CENTER OF THE MARK SLIGHTLY OFFSET UPWARDS TOWARDS THE TWELVE O'CLOCK POSITION OF THE MARK. THE SCALES ARE DISPLAYED BALANCED WITH THE BASE OF THE SCALES APPROXIMATELY WITH THE HORIZONTAL POSITION ACROSS THE MARK. THE COLOR OF THESE SCALES MATCHES THE OUTER CONCENTRIC BAND OF THE INNER SET OF CIRCLES. THE MARK FURTHER DISPLAYS TWO IDENTICAL DIMENSIONS OF PADDLES WHICH ARE CROSSED. THE POSITIONAL LOCATION OF THESE CROSSED PADDLES ARE ALSO LOCATED IN THE CENTER OF THE MARK, OFFSET TOWARD THE SIX O'CLOCK POSITION OF THE MARK, AS TO BE POSITIONED ALIGNED AT THE BASE OF THE SCALES. THE COLOR OF THESE CROSSED PADDLES ALSO CORRESPONDS TO THE COLOR OF THE SCALES AND OUTER CONCENTRIC CIRCLE OF THE INNER CIRCLES. FURTHER TO DESCRIBE THE MARK,

**CLASS 9—(Continued).**

THE LETTERS AND WORDING ARE PLACED UPON THE AREA BETWEEN THE INNER CONCENTRIC CIRCLE OF THE OUTER SET OF CIRCLES AND THE OUTER CONCENTRIC CIRCLE OF THE INNER SET OF CIRCLES. THE WORDING IS DISPLAYED IN ALL UPPER-CASE LETTERS AS FOLLOWS: THE SPANKING COURT. THE LETTER "T" IN THE WORD "THE" IS POSITIONED AT THE SEVEN O'CLOCK POSITION ON THE MARK; CORRESPONDINGLY THE LETTER "T" IN THE WORD "COURT" IS ALIGNED IN THE FIVE O'CLOCK POSITION. THESE TWO "T'S" ARE INVERTED SO THE BASE OF THE "T'S" ARE FACING INWARDS TOWARDS THE INNER SET OF CONCENTRIC BANDS. THE SIX O'CLOCK POSITION IS BLANK WITH ONLY A WHITE BACKGROUND. BETWEEN THE TWO "T'S" PLACED AT THE SEVEN AND FIVE O'CLOCK POSITIONS. THE COLOR OF ALL LETTER APPEARING ON THE MARK IS THE SAME COLOR AS THE SCALES AND THE PADDLES. ALL OF THE MARKINGS, WORDINGS, AND CONCENTRIC BANDS ARE DISPLAYED AGAINST A SOLID WHITE BACKGROUND.

FOR DIGITAL MATERIALS, NAMELY, DOWNLOADABLE AND PRERECORDED DVDS, AUDIO AND VISUAL FILES FEATURING ADULT CONTENT (U.S. CLS. 21, 23, 26, 36 AND 38).

FIRST USE 6-12-2010; IN COMMERCE 10-15-2010.

JACQUELINE A. LAVINE, EXAMINING ATTORNEY

**CLASS 9—(Continued).**

SN 85-279,647. T-MOBILE USA, INC., BELLEVUE, WA. FILED 3-29-2011.

# SONIC

THE MARK CONSISTS OF STANDARD CHARACTERS WITHOUT CLAIM TO ANY PARTICULAR FONT, STYLE, SIZE, OR COLOR.

FOR WIRELESS ROUTERS AND WIRELESS ACCESS POINTS (U.S. CLS. 21, 23, 26, 36 AND 38).

TRACY FLETCHER, EXAMINING ATTORNEY

SN 85-279,859. SIRIUS XM RADIO INC., NEW YORK, NY. FILED 3-29-2011.

# SIRIUSXM

THE MARK CONSISTS OF STANDARD CHARACTERS WITHOUT CLAIM TO ANY PARTICULAR FONT, STYLE, SIZE, OR COLOR.

OWNER OF U.S. REG. NOS. 2,547,677, 3,204,232 AND OTHERS.

FOR ELECTRONIC HARDWARE DEVICE FOR RECEIVING BROADCAST RADIO TRANSMISSIONS AND AUDIO, VISUAL AND DATA INFORMATION (U.S. CLS. 21, 23, 26, 36 AND 38).

ANGELA M. MICHELI, EXAMINING ATTORNEY

# REVO

THE MARK CONSISTS OF STANDARD CHARACTERS WITHOUT CLAIM TO ANY PARTICULAR FONT, STYLE, SIZE, OR COLOR.

FOR MOBILE TELEPHONES; MODEMS; USB MODEMS; WIRELESS MODEMS; COMPUTERS; DIGITAL PHOTO FRAMES FOR DISPLAYING DIGITAL PICTURES, VIDEO CLIPS AND MUSIC; TABLET COMPUTERS; DIGITAL BOOK READERS; PERSONAL DIGITAL ASSISTANTS (PDA); NETWORK ROUTERS; GATEWAY ROUTERS IN THE NATURE OF COMPUTER CONTROL HARDWARE; COMPUTER HARDWARE AND PERIPHERAL DEVICES AND COMPUTER SOFTWARE FOR DATA COMMUNICATION AND TRANSLATING AND TRANSMITTING DATA SOLD THEREWITH; ELECTRONIC COMMUNICATIONS SYSTEMS COMPRISED OF COMPUTER HARDWARE AND SOFTWARE FOR THE TRANSMISSION OF DATA BETWEEN TWO POINTS; ALL OF THE FOREGOING NOT RELATING TO HOME AUTOMATION SYSTEMS AND COMPONENTS FOR USE IN THE AREA OF ENVIRONMENTAL, ACCESS AND SECURITY SYSTEMS (U.S. CLS. 21, 23, 26, 36 AND 38).

JULIE GUTTADAURO, EXAMINING ATTORNEY

SN 85-279,869. SIRIUS XM RADIO INC., NEW YORK, NY. FILED 3-29-2011.



The logo features the word "SiriusXM" in a bold, sans-serif font, enclosed within three curved lines on each side. Below it, the words "SATELLITE RADIO" are written in a smaller, all-caps, sans-serif font.

OWNER OF U.S. REG. NOS. 3,071,291, 3,818,003 AND OTHERS.

NO CLAIM IS MADE TO THE EXCLUSIVE RIGHT TO USE "SATELLITE RADIO", APART FROM THE MARK AS SHOWN.

THE MARK CONSISTS OF THE WORD "SIRIUSXM" WITH THREE CURVED LINES ON EACH SIDE ABOVE THE WORDS "SATELLITE RADIO".

FOR ELECTRONIC HARDWARE DEVICE FOR RECEIVING BROADCAST RADIO TRANSMISSIONS AND AUDIO, VISUAL AND DATA INFORMATION (U.S. CLS. 21, 23, 26, 36 AND 38).

ANGELA M. MICHELI, EXAMINING ATTORNEY

**CLASS 9—(Continued).**

SN 85-280,316. TSE, TERRY, CORONA, CA. FILED 3-29-2011.

**XFORCE**

THE MARK CONSISTS OF STANDARD CHARACTERS WITHOUT CLAIM TO ANY PARTICULAR FONT, STYLE, SIZE, OR COLOR.

FOR PROTECTIVE SLEEVES, CASES AND HOLDERS FOR LAPTOP, TABLET AND NETBOOK COMPUTERS; LEATHER CELL PHONE CASES; EQUIPMENT FOR REPRODUCING STEREOPHONIC SOUND, NAMELY, RADIOS, AUDIO AND VIDEO CASSETTE PLAYERS, TELEVISIONS, HEADPHONES, VEHICLE RADIOS, COMPACT DISC (CD) PLAYERS AND AUDIO SPEAKERS AND CASES FOR THE FOREGOING (U.S. CLS. 21, 23, 26, 36 AND 38).

HEATHER THOMPSON, EXAMINING ATTORNEY

SN 85-280,463. RED.COM, INC., LAKE FOREST, CA. FILED 3-29-2011.

**RED DRAGON**

THE MARK CONSISTS OF STANDARD CHARACTERS WITHOUT CLAIM TO ANY PARTICULAR FONT, STYLE, SIZE, OR COLOR.

FOR DIGITAL IMAGE SENSORS FOR DIGITAL STILL AND MOTION CAMERAS; DIGITAL CINEMA CAMERA SYSTEMS AND ACCESSORIES, SOLD INDIVIDUALLY OR AS A UNIT, COMPRISED OF, CAMERAS, CAMERA LENSES, DIGITAL IMAGE SENSORS, FLASH MEMORY CARDS, ELECTRONIC MEMORIES, HARD DRIVES FOR VIDEO RECORDERS, VIDEO MONITORS AND FLAT PANEL DISPLAY SCREENS, ALL FOR USE IN THE CREATION, STORAGE, DELIVERY, MANIPULATION, RECORDING, PLAYBACK OR VIEWING OF PHOTOGRAPHS AND VIDEOS (U.S. CLS. 21, 23, 26, 36 AND 38).

NELSON SNYDER, EXAMINING ATTORNEY

SN 85-281,016. DAVID LEVY COMPANY, INC., CERRITOS, CA. FILED 3-30-2011.

**iSTYLE**

THE MARK CONSISTS OF STANDARD CHARACTERS WITHOUT CLAIM TO ANY PARTICULAR FONT, STYLE, SIZE, OR COLOR.

FOR DISPLAY MONITORS FOR USE IN CONNECTION WITH VEHICLE PARKING ASSIST DEVICES, GPS SYSTEMS, VEHICLE DIAGNOSTICS SYSTEMS COMPRISING A TIME, DATE AND TEMPERATURE COMPASS, MULTIMEDIA SYSTEMS, AND MOBILE ELECTRONICS DEVICES (U.S. CLS. 21, 23, 26, 36 AND 38).

REGINA DRUMMOND, EXAMINING ATTORNEY

**CLASS 9—(Continued).**

SN 85-281,095. TRANG BRIAN T, NAPLES, FL. FILED 3-30-2011.

**GADGET FEET**

THE MARK CONSISTS OF STANDARD CHARACTERS WITHOUT CLAIM TO ANY PARTICULAR FONT, STYLE, SIZE, OR COLOR.

NO CLAIM IS MADE TO THE EXCLUSIVE RIGHT TO USE "GADGET", APART FROM THE MARK AS SHOWN.

FOR STAND TO ELEVATE PERSONAL ELECTRONIC DEVICES IN THE NATURE OF LAPTOPS, TABLET PCS, HANDHELD COMPUTING DEVICES, SMARTPHONES, KEYBOARDS, CALCULATORS AND PORTABLE PROJECTORS (U.S. CLS. 21, 23, 26, 36 AND 38).

ANN E. SAPPENFIELD, EXAMINING ATTORNEY

SN 85-282,151. CURIEL, JESSEE LEE, DBA ABERNATHY AVENUE, CUMMING, GA. FILED 3-31-2011.

**ABERNATHY AVENUE**

THE MARK CONSISTS OF STANDARD CHARACTERS WITHOUT CLAIM TO ANY PARTICULAR FONT, STYLE, SIZE, OR COLOR.

NO CLAIM IS MADE TO THE EXCLUSIVE RIGHT TO USE "AVENUE", APART FROM THE MARK AS SHOWN.

FOR AUDIO AND VIDEO RECORDINGS FEATURING MUSIC AND ARTISTIC PERFORMANCES; DOWNLOADABLE MUSICAL SOUND RECORDINGS; MUSICAL RECORDINGS; SERIES OF MUSICAL SOUND RECORDINGS (U.S. CLS. 21, 23, 26, 36 AND 38).

MAYUR VAGHANI, EXAMINING ATTORNEY

SN 85-282,337. CANION, STEVEN, C, PORT ARANSAS, TX. FILED 3-31-2011.

**Merry Turtle**

THE MARK CONSISTS OF STANDARD CHARACTERS WITHOUT CLAIM TO ANY PARTICULAR FONT, STYLE, SIZE, OR COLOR.

NO CLAIM IS MADE TO THE EXCLUSIVE RIGHT TO USE "TURTLE", APART FROM THE MARK AS SHOWN.

FOR SOLAR CELLS (U.S. CLS. 21, 23, 26, 36 AND 38). FIRST USE 12-15-2010; IN COMMERCE 12-15-2010.

JENNY PARK, EXAMINING ATTORNEY

**CLASS 9—(Continued).**

SN 85-282,606. COMPASS BANCSHARES, INC., BIRMINGHAM, AL. FILED 3-31-2011.

# SAFESPEND

THE MARK CONSISTS OF STANDARD CHARACTERS WITHOUT CLAIM TO ANY PARTICULAR FONT, STYLE, SIZE, OR COLOR.

FOR GENERAL PURPOSE RELOADABLE PAYMENT CARD, NAMELY, A MAGNETIC PREPAID MONEY TRANSACTION CARD WHEREBY CUSTOMERS MAY CONDUCT FINANCIAL TRANSACTIONS AND INQUIRIES, INCLUDING DIRECT DEPOSIT PAYROLL, ADDITIONAL DEPOSITS AND FUND RELOADS TO THE CARD, CHECK BALANCES, TRACK SPENDING AND PAY BILLS (U.S. CLS. 21, 23, 26, 36 AND 38).

FIRST USE 8-3-2011; IN COMMERCE 8-3-2011.  
MICHAEL WIENER, EXAMINING ATTORNEY

SN 85-282,663. COMPASS BANCSHARES, INC., BIRMINGHAM, AL. FILED 3-31-2011.

# SAFESPEND CARD

THE MARK CONSISTS OF STANDARD CHARACTERS WITHOUT CLAIM TO ANY PARTICULAR FONT, STYLE, SIZE, OR COLOR.

NO CLAIM IS MADE TO THE EXCLUSIVE RIGHT TO USE "CARD", APART FROM THE MARK AS SHOWN.

FOR GENERAL PURPOSE RELOADABLE PAYMENT CARD, NAMELY, A MAGNETIC PREPAID MONEY TRANSACTION CARD WHEREBY CUSTOMERS MAY CONDUCT FINANCIAL TRANSACTIONS AND INQUIRIES, INCLUDING DIRECT DEPOSIT PAYROLL, ADDITIONAL DEPOSITS AND FUND RELOADS TO THE CARD, CHECK BALANCES, TRACK SPENDING AND PAY BILLS (U.S. CLS. 21, 23, 26, 36 AND 38).

FIRST USE 8-3-2011; IN COMMERCE 8-3-2011.  
MICHAEL WIENER, EXAMINING ATTORNEY

**CLASS 9—(Continued).**

SN 85-285,744. EASTER UNLIMITED, INC., CARLE PLACE, NY. FILED 4-4-2011.

# GHOST FACE

THE MARK CONSISTS OF STANDARD CHARACTERS WITHOUT CLAIM TO ANY PARTICULAR FONT, STYLE, SIZE, OR COLOR.

OWNER OF U.S. REG. NO. 2,643,643.

FOR COMPUTER APPLICATION SOFTWARE FOR MOBILE PHONES, PORTABLE ELECTRONIC DEVICES, PORTABLE MEDIA PLAYERS AND HANDHELD COMPUTERS, NAMELY, SOCIAL PHOTO SHARING APPLICATION, SOFTWARE THAT ALLOWS TO COMBINE PHOTOS FROM YOUR PERSONAL ALBUM, USE YOUR CAMERA TO TAKE PICTURES, SOFTWARE THAT ALLOWS TO IMPORT INTO PROGRAMS AND COMBINE WITH IMAGES, SOFTWARE FOR CREATING GAMES FOR MOBILE PHONES, PORTABLE ELECTRONIC DEVICES, PORTABLE MEDIA PLAYERS AND HANDHELD COMPUTERS; COMPUTER APPLICATION SOFTWARE FOR MOBILE PHONES, PORTABLE ELECTRONIC DEVICES, PORTABLE MEDIA PLAYERS AND HANDHELD COMPUTERS (U.S. CLS. 21, 23, 26, 36 AND 38).

JOHN KELLY, EXAMINING ATTORNEY

SN 85-286,547. MICROSYSTEMS TECHNOLOGY, INC., TAMPA, FL. FILED 4-5-2011.

# AnyApp

THE MARK CONSISTS OF STANDARD CHARACTERS WITHOUT CLAIM TO ANY PARTICULAR FONT, STYLE, SIZE, OR COLOR.

FOR A FEATURE OF COMPUTER PROCESSING SOFTWARE THAT PROCESSES SEMI-STRUCTURED AND UNSTRUCTURED DOCUMENTS AND ELIMINATES THE NEED FOR MEMORIZATION OF DATA COORDINATES BY CAPTURING DATA REGARDLESS OF LOCATION ON THE DOCUMENT USING SPECIAL ALGORITHMS AND KEYWORDS (U.S. CLS. 21, 23, 26, 36 AND 38).

FIRST USE 9-1-2003; IN COMMERCE 9-1-2003.  
ALLISON SCHRODY, EXAMINING ATTORNEY

**CLASS 9—(Continued).**

SN 85-286,582. MICROSYSTEMS TECHNOLOGY, INC., TAMPA, FL. FILED 4-5-2011.

# QuickApp

THE MARK CONSISTS OF STANDARD CHARACTERS WITHOUT CLAIM TO ANY PARTICULAR FONT, STYLE, SIZE, OR COLOR.

FOR A FEATURE OF COMPUTER PROCESSING SOFTWARE THAT ALLOWS AN OPERATOR TO AUTOMATICALLY CAPTURE DATA WITHIN A SELECTED REGION AND CREATE A MEMORY PROFILE USING KEY DATA ELEMENTS AND LOCATION TO SPEED SUBSEQUENT PROCESSING AND DATA EXTRACTION FOR THE SAME DOCUMENT TYPE (U.S. CLS. 21, 23, 26, 36 AND 38).

FIRST USE 1-2-2004; IN COMMERCE 1-2-2004.  
ALLISON SCHRODY, EXAMINING ATTORNEY

SN 85-288,096. HTC CORPORATION, TAOYUAN CITY, TAIWAN, FILED 4-6-2011.

# HTC VIVID

THE MARK CONSISTS OF STANDARD CHARACTERS WITHOUT CLAIM TO ANY PARTICULAR FONT, STYLE, SIZE, OR COLOR.

OWNER OF U.S. REG. NOS. 3,584,881, 3,919,900 AND OTHERS.

FOR MOBILE PHONES; SMARTPHONES; WIRELESS PHONES; CELLULAR PHONES (U.S. CLS. 21, 23, 26, 36 AND 38).

REBECCA GILBERT, EXAMINING ATTORNEY

SN 85-288,603. CHAMPAGNE WINDS INC. DBA SIESTA KEY COMMUNITY INC, SARASOTA, FL. FILED 4-7-2011.



NO CLAIM IS MADE TO THE EXCLUSIVE RIGHT TO USE "SIESTA KEY", APART FROM THE MARK AS SHOWN.

THE COLOR(S) DARK BLUE, BLACK, YELLOW, LIGHT BLUE, GREEN, RED, WHITE, BROWN, BEIGE, GOLD AND PINK IS/ARE CLAIMED AS A FEATURE OF THE MARK.

THE MARK CONSISTS OF THE WORDING "SIESTA KEY SUN" IN THE COLOR DARK BLUE COMBINED WITH A DESIGN OF A YELLOW SUN SUPERIMPOSED UPON A STYLIZED DESIGN OF SIESTA KEY ISLAND IN THE

**CLASS 9—(Continued).**

COLOR LIGHT BLUE. THE LETTER "I" IN "SIESTA" IS FORMED IN PART OR DOTTED BY A BEACH BALL IN THE COLORS GREEN, RED, YELLOW AND WHITE WITH A BLACK OUTLINE. THE LETTER "T" IN "SIESTA" FORMS A BROWN PALM TREE WITH GREEN LEAVES AND FIVE BEIGE COCONUTS. THE LETTER "Y" IN "KEY" IS FORMED IN PART BY A BEACH UMBRELLA IN THE COLORS GOLD, GREEN AND PINK OUTLINED IN BLACK. THE DESIGN OF THE YELLOW SUN APPEARS WITHIN THE LETTER "U" IN THE WORD "SUN" WITH 14 YELLOW SUN RAYS EXTENDING THEREFROM.

FOR DOWNLOADABLE ELECTRONIC NEWSLETTERS DELIVERED BY E-MAIL IN THE FIELD OF COMMUNITY NEWS (U.S. CLS. 21, 23, 26, 36 AND 38).

FIRST USE 4-7-2011; IN COMMERCE 4-7-2011.  
ZHALEH DELANEY, EXAMINING ATTORNEY

SN 85-289,039. BUCK CONSULTANTS, LLC, NEW YORK, NY. FILED 4-7-2011.

# My Mobile Benefits

THE MARK CONSISTS OF STANDARD CHARACTERS WITHOUT CLAIM TO ANY PARTICULAR FONT, STYLE, SIZE, OR COLOR.

NO CLAIM IS MADE TO THE EXCLUSIVE RIGHT TO USE "MOBILE BENEFITS", APART FROM THE MARK AS SHOWN.

FOR COMPUTER SOFTWARE FOR MANAGEMENT OF EMPLOYEE BENEFITS, NAMELY, COMPUTER SOFTWARE FOR STORING AND RETRIEVING USER MEDICAL INFORMATION, INSURANCE INFORMATION, HUMAN RESOURCES INFORMATION, AND FOR CALENDARING APPOINTMENTS (U.S. CLS. 21, 23, 26, 36 AND 38).

DAWN HAN, EXAMINING ATTORNEY

SN 85-290,429. THE TRAVEL CHANNEL, L.L.C., CHEVY CHASE, MD. FILED 4-8-2011.

# SAND MASTERS

THE MARK CONSISTS OF STANDARD CHARACTERS WITHOUT CLAIM TO ANY PARTICULAR FONT, STYLE, SIZE, OR COLOR.

NO CLAIM IS MADE TO THE EXCLUSIVE RIGHT TO USE "SAND", APART FROM THE MARK AS SHOWN.

FOR PRERECORDED VIDEO DISKS, AUDIO-VISUAL RECORDINGS, AND DVDS, ALL FEATURING CONTENT IN THE FIELDS OF RUNNING A BUSINESS, TRAVELLING THE WORLD, INTERPERSONAL RELATIONSHIPS AND THE CONSTRUCTION OF SCULPTURES AND ARCHITECTURAL STRUCTURES MADE OF SAND FOR OTHERS (U.S. CLS. 21, 23, 26, 36 AND 38).

DAVID I, EXAMINING ATTORNEY

**CLASS 9—(Continued).**

SN 85-290,711. PANORAMIC VISION INC, WOODSIDE, NY. FILED 4-8-2011.

## Handroid Power

THE MARK CONSISTS OF STANDARD CHARACTERS WITHOUT CLAIM TO ANY PARTICULAR FONT, STYLE, SIZE, OR COLOR.

NO CLAIM IS MADE TO THE EXCLUSIVE RIGHT TO USE "POWER", APART FROM THE MARK AS SHOWN.

FOR CELL PHONE BATTERY CHARGERS; CONNECTING ELECTRICAL CABLES; DISPLAY PROTECTOR TO PROVIDE SHADE AND PRIVACY FOR ELECTRONIC DEVICES HAVING SCREENS; ELECTRONIC CARD READERS; MOBILE TELEPHONE BATTERIES; PROTECTIVE COVERS AND CASES FOR CELL PHONES, LAPTOPS AND PORTABLE MEDIA PLAYERS (U.S. CLS. 21, 23, 26, 36 AND 38).

GEOFFREY FOSDICK, EXAMINING ATTORNEY

SN 85-290,796. ELSEMA PTY LTD., SMITHFIELD, AUSTRALIA, FILED 4-8-2011.

## ELSEMA

THE MARK CONSISTS OF STANDARD CHARACTERS WITHOUT CLAIM TO ANY PARTICULAR FONT, STYLE, SIZE, OR COLOR.

FOR APPARATUS AND INSTRUMENTS FOR CONDUCTING, SWITCHING, TRANSFORMING, ACCUMULATING, REGULATING OR CONTROLLING ELECTRICITY; DATA PROCESSING EQUIPMENT AND COMPUTERS; WIRELESS TRANSMITTERS; RADIO CONTROL UNITS FOR REMOTE KEYLESS ENTRY INSTALLATIONS; ELECTRONICALLY OPERATED REMOTE CONTROL MECHANISMS FOR CLOSING DOORS; ELECTRONICALLY OPERATED REMOTE CONTROL MECHANISMS FOR OPENING DOORS; REMOTE CONTROLLED APPARATUS FOR USE WITH GARAGE DOORS; REMOTE CONTROLLED APPARATUS FOR USE WITH GATES; ELECTRIC INSTALLATIONS FOR THE REMOTE CONTROL OF INDUSTRIAL OPERATIONS; ELECTRONICALLY OPERATED REMOTE CONTROL UNITS (U.S. CLS. 21, 23, 26, 36 AND 38).

GRETTA YAO, EXAMINING ATTORNEY

**CLASS 9—(Continued).**

SN 85-291,183. IMADA, INC., NORTHBROOK, IL. FILED 4-10-2011.



OWNER OF U.S. REG. NO. 3,037,799.

THE MARK CONSISTS OF WORD IMADA APPEARS IN THE CENTER OF AN OVAL.

FOR INDUSTRIAL AND SCIENTIFIC MEASURING INSTRUMENTS, NAMELY, MECHANICAL AND DIGITAL FORCE GAUGES, DIGITAL TORQUE GAUGES, TORQUE TESTERS, PUSH/PULL TESTERS, WIRE PULL TESTERS, PEEL TESTERS, SPRING TESTERS, PUNCTURE TESTERS, COMPRESSION TESTERS, STRENGTH TESTERS AND SOFTWARE, TEST STANDS AND ATTACHMENTS THEREFOR, SOLD TOGETHER AS A UNIT, FOR USE IN MEASURING FORCE, TORQUE, HARDNESS, WEIGHT, CALIBRATION, THICKNESS, DISTANCE, SPEED, VIBRATION, FLOW, AIR FLOW, TEMPERATURE, HUMIDITY, ELECTRICAL VOLTAGE AND ELECTRICAL CURRENT; DYNAMOMETERS, DURROMETERS, TACHOMETERS, STROBOSCOPES (U.S. CLS. 21, 23, 26, 36 AND 38).

BRIAN CALLAGHAN, EXAMINING ATTORNEY

SN 85-291,666. KALFUS, MAXWELL, BOONTON, NJ. FILED 4-11-2011.

## That Riff

THE MARK CONSISTS OF STANDARD CHARACTERS WITHOUT CLAIM TO ANY PARTICULAR FONT, STYLE, SIZE, OR COLOR.

FOR COMPUTER SOFTWARE FOR CREATING AND EDITING MUSIC AND SOUNDS (U.S. CLS. 21, 23, 26, 36 AND 38).

REBECCA EISINGER, EXAMINING ATTORNEY

SN 85-293,651. STAPLES THE OFFICE SUPERSTORE, LLC., FRAMINGHAM, MA. FILED 4-13-2011.



NO CLAIM IS MADE TO THE EXCLUSIVE RIGHT TO USE "PROFESSIONAL", APART FROM THE MARK AS SHOWN.

THE MARK CONSISTS OF A CIRCLE COMPRISED OF 4 CRESCENTS OVER THE WORDS "BRIGHTON PROFESSIONAL".

FOR PROTECTIVE EAR COVERINGS, PROTECTIVE EYE COVERS, PROTECTIVE WORK GLOVES (U.S. CLS. 21, 23, 26, 36 AND 38).

GIANCARLO CASTRO, EXAMINING ATTORNEY

**CLASS 9—(Continued).**

SN 85-294,314. HOYT MONITOR TECHNOLOGIES, LLC, PENACOOK, NH. FILED 4-13-2011.

## Hoyt Monitor Technologies

THE MARK CONSISTS OF STANDARD CHARACTERS WITHOUT CLAIM TO ANY PARTICULAR FONT, STYLE, SIZE, OR COLOR.

NO CLAIM IS MADE TO THE EXCLUSIVE RIGHT TO USE "MONITOR TECHNOLOGIES", APART FROM THE MARK AS SHOWN.

FOR ELECTRONIC DEVICES FOR RECORDING, STORING, DISPLAYING, AND TRANSMITTING POWER USAGE DATA FROM ANY OBJECT THAT USES OR PRODUCES ELECTRICAL POWER; SOFTWARE USED TO PROGRAM AND CONTROL DEVICES THAT RECORD, STORE, DISPLAY AND TRANSMIT ELECTRICAL POWER USAGE DATA; AND PANEL METERS FOR MONITORING ELECTRICAL POWER USAGE THAT RECORD, STORE, DISPLAY AND TRANSMIT ELECTRICAL FUNCTIONS, IMPULSES, AND SIGNALS OF DEVICES BEING MONITORED (U.S. CLS. 21, 23, 26, 36 AND 38).

DAWN HAN, EXAMINING ATTORNEY

**CLASS 9—(Continued).**

SN 85-295,219. VARSITY SPIRIT CORPORATION, MEMPHIS, TN. FILED 4-14-2011.

## VARSITY

THE MARK CONSISTS OF STANDARD CHARACTERS WITHOUT CLAIM TO ANY PARTICULAR FONT, STYLE, SIZE, OR COLOR.

OWNER OF U.S. REG. NOS. 879,543, 3,436,493 AND OTHERS.

FOR DOWNLOADABLE SOFTWARE IN THE NATURE OF A MOBILE APPLICATION, NAMELY, SOFTWARE FOR ACCESSING, VIEWING, INTERACTING WITH AND DOWNLOADING CONTENT IN THE FIELD OF ENTERTAINMENT, SCHOOL SPIRIT, DANCE, AND CULTURAL CONTENT DIRECTED AT YOUNG ADULTS FOR MOBILE PHONES, HANDHELD COMPUTERS, AND PORTABLE AND HANDHELD DIGITAL ELECTRONIC DEVICES (U.S. CLS. 21, 23, 26, 36 AND 38).

KYLE PEETE, EXAMINING ATTORNEY

SN 85-295,125. CHECKPOINT SYSTEMS, INC., PHILADELPHIA, PA. FILED 4-14-2011.



THE MARK CONSISTS OF THE STYLIZED LETTERS "SIDEP" WITH TWO STYLIZED ELLIPSES PASSING IN FRONT OF THE STYLIZED "D" AND PASSING BEHIND THE STYLIZED LETTERS "S" AND "I".

FOR ELECTRONIC ARTICLE SURVEILLANCE EQUIPMENT, NAMELY, ELECTRONIC SECURITY TAGS, ELECTRONIC SECURITY LABELS, DETACHERS AND DEACTIVATION PADS, ANTENNAS AND SECURITY GATES, ELECTRONIC ARTICLE SURVEILLANCE READERS, ACTIVATORS AND DEACTIVATORS USED TO ATTACH, SECURE, ACTIVATE, DE-ACTIVATE AND REMOVE ELECTRONIC TAGS AND LABELS FROM PACKAGES, GOODS AND WARES; ALARMING UNITS TO BE ATTACHED TO RETAIL MERCHANDISE AND SECURITY DEVICES, NAMELY, AN ELECTRONIC ARTICLE SURVEILLANCE TAG OR ELECTRONIC ARTICLE SURVEILLANCE LABEL TO BE ATTACHED TO RETAIL MERCHANDISE; AND AUTOMATED SECURITY GATES FOR USE IN RETAIL STORES TO PREVENT THEFT (U.S. CLS. 21, 23, 26, 36 AND 38).

WILLIAM ROSSMAN, EXAMINING ATTORNEY

SN 85-295,735. MERCURY RADIO ARTS, INC., NEW YORK, NY. FILED 4-14-2011.

## GBTV

THE MARK CONSISTS OF STANDARD CHARACTERS WITHOUT CLAIM TO ANY PARTICULAR FONT, STYLE, SIZE, OR COLOR.

FOR DIGITAL MATERIALS, NAMELY, PODCASTS IN THE FIELD OF CURRENT EVENTS NEWS, POLITICS, PUBLIC AFFAIRS, NEWS MEDIA AND JOURNALISM, AND ENTERTAINMENT NEWS AND FEATURING PICTURES, VIDEO, AND MUSIC; MOBILE VIDEO GAME APPLICATIONS; DIGITAL MEDIA, NAMELY, PRE-RECORDED VIDEO CASSETTES, DIGITAL VIDEO DISCS, DOWNLOADABLE AUDIO AND VIDEO RECORDINGS, DVDS, AND HIGH DEFINITION DIGITAL DISCS FEATURING CURRENT EVENTS NEWS, POLITICS, PUBLIC AFFAIRS, NEWS MEDIA AND JOURNALISM, AND ENTERTAINMENT NEWS; DOWNLOADABLE ELECTRONIC PUBLICATIONS IN THE NATURE OF JOURNALS AND NEWSLETTERS IN THE FIELD OF CURRENT EVENTS NEWS, POLITICS, PUBLIC AFFAIRS, NEWS MEDIA AND JOURNALISM, AND ENTERTAINMENT NEWS; MOBILE APPLICATIONS FOR USE IN DOWNLOADING AND VIEWING CONTENT IN THE FIELD OF CURRENT EVENTS NEWS, POLITICS, PUBLIC AFFAIRS, NEWS MEDIA AND JOURNALISM, AND ENTERTAINMENT NEWS; COMPUTER ACCESSORIES, NAMELY, MOUSE PADS, MICE, COMPACT DISC OR "DISKETTE" CASES, COMPUTER CARRY-ON CASES, KEYBOARD WRIST PADS, COMPUTER MONITOR CARDBOARD FRAMES; COMPUTER SOFTWARE,



**CLASS 9—(Continued).**

NAMELY, SCREEN SAVERS; USER INTERFACES FOR ELECTRONIC DEVICES KNOWN AS SKINS; FITTED PLASTIC FILMS KNOWN AS SKINS FOR COVERING AND PROTECTING ELECTRONIC APPARATUS, NAMELY, COMPUTERS; COMPUTER SOFTWARE FOR CREATING CURSORS AND AVATARS; RADIOS, TELEPHONES, AND CELL PHONE ACCESSORIES, NAMELY, FACE PLATES AND CELL PHONE COVERS; VIDEO MONITORS, COMPUTER MONITORS; BINOCULARS, SUNGLASSES, EYEGLASS FRAMES, EYEWEAR STRAPS AND CHAINS, EYEGLASS AND SUNGLASS CASES, MAGNETS, DISPOSABLE CAMERAS; CREDIT CARDS AND PRE-PAID TELEPHONE CALLING CARDS, BOTH MAGNETICALLY ENCODED; DOWNLOADABLE COMPUTER SOFTWARE FOR VIEWING DATABASES OF INFORMATION, STATISTICAL INFORMATION, TRIVIA, POLLING INFORMATION, AND INTERACTIVE POLLING IN THE FIELD OF POLITICS PROVIDED OVER THE INTERNET; DOWNLOADABLE GREETING CARDS PROVIDED OVER THE INTERNET (U.S. CLS. 21, 23, 26, 36 AND 38).

JAMES GRIFFIN, EXAMINING ATTORNEY

SN 85-295,820. UTSTARCOM, INC., ALAMEDA, CA. FILED 4-14-2011.



OWNER OF U.S. REG. NOS. 3,257,655, 3,259,483 AND 3,406,764.

THE MARK CONSISTS OF THE LETTERS "UT" IN AN INCOMPLETE CIRCLE, FOLLOWED BY THE LETTERS "STARCOM", WITH THE OPEN SPACE IN THE LETTER "A" REPRESENTED BY A FOUR-POINTED STAR.

THE WORDING "UTSTARCOM" HAS NO MEANING IN A FOREIGN LANGUAGE.

FOR TELECOMMUNICATION SYSTEMS FOR TRANSMITTING AND RECEIVING DATA AND VOICE SIGNALS OVER PHYSICAL LINES OR WIRELESS COMMUNICATION NETWORKS, NAMELY, WIRELESS TELEPHONES AND PARTS THEREFOR, WIRELESS LOCAL LOOP CIRCUITS, COMPUTER HARDWARE MULTIPLEXERS, LINE TERMINALS, CENTRAL OFFICE TERMINALS, AIR TRAFFIC CONTROLLERS, ATM CONCENTRATORS, REMOTE PORT CONTROLLERS, RADIO PORTS, WIRELESS SUBSCRIBER BASE STATIONS, AND SOFTWARE FOR TELECOMMUNICATIONS APPLICATIONS (U.S. CLS. 21, 23, 26, 36 AND 38).

ALLISON HOLTZ, EXAMINING ATTORNEY

**CLASS 9—(Continued).**

SN 85-296,577. HOYT MONITOR TECHNOLOGIES, LLC, PENACOOK, NH. FILED 4-15-2011.



THE MARK CONSISTS OF THE DESIGN OF A BULLDOG'S HEAD WITH A COLLAR THAT BEARS THE WORDING "HMT" THEREON AND A TAG SHAPED LIKE A LIGHTNING BOLT.

FOR ELECTRONIC DEVICES FOR RECORDING, STORING, DISPLAYING, AND TRANSMITTING POWER USAGE DATA FROM ANY OBJECT THAT USES OR PRODUCES ELECTRICAL POWER; SOFTWARE USED TO PROGRAM AND CONTROL DEVICES THAT RECORD, STORE, DISPLAY AND TRANSMIT ELECTRICAL POWER USAGE DATA; AND PANEL METERS FOR MONITORING ELECTRICAL POWER USAGE THAT RECORD, STORE, DISPLAY AND TRANSMIT ELECTRICAL FUNCTIONS, IMPULSES, AND SIGNALS OF DEVICES BEING MONITORED (U.S. CLS. 21, 23, 26, 36 AND 38).

DAWN HAN, EXAMINING ATTORNEY

SN 85-296,596. HOYT MONITOR TECHNOLOGIES, LLC, PENACOOK, NH. FILED 4-15-2011.



THE MARK CONSISTS OF THE STYLIZED GREEK LETTER "OMEGA" BISECTED BY THE DESIGN OF A LIGHTNING BOLT.

FOR ELECTRONIC DEVICES FOR RECORDING, STORING, DISPLAYING, AND TRANSMITTING POWER USAGE DATA FROM ANY OBJECT THAT USES OR PRODUCES ELECTRICAL POWER; SOFTWARE USED TO PROGRAM AND CONTROL DEVICES THAT RECORD, STORE, DISPLAY AND TRANSMIT ELECTRICAL POWER USAGE DATA; AND PANEL METERS FOR MONITORING ELECTRICAL POWER USAGE THAT RECORD, STORE, DISPLAY AND TRANSMIT ELECTRICAL FUNCTIONS, IMPULSES, AND SIGNALS OF DEVICES BEING MONITORED (U.S. CLS. 21, 23, 26, 36 AND 38).

DAWN HAN, EXAMINING ATTORNEY

**CLASS 9—(Continued).**

SN 85-298,231. EVERGLADE SOLUTIONS, INC., ST AUGUSTINE, FL. FILED 4-18-2011.

# Insight Pop

THE MARK CONSISTS OF STANDARD CHARACTERS WITHOUT CLAIM TO ANY PARTICULAR FONT, STYLE, SIZE, OR COLOR.

FOR COMPUTER APPLICATION SOFTWARE FOR MOBILE PHONES, PORTABLE MEDIA PLAYERS, HANDHELD COMPUTERS, AND COMPUTERS, NAMELY, SOFTWARE FOR VIEWING CHARTS THROUGH A MOBILE COMMUNICATION INTERFACE (U.S. CLS. 21, 23, 26, 36 AND 38).

FIRST USE 6-1-2010; IN COMMERCE 6-1-2010.  
GRETCHEN ULRICH, EXAMINING ATTORNEY

SN 85-299,110. KING SCHOOLS, INC., SAN DIEGO, CA. FILED 4-19-2011.



NO CLAIM IS MADE TO THE EXCLUSIVE RIGHT TO USE "SCHOOLS", APART FROM THE MARK AS SHOWN.

THE MARK CONSISTS OF PART OF THE DESIGN OF A LOW-WING AIRPLANE IN PROFILE IN A VERTICAL POSITION IN THE UPPER RIGHT CORNER OF THE LOGO WITH LINES FLOWING DOWNWARD ON THE RIGHT SIDE OF THE LOGO AND CURVING FROM THE RIGHT TO THE LEFT HORIZONTALLY.

FOR INTERACTIVE COMPUTER SOFTWARE AND VIDEOS FOR AVIATION TRAINING COURSES USED BY STUDENTS TO LEARN, AND BY FLIGHT SCHOOLS TO TEACH, FLYING SKILLS AND KNOWLEDGE REQUIRED TO PASS FEDERAL AVIATION ADMINISTRATION KNOWLEDGE TESTS AND FEDERAL AVIATION ADMINISTRATION PRACTICAL FLIGHT EXAMS, AND PRE-RECORDED VIDEOS FEATURING AVIATION INSTRUCTION FOR STUDENTS AND FLIGHT SCHOOLS DEPICTING THE NECESSARY SKILLS AND KNOWLEDGE REQUIRED TO PASS FEDERAL AVIATION ADMINISTRATION KNOWLEDGE TESTS AND PRACTICAL FLIGHT EXAMS (U.S. CLS. 21, 23, 26, 36 AND 38).

FIRST USE 10-0-1991; IN COMMERCE 1-0-1992.  
ALEX KEAM, EXAMINING ATTORNEY

**CLASS 9—(Continued).**

SN 85-302,171. ROBERT J. COTTER, JR., DBA INSTANT GOLF, LLC, LAWRENCEVILLE, NJ. FILED 4-22-2011.



NO CLAIM IS MADE TO THE EXCLUSIVE RIGHT TO USE "GOLF BALL GUIDE.COM", APART FROM THE MARK AS SHOWN.

THE COLOR(S) BLUE AND WHITE IS/ARE CLAIMED AS A FEATURE OF THE MARK.

THE MARK CONSISTS OF A REPRESENTATION OF A WHITE GOLF BALL WITH BLUE DIMPLES AND A THREE PRONGED TRAIL IN WHITE OUTLINED IN BLUE DEPICTING MOVEMENT OF A GOLF BALL ABOVE THE WORDING "GOLF BALL GUIDE.COM", IN WHITE OUTLINED IN BLUE.

FOR DOWNLOADABLE ELECTRONIC PUBLICATIONS IN THE NATURE OF INSTRUCTION MANUALS AND GUIDES IN THE FIELD OF GOLF, NAMELY, FOR PROVIDING GOLF BALL SELECTION EXPERTISE AND IMPROVING GOLFING SKILLS (U.S. CLS. 21, 23, 26, 36 AND 38).

FIRST USE 5-1-2003; IN COMMERCE 5-5-2003.  
LESLEY LAMOTHE, EXAMINING ATTORNEY

SN 85-302,496. J28 DESIGN, INC., COTATI, CA. FILED 4-22-2011.



NO CLAIM IS MADE TO THE EXCLUSIVE RIGHT TO USE "POWER CORDS", APART FROM THE MARK AS SHOWN.

THE MARK CONSISTS OF THE DESIGN OF A REAR VIEW MIRROR; IN THE CENTER OF THE MIRROR IS THE TERM "MIRRORTAP" IN LARGE FONT WITH THE LETTER "T" HAVING AN ELONGATED LINE WHICH RUNS ACROSS THE TOP OF THE TERM "MIRRORTAP"; TO THE LEFT OF THE ELONGATED LINE IS A CIRCLE WITH A MINUS SIGN INSIDE; TO THE RIGHT OF THE ELONGATED LINE IS A CIRCLE WITH A PLUS SIGN INSIDE; BELOW THE TERM "MIRRORTAP" CENTERED WITHIN THE REAR VIEW MIRROR FRAME IS THE TERM "POWER CORDS" IN SMALL FONT.

FOR RADAR DETECTOR POWER CORD (U.S. CLS. 21, 23, 26, 36 AND 38).

FIRST USE 3-31-2011; IN COMMERCE 3-31-2011.  
SHAUNIA CARLYLE, EXAMINING ATTORNEY

**CLASS 9—(Continued).**

SN 85-303,702. TECHNOLOGY FOR ENERGY CORPORATION, KNOXVILLE, TN. FILED 4-25-2011.

**CLASS 9—(Continued).**

SN 85-305,252. HINDEN, JOSHUA DEAN, DBA TWISTED TOOLS, SAN FRANCISCO, CA. FILED 4-26-2011.



THE MARK CONSISTS OF THE STYLIZED LETTER "P" ABOVE THE LITERAL ELEMENT "POWERMETRIX".  
 FOR ELECTRICAL TESTING INSTRUMENTS FOR THE MEASUREMENT OF AC ELECTRICAL PARAMETERS, NAMELY, VOLTMETERS, AMP METERS, WATT METERS, POWER METERS AND FOR TESTING AND CALIBRATION OF ELECTRIC METERING INSTALLATIONS; COMPUTER SOFTWARE FOR ELECTRICAL TESTING INSTRUMENTS FOR THE MEASUREMENT OF AC ELECTRICAL PARAMETERS, NAMELY, VOLTS, AMPS, WATTS, VA (VOLT-AMPERES), VARS (VOLT-AMPERES REACTIVE), AND FOR TESTING AND CALIBRATION OF ELECTRIC METERING INSTALLATIONS INCLUDING TESTING OF METERS, CURRENT TRANSFORMERS, POTENTIAL TRANSFORMERS AND WIRING (U.S. CLS. 21, 23, 26, 36 AND 38).  
 FIRST USE 10-5-2005; IN COMMERCE 10-5-2008.  
 HANNO RITTNER, EXAMINING ATTORNEY



NO CLAIM IS MADE TO THE EXCLUSIVE RIGHT TO USE "TOOLS", APART FROM THE MARK AS SHOWN.  
 THE MARK CONSISTS OF THE WORDS "TWISTED TOOLS" CAN BE SEEN INSIDE THE IMAGE OF A TOOLBOX. TO THE RIGHT OF THE WORDS ARE A SERIES OF VERTICAL AUDIO LEVEL METERS, DEPICTED AS VERTICAL RECTANGLES THAT VARY IN SIZE.  
 FOR AUDIO AND VIDEO RECORDINGS FEATURING MUSIC AND ARTISTIC PERFORMANCES; COMPUTER SOFTWARE FEATURING MUSICAL SOUND RECORDINGS AND MUSICAL VIDEO RECORDINGS; COMPUTER SOFTWARE FOR CREATING AND EDITING MUSIC AND SOUNDS; DOWNLOADABLE MUSICAL SOUND RECORDINGS; MUSIC-COMPOSITION SOFTWARE; MUSICAL SOUND RECORDINGS; SERIES OF MUSICAL SOUND RECORDINGS; VISUAL RECORDINGS AND AUDIOVISUAL RECORDINGS FEATURING MUSIC AND ANIMATION (U.S. CLS. 21, 23, 26, 36 AND 38).  
 FIRST USE 12-24-2009; IN COMMERCE 1-4-2010.  
 MARK SPARACINO, EXAMINING ATTORNEY

SN 85-305,408. FUTURE DIAL INCORPORATED, SUNNYVALE, CA. FILED 4-26-2011.

# Green T

THE MARK CONSISTS OF STANDARD CHARACTERS WITHOUT CLAIM TO ANY PARTICULAR FONT, STYLE, SIZE, OR COLOR.  
 FOR COMPUTER APPLICATION SOFTWARE FOR MOBILE PHONES, HANDHELD COMPUTERS AND OTHER MOBILE DEVICES, NAMELY, SOFTWARE FOR USE IN ERASING, DOWNLOADING AND UPDATING DATA, DOWNLOADING AND UPDATING FIRMWARE AND SOFTWARE, AND REFURBISHING (U.S. CLS. 21, 23, 26, 36 AND 38).  
 FIRST USE 2-11-2011; IN COMMERCE 2-11-2011.  
 WANDA KAY PRICE, EXAMINING ATTORNEY

**CLASS 9—(Continued).**

SN 85-305,567. WAYBETTER LTD, OR YEHUDA, ISRAEL, FILED 4-27-2011.

# WAYBETTER

THE MARK CONSISTS OF STANDARD CHARACTERS WITHOUT CLAIM TO ANY PARTICULAR FONT, STYLE, SIZE, OR COLOR.

FOR COMPUTER SOFTWARE AND APPLICATION SOFTWARE FOR ENABLING VEHICLE DISPATCH, TAXI DISPATCH, PUBLIC TRANSPORTATION SCHEDULING, RIDE-SHARING, RIDE ORDERING, CAR-POOLING, CARGO TRANSPORT AND OPTIMIZATION OF VEHICLE FLEETS (U.S. CLS. 21, 23, 26, 36 AND 38).

JANICE L. MCMORROW, EXAMINING ATTORNEY

**CLASS 9—(Continued).**

SN 85-306,567. INTERMIND CONNECTIONS, LLC, NORTH-BROOK, IL. FILED 4-27-2011.



SN 85-305,569. SAFETICA TECHNOLOGIES S.R.O., PRAHA, CZECH REPUBLIC, FILED 4-27-2011.



OWNER OF CZECH REPUBLIC REG. NO. 313336, DATED 7-21-2010, EXPIRES 7-21-2020.

THE MARK CONSISTS OF THE MARK CONSISTS THE TERM "SAFETICA" TOGETHER IS A STYLIZED GRAPHIC "S" ON A DESIGN OF TWO OVERLAID SQUARES.

FOR ANTI-SPYWARE SOFTWARE; AUTOMATED SYSTEMS, NAMELY, SOFTWARE, HARDWARE AND COMMUNICATIONS DEVICES FOR PLANNING, SCHEDULING, CONTROLLING, MONITORING AND PROVIDING INFORMATION ON TRANSPORTATION ASSETS AND PARTS THEREOF; COMMUNICATION SOFTWARE FOR PROVIDING ACCESS TO THE INTERNET; COMPUTER ANTI-VIRUS SOFTWARE; COMPUTER APPLICATION SOFTWARE FOR MOBILE PHONES, NAMELY, SOFTWARE FOR DATA LEAKAGE PREVENTION, APPLICATION CONTROL; COMPUTER APPLICATION SOFTWARE FOR MONITORING AND DATA LEAKAGE PREVENTION, NAMELY, SOFTWARE FOR MONITORING, DATA LEAKAGE, BEHAVIOR ANALYSIS OF USERS; COMPUTER SOFTWARE FOR ENCRYPTION; COMPUTER SOFTWARE FOR USE IN THE ENCRYPTION AND DECRYPTION OF DIGITAL FILES, INCLUDING AUDIO, VIDEO, TEXT, BINARY, STILL IMAGES, GRAPHICS AND MULTIMEDIA FILES; COMPUTER SOFTWARE FOR USE IN THE SAFEGUARDING OF DIGITAL FILES, INCLUDING AUDIO, VIDEO, TEXT, BINARY, STILL IMAGES, GRAPHICS AND MULTIMEDIA FILES; SOFTWARE FOR MONITORING AND CONTROLLING COMMUNICATION BETWEEN COMPUTERS AND AUTOMATED MACHINE SYSTEMS (U.S. CLS. 21, 23, 26, 36 AND 38).

JANICE L. MCMORROW, EXAMINING ATTORNEY

THE COLOR(S) BLACK, DARK BLUE AND LIGHT BLUE IS/ARE CLAIMED AS A FEATURE OF THE MARK.

THE MARK CONSISTS OF THE STYLIZED WORDING "INTERMIND CONNECTIONS" IN BLACK AND A FANCIFUL "I" APPEARING ABOVE THE TWO WORDS WITH THREE ARCS APPEARING TO THE UPPER RIGHT OF THE DOT ON THE LOWERCASE "I", ALL IN LIGHT BLUE AND DARK BLUE.

FOR USB OPERATING SOFTWARE, EPROM-BASED KEY SOFTWARE, AND COMPUTER APPLICATION SOFTWARE FOR MOBILE ELECTRONIC DEVICES THAT WHEN COMBINED WITH SUPPORTING TECHNOLOGY AND INFRASTRUCTURE IS DESIGNED TO FACILITATE AN ON-GOING, TWO-WAY, DIALOGUE WITH TARGET CUSTOMERS, DELIVERING MARKETING INFORMATION, PROMOTIONS OR EDUCATION INFORMATION IN A SECURE, PRIVATE ENVIRONMENT DEVOID OF INTERNET MONITORING ACTIVITIES, METHODOLOGIES OR TACTICS, THAT INFRINGE ON VISITOR'S PRIVACY RIGHTS WHILE SIMULTANEOUSLY PROVIDING CMOS AND CFOS WITH THE ABILITY TO GIVE VISIBILITY TO SALES, MARKETING AND DISTRIBUTION CHANNEL KEY PERFORMANCE INDICATORS THAT ARE CURRENTLY NOT AVAILABLE OR ONLY ACCESSIBLE AT A CONSIDERABLE COST TO THE SPONSORING ORGANIZATION (U.S. CLS. 21, 23, 26, 36 AND 38).

JULIE GUTTADAURO, EXAMINING ATTORNEY

**CLASS 9—(Continued).**

SN 85-307,948. GAOLI, XI'AN, SHAANXI PROVINCE, CHINA, FILED 4-29-2011.

# LAMPTRON

THE MARK CONSISTS OF STYLIZED WORDING "LAMPTRON".

THE WORDING "LAMPTRON" HAS NO MEANING IN A FOREIGN LANGUAGE.

FOR BABY MONITORS; BATTERY MONITORS; BLANK INTEGRATED CIRCUIT CARDS; CARD READERS FOR CREDIT CARDS; CARDS WITH INTEGRATED CIRCUITS; CHIP CARD READERS; COMPUTER MONITORS; COMPUTER PERIPHERAL DEVICES; ELECTRONIC CARD READERS; FLASH CARD READERS; INTERACTIVE VIDEO GAMES OF VIRTUAL REALITY COMPRISED OF COMPUTER HARDWARE FOR USE WITH AN EXTERNAL MONITOR AND SOFTWARE; LEVEL INDICATORS; MAGNETIC CODED CARD READERS; MAGNETIC ENCODED CARD READERS; OPTICAL CHARACTER READERS; OPTICAL DISK READERS; OPTICAL READERS; PRESSURE INDICATORS; REMOTE CONTROLS FOR ELECTRO-DYNAMIC APPARATUS; SIGNAL CONDITIONING AND COMMUNICATION DEVICES FOR INDUSTRIAL PROCESS CONTROL; SMART CARD READERS; SPEED INDICATORS; TECHNICAL MEASURING, TESTING AND CHECKING APPARATUS AND INSTRUMENTS FOR MEASURING, TESTING AND CHECKING THE TEMPERATURE, PRESSURE, QUANTITY AND CONCENTRATION OF GAS AND LIQUIDS; TELEVISION MONITORS; TEMPERATURE INDICATORS; TRANSMITTERS OF ELECTRONIC SIGNALS; VIDEO MONITORS; WATER LEVEL INDICATORS (U.S. CLS. 21, 23, 26, 36 AND 38).

JEFF DEFORD, EXAMINING ATTORNEY

SN 85-309,128. RETRAINER LLC, HENDERSON, NV. FILED 4-30-2011.

# hopeless in america

THE MARK CONSISTS OF STANDARD CHARACTERS WITHOUT CLAIM TO ANY PARTICULAR FONT, STYLE, SIZE, OR COLOR.

NO CLAIM IS MADE TO THE EXCLUSIVE RIGHT TO USE "AMERICA", APART FROM THE MARK AS SHOWN.

FOR MOTION PICTURE FILMS ABOUT REHABILITATION CENTERS, THEIR PATIENTS, AND NEW AND EXPERIMENTAL CURES AND TREATMENTS (U.S. CLS. 21, 23, 26, 36 AND 38).

GINA HAYES, EXAMINING ATTORNEY

**CLASS 9—(Continued).**

SN 85-309,416. MICHAEL N. RUBINSTEIN, DBA HYLOWARE, SAN FRANCISCO, CA, CA. FILED 5-2-2011.

# Hyloware

THE MARK CONSISTS OF STANDARD CHARACTERS WITHOUT CLAIM TO ANY PARTICULAR FONT, STYLE, SIZE, OR COLOR.

FOR COMPUTER APPLICATION SOFTWARE FOR MOBILE PHONES, DESKTOP COMPUTERS, AND HANDHELD COMPUTERS, NAMELY, SOFTWARE FOR PERSONAL ORGANIZATION, LIFE MANAGEMENT, AND TIME MAXIMIZATION; COMPUTER SOFTWARE FOR PERSONAL ORGANIZATION, LIFE MANAGEMENT, AND TIME MAXIMIZATION; COMPUTER SOFTWARE PLATFORMS FOR PERSONAL ORGANIZATION, LIFE MANAGEMENT, AND TIME MAXIMIZATION; DOWNLOADABLE SOFTWARE IN THE NATURE OF A MOBILE APPLICATION FOR PERSONAL ORGANIZATION, LIFE MANAGEMENT, AND TIME MAXIMIZATION (U.S. CLS. 21, 23, 26, 36 AND 38).

BARBARA GAYNOR, EXAMINING ATTORNEY

SN 85-309,841. LIVE NATION ENTERTAINMENT, INC., BEVERLY HILLS, CA. FILED 5-2-2011.

# PRICEMASTER

THE MARK CONSISTS OF STANDARD CHARACTERS WITHOUT CLAIM TO ANY PARTICULAR FONT, STYLE, SIZE, OR COLOR.

FOR COMPUTER SOFTWARE FOR FORECASTING AND OPTIMIZING TICKET SALES FOR LIVE EVENTS (U.S. CLS. 21, 23, 26, 36 AND 38).

FIRST USE 1-12-2011; IN COMMERCE 1-12-2011.

MATTHEW PAPPAS, EXAMINING ATTORNEY

**CLASS 9—(Continued).**

SN 85-310,369. ATLANTA BELTLINE, INC., ATLANTA, GA. FILED 5-2-2011.

## ATLANTA BELTLINE

THE MARK CONSISTS OF STANDARD CHARACTERS WITHOUT CLAIM TO ANY PARTICULAR FONT, STYLE, SIZE, OR COLOR.

OWNER OF U.S. REG. NOS. 3,356,126, 3,936,660 AND OTHERS.

NO CLAIM IS MADE TO THE EXCLUSIVE RIGHT TO USE "ATLANTA", APART FROM THE MARK AS SHOWN.

FOR DOWNLOADABLE ELECTRONIC NEWSLETTERS, WEBCASTS, ONLINE DISCUSSION BOARDS, NEWS BROADCASTS RELATING TO URBAN REDEVELOPMENT, TRANSIT, PARKS AND RECREATION, ECONOMIC DEVELOPMENT, AFFORDABLE HOUSING, ART, HISTORIC PRESERVATION, ENVIRONMENTAL CLEANUP AND RE-USE, WORKFORCE DEVELOPMENT, COMMUNITY INVOLVEMENT AND RELATED TOPICS (U.S. CLS. 21, 23, 26, 36 AND 38).

FIRST USE 8-1-2010; IN COMMERCE 8-1-2010.

TRACY CROSS, EXAMINING ATTORNEY

**CLASS 9—(Continued).**

SN 85-311,373. HARDAMON, HAROLD, DOTHAN, AL. AND KEYES, CHARLES SR, DOTHAN, AL. FILED 5-3-2011.



NO CLAIM IS MADE TO THE EXCLUSIVE RIGHT TO USE "BETHESDA PRODUCTION & FILM", APART FROM THE MARK AS SHOWN.

THE MARK CONSISTS OF THE STYLIZED TEXT "BETHESDA PRODUCTION & FILM" WITH A DESIGN OF AN OLD STYLE FILM CAMERA.

FOR DIGITAL MEDIA, NAMELY, DVDS FEATURING FILMS, NAMELY, MOVIES (U.S. CLS. 21, 23, 26, 36 AND 38).

RENEE MCCRAY, EXAMINING ATTORNEY

SN 85-311,421. JIN LIJIE, CHINO, CA. FILED 5-3-2011.

SN 85-310,716. CLASSIC INSTRUMENTS, INC., BOYNE CITY, MI. FILED 5-3-2011.



## THE FINISHING TOUCH

THE MARK CONSISTS OF STANDARD CHARACTERS WITHOUT CLAIM TO ANY PARTICULAR FONT, STYLE, SIZE, OR COLOR.

FOR GAUGES FOR VEHICLES, SPECIFICALLY, SPEEDOMETERS, TACHOMETERS, OIL PRESSURE GAUGES, OIL TEMPERATURE GAUGES, WATER PRESSURE GAUGES, WATER TEMPERATURE GAUGES, CYLINDER HEAD TEMPERATURE GAUGES, EXHAUST GAS TEMPERATURE GAUGES, VOLTMETERS, AMMETERS, AUTOMATIC GEAR SELECTOR INDICATORS, ODOMETERS AND ELECTRONIC TRANSDUCERS (U.S. CLS. 21, 23, 26, 36 AND 38).

ANTHONY RINKER, EXAMINING ATTORNEY

NO CLAIM IS MADE TO THE EXCLUSIVE RIGHT TO USE "SCALE", APART FROM THE MARK AS SHOWN.

THE COLOR(S) BLUE, BLACK, WHITE, GRAY, ORANGE AND PINK IS/ARE CLAIMED AS A FEATURE OF THE MARK.

THE MARK CONSISTS OF THE STYLIZED WORDING "ELITE SCALE" AND DESIGN OF AN ELECTRONIC SCALE. THE WORD "ELITE" APPEARS IN GRADUATED BLUE, WITH THE WORD "SCALE" APPEARING IN BLACK SCRIPT WITHIN THE BOTTOM PORTION OF THE LAST "E" IN "ELITE". TO THE LEFT OF THE WORDING IS THE DESIGN OF AN OPEN ELECTRONIC SCALE IN BLACK, GRAY AND WHITE. THE SCALE APPEARS AGAINST AN OVERLAPPING PATTERN OF OVAL-LIKE SHAPES IN PINK, ORANGE AND BLUE.

FOR WEIGHING EQUIPMENT, NAMELY, SCALES AND BALANCES INCLUDING POCKET SCALES, POSTAL SCALES, SHIPPING SCALES, JEWELRY SCALES, PRECISION BALANCES, INDUSTRIAL SCALES (U.S. CLS. 21, 23, 26, 36 AND 38).

JERI J. FICKES, EXAMINING ATTORNEY

**CLASS 9—(Continued).**

SN 85-311,934. PETERSON ADAPTATIONS, LLC, KIRKLAND, WA. FILED 5-4-2011.

**CLASS 9—(Continued).**

SN 85-312,638. MNB TECHNOLOGIES, INC., BLOOMINGTON, IN. FILED 5-4-2011.

iAdapt Fitness

fpgaEXPERT

THE MARK CONSISTS OF STANDARD CHARACTERS WITHOUT CLAIM TO ANY PARTICULAR FONT, STYLE, SIZE, OR COLOR.

NO CLAIM IS MADE TO THE EXCLUSIVE RIGHT TO USE "FITNESS", APART FROM THE MARK AS SHOWN.

FOR COMPUTER SOFTWARE FOR PROVIDING AUTOMATED FITNESS GUIDANCE AND ADVICE (U.S. CLS. 21, 23, 26, 36 AND 38).

BILL DAWE, EXAMINING ATTORNEY

THE MARK CONSISTS OF STANDARD CHARACTERS WITHOUT CLAIM TO ANY PARTICULAR FONT, STYLE, SIZE, OR COLOR.

FOR DOWNLOADABLE COMPUTER SOFTWARE FOR ELECTRONIC DESIGN AUTOMATION, NAMELY, IMPLEMENTATION AND VERIFICATION SOFTWARE PROGRAMS FOR THE DESIGN OF ELECTRONIC COMPONENTS AND BEHAVIORAL AND STRUCTURAL MODELS OF ELECTRONIC COMPONENTS; DOWNLOADABLE AUTOMATED TEST PROGRAM GENERATION SOFTWARE THAT CREATES COMPUTER PROGRAMS FOR TESTING THE FUNCTIONALITY OF ELECTRONIC AND ELECTRICAL APPARATUS, AND COMPUTER SOFTWARE FOR VALIDATING TEST PROGRAMS THAT HAVE BEEN GENERATED (U.S. CLS. 21, 23, 26, 36 AND 38).

FIRST USE 9-11-2009; IN COMMERCE 9-11-2009.  
JIM RINGLE, EXAMINING ATTORNEY

SN 85-312,535. MEITEK, INC., EL MONTE, CA. FILED 5-4-2011.

SN 85-312,964. ANDREW LESAVAGE, ASPEN, CO. FILED 5-5-2011.

meitrack

TUNNIK

THE COLOR(S) BLACK AND GREEN IS/ARE CLAIMED AS A FEATURE OF THE MARK.

THE MARK CONSISTS OF THE LITERAL ELEMENT OF THE MARK STYLIZED WITH THE "MEI" IN BLACK AND THE "TRACK" IN GREEN.

FOR GLOBAL POSITIONING SYSTEM (GPS) CONSISTING OF COMPUTERS, COMPUTER SOFTWARE, TRANSMITTERS, RECEIVERS, AND NETWORK INTERFACE DEVICES; SATELLITE NAVIGATIONAL SYSTEM, NAMELY, A GLOBAL POSITIONING SYSTEM (GPS) (U.S. CLS. 21, 23, 26, 36 AND 38).

FIRST USE 1-1-2011; IN COMMERCE 1-1-2011.  
JORDAN BAKER, EXAMINING ATTORNEY

THE MARK CONSISTS OF STANDARD CHARACTERS WITHOUT CLAIM TO ANY PARTICULAR FONT, STYLE, SIZE, OR COLOR.

FOR EYEWEAR STRAPS (U.S. CLS. 21, 23, 26, 36 AND 38).  
MARGERY A. TIERNEY, EXAMINING ATTORNEY

**CLASS 9—(Continued).**

SN 85-313,108. GAMESTOP, INC., GRAPEVINE, TX. FILED 5-5-2011.



THE MARK CONSISTS OF THE TERMS "RED" AND "SAMURAI" WITH A SAMURAI SWORD SLASH MARK ACROSS THE TERM "RED".

FOR COMPUTER, VIDEO AND ELECTRONIC GAME HARDWARE AND ACCESSORIES THEREFOR, NAMELY, COMPUTER PROGRAMS FOR VIDEO AND COMPUTER GAMES, HANDHELD JOY STICK UNITS FOR PLAYING VIDEO GAMES HEADSETS, MICROPHONES, CABLES, CONTROLLERS, REMOTE CONTROLS FOR USE WITH VIDEO AND COMPUTER GAMES, KEYBOARDS, PROTECTIVE CARRYING CASES SPECIALLY ADAPTED FOR VIDEO GAME CONSOLES FOR USE WITH AN EXTERNAL DISPLAY SCREEN OR MONITOR; COMPUTER GAME DISC CARRYING CASES, CONTROLLER CHARGING BASES, GAMEPADS; COMPUTER AND VIDEO GAME STARTER KITS COMPRISED OF EARPHONES, SCREEN PROTECTOR, STYLUS, CARRYING BAG, CLEANING CLOTH AND SOFT CARD FOR APPLYING SCREEN A PROTECTOR, POWER SUPPLIES, STEERING WHEELS, MOTION CONTROLLER ATTACHMENTS (U.S. CLS. 21, 23, 26, 36 AND 38).

KELLEY WELLS, EXAMINING ATTORNEY

SN 85-313,763. BREVIUM, INC., EAGLE MOUNTAIN, UT. FILED 5-5-2011.



NO CLAIM IS MADE TO THE EXCLUSIVE RIGHT TO USE "PATIENT REACTIVATION SOFTWARE", APART FROM THE MARK AS SHOWN.

THE MARK CONSISTS OF THE WORD "BREVIUM" FOLLOWED BY A DESIGN OF A STETHOSCOPE WITH A STOPWATCH AT ONE END, AND THE WORDING "PATIENT REACTIVATION SOFTWARE" APPEARING UNDERNEATH THE WORD "BREVIUM" AND THE STETHOSCOPE DESIGN.

FOR COMPUTER SOFTWARE FOR CONTROLLING AND MANAGING PATIENT MEDICAL INFORMATION (U.S. CLS. 21, 23, 26, 36 AND 38).

FIRST USE 4-0-2004; IN COMMERCE 4-0-2004.  
MORGAN WYNNE, EXAMINING ATTORNEY

**CLASS 9—(Continued).**

SN 85-314,354. LOUIS VALENTIN EYEWEAR, VERNON, CA. FILED 5-6-2011.

## Louis Valentin

THE MARK CONSISTS OF STANDARD CHARACTERS WITHOUT CLAIM TO ANY PARTICULAR FONT, STYLE, SIZE, OR COLOR.

THE NAME(S), PORTRAIT(S), AND/OR SIGNATURE(S) SHOWN IN THE MARK DOES NOT IDENTIFY A PARTICULAR LIVING INDIVIDUAL.

FOR CASES FOR EYEGLASSES AND SUNGLASSES; EYEWEAR ACCESSORIES, NAMELY, STRAPS, NECK CORDS AND HEAD STRAPS WHICH RESTRAIN EYEWEAR FROM MOVEMENT ON A WEARER; EYEWEAR CASES; EYEWEAR, NAMELY, SUNGLASSES, EYEGLASSES AND OPHTHALMIC FRAMES AND CASES THEREFOR; FRAMES FOR SPECTACLES AND SUNGLASSES; LENSES FOR SUNGLASSES; OPTICAL READERS; SUNGLASSES (U.S. CLS. 21, 23, 26, 36 AND 38).

FIRST USE 4-1-2010; IN COMMERCE 4-1-2010.  
TRACY CROSS, EXAMINING ATTORNEY

SN 85-314,621. WEBEXPANSION CYPRUS LIMITED, NICOSIA, CYPRUS, FILED 5-6-2011.

## TANSO APPS

THE MARK CONSISTS OF STANDARD CHARACTERS WITHOUT CLAIM TO ANY PARTICULAR FONT, STYLE, SIZE, OR COLOR.

NO CLAIM IS MADE TO THE EXCLUSIVE RIGHT TO USE "APPS", APART FROM THE MARK AS SHOWN.

THE ENGLISH TRANSLATION OF THE WORD "TANSO" IN THE MARK IS KOREAN FLUTE.

FOR DOWNLOADABLE SOFTWARE, NAMELY, DOWNLOADABLE COMPUTER GAMING SOFTWARE AND DOWNLOADABLE SOFTWARE FOR ORGANIZING, UPDATING AND MANAGING MULTIMEDIA COMPUTER FILES FOR USE WITH MOBILE DEVICES (U.S. CLS. 21, 23, 26, 36 AND 38).

FIRST USE 1-24-2011; IN COMMERCE 1-24-2011.  
MICHAEL TANNER, EXAMINING ATTORNEY



**CLASS 9—(Continued).**

SN 85-315,783. GLOBAL HARDGOODS, INC., CHAGRIN FALLS, OH. FILED 5-9-2011.

## Global Hardgoods

THE MARK CONSISTS OF STANDARD CHARACTERS WITHOUT CLAIM TO ANY PARTICULAR FONT, STYLE, SIZE, OR COLOR.

NO CLAIM IS MADE TO THE EXCLUSIVE RIGHT TO USE "HARDGOODS", APART FROM THE MARK AS SHOWN.

FOR ACETYLENE REGULATORS ; OXYGEN REGULATORS ; PRESSURE GAUGES ; FLOWMETERS ; SAFETY EYEWEAR ; SAFETY GOGGLES ; RESPIRATORS OTHER THAN FOR ARTIFICIAL RESPIRATION ; EAR PLUGS NOT FOR MEDICAL PURPOSES ; FACE PROTECTION SHIELDS ; WELDING HELMETS ; PROTECTIVE WORK GLOVES ; WELDING TORCHES ; WELDING ELECTRODES; WELDING TRANSFORMERS; BATTERY CABLES ; CABLE CONNECTORS ; ELECTRIC CABLES ; POWER CABLES ; EXTENSION CABLES ; TOOL MEASURING INSTRUMENTS ; MAGNETS, INCLUDING, DECORATIVE MAGNETS (U.S. CLS. 21, 23, 26, 36 AND 38).

FIRST USE 2-10-2011; IN COMMERCE 2-10-2011.  
ELI HELLMAN, EXAMINING ATTORNEY

**CLASS 9—(Continued).**

SN 85-315,933. HEWLETT-PACKARD DEVELOPMENT COMPANY, L.P., HOUSTON, TX. FILED 5-9-2011.



OWNER OF U.S. REG. NOS. 1,840,215, 3,412,631 AND OTHERS.

THE MARK CONSISTS OF A STYLIZED DRAWING OF A MOBILE DIGITAL ELECTRONIC DEVICE WITH AN IMAGE RESEMBLING STACKED PAPERS ON THE SCREEN, WITH THE WORDING "MADE FOR HP TOUCHPAD", ALL SURROUNDED BY A RECTANGLE WITH ROUNDED CORNERS.

FOR MOBILE COMPUTERS AND TABLET COMPUTERS; ACCESSORIES FOR THE FOREGOING, NAMELY, DOCKING CRADLES AND STANDS, CARRYING CASES, PROTECTIVE SCREEN COVERS, PROTECTIVE OR DECORATIVE SKINS FOR COVERING AND PROTECTING MOBILE COMPUTERS, BATTERIES, POWER ADAPTORS, COMPUTER CABLES, CABLE CONNECTORS, HEADSETS, MICROPHONES, AUDIO SPEAKERS, SPEAKER BASE STATIONS, BELT CLIPS; HOME THEATER SYSTEMS COMPRISING AUDIO SPEAKERS, AUDIO AND VIDEO RECEIVERS, AND AUDIO AND VIDEO MEDIA PLAYERS (U.S. CLS. 21, 23, 26, 36 AND 38).

MARK SHINER, EXAMINING ATTORNEY

SN 85-315,880. HEWLETT-PACKARD DEVELOPMENT COMPANY, L.P., HOUSTON, TX. FILED 5-9-2011.



OWNER OF U.S. REG. NOS. 1,840,215, 3,412,631 AND OTHERS.

THE MARK CONSISTS OF A STYLIZED DRAWING OF A MOBILE DIGITAL ELECTRONIC DEVICE WITH AN IMAGE RESEMBLING STACKED PAPERS ON THE SCREEN, WITH THE WORDING "MADE FOR HP TOUCHPAD", ALL SURROUNDED BY A RECTANGLE WITH ROUNDED CORNERS.

FOR MOBILE COMPUTERS AND TABLET COMPUTERS; ACCESSORIES FOR THE FOREGOING, NAMELY, DOCKING CRADLES AND STANDS, CARRYING CASES, PROTECTIVE SCREEN COVERS, PROTECTIVE OR DECORATIVE SKINS FOR COVERING AND PROTECTING MOBILE COMPUTERS, BATTERIES, POWER ADAPTORS, COMPUTER CABLES, CABLE CONNECTORS, HEADSETS, MICROPHONES, AUDIO SPEAKERS, SPEAKER BASE STATIONS, BELT CLIPS; HOME THEATER SYSTEMS COMPRISING AUDIO SPEAKERS, AUDIO AND VIDEO RECEIVERS, AND AUDIO AND VIDEO MEDIA PLAYERS (U.S. CLS. 21, 23, 26, 36 AND 38).

MARK SHINER, EXAMINING ATTORNEY

SN 85-315,959. HEWLETT-PACKARD DEVELOPMENT COMPANY, L.P., HOUSTON, TX. FILED 5-9-2011.

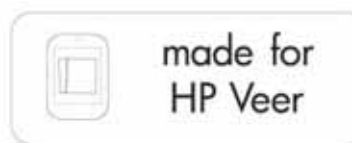

OWNER OF U.S. REG. NOS. 1,840,215, 3,412,631 AND OTHERS.

THE MARK CONSISTS OF A STYLIZED DRAWING OF A MOBILE DIGITAL ELECTRONIC DEVICE WITH AN IMAGE RESEMBLING STACKED PAPERS ON THE SCREEN, WITH THE WORDING "MADE FOR HP VEER", ALL SURROUNDED BY A RECTANGLE WITH ROUNDED CORNERS.

FOR MOBILE AND HANDHELD COMMUNICATIONS DEVICES FOR SENDING AND RECEIVING DATA, INFORMATION AND OTHER DIGITAL CONTENT, INCLUDING AUDIO AND VIDEO CONTENT, NAMELY, HANDHELD COMPUTERS, MOBILE PHONES AND SMARTPHONES; ACCESSORIES FOR THE FOREGOING, NAMELY, CAR PHONE MOUNTS, BICYCLE OR MOTORCYCLE HANDLEBAR PHONE HOLDERS, CARRYING CASES, PROTECTIVE SCREEN COVERS, PROTECTIVE OR DECORATIVE SKINS FOR COVERING AND PROTECTIVE MOBILE PHONES AND SMARTPHONES, BATTERIES, POWER ADAPTORS, COMPUTER CABLES, CABLE CONNECTORS, HEADSETS, MICROPHONES, AUDIO SPEAKERS, SPEAKER BASE STATIONS, BELT CLIPS; HOME THEATER SYSTEMS COMPRISING AUDIO SPEAKERS, AUDIO AND VIDEO RECEIVERS, AND AUDIO AND VIDEO MEDIA PLAYERS (U.S. CLS. 21, 23, 26, 36 AND 38).

MARK SHINER, EXAMINING ATTORNEY

**CLASS 9—(Continued).**

SN 85-315,996. HEWLETT-PACKARD DEVELOPMENT COMPANY, L.P., HOUSTON, TX. FILED 5-9-2011.



OWNER OF U.S. REG. NOS. 1,840,215, 3,412,631 AND OTHERS.

THE MARK CONSISTS OF A STYLIZED DRAWING OF A MOBILE DIGITAL ELECTRONIC DEVICE WITH AN IMAGE RESEMBLING STACKED PAPERS ON THE SCREEN, WITH THE WORDING "MADE FOR HP PRE3", ALL SURROUNDED BY A RECTANGLE WITH ROUNDED CORNERS.

FOR MOBILE AND HANDHELD COMMUNICATIONS DEVICES FOR SENDING AND RECEIVING DATA, INFORMATION AND OTHER DIGITAL CONTENT, INCLUDING AUDIO AND VIDEO CONTENT, NAMELY, HANDHELD COMPUTERS, MOBILE PHONES AND SMARTPHONES; ACCESSORIES FOR THE FOREGOING, NAMELY, CAR PHONE MOUNTS, BICYCLE OR MOTORCYCLE HANDLEBAR PHONE HOLDERS, CARRYING CASES, PROTECTIVE SCREEN COVERS, PROTECTIVE OR DECORATIVE SKINS FOR COVERING AND PROTECTIVE MOBILE PHONES AND SMARTPHONES, BATTERIES, POWER ADAPTORS, COMPUTER CABLES, CABLE CONNECTORS, HEADSETS, MICROPHONES, AUDIO SPEAKERS, SPEAKER BASE STATIONS, BELT CLIPS; HOME THEATER SYSTEMS COMPRISING AUDIO SPEAKERS, AUDIO AND VIDEO RECEIVERS, AND AUDIO AND VIDEO MEDIA PLAYERS (U.S. CLS. 21, 23, 26, 36 AND 38).

MARK SHINER, EXAMINING ATTORNEY

**CLASS 9—(Continued).**

SN 85-316,242. PROCOMSOL LTD, LAKEWOOD, OH. FILED 5-9-2011.

**DEVCOM2000**

THE MARK CONSISTS OF STANDARD CHARACTERS WITHOUT CLAIM TO ANY PARTICULAR FONT, STYLE, SIZE, OR COLOR.

FOR COMPUTER SOFTWARE FOR COMMUNICATING, CONFIGURING, CALIBRATING, MONITORING AND PERFORMING DIAGNOSTICS ON INSTRUMENTS IN THE FIELDS OF FACTORY AUTOMATION AND PROCESS CONTROL (U.S. CLS. 21, 23, 26, 36 AND 38).

FIRST USE 8-10-2006; IN COMMERCE 8-10-2006.

MARCIE MILONE, EXAMINING ATTORNEY

SN 85-317,100. 745 LLC, BOSTON, MA. FILED 5-10-2011.

**SOULO**

THE MARK CONSISTS OF STANDARD CHARACTERS WITHOUT CLAIM TO ANY PARTICULAR FONT, STYLE, SIZE, OR COLOR.

FOR COMPUTER SOFTWARE APPLICATIONS IN THE FIELD OF MUSICAL VIDEO AND AUDIO RECORDING, FOR USE IN CONNECTION WITH MOBILE WIRELESS DEVICES, CELLULAR AND MOBILE PHONES, AND OTHER HANDHELD ELECTRONIC DEVICES; COMPUTER SOFTWARE APPLICATIONS FOR THE DOWNLOADING AND REPLAYING OF KARAOKE MUSIC TRACKS ON WIRELESS DEVICES, CELLULAR AND MOBILE PHONE, AND OTHER HANDHELD ELECTRONIC DEVICES; COMPUTER SOFTWARE APPLICATIONS FOR THE RECORDING AND PLAYBACK OF AUDIO TRACKS AND VIDEO FILES ON WIRELESS DEVICES, CELLULAR AND MOBILE PHONE, AND OTHER HANDHELD ELECTRONIC DEVICES; COMPUTER SOFTWARE APPLICATIONS FOR POSTING OF AUDIO TRACKS AND VIDEO FILES ON SOCIAL NETWORKING WEB SITES BY MEANS OF MOBILE WIRELESS DEVICES, CELLULAR AND MOBILE PHONES AND OTHER HANDHELD ELECTRONIC DEVICES; MICROPHONES; MICROPHONES FOR USE WITH HAND-HELD ELECTRONIC DEVICES (U.S. CLS. 21, 23, 26, 36 AND 38).

MORGAN WYNNE, EXAMINING ATTORNEY

SN 85-316,223. PROCOMSOL LTD, LAKEWOOD, OH. FILED 5-9-2011.

**PROCOMSOL**

THE MARK CONSISTS OF STANDARD CHARACTERS WITHOUT CLAIM TO ANY PARTICULAR FONT, STYLE, SIZE, OR COLOR.

FOR COMPUTER SOFTWARE FOR COMMUNICATING, CONFIGURING, CALIBRATING, MONITORING AND PERFORMING DIAGNOSTICS ON INSTRUMENTS IN THE FIELDS OF FACTORY AUTOMATION AND PROCESS CONTROL; COMPUTER HARDWARE FOR COMMUNICATING AND PROVIDING THE CAPABILITY OF CONFIGURING, CALIBRATING, MONITORING AND PERFORMING DIAGNOSTICS ON INSTRUMENTS IN THE FIELDS OF FACTORY AUTOMATION AND PROCESS CONTROL (U.S. CLS. 21, 23, 26, 36 AND 38).

FIRST USE 5-18-2005; IN COMMERCE 5-18-2005.

MARCIE MILONE, EXAMINING ATTORNEY

**CLASS 9—(Continued).**

SN 85-317,459. MIZCO INTERNATIONAL INC., AVENEL, NJ. FILED 5-10-2011.



THE COLOR(S) CHROME YELLOW, BLACK, AND WHITE IS/ARE CLAIMED AS A FEATURE OF THE MARK. THE MARK CONSISTS OF A SOLID BLACK HEXAGON CONTAINING A LETTER "T" APPEARING IN CHROME YELLOW, BLACK AND WHITE, FOLLOWED BY THE WORDING "TOUGHTTESTED" IN BLACK.

FOR BATTERY CABLES; BATTERY CASES; BATTERY CHARGERS; BEEPER CARRYING CASES; CARRYING CASES FOR CELL PHONES; CARRYING CASES FOR RADIO PAGERS; CARRYING CASES SPECIALLY ADAPTED FOR POCKET CALCULATORS AND CELLPHONES; CASES FOR DISKETTES AND COMPACT DISKS; CASES FOR ELECTRONIC DIARIES; CASES FOR MOBILE PHONES; CASES FOR POCKET CALCULATORS; CASES FOR TELEPHONES; COMPACT DISC CASES; COMPUTER CARRYING CASES; DVD CASES; LAPTOP CARRYING CASES; PROTECTIVE CARRYING CASES FOR PORTABLE MUSIC PLAYERS, NAMELY, MP3 PLAYERS; PROTECTIVE CARRYING CASES SPECIALLY ADAPTED FOR PERSONAL DIGITAL ASSISTANTS (PDA) (U.S. CLS. 21, 23, 26, 36 AND 38).

FIRST USE 6-15-2009; IN COMMERCE 1-21-2010.  
DEBRA LEE, EXAMINING ATTORNEY

SN 85-317,586. ON THE LEVEL GAME STUDIOS, LLC, HOUSTON, TX. FILED 5-10-2011.



NO CLAIM IS MADE TO THE EXCLUSIVE RIGHT TO USE "GAME STUDIOS", APART FROM THE MARK AS SHOWN.

THE COLOR(S) RED, BLACK AND GRAY IS/ARE CLAIMED AS A FEATURE OF THE MARK.

THE MARK CONSISTS OF CIRCLE DESIGN, WITH A CENTER CIRCLE OF GRAY AND CIRCLE OF BLACK LEAVES WITHIN, SURROUNDED BY A BAND OF RED, WHICH IS SURROUNDED BY A BAND OF GRAY WITH THE WORDING "ON THE LEVEL GAME STUDIOS" WRITTEN IN BLACK LETTERS.

FOR COMPUTER PROGRAMS FOR VIDEO AND COMPUTER GAMES (U.S. CLS. 21, 23, 26, 36 AND 38).

CURTIS FRENCH, EXAMINING ATTORNEY

**CLASS 9—(Continued).**

SN 85-317,589. ON THE LEVEL GAME STUDIOS, LLC, HOUSTON, TX. FILED 5-10-2011.

ON THE LEVEL GAME STUDIOS

THE MARK CONSISTS OF STANDARD CHARACTERS WITHOUT CLAIM TO ANY PARTICULAR FONT, STYLE, SIZE, OR COLOR.

NO CLAIM IS MADE TO THE EXCLUSIVE RIGHT TO USE "GAME STUDIOS", APART FROM THE MARK AS SHOWN.

FOR COMPUTER PROGRAMS FOR VIDEO AND COMPUTER GAMES (U.S. CLS. 21, 23, 26, 36 AND 38).

CURTIS FRENCH, EXAMINING ATTORNEY

SN 85-317,599. CHENGDU PARAKEN TECHNOLOGY LTD, CHENGDU, SICHUAN, CHINA, FILED 5-11-2011.



THE COLOR(S) RED, BLUE, WHITE, GRAY, GREEN, ORANGE, TURQUOISE AND PURPLE IS/ARE CLAIMED AS A FEATURE OF THE MARK.

THE MARK CONSISTS OF A STYLIZED WHITE "M" ON TOP OF THREE SUPERIMPOSED IRIDESCENT TRIANGLES APPEARING IN GREEN, RED, BLUE, ORANGE, TURQUOISE AND PURPLE. THE WORD "MUSEMAGE" APPEARS IN GRAY.

FOR COMPUTER PROGRAMS FOR EDITING IMAGES, SOUND AND VIDEO; SOFTWARE FOR PROCESSING IMAGES, GRAPHICS AND TEXT (U.S. CLS. 21, 23, 26, 36 AND 38).

SAIMA MAKHDOOM, EXAMINING ATTORNEY

**CLASS 9—(Continued).**

SN 85-317,884. INTERNATIONAL MAPS, INC., REDONDO BEACH, CA. FILED 5-11-2011.



THE COLOR(S) BLUE, BLACK AND WHITE IS/ARE CLAIMED AS A FEATURE OF THE MARK.

THE MARK CONSISTS OF A FACE OF A BLACK AND WHITE MONKEY WITHIN A BLUE AND BLACK GLOBE OF THE EARTH.

FOR COMPUTER SOFTWARE AND PROGRAMS USED FOR NAVIGATIONAL PURPOSES; COMPUTER SOFTWARE AND PROGRAMS THAT ENABLE DIVERSE SYSTEMS TO BE USED COMPATIBLY; COMPUTER SOFTWARE AND PROGRAMS THAT PROVIDE GRAPHIC ILLUSTRATIONS, MAPS AND LOCATIONS TO THE USER; COMPUTER SOFTWARE AND PROGRAMS THAT PROVIDE ASSISTANCE IN ARRIVING AT A DESTINATION (U.S. CLS. 21, 23, 26, 36 AND 38).

DAVID COLLIER, EXAMINING ATTORNEY

---

SN 85-318,461. PEAKLAND INNOVATION GROUP, LLC, CHARLOTTE, NC. FILED 5-11-2011.



THE MARK CONSISTS OF AN UPSIDE DOWN DIALOGUE BALLOON FORMING A LOWERCASE LETTER "b".

FOR COMPUTER SOFTWARE FOR MESSAGING BETWEEN USERS; COMPUTER SOFTWARE FOR INSTANT MESSAGING THAT MAY BE DOWNLOADED FROM A GLOBAL COMPUTER NETWORK; DOWNLOADABLE SOFTWARE FOR USER MESSAGING BETWEEN WIRELESS ELECTRONIC DEVICES (U.S. CLS. 21, 23, 26, 36 AND 38).

FIRST USE 5-11-2011; IN COMMERCE 5-11-2011.

NELSON SNYDER, EXAMINING ATTORNEY

**CLASS 9—(Continued).**

SN 85-319,057. NET POWER AND LIGHT, INC., SAN FRANCISCO, CA. FILED 5-12-2011.

YOU AND YOUR WORLD TURNED  
ON

THE MARK CONSISTS OF STANDARD CHARACTERS WITHOUT CLAIM TO ANY PARTICULAR FONT, STYLE, SIZE, OR COLOR.

FOR MOBILE ELECTRONIC DEVICES, NAMELY, RECEPTORS AND TRANSMITTERS TO PROCESS DATA FOR REMOTE COMPUTING APPLICATIONS; COMPUTER SOFTWARE FOR RECEPTORS AND TRANSMITTERS TO PROCESS DATA FOR REMOTE COMPUTING APPLICATIONS; COMPUTER SOFTWARE TO PROCESS DATA FOR DISTRIBUTED COMPUTING APPLICATIONS; COMPUTER SOFTWARE FOR STREAMING AUDIO AND VIDEO CONTENT TO A VARIETY OF REMOTE DEVICES, NAMELY, HANDHELD COMPUTERS, LAPTOPS, PERSONAL COMPUTERS, MOBILE PHONES, TV'S, PROJECTORS, STAND-ALONE HARDWARE DECODERS AND MOBILE ELECTRONIC DEVICES; COMPUTER HARDWARE, INTEGRATED CIRCUITS, DIGITAL MEDIA SERVERS; COMPUTER SOFTWARE DEVELOPMENT TOOLS; COMPUTER SOFTWARE DEVELOPMENT TOOLS FOR CREATING COMPUTER SOFTWARE TO PROCESS DATA FOR DISTRIBUTED COMPUTING APPLICATIONS; COMPUTER SOFTWARE DEVELOPMENT TOOLS FOR CREATING COMPUTER SOFTWARE FOR STREAMING AUDIO AND VIDEO CONTENT TO A VARIETY OF REMOTE DEVICES, NAMELY, HANDHELD COMPUTERS, LAPTOPS, PERSONAL COMPUTERS, MOBILE PHONES, TV'S, PROJECTORS, STAND-ALONE HARDWARE DECODERS AND MOBILE ELECTRONIC DEVICES; COMPUTER DEVELOPMENT TOOLS FOR CREATING SOFTWARE FOR USE IN PROVIDING, HOSTING, MANAGING, DEVELOPING, AND MAINTAINING APPLICATIONS, SOFTWARE, WEB SITES, AND DATABASES FOR WIRELESS COMMUNICATION, MOBILE INFORMATION ACCESS, AND REMOTE DATA MANAGEMENT FOR WIRELESS DELIVERY OF DATA AND CONTENT TO HANDHELD COMPUTERS, LAPTOPS, PERSONAL COMPUTERS, MOBILE PHONES, TV'S, PROJECTORS, STAND-ALONE HARDWARE DECODERS AND MOBILE ELECTRONIC DEVICES; COMPUTER SOFTWARE DEVELOPMENT TOOLS FOR CREATING SOFTWARE FOR USE IN DISTRIBUTED COMPUTING FEATURING NON-DOWNLOADABLE SOFTWARE ALLOWING USERS TO UPLOAD, POST AND DISPLAY ONLINE DIGITAL CONTENT FOR SHARING WITH OTHERS FOR ENTERTAINMENT PURPOSES; COMPUTER SOFTWARE DEVELOPMENT TOOLS FOR CREATING SOFTWARE WHICH ALLOWS USERS TO COLLABORATE IN THE PREPARATION, UPLOADING, DOWNLOADING, SHARING, PUBLISHING, RECEPTION AND TRANSMISSION OF DIGITAL CONTENT TO REMOTE DEVICES; COMPUTER SOFTWARE FOR PLAYING VIDEO GAMES AND OPERATING SENSOR DEVICES; COMPUTER PERIPHERALS; COMPUTER AND VIDEO GAME SYSTEM DEVICES, NAMELY, ELECTRONIC SENSOR DEVICES, CAMERAS, PROJECTORS, AND MICROPHONES FOR CAPTURING HUMAN GESTURES AND FACIAL EXPRESSIONS AND FOR VOICE RECOGNITION; COMPUTER SOFTWARE FOR CONTROLLING MOBILE AND ENTERTAINMENT DEVICES; COMPUTER SOFTWARE FOR CONTROLLING, VIEWING, ACCESSING, BROWSING AND UTILIZING GLOBAL COMPUTER, COMMUNICATION AND ENTERTAINMENT NETWORKS; COMPUTER SOFTWARE FOR ACCESSING FILES FROM THE INTERNET AND FROM LOCAL NETWORKS AND DISPLAYING THEM ON COMPUTERS AND MOBILE DEVICES; COMPUTER OPERATING SOFTWARE; INTERNET BROWSER SOFTWARE; DOWNLOADABLE

**CLASS 9—(Continued).**

INTERNET BROWSER SOFTWARE; COMPUTER SOFTWARE FOR USE IN ORGANIZING, TRANSMITTING, MANIPULATING AND REVIEWING TEXT, DATA AND AUDIO FILES ON PORTABLE AND HANDHELD DIGITAL ELECTRONIC DEVICES; WIRELESS DEVICES FOR COMMUNICATIONS, NAMELY, TELEPHONES AND MOBILE DIGITAL DEVICES, NAMELY, MOBILE PHONES, SMART PHONES, TABLET COMPUTERS, HAND-HELD COMPUTERS, LAPTOPS, DIGITAL AUDIO AND VIDEO PLAYERS, COMPUTER GAME CONSOLES FOR USE WITH AN EXTERNAL DISPLAY SCREEN OR MONITOR (U.S. CLS. 21, 23, 26, 36 AND 38).  
ALEX KEAM, EXAMINING ATTORNEY

**CLASS 9—(Continued).**

SN 85-319,542. INTERSERV INTERNATIONAL INC., TAIPEI CITY, TAIWAN, FILED 5-12-2011.



SN 85-319,103. SPIELO INTERNATIONAL CANADA ULC, MONCTON, NEW BRUNSWICK, CANADA, FILED 5-12-2011.

**QUICK PAY JACKPOTS**

THE MARK CONSISTS OF STANDARD CHARACTERS WITHOUT CLAIM TO ANY PARTICULAR FONT, STYLE, SIZE, OR COLOR.

PRIORITY CLAIMED UNDER SEC. 44(D) ON CANADA APPLICATION NO. 1518127, FILED 3-8-2011.

OWNER OF U.S. REG. NOS. 3,292,756 AND 3,716,759.

NO CLAIM IS MADE TO THE EXCLUSIVE RIGHT TO USE "JACKPOTS", APART FROM THE MARK AS SHOWN.

FOR RECONFIGURABLE CASINO AND LOTTERY GAMING EQUIPMENT, NAMELY, GAMING MACHINES AND OPERATIONAL COMPUTER GAME SOFTWARE THEREFOR (U.S. CLS. 21, 23, 26, 36 AND 38).

DANIEL CAPSHAW, EXAMINING ATTORNEY

THE COLOR(S) YELLOW, ORANGE, RED, BROWN, GRAY, LIGHT YELLOW AND DARK YELLOW IS/ARE CLAIMED AS A FEATURE OF THE MARK.

THE MARK CONSISTS OF THE WORDS "SCARLET LEGACY" IN LIGHT YELLOW, DARK YELLOW, GRAY AND BROWN WITH THE DESIGN OF A YELLOW, RED AND ORANGE DRAGON IN THE BACKGROUND. THE LETTER "S" IN "SCARLET" IS SHAPED IN THE DESIGN OF A SECOND DRAGON.

FOR COMPUTER HARDWARE; COMPUTER GAME SOFTWARE; COMPUTER GAME SOFTWARE THAT MAY BE DOWNLOADED FROM A GLOBAL COMPUTER NETWORK; COMPUTER INTERFACE CARDS; PERSONAL DIGITAL ASSISTANTS (PDA); ELECTRONIC BOOKS IN THE FIELDS OF COMPUTERS, SCIENCE, LITERATURE, ART, TRAVELING AND COMPUTER GAMES; BLANK COMPACT DISCS; MOUSE PADS; MUSIC DOWNLOADED FROM A GLOBAL COMPUTER NETWORK; MOTION PICTURE FILMS DOWNLOADED FROM A GLOBAL COMPUTER NETWORK IN THE FIELDS OF COMPUTERS, SCIENCE, LITERATURE, ART, TRAVELING AND COMPUTER GAMES; BOOKS DOWNLOADED FROM A GLOBAL COMPUTER NETWORK IN THE FIELDS OF COMPUTERS, SCIENCE, LITERATURE, ART, TRAVELING AND COMPUTER GAMES; PICTURES DOWNLOADED FROM A GLOBAL COMPUTER NETWORK IN THE FIELDS OF COMPUTERS, SCIENCE, LITERATURE, ART, TRAVELING AND COMPUTER GAMES; PORTABLE FLASH MEMORIES; COMPUTER GAME PROGRAMS RECORDED ON MAGNETIC DATA CARRIERS; COMPUTER GAME PROGRAMS RECORDED ON MAGNETIC DISCS; COMPUTER GAME PROGRAMS RECORDED ON COMPACT DISCS; COMPUTER GAME PROGRAMS RECORDED ON VIDEO COMPACT DISCS; COMPUTER GAME PROGRAMS RECORDED ON CD-ROMS; COMPUTER GAME PROGRAMS DOWNLOADED FROM A GLOBAL COMPUTER NETWORK; VIDEO GAME SOFTWARE FOR USE WITH TELEVISIONS; VIDEO GAME MACHINES FOR USE WITH TELEVISIONS (U.S. CLS. 21, 23, 26, 36 AND 38).

TINA MAI, EXAMINING ATTORNEY



**CLASS 9—(Continued).**

SN 85-319,700. KABUSHIKI KAISHA TAITO, TOKYO 151-0053, JAPAN, FILED 5-12-2011.

**BUST A MOVE UNIVERSE**

THE MARK CONSISTS OF STANDARD CHARACTERS WITHOUT CLAIM TO ANY PARTICULAR FONT, STYLE, SIZE, OR COLOR.

OWNER OF U.S. REG. NOS. 3,373,500 AND 3,926,389.  
FOR VIDEO AND COMPUTER GAME PROGRAMS FOR HANDHELD GAME MACHINES WITH A DISPLAY SCREEN; DOWNLOADABLE SOFTWARE FOR USE AS GAME PROGRAMS ON HANDHELD GAME MACHINES WITH A DISPLAY SCREEN; COMPUTER GAME PROGRAMS FOR HANDHELD GAME MACHINES WITH A DISPLAY SCREEN PRE-RECORDED ON CARTRIDGES; PRE-RECORDED MAGNETIC DATA CARRIERS FEATURING GAMES; PRE-RECORDED DIGITAL VIDEO DISCS FEATURING GAMES; COMPUTER GAME PROGRAMS FOR CELLULAR PHONES; DOWNLOADABLE COMPUTER GAME PROGRAMS FOR CELLULAR PHONES; COMPUTER GAME PROGRAMS FOR PERSONAL DIGITAL ASSISTANTS; DOWNLOADABLE GAME PROGRAMS FOR PERSONAL DIGITAL ASSISTANTS; COMPUTER GAME PROGRAMS FOR PERSONAL COMPUTERS; DOWNLOADABLE COMPUTER GAME PROGRAMS FOR PERSONAL COMPUTERS; PRE-RECORDED COMPUTER GAME PROGRAMS FOR PERSONAL COMPUTERS ON ELECTRONIC CIRCUITS, OPTICAL DISCS, MAGNETIC DISCS, TAPES AND ROM CARTRIDGES; VIDEO GAME PROGRAMS FOR HOME USE GAME MACHINES; VIDEO GAME PROGRAMS FOR HOME USE GAME MACHINES PRE-RECORDED ON ELECTRONIC CIRCUITS, OPTICAL DISCS, MAGNETIC DISCS, TAPES AND ROM CARTRIDGES; DOWNLOADABLE VIDEO GAME PROGRAMS FOR HOME USE GAME MACHINES; COMPUTER GAME SOFTWARE; VIDEO GAME SOFTWARE (U.S. CLS. 21, 23, 26, 36 AND 38).

FIRST USE 2-26-2011; IN COMMERCE 3-27-2011.  
KAELIE KUNG, EXAMINING ATTORNEY

SN 85-319,769. SCL ÉLÉMENTS INC., MONTRÉAL (QUÉBEC), CANADA, FILED 5-12-2011.

**Can2Go**

THE MARK CONSISTS OF STANDARD CHARACTERS WITHOUT CLAIM TO ANY PARTICULAR FONT, STYLE, SIZE, OR COLOR.

FOR BUILDING CONTROL AUTOMATION SYSTEM COMPRISING OF WIRELESS AND WIRED CONTROLLERS FOR LIGHTING, HVAC, SECURITY, AND SENSORS FOR TEMPERATURE, HUMIDITY, CO<sub>2</sub>, PRESSURE, LUMINOSITY AND OCCUPANCY (U.S. CLS. 21, 23, 26, 36 AND 38).

FIRST USE 3-30-2008; IN COMMERCE 1-31-2010.  
ROSELLE HERRERA, EXAMINING ATTORNEY

**CLASS 9—(Continued).**

SN 85-320,210. COLEMAN CABLE, INC., WAUKEGAN, IL. FILED 5-13-2011.

**CONTINENTAL**

THE MARK CONSISTS OF STANDARD CHARACTERS WITHOUT CLAIM TO ANY PARTICULAR FONT, STYLE, SIZE, OR COLOR.

FOR POWER OR ELECTRIC HIGH TEMPERATURE LEAD WIRE AND CONTROL CABLES (U.S. CLS. 21, 23, 26, 36 AND 38).

FIRST USE 0-0-1997; IN COMMERCE 0-0-1997.  
ANGELA M. MICHELI, EXAMINING ATTORNEY

SN 85-320,997. POSI-MED LLC, STERLING, VA. FILED 5-13-2011.

**AseptiLab**

THE MARK CONSISTS OF STANDARD CHARACTERS WITHOUT CLAIM TO ANY PARTICULAR FONT, STYLE, SIZE, OR COLOR.

FOR LABORATORY CHEMICAL REACTORS (U.S. CLS. 21, 23, 26, 36 AND 38).

FIRST USE 5-13-2011; IN COMMERCE 5-13-2011.  
LAURA HAMMEL, EXAMINING ATTORNEY

SN 85-321,124. DAYCATIONS, LLC, CHICAGO, IL. FILED 5-14-2011.

**DAYCATIONS**

NO CLAIM IS MADE TO THE EXCLUSIVE RIGHT TO USE "DAYCATIONS", APART FROM THE MARK AS SHOWN.

THE MARK CONSISTS OF THE WORD "DAYCATIONS" WITH THE "O" REPRESENTED AS A BOUNCING BEACH BALL.

FOR DOWNLOADABLE ELECTRONIC TRAVEL GUIDES AND ITINERARIES FEATURING LOCAL ATTRACTIONS, RESTAURANTS, AMUSEMENTS, AND LANDMARKS (U.S. CLS. 21, 23, 26, 36 AND 38).

HEATHER THOMPSON, EXAMINING ATTORNEY

**CLASS 9—(Continued).**

SN 85-321,177. SOLCON CORPORATION, DBA QUICKMEDICAL, ISSAQUAH, WA. FILED 5-14-2011.

# Heightronic

THE MARK CONSISTS OF STANDARD CHARACTERS WITHOUT CLAIM TO ANY PARTICULAR FONT, STYLE, SIZE, OR COLOR.

FOR WALL-MOUNTED RULERS FOR MEASURING A PERSON'S HEIGHT (U.S. CLS. 21, 23, 26, 36 AND 38).  
FIRST USE 1-31-1993; IN COMMERCE 1-31-1994.  
TRACY FLETCHER, EXAMINING ATTORNEY

---

SN 85-321,451. ELECTRONIC THEATRE CONTROLS, INC., MIDDLETON, WI. FILED 5-16-2011.

# EOS T3

THE MARK CONSISTS OF STANDARD CHARACTERS WITHOUT CLAIM TO ANY PARTICULAR FONT, STYLE, SIZE, OR COLOR.

OWNER OF U.S. REG. NO. 3,299,665.  
FOR ELECTRIC LIGHTING CONTROL CONSOLES (U.S. CLS. 21, 23, 26, 36 AND 38).  
NATALIE POLZER, EXAMINING ATTORNEY

---

SN 85-321,530. SIMON, ISIAH E, DBA THONG MAGAZINE, GARDENA, CA. FILED 5-16-2011.



NO CLAIM IS MADE TO THE EXCLUSIVE RIGHT TO USE "THONG", APART FROM THE MARK AS SHOWN.

THE MARK CONSISTS OF THE WORDING "THONG" WITH THE LETTER "O" OF THAT WORDING APPEARING IN A DESIGN OF AN UPSIDE DOWN HEART SHAPE WEARING A THONG PANTY. THE BLACK RECTANGLE REPRESENTS BACKGROUND AND IS NOT INTENDED AS PART OF THE MARK.

FOR VIDEO MAGAZINE RECORDED ON ELECTRONIC MEDIA FEATURING FEMALES WEARING THONG PANTIES (U.S. CLS. 21, 23, 26, 36 AND 38).

FIRST USE 6-22-2008; IN COMMERCE 9-27-2010.  
SAMUEL E. SHARPER JR., EXAMINING ATTORNEY

**CLASS 9—(Continued).**

SN 85-321,775. FUNDRIVER, INC., CINCINNATI, OH. FILED 5-16-2011.

# FUNDRIVER

THE MARK CONSISTS OF STANDARD CHARACTERS WITHOUT CLAIM TO ANY PARTICULAR FONT, STYLE, SIZE, OR COLOR.

OWNER OF U.S. REG. NO. 2,911,740.  
FOR COMPUTER SOFTWARE FOR USE BY NON-PROFIT ORGANIZATIONS TO PERFORM ACCOUNTING TASKS (U.S. CLS. 21, 23, 26, 36 AND 38).  
FIRST USE 1-0-2003; IN COMMERCE 2-26-2003.  
MATTHEW EINSTEIN, EXAMINING ATTORNEY

---

SN 85-321,871. CANTER, GARY, LOS ANGELES, CA. AND CANTER, TRACI, LOS ANGELES, CA. FILED 5-16-2011.

# Deliboy Slots

THE MARK CONSISTS OF STANDARD CHARACTERS WITHOUT CLAIM TO ANY PARTICULAR FONT, STYLE, SIZE, OR COLOR.

NO CLAIM IS MADE TO THE EXCLUSIVE RIGHT TO USE "SLOTS", APART FROM THE MARK AS SHOWN.  
FOR SLOT MACHINES (U.S. CLS. 21, 23, 26, 36 AND 38).

CAROLINE WOOD, EXAMINING ATTORNEY

---

SN 85-321,878. CODING STRATEGIES, INC., POWDER SPRINGS, GA. FILED 5-16-2011.

# eNAV

THE MARK CONSISTS OF STANDARD CHARACTERS WITHOUT CLAIM TO ANY PARTICULAR FONT, STYLE, SIZE, OR COLOR.

FOR DIGITAL MATERIALS, NAMELY, DOWNLOADABLE REFERENCE GUIDES IN THE FIELD OF MEDICAL CODING (U.S. CLS. 21, 23, 26, 36 AND 38).

KRISTIN CARLSON, EXAMINING ATTORNEY

**CLASS 9—(Continued).**

SN 85-321,888. PAPA PRODUCTS, LLC, BOSTON, MA. FILED 5-16-2011.



THE COLOR(S) ORANGE, WHITE AND GRAY IS/ARE CLAIMED AS A FEATURE OF THE MARK.

THE MARK CONSISTS OF A STYLIZED IMAGE IN WHITE OF A CHILD IN A STROLLER INSIDE AN ORANGE CIRCLE THAT IS SUPERIMPOSED ON A DESIGN OF A STYLIZED STREET MAP THAT IS COMPOSED OF A GROUP OF EVENLY SPACED GREY RECTANGLE WITH WHITE LINES BETWEEN THEM THAT FORMS AN OVER-ALL SQUARE BACKGROUND SHAPE WITH ROUNDED CORNERS.

FOR DOWNLOADABLE SOFTWARE IN THE NATURE OF A MOBILE APPLICATION FOR USE BY PARENTS IN CITIES CONSISTING OF LOCATION BASED INFORMATION REGARDING THE LOCATIONS OF BABY AND CHILDREN'S RETAILERS, NURSING SPOTS, CHANGING TABLES, STROLLER FRIENDLY PUBLIC TRANSPORTATION, STROLLER REPAIR, PARKS, PLAYGROUNDS, INDOOR PLAY SPACES AND STROLLER-FRIENDLY RESTAURANTS AND CAFES (U.S. CLS. 21, 23, 26, 36 AND 38).

FIRST USE 10-0-2009; IN COMMERCE 1-0-2010.  
ANTHONY RINKER, EXAMINING ATTORNEY

---

SN 85-322,512. SHENZHEN SANG FEI CONSUMER COMMUNICATIONS CO., LTD., SHENZHEN, GUANGDONG, CHINA, FILED 5-17-2011.

**Xenium**

THE MARK CONSISTS OF, FROM LEFT TO RIGHT, A STYLIZED LETTER "X" AND STANDARD LETTERS "E" "N" "I" "U" "M".

FOR PORTABLE TELEPHONES; VIDEO TELEPHONES; CHARGERS FOR ELECTRIC BATTERIES; GALVANIC CELLS; VACUUM TUBES FOR RADIOS; JUKE BOXES, MUSICAL; AUDIO AND VIDEO RECEIVERS; SOUND RECORDING APPARATUS; EAR PLUGS FOR SOUNDPROOFING; BLANK CD-ROMS FOR SOUND OR VIDEO RECORDING (U.S. CLS. 21, 23, 26, 36 AND 38).

TOBY BULLOFF, EXAMINING ATTORNEY

**CLASS 9—(Continued).**

SN 85-322,661. EVERSITAS, LLC, CAMBRIDGE, MA. FILED 5-17-2011.

**Pinbit**

THE MARK CONSISTS OF STANDARD CHARACTERS WITHOUT CLAIM TO ANY PARTICULAR FONT, STYLE, SIZE, OR COLOR.

FOR COMPUTER SOFTWARE FOR INFORMATION MANAGEMENT FOR COMMERCIAL CONSUMERS, EDUCATORS/LEARNERS, AND INTELLIGENCE ANALYSTS (U.S. CLS. 21, 23, 26, 36 AND 38).

LEIGH LOWRY, EXAMINING ATTORNEY

---

SN 85-322,723. ALARMS GPS INC., FORT LAUDERDALE, FL. FILED 5-17-2011.

**MotoTrac** 

THE COLOR(S) ORANGE, GRAY IS/ARE CLAIMED AS A FEATURE OF THE MARK.

THE MARK CONSISTS OF BI-COLORED WORD WITH "MOTO" IN ORANGE AND "TRAC" IN GRAY, FOLLOWED BY THREE ARCHES DEPICTING SIGNAL WAVES WHICH IS IN GRAY.

FOR COMPUTER HARDWARE AND SOFTWARE SYSTEM FOR TRACKING PEOPLE, OBJECTS AND PETS USING GPS DATA ON A DEVICE ON THE TRACKED PEOPLE, OBJECTS AND PETS; VEHICLE LOCATOR AND RECOVERY DEVICE PROGRAMMED TO USE GLOBAL POSITIONING SYSTEMS (GPS) AND CELLULAR TELECOMMUNICATIONS (U.S. CLS. 21, 23, 26, 36 AND 38).

FIRST USE 5-1-2011; IN COMMERCE 5-1-2011.  
MORGAN WYNNE, EXAMINING ATTORNEY

---

SN 85-322,831. MUSEAMI, INC., PRINCETON, NJ. FILED 5-17-2011.

**DROP THE NEEDLE**

THE MARK CONSISTS OF STANDARD CHARACTERS WITHOUT CLAIM TO ANY PARTICULAR FONT, STYLE, SIZE, OR COLOR.

FOR INTERACTIVE VIDEO GAMES COMPRISED OF SOFTWARE FEATURING MUSIC (U.S. CLS. 21, 23, 26, 36 AND 38).

FIRST USE 5-16-2011; IN COMMERCE 5-16-2011.  
CHRISTINE COOPER, EXAMINING ATTORNEY



**CLASS 9—(Continued).**

SN 85-322,848. ALARMS GPS INC., FORT LAUDERDALE, FL. FILED 5-17-2011.



THE COLOR(S) BLUE AND GRAY IS/ARE CLAIMED AS A FEATURE OF THE MARK.

THE MARK CONSISTS OF BI-COLORED WORD WITH "MARINE" IN BLUE AND "TRAC" IN GRAY, FOLLOWED BY THREE ARCHES DEPICTING SIGNAL WAVES WHICH IS IN GRAY.

FOR COMPUTER HARDWARE AND SOFTWARE SYSTEM FOR TRACKING PEOPLE, OBJECTS AND PETS USING GPS DATA ON A DEVICE ON THE TRACKED PEOPLE, OBJECTS AND PETS; VEHICLE LOCATOR AND RECOVERY DEVICE PROGRAMMED TO USE GLOBAL POSITIONING SYSTEMS (GPS) AND CELLULAR TELECOMMUNICATIONS (U.S. CLS. 21, 23, 26, 36 AND 38).

FIRST USE 5-1-2011; IN COMMERCE 5-1-2011.  
MORGAN WYNNE, EXAMINING ATTORNEY

SN 85-322,865. ARCSOFT, INC., FREMONT, CA. FILED 5-17-2011.

ARCSOFT HOMERUN

THE MARK CONSISTS OF STANDARD CHARACTERS WITHOUT CLAIM TO ANY PARTICULAR FONT, STYLE, SIZE, OR COLOR.

OWNER OF U.S. REG. NOS. 2,334,476, 3,091,316 AND OTHERS.

FOR COMPUTER SOFTWARE FOR USE IN PLAYING, STORING, ORGANIZING, RECORDING, TRANSCODING, STREAMING, BROADCASTING, SYNCHRONIZING, ACCESSING, AND SHARING DIGITAL MEDIA OVER HOME NETWORKS, COMPUTER NETWORKS, WIRELESS NETWORKS AND GLOBAL COMMUNICATION NETWORKS; COMPUTER SOFTWARE FOR USE IN CONNECTING, DISCOVERING AND COMMUNICATING BETWEEN ELECTRONIC DEVICES OVER HOME NETWORKS, COMPUTER NETWORKS, WIRELESS NETWORKS AND GLOBAL COMMUNICATION NETWORKS (U.S. CLS. 21, 23, 26, 36 AND 38).

SUZANNE BLANE, EXAMINING ATTORNEY

**CLASS 9—(Continued).**

SN 85-322,976. THE SPANISH CENTER, LLC, DALLAS, TX. FILED 5-17-2011.

MUEVETE

THE MARK CONSISTS OF STANDARD CHARACTERS WITHOUT CLAIM TO ANY PARTICULAR FONT, STYLE, SIZE, OR COLOR.

THE ENGLISH TRANSLATION OF "MUEVETE" IN THE MARK IS "MOVE IT".

FOR DIGITAL MEDIA, NAMELY, CDS, DVDS AND DOWNLOADABLE MUSIC FEATURING CHILDREN'S MUSIC (U.S. CLS. 21, 23, 26, 36 AND 38).

FIRST USE 7-28-2004; IN COMMERCE 7-28-2004.

JACLYN KIDWELL WALKER, EXAMINING ATTORNEY

SN 85-323,084. S & S MAGJUMPER LLC, NEWPORT, MN. FILED 5-17-2011.



THE COLOR(S) YELLOW AND GRAY IS/ARE CLAIMED AS A FEATURE OF THE MARK.

THE MARK CONSISTS OF THE WORD "MAGJUMPER" WRITTEN IN STYLIZED WRITING, WHEREIN THE LETTERS AND THE BAR CONNECTING THE "M" AND THE "R" UNDERNEATH THE WORD MAGJUMPER ARE YELLOW. THE MAGNET AFFIXED TO THE BOTTOM OF THE RIGHT VERTICAL LINE OF THE "M" IS GRAY, AND THE MAGNET AFFIXED TO THE RIGHT END OF THE HORIZONTAL LINE OF THE "R" IS ALSO GRAY. THE BLACK BACKGROUND IS NOT CLAIMED AS A FEATURE OF THE MARK.

FOR JUMPERS, NAMELY, DEVICES THAT TEMPORARILY ATTACH TO THE TERMINALS OF AN ELECTRICAL CIRCUIT IN ORDER TO BYPASS THAT CIRCUIT FOR TESTING AND TROUBLESHOOTING PURPOSES (U.S. CLS. 21, 23, 26, 36 AND 38).

FIRST USE 2-7-2011; IN COMMERCE 2-7-2011.

LINDSEY RUBIN, EXAMINING ATTORNEY

**CLASS 9—(Continued).**

SN 85-323,504. ONSTAR LLC, DETROIT, MI. FILED 5-18-2011.

**ONSTAR REMOTELINK**

THE MARK CONSISTS OF STANDARD CHARACTERS WITHOUT CLAIM TO ANY PARTICULAR FONT, STYLE, SIZE, OR COLOR.

OWNER OF U.S. REG. NOS. 2,088,310, 3,365,669 AND OTHERS.

NO CLAIM IS MADE TO THE EXCLUSIVE RIGHT TO USE "REMOTELINK", APART FROM THE MARK AS SHOWN.

FOR SOFTWARE FOR SMARTPHONES THAT PROVIDES USERS THE ABILITY TO REMOTELY CONTROL FEATURES OF THEIR MOTOR VEHICLE, NAMELY, LOCKING AND UNLOCKING VEHICLE DOORS AND STARTING AND TURNING OFF THE VEHICLE; SOFTWARE FOR SMARTPHONES THAT PROVIDES USERS THE ABILITY TO REMOTELY CHECK STATUSES OF MOTOR VEHICLE OPERATING SYSTEMS, NAMELY, ENGINE OIL LIFE, FUEL LEVEL, TIRE PRESSURE AND BATTERY CHARGE; SOFTWARE FOR SMARTPHONES THAT PROVIDES USERS THE ABILITY TO CONNECT TO AN ONSTAR TELECOMMUNICATIONS SERVICE ADVISOR AT A CALL CENTER (U.S. CLS. 21, 23, 26, 36 AND 38).

DAVID YONTEF, EXAMINING ATTORNEY

SN 85-323,746. DYEZZ SURVEILLANCE & SECURITY, INC., AUSTIN, TX. FILED 5-18-2011.



NO CLAIM IS MADE TO THE EXCLUSIVE RIGHT TO USE "SURVEILLANCE", APART FROM THE MARK AS SHOWN.

THE MARK CONSISTS OF A CROSS HAIR GOING THROUGH THE LOGO. THE LETTER E WITH THE OPENING OF THE E POINTING TO THE NORTHEAST WITH THE STYLIZED TEXT "SURVEILLANCE" UNDER THE STYLIZED TEXT "DYEZZ". THE CROSS HAIR IS CENTERED OVER THE WEST SIDE OF THE D WITH ONE LINE GOING THROUGH THE STYLIZED TEXT "DYEZZ".

FOR ACCESS CONTROL AND ALARM MONITORING SYSTEMS; CLOSED CIRCUIT TV SYSTEMS FOR SECURITY AND SURVEILLANCE, NAMELY, CAMERAS, SWITCHERS, MONITORS, MICROPHONES, AND RECORDERS; INTERCOMS; MOUSE PADS; VIDEO CAMERAS (U.S. CLS. 21, 23, 26, 36 AND 38).

FIRST USE 9-16-2001; IN COMMERCE 10-16-2001.

ROBIN CHOSID, EXAMINING ATTORNEY

**CLASS 9—(Continued).**

SN 85-324,108. THE YOFACE, NEW YORK, NY. FILED 5-18-2011.

**Emoticons on Steroids**

THE MARK CONSISTS OF STANDARD CHARACTERS WITHOUT CLAIM TO ANY PARTICULAR FONT, STYLE, SIZE, OR COLOR.

NO CLAIM IS MADE TO THE EXCLUSIVE RIGHT TO USE "EMOTICONS", APART FROM THE MARK AS SHOWN.

FOR COMPUTER APPLICATION SOFTWARE FOR MOBILE PHONES, NAMELY, SOFTWARE FOR CREATING EMOTICONS (U.S. CLS. 21, 23, 26, 36 AND 38).

RENEE MCCRAY, EXAMINING ATTORNEY

SN 85-324,286. IOTTIE INC., TA DUOGREEN, NEW YORK, NY. FILED 5-18-2011.



THE COLOR(S) GREEN AND BLUE IS/ARE CLAIMED AS A FEATURE OF THE MARK.

THE MARK CONSISTS OF THE WORD "DUO" AND THE LEAF DESIGN IN BLUE AND THE WORD "GREEN" IN GREEN.

FOR BATTERIES AND BATTERY CHARGERS (U.S. CLS. 21, 23, 26, 36 AND 38).

FIRST USE 5-1-2010; IN COMMERCE 6-1-2010.

HOWARD SMIGA, EXAMINING ATTORNEY

SN 85-324,431. BTRADE, LLC, BURBANK, CA. FILED 5-18-2011.

**TDACCESS**

THE MARK CONSISTS OF STANDARD CHARACTERS WITHOUT CLAIM TO ANY PARTICULAR FONT, STYLE, SIZE, OR COLOR.

FOR COMPUTER SOFTWARE USED TO ENCRYPT, COMPRESS AND AUTHENTICATE DATA TRANSMITTED ACROSS COMPUTER NETWORKS (U.S. CLS. 21, 23, 26, 36 AND 38).

FIRST USE 2-9-2001; IN COMMERCE 2-9-2001.

RON FAIRBANKS, EXAMINING ATTORNEY

**CLASS 9—(Continued).**

SN 85-324,464. HAGAN, DANIEL ALEXANDER, SANTA FE, NM. FILED 5-18-2011.

**MOST RECORDS**

THE MARK CONSISTS OF STANDARD CHARACTERS WITHOUT CLAIM TO ANY PARTICULAR FONT, STYLE, SIZE, OR COLOR.

NO CLAIM IS MADE TO THE EXCLUSIVE RIGHT TO USE "RECORDS", APART FROM THE MARK AS SHOWN.

FOR AUDIO AND VIDEO RECORDINGS FEATURING MUSIC AND ARTISTIC PERFORMANCES (U.S. CLS. 21, 23, 26, 36 AND 38).

FIRST USE 4-3-2011; IN COMMERCE 4-3-2011.  
RON FAIRBANKS, EXAMINING ATTORNEY

---

SN 85-324,495. A.N LAB JOINT STOCK COMPANY, HANOI CITY, VIETNAM, FILED 5-19-2011.

**OhMyPic**

THE MARK CONSISTS OF STANDARD CHARACTERS WITHOUT CLAIM TO ANY PARTICULAR FONT, STYLE, SIZE, OR COLOR.

FOR DOWNLOADABLE COMPUTER SOFTWARE FOR ATTACHING TAGS, TEXT, LABELS AND WATERMARKS ON PHOTOS (U.S. CLS. 21, 23, 26, 36 AND 38).

FIRST USE 2-23-2011; IN COMMERCE 2-23-2011.  
MELISSA VALLILLO, EXAMINING ATTORNEY

---

SN 85-324,605. QUALITY COMPUTER PRODUCTS, INC., DBA QUALITY DIGITAL OFFICE TECHNOLOGY, INC., YORK, PA. FILED 5-19-2011.

**QPortal**

THE MARK CONSISTS OF STANDARD CHARACTERS WITHOUT CLAIM TO ANY PARTICULAR FONT, STYLE, SIZE, OR COLOR.

FOR COMPUTER SOFTWARE FOR CREATING SEARCHABLE DATABASES OF INFORMATION AND DATA; COMPUTER SOFTWARE THAT PROVIDES REAL-TIME, INTEGRATED BUSINESS MANAGEMENT INTELLIGENCE BY COMBINING INFORMATION FROM VARIOUS DATABASES AND PRESENTING IT IN AN EASY-TO-UNDERSTAND USER INTERFACE; COMPUTER SOFTWARE THAT PROVIDES WEB-BASED ACCESS TO APPLICATIONS AND SERVICES THROUGH A WEB OPERATING SYSTEM OR PORTAL INTERFACE (U.S. CLS. 21, 23, 26, 36 AND 38).

KATHERINE STOIDES, EXAMINING ATTORNEY

**CLASS 9—(Continued).**

SN 85-325,084. DRINK PASS INC., SANTA ANA, CA. FILED 5-19-2011.

**DRINK PASS**

THE MARK CONSISTS OF STANDARD CHARACTERS WITHOUT CLAIM TO ANY PARTICULAR FONT, STYLE, SIZE, OR COLOR.

NO CLAIM IS MADE TO THE EXCLUSIVE RIGHT TO USE "DRINK", APART FROM THE MARK AS SHOWN.

FOR COMPUTER SOFTWARE USED IN THE FIELD OF OPERATION, MANAGEMENT AND SUPPORT OF POINT OF SALE SYSTEMS, NAMELY, SOFTWARE OPERATING ON A MOBILE COMMUNICATIONS DEVICE PROVIDING A CUSTOMER INTERFACE WITH A POINT OF SALE SYSTEM IN A RESTAURANT OR BAR THAT ALLOWS CUSTOMERS TO VIEW, ORDER AND PAY FOR VARIOUS GOODS AVAILABLE FOR SALE AND PURCHASE DIRECTLY ON THEIR MOBILE DEVICE AND THE ABILITY TO CONNECT TO A SOCIAL NETWORK (U.S. CLS. 21, 23, 26, 36 AND 38).

KAPIL BHANOT, EXAMINING ATTORNEY

---

SN 85-325,159. ALLSUP, INC., BELLEVILLE, IL. FILED 5-19-2011.

**ALLSUP ALLIANCE NEWS NETWORK**

THE MARK CONSISTS OF STANDARD CHARACTERS WITHOUT CLAIM TO ANY PARTICULAR FONT, STYLE, SIZE, OR COLOR.

OWNER OF U.S. REG. NOS. 1,731,614, 3,598,154 AND OTHERS.

NO CLAIM IS MADE TO THE EXCLUSIVE RIGHT TO USE "NEWS", APART FROM THE MARK AS SHOWN.

FOR AN EMAIL NEWSLETTER FEATURING LINKS TO ONLINE ARTICLES ON CURRENT DISABILITY AND HEALTH, SOCIAL SECURITY, MEDICARE AND FINANCIAL PLANNING NEWS (U.S. CLS. 21, 23, 26, 36 AND 38).

ALLISON HOLTZ, EXAMINING ATTORNEY

**CLASS 9—(Continued).**

SN 85-325,283. UNIVERSAL ENTERTAINMENT CORPORATION, TOKYO, JAPAN, FILED 5-19-2011.



THE MARK CONSISTS OF THREE LARGE STYLIZED CHINESE CHARACTERS ABOVE A BANNER CARRYING THE TERMS "FU LU SHOU" IN A STYLIZED FORM, ON EACH SIDE OF A BANNER ARE DECORATIVE SCROLLED DESIGNS.

THE NON-LATIN CHARACTERS IN THE MARK TRANSLITERATE TO "FU LU SHOU" AND THIS MEANS GENERALLY IN ENGLISH.

FOR SLOT MACHINES AND REPLACEMENT PARTS THEREFORE; VIDEO SLOT MACHINES AND REPLACEMENT PARTS THEREFORE; GAMING MACHINES AND REPLACEMENT PARTS THEREFORE; GAMING MACHINES WITH LIQUID CRYSTAL DISPLAYS AND REPLACEMENT PARTS THEREFORE; MECHANICAL REEL TYPE SLOT MACHINES WITH LIQUID CRYSTAL DISPLAYS AND REPLACEMENT PARTS THEREFORE; MEDIA STORAGE COMPUTER SOFTWARE FOR ELECTRONIC CIRCUITS, OPTICAL DISKS, MAGNETIC TAPES, MAGNETIC DISKS, MAGNETIC CARDS, OPTICAL-MAGNETIC DISKS, CD-ROMS, ROM-CARTRIDGES AND DVDS, NAMELY, COMPUTER SOFTWARE FOR CONTROLLING SLOT MACHINES AND GAME MACHINES; COMPUTER GAME SOFTWARE FOR GAME MACHINES AND SLOT MACHINES (U.S. CLS. 21, 23, 26, 36 AND 38).

ANTHONY RINKER, EXAMINING ATTORNEY

**CLASS 9—(Continued).**

SN 85-325,655. SOFTWARE CARPENTER INC, CHARLOTTE, NC. FILED 5-20-2011.

Software Carpenter

THE MARK CONSISTS OF STANDARD CHARACTERS WITHOUT CLAIM TO ANY PARTICULAR FONT, STYLE, SIZE, OR COLOR.

NO CLAIM IS MADE TO THE EXCLUSIVE RIGHT TO USE "SOFTWARE", APART FROM THE MARK AS SHOWN.

FOR COMPUTER SOFTWARE FOR COMPUTER SYSTEM AND APPLICATION DEVELOPMENT, DEPLOYMENT AND MANAGEMENT (U.S. CLS. 21, 23, 26, 36 AND 38).

TRACY WHITTAKER-BROWN, EXAMINING ATTORNEY

SN 85-325,981. BARBIS, RICHARD A., EUGENE, OR. FILED 5-20-2011.

SN 85-325,525. AINSWORTH GAME TECHNOLOGY LIMITED, NEWINGTON, AUSTRALIA, FILED 5-20-2011.



THE COLOR(S) YELLOW, GOLD, ORANGE, RED, BLUE, BLACK AND WHITE IS/ARE CLAIMED AS A FEATURE OF THE MARK.

THE MARK CONSISTS OF THE WORDING "RAPID STRIKE" WITH THE WORD "RAPID" IN WHITE, BLUE AND BLACK WITH WHITE AND GOLD OUTLINE WITH EACH LETTER. TO THE RIGHT THE WORDING "STRIKE" IN WHITE, ORANGE, RED AND BLACK WITH WHITE AND GOLD OUTLINE WITH EACH LETTER. IN BETWEEN THE WORDING IS A ORANGE AND RED BOWLING BALL. BEHIND THE BOWLING BALL IS A YELLOW AND BLACK "X" OR CROSS. BEHIND THE WORDING AND CROSS IS ANOTHER BLACK AND YELLOW BORDER.

FOR COMPUTER SOFTWARE AND FIRMWARE FOR GAMES OF CHANCE ON ANY COMPUTERIZED PLATFORM, INCLUDING DEDICATED GAMING CONSOLES, VIDEO BASED SLOT MACHINES, REEL BASED SLOT MACHINES, AND VIDEO LOTTERY TERMINALS (U.S. CLS. 21, 23, 26, 36 AND 38).

MARIA-VICTORIA SUAREZ, EXAMINING ATTORNEY

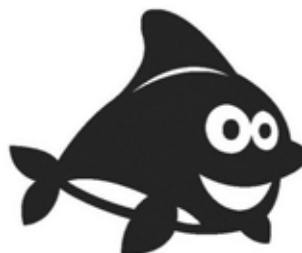

THE MARK CONSISTS OF A STYLIZED DRAWING OF A DOLPHIN.

FOR LIFE JACKETS; LIFE PRESERVERS; SWIM ASSIST VESTS AND SWIM FLOATS FOR SAFETY PURPOSES (U.S. CLS. 21, 23, 26, 36 AND 38).

FIRST USE 6-1-2010; IN COMMERCE 6-1-2010.

HOWARD B. LEVINE, EXAMINING ATTORNEY

**CLASS 9—(Continued).**

SN 85-326,056. BARBIS, RICHARD A., EUGENE, OR. FILED 5-20-2011.

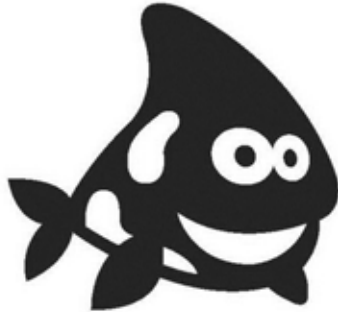

THE MARK CONSISTS OF A STYLIZED DRAWING OF A KILLER WHALE.  
 FOR LIFE JACKETS; LIFE PRESERVERS; SWIM ASSIST VESTS AND SWIM FLOATS FOR SAFETY PURPOSES (U.S. CLS. 21, 23, 26, 36 AND 38).  
 FIRST USE 6-1-2010; IN COMMERCE 6-1-2010.  
 HOWARD B. LEVINE, EXAMINING ATTORNEY

---

SN 85-326,124. BARBIS, RICHARD A., EUGENE, OR. FILED 5-20-2011.

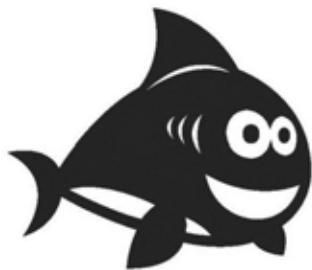

THE MARK CONSISTS OF A STYLIZED DRAWING OF A GREAT WHITE SHARK.  
 FOR LIFE JACKETS; LIFE PRESERVERS; SWIM ASSIST VESTS AND SWIM FLOATS FOR SAFETY PURPOSES (U.S. CLS. 21, 23, 26, 36 AND 38).  
 FIRST USE 6-1-2010; IN COMMERCE 6-1-2010.  
 HOWARD B. LEVINE, EXAMINING ATTORNEY

**CLASS 9—(Continued).**

SN 85-326,399. SAMSUNG ELECTRONICS CO., LTD., SU-WON-SI, GYEONGGI-DO, REPUBLIC OF KOREA, FILED 5-20-2011.



OWNER OF U.S. REG. NOS. 2,882,774, 2,929,523 AND OTHERS.  
 NO CLAIM IS MADE TO THE EXCLUSIVE RIGHT TO USE "GREEN MEMORY", APART FROM THE MARK AS SHOWN.

THE COLOR(S) BLUE, GREEN, LIGHT GREEN, YELLOW AND WHITE IS/ARE CLAIMED AS A FEATURE OF THE MARK.

THE MARK CONSISTS OF A VERTICAL GREEN LINED RECTANGLE WITH THE STYLIZED WORDING "SAMSUNG" IN THE COLOR BLUE AND "GREEN MEMORY" IN THE COLOR GREEN STACKED ON TOP OF EACH OTHER, WITH A DESIGN OF TWO LEAVES IN GREEN AND LIGHT GREEN BELOW THE WORDS; THE INTERIOR OF THE LOWER PORTION OF THE RECTANGLE IS WHITE AND THE LOWER PORTION OF THE RECTANGLE HAS A YELLOW AND LIGHT GREEN BAND AND IS FILLED IN WITH THE COLOR GREEN AND HAS THE STYLIZED WORD "SAMSUNG" IN WHITE WITH A BLUE FILLED OVAL SURROUNDING IT.

THE ENGLISH TRANSLATION OF "SAMSUNG" IN THE MARK IS "THREE STARS".

FOR SEMICONDUCTOR; CENTRAL PROCESSOR UNIT; MEMORY CARD; SEMICONDUCTOR CHIPS (U.S. CLS. 21, 23, 26, 36 AND 38).

JULIE GUTTADAURO, EXAMINING ATTORNEY

---

SN 85-326,485. BARBIS, RICHARD A., EUGENE, OR. FILED 5-20-2011.



THE MARK CONSISTS OF A STYLIZED DRAWING OF A CLOWN FISH.  
 FOR LIFE JACKETS; LIFE PRESERVERS; SWIM ASSIST VESTS AND SWIM FLOATS FOR SAFETY PURPOSES (U.S. CLS. 21, 23, 26, 36 AND 38).  
 FIRST USE 6-1-2010; IN COMMERCE 6-1-2010.  
 HOWARD B. LEVINE, EXAMINING ATTORNEY

**CLASS 9—(Continued).**

SN 85-326,748. BIOMETRIC SIGNATURE ID, LEWISVILLE, TX. FILED 5-21-2011.

# BioSig-ID

THE MARK CONSISTS OF STANDARD CHARACTERS WITHOUT CLAIM TO ANY PARTICULAR FONT, STYLE, SIZE, OR COLOR.

FOR COMPUTER SOFTWARE FOR HAND WRITING IDENTIFICATION (U.S. CLS. 21, 23, 26, 36 AND 38).  
SKYE YOUNG, EXAMINING ATTORNEY

---

SN 85-326,857. STEVEN W PEDERSON, DBA SOFTWAYS, SAN DIEGO, CA. FILED 5-22-2011.

# iVinyl

THE MARK CONSISTS OF STANDARD CHARACTERS WITHOUT CLAIM TO ANY PARTICULAR FONT, STYLE, SIZE, OR COLOR.

FOR COMPUTER SOFTWARE FOR CONTROLLING THE OPERATION OF AUDIO AND VIDEO DEVICES; COMPUTER SOFTWARE FOR MANIPULATING DIGITAL AUDIO INFORMATION FOR USE IN AUDIO MEDIA APPLICATIONS (U.S. CLS. 21, 23, 26, 36 AND 38).  
FIRST USE 6-28-2009; IN COMMERCE 8-18-2009.  
TAMARA FRAZIER, EXAMINING ATTORNEY

---

SN 85-327,020. ADVANCED MATERIALS TECHNOLOGY, INC., WILMINGTON, DE. FILED 5-23-2011.

# BRIDGE THE GAP

THE MARK CONSISTS OF STANDARD CHARACTERS WITHOUT CLAIM TO ANY PARTICULAR FONT, STYLE, SIZE, OR COLOR.

FOR HIGH PERFORMANCE LIQUID CHROMATOGRAPHY COLUMNS (U.S. CLS. 21, 23, 26, 36 AND 38).  
COLLEEN KEARNEY, EXAMINING ATTORNEY

**CLASS 9—(Continued).**

SN 85-328,552. TMAX DIGITAL, INC., CHINO, CA. FILED 5-24-2011.

The logo for TMAX consists of the letters 'T', 'M', and 'X' in a bold, sans-serif font. The 'T' is significantly larger than the 'M' and 'X'. The top horizontal bar of the 'T' extends to the right, overlapping the top of the 'M' and 'X'.

THE MARK CONSISTS OF THE STYLIZED TERMS "TMAX" THE TOP PORTION OF THE "T" EXTENDS THE LENGTH OF THE TERM.

FOR DVD PLAYERS; MEDIA PLAYERS; TELEVISION MONITORS; TELEVISIONS; TELEVISIONS AND MONITORS (U.S. CLS. 21, 23, 26, 36 AND 38).

BARBARA RUTLAND, EXAMINING ATTORNEY

---

SN 85-329,054. HTC CORPORATION, TAOYUAN CITY, TAIWAN, FILED 5-24-2011.

# INNOVATION INSPIRED BY YOU

THE MARK CONSISTS OF STANDARD CHARACTERS WITHOUT CLAIM TO ANY PARTICULAR FONT, STYLE, SIZE, OR COLOR.

OWNER OF U.S. REG. NO. 3,750,693.

FOR TELECOMMUNICATIONS DEVICES, NAMELY, MOBILE PHONES, SMARTPHONES, CELLULAR PHONES, PORTABLE COMPUTERS, AND PERSONAL DIGITAL ASSISTANTS AND WIRELESS HANDHELD DIGITAL ELECTRONIC DEVICES FOR COMMUNICATING, RECORDING, ORGANIZING, TRANSMITTING, MANIPULATING, STORING AND REVIEWING TEXT, DATA, IMAGE, AND AUDIO FILES; COMPUTER HARDWARE AND SOFTWARE FOR ENABLING, OPERATING, ENHANCING, CUSTOMIZING, UPDATING AND MANAGING THE ABOVE-LISTED GOODS; USER INTERFACE SOFTWARE FOR ELECTRONIC DEVICES; COMPUTER HARDWARE AND SOFTWARE FOR DELIVERING WIRELESSLY, ENABLING, CREATING, ENHANCING, CUSTOMIZING, UPDATING, AND MANAGING TELECOMMUNICATIONS AND TELECOMMUNICATIONS SERVICES FOR OPERATING, INSTALLING, TESTING, DIAGNOSING, AND MANAGING THE FOREGOING TELECOMMUNICATION EQUIPMENT; COMPUTER HARDWARE AND SOFTWARE FOR TRANSMITTING AND RECEIVING VOICE, IMAGE, DATA, AUDIO, VIDEO AND MULTIMEDIA CONTENT; WIRELESS MODEMS (U.S. CLS. 21, 23, 26, 36 AND 38).

AMY C. KEAN, EXAMINING ATTORNEY

**CLASS 9—(Continued).**

SN 85-329,420. BOOK OF ME, LLC, SEATTLE, WA. FILED 5-25-2011.

# Book of Me

THE MARK CONSISTS OF STANDARD CHARACTERS WITHOUT CLAIM TO ANY PARTICULAR FONT, STYLE, SIZE, OR COLOR.

FOR CHILDREN'S EDUCATIONAL SOFTWARE (U.S. CLS. 21, 23, 26, 36 AND 38).

FIRST USE 5-16-2011; IN COMMERCE 5-16-2011.  
PAULA MAHONEY, EXAMINING ATTORNEY

**CLASS 9—(Continued).**

SN 85-330,131. MASTROMATTEI, NICHOLAS ANTHONY, WINDSOR, CANADA, FILED 5-25-2011.

# Lockerroom

THE MARK CONSISTS OF STANDARD CHARACTERS WITHOUT CLAIM TO ANY PARTICULAR FONT, STYLE, SIZE, OR COLOR.

FOR COMPUTER APPLICATION SOFTWARE FOR MOBILE PHONES, NAMELY, SOFTWARE FOR TEAM, LEAGUE, AND ORGANIZATION OF SPORTS MANAGEMENT; COMPUTER APPLICATION SOFTWARE FOR WEB, NAMELY, SOFTWARE FOR TEAM, LEAGUE, AND ORGANIZATION OF SPORTS MANAGEMENT; COMPUTER DATABASE MANAGEMENT SOFTWARE FOR USE IN PERSONALIZING THE CONTENT OF E-MAIL COMMUNICATIONS (U.S. CLS. 21, 23, 26, 36 AND 38).

CHRIS WELLS, EXAMINING ATTORNEY

SN 85-329,823. WAVEMACHINE LABS, INC., CHICAGO, IL. FILED 5-25-2011.

# IMIX STUDIO

THE MARK CONSISTS OF STANDARD CHARACTERS WITHOUT CLAIM TO ANY PARTICULAR FONT, STYLE, SIZE, OR COLOR.

NO CLAIM IS MADE TO THE EXCLUSIVE RIGHT TO USE "STUDIO", APART FROM THE MARK AS SHOWN.

FOR APPARATUS FOR RECORDING, TRANSMISSION, PROCESSING AND REPRODUCTION OF SOUND, IMAGES OR DATA; COMPUTER HARDWARE FOR UPLOAD, STORAGE, RETRIEVAL, DOWNLOAD, TRANSMISSION AND DELIVERY OF DIGITAL CONTENT; COMPUTER SOFTWARE FOR CREATING AND EDITING MUSIC AND SOUNDS; COMPUTER SOFTWARE FOR MANIPULATING DIGITAL AUDIO INFORMATION FOR USE IN AUDIO MEDIA APPLICATIONS; CONVERTERS; DIGITAL SIGNAL PROCESSORS; DISTRIBUTION AMPLIFIERS FOR AUDIO AND VIDEO SIGNALS; INTERFACES FOR COMPUTERS (U.S. CLS. 21, 23, 26, 36 AND 38).

TIMOTHY FINNEGAN, EXAMINING ATTORNEY

SN 85-330,144. LEVINAS, YESHAI AHARON, KEY LARGO, FL. FILED 5-25-2011.



## BatteryProgBrain

THE MARK CONSISTS OF A STYLIZED BATTERY WITHIN WHICH ARE THE LETTERS B P B. INSIDE THE TOP PORTION OF THE FIRST B IS THE "+" SYMBOL, INSIDE THE TOP PORTION OF THE SECOND B IS THE "-" SYMBOL. UNDERNEATH THE STYLIZED BATTERY APPEARS THE LITERAL ELEMENT, "BATTERYPROG-BRAIN".

FOR AUTOMATIC BATTERY POWER CONTROLLER (U.S. CLS. 21, 23, 26, 36 AND 38).

WILLIAM ROSSMAN, EXAMINING ATTORNEY



**CLASS 9—(Continued).**

SN 85-330,356. NEW DREAM NETWORK, LLC, BREA, CA. FILED 5-25-2011.



OWNER OF U.S. REG. NO. 3,581,493.  
THE MARK CONSISTS OF A STYLIZED DRAWING OF AN OCTOPUS.

FOR COMPUTER SOFTWARE, NAMELY, SOFTWARE FOR DATA MANAGEMENT, SOFTWARE FOR DATA STORAGE, SOFTWARE FOR DATA ARCHIVING (U.S. CLS. 21, 23, 26, 36 AND 38).

FIRST USE 12-4-2008; IN COMMERCE 12-4-2008.  
KAELE KUNG, EXAMINING ATTORNEY

---

SN 85-330,378. HEADLANDS VENTURES, LLC, SAN RAFAEL, CA. FILED 5-25-2011.

## ICYCLE

THE MARK CONSISTS OF STANDARD CHARACTERS WITHOUT CLAIM TO ANY PARTICULAR FONT, STYLE, SIZE, OR COLOR.

FOR COMPUTER APPLICATION SOFTWARE FOR MOBILE PHONES AND WIRELESS LOCAL AREA NETWORK PLATFORMS NAMELY, SOFTWARE FOR BICYCLISTS (U.S. CLS. 21, 23, 26, 36 AND 38).

JACQUELINE A. LAVINE, EXAMINING ATTORNEY

---

SN 85-330,488. TEAMCRITTER, LLC, OMAHA, NE. FILED 5-25-2011.

## STEMB0T

THE MARK CONSISTS OF STANDARD CHARACTERS WITHOUT CLAIM TO ANY PARTICULAR FONT, STYLE, SIZE, OR COLOR.

FOR ROBOTS FOR PERSONAL, EDUCATIONAL AND HOBBY USE AND STRUCTURAL PARTS THEREFOR (U.S. CLS. 21, 23, 26, 36 AND 38).

KATHERINE STOIDES, EXAMINING ATTORNEY

**CLASS 9—(Continued).**

SN 85-330,528. DO GOOD LABS, INC., SAN FRANCISCO, CA. FILED 5-26-2011.

## SAVEUP

THE MARK CONSISTS OF STANDARD CHARACTERS WITHOUT CLAIM TO ANY PARTICULAR FONT, STYLE, SIZE, OR COLOR.

FOR COMPUTER GAME SOFTWARE FOCUSING ON ACHIEVING A SET OF FINANCIAL GOALS (U.S. CLS. 21, 23, 26, 36 AND 38).

SHANNON TWOHIG, EXAMINING ATTORNEY

---

SN 85-330,673. VIRTUALWORKS GROUP INC., BOCA RATON, FL. FILED 5-26-2011.



THE COLOR(S) FOUR SHADES OF RED IS/ARE CLAIMED AS A FEATURE OF THE MARK.

THE MARK CONSISTS OF CONCENTRIC SERIES OF FOUR (4) STYLIZED DIAMONDS OF DIFFERING TINTS OF RED THAT JOIN IN THE MIDDLE TO FORM A COMPASS ROSE ICON. THE SERIES OF FOUR (4) STYLIZED DIAMONDS ARE GRADED FROM DARK RED TO A LIGHTER TONE OF RED. THE WHOLE ICON CONTAINS FOUR DIFFERENT SHADES OF RED.

FOR COMPUTER SOFTWARE FOR CREATING AND MAINTAINING AN ENTERPRISE-WIDE VIRTUAL CONTENT INDEX INCLUDING THE TOOLS TO SEARCH, RETRIEVE, ANALYZE OR MANAGE THE INDEXED DATA (U.S. CLS. 21, 23, 26, 36 AND 38).

MORGAN WYNNE, EXAMINING ATTORNEY



**CLASS 9—(Continued).**

SN 85-330,690. VIRTUALWORKS GROUP INC., BOCA RATON, FL. FILED 5-26-2011.



THE COLOR(S) RED IS/ARE CLAIMED AS A FEATURE OF THE MARK.

THE MARK CONSISTS OF STYLIZED V, I AND A COLORED IN RED.

FOR COMPUTER SOFTWARE ARCHITECTURE USED BY PRODUCTS THAT CREATE AND MAINTAIN AN ENTERPRISE-WIDE VIRTUAL CONTENT INDEX (U.S. CLS. 21, 23, 26, 36 AND 38).

MORGAN WYNNE, EXAMINING ATTORNEY

SN 85-330,710. STENOGRAPH, ELMHURST, IL. FILED 5-26-2011.

## TrueView

THE MARK CONSISTS OF STANDARD CHARACTERS WITHOUT CLAIM TO ANY PARTICULAR FONT, STYLE, SIZE, OR COLOR.

FOR ALGORITHMIC SOFTWARE PROGRAM FOR VIEWING KEY STROKES RELATED TO SHORTHAND MACHINE WRITING (U.S. CLS. 21, 23, 26, 36 AND 38).

FIRST USE 9-21-2009; IN COMMERCE 5-6-2010.

MATTHEW MCDOWELL, EXAMINING ATTORNEY

SN 85-331,083. L-3 SERVICES, INC., SAN DIEGO, CA. FILED 5-26-2011.

## ROVERSCOUT

THE MARK CONSISTS OF STANDARD CHARACTERS WITHOUT CLAIM TO ANY PARTICULAR FONT, STYLE, SIZE, OR COLOR.

FOR INTEGRATED SYSTEM COMPRISING RUGGEDIZED PERSONAL AND LAPTOP COMPUTERS, DATA LINKS, EMBEDDED VIDEO PROCESSING BOARDS, AND VIDEO ASSET MANAGEMENT SOFTWARE FOR THE CAPTURE, ANALYSIS, ANNOTATION, STORAGE AND DISSEMINATION OF VIDEO LOCALLY AND ACROSS NETWORKS (U.S. CLS. 21, 23, 26, 36 AND 38).

LYDIA BELZER, EXAMINING ATTORNEY

**CLASS 9—(Continued).**

SN 85-331,139. DEFLUSTER!, LLC, MORRISTOWN, TN. FILED 5-26-2011.



THE MARK CONSISTS OF THE STYLIZED TEXT "DEFLUSTER!" WITH THE LETTERS "DE" INSIDE A CIRCLE.

FOR COMPUTER SOFTWARE FOR BUSINESS PROCESS AUTOMATION (U.S. CLS. 21, 23, 26, 36 AND 38).

DEBRA LEE, EXAMINING ATTORNEY

SN 85-331,145. GOLDEN, JOHN, PELL CITY, AL. FILED 5-26-2011.

## Tract-Lock

THE MARK CONSISTS OF STANDARD CHARACTERS WITHOUT CLAIM TO ANY PARTICULAR FONT, STYLE, SIZE, OR COLOR.

FOR COMPUTER APPLICATION SOFTWARE FOR MOBILE PHONES AND HANDHELD COMPUTERS, NAMELY, SOFTWARE FOR MEASURING AND MARKING GEOGRAPHICAL INFORMATION RELATING TO TRACTS OF LAND AND PROPERTY BOUNDARIES (U.S. CLS. 21, 23, 26, 36 AND 38).

FIRST USE 2-1-2011; IN COMMERCE 2-1-2011.

LAURIE MAYES, EXAMINING ATTORNEY

SN 85-331,248. MICRONOR INC., NEWBURY PARK, CA. FILED 5-26-2011.

## ZAPPY

THE MARK CONSISTS OF STANDARD CHARACTERS WITHOUT CLAIM TO ANY PARTICULAR FONT, STYLE, SIZE, OR COLOR.

OWNER OF U.S. REG. NO. 3,005,896.  
FOR COMPUTER HARDWARE AND SOFTWARE SYSTEMS FOR SETUP, CONFIGURATIONS, OPERATION, DIAGNOSTICS AND TROUBLESHOOTING OF INDUSTRIAL SENSORS AND CONTROLS (U.S. CLS. 21, 23, 26, 36 AND 38).

FIRST USE 9-1-2004; IN COMMERCE 9-1-2004.

LINDA MICKLEBURGH, EXAMINING ATTORNEY

**CLASS 9—(Continued).**

SN 85-331,296. HERSCH AND COMPANY, LOS ANGELES, CA. FILED 5-26-2011.

# EyeCons

THE MARK CONSISTS OF STANDARD CHARACTERS WITHOUT CLAIM TO ANY PARTICULAR FONT, STYLE, SIZE, OR COLOR.

FOR GAME SOFTWARE (U.S. CLS. 21, 23, 26, 36 AND 38).

LEIGH CAROLINE CASE, EXAMINING ATTORNEY

---

SN 85-331,372. DIG-IT! GAMES, LLC, CHEVY CHASE, MD. FILED 5-26-2011.

# ROMAN TOWN

THE MARK CONSISTS OF STANDARD CHARACTERS WITHOUT CLAIM TO ANY PARTICULAR FONT, STYLE, SIZE, OR COLOR.

FOR INTERACTIVE MULTIMEDIA COMPUTER GAME PROGRAM (U.S. CLS. 21, 23, 26, 36 AND 38).

FIRST USE 10-31-2009; IN COMMERCE 10-31-2009.

JAMES STEIN, EXAMINING ATTORNEY

---

SN 85-331,381. MICRONOR INC., NEWBURY PARK, CA. FILED 5-26-2011.

# ZapView

THE MARK CONSISTS OF STANDARD CHARACTERS WITHOUT CLAIM TO ANY PARTICULAR FONT, STYLE, SIZE, OR COLOR.

OWNER OF U.S. REG. NO. 3,005,896.

FOR COMPUTER HARDWARE AND SOFTWARE SYSTEMS FOR SETUP, CONFIGURATION, OPERATION, DIAGNOSTICS AND TROUBLESHOOTING OF INDUSTRIAL SENSORS AND CONTROLS (U.S. CLS. 21, 23, 26, 36 AND 38).

FIRST USE 5-25-2011; IN COMMERCE 5-25-2011.

LINDA MICKLEBURGH, EXAMINING ATTORNEY

**CLASS 9—(Continued).**

SN 85-331,477. CASA GRANDE INTERACTIVE COMMUNICATIONS, INC., SAN JUAN, PUERTO RICO, FILED 5-26-2011.



THE COLOR(S) DARK BLUE, MEDIUM BLUE, LIGHT BLUE, GRAY AND WHITE IS/ARE CLAIMED AS A FEATURE OF THE MARK.

THE MARK CONSISTS OF THE LETTERS "O" AND "S" IN LOWERCASE AND IN STYLIZED FORMAT. THE LETTERS ARE IN WHITE COLOR AND SHADES OF GRAY COLOR, AND BOTH LETTERS ARE JOINED IN THE MIDDLE. THE UPPER PART OF THE "O" DOES NOT CLOSE AND EXTENDS OUTWARDS OF THE CIRCLE. THE UPPER PART OF THE "S" ALSO EXTENDS OUTWARDS OF THE CIRCLE. BOTH LETTERS ARE LOCATED WITHIN A CIRCLE WHOSE LOWER BOTTOM PORTION IS DARK BLUE AND EXTENDS TO THE INNER CIRCLE AND ALONG THE LOWER BORDER OF THE CIRCLE UP UNTIL THE MIDDLE OF THE CIRCLE DIFFUSING SAID DARK BLUE COLOR TO A LESS DARKER BLUE COLOR. THE REST OF THE CIRCLE CONSISTS OF A LIGHT BLUE COLOR AT THE CENTER AND TOWARDS THE UPPER PORTION OF THE CIRCLE. A TOP OF THE LETTERS "O" "S" IS A SMALL OVAL WHOSE COLOR DEFUSES FROM THE LOWER PART OF THE OVAL IN A LIGHT BLUE AND ENDING IN WHITE COLOR.

FOR INTERACTIVE MULTIMEDIA COMPUTER PROGRAM FOR PROVIDING EDUCATIONAL SERVICES THROUGH COMPETITION (U.S. CLS. 21, 23, 26, 36 AND 38).

FIRST USE 8-1-2010; IN COMMERCE 8-1-2010.

DORITT L. CARROLL, EXAMINING ATTORNEY

---

SN 85-331,806. IOG LLC, CHATSWORTH, CA. FILED 5-26-2011.

# Trans-Monitor

THE MARK CONSISTS OF STANDARD CHARACTERS WITHOUT CLAIM TO ANY PARTICULAR FONT, STYLE, SIZE, OR COLOR.

FOR INSTRUMENTS FOR DETECTING AND MEASURING THREE-DIMENSIONAL DISTRIBUTION OF FORCE AND PRESSURE (U.S. CLS. 21, 23, 26, 36 AND 38).

FIRST USE 8-8-2010; IN COMMERCE 8-8-2010.

AMY HELLA, EXAMINING ATTORNEY

**CLASS 9—(Continued).**

SN 85-331,930. RODIC, DANIEL, DBA TASTEBUDDY, TORONTO, CANADA, FILED 5-26-2011.

# TasteBuddy

THE MARK CONSISTS OF STANDARD CHARACTERS WITHOUT CLAIM TO ANY PARTICULAR FONT, STYLE, SIZE, OR COLOR.

FOR COMPUTER APPLICATION SOFTWARE FOR MOBILE PHONES, NAMELY, SOFTWARE FOR USE IN RECOMMENDATIONS BASED ON USER DATA (U.S. CLS. 21, 23, 26, 36 AND 38).

HEATHER THOMPSON, EXAMINING ATTORNEY

**CLASS 9—(Continued).**

SN 85-332,276. PROVISIO, LLC, AVENTURA, FL. FILED 5-27-2011.

# SITEKIOSK

THE MARK CONSISTS OF STANDARD CHARACTERS WITHOUT CLAIM TO ANY PARTICULAR FONT, STYLE, SIZE, OR COLOR.

FOR COMPUTER SOFTWARE FOR INTERNET USE, NAMELY, SOFTWARE FOR PROVIDING SECURE USER IDENTIFICATION AND FOR PROTECTING COMPUTER SYSTEMS FROM CRASHING FROM UNAUTHORIZED USE (U.S. CLS. 21, 23, 26, 36 AND 38).

FIRST USE 2-1-1998; IN COMMERCE 2-1-1998.

JOHN SCHUYLER YARD, EXAMINING ATTORNEY

SN 85-332,059. UNITED NATURAL FOODS, INC., PROVIDENCE, RI. FILED 5-27-2011.

# IUNFI

THE MARK CONSISTS OF STANDARD CHARACTERS WITHOUT CLAIM TO ANY PARTICULAR FONT, STYLE, SIZE, OR COLOR.

OWNER OF U.S. REG. NOS. 3,615,593 AND 3,634,425.  
FOR COMPUTER SOFTWARE FOR ACCESSING PRODUCT INFORMATION, PLACING ORDERS FOR PRODUCTS, VIEWING PRODUCT REPORTS, VIEWING PRODUCT PRICING, VIEWING PRODUCT PROMOTIONS, AND PLACING REQUESTS FOR RETURN OF PRODUCTS (U.S. CLS. 21, 23, 26, 36 AND 38).

FIRST USE 2-21-2011; IN COMMERCE 2-21-2011.

JEFFERY COWARD, EXAMINING ATTORNEY

SN 85-332,330. SU, WILLIAM WEI-LIEN, IRVINE, CA. FILED 5-27-2011.

# WORDMAN

SN 85-332,255. THE YOFACE, NEW YORK, NY. FILED 5-27-2011.

# YoTICONS

THE MARK CONSISTS OF THE WORDING "YOTICONS" IN A STYLIZED FONT.

FOR COMPUTER APPLICATION SOFTWARE FOR MOBILE PHONES, NAMELY, SOFTWARE FOR CREATING EMOTICONS (U.S. CLS. 21, 23, 26, 36 AND 38).

RENEE MCCRAY, EXAMINING ATTORNEY

THE MARK CONSISTS OF STANDARD CHARACTERS WITHOUT CLAIM TO ANY PARTICULAR FONT, STYLE, SIZE, OR COLOR.

FOR COMPUTER GAME SOFTWARE; COMPUTER GAME SOFTWARE FOR USE ON MOBILE AND CELLULAR PHONES; ELECTRONIC GAME SOFTWARE; ELECTRONIC GAME SOFTWARE FOR HANDHELD ELECTRONIC DEVICES (U.S. CLS. 21, 23, 26, 36 AND 38).

B. PARADEWELAI, EXAMINING ATTORNEY

**CLASS 9—(Continued).**

SN 85-332,356. SINGLEWIRE SOFTWARE, LLC, MADISON, WI. FILED 5-27-2011.



THE COLOR(S) GREEN, WHITE AND BLACK IS/ARE CLAIMED AS A FEATURE OF THE MARK.

THE MARK CONSISTS OF A GREEN SQUARE WITH ROUNDED CORNERS HAVING A BLACK SHADOW SURROUNDING THE GREEN BOX. WITHIN THE GREEN BOX IS A LARGE SQUARE OUTLINED IN WHITE, WITH A WHITE ARROW PROJECTING UP FROM THE LOWER LEFT CORNER OF THE LARGE WHITE SQUARE TOWARDS THE UPPER RIGHT CORNER OF THE LARGE WHITE SQUARE. A SMALL WHITE SQUARE IS LOCATED IN THE UPPER RIGHT CORNER OF THE LARGE WHITE SQUARE.

FOR DOWNLOADABLE SOFTWARE, NAMELY, AN IP TELEPHONY SOFTWARE PROGRAM THAT ALLOWS SIMULTANEOUS TRANSMISSION OF BOTH VOICE AND TEXT TO MULTIPLE USERS OVER A PAGING NETWORK (U.S. CLS. 21, 23, 26, 36 AND 38).

FIRST USE 3-1-2011; IN COMMERCE 3-1-2011.  
TINA BROWN, EXAMINING ATTORNEY

SN 85-332,402. CAVIUM, INC., MOUNTAIN VIEW, CA. FILED 5-27-2011.

# AUTHENTIK

THE MARK CONSISTS OF STANDARD CHARACTERS WITHOUT CLAIM TO ANY PARTICULAR FONT, STYLE, SIZE, OR COLOR.

FOR FEATURE OF A COMPUTER CHIP WHICH PREVENTS THE EXECUTION OF UNAUTHORIZED SOFTWARE AND PREVENTS THE UNAUTHORIZED MANUFACTURING OF FINISHED PRODUCTS USING THE CHIP (U.S. CLS. 21, 23, 26, 36 AND 38).

PAM WILLIS, EXAMINING ATTORNEY

**CLASS 9—(Continued).**

SN 85-332,588. APPPOWERGROUP, PORTER RANCH, CA. FILED 5-27-2011.

# SoPoll

THE MARK CONSISTS OF STANDARD CHARACTERS WITHOUT CLAIM TO ANY PARTICULAR FONT, STYLE, SIZE, OR COLOR.

FOR A COMPONENT FEATURE OF COMPUTER GAME SOFTWARE FOR THE COLLECTION, EDITING, ORGANIZING, MODIFYING, BOOK MARKING, TRANSMISSION, STORAGE, AND SHARING OF DATA AND INFORMATION FOR USE ON PERSONAL COMPUTERS, HANDHELD COMPUTERS, AND MOBILE AND CELLULAR PHONES (U.S. CLS. 21, 23, 26, 36 AND 38).

FIRST USE 12-9-2010; IN COMMERCE 12-9-2010.  
MICHAEL WEBSTER, EXAMINING ATTORNEY

SN 85-333,081. GOLDEN, JOHN, PELL CITY, AL. FILED 5-28-2011.



THE STIPPLING IS FOR SHADING PURPOSES ONLY. THE MARK CONSISTS OF A STYLIZED OUTLINE OF A WOLF HOWLING AT THE SUN/MOON BEHIND A GLOWING TIMBERLINE, AND THE TEXT "WOLFGIS" BELOW THE DESIGN.

FOR COMPUTER APPLICATION SOFTWARE FOR MOBILE PHONES AND HANDHELD COMPUTERS, NAMELY, SOFTWARE FOR MEASURING AND MARKING GEOGRAPHICAL INFORMATION RELATING TO TRACTS OF LAND AND PROPERTY BOUNDARIES (U.S. CLS. 21, 23, 26, 36 AND 38).

FIRST USE 2-1-2011; IN COMMERCE 2-1-2011.  
LAURIE MAYES, EXAMINING ATTORNEY

**CLASS 9—(Continued).**

SN 85-333,108. JIM CHARNE, SANTA MONICA, CA. FILED 5-28-2011.

# Hi :)

THE MARK CONSISTS OF STANDARD CHARACTERS WITHOUT CLAIM TO ANY PARTICULAR FONT, STYLE, SIZE, OR COLOR.

FOR COMPUTER GAME PROGRAMMES DOWNLOADABLE VIA THE INTERNET; COMPUTER GAME SOFTWARE DOWNLOADABLE FROM A GLOBAL COMPUTER NETWORK; COMPUTER GAME SOFTWARE FOR USE ON MOBILE AND CELLULAR PHONES; DOWNLOADABLE COMPUTER GAME PROGRAMS; DOWNLOADABLE COMPUTER GAME SOFTWARE VIA A GLOBAL COMPUTER NETWORK AND WIRELESS DEVICES; DOWNLOADABLE ELECTRONIC GAME PROGRAMS; ELECTRONIC GAME SOFTWARE FOR CELLULAR TELEPHONES; ELECTRONIC GAME SOFTWARE FOR HANDHELD ELECTRONIC DEVICES; ELECTRONIC GAME SOFTWARE FOR WIRELESS DEVICES (U.S. CLS. 21, 23, 26, 36 AND 38).

JACQUELINE A. LAVINE, EXAMINING ATTORNEY

**CLASS 9—(Continued).**

SN 85-333,146. ETRON TECHNOLOGY, INC., HSINCHU, TAIWAN, FILED 5-28-2011.

# Livingtronics

SN 85-333,140. ETRON TECHNOLOGY, INC., HSINCHU, TAIWAN, FILED 5-28-2011.

# LifeSense

THE MARK CONSISTS OF STANDARD CHARACTERS WITHOUT CLAIM TO ANY PARTICULAR FONT, STYLE, SIZE, OR COLOR.

FOR USB (UNIVERSAL SERIAL BUS) OPERATING SOFTWARE, USB (UNIVERSAL SERIAL BUS) HARDWARE, LARGE SCALE INTEGRATED CIRCUITS, INTERFACE CARDS FOR DATA PROCESSING EQUIPMENT IN THE FORM OF PRINTED CIRCUITS, INTERFACES FOR COMPUTERS, USER INTERFACES FOR ELECTROTECHNICAL AND ELECTRONIC DEVICES, COMPUTER INTERFACE BOARDS, SEMICONDUCTORS, SEMICONDUCTOR DEVICES, SEMICONDUCTOR CHIPS, SILICON CHIPS, SILICON WAFERS, OBJECTS MADE OF SILICON, NAMELY, CARBIDE DIODES, OSCILLATORS AND TRANSISTORS; OSCILLATORS, ELECTRICAL CONTROLLERS, COMPUTER CHIPS, SILICON WAFERS AND MICROCHANNEL WAFERS; TELECOMMUNICATIONS AND DATA NETWORKING HARDWARE, NAMELY, DEVICES FOR TRANSPORTING AND AGGREGATING VOICE, DATA, AND VIDEO COMMUNICATIONS ACROSS MULTIPLE NETWORK INFRASTRUCTURES AND COMMUNICATIONS PROTOCOLS; VIDEO PHONES, VERY LARGE SCALE INTEGRATION (VLSI) SEMICONDUCTOR INTEGRATED CIRCUITS, COMPUTERS, ELECTRONIC CIRCUITS, COMPUTER HARDWARE, INTEGRATED CIRCUITS, KEYBOARDS; COMPUTER STORAGE DEVICES, NAMELY, BLANK FLASH DRIVES; USB COMPUTER ACCESS CONTROL KEY, BACKUP DRIVES FOR COMPUTERS, SOLID STATE DRIVES, CHIP CARD READERS, ELECTRONIC CARD READERS, ELECTRONIC MEMORY CARD READERS, FLASH CARD READERS, SMART CARD READERS (U.S. CLS. 21, 23, 26, 36 AND 38).

FIRST USE 3-26-2011; IN COMMERCE 3-26-2011.

CAROLINE WOOD, EXAMINING ATTORNEY

THE MARK CONSISTS OF STANDARD CHARACTERS WITHOUT CLAIM TO ANY PARTICULAR FONT, STYLE, SIZE, OR COLOR.

FOR USB (UNIVERSAL SERIAL BUS) OPERATING SOFTWARE, USB (UNIVERSAL SERIAL BUS) HARDWARE, LARGE SCALE INTEGRATED CIRCUITS, INTERFACE CARDS FOR DATA PROCESSING EQUIPMENT IN THE FORM OF PRINTED CIRCUITS, INTERFACES FOR COMPUTERS, USER INTERFACES FOR ELECTROTECHNICAL AND ELECTRONIC DEVICES, COMPUTER INTERFACE BOARDS, SEMICONDUCTORS, SEMICONDUCTOR DEVICES, SEMICONDUCTOR CHIPS, SILICON CHIPS, SILICON WAFERS, OBJECTS MADE OF SILICON, NAMELY, CARBIDE DIODES, OSCILLATORS AND TRANSISTORS; OSCILLATORS, ELECTRICAL CONTROLLERS, COMPUTER CHIPS, SILICON WAFERS AND MICROCHANNEL WAFERS; TELECOMMUNICATIONS AND DATA NETWORKING HARDWARE, NAMELY, DEVICES FOR TRANSPORTING AND AGGREGATING VOICE, DATA, AND VIDEO COMMUNICATIONS ACROSS MULTIPLE NETWORK INFRASTRUCTURES AND COMMUNICATIONS PROTOCOLS; VIDEO PHONES, VERY LARGE SCALE INTEGRATION (VLSI) SEMICONDUCTOR INTEGRATED CIRCUITS, COMPUTERS, ELECTRONIC CIRCUITS, COMPUTER HARDWARE, INTEGRATED CIRCUITS, KEYBOARDS; COMPUTER STORAGE DEVICES, NAMELY, BLANK FLASH DRIVES; USB COMPUTER ACCESS CONTROL KEY, BACKUP DRIVES FOR COMPUTERS, SOLID STATE DRIVES, CHIP CARD READERS, ELECTRONIC CARD READERS, ELECTRONIC MEMORY CARD READERS, FLASH CARD READERS, SMART CARD READERS (U.S. CLS. 21, 23, 26, 36 AND 38).

FIRST USE 3-26-2011; IN COMMERCE 3-26-2011.

CAROLINE WOOD, EXAMINING ATTORNEY

**CLASS 9—(Continued).**

SN 85-333,373. PACINIAN CORPORATION, SPOKANE, WA. FILED 5-30-2011.

# ThinTouch

THE MARK CONSISTS OF STANDARD CHARACTERS WITHOUT CLAIM TO ANY PARTICULAR FONT, STYLE, SIZE, OR COLOR.

FOR COMPUTER PERIPHERALS, NAMELY KEYBOARDS, TOUCHPADS, CONTROL PANELS, BUTTONS, TOUCHSCREENS, KEYPADS, AND MICE; MULTIFUNCTION KEYBOARDS; KEYBOARDS; COMPUTER KEYBOARDS; KEYBOARDS FOR MOBILE PHONES; KEYBOARDS FOR TABLET COMPUTERS; KEYBOARDS FOR LAPTOPS, NOTEBOOKS, AND OTHER COMPUTERS; WIRELESS COMPUTER PERIPHERALS; WIRED COMPUTER PERIPHERALS; COMPONENTS INTEGRATED INTO A COMPUTER SYSTEM, NAMELY KEYBOARDS, TOUCHPADS, CONTROL PANELS, BUTTONS, TOUCHSCREENS, KEYPADS, AND MICE; HUMAN-MACHINE INTERFACE DEVICES; COMPUTERS HAVING HUMAN-MACHINE INTERFACE DEVICES OR COMPONENTS; LAPTOP OR NOTEBOOK COMPUTERS; INPUT DEVICES FOR COMPUTERS; COMPUTER HARDWARE AND COMPUTER PERIPHERAL DEVICES; COMPUTER PERIPHERAL DEVICES; COMPUTER PERIPHERAL EQUIPMENT; INTERFACES AND PERIPHERAL DEVICES FOR COMPUTERS (U.S. CLS. 21, 23, 26, 36 AND 38).

TOBY BULLOFF, EXAMINING ATTORNEY

SN 85-333,614. HENRY, TAHMEL, BROOKLYN, NY. FILED 5-31-2011.

# Visdolens

THE MARK CONSISTS OF STANDARD CHARACTERS WITHOUT CLAIM TO ANY PARTICULAR FONT, STYLE, SIZE, OR COLOR.

FOR SUNGLASSES (U.S. CLS. 21, 23, 26, 36 AND 38). FIRST USE 4-14-2011; IN COMMERCE 4-14-2011. JOHN GARTNER, EXAMINING ATTORNEY

**CLASS 9—(Continued).**

SN 85-333,618. HENRY, TAHMEL, BROOKLYN, NY. FILED 5-31-2011.



THE MARK CONSISTS OF THE STYLIZED TEXT "VS" IN WHICH THE RIGHT SIDE OF THE "V" IS MADE UP OF TWO BARS THAT ACT AS THE CROSSBARS IN THE DOLLAR SIGN.

FOR SUNGLASSES (U.S. CLS. 21, 23, 26, 36 AND 38). JOHN GARTNER, EXAMINING ATTORNEY

SN 85-333,665. BRUKER CORPORATION, BILLERICA, MA. FILED 5-31-2011.

# SCION

THE MARK CONSISTS OF STANDARD CHARACTERS WITHOUT CLAIM TO ANY PARTICULAR FONT, STYLE, SIZE, OR COLOR.

FOR GAS CHROMATOGRAPH-MASS SPECTROMETERS (U.S. CLS. 21, 23, 26, 36 AND 38). WANDA KAY PRICE, EXAMINING ATTORNEY

SN 85-333,748. AGS, LLC, HENDERSON, NV. FILED 5-31-2011.

# \$10,000 QUESTION

THE MARK CONSISTS OF STANDARD CHARACTERS WITHOUT CLAIM TO ANY PARTICULAR FONT, STYLE, SIZE, OR COLOR.

FOR GAMING MACHINES; GAMING MACHINES, NAMELY, DEVICES THAT ACCEPT A WAGER; GAMING MACHINES, NAMELY, SLOT MACHINES AND VIDEO GAMBLING TERMINALS; MACHINES FOR PLAYING GAMES OF CHANCE; VIDEO GAME MACHINES FOR USE WITH EXTERNAL DISPLAY SCREEN OR MONITOR (U.S. CLS. 21, 23, 26, 36 AND 38). RONALD AIKENS, EXAMINING ATTORNEY

**CLASS 9—(Continued).**

SN 85-333,759. AGS, LLC, HENDERSON, NV. FILED 5-31-2011.

**\$100,000 QUESTION**

THE MARK CONSISTS OF STANDARD CHARACTERS WITHOUT CLAIM TO ANY PARTICULAR FONT, STYLE, SIZE, OR COLOR.

FOR GAMING MACHINES; GAMING MACHINES, NAMELY, DEVICES THAT ACCEPT A WAGER; GAMING MACHINES, NAMELY, SLOT MACHINES AND VIDEO GAMBLING TERMINALS; MACHINES FOR PLAYING GAMES OF CHANCE; VIDEO GAME MACHINES FOR USE WITH EXTERNAL DISPLAY SCREEN OR MONITOR (U.S. CLS. 21, 23, 26, 36 AND 38).

RONALD AIKENS, EXAMINING ATTORNEY

---

SN 85-333,807. SYNAPTICS INCORPORATED, SANTA CLARA, CA. FILED 5-31-2011.

**InterTouch**

THE MARK CONSISTS OF STANDARD CHARACTERS WITHOUT CLAIM TO ANY PARTICULAR FONT, STYLE, SIZE, OR COLOR.

FOR TOUCH-SENSITIVE INPUT DEVICES FOR CONSUMER ELECTRONIC PRODUCTS THAT ALLOW THE USER TO INTERFACE WITH OR CONTROL THE PRODUCTS; BIOMETRIC SYSTEMS COMPRISING ONE OR MORE BIOMETRIC SENSORS OR SOFTWARE FOR IDENTIFYING OR VERIFYING A USER OF A DEVICE; CAPACITIVE SENSORS TO INTERFACE WITH OR CONTROL A CONSUMER ELECTRONIC DEVICE; AND SOFTWARE FOR DEVELOPING, DESIGNING, OPERATING, OR CONTROLLING TOUCH-SENSITIVE INPUT DEVICES FOR CONSUMER ELECTRONIC PRODUCTS OR CAPACITIVE SENSORS TO INTERFACE WITH OR CONTROL A CONSUMER ELECTRONIC DEVICE (U.S. CLS. 21, 23, 26, 36 AND 38).

HOWARD B. LEVINE, EXAMINING ATTORNEY

**CLASS 9—(Continued).**

SN 85-333,819. TACT AUDIO, INC., ALBUQUERQUE, NM. FILED 5-31-2011.

**TACT**

THE MARK CONSISTS OF STANDARD CHARACTERS WITHOUT CLAIM TO ANY PARTICULAR FONT, STYLE, SIZE, OR COLOR.

FOR AUDIO AMPLIFIERS; AUDIO CIRCUIT BOARDS; AUDIO ELECTRONIC COMPONENTS, NAMELY, SURROUND SOUND SYSTEMS; COMPUTER SOFTWARE FOR CONTROLLING THE OPERATION OF AUDIO AND VIDEO DEVICES; COMPUTER SOFTWARE FOR MANIPULATING DIGITAL AUDIO INFORMATION FOR USE IN AUDIO MEDIA APPLICATIONS; COMPUTER SOFTWARE TO CONTROL AND IMPROVE COMPUTER AND AUDIO EQUIPMENT SOUND QUALITY; CONSUMER ELECTRONIC PRODUCTS, NAMELY, AUDIO AMPLIFIERS, AUDIO SPEAKERS, AUDIO RECEIVERS, ELECTRICAL AUDIO AND SPEAKER CABLES AND CONNECTORS, AUDIO DECODERS, VIDEO DECODERS, SPEAKERS, POWER CONVERSION DEVICES, POWER CONVERTERS, AND POWER INVERTERS; DIGITAL AUDIO PLAYERS; ELECTRIC AUDIO PLAYBACK UNITS; ELECTRONIC PRODUCTS FOR THE GENERATION, MEASUREMENT, AND ANALYSIS OF AUDIO SIGNALS, NAMELY, AUDIO ANALYZERS; ELECTRONIC PRODUCTS FOR THE MANIPULATION OF THE FREQUENCY, TIME, AND AMPLITUDE CHARACTERISTICS OF AUDIO SIGNALS, NAMELY, AUDIO PROCESSORS; HOME THEATER SYSTEMS COMPRISING PREAMPLIFIERS, COMPUTER HARDWARE AND COMPUTER SOFTWARE, ALL USED IN SOUND EQUIPMENT FOR ACOUSTIC CORRECTION AND ENVIRONMENTAL ACOUSTIC COMPENSATION; SOFTWARE TO CONTROL AND IMPROVE AUDIO EQUIPMENT SOUND QUALITY (U.S. CLS. 21, 23, 26, 36 AND 38).

FIRST USE 1-31-1999; IN COMMERCE 1-31-1999.

DAVID TAYLOR, EXAMINING ATTORNEY

---

SN 85-333,894. TOSHIBA INTERNATIONAL CORPORATION, HOUSTON, TX. FILED 5-31-2011.

**NetPac**

THE MARK CONSISTS OF STANDARD CHARACTERS WITHOUT CLAIM TO ANY PARTICULAR FONT, STYLE, SIZE, OR COLOR.

FOR WIRELESS COMMUNICATIONS DEVICE, NAMELY A WIRELESS DRIVE INTERFACE DEVICE USED TO FACILITATE COMMUNICATIONS BETWEEN MULTIPLE ADJUSTABLE SPEED DRIVES AND A CENTRAL COMPUTER THAT ALLOWS ONE TO MONITOR AND CONTROL THE ADJUSTABLE SPEED DRIVES (U.S. CLS. 21, 23, 26, 36 AND 38).

LINDA M. KING, EXAMINING ATTORNEY

**CLASS 9—(Continued).**

SN 85-333,968. AIRPATROL CORPORATION, COLUMBIA, MD. FILED 5-31-2011.

**Zone Defense**

THE MARK CONSISTS OF STANDARD CHARACTERS WITHOUT CLAIM TO ANY PARTICULAR FONT, STYLE, SIZE, OR COLOR.

FOR COMPUTER APPLICATION SOFTWARE FOR MOBILE PHONES, MEDIA PLAYERS, AND COMPUTERS, NAMELY, SOFTWARE FOR USE IN THE CONTROL OF PERIPHERAL FUNCTIONALITIES OF DEVICES (U.S. CLS. 21, 23, 26, 36 AND 38).

DORITT L. CARROLL, EXAMINING ATTORNEY

SN 85-334,049. OBJECT RESERVOIR, INC., HOUSTON, TX. FILED 5-31-2011.

**LIMITS**

THE MARK CONSISTS OF STANDARD CHARACTERS WITHOUT CLAIM TO ANY PARTICULAR FONT, STYLE, SIZE, OR COLOR.

FOR COMPUTER SOFTWARE FOR ANALYSIS OF NATURAL RESOURCE RESERVES AND PLANNING FOR RECOVERY OF NATURAL RESOURCE RESERVES (U.S. CLS. 21, 23, 26, 36 AND 38).

JENNIFER VASQUEZ, EXAMINING ATTORNEY

SN 85-334,053. ROWAMPS LLC, POWELL, OH. FILED 5-31-2011.

**rowAMPS**

THE MARK CONSISTS OF STANDARD CHARACTERS WITHOUT CLAIM TO ANY PARTICULAR FONT, STYLE, SIZE, OR COLOR.

FOR COMPUTER SOFTWARE FOR USE IN ASSET MANAGEMENT, NAMELY, IN THE ENERGY AND TRANSPORTATION INDUSTRIES (U.S. CLS. 21, 23, 26, 36 AND 38).

FIRST USE 1-1-2011; IN COMMERCE 2-1-2011.

DAVID I, EXAMINING ATTORNEY

**CLASS 9—(Continued).**

SN 85-334,068. SEENWAY USA, LLC, HERCULES, CA. FILED 5-31-2011.

**NETWELL**

THE MARK CONSISTS OF STANDARD CHARACTERS WITHOUT CLAIM TO ANY PARTICULAR FONT, STYLE, SIZE, OR COLOR.

FOR VIDEOPHONES USED FOR DOORWAY ENTRY (U.S. CLS. 21, 23, 26, 36 AND 38).

FRED CARL, EXAMINING ATTORNEY

SN 85-334,088. NELSON, STEVEN L., HAMPTON, MN. FILED 5-31-2011.



THE MARK CONSISTS OF A STYLIZED LETTER G SUPERIMPOSED OVER FOUR EQUIDISTANT NARROW HORIZONTAL SLIGHTLY CURVED ARROW POINTS, THE ARROW POINTS POINTING RIGHT AND THE WORD GENAVE CENTERED BELOW THE STYLIZED G AND ARROW POINTS.

FOR DEVICES, NAMELY, ELECTRONIC CONTROL DEVICES, AND SOFTWARE FOR USE BY OTHERS FOR REMOTELY CONTROLLING EQUIPMENT AND LOGIC PROCESSES VIA WIRELESS OR WIRED CONNECTIONS (U.S. CLS. 21, 23, 26, 36 AND 38).

FIRST USE 3-31-2011; IN COMMERCE 3-31-2011.

DAVID H. STINE, EXAMINING ATTORNEY

SN 85-334,097. OBJECT RESERVOIR, INC., HOUSTON, TX. FILED 5-31-2011.

**ORKA**

THE MARK CONSISTS OF STANDARD CHARACTERS WITHOUT CLAIM TO ANY PARTICULAR FONT, STYLE, SIZE, OR COLOR.

FOR COMPUTER SOFTWARE FOR WORKFLOW MANAGEMENT, DATA ORGANIZATION AND DATA PROVENANCE (U.S. CLS. 21, 23, 26, 36 AND 38).

JENNIFER VASQUEZ, EXAMINING ATTORNEY



**CLASS 9—(Continued).**

SN 85-334,130. NELSON, STEVEN L., HAMPTON, MN. FILED 5-31-2011.

# Genave

THE MARK CONSISTS OF STANDARD CHARACTERS WITHOUT CLAIM TO ANY PARTICULAR FONT, STYLE, SIZE, OR COLOR.

FOR DEVICES, NAMELY, ELECTRONIC CONTROL DEVICES, AND SOFTWARE FOR USE BY OTHERS FOR REMOTELY CONTROLLING EQUIPMENT AND LOGIC PROCESSES VIA WIRELESS OR WIRED CONNECTIONS (U.S. CLS. 21, 23, 26, 36 AND 38).

FIRST USE 3-31-2011; IN COMMERCE 3-31-2011.  
DAVID H. STINE, EXAMINING ATTORNEY

**CLASS 9—(Continued).**

SN 85-334,326. FRESENIUS KABI AG, BAD HOMBURG, FED REP GERMANY, FILED 5-31-2011.

# PARTNER AGILIA

THE MARK CONSISTS OF STANDARD CHARACTERS WITHOUT CLAIM TO ANY PARTICULAR FONT, STYLE, SIZE, OR COLOR.

FOR COMPUTER SOFTWARE, NAMELY, MAINTENANCE SOFTWARE IN THE MEDICAL AREA OF INFUSION, COMPRISING PARAMETERS CONFIGURATION, MAINTENANCE OPERATIONS AND CALIBRATION, AND DATA LOG EVENT DOWNLOAD (U.S. CLS. 21, 23, 26, 36 AND 38).

ANGELA M. MICHELI, EXAMINING ATTORNEY

SN 85-334,210. BITCYCLE AB, UPPSALA, SWEDEN, FILED 5-31-2011.

# WORDFOTO

THE MARK CONSISTS OF STANDARD CHARACTERS WITHOUT CLAIM TO ANY PARTICULAR FONT, STYLE, SIZE, OR COLOR.

FOR DOWNLOADABLE SOFTWARE IN THE NATURE OF A MOBILE APPLICATION FOR PHOTOGRAPHY THAT ENABLES THE USER TO APPLY VARIOUS EFFECTS OF A TYPOGRAPHICAL NATURE ON HIS OR HER PHOTOGRAPHS (U.S. CLS. 21, 23, 26, 36 AND 38).

FIRST USE 11-2-2010; IN COMMERCE 12-28-2010.  
KATHERINE CHANG, EXAMINING ATTORNEY

SN 85-334,347. CICI VISION INC, CORONA, NY. FILED 5-31-2011.

# CICI

THE MARK CONSISTS OF STANDARD CHARACTERS WITHOUT CLAIM TO ANY PARTICULAR FONT, STYLE, SIZE, OR COLOR.

FOR SUNGLASSES AND SPECTACLES (U.S. CLS. 21, 23, 26, 36 AND 38).

FIRST USE 4-1-2011; IN COMMERCE 4-1-2011.  
DOMINICK J. SALEMI, EXAMINING ATTORNEY

SN 85-334,212. TLV CO., LTD., HYOGO-KEN, JAPAN, FILED 5-31-2011.

# PLANTMAP

THE MARK CONSISTS OF STANDARD CHARACTERS WITHOUT CLAIM TO ANY PARTICULAR FONT, STYLE, SIZE, OR COLOR.

FOR COMPUTER SOFTWARE FOR DRAWINGS AND DIAGRAMS DEFINED BY USER INPUTS AND DATA, SHOWING LOCATION AND LAYOUT OF THE POPULATION OF TRAPS, VALVES, AND ROTATING EQUIPMENT AND MACHINERY IN INDUSTRIAL FACILITIES (U.S. CLS. 21, 23, 26, 36 AND 38).

FIRST USE 12-0-2008; IN COMMERCE 12-0-2008.  
KATHERINE E. HALMEN, EXAMINING ATTORNEY

SN 85-334,502. NEW AMSTERDAM CONSULTING, INC., SCOTTSDALE, AZ. FILED 5-31-2011.

# Joshua

THE MARK CONSISTS OF STANDARD CHARACTERS WITHOUT CLAIM TO ANY PARTICULAR FONT, STYLE, SIZE, OR COLOR.

FOR COMPUTER SOFTWARE FOR THE COLLECTION, EDITING, ORGANIZING, MODIFYING, BOOK MARKING, TRANSMISSION, STORAGE AND SHARING OF DATA AND INFORMATION (U.S. CLS. 21, 23, 26, 36 AND 38).

LINDA MICKLEBURGH, EXAMINING ATTORNEY

**CLASS 9—(Continued).**

SN 85-334,590. ENHANCED VISION SYSTEMS, HUNTINGTON BEACH, CA. FILED 5-31-2011.

# MOJO

THE MARK CONSISTS OF STANDARD CHARACTERS WITHOUT CLAIM TO ANY PARTICULAR FONT, STYLE, SIZE, OR COLOR.

FOR MEDICAL APPARATUS IN THE FORM OF VIDEO HEADSETS FOR PROVIDING VISUAL ASSISTANCE TO PERSONS WITH SYMPTOMS ASSOCIATED WITH LOW VISION (U.S. CLS. 21, 23, 26, 36 AND 38).

LINDA ORNDORFF, EXAMINING ATTORNEY

---

SN 85-334,611. FRACTAL ANTENNA SYSTEMS, INC., WALTHAM, MA. FILED 5-31-2011.

# Dissimulation

THE MARK CONSISTS OF STANDARD CHARACTERS WITHOUT CLAIM TO ANY PARTICULAR FONT, STYLE, SIZE, OR COLOR.

FOR ANTENNAS FOR WIRELESS COMMUNICATIONS APPARATUS (U.S. CLS. 21, 23, 26, 36 AND 38).

JOHN GARTNER, EXAMINING ATTORNEY

---

SN 85-334,616. CYPHER PSYCHOLOGICAL SERVICES, P.C., ROCHESTER, NY. FILED 5-31-2011.

# Cohesive Self

THE MARK CONSISTS OF STANDARD CHARACTERS WITHOUT CLAIM TO ANY PARTICULAR FONT, STYLE, SIZE, OR COLOR.

FOR CHILDREN'S EDUCATIONAL SOFTWARE; COMPUTER APPLICATION SOFTWARE FOR MOBILE PHONES, PORTABLE MEDIA PLAYERS, AND HANDHELD OR TABLET COMPUTERS, NAMELY, SOFTWARE FOR THE DEVELOPMENT OF MENTAL SKILLS AND EMOTIONAL WELL-BEING (U.S. CLS. 21, 23, 26, 36 AND 38).

TINA L. SNAPP, EXAMINING ATTORNEY

**CLASS 9—(Continued).**

SN 85-334,623. HIGH TECH ACCESSORY ITEMS, INC., ROCKY MOUNT, NC. FILED 5-31-2011.

# DocuGate

THE MARK CONSISTS OF STANDARD CHARACTERS WITHOUT CLAIM TO ANY PARTICULAR FONT, STYLE, SIZE, OR COLOR.

FOR COMPUTER SOFTWARE FOR SECURELY PRINTING DOCUMENTS THROUGH A CENTRALLY MANAGED SERVER TO THE USER'S OUTPUT DEVICE OF CHOICE, AND FOR MONITORING AND REPORTING THE USE MADE OF SUCH OUTPUT DEVICES (U.S. CLS. 21, 23, 26, 36 AND 38).

FIRST USE 5-18-2010; IN COMMERCE 5-18-2010.

TINA L. SNAPP, EXAMINING ATTORNEY

---

SN 85-334,747. EMPRIMUS, LLC, ST. LOUIS PARK, MN. FILED 6-1-2011.

# SOLIDGROUND

THE MARK CONSISTS OF STANDARD CHARACTERS WITHOUT CLAIM TO ANY PARTICULAR FONT, STYLE, SIZE, OR COLOR.

FOR POWER GRID PROTECTION DEVICE COMPOSED OF A SWITCHED GROUNDING CONNECTION, CIRCUIT BLOCKING COMPONENT AND DC CURRENT / POWER HARMONIC SENSING CONTROL CIRCUIT INTENDED TO PROVIDE A SOLID AC ELECTRICAL GROUND AND TO BLOCK INDUCED DC ELECTRIC CURRENTS (U.S. CLS. 21, 23, 26, 36 AND 38).

AISHA CLARKE, EXAMINING ATTORNEY

**CLASS 9—(Continued).**

SN 85-334,773. GAMELOFT S.A., PARIS, FRANCE, FILED 6-1-2011.

**ASPHALT: INJECTION**

THE MARK CONSISTS OF STANDARD CHARACTERS WITHOUT CLAIM TO ANY PARTICULAR FONT, STYLE, SIZE, OR COLOR.

OWNER OF U.S. REG. NOS. 3,101,318, 3,540,639 AND 3,905,304.

FOR COMPUTER SOFTWARE FOR ELECTRONIC GAMES AND ENTERTAINMENT, NAMELY, COMPUTER GAME SOFTWARE USED AND PLAYED ON MOBILE AND CELLULAR TELEPHONES, HANDHELD COMPUTERS, HANDHELD CONSOLES, HOME CONSOLES, PERSONAL COMPUTERS AND PERSONAL DIGITAL ASSISTANTS; DOWNLOADABLE ELECTRONIC GAME PROGRAMS; DOWNLOADABLE RING TONES FOR MOBILE TELECOMMUNICATIONS DEVICES; DOWNLOADABLE VOICE RINGERS FOR MOBILE TELECOMMUNICATIONS DEVICES; COMPUTER SOFTWARE FOR WALL PAPERS, NAMELY, STILL IMAGES FOR USE IN BACKGROUNDS ON MOBILE PHONE SCREENS; COMPUTER SCREEN SAVER SOFTWARE; COMPUTER SOFTWARE FOR PROCESSING ANIMATED IMAGES FOR USE ON MOBILE PHONE SCREENS; AND COMPUTER PROGRAMS FOR DOWNLOADING IMAGES TO MOBILE TELECOMMUNICATION DEVICES, NAMELY, MOBILE AND CELLULAR TELEPHONES, HANDHELD COMPUTERS, HANDHELD CONSOLES, HOME CONSOLES, PERSONAL COMPUTERS AND PERSONAL DIGITAL ASSISTANTS VIA THE GLOBAL COMPUTER NETWORK AND WIRELESS DEVICES; AND COMPUTER SOFTWARE FOR USE IN THE DESIGN, DEVELOPMENT AND EXECUTION OF WIRELESS COMPUTER GAMES (U.S. CLS. 21, 23, 26, 36 AND 38).

HEATHER THOMPSON, EXAMINING ATTORNEY

SN 85-334,775. LARK TECHNOLOGIES, INC., PALO ALTO, CA. FILED 6-1-2011.

**LARK**

THE MARK CONSISTS OF STANDARD CHARACTERS WITHOUT CLAIM TO ANY PARTICULAR FONT, STYLE, SIZE, OR COLOR.

FOR BABY MONITORS; EYEWEAR (U.S. CLS. 21, 23, 26, 36 AND 38).

WENDY JUN, EXAMINING ATTORNEY

**CLASS 9—(Continued).**

SN 85-334,814. LITEL VENTURES LLC, THE WOODLANDS, TX. FILED 6-1-2011.

**SWIGGLES**

THE MARK CONSISTS OF STANDARD CHARACTERS WITHOUT CLAIM TO ANY PARTICULAR FONT, STYLE, SIZE, OR COLOR.

FOR SWIMMING GOGGLES, NAMELY, SPECIALLY DESIGNED GOGGLES WITH A UNIQUE NEOPRENE STRAP (U.S. CLS. 21, 23, 26, 36 AND 38).

COURTNEY ALVAREZ, EXAMINING ATTORNEY

SN 85-334,891. MATTHEW L FRANCIS, BRASELTON, GA. FILED 6-1-2011.

**everchime**

THE MARK CONSISTS OF STANDARD CHARACTERS WITHOUT CLAIM TO ANY PARTICULAR FONT, STYLE, SIZE, OR COLOR.

FOR ALARM CENTRAL UNITS; ALARM INSTALLATIONS AND ALARMS; ALARM MONITORING SYSTEMS; ANTI-INTRUSION ALARMS (U.S. CLS. 21, 23, 26, 36 AND 38).

RONALD MCMORROW, EXAMINING ATTORNEY

SN 85-334,951. ITRAIN, LLC, BEVERLY HILLS, CA. FILED 6-1-2011.

**ITRAIN**

THE MARK CONSISTS OF STANDARD CHARACTERS WITHOUT CLAIM TO ANY PARTICULAR FONT, STYLE, SIZE, OR COLOR.

OWNER OF U.S. REG. NOS. 3,459,770 AND 3,633,138. FOR COMPUTER APPLICATION SOFTWARE FOR MOBILE PHONES, NAMELY, SOFTWARE FOR FITNESS (U.S. CLS. 21, 23, 26, 36 AND 38).

FIRST USE 5-1-2011; IN COMMERCE 5-1-2011.

ANNE MADDEN, EXAMINING ATTORNEY

**CLASS 9—(Continued).**

SN 85-335,262. TAVAT - TRADING, MARKETING E EXPLORACÃO DE MARCAS, SOCIEDADE UNIPESSOAL LDA, 3.0, LETRA G, MADEIRA, PORTUGAL, FILED 6-1-2011.

TAVAT

THE MARK CONSISTS OF THE WORD TAVAT IN STYLIZED LETTERING.

THE WORDING TAVAT HAS NO MEANING IN A FOREIGN LANGUAGE.

FOR CASES FOR EYEGLASSES AND SUNGLASSES; CHAINS FOR SPECTACLES; EYEGLOSS CORDS; EYEGLASSES; EYEWEAR, NAMELY, SUNGLASSES, EYEGLASSES AND OPHTHALMIC FRAMES AND CASES THEREFOR; SPECTACLE CASES; SPECTACLE FRAMES; SPECTACLE LENSES; SPECTACLES; SUNGLASS CHAINS AND CORDS; SUNGLASSES (U.S. CLS. 21, 23, 26, 36 AND 38).

FIRST USE 3-0-2010; IN COMMERCE 4-30-2010.  
EMILY CHUO, EXAMINING ATTORNEY

SN 85-335,481. MATHLYNX, LLC, MILLINGTON, NJ. FILED 6-1-2011.

MATHLYNX

THE MARK CONSISTS OF STANDARD CHARACTERS WITHOUT CLAIM TO ANY PARTICULAR FONT, STYLE, SIZE, OR COLOR.

FOR INTERACTIVE SOFTWARE FEATURING MATHEMATICS TEACHING AND LEARNING MATERIALS (U.S. CLS. 21, 23, 26, 36 AND 38).

FIRST USE 8-30-2010; IN COMMERCE 8-30-2010.  
LINDA MICKLEBURGH, EXAMINING ATTORNEY

**CLASS 9—(Continued).**

SN 85-335,485. MRM HOLDINGS LIMITED, PORT LOUIS, MAURITIUS, FILED 6-1-2011.

CARRYSAFE

THE MARK CONSISTS OF STANDARD CHARACTERS WITHOUT CLAIM TO ANY PARTICULAR FONT, STYLE, SIZE, OR COLOR.

OWNER OF U.S. REG. NO. 3,879,712.  
FOR STRAPS FOR CAMERAS AND CAMERA CASES (U.S. CLS. 21, 23, 26, 36 AND 38).

FIRST USE 1-29-2004; IN COMMERCE 1-29-2004.  
C. DIONNE CLYBURN, EXAMINING ATTORNEY

SN 85-335,492. LEDTRONICS, INC., TORRANCE, CA. FILED 6-1-2011.

LED

NO CLAIM IS MADE TO THE EXCLUSIVE RIGHT TO USE "LED", APART FROM THE MARK AS SHOWN.

THE MARK CONSISTS OF THE MARK COMPRISES THE LETTERS LED ARRANGED TO RESEMBLE A LIGHT; SPECIFICALLY, THE LETTER "L" IS ELEVATED AND APPEARS TO BE A WIRE ATTACHED TO THE CENTER OF THE LEFT SIDE OF THE LETTER "E", AND THE ROUNDED PORTION OF THE LETTER "D" APPEARS TO BE THE SURFACE OF A BULB.

FOR LIGHT EMITTING DIODE (LED) DEVICES, NAMELY ARRAYS, CLUSTERS AND DISPLAYS OF LED DEVICES FOR INSTRUMENTATION, INDICATION AND ILLUMINATION WITHIN THE VISIBLE LIGHT AND INFRARED SPECTRUM (U.S. CLS. 21, 23, 26, 36 AND 38).

FIRST USE 1-0-1984; IN COMMERCE 1-0-1984.  
C. DIONNE CLYBURN, EXAMINING ATTORNEY

**CLASS 9—(Continued).**

SN 85-335,517. RAGE RECORDS INC, NEW YORK, NY.  
FILED 6-1-2011.



NO CLAIM IS MADE TO THE EXCLUSIVE RIGHT TO USE RECORDS, APART FROM THE MARK AS SHOWN.

THE MARK CONSISTS OF THE WORDING RAGE RECORDS & DESIGN COMPRISED IN PART OF A PAIR OF EYES.

FOR DIGITAL MUSIC DOWNLOADABLE FROM THE INTERNET; MUSICAL SOUND RECORDINGS (U.S. CLS. 21, 23, 26, 36 AND 38).

FIRST USE 1-1-1993; IN COMMERCE 1-1-1993.

C. DIONNE CLYBURN, EXAMINING ATTORNEY

**CLASS 9—(Continued).**

SN 85-335,657. TXT ENTERPRISES, INC, SOUTH EL MONTE, CA. FILED 6-1-2011.

IG

THE MARK CONSISTS OF STANDARD CHARACTERS WITHOUT CLAIM TO ANY PARTICULAR FONT, STYLE, SIZE, OR COLOR.

OWNER OF U.S. REG. NOS. 3,295,767, 3,856,464 AND OTHERS.

FOR CASES FOR EYEGLASSES AND SUNGLASSES; CHILDREN'S EYE GLASSES; CORRECTIVE GLASSES; FRAMES FOR SPECTACLES AND SUNGLASSES; LENSES FOR SUNGLASSES; SUNGLASS CHAINS AND CORDS; SUNGLASSES (U.S. CLS. 21, 23, 26, 36 AND 38).

FIRST USE 4-11-2007; IN COMMERCE 5-30-2007.

PAUL MORENO, EXAMINING ATTORNEY

SN 85-335,665. WORX AUDIO TECHNOLOGIES, INC., GREENSBORO, NC. FILED 6-1-2011.

WORXAUDIO

THE MARK CONSISTS OF STANDARD CHARACTERS WITHOUT CLAIM TO ANY PARTICULAR FONT, STYLE, SIZE, OR COLOR.

FOR AUDIO SPEAKERS (U.S. CLS. 21, 23, 26, 36 AND 38).

FIRST USE 6-0-2001; IN COMMERCE 6-0-2001.

MAYUR VAGHANI, EXAMINING ATTORNEY

SN 85-335,625. BLAIR, ELIZABETH L., KANSAS CITY, MO.  
FILED 6-1-2011.

descaid

THE MARK CONSISTS OF STANDARD CHARACTERS WITHOUT CLAIM TO ANY PARTICULAR FONT, STYLE, SIZE, OR COLOR.

FOR COMPUTER APPLICATION SOFTWARE FOR HANDHELD COMPUTERS, PERSONAL DIGITAL ASSISTANTS, ELECTRONIC ORGANIZERS, ELECTRONIC NOTEPADS, MOBILE PHONES, AND VIDEOPHONES, NAMELY, SOFTWARE FOR RECEIVING REMINDERS TO ENGAGE IN HEALTH AND WELLNESS ACTIVITIES, NAMELY, EXERCISE, STRETCHING, DRINKING WATER, AND UTILIZING HEALTHY EATING HABITS; COMPUTER SOFTWARE FOR A PROGRAM THAT DISTRIBUTES REMINDERS TO ENGAGE IN HEALTH AND WELLNESS ACTIVITIES, NAMELY, EXERCISE, STRETCHING, DRINKING WATER, AND UTILIZING HEALTHY EATING HABITS (U.S. CLS. 21, 23, 26, 36 AND 38).

JANICE L. MCMORROW, EXAMINING ATTORNEY

SN 85-335,675. TXT ENTERPRISES, INC, SOUTH EL MONTE, CA. FILED 6-1-2011.

Kyra

OWNER OF U.S. REG. NO. 3,512,339.

THE MARK CONSISTS OF LETTERS K Y R A.

FOR CASES FOR EYEGLASSES AND SUNGLASSES; CHAINS FOR SPECTACLES AND FOR SUNGLASSES; CHILDREN'S EYE GLASSES; LENSES FOR SUNGLASSES; SUNGLASSES AND SPECTACLES (U.S. CLS. 21, 23, 26, 36 AND 38).

FIRST USE 5-9-2008; IN COMMERCE 5-9-2008.

PAUL MORENO, EXAMINING ATTORNEY

**CLASS 9—(Continued).**

SN 85-335,720. CICI VISION INC, CORONA, NY. FILED 6-1-2011.



THE MARK CONSISTS OF A STYLIZED SCRIPT OF LETTERS CICI.  
FOR SPECTACLES AND SUNGLASSES (U.S. CLS. 21, 23, 26, 36 AND 38).  
FIRST USE 4-1-2011; IN COMMERCE 4-1-2011.  
DOMINICK J. SALEMI, EXAMINING ATTORNEY

SN 85-335,722. XENTRIS WIRELESS, LLC, ADDISON, IL. FILED 6-1-2011.

## OPTI FX

THE MARK CONSISTS OF STANDARD CHARACTERS WITHOUT CLAIM TO ANY PARTICULAR FONT, STYLE, SIZE, OR COLOR.  
FOR CELL PHONE COVERS; CLEAR PROTECTIVE COVERS SPECIALLY ADAPTED FOR PERSONAL ELECTRONIC DEVICES; PROTECTIVE COVERS AND CASES FOR CELL PHONES, LAPTOPS AND PORTABLE MEDIA PLAYERS; PROTECTIVE COVERS FOR ELECTRONIC READING DEVICES (U.S. CLS. 21, 23, 26, 36 AND 38).  
WILLIAM P. SHANAHAN, EXAMINING ATTORNEY

SN 85-335,726. XENTRIS WIRELESS, LLC, ADDISON, IL. FILED 6-1-2011.

## OPTI F/X

THE MARK CONSISTS OF STANDARD CHARACTERS WITHOUT CLAIM TO ANY PARTICULAR FONT, STYLE, SIZE, OR COLOR.  
FOR CELL PHONE COVERS; CLEAR PROTECTIVE COVERS SPECIALLY ADAPTED FOR PERSONAL ELECTRONIC DEVICES; PROTECTIVE COVERS AND CASES FOR CELL PHONES, LAPTOPS AND PORTABLE MEDIA PLAYERS; PROTECTIVE COVERS FOR ELECTRONIC READING DEVICES (U.S. CLS. 21, 23, 26, 36 AND 38).  
WILLIAM P. SHANAHAN, EXAMINING ATTORNEY

**CLASS 9—(Continued).**

SN 85-335,730. XENTRIS WIRELESS, LLC, ADDISON, IL. FILED 6-1-2011.

## OPTI EFX

THE MARK CONSISTS OF STANDARD CHARACTERS WITHOUT CLAIM TO ANY PARTICULAR FONT, STYLE, SIZE, OR COLOR.  
FOR CELL PHONE COVERS; CLEAR PROTECTIVE COVERS SPECIALLY ADAPTED FOR PERSONAL ELECTRONIC DEVICES; PROTECTIVE COVERS AND CASES FOR CELL PHONES, LAPTOPS AND PORTABLE MEDIA PLAYERS; PROTECTIVE COVERS FOR ELECTRONIC READING DEVICES (U.S. CLS. 21, 23, 26, 36 AND 38).  
WILLIAM P. SHANAHAN, EXAMINING ATTORNEY

SN 85-335,883. FISSION MEDIA GROUP INC., EDMONTON, CANADA, FILED 6-2-2011.

## BACK IN BLACK

THE MARK CONSISTS OF STANDARD CHARACTERS WITHOUT CLAIM TO ANY PARTICULAR FONT, STYLE, SIZE, OR COLOR.  
FOR COMPUTER SOFTWARE THAT PROVIDES A TOOL TO CREATE AND MANAGE A BUDGET, EXPENSES, FINANCIAL GOALS, SPENDING, SALES AND CASH-FLOW FOR INDIVIDUALS, FAMILIES AND SMALL BUSINESSES (U.S. CLS. 21, 23, 26, 36 AND 38).  
JOHN E. MICHOS, EXAMINING ATTORNEY

SN 85-335,927. ALLSTATE INSURANCE COMPANY, NORTHBROOK, IL. FILED 6-2-2011.

## KAPTURA

THE MARK CONSISTS OF STANDARD CHARACTERS WITHOUT CLAIM TO ANY PARTICULAR FONT, STYLE, SIZE, OR COLOR.  
FOR COMPUTER APPLICATION SOFTWARE FOR MOBILE PHONES, NAMELY, SOFTWARE FOR PLAYING VIDEO GAMES (U.S. CLS. 21, 23, 26, 36 AND 38).  
SHAUNIA CARLYLE, EXAMINING ATTORNEY

**CLASS 9—(Continued).**

SN 85-335,996. CUETEC CO., LTD., TAICHUNG CITY, TAIWAN, FILED 6-2-2011.

# CARBONADO

THE MARK CONSISTS OF A STYLIZED WORD "CARBONADO" FOR EYEWEAR, NAMELY, SUNGLASSES, EYEGLASSES AND OPHTHALMIC FRAMES AND CASES THEREFOR; FRAMES FOR SPECTACLES AND SUNGLASSES, EYEGLASS LENSES, SUNGLASS LENSES (U.S. CLS. 21, 23, 26, 36 AND 38).

IRA J. GOODSaid, EXAMINING ATTORNEY

SN 85-336,008. AZZARA, MICHAEL, HOLBROOK, NY, FILED 6-2-2011.

# Achocolypse

THE MARK CONSISTS OF STANDARD CHARACTERS WITHOUT CLAIM TO ANY PARTICULAR FONT, STYLE, SIZE, OR COLOR.

FOR VIDEO AND COMPUTER GAME PROGRAMS (U.S. CLS. 21, 23, 26, 36 AND 38).

FIRST USE 6-1-2003; IN COMMERCE 6-1-2003.

HENRY S. ZAK, EXAMINING ATTORNEY

SN 85-336,079. RETINA-X STUDIOS, LLC, JACKSONVILLE, FL, FILED 6-2-2011.

# ACESPY

THE MARK CONSISTS OF STANDARD CHARACTERS WITHOUT CLAIM TO ANY PARTICULAR FONT, STYLE, SIZE, OR COLOR.

FOR COMPUTER SOFTWARE FOR USE IN MONITORING AND RESTRICTING INTERNET AND COMPUTER ACTIVITY (U.S. CLS. 21, 23, 26, 36 AND 38).

FIRST USE 4-23-2003; IN COMMERCE 4-23-2003.

LINDA E. BLOHM, EXAMINING ATTORNEY

**CLASS 9—(Continued).**

SN 85-336,105. BAD MEETS EVIL, LLC, NEW YORK, NY, FILED 6-2-2011.

# BAD MEETS EVIL

THE MARK CONSISTS OF STANDARD CHARACTERS WITHOUT CLAIM TO ANY PARTICULAR FONT, STYLE, SIZE, OR COLOR.

FOR MUSICAL SOUND RECORDINGS; MUSICAL VIDEO RECORDINGS; AUDIO AND VIDEO RECORDINGS FEATURING MUSIC AND ARTISTIC PERFORMANCES; DOWNLOADABLE RING TONES, MUSIC, AND VIDEO RECORDINGS VIA THE INTERNET AND WIRELESS DEVICES (U.S. CLS. 21, 23, 26, 36 AND 38).

FIRST USE 5-4-1999; IN COMMERCE 5-4-1999.

LOURDES AYALA, EXAMINING ATTORNEY

SN 85-336,116. HITPAD INC., PASADENA, CA, FILED 6-2-2011.

# Hitpad

THE MARK CONSISTS OF STANDARD CHARACTERS WITHOUT CLAIM TO ANY PARTICULAR FONT, STYLE, SIZE, OR COLOR.

FOR COMPUTER APPLICATION SOFTWARE FOR TABLET COMPUTERS, NAMELY, SOFTWARE FOR USE IN NAVIGATING THE INTERNET, NAMELY, FOR QUICKLY ACCESSING INFORMATION, PHOTOS, AND VIDEOS ON TOPICS CONSIDERED IMPORTANT BY THE USER (U.S. CLS. 21, 23, 26, 36 AND 38).

FIRST USE 4-5-2011; IN COMMERCE 4-5-2011.

FLORENTINA BLANDU, EXAMINING ATTORNEY

SN 85-336,142. RETINA-X STUDIOS, LLC, JACKSONVILLE, FL, FILED 6-2-2011.

# PHONESHERIFF

THE MARK CONSISTS OF STANDARD CHARACTERS WITHOUT CLAIM TO ANY PARTICULAR FONT, STYLE, SIZE, OR COLOR.

FOR COMPUTER SOFTWARE FOR USE IN MONITORING COMPUTER AND COMPUTER NETWORK ACTIVITY (U.S. CLS. 21, 23, 26, 36 AND 38).

FIRST USE 4-25-2011; IN COMMERCE 4-25-2011.

LINDA E. BLOHM, EXAMINING ATTORNEY

**CLASS 9—(Continued).**

SN 85-336,170. GREENVITY COMMUNICATIONS, INC., MILPITAS, CA. FILED 6-2-2011.

# HYBRII

THE MARK CONSISTS OF STANDARD CHARACTERS WITHOUT CLAIM TO ANY PARTICULAR FONT, STYLE, SIZE, OR COLOR.

FOR SEMICONDUCTOR CHIPS, CIRCUIT BOARDS (U.S. CLS. 21, 23, 26, 36 AND 38).  
YAT SYE, LEE, EXAMINING ATTORNEY

---

SN 85-336,173. GREENVITY COMMUNICATIONS, INC., MILPITAS, CA. FILED 6-2-2011.

# GREENLITE

THE MARK CONSISTS OF STANDARD CHARACTERS WITHOUT CLAIM TO ANY PARTICULAR FONT, STYLE, SIZE, OR COLOR.

FOR SEMICONDUCTOR CHIPS, CIRCUIT BOARDS (U.S. CLS. 21, 23, 26, 36 AND 38).  
YAT SYE, LEE, EXAMINING ATTORNEY

---

SN 85-336,250. HOMERUN HOLDINGS CORPORATION, PENSACOLA, FL. FILED 6-2-2011.

# QMOTION

THE MARK CONSISTS OF STANDARD CHARACTERS WITHOUT CLAIM TO ANY PARTICULAR FONT, STYLE, SIZE, OR COLOR.

FOR ELECTRONIC CONTROLS FOR MANAGING, ACTUATING, MONITORING AND CONTROLLING WINDOWS, SHADING SYSTEMS, TEMPERATURE, AND LIGHTING CONTROLS (U.S. CLS. 21, 23, 26, 36 AND 38).

FIRST USE 3-24-2011; IN COMMERCE 3-24-2011.  
LOURDES AYALA, EXAMINING ATTORNEY

**CLASS 9—(Continued).**

SN 85-336,282. ELECTRONICS WONDER INC., HOPKINTON, MA. FILED 6-2-2011.

# eWonder

THE MARK CONSISTS OF STANDARD CHARACTERS WITHOUT CLAIM TO ANY PARTICULAR FONT, STYLE, SIZE, OR COLOR.

FOR TABLET COMPUTER ACCESSORIES, NAMELY, WIRELESS KEYBOARDS, KEYBOARD CASES AND STAND CASES (U.S. CLS. 21, 23, 26, 36 AND 38).  
FIRST USE 6-2-2011; IN COMMERCE 6-2-2011.  
HOWARD SMIGA, EXAMINING ATTORNEY

---

SN 85-336,359. DILLINGER, LLC, MOORESVILLE, IN. FILED 6-2-2011.

# PUBLIC ENEMIES

THE MARK CONSISTS OF STANDARD CHARACTERS WITHOUT CLAIM TO ANY PARTICULAR FONT, STYLE, SIZE, OR COLOR.

FOR VIDEO AND COMPUTER GAME PROGRAMS (U.S. CLS. 21, 23, 26, 36 AND 38).  
MIDGE BUTLER, EXAMINING ATTORNEY

---

SN 85-336,441. WALLS, DAVID M, BOXFORD, MA. FILED 6-2-2011.

# word bird

THE MARK CONSISTS OF STANDARD CHARACTERS WITHOUT CLAIM TO ANY PARTICULAR FONT, STYLE, SIZE, OR COLOR.

FOR COMPUTER GAME SOFTWARE (U.S. CLS. 21, 23, 26, 36 AND 38).  
KEVIN CORWIN, EXAMINING ATTORNEY



**CLASS 9—(Continued).**

SN 85-336,494. BALGLOW FINANCE S/A, MONTEVIDEO, URUGUAY, FILED 6-2-2011.



THE MARK CONSISTS OF THE WORDING "VISTA" WITH AN OVAL-SHAPED DESIGN BENEATH THE WORDING.

THE ENGLISH TRANSLATION OF "VISTA" IN THE MARK IS "VIEW".

FOR EYEGGLASS FRAMES, SPECTACLE FRAMES, EYEGGLASS CASES, SPECTACLE CASES (U.S. CLS. 21, 23, 26, 36 AND 38).

NAAKWAMA ANKRAH, EXAMINING ATTORNEY

SN 85-336,535. PHAST DATA, INC., BOXBOROUGH, MA. FILED 6-2-2011.

# VELOBIT

THE MARK CONSISTS OF STANDARD CHARACTERS WITHOUT CLAIM TO ANY PARTICULAR FONT, STYLE, SIZE, OR COLOR.

FOR SERVER SOFTWARE FOR ACCELERATING THE PERFORMANCE OF DATA STORAGE SYSTEMS; DOWNLOADABLE SOFTWARE FOR ACCELERATING THE PERFORMANCE OF DATA STORAGE SYSTEMS; COMPUTER SOFTWARE FOR ACCELERATING THE PERFORMANCE OF DATA STORAGE SYSTEMS (U.S. CLS. 21, 23, 26, 36 AND 38).

TRACY FLETCHER, EXAMINING ATTORNEY

SN 85-336,554. INTEGRO, LLC, NEW BRITAIN, CT. FILED 6-2-2011.

# TUTOR

THE MARK CONSISTS OF STANDARD CHARACTERS WITHOUT CLAIM TO ANY PARTICULAR FONT, STYLE, SIZE, OR COLOR.

FOR BREAK-AWAY CABLE ASSEMBLY FOR ELECTRICAL VEHICLE CHARGING (U.S. CLS. 21, 23, 26, 36 AND 38).

JILL C. ALT, EXAMINING ATTORNEY

**CLASS 9—(Continued).**

SN 85-336,686. GREER, KEITH G., LAGUNA BEACH, CA. FILED 6-2-2011.

# TOONSTRUCK

THE MARK CONSISTS OF STANDARD CHARACTERS WITHOUT CLAIM TO ANY PARTICULAR FONT, STYLE, SIZE, OR COLOR.

FOR VIDEO AND COMPUTER GAME PROGRAMS (U.S. CLS. 21, 23, 26, 36 AND 38).

BARBARA BROWN, EXAMINING ATTORNEY

SN 85-336,697. AISLEBUYER LLC, BOSTON, MA. FILED 6-2-2011.

# CARDCAPTURE

THE MARK CONSISTS OF STANDARD CHARACTERS WITHOUT CLAIM TO ANY PARTICULAR FONT, STYLE, SIZE, OR COLOR.

FOR COMPUTER SOFTWARE, NAMELY, DOWNLOADABLE SOFTWARE THAT ALLOWS A USER TO PROVIDE CREDIT CARD PAYMENT INFORMATION USING THE CAMERA FUNCTION OF A MOBILE DEVICE (U.S. CLS. 21, 23, 26, 36 AND 38).

ALLISON HOLTZ, EXAMINING ATTORNEY

SN 85-336,793. IMAGINIT, INC, GOLDEN, CO. FILED 6-2-2011.

# CoolPly Plus

THE MARK CONSISTS OF STANDARD CHARACTERS WITHOUT CLAIM TO ANY PARTICULAR FONT, STYLE, SIZE, OR COLOR.

FOR PHOTOVOLTAIC SYSTEMS THAT CONVERT SUNLIGHT INTO ELECTRIC AND THERMAL ENERGY (U.S. CLS. 21, 23, 26, 36 AND 38).

FIRST USE 5-7-2009; IN COMMERCE 5-7-2009.

RONALD DELGIZZI, EXAMINING ATTORNEY

**CLASS 9—(Continued).**

SN 85-336,822. ADAMS RITE MANUFACTURING CO., DBA ADAMS RITE MANUFACTURING CO., POMONA, CA. FILED 6-2-2011.

## Steel Hawk

THE MARK CONSISTS OF STANDARD CHARACTERS WITHOUT CLAIM TO ANY PARTICULAR FONT, STYLE, SIZE, OR COLOR.

FOR ELECTRONICALLY-OPERATED DOOR LATCHES (U.S. CLS. 21, 23, 26, 36 AND 38).  
FIRST USE 3-1-2011; IN COMMERCE 3-1-2011.  
AISHA CLARKE, EXAMINING ATTORNEY

**CLASS 9—(Continued).**

SN 85-336,947. LUBLIN, JEREMY, CANTON, MI. FILED 6-2-2011.

## The Final Cut

THE MARK CONSISTS OF STANDARD CHARACTERS WITHOUT CLAIM TO ANY PARTICULAR FONT, STYLE, SIZE, OR COLOR.

FOR DIGITAL MEDIA, NAMELY, DVD'S FEATURING EXERCISE PROGRAMS (U.S. CLS. 21, 23, 26, 36 AND 38).  
BENJAMIN OKEKE, EXAMINING ATTORNEY

SN 85-336,890. ZULTYS, INC., SUNNYVALE, CA. FILED 6-2-2011.

## SuperView

THE MARK CONSISTS OF STANDARD CHARACTERS WITHOUT CLAIM TO ANY PARTICULAR FONT, STYLE, SIZE, OR COLOR.

FOR COMPUTER SOFTWARE FOR PROVIDING AN ON-LINE DATABASE IN THE FIELD OF TRANSACTION PROCESSING TO UPLOAD TRANSACTIONAL DATA, PROVIDE STATISTICAL ANALYSIS, AND PRODUCE NOTIFICATIONS AND REPORTS; COMPUTER SOFTWARE THAT PROVIDES REAL-TIME, INTEGRATED BUSINESS MANAGEMENT INTELLIGENCE BY COMBINING INFORMATION FROM VARIOUS DATABASES AND PRESENTING IT IN AN EASY-TO-UNDERSTAND USER INTERFACE (U.S. CLS. 21, 23, 26, 36 AND 38).

CHERYL CLAYTON, EXAMINING ATTORNEY

SN 85-336,954. MONSTER CABLE PRODUCTS, INC., BRISBANE, CA. FILED 6-2-2011.

## FANTASY

THE MARK CONSISTS OF STANDARD CHARACTERS WITHOUT CLAIM TO ANY PARTICULAR FONT, STYLE, SIZE, OR COLOR.

FOR AUDIO SPEAKERS; ELECTRONIC DOCKING STATIONS; HEADPHONES (U.S. CLS. 21, 23, 26, 36 AND 38).

TRACY CROSS, EXAMINING ATTORNEY

SN 85-336,911. DIAMOND GAME ENTERPRISES, CHATSWORTH, CA. FILED 6-2-2011.

## Bonus Factory

THE MARK CONSISTS OF STANDARD CHARACTERS WITHOUT CLAIM TO ANY PARTICULAR FONT, STYLE, SIZE, OR COLOR.

FOR GAMING EQUIPMENT, NAMELY, ELECTRONIC GAMING MACHINES AND GAMING MACHINES WITH VIDEO OUTPUT (U.S. CLS. 21, 23, 26, 36 AND 38).

ROSELLE HERRERA, EXAMINING ATTORNEY

SN 85-336,961. AINSWORTH GAME TECHNOLOGY LIMITED, NEWINGTON, AUSTRALIA, FILED 6-2-2011.

## WINGS OF FORTUNE

THE MARK CONSISTS OF STANDARD CHARACTERS WITHOUT CLAIM TO ANY PARTICULAR FONT, STYLE, SIZE, OR COLOR.

FOR COMPUTER SOFTWARE AND FIRMWARE FOR GAMES OF CHANCE ON ANY COMPUTERIZED PLATFORM, INCLUDING DEDICATED GAMING CONSOLES, VIDEO BASED SLOT MACHINES, REEL BASED SLOT MACHINES, AND VIDEO LOTTERY TERMINALS (U.S. CLS. 21, 23, 26, 36 AND 38).

KATHLEEN M. VANSTON, EXAMINING ATTORNEY

**CLASS 9—(Continued).**

SN 85-337,108. ROVELLI, MEGHAN, NEW YORK, NY. AND ROVELLI, MATT, NEW YORK, NY. FILED 6-3-2011.

## PupPee Paw

THE MARK CONSISTS OF STANDARD CHARACTERS WITHOUT CLAIM TO ANY PARTICULAR FONT, STYLE, SIZE, OR COLOR.

FOR WARNING DEVICES, NAMELY, BELLS (U.S. CLS. 21, 23, 26, 36 AND 38).

CHARLOTTE CORWIN, EXAMINING ATTORNEY

SN 85-337,116. IDEXX LABORATORIES, INC., WESTBROOK, ME. FILED 6-3-2011.

## XCHEKPLUS

THE MARK CONSISTS OF STANDARD CHARACTERS WITHOUT CLAIM TO ANY PARTICULAR FONT, STYLE, SIZE, OR COLOR.

OWNER OF U.S. REG. NO. 2,816,685.

FOR SOFTWARE FOR CALCULATING RESULTS OF LIVESTOCK AND POULTRY DIAGNOSTIC TESTS (U.S. CLS. 21, 23, 26, 36 AND 38).

CYNTHIA TRIPI, EXAMINING ATTORNEY

SN 85-337,343. STREMLINE, LLC, MONTCLAIR, NJ. FILED 6-3-2011.

## STREMLINE

THE MARK CONSISTS OF STANDARD CHARACTERS WITHOUT CLAIM TO ANY PARTICULAR FONT, STYLE, SIZE, OR COLOR.

FOR ANTENNAS FOR RADIO, FOR TELEVISION; ANTI-GLARE FILTERS FOR TELEVISIONS AND COMPUTER MONITORS; AUDIO ELECTRONIC COMPONENTS, NAMELY, SURROUND SOUND SYSTEMS; AUDIOVISUAL RECEIVERS; BRACKETS SPECIALLY ADAPTED FOR SETTING UP FLAT SCREEN TV SETS; CABLE TELEVISION CONVERTERS; CABLE TELEVISION TRANSMITTERS; CAMERA MOUNTS AND SUPPORTS; CASES FOR MUSIC, AUDIO AND RELATED ELECTRONIC EQUIPMENT, NAMELY, CASES FOR AUDIO TUNERS, AUDIO RECEIVERS, AMPLIFIERS, TAPE PLAYERS, COMPACT DISC PLAYERS, MP3 CONTROLLERS/PLAYERS, AUDIO MIXERS, AUDIO SPEAKERS IN THE NATURE OF MUSIC STUDIO MONITORS, MICROPHONES, AUDIO SPEAKERS, COMPACT DISCS, AUDIO TAPES, PORTABLE COMPUTERS, ANTENNAS, PHONOGRAPHIC RECORD PLAYERS, AUDIO RECORDING EQUIPMENT, AND THE CABLES ASSOCIATED WITH ALL OF THE FOREGOING EQUIPMENT; CONSUMER ELECTRONIC PRODUCTS, NAMELY, AUDIO AMPLIFIERS, AUDIO SPEAKERS, AUDIO RECEIVERS, ELECTRICAL AUDIO AND

**CLASS 9—(Continued).**

SPEAKER CABLES AND CONNECTORS, AUDIO DECODERS, VIDEO DECODERS, SPEAKERS, POWER CONVERSION DEVICES, POWER CONVERTERS, AND POWER INVERTERS; DISPLAY PROTECTOR TO PROVIDE SHADE AND PRIVACY FOR ELECTRONIC DEVICES HAVING SCREENS; ELECTRICAL AND ELECTRONIC CONNECTORS; ELECTRONIC AND OPTICAL COMMUNICATIONS INSTRUMENTS AND COMPONENTS, NAMELY, CABLE TELEVISION TRANSMITTERS; ELECTRONIC AND OPTICAL COMMUNICATIONS INSTRUMENTS AND COMPONENTS, NAMELY, DIGITAL TRANSMITTERS; ELECTRONIC AND OPTICAL COMMUNICATIONS INSTRUMENTS AND COMPONENTS, NAMELY, OPTICAL DATA LINKS; ELECTRONIC AND OPTICAL COMMUNICATIONS INSTRUMENTS AND COMPONENTS, NAMELY, OPTICAL RECEIVERS; ELECTRONIC AND OPTICAL COMMUNICATIONS INSTRUMENTS AND COMPONENTS, NAMELY, OPTICAL TRANSCIVERS; ELECTRONIC AND OPTICAL COMMUNICATIONS INSTRUMENTS AND COMPONENTS, NAMELY, OPTICAL TRANSMITTERS; ELECTRONIC APPARATUS, NAMELY, ELECTRONIC DISPLAY BOARDS, PLASMA DISPLAY BOARDS, ELECTRONIC DISPLAY SCREENS; ELECTRONIC APPARATUS, NAMELY, PLASMA DISPLAY PANELS; ELECTRONIC COMBINERS FOR CONNECTING ANTENNAS AND RECEIVERS; ELECTRONIC DOCKING STATIONS; ELECTRONIC EQUIPMENT, NAMELY, TRANSFORMERS, BALUNS, CABLES USED IN CONNECTION WITH COMPUTERS, COMPUTER PERIPHERAL DEVICES, TELEVISIONS, AUDIO-VIDEO EQUIPMENT, CLOSED-CIRCUIT TV EQUIPMENT AND TELECOMMUNICATION EQUIPMENT; ELECTRONIC INTERCONNECTERS FOR AUDIO AND VIDEO SIGNALS; ELECTRONIC SWITCHERS FOR AUDIO AND VIDEO SIGNALS; HOME THEATER SYSTEMS COMPRISING DVD PLAYERS, TELEVISIONS, MONITORS, COMPUTERS, VIDEO GAMING DEVICES, STEREO AND OTHER MUSIC EQUIPMENT; LIQUID CRYSTAL DISPLAY (LCD) TELEVISIONS; METAL TOWER CART WITH WHEELS SPECIALLY ADAPTED FOR COMPUTERS; MOUNTING DEVICES FOR CAMERAS AND MONITORS; MOUNTING DEVICES FOR MONITORS; MOUNTING RACKS FOR COMPUTER HARDWARE; MOUNTING RACKS FOR TELECOMMUNICATIONS HARDWARE; PLASMA TELEVISIONS; PLASTIC CASES SPECIALLY ADAPTED HOLDING COMPACT DISCS, DVDS AND OTHER ELECTRONIC MEDIA; PORTABLE TELEVISIONS; POWER SUPPLY CONNECTORS AND ADAPTORS FOR USE WITH PORTABLE ELECTRONIC DEVICES; PROGRAMMABLE ELECTRONIC CONTROLLERS FOR HOME ENTERTAINMENT EQUIPMENT; RADIO AND TELEVISION AERIALS; RECEIVERS FOR RECEIVING CABLE TELEVISION; RECEIVERS OF ELECTRONIC SIGNALS; REMOTE CONTROLS FOR RADIOS, TELEVISION, STEREOS; TELEVISION AND VIDEO CONVERTERS; TELEVISION APPARATUS FOR PROJECTION PURPOSES; TELEVISION MONITORS; TELEVISION MONITORS WITH TELEVISION TUNERS; TELEVISION SCREEN PROTECTORS IN THE NATURE OF ACRYLIC SHIELDS TO BE MOUNTED OVER TELEVISION SCREENS; VIDEO CASSETTE RECORDERS AND PLAYERS, COMPACT DISC PLAYERS, DIGITAL AUDIO TAPE RECORDERS AND PLAYERS, ELECTRONIC DIARIES; WIRELESS CONTROLLER TO MONITOR AND CONTROL THE FUNCTIONING OF OTHER ELECTRONIC DEVICES (U.S. CLS. 21, 23, 26, 36 AND 38).

MORGAN WYNNE, EXAMINING ATTORNEY

**CLASS 9—(Continued).**

SN 85-337,641. SANTA CRUZ BIOTECHNOLOGY, INC., SANTA CRUZ, CA. FILED 6-3-2011.

# EZ TOUCH

THE MARK CONSISTS OF STANDARD CHARACTERS WITHOUT CLAIM TO ANY PARTICULAR FONT, STYLE, SIZE, OR COLOR.

FOR LABORATORY CONSUMABLES, NAMELY, PIPETTE TIPS (U.S. CLS. 21, 23, 26, 36 AND 38).

FIRST USE 10-12-2010; IN COMMERCE 10-12-2010.

ROBIN MITTLER, EXAMINING ATTORNEY

SN 85-337,660. AOKI, STEVE, HOLLYWOOD, CA. FILED 6-3-2011.

# D1M MAK

THE MARK CONSISTS OF STANDARD CHARACTERS WITHOUT CLAIM TO ANY PARTICULAR FONT, STYLE, SIZE, OR COLOR.

OWNER OF U.S. REG. NO. 3,312,474.

FOR SUNGLASSES; EYEGASSES; EYEGASS FRAMES; EYEGASS CASES; SKI GOGGLES; GOGGLES FOR SPORTS (U.S. CLS. 21, 23, 26, 36 AND 38).

KATHERINE STOIDES, EXAMINING ATTORNEY

SN 85-337,761. BROADSOFT, INC., GAITHERSBURG, MD. FILED 6-3-2011.

# UC-One

THE MARK CONSISTS OF STANDARD CHARACTERS WITHOUT CLAIM TO ANY PARTICULAR FONT, STYLE, SIZE, OR COLOR.

FOR COMMUNICATIONS SOFTWARE USED TO FACILITATE THE TRANSMISSION OF VOICE, DATA, GRAPHICS, IMAGES, AUDIO AND VIDEO BETWEEN TWO POINTS (U.S. CLS. 21, 23, 26, 36 AND 38).

CAROLINE WOOD, EXAMINING ATTORNEY

**CLASS 9—(Continued).**

SN 85-337,868. SUGMET LLC, CORAL GABLES, FL. FILED 6-3-2011.



THE MARK CONSISTS OF THE STYLIZED TEXT "SUGMET" FOLLOWED BY A DESIGN OF A HAND IN A THUMBS UP POSE WITH A DOT ON THE THUMB.

FOR COMPUTER SOFTWARE FOR USE IN MANAGEMENT OF DIABETES, NAMELY, FOR CHARTING AND MONITORING BLOOD SUGAR LEVELS (U.S. CLS. 21, 23, 26, 36 AND 38).

FIRST USE 10-1-2010; IN COMMERCE 10-1-2010.

JAMES A. RAUEN, EXAMINING ATTORNEY

SN 85-337,889. GENTAG, INC., WASHINGTON, DC. FILED 6-3-2011.

# GENTAG

THE MARK CONSISTS OF STANDARD CHARACTERS WITHOUT CLAIM TO ANY PARTICULAR FONT, STYLE, SIZE, OR COLOR.

FOR NEAR FIELD COMMUNICATIONS SENSORS (U.S. CLS. 21, 23, 26, 36 AND 38).

JEAN IM, EXAMINING ATTORNEY

SN 85-337,980. POWER MUSIC, INC., LOS ANGELES, CA. FILED 6-3-2011.

# ZABUMBA!

THE MARK CONSISTS OF STANDARD CHARACTERS WITHOUT CLAIM TO ANY PARTICULAR FONT, STYLE, SIZE, OR COLOR.

FOR COMPACT DISCS FEATURING MUSIC; DIGITAL MUSIC DOWNLOADABLE FROM THE INTERNET (U.S. CLS. 21, 23, 26, 36 AND 38).

FIRST USE 5-24-2011; IN COMMERCE 5-24-2011.

VIVIAN MICZNIK FIRST, EXAMINING ATTORNEY

**CLASS 9—(Continued).**

SN 85-338,060. CELESTRON ACQUISITION LLC, TORRANCE, CA. FILED 6-3-2011.

# CELESTRON

THE MARK CONSISTS OF STANDARD CHARACTERS WITHOUT CLAIM TO ANY PARTICULAR FONT, STYLE, SIZE, OR COLOR.

OWNER OF U.S. REG. NOS. 1,139,857 AND 3,005,393. FOR (BASED ON USE IN COMMERCE) GPS DEVICES; (BASED ON INTENT TO USE) CCD (CHARGE-COUPLED DEVICE) CAMERAS (U.S. CLS. 21, 23, 26, 36 AND 38).

FIRST USE 1-4-2011; IN COMMERCE 5-20-2011.  
KEVIN CORWIN, EXAMINING ATTORNEY

SN 85-338,085. EAGLE ZAP TECHNOLOGIES, INC., PORT SAINT LUCIE, FL. FILED 6-4-2011.

# TwistGist

THE MARK CONSISTS OF STANDARD CHARACTERS WITHOUT CLAIM TO ANY PARTICULAR FONT, STYLE, SIZE, OR COLOR.

FOR COMPUTER GAME PROGRAMS; COMPUTER GAME SOFTWARE; COMPUTER GAME SOFTWARE DOWNLOADABLE FROM A GLOBAL COMPUTER NETWORK; COMPUTER GAME SOFTWARE FOCUSING ON ACHIEVING A SET OF GOALS, POSITIONS, OWNERSHIP, AND CREDENTIALS, AND PROFESSIONAL AND SOCIAL STATUS, AND GOOD FORTUNE NECESSARY TO SUCCEED PROFESSIONALLY AND PERSONALLY, AND NOT REFERRING EITHER TO A GROUP OF SOFTWARE FOR USE IN COMMERCE OR TO A GROUP OF OFFICES; COMPUTER GAME SOFTWARE FOR GAMING MACHINES INCLUDING SLOT MACHINES OR VIDEO LOTTERY TERMINALS; COMPUTER GAME SOFTWARE FOR PERSONAL COMPUTERS AND HOME VIDEO GAME CONSOLES; COMPUTER GAME SOFTWARE FOR USE ON MOBILE AND CELLULAR PHONES; COMPUTER GAME SOFTWARE FOR USE WITH PERSONAL COMPUTERS, HOME VIDEO GAME CONSOLES USED WITH TELEVISIONS AND ARCADE-BASED VIDEO GAME CONSOLES; COMPUTER SOFTWARE, NAMELY, GAME ENGINE SOFTWARE FOR VIDEO GAME DEVELOPMENT AND OPERATION; ELECTRONIC GAME PROGRAMS; ELECTRONIC GAME SOFTWARE; ELECTRONIC GAME SOFTWARE FOR CELLULAR TELEPHONES; ELECTRONIC GAME SOFTWARE FOR HANDHELD ELECTRONIC DEVICES; ELECTRONIC GAME SOFTWARE FOR WIRELESS DEVICES; ELECTRONIC GAMING MACHINES, NAMELY, DEVICES WHICH ACCEPT A WAGER; ELECTRONIC INTERACTIVE BOARD GAMES FOR USE WITH EXTERNAL MONITOR; INTERACTIVE GAME PROGRAMS; INTERACTIVE GAME SOFTWARE; INTERACTIVE MULTIMEDIA COMPUTER GAME PROGRAM; INTERACTIVE VIDEO GAME PROGRAMS; INTERACTIVE VIDEO GAMES OF VIRTUAL REALITY COMPRISED OF COMPUTER HARDWARE FOR USE WITH AN EXTERNAL MONITOR AND SOFTWARE; VIRTUAL REALITY GAME SOFTWARE (U.S. CLS. 21, 23, 26, 36 AND 38).

LINDSEY RUBIN, EXAMINING ATTORNEY

**CLASS 9—(Continued).**

SN 85-338,089. MR2 GROUP USA LLC, BEVERLY HILLS, CA. FILED 6-4-2011.



THE MARK CONSISTS OF A STYLIZED COMBINATION OF THE LETTERS "M" AND "R," (IN THAT ORDER) WHEREIN THE THIRD "LEG" OF THE CAPITAL LETTER "M" IS DRAWN SO AS TO APPEAR BEHIND AND/OR SHARE THE INITIAL DOWN-STROKE OF THE CAPITAL LETTER "R," FOLLOWED BY A SUPERSCRIPIT NUMERAL "2".

FOR AUDIO HEADPHONES; EARPHONES AND HEADPHONES; HEADSETS FOR CELLULAR OR MOBILE PHONES (U.S. CLS. 21, 23, 26, 36 AND 38).

FIRST USE 12-17-2010; IN COMMERCE 1-6-2011.  
ALICE BENMAMAN, EXAMINING ATTORNEY

SN 85-338,174. TECHNOLOGY INTEGRATIONS FOR MEDICAL APPLICATIONS, INC., DBA TIMA, INC., AVON BY THE SEA, NJ. FILED 6-4-2011.

# TELMEDICOM

THE MARK CONSISTS OF STANDARD CHARACTERS WITHOUT CLAIM TO ANY PARTICULAR FONT, STYLE, SIZE, OR COLOR.

FOR COMPUTER SOFTWARE FOR CONTROLLING AND MANAGING PATIENT MEDICAL INFORMATION (U.S. CLS. 21, 23, 26, 36 AND 38).

KIMBERLY PERRY, EXAMINING ATTORNEY

SN 85-338,177. TECHNOLOGY INTEGRATIONS FOR MEDICAL APPLICATIONS, INC., DBA TIMA, INC., AVON BY THE SEA, NJ. FILED 6-4-2011.

# MEDICAL TELEPHONY

THE MARK CONSISTS OF STANDARD CHARACTERS WITHOUT CLAIM TO ANY PARTICULAR FONT, STYLE, SIZE, OR COLOR.

NO CLAIM IS MADE TO THE EXCLUSIVE RIGHT TO USE "MEDICAL", APART FROM THE MARK AS SHOWN.

FOR COMPUTER SOFTWARE FOR CONTROLLING AND MANAGING PATIENT MEDICAL INFORMATION (U.S. CLS. 21, 23, 26, 36 AND 38).

KIMBERLY PERRY, EXAMINING ATTORNEY

**CLASS 9—(Continued).**

SN 85-338,230. WEISS, SCOTT B., CONCORD, CA. AND PERSOL, JOHN S., SAN FRANCISCO, CA. FILED 6-4-2011.

# UpTicket

THE MARK CONSISTS OF STANDARD CHARACTERS WITHOUT CLAIM TO ANY PARTICULAR FONT, STYLE, SIZE, OR COLOR.

FOR COMPUTER APPLICATION SOFTWARE FOR MOBILE PHONES, NAMELY, SOFTWARE FOR SOCIAL NETWORKING AND TRADING GOODS (U.S. CLS. 21, 23, 26, 36 AND 38).  
SIMON TENG, EXAMINING ATTORNEY

SN 85-338,303. PUCCI, CLAUDIA, BOSTON, MA. FILED 6-5-2011.

# CaseReportal

THE MARK CONSISTS OF STANDARD CHARACTERS WITHOUT CLAIM TO ANY PARTICULAR FONT, STYLE, SIZE, OR COLOR.

FOR COMPUTER SOFTWARE THAT PROVIDES WEB-BASED ACCESS TO APPLICATIONS AND SERVICES THROUGH A WEB OPERATING SYSTEM OR PORTAL INTERFACE (U.S. CLS. 21, 23, 26, 36 AND 38).  
DAVID C. REIHNER, EXAMINING ATTORNEY

SN 85-338,389. SMART MODULAR TECHNOLOGIES, INC., NEWARK, CA. FILED 6-6-2011.

# OPTIMUS

THE MARK CONSISTS OF STANDARD CHARACTERS WITHOUT CLAIM TO ANY PARTICULAR FONT, STYLE, SIZE, OR COLOR.

FOR SOLID STATE DRIVES (U.S. CLS. 21, 23, 26, 36 AND 38).  
ALICIA COLLINS, EXAMINING ATTORNEY

**CLASS 9—(Continued).**

SN 85-338,600. HAINES HOLDINGS, INC., LANCASTER, PA. FILED 6-6-2011.

# HoloTV

THE MARK CONSISTS OF STANDARD CHARACTERS WITHOUT CLAIM TO ANY PARTICULAR FONT, STYLE, SIZE, OR COLOR.

FOR TELEVISIONS (U.S. CLS. 21, 23, 26, 36 AND 38).  
JULIE WATSON, EXAMINING ATTORNEY

SN 85-338,735. AGILENT TECHNOLOGIES, INC., SANTA CLARA, CA. FILED 6-6-2011.

# SUPERFLASH

THE MARK CONSISTS OF STANDARD CHARACTERS WITHOUT CLAIM TO ANY PARTICULAR FONT, STYLE, SIZE, OR COLOR.

FOR LIQUID CHROMATOGRAPHY PRODUCTS FOR LABORATORY AND INDUSTRIAL USE, NAMELY, FLASH CHROMATOGRAPHY CARTRIDGES AND COLUMNS FOR USE IN PURIFICATION (U.S. CLS. 21, 23, 26, 36 AND 38).

FIRST USE 0-0-2005; IN COMMERCE 0-0-2005.  
JOHN E. MICHOS, EXAMINING ATTORNEY

SN 85-338,742. CANADIAN SOLAR (USA) INC., SAN RAMON, CA. FILED 6-6-2011.

# ELPS

THE MARK CONSISTS OF STANDARD CHARACTERS WITHOUT CLAIM TO ANY PARTICULAR FONT, STYLE, SIZE, OR COLOR.

FOR PHOTOVOLTAIC CELLS; PHOTOVOLTAIC PANELS; SOLAR CELLS; SILICON WAFERS; SOLAR CHARGERS; SOLAR SIGNALING SYSTEMS CONSISTING OF SOLAR-POWERED BUOYS, SOLAR PANELS FOR PRODUCTION ELECTRICITY, ELECTRICAL CONTROLLERS, AND SIGNALING LIGHTS; GPS SOLAR SYSTEM CONSISTING OF GPS CONTROLLER, SOLAR POWERING UNIT AND GPS DISPLAY; HOME SOLAR SYSTEM CONSISTING OF PHOTOVOLTAIC PANEL, ELECTRICAL CONTROLLER, INVERTER, VIDEO MONITOR, DISPLAY SCREEN, AND BATTERY; SUN TRACKING MOUNTING SYSTEMS CONSISTING OF CONTROLLERS, PANELS, AND MOUNTING FRAMES; PRE-CONFIGURED ENGINEERED SOLUTION FOR RESIDENTIAL, COMMERCIAL, AND INDUSTRIAL USE CONSISTING OF SOLAR PANELS, INVERTERS, MOUNTING FRAMES, ISOLATION DISCONNECTS, NAMELY, ELECTRICAL DEVICE USED TO ISOLATE OR SHUT OFF SOURCES OF DC OR AC ELECTRICITY;

**CLASS 9—(Continued).**

TRANSFORMERS, AND DC CABLES; J-BOX CONSISTING OF CONTAINER FOR ELECTRICAL JUNCTIONS, DIODES, CONNECTORS; ELECTRICAL CABLES; CONVERTERS; WATER PUMPING SYSTEM CONSISTING OF PHOTOVOLTAIC PANEL, CONTROLLER, BATTERY AND PUMPING EQUIPMENT, NAMELY, PUMP USED TO PUMP WATER USING PHOTOVOLTAIC SYSTEMS AND MOTORS AS THE POWER SOURCE; SOLAR-POWERED CONSUMER ELECTRONIC APPLIANCES, NAMELY, MOBILE CHARGERS, MOBILE PHONES, POWER PACKS, INVERTERS, CHARGE CONTROLLERS; THIN FILM CELL; SOLAR MODULE CONSISTING OF AN ARRAY OF SOLAR CELLS FOR SOLAR ENERGY COLLECTION AND CONVERSION; GRID CONNECTED POWER SYSTEM CONSISTING OF PHOTOVOLTAIC ARRAY, MOUNTING SYSTEM, WIRING, COMBINER, INVERTER, GRID INTERCONNECT, TRANSFORMER; STAND-ALONE POWER SYSTEM CONSISTING OF PHOTOVOLTAIC ARRAY, PHOTOVOLTAIC PANEL, WIRING, INVERTER, CHARGE CONTROLLER, BATTERY (U.S. CLS. 21, 23, 26, 36 AND 38).  
APRIL ROACH, EXAMINING ATTORNEY

---

SN 85-338,791. INSURANCE DATA PROCESSING, INC., WYNCOTE, PA. FILED 6-6-2011.

**INSURASPHERE**

THE MARK CONSISTS OF STANDARD CHARACTERS WITHOUT CLAIM TO ANY PARTICULAR FONT, STYLE, SIZE, OR COLOR.

FOR COMPUTER SOFTWARE FOR USE BY INSURANCE CARRIERS, MANAGING GENERAL AGENTS, INSURANCE AGENCIES AND INSURANCE AGENTS, NAMELY, SOFTWARE USED FOR DATABASE MANAGEMENT, DOCUMENT MANAGEMENT, INSURANCE POLICY ADMINISTRATION, INSURANCE CLAIMS PROCESSING AND SERVICES, INSURANCE POLICY BILLING, ACCOUNTING AND PAYMENT FUNCTIONS, INSURANCE AND REINSURANCE SALES BY AGENTS AND MANAGING GENERAL AGENTS, AND FOR CUSTOMER RELATIONSHIP MANAGEMENT AND CUSTOMER COMMUNICATIONS, CUSTOMER INTERACTION AND CUSTOMER WORKFLOW (U.S. CLS. 21, 23, 26, 36 AND 38).  
JOHN WILKE, EXAMINING ATTORNEY

**CLASS 9—(Continued).**

SN 85-338,830. INSURANCE DATA PROCESSING, INC., WYNCOTE, PA. FILED 6-6-2011.



THE MARK CONSISTS OF THE WORD "INSURASPHERE" WITH A PARTIAL GLOBE ON TOP OF THE WORDS, CONSISTING OF LINES WITH ARROWS.

FOR COMPUTER SOFTWARE FOR USE BY INSURANCE CARRIERS, MANAGING GENERAL AGENTS, INSURANCE AGENCIES AND INSURANCE AGENTS, NAMELY, SOFTWARE USED FOR DATABASE MANAGEMENT, DOCUMENT MANAGEMENT, INSURANCE POLICY ADMINISTRATION, INSURANCE CLAIMS PROCESSING AND SERVICES, INSURANCE POLICY BILLING, ACCOUNTING AND PAYMENT FUNCTIONS, INSURANCE AND REINSURANCE SALES BY AGENTS AND MANAGING GENERAL AGENTS, AND FOR CUSTOMER RELATIONSHIP MANAGEMENT AND CUSTOMER COMMUNICATIONS, CUSTOMER INTERACTION AND CUSTOMER WORKFLOW (U.S. CLS. 21, 23, 26, 36 AND 38).

JOHN WILKE, EXAMINING ATTORNEY

---

SN 85-338,837. RETINA-X STUDIOS, LLC, JACKSONVILLE, FL. FILED 6-6-2011.

**Retina-X Studios**

THE MARK CONSISTS OF STANDARD CHARACTERS WITHOUT CLAIM TO ANY PARTICULAR FONT, STYLE, SIZE, OR COLOR.

FOR COMPUTER SOFTWARE FOR USE IN MONITORING AND RESTRICTING INTERNET ACTIVITY, COMPUTER NETWORK ACTIVITY, AND PHONE ACTIVITY (U.S. CLS. 21, 23, 26, 36 AND 38).  
FIRST USE 4-23-2003; IN COMMERCE 4-23-2003.  
LINDA E. BLOHM, EXAMINING ATTORNEY

**CLASS 9—(Continued).**

SN 85-338,895. ENERGY CONTROL TECHNOLOGIES, INC., WEST DES MOINES, IA. FILED 6-6-2011.

# NetPAC

THE MARK CONSISTS OF THE WORD "NETPAC" IN STYLIZED FONT.

FOR PROCESS AUTOMATION CONTROL SYSTEM COMPRISING OF MICRO-PROCESSOR BASED HARDWARE AND SOFTWARE, NAMELY FOR USE IN LOAD DISTRIBUTION AMONG A COMPRESSOR NETWORK INCLUDING TURBOCOMPRESSORS SUCH AS CENTRIFUGAL AND AXIAL COMPRESSORS, SCREW COMPRESSORS, RECIPROCATING COMPRESSORS DRIVEN BY EITHER STEAM OR GAS TURBINE OR ELECTRIC MOTOR TO CONTROL PROCESS VARIABLES ASSOCIATED WITH A PROCESS COMPRESSION NETWORK (U.S. CLS. 21, 23, 26, 36 AND 38).

FIRST USE 2-21-2011; IN COMMERCE 2-21-2011.  
KAREN K. BUSH, EXAMINING ATTORNEY

**CLASS 9—(Continued).**

SN 85-338,961. YU CHOU, OCEANSIDE, NY. FILED 6-6-2011.



THE MARK CONSISTS OF ENGLISH LETTERS "8E" IN STYLIZED FONTS.

FOR EYEWEAR, NAMELY, SUNGLASSES, OPTICAL GLASSES, READING GLASSES, SKI GLASSES, SPORTS GLASSES, FIELD GLASSES; SUNGLASSES FRAMES AND SUNGLASSES CASES (U.S. CLS. 21, 23, 26, 36 AND 38).

FIRST USE 7-31-2008; IN COMMERCE 7-31-2008.  
ADA HAN, EXAMINING ATTORNEY

SN 85-338,989. CLEARVISION OPTICAL COMPANY, HAUPAUGE, NY. FILED 6-6-2011.

# XLFIT

SN 85-338,945. ENERGY CONTROL TECHNOLOGIES, INC., WEST DES MOINES, IA. FILED 6-6-2011.

# LoadPAC

THE MARK CONSISTS OF THE WORD LOADPAC APPEARING IN STYLIZED FONT.

FOR PROCESS AUTOMATION CONTROL SYSTEM COMPRISING OF MICRO-PROCESSOR BASED HARDWARE AND SOFTWARE, NAMELY FOR USE IN LOAD MANAGEMENT OF A TURBOCOMPRESSOR SUCH AS CENTRIFUGAL AND AXIAL COMPRESSORS, OR A SCREW COMPRESSOR, OR A RECIPROCATING COMPRESSOR DRIVEN BY EITHER STEAM OR GAS TURBINE OR ELECTRIC MOTOR TO CONTROL LOAD VARIABLES ASSOCIATED WITH THE COMPRESSOR (U.S. CLS. 21, 23, 26, 36 AND 38).

FIRST USE 7-1-2010; IN COMMERCE 7-1-2010.  
KAREN K. BUSH, EXAMINING ATTORNEY

THE MARK CONSISTS OF STANDARD CHARACTERS WITHOUT CLAIM TO ANY PARTICULAR FONT, STYLE, SIZE, OR COLOR.

FOR EYEWEAR, NAMELY, SUNGLASSES, EYEGLASSES AND OPHTHALMIC FRAMES AND CASES THEREFOR (U.S. CLS. 21, 23, 26, 36 AND 38).

FIRST USE 2-19-2010; IN COMMERCE 2-19-2010.  
JULIE VEPPUMTHARA, EXAMINING ATTORNEY

SN 85-339,013. FLORE GEFFROY-KEARLEY, DBA LE GAULOIS NOMADE, SPRING VALLEY, CA. FILED 6-6-2011.

# Le Gaulois nomade

THE MARK CONSISTS OF STANDARD CHARACTERS WITHOUT CLAIM TO ANY PARTICULAR FONT, STYLE, SIZE, OR COLOR.

THE ENGLISH TRANSLATION OF LE GAULOIS NOMADE IN THE MARK IS THE NOMADIC GAUL.

FOR DIGITAL MATERIALS, NAMELY, TEXT FILES FEATURING FRENCH LANGUAGE; DOWNLOADABLE ELECTRONIC PUBLICATIONS IN THE NATURE OF BOOKS IN THE FIELD OF FICTION AND NON FICTION (U.S. CLS. 21, 23, 26, 36 AND 38).

ALLISON HOLTZ, EXAMINING ATTORNEY



**CLASS 9—(Continued).**

SN 85-339,052. GOLDSTEIN, THEODORE A, CENTERPORT, NY. FILED 6-6-2011.

# Casketball

THE MARK CONSISTS OF STANDARD CHARACTERS WITHOUT CLAIM TO ANY PARTICULAR FONT, STYLE, SIZE, OR COLOR.

FOR DOWNLOADABLE ELECTRONIC GAME PROGRAMS (U.S. CLS. 21, 23, 26, 36 AND 38).

DAVID TAYLOR, EXAMINING ATTORNEY

---

SN 85-339,119. UNITED POS SOLUTIONS, INC., DBA UP SOLUTION, HACKENSACK, NJ. FILED 6-6-2011.

# UP RETAIL

THE MARK CONSISTS OF STANDARD CHARACTERS WITHOUT CLAIM TO ANY PARTICULAR FONT, STYLE, SIZE, OR COLOR.

OWNER OF U.S. REG. NOS. 3,860,131 AND 3,860,134.

NO CLAIM IS MADE TO THE EXCLUSIVE RIGHT TO USE "RETAIL", APART FROM THE MARK AS SHOWN.

FOR COMPUTER SOFTWARE FOR THE MANAGEMENT OF BUSINESS OPERATIONS (U.S. CLS. 21, 23, 26, 36 AND 38).

MARGERY A. TIERNEY, EXAMINING ATTORNEY

---

SN 85-339,168. MILNER TRADEMARKS & LICENSING, INC., MONUMENT, CO. FILED 6-6-2011.

# MAXX

THE MARK CONSISTS OF STANDARD CHARACTERS WITHOUT CLAIM TO ANY PARTICULAR FONT, STYLE, SIZE, OR COLOR.

OWNER OF U.S. REG. NOS. 3,460,624, 3,581,007 AND OTHERS.

FOR SUNGLASSES (U.S. CLS. 21, 23, 26, 36 AND 38).

FIRST USE 12-5-2004; IN COMMERCE 12-5-2004.

EMILY CARLSEN, EXAMINING ATTORNEY

**CLASS 9—(Continued).**

SN 85-339,169. TRIZENTER, LLC, LOUISVILLE, KY. FILED 6-6-2011.

# TROUPE

THE MARK CONSISTS OF STANDARD CHARACTERS WITHOUT CLAIM TO ANY PARTICULAR FONT, STYLE, SIZE, OR COLOR.

FOR COMPUTER SOFTWARE FOR CREATING AND DISPLAYING PRESENTATIONS (U.S. CLS. 21, 23, 26, 36 AND 38).

EMILY CARLSEN, EXAMINING ATTORNEY

---

SN 85-339,197. PIXELLOOP, LLC, SAN ANTONIO, TX. FILED 6-6-2011.

# RUFFLED

THE MARK CONSISTS OF STANDARD CHARACTERS WITHOUT CLAIM TO ANY PARTICULAR FONT, STYLE, SIZE, OR COLOR.

FOR COMPUTER GAME PROGRAMMES; COMPUTER GAME PROGRAMMES DOWNLOADABLE VIA THE INTERNET; COMPUTER GAME PROGRAMS; COMPUTER GAME SOFTWARE; COMPUTER GAME SOFTWARE DOWNLOADABLE FROM A GLOBAL COMPUTER NETWORK; COMPUTER GAME SOFTWARE FOR PERSONAL COMPUTERS AND HOME VIDEO GAME CONSOLES; COMPUTER GAME SOFTWARE FOR USE ON MOBILE AND CELLULAR PHONES; COMPUTER GAME SOFTWARE FOR USE WITH PERSONAL COMPUTERS, HOME VIDEO GAME CONSOLES USED WITH TELEVISIONS AND ARCADE-BASED VIDEO GAME CONSOLES; DOWNLOADABLE COMPUTER GAME PROGRAMS; DOWNLOADABLE COMPUTER GAME SOFTWARE VIA A GLOBAL COMPUTER NETWORK AND WIRELESS DEVICES; VIDEO AND COMPUTER GAME PROGRAMS (U.S. CLS. 21, 23, 26, 36 AND 38).

CHRISTINA SOBRAL, EXAMINING ATTORNEY

**CLASS 9—(Continued).**

SN 85-339,210. PROXIM WIRELESS CORPORATION, MILPITAS, CA. FILED 6-6-2011.

# WORP

THE MARK CONSISTS OF STANDARD CHARACTERS WITHOUT CLAIM TO ANY PARTICULAR FONT, STYLE, SIZE, OR COLOR.

FOR WIRELESS COMMUNICATIONS HARDWARE AND SOFTWARE SOLD TOGETHER AS A UNIT FOR VOICE, DATA OR IMAGE TRANSMISSION, NAMELY, OUTDOOR POINT-TO-POINT AND POINT-TO-MULTI-POINT ROUTERS, LINKS, RADIOS AND BRIDGES; COMPUTER SOFTWARE, NAMELY, LOCAL AREA NETWORK OPERATING SOFTWARE, COMPUTER OPERATING SYSTEMS, COMPUTER SOFTWARE FOR MANAGING TELECOMMUNICATIONS NETWORKS, SYSTEMS AND DEVICES, AND COMPUTER SOFTWARE FOR IMPROVING THE OPERATING PERFORMANCE OF TELECOMMUNICATIONS NETWORKS, SYSTEMS AND DEVICES (U.S. CLS. 21, 23, 26, 36 AND 38).

ODESSA BIBBINS, EXAMINING ATTORNEY

SN 85-339,296. PENTA FINANCIAL INCORPORATED, DBA PENTA LABORATORIES, CHATSWORTH, CA. FILED 6-6-2011.



THE MARK CONSISTS OF THREE RECTANGLES ONE ANGLED TO THE RIGHT, ONE ANGLED TO THE LEFT AND ONE ABOVE THE TWO ALL INTERSECTING WITHOUT TOUCHING IN THE MIDDLE AND THE LETTERS EG&G TO ITS RIGHT.

FOR ELECTRON TUBES AND VACUUM TUBES (U.S. CLS. 21, 23, 26, 36 AND 38).

FIRST USE 6-1-2011; IN COMMERCE 6-1-2011.

SHAUNIA CARLYLE, EXAMINING ATTORNEY

SN 85-339,393. THOMA, MATTHIAS, UETIKON AM SEE, SWITZERLAND, FILED 6-6-2011.

# CHEZZTER

THE MARK CONSISTS OF STANDARD CHARACTERS WITHOUT CLAIM TO ANY PARTICULAR FONT, STYLE, SIZE, OR COLOR.

FOR COMPUTER GAME SOFTWARE FOR USE ON MOBILE AND CELLULAR PHONES; DOWNLOADABLE COMPUTER GAME PROGRAMS; ELECTRONIC GAME SOFTWARE FOR HANDHELD ELECTRONIC DEVICES (U.S. CLS. 21, 23, 26, 36 AND 38).

FIRST USE 5-20-2011; IN COMMERCE 6-6-2011.

CIMMERIAN COLEMAN, EXAMINING ATTORNEY

**CLASS 9—(Continued).**

SN 85-339,396. MCCOY, SHERRI, CERES, CA. FILED 6-6-2011.

# BUUG

THE MARK CONSISTS OF STANDARD CHARACTERS WITHOUT CLAIM TO ANY PARTICULAR FONT, STYLE, SIZE, OR COLOR.

FOR MOBILE PHONE EARPIECE ACCESSORIES, NAMELY COVERS; WIRELESS DEVICE EARPIECE ACCESSORIES, NAMELY COVERS; HEADSET ACCESSORIES, NAMELY COVERS (U.S. CLS. 21, 23, 26, 36 AND 38).

FIRST USE 12-1-2010; IN COMMERCE 12-1-2010.

KELLEY WELLS, EXAMINING ATTORNEY

SN 85-339,561. BOARD OF TRUSTEES UNIVERSITY OF MASSACHUSETTS, AMHERST, MA. FILED 6-7-2011.

# SMASH

THE MARK CONSISTS OF STANDARD CHARACTERS WITHOUT CLAIM TO ANY PARTICULAR FONT, STYLE, SIZE, OR COLOR.

FOR COMPUTER SOFTWARE FOR REDUCING THE ENERGY CONSUMPTION OF LOW-POWER DEVICES WITH EMBEDDED FLASH MEMORY (U.S. CLS. 21, 23, 26, 36 AND 38).

MATTHEW KLINE, EXAMINING ATTORNEY

SN 85-339,779. TEAM OF LIGHT LTD., TEL MOND, ISRAEL, FILED 6-7-2011.

# SPARKUP

THE MARK CONSISTS OF STANDARD CHARACTERS WITHOUT CLAIM TO ANY PARTICULAR FONT, STYLE, SIZE, OR COLOR.

FOR BATTERY-OPERATED ELECTRONIC DEVICE WHICH RECORDS AUDIO TO BE PLAYED BACK IN CONJUNCTION WITH THE READING OF BOOKS; PATTERN RECOGNITION SYSTEMS COMPOSED OF COMPUTER CHIPS, COMPUTER HARDWARE AND SOFTWARE (U.S. CLS. 21, 23, 26, 36 AND 38).

PAM WILLIS, EXAMINING ATTORNEY

**CLASS 9—(Continued).**

SN 85-339,789. KINGSTON TECHNOLOGY CORPORATION, FOUNTAIN VALLEY, CA. FILED 6-7-2011.

# HYPERX

THE MARK CONSISTS OF STANDARD CHARACTERS WITHOUT CLAIM TO ANY PARTICULAR FONT, STYLE, SIZE, OR COLOR.  
OWNER OF U.S. REG. NO. 2,848,874.  
FOR SOLID STATE DRIVES FOR DATA STORAGE DEVICES (U.S. CLS. 21, 23, 26, 36 AND 38).  
ASMAT KHAN, EXAMINING ATTORNEY

---

SN 85-339,908. SUMMITAS, LLC, NEW YORK, NY. FILED 6-7-2011.

# YourSafe

THE MARK CONSISTS OF STANDARD CHARACTERS WITHOUT CLAIM TO ANY PARTICULAR FONT, STYLE, SIZE, OR COLOR.  
FOR COMPUTER APPLICATION SOFTWARE FOR MOBILE PHONES AND HANDHELD COMPUTERS, NAMELY, SOFTWARE FOR USE IN DOCUMENT MANAGEMENT AND ELECTRONIC STORAGE AND RETRIEVAL OF DOCUMENTS; COMPUTER SOFTWARE FOR DOCUMENT MANAGEMENT (U.S. CLS. 21, 23, 26, 36 AND 38).  
CHRISTINA SOBRAL, EXAMINING ATTORNEY

---

SN 85-339,975. MORE MOJO, L.P., AUSTIN, TX. FILED 6-7-2011.

# Date or Dump

THE MARK CONSISTS OF STANDARD CHARACTERS WITHOUT CLAIM TO ANY PARTICULAR FONT, STYLE, SIZE, OR COLOR.  
FOR COMPUTER APPLICATION SOFTWARE FOR MOBILE PHONES, NAMELY, SOFTWARE FOR CREATING A LIST OF QUALITIES USERS WOULD LIKE THEIR "PERFECT PARTNER" TO HAVE, THEN ALLOWS THEM TO ADD "POTENTIAL PARTNERS" TO THE APPLICATION AND RATE THEM AGAINST THEIR LIST OF QUALITIES (U.S. CLS. 21, 23, 26, 36 AND 38).  
FIRST USE 11-1-2010; IN COMMERCE 11-15-2010.  
TOBY BULLOFF, EXAMINING ATTORNEY

**CLASS 9—(Continued).**

SN 85-340,013. CROSSBORDERS, LLC, NEW YORK, NY. FILED 6-7-2011.

# The Adventures of Timmy: Run Kitty Run

THE MARK CONSISTS OF STANDARD CHARACTERS WITHOUT CLAIM TO ANY PARTICULAR FONT, STYLE, SIZE, OR COLOR.  
FOR DOWNLOADABLE VIDEO GAME SOFTWARE FOR MOBILE DEVICES AND PERSONAL COMPUTERS; COMPUTER GAME SOFTWARE, COMPUTER GAME PROGRAMS; VIDEO GAME SOFTWARE, INTERACTIVE VIDEO GAME PROGRAMS; ELECTRONIC GAME SOFTWARE, ELECTRONIC GAME PROGRAMS, INTERACTIVE GAME SOFTWARE, INTERACTIVE GAME PROGRAMS (U.S. CLS. 21, 23, 26, 36 AND 38).  
ERNEST SHOSHO, EXAMINING ATTORNEY

---

SN 85-340,108. JAMMY JAMS, LLC, LAUREL, MD. FILED 6-7-2011.

# JAMMY JAMS

THE MARK CONSISTS OF STANDARD CHARACTERS WITHOUT CLAIM TO ANY PARTICULAR FONT, STYLE, SIZE, OR COLOR.  
FOR DOWNLOADABLE MP3 FILES AND MP3 RECORDINGS FEATURING MUSIC; PRE-RECORDED CDS FEATURING MUSIC (U.S. CLS. 21, 23, 26, 36 AND 38).  
ELLEN B. AWRICH, EXAMINING ATTORNEY

---

SN 85-340,155. PAWTRACK GLOBAL SERVICES LIMITED, DEVON, UNITED KINGDOM, FILED 6-7-2011.

# PAWTRACK

THE MARK CONSISTS OF STANDARD CHARACTERS WITHOUT CLAIM TO ANY PARTICULAR FONT, STYLE, SIZE, OR COLOR.  
FOR ELECTRONIC DEVICES FOR ANIMAL LOCATING AND TRACKING PROGRAMMED TO USE GLOBAL POSITIONING SYSTEMS (GPS) AND CELLULAR COMMUNICATIONS (U.S. CLS. 21, 23, 26, 36 AND 38).  
ALLISON HOLTZ, EXAMINING ATTORNEY

**CLASS 9—(Continued).**

SN 85-340,285. ANDREW LLC, HICKORY, NC. FILED 6-7-2011.

**ULINE**

THE MARK CONSISTS OF STANDARD CHARACTERS WITHOUT CLAIM TO ANY PARTICULAR FONT, STYLE, SIZE, OR COLOR.

FOR MICROWAVE ANTENNAS (U.S. CLS. 21, 23, 26, 36 AND 38).

JOHN SCHUYLER YARD, EXAMINING ATTORNEY

SN 85-340,327. PROXIM WIRELESS CORPORATION, MILPITAS, CA. FILED 6-7-2011.

**WORP DRIVE**

THE MARK CONSISTS OF STANDARD CHARACTERS WITHOUT CLAIM TO ANY PARTICULAR FONT, STYLE, SIZE, OR COLOR.

FOR WIRELESS COMMUNICATIONS HARDWARE AND SOFTWARE SOLD TOGETHER AS A UNIT FOR VOICE, DATA OR IMAGE TRANSMISSION, NAMELY, OUTDOOR POINT-TO-POINT AND POINT-TO-MULTI-POINT ROUTERS, LINKS, RADIOS AND BRIDGES; COMPUTER SOFTWARE, NAMELY, LOCAL AREA NETWORK OPERATING SOFTWARE, COMPUTER OPERATING SYSTEMS, COMPUTER SOFTWARE FOR MANAGING TELECOMMUNICATIONS NETWORKS, SYSTEMS AND DEVICES, AND COMPUTER SOFTWARE FOR IMPROVING THE OPERATING PERFORMANCE OF TELECOMMUNICATIONS NETWORKS, SYSTEMS AND DEVICES (U.S. CLS. 21, 23, 26, 36 AND 38).

ODESSA BIBBINS, EXAMINING ATTORNEY

SN 85-340,373. INSTEP SOFTWARE, LLC, CHICAGO, IL. FILED 6-7-2011.



FOR COMPUTER SOFTWARE FOR PROVIDING A SINGLE, SECURE SOURCE FOR DETAILED COMPANY INFORMATION BY SYNTHESIZING DATA FROM DIVERSE DATA SOURCES OVER THE GLOBAL COMPUTER NETWORK/CORPORATE COMPUTER NETWORK, IN THE FIELDS OF ENGINEERING, GENERATING PLANT PROCESSES, AND FINANCIAL ANALYSIS (U.S. CLS. 21, 23, 26, 36 AND 38).

FIRST USE 6-1-1998; IN COMMERCE 6-1-1998.

REBECCA POVARCHUK, EXAMINING ATTORNEY

**CLASS 9—(Continued).**

SN 85-340,627. MONSTER CABLE PRODUCTS, INC., BRISBANE, CA. FILED 6-8-2011.

**ILLUMINESSENCE**

THE MARK CONSISTS OF STANDARD CHARACTERS WITHOUT CLAIM TO ANY PARTICULAR FONT, STYLE, SIZE, OR COLOR.

FOR AUDIO SPEAKERS; ELECTRONIC DOCKING STATIONS; HEADPHONES (U.S. CLS. 21, 23, 26, 36 AND 38).

TRACY CROSS, EXAMINING ATTORNEY

SN 85-340,707. CELLCO PARTNERSHIP, DBA VERIZON WIRELESS, BASKING RIDGE, NJ. FILED 6-8-2011.

**LANCER**

THE MARK CONSISTS OF STANDARD CHARACTERS WITHOUT CLAIM TO ANY PARTICULAR FONT, STYLE, SIZE, OR COLOR.

FOR WIRELESS TELECOMMUNICATIONS DEVICE FEATURING TRANSMISSION OF VOICE, DATA, IMAGE AND VIDEO, INCLUDING VOICE, TEXT, PICTURE AND VIDEO MESSAGING, INTERNET ACCESS, ACCESS TO NAVIGATION AND DIRECTIONAL SERVICE OVER THE AIR, THE ABILITY TO DOWNLOAD MUSIC, VIDEOS AND APPLICATIONS OVER THE AIR, AND WHICH HAS A MUSIC PLAYER AND A STILL IMAGE AND VIDEO CAMERA (U.S. CLS. 21, 23, 26, 36 AND 38).

KEVIN CORWIN, EXAMINING ATTORNEY

SN 85-340,844. NTHDEGREE TECHNOLOGIES WORLD-WIDE INC., TEMPE, AZ. FILED 6-8-2011.

**NTH-ENERGY**

THE MARK CONSISTS OF STANDARD CHARACTERS WITHOUT CLAIM TO ANY PARTICULAR FONT, STYLE, SIZE, OR COLOR.

FOR RECHARGEABLE ELECTRICITY STORING PRINTED CIRCUITS (U.S. CLS. 21, 23, 26, 36 AND 38).

DAVID TOOLEY, EXAMINING ATTORNEY

**CLASS 9—(Continued).**

SN 85-341,022. 3G STUDIOS, INC., RENO, NV. FILED 6-8-2011.

# Toucan Treasure

THE MARK CONSISTS OF STANDARD CHARACTERS WITHOUT CLAIM TO ANY PARTICULAR FONT, STYLE, SIZE, OR COLOR.

FOR AMUSEMENT MACHINES, NAMELY, HAND-HELD ELECTRONIC GAME UNITS ADAPTED FOR USE WITH AN EXTERNAL DISPLAY SCREEN OR MONITOR; COMPUTER GAME SOFTWARE; ELECTRONIC GAMING MACHINES, NAMELY, DEVICES WHICH ACCEPT A WAGER (U.S. CLS. 21, 23, 26, 36 AND 38).  
CHERYL CLAYTON, EXAMINING ATTORNEY

SN 85-341,113. ANAJET, INC., COSTA MESA, CA. FILED 6-8-2011.

# mPower

THE MARK CONSISTS OF STANDARD CHARACTERS WITHOUT CLAIM TO ANY PARTICULAR FONT, STYLE, SIZE, OR COLOR.

FOR PRINTERS (U.S. CLS. 21, 23, 26, 36 AND 38).  
BARBARA GAYNOR, EXAMINING ATTORNEY

SN 85-341,189. ENERGY CONTROL TECHNOLOGIES, INC., WEST DES MOINES, IA. FILED 6-8-2011.

# AirPAC

THE MARK CONSISTS OF THE WORD AIRPAC IN STYLIZED FONT.

FOR PROCESS AUTOMATION CONTROL SYSTEM COMPRISING OF MICRO-PROCESSOR BASED HARDWARE AND SOFTWARE, NAMELY A COMPRESSOR CONTROLLER FOR USE IN AIR COMPRESSOR NETWORK MANAGEMENT COMPRISING OF A MIX OF SINGLE OR MULTI-STAGE CENTRIFUGAL OR AXIAL COMPRESSORS, SCREW COMPRESSORS, RECIPROCATING COMPRESSORS DRIVEN BY EITHER STEAM OR GAS TURBINE OR ELECTRIC MOTOR TO CONTROL PROCESS VARIABLES ASSOCIATED WITH COMPRESSED AIR NETWORK (U.S. CLS. 21, 23, 26, 36 AND 38).

FIRST USE 5-13-2010; IN COMMERCE 5-13-2010.  
KAREN K. BUSH, EXAMINING ATTORNEY

**CLASS 9—(Continued).**

SN 85-341,328. GHI, LLC, AUSTIN, TX. FILED 6-8-2011.

# Gathering Of Developers

THE MARK CONSISTS OF STANDARD CHARACTERS WITHOUT CLAIM TO ANY PARTICULAR FONT, STYLE, SIZE, OR COLOR.

FOR COMPUTER GAME SOFTWARE AND RELATED INSTRUCTION MANUALS SOLD TOGETHER AS A UNIT AND DOWNLOADABLE COMPUTER GAME SOFTWARE (U.S. CLS. 21, 23, 26, 36 AND 38).  
ZACHARY BELLO, EXAMINING ATTORNEY

SN 85-341,359. CELLCO PARTNERSHIP, DBA VERIZON WIRELESS, BASKING RIDGE, NJ. FILED 6-8-2011.

# STRATOSPHERE

THE MARK CONSISTS OF STANDARD CHARACTERS WITHOUT CLAIM TO ANY PARTICULAR FONT, STYLE, SIZE, OR COLOR.

FOR WIRELESS TELECOMMUNICATIONS DEVICE FEATURING TRANSMISSION OF VOICE, DATA, IMAGE AND VIDEO, INCLUDING VOICE, TEXT, PICTURE AND VIDEO MESSAGING, INTERNET ACCESS, ACCESS TO NAVIGATION AND DIRECTIONAL SERVICE OVER THE AIR, THE ABILITY TO DOWNLOAD MUSIC, VIDEOS AND APPLICATIONS OVER THE AIR, AND WHICH HAS A MUSIC PLAYER AND A STILL IMAGE AND VIDEO CAMERA (U.S. CLS. 21, 23, 26, 36 AND 38).

KEVIN CORWIN, EXAMINING ATTORNEY

SN 85-341,422. CELLCO PARTNERSHIP, DBA VERIZON WIRELESS, BASKING RIDGE, NJ. FILED 6-8-2011.

# DEPARTURE

THE MARK CONSISTS OF STANDARD CHARACTERS WITHOUT CLAIM TO ANY PARTICULAR FONT, STYLE, SIZE, OR COLOR.

FOR WIRELESS TELECOMMUNICATIONS DEVICE FEATURING TRANSMISSION OF VOICE, DATA, IMAGE AND VIDEO, INCLUDING VOICE, TEXT, PICTURE AND VIDEO MESSAGING, INTERNET ACCESS, ACCESS TO NAVIGATION AND DIRECTIONAL SERVICE OVER THE AIR, THE ABILITY TO DOWNLOAD MUSIC, VIDEOS AND APPLICATIONS OVER THE AIR, AND WHICH HAS A MUSIC PLAYER AND A STILL IMAGE AND VIDEO CAMERA (U.S. CLS. 21, 23, 26, 36 AND 38).

KEVIN CORWIN, EXAMINING ATTORNEY

**CLASS 9—(Continued).**

SN 85-341,480. OUYANG, YONGBIN, MONTEREY PARK, CA. FILED 6-8-2011.

# KOK

THE MARK CONSISTS OF STANDARD CHARACTERS WITHOUT CLAIM TO ANY PARTICULAR FONT, STYLE, SIZE, OR COLOR.

FOR BABY SCALES; CALCULATING SCALES; SCALES; WEIGHING EQUIPMENT, NAMELY, SCALES AND BALANCES; WEIGHING SCALES (U.S. CLS. 21, 23, 26, 36 AND 38).

FIRST USE 1-1-2011; IN COMMERCE 1-1-2011.  
H. M. FISHER, EXAMINING ATTORNEY

---

SN 85-341,519. BURRIS COMPANY, INC., GREELEY, CO. FILED 6-8-2011.

# MTAC

THE MARK CONSISTS OF STANDARD CHARACTERS WITHOUT CLAIM TO ANY PARTICULAR FONT, STYLE, SIZE, OR COLOR.

FOR TELESCOPIC GUN SIGHTS (U.S. CLS. 21, 23, 26, 36 AND 38).

FIRST USE 7-22-2011; IN COMMERCE 7-22-2011.  
DAVID TAYLOR, EXAMINING ATTORNEY

---

SN 85-341,636. BOINNARD, LUDOVIC, SAN DIEGO, CA. FILED 6-8-2011.

# ACCURI

THE MARK CONSISTS OF STANDARD CHARACTERS WITHOUT CLAIM TO ANY PARTICULAR FONT, STYLE, SIZE, OR COLOR.

FOR GOGGLES FOR SPORTS; SAFETY HELMETS; SPECTACLES; SUNGLASSES (U.S. CLS. 21, 23, 26, 36 AND 38).

INGA ERVIN, EXAMINING ATTORNEY

**CLASS 9—(Continued).**

SN 85-341,654. ROLAND,JACOB,J, TITUSVILLE, FL. FILED 6-8-2011.

# The Rolling Westerns

THE MARK CONSISTS OF STANDARD CHARACTERS WITHOUT CLAIM TO ANY PARTICULAR FONT, STYLE, SIZE, OR COLOR.

FOR AUDIO AND VIDEO RECORDINGS FEATURING MUSIC AND ARTISTIC PERFORMANCES; AUDIO TAPES FEATURING MUSIC; COMPACT DISCS FEATURING MUSIC; COMPACT DISCS FEATURING MUSIC AND SPOKEN WORD IN THE FORM OF POETRY; DIGITAL MUSIC DOWNLOADABLE FROM THE INTERNET; DOWNLOADABLE MUSICAL SOUND RECORDINGS; DOWNLOADABLE RING TONES, GRAPHICS AND MUSIC VIA A GLOBAL COMPUTER NETWORK AND WIRELESS DEVICES; MUSICAL RECORDINGS; MUSICAL SOUND RECORDINGS (U.S. CLS. 21, 23, 26, 36 AND 38).

FIRST USE 4-30-2010; IN COMMERCE 4-30-2010.  
DORITT L. CARROLL, EXAMINING ATTORNEY

---

SN 85-341,677. DELANY KOU, SAN JOSE, CA. FILED 6-8-2011.

# iPrincess

THE MARK CONSISTS OF STANDARD CHARACTERS WITHOUT CLAIM TO ANY PARTICULAR FONT, STYLE, SIZE, OR COLOR.

FOR COMPUTER GAME SOFTWARE (U.S. CLS. 21, 23, 26, 36 AND 38).

JEFFREY LOOK, EXAMINING ATTORNEY

---

SN 85-341,681. ESILO, LLC, JUPITER, FL. FILED 6-8-2011.

# REDUPLICATION

THE MARK CONSISTS OF STANDARD CHARACTERS WITHOUT CLAIM TO ANY PARTICULAR FONT, STYLE, SIZE, OR COLOR.

FOR COMPUTER SOFTWARE FOR THE COLLECTION, ORGANIZING, TRANSMISSION, MANAGEMENT, BACKUP AND STORAGE OF ELECTRONIC DATA AND INFORMATION (U.S. CLS. 21, 23, 26, 36 AND 38).

LINDA MICKLEBURGH, EXAMINING ATTORNEY

**CLASS 9—(Continued).**

SN 85-341,696. ESILO, LLC, JUPITER, FL. FILED 6-8-2011.

# SILOSPHERE

THE MARK CONSISTS OF STANDARD CHARACTERS WITHOUT CLAIM TO ANY PARTICULAR FONT, STYLE, SIZE, OR COLOR.

FOR COMPUTER SOFTWARE FOR THE COLLECTION, ORGANIZING, TRANSMISSION, MANAGEMENT, BACKUP AND STORAGE OF ELECTRONIC DATA AND INFORMATION (U.S. CLS. 21, 23, 26, 36 AND 38).

LINDA MICKLEBURGH, EXAMINING ATTORNEY

**CLASS 9—(Continued).**

SN 85-341,885. ANDREW LLC, HICKORY, NC. FILED 6-9-2011.

# EXTREMELINE

THE MARK CONSISTS OF STANDARD CHARACTERS WITHOUT CLAIM TO ANY PARTICULAR FONT, STYLE, SIZE, OR COLOR.

FOR MICROWAVE ANTENNAS (U.S. CLS. 21, 23, 26, 36 AND 38).

JOHN SCHUYLER YARD, EXAMINING ATTORNEY

---

SN 85-341,718. JACQUIE CARTER, PLAYA DEL REY, CA. FILED 6-8-2011.

# TWURLERS

THE MARK CONSISTS OF STANDARD CHARACTERS WITHOUT CLAIM TO ANY PARTICULAR FONT, STYLE, SIZE, OR COLOR.

FOR HAIR-CURLERS, ELECTRICALLY HEATED (U.S. CLS. 21, 23, 26, 36 AND 38).

MARK SHINER, EXAMINING ATTORNEY

---

SN 85-342,348. WEISS, BOB, NEW YORK, NY. FILED 6-9-2011.

# Picturegram

THE MARK CONSISTS OF STANDARD CHARACTERS WITHOUT CLAIM TO ANY PARTICULAR FONT, STYLE, SIZE, OR COLOR.

FOR COMPUTER SOFTWARE FOR USE IN CAPTURING, ORGANIZING, SEARCHING, INDEXING, STORING, SYNCHRONIZING, RECOGNIZING, SHARING, RATING, LIKING OR DISLIKING, TRANSMITTING AND DISPLAYING DIGITAL OR ANALOG FILES, NAMELY, AUDIO, VIDEO, TEXT, BINARY, STILL IMAGES, GRAPHICS, DIGITAL CONTENT AND MULTIMEDIA FILES; DOWNLOADABLE COMPUTER SOFTWARE FOR USE IN CAPTURING, ORGANIZING, SEARCHING, INDEXING, STORING, SYNCHRONIZING, RECOGNIZING, SHARING AND TRANSMITTING DIGITAL AND ANALOG FILES, NAMELY, AUDIO, VIDEO, TEXT, BINARY, STILL IMAGES, GRAPHICS, DIGITAL CONTENT, AND MULTIMEDIA FILES; COMPUTER SOFTWARE, NAMELY, SOFTWARE THAT GIVES USERS THE ABILITY TO SEND AND RECEIVE SMS MESSAGES AND TEXT MESSAGES VIA THE INTERNET AND WIRELESS DEVICES; SOFTWARE AND SOFTWARE APPLICATIONS TO ENABLE TRANSMISSION, ACCESS, ORGANIZATION, AND MANAGEMENT OF TEXT MESSAGING, INSTANT MESSAGING, ONLINE BLOG JOURNALS, TEXT, WEBLINKS, PICTURES, PHOTOS AND IMAGES VIA THE INTERNET AND OTHER COMMUNICATIONS NETWORKS; COMPUTER SOFTWARE USED TO ENHANCE THE CAPABILITIES AND FEATURES OF OTHER SOFTWARE AND NONDOWNLOADABLE ONLINE SOFTWARE,

---

SN 85-341,874. ANDREW LLC, HICKORY, NC. FILED 6-9-2011.

# FLASHLINE

THE MARK CONSISTS OF STANDARD CHARACTERS WITHOUT CLAIM TO ANY PARTICULAR FONT, STYLE, SIZE, OR COLOR.

FOR MICROWAVE ANTENNAS (U.S. CLS. 21, 23, 26, 36 AND 38).

JOHN SCHUYLER YARD, EXAMINING ATTORNEY

**CLASS 9—(Continued).**

NAMELY, SOFTWARE FOR ENHANCING, CLARIFYING, TOUCHING UP OR REFOCUSING DIGITAL PICTURES, IMAGES AND VIDEOS; SOFTWARE FOR ACCESSING INFORMATION ON A GLOBAL COMPUTER NETWORK; DOWNLOADABLE SOFTWARE VIA THE INTERNET AND WIRELESS DEVICES, NAMELY, SOFTWARE THAT GIVES USERS THE ABILITY TO SEND AND RECEIVE MESSAGES, NEWS ARTICLES AND INFORMATION AND PICTURES VIA WEBSITE OR WIRELESS DEVICES; DOWNLOADABLE SOFTWARE IN THE FIELD OF SOCIAL NETWORKING, NAMELY, SOFTWARE THAT GIVES USERS THE ABILITY TO SEARCH PICTURE AND VIDEO DATABASES AND USE FACIAL RECOGNITION SOFTWARE TO IDENTIFY INDIVIDUALS FROM A DATABASE; DOWNLOADABLE SOFTWARE IN THE NATURE OF A MOBILE APPLICATION, NAMELY, PROVIDING SOFTWARE THAT GIVES USERS THE ABILITY TO SEND AND RECEIVE MESSAGES, PICTURES AND VIDEOS VIA THE INTERNET AND WIRELESS DEVICES (U.S. CLS. 21, 23, 26, 36 AND 38).

SHANNON TWOHIG, EXAMINING ATTORNEY

---

SN 85-343,173. LG ELECTRONICS INC., SEOUL 150-721, REPUBLIC OF KOREA, FILED 6-10-2011.

# ESTEEM

THE MARK CONSISTS OF STANDARD CHARACTERS WITHOUT CLAIM TO ANY PARTICULAR FONT, STYLE, SIZE, OR COLOR.

FOR MOBILE PHONES (U.S. CLS. 21, 23, 26, 36 AND 38).

JACLYN KIDWELL WALKER, EXAMINING ATTORNEY

---

SN 85-344,210. MONSTER CABLE PRODUCTS, INC., BRISBANE, CA. FILED 6-13-2011.

# VEKTR

THE MARK CONSISTS OF STANDARD CHARACTERS WITHOUT CLAIM TO ANY PARTICULAR FONT, STYLE, SIZE, OR COLOR.

FOR AUDIO SPEAKERS; ELECTRONIC DOCKING STATIONS; HEADPHONES (U.S. CLS. 21, 23, 26, 36 AND 38).

TRACY CROSS, EXAMINING ATTORNEY

**CLASS 9—(Continued).**

SN 85-344,790. FRACTAL ANTENNA SYSTEMS, INC., WALTHAM, MA. FILED 6-13-2011.

# WhipBeater

THE MARK CONSISTS OF STANDARD CHARACTERS WITHOUT CLAIM TO ANY PARTICULAR FONT, STYLE, SIZE, OR COLOR.

FOR ANTENNAS FOR WIRELESS COMMUNICATIONS APPARATUS (U.S. CLS. 21, 23, 26, 36 AND 38).

JOHN GARTNER, EXAMINING ATTORNEY

---

SN 85-346,276. SAMSUNG ELECTRONICS CO., LTD., SUWON-SI, GYEONGGI-DO, REPUBLIC OF KOREA, FILED 6-14-2011.

# DOUBLELIFE

THE MARK CONSISTS OF STANDARD CHARACTERS WITHOUT CLAIM TO ANY PARTICULAR FONT, STYLE, SIZE, OR COLOR.

FOR MOBILE PHONES; SMARTPHONES (U.S. CLS. 21, 23, 26, 36 AND 38).

PAULA MAHONEY, EXAMINING ATTORNEY

---

SN 85-346,277. SAMSUNG ELECTRONICS CO., LTD., SUWON-SI, GYEONGGI-DO, REPUBLIC OF KOREA, FILED 6-14-2011.

THE MARK CONSISTS OF A LOWER CASE "I" IN CURSIVE, UPPER CASE "F" AND LOWER CASE "N" WITH A DESIGN OF A HALF CIRCLE ENCOMPASSING THE LOWER CASE "I".

FOR LENSES FOR CAMERAS; DIGITAL CAMERAS; CAMCORDERS; CAMERA CASES; FLASH LAMPS FOR CAMERAS; TRIPODS FOR CAMERAS (U.S. CLS. 21, 23, 26, 36 AND 38).

PAULA MAHONEY, EXAMINING ATTORNEY



**CLASS 9—(Continued).**

SN 85-346,282. SAMSUNG ELECTRONICS CO., LTD., SU-WON-SI, GYEONGGI-DO, REPUBLIC OF KOREA, FILED 6-14-2011.

SAMSUNG 

OWNER OF U.S. REG. NOS. 2,929,519, 3,410,845 AND 3,503,660.

THE MARK CONSISTS OF THE WORD SAMSUNG IN ALL CAPITAL LETTERS NEXT TO A LOWER CASE "I", UPPER CASE "F" AND LOWER CASE "N" WITH A DESIGN OF A HALF CIRCLE ENCOMPASSING THE LOWER CASE "I".

THE ENGLISH TRANSLATION OF SAMSUNG IN THE MARK IS THREE STARS.

FOR LENSES FOR CAMERAS; DIGITAL CAMERAS; CAMCORDERS; CAMERA CASES; FLASH LAMPS FOR CAMERAS; TRIPODS FOR CAMERAS (U.S. CLS. 21, 23, 26, 36 AND 38).

PAULA MAHONEY, EXAMINING ATTORNEY

SN 85-346,436. NIKON CORPORATION, TOKYO, JAPAN, FILED 6-15-2011.

Coolshot

THE MARK CONSISTS OF STANDARD CHARACTERS WITHOUT CLAIM TO ANY PARTICULAR FONT, STYLE, SIZE, OR COLOR.

FOR LASER RANGEFINDERS (U.S. CLS. 21, 23, 26, 36 AND 38).

ANTHONY RINKER, EXAMINING ATTORNEY

SN 85-347,292. PANASONIC CORPORATION OF NORTH AMERICA, SECAUCUS, NJ. FILED 6-15-2011.

STINGRAY ENVO

THE MARK CONSISTS OF STANDARD CHARACTERS WITHOUT CLAIM TO ANY PARTICULAR FONT, STYLE, SIZE, OR COLOR.

OWNER OF U.S. REG. NO. 3,459,233.

FOR ELECTRONIC CASH REGISTERS (U.S. CLS. 21, 23, 26, 36 AND 38).

KATHERINE CHANG, EXAMINING ATTORNEY

**CLASS 9—(Continued).**

SN 85-349,752. CISCO TECHNOLOGY, INC., SAN JOSE, CA. FILED 6-17-2011.

CISCO CLEANAIR

THE MARK CONSISTS OF STANDARD CHARACTERS WITHOUT CLAIM TO ANY PARTICULAR FONT, STYLE, SIZE, OR COLOR.

OWNER OF U.S. REG. NOS. 3,747,597, 3,978,294 AND OTHERS.

FOR WIRELESS NETWORKING SOFTWARE; SOFTWARE FOR MANAGING, MONITORING AND SCANNING WIRELESS NETWORKS; SOFTWARE FOR TRACKING AND GENERATING REPORTS CONCERNING WIRELESS NETWORKS; SOFTWARE FOR DETECTING, CLASSIFYING, LOCALIZING AND REMEDYING NETWORK AND RADIO INTERFERENCE (U.S. CLS. 21, 23, 26, 36 AND 38).

FIRST USE 6-30-2010; IN COMMERCE 6-30-2010.

LAURIE KAUFMAN, EXAMINING ATTORNEY

SN 85-350,100. FRACTAL ANTENNA SYSTEMS, INC., WALTHAM, MA. FILED 6-20-2011.

PowerBow

THE MARK CONSISTS OF STANDARD CHARACTERS WITHOUT CLAIM TO ANY PARTICULAR FONT, STYLE, SIZE, OR COLOR.

FOR ANTENNAS; ANTENNAS FOR WIRELESS COMMUNICATIONS APPARATUS; MICROWAVE ANTENNAE (U.S. CLS. 21, 23, 26, 36 AND 38).

JOHN GARTNER, EXAMINING ATTORNEY

SN 85-352,208. L-3 SERVICES, INC., SAN DIEGO, CA. FILED 6-21-2011.

VIDEOROVER

THE MARK CONSISTS OF STANDARD CHARACTERS WITHOUT CLAIM TO ANY PARTICULAR FONT, STYLE, SIZE, OR COLOR.

FOR INTEGRATED SYSTEM COMPRISING RUGGEDIZED PERSONAL AND LAPTOP COMPUTERS, DATA LINKS, EMBEDDED VIDEO PROCESSING BOARDS, AND VIDEO ASSET MANAGEMENT SOFTWARE FOR THE CAPTURE, ANALYSIS, ANNOTATION, STORAGE AND DISSEMINATION OF VIDEO LOCALLY AND ACROSS NETWORKS (U.S. CLS. 21, 23, 26, 36 AND 38).

LYDIA BELZER, EXAMINING ATTORNEY

**CLASS 9—(Continued).**

SN 85-352,225. L-3 SERVICES, INC., SAN DIEGO, CA. FILED 6-21-2011.

**SENSORS**SCOUT

THE MARK CONSISTS OF STANDARD CHARACTERS WITHOUT CLAIM TO ANY PARTICULAR FONT, STYLE, SIZE, OR COLOR.

FOR INTEGRATED SYSTEM COMPRISING RUGGEDIZED PERSONAL AND LAPTOP COMPUTERS, DATA LINKS, EMBEDDED VIDEO PROCESSING BOARDS, AND VIDEO ASSET MANAGEMENT SOFTWARE FOR THE CAPTURE, ANALYSIS, ANNOTATION, STORAGE AND DISSEMINATION OF VIDEO AND MULTI-SENSOR DATA LOCALLY AND ACROSS NETWORKS (U.S. CLS. 21, 23, 26, 36 AND 38).

LYDIA BELZER, EXAMINING ATTORNEY

SN 85-352,264. DIAMOND GAME ENTERPRISES, CHATSWORTH, CA. FILED 6-21-2011.

**Lucky Tab**

THE MARK CONSISTS OF STANDARD CHARACTERS WITHOUT CLAIM TO ANY PARTICULAR FONT, STYLE, SIZE, OR COLOR.

FOR GAMING EQUIPMENT, NAMELY, ELECTRONIC GAMING MACHINES AND GAMING MACHINES WITH VIDEO OUTPUT (U.S. CLS. 21, 23, 26, 36 AND 38).

ROSELLE HERRERA, EXAMINING ATTORNEY

SN 85-352,272. DIAMOND GAME ENTERPRISES, CHATSWORTH, CA. FILED 6-21-2011.

**Lucky Tabs**

THE MARK CONSISTS OF STANDARD CHARACTERS WITHOUT CLAIM TO ANY PARTICULAR FONT, STYLE, SIZE, OR COLOR.

FOR GAMING EQUIPMENT, NAMELY, ELECTRONIC GAMING MACHINES AND GAMING MACHINES WITH VIDEO OUTPUT (U.S. CLS. 21, 23, 26, 36 AND 38).

ROSELLE HERRERA, EXAMINING ATTORNEY

**CLASS 9—(Continued).**

SN 85-352,370. MONSTER CABLE PRODUCTS, INC., BRISBANE, CA. FILED 6-21-2011.

**ALLEGRO**

THE MARK CONSISTS OF STANDARD CHARACTERS WITHOUT CLAIM TO ANY PARTICULAR FONT, STYLE, SIZE, OR COLOR.

FOR HEADPHONES (U.S. CLS. 21, 23, 26, 36 AND 38).  
TRACY CROSS, EXAMINING ATTORNEY

SN 85-352,373. MONSTER CABLE PRODUCTS, INC., BRISBANE, CA. FILED 6-21-2011.

**BREEZIN**

THE MARK CONSISTS OF STANDARD CHARACTERS WITHOUT CLAIM TO ANY PARTICULAR FONT, STYLE, SIZE, OR COLOR.

FOR AUDIO SPEAKERS; ELECTRONIC DOCKING STATIONS; HEADPHONES (U.S. CLS. 21, 23, 26, 36 AND 38).

TRACY CROSS, EXAMINING ATTORNEY

SN 85-352,675. LIN, ZHONG JIAN, OZONE PARK, NY. FILED 6-22-2011.



THE MARK CONSISTS OF THE MARK CONSISTS OF STYLIZED NUMBER "3" AND LETTERS "A" AND "E".

FOR EYEWEAR; EYEWEAR ACCESSORIES, NAMELY, STRAPS, NECK CORDS AND HEAD STRAPS WHICH RESTRAIN EYEWEAR FROM MOVEMENT ON A WEARER; EYEWEAR CASES; EYEWEAR RETAINERS; EYEWEAR, NAMELY, SUNGLASSES, EYEGLASSES AND OPHTHALMIC FRAMES AND CASES THEREFOR; NOSE GUARDS WHICH CAN BE WORN BY ATTACHMENT TO EYEWEAR SUCH AS SUNGLASSES AND SKI GOGGLES; PROTECTIVE EYEWEAR; PROTECTIVE EYEWEAR AND COMPONENT PARTS THEREOF; SAFETY EYEWEAR; SPORTS EYEWEAR (U.S. CLS. 21, 23, 26, 36 AND 38).

FIRST USE 7-12-2009; IN COMMERCE 7-12-2009.  
JENNIFER MARTIN, EXAMINING ATTORNEY

**CLASS 9—(Continued).**

SN 85-356,176. CELLCO PARTNERSHIP, DBA VERIZON WIRELESS, BASKING RIDGE, NJ. FILED 6-24-2011.

**ARTFORM**

THE MARK CONSISTS OF STANDARD CHARACTERS WITHOUT CLAIM TO ANY PARTICULAR FONT, STYLE, SIZE, OR COLOR.

FOR WIRELESS TELECOMMUNICATION DEVICE FEATURING VOICE, DATA, IMAGE AND VIDEO TRANSMISSION AND WHICH IS CAPABLE OF DIRECTION AND NAVIGATION SERVICES, INTERNET ACCESS, DOWNLOADING OF MUSIC, VIDEO AND APPLICATIONS OVER THE AIR, AND WHICH HAVE A MUSIC PLAYER AND STILL IMAGE AND VIDEO CAMERA (U.S. CLS. 21, 23, 26, 36 AND 38).

KEVIN CORWIN, EXAMINING ATTORNEY

SN 85-356,489. AINSWORTH GAME TECHNOLOGY LIMITED, NEWINGTON, AUSTRALIA, FILED 6-26-2011.

**EMPEROR'S PALACE**

THE MARK CONSISTS OF STANDARD CHARACTERS WITHOUT CLAIM TO ANY PARTICULAR FONT, STYLE, SIZE, OR COLOR.

FOR COMPUTER SOFTWARE AND FIRMWARE FOR GAMES OF CHANCE ON ANY COMPUTERIZED PLATFORM, INCLUDING DEDICATED GAMING CONSOLES, VIDEO BASED SLOT MACHINES, REEL BASED SLOT MACHINES, AND VIDEO LOTTERY TERMINALS (U.S. CLS. 21, 23, 26, 36 AND 38).

KATHLEEN M. VANSTON, EXAMINING ATTORNEY

SN 85-357,733. TRIMBLE NAVIGATION LIMITED, SUNNYVALE, CA. FILED 6-28-2011.

**NETR9**

THE MARK CONSISTS OF STANDARD CHARACTERS WITHOUT CLAIM TO ANY PARTICULAR FONT, STYLE, SIZE, OR COLOR.

FOR GLOBAL NAVIGATION SATELLITE SYSTEM (GNSS) RECEIVERS (U.S. CLS. 21, 23, 26, 36 AND 38). FIRST USE 6-9-2011; IN COMMERCE 6-9-2011.

DOUGLAS LEE, EXAMINING ATTORNEY

**CLASS 9—(Continued).**

SN 85-357,833. 3G STUDIOS, INC., RENO, NV. FILED 6-28-2011.

**Barney's Bounty**

THE MARK CONSISTS OF STANDARD CHARACTERS WITHOUT CLAIM TO ANY PARTICULAR FONT, STYLE, SIZE, OR COLOR.

FOR COMPUTER GAME SOFTWARE (U.S. CLS. 21, 23, 26, 36 AND 38).

CHERYL CLAYTON, EXAMINING ATTORNEY

SN 85-357,864. 3G STUDIOS, INC., RENO, NV. FILED 6-28-2011.

**Deep Treasure**

THE MARK CONSISTS OF STANDARD CHARACTERS WITHOUT CLAIM TO ANY PARTICULAR FONT, STYLE, SIZE, OR COLOR.

FOR GAMING MACHINES, NAMELY, DEVICES WHICH ACCEPT A WAGER (U.S. CLS. 21, 23, 26, 36 AND 38).

CHERYL CLAYTON, EXAMINING ATTORNEY

SN 85-358,511. CELLCO PARTNERSHIP, DBA VERIZON WIRELESS, BASKING RIDGE, NJ. FILED 6-28-2011.

**FIREWORX**

THE MARK CONSISTS OF STANDARD CHARACTERS WITHOUT CLAIM TO ANY PARTICULAR FONT, STYLE, SIZE, OR COLOR.

FOR WIRELESS TELECOMMUNICATIONS DEVICE FEATURING TRANSMISSION OF VOICE, DATA, IMAGE AND VIDEO, INCLUDING VOICE, TEXT, PICTURE AND VIDEO MESSAGING, INTERNET ACCESS, ACCESS TO NAVIGATION AND DIRECTIONAL SERVICE OVER THE AIR, THE ABILITY TO DOWNLOAD MUSIC, VIDEOS AND APPLICATIONS OVER THE AIR, AND WHICH HAS A MUSIC PLAYER AND A STILL IMAGE AND VIDEO CAMERA (U.S. CLS. 21, 23, 26, 36 AND 38).

KEVIN CORWIN, EXAMINING ATTORNEY

**CLASS 9—(Continued).**

SN 85-359,108. AIR TECHNIQUES, INC., MELVILLE, NY.  
FILED 6-29-2011.

**SCANSMART**

THE MARK CONSISTS OF STANDARD CHARACTERS WITHOUT CLAIM TO ANY PARTICULAR FONT, STYLE, SIZE, OR COLOR.

FOR DENTAL IMAGING SOFTWARE THAT WILL ENABLE THE ACQUISITION AND VIEWING OF DENTAL RADIOGRAPHS (U.S. CLS. 21, 23, 26, 36 AND 38).  
JESSICA FATHY, EXAMINING ATTORNEY

**CLASS 9—(Continued).**

SN 85-360,495. WAVEMACHINE LABS, INC., CHICAGO, IL.  
FILED 6-30-2011.

**ReBass**

THE MARK CONSISTS OF STANDARD CHARACTERS WITHOUT CLAIM TO ANY PARTICULAR FONT, STYLE, SIZE, OR COLOR.

FOR COMPUTER SOFTWARE FOR CREATING AND EDITING MUSIC AND SOUNDS (U.S. CLS. 21, 23, 26, 36 AND 38).

TIMOTHY FINNEGAN, EXAMINING ATTORNEY

SN 85-359,871. DISCOVERY COMMUNICATIONS, LLC,  
SILVER SPRING, MD. FILED 6-29-2011.

**QUESTION EVERYTHING**

THE MARK CONSISTS OF STANDARD CHARACTERS WITHOUT CLAIM TO ANY PARTICULAR FONT, STYLE, SIZE, OR COLOR.

FOR PRE-RECORDED VIDEO DISKS, AUDIO-VISUAL RECORDINGS, VIDEOTAPES, COMPACT DISKS, DVDS AND CD-ROM'S, ALL FEATURING SUBJECTS RELATING TO SCIENCE, RESEARCH, INVENTIONS, TECHNOLOGY, ANIMALS, NATURE, COSMOLOGY, HISTORY, CULTURE AND HUMAN ACHIEVEMENT (U.S. CLS. 21, 23, 26, 36 AND 38).

HOWARD FRIEDMAN, EXAMINING ATTORNEY

SN 85-361,323. BROWSIUM, INC., REDMOND, WA. FILED 7-1-2011.

**Bromium**

THE MARK CONSISTS OF STANDARD CHARACTERS WITHOUT CLAIM TO ANY PARTICULAR FONT, STYLE, SIZE, OR COLOR.

FOR COMPILER SOFTWARE (U.S. CLS. 21, 23, 26, 36 AND 38).

BRIAN CALLAGHAN, EXAMINING ATTORNEY

SN 85-360,449. CELLCO PARTNERSHIP, DBA VERIZON WIRELESS, BASKING RIDGE, NJ. FILED 6-30-2011.

**WINDPIPE**

THE MARK CONSISTS OF STANDARD CHARACTERS WITHOUT CLAIM TO ANY PARTICULAR FONT, STYLE, SIZE, OR COLOR.

FOR TABLET COMPUTER (U.S. CLS. 21, 23, 26, 36 AND 38).

KEVIN CORWIN, EXAMINING ATTORNEY

SN 85-361,723. TRACFONE WIRELESS, INC., MIAMI, FL.  
FILED 7-1-2011.

**EVERYWHERENESS**

THE MARK CONSISTS OF STANDARD CHARACTERS WITHOUT CLAIM TO ANY PARTICULAR FONT, STYLE, SIZE, OR COLOR.

FOR ELECTRONIC COMMUNICATIONS EQUIPMENT, NAMELY, CELLULAR TELEPHONES; PREPAID AIR TIME CELLULAR TELEPHONES; CELLULAR TELEPHONE ACCESSORIES, NAMELY, BATTERY CHARGERS, STANDS, ANTENNAE, HEADSET KITS COMPRISED OF HANDS FREE ELECTRONIC EARPIECE WITH MICROPHONE AND HOLSTER, HANDS FREE HEADSETS, CASES WITH FLAPS, POWER ADAPTERS, BATTERIES, CARRY SLEEVES, FACE PLATES, BELT CLIPS, HOLSTERS, MOUNTING ATTACHMENTS (U.S. CLS. 21, 23, 26, 36 AND 38).

PAUL E. FAHRENKOPF, EXAMINING ATTORNEY

**CLASS 9—(Continued).**

SN 85-363,528. SAMSUNG ELECTRONICS CO., LTD., SU-WON-SI, GYEONGGI-DO, REPUBLIC OF KOREA, FILED 7-5-2011.

**SAMSUNG REVERB**

THE MARK CONSISTS OF STANDARD CHARACTERS WITHOUT CLAIM TO ANY PARTICULAR FONT, STYLE, SIZE, OR COLOR.

OWNER OF U.S. REG. NOS. 2,929,519, 3,503,660 AND OTHERS.

THE ENGLISH TRANSLATION OF "SAMSUNG" IN THE MARK IS "THREE STARS".

FOR MOBILE PHONES; SMARTPHONES (U.S. CLS. 21, 23, 26, 36 AND 38).

PAULA MAHONEY, EXAMINING ATTORNEY

SN 85-363,535. SAMSUNG ELECTRONICS CO., LTD., SU-WON-SI, GYEONGGI-DO, REPUBLIC OF KOREA, FILED 7-5-2011.

**SAMSUNG INTIATE**

THE MARK CONSISTS OF STANDARD CHARACTERS WITHOUT CLAIM TO ANY PARTICULAR FONT, STYLE, SIZE, OR COLOR.

OWNER OF U.S. REG. NOS. 2,929,519, 3,503,660 AND OTHERS.

THE ENGLISH TRANSLATION OF "SAMSUNG" IN THE MARK IS "THREE STARS".

FOR MOBILE PHONES; SMARTPHONES (U.S. CLS. 21, 23, 26, 36 AND 38).

PAULA MAHONEY, EXAMINING ATTORNEY

SN 85-363,617. HTC CORPORATION, TAOYUAN CITY, TAIWAN, FILED 7-5-2011.

**SHOW ME**

THE MARK CONSISTS OF STANDARD CHARACTERS WITHOUT CLAIM TO ANY PARTICULAR FONT, STYLE, SIZE, OR COLOR.

FOR COMPUTER APPLICATION SOFTWARE AND COMPUTER APPLICATION SOFTWARE FOR MOBILE PHONES, NAMELY, SOFTWARE FOR DISPLAYING TUTORIAL ARTICLES AND VIDEOS EDUCATING USERS ON VARIOUS FUNCTIONS AND FEATURES OF MOBILE PHONES, SMARTPHONES, WIRELESS PHONES, CELLULAR PHONES, TABLET COMPUTERS, PERSONAL DIGITAL ASSISTANTS, AND WIRELESS HANDHELD DEVICES (U.S. CLS. 21, 23, 26, 36 AND 38).

AMY C. KEAN, EXAMINING ATTORNEY

**CLASS 9—(Continued).**

SN 85-364,745. CISCO TECHNOLOGY, INC., SAN JOSE, CA, FILED 7-6-2011.

**CISCO UCS**

THE MARK CONSISTS OF STANDARD CHARACTERS WITHOUT CLAIM TO ANY PARTICULAR FONT, STYLE, SIZE, OR COLOR.

OWNER OF U.S. REG. NOS. 3,747,597, 3,978,294 AND OTHERS.

FOR COMPUTER SERVERS, BLADE SERVERS, COMPUTER NETWORK ADAPTERS, COMPUTER SWITCHES, ETHERNET SWITCHES AND COMPUTER CHASSIS, ALL FOR USE IN DATA CENTERS (U.S. CLS. 21, 23, 26, 36 AND 38).

FIRST USE 11-0-2009; IN COMMERCE 11-0-2009.  
LAURIE KAUFMAN, EXAMINING ATTORNEY

SN 85-369,859. NIKON CORPORATION, TOKYO, JAPAN, FILED 7-13-2011.

**Force XR**

THE MARK CONSISTS OF STANDARD CHARACTERS WITHOUT CLAIM TO ANY PARTICULAR FONT, STYLE, SIZE, OR COLOR.

FOR RIFLESCOPES (U.S. CLS. 21, 23, 26, 36 AND 38).  
ANTHONY RINKER, EXAMINING ATTORNEY

SN 85-370,726. CELESTRON ACQUISITION LLC, TORRANCE, CA, FILED 7-13-2011.

**IMPULSE**

THE MARK CONSISTS OF STANDARD CHARACTERS WITHOUT CLAIM TO ANY PARTICULAR FONT, STYLE, SIZE, OR COLOR.

FOR BINOCULARS (U.S. CLS. 21, 23, 26, 36 AND 38).  
KEVIN CORWIN, EXAMINING ATTORNEY

**CLASS 9—(Continued).**

SN 85-370,733. CELESTRON ACQUISITION LLC, TORRANCE, CA. FILED 7-13-2011.

# AMOEBEA

THE MARK CONSISTS OF STANDARD CHARACTERS WITHOUT CLAIM TO ANY PARTICULAR FONT, STYLE, SIZE, OR COLOR.

FOR MICROSCOPES (U.S. CLS. 21, 23, 26, 36 AND 38).  
KEVIN CORWIN, EXAMINING ATTORNEY

---

SN 85-370,736. CELESTRON ACQUISITION LLC, TORRANCE, CA. FILED 7-13-2011.

# WINDGUIDE

THE MARK CONSISTS OF STANDARD CHARACTERS WITHOUT CLAIM TO ANY PARTICULAR FONT, STYLE, SIZE, OR COLOR.

FOR ANEMOMETERS (U.S. CLS. 21, 23, 26, 36 AND 38).  
KEVIN CORWIN, EXAMINING ATTORNEY

---

SN 85-374,337. HTC CORPORATION, TAOYUAN CITY, TAIWAN, FILED 7-18-2011.

# HTC DYNAMO

THE MARK CONSISTS OF STANDARD CHARACTERS WITHOUT CLAIM TO ANY PARTICULAR FONT, STYLE, SIZE, OR COLOR.

OWNER OF U.S. REG. NOS. 3,584,881, 3,919,900 AND OTHERS.

FOR MOBILE PHONES, SMARTPHONES, CELLULAR PHONES, PORTABLE COMPUTERS, TABLET COMPUTERS, AND PERSONAL DIGITAL ASSISTANTS AND WIRELESS HANDHELD DIGITAL ELECTRONIC DEVICES FOR COMMUNICATING, RECORDING, ORGANIZING, TRANSMITTING, MANIPULATING, STORING, AND REVIEWING TEXT, DATA, IMAGE, AND AUDIO FILES (U.S. CLS. 21, 23, 26, 36 AND 38).  
AMY C. KEAN, EXAMINING ATTORNEY

**CLASS 9—(Continued).**

SN 85-374,352. HTC CORPORATION, TAOYUAN CITY, TAIWAN, FILED 7-18-2011.

# HTC AMAZE

THE MARK CONSISTS OF STANDARD CHARACTERS WITHOUT CLAIM TO ANY PARTICULAR FONT, STYLE, SIZE, OR COLOR.

OWNER OF U.S. REG. NOS. 3,584,881, 3,919,900 AND OTHERS.

FOR MOBILE PHONES, SMARTPHONES, CELLULAR PHONES, PORTABLE COMPUTERS, TABLET COMPUTERS, AND PERSONAL DIGITAL ASSISTANTS AND WIRELESS HANDHELD DIGITAL ELECTRONIC DEVICES FOR COMMUNICATING, RECORDING, ORGANIZING, TRANSMITTING, MANIPULATING, STORING, AND REVIEWING TEXT, DATA, IMAGE, AND AUDIO FILES (U.S. CLS. 21, 23, 26, 36 AND 38).  
AMY C. KEAN, EXAMINING ATTORNEY

---

SN 85-374,385. HTC CORPORATION, TAOYUAN CITY, TAIWAN, FILED 7-18-2011.

# HTC AMUSE

THE MARK CONSISTS OF STANDARD CHARACTERS WITHOUT CLAIM TO ANY PARTICULAR FONT, STYLE, SIZE, OR COLOR.

OWNER OF U.S. REG. NOS. 3,584,881, 3,919,900 AND OTHERS.

FOR MOBILE PHONES, SMARTPHONES, CELLULAR PHONES, PORTABLE COMPUTERS, TABLET COMPUTERS, AND PERSONAL DIGITAL ASSISTANTS AND WIRELESS HANDHELD DIGITAL ELECTRONIC DEVICES FOR COMMUNICATING, RECORDING, ORGANIZING, TRANSMITTING, MANIPULATING, STORING, AND REVIEWING TEXT, DATA, IMAGE, AND AUDIO FILES (U.S. CLS. 21, 23, 26, 36 AND 38).  
AMY C. KEAN, EXAMINING ATTORNEY

**CLASS 9—(Continued).**

SN 85-374,704. SCHLUMBERGER TECHNOLOGY CORPORATION, HOUSTON, TX. FILED 7-19-2011.

**STUDIO**

THE MARK CONSISTS OF STANDARD CHARACTERS WITHOUT CLAIM TO ANY PARTICULAR FONT, STYLE, SIZE, OR COLOR.

FOR SOFTWARE FOR ENHANCING PRODUCTIVITY, USABILITY AND KNOWLEDGE MANAGEMENT THROUGH THE ABILITY TO SEARCH, STORE, TRANSFER, ANNOTATE, COLLABORATE AND SHARE INFORMATION, THROUGH PERSONALIZATION AND USE ON MULTIPLE PLATFORMS AND PERSONAL TECHNOLOGY TOOLS (U.S. CLS. 21, 23, 26, 36 AND 38).

FIRST USE 7-15-2011; IN COMMERCE 7-15-2011.  
SKYE YOUNG, EXAMINING ATTORNEY

**CLASS 9—(Continued).**

SN 85-375,478. APPPOWERGROUP, PORTER RANCH, CA. FILED 7-19-2011.



THE MARK CONSISTS OF A HEART CONTAINING THE STYLIZED LETTERS "LSL".

FOR COMPUTER GAME SOFTWARE FOR USE ON PERSONAL COMPUTERS, TABLET DEVICES, PORTABLE GAME AND MP3 PLAYERS, AND ON MOBILE AND CELLULAR PHONES (U.S. CLS. 21, 23, 26, 36 AND 38).

FIRST USE 12-22-2009; IN COMMERCE 12-9-2010.  
MICHAEL WEBSTER, EXAMINING ATTORNEY

SN 85-376,471. L & P PROPERTY MANAGEMENT COMPANY, SOUTH GATE, CA. FILED 7-20-2011.

**MONGOOSE**

THE MARK CONSISTS OF STANDARD CHARACTERS WITHOUT CLAIM TO ANY PARTICULAR FONT, STYLE, SIZE, OR COLOR.

FOR COMPUTER DOCKING STATION (U.S. CLS. 21, 23, 26, 36 AND 38).

FIRST USE 8-11-2009; IN COMMERCE 9-9-2009.  
GRETTA YAO, EXAMINING ATTORNEY

SN 85-376,946. EMPRIMUS, LLC, ST. LOUIS PARK, MN. FILED 7-21-2011.

**LSL**

**INFERENCEALDETECTOR**

THE MARK CONSISTS OF STANDARD CHARACTERS WITHOUT CLAIM TO ANY PARTICULAR FONT, STYLE, SIZE, OR COLOR.

FOR ELECTROMAGNETIC DETECTOR DEVICE COMPOSED OF A LOOP ANTENNA, ELECTRONICS, PROCESSOR, COMMUNICATIONS BUS INTENDED FOR DETECTING AND MEASURING A WIDE RANGE RADIO FREQUENCIES (RF) AND AMPLITUDES OF ELECTROMAGNETIC PULSES AND OTHER INTENTIONAL ELECTROMAGNETIC INTERFERENCE PULSES (U.S. CLS. 21, 23, 26, 36 AND 38).

AISHA CLARKE, EXAMINING ATTORNEY

THE MARK CONSISTS OF STANDARD CHARACTERS WITHOUT CLAIM TO ANY PARTICULAR FONT, STYLE, SIZE, OR COLOR.

FOR COMPUTER GAME SOFTWARE FOR USE ON PERSONAL COMPUTERS, TABLET DEVICES, PORTABLE GAME AND MP3 PLAYERS, AND ON MOBILE AND CELLULAR PHONES (U.S. CLS. 21, 23, 26, 36 AND 38).

FIRST USE 12-22-2009; IN COMMERCE 12-9-2010.  
MICHAEL WEBSTER, EXAMINING ATTORNEY

**CLASS 9—(Continued).**

SN 85-377,792. HTC CORPORATION, TAOYUAN CITY, TAIWAN, FILED 7-21-2011.

**HTC JETSTREAM**

THE MARK CONSISTS OF STANDARD CHARACTERS WITHOUT CLAIM TO ANY PARTICULAR FONT, STYLE, SIZE, OR COLOR.

OWNER OF U.S. REG. NOS. 3,584,881, 3,919,900 AND OTHERS.

FOR MOBILE PHONES, SMARTPHONES, CELLULAR PHONES, PORTABLE COMPUTERS, TABLET COMPUTERS, AND PERSONAL DIGITAL ASSISTANTS AND WIRELESS HANDHELD DIGITAL ELECTRONIC DEVICES FOR COMMUNICATING, RECORDING, ORGANIZING, TRANSMITTING, MANIPULATING, STORING, AND REVIEWING TEXT, DATA, IMAGE, AND AUDIO FILES; ACCESSORIES FOR THE ABOVE GOODS, NAMELY, STYLUS PENS, CASES AND POUCHES SPECIFICALLY ADAPTED FOR CARRYING MOBILE PHONES, SMARTPHONES, CELLULAR PHONES, TABLET COMPUTERS AND PERSONAL DIGITAL ASSISTANTS; COMPUTER HARDWARE AND SOFTWARE FOR ENABLING, OPERATING, ENHANCING, CUSTOMIZING, UPDATING AND MANAGING MOBILE, PORTABLE, SMART, VOICE-OVER-INTERNET-PROTOCOL, WIRELESS TELEPHONES, TABLET COMPUTERS, AND WIRELESS DEVICES; USER INTERFACE SOFTWARE; COMPUTER HARDWARE AND SOFTWARE FOR DELIVERING, ENABLING, CREATING, ENHANCING, CUSTOMIZING, UPDATING, AND MANAGING USER INTERFACING, TELECOMMUNICATIONS AND TELECOMMUNICATIONS SERVICES; COMPUTER HARDWARE AND SOFTWARE FOR TRANSMITTING AND RECEIVING VOICE, IMAGE, DATA, AUDIO, VIDEO AND MULTIMEDIA CONTENT; WIRELESS MODEMS (U.S. CLS. 21, 23, 26, 36 AND 38).

AMY C. KEAN, EXAMINING ATTORNEY

SN 85-378,649. SEIKO HOLDINGS KABUSHIKI KAISHA, TA SEIKO HOLDINGS CORPORATION, TOKYO, JAPAN, FILED 7-22-2011.

**SEIKO PCWIDE**

THE MARK CONSISTS OF STANDARD CHARACTERS WITHOUT CLAIM TO ANY PARTICULAR FONT, STYLE, SIZE, OR COLOR.

FOR EYEGLASSES, SUNGLASSES, LENSES FOR EYEGLASSES AND SUNGLASSES AND PARTS FOR EYEGLASSES AND SUNGLASSES, NAMELY FRAMES AND PINCE-NEZ (U.S. CLS. 21, 23, 26, 36 AND 38).

CHARLES L. JENKINS, EXAMINING ATTORNEY

**CLASS 9—(Continued).**

SN 85-379,066. AGILENT TECHNOLOGIES, INC., SANTA CLARA, CA. FILED 7-22-2011.

**POLYPORE**

THE MARK CONSISTS OF STANDARD CHARACTERS WITHOUT CLAIM TO ANY PARTICULAR FONT, STYLE, SIZE, OR COLOR.

FOR LIQUID CHROMATOGRAPHY PRODUCTS FOR LABORATORY AND INDUSTRIAL USE, NAMELY, GEL PERMEATION CHROMATOGRAPHY COLUMNS USED FOR THE ANALYSIS OF POLYMERS (U.S. CLS. 21, 23, 26, 36 AND 38).

FIRST USE 2-0-2004; IN COMMERCE 2-0-2004.

JOHN E. MICHOS, EXAMINING ATTORNEY

SN 85-379,366. SCG POWER RANGERS LLC, LOS ANGELES, CA. FILED 7-24-2011.

**POWER RIDER**

THE MARK CONSISTS OF STANDARD CHARACTERS WITHOUT CLAIM TO ANY PARTICULAR FONT, STYLE, SIZE, OR COLOR.

FOR VIDEO GAME CARTRIDGES, CASSETTES, DISCS AND TAPES; COMPUTER GAME PROGRAMS, CARTRIDGES AND DISCS; CAMERAS; DIGITAL CAMERAS; PRERECORDED DVDS FEATURING LIVE ACTION ENTERTAINMENT FOR CHILDREN AND MUSIC; EYEWEAR, NAMELY, SUNGLASSES, EYEGLASSES AND OPHTHALMIC FRAMES AND CASES THEREFORE; AND EYEWEAR ACCESSORIES, NAMELY, STRAPS, NECK CORDS AND HEAD STRAPS WHICH RESTRAIN EYEWEAR FROM MOVEMENT ON A WEARER (U.S. CLS. 21, 23, 26, 36 AND 38).

THOMAS MANOR, EXAMINING ATTORNEY

SN 85-381,307. AGILENT TECHNOLOGIES, INC., SANTA CLARA, CA. FILED 7-26-2011.

**PLUSPORE**

THE MARK CONSISTS OF STANDARD CHARACTERS WITHOUT CLAIM TO ANY PARTICULAR FONT, STYLE, SIZE, OR COLOR.

FOR LIQUID CHROMATOGRAPHY PRODUCTS FOR LABORATORY AND INDUSTRIAL USE, NAMELY, GEL PERMEATION CHROMATOGRAPHY COLUMNS USED FOR THE ANALYSIS OF POLYMERS (U.S. CLS. 21, 23, 26, 36 AND 38).

FIRST USE 2-0-2004; IN COMMERCE 2-0-2004.

JOHN E. MICHOS, EXAMINING ATTORNEY



**CLASS 9—(Continued).**

SN 85-381,331. AGILENT TECHNOLOGIES, INC., SANTA CLARA, CA. FILED 7-26-2011.

# OLIGOPORE

THE MARK CONSISTS OF STANDARD CHARACTERS WITHOUT CLAIM TO ANY PARTICULAR FONT, STYLE, SIZE, OR COLOR.

FOR LIQUID CHROMATOGRAPHY PRODUCTS FOR LABORATORY AND INDUSTRIAL USE, NAMELY, GEL PERMEATION CHROMATOGRAPHY COLUMNS USED FOR THE ANALYSIS OF POLYMERS (U.S. CLS. 21, 23, 26, 36 AND 38).

FIRST USE 3-0-2000; IN COMMERCE 3-0-2000.  
JOHN E. MICHOS, EXAMINING ATTORNEY

**CLASS 9—(Continued).**

SN 85-381,874. AGILENT TECHNOLOGIES, INC., SANTA CLARA, CA. FILED 7-27-2011.

# PLRP-S

THE MARK CONSISTS OF STANDARD CHARACTERS WITHOUT CLAIM TO ANY PARTICULAR FONT, STYLE, SIZE, OR COLOR.

FOR LIQUID CHROMATOGRAPHY COLUMNS (U.S. CLS. 21, 23, 26, 36 AND 38).

FIRST USE 0-0-1984; IN COMMERCE 0-0-1984.  
JOHN E. MICHOS, EXAMINING ATTORNEY

SN 85-381,365. AGILENT TECHNOLOGIES, INC., SANTA CLARA, CA. FILED 7-26-2011.

# RESIPORE

THE MARK CONSISTS OF STANDARD CHARACTERS WITHOUT CLAIM TO ANY PARTICULAR FONT, STYLE, SIZE, OR COLOR.

FOR LIQUID CHROMATOGRAPHY PRODUCTS FOR LABORATORY AND INDUSTRIAL USE, NAMELY, GEL PERMEATION CHROMATOGRAPHY COLUMNS USED FOR THE ANALYSIS OF POLYMERS (U.S. CLS. 21, 23, 26, 36 AND 38).

FIRST USE 2-0-2004; IN COMMERCE 2-0-2004.  
JOHN E. MICHOS, EXAMINING ATTORNEY

SN 85-381,876. AGILENT TECHNOLOGIES, INC., SANTA CLARA, CA. FILED 7-27-2011.

# PL-SAX

THE MARK CONSISTS OF STANDARD CHARACTERS WITHOUT CLAIM TO ANY PARTICULAR FONT, STYLE, SIZE, OR COLOR.

FOR LIQUID CHROMATOGRAPHY COLUMNS (U.S. CLS. 21, 23, 26, 36 AND 38).

FIRST USE 0-0-1987; IN COMMERCE 0-0-1987.  
JOHN E. MICHOS, EXAMINING ATTORNEY

SN 85-381,730. 3G STUDIOS, INC., RENO, NV. FILED 7-26-2011.

# The Deep

THE MARK CONSISTS OF STANDARD CHARACTERS WITHOUT CLAIM TO ANY PARTICULAR FONT, STYLE, SIZE, OR COLOR.

FOR COMPUTER GAME SOFTWARE (U.S. CLS. 21, 23, 26, 36 AND 38).

FIRST USE 2-19-2007; IN COMMERCE 4-23-2007.  
CHERYL CLAYTON, EXAMINING ATTORNEY

SN 85-381,881. AGILENT TECHNOLOGIES, INC., SANTA CLARA, CA. FILED 7-27-2011.

# PL-SCX

THE MARK CONSISTS OF STANDARD CHARACTERS WITHOUT CLAIM TO ANY PARTICULAR FONT, STYLE, SIZE, OR COLOR.

FOR LIQUID CHROMATOGRAPHY COLUMNS (U.S. CLS. 21, 23, 26, 36 AND 38).

FIRST USE 0-0-1990; IN COMMERCE 0-0-1990.  
JOHN E. MICHOS, EXAMINING ATTORNEY

**CLASS 9—(Continued).**

SN 85-384,066. BASS PRO INTELLECTUAL PROPERTY, L.L.C., SPRINGFIELD, MO. FILED 7-28-2011.

**OCULUS**

THE MARK CONSISTS OF STANDARD CHARACTERS WITHOUT CLAIM TO ANY PARTICULAR FONT, STYLE, SIZE, OR COLOR.

FOR RIFLE SCOPES, SPOTTING SCOPES, SCOPE CAP COVERS, SCOPE CASES, TRIPODS, BINOCULARS, AND BINOCULAR HARNESES (U.S. CLS. 21, 23, 26, 36 AND 38).

ELLEN BURNS, EXAMINING ATTORNEY

**CLASS 9—(Continued).**

SN 85-384,578. DIGIOP, INC., AUSTIN, TX. FILED 7-29-2011.



SN 85-384,168. SMART MODULAR TECHNOLOGIES, INC., NEWARK, CA. FILED 7-29-2011.

**EVERGUARD**

THE MARK CONSISTS OF STANDARD CHARACTERS WITHOUT CLAIM TO ANY PARTICULAR FONT, STYLE, SIZE, OR COLOR.

FOR SOLID STATE DRIVES (U.S. CLS. 21, 23, 26, 36 AND 38).

ALICIA COLLINS, EXAMINING ATTORNEY

SN 85-384,241. IDEAVILLAGE PRODUCTS CORP., WAYNE, NJ. FILED 7-29-2011.

**PARTY PETS**

THE MARK CONSISTS OF STANDARD CHARACTERS WITHOUT CLAIM TO ANY PARTICULAR FONT, STYLE, SIZE, OR COLOR.

NO CLAIM IS MADE TO THE EXCLUSIVE RIGHT TO USE "PETS", APART FROM THE MARK AS SHOWN.

FOR AUDIO SPEAKERS; AUDIO SPEAKERS FOR MP3 PLAYERS; AUDIO SPEAKERS FOR TELEPHONES (U.S. CLS. 21, 23, 26, 36 AND 38).

GRETCHEN ULRICH, EXAMINING ATTORNEY

THE MARK CONSISTS OF STRINGS OF DOTS OR CIRCLES ARRANGED IN FOUR, NON-INTERSECTING SEMI-CIRCLES, WITH A CIRCLE IN THE MIDDLE OF THE SEMI-CIRCLES, AND THE WORD "DIGIOP" NEXT TO THEM.

FOR PHOTOGRAPHIC CAMERAS; VIDEO CAMERAS; CAMERA LENSES; CAMERA HOUSINGS; DIGITAL VIDEO RECORDERS; NETWORK VIDEO RECORDERS; ELECTRIC SWITCHES; DIGITAL QUAD UNITS FOR VIEWING MULTIPLE VIDEO IMAGES ON ONE MONITOR; AUDIO MONITORS; VIDEO MONITORS; AUDIO TRANSMITTERS; VIDEO TRANSMITTERS; AUDIO RECEIVERS; VIDEO RECEIVERS; ANTENNAS; MICROPHONES; SECURITY EQUIPMENT, NAMELY, BURGLAR ALARMS, MOTION SENSORS, AND ELECTRONIC EQUIPMENT FOR ACCESS CONTROL; INTRUSION DETECTION EQUIPMENT, NAMELY, BURGLAR ALARMS, MOTION SENSORS, AND ELECTRONIC EQUIPMENT FOR ACCESS CONTROL; COMPUTER SOFTWARE AND SOFTWARE PROGRAMS FOR USE WITH SURVEILLANCE EQUIPMENT, BURGLAR ALARMS, MOTION SENSORS, DIGITAL VIDEO SYSTEMS, NETWORK VIDEO RECORDERS, DIGITAL VIDEO RECORDERS, AND ELECTRONIC EQUIPMENT FOR ACCESS CONTROL; DIGITAL AND ANALOG VIDEO MANAGEMENT SYSTEMS (U.S. CLS. 21, 23, 26, 36 AND 38).

FIRST USE 3-0-2007; IN COMMERCE 3-0-2007.

FRANK LATTUCA, EXAMINING ATTORNEY

**CLASS 9—(Continued).**

SN 85-384,718. DIGIOP, INC., AUSTIN, TX. FILED 7-29-2011.



THE MARK CONSISTS OF STRINGS OF SOLID DOTS OR CIRCLES ARRANGED IN FOUR, NON-INTERSECTING SEMI-CIRCLES, WITH A CIRCLE IN THE MIDDLE OF THE SEMI-CIRCLES.

FOR PHOTOGRAPHIC CAMERAS; VIDEO CAMERAS; CAMERA LENSES; CAMERA HOUSINGS; DIGITAL VIDEO RECORDERS; NETWORK VIDEO RECORDERS; ELECTRIC SWITCHES; DIGITAL QUAD UNITS FOR VIEWING MULTIPLE VIDEO IMAGES ON ONE MONITOR; AUDIO MONITORS; VIDEO MONITORS; AUDIO TRANSMITTERS; VIDEO TRANSMITTERS; AUDIO RECEIVERS; VIDEO RECEIVERS; ANTENNAS; MICROPHONES; SECURITY EQUIPMENT, NAMELY, BURGLAR ALARMS, MOTION SENSORS, AND ELECTRONIC EQUIPMENT FOR ACCESS CONTROL; INTRUSION DETECTION EQUIPMENT, NAMELY, BURGLAR ALARMS, MOTION SENSORS, AND ELECTRONIC EQUIPMENT FOR ACCESS CONTROL; COMPUTER SOFTWARE AND SOFTWARE PROGRAMS FOR USE WITH SURVEILLANCE EQUIPMENT, BURGLAR ALARMS, MOTION SENSORS, DIGITAL VIDEO SYSTEMS, NETWORK VIDEO RECORDERS, DIGITAL VIDEO RECORDERS, AND ELECTRONIC EQUIPMENT FOR ACCESS CONTROL; DIGITAL AND ANALOG VIDEO MANAGEMENT SYSTEMS (U.S. CLS. 21, 23, 26, 36 AND 38).

FIRST USE 11-0-2008; IN COMMERCE 11-0-2008.  
FRANK LATTUCA, EXAMINING ATTORNEY

SN 85-385,938. CELESTRON ACQUISITION LLC, TORRANCE, CA. FILED 8-1-2011.

# MICRO360

THE MARK CONSISTS OF STANDARD CHARACTERS WITHOUT CLAIM TO ANY PARTICULAR FONT, STYLE, SIZE, OR COLOR.

FOR MICROSCOPES (U.S. CLS. 21, 23, 26, 36 AND 38).  
KEVIN CORWIN, EXAMINING ATTORNEY

**CLASS 9—(Continued).**

SN 85-387,863. QUICKOFFICE, INC, PLANO, TX. FILED 8-3-2011.

# Quickoffice Sky

THE MARK CONSISTS OF STANDARD CHARACTERS WITHOUT CLAIM TO ANY PARTICULAR FONT, STYLE, SIZE, OR COLOR.

FOR COMPUTER SOFTWARE THAT PROVIDES WEB-BASED ACCESS TO APPLICATIONS AND SERVICES THROUGH A WEB OPERATING SYSTEM OR PORTAL INTERFACE (U.S. CLS. 21, 23, 26, 36 AND 38).

MELISSA VALLILLO, EXAMINING ATTORNEY

SN 85-387,865. QUICKOFFICE, INC, PLANO, TX. FILED 8-3-2011.

# Quickoffice Link

THE MARK CONSISTS OF STANDARD CHARACTERS WITHOUT CLAIM TO ANY PARTICULAR FONT, STYLE, SIZE, OR COLOR.

NO CLAIM IS MADE TO THE EXCLUSIVE RIGHT TO USE "LINK", APART FROM THE MARK AS SHOWN.

FOR COMPUTER SOFTWARE THAT PROVIDES WEB-BASED ACCESS TO APPLICATIONS AND SERVICES THROUGH A WEB OPERATING SYSTEM OR PORTAL INTERFACE (U.S. CLS. 21, 23, 26, 36 AND 38).

MELISSA VALLILLO, EXAMINING ATTORNEY

SN 85-391,184. NEW CONCEPTS DEVELOPMENT CORPORATION, WOODSTOCK, IL. FILED 8-5-2011.

# MERCURY ENTERPRISE

THE MARK CONSISTS OF STANDARD CHARACTERS WITHOUT CLAIM TO ANY PARTICULAR FONT, STYLE, SIZE, OR COLOR.

OWNER OF U.S. REG. NOS. 3,996,394 AND 4,019,034.  
NO CLAIM IS MADE TO THE EXCLUSIVE RIGHT TO USE "ENTERPRISE", APART FROM THE MARK AS SHOWN.

FOR DATA STORAGE DEVICES, NAMELY, SOLID STATE DRIVES (U.S. CLS. 21, 23, 26, 36 AND 38).

LAURA HAMMEL, EXAMINING ATTORNEY

**CLASS 9—(Continued).**

SN 85-393,256. NEWBLUE, INC., LA JOLLA, CA. FILED 8-9-2011.

# NEWBLUE

THE MARK CONSISTS OF STANDARD CHARACTERS WITHOUT CLAIM TO ANY PARTICULAR FONT, STYLE, SIZE, OR COLOR.

FOR COMPUTER SOFTWARE TO ENHANCE THE AUDIO-VISUAL CAPABILITIES OF MULTIMEDIA APPLICATIONS, NAMELY, FOR THE INTEGRATION OF TEXT, AUDIO, GRAPHICS, STILL IMAGES AND MOVING PICTURES (U.S. CLS. 21, 23, 26, 36 AND 38).

FIRST USE 9-1-2002; IN COMMERCE 9-1-2002.  
GEORGE LORENZO, EXAMINING ATTORNEY

**CLASS 9—(Continued).**

SN 85-393,430. SYNAPTICS INCORPORATED, SANTA CLARA, CA. FILED 8-9-2011.

# SmartSense

THE MARK CONSISTS OF STANDARD CHARACTERS WITHOUT CLAIM TO ANY PARTICULAR FONT, STYLE, SIZE, OR COLOR.

FOR ELECTRONIC CIRCUITRY, INTEGRATED CIRCUITS AND CIRCUIT BOARDS; TOUCH-SENSITIVE INPUT DEVICES FOR CONSUMER ELECTRONIC PRODUCTS THAT ALLOW THE USER TO INTERFACE WITH OR CONTROL THE PRODUCTS AND SOFTWARE AND FIRMWARE THEREFOR; CAPACITIVE SENSORS TO INTERFACE WITH OR CONTROL A CONSUMER ELECTRONIC DEVICE AND SOFTWARE AND FIRMWARE THEREFOR; AND GRAPHICAL USER INTERFACE SOFTWARE AND FIRMWARE (U.S. CLS. 21, 23, 26, 36 AND 38).

HOWARD B. LEVINE, EXAMINING ATTORNEY

SN 85-393,492. SYNAPTICS INCORPORATED, SANTA CLARA, CA. FILED 8-9-2011.

# ClickButtons

THE MARK CONSISTS OF STANDARD CHARACTERS WITHOUT CLAIM TO ANY PARTICULAR FONT, STYLE, SIZE, OR COLOR.

FOR ELECTRONIC CIRCUITRY, INTEGRATED CIRCUITS AND CIRCUIT BOARDS; TOUCH-SENSITIVE INPUT DEVICES FOR CONSUMER ELECTRONIC PRODUCTS THAT ALLOW THE USER TO INTERFACE WITH OR CONTROL THE PRODUCTS AND SOFTWARE AND FIRMWARE THEREFOR; CAPACITIVE SENSORS TO INTERFACE WITH OR CONTROL A CONSUMER ELECTRONIC DEVICE AND SOFTWARE AND FIRMWARE THEREFOR; AND GRAPHICAL USER INTERFACE SOFTWARE AND FIRMWARE (U.S. CLS. 21, 23, 26, 36 AND 38).

HOWARD B. LEVINE, EXAMINING ATTORNEY

SN 85-393,413. SYNAPTICS INCORPORATED, SANTA CLARA, CA. FILED 8-9-2011.

# ClickZones

THE MARK CONSISTS OF STANDARD CHARACTERS WITHOUT CLAIM TO ANY PARTICULAR FONT, STYLE, SIZE, OR COLOR.

FOR ELECTRONIC CIRCUITRY, INTEGRATED CIRCUITS AND CIRCUIT BOARDS; TOUCH-SENSITIVE INPUT DEVICES FOR CONSUMER ELECTRONIC PRODUCTS THAT ALLOW THE USER TO INTERFACE WITH OR CONTROL THE PRODUCTS AND SOFTWARE AND FIRMWARE THEREFOR; CAPACITIVE SENSORS TO INTERFACE WITH OR CONTROL A CONSUMER ELECTRONIC DEVICE AND SOFTWARE AND FIRMWARE THEREFOR; AND GRAPHICAL USER INTERFACE SOFTWARE AND FIRMWARE (U.S. CLS. 21, 23, 26, 36 AND 38).

HOWARD B. LEVINE, EXAMINING ATTORNEY

SN 85-395,749. STRIKE KING LURE COMPANY, COLLIERVILLE, TN. FILED 8-11-2011.

# STRIKE KING

THE MARK CONSISTS OF STANDARD CHARACTERS WITHOUT CLAIM TO ANY PARTICULAR FONT, STYLE, SIZE, OR COLOR.

OWNER OF U.S. REG. NOS. 1,327,249 AND 2,960,530.  
FOR SUNGLASSES (U.S. CLS. 21, 23, 26, 36 AND 38).  
FIRST USE 1-31-1990; IN COMMERCE 1-31-1990.  
ANNE MADDEN, EXAMINING ATTORNEY

**CLASS 9—(Continued).**

SN 85-396,291. DIGITAL MINT LLC, SARASOTA, FL. FILED 8-12-2011.

**FRUSTRATION STATION**

THE MARK CONSISTS OF STANDARD CHARACTERS WITHOUT CLAIM TO ANY PARTICULAR FONT, STYLE, SIZE, OR COLOR.

FOR COMPUTER APPLICATION SOFTWARE FOR PORTABLE HAND-HELD COMPUTER DEVICES, SMART PHONES, AND MOBILE PHONES, NAMELY, SOFTWARE FOR GAMING; COMPUTER GAME SOFTWARE FOR USE ON PORTABLE HAND-HELD COMPUTER DEVICES, SMART PHONES, AND MOBILE PHONES; DOWNLOADABLE SOFTWARE IN THE NATURE OF A MOBILE APPLICATION FOR GAMING (U.S. CLS. 21, 23, 26, 36 AND 38).

KATHERINE STOIDES, EXAMINING ATTORNEY

**CLASS 9—(Continued).**

SN 85-406,811. GRAPHIC MINING SOLUTIONS INTERNATIONAL (PTY) LIMITED, CENTURION, SOUTH AFRICA, FILED 8-25-2011.

**MINERP**

THE MARK CONSISTS OF STANDARD CHARACTERS WITHOUT CLAIM TO ANY PARTICULAR FONT, STYLE, SIZE, OR COLOR.

FOR COMPUTER SOFTWARE FOR MANAGING, MONITORING, DEVELOPING AND FACILITATING MINING OPERATIONS, NAMELY, MINE SURVEYING, MINE PLANNING, AND MINING EQUIPMENT MONITORING; COMPUTING SOFTWARE FOR USE IN GEOLOGY AND MINING APPLICATIONS (U.S. CLS. 21, 23, 26, 36 AND 38).

JULIE GUTTADAURO, EXAMINING ATTORNEY

SN 85-400,619. DIAMOND GAME ENTERPRISES, CHATSWORTH, CA. FILED 8-17-2011.

**Jack and Jill**

THE MARK CONSISTS OF STANDARD CHARACTERS WITHOUT CLAIM TO ANY PARTICULAR FONT, STYLE, SIZE, OR COLOR.

FOR GAMING EQUIPMENT, NAMELY, ELECTRONIC GAMING MACHINES AND GAMING MACHINES WITH VIDEO OUTPUT (U.S. CLS. 21, 23, 26, 36 AND 38).

ROSELLE HERRERA, EXAMINING ATTORNEY

SN 85-408,774. MERCURY RETAIL SERVICES LLC, SAN ANTONIO, TX. FILED 8-26-2011.

**KYLA & CARLOS**

THE MARK CONSISTS OF STANDARD CHARACTERS WITHOUT CLAIM TO ANY PARTICULAR FONT, STYLE, SIZE, OR COLOR.

THE NAME(S), PORTRAIT(S), AND/OR SIGNATURE(S) SHOWN IN THE MARK IDENTIFIES KYLA HOLDER, MINOR DAUGHTER OF LOUIE LEE HOLDER III, WHOSE CONSENT(S) TO REGISTER IS MADE OF RECORD.

FOR SUNGLASSES (U.S. CLS. 21, 23, 26, 36 AND 38).

FIRST USE 6-30-2011; IN COMMERCE 6-30-2011.

FLORENTINA BLANDU, EXAMINING ATTORNEY

SN 85-405,957. UNITED NATURAL FOODS, INC., PROVIDENCE, RI. FILED 8-24-2011.



OWNER OF U.S. REG. NOS. 3,615,593 AND 3,634,425.  
THE MARK CONSISTS OF THE TEXT "IUNFI" WITH A ROUNDED SQUARE BOX TO THE LEFT THEREOF WITH TWO LEAVES THEREIN.

FOR COMPUTER SOFTWARE FOR ACCESSING PRODUCT INFORMATION, PLACING ORDERS FOR PRODUCTS, VIEWING PRODUCT REPORTS, VIEWING PRODUCT PRICING, VIEWING PRODUCT PROMOTIONS, AND PLACING REQUESTS FOR RETURN OF PRODUCTS (U.S. CLS. 21, 23, 26, 36 AND 38).

FIRST USE 9-0-2010; IN COMMERCE 9-0-2010.

JEFFERY COWARD, EXAMINING ATTORNEY

SN 85-410,000. MIAMI TRIBE OF OKLAHOMA BUSINESS DEVELOPMENT AUTHORITY, A TRIBAL ENTERPRISE OF THE MIAMI TRIBE OF OKLAHOMA, MIAMI, OK. FILED 8-29-2011.

**PRETTY IN PINK**

THE MARK CONSISTS OF STANDARD CHARACTERS WITHOUT CLAIM TO ANY PARTICULAR FONT, STYLE, SIZE, OR COLOR.

FOR GAMING MACHINES, NAMELY, BINGO-RELATED GAMES AND SLOT MACHINES (U.S. CLS. 21, 23, 26, 36 AND 38).

KATHLEEN M. VANSTON, EXAMINING ATTORNEY

**CLASS 9—(Continued).**

SN 85-975,568. BENN, JAYSON, AKRON, OH. AND BENN, SARAH, AKRON, OH. FILED 12-27-2010.

Shivering Timbers

THE MARK CONSISTS OF STANDARD CHARACTERS WITHOUT CLAIM TO ANY PARTICULAR FONT, STYLE, SIZE, OR COLOR.

FOR MUSICAL SOUND RECORDINGS, NAMELY, COMPACT DISCS, TAPE CASSETTES, AUDIO CASSETTES, AUDIO TAPES, AUDIO DISCS, RECORDS, CD-ROMS, VIDEO DISCS, DVDS, AND MP3S, ALL FEATURING MUSIC; DOWNLOADABLE MUSICAL SOUND RECORDINGS; DOWNLOADABLE VIDEO RECORDINGS FEATURING MUSIC (U.S. CLS. 21, 23, 26, 36 AND 38).

ADA HAN, EXAMINING ATTORNEY

SN 85-975,715. DOCUMATICS, INC., TEMECULA, CA. FILED 1-10-2011.

OLIVE BEAR

THE MARK CONSISTS OF STANDARD CHARACTERS WITHOUT CLAIM TO ANY PARTICULAR FONT, STYLE, SIZE, OR COLOR.

FOR COMPUTER SOFTWARE FOR BUSINESS PROCESS MANAGEMENT FOR THE FINANCE, LEGAL, INSURANCE, ENGINEERING AND MANUFACTURING INDUSTRIES (U.S. CLS. 21, 23, 26, 36 AND 38).

FIRST USE 6-21-2010; IN COMMERCE 9-23-2010.  
JOHN KELLY, EXAMINING ATTORNEY

**CLASS 10—MEDICAL APPARATUS**

SN 76-707,462. TWENTY-FIRST CENTURY HEALTHCARE, INC., TEMPE, AZ. FILED 5-2-2011.

**21<sup>ST</sup>  
CENTURY**

OWNER OF U.S. REG. NOS. 1,790,110, 2,463,948 AND 3,645,342.

THE MARK CONSISTS OF THE WORD "21ST" OVER THE WORD "CENTURY" IN A TIMES NEW ROMAN FONT, WITH FOUR LINES OF STAGGERED LENGTH TO THE LEFT OF "21" AND TWO LINES OF STAGGERED LENGTH UNDERNEATH THE "ST".

FOR OTOSCOPES FOR PETS; NURSING KITS FOR PETS CONTAINING A FEEDING BOTTLE, NIPPLES AND CLEANING BRUSH; MEDICAL APPARATUS FOR PETS, NAMELY, HEMOSTATS IN THE NATURE OF GRAB AND HOLD TOOLS FOR SAFE REMOVAL OF THORNS, BURRS, TICKS AND OTHER OBJECTS AND FOR HOLDING WOUND AREAS STABLE FOR EASE OF MEDICAL TREATMENT; MEDICAL SYRINGES FOR PETS; MEDICAL TWEEZERS FOR PETS; MEDICAL SCISSORS FOR PETS; DROPPERS FOR ADMINISTERING MEDICATION TO PETS SOLD EMPTY; THERMOMETERS FOR MEDICAL PURPOSES FOR PETS; MEDICAL PROTECTIVE DEVICES, NAMELY, INFLATABLE PROTECTIVE COLLARS FOR PETS; AND DEVICES, NAMELY, PILL GUNS CONSISTING OF A BARREL AND PLUNGER, FOR DISPENSING MEDICATIONS TO PETS IN TABLET OR CAPSULE FORM (U.S. CLS. 26, 39 AND 44).

FIRST USE 8-10-2010; IN COMMERCE 8-10-2010.  
MEGHAN REINHART, EXAMINING ATTORNEY

SN 76-707,657. HOUCHEMS MS., MICHELLE, CASTLE ROCK, CO. FILED 5-18-2011.

**IHEAL**

THE MARK CONSISTS OF STANDARD CHARACTERS WITHOUT CLAIM TO ANY PARTICULAR FONT, STYLE, SIZE, OR COLOR.

FOR THREE DIMENSIONAL HEAD MOUNTED VISUAL AND AUDIO DISPLAY UNIT WITH PROGRAMMED COMPUTER FOR TREATMENT OF CHRONIC DISEASE CONDITIONS THROUGH BRAIN ENTERTAINMENT AND COGNITIVE RESILIENCE BUILDING (U.S. CLS. 26, 39 AND 44).

FIRST USE 4-1-2011; IN COMMERCE 4-1-2011.  
TINA L. SNAPP, EXAMINING ATTORNEY

**CLASS 10—(Continued).**

SN 77-969,192. CHOI, JIN-HONG, GYEONGGI-DO, REPUBLIC OF KOREA, FILED 3-26-2010.

# snowline

THE MARK CONSISTS OF STANDARD CHARACTERS WITHOUT CLAIM TO ANY PARTICULAR FONT, STYLE, SIZE, OR COLOR.

FOR MEDICAL CANES, AND METAL PARTS FOR MEDICAL CANES (U.S. CLS. 26, 39 AND 44).  
SHARON MEIER, EXAMINING ATTORNEY

SN 79-089,743. KABUSHIKI KAISHA TOP, JAPAN, FILED 10-26-2010.

# MEDIJOY

THE MARK CONSISTS OF STANDARD CHARACTERS WITHOUT CLAIM TO ANY PARTICULAR FONT, STYLE, SIZE, OR COLOR.

PRIORITY DATE OF 8-5-2010 IS CLAIMED.

OWNER OF INTERNATIONAL REGISTRATION 1057632 DATED 10-26-2010, EXPIRES 10-26-2020.

FOR SURGICAL APPARATUS AND INSTRUMENTS, NAMELY, SHARP CURETTES, SURGICAL RETRACTORS, SURGICAL FORCEPS, SURGICAL ELEVATORS, THORACOSCOPES, OBSTETRIC DILATORS, GYNECOLOGICAL DILATORS, SURGICAL EXCISERS, NAMELY, SURGICAL SCISSORS, SURGICAL AMPUTATORS AND ELECTRIC BONE OPERATING MACHINES, NAMELY, SURGICAL SAWS, SURGICAL PERFORATORS, DRESSING FORCEPS FOR SURGICAL USE, ELECTRIC SCALPES FOR SURGICAL PURPOSES, BLUNT CURETTES FOR SURGICAL USE, SURGICAL KNIVES, BOUGIES AND ANAESTHETIC MASKS, INJECTION NEEDLES FOR NERVE BLOCK; DENTAL APPARATUS AND INSTRUMENTS, NAMELY, DRILLS FOR DENTAL APPLICATIONS, X-RAY APPLIANCES FOR DENTAL AND MEDICAL USE; AND VETERINARY APPARATUS AND INSTRUMENTS, NAMELY, INJECTION SYRINGES, SYRINGE BARRELS, INJECTION NEEDLES, INFUSION SETS WITH INJECTION NEEDLE, INTRAVENOUS CATHETERS, INFUSION PUMPS, SYRINGE PUMPS; ELECTROCARDIOGRAPHS; MEDICAL DIAGNOSTIC APPARATUS AND INSTRUMENTS, NAMELY, GASTROSCOPES, MAGNETIC RESONANCE CT IMAGING APPARATUS, KERATOSCOPES, TONOMETERS, SPECULUMS, SPHYGMOMANOMETERS, PELVIMETERS, CLINICAL URETHRAL AND CARDIAC PROBES, ELECTROCARDIOGRAPHS, TONGUE DEPRESSORS, CLINICAL THERMOMETERS FOR MEDICAL USE, BODY-FAT MONITORS, STETHOSCOPES, AUDIOMETERS AND ELECTROENCEPHALOGRAPHS AND BLOOD TESTING APPARATUS, NAMELY, BLOOD DRAWING APPARATUS AND BLOOD GLUCOSE METER; SURGICAL APPARATUS AND INSTRUMENTS; THERAPEUTIC APPARATUS AND INSTRUMENTS, NAMELY, THERAPEUTIC INHALERS, RADIO-FREQUENCY ELECTRODES FOR PAIN THERAPY, OXYGEN INHALERS FOR THERAPEUTIC PURPOSES, ULTRAVIOLET RADIATOR UNITS FOR THERAPEUTIC PURPOSES, DEFIBRILLATORS, PNEUMOTHORAX APPARATUS FOR REINFLATING A COLLAPSED LUNG, HEART PACEMAKERS, INFRARED RADIATOR UNITS FOR THERAPEUTIC PURPOSES, PUNCTURE APPARATUS FOR THERAPEUTIC PURPOSES, NAMELY, ACUPUNCTURE NEEDLES, LAVAGE APPARATUS FOR THERAPEUTIC PURPOSES, INFUSION APPARATUS FOR THERAPEUTIC PURPOSE, DIALYZERS, SPRAYERS FOR MEDICAL PURPOSES SOLD EMPTY, SUTURE APPARATUS FOR MEDICAL PURPOSES, NAMELY,

**CLASS 10—(Continued).**

SUTURING NEEDLES, MASSAGE APPARATUS FOR MEDICAL PURPOSES, INCUBATORS FOR BABIES AND BLOOD TRANSFUSION APPARATUS; MEDICAL SUPPORTIVE EQUIPMENT FOR HOSPITALS, NAMELY, SUPPORT BELTS, BACK SUPPORTS; ARTIFICIAL EYES; ARTIFICIAL LIMBS; ACOUSTIC AIDS, NAMELY, HEARING AIDS FOR THE DEAF; AUXILIARY MEDICAL DEVICES, NAMELY, STETHOSCOPES AND ORTHODONTIC APPLIANCES; MEDICAL X-RAY APPARATUS; ORTHOPEDIC ARTICLES, NAMELY, ORTHOPEDIC FOOTWEAR, ORTHOPEDIC CUSHIONS; THREE-WAY STOPCOCKS FOR MEDICAL USE; TUBES FOR MEDICAL PURPOSES, NAMELY, ENDOTRACHEAL TUBES, INFUSION TUBES, GASTROSTOMY TUBES, FEEDING TUBES; DRAINAGE TUBES FOR MEDICAL PURPOSES; CATHETERS; GASTROSTOMY KITS COMPRISING CATHETER TIPS AND UNIVERSAL ADAPTERS; PEG (PERCUTANEOUS ENDOSCOPIC GASTROSTOMY) KITS, COMPRISED ESSENTIALLY OF PEG TUBE, FEEDING ADAPTER, RETENTION DISC, AND LOOP INSERTION WIRE; INFUSION BAGS FOR MEDICAL PURPOSES, SOLD EMPTY; FEEDING BAGS FOR MEDICAL PURPOSES, SOLD EMPTY; INJECTORS FOR MEDICAL PURPOSES, NAMELY, SYRINGES AND NEEDLES; INJECTION SYRINGES; SYRINGE BARRELS; INJECTION NEEDLES; INFUSION SETS WITH INJECTION NEEDLES FOR MEDICAL PURPOSES; INTRAVENOUS CATHETERS; URINARY BAGS FOR MEDICAL PURPOSES; TUBING CONNECTORS FOR MEDICAL PURPOSES; PUMPS FOR MEDICAL PURPOSES, NAMELY, SYRINGE PUMPS; INFUSION PUMPS FOR MEDICAL PURPOSES; SUTURE NEEDLES; ULTRAVIOLET STERILIZER FOR MEDICAL PURPOSES; RIGID AND FLEXIBLE MEDICAL ENDOSCOPES; MEDICAL APPARATUS IN THE NATURE OF TUBES THROUGH WHICH THE ENDOSCOPE IS INSERTED; PUNCTURE NEEDLES FOR MEDICAL ENDOSCOPES; SURGICAL DRAPES; SURGICAL THREAD; TEETHING RINGS; ICE BAG PILLOWS FOR MEDICAL PURPOSES; TRIANGULAR BANDAGES, NAMELY, ELASTIC BANDAGES, SUPPORTIVE BANDAGES, COMPRESSION BANDAGES; SUPPORTIVE BANDAGES; CATGUT FOR SURGICAL USE; FEEDING CUPS; DROPPING PIPETTES FOR MEDICAL PURPOSES; TEATS; MEDICAL ICE BAGS; MEDICAL ICE BAG HOLDERS; BABIES' BOTTLES; VACUUM BOTTLES FOR NURSING; FINGER GUARDS FOR MEDICAL PURPOSES; ONE-PIECE CLOTHING ESPECIALLY FOR OPERATING ROOMS, NAMELY, SURGICAL SCRUB SUITS; MEDICAL TREATMENT APPAREL, NAMELY, CLOTHING FOR TREATMENT BEFORE OR AFTER OPERATION; GLOVES FOR MEDICAL PURPOSES; APRONS FOR SURGICAL USE; SURGICAL CAPS; MASKS FOR SURGICAL USE (U.S. CLS. 26, 39 AND 44).

RICHARD WHITE, EXAMINING ATTORNEY

SN 79-091,435. OTICON A/S, SMØRUM, DENMARK, FILED 12-15-2010.

# OTICON INO

THE MARK CONSISTS OF STANDARD CHARACTERS WITHOUT CLAIM TO ANY PARTICULAR FONT, STYLE, SIZE, OR COLOR.

PRIORITY DATE OF 6-22-2010 IS CLAIMED.

OWNER OF INTERNATIONAL REGISTRATION 1062180 DATED 12-15-2010, EXPIRES 12-15-2020.

OWNER OF U.S. REG. NOS. 2,655,786, 3,733,075 AND OTHERS.

FOR HEARING AIDS AND REPLACEMENT AND STRUCTURAL PARTS THEREFOR (U.S. CLS. 26, 39 AND 44).

MARY CRAWFORD, EXAMINING ATTORNEY

**CLASS 10—(Continued).**

SN 79-091,627. OTICON A/S, SMØRUM, DENMARK, FILED 12-15-2010.

**OTICON INO PRO**

THE MARK CONSISTS OF STANDARD CHARACTERS WITHOUT CLAIM TO ANY PARTICULAR FONT, STYLE, SIZE, OR COLOR.

PRIORITY DATE OF 6-22-2010 IS CLAIMED. OWNER OF INTERNATIONAL REGISTRATION 1062521 DATED 12-15-2010, EXPIRES 12-15-2020.

OWNER OF U.S. REG. NOS. 2,655,786, 3,733,075 AND OTHERS.

FOR HEARING AIDS AND REPLACEMENT AND STRUCTURAL PARTS THEREFOR (U.S. CLS. 26, 39 AND 44).

MARY CRAWFORD, EXAMINING ATTORNEY

SN 85-052,994. ARES TRADING S.A., AUBONNE CH-1170, SWITZERLAND, FILED 6-2-2010.



OWNER OF U.S. REG. NO. 2,616,851. THE MARK CONSISTS OF THE WORDING "COOL-CLICK" WITH A CURVED ARROW DESIGN ABOVE THE LETTER "I".

FOR NEEDLE-FREE INJECTION DEVICE FOR MEDICAL USE (U.S. CLS. 26, 39 AND 44).

LINDSEY RUBIN, EXAMINING ATTORNEY

SN 85-146,471. HUNT, CHRISTIAN E., ARLINGTON, VA, FILED 10-6-2010.

**COMFORTRAC**

THE MARK CONSISTS OF STANDARD CHARACTERS WITHOUT CLAIM TO ANY PARTICULAR FONT, STYLE, SIZE, OR COLOR.

FOR MEDICAL CERVICAL AND LUMBAR TRACTION DEVICES (U.S. CLS. 26, 39 AND 44).

FIRST USE 11-19-2003; IN COMMERCE 11-19-2003.

FRED CARL, EXAMINING ATTORNEY

**CLASS 10—(Continued).**

SN 85-147,987. DEAN ELLIOTT, DALLAS, TX. FILED 10-7-2010.

**OH! RABBIT**

THE MARK CONSISTS OF STANDARD CHARACTERS WITHOUT CLAIM TO ANY PARTICULAR FONT, STYLE, SIZE, OR COLOR.

NO CLAIM IS MADE TO THE EXCLUSIVE RIGHT TO USE "RABBIT", APART FROM THE MARK AS SHOWN.

FOR ADULT SEXUAL STIMULATION AIDS, NAMELY, VIBRATORS (U.S. CLS. 26, 39 AND 44).

JOHN GARTNER, EXAMINING ATTORNEY

SN 85-154,620. FUN AND FUNCTION LLC, MERION STATION, PA. FILED 10-18-2010.

**COOL CHEWS**

THE MARK CONSISTS OF STANDARD CHARACTERS WITHOUT CLAIM TO ANY PARTICULAR FONT, STYLE, SIZE, OR COLOR.

FOR ORAL THERAPY APPARATUS FOR CHILDREN, NAMELY, CHEWABLE PLASTIC PENCIL TOPPERS, CHEWABLE PLASTIC NECKLACES AND CHEWABLE PLASTIC BRACELETS FOR ORAL STIMULATION PURPOSES (U.S. CLS. 26, 39 AND 44).

DAVID HOFFMAN, EXAMINING ATTORNEY

SN 85-159,094. THERMOTEK, INC., FLOWER MOUND, TX, FILED 10-22-2010.

**VASCUCOMP**

THE MARK CONSISTS OF STANDARD CHARACTERS WITHOUT CLAIM TO ANY PARTICULAR FONT, STYLE, SIZE, OR COLOR.

FOR MEDICAL DEVICE, NAMELY, PNEUMATIC COMPRESSION SYSTEM CONSISTING OF COMPRESSOR AND PATIENT COMPRESSION WRAPS FOR ENHANCING ARTERIAL BLOOD FLOW (U.S. CLS. 26, 39 AND 44).

FIRST USE 10-0-2009; IN COMMERCE 10-0-2009.

BARBARA A. GOLD, EXAMINING ATTORNEY



**CLASS 10—(Continued).**

SN 85-173,282. JEITO INNOVATIONS LLC, BEVERLY HILLS, CA. FILED 11-10-2010.

The logo for LymphFaux features the word "LYMPH" in pink and "FAUX" in gray, with a pink horizontal line underneath. The "X" in "FAUX" has a diagonal slash through it.

THE COLOR(S) PINK AND GRAY IS/ARE CLAIMED AS A FEATURE OF THE MARK.

THE MARK CONSISTS OF THE STYLIZED TEXT "LYMPHFAUX" WITH "LYMPH" IN PINK AND "FAUX" IN GRAY, BELOW A LINE IN PINK TRANSECTED BY LOWER LEFT LEG OF THE "X" IN GRAY.

THE ENGLISH TRANSLATION OF "FAUX" IN THE MARK IS IMITATION.

FOR MEDICAL COMPRESSION THERAPY DEVICE, NAMELY, MEDICAL COMPRESSION SLEEVES FOR TREATING LYMPHEDEMA (U.S. CLS. 26, 39 AND 44).

JOHN DALIER, EXAMINING ATTORNEY

SN 85-173,389. MEDTRONIC MINIMED, INC., NORTH-RIDGE, CA. FILED 11-10-2010.

The logo for EDGE consists of the word "EDGE" in a bold, serif font.

THE MARK CONSISTS OF STANDARD CHARACTERS WITHOUT CLAIM TO ANY PARTICULAR FONT, STYLE, SIZE, OR COLOR.

FOR PROGRAMMABLE MEDICATION INFUSION PUMPS FOR THE SUBCUTANEOUS DELIVERY OF INSULIN USED IN THE TREATMENT OF DIABETES (U.S. CLS. 26, 39 AND 44).

KELLY BOULTON, EXAMINING ATTORNEY

SN 85-175,487. PLAYTEX PRODUCTS, LLC, SHELTON, CT. FILED 11-12-2010.

The logo for DROP-INS features the word "DROP-INS" in a bold, serif font. The letter "O" in "DROP" is stylized to look like a baby bottle with a nipple.

OWNER OF U.S. REG. NOS. 2,027,629, 3,308,898 AND 3,656,837.

THE MARK CONSISTS OF THE WORDING "DROP-INS" WITH A PORTION OF A BABY BOTTLE ENCIRCLED BY THE LETTER "O".

FOR BABY BOTTLES, DISPOSABLE BABY BOTTLE LINERS; BABY BOTTLE KITS CONTAINING BABY BOTTLES AND BABY FEEDING ACCESSORIES, NAMELY, BABY BOTTLES, NIPPLES, LINERS, RETAINER RINGS, AND CAPS; BREAST PUMPS; BREAST PUMP SYSTEMS COMPRISING BREAST PUMPS; BREAST PADS, BABY BOTTLES, AND BREAST MILK STORAGE BOTTLES AND BREAST MILK STORAGE KITS CONTAINING CAPS, LINERS, ADAPTERS, AND RETAINER RINGS (U.S. CLS. 26, 39 AND 44).

SANJEEV VOHRA, EXAMINING ATTORNEY

**CLASS 10—(Continued).**

SN 85-180,067. BAYLIS MEDICAL COMPANY INC., SAINT-LAURENT, QC, CANADA, FILED 11-18-2010.

The logo for NRG consists of the letters "NRG" in a bold, serif font.

THE MARK CONSISTS OF STANDARD CHARACTERS WITHOUT CLAIM TO ANY PARTICULAR FONT, STYLE, SIZE, OR COLOR.

FOR NEEDLES FOR USE IN TRANSSEPTAL MEDICAL PROCEDURES, NAMELY, FOR DELIVERY OF RADIO FREQUENCY ENERGY; MEDICAL DEVICES FOR USE IN CARDIAC MEDICAL PROCEDURES, NAMELY, WIRES, SHEATHS, CATHETERS, INTRODUCERS AND DILATORS SOLD SEPARATELY, SOLD IN COMBINATION OR SOLD AS A UNIT WITH NEEDLES (U.S. CLS. 26, 39 AND 44).

FIRST USE 4-3-2008; IN COMMERCE 5-3-2008.

HANNO RITTNER, EXAMINING ATTORNEY

SN 85-183,062. LEE, EDWIN, IRVING, TX. FILED 11-23-2010.

The logo for SURGERA consists of the word "SURGERA" in a bold, serif font.

THE MARK CONSISTS OF STANDARD CHARACTERS WITHOUT CLAIM TO ANY PARTICULAR FONT, STYLE, SIZE, OR COLOR.

FOR MEDICAL WEARING APPAREL, NAMELY, SCRUB TOPS AND BOTTOMS, NURSING SHOES, AND MEDICAL UNIFORMS IN THE NATURE OF SCRUBS, SURGICAL GOWNS (U.S. CLS. 26, 39 AND 44).

B. PARADEWELAI, EXAMINING ATTORNEY

SN 85-188,003. SYNOVIS LIFE TECHNOLOGIES, INC., ST. PAUL, MN. FILED 12-1-2010.

The logo for PRO FIXATION consists of the words "PRO FIXATION" in a bold, serif font.

THE MARK CONSISTS OF STANDARD CHARACTERS WITHOUT CLAIM TO ANY PARTICULAR FONT, STYLE, SIZE, OR COLOR.

NO CLAIM IS MADE TO THE EXCLUSIVE RIGHT TO USE "FIXATION", APART FROM THE MARK AS SHOWN.

FOR SURGICAL INSTRUMENTS ASSOCIATED WITH THE IMPLANTATION OF ORTHOPEDIC BIOMATERIALS AND NOT FOR USE IN DENTAL SURGERY (U.S. CLS. 26, 39 AND 44).

EMILY CHUO, EXAMINING ATTORNEY

**CLASS 10—(Continued).**

SN 85-188,634. GARY HOWERTON, BOWLING GREEN, KY.  
FILED 12-1-2010.

# ishock

THE MARK CONSISTS OF STANDARD CHARACTERS WITHOUT CLAIM TO ANY PARTICULAR FONT, STYLE, SIZE, OR COLOR.

FOR EXTERNAL DEFIBRILLATORS; MEDICAL EQUIPMENT ACCESSORIES, NAMELY, ELECTRO-DIAGNOSTIC AUTOMATED CONSTANT CURRENT SINUSOID WAVEFORM NEUROSELECTIVE SENSORY NERVE TESTING DEVICES, NAMELY, DISPOSABLE ELECTRODES (U.S. CLS. 26, 39 AND 44).

GISELLE AGOSTO, EXAMINING ATTORNEY

SN 85-192,155. DAYA MEDICALS, INC., BOCA RATON, FL.  
FILED 12-7-2010.

# MedPod

THE MARK CONSISTS OF STANDARD CHARACTERS WITHOUT CLAIM TO ANY PARTICULAR FONT, STYLE, SIZE, OR COLOR.

FOR PORTABLE COMPUTERIZED MEDICAL DEVICES, NAMELY, ELECTRONIC MEDICATION DISPENSERS THAT MONITOR AND ADMINISTER A PATIENT'S TIMELY PRESCRIBED MEDICATION DOSAGE REGIMENS IN ACCORDANCE WITH OR WITHOUT AN ALREADY STORED MEDICAL PROFILE OF THE PATIENT BY NOTIFYING THE PATIENT OF TIMELY PRESCRIBED DOSAGE TO BE ADMINISTERED AND ALERTING THE PATIENT AND OTHER DESIGNATED INDIVIDUALS OF ANY MISSED DOSAGE OF THE MEDICATION OR MEDICATION REGIMEN, THE ELECTRONIC MEDICATION DISPENSER COMMUNICATING IN TWO WAY WITH A CLOUD DATABASE VIA A WIRELESS COMMUNICATION SYSTEM AND WITH EXTERNAL COMPUTERIZED, ELECTRONIC AND/OR PHYSIOLOGICAL MONITORING-TYPE PERIPHERAL DEVICES THAT CAN COMPLEMENT AND ENHANCE THE MONITORING/COMPLIANCE FUNCTIONALITY OF THE MEDICATION DISPENSER, ALL FOR USE AS PART OF AN INTEGRATED PRESCRIBED MEDICATION ADMINISTRATION COMPLIANCE SYSTEM CUSTOMIZED AND PERSONALIZED FOR INDIVIDUAL PATIENT USERS (U.S. CLS. 26, 39 AND 44).

ALICIA COLLINS, EXAMINING ATTORNEY

**CLASS 10—(Continued).**

SN 85-193,789. SPINEWAY, F-69500 BRON, FRANCE, FILED  
12-9-2010.



NO CLAIM IS MADE TO THE EXCLUSIVE RIGHT TO USE "CORRECTION", APART FROM THE MARK AS SHOWN.

THE COLOR(S) GREENISH BLUE AND WHITE IS/ARE CLAIMED AS A FEATURE OF THE MARK.

THE MARK CONSISTS OF THE WORDS "GLOBAL DIRECT CORRECTION" IN LOWER CASE LETTERS AND IN GREENISH BLUE AND A CIRCLE WITH A WAVY LINE NEXT TO THE "N" IN "CORRECTION" ALSO IN GREENISH BLUE WITH A WHITE BACKGROUND IN THE CIRCLE.

FOR SURGICAL INSTRUMENTS FOR USE IN SPINAL SURGERY, SPINAL IMPLANTS COMPOSED OF ARTIFICIAL MATERIAL FOR USE IN SPINAL SURGERY (U.S. CLS. 26, 39 AND 44).

LAKEISHA LEWIS, EXAMINING ATTORNEY

SN 85-196,583. STRYKER CORPORATION, KALAMAZOO, MI. FILED 12-13-2010.

# FLEXIS

THE MARK CONSISTS OF STANDARD CHARACTERS WITHOUT CLAIM TO ANY PARTICULAR FONT, STYLE, SIZE, OR COLOR.

FOR EQUIPMENT CARRIERS FOR SUPPORTING AND SUSPENDING MEDICAL OR SURGICAL EQUIPMENT FOR USE IN A HOSPITAL OR MEDICAL ENVIRONMENT; SERVICE HEADS FOR PROVIDING ELECTRICAL POWER, GAS AND COMMUNICATIONS CONNECTIONS TO OPERATE MEDICAL OR SURGICAL EQUIPMENT, WHICH SERVICE HEADS ARE SOLD AS A COMPONENT OF THE EQUIPMENT CARRIERS (U.S. CLS. 26, 39 AND 44).

JANICE L. MCMORROW, EXAMINING ATTORNEY

SN 85-219,002. ALPHATEC SPINE, INC., CARLSBAD, CA.  
FILED 1-17-2011.

# ALPHAGUARD

THE MARK CONSISTS OF STANDARD CHARACTERS WITHOUT CLAIM TO ANY PARTICULAR FONT, STYLE, SIZE, OR COLOR.

FOR A FLEXIBLE COVER FOR BLOOD VESSELS FOLLOWING A SURGICAL PROCEDURE TO ACT AS A BARRIER AGAINST VESSEL DAMAGE (U.S. CLS. 26, 39 AND 44).

BRENDAN REGAN, EXAMINING ATTORNEY

**CLASS 10—(Continued).**

SN 85-230,090. ERBE USA, INC., MARIETTA, GA. FILED 1-31-2011.

# CLEVERCAP

THE MARK CONSISTS OF STANDARD CHARACTERS WITHOUT CLAIM TO ANY PARTICULAR FONT, STYLE, SIZE, OR COLOR.

FOR MEDICAL DEVICE, NAMELY, A WATER BOTTLE ADAPTER FOR USE IN ENDOSCOPIC PROCEDURES CONSISTING OF A HYBRID TUBING AND CAP SET THAT IS USED TO PROVIDE A SINGLE SOURCE FOR AIR/WATER CONNECTION AND IRRIGATION FROM THE SAME WATER BOTTLE (U.S. CLS. 26, 39 AND 44).

FIRST USE 7-26-2011; IN COMMERCE 7-26-2011.  
DEZMONA MIZELLE, EXAMINING ATTORNEY

**CLASS 10—(Continued).**

SN 85-258,514. PEAK HUMAN POTENTIAL PTY LTD, KIRRA, AUSTRALIA, FILED 3-4-2011.



THE COLOR(S) AQUA, LIGHT BLUE, BLUE, BLACK, GREY, DARK BLUE, GREEN, AND WHITE IS/ARE CLAIMED AS A FEATURE OF THE MARK.

THE MARK CONSISTS OF A CIRCLE CONTAINING AQUA, LIGHT BLUE, AND BLUE WAVES SWIRLING INTO THE CENTRE WITH A BLACK BORDER AROUND IT AND A GREY SHADOW. THE CIRCLE APPEARS ABOVE THE WORDING "WAVECHARGER" IN DARK BLUE AND UNDERLINED IN BLACK. BENEATH THE LINE IS A GREEN DOT TO THE CENTRE RIGHT WITH THE WORDING "WWW.PEPSURF.COM" IN BLACK, ALL SET ON A WHITE BACKGROUND.

FOR LOW FREQUENCY ELECTRIC THERAPY APPARATUS (U.S. CLS. 26, 39 AND 44).

FIRST USE 11-11-2010; IN COMMERCE 11-11-2010.  
CIMMERIAN COLEMAN, EXAMINING ATTORNEY

SN 85-259,920. LIFE MASSAGER LLC, THE WOODLANDS, TX. FILED 3-7-2011.

SN 85-241,212. IVOCLAR VIVADENT, INC., AMHERST, NY. FILED 2-14-2011.



# BLUEPHASE STYLE

THE MARK CONSISTS OF STANDARD CHARACTERS WITHOUT CLAIM TO ANY PARTICULAR FONT, STYLE, SIZE, OR COLOR.

OWNER OF U.S. REG. NO. 2,879,886.  
FOR DENTAL CURING LIGHTS (U.S. CLS. 26, 39 AND 44).

DEZMONA MIZELLE, EXAMINING ATTORNEY

NO CLAIM IS MADE TO THE EXCLUSIVE RIGHT TO USE "MASSAGER", APART FROM THE MARK AS SHOWN.

THE COLOR(S) GREEN, YELLOW-GREEN, AND GREY IS/ARE CLAIMED AS A FEATURE OF THE MARK.

THE MARK CONSISTS OF A YELLOW-GREEN STRAIGHT VERTICAL LINE PARALLEL TO AND FOLLOWED BY A GREEN STRAIGHT VERTICAL LINE FOLLOWED BY THE WORD "LIMA" APPEARING IN THE COLOR GREY AND IN ALL CAPITAL LETTERS. THE WORDS "LIFE MASSAGER" APPEAR IN GREEN DIRECTLY ABOVE THE LAST HALF OF THE LETTER "M" AND THE ENTIRE LETTER "A" IN THE WORD "LIMA".

FOR MESSAGE CHAIRS WITH BUILT-IN MESSAGE APPARATUS (U.S. CLS. 26, 39 AND 44).

FIRST USE 2-21-2011; IN COMMERCE 2-21-2011.  
JORDAN BAKER, EXAMINING ATTORNEY

**CLASS 10—(Continued).**

SN 85-273,368. TIPLINE MEDICAL, LLC, LEXINGTON, KY. FILED 3-22-2011.



THE MARK CONSISTS OF A CIRCULAR DESIGN, WITHIN THE CIRCLE IS AN UMBRELLA OVER A STYLIZED ARM WITH AN IV COVER. STILL WITHIN THE CIRCLE DESIGN, ON THE SIDE OPPOSITE THE UMBRELLA APPEARS THE WORDING, "THE ARMBRELLA".

FOR MEDICAL APPARATUS, NAMELY, NON-LATEX WATER REPELLANT SLEEVES FOR USE OVER INTRAVENOUS ENTRY SITES (U.S. CLS. 26, 39 AND 44).  
C. DIONNE CLYBURN, EXAMINING ATTORNEY

SN 85-277,193. AMERICAN MEDICAL SERVICES, INC., ROCHESTER HILLS, MI. FILED 3-25-2011.

**STRIDE IN STYLE**

THE MARK CONSISTS OF STANDARD CHARACTERS WITHOUT CLAIM TO ANY PARTICULAR FONT, STYLE, SIZE, OR COLOR.

FOR MEDICAL HOSIERY, NAMELY, SUPPORT SOCKS (U.S. CLS. 26, 39 AND 44).  
PAM WILLIS, EXAMINING ATTORNEY

SN 85-285,886. MICRO DENTAL LABORATORIES, DUBLIN, CA. FILED 4-4-2011.

**ZEUS**

THE MARK CONSISTS OF STANDARD CHARACTERS WITHOUT CLAIM TO ANY PARTICULAR FONT, STYLE, SIZE, OR COLOR.

FOR DENTAL CROWNS (U.S. CLS. 26, 39 AND 44).  
BRIDGETT SMITH, EXAMINING ATTORNEY

**CLASS 10—(Continued).**

SN 85-295,981. KALYPTO MEDICAL, INC., MENDOTA HEIGHTS, MN. FILED 4-15-2011.

**NPD 2000 SP**

THE MARK CONSISTS OF STANDARD CHARACTERS WITHOUT CLAIM TO ANY PARTICULAR FONT, STYLE, SIZE, OR COLOR.

NO CLAIM IS MADE TO THE EXCLUSIVE RIGHT TO USE "NPD", APART FROM THE MARK AS SHOWN.

FOR NEGATIVE PRESSURE WOUND THERAPY DEVICE (U.S. CLS. 26, 39 AND 44).

KELLEY WELLS, EXAMINING ATTORNEY

SN 85-298,361. ULTRADENT PRODUCTS, INC., SOUTH JORDAN, UT. FILED 4-19-2011.

**The One With The Stripe**

THE MARK CONSISTS OF STANDARD CHARACTERS WITHOUT CLAIM TO ANY PARTICULAR FONT, STYLE, SIZE, OR COLOR.

OWNER OF U.S. REG. NO. 2,956,010.

SEC. 2(F).

FOR DENTAL PRODUCTS, NAMELY DENTAL REACTION CORDS (U.S. CLS. 26, 39 AND 44).

FIRST USE 10-29-2003; IN COMMERCE 10-29-2003.

LOURDES AYALA, EXAMINING ATTORNEY

SN 85-307,764. DC INTERNATIONAL LLC, WELLINGTON, FL. FILED 4-28-2011.

**Einstein DL**

THE MARK CONSISTS OF STANDARD CHARACTERS WITHOUT CLAIM TO ANY PARTICULAR FONT, STYLE, SIZE, OR COLOR.

NO CLAIM IS MADE TO THE EXCLUSIVE RIGHT TO USE "DL", APART FROM THE MARK AS SHOWN.

FOR LASERS FOR MEDICAL USE (U.S. CLS. 26, 39 AND 44).

FIRST USE 2-1-2011; IN COMMERCE 2-1-2011.

MICHELE SWAIN, EXAMINING ATTORNEY

**CLASS 10—(Continued).**

SN 85-308,238. WEXLER, TOBY J., LAFAYETTE, LA. FILED 4-29-2011.

**AIR MUZZLE**

THE MARK CONSISTS OF STANDARD CHARACTERS WITHOUT CLAIM TO ANY PARTICULAR FONT, STYLE, SIZE, OR COLOR.

NO CLAIM IS MADE TO THE EXCLUSIVE RIGHT TO USE "MUZZLE", APART FROM THE MARK AS SHOWN.

FOR VETERINARY APPARATUS, NAMELY, A SPHERICAL HEAD CONTAINMENT FOR LIVE ANIMALS DURING TREATMENT (U.S. CLS. 26, 39 AND 44).

FIRST USE 2-15-2000; IN COMMERCE 8-30-2000.

YAT SYE, LEE, EXAMINING ATTORNEY

---

SN 85-313,233. MANDARIN ENTERPRISES, ATLANTA, GA. FILED 5-5-2011.

**FeverWatch**

THE MARK CONSISTS OF STANDARD CHARACTERS WITHOUT CLAIM TO ANY PARTICULAR FONT, STYLE, SIZE, OR COLOR.

FOR THERMOMETERS FOR MEDICAL PURPOSES (U.S. CLS. 26, 39 AND 44).

FIRST USE 5-24-2008; IN COMMERCE 9-1-2008.

INGRID C. EULIN, EXAMINING ATTORNEY

---

SN 85-314,188. BYRNE MEDICAL, INC., CONROE, TX. FILED 5-6-2011.

**ENDOGATOR ADVANTAGE IRRIGATION SYSTEM**

THE MARK CONSISTS OF STANDARD CHARACTERS WITHOUT CLAIM TO ANY PARTICULAR FONT, STYLE, SIZE, OR COLOR.

OWNER OF U.S. REG. NO. 2,931,337.

NO CLAIM IS MADE TO THE EXCLUSIVE RIGHT TO USE "IRRIGATION SYSTEM", APART FROM THE MARK AS SHOWN.

FOR MEDICAL DEVICES, NAMELY, AN ELECTRIC MOTOR DRIVEN PERISTALTIC PUMP, SPECIFICALLY ADAPTED FOR USE WITH AN ENDOSCOPE, USED TO SUPPLY WATER FROM A WATER BOTTLE TO AN ENDOSCOPE FOR IRRIGATION WITH THE ABILITY TO HEAT WATER IN THE BOTTLE (U.S. CLS. 26, 39 AND 44).

B. PARADEWELAI, EXAMINING ATTORNEY

**CLASS 10—(Continued).**

SN 85-319,480. TEMCARE MEDICAL DESIGN AND MANUFACTURING, INC., POMPANO BEACH, FL. FILED 5-12-2011.

**TEMCARE LITE**

THE MARK CONSISTS OF STANDARD CHARACTERS WITHOUT CLAIM TO ANY PARTICULAR FONT, STYLE, SIZE, OR COLOR.

OWNER OF U.S. REG. NOS. 3,881,235, 3,993,037 AND 3,993,324.

NO CLAIM IS MADE TO THE EXCLUSIVE RIGHT TO USE "LITE", APART FROM THE MARK AS SHOWN.

FOR BACK SUPPORTS FOR MEDICAL PURPOSES (U.S. CLS. 26, 39 AND 44).

ESTHER BELENKER, EXAMINING ATTORNEY

---

SN 85-319,888. NIKOLAY, SAMOTAEV, MOSCOW, RUSSIAN FED., FILED 5-12-2011.

**SONIDODEVIDA**

THE MARK CONSISTS OF STANDARD CHARACTERS WITHOUT CLAIM TO ANY PARTICULAR FONT, STYLE, SIZE, OR COLOR.

THE ENGLISH TRANSLATION OF "SONIDODEVIDA" IS LIFE SOUND.

FOR MASSAGE APPARATUS, NAMELY, AN APPARATUS FOR VIBROACOUSTIC MASSAGE AND PHYSIOTHERAPY (U.S. CLS. 26, 39 AND 44).

BENJAMIN OKEKE, EXAMINING ATTORNEY

---

SN 85-320,757. LAWRENCE PRAEGER, ELMWOOD PARK, NJ. FILED 5-13-2011.

**CORTEX**

THE MARK CONSISTS OF STANDARD CHARACTERS WITHOUT CLAIM TO ANY PARTICULAR FONT, STYLE, SIZE, OR COLOR.

FOR DENTAL IMPLANTS AND SURGICAL INSTRUMENTS FOR USE IN INSTALLING DENTAL IMPLANTS (U.S. CLS. 26, 39 AND 44).

SHARON MEIER, EXAMINING ATTORNEY

**CLASS 10—(Continued).**

SN 85-320,856. DAVIS, TIMOTHY T., SANTA MONICA, CA. FILED 5-13-2011.

**NEUROGUARD**

THE MARK CONSISTS OF STANDARD CHARACTERS WITHOUT CLAIM TO ANY PARTICULAR FONT, STYLE, SIZE, OR COLOR.

FOR MEDICAL MONITORING DEVICES FOR MONITORING NERVES AND RELATED SOFTWARE SOLD AS A UNIT; MEDICAL DEVICES, NAMELY, ELECTRODES, RETRACTORS AND ELECTRODE CONNECTION BOXES FOR USE WITH NERVE MONITORING DEVICES (U.S. CLS. 26, 39 AND 44).

JEFFERY COWARD, EXAMINING ATTORNEY

**CLASS 10—(Continued).**

SN 85-324,672. GLOVE LABS LLC, LUBBOCK, TX. FILED 5-19-2011.

**AVEEA**

THE MARK CONSISTS OF STANDARD CHARACTERS WITHOUT CLAIM TO ANY PARTICULAR FONT, STYLE, SIZE, OR COLOR.

THE NAME "AVEEA" DOES NOT IDENTIFY A LIVING INDIVIDUAL.

FOR FACE MASKS FOR USE BY HEALTH CARE PROVIDERS (U.S. CLS. 26, 39 AND 44).

MARGERY A. TIERNEY, EXAMINING ATTORNEY

SN 85-321,097. MORAWSKI, GINA M, MOUNT LAUREL, NJ. AND MORAWSKI, JAMES M, MOUNT LAUREL, NJ. FILED 5-14-2011.

**Bottle Bonder**

THE MARK CONSISTS OF STANDARD CHARACTERS WITHOUT CLAIM TO ANY PARTICULAR FONT, STYLE, SIZE, OR COLOR.

NO CLAIM IS MADE TO THE EXCLUSIVE RIGHT TO USE "BOTTLE", APART FROM THE MARK AS SHOWN.

FOR BABY BOTTLE HOLDERS IN THE NATURE OF FABRIC SLINGS WORN BY THE PERSON HOLDING THE BABY (U.S. CLS. 26, 39 AND 44).

PATRICIA EVANKO, EXAMINING ATTORNEY

SN 85-325,001. CAYENNE MEDICAL, INC., SCOTTSDALE, AZ. FILED 5-19-2011.

**EZ SHUTTLE**

SN 85-321,104. P+P CUSTOM MEDICAL SUPPLIES INC., BRIDGEVILLE, PA. FILED 5-14-2011.

DISPOSABLE  
**piccsoc**

NO CLAIM IS MADE TO THE EXCLUSIVE RIGHT TO USE "DISPOSABLE", APART FROM THE MARK AS SHOWN.

THE MARK CONSISTS OF THE STYLIZED TEXT "DISPOSABLE PICCSOC" WITH A HEART IN PLACE OF THE LETTER "O".

FOR TUBULAR ELASTIC COMPRESSION BANDAGE USED POST OPERATIVE TO HOLD PERIPHERALLY INSERTED CENTRAL CATHETER LINES, PORTS AND INTRAVENOUS TUBES IN PLACE, AND CAN ALSO BE USED FOR JOINT SUPPORT AND FOR TREATING VARICOSE VEINS (U.S. CLS. 26, 39 AND 44).

FIRST USE 8-0-2010; IN COMMERCE 10-15-2010.

HOWARD SMIGA, EXAMINING ATTORNEY

THE MARK CONSISTS OF STANDARD CHARACTERS WITHOUT CLAIM TO ANY PARTICULAR FONT, STYLE, SIZE, OR COLOR.

NO CLAIM IS MADE TO THE EXCLUSIVE RIGHT TO USE "SHUTTLE", APART FROM THE MARK AS SHOWN.

FOR MEDICAL DEVICES, NAMELY, DISPOSABLE KITS INCLUDING A DRILL AND A CONTINUOUS SUTURE LOOP FOR ORTHOPEDIC TISSUE REPAIR PROCEDURES (U.S. CLS. 26, 39 AND 44).

MARK SHINER, EXAMINING ATTORNEY

**CLASS 10—(Continued).**

SN 85-329,440. SHENZHEN UPCERA CO., LTD., NANSHAN, SHENZHEN, CHINA, FILED 5-25-2011.

**UPCERA**

FOR ARTIFICIAL JAWS; ARTIFICIAL LIMBS; ARTIFICIAL TEETH; ARTIFICIAL TEETH AND CAPS; DENTAL AND MEDICAL DRILL BITS FOR CUTTING TEETH OR BONE; DENTAL APPARATUS, NAMELY, APEX LOCATOR; DENTAL APPARATUS, NAMELY, INTRA-ORAL LIGHT SYSTEMS; DENTAL IMPLANTS; DENTAL INSTRUMENTS, NAMELY, DENTAL ROOT FILES USED IN ROOT CANAL THERAPY PROCEDURES; DENTAL INSTRUMENTS, NAMELY, ORAL IRRIGATORS; IMPLANTS CONSISTING OF ARTIFICIAL MATERIALS; MILLING APPARATUS FOR DENTAL PURPOSES; STATIC ELECTRIC THERAPY APPARATUS; SURGICAL APPARATUS AND INSTRUMENTS FOR MEDICAL, DENTAL OR VETERINARY USE (U.S. CLS. 26, 39 AND 44).

FIRST USE 2-14-2010; IN COMMERCE 2-14-2010.  
TRICIA SONNEBORN, EXAMINING ATTORNEY

SN 85-330,597. BUSCH, WILLIAM, N KANSAS CITY, MO. FILED 5-26-2011.

**Ti**

THE MARK CONSISTS OF STANDARD CHARACTERS WITHOUT CLAIM TO ANY PARTICULAR FONT, STYLE, SIZE, OR COLOR.

FOR MEDICAL WEARING APPAREL, NAMELY, SCRUB PANTS; MEDICAL WEARING APPAREL, NAMELY, SCRUB TOPS (U.S. CLS. 26, 39 AND 44).

MARCIE MILONE, EXAMINING ATTORNEY

**CLASS 10—(Continued).**

SN 85-331,324. ECOSPAN, LLC, GREENBRAE, CA. FILED 5-26-2011.



THE MARK CONSISTS OF THE WORD ECOSPAN IN A STYLIZED FORMAT PLUS PARTIAL CONCENTRIC OVAL SHAPES.

FOR PLASTIC MEDICAL GOWNS (U.S. CLS. 26, 39 AND 44).

ALLISON SCHRODY, EXAMINING ATTORNEY

SN 85-331,951. FITZ SCIENTIFIC, LLC, MOUND, MN. FILED 5-27-2011.

**CEP**

THE MARK CONSISTS OF STANDARD CHARACTERS WITHOUT CLAIM TO ANY PARTICULAR FONT, STYLE, SIZE, OR COLOR.

FOR MEDICAL APPARATUS, NAMELY, HANDHELD DEVICES CONTAINING A FOAM SWAB FOR OBTAINING BUCCAL CELLS (U.S. CLS. 26, 39 AND 44).

FIRST USE 1-1-2009; IN COMMERCE 1-1-2009.

CIMMERIAN COLEMAN, EXAMINING ATTORNEY

SN 85-332,003. PEDIACATH INC., CLEVELAND, OH. FILED 5-27-2011.

**MONGOOSE**

THE MARK CONSISTS OF STANDARD CHARACTERS WITHOUT CLAIM TO ANY PARTICULAR FONT, STYLE, SIZE, OR COLOR.

FOR MEDICAL DEVICES FOR GAINING VASCULAR ACCESSES, AND TREATING AND DIAGNOSING CARDIAC ABNORMALITIES (U.S. CLS. 26, 39 AND 44).

ANNE MADDEN, EXAMINING ATTORNEY

**CLASS 10—(Continued).**

SN 85-332,344. BIOQUANTETICS, INC., LOS ANGELES, CA. FILED 5-27-2011.

# IDUS

THE MARK CONSISTS OF STANDARD CHARACTERS WITHOUT CLAIM TO ANY PARTICULAR FONT, STYLE, SIZE, OR COLOR.

FOR MEDICAL DIAGNOSTIC APPARATUS WHICH IS IMAGE-BASED DYNAMIC ULTRASOUND SPECTROGRAPHY FOR DETECTION AND LOCALIZATION OF BREAST MICRO-CALCIFICATION (U.S. CLS. 26, 39 AND 44).

ELLEN B. AWRICH, EXAMINING ATTORNEY

**CLASS 10—(Continued).**

SN 85-333,700. MEDTRONIC, INC., MINNEAPOLIS, MN. FILED 5-31-2011.

# VERIFY

THE MARK CONSISTS OF STANDARD CHARACTERS WITHOUT CLAIM TO ANY PARTICULAR FONT, STYLE, SIZE, OR COLOR.

FOR NEUROSTIMULATION SYSTEM COMPRISED OF AN EXTERNAL PULSE GENERATOR AND TEMPORARY STIMULATION LEADS (U.S. CLS. 26, 39 AND 44).

CHARLOTTE CORWIN, EXAMINING ATTORNEY

SN 85-333,252. AVACEN, INC., SAN DIEGO, CA. FILED 5-29-2011.

# AVACEN

THE MARK CONSISTS OF STANDARD CHARACTERS WITHOUT CLAIM TO ANY PARTICULAR FONT, STYLE, SIZE, OR COLOR.

FOR MEDICAL APPARATUS, NAMELY, ELECTRIC HEATING DEVICES FOR CURATIVE TREATMENT; MITTENS FOR MEDICAL USE (U.S. CLS. 26, 39 AND 44).

FIRST USE 2-6-2009; IN COMMERCE 2-6-2009.

DEIRDRE ROBERTSON, EXAMINING ATTORNEY

SN 85-333,714. DIFUSION, INC., AUSTIN, TX. FILED 5-31-2011.

# ASPIS

THE MARK CONSISTS OF STANDARD CHARACTERS WITHOUT CLAIM TO ANY PARTICULAR FONT, STYLE, SIZE, OR COLOR.

THE ENGLISH TRANSLATION OF "ASPIS" IN THE MARK IS "SHIELD".

FOR ORTHOPAEDIC IMPLANTS COMPOSED OF NON-LIVING MATERIAL (U.S. CLS. 26, 39 AND 44).

ALEXANDER L. POWERS, EXAMINING ATTORNEY

SN 85-333,479. MEDICAL COMPRESSION SYSTEMS, (DBN) LTD., OR-AQIVA, ISRAEL, FILED 5-30-2011.

# ACTIVECAST

THE MARK CONSISTS OF STANDARD CHARACTERS WITHOUT CLAIM TO ANY PARTICULAR FONT, STYLE, SIZE, OR COLOR.

FOR MEDICAL DEVICES, NAMELY AN INFLATABLE SLEEVE SYSTEM COMPRISED OF INFLATABLE PILLLOW COMPRESSION CUFFS AND BLOOD CIRCULATION MONITORS FOR IMPROVING CIRCULATION ON FRACTURED LOWER LIMBS (U.S. CLS. 26, 39 AND 44).

FRANK LATTUCA, EXAMINING ATTORNEY

SN 85-334,216. MEDICAL COMPONENTS, INC., AKA MED-COMP, HARLEYSVILLE, PA. FILED 5-31-2011.

# SPLIT CATH CORE

THE MARK CONSISTS OF STANDARD CHARACTERS WITHOUT CLAIM TO ANY PARTICULAR FONT, STYLE, SIZE, OR COLOR.

OWNER OF U.S. REG. NOS. 2,535,160 AND 2,545,545. NO CLAIM IS MADE TO THE EXCLUSIVE RIGHT TO USE "CATH", APART FROM THE MARK AS SHOWN.

SEC. 2(F) AS TO SPLIT CATH.

FOR CATHETERS (U.S. CLS. 26, 39 AND 44).

MYRIAH HABEEB, EXAMINING ATTORNEY



**CLASS 10—(Continued).**

SN 85-334,273. FRESENIUS KABI AG, BAD HOMBURG, FED REP GERMANY, FILED 5-31-2011.

**VOLUMAT SAFECLIP**

THE MARK CONSISTS OF STANDARD CHARACTERS WITHOUT CLAIM TO ANY PARTICULAR FONT, STYLE, SIZE, OR COLOR.

OWNER OF U.S. REG. NO. 3,587,415.  
FOR MEDICAL CLIP, FOR INFUSION, NAMELY, MEDICAL CLAMP FOR INFUSION SETS, INFUSION TUBES, AND INTRAVENOUS LINES OF MEDICAL INFUSION PUMPS (U.S. CLS. 26, 39 AND 44).  
ANGELA M. MICHELI, EXAMINING ATTORNEY

**CLASS 10—(Continued).**

SN 85-335,103. CORE ONCOLOGY, INC., MERCER ISLAND, WA. FILED 6-1-2011.

**Contour<sup>COIL</sup>**

THE MARK CONSISTS OF THE WORD "CONTOURCOIL" WITH "COIL" SUPERSCRIPED TO "CONTOUR".

FOR MEDICAL APPARATUS, NAMELY, IMPLANTABLE FIDUCIAL MARKER FOR USE IN MARKING TISSUES UNDERGOING RADIOGRAPHIC PROCEDURES (U.S. CLS. 26, 39 AND 44).  
KEVON CHISOLM, EXAMINING ATTORNEY

SN 85-334,588. ENTOURAGE MEDICAL TECHNOLOGIES, INC., MENLO PARK, CA. FILED 5-31-2011.

**CARDIOCLOSE**

THE MARK CONSISTS OF STANDARD CHARACTERS WITHOUT CLAIM TO ANY PARTICULAR FONT, STYLE, SIZE, OR COLOR.

FOR MEDICAL INSTRUMENTS AND APPARATUSES FOR TREATING CARDIOVASCULAR DISEASES (U.S. CLS. 26, 39 AND 44).  
ERIN FALK, EXAMINING ATTORNEY

SN 85-335,182. O2OOL LLC, FORT COLLINS, CO. FILED 6-1-2011.

**O2OOL**

THE MARK CONSISTS OF STANDARD CHARACTERS WITHOUT CLAIM TO ANY PARTICULAR FONT, STYLE, SIZE, OR COLOR.

FOR NASAL CANNULA POSITIONING DEVICE (U.S. CLS. 26, 39 AND 44).  
DOMINIC FATHY, EXAMINING ATTORNEY

SN 85-335,098. CORE ONCOLOGY, INC., MERCER ISLAND, WA. FILED 6-1-2011.



THE MARK CONSISTS OF THE WORDS "CONTOUR COIL" WITH AN ARROW-SHAPE SURROUNDING PART OF THE "C" OF "CONTOUR" AND LINE OVERLAPPING THE ARROW SHAPE AND THE "C" IN THE FORM OF A COIL.

FOR MEDICAL APPARATUS, NAMELY, IMPLANTABLE FIDUCIAL MARKER FOR USE IN MARKING TISSUES UNDERGOING RADIOGRAPHIC PROCEDURES (U.S. CLS. 26, 39 AND 44).  
KEVON CHISOLM, EXAMINING ATTORNEY

SN 85-335,317. ARTHROSURFACE INCORPORATED, FRANKLIN, MA. FILED 6-1-2011.

**reCAPture Life!**

THE MARK CONSISTS OF STANDARD CHARACTERS WITHOUT CLAIM TO ANY PARTICULAR FONT, STYLE, SIZE, OR COLOR.

FOR PROSTHETIC IMPLANTS FOR ARTICULAR RESURFACING (U.S. CLS. 26, 39 AND 44).  
MAYUR VAGHANI, EXAMINING ATTORNEY

**CLASS 10—(Continued).**

SN 85-335,534. HOOPER MEDICAL DEVICES, LLC, LAGUNA BEACH, CA. FILED 6-1-2011.

**HOOPER SUCTION UNIT**

THE MARK CONSISTS OF STANDARD CHARACTERS WITHOUT CLAIM TO ANY PARTICULAR FONT, STYLE, SIZE, OR COLOR.

NO CLAIM IS MADE TO THE EXCLUSIVE RIGHT TO USE "SUCTION UNIT", APART FROM THE MARK AS SHOWN.

FOR PORTABLE MEDICAL DEVICES TO REMOVE OBSTRUCTIONS IN HUMAN AIRWAYS (U.S. CLS. 26, 39 AND 44).

LINDA M. KING, EXAMINING ATTORNEY

**CLASS 10—(Continued).**

SN 85-336,549. FELDMEIER EQUIPMENT, INC., SYRACUSE, NY. FILED 6-2-2011.

**MED-POLE**

THE MARK CONSISTS OF STANDARD CHARACTERS WITHOUT CLAIM TO ANY PARTICULAR FONT, STYLE, SIZE, OR COLOR.

FOR VERTICAL POLE SUPPORT AND MOBILITY TRANSFER AID FOR ELDERLY, INFIRM, AND DISABLED PERSONS (U.S. CLS. 26, 39 AND 44).

FIRST USE 4-0-2004; IN COMMERCE 4-0-2004.

JILL C. ALT, EXAMINING ATTORNEY

SN 85-335,986. KIRN MEDICAL DESIGN, LLC, LEXINGTON, KY. FILED 6-2-2011.

**CRYOPRECISION**

THE MARK CONSISTS OF STANDARD CHARACTERS WITHOUT CLAIM TO ANY PARTICULAR FONT, STYLE, SIZE, OR COLOR.

FOR SKIN TREATMENT DEVICES, NAMELY, CRYOSURGICAL APPARATUS FOR USE IN PERFORMING ABLATIVE SURGERY; AND SKIN COOLING DEVICES, NAMELY, CRYOSURGICAL DEVICES FOR THE REMOVAL OF HEAT FROM A TARGET AREA (U.S. CLS. 26, 39 AND 44).

COURTNEY ALVAREZ, EXAMINING ATTORNEY

SN 85-336,582. ST. JUDE MEDICAL, CARDIOLOGY DIVISION, INC., ST. PAUL, MN. FILED 6-2-2011.

**NAVITOR**

THE MARK CONSISTS OF STANDARD CHARACTERS WITHOUT CLAIM TO ANY PARTICULAR FONT, STYLE, SIZE, OR COLOR.

FOR PROSTHETIC HEART VALVES; IMPLANTATION INSTRUMENTS FOR HEART VALVES (U.S. CLS. 26, 39 AND 44).

WENDY JUN, EXAMINING ATTORNEY

SN 85-336,303. MILLER, SUELLEN, SAN FRANCISCO, CA. FILED 6-2-2011.

**LIFEWRAP**

THE MARK CONSISTS OF STANDARD CHARACTERS WITHOUT CLAIM TO ANY PARTICULAR FONT, STYLE, SIZE, OR COLOR.

FOR NON-PNEUMATIC, ANTI-SHOCK WRAPS AND GARMENTS FOR OBSTETRIC PATIENTS (U.S. CLS. 26, 39 AND 44).

AMY KERTGATE, EXAMINING ATTORNEY

SN 85-336,610. ST. JUDE MEDICAL, CARDIOLOGY DIVISION, INC., ST. PAUL, MN. FILED 6-2-2011.

**PORTICO**

THE MARK CONSISTS OF STANDARD CHARACTERS WITHOUT CLAIM TO ANY PARTICULAR FONT, STYLE, SIZE, OR COLOR.

FOR PROSTHETIC HEART VALVES; IMPLANTATION INSTRUMENTS FOR HEART VALVES (U.S. CLS. 26, 39 AND 44).

WENDY JUN, EXAMINING ATTORNEY

**CLASS 10—(Continued).**

SN 85-336,619. ERGOCARE, INC., RIVERSIDE, CA. FILED 6-2-2011.

**TECHNOLOGY THAT MOVES**

THE MARK CONSISTS OF STANDARD CHARACTERS WITHOUT CLAIM TO ANY PARTICULAR FONT, STYLE, SIZE, OR COLOR.

FOR INVALID HOISTS; INVALID LIFTS; INVALID WALKERS; MEDICAL PATIENT TREATMENT CHAIRS; SLINGS FOR MEDICAL USE; WALKING AIDS FOR HANDICAPPED PERSONS, NAMELY, WALKING FRAMES (U.S. CLS. 26, 39 AND 44).

FIRST USE 6-21-2002; IN COMMERCE 7-11-2003.  
SKYE YOUNG, EXAMINING ATTORNEY

SN 85-336,624. ST. JUDE MEDICAL, CARDIOLOGY DIVISION, INC., ST. PAUL, MN. FILED 6-2-2011.

**OPTIVALVE**

THE MARK CONSISTS OF STANDARD CHARACTERS WITHOUT CLAIM TO ANY PARTICULAR FONT, STYLE, SIZE, OR COLOR.

FOR PROSTHETIC HEART VALVES; IMPLANTATION INSTRUMENTS FOR HEART VALVES (U.S. CLS. 26, 39 AND 44).

WENDY JUN, EXAMINING ATTORNEY

SN 85-337,063. INDOGROUP UNITED, INC., SAN DIEGO, CA. FILED 6-3-2011.

**VIRAVUE**

THE MARK CONSISTS OF STANDARD CHARACTERS WITHOUT CLAIM TO ANY PARTICULAR FONT, STYLE, SIZE, OR COLOR.

FOR MEDICAL DIAGNOSTIC APPARATUS FOR PERFORMING POLYMERASE CHAIN REACTION (PCR) TESTS FOR INFECTIOUS DISEASES (U.S. CLS. 26, 39 AND 44).

WENDY JUN, EXAMINING ATTORNEY

**CLASS 10—(Continued).**

SN 85-338,520. SHIPE, KIM L., MESA, AZ. FILED 6-6-2011.

**uWrap**

THE MARK CONSISTS OF STANDARD CHARACTERS WITHOUT CLAIM TO ANY PARTICULAR FONT, STYLE, SIZE, OR COLOR.

FOR COMPRESSION BANDAGES (U.S. CLS. 26, 39 AND 44).

BARNEY CHARLON, EXAMINING ATTORNEY

SN 85-339,270. EMBRACE LLC, SARASOTA, FL. FILED 6-6-2011.

**LIVE YOUR LIFE**

THE MARK CONSISTS OF STANDARD CHARACTERS WITHOUT CLAIM TO ANY PARTICULAR FONT, STYLE, SIZE, OR COLOR.

FOR MEDICAL APPARATUS, NAMELY, A COMPRESSION ASSEMBLY COMPRISING BELTS WITH INTEGRATED AND ADJUSTABLE PADS FOR USE IN THE TREATMENT OF AND RELIEF FROM THE SYMPTOMS OF MENSTRUAL CRAMPING (U.S. CLS. 26, 39 AND 44).

FLORENTINA BLANDU, EXAMINING ATTORNEY

SN 85-339,406. CARBONEL, RICARDO A., CHACARILLA, SURCO-LIMA, PERU, FILED 6-6-2011.

**Sashbelle**

THE MARK CONSISTS OF STANDARD CHARACTERS WITHOUT CLAIM TO ANY PARTICULAR FONT, STYLE, SIZE, OR COLOR.

FOR ABDOMINAL CORSETS; CORSETS FOR THERAPEUTIC USE; POST-NATAL GIRDLES FOR MEDICAL PURPOSES; POST-SURGICAL GIRDLES FOR MEDICAL PURPOSES; PREGNANCY GIRDLES FOR MEDICAL PURPOSES; UNDERGARMENTS AND GIRDLES PROVIDING COMPRESSION USED FOR POST-PREGNANCY ABDOMINAL SUPPORT AND COMPRESSION (U.S. CLS. 26, 39 AND 44).

FIRST USE 5-25-2011; IN COMMERCE 5-25-2011.

KELLEY WELLS, EXAMINING ATTORNEY

**CLASS 10—(Continued).**

SN 85-339,611. MERRY X-RAY CHEMICAL CORPORATION,  
SAN DIEGO, CA. FILED 6-7-2011.

## FreedomDR

THE MARK CONSISTS OF STANDARD CHARACTERS WITHOUT CLAIM TO ANY PARTICULAR FONT, STYLE, SIZE, OR COLOR.

FOR X-RAY DIAGNOSTIC APPARATUS USING WIRELESS DETECTOR AND COMMUNICATIONS, AND COMPUTERIZED DIAGNOSTIC MEDICAL IMAGING AND IMAGE PROCESSING SOFTWARE, FOR PORTABLE DIGITAL AND ANALOG RADIOGRAPHIC AND X-RAY IMAGING FOR MEDICAL AND VETERINARY USE (U.S. CLS. 26, 39 AND 44).

FIRST USE 11-5-2010; IN COMMERCE 11-10-2010.  
HANNO RITTNER, EXAMINING ATTORNEY

---

SN 85-339,761. JOHNSON & JOHNSON, NEW BRUNSWICK,  
NJ. FILED 6-7-2011.

## ESPRIVA

THE MARK CONSISTS OF STANDARD CHARACTERS WITHOUT CLAIM TO ANY PARTICULAR FONT, STYLE, SIZE, OR COLOR.

FOR SURGICAL APPARATUS USED IN GYNECOLOGICAL PROCEDURES TO REPAIR AND RECONSTRUCT VAGINAL PELVIC FLOOR (U.S. CLS. 26, 39 AND 44).

ALEXANDER L. POWERS, EXAMINING ATTORNEY

---

SN 85-339,935. NDI MEDICAL, LLC, CLEVELAND, OH.  
FILED 6-7-2011.

## ISTIM

THE MARK CONSISTS OF STANDARD CHARACTERS WITHOUT CLAIM TO ANY PARTICULAR FONT, STYLE, SIZE, OR COLOR.

FOR NERVE STIMULATOR APPARATUS (U.S. CLS. 26, 39 AND 44).

JAY FLOWERS, EXAMINING ATTORNEY

**CLASS 10—(Continued).**

SN 85-340,395. ADVANCED MICRONIC DEVICES LIMITED,  
DBA FAICHNEY MEDICAL COMPANY, CERRITOS, CA.  
FILED 6-7-2011.

## SAFETY-GUARD

THE MARK CONSISTS OF STANDARD CHARACTERS WITHOUT CLAIM TO ANY PARTICULAR FONT, STYLE, SIZE, OR COLOR.

FOR MEDICAL INSTRUMENTS AND APPARATUS, NAMELY, DIGITAL THERMOMETERS AND THEIR PARTS AND ACCESSORIES, NAMELY, PROBE COVERS AND STORAGE CASES; VETERINARIAN INSTRUMENTS AND APPARATUS, NAMELY, VETERINARY THERMOMETERS AND THEIR PARTS AND ACCESSORIES, NAMELY, STORAGE CASES (U.S. CLS. 26, 39 AND 44).

PAUL E. FAHRENKOPF, EXAMINING ATTORNEY

---

SN 85-343,516. TERUMO KABUSHIKI KAISHA, DBA TERUMO CORPORATION, SHIBUYA-KU, TOKYO, JAPAN,  
FILED 6-10-2011.

## NAVIFOCUS

THE MARK CONSISTS OF STANDARD CHARACTERS WITHOUT CLAIM TO ANY PARTICULAR FONT, STYLE, SIZE, OR COLOR.

FOR MEDICAL ULTRASOUND APPARATUS; MEDICAL AND SURGICAL CATHETERS; INTRAVASCULAR ULTRASOUND PROBING CATHETERS (U.S. CLS. 26, 39 AND 44).

ELI HELLMAN, EXAMINING ATTORNEY

---

SN 85-355,662. TERUMO KABUSHIKI KAISHA, DBA TERUMO CORPORATION, SHIBUYA-KU, TOKYO, JAPAN,  
FILED 6-24-2011.

## DATAVISION

THE MARK CONSISTS OF STANDARD CHARACTERS WITHOUT CLAIM TO ANY PARTICULAR FONT, STYLE, SIZE, OR COLOR.

OWNER OF JAPAN REG. NO. 4392878, DATED 6-16-2000,  
EXPIRES 6-16-2020.

FOR BLOOD TESTING APPARATUS; BLOOD TESTING TIPS; BLOOD GLUCOSE MONITORS; APPARATUS FOR TAKING BLOOD SAMPLES; LANCETS; LANCET DEVICES; MEDICAL APPARATUS AND INSTRUMENTS FOR MONITORING AND MANAGING BLOOD PROPERTIES DATA (U.S. CLS. 26, 39 AND 44).

ELI HELLMAN, EXAMINING ATTORNEY

**CLASS 10—(Continued).**

SN 85-358,192. MIZUHO ORTHOPEDIC SYSTEMS, INC.,  
DBA MIZUHOSI, SACRAMENTO, CA. FILED 6-28-2011.

**INSITE**

THE MARK CONSISTS OF STANDARD CHARACTERS  
WITHOUT CLAIM TO ANY PARTICULAR FONT, STYLE,  
SIZE, OR COLOR.

FOR OPERATING TABLES; PATIENT EXAMINATION  
AND/OR TREATMENT TABLES (U.S. CLS. 26, 39 AND  
44).

WENDY GOODMAN, EXAMINING ATTORNEY

**CLASS 10—(Continued).**

SN 85-378,313. DIFUSION, INC., GEORGETOWN, TX. FILED  
7-22-2011.

**CONTEGO**

THE MARK CONSISTS OF STANDARD CHARACTERS  
WITHOUT CLAIM TO ANY PARTICULAR FONT, STYLE,  
SIZE, OR COLOR.

FOR ORTHOPAEDIC IMPLANTS COMPOSED OF  
NON-LIVING MATERIAL (U.S. CLS. 26, 39 AND 44).

ALEXANDER L. POWERS, EXAMINING ATTORNEY

SN 85-359,456. JOHNSON & JOHNSON, NEW BRUNSWICK,  
NJ. FILED 6-29-2011.

**SURESTREAM**

THE MARK CONSISTS OF STANDARD CHARACTERS  
WITHOUT CLAIM TO ANY PARTICULAR FONT, STYLE,  
SIZE, OR COLOR.

FOR INTRASPINAL CATHETERS (U.S. CLS. 26, 39  
AND 44).

ALEXANDER L. POWERS, EXAMINING ATTORNEY

SN 85-379,539. MEDLINE INDUSTRIES, INC., MUNDELEIN,  
IL. FILED 7-25-2011.

**AVANT DELUXE**

THE MARK CONSISTS OF STANDARD CHARACTERS  
WITHOUT CLAIM TO ANY PARTICULAR FONT, STYLE,  
SIZE, OR COLOR.

OWNER OF U.S. REG. NO. 2,039,105.  
THE ENGLISH TRANSLATION OF "AVANT" IN THE  
MARK IS "BEFORE".

FOR SURGICAL SPONGES (U.S. CLS. 26, 39 AND 44).  
FIRST USE 1-31-1999; IN COMMERCE 1-31-1999.

MORGAN WYNNE, EXAMINING ATTORNEY

SN 85-372,710. MEDTRONIC, INC., MINNEAPOLIS, MN.  
FILED 7-15-2011.

**EVERA**

THE MARK CONSISTS OF STANDARD CHARACTERS  
WITHOUT CLAIM TO ANY PARTICULAR FONT, STYLE,  
SIZE, OR COLOR.

FOR MEDICAL DEVICES USED IN CARDIAC RE-  
SYNCHRONIZATION AND THE TREATMENT OF  
HEART FAILURE, NAMELY, IMPLANTABLE DEFI-  
BRILLATORS AND IMPLANTABLE PULSE GENERA-  
TORS, COMPONENT PARTS AND FITTINGS  
THEREFOR (U.S. CLS. 26, 39 AND 44).

CHARLOTTE CORWIN, EXAMINING ATTORNEY

SN 85-382,357. MIZUHO ORTHOPEDIC SYSTEMS, INC.,  
SACRAMENTO, CA. FILED 7-27-2011.

**IntelliPENDANT**

THE MARK CONSISTS OF STANDARD CHARACTERS  
WITHOUT CLAIM TO ANY PARTICULAR FONT, STYLE,  
SIZE, OR COLOR.

FOR MEDICAL APPARATUS AND INSTRUMENTS  
FOR USE IN SURGERY (U.S. CLS. 26, 39 AND 44).

WENDY GOODMAN, EXAMINING ATTORNEY

**CLASS 10—(Continued).**

SN 85-385,465. GREEN, DONALD M, RIVERSIDE, CA.  
FILED 7-30-2011.



NO CLAIM IS MADE TO THE EXCLUSIVE RIGHT TO USE "CONDOMS", APART FROM THE MARK AS SHOWN. THE MARK CONSISTS OF THE WORDS "BOOM BOOM CONDOMS" WITH ONE "BOOM" APPEARING HORIZONTALLY AND THE OTHER "BOOM" APPEARING ON AN ANGLE. THE TWO "BOOM" WORDS SHARE THE LETTER "O". ONE LETTER "O" HAS THE MALE GENDER SIGN WITH AN ARROW AND ONE LETTER "O" HAS THE FEMALE GENDER SIGN WITH A PLUS SIGN.  
FOR CONDOMS (U.S. CLS. 26, 39 AND 44).  
ROBERT C. CLARK JR., EXAMINING ATTORNEY

SN 85-391,075. SHIPE, KIM L., MESA, AZ. FILED 8-5-2011.



THE MARK CONSISTS OF AN IMAGE OF A BEE TO THE LEFT OF THE WORD BOLD.  
FOR COMPRESSION BANDAGES (U.S. CLS. 26, 39 AND 44).  
BARNEY CHARLON, EXAMINING ATTORNEY

SN 85-392,020. PACESETTER, INC., DBA ST. JUDE MEDICAL CARDIAC RHYTHM MANAGEMENT DIVISION, SYLMAR, CA. FILED 8-8-2011.

**QUADRA ASSURA MP**

THE MARK CONSISTS OF STANDARD CHARACTERS WITHOUT CLAIM TO ANY PARTICULAR FONT, STYLE, SIZE, OR COLOR.  
OWNER OF U.S. REG. NOS. 3,874,233 AND 3,967,712.  
FOR IMPLANTABLE CARディオVERTER DEFIBRILLATORS AND IMPLANTABLE CARDIAC PULSE GENERATORS (U.S. CLS. 26, 39 AND 44).  
TINA MAI, EXAMINING ATTORNEY

**CLASS 11—ENVIRONMENTAL CONTROL APPARATUS**

SN 76-706,295. AQUACAL AUTOPILOT, INC., ST PETERSBURG, FL. FILED 2-7-2011.

**COPILOT**

THE MARK CONSISTS OF STANDARD CHARACTERS WITHOUT CLAIM TO ANY PARTICULAR FONT, STYLE, SIZE, OR COLOR.  
FOR OZONE GENERATORS THAT SANITIZE WATER FOR USE IN SWIMMING POOLS AND SPAS (U.S. CLS. 13, 21, 23, 31 AND 34).  
FIRST USE 6-25-1998; IN COMMERCE 6-25-1998.  
KATINA MISTER, EXAMINING ATTORNEY

SN 76-707,522. FAN FI INTERNATIONAL, INC., SPARKS, NV. FILED 5-9-2011.

**OXYGENICS POWERSELECT**

THE MARK CONSISTS OF STANDARD CHARACTERS WITHOUT CLAIM TO ANY PARTICULAR FONT, STYLE, SIZE, OR COLOR.  
OWNER OF U.S. REG. NOS. 3,709,028, 3,941,005 AND OTHERS.  
FOR SHOWERHEADS (U.S. CLS. 13, 21, 23, 31 AND 34).  
DAVID I, EXAMINING ATTORNEY

SN 78-906,784. ONWARD MULTI-CORP INC., WATERLOO, ONTARIO, CANADA, FILED 6-13-2006.

**FALCON**

THE MARK CONSISTS OF STANDARD CHARACTERS WITHOUT CLAIM TO ANY PARTICULAR FONT, STYLE, SIZE, OR COLOR.  
PRIORITY CLAIMED UNDER SEC. 44(D) ON CANADA APPLICATION NO. 1301257, FILED 5-12-2006.  
FOR BARBECUE GRILLS; BARBECUES; CERAMIC BRIQUETTES FOR USE IN BARBECUE GRILLS; GAS GRILLS (U.S. CLS. 13, 21, 23, 31 AND 34).  
TIMOTHY FINNEGAN, EXAMINING ATTORNEY

**CLASS 11—(Continued).**

SN 79-085,188. DAVEY WATER PRODUCTS PTY LTD, AUSTRALIA, FILED 7-13-2010.

**DAVEY SPAPOWER**

THE MARK CONSISTS OF STANDARD CHARACTERS WITHOUT CLAIM TO ANY PARTICULAR FONT, STYLE, SIZE, OR COLOR.

OWNER OF INTERNATIONAL REGISTRATION 1030399 DATED 2-3-2010, EXPIRES 2-3-2020.

FOR WATER SUPPLY AND HEATING APPARATUS FOR SPAS, NAMELY, HEATERS FOR SPAS; HEAT CONTROLLERS FOR SPAS; PARTS AND FITTINGS FOR SPAS, NAMELY, AIR BLOWERS FOR SPAS AND REGULATING ACCESSORIES FOR WATER APPARATUS FOR SPAS, NAMELY, WATER FLOW CONTROLLERS FOR SPAS AND REPLACEMENT PARTS FOR ALL OF THE ABOVE (U.S. CLS. 13, 21, 23, 31 AND 34).

BERNICE MIDDLETON, EXAMINING ATTORNEY

**CLASS 11—(Continued).**

SN 85-086,569. VODE LIGHTING LLC, SONOMA, CA. FILED 7-16-2010.

**BoxRail**

THE MARK CONSISTS OF STANDARD CHARACTERS WITHOUT CLAIM TO ANY PARTICULAR FONT, STYLE, SIZE, OR COLOR.

FOR LIGHTING FIXTURES (U.S. CLS. 13, 21, 23, 31 AND 34).

FIRST USE 11-1-2006; IN COMMERCE 8-3-2007.

JULIE VEPPUMTHARA, EXAMINING ATTORNEY

SN 85-003,802. ARTILIZE WORLDWIDE CO., LTD., TAIPEI, TAIWAN, FILED 4-1-2010.

**Giimmö**

THE MARK CONSISTS OF THE WORDING "GIIMMÖ" IN STYLIZED LETTERING.

THE WORDING "GIIMMÖ" HAS NO MEANING IN A FOREIGN LANGUAGE.

FOR ELECTRIC NIGHT LIGHTS; LAMPS; LED LIGHTING FIXTURES FOR INDOOR AND OUTDOOR LIGHTING APPLICATIONS (U.S. CLS. 13, 21, 23, 31 AND 34).

FIRST USE 1-1-2008; IN COMMERCE 1-1-2008.

ANDREA K. NADELMAN, EXAMINING ATTORNEY

SN 85-086,744. DAIMLER AG, STUTTGART, FED REP GERMANY, FILED 7-16-2010.

**EFFICIENT PERFORMANCE**

THE MARK CONSISTS OF STANDARD CHARACTERS WITHOUT CLAIM TO ANY PARTICULAR FONT, STYLE, SIZE, OR COLOR.

PRIORITY CLAIMED UNDER SEC. 44(D) ON FED REP GERMANY APPLICATION NO. 302010011568, FILED 2-25-2010.

FOR LIGHTS FOR MOTOR VEHICLES (U.S. CLS. 13, 21, 23, 31 AND 34).

JAMES MACFARLANE, EXAMINING ATTORNEY

SN 85-086,464. VODE LIGHTING LLC, SONOMA, CA. FILED 7-16-2010.

**BeeRail**

THE MARK CONSISTS OF STANDARD CHARACTERS WITHOUT CLAIM TO ANY PARTICULAR FONT, STYLE, SIZE, OR COLOR.

FOR LIGHTING FIXTURES (U.S. CLS. 13, 21, 23, 31 AND 34).

FIRST USE 11-1-2006; IN COMMERCE 8-3-2007.

JULIE VEPPUMTHARA, EXAMINING ATTORNEY

SN 85-155,033. AGUA DULCE WINERY LLC, LOS ANGELES, CA. FILED 10-18-2010.

**Responsibly**

THE MARK CONSISTS OF STANDARD CHARACTERS WITHOUT CLAIM TO ANY PARTICULAR FONT, STYLE, SIZE, OR COLOR.

FOR WINE COOLERS, NAMELY, REFRIGERATED CABINETS CONTAINING RACKS FOR WINE BOTTLES AND STORAGE SHELVES (U.S. CLS. 13, 21, 23, 31 AND 34).

BRENDAN MCCAULEY, EXAMINING ATTORNEY

**CLASS 11—(Continued).**

SN 85-173,412. WASTEWATER COMPLIANCE SYSTEMS, INC., SALT LAKE CITY, UT. FILED 11-10-2010.

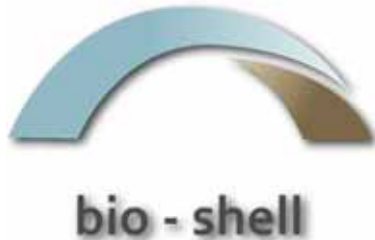

NO CLAIM IS MADE TO THE EXCLUSIVE RIGHT TO USE "SHELL", APART FROM THE MARK AS SHOWN.

THE COLOR(S) BLUE, BROWN, AND GRAY IS/ARE CLAIMED AS A FEATURE OF THE MARK.

THE MARK CONSISTS OF THE STYLIZED WORDING "BIO - SHELL", WITH SHADOWING PLACED BEHIND THE WORDING "BIO - SHELL", SET BELOW AN ARCH FORMED BY TWO CURVED BANDS, WITH SHADOWING BEHIND THE ARCH. THE COLOR GRAY APPEARS IN THE WORDING "BIO - SHELL", IN THE SHADOWING BEHIND THE WORDING "BIO - SHELL" AND IN THE SHADOWING BEHIND THE ARCH; THE COLOR BLUE APPEARS IN THE LIGHTER CURVED BAND FORMING THE ARCH; THE COLOR BROWN APPEARS IN THE DARKER CURVED BAND FORMING THE ARCH.

FOR WATER FILTERING APPARATUS (U.S. CLS. 13, 21, 23, 31 AND 34).

MARC LEIPZIG, EXAMINING ATTORNEY

SN 85-175,734. TANIA RODRIGUEZ, MEXICO CITY, MEXICO, AND ERIC TALBOTT COLE, PARKERSBURG, WV. FILED 11-12-2010.



OWNER OF U.S. REG. NO. 3,588,478.

THE MARK CONSISTS OF STYLIZED LETTERS "E", "V" AND "O". THERE IS A FLOATING SYMBOL CENTERED ABOVE THE LETTER "V". THIS SYMBOL FOLLOWS THE CONTOURS OF THE TOP OF "E", "V" AND "O" LETTERS. BELOW THE "E", "V" AND "O" LETTERS ARE THE LETTERS: "F", "O", "R", "M", "A", "N", "C" AND "E" WITH "FORM" ON THE LEFT SIDE OF THE "V" AND "ANCE" ON THE RIGHT SIDE OF THE "V". THE LETTERS "PERFORMANCE" ARE ABOUT 7 TIMES SMALLER THAN THE "EVO" LETTERS.

FOR BACKUP LIGHTS FOR LAND VEHICLES (U.S. CLS. 13, 21, 23, 31 AND 34).

FIRST USE 12-12-2008; IN COMMERCE 12-12-2008.

SUE LAWRENCE, EXAMINING ATTORNEY

**CLASS 11—(Continued).**

SN 85-178,217. TRAEGER PELLET GRILLS LLC, WILSONVILLE, OR. FILED 11-16-2010.

# TRAEGER

THE MARK CONSISTS OF STANDARD CHARACTERS WITHOUT CLAIM TO ANY PARTICULAR FONT, STYLE, SIZE, OR COLOR.

OWNER OF U.S. REG. NOS. 1,425,662, 3,244,719 AND OTHERS.

SEC. 2(F).  
FOR BARBECUE SMOKERS (U.S. CLS. 13, 21, 23, 31 AND 34).

FIRST USE 1-1-1986; IN COMMERCE 1-1-1986.

ANTHONY RINKER, EXAMINING ATTORNEY

SN 85-178,243. TRAEGER PELLET GRILLS LLC, WILSONVILLE, OR. FILED 11-16-2010.

## TRAEGER WOOD PELLET GRILLS

THE MARK CONSISTS OF STANDARD CHARACTERS WITHOUT CLAIM TO ANY PARTICULAR FONT, STYLE, SIZE, OR COLOR.

OWNER OF U.S. REG. NOS. 1,425,662, 3,244,718 AND OTHERS.

NO CLAIM IS MADE TO THE EXCLUSIVE RIGHT TO USE "WOOD PELLET GRILLS", APART FROM THE MARK AS SHOWN.

SEC. 2(F).  
FOR BARBECUE SMOKERS (U.S. CLS. 13, 21, 23, 31 AND 34).

FIRST USE 0-0-1985; IN COMMERCE 0-0-1985.

ANTHONY RINKER, EXAMINING ATTORNEY

SN 85-180,280. BANNER ENGINEERING & SALES, INC., SAGINAW, MI. FILED 11-18-2010.

# TOC

THE MARK CONSISTS OF STANDARD CHARACTERS WITHOUT CLAIM TO ANY PARTICULAR FONT, STYLE, SIZE, OR COLOR.

FOR COMMERCIAL COOKING OVENS (U.S. CLS. 13, 21, 23, 31 AND 34).

FIRST USE 5-3-2006; IN COMMERCE 12-19-2007.

DEZMONA MIZELLE, EXAMINING ATTORNEY



**CLASS 11—(Continued).**

SN 85-181,057. THE CLEAN AIR FACTORY B.V., TILBURG, NETHERLANDS, FILED 11-19-2010.

# BLOE

THE MARK CONSISTS OF STANDARD CHARACTERS WITHOUT CLAIM TO ANY PARTICULAR FONT, STYLE, SIZE, OR COLOR.

FOR ODOR REMOVING APPARATUS, NAMELY, A DEVICE AFFIXED TO TOILETS WHICH EXHAUSTS ODORS INTO THE SEWER; AUTOMATIC HYGIENE SYSTEMS, NAMELY, AUTOMATIC AIR DEODORANT DISPENSERS FOR AIR FRESHENING; AUTOMATIC CHEMICAL DOSING DISPENSERS OR DRIP DISPENSERS FOR URINALS AND TOILETS; AIR FILTERS FOR USE IN REST ROOMS; VENTILATORS FOR REMOVAL OF ODORS; SANITARY APPARATUS AND INSTALLATIONS, NAMELY, TOILETS, URINALS, WASHING BASINS, HAND-DRYING APPARATUS, TOWEL DISPENSERS, SPRAY CANS (U.S. CLS. 13, 21, 23, 31 AND 34).

CAROLYN CATALDO, EXAMINING ATTORNEY

SN 85-182,299. HUBBELL INCORPORATED, SHELTON, CT. FILED 11-22-2010.

# EMITTERDECK

THE MARK CONSISTS OF STANDARD CHARACTERS WITHOUT CLAIM TO ANY PARTICULAR FONT, STYLE, SIZE, OR COLOR.

FOR MOUNTING ASSEMBLY COMPRISED PRIMARILY OF A MOUNTING PLATE SOLD AS A COMPONENT OF A LIGHTING FIXTURE (U.S. CLS. 13, 21, 23, 31 AND 34).

FIRST USE 7-20-2010; IN COMMERCE 7-20-2010.  
ALICIA COLLINS, EXAMINING ATTORNEY

SN 85-189,608. THE SLOAN COMPANY, INC. DBA SLOANLED, VENTURA, CA. FILED 12-2-2010.

# RDL

THE MARK CONSISTS OF STANDARD CHARACTERS WITHOUT CLAIM TO ANY PARTICULAR FONT, STYLE, SIZE, OR COLOR.

FOR LIGHTING SYSTEMS, NAMELY, LIGHT EMITTING DIODE (LED) BASED LIGHTING MODULES FOR ILLUMINATING DISPLAYS (U.S. CLS. 13, 21, 23, 31 AND 34).

FIRST USE 5-0-2010; IN COMMERCE 5-0-2010.  
DAVID C. REIHNER, EXAMINING ATTORNEY

**CLASS 11—(Continued).**

SN 85-193,832. UNIFIED BRANDS, INC., JACKSON, MS. FILED 12-9-2010.

# LOLO

THE MARK CONSISTS OF STANDARD CHARACTERS WITHOUT CLAIM TO ANY PARTICULAR FONT, STYLE, SIZE, OR COLOR.

THE ENGLISH TRANSLATION OF "LOLO" IN THE MARK IS "TEENAGE BOY".

FOR COMMERCIAL COOKING EQUIPMENT, NAMELY, CHARBROILERS, GRIDDLES, FRYERS AND HOT PLATES (U.S. CLS. 13, 21, 23, 31 AND 34).

SUZANNE BLANE, EXAMINING ATTORNEY

SN 85-195,445. UNIFIED BRANDS, INC., JACKSON, MS. FILED 12-10-2010.



THE COLOR(S) BLACK, WHITE AND GREEN IS/ARE CLAIMED AS A FEATURE OF THE MARK.

THE MARK CONSISTS OF THE WORDING "LOLO" CENTERED IN A BLACK OVAL, WITH THE FIRST "LO" IN THE COLOR WHITE AND THE SECOND "LO" IN THE COLOR GREEN.

THE ENGLISH TRANSLATION OF "LOLO" IN THE MARK IS "TEENAGE BOY".

FOR COMMERCIAL COOKING EQUIPMENT, NAMELY, CHARBROILERS, GRIDDLES, FRYERS AND HOT PLATES (U.S. CLS. 13, 21, 23, 31 AND 34).

SUZANNE BLANE, EXAMINING ATTORNEY

SN 85-201,401. RUSCO INC., BROOKSVILLE, FL. FILED 12-19-2010.

# Rusco SPIN-DOWN

THE MARK CONSISTS OF STANDARD CHARACTERS WITHOUT CLAIM TO ANY PARTICULAR FONT, STYLE, SIZE, OR COLOR.

NO CLAIM IS MADE TO THE EXCLUSIVE RIGHT TO USE "SPIN-DOWN", APART FROM THE MARK AS SHOWN.

FOR WATER FILTERS (U.S. CLS. 13, 21, 23, 31 AND 34).

FIRST USE 4-7-1985; IN COMMERCE 4-7-1985.  
KELLY BOULTON, EXAMINING ATTORNEY

**CLASS 11—(Continued).**

SN 85-240,851. CASCADE WATER SERVICES, INC., HICKSVILLE, NY. FILED 2-12-2011.

UVOX

THE MARK CONSISTS OF STANDARD CHARACTERS WITHOUT CLAIM TO ANY PARTICULAR FONT, STYLE, SIZE, OR COLOR.

FOR ELECTROMECHANICAL DEVICES FOR TREATING WATER UTILIZED IN OPEN AND CLOSED SYSTEMS TO REDUCE OCCURRENCE OF SCALE AND BIOMASS THEREIN; WATER TREATMENT EQUIPMENT, NAMELY, WATER FILTRATION UNITS THAT DELIVER ADDITIVES TO WATER WITHIN OPEN AND CLOSED SYSTEMS TO REDUCE OCCURRENCE OF SCALE AND BIOMASS (U.S. CLS. 13, 21, 23, 31 AND 34).  
FIRST USE 1-31-2009; IN COMMERCE 1-31-2009.

MORGAN WYNNE, EXAMINING ATTORNEY

SN 85-252,015. STARJEM RESTAURANT, INC., NEW YORK, NY. FILED 2-25-2011.

AL DENTE

THE MARK CONSISTS OF STANDARD CHARACTERS WITHOUT CLAIM TO ANY PARTICULAR FONT, STYLE, SIZE, OR COLOR.

FOR ELECTRIC PASTA COOKERS FOR DOMESTIC USE (U.S. CLS. 13, 21, 23, 31 AND 34).

KRISTIN CARLSON, EXAMINING ATTORNEY

**CLASS 11—(Continued).**

SN 85-265,718. GUANGDONG YINGAO KITCHEN UTENSILS CO., LTD., SHUNDE, FOSHAN, CHINA, FILED 3-14-2011.



NO CLAIM IS MADE TO THE EXCLUSIVE RIGHT TO USE THE NON-LATIN CHARACTERS THAT TRANSLITERATE TO CHU JU, APART FROM THE MARK AS SHOWN.

THE MARK CONSISTS OF FOUR CHINESE CHARACTERS APPEARING INSIDE A SHADED SQUARE BACKGROUND.

THE NON-LATIN CHARACTERS IN THE MARK TRANSLITERATE TO YING; AO; CHU; JU AND THIS MEANS CHERRY; ABSTRUSE; KITCHEN; UTENSIL IN ENGLISH.

FOR BATHS, BATHTUBS, WHIRLPOOL BATHS AND BATH INSTALLATIONS; ELECTRIC COOKING STOVES; EXTRACTOR HOODS FOR KITCHENS; GAS BURNERS; HYDRANTS; LAMP MANTLES; LAMPS; PIPES FOR HEATING BOILERS; SINKS; STERILIZERS (U.S. CLS. 13, 21, 23, 31 AND 34).

PAM WILLIS, EXAMINING ATTORNEY

SN 85-285,203. AKRON BRASS COMPANY, WOOSTER, OH. FILED 4-4-2011.

SCENESTAR

THE MARK CONSISTS OF STANDARD CHARACTERS WITHOUT CLAIM TO ANY PARTICULAR FONT, STYLE, SIZE, OR COLOR.

FOR LIGHTING FIXTURES; LED (LIGHT EMITTING DIODES) LIGHTING FIXTURES (U.S. CLS. 13, 21, 23, 31 AND 34).

FIRST USE 3-21-2011; IN COMMERCE 3-21-2011.

MARCIE MILONE, EXAMINING ATTORNEY

**CLASS 11—(Continued).**

SN 85-289,923. ABS MATERIALS, INC., WOOSTER, OH.  
FILED 4-8-2011.

**VOC SOCKS**

THE MARK CONSISTS OF STANDARD CHARACTERS WITHOUT CLAIM TO ANY PARTICULAR FONT, STYLE, SIZE, OR COLOR.

FOR WATER TREATMENT EQUIPMENT, NAMELY, AN APPARATUS FOR TREATING GROUNDWATER COMPRISED OF A WATER PERMEABLE TREATMENT TUBE OR OTHER CONTAINERS LOADED WITH A SORBENT MATERIAL FOR REMOVING ORGANIC COMPOUNDS AND OTHER CONTAINMENTS FROM GROUNDWATER (U.S. CLS. 13, 21, 23, 31 AND 34).

FIRST USE 4-18-2010; IN COMMERCE 12-6-2010.

KATHERINE M. DUBRAY, EXAMINING ATTORNEY

---

SN 85-293,650. STAPLES THE OFFICE SUPERSTORE, LLC.,  
FRAMINGHAM, MA. FILED 4-13-2011.



NO CLAIM IS MADE TO THE EXCLUSIVE RIGHT TO USE "PROFESSIONAL", APART FROM THE MARK AS SHOWN.

THE MARK CONSISTS OF A CIRCLE COMPRISED OF 4 CRESCENTS OVER THE WORDS "BRIGHTON PROFESSIONAL".

FOR URINAL SCREENS AND LIGHT BULBS (U.S. CLS. 13, 21, 23, 31 AND 34).

GIANCARLO CASTRO, EXAMINING ATTORNEY

---

SN 85-303,217. ROSCO LABORATORIES, INC., STAMFORD,  
CT. FILED 4-25-2011.

**LITEPAD AXIOM**

THE MARK CONSISTS OF STANDARD CHARACTERS WITHOUT CLAIM TO ANY PARTICULAR FONT, STYLE, SIZE, OR COLOR.

FOR PORTABLE ELECTRICAL LIGHTING DEVICES FOR THEATRICAL, FILM, VIDEO AND PHOTOGRAPHY PRODUCTIONS, ARCHITECTURAL AND SIGNAGE APPLICATIONS; LIGHT FILTERS FOR PHOTOGRAPHIC, CINEMATOGRAPHIC, VIDEO AND PERFORMANCE ARTS LIGHTING; CARRYING CASES SPECIFICALLY ADAPTED FOR SAID PORTABLE ELECTRICAL LIGHTING DEVICES (U.S. CLS. 13, 21, 23, 31 AND 34).

FIRST USE 11-15-2010; IN COMMERCE 11-15-2010.

WILLIAM P. SHANAHAN, EXAMINING ATTORNEY

**CLASS 11—(Continued).**

SN 85-303,221. ROSCO LABORATORIES, INC., STAMFORD,  
CT. FILED 4-25-2011.

**LITEPAD**

THE MARK CONSISTS OF STANDARD CHARACTERS WITHOUT CLAIM TO ANY PARTICULAR FONT, STYLE, SIZE, OR COLOR.

FOR PORTABLE ELECTRICAL LIGHTING DEVICES FOR THEATRICAL, FILM, VIDEO AND PHOTOGRAPHY PRODUCTIONS, ARCHITECTURAL AND SIGNAGE APPLICATIONS; LIGHT FILTERS FOR PHOTOGRAPHIC, CINEMATOGRAPHIC, VIDEO AND PERFORMANCE ARTS LIGHTING; CARRYING CASES SPECIFICALLY ADAPTED FOR SAID PORTABLE ELECTRICAL LIGHTING DEVICES (U.S. CLS. 13, 21, 23, 31 AND 34).

FIRST USE 12-8-2006; IN COMMERCE 12-8-2006.

WILLIAM P. SHANAHAN, EXAMINING ATTORNEY

---

SN 85-309,898. VENTILATION MAXIMUM LTEE, MON-  
TREAL, QUEBEC, CANADA, FILED 5-2-2011.

**MAXIMUM**

THE MARK CONSISTS OF STANDARD CHARACTERS WITHOUT CLAIM TO ANY PARTICULAR FONT, STYLE, SIZE, OR COLOR.

OWNER OF CANADA REG. NO. TMA300660, DATED 3-8-1985, EXPIRES 3-8-2015.

FOR ATTIC ROOF VENTILATORS (U.S. CLS. 13, 21, 23, 31 AND 34).

C. DIONNE CLYBURN, EXAMINING ATTORNEY

**CLASS 11—(Continued).**

SN 85-311,430. TRACTOR SUPPLY CO. OF TEXAS, LP, BRENTWOOD, TN. FILED 5-3-2011.



THE MARK CONSISTS OF THE WORD "RED" WITH A SMALL CIRCLE ABOVE AND TO THE RIGHT OF THE LETTER "D" IN "RED" AND THE WORD "STONE" APPEARING DIRECTLY UNDER THE WORD "RED".

FOR ELECTRIC HEATERS, NAMELY, ELECTRIC HOME, WORK SHOP, AND PATIO HEATERS; BBQ GRILLS; ELECTRIC GRIDDLES; DUAL GRILLS, NAMELY, ELECTRIC AND GAS GRILLS; COOKERS/FRYERS, NAMELY, CHARCOAL, GAS, AND WOOD OUTDOOR TURKEY FRYERS; ELECTRIC BARBECUE SMOKERS; FISH FRYERS, NAMELY, CHARCOAL, GAS, AND WOOD OUTDOOR FISH FRYERS; PORTABLE FIREPLACES AND PORTABLE FIREPLACES WITH COOLERS; STOVES, NAMELY, WOOD BURNING, PELLET BURNING, AND GAS BURNING STOVES FOR HOME HEATING AND COOKING; LOUVERS, BLOWERS, AND DAMPERS FOR WOOD BURNING STOVES; ASH PANS FOR WOOD BURNING STOVES (U.S. CLS. 13, 21, 23, 31 AND 34).

ROBERT C. CLARK JR., EXAMINING ATTORNEY

---

SN 85-311,571. NGL ENERGY PARTNERS LP, TULSA, OK. FILED 5-3-2011.

**SIMPLY CLEAR**

THE MARK CONSISTS OF STANDARD CHARACTERS WITHOUT CLAIM TO ANY PARTICULAR FONT, STYLE, SIZE, OR COLOR.

FOR WATER TREATMENT EQUIPMENT, NAMELY, WATER SOFTENERS (U.S. CLS. 13, 21, 23, 31 AND 34). FIRST USE 5-2-2011; IN COMMERCE 5-2-2011. CHRISTOPHER BUONGIORNO, EXAMINING ATTORNEY

**CLASS 11—(Continued).**

SN 85-311,576. NGL ENERGY PARTNERS LP, TULSA, OK. FILED 5-3-2011.

**OXY AIR**

THE MARK CONSISTS OF STANDARD CHARACTERS WITHOUT CLAIM TO ANY PARTICULAR FONT, STYLE, SIZE, OR COLOR.

FOR WATER TREATMENT EQUIPMENT, NAMELY, WATER FILTERS (U.S. CLS. 13, 21, 23, 31 AND 34).

FIRST USE 5-2-2011; IN COMMERCE 5-2-2011. CHRISTOPHER BUONGIORNO, EXAMINING ATTORNEY

---

SN 85-311,581. NGL ENERGY PARTNERS LP, TULSA, OK. FILED 5-3-2011.

**COMPLETE CARE**

THE MARK CONSISTS OF STANDARD CHARACTERS WITHOUT CLAIM TO ANY PARTICULAR FONT, STYLE, SIZE, OR COLOR.

FOR WATER TREATMENT EQUIPMENT, NAMELY, WATER SOFTENERS (U.S. CLS. 13, 21, 23, 31 AND 34).

FIRST USE 5-2-2011; IN COMMERCE 5-2-2011. CHRISTOPHER BUONGIORNO, EXAMINING ATTORNEY

---

SN 85-311,603. MC CABINETCO, INC., SANTA ANA, CA. FILED 5-3-2011.



THE MARK CONSISTS OF THE WORDING "XTREMEAIR" IN STYLIZED FORM SET AGAINST A SHADED RECTANGULAR BACKGROUND.

FOR RANGE HOODS (U.S. CLS. 13, 21, 23, 31 AND 34). FIRST USE 5-2-2011; IN COMMERCE 5-2-2011. JEFFREY LOOK, EXAMINING ATTORNEY

**CLASS 11—(Continued).**

SN 85-316,547. SUNBEAM PRODUCTS, INC., BOCA RATON, FL. FILED 5-10-2011.

**Tasty Treats!**

THE MARK CONSISTS OF STANDARD CHARACTERS WITHOUT CLAIM TO ANY PARTICULAR FONT, STYLE, SIZE, OR COLOR.

FOR DESSERT MAKERS, NAMELY, DONUT MAKERS IN THE NATURE OF PORTABLE ELECTRIC BAKING MACHINES, ELECTRIC HOT AIR POPCORN POPPERS, PIE MAKERS IN THE NATURE OF PORTABLE ELECTRIC BAKING MACHINES, CUPCAKE MAKERS IN THE NATURE OF PORTABLE ELECTRIC BAKING MACHINES, CAKE MAKERS IN THE NATURE OF PORTABLE ELECTRIC BAKING MACHINES, COOKIE MAKERS IN THE NATURE OF PORTABLE ELECTRIC BAKING MACHINES, AND BROWNIE MAKERS IN THE NATURE OF PORTABLE ELECTRIC BAKING MACHINES (U.S. CLS. 13, 21, 23, 31 AND 34).

LEIGH LOWRY, EXAMINING ATTORNEY

**CLASS 11—(Continued).**

SN 85-319,722. SECCUA GMBH, STEINGADEN, FED REP GERMANY, FILED 5-12-2011.

*Water  
Wonderful  
Life*

NO CLAIM IS MADE TO THE EXCLUSIVE RIGHT TO USE "WATER", APART FROM THE MARK AS SHOWN.

THE COLOR(S) BLUE, WHITE IS/ARE CLAIMED AS A FEATURE OF THE MARK.

THE MARK CONSISTS OF "WATER WONDERFUL LIFE" IS THE LITERAL ELEMENT OF THE DESIGN. "WATER" IS ON LINE ONE. "WONDERFUL LIFE" IS ON LINE TWO. "WATER" AND "LIFE" ARE IN LARGER FONT SIZE THAN "WONDERFUL". ALL TEXT IS WRITTEN IN BLUE. THE BACKGROUND IS COLORED WHITE. THE FONT IS CURSIVE. THE FONT HAS A WEATHERED LOOK TO IT.

FOR FILTERS MADE OF FIBER FOR WATER FILTRATION (U.S. CLS. 13, 21, 23, 31 AND 34).

H. M. FISHER, EXAMINING ATTORNEY

SN 85-319,216. LUMIVERT LIGHTING, HOUSTON, TX. FILED 5-12-2011.

**L  V**

THE COLOR(S) BROWN AND GREEN IS/ARE CLAIMED AS A FEATURE OF THE MARK.

THE MARK CONSISTS OF THE LETTERS "L", "M", "V" IN A STYLIZED, BROWN FONT THE LETTER "M" IS PLACED IN THE CENTER OF A GREEN LEAF DESIGN.

FOR ELECTRIC LIGHT BULBS; ELECTRIC LIGHTING FIXTURES; ELECTRIC TRACK LIGHTING UNITS; FIXTURES FOR INCANDESCENT LIGHT BULBS; FLUORESCENT ELECTRIC LIGHT BULBS; LIGHTING FIXTURES; SOCKETS FOR ELECTRIC LIGHTS (U.S. CLS. 13, 21, 23, 31 AND 34).

FIRST USE 2-1-2011; IN COMMERCE 5-2-2011.

GEORGE LORENZO, EXAMINING ATTORNEY

SN 85-319,774. SECCUA GMBH, STEINGADEN, FED REP GERMANY, FILED 5-12-2011.

  
**seccua**

THE COLOR(S) BLUE, WHITE IS/ARE CLAIMED AS A FEATURE OF THE MARK.

THE MARK CONSISTS OF "SECCUA" IS THE LITERAL ELEMENT. THE WORD "SECCUA" IS WRITTEN IN BLUE IN ALL LOWERCASE LETTERS WITH A WHITE BACKGROUND. ABOVE THE WORD "SECCUA" IS A BLUE CIRCLE WITH A WHITE "S" RUNNING FROM THE TOP OF THE CIRCLE TO THE BOTTOM OF THE CIRCLE. THE CIRCLE HAS THE APPEARANCE OF A YING YANG SHAPE.

THE WORDING "SECCUA" HAS NO MEANING IN A FOREIGN LANGUAGE.

FOR FILTERS MADE OF FIBER FOR WATER FILTRATION (U.S. CLS. 13, 21, 23, 31 AND 34).

H. M. FISHER, EXAMINING ATTORNEY

**CLASS 11—(Continued).**

SN 85-320,165. STEED TECHNOLOGY INC., SCOTTS VALLEY, CA. FILED 5-13-2011.

# EcoGuard

THE MARK CONSISTS OF STANDARD CHARACTERS WITHOUT CLAIM TO ANY PARTICULAR FONT, STYLE, SIZE, OR COLOR.

FOR GAS ABATEMENT APPARATUS FOR INDUSTRIAL PURPOSES, NAMELY, SCRUBBERS AND REGENERATIVE THERMAL OXIDIZERS THAT REMOVE TOXIC OR EXPLOSIVE GASES FROM EXHAUST STREAMS BEFORE THOSE GASES ARE RELEASED INTO THE ATMOSPHERE (U.S. CLS. 13, 21, 23, 31 AND 34).

FIRST USE 2-1-2004; IN COMMERCE 2-1-2004.  
HANNO RITTNER, EXAMINING ATTORNEY

---

SN 85-321,782. BURN ENTERPRISES LLC, AVENTURA, FL. FILED 5-16-2011.

# Solar Twist Light

THE MARK CONSISTS OF STANDARD CHARACTERS WITHOUT CLAIM TO ANY PARTICULAR FONT, STYLE, SIZE, OR COLOR.

NO CLAIM IS MADE TO THE EXCLUSIVE RIGHT TO USE "SOLAR AND LIGHT", APART FROM THE MARK AS SHOWN.

FOR LED LANDSCAPE LIGHTS (U.S. CLS. 13, 21, 23, 31 AND 34).

FIRST USE 4-30-2011; IN COMMERCE 4-30-2011.  
MIDGE BUTLER, EXAMINING ATTORNEY

**CLASS 11—(Continued).**

SN 85-323,036. INTERNATIONAL BUSINESS DEVELOPMENT, INC., DBA ALPINE COOLERS, DULUTH, GA. FILED 5-17-2011.

# Feel Well

THE MARK CONSISTS OF STANDARD CHARACTERS WITHOUT CLAIM TO ANY PARTICULAR FONT, STYLE, SIZE, OR COLOR.

FOR BEVERAGES COOLING APPARATUS; DECORATIVE WATER FOUNTAINS; FILTERS FOR DRINKING WATER; OZONE SANITIZERS FOR AIR AND WATER; REFRIGERATED BEVERAGE DISPENSING UNITS; TAP-WATER PURIFYING APPARATUS; WATER COOLERS; WATER FILTERING APPARATUS; WATER FILTERING UNITS FOR DRINKING WATER FOR DOMESTIC, COMMERCIAL, AND INDUSTRIAL USE; WATER FILTERS; WATER FILTRATION AND PURIFICATION UNITS AND REPLACEMENT CARTRIDGES AND FILTERS THEREFOR; WATER FILTRATION APPARATUS FOR THE DEIONIZATION OF WATER; WATER FILTRATION PITCHERS SOLD EMPTY; WATER FOUNTAINS; WATER PURIFICATION AND FILTRATION APPARATUS; WATER PURIFICATION INSTALLATIONS; WATER PURIFICATION MACHINES; WATER PURIFICATION UNITS; WATER PURIFYING APPARATUS; WATER PURIFYING UNITS, FOR POTABLE WATER FOR DRINKING FOR DOMESTIC, COMMERCIAL, AND INDUSTRIAL USE (U.S. CLS. 13, 21, 23, 31 AND 34).

FIRST USE 12-8-1999; IN COMMERCE 12-8-2000.  
ROBIN MITTLER, EXAMINING ATTORNEY

---

SN 85-323,811. LEADER MANUFACTURING, INC., PORT ORCHARD, WA. FILED 5-18-2011.



NO CLAIM IS MADE TO THE EXCLUSIVE RIGHT TO USE "LED", APART FROM THE MARK AS SHOWN.

THE MARK CONSISTS OF THE WORDS "HI-LAMP" AND "LED" IN COMBINATION WITH A FANCIFUL PARTIAL DESIGN OF A LIGHT BULB. THE "L" IS COMMON TO BOTH THE WORD "LAMP" AND "LED".

FOR LED LIGHT EMITTING DIODE LIGHTING FIXTURES (U.S. CLS. 13, 21, 23, 31 AND 34).

ALEXANDER L. POWERS, EXAMINING ATTORNEY

**CLASS 11—(Continued).**

SN 85-324,838. SAMSUNG ELECTRONICS CO., LTD., SU-WON-SI, GYEONGGI-DO, REPUBLIC OF KOREA, FILED 5-19-2011.



NO CLAIM IS MADE TO THE EXCLUSIVE RIGHT TO USE "ION", APART FROM THE MARK AS SHOWN.

THE COLOR(S) BLUE AND GREY IS/ARE CLAIMED AS A FEATURE OF THE MARK.

THE MARK CONSISTS OF THE WORDING "S-PLASMA ION" IN BLUE WITH EIGHT SMALL CIRCLES FORMING ONE LARGE CIRCLE CENTERED ABOVE THE WORDING. FIVE OF THE SMALL CIRCLES ON THE LEFT SIDE OF THE LARGER CIRCLE ARE GREY AND THE REMAINING THREE SMALL CIRCLES ON THE CENTER AND UPPER RIGHT SIDE OF THE LARGER CIRCLE ARE BLUE.

FOR AIR PURIFYING APPARATUS AND AIR IONIZATION APPARATUS FOR HOUSEHOLD PURPOSES (U.S. CLS. 13, 21, 23, 31 AND 34).

FIRST USE 11-0-2010; IN COMMERCE 11-0-2010.  
TINA BROWN, EXAMINING ATTORNEY

SN 85-325,972. ELIOSOLAR, BEVERLY HILLS, CA. FILED 5-20-2011.

**eliosolar hybrid shade**

THE MARK CONSISTS OF STANDARD CHARACTERS WITHOUT CLAIM TO ANY PARTICULAR FONT, STYLE, SIZE, OR COLOR.

NO CLAIM IS MADE TO THE EXCLUSIVE RIGHT TO USE "HYBRID SHADE", APART FROM THE MARK AS SHOWN.

FOR SOLAR COLLECTORS (U.S. CLS. 13, 21, 23, 31 AND 34).

FIRST USE 5-1-2011; IN COMMERCE 5-1-2011.  
IRA J. GOODSaid, EXAMINING ATTORNEY

**CLASS 11—(Continued).**

SN 85-326,901. XPRESS BATH, INC., PURCHASE, NY. FILED 5-22-2011.

**Xpress Bath**

THE MARK CONSISTS OF STANDARD CHARACTERS WITHOUT CLAIM TO ANY PARTICULAR FONT, STYLE, SIZE, OR COLOR.

NO CLAIM IS MADE TO THE EXCLUSIVE RIGHT TO USE "BATH", APART FROM THE MARK AS SHOWN.

FOR BATHS, BATHTUBS, WHIRLPOOL BATHS AND BATH INSTALLATIONS; SIDE-ENTRY BATHS FOR USE BY THE PHYSICALLY HANDICAPPED (U.S. CLS. 13, 21, 23, 31 AND 34).

FIRST USE 3-1-2009; IN COMMERCE 3-1-2009.  
LOURDES AYALA, EXAMINING ATTORNEY

SN 85-328,255. GOLIGHT, INC, CULBERTSON, NE. FILED 5-24-2011.

**JANUS**

THE MARK CONSISTS OF STANDARD CHARACTERS WITHOUT CLAIM TO ANY PARTICULAR FONT, STYLE, SIZE, OR COLOR.

FOR SEARCHLIGHTS (U.S. CLS. 13, 21, 23, 31 AND 34).  
LINDA ESTRADA, EXAMINING ATTORNEY

SN 85-329,419. BUSINESS RUSSIA, LLC, MOSCOW, RUSSIAN FED., FILED 5-25-2011.

**Robopop**

THE MARK CONSISTS OF STANDARD CHARACTERS WITHOUT CLAIM TO ANY PARTICULAR FONT, STYLE, SIZE, OR COLOR.

FOR POPCORN POPPING MACHINE (U.S. CLS. 13, 21, 23, 31 AND 34).

PAULA MAHONEY, EXAMINING ATTORNEY

**CLASS 11—(Continued).**

SN 85-330,566. HANGZHOU LI-TECH ELECTRIC CO., LTD., LIN'AN, ZHEJIANG, CHINA, FILED 5-26-2011.

# ***BATEC***

THE MARK CONSISTS OF THE STYLIZED WORD "BATEC".

THE WORDING BATEC HAS NO MEANING IN A FOREIGN LANGUAGE.

FOR ELECTRIC LAMPS; INCANDESCENT LAMPS AND THEIR FITTINGS; LAMP GLASSES; LAMPS; LANTERNS FOR LIGHTING; LIGHT BULBS; LIGHTED PARTY-THEMED DECORATIONS, ELECTRIC LIGHT DECORATIVE STRINGS; SAFETY LAMPS FOR UNDERGROUND USE; ULTRAVIOLET LAMPS NOT FOR MEDICAL PURPOSES; STREET LAMPS (U.S. CLS. 13, 21, 23, 31 AND 34).

FIRST USE 5-28-2005; IN COMMERCE 12-20-2010.  
JOSETTE BEVERLY, EXAMINING ATTORNEY

---

SN 85-331,046. THE AGENCY ACBH, INC., LINCOLN UNIVERSITY, PA. FILED 5-26-2011.

# **PartsmasterPro**

THE MARK CONSISTS OF STANDARD CHARACTERS WITHOUT CLAIM TO ANY PARTICULAR FONT, STYLE, SIZE, OR COLOR.

FOR PLUMBING FITTINGS, NAMELY, AERATORS FOR FAUCETS; PLUMBING FITTINGS, NAMELY, BAFFLES; PLUMBING FITTINGS, NAMELY, BIBBS; PLUMBING FITTINGS, NAMELY, COCKS; PLUMBING FITTINGS, NAMELY, COUPLERS; PLUMBING FITTINGS, NAMELY, DRAINS; PLUMBING FITTINGS, NAMELY, FAUCET FILTERS; PLUMBING FITTINGS, NAMELY, SHOWER CONTROL VALVES; PLUMBING FITTINGS, NAMELY, SINK STRAINERS; PLUMBING FITTINGS, NAMELY, SPOUTS; PLUMBING FITTINGS, NAMELY, TRAPS; PLUMBING FITTINGS, NAMELY, TUB CONTROL VALVES; PLUMBING FITTINGS, NAMELY, VALVES; PLUMBING FIXTURES, NAMELY, SHOWER MIXERS; PLUMBING FIXTURES, NAMELY, SHOWER SPRAYERS; PLUMBING FIXTURES, NAMELY, SINK SPRAYERS; PLUMBING FIXTURES, NAMELY, SINK TRAPS; PLUMBING SUPPLIES, NAMELY, SINK STRAINERS; STRAINERS FOR PLUMBING DRAINS (U.S. CLS. 13, 21, 23, 31 AND 34).

EMILY CARLSEN, EXAMINING ATTORNEY

**CLASS 11—(Continued).**

SN 85-331,140. THE AGENCY ACBH, INC., LINCOLN UNIVERSITY, PA. FILED 5-26-2011.

# **(pm)<sup>P</sup>**

THE MARK CONSISTS OF THE SMALL LETTERS P AND M IN PARENTHESIS FOLLOWED BY THE SMALL LETTER P AS A SUPERSCRIPIT.

FOR FLEXIBLE PIPES BEING PARTS OF BASIN PLUMBING INSTALLATIONS; FLEXIBLE PIPES BEING PARTS OF BATH PLUMBING INSTALLATIONS; FLEXIBLE PIPES BEING PARTS OF SHOWER PLUMBING INSTALLATIONS; FLEXIBLE PIPES BEING PARTS OF SINK PLUMBING INSTALLATIONS; MANUALLY-OPERATED PLUMBING VALVES; PLUMBING FITTINGS, NAMELY, AERATORS FOR FAUCETS; PLUMBING FITTINGS, NAMELY, BAFFLES; PLUMBING FITTINGS, NAMELY, BIBBS; PLUMBING FITTINGS, NAMELY, COCKS; PLUMBING FITTINGS, NAMELY, COUPLERS; PLUMBING FITTINGS, NAMELY, DRAINS; PLUMBING FITTINGS, NAMELY, FAUCET FILTERS; PLUMBING FITTINGS, NAMELY, SHOWER CONTROL VALVES; PLUMBING FITTINGS, NAMELY, SINK STRAINERS; PLUMBING FITTINGS, NAMELY, SPOUTS; PLUMBING FITTINGS, NAMELY, TRAPS; PLUMBING FITTINGS, NAMELY, TUB CONTROL VALVES; PLUMBING FITTINGS, NAMELY, VALVES; PLUMBING FIXTURES, NAMELY, SHOWER MIXERS; PLUMBING FIXTURES, NAMELY, SHOWER SPRAYERS; PLUMBING FIXTURES, NAMELY, SINK SPRAYERS; PLUMBING FIXTURES, NAMELY, SINK TRAPS; PLUMBING SUPPLIES, NAMELY, SINK STRAINERS; STRAINERS FOR PLUMBING DRAINS (U.S. CLS. 13, 21, 23, 31 AND 34).

EMILY CARLSEN, EXAMINING ATTORNEY

---

SN 85-331,498. BE AEROSPACE, INC., WELLINGTON, FL. FILED 5-26-2011.

# **ESSENCE**

THE MARK CONSISTS OF STANDARD CHARACTERS WITHOUT CLAIM TO ANY PARTICULAR FONT, STYLE, SIZE, OR COLOR.

FOR AIRPLANE GALLERY EQUIPMENT, NAMELY, ELECTRIC FOOD AND BEVERAGE PREPARATION UNITS, NAMELY, COOKING OVENS, COFFEE MAKERS, HOT WATER DISPENSERS; FOOD AND BEVERAGE CHILLING UNITS, NAMELY, REFRIGERATORS, FREEZERS AND BEVERAGE DISPENSERS; AND FOOD AND BEVERAGE HEATING UNITS (U.S. CLS. 13, 21, 23, 31 AND 34).

RENEE MCCRAY, EXAMINING ATTORNEY



**CLASS 11—(Continued).**

SN 85-332,363. O'BRIEN, TRUMAN, VASHON, WA. FILED 5-27-2011.



NO CLAIM IS MADE TO THE EXCLUSIVE RIGHT TO USE "CONDUCTIVE HEATING PRODUCTS", APART FROM THE MARK AS SHOWN.

THE MARK CONSISTS OF A STYLIZED ORCHESTRA CONDUCTOR WITH A BATON AND A BOWTIE. THE ARMS FORM AN ARC INSIDE OF WHICH IS A PERFECTLY CIRCULAR SOLID HEAD, AND THE TEXT "MAESTRO CONDUCTIVE HEATING PRODUCTS" IN A STACKED FORMATION TO THE RIGHT.

FOR ELECTRIC HEATER FOR OFFICE AND HOUSEHOLD USE, NAMELY, CONDUCTIVE HEATING CHAIR MATS (U.S. CLS. 13, 21, 23, 31 AND 34).

FIRST USE 4-15-2011; IN COMMERCE 4-25-2011.  
WENDY JUN, EXAMINING ATTORNEY

**CLASS 11—(Continued).**

SN 85-332,753. HESHAN GMY LIGHTING & ELECTRICAL CO., LTD., HESHAN CITY, GUANGDONG, CHINA, FILED 5-27-2011.

# COMYAN

THE MARK CONSISTS OF THE TERM COMYAN IN STYLIZED FONT WITH AN ARC-SHAPED CUT-OUT EXTENDING FROM THE FIRST LETTER "C" TO THE LAST LETTER "N".

FOR ELECTRIC LIGHT BULBS; ELECTRIC LAMPS; SPOTLIGHTS; AQUARIUM LIGHTS; LIGHTS FOR VEHICLES; LIGHTING APPARATUS, NAMELY, LIGHTING INSTALLATIONS; LIGHTING FIXTURES; ULTRAVIOLET RAY LAMPS, NOT FOR MEDICAL PURPOSES; CULTIVATION LAMPS AND PARTS THEREOF, NAMELY, HIGH PRESSURE SODIUM, METAL HALIDE, PLASMA, AND LIGHT EMITTING DIODE; LIGHT EMITTING DIODE LIGHTING FIXTURES FOR USE IN DISPLAY, COMMERCIAL, INDUSTRIAL, RESIDENTIAL, AND ARCHITECTURAL ACCENT LIGHTING APPLICATIONS; LED AND HID LIGHT FIXTURES; LED LIGHTING SYSTEMS, NAMELY, LED MODULES, POWER SUPPLIES, AND WIRING; LED LUMINARIES; LED UNDERWATER LIGHTS; RED LED FLASHLIGHTS FOR ILLUMINATION PURPOSES; WATER PURIFICATION INSTALLATIONS; WATER STERILIZERS; WATER TREATMENT EQUIPMENT, NAMELY, ULTRAVIOLET STERILIZATION UNITS; SUSTAINABLE ONSITE WATER RECYCLING AND WASTEWATER TREATMENT SYSTEMS; AIR STERILIZERS; AIR PURIFYING APPARATUS AND MACHINES; SANITIZING APPARATUS FOR LINENS USING ULTRAVIOLET LIGHT, OZONE STERILIZATION AND LOW PRESSURE TECHNIQUES; DISINFECTING ULTRAVIOLET LAMPS HOUSED IN A CONTAINER OR COVER FOR DISINFECTING OBJECTS PLACED THEREIN; HUMIDIFIERS; DRYING APPARATUS FOR USE IN HEATING, VENTILATION SYSTEMS, AIR CONDITIONING SYSTEMS AND REFRIGERATION SYSTEMS; INTERIOR ENVIRONMENT CONTROL SYSTEM FOR COMMERCIAL BUILDINGS, NAMELY, HEATERS, VENTILATORS AND HUMIDIFIERS ALL SOLD AS A UNIT; ELECTRIC RADIATORS; ELECTRIC SPACE HEATERS; PORTABLE ELECTRIC HEATERS; HEATING INSTALLATIONS (U.S. CLS. 13, 21, 23, 31 AND 34).

FIRST USE 4-27-2011; IN COMMERCE 4-27-2011.  
DEBRA LEE, EXAMINING ATTORNEY

SN 85-333,092. SOLAROASIS, LLC, RENO, NV. FILED 5-28-2011.

# ACCUSTAR

THE MARK CONSISTS OF STANDARD CHARACTERS WITHOUT CLAIM TO ANY PARTICULAR FONT, STYLE, SIZE, OR COLOR.

FOR LED (LIGHT EMITTING DIODES) LIGHTING FIXTURES FOR USE IN DISPLAY, COMMERCIAL, INDUSTRIAL, RESIDENTIAL, AND ARCHITECTURAL ACCENT LIGHTING APPLICATIONS (U.S. CLS. 13, 21, 23, 31 AND 34).

FIRST USE 2-14-2011; IN COMMERCE 5-31-2011.  
PRISCILLA MILTON, EXAMINING ATTORNEY

**CLASS 11—(Continued).**

SN 85-334,030. NEWMAN, DENICE, CHESTERFIELD, MI. FILED 5-31-2011.

# SQUATSHOT

THE MARK CONSISTS OF STANDARD CHARACTERS WITHOUT CLAIM TO ANY PARTICULAR FONT, STYLE, SIZE, OR COLOR.

FOR PORTABLE TOILETS (U.S. CLS. 13, 21, 23, 31 AND 34).

APRIL HESIK, EXAMINING ATTORNEY

SN 85-335,048. MICHAEL RYAN, CARMEL, CA. FILED 6-1-2011.

# PLAY IT SAFE

THE MARK CONSISTS OF STANDARD CHARACTERS WITHOUT CLAIM TO ANY PARTICULAR FONT, STYLE, SIZE, OR COLOR.

FOR STERILIZERS (U.S. CLS. 13, 21, 23, 31 AND 34).

KATHY DE JONGE, EXAMINING ATTORNEY

SN 85-335,600. NEPTUN LIGHT, INC., LAKE BLUFF, IL. FILED 6-1-2011.

# ADPOSTER

THE MARK CONSISTS OF STANDARD CHARACTERS WITHOUT CLAIM TO ANY PARTICULAR FONT, STYLE, SIZE, OR COLOR.

FOR ELECTRIC LIGHTING FIXTURES (U.S. CLS. 13, 21, 23, 31 AND 34).

SANI KHOURI, EXAMINING ATTORNEY

**CLASS 11—(Continued).**

SN 85-335,971. ICERA LLC, EL SEGUNDO, CA. FILED 6-2-2011.

# Icera

THE MARK CONSISTS OF STANDARD CHARACTERS WITHOUT CLAIM TO ANY PARTICULAR FONT, STYLE, SIZE, OR COLOR.

FOR BATHTUBS; WHIRLPOOL BATHS; SHOWERS AND SHOWER INSTALLATIONS, NAMELY, SHOWER RECEPTORS; SHOWER AND BATH CUBICLES; SHOWER HEADS; SHOWER DOORS; WATER DIVERTERS FOR SHOWERS AND BATHS; BATH SPOUTS; BIDETS; LAVATORIES; SINKS; PEDESTALS, NAMELY, SINK PEDESTALS AND LAVATORY PEDESTALS; TOILETS; TOILET BOWLS; TOILET SEATS; WATER CISTERNS, NAMELY, TOILET TANKS; URINALS; TOUCHLESS FLUSHING APPARATUS, NAMELY, TOUCHLESS WATER CONTROL VALVE; LIGHTING FIXTURES; TAPS; FAUCETS; WATER CONTROL VALVES FOR FAUCETS; TOUCHLESS FAUCETS; STRAINERS FOR USE WITH PLUMBING FIXTURES, NAMELY, SINKS AND URINALS; AND DRINKING FOUNTAINS (U.S. CLS. 13, 21, 23, 31 AND 34).

FIRST USE 2-2-2010; IN COMMERCE 2-2-2010.

PAM WILLIS, EXAMINING ATTORNEY

SN 85-336,128. RADIX POWER AND ENERGY CORPORATION, SETAUKET, NY. FILED 6-2-2011.

# RADIX

THE MARK CONSISTS OF THE STYLIZED VERSION OF THE LETTERS "RADIX".

FOR NUCLEAR GENERATORS, NUCLEAR POWER PLANTS, NUCLEAR REACTORS, POWER PLANTS, AND ENERGY STORAGE PLANTS (U.S. CLS. 13, 21, 23, 31 AND 34).

DAVID C. REIHNER, EXAMINING ATTORNEY

SN 85-336,437. KAZ USA, INC., SOUTHBOROUGH, MA. FILED 6-2-2011.

# Pro Care

THE MARK CONSISTS OF STANDARD CHARACTERS WITHOUT CLAIM TO ANY PARTICULAR FONT, STYLE, SIZE, OR COLOR.

FOR AIR FILTERS FOR DOMESTIC USE; HUMIDIFIERS (U.S. CLS. 13, 21, 23, 31 AND 34).

KEVIN CORWIN, EXAMINING ATTORNEY

**CLASS 11—(Continued).**

SN 85-336,475. PRODUCT INNOVATIONS LICENSING, LLC, SPRING LAKE, MI. FILED 6-2-2011.

# Hot Sok

THE MARK CONSISTS OF STANDARD CHARACTERS WITHOUT CLAIM TO ANY PARTICULAR FONT, STYLE, SIZE, OR COLOR.

FOR APPARATUS FOR MELTING BUILDING AND ROOF ICE AND SNOW (U.S. CLS. 13, 21, 23, 31 AND 34).  
FIRST USE 10-31-2009; IN COMMERCE 10-31-2009.  
EMILY CHUO, EXAMINING ATTORNEY

**CLASS 11—(Continued).**

SN 85-337,087. LED LIGHT & POWER, LLC, LAS VEGAS, NV. FILED 6-3-2011.

# ADAPTATUBE

THE MARK CONSISTS OF STANDARD CHARACTERS WITHOUT CLAIM TO ANY PARTICULAR FONT, STYLE, SIZE, OR COLOR.

FOR LED (LIGHT EMITTING DIODE) LAMPS (U.S. CLS. 13, 21, 23, 31 AND 34).  
TAMARA FRAZIER, EXAMINING ATTORNEY

SN 85-336,553. LED LENSER CORPORATION, LTD, YANG-JIANG, GUANGDONG, CHINA, FILED 6-2-2011.

## CREATING NEW WORLDS OF LIGHT.

THE MARK CONSISTS OF STANDARD CHARACTERS WITHOUT CLAIM TO ANY PARTICULAR FONT, STYLE, SIZE, OR COLOR.

FOR FLASHLIGHTS (U.S. CLS. 13, 21, 23, 31 AND 34).  
TRACY CROSS, EXAMINING ATTORNEY

SN 85-336,573. LED LENSER CORPORATION, LTD, YANG-JIANG, GUANGDONG, CHINA, FILED 6-2-2011.



THE COLOR(S) RED IS/ARE CLAIMED AS A FEATURE OF THE MARK.

THE MARK CONSISTS OF A RED CIRCLE WITH A SURROUNDING THIN RED CIRCLE.  
FOR FLASHLIGHTS (U.S. CLS. 13, 21, 23, 31 AND 34).  
TRACY CROSS, EXAMINING ATTORNEY

SN 85-338,122. PROJECT RESPONDER PUBLIC SAFETY EQUIPMENT, ST. LOUIS, MO. FILED 6-4-2011.

THE MARK CONSISTS OF THE WORDING "SHOCKWING", STYLIZED WITH A HORIZONTAL BREAK ALONG THE LENGTH OF THE WORDS, AND BEVELING. THEN THERE ARE STYLIZED "WINGS" ON EACH END OF THE WORDS.

FOR LIGHT BARS FOR VEHICLES, NAMELY, EXTERIOR, REAR-MOUNTED, OEM-STYLE, LED LIGHT BARS FOR THE REAR OF SPORTS UTILITY VEHICLES (U.S. CLS. 13, 21, 23, 31 AND 34).

FIRST USE 4-18-2011; IN COMMERCE 4-18-2011.  
KIM SAITO, EXAMINING ATTORNEY

SN 85-339,244. JERDON STYLE, LLC, VERNON HILLS, IL. FILED 6-6-2011.

# PROVERSA

THE MARK CONSISTS OF STANDARD CHARACTERS WITHOUT CLAIM TO ANY PARTICULAR FONT, STYLE, SIZE, OR COLOR.

FOR HAIR DRYERS FOR COMMERCIAL AND DOMESTIC USE; HAND-HELD ELECTRIC HAIR DRYERS; STATIONARY HAIR DRYERS FOR COMMERCIAL AND DOMESTIC USE (U.S. CLS. 13, 21, 23, 31 AND 34).

MIDGE BUTLER, EXAMINING ATTORNEY

**CLASS 11—(Continued).**

SN 85-341,071. UNI, TUSTIN, CA. FILED 6-8-2011.



THE MARK CONSISTS OF STYLIZED LETTER "U".  
 FOR PLUMBING FITTINGS, NAMELY PEX FITTINGS; PLUMBING FITTINGS, NAMELY, AERATORS FOR FAUCETS; PLUMBING FITTINGS, NAMELY, DRAINS; PLUMBING FITTINGS, NAMELY, VALVES; PLUMBING FIXTURES, NAMELY, SHOWER MIXERS; PLUMBING FIXTURES, NAMELY, SHOWER SPRAYERS (U.S. CLS. 13, 21, 23, 31 AND 34).  
 FIRST USE 1-1-2000; IN COMMERCE 1-1-2000.  
 MATTHEW KLINE, EXAMINING ATTORNEY

SN 85-341,425. WESTINGHOUSE LIGHTING CORPORATION, PHILADELPHIA, PA. FILED 6-8-2011.

# ECO-SOL

THE MARK CONSISTS OF STANDARD CHARACTERS WITHOUT CLAIM TO ANY PARTICULAR FONT, STYLE, SIZE, OR COLOR.  
 FOR ELECTRIC LIGHT BULBS; LED LIGHT BULBS; LIGHT BULBS (U.S. CLS. 13, 21, 23, 31 AND 34).  
 ANDREA HACK, EXAMINING ATTORNEY

**CLASS 11—(Continued).**

SN 85-356,686. FERGUSON ENTERPRISES, INC., NEWPORT NEWS, VA. FILED 6-27-2011.

# BRADENTON

THE MARK CONSISTS OF STANDARD CHARACTERS WITHOUT CLAIM TO ANY PARTICULAR FONT, STYLE, SIZE, OR COLOR.

OWNER OF U.S. REG. NO. 3,974,966.

FOR PLUMBING FIXTURES, NAMELY, BATH TUB JETS, WHIRLPOOL BATHS, BATH INSTALLATIONS; FAUCET SPRAYERS; BIDETS; DRAIN STRUCTURES FOR USE IN SPAS, STEAM ROOMS AND BATHS; SITZ BATHS; SPOUTS FOR AFFIXING ON WALLS FOR BATHS, BASINS, BIDETS; SHOWERS, SHOWER HEADS, HAND HELD SHOWER HEADS, HAND SHOWERS, HAND HELD SHOWERS, SHOWER SPRAYERS, SHOWER HEAD SPRAYERS, SHOWER MIXERS, SHOWER AND BATH CUBICLES, SHOWER BASES, SHOWER CONTROL FITTINGS, NAMELY, ESCUTCHEONS, SHOWER DOORS, SHOWER ENCLOSURES, SHOWER FAUCET EXTENSIONS, SHOWER PANELS, SHOWER SURROUNDS, SHOWER TRAYS, SHOWER TUBS; ELECTRIC TOWEL WARMERS, INDOOR ELECTRIC LIGHTING FIXTURES AND CEILING FANS AND STAINLESS STEEL SINK BOTTOM GRIDS SPECIALLY ADAPTED AND SHAPED FOR USE IN SINKS (U.S. CLS. 13, 21, 23, 31 AND 34).

INGRID C. EULIN, EXAMINING ATTORNEY

SN 85-356,697. FERGUSON ENTERPRISES, INC., NEWPORT NEWS, VA. FILED 6-27-2011.

# CORDOBA

THE MARK CONSISTS OF STANDARD CHARACTERS WITHOUT CLAIM TO ANY PARTICULAR FONT, STYLE, SIZE, OR COLOR.

OWNER OF U.S. REG. NO. 3,535,254.

FOR PLUMBING FIXTURES, NAMELY, BATH TUB JETS, WHIRLPOOL BATHS, BATH INSTALLATIONS; FAUCET SPRAYERS; BIDETS; DRAIN STRUCTURES FOR USE IN SPAS, STEAM ROOMS AND BATHS; SITZ BATHS; SPOUTS FOR AFFIXING ON WALLS FOR BATHS, BASINS, BIDETS; SHOWERS, SHOWER HEADS, HAND HELD SHOWER HEADS, HAND SHOWERS, HAND HELD SHOWERS, SHOWER SPRAYERS, SHOWER HEAD SPRAYERS, SHOWER MIXERS, SHOWER AND BATH CUBICLES, SHOWER BASES, SHOWER CONTROL FITTINGS, NAMELY, ESCUTCHEONS, SHOWER DOORS, SHOWER ENCLOSURES, SHOWER FAUCET EXTENSIONS, SHOWER PANELS, SHOWER SURROUNDS, SHOWER TRAYS, SHOWER TUBS; ELECTRIC TOWEL WARMERS, INDOOR ELECTRIC LIGHTING FIXTURES AND CEILING FANS AND STAINLESS STEEL SINK BOTTOM GRIDS SPECIALLY ADAPTED AND SHAPED FOR USE IN SINKS (U.S. CLS. 13, 21, 23, 31 AND 34).

INGRID C. EULIN, EXAMINING ATTORNEY

**CLASS 11—(Continued).**

SN 85-356,706. FERGUSON ENTERPRISES, INC., NEWPORT NEWS, VA. FILED 6-27-2011.

**EDENTON**

THE MARK CONSISTS OF STANDARD CHARACTERS WITHOUT CLAIM TO ANY PARTICULAR FONT, STYLE, SIZE, OR COLOR.

OWNER OF U.S. REG. NO. 3,962,133.

FOR PLUMBING FIXTURES, NAMELY, BATH TUB JETS, WHIRLPOOL BATHS, BATH INSTALLATIONS; FAUCET SPRAYERS; BIDETS; DRAIN STRUCTURES FOR USE IN SPAS, STEAM ROOMS AND BATHS; SITZ BATHS; SPOUTS FOR AFFIXING ON WALLS FOR BATHS, BASINS, BIDETS; SHOWERS, SHOWER HEADS, HAND HELD SHOWER HEADS, HAND SHOWERS, HAND HELD SHOWERS, SHOWER SPRAYERS, SHOWER HEAD SPRAYERS, SHOWER MIXERS, SHOWER AND BATH CUBICLES, SHOWER BASES, SHOWER CONTROL FITTINGS, NAMELY, ESCUTCHEONS, SHOWER DOORS, SHOWER ENCLOSURES, SHOWER FAUCET EXTENSIONS, SHOWER PANELS, SHOWER SURROUNDS, SHOWER TRAYS, SHOWER TUBS; ELECTRIC TOWEL WARMERS, INDOOR ELECTRIC LIGHTING FIXTURES AND CEILING FANS AND STAINLESS STEEL SINK BOTTOM GRIDS SPECIALLY ADAPTED AND SHAPED FOR USE IN SINKS (U.S. CLS. 13, 21, 23, 31 AND 34).

INGRID C. EULIN, EXAMINING ATTORNEY

**CLASS 11—(Continued).**

SN 85-356,722. FERGUSON ENTERPRISES, INC., NEWPORT NEWS, VA. FILED 6-27-2011.

**MARICOPA**

THE MARK CONSISTS OF STANDARD CHARACTERS WITHOUT CLAIM TO ANY PARTICULAR FONT, STYLE, SIZE, OR COLOR.

OWNER OF U.S. REG. NO. 3,966,697.

FOR PLUMBING FIXTURES, NAMELY, BATH TUB JETS, WHIRLPOOL BATHS, BATH INSTALLATIONS; FAUCET SPRAYERS; BIDETS; DRAIN STRUCTURES FOR USE IN SPAS, STEAM ROOMS AND BATHS; SITZ BATHS; SPOUTS FOR AFFIXING ON WALLS FOR BATHS, BASINS, BIDETS; SHOWERS, SHOWER HEADS, HAND HELD SHOWER HEADS, HAND SHOWERS, HAND HELD SHOWERS, SHOWER SPRAYERS, SHOWER HEAD SPRAYERS, SHOWER MIXERS, SHOWER AND BATH CUBICLES, SHOWER BASES, SHOWER CONTROL FITTINGS, NAMELY, ESCUTCHEONS, SHOWER DOORS, SHOWER ENCLOSURES, SHOWER FAUCET EXTENSIONS, SHOWER PANELS, SHOWER SURROUNDS, SHOWER TRAYS, SHOWER TUBS; ELECTRIC TOWEL WARMERS, INDOOR ELECTRIC LIGHTING FIXTURES AND CEILING FANS AND STAINLESS STEEL SINK BOTTOM GRIDS SPECIALLY ADAPTED AND SHAPED FOR USE IN SINKS (U.S. CLS. 13, 21, 23, 31 AND 34).

INGRID C. EULIN, EXAMINING ATTORNEY

SN 85-356,712. FERGUSON ENTERPRISES, INC., NEWPORT NEWS, VA. FILED 6-27-2011.

**KEY WEST**

THE MARK CONSISTS OF STANDARD CHARACTERS WITHOUT CLAIM TO ANY PARTICULAR FONT, STYLE, SIZE, OR COLOR.

FOR PLUMBING FIXTURES, NAMELY, BATH TUB JETS, WHIRLPOOL BATHS, BATH INSTALLATIONS; FAUCET SPRAYERS; BIDETS; DRAIN STRUCTURES FOR USE IN SPAS, STEAM ROOMS AND BATHS; SITZ BATHS; SPOUTS FOR AFFIXING ON WALLS FOR BATHS, BASINS, BIDETS; SHOWERS, SHOWER HEADS, HAND HELD SHOWER HEADS, HAND SHOWERS, HAND HELD SHOWERS, SHOWER SPRAYERS, SHOWER HEAD SPRAYERS, SHOWER MIXERS, SHOWER AND BATH CUBICLES, SHOWER BASES, SHOWER CONTROL FITTINGS, NAMELY, ESCUTCHEONS, SHOWER DOORS, SHOWER ENCLOSURES, SHOWER FAUCET EXTENSIONS, SHOWER PANELS, SHOWER SURROUNDS, SHOWER TRAYS, SHOWER TUBS; ELECTRIC TOWEL WARMERS, INDOOR ELECTRIC LIGHTING FIXTURES AND CEILING FANS AND STAINLESS STEEL SINK BOTTOM GRIDS SPECIALLY ADAPTED AND SHAPED FOR USE IN SINKS (U.S. CLS. 13, 21, 23, 31 AND 34).

INGRID C. EULIN, EXAMINING ATTORNEY

SN 85-356,735. FERGUSON ENTERPRISES, INC., NEWPORT NEWS, VA. FILED 6-27-2011.

**ST AUGUSTINE**

THE MARK CONSISTS OF STANDARD CHARACTERS WITHOUT CLAIM TO ANY PARTICULAR FONT, STYLE, SIZE, OR COLOR.

OWNER OF U.S. REG. NO. 3,966,703.

FOR PLUMBING FIXTURES, NAMELY, BATH TUB JETS, WHIRLPOOL BATHS, BATH INSTALLATIONS; FAUCET SPRAYERS; BIDETS; DRAIN STRUCTURES FOR USE IN SPAS, STEAM ROOMS AND BATHS; SITZ BATHS; SPOUTS FOR AFFIXING ON WALLS FOR BATHS, BASINS, BIDETS; SHOWERS, SHOWER HEADS, HAND HELD SHOWER HEADS, HAND SHOWERS, HAND HELD SHOWERS, SHOWER SPRAYERS, SHOWER HEAD SPRAYERS, SHOWER MIXERS, SHOWER AND BATH CUBICLES, SHOWER BASES, SHOWER CONTROL FITTINGS, NAMELY, ESCUTCHEONS, SHOWER DOORS, SHOWER ENCLOSURES, SHOWER FAUCET EXTENSIONS, SHOWER PANELS, SHOWER SURROUNDS, SHOWER TRAYS, SHOWER TUBS; ELECTRIC TOWEL WARMERS, INDOOR ELECTRIC LIGHTING FIXTURES AND CEILING FANS AND STAINLESS STEEL SINK BOTTOM GRIDS SPECIALLY ADAPTED AND SHAPED FOR USE IN SINKS (U.S. CLS. 13, 21, 23, 31 AND 34).

INGRID C. EULIN, EXAMINING ATTORNEY

**CLASS 11—(Continued).**

SN 85-373,273. AS IP HOLDCO, LLC, PISCATAWAY, NJ.  
FILED 7-17-2011.

# EQUILITY

THE MARK CONSISTS OF STANDARD CHARACTERS  
WITHOUT CLAIM TO ANY PARTICULAR FONT, STYLE,  
SIZE, OR COLOR.

FOR SINKS (U.S. CLS. 13, 21, 23, 31 AND 34).  
FIRST USE 1-1-2010; IN COMMERCE 1-1-2010.  
THOMAS MANOR, EXAMINING ATTORNEY

---

SN 85-373,279. AS IP HOLDCO, LLC, PISCATAWAY, NJ.  
FILED 7-17-2011.

# CALLA

THE MARK CONSISTS OF STANDARD CHARACTERS  
WITHOUT CLAIM TO ANY PARTICULAR FONT, STYLE,  
SIZE, OR COLOR.

FOR BATH TUBS; BIDETS; LAVATORIES; TOILETS  
(U.S. CLS. 13, 21, 23, 31 AND 34).  
FIRST USE 1-1-2005; IN COMMERCE 1-1-2005.  
THOMAS MANOR, EXAMINING ATTORNEY

---

SN 85-375,863. AS IP HOLDCO, LLC, PISCATAWAY, NJ.  
FILED 7-20-2011.

# VALERA

THE MARK CONSISTS OF STANDARD CHARACTERS  
WITHOUT CLAIM TO ANY PARTICULAR FONT, STYLE,  
SIZE, OR COLOR.

FOR FAUCETS (U.S. CLS. 13, 21, 23, 31 AND 34).  
THOMAS MANOR, EXAMINING ATTORNEY

**CLASS 11—(Continued).**

SN 85-375,888. AS IP HOLDCO, LLC, PISCATAWAY, NJ.  
FILED 7-20-2011.

# WESLEY

THE MARK CONSISTS OF STANDARD CHARACTERS  
WITHOUT CLAIM TO ANY PARTICULAR FONT, STYLE,  
SIZE, OR COLOR.

FOR FAUCETS (U.S. CLS. 13, 21, 23, 31 AND 34).  
THOMAS MANOR, EXAMINING ATTORNEY

---

SN 85-375,927. AS IP HOLDCO, LLC, PISCATAWAY, NJ.  
FILED 7-20-2011.

# AVERY

THE MARK CONSISTS OF STANDARD CHARACTERS  
WITHOUT CLAIM TO ANY PARTICULAR FONT, STYLE,  
SIZE, OR COLOR.

FOR FAUCETS (U.S. CLS. 13, 21, 23, 31 AND 34).  
THOMAS MANOR, EXAMINING ATTORNEY

---

SN 85-397,055. AG GLOBAL PRODUCTS, LLC, LOS AN-  
GELES, CA. FILED 8-12-2011.

# RUNWAY

THE MARK CONSISTS OF STANDARD CHARACTERS  
WITHOUT CLAIM TO ANY PARTICULAR FONT, STYLE,  
SIZE, OR COLOR.

OWNER OF U.S. REG. NO. 3,745,815.  
FOR HAIR DRYERS (U.S. CLS. 13, 21, 23, 31 AND 34).  
GINA FINK, EXAMINING ATTORNEY

---

SN 85-397,056. AG GLOBAL PRODUCTS, LLC, LOS AN-  
GELES, CA. FILED 8-12-2011.

# PLATFORM

THE MARK CONSISTS OF STANDARD CHARACTERS  
WITHOUT CLAIM TO ANY PARTICULAR FONT, STYLE,  
SIZE, OR COLOR.

OWNER OF U.S. REG. NO. 3,572,293.  
FOR HAIR DRYERS (U.S. CLS. 13, 21, 23, 31 AND 34).  
GINA FINK, EXAMINING ATTORNEY

**CLASS 11—(Continued).**

SN 85-397,341. SOLAROASIS, LLC, RENO, NV. FILED 8-13-2011.

# FRESHSTAR

THE MARK CONSISTS OF STANDARD CHARACTERS WITHOUT CLAIM TO ANY PARTICULAR FONT, STYLE, SIZE, OR COLOR.

FOR LED (LIGHT EMITTING DIODES) LIGHTING FIXTURES FOR USE IN DISPLAY, COMMERCIAL, INDUSTRIAL, RESIDENTIAL, AND ARCHITECTURAL ACCENT LIGHTING APPLICATIONS (U.S. CLS. 13, 21, 23, 31 AND 34).

FIRST USE 6-9-2011; IN COMMERCE 7-22-2011.  
PRISCILLA MILTON, EXAMINING ATTORNEY

SN 85-403,818. OSRAM SYLVANIA INC., DANVERS, MA. FILED 8-22-2011.

# SYLVANIA

THE MARK CONSISTS OF STANDARD CHARACTERS WITHOUT CLAIM TO ANY PARTICULAR FONT, STYLE, SIZE, OR COLOR.

OWNER OF U.S. REG. NOS. 434,729, 3,687,126 AND OTHERS.

FOR HOLIDAY LIGHTING CONSISTING OF INCANDESCENT AND LED LIGHTING (U.S. CLS. 13, 21, 23, 31 AND 34).

FIRST USE 4-0-2007; IN COMMERCE 4-0-2007.  
HEATHER THOMPSON, EXAMINING ATTORNEY

**CLASS 12—VEHICLES**

SN 78-800,334. ROKON INTERNATIONAL, INC., ROCHESTER, NH. FILED 1-26-2006.

# SCOUT

THE MARK CONSISTS OF STANDARD CHARACTERS WITHOUT CLAIM TO ANY PARTICULAR FONT, STYLE, SIZE, OR COLOR.

FOR DUAL-WHEEL DRIVE HEAVY-DUTY MOTORCYCLES FOR OFF-ROAD USE (U.S. CLS. 19, 21, 23, 31, 35 AND 44).

FIRST USE 12-31-1981; IN COMMERCE 12-31-1981.  
GEOFFREY FOSDICK, EXAMINING ATTORNEY

**CLASS 12—(Continued).**

SN 79-081,711. SHANGHAI JILONG ECONOMY; DEVELOPMENT CO., LTD., CHINA, FILED 3-31-2010.



OWNER OF INTERNATIONAL REGISTRATION 1036326 DATED 3-31-2010, EXPIRES 3-31-2020.

THE MARK CONSISTS OF THE STYLIZED WORDING "Z-RAY" WITH A STINGRAY APPEARING BEHIND THE LETTER "Z".

FOR BOATS; SHIPS' HULLS; OARS; LAUNCHES; YACHTS; SCULLS; PADDLES FOR CANOES; FENDERS FOR SHIPS (U.S. CLS. 19, 21, 23, 31, 35 AND 44).

DARRYL SPRUILL, EXAMINING ATTORNEY

SN 79-091,997. BAYERISCHE MOTOREN WERKE AKTIENGESELLSCHAFT, 80809 MÜNCHEN, FED REP GERMANY, FILED 12-15-2010.

# LifeDrive

THE MARK CONSISTS OF STANDARD CHARACTERS WITHOUT CLAIM TO ANY PARTICULAR FONT, STYLE, SIZE, OR COLOR.

PRIORITY DATE OF 7-26-2010 IS CLAIMED.

OWNER OF INTERNATIONAL REGISTRATION 1063516 DATED 12-15-2010, EXPIRES 12-15-2020.

FOR AUTOMOBILES AND PARTS THEREFOR, NAMELY, STRUCTURAL PARTS COMPRISING VEHICLE BODY, BODYWORK, BODY SHELL, FLOOR ASSEMBLY, AND DEFORMATION ELEMENTS, CHASSIS, DRIVE MECHANISMS, NAMELY, VEHICLE POWER TRAIN MECHANISM COMPRISED OF CLUTCH, TRANSMISSION, DRIVE SHAFT, DIFFERENTIAL, AND CONTROL APPARATUS, AUTOMOBILE ENGINES AND CRASH-SAFETY MECHANISMS, NAMELY, VEHICLE-MOUNTED MOTOR VEHICLE CRASH ATTENUATORS AND IMPACT ABSORBING MECHANISMS (U.S. CLS. 19, 21, 23, 31, 35 AND 44).

NAPOLEON SHARMA, EXAMINING ATTORNEY

SN 79-094,482. SIEMENS AKTIENGESELLSCHAFT, 80333 MÜNCHEN, FED REP GERMANY, FILED 2-23-2011.

# lighttree

THE MARK CONSISTS OF STANDARD CHARACTERS WITHOUT CLAIM TO ANY PARTICULAR FONT, STYLE, SIZE, OR COLOR.

PRIORITY DATE OF 9-20-2010 IS CLAIMED.

OWNER OF INTERNATIONAL REGISTRATION 1069494 DATED 2-23-2011, EXPIRES 2-23-2021.

FOR RAIL VEHICLES, NAMELY, TRAINS AND RAILCARS; STRUCTURAL PARTS OF TRAINS AND RAILCARS; METAL HANDHOLDS AND INTEGRATED LIGHTING SOLD AS A COMPONENT PART OF TRAINS AND RAILCARS (U.S. CLS. 19, 21, 23, 31, 35 AND 44).

JOHN GARTNER, EXAMINING ATTORNEY

**CLASS 12—(Continued).**

SN 79-094,606. REGGIANA MACCHINE UTENSILI SRL, ITALY, FILED 12-14-2010.



PRIORITY DATE OF 12-10-2010 IS CLAIMED.  
 OWNER OF INTERNATIONAL REGISTRATION 1069804 DATED 12-14-2010, EXPIRES 12-14-2020.  
 NO CLAIM IS MADE TO THE EXCLUSIVE RIGHT TO USE "MOTO", APART FROM THE MARK AS SHOWN.  
 THE COLOR(S) RED, WHITE, GREEN AND BLACK IS/ARE CLAIMED AS A FEATURE OF THE MARK.  
 THE MARK CONSISTS OF THE WORDING "RMU MOTO" IN STYLIZED LETTERING. THE LETTER "R" IS IN BLACK OUTLINED, GREEN QUADRILATERAL ABOVE THE LETTER; THE LETTER "M" IS IN BLACK OUTLINED, WHITE LETTERING WITH A BLACK OUTLINED, WHITE PENTAGON ABOVE AND A BLACK OUTLINED, WHITE TRIANGLE BELOW THE LETTER; THE LETTER "U" IS IN BLACK OUTLINED, RED LETTERING, WITH A BLACK OUTLINED, RED QUADRILATERAL ABOVE AND THE WORDING "OTO" IN RED OUTLINED, BLACK LETTERING BELOW THE LETTER.  
 THE ENGLISH TRANSLATION OF "MOTO" IN THE MARK IS "MOTORCYCLE".  
 FOR MOTORCYCLES (U.S. CLS. 19, 21, 23, 31, 35 AND 44).  
 JULIE VEPPUMTHARA, EXAMINING ATTORNEY

**CLASS 12—(Continued).**

SN 79-098,244. NIHON TIGER-DENKI CO., LTD, JAPAN, FILED 4-25-2011.



OWNER OF INTERNATIONAL REGISTRATION 1079627 DATED 4-25-2011, EXPIRES 4-25-2021.  
 NO CLAIM IS MADE TO THE EXCLUSIVE RIGHT TO USE "AIR BIKE", APART FROM THE MARK AS SHOWN.  
 THE MARK CONSISTS OF THE WORDING "AIR BIKE" IN STYLIZED FONT APPEARING OVER A BAND WITH CURVED ENDS.  
 FOR TWO-WHEELED CAR; MOTORCYCLES; BICYCLES; FOLD TYPE BICYCLES; ELECTRIC MOTORIZED BICYCLES; SCOOTERS (U.S. CLS. 19, 21, 23, 31, 35 AND 44).  
 KATHERINE E. HALMEN, EXAMINING ATTORNEY

SN 79-096,860. TOYO TIRE & RUBBER CO., LTD., JAPAN, FILED 3-28-2011.

**WINTER GRAPPLER**

THE MARK CONSISTS OF STANDARD CHARACTERS WITHOUT CLAIM TO ANY PARTICULAR FONT, STYLE, SIZE, OR COLOR.  
 PRIORITY DATE OF 3-4-2011 IS CLAIMED.  
 OWNER OF INTERNATIONAL REGISTRATION 1075660 DATED 3-28-2011, EXPIRES 3-28-2021.  
 OWNER OF U.S. REG. NOS. 3,230,678, 3,390,759 AND OTHERS.  
 NO CLAIM IS MADE TO THE EXCLUSIVE RIGHT TO USE "WINTER", APART FROM THE MARK AS SHOWN.  
 FOR TIRES FOR AUTOMOBILES; INNER TUBES FOR AUTOMOBILE TIRES; WHEELS FOR AUTOMOBILES; AUTOMOBILES AND THEIR STRUCTURAL PARTS (U.S. CLS. 19, 21, 23, 31, 35 AND 44).  
 CARRIE GENOVESE, EXAMINING ATTORNEY

SN 79-098,323. CONTINENTAL REIFEN DEUTSCHLAND GMBH, FED REP GERMANY, FILED 4-28-2011.

**Conti ATTACK**

PRIORITY DATE OF 1-20-2011 IS CLAIMED.  
 OWNER OF INTERNATIONAL REGISTRATION 1079820 DATED 4-28-2011, EXPIRES 4-28-2021.  
 OWNER OF U.S. REG. NOS. 622,300, 3,918,993 AND OTHERS.  
 FOR TIRES, SOLID RUBBER TIRES, COMPLETE TIRES, TUBES FOR TIRES (U.S. CLS. 19, 21, 23, 31, 35 AND 44).  
 DORITT L. CARROLL, EXAMINING ATTORNEY



**CLASS 12—(Continued).**

SN 79-099,466. KRONAN TRADEMARK AB, SWEDEN,  
FILED 4-18-2011.



OWNER OF INTERNATIONAL REGISTRATION 1082867  
DATED 4-18-2011, EXPIRES 1-22-2022.

OWNER OF U.S. REG. NO. 3,261,411.

THE MARK CONSISTS OF THE WORD "KRONAN" WITH  
A PORTION OF A CROWN ABOVE THE WORDING, ALL  
WITHIN A SHADED SQUARE.

THE ENGLISH TRANSLATION OF "KRONAN" IN THE  
MARK IS "CROWN".

FOR BICYCLES, BICYCLE BRAKES, BICYCLE TIRES,  
BICYCLE SPOKES, BICYCLE RIMS, BICYCLES CHAINS,  
BICYCLE PUMPS, BICYCLE FRAMES, BICYCLE BELLS,  
BICYCLE SADDLES, BICYCLE HANDLE BARS, BI-  
CYCLE STANDS, STUDS FOR TIRES, WHEELS TIGH-  
TENERS, NAMELY, WHEEL HUBS FOR BICYCLES,  
SPRING SHOCK ABSORBERS FOR VEHICLES, BRAKE  
SHOES FOR LAND VEHICLES, SUSPENSION SHOCK  
ABSORBERS FOR VEHICLES, HUBS FOR VEHICLE  
WHEELS, BICYCLE WHEELS, LUGGAGE CARRIERS  
FOR VEHICLES, INNER TUBES FOR BICYCLES, RE-  
PAIR KITS FOR INNER TUBES, NAMELY, ADHESIVE  
RUBBER PATCHES FOR REPAIRING TUBES OR TIRES,  
TIRE LINERS, TIRE VALVES FOR VEHICLE TIRES,  
VALVE STEMS FOR VEHICLE TIRES, AND VEHICLE  
TIRE VALVE STEM CAPS, SADDLE COVERS FOR  
BICYCLES, SEAT COVERS FOR VEHICLES, MUD-  
GUARDS, ANTI-THEFT DEVICES FOR VEHICLES,  
VALVES FOR VEHICLE TIRES, GEARS FOR BICYCLES,  
BASKETS ADAPTED FOR BICYCLES, PANNIERS BAGS  
ADAPTED FOR BICYCLES, BABY CARRIAGES, TAI-  
LORED COVERS FOR BABY CARRIAGES, PUSH  
CHAIRS, PUSH CHAIRS HOODS FOR BABY CAR-  
RIAGES, SLEEPING CARS, STROLLERS, PUSH CHAIR  
COVERS, MOTOR VEHICLE CHASSIS (U.S. CLS. 19, 21,  
23, 31, 35 AND 44).

TAMARA FRAZIER, EXAMINING ATTORNEY

**CLASS 12—(Continued).**

SN 85-107,755. MEGAN RACING, INC, CITY OF INDUSTRY,  
CA. FILED 8-14-2010.



NO CLAIM IS MADE TO THE EXCLUSIVE RIGHT TO  
USE "WHEELS", APART FROM THE MARK AS SHOWN.  
THE COLOR(S) RED, BLACK AND WHITE IS/ARE  
CLAIMED AS A FEATURE OF THE MARK.

THE MARK CONSISTS OF A BLACK CIRCLE THAT HAS  
A WHITE BORDER THEN AN EXTERIOR BLACK BORDER  
WITHIN THE CIRCLE IS A RED LETTER "G" WITH THE  
WORD "WHEELS" APPEARING IN WHITE BENEATH THE  
"G".

FOR WHEELS (U.S. CLS. 19, 21, 23, 31, 35 AND 44).  
CHRISTINA SOBRAL, EXAMINING ATTORNEY

SN 85-146,254. WORLD TRIATHLON CORPORATION, TAM-  
PA, FL. FILED 10-6-2010.



OWNER OF U.S. REG. NOS. 2,908,850 AND 2,945,327.

THE MARK CONSISTS OF A GRAPHICAL ELEMENT  
DEPICTING A FANCIFUL BUTTERFLY THAT MIGHT  
EVOKE A HUMAN FIGURE DOING A JUMPING JACK.

FOR BICYCLES (U.S. CLS. 19, 21, 23, 31, 35 AND 44).

FIRST USE 10-1-2010; IN COMMERCE 10-1-2010.  
RONALD DELGIZZI, EXAMINING ATTORNEY

**CLASS 12—(Continued).**

SN 85-156,614. LOVING, JAMES, ST PETERSBURG, FL.  
FILED 10-20-2010.

**BOATBOSS**

THE MARK CONSISTS OF STANDARD CHARACTERS WITHOUT CLAIM TO ANY PARTICULAR FONT, STYLE, SIZE, OR COLOR.

FOR BOAT HOOKS, MASTS FOR BOATS, DAVITS FOR BOATS; VESSELS, NAMELY, DREDGER BOATS, FERRY BOATS, SCREW PROPELLERS FOR BOATS (U.S. CLS. 19, 21, 23, 31, 35 AND 44).

FIRST USE 6-11-2005; IN COMMERCE 6-25-2005.

ERIN FALK, EXAMINING ATTORNEY

**CLASS 12—(Continued).**

SN 85-174,197. ULTRA MANUFACTURING LIMITED,  
KITCHENER, ONTARIO, CANADA, FILED 11-11-2010.

**ULTRACYCLE**

THE MARK CONSISTS OF STANDARD CHARACTERS WITHOUT CLAIM TO ANY PARTICULAR FONT, STYLE, SIZE, OR COLOR.

OWNER OF CANADA REG. NO. TMA802,523, DATED 7-20-2011, EXPIRES 7-20-2026.

FOR FUNCTIONAL AND DECORATIVE PLASTIC PARTS FOR AUTOMOBILES MANUFACTURED USING A SPECIAL TECHNOLOGY TO REDUCE THE INCIDENCE OF DEFECTS, NAMELY, INTERIOR PLASTIC DECORATIVE AND PROTECTIVE TRIM FOR THE INSTRUMENT PANEL, INTERIOR DECORATIVE TRIM FOR THE FRONT AND REAR DOORS, GLOVEBOX, CENTER STACK BEZEL, CLUSTER BEZEL, FLOOR CONSOLE, CUPHOLDER, OVERHEAD CONSOLE, RADIO BEZEL, REAR SEAT CONSOLE, REAR SEAT CUPHOLDER, AND AIR VENT COVERINGS, ALL BEING STRUCTURAL PARTS OF AUTOMOBILES (U.S. CLS. 19, 21, 23, 31, 35 AND 44).

CARYN GLASSER, EXAMINING ATTORNEY

SN 85-177,604. MICHELIN NORTH AMERICA, INC.,  
GREENVILLE, SC. FILED 11-16-2010.

**DEFENDER**

THE MARK CONSISTS OF STANDARD CHARACTERS WITHOUT CLAIM TO ANY PARTICULAR FONT, STYLE, SIZE, OR COLOR.

FOR PNEUMATIC TIRES FOR PASSENGER CARS (U.S. CLS. 19, 21, 23, 31, 35 AND 44).

CURTIS FRENCH, EXAMINING ATTORNEY

SN 85-174,194. ULTRA MANUFACTURING LIMITED,  
KITCHENER, ONTARIO, CANADA, FILED 11-11-2010.

**ULTRATHERM**

THE MARK CONSISTS OF STANDARD CHARACTERS WITHOUT CLAIM TO ANY PARTICULAR FONT, STYLE, SIZE, OR COLOR.

OWNER OF CANADA REG. NO. TMA802,522, DATED 7-20-2011, EXPIRES 7-20-2026.

FOR FUNCTIONAL AND DECORATIVE PLASTIC PARTS FOR AUTOMOBILES MANUFACTURED USING A SPECIAL TECHNOLOGY TO REDUCE THE INCIDENCE OF DEFECTS, NAMELY, INTERIOR PLASTIC DECORATIVE AND PROTECTIVE TRIM FOR THE INSTRUMENT PANEL, INTERIOR DECORATIVE TRIM FOR THE FRONT AND REAR DOORS, GLOVEBOX, CENTER STACK BEZEL, CLUSTER BEZEL, FLOOR CONSOLE, CUPHOLDER, OVERHEAD CONSOLE, RADIO BEZEL, REAR SEAT CONSOLE, REAR SEAT CUPHOLDER, AND AIR VENT COVERINGS, ALL BEING STRUCTURAL PARTS OF AUTOMOBILES (U.S. CLS. 19, 21, 23, 31, 35 AND 44).

CARYN GLASSER, EXAMINING ATTORNEY

SN 85-180,136. D & L CHAIN INC., AUMSVILLE, OR. FILED  
11-18-2010.

**POWER TOOTH**

THE MARK CONSISTS OF STANDARD CHARACTERS WITHOUT CLAIM TO ANY PARTICULAR FONT, STYLE, SIZE, OR COLOR.

NO CLAIM IS MADE TO THE EXCLUSIVE RIGHT TO USE "TOOTH", APART FROM THE MARK AS SHOWN.

FOR DRIVE CHAIN SPROCKETS FOR LAND VEHICLES, TRAILERS AND AGRICULTURAL VEHICLES (U.S. CLS. 19, 21, 23, 31, 35 AND 44).

MELISSA VALLILLO, EXAMINING ATTORNEY

**CLASS 12—(Continued).**

SN 85-185,485. GUSTAV MAGENWIRTH GMBH & CO. KG, 72574 BAD URACH, FED REP GERMANY, FILED 11-26-2010.

# MT

THE MARK CONSISTS OF STANDARD CHARACTERS WITHOUT CLAIM TO ANY PARTICULAR FONT, STYLE, SIZE, OR COLOR.

PRIORITY CLAIMED UNDER SEC. 44(D) ON FED REP GERMANY APPLICATION NO. 302010032619, FILED 5-29-2010, REG. NO. 302010032619, DATED 7-14-2010, EXPIRES 5-29-2020.

FOR BICYCLE DISC BRAKES AND STRUCTURAL PARTS THEREOF (U.S. CLS. 19, 21, 23, 31, 35 AND 44).  
KRISTINA MORRIS, EXAMINING ATTORNEY

---

SN 85-187,040. DEKA PRODUCTS LIMITED PARTNERSHIP, MANCHESTER, NH. FILED 11-30-2010.

# MOBIUS

THE MARK CONSISTS OF STANDARD CHARACTERS WITHOUT CLAIM TO ANY PARTICULAR FONT, STYLE, SIZE, OR COLOR.

FOR VEHICLES, NAMELY, MOTORIZED WHEELCHAIRS TO PROVIDE MULTIPLE FUNCTIONS FOR INDIVIDUALS WITH MOBILITY-RELATED DISABILITY (U.S. CLS. 19, 21, 23, 31, 35 AND 44).

ANN E. SAPPENFIELD, EXAMINING ATTORNEY

---

SN 85-187,995. STOMPTECH INDUSTRIES, INC., CLEARWATER, MN. FILED 12-1-2010.

# Stompertech

THE MARK CONSISTS OF STANDARD CHARACTERS WITHOUT CLAIM TO ANY PARTICULAR FONT, STYLE, SIZE, OR COLOR.

FOR ALL-TERRAIN VEHICLES, CAMPERS, RECREATIONAL WATERCRAFT, NAMELY, MOTORIZED VESSELS EQUIPPED TO PROVIDE ICE FISHING HOUSING, LAND VEHICLES SPECIFICALLY AFFIXED WITH DEER STANDS, OFF ROAD CAMPERS, TRAILERS, LAND VEHICLES FOR HUNTING, ATV TRAILERS, AND RECREATIONAL VEHICLE PARTS AND ACCESSORIES, NAMELY, SCISSOR LIFTS THAT ARE SPECIFICALLY MOUNTED TO LAND VEHICLES TO LIFT OUTDOOR EQUIPMENT, TRAILER FRAMES THAT ARE SPECIFICALLY DESIGNED TO MOUNT TO LAND VEHICLES TO HAUL EQUIPMENT, AND PULL OUT CANOPIES SPECIFICALLY DESIGNED TO AFFIX TO LAND VEHICLES (U.S. CLS. 19, 21, 23, 31, 35 AND 44).

FIRST USE 12-1-2010; IN COMMERCE 2-1-2011.  
JUDITH HELFMAN, EXAMINING ATTORNEY

**CLASS 12—(Continued).**

SN 85-203,207. METRO INDUSTRIES, INC., WILKES-BARRE, PA. FILED 12-21-2010.

# METRO SECURERX

THE MARK CONSISTS OF STANDARD CHARACTERS WITHOUT CLAIM TO ANY PARTICULAR FONT, STYLE, SIZE, OR COLOR.

OWNER OF U.S. REG. NOS. 1,483,039, 1,557,853 AND OTHERS.

FOR CARTS, NAMELY, COMPUTERIZED AND NON-COMPUTERIZED CARTS IN THE NATURE OF MOTORIZED AND NON-MOTORIZED CARTS, FOR THE DELIVERY OF MEDICATIONS (U.S. CLS. 19, 21, 23, 31, 35 AND 44).

RONALD DELGIZZI, EXAMINING ATTORNEY

---

SN 85-205,629. JOY INDUSTRIAL CO., LTD., TAICHUNG HSIEN, TAIWAN, FILED 12-25-2010.



THE MARK CONSISTS OF THE HIGHLY STYLIZED LETTER "D" NEXT TO THE LETTERS "IENATRONIC" FORMING ONE WORD "DIENATRONIC".

FOR BICYCLE AND BICYCLE PARTS AND ACCESSORIES, NAMELY, BICYCLE FRAME, FOLDING BIKE, BICYCLE FORK, BICYCLE SEAT POST, BICYCLE STEM, BICYCLE REAR SHOCK, BICYCLE RIM, BICYCLE SADDLE, BICYCLE SADDLE CUSHION, BICYCLE WHEEL, BICYCLE HUB, BICYCLE CRANK, BICYCLE PUMP, BICYCLE MUDGUARD, BICYCLE CARRIER FOR VEHICLES, MOTORIZED ELECTRIC SCOOTERS, ELECTRIC BICYCLES, ELECTRIC-ASSISTED BICYCLES; MOTORCYCLE PARTS AND ACCESSORIES, NAMELY, MOTORCYCLE BRAKES, MOTORCYCLE WHEEL, MOTORCYCLE WHEEL HUBS, MOTORCYCLE SHOCK ABSORBERS, MOTORCYCLE CLUTCH BRAKE LEVER, MOTORCYCLE RIM LOCKING NUTS (U.S. CLS. 19, 21, 23, 31, 35 AND 44).

FIRST USE 4-20-2010; IN COMMERCE 4-20-2010.  
MICHAEL KEATING, EXAMINING ATTORNEY

**CLASS 12—(Continued).**

SN 85-222,970. LAM INDUSTRIES INC, IOWA PARK, TX.  
FILED 1-21-2011.



THE MARK CONSISTS OF A TRACTOR SILHOUETTE COMPOSED OF TWO GEAR DESIGNS AND AN IRREGULAR LINE.

FOR REPLACEMENT PARTS AND STRUCTURAL COMPONENTS FOR AGRICULTURAL TRACTORS (U.S. CLS. 19, 21, 23, 31, 35 AND 44).

FIRST USE 3-10-2006; IN COMMERCE 3-10-2006.  
TIMOTHY FINNEGAN, EXAMINING ATTORNEY

SN 85-233,623. LIFT TECHNOLOGIES, INC., WESTMINSTER, SC. FILED 2-3-2011.



OWNER OF U.S. REG. NO. 2,601,772.

THE MARK CONSISTS OF THE WORDS "LIFT-TEK" APPEARING UNDER A STYLIZED DRAWING OF AN OUTLINED GLOBE WITH A SEMI-CIRCULAR ARCH RUNNING ACROSS THE TOP, BOTTOM, LEFT SIDE, AND RIGHT SIDE OF THE INSIDE OF THE GLOBE AND A STRAIGHT LINE RUNNING HORIZONTALLY AND PERPENDICULARLY ACROSS THE CENTER OF THE GLOBE, WHICH INTERSECT IN THE CENTER AND FOUR ARROWS IN A ROW; ONE POINTING LEFT, ONE POINTING UP, ONE POINTING DOWN, AND ONE POINTING RIGHT, WITH THE ARROW POINTING LEFT STARTING AT THE LEFT SIDE OF THE GLOBE AND THE OTHER ARROWS EXTENDING ACROSS THE CENTER OF THE GLOBE.

FOR PARTS FOR FORK LIFT TRUCKS, NAMELY MASTS, CARRIAGES, SIDESHIFTERS, FORK POSITIONERS, CARRIAGE BARS, MAST RAILS, AND TELEHANDLER CARRIAGES (U.S. CLS. 19, 21, 23, 31, 35 AND 44).

FIRST USE 2-28-2009; IN COMMERCE 2-28-2009.  
ESTHER A. BORSUK, EXAMINING ATTORNEY

**CLASS 12—(Continued).**

SN 85-280,983. BROWN, DORSEY M., KINGFISHER, OK.  
FILED 3-30-2011.



NO CLAIM IS MADE TO THE EXCLUSIVE RIGHT TO USE "TRAILERS" AND "CUSTOM BOAT TRAILERS", APART FROM THE MARK AS SHOWN.

THE COLOR(S) GREEN, BLACK, WHITE IS/ARE CLAIMED AS A FEATURE OF THE MARK.

THE MARK CONSISTS THE WORDING "TRAILERS BY DORSEY" IN BLACK WITH A SINGLE GREEN WAVE LINE CUTTING THROUGH THE WORD "TRAILERS". THE WORDING "CUSTOM BOAT TRAILERS" APPEARS UNDERNEATH IN BLACK, ALL INSIDE A RECTANGULAR DESIGN WITH A GREEN OUTLINE ON WHITE BACKGROUND.

FOR RECREATIONAL VEHICLES, NAMELY, TOWABLE TRAILERS (U.S. CLS. 19, 21, 23, 31, 35 AND 44).

FIRST USE 1-3-1993; IN COMMERCE 1-3-1993.  
ALICE BENMAMAN, EXAMINING ATTORNEY

SN 85-290,890. BOKER HOLDINGS, L.L.C., DBA DEMENTED CYCLES, BRIDGEPORT, TX. FILED 4-8-2011.



NO CLAIM IS MADE TO THE EXCLUSIVE RIGHT TO USE "CYCLES", APART FROM THE MARK AS SHOWN.

THE MARK CONSISTS OF THE WORD "DEMENTED" IN AN OVAL SET INSIDE A WING DESIGN WITH SMALL HORNS ON THE TOP WITH THE WORD "CYCLES" BENEATH THE WING PORTION OF THE MARK.

FOR MOTORCYCLES (U.S. CLS. 19, 21, 23, 31, 35 AND 44).

FIRST USE 4-15-2004; IN COMMERCE 4-15-2004.  
INGRID C. EULIN, EXAMINING ATTORNEY

SN 85-312,716. WILLIAM E. KELLY, MANCHESTER, CT.  
FILED 5-4-2011.

**SNOW RAK IT**

THE MARK CONSISTS OF STANDARD CHARACTERS WITHOUT CLAIM TO ANY PARTICULAR FONT, STYLE, SIZE, OR COLOR.

FOR LAND VEHICLE PARTS, NAMELY, SNOW BLOWER SUPPORT BRACKETS FOR ATTACHMENT TO SANDING VEHICLES (U.S. CLS. 19, 21, 23, 31, 35 AND 44).

FIRST USE 4-4-2011; IN COMMERCE 4-4-2011.  
MAYUR VAGHANI, EXAMINING ATTORNEY

**CLASS 12—(Continued).**

SN 85-316,541. RADIO FLYER, INC., CHICAGO, IL. FILED 5-10-2011.

**GLIDE & GO BALANCE BIKE**

THE MARK CONSISTS OF STANDARD CHARACTERS WITHOUT CLAIM TO ANY PARTICULAR FONT, STYLE, SIZE, OR COLOR.

OWNER OF U.S. REG. NO. 3,328,142.

NO CLAIM IS MADE TO THE EXCLUSIVE RIGHT TO USE "BALANCE BIKE", APART FROM THE MARK AS SHOWN.

FOR BICYCLES (U.S. CLS. 19, 21, 23, 31, 35 AND 44).  
KEVIN CORWIN, EXAMINING ATTORNEY

**CLASS 12—(Continued).**

SN 85-320,299. SHOPPERSGARD, INC., PALM BEACH, FL. FILED 5-13-2011.

**TOTGARD**

THE MARK CONSISTS OF STANDARD CHARACTERS WITHOUT CLAIM TO ANY PARTICULAR FONT, STYLE, SIZE, OR COLOR.

FOR SHOPPING CART SEAT LINER (U.S. CLS. 19, 21, 23, 31, 35 AND 44).

FIRST USE 12-0-2009; IN COMMERCE 3-0-2010.

BRIAN PINO, EXAMINING ATTORNEY

SN 85-321,426. HIGH WHEELS SOLUTIONS, LLC, HARLEYSVILLE, PA. FILED 5-16-2011.

**Q-CADDY**

THE MARK CONSISTS OF STANDARD CHARACTERS WITHOUT CLAIM TO ANY PARTICULAR FONT, STYLE, SIZE, OR COLOR.

FOR BICYCLE ACCESSORIES, NAMELY, CLIPS SPECIALLY ADAPTED FOR SECURING SHEETS OF PAPER SUCH AS DIRECTIONS TO BICYCLE HANDLEBARS (U.S. CLS. 19, 21, 23, 31, 35 AND 44).

FIRST USE 3-11-2011; IN COMMERCE 3-11-2011.

CARRIE GENOVESE, EXAMINING ATTORNEY

SN 85-322,277. ALTRIDER, LLC, SEATTLE, WA. FILED 5-16-2011.

**ALTRIDER**

THE MARK CONSISTS OF STANDARD CHARACTERS WITHOUT CLAIM TO ANY PARTICULAR FONT, STYLE, SIZE, OR COLOR.

FOR MOTORCYCLE PARTS AND ACCESSORIES, NAMELY, CRASH BARS, SKID PLATES, LUGGAGE RACKS, HEADLIGHT GUARDS, RADIATOR GUARDS, OIL COOLER GUARDS, SIDE FOOT STANDS, VOLTAGE REGULATOR GUARD, POTENTIOMETER GUARDS, SEATS, MASTER CYLINDER GUARD, EXHAUST GUARDS, FRAME SLIDERS (U.S. CLS. 19, 21, 23, 31, 35 AND 44).

FIRST USE 12-0-2008; IN COMMERCE 3-31-2010.

KAPIL BHANOT, EXAMINING ATTORNEY

SN 85-317,364. POLY PERFORMANCE, INC., SAN LUIS OBISPO, CA. FILED 5-10-2011.



OWNER OF U.S. REG. NO. 3,467,057.

NO CLAIM IS MADE TO THE EXCLUSIVE RIGHT TO USE "SUSPENSION", APART FROM THE MARK AS SHOWN.

THE COLOR(S) RED, BLACK AND WHITE IS/ARE CLAIMED AS A FEATURE OF THE MARK.

THE MARK CONSISTS OF THE STYLIZED LETTER "S" IN RED AND OUTLINED IN WHITE APPEARING ABOVE THE WORDS "SYNERGY SUSPENSION" IN WHITE AND THE WORDS "SYNERGYSUSPENSION.COM" IN WHITE APPEARING IN THE TOP LEFT. ALL OF THIS IS WITHIN A BLACK CIRCLE.

FOR SUSPENSION SYSTEMS FOR LAND VEHICLES (U.S. CLS. 19, 21, 23, 31, 35 AND 44).

FIRST USE 11-1-2010; IN COMMERCE 11-1-2010.

SIMON TENG, EXAMINING ATTORNEY

**CLASS 12—(Continued).**

SN 85-324,349. TRACTOR SUPPLY CO. OF TEXAS, LP, BRENTWOOD, TN. FILED 5-18-2011.



OWNER OF U.S. REG. NOS. 3,307,885 AND 3,420,720.  
THE MARK CONSISTS OF THE WORD GROUNDWORK IN A STYLIZED FONT APPEARING WITHIN A SLIGHTLY ARCHED RECTANGLE BANNER WITH A SEMI CIRCLE PROTRUSION AT THE TOP CENTER. CENTERED ABOVE THE WORD GROUNDWORK AND WITHIN THE SEMI CIRCLE PROTRUSION APPEARS THE IMAGE OF THREE LEAVES.

FOR LAWN AND GARDEN CARTS; WHEELBARROWS (U.S. CLS. 19, 21, 23, 31, 35 AND 44).

REGINA DRUMMOND, EXAMINING ATTORNEY

SN 85-325,087. HAABERG, BJORN, MONTE SERENO, CA. FILED 5-19-2011.



THE MARK CONSISTS OF THE LETTER "M" WITH A CRESCENT MOON ABOVE AND THE LETTER "T" ON THE RIGHT SIDE. UNDERNEATH THERE IS THE STYLIZED TEXT "MOBITOOL".

FOR TRUCK BED STORAGE ORGANIZERS, NAMELY, A PORTABLE TOOL STORAGE UNIT FOR THE BED OF A PICK-UP TRUCK (U.S. CLS. 19, 21, 23, 31, 35 AND 44).

CARYN GLASSER, EXAMINING ATTORNEY

SN 85-330,061. AIRBORNE SYSTEMS NORTH AMERICA OF NJ INC., PENNSAUKEN, NJ. FILED 5-25-2011.

**RAIDER**

THE MARK CONSISTS OF STANDARD CHARACTERS WITHOUT CLAIM TO ANY PARTICULAR FONT, STYLE, SIZE, OR COLOR.

FOR PARACHUTE SYSTEMS, NAMELY, A MAN-CARRYING HARNESS (U.S. CLS. 19, 21, 23, 31, 35 AND 44).

C. DIONNE CLYBURN, EXAMINING ATTORNEY

**CLASS 12—(Continued).**

SN 85-330,083. AIRBORNE SYSTEMS NORTH AMERICA OF NJ INC., PENNSAUKEN, NJ. FILED 5-25-2011.

**INTRUDER**

THE MARK CONSISTS OF STANDARD CHARACTERS WITHOUT CLAIM TO ANY PARTICULAR FONT, STYLE, SIZE, OR COLOR.

FOR PARACHUTE SYSTEMS, NAMELY, A PARACHUTE CANOPY (U.S. CLS. 19, 21, 23, 31, 35 AND 44).

C. DIONNE CLYBURN, EXAMINING ATTORNEY

SN 85-331,056. JAIR TREJO, LLC, SOUTH EL MONTE, CA. FILED 5-26-2011.



THE MARK CONSISTS OF A DESIGN THAT DEPICTS AN ANCHOR. THE TOP PORTION OF THE MARK FEATURES A DESIGN OF A CROWN AND ABOVE THE CROWN IS A DESIGN OF A GLOBE.

FOR DOLLIES (U.S. CLS. 19, 21, 23, 31, 35 AND 44).

WILLIAM VERHOSEK, EXAMINING ATTORNEY

SN 85-331,076. TOYO TIRE & RUBBER CO., LTD., OSAKA, JAPAN, FILED 5-26-2011.

**OPEN COUNTRY XTREME**

THE MARK CONSISTS OF STANDARD CHARACTERS WITHOUT CLAIM TO ANY PARTICULAR FONT, STYLE, SIZE, OR COLOR.

FOR TIRES FOR VEHICLES, INNER TUBES FOR VEHICLE TIRES AND WHEELS FOR VEHICLES (U.S. CLS. 19, 21, 23, 31, 35 AND 44).

STEVEN R. FINE, EXAMINING ATTORNEY

**CLASS 12—(Continued).**

SN 85-331,092. TIANJIN WANDA TYRE GROUP CO., LTD.,  
TIANJIN, CHINA, FILED 5-26-2011.

# H188

THE MARK CONSISTS OF STANDARD CHARACTERS  
WITHOUT CLAIM TO ANY PARTICULAR FONT, STYLE,  
SIZE, OR COLOR.

FOR TIRES (U.S. CLS. 19, 21, 23, 31, 35 AND 44).  
FIRST USE 11-23-2008; IN COMMERCE 1-4-2009.  
VERNA BETH RIRIE, EXAMINING ATTORNEY

**CLASS 12—(Continued).**

SN 85-332,835. FLEXSTEEL INDUSTRIES, INC., DUBUQUE,  
IA. FILED 5-27-2011.

# EXTENDA FLEX

THE MARK CONSISTS OF STANDARD CHARACTERS  
WITHOUT CLAIM TO ANY PARTICULAR FONT, STYLE,  
SIZE, OR COLOR.

OWNER OF U.S. REG. NOS. 1,281,464, 2,734,949 AND  
OTHERS.

FOR VEHICLE SEATING (U.S. CLS. 19, 21, 23, 31, 35  
AND 44).

FIRST USE 5-5-2011; IN COMMERCE 5-5-2011.  
FRED CARL, EXAMINING ATTORNEY

SN 85-332,085. RAMSTAD, ROBERT J., ISANTI, MN. FILED  
5-27-2011.

# BuddyBar

THE MARK CONSISTS OF STANDARD CHARACTERS  
WITHOUT CLAIM TO ANY PARTICULAR FONT, STYLE,  
SIZE, OR COLOR.

FOR TOW BARS FOR VEHICLES; TRAILER HITCHES;  
VEHICLE TOW BARS (U.S. CLS. 19, 21, 23, 31, 35 AND  
44).

JENNIFER VASQUEZ, EXAMINING ATTORNEY

SN 85-333,725. EICHER MOTORS LIMITED, NEW DELHI -  
110 048, INDIA, FILED 5-31-2011.

# ROYAL ENFIELD

THE MARK CONSISTS OF STANDARD CHARACTERS  
WITHOUT CLAIM TO ANY PARTICULAR FONT, STYLE,  
SIZE, OR COLOR.

FOR MOTORBIKES, MOTOR CYCLES, MOTORIZED  
SCOOTERS, MOPEDS AND PARTS THEREFOR,  
NAMELY ENGINES AND SADDLES, SHOCK ABSOR-  
BERS, CLUTCHES, CLUTCH PLATES, BRAKE LININGS,  
WHEELS AND RIMS (U.S. CLS. 19, 21, 23, 31, 35 AND 44).

FIRST USE 0-0-1955; IN COMMERCE 0-0-1998.  
EMILY CARLSEN, EXAMINING ATTORNEY

SN 85-332,271. SYNTEC SEATING SOLUTIONS LLC, STER-  
LING HEIGHTS, MI. FILED 5-27-2011.

# We've saved you a seat

THE MARK CONSISTS OF STANDARD CHARACTERS  
WITHOUT CLAIM TO ANY PARTICULAR FONT, STYLE,  
SIZE, OR COLOR.

FOR SEATS FOR VEHICLES SUCH AS BUSES (U.S.  
CLS. 19, 21, 23, 31, 35 AND 44).

HEATHER SAPP, EXAMINING ATTORNEY

SN 85-334,416. LEOPARD CYCLES, INC., SUNNYVALE, CA.  
FILED 5-31-2011.

# LEOPARD

THE MARK CONSISTS OF STANDARD CHARACTERS  
WITHOUT CLAIM TO ANY PARTICULAR FONT, STYLE,  
SIZE, OR COLOR.

FOR BICYCLE PARTS, NAMELY, FORKS, HEADSETS,  
HANDLEBARS, HANDLEBAR TAPE, HANDLEBAR  
STEMS, SEAT POSTS, SADDLES, CRANK SETS; BI-  
CYCLE WHEELS; FRAMES FOR BICYCLES (U.S. CLS.  
19, 21, 23, 31, 35 AND 44).

FIRST USE 1-1-2005; IN COMMERCE 1-1-2005.  
KYLE PEETE, EXAMINING ATTORNEY

**CLASS 12—(Continued).**

SN 85-334,507. JAIR TREJO, LLC., SOUTH EL MONTE, CA.  
FILED 5-31-2011.

# Brute Dolly

THE MARK CONSISTS OF STANDARD CHARACTERS WITHOUT CLAIM TO ANY PARTICULAR FONT, STYLE, SIZE, OR COLOR.

NO CLAIM IS MADE TO THE EXCLUSIVE RIGHT TO USE "DOLLY", APART FROM THE MARK AS SHOWN.

FOR DOLLIES (U.S. CLS. 19, 21, 23, 31, 35 AND 44).  
H. M. FISHER, EXAMINING ATTORNEY

SN 85-334,706. GENERAL MOTORS LLC, DETROIT, MI.  
FILED 6-1-2011.



THE MARK CONSISTS OF THE DEPICTION OF A STINGRAY.

FOR MOTOR LAND VEHICLES, NAMELY, AUTOMOBILES (U.S. CLS. 19, 21, 23, 31, 35 AND 44).

H. M. FISHER, EXAMINING ATTORNEY

SN 85-334,738. BENDIX SPICER FOUNDATION BRAKE LLC, ELYRIA, OH. FILED 6-1-2011.

# DI-PRO

THE MARK CONSISTS OF STANDARD CHARACTERS WITHOUT CLAIM TO ANY PARTICULAR FONT, STYLE, SIZE, OR COLOR.

OWNER OF U.S. REG. NO. 3,274,429.

FOR BRAKE ACTUATORS, SLACK ADJUSTERS AND AXLE HUBCAPS FOR LAND VEHICLES AND PARTS THEREFOR (U.S. CLS. 19, 21, 23, 31, 35 AND 44).

FIRST USE 11-1-2005. THE MARK WAS FIRST USED ANYWHERE IN A DIFFERENT FORM OTHER THAN THAT SOUGHT TO BE REGISTERED AT LEAST AS EARLY AS 11/01/2005; IN COMMERCE 11-1-2005, THE MARK WAS FIRST USED IN COMMERCE IN A DIFFERENT FORM OTHER THAN THAT SOUGHT TO BE REGISTERED AT LEAST AS EARLY AS 11/01/2005.

EMILY CHUO, EXAMINING ATTORNEY

**CLASS 12—(Continued).**

SN 85-334,828. ATTEO, THOMAS SIMON, ROHNERT PARK, CA. FILED 6-1-2011.



THE MARK CONSISTS OF THE STYLIZED TEXT "LOVE HANDLES". THE L IN "LOVE" IS IN THE FORM OF A TALL, HIGH-HEELED LADIES' BOOT. THE LETTERS "OVE" ARE TO THE RIGHT OF THE BOOT AND ABOVE THE WORD "HANDLES" WHICH IS SPELLED OUT TOWARD THE RIGHT FROM TOE OF THE BOOT.

FOR PARTS OF MOTORCYCLES, NAMELY, HANDLE BARS (U.S. CLS. 19, 21, 23, 31, 35 AND 44).  
ODESSA BIBBINS, EXAMINING ATTORNEY

SN 85-334,893. FULLER BICYCLES, LAWRENCEBURG, KY.  
FILED 6-1-2011.

# FULLER

THE MARK CONSISTS OF STANDARD CHARACTERS WITHOUT CLAIM TO ANY PARTICULAR FONT, STYLE, SIZE, OR COLOR.

FOR BICYCLE FRAMES (U.S. CLS. 19, 21, 23, 31, 35 AND 44).

FIRST USE 7-15-2010; IN COMMERCE 3-6-2011.

RONALD MCMORROW, EXAMINING ATTORNEY

SN 85-335,016. AWOL OUTDOORS, INC., SOMERSET, WI.  
FILED 6-1-2011.

# CAMP365

THE MARK CONSISTS OF STANDARD CHARACTERS WITHOUT CLAIM TO ANY PARTICULAR FONT, STYLE, SIZE, OR COLOR.

FOR FOLDABLE TRAILER ENCLOSURE (U.S. CLS. 19, 21, 23, 31, 35 AND 44).

ELLEN BURNS, EXAMINING ATTORNEY



**CLASS 12—(Continued).**

SN 85-335,064. BENDIX SPICER FOUNDATION BRAKE LLC, ELYRIA, OH. FILED 6-1-2011.

# Versajust

THE MARK CONSISTS OF STANDARD CHARACTERS WITHOUT CLAIM TO ANY PARTICULAR FONT, STYLE, SIZE, OR COLOR.

FOR SLACK ADJUSTERS FOR LAND VEHICLES AND PARTS THEREFOR (U.S. CLS. 19, 21, 23, 31, 35 AND 44).  
FIRST USE 4-30-2011; IN COMMERCE 4-30-2011.  
EMILY CHUO, EXAMINING ATTORNEY

**CLASS 12—(Continued).**

SN 85-336,829. RAD MANUFACTURING, INC., VEYO, UT. FILED 6-2-2011.

# CACR

THE MARK CONSISTS OF STANDARD CHARACTERS WITHOUT CLAIM TO ANY PARTICULAR FONT, STYLE, SIZE, OR COLOR.

FOR TWO-WHEELED MOTORCYCLE PARTS, NAMELY, WHEEL RIMS (U.S. CLS. 19, 21, 23, 31, 35 AND 44).  
FIRST USE 5-1-2007; IN COMMERCE 5-1-2007.  
CHERYL CLAYTON, EXAMINING ATTORNEY

SN 85-335,624. FINELINE INDUSTRIES, INC., MERCED, CA. FILED 6-1-2011.

# TripleFork

THE MARK CONSISTS OF STANDARD CHARACTERS WITHOUT CLAIM TO ANY PARTICULAR FONT, STYLE, SIZE, OR COLOR.

FOR BOATS (U.S. CLS. 19, 21, 23, 31, 35 AND 44).  
JANICE L. MCMORROW, EXAMINING ATTORNEY

SN 85-336,840. RAD MANUFACTURING, INC., VEYO, UT. FILED 6-2-2011.

# CACR

THE MARK CONSISTS OF STYLIZED "CACR".  
FOR TWO-WHEELED MOTORCYCLE PARTS, NAMELY, WHEEL RIMS (U.S. CLS. 19, 21, 23, 31, 35 AND 44).

FIRST USE 5-1-2010; IN COMMERCE 5-1-2010.  
CHERYL CLAYTON, EXAMINING ATTORNEY

SN 85-336,694. ALCOM, INC., WINSLOW, ME. FILED 6-2-2011.

# CARGOPRO TRAILERS

THE MARK CONSISTS OF STANDARD CHARACTERS WITHOUT CLAIM TO ANY PARTICULAR FONT, STYLE, SIZE, OR COLOR.

OWNER OF U.S. REG. NO. 2,487,721.  
NO CLAIM IS MADE TO THE EXCLUSIVE RIGHT TO USE "TRAILERS", APART FROM THE MARK AS SHOWN.  
FOR CARGO TRAILERS (U.S. CLS. 19, 21, 23, 31, 35 AND 44).

FIRST USE 3-0-2000; IN COMMERCE 3-0-2000.  
ALLISON HOLTZ, EXAMINING ATTORNEY

SN 85-337,909. RAD MANUFACTURING, INC., VEYO, UT. FILED 6-3-2011.

# HEX

THE MARK CONSISTS OF STANDARD CHARACTERS WITHOUT CLAIM TO ANY PARTICULAR FONT, STYLE, SIZE, OR COLOR.

FOR TWO-WHEELED MOTORCYCLE PARTS, NAMELY, WHEEL HUBS (U.S. CLS. 19, 21, 23, 31, 35 AND 44).

FIRST USE 1-1-1998; IN COMMERCE 1-1-1998.  
CHERYL CLAYTON, EXAMINING ATTORNEY

**CLASS 12—(Continued).**

SN 85-337,947. RAD MANUFACTURING, INC., VEYO, UT.  
FILED 6-3-2011.



THE MARK CONSISTS OF THE WORDING, "HEX" SURROUNDED BY A HEXAGONAL SHAPED BOX.

FOR TWO-WHEELED MOTORCYCLE PARTS, NAMELY, WHEEL HUBS (U.S. CLS. 19, 21, 23, 31, 35 AND 44).

FIRST USE 5-1-2010; IN COMMERCE 5-1-2010.  
CHERYL CLAYTON, EXAMINING ATTORNEY

SN 85-337,949. AMERI-KART CORP., BRISTOL, IN. FILED 6-3-2011.



FOR MARINE VESSEL PARTS, NAMELY, AN EVAPORATIVE EMISSION CONTROL DEVICE CONSISTING PRIMARILY OF A DECK FITTING FOR FILLING FUEL AND A FUEL VENT; MARINE VESSEL PARTS, NAMELY, A FUEL OVERFILL PREVENTION SYSTEM CONSISTING PRIMARILY OF A DECK FITTING FOR FILLING FUEL AND A FUEL SENSOR (U.S. CLS. 19, 21, 23, 31, 35 AND 44).

HEATHER BIDDULPH, EXAMINING ATTORNEY

SN 85-338,283. JACK D. HERNANDEZ, BOYNTON BEACH, FL. FILED 6-5-2011.

# ecofriend

THE MARK CONSISTS OF STANDARD CHARACTERS WITHOUT CLAIM TO ANY PARTICULAR FONT, STYLE, SIZE, OR COLOR.

FOR AIRPLANES; BICYCLES; BOATS; ELECTRIC CARS; ELECTRIC MOTORS FOR MOTOR CARS; MOTOR VEHICLES, NAMELY, AUTOMOBILES, TRUCKS, VANS, SPORT UTILITY VEHICLES AND STRUCTURAL PARTS THEREFOR; MOTORCYCLES; MOTORIZED GOLF CARTS; RECREATIONAL JET BOATS; UTVS (UTILITY TERRAIN VEHICLES); YACHTS (U.S. CLS. 19, 21, 23, 31, 35 AND 44).

JACLYN KIDWELL WALKER, EXAMINING ATTORNEY

**CLASS 12—(Continued).**

SN 85-338,993. GOODRICH CORPORATION, CHARLOTTE, NC. FILED 6-6-2011.

# FASTBOOT

THE MARK CONSISTS OF STANDARD CHARACTERS WITHOUT CLAIM TO ANY PARTICULAR FONT, STYLE, SIZE, OR COLOR.

OWNER OF U.S. REG. NO. 2,460,551.

SEC. 2(F).

FOR PNEUMATIC AIRCRAFT DEICERS (U.S. CLS. 19, 21, 23, 31, 35 AND 44).

FIRST USE 5-0-1999; IN COMMERCE 5-0-1999.

MARK RADEMACHER, EXAMINING ATTORNEY

SN 85-339,010. JIANGSU GENERAL SCIENCE TECHNOLOGY CO. LTD., WUXI CITY, JIANGSU, CHINA, FILED 6-6-2011.

# TBB

THE MARK CONSISTS OF STANDARD CHARACTERS WITHOUT CLAIM TO ANY PARTICULAR FONT, STYLE, SIZE, OR COLOR.

FOR TIRES (U.S. CLS. 19, 21, 23, 31, 35 AND 44).

KATHERINE STOIDES, EXAMINING ATTORNEY

SN 85-344,174. CARLISLE INTANGIBLE COMPANY, SYRACUSE, NY. FILED 6-13-2011.

# SIDEWALL ARMOR

THE MARK CONSISTS OF STANDARD CHARACTERS WITHOUT CLAIM TO ANY PARTICULAR FONT, STYLE, SIZE, OR COLOR.

NO CLAIM IS MADE TO THE EXCLUSIVE RIGHT TO USE SIDEWALL, APART FROM THE MARK AS SHOWN.

FOR ATV TIRES (U.S. CLS. 19, 21, 23, 31, 35 AND 44).

FLORENTINA BLANDU, EXAMINING ATTORNEY

**CLASS 12—(Continued).**

SN 85-345,319. TECTRAN CORPORATION, CHUNGLI, TAOYUAN, TAIWAN, FILED 6-14-2011.



NO CLAIM IS MADE TO THE EXCLUSIVE RIGHT TO USE "WHEELS", APART FROM THE MARK AS SHOWN.  
 THE MARK CONSISTS OF THE TERM "POLO" WITH THE LETTER "L" IN REVERSE LETTERING SITUATED ABOVE THE ITALICIZED TERM "WHEELS".  
 FOR VEHICLE WHEEL RIMS, WHEEL RIMS FOR TWO-WHEELED MOTOR VEHICLES, VEHICLE WHEEL TIRES (U.S. CLS. 19, 21, 23, 31, 35 AND 44).  
 FIRST USE 1-1-2007; IN COMMERCE 1-1-2007.  
 ANNE MADDEN, EXAMINING ATTORNEY

SN 85-349,168. SEARS BRANDS, LLC, HOFFMAN ESTATES, IL. FILED 6-17-2011.

**ECOHANDLER**

THE MARK CONSISTS OF STANDARD CHARACTERS WITHOUT CLAIM TO ANY PARTICULAR FONT, STYLE, SIZE, OR COLOR.  
 FOR TIRES (U.S. CLS. 19, 21, 23, 31, 35 AND 44).  
 JANICE KIM, EXAMINING ATTORNEY

SN 85-353,894. YAMAHA HATSUDOKI KABUSHIKI KAISHA, SHIZUOKA-KEN, JAPAN, FILED 6-23-2011.

**WORLD CROSSER**

THE MARK CONSISTS OF STANDARD CHARACTERS WITHOUT CLAIM TO ANY PARTICULAR FONT, STYLE, SIZE, OR COLOR.  
 FOR MOTORCYCLES AND STRUCTURAL PARTS THEREFOR (U.S. CLS. 19, 21, 23, 31, 35 AND 44).  
 REGINA DRUMMOND, EXAMINING ATTORNEY

**CLASS 12—(Continued).**

SN 85-357,299. ALCOM, INC., WINSLOW, ME. FILED 6-27-2011.

**SNOPRO TRAILERS**

THE MARK CONSISTS OF STANDARD CHARACTERS WITHOUT CLAIM TO ANY PARTICULAR FONT, STYLE, SIZE, OR COLOR.  
 NO CLAIM IS MADE TO THE EXCLUSIVE RIGHT TO USE "TRAILERS", APART FROM THE MARK AS SHOWN.  
 FOR CARGO TRAILERS (U.S. CLS. 19, 21, 23, 31, 35 AND 44).  
 FIRST USE 3-0-2000; IN COMMERCE 3-0-2000.  
 ALLISON HOLTZ, EXAMINING ATTORNEY

SN 85-359,792. HARO BICYCLE CORPORATION, VISTA, CA. FILED 6-29-2011.

**HARO BIKES**

THE MARK CONSISTS OF STANDARD CHARACTERS WITHOUT CLAIM TO ANY PARTICULAR FONT, STYLE, SIZE, OR COLOR.  
 OWNER OF U.S. REG. NO. 1,477,581.  
 NO CLAIM IS MADE TO THE EXCLUSIVE RIGHT TO USE "BIKES", APART FROM THE MARK AS SHOWN.  
 FOR BICYCLE FRAMES; BICYCLE PARTS, NAMELY, FORKS; BICYCLE PARTS, NAMELY, HANDLE BAR STEMS; BICYCLE SEAT POSTS; BICYCLE SEATS; BICYCLES; HANDLEBARS (U.S. CLS. 19, 21, 23, 31, 35 AND 44).  
 MORGAN WYNNE, EXAMINING ATTORNEY

SN 85-376,912. GENERAL MOTORS LLC, DETROIT, MI. FILED 7-21-2011.

**SEASON OF DOING**

THE MARK CONSISTS OF STANDARD CHARACTERS WITHOUT CLAIM TO ANY PARTICULAR FONT, STYLE, SIZE, OR COLOR.  
 FOR MOTOR LAND VEHICLES, NAMELY, AUTOMOBILES, SPORT UTILITY VEHICLES, TRUCKS AND VANS (U.S. CLS. 19, 21, 23, 31, 35 AND 44).  
 H. M. FISHER, EXAMINING ATTORNEY

**CLASS 12—(Continued).**

SN 85-388,002. GENERAL MOTORS LLC, DETROIT, MI.  
FILED 8-3-2011.

# LS3

THE MARK CONSISTS OF STANDARD CHARACTERS  
WITHOUT CLAIM TO ANY PARTICULAR FONT, STYLE,  
SIZE, OR COLOR.

FOR ENGINES FOR LAND VEHICLES (U.S. CLS. 19,  
21, 23, 31, 35 AND 44).

FIRST USE 12-31-2006; IN COMMERCE 12-31-2006.  
H. M. FISHER, EXAMINING ATTORNEY

---

SN 85-388,033. GENERAL MOTORS LLC, DETROIT, MI.  
FILED 8-3-2011.

# LS9

THE MARK CONSISTS OF STANDARD CHARACTERS  
WITHOUT CLAIM TO ANY PARTICULAR FONT, STYLE,  
SIZE, OR COLOR.

FOR ENGINES FOR LAND VEHICLES (U.S. CLS. 19,  
21, 23, 31, 35 AND 44).

FIRST USE 12-31-2009; IN COMMERCE 12-31-2009.  
H. M. FISHER, EXAMINING ATTORNEY

---

SN 85-388,064. GENERAL MOTORS LLC, DETROIT, MI.  
FILED 8-3-2011.

# LS7

THE MARK CONSISTS OF STANDARD CHARACTERS  
WITHOUT CLAIM TO ANY PARTICULAR FONT, STYLE,  
SIZE, OR COLOR.

FOR ENGINES FOR LAND VEHICLES (U.S. CLS. 19,  
21, 23, 31, 35 AND 44).

FIRST USE 12-31-2006; IN COMMERCE 12-31-2006.  
H. M. FISHER, EXAMINING ATTORNEY

**CLASS 12—(Continued).**

SN 85-392,045. TBC TRADEMARKS, LLC, LAS VEGAS, NV.  
FILED 8-8-2011.

# ENHANCE

THE MARK CONSISTS OF STANDARD CHARACTERS  
WITHOUT CLAIM TO ANY PARTICULAR FONT, STYLE,  
SIZE, OR COLOR.

FOR TIRES (U.S. CLS. 19, 21, 23, 31, 35 AND 44).  
SCOTT BIBB, EXAMINING ATTORNEY

---

SN 85-412,476. MELONE, FRANCIS, HUNTINGTON, NY.  
FILED 8-31-2011.



THE MARK CONSISTS OF THE WORD SEATSHIRT,  
WRITTEN IN CAPITAL LETTERS INSIDE AN IRREGULAR  
PENTAGON.

FOR FITTED FABRIC COVER FOR MOTOR VEHICLE  
SEATS (U.S. CLS. 19, 21, 23, 31, 35 AND 44).

FIRST USE 5-27-1999; IN COMMERCE 5-27-1999.  
TRACY FLETCHER, EXAMINING ATTORNEY

**CLASS 13—FIREARMS**

---

SN 85-002,816. TAURUS INTERNATIONAL MANUFAC-  
TURING INC., MIAMI, FL. FILED 3-31-2010.

# ROCKET PISTOL

THE MARK CONSISTS OF STANDARD CHARACTERS  
WITHOUT CLAIM TO ANY PARTICULAR FONT, STYLE,  
SIZE, OR COLOR.

NO CLAIM IS MADE TO THE EXCLUSIVE RIGHT TO  
USE "PISTOL", APART FROM THE MARK AS SHOWN.

FOR HANDGUN WEAPONS USING AN EXPLOSIVE  
CHARGE AS A PROPELLANT (U.S. CLS. 2 AND 9).

JOHN SCHUYLER YARD, EXAMINING ATTORNEY

**CLASS 13—(Continued).**

SN 85-129,980. DIEHL BGT DEFENCE GMBH & CO. KG, UEBERLINGEN, FED REP GERMANY, FILED 9-15-2010.

# BUSSARD

THE MARK CONSISTS OF STANDARD CHARACTERS WITHOUT CLAIM TO ANY PARTICULAR FONT, STYLE, SIZE, OR COLOR.

PRIORITY CLAIMED UNDER SEC. 44(D) ON ERP NCNTY TM OFC APPLICATION NO. 009086992, FILED 4-23-2010, REG. NO. 009086992, DATED 9-28-2010, EXPIRES 4-23-2020.

THE ENGLISH TRANSLATION OF "BUSSARD" IN THE MARK IS "BUZZARD".

FOR MUNITIONS; MISSILES; INTELLIGENT MUNITIONS; GUIDED MORTAR MUNITIONS; GUIDED MORTAR PROJECTILES; SEEKING DETONATOR MUNITIONS (U.S. CLS. 2 AND 9).  
JERI J. FICKES, EXAMINING ATTORNEY

**CLASS 13—(Continued).**

SN 85-162,487. TACTICAL CONCEALMENT PRODUCTS, PALM COAST, FL. FILED 10-27-2010.



NO CLAIM IS MADE TO THE EXCLUSIVE RIGHT TO USE "FAST DRAW", APART FROM THE MARK AS SHOWN.

THE COLOR(S) BLUE, BLACK, YELLOW IS/ARE CLAIMED AS A FEATURE OF THE MARK.

THE MARK CONSISTS OF THE WORDING "FAST DRAW" IN ANGLED STYLIZED BLUE AND BLACK LETTERS SUPERIMPOSED OVER A FLASH OF LIGHT THAT IS YELLOW WITH SEVERAL BLACK STREAKS. THE COLOR WHITE REPRESENTS BACKGROUND AND TRANSPARENT AREAS ONLY AND IS NOT PART OF THE MARK.

FOR GUN MOUNTS; HOLSTERS (U.S. CLS. 2 AND 9).  
FIRST USE 9-21-2010; IN COMMERCE 9-21-2010.  
DANNEAN HETZEL, EXAMINING ATTORNEY

SN 85-202,821. ROGER CLOUSER, BALDWIN CITY, KS. FILED 12-21-2010.

# TRIPLE CIRCLE SIGHTS

THE MARK CONSISTS OF STANDARD CHARACTERS WITHOUT CLAIM TO ANY PARTICULAR FONT, STYLE, SIZE, OR COLOR.

NO CLAIM IS MADE TO THE EXCLUSIVE RIGHT TO USE "SIGHTS", APART FROM THE MARK AS SHOWN.

FOR SIGHTING SYSTEMS, NAMELY, NON-TELESCOPIC GUN SIGHTS FOR FIREARMS (U.S. CLS. 2 AND 9).

TINA L. SNAPP, EXAMINING ATTORNEY

SN 85-154,649. MBDA INC., WESTLAKE VILLAGE, CA. FILED 10-18-2010.

# TiGER

SN 85-292,775. SAFE TECH, INC., KNOXVILLE, TN. FILED 4-12-2011.

# SAF-T-ROUND

THE MARK CONSISTS OF STANDARD CHARACTERS WITHOUT CLAIM TO ANY PARTICULAR FONT, STYLE, SIZE, OR COLOR.

FOR MILITARY WEAPONS, NAMELY, MANNED PORTABLE HAND-LAUNCHED EXTENDIBLE TACTICAL GRENADE WEAPON FOR RAPID RESPONSE EMPLOYMENT TO PROTECT DEPLOYED TROOPS (U.S. CLS. 2 AND 9).  
NAKIA HENRY, EXAMINING ATTORNEY

THE MARK CONSISTS OF STANDARD CHARACTERS WITHOUT CLAIM TO ANY PARTICULAR FONT, STYLE, SIZE, OR COLOR.

SEC. 2(F).  
FOR EJECTABLE GUN CHAMBER PLUGS FOR LESSENING THE CHANCES OF ACCIDENTAL DISCHARGE OF THE GUN (U.S. CLS. 2 AND 9).

FIRST USE 9-1-1997; IN COMMERCE 9-1-1997.  
JUDITH HELFMAN, EXAMINING ATTORNEY

**CLASS 13—(Continued).**

SN 85-314,613. CUSTOM FIREWORKS,LLC, ALLENTON, WI.  
FILED 5-6-2011.

**SHOW TO GO**

THE MARK CONSISTS OF STANDARD CHARACTERS  
WITHOUT CLAIM TO ANY PARTICULAR FONT, STYLE,  
SIZE, OR COLOR.

FOR FIREWORKS (U.S. CLS. 2 AND 9).  
FIRST USE 5-1-2005; IN COMMERCE 5-1-2005.  
CHRISTINE MARTIN, EXAMINING ATTORNEY

---

SN 85-325,509. DRAGON IMPORTS LLC, LANSING, MI.  
FILED 5-19-2011.



OWNER OF U.S. REG. NOS. 3,995,265 AND 3,995,271.  
NO CLAIM IS MADE TO THE EXCLUSIVE RIGHT TO  
USE "LTD", APART FROM THE MARK AS SHOWN.

THE MARK CONSISTS OF A DESIGN COMPRISING A  
DRAGON IN CIRCULAR FORMATION WITH OPEN  
CLAWS EXTENDING OUTWARD FROM THE CENTERED  
DRAGON'S HEAD. THE HEAD HAVING AN OPEN MOUTH  
SHOWING THE DRAGON'S TEETH AND EXTENDED  
TONGUE. THE WORDING "DRAGON LTD" APPEARS IN  
A BANNER ACROSS THE LOWER PORTION OF THE  
DRAGON DESIGN.

FOR FIREWORKS (U.S. CLS. 2 AND 9).  
FIRST USE 6-10-2010; IN COMMERCE 1-10-2011.  
MARK SHINER, EXAMINING ATTORNEY

---

SN 85-334,975. INGRAM ENTERPRISES, INC., SPRING-  
FIELD, MO. FILED 6-1-2011.

**FIRE FRENZY**

THE MARK CONSISTS OF STANDARD CHARACTERS  
WITHOUT CLAIM TO ANY PARTICULAR FONT, STYLE,  
SIZE, OR COLOR.

FOR FIREWORKS IN SHELL FORMS (U.S. CLS. 2  
AND 9).  
FIRST USE 1-13-2011; IN COMMERCE 1-13-2011.  
KATHERINE M. DUBRAY, EXAMINING ATTORNEY

**CLASS 13—(Continued).**

SN 85-335,065. INGRAM ENTERPRISES, INC., SPRING-  
FIELD, MO. FILED 6-1-2011.

**FIRE IN THE HOLE**

THE MARK CONSISTS OF STANDARD CHARACTERS  
WITHOUT CLAIM TO ANY PARTICULAR FONT, STYLE,  
SIZE, OR COLOR.

FOR FIREWORKS IN SHELL FORMS (U.S. CLS. 2  
AND 9).  
KATHERINE M. DUBRAY, EXAMINING ATTORNEY

---

SN 85-335,077. INGRAM ENTERPRISES, INC., SPRING-  
FIELD, MO. FILED 6-1-2011.

**TEMPER TANTRUM**

THE MARK CONSISTS OF STANDARD CHARACTERS  
WITHOUT CLAIM TO ANY PARTICULAR FONT, STYLE,  
SIZE, OR COLOR.

FOR FIREWORKS IN SHELL FORMS (U.S. CLS. 2  
AND 9).  
KATHERINE M. DUBRAY, EXAMINING ATTORNEY

---

SN 85-336,485. HENRY REPEATING ARMS COMPANY,  
BAYONNE, NJ. FILED 6-2-2011.

"LOAD ON SUNDAY, SHOOT ALL  
WEEK LONG"

THE MARK CONSISTS OF STANDARD CHARACTERS  
WITHOUT CLAIM TO ANY PARTICULAR FONT, STYLE,  
SIZE, OR COLOR.

FOR GUNS, RIFLES AND FIREARMS (U.S. CLS. 2  
AND 9).  
FIRST USE 3-31-1997; IN COMMERCE 3-31-1997.  
TRICIA SONNEBORN, EXAMINING ATTORNEY

**CLASS 13—(Continued).**

SN 85-336,816. GOOD TIME OUTDOORS, INC., OCALA, FL.  
FILED 6-2-2011.

**CORE 15**

THE MARK CONSISTS OF STANDARD CHARACTERS  
WITHOUT CLAIM TO ANY PARTICULAR FONT, STYLE,  
SIZE, OR COLOR.

FOR COMPONENT PARTS FOR RIFLES; RIFLE  
STOCKS; RIFLES AND PARTS THEREOF (U.S. CLS. 2  
AND 9).

FIRST USE 12-31-2009; IN COMMERCE 12-31-2009.  
WENDY GOODMAN, EXAMINING ATTORNEY

**CLASS 13—(Continued).**

SN 85-340,091. B.J. ALAN COMPANY, YOUNGSTOWN, OH.  
FILED 6-7-2011.

**ANIMAL KINGDOM**

THE MARK CONSISTS OF STANDARD CHARACTERS  
WITHOUT CLAIM TO ANY PARTICULAR FONT, STYLE,  
SIZE, OR COLOR.

FOR FIREWORKS (U.S. CLS. 2 AND 9).  
NELSON SNYDER, EXAMINING ATTORNEY

SN 85-339,301. OSHA DATA/CIH, INC., DBA CONSTITU-  
TION ARMS, MAPLEWOOD, NJ. FILED 6-6-2011.

**TRI-COR**

THE MARK CONSISTS OF STANDARD CHARACTERS  
WITHOUT CLAIM TO ANY PARTICULAR FONT, STYLE,  
SIZE, OR COLOR.

FOR AMMUNITION FOR FIREARMS (U.S. CLS. 2  
AND 9).

FIRST USE 6-0-2011; IN COMMERCE 6-0-2011.  
SHAUNIA CARLYLE, EXAMINING ATTORNEY

SN 85-343,141. TRUGLO, INC., RICHARDSON, TX. FILED 6-  
10-2011.

**SMACKDOWN**

THE MARK CONSISTS OF STANDARD CHARACTERS  
WITHOUT CLAIM TO ANY PARTICULAR FONT, STYLE,  
SIZE, OR COLOR.

FOR GUN CHOKES (U.S. CLS. 2 AND 9).  
KATHLEEN LORENZO, EXAMINING ATTORNEY

SN 85-339,606. PERFECT PRODUCT LLC, ROSWELL, GA.  
FILED 6-7-2011.

**TERMINATOR**

THE MARK CONSISTS OF THE STYLIZED TEXT "TER-  
MINATOR" IN WHICH THE "N" IS ELONGATED AT THE  
POINTS.

FOR STUN GUNS (U.S. CLS. 2 AND 9).  
FIRST USE 3-1-2010; IN COMMERCE 3-1-2010.  
HANNO RITTNER, EXAMINING ATTORNEY

SN 85-390,996. GOOD TIME OUTDOORS, INC., DBA BLUE  
GRASS ARMORY, OCALA, FL. FILED 8-5-2011.

**ONE SHOT'LL DO YA**

THE MARK CONSISTS OF STANDARD CHARACTERS  
WITHOUT CLAIM TO ANY PARTICULAR FONT, STYLE,  
SIZE, OR COLOR.

FOR RIFLES (U.S. CLS. 2 AND 9).  
FIRST USE 1-31-2011; IN COMMERCE 1-31-2011.  
WENDY GOODMAN, EXAMINING ATTORNEY

**CLASS 14—JEWELRY**

SN 77-031,382. NUAW DESIGNS, LLC, WILMINGTON, DE.  
FILED 10-27-2006.

# ZENNA

THE MARK CONSISTS OF STANDARD CHARACTERS WITHOUT CLAIM TO ANY PARTICULAR FONT, STYLE, SIZE, OR COLOR.

FOR JEWELRY (U.S. CLS. 2, 27, 28 AND 50).  
MARTHA FROMM, EXAMINING ATTORNEY

SN 77-944,302. LAMAR, DOLORES RAYE, DBA CENORA  
STELLE BOUTIQUE, DUMFRIES, VA. FILED 2-24-2010.

# CENORA STELLE

THE MARK CONSISTS OF STANDARD CHARACTERS WITHOUT CLAIM TO ANY PARTICULAR FONT, STYLE, SIZE, OR COLOR.

THE NAME(S), PORTRAIT(S), AND/OR SIGNATURE(S) SHOWN IN THE MARK DOES NOT IDENTIFY A PARTICULAR LIVING INDIVIDUAL.

THE ENGLISH TRANSLATION OF "STELLE" IN THE MARK IS "STARS".

FOR BEADS FOR USE IN THE MANUFACTURE OF JEWELRY; BODY JEWELRY; BRACELETS; BROACHES; BRONZE JEWELRY; BROOCHES; CHARMS; CHARMS FOR COLLAR JEWELRY AND BRACELET; COSTUME JEWELRY; GEMSTONE JEWELRY; IDENTIFICATION BRACELETS; JEWELRY; JEWELRY AND IMITATION JEWELRY; JEWELRY BOXES; JEWELRY BOXES NOT OF METAL; JEWELRY BOXES OF METAL; JEWELRY BROOCHES; JEWELRY CHAINS; JEWELRY FINDINGS; JEWELRY FOR ATTACHMENT TO CLOTHING; JEWELRY FOR THE HEAD; JEWELRY IN THE NATURE OF ARMBANDS; JEWELRY MAKING KITS; JEWELRY ORGANIZERS; JEWELRY PINS FOR USE ON HATS; JEWELRY RING HOLDERS; JEWELRY TO BE AFFIXED TO BIKINIS; JEWELRY WATCHES; JEWELRY, NAMELY, AMULETS; JEWELRY, NAMELY, ANKLETS; JEWELRY, NAMELY, ARM CUFFS; JEWELRY, NAMELY, CROSSES; JEWELRY, NAMELY, DOG TAGS FOR WEAR BY HUMANS FOR DECORATIVE PURPOSES; JEWELRY, NAMELY, MAGNETIC NECKLACES; JEWELRY, NAMELY, MAGNETIC PENDANTS; JEWELRY, NAMELY, PRECIOUS METAL PLATED REAL LEAVES AND FLOWERS; JEWELRY, NAMELY, STONE PENDANTS; LAPEL PINS; LEATHER JEWELRY AND ACCESSORY BOXES; PET JEWELRY; PINS BEING JEWELRY; PLASTIC BRACELETS IN THE NATURE OF JEWELRY; PRECIOUS AND SEMI-PRECIOUS CRYSTAL STONES AND BEADS FOR USE IN JEWELRY; RINGS; RINGS BEING JEWELRY; STAINLESS STEEL JEWELRY BRACELETS; WATCHES AND JEWELRY; WATCHES, CLOCKS, JEWELRY AND IMITATION JEWELRY (U.S. CLS. 2, 27, 28 AND 50).

FIRST USE 7-11-2009; IN COMMERCE 7-11-2009.  
LAURIE KAUFMAN, EXAMINING ATTORNEY

**CLASS 14—(Continued).**

SN 79-090,572. DA LIAN YA TU TOU ZI ZI XUN YOU XIAN  
GONG SI, DALIAN CITY; LIAONING PROVINCE, CHINA, FILED 11-25-2010.



OWNER OF INTERNATIONAL REGISTRATION 1060035  
DATED 11-25-2010, EXPIRES 11-25-2020.

THE MARK CONSISTS OF SHIELD THAT IS SQUARED ON TOP AND COMES TO A POINT ON THE BOTTOM. AT THE TOP OF THE SHIELD ON THE TOP BORDER IS THREE STARS. THE TWO SIDES OF THE BORDER OF THE SHIELD ARE SHADED. THE BOTTOM POINT OF THE SHIELD CONTAINS THE MALE GENDER SYMBOL. AT THE CENTER OF THE SHIELD IS THE ZODIAC SYMBOL FOR LEO. AT THE END OF THE CURVED LINE IS A SHADED CIRCLE WITH AN ARROW IN THE MIDDLE.

FOR BOXES OF PRECIOUS METAL; SILVER ORNAMENTS; COLLECTABLE COINS; JEWELLERY; WORKS OF ART OF PRECIOUS METAL; BADGES OF PRECIOUS METAL; JADE CARVINGS; CLOISONNE JEWELRY; HORN, BONE, TOOTH AND SHELL JEWELRY; WRIST-WATCHES (U.S. CLS. 2, 27, 28 AND 50).

DAWN FELDMAN, EXAMINING ATTORNEY



**CLASS 14—(Continued).**

SN 79-090,573. DA LIAN YA TU TOU ZI ZI XUN YOU XIAN GONG SI, CHINA, FILED 11-25-2010.

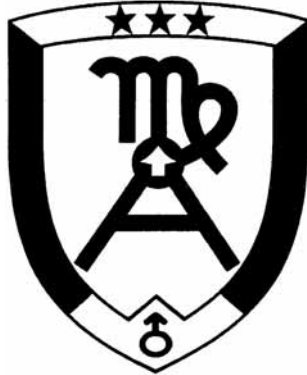

OWNER OF INTERNATIONAL REGISTRATION 1060036 DATED 11-25-2010, EXPIRES 11-25-2020.

THE MARK CONSISTS OF SHIELD THAT IS SQUARED ON TOP AND COMES TO A POINT ON THE BOTTOM. AT THE TOP OF THE SHIELD ON THE TOP BORDER IS THREE STARS. THE TWO SIDES OF THE BORDER OF THE SHIELD ARE SHADED. THE BOTTOM POINT OF THE SHIELD CONTAINS THE MALE GENDER SYMBOL. AT THE CENTER OF THE SHIELD ARE THE LETTERS "M" AND "A" WITH THE LETTER "M" ON TOP OF THE LETTER "A". IN BETWEEN THE TWO LETTERS IS THE ZODIAC SYMBOL FOR VIRGO.

FOR BOXES OF PRECIOUS METAL; SILVER ORNAMENTS; COLLECTABLE COINS; JEWELLERY; WORKS OF ART OF PRECIOUS METAL; BADGES OF PRECIOUS METAL; JADE CARVINGS; CLOISONNE JEWELRY; HORN, BONE, TOOTH AND SHELL JEWELRY; WRIST-WATCHES (U.S. CLS. 2, 27, 28 AND 50).

DAWN FELDMAN, EXAMINING ATTORNEY

**CLASS 14—(Continued).**

THE TOP OF THE SHIELD ON THE TOP BORDER IS THREE STARS. THE TWO SIDES OF THE BORDER OF THE SHIELD ARE SHADED. THE BOTTOM POINT OF THE SHIELD CONTAINS THE FEMALE GENDER SYMBOL. IN THE CENTER OF THE SHIELD IS THE LETTER B WITH A CIRCLE WITH A LINE TO THE LEFT AND THE RIGHT OF THE CIRCLE AT THE TOP OF THE B. ON TOP OF THE B IS A DESIGN THAT APPROXIMATES THE GREEK LETTER OMEGA WITH THE CENTER OF THE LETTER TOUCHING THE CIRCLE DESIGN OF THE B.

FOR BOXES OF PRECIOUS METAL; SILVER ORNAMENTS; COLLECTABLE COINS; JEWELLERY; WORKS OF ART OF PRECIOUS METAL; BADGES OF PRECIOUS METAL; JADE CARVINGS; CLOISONNE JEWELRY; HORN, BONE, TOOTH AND SHELL JEWELRY; WRIST-WATCHES (U.S. CLS. 2, 27, 28 AND 50).

DAWN FELDMAN, EXAMINING ATTORNEY

SN 79-090,575. DA LIAN YA TU TOU ZI ZI XUN YOU XIAN GONG SI, DALIAN CITY, LIAONING PROVINCE, CHINA, FILED 11-25-2010.



SN 79-090,574. DA LIAN YA TU TOU ZI ZI XUN YOU XIAN GONG SI, DALIAN CITY, LIAONING PROVINCE, CHINA, FILED 11-25-2010.



OWNER OF INTERNATIONAL REGISTRATION 1060038 DATED 11-25-2010, EXPIRES 11-25-2020.

THE MARK CONSISTS OF SHIELD THAT IS SQUARED ON TOP AND COMES TO A POINT ON THE BOTTOM. AT THE TOP OF THE SHIELD ON THE TOP BORDER IS THREE STARS. THE TWO SIDES OF THE BORDER OF THE SHIELD ARE SHADED. THE BOTTOM POINT OF THE SHIELD CONTAINS THE FEMALE GENDER SYMBOL. THE LETTERS "MAB" ARE AT THE CENTER OF THE SHIELD. THE LETTER "M" CONTAINS THE ZODIAC SYMBOL LEO, IN PART. THE LETTERS "AB" ARE BELOW THE "M" CONTAIN THE ZODIAC SYMBOL SCORPIO.

FOR BOXES OF PRECIOUS METAL; SILVER ORNAMENTS; COLLECTABLE COINS; JEWELLERY; WORKS OF ART OF PRECIOUS METAL; BADGES OF PRECIOUS METAL; JADE CARVINGS; CLOISONNE JEWELRY; HORN, BONE, TOOTH AND SHELL JEWELRY; WRIST-WATCHES (U.S. CLS. 2, 27, 28 AND 50).

DAWN FELDMAN, EXAMINING ATTORNEY

OWNER OF INTERNATIONAL REGISTRATION 1060037 DATED 11-25-2010, EXPIRES 11-25-2020.

THE MARK CONSISTS OF SHIELD THAT IS SQUARED ON TOP AND COMES TO A POINT ON THE BOTTOM. AT

**CLASS 14—(Continued).**

SN 79-090,651. DA LIAN YA TU TOU ZI ZI XUN YOU XIAN GONG SI, LIAONING PROVINCE, CHINA, FILED 11-25-2010.

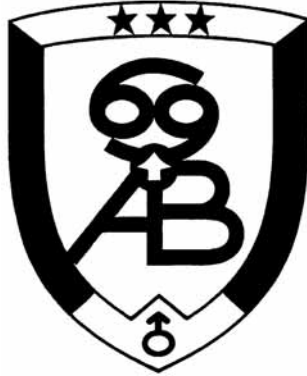

OWNER OF INTERNATIONAL REGISTRATION 1060211 DATED 11-25-2010, EXPIRES 11-25-2020.

THE MARK CONSISTS OF A STYLIZED SHIELD WITH THREE STARS WITHIN THE TOP BORDER OF THE SHIELD, AND A MALE GENDER SYMBOL WITHIN THE BOTTOM BORDER. WITHIN THE SHIELD AT THE TOP IS THE ZODIAC SYMBOL FOR CANCER, ATOP THE LETTERS "AB" FORMED AS ONE LETTER, WITH AN ARROWHEAD IN THE MIDDLE OF THE DESIGN.

FOR BOXES OF PRECIOUS METAL; SILVER ORNAMENTS; NON-MONETARY COINS; JEWELLERY; WORKS OF ART OF PRECIOUS METAL; BADGES OF PRECIOUS METAL; JADE CARVINGS; CLOISSONNE JEWELRY; HORN, BONE, TOOTH AND SHELL JEWELRY; WRISTWATCHES (U.S. CLS. 2, 27, 28 AND 50).

SCOTT BIBB, EXAMINING ATTORNEY

**CLASS 14—(Continued).**

SN 79-090,652. DA LIAN YA TU TOU ZI ZI XUN YOU XIAN GONG SI, LIAONING PROVINCE, CHINA, FILED 11-25-2010.

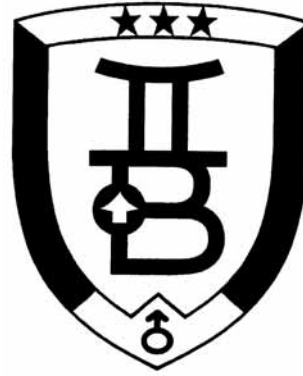

OWNER OF INTERNATIONAL REGISTRATION 1060212 DATED 11-25-2010, EXPIRES 11-25-2020.

THE MARK CONSISTS OF A STYLIZED SHIELD WITH THREE STARS WITHIN THE TOP BORDER OF THE SHIELD, AND A MALE GENDER SYMBOL WITHIN THE BOTTOM BORDER. WITHIN THE SHIELD AT THE TOP IS THE ZODIAC SYMBOL FOR GEMINI ATOP THE LETTER "B" WITH A STYLIZED ARROWHEAD WITHIN AN OVAL IN THE VERTICAL LINE FORMING THE "B".

FOR BOXES OF PRECIOUS METAL; SILVER ORNAMENTS; NON-MONETARY COINS; JEWELLERY; WORKS OF ART OF PRECIOUS METAL; BADGES OF PRECIOUS METAL; JADE CARVINGS; CLOISSONNE JEWELRY; HORN, BONE, TOOTH AND SHELL JEWELRY; WRISTWATCHES (U.S. CLS. 2, 27, 28 AND 50).

SCOTT BIBB, EXAMINING ATTORNEY

**CLASS 14—(Continued).**

SN 79-090,653. DA LIAN YA TU TOU ZI ZI XUN YOU XIAN GONG SI, LIAONING PROVINCE, CHINA, FILED 11-25-2010.

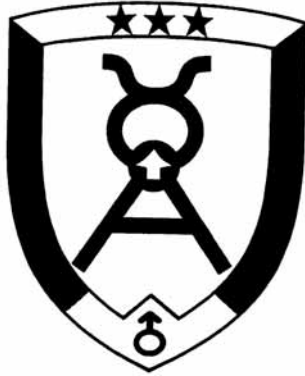

OWNER OF INTERNATIONAL REGISTRATION 1060213 DATED 11-25-2010, EXPIRES 11-25-2020.

THE MARK CONSISTS OF A STYLIZED SHIELD WITH THREE STARS WITHIN THE TOP BORDER OF THE SHIELD, AND A MALE GENDER SYMBOL WITHIN THE BOTTOM BORDER. WITHIN THE SHIELD AT THE TOP IS THE ZODIAC SYMBOL FOR TAURUS ATOP THE LETTER "A" WITH A STYLIZED ARROWHEAD WITHIN AN OVAL CONNECTING THE TWO SYMBOLS.

FOR BOXES OF PRECIOUS METAL; SILVER ORNAMENTS; NON-MONETARY COINS; JEWELLERY; WORKS OF ART OF PRECIOUS METAL; BADGES OF PRECIOUS METAL; JADE CARVINGS; CLOISSONNÉ JEWELRY; HORN, BONE, TOOTH AND SHELL JEWELRY; WRISTWATCHES (U.S. CLS. 2, 27, 28 AND 50).

SCOTT BIBB, EXAMINING ATTORNEY

**CLASS 14—(Continued).**

SN 79-090,654. DA LIAN YA TU TOU ZI ZI XUN YOU XIAN GONG SI, LIAONING PROVINCE, CHINA, FILED 11-25-2010.



OWNER OF INTERNATIONAL REGISTRATION 1060214 DATED 11-25-2010, EXPIRES 11-25-2020.

THE MARK CONSISTS OF A STYLIZED SHIELD WITH THREE STARS WITHIN THE TOP BORDER OF THE SHIELD, AND A MALE GENDER SYMBOL WITHIN THE BOTTOM BORDER. WITHIN THE SHIELD AT THE TOP IS THE ZODIAC SYMBOL FOR ARIES ATOP THE LETTER "O" WITH A STYLIZED ARROWHEAD WITHIN AN OVAL CONNECTING THE TWO SYMBOLS.

FOR BOXES OF PRECIOUS METAL; SILVER ORNAMENTS; NON-MONETARY COINS; JEWELLERY; WORKS OF ART OF PRECIOUS METAL; BADGES OF PRECIOUS METAL; JADE CARVINGS; CLOISSONNÉ JEWELRY; HORN, BONE, TOOTH AND SHELL JEWELRY; WRISTWATCHES (U.S. CLS. 2, 27, 28 AND 50).

SCOTT BIBB, EXAMINING ATTORNEY

SN 79-092,953. FRATELLI DIVERSI S.R.L., ITALY, FILED 11-9-2010.

# WEWOOD

THE MARK CONSISTS OF STANDARD CHARACTERS WITHOUT CLAIM TO ANY PARTICULAR FONT, STYLE, SIZE, OR COLOR.

PRIORITY DATE OF 7-19-2010 IS CLAIMED.

OWNER OF INTERNATIONAL REGISTRATION 1066172 DATED 11-9-2010, EXPIRES 11-9-2020.

FOR PRECIOUS METALS AND THEIR ALLOYS; JEWELRY; PRECIOUS STONES; HOROLOGICAL AND CHRONOMETRIC INSTRUMENTS (U.S. CLS. 2, 27, 28 AND 50).

EDWARD FENNESSY, EXAMINING ATTORNEY

**CLASS 14—(Continued).**

SN 79-095,884. VDW, PARIS, FRANCE, FILED 3-1-2011.

**BREVA**

THE MARK CONSISTS OF STANDARD CHARACTERS WITHOUT CLAIM TO ANY PARTICULAR FONT, STYLE, SIZE, OR COLOR.

PRIORITY DATE OF 9-2-2010 IS CLAIMED.

OWNER OF INTERNATIONAL REGISTRATION 1073346 DATED 3-1-2011, EXPIRES 3-1-2021.

THE WORDING "BREVA" HAS NO MEANING IN A FOREIGN LANGUAGE.

FOR JEWELRY; PRECIOUS STONES; HOROLOGICAL AND CHRONOMETRIC INSTRUMENTS; PRECIOUS METALS AND THEIR ALLOYS; COINS, NAMELY, COLLECTIBLE COINS, COMMEMORATIVE COINS, MONETARY COIN SETS FOR COLLECTING PURPOSES, SOUVENIR PRESSED COINS; WORKS OF ART OF PRECIOUS METAL; JEWELRY CASES; BOXES OF PRECIOUS METAL; WATCH CASES, WATCH BANDS, CHAINS, NAMELY, WATCH CHAINS, JEWELRY CHAINS; WATCH SPRINGS; WATCH GLASSES; KEY RING TRINKETS OR FOBS OF PRECIOUS METAL; STATUES OR FIGURINES STATUETTES OF PRECIOUS METAL; CASES OR PRESENTATION CASES, NAMELY, JEWELRY BOXES AND WATCH BOXES FOR TIMEPIECES; MEDALS (U.S. CLS. 2, 27, 28 AND 50).

CARYN GLASSER, EXAMINING ATTORNEY

SN 79-099,075. MONTRES CORUM SÀRL, SWITZERLAND, FILED 5-30-2011.

**SEAFENDER**

THE MARK CONSISTS OF STANDARD CHARACTERS WITHOUT CLAIM TO ANY PARTICULAR FONT, STYLE, SIZE, OR COLOR.

PRIORITY DATE OF 5-2-2011 IS CLAIMED.

OWNER OF INTERNATIONAL REGISTRATION 1081866 DATED 5-30-2011, EXPIRES 5-14-2022.

FOR JEWELRY; TIMEPIECES AND CHRONOMETRIC INSTRUMENTS, NAMELY WATCHES, WRIST-WATCHES, WATCH BANDS, WATCH CASES, DIALS, CLOCKS, WALL CLOCKS, CHRONOMETERS, CHRONOGRAPHS (U.S. CLS. 2, 27, 28 AND 50).

KRISTINA MORRIS, EXAMINING ATTORNEY

SN 79-100,195. UWE ZIMMER, FED REP GERMANY, FILED 5-30-2011.

**JETON**

THE MARK CONSISTS OF STANDARD CHARACTERS WITHOUT CLAIM TO ANY PARTICULAR FONT, STYLE, SIZE, OR COLOR.

PRIORITY DATE OF 12-17-2010 IS CLAIMED.

OWNER OF INTERNATIONAL REGISTRATION 1084611 DATED 5-30-2011, EXPIRES 5-14-2022.

THE ENGLISH TRANSLATION OF "JETON" IS "CHIP". FOR WATCHES, ESPECIALLY WRIST WATCHES (U.S. CLS. 2, 27, 28 AND 50).

KRISTINA MORRIS, EXAMINING ATTORNEY

**CLASS 14—(Continued).**

SN 85-094,067. M. Z. BERGER &amp; CO., INC, LONG ISLAND CITY, NY. FILED 7-27-2010.

**COOL BANDZ**

THE MARK CONSISTS OF STANDARD CHARACTERS WITHOUT CLAIM TO ANY PARTICULAR FONT, STYLE, SIZE, OR COLOR.

NO CLAIM IS MADE TO THE EXCLUSIVE RIGHT TO USE "BANDS", APART FROM THE MARK AS SHOWN.

FOR WATCHES (U.S. CLS. 2, 27, 28 AND 50).

KELLY BOULTON, EXAMINING ATTORNEY

SN 85-113,504. TOCARA INC., ST. LAURENT, QUEBEC, CANADA, FILED 8-23-2010.

**DIAMI**

THE MARK CONSISTS OF STANDARD CHARACTERS WITHOUT CLAIM TO ANY PARTICULAR FONT, STYLE, SIZE, OR COLOR.

OWNER OF CANADA REG. NO. 795525, DATED 4-13-2011, EXPIRES 4-13-2026.

FOR CUBIC ZIRCONIA JEWELRY (U.S. CLS. 2, 27, 28 AND 50).

LINDA E. BLOHM, EXAMINING ATTORNEY

SN 85-186,564. SUN DIAMOND, INC., DBA SUN SOURCE, NEW YORK, NY. FILED 11-29-2010.

**SILVER14**

THE MARK CONSISTS OF STANDARD CHARACTERS WITHOUT CLAIM TO ANY PARTICULAR FONT, STYLE, SIZE, OR COLOR.

FOR PRECIOUS METAL ALLOYS, NAMELY, SILVER ALLOYS; PROCESSED OR SEMI-PROCESSED SILVER; JEWELRY AND WATCHES CONTAINING PROCESSED OR SEMI-PROCESSED SILVER OR SILVER ALLOYS (U.S. CLS. 2, 27, 28 AND 50).

JOHN SCHUYLER YARD, EXAMINING ATTORNEY

**CLASS 14—(Continued).**

SN 85-192,168. LOS ANGELES JEWELRY PRODUCTION, INC., DBA LAJ, INC., LOS ANGELES, CO. FILED 12-7-2010.



THE MARK CONSISTS OF TWO WORDS, FOR JEWELRY, NAMELY, RINGS, EARRINGS, BRACELETS, PENDANTS, NECKLACES AND CHARMS (U.S. CLS. 2, 27, 28 AND 50).  
JACQUELINE A. LAVINE, EXAMINING ATTORNEY

**CLASS 14—(Continued).**

SN 85-204,957. SCOTT KAY, INC., TEANECK, NJ. FILED 12-23-2010.

SCOTT KAY GUARDIAN

THE MARK CONSISTS OF STANDARD CHARACTERS WITHOUT CLAIM TO ANY PARTICULAR FONT, STYLE, SIZE, OR COLOR.

OWNER OF U.S. REG. NOS. 2,827,785 AND 3,060,827. THE NAME(S), PORTRAIT(S), AND/OR SIGNATURE(S) SHOWN IN THE MARK IDENTIFIES "SCOTT KAY", WHOSE CONSENT(S) TO REGISTER IS MADE OF RECORD.

FOR JEWELRY (U.S. CLS. 2, 27, 28 AND 50).  
BARBARA A. GOLD, EXAMINING ATTORNEY

SN 85-194,229. AMY CONWAY STUDIO LLC, SANTA FE, NM. FILED 12-9-2010.



THE MARK CONSISTS OF A STYLIZED REPRESENTATION OF A BUTTERFLY. FOR JEWELRY; RINGS (U.S. CLS. 2, 27, 28 AND 50). FIRST USE 10-15-2010; IN COMMERCE 10-15-2010.  
ODESSA BIBBINS, EXAMINING ATTORNEY

SN 85-212,397. DISNEY ENTERPRISES, INC., BURBANK, CA. FILED 1-6-2011.

D23

SN 85-204,934. SCOTT KAY, INC., TEANECK, NJ. FILED 12-23-2010.

THE GUARDIAN BY SCOTT KAY

THE MARK CONSISTS OF STANDARD CHARACTERS WITHOUT CLAIM TO ANY PARTICULAR FONT, STYLE, SIZE, OR COLOR.

OWNER OF U.S. REG. NOS. 2,827,785 AND 3,060,827. THE NAME(S), PORTRAIT(S), AND/OR SIGNATURE(S) SHOWN IN THE MARK IDENTIFIES "SCOTT KAY", WHOSE CONSENT(S) TO REGISTER IS MADE OF RECORD.

FOR JEWELRY (U.S. CLS. 2, 27, 28 AND 50).  
BARBARA A. GOLD, EXAMINING ATTORNEY

THE MARK CONSISTS OF STANDARD CHARACTERS WITHOUT CLAIM TO ANY PARTICULAR FONT, STYLE, SIZE, OR COLOR.

OWNER OF U.S. REG. NOS. 3,825,617, 3,912,333 AND OTHERS.

FOR CLOCKS; JEWELRY; JEWELRY BOXES; JEWELRY CASES; KEY RINGS OF PRECIOUS METAL; COMMEMORATIVE, COLLECTIBLE AND NON-MONETARY COINS; WATCHES; WATCH BANDS (U.S. CLS. 2, 27, 28 AND 50).

SOPHIA S. KIM, EXAMINING ATTORNEY

**CLASS 14—(Continued).**

SN 85-249,916. TIMOTHY LINCECUM, BEVERLY HILLS, CA. FILED 2-23-2011.



THE MARK CONSISTS OF AN ATHLETE DEPICTED AS A SILHOUETTE THROWING A BASEBALL IN ONE HAND, AND HOLDING A BASEBALL MITT IN THE OTHER HAND.

FOR JEWELRY, NAMELY, LAPEL PINS; ORNAMENTAL LAPEL PINS; TIE PINS; TIE CLIPS; TIE BARS; TIE TACKS; TIE FASTENERS; CUFF-LINKS; SHIRT STUDS; BADGES OF PRECIOUS METAL; JEWELRY PINS FOR USE ON HATS; HAT ORNAMENTS OF PRECIOUS METAL; HOLIDAY ORNAMENTS OF PRECIOUS METAL; JEWELRY BOXES AND CASES; KEY HOLDERS OF PRECIOUS METALS; KEY CHAINS OF PRECIOUS METAL; WATCHES; WATCH BRACELETS; WATCH ACCESSORIES, NAMELY, PARTS OF WATCHES; WRISTWATCHES; POCKET WATCHES; STOP WATCHES; WATCH STRAPS AND BANDS; WATCH CHAINS AND FOBS; WATCH CASES; WATCH BOXES; CLOCKS; ALARM CLOCKS; CLOCKS INCORPORATING RADIOS; WALL CLOCKS; TIMEPIECES; BOXES FOR TIMEPIECES; FIGURINES, STATUES, AND STATUETTES, ALL OF THE FOREGOING OF PRECIOUS METAL (U.S. CLS. 2, 27, 28 AND 50).

ANNE MADDEN, EXAMINING ATTORNEY

SN 85-255,485. IS IT REAL, INC., BOCA RATON, FL. FILED 3-2-2011.

**BUDDHALUV**

THE MARK CONSISTS OF STANDARD CHARACTERS WITHOUT CLAIM TO ANY PARTICULAR FONT, STYLE, SIZE, OR COLOR.

FOR BRACELETS; NECKLACES (U.S. CLS. 2, 27, 28 AND 50).

FIRST USE 12-15-2010; IN COMMERCE 12-15-2010.  
MARK PILARO, EXAMINING ATTORNEY

**CLASS 14—(Continued).**

SN 85-278,419. DAKOTA WEST DESIGN, INC., ALBUQUERQUE, NM. FILED 3-28-2011.

**SILVER ELEGANCE**

THE MARK CONSISTS OF STANDARD CHARACTERS WITHOUT CLAIM TO ANY PARTICULAR FONT, STYLE, SIZE, OR COLOR.

NO CLAIM IS MADE TO THE EXCLUSIVE RIGHT TO USE "SILVER", APART FROM THE MARK AS SHOWN.  
FOR JEWELRY MADE OF SILVER (U.S. CLS. 2, 27, 28 AND 50).

FIRST USE 6-0-2004; IN COMMERCE 6-0-2004.  
LINDA ESTRADA, EXAMINING ATTORNEY

SN 85-280,128. DAKOTA WEST DESIGN, INC., ALBUQUERQUE, NM. FILED 3-29-2011.

**SILVER MOON**

THE MARK CONSISTS OF STANDARD CHARACTERS WITHOUT CLAIM TO ANY PARTICULAR FONT, STYLE, SIZE, OR COLOR.

NO CLAIM IS MADE TO THE EXCLUSIVE RIGHT TO USE "SILVER", APART FROM THE MARK AS SHOWN.  
FOR JEWELRY MADE OF SILVER (U.S. CLS. 2, 27, 28 AND 50).

FIRST USE 0-0-1975; IN COMMERCE 0-0-1975.  
LINDA ESTRADA, EXAMINING ATTORNEY

SN 85-288,572. DEBRA ANNA GODSEY, DALLAS, GA. FILED S.R. 4-7-2011; AM. P.R. 8-17-2011.

**ANNA'S JEWEL'S**

THE MARK CONSISTS OF STANDARD CHARACTERS WITHOUT CLAIM TO ANY PARTICULAR FONT, STYLE, SIZE, OR COLOR.

NO CLAIM IS MADE TO THE EXCLUSIVE RIGHT TO USE "JEWELS", APART FROM THE MARK AS SHOWN.  
FOR JEWELRY (U.S. CLS. 2, 27, 28 AND 50).

STEVEN JACKSON, EXAMINING ATTORNEY

**CLASS 14—(Continued).**

SN 85-291,186. WENDY MIGNOT, SANTA ROSA BEACH, FL. FILED 4-10-2011.

## Wendy Mignot

THE MARK CONSISTS OF STANDARD CHARACTERS WITHOUT CLAIM TO ANY PARTICULAR FONT, STYLE, SIZE, OR COLOR.

THE NAME(S), PORTRAIT(S), AND/OR SIGNATURE(S) SHOWN IN THE MARK IDENTIFIES "WENDY MIGNOT", WHOSE CONSENT(S) TO REGISTER IS MADE OF RECORD.

FOR JEWELRY (U.S. CLS. 2, 27, 28 AND 50).  
FIRST USE 11-30-1998; IN COMMERCE 11-30-1998.  
JOHN DWYER, EXAMINING ATTORNEY

---

SN 85-294,381. LE VIAN CORP., GREAT NECK, NY. FILED 4-13-2011.

## ZIBA

THE MARK CONSISTS OF STANDARD CHARACTERS WITHOUT CLAIM TO ANY PARTICULAR FONT, STYLE, SIZE, OR COLOR.

THE ENGLISH TRANSLATION OF "ZIBA" IN FARSI IN THE MARK IS "BEAUTIFUL".

FOR BRACELETS; EARRINGS; GEMS; JEWELRY; NECKLACES; PENDANTS; RINGS (U.S. CLS. 2, 27, 28 AND 50).

FIRST USE 7-1-1983; IN COMMERCE 4-1-1984.  
INGRID C. EULIN, EXAMINING ATTORNEY

---

SN 85-295,328. CHRISTINE GELIEBTER, DBA CHRISTINE CARSON LLC, FRANKLIN LAKES, NJ. FILED 4-14-2011.

## Christine Carson LLC

THE MARK CONSISTS OF STANDARD CHARACTERS WITHOUT CLAIM TO ANY PARTICULAR FONT, STYLE, SIZE, OR COLOR.

NO CLAIM IS MADE TO THE EXCLUSIVE RIGHT TO USE "LLC", APART FROM THE MARK AS SHOWN.

THE NAME "CHRISTINE CARSON" DOES NOT IDENTIFY A LIVING INDIVIDUAL.

FOR BRACELETS; CUFFLINKS; EARRINGS; NECKLACES; PENDANTS; RINGS (U.S. CLS. 2, 27, 28 AND 50).  
MATTHEW KLINE, EXAMINING ATTORNEY

**CLASS 14—(Continued).**

SN 85-302,749. ADFA, INC., DBA A&A JEWELRY SUPPLY, LOS ANGELES, CA. FILED 4-22-2011.



NO CLAIM IS MADE TO THE EXCLUSIVE RIGHT TO USE "VOLTA", APART FROM THE MARK AS SHOWN.

THE MARK CONSISTS OF A LARGE "V" WHICH IS NESTLED BETWEEN TWO TRAPEZOID-TYPE OBJECTS. THE TWO PARTS OF THE "V" START WIDER ON TOP AND TAPER DOWN TO A POINT TOWARDS THE BOTTOM. THE WORD "VOLTA" IS WRITTEN IN BLOCK LETTERS UNDER THE LOGO.

THE ENGLISH TRANSLATION OF THE WORD "VOLTA" IN THE MARK IS "TIME".

FOR CASES FOR CLOCK AND WATCH-MAKING; CASES FOR WATCHES AND CLOCKS; JEWELLERY AND WATCHES; JEWELLERY, CLOCKS AND WATCHES; JEWELRY WATCHES; MECHANICAL AND AUTOMATIC WATCHES; PARTS FOR WATCHES; WATCH CASES; WATCH POUCHES; WATCH WINDERS; WATCHES; WATCHES, CLOCKS (U.S. CLS. 2, 27, 28 AND 50).

FIRST USE 1-12-2011; IN COMMERCE 1-12-2011.  
HENRY S. ZAK, EXAMINING ATTORNEY

---

SN 85-305,306. DIRECT SILVER FACTORY INC, DALLAS, TX. FILED 4-26-2011.

## ICE NATION

THE MARK CONSISTS OF STANDARD CHARACTERS WITHOUT CLAIM TO ANY PARTICULAR FONT, STYLE, SIZE, OR COLOR.

NO CLAIM IS MADE TO THE EXCLUSIVE RIGHT TO USE "ICE", APART FROM THE MARK AS SHOWN.

FOR JEWELRY; WATCHES (U.S. CLS. 2, 27, 28 AND 50).

KHANH LE, EXAMINING ATTORNEY

**CLASS 14—(Continued).**

SN 85-307,775. PATRICIA ROBALINO DESIGNS, LLC., FAIRFIELD, NJ. FILED 4-28-2011.



Patricia Robalino Designs

NO CLAIM IS MADE TO THE EXCLUSIVE RIGHT TO USE "DESIGNS", APART FROM THE MARK AS SHOWN.

THE NAME(S), PORTRAIT(S), AND/OR SIGNATURE(S) SHOWN IN THE MARK IDENTIFIES PATRICIA ROBALINO, WHOSE CONSENT(S) TO REGISTER IS MADE OF RECORD.

THE MARK CONSISTS OF A HIGHLY STYLIZED "PR" LOGO ABOVE THE WORDS "PATRICIA ROBALINO" DESIGN.

FOR BRACELETS; BROACHES; CUFFLINKS; EARRINGS; NECKLACES; PENDANTS; RINGS (U.S. CLS. 2, 27, 28 AND 50).

FIRST USE 6-9-2009; IN COMMERCE 6-9-2009.  
MICHELE SWAIN, EXAMINING ATTORNEY

SN 85-316,381. KINGSID VENTURES, LTD., LAS VEGAS, NV. FILED 5-9-2011.

**BB KING'S BLUES CLUB**

THE MARK CONSISTS OF STANDARD CHARACTERS WITHOUT CLAIM TO ANY PARTICULAR FONT, STYLE, SIZE, OR COLOR.

OWNER OF U.S. REG. NOS. 1,878,090, 2,235,556 AND OTHERS.

THE NAME(S), PORTRAIT(S), AND/OR SIGNATURE(S) SHOWN IN THE MARK IDENTIFIES "B.B. KING", WHOSE CONSENT(S) TO REGISTER IS MADE OF RECORD.

FOR BADGES OF PRECIOUS METAL; BRACELETS; EARRINGS; FANCY KEYRINGS OF PRECIOUS METALS; NECKLACES; ORNAMENTAL PINS; PINS BEING JEWELRY; TIE PINS (U.S. CLS. 2, 27, 28 AND 50).

FIRST USE 8-15-1991; IN COMMERCE 8-15-1991.  
DAVID I, EXAMINING ATTORNEY

**CLASS 14—(Continued).**

SN 85-321,066. EDUS & CO, NEW YORK, NY. FILED 5-14-2011.

**EDUS & CO**

THE MARK CONSISTS OF STANDARD CHARACTERS WITHOUT CLAIM TO ANY PARTICULAR FONT, STYLE, SIZE, OR COLOR.

NO CLAIM IS MADE TO THE EXCLUSIVE RIGHT TO USE "& CO", APART FROM THE MARK AS SHOWN.

FOR WRISTWATCHES; JEWELRY (U.S. CLS. 2, 27, 28 AND 50).

MICHAEL WIENER, EXAMINING ATTORNEY

SN 85-322,040. ELEGANT COLLECTION PVT. LTD., MUMBAI 400096, INDIA, FILED 5-16-2011.

**DREAM LINKS**

THE MARK CONSISTS OF STANDARD CHARACTERS WITHOUT CLAIM TO ANY PARTICULAR FONT, STYLE, SIZE, OR COLOR.

NO CLAIM IS MADE TO THE EXCLUSIVE RIGHT TO USE "LINKS", APART FROM THE MARK AS SHOWN.

FOR JEWELRY (U.S. CLS. 2, 27, 28 AND 50).  
LINDA E. BLOHM, EXAMINING ATTORNEY

SN 85-323,365. GOGNA, NISHANT, SANFORD, FL. AND VARGAS, STEPHANO, KISSIMMEE, FL. FILED 5-17-2011.

**WhosSingle.com**

THE MARK CONSISTS OF STANDARD CHARACTERS WITHOUT CLAIM TO ANY PARTICULAR FONT, STYLE, SIZE, OR COLOR.

FOR (BASED ON USE IN COMMERCE) BRACELETS; BRACELETS MADE OF RUBBER SILICON; RUBBER OR SILICON WRISTBANDS IN THE NATURE OF A BRACELET; (BASED ON INTENT TO USE) ANKLE BRACELETS; BANGLE BRACELETS; BRACELETS OF PRECIOUS METAL; JEWELLERY CHAIN OF PRECIOUS METAL FOR BRACELETS; STAINLESS STEEL JEWELRY BRACELETS (U.S. CLS. 2, 27, 28 AND 50).

FIRST USE 12-15-2010; IN COMMERCE 2-11-2011.  
KATHY DE JONGE, EXAMINING ATTORNEY



**CLASS 14—(Continued).**

SN 85-323,586. HEIDI RHONE, TA HEIDI RHONE, MER-  
RIAM, KS. FILED 5-18-2011.

W8 4 ME... I'LL W8 4 U!

THE MARK CONSISTS OF STANDARD CHARACTERS  
WITHOUT CLAIM TO ANY PARTICULAR FONT, STYLE,  
SIZE, OR COLOR.

FOR JEWELRY, NAMELY, BRACELETS (U.S. CLS. 2,  
27, 28 AND 50).

FIRST USE 9-5-2010; IN COMMERCE 4-14-2011.

SAMUEL E. SHARPER JR., EXAMINING ATTORNEY

---

SN 85-323,656. LOUSKY, HAIM, CALABASAS, CA. FILED 5-  
18-2011.



NO CLAIM IS MADE TO THE EXCLUSIVE RIGHT TO  
USE "PARIS", APART FROM THE MARK AS SHOWN.

THE MARK CONSISTS OF THE TEXT "TRESOR PARIS"  
WITH A HALF HEART SHAPE AROUND IT AND A  
DIAMOND OVER THE "I" IN "PARIS".

THE ENGLISH TRANSLATION OF THE WORD "TRE-  
SOR" IN THE MARK IS "TREASURE".

FOR BRACELETS; EARRINGS; NECKLACES; RINGS;  
WOMEN'S JEWELRY (U.S. CLS. 2, 27, 28 AND 50).

FIRST USE 11-1-2007; IN COMMERCE 1-1-2008.

SKYE YOUNG, EXAMINING ATTORNEY

**CLASS 14—(Continued).**

SN 85-323,966. FABRIKANT TARA INTERNATIONAL LLC,  
NEW YORK, NY. FILED 5-18-2011.



NO CLAIM IS MADE TO THE EXCLUSIVE RIGHT TO  
USE "HEART LINKS", APART FROM THE MARK AS  
SHOWN.

THE MARK CONSISTS OF THE STYLIZED WORDS  
"HEART LINKS" WITH A HEART DESIGN USED IN PLACE  
OF THE LETTER "A" IN "HEART". THE HEART DESIGN  
INTERSECTS THE LEG OF THE LOWER CASE LETTER "E"  
PROCEEDING IT IN THE WORD "HEART". THE WORD  
"LINKS" IS FEATURED BELOW THE WORD "HEART"  
WITH ONE RAISED DOT BEFORE AND ONE AFTER THE  
WORD "LINKS". BOTH WORDS ARE SHOWN WITH  
HORIZONTAL LINES ABOVE AND BELOW THE ENTIRE  
MARK.

FOR JEWELRY (U.S. CLS. 2, 27, 28 AND 50).  
JERI J. FICKES, EXAMINING ATTORNEY

---

SN 85-324,258. SENO JEWELRY, LLC, NEW YORK, NY.  
FILED 5-18-2011.

IPPOLITA WICKED

THE MARK CONSISTS OF STANDARD CHARACTERS  
WITHOUT CLAIM TO ANY PARTICULAR FONT, STYLE,  
SIZE, OR COLOR.

OWNER OF U.S. REG. NOS. 2,829,602, 3,857,388 AND  
OTHERS.

THE NAME SHOWN IN THE MARK IDENTIFIES "IPPO-  
LITA ROSTAGNO", A LIVING INDIVIDUAL WHOSE CON-  
SENT IS OF RECORD.

FOR JEWELRY (U.S. CLS. 2, 27, 28 AND 50).

MARLENE BELL, EXAMINING ATTORNEY

**CLASS 14—(Continued).**

SN 85-329,933. ELEGANT COLLECTION PVT. LTD., MUMBAI, INDIA, FILED 5-25-2011.

**CLASS 14—(Continued).**

SN 85-332,258. PEARCE, RICHARD, J., GOLDEN, CO. FILED 5-27-2011.

**TOGETHER AS ONE**

THE MARK CONSISTS OF STANDARD CHARACTERS WITHOUT CLAIM TO ANY PARTICULAR FONT, STYLE, SIZE, OR COLOR.

FOR JEWELRY (U.S. CLS. 2, 27, 28 AND 50).  
LINDA E. BLOHM, EXAMINING ATTORNEY

**FLAW**

THE MARK CONSISTS OF STANDARD CHARACTERS WITHOUT CLAIM TO ANY PARTICULAR FONT, STYLE, SIZE, OR COLOR.

FOR BEADS FOR USE IN THE MANUFACTURE OF JEWELRY; BRACELETS; BRONZE JEWELRY; BROOCHES; CHARMS; COSTUME JEWELRY; IDENTIFICATION BRACELETS; JEWELRY; JEWELRY CHAINS; JEWELRY FINDINGS (U.S. CLS. 2, 27, 28 AND 50).  
DAVID H. STINE, EXAMINING ATTORNEY

SN 85-331,205. ASHI DIAMONDS LLC, NEW YORK, NY. FILED 5-26-2011.

SN 85-332,320. WEINDLING, ALEXANDER, NEW YORK, NY. FILED 5-27-2011.

**LOVEBRIGHT**

THE MARK CONSISTS OF STANDARD CHARACTERS WITHOUT CLAIM TO ANY PARTICULAR FONT, STYLE, SIZE, OR COLOR.

FOR JEWELLERY AND PRECIOUS STONES (U.S. CLS. 2, 27, 28 AND 50).  
FIRST USE 3-1-2011; IN COMMERCE 4-1-2011.  
SHARON MEIER, EXAMINING ATTORNEY

**LOVE YOU, I DO**

THE MARK CONSISTS OF STANDARD CHARACTERS WITHOUT CLAIM TO ANY PARTICULAR FONT, STYLE, SIZE, OR COLOR.

FOR JEWELRY (U.S. CLS. 2, 27, 28 AND 50).  
FRANK LATTUCA, EXAMINING ATTORNEY

SN 85-331,362. MEL BERNIE AND COMPANY, INC., BURBANK, CA. FILED 5-26-2011.

SN 85-333,050. RIVERA, BARBARA, WOODBRIDGE, NJ. FILED 5-28-2011.

**Seeds of Wisdom**

THE MARK CONSISTS OF STANDARD CHARACTERS WITHOUT CLAIM TO ANY PARTICULAR FONT, STYLE, SIZE, OR COLOR.

FOR JEWELRY (U.S. CLS. 2, 27, 28 AND 50).  
JAMES STEIN, EXAMINING ATTORNEY

**Birth Power**

THE MARK CONSISTS OF STANDARD CHARACTERS WITHOUT CLAIM TO ANY PARTICULAR FONT, STYLE, SIZE, OR COLOR.

FOR JEWELRY (U.S. CLS. 2, 27, 28 AND 50).  
FIRST USE 4-0-2008; IN COMMERCE 5-0-2011.  
SAMUEL E. SHARPER JR., EXAMINING ATTORNEY

**CLASS 14—(Continued).**

SN 85-333,268. THE WITNESS REVOLUTION, LLC, KING GEORGE, VA. FILED 5-29-2011.



THE COLOR(S) RED, BLACK AND WHITE IS/ARE CLAIMED AS A FEATURE OF THE MARK.

THE MARK CONSISTS OF THE STYLIZED WORD WITNESS IN RED WITH THE T IN WITNESS APPEARING AS A CROSS IN BLACK AND WHITE WITH A WHITE AND BLACK CLOTH DRAPED OVER THE CROSS.

FOR COLLECTIBLE COINS; JEWELRY (U.S. CLS. 2, 27, 28 AND 50).

FIRST USE 5-27-2011; IN COMMERCE 5-27-2011.  
RENEE MCCRAY, EXAMINING ATTORNEY

SN 85-333,305. GARCIA, NATASHA, MIAMI, FL. FILED 5-30-2011.

## Bunch of Hope

THE MARK CONSISTS OF STANDARD CHARACTERS WITHOUT CLAIM TO ANY PARTICULAR FONT, STYLE, SIZE, OR COLOR.

FOR BRACELETS (U.S. CLS. 2, 27, 28 AND 50).

FIRST USE 4-1-2011; IN COMMERCE 4-1-2011.  
JEFFREY LOOK, EXAMINING ATTORNEY

SN 85-333,310. EASEPAL ENTERPRISES LTD, FUJIAN PROVINCE, CHINA, FILED 5-30-2011.



THE MARK CONSISTS OF THE STYLIZED WORD KNINK ON THE LEFT, AND TWO CHINESE CHARACTERS WHICH TRANSLITERATE INTO YIN KE ON THE RIGHT. THE WORDING KNINK HAS NO MEANING IN A FOREIGN LANGUAGE.

THE NON-LATIN CHARACTERS IN THE MARK TRANSLITERATE TO YIN; KE AND THIS MEANS STAMP; GUEST IN ENGLISH.

FOR ALARM CLOCKS; CLOCKS; INGOTS OF PRECIOUS METAL; JADE; JEWELLERY; KEY RINGS OF PRECIOUS METAL; ORNAMENTS OF PRECIOUS METAL IN THE NATURE OF JEWELRY; WATCHES; WORKS OF ART OF PRECIOUS METAL; WRISTWATCHES (U.S. CLS. 2, 27, 28 AND 50).

BARBARA BROWN, EXAMINING ATTORNEY

**CLASS 14—(Continued).**

SN 85-333,485. DINGLE, JASON, NEW YORK, NY. FILED 5-30-2011.

## Rich Girlz

THE MARK CONSISTS OF STANDARD CHARACTERS WITHOUT CLAIM TO ANY PARTICULAR FONT, STYLE, SIZE, OR COLOR.

FOR BEADS FOR USE IN THE MANUFACTURE OF JEWELRY; BODY JEWELRY; BRACELETS; BRACELETS AND JEWELRY FEATURING ELECTRONIC CHIPS FOR ATTRACTING ENERGY TO THE BODY WHEREIN THE ELECTRONIC CHIPS INCREASE IN POWER IN THE PRESENCE OF ELECTROMAGNETIC FIELDS, FOR THE PURPOSE OF RE-BALANCING THE HUMAN ENERGY FIELD; BROACHES; BRONZE JEWELRY; BROOCHES; CAMEOS; CHARMS; CHARMS FOR COLLAR JEWELRY AND BRACELET; COSTUME JEWELRY; DIAMOND JEWELRY; GEMSTONE JEWELRY; GOLD THREAD JEWELRY; HAIR JEWELRY IN THE NATURE OF JEWELRY FOR USE IN THE HAIR; IDENTIFICATION BRACELETS; INEXPENSIVE NON-JEWELRY WATCHES; JEWELRY; JEWELRY AND IMITATION JEWELRY; JEWELRY ARMOIRES; JEWELRY BOXES; JEWELRY BOXES NOT OF METAL; JEWELRY BOXES OF METAL; JEWELRY BOXES OF PRECIOUS METAL; JEWELRY BROOCHES; JEWELRY CASES; JEWELRY CASES NOT OF PRECIOUS METAL; JEWELRY CASES OF PRECIOUS METAL; JEWELRY CASKETS; JEWELRY CASKETS OF PRECIOUS METAL; JEWELRY CHAINS; JEWELRY DISHES; JEWELRY FINDINGS; JEWELRY FOR ATTACHMENT TO CLOTHING; JEWELRY FOR THE HEAD; JEWELRY IN THE NATURE OF ARMBANDS; JEWELRY INCORPORATING A COMPUTER STORAGE DEVICE CONTAINING MEDICAL INFORMATION FOR MEDICAL ALERT PURPOSES; JEWELRY MAKING KITS; JEWELRY ORGANIZERS; JEWELRY PINS FOR USE ON HATS; JEWELRY RING HOLDERS; JEWELRY STICKPINS; JEWELRY THAT FITS OVER THE FRONT TEETH; JEWELRY THAT INCORPORATES TECHNOLOGY FOR REBALANCING THE HUMAN ENERGY FIELD; JEWELRY TO BE AFFIXED TO BIKINIS; JEWELRY WATCHES; JEWELRY, NAMELY, AMULETS; JEWELRY, NAMELY, ANKLETS; JEWELRY, NAMELY, ARM CUFFS; JEWELRY, NAMELY, BRACELETS, WRISTBANDS AND NECKLACES THAT ALSO PROVIDES NOTIFICATION TO THE WEARER OF A PENDING MEDICAL RELATED TASK; JEWELRY, NAMELY, CROSSES; JEWELRY, NAMELY, DOG TAGS FOR WEAR BY HUMANS FOR DECORATIVE PURPOSES; JEWELRY, NAMELY, MAGNETIC NECKLACES; JEWELRY, NAMELY, MAGNETIC PENDANTS; JEWELRY, NAMELY, PRECIOUS METAL PLATED REAL LEAVES AND FLOWERS; JEWELRY, NAMELY, STONE PENDANTS; LAPEL PINS; LEATHER JEWELRY AND ACCESSORY BOXES; METAL WIRE FOR USE IN THE MAKING OF JEWELRY, NAMELY, JEWELRY CABLE; ORNAMENTS OF PRECIOUS METAL IN THE NATURE OF JEWELRY; PET JEWELRY; PINS BEING JEWELRY; PLASTIC BRACELETS IN THE NATURE OF JEWELRY; PRECIOUS AND SEMI-PRECIOUS CRYSTAL STONES AND BEADS FOR USE IN JEWELRY; RINGS; RINGS BEING JEWELRY; STAINLESS STEEL JEWELRY BRACELETS; WATCHES AND JEWELRY; WATCHES, CLOCKS, JEWELRY AND IMITATION JEWELRY; WOMEN'S JEWELRY (U.S. CLS. 2, 27, 28 AND 50).

JERI J. FICKES, EXAMINING ATTORNEY

**CLASS 14—(Continued).**

SN 85-333,742. VARTANIAN, LEON, ENCINO, CA. FILED 5-31-2011.

# KENDORF

THE MARK CONSISTS OF STANDARD CHARACTERS WITHOUT CLAIM TO ANY PARTICULAR FONT, STYLE, SIZE, OR COLOR.

FOR JEWELRY (U.S. CLS. 2, 27, 28 AND 50).  
FIRST USE 5-19-2011; IN COMMERCE 5-19-2011.  
COURTNEY ALVAREZ, EXAMINING ATTORNEY

**CLASS 14—(Continued).**

SN 85-334,539. GLEN M KELLEY, DBA TIESTAYCLIP, INC., CUMMING, GA. FILED 5-31-2011.

# TieStayClip

THE MARK CONSISTS OF STANDARD CHARACTERS WITHOUT CLAIM TO ANY PARTICULAR FONT, STYLE, SIZE, OR COLOR.

FOR CUFF LINKS AND TIE CLIPS; TIE CLIPS; TIE CLIPS OF PRECIOUS METAL (U.S. CLS. 2, 27, 28 AND 50).

NAAKWAMA ANKRAH, EXAMINING ATTORNEY

SN 85-333,970. SEIKO HOLDINGS KABUSHIKI KAISHA, TA SEIKO HOLDINGS CORPORATION, TOKYO, JAPAN, FILED 5-31-2011.

# SEIKO RIVOLI

THE MARK CONSISTS OF STANDARD CHARACTERS WITHOUT CLAIM TO ANY PARTICULAR FONT, STYLE, SIZE, OR COLOR.

OWNER OF U.S. REG. NOS. 686,264 AND 1,159,088.  
FOR WATCHES AND PARTS THEREOF (U.S. CLS. 2, 27, 28 AND 50).  
CHARLES L. JENKINS, EXAMINING ATTORNEY

SN 85-336,029. NEGRON, PERLA, PALM SPRINGS, CA. FILED 6-2-2011.

# perlanegron.com

SN 85-334,186. ZAIDAN DESIGNS, L.L.C., SHREVEPORT, LA. FILED 5-31-2011.

# Timeless Charms

THE MARK CONSISTS OF STANDARD CHARACTERS WITHOUT CLAIM TO ANY PARTICULAR FONT, STYLE, SIZE, OR COLOR.

NO CLAIM IS MADE TO THE EXCLUSIVE RIGHT TO USE "CHARMS", APART FROM THE MARK AS SHOWN.

FOR BRACELETS; CHARMS; COSTUME JEWELRY; JEWELRY; WOMEN'S JEWELRY (U.S. CLS. 2, 27, 28 AND 50).

FIRST USE 1-6-2000; IN COMMERCE 1-6-2000.  
EVELYN BRADLEY, EXAMINING ATTORNEY

THE MARK CONSISTS OF STANDARD CHARACTERS WITHOUT CLAIM TO ANY PARTICULAR FONT, STYLE, SIZE, OR COLOR.

THE NAME PERLA NEGRON IDENTIFIES A LIVING INDIVIDUAL WHOSE CONSENT IS OF RECORD.

FOR BRACELETS; EARRINGS; JEWELLERY AND PRECIOUS STONES; NECKLACES; RINGS BEING JEWELRY (U.S. CLS. 2, 27, 28 AND 50).

LAURIE KAUFMAN, EXAMINING ATTORNEY

**CLASS 14—(Continued).**

SN 85-336,229. D.M. ROTTERMOND INC., DBA ROTTERMOND JEWELERS, MILFORD, MI. FILED 6-2-2011.



THE MARK CONSISTS OF THE LETTERS R AND J WITH THE LETTER R PRECEDING THE LETTER J AND BEING SLIGHTLY RAISED IN POSITION RELATIVE TO THE LETTER J. THE LETTERS R AND J ARE POSITIONED WITHIN A PENTAGONAL SHIELD. THE PENTAGONAL SHIELD IS CONTINUOUS EXCEPT FOR A TOP PORTION THEREOF WHICH IS SPLIT TO PROVIDE LEFT AND RIGHT ENDS OF THE SHIELD. A DIAMOND IS POSITIONED BETWEEN, AND SEPARATED FROM, THE LEFT AND RIGHT ENDS OF THE SHIELD.  
FOR JEWELRY (U.S. CLS. 2, 27, 28 AND 50).  
FIRST USE 6-30-1997; IN COMMERCE 12-31-1998.  
DEIRDRE ROBERTSON, EXAMINING ATTORNEY

SN 85-336,504. MERIT DIAMOND CORPORATION, HOLLYWOOD, FL. FILED 6-2-2011.

**THE ROAD TO HER HEART  
STARTS IN HER EYES**

THE MARK CONSISTS OF STANDARD CHARACTERS WITHOUT CLAIM TO ANY PARTICULAR FONT, STYLE, SIZE, OR COLOR.  
FOR JEWELRY (U.S. CLS. 2, 27, 28 AND 50).  
JENNIFER MARTIN, EXAMINING ATTORNEY

**CLASS 14—(Continued).**

SN 85-337,298. TXDC, L.P., IRVING, TX. FILED 6-3-2011.



THE MARK CONSISTS OF THE TERM "TINY TOES" IN STYLIZED FONT WITH A LARGER AND SMALLER FOOTPRINT DESIGN BETWEEN THE TERMS "TINY" AND "TOES".  
FOR JEWELRY (U.S. CLS. 2, 27, 28 AND 50).  
JEFF DEFORD, EXAMINING ATTORNEY

SN 85-337,315. UNITED BEAUTY PRODUCTS, INC., ALPHARETTA, GA. FILED 6-3-2011.

**FLASH IT!**

THE MARK CONSISTS OF STANDARD CHARACTERS WITHOUT CLAIM TO ANY PARTICULAR FONT, STYLE, SIZE, OR COLOR.  
FOR BODY JEWELRY (U.S. CLS. 2, 27, 28 AND 50).  
KYLE PEETE, EXAMINING ATTORNEY

SN 85-337,494. PEIGI GUERRA, STOWE, VT. FILED 6-3-2011.

**TWIN TEARS**

THE MARK CONSISTS OF STANDARD CHARACTERS WITHOUT CLAIM TO ANY PARTICULAR FONT, STYLE, SIZE, OR COLOR.  
FOR JEWELRY (U.S. CLS. 2, 27, 28 AND 50).  
MELISSA VALLILLO, EXAMINING ATTORNEY

**CLASS 14—(Continued).**

SN 85-337,613. AOKI, STEVE, HOLLYWOOD, CA. FILED 6-3-2011.

**D1**

THE MARK CONSISTS OF STANDARD CHARACTERS WITHOUT CLAIM TO ANY PARTICULAR FONT, STYLE, SIZE, OR COLOR.  
FOR JEWELRY, WATCHES, CUFFLINKS, WATCH BANDS, LEATHER BRACELETS (U.S. CLS. 2, 27, 28 AND 50).  
KATHERINE STOIDES, EXAMINING ATTORNEY

SN 85-337,640. AOKI, STEVE, HOLLYWOOD, CA. FILED 6-3-2011.

**D1M MAK**

THE MARK CONSISTS OF STANDARD CHARACTERS WITHOUT CLAIM TO ANY PARTICULAR FONT, STYLE, SIZE, OR COLOR.  
OWNER OF U.S. REG. NO. 3,312,474.  
FOR JEWELRY, WATCHES, CUFFLINKS, WATCH BANDS, LEATHER BRACELETS (U.S. CLS. 2, 27, 28 AND 50).  
KATHERINE STOIDES, EXAMINING ATTORNEY

SN 85-338,452. SIMPLE STARFISH, LLC, JACKSON, NJ. FILED 6-6-2011.

**{simple starfish}**

THE MARK CONSISTS OF STANDARD CHARACTERS WITHOUT CLAIM TO ANY PARTICULAR FONT, STYLE, SIZE, OR COLOR.  
FOR JEWELRY (U.S. CLS. 2, 27, 28 AND 50).  
FIRST USE 0-0-2008; IN COMMERCE 0-0-2008.  
HAI-LY LAM, EXAMINING ATTORNEY

**CLASS 14—(Continued).**

SN 85-338,782. MARAWATCH & COMPANY LLC, CAMBRIDGE, MA. FILED 6-6-2011.

**MARAWATCH**

THE MARK CONSISTS OF STANDARD CHARACTERS WITHOUT CLAIM TO ANY PARTICULAR FONT, STYLE, SIZE, OR COLOR.  
FOR WATCHES (U.S. CLS. 2, 27, 28 AND 50).  
KEVON CHISOLM, EXAMINING ATTORNEY

SN 85-340,006. WINSTON WILLIAMS, LAURELTON, NY. FILED 6-7-2011.

**ROZAN**

THE MARK CONSISTS OF STANDARD CHARACTERS WITHOUT CLAIM TO ANY PARTICULAR FONT, STYLE, SIZE, OR COLOR.  
FOR JEWELRY (U.S. CLS. 2, 27, 28 AND 50).  
JASON TURNER, EXAMINING ATTORNEY

SN 85-341,394. VOETSCH & COMPANY, INC., PRAIRIE VILLAGE, KS. FILED 6-8-2011.



OWNER OF U.S. REG. NO. 1,613,757.  
THE MARK CONSISTS OF A RECTANGULAR ELEMENT PARTIALLY SHADED COMPRISED OF FIVE CURVED TRIANGULAR ELEMENTS WHEREIN THREE TRIANGULAR ELEMENTS ARE SHADED AND TWO TRIANGULAR ELEMENTS ARE NOT SHADED OR PARTIALLY SHADED.  
FOR JEWELRY (U.S. CLS. 2, 27, 28 AND 50).  
FIRST USE 3-23-1987; IN COMMERCE 3-23-1987.  
INGA ERVIN, EXAMINING ATTORNEY

**CLASS 14—(Continued).**

SN 85-347,673. THE ANDERSON-MCQUEEN COMPANY, ST. PETERSBURG, FL. FILED 6-16-2011.

**PAWS TO REMEMBER**

THE MARK CONSISTS OF STANDARD CHARACTERS WITHOUT CLAIM TO ANY PARTICULAR FONT, STYLE, SIZE, OR COLOR.

FOR JEWELRY; JEWELRY IN THE NATURE OF ARMBANDS (U.S. CLS. 2, 27, 28 AND 50).

FIRST USE 4-22-2011; IN COMMERCE 4-22-2011.

THEODORE MCBRIDE, EXAMINING ATTORNEY

---

SN 85-353,839. ROYAL CHAIN, INC., NEW YORK, NY. FILED 6-23-2011.

**KARISMA**

THE MARK CONSISTS OF STANDARD CHARACTERS WITHOUT CLAIM TO ANY PARTICULAR FONT, STYLE, SIZE, OR COLOR.

FOR JEWELRY, NAMELY, RINGS, BROOCHES, EARRINGS, NECKLACES, PINS, CHAINS, PENDANTS, BRACELETS, CHARMS (U.S. CLS. 2, 27, 28 AND 50).

KEVON CHISOLM, EXAMINING ATTORNEY

---

SN 85-356,940. GAP (APPAREL), LLC, SAN FRANCISCO, CA. FILED 6-27-2011.

**PIM + LARKIN**

THE MARK CONSISTS OF STANDARD CHARACTERS WITHOUT CLAIM TO ANY PARTICULAR FONT, STYLE, SIZE, OR COLOR.

FOR JEWELRY, NAMELY, RINGS, BRACELETS, NECKLACES, BROOCHES, EARRINGS AND CUFF-LINKS; WATCHES AND CLOCKS (U.S. CLS. 2, 27, 28 AND 50).

BRENDAN MCCAULEY, EXAMINING ATTORNEY

**CLASS 14—(Continued).**

SN 85-374,818. CHRISTIAN BAUER GMBH + CO. KG, WELZHEIM, FED REP GERMANY, FILED 7-19-2011.

**passion in true values**

THE MARK CONSISTS OF STANDARD CHARACTERS WITHOUT CLAIM TO ANY PARTICULAR FONT, STYLE, SIZE, OR COLOR.

PRIORITY CLAIMED UNDER SEC. 44(D) ON ERPN CMNTY TM OFC APPLICATION NO. 009685389, FILED 1-26-2011.

FOR JEWELLERY; COSTUME JEWELLERY; CLOCKS; RINGS (U.S. CLS. 2, 27, 28 AND 50).

FONG HSU, EXAMINING ATTORNEY

---

SN 85-375,395. VALUEVISION MEDIA, INC., EDEN PRAIRIE, MN. FILED 7-19-2011.

**VIALE18**

THE MARK CONSISTS OF STANDARD CHARACTERS WITHOUT CLAIM TO ANY PARTICULAR FONT, STYLE, SIZE, OR COLOR.

THE ENGLISH TRANSLATION OF "VIALE" IN THE MARK IS "AVENUE, PATH, WALK, PARKWAY, OR BOULEVARD".

FOR JEWELRY (U.S. CLS. 2, 27, 28 AND 50).

BRENDAN MCCAULEY, EXAMINING ATTORNEY

---

SN 85-379,369. SCG POWER RANGERS LLC, LOS ANGELES, CA. FILED 7-24-2011.

**POWER RIDER**

THE MARK CONSISTS OF STANDARD CHARACTERS WITHOUT CLAIM TO ANY PARTICULAR FONT, STYLE, SIZE, OR COLOR.

FOR WATCHES AND WATCH STRAPS (U.S. CLS. 2, 27, 28 AND 50).

THOMAS MANOR, EXAMINING ATTORNEY

**CLASS 14—(Continued).**

SN 85-382,460. VALUEVISION MEDIA, INC., EDEN PRAIRIE, MN. FILED 7-27-2011.

# CADEAUX

THE MARK CONSISTS OF STANDARD CHARACTERS WITHOUT CLAIM TO ANY PARTICULAR FONT, STYLE, SIZE, OR COLOR.

THE ENGLISH TRANSLATION OF "CADEAUX" IN THE MARK IS "PRESENTS OR GIFTS".

FOR CHARMS; JEWELRY (U.S. CLS. 2, 27, 28 AND 50).  
BRENDAN MCCAULEY, EXAMINING ATTORNEY

---

SN 85-395,644. TXDC, L.P., IRVING, TX. FILED 8-11-2011.

# IDEAL ROMANCE

THE MARK CONSISTS OF STANDARD CHARACTERS WITHOUT CLAIM TO ANY PARTICULAR FONT, STYLE, SIZE, OR COLOR.

FOR JEWELRY (U.S. CLS. 2, 27, 28 AND 50).  
JEFF DEFORD, EXAMINING ATTORNEY

---

SN 85-397,875. LIN, ZHONG JIAN, OZONE PARK, NY. FILED 8-15-2011.

# P&G

## Peace Grace

THE MARK CONSISTS OF THE MARK CONSISTS OF TWO LINES: THE TOP LINE IS "P&G" AND THE BOTTOM LINE IS "PEACE GRACE".

FOR BEADS FOR USE IN THE MANUFACTURE OF JEWELRY; BODY JEWELRY; BRACELETS; BRACELETS AND JEWELRY FEATURING ELECTRONIC CHIPS FOR ATTRACTING ENERGY TO THE BODY WHEREIN THE ELECTRONIC CHIPS INCREASE IN POWER IN THE PRESENCE OF ELECTROMAGNETIC FIELDS, FOR THE PURPOSE OF RE-BALANCING THE HUMAN ENERGY FIELD; BROACHES; BRONZE JEWELRY; BROOCHES; CAMEOS; CASES FOR CLOCK AND WATCH-MAKING; CASES FOR WATCHES AND CLOCKS; CHARMS; CHARMS FOR COLLAR JEWELRY AND BRACELET; CHRONOGRAPHS AS WATCHES; CHRONOGRAPHS FOR USE AS WATCHES; CHRONOMETRIC INSTRUMENTS AND WATCH MOVEMENTS; CLOCK AND WATCH HANDS; CLOCKS AND WATCHES; CLOCKS AND WATCHES FOR PIGEON-FANCIERS; COMPLICATION WATCHES; COSTUME JEWELRY; DIALS FOR CLOCK-AND-WATCH-MAKING; DIAMOND JEWELRY; DIVING WATCHES; DRESS WATCHES; EQUESTRIAN WATCHES; GEMSTONE JEWELRY; GOLD THREAD JEWELRY; HAIR JEWELRY IN THE NATURE OF JEWELRY FOR USE IN THE HAIR; IDENTIFICATION BRACELETS; INEXPENSIVE NON-JEWELRY WATCHES; JEWELLERY AND WATCHES; JEWELLERY,

**CLASS 14—(Continued).**

CLOCKS AND WATCHES; JEWELRY; JEWELRY AND IMITATION JEWELRY; JEWELRY ARMOIRES; JEWELRY BOXES; JEWELRY BOXES NOT OF METAL; JEWELRY BOXES OF METAL; JEWELRY BOXES OF PRECIOUS METAL; JEWELRY BROOCHES; JEWELRY CASES; JEWELRY CASES NOT OF PRECIOUS METAL; JEWELRY CASES OF PRECIOUS METAL; JEWELRY CASKETS; JEWELRY CASKETS OF PRECIOUS METAL; JEWELRY CHAINS; JEWELRY DISHES; JEWELRY FINDINGS; JEWELRY FOR ATTACHMENT TO CLOTHING; JEWELRY FOR THE HEAD; JEWELRY IN THE NATURE OF ARMBANDS; JEWELRY INCORPORATING A COMPUTER STORAGE DEVICE CONTAINING MEDICAL INFORMATION FOR MEDICAL ALERT PURPOSES; JEWELRY MAKING KITS; JEWELRY ORGANIZERS; JEWELRY PINS FOR USE ON HATS; JEWELRY RING HOLDERS; JEWELRY STICKPINS; JEWELRY THAT FITS OVER THE FRONT TEETH; JEWELRY THAT INCORPORATES TECHNOLOGY FOR REBALANCING THE HUMAN ENERGY FIELD; JEWELRY TO BE AFFIXED TO BIKINIS; JEWELRY WATCHES; JEWELRY, NAMELY, AMULETS; JEWELRY, NAMELY, ANKLETS; JEWELRY, NAMELY, ARM CUFFS; JEWELRY, NAMELY, BRACELETS, WRISTBANDS AND NECKLACES THAT ALSO PROVIDES NOTIFICATION TO THE WEARER OF A PENDING MEDICAL RELATED TASK; JEWELRY, NAMELY, CROSSES; JEWELRY, NAMELY, DOG TAGS FOR WEAR BY HUMANS FOR DECORATIVE PURPOSES; JEWELRY, NAMELY, MAGNETIC NECKLACES; JEWELRY, NAMELY, MAGNETIC PENDANTS; JEWELRY, NAMELY, PRECIOUS METAL PLATED REAL LEAVES AND FLOWERS; JEWELRY, NAMELY, STONE PENDANTS; LAPEL PINS; LEATHER JEWELRY AND ACCESSORY BOXES; MECHANICAL AND AUTOMATIC WATCHES; METAL WIRE FOR USE IN THE MAKING OF JEWELRY, NAMELY, JEWELRY CABLE; ORNAMENTS OF PRECIOUS METAL IN THE NATURE OF JEWELRY; PARTS FOR WATCHES; PET JEWELRY; PINS BEING JEWELRY; PLASTIC BRACELETS IN THE NATURE OF JEWELRY; POCKET WATCHES; PRECIOUS AND SEMI-PRECIOUS CRYSTAL STONES AND BEADS FOR USE IN JEWELRY; PRECIOUS STONES AND WATCHES; RINGS; RINGS BEING JEWELRY; SPORTS WATCHES; STAINLESS STEEL JEWELRY BRACELETS; STOP WATCHES; WATCH AND CLOCK SPRINGS; WATCH BANDS; WATCH BANDS AND STRAPS; WATCH BOXES; WATCH BRACELETS; WATCH CASES; WATCH CHAINS; WATCH CLASPS; WATCH CROWNS; WATCH FACES; WATCH FOBS; WATCH GLASSES; WATCH MOVEMENTS; WATCH PARTS; WATCH POUCHES; WATCH STRAPS; WATCH STRAPS MADE OF METAL OR LEATHER OR PLASTIC; WATCH WINDERS; WATCH WINDING BUTTONS; WATCHES; WATCHES AND CLOCKS; WATCHES AND JEWELLERY; WATCHES AND JEWELRY; WATCHES AND STRAPS FOR WATCHES; WATCHES CONTAINING A GAME FUNCTION; WATCHES CONTAINING AN ELECTRONIC GAME FUNCTION; WATCHES FOR OUTDOOR USE; WATCHES FOR SPORTING USE; WATCHES MADE OF PRECIOUS METALS OR COATED THEREWITH; WATCHES, CLOCKS; WATCHES, CLOCKS, JEWELLERY AND IMITATION JEWELLERY; WATCHES, CLOCKS, JEWELRY AND IMITATION JEWELRY; WOMEN'S JEWELRY; WOMEN'S WATCHES; WRIST WATCHES (U.S. CLS. 2, 27, 28 AND 50).

FIRST USE 8-9-2008; IN COMMERCE 8-9-2008.  
JENNIFER MARTIN, EXAMINING ATTORNEY



**CLASS 14—(Continued).**

SN 85-975,703. FARMER, DANIEL CHARLES, BIRMINGHAM, AL. AND FARMER, ANN SCIRO, BIRMINGHAM, AL. FILED 5-6-2011.

iCAN

THE MARK CONSISTS OF STANDARD CHARACTERS WITHOUT CLAIM TO ANY PARTICULAR FONT, STYLE, SIZE, OR COLOR.

FOR JEWELRY, NAMELY, BRACELETS FEATURING ICAN LOGO (U.S. CLS. 2, 27, 28 AND 50).  
ERNEST SHOSHO, EXAMINING ATTORNEY

**CLASS 15—MUSICAL INSTRUMENTS**

SN 85-176,264. J.R. GIARDULLO & CO., INC, DBA SOPRANOPLANET, COTTEKILL, NY. FILED 11-14-2010.

SOPRANOPLANET

THE MARK CONSISTS OF STANDARD CHARACTERS WITHOUT CLAIM TO ANY PARTICULAR FONT, STYLE, SIZE, OR COLOR.

FOR MOUTHPIECES FOR MUSICAL INSTRUMENTS (U.S. CLS. 2, 21 AND 36).  
FIRST USE 8-1-2009; IN COMMERCE 8-1-2009.  
CYNTHIA TRIPI, EXAMINING ATTORNEY

**CLASS 15—(Continued).**

SN 85-184,622. PEACE MUSICAL CO., LTD., TAICHUNG HSIEN, TAIWAN, FILED 11-24-2010.



OWNER OF U.S. REG. NO. 1,813,627.

THE MARK CONSISTS OF A VERTICAL ARROW POINTING UPWARD OVER THE WORD "PEACE" UNDERSCORED AND CONTAINED IN A BLACK BOX WITH ROUNDED CORNERS.

FOR DRUMS, SAXOPHONES, VIOLINS, VIOLAS, HARPS, GUITARS, ELECTRONIC ORGANS, STRINGED INSTRUMENTS, MUSICAL KEYBOARDS, PIANOS, BOWS FOR MUSICAL INSTRUMENTS, BRASS INSTRUMENTS, CASTANETS, DRUM PEDALS, DRUMSTICKS, ELECTRONIC EFFECTS PEDALS FOR USE WITH MUSICAL INSTRUMENTS, FOOT PEDALS FOR USE IN CONNECTION WITH MUSICAL INSTRUMENTS, GUITAR PEDALS, KEYBOARD INSTRUMENTS, MUSIC SYNTHESIZERS, PERCUSSION INSTRUMENTS, SHEET MUSIC STANDS, SOUND EFFECT PEDALS FOR MUSICAL INSTRUMENTS, STANDS FOR MUSICAL INSTRUMENTS, TUNERS FOR MUSICAL INSTRUMENTS (U.S. CLS. 2, 21 AND 36).

FIRST USE 11-2-2010; IN COMMERCE 11-2-2010.  
COLLEEN DOMBROW, EXAMINING ATTORNEY

SN 85-195,496. ELECTRIC LADY, LLC, GREENVILLE, DE. FILED 12-10-2010.

ELECTRIC LADY

THE MARK CONSISTS OF STANDARD CHARACTERS WITHOUT CLAIM TO ANY PARTICULAR FONT, STYLE, SIZE, OR COLOR.

NO CLAIM IS MADE TO THE EXCLUSIVE RIGHT TO USE "ELECTRIC", APART FROM THE MARK AS SHOWN.

FOR MUSICAL INSTRUMENTS, IN PARTICULAR, GUITARS AND THEIR PARTS, KEYBOARD AND PERCUSSION MUSICAL INSTRUMENTS, AND BASS INSTRUMENTS (U.S. CLS. 2, 21 AND 36).

DOUGLAS LEE, EXAMINING ATTORNEY

**CLASS 15—(Continued).**

SN 85-321,350. ZHANG, ZHEN, BEIJING, CHINA, FILED 5-15-2011.

**DUXTON**

THE MARK CONSISTS OF STANDARD CHARACTERS WITHOUT CLAIM TO ANY PARTICULAR FONT, STYLE, SIZE, OR COLOR.  
FOR MUSICAL INSTRUMENTS (U.S. CLS. 2, 21 AND 36).  
FIRST USE 3-1-2011; IN COMMERCE 3-1-2011.  
PRISCILLA MILTON, EXAMINING ATTORNEY

SN 85-331,134. LEMAS, ROBERT, CITRUS HEIGHTS, CA. FILED 5-26-2011.

**SWINGBOX**

THE MARK CONSISTS OF STANDARD CHARACTERS WITHOUT CLAIM TO ANY PARTICULAR FONT, STYLE, SIZE, OR COLOR.  
FOR MUSICAL INSTRUMENTS, NAMELY, GUITARS (U.S. CLS. 2, 21 AND 36).  
KAREN K. BUSH, EXAMINING ATTORNEY

SN 85-333,752. GREEN, PAUL M., ST. AUGUSTINE, FL. FILED 5-31-2011.

**STAR STRAP**

THE MARK CONSISTS OF STANDARD CHARACTERS WITHOUT CLAIM TO ANY PARTICULAR FONT, STYLE, SIZE, OR COLOR.  
NO CLAIM IS MADE TO THE EXCLUSIVE RIGHT TO USE "STRAP", APART FROM THE MARK AS SHOWN.  
FOR GUITAR STRAPS (U.S. CLS. 2, 21 AND 36).  
GINA FINK, EXAMINING ATTORNEY

**CLASS 15—(Continued).**

SN 85-335,886. BLANCO LLC, DBA LOU, TACOMA, WA. FILED 6-2-2011.

**THE PREDATOR**

THE MARK CONSISTS OF STANDARD CHARACTERS WITHOUT CLAIM TO ANY PARTICULAR FONT, STYLE, SIZE, OR COLOR.  
FOR GUITARS, NAMELY, CUSTOM, BASS AND KEYBOARD PEDAL BOARD MODEL GUITARS (U.S. CLS. 2, 21 AND 36).  
FIRST USE 6-1-2011; IN COMMERCE 6-1-2011.  
JOHN E. MICHOS, EXAMINING ATTORNEY

SN 85-338,373. ELITE MUSICAL INSTRUMENTS, CORP., WALNUT, CA. FILED 6-5-2011.

**Crystalcello**

THE MARK CONSISTS OF STANDARD CHARACTERS WITHOUT CLAIM TO ANY PARTICULAR FONT, STYLE, SIZE, OR COLOR.  
FOR MUSICAL INSTRUMENTS: STRINGS, WOODWIND AND BRASS MUSICAL INSTRUMENTS (U.S. CLS. 2, 21 AND 36).  
ZACHARY BELLO, EXAMINING ATTORNEY

**CLASS 16—PAPER GOODS AND PRINTED MATTER**

SN 77-719,353. OMNIA EDUCATION INC., FORT WASHINGTON, PA. FILED 4-22-2009.

**ECHO**

THE MARK CONSISTS OF STANDARD CHARACTERS WITHOUT CLAIM TO ANY PARTICULAR FONT, STYLE, SIZE, OR COLOR.  
FOR EDUCATIONAL PUBLICATIONS, NAMELY, EDUCATIONAL BOOKLETS IN THE FIELD OF WOMEN'S HEALTH FOR CONTINUING MEDICAL EDUCATION (U.S. CLS. 2, 5, 22, 23, 29, 37, 38 AND 50).  
FIRST USE 8-11-2008; IN COMMERCE 8-11-2008.  
BRIAN NEVILLE, EXAMINING ATTORNEY

**CLASS 16—(Continued).**

SN 77-806,351. TRIUMPH INTERNATIONAL, INC., ATLANTA, GA. FILED 8-17-2009.

MICHAEL JACKSON

THE MARK CONSISTS OF STANDARD CHARACTERS WITHOUT CLAIM TO ANY PARTICULAR FONT, STYLE, SIZE, OR COLOR.

OWNER OF U.S. REG. NO. 1,908,209.  
THE NAME "MICHAEL JACKSON" DOES NOT IDENTIFY A LIVING INDIVIDUAL.

FOR PAPER GOODS AND PRINTED MATTER, NAMELY, POSTERS; CHILDREN'S BOOKS; BOOKS IN THE FIELD OF MUSIC AND ENTERTAINMENT, SERIES OF FICTION BOOKS; COMIC BOOKS, BUMPER STICKERS, STICKERS, CALENDARS, PENCIL SHARPENERS, PENCIL CASES, ACTIVITY BOOKS, BOTH PRINTED AND BLANK; BINDERS, NOTEBOOKS, STATIONERY, NOTE PADS, WRITING TABLETS, PAPER TABLE CLOTHS, PAPER NAPKINS, PENCILS, MARKERS, ERASERS, COLORING BOOKS, WRITING PENS, NON-CALIBRATED RULERS, PAPER WEIGHTS, PAPER COASTERS, BOOKMARKS, BOOK COVERS AND HOLDERS, PAPER PLACE MATS; PHOTO ALBUMS; ADDRESS BOOKS; FAN CLUB NEWSLETTERS, POST CARDS, HOLIDAY CARDS, GREETING CARDS, ART PRINTS, PRINTED ART REPRODUCTIONS, MERCHANDISE BAGS; CHILDREN'S ACTIVITY BOOKS AND PICTURE BOOKS; PHOTOGRAPHS, GIFT WRAP PAPER; SOUVENIR COLLECTION BOOKS FOR MOVIES AND OTHER AUDIOVISUAL PRODUCTIONS; SOUVENIR COLLECTION BOOKS COMMEMORATING THE LIFE OF A FAMOUS POP STAR; ENTERTAINMENT TOUR MEMORABILIA COLLECTION BOOKS; EVENT PROGRAMS; SONG BOOKS; SHEET MUSIC BOOKS; PICTURE BOOKS; DECALS; MAGAZINES, NEWSLETTERS, BOOKLETS, PAMPHLETS AND BROCHURES IN THE FIELD OF MUSIC AND ENTERTAINMENT; LITHOGRAPHS; PRECIOUS METAL MONEY CLIPS; LETTER OPENERS OF PRECIOUS METAL AND BOOK MARKERS OF PRECIOUS METAL (U.S. CLS. 2, 5, 22, 23, 29, 37, 38 AND 50).

HEATHER THOMPSON, EXAMINING ATTORNEY

**CLASS 16—(Continued).**

SN 77-806,393. TRIUMPH INTERNATIONAL, INC., ATLANTA, GA. FILED 8-17-2009.

 A stylized, handwritten signature of Michael Jackson. The signature is written in black ink and features a prominent, vertical line extending upwards from the letter 'N' at the end of the name. The signature is highly decorative and cursive.

OWNER OF U.S. REG. NO. 1,908,209.  
THE NAME "MICHAEL JACKSON" DOES NOT IDENTIFY A LIVING INDIVIDUAL.

THE MARK CONSISTS OF THE NAME "MICHAEL JACKSON" WRITTEN IN STYLIZED FORM WHEN THE END OF THE LETTER "N" HAS A VERTICAL LINE UP AND AT THE PEAK HAS A SLIGHTLY CURVED LINE DOWN ENDING WITH A STYLIZED STARBURST.

FOR PAPER GOODS AND PRINTED MATTER, NAMELY, POSTERS; CHILDREN'S BOOKS; BOOKS IN THE FIELD OF MUSIC AND ENTERTAINMENT, SERIES OF FICTION BOOKS; COMIC BOOKS, BUMPER STICKERS, STICKERS, CALENDARS, PENCIL SHARPENERS, PENCIL CASES, ACTIVITY BOOKS, BOTH PRINTED AND BLANK; BINDERS, NOTEBOOKS, STATIONERY, NOTE PADS, WRITING TABLETS, PAPER TABLE CLOTHS, PAPER NAPKINS, PENCILS, MARKERS, ERASERS, COLORING BOOKS, WRITING PENS, NON-CALIBRATED RULERS, PAPER WEIGHTS, PAPER COASTERS, BOOKMARKS, BOOK COVERS AND HOLDERS, PAPER PLACE MATS; PHOTO ALBUMS; ADDRESS BOOKS; FAN CLUB NEWSLETTERS, POST CARDS, HOLIDAY CARDS, GREETING CARDS, ART PRINTS, PRINTED ART REPRODUCTIONS, MERCHANDISE BAGS; CHILDREN'S ACTIVITY BOOKS AND PICTURE BOOKS; PHOTOGRAPHS, GIFT WRAP PAPER; SOUVENIR COLLECTION BOOKS FOR MOVIES AND OTHER AUDIOVISUAL PRODUCTIONS; SOUVENIR COLLECTION BOOKS COMMEMORATING THE LIFE OF A FAMOUS POP STAR; ENTERTAINMENT TOUR MEMORABILIA COLLECTION BOOKS; EVENT PROGRAMS; SONG BOOKS; SHEET MUSIC BOOKS; PICTURE BOOKS; DECALS; MAGAZINES, NEWSLETTERS, BOOKLETS, PAMPHLETS AND BROCHURES IN THE FIELD OF MUSIC AND ENTERTAINMENT; LITHOGRAPHS; PRECIOUS METAL MONEY CLIPS; LETTER OPENERS OF PRECIOUS METAL AND BOOK MARKERS OF PRECIOUS METAL (U.S. CLS. 2, 5, 22, 23, 29, 37, 38 AND 50).

HEATHER THOMPSON, EXAMINING ATTORNEY

**CLASS 16—(Continued).**

SN 79-092,249. DA LIAN YA TU TOU ZI ZI XUN YOU XIAN GONG SI, DALIAN CITY, LIAONING PROVINCE, CHINA, FILED 1-4-2011.

**CLASS 16—(Continued).**

SN 79-092,250. DA LIAN YA TU TOU ZI ZI XUN YOU XIAN GONG SI, DALIAN CITY, LIAONING PROVINCE, CHINA, FILED 1-4-2011.



OWNER OF INTERNATIONAL REGISTRATION 1064185 DATED 1-4-2011, EXPIRES 1-4-2021.

THE MARK CONSISTS OF A THREE SIDED SHIELD WITH STARS IN THE BORDER AND THE SYMBOL FOR FEMALE IN THE BOTTOM. IN THE CENTER IS THE LETTER "O" WITH THE ASTROLOGICAL SIGN FOR PISCES.

FOR PAPER; TOWELS OF PAPER; PRINTED MATTER, NAMELY, CALENDARS, NEWSPAPERS, NOTEBOOKS; PRINTED PUBLICATIONS, NAMELY, BOOKS AND BROCHURES IN THE FIELD OF SCIENCE, SPORTS, FASHION, CLOTHING, CULTURE, ARTS, ENTERTAINMENT, HEALTH; PERIODICALS, NAMELY, MAGAZINES IN THE FIELD OF SCIENCE, SPORTS, FASHION, CLOTHING, CULTURE, ARTS, ENTERTAINMENT, HEALTH; PICTURES; WRAPPING PAPER, STATIONERY; STAMPS NAMELY, SEALS; WRITING INSTRUMENTS (U.S. CLS. 2, 5, 22, 23, 29, 37, 38 AND 50).  
EUGENIA MARTIN, EXAMINING ATTORNEY

OWNER OF INTERNATIONAL REGISTRATION 1064186 DATED 1-4-2011, EXPIRES 1-4-2021.

THE MARK CONSISTS OF A THREE SIDED SHIELD WITH STARS IN THE BORDER AND THE SYMBOL FOR FEMALE IN THE BOTTOM. IN THE CENTER ARE THE LETTERS "AB" WITH THE ASTROLOGICAL SIGN FOR AQUARIUS ABOVE WITH A CIRCLE IN THE CENTER OF THE SYMBOL.

FOR PAPER; TOWELS OF PAPER; PRINTED MATTER, NAMELY, CALENDARS, NEWSPAPERS, NOTEBOOKS; PRINTED PUBLICATIONS, NAMELY, BOOKS AND BROCHURES IN THE FIELD OF SCIENCE, SPORTS, FASHION, CLOTHING, CULTURE, ARTS, ENTERTAINMENT, HEALTH; PERIODICALS, NAMELY, MAGAZINES IN THE FIELD OF SCIENCE, SPORTS, FASHION, CLOTHING, CULTURE, ARTS, ENTERTAINMENT, HEALTH; PICTURES; WRAPPING PAPER, STATIONERY; STAMPS NAMELY, SEALS; WRITING INSTRUMENTS (U.S. CLS. 2, 5, 22, 23, 29, 37, 38 AND 50).  
EUGENIA MARTIN, EXAMINING ATTORNEY

**CLASS 16—(Continued).**

SN 79-092,251. DA LIAN YA TU TOU ZI ZI XUN YOU XIAN GONG SI, DALIAN CITY, LIAONING PROVINCE, CHINA, FILED 1-4-2011.



OWNER OF INTERNATIONAL REGISTRATION 1064187 DATED 1-4-2011, EXPIRES 1-4-2021.

THE MARK CONSISTS OF A THREE SIDED SHIELD WITH STARS IN THE BORDER AND THE SYMBOL FOR FEMALE IN THE BOTTOM. IN THE CENTER IS THE LETTER B WITH THE ASTROLOGICAL SYMBOL FOR CAPRICORN ATTACHED AT THE TOP OF THE LETTERS.

FOR PAPER; TOWELS OF PAPER; PRINTED MATTER, NAMELY, CALENDARS, NEWSPAPERS, NOTEBOOKS; PRINTED PUBLICATIONS, NAMELY, BOOKS AND BROCHURES IN THE FIELD OF SCIENCE, SPORTS, FASHION, CLOTHING, CULTURE, ARTS, ENTERTAINMENT, HEALTH; PERIODICALS, NAMELY, MAGAZINES IN THE FIELD OF SCIENCE, SPORTS, FASHION, CLOTHING, CULTURE, ARTS, ENTERTAINMENT, HEALTH; PICTURES; WRAPPING PAPER, STATIONERY; STAMPS NAMELY, SEALS; WRITING INSTRUMENTS (U.S. CLS. 2, 5, 22, 23, 29, 37, 38 AND 50).  
EUGENIA MARTIN, EXAMINING ATTORNEY

**CLASS 16—(Continued).**

SN 79-092,252. DA LIAN YA TU TOU ZI ZI XUN YOU XIAN GONG SI, DALIAN CITY, LIAONING PROVINCE, CHINA, FILED 1-4-2011.



OWNER OF INTERNATIONAL REGISTRATION 1064188 DATED 1-4-2011, EXPIRES 1-4-2021.

THE MARK CONSISTS OF A THREE SIDED SHIELD WITH STARS IN THE BORDER AND THE SYMBOL FOR FEMALE IN THE BOTTOM. IN THE CENTER IS THE LETTER A WITH THE ASTROLOGICAL SYMBOL FOR SAGITTARIUS ATTACHED AT THE TOP OF THE LETTER.

FOR PAPER; TOWELS OF PAPER; PRINTED MATTER, NAMELY, CALENDARS, NEWSPAPERS, NOTEBOOKS; PRINTED PUBLICATIONS, NAMELY, BOOKS AND BROCHURES IN THE FIELD OF SCIENCE, SPORTS, FASHION, CLOTHING, CULTURE, ARTS, ENTERTAINMENT, HEALTH; PERIODICALS, NAMELY, MAGAZINES IN THE FIELD OF SCIENCE, SPORTS, FASHION, CLOTHING, CULTURE, ARTS, ENTERTAINMENT, HEALTH; PICTURES; WRAPPING PAPER, STATIONERY; STAMPS NAMELY, SEALS; WRITING INSTRUMENTS (U.S. CLS. 2, 5, 22, 23, 29, 37, 38 AND 50).  
EUGENIA MARTIN, EXAMINING ATTORNEY

SN 85-012,867. READY, SET, READ, INC., ALISO VIEJO, CA. FILED 4-13-2010.

**READY, SET, READ**

THE MARK CONSISTS OF STANDARD CHARACTERS WITHOUT CLAIM TO ANY PARTICULAR FONT, STYLE, SIZE, OR COLOR.

FOR EDUCATIONAL MATERIALS, NAMELY, A SERIES OF BOOKS FEATURING A COMPREHENSIVE READING PROGRAM, WITH EACH BOOK FEATURING ONE OR MORE LITERARY CHARACTERS, FOR ENABLING THE READER TO STRENGTHEN PHONICS SKILLS, UNDERSTAND THE MEANING OF WORDS, AND BUILD VOCABULARY THROUGH INDIVIDUAL LESSONS (U.S. CLS. 2, 5, 22, 23, 29, 37, 38 AND 50).  
DOMINICK J. SALEMI, EXAMINING ATTORNEY

**CLASS 16—(Continued).**

SN 85-021,120. RIVER CITY PAPER CO., INC., RANCHO CORDOVA, CA. FILED 4-22-2010.

## Renew Packaging Solutions

THE MARK CONSISTS OF STANDARD CHARACTERS WITHOUT CLAIM TO ANY PARTICULAR FONT, STYLE, SIZE, OR COLOR.

NO CLAIM IS MADE TO THE EXCLUSIVE RIGHT TO USE "PACKAGING SOLUTIONS", APART FROM THE MARK AS SHOWN.

FOR ABSORBENT PADS OF PAPER AND CELLULOSE FOR USE IN FOOD PACKAGING; CARDBOARD PACKAGING; CARDBOARD PACKAGING BOXES IN COLLAPSIBLE FORM; CARDBOARD PACKAGING BOXES IN MADE-UP FORM; INDUSTRIAL PACKAGING CONTAINERS OF PAPER; PACKAGED KITS COMPOSED PRIMARILY OF PRINTED INSTRUCTIONAL MATERIALS AND ALSO INCLUDING TOOLS FOR COLLECTING SAMPLES AND INFORMATION CONCERNING THE FEEDING OF HORSES; PACKAGING AND CONTAINERS COMPRISED OF STARCH-BASED MATERIALS IN THE NATURE OF A PAPER SUBSTITUTE FOR FOOD, BEVERAGES AND CONSUMER PRODUCTS; PACKAGING CONTAINERS OF PAPER; PACKAGING MATERIALS MADE FROM MINERAL-BASED PAPER SUBSTITUTES; PACKAGING MATERIALS MADE OF RECYCLED PAPER; PACKAGING, NAMELY, BLISTER CARDS; PAPER BAGS FOR PACKAGING; PAPER ENVELOPES FOR PACKAGING; PAPER FOR WRAPPING AND PACKAGING; PAPER PACKAGING AND CONTAINERS FOR FOOD AND BEVERAGES COMPRISED OF MATERIALS DESIGNED TO LESSEN ADVERSE EFFECTS ON THE ENVIRONMENT; PAPER POUCHES FOR PACKAGING; PAPERBOARD BOXES; PLASTIC BAGS FOR PACKAGING; PLASTIC BAGS FOR PACKAGING ICE; PLASTIC BUBBLE PACKS FOR WRAPPING OR PACKAGING; PLASTIC OR PAPER BAGS FOR MERCHANDISE PACKAGING; PRINTED RECIPES SOLD AS A COMPONENT OF FOOD PACKAGING; SPECIALTY PAPERS, NAMELY, VEGETABLE PARCHMENT, FOR USE IN FOOD WRAPPING, PREPARATION, PROCESSING AND PACKAGING APPLICATIONS (U.S. CLS. 2, 5, 22, 23, 29, 37, 38 AND 50).

ELIZABETH KAJUBI, EXAMINING ATTORNEY

**CLASS 16—(Continued).**

SN 85-043,128. MARTHA STEWART LIVING OMNIMEDIA, INC., NEW YORK, NY. FILED 5-19-2010.

## MARTHA STEWART CRAFTS

THE MARK CONSISTS OF STANDARD CHARACTERS WITHOUT CLAIM TO ANY PARTICULAR FONT, STYLE, SIZE, OR COLOR.

OWNER OF U.S. REG. NOS. 3,592,212, 3,700,447 AND 3,730,165.

NO CLAIM IS MADE TO THE EXCLUSIVE RIGHT TO USE "CRAFTS", APART FROM THE MARK AS SHOWN.

THE NAME "MARTHA" REFERS TO "MARTHA STEWART" A LIVING INDIVIDUAL WHOSE CONSENT IS OF RECORD.

FOR ADHESIVES AND GLUE FOR STATIONERY PURPOSES; PENS; GLITTER PENS AND GLITTER GLUES FOR STATIONERY PURPOSES; MARKERS; PENCILS; WRITING INK; INK PADS; SILICONE MARKING STAMPS; MARKING STAMPS; INK STAMPS; SELF-INKING STAMPS; CUTTING MATS; GLITTERING TRAYS IN THE NATURE OF TRAYS USED TO DECORATE ARTWORK WITH GLITTER; EMBOSSING POWDER, NAMELY, A HEAT-SENSITIVE POWDER THAT ATTACHES TO EMBOSSING INK AND THEN RAISES WHEN HEAT IS APPLIED FOR PENS AND STAMPS; ARTS AND CRAFT FLOCKING POWDER KITS; ARTS AND CRAFT MICROBEAD KITS; ARTS AND CRAFT INK STAMP KITS; ARTS AND CRAFT TISSUE PAPER POM POM KITS; CHILDREN'S ARTS AND CRAFTS PAPER KITS (U.S. CLS. 2, 5, 22, 23, 29, 37, 38 AND 50).

FIRST USE 5-0-2007; IN COMMERCE 5-0-2007.

GEOFFREY FOSDICK, EXAMINING ATTORNEY

SN 85-081,734. SHIPLEY BUSINESS DEVELOPMENT SERVICES, INC., DBA SHIPLEY ASSOCIATES, KAYSVILLE, UT. FILED 7-9-2010.

## SHIPLEY ASSOCIATES

THE MARK CONSISTS OF STANDARD CHARACTERS WITHOUT CLAIM TO ANY PARTICULAR FONT, STYLE, SIZE, OR COLOR.

NO CLAIM IS MADE TO THE EXCLUSIVE RIGHT TO USE "ASSOCIATES", APART FROM THE MARK AS SHOWN.

SEC. 2(F).

FOR EDUCATIONAL PUBLICATIONS, NAMELY, TRAINING MANUALS IN THE FIELD OF BUSINESS DEVELOPMENT, PROPOSAL DEVELOPMENT CAPTURE PLANNING, BUSINESS AND TECHNICAL COMMUNICATION; EDUCATIONAL PUBLICATIONS, NAMELY, PROPOSAL GUIDES, CAPTURE GUIDES, BUSINESS DEVELOPMENT GUIDES, PROCESS FLOW CHARTS AND DESCRIPTIONS IN THE FIELDS OF PROPOSAL AND CAPTURE MANAGEMENT, SALES, AND BUSINESS DEVELOPMENT; PRINTED EDUCATIONAL MATERIALS IN THE FIELD OF PROPOSAL AND CAPTURE PLANNING, BUSINESS DEVELOPMENT, AND SALES; PRINTED INSTRUCTIONAL, EDUCATIONAL, AND TEACHING MATERIALS IN THE FIELD OF PROPOSAL AND CAPTURE MANAGEMENT, BUSINESS DEVELOPMENT PROCESS AND ALL ASPECTS OF BUSINESS CAPTURE (U.S. CLS. 2, 5, 22, 23, 29, 37, 38 AND 50).

FIRST USE 12-0-1976; IN COMMERCE 12-0-1976.

ESTHER A. BORSUK, EXAMINING ATTORNEY

**CLASS 16—(Continued).**

SN 85-131,952. LOVE BOOK, LLC, ANN ARBOR, MI. FILED 9-17-2010.



NO CLAIM IS MADE TO THE EXCLUSIVE RIGHT TO USE "ONLINE.COM", APART FROM THE MARK AS SHOWN.

THE COLOR(S) RED, BLACK AND WHITE IS/ARE CLAIMED AS A FEATURE OF THE MARK.

THE MARK CONSISTS OF THE RED WORD "LOVEBOOK" WITH THE BLACK TEXT "ONLINE.COM" BENEATH IT AND, BELOW THOSE ELEMENTS, THE BLACK TEXT "YOU'VE JUST BEEN LOVED.". TO THE RIGHT OF THE TEXT IS A PAIR OF BLACK-AND-WHITE STICK FIGURES. ONE STICK FIGURE IS A MAN HOLDING A PENCIL; THE OTHER STICK FIGURE IS A WOMAN KISSING THE MAN AND HOLDING A BOOK WITH A HEART ON ITS COVER.

FOR GIFT BOOKS FEATURING CUSTOMIZED DECLARATIONS OF LOVE AND APPRECIATION WITH ACCOMPANYING GRAPHICS, CREATED ONLINE BY CUSTOMERS USING A PROPRIETARY AUTHORING SYSTEM (U.S. CLS. 2, 5, 22, 23, 29, 37, 38 AND 50).

FIRST USE 1-28-2008; IN COMMERCE 2-28-2008.  
REBECCA EISINGER, EXAMINING ATTORNEY

---

SN 85-143,622. PLANET PIGSKIN PICTURES LLC, BATON ROUGE, LA. FILED 10-1-2010.

# TRY US

THE MARK CONSISTS OF STANDARD CHARACTERS WITHOUT CLAIM TO ANY PARTICULAR FONT, STYLE, SIZE, OR COLOR.

FOR STATIONERY, NAMELY, STATIONERY SETS COMPRISED OF WRITING PAPER, NOTE CARDS AND ENVELOPES; ART PRINTS, BLANK JOURNALS, PERSONALIZED WRITING JOURNALS, BOOKMARKS, COLOR PRINTS, ENVELOPES, NOTE BOOKS, NOTE CARDS, NOTE PADS, FOLDERS, PAPER FLAGS, PAPER BADGES, STICKERS, POSTCARDS, GREETING CARDS, POSTERS, AND PENS (U.S. CLS. 2, 5, 22, 23, 29, 37, 38 AND 50).

BERNICE MIDDLETON, EXAMINING ATTORNEY

**CLASS 16—(Continued).**

SN 85-153,823. THE COACHES TRAINING INSTITUTE, SAN RAFAEL, CA. FILED 10-15-2010.

## CO-ACTIVE COACHING

THE MARK CONSISTS OF STANDARD CHARACTERS WITHOUT CLAIM TO ANY PARTICULAR FONT, STYLE, SIZE, OR COLOR.

NO CLAIM IS MADE TO THE EXCLUSIVE RIGHT TO USE "COACHING", APART FROM THE MARK AS SHOWN. FOR WRITTEN ARTICLES, PRINTED TRAINING MATERIALS, AND PRINTED COURSE MATERIALS, ALL IN THE FIELD OF PROFESSIONAL COACHING (U.S. CLS. 2, 5, 22, 23, 29, 37, 38 AND 50).

FIRST USE 5-0-2007; IN COMMERCE 5-0-2007.  
JANICE KIM, EXAMINING ATTORNEY

---

SN 85-158,908. PERFORMANCE GROUP, INC., OMAHA, NE. FILED 10-22-2010.

## NATURE'S KETTLE

THE MARK CONSISTS OF STANDARD CHARACTERS WITHOUT CLAIM TO ANY PARTICULAR FONT, STYLE, SIZE, OR COLOR.

NO CLAIM IS MADE TO THE EXCLUSIVE RIGHT TO USE "KETTLE", APART FROM THE MARK AS SHOWN.

FOR COOKING CONTAINERS, NAMELY, PLASTIC COOKING PUCHES FOR USE IN COOKING AND DISPENSING FOOD AND BEVERAGES (U.S. CLS. 2, 5, 22, 23, 29, 37, 38 AND 50).

RONALD DELGIZZI, EXAMINING ATTORNEY

---

SN 85-159,165. PERFORMANCE GROUP, INC., OMAHA, NE. FILED 10-22-2010.

## NATURE'S COFFEE KETTLE

THE MARK CONSISTS OF STANDARD CHARACTERS WITHOUT CLAIM TO ANY PARTICULAR FONT, STYLE, SIZE, OR COLOR.

NO CLAIM IS MADE TO THE EXCLUSIVE RIGHT TO USE "COFFEE KETTLE", APART FROM THE MARK AS SHOWN.

FOR COOKING CONTAINERS, NAMELY, PLASTIC COOKING POUCHES FOR USE IN COOKING AND DISPENSING FOOD AND BEVERAGES (U.S. CLS. 2, 5, 22, 23, 29, 37, 38 AND 50).

FIRST USE 5-1-2009; IN COMMERCE 8-1-2009.  
RONALD DELGIZZI, EXAMINING ATTORNEY

**CLASS 16—(Continued).**

SN 85-159,532. BENEDENT CORPORATION, HOUSTON, TX.  
FILED 10-22-2010.

**BENEFIT**

THE MARK CONSISTS OF STANDARD CHARACTERS WITHOUT CLAIM TO ANY PARTICULAR FONT, STYLE, SIZE, OR COLOR.

OWNER OF U.S. REG. NO. 3,515,828.  
FOR PAPER, CARDBOARD, PLASTIC AND BLISTER PACKAGING FOR TOOTHBRUSHES AND TOOTH-PASTE (U.S. CLS. 2, 5, 22, 23, 29, 37, 38 AND 50).  
TRACY FLETCHER, EXAMINING ATTORNEY

---

SN 85-166,501. MAGUIRE PUBLICATIONS LLC, MESA, AZ.  
FILED 11-1-2010.

**SAFEDDY**

THE MARK CONSISTS OF STANDARD CHARACTERS WITHOUT CLAIM TO ANY PARTICULAR FONT, STYLE, SIZE, OR COLOR.

FOR MEDICAL IDENTIFICATION CARDS, NOT MAGNETICALLY ENCODED, FOR INDIVIDUALS WITH DEVELOPMENTAL DISABILITIES (U.S. CLS. 2, 5, 22, 23, 29, 37, 38 AND 50).  
FIRST USE 4-1-2010; IN COMMERCE 4-1-2010.  
MARK SPARACINO, EXAMINING ATTORNEY

---

SN 85-174,231. FITZHENRY, AMY, VENICE, CA. FILED 11-11-2010.

**Dating Mr. Yuck**

THE MARK CONSISTS OF STANDARD CHARACTERS WITHOUT CLAIM TO ANY PARTICULAR FONT, STYLE, SIZE, OR COLOR.

NO CLAIM IS MADE TO THE EXCLUSIVE RIGHT TO USE "DATING", APART FROM THE MARK AS SHOWN.  
THE NAME(S), PORTRAIT(S), AND/OR SIGNATURE(S) SHOWN IN THE MARK DOES NOT IDENTIFY A PARTICULAR LIVING INDIVIDUAL.

FOR A SERIES OF BOOKS AND WRITTEN ARTICLES IN THE FIELD OF DATING (U.S. CLS. 2, 5, 22, 23, 29, 37, 38 AND 50).  
SUZANNE BLANE, EXAMINING ATTORNEY

**CLASS 16—(Continued).**

SN 85-181,192. HARRIS PUBLICATIONS, INC., NEW YORK, NY. FILED 11-19-2010.

**MUSCLE PRESS**

THE MARK CONSISTS OF STANDARD CHARACTERS WITHOUT CLAIM TO ANY PARTICULAR FONT, STYLE, SIZE, OR COLOR.

NO CLAIM IS MADE TO THE EXCLUSIVE RIGHT TO USE "MUSCLE", APART FROM THE MARK AS SHOWN.  
FOR MAGAZINES IN THE FIELD OF BODYBUILDING, FITNESS, DIET, NUTRITION, AND EXERCISE (U.S. CLS. 2, 5, 22, 23, 29, 37, 38 AND 50).  
ELI HELLMAN, EXAMINING ATTORNEY

---

SN 85-181,205. HARRIS PUBLICATIONS, INC., NEW YORK, NY. FILED 11-19-2010.

**EXTREME MUSCLE**

THE MARK CONSISTS OF STANDARD CHARACTERS WITHOUT CLAIM TO ANY PARTICULAR FONT, STYLE, SIZE, OR COLOR.

NO CLAIM IS MADE TO THE EXCLUSIVE RIGHT TO USE "MUSCLE", APART FROM THE MARK AS SHOWN.  
FOR MAGAZINES IN THE FIELD OF BODYBUILDING, FITNESS, DIET, NUTRITION, AND EXERCISE (U.S. CLS. 2, 5, 22, 23, 29, 37, 38 AND 50).  
ELI HELLMAN, EXAMINING ATTORNEY

---

SN 85-183,109. SAFE-STRAP COMPANY, INC., WHARTON, NJ. FILED 11-23-2010.

**PALLET-DECOY**

THE MARK CONSISTS OF STANDARD CHARACTERS WITHOUT CLAIM TO ANY PARTICULAR FONT, STYLE, SIZE, OR COLOR.

FOR PRINTED PLASTIC FABRIC TO BE SUSPENDED ON A FRAME IN A RETAIL SETTING TO SIMULATE THE APPEARANCE OF PACKAGED GOODS STACKED IN BULK ON A PALLET (U.S. CLS. 2, 5, 22, 23, 29, 37, 38 AND 50).

CHRISTOPHER BUONGIORNO, EXAMINING ATTORNEY



**CLASS 16—(Continued).**

SN 85-183,543. STAFFORD, FRANCIS GREGORY, ARCATA, CA. FILED 11-23-2010.

# Heroquest

THE MARK CONSISTS OF STANDARD CHARACTERS WITHOUT CLAIM TO ANY PARTICULAR FONT, STYLE, SIZE, OR COLOR.

FOR ROLE PLAYING GAME EQUIPMENT IN THE NATURE OF GAME BOOK MANUALS (U.S. CLS. 2, 5, 22, 23, 29, 37, 38 AND 50).

FIRST USE 5-15-2001; IN COMMERCE 5-15-2001.  
IRA J. GOODSAD, EXAMINING ATTORNEY

**CLASS 16—(Continued).**

SN 85-188,440. B&D LITHO OF ARIZONA, INC., DBA B&D LITHO, PHOENIX, AZ. FILED 12-1-2010.

# B&D LITHO

THE MARK CONSISTS OF STANDARD CHARACTERS WITHOUT CLAIM TO ANY PARTICULAR FONT, STYLE, SIZE, OR COLOR.

NO CLAIM IS MADE TO THE EXCLUSIVE RIGHT TO USE "LITHO", APART FROM THE MARK AS SHOWN.

FOR PRINTED FORMS (U.S. CLS. 2, 5, 22, 23, 29, 37, 38 AND 50).

FIRST USE 12-31-1960; IN COMMERCE 12-31-1960.  
KATHLEEN M. VANSTON, EXAMINING ATTORNEY

SN 85-185,297. PEIRET, ROBERTO, VALENCIA, VENEZUELA, AND PEIRET, CRISTIAN, VALENCIA, VENEZUELA, AND BOURGY, CRISTOBAL, VALENCIA, VENEZUELA, FILED 11-25-2010.

# Autoparts 4 USA

THE MARK CONSISTS OF STANDARD CHARACTERS WITHOUT CLAIM TO ANY PARTICULAR FONT, STYLE, SIZE, OR COLOR.

NO CLAIM IS MADE TO THE EXCLUSIVE RIGHT TO USE "USA", APART FROM THE MARK AS SHOWN.

FOR CARDBOARD BOXES; MATERIALS FOR PACKAGING, NAMELY, WRAPPING PAPER AND ADHESIVE PACKING TAPE FOR INDUSTRIAL OR COMMERCIAL USE (U.S. CLS. 2, 5, 22, 23, 29, 37, 38 AND 50).

JORDAN BAKER, EXAMINING ATTORNEY

SN 85-188,502. B&D LITHO OF ARIZONA, INC., DBA B&D LITHO, PHOENIX, AZ. FILED 12-1-2010.



NO CLAIM IS MADE TO THE EXCLUSIVE RIGHT TO USE "LITHO", APART FROM THE MARK AS SHOWN.

THE MARK CONSISTS OF A SETTING SUN WITH "B&D" IN FRONT OF THE SETTING SUN AND THE WORD "LITHO" IN FRONT OF THE LETTER "D".

FOR PRINTED FORMS (U.S. CLS. 2, 5, 22, 23, 29, 37, 38 AND 50).

FIRST USE 12-31-1960; IN COMMERCE 12-31-1960.  
KATHLEEN M. VANSTON, EXAMINING ATTORNEY

SN 85-187,112. WELLER SPORTS VENTURES, LLC, SAVANNAH, GA. FILED 11-30-2010.

# STICK TO SPORTS

THE MARK CONSISTS OF STANDARD CHARACTERS WITHOUT CLAIM TO ANY PARTICULAR FONT, STYLE, SIZE, OR COLOR.

NO CLAIM IS MADE TO THE EXCLUSIVE RIGHT TO USE "SPORTS", APART FROM THE MARK AS SHOWN.

FOR EDUCATIONAL PUBLICATIONS, NAMELY, PRINTED EDUCATIONAL TEACHING ACTIVITY GUIDES, WORKBOOKS AND ACTIVITY BOOKS IN THE FIELD OF SPORTS INSTRUCTIONAL TRAINING (U.S. CLS. 2, 5, 22, 23, 29, 37, 38 AND 50).

SUNG IN, EXAMINING ATTORNEY

SN 85-193,695. SHERLOCK, MICHAEL T, SEATTLE, WA. FILED 12-8-2010.

# let the magic begin

THE MARK CONSISTS OF STANDARD CHARACTERS WITHOUT CLAIM TO ANY PARTICULAR FONT, STYLE, SIZE, OR COLOR.

FOR DATE NIGHT KITS FOR ROMANCE COMPRISED PRIMARILY OF 6-PACK CARRIER WITH NOTE CARDS AND BOOKLETS IN THE FIELD OF ROMANCE, WITH IDEAS FOR PAMPERING ONESELF AND WITH COCKTAIL GLASSES, SPIRITS AND/OR COCKTAIL SHAKER (U.S. CLS. 2, 5, 22, 23, 29, 37, 38 AND 50).

FIRST USE 1-6-2011; IN COMMERCE 8-15-2011.  
CHRIS DONINGER, EXAMINING ATTORNEY

**CLASS 16—(Continued).**

SN 85-194,249. JOHNSON & JOHNSON, NEW BRUNSWICK, NJ. FILED 12-9-2010.

**STEREO PRECISION SELECT**

THE MARK CONSISTS OF STANDARD CHARACTERS WITHOUT CLAIM TO ANY PARTICULAR FONT, STYLE, SIZE, OR COLOR.

NO CLAIM IS MADE TO THE EXCLUSIVE RIGHT TO USE "SELECT", APART FROM THE MARK AS SHOWN.

FOR PRINTED GUIDE IN THE FIELD OF FITTING CONTACT LENSES (U.S. CLS. 2, 5, 22, 23, 29, 37, 38 AND 50).

FIRST USE 7-31-2009; IN COMMERCE 7-31-2009.  
TRACY FLETCHER, EXAMINING ATTORNEY

SN 85-199,242. GEORGIA-PACIFIC S.A.R.L., LUXEMBOURG, LUXEMBOURG, FILED 12-16-2010.

**AQUA TUBE**

THE MARK CONSISTS OF STANDARD CHARACTERS WITHOUT CLAIM TO ANY PARTICULAR FONT, STYLE, SIZE, OR COLOR.

NO CLAIM IS MADE TO THE EXCLUSIVE RIGHT TO USE "TUBE", APART FROM THE MARK AS SHOWN.

FOR BATHROOM TISSUE (U.S. CLS. 2, 5, 22, 23, 29, 37, 38 AND 50).

WENDY JUN, EXAMINING ATTORNEY

SN 85-203,215. POWER LITERACY, L.L.C., OVERLAND PARK, KS. FILED 12-21-2010.

**POWER LITERACY TEACHING AND LEARNING FRAMEWORK**

THE MARK CONSISTS OF STANDARD CHARACTERS WITHOUT CLAIM TO ANY PARTICULAR FONT, STYLE, SIZE, OR COLOR.

OWNER OF U.S. REG. NOS. 2,452,531 AND 2,454,604.  
NO CLAIM IS MADE TO THE EXCLUSIVE RIGHT TO USE "LITERACY TEACHING AND LEARNING FRAMEWORK", APART FROM THE MARK AS SHOWN.

FOR PRINTED MATTER, NAMELY, INSTRUCTIONAL BOOKS AND BOOKLETS FOR TEACHING STUDENTS LITERACY AND READING SKILLS AT ALL LEVELS AND IN TRAINING TEACHERS WHO WILL TEACH STUDENTS LITERACY AND READING AT ALL LEVELS (U.S. CLS. 2, 5, 22, 23, 29, 37, 38 AND 50).

FIRST USE 12-31-2004; IN COMMERCE 12-31-2004.  
JULIE WATSON, EXAMINING ATTORNEY

**CLASS 16—(Continued).**

SN 85-204,333. DISCOVERY COMMUNICATIONS, LLC, SILVER SPRING, MD. FILED 12-22-2010.

**NY INK**

THE MARK CONSISTS OF STANDARD CHARACTERS WITHOUT CLAIM TO ANY PARTICULAR FONT, STYLE, SIZE, OR COLOR.

FOR POSTERS; DESK SETS; DESK PADS; BLOTTERS; PERSONAL ORGANIZERS; BULLETIN BOARDS; PENS; PENCILS; PENCIL CASES; PEN CASES; DRAWING RULERS; NON-ELECTRIC ERASERS; NON-ELECTRIC PENCIL SHARPENERS; STATIONERY; POSTCARDS; STATIONERY FOLDERS; FILE FOLDERS; RUBBER STAMPS; ENVELOPES; WRITING PAPER; NOTEBOOKS; NOTE PADS; STENCILS; STICKERS; DECALS; WRAPPING PAPER; CARDS, NAMELY, TRADING CARDS, BLANK CARDS, GREETING CARDS, NOTE CARDS, BUSINESS CARDS, GIFT CARDS; CALENDARS, NAMELY, DESK CALENDARS, WALL CALENDARS AND DAILY CALENDARS; PAPER, NAMELY, ART PAPER AND CONSTRUCTION PAPER; CRAFT PAINT KITS; ART PAINT KITS; ART PRINTS; COLOR PRINTS; LITHOGRAPHIC PRINTS; PHOTOGRAPHIC PRINTS; BOOKS AND MAGAZINES FEATURING TATTOOS AND TATTOO ARTISTS; BOOKMARKS; BOOK PLATES; BOOK COVERS; EDUCATIONAL ACTIVITY KITS CONSISTING PRIMARILY OF BOOKS, PUZZLES, WORD GAMES, FLASHCARDS, COLLECTIBLE CARDS, BOOKS AND MAGAZINES, ALL IN THE FIELD OF TATTOOS AND TATTOO ARTISTS; COMPOSITION BOOKS; COMIC STRIPS; DIARIES; PAPER GOODS, NAMELY, PAPER NAPKINS, PAPER PLACE MATS, PAPER PARTY FAVORS, PAPER PARTY DECORATIONS, PAPER PARTY HATS, PAPER PARTY BAGS, PAPER COASTERS; TEMPORARY TATTOOS; STENCIL KITS COMPRISED PRIMARILY OF STENCILS, FILM, BRUSHES AND PAINT; PAINTING KITS COMPRISED PRIMARILY OF DRAWINGS OR PICTURES, PAINTBRUSHES AND MATS FOR FRAMING; BUMPER STICKERS (U.S. CLS. 2, 5, 22, 23, 29, 37, 38 AND 50).

TRICIA SONNEBORN, EXAMINING ATTORNEY

**CLASS 16—(Continued).**

SN 85-204,950. URBAN PARTNERSHIP BANK, CHICAGO, IL. FILED 12-23-2010.

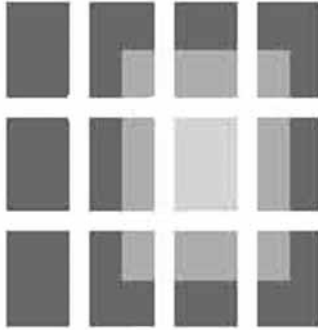

THE MARK CONSISTS OF TWELVE RECTANGLES FORMING RECTANGLE BOX WITH FOUR BOXES ACROSS AND THREE BOXES VERTICALLY PLACED WITH INTERSECTING LINES. SHADED RECTANGLE INSIDE RIGHT THREE ROWS.

FOR PUBLICATIONS, NAMELY, PRINTED INFORMATIONAL MATERIALS IN THE NATURE OF PAMPHLETS FOR USE IN THE FIELDS OF BANKING, FINANCIAL, INVESTMENT INDUSTRIES (U.S. CLS. 2, 5, 22, 23, 29, 37, 38 AND 50).

FIRST USE 12-10-2010; IN COMMERCE 12-10-2010.  
DAVID I, EXAMINING ATTORNEY

SN 85-210,950. TELEFONICA, S.A., MADRID, SPAIN, FILED 1-5-2011.

# MOVISTAR

THE MARK CONSISTS OF STANDARD CHARACTERS WITHOUT CLAIM TO ANY PARTICULAR FONT, STYLE, SIZE, OR COLOR.

OWNER OF ERPN CMNTY TM OFC REG. NO. 005069059, DATED 6-5-2010, EXPIRES 5-11-2016.

OWNER OF U.S. REG. NOS. 2,930,460, 3,381,838 AND OTHERS.

FOR PRINTED MATTER, NAMELY, VISITOR'S CARDS, LEAFLETS, MAGAZINES, AND CATALOGS IN THE FIELD OF TELECOMMUNICATIONS AND TELECOMMUNICATION PRODUCTS (U.S. CLS. 2, 5, 22, 23, 29, 37, 38 AND 50).

TINA MAI, EXAMINING ATTORNEY

**CLASS 16—(Continued).**

SN 85-216,428. JAMIE RAQUEL, INC., VISALIA, CA. FILED 1-12-2011.

THE NAME "JAMIE RAQUEL" DOES NOT IDENTIFY A LIVING INDIVIDUAL.

THE MARK CONSISTS OF THE WORDS "JAMIE RAQUEL" IN CURSIVE FONT WITH A FLOWER DOTTING THE "I".

FOR FIBERBOARD BOXES; FILE BOXES FOR STORAGE OF BUSINESS AND PERSONAL RECORD (U.S. CLS. 2, 5, 22, 23, 29, 37, 38 AND 50).

FIRST USE 7-1-2008; IN COMMERCE 7-1-2008.  
MARK SHINER, EXAMINING ATTORNEY

SN 85-220,244. BIG HISTORY PROJECT, LLC, KIRKLAND, WA. FILED 1-18-2011.

## BIG HISTORY PROJECT

THE MARK CONSISTS OF STANDARD CHARACTERS WITHOUT CLAIM TO ANY PARTICULAR FONT, STYLE, SIZE, OR COLOR.

NO CLAIM IS MADE TO THE EXCLUSIVE RIGHT TO USE "HISTORY PROJECT", APART FROM THE MARK AS SHOWN.

FOR PRINTED EDUCATIONAL MATERIALS, NAMELY, BOOKS, MAGAZINES, WORKBOOKS AND HANDOUTS IN THE FIELDS OF HISTORY AND SCIENCE (U.S. CLS. 2, 5, 22, 23, 29, 37, 38 AND 50).

RICHARD WHITE, EXAMINING ATTORNEY

SN 85-232,278. LIPTON, LAURIE, LONDON, UNITED KINGDOM, FILED 2-2-2011.

## LAURIE LIPTON

THE MARK CONSISTS OF STANDARD CHARACTERS WITHOUT CLAIM TO ANY PARTICULAR FONT, STYLE, SIZE, OR COLOR.

THE NAME "LAURIE LIPTON" IDENTIFIES A LIVING INDIVIDUAL WHOSE CONSENT IS OF RECORD.

FOR BOOKS IN THE FIELD OF ART; CATALOGS IN THE FIELD OF ART; DRAWINGS; POSTERS (U.S. CLS. 2, 5, 22, 23, 29, 37, 38 AND 50).

FIRST USE 10-0-1974; IN COMMERCE 10-0-1974.  
REBECCA EISINGER, EXAMINING ATTORNEY

**CLASS 16—(Continued).**

SN 85-243,206. MEZA, MICHAEL G, AZUSA, CA. FILED 2-15-2011.

## La Placa Social

THE MARK CONSISTS OF STANDARD CHARACTERS WITHOUT CLAIM TO ANY PARTICULAR FONT, STYLE, SIZE, OR COLOR.

NO CLAIM IS MADE TO THE EXCLUSIVE RIGHT TO USE "PLACA", APART FROM THE MARK AS SHOWN.

THE ENGLISH TRANSLATION OF "LA PLACA SOCIAL" IN THE MARK IS "THE SOCIAL POLICE".

FOR EDUCATIONAL PUBLICATIONS, NAMELY, TRAINING MANUALS IN THE FIELD OF GOVERNMENT AND LAW ENFORCEMENTS; EDUCATIONAL PUBLICATIONS, NAMELY, PERIODICALS, BOOKS, HANDOUTS, WORKBOOKS, INTERNET POSTINGS ETC FEATURING OPINIONS IN THE FIELDS OF GOVERNMENT AND LAW ENFORCEMENT; PUBLICATION PAPER; PUBLICATIONS, NAMELY, BROCHURES, BOOKLETS, AND TEACHING MATERIALS IN THE FIELD OF GOVERNMENT AND LAW ENFORCEMENT; PUBLICATIONS, NAMELY, PERIODICALS, BOOKS, HANDOUTS, WORKBOOKS, INTERNET POSTINGS, FEATURING OPINIONS IN THE FIELDS OF GOVERNMENT AND LAW ENFORCEMENT (U.S. CLS. 2, 5, 22, 23, 29, 37, 38 AND 50).

FIRST USE 6-21-2008; IN COMMERCE 7-17-2008.

NAKWAMA ANKRAH, EXAMINING ATTORNEY

**CLASS 16—(Continued).**

SN 85-251,987. THE PHILLIES, PHILADELPHIA, PA. FILED 2-25-2011.

## PHILLIE PHANATIC

THE MARK CONSISTS OF STANDARD CHARACTERS WITHOUT CLAIM TO ANY PARTICULAR FONT, STYLE, SIZE, OR COLOR.

OWNER OF U.S. REG. NOS. 1,604,774, 3,747,556 AND OTHERS.

FOR PAPER GOODS AND PRINTED MATTER, NAMELY, TRADING CARDS, POSTERS, STICKERS, DECALS, TEMPORARY TATTOOS, BUMPER STICKERS, SCORE BOOKS, SCORECARDS, PRINTED BASEBALL GAME PROGRAMS, MAGAZINES, BOOKS, NEWSLETTERS, BROCHURES AND PAMPHLETS FEATURING BASEBALL, WRITING PADS, NOTE PAPER, NOTEBOOKS, BINDERS, STATIONERY-TYPE PORTFOLIOS, STATIONERY FOLDERS, STATIONERY SETS, NAMELY, WRITING PAPER, CARDS, AND ENVELOPES, COMMEMORATIVE ENVELOPES, FLIP BOOKS, PREPRINTED AGENDA ORGANIZERS, MEMO BOARDS, SCRAPBOOKS, AUTOGRAPH BOOKS, BASEBALL CARD ALBUMS, BOOK COVERS, BOOKMARKS, BOOKENDS, CALENDARS, GREETING CARDS, POSTCARDS, PRINTED BANK CHECKBOOKS, CHECKBOOK COVERS, COLLECTIBLE STAMPS, RUBBER STAMPS, INK STAMPS, COMMEMORATIVE STAMPS, PAPER PENNANTS, GIFT WRAPPING PAPER, PAPER GIFT AND PARTY BAGS, PAPER PARTY GOODS IN THE NATURE OF PAPER PARTY DECORATIONS, PAPER COASTERS, PAPER NAPKINS, FACIAL TISSUE, PAPER TABLECLOTHS, MOUNTED AND UN-MOUNTED PHOTOGRAPHS, PHOTOGRAPH ALBUMS, LITHOGRAPHS, PLASTIC BASEBALL CARD HOLDERS, CHRISTMAS CARD HOLDERS, PAPERWEIGHTS, LETTER OPENERS, PENS, PENCILS, PENCIL TOP ORNAMENTS, CRAYONS, MARKERS, NON-ELECTRIC ERASERS, PENCIL SHARPENERS, PENCIL CASES, UNGRADUATED RULERS, PAPER TICKET HOLDERS AND NON-METAL LANYARDS FOR PAPER TICKET HOLDERS SOLD AS A UNIT, ART PICTURES, AND ART PRINTS (U.S. CLS. 2, 5, 22, 23, 29, 37, 38 AND 50).

RON FAIRBANKS, EXAMINING ATTORNEY

SN 85-283,501. IRON DISORDERS INSTITUTE, GREENVILLE, SC. FILED 4-1-2011.



OWNER OF U.S. REG. NO. 3,074,397.

NO CLAIM IS MADE TO THE EXCLUSIVE RIGHT TO USE "FE" OR "IRON DISORDERS INSTITUTE", APART FROM THE MARK AS SHOWN.

THE COLOR(S) RED, BLACK, GRAY, WHITE IS/ARE CLAIMED AS A FEATURE OF THE MARK.

THE MARK CONSISTS OF THE WORDING "IRON

**CLASS 16—(Continued).**

DISORDERS" IN BLACK LETTERING, TO THE RIGHT OF DESIGNS, ALL ABOVE THE WORD "INSTITUTE", WHICH IS IN BLACK LETTERS AND IS UNDERLINED IN BLACK. THE DESIGNS CONSIST OF AN UPRIGHT RECTANGLE DIVIDED BY A DIAGONAL SPACE INTO TWO TRIANGLES. THE UPPER-LEFT TRIANGLE IS RED, AND CONTAINS A GRAY CIRCLE WITH THE LETTERS "FE" IN WHITE. THE LOWER-RIGHT TRIANGLE IS BLACK AND CONTAINS A RED CIRCLE WITH THE LETTERS "FE" IN WHITE.

FOR EDUCATIONAL PUBLICATIONS, NAMELY, HANDOUTS, BOOKS IN THE FIELDS OF IRON IN THE HUMAN BODY (U.S. CLS. 2, 5, 22, 23, 29, 37, 38 AND 50).

FIRST USE 5-1-2000; IN COMMERCE 5-1-2000.  
CORY BOONE, EXAMINING ATTORNEY

**CLASS 16—(Continued).**

WITH A RED CIRCLE UNDER THE WORDING "SKIN:", A YELLOW CIRCLE UNDER THE WORDING "FACE:", A GREEN CIRCLE UNDER THE WORDING "EYES:", AND A BLUE CIRCLE OVER THE WORDING "DEFINE LINER"; AND A WHITE RECTANGLE OUTLINED IN DARK GRAY WITH A BLACK AND WHITE EYE OUTLINED IN LIGHT AND DARK GRAY WITH AN EYE PUPIL IN BLACK, WHITE, AND SHADES OF BROWN, BLACK EYELASHES, BLACK EYELINER, FOUR GREEN CIRCLES AND FIVE BLUE CIRCLES.

FOR MAKEUP LESSON CHARTS USED TO PROVIDE INFORMATION IN THE FIELD OF BEAUTY IN THE NATURE OF A TOOL USED IN THE SELECTION AND USE OF COSMETICS, NAMELY, TO GUIDE THE USAGE OF MAKEUP BRUSHES, CONCEALER BRUSHES, FOUNDATION BRUSHES, POWDER BRUSHES, BLUSH BRUSHES, LIP BRUSHES, EYESHADOW BRUSHES (U.S. CLS. 2, 5, 22, 23, 29, 37, 38 AND 50).

TINA MAI, EXAMINING ATTORNEY

SN 85-286,522. FAIRWEATHER, ANDREA M, BROOKLYN, NY. FILED 4-5-2011.

SN 85-287,859. JAMES WEICHERT, MENDOTA HEIGHTS, MN. FILED 4-6-2011.

**HAPPINESS IN A BOX**

THE MARK CONSISTS OF STANDARD CHARACTERS WITHOUT CLAIM TO ANY PARTICULAR FONT, STYLE, SIZE, OR COLOR.

FOR BOXES OF PAPER AND CARDBOARD (U.S. CLS. 2, 5, 22, 23, 29, 37, 38 AND 50).

APRIL ROACH, EXAMINING ATTORNEY

NO CLAIM IS MADE TO THE EXCLUSIVE RIGHT TO USE "FACES", "SKIN", "CONCEALOR/FOUNDATION", "FACE", "POWDER", "BLUSH BRONZER", "EYES", "BASE COLOR", "LINER" AND "FACE CHART", APART FROM THE MARK AS SHOWN.

THE COLOR(S) WHITE, RED, YELLOW, GREEN, BLUE, BLACK, BROWN, LIGHT BROWN, LIGHT GRAY, AND DARK GRAY IS/ARE CLAIMED AS A FEATURE OF THE MARK.

THE MARK CONSISTS OF A FACE CHART WITH A RECTANGULAR BLACK BACKGROUND WITH LIGHT GRAY WORDING "FAIRWEATHER FACES FACE CHART", "(718)398-6938", AND "WWW.FAIRWEATHERFACES.COM"; BLACK WORDING "SKIN: CONCEALOR/FOUNDATION", "FACE: POWDER (ALL OVER) BLUSH BRONZER", "EYES: BASE COLOR", AND "DEFINE LINER"; A UNIVERSAL FEMALE WHITE FACE AGAINST A LIGHT GRAY BACKGROUND OUTLINED IN LIGHT AND DARK GRAY WITH BLACK AND WHITE EYES, EYE PUPILS IN BLACK, WHITE, AND SHADES OF BROWN, BLACK EYELASHES, BLACK EYELINER, EYESHADOW ON THE RIGHT EYE IN SHADES OF BROWN, LIGHT GRAY AND DARK GRAY BLUSH ON THE RIGHT CHEEK, LIGHT BROWN LIPSTICK ON THE RIGHT SIDE OF THE LIPS, 2 YELLOW CIRCLES, 2 RED CIRCLES, 2 BLUE CIRCLES, AND 1 GREEN CIRCLE ON THE LEFT SIDE OF FACE; A DARK GRAY RECTANGLE ON THE RIGHT OF THE FACE

SN 85-290,314. REGINA MEREDITH, PENRYN, CA. FILED 4-8-2011.

**Regina Meredith's Open Minds**

THE MARK CONSISTS OF STANDARD CHARACTERS WITHOUT CLAIM TO ANY PARTICULAR FONT, STYLE, SIZE, OR COLOR.

THE NAME "REGINA MEREDITH" IDENTIFIES A LIVING INDIVIDUAL WHOSE CONSENT IS OF RECORD.

FOR A SERIES OF BOOKS AND WRITTEN ARTICLES IN THE FIELD OF CONSCIOUSNESS (U.S. CLS. 2, 5, 22, 23, 29, 37, 38 AND 50).

DAWN HAN, EXAMINING ATTORNEY

**CLASS 16—(Continued).**

SN 85-293,069. KRUGER PRODUCTS L.P., MISSISSAUGA, ON, CANADA, FILED 4-12-2011.



NO CLAIM IS MADE TO THE EXCLUSIVE RIGHT TO USE "FULL SHEET", APART FROM THE MARK AS SHOWN.

THE MARK CONSISTS OF A PAPER TOWEL ROLL WITH THE WORDS "FULL SHEET" BELOW.

FOR PAPER TOWELS (U.S. CLS. 2, 5, 22, 23, 29, 37, 38 AND 50).

GRETTA YAO, EXAMINING ATTORNEY

SN 85-293,647. STAPLES THE OFFICE SUPERSTORE, LLC., FRAMINGHAM, MA. FILED 4-13-2011.



NO CLAIM IS MADE TO THE EXCLUSIVE RIGHT TO USE "PROFESSIONAL", APART FROM THE MARK AS SHOWN.

THE MARK CONSISTS OF A CIRCLE COMPRISED OF 4 CRESCENTS OVER THE WORDS "BRIGHTON PROFESSIONAL".

FOR PLASTIC PACKAGING FOIL, PAPER TABLE COVERS, PLASTIC BAGS FOR THE STORAGE AND DISPOSAL OF WASTE, PAPER AND PLASTIC GARBAGE BAGS, TRASH CAN LINERS, PAPER NAPKINS, TOILET PAPER, PAPER TOWELS, FACIAL TISSUE, TOILET SEAT COVERS, DISPOSABLE ABSORBENT WIPES NOT IMPREGNATED WITH CHEMICALS (U.S. CLS. 2, 5, 22, 23, 29, 37, 38 AND 50).

GIANCARLO CASTRO, EXAMINING ATTORNEY

**CLASS 16—(Continued).**

SN 85-294,760. BOUCARD, JOHN, DANVILLE, CA. FILED 4-14-2011.



NO CLAIM IS MADE TO THE EXCLUSIVE RIGHT TO USE "CARD", APART FROM THE MARK AS SHOWN.

THE MARK CONSISTS OF THE WORDS "LIFE CARD" WHEREIN FOUR HALF ELLIPSES ARRANGED END TO END IN A PIN WHEEL SHAPE ARE PLACED BETWEEN THE WORDS "LIFE" AND "CARD" AS SHOWN IN THE MARK.

FOR STATIONERY GOODS, NAMELY, INTERACTIVE GREETING CARDS, STATIONERY, INVITATIONS, PICTURES, SCRAPBOOKS, AND BUSINESS CARDS THAT CONTAIN ELECTRONIC DEVICES, NAMELY, RECORDING AND PLAYING DEVICES FOR USE IN RECORDING SOUND OR DIGITAL CONTENT (U.S. CLS. 2, 5, 22, 23, 29, 37, 38 AND 50).

FIRST USE 3-1-2011; IN COMMERCE 3-29-2011.

LINDA POWELL, EXAMINING ATTORNEY

SN 85-295,705. SECURE-IT-EZE INC., LAHAINA, HI. FILED 4-14-2011.



NO CLAIM IS MADE TO THE EXCLUSIVE RIGHT TO USE "BOARDING", APART FROM THE MARK AS SHOWN.

THE MARK CONSISTS OF THE STYLIZED WORDS "E-Z BOARDING" ABOVE A DESIGN FEATURING A GLOBE WITH AN AIRPLANE CIRCLING AND WINGS COMING FROM EITHER SIDE.

FOR DOCUMENT HOLDERS (U.S. CLS. 2, 5, 22, 23, 29, 37, 38 AND 50).

FIRST USE 7-1-2002; IN COMMERCE 7-1-2002.

DAWN HAN, EXAMINING ATTORNEY

SN 85-296,939. WOODBURY, NATHAN J, LEHI, UT. FILED 4-15-2011.

**The Business Paradigm**

THE MARK CONSISTS OF STANDARD CHARACTERS WITHOUT CLAIM TO ANY PARTICULAR FONT, STYLE, SIZE, OR COLOR.

NO CLAIM IS MADE TO THE EXCLUSIVE RIGHT TO USE "BUSINESS", APART FROM THE MARK AS SHOWN.

FOR PRINTED MATTER, NAMELY, PAPER SIGNS, BOOKS, MANUALS, CURRICULUM, NEWSLETTERS, INFORMATIONAL CARDS AND BROCHURES IN THE FIELD OF BUSINESS EDUCATION (U.S. CLS. 2, 5, 22, 23, 29, 37, 38 AND 50).

MARY CRAWFORD, EXAMINING ATTORNEY

**CLASS 16—(Continued).**

SN 85-299,108. PARKER PEN PRODUCTS, LICHFIELD, UNITED KINGDOM, FILED 4-19-2011.

**PARKER 5TH**

THE MARK CONSISTS OF STANDARD CHARACTERS WITHOUT CLAIM TO ANY PARTICULAR FONT, STYLE, SIZE, OR COLOR.

OWNER OF U.S. REG. NOS. 165,783, 2,925,750 AND OTHERS.

FOR WRITING INSTRUMENTS AND REFILLS FOR WRITING INSTRUMENTS (U.S. CLS. 2, 5, 22, 23, 29, 37, 38 AND 50).

ALEX KEAM, EXAMINING ATTORNEY

**CLASS 16—(Continued).**

SN 85-301,416. MILLY LLC, NEW YORK, NY. FILED 4-21-2011.

THE MARK CONSISTS OF THE WORD "MILLY" IN A STYLIZED FONT.

FOR PAPER AND PRINTED PRODUCTS, NAMELY, ADDRESS BOOKS AND DIARIES, ANNOUNCEMENT CARDS, BLANK JOURNALS, ENVELOPE PAPER, ENVELOPES, EVENTS ALBUMS, GIFT BAGS, GIFT BOXES AND CARDS, GIFT WRAP PAPER, GREETING CARDS, HOLDERS MADE OF PAPER FOR DESK ACCESSORIES, NOTE PADS, NOTEBOOKS, OCCASION CARDS, PAPER, PLACE CARDS, POST CARDS, PRINTS, SCENTED DRAWER LINERS, SCRAP BOOKS, SOCIAL NOTE CARDS, STATIONERY, STATIONERY CASES MADE OF PAPER, TABLE LINENS OF PAPER, TABLE NAPKINS OF PAPER, TISSUE PAPER, TRAVEL BOOKS, UNPRINTED PAPER, WEDDING ALBUMS, WEDDING BOOKS, WRAPPING PAPER, WRITING PAPER AND HOLDERS MADE OF PAPER (U.S. CLS. 2, 5, 22, 23, 29, 37, 38 AND 50).

KAREN SEVERSON, EXAMINING ATTORNEY

SN 85-300,436. PAWSOME PET PRODUCTS, LLC, BOCA RATON, FL. FILED 4-20-2011.

**Flush Puppies**

THE MARK CONSISTS OF STANDARD CHARACTERS WITHOUT CLAIM TO ANY PARTICULAR FONT, STYLE, SIZE, OR COLOR.

FOR FLUSHABLE, BIODEGRADABLE BAGS MADE OF POLYVINYL ALCOHOL-BASED FILM FOR DISPOSAL OF DOG WASTE AND PLASTIC DISPENSERS AND CONTAINERS FOR BAGS, SOLD AS A UNIT (U.S. CLS. 2, 5, 22, 23, 29, 37, 38 AND 50).

FIRST USE 5-25-2006; IN COMMERCE 5-25-2006.  
THEODORE MCBRIDE, EXAMINING ATTORNEY

SN 85-304,978. OVERTIME INC., DBA FEDERAL WAGE AND LABOR LAW INSTITUTE, HOUSTON, TX. FILED 4-26-2011.

**ALL-IN-ONE**

THE MARK CONSISTS OF STANDARD CHARACTERS WITHOUT CLAIM TO ANY PARTICULAR FONT, STYLE, SIZE, OR COLOR.

FOR FEDERAL AND STATE LABOR LAW POSTERS FOR ALL 50 STATES (U.S. CLS. 2, 5, 22, 23, 29, 37, 38 AND 50).

FIRST USE 4-1-1990; IN COMMERCE 4-1-1990.  
EMILY CARLSEN, EXAMINING ATTORNEY

**CLASS 16—(Continued).**

SN 85-307,745. CHMELA, JOHN, FORT MYERS, FL. FILED 4-28-2011.

## Articles

THE MARK CONSISTS OF STANDARD CHARACTERS WITHOUT CLAIM TO ANY PARTICULAR FONT, STYLE, SIZE, OR COLOR.

FOR MAGAZINES FEATURING ARTICLES IN THE FIELD OF TWO DIMENSIONAL DATA CODES (U.S. CLS. 2, 5, 22, 23, 29, 37, 38 AND 50).

FONG HSÜ, EXAMINING ATTORNEY

SN 85-308,102. PROVEN PUBLICATIONS, LLC, VIRGINIA BEACH, VA. FILED 4-29-2011.

**PROVEN**  
BEYOND THE PROCESS

THE MARK CONSISTS OF THE WORD "PROVEN" IN ALL CAPITAL LETTERS THEN THE WORDS "BEYOND THE PROCESS" ALSO IN ALL CAPITAL LETTERS UNDER THE WORD "PROVEN" STARTING BELOW THE LETTER "O".

FOR GENERAL FEATURE MAGAZINE IN THE FIELD OF WORKFORCE DEVELOPMENT, TRAINING, AND PERFORMANCE (U.S. CLS. 2, 5, 22, 23, 29, 37, 38 AND 50).

FIRST USE 5-1-2008; IN COMMERCE 5-1-2008.  
ANDREW LEASER, EXAMINING ATTORNEY

SN 85-310,400. ATLANTA BELTLINE, INC., ATLANTA, GA. FILED 5-2-2011.

## ATLANTA BELTLINE

THE MARK CONSISTS OF STANDARD CHARACTERS WITHOUT CLAIM TO ANY PARTICULAR FONT, STYLE, SIZE, OR COLOR.

OWNER OF U.S. REG. NOS. 3,356,126, 3,936,660 AND OTHERS.

NO CLAIM IS MADE TO THE EXCLUSIVE RIGHT TO USE "ATLANTA", APART FROM THE MARK AS SHOWN.

FOR BROCHURES ABOUT URBAN REDEVELOPMENT PROJECTS IN ATLANTA; BUMPER STICKERS; INFORMATIONAL FLYERS FEATURING INFORMATION RELATING TO URBAN REDEVELOPMENT PROJECTS IN ATLANTA; MAPS, NEWSLETTERS IN THE FIELD OF URBAN REDEVELOPMENT PROJECTS IN ATLANTA; PHOTOGRAPHS, PRINTED GUIDES FOR TOURS OF SECTIONS OF ATLANTA; PRINTED PAPER SIGNS AND STATIONERY (U.S. CLS. 2, 5, 22, 23, 29, 37, 38 AND 50).

FIRST USE 8-1-2010; IN COMMERCE 8-1-2010.  
TRACY CROSS, EXAMINING ATTORNEY

**CLASS 16—(Continued).**

SN 85-312,303. DISASTER MANAGEMENT SYSTEMS, INC., POMONA, CA. FILED 5-4-2011.

## OPTIMIZED FOR EMT3

THE MARK CONSISTS OF STANDARD CHARACTERS WITHOUT CLAIM TO ANY PARTICULAR FONT, STYLE, SIZE, OR COLOR.

FOR PRINTED MATTER, NAMELY, BAR CODED PAPER WRIST BANDS FOR TRIAGE (U.S. CLS. 2, 5, 22, 23, 29, 37, 38 AND 50).

FIRST USE 2-28-2011; IN COMMERCE 2-28-2011.  
WILLIAM P. SHANAHAN, EXAMINING ATTORNEY

SN 85-314,275. BAYSHORE HISTORY, LLC, MARGATE, NJ. FILED 5-6-2011.

## THE CIVIL WAR MONITOR

THE MARK CONSISTS OF STANDARD CHARACTERS WITHOUT CLAIM TO ANY PARTICULAR FONT, STYLE, SIZE, OR COLOR.

NO CLAIM IS MADE TO THE EXCLUSIVE RIGHT TO USE "CIVIL WAR", APART FROM THE MARK AS SHOWN.

FOR GENERAL FEATURE MAGAZINE IN THE FIELD OF CIVIL WAR HISTORY (U.S. CLS. 2, 5, 22, 23, 29, 37, 38 AND 50).

MARLENE BELL, EXAMINING ATTORNEY

SN 85-315,839. ABIDING LIGHT PUBLICATIONS LLC, SIMPSONVILLE, SC. FILED 5-9-2011.

  
shine  
GREETINGS

NO CLAIM IS MADE TO THE EXCLUSIVE RIGHT TO USE "GREETINGS", APART FROM THE MARK AS SHOWN.

THE MARK CONSISTS OF THE STYLIZED WORD "SHINE" WRITTEN IN CURSVIE WITH A LIGHTED CANDLE WICK REPRESENTING THE LETTER I AND RAYS OF LIGHT COMING OUT IN EVEN INCREMENTS AROUND THE WICK AND THE WORD "GREETINGS" UNDERNEATH.

FOR GREETING CARDS (U.S. CLS. 2, 5, 22, 23, 29, 37, 38 AND 50).

FIRST USE 3-1-2011; IN COMMERCE 3-1-2011.  
CURTIS FRENCH, EXAMINING ATTORNEY



**CLASS 16—(Continued).**

SN 85-316,237. RAREINK, INCORPORATED, ENCINITAS, CA. FILED 5-9-2011.

**REAL AUTOGRAPHS. REAL  
CAUSES**

THE MARK CONSISTS OF STANDARD CHARACTERS WITHOUT CLAIM TO ANY PARTICULAR FONT, STYLE, SIZE, OR COLOR.

NO CLAIM IS MADE TO THE EXCLUSIVE RIGHT TO USE "REAL AUTOGRAPHS", APART FROM THE MARK AS SHOWN.

FOR PHOTOGRAPHS, PAINTINGS, POSTERS, RECORD ALBUM COVERS, FRAMED AND MATTED ART PICTURES FEATURING ENTERTAINMENT AND SPORTS IMAGES, TRADING CARDS, LITHOGRAPHS, ANIMATION CELS, NEWSPAPERS, BOOKS IN THE FIELD OF ENTERTAINMENT AND SPORTS, ALL FEATURING GENUINE AUTOGRAPHS; PRINTED GAME TICKETS, PRINTED CONCERT TICKETS, EVENT PROGRAMS FOR GAMES, ALL FEATURING GENUINE AUTOGRAPHS (U.S. CLS. 2, 5, 22, 23, 29, 37, 38 AND 50).

FIRST USE 2-1-2011; IN COMMERCE 2-1-2011.  
STEVEN PEREZ, EXAMINING ATTORNEY

**CLASS 16—(Continued).**

SN 85-319,554. PAWSOME PET PRODUCTS, LLC, BOCA RATON, FL. FILED 5-12-2011.



NO CLAIM IS MADE TO THE EXCLUSIVE RIGHT TO USE "FLUSHABLE", APART FROM THE MARK AS SHOWN.

THE COLOR(S) BLUE AND RED IS/ARE CLAIMED AS A FEATURE OF THE MARK.

THE MARK CONSISTS OF THE WORDS "FLUSH PUPPIES" IN STYLIZED LETTERING WITH A BLUE BORDER, WITH THE "H" IN "FLUSH" A GRAPHIC OF A BLUE OUTLINE OF A DOG WEARING A COLLAR WITH ITS HEAD TURNED BACKWARDS, ABOVE A STYLIZED TOILET PAPER ROLL WITH THE WORDING "FLUSHABLE!!" IN RED ON THE TOILET PAPER ROLL.

FOR FLUSHABLE, BIODEGRADABLE BAGS MADE OF POLYVINYL ALCOHOL-BASED FILM FOR DISPOSAL OF DOG WASTE AND PLASTIC DISPENSERS AND CONTAINERS FOR BAGS, SOLD AS A UNIT (U.S. CLS. 2, 5, 22, 23, 29, 37, 38 AND 50).

FIRST USE 7-15-2007; IN COMMERCE 7-15-2007.  
THEODORE MCBRIDE, EXAMINING ATTORNEY

SN 85-316,293. SHAMBHALA PUBLICATIONS, INC., BOSTON, MA. FILED 5-9-2011.



THE MARK CONSISTS OF THE LETTERS "RB" WITH A STYLIZED BRANCH WITH LEAVES ACROSS THE LETTERS AND A STYLIZED BIRD ABOVE THE LETTER "B".

FOR FICTION AND NON-FICTION BOOKS ON A VARIETY OF TOPICS (U.S. CLS. 2, 5, 22, 23, 29, 37, 38 AND 50).

JIM RINGLE, EXAMINING ATTORNEY

SN 85-319,677. WAX EYE LLC, FREDERICKSBURG, VA. FILED 5-12-2011.



NO CLAIM IS MADE TO THE EXCLUSIVE RIGHT TO USE "TRADING CARDS", APART FROM THE MARK AS SHOWN.

THE COLOR(S) MAGENTA, BLUE, YELLOW, AND WHITE IS/ARE CLAIMED AS A FEATURE OF THE MARK.

THE MARK CONSISTS OF THE STYLIZED WORDING "CEREAL KILLERS TRADING CARDS" COLORED IN YELLOW WITH BLUE SHADOWS AND OUTLINED IN MAGENTA, EACH LETTER HAS WHITE HIGHLIGHTS AND THE WORDING "CEREAL KILLERS" TAKES UP 75 PERCENT OF THE MARK WITH THE WORDING "TRADING CARDS" TAKING UP ABOUT 25 PERCENT OF THE SPACE.

FOR TRADING CARD DISCS OF PAPER OR CARDBOARD (U.S. CLS. 2, 5, 22, 23, 29, 37, 38 AND 50).

FIRST USE 1-1-2011; IN COMMERCE 5-1-2011.  
TRICIA SONNEBORN, EXAMINING ATTORNEY

**CLASS 16—(Continued).**

SN 85-321,173. WAX EYE LLC, FREDERICKSBURG, VA. FILED 5-14-2011.



NO CLAIM IS MADE TO THE EXCLUSIVE RIGHT TO USE "STICKER CARDS", APART FROM THE MARK AS SHOWN.

THE COLOR(S) MAGENTA, BLUE, YELLOW AND WHITE IS/ARE CLAIMED AS A FEATURE OF THE MARK. THE MARK CONSISTS OF THE STYLIZED WORDING "CEREAL KILLERS STICKER CARDS" COLORED IN YELLOW WITH BLUE SHADOWS AND OUTLINED IN MAGENTA, WITH WHITE HIGHLIGHTS AND THE WORDING "CEREAL KILLERS" TAKING UP 75 PERCENT OF THE MARK AND THE WORDING "STICKER CARDS" TAKING UP ABOUT 25 PERCENT OF THE SPACE.

FOR STICKERS (U.S. CLS. 2, 5, 22, 23, 29, 37, 38 AND 50).

TRICIA SONNEBORN, EXAMINING ATTORNEY

SN 85-321,593. PEEPLES, LEROY, DORCHESTER, MA. FILED 5-16-2011.



NO CLAIM IS MADE TO THE EXCLUSIVE RIGHT TO USE "MAGAZINE", APART FROM THE MARK AS SHOWN.

THE MARK CONSISTS OF THE STYLIZED TEXT "KYTE MAGAZINE", WRITTEN IN TWO LINES. TO THE RIGHT THERE IS A BIRD HOLDING AN ENVELOPE IN HIS FEET.

FOR MAGAZINES IN THE FIELD OF MOTIVATIONAL TESTIMONIALS AND POETRY BY INMATES (U.S. CLS. 2, 5, 22, 23, 29, 37, 38 AND 50).

GIANCARLO CASTRO, EXAMINING ATTORNEY

SN 85-322,728. SOUTHWEST SPECIALTY FOOD, INC., GOODYEAR, AZ. FILED 5-17-2011.

**ASS KICKIN'**

THE MARK CONSISTS OF STANDARD CHARACTERS WITHOUT CLAIM TO ANY PARTICULAR FONT, STYLE, SIZE, OR COLOR.

FOR GREETING CARDS (U.S. CLS. 2, 5, 22, 23, 29, 37, 38 AND 50).

FIRST USE 9-25-1991; IN COMMERCE 9-25-1991.

MARK SHINER, EXAMINING ATTORNEY

**CLASS 16—(Continued).**

SN 85-323,050. NUTIS PRESS, INC., COLUMBUS, OH. FILED 5-17-2011.

**WELL HUNG DESIGN**

THE MARK CONSISTS OF STANDARD CHARACTERS WITHOUT CLAIM TO ANY PARTICULAR FONT, STYLE, SIZE, OR COLOR.

NO CLAIM IS MADE TO THE EXCLUSIVE RIGHT TO USE "DESIGN", APART FROM THE MARK AS SHOWN.

FOR POSTERS (U.S. CLS. 2, 5, 22, 23, 29, 37, 38 AND 50).

MATTHEW EINSTEIN, EXAMINING ATTORNEY

SN 85-323,399. LYDIA RUTH BATES, KENNEWICK, WA. FILED 5-17-2011.



THE COLOR(S) GOLD IS/ARE CLAIMED AS A FEATURE OF THE MARK.

THE MARK CONSISTS OF JOINED RECTANGLES, ONE ABOVE THE OTHER. THE UPPER RECTANGLE ENCLOSING A CROWN. THE LOWER RECTANGLE ENCLOSING THE LITERAL ELEMENTS "LYASE EDWARDA JEWEL ALEXANDRA LYDIA RUTH BARTHLOMEW BATES PRINCESS PRODUCTS" ALL IN GOLD.

FOR SERIES OF FICTION BOOKS; SERIES OF NON-FICTION BOOKS IN THE FIELD OF THE CHRISTIAN FAITH FOR ADULTS AND FOR CHILDREN (U.S. CLS. 2, 5, 22, 23, 29, 37, 38 AND 50).

MATTHEW KLINE, EXAMINING ATTORNEY

**CLASS 16—(Continued).**

SN 85-323,408. FILE FOR FINAL WISHES, LLC, LAFAYETTE, LA. FILED 5-17-2011.

*File For*  
**FINAL WISHES**

NO CLAIM IS MADE TO THE EXCLUSIVE RIGHT TO USE "FILE", APART FROM THE MARK AS SHOWN.

THE MARK CONSISTS OF THE WORDS "FILE FOR FINAL WISHES" PLUS A DESIGN COMPRISING A PLURALITY OF STARS.

FOR MULTI-POCKET EXPANDABLE FOLDERS HAVING TAB LABELS FOR EACH POCKET, AND A SLEEVE FOR HOLDING A COMPACT DISC (U.S. CLS. 2, 5, 22, 23, 29, 37, 38 AND 50).

WENDY GOODMAN, EXAMINING ATTORNEY

SN 85-325,003. MEADWESTVACO CORPORATION, RICHMOND, VA. FILED 5-19-2011.

**BETTER ON PAPER**

THE MARK CONSISTS OF STANDARD CHARACTERS WITHOUT CLAIM TO ANY PARTICULAR FONT, STYLE, SIZE, OR COLOR.

NO CLAIM IS MADE TO THE EXCLUSIVE RIGHT TO USE "PAPER", APART FROM THE MARK AS SHOWN.

FOR DATE PLANNERS AND CALENDARS; DESK PADS; FILE FOLDERS; LEGAL PADS, NOTEBOOKS AND NOTEPADS; WRITING PADS, BLANK JOURNALS, NOTE CARDS AND ENVELOPES; NOTEBOOKS AND NOTEPADS; PADFOLIOS (U.S. CLS. 2, 5, 22, 23, 29, 37, 38 AND 50).

DORITT L. CARROLL, EXAMINING ATTORNEY

SN 85-326,957. KABIR, TANVIR FAYAZ, LEXINGTON, KY. FILED 5-23-2011.

**Kabir Academy**

THE MARK CONSISTS OF STANDARD CHARACTERS WITHOUT CLAIM TO ANY PARTICULAR FONT, STYLE, SIZE, OR COLOR.

NO CLAIM IS MADE TO THE EXCLUSIVE RIGHT TO USE "ACADEMY", APART FROM THE MARK AS SHOWN.

THE WORDING "KABIR" HAS NO MEANING IN A FOREIGN LANGUAGE.

FOR EDUCATIONAL PUBLICATIONS, NAMELY, EDUCATIONAL LEARNING CARDS, FLASH CARDS, ACTIVITY CARDS, WORKBOOKS, TEXTBOOKS, ACTIVITY BOOKS, STORY BOOKS, PUZZLE BOOKS, PRINTED PUZZLES, TEACHER GUIDES, MANUALS, POSTERS AND EDUCATIONAL BOOKLETS IN THE FIELD OF SCIENCE (U.S. CLS. 2, 5, 22, 23, 29, 37, 38 AND 50).

JOHN E. MICHOS, EXAMINING ATTORNEY

**CLASS 16—(Continued).**

SN 85-327,141. WAX EYE LLC, FREDERICKSBURG, VA. FILED 5-23-2011.



THE COLOR(S) MAGENTA, BLUE, YELLOW, AND WHITE IS/ARE CLAIMED AS A FEATURE OF THE MARK.

THE MARK CONSISTS OF THE STYLIZED WORDING "CEREAL KILLERS" COLORED IN YELLOW WITH BLUE SHADOWS AND OUTLINED IN MAGENTA, EACH LETTER HAVING A WHITE HIGHLIGHT.

FOR (BASED ON USE IN COMMERCE) TRADING CARD DISCS OF PAPER OR CARDBOARD (BASED ON INTENT TO USE) STICKERS (U.S. CLS. 2, 5, 22, 23, 29, 37, 38 AND 50).

FIRST USE 1-1-2011; IN COMMERCE 5-1-2011.

TRICIA SONNEBORN, EXAMINING ATTORNEY

SN 85-327,188. WAX EYE LLC, FREDERICKSBURG, VA. FILED 5-23-2011.



THE COLOR(S) MAGENTA, BLUE, YELLOW, AND WHITE IS/ARE CLAIMED AS A FEATURE OF THE MARK.

THE MARK CONSISTS OF THE STYLIZED WORDING "THE REAL" COLORED IN BLUE WITH YELLOW SHADOWS TAKING UP ABOUT 15 PERCENT OF THE MARK AND THE STYLIZED WORDING "CEREAL KILLERS" COLORED IN YELLOW WITH WHITE HIGHLIGHTS, BLUE SHADOWS AND OUTLINED IN MAGENTA, TAKING UP ABOUT 85 PERCENT OF THE MARK.

FOR STICKERS; TRADING CARD DISCS OF PAPER OR CARDBOARD (U.S. CLS. 2, 5, 22, 23, 29, 37, 38 AND 50).

TRICIA SONNEBORN, EXAMINING ATTORNEY

**CLASS 16—(Continued).**

SN 85-327,409. MARV RUSSELL ENTERPRISES LIMITED, BOYNTON BEACH, FL. FILED 5-23-2011.

LINEBACKER IN THE  
BOARDROOM: LESSONS IN LIFE  
AND LEADERSHIP

THE MARK CONSISTS OF STANDARD CHARACTERS WITHOUT CLAIM TO ANY PARTICULAR FONT, STYLE, SIZE, OR COLOR.

FOR PRINTED MATERIAL AND PUBLICATIONS, NAMELY, WRITTEN ARTICLES, MAGAZINES, BOOKLETS, BROCHURES, PAMPHLETS, NEWSLETTERS, BOOKS, AND PRINTED INSTRUCTIONAL AND TEACHING MATERIALS ALL IN THE FIELD OF LEADERSHIP ASSESSMENT, DEVELOPMENT, AND ENHANCEMENT, BUSINESS ETHICS AND HUMAN RESOURCE PRACTICES (U.S. CLS. 2, 5, 22, 23, 29, 37, 38 AND 50).

JUDITH HELFMAN, EXAMINING ATTORNEY

SN 85-327,414. MARV RUSSELL ENTERPRISES LIMITED, BOYNTON BEACH, FL. FILED 5-23-2011.

LINEBACKER IN THE  
BOARDROOM: FINDING YOUR  
IMPACT ZONE

THE MARK CONSISTS OF STANDARD CHARACTERS WITHOUT CLAIM TO ANY PARTICULAR FONT, STYLE, SIZE, OR COLOR.

FOR PRINTED MATERIAL AND PUBLICATIONS, NAMELY, WRITTEN ARTICLES, MAGAZINES, BOOKLETS, BROCHURES, PAMPHLETS, NEWSLETTERS, BOOKS, AND PRINTED INSTRUCTIONAL AND TEACHING MATERIALS ALL IN THE FIELD OF LEADERSHIP ASSESSMENT, DEVELOPMENT, AND ENHANCEMENT, BUSINESS ETHICS AND HUMAN RESOURCE PRACTICES (U.S. CLS. 2, 5, 22, 23, 29, 37, 38 AND 50).

JUDITH HELFMAN, EXAMINING ATTORNEY

SN 85-327,419. MARV RUSSELL ENTERPRISES LIMITED, BOYNTON BEACH, FL. FILED 5-23-2011.

DON'T EAT THE DONUTS

THE MARK CONSISTS OF STANDARD CHARACTERS WITHOUT CLAIM TO ANY PARTICULAR FONT, STYLE, SIZE, OR COLOR.

FOR PRINTED MATERIAL AND PUBLICATIONS, NAMELY, WRITTEN ARTICLES, MAGAZINES, BOOKLETS, BROCHURES, PAMPHLETS, NEWSLETTERS, BOOKS, AND PRINTED INSTRUCTIONAL AND TEACHING MATERIALS ALL IN THE FIELD OF LEADERSHIP ASSESSMENT, DEVELOPMENT, AND ENHANCEMENT, BUSINESS ETHICS AND HUMAN RESOURCE PRACTICES (U.S. CLS. 2, 5, 22, 23, 29, 37, 38 AND 50).

JUDITH HELFMAN, EXAMINING ATTORNEY

**CLASS 16—(Continued).**

SN 85-329,031. CAMPBELL, TERRY ALVIN, PRINCE GEORGE, BC, CANADA, FILED 5-24-2011.

**Buckle Up**

THE MARK CONSISTS OF THE WORD BUCKLE FOLLOWED BY THE WORD UP. THE E IN THE WORD BUCKLE AND THE U IN THE WORD UP BOTH HAVE SEAT BUCKLES MERGING OFF OF THEM THAT ARE ALMOST CONNECTING.

FOR DECALS (U.S. CLS. 2, 5, 22, 23, 29, 37, 38 AND 50).  
AMY C. KEAN, EXAMINING ATTORNEY

SN 85-329,280. DEBORAH L. HORN, SANDY, UT. FILED 5-24-2011.

**idonnab**

THE MARK CONSISTS OF STANDARD CHARACTERS WITHOUT CLAIM TO ANY PARTICULAR FONT, STYLE, SIZE, OR COLOR.

FOR PRINTED MATTER, NAMELY, PRINTED PERIODICALS, BOOKS, MAGAZINES, BROCHURES, CATALOGUES, NEWSLETTERS, PAMPHLETS, WRITTEN ARTICLES, INSTRUCTIONAL MANUALS, POSTERS, USER GUIDES, REFERENCE GUIDES, AND INFORMATIONAL FLYERS IN THE FIELDS OF HEALTH, FITNESS AND EXERCISE, HEALTHCARE, AND PERSONAL CARE; PAPER GOODS, NAMELY, CALENDARS, GREETING CARDS, STATIONERY AND ENVELOPES, MEMO PADS, NOTE PADS, NOTEBOOKS, NOTE PAPER AND SCRATCH PADS, DAILY PLANNERS AND PERSONAL ORGANIZERS; MOUNTED AND UNMOUNTED PHOTOGRAPHIC AND PICTORIAL PRINTS, AND PRINTED ART REPRODUCTIONS; MERCHANDISE AND GENERAL PURPOSE PAPER AND PLASTIC BAGS; PENS, PENCILS, PEN AND PENCIL TRAYS, HOLDERS AND CASES; CLIP BOARDS, BINDERS, PAPERWEIGHTS, STATIONERY-TYPE PORTFOLIOS, BOOK COVERS; DESK PADS, DESK BASKETS, DESK ORGANIZERS, NOTEPAD HOLDERS, PHOTOGRAPH AND SCRAPBOOK ALBUMS; BOOK HOLDERS, BOOKENDS, AND BOOKMARKS; PRINTED INSTRUCTIONAL AND TEACHING MATERIALS IN THE FIELDS OF HEALTH, FITNESS AND EXERCISE, HEALTHCARE, AND PERSONAL CARE; PHOTOGRAPHS; DECALS; BUMPER STICKERS (U.S. CLS. 2, 5, 22, 23, 29, 37, 38 AND 50).

LESLIE RICHARDS, EXAMINING ATTORNEY

**CLASS 16—(Continued).**

SN 85-329,426. KARIN ZELL, LA JOLLA, CA. FILED 5-25-2011.

**Door Opens Wide**

THE MARK CONSISTS OF STANDARD CHARACTERS WITHOUT CLAIM TO ANY PARTICULAR FONT, STYLE, SIZE, OR COLOR.

FOR BUMPER STICKERS; DECORATIVE DECALS FOR VEHICLE WINDOWS; MAGNETIC BUMPER STICKERS (U.S. CLS. 2, 5, 22, 23, 29, 37, 38 AND 50).  
PAULA MAHONEY, EXAMINING ATTORNEY

SN 85-331,328. BENTON, JAMES K., BLOOMFIELD, MI. FILED 5-26-2011.

**CATWAD**

THE MARK CONSISTS OF STANDARD CHARACTERS WITHOUT CLAIM TO ANY PARTICULAR FONT, STYLE, SIZE, OR COLOR.

FOR ILLUSTRATIONS (U.S. CLS. 2, 5, 22, 23, 29, 37, 38 AND 50).

ALLISON HOLTZ, EXAMINING ATTORNEY

SN 85-331,696. SHYLA T. HIGH, DALLAS, TX. FILED 5-26-2011.

**RxCOLOR**

THE MARK CONSISTS OF STANDARD CHARACTERS WITHOUT CLAIM TO ANY PARTICULAR FONT, STYLE, SIZE, OR COLOR.

FOR COLORING BOOKS, NAMELY COLORING BOOKS FOR ADULTS FOR THERAPEUTIC, REHABILITATIVE, AND GERIATRIC PURPOSES (U.S. CLS. 2, 5, 22, 23, 29, 37, 38 AND 50).

BARBARA BROWN, EXAMINING ATTORNEY

**CLASS 16—(Continued).**

SN 85-331,698. YELLIN, DUSTIN, DBA DUSTIN YELLIN LLC, BROOKLYN, NY. FILED 5-26-2011.

**INTERCOURSE**

THE MARK CONSISTS OF STANDARD CHARACTERS WITHOUT CLAIM TO ANY PARTICULAR FONT, STYLE, SIZE, OR COLOR.

FOR MAGAZINES IN THE FIELD OF CULTURE (U.S. CLS. 2, 5, 22, 23, 29, 37, 38 AND 50).

BARBARA BROWN, EXAMINING ATTORNEY

SN 85-332,591. OLSON, KATIE, AURORA, CO. AND FOX, S. JOY, AURORA, CO. FILED 5-27-2011.

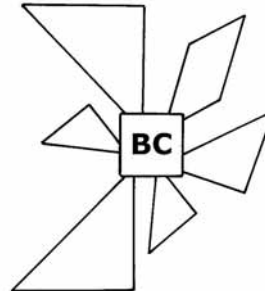

THE MARK CONSISTS OF A SQUARE WITH THE STYLIZED TEXT "BC" SURROUNDED BY 6 GEOMETRICAL PATTERNS.

FOR BOOKLETS IN THE FIELD OF VARIOUS BRAIN ACTIVITIES TO CURB THE EFFECTS OF DEMENTIA (U.S. CLS. 2, 5, 22, 23, 29, 37, 38 AND 50).

MICHAEL WEBSTER, EXAMINING ATTORNEY

SN 85-333,023. I LOVE YOU SO PRODUCTIONS, LLC, TEMPE, AZ. FILED 5-28-2011.

**SCIENCE OF SKINNY**

THE MARK CONSISTS OF STANDARD CHARACTERS WITHOUT CLAIM TO ANY PARTICULAR FONT, STYLE, SIZE, OR COLOR.

FOR SERIES OF NON-FICTION BOOKS IN THE FIELD OF NUTRITION AND WEIGHT LOSS (U.S. CLS. 2, 5, 22, 23, 29, 37, 38 AND 50).

AMY KERTGATE, EXAMINING ATTORNEY

**CLASS 16—(Continued).**

SN 85-333,575. KJLM VENTURES LLC, WASHINGTON, DC. AND SHEILA WILLARD, PHILADELPHIA, PA. FILED 5-31-2011.

**GET FIXED**

THE MARK CONSISTS OF STANDARD CHARACTERS WITHOUT CLAIM TO ANY PARTICULAR FONT, STYLE, SIZE, OR COLOR.

FOR PICTURE BOOKS AND BUMPER STICKERS (U.S. CLS. 2, 5, 22, 23, 29, 37, 38 AND 50).

LINDA ORNDORFF, EXAMINING ATTORNEY

---

SN 85-333,675. AMERICAN ASSOCIATION OF CLINICAL ENDOCRINOLOGISTS, INC., JACKSONVILLE, FL. FILED 5-31-2011.

**Endonomics**

THE MARK CONSISTS OF STANDARD CHARACTERS WITHOUT CLAIM TO ANY PARTICULAR FONT, STYLE, SIZE, OR COLOR.

FOR NEWSLETTERS IN THE FIELD OF ENDOCRINOLOGY PRACTICE MANAGEMENT (U.S. CLS. 2, 5, 22, 23, 29, 37, 38 AND 50).

FIRST USE 5-1-2011; IN COMMERCE 5-1-2011.

ASMAT KHAN, EXAMINING ATTORNEY

---

SN 85-333,753. BROWN, BRAD, LEES SUMMIT, MO. FILED 5-31-2011.

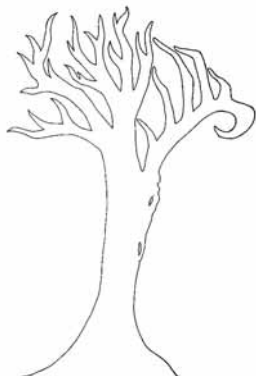

THE MARK CONSISTS OF A TREE BLENDING INTO ONE ANOTHER WITH THE SKULL OF THE BUCK DEER BLENDING INTO THE TRUNK OF THE TREE AND THE ANTLERS OF THE BUCK DEER BLENDING INTO THE BRANCHES OF THE TREE REPRESENTING HALF OF THE BRANCHES.

FOR DECALS; STICKERS (U.S. CLS. 2, 5, 22, 23, 29, 37, 38 AND 50).

GINA FINK, EXAMINING ATTORNEY

**CLASS 16—(Continued).**

SN 85-333,960. JKLM VENTURES LLC, WASHINGTON, DC. AND SHEILA WILLARD, PHILADELPHIA, PA. FILED 5-31-2011.

**SHERMAN**

THE MARK CONSISTS OF STANDARD CHARACTERS WITHOUT CLAIM TO ANY PARTICULAR FONT, STYLE, SIZE, OR COLOR.

FOR PICTURE BOOKS AND BUMPER STICKERS (U.S. CLS. 2, 5, 22, 23, 29, 37, 38 AND 50).

JENNY PARK, EXAMINING ATTORNEY

---

SN 85-334,179. BLUE ZONES, LLC, MINNEAPOLIS, MN. FILED 5-31-2011.

**BLUE ZONES**

THE MARK CONSISTS OF STANDARD CHARACTERS WITHOUT CLAIM TO ANY PARTICULAR FONT, STYLE, SIZE, OR COLOR.

FOR COOK BOOKS; PRINTED GUIDES FOR DIET, NUTRITION, HEALTHY FOOD, MENU PLANNING, RECIPES, FOOD PREPARATION, COOKING, FITNESS, AND WEIGHT LOSS AND CONTROL; RECIPE BOOKS; SERIES OF NON-FICTION BOOKS IN THE FIELD OF DIET, NUTRITION, HEALTHY FOOD, MENU PLANNING, RECIPES, FOOD PREPARATION, COOKING, FITNESS, AND WEIGHT LOSS AND CONTROL (U.S. CLS. 2, 5, 22, 23, 29, 37, 38 AND 50).

JILL C. ALT, EXAMINING ATTORNEY

---

SN 85-334,184. MARGARET CLAY, SAVANNAH, GA. FILED 5-31-2011.

**MONKEYMINDERS**

THE MARK CONSISTS OF STANDARD CHARACTERS WITHOUT CLAIM TO ANY PARTICULAR FONT, STYLE, SIZE, OR COLOR.

FOR MOTIVATIONAL CARDS (U.S. CLS. 2, 5, 22, 23, 29, 37, 38 AND 50).

FIRST USE 1-30-2001; IN COMMERCE 1-30-2001.

JILL C. ALT, EXAMINING ATTORNEY

**CLASS 16—(Continued).**

SN 85-334,272. GEAMI, LTD., MORRISVILLE, NC. FILED 5-31-2011.



The logo for "iWrap" features the word "iWrap" in a serif font. The letter "i" is lowercase, and "Wrap" is uppercase. A small leaf is positioned above the letter "r".

THE MARK CONSISTS OF THE LETTERS "IWRAP" WITH A LOWER CASE "I", THEN CAPITAL "W", FOLLOWED BY "RAP"...ALL ONE WORD. THE LETTER "R" HAS A DESIGN OF A LEAF LOCATED RIGHT ABOVE, WITH THE IMAGE OF A 3-LEGGED TREE BRANCH LOCATED WITHIN THE LEAF.

FOR PAPER FOR WRAPPING AND PACKAGING; WRAPPING PAPER (U.S. CLS. 2, 5, 22, 23, 29, 37, 38 AND 50).

FIRST USE 4-29-2011; IN COMMERCE 4-29-2011.  
WILLIAM P. SHANAHAN, EXAMINING ATTORNEY

SN 85-334,415. PAGE UP GLOBAL INC., MIAMI, FL. FILED 5-31-2011.

SEE . LIFE . MOVE .

THE MARK CONSISTS OF STANDARD CHARACTERS WITHOUT CLAIM TO ANY PARTICULAR FONT, STYLE, SIZE, OR COLOR.

FOR FLIP BOOKS (U.S. CLS. 2, 5, 22, 23, 29, 37, 38 AND 50).

KYLE PEETE, EXAMINING ATTORNEY

SN 85-334,462. TAJUDEEN, NICK, R, RIDGEWOOD, NY. FILED 5-31-2011.

The Dead Wakers

THE MARK CONSISTS OF STANDARD CHARACTERS WITHOUT CLAIM TO ANY PARTICULAR FONT, STYLE, SIZE, OR COLOR.

FOR GRAPHIC NOVELS; NOVELS; SERIES OF FICTION WORKS, NAMELY, NOVELS AND BOOKS (U.S. CLS. 2, 5, 22, 23, 29, 37, 38 AND 50).

LINDA ORNDORFF, EXAMINING ATTORNEY

**CLASS 16—(Continued).**

SN 85-334,816. MERCURY RETAIL SERVICES LLC, SAN ANTONIO, TX. FILED 6-1-2011.

KYLA & CARLOS

THE MARK CONSISTS OF STANDARD CHARACTERS WITHOUT CLAIM TO ANY PARTICULAR FONT, STYLE, SIZE, OR COLOR.

THE NAME(S), PORTRAIT(S), AND/OR SIGNATURE(S) SHOWN IN THE MARK IDENTIFIES KYLA HOLDER, MINOR DAUGHTER OF LOUIE LEE HOLDER III, WHOSE CONSENT(S) TO REGISTER IS MADE OF RECORD.

FOR BOOKMARKS; CHILDREN'S BOOKS; COLORING BOOKS; CRAYONS (U.S. CLS. 2, 5, 22, 23, 29, 37, 38 AND 50).

FIRST USE 6-3-2011; IN COMMERCE 7-12-2011.  
FLORENTINA BLANDU, EXAMINING ATTORNEY

SN 85-335,043. EXCESS PAPER TOWELS, LLC., MIAMI, FL. FILED 6-1-2011.



NO CLAIM IS MADE TO THE EXCLUSIVE RIGHT TO USE "PAPER", APART FROM THE MARK AS SHOWN.

THE MARK CONSISTS OF THE WORDS "EXCESS" AND "PAPER" WITHIN AN OVAL.

FOR PAPER TOWELS (U.S. CLS. 2, 5, 22, 23, 29, 37, 38 AND 50).

FIRST USE 5-27-2011; IN COMMERCE 5-27-2011.  
ELISSA GARBER KON, EXAMINING ATTORNEY

SN 85-335,121. MONSTAPODS, LLC, GREENWICH, CT. FILED 6-1-2011.

Monstapods

THE MARK CONSISTS OF STANDARD CHARACTERS WITHOUT CLAIM TO ANY PARTICULAR FONT, STYLE, SIZE, OR COLOR.

FOR STICKERS (U.S. CLS. 2, 5, 22, 23, 29, 37, 38 AND 50).

ROBIN MITTLER, EXAMINING ATTORNEY

**CLASS 16—(Continued).**

SN 85-335,141. HALLMARK LICENSING, INC., KANSAS CITY, MO. FILED 6-1-2011.

**MY FIRST WORDS**

THE MARK CONSISTS OF STANDARD CHARACTERS WITHOUT CLAIM TO ANY PARTICULAR FONT, STYLE, SIZE, OR COLOR.

FOR PRINTED CHILDREN'S BOOKS, BLANK BOOKS, MEMORY-KEEPING ALBUMS, PHOTO ALBUMS AND SCRAPBOOKS WITH A RECORDABLE FEATURE THAT ALLOWS THE USER TO RECORD PERSONAL MESSAGES AND INFORMATION ON THE BOOKS OR ALBUMS (U.S. CLS. 2, 5, 22, 23, 29, 37, 38 AND 50).

LINDA M. KING, EXAMINING ATTORNEY

SN 85-335,274. BLUE ZONES, LLC, MINNEAPOLIS, MN. FILED 6-1-2011.

**BLUE ZONES**

THE MARK CONSISTS OF STANDARD CHARACTERS WITHOUT CLAIM TO ANY PARTICULAR FONT, STYLE, SIZE, OR COLOR.

FOR A SERIES OF BOOKS, WRITTEN ARTICLES, HANDOUTS AND WORKSHEETS IN THE FIELD OF HEALTHY LIFESTYLES, HAPPINESS AND LONGEVITY; BOOKS IN THE FIELD OF HEALTHY LIFESTYLES, HAPPINESS AND LONGEVITY; PRINTED INSTRUCTIONAL, EDUCATIONAL, AND TEACHING MATERIALS IN THE FIELD OF HEALTHY LIFESTYLES, HAPPINESS AND LONGEVITY (U.S. CLS. 2, 5, 22, 23, 29, 37, 38 AND 50).

FIRST USE 5-1-2005; IN COMMERCE 5-1-2005.

JILL C. ALT, EXAMINING ATTORNEY

SN 85-335,377. FROM WAR TO PEACE, SAN LUIS OBISPO, CA. FILED 6-1-2011.

**Peace of History**

THE MARK CONSISTS OF STANDARD CHARACTERS WITHOUT CLAIM TO ANY PARTICULAR FONT, STYLE, SIZE, OR COLOR.

FOR BOOKENDS; PAPER WEIGHTS (U.S. CLS. 2, 5, 22, 23, 29, 37, 38 AND 50).

JAY BESCH, EXAMINING ATTORNEY

**CLASS 16—(Continued).**

SN 85-335,382. ECOLOGICAL FIBERS, INC., LUNENBURG, MA. FILED 6-1-2011.

**ACURA**

THE MARK CONSISTS OF STANDARD CHARACTERS WITHOUT CLAIM TO ANY PARTICULAR FONT, STYLE, SIZE, OR COLOR.

FOR LATEX REINFORCED PAPER SUBSTRATE WITH 100 (PERCENT) WATER BASED ACRYLIC SURFACE COATING WHICH CAN BE PROCESSED THROUGH PASSPORT LAMINATORS (U.S. CLS. 2, 5, 22, 23, 29, 37, 38 AND 50).

FIRST USE 12-3-2001; IN COMMERCE 12-3-2001.

KYLE PEETE, EXAMINING ATTORNEY

SN 85-335,656. LOWENSTEIN SOLOMON, LORI, MORGANVILLE, NJ. FILED 6-1-2011.

**A LITTLE RED IN THE FACE**

THE MARK CONSISTS OF STANDARD CHARACTERS WITHOUT CLAIM TO ANY PARTICULAR FONT, STYLE, SIZE, OR COLOR.

FOR CHILDREN'S INTERACTIVE EDUCATIONAL BOOKS; CHILDREN'S STORYBOOKS; CHILDREN'S BOOKS; CHILDREN'S ACTIVITY BOOKS; COLORING BOOKS; COMIC BOOKS; CALENDARS; STICKERS; PHOTO ALBUMS; GREETING CARDS; NOTEBOOKS (U.S. CLS. 2, 5, 22, 23, 29, 37, 38 AND 50).

MARC LEIPZIG, EXAMINING ATTORNEY

SN 85-335,684. GRUPO YSANT C.A, EL HATILLO, MIRANDA, VENEZUELA, FILED 6-1-2011.

**ychux**

THE MARK CONSISTS OF STANDARD CHARACTERS WITHOUT CLAIM TO ANY PARTICULAR FONT, STYLE, SIZE, OR COLOR.

FOR ADHESIVE LABELS; ADHESIVE NOTE PADS; ADHESIVE NOTE PAPER; ADHESIVE TAPE DISPENSERS; ADHESIVE TAPES FOR STATIONERY PURPOSES; ADHESIVE-APPLYING MACHINES FOR HOME AND OFFICE USE; ARTISTS' BRUSHES; ARTISTS' PASTELS; ARTISTS' PENCILS; ARTISTS' PENS; AUTOMATIC ADHESIVE DISPENSERS FOR OFFICE USE; BOXES OF CARDBOARD OR PAPER; BOXES, CARTONS, STORAGE CONTAINERS, AND PACKAGING CONTAINERS MADE OF PAPER OR CARDBOARD; BOXES, CONTAINERS, AND CARTONS OF PAPERBOARD OR CARDBOARD FOR COMMERCIAL OR INDUSTRIAL PACKAGING; CANVAS PANELS FOR ARTISTS; CARDBOARD; CORRECTING FLUID FOR TYPE; CRAFT PAPER; CREPE PAPER; CYANOACRYLATE ADHESIVES FOR HOME AND HOBBY USE;



**CLASS 16—(Continued).**

DIGITAL PRINTING PAPER; DRAWING PAPER; ELECTRIC PAPER HOLE PERFORATORS BEING OFFICE REQUISITES AND PARTS THEREFOR, NAMELY, BORING BITS, PROTECTION PLATES, AND GRINDERS; ELECTRIC PAPER HOLE PUNCHES; ELECTRIC PAPER HOLE PUNCHES BEING OFFICE REQUISITES AND PARTS THEREFOR, NAMELY, BORING BITS, PROTECTION PLATES, AND GRINDERS; EMBROIDERY DESIGN PATTERNS; ENVELOPE PAPER; FINGER-STALLS; FRANKING MACHINES; GIFT WRAP PAPER; GUMMED PAPER; INK STAMPS; LAMINATED PAPER; LASER PRINTING PAPER; LETTER PAPER; LETTER-HEAD PAPER; MAGAZINE PAPER; MARKING STAMPS; NEWSPRINT PAPER; NOTE PAPER; OFFICE REQUISITES, NAMELY, ENVELOPE SEALING MACHINES; PACKING PAPER; PAPER AND CARDBOARD; PAPER BAGS AND SACKS; PAPER BOXES; PAPER CONTAINERS; PAPER EMBOSSERS; PAPER FOLDERS; PAPER FOLDING MACHINES AS OFFICE REQUISITES; PAPER FOR USE IN THE GRAPHIC ARTS INDUSTRY; PAPER GIFT BAGS; PAPER GIFT WRAP; PAPER LABELS; PAPER NAPKINS; PAPER NOTE TABLETS; PAPER NOTEBOOKS; PAPER PARTY DECORATIONS; PAPER PARTY FAVORS; PAPER PLACE MATS; PAPER SIGNBOARDS; PAPER STATIONERY; PAPER TAGS; PAPER TAPES; PAPER TISSUES; PAPER TOWELS; PAPER TRIMMERS; PLASTIC ADHESIVES FOR HOUSEHOLD OR DOMESTIC USE; PLASTIC BAGS FOR PACKAGING; PLASTIC BAGS FOR PACKING; PLASTIC COATED COPYING PAPER; PLASTIC FOILS; PLASTIC GIFT WRAP; PLASTIC OR PAPER BAGS FOR HOUSEHOLD USE; PLASTIC SANDWICH BAGS; PLASTIC SHEETS FOR WRITING, PRINTING, AND MARKING; PLASTIC SHOPPING BAGS; PLASTIC TRANSPARENCIES; PLASTIC TRASH BAGS; PLASTIC WRAP; PLASTIC-COATED COPYING PAPER; PRESSURE SENSITIVE ADHESIVE IMAGES IN THE NATURE OF DOUBLE-SIDED TAPE THAT CAN ADHERE TO A SURFACE ON ONE SIDE AND RECEIVE AND RETAIN DECORATIVE MATERIALS ON AN OPPOSING SIDE FOR DECORATIVE HOUSEHOLD PURPOSES; PRINTED MATTER, NAMELY, PAPER SIGNS, BOOKS, MANUALS, CURRICULUM, NEWSLETTERS, INFORMATIONAL CARDS AND BROCHURES IN THE FIELD OF EDUCATION AND PROFESSIONAL DEVELOPMENT; PRINTED TEACHING MATERIALS IN THE FIELD OF EDUCATION AND PROFESSIONAL DEVELOPMENT; PRINTING BLOCKS; PUNCHES; RUBBER BANDS; RUBBER DOCUMENT STAMPS; RUBBER STAMPS; SELF-ADHESIVE PLASTIC SHEETS FOR LINING SHELVES; SELF-ADHESIVE TAPES FOR STATIONERY AND HOUSEHOLD PURPOSES; STAMP INKS; STAMP PAD INKS; STAMP PADS; STAPLERS; STENCIL PAPER; STENCIL PAPER; STENCILS (U.S. CLS. 2, 5, 22, 23, 29, 37, 38 AND 50).

PAUL MORENO, EXAMINING ATTORNEY

**CLASS 16—(Continued).**

SN 85-335,692. GRUPO YSANT C.A, EL HATILLO, MIRANDA, VENEZUELA, FILED 6-1-2011.



THE COLOR(S) CYAN IS/ARE CLAIMED AS A FEATURE OF THE MARK.

THE MARK CONSISTS OF THE WORD, YCHUX, IN A STYLISTIC, CYAN FONT, NEXT TO THE STYLISTIC IMAGE OF A BUTTERFLY, ALSO IN CYAN.

FOR ADHESIVE LABELS; ADHESIVE NOTE PADS; ADHESIVE NOTE PAPER; ADHESIVE TAPE DISPENSERS; ADHESIVE TAPES FOR STATIONERY PURPOSES; ADHESIVE-APPLYING MACHINES FOR HOME AND OFFICE USE; ARTISTS' BRUSHES; ARTISTS' PASTELS; ARTISTS' PENCILS; ARTISTS' PENS; AUTOMATIC ADHESIVE DISPENSERS FOR OFFICE USE; BOXES OF CARDBOARD OR PAPER; BOXES, CARTONS, STORAGE CONTAINERS, AND PACKAGING CONTAINERS MADE OF PAPER OR CARDBOARD; BOXES, CONTAINERS, AND CARTONS OF PAPERBOARD OR CARDBOARD FOR COMMERCIAL OR INDUSTRIAL PACKAGING; CANVAS PANELS FOR ARTISTS; CARDBOARD; CORRECTING FLUID FOR TYPE; CRAFT PAPER; CREPE PAPER; CYANOACRYLATE ADHESIVES FOR HOME AND HOBBY USE; DIGITAL PRINTING PAPER; DRAWING PAPER; ELECTRIC PAPER HOLE PERFORATORS BEING OFFICE REQUISITES AND PARTS THEREFOR, NAMELY, BORING BITS, PROTECTION PLATES, AND GRINDERS; ELECTRIC PAPER HOLE PUNCHES; ELECTRIC PAPER HOLE PUNCHES BEING OFFICE REQUISITES AND PARTS THEREFOR, NAMELY, BORING BITS, PROTECTION PLATES, AND GRINDERS; EMBROIDERY DESIGN PATTERNS; ENVELOPE PAPER; FINGER-STALLS; FRANKING MACHINES; GIFT WRAP PAPER; GUMMED PAPER; INK STAMPS; LAMINATED PAPER; LASER PRINTING PAPER; LETTER PAPER; LETTER-HEAD PAPER; MAGAZINE PAPER; MARKING STAMPS; NEWSPRINT PAPER; NOTE PAPER; OFFICE REQUISITES, NAMELY, ENVELOPE SEALING MACHINES; PACKING PAPER; PAPER AND CARDBOARD; PAPER BAGS AND SACKS; PAPER BOXES; PAPER CONTAINERS; PAPER EMBOSSERS; PAPER FOLDERS; PAPER FOLDING MACHINES AS OFFICE REQUISITES; PAPER FOR USE IN THE GRAPHIC ARTS INDUSTRY; PAPER GIFT BAGS; PAPER GIFT WRAP; PAPER LABELS; PAPER NAPKINS; PAPER NOTE TABLETS; PAPER NOTEBOOKS; PAPER PARTY DECORATIONS; PAPER PARTY FAVORS; PAPER PLACE MATS; PAPER SIGNBOARDS; PAPER STATIONERY; PAPER TAGS; PAPER TAPES; PAPER TISSUES; PAPER TOWELS; PAPER TRIMMERS; PLASTIC ADHESIVES FOR HOUSEHOLD OR DOMESTIC USE; PLASTIC BAGS FOR PACKAGING; PLASTIC BAGS FOR PACKING; PLASTIC COATED COPYING PAPER; PLASTIC FOILS; PLASTIC GIFT WRAP; PLASTIC OR PAPER BAGS FOR HOUSEHOLD USE; PLASTIC SANDWICH BAGS; PLASTIC SHEETS FOR WRITING, PRINTING, AND MARKING; PLASTIC SHOPPING BAGS; PLASTIC TRANSPARENCIES; PLASTIC TRASH BAGS; PLASTIC WRAP; PLASTIC-COATED COPYING PAPER; PRESSURE SENSITIVE ADHESIVE IMAGES IN THE NATURE OF DOUBLE-SIDED TAPE THAT CAN ADHERE TO A SURFACE ON ONE SIDE AND RECEIVE AND RETAIN DECORATIVE MATERIALS ON AN OPPOSING SIDE FOR DECORATIVE HOUSEHOLD PURPOSES; PRINTED MATTER, NAMELY, PAPER SIGNS, BOOKS, MANUALS, CURRICULUM, NEWSLETTERS, INFORMATIONAL CARDS

**CLASS 16—(Continued).**

AND BROCHURES IN THE FIELD OF EDUCATION AND PROFESSIONAL DEVELOPMENT; PRINTED TEACHING MATERIALS IN THE FIELD OF EDUCATION AND PROFESSIONAL DEVELOPMENT; PRINTING BLOCKS; PUNCHES; RUBBER BANDS; RUBBER DOCUMENT STAMPS; RUBBER STAMPS; SELF-ADHESIVE PLASTIC SHEETS FOR LINING SHELVES; SELF-ADHESIVE TAPES FOR STATIONERY AND HOUSEHOLD PURPOSES; STAMP INKS; STAMP PAD INKS; STAMP PADS; STAPLERS; STENCIL PAPER; STENCIL PAPER; STENCILS (U.S. CLS. 2, 5, 22, 23, 29, 37, 38 AND 50).

PAUL MORENO, EXAMINING ATTORNEY

SN 85-335,832. SNEAD, ANGELA H, SAN FRANCISCO, CA. FILED 6-1-2011.

**PLAYING IT SMART**

THE MARK CONSISTS OF STANDARD CHARACTERS WITHOUT CLAIM TO ANY PARTICULAR FONT, STYLE, SIZE, OR COLOR.

FOR PUBLICATIONS, NAMELY, BOOKS, WORKBOOKS, HAND-OUTS, NEWSLETTERS, FEATURING GAME BASED LEARNING, NAMELY, GAMES AND PUZZLES FEATURING MATHEMATICAL CONTENT; PUBLICATIONS, NAMELY, BOOKS, HAND-OUTS, WORKBOOKS, NEWSLETTERS, FEATURING SEQUENTIAL REASONING AND LOGICAL THINKING GAMES AND PUZZLES, IN THE FIELD OF BRAIN FITNESS; PUBLICATIONS, NAMELY, BOOKS, HAND-OUTS, WORKBOOKS, NEWSLETTERS, IN THE FIELD OF MATHEMATICS; EDUCATIONAL PUBLICATIONS, NAMELY, BOOKS, WORKBOOKS, HAND-OUTS, NEWSLETTERS, FEATURING GAMES AND PUZZLES TO DEVELOP MATHEMATICAL REASONING, FOR GRADES 5 - 12; EDUCATIONAL PUBLICATIONS, NAMELY, TEACHING MATERIALS FOR TEACHERS, EDUCATORS, AND OTHERS, FEATURING GAMES AND PUZZLES IN THE FIELD OF MATHEMATICAL CONTENT (U.S. CLS. 2, 5, 22, 23, 29, 37, 38 AND 50).

FIRST USE 4-18-2011; IN COMMERCE 4-22-2011.  
LINDA M. KING, EXAMINING ATTORNEY

**CLASS 16—(Continued).**

SN 85-335,872. KARIN ZELL, LA JOLLA, CA. FILED 6-2-2011.



THE COLOR(S) YELLOW AND BLACK IS/ARE CLAIMED AS A FEATURE OF THE MARK.

THE MARK CONSISTS OF THE PHRASE DOOR OPENS WIDE IN BLACK TEXT IN A YELLOW TRIANGLE WITH A BLACK BORDER.

FOR BUMPER STICKERS; DECORATIVE DECALS FOR VEHICLE WINDOWS; MAGNETIC BUMPER STICKERS (U.S. CLS. 2, 5, 22, 23, 29, 37, 38 AND 50).

PAULA MAHONEY, EXAMINING ATTORNEY

SN 85-336,606. SANFORD L.P., OAK BROOK, IL. FILED 6-2-2011.

**SEE HOW IT FEELS**

THE MARK CONSISTS OF STANDARD CHARACTERS WITHOUT CLAIM TO ANY PARTICULAR FONT, STYLE, SIZE, OR COLOR.

FOR PENS (U.S. CLS. 2, 5, 22, 23, 29, 37, 38 AND 50).  
NICHOLAS ALTREE, EXAMINING ATTORNEY

SN 85-336,695. TEAZLED, LLC, LAS VEGAS, NV. FILED 6-2-2011.

**Teazled**

THE MARK CONSISTS OF STANDARD CHARACTERS WITHOUT CLAIM TO ANY PARTICULAR FONT, STYLE, SIZE, OR COLOR.

FOR GREETINGS CARDS AND POSTCARDS (U.S. CLS. 2, 5, 22, 23, 29, 37, 38 AND 50).

KATHERINE STOIDES, EXAMINING ATTORNEY

**CLASS 16—(Continued).**

SN 85-336,719. BOERCKEL, DARREN, FRANKLIN SQUARE, NY. FILED 6-2-2011.

**BILLYTOON**

THE MARK CONSISTS OF STANDARD CHARACTERS WITHOUT CLAIM TO ANY PARTICULAR FONT, STYLE, SIZE, OR COLOR.

FOR PAINTINGS AND THEIR REPRODUCTIONS, PRINTED ART REPRODUCTIONS, CALENDARS, ART ETCHINGS, NOTEPADS AND GREETING CARDS (U.S. CLS. 2, 5, 22, 23, 29, 37, 38 AND 50).

TINA BROWN, EXAMINING ATTORNEY

**CLASS 16—(Continued).**

SN 85-337,078. GORHAM ASSOCIATES, WOODBRIDGE, CT. FILED 6-3-2011.

**Buzzbox**

THE MARK CONSISTS OF STANDARD CHARACTERS WITHOUT CLAIM TO ANY PARTICULAR FONT, STYLE, SIZE, OR COLOR.

FOR CARDBOARD BOXES; CHILDREN'S ARTS AND CRAFTS PAPER KITS; COLLAPSIBLE BOXES OF PAPER (U.S. CLS. 2, 5, 22, 23, 29, 37, 38 AND 50).

FIRST USE 6-17-2008; IN COMMERCE 6-17-2008.  
PRISCILLA MILTON, EXAMINING ATTORNEY

SN 85-336,906. MOVEON.ORG CIVIC ACTION, BERKELEY, CA. FILED 6-2-2011.

**MOVEON**

THE MARK CONSISTS OF STANDARD CHARACTERS WITHOUT CLAIM TO ANY PARTICULAR FONT, STYLE, SIZE, OR COLOR.

OWNER OF U.S. REG. NOS. 2,970,317, 3,107,969 AND 3,154,942.

FOR NOTE PAPER BOXES; GENERAL PURPOSE PLASTIC BAGS; TRADING CARDS; BLANK AND PICTURE POSTCARDS; NOTECARDS; NOTE PADS; GREETING CARDS; PHOTOGRAPH ALBUMS; MEMORANDUM BOOKS; PENS; PENCILS; MEMO SORTERS; DIARIES; CLIPBOARDS; PEN AND PENCIL HOLDERS; PAPER WEIGHTS; BUMPER STICKERS; PENCIL CASES; MEMO PADS; ERASERS; STATIONERY BOXES AND STATIONERY FOLDERS; STATIONERY; PRINTED PAPER SIGNS, NAMELY, PARTY AND LAWN SIGNS; STAMP PADS; NEWSLETTERS IN THE FIELDS OF POLITICS, POLITICAL CAMPAIGNS, MEDIA RELATIONS, PUBLIC POLICY, LEADERSHIP, NETWORKING, AND THE LEGISLATIVE PROCESS (U.S. CLS. 2, 5, 22, 23, 29, 37, 38 AND 50).

TRACY FLETCHER, EXAMINING ATTORNEY

SN 85-337,191. JEAN-JACQUES, KESLIN, MILWAUKEE, WI. FILED 6-3-2011.



THE MARK CONSISTS OF THE TEXT "THANKS FOR THE PASS" WRITTEN ON THE PALM OF A HAND, AND THE FONT STYLE IS A COMIC EXTENDED FONT.

FOR BUMPER STICKERS (U.S. CLS. 2, 5, 22, 23, 29, 37, 38 AND 50).

LINDA ESTRADA, EXAMINING ATTORNEY

SN 85-336,923. SUMMIT ENTERTAINMENT, LLC, SANTA MONICA, CA. FILED 6-2-2011.

**ISLE ESME**

THE MARK CONSISTS OF STANDARD CHARACTERS WITHOUT CLAIM TO ANY PARTICULAR FONT, STYLE, SIZE, OR COLOR.

FOR STICKERS; POSTERS; GREETING CARDS; POSTCARDS; MAPS; SCRAPBOOKS; TOUR BOOKS (U.S. CLS. 2, 5, 22, 23, 29, 37, 38 AND 50).

ASMAT KHAN, EXAMINING ATTORNEY

SN 85-337,214. LAROSE INDUSTRIES, LLC, RANDOLPH, NJ. FILED 6-3-2011.

**CRA-Z-TOOLZ**

THE MARK CONSISTS OF STANDARD CHARACTERS WITHOUT CLAIM TO ANY PARTICULAR FONT, STYLE, SIZE, OR COLOR.

FOR MODELING COMPOUNDS; MODELING COMPOUNDS AND RELATED ACCESSORIES FOR USE WITH MODELING COMPOUNDS SOLD AS A UNIT (U.S. CLS. 2, 5, 22, 23, 29, 37, 38 AND 50).

TRACY FLETCHER, EXAMINING ATTORNEY

**CLASS 16—(Continued).**

SN 85-337,362. LAROSE INDUSTRIES, LLC, RANDOLPH, NJ. FILED 6-3-2011.

**CRA-Z-HAIRDOOZ**

THE MARK CONSISTS OF STANDARD CHARACTERS WITHOUT CLAIM TO ANY PARTICULAR FONT, STYLE, SIZE, OR COLOR.

FOR MODELING COMPOUNDS; MODELING COMPOUNDS AND RELATED ACCESSORIES FOR USE WITH MODELING COMPOUNDS SOLD AS A UNIT (U.S. CLS. 2, 5, 22, 23, 29, 37, 38 AND 50).

TRACY FLETCHER, EXAMINING ATTORNEY

**CLASS 16—(Continued).**

SN 85-337,592. JERICIAU, JOHN, ORLANDO, FL. FILED 6-3-2011.

**TheMenuChoice**

THE MARK CONSISTS OF STANDARD CHARACTERS WITHOUT CLAIM TO ANY PARTICULAR FONT, STYLE, SIZE, OR COLOR.

FOR MAGAZINES FEATURING RESTAURANT MENUS (U.S. CLS. 2, 5, 22, 23, 29, 37, 38 AND 50).

EDWARD FENNESSY, EXAMINING ATTORNEY

SN 85-337,638. CLEMENT COMMUNICATIONS INC., UPPER CHICHESTER, PA. FILED 6-3-2011.

SN 85-337,430. HUNTER'S MOON LLC, LOUISVILLE, KY. FILED 6-3-2011.

**THE BOURBON CHASE**

THE MARK CONSISTS OF STANDARD CHARACTERS WITHOUT CLAIM TO ANY PARTICULAR FONT, STYLE, SIZE, OR COLOR.

OWNER OF U.S. REG. NO. 3,786,937.

FOR DECALS (U.S. CLS. 2, 5, 22, 23, 29, 37, 38 AND 50).

FIRST USE 4-8-2011; IN COMMERCE 4-8-2011.

JANET LEE, EXAMINING ATTORNEY

**PERSONAL CONSEQUENCES**

THE MARK CONSISTS OF STANDARD CHARACTERS WITHOUT CLAIM TO ANY PARTICULAR FONT, STYLE, SIZE, OR COLOR.

FOR POSTERS (U.S. CLS. 2, 5, 22, 23, 29, 37, 38 AND 50).

FIRST USE 3-4-2011; IN COMMERCE 3-7-2011.

HOWARD B. LEVINE, EXAMINING ATTORNEY

SN 85-338,162. LAVENDER THIEF LLC, SEATTLE, WA. FILED 6-4-2011.

SN 85-337,459. LAROSE INDUSTRIES, LLC, RANDOLPH, NJ. FILED 6-3-2011.

**CRA-Z-FARM FUN**

THE MARK CONSISTS OF STANDARD CHARACTERS WITHOUT CLAIM TO ANY PARTICULAR FONT, STYLE, SIZE, OR COLOR.

FOR MODELING COMPOUNDS; MODELING COMPOUNDS AND RELATED ACCESSORIES FOR USE WITH MODELING COMPOUNDS SOLD AS A UNIT (U.S. CLS. 2, 5, 22, 23, 29, 37, 38 AND 50).

TRACY FLETCHER, EXAMINING ATTORNEY



THE MARK CONSISTS OF THE WORDING LAVENDER ALL CAPITAL LETTERS, THIEF IN SMALL LETTERS BELOW LAVENDER THIEF APPEARS A TAG LINE LIFE IS FLEETING-CAPTURE THE ESSENCE TO THE RIGHT IF THE WORDS APPEARS TWO SPRIGS OF STYLIZED LAVENDER BLOSSOM THAT IS ARCHED AND A BUTTERFLY IN SIDE VIEW OR PROFILE VIEW TO THE RIGHT OF THE LAVENDER SPRIG.

FOR GREETINGS CARDS AND POSTCARDS; PRINTED CALENDARS; PUBLICATIONS, NAMELY, BROCHURES, BOOKLETS, AND TEACHING MATERIALS IN THE FIELD OF TRAVEL AND ROMANCE (U.S. CLS. 2, 5, 22, 23, 29, 37, 38 AND 50).

DORITT L. CARROLL, EXAMINING ATTORNEY

**CLASS 16—(Continued).**

SN 85-338,448. INTOWNUSA, INC., FORT LAUDERDALE, FL. FILED 6-6-2011.

# INTOWN

THE MARK CONSISTS OF STANDARD CHARACTERS WITHOUT CLAIM TO ANY PARTICULAR FONT, STYLE, SIZE, OR COLOR.

FOR PRINTED PUBLICATIONS FEATURING ENTERTAINMENT, ARTS, AND BUSINESS INFORMATION, NAMELY, CITY GUIDE AND DIRECTORIES AND MAPS FEATURING RESTAURANTS, SPECIAL EVENTS, BUSINESSES, ADVERTISING SERVICES, SHOPPING, ARTS, MUSIC THEATER, RECREATIONAL ACTIVITIES, BEAUTY AND FITNESS, AND REAL ESTATE AND TRAVEL SERVICES (U.S. CLS. 2, 5, 22, 23, 29, 37, 38 AND 50).

FIRST USE 10-1-2006; IN COMMERCE 10-1-2006.  
SUE LAWRENCE, EXAMINING ATTORNEY

---

SN 85-338,861. LAROSE INDUSTRIES, LLC, RANDOLPH, NJ. FILED 6-6-2011.

# X-TREME FX

THE MARK CONSISTS OF STANDARD CHARACTERS WITHOUT CLAIM TO ANY PARTICULAR FONT, STYLE, SIZE, OR COLOR.

FOR WRITING INSTRUMENTS, NAMELY, MARKERS, PENS, PENCILS, COLORED PENCILS, MECHANICAL PENCILS, AND HIGHLIGHTER PENS (U.S. CLS. 2, 5, 22, 23, 29, 37, 38 AND 50).

TRACY FLETCHER, EXAMINING ATTORNEY

---

SN 85-338,977. WILLIAM S. MOULTON, SAN ANSELMO, CA. FILED 6-6-2011.

# Brotherhood of Eternal Love

THE MARK CONSISTS OF STANDARD CHARACTERS WITHOUT CLAIM TO ANY PARTICULAR FONT, STYLE, SIZE, OR COLOR.

FOR PRINTED PAMPHLETS, BROCHURES, MANUALS, BOOKS, BOOKLETS, LEAFLETS, FLYERS, INFORMATIONAL SHEETS AND NEWSLETTERS, ADHESIVE BACKED STICKERS, AND KITS COMPRISING ONE OR MORE OF THE FOREGOING MATERIALS IN THE FIELD OF HISTORY OF SOCIAL CHANGE IN THE USA FROM 1960-1980 (U.S. CLS. 2, 5, 22, 23, 29, 37, 38 AND 50).

JOHN DALIER, EXAMINING ATTORNEY

**CLASS 16—(Continued).**

SN 85-339,388. CARAPETYAN, WARD R, RIDGEWOOD, NJ. FILED 6-6-2011.

# Compromise Is Planned Failure

THE MARK CONSISTS OF STANDARD CHARACTERS WITHOUT CLAIM TO ANY PARTICULAR FONT, STYLE, SIZE, OR COLOR.

FOR ART AND PHOTOGRAPH PORTFOLIO CASES; ART ETCHINGS; ART MOUNTS; ART PADS; ART PAPER; ART PICTURES; ART PRINTS; ART PRINTS COMPRISED OF DIGITAL ILLUSTRATIONS ORIGINATING FROM PHOTOGRAPHS; ART PRINTS ON CANVAS; ARTS AND CRAFT CLAY KITS (U.S. CLS. 2, 5, 22, 23, 29, 37, 38 AND 50).

KIMBERLY FRYE, EXAMINING ATTORNEY

---

SN 85-339,456. CHEN CHENGKAI, BAIYUN AREA, GUANGZHOU, CHINA, FILED 6-7-2011.



THE MARK CONSISTS OF THE STYLIZED WORD BS ABOVE TWO CHINESE CHARACTERS WHICH TRANSLITERATE INTO BAO; SHEN AND THE STYLIZED WORD BAOSHEN.

THE WORDING BS HAS NO MEANING IN A FOREIGN LANGUAGE.

THE NON-LATIN CHARACTERS IN THE MARK TRANSLITERATE TO "BAO"; "SHEN" AND THIS MEANS "TREASURE"; "GENTLEMAN" IN ENGLISH.

FOR ALUMINUM FOIL LAMINATED PAPER FOR PRINTING PURPOSES; CARDBOARD; COASTERS OF PAPER; FILTER PAPER; GENERAL FEATURE MAGAZINES; GUMMED TAPE FOR STATIONERY OR HOUSEHOLD USE; LITHOGRAPHS; PAPER; PAPER FOR WRAPPING AND PACKAGING; PRINTED MENUS; STEEL PENS (U.S. CLS. 2, 5, 22, 23, 29, 37, 38 AND 50).

FIRST USE 1-1-2009; IN COMMERCE 12-15-2009.  
DORITT L. CARROLL, EXAMINING ATTORNEY

**CLASS 16—(Continued).**

SN 85-339,659. WILLIAM M. GAINES AGENT, INC., MANHASSET HILLS, NY. FILED 6-7-2011.

**THE HAUNT OF FEAR**

THE MARK CONSISTS OF STANDARD CHARACTERS WITHOUT CLAIM TO ANY PARTICULAR FONT, STYLE, SIZE, OR COLOR.

FOR SERIES OF FICTION WORKS, NAMELY, NOVELS, BOOKS, COMICS, AND MAGAZINES (U.S. CLS. 2, 5, 22, 23, 29, 37, 38 AND 50).

FIRST USE 5-0-1950; IN COMMERCE 5-0-1950.  
FLORENTINA BLANDU, EXAMINING ATTORNEY

**CLASS 16—(Continued).**

SN 85-340,387. BARRERO II, BENHUR, FT. LAUDERDALE, FL. FILED 6-7-2011.

**Glamism**

THE MARK CONSISTS OF STANDARD CHARACTERS WITHOUT CLAIM TO ANY PARTICULAR FONT, STYLE, SIZE, OR COLOR.

FOR ART PRINTS; CALENDARS; POSTERS (U.S. CLS. 2, 5, 22, 23, 29, 37, 38 AND 50).

THEODORE MCBRIDE, EXAMINING ATTORNEY

SN 85-340,154. INTOWNUSA, INC., FORT LAUDERDALE, FL. FILED 6-7-2011.



THE MARK CONSISTS OF A CIRCLE WITH AN OUTLINE OF ANOTHER CIRCLE WITH THE LETTERS "IN" IN A STYLIZED FONT, EMBODIED WITHIN THE DESIGN FOLLOWED BY THE LETTERS "TOWN" IN A STYLIZED FONT.

FOR PRINTED PUBLICATIONS FEATURING ENTERTAINMENT, ARTS AND BUSINESS INFORMATION, NAMELY, CITY GUIDE AND DIRECTORIES AND MAPS FEATURING RESTAURANTS, SPECIAL EVENTS, BUSINESSES, ADVERTISING SERVICES, SHOPPING, ARTS, MUSIC, THEATER, RECREATIONAL ACTIVITIES, BEAUTY AND FITNESS, AND REAL ESTATE AND TRAVEL SERVICES (U.S. CLS. 2, 5, 22, 23, 29, 37, 38 AND 50).

FIRST USE 10-1-2006; IN COMMERCE 10-1-2006.  
SUE LAWRENCE, EXAMINING ATTORNEY

SN 85-340,405. TAITT CONSUMER VENTURES, LLC, ARDMORE, PA. FILED 6-7-2011.



THE MARK CONSISTS OF THE WORD "FATHERBOX" ABOVE AN UNDERLINE AND TO THE LEFT OF A BOX WITH A ANGLED OPEN LID WHICH HAS THE BOTTOM HALF OF A HEART IN THE BOX AND THE TOP HALF BENEATH THE OPEN LID. THE "F" AND "B" IN THE WORD "FATHERBOX" ARE CAPITALIZED.

FOR BOXES, CARTONS, STORAGE CONTAINERS, AND PACKAGING CONTAINERS MADE OF PAPER OR CARDBOARD (U.S. CLS. 2, 5, 22, 23, 29, 37, 38 AND 50).

FIRST USE 6-7-2011; IN COMMERCE 6-7-2011.  
TINA BROWN, EXAMINING ATTORNEY

SN 85-340,271. ALLY'S LITTLE ANGELS, INC., LOS ANGELES, CA. FILED 6-7-2011.

**CUSTARD N JELLY**

THE MARK CONSISTS OF STANDARD CHARACTERS WITHOUT CLAIM TO ANY PARTICULAR FONT, STYLE, SIZE, OR COLOR.

FOR CALENDARS; FOLDERS; NOTE PADS; PENS; STATIONERY; STICKERS (U.S. CLS. 2, 5, 22, 23, 29, 37, 38 AND 50).

BARBARA BROWN, EXAMINING ATTORNEY

SN 85-340,774. KIDZ ON SAFARI NEW YORK, INC., BROOKLYN, NY. FILED 6-8-2011.

**BAMINGO**

THE MARK CONSISTS OF STANDARD CHARACTERS WITHOUT CLAIM TO ANY PARTICULAR FONT, STYLE, SIZE, OR COLOR.

FOR CHILDREN'S WALL STICKERS AND MURALS (U.S. CLS. 2, 5, 22, 23, 29, 37, 38 AND 50).

JESSICA A. POWERS, EXAMINING ATTORNEY

**CLASS 16—(Continued).**

SN 85-340,806. AMOS CORPORATION, SEOUL, REPUBLIC OF KOREA, FILED 6-8-2011.

**NEO STICK d**

THE MARK CONSISTS OF STANDARD CHARACTERS WITHOUT CLAIM TO ANY PARTICULAR FONT, STYLE, SIZE, OR COLOR.

FOR HIGHLIGHTER PENS; MARKING PENS; WRITING INSTRUMENTS (U.S. CLS. 2, 5, 22, 23, 29, 37, 38 AND 50).

KEVIN CORWIN, EXAMINING ATTORNEY

**CLASS 16—(Continued).**

SN 85-346,827. LAROSE INDUSTRIES, LLC, RANDOLPH, NJ. FILED 6-15-2011.

**SNACK CRAZE**

THE MARK CONSISTS OF STANDARD CHARACTERS WITHOUT CLAIM TO ANY PARTICULAR FONT, STYLE, SIZE, OR COLOR.

FOR MODELING COMPOUNDS; MODELING COMPOUNDS AND RELATED ACCESSORIES FOR USE WITH MODELING COMPOUNDS SOLD AS A UNIT (U.S. CLS. 2, 5, 22, 23, 29, 37, 38 AND 50).

TRACY FLETCHER, EXAMINING ATTORNEY

SN 85-341,138. WOODS, CYNTHIA, BELLFLOWER, CA. FILED 6-8-2011.

**Tots in Flops**

THE MARK CONSISTS OF STANDARD CHARACTERS WITHOUT CLAIM TO ANY PARTICULAR FONT, STYLE, SIZE, OR COLOR.

FOR ADDRESS LABELS; CALENDARS; CARTOON PRINTS; CARTOON STRIPS; CHILDREN'S BOOKS; COMICS; GREETING CARDS; NOTE CARDS; NOTEBOOKS; PAPER MATS; PAPER TABLECLOTHS; POST CARDS; PRINTED INVITATIONS; SCRAP BOOKS; STATIONERY; STICKERS; TABLE NAPKINS OF PAPER; WRAPPING PAPER; WRITING PAPER PADS; IRON-ON, VINYL, AND PLASTIC TRANSFERS (U.S. CLS. 2, 5, 22, 23, 29, 37, 38 AND 50).

JACQUELINE A. LAVINE, EXAMINING ATTORNEY

SN 85-351,458. J. & P. COATS, LIMITED, GLASGOW, UNITED KINGDOM, FILED 6-21-2011.

**YOUR SEWING LIFE!**

THE MARK CONSISTS OF STANDARD CHARACTERS WITHOUT CLAIM TO ANY PARTICULAR FONT, STYLE, SIZE, OR COLOR.

NO CLAIM IS MADE TO THE EXCLUSIVE RIGHT TO USE "SEWING", APART FROM THE MARK AS SHOWN.

FOR MAGAZINES, LEAFLETS AND NEWSLETTERS IN THE FIELD OF SEWING AND QUILTING (U.S. CLS. 2, 5, 22, 23, 29, 37, 38 AND 50).

NAKWAMA ANKRAH, EXAMINING ATTORNEY

SN 85-346,110. WAL-MART STORES, INC., BENTONVILLE, AR. FILED 6-14-2011.

**SIZED-4-SPILLS**

THE MARK CONSISTS OF STANDARD CHARACTERS WITHOUT CLAIM TO ANY PARTICULAR FONT, STYLE, SIZE, OR COLOR.

FOR PAPER TOWELS (U.S. CLS. 2, 5, 22, 23, 29, 37, 38 AND 50).

SUSAN RICHARDS, EXAMINING ATTORNEY

SN 85-353,829. HOME BOX OFFICE, INC., NEW YORK, NY. FILED 6-23-2011.

**FORTY**

THE MARK CONSISTS OF STANDARD CHARACTERS WITHOUT CLAIM TO ANY PARTICULAR FONT, STYLE, SIZE, OR COLOR.

FOR PRINTED MATTER, NAMELY, CALENDARS, POSTERS, POSTCARDS, NEWSLETTERS, FAN MAGAZINES, NOTEBOOKS, STICKERS, DECALS, PHOTOGRAPHS, TEMPORARY TATTOOS, PAPER COASTERS, TRADING CARDS, TRIVIA CARDS; BLANK JOURNALS; PENS; PENCILS; AND A SERIES OF BOOKS, ALL FEATURING CONTENT FROM OR RELATING TO AN ONGOING COMEDY TELEVISION SERIES (U.S. CLS. 2, 5, 22, 23, 29, 37, 38 AND 50).

SUSAN RICHARDS, EXAMINING ATTORNEY

**CLASS 16—(Continued).**

SN 85-355,096. LAROSE INDUSTRIES, LLC, RANDOLPH, NJ. FILED 6-24-2011.

**Z-BALL**

THE MARK CONSISTS OF STANDARD CHARACTERS WITHOUT CLAIM TO ANY PARTICULAR FONT, STYLE, SIZE, OR COLOR.

FOR WRITING INSTRUMENTS (U.S. CLS. 2, 5, 22, 23, 29, 37, 38 AND 50).

TRACY FLETCHER, EXAMINING ATTORNEY

SN 85-355,118. LAROSE INDUSTRIES, LLC, RANDOLPH, NJ. FILED 6-24-2011.

**Z-POINT**

THE MARK CONSISTS OF STANDARD CHARACTERS WITHOUT CLAIM TO ANY PARTICULAR FONT, STYLE, SIZE, OR COLOR.

FOR WRITING INSTRUMENTS (U.S. CLS. 2, 5, 22, 23, 29, 37, 38 AND 50).

TRACY FLETCHER, EXAMINING ATTORNEY

SN 85-355,129. LAROSE INDUSTRIES, LLC, RANDOLPH, NJ. FILED 6-24-2011.

**Z-HIGHLIGHTERS**

THE MARK CONSISTS OF STANDARD CHARACTERS WITHOUT CLAIM TO ANY PARTICULAR FONT, STYLE, SIZE, OR COLOR.

FOR HIGHLIGHTERS (U.S. CLS. 2, 5, 22, 23, 29, 37, 38 AND 50).

TRACY FLETCHER, EXAMINING ATTORNEY

**CLASS 16—(Continued).**

SN 85-355,146. LAROSE INDUSTRIES, LLC, RANDOLPH, NJ. FILED 6-24-2011.

**Z-MARK**

THE MARK CONSISTS OF STANDARD CHARACTERS WITHOUT CLAIM TO ANY PARTICULAR FONT, STYLE, SIZE, OR COLOR.

FOR WRITING INSTRUMENTS, MARKERS AND HIGHLIGHTERS (U.S. CLS. 2, 5, 22, 23, 29, 37, 38 AND 50).

TRACY FLETCHER, EXAMINING ATTORNEY

SN 85-357,467. LEONARD G. DAVIS, NEWPORT BEACH, CA. FILED 6-27-2011.

**FEAR THE FORK**

THE MARK CONSISTS OF STANDARD CHARACTERS WITHOUT CLAIM TO ANY PARTICULAR FONT, STYLE, SIZE, OR COLOR.

FOR 3D DECALS FOR USE ON ANY SURFACE; ALBUMS FOR STICKERS; APPLIQUES IN THE FORM OF DECALS; BUMPER STICKERS; CHILDREN'S WALL STICKERS AND MURALS; DECALS; DECORATIVE DECALS FOR VEHICLE WINDOWS; DECORATIVE STICKERS FOR HELMETS; MAGNETIC BUMPER STICKERS; STICKER ALBUMS; STICKERS; STICKERS; STICKERS AND STICKER ALBUMS; STICKERS AND TRANSFERS; IRON ON, PLASTIC TRANSFERS (U.S. CLS. 2, 5, 22, 23, 29, 37, 38 AND 50).

STEVEN PEREZ, EXAMINING ATTORNEY

SN 85-372,620. COLUMBIA INSURANCE COMPANY, OMAHA, NE. FILED 7-15-2011.

**COLOR STORIES**

THE MARK CONSISTS OF STANDARD CHARACTERS WITHOUT CLAIM TO ANY PARTICULAR FONT, STYLE, SIZE, OR COLOR.

NO CLAIM IS MADE TO THE EXCLUSIVE RIGHT TO USE "COLOR", APART FROM THE MARK AS SHOWN.

FOR PAINT COLOR DISPLAY SYSTEM, NAMELY, PAINT COLOR CARDS, PAINT COLOR SAMPLE CARDS, PAINT COLOR SAMPLE BOOKS, PAINT COLOR FAN DECKS AND PRINTED INSTRUCTIONAL MATERIALS IN THE FIELDS OF PAINTING AND DECORATING (U.S. CLS. 2, 5, 22, 23, 29, 37, 38 AND 50).

FIRST USE 11-30-2010; IN COMMERCE 11-30-2010.

DOUGLAS LEE, EXAMINING ATTORNEY



**CLASS 16—(Continued).**

SN 85-372,635. CYI, INC., CHATSWORTH, CA. FILED 7-15-2011.

IT'S A PIECE OF CAKE

THE MARK CONSISTS OF STANDARD CHARACTERS WITHOUT CLAIM TO ANY PARTICULAR FONT, STYLE, SIZE, OR COLOR.

FOR GIFT BOXES (U.S. CLS. 2, 5, 22, 23, 29, 37, 38 AND 50).

FIRST USE 7-12-2011; IN COMMERCE 7-12-2011.  
ADA HAN, EXAMINING ATTORNEY

---

SN 85-375,635. TEAZLED, LLC, LAS VEGAS, NV. FILED 7-19-2011.

DOM

THE MARK CONSISTS OF STANDARD CHARACTERS WITHOUT CLAIM TO ANY PARTICULAR FONT, STYLE, SIZE, OR COLOR.

FOR GREETINGS CARDS AND POSTCARDS (U.S. CLS. 2, 5, 22, 23, 29, 37, 38 AND 50).

KATHERINE STOIDES, EXAMINING ATTORNEY

---

SN 85-376,340. KONSTANTINE BAKALIS, BROOKLYN, NY. AND MARK TARRANT, CHICOPEE, MA. FILED 7-20-2011.

THE BLOOD RIDER

THE MARK CONSISTS OF STANDARD CHARACTERS WITHOUT CLAIM TO ANY PARTICULAR FONT, STYLE, SIZE, OR COLOR.

FOR BOOKS IN THE FIELD OF SUPERNATURAL, HORROR, WESTERN; COMIC BOOKS; GRAPHIC NOVELS; NOVELS (U.S. CLS. 2, 5, 22, 23, 29, 37, 38 AND 50).

FIRST USE 9-0-2009; IN COMMERCE 9-0-2009.  
CHRISTINE COOPER, EXAMINING ATTORNEY

**CLASS 16—(Continued).**

SN 85-381,500. W. W. GRAINGER, INC., LAKE FOREST, IL. FILED 7-26-2011.

CALL. CLICK. STOP BY.

THE MARK CONSISTS OF STANDARD CHARACTERS WITHOUT CLAIM TO ANY PARTICULAR FONT, STYLE, SIZE, OR COLOR.

OWNER OF U.S. REG. NO. 2,471,377.  
FOR CATALOGS IN THE FIELD OF INDUSTRIAL, INSTITUTIONAL, COMMERCIAL, AND JANITORIAL EQUIPMENT AND SUPPLIES (U.S. CLS. 2, 5, 22, 23, 29, 37, 38 AND 50).

FIRST USE 2-1-2011; IN COMMERCE 2-1-2011.  
DEZMONA MIZELLE, EXAMINING ATTORNEY

---

SN 85-407,380. COOKIE BEAR PRESS, INC., BUFFALO GROVE, IL. FILED 8-25-2011.



NO CLAIM IS MADE TO THE EXCLUSIVE RIGHT TO USE "PRESS", APART FROM THE MARK AS SHOWN.

THE MARK CONSISTS OF DRAWING OF A SMILING TEDDY BEAR HOLDING AND READING AN OPEN BOOK WITH THE WORDS "COOKIE BEAR PRESS" IN STYLIZED PRINTING CURVED ABOVE THE BEAR'S HEAD.

FOR CHILDREN'S BOOKS AND COLORING BOOKS (U.S. CLS. 2, 5, 22, 23, 29, 37, 38 AND 50).

FIRST USE 1-16-2001; IN COMMERCE 12-1-2001.  
DAVID I, EXAMINING ATTORNEY

**CLASS 16—(Continued).**

SN 85-408,543. CLOUDCO, INC., CLEVELAND, OH. FILED 8-26-2011.

**THOSE DARNED SOCKS**

THE MARK CONSISTS OF STANDARD CHARACTERS WITHOUT CLAIM TO ANY PARTICULAR FONT, STYLE, SIZE, OR COLOR.

FOR BOOKS, NAMELY, SERIES OF CHILDREN'S BOOKS, BOOKS FEATURING TRAVEL, ADVENTURE STORIES, HOLIDAYS AND CULTURES, FILL-IN-THE-BLANK BOOKS, AND FUN PROJECTS TO DO, PHOTO ALBUMS, WRITING JOURNALS, CHILDREN'S FILL-IN BOOKS, BOOKS FOR STAMP COLLECTIONS, COLLAGES, VERY SMALL PAINTINGS, AUTOGRAPH BOOKS, PICTURES, PRE-MADE STICKERS, SCRAPBOOKS, ADDRESS AND TELEPHONE BOOKS, STATIONERY ORGANIZERS, GENERAL BOOKS ON TRAVEL, PAPER AND PLASTIC BOOKMARKS, BOOK COVERS, STORY BOOKS, PAPER NOTE TABLETS, PASSPORT HOLDERS, PICTURE BOOKS, COLORING BOOKS, PRINTED GUIDES FOR CHILDREN'S TRAVEL, WIRE-BOUND BOOKS, RECIPE BOOKS, SONG BOOKS, TALKING CHILDREN'S BOOKS, MAGAZINES FOR CHILDREN FEATURING INFORMATION, NAMELY, PARENTING AND CHILDREN'S ART AND CHILDREN'S CARE AND CHILDREN'S EVENTS AND CHILDREN'S CONTESTS AND CHILDREN'S AWARDS AND CHILDREN'S TRAVEL GUIDES AND LISTS OF THE BEST CHILDREN'S BOOKS AND CHILDREN'S WEBSITES; DESK SUPPLIES, NAMELY, PAPER CLIP HOLDERS, DRAWING RULERS, STRAIGHT EDGES, STAMP PADS, STATIONERY AND ENVELOPES, STATIONERY BOXES, STENCILING MACHINES, STENCILS, STICKERS, STORAGE CONTAINERS MADE OF PAPER, PAPER ENVELOPES FOR PACKAGING, PAPER EXPANDING FILES, PAPER FILE JACKETS, PAPER REPORT COVERS, PAPER STAPLERS, PAPER STOCK, PAPER TRAYS, PARTIALLY PRINTED FORMS, PASTE FOR STATIONERY OR HOUSEHOLD PURPOSES, PEN AND PENCIL TRAYS, PEN CASES, PEN OR PENCIL HOLDERS, PENCIL AND PEN BOXES, PENCIL CASES, PENCIL SHARPENERS, PENCILS, PENS, PERSONAL ORGANIZERS, POCKET CALENDARS, POCKET SECRETARIES, PLASTIC PORTABLE DESKS, AQUARIUMS, BULLETIN BOARDS, BUSINESS CARDS, DESK BLOTTERS, BOOK COVERS, THREE-RING BINDERS, RECEIPT BOOKS, ADHESIVE TAPE DISPENSERS FOR HOUSEHOLD OR STATIONERY USE, ADHESIVE TAPES FOR STATIONERY OR HOUSEHOLD PURPOSES, STAPLERS, STAPLES; CARDS, POSTERS, CHARTS AND CERTIFICATES, NAMELY, PRINTED INVITATIONS, POSTCARDS, SOCIAL NOTE CARDS, PICTORIAL PRINTS, TRIVIA CARDS, POSTERS, TRADING CARDS, PICTURE POSTCARDS, PLACE CARDS, POSTERS, NOT MAGNETICALLY ENCODED PRE-PAID TELEPHONE CALLING CARD, PRINTED GREETING CARDS, PRINTED AWARD CERTIFICATES, PRINTED CERTIFICATES, PRINTED CHARTS, PRINTED EMBLEMS, PRINTED FORMS, WALL CALENDARS, TABLE-TOP CALENDARS, PRINTED GREETING CARDS WITH ELECTRONIC INFORMATION STORED THEREIN, PAPER FLIP CHARTS, WALL CHARTS, TAROT CARDS, SELF-ESTEEM CARDS, BUMPER STICKERS, MOTIVATIONAL CARDS, GAME CARDS; HOME ITEMS, NAMELY, PAPER DOILIES, PAPER BABY BIBS, PAPER TABLEMATS, PAPER NAPKINS, TISSUE PAPER, TOILET PAPER, PAPER TABLE LINENS, PAPER TOWELS, PAPER WASHCLOTHS, PLASTIC FOOD STORAGE BAGS FOR HOUSEHOLD USE, PLASTIC SANDWICH BAGS; ART SUPPLIES, NAMELY, PAINT BRUSHES, PAINT PADDLES, PALETTES, PAINTING SETS FOR CHILDREN, PRINTED HOLOGRAM STICKERS, PAPER DIE CUT SHAPES, TEMPORARY TATTOOS, PAPER EMBLEMS, PAPER MACHE, PAPER MACHE FIGURINES, PAPER PARTY BAGS, PAPER PARTY DECORATIONS, PAPER PARTY FAVORS, PAPER PARTY HATS, PAPER PENNANTS, PAPER FLAGS, PAPER RIBBONS, ADHESIVE-BACKED LETTERS AND

**CLASS 16—(Continued).**

NUMBERS FOR USE IN MAKING SIGNS, PASTELS, PAPER PATTERNS FOR COLORING AND PAINTING, PAPER STENCILS, PATTERNS FOR MAKING COSTUMES, RUBBER STAMPS, AND PLASTIC SHEETS FOR WRITING, PRINTING, PAINTING AND MARKING ON; PAPER NAME BADGES, PAPER BANNERS, PRICE TAGS, PRICE TICKETS, PRINTED MAIL RESPONSE CARDS RELATING TO INVITATION TO EVENTS, PRINTED PAPER SIGNS, PAPER BAGS FOR PACKAGING GIFTS, PAPER GIFT BOXES, PAPER CARTONS FOR DELIVERING GOODS, PAPER CONTAINERS, PAPER DISPLAY BOXES, HOLIDAY-DECORATED PAPER BAGS, PAPER POUCHES FOR PACKAGING, PLASTIC GIFT WRAP, PAPER SHOPPING BAGS, PAPER TAGS, NON-TEXTILE PRINTED PACKAGING LABELS (U.S. CLS. 2, 5, 22, 23, 29, 37, 38 AND 50).

WENDY GOODMAN, EXAMINING ATTORNEY

**CLASS 17—RUBBER GOODS**

SN 79-098,917. CONTITECH SCHLAUCH GMBH, FED REP GERMANY, FILED 10-1-2010.

**GOLDSCHLANGE**

OWNER OF INTERNATIONAL REGISTRATION 0152232 DATED 3-5-1951, EXPIRES 3-5-2021.

THE ENGLISH TRANSLATION OF "SCHLANGE" IN THE MARK IS "SNAKE".

FOR FLEXIBLE PIPES, NOT OF METAL (U.S. CLS. 1, 5, 12, 13, 35 AND 50).

CARYN GLASSER, EXAMINING ATTORNEY

SN 85-169,948. LUZERNE INVESTMENTS LTD., WICKHAM CITY, BR. VIRGIN ISLANDS, FILED 11-5-2010.



OWNER OF U.S. REG. NO. 2,192,494.

NO CLAIM IS MADE TO THE EXCLUSIVE RIGHT TO USE "CLEAN", APART FROM THE MARK AS SHOWN.

THE COLOR(S) BLUE AND WHITE IS/ARE CLAIMED AS A FEATURE OF THE MARK.

THE MARK CONSISTS OF THE WORDS "DARNEL CLEAN ADVANTAGE" AND THE DESIGN OF TWO LEAVES AND A CIRCLE ALL IN WHITE WITH A BLUE BACKGROUND.

FOR BIODEGRADABLE FOAM FOR USE IN THE FURTHER MANUFACTURE OF GOODS (U.S. CLS. 1, 5, 12, 13, 35 AND 50).

KEVON CHISOLM, EXAMINING ATTORNEY

**CLASS 17—(Continued).**

SN 85-193,977. HUF, GERALD, D., DBA NORTHWEST, MEADVILLE, PA. FILED 12-9-2010.

# THERMA-LOCK

THE MARK CONSISTS OF STANDARD CHARACTERS WITHOUT CLAIM TO ANY PARTICULAR FONT, STYLE, SIZE, OR COLOR.

FOR FOILS OF METAL FOR BUILDING INSULATION (U.S. CLS. 1, 5, 12, 13, 35 AND 50).

KATINA MISTER, EXAMINING ATTORNEY



SN 85-248,784. UP NORTH PLASTICS, INC., COTTAGE GROVE, MN. FILED 2-22-2011.

# SILAGE SHIELD

THE MARK CONSISTS OF STANDARD CHARACTERS WITHOUT CLAIM TO ANY PARTICULAR FONT, STYLE, SIZE, OR COLOR.

NO CLAIM IS MADE TO THE EXCLUSIVE RIGHT TO USE "SILAGE", APART FROM THE MARK AS SHOWN.

FOR PLASTIC SHEETING FOR AGRICULTURAL PURPOSES (U.S. CLS. 1, 5, 12, 13, 35 AND 50).

FIRST USE 4-1-2011; IN COMMERCE 4-1-2011.

MARK SPARACINO, EXAMINING ATTORNEY



SN 85-266,597. ORBIT IRRIGATION PRODUCTS, INC., NORTH SALT LAKE, UT. FILED 3-14-2011.

# ORBIT

THE MARK CONSISTS OF STANDARD CHARACTERS WITHOUT CLAIM TO ANY PARTICULAR FONT, STYLE, SIZE, OR COLOR.

OWNER OF U.S. REG. NO. 2,819,521.

FOR NON-METAL HOSE FITTINGS FOR USE WITH WATER PIPES IN SPRINKLER SYSTEMS, NAMELY, TEES, ELBOWS, NIPPLES, RISERS, BUSHINGS, UNION PIPE END SPRAYERS AND DRIPPERS, EMITTERS, AND WATER TUBING (U.S. CLS. 1, 5, 12, 13, 35 AND 50).

FIRST USE 12-31-1971; IN COMMERCE 12-31-1971.

ASMAT KHAN, EXAMINING ATTORNEY

**CLASS 17—(Continued).**

SN 85-267,679. JESSUP MANUFACTURING COMPANY, MCHENRY, IL. FILED 3-15-2011.

# ILLUMINATING YOUR PATH TO A SAFER WORLD

THE MARK CONSISTS OF STANDARD CHARACTERS WITHOUT CLAIM TO ANY PARTICULAR FONT, STYLE, SIZE, OR COLOR.

FOR PHOTOLUMINESCENT FILMS WITH AND WITHOUT ADHESIVE BACKING, FOR USE AS SIGNAGE, DIRECTIONAL IDENTIFICATION, WARNING LABELS, IDENTIFICATION LABELS, DECORATION, SAFETY DEVICES, FLOOR MARKINGS, WALL MARKINGS, PROMOTIONAL STICKERS, AND NOVELTY ITEMS (U.S. CLS. 1, 5, 12, 13, 35 AND 50).

PAUL MORENO, EXAMINING ATTORNEY

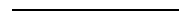

SN 85-271,509. WORTHINGTON PRODUCTS, INC., CANTON, OH. FILED 3-19-2011.

# BOATBUSTER

THE MARK CONSISTS OF STANDARD CHARACTERS WITHOUT CLAIM TO ANY PARTICULAR FONT, STYLE, SIZE, OR COLOR.

SEC. 2(F).

FOR BARRIER CURTAINS IN THE NATURE OF FLOATING BAFFLES OR BOOMS FOR THE CONTAINMENT OF POLLUTANTS (U.S. CLS. 1, 5, 12, 13, 35 AND 50).

FIRST USE 11-1-2002; IN COMMERCE 11-1-2002.

CHARLOTTE CORWIN, EXAMINING ATTORNEY

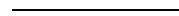

SN 85-288,805. FUTURAMIK INDUSTRIES, INC., HARTFORD, CT. FILED 4-7-2011.

# LAM-FLEX

THE MARK CONSISTS OF STANDARD CHARACTERS WITHOUT CLAIM TO ANY PARTICULAR FONT, STYLE, SIZE, OR COLOR.

FOR PLASTIC SIGN BLANKS FOR ENGRAVING; PLASTIC SHEETS AND SUBSTRATES FOR USE IN THE MANUFACTURE OF SIGNS (U.S. CLS. 1, 5, 12, 13, 35 AND 50).

FIRST USE 11-30-2010; IN COMMERCE 11-30-2010.

KRISTINA MORRIS, EXAMINING ATTORNEY

**CLASS 17—(Continued).**

SN 85-293,527. LIGUANG HUANG, SAN.FRANCISCO, CA.  
FILED 4-12-2011.



THE MARK CONSISTS OF CONSISTS OF THE STYLIZED WORD "GANGLI" SUPERIMPOSED OVER AN INCOMPLETE OVAL AND WITH THE LETTER "I" FEATURING A CHECKERBOARD PATTERN.

THE WORDING "GANGLI" HAS NO MEANING IN A FOREIGN LANGUAGE.

FOR EXPANSION JOINT FILLERS; PACKING PADDING OF PLASTIC FOR SHIPPING CONTAINERS; PACKING PADDING OF RUBBER FOR SHIPPING CONTAINERS; PADDING MATERIALS OF RUBBER OR PLASTIC; PLASTIC PACKING FOR SHIPPING CONTAINERS; RUBBER BAGS FOR MERCHANDISE PACKAGING; RUBBER PACKING FOR SHIPPING CONTAINERS; WATERPROOF PACKINGS FOR SHIPPING CONTAINERS (U.S. CLS. 1, 5, 12, 13, 35 AND 50).

JAMES GRIFFIN, EXAMINING ATTORNEY

SN 85-323,937. OCTAL HOLDINGS & CO., RUWI, OMAN,  
FILED 5-18-2011.

## DPET

THE MARK CONSISTS OF STANDARD CHARACTERS WITHOUT CLAIM TO ANY PARTICULAR FONT, STYLE, SIZE, OR COLOR.

OWNER OF U.S. REG. NO. 3,766,151.

FOR AMORPHOUS POLYETHYLENE TEREPHTHALATE PLASTIC FILM SHEETS USED FOR PACKAGING FOOD AND CONSUMER GOODS (U.S. CLS. 1, 5, 12, 13, 35 AND 50).

FIRST USE 1-0-2009; IN COMMERCE 1-0-2009.  
HOWARD SMIGA, EXAMINING ATTORNEY

**CLASS 17—(Continued).**

SN 85-331,457. PLANTRA, INC., MENDOTA HEIGHTS, MN.  
FILED 5-26-2011.

## TUFF GRID

THE MARK CONSISTS OF STANDARD CHARACTERS WITHOUT CLAIM TO ANY PARTICULAR FONT, STYLE, SIZE, OR COLOR.

NO CLAIM IS MADE TO THE EXCLUSIVE RIGHT TO USE "GRID", APART FROM THE MARK AS SHOWN.

FOR PLASTIC PLANT AND TREE GROW TUBES FOR THE ESTABLISHMENT OF PLANTS (U.S. CLS. 1, 5, 12, 13, 35 AND 50).

JENNY PARK, EXAMINING ATTORNEY

SN 85-332,468. DURA-LINE CORPORATION, KNOXVILLE,  
TN. FILED 5-27-2011.

## PRESSURE FLEX

THE MARK CONSISTS OF STANDARD CHARACTERS WITHOUT CLAIM TO ANY PARTICULAR FONT, STYLE, SIZE, OR COLOR.

FOR POLYMER PIPE AND CONDUIT FOR USE IN PRESSURE, GAS, WATER AND OIL INDUSTRIES (U.S. CLS. 1, 5, 12, 13, 35 AND 50).

FIRST USE 12-31-2001; IN COMMERCE 12-31-2001.

LINDA E. BLOHM, EXAMINING ATTORNEY

SN 85-336,854. ECOSPAN, LLC, GREENBRAE, CA. FILED 6-2-2011.

## BIOFLOW

THE MARK CONSISTS OF STANDARD CHARACTERS WITHOUT CLAIM TO ANY PARTICULAR FONT, STYLE, SIZE, OR COLOR.

FOR BIOPOLYMER-BASED RESINS IN PELLET FORM FOR USE IN MANUFACTURING BIOPLASTICS (U.S. CLS. 1, 5, 12, 13, 35 AND 50).

FIRST USE 2-18-2010; IN COMMERCE 2-18-2010.

CHRISTOPHER BUONGIORNO, EXAMINING ATTORNEY

**CLASS 17—(Continued).**

SN 85-339,604. O'SULLIVAN FILMS, INC., WINCHESTER, VA. FILED 6-7-2011.

# O'SEA

THE MARK CONSISTS OF STANDARD CHARACTERS WITHOUT CLAIM TO ANY PARTICULAR FONT, STYLE, SIZE, OR COLOR.

OWNER OF U.S. REG. NOS. 1,723,596 AND 3,945,350.  
FOR VINYL IN SHEET FORM FOR USE IN THE FURTHER MANUFACTURE IN THE MARINE INDUSTRY (U.S. CLS. 1, 5, 12, 13, 35 AND 50).  
FIRST USE 2-0-2010; IN COMMERCE 2-0-2010.  
KHANH LE, EXAMINING ATTORNEY

**CLASS 17—(Continued).**

SN 85-340,217. IGS CHEMICALS LLC, BEVERLY HILLS, CA. FILED 6-7-2011.

# ARMOLAN

THE MARK CONSISTS OF STANDARD CHARACTERS WITHOUT CLAIM TO ANY PARTICULAR FONT, STYLE, SIZE, OR COLOR.

THE WORDING ARMOLAN HAS NO MEANING IN A FOREIGN LANGUAGE.  
FOR TINTED, LAMINATED AND REFLECTIVE PLASTIC FILMS FOR USE IN HOME OR AUTO WINDOWS (U.S. CLS. 1, 5, 12, 13, 35 AND 50).  
FRED CARL, EXAMINING ATTORNEY

SN 85-339,816. O'SULLIVAN FILMS, INC., WINCHESTER, VA. FILED 6-7-2011.

# O'SOFT

THE MARK CONSISTS OF STANDARD CHARACTERS WITHOUT CLAIM TO ANY PARTICULAR FONT, STYLE, SIZE, OR COLOR.

OWNER OF U.S. REG. NOS. 1,723,596 AND 3,945,350.  
FOR VINYL IN SHEET FORM FOR USE IN FURTHER MANUFACTURE IN THE AUTOMOTIVE INDUSTRY (U.S. CLS. 1, 5, 12, 13, 35 AND 50).  
KHANH LE, EXAMINING ATTORNEY

SN 85-343,512. USA INSULATION FRANCHISE CORPORATION, EASTLAKE, OH. FILED 6-10-2011.

# ClimaFoam Insulation

THE MARK CONSISTS OF STANDARD CHARACTERS WITHOUT CLAIM TO ANY PARTICULAR FONT, STYLE, SIZE, OR COLOR.

NO CLAIM IS MADE TO THE EXCLUSIVE RIGHT TO USE "INSULATION", APART FROM THE MARK AS SHOWN.  
FOR FOAM INSULATION FOR USE IN BUILDING AND CONSTRUCTION (U.S. CLS. 1, 5, 12, 13, 35 AND 50).  
MARIA-VICTORIA SUAREZ, EXAMINING ATTORNEY

SN 85-339,828. O'SULLIVAN FILMS, INC., WINCHESTER, VA. FILED 6-7-2011.



OWNER OF U.S. REG. NOS. 1,723,596 AND 3,945,350.  
THE MARK CONSISTS OF A LARGE LETTER "O" OVERLAPPED BY "SOFT" ALL WITH A THREE DIMENSIONAL APPEARANCE. THE TERM "SOFT" IS UNDERSCORED BY A WAVY LINE.  
FOR VINYL IN SHEET FORM FOR USE IN FURTHER MANUFACTURE IN THE AUTOMOTIVE INDUSTRY (U.S. CLS. 1, 5, 12, 13, 35 AND 50).  
KHANH LE, EXAMINING ATTORNEY

SN 85-391,843. INTERTAPE POLYMER CORP., BRADENTON, FL. FILED 8-8-2011.

# FIREFLY

THE MARK CONSISTS OF STANDARD CHARACTERS WITHOUT CLAIM TO ANY PARTICULAR FONT, STYLE, SIZE, OR COLOR.

FOR GLOW-IN-THE-DARK DUCT TAPE (U.S. CLS. 1, 5, 12, 13, 35 AND 50).  
FIRST USE 7-15-2011; IN COMMERCE 7-15-2011.  
SHANNON TWOHIG, EXAMINING ATTORNEY

**CLASS 18—LEATHER GOODS**

SN 76-705,497. STEELE SADDLE TREE, LLC, ASHLAND CITY, TN. FILED 11-29-2010.



THE MARK CONSISTS OF THE STYLIZED WORDING "EQUI-FIT" BELOW THE DESIGN OF A WINGED HORSE DESIGN.

FOR SADDLE TREE (U.S. CLS. 1, 2, 3, 22 AND 41).  
FIRST USE 10-15-1993; IN COMMERCE 12-16-1993.  
DAVID HOFFMAN, EXAMINING ATTORNEY

SN 76-705,498. STEELE SADDLE TREE, LLC, ASHLAND CITY, TN. FILED 11-29-2010.



THE MARK CONSISTS OF THE STYLIZED WORDING "EQUI-FLEX" BELOW THE DESIGN OF A WINGED HORSE DESIGN.

FOR FLEXIBLE SADDLE TREES (U.S. CLS. 1, 2, 3, 22 AND 41).  
FIRST USE 7-10-1998; IN COMMERCE 10-15-1998.  
DAVID HOFFMAN, EXAMINING ATTORNEY

SN 76-707,490. CHEN, JIEKAI, WALNUT, CA. FILED 5-3-2011.

# CCS

THE MARK CONSISTS OF STANDARD CHARACTERS WITHOUT CLAIM TO ANY PARTICULAR FONT, STYLE, SIZE, OR COLOR.

FOR BACKPACKS, LUGGAGE, TRAVELING BAGS, TRUNKS, BRIEFCASES, HANDBAGS, TOTE BAGS, SUITCASES, LUGGAGE GARMENT BAGS FOR TRAVEL, AND DUFFEL BAGS (U.S. CLS. 1, 2, 3, 22 AND 41).  
SHAUNIA CARLYLE, EXAMINING ATTORNEY

**CLASS 18—(Continued).**

SN 76-708,021. CHEN, JIEKAI, WALNUT, CA. FILED 6-17-2011.

# COOL.9

THE MARK CONSISTS OF STANDARD CHARACTERS WITHOUT CLAIM TO ANY PARTICULAR FONT, STYLE, SIZE, OR COLOR.

FOR BACKPACKS, LUGGAGE, TRAVELING BAGS, TRUNKS, BRIEFCASES, HANDBAGS, TOTE BAGS, SUITCASES, LUGGAGE GARMENT BAGS FOR TRAVEL, AND DUFFEL BAGS (U.S. CLS. 1, 2, 3, 22 AND 41).  
SHAUNIA CARLYLE, EXAMINING ATTORNEY

SN 77-921,022. NORTH FACE APPAREL CORP., THE, WILMINGTON, DE. FILED 1-27-2010.

# X RADIAL

THE MARK CONSISTS OF STANDARD CHARACTERS WITHOUT CLAIM TO ANY PARTICULAR FONT, STYLE, SIZE, OR COLOR.

FOR BACK PACKS FEATURING TUBULAR ALUMINUM FRAME (U.S. CLS. 1, 2, 3, 22 AND 41).  
BRIDGETT SMITH, EXAMINING ATTORNEY

SN 85-138,555. BARNES, LISA, DBA LMB DESIGNS, HOBOKEN, NJ. FILED 9-27-2010.

# TURTLEBACKS

THE MARK CONSISTS OF STANDARD CHARACTERS WITHOUT CLAIM TO ANY PARTICULAR FONT, STYLE, SIZE, OR COLOR.

FOR CLOTHING FOR ANIMALS (U.S. CLS. 1, 2, 3, 22 AND 41).  
FIRST USE 8-21-2010; IN COMMERCE 8-21-2010.  
DAWN HAN, EXAMINING ATTORNEY

**CLASS 18—(Continued).**

SN 85-197,455. JC 23 ENTERTAINMENT, INC., BEVERLY HILLS, CA. FILED 12-14-2010.

**GOODMORNOONEVENING**

THE MARK CONSISTS OF STANDARD CHARACTERS WITHOUT CLAIM TO ANY PARTICULAR FONT, STYLE, SIZE, OR COLOR.

FOR HANDBAGS, CLUTCHES, SHOULDER BAGS, TOTE BAGS, BACK PACKS, BOOK BAGS, DUFFLE BAGS, TRAVEL BAGS, SACHELS, DRAW STRING BAGS, OVERNIGHT BAGS, WALLETS, KEY CASES, UMBRELLAS, ALL PURPOSE SPORTS BAGS, ATHLETIC BAGS, ATTACHE CASES, LEATHER BRIEF-CASES, CLUTCH BAGS, BEACH BAGS, DIAPER BAGS, COSMETIC CASES SOLD EMPTY, TOILETRY CASES SOLD EMPTY, COIN PURSES, LUGGAGE TAGS, POCKETBOOKS, PURSES, AND LUGGAGE (U.S. CLS. 1, 2, 3, 22 AND 41).

LINDA ESTRADA, EXAMINING ATTORNEY

**CLASS 18—(Continued).**

SN 85-244,181. SPRAYGROUND LIMITED LIABILITY COMPANY, ELBERON, NJ. FILED 2-16-2011.

**SPRAYGROUND**

THE MARK CONSISTS OF STANDARD CHARACTERS WITHOUT CLAIM TO ANY PARTICULAR FONT, STYLE, SIZE, OR COLOR.

OWNER OF U.S. REG. NO. 3,805,977.  
FOR CARRY-ALL BAGS, BACKPACKS, DUFFEL BAGS, TOTE BAGS, SHOULDER BAGS, WALLETS AND HAND BAGS (U.S. CLS. 1, 2, 3, 22 AND 41).  
FIRST USE 6-1-2009; IN COMMERCE 6-1-2009.  
SUZANNE BLANE, EXAMINING ATTORNEY

SN 85-239,754. TIJS VERWEST, NEW YORK, NY. FILED 2-11-2011.

**CLUB LIFE**

THE MARK CONSISTS OF STANDARD CHARACTERS WITHOUT CLAIM TO ANY PARTICULAR FONT, STYLE, SIZE, OR COLOR.

FOR ALL-PURPOSE SPORTS AND ATHLETIC BAGS; BEACH, BOOK, CARRY-ON, DJ, DUFFEL, DIAPER, GYM, LEATHER SHOPPING, MESSENGER, SHOULDER, TOTE AND TRAVEL BAGS; LEATHER AND IMITATION LEATHER; CANVAS SHOPPING BAGS; FANNY PACKS AND WAIST PACKS; BACKPACKS; KNAPSACKS; OVERNIGHT BAGS; HANDBAGS; PURSES; GARMENT BAGS FOR TRAVEL; GROOMING ORGANIZERS FOR TRAVEL; JEWELRY ORGANIZERS FOR TRAVEL; SHOE BAGS FOR TRAVEL; SACHELS; LUGGAGE; LUGGAGE TAGS; TRUNKS; SUITCASES; HAT BOXES FOR TRAVEL NOT OF PAPER OR CARDBOARD; TRAVEL CASES; AMENITY BAGS SOLD EMPTY; COSMETIC CASES AND BAGS SOLD EMPTY; TOILETRY AND VANITY CASES SOLD EMPTY; TOOL BAGS SOLD EMPTY; BAGS FOR CARRYING BABIES' ACCESSORIES; ATTACHE CASES; BRIEFCASES; BRIEF-CASE-TYPE PORTFOLIOS; DOCUMENT CASES; MEN'S CLUTCHES; BUSINESS CASES; BUSINESS CARD CASES; CALLING AND CREDIT CARD CASES; KEY CASES; LEATHER KEY CHAINS; WALLETS; BANK-NOTE HOLDERS; BILLFOLDS; UMBRELLAS; PARASOLS; WALKING STICKS (U.S. CLS. 1, 2, 3, 22 AND 41).

JOHN KELLY, EXAMINING ATTORNEY

SN 85-282,986. UNIVERSITY OF MIAMI, CORAL GABLES, FL. FILED 3-31-2011.



NO CLAIM IS MADE TO THE EXCLUSIVE RIGHT TO USE "UMBRELLA" AND THE DESIGN OF THE UMBRELLA, APART FROM THE MARK AS SHOWN.

THE MARK CONSISTS OF A STYLIZED LETTER "U" SPLIT IN THE MIDDLE AND TO THE LEFT OF AND BENEATH A STYLIZED UMBRELLA IMAGE. BELOW THE LETTER "U" AND UMBRELLA IS A HORIZONTAL LINE, AND THE WORD "UMBRELLA" BENEATH THE LINE, WITH THE FIRST TWO LETTERS "UM" IN "UMBRELLA" BEING OF A LARGER FONT THAN THE REST OF THE WORD.

FOR UMBRELLAS (U.S. CLS. 1, 2, 3, 22 AND 41).  
MICHELE SWAIN, EXAMINING ATTORNEY

**CLASS 18—(Continued).**

SN 85-292,096. CHEN, YAO, BAIYUN BLOCK, GUANGZHO, CHINA, FILED 4-11-2011.



THE MARK CONSISTS OF LINES THAT MAKE UP A DESIGN OF FOUR CROSSES WITH A SQUARE IN THE MIDDLE.

FOR ALL PURPOSE SPORT BAGS; ALL-PURPOSE CARRYING BAGS; BACKPACKS, BOOK BAGS, SPORTS BAGS, BUM BAGS, WALLETS AND HANDBAGS; CARRY-ALL BAGS; CARRY-ON BAGS; DUFFEL BAGS; DUFFEL BAGS FOR TRAVEL; FLIGHT BAGS; LEATHER AND IMITATION LEATHER BAGS; LEATHER BAGS AND WALLETS; LEATHER SHOPPING BAGS; TOTE BAGS; TRAVEL BAGS (U.S. CLS. 1, 2, 3, 22 AND 41).

LAKEISHA LEWIS, EXAMINING ATTORNEY

SN 85-292,881. WU, TZU YING, LITTLE ROCK, AR. FILED 4-12-2011.

THE MARK CONSISTS OF THE STYLIZED WORDING "GEANNA'S" WITH A STYLIZED FLOWER IN PLACE OF THE APOSTROPHE.

FOR HANDBAGS, PURSES AND WALLETS (U.S. CLS. 1, 2, 3, 22 AND 41).

KRISTINA MORRIS, EXAMINING ATTORNEY

SN 85-304,366. BELLO, ANTOINETTE, DBA BELLOBERRY DESIGNS, EVANSTON, IL. FILED 4-25-2011.

## BelloBerry Designs

THE MARK CONSISTS OF STANDARD CHARACTERS WITHOUT CLAIM TO ANY PARTICULAR FONT, STYLE, SIZE, OR COLOR.

NO CLAIM IS MADE TO THE EXCLUSIVE RIGHT TO USE "DESIGNS", APART FROM THE MARK AS SHOWN.

FOR FASHION HANDBAGS; HANDBAGS FOR LADIES (U.S. CLS. 1, 2, 3, 22 AND 41).

FIRST USE 9-0-2009; IN COMMERCE 9-0-2009.

NAKWAMA ANKRAH, EXAMINING ATTORNEY

**CLASS 18—(Continued).**

SN 85-311,514. MULTISPORT JOURNEYS, LLC, RIDGWAY, CO. FILED 5-3-2011.



OWNER OF U.S. REG. NO. 3,987,059.

THE MARK CONSISTS OF THE STYLIZED INITIALS "MSJ" WITH A DESIGN OF A BIKER TO THE LEFT, A DESIGN OF A ROWER ABOVE, AND A DESIGN OF A HIKER TO THE RIGHT OF "MSJ." THE STACKED STYLIZED WORDING "WWW.MULTISPORTJOURNEYS.COM" AND "LIVE TO PLAY ANOTHER DAY" ARE CENTERED AT THE BOTTOM OF THE MARK.

FOR TOTE BAGS (U.S. CLS. 1, 2, 3, 22 AND 41).

FIRST USE 6-20-2010; IN COMMERCE 10-29-2010.

PAULA MAHONEY, EXAMINING ATTORNEY

SN 85-313,701. WOOSTER STREET SOCIAL CLUB, INC., NEW YORK, NY. FILED 5-5-2011.

WOOSTER STREET SOCIAL CLUB

THE MARK CONSISTS OF STANDARD CHARACTERS WITHOUT CLAIM TO ANY PARTICULAR FONT, STYLE, SIZE, OR COLOR.

FOR PURSES, HANDBAGS, SHOULDER BAGS, MESSENGER BAGS, BACKPACKS, WALLETS, BILLFOLDS, POCKETBOOKS, COIN PURSES, TRAVEL CASES, COSMETIC BAGS SOLD EMPTY, LEATHER KEY CHAINS, PET COLLARS (U.S. CLS. 1, 2, 3, 22 AND 41).

ESTHER BELENKER, EXAMINING ATTORNEY



**CLASS 18—(Continued).**

SN 85-316,398. FASHION BRANDS HOLDING CORPORATION, CARSON CITY, NV. FILED 5-9-2011.



NO CLAIM IS MADE TO THE EXCLUSIVE RIGHT TO USE "YOGA", APART FROM THE MARK AS SHOWN.

THE NAME(S), PORTRAIT(S), AND/OR SIGNATURE(S) SHOWN IN THE MARK IDENTIFIES "MICHELE BOHBOT", WHOSE CONSENT(S) TO REGISTER IS MADE OF RECORD.

THE COLOR(S) BLACK, TURQUOISE BLUE, AND BRIGHT PINK IS/ARE CLAIMED AS A FEATURE OF THE MARK.

THE MARK CONSISTS OF THE WORDS "ELECTRIC" AND "YOGA" IN BLACK. THE NAME "MICHELE BOHBOT" IS DISPLAYED IN SMALLER TEXT BELOW. THE WORDS "ELECTRIC" AND "YOGA" AND "MICHELE" AND "BOHBOT" ARE SEPARATED BY A CUSTOM DRAWN LIGHTNING BOLT DISPLAYED IN THE CENTER. THE LIGHTNING BOLT IS OUTLINED ON THE LEFT SIDE WITH TURQUOISE BLUE AND ON THE RIGHT SIDE IT IS OUTLINED BRIGHT PINK WITH THE BODY OF THE LIGHTNING BOLT IS FILLED IN WITH BLACK.

FOR COSMETIC CASES SOLD EMPTY; DUFFEL BAGS; HANDBAGS; KEY CASES; PURSES; SHOULDER BAGS; WALLETS; BILLFOLDS (U.S. CLS. 1, 2, 3, 22 AND 41).

GEORGE LORENZO, EXAMINING ATTORNEY

SN 85-319,405. MOLTZ, ASHLEY, VENICE, CA. FILED 5-12-2011.

**ZEPHYR TEAL**

THE MARK CONSISTS OF STANDARD CHARACTERS WITHOUT CLAIM TO ANY PARTICULAR FONT, STYLE, SIZE, OR COLOR.

FOR HANDBAGS MADE OF SUSTAINABLE MATERIALS, NAMELY, RE-USABLE LEATHER BAGS, FAUX LEATHER BAGS, BAGS MADE OF POLYESTER, NYLON, AND STRAW; CANVAS SHOPPING BAGS (U.S. CLS. 1, 2, 3, 22 AND 41).

ANDREA HACK, EXAMINING ATTORNEY

**CLASS 18—(Continued).**

SN 85-320,624. EUROW & O'REILLY CORPORATION, DBA EQUINE COMFORT PRODUCTS, CAMARILLO, CA. FILED 5-13-2011.

**ECP AIR RIDE**

THE MARK CONSISTS OF STANDARD CHARACTERS WITHOUT CLAIM TO ANY PARTICULAR FONT, STYLE, SIZE, OR COLOR.

OWNER OF U.S. REG. NO. 3,656,312.  
FOR PADS FOR HORSE SADDLES (U.S. CLS. 1, 2, 3, 22 AND 41).

FIRST USE 8-1-2009; IN COMMERCE 8-1-2009.

CHARLOTTE CORWIN, EXAMINING ATTORNEY

SN 85-320,796. EUROW & O'REILLY CORPORATION, DBA EQUINE COMFORT PRODUCTS, CAMARILLO, CA. FILED 5-13-2011.

**AIR RIDE BY ECP**

THE MARK CONSISTS OF STANDARD CHARACTERS WITHOUT CLAIM TO ANY PARTICULAR FONT, STYLE, SIZE, OR COLOR.

OWNER OF U.S. REG. NO. 3,656,312.  
FOR PADS FOR HORSE SADDLES (U.S. CLS. 1, 2, 3, 22 AND 41).

CHARLOTTE CORWIN, EXAMINING ATTORNEY

SN 85-321,108. TONI AND LULA CORPORATION, CARLSBAD, CA. FILED 5-14-2011.

**TONI AND LULA**

THE MARK CONSISTS OF STANDARD CHARACTERS WITHOUT CLAIM TO ANY PARTICULAR FONT, STYLE, SIZE, OR COLOR.

FOR ALL PURPOSE SPORTS BAGS; ALL PURPOSE ATHLETIC CARRYING BAGS; BACK PACKS; BOOK BAGS; DUFFEL BAGS; GYM BAGS; TOTE BAGS; KNAPSACKS; LUGGAGE; BACKPACKS; BEACH BAGS; DIAPER BAGS; COIN PURSES; FANNY PACKS; WAIST PACKS; SHOPPING BAGS OF LEATHER; SHOPPING BAGS OF VINYL BEING IMITATION LEATHER; WALLETS; HANDBAGS; PURSES (U.S. CLS. 1, 2, 3, 22 AND 41).

DEBRA LEE, EXAMINING ATTORNEY

**CLASS 18—(Continued).**

SN 85-321,359. OLALA, INC., NEW YORK, NY. FILED 5-15-2011.

# OLALA

THE MARK CONSISTS OF STANDARD CHARACTERS WITHOUT CLAIM TO ANY PARTICULAR FONT, STYLE, SIZE, OR COLOR.

FOR ATTACHE CASES MADE OF IMITATION LEATHER; BAGS FOR PACKAGING OF LEATHER; BANDS OF LEATHER; BRIEFCASE-TYPE LEATHER BUSINESS FOLDERS; BRIEFCASES; CASES OF IMITATION LEATHER; GARMENT BAGS FOR TRAVEL MADE OF LEATHER; HAT BOXES OF LEATHER; IMITATION LEATHER; IMITATION LEATHER KEY CHAINS; IMITATION LEATHER SOLD IN BULK; INDUSTRIAL PACKAGING CONTAINERS OF LEATHER; KEY CASES; KEY CASES OF LEATHER OR IMITATION LEATHER; KEY-CASES OF LEATHER AND SKINS; LEATHER; LEATHER AND IMITATION LEATHER; LEATHER AND IMITATION LEATHER BAGS; LEATHER AND IMITATION LEATHER SPORT BAGS AND GENERAL PURPOSE TROLLEY BAGS; LEATHER BAGS AND WALLETS; LEATHER BAGS FOR MERCHANDISE PACKAGING; LEATHER BAGS, SUITCASES AND WALLETS; LEATHER BINDERS FOR TRAVEL PURPOSES; LEATHER BOXES FOR STORING GREETING CARDS; LEATHER BRIEFCASES; LEATHER CASES; LEATHER CASES FOR KEYS; LEATHER CREDIT CARD CASES; LEATHER CREDIT CARD HOLDER; LEATHER CREDIT CARD WALLETS; LEATHER FOR FURNITURE; LEATHER FOR HARNESSSES; LEATHER FOR SHOES; LEATHER HANDBAGS; LEATHER KEY CASES; LEATHER KEY CHAINS; LEATHER LEADS; LEATHER LEASHES; LEATHER OR LEATHER-BOARD BOXES; LEATHER POUCHES; LEATHER PURSES; LEATHER SHOPPING BAGS; LEATHER SHOULDER BELTS; LEATHER SOLD IN BULK; LEATHER STRAPS; LEATHER THONGS; LEATHER THREAD; LEATHER, UNWROUGHT OR SEMI-WROUGHT; PET ACCESSORIES, NAMELY, CANVAS, VINYL AND LEATHER POUCHES FOR HOLDING DISPOSABLE BAGS TO PLACE PET WASTE IN; PET ACCESSORIES, NAMELY, SPECIALLY DESIGNED CANVAS, VINYL OR LEATHER BAGS ATTACHED TO ANIMAL LEASHES FOR HOLDING SMALL ITEMS SUCH AS KEYS, CREDIT CARDS, MONEY OR DISPOSABLE BAGS FOR DISPOSING OF PET WASTE; POLYURETHANE LEATHER; POUCHES MADE FROM IMITATION LEATHER; POUCHES OF LEATHER; SADDLERY OF LEATHER; TANNED LEATHER; THONGS; TRAVELLING CASES OF LEATHER; WALLETS MADE OF LEATHER OR OTHER MATERIALS; WORKED OR SEMI-WORKED HIDES AND OTHER LEATHER (U.S. CLS. 1, 2, 3, 22 AND 41). FIRST USE 3-15-2011; IN COMMERCE 3-15-2011.

TINA MAI, EXAMINING ATTORNEY

**CLASS 18—(Continued).**

SN 85-323,930. TIERNAN, JOY, SANTA MONICA, CA. FILED 5-18-2011.

# BRAIN FREEZE

THE MARK CONSISTS OF STANDARD CHARACTERS WITHOUT CLAIM TO ANY PARTICULAR FONT, STYLE, SIZE, OR COLOR.

FOR CLOTHING FOR DOMESTIC PETS; COLLARS FOR PETS; DOG APPAREL; DOG CLOTHING; DOG COATS; DOG COLLARS; DOG COLLARS AND LEADS; DOG LEASHES; DOG PARKAS; DOG SHOES; GARMENTS FOR PETS; NECKWEAR FOR DOGS; PET ACCESSORIES, NAMELY, SPECIALLY DESIGNED CANVAS, VINYL OR LEATHER BAGS ATTACHED TO ANIMAL LEASHES FOR HOLDING SMALL ITEMS SUCH AS KEYS, CREDIT CARDS, MONEY OR DISPOSABLE BAGS FOR DISPOSING OF PET WASTE; PET CLOTHING; PET COLLAR ACCESSORIES, NAMELY, BOWS AND CHARMS; PET COLLAR ACCESSORIES, NAMELY, CHARMS; PET HAIR ORNAMENTS; PET PRODUCTS, NAMELY, PET RESTRAINING DEVICES CONSISTING OF LEASHES, COLLARS, HARNESSSES, RESTRAINING STRAPS, AND LEASHES WITH LOCKING DEVICES (U.S. CLS. 1, 2, 3, 22 AND 41).

RENEE MCCRAY, EXAMINING ATTORNEY

SN 85-332,234. SHIMANO AMERICAN CORPORATION, IRVINE, CA. FILED 5-27-2011.

# BALANCA

THE MARK CONSISTS OF STANDARD CHARACTERS WITHOUT CLAIM TO ANY PARTICULAR FONT, STYLE, SIZE, OR COLOR.

FOR BAGS FOR SPORTS; DUFFLE BAGS; LUGGAGE; SPORTS BAGS (U.S. CLS. 1, 2, 3, 22 AND 41).

BRIAN NEVILLE, EXAMINING ATTORNEY

SN 85-333,068. LI, FUYU, ANAHEIM, CA. FILED 5-28-2011.

# Al-n-k

THE MARK CONSISTS OF STANDARD CHARACTERS WITHOUT CLAIM TO ANY PARTICULAR FONT, STYLE, SIZE, OR COLOR.

FOR HANDBAGS (U.S. CLS. 1, 2, 3, 22 AND 41).

MICHAEL TANNER, EXAMINING ATTORNEY

**CLASS 18—(Continued).**

SN 85-333,311. EASEPAL ENTERPRISES LTD, FUJIAN PROVINCE, CHINA, FILED 5-30-2011.



THE MARK CONSISTS OF THE STYLIZED WORD KNINK ON THE LEFT, AND TWO CHINESE CHARACTERS WHICH TRANSLITERATE INTO YIN KE ON THE RIGHT.

THE WORDING KNINK HAS NO MEANING IN A FOREIGN LANGUAGE.

THE NON-LATIN CHARACTERS IN THE MARK TRANSLITERATE TO YIN; KE AND THIS MEANS STAMP; GUEST IN ENGLISH.

FOR ALL-PURPOSE CARRYING BAGS; BACKPACKS; BRIEFCASE-TYPE LEATHER BUSINESS FOLDERS; BRIEFCASES; CARRYING CASES; HANDBAGS; HAVESACKS; PURSES; REUSABLE SHOPPING BAGS; SCHOOL SATCHELS; TRAVELLING BAGS; UNFITTED VANITY CASES; VALISES (U.S. CLS. 1, 2, 3, 22 AND 41).  
BARBARA BROWN, EXAMINING ATTORNEY

SN 85-333,745. ALEJANDRA GUADALUPE FERNANDEZ ABARCA, JALISCO, MEXICO, FILED 5-31-2011.



THE NAME(S), PORTRAIT(S), AND/OR SIGNATURE(S) SHOWN IN THE MARK IDENTIFIES ALEJANDRA GUADALUPE FERNANDEZ ABARCA, WHOSE CONSENT(S) TO REGISTER IS MADE OF RECORD.

THE MARK CONSISTS OF THE WORD "ALLEZA" IN ALL LOWERCASE LETTERS WITH THE WORDS "BY ALEJANDRA FERNANDEZ" WRITTEN BENEATH THE WORD IN SMALLER LETTERS. ABOVE THE WORD "ALLEZA" IS A FANCIFUL SHIELD DESIGN.

THE WORDING ALLEZA HAS NO MEANING IN A FOREIGN LANGUAGE.

FOR LEATHER AND IMITATION LEATHER BAGS; LEATHER AND IMITATION LEATHER SPORT BAGS AND GENERAL PURPOSE TROLLEY BAGS; LEATHER BAGS AND WALLETS; LEATHER BAGS FOR MERCHANDISE PACKAGING; LEATHER BAGS, SUITCASES AND WALLETS; AND LEATHER SHOPPING BAGS (U.S. CLS. 1, 2, 3, 22 AND 41).

GINA FINK, EXAMINING ATTORNEY

**CLASS 18—(Continued).**

SN 85-333,851. TRACI L. CLAUSSEN, NEW ORLEANS, LA. FILED 5-31-2011.



NO CLAIM IS MADE TO THE EXCLUSIVE RIGHT TO USE "MADE IN NEW ORLEANS", APART FROM THE MARK AS SHOWN.

THE COLOR(S) BLACK AND MAROON IS/ARE CLAIMED AS A FEATURE OF THE MARK.

THE MARK CONSISTS OF THE WORDS "MADE IN NEW ORLEANS" IN BLACK AND "REPURPOSINGNOLA" IN MAROON WITH "PIECE BY[THE PEACE SIGN]" IN MAROON SHOWN BELOW "REPURPOSING NOLA".

FOR BAGS, NAMELY, TRAVEL BAGS, CARRY-ALL BAGS, DUFFEL BAGS, TOTE BAGS, REUSABLE SHOPPING BAGS, MAKEUP BAGS SOLD EMPTY, AND ALL PURPOSE CARRYING BAGS MADE OF BURLAP (U.S. CLS. 1, 2, 3, 22 AND 41).

FIRST USE 1-1-2011; IN COMMERCE 1-1-2011.

JOHN HWANG, EXAMINING ATTORNEY

SN 85-334,267. MR. MARC ICEBERG, ORLANDO, FL. FILED 5-31-2011.

**THE HEAT BEATER**

THE MARK CONSISTS OF STANDARD CHARACTERS WITHOUT CLAIM TO ANY PARTICULAR FONT, STYLE, SIZE, OR COLOR.

FOR ALL PURPOSE SPORT BAGS; ALL-PURPOSE ATHLETIC BAGS; ALL-PURPOSE CARRYING BAGS; ALL-PURPOSE REUSABLE CARRYING BAGS; ATHLETIC BAGS; BAGS FOR SPORTS; SPORT BAGS; SPORTS BAGS (U.S. CLS. 1, 2, 3, 22 AND 41).

CIMMERIAN COLEMAN, EXAMINING ATTORNEY

SN 85-335,032. THURSDAY FRIDAY, INC., LOS ANGELES, CA. FILED 6-1-2011.

**THURSDAY FRIDAY**

THE MARK CONSISTS OF STANDARD CHARACTERS WITHOUT CLAIM TO ANY PARTICULAR FONT, STYLE, SIZE, OR COLOR.

FOR HANDBAGS (U.S. CLS. 1, 2, 3, 22 AND 41).

FIRST USE 9-1-2010; IN COMMERCE 9-1-2010.

MARGARET POWER, EXAMINING ATTORNEY

**CLASS 18—(Continued).**

SN 85-335,310. FORTUNY INC., NEW YORK, NY. FILED 6-1-2011.

**FORTUNY**

THE MARK CONSISTS OF STANDARD CHARACTERS WITHOUT CLAIM TO ANY PARTICULAR FONT, STYLE, SIZE, OR COLOR.

OWNER OF U.S. REG. NOS. 2,825,065, 3,909,343 AND 3,920,089.

FOR MESSENGER BAGS; BEACH BAGS; BOOK BAGS; CLUTCH BAGS; DUFFLE BAGS; GYM BAGS; OVERNIGHT BAGS; TOILETRY BAGS SOLD EMPTY; TRAVEL BAGS; GARMENT BAGS FOR TRAVEL; PURSES; CLUTCH PURSES; POCKETBOOKS (U.S. CLS. 1, 2, 3, 22 AND 41).

KHANH LE, EXAMINING ATTORNEY

SN 85-335,410. GREEN HANNAH, INC., SANTA CLARA, CA. FILED 6-1-2011.

**GREEN HANNAH**

THE MARK CONSISTS OF STANDARD CHARACTERS WITHOUT CLAIM TO ANY PARTICULAR FONT, STYLE, SIZE, OR COLOR.

FOR A FULL LINE OF WOMEN'S AND MEN'S BAGS (U.S. CLS. 1, 2, 3, 22 AND 41).

MARIA-VICTORIA SUAREZ, EXAMINING ATTORNEY

SN 85-335,475. THE STATE OF CONNECTICUT, HARTFORD, CT. FILED 6-1-2011.



THE MARK CONSISTS OF THE OUTLINE OF THE FRONT OF A FOOTBALL STADIUM WITH THREE PENNANTS ABOVE IT. BELOW THE STADIUM IS THE WORD RENTSCHLER IN AN UPWARD CURVE UNDER WHICH IS THE WORD FIELD.

FOR LUGGAGE; LUGGAGE TAGS; HANDBAGS, PURSES AND WALLETS; COIN PURSES; PURSE CHARMS; BACKPACKS, BOOKS BAGS, SPORTS BAGS, BUM BAGS, WALLETS AND HANDBAGS; TOTE BAGS; TOOL BAGS SOLD EMPTY (U.S. CLS. 1, 2, 3, 22 AND 41).

KAREN BRACEY, EXAMINING ATTORNEY

**CLASS 18—(Continued).**

SN 85-335,523. MRM HOLDINGS LIMITED, PORT LOUIS, MAURITIUS, FILED 6-1-2011.

**TRAVELSAFE**

THE MARK CONSISTS OF STANDARD CHARACTERS WITHOUT CLAIM TO ANY PARTICULAR FONT, STYLE, SIZE, OR COLOR.

FOR THEFT-RESISTANT AND TAMPER-RESISTANT BAGS, POUCHES, AND CASES FOR TRANSPORT OF PERSONAL ITEMS, NAMELY, LUGGAGE, ATHLETIC BAGS, CARRY-ALL BAGS, KIT BAGS, OVERNIGHT BAGS, TRAVEL BAGS AND DOCUMENT CASES SOLD IN LOCKABLE AND/OR REINFORCED FORM (U.S. CLS. 1, 2, 3, 22 AND 41).

FIRST USE 1-29-2004; IN COMMERCE 1-29-2004.

C. DIONNE CLYBURN, EXAMINING ATTORNEY

SN 85-336,925. SUMMIT ENTERTAINMENT, LLC, SANTA MONICA, CA. FILED 6-2-2011.

**ISLE ESME**

THE MARK CONSISTS OF STANDARD CHARACTERS WITHOUT CLAIM TO ANY PARTICULAR FONT, STYLE, SIZE, OR COLOR.

FOR ALL-PURPOSE CARRYING BAGS; ALL-PURPOSE CARRYING CASES; BEACH BAGS; TOTE BAGS; COSMETIC CASES SOLD EMPTY; HANDBAGS; AND MAKEUP BAGS SOLD EMPTY (U.S. CLS. 1, 2, 3, 22 AND 41).

ASMAT KHAN, EXAMINING ATTORNEY

SN 85-337,961. ANASTASIA KERIOTIS, SANTA CRUZ, CA. FILED 6-3-2011.

**DHARMA LOVE**

THE MARK CONSISTS OF STANDARD CHARACTERS WITHOUT CLAIM TO ANY PARTICULAR FONT, STYLE, SIZE, OR COLOR.

FOR ALL-PURPOSE REUSABLE CARRYING BAGS; COIN PURSES; HANDBAGS; MESSENGER BAGS; PURSES; TOTE BAGS (U.S. CLS. 1, 2, 3, 22 AND 41).

FIRST USE 6-13-2005; IN COMMERCE 7-13-2005.

TIMOTHY FINNEGAN, EXAMINING ATTORNEY

**CLASS 18—(Continued).**

SN 85-337,996. COPELAND, LORRI, ASTORIA, OR. FILED 6-3-2011.

# Chichuahua

THE MARK CONSISTS OF STANDARD CHARACTERS WITHOUT CLAIM TO ANY PARTICULAR FONT, STYLE, SIZE, OR COLOR.

FOR DOG APPAREL; DOG CLOTHING; DOG COLLARS; DOG LEASHES (U.S. CLS. 1, 2, 3, 22 AND 41).  
CARRIE GENOVESE, EXAMINING ATTORNEY

**CLASS 18—(Continued).**

SN 85-338,468. GOOD WISH UMBRELLA NY INC., HARRISON, NY. FILED 6-6-2011.



SN 85-338,408. PIPER, DIANE E., ALEXANDRIA, VA. FILED 6-6-2011.

## THE BAG FOR ALL SEASONS; THE BAG FOR ALL REASONS

THE MARK CONSISTS OF STANDARD CHARACTERS WITHOUT CLAIM TO ANY PARTICULAR FONT, STYLE, SIZE, OR COLOR.

FOR FITTED PROTECTIVE COVERS FOR HANDBAGS, BRIEFCASES, VALISES, SUITCASES, AND BRIEFCASE-LIKE PORTFOLIOS (U.S. CLS. 1, 2, 3, 22 AND 41).

EDWARD FENNESSY, EXAMINING ATTORNEY

NO CLAIM IS MADE TO THE EXCLUSIVE RIGHT TO USE "UMBRELLA", APART FROM THE MARK AS SHOWN.

THE MARK CONSISTS OF GOOD WISH UMBRELLA IN STYLIZED FONT WITH THE U FORMED BY THE UMBRELLA HANDLE. ON THE UMBRELLA ARE RIBBONS AND BOWS. BELOW GOOD WISH UMBRELLA IS DECORATE THEN CELEBRATE! IN STYLIZED FONT.

FOR UMBRELLAS AND PARASOLS (U.S. CLS. 1, 2, 3, 22 AND 41).

FIRST USE 4-0-2011; IN COMMERCE 4-0-2011.  
SHAUNIA CARLYLE, EXAMINING ATTORNEY

SN 85-338,410. PIPER, DIANE E., ALEXANDRIA, VA. FILED 6-6-2011.

## SHOULD YOU COVER?

THE MARK CONSISTS OF STANDARD CHARACTERS WITHOUT CLAIM TO ANY PARTICULAR FONT, STYLE, SIZE, OR COLOR.

FOR FITTED PROTECTIVE COVERS FOR HANDBAGS, BRIEFCASES, VALISES, SUITCASES, AND BRIEFCASE-LIKE PORTFOLIOS (U.S. CLS. 1, 2, 3, 22 AND 41).

EDWARD FENNESSY, EXAMINING ATTORNEY

SN 85-338,707. ROCHA, KATE, WOODLAND HILLS, CA. FILED 6-6-2011.

# RICH RAGZ

THE MARK CONSISTS OF STANDARD CHARACTERS WITHOUT CLAIM TO ANY PARTICULAR FONT, STYLE, SIZE, OR COLOR.

FOR HANDBAGS (U.S. CLS. 1, 2, 3, 22 AND 41).  
FIRST USE 2-20-2011; IN COMMERCE 4-8-2011.  
TRACY WHITTAKER-BROWN, EXAMINING ATTORNEY

**CLASS 18—(Continued).**

SN 85-338,963. FASHION DISTRIBUTION CENTER INC., DBA LA TERRE FASHION, LA CRESCENTA, CA. FILED 6-6-2011.



THE MARK CONSISTS OF TWO ALPHABET LETTER "T" ARE IN THE OVAL RING OR CIRCULAR OUTLINE. ONE OF THE LETTERS "T" IS UPSIDE-DOWN TOUCHING THE VERTICAL CENTER BAR OF THE OTHER LETTER "T".

FOR BACKPACKS, BOOK BAGS, SPORTS BAGS, BUM BAGS, WALLETS AND HANDBAGS; FASHION HANDBAGS; HANDBAGS FOR LADIES; HANDBAGS FOR MEN; LEATHER HANDBAGS (U.S. CLS. 1, 2, 3, 22 AND 41).

FIRST USE 5-1-2011; IN COMMERCE 5-1-2011.  
KAREN K. BUSH, EXAMINING ATTORNEY

**CLASS 18—(Continued).**

SN 85-339,868. MCGILLICUDDY ENTERPRISES LLC, NEW YORK, NY. FILED 6-7-2011.

## Garment Guardian

THE MARK CONSISTS OF STANDARD CHARACTERS WITHOUT CLAIM TO ANY PARTICULAR FONT, STYLE, SIZE, OR COLOR.

FOR LUGGAGE (U.S. CLS. 1, 2, 3, 22 AND 41).  
CHRISTINA SOBRAL, EXAMINING ATTORNEY

SN 85-362,013. SKIP HOP, INC., NEW YORK, NY. FILED 7-1-2011.

## ALWAYS A LEAP AHEAD

THE MARK CONSISTS OF STANDARD CHARACTERS WITHOUT CLAIM TO ANY PARTICULAR FONT, STYLE, SIZE, OR COLOR.

FOR BACKPACKS; DIAPER BAGS (U.S. CLS. 1, 2, 3, 22 AND 41).

FIRST USE 5-1-2011; IN COMMERCE 5-1-2011.  
DEBRA LEE, EXAMINING ATTORNEY

SN 85-339,614. BALL, PENNY C., ACWORTH, GA. FILED 6-7-2011.



THE MARK CONSISTS OF THE LETTERS "P", "B", AND "C" INTERTWINED TO FORM A MONOGRAM.

FOR HANDBAGS; PURSE CHARMS; PURSES (U.S. CLS. 1, 2, 3, 22 AND 41).

HANNO RITTNER, EXAMINING ATTORNEY

SN 85-379,377. SCG POWER RANGERS LLC, LOS ANGELES, CA. FILED 7-24-2011.

## POWER RIDER

THE MARK CONSISTS OF STANDARD CHARACTERS WITHOUT CLAIM TO ANY PARTICULAR FONT, STYLE, SIZE, OR COLOR.

FOR ALL PURPOSE SPORT BAGS; ATHLETIC BAGS; BACKPACKS; KNAPSACKS; WALLETS; UMBRELLAS (U.S. CLS. 1, 2, 3, 22 AND 41).

THOMAS MANOR, EXAMINING ATTORNEY

**CLASS 18—(Continued).**

SN 85-390,319. CROTON WATCH CO. INC., MOONACHIE, NJ. FILED 8-5-2011.

iLuxury

THE MARK CONSISTS OF STANDARD CHARACTERS WITHOUT CLAIM TO ANY PARTICULAR FONT, STYLE, SIZE, OR COLOR.

FOR ATTACHE CASES MADE OF IMITATION LEATHER; ATTACHE CASES MADE OF LEATHER; BAGS FOR PACKAGING OF LEATHER; BANDS OF LEATHER; BRIEFCASE-TYPE LEATHER BUSINESS FOLDERS; BRIEFCASES; CASES OF IMITATION LEATHER; GARMENT BAGS FOR TRAVEL MADE OF LEATHER; HAT BOXES OF LEATHER; IMITATION LEATHER; IMITATION LEATHER KEY CHAINS; IMITATION LEATHER SOLD IN BULK; INDUSTRIAL PACKAGING CONTAINERS OF LEATHER; KEY CASES; KEY CASES OF LEATHER OR IMITATION LEATHER; KEY-CASES OF LEATHER AND SKINS; LEATHER; LEATHER AND IMITATION LEATHER; LEATHER AND IMITATION LEATHER BAGS; LEATHER AND IMITATION LEATHER SPORT BAGS AND GENERAL PURPOSE TROLLEY BAGS; LEATHER BAGS AND WALLETS; LEATHER BAGS FOR MERCHANDISE PACKAGING; LEATHER BAGS, SUITCASES AND WALLETS; LEATHER BINDERS FOR TRAVEL PURPOSES; LEATHER BOXES FOR STORING GREETING CARDS; LEATHER BRIEFCASES; LEATHER CASES; LEATHER CASES FOR KEYS; LEATHER CREDIT CARD CASES; LEATHER CREDIT CARD HOLDER; LEATHER CREDIT CARD WALLETS; LEATHER FOR FURNITURE; LEATHER FOR HARNESSSES; LEATHER FOR SHOES; LEATHER HANDBAGS; LEATHER KEY CASES; LEATHER KEY CHAINS; LEATHER LEADS; LEATHER LEASHES; LEATHER OR LEATHER-BOARD BOXES; LEATHER POUCHES; LEATHER PURSES; LEATHER SHOPPING BAGS; LEATHER SHOULDER BELTS; LEATHER SOLD IN BULK; LEATHER STRAPS; LEATHER THONGS; LEATHER THREAD; LEATHER, UNWROUGHT OR SEMI-WROUGHT; PET ACCESSORIES, NAMELY, CANVAS, VINYL AND LEATHER POUCHES FOR HOLDING DISPOSABLE BAGS TO PLACE PET WASTE IN; PET ACCESSORIES, NAMELY, SPECIALLY DESIGNED CANVAS, VINYL OR LEATHER BAGS ATTACHED TO ANIMAL LEASHES FOR HOLDING SMALL ITEMS SUCH AS KEYS, CREDIT CARDS, MONEY OR DISPOSABLE BAGS FOR DISPOSING OF PET WASTE; POLYURETHANE LEATHER; POUCHES MADE FROM IMITATION LEATHER; POUCHES OF LEATHER; SADDLERY OF LEATHER; TANNED LEATHER; THONGS; TRAVELLING CASES OF LEATHER; WALLETS MADE OF LEATHER OR OTHER MATERIALS; WORKED OR SEMI-WORKED HIDES AND OTHER LEATHER (U.S. CLS. 1, 2, 3, 22 AND 41).

LINDA POWELL, EXAMINING ATTORNEY

**CLASS 18—(Continued).**

SN 85-394,880. ANVIL KNITWEAR, INC., NEW YORK, NY. FILED 8-10-2011.



OWNER OF U.S. REG. NOS. 1,659,008, 3,083,117 AND OTHERS.

THE COLOR(S) BLACK AND RED IS/ARE CLAIMED AS A FEATURE OF THE MARK.

THE MARK CONSISTS OF THE WORD "ANVIL" IN BLACK WITH A RED LINE BELOW. THE WORDS "NOT JUST A T-SHIRT" APPEAR IN BLACK BENEATH THE RED LINE.

FOR BAGS, NAMELY, SHOULDER BAGS, DUFFLE BAGS, ATTACHE CASES, TOTE BAGS, ALL PURPOSE CARRYING BAGS; BOATER TOTE BAGS; SPORTS BAGS; MESSENGER BAGS (U.S. CLS. 1, 2, 3, 22 AND 41).

EMILY CARLSEN, EXAMINING ATTORNEY

**CLASS 19—NON-METALLIC BUILDING MATERIALS**

SN 76-703,761. CENTRAL STATES MANUFACTURING, INC., LOWELL, AR. FILED 7-12-2010.

**DRIPX**

THE MARK CONSISTS OF STANDARD CHARACTERS WITHOUT CLAIM TO ANY PARTICULAR FONT, STYLE, SIZE, OR COLOR.

FOR ROOFING MEMBRANES FOR APPLICATION ON METAL ROOF PANELS TO CONTROL CONDENSATION, NOT FOR INSULATING AND WATERPROOFING PURPOSES (U.S. CLS. 1, 12, 33 AND 50).

DAWN HAN, EXAMINING ATTORNEY

SN 85-068,339. HC BRIDGE COMPANY, LLC, WILMETTE, IL. FILED 6-22-2010.



THE MARK CONSISTS OF STYLIZED LETTERS "HCB" WITH AN ARC ELEMENT BEHIND THE LETTERS.

FOR BRIDGE BEAMS COMPOSED PRIMARILY OF NONMETAL MATERIALS (U.S. CLS. 1, 12, 33 AND 50).

FIRST USE 6-4-2010; IN COMMERCE 3-16-2011.

JULIE VEPPUMTHARA, EXAMINING ATTORNEY

**CLASS 19—(Continued).**

SN 85-089,180. COLUMBIA INSURANCE COMPANY, OMAHA, NE. FILED 7-21-2010.

**STA TITE**

THE MARK CONSISTS OF STANDARD CHARACTERS WITHOUT CLAIM TO ANY PARTICULAR FONT, STYLE, SIZE, OR COLOR.

FOR LOCKING SYSTEM SOLD AS A FEATURE OF VINYL FLOORING COMPRISING SELF LOCKING EDGE COMPONENTS MOLDED AS PART OF THE FLOORING (U.S. CLS. 1, 12, 33 AND 50).

JOSETTE BEVERLY, EXAMINING ATTORNEY

---

SN 85-193,519. FAIRY GARDENING, INC., LOVELAND, CO. FILED 12-8-2010.

**Fairy Gardening**

THE MARK CONSISTS OF STANDARD CHARACTERS WITHOUT CLAIM TO ANY PARTICULAR FONT, STYLE, SIZE, OR COLOR.

NO CLAIM IS MADE TO THE EXCLUSIVE RIGHT TO USE "GARDENING", APART FROM THE MARK AS SHOWN.

FOR DECORATIVE GARDEN PRODUCTS, NAMELY, MINIATURE FURNITURE MADE OF METAL, METAL GARDEN AND HOUSEHOLD ORNAMENTS; NATURAL ROCK PEBBLES FOR GARDENING LANDSCAPES (U.S. CLS. 1, 12, 33 AND 50).

FIRST USE 10-11-2005; IN COMMERCE 10-11-2005.  
ARETHA SOMERVILLE, EXAMINING ATTORNEY

---

SN 85-200,801. HOLTBY, QUINN, EDMONTON, CANADA, FILED 12-17-2010.

**KELLY KAN**

THE MARK CONSISTS OF STANDARD CHARACTERS WITHOUT CLAIM TO ANY PARTICULAR FONT, STYLE, SIZE, OR COLOR.

OWNER OF CANADA REG. NO. TMA478674, DATED 7-17-1997, EXPIRES 7-17-2012.

NO CLAIM IS MADE TO THE EXCLUSIVE RIGHT TO USE "KELLY", APART FROM THE MARK AS SHOWN.

FOR FLUID CONTAINMENT AND REDIRECTION APPARATUSES, NAMELY, NON-METAL PIPE JOINT ENCLOSURES FOR USE ON PIPE USED IN THE DRILLING AND SERVICING OF WELLS (U.S. CLS. 1, 12, 33 AND 50).

ANTHONY RINKER, EXAMINING ATTORNEY

**CLASS 19—(Continued).**

SN 85-265,577. CONSORCIO COMEX, S.A. DE C.V., MEXICO, D.F., MEXICO, FILED 3-13-2011.

**COMEX**

THE MARK CONSISTS OF STANDARD CHARACTERS WITHOUT CLAIM TO ANY PARTICULAR FONT, STYLE, SIZE, OR COLOR.

OWNER OF MEXICO REG. NO. 813653, DATED 11-24-2003, EXPIRES 8-13-2013.

OWNER OF U.S. REG. NOS. 1,958,222, 2,909,357 AND OTHERS.

FOR BUILDING MATERIALS, NAMELY, DRY WALL PANELS, PASTES, PLASTERS AND NON-METALLIC RIGID TUBES; ASPHALT, PITCH, AND BITUMEN (U.S. CLS. 1, 12, 33 AND 50).

MARK T. MULLEN, EXAMINING ATTORNEY

---

SN 85-272,214. TARKETT INC., FARNHAM, CANADA, FILED 3-21-2011.

**TRANSCEND**

THE MARK CONSISTS OF STANDARD CHARACTERS WITHOUT CLAIM TO ANY PARTICULAR FONT, STYLE, SIZE, OR COLOR.

FOR VINYL TILES (U.S. CLS. 1, 12, 33 AND 50).  
NORA BUCHANAN WILL, EXAMINING ATTORNEY

---

SN 85-286,737. EXTERIOR PORTFOLIO, LLC, COLUMBUS, OH. FILED 4-5-2011.

**SOLID CORE SYSTEM**

THE MARK CONSISTS OF STANDARD CHARACTERS WITHOUT CLAIM TO ANY PARTICULAR FONT, STYLE, SIZE, OR COLOR.

OWNER OF U.S. REG. NO. 2,938,988.  
NO CLAIM IS MADE TO THE EXCLUSIVE RIGHT TO USE "SYSTEM", APART FROM THE MARK AS SHOWN.  
SEC. 2(F).

FOR NON-METALLIC SIDING; NON-METALLIC DECORATIVE MOLDING AND DECORATIVE TRIM FOR USE IN BUILDING CONSTRUCTION, NAMELY, WINDOW AND CORNER LINEALS, WINDOW AND CORNER SILLS, AND WINDOW AND CORNER MOLDINGS, TRIM BOARDS, FINISH BOARDS, STARTER STRIPS, CORNER BOARDS AND CONNECTORS; NON-METAL CROWN MOLDING (U.S. CLS. 1, 12, 33 AND 50).

FIRST USE 12-31-2004; IN COMMERCE 12-31-2004.  
KIM SAITO, EXAMINING ATTORNEY



**CLASS 19—(Continued).**

SN 85-290,737. EXPERT POOL SUPPLY, INC., LAND O' LAKES, FL. FILED 4-8-2011.



OWNER OF U.S. REG. NO. 3,572,094.  
THE MARK CONSISTS OF A CHILD-LIKE STICK FIGURE WITH TEAR DROPS, OR RAIN DROPS AROUND IT. FOR NON-METAL SWIMMING POOL FENCING (U.S. CLS. 1, 12, 33 AND 50).  
FIRST USE 4-30-2008; IN COMMERCE 5-1-2008.  
KAREN K. BUSH, EXAMINING ATTORNEY

SN 85-293,640. STAPLES THE OFFICE SUPERSTORE, LLC., FRAMINGHAM, MA. FILED 4-13-2011.



NO CLAIM IS MADE TO THE EXCLUSIVE RIGHT TO USE "PROFESSIONAL", APART FROM THE MARK AS SHOWN.  
THE MARK CONSISTS OF A CIRCLE COMPRISED OF 4 CRESCENTS OVER THE WORDS "BRIGHTON PROFESSIONAL".  
FOR NON-LUMINOUS, NON-MECHANICAL FLOOR SIGNS NOT OF METAL (U.S. CLS. 1, 12, 33 AND 50).  
GIANCARLO CASTRO, EXAMINING ATTORNEY

SN 85-311,897. QUIRING MONUMENTS, INC., SEATTLE, WA. FILED 5-4-2011.

**LIVING HEADSTONE**

THE MARK CONSISTS OF STANDARD CHARACTERS WITHOUT CLAIM TO ANY PARTICULAR FONT, STYLE, SIZE, OR COLOR.  
NO CLAIM IS MADE TO THE EXCLUSIVE RIGHT TO USE "HEADSTONE", APART FROM THE MARK AS SHOWN.  
FOR GRAVE MARKERS AND MONUMENTS OF STONE (U.S. CLS. 1, 12, 33 AND 50).  
AMY HELLA, EXAMINING ATTORNEY

**CLASS 19—(Continued).**

SN 85-318,329. ASPHALT POTHOLE SOLUTIONS, LLC, NORWALK, OH. FILED 5-11-2011.



NO CLAIM IS MADE TO THE EXCLUSIVE RIGHT TO USE "SUPER PREMIUM" AND "PERMANENT ASPHALT REPAIR", APART FROM THE MARK AS SHOWN.  
THE COLOR(S) BLACK, GOLD, SILVER AND WHITE IS/ARE CLAIMED AS A FEATURE OF THE MARK.  
THE MARK CONSISTS OF THE WORDS "SUPER PREMIUM" IN GOLD LOCATED ABOVE "APS" LOCATED ABOVE "PERMANENT ASPHALT REPAIR" IN GOLD AGAINST A BLACK BACKGROUND WITH A COLOR GRADIENT AS TO THE LETTERS "APS" FROM WHITE TO GOLD ABOVE AN ARC STARTING AT THE BOTTOM LEFT OF THE "A" AND TRAVELING ACROSS TO THE UPPER RIGHT OF THE "S" WITH THE LETTERS IN GOLD BELOW SAID ARC WITH ALL LETTERS OUTLINED IN SILVER.  
FOR ASPHALT; ASPHALT COMPOSITION PAVING; ASPHALT PATCHING COMPOUND MADE OF A TAR BASE; ASPHALT PAVING COMPOSITIONS; ASPHALT, PITCH AND BITUMEN; BITUMEN ASPHALT; TAR-BASED CONCRETE AND ASPHALT PATCHING COMPOUND (U.S. CLS. 1, 12, 33 AND 50).  
CAROLINE WOOD, EXAMINING ATTORNEY

SN 85-321,536. CARMEUSE LIME, INC., PITTSBURGH, PA. FILED 5-16-2011.

**MIRACLE E-Z SPREAD**

THE MARK CONSISTS OF STANDARD CHARACTERS WITHOUT CLAIM TO ANY PARTICULAR FONT, STYLE, SIZE, OR COLOR.  
OWNER OF U.S. REG. NO. 705,137.  
NO CLAIM IS MADE TO THE EXCLUSIVE RIGHT TO USE "SPREAD", APART FROM THE MARK AS SHOWN.  
FOR NON-AGRICULTURAL BUILDING LIME (U.S. CLS. 1, 12, 33 AND 50).  
FIRST USE 10-31-2010; IN COMMERCE 10-31-2010.  
EMILY CHUO, EXAMINING ATTORNEY

**CLASS 19—(Continued).**

SN 85-325,066. FO4, LLC, GROSSE POINTE, MI. FILED 5-19-2011.



THE MARK CONSISTS OF THE STYLIZED WORDING "GUTTERPULT" WITH THE DESIGN OF A GUARD FOR GUTTERS HINGED ON THE LETTER "U" WITH DISPERSED STICK, LEAVES, AND ACORNS ABOVE THE LETTER "P".

FOR NON-METAL DEBRIS GUARDS FOR GUTTERS (U.S. CLS. 1, 12, 33 AND 50).  
JEAN IM, EXAMINING ATTORNEY

SN 85-332,024. STUBENRAUCH, FRED, MERRIAM, KS. FILED 5-27-2011.

# SURFAUX

THE MARK CONSISTS OF STANDARD CHARACTERS WITHOUT CLAIM TO ANY PARTICULAR FONT, STYLE, SIZE, OR COLOR.

FOR CERAMIC TILES; NON-METAL CEILING PANELS; NON-METAL CEILING TILES; NON-METAL WAINSCOTTING; PLASTIC TILES; TILES OF CERAMIC FOR WALL, FLOOR OR CEILING; WOOD BOARDS; WOOD MOLDINGS; WOOD PANELLING; WOOD TRIM; WOOD WINDOW FRAMES; WOODEN WAINSCOTING (U.S. CLS. 1, 12, 33 AND 50).

REBECCA POVARCHUK, EXAMINING ATTORNEY

SN 85-332,252. QUARRY TILE COMPANY, SPOKANE, WA. FILED 5-27-2011.

# Natural Hues

THE MARK CONSISTS OF STANDARD CHARACTERS WITHOUT CLAIM TO ANY PARTICULAR FONT, STYLE, SIZE, OR COLOR.

SEC. 2(F).

FOR CERAMIC TILES (U.S. CLS. 1, 12, 33 AND 50).  
FIRST USE 1-1-1970; IN COMMERCE 1-1-1970.

JEAN IM, EXAMINING ATTORNEY

**CLASS 19—(Continued).**

SN 85-333,203. PRODUITS FORESTIERS LAMCO INC., ST-FÉLICIEN, QUÉBEC, CANADA, FILED 5-29-2011.

# LAMCO

THE MARK CONSISTS OF STANDARD CHARACTERS WITHOUT CLAIM TO ANY PARTICULAR FONT, STYLE, SIZE, OR COLOR.

FOR WOOD PLANKS; PREFABRICATED ADVANCED ENGINEERED LUMBER (U.S. CLS. 1, 12, 33 AND 50).

FIRST USE 1-29-2002; IN COMMERCE 1-29-2002.

ELISSA GARBER KON, EXAMINING ATTORNEY

SN 85-333,241. PRODUITS FORESTIERS LAMCO INC., ST-FÉLICIEN, QUÉBEC, CANADA, FILED 5-29-2011.

# LAMLOCK

THE MARK CONSISTS OF STANDARD CHARACTERS WITHOUT CLAIM TO ANY PARTICULAR FONT, STYLE, SIZE, OR COLOR.

FOR WOOD PLANKS; PREFABRICATED ADVANCED ENGINEERED LUMBER (U.S. CLS. 1, 12, 33 AND 50).

ELISSA GARBER KON, EXAMINING ATTORNEY

SN 85-333,245. PRODUITS FORESTIERS LAMCO INC., ST-FÉLICIEN, QUÉBEC, CANADA, FILED 5-29-2011.

# LJL

THE MARK CONSISTS OF STANDARD CHARACTERS WITHOUT CLAIM TO ANY PARTICULAR FONT, STYLE, SIZE, OR COLOR.

FOR WOOD PLANKS; PREFABRICATED ADVANCED ENGINEERED LUMBER (U.S. CLS. 1, 12, 33 AND 50).

ELISSA GARBER KON, EXAMINING ATTORNEY

**CLASS 19—(Continued).**

SN 85-333,608. MULTY HOME, LP, CONCORD, CANADA,  
FILED 5-31-2011.

# ENVIROTILE

THE MARK CONSISTS OF STANDARD CHARACTERS  
WITHOUT CLAIM TO ANY PARTICULAR FONT, STYLE,  
SIZE, OR COLOR.

FOR PAVING TILES, PATIO PAVERS, RUBBER PATIO  
STONES, RUBBER FLOOR TILES (U.S. CLS. 1, 12, 33  
AND 50).

FIRST USE 11-0-2010; IN COMMERCE 11-0-2010.  
KIM MONINGHOFF, EXAMINING ATTORNEY

SN 85-333,919. MAJESKA & ASSOCIATES LLC, TULSA, OK.  
FILED 5-31-2011.

# AXYS

THE MARK CONSISTS OF STANDARD CHARACTERS  
WITHOUT CLAIM TO ANY PARTICULAR FONT, STYLE,  
SIZE, OR COLOR.

FOR ASPHALT-BASED SEALANTS FOR USE ON  
PAVEMENTS (U.S. CLS. 1, 12, 33 AND 50).

TRACY FLETCHER, EXAMINING ATTORNEY

SN 85-334,295. MARVIN LUMBER AND CEDAR COMPANY,  
WARROD, MN. FILED 5-31-2011.

# INTEGRITY FROM MARVIN

THE MARK CONSISTS OF STANDARD CHARACTERS  
WITHOUT CLAIM TO ANY PARTICULAR FONT, STYLE,  
SIZE, OR COLOR.

OWNER OF U.S. REG. NOS. 1,947,296, 3,849,838 AND  
OTHERS.  
FOR NON-METAL WINDOWS AND DOORS (U.S. CLS.  
1, 12, 33 AND 50).

FIRST USE 11-30-1993; IN COMMERCE 11-30-1993.  
ALICE BENMAMAN, EXAMINING ATTORNEY

**CLASS 19—(Continued).**

SN 85-336,046. MILGARD MANUFACTURING INCORPO-  
RATED, TACOMA, WA. FILED 6-2-2011.

# ProAssist

THE MARK CONSISTS OF STANDARD CHARACTERS  
WITHOUT CLAIM TO ANY PARTICULAR FONT, STYLE,  
SIZE, OR COLOR.

FOR NON-METAL WINDOWS AND PATIO DOORS  
(U.S. CLS. 1, 12, 33 AND 50).

TRICIA SONNEBORN, EXAMINING ATTORNEY

SN 85-337,577. LANCIAUX, FRAN, GRAND RAPIDS, OH.  
FILED 6-3-2011.

# ThermaDuct

THE MARK CONSISTS OF STANDARD CHARACTERS  
WITHOUT CLAIM TO ANY PARTICULAR FONT, STYLE,  
SIZE, OR COLOR.

FOR NON-METAL AIR CONDITIONING DUCTS;  
NON-METAL DUCTS; NON-METAL HEATING DUCTS;  
NON-METAL VENTILATING DUCTS (U.S. CLS. 1, 12, 33  
AND 50).

KATHLEEN LORENZO, EXAMINING ATTORNEY

SN 85-337,697. HECHT, JAMES CHRISTOPHER, SAGLE, ID.  
FILED 6-3-2011.

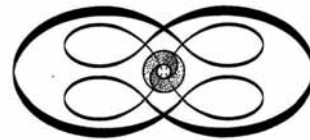

# DESIGN FOR LIFE

NO CLAIM IS MADE TO THE EXCLUSIVE RIGHT TO  
USE "DESIGN", APART FROM THE MARK AS SHOWN.

THE STIPPLING IS A FEATURE OF THE MARK AND  
DOES NOT INDICATE COLOR.

THE MARK CONSISTS OF THE WORDS "DESIGN FOR  
LIFE" AND TWO SIDE BY SIDE HORIZONTALLY  
ALIGNED INTERSECTING OVALS, EACH OVAL HAVING  
WITHIN ITS CENTER PORTION TWO SPACED APART  
VERTICALLY ALIGNED OVALS, AND A CIRCLE AT THE  
CENTER.

FOR SCULPTURES MADE OF CONCRETE FOR  
HOLDING AND CASCADING WATER (U.S. CLS. 1, 12,  
33 AND 50).

FIRST USE 2-1-1994; IN COMMERCE 2-1-1994.  
RICHARD WHITE, EXAMINING ATTORNEY

**CLASS 19—(Continued).**

SN 85-337,716. PERGO (EUROPE) AB, TRELLEBORG, SWEDEN, FILED 6-3-2011.

**GRAND EXPRESSIONS**

THE MARK CONSISTS OF STANDARD CHARACTERS WITHOUT CLAIM TO ANY PARTICULAR FONT, STYLE, SIZE, OR COLOR.

FOR FLOORING, NAMELY, WOOD, THERMOSETTING LAMINATE, THERMOSETTING LAMINATE BONDED TO A BASE OF PARTICLE BOARD OR FIBERBOARD AND PARTICLE BOARD OR FIBERBOARD PROVIDED WITH A DECORATIVE SURFACE OR COATING (U.S. CLS. 1, 12, 33 AND 50).

FIRST USE 5-1-2011; IN COMMERCE 5-1-2011.  
MICHELE SWAIN, EXAMINING ATTORNEY

---

SN 85-339,767. JEFFREY COURT, INC., ANAHEIM HILLS, CA. FILED 6-7-2011.

**COURTLY**

THE MARK CONSISTS OF STANDARD CHARACTERS WITHOUT CLAIM TO ANY PARTICULAR FONT, STYLE, SIZE, OR COLOR.

FOR GLASS TILES; CERAMIC TILES (U.S. CLS. 1, 12, 33 AND 50).

FIRST USE 1-0-2009; IN COMMERCE 1-0-2009.  
JIM RINGLE, EXAMINING ATTORNEY

---

SN 85-340,055. POLYCEM, LLC, SPRING LAKE, MI. FILED 6-7-2011.

**BETONA**

THE MARK CONSISTS OF STANDARD CHARACTERS WITHOUT CLAIM TO ANY PARTICULAR FONT, STYLE, SIZE, OR COLOR.

FOR TILES MADE OF POLYMERS AND CONCRETE FOR INTERIOR AND EXTERIOR USE ON WALLS AND FLOORS (U.S. CLS. 1, 12, 33 AND 50).

FIRST USE 11-11-2009; IN COMMERCE 11-11-2009.  
KATHRYN COWARD, EXAMINING ATTORNEY

**CLASS 19—(Continued).**

SN 85-340,125. INDÚSTRIA MECÂNICA NTC LTDA., CAXIAS DO SUL, RS, BRAZIL, FILED 6-7-2011.



OWNER OF BRAZIL REG. NO. 900671041, DATED 3-9-2010, EXPIRES 3-9-2020.

NO CLAIM IS MADE TO THE EXCLUSIVE RIGHT TO USE "PIER", APART FROM THE MARK AS SHOWN.

THE MARK CONSISTS OF THE STYLIZED WORDS PIER PLUS WITH A DESIGN OF TWO SQUARES IN BETWEEN THE TWO WORDS, THE BIGGER OF WHICH IS TILTED TO THE RIGHT AND THE SMALLER OF WHICH IS TILTED TO THE LEFT AND VARIOUS SIZED CIRCLES APPEARING IN FRONT OF THE SQUARES DESIGN. A DESIGN OF OVAL RINGS GRADUALLY BECOMING LARGER FROM ITS CENTER POINT APPEARS BELOW AND BEHIND THE SQUARES DESIGN AND THE WORDS PIER PLUS.

FOR NON-METAL FLOATING DOCKS; NON-METAL PORTABLE PIER WHICH EXTENDS FROM A SHORE LINE OUT OVER WATER (U.S. CLS. 1, 12, 33 AND 50).  
ALLISON HOLTZ, EXAMINING ATTORNEY

---

SN 85-370,556. HORIZON GROUP USA, INC., WARREN, NJ. FILED 7-13-2011.

**CREATIVE ROOTS**

THE MARK CONSISTS OF STANDARD CHARACTERS WITHOUT CLAIM TO ANY PARTICULAR FONT, STYLE, SIZE, OR COLOR.

FOR STEPPING AND FOOTING STONES OF CONCRETE OR WOOD FOR USE IN LAWNS AND PATHWAYS (U.S. CLS. 1, 12, 33 AND 50).

REGINA DRUMMOND, EXAMINING ATTORNEY

---

SN 85-378,934. LATHAM POOL PRODUCTS, INC., LATHAM, NY. FILED 7-22-2011.

**INVIS-A-DRAIN**

THE MARK CONSISTS OF STANDARD CHARACTERS WITHOUT CLAIM TO ANY PARTICULAR FONT, STYLE, SIZE, OR COLOR.

FOR A COMPONENT OF FITTED POOL COVERS COMPRISING DRAIN HOLES AND A DRAIN FILTER PANEL FOR REMOVING AND FILTERING WATER THAT COLLECTS ON THE POOL COVER DURING USE (U.S. CLS. 1, 12, 33 AND 50).

FIRST USE 5-3-1999; IN COMMERCE 5-3-1999.  
JESSICA A. POWERS, EXAMINING ATTORNEY

**CLASS 19—(Continued).**

SN 85-386,402. BESTWOODS.COM LC, FORMERLY BEST WOODS, INC., OREM, UT. FILED 8-1-2011.



NO CLAIM IS MADE TO THE EXCLUSIVE RIGHT TO USE "BEST WOODS", APART FROM THE MARK AS SHOWN.

THE COLOR(S) MAROON, YELLOW, GREEN, LIGHT GREEN, GOLD AND BLACK IS/ARE CLAIMED AS A FEATURE OF THE MARK.

THE MARK CONSISTS OF THE YELLOW PINSTRIPED WORDING "BEST" ABOVE THE YELLOW WORDING "WOODS" WITH A BLACK DROP SHADOW CENTERED IN THE MIDDLE OF A GREEN OVAL WITH LIGHT GREEN HORIZONTAL PINSTRIPES, WITH THE YELLOW WORDING "BUILT TO LAST" ON A MAROON BANNER OUTLINED IN GOLD AND BLACK POSITIONED AT THE TOP OF THE GREEN OVAL, AND THE YELLOW WORDING "A LIFETIME" ON A MAROON BANNER OUTLINED IN GOLD AND BLACK POSITIONED BELOW.

FOR NON-METAL PREFABRICATED WOODWORK, NAMELY, DOOR AND WINDOW PEDIMENTS, FIRE-PLACE MANTELS, DOOR AND WINDOW CASINGS AND TRIM, AND MOLDING, ALL ITEMS MADE OF WOOD (U.S. CLS. 1, 12, 33 AND 50).

FIRST USE 6-27-1997; IN COMMERCE 7-28-1997.  
TRACY FLETCHER, EXAMINING ATTORNEY

**CLASS 20—FURNITURE AND ARTICLES NOT OTHERWISE CLASSIFIED**

SN 76-162,990. NATIONAL COUNCIL OF THE LEWIS & CLARK BICENTENNIAL, PORTLAND, OR. FILED 11-9-2000.



NO CLAIM IS MADE TO THE EXCLUSIVE RIGHT TO USE "LEWIS & CLARK BICENTENNIAL", APART FROM THE MARK AS SHOWN.

FOR PLASTIC KEY CHAINS; PICTURE FRAMES; PLASTIC LICENSE PLATES; SEAT CUSHIONS (U.S. CLS. 2, 13, 22, 25, 32 AND 50).

HENRY S. ZAK, EXAMINING ATTORNEY

SN 76-705,923. DUTCH MADE, INC., GRABILL, IN. FILED 1-6-2011.

SN 85-400,379. H.B. FULLER CONSTRUCTION PRODUCTS INC., SAINT PAUL, MN. FILED 8-17-2011.



**DESIGNCOLOR**

THE MARK CONSISTS OF STANDARD CHARACTERS WITHOUT CLAIM TO ANY PARTICULAR FONT, STYLE, SIZE, OR COLOR.

OWNER OF U.S. REG. NOS. 2,085,897, 3,313,302 AND 3,681,249.

FOR COLOR CONSISTENT PORTLAND CEMENT GROUT FOR INTERIOR AND EXTERIOR USE (U.S. CLS. 1, 12, 33 AND 50).

MIDGE BUTLER, EXAMINING ATTORNEY

OWNER OF U.S. REG. NOS. 2,407,888 AND 3,387,240.  
NO CLAIM IS MADE TO THE EXCLUSIVE RIGHT TO USE "INC. CUSTOM CABINETRY", APART FROM THE MARK AS SHOWN.

THE MARK CONSISTS OF THE DESIGN OF A MAN WITH A HORSE AND BUGGY IN A SQUARE. TO THE RIGHT OF THE DESIGN IS THE STYLIZED TEXT "DUTCH MADE INC." OVER A HORIZONTAL LINE AND BELOW THE HORIZONTAL LINE IS THE STYLIZED TEXT "CUSTOM CABINETRY".

SEC. 2(F) AS TO "DUTCH MADE INC. CUSTOM CABINETRY".

FOR WOOD CABINETS (U.S. CLS. 2, 13, 22, 25, 32 AND 50).

FIRST USE 0-0-1967; IN COMMERCE 0-0-1984.  
KIM SAITO, EXAMINING ATTORNEY

**CLASS 20—(Continued).**

SN 77-775,026. AYA KITCHENS AND BATHS LTD., MISSISSAUGUA, ONTARIO, CANADA, FILED 7-6-2009.

# AYA

THE MARK CONSISTS OF STANDARD CHARACTERS WITHOUT CLAIM TO ANY PARTICULAR FONT, STYLE, SIZE, OR COLOR.

OWNER OF U.S. REG. NOS. 2,903,723, 2,903,725 AND 2,914,884.

THE ENGLISH TRANSLATION OF "AYA" IN THE MARK IS "DESIGN".

FOR CABINETS, NAMELY, CABINETS, DRAWERS, AND SHELVING; FURNITURE, NAMELY, COUNTERS; AND NON-METAL CABINETS HARDWARE, NAMELY, NON-METAL HANDLES AND KNOBS (U.S. CLS. 2, 13, 22, 25, 32 AND 50).

FIRST USE 8-1-2001; IN COMMERCE 8-1-2001.  
JOHN DALIER, EXAMINING ATTORNEY

---

SN 79-055,629. SIEMATIC MÖBELWERKE GMBH & CO. KG, FED REP GERMANY, FILED 6-10-2008.

# SIGNIA

THE MARK CONSISTS OF STANDARD CHARACTERS WITHOUT CLAIM TO ANY PARTICULAR FONT, STYLE, SIZE, OR COLOR.

OWNER OF INTERNATIONAL REGISTRATION 0865328 DATED 8-23-2005, EXPIRES 8-23-2015.

OWNER OF U.S. REG. NO. 3,485,313.

FOR FURNITURE, ESPECIALLY KITCHEN FURNITURE AND THEIR PARTS, INCLUDED IN THIS CLASS (U.S. CLS. 2, 13, 22, 25, 32 AND 50).

DAYNA BROWNE, EXAMINING ATTORNEY

---

SN 85-153,263. WILLIS R PARSONS III, DBA WILLIS CUSTOM CRAFT, LLC, RICHMOND, VA. FILED 10-14-2010.

# Sleep-n-Swing

THE MARK CONSISTS OF STANDARD CHARACTERS WITHOUT CLAIM TO ANY PARTICULAR FONT, STYLE, SIZE, OR COLOR.

FOR PORCH SWINGS (U.S. CLS. 2, 13, 22, 25, 32 AND 50).

FIRST USE 7-1-2007; IN COMMERCE 2-1-2010.  
DAVID TOOLEY, EXAMINING ATTORNEY

**CLASS 20—(Continued).**

SN 85-160,269. JANUS ET CIE, WEST HOLLYWOOD, CA. FILED 10-25-2010.

# RELAIS

THE MARK CONSISTS OF STANDARD CHARACTERS WITHOUT CLAIM TO ANY PARTICULAR FONT, STYLE, SIZE, OR COLOR.

FOR INDOOR AND OUTDOOR FURNITURE, NAMELY, ARMCHAIRS, ARMOIRES, BENCHES, BOOK STANDS, BOOKCASES, CABINETS, PLANT STANDS, HAND OPERATED NON-METAL GARDEN HOSE REELS, HOSE HANGERS NOT OF METAL, CHAIRS, ROCKING CHAIRS, CHAISE LOUNGES, SETTEES, BEDROOM FURNITURE, CHESTS OF DRAWERS, LOVE SEATS, COUCHES, CREDENZAS, PLASTIC TUBS, CUSHIONS, DESKS, DINING ROOM TABLES, COFFEE TABLES, CONSOLES, END TABLES, CAFE TABLES, SOFA TABLES, PEDESTAL TABLES, EXTENSION TABLES, OFFICE FURNITURE, CHILDREN'S FURNITURE, OTTOMANS, DRESSERS, WALL UNITS, SEATS, SOFAS AND STOOLS (U.S. CLS. 2, 13, 22, 25, 32 AND 50).

ANTHONY RINKER, EXAMINING ATTORNEY

---

SN 85-165,949. MULLINIX PACKAGES, INC., FORT WAYNE, IN. FILED 11-1-2010.

# MX Stay Cool

THE MARK CONSISTS OF STANDARD CHARACTERS WITHOUT CLAIM TO ANY PARTICULAR FONT, STYLE, SIZE, OR COLOR.

FOR PLASTIC BEVERAGE, CONFECTION AND FANCY AND STAPLE FOODSTUFF CONTAINERS FOR THE FOOD INDUSTRY (U.S. CLS. 2, 13, 22, 25, 32 AND 50).

JAMES A. RAUEN, EXAMINING ATTORNEY

**CLASS 20—(Continued).**

SN 85-174,302. EASTER UNLIMITED, INC., CARLE PLACE, NY. FILED 11-11-2010.

**TOMBSTONE HUGGERS**

THE MARK CONSISTS OF STANDARD CHARACTERS WITHOUT CLAIM TO ANY PARTICULAR FONT, STYLE, SIZE, OR COLOR.

NO CLAIM IS MADE TO THE EXCLUSIVE RIGHT TO USE "TOMBSTONE", APART FROM THE MARK AS SHOWN.

FOR OUTDOOR DECORATIONS, NAMELY, POLY RESIN FIGURINES, POLYSTONE FIGURINES, SHELVES, WOOD FIGURES; OUTDOOR HOLIDAY DECORATIONS, NAMELY, OUTDOOR HOLIDAY DECORATIONS MADE OF CLEAR OR TRANSLUCENT PVC OR POLYPROPYLENE DIE CUT FORMS HAVING HOLIDAY THEMED SHAPES AND ICONS, DECORATIVE DISPLAY STANDS, SEASONAL HOLIDAY DECORATIONS OF PLASTIC; DISPLAY STANDS EXHIBITING THEME DECORATIONS; PLASTIC FIGURINES; SOFT SCULPTURE DECORATIONS, NAMELY, SOFT SCULPTURE WALL, TABLETOP OR HANGING DECORATIONS; FIGURINES AND SCULPTURES OF BONE, IVORY, PLASTER, PLASTIC, WAX, WOOD (U.S. CLS. 2, 13, 22, 25, 32 AND 50).

LINDA POWELL, EXAMINING ATTORNEY

SN 85-182,530. UNSPOKEN EMOTIONS, GRAFTON, MA. FILED 11-22-2010.

**Unspoken Emotions**

THE MARK CONSISTS OF STANDARD CHARACTERS WITHOUT CLAIM TO ANY PARTICULAR FONT, STYLE, SIZE, OR COLOR.

FOR DECORATIVE BOXES MADE OF WOOD (U.S. CLS. 2, 13, 22, 25, 32 AND 50).

FIRST USE 5-5-2010; IN COMMERCE 5-5-2010.  
SALLY SHIH, EXAMINING ATTORNEY

**CLASS 20—(Continued).**

SN 85-184,555. LOZANO, ANTHONY, SAN JOSE, CA. FILED 11-24-2010.

**HOSPITALITY MOUNT**

THE MARK CONSISTS OF STANDARD CHARACTERS WITHOUT CLAIM TO ANY PARTICULAR FONT, STYLE, SIZE, OR COLOR.

OWNER OF U.S. REG. NO. 3,868,203.

NO CLAIM IS MADE TO THE EXCLUSIVE RIGHT TO USE "MOUNT", APART FROM THE MARK AS SHOWN.

FOR MOUNTING DEVICES AND MOUNTING AIDS NOT OF METAL, FIXED OR MOVABLE, NAMELY, MOUNTING PANELS USED TO MOUNT FLAT SCREEN TV MONITORS (U.S. CLS. 2, 13, 22, 25, 32 AND 50).

FIRST USE 11-3-2009; IN COMMERCE 11-3-2009.

KAREN SEVERSON, EXAMINING ATTORNEY

SN 85-195,568. TARGET BRANDS, INC., MINNEAPOLIS, MN. FILED 12-10-2010.

**SOLENTI**

THE MARK CONSISTS OF STANDARD CHARACTERS WITHOUT CLAIM TO ANY PARTICULAR FONT, STYLE, SIZE, OR COLOR.

THE WORDING "SOLENTI" HAS NO MEANING IN A FOREIGN LANGUAGE.

FOR FURNITURE (U.S. CLS. 2, 13, 22, 25, 32 AND 50).

CHRISTINA SOBRAL, EXAMINING ATTORNEY

SN 85-199,845. FELDENKRAIS GUILD OF NORTH AMERICA, PORTLAND, OR. FILED 12-16-2010.

**FELDENKRAIS**

THE MARK CONSISTS OF STANDARD CHARACTERS WITHOUT CLAIM TO ANY PARTICULAR FONT, STYLE, SIZE, OR COLOR.

OWNER OF U.S. REG. NOS. 1,337,397 AND 1,374,266.  
SEC. 2(F).

FOR FURNITURE, NAMELY, TABLES AND STOOLS (U.S. CLS. 2, 13, 22, 25, 32 AND 50).

FIRST USE 9-30-1980; IN COMMERCE 9-30-1980.

JOHN SCHUYLER YARD, EXAMINING ATTORNEY

**CLASS 20—(Continued).**

SN 85-200,367. CLEAF S.P.A., MACHERIO, ITALY, FILED 12-17-2010.

**CLEAF**

THE MARK CONSISTS OF STANDARD CHARACTERS WITHOUT CLAIM TO ANY PARTICULAR FONT, STYLE, SIZE, OR COLOR.

FOR DOOR STOPS OF WOOD; FURNITURE MADE FROM WOOD OR SUBSTITUTES FOR WOOD; LAMINATED VINYL TO BE AFFIXED TO THE SURFACE OF FURNITURE; PLACARDS OF WOOD OR PLASTIC; WOOD PRODUCTS, NAMELY, COMPOSITE PANELS, PARTICLEBOARD AND FIBERBOARD FOR USE IN FURTHER MANUFACTURING (U.S. CLS. 2, 13, 22, 25, 32 AND 50).

FIRST USE 7-23-2004; IN COMMERCE 7-23-2004.  
CHRISTINE COOPER, EXAMINING ATTORNEY

SN 85-204,299. TARGET BRANDS, INC., MINNEAPOLIS, MN. FILED 12-22-2010.

**MORAVA**

THE MARK CONSISTS OF STANDARD CHARACTERS WITHOUT CLAIM TO ANY PARTICULAR FONT, STYLE, SIZE, OR COLOR.

THE WORDING "MORAVA" HAS NO MEANING IN A FOREIGN LANGUAGE.

FOR FURNITURE (U.S. CLS. 2, 13, 22, 25, 32 AND 50).  
CHRISTINA SOBRAL, EXAMINING ATTORNEY

SN 85-214,087. MATTRESS DEVELOPMENT COMPANY OF DELAWARE LLC, NORTH BRUNSWICK, NJ. FILED 1-10-2011.

**HEART OF GOLD BRAND**

THE MARK CONSISTS OF STANDARD CHARACTERS WITHOUT CLAIM TO ANY PARTICULAR FONT, STYLE, SIZE, OR COLOR.

NO CLAIM IS MADE TO THE EXCLUSIVE RIGHT TO USE "BRAND", APART FROM THE MARK AS SHOWN.

FOR MATTRESSES (U.S. CLS. 2, 13, 22, 25, 32 AND 50).  
APRIL ROACH, EXAMINING ATTORNEY

**CLASS 20—(Continued).**

SN 85-241,315. FPRODUCT INC, BROOKLYN, NY. FILED 2-14-2011.

**Gel Pal**

THE MARK CONSISTS OF STANDARD CHARACTERS WITHOUT CLAIM TO ANY PARTICULAR FONT, STYLE, SIZE, OR COLOR.

NO CLAIM IS MADE TO THE EXCLUSIVE RIGHT TO USE "GEL", APART FROM THE MARK AS SHOWN.

FOR SILICONE CUSHION FILLED WITH SILICONE GEL (U.S. CLS. 2, 13, 22, 25, 32 AND 50).

FIRST USE 10-1-2010; IN COMMERCE 10-1-2010.  
MARK SPARACINO, EXAMINING ATTORNEY

SN 85-242,861. BEDFORD INDUSTRIES, INC., WORTHINGTON, MN. FILED 2-15-2011.

**ELASTIPAK**

THE MARK CONSISTS OF STANDARD CHARACTERS WITHOUT CLAIM TO ANY PARTICULAR FONT, STYLE, SIZE, OR COLOR.

OWNER OF U.S. REG. NOS. 3,327,803 AND 3,538,259.

FOR PLASTIC HANG TAG HAVING A RESILIENT FASTENER (U.S. CLS. 2, 13, 22, 25, 32 AND 50).

MARTHA FROMM, EXAMINING ATTORNEY

SN 85-252,123. THE STOW COMPANY, FORMERLY WINDQUEST COMPANIES, INC, HOLLAND, MI. FILED 2-25-2011.

**Bringing Order To Life**

THE MARK CONSISTS OF STANDARD CHARACTERS WITHOUT CLAIM TO ANY PARTICULAR FONT, STYLE, SIZE, OR COLOR.

FOR STORAGE AND ORGANIZATION SYSTEMS COMPRISING SHELVES, DRAWERS, CUPBOARDS, BASKETS AND CLOTHES RODS, SOLD AS A UNIT (U.S. CLS. 2, 13, 22, 25, 32 AND 50).

FIRST USE 1-21-2011; IN COMMERCE 1-21-2011.  
LINDA POWELL, EXAMINING ATTORNEY



**CLASS 20—(Continued).**

SN 85-260,678. GROUPE CABICO INC., COATICOOK (QUEBEC), CANADA, FILED 3-8-2011.



OWNER OF U.S. REG. NOS. 3,078,846 AND 3,850,438.  
NO CLAIM IS MADE TO THE EXCLUSIVE RIGHT TO USE "VANITIES COLLECTION" AND "CUSTOM CABINETRY", APART FROM THE MARK AS SHOWN.

THE COLOR(S) RED, BLACK AND LIGHT YELLOW IS/ARE CLAIMED AS A FEATURE OF THE MARK.

THE MARK CONSISTS OF THE WORD "TANGO" COLORED IN RED, THE WORDS "STYLE & FUNCTION IN PERFECT STEP" COLORED IN BLACK, THE WORDS "VANITIES COLLECTION BY" COLORED IN BLACK, AND THE WORDS "CABICO CUSTOM CABINETRY" IN A SQUARE COLORED IN LIGHT YELLOW OUTLINED IN BLACK WITH "CABICO" APPEARING IN BLACK AND "CUSTOM CABINETRY" IN RED.

FOR BATHROOM VANITIES (U.S. CLS. 2, 13, 22, 25, 32 AND 50).

MARILYN IZZI, EXAMINING ATTORNEY

**CLASS 20—(Continued).**

SN 85-304,293. WADHWANI, CHANDRU, GARDEN GROVE, CA. FILED 4-25-2011.



NO CLAIM IS MADE TO THE EXCLUSIVE RIGHT TO USE "PILLOW", APART FROM THE MARK AS SHOWN.

THE MARK CONSISTS OF AN IMAGE OF A DOG'S HEAD AT THE CENTER, THE TEXT "GET ME OUT!" ARCHED ABOVE, AND "PILLOW" IN AN INVERTED ARCH BELOW THE IMAGE.

FOR PILLOWS AND CUSHIONS THAT TRANSFORM INTO PLUSH TOYS (U.S. CLS. 2, 13, 22, 25, 32 AND 50).

FIRST USE 2-10-2011; IN COMMERCE 2-20-2011.

KEVON CHISOLM, EXAMINING ATTORNEY

SN 85-277,959. BERRYMAN-KENT, ELIZABETH, DBA DECORATIVE WALLS & CREATIVE ARTS LLC, RICHMOND, VA. FILED 3-26-2011.

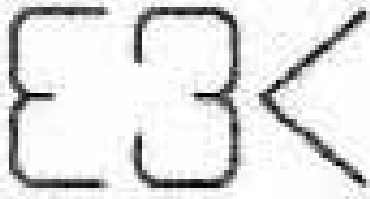

THE MARK CONSISTS OF THE TERM "E3" AND THE LESS-THAN SIGN IN STYLIZED FORM.

FOR END TABLES; OTTOMAN SEATS; OTTOMANS (U.S. CLS. 2, 13, 22, 25, 32 AND 50).

TARA PATE, EXAMINING ATTORNEY

SN 85-305,656. LOIS SIMON, PONTE VEDRA BEACH, FL. FILED 4-27-2011.



NO CLAIM IS MADE TO THE EXCLUSIVE RIGHT TO USE "STAND", APART FROM THE MARK AS SHOWN.

THE MARK CONSISTS OF THE MARK IS COMPRISED OF TWO (2) VERTICAL LINES WITH A SMALL SPACE BETWEEN THE TWO VERTICAL LINES. THE VERTICAL LINES INTERSECT WITH HORIZONTAL LINES AT THE TOP AND BOTTOM TO GIVE THE APPEARANCE OF AN UPPER CASE "I". THE UPPER HORIZONTAL LINE SHOW SLIGHT PROTRUSIONS FROM THE TWO VERTICAL LINES, WHILE THE LOWER, HORIZONTAL INTERSECTION LINE IS SLIGHTLY LONGER THAN THE UPPER HORIZONTAL LINE, AND REPRESENTS THE BASE OF THE "I" STAND TABLE. THIS RENDERING SETS ATOP THE LETTERS "S", "T", "A", "N" AND "D" AND TOGETHER CREATES THE "I STAND" MARK.

FOR BEDSIDE TABLES; CONSOLE TABLES; DINING ROOM TABLES; DISPLAY TABLES; END TABLES; FURNITURE PRIMARILY OF METAL, NAMELY, MIRRORS, BED FRAMES, DINING TABLES, COFFEE TABLES, END TABLES, DESKS, DISPLAY CASES, SHELVING, DOG GATES, AND BABY GATES; NIGHT TABLES; OCCASIONAL TABLES (U.S. CLS. 2, 13, 22, 25, 32 AND 50).

FIRST USE 10-1-2010; IN COMMERCE 10-1-2010.

MATTHEW EINSTEIN, EXAMINING ATTORNEY

SN 85-294,873. CHIC TEAK INCORPORATED, FOLEY, AL. FILED 4-14-2011.

# Chic Teak

THE MARK CONSISTS OF STANDARD CHARACTERS WITHOUT CLAIM TO ANY PARTICULAR FONT, STYLE, SIZE, OR COLOR.

OWNER OF U.S. REG. NO. 2,805,600.

NO CLAIM IS MADE TO THE EXCLUSIVE RIGHT TO USE "TEAK", APART FROM THE MARK AS SHOWN.

FOR FURNITURE (U.S. CLS. 2, 13, 22, 25, 32 AND 50).

FIRST USE 1-13-2004; IN COMMERCE 1-13-2004.

RICHARD WHITE, EXAMINING ATTORNEY

**CLASS 20—(Continued).**

SN 85-307,637. REIMERS FURNITURE MFG., INC., HILLSBORO, OR. FILED 4-28-2011.

# RFM

THE MARK CONSISTS OF STANDARD CHARACTERS WITHOUT CLAIM TO ANY PARTICULAR FONT, STYLE, SIZE, OR COLOR.

OWNER OF U.S. REG. NO. 3,003,500.  
FOR CHAIRS (U.S. CLS. 2, 13, 22, 25, 32 AND 50).  
FIRST USE 6-0-1977; IN COMMERCE 6-0-1977.  
BRENDAN REGAN, EXAMINING ATTORNEY

---

SN 85-310,532. NOMACORC, LLC, ZEBULON, NC. FILED 5-3-2011.

# SELECT

THE MARK CONSISTS OF STANDARD CHARACTERS WITHOUT CLAIM TO ANY PARTICULAR FONT, STYLE, SIZE, OR COLOR.

FOR SYNTHETIC POLYMER EXTRUSIONS FOR USE AS CLOSURES FOR BOTTLES; SYNTHETIC CORK OR CORK IMITATION STOPPERS FOR BOTTLES (U.S. CLS. 2, 13, 22, 25, 32 AND 50).  
TRICIA SONNEBORN, EXAMINING ATTORNEY

---

SN 85-313,381. ARK-PLAS PRODUCTS INC., FLIPPIN, CA. FILED 5-5-2011.

# HEX HIDER

THE MARK CONSISTS OF STANDARD CHARACTERS WITHOUT CLAIM TO ANY PARTICULAR FONT, STYLE, SIZE, OR COLOR.

NO CLAIM IS MADE TO THE EXCLUSIVE RIGHT TO USE "HEX", APART FROM THE MARK AS SHOWN.  
FOR PLASTIC CAPS (U.S. CLS. 2, 13, 22, 25, 32 AND 50).  
FIRST USE 6-15-2001; IN COMMERCE 6-15-2001.  
INGA ERVIN, EXAMINING ATTORNEY

**CLASS 20—(Continued).**

SN 85-315,871. GIANNI VERSACE S.P.A., MILAN, ITALY, FILED 5-9-2011.

# VERSACE

THE MARK CONSISTS OF STANDARD CHARACTERS WITHOUT CLAIM TO ANY PARTICULAR FONT, STYLE, SIZE, OR COLOR.

OWNER OF U.S. REG. NOS. 2,121,984, 2,440,541 AND OTHERS.

SEC. 2(F).  
FOR FURNITURE, NAMELY, FURNITURE FOR HOUSE, OFFICE AND GARDEN, LIVING ROOM FURNITURE, BEDROOM FURNITURE, CABINETS, DRESSERS, WARDROBES, CHESTS OF DRAWERS, CHESTS, CORNER DESKS, BOOKCASES, BEDS, HEADBOARDS FOR BEDS, BREAKFRONTS, WALL RACKS, BUFFETS, UPHOLSTERED AND NON-UPHOLSTERED SOFAS, LEATHER SOFAS, LOVE SEATS, CHAIRS, RECLINING CHAIRS, ARMCHAIRS, POUFS, OTTOMANS, CHAISE LOUNGES, BENCHES, STOOLS, DINING TABLES, END TABLES, SIDE TABLES, BED SIDE TABLES, CONSOLE TABLES, CORNER TABLES, NIGHT TABLES, COCKTAIL TABLES, LAMP TABLES, DROP-LEAF TABLES, BOOK SHELVES, SHELVES, MIRRORS, MAGAZINE RACKS, AND PLANTERS, NAMELY, PLANT RACKS AND PLANT STANDS (U.S. CLS. 2, 13, 22, 25, 32 AND 50).

FIRST USE 0-0-1995; IN COMMERCE 0-0-1995.  
DOMINICK J. SALEMI, EXAMINING ATTORNEY

---

SN 85-317,145. KINGSDOWN, INC., MEBANE, NC. FILED 5-10-2011.

# ROYALL & BORDEN

THE MARK CONSISTS OF STANDARD CHARACTERS WITHOUT CLAIM TO ANY PARTICULAR FONT, STYLE, SIZE, OR COLOR.

FOR MATTRESSES AND BOX SPRINGS (U.S. CLS. 2, 13, 22, 25, 32 AND 50).  
CAROLINE WOOD, EXAMINING ATTORNEY

**CLASS 20—(Continued).**

SN 85-318,233. TEAM EFFORTS COMPANY, OAKLAND, CA. FILED 5-11-2011.

**Team efforts**  
MANUFACTURERS

NO CLAIM IS MADE TO THE EXCLUSIVE RIGHT TO USE "MANUFACTURERS", APART FROM THE MARK AS SHOWN.

THE MARK CONSISTS OF THE STYLIZED TEXT "TEAM EFFORTS" ON TOP OF THE STYLIZED WORD "MANUFACTURERS".

FOR BATHROOM VANITIES; KITCHEN CABINETS (U.S. CLS. 2, 13, 22, 25, 32 AND 50).

FIRST USE 8-1-1995; IN COMMERCE 8-1-1995.

C. DIONNE CLYBURN, EXAMINING ATTORNEY

SN 85-319,251. MARVEL CHARACTERS, INC., MANHATTAN BEACH, CA. FILED 5-12-2011.



OWNER OF U.S. REG. NOS. 870,506, 3,116,241 AND OTHERS.

THE COLOR(S) RED AND WHITE IS/ARE CLAIMED AS A FEATURE OF THE MARK.

THE MARK CONSISTS OF THE WORD "MARVEL" IN WHITE LETTERS IN A RED RECTANGLE.

FOR BUSTS OF RESIN AND BUSTS PRIMARILY OF RESIN WHICH INCLUDE CALCIUM CARBONATE POWDER; NON-METAL AND NON-LEATHER KEY CHAINS; PILLOWS; PLASTIC BOXES; PLASTIC CAKE DECORATIONS; PLASTIC KEY CHAINS; SLEEPING BAGS; STATUES OF RESIN, AND STATUES PRIMARILY OF RESIN WHICH INCLUDE CALCIUM CARBONATE POWDER (U.S. CLS. 2, 13, 22, 25, 32 AND 50).

FIRST USE 2-28-2006; IN COMMERCE 2-28-2006.

MARC LEIPZIG, EXAMINING ATTORNEY

SN 85-319,263. SHUMSKY ENTERPRISES, INC., DBA SHUMSKY THERAPEUTIC PILLOWS, DAYTON, OH. FILED 5-12-2011.

**HEARTS 4 HEROES**

THE MARK CONSISTS OF STANDARD CHARACTERS WITHOUT CLAIM TO ANY PARTICULAR FONT, STYLE, SIZE, OR COLOR.

OWNER OF U.S. REG. NO. 1,938,557.

FOR NOVELTY PILLOWS (U.S. CLS. 2, 13, 22, 25, 32 AND 50).

BRENDAN REGAN, EXAMINING ATTORNEY

**CLASS 20—(Continued).**

SN 85-324,011. BABIKIN LLC, LAS VEGAS, NV. FILED 5-18-2011.

**Mommy's Little Mannequin**

THE MARK CONSISTS OF STANDARD CHARACTERS WITHOUT CLAIM TO ANY PARTICULAR FONT, STYLE, SIZE, OR COLOR.

NO CLAIM IS MADE TO THE EXCLUSIVE RIGHT TO USE "MANNEQUIN", APART FROM THE MARK AS SHOWN.

FOR MANNEQUINS (U.S. CLS. 2, 13, 22, 25, 32 AND 50).

ALEXANDER L. POWERS, EXAMINING ATTORNEY

SN 85-324,755. PARABELLUM COLLECTION, INC., LOS ANGELES, CA. FILED 5-19-2011.

**PARABELLUM**

THE MARK CONSISTS OF STANDARD CHARACTERS WITHOUT CLAIM TO ANY PARTICULAR FONT, STYLE, SIZE, OR COLOR.

OWNER OF U.S. REG. NOS. 3,750,271, 3,750,702 AND 4,016,205.

FOR FURNITURE (U.S. CLS. 2, 13, 22, 25, 32 AND 50).

SUNG IN, EXAMINING ATTORNEY

SN 85-325,020. WINNEBAGO INDUSTRIES, INC., FOREST CITY, IA. FILED 5-19-2011.

**Plus Lounger**

THE MARK CONSISTS OF STANDARD CHARACTERS WITHOUT CLAIM TO ANY PARTICULAR FONT, STYLE, SIZE, OR COLOR.

NO CLAIM IS MADE TO THE EXCLUSIVE RIGHT TO USE "LOUNGER", APART FROM THE MARK AS SHOWN.

FOR FURNITURE FOR MOTOR HOMES (U.S. CLS. 2, 13, 22, 25, 32 AND 50).

CAROLYN CATALDO, EXAMINING ATTORNEY

**CLASS 20—(Continued).**

SN 85-325,282. DEFLECTO, LLC, INDIANAPOLIS, IN. FILED 5-19-2011.

**DESIGNSCAPES**

THE MARK CONSISTS OF STANDARD CHARACTERS WITHOUT CLAIM TO ANY PARTICULAR FONT, STYLE, SIZE, OR COLOR.

FOR NON-METAL HOLDERS FOR THE DISPLAY OF PRINTED MATERIALS, NAMELY, SIGNS (U.S. CLS. 2, 13, 22, 25, 32 AND 50).

JOHN WILKE, EXAMINING ATTORNEY

---

SN 85-325,565. DE RUCCI BEDDINGS CO., LTD., DONG-GUAN CITY, CHINA, FILED 5-20-2011.



THE MARK CONSISTS OF STYLIZED LETTERS "DR", WORD "DE RUCCI" AND CHINESE CHARACTERS.

THE ENGLISH TRANSLATION OF "MU SI" IN THE MARK IS "ADMIRE THOUGHT".

THE NON-LATIN CHARACTERS IN THE MARK TRANSLITERATE TO "MU SI" AND THIS MEANS "ADMIRE THOUGHT" IN ENGLISH.

FOR BEDS; BENCHES; BOLSTERS; CHAIRS; COTS; CUSHIONS; FITTED FURNITURE COVER NOT OF FABRIC; FURNITURE; MATTRESSES; PILLOWS; SOFAS; SPRING MATTRESSES; WOOD BEDSTEADS (U.S. CLS. 2, 13, 22, 25, 32 AND 50).

JASON TURNER, EXAMINING ATTORNEY

---

SN 85-327,279. ANATOMIC GLOBAL, INC., CORONA, CA. FILED 5-23-2011.

**iConnect**

THE MARK CONSISTS OF STANDARD CHARACTERS WITHOUT CLAIM TO ANY PARTICULAR FONT, STYLE, SIZE, OR COLOR.

FOR MATTRESS, SPECIFICALLY MADE WITH MEMORY FOAM, WITH A GROUNDING CORD THAT CONNECTS TO AN ELECTRICAL OUTLET OR A GROUND ROD (U.S. CLS. 2, 13, 22, 25, 32 AND 50).

COLLEEN KEARNEY, EXAMINING ATTORNEY

**CLASS 20—(Continued).**

SN 85-327,344. JGR COPA, LLC, HOLLYWOOD, FL. FILED 5-23-2011.

**STS**

THE MARK CONSISTS OF STANDARD CHARACTERS WITHOUT CLAIM TO ANY PARTICULAR FONT, STYLE, SIZE, OR COLOR.

FOR FURNITURE PARTS, NAMELY, ADJUSTMENT MECHANISMS FOR CHAIRS (U.S. CLS. 2, 13, 22, 25, 32 AND 50).

TRACY CROSS, EXAMINING ATTORNEY

---

SN 85-328,153. CALUCO, LLC, SAN FERNANDO, CA. FILED 5-24-2011.



OWNER OF U.S. REG. NO. 3,626,171.

THE COLOR(S) YELLOW IS/ARE CLAIMED AS A FEATURE OF THE MARK.

THE MARK CONSISTS OF THE WORDING CALUCO (WITH A CAPITAL LETTER C) ALL IN YELLOW.

FOR OUTDOOR FURNITURE (U.S. CLS. 2, 13, 22, 25, 32 AND 50).

FIRST USE 9-11-2009; IN COMMERCE 9-11-2009.

PAUL E. FAHRENKOPF, EXAMINING ATTORNEY

---

SN 85-328,558. GOLD & LEVY, INC., DBA ROSSETO, LINCOLNWOOD, IL. FILED 5-24-2011.

**SKYCAP**

THE MARK CONSISTS OF STANDARD CHARACTERS WITHOUT CLAIM TO ANY PARTICULAR FONT, STYLE, SIZE, OR COLOR.

FOR BUFFET AND CATERING TABLE DISPLAY STANDS (U.S. CLS. 2, 13, 22, 25, 32 AND 50).

FIRST USE 4-2-2011; IN COMMERCE 5-1-2011.

BARBARA RUTLAND, EXAMINING ATTORNEY

**CLASS 20—(Continued).**

SN 85-329,070. MATTEL, INC., EL SEGUNDO, CA. FILED 5-24-2011.

**MONSTER HIGH**

THE MARK CONSISTS OF STANDARD CHARACTERS WITHOUT CLAIM TO ANY PARTICULAR FONT, STYLE, SIZE, OR COLOR.

OWNER OF U.S. REG. NOS. 3,828,721, 3,877,972 AND OTHERS.

FOR CLOTHING HANGERS (U.S. CLS. 2, 13, 22, 25, 32 AND 50).

WENDY GOODMAN, EXAMINING ATTORNEY

SN 85-330,567. CHANGCHUNTENG HOME FURNISHINGS CO., LTD, GUANGZHOU, CHINA, FILED 5-26-2011.



THE MARK CONSISTS OF A DESIGNED LETTER "S" HELD BY A PAIR OF WINGS.

FOR BEDSTEADS OF WOOD; FURNITURE; MATTRESSES; BEDS FOR HOUSEHOLD PETS; CUSHIONS FOR PETS; TABLE TOPS; DOORS FOR FURNITURE; PILLOWS; CUSHIONS; BOLSTERS (U.S. CLS. 2, 13, 22, 25, 32 AND 50).

JOSETTE BEVERLY, EXAMINING ATTORNEY

SN 85-333,221. MURRAY MICHAEL T, WHITEFISH, MT. FILED 5-29-2011.

**HOG ENHANCER**

THE MARK CONSISTS OF STANDARD CHARACTERS WITHOUT CLAIM TO ANY PARTICULAR FONT, STYLE, SIZE, OR COLOR.

FOR NOVELTY GOODS IN THE NATURE OF A PLACEBO SPRAY USED TO MAKE SOMEONE LAUGH OR SMILE (U.S. CLS. 2, 13, 22, 25, 32 AND 50).

KIMBERLY FRYE, EXAMINING ATTORNEY

**CLASS 20—(Continued).**

SN 85-333,765. 2SP DESIGN INC., ST-ANDRE D'ARGENTEUIL, CANADA, FILED 5-31-2011.

**BedBugBodyshield**

THE MARK CONSISTS OF STANDARD CHARACTERS WITHOUT CLAIM TO ANY PARTICULAR FONT, STYLE, SIZE, OR COLOR.

FOR A BED LINER WITH A HOOD MESH THAT PROTECTS THE SLEEPER AGAINST BED BUGS (U.S. CLS. 2, 13, 22, 25, 32 AND 50).

FIRST USE 3-14-2011; IN COMMERCE 5-19-2011.

RONALD AIKENS, EXAMINING ATTORNEY

SN 85-334,261. KENNEY MANUFACTURING COMPANY, WARWICK, RI. FILED 5-31-2011.

**Tweeners**

THE MARK CONSISTS OF STANDARD CHARACTERS WITHOUT CLAIM TO ANY PARTICULAR FONT, STYLE, SIZE, OR COLOR.

FOR DECORATIVE WINDOW FINIALS; DRAPERY HARDWARE, NAMELY, TRAVERSE RODS, POLES, CURTAIN HOOKS, CURTAIN RODS AND FINIALS (U.S. CLS. 2, 13, 22, 25, 32 AND 50).

FIRST USE 1-31-2005; IN COMMERCE 12-31-2005.

NICHOLAS ALTREE, EXAMINING ATTORNEY

SN 85-334,364. FILTRONA PLC, MILTON KEYNES, UNITED KINGDOM, FILED 5-31-2011.

**MAXX**

THE MARK CONSISTS OF STANDARD CHARACTERS WITHOUT CLAIM TO ANY PARTICULAR FONT, STYLE, SIZE, OR COLOR.

FOR PROTECTIVE PLASTIC PARTS, NAMELY, THREAD PROTECTORS FOR PIPES, TUBES AND CASINGS (U.S. CLS. 2, 13, 22, 25, 32 AND 50).

DOMINICK J. SALEMI, EXAMINING ATTORNEY

**CLASS 20—(Continued).**

SN 85-335,027. BLACK CUOCO, LEE, MA. FILED 6-1-2011.

**FUTURE CHIC FURNITURE**

THE MARK CONSISTS OF STANDARD CHARACTERS WITHOUT CLAIM TO ANY PARTICULAR FONT, STYLE, SIZE, OR COLOR.

NO CLAIM IS MADE TO THE EXCLUSIVE RIGHT TO USE "FURNITURE", APART FROM THE MARK AS SHOWN.

FOR FURNITURE (U.S. CLS. 2, 13, 22, 25, 32 AND 50).  
SUSAN RICHARDS, EXAMINING ATTORNEY

**CLASS 20—(Continued).**

SN 85-336,237. MIRAGE CORPORATION, LOS ANGELES, CA. FILED 6-2-2011.

**HANZ**

THE MARK CONSISTS OF STANDARD CHARACTERS WITHOUT CLAIM TO ANY PARTICULAR FONT, STYLE, SIZE, OR COLOR.

FOR BEAUTY SALON FURNITURE, NAMELY, STYLING STATIONS; CABINETS; CONSOLE TABLES; DISPLAY TABLES; END TABLES; FURNITURE; FURNITURE FOR DISPLAYING GOODS; FURNITURE, NAMELY, SHOWCASES; OFFICE TABLES; TABLES (U.S. CLS. 2, 13, 22, 25, 32 AND 50).

FIRST USE 1-1-2005; IN COMMERCE 1-1-2005.  
KIMBERLY FRYE, EXAMINING ATTORNEY

SN 85-335,426. CHRISTINA M. DUNCAN, DALLAS, TX. FILED 6-1-2011.

**DUETTE**

THE MARK CONSISTS OF STANDARD CHARACTERS WITHOUT CLAIM TO ANY PARTICULAR FONT, STYLE, SIZE, OR COLOR.

FOR MIRRORS AND MAGNIFYING MIRRORS FOR COSMETICS (U.S. CLS. 2, 13, 22, 25, 32 AND 50).

MARIA-VICTORIA SUAREZ, EXAMINING ATTORNEY

SN 85-336,753. VELORA INC., BENTONVILLE, AR. FILED 6-2-2011.

**VELORA**

THE MARK CONSISTS OF STANDARD CHARACTERS WITHOUT CLAIM TO ANY PARTICULAR FONT, STYLE, SIZE, OR COLOR.

FOR PILLOWS, NAMELY BED PILLOWS, BODY PILLOWS AND SPECIALTY PILLOWS; CHAIR PADS; MATTRESS TOPPERS; CUSHIONS (U.S. CLS. 2, 13, 22, 25, 32 AND 50).

PRISCILLA MILTON, EXAMINING ATTORNEY

SN 85-335,799. NANCY MCKEON, ROYAL OAK, MI. FILED 6-1-2011.

**Presto!**

THE MARK CONSISTS OF STANDARD CHARACTERS WITHOUT CLAIM TO ANY PARTICULAR FONT, STYLE, SIZE, OR COLOR.

FOR CUSTOM FURNITURE (U.S. CLS. 2, 13, 22, 25, 32 AND 50).

HEATHER SAPP, EXAMINING ATTORNEY

SN 85-336,926. SUMMIT ENTERTAINMENT, LLC, SANTA MONICA, CA. FILED 6-2-2011.

**ISLE ESME**

THE MARK CONSISTS OF STANDARD CHARACTERS WITHOUT CLAIM TO ANY PARTICULAR FONT, STYLE, SIZE, OR COLOR.

FOR BEACH CHAIRS; BED OR ACCENT PILLOWS; DECORATIVE BOXES OF WOOD OR PLASTIC; DECORATIVE WALL PLAQUES OF WOOD OR PLASTIC; KEY CHAINS MADE OF PLASTIC; PERSONAL COMPACT MIRRORS; AND PICTURE FRAMES (U.S. CLS. 2, 13, 22, 25, 32 AND 50).

ASMAT KHAN, EXAMINING ATTORNEY

**CLASS 20—(Continued).**

SN 85-337,171. STRUHL, CLIFFORD, GARDEN CITY PARK, NY. FILED 6-3-2011.

# BEE SMART

THE MARK CONSISTS OF STANDARD CHARACTERS WITHOUT CLAIM TO ANY PARTICULAR FONT, STYLE, SIZE, OR COLOR.

NO CLAIM IS MADE TO THE EXCLUSIVE RIGHT TO USE "BEE", APART FROM THE MARK AS SHOWN. FOR BEE HIVE STANDS (U.S. CLS. 2, 13, 22, 25, 32 AND 50).

FIRST USE 5-31-2011; IN COMMERCE 5-31-2011.  
LINDA ESTRADA, EXAMINING ATTORNEY

**CLASS 20—(Continued).**

SN 85-337,817. COUNTRY CASUAL, INC., GAITHERSBURG, MD. FILED 6-3-2011.

# FOXHALL

THE MARK CONSISTS OF STANDARD CHARACTERS WITHOUT CLAIM TO ANY PARTICULAR FONT, STYLE, SIZE, OR COLOR.

FOR FURNITURE (U.S. CLS. 2, 13, 22, 25, 32 AND 50).  
FIRST USE 2-28-2000; IN COMMERCE 2-28-2000.  
SUSAN RICHARDS, EXAMINING ATTORNEY

SN 85-337,872. COUNTRY CASUAL, INC., GAITHERSBURG, MD. FILED 6-3-2011.

SN 85-337,393. PRECISION PET PRODUCTS, DBA PRECISION PET PRODUCTS, COSTA MESA, CA. FILED 6-3-2011.

## Always Unique, Never Boring

THE MARK CONSISTS OF STANDARD CHARACTERS WITHOUT CLAIM TO ANY PARTICULAR FONT, STYLE, SIZE, OR COLOR.

FOR BEDS FOR HOUSEHOLD PETS (U.S. CLS. 2, 13, 22, 25, 32 AND 50).  
STEVEN PEREZ, EXAMINING ATTORNEY

THE MARK CONSISTS OF STANDARD CHARACTERS WITHOUT CLAIM TO ANY PARTICULAR FONT, STYLE, SIZE, OR COLOR.

FOR FURNITURE (U.S. CLS. 2, 13, 22, 25, 32 AND 50).  
FIRST USE 2-28-2005; IN COMMERCE 2-28-2005.  
SUSAN RICHARDS, EXAMINING ATTORNEY

SN 85-337,887. CLOTHES SHAPERS, LLC, WILSON, WY. FILED 6-3-2011.

# Clothes Shapers

SN 85-337,735. THE OFFICE CLUB, INC., BOCA RATON, FL. FILED 6-3-2011.

# MODOFFICE

THE MARK CONSISTS OF STANDARD CHARACTERS WITHOUT CLAIM TO ANY PARTICULAR FONT, STYLE, SIZE, OR COLOR.

FOR FURNITURE (U.S. CLS. 2, 13, 22, 25, 32 AND 50).  
DANNEAN HETZEL, EXAMINING ATTORNEY

THE MARK CONSISTS OF STANDARD CHARACTERS WITHOUT CLAIM TO ANY PARTICULAR FONT, STYLE, SIZE, OR COLOR.

NO CLAIM IS MADE TO THE EXCLUSIVE RIGHT TO USE "CLOTHES", APART FROM THE MARK AS SHOWN.

FOR CLOSET ACCESSORIES, NAMELY, CLOTHES BARS; CLOSET ACCESSORIES, NAMELY, SLIDING CLOTHES RAILS; CLOTHES HANGERS; CLOTHES HANGERS HAVING SLIDING ARMS FOR USE WITH SHIRTS, SWEATERS OR TURTLENECKS BY PLACEMENT THROUGH THE NECK HOLE; CLOTHES RODS; DISPLAYS IN THE FORM OF A FRAME OR HOLDER FOR DISPLAYING CLOTHING ACCESSORIES SUCH AS HAIR BOWS AND THE LIKE; HANGERS FOR CLOTHES; LIFE-SIZE FORMS OF THE HUMAN BODY TO DISPLAY CLOTHES; NON-METAL CLOTHES HOOKS (U.S. CLS. 2, 13, 22, 25, 32 AND 50).

TINA BROWN, EXAMINING ATTORNEY

**CLASS 20—(Continued).**

SN 85-337,890. COUNTRY CASUAL, INC., GAITHERSBURG, MD. FILED 6-3-2011.

**PALISADE**

THE MARK CONSISTS OF STANDARD CHARACTERS WITHOUT CLAIM TO ANY PARTICULAR FONT, STYLE, SIZE, OR COLOR.

FOR FURNITURE (U.S. CLS. 2, 13, 22, 25, 32 AND 50).  
FIRST USE 2-28-2010; IN COMMERCE 2-28-2010.  
SUSAN RICHARDS, EXAMINING ATTORNEY

SN 85-337,899. CLOTHES SHAPERS, LLC, WILSON, WY. FILED 6-3-2011.

**Sweater Shaper**

THE MARK CONSISTS OF STANDARD CHARACTERS WITHOUT CLAIM TO ANY PARTICULAR FONT, STYLE, SIZE, OR COLOR.

NO CLAIM IS MADE TO THE EXCLUSIVE RIGHT TO USE "SWEATER", APART FROM THE MARK AS SHOWN.

FOR CLOSET ACCESSORIES, NAMELY, CLOTHES BARS; CLOSET ACCESSORIES, NAMELY, SLIDING CLOTHES RAILS; CLOTHES HANGERS; CLOTHES HANGERS HAVING SLIDING ARMS FOR USE WITH SHIRTS, SWEATERS OR TURTLENECKS BY PLACEMENT THROUGH THE NECK HOLE; CLOTHES RODS; DISPLAYS IN THE FORM OF A FRAME OR HOLDER FOR DISPLAYING CLOTHING ACCESSORIES SUCH AS HAIR BOWS AND THE LIKE; HANGERS FOR CLOTHES; LIFE-SIZE FORMS OF THE HUMAN BODY TO DISPLAY CLOTHES; NON-METAL CLOTHES HOOKS; STORAGE AND ORGANIZATION SYSTEMS COMPRISING SHELVES, DRAWERS, CUPBOARDS, BASKETS AND CLOTHES RODS, SOLD AS A UNIT (U.S. CLS. 2, 13, 22, 25, 32 AND 50).  
TINA BROWN, EXAMINING ATTORNEY

SN 85-337,904. COUNTRY CASUAL, INC., GAITHERSBURG, MD. FILED 6-3-2011.

**CALYPSO**

THE MARK CONSISTS OF STANDARD CHARACTERS WITHOUT CLAIM TO ANY PARTICULAR FONT, STYLE, SIZE, OR COLOR.

FOR FURNITURE (U.S. CLS. 2, 13, 22, 25, 32 AND 50).  
FIRST USE 2-28-2003; IN COMMERCE 2-28-2003.  
SUSAN RICHARDS, EXAMINING ATTORNEY

**CLASS 20—(Continued).**

SN 85-337,923. COUNTRY CASUAL, INC., GAITHERSBURG, MD. FILED 6-3-2011.

**HARBORSIDE**

THE MARK CONSISTS OF STANDARD CHARACTERS WITHOUT CLAIM TO ANY PARTICULAR FONT, STYLE, SIZE, OR COLOR.

FOR FURNITURE (U.S. CLS. 2, 13, 22, 25, 32 AND 50).  
FIRST USE 2-28-2009; IN COMMERCE 2-28-2009.  
SUSAN RICHARDS, EXAMINING ATTORNEY

SN 85-339,469. CHANGCHUNTENG HOME FURNISHINGS CO., LTD, GUANGZHOU, CHINA, FILED 6-7-2011.

**NEW DREAM OF ORIGIN**

THE MARK CONSISTS OF A PHRASE "NEW DREAM OF ORIGIN" IN STYLIZED LETTERS.

FOR BEDSTEADS OF WOOD; FURNITURE; MATTRESSES; BEDS FOR HOUSEHOLD PETS; CUSHIONS FOR PETS; TABLE TOPS; DOORS FOR FURNITURE; PILLOWS; CUSHIONS; BOLSTERS (U.S. CLS. 2, 13, 22, 25, 32 AND 50).

JOSETTE BEVERLY, EXAMINING ATTORNEY

SN 85-339,806. THORLEY INDUSTRIES LLC, PITTSBURGH, PA. FILED 6-7-2011.

**BREEZE**

THE MARK CONSISTS OF STANDARD CHARACTERS WITHOUT CLAIM TO ANY PARTICULAR FONT, STYLE, SIZE, OR COLOR.

FOR PLAYPENS; PLAY-YARDS (U.S. CLS. 2, 13, 22, 25, 32 AND 50).

EUGENIA MARTIN, EXAMINING ATTORNEY



**CLASS 20—(Continued).**

SN 85-340,384. INTERNATIONAL BEDDING CORPORATION, FT. LAUDERDALE, FL. FILED 6-7-2011.

# INVISIQUILT

THE MARK CONSISTS OF STANDARD CHARACTERS WITHOUT CLAIM TO ANY PARTICULAR FONT, STYLE, SIZE, OR COLOR.

FOR SLEEP PRODUCTS, NAMELY, MATTRESSES, SPRING MATTRESSES, BOX SPRINGS AND MATTRESS FOUNDATIONS (U.S. CLS. 2, 13, 22, 25, 32 AND 50).

KATHERINE STOIDES, EXAMINING ATTORNEY

---

SN 85-340,770. KIDZ ON SAFARI NEW YORK, INC., BROOKLYN, NY. FILED 6-8-2011.

# BAMINGO

THE MARK CONSISTS OF STANDARD CHARACTERS WITHOUT CLAIM TO ANY PARTICULAR FONT, STYLE, SIZE, OR COLOR.

FOR PLAY-PENS; MATS FOR INFANT PLAYPENS; FURNITURE, NAMELY, SOFT FURNITURE FOR CHILDREN CONSISTING OF CHAIRS, BEAN BAG CHAIRS, AND SOFAS (U.S. CLS. 2, 13, 22, 25, 32 AND 50).

JESSICA A. POWERS, EXAMINING ATTORNEY

---

SN 85-343,183. KELLWOOD COMPANY, CHESTERFIELD, MO. FILED 6-10-2011.

# CHIME

THE MARK CONSISTS OF STANDARD CHARACTERS WITHOUT CLAIM TO ANY PARTICULAR FONT, STYLE, SIZE, OR COLOR.

OWNER OF U.S. REG. NO. 3,702,523.  
FOR ACCENT PILLOWS; BED PILLOWS; PILLOWS (U.S. CLS. 2, 13, 22, 25, 32 AND 50).

ANDREW RHIM, EXAMINING ATTORNEY

**CLASS 20—(Continued).**

SN 85-344,845. JOHN RICH & SONS INVESTMENT HOLDING COMPANY, WILMINGTON, DE. FILED 6-13-2011.



# WOOLRICH

OWNER OF U.S. REG. NOS. 3,072,062, 3,541,647 AND OTHERS.

THE MARK CONSISTS OF THE WORD "WOOLRICH" AND A STYLIZED SQUARE DESIGN COMPRISED OF FOUR SMALLER SQUARES WHEREBY THE UPPER LEFT SQUARE IS SHADED, THE LOWER RIGHT SQUARE IS OPEN AND THE DIAGONALLY-SITUATED UPPER RIGHT AND LOWER LEFT SQUARES FEATURE DIAGONAL LINING.

FOR DECORATIVE UPHOLSTERED OTTOMANS, TABLES, FLOOR PILLOWS AND ACCENT PILLOWS (U.S. CLS. 2, 13, 22, 25, 32 AND 50).

RICHARD WHITE, EXAMINING ATTORNEY

---

SN 85-345,912. INTERNATIONAL BEDDING CORPORATION, FT. LAUDERDALE, FL. FILED 6-14-2011.

# RESTORATION ZONE

THE MARK CONSISTS OF STANDARD CHARACTERS WITHOUT CLAIM TO ANY PARTICULAR FONT, STYLE, SIZE, OR COLOR.

FOR SLEEP PRODUCTS, NAMELY, MATTRESSES, SPRING MATTRESSES, BOX SPRINGS AND MATTRESS FOUNDATIONS (U.S. CLS. 2, 13, 22, 25, 32 AND 50).

KATHERINE STOIDES, EXAMINING ATTORNEY

---

SN 85-346,818. INTERNATIONAL BEDDING CORPORATION, FT. LAUDERDALE, FL. FILED 6-15-2011.

# VERIDIAN

THE MARK CONSISTS OF STANDARD CHARACTERS WITHOUT CLAIM TO ANY PARTICULAR FONT, STYLE, SIZE, OR COLOR.

FOR SLEEP PRODUCTS, NAMELY, MATTRESSES, SPRING MATTRESSES, BOX SPRINGS AND MATTRESS FOUNDATIONS (U.S. CLS. 2, 13, 22, 25, 32 AND 50).

KATHERINE STOIDES, EXAMINING ATTORNEY

**CLASS 20—(Continued).**

SN 85-355,228. INTERNATIONAL BEDDING CORPORATION, FT. LAUDERDALE, FL. FILED 6-24-2011.

When your life changes, so  
should your mattress.

THE MARK CONSISTS OF STANDARD CHARACTERS WITHOUT CLAIM TO ANY PARTICULAR FONT, STYLE, SIZE, OR COLOR.

FOR SLEEP PRODUCTS, NAMELY, MATTRESSES, SPRING MATTRESSES, BOX SPRINGS AND MATTRESS FOUNDATIONS (U.S. CLS. 2, 13, 22, 25, 32 AND 50).  
KATHERINE STOIDES, EXAMINING ATTORNEY

SN 85-357,901. INTERNATIONAL BEDDING CORPORATION, FT. LAUDERDALE, FL. FILED 6-28-2011.

VERIDIAN

THE MARK CONSISTS OF TWO TRIANGLES, AND THE LITERAL ELEMENT VERIDIAN, IN STYLIZED LETTERS, AS SHOWN.

FOR SLEEP PRODUCTS, NAMELY, MATTRESSES, SPRING MATTRESSES, BOX SPRINGS AND MATTRESS FOUNDATIONS (U.S. CLS. 2, 13, 22, 25, 32 AND 50).  
KATHERINE STOIDES, EXAMINING ATTORNEY

SN 85-370,575. HORIZON GROUP USA, INC., WARREN, NJ. FILED 7-13-2011.

CREATIVE ROOTS

THE MARK CONSISTS OF STANDARD CHARACTERS WITHOUT CLAIM TO ANY PARTICULAR FONT, STYLE, SIZE, OR COLOR.

FOR NAMEPLATES, NOT OF METAL (U.S. CLS. 2, 13, 22, 25, 32 AND 50).  
REGINA DRUMMOND, EXAMINING ATTORNEY

**CLASS 20—(Continued).**

SN 85-379,379. SCG POWER RANGERS LLC, LOS ANGELES, CA. FILED 7-24-2011.

POWER RIDER

THE MARK CONSISTS OF STANDARD CHARACTERS WITHOUT CLAIM TO ANY PARTICULAR FONT, STYLE, SIZE, OR COLOR.

FOR FURNITURE; PLASTIC CAKE DECORATIONS (U.S. CLS. 2, 13, 22, 25, 32 AND 50).  
THOMAS MANOR, EXAMINING ATTORNEY

SN 85-381,719. ZINUS INC., HAYWARD, CA. FILED 7-26-2011.

WonderMattress

THE MARK CONSISTS OF STANDARD CHARACTERS WITHOUT CLAIM TO ANY PARTICULAR FONT, STYLE, SIZE, OR COLOR.

FOR BEDS, MATTRESSES, PILLOWS AND BOLSTERS; MATTRESS TOPPERS (U.S. CLS. 2, 13, 22, 25, 32 AND 50).  
JEFFREY LOOK, EXAMINING ATTORNEY

SN 85-386,194. SERTA, INC., HOFFMAN ESTATES, IL. FILED 8-1-2011.

GENIUS

THE MARK CONSISTS OF STANDARD CHARACTERS WITHOUT CLAIM TO ANY PARTICULAR FONT, STYLE, SIZE, OR COLOR.

FOR MATTRESSES (U.S. CLS. 2, 13, 22, 25, 32 AND 50). FIRST USE 3-1-2011; IN COMMERCE 3-1-2011.  
RENEE MCCRAY, EXAMINING ATTORNEY

**CLASS 20—(Continued).**

SN 85-393,753. ZINUS INC., HAYWARD, CA. FILED 8-9-2011.

# MicroCool

THE MARK CONSISTS OF STANDARD CHARACTERS WITHOUT CLAIM TO ANY PARTICULAR FONT, STYLE, SIZE, OR COLOR.

FOR MATTRESS CUSHIONS; MATTRESS TOPPERS; MATTRESSES AND PILLOWS (U.S. CLS. 2, 13, 22, 25, 32 AND 50).

JEFFREY LOOK, EXAMINING ATTORNEY

**CLASS 21—HOUSEWARES AND GLASS**

SN 77-617,433. PURE &amp; SIMPLE SOLUTIONS, LLC, HUNTINGTON WOODS, MI. FILED 11-19-2008.



NO CLAIM IS MADE TO THE EXCLUSIVE RIGHT TO USE "GREEN BOTTLE", APART FROM THE MARK AS SHOWN.

THE MARK CONSISTS OF THE WORDS "GREEN BOTTLE" WITH A PLURALITY OF LEAVES ABOVE THE "L" IN THE WORD "BOTTLE".

FOR METAL BOTTLES SOLD EMPTY (U.S. CLS. 2, 13, 23, 29, 30, 33, 40 AND 50).

FIRST USE 9-22-2008; IN COMMERCE 9-22-2008.  
JIM RINGLE, EXAMINING ATTORNEY

SN 77-767,911. DIVERSIFIED GLOBAL TECHNOLOGIES, LLC, WOONSOCKET, RI. FILED 6-25-2009.

# BEAUTIFUL DIFFERENCE

THE MARK CONSISTS OF STANDARD CHARACTERS WITHOUT CLAIM TO ANY PARTICULAR FONT, STYLE, SIZE, OR COLOR.

FOR COSMETIC BRUSHES (U.S. CLS. 2, 13, 23, 29, 30, 33, 40 AND 50).

HOWARD B. LEVINE, EXAMINING ATTORNEY

**CLASS 21—(Continued).**

SN 79-092,091. H.A.G. IMPORT CORPORATION (AUSTRALIA) PTY. LTD, AUSTRALIA, FILED 12-3-2010.

# MELAGREEN

THE MARK CONSISTS OF STANDARD CHARACTERS WITHOUT CLAIM TO ANY PARTICULAR FONT, STYLE, SIZE, OR COLOR.

PRIORITY DATE OF 6-29-2010 IS CLAIMED.

OWNER OF INTERNATIONAL REGISTRATION 1063811 DATED 12-3-2010, EXPIRES 12-3-2020.

FOR HOUSEHOLD OR KITCHEN UTENSILS AND CONTAINERS NOT OF PRECIOUS METAL OR COATED THEREWITH, NAMELY, CANISTER SETS, BREAD BINS, BREAD BOARDS, CONTAINERS FOR HOUSEHOLD OR KITCHEN USE, SPICE RACKS, CONTAINERS FOR FOODS, HOUSEHOLD CONTAINERS FOR PET FOOD, INSULATED CONTAINERS FOR FOOD OR BEVERAGE FOR DOMESTIC USE, SOAP CONTAINERS, TRASH CONTAINERS FOR HOUSEHOLD USE, LUNCH BOXES, HAND OPERATED COFFEE GRINDERS, CHOPSTICKS, COOKERY MOULDS, COOKIE CUTTERS, COOKIE JARS, COOKING SKEWERS, CRUET STANDS FOR OIL AND VINEGAR, CRUETS, CUTTING BOARDS, NON-ELECTRIC FRUIT PRESSES FOR HOUSEHOLD USE, GLASS JARS FOR STORING FOOD, INSULATING JARS, FOOD PRESERVING JARS, NON-ELECTRIC KETTLES, TEA KETTLES, WHISKS, CORN COB HOLDERS, MIXING SPOONS, NON ELECTRIC FOOD MIXERS, JUGS, FLASKS, GRATERS, SPATULAS, SIEVES, STRAINERS, TURNERS, GRILL COVERS, ROLLING PINS, POT AND PAN SCRAPERS, SPLATTER SCREENS, KITCHEN TONGS, FOOD SCOOPS, DOG FOOD SCOOPS, TEA INFUSERS, TEA STRAINERS, TEA POTS, TEA SERVICE, TEA SETS, TEA BALLS, PORTABLE COOLERS, COOLERS FOR WINE, VESSELS FOR MAKING ICES AND ICED DRINKS IN THE NATURE OF COCKTAIL SHAKERS, ICE PAILS, CORKSCREWS, URNS, ICE CUBE MOLDS, ICE SCOOPS, ICE CREAM SCOOPS, CONTAINERS FOR ICE, BASINS, BUTTER DISHES AND COVERS, EGG CUPS, NON ELECTRIC EGG BEATERS, PITCHERS, DISH COVERS, COFFEE MEASURES, COFFEE POTS, COFFEE SERVERS, COFFEE SERVICE, COFFEE STIRRERS, NON ELECTRIC COFFEE MAKERS, COFFEE PLUNGERS IN THE NATURE OF NON-ELECTRIC COFFEE POTS, NON-ELECTRIC COFFEE PERCOLATORS, NON ELECTRIC COFFEE GRINDERS, VACUUM BOTTLE STOPPERS, BOTTLE OPENERS, BOTTLE STOPPERS SPECIALLY ADAPTED FOR USE WITH WINE BOTTLES, BOWLS, PLATES, LAZY SUSANS, DRINKING VESSELS, SUGAR BOWLS, MUGS, CUPS, DISHES, UTENSILS FOR BARBECUES, NAMELY, FORKS, TONGS AND TURNERS, ALL THE AFORESAID GOODS BEING MADE OF ENVIRONMENTALLY FRIENDLY BIODEGRADABLE OR RECYCLABLE MATERIAL; GLASSWARE, NAMELY, BEVERAGE GLASSWARE, TEA PLUNGERS IN THE NATURE OF NON-ELECTRIC TEA POTS, CANDLE RINGS, CANDLESTICKS, DECANTERS, SALT AND PEPPER SHAKERS, SALT CELLARS, VACUUM BOTTLE STOPPERS, TOOTHPICK HOLDERS, SALT AND PEPPER GRINDERS, NAPKIN RINGS, GOBLET, BEER MUGS, COCKTAIL SHAKERS, KNIFE RESTS, NAPKIN HOLDERS, PEPPER POTS, WINE TASTERS ALL THE AFORESAID GOODS BEING MADE OF ENVIRONMENTALLY FRIENDLY BIODEGRADABLE OR RECYCLABLE MATERIAL; DINNERWARE ALL THE AFORESAID GOODS BEING MADE OF ENVIRONMENTALLY FRIENDLY BIODEGRADABLE OR RECYCLABLE MATERIAL; TABLEWARE, NAMELY, SERVING AND MEAL TRAYS, VASES, BEVERAGE GLASSES, COASTERS NOT OF PAPER AND NOT BEING TABLE LINEN, CANDLE HOLDERS, SERVIETTE HOLDERS AND SERVIETTE RINGS ALL THE AFORESAID GOODS BEING MADE OF ENVIRONMENTALLY FRIENDLY BIODEGRADABLE OR RECYCLABLE MATERIAL; COOKWARE, NAMELY, CASSEROLE DISHES, FRYING PANS, MUFFIN TINS, CAKE TINS, CUP CAKE MOLDS, PAPER BAKING CUPS, COOKING STEAMERS, SAUCEPANS, COOKING UTENSILS IN THE NATURE OF GRILLS, GRILL COVERS, PORTABLE COOKING KITS FOR OUTDOOR USE, RICE COOKING POTS, BAKING DISHES, BASTING SPOONS, COOKING FORKS, POTS,

**CLASS 21—(Continued).**

PANS, ALL THE AFORESAID GOODS BEING MADE OF ENVIRONMENTALLY FRIENDLY BIODEGRADABLE OR RECYCLABLE MATERIAL; CROCKERY, NAMELY, PLATES, SAUCERS, BOWLS, CUPS, MUGS, DISHES ALL THE AFORESAID GOODS BEING MADE OF ENVIRONMENTALLY FRIENDLY BIODEGRADABLE OR RECYCLABLE MATERIAL; SERVINGWARE FOR SERVING FOOD AND DRINKS, SERVING TRAYS, PIE SERVERS, LAZY SUSANS ALL THE AFORESAID GOODS BEING MADE OF ENVIRONMENTALLY FRIENDLY BIODEGRADABLE OR RECYCLABLE MATERIAL; CHINAWARE, PORCELAIN AND EARTHENWARE, NAMELY, NON-ELECTRIC KETTLES, TEA KETTLES, TEA INFUSERS, TEA STRAINERS, TEA POTS, TEA SERVICE, TEA SETS, TEA BALLS, COFFEE PLUNGERS IN THE NATURE OF NON-ELECTRIC COFFEE POTS, NON-ELECTRIC COFFEE PERCOLATORS, COFFEE SERVICE, COFFEE POTS, CANDLE RINGS, CANDLESTICKS, DECANTERS, SALT AND PEPPER SHAKERS, SALT CELLARS, TOOTHPICK HOLDERS, SALT AND PEPPER GRINDERS, SUGAR BOWLS, NAPKIN RINGS, OIL AND VINEGAR CRUETS, GOBLETS, BEER MUGS, COCKTAIL SHAKERS, KNIFE RESTS, TEA POTS, NAPKIN HOLDERS, PEPPER POTS, SPICE SETS IN THE NATURE OF SPICE RACKS, WINE TASTERS, BOWLS, PLATES, MUGS, CUPS, DISHES, SOUP TUREENS, AND VASES BEING MADE OF ENVIRONMENTALLY FRIENDLY BIODEGRADABLE OR RECYCLABLE MATERIAL (U.S. CLS. 2, 13, 23, 29, 30, 33, 40 AND 50).

MICHAEL WEBSTER, EXAMINING ATTORNEY

SN 79-095,929. MOLOK OY, FINLAND, FILED 2-23-2011.

# MOLOK

OWNER OF INTERNATIONAL REGISTRATION 0784275 DATED 6-26-2002, EXPIRES 6-26-2012.

THE WORDING "MOLOK" HAS NO MEANING IN A FOREIGN LANGUAGE.

FOR REFUSE CONTAINERS MADE PRIMARILY OF PLASTIC, REFUSE CONTAINERS MADE PRIMARILY OF CONCRETE, DUSTBINS AND THEIR PARTS, FOR HOUSEHOLD USE, REAL ESTATES, RESIDENTIAL AREAS, PUBLIC PLACES, ROAD AND STREET AREAS, PARK AREAS, RECREATIONAL AREAS AND HOLIDAY RESORTS (U.S. CLS. 2, 13, 23, 29, 30, 33, 40 AND 50).

DAVID HOFFMAN, EXAMINING ATTORNEY

**CLASS 21—(Continued).**

SN 85-084,736. MAN COOK LLC, COLUMBUS, GA. AND NICHOLS, COY E, COLUMBUS, GA. AND HARDIN, JAMES, COLUMBUS, GA. FILED 7-14-2010.



NO CLAIM IS MADE TO THE EXCLUSIVE RIGHT TO USE "COOK", APART FROM THE MARK AS SHOWN.

THE COLOR(S) BLACK, WHITE AND ORANGE IS/ARE CLAIMED AS A FEATURE OF THE MARK.

THE MARK CONSISTS OF THE WORDING "MAN COOK" IN WHITE, SURROUNDED BY A BADGE SHAPE IN BLACK WITH A BORDER IN ORANGE AND AN OUTER BORDER IN BLACK, AND A FLAME DESIGN INSIDE THE "A" IN ORANGE AND INNER BORDER TRIM IN ORANGE.

FOR PORTABLE COOKING KITS FOR OUTDOOR USE (U.S. CLS. 2, 13, 23, 29, 30, 33, 40 AND 50).

MATTHEW EINSTEIN, EXAMINING ATTORNEY

SN 85-130,447. MIKAEL NILSSON, VÄSTERÅS, SWEDEN, FILED 9-15-2010.



THE MARK CONSISTS OF STYLIZED "S" TO THE LEFT OF THE WORD "SMARTSHAKE".

FOR NON-ELECTRIC FOOD, BEVERAGE AND DRINK MIXERS FOR HOUSEHOLD, KITCHEN, DOMESTIC OR OUTDOOR USE; BOTTLES, SOLD EMPTY; CONTAINERS FOR HOUSEHOLD OR KITCHEN USE; SPORTS BOTTLES, SOLD EMPTY, FOR THE PURPOSE OF MIXING SUPPLEMENTS (U.S. CLS. 2, 13, 23, 29, 30, 33, 40 AND 50).

JACQUELINE A. LAVINE, EXAMINING ATTORNEY

SN 85-170,598. MIMI SHLANSKY, BOCA RATON, FL. FILED 11-5-2010.

# DIBS

THE MARK CONSISTS OF STANDARD CHARACTERS WITHOUT CLAIM TO ANY PARTICULAR FONT, STYLE, SIZE, OR COLOR.

FOR CHARMS FOR ATTACHMENT TO BEVERAGEWARE, TABLEWARE AND CONTAINERS FOR IDENTIFICATION PURPOSES (U.S. CLS. 2, 13, 23, 29, 30, 33, 40 AND 50).

SUSAN LESLIE DUBOIS, EXAMINING ATTORNEY

**CLASS 21—(Continued).**

SN 85-175,776. LOGIC AQUATIC AND PET, LLC, TEMECULA, CA. FILED 11-12-2010.

**LOGIC AQUATIC & PET**

THE MARK CONSISTS OF STANDARD CHARACTERS WITHOUT CLAIM TO ANY PARTICULAR FONT, STYLE, SIZE, OR COLOR.

NO CLAIM IS MADE TO THE EXCLUSIVE RIGHT TO USE "PET", APART FROM THE MARK AS SHOWN.

FOR PET CRATES; PET KENNELS; KENNELS IN THE NATURE OF AN EXERCISE PEN FOR PETS (U.S. CLS. 2, 13, 23, 29, 30, 33, 40 AND 50).

JOHN SCHUYLER YARD, EXAMINING ATTORNEY

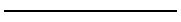

SN 85-176,021. NOBLE IDEAS, INC., CORONA DEL MAR, CA. FILED 11-12-2010.

**CATCHALL**

THE MARK CONSISTS OF STANDARD CHARACTERS WITHOUT CLAIM TO ANY PARTICULAR FONT, STYLE, SIZE, OR COLOR.

FOR BROOMS, BROOM BRISTLE ATTACHMENTS, AND BROOM HEADS (U.S. CLS. 2, 13, 23, 29, 30, 33, 40 AND 50).

PAUL F. GAST, EXAMINING ATTORNEY

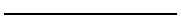

SN 85-176,857. WELL MADE TOY MFG. CORP., MASPETH, NY. FILED 11-15-2010.

**PetCakes Dreams**

THE MARK CONSISTS OF STANDARD CHARACTERS WITHOUT CLAIM TO ANY PARTICULAR FONT, STYLE, SIZE, OR COLOR.

OWNER OF U.S. REG. NO. 3,890,398.  
FOR PILLOW SOLD AS A UNIT WITH A PLUSH TOY (U.S. CLS. 2, 13, 23, 29, 30, 33, 40 AND 50).

SANJEEV VOHRA, EXAMINING ATTORNEY

**CLASS 21—(Continued).**

SN 85-182,395. TRECE, INC., ADAIR, OK. FILED 11-22-2010.

**INTELLIGENT DETECTION**

THE MARK CONSISTS OF STANDARD CHARACTERS WITHOUT CLAIM TO ANY PARTICULAR FONT, STYLE, SIZE, OR COLOR.

FOR INSECT TRAPS (U.S. CLS. 2, 13, 23, 29, 30, 33, 40 AND 50).

FIRST USE 8-9-2010; IN COMMERCE 8-9-2010.

MATTHEW EINSTEIN, EXAMINING ATTORNEY

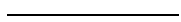

SN 85-182,555. HUMBOLDT WHOLESALE, INC., EUREKA, CA. FILED 11-22-2010.

**TRAY HUGGER**

THE MARK CONSISTS OF STANDARD CHARACTERS WITHOUT CLAIM TO ANY PARTICULAR FONT, STYLE, SIZE, OR COLOR.

OWNER OF U.S. REG. NO. 3,762,721.  
NO CLAIM IS MADE TO THE EXCLUSIVE RIGHT TO USE "TRAY", APART FROM THE MARK AS SHOWN.

FOR HYDROPONIC GROWING EQUIPMENT, NAMELY, DEVICES FOR HOLDING OR GROWING PLANTS, NAMELY, FLOWER AND PLANT CULTIVATION TRAYS, PLANT BASKETS, FLOWER POTS, PLANTERS FOR FLOWERS AND PLANTS, AND PLANT SYRINGES (U.S. CLS. 2, 13, 23, 29, 30, 33, 40 AND 50).

FIRST USE 10-29-2008; IN COMMERCE 1-27-2009.

ROBERT STRUCK, EXAMINING ATTORNEY

**CLASS 21—(Continued).**

SN 85-185,192. AMUSEMENT ART LLC, LOS ANGELES, CA. FILED 11-24-2010.

**MR BRAINWASH**

THE MARK CONSISTS OF STANDARD CHARACTERS WITHOUT CLAIM TO ANY PARTICULAR FONT, STYLE, SIZE, OR COLOR.

OWNER OF U.S. REG. NO. 3,695,896.

FOR BAKEWARE; BATH SPONGES; BEVERAGE GLASSWARE; BOTTLE OPENERS; BOTTLES, SOLD EMPTY; BOWLS; BREAD BASKETS FOR DOMESTIC USE; BREAD BOARDS; BRUSHES FOR PETS; BUCKETS; BUTTER DISHES; CAKE MOLDS; CANDLE HOLDERS; CANDLE HOLDERS NOT OF PRECIOUS METAL; CARAFES; CARDBOARD CUPS; CERAMIC TISSUE BOX COVERS; CLEANING SPONGES; COASTERS NOT OF PAPER AND NOT BEING TABLE LINEN; COCKTAIL PICKS; COCKTAIL SHAKERS; COOKIE JARS; COOKWARE, NAMELY, POTS AND PANS; CUPS; DISPENSERS FOR PAPER TOWELS; DRINKING GLASSES; DRINKING GLASSES, NAMELY, TUMBLERS; EARTHENWARE BASINS; EARTHENWARE MUGS; FIGURINES MADE OUT OF FIBERGLASS; FIGURINES OF GLASS OR PORCELAIN; FLASKS; FLOWER VASES; HAIR BRUSHES; HAIR COMBS; HAIRBRUSHES; HOLIDAY ORNAMENTS OF PORCELAIN; HOUSEHOLD UTENSILS, NAMELY, SPATULAS; HOUSEHOLD UTENSILS, NAMELY, TURNERS; HOUSEHOLD UTENSILS, NAMELY, BEATERS, SALT AND PEPPER CELLARS; ICE BUCKETS; ICE CUBE MOLDS; ICE SCOOPS; JUGS; KNIFE BOARDS; LUNCH BOXES; MEAL TRAYS; MUGS; NAPKIN HOLDERS, NOT OF PRECIOUS METAL; OVENWARE; PAPER CUPS; PAPER PLATES; PEPPER GRINDERS; PET FEEDING AND DRINKING BOWLS; PLASTIC CUPS; PLATES; PORTABLE COOLERS; PORTABLE ICE CHESTS FOR FOOD AND BEVERAGES; POTS; ROLLING PINS; SALT AND PEPPER SHAKERS; SCULPTURES OF EARTHENWARE, FIBERGLASS; SERVING TRAYS; SOAP DISHES; STATUES OF CHINA, EARTHENWARE, GLASS, TERRA COTTA, PORCELAIN; TEA POTS; TEA POTS NOT OF PRECIOUS METAL; TOOTH BRUSHES; TOOTHBRUSH CASES; TOOTHBRUSH HOLDERS; TRASH CANS; SERVING TRAYS; VASES; WORK GLOVES; WORKS OF ART OF CHINA, EARTHENWARE, GLASS, PORCELAIN, TERRA COTTA; HOUSE WARE AND GLASSWARE, NAMELY, SHOT GLASSES; HOLIDAY ORNAMENTS OF GLASS; TABLE CENTER SCULPTURE MADE OF CERAMIC, CHINA, CRYSTAL, EARTHENWARE, GLASS, PORCELAIN; PORCELAIN FIGURINES THAT MAY BE HUNG ON WALLS (U.S. CLS. 2, 13, 23, 29, 30, 33, 40 AND 50).

KHANH LE, EXAMINING ATTORNEY

**CLASS 21—(Continued).**

SN 85-186,841. JOAQUIN, ALAN, C., HONOLULU, HI. FILED 11-30-2010.

**FARMROOF**

THE MARK CONSISTS OF STANDARD CHARACTERS WITHOUT CLAIM TO ANY PARTICULAR FONT, STYLE, SIZE, OR COLOR.

FOR MODULAR GROWING SYSTEM FOR ROOFTOP AGRICULTURE, NAMELY, AGRICULTURAL CULTIVATION MODULE CONTAINERS INCORPORATING A MICRO-DRIP IRRIGATION SYSTEM, MESH WRAPS FOR PLANTS AND PLANT GROWING MEDIA FOR USE IN GROWING ANY TYPE OF VEGETABLE, PLANT OR SHRUB (U.S. CLS. 2, 13, 23, 29, 30, 33, 40 AND 50).

FIRST USE 9-19-2010; IN COMMERCE 9-19-2010.

KATHERINE CONNOLLY, EXAMINING ATTORNEY

SN 85-218,431. BRUSH WELLMAN INC., MAYFIELD HEIGHTS, OH. FILED 1-14-2011.

**DUROX AL**

THE MARK CONSISTS OF STANDARD CHARACTERS WITHOUT CLAIM TO ANY PARTICULAR FONT, STYLE, SIZE, OR COLOR.

OWNER OF U.S. REG. NO. 3,576,675.

NO CLAIM IS MADE TO THE EXCLUSIVE RIGHT TO USE "AL", APART FROM THE MARK AS SHOWN.

FOR SINTERED HIGH PURITY ALUMINA CERAMIC FOR GENERAL INDUSTRIAL AND FURTHER MANUFACTURING USE (U.S. CLS. 2, 13, 23, 29, 30, 33, 40 AND 50).

MICHELLE DUBOIS, EXAMINING ATTORNEY

SN 85-240,975. ICEKOOL LIMITED, DBA ICEKOOL, TORONTO, CANADA, FILED 2-13-2011.

**ICEKOOL**

THE MARK CONSISTS OF STANDARD CHARACTERS WITHOUT CLAIM TO ANY PARTICULAR FONT, STYLE, SIZE, OR COLOR.

FOR PORTABLE COOLERS (U.S. CLS. 2, 13, 23, 29, 30, 33, 40 AND 50).

FIRST USE 12-1-2010; IN COMMERCE 12-1-2010.  
ELIZABETH KAJUBI, EXAMINING ATTORNEY

**CLASS 21—(Continued).**

SN 85-260,977. THE HARTZ MOUNTAIN CORPORATION, SECAUCUS, NJ. FILED 3-8-2011.

**GROOMER'S BEST SHED MAX**

THE MARK CONSISTS OF STANDARD CHARACTERS WITHOUT CLAIM TO ANY PARTICULAR FONT, STYLE, SIZE, OR COLOR.

OWNER OF U.S. REG. NO. 2,404,707.

NO CLAIM IS MADE TO THE EXCLUSIVE RIGHT TO USE "GROOMER'S" AND "SHED", APART FROM THE MARK AS SHOWN.

FOR GROOMING TOOLS FOR PETS, NAMELY, COMBING RAKE UTENSIL, BRUSHES AND COMBS (U.S. CLS. 2, 13, 23, 29, 30, 33, 40 AND 50).

DAVID COLLIER, EXAMINING ATTORNEY

SN 85-265,719. GUANGDONG YINGAO KITCHEN UTENSILS CO., LTD., SHUNDE, FOSHAN, CHINA, FILED 3-14-2011.



NO CLAIM IS MADE TO THE EXCLUSIVE RIGHT TO USE THE NON-LATIN CHARACTERS THAT TRANSLITERATE TO CHU JU, APART FROM THE MARK AS SHOWN.

THE MARK CONSISTS OF FOUR CHINESE CHARACTERS APPEARING INSIDE A SHADED SQUARE BACKGROUND.

THE NON-LATIN CHARACTERS IN THE MARK TRANSLITERATE TO YING; AO; CHU; JU AND THIS MEANS CHERRY; ABSTRUSE; KITCHEN; UTENSIL IN ENGLISH.

FOR BASINS; CERAMIC SCULPTURES, VASES, VESSELS, BOWLS, PLATES AND POTS; CLEANING BRUSHES FOR HOUSEHOLD USE; CLEANING CLOTHS; CLEANING SPONGES; CONTAINERS FOR HOUSEHOLD OR KITCHEN USE; DRINKING VESSELS; ENAMELLED GLASS; GLASS JARS; HOUSEHOLD UTENSILS, NAMELY, KITCHEN TONGS; HOUSEHOLD UTENSILS, NAMELY, POT AND PAN SCRAPERS, ROLLING PINS, SPATULAS, TURNERS, WHISKS; INSULATED CONTAINERS FOR FOOD OR BEVERAGE FOR DOMESTIC USE; WATER TROUGHS (U.S. CLS. 2, 13, 23, 29, 30, 33, 40 AND 50).

PAM WILLIS, EXAMINING ATTORNEY

**CLASS 21—(Continued).**

SN 85-286,082. SIPPER DESIGNS, INC., DBA SIPPERS BY DESIGN, MIAMI, FL. FILED 4-5-2011.

**Sippers By Design**

THE MARK CONSISTS OF STANDARD CHARACTERS WITHOUT CLAIM TO ANY PARTICULAR FONT, STYLE, SIZE, OR COLOR.

NO CLAIM IS MADE TO THE EXCLUSIVE RIGHT TO USE "SIPPERS", APART FROM THE MARK AS SHOWN.

FOR DRINKING VESSELS (U.S. CLS. 2, 13, 23, 29, 30, 33, 40 AND 50).

FIRST USE 1-15-1991; IN COMMERCE 1-15-1991.

SETH A. RAPPAPORT, EXAMINING ATTORNEY

SN 85-293,631. STAPLES THE OFFICE SUPERSTORE, LLC., FRAMINGHAM, MA. FILED 4-13-2011.



NO CLAIM IS MADE TO THE EXCLUSIVE RIGHT TO USE "PROFESSIONAL", APART FROM THE MARK AS SHOWN.

THE MARK CONSISTS OF A CIRCLE COMPRISED OF 4 CRESCENTS OVER THE WORDS "BRIGHTON PROFESSIONAL".

FOR CUTLERY DISPENSERS, DRINK STIRRERS, PAPER AND PLASTIC PLATES AND BOWLS, PAPER AND PLASTIC HOT AND COLD DRINK CUPS AND LIDS, PAPER HOT CUP SLEEVES, PAPER PLATES, CUPS, PAPER DISPENSERS, SOAP AND SANITIZER DISPENSERS, EMPTY SPRAY BOTTLES AND TRIGGER SPRAYERS, TRASH CANS, WASTE BASKETS, BUCKETS, RECYCLING WASTE BASKETS (U.S. CLS. 2, 13, 23, 29, 30, 33, 40 AND 50).

GIANCARLO CASTRO, EXAMINING ATTORNEY

SN 85-309,985. SUMMIT GLOVE, INC., MINERVA, OH. FILED 5-2-2011.

**MILKER'S HELPERS**

THE MARK CONSISTS OF STANDARD CHARACTERS WITHOUT CLAIM TO ANY PARTICULAR FONT, STYLE, SIZE, OR COLOR.

NO CLAIM IS MADE TO THE EXCLUSIVE RIGHT TO USE "MILKER'S", APART FROM THE MARK AS SHOWN.

FOR DISPOSABLE LATEX GLOVES FOR GENERAL USE (U.S. CLS. 2, 13, 23, 29, 30, 33, 40 AND 50).

FIRST USE 9-23-2008; IN COMMERCE 9-23-2008.

PAULA MAHONEY, EXAMINING ATTORNEY

**CLASS 21—(Continued).**

SN 85-311,221. PEAK ENTERPRISES, INC., SARASOTA, FL. FILED 5-3-2011.

## PEAK ESSENTIALS THE ORIGINAL TUNG BRUSH

THE MARK CONSISTS OF STANDARD CHARACTERS WITHOUT CLAIM TO ANY PARTICULAR FONT, STYLE, SIZE, OR COLOR.

NO CLAIM IS MADE TO THE EXCLUSIVE RIGHT TO USE "THE ORIGINAL TONGUE BRUSH", APART FROM THE MARK AS SHOWN.

FOR ORAL HYGIENE BRUSH FOR THE TONGUE (U.S. CLS. 2, 13, 23, 29, 30, 33, 40 AND 50).  
APRIL ROACH, EXAMINING ATTORNEY

SN 85-311,517. MULTISPORT JOURNEYS, LLC, RIDGWAY, CO. FILED 5-3-2011.



OWNER OF U.S. REG. NO. 3,987,059.

THE MARK CONSISTS OF THE STYLIZED INITIALS "MSJ" WITH A DESIGN OF A BIKER TO THE LEFT, A DESIGN OF A ROWER ABOVE, AND A DESIGN OF A HIKER TO THE RIGHT OF "MSJ." THE STACKED STYLIZED WORDING "WWW.MULTISPORTJOURNEYS.COM" AND "LIVE TO PLAY ANOTHER DAY" ARE CENTERED AT THE BOTTOM OF THE MARK.

FOR DRINKING STEINS; INSULATING SLEEVE HOLDERS FOR BEVERAGE CANS; MUGS (U.S. CLS. 2, 13, 23, 29, 30, 33, 40 AND 50).

FIRST USE 6-20-2010; IN COMMERCE 10-29-2010.  
PAULA MAHONEY, EXAMINING ATTORNEY

SN 85-312,573. TRACTOR SUPPLY CO. OF TEXAS, LP, BRENTWOOD, TN. FILED 5-4-2011.

## 4HEALTH

THE MARK CONSISTS OF STANDARD CHARACTERS WITHOUT CLAIM TO ANY PARTICULAR FONT, STYLE, SIZE, OR COLOR.

OWNER OF U.S. REG. NOS. 3,846,317 AND 3,846,326.

FOR PET CARE PRODUCTS, NAMELY, BRUSHES AND COMBS; TOOTH BRUSHES; TOOTH AND GUM CLEANING DEVICES, NAMELY, APPARATUS CONTAINING A SOFT BRISTLE BRUSH WHICH FITS OVER THE TIP OF ONE'S FINGER; CAT LITTER BOXES; AUTOMATED PET APPLIANCES, NAMELY, LITTER BOXES; PET FEEDING AND DRINKING BOWLS (U.S. CLS. 2, 13, 23, 29, 30, 33, 40 AND 50).

ROBERT C. CLARK JR., EXAMINING ATTORNEY

**CLASS 21—(Continued).**

SN 85-319,123. MARVEL CHARACTERS, INC., MANHATTAN BEACH, CA. FILED 5-12-2011.

## MARVEL

THE MARK CONSISTS OF STANDARD CHARACTERS WITHOUT CLAIM TO ANY PARTICULAR FONT, STYLE, SIZE, OR COLOR.

OWNER OF U.S. REG. NOS. 870,506, 2,918,286 AND OTHERS.

FOR BOTTLES, SOLD EMPTY; BOWLS; CANTEENS; CERAMIC FIGURINES; CONTAINERS FOR HOUSEHOLD OR KITCHEN USE NOT OF PRECIOUS METAL; CUPS; DISHES; DRINKING CUPS; DRINKING CUPS FOR CHILDREN AND PARTS AND FITTINGS THEREFOR, NAMELY, DRINKING CUPS FOR CHILDREN SOLD AS A UNIT WITH NON-INSULATED LIDS; DRINKING GLASSES; LUNCH BOXES; LUNCH PAILS; MUGS; NON-METAL PIGGY BANKS; PAPER CUPS; PAPER PLATES; PLASTIC CUPS; PLASTIC PLATES; PLASTIC STORAGE CONTAINERS FOR HOUSEHOLD USE; SHOT GLASSES; SPORTS BOTTLES SOLD EMPTY; THERMAL INSULATED CONTAINERS FOR FOOD OR BEVERAGES; TOOTHBRUSHES (U.S. CLS. 2, 13, 23, 29, 30, 33, 40 AND 50).

FIRST USE 9-30-1978; IN COMMERCE 9-30-1978.  
MARC LEIPZIG, EXAMINING ATTORNEY

SN 85-319,128. MARVEL CHARACTERS, INC., MANHATTAN BEACH, CA. FILED 5-12-2011.



OWNER OF U.S. REG. NOS. 1,754,033, 3,116,241 AND OTHERS.

THE COLOR(S) RED AND WHITE IS/ARE CLAIMED AS A FEATURE OF THE MARK.

THE MARK CONSISTS OF THE WORD "MARVEL" IN WHITE LETTERS IN A RED RECTANGLE.

FOR BOTTLES, SOLD EMPTY; BOWLS; CANTEENS; CERAMIC FIGURINES; CONTAINERS FOR HOUSEHOLD OR KITCHEN USE NOT OF PRECIOUS METAL; CUPS; DISHES; DRINKING CUPS; DRINKING CUPS FOR CHILDREN AND PARTS AND FITTINGS THEREFOR, NAMELY, DRINKING CUPS FOR CHILDREN SOLD AS A UNIT WITH NON-INSULATED LIDS; DRINKING GLASSES; LUNCH BOXES; LUNCH PAILS; MUGS; NON-METAL PIGGY BANKS; PAPER CUPS; PAPER PLATES; PLASTIC CUPS; PLASTIC PLATES; PLASTIC STORAGE CONTAINERS FOR HOUSEHOLD USE; SHOT GLASSES; SPORTS BOTTLES SOLD EMPTY; THERMAL INSULATED CONTAINERS FOR FOOD OR BEVERAGES; TOOTHBRUSHES (U.S. CLS. 2, 13, 23, 29, 30, 33, 40 AND 50).

FIRST USE 12-31-2001; IN COMMERCE 12-31-2001.  
MARC LEIPZIG, EXAMINING ATTORNEY



**CLASS 21—(Continued).**

SN 85-321,088. GUEY N. CHIN, FLORHAM PARK, NJ. FILED 5-14-2011.

# WIPEE

THE MARK CONSISTS OF STANDARD CHARACTERS WITHOUT CLAIM TO ANY PARTICULAR FONT, STYLE, SIZE, OR COLOR.

FOR CLOTH FOR WIPING OR DUSTING (U.S. CLS. 2, 13, 23, 29, 30, 33, 40 AND 50).

FIRST USE 2-1-2009; IN COMMERCE 6-1-2010.  
DEBRA LEE, EXAMINING ATTORNEY

---

SN 85-321,578. NIEMI, NANCY, ARLINGTON, WA. FILED 5-16-2011.

# NKRN

THE MARK CONSISTS OF STANDARD CHARACTERS WITHOUT CLAIM TO ANY PARTICULAR FONT, STYLE, SIZE, OR COLOR.

FOR MOSAIC FLOWER POTS (U.S. CLS. 2, 13, 23, 29, 30, 33, 40 AND 50).

PAUL E. FAHRENKOPF, EXAMINING ATTORNEY

---

SN 85-322,982. LIFT FLASK, L.L.C., PARK CITY, UT. FILED 5-17-2011.

# Lift Flask

THE MARK CONSISTS OF STANDARD CHARACTERS WITHOUT CLAIM TO ANY PARTICULAR FONT, STYLE, SIZE, OR COLOR.

NO CLAIM IS MADE TO THE EXCLUSIVE RIGHT TO USE "FLASK", APART FROM THE MARK AS SHOWN.

FOR DRINKING FLASKS; FLASKS; HIP FLASKS (U.S. CLS. 2, 13, 23, 29, 30, 33, 40 AND 50).

FIRST USE 5-1-2008; IN COMMERCE 3-9-2009.  
JACLYN KIDWELL WALKER, EXAMINING ATTORNEY

**CLASS 21—(Continued).**

SN 85-323,762. ORTIZ, JUANA, SAN MARCOS, CA. FILED 5-18-2011.



NO CLAIM IS MADE TO THE EXCLUSIVE RIGHT TO USE "STAINLESS BOX" AND "DISPENSER HOLDER", APART FROM THE MARK AS SHOWN.

THE MARK CONSISTS OF THE STYLIZED TEXT "STNLESS BX HASSLE FREE DISPENSER HOLDER" WITH A CURVED ZIGZAG UNDERNEATH THE STYLIZED TEXT "STNLESS".

FOR CONTAINERS FOR HOUSEHOLD OR KITCHEN USE OF PRECIOUS METAL (U.S. CLS. 2, 13, 23, 29, 30, 33, 40 AND 50).

FLORENTINA BLANDU, EXAMINING ATTORNEY

---

SN 85-324,347. TRACTOR SUPPLY CO. OF TEXAS, LP, BRENTWOOD, TN. FILED 5-18-2011.



OWNER OF U.S. REG. NOS. 3,319,816 AND 3,420,720.

THE MARK CONSISTS OF THE WORD GROUNDWORK IN A STYLIZED FONT APPEARING WITHIN A SLIGHTLY ARCHED RECTANGLE BANNER WITH A SEMI CIRCLE PROTRUSION AT THE TOP CENTER. CENTERED ABOVE THE WORD GROUNDWORK AND WITHIN THE SEMI CIRCLE PROTRUSION APPEARS THE IMAGE OF THREE LEAVES.

FOR LAWN AND GARDEN SPRINKLERS; SPRINKLER ACCESSORIES, NAMELY, SPIKES, NOZZLES, FAUCET CONNECTIONS AND SPRAYER WANDS FOR GARDEN HOSES; LAWN AND GARDEN HOSE NOZZLES AND SPRAYERS ATTACHED TO GARDEN HOSES (U.S. CLS. 2, 13, 23, 29, 30, 33, 40 AND 50).

REGINA DRUMMOND, EXAMINING ATTORNEY

**CLASS 21—(Continued).**

SN 85-332,307. EVRIHOLDER PRODUCTS LLC, ANAHEIM, CA. FILED 5-27-2011.

**KIDZ'TAINER**

THE MARK CONSISTS OF STANDARD CHARACTERS WITHOUT CLAIM TO ANY PARTICULAR FONT, STYLE, SIZE, OR COLOR.

FOR ALL PURPOSE PORTABLE HOUSEHOLD CONTAINERS (U.S. CLS. 2, 13, 23, 29, 30, 33, 40 AND 50).

Laurie Mayes, Examining Attorney

**CLASS 21—(Continued).**

SN 85-334,066. DAVID BERKO, WEST PALM BEACH, FL. FILED 5-31-2011.

**CORRECTBRUSH**

THE MARK CONSISTS OF STANDARD CHARACTERS WITHOUT CLAIM TO ANY PARTICULAR FONT, STYLE, SIZE, OR COLOR.

FOR MANUAL TOOTHBRUSH. SPECIFICALLY DESIGNED FOR INCARCERATED PRISONERS THAT BRUSHES AND FLOSSES THE TEETH, DISINFECTS THE TONGUE, AND DOES NOT LEND ITSELF TO USE OR RECONFIGURATION AS A WEAPON (U.S. CLS. 2, 13, 23, 29, 30, 33, 40 AND 50).

Fred Carl, Examining Attorney

SN 85-333,200. GUERRIERI, MICHAEL JAMES, WASHINGTON, DC, DC. FILED 5-29-2011.

**Smooth Scoop**

THE MARK CONSISTS OF STANDARD CHARACTERS WITHOUT CLAIM TO ANY PARTICULAR FONT, STYLE, SIZE, OR COLOR.

FOR PET LITTER BOX LINERS (U.S. CLS. 2, 13, 23, 29, 30, 33, 40 AND 50).

Matthew Einstein, Examining Attorney

SN 85-334,135. RICHELL U.S.A., INC., GRAND PRAIRIE, TX. FILED 5-31-2011.

**PAW TRAX**

THE MARK CONSISTS OF STANDARD CHARACTERS WITHOUT CLAIM TO ANY PARTICULAR FONT, STYLE, SIZE, OR COLOR.

OWNER OF U.S. REG. NO. 3,098,701.  
FOR CAT LITTER BOXES (U.S. CLS. 2, 13, 23, 29, 30, 33, 40 AND 50).

First Use 3-13-2005; In Commerce 3-13-2005.  
Patricia Evanko, Examining Attorney

SN 85-333,314. EASEPAL ENTERPRISES LTD, FUJIAN PROVINCE, CHINA, FILED 5-30-2011.



THE MARK CONSISTS OF THE STYLIZED WORD KNINK ON THE LEFT, AND TWO CHINESE CHARACTERS WHICH TRANSLITERATE INTO YIN KE ON THE RIGHT. THE WORDING KNINK HAS NO MEANING IN A FOREIGN LANGUAGE.

THE NON-LATIN CHARACTERS IN THE MARK TRANSLITERATE TO YIN; KE AND THIS MEANS STAMP; GUEST IN ENGLISH.

FOR BEER MUGS; BEVERAGE GLASSWARE; BOWLS; CERAMIC SCULPTURES, VASES, VESSELS, BOWLS, PLATES AND POTS; CONTAINERS FOR HOUSEHOLD OR KITCHEN USE; CUPS; DISHES; DRINKING GLASSES; ENAMELLED GLASS; GOBLET; PAPER AND PLASTIC CUPS; WATERING POTS (U.S. CLS. 2, 13, 23, 29, 30, 33, 40 AND 50).

Barbara Brown, Examining Attorney

SN 85-334,183. HARRINGTON MULTI MEDIA MARKETING LLC, CLEARWATER, FL. FILED 5-31-2011.

**COOKOLOGY**

THE MARK CONSISTS OF STANDARD CHARACTERS WITHOUT CLAIM TO ANY PARTICULAR FONT, STYLE, SIZE, OR COLOR.

FOR CLEANING PANS FOR GRILL COOKING GRIDS AND COOKING GRATES, NAMELY, GRILL SOAKERS; COOKING FORKS; COOKING FUNNELS; COOKING GRATERS; COOKING PANS; COOKING POT SETS; COOKING POTS; COOKING POTS AND PANS; COOKING SIEVES AND SIFTERS; COOKING SKEWERS; COOKING STEAMERS; COOKING STRAINERS; COOKING UTENSIL, NAMELY, BATTER DISPENSER; COOKING UTENSILS, NAMELY, BARBECUE BRANDERS; COOKING UTENSILS, NAMELY, GRILL COVERS; COOKING UTENSILS, NAMELY, GRILLS; COOKING UTENSILS, NAMELY, WIRE BASKETS; COOKWARE FOR USE IN MICROWAVE OVENS; COOKWARE, NAMELY, POTS AND PANS; COOKWARE, NAMELY, ROASTING PANS; COOKWARE, NAMELY, STEAMERS; HIGH TEMPERATURE NYLON AND POLYETHYLENE PAN LINERS THAT HELP PREVENT FOOD FROM STICKING TO THE PAN WHILE STORING, WARMING

**CLASS 21—(Continued).**

AND COOKING FOOD; HOTDOG COOKING FORKS AND MARSHMALLOW COOKING FORKS; HOUSEHOLD UTENSILS, NAMELY, GRATERS; HOUSEHOLD UTENSILS, NAMELY, KITCHEN TONGS; HOUSEHOLD UTENSILS, NAMELY, SIEVES; HOUSEHOLD UTENSILS, NAMELY, SKIMMERS; HOUSEHOLD UTENSILS, NAMELY, SPATULAS; HOUSEHOLD UTENSILS, NAMELY, STRAINERS; HOUSEHOLD UTENSILS, NAMELY, TURNERS; JAPANESE STYLE COOKED RICE SCOOPS (SHAMOJI); JARS FOR COOKING GREASE SOLD EMPTY; KITCHEN UTENSIL, NAMELY, NON-METAL FLEXIBLE LID DESIGNED FOR DRAINING OR PRESSING LIQUIDS FROM A FOOD CAN; KITCHEN UTENSILS, NAMELY, POURING AND STRAINING SPOUTS; KITCHEN UTENSILS, NAMELY, SPLATTER SCREENS; MESS-TINS; METAL COOKING PANS; NON-ELECTRIC PRESSURE COOKING SAUCEPANS; PORTABLE COOKING KITS FOR OUTDOOR USE; RICE COOKING POTS; ROLLING PINS; UTENSILS FOR BARBECUES, NAMELY, FORKS, TONGS, TURNERS; WOOD CHOPPING BLOCKS; WOOD COOKING PLANKS FOR USE IN GRILLING (U.S. CLS. 2, 13, 23, 29, 30, 33, 40 AND 50).

JILL C. ALT, EXAMINING ATTORNEY

SN 85-334,224. HANTOVER, INC., KANSAS CITY, MO. FILED 5-31-2011.

# KAPOOSH

THE MARK CONSISTS OF STANDARD CHARACTERS WITHOUT CLAIM TO ANY PARTICULAR FONT, STYLE, SIZE, OR COLOR.

OWNER OF U.S. REG. NO. 3,730,118.

FOR TRASH BINS; WASTE BASKETS; BOTTLE STOPPERS SPECIALLY ADAPTED FOR USE WITH WINE BOTTLES; COOLERS FOR WINE; COOLING BUCKETS FOR WINE; WINE COOLING PAILS; WINE DRIP COLLARS SPECIALLY ADAPTED FOR USE AROUND THE TOP OF WINE BOTTLES TO STOP DRIPS; WINE OPENERS; WINE POURERS; WINE STRAINERS; AND VACUUM PUMPS FOR WINE BOTTLES (U.S. CLS. 2, 13, 23, 29, 30, 33, 40 AND 50).

JOHN DALIER, EXAMINING ATTORNEY

SN 85-334,542. TIGHTPAC AMERICA INC., VENICE, CA. FILED 5-31-2011.

# SNACKVAC

THE MARK CONSISTS OF STANDARD CHARACTERS WITHOUT CLAIM TO ANY PARTICULAR FONT, STYLE, SIZE, OR COLOR.

FOR PLASTIC STORAGE CONTAINERS FOR HOUSEHOLD USE (U.S. CLS. 2, 13, 23, 29, 30, 33, 40 AND 50).

JOHN DWYER, EXAMINING ATTORNEY

**CLASS 21—(Continued).**

SN 85-335,460. THE STATE OF CONNECTICUT, HARTFORD, CT. FILED 6-1-2011.



THE MARK CONSISTS OF THE OUTLINE OF THE FRONT OF A FOOTBALL STADIUM WITH THREE PENNANTS ABOVE IT. BELOW THE STADIUM IS THE WORD RENTSCHLER IN AN UPWARD CURVE UNDER WHICH IS THE WORD FIELD.

FOR CUPS AND MUGS; BEER MUGS; DINNERWARE; DRINKING CUPS SOLD WITH LIDS THEREFORE; DRINKING CUPS FOR BABIES AND CHILDREN AND PARTS AND FITTINGS THEREFORE, NAMELY, DRINKING CUPS FOR CHILDREN SOLD AS A UNIT WITH NON-INSULATED LIDS; PAPER AND PLASTIC CUPS; INSULATED CONTAINERS FOR FOOD OR BEVERAGE FOR DOMESTIC USE; INSULATED FLASKS; EMPTY WATER BOTTLES FOR BICYCLES; REUSABLE PLASTIC WATER BOTTLES SOLD EMPTY; REUSABLE STAINLESS STEEL WATER BOTTLES SOLD EMPTY; ALUMINUM WATER BOTTLES SOLD EMPTY; SOAP DISHES; PET FEEDING DISHES; PORTABLE COOLERS (U.S. CLS. 2, 13, 23, 29, 30, 33, 40 AND 50).

KAREN BRACEY, EXAMINING ATTORNEY

SN 85-335,518. PILL PICK UP, LLC, DOWNERS GROVE, IL. FILED 6-1-2011.

# SKIO

THE MARK CONSISTS OF THE STYLIZED WORD SKIO. FOR PERSONAL PILL DISPENSERS FOR PILLS OR CAPSULES FOR DOMESTIC USE (U.S. CLS. 2, 13, 23, 29, 30, 33, 40 AND 50).

C. DIONNE CLYBURN, EXAMINING ATTORNEY

**CLASS 21—(Continued).**

SN 85-335,775. MBGA HOLDING COMPANY LLC, WEST HOLLYWOOD, CA. FILED 6-1-2011.

# GLUBBIE

THE MARK CONSISTS OF STANDARD CHARACTERS WITHOUT CLAIM TO ANY PARTICULAR FONT, STYLE, SIZE, OR COLOR.

FOR DISPOSABLE PLASTIC GLOVES FOR GENERAL USE; DISPOSABLE PLASTIC GLOVES FOR HYGIENE; DISPOSABLE PLASTIC GLOVES FOR HANDLING AND DISPOSING OF FEMININE PRODUCTS, TAMPONS, SANITARY PADS AND PANTY LINERS; DISPOSABLE PLASTIC GLOVES FOR HANDLING AND DISPOSING OF ANIMAL AND PET WASTE; DISPOSABLE PLASTIC GLOVES FOR HANDLING AND DISPOSING OF SOILED DIAPERS; CLOTH CARRYING CASES SPECIFICALLY ADAPTED FOR THE FOREGOING DISPOSABLE PLASTIC GLOVES (U.S. CLS. 2, 13, 23, 29, 30, 33, 40 AND 50).  
LEIGH CAROLINE CASE, EXAMINING ATTORNEY

---

SN 85-337,442. LIBBEY GLASS INC., TOLEDO, OH. FILED 6-3-2011.

# BRIOSSA

THE MARK CONSISTS OF STANDARD CHARACTERS WITHOUT CLAIM TO ANY PARTICULAR FONT, STYLE, SIZE, OR COLOR.

FOR BEVERAGE GLASSWARE (U.S. CLS. 2, 13, 23, 29, 30, 33, 40 AND 50).  
MORGAN WYNNE, EXAMINING ATTORNEY

---

SN 85-337,533. MWP INDUSTRIAL SUPPLY, LLC, PONTIAC, MI. FILED 6-3-2011.

## HE WAS BORN IN THE USA

THE MARK CONSISTS OF STANDARD CHARACTERS WITHOUT CLAIM TO ANY PARTICULAR FONT, STYLE, SIZE, OR COLOR.

FOR COFFEE MUGS (U.S. CLS. 2, 13, 23, 29, 30, 33, 40 AND 50).  
JASON TURNER, EXAMINING ATTORNEY

**CLASS 21—(Continued).**

SN 85-340,219. YANGZHOU QUANHUA GLASS ARTS CO., LTD, JIANGSU PROVINCE, CHINA, FILED 6-7-2011.



THE MARK CONSISTS OF THE STYLIZED WORDING "MOOSTAR" WITHIN A SPHERE, WITH THREE INTERSECTING RINGS APPEARING WITHIN THE SPHERE AND SURROUNDING THE "MOOSTAR" WORDING, AND FOUR DOTS APPEARS ON THE LEFT SIDE OF THE SPHERE AND AT POINTS WHERE THE THREE RINGS INTERSECT.

THE WORDING MOOSTAR HAS NO MEANING IN A FOREIGN LANGUAGE.

FOR BATH SPONGES; BEVERAGE GLASSWARE; CLEANING AND POLISHING CLOTHS; CLEANING COMBS; CLEANING RAGS; CLEANING SPONGES; COMBS; DRAWER PULLS OF GLASS, PORCELAIN OR EARTHENWARE; EARTHENWARE BASINS; EARTHENWARE MUGS; HOUSEHOLD UTENSILS, NAMELY, GRATERS; HOUSEHOLD UTENSILS, NAMELY, KITCHEN TONGS; HOUSEHOLD UTENSILS, NAMELY, SIEVES; HOUSEHOLD UTENSILS, NAMELY, SKIMMERS; HOUSEHOLD UTENSILS, NAMELY, SPATULAS; HOUSEHOLD UTENSILS, NAMELY, STRAINERS; HOUSEHOLD UTENSILS, NAMELY, TURNERS; HOUSEHOLD UTENSILS, NAMELY, POT AND PAN SCRAPERS, ROLLING PINS, AND WHISKS; MATERIAL FOR BRUSH-MAKING; PORCELAIN MUGS; SCRUB SPONGES; STEEL WOOL; UNWORKED OR SEMI-WORKED GLASS (U.S. CLS. 2, 13, 23, 29, 30, 33, 40 AND 50).

FIRST USE 8-0-2010; IN COMMERCE 2-0-2011.  
FRED CARL, EXAMINING ATTORNEY

---

SN 85-340,450. YETI COOLERS INC., AUSTIN, TX. FILED 6-7-2011.

## WILDLY STRONGER! KEEP ICE LONGER!

THE MARK CONSISTS OF STANDARD CHARACTERS WITHOUT CLAIM TO ANY PARTICULAR FONT, STYLE, SIZE, OR COLOR.

FOR PORTABLE COOLERS (U.S. CLS. 2, 13, 23, 29, 30, 33, 40 AND 50).  
FIRST USE 11-5-2008; IN COMMERCE 2-1-2009.  
NORA BUCHANAN WILL, EXAMINING ATTORNEY

**CLASS 21—(Continued).**

SN 85-340,490. YETI COOLERS INC., AUSTIN, TX. FILED 6-7-2011.

**TUNDRA**

THE MARK CONSISTS OF STANDARD CHARACTERS WITHOUT CLAIM TO ANY PARTICULAR FONT, STYLE, SIZE, OR COLOR.

FOR PORTABLE COOLERS (U.S. CLS. 2, 13, 23, 29, 30, 33, 40 AND 50).

FIRST USE 12-12-2007; IN COMMERCE 3-18-2008.

NORA BUCHANAN WILL, EXAMINING ATTORNEY

---

SN 85-340,505. YETI COOLERS INC., AUSTIN, TX. FILED 6-7-2011.

**ROADIE**

THE MARK CONSISTS OF STANDARD CHARACTERS WITHOUT CLAIM TO ANY PARTICULAR FONT, STYLE, SIZE, OR COLOR.

FOR PORTABLE COOLERS (U.S. CLS. 2, 13, 23, 29, 30, 33, 40 AND 50).

FIRST USE 12-13-2007; IN COMMERCE 4-23-2008.

NORA BUCHANAN WILL, EXAMINING ATTORNEY

---

SN 85-341,339. CROWN INDUSTRIES INC., CROWN POINT, IN. FILED 6-8-2011.

**CROWN BRUSH**

THE MARK CONSISTS OF STANDARD CHARACTERS WITHOUT CLAIM TO ANY PARTICULAR FONT, STYLE, SIZE, OR COLOR.

NO CLAIM IS MADE TO THE EXCLUSIVE RIGHT TO USE "BRUSH", APART FROM THE MARK AS SHOWN.

FOR APPLICATOR STICKS FOR APPLYING MAKE-UP; COSMETIC BRUSHES; FACIAL SPONGES FOR APPLYING MAKE-UP; MAKE-UP BRUSHES; NAIL BRUSHES (U.S. CLS. 2, 13, 23, 29, 30, 33, 40 AND 50).

FIRST USE 1-1-1985; IN COMMERCE 1-1-1985.

KATHERINE CONNOLLY, EXAMINING ATTORNEY

**CLASS 21—(Continued).**

SN 85-341,492. CROWN INDUSTRIES INC., CROWN POINT, IN. FILED 6-8-2011.

**STUDIO SERIES**

THE MARK CONSISTS OF STANDARD CHARACTERS WITHOUT CLAIM TO ANY PARTICULAR FONT, STYLE, SIZE, OR COLOR.

NO CLAIM IS MADE TO THE EXCLUSIVE RIGHT TO USE "SERIES", APART FROM THE MARK AS SHOWN.

FOR COSMETIC BRUSHES; MAKE-UP BRUSHES (U.S. CLS. 2, 13, 23, 29, 30, 33, 40 AND 50).

FIRST USE 1-1-2001; IN COMMERCE 1-1-2001.

KATHERINE CONNOLLY, EXAMINING ATTORNEY

---

SN 85-341,713. KELLY C. KRZEMIEN, MIDLOTHIAN, VA. FILED 6-8-2011.

**FEEL THE LOVE**

THE MARK CONSISTS OF STANDARD CHARACTERS WITHOUT CLAIM TO ANY PARTICULAR FONT, STYLE, SIZE, OR COLOR.

OWNER OF U.S. REG. NOS. 3,755,548, 3,865,877 AND 3,884,228.

FOR BOTTLES, SOLD EMPTY; COFFEE CUPS, TEA CUPS AND MUGS; PLASTIC WATER BOTTLES SOLD EMPTY; REUSABLE PLASTIC WATER BOTTLES SOLD EMPTY; SPORTS BOTTLES SOLD EMPTY (U.S. CLS. 2, 13, 23, 29, 30, 33, 40 AND 50).

FIRST USE 4-1-2011; IN COMMERCE 4-1-2011.

MIDGE BUTLER, EXAMINING ATTORNEY

---

SN 85-348,788. WILTON INDUSTRIES, INC., WOODRIDGE, IL. FILED 6-17-2011.

**BUCCANEER**

THE MARK CONSISTS OF STANDARD CHARACTERS WITHOUT CLAIM TO ANY PARTICULAR FONT, STYLE, SIZE, OR COLOR.

FOR CUPS (U.S. CLS. 2, 13, 23, 29, 30, 33, 40 AND 50).

SANI KHOURI, EXAMINING ATTORNEY

**CLASS 21—(Continued).**

SN 85-349,769. EVRIHOLDER PRODUCTS LLC, ANAHEIM, CA. FILED 6-17-2011.

**HANDY BAGG'R**

THE MARK CONSISTS OF STANDARD CHARACTERS WITHOUT CLAIM TO ANY PARTICULAR FONT, STYLE, SIZE, OR COLOR.

FOR PLASTIC BAG HOLDERS FOR HOUSEHOLD USE (U.S. CLS. 2, 13, 23, 29, 30, 33, 40 AND 50).  
LAURIE MAYES, EXAMINING ATTORNEY

SN 85-353,490. COLGATE-PALMOLIVE COMPANY, NEW YORK, NY. FILED 6-22-2011.

**MAX FRESH**

THE MARK CONSISTS OF STANDARD CHARACTERS WITHOUT CLAIM TO ANY PARTICULAR FONT, STYLE, SIZE, OR COLOR.

OWNER OF U.S. REG. NOS. 3,189,537, 3,693,715 AND OTHERS.

FOR DENTAL FLOSS AND INTERDENTAL CLEANERS (U.S. CLS. 2, 13, 23, 29, 30, 33, 40 AND 50).  
JAY FLOWERS, EXAMINING ATTORNEY

SN 85-356,753. FERGUSON ENTERPRISES, INC., NEWPORT NEWS, VA. FILED 6-27-2011.

**BRADENTON**

THE MARK CONSISTS OF STANDARD CHARACTERS WITHOUT CLAIM TO ANY PARTICULAR FONT, STYLE, SIZE, OR COLOR.

OWNER OF U.S. REG. NO. 3,974,966.  
FOR BATHROOM ACCESSORIES, NAMELY, TOWEL RAILS, BATHROOM GLASS HOLDERS NOT OF PRECIOUS METAL, WASHTUBS, STAINLESS STEEL SINK BOTTOM GRIDS AND CUTTING BOARDS FOR STAINLESS STEEL SINKS (U.S. CLS. 2, 13, 23, 29, 30, 33, 40 AND 50).  
INGRID C. EULIN, EXAMINING ATTORNEY

**CLASS 21—(Continued).**

SN 85-356,766. FERGUSON ENTERPRISES, INC., NEWPORT NEWS, VA. FILED 6-27-2011.

**CORDOBA**

THE MARK CONSISTS OF STANDARD CHARACTERS WITHOUT CLAIM TO ANY PARTICULAR FONT, STYLE, SIZE, OR COLOR.

OWNER OF U.S. REG. NO. 3,535,254.  
FOR BATHROOM ACCESSORIES, NAMELY, TOWEL RAILS, BATHROOM GLASS HOLDERS NOT OF PRECIOUS METAL, WASHTUBS, STAINLESS STEEL SINK BOTTOM GRIDS AND CUTTING BOARDS FOR STAINLESS STEEL SINKS (U.S. CLS. 2, 13, 23, 29, 30, 33, 40 AND 50).  
INGRID C. EULIN, EXAMINING ATTORNEY

SN 85-360,242. LOTTA LUV, LLC, NEW YORK, NY. FILED 6-30-2011.

**MANE SQUEEZE**

THE MARK CONSISTS OF STANDARD CHARACTERS WITHOUT CLAIM TO ANY PARTICULAR FONT, STYLE, SIZE, OR COLOR.

FOR HAIR BRUSHES; HAIR COMBS (U.S. CLS. 2, 13, 23, 29, 30, 33, 40 AND 50).  
MARGARET POWER, EXAMINING ATTORNEY

SN 85-366,162. BRADSHAW INTERNATIONAL, INC., RANCHO CUCAMONGA, CA. FILED 7-8-2011.

**OVEN FRESH**

THE MARK CONSISTS OF STANDARD CHARACTERS WITHOUT CLAIM TO ANY PARTICULAR FONT, STYLE, SIZE, OR COLOR.

OWNER OF U.S. REG. NOS. 2,094,958 AND 3,641,767.  
FOR CERAMIC BAKING DISHES (U.S. CLS. 2, 13, 23, 29, 30, 33, 40 AND 50).  
KIMBERLY PERRY, EXAMINING ATTORNEY

**CLASS 21—(Continued).**

SN 85-371,642. STEEL TECHNOLOGY, LLC, BEND, OR. FILED 7-14-2011.

**HYDRATE YOUR LIFE**

THE MARK CONSISTS OF STANDARD CHARACTERS WITHOUT CLAIM TO ANY PARTICULAR FONT, STYLE, SIZE, OR COLOR.

FOR DRINKING FLASKS; DRINKING VESSELS; FLASKS; INSULATED VACUUM FLASKS; REUSABLE STAINLESS STEEL WATER BOTTLES SOLD EMPTY; VACUUM BOTTLES; VACUUM FLASKS (U.S. CLS. 2, 13, 23, 29, 30, 33, 40 AND 50).

CARRIE GENOVESE, EXAMINING ATTORNEY

SN 85-383,687. HANDI-FOIL CORPORATION, WHEELING, IL. FILED 7-28-2011.

**CHANGING TRENDS**

THE MARK CONSISTS OF STANDARD CHARACTERS WITHOUT CLAIM TO ANY PARTICULAR FONT, STYLE, SIZE, OR COLOR.

FOR NON-ELECTRIC ALUMINUM AND ROASTING PANS WITH PLASTIC LIDS, CONTAINERS FORMED OF ALUMINUM FOIL WITH PLASTIC LIDS FOR HOUSEHOLD USE, PANS FORMED OF ALUMINUM FOIL WITH WIRE HANDLES AND PLASTIC LIDS, AND PANS FORMED OF ALUMINUM FOIL WITH PLASTIC LIDS (U.S. CLS. 2, 13, 23, 29, 30, 33, 40 AND 50).

JASON BLAIR, EXAMINING ATTORNEY

SN 85-384,936. DIAGEO IRELAND, DUBLIN 8, IRELAND, FILED 7-29-2011.

**MATCHMAKER**

THE MARK CONSISTS OF STANDARD CHARACTERS WITHOUT CLAIM TO ANY PARTICULAR FONT, STYLE, SIZE, OR COLOR.

FOR PORTABLE BEVERAGE DISPENSERS (U.S. CLS. 2, 13, 23, 29, 30, 33, 40 AND 50).

GRETTA YAO, EXAMINING ATTORNEY

**CLASS 21—(Continued).**

SN 85-395,116. VM PRODUCTS INC., BEDFORD, TX. FILED 8-11-2011.



THE MARK CONSISTS OF A MOUSE ABOVE A BROKEN LINE ENDING WITH AN ARROW POINTING UP AND IN FRONT OF THE FACE OF THE MOUSE ALL ABOVE THE STYLIZED WORDS EZ MOVER.

FOR BAIT STATIONS FOR RODENTS (U.S. CLS. 2, 13, 23, 29, 30, 33, 40 AND 50).

CURTIS FRENCH, EXAMINING ATTORNEY

SN 85-395,126. VM PRODUCTS INC., BEDFORD, TX. FILED 8-11-2011.

**EZ MOVER**

THE MARK CONSISTS OF STANDARD CHARACTERS WITHOUT CLAIM TO ANY PARTICULAR FONT, STYLE, SIZE, OR COLOR.

FOR BAIT STATIONS FOR RODENTS (U.S. CLS. 2, 13, 23, 29, 30, 33, 40 AND 50).

CURTIS FRENCH, EXAMINING ATTORNEY

SN 85-399,153. HANDI-FOIL CORPORATION, WHEELING, IL. FILED 8-16-2011.

**CHOICES FOR CHANGING TRENDS**

THE MARK CONSISTS OF STANDARD CHARACTERS WITHOUT CLAIM TO ANY PARTICULAR FONT, STYLE, SIZE, OR COLOR.

FOR NON-ELECTRIC ALUMINUM AND ROASTING PANS WITH PLASTIC LIDS, CONTAINERS FORMED OF ALUMINUM FOIL WITH PLASTIC LIDS FOR HOUSEHOLD USE, PANS FORMED OF ALUMINUM FOIL WITH WIRE HANDLES AND PLASTIC LIDS, AND PANS FORMED OF ALUMINUM FOIL WITH PLASTIC LIDS (U.S. CLS. 2, 13, 23, 29, 30, 33, 40 AND 50).

JASON BLAIR, EXAMINING ATTORNEY

**CLASS 22—CORDAGE AND FIBERS**

SN 79-089,865. ZHEJIANG TIANYUAN FABRIC CO., LTD.,  
317513 ZHEJIANG, CHINA, FILED 11-9-2010.

# WADUN

OWNER OF INTERNATIONAL REGISTRATION 1058010  
DATED 11-9-2010, EXPIRES 11-9-2020.

THE WORDING "WADUN" HAS NO MEANING IN A  
FOREIGN LANGUAGE.

FOR NETS, NAMELY, COMMERCIAL NETS, FISHING  
NETS; UNFITTED VEHICLE COVERS; COVERS FOR  
CAMOUFLAGE, NAMELY, CAMOUFLAGE NETS FOR  
VISUAL AND RADAR USES; SACKS OR BAGS FOR THE  
TRANSPORT AND STORAGE OF MATERIALS IN  
BULK; WOVEN BAGS, NAMELY, TEXTILE BAGS FOR  
MERCHANDISE PACKAGING, CLOTH BAGS FOR STO-  
RAGE; SILK ROPE; FISHING NETS; TWINE FOR NETS;  
TENTS; NETWORK, NAMELY, AWNINGS, BURLAP  
WRAPS FOR PLANTS, INSECT PROTECTION NETS  
(U.S. CLS. 1, 2, 7, 19, 22, 42 AND 50).

CHRISTINE MARTIN, EXAMINING ATTORNEY

SN 79-095,201. FISHERING SERVICE LTD, RUSSIAN FED.,  
FILED 1-19-2011.

# RAPTOR РАПТОР

OWNER OF INTERNATIONAL REGISTRATION 1071432  
DATED 1-19-2011, EXPIRES 1-19-2021.

THE MARK CONSISTS OF THE WORDING "RAPTOR" IN  
LATIN AND CYRILLIC CHARACTERS.

THE TRANSLITERATION OF THE NON-LATIN CHAR-  
ACTERS IN THE MARK IS: "RAPTOR".

FOR FISHING NETS (U.S. CLS. 1, 2, 7, 19, 22, 42 AND  
50).

KRISTIN DAHLING, EXAMINING ATTORNEY

SN 85-231,856. EUREKA PRODUCT DEVELOPMENT LLC,  
HOOVER, AL. FILED 2-1-2011.

# Dragit

THE MARK CONSISTS OF STANDARD CHARACTERS  
WITHOUT CLAIM TO ANY PARTICULAR FONT, STYLE,  
SIZE, OR COLOR.

THE WORDING "DRAGIT" HAS NO MEANING IN A  
FOREIGN LANGUAGE.

FOR TARPAULINS MADE FROM PLASTICS COATED  
MATERIALS (U.S. CLS. 1, 2, 7, 19, 22, 42 AND 50).

CHARISMA HAMPTON, EXAMINING ATTORNEY

**CLASS 22—(Continued).**

SN 85-323,645. UNITEX GROUP U.S.A., PIEDMONT, SC.  
FILED 5-18-2011.

# ULTRALIFT

THE MARK CONSISTS OF STANDARD CHARACTERS  
WITHOUT CLAIM TO ANY PARTICULAR FONT, STYLE,  
SIZE, OR COLOR.

FOR INDUSTRIAL LIFTING SLINGS MADE OF NON  
METAL MATERIAL (U.S. CLS. 1, 2, 7, 19, 22, 42 AND 50).

FIRST USE 1-1-2007; IN COMMERCE 1-1-2007.

SKYE YOUNG, EXAMINING ATTORNEY

SN 85-329,788. UNITEX GROUP U.S.A., PIEDMONT, SC.  
FILED 5-25-2011.

# SuperTechlon

THE MARK CONSISTS OF STANDARD CHARACTERS  
WITHOUT CLAIM TO ANY PARTICULAR FONT, STYLE,  
SIZE, OR COLOR.

FOR NON-METALLIC SLINGS USED FOR INDUS-  
TRIAL LIFTING (U.S. CLS. 1, 2, 7, 19, 22, 42 AND 50).

FIRST USE 1-1-2007; IN COMMERCE 1-1-2007.

SKYE YOUNG, EXAMINING ATTORNEY

SN 85-334,551. BASS PRO INTELLECTUAL PROPERTY,  
L.L.C., SPRINGFIELD, MO. FILED 5-31-2011.

# HOBBS CREEK

THE MARK CONSISTS OF STANDARD CHARACTERS  
WITHOUT CLAIM TO ANY PARTICULAR FONT, STYLE,  
SIZE, OR COLOR.

FOR FISHING NETS (U.S. CLS. 1, 2, 7, 19, 22, 42 AND  
50).

ELLEN BURNS, EXAMINING ATTORNEY



**CLASS 22—(Continued).**

SN 85-335,464. THE STATE OF CONNECTICUT, HARTFORD, CT. FILED 6-1-2011.



THE MARK CONSISTS OF THE OUTLINE OF THE FRONT OF A FOOTBALL STADIUM WITH THREE PENNANTS ABOVE IT. BELOW THE STADIUM IS THE WORD RENTSCHLER IN AN UPWARD CURVE UNDER WHICH IS THE WORD FIELD.

FOR LANYARDS FOR HOLDING BADGES, KEYS, OR GLASSES (U.S. CLS. 1, 2, 7, 19, 22, 42 AND 50).  
KAREN BRACEY, EXAMINING ATTORNEY

SN 85-385,135. PURTHREAD TECHNOLOGIES, INC., SAN FRANCISCO, CA. FILED 7-29-2011.

# SABIYA

THE MARK CONSISTS OF STANDARD CHARACTERS WITHOUT CLAIM TO ANY PARTICULAR FONT, STYLE, SIZE, OR COLOR.

FOR SYNTHETIC FIBERS FOR USE IN THE MANUFACTURE OF FABRICS, TEXTILES, YARNS AND CARPETS (U.S. CLS. 1, 2, 7, 19, 22, 42 AND 50).  
MARTHA FROMM, EXAMINING ATTORNEY

**CLASS 23—YARNS AND THREADS**

SN 85-276,708. DEBORAH S. STOLLER, BROOKLYN, NY. FILED 3-25-2011.

STITCH NATION WASHABLE EWE

THE MARK CONSISTS OF STANDARD CHARACTERS WITHOUT CLAIM TO ANY PARTICULAR FONT, STYLE, SIZE, OR COLOR.

OWNER OF U.S. REG. NO. 3,786,148.  
FOR YARNS FOR KNITTING, SEWING AND CROCHETING, MADE IN PART OR IN WHOLE WITH SHEEP'S WOOL (U.S. CL. 43).  
JOHN DWYER, EXAMINING ATTORNEY

**CLASS 23—(Continued).**

SN 85-348,872. J. & P. COATS, LIMITED, GLASGOW, UNITED KINGDOM, FILED 6-17-2011.

AUNT LYDIA'S CROCHET THREAD

THE MARK CONSISTS OF STANDARD CHARACTERS WITHOUT CLAIM TO ANY PARTICULAR FONT, STYLE, SIZE, OR COLOR.

NO CLAIM IS MADE TO THE EXCLUSIVE RIGHT TO USE "CROCHET THREAD", APART FROM THE MARK AS SHOWN.

FOR YARNS FOR CROCHET AND THREADS FOR CROCHET (U.S. CL. 43).

FIRST USE 1-4-2005; IN COMMERCE 1-4-2005.

NAAKWAMA ANKRAH, EXAMINING ATTORNEY

SN 85-385,149. PURTHREAD TECHNOLOGIES, INC., SAN FRANCISCO, CA. FILED 7-29-2011.

# SABIYA

THE MARK CONSISTS OF STANDARD CHARACTERS WITHOUT CLAIM TO ANY PARTICULAR FONT, STYLE, SIZE, OR COLOR.

FOR YARN (U.S. CL. 43).

MARTHA FROMM, EXAMINING ATTORNEY

**CLASS 24—FABRICS**

SN 79-096,935. MERKAS TEKSTIL SANAYI VE TICARET ANONIM SIRKETI, ISTANBUL, TURKEY, FILED 4-7-2011.

PRIORITY DATE OF 12-31-2010 IS CLAIMED.  
OWNER OF INTERNATIONAL REGISTRATION 1075926 DATED 4-7-2011, EXPIRES 4-7-2021.

THE MARK CONSISTS OF A CIRCULAR DESIGN WITH TWO CURVES TO THE LEFT OF THE WORDING "HYGENIUS" IN STYLIZED FONT.

FOR TEXTILES AND TEXTILE GOODS, NAMELY, NON-WOVEN FABRICS AND FELTS, NON-WOVEN TEXTILE FABRICS USED AS LININGS FOR CLOTHING, NAMELY, INTERLININGS; BED COVERS AND TABLE CLOTHS NOT OF PAPER (U.S. CLS. 42 AND 50).  
JULIE VEPPUMTHARA, EXAMINING ATTORNEY

**CLASS 24—(Continued).**

SN 85-086,868. MORAN, JIM, PARK CITY, UT. FILED 7-16-2010.

**NO PHONE ZONE**

THE MARK CONSISTS OF STANDARD CHARACTERS WITHOUT CLAIM TO ANY PARTICULAR FONT, STYLE, SIZE, OR COLOR.

FOR CLOTH LABELS (U.S. CLS. 42 AND 50).  
MICHAEL SOUDERS, EXAMINING ATTORNEY

---

SN 85-171,810. FAB INDUSTRIES CORP., GREAT NECK, NY. FILED 11-8-2010.

**GRAND SATIN**

THE MARK CONSISTS OF STANDARD CHARACTERS WITHOUT CLAIM TO ANY PARTICULAR FONT, STYLE, SIZE, OR COLOR.

OWNER OF U.S. REG. NOS. 1,124,311 AND 1,346,269.  
NO CLAIM IS MADE TO THE EXCLUSIVE RIGHT TO USE "SATIN", APART FROM THE MARK AS SHOWN.  
FOR COMFORTERS, BED SHEETS, BED BLANKETS, BABY BLANKETS, AND PILLOW CASES (U.S. CLS. 42 AND 50).

FIRST USE 9-30-1983; IN COMMERCE 9-30-1983.  
KEVON CHISOLM, EXAMINING ATTORNEY

---

SN 85-175,483. OCV INTELLECTUAL CAPITAL, LLC, TOLEDO, OH. FILED 11-12-2010.

**THERMOPREG**

THE MARK CONSISTS OF STANDARD CHARACTERS WITHOUT CLAIM TO ANY PARTICULAR FONT, STYLE, SIZE, OR COLOR.

FOR FIBERGLASS REINFORCEMENT FABRIC MADE OF GLASS FIBERS OR GLASS FIBERS COMBINED WITH THERMOPLASTIC FIBERS FOR USE IN REINFORCING STRUCTURAL APPLICATIONS IN THE AUTOMOTIVE, TRANSPORTATION AND INDUSTRIAL MARKETS (U.S. CLS. 42 AND 50).

TIMOTHY FINNEGAN, EXAMINING ATTORNEY

**CLASS 24—(Continued).**

SN 85-182,107. MALOUF MARKETING, INC., DBA MALOUF FINE LINENS, LOGAN, UT. FILED 11-22-2010.

**Quilt Tite**

THE MARK CONSISTS OF STANDARD CHARACTERS WITHOUT CLAIM TO ANY PARTICULAR FONT, STYLE, SIZE, OR COLOR.

NO CLAIM IS MADE TO THE EXCLUSIVE RIGHT TO USE "QUILT", APART FROM THE MARK AS SHOWN.

FOR QUILTED MATTRESS PAD; QUILTED MATTRESS PROTECTOR, NAMELY, QUILTED MATTRESS COVER (U.S. CLS. 42 AND 50).

EMILY CHUO, EXAMINING ATTORNEY

---

SN 85-182,115. MALOUF MARKETING, INC., DBA MALOUF FINE LINENS, LOGAN, UT. FILED 11-22-2010.

**Micro Tite**

THE MARK CONSISTS OF STANDARD CHARACTERS WITHOUT CLAIM TO ANY PARTICULAR FONT, STYLE, SIZE, OR COLOR.

FOR MATTRESS PROTECTORS, NAMELY, MATTRESS COVERS; MATTRESS PROTECTORS, NAMELY, MATTRESS COVERS, THAT SUBSTANTIALLY SURROUND THE ENTIRETY OF THE MATTRESS; MATTRESS PROTECTORS, NAMELY, MATTRESS COVERS, COVERING AND SURROUNDING THE ENTIRETY OF THE MATTRESS AND HAVING A REMOVABLE TOP PORTION (U.S. CLS. 42 AND 50).

EMILY CHUO, EXAMINING ATTORNEY

**CLASS 24—(Continued).**

SN 85-185,208. AMUSEMENT ART LLC, LOS ANGELES, CA.  
FILED 11-24-2010.

**CLASS 24—(Continued).**

SN 85-199,435. KOMATSU SEIREN KABUSHIKI KAISHA  
(KOMATSU SEIREN CO., LTD.), NOMI-SHI, ISHIKAWA,  
JAPAN, FILED 12-16-2010.



MR BRAINWASH

THE MARK CONSISTS OF STANDARD CHARACTERS WITHOUT CLAIM TO ANY PARTICULAR FONT, STYLE, SIZE, OR COLOR.

OWNER OF U.S. REG. NO. 3,695,896.

FOR BANNERS AND FLAGS OF TEXTILE; BATH LINEN; BATH SHEETS; BATH TOWELS; BEACH TOWELS; BED BLANKETS; BED COVERS; BED LINEN; BED SHEETS; BED SPREADS; BLANKET TROWS; BLANKETS FOR OUTDOOR USE; CASHMERE BLANKETS; COMFORTERS; CURTAINS; CURTAINS OF TEXTILE OR PLASTIC; DUVET COVERS; DUVETS; EIDERDOWN COVERS; EIDERDOWNS; FABRICS FOR TEXTILE USE; FLAT BED SHEETS; HAND TOWELS; KITCHEN TOWELS; PILLOW SHAMS; PILLOWCASES; PLACE MATS, NOT OF PAPER; PLASTIC PLACE MATS; SHOWER CURTAINS; TABLE LINEN; TABLE LINEN, NAMELY, NAPKINS; TABLE MATS NOT OF PAPER; TABLECLOTHS, NOT OF PAPER; TROWS; TOWELS; VINYL PLACE MATS; BED SHEETS (U.S. CLS. 42 AND 50).

KHANH LE, EXAMINING ATTORNEY

OWNER OF JAPAN REG. NO. 4771069, DATED 5-14-2004, EXPIRES 5-14-2014.

OWNER OF U.S. REG. NOS. 2,954,786, 3,007,238 AND OTHERS.

THE MARK CONSISTS OF THE STYLIZED WORDING "KOMATSU" AND AN INCOMPLETE DECORATIVE ORB. THE INCOMPLETE DECORATIVE ORB DESIGN APPEARS ABOVE THE WORDING AND CONTAINS A STYLIZED MOUNTAIN DESIGN. THE "O" IN "KOMATSU" IS A SHADED INCOMPLETE ORB WITH THE BOTTOM REMOVED.

THE ENGLISH TRANSLATION OF "KOMATSU" IN THE MARK IS "SMALL OR TINY PINE TREE".

FOR WOVEN FABRICS COMPOSED OF NYLON, POLYESTER, POLYETHYLENE OR POLYURETHANE; KNITTED FABRICS COMPOSED OF NYLON, POLYESTER, POLYETHYLENE OR POLYURETHANE; FELT CLOTH; NON-WOVEN TEXTILE FABRICS COMPOSED OF NYLON, POLYESTER, POLYETHYLENE OR POLYURETHANE; OILCLOTH; GUMMED WATERPROOF CLOTH; VINYL COATED CLOTH; RUBBERIZED CLOTH; PERSONAL ARTICLES OF WOVEN TEXTILE NOT FOR WEAR, NAMELY, TOWELS, HANDKERCHIEFS, JAPANESE CEREMONIAL WRAPPING CLOTH, JAPANESE GENERAL WRAPPING CLOTH, TABLE NAPKINS OF TEXTILE, DISH CLOTHS, MOSQUITO NETS, PILLOWCASES, BED BLANKETS, SHOWER CURTAINS, DRAPERIES, SHROUDS, AND BILLIARD CLOTH; BED SHEETS; QUILTS; BED LINENS, NAMELY, FUTON AND QUILT CASES; PILLOWCASES; FITTED TOILET SEAT COVERS OF TEXTILES; WALL HANGINGS OF TEXTILE; CURTAINS; SHOWER CURTAINS; TABLE CLOTHS NOT OF PAPER; LABELS OF CLOTH; CLOTH BANNERS AND FLAGS; FABRIC COVERED WITH PLASTIC FILM IN THE NATURE OF POLYESTER, KNITTED POLYESTER, NYLON, KNITTED NYLON, TRIACETATE, KNITTED TRIACETATE, RAYON, KNITTED RAYON, COTTON, AND KNITTED COTTON FOR USE AS A TEXTILE IN THE MANUFACTURE OF CLOTHING, CLOTHES FOR SPORTS, SWIMSUITS, SKI JACKETS, SKI PANTS, WIND RESISTANT JACKETS, FISHING VESTS, CLOTHING FOR GYMNASTICS, CLOTHING FOR GOLF, CLOTHING FOR RUNNING, CLOTHING FOR CLIMBING, ANORAKS, SPORTS OVERUNIFORMS, SKI SUITS FOR COMPETITION, SPORTS JERSEYS, WIND-JACKETS, BOOTS FOR SPORTS, FOOTBALL SHOES, GYMNASTIC SHOES,

**CLASS 24—(Continued).**

GOLF SHOES, MOUNTAIN CLIMBING SHOES, SKI BOOTS, BASEBALL SHOES, SPORTS SHOES, RUNNING SHOES, FOOTWEAR, HEADGEAR FOR WEAR, GLOVES FOR CLOTHING PURPOSES, GLOVES FOR SPORTS, CLOTHING, AND FURNITURE UPHOLSTERY; FABRIC COVERED WITH RESIN IN THE NATURE OF POLYESTER, KNITTED POLYESTER, NYLON, KNITTED NYLON, TRIACETATE, KNITTED TRIACETATE, RAYON, KNITTED RAYON, COTTON, AND KNITTED COTTON FOR USE AS A TEXTILE IN THE MANUFACTURE OF CLOTHING, CLOTHES FOR SPORTS, SWIMSUITS, SKI JACKETS, SKI PANTS, WIND RESISTANT JACKETS, FISHING VESTS, CLOTHING FOR GYMNASTICS, CLOTHING FOR GOLF, CLOTHING FOR RUNNING, CLOTHING FOR CLIMBING, ANORAKS, SPORTS OVERUNIFORMS, SKI SUITS FOR COMPETITION, SPORTS JERSEYS, WIND-JACKETS, BOOTS FOR SPORTS, FOOTBALL SHOES, GYMNASTIC SHOES, GOLF SHOES, MOUNTAIN CLIMBING SHOES, SKI BOOTS, BASEBALL SHOES, SPORTS SHOES, RUNNING SHOES (U.S. CLS. 42 AND 50).

INGRID C. EULIN, EXAMINING ATTORNEY

SN 85-208,829. CAI GLOBAL GROUP LTD., KOWLOON, HONG KONG, FILED 1-2-2011.

# RPET

THE MARK CONSISTS OF STANDARD CHARACTERS WITHOUT CLAIM TO ANY PARTICULAR FONT, STYLE, SIZE, OR COLOR.

OWNER OF U.S. REG. NOS. 3,632,495 AND 3,778,791.

FOR BATH TOWELS; BEACH TOWELS; BED AND TABLE LINEN; BED AND TABLE LINEN, WALL HANGINGS OF TEXTILE; BED COVERS; BED LINEN; BED LINEN AND TABLE LINEN; BED SHEETS; BED SHEETS, FITTED BED SHEET COVERS, BED FLAT SHEETS, AND PILLOW CASES USED IN THE BEDDING, HEALTH CARE, HOME-HEALTH CARE AND NURSING HOME INDUSTRIES MADE OF BIODEGRADABLE FILM CREATED FROM RENEWABLE BIO-POLYMER RESOURCES; BED SPREADS; BED THROWS; CHILDREN'S TOWELS; COMPRESSED TOWELS; CURTAINS AND TOWELS; FACE TOWELS; FACE TOWELS OF TEXTILES; FOOTBALL TOWELS; GOLF TOWELS; HAND TOWELS; HAND TOWELS OF TEXTILE; HOODED TOWELS; HOUSEHOLD LINEN, INCLUDING FACE TOWELS; KITCHEN TOWELS; LARGE BATH TOWELS; MOISTURE ABSORBENT MICROFIBER TEXTILE FABRICS FOR USE IN THE MANUFACTURE OF ATHLETIC APPAREL, NAMELY, SHIRTS, PANTS, SHORTS, JACKETS, BAGS, TOWELS AND ATHLETIC UNIFORMS; QUILTS OF TOWELS; TABLE AND BED LINEN; TERRY TOWELS; TOWEL SETS; TOWELS; TOWELS MADE OF TEXTILE MATERIALS; TOWELS THAT MAY BE WORN AS A DRESS OR SIMILAR GARMENT (U.S. CLS. 42 AND 50).

FIRST USE 1-1-1998; IN COMMERCE 1-1-1999.

CARRIE GENOVESE, EXAMINING ATTORNEY

**CLASS 24—(Continued).**

SN 85-286,990. ALOK INTERNATIONAL INC., DALLAS, TX. FILED 4-5-2011.

**BUTTON-IT-DOWN SHEETS**

THE MARK CONSISTS OF STANDARD CHARACTERS WITHOUT CLAIM TO ANY PARTICULAR FONT, STYLE, SIZE, OR COLOR.

NO CLAIM IS MADE TO THE EXCLUSIVE RIGHT TO USE "SHEETS", APART FROM THE MARK AS SHOWN.

FOR BED SHEETS (U.S. CLS. 42 AND 50).

MICHAEL WIENER, EXAMINING ATTORNEY

SN 85-295,289. AK ASSOCIATES, LLC, SOUTH RIVER, NJ. FILED 4-14-2011.

# AKASOFT

THE MARK CONSISTS OF STANDARD CHARACTERS WITHOUT CLAIM TO ANY PARTICULAR FONT, STYLE, SIZE, OR COLOR.

FOR POLYURETHANE LAMINATED FABRIC FEATURING A 0.001" (1 MIL) AND 0.002" (2 MIL) THICKNESS POLYURETHANE LAMINATE; POLYURETHANE LAMINATED FABRIC FEATURING A 0.001" (1 MIL) AND 0.002" (2 MIL) THICKNESS POLYURETHANE LAMINATE SANDWICHED BETWEEN TWO LAYERS OF FABRIC (U.S. CLS. 42 AND 50).

FIRST USE 6-1-2010; IN COMMERCE 6-1-2010.

ERNEST SHOSHO, EXAMINING ATTORNEY

SN 85-301,651. E & E CO., LTD., FREMONT, CA. FILED 4-21-2011.

# Velvet Elegance

THE MARK CONSISTS OF STANDARD CHARACTERS WITHOUT CLAIM TO ANY PARTICULAR FONT, STYLE, SIZE, OR COLOR.

NO CLAIM IS MADE TO THE EXCLUSIVE RIGHT TO USE "VELVET", APART FROM THE MARK AS SHOWN.

FOR BED BLANKETS; BLANKET THROWS; LAP BLANKETS (U.S. CLS. 42 AND 50).

FIRST USE 5-4-2010; IN COMMERCE 5-4-2010.

NAKWAMA ANKRAH, EXAMINING ATTORNEY

**CLASS 24—(Continued).**

SN 85-302,673. E & E CO., LTD., FREMONT, CA. FILED 4-22-2011.



THE COLOR(S) WHITE, ORANGE, AND TAUPE IS/ARE CLAIMED AS A FEATURE OF THE MARK.

THE MARK CONSISTS OF WORK "MI" AND "ZONE" IN WHITE WITH AN ORANGE DOT BETWEEN THE WORD "MI" AND "ZONE" WITH A TAUPE BACKGROUND.

FOR BED BLANKETS; BED COVERS; BED SHEETS; BED SKIRTS; BED THROWS; COMFORTERS; PILLOW CASES; QUILTS OF TEXTILE (U.S. CLS. 42 AND 50).

FIRST USE 8-23-2010; IN COMMERCE 8-23-2010.  
 NAAKWAMA ANKRAH, EXAMINING ATTORNEY

SN 85-302,690. E & E CO., LTD., FREMONT, CA. FILED 4-22-2011.



THE MARK CONSISTS OF AN ORANGE BACK GROUND WITH WHITE LETTERING OF THE WORD "SQUEEKIE" WITH A FLOWER IN ORANGE AND AN OUTER COVERING IN WHITE REPRESENTING THE DOTTED I IN THE WORDING "SQUEEKIE". THERE IS A WHITE BORDER RUNNING AROUND THE MARK WITH ORANGE DOTS RUNNING THROUGHOUT THE BORDER.

FOR BED BLANKETS; BLANKET THROWS; COMFORTERS; LAP BLANKETS; PILLOW CASES; PILLOW SHAMS; SHEET SETS (U.S. CLS. 42 AND 50).

FIRST USE 8-23-2010; IN COMMERCE 8-23-2010.  
 NAAKWAMA ANKRAH, EXAMINING ATTORNEY

SN 85-302,782. E & E CO., LTD., FREMONT, CA. FILED 4-22-2011.

**HOMEESENCE**

THE MARK CONSISTS OF STANDARD CHARACTERS WITHOUT CLAIM TO ANY PARTICULAR FONT, STYLE, SIZE, OR COLOR.

FOR BED BLANKETS; BED SHEETS; BED SKIRTS; BED THROWS; BLANKET THROWS; COMFORTERS; LAP BLANKETS; PILLOW CASES; PILLOW SHAMS; SHEET SETS (U.S. CLS. 42 AND 50).

FIRST USE 6-1-2009; IN COMMERCE 6-1-2009.  
 NAAKWAMA ANKRAH, EXAMINING ATTORNEY

**CLASS 24—(Continued).**

SN 85-313,741. E & E CO., LTD., FREMONT, CA. FILED 5-5-2011.



NO CLAIM IS MADE TO THE EXCLUSIVE RIGHT TO USE "BED", APART FROM THE MARK AS SHOWN.

THE COLOR(S) WHITE, BLACK AND RED IS/ARE CLAIMED AS A FEATURE OF THE MARK.

THE MARK CONSISTS OF A DESIGN OF A RED SHIELD WITH BLACK BORDER AND A BLACK BUG WITH A BLACK DIAGONAL LINE ACROSS THE BUG; THE DESIGN IS BETWEEN THE TERMS "BED" AND "GUARDIAN" BOTH IN WHITE.

FOR CONTOURED MATTRESS COVERS; MATTRESS COVERS; MATTRESS PADS; PILLOW COVERS (U.S. CLS. 42 AND 50).

FIRST USE 4-7-2011; IN COMMERCE 4-7-2011.  
 SALLY SHIH, EXAMINING ATTORNEY

SN 85-317,451. FRANCIS LEPLUS, DBA JAN DE LUZ, CARMEL, CA. FILED 5-10-2011.



OWNER OF U.S. REG. NO. 2,430,974.

NO CLAIM IS MADE TO THE EXCLUSIVE RIGHT TO USE "CARMEL", APART FROM THE MARK AS SHOWN.

THE NAME(S), PORTRAIT(S), AND/OR SIGNATURE(S) SHOWN IN THE MARK DOES NOT IDENTIFY A PARTICULAR LIVING INDIVIDUAL.

THE MARK CONSISTS OF THE WORDS "JAN DE LUZ" IN STYLIZED SCRIPT FONT ABOVE A SOLID LINE. BELOW THE LINE, TO THE RIGHT, IS THE STYLIZED WORD "CARMEL".

FOR TABLE LINEN, NAMELY, NAPKINS, PLACE MATS, TABLE CLOTHS, TABLE PADS, TABLE RUNNERS; CLOTH, NAMELY, COTTON SILK, WOOL AND LINEN; BABY BLANKETS; BATH LINEN; BATH TOWELS; HOUSEHOLD LINEN (U.S. CLS. 42 AND 50).

FIRST USE 1-1-1998; IN COMMERCE 1-1-1998.  
 WARREN L. OLANDRIA, EXAMINING ATTORNEY

**CLASS 24—(Continued).**

SN 85-320,139. HUANG, CHU-CHING, TAINAN CITY, TAIWAN, FILED 5-13-2011.



THE MARK CONSISTS OF THE WORD "MIHARO" IN A STYLIZED FONT.

THE WORDING "MIHARO" HAS NO MEANING IN A FOREIGN LANGUAGE.

FOR CALICO; POLYESTER FABRIC; FLANNEL; NYLON FABRIC; MIXED FIBER FABRIC; SYNTHETIC FIBER FABRICS; GUMMED WATERPROOF CLOTH; ELASTIC FABRIC FOR CLOTHING; KNITTED FABRIC (U.S. CLS. 42 AND 50).

FIRST USE 3-16-2011; IN COMMERCE 3-16-2011.  
JULIE WATSON, EXAMINING ATTORNEY

**CLASS 24—(Continued).**

SN 85-325,306. WEST COAST IMPORTS, INC., COMMERCE, CA. FILED 5-19-2011.

## HUG MY PET

THE MARK CONSISTS OF STANDARD CHARACTERS WITHOUT CLAIM TO ANY PARTICULAR FONT, STYLE, SIZE, OR COLOR.

NO CLAIM IS MADE TO THE EXCLUSIVE RIGHT TO USE "PET", APART FROM THE MARK AS SHOWN.

FOR PET BLANKETS (U.S. CLS. 42 AND 50).

FIRST USE 3-10-2011; IN COMMERCE 3-10-2011.

LEIGH LOWRY, EXAMINING ATTORNEY

SN 85-327,152. ZHONGWANG HOLDING GROUP CO., LTD, HANGZHOU, CHINA, FILED 5-23-2011.



THE MARK CONSISTS OF THE WORDING "Z-WOVENS" IN WHITE WITH A BLACK BACKGROUND.

FOR BED COVERS; BED LINEN; BROCADE; CALICO; COTTON FABRIC; HEMP CLOTH; HOUSEHOLD LINEN; KNITTED FABRICS; LINEN CLOTH; QUILTS; RAYON FABRIC; SHOWER CURTAINS; SILK CLOTH; SILK FABRIC FOR PRINTING PATTERNS; TAPESTRIES OF TEXTILE; TEXTILE WALL HANGINGS; UPHOLSTERY FABRICS; VELVET (U.S. CLS. 42 AND 50).

CHERYL CLAYTON, EXAMINING ATTORNEY

SN 85-320,803. TARGET BRANDS, INC., MINNEAPOLIS, MN. FILED 5-13-2011.

## THRESHOLD

THE MARK CONSISTS OF STANDARD CHARACTERS WITHOUT CLAIM TO ANY PARTICULAR FONT, STYLE, SIZE, OR COLOR.

FOR LINENS; SHOWER CURTAINS; SHOWER CURTAIN LINERS; MATTRESS PADS OF COTTON; MATTRESS PADS OF FOAM; BEDDING, NAMELY, COMFORTERS, SHEETS AND SHEET SETS, SHAMS, PILLOW CASES, BED SKIRTS, BED SPREADS, BLANKETS, COVERLETS, DUVETS, QUILTS AND TROWS; TABLE LINENS NOT OF PAPER, NAMELY, PLACEMENTS, NAPKINS, TABLECLOTHS, FABRIC TABLE RUNNERS AND FABRIC TABLE TOPPERS; FABRIC WINDOW COVERINGS, NAMELY, CURTAINS, DRAPERIES, SHEERS, SWAGS, VALANCES; TOWELS; WASH CLOTHS; DISH CLOTHS; OVEN MITTS; UNFITTED FABRIC SLIP COVERS; BATH MITTS; COVERS FOR CUSHIONS; FITTED TOILET LID COVERS MADE OF FABRIC; CURTAIN TIE-BACKS IN THE NATURE OF TEXTILE CURTAIN HOLDERS (U.S. CLS. 42 AND 50).

RON FAIRBANKS, EXAMINING ATTORNEY

SN 85-333,163. CHERYL JORANDBY, JUPITER, FL. FILED 5-28-2011.

## Dogs in the Kitchen

THE MARK CONSISTS OF STANDARD CHARACTERS WITHOUT CLAIM TO ANY PARTICULAR FONT, STYLE, SIZE, OR COLOR.

FOR KITCHEN LINENS (U.S. CLS. 42 AND 50).

SKYE YOUNG, EXAMINING ATTORNEY

**CLASS 24—(Continued).**

SN 85-335,166. TAYLOR HOME FASHIONS LIMITED, KWUN TONG, KOWLOON, HONG KONG, FILED 6-1-2011.

# T-TEX

THE MARK CONSISTS OF STANDARD CHARACTERS WITHOUT CLAIM TO ANY PARTICULAR FONT, STYLE, SIZE, OR COLOR.

FOR TOWELS (U.S. CLS. 42 AND 50).  
KATHERINE E. HALMEN, EXAMINING ATTORNEY

**CLASS 24—(Continued).**

SN 85-338,336. LITTLE HALO LLC, SCARSDALE, NY. FILED 6-5-2011.

# LITTLE HALO

THE MARK CONSISTS OF STANDARD CHARACTERS WITHOUT CLAIM TO ANY PARTICULAR FONT, STYLE, SIZE, OR COLOR.

FOR BABY BLANKETS; BED BLANKETS; BLANKET THROWS; CHILDREN'S BLANKETS (U.S. CLS. 42 AND 50).  
ZACHARY BELLO, EXAMINING ATTORNEY

SN 85-336,927. SUMMIT ENTERTAINMENT, LLC, SANTA MONICA, CA. FILED 6-2-2011.

# ISLE ESME

THE MARK CONSISTS OF STANDARD CHARACTERS WITHOUT CLAIM TO ANY PARTICULAR FONT, STYLE, SIZE, OR COLOR.

FOR BED LINENS; BEACH TOWELS; CURTAINS OF TEXTILE OR PLASTIC; BED OR THROW BLANKETS; DUVET COVERS; AND TABLE LINENS (U.S. CLS. 42 AND 50).  
ASMAT KHAN, EXAMINING ATTORNEY

SN 85-338,691. HUNTER DOUGLAS INC., UPPER SADDLE RIVER, NJ. FILED 6-6-2011.

# SOLARFLECT

THE MARK CONSISTS OF STANDARD CHARACTERS WITHOUT CLAIM TO ANY PARTICULAR FONT, STYLE, SIZE, OR COLOR.

FOR FABRICS FOR THE MANUFACTURE OF INTERIOR WINDOW BLINDS AND INTERIOR WINDOW SHADES (U.S. CLS. 42 AND 50).  
JOHN SCHUYLER YARD, EXAMINING ATTORNEY

SN 85-337,584. KIDZ ON SAFARI NEW YORK, INC., BROOKLYN, NY. FILED 6-3-2011.

# BAMINGO

THE MARK CONSISTS OF STANDARD CHARACTERS WITHOUT CLAIM TO ANY PARTICULAR FONT, STYLE, SIZE, OR COLOR.

FOR BEDDING, NAMELY, BED SHEETS, BED-COVERS, BED SPREADS, BED SKIRTS, AND PILLOW CASES; BABY BEDDING, NAMELY, SWADDLING BLANKETS, CRIB BUMPERS, CRIB COVERS, FITTED CRIB SHEETS, CRIB SKIRTS, CRIB BLANKETS, AND DIAPER CHANGING PAD COVERS NOT OF PAPER; RECEIVING BLANKETS (U.S. CLS. 42 AND 50).  
JESSICA A. POWERS, EXAMINING ATTORNEY

SN 85-338,739. TRINITY GUARDION, LLC, BATESVILLE, IN. FILED 6-6-2011.

# TRINITY GUARDION

THE MARK CONSISTS OF STANDARD CHARACTERS WITHOUT CLAIM TO ANY PARTICULAR FONT, STYLE, SIZE, OR COLOR.

FOR BED COVERS; MATTRESS COVERS; COVERS FOR HOSPITAL BEDS AND NURSING HOME BEDS (U.S. CLS. 42 AND 50).  
KEVON CHISOLM, EXAMINING ATTORNEY

**CLASS 24—(Continued).**

SN 85-338,787. TRINITY GUARDION, LLC, BATESVILLE, IN. FILED 6-6-2011.



THE MARK CONSISTS OF A CIRCLE, LIGHTENING FROM ITS CIRCUMFERENCE TO ITS CENTER, SURROUNDED BY, BUT NOT CONTACTING, A RING DIVIDED INTO THREE EQUAL-SIZED SECTIONS, THE LEFT SECTION DARKER THAN THE UPPER RIGHT SECTION, DARKER THAN THE LOWER RIGHT SECTION.

FOR BED COVERS; MATTRESS COVERS; COVERS FOR HOSPITAL BEDS AND NURSING HOME BEDS (U.S. CLS. 42 AND 50).

KEVON CHISOLM, EXAMINING ATTORNEY

SN 85-341,294. MOUNT VERNON MILLS, INC., MAULDIN, SC. FILED 6-8-2011.

**RIENU BY RIEGEL**

THE MARK CONSISTS OF STANDARD CHARACTERS WITHOUT CLAIM TO ANY PARTICULAR FONT, STYLE, SIZE, OR COLOR.

OWNER OF U.S. REG. NOS. 792,620 AND 1,323,054. FOR TEXTILE PRODUCTS, NAMELY, TABLE-CLOTHS, NAPKINS, TABLESKIRTS, BED SHEETS, TOWELS, AND MATTRESS PADS (U.S. CLS. 42 AND 50).

FIRST USE 3-17-2011; IN COMMERCE 3-17-2011.

KEVIN CORWIN, EXAMINING ATTORNEY

SN 85-341,598. D&L INTERNATIONAL, LLC., HOLLYWOOD, FL. FILED 6-8-2011.

**Wind Bling**

THE MARK CONSISTS OF STANDARD CHARACTERS WITHOUT CLAIM TO ANY PARTICULAR FONT, STYLE, SIZE, OR COLOR.

FOR BANNERS AND FLAGS OF TEXTILE; BED BLANKETS; FABRIC FLAGS; TOWELS (U.S. CLS. 42 AND 50).

NAKIA HENRY, EXAMINING ATTORNEY

**CLASS 24—(Continued).**

SN 85-343,172. KELLWOOD COMPANY, CHESTERFIELD, MO. FILED 6-10-2011.

**CHIME**

THE MARK CONSISTS OF STANDARD CHARACTERS WITHOUT CLAIM TO ANY PARTICULAR FONT, STYLE, SIZE, OR COLOR.

OWNER OF U.S. REG. NO. 3,702,523.

FOR BED BLANKETS; BED CANOPIES; BED COVERS; BED LINEN; BED PADS; BED SHEETS; BED SKIRTS; BED SPREADS; BED THROWS; BLANKET THROWS; COMFORTERS; DUVET COVERS; DUVETS; PILLOW CASES; PILLOW SHAMS; QUILTS; SHEET SETS; THROWS (U.S. CLS. 42 AND 50).

ANDREW RHIM, EXAMINING ATTORNEY

SN 85-358,497. HEARST COMMUNICATIONS, INC., NEW YORK, NY. FILED 6-28-2011.

**REDBOOK**

THE MARK CONSISTS OF STANDARD CHARACTERS WITHOUT CLAIM TO ANY PARTICULAR FONT, STYLE, SIZE, OR COLOR.

OWNER OF U.S. REG. NOS. 968,669 AND 3,598,344.

FOR BED BLANKETS, BED LINEN, DUVETS AND TOWELS (U.S. CLS. 42 AND 50).

KELLY TRUSILO, EXAMINING ATTORNEY

SN 85-370,168. SOBEL WESTEX, LAS VEGAS, NV. FILED 7-13-2011.

**SOBELLISSIMA**

THE MARK CONSISTS OF STANDARD CHARACTERS WITHOUT CLAIM TO ANY PARTICULAR FONT, STYLE, SIZE, OR COLOR.

OWNER OF U.S. REG. NOS. 3,728,172, 3,739,260 AND 3,851,088.

FOR TOWELS, WASHCLOTHS AND BED SHEETS (U.S. CLS. 42 AND 50).

FIRST USE 11-17-2003; IN COMMERCE 11-17-2003.

WENDY GOODMAN, EXAMINING ATTORNEY



**CLASS 24—(Continued).**

SN 85-381,437. MEDLINE INDUSTRIES, INC., MUNDELEIN, IL. FILED 7-26-2011.

MEDLINE HERITAGE

THE MARK CONSISTS OF STANDARD CHARACTERS WITHOUT CLAIM TO ANY PARTICULAR FONT, STYLE, SIZE, OR COLOR.

OWNER OF U.S. REG. NOS. 894,673, 3,311,664 AND OTHERS.

FOR BATH TOWELS; HAND TOWELS; WASHCLOTHS (U.S. CLS. 42 AND 50).

MORGAN WYNNE, EXAMINING ATTORNEY

**CLASS 25—(Continued).**

SN 76-705,212. ATHLOS, LLC, MCKINNEY, TX. FILED 11-4-2010.

ATHLOS

THE MARK CONSISTS OF STANDARD CHARACTERS WITHOUT CLAIM TO ANY PARTICULAR FONT, STYLE, SIZE, OR COLOR.

OWNER OF U.S. REG. NO. 3,900,837.

THE ENGLISH TRANSLATION OF "ATHLOS" IS "FEAT". FOR CLOTHING, NAMELY, ATHLETIC AND FITNESS APPAREL, NAMELY, SHIRTS, SHORTS, PANTS, JERSEYS AND HATS (U.S. CLS. 22 AND 39).

FIRST USE 12-6-2008; IN COMMERCE 3-1-2010.

DEBRA LEE, EXAMINING ATTORNEY

**CLASS 25—CLOTHING**

SN 76-703,478. CHODECKI, JOSEPH, HNL, HI. FILED 6-22-2010.



THE COLORS BLUE, WHITE, YELLOW, BROWN, BLACK AND RED ARE CLAIMED AS A FEATURE OF THE MARK

THE MARK CONSISTS OF THE WORDING "HELLO DOGGY" IN THE COLOR RED WITH BLACK OUTLINING AND YELLOW HIGHLIGHTS, ABOVE THE DESIGN OF A DOGS HEAD AND TORSO. THE DOG'S HAIR IS IN YELLOW AND WHITE. THE EYES ARE BROWN AND THE NOSE AND MOUTH ARE BLACK. THE DOGS TONGUE IS RED AND THE TEETH ARE WHITE. THE WORDING AND DESIGN ARE ON A BLUE BACKGROUND.

FOR CLOTHING, NAMELY, T-SHIRTS, BASEBALL CAPS (U.S. CLS. 22 AND 39).

DAVID HOFFMAN, EXAMINING ATTORNEY

SN 76-705,214. ATHLOS, LLC, MCKINNEY, TX. FILED 11-4-2010.



OWNER OF U.S. REG. NO. 3,861,142.

THE MARK CONSISTS OF THREE STYLIZED ARROWS ARRAYED FROM LEFT TO RIGHT.

FOR CLOTHING, NAMELY, ATHLETIC AND FITNESS APPAREL, NAMELY, SHIRTS, SHORTS, PANTS, JERSEYS AND HATS (U.S. CLS. 22 AND 39).

FIRST USE 12-6-2008; IN COMMERCE 3-1-2010.

DEBRA LEE, EXAMINING ATTORNEY

**CLASS 25—(Continued).**

SN 76-706,065. KEM ROUNDS, MEMPHIS, TN. AND BRENDA ROUNDS, MEMPHIS, TN. FILED 1-18-2011.



THE COLOR(S) RED, GREEN, AND BLACK IS/ARE CLAIMED AS A FEATURE OF THE MARK.

THE MARK CONSISTS OF THE STYLIZED LETTERS AND NUMERAL "TO4E" INTERTWINED IN THE COLOR RED, WITH A GREEN OUTLINE, AND THE STYLIZED WORDING "THUGGED OUT 4 EVER" IN THE COLOR BLACK.

FOR T-SHIRT (U.S. CLS. 22 AND 39).  
JAY BESCH, EXAMINING ATTORNEY

SN 76-707,602. ARMOUTH INTERNATIONAL INC., NEW YORK, NY. FILED 5-13-2011.

**DAKOTA SCRUBS**

THE MARK CONSISTS OF STANDARD CHARACTERS WITHOUT CLAIM TO ANY PARTICULAR FONT, STYLE, SIZE, OR COLOR.

NO CLAIM IS MADE TO THE EXCLUSIVE RIGHT TO USE "SCRUBS", APART FROM THE MARK AS SHOWN.

FOR CLOTHING, NAMELY, SCHOOL UNIFORMS, SHIRTS, BLOUSES, PANTS, SKIRTS, SOCKS, JACKETS, SWEATERS, SHORTS, FOOTWEAR, LADIES SLEEPWEAR, BATH ROBES, LOUNGE PANTS, SCRUBS NOT FOR MEDICAL PURPOSES, AND INTIMATES, NAMELY, BRAS AND PANTIES (U.S. CLS. 22 AND 39).  
LESLIE RICHARDS, EXAMINING ATTORNEY

SN 77-325,267. LOEF, MADELINE, SANTA MONICA, CA. AND LOEF, ADAM, SANTA MONICA, CA. FILED 11-8-2007.

**RIDE THE EDGE**

THE MARK CONSISTS OF STANDARD CHARACTERS WITHOUT CLAIM TO ANY PARTICULAR FONT, STYLE, SIZE, OR COLOR.

FOR CLOTHING, NAMELY, T-SHIRTS (U.S. CLS. 22 AND 39).

SAIMA MAKHDOOM, EXAMINING ATTORNEY

**CLASS 25—(Continued).**

SN 77-368,661. DELAWARE CAPITAL FORMATION, INC., WILMINGTON, DE. FILED 1-10-2008.

**POWER to Move the World**

THE MARK CONSISTS OF STANDARD CHARACTERS WITHOUT CLAIM TO ANY PARTICULAR FONT, STYLE, SIZE, OR COLOR.

FOR POLO SHIRTS (U.S. CLS. 22 AND 39).

JACLYN KIDWELL WALKER, EXAMINING ATTORNEY

SN 77-431,729. JING HONG WEI, TUCKER, GA. FILED 3-26-2008.

**Winner Jeans**

THE MARK CONSISTS OF STANDARD CHARACTERS WITHOUT CLAIM TO ANY PARTICULAR FONT, STYLE, SIZE, OR COLOR.

NO CLAIM IS MADE TO THE EXCLUSIVE RIGHT TO USE "JEANS", APART FROM THE MARK AS SHOWN.

FOR JEANS (U.S. CLS. 22 AND 39).

ANTHONY RINKER, EXAMINING ATTORNEY

SN 77-522,251. ESTILO USA INC., BURLINGTON, NJ. FILED 7-15-2008.

**D'Snyper Division**

THE MARK CONSISTS OF STANDARD CHARACTERS WITHOUT CLAIM TO ANY PARTICULAR FONT, STYLE, SIZE, OR COLOR.

FOR JEANS, JACKETS, SHIRTS, T-SHIRTS, PANTS, SHORTS, HATS, BELTS, SHOES, SWEATERS, SWEATSHIRTS, AND SWEATPANTS (U.S. CLS. 22 AND 39).

DAVID TAYLOR, EXAMINING ATTORNEY

**CLASS 25—(Continued).**

SN 77-612,350. RACK ROOM SHOES OF VIRGINIA, LLC, CHARLOTTE, NC. FILED 11-11-2008.

# Bobbi Shoes

THE MARK CONSISTS OF STANDARD CHARACTERS WITHOUT CLAIM TO ANY PARTICULAR FONT, STYLE, SIZE, OR COLOR.

NO CLAIM IS MADE TO THE EXCLUSIVE RIGHT TO USE "SHOES", APART FROM THE MARK AS SHOWN.

FOR FOOTWEAR SOLD IN SPECIALTY RETAIL STORES SELLING ONLY FOOTWEAR AND RELATED ACCESSORIES (U.S. CLS. 22 AND 39).

MICHAEL WEBSTER, EXAMINING ATTORNEY

**CLASS 25—(Continued).**

SN 77-728,569. RELAXO FOOTWEARS LIMITED, NEW DELHI, INDIA, FILED 5-4-2009.



NO CLAIM IS MADE TO THE EXCLUSIVE RIGHT TO USE "PRODUCT", APART FROM THE MARK AS SHOWN.

THE MARK CONSISTS OF THREE BANDS OF HORIZONTAL SHADING, WITH THE MIDDLE BAND COMPRISING THE STYLIZED WORD "SPARX" ABOVE THE STYLIZED WORDING "GO FOR IT", AND THE LOWEST BAND COMPRISING THE WORDING "A RELAXO PRODUCT".

FOR BELTS; FOOTWEAR; GLOVES; HEADWEAR; HOSIERY; JACKETS; PANTS; SHIRTS; SOCKS; SUITS; TIES (U.S. CLS. 22 AND 39).

LAURA KOVALSKY, EXAMINING ATTORNEY

SN 77-649,379. DBD, INC., CONSHOHOCKEN, PA. FILED 1-14-2009.

# jewel

BY PRISCILLA OF BOSTON

OWNER OF U.S. REG. NOS. 1,987,088, 3,282,912 AND OTHERS.

NO CLAIM IS MADE TO THE EXCLUSIVE RIGHT TO USE "OF BOSTON", APART FROM THE MARK AS SHOWN.

THE MARK CONSISTS OF JEWEL WRITTEN IN LOWER CASE LETTERS IN A LARGE FONT AND BENEATH THE FIRST "E" IS THE REMAINDER OF THE MARK "BY PRISCILLA OF BOSTON" IN ALL CAPITALS IN A SMALLER FONT.

FOR BRIDAL GOWNS AND BRIDESMAIDS GOWNS SOLD IN SIGNATURE SALONS AND SPECIALTY BOUTIQUES (U.S. CLS. 22 AND 39).

FIRST USE 3-16-2009; IN COMMERCE 3-16-2009.  
CARYN GLASSER, EXAMINING ATTORNEY

SN 77-748,871. LUND, JOHN, BATON ROUGE, LA. FILED 6-1-2009.

# Swirl

THE MARK CONSISTS OF STANDARD CHARACTERS WITHOUT CLAIM TO ANY PARTICULAR FONT, STYLE, SIZE, OR COLOR.

FOR CLOTHING, NAMELY, SHOES, DRESSES, TOPS, SHIRTS, T-SHIRTS, SHORTS, SKIRTS, JUMPERS, PANTS, JEANS, BERMUDA SHORTS, SCARVES, BELTS, BOOTS (U.S. CLS. 22 AND 39).

FIRST USE 8-1-2007; IN COMMERCE 8-1-2007.  
ELLEN PERKINS, EXAMINING ATTORNEY

**CLASS 25—(Continued).**

SN 77-806,355. TRIUMPH INTERNATIONAL, INC., ATLANTA, GA. FILED 8-17-2009.

**MICHAEL JACKSON**

THE MARK CONSISTS OF STANDARD CHARACTERS WITHOUT CLAIM TO ANY PARTICULAR FONT, STYLE, SIZE, OR COLOR.

OWNER OF U.S. REG. NO. 1,908,209.

THE NAME "MICHAEL JACKSON" DOES NOT IDENTIFY A LIVING INDIVIDUAL.

FOR CLOTHING, NAMELY, SHIRTS, JACKETS, SWEATERS, PANTS, BELTS, SOCKS, SWEATSHIRTS, JERSEYS, SHORTS, JOGGING SUITS, SWEAT PANTS; HEADWEAR; SCARVES, GLOVES, COATS, HOSIERY, NECKTIES, RAINWEAR, SWIMWEAR, SLEEPWEAR, ROBES, THERMAL UNDERWEAR, HEADBANDS, AND WRISTBANDS; FOOTWEAR; COSTUMES FOR USE IN CHILDREN'S DRESS UP PLAY; COSTUMES FOR USE IN ROLE-PLAYING GAMES; DANCE SHOES; DANCE COSTUMES; MASQUERADE COSTUMES AND MASKS SOLD IN CONNECTION THEREWITH; NOVELTY HEADWEAR WITH ATTACHED WIGS; INFANT WEAR; INFANTS' SHOES AND BOOTS (U.S. CLS. 22 AND 39).

HEATHER THOMPSON, EXAMINING ATTORNEY

SN 77-806,395. TRIUMPH INTERNATIONAL, INC., ATLANTA, GA. FILED 8-17-2009.



OWNER OF U.S. REG. NO. 1,908,209.

THE NAME "MICHAEL JACKSON" DOES NOT IDENTIFY A LIVING INDIVIDUAL.

THE MARK CONSISTS OF THE NAME "MICHAEL JACKSON" WRITTEN IN STYLIZED FORM WHEN THE END OF THE LETTER "N" HAS A VERTICAL LINE UP AND AT THE PEAK HAS A SLIGHTLY CURVED LINE DOWN ENDING WITH A STYLIZED STARBURST.

FOR CLOTHING, NAMELY, SHIRTS, JACKETS, SWEATERS, PANTS, BELTS, SOCKS, SWEATSHIRTS, JERSEYS, SHORTS, JOGGING SUITS, SWEAT PANTS; HEADWEAR; SCARVES, GLOVES, COATS, HOSIERY, NECKTIES, RAINWEAR, SWIMWEAR, SLEEPWEAR, ROBES, THERMAL UNDERWEAR, HEADBANDS, AND WRISTBANDS; FOOTWEAR; COSTUMES FOR USE IN CHILDREN'S DRESS UP PLAY; COSTUMES FOR USE IN ROLE-PLAYING GAMES; DANCE SHOES; DANCE COSTUMES; MASQUERADE COSTUMES AND MASKS SOLD IN CONNECTION THEREWITH; NOVELTY HEADWEAR WITH ATTACHED WIGS; INFANT WEAR; INFANTS' SHOES AND BOOTS (U.S. CLS. 22 AND 39).

HEATHER THOMPSON, EXAMINING ATTORNEY

**CLASS 25—(Continued).**

SN 77-935,461. AMARYLLIS KNIGHT, DBA CAFE RACERS LLC (LLC SENT TO BE FILED WITH CA SECRETARY OF STATE ON 2/4/2010), LOS ANGELES, CA. FILED 2-14-2010.

**Café Racers**

THE MARK CONSISTS OF STANDARD CHARACTERS WITHOUT CLAIM TO ANY PARTICULAR FONT, STYLE, SIZE, OR COLOR.

THE ENGLISH TRANSLATION OF "CAFÉ" IN THE MARK IS "CAFE".

FOR ANKLE BOOTS; ATHLETIC APPAREL, NAMELY, SHIRTS, PANTS, JACKETS, FOOTWEAR, HATS AND CAPS, ATHLETIC UNIFORMS; BELTS; BELTS FOR CLOTHING; BELTS MADE OUT OF CLOTH; BICYCLING GLOVES; BODY SHIRTS; BOMBER JACKETS; BOOTS; BOOTS FOR MOTORCYCLING; BOOTS FOR SPORT; BOTTOMS; CAMOUFLAGE GLOVES; CAMOUFLAGE JACKETS; CAMOUFLAGE PANTS; CAMOUFLAGE SHIRTS; CAPRI PANTS; CARGO PANTS; CHILDREN'S AND INFANTS' CLOTH BIBS; CHILDREN'S CLOTH EATING BIBS; CLIMBING BOOTS; CLOTH BIBS; CLOTHING FOR ATHLETIC USE, NAMELY, PADDED ELBOW COMPRESSION SLEEVES BEING PART OF AN ATHLETIC GARMENT; CLOTHING FOR ATHLETIC USE, NAMELY, PADDED PANTS; CLOTHING FOR ATHLETIC USE, NAMELY, PADDED SHIRTS; CLOTHING FOR ATHLETIC USE, NAMELY, PADDED SHORTS; CLOTHING ITEMS, NAMELY, ADHESIVE POCKETS THAT MAY BE AFFIXED DIRECTLY TO THE BODY AS A DECORATIVE PIECE OF CLOTHING WITH UTILITY; CLOTHING ITEMS, NAMELY, ADHESIVE POCKETS THAT MAY BE AFFIXED DIRECTLY TO THE INSIDE OF CLOTHING FOR STORAGE AND SAFEKEEPING OF PERSONAL ITEMS; CLOTHING, NAMELY, ARM WARMERS; CLOTHING, NAMELY, BASE LAYERS; CLOTHING, NAMELY, HAND-WARMERS; CLOTHING, NAMELY, KHAKIS; CLOTHING, NAMELY, NECK TUBES; CLOTHING, NAMELY, THOBES; CLOTHING, NAMELY, WRAP-AROUNDS; COATS OF DENIM; CORSETS; CROSS-COUNTRY GLOVES; DENIM JACKETS; DENIMS; DOWN JACKETS; DRESS SHIRTS; EYESHADES; FITTED SHOE OR BOOT COVERING TO PROTECT THE SHOES OR BOOT FROM WATER OR OTHER DAMAGE; FOOTWEAR, NAMELY, WORK BOOTS; FOUL WEATHER GEAR; FOULARDS; FUR COATS AND JACKETS; FUR HATS; FUR JACKETS; GLOVES; GLOVES AS CLOTHING; GLOVES FOR PERSONAL HAND CONDITIONING USE; GLOVES INCLUDING THOSE MADE OF SKIN, HIDE OR FUR; HAT BANDS; HATS; HATS FOR INFANTS, BABIES, TODDLERS AND CHILDREN; HEADBANDS FOR CLOTHING; HEAVY COATS; HEAVY JACKETS; HIKING BOOTS; HOODED SWEAT SHIRTS; HOODS; HORSE-RIDING BOOTS; HUNTING BOOT BAGS; HUNTING JACKETS; HUNTING PANTS; HUNTING SHIRTS; INFANT AND TODDLER ONE PIECE CLOTHING; JACKET LINERS; JACKETS; JACKETS AND SOCKS; JEANS; JERSEYS; JOGGING PANTS; KNIT SHIRTS; KNITTED GLOVES; LADIES' BOOTS; LEATHER COATS; LEATHER JACKETS; LEATHER PANTS; LIGHT-REFLECTING COATS; LIGHT-REFLECTING JACKETS; LONG JACKETS; LONG-SLEEVED SHIRTS; LOUNGE PANTS; MANTLES; MEN'S AND WOMEN'S JACKETS, COATS, TROUSERS, VESTS; MORNING COATS; MUFFLERS; NIGHT SHIRTS; OPEN-NECKED SHIRTS; OUTDOOR GLOVES; OUTER JACKETS; OVER COATS; OVER SHIRTS; PADDED JACKETS; PADDING JACKETS; PANTS; PARTS OF CLOTHING, NAMELY, GUSSETS FOR TIGHTS, GUSSETS FOR STOCKINGS, GUSSETS FOR BATHING SUITS, GUSSETS FOR UNDERWEAR, GUSSETS FOR LEOTARDS AND GUSSETS FOR FOOTLETS; PERSPIRATION ABSORBENT STRAP TO BE USED IN THE BILL OF A HAT; PERSPIRATION ABSORBENT UNDERWEAR CLOTHING; POCKET SQUARES; POLO SHIRTS; PROTECTIVE METAL MEMBERS FOR SHOES AND BOOTS; RAIN BOOTS; RAIN COATS; RAIN HATS; RAIN JACKETS; RAINPROOF JACKETS; REVERSIBLE

**CLASS 25—(Continued).**

JACKETS; RIDING BOOTS; RIDING COATS; RIDING GLOVES; RUGBY SHIRTS; SHELL JACKETS; SHIRT FRONTS; SHIRTS; SHIRTS AND SHORT-SLEEVED SHIRTS; SHIRTS FOR SUITS; SHOES; SHORT-SLEEVED OR LONG-SLEEVED T-SHIRTS; SHORT-SLEEVED SHIRTS; SHOULDER WRAPS; SHOULDER WRAPS FOR CLOTHING; SLEEP PANTS; SLEEP SHIRTS; SLEEVED OR SLEEVELESS JACKETS; SMALL HATS; SMOKING JACKETS; SNOWBOARD GLOVES; SPORT COATS; SPORT SHIRTS; SPORTS CAPS AND HATS; SPORTS JACKETS; SPORTS SHIRTS; SPORTS SHIRTS WITH SHORT SLEEVES; STRETCH PANTS; STUFF JACKETS; SUEDE JACKETS; SUIT COATS; SWADDLING CLOTHES; SWEAT JACKETS; SWEAT PANTS; SWEAT SHIRTS; T-SHIRTS; TANK TOPS; TANK-TOPS; TEE SHIRTS; TIES; TOP COATS; TOPS; TRACK JACKETS; TRACK PANTS; TRAVEL CLOTHING CONTAINED IN A PACKAGE COMPRISING REVERSIBLE JACKETS, PANTS, SKIRTS, TOPS AND A BELT OR SCARF; TRENCH COATS; TRIATHLON CLOTHING, NAMELY, TRIATHLON TIGHTS, TRIATHLON SHORTS, TRIATHLON SINGLET, TRIATHLON SHIRTS, TRIATHLON SUITS; TURTLE NECK SHIRTS; WATERPROOF JACKETS AND PANTS; WEARABLE GARMENTS AND CLOTHING, NAMELY, SHIRTS; WET SUIT GLOVES; WIND COATS; WIND RESISTANT JACKETS; WIND SHIRTS; WIND-JACKETS; WOMEN'S HATS AND HOODS; WOOLLY HATS; WORK SHOES AND BOOTS; WRAPS (U.S. CLS. 22 AND 39).

CAROLINE WOOD, EXAMINING ATTORNEY

SN 77-964,277. FIERCE FANS LLC, COVINGTON, KY.  
FILED 3-21-2010.

# Fierce Fans

THE MARK CONSISTS OF STANDARD CHARACTERS WITHOUT CLAIM TO ANY PARTICULAR FONT, STYLE, SIZE, OR COLOR.

NO CLAIM IS MADE TO THE EXCLUSIVE RIGHT TO USE "FANS", APART FROM THE MARK AS SHOWN.

FOR CLOTHING, NAMELY, SPIRITWEAR FOR THE PROMOTION OF TEAMS AND ORGANIZATIONS, NAMELY, GLOVES, SCARVES, NECKWARMERS, HEADBANDS, BANDANAS, AND KERCHIEFS (U.S. CLS. 22 AND 39).

FIRST USE 6-11-2009; IN COMMERCE 11-7-2009.  
HEATHER THOMPSON, EXAMINING ATTORNEY

**CLASS 25—(Continued).**

SN 79-092,361. KIM, MYUNG MOON, REPUBLIC OF KOREA, FILED 11-12-2010.



OWNER OF INTERNATIONAL REGISTRATION 1064508 DATED 11-12-2010, EXPIRES 11-12-2020.

THE MARK CONSISTS OF THE STYLIZED WORD "KOUUM" ABOVE A RECTANGLE AND THE STYLIZED WORD "KOUU" IN ANCIENT GREEK CHARACTERS.

THE ENGLISH TRANSLATION OF "KOUUM" IN THE MARK IS "ARISE".

THE TRANSLITERATION OF THE NON-LATIN CHARACTERS IN THE MARK IS: "KOUUM".

FOR LEATHER SHOES; MOUNTAINEERING BOOTS; WINTER BOOTS; ATHLETIC FOOTWEAR; ESPARTO SHOES OR SANDALS; WORK SHOES AND BOOTS; SPORTS WEAR FOR EXCLUSIVE USE FOR SPORTS, NAMELY, SHIRTS AND PANTS; CLOTHING OF LEATHER, NAMELY, JACKETS AND PANTS; CLIMBING CLOTHES, NAMELY, JACKETS AND PANTS; WINTER CLOTHES, NAMELY, COATS; LADIES' SUITS; BLUE JEANS; SHORT-SLEEVED OR LONG-SLEEVED T-SHIRTS; UNDERWEAR; SWEATERS; ATHLETIC UNIFORMS; SLEEPING GARMENTS; PANTYHOSE; MUFFLERS; WINTER GLOVES; SOCKS; CAPS; BELTS MADE OF LEATHER (U.S. CLS. 22 AND 39).

MARY BOAGNI, EXAMINING ATTORNEY

SN 79-092,460. VULPINE PERFORMANCE LTD, UNITED KINGDOM, FILED 1-11-2011.

# Vulpine

THE MARK CONSISTS OF STANDARD CHARACTERS WITHOUT CLAIM TO ANY PARTICULAR FONT, STYLE, SIZE, OR COLOR.

OWNER OF INTERNATIONAL REGISTRATION 1064843 DATED 1-11-2011, EXPIRES 1-11-2021.

FOR CLOTHING, NAMELY, SHIRTS, T-SHIRTS, PANTS, SHORTS, JACKETS, RAINCOATS, ATHLETIC UNIFORMS, JERSEYS, BODYSUITS, GLOVES, SOCKS, TIGHTS, UNDERSHIRTS, UNDERWEAR, NECK WARMERS, SWEATERS, SWEATSHIRTS, HOODED TOPS, GILETS, SKIRTS, DRESSES, SUITS, WAISTCOATS, VESTS, FOOTWEAR, HEADGEAR, NAMELY, HATS AND CAPS (U.S. CLS. 22 AND 39).

TASNEEM HUSSAIN, EXAMINING ATTORNEY

**CLASS 25—(Continued).**

SN 79-092,904. DING SIEN, FUJIAN PROVINCE, CHINA, FILED 1-21-2011.



OWNER OF INTERNATIONAL REGISTRATION 1066009 DATED 1-21-2011, EXPIRES 1-21-2021.

THE LETTERS "KPP" IN THE MARK HAVE NO MEANING IN A FOREIGN LANGUAGE.

FOR SHOES AND FOOTWEAR, NAMELY, SPORTS SHOES, SANDALS, SLIPPERS, GAITERS; SOLES FOR FOOTWEAR (U.S. CLS. 22 AND 39).

ELI HELLMAN, EXAMINING ATTORNEY

SN 79-093,108. FORTE DI GOLIATH B.V., NL-3263 NE OUD-BEIJERLAND, NETHERLANDS, FILED 12-20-2010.



THE MARK CONSISTS OF STANDARD CHARACTERS WITHOUT CLAIM TO ANY PARTICULAR FONT, STYLE, SIZE, OR COLOR.

OWNER OF INTERNATIONAL REGISTRATION 0838925 DATED 11-29-2004, EXPIRES 11-29-2014.

FOR LEISURE AND FASHION SHOES, SNEAKERS (U.S. CLS. 22 AND 39).

ROBERT STRUCK, EXAMINING ATTORNEY

SN 79-095,338. EMIL VEINEDOTTER, UNITED KINGDOM, FILED 3-1-2011.



THE MARK CONSISTS OF STANDARD CHARACTERS WITHOUT CLAIM TO ANY PARTICULAR FONT, STYLE, SIZE, OR COLOR.

OWNER OF INTERNATIONAL REGISTRATION 1071865 DATED 3-1-2011, EXPIRES 3-1-2021.

FOR T-SHIRTS, FORMAL AND CASUAL SHORTS, LEATHER COATS AND LEATHER JACKETS, TRENCH COATS, JEANS, BELTS, UNDERWEAR (U.S. CLS. 22 AND 39).

CARYN GLASSER, EXAMINING ATTORNEY

**CLASS 25—(Continued).**

SN 79-095,834. LI JUN, CHINA, FILED 3-1-2011.



OWNER OF INTERNATIONAL REGISTRATION 1073193 DATED 3-1-2011, EXPIRES 3-1-2021.

THE MARK CONSISTS OF THE TEXT "SANDSTONE" WITH A GEOMETRIC DESIGN WITHIN AN OPEN CIRCLE TO THE LEFT.

FOR CLOTHING, NAMELY, SHIRTS, TROUSERS AND WAISTCOATS; OUTERCLOTHING, NAMELY, COATS, RAINCOATS, JACKETS, WIND RESISTANT JACKETS; KNITWEAR, NAMELY, SWEATERS; LAYETTES; HIKING SHOES; CAPS AS HEADWEAR; GLOVES AS CLOTHING; SCARFS; WET SUITS FOR WATER-SKIING; SOCKS (U.S. CLS. 22 AND 39).

CARYN GLASSER, EXAMINING ATTORNEY

SN 79-097,069. GUANGZHOU JINZUYOUYUAN SHOES & LEATHER CO., LTD., GUANGZHOU CITY; GUANGDONG, CHINA, FILED 4-21-2011.



OWNER OF INTERNATIONAL REGISTRATION 1076284 DATED 4-21-2011, EXPIRES 4-21-2021.

THE MARK CONSISTS OF THE WORDING "KADAN" SEPARATED FROM THE WORDING "DI TU" BY A SMALL DIAMOND; CENTERED UNDERNEATH THIS WORDING ARE CHINESE CHARACTERS SEPARATED BY A SMALL DIAMOND AND CENTERED BETWEEN A SINGLE HORIZONTAL BAR ON EACH SIDE.

THE WORDING "KADAN DI TU" HAS NO MEANING IN A FOREIGN LANGUAGE.

THE NON-LATIN CHARACTERS IN THE MARK TRANSLITERATE TO "KA DAN DI TU" AND THIS HAS NO MEANING IN A FOREIGN LANGUAGE.

FOR SHOES; BOOTS; SANDALS; SPORTS SHOES (U.S. CLS. 22 AND 39).

SHAILA SETTLES, EXAMINING ATTORNEY

SN 79-097,340. PAVI GROUP SRL, I-66010 RIPA TEATINA (CH), ITALY, FILED 2-28-2011.



OWNER OF INTERNATIONAL REGISTRATION 1077005 DATED 2-28-2011, EXPIRES 2-28-2021.

THE TRADEMARK IS COMPOSED OF THE FOLLOWING NAME: "RIPOSELLA".

FOR FOOTWEAR, SLIPPERS, SANDALS, SHOES, BELTS AND HATS (U.S. CLS. 22 AND 39).

CHRISIE B. KING, EXAMINING ATTORNEY

**CLASS 25—(Continued).**

SN 79-097,928. SARL RAXMAX, FRANCE, FILED 5-3-2011.

**RAXMAX**

THE MARK CONSISTS OF STANDARD CHARACTERS WITHOUT CLAIM TO ANY PARTICULAR FONT, STYLE, SIZE, OR COLOR.

OWNER OF INTERNATIONAL REGISTRATION 1078818 DATED 5-3-2011, EXPIRES 5-3-2021.

FOR SHOES (U.S. CLS. 22 AND 39).

LIEF MARTIN, EXAMINING ATTORNEY

SN 79-101,354. ZHUJI BIAOBANG GARMENTS CO., LTD., CHINA, FILED 6-1-2011.

**WEEKLY SOCKS**  
**星期袜**

OWNER OF INTERNATIONAL REGISTRATION 1087527 DATED 6-1-2011, EXPIRES 7-24-2022.

NO CLAIM IS MADE TO THE EXCLUSIVE RIGHT TO USE "SOCKS" OR THE NON-LATIN CHARACTER THAT MEANS "SOCKS", APART FROM THE MARK AS SHOWN.

THE MARK HAS NO SIGNIFICANCE IN THE RELEVANT TRADE OR INDUSTRY, OR ANY GEOGRAPHICAL SIGNIFICANCE.

THE FIRST CHARACTER MEANS "STAR", THE SECOND CHARACTER MEANS "TERM"; THE FIRST TWO CHARACTERS MEAN "WEEK", AND THE THIRD MEANS "SOCK"; THE WHOLE OF THE THREE CHINESE CHARACTERS COULD NOT BE TRANSLATED INTO OTHER FOREIGN LANGUAGE.

THE TRANSLITERATION OF THE NON-LATIN CHARACTERS IN THE MARK IS: "XING QI WA".

FOR STOCKINGS; HEELPIECES FOR STOCKINGS; HOSIERY; SOCKS; GARTERS; SOCK SUSPENDERS; LEGGINGS; FOOTMUFFS, NOT ELECTRICALLY HEATED; PANTYHOSE; ANKLE SOCKS (U.S. CLS. 22 AND 39).

CARYN GLASSER, EXAMINING ATTORNEY

SN 85-003,785. COOKIE'S, INC., DBA COOKIES CLOTHING CO., HONOLULU, HI. FILED 4-1-2010.

**COOKIES**

THE MARK CONSISTS OF STANDARD CHARACTERS WITHOUT CLAIM TO ANY PARTICULAR FONT, STYLE, SIZE, OR COLOR.

FOR WOMEN'S APPAREL, NAMELY, SHIRTS, BLOUSES, PANTS, JACKETS, COATS, SWEATERS, SUITS AND DRESSES; AND ACCESSORIES, NAMELY, BELTS, SCARVES AND HATS (U.S. CLS. 22 AND 39).

FIRST USE 12-13-2008; IN COMMERCE 12-13-2008.

DAVID MURRAY, EXAMINING ATTORNEY

**CLASS 25—(Continued).**

SN 85-008,706. THE COCOA BEAN, LLC, REXBURG, ID. FILED 4-7-2010.

**THE COCOA BEAN CUPCAKE CAFE**

THE MARK CONSISTS OF STANDARD CHARACTERS WITHOUT CLAIM TO ANY PARTICULAR FONT, STYLE, SIZE, OR COLOR.

FOR (BASED ON USE IN COMMERCE) APRONS; BEANIES; BOXER BRIEFS; BOXER SHORTS; SHIRTS AND SHORT-SLEEVED SHIRTS; SHORT-SLEEVED OR LONG-SLEEVED T-SHIRTS; T-SHIRTS; TEE SHIRTS (BASED ON INTENT TO USE) ANKLE SOCKS; BABY BODYSUITS; BASEBALL CAPS; BASEBALL CAPS AND HATS; BRIEFS; CAPS; CLOTH BIBS; CLOTHING, NAMELY, ARM WARMERS; EAR BANDS; EAR MUFFS; EAR WARMERS; EARBANDS; FLIP FLOPS; GYM PANTS; GYM SHORTS; HATS; HATS FOR INFANTS, BABIES, TODDLERS AND CHILDREN; HEADBANDS; HEADBANDS AGAINST SWEATING; HOODED PULL-OVERS; HOODED SWEAT SHIRTS; INFANT AND TODDLER ONE PIECE CLOTHING; JACKETS; KNITTED GLOVES; LADIES' UNDERWEAR; MUSCLE TOPS; PANTIES; PANTIES, SHORTS AND BRIEFS; SANDALS; SANDALS AND BEACH SHOES; SCARFS; SCARVES; SHIRTS FOR INFANTS, BABIES, TODDLERS AND CHILDREN; SKIRTS; SLIPPERS; SOCKS; SWEAT BANDS; SWEATERS; SWIM TRUNKS; SWIM WEAR; SWIM WEAR FOR GENTLEMEN AND LADIES; TANK TOPS; TANK-TOPS; THONGS; TURTLE NECK SHIRTS; TURTLENECK SWEATERS; TURTLENECKS; WRIST BANDS; WRISTBANDS (U.S. CLS. 22 AND 39).

FIRST USE 1-16-2007; IN COMMERCE 1-16-2007.

LOURDES AYALA, EXAMINING ATTORNEY

SN 85-036,439. BEACH RECOVERY LLC, NORWALK, CT. FILED 5-12-2010.

**Beach  Recovery**

NO CLAIM IS MADE TO THE EXCLUSIVE RIGHT TO USE "BEACH", APART FROM THE MARK AS SHOWN.

THE MARK CONSISTS OF A CROSS WITH A WAVE THROUGH THE CROSS IN BETWEEN THE WORDS "BEACH" AND "RECOVERY".

FOR SWEATERS, JACKETS, PARKAS, SHIRTS, T-SHIRTS; SWEATSHIRTS, HOODED SWEATSHIRTS, CAPS, HATS, GLOVES, PANTS, SWEATPANTS, SHORTS, SWIMWEAR, SKIRTS, DRESSES, BLOUSES, JEANS, SOCKS, BELTS, SCARVES, TANK TOPS, VESTS, PAJAMAS, NIGHTSHIRTS, UNDERWEAR, SANDALS AND FOOTWEAR (U.S. CLS. 22 AND 39).

ROBERT C. CLARK JR., EXAMINING ATTORNEY

**CLASS 25—(Continued).**

SN 85-038,769. INTERNATIONAL NATION, LTD., LOS ANGELES, CA. FILED 5-14-2010.

# NATION LTD

THE MARK CONSISTS OF STANDARD CHARACTERS WITHOUT CLAIM TO ANY PARTICULAR FONT, STYLE, SIZE, OR COLOR.

NO CLAIM IS MADE TO THE EXCLUSIVE RIGHT TO USE "LTD", APART FROM THE MARK AS SHOWN.

FOR WOMEN'S APPAREL, NAMELY, TEE SHIRTS, SWEATSHIRTS, TANK TOPS, DRESSES, TUNICS, LEGGINGS, SCARVES, BRALETTES, SWEATPANTS, HOODED JACKETS, HOODED TOPS, PONCHOS; OUTERWEAR, NAMELY, COATS, PARKAS, JACKETS AND VESTS; SKIRTS; MEN'S APPAREL, NAMELY, TEE SHIRTS AND SWEATSHIRTS (U.S. CLS. 22 AND 39).

FIRST USE 8-15-2005; IN COMMERCE 8-15-2005.  
WILLIAM VERHOSEK, EXAMINING ATTORNEY

---

SN 85-038,772. INTERNATIONAL NATION, LTD., LOS ANGELES, CA. FILED 5-14-2010.

NATION LTD BY JEN MENCHACA

THE MARK CONSISTS OF STANDARD CHARACTERS WITHOUT CLAIM TO ANY PARTICULAR FONT, STYLE, SIZE, OR COLOR.

NO CLAIM IS MADE TO THE EXCLUSIVE RIGHT TO USE "LTD", APART FROM THE MARK AS SHOWN.

THE NAME(S), PORTRAIT(S), AND/OR SIGNATURE(S) SHOWN IN THE MARK IDENTIFIES "JEN MENCHACA", WHOSE CONSENT(S) TO REGISTER IS MADE OF RECORD.

FOR WOMEN'S APPAREL, NAMELY, TEESHIRTS, SWEATSHIRTS, TANK TOPS, DRESSES, TUNICS, LEGGINGS, SCARVES, BRALETTES, SWEATPANTS, HOODED JACKETS, HOODED TOPS, PONCHOS; OUTERWEAR, NAMELY, COATS, JACKETS, PARKAS AND VESTS; SKIRTS (U.S. CLS. 22 AND 39).

FIRST USE 11-15-2008, THE MARK WAS FIRST USED ANYWHERE IN A DIFFERENT FORM OTHER THAN THAT SOUGHT TO BE REGISTERED AT LEAST AS EARLY AS 08/15/2005; IN COMMERCE 11-15-2008, THE MARK WAS FIRST USED IN COMMERCE IN A DIFFERENT FORM OTHER THAN THAT SOUGHT TO BE REGISTERED AT LEAST AS EARLY AS 08/15/2005 .

RAUL CORDOVA, EXAMINING ATTORNEY

**CLASS 25—(Continued).**

SN 85-040,418. DALEY, MICHAEL, HUNTINGTON BEACH, CA. FILED 5-17-2010.

HOLLYWOOD GOLD AWARDS

THE MARK CONSISTS OF STANDARD CHARACTERS WITHOUT CLAIM TO ANY PARTICULAR FONT, STYLE, SIZE, OR COLOR.

FOR SHIRTS, T-SHIRTS, SWEATSHIRTS, JACKETS, COATS, HATS AND SUN VISORS (U.S. CLS. 22 AND 39).  
ESTHER A. BORSUK, EXAMINING ATTORNEY

---

SN 85-042,244. ASICS CORPORATION, CHUO-KU, KOBE, JAPAN, FILED 5-19-2010.

# PIVOT

THE MARK CONSISTS OF STANDARD CHARACTERS WITHOUT CLAIM TO ANY PARTICULAR FONT, STYLE, SIZE, OR COLOR.

FOR ATHLETIC APPAREL, NAMELY, SINGLET(S) (U.S. CLS. 22 AND 39).

FIRST USE 12-31-2006; IN COMMERCE 12-31-2006.  
ODESSA BIBBINS, EXAMINING ATTORNEY

---

SN 85-042,734. THE AR GROUP LLC, DBA ATTITUDE RULES, GIG HARBOR, WA. FILED 5-19-2010.

Attitude Rules



Have a good one!

THE COLOR(S) WHITE, RED, GRAY AND BLACK IS/ ARE CLAIMED AS A FEATURE OF THE MARK.

THE MARK CONSISTS OF AN IMAGE OF A WHITE DOG WITH ONE EAR UP AND THE OTHER EAR DOWN, BOWED LEGS, A RED TONGUE, AND A GRAY FACE. THE TEXT LINE ABOVE THE DESIGN READS "ATTITUDE RULES" IN THE COLOR BLACK AND A TEXT LINE BELOW THE DESIGN READS "HAVE A GOOD ONE!" IN THE COLOR BLACK.

FOR CAPS (U.S. CLS. 22 AND 39).  
KATHRYN COWARD, EXAMINING ATTORNEY



**CLASS 25—(Continued).**

SN 85-117,166. RAMOS, WARREN CHRISTIAN, ROWLAND HEIGHTS, CA. FILED 8-27-2010.

**FLEXCUT**

THE MARK CONSISTS OF THE LETTERS "FLEXCUT" WITH THE "X" SEPARATED AT THE INTERSECT AND SLIGHTLY ENLARGED RELATIVE TO THE OTHER LETTERS.

FOR ATHLETIC APPAREL, NAMELY, SHIRTS, PANTS, JACKETS, FOOTWEAR, HATS AND CAPS, ATHLETIC UNIFORMS; SLEEVELESS JERSEYS (U.S. CLS. 22 AND 39).

FIRST USE 10-1-2009; IN COMMERCE 10-1-2009.  
GEOFFREY FOSDICK, EXAMINING ATTORNEY

**CLASS 25—(Continued).**

SN 85-146,134. MI YOUNG SONG, YONGSAN-GU, SEOUL, REPUBLIC OF KOREA, FILED 10-6-2010.

**matin de mai**

THE MARK CONSISTS OF STANDARD CHARACTERS WITHOUT CLAIM TO ANY PARTICULAR FONT, STYLE, SIZE, OR COLOR.

PRIORITY CLAIMED UNDER SEC. 44(D) ON REPUBLIC OF KOREA APPLICATION NO. 2010-0049154, FILED 9-18-2010.

THE ENGLISH TRANSLATION OF "MATIN DE MAI" IN THE MARK IS "MORNING OF MAY".

FOR CLOTHING, NAMELY, JUMPERS, SWEATERS, JACKETS, T-SHIRTS, BLOUSES, CARDIGANS, VESTS, JEANS, SKIRTS, COATS, PANTS, ONE PIECE SUITS, SWIMSUITS, UNDERWEAR, NIGHTWEAR; BELTS FOR CLOTHING; HEADWEAR; SOCKS; GLOVES FOR CLOTHING; MUFFLERS; FOOTWEAR, NAMELY, SHOES, SANDALS, SLIPPERS, BOOTS; GOLF SHOES, RUNNING SHOES (U.S. CLS. 22 AND 39).

FIRST USE 7-18-2011; IN COMMERCE 7-18-2011.  
GRETTA YAO, EXAMINING ATTORNEY

SN 85-120,409. SCHAUBACH, JOHN, DEERWOOD, MN. FILED 8-31-2010.

**CUYUNA LAKES IRON MOUNTAIN  
BIKING**

THE MARK CONSISTS OF STANDARD CHARACTERS WITHOUT CLAIM TO ANY PARTICULAR FONT, STYLE, SIZE, OR COLOR.

NO CLAIM IS MADE TO THE EXCLUSIVE RIGHT TO USE "CUYUNA LAKES" OR "MOUNTAIN BIKING", APART FROM THE MARK AS SHOWN.

FOR BELTS; COATS; FOOTWEAR; HEADWEAR; JACKETS; PANTS; SHIRTS; SOCKS; SWEAT SUITS; SWEATERS; TIES; UNDERGARMENTS (U.S. CLS. 22 AND 39).

TINA L. SNAPP, EXAMINING ATTORNEY

SN 85-156,630. SOCATOA INC., LOS ANGELES, CA. FILED 10-20-2010.

**Sanshuz**

THE MARK CONSISTS OF STANDARD CHARACTERS WITHOUT CLAIM TO ANY PARTICULAR FONT, STYLE, SIZE, OR COLOR.

FOR ATHLETIC APPAREL, NAMELY, SHIRTS, PANTS, JACKETS, HATS AND CAPS, ATHLETIC UNIFORMS (U.S. CLS. 22 AND 39).

JASON BLAIR, EXAMINING ATTORNEY

**CLASS 25—(Continued).**

SN 85-160,758. BLAISE KAVANAGH, LLC, RIDGEWOOD, NY. FILED 10-25-2010.



BLAISE KAVANAGH

THE NAME "BLAISE KAVANAGH" IDENTIFIES A LIVING INDIVIDUAL WHOSE CONSENT IS OF RECORD.

THE MARK CONSISTS OF A STYLIZED "BK" LOGO THAT CONSISTS OF THE LETTERS "B" AND A "K" OVERLAPPING EACH OTHER WITHIN A RECTANGLE. BENEATH THE LOGO IS THE WORDING "BLAISE KAVANAGH".

FOR BLOUSES; COATS; DRESSES; JACKETS; PANTS; SKIRTS; SWEATERS (U.S. CLS. 22 AND 39).

FIRST USE 9-1-2007; IN COMMERCE 9-1-2007.

MATTHEW MCDOWELL, EXAMINING ATTORNEY

**CLASS 25—(Continued).**

SN 85-168,552. WHELAN, JOAN MARIE, CORONA DEL MAR, CA. FILED 11-3-2010.

THE BABY WHISPERER WITH  
JOAN MARIE

THE MARK CONSISTS OF STANDARD CHARACTERS WITHOUT CLAIM TO ANY PARTICULAR FONT, STYLE, SIZE, OR COLOR.

NO CLAIM IS MADE TO THE EXCLUSIVE RIGHT TO USE "BABY", APART FROM THE MARK AS SHOWN.

THE NAME(S), PORTRAIT(S), AND/OR SIGNATURE(S) SHOWN IN THE MARK IDENTIFIES "JOAN MARIE WHELAN", WHOSE CONSENT(S) TO REGISTER IS MADE OF RECORD.

FOR CLOTHING, NAMELY, T-SHIRTS, SWEATSHIRTS, JACKETS, UNDERWEAR, PAJAMAS, HOODED SWEATSHIRTS, SWEATERS, SHORTS, PANTS, SCARVES, SOCKS, FOOTWEAR; HEADWEAR (U.S. CLS. 22 AND 39).

VIVIAN MICZNIK FIRST, EXAMINING ATTORNEY

SN 85-163,110. MM COMPOUND, INC., IRVINE, CA. FILED 10-27-2010.

TWITCH

THE MARK CONSISTS OF STANDARD CHARACTERS WITHOUT CLAIM TO ANY PARTICULAR FONT, STYLE, SIZE, OR COLOR.

FOR APPAREL PRODUCTS, NAMELY, SHIRTS, BLOUSES, TANK TOPS, JACKETS, JERSEYS, HOODED JACKETS, PANTS, SHORTS, UNDERWEAR, LINGERIE, SWIM WEAR, SWEAT SUITS, SWEATERS, SUITS, HATS, GLOVES, SOCKS, AND FOOT WEAR (U.S. CLS. 22 AND 39).

RUDY R. SINGLETON, EXAMINING ATTORNEY

SN 85-169,733. TROMPETER, SCOTT A., DBA TEAM BOGEY, SAN MIGUEL, CA. FILED 11-4-2010.

Keep Battlin'

THE MARK CONSISTS OF STANDARD CHARACTERS WITHOUT CLAIM TO ANY PARTICULAR FONT, STYLE, SIZE, OR COLOR.

FOR CLOTHING, NAMELY, SHIRTS, HATS, CAPS, SHORTS, JACKETS, SWEATERS (U.S. CLS. 22 AND 39).

FIRST USE 2-1-2002; IN COMMERCE 8-1-2010.

ALEX KEAM, EXAMINING ATTORNEY

**CLASS 25—(Continued).**

SN 85-174,039. CANTRELL, RICHARD R., SANTA MONICA, CA. AND CANTRELL, PATRICIA L., SANTA MONICA, CA. FILED 11-10-2010.

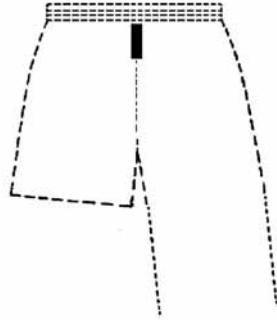

OWNER OF U.S. REG. NO. 2,938,965.  
THE STIPPLING IS FOR SHADING PURPOSES ONLY.  
THE MARK CONSISTS OF A WOVEN RECTANGULAR CLOTH LABEL SEWN FLAT AND POSITIONED VERTICALLY OVER THE CENTER SEAM ON THE BACK OF A PAIR OF SHORTS OR PANTS AT THE BOTTOM EDGE OF A WAIST BAND. THE DOTTED LINES ARE NOT PART OF THE MARK AND ARE INTENDED ONLY TO SHOW THE POSITION OF THE LABEL.

SEC. 2(F).

FOR PANTS; SHORTS (U.S. CLS. 22 AND 39).  
FIRST USE 5-0-1994; IN COMMERCE 5-0-1994.  
DAVID I, EXAMINING ATTORNEY

SN 85-174,463. MARCO REVAH, BOCA RATON, FL. FILED 11-11-2010.

NO CLAIM IS MADE TO THE EXCLUSIVE RIGHT TO USE "MEN", APART FROM THE MARK AS SHOWN.

THE MARK CONSISTS OF THE WORDS "EVER" AND "MEN" FOLLOWING THE NUMBER "4"

FOR JEANS; PANTS; SCARVES; SHIRTS; SHORTS; SUITS; SWEATERS; SWEATSHIRTS; T-SHIRTS; TIES; UNDERWEAR (U.S. CLS. 22 AND 39).

ROBERT STRUCK, EXAMINING ATTORNEY

**CLASS 25—(Continued).**

SN 85-174,867. JOY CIOCI, LLC, NEW YORK, NY. FILED 11-11-2010.

# JOY CIOCI

THE MARK CONSISTS OF STANDARD CHARACTERS WITHOUT CLAIM TO ANY PARTICULAR FONT, STYLE, SIZE, OR COLOR.

THE NAME "JOY CIOCI" IDENTIFIES A LIVING INDIVIDUAL WHOSE CONSENT IS OF RECORD.

FOR CLOTHING, NAMELY, SHIRTS, T-SHIRTS, UNDER SHIRTS, NIGHT SHIRTS, RUGBY SHIRTS, POLO SHIRTS, CARDIGANS, JERSEYS, UNIFORMS, ATHLETIC UNIFORMS, PANTS, TROUSERS, SLACKS, JEANS, DENIM JEANS, CULOTTES, CARGO PANTS, OVERALLS, COVERALLS, JUMPERS, JUMP SUITS, SHORTS, BOXER SHORTS, TOPS, CROP TOPS, TANK TOPS, HALTER TOPS, SWEAT SHIRTS, SWEAT SHORTS, SWEAT PANTS, WRAPS, WARM-UP SUITS, JOGGING SUITS, TRACK SUITS, BLOUSES, SKIRTS, DRESSES, GOWNS, SWEATERS, VESTS, FLEECE VESTS, PULLOVERS, PARKAS, CAPES, ANORAKS, PONCHOS, JACKETS, REVERSIBLE JACKETS, COATS, BLAZERS, SUITS, TURTLENECKS, SWIMWEAR, BEACHWEAR, TENNIS WEAR, SURF WEAR, SKI WEAR, CAPS, SWIM CAPS, BERETS, BEANIES, HATS, VISORS, HEADBANDS, WRIST BANDS, SWEAT BANDS, HEADWEAR, EAR MUFFS, APRONS, SCARVES, BANDANAS, BELTS, SUSPENDERS, NECKWEAR, NECKTIES, TIES, NECKERCHIEFS, ASCOTS, UNDERWEAR, BRIEFS, SWIM AND BATHING TRUNKS, BRAS, SPORTS BRAS, BRASSIERES, BUSTIERS, CORSETS, PANTIES, GARTERS AND GARTER BELTS, TEDDIES, GIRDLES, FOUNDATION GARMENTS, SINGLET, SOCKS, LOUNGEWEAR, ROBES, BATHROBES, UNDERCLOTHES, PAJAMAS, SLEEPWEAR, NIGHT GOWNS, LINGERIE, CAMISOLES, NEGLIGEEES, CHEMISES, CHEMISETTES, SLIPS, SARONGS, HOSIERY, PANTYHOSE, BODY STOCKINGS, KNEE HIGHS, LEGGINGS, TIGHTS, LEOTARDS, BODY SUITS, UNITARDS, BODY SHAPERS, GLOVES, MITTENS, FOOTWEAR, SHOES, SNEAKERS, BOOTS, GALOSHES, SANDALS, FLIP-FLOPS, ZORI, SLIPPERS, RAINWEAR, BOLEROS, BOW TIES, FUR STOLEES, FUR JACKETS, FUR COATS, GARTER BELTS, MINI SKIRTS, PANT SUITS, KNITWEAR, NAMELY, KNIT BOTTOMS, KNIT DRESSES, KNIT FACE MASKS, KNIT JACKETS, KNIT SHIRTS, KNIT SKIRTS, KNIT TOPS, KNIT TOPS, KNITTED CAPS, KNITTED GLOVES, AND KNITTED UNDERWEAR; LEATHER COATS, LEATHER SKIRTS, LEATHER SHORTS, LEATHER DRESSES, LEATHER BLOUSES, TUNICS, TOP COATS, TUXEDOS, VEILS, BRIDAL GOWNS, WRAPS, OUTER GARMENTS, NAMELY, COATS, JACKETS, VESTS, SWEATERS, SWEATSHIRTS, CAPES, CLOAKS, PARKAS, PONCHOS AND PULLOVERS (U.S. CLS. 22 AND 39).

JAMES LOVELACE, EXAMINING ATTORNEY

**CLASS 25—(Continued).**

SN 85-175,063. 40 PLUS 2, INC., TUSTIN, CA. FILED 11-11-2010.



NO CLAIM IS MADE TO THE EXCLUSIVE RIGHT TO USE "CLOTHING COMPANY", APART FROM THE MARK AS SHOWN.

FOR CLOTHING, NAMELY, TOPS AND BOTTOMS; HEADWEAR AND FOOTWEAR (U.S. CLS. 22 AND 39).  
MARIA-VICTORIA SUAREZ, EXAMINING ATTORNEY

SN 85-175,068. 40 PLUS 2, INC., TUSTIN, CA. FILED 11-11-2010.

**CHECKERED PAST CLOTHING  
COMPANY**

THE MARK CONSISTS OF STANDARD CHARACTERS WITHOUT CLAIM TO ANY PARTICULAR FONT, STYLE, SIZE, OR COLOR.

NO CLAIM IS MADE TO THE EXCLUSIVE RIGHT TO USE "CLOTHING COMPANY", APART FROM THE MARK AS SHOWN.

FOR CLOTHING, NAMELY, TOPS, BOTTOMS; HEADWEAR AND FOOTWEAR (U.S. CLS. 22 AND 39).  
MARIA-VICTORIA SUAREZ, EXAMINING ATTORNEY

SN 85-177,376. MARBEY NEW YORK CLOTHING COMPANY, SPRINGFIELD GARDENS, NY. FILED 11-15-2010.



**MARBEBY CLOTHING**

NO CLAIM IS MADE TO THE EXCLUSIVE RIGHT TO USE "CLOTHING", APART FROM THE MARK AS SHOWN.

THE MARK CONSISTS OF A STYLIZED CURSIVE "M" INSIDE A PENTAGON-LIKE SHAPE HAVING AN OUTLINE AROUND IT; BENEATH THE AFOREMENTIONED ELEMENTS APPEARS THE STYLIZED WORDING "MARBEBY CLOTHING".

FOR T-SHIRTS, SHIRTS, SWEATERS, PANTS, JEANS, SHOES, SNEAKERS, SOCKS, UNDERGARMENTS, SCARVES, JACKETS, SUITS, HOODED SWEATSHIRTS, SWEATSHIRTS AND TIES (U.S. CLS. 22 AND 39).

FIRST USE 5-20-2008; IN COMMERCE 4-27-2010.  
KEVIN CORWIN, EXAMINING ATTORNEY

**CLASS 25—(Continued).**

SN 85-177,531. BROWN UNIVERSITY, PROVIDENCE, RI. FILED 11-16-2010.



THE MARK CONSISTS OF A VINE WRAPPING BEHIND A STYLIZED CAPITAL LETTER "B" WITH A STRAY THREE-LEAF ARRAY NEAR THE UPPER RIGHT OF THE "B".

FOR BOOTIES; HATS; JACKETS; SHORTS; SOCKS; SWEATPANTS; SWEATSHIRTS; T-SHIRTS; TIES (U.S. CLS. 22 AND 39).

FIRST USE 10-31-1997; IN COMMERCE 10-31-1997.  
BRENDAN REGAN, EXAMINING ATTORNEY

SN 85-180,460. REVILLE, TRAVIS, VIRGINIA BEACH, VA. FILED 11-18-2010.

**CASUAL THUG**

THE MARK CONSISTS OF STANDARD CHARACTERS WITHOUT CLAIM TO ANY PARTICULAR FONT, STYLE, SIZE, OR COLOR.

NO CLAIM IS MADE TO THE EXCLUSIVE RIGHT TO USE "CASUAL", APART FROM THE MARK AS SHOWN.

FOR SHIRTS; SWEAT SUITS (U.S. CLS. 22 AND 39).  
GENE MACIOL, EXAMINING ATTORNEY

SN 85-181,350. SMUGGLER'S EVENT MANAGEMENT, LLC, PUNTA GORDA, FL. FILED 11-19-2010.

**FLATSMASTERS**

THE MARK CONSISTS OF STANDARD CHARACTERS WITHOUT CLAIM TO ANY PARTICULAR FONT, STYLE, SIZE, OR COLOR.

FOR CLOTHING, NAMELY, TEE SHIRTS, POLO SHIRTS, BUTTON DOWN SHIRTS, SHORTS, AND HEADGEAR, NAMELY, HATS, VISORS, CAPS, BANDANAS (U.S. CLS. 22 AND 39).

FIRST USE 3-1-2001; IN COMMERCE 3-1-2001.  
LOURDES AYALA, EXAMINING ATTORNEY

**CLASS 25—(Continued).**

SN 85-181,491. KEITHA WYATT, EDMOND, OK. FILED 11-19-2010.

**CLASS 25—(Continued).**

SN 85-182,565. CHAN, DAVID M., TEMPLE CITY, CA. FILED 11-22-2010.

**FINGERBOARD**

THE COLOR(S) RED AND BLACK IS/ARE CLAIMED AS A FEATURE OF THE MARK.

THE MARK CONSISTS OF A WOMAN APPEARING IN BLACK WITH A RED SPORTS BRA, WITH BLACK SPLATTER DOTS BEHIND THE TOP HEAD AREA, RED CURVED STRIPE LINE EXTENDING FROM THE FACE UNDERNEATH THE FOREARM AREA, BLACK CURVED STRIPE PROTRUDING FROM THE BACK OF THE HEAD, RED CURVED STRIPE FROM THE FIST AREA.

FOR SHORT-SLEEVED OR LONG-SLEEVED T-SHIRTS (U.S. CLS. 22 AND 39).

CHARLES L. JENKINS, EXAMINING ATTORNEY

THE MARK CONSISTS OF STANDARD CHARACTERS WITHOUT CLAIM TO ANY PARTICULAR FONT, STYLE, SIZE, OR COLOR.

FOR A-SHIRTS; ATHLETIC APPAREL, NAMELY, SHIRTS, PANTS, JACKETS, FOOTWEAR, HATS AND CAPS, ATHLETIC UNIFORMS; ATHLETIC FOOTWEAR; BEACH FOOTWEAR; BERMUDA SHORTS; BIB SHORTS; BOARD SHORTS; BODY SHIRTS; BUTTON-FRONT ALOHA SHIRTS; CAMOUFLAGE SHIRTS; CAMP SHIRTS; CAPS; CHILDREN'S HEADWEAR; CLOTHING FOR ATHLETIC USE, NAMELY, PADDED SHIRTS; CLOTHING FOR ATHLETIC USE, NAMELY, PADDED SHORTS; CYCLING SHORTS; FLEECE SHORTS; FLIP FLOPS; FOOTWEAR; FOOTWEAR; FOOTWEAR FOR MEN; FOOTWEAR FOR MEN AND WOMEN; FOOTWEAR FOR TRACK AND FIELD ATHLETICS; FOOTWEAR FOR WOMEN; FOOTWEAR, NAMELY, RUBBERS; GOLF PANTS, SHIRTS AND SKIRTS; GOLF SHIRTS; GOLF SHORTS; GYM SHORTS; HEADBANDS AGAINST SWEATING; HEADWEAR; HOODED SWEAT SHIRTS; KNIT SHIRTS; LONG-SLEEVED SHIRTS; MOISTURE-WICKING SPORTS SHIRTS; OPEN-NECKED SHIRTS; OVER SHIRTS; POLO SHIRTS; RUGBY SHIRTS; RUGBY SHORTS; SHIRT FRONTS; SHIRTS; SHIRTS AND SHORT-SLEEVED SHIRTS; SHIRTS AND SLIPS; SHORT SETS; SHORT TROUSERS; SHORT-SLEEVED OR LONG-SLEEVED T-SHIRTS; SHORT-SLEEVED SHIRTS; SHORTS; SKULLIES; SPORT SHIRTS; SPORTS SHIRTS; SPORTS SHIRTS WITH SHORT SLEEVES; SWEAT BANDS; SWEAT JACKETS; SWEAT PANTS; SWEAT SHIRTS; SWEAT SHORTS; SWEAT SUITS; SWEAT-PANTS; T-SHIRTS; TEE SHIRTS; TROUSERS FOR SWEATING; TURTLE NECK SHIRTS; WALKING SHORTS; WATER REPELLING FOOTWEAR; WATER-PROOF FOOTWEAR; WEARABLE GARMENTS AND CLOTHING, NAMELY, SHIRTS; WIND SHIRTS (U.S. CLS. 22 AND 39).

FIRST USE 11-10-1995; IN COMMERCE 11-10-1995.

WILLIAM BRECKENFELD, EXAMINING ATTORNEY

**CLASS 25—(Continued).**

SN 85-184,537. GERMAIN, SHYLOV FIGARO, ORANGE PARK, FL. FILED 11-24-2010.

# Shy Figaro

THE MARK CONSISTS OF STANDARD CHARACTERS WITHOUT CLAIM TO ANY PARTICULAR FONT, STYLE, SIZE, OR COLOR.

THE NAME(S), PORTRAIT(S), AND/OR SIGNATURE(S) SHOWN IN THE MARK IDENTIFIES "SHY FIGARO", WHOSE CONSENT(S) TO REGISTER IS MADE OF RECORD.

FOR BATHING SUITS; BATHING SUITS FOR MEN; BELTS; BOARD SHORTS; BODY SHIRTS; BOOTS; BOXER SHORTS; BOXING SHORTS; BUTTON DOWN SHIRTS; CAP VISORS; CAPS; CAPS WITH VISORS; COATS; COATS FOR MEN AND WOMEN; COLLARED SHIRTS; CORSETS; DENIMS; DRESS PANTS; DRESS SHIRTS; DRESS SUITS; DRESSES; EVENING DRESSES; FOOTWEAR; FOOTWEAR FOR MEN; FOOTWEAR FOR MEN AND WOMEN; FOOTWEAR FOR WOMEN; GLOVES; GLOVES AS CLOTHING; GLOVES FOR APPAREL; HATS; HEADBANDS; HEADBANDS FOR CLOTHING; HEADWEAR; HOODED SWEATSHIRTS; JACKETS; JEANS; JERSEYS; LINGERIE; MEN'S AND WOMEN'S JACKETS, COATS, TROUSERS, VESTS; MEN'S DRESS SOCKS; MEN'S SOCKS; MEN'S SUITS; MEN'S SUITS, WOMEN'S SUITS; PANTIES, SHORTS AND BRIEFS; PANTS; SANDALS; SHIRTS AND SHORT-SLEEVED SHIRTS; SHIRTS FOR SUITS; SHOES; SHORT SETS; SHORT-SLEEVED OR LONG-SLEEVED T-SHIRTS; SLEEP PANTS; SLEEPWEAR; SNEAKERS; SOCKS; SUIT COATS; SUITS; SWEATERS; SWEATPANTS; SWEATSHIRTS; SWIMWEAR; T-SHIRTS; TIES; TOPS; TROUSERS; UNDERGARMENTS; UNIFORMS; VISORS; WEARABLE GARMENTS AND CLOTHING, NAMELY, SHIRTS; WOMEN'S HATS AND HOODS; WOMEN'S SHOES; WOMEN'S TOPS, NAMELY, CAMIS; WOMEN'S UNDERWEAR; WRISTBANDS (U.S. CLS. 22 AND 39).

FIRST USE 1-10-1988; IN COMMERCE 1-10-1988.  
COLLEEN DOMBROW, EXAMINING ATTORNEY

SN 85-185,498. TREVOR DELMORE, SR., STAMFORD, CT. AND BRENDA DELMORE, STAMFORD, CT. AND TREVOR DELMORE II, STAMFORD, CT. AND MATTHEW DELMORE, STAMFORD, CT. AND CHRISTIAN DELMORE, STAMFORD, CT. FILED 11-26-2010.

# DECOR

THE MARK CONSISTS OF STANDARD CHARACTERS WITHOUT CLAIM TO ANY PARTICULAR FONT, STYLE, SIZE, OR COLOR.

FOR CLOTHING, NAMELY, T-SHIRTS, TOPS, BOTTOMS, JACKETS, PANTS, SWEATSHIRTS, HEADWEAR, FOOTWEAR (U.S. CLS. 22 AND 39).

THOMAS MANOR, EXAMINING ATTORNEY

**CLASS 25—(Continued).**

SN 85-186,301. THE NORTH FACE APPAREL CORP., WILMINGTON, DE. FILED 11-29-2010.

# PHYSIOLOGIC

THE MARK CONSISTS OF STANDARD CHARACTERS WITHOUT CLAIM TO ANY PARTICULAR FONT, STYLE, SIZE, OR COLOR.

FOR APPAREL, NAMELY, TOPS, BOTTOMS, JACKETS, COATS, SKI WEAR, GLOVES, BASELAYER TOPS AND BASELAYER BOTTOMS; FOOTWEAR AND HEADWEAR (U.S. CLS. 22 AND 39).

MICHELE SWAIN, EXAMINING ATTORNEY

SN 85-187,009. WICKED FASHIONS, INC., FORT LEE, NJ. FILED 11-30-2010.

**POLOSUR**  
ESSENTIALS

OWNER OF U.S. REG. NOS. 2,905,147, 3,686,726 AND OTHERS.

NO CLAIM IS MADE TO THE EXCLUSIVE RIGHT TO USE "ESSENTIALS", APART FROM THE MARK AS SHOWN.

THE MARK CONSISTS OF THE WORD "POLOSUR" WITH A DEPICTION OF A HEXAGON FOR THE LETTER "O". "POLOSUR" IS ABOVE THE WORD "ESSENTIALS". THE WORD "ESSENTIALS" IS IN WHITE IN A BLACK RECTANGLE.

THE ENGLISH TRANSLATION OF "POLOSUR" IN THE MARK IS "SOUTHPOLE".

FOR CLOTHING, NAMELY, SHIRTS, PANTS, SHORTS, JACKETS, SWEATERS, THERMALS, DRESSES, SKIRTS, FLEECE PULLOVERS; SWEATSHIRTS, BELTS, LEGGINGS, JEGGINGS, NAMELY, PANTS THAT ARE PARTIALLY JEANS AND PARTIALLY LEGGINGS (U.S. CLS. 22 AND 39).

JACQUELINE A. LAVINE, EXAMINING ATTORNEY

**CLASS 25—(Continued).**

SN 85-188,360. RAWLINGS SPORTING GOODS COMPANY, INC., ST. LOUIS, MO. FILED 12-1-2010.

**RAWLINGS**

THE MARK CONSISTS OF STANDARD CHARACTERS WITHOUT CLAIM TO ANY PARTICULAR FONT, STYLE, SIZE, OR COLOR.

OWNER OF U.S. REG. NOS. 799,922, 1,147,720 AND 1,252,330.

SEC. 2(F).  
FOR HEADBANDS; WRISTBANDS; SKULL CAPS; HANDWARMERS; SPORTS JERSEYS; SPORTS GAME JACKETS; BASEBALL BATTING PRACTICE JERSEYS; SOFTBALL BATTING PRACTICE JERSEYS; T-SHIRTS; FLEECE TOPS; FLEECE PANTS; POLO SHIRTS; WIND RESISTANT JACKETS (U.S. CLS. 22 AND 39).

LEIGH LOWRY, EXAMINING ATTORNEY

**CLASS 25—(Continued).**

SN 85-193,268. DA-SEIN SOCKS LIMITED, KOWLOON, HONG KONG, FILED 12-8-2010.

**Da-  
SEIN**  
the question of Being

THE MARK CONSISTS OF STYLIZED WORDING "DA-SEIN THE QUESTION OF BEING".

THE ENGLISH TRANSLATION OF "DA-SEIN" IN THE MARK IS "BEING THERE".

FOR CLOTHING, NAMELY, T-SHIRTS, SHIRTS, SWEATERS, DRESS, JACKETS, SHOES, TROUSERS, LEGGINGS, STOCKINGS, LINGERIE, COATS, SUITS, GLOVES, SCARVES, TIES; FOOTWEAR; HEADWEAR; SOCKS (U.S. CLS. 22 AND 39).

GRETTA YAO, EXAMINING ATTORNEY

SN 85-193,274. DA-SEIN SOCKS LIMITED, KOWLOON, HONG KONG, FILED 12-8-2010.

SN 85-188,397. RAWLINGS SPORTING GOODS COMPANY, INC., ST. LOUIS, MO. FILED 12-1-2010.

**RAWLINGS**

OWNER OF U.S. REG. NOS. 799,922, 1,147,720 AND 1,252,330.

THE MARK CONSISTS OF THE STYLIZED WORD "RAWLINGS" OUTLINED BY A SINGLE LINE.

SEC. 2(F).  
FOR HEADBANDS; WRISTBANDS; SKULL CAPS; HANDWARMERS; SPORTS JERSEYS; SPORTS GAME JACKETS; BASEBALL BATTING PRACTICE JERSEYS; SOFTBALL BATTING PRACTICE JERSEYS; T-SHIRTS; FLEECE TOPS; FLEECE PANTS; POLO SHIRTS; WIND RESISTANT JACKETS (U.S. CLS. 22 AND 39).

LEIGH LOWRY, EXAMINING ATTORNEY



THE MARK CONSISTS OF A QUESTION MARK DESIGN. FOR CLOTHING, NAMELY, T-SHIRTS, SHIRTS, SWEATERS, DRESS, JACKETS, SHOES, TROUSERS, LEGGINGS, STOCKINGS, LINGERIE, COATS, SUITS, GLOVES, SCARVES, TIES; HEADWEAR; FOOTWEAR; SOCKS (U.S. CLS. 22 AND 39).

GRETTA YAO, EXAMINING ATTORNEY

**CLASS 25—(Continued).**

SN 85-193,332. UNIFIED SCHOOL DISTRICT NO. 400, AKA SMOKY VALLEY PUBLIC SCHOOLS, LINDSBORG, KS. FILED 12-8-2010.



THE MARK CONSISTS OF A LEFT-FACING PROFILE OF A HEAD OF A VIKING HAVING A ZIG ZAG DESIGN ON THE HELMET.

FOR CLOTHING, NAMELY, T-SHIRTS, SWEATSHIRTS, POLO SHIRTS, CAPS AND JACKETS (U.S. CLS. 22 AND 39).

FIRST USE 11-5-2010; IN COMMERCE 11-27-2010.  
JULIE GUTTADAURO, EXAMINING ATTORNEY

**CLASS 25—(Continued).**

SN 85-197,576. GAKM RESOURCES LLC, NEWTON, NC. FILED 12-14-2010.

## RELAXOLOGY

THE MARK CONSISTS OF STANDARD CHARACTERS WITHOUT CLAIM TO ANY PARTICULAR FONT, STYLE, SIZE, OR COLOR.

FOR CLOTHING, NAMELY, T-SHIRTS, SWEATSHIRTS, SWEATPANTS, SHIRTS, PANTS, SHORTS; FOOTWEAR, NAMELY, HOSIERY AND SOCKS; AND HEADWEAR (U.S. CLS. 22 AND 39).

ERIN FALK, EXAMINING ATTORNEY

SN 85-197,654. TIMOTHY LINCECUM, BEVERLY HILLS, CA. FILED 12-14-2010.



THE COLOR(S) ORANGE, BLACK AND WHITE IS/ARE CLAIMED AS A FEATURE OF THE MARK.

THE MARK CONSISTS OF A RECTANGLE WHERE THE LEFT HALF OF THE RECTANGLE IS BLACK, AND THE RIGHT HALF OF THE RECTANGLE IS ORANGE. IN THE MIDDLE OF THE RECTANGLE SEPARATING THE TWO COLORS IS AN ATHLETE DEPICTED AS A SILHOUETTE IN WHITE THROWING A BASEBALL IN ONE HAND, AND HOLDING A BASEBALL MITT IN THE OTHER HAND.

FOR CLOTHING, NAMELY, SHIRTS, T-SHIRTS, UNDER SHIRTS, NIGHT SHIRTS, RUGBY SHIRTS, POLO SHIRTS, CARDIGANS, JERSEYS, UNIFORMS, ATHLETIC UNIFORMS, PANTS, TROUSERS, SLACKS, JEANS, DENIM JEANS, CULOTTES, CARGO PANTS, OVERALLS, COVERALLS, JUMPERS, JUMP SUITS, SHORTS, BOXER SHORTS, TOPS, CROP TOPS, TANK TOPS, HALTER TOPS, SWEAT SHIRTS, SWEAT SHORTS, SWEAT PANTS, WRAPS, WARM-UP SUITS, JOGGING SUITS, TRACK SUITS, BLOUSES, SKIRTS, DRESSES, GOWNS, SWEATERS, VESTS, FLEECE VESTS, PULLOVERS, SNOW SUITS, PARKAS, CAPES, ANORAKS, PONCHOS, JACKETS, REVERSIBLE JACKETS, COATS, BLAZERS, SUITS, TURTLENECKS, CLOTH SKI BIBS, SWIMWEAR, BEACHWEAR, TENNIS WEAR, SURF WEAR, SKI WEAR, INFANTWEAR, UNDERWEAR, BRIEFS, SWIM AND BATHING TRUNKS, BRAS, SPORTS BRAS, BRASSIERES, BUSTIERS, CORSETS, PANTIES, FOUNDATION GARMENTS, LOUNGEWEAR, ROBES, BATHROBES, UNDERCLOTHES, PAJAMAS, SLEEPWEAR, NIGHT GOWNS, LINGERIE, CAMISOLES, NEGLIGEEES, CHEMISES, CHEMISETTES, SLIPS, SARONGS, LEG WARMERS, BODY SUITS, UNITARDS, BODY SHAPERS (U.S. CLS. 22 AND 39).

ANNE MADDEN, EXAMINING ATTORNEY

SN 85-193,924. HEY CUPCAKE! INC., DBA HEY CUPCAKE!, AUSTIN, TX. FILED 12-9-2010.



THE MARK CONSISTS OF A TWO-DIMENSIONAL IMAGE OF A TRAVEL TRAILER WITH AN IMAGE OF A CUPCAKE POSITIONED ATOP.

FOR ATHLETIC APPAREL, NAMELY, SHIRTS, PANTS, JACKETS, FOOTWEAR, HATS AND CAPS, ATHLETIC UNIFORMS (U.S. CLS. 22 AND 39).

FIRST USE 6-1-2010; IN COMMERCE 9-1-2010.  
MARK SPARACINO, EXAMINING ATTORNEY



**CLASS 25—(Continued).**

SN 85-197,660. TIMOTHY LINCECUM, BEVERLY HILLS, CA. FILED 12-14-2010.



THE COLOR(S) ORANGE, BLACK AND WHITE IS/ARE CLAIMED AS A FEATURE OF THE MARK.

THE MARK CONSISTS OF A CIRCLE WHERE THE UPPER HALF OF THE CIRCLE IS BLACK, AND THE LOWER HALF OF THE CIRCLE IS ORANGE. IN THE MIDDLE OF THE CIRCLE SEPARATING THE TWO COLORS IS AN ATHLETE DEPICTED AS A SILHOUETTE IN WHITE THROWING A BASEBALL IN ONE HAND, AND HOLDING A BASEBALL MITT IN THE OTHER HAND.

FOR CLOTHING, NAMELY, SHIRTS, T-SHIRTS, UNDER SHIRTS, NIGHT SHIRTS, RUGBY SHIRTS, POLO SHIRTS, CARDIGANS, JERSEYS, UNIFORMS, ATHLETIC UNIFORMS, PANTS, TROUSERS, SLACKS, JEANS, DENIM JEANS, CULOTTES, CARGO PANTS, OVERALLS, COVERALLS, JUMPERS, JUMP SUITS, SHORTS, BOXER SHORTS, TOPS, CROP TOPS, TANK TOPS, HALTER TOPS, SWEAT SHIRTS, SWEAT SHORTS, SWEAT PANTS, WRAPS, WARM-UP SUITS, JOGGING SUITS, TRACK SUITS, BLOUSES, SKIRTS, DRESSES, GOWNS, SWEATERS, VESTS, FLEECE VESTS, PULLOVERS, SNOW SUITS, PARKAS, CAPES, ANORAKS, PONCHOS, JACKETS, REVERSIBLE JACKETS, COATS, BLAZERS, SUITS, TURTLENECKS, CLOTH SKI BIBS, SWIMWEAR, BEACHWEAR, TENNIS WEAR, SURF WEAR, SKI WEAR, INFANTWEAR, UNDERWEAR, BRIEFS, SWIM AND BATHING TRUNKS, BRAS, SPORTS BRAS, BRASSIERES, BUSTIERS, CORSETS, PANTIES, FOUNDATION GARMENTS, LOUNGEWEAR, ROBES, BATHROBES, UNDERCLOTHES, PAJAMAS, SLEEPWEAR, NIGHT GOWNS, LINGERIE, CAMISOLES, NEGLIGENCES, CHEMISES, CHEMISETTES, SLIPS, SARONGS, LEG WARMERS, BODY SUITS, UNITARDS, BODY SHAPERS (U.S. CLS. 22 AND 39).

ANNE MADDEN, EXAMINING ATTORNEY

**CLASS 25—(Continued).**

SN 85-200,706. SOFIA VERGARA, MIAMI, FL. FILED 12-17-2010.

## SOFIA VERGARA

THE MARK CONSISTS OF STANDARD CHARACTERS WITHOUT CLAIM TO ANY PARTICULAR FONT, STYLE, SIZE, OR COLOR.

THE NAME(S), PORTRAIT(S), AND/OR SIGNATURE(S) SHOWN IN THE MARK IDENTIFIES "SOFIA VERGARA", WHOSE CONSENT(S) TO REGISTER IS MADE OF RECORD.

FOR WOMEN'S FOOTWEAR AND APPAREL, NAMELY, T-SHIRTS, TANK TOPS, KNIT TOPS, WOVEN TOPS, SHIRTS, BLOUSES, VESTS, COATS, JACKETS, BLAZERS, SUITS, PANTS, JEANS, SHORTS, SKIRTS, DRESSES, SWEATERS, SWEATSHIRTS, SWEATPANTS, GLOVES, SCARVES, HATS, ACTIVEWEAR, SWIMWEAR, OUTERWEAR, INTIMATE APPAREL, SPORTSWEAR, JUMPSUITS, OVERALLS, SOCKS, HOSIERY, HEADBANDS, HAIR ACCESSORIES (U.S. CLS. 22 AND 39).

CAROLYN CATALDO, EXAMINING ATTORNEY

SN 85-201,226. MOORE, JOHN REESE, CONROE, TX. FILED 12-18-2010.

## Cowgirl Clothing Company

THE MARK CONSISTS OF STANDARD CHARACTERS WITHOUT CLAIM TO ANY PARTICULAR FONT, STYLE, SIZE, OR COLOR.

NO CLAIM IS MADE TO THE EXCLUSIVE RIGHT TO USE "CLOTHING COMPANY", APART FROM THE MARK AS SHOWN.

FOR BUTTON DOWN SHIRTS; CAMOUFLAGE JACKETS; CAMOUFLAGE SHIRTS; CAMOUFLAGE VESTS; CAPS; COLLARED SHIRTS; DENIM JACKETS; DOWN JACKETS; DRESS SHIRTS; FUR COATS AND JACKETS; GOLF SHIRTS; HEADWEAR; HEAVY JACKETS; HOODED SWEAT SHIRTS; HUNTING JACKETS; HUNTING SHIRTS; HUNTING VESTS; JACKET LINERS; JACKETS; JEANS; KNIT JACKETS; KNIT SHIRTS; LEATHER JACKETS; LEATHER VESTS; LONG JACKETS; LONG-SLEEVED SHIRTS; LOUNGE PANTS; MOTORCYCLE JACKETS; NIGHT SHIRTS; OPEN-NECKED SHIRTS; POLO SHIRTS; QUILTED VESTS; REVERSIBLE JACKETS; SHIRT YOKES; SHIRTS; SHIRTS AND SHORT-SLEEVED SHIRTS; SHORT-SLEEVED OR LONG-SLEEVED T-SHIRTS; SHORT-SLEEVED SHIRTS; SKULLIES; SLEEP SHIRTS; SLEEVED OR SLEEVELESS JACKETS; SUEDE JACKETS; SWEAT SHIRTS; T-SHIRTS; TEE SHIRTS; VESTS; WEARABLE GARMENTS AND CLOTHING, NAMELY, SHIRTS (U.S. CLS. 22 AND 39).

ROBERT STRUCK, EXAMINING ATTORNEY

**CLASS 25—(Continued).**

SN 85-202,372. CPHARM.D. CONSULTANT SERVICES, LLC, OVIEDO, FL. FILED 12-21-2010.

**RXCELLENCE**

THE MARK CONSISTS OF STANDARD CHARACTERS WITHOUT CLAIM TO ANY PARTICULAR FONT, STYLE, SIZE, OR COLOR.

FOR CLOTHING, NAMELY, BODY SUITS, HATS, HEADBANDS, JACKETS, JERSEY, LAB COATS, LEGGINGS, LEISURE PANTS, LEOTARDS, SHIRTS, SPORTS PANTS, SPORTS SHIRTS, SPORT SKIRTS (U.S. CLS. 22 AND 39).

CIMMERIAN COLEMAN, EXAMINING ATTORNEY

SN 85-202,949. SALTAIR, INC., BAR HARBOR, ME. FILED 12-21-2010.

**COOL AS A GATOR**

THE MARK CONSISTS OF STANDARD CHARACTERS WITHOUT CLAIM TO ANY PARTICULAR FONT, STYLE, SIZE, OR COLOR.

OWNER OF U.S. REG. NOS. 2,345,286, 3,097,839 AND 3,097,840.

FOR CLOTHING, NAMELY, SHIRTS (U.S. CLS. 22 AND 39).

FIRST USE 2-5-2010; IN COMMERCE 2-5-2010.  
LAKEISHA LEWIS, EXAMINING ATTORNEY

SN 85-203,955. PRL USA HOLDINGS, INC., NEW YORK, NY. FILED 12-22-2010.

**LRL LAUREN JEANS CO. RALPH  
LAUREN**

THE MARK CONSISTS OF STANDARD CHARACTERS WITHOUT CLAIM TO ANY PARTICULAR FONT, STYLE, SIZE, OR COLOR.

OWNER OF U.S. REG. NOS. 1,212,059, 3,810,821 AND OTHERS.

NO CLAIM IS MADE TO THE EXCLUSIVE RIGHT TO USE "JEANS CO.", APART FROM THE MARK AS SHOWN.

THE NAME(S), PORTRAIT(S), AND/OR SIGNATURE(S) SHOWN IN THE MARK IDENTIFIES AN INDIVIDUAL, WHOSE CONSENT(S) TO REGISTER IS MADE OF RECORD.

FOR CLOTHING, NAMELY, KHAKIS; DRESSES; JACKETS; JEANS; SHIRTS; SKIRTS; SWEATERS; T-SHIRTS (U.S. CLS. 22 AND 39).

FIRST USE 6-25-2009; IN COMMERCE 6-25-2009.  
DAVID H. STINE, EXAMINING ATTORNEY

**CLASS 25—(Continued).**

SN 85-205,961. CONCEPTWEAR INC., MOUNT ROYAL, QUEBEC, CANADA, FILED 12-27-2010.



THE MARK CONSISTS OF AN OVERLAPPING DESIGN RESEMBLING THE LETTERS "N" AND "U" AND THE STYLIZED WORDING "NUMERO".

FOR SPORT SHIRTS, DRESS SHIRTS, SUITS, TROUSERS, SWEATERS, PAJAMAS, UNDERWEAR, BODYSUITS, BRAS, ROBES, PANTS, SHORTS, OUTERWEAR, NAMELY, JACKETS, WIND-RESISTANT JACKETS, PARKAS, COATS, VESTS, SKIRTS, TIES, GLOVES, BELTS, SCARVES, HATS, CAPS, TOQUES, SOCKS, TIGHTS, SHOES (U.S. CLS. 22 AND 39).

FIRST USE 9-0-2006; IN COMMERCE 9-0-2006.  
ELIZABETH KAJUBI, EXAMINING ATTORNEY

SN 85-209,942. WP LAVORI IN CORSO S.R.L., BOLOGNA, ITALY, FILED 1-4-2011.

**BYRD CLOTH**

THE MARK CONSISTS OF STANDARD CHARACTERS WITHOUT CLAIM TO ANY PARTICULAR FONT, STYLE, SIZE, OR COLOR.

NO CLAIM IS MADE TO THE EXCLUSIVE RIGHT TO USE "CLOTH", APART FROM THE MARK AS SHOWN.

FOR FABRIC SOLD AS AN INTEGRAL COMPONENT OF FINISHED CLOTHING ITEMS, NAMELY, SHIRTS, T-SHIRTS, POLO SHIRTS, BLOUSES, SKIRTS, PANTS, JEANS, SHORTS, PARKAS, ANORAKS, JACKETS, BLAZERS, COATS, RAIN COATS, OVERCOATS, FLEECE PULLOVERS, TIES, FOOTWEAR, HEADWEAR, ARTICLES OF UNDERWEAR, AND CLOTHING BELTS; FABRIC SOLD AS AN INTEGRAL COMPONENT OF FINISHED CLOTHING ITEMS IN THE NATURE OF HEADGEAR, NAMELY, HATS, CAPS, AND SKULL CAPS; FABRIC SOLD AS AN INTEGRAL COMPONENT OF FINISHED CLOTHING ITEMS IN THE NATURE OF KNITWEAR, NAMELY, SWEATERS, KNIT SHIRTS, AND PULLOVERS (U.S. CLS. 22 AND 39).

JULIE GUTTADAURO, EXAMINING ATTORNEY

**CLASS 25—(Continued).**

SN 85-213,324. MICHAEL F. BALL, INGLEWOOD, CA.  
FILED 1-7-2011.



THE MARK CONSISTS OF A STYLIZED ZIG ZAG.  
FOR APPAREL, NAMELY, ONE PIECE GARMENTS  
FOR INFANTS, BELTS, BLAZERS, BLOUSES, CAPRIS,  
COATS, CORSETS, DRESSES, GOWNS, HALTER TOPS,  
HATS, JACKETS, JEANS, TOPS, LINGERIE, SCARVES,  
SHIRTS, SHOES, SWEATERS, SWEATSHIRTS, SWEAT-  
PANTS, SWIMWEAR, TEE SHIRTS, THERMAL SHIRTS,  
THERMAL PANTS, TROUSERS, TIES, TANK TOPS,  
TRENCH COATS, WINTER COATS, SKIRTS, SHORTS,  
VESTS, PANTS, COVER-UPS, JUMPERS, ROMPERS,  
JUMPSUITS, AND HOSIERY (U.S. CLS. 22 AND 39).  
CHARLES L. JENKINS, EXAMINING ATTORNEY

SN 85-214,721. RENEE GREENSTEIN, NEW YORK, NY.  
FILED 1-11-2011.

MY WONDER COMFORT JEAN

THE MARK CONSISTS OF STANDARD CHARACTERS  
WITHOUT CLAIM TO ANY PARTICULAR FONT, STYLE,  
SIZE, OR COLOR.

NO CLAIM IS MADE TO THE EXCLUSIVE RIGHT TO  
USE "JEAN", APART FROM THE MARK AS SHOWN.

FOR LADIES JEANS, JACKETS AND SKIRTS; MEN'S  
JEANS AND JACKETS; AND CHILDREN'S JEANS,  
JACKETS AND SKIRTS (U.S. CLS. 22 AND 39).

CARYN GLASSER, EXAMINING ATTORNEY

**CLASS 25—(Continued).**

SN 85-217,479. ROBINSON, BLAKE, DBA BLAKE DEON  
ROBINSON, HARVEY, LA. FILED 1-13-2011.



THE MARK CONSISTS OF A CIRCLE WITH THREE  
LINES LOCATED ON TOP OF THE CIRCLE AND BEHIND  
A CLUB SYMBOL WITH THE LETTERS "L" AND "C"  
LOCATED ON TOP OF THE CLUB SYMBOL, ALSO "THE  
LOYALTY CLUB!" WRITTEN ON THE CIRCLE.

FOR BEANIES; CREW NECKS; HOODED SWEAT-  
SHIRTS; JEANS; SOCKS; SWEATSHIRTS; T-SHIRTS;  
TENNIS SHOES (U.S. CLS. 22 AND 39).

FIRST USE 2-4-2010; IN COMMERCE 2-4-2010.

BERNICE MIDDLETON, EXAMINING ATTORNEY

SN 85-217,601. MERIDIAN IMPRESSION LLC, ADDISON,  
TX. FILED 1-14-2011.

FANFII

THE MARK CONSISTS OF STANDARD CHARACTERS  
WITHOUT CLAIM TO ANY PARTICULAR FONT, STYLE,  
SIZE, OR COLOR.

THE WORDING "FANFII" HAS NO MEANING IN A  
FOREIGN LANGUAGE.

FOR CLOTHING, NAMELY, TOPS, T-SHIRTS,  
DRESSES, SKIRTS, SCARVES, HEADWEAR (U.S. CLS.  
22 AND 39).

BRENDAN REGAN, EXAMINING ATTORNEY

**CLASS 25—(Continued).**

SN 85-226,680. AUDIGIER BRAND MANAGEMENT GROUP, LLC, CULVER CITY, CA. FILED 1-26-2011.

**GARAGE PARTS**

THE MARK CONSISTS OF STANDARD CHARACTERS WITHOUT CLAIM TO ANY PARTICULAR FONT, STYLE, SIZE, OR COLOR.

FOR CLOTHING, NAMELY, SHORTS, DRESSES, SHIRTS, JACKETS, T-SHIRTS, LONG SLEEVED T-SHIRTS, TANK TOPS, SKIRTS, PANTS, SWEATPANTS, SWEAT SHORTS, SWEAT JACKETS, HOODED SWEAT-SHIRTS, UNDERWEAR, SLEEPWEAR, LOUNGEWEAR, SWEATERS, LEGGINGS, BELTS, SOCKS, HEADWEAR, AND FOOTWEAR (U.S. CLS. 22 AND 39).

RUSS HERMAN, EXAMINING ATTORNEY

SN 85-226,785. AUDIGIER BRAND MANAGEMENT GROUP, LLC., CULVER CITY, CA. FILED 1-26-2011.

**GARAGE PARTS BY CHRISTIAN  
AUDIGIER**

THE MARK CONSISTS OF STANDARD CHARACTERS WITHOUT CLAIM TO ANY PARTICULAR FONT, STYLE, SIZE, OR COLOR.

THE NAME(S), PORTRAIT(S), AND/OR SIGNATURE(S) SHOWN IN THE MARK IDENTIFIES "CHRISTIAN AUDIGIER", WHOSE CONSENT(S) TO REGISTER IS MADE OF RECORD.

FOR CLOTHING, NAMELY, SHORTS, DRESSES, SHIRTS, JACKETS, T-SHIRTS, LONG SLEEVED T-SHIRTS, TANK TOPS, SKIRTS, PANTS, SWEATPANTS, SWEAT SHORTS, SWEAT JACKETS, HOODED SWEAT-SHIRTS, UNDERWEAR, SLEEPWEAR, LOUNGEWEAR, SWEATERS, LEGGINGS, BELTS, SOCKS, HEADWEAR, AND FOOTWEAR (U.S. CLS. 22 AND 39).

RUSS HERMAN, EXAMINING ATTORNEY

SN 85-229,335. ALIKA ELECTRONICS, LLC, DBA TULIP BRIDAL, HONOLULU, HI. FILED 1-28-2011.

**Tulip Bridal**

THE MARK CONSISTS OF STANDARD CHARACTERS WITHOUT CLAIM TO ANY PARTICULAR FONT, STYLE, SIZE, OR COLOR.

NO CLAIM IS MADE TO THE EXCLUSIVE RIGHT TO USE "BRIDAL", APART FROM THE MARK AS SHOWN.

FOR JACKETS; SHAWLS AND STOLE; SHOULDER WRAPS; SHOULDER WRAPS FOR CLOTHING; VEILS; WRAPS (U.S. CLS. 22 AND 39).

FIRST USE 10-21-2008; IN COMMERCE 10-21-2008.

HENRY S. ZAK, EXAMINING ATTORNEY

**CLASS 25—(Continued).**

SN 85-230,707. KING, DANIEL J., DBA EVERYTHING SPARKLE / EV SPARKLE, THOUSAND OAKS, CA. FILED 1-31-2011.



THE MARK CONSISTS OF THE WORD "EVSPARKLE", ACCOMPANIED BY A DEPICTION OF A LLAMA DIRECTLY TO THE RIGHT OF THE WORDS "EVSPARKLE" ALL LOCATED INSIDE OF AN OVAL.

FOR WEARABLE GARMENTS AND CLOTHING, NAMELY, SHIRTS (U.S. CLS. 22 AND 39).

FIRST USE 12-1-2010; IN COMMERCE 12-1-2010.

ROBERT C. CLARK JR., EXAMINING ATTORNEY

SN 85-231,690. BOTICA COMERCIAL FARMACEUTICA LTDA, S. JOSE DOS PINHAIS PR, BRAZIL, FILED 2-1-2011.

**EUDORA**

THE MARK CONSISTS OF STANDARD CHARACTERS WITHOUT CLAIM TO ANY PARTICULAR FONT, STYLE, SIZE, OR COLOR.

FOR SHOES; FOOTWEAR; HEADGEAR FOR WEAR, NAMELY, HATS, CAPS; LINEN CLOTHING, NAMELY, PANTS, SHIRTS, DRESSES, SKIRTS, BATHING SUITS; CLOTHING, NAMELY, JACKETS, COATS, UNDERWEAR, PANTS, SHIRTS, DRESSES, SKIRTS, BLOUSES, TOPS, SLEEPING GARMENTS (U.S. CLS. 22 AND 39).

CAROLINE WOOD, EXAMINING ATTORNEY

SN 85-236,165. AS PRESCRIBED INDUSTRIES, LLC, ENCINITAS, CA. FILED 2-7-2011.

**LIFE AsRx**

THE MARK CONSISTS OF EUROSTILE UNICASE LT PRO FONT OF THE WORDS "LIFE ASRX". "ASRX" IS ALL ONE WORD.

FOR ATHLETIC APPAREL, NAMELY, SHIRTS, PANTS, JACKETS, FOOTWEAR, HATS AND CAPS, ATHLETIC UNIFORMS (U.S. CLS. 22 AND 39).

FIRST USE 1-30-2009; IN COMMERCE 1-30-2009.

LINDA ESTRADA, EXAMINING ATTORNEY

**CLASS 25—(Continued).**

SN 85-236,328. BALCONI GEAR, LLC, MAINEVILLE, OH. FILED 2-8-2011.

FAMILY PASSION CONFIDENCE

THE MARK CONSISTS OF STANDARD CHARACTERS WITHOUT CLAIM TO ANY PARTICULAR FONT, STYLE, SIZE, OR COLOR.

FOR CLOTHING, NAMELY, ATHLETIC GEAR, NAMELY, SWEATSHIRTS, FLEECE TOPS, SWEATPANTS, SHIRTS, TANK TOPS, SHORTS, HATS, HEADBANDS, GLOVES, AND NECK GAITERS (U.S. CLS. 22 AND 39).

FIRST USE 1-0-2010; IN COMMERCE 1-0-2010.  
JEFF DEFORD, EXAMINING ATTORNEY

SN 85-238,457. KOMEX INTERNATIONAL, INC., LOS ANGELES, CA. FILED 2-9-2011.

**bluBlack**

THE MARK CONSISTS OF STANDARD CHARACTERS WITHOUT CLAIM TO ANY PARTICULAR FONT, STYLE, SIZE, OR COLOR.

FOR CLOTHING, NAMELY, JEANS, PANTS, SHORTS, SKIRTS, DENIM JACKETS, CAPRIS, FLOODES IN THE NATURE OF PANTS, OVERALLS, SHORTALLS, MINISKIRTS, T-SHIRTS, KNIT TANK TOPS, KNIT T-SHIRTS, KNIT SHIRTS, KNIT SHORT SLEEVE SHIRTS, KNIT LONG SLEEVE SHIRTS, KNIT TOPS AND DRESSES (U.S. CLS. 22 AND 39).

FIRST USE 6-14-2011; IN COMMERCE 6-14-2011.  
ANDREW LEASER, EXAMINING ATTORNEY

**CLASS 25—(Continued).**

SN 85-239,757. TIJS VERWEST, NEW YORK, NY. FILED 2-11-2011.

**CLUB LIFE**

THE MARK CONSISTS OF STANDARD CHARACTERS WITHOUT CLAIM TO ANY PARTICULAR FONT, STYLE, SIZE, OR COLOR.

FOR CLOTHING, NAMELY, SHIRTS, LONG-SLEEVED SHIRTS, T-SHIRTS, UNDER SHIRTS, NIGHT SHIRTS, RUGBY SHIRTS, POLO SHIRTS, CARDIGANS, JERSEYS, UNIFORMS, SCRUBS NOT FOR MEDICAL PURPOSES, SMOCKS, DRESS SHIRTS, BOTTOMS, PANTS, JEANS, CULOTTES, CARGO PANTS, STRETCH PANTS, DENIM JEANS, OVERALLS, COVERALLS, JUMPERS, JUMP SUITS, SHORTS, BOXER SHORTS, TOPS, STRETCH TOPS, TUBE TOPS, CROP TOPS, TANK TOPS, TANKINIS, HALTER TOPS, SWEAT SHIRTS, HOODED SWEAT SHIRTS, SWEAT JACKETS, SWEAT SHORTS, SWEAT PANTS, WRAPS, WARM-UP SUITS, JOGGING SUITS, TRACK SUITS, TRACK PANTS, PLAY SUITS, BLOUSES, SKIRTS, DRESSES, GOWNS, SWEATERS, VESTS, FLEECE VESTS, PULLOVERS, SNOW SUITS, PARKAS, CAPES, ANORAKS, PONCHOS, CLOAKS, SHRUGS, SHAWLS, PASHMINAS, JACKETS, DINNER JACKETS, REVERSIBLE JACKETS, WIND-RESISTANT JACKETS, SHELL JACKETS, SPORTS JACKETS, GOLF AND SKI JACKETS, JEAN JACKETS, COATS, HEAVY COATS, OVER COATS, TOP COATS, PETTICOATS, BLAZERS, SUITS, TUXEDOS, CUMMERBUNDS, CUFFS, COLLARS, REMOVABLE COLLARS, COLLAR PROTECTORS, TURTLENECKS, CLOTH SKI BIBS, SWIMWEAR, BEACHWEAR, TENNIS WEAR, SURF WEAR, SKI WEAR, LAYETTES, INFANTWEAR, INFANTS SLEEPERS, BOOTIES, BABY BIBS NOT OF PAPER, CLOTH DIAPERS, CAPS, SWIM CAPS, BERETS, BEANIES, HATS, VISORS, HEADBANDS, WRIST BANDS, SWEAT BANDS, HEADWEAR, EAR MUFFS, APRONS, SCARVES, BANDANAS, BELTS, SUSPENDERS, NECKWEAR, TIES, NECKERCHIEFS, POCKET SQUARES, ASCOTS, UNDERWEAR, THERMAL UNDERWEAR, LONG UNDERWEAR, BRIEFS, SWIM AND BATHING TRUNKS, BRAS, SPORTS BRAS, BRASSIERES, BUSTIERS, CORSETS, PANTIES, THONGS, G-STRINGS, GARTERS AND GARTER BELTS, TEDDIES, GIRDLES, FOUNDATION GARMENTS, SINGLETES, SOCKS, LOUNGEWEAR, ROBES, UNDERCLOTHES, PAJAMAS, SLEEPWEAR, NIGHT GOWNS, NIGHTIES, LINGERIE, CAMISOLES, NEGLIGEEES, CHEMISES, CHEMISETTES, SLIPS, SARONGS, LEG WARMERS, HOSIERY, PANTYHOSE, BODY STOCKINGS, KNEE HIGHS, LEGGINGS, TIGHTS, LEOTARDS, BODY SUITS, UNITARDS, BODY SHAPERS, GLOVES, MITTENS, RAIN SLICKERS, RAINWEAR, FOOTWEAR, SHOES, MULES, SNEAKERS, BOOTS, GALOSHES, SANDALS, FLIP-FLOPS, AND SLIPPERS (U.S. CLS. 22 AND 39).

JOHN KELLY, EXAMINING ATTORNEY

**CLASS 25—(Continued).**

SN 85-243,411. MUECKE-SOBIE UPHOLSTERY LEATHER CO., MIAMI, FL. FILED 2-16-2011.



THE MARK CONSISTS OF THE TERM "SOBIE" INSIDE OF A DESIGN OF A GUITAR PICK AND WITH A STAR DESIGN OVER THE LETTER "I".

FOR BAGS, NAMELY, DUFFLE BAGS, GARMENT BAGS FOR TRAVEL, ALL-PURPOSE SPORT BAGS, ALL-PURPOSE CARRYING BAGS, CARRY-ALL BAGS, LEATHER AND IMITATION LEATHER BAGS, OVER-NIGHT BAGS, SCHOOL BAGS, SHOULDER BAGS (U.S. CLS. 22 AND 39).

FIRST USE 12-0-2008; IN COMMERCE 12-0-2008.  
SETH A. RAPPAPORT, EXAMINING ATTORNEY

**CLASS 25—(Continued).**

SN 85-245,041. BUCKLES, COREY, CEDAR HILLS, UT. FILED 2-17-2011.



THE MARK CONSISTS OF THE WORDING "CORPORATE INFIDEL" IN STYLIZED FONT. THE LETTER "C" IN "CORPORATE" IS SURROUNDED BY A CIRCLE. THE WORD "CORPORATE" AND THE LETTERS "IN" IN "INFIDEL" ARE UNDERLINED.

FOR SHORT-SLEEVED OR LONG-SLEEVED T-SHIRTS (U.S. CLS. 22 AND 39).

FIRST USE 1-15-2011; IN COMMERCE 2-12-2011.  
PAULA MAHONEY, EXAMINING ATTORNEY

SN 85-244,050. MEYNARD DESIGNS, INC., WALTHAM, MA. FILED 2-16-2011.



OWNER OF U.S. REG. NOS. 2,753,975 AND 3,507,355.  
THE MARK CONSISTS OF THE WORDS "EARTH ORIGINS" WITH A STYLIZED REPRESENTATION OF A SUN RISING OVER A MOUNTAIN SHAPE WITH THE WORDS "EARTH ORIGINS" BELOW AND TO THE RIGHT.  
FOR FOOTWEAR (U.S. CLS. 22 AND 39).  
DOMINIC FATHY, EXAMINING ATTORNEY

SN 85-247,116. MARTIN BELL PRODUCTIONS, LLC, LOS ANGELES, CA. FILED 2-20-2011.

**JUST OFF RODEO**

THE MARK CONSISTS OF STANDARD CHARACTERS WITHOUT CLAIM TO ANY PARTICULAR FONT, STYLE, SIZE, OR COLOR.

FOR CLOTHING, NAMELY, SHIRTS, T-SHIRTS, SCARVES, PANTS, SWEAT PANTS AND JACKETS; AND HEADWEAR (U.S. CLS. 22 AND 39).

NORA BUCHANAN WILL, EXAMINING ATTORNEY

**CLASS 25—(Continued).**

SN 85-252,846. HUMAN RIGHTS CAMPAIGN FOUNDATION, WASHINGTON, DC. FILED 2-27-2011.



OWNER OF U.S. REG. NOS. 2,331,645, 2,486,562 AND OTHERS.

THE MARK CONSISTS OF THE WORDING "LOVE CONQUERS HATE" AND THE APPLICANT'S REGISTERED EQUALITY LOGO. THE WORD "LOVE" APPEARS ON TOP OF THE TERM "CONQUERS" AND THE WORD "HATE" APPEARS UPSIDE DOWN AND UNDERNEATH THE WORD "CONQUERS". THE WORD "HATE" IS SPELLED FROM RIGHT TO LEFT AND THE APPLICANT'S REGISTERED EQUALITY LOGO APPEARS NEXT TO THE LETTER "H" IN THE WORD "HATE".

FOR CLOTHING, NAMELY, T-SHIRTS (U.S. CLS. 22 AND 39).

FIRST USE 12-10-2007; IN COMMERCE 12-10-2007.  
JORDAN BAKER, EXAMINING ATTORNEY

**CLASS 25—(Continued).**

SN 85-267,274. IQBAL, RAHAT, BELTSVILLE, MD. FILED 3-15-2011.



THE STIPPLING IS FOR SHADING PURPOSES ONLY. THE MARK CONSISTS OF AN EAGLE WITH ITS WINGS SPREAD, WITH STARS ON ONE WING AND STRIPES ON THE OTHER.

FOR BASEBALL CAPS; BELTS; DRESS SHIRTS; JACKETS; POLO SHIRTS; SHORTS; SWEATPANTS; SWEATSHIRTS; T-SHIRTS; WARM-UP SUITS (U.S. CLS. 22 AND 39).

BRIAN NEVILLE, EXAMINING ATTORNEY

SN 85-266,119. DEANNA KASTAN, MAINEVILLE, OH. FILED 3-14-2011.



NO CLAIM IS MADE TO THE EXCLUSIVE RIGHT TO USE "RAIN", APART FROM THE MARK AS SHOWN.

THE MARK CONSISTS OF THE WORD "RAIN" IN STYLIZED LETTERING WITH THE DOWNWARD PORTION OF THE LETTER "R" FORMING A REVERSE CHECK MARK. A STYLIZED CHECK MARK APPEARS UNDER THE "N" IN "RAIN" AND EXTENDS UPWARD TO THE RIGHT OF THE TERM "RAIN".

FOR HEADWEAR AND NECKWEAR (U.S. CLS. 22 AND 39).

PAULA MAHONEY, EXAMINING ATTORNEY

SN 85-272,902. SAWYER, JEFFREY LEE JR., CHARLOTTE, NC. FILED S.R. 3-21-2011; AM. P.R. 9-6-2011.



THE MARK CONSISTS OF THE WORD "HTDOGWTR"; FOLLOWED WITH A TILTED GLASS OF WATER, WITH A HOT DOG WIENER STICKING OUT THE TOP; FOLLOWED WITH THREE DROPS OF WATER DRIPPING FROM THE GLASS.

FOR ATHLETIC APPAREL, NAMELY, SHIRTS, PANTS, JACKETS, FOOTWEAR, HATS AND CAPS, TOBOGGAN HATS ATHLETIC UNIFORMS, TEE SHIRTS, SWEATSHIRTS, PANTS, LEGGINGS, SHORTS, ATHLETIC SHOES, BLOUSES, CANVAS SHOES, DENIMS, DRESS SHIRTS, POLO SHIRTS, SOCKS, SHORT-SLEEVED OR LONG-SLEEVED T-SHIRTS, DENIM PANTS, STRETCH PANTS (U.S. CLS. 22 AND 39).

FIRST USE 2-3-2006; IN COMMERCE 2-3-2006.  
RAMONA ORTIGA, EXAMINING ATTORNEY

**CLASS 25—(Continued).**

SN 85-273,737. WHITE RONALD, DBA HUSTLE HARD, SACRAMENTO, CA. AND WHITE CHARLES, DBA HUSTLE HARD, SACRAMENTO, CA. FILED 3-22-2011.

# Hustle Hard

THE MARK CONSISTS OF STANDARD CHARACTERS WITHOUT CLAIM TO ANY PARTICULAR FONT, STYLE, SIZE, OR COLOR.

FOR APPAREL FOR DANCERS, NAMELY, TEE SHIRTS, SWEATSHIRTS, PANTS, LEGGINGS, SHORTS AND JACKETS; ATHLETIC APPAREL, NAMELY, SHIRTS, PANTS, JACKETS, FOOTWEAR, HATS AND CAPS, ATHLETIC UNIFORMS; BUTTON DOWN SHIRTS; COLLARED SHIRTS; DRESS SHIRTS; HOODED SWEAT SHIRTS; LONG-SLEEVED SHIRTS; OPEN-NECKED SHIRTS; POLO SHIRTS; SHIRTS FOR INFANTS, BABIES, TODDLERS AND CHILDREN; SHIRTS FOR SUITS; SHORT-SLEEVED OR LONG-SLEEVED T-SHIRTS; SHORT-SLEEVED SHIRTS; SPORT SHIRTS; SPORTS SHIRTS; SPORTS SHIRTS WITH SHORT SLEEVES; SWEAT SHIRTS; T-SHIRTS; T-SHIRTS FOR MEN WOMAN AND KIDS; TEE SHIRTS; WOMEN'S CLOTHING, NAMELY, SHIRTS, DRESSES, SKIRTS, BLOUSES (U.S. CLS. 22 AND 39).

KIMBERLY PERRY, EXAMINING ATTORNEY

**CLASS 25—(Continued).**

SN 85-277,842. ANGRY GIRL INC., LIGNUM, VA. FILED 3-26-2011.

# Angry Girl Inc.

THE MARK CONSISTS OF STANDARD CHARACTERS WITHOUT CLAIM TO ANY PARTICULAR FONT, STYLE, SIZE, OR COLOR.

NO CLAIM IS MADE TO THE EXCLUSIVE RIGHT TO USE "GIRL INC.", APART FROM THE MARK AS SHOWN. FOR HATS; JACKETS; SHIRTS; SHOES; SWEAT SHIRTS (U.S. CLS. 22 AND 39).

GISELLE AGOSTO, EXAMINING ATTORNEY

SN 85-282,477. BROWN, JOHN, EULESS, TX. FILED 3-31-2011.

# 69 Lunch For Two

THE MARK CONSISTS OF STANDARD CHARACTERS WITHOUT CLAIM TO ANY PARTICULAR FONT, STYLE, SIZE, OR COLOR.

FOR JACKETS; PANTS; SHIRTS; SHOES (U.S. CLS. 22 AND 39).

BARBARA RUTLAND, EXAMINING ATTORNEY

SN 85-273,765. BURLESON INDEPENDENT SCHOOL DISTRICT, FORT WORTH, TX. FILED 3-22-2011.



OWNER OF U.S. REG. NO. 3,967,766. THE COLOR(S) BLUE AND GRAY IS/ARE CLAIMED AS A FEATURE OF THE MARK.

THE MARK CONSISTS OF A LARGE LETTER "C" SURROUNDING THE REST OF WORD "CENTENNIAL"; THE WORD "CENTENNIAL" CONSISTS OF STYLIZED BLUE LETTERS OUTLINED IN GRAY; THE WORD "SPARTANS" IS BELOW "CENTENNIAL" AND CONSISTS OF STYLIZED GRAY LETTERS.

SEC. 2(F).

FOR ATHLETIC APPAREL, NAMELY, SHIRTS, PANTS, JACKETS, FOOTWEAR, HATS AND CAPS, ATHLETIC UNIFORMS (U.S. CLS. 22 AND 39).

FIRST USE 8-24-2010; IN COMMERCE 8-24-2010.

STEVEN JACKSON, EXAMINING ATTORNEY

SN 85-283,720. INTERNATIONAL INTIMATES INC., NEW YORK, NY. FILED 4-1-2011.

# TURN ME 'ROUND

THE MARK CONSISTS OF STANDARD CHARACTERS WITHOUT CLAIM TO ANY PARTICULAR FONT, STYLE, SIZE, OR COLOR.

FOR CLOTHING AND APPAREL, NAMELY, NEW-BORN/INFANT BODY SUITS AND PANT SETS (U.S. CLS. 22 AND 39).

FIRST USE 3-0-2003; IN COMMERCE 7-0-2003.

RAMONA ORTIGA, EXAMINING ATTORNEY



**CLASS 25—(Continued).**

SN 85-284,404. HEWITT, TIFFANY, GALVESTON, TX.  
FILED 4-1-2011.



THE MARK CONSISTS OF THE TEXT "PESCADO NATION" IN THE SHAPE OF A FISH WITH THE TEXT "GET HOOKED..." UNDER IT TO THE SIDE.

THE ENGLISH TRANSLATION OF "PESCADO" IN THE MARK IS "FISH".

FOR ATHLETIC AND CASUAL CLOTHING FOR MEN WOMEN AND CHILDREN, NAMELY, SHIRTS, PANTS, SHORTS, JACKETS, WARM UP SUITS, SWIM WEAR, TENNIS WEAR, SKIRTS, SWEATERS, HEAD WEAR, SOCKS, WRIST BANDS AND HAND GEAR, NAMELY, GLOVES AND MITTENS (U.S. CLS. 22 AND 39).

FIRST USE 9-1-2010; IN COMMERCE 9-1-2010.

JUDITH HELFMAN, EXAMINING ATTORNEY

SN 85-287,961. A DRINKING SPORT, LLC, WINSTED, CT.  
FILED 4-6-2011.

... is a drinking sport

THE MARK CONSISTS OF STANDARD CHARACTERS WITHOUT CLAIM TO ANY PARTICULAR FONT, STYLE, SIZE, OR COLOR.

FOR T-SHIRTS (U.S. CLS. 22 AND 39).

CORY BOONE, EXAMINING ATTORNEY

SN 85-288,169. BUCKLE BRANDS, INC., KEARNEY, NE.  
FILED 4-6-2011.

**BKE SOLE**

THE MARK CONSISTS OF STANDARD CHARACTERS WITHOUT CLAIM TO ANY PARTICULAR FONT, STYLE, SIZE, OR COLOR.

OWNER OF U.S. REG. NOS. 2,447,957, 3,752,333 AND OTHERS.

NO CLAIM IS MADE TO THE EXCLUSIVE RIGHT TO USE "SOLE", APART FROM THE MARK AS SHOWN.

FOR SHOES (U.S. CLS. 22 AND 39).

FIRST USE 1-20-2006; IN COMMERCE 1-20-2006.

ROSELLE HERRERA, EXAMINING ATTORNEY

**CLASS 25—(Continued).**

SN 85-289,034. COLIN, JUSTIN A., SANTA FE, NM. FILED 4-7-2011.



THE MARK CONSISTS OF THE DESIGN OF A HAND THAT FORMS THE LETTERS "W" AND "C". BELOW IT IS THE STYLIZED WORDING "COLD WATER PRO", WITH A MICROPHONE COMING OUT OF THE LETTER "P" THEREOF.

FOR ATHLETIC APPAREL, NAMELY, SHIRTS, PANTS, JACKETS, FOOTWEAR, HATS AND CAPS; ATHLETIC UNIFORMS; BASEBALL CAPS AND HATS; FUR HATS; LEATHER HATS; PARTY HATS; SCIENTIFIC AND TECHNOLOGICAL APPAREL, NAMELY, SHIRTS, PANTS, JACKETS, FOOTWEAR, HATS AND CAPS, UNIFORMS; TOBOGGAN HATS, PANTS AND CAPS; WOOLLY HATS (U.S. CLS. 22 AND 39).

DAWN HAN, EXAMINING ATTORNEY

SN 85-295,704. NIZAMI, LLC, ST. LOUIS, MO. FILED 4-14-2011.

**NIZAMI PRO FITNESS**

THE MARK CONSISTS OF STANDARD CHARACTERS WITHOUT CLAIM TO ANY PARTICULAR FONT, STYLE, SIZE, OR COLOR.

NO CLAIM IS MADE TO THE EXCLUSIVE RIGHT TO USE "FITNESS", APART FROM THE MARK AS SHOWN.

FOR EXERCISE CLOTHING, NAMELY, HATS AND SHIRTS (U.S. CLS. 22 AND 39).

DAWN HAN, EXAMINING ATTORNEY

**CLASS 25—(Continued).**

SN 85-296,102. ROLLIN' WEAR INC., ROCHESTER, MN. FILED 4-15-2011.



NO CLAIM IS MADE TO THE EXCLUSIVE RIGHT TO USE "WEAR", APART FROM THE MARK AS SHOWN.

THE COLOR(S) ORANGE AND GRAY IS/ARE CLAIMED AS A FEATURE OF THE MARK.

THE MARK CONSISTS OF THE WORDS "ROLLIN' WEAR" IN GRAY, WITH AN ORANGE BROWN CIRCLE BETWEEN THE WORDS AND AN ORANGE ARROW INSIDE THE CIRCLE.

FOR CLOTHING TO BE WORN BY PEOPLE WHO USE WHEELCHAIRS, NAMELY, PANTS, T-SHIRTS, HATS, TOPS, JACKETS, ATHLETIC PANTS AND SHORTS, WARM UP OUTFITS, SWEATSHIRTS, GLOVES (U.S. CLS. 22 AND 39).

DOMINIC FATHY, EXAMINING ATTORNEY

---

SN 85-299,722. GEOFFREY BEENE, LLC, NEW YORK, NY. FILED 4-20-2011.

## GEOFFREY BEENE

THE MARK CONSISTS OF STANDARD CHARACTERS WITHOUT CLAIM TO ANY PARTICULAR FONT, STYLE, SIZE, OR COLOR.

OWNER OF U.S. REG. NOS. 899,265, 2,183,725 AND OTHERS.

THE NAME(S), PORTRAIT(S), AND/OR SIGNATURE(S) SHOWN IN THE MARK DOES NOT IDENTIFY A PARTICULAR LIVING INDIVIDUAL.

FOR WOMEN'S CLOTHING, NAMELY, SHIRTS, DRESSES, SKIRTS, BLOUSES, SWEATERS, SUITS, COATS, EVENING DRESSES, JACKETS, PANTS, SHORTS AND SHOES (U.S. CLS. 22 AND 39).

CHARLOTTE CORWIN, EXAMINING ATTORNEY

---

SN 85-300,648. JUAN DEJESUS, DBA ARCH FOREVERFLY, BRONX, NY. AND CRYSTAL MARTINEZ, AKA (CC), BRONX, NY. FILED 4-21-2011.

## DESTIN DENIM COUTURE

THE MARK CONSISTS OF STANDARD CHARACTERS WITHOUT CLAIM TO ANY PARTICULAR FONT, STYLE, SIZE, OR COLOR.

NO CLAIM IS MADE TO THE EXCLUSIVE RIGHT TO USE "DENIM COUTURE", APART FROM THE MARK AS SHOWN.

FOR SHIRTS AND PANTS MADE IN WHOLE OR IN SIGNIFICANT PART OF DENIM (U.S. CLS. 22 AND 39).

ESTHER A. BORSUK, EXAMINING ATTORNEY

**CLASS 25—(Continued).**

SN 85-301,700. WHITFIELD, RYAN, CAPITOL HEIGHTS, MD. FILED 4-21-2011.

## PURPLE COW REMARKABLE GARMENTS

THE MARK CONSISTS OF STANDARD CHARACTERS WITHOUT CLAIM TO ANY PARTICULAR FONT, STYLE, SIZE, OR COLOR.

NO CLAIM IS MADE TO THE EXCLUSIVE RIGHT TO USE "GARMENTS", APART FROM THE MARK AS SHOWN.

FOR CLOTHING FOR MEN, WOMEN AND CHILDREN, NAMELY, TOPS, BOTTOMS, JACKETS, JEANS, T-SHIRTS, BUTTON UP SHIRTS, POLO SHIRTS, SWEATERS, SWEATSHIRTS AND PANTS, BELTS, LOUNGEWEAR, HEADWEAR AND SHOES (U.S. CLS. 22 AND 39).

FIRST USE 8-10-2010; IN COMMERCE 8-10-2010.

JENNY PARK, EXAMINING ATTORNEY

---

SN 85-301,953. DALMATION CORPORATION, BALTIMORE, MD. FILED 4-22-2011.

## FOOTIE FACTORY

THE MARK CONSISTS OF STANDARD CHARACTERS WITHOUT CLAIM TO ANY PARTICULAR FONT, STYLE, SIZE, OR COLOR.

NO CLAIM IS MADE TO THE EXCLUSIVE RIGHT TO USE "FOOTIE", APART FROM THE MARK AS SHOWN.

FOR PAJAMAS (U.S. CLS. 22 AND 39).

FIRST USE 0-0-2009; IN COMMERCE 0-0-2009.

NICHOLAS COLEMAN, EXAMINING ATTORNEY

---

SN 85-302,523. LAURIE SCAFIDI, LITCHFIELD, NH. FILED 4-22-2011.



NO CLAIM IS MADE TO THE EXCLUSIVE RIGHT TO USE "TEES", APART FROM THE MARK AS SHOWN.

THE MARK CONSISTS OF THE WORD "TALK" WRIT-

**CLASS 25—(Continued).**

TEN HORIZONTALLY IN LOWER CASE BLOCK LETTERS, WITH THE WORDS "IT" AND "UP" WRITTEN VERTICALLY IN SMALLER FONT, LOWER CASE BLOCK LETTERS DIRECTLY BELOW THE "T" IN "TALK", FOLLOWED BY THE WORD "TEES", WRITTEN IN LARGE CAPITAL UPPER CASE BLOCK LETTERS. THE WORDS "TALK IT UP TEES" ARE ALL WITHIN A SPEECH BUBBLE, WITH THE ARROW OF THE BUBBLE POINTING TO THE LOWER LEFT, AND THE BACKGROUND OF THE ENTIRE SPEECH BUBBLE HAS A GEOMETRIC PATTERN.

FOR SHORT-SLEEVED OR LONG-SLEEVED T-SHIRTS (U.S. CLS. 22 AND 39).

FRANK LATTUCA, EXAMINING ATTORNEY

SN 85-303,524. BEYOND CLOTHING LLC, AKA BEYOND, SEATTLE, WA. FILED 4-25-2011.



OWNER OF U.S. REG. NO. 2,922,594.  
THE STIPPLING IS FOR SHADING PURPOSES ONLY.  
THE MARK CONSISTS OF A HEXAGONAL SHAPE IN 3D FORM, KNOWN AS A HEXANE, WITH ONE SIDE BENDING INWARD TO THE CENTER, TO THE RIGHT OF THE HEXANE IS THE STYLIZED TEXT "BEYOND".

FOR CAMOUFLAGE PANTS; CARGO PANTS; HUNTING PANTS; MEN'S AND WOMEN'S JACKETS, COATS, TROUSERS, VESTS; OUTER JACKETS; PANTS; RAIN JACKETS; RAINPROOF JACKETS; SHELL JACKETS; SKI JACKETS; SKI PANTS; SLEEVED OR SLEEVELESS JACKETS; SNOW PANTS; SNOWBOARD JACKETS; SNOWBOARD PANTS; WATERPROOF JACKETS AND PANTS; WIND RESISTANT JACKETS (U.S. CLS. 22 AND 39).

FIRST USE 6-1-2004; IN COMMERCE 6-1-2004.  
KAREN K. BUSH, EXAMINING ATTORNEY

**CLASS 25—(Continued).**

SN 85-303,544. LÉ D, LOS ANGELES, CA. FILED 4-25-2011.



THE MARK CONSISTS OF THE VENUS SYMBOL (FEMALE SYMBOL) ABSTRACTED TO LOOK LIKE A SIGNATURE, AND THE TEXT "LÉ D" APPEARS BELOW THE LOGO IN STYLIZED FONT.

FOR CLOTHING FOR THE LESBIAN COMMUNITY, NAMELY, BASEBALL CAPS, BATHING SUITS, BEACHWEAR, BEANIES, BELTS, BOTTOMS, BRIEFS, DRESSES, FOOTWEAR, GYM PANTS, GYM SHORTS, HATS, HOODED SWEAT SHIRTS, JACKETS, JEANS, PAJAMAS, PANTIES, PANTS, RAIN WEAR, SCARVES, SHIRTS, SHORTS, SKIRTS, SWEAT PANTS, SWEATERS, TANK TOPS, TOPS, AND UNDERGARMENTS (U.S. CLS. 22 AND 39).

JESSICA A. POWERS, EXAMINING ATTORNEY

SN 85-304,377. ALVIN MAURICE ELLERBEE II, AKA ALVIN ELLIE, SHERMAN OAKS, CA. FILED 4-26-2011.

REBEL & REBEL CLOTHING CO.

THE MARK CONSISTS OF STANDARD CHARACTERS WITHOUT CLAIM TO ANY PARTICULAR FONT, STYLE, SIZE, OR COLOR.

NO CLAIM IS MADE TO THE EXCLUSIVE RIGHT TO USE "CLOTHING CO.", APART FROM THE MARK AS SHOWN.

FOR MEN'S CLOTHING NAMELY, SHIRTS, TEE-SHIRTS, PANTS, JACKETS, HATS AND CAPS, BASEBALL CAPS AND HATS; BELTS; BELTS FOR CLOTHING; BELTS MADE OUT OF CLOTH; BODY SHIRTS; BOTTOMS; BUTTON DOWN SHIRTS; CLOTHING FOR BABIES, TODDLERS AND CHILDREN, NAMELY, PAJAMAS, JACKETS, SHIRTS, PANTS, JUMPERS; JACKETS; LONG-SLEEVED SHIRTS; NIGHT SHIRTS; OVER SHIRTS; POCKET SQUARES; POLO SHIRTS; RUGBY SHIRTS; SHIRT FRONTS; SHIRT INSERTS, NAMELY, DICKIES; SHIRTS; SHIRTS AND SHORT-SLEEVED SHIRTS; SHIRTS FOR INFANTS, BABIES, TODDLERS AND CHILDREN; SHIRTS FOR SUITS; SHORT-SLEEVED OR LONG-SLEEVED T-SHIRTS; SHORT-SLEEVED SHIRTS; SKI PANTS; SLEEP PANTS; SLEEP SHIRTS; SNOW PANTS; SNOWBOARD PANTS; SPORT SHIRTS; SPORTS CAPS AND HATS; SPORTS PANTS; SPORTS SHIRTS; SPORTS SHIRTS WITH SHORT SLEEVES; STRETCH PANTS; SWEAT PANTS; T-SHIRTS; T-SHIRTS FOR MEN, WOMEN, CHILDREN, INFANTS, BABIES; TEE SHIRTS (U.S. CLS. 22 AND 39).

FIRST USE 1-1-2007; IN COMMERCE 1-1-2008.  
AMY HELLA, EXAMINING ATTORNEY

**CLASS 25—(Continued).**

SN 85-305,407. BARTLING, SHANA, CHANDLER, AZ.  
FILED 4-26-2011.

## Dirty Little Secret Racing Gear

THE MARK CONSISTS OF STANDARD CHARACTERS WITHOUT CLAIM TO ANY PARTICULAR FONT, STYLE, SIZE, OR COLOR.

NO CLAIM IS MADE TO THE EXCLUSIVE RIGHT TO USE "RACING GEAR", APART FROM THE MARK AS SHOWN.

FOR DRESS SHIRTS; HATS; HOODED SWEATSHIRTS; T-SHIRTS; TANK TOPS; UNDERGARMENTS (U.S. CLS. 22 AND 39).

WANDA KAY PRICE, EXAMINING ATTORNEY

SN 85-307,065. STAR OF TEXAS FAIR & RODEO, AUSTIN, TX. FILED 4-28-2011.

## LIVE ACTION LIVE MUSIC LIVE STOCK

THE MARK CONSISTS OF STANDARD CHARACTERS WITHOUT CLAIM TO ANY PARTICULAR FONT, STYLE, SIZE, OR COLOR.

NO CLAIM IS MADE TO THE EXCLUSIVE RIGHT TO USE "LIVE MUSIC LIVE STOCK", APART FROM THE MARK AS SHOWN.

FOR CLOTHING, NAMELY, T-SHIRTS, GOLF SHIRTS, SWEAT SHIRTS, SHIRTS, JERSEYS, JACKETS, PANTS, SHORTS, SWEAT PANTS, HEADBANDS, SUN VISORS, CAPS, BASEBALL CAPS, HATS (U.S. CLS. 22 AND 39).

MARK SPARACINO, EXAMINING ATTORNEY

SN 85-307,363. MOTUS LAURAGE, MIAMI, FL. FILED 4-28-2011.

## Motus Laurage

THE MARK CONSISTS OF STANDARD CHARACTERS WITHOUT CLAIM TO ANY PARTICULAR FONT, STYLE, SIZE, OR COLOR.

THE ENGLISH TRANSLATION OF "MOTUS LAURAGE" IS "DRIVEN, VICTORY AND UP TO DATE FASHION".

FOR CLOTHING, NAMELY, T-SHIRTS, V-NECK SWEATERS, DRESS SHIRTS, JACKETS, SWEATERS, TANK TOPS, BUTTON DOWN SHIRTS, LONG SLEEVED SHIRTS, COATS, VESTS, DRESSES, JEANS, SLACKS, CARGO SHORTS, BERMUDA SHORTS, CAPRIS, SUITS, SKIRTS, BLOUSES, FLEECE PULLOVERS, FLEECE TOPS, FLEECE VEST, FLEECE BOTTOMS, BOXER BRIEFS, BOXER SHORTS, THONGS, SHOES, SOCKS, BELTS, HATS, TIES, SCARFS, FLIP FLOPS, SANDALS, HEELS, BOOTS (U.S. CLS. 22 AND 39).

KIM MONINGHOFF, EXAMINING ATTORNEY

**CLASS 25—(Continued).**

SN 85-307,460. RICHARDS, DEAN A., JR., KEY WEST, FL.  
FILED 4-28-2011.

## ConTerras

THE MARK CONSISTS OF STANDARD CHARACTERS WITHOUT CLAIM TO ANY PARTICULAR FONT, STYLE, SIZE, OR COLOR.

FOR FOOTWEAR (U.S. CLS. 22 AND 39).  
JAY FLOWERS, EXAMINING ATTORNEY

SN 85-307,482. RICHARDS, DEAN A., JR., KEY WEST, FL.  
FILED 4-28-2011.

## 3rd Planet Footwear

THE MARK CONSISTS OF STANDARD CHARACTERS WITHOUT CLAIM TO ANY PARTICULAR FONT, STYLE, SIZE, OR COLOR.

NO CLAIM IS MADE TO THE EXCLUSIVE RIGHT TO USE "FOOTWEAR", APART FROM THE MARK AS SHOWN.

FOR FOOTWEAR (U.S. CLS. 22 AND 39).  
JAY FLOWERS, EXAMINING ATTORNEY

SN 85-307,771. KENNETH C. HORTON, DBA MSHF LLC,  
INGLEWOOD, CA. FILED 4-28-2011.



THE COLOR(S) BLACK, RED, WHITE AND GRAY IS/ARE CLAIMED AS A FEATURE OF THE MARK.

THE MARK CONSISTS OF A BLACK BACKGROUND RECTANGLE WITH THE TERM "MSHF MYSPORTSHIGHLIGHTFILM.COM" IN THE CENTER. THE LETTERS "M", "S" AND "F" ARE GRAY WITH WHITE SHADING, THE LETTER "H" IS RED AND THE WORDING "MYSPORTSHIGHLIGHTFILM.COM" IS WHITE.

FOR ATHLETIC APPAREL, NAMELY, SHIRTS, PANTS, JACKETS, FOOTWEAR, HATS AND CAPS, ATHLETIC UNIFORMS; BALLOON PANTS; BASEBALL CAPS; BASEBALL CAPS AND HATS; BATHING CAPS; BED JACKETS; BODY SHIRTS; BOMBER JACKETS; BUCKET CAPS; BUTTON DOWN SHIRTS; BUTTON-FRONT ALOHA SHIRTS; CAMOUFLAGE JACKETS; CAMOUFLAGE PANTS; CAMOUFLAGE SHIRTS; CAMP SHIRTS; CAP PEAKS; CAP VISORS; CAPRI PANTS; CAPS; CAPS WITH VISORS; CARGO PANTS; CHEF'S HATS; CLOTHING FOR ATHLETIC USE, NAMELY, PADDED PANTS; CLOTHING FOR ATHLETIC USE, NAMELY, PADDED SHIRTS; CLOTHING FOR BABIES, TODDLERS AND CHILDREN, TREATED WITH FIRE AND HEAT RETARDANTS, NAMELY, PAJAMAS, JACKETS, SHIRTS, PANTS, JUMPERS; CLOTHING SHIELDS, NAMELY, PADS APPLIED TO THE UNDER-ARMS OF SHIRTS, BLOUSES AND SWEATERS; COL-

**CLASS 25—(Continued).**

LARED SHIRTS; CROP PANTS; DENIM JACKETS; DENIMS; DOWN JACKETS; DRESS PANTS; DRESS SHIRTS; FISHERMEN'S JACKETS; FISHING SHIRTS; FLOOD PANTS; FUR COATS AND JACKETS; FUR HATS; FUR JACKETS; GOLF CAPS; GOLF PANTS, SHIRTS AND SKIRTS; GOLF SHIRTS; GYM PANTS; HAT BANDS; HATS; HATS FOR INFANTS, BABIES, TODDLERS AND CHILDREN; HEADBANDS AGAINST SWEATING; HEADGEAR, NAMELY, HATS AND CAPS; HEAVY JACKETS; HOODED SWEAT SHIRTS; HUNTING JACKETS; HUNTING PANTS; HUNTING SHIRTS; JACKET LINERS; JACKETS; JACKETS AND SOCKS; JEGGINGS, NAMELY, PANTS THAT ARE PARTIALLY JEANS AND PARTIALLY LEGGINGS; JOGGING PANTS; KNIT JACKETS; KNIT SHIRTS; KNITTED CAPS; KNOT CAPS; KNOTTED CAPS; LEATHER HATS; LEATHER JACKETS; LEATHER PANTS; LEATHER SHIRTS; LEG SHIELDING DEVICE, ATTACHABLE TO AND DETACHABLE FROM A PERSON'S PANTS, COMPRISED OF PADDING TO SHIELD THE LEGS FROM FLYING DEBRIS WHEN MOWING WITH A STRING TRIMMER; LIGHT-REFLECTING JACKETS; LONG JACKETS; LONG-SLEEVED SHIRTS; LOUNGE PANTS; MATERNITY CLOTHING, NAMELY, BUTTON DOWN, COLLAR SHIRTS AND PULLOVER SHIRTS; MEN'S AND WOMEN'S JACKETS, COATS, TROUSERS, VESTS; MOISTURE-WICKING SPORTS PANTS; MOISTURE-WICKING SPORTS SHIRTS; MOTORCYCLE JACKETS; NIGHT SHIRTS; NON-DISPOSABLE CLOTH TRAINING PANTS; NURSE PANTS; OPEN-NECKED SHIRTS; OUTER JACKETS; OVER SHIRTS; PADDED JACKETS; PADDING JACKETS; PANTS; PAPER HATS FOR USE AS CLOTHING ITEMS; PARTY HATS; PERSPIRATION ABSORBENT STRAP TO BE USED IN THE BILL OF A HAT; PETTI-PANTS; PIQUE SHIRTS; POLO SHIRTS; RAIN HATS; RAIN JACKETS; RAINPROOF JACKETS; REVERSIBLE JACKETS; RUGBY SHIRTS; SCIENTIFIC AND TECHNOLOGICAL APPAREL, NAMELY, SHIRTS, PANTS, JACKETS, FOOTWEAR, HATS AND CAPS, UNIFORMS; SEDGE HATS (SUGE-GASA); SHELL JACKETS; SHIRT FRONTS; SHIRT INSERTS, NAMELY, DICKIES; SHIRT YOKES; SHIRTS; SHIRTS AND SHORT-SLEEVED SHIRTS; SHIRTS AND SLIPS; SHIRTS FOR INFANTS, BABIES, TODDLERS AND CHILDREN; SHIRTS FOR SUITS; SHORT-SLEEVED OR LONG-SLEEVED T-SHIRTS; SHORT-SLEEVED SHIRTS; SHOWER CAPS; SKI JACKETS; SKI PANTS; SKULL CAPS; SLEEP PANTS; SLEEP SHIRTS; SLEEVED OR SLEEVELESS JACKETS; SLEEVES WORN SEPARATE AND APART FROM BLOUSES, SHIRTS AND OTHER TOPS; SMALL HATS; SMOKING JACKETS; SNAP CROTCH SHIRTS FOR INFANTS AND TODDLERS; SNOW PANTS; SNOWBOARD JACKETS; SNOWBOARD PANTS; SPORT SHIRTS; SPORTS CAPS AND HATS; SPORTS JACKETS; SPORTS PANTS; SPORTS SHIRTS; SPORTS SHIRTS WITH SHORT SLEEVES; STOCKINGS; STRETCH PANTS; STUFF JACKETS; SUEDE JACKETS; SWEAT BANDS; SWEAT JACKETS; SWEAT PANTS; SWEAT SHIRTS; SWEAT SHORTS; SWEAT SUITS; SWIM CAPS; SWIMMING CAPS; SWIMMING CAPS; T-SHIRTS; T-SHIRTS FOR BABIES, ADULTS, WOMEN, MEN, AND CHILDREN; TAP PANTS; TEE SHIRTS; TOBOGGAN HATS, PANTS AND CAPS; TOE CAPS; TRACK JACKETS; TRACK PANTS; TRAVEL CLOTHING CONTAINED IN A PACKAGE COMPRISING REVERSIBLE JACKETS, PANTS, SKIRTS, TOPS AND A BELT OR SCARF; TRIATHLON CLOTHING, NAMELY, TRIATHLON TIGHTS, TRIATHLON SHORTS, TRIATHLON SINGLET, TRIATHLON SHIRTS, TRIATHLON SUITS; TROUSERS FOR SWEATING; TURTLE NECK SHIRTS; WATERPROOF JACKETS AND PANTS; WEARABLE GARMENTS AND CLOTHING, NAMELY, SHIRTS; WIND PANTS; WIND RESISTANT JACKETS; WIND SHIRTS; WIND-JACKETS; WOMEN'S CLOTHING, NAMELY, SHIRTS, DRESSES, SKIRTS, BLOUSES; WOMEN'S HATS AND HOODS; WOOLLY HATS; YOGA PANTS; YOGA SHIRTS (U.S. CLS. 22 AND 39).

MICHELE SWAIN, EXAMINING ATTORNEY

**CLASS 25—(Continued).**

SN 85-308,080. ANNIE GRIFFIN, LLC, ATLANTA, GA. FILED 4-29-2011.

**ANNIE GRIFFIN**

THE MARK CONSISTS OF STANDARD CHARACTERS WITHOUT CLAIM TO ANY PARTICULAR FONT, STYLE, SIZE, OR COLOR.

THE NAME "ANNIE GRIFFIN" IDENTIFIES A LIVING INDIVIDUAL WHOSE CONSENT IS OF RECORD.

FOR WOMEN'S CLOTHING, NAMELY, DRESSES, BLOUSES, PANTS, BLAZERS AND TOPS (U.S. CLS. 22 AND 39).

FIRST USE 9-7-2010; IN COMMERCE 9-7-2010.

BARNEY CHARLON, EXAMINING ATTORNEY

SN 85-308,746. ROMANO, NATHAN, BROOKLYN, NY. FILED 4-29-2011.

**NATHAN ROMANO**

THE MARK CONSISTS OF STANDARD CHARACTERS WITHOUT CLAIM TO ANY PARTICULAR FONT, STYLE, SIZE, OR COLOR.

THE NAME(S), PORTRAIT(S), AND/OR SIGNATURE(S) SHOWN IN THE MARK IDENTIFIES "NATHAN ROMANO", WHOSE CONSENT(S) TO REGISTER IS MADE OF RECORD.

FOR CLOTHING, NAMELY, TOPS, BOTTOMS, DRESS SHIRTS, COLLARED SHIRTS, RUGBY SHIRTS, KNIT SHIRTS, SWEATSHIRTS, JEANS, JACKETS, COATS, SWEATPANTS, SLACKS, SUITS, HATS, CAPS, DRESSES, T-SHIRTS, BELTS, SCARVES, UNDERGARMENTS, NECKTIES, AND SHORTS FOR MEN, WOMEN AND CONSUMERS OF ALL AGES (U.S. CLS. 22 AND 39).

HENRY S. ZAK, EXAMINING ATTORNEY

SN 85-309,050. NEW BEGINNINGS PACKAGING MDB, INC., FARMERS BRANCH, TX. FILED 4-30-2011.

**ATTITUDE@ALTITUDE**

THE MARK CONSISTS OF STANDARD CHARACTERS WITHOUT CLAIM TO ANY PARTICULAR FONT, STYLE, SIZE, OR COLOR.

FOR CLOTHING, NAMELY, T-SHIRTS, PANTS, SWEATSHIRTS, HATS (U.S. CLS. 22 AND 39).

CHRISTINE MARTIN, EXAMINING ATTORNEY

**CLASS 25—(Continued).**

SN 85-311,521. MULTISPORT JOURNEYS, LLC, RIDGWAY, CO. FILED 5-3-2011.



OWNER OF U.S. REG. NO. 3,987,059.  
THE MARK CONSISTS OF THE STYLIZED INITIALS "MSJ" WITH A DESIGN OF A BIKER TO THE LEFT, A DESIGN OF A ROWER ABOVE, AND A DESIGN OF A HIKER TO THE RIGHT OF "MSJ." THE STACKED STYLIZED WORDING "WWW.MULTISPORTJOURNEYS.COM" AND "LIVE TO PLAY ANOTHER DAY" ARE CENTERED AT THE BOTTOM OF THE MARK.

FOR APRONS; BASEBALL CAPS; BEANIES; CAPS; FLEECE TOPS; HATS; MOISTURE-WICKING SPORTS SHIRTS; POLO SHIRTS; SHIRTS; SHORT-SLEEVED OR LONG-SLEEVED T-SHIRTS (U.S. CLS. 22 AND 39).

FIRST USE 6-20-2010; IN COMMERCE 10-29-2010.  
PAULA MAHONEY, EXAMINING ATTORNEY

SN 85-312,155. BEN ELIAS INDUSTRIES CORP., NEW YORK, NY. FILED 5-4-2011.

**LIVE FROM AMERICA**

THE MARK CONSISTS OF STANDARD CHARACTERS WITHOUT CLAIM TO ANY PARTICULAR FONT, STYLE, SIZE, OR COLOR.

OWNER OF U.S. REG. NO. 2,030,430.  
NO CLAIM IS MADE TO THE EXCLUSIVE RIGHT TO USE "AMERICA", APART FROM THE MARK AS SHOWN.

FOR MEN'S, WOMEN'S, AND CHILDREN'S CLOTHING, NAMELY, JEANS, SKIRTS, SHORTS, DRESSES, VESTS, TIES, SUITS, T-SHIRTS AND FOOTWEAR; WARM-UP SUITS; HATS, CAPS, BERETS, SCARVES, CLOTHING BELTS, GLOVES, MITTENS; PAJAMAS; BATHROBES; NIGHTGOWNS (U.S. CLS. 22 AND 39).

MORGAN WYNNE, EXAMINING ATTORNEY

**CLASS 25—(Continued).**

SN 85-313,899. BRUHN, MAX, ASTORIA, NY. FILED 5-5-2011.



NO CLAIM IS MADE TO THE EXCLUSIVE RIGHT TO USE "NYC", APART FROM THE MARK AS SHOWN.  
THE MARK CONSISTS OF SILHOUETTE OF AN AARDVARK WITH "AARDVARK NYC" BELOW.

FOR BOTTOMS; BUTTON DOWN SHIRTS; HOODS; JACKETS; TOPS; WEARABLE GARMENTS AND CLOTHING, NAMELY, SHIRTS; WOMEN'S CLOTHING, NAMELY, SHIRTS, DRESSES, SKIRTS, BLOUSES (U.S. CLS. 22 AND 39).

DAVID HOFFMAN, EXAMINING ATTORNEY

SN 85-314,311. HENDRICKS, JOEL C., AMERICAN FORK, UT. FILED 5-6-2011.

**HempEnvy**

THE MARK CONSISTS OF STANDARD CHARACTERS WITHOUT CLAIM TO ANY PARTICULAR FONT, STYLE, SIZE, OR COLOR.

FOR BOTTOMS; INFANTWEAR; PANTS; SHIRTS; SHOES; SHORTS; SWEATPANTS; SWIMWEAR; T-SHIRTS; TOPS; UNDERWEAR; ALL OF THE AFOREMENTIONED GOODS MADE WHOLLY OR SUBSTANTIALLY IN PART FROM HEMP (U.S. CLS. 22 AND 39).

DARRYL SPRULL, EXAMINING ATTORNEY

SN 85-314,663. REEL CAROLINA, INC., HILTON HEAD ISLAND, SC. FILED 5-6-2011.

**REEL CAROLINA**

THE MARK CONSISTS OF STANDARD CHARACTERS WITHOUT CLAIM TO ANY PARTICULAR FONT, STYLE, SIZE, OR COLOR.

NO CLAIM IS MADE TO THE EXCLUSIVE RIGHT TO USE "CAROLINA", APART FROM THE MARK AS SHOWN.  
FOR HATS; LONG-SLEEVED SHIRTS; SHIRTS AND SHORT-SLEEVED SHIRTS; SWEATSHIRTS; VISORS (U.S. CLS. 22 AND 39).

FIRST USE 6-25-2008; IN COMMERCE 7-25-2008.  
JAMES A. RAUEN, EXAMINING ATTORNEY

**CLASS 25—(Continued).**

SN 85-316,316. GERS, JEREMY, BAYOONE, NJ. FILED 5-9-2011.

**East Coast Hooked**

THE MARK CONSISTS OF STANDARD CHARACTERS WITHOUT CLAIM TO ANY PARTICULAR FONT, STYLE, SIZE, OR COLOR.

NO CLAIM IS MADE TO THE EXCLUSIVE RIGHT TO USE "EAST COAST", APART FROM THE MARK AS SHOWN.

FOR HATS; JACKETS; T-SHIRTS (U.S. CLS. 22 AND 39).

HEATHER BIDDULPH, EXAMINING ATTORNEY

SN 85-316,374. KINGSID VENTURES, LTD., LAS VEGAS, NV. FILED 5-9-2011.

**BB KING'S BLUES CLUB**

THE MARK CONSISTS OF STANDARD CHARACTERS WITHOUT CLAIM TO ANY PARTICULAR FONT, STYLE, SIZE, OR COLOR.

OWNER OF U.S. REG. NOS. 1,878,090, 2,235,556 AND OTHERS.

THE NAME(S), PORTRAIT(S), AND/OR SIGNATURE(S) SHOWN IN THE MARK IDENTIFIES "B.B. KING", WHOSE CONSENT(S) TO REGISTER IS MADE OF RECORD.

FOR BANDANAS; CAPS; HATS; JACKETS; JERSEYS; SCARVES; SWEATSHIRTS; T-SHIRTS; TOPS; VISORS; WOMEN'S CLOTHING, NAMELY, SHIRTS, DRESSES, SKIRTS, BLOUSES; WRISTBANDS (U.S. CLS. 22 AND 39).

FIRST USE 8-15-1991; IN COMMERCE 8-15-1991.  
DAVID I, EXAMINING ATTORNEY

**CLASS 25—(Continued).**

SN 85-316,403. FASHION BRANDS HOLDING CORPORATION, CARSON CITY, NV. FILED 5-9-2011.



NO CLAIM IS MADE TO THE EXCLUSIVE RIGHT TO USE "YOGA", APART FROM THE MARK AS SHOWN.

THE NAME(S), PORTRAIT(S), AND/OR SIGNATURE(S) SHOWN IN THE MARK IDENTIFIES "MICHELE BOHBOT", WHOSE CONSENT(S) TO REGISTER IS MADE OF RECORD.

THE COLOR(S) BLACK, TURQUOISE BLUE, AND BRIGHT PINK IS/ARE CLAIMED AS A FEATURE OF THE MARK.

THE MARK CONSISTS OF THE WORDS "ELECTRIC" AND "YOGA" IN BLACK. THE NAME "MICHELE BOHBOT" IS DISPLAYED IN SMALLER TEXT BELOW. THE WORDS "ELECTRIC" AND "YOGA" AND "MICHELE" AND "BOHBOT" ARE SEPARATED BY A CUSTOM DRAWN LIGHTNING BOLT DISPLAYED IN THE CENTER. THE LIGHTNING BOLT IS OUTLINED ON THE LEFT SIDE WITH TURQUOISE BLUE AND ON THE RIGHT SIDE IT IS OUTLINED BRIGHT PINK WITH THE BODY OF THE LIGHTNING BOLT IS FILLED IN WITH BLACK.

FOR BOTTOMS; CAPRIS; PANTS; SHORTS; JEANS; DRESSES; BODY SUITS; JUMPERS; HEADWEAR; HATS; HEADBANDS; SOCKS; TOPS; TANK TOPS; HOODED SWEATSHIRTS; JACKETS; SHIRTS; T-SHIRTS; OUTERWEAR, NAMELY RAIN COATS; VESTS; COATS (U.S. CLS. 22 AND 39).

GEORGE LORENZO, EXAMINING ATTORNEY

SN 85-316,987. TAH HSIN INDUSTRIAL CORP., TAICHUNG CITY, TAIWAN, FILED 5-10-2011.

**RED LEDGE**

THE MARK CONSISTS OF STANDARD CHARACTERS WITHOUT CLAIM TO ANY PARTICULAR FONT, STYLE, SIZE, OR COLOR.

OWNER OF U.S. REG. NO. 1,916,597.

FOR RAINCOATS, AND OUTERWEAR, NAMELY, OVERCOATS, JACKETS, PANTS, VEST, PARKAS, OVERALLS, TWO PIECE RAIN SUITS, AND SKIWEAR (U.S. CLS. 22 AND 39).

FIRST USE 8-1-1994; IN COMMERCE 8-1-1994.

PAUL E. FAHRENKOPF, EXAMINING ATTORNEY

**CLASS 25—(Continued).**

SN 85-317,801. CHITWOOD, DEREK S., CANON, GA. FILED 5-11-2011.

**PEACH STATE PRIDE**

THE MARK CONSISTS OF STANDARD CHARACTERS WITHOUT CLAIM TO ANY PARTICULAR FONT, STYLE, SIZE, OR COLOR.

NO CLAIM IS MADE TO THE EXCLUSIVE RIGHT TO USE "PEACH STATE", APART FROM THE MARK AS SHOWN.

FOR CAMOUFLAGE SHIRTS; COLLARED SHIRTS; HATS; LONG-SLEEVED SHIRTS; POLO SHIRTS; SHIRTS; SHORT-SLEEVED OR LONG-SLEEVED T-SHIRTS; T-SHIRTS (U.S. CLS. 22 AND 39).

FIRST USE 7-0-2009; IN COMMERCE 7-0-2009.  
DAVID COLLIER, EXAMINING ATTORNEY

SN 85-318,078. MCKOY, HOWARD, OAKLAND, CA. FILED 5-11-2011.

**SPORTSBUM**

THE MARK CONSISTS OF STANDARD CHARACTERS WITHOUT CLAIM TO ANY PARTICULAR FONT, STYLE, SIZE, OR COLOR.

FOR CLOTHING, NAMELY, T-SHIRTS, SWEATSHIRTS, TANK TOPS, WOVEN SHIRTS, SWEATERS, CARDIGANS, VESTS, JACKETS, PANTS, SWEATPANTS, SHORTS, HATS, CAPS, COATS, SHOES, SOCKS, AND UNDERWEAR, SKIRTS, DRESSES, BLOUSES (U.S. CLS. 22 AND 39).

MARTHA FROMM, EXAMINING ATTORNEY

**CLASS 25—(Continued).**

SN 85-318,126. LEVINE'S RESTORATIONS, ARLINGTON, VA. FILED 5-11-2011.



NO CLAIM IS MADE TO THE EXCLUSIVE RIGHT TO USE "CO" AND "TRADE MARK", APART FROM THE MARK AS SHOWN.

THE MARK CONSISTS OF AN OWL PERCHED ON A MORTAR WITH A PESTLE PARTIALLY OUTSIDE THE MORTAR. ONE CLAW OF THE OWL IS HOLDING ONTO THE PESTLE WITH THE WORDS "THE OWL DRUG CO. TODCO TRADE MARK".

FOR ANKLE SOCKS; ANKLETS; APPAREL FOR DANCERS, NAMELY, TEE SHIRTS, SWEATSHIRTS, PANTS, LEGGINGS, SHORTS AND JACKETS; ATHLETIC APPAREL, NAMELY, SHIRTS, PANTS, JACKETS, FOOTWEAR, HATS AND CAPS, ATHLETIC UNIFORMS; BASEBALL CAPS AND HATS; BOMBER JACKETS; CAMOUFLAGE JACKETS; CAMOUFLAGE PANTS; CAMOUFLAGE VESTS; CAMP SHIRTS; CAP VISORS; CAPS; CAPS WITH VISORS; CARGO PANTS; DENIM JACKETS; DENIMS; FISHERMEN'S JACKETS; FISHING VESTS; FLEECE VESTS; GOLF CAPS; GOLF PANTS, SHIRTS AND SKIRTS; GOLF SHIRTS; GYM PANTS; HATS; HEADGEAR, NAMELY, BEENIES; HOODED SWEAT SHIRTS; HUNTING JACKETS; HUNTING PANTS; HUNTING SHIRTS; HUNTING VESTS; JACKETS; JACKETS AND SOCKS; JEGGINGS, NAMELY, PANTS THAT ARE PARTIALLY JEANS AND PARTIALLY LEGGINGS; JOGGING PANTS; KNIT JACKETS; KNIT SHIRTS; KNITTED CAPS; LEATHER JACKETS; LEATHER VESTS; LONG JACKETS; LONG SLEEVED VESTS; LONG-SLEEVED SHIRTS; MEN'S AND WOMEN'S JACKETS, COATS, TROUSERS, VESTS; MEN'S SOCKS; MOISTURE-WICKING SPORTS SHIRTS; MOTORCYCLE JACKETS; NON-SLIP SOCKS; OPEN-NECKED SHIRTS; OUTER JACKETS; PANTS; POLO SHIRTS; QUILTED VESTS; RAIN JACKETS; REVERSIBLE JACKETS; RUGBY SHIRTS; SHELL JACKETS; SHIRT INSERTS, NAMELY, DICKIES; SHIRTS; SHIRTS AND SHORT-SLEEVED SHIRTS; SHORT-SLEEVED OR LONG-SLEEVED T-SHIRTS; SHORT-SLEEVED SHIRTS; SKI JACKETS; SKI PANTS; SKULL CAPS; SLEEP PANTS; SLEEVED OR SLEEVELESS JACKETS; SNOW PANTS; SNOWBOARD JACKETS; SNOWBOARD PANTS; SOCKS; SOCKS AND STOCKINGS; SPORT SHIRTS; SPORTS CAPS AND HATS; SPORTS JACKETS; SPORTS PANTS; SPORTS SHIRTS; SPORTS SHIRTS WITH SHORT SLEEVES; SPORTS VESTS; STRETCH PANTS; SWEAT JACKETS; SWEAT PANTS; SWEAT SHIRTS; SWEATSUITS; T-SHIRTS; T-SHIRTS FOR ADULTS, CHILDREN, WOMEN, MEN; TEE SHIRTS; THERMAL SOCKS; TOBOGGAN HATS, PANTS AND CAPS; TRACK JACKETS; TRACK PANTS; TURTLE NECK SHIRTS; VESTS; WEARABLE GARMENTS AND CLOTHING, NAMELY, SHIRTS; WIND RESISTANT JACKETS; WIND VESTS; WIND-JACKETS; WOMEN'S CLOTHING, NAMELY, SHIRTS, DRESSES, SKIRTS, BLOUSES; WOOLLEN SOCKS (U.S. CLS. 22 AND 39).

ALICIA COLLINS, EXAMINING ATTORNEY



**CLASS 25—(Continued).**

SN 85-318,474. LEVINE'S RESTORATIONS, ARLINGTON, VA. FILED 5-11-2011.



NO CLAIM IS MADE TO THE EXCLUSIVE RIGHT TO USE "CO. INCORPORATED" AND "WHOLESALE AND RETAIL", APART FROM THE MARK AS SHOWN.

THE MARK CONSISTS OF FLYING OWL WITH OUTSTRETCHED WINGS FLYING OVER A BRIGHT SUN WITH SUNBEAMS FLARING OUTWARD AND THE WORDS "THE OWL DRUG CO. INCORPORATED WHOLESALE AND RETAIL DRUGGISTS".

FOR ANKLE SOCKS; ANKLETS; APPAREL FOR DANCERS, NAMELY, TEE SHIRTS, SWEATSHIRTS, PANTS, LEGGINGS, SHORTS AND JACKETS; ATHLETIC APPAREL, NAMELY, SHIRTS, PANTS, JACKETS, FOOTWEAR, HATS AND CAPS, ATHLETIC UNIFORMS; BASEBALL CAPS; BASEBALL CAPS AND HATS; BOMBER JACKETS; CAMOUFLAGE JACKETS; CAMOUFLAGE PANTS; CAMOUFLAGE SHIRTS; CAMOUFLAGE VESTS; CAMP SHIRTS; CAP PEAKS; CAP VISORS; CAPS; CAPS WITH VISORS; CARGO PANTS; COLLARED SHIRTS; DENIM JACKETS; DENIMS; FISHING SHIRTS; FISHING VESTS; FLEECE VESTS; GOLF CAPS; GOLF PANTS, SHIRTS AND SKIRTS; GOLF SHIRTS; GYM PANTS; HATS; HEADGEAR, NAMELY, BEENIES, HATS, CAPS; HEAVY JACKETS; HOODED SWEAT SHIRTS; HUNTING JACKETS; HUNTING PANTS; HUNTING SHIRTS; HUNTING VESTS; JACKETS; JACKETS AND SOCKS; JEGGINGS, NAMELY, PANTS THAT ARE PARTIALLY JEANS AND PARTIALLY LEGGINGS; JOGGING PANTS; KNIT JACKETS; KNIT SHIRTS; KNITTED CAPS; LEATHER HATS; LEATHER JACKETS; LEATHER PANTS; LEATHER VESTS; LONG JACKETS; LONG SLEEVED VESTS; LONG-SLEEVED SHIRTS; MEN'S AND WOMEN'S JACKETS, COATS, TROUSERS, VESTS; MEN'S SOCKS; MOTORCYCLE JACKETS; NON-SLIP SOCKS; OPEN-NECKED SHIRTS; OUTER JACKETS; PADDED JACKETS; PANTS; POLO SHIRTS; QUILTED VESTS; RAIN JACKETS; RUGBY SHIRTS; SHIRTS; SHIRTS AND SHORT-SLEEVED SHIRTS; SHIRTS AND SLIPS; SHORT-SLEEVED OR LONG-SLEEVED T-SHIRTS; SHORT-SLEEVED SHIRTS; SKI JACKETS; SKI PANTS; SLEEVED OR SLEEVELESS JACKETS; SMALL HATS; SNOW PANTS; SNOWBOARD JACKETS; SNOWBOARD PANTS; SOCKS; SOCKS AND STOCKINGS; SPORT SHIRTS; SPORTS CAPS AND HATS; SPORTS JACKETS; SPORTS PANTS; SPORTS SHIRTS; SPORTS SHIRTS WITH SHORT SLEEVES; STRETCH PANTS; SWEAT JACKETS; SWEAT PANTS; SWEAT SHIRTS; SWEATSUITS; T-SHIRTS; TEE SHIRTS; THERMAL SOCKS; TURTLE NECK SHIRTS; VESTS; WIND PANTS; WIND RESISTANT JACKETS; WIND VESTS; WIND-JACKETS; WOMEN'S CLOTHING, NAMELY, SHIRTS, DRESSES, SKIRTS, BLOUSES; WOOLLEN SOCKS; WOOLLY HATS (U.S. CLS. 22 AND 39).

ALICIA COLLINS, EXAMINING ATTORNEY

**CLASS 25—(Continued).**

SN 85-318,748. NOEL NEVILLE COMRIE, DBA ABSOYA'62, HOUSTON, TX. FILED 5-12-2011.

# Absoya'62

THE MARK CONSISTS OF STANDARD CHARACTERS WITHOUT CLAIM TO ANY PARTICULAR FONT, STYLE, SIZE, OR COLOR.

FOR T-SHIRTS (U.S. CLS. 22 AND 39).  
FIRST USE 3-2-2011; IN COMMERCE 3-2-2011.  
KYLE PEETE, EXAMINING ATTORNEY

SN 85-320,579. PACIFIC CLUB OF NANTUCKET, INC., NANTUCKET, MA. FILED 5-13-2011.

# Pacific Club

THE MARK CONSISTS OF STANDARD CHARACTERS WITHOUT CLAIM TO ANY PARTICULAR FONT, STYLE, SIZE, OR COLOR.

NO CLAIM IS MADE TO THE EXCLUSIVE RIGHT TO USE "CLUB", APART FROM THE MARK AS SHOWN.

FOR CLOTHING FOR BABIES, TODDLERS AND CHILDREN, TREATED WITH FIRE AND HEAT RETARDANTS, NAMELY, PAJAMAS, JACKETS, SHIRTS, PANTS, JUMPERS; FLEECE PULLOVERS; FLEECE VESTS; GOLF SHIRTS; HOODED SWEAT SHIRTS; JACKETS; POLO SHIRTS; RUGBY SHIRTS; SHIRTS AND SHORT-SLEEVED SHIRTS; SHIRTS FOR INFANTS, BABIES, TODDLERS AND CHILDREN; SHORT-SLEEVED OR LONG-SLEEVED T-SHIRTS; SUN PROTECTIVE CLOTHING, NAMELY, HATS, SHIRTS; SWEAT SHIRTS; T-SHIRTS; TEE SHIRTS; WIND-JACKETS (U.S. CLS. 22 AND 39).

JAY BESCH, EXAMINING ATTORNEY

**CLASS 25—(Continued).**

SN 85-320,583. MILANOO.COM LIMITED, WANCHAI HK, CHINA, FILED 5-13-2011.



THE NAME(S), PORTRAIT(S), AND/OR SIGNATURE(S) SHOWN IN THE MARK DOES NOT IDENTIFY A PARTICULAR LIVING INDIVIDUAL.

THE MARK CONSISTS OF A WOMAN IN A DRESS WITH THE STYLIZED WORDING "LOLILA" FORMING THE BOTTOM TRIM OF THE DRESS.

THE WORDING "LOLILA" HAS NO MEANING IN A FOREIGN LANGUAGE.

FOR BOTTOMS; DRESSES; GIRDLES; GLOVES; HATS; HOSIERY; JACKETS; MASQUERADE COSTUMES; SCARFS; SHIRTS; SHOES; TOPS; UNDERGARMENTS; WEDDING DRESSES (U.S. CLS. 22 AND 39).

FIRST USE 4-6-2011; IN COMMERCE 4-6-2011.  
JAY BESCH, EXAMINING ATTORNEY

SN 85-320,663. SPECIAL TEAMS SOLUTIONS, MANALAPAN, NJ. FILED 5-13-2011.



NO CLAIM IS MADE TO THE EXCLUSIVE RIGHT TO USE "THREADS", APART FROM THE MARK AS SHOWN.

THE MARK CONSISTS OF A FOOTBALL WITH THE WORDS "4TH DOWN THREADS" WRITTEN INSIDE AND STITCHES AROUND THE PERIMETER.

FOR ATHLETIC APPAREL, NAMELY, SHIRTS, PANTS, JACKETS, FOOTWEAR, HATS AND CAPS, ATHLETIC UNIFORMS (U.S. CLS. 22 AND 39).

JERI J. FICKES, EXAMINING ATTORNEY

**CLASS 25—(Continued).**

SN 85-320,824. PROPER COURSE & CO., LLC, PORTLAND, OR. FILED 5-13-2011.



NO CLAIM IS MADE TO THE EXCLUSIVE RIGHT TO USE "CO" AND "CO.", APART FROM THE MARK AS SHOWN.

THE MARK CONSISTS OF THE WORDS "PC&CO PROPER COURSE & CO.". THE LETTERS "P", "C" ARE ABOVE "&CO". THE LETTERS "C", "O" ARE STACKED VERTICALLY AND APPEAR TO THE RIGHT OF A STYLIZED "&". THE "&" SYMBOL INCLUDES A DIAGONAL ARROW AS PART OF THE SYMBOL. A VERTICAL LINE SEPARATES THE LETTERS "P", "C", "&", "C", "O" FROM THE WORDS "PROPER COURSE & CO.". A STYLIZED BIRD DESIGN IS ON TOP OF THE LETTER "E" IN THE WORD "COURSE".

FOR FOOTWEAR, SANDALS, FLIP-FLOPS (U.S. CLS. 22 AND 39).

JOHN DWYER, EXAMINING ATTORNEY

SN 85-320,982. GLORIA LANCE, INC., GARDENA, CA. FILED 5-13-2011.

**VIOLET KAY**

THE MARK CONSISTS OF STANDARD CHARACTERS WITHOUT CLAIM TO ANY PARTICULAR FONT, STYLE, SIZE, OR COLOR.

THE NAME(S), PORTRAIT(S), AND/OR SIGNATURE(S) SHOWN IN THE MARK DOES NOT IDENTIFY A PARTICULAR LIVING INDIVIDUAL.

FOR BOTTOMS; DRESSES; JACKETS; TOPS (U.S. CLS. 22 AND 39).

FIRST USE 1-0-2010; IN COMMERCE 1-0-2010.  
KEVON CHISOLM, EXAMINING ATTORNEY

SN 85-321,023. SIMPSON, CHERYL LORRAINE, DBA THE FIRST STOP WEDDING SHOP, HARRISON, TN. FILED 5-13-2011.

**The First Stop Wedding Shop**

THE MARK CONSISTS OF STANDARD CHARACTERS WITHOUT CLAIM TO ANY PARTICULAR FONT, STYLE, SIZE, OR COLOR.

NO CLAIM IS MADE TO THE EXCLUSIVE RIGHT TO USE "WEDDING SHOP", APART FROM THE MARK AS SHOWN.

FOR WEDDING GOWNS (U.S. CLS. 22 AND 39).  
JILL C. ALT, EXAMINING ATTORNEY

**CLASS 25—(Continued).**

SN 85-321,377. WOLF, MICHAEL, LOS ANGELES, CA.  
FILED 5-16-2011.

**IDKYBILY**

THE MARK CONSISTS OF STANDARD CHARACTERS WITHOUT CLAIM TO ANY PARTICULAR FONT, STYLE, SIZE, OR COLOR.

THE WORDING "IDKYBILY" HAS NO MEANING IN A FOREIGN LANGUAGE.

FOR T-SHIRTS (U.S. CLS. 22 AND 39).

AMY KERTGATE, EXAMINING ATTORNEY

SN 85-321,682. CALLEJERO CLOTHING COMPANY INC.,  
SANTA ANA, CA. FILED 5-16-2011.

**CALLEJERO CLOTHING COMPANY**

THE MARK CONSISTS OF STANDARD CHARACTERS WITHOUT CLAIM TO ANY PARTICULAR FONT, STYLE, SIZE, OR COLOR.

NO CLAIM IS MADE TO THE EXCLUSIVE RIGHT TO USE "CLOTHING COMPANY", APART FROM THE MARK AS SHOWN.

THE ENGLISH TRANSLATION OF "CALLEJERO" IN THE MARK IS "STREET MAN", "PERSON OF THE STREET".

FOR BELTS; HEADBANDS FOR CLOTHING; HOODS; JACKETS; JERSEYS; LEATHER BELTS; PARTY HATS; TIES; TOPS; TRAVEL CLOTHING CONTAINED IN A PACKAGE COMPRISING REVERSIBLE JACKETS, PANTS, SKIRTS, TOPS AND A BELT OR SCARF; WEARABLE GARMENTS AND CLOTHING, NAMELY, SHIRTS; WOMEN'S CLOTHING, NAMELY, SHIRTS, DRESSES, SKIRTS, BLOUSES (U.S. CLS. 22 AND 39).

ANDREA HACK, EXAMINING ATTORNEY

SN 85-321,998. JUPI PTY LTD., SYDNEY, AUSTRALIA,  
FILED S.R. 5-16-2011; AM. P.R. 8-31-2011.

**MENSFIT**

THE MARK CONSISTS OF STANDARD CHARACTERS WITHOUT CLAIM TO ANY PARTICULAR FONT, STYLE, SIZE, OR COLOR.

FOR MEN'S APPAREL, NAMELY, UNDERWEAR, SINGLET, SLEEPWEAR, BATHROBES, SOCKS, SHIRTS, TSHIRTS; MEN'S EXERCISE APPAREL, NAMELY, LEGGINGS, TRACK PANTS, HOODED SWEATSHIRTS AND COMPRESSION SHORTS; MEN'S SHAPEWEAR, NAMELY, SINGLET, BRIEFS, SHORTS AND LEGGINGS; MEN'S SWIMWEAR, NAMELY, TRUNKS, BRIEFS AND BOARD SHORTS (U.S. CLS. 22 AND 39).

FIRST USE 8-1-2010; IN COMMERCE 8-1-2010.

DOMINICK J. SALEMI, EXAMINING ATTORNEY

**CLASS 25—(Continued).**

SN 85-322,008. THE UNIVERSITY OF NORTH CAROLINA  
AT CHAPEL HILL, CHAPEL HILL, NC. FILED 5-16-2011.



OWNER OF U.S. REG. NO. 1,262,384.

THE MARK CONSISTS OF THE IMAGE OF A RAM'S HEAD. THE RAM IS WEARING A HAT. THE LETTERS "UNC" APPEAR ON THE HAT.

FOR CLOTHING, NAMELY, T-SHIRTS, POLO SHIRTS, SWEATSHIRTS, SWEATPANTS, LOUNGEWEAR, OUTERWEAR, BOXERS, SOCKS, AND HEADWEAR (U.S. CLS. 22 AND 39).

FIRST USE 0-0-1968; IN COMMERCE 0-0-1968.

DOMINICK J. SALEMI, EXAMINING ATTORNEY

SN 85-322,034. DML MARKETING GROUP LTD, VAN  
NUYS, CA. FILED 5-16-2011.

**FLIP FLATZ**

THE MARK CONSISTS OF STANDARD CHARACTERS WITHOUT CLAIM TO ANY PARTICULAR FONT, STYLE, SIZE, OR COLOR.

NO CLAIM IS MADE TO THE EXCLUSIVE RIGHT TO USE "FLATS", APART FROM THE MARK AS SHOWN.

FOR BALLET SLIPPERS; SANDALS; SLIPPERS (U.S. CLS. 22 AND 39).

ANGELA DUONG, EXAMINING ATTORNEY

**CLASS 25—(Continued).**

SN 85-322,134. INK BOMBERS, SAN DIMAS, CA. FILED 5-16-2011.



THE MARK CONSISTS OF THE STYLIZED WORDING "INK BOMBERS" APPEARING TO THE RIGHT OF THE DEPICTION OF A BOMB SURROUNDED BY CIRCLE.

FOR CLOTHING, NAMELY, SHIRTS, HATS, SWEATERS, JACKETS, SOCKS, BANDANAS, BEANIES, SHOES, UNDERWEAR, PANTS, SWIMWEAR, SHORTS, SKIRTS, DRESSES, TIES, BELTS, LONG SLEEVE SHIRTS, JACKETS, SPORTS BRAS, VISORS, SCARVES AND DRESS SUITS (U.S. CLS. 22 AND 39).

FIRST USE 1-15-2008; IN COMMERCE 8-9-2009.  
MICHAEL TANNER, EXAMINING ATTORNEY

**CLASS 25—(Continued).**

SN 85-322,940. RUSSELL BRANDS, LLC, ALEXANDER CITY, AL. FILED 5-17-2011.

OWNER OF U.S. REG. NOS. 2,305,965, 3,285,057 AND OTHERS.

SEC. 2(F).  
FOR BOTTOMS; CAPS; FOOTWEAR; JACKETS; SHOES; SWEAT PANTS; SWEAT SHIRTS; SWEAT SUITS; TOPS (U.S. CLS. 22 AND 39).

GEORGE LORENZO, EXAMINING ATTORNEY

SN 85-323,148. HIGH POINT DESIGN LLC, NEW YORK, NY. FILED 5-17-2011.

## KOOKIE KRITTERS

SN 85-322,225. COKLEY, DONTELL, DETROIT, MI. FILED 5-16-2011.



THE MARK CONSISTS OF STANDARD CHARACTERS WITHOUT CLAIM TO ANY PARTICULAR FONT, STYLE, SIZE, OR COLOR.

NO CLAIM IS MADE TO THE EXCLUSIVE RIGHT TO USE "KRITTERS", APART FROM THE MARK AS SHOWN.  
FOR SOCKS, SLIPPER SOCKS, SLIPPERS, SOFT SLIPPERS, MUKLUKS, FLIP FLOPS, ARM WARMERS, LEG WARMERS, LEGGINGS, AND TIGHTS (U.S. CLS. 22 AND 39).

EMILY CARLSEN, EXAMINING ATTORNEY

SN 85-323,161. HIGH POINT DESIGN LLC, NEW YORK, NY. FILED 5-17-2011.

## KOOKIE KOMBOS

NO CLAIM IS MADE TO THE EXCLUSIVE RIGHT TO USE "CLOTHING COMPANY", APART FROM THE MARK AS SHOWN.

THE MARK CONSISTS OF A TWO-HEADED BIRD LIKE IMAGE WITH 3 SLASHES ON EACH SIDE, THE WORDING "6TH REPUBLIC" BELOW THE IMAGE, AND "CLOTHING COMPANY" BELOW "6TH REPUBLIC".

FOR COATS; DRESSES; JACKETS; PANTS; SHIRTS; SHOES; SOCKS; TIES; UNDER GARMENTS (U.S. CLS. 22 AND 39).

AMY HELLA, EXAMINING ATTORNEY

THE MARK CONSISTS OF STANDARD CHARACTERS WITHOUT CLAIM TO ANY PARTICULAR FONT, STYLE, SIZE, OR COLOR.

NO CLAIM IS MADE TO THE EXCLUSIVE RIGHT TO USE "KOMBOS", APART FROM THE MARK AS SHOWN.

FOR SOCKS, SLIPPER SOCKS, SLIPPERS, SOFT SLIPPERS, MUKLUKS, FLIP FLOPS, ARM WARMERS, LEG WARMERS, LEGGINGS, AND TIGHTS (U.S. CLS. 22 AND 39).

EMILY CARLSEN, EXAMINING ATTORNEY

**CLASS 25—(Continued).**

SN 85-323,172. JUPI PTY LTD., SYDNEY, AUSTRALIA, FILED S.R. 5-17-2011; AM. P.R. 8-31-2011.



THE MARK CONSISTS OF THE WORD "MENSFIT" WITH A BAR UNDERNEATH THE WORD.

FOR MEN'S APPAREL, NAMELY, UNDERWEAR, SINGLETS, SLEEPWEAR, BATHROBES, SOCKS, SHIRTS, TSHIRTS; MEN'S EXERCISE APPAREL, NAMELY, LEGGINGS, TRACK PANTS, HOODED SWEATSHIRTS AND COMPRESSION SHORTS; MEN'S SHAPEWEAR, NAMELY, SINGLETS, BRIEFS, SHORTS AND LEGGINGS; MEN'S SWIMWEAR, NAMELY, TRUNKS, BRIEFS AND BOARD SHORTS (U.S. CLS. 22 AND 39).

FIRST USE 8-1-2010; IN COMMERCE 8-1-2010.  
DOMINICK J. SALEMI, EXAMINING ATTORNEY

SN 85-323,230. OUTERSTUFF, LTD., NEW YORK, NY. FILED 5-17-2011.



THE MARK CONSISTS OF STANDARD CHARACTERS WITHOUT CLAIM TO ANY PARTICULAR FONT, STYLE, SIZE, OR COLOR.

OWNER OF U.S. REG. NOS. 2,615,214, 2,695,002 AND 3,768,824.

NO CLAIM IS MADE TO THE EXCLUSIVE RIGHT TO USE "PRO", APART FROM THE MARK AS SHOWN.

FOR COATS; JACKETS; OVERALLS; PARKAS; SNOW PANTS; SNOW SUITS; WIND RESISTANT JACKETS (U.S. CLS. 22 AND 39).

JORDAN BAKER, EXAMINING ATTORNEY

SN 85-323,252. FIELER, AMANDA, MIAMI, FL. FILED 5-17-2011.



THE MARK CONSISTS OF STANDARD CHARACTERS WITHOUT CLAIM TO ANY PARTICULAR FONT, STYLE, SIZE, OR COLOR.

NO CLAIM IS MADE TO THE EXCLUSIVE RIGHT TO USE "MODU", APART FROM THE MARK AS SHOWN.

THE ENGLISH TRANSLATION OF THE WORD "MODU" IN THE MARK IS "FASHION".

FOR BOTTOMS; DRESSES; LINGERIE; SWIMWEAR; TOPS (U.S. CLS. 22 AND 39).

HELENE LIWINSKI, EXAMINING ATTORNEY

**CLASS 25—(Continued).**

SN 85-323,475. SEI SHIMURA, DBA YOUNG ELITE SOCIETY, CULVER CITY, CA. FILED 5-18-2011.



THE MARK CONSISTS OF THE WORDING "YOUNG ELITE SOCIETY" CONSISTING OF A YEN CURRENCY SYMBOL, EURO CURRENCY SYMBOL, AND DOLLAR SYMBOL IN A STYLIZED LETTERING WITH A THREE DIMENSIONAL EXTRUSION AND DROP SHADOW, WITH A STYLIZED DESIGN ELEMENT INSPIRED BY THE LETTERS Y, E, AND S.

FOR A-SHIRTS; ANKLE SOCKS; ANKLETS; ANTI-PERSPIRANT SOCKS; APPAREL FOR DANCERS, NAMELY, TEE SHIRTS, SWEATSHIRTS, PANTS, LEGGINGS, SHORTS AND JACKETS; ATHLETIC APPAREL, NAMELY, SHIRTS, PANTS, JACKETS, FOOTWEAR, HATS AND CAPS, ATHLETIC UNIFORMS; BALLOON PANTS; BASEBALL CAPS; BASEBALL CAPS AND HATS; BATHING CAPS; BED JACKETS; BELTS; BELTS FOR CLOTHING; BELTS MADE FROM IMITATION LEATHER; BELTS MADE OF LEATHER; BELTS MADE OUT OF CLOTH; BELTS OF TEXTILE; BELTS THAT ARE DESIGNED TO ACCOMMODATE PREGNANCY SIZE CHANGES; BODY SHIRTS; BOMBER JACKETS; BRIEFS; BUCKET CAPS; BUTTON DOWN SHIRTS; BUTTON-FRONT ALOHA SHIRTS; CAMOUFLAGE JACKETS; CAMOUFLAGE PANTS; CAMOUFLAGE SHIRTS; CAMP SHIRTS; CAP PEAKS; CAP VISORS; CAPRI PANTS; CAPS; CAPS WITH VISORS; CARGO PANTS; CHEF'S HATS; CLOTHING FOR ATHLETIC USE, NAMELY, PADDED PANTS; CLOTHING FOR ATHLETIC USE, NAMELY, PADDED SHIRTS; CLOTHING FOR BABIES, TODDLERS AND CHILDREN, TREATED WITH FIRE AND HEAT RETARDANTS, NAMELY, PAJAMAS, JACKETS, SHIRTS, PANTS, JUMPERS; CLOTHING SHIELDS, NAMELY, PADS APPLIED TO THE UNDERARMS OF SHIRTS, BLOUSES AND SWEATERS; COATS OF DENIM; COLLARED SHIRTS; CREW NECK SWEATERS; CROP PANTS; DENIM JACKETS; DENIMS; DISPOSABLE UNDERWEAR; DOWN JACKETS; DRESS PANTS; DRESS SHIRTS; FABRIC BELTS; FISHERMEN'S JACKETS; FISHING SHIRTS; FLOOD PANTS; FUR COATS AND JACKETS; FUR HATS; FUR JACKETS; GARTER BELTS; GOLF CAPS; GOLF PANTS, SHIRTS AND SKIRTS; GOLF SHIRTS; GYM PANTS; HAT BANDS; HATS; HATS FOR INFANTS, BABIES, TODDLERS AND CHILDREN; HEAVY JACKETS; HOODED SWEAT SHIRTS; HUNTING JACKETS; HUNTING PANTS; HUNTING SHIRTS; JACKET LINERS; JACKETS; JACKETS AND SOCKS; JAPANESE STYLE SOCKS (TABI COVERS); JAPANESE STYLE SOCKS (TABI); JEANS; JEGGINGS, NAMELY, PANTS THAT ARE PARTIALLY JEANS AND PARTIALLY LEGGINGS; JOGGING PANTS; KNIT JACKETS; KNIT SHIRTS; KNITTED CAPS; KNITTED UNDERWEAR; KNOT CAPS; KNOTTED CAPS; LADIES' UNDERWEAR; LEATHER BELTS; LEATHER HATS; LEATHER JACKETS; LEATHER PANTS; LEATHER SHIRTS; LEG SHIELDING DEVICE, ATTACHABLE TO AND DETACHABLE FROM A PERSON'S PANTS, COMPRISED OF PADDING TO SHIELD THE LEGS FROM FLYING DEBRIS WHEN MOWING WITH A STRING TRIMMER; LIGHT-REFLECTING JACKETS; LONG JACKETS; LONG UNDERWEAR; LONG-SLEEVED SHIRTS; LOUNGE PANTS; MEN'S AND WOMEN'S JACKETS, COATS, TROUSERS, VESTS; MEN'S DRESS SOCKS; MEN'S SOCKS; MEN'S UNDERWEAR; MOCK TURTLE-NECK SWEATERS; MOISTURE-WICKING SPORTS PANTS; MOISTURE-WICKING SPORTS SHIRTS; MONEY BELTS; MOTORCYCLE JACKETS; NIGHT SHIRTS; NON-DISPOSABLE CLOTH TRAINING PANTS; NON-SLIP SOCKS; NURSE PANTS; OPEN-NECKED SHIRTS; OUTER JACKETS; OVER SHIRTS; PADDED JACKETS; PADDING JACKETS; PANTS; PAPER HATS FOR USE AS CLOTHING ITEMS; PAPER SHOES USED WHEN GOING THROUGH METAL DETECTORS TO KEEP FEET AND SOCKS

**CLASS 25—(Continued).**

CLEAN; PARTS OF CLOTHING, NAMELY, GUSSETS FOR TIGHTS, GUSSETS FOR STOCKINGS, GUSSETS FOR BATHING SUITS, GUSSETS FOR UNDERWEAR, GUSSETS FOR LEOTARDS AND GUSSETS FOR FOOTLETS; PARTY HATS; PERSPIRATION ABSORBENT STRAP TO BE USED IN THE BILL OF A HAT; PERSPIRATION ABSORBENT UNDERWEAR CLOTHING; PETTI-PANTS; PIQUE SHIRTS; POLO SHIRTS; RACE NUMBER BELTS THAT HOLD A PAPER NUMBER ON THE RACE PARTICIPANT'S FRONT OR BACK DURING COMPETITION; RAIN HATS; RAIN JACKETS; RAINPROOF JACKETS; REVERSIBLE JACKETS; RUGBY SHIRTS; SCARFS; SCIENTIFIC AND TECHNOLOGICAL APPAREL, NAMELY, SHIRTS, PANTS, JACKETS, FOOTWEAR, HATS AND CAPS, UNIFORMS; SEDGE HATS (SUGE-GASA); SHELL JACKETS; SHIRT FRONTS; SHIRT INSERTS, NAMELY, DICKIES; SHIRT YOKES; SHIRTS; SHIRTS AND SHORT-SLEEVED SHIRTS; SHIRTS AND SLIPS; SHIRTS FOR INFANTS, BABIES, TODDLERS AND CHILDREN; SHIRTS FOR SUITS; SHORT-SLEEVED OR LONG-SLEEVED T-SHIRTS; SHORT-SLEEVED SHIRTS; SHOWER CAPS; SKI JACKETS; SKI PANTS; SKULL CAPS; SLEEP PANTS; SLEEP SHIRTS; SLEEVED OR SLEEVELESS JACKETS; SLEEVES WORN SEPARATE AND APART FROM BLOUSES, SHIRTS AND OTHER TOPS; SLIPPER SOCKS; SMALL HATS; SMOKING JACKETS; SNAP CROTCH SHIRTS FOR INFANTS AND TODDLERS; SNOW PANTS; SNOWBOARD JACKETS; SNOWBOARD PANTS; SOCK SUSPENDERS; SOCKS; SOCKS AND STOCKINGS; SPORT SHIRTS; SPORTS CAPS AND HATS; SPORTS JACKETS; SPORTS PANTS; SPORTS SHIRTS; SPORTS SHIRTS WITH SHORT SLEEVES; STRETCH PANTS; STUFF JACKETS; SUEDE JACKETS; SUSPENDER BELTS; SUSPENDER BELTS FOR MEN; SUSPENDER BELTS FOR WOMEN; SWEAT JACKETS; SWEAT PANTS; SWEAT SHIRTS; SWEATERS; T-SHIRTS; TAP PANTS; TEE SHIRTS; THERMAL SOCKS; THERMAL UNDERWEAR; THONGS; TOBOGGAN HATS, PANTS AND CAPS; TOE CAPS; TRACK JACKETS; TRACK PANTS; TRAVEL CLOTHING CONTAINED IN A PACKAGE COMPRISING REVERSIBLE JACKETS, PANTS, SKIRTS, TOPS AND A BELT OR SCARF; TRIATHLON CLOTHING, NAMELY, TRIATHLON TIGHTS, TRIATHLON SHORTS, TRIATHLON SINGLET, TRIATHLON SHIRTS, TRIATHLON SUITS; TURTLE NECK SHIRTS; TURTLENECK SWEATERS; TUXEDO BELTS; UNDERWEAR; UNDERWEAR, NAMELY, BOY SHORTS; V-NECK SWEATERS; WAIST BELTS; WATER SOCKS; WATERPROOF JACKETS AND PANTS; WEARABLE GARMENTS AND CLOTHING, NAMELY, SHIRTS; WIND PANTS; WIND RESISTANT JACKETS; WIND SHIRTS; WIND-JACKETS; WOMEN'S CLOTHING, NAMELY, SHIRTS, DRESSES, SKIRTS, BLOUSES; WOMEN'S HATS AND HOODS; WOMEN'S UNDERWEAR; WOOLLEN SOCKS (U.S. CLS. 22 AND 39).

KAPIL BHANOT, EXAMINING ATTORNEY

SN 85-323,519. HOODYKOO, LLC, EDEN PRAIRIE, MN. FILED 5-18-2011.



THE MARK CONSISTS OF AN OVAL AROUND THE LETTERS "S I P S" WITH A DOT CENTERED BETWEEN EACH LETTER.

FOR CLOTHING, NAMELY, SWEATSHIRTS (U.S. CLS. 22 AND 39).

EDWARD NELSON, EXAMINING ATTORNEY

**CLASS 25—(Continued).**

SN 85-323,594. CHIC BABY ROSE, LLC, FOLSOM, CA. FILED 5-18-2011.



NO CLAIM IS MADE TO THE EXCLUSIVE RIGHT TO USE "BABY", APART FROM THE MARK AS SHOWN.

THE MARK CONSISTS OF AN IMAGE OF A SOCK MONKEY AND RAG DOLL HOLDING HANDS. THE SOCK MONKEY IS ON THE LEFT, AND THE RAG DOLL IS ON THE RIGHT WITH POLKA DOT DRESS. THE TEXT "CHIC BABY ROSE" IS DIRECTLY UNDER THE IMAGE OF THE SOCK MONKEY AND RAG DOLL.

FOR BLOOMERS; BRAS; DRESSES; GLOVES; HATS; JACKETS; JUMPERS; LEGGINGS; PANTS; ROMPERS; SCARVES; SHIRTS; SHOES; SKIRTS; SOCKS; SWIMWEAR; TIGHTS; UNDERGARMENTS (U.S. CLS. 22 AND 39).

FIRST USE 3-1-2007; IN COMMERCE 6-1-2007.  
KAREN K. BUSH, EXAMINING ATTORNEY

SN 85-323,823. VAUGHAN, JEFFREY, ALEXANDRIA, VA. FILED 5-18-2011.

**Uptown Sneaker Gear**

THE MARK CONSISTS OF STANDARD CHARACTERS WITHOUT CLAIM TO ANY PARTICULAR FONT, STYLE, SIZE, OR COLOR.

NO CLAIM IS MADE TO THE EXCLUSIVE RIGHT TO USE "SNEAKER GEAR", APART FROM THE MARK AS SHOWN.

FOR ATHLETIC SHOES; BASKETBALL SNEAKERS; HOODED SWEAT SHIRTS; HOODED SWEATSHIRTS; PANTS; SHOES; SHORT-SLEEVED OR LONG-SLEEVED T-SHIRTS; SHORTS; SNEAKERS; SWEAT SHIRTS; SWEATSHIRTS; T-SHIRTS (U.S. CLS. 22 AND 39).

MICHAEL ENGEL, EXAMINING ATTORNEY

**CLASS 25—(Continued).**

SN 85-324,371. BAREFOOTERS CORP., TORONTO, ONTARIO, CANADA, FILED 5-18-2011.

# FEEL GREAT

THE MARK CONSISTS OF STANDARD CHARACTERS WITHOUT CLAIM TO ANY PARTICULAR FONT, STYLE, SIZE, OR COLOR.

FOR SLIP-RESISTANT BOOTS, SANDALS AND SHOES; T-SHIRTS, HATS (U.S. CLS. 22 AND 39).  
FONG HSU, EXAMINING ATTORNEY

SN 85-324,387. ROGERS, JOHN ANTHONY, NORTH HOLYWOOD, CA. FILED 5-18-2011.

**KING**  **QUEEN**  
L I F E L O V E

THE MARK CONSISTS OF THE MARK CONSIST OF THE WORDS "KING LIFE QUEEN LOVE" IN ITS ENTIRETY AND NOT INDIVIDUALLY. "KING" IS LOCATED ABOVE "LIFE" AND "QUEEN" IS LOCATED ABOVE "LOVE", WITH A DESIGNED CROWN SEPARATING BOTH PHRASES.

FOR ANKLE SOCKS; APPAREL FOR DANCERS, NAMELY, TEE SHIRTS, SWEATSHIRTS, PANTS, LEGGINGS, SHORTS AND JACKETS; ATHLETIC APPAREL, NAMELY, SHIRTS, PANTS, JACKETS, FOOTWEAR, HATS AND CAPS, ATHLETIC UNIFORMS; ATHLETIC FOOTWEAR; ATHLETIC SHOES; BANDANAS; BASKETBALL SNEAKERS; BATHING SUITS; BATHING SUITS FOR MEN; BEACH FOOTWEAR; BEACHWEAR; BEANIES; BELTS; BELTS FOR CLOTHING; BIKINIS; BLAZERS; BLOUSES; BOOTS; BOTTOMS; BOXER SHORTS; BRIEFS; CAPS; CARGO PANTS; COATS OF DENIM; COLLARED SHIRTS; DENIM JACKETS; DENIMS; DO RAGS; DRESS PANTS; DRESS SHIRTS; EAR MUFFS; EARBANDS; FLEECE BOTTOMS; FLEECE PULLOVERS; FLEECE SHORTS; FLEECE TOPS; FLEECE VESTS; FOOTWEAR FOR MEN AND WOMEN; GLOVES AS CLOTHING; GOLF PANTS, SHIRTS AND SKIRTS; GOWNS; GYM SHORTS; HATS; HEAD SCARVES; HEADBANDS AGAINST SWEATING; HEAVY COATS; HEAVY JACKETS; HOODED PULLOVERS; HOODED SWEAT SHIRTS; HOODED SWEATSHIRTS; JACKETS; JEANS; JOGGING OUTFITS; JOGGING PANTS; JOGGING SUITS; LADIES' UNDERWEAR; LEATHER BELTS; LEATHER BOOTS; LEATHER COATS; LEATHER JACKETS; LEATHER PANTS; LEATHER SLIPPERS; LEG WARMERS; LONG SLEEVE PULLOVERS; LONG UNDERWEAR; LONG-SLEEVED SHIRTS; MEN'S AND WOMEN'S JACKETS, COATS, TROUSERS, VESTS; MEN'S UNDERWEAR; MINISKIRTS; NECKTIES; NIGHT GOWNS; NIGHT SHIRTS; NIGHTGOWNS; NIGHTIES; NIGHTSHIRTS; OPEN-NECKED SHIRTS; PANTIES;

**CLASS 25—(Continued).**

PANTIES, SHORTS AND BRIEFS; POLO SHIRTS; RUGBY SHIRTS; RUGBY TOPS; SANDALS; SANDALS AND BEACH SHOES; SCARVES; SHIRTS; SHIRTS AND SHORT-SLEEVED SHIRTS; SHIRTS FOR SUITS; SHORT TROUSERS; SHORT-SLEEVED OR LONG-SLEEVED T-SHIRTS; SHORT-SLEEVED SHIRTS; SILK SCARVES; SKIRT SUITS; SKIRTS; SKIRTS AND DRESSES; SKULLIES; SLEEP SHIRTS; SNEAKERS; SPORT SHIRTS; SPORTS VESTS; STRETCH PANTS; SUEDE JACKETS; SUIT COATS; SUSPENDER BELTS; SWEAT PANTS; SWEAT SHIRTS; SWEAT SHORTS; SWEATERS; SWEATSHIRTS; SWIMWEAR; T-SHIRTS; TANK TOPS; TANK-TOPS; TEE SHIRTS; TENNIS SHOES; TENNIS WEAR; THONGS; TIES; TOP COATS; TOPS; TRACK SUITS; TURTLENECKS; UNDERPANTS; UNDERSHIRTS; UNDERWEAR, NAMELY, BOY SHORTS; VESTED SUITS; VESTS; WARM UP SUITS; WEARABLE GARMENTS AND CLOTHING, NAMELY, SHIRTS; WOMEN'S CLOTHING, NAMELY, SHIRTS, DRESSES, SKIRTS, BLOUSES; WOMEN'S UNDERWEAR; WOVEN DRESSES; WRISTBANDS (U.S. CLS. 22 AND 39).

FIRST USE 8-1-2010; IN COMMERCE 5-12-2011.

MARK RADEMACHER, EXAMINING ATTORNEY

SN 85-324,392. NISKY, KAREN, STUART, FL. FILED 5-18-2011.



THE COLOR(S) BLACK AND PINK IS/ARE CLAIMED AS A FEATURE OF THE MARK.

THE MARK CONSISTS OF A WOMAN IN BLACK WEARING A PINK SKIRT WITH THE WORDS "BARI-BABE" APPEARING IN BLACK WITH A PINK STAR ABOVE THE I IN "BARI" AND THE WORDS "FEEL LIKE A STAR!" WITH "STAR!" APPEARING IN PINK BELOW THE WORD "BABE".

FOR BIBS NOT OF PAPER; BODY SHAPERS; CAPS; CHILDREN'S AND INFANT'S APPAREL, NAMELY, JUMPERS, OVERALL SLEEPWEAR, PAJAMAS, ROMPERS AND ONE-PIECE GARMENTS; GOWNS; HATS; HEADWEAR; LAB COATS; PAJAMAS; POLO SHIRTS; SWEATSHIRTS; T-SHIRTS; TANK TOPS; TIES; UNDERGARMENTS; VISORS; WARM-UP SUITS (U.S. CLS. 22 AND 39).

FIRST USE 10-31-2009; IN COMMERCE 10-31-2009.

SKYE YOUNG, EXAMINING ATTORNEY

SN 85-324,402. DECICCO, CHRISTOPHER, LOS ANGELES, CA. FILED 5-18-2011.

## Breakfast in Bed Apparel

THE MARK CONSISTS OF STANDARD CHARACTERS WITHOUT CLAIM TO ANY PARTICULAR FONT, STYLE, SIZE, OR COLOR.

NO CLAIM IS MADE TO THE EXCLUSIVE RIGHT TO USE "APPAREL", APART FROM THE MARK AS SHOWN.

FOR UNDERGARMENTS (U.S. CLS. 22 AND 39).

SKYE YOUNG, EXAMINING ATTORNEY

**CLASS 25—(Continued).**

SN 85-324,648. MTANGO, SAMORA, GAITHERSBURG, MD. FILED 5-19-2011.



THE NAME "SAMORA" IDENTIFIES A LIVING INDIVIDUAL WHOSE CONSENT IS OF RECORD.

THE MARK CONSISTS OF AN "R" INSIDE A DIAMOND WITH AN OPEN TOP NEXT TO THE STYLIZED WORDING "SAMORA.M" ALL INSIDE TWO RECTANGLES.

FOR ADULT CLOTHING, NAMELY, BELTS, PANTS, SHIRTS AND SWEATERS (U.S. CLS. 22 AND 39).  
TRICIA SONNEBORN, EXAMINING ATTORNEY

SN 85-325,310. CALIFORNIA COSTUME COLLECTIONS, INC., LOS ANGELES, CA. FILED 5-19-2011.

## CALIFORNIA COSTUME COLLECTIONS

THE MARK CONSISTS OF STANDARD CHARACTERS WITHOUT CLAIM TO ANY PARTICULAR FONT, STYLE, SIZE, OR COLOR.

OWNER OF U.S. REG. NO. 3,232,441.

NO CLAIM IS MADE TO THE EXCLUSIVE RIGHT TO USE "COSTUME COLLECTIONS", APART FROM THE MARK AS SHOWN.

SEC. 2(F).

FOR HALLOWEEN COSTUMES AND MASKS SOLD IN CONNECTION THEREWITH (U.S. CLS. 22 AND 39).

FIRST USE 2-0-1986; IN COMMERCE 2-0-1986.

LEIGH LOWRY, EXAMINING ATTORNEY

SN 85-325,349. CHIC BABY ROSE, LLC, FOLSOM, CA. FILED 5-19-2011.

## Chic Baby Rose

THE MARK CONSISTS OF STANDARD CHARACTERS WITHOUT CLAIM TO ANY PARTICULAR FONT, STYLE, SIZE, OR COLOR.

NO CLAIM IS MADE TO THE EXCLUSIVE RIGHT TO USE "BABY", APART FROM THE MARK AS SHOWN.

FOR BLOOMERS; BRAS; DRESSES; GLOVES; HATS; JACKETS; JUMPERS; LEGGINGS; PANTS; ROMPERS; SCARVES; SHIRTS; SHOES; SKIRTS; SOCKS; SWIMWEAR; TIGHTS; UNDERGARMENTS (U.S. CLS. 22 AND 39).

FIRST USE 2-1-2007; IN COMMERCE 6-1-2007.

KAREN K. BUSH, EXAMINING ATTORNEY

**CLASS 25—(Continued).**

SN 85-326,924. ECOCLEAN CORPORATION, DBA NAEL COCE, RANDALLSTOWN, MD. FILED 5-22-2011.



THE COLOR(S) GREEN AND BLACK IS/ARE CLAIMED AS A FEATURE OF THE MARK.

THE MARK CONSISTS OF THE TEXT NAEL COCE COLLECTION. NAEL IS GREEN WITH A CAPITALIZED N AND LOWERCASE AEL. THE C IN COCE AND COLLECTION IS CAPITALIZED AND GREEN. THE SINGLE C IS SHARED TO SPELL BOTH WORDS. THE OCE IN COCE AND COLLECTION IN COLLECTION ARE LOWERCASE AND BLACK.

FOR FOOTWEAR (U.S. CLS. 22 AND 39).

PATRICIA EVANKO, EXAMINING ATTORNEY

SN 85-327,987. MCBRIDE, DOMINIC ALEXANDER, COLLIERVILLE, TN. FILED 5-23-2011.



THE MARK CONSISTS OF THE WORDS "DID I" BELOW AN IMAGE OF A GIRAFFE.

FOR JACKETS; JEANS; PULLOVERS; SHIRTS; SWEATPANTS; SWEATSHIRTS; T-SHIRTS (U.S. CLS. 22 AND 39).

SANJEEV VOHRA, EXAMINING ATTORNEY



**CLASS 25—(Continued).**

SN 85-328,138. FRANCIS KAMAAL L, SILVER SPRING, MD. FILED 5-23-2011.



THE COLOR(S) BLACK, RED, GREEN AND YELLOW IS/ ARE CLAIMED AS A FEATURE OF THE MARK.

THE MARK CONSISTS OF THE STYLIZED WORDING "STARBWOY" IN BLACK WITH A TINY BLACK-OUTLINED STAR ON THE LINE CONNECTING THE "T" AND THE "A" AND A TINY BLACK-OUTLINED STAR ON THE CURVED END OF THE LETTER "B" AND A TINY BLACK-OUTLINED STAR ON THE CURVED END OF THE LETTER "Y". THE LETTER "O" IS REPLACED BY THREE BLACK-OUTLINED STARS ASCENDING DIAGONALLY, FROM BOTTOM TO TOP IN THE COLORS GREEN, YELLOW, AND RED.

FOR APPAREL FOR DANCERS, NAMELY, TEE SHIRTS, SWEATSHIRTS, PANTS, LEGGINGS, SHORTS AND JACKETS; ATHLETIC APPAREL, NAMELY, SHIRTS, PANTS, JACKETS, FOOTWEAR, HATS AND CAPS, ATHLETIC UNIFORMS; BRIEFS; CAPRI PANTS; CARGO PANTS; DENIMS; DRESS PANTS; FOOTWEAR; FOOTWEAR FOR MEN; FOOTWEAR FOR MEN AND WOMEN; LONG UNDERWEAR; MEN'S UNDERWEAR; SHORT-SLEEVED OR LONG-SLEEVED T-SHIRTS; WOVEN OR KNITTED UNDERWEAR (U.S. CLS. 22 AND 39).

ELLEN B. AWRICH, EXAMINING ATTORNEY

**CLASS 25—(Continued).**

SN 85-328,206. CHIU, SHAO-HSING, NEW TAIPEI CITY, TAIWAN, FILED 5-24-2011.



THE COLOR(S) YELLOW AND BLUE IS/ARE CLAIMED AS A FEATURE OF THE MARK.

THE MARK CONSISTS OF A MAP SIMILAR TO THE CONTIGUOUS UNITED STATES IN COLOR YELLOW WITH BLUE EDGE, A STYLIZED WORDING "KAWAK" IN COLOR BLUE ACROSS THE MAP, EIGHT STARS EACH IN COLOR YELLOW WITH BLUE EDGE, AND THE STARS ARRANGED AS AN ARC ABOVE THE MAP.

FOR ATHLETIC SHOES; BOOTS; BOOTS FOR SPORT; CLIMBING SHOES; FOOTBALL BOOTS; FOOTBALL SHOES; HIKING BOOTS; MOUNTAINEERING BOOTS; MOUNTAINEERING SHOES; SHOES; TREKKING BOOTS; WATER PROOF BOOTS; WINTER BOOTS (U.S. CLS. 22 AND 39).

FIRST USE 3-3-2011; IN COMMERCE 3-3-2011.

SHARON MEIER, EXAMINING ATTORNEY

SN 85-328,152. PEDRAZA, ALISON, LOS ANGELES, CA. FILED 5-24-2011.



THE MARK CONSISTS OF THE MARK CONSISTS OF A FIGURE OF A WOMAN ENCLOSED IN THREE CIRCLES WITH THE WODS 'BOOTY TRAP' ALSO ENCIRCLED ABOVE HER AND ALSO WITHIN THE 3 CIRCLES. THE TWO INNER-MOST CIRCLES AND IN A BOW AT THE LOWER LEFT SIDE OF THE IMAGE.

FOR LINGERIE (U.S. CLS. 22 AND 39).  
PAUL E. FAHRENKOPF, EXAMINING ATTORNEY

SN 85-328,323. COX, SUE, WOODLAND HILLS, CA. FILED 5-24-2011.

**HEAVILY MEDITATED**

THE MARK CONSISTS OF STANDARD CHARACTERS WITHOUT CLAIM TO ANY PARTICULAR FONT, STYLE, SIZE, OR COLOR.

FOR BABY LAYETTES FOR CLOTHING; HATS; JACKETS; PANTS; SHIRTS; SHORTS; SWEATERS; SWEATSHIRTS; T-SHIRTS (U.S. CLS. 22 AND 39).

RUDY R. SINGLETON, EXAMINING ATTORNEY

**CLASS 25—(Continued).**

SN 85-328,350. MICHAEL SHEA, LAKE FOREST, IL. FILED 5-24-2011.

## Love My Earth

THE MARK CONSISTS OF STANDARD CHARACTERS WITHOUT CLAIM TO ANY PARTICULAR FONT, STYLE, SIZE, OR COLOR.

FOR BANDANAS; BATHING SUITS; BATHROBES; BEACH COVERUPS; BEACH FOOTWEAR; BEANIES; BELTS; BELTS MADE OF LEATHER; BELTS MADE OUT OF CLOTH; BLOUSES; BOXER SHORTS; BRAS; BUTTON DOWN SHIRTS; CAMP SHIRTS; CANVAS SHOES; CAP VISORS; CAPRI PANTS; CARGO PANTS; COATS; GLOVES; HATS; HEAD SCARVES; HEADBANDS; HEADWEAR; JACKETS; JERSEYS; LEGGINGS; LINGERIE; NECKTIES; PAJAMAS; PANTS; SHIRTS; SHORTS; SLEEPWEAR; SOCKS; SWEATERS; SWIM WEAR; UNDERWEAR; UNITARDS; VISORS; WARM UP SUITS; WIND PANTS; WIND RESISTANT JACKETS; WRISTBANDS; YOGA PANTS; YOGA SHIRTS (U.S. CLS. 22 AND 39).

ZHALEH DELANEY, EXAMINING ATTORNEY

SN 85-329,010. JONATHAN ABEL MENDIOLA, SAN DIEGO, CA. FILED 5-24-2011.

## Freshly Baked

THE MARK CONSISTS OF STANDARD CHARACTERS WITHOUT CLAIM TO ANY PARTICULAR FONT, STYLE, SIZE, OR COLOR.

FOR APPAREL FOR DANCERS, NAMELY, TEE SHIRTS, SWEATSHIRTS, PANTS, LEGGINGS, SHORTS AND JACKETS; BABY TOPS; BANDEAU TOPS; BASEBALL CAPS AND HATS; BEANIES; BODY SHIRTS; BUTTON DOWN SHIRTS; CLOTHING FOR BABIES, TODDLERS AND CHILDREN, TREATED WITH FIRE AND HEAT RETARDANTS, NAMELY, PAJAMAS, JACKETS, SHIRTS, PANTS, JUMPERS; COLLARED SHIRTS; CREW NECK SWEATERS; CROP TOPS; DRESS SHIRTS; HATS; HATS FOR INFANTS, BABIES, TODDLERS AND CHILDREN; HOODED SWEAT SHIRTS; KNIT SHIRTS; KNIT TOPS; LONG-SLEEVED SHIRTS; MATERNITY CLOTHING, NAMELY, SHIRTS; POLO KNIT TOPS; POLO SHIRTS; SHIRTS; SHIRTS AND SHORT-SLEEVED SHIRTS; SHIRTS FOR INFANTS, BABIES, TODDLERS AND CHILDREN; SHORT-SLEEVED OR LONG-SLEEVED T-SHIRTS; SHORT-SLEEVED SHIRTS; SNAP CROTCH SHIRTS FOR INFANTS AND TODDLERS; SPORTS CAPS AND HATS; SWEAT SHIRTS; SWEATERS; T-SHIRTS; TANK TOPS; TANK-TOPS; V-NECK SWEATERS; WOMEN'S CLOTHING, NAMELY, SHIRTS, DRESSES, SKIRTS, BLOUSES; WOMEN'S HATS AND HOODS; WOMEN'S TOPS, NAMELY, CAMIS (U.S. CLS. 22 AND 39).

THEODORE MCBRIDE, EXAMINING ATTORNEY

**CLASS 25—(Continued).**

SN 85-329,162. BAILEY, MEGHAN, WACO, GA. FILED 5-24-2011.

## Girls Gone Camo

THE MARK CONSISTS OF STANDARD CHARACTERS WITHOUT CLAIM TO ANY PARTICULAR FONT, STYLE, SIZE, OR COLOR.

FOR BATHING SUITS; BIKINIS; BRAS; CLOTHING, NAMELY, BASE LAYERS; FLIP FLOPS; GLOVES; HATS; HOODED SWEATSHIRTS; JACKETS; PANTS; SHIRTS; SHORTS; SWEATSUITS; T-SHIRTS; TANK TOPS; UNDERWEAR (U.S. CLS. 22 AND 39).

JACLYN KIDWELL WALKER, EXAMINING ATTORNEY

SN 85-329,261. METABOLIC BALANCE, INC., LA JOLLA, CA. FILED 5-24-2011.

## METABOLIC BALANCE

THE MARK CONSISTS OF STANDARD CHARACTERS WITHOUT CLAIM TO ANY PARTICULAR FONT, STYLE, SIZE, OR COLOR.

FOR CLOTHING, NAMELY, T-SHIRTS, HATS, POLO SHIRTS (U.S. CLS. 22 AND 39).

DAWN FELDMAN, EXAMINING ATTORNEY

SN 85-329,559. JOHNSON, JESSICA, ALBUQUERQUE, NM. FILED 5-25-2011.

## NakedAPE

THE MARK CONSISTS OF THE STYLIZED WORDS "NAKEDAPE". AN IMAGE OF A HAND PRINT TO THE RIGHT OF THE TEXT.

FOR SHIRTS (U.S. CLS. 22 AND 39).

ALLISON SCHRODY, EXAMINING ATTORNEY

**CLASS 25—(Continued).**

SN 85-330,858. CHARLES, ISSA, BROOKLYN, NY. FILED 5-26-2011.



THE MARK CONSISTS OF A ROCKET LEAVING THE EARTH HEADING INTO SPACE WITH THE WORDS "SKYY RICH" ON THE BASE, A POINTED NOSE WITH THREE RINGS BEFORE THE TIP ENDING WITH A SMALL BALL ON THE VERY END. THREE DOLLAR BILLS ARE WITHIN THE FLAMES COMING OUT THE ROCKET AND THE WORLD IS SURROUNDING BY DIFFERENT SHAPES OF STARS.

FOR BELTS; CAPS; T-SHIRTS (U.S. CLS. 22 AND 39).  
JOHN DWYER, EXAMINING ATTORNEY

**CLASS 25—(Continued).**

SN 85-331,556. TAMARINS SPORTS, LLC, DBA TAMARINS, DENVER, CO. FILED 5-26-2011.



THE MARK CONSISTS OF A STYLIZED DESIGN OF A TAMARINS FACE.

FOR A-SHIRTS; ATHLETIC APPAREL, NAMELY, SHIRTS, PANTS, JACKETS, FOOTWEAR, HATS AND CAPS, ATHLETIC UNIFORMS; BASEBALL CAPS; BASEBALL CAPS AND HATS; BASELAYER BOTTOMS; BASELAYER TOPS; BEANIES; BICYCLING GLOVES; CAP VISORS; CAPS; CROSS-COUNTRY GLOVES; DOWN JACKETS; GLOVES; GLOVES FOR APPAREL; GOLF CAPS; GOLF PANTS, SHIRTS AND SKIRTS; GOLF SHIRTS; HEAD WEAR; JACKET LINERS; JACKETS AND SOCKS; MOISTURE-WICKING SPORTS BRAS; MOISTURE-WICKING SPORTS PANTS; MOISTURE-WICKING SPORTS SHIRTS; OUTDOOR GLOVES; POLO SHIRTS; RAINPROOF JACKETS; RUGBY SHIRTS; SHELL JACKETS; SHIRTS; SKI JACKETS; SKI WEAR; SNOW BOARDING SUITS; SNOW BOOTS; SNOW PANTS; SNOW SUITS; SOCKS; SPORT SHIRTS; SPORTS BRA; SPORTS CAPS AND HATS; SPORTS JACKETS; SPORTS JERSEYS; SPORTS SHIRTS; SURF WEAR; SWEAT JACKETS; SWEAT SHIRTS; SWIM WEAR; T-SHIRTS; TEE SHIRTS; TENNIS WEAR; TRIATHLON CLOTHING, NAMELY, TRIATHLON TIGHTS, TRIATHLON SHORTS, TRIATHLON SINGLETS, TRIATHLON SHIRTS, TRIATHLON SUITS; WATERPROOF JACKETS AND PANTS; WEARABLE GARMENTS AND CLOTHING, NAMELY, SHIRTS; WIND RESISTANT JACKETS; WIND-JACKETS; YOGA PANTS; YOGA SHIRTS (U.S. CLS. 22 AND 39).

FIRST USE 4-8-2011; IN COMMERCE 4-8-2011.  
GEORGE LORENZO, EXAMINING ATTORNEY

SN 85-330,967. FERRIS, SHAWN, APOPKA, FL. FILED 5-26-2011.



THE MARK CONSISTS OF THE STYLIZED WORDS "SPIRIT LIFE". AN IMAGE OF A DOVE ABOVE.  
FOR HATS; SHIRTS (U.S. CLS. 22 AND 39).  
KATHLEEN LORENZO, EXAMINING ATTORNEY

SN 85-331,001. FITSOK, LLC, CHANHASSEN, MN. FILED 5-26-2011.

# RUN FOR IT

THE MARK CONSISTS OF STANDARD CHARACTERS WITHOUT CLAIM TO ANY PARTICULAR FONT, STYLE, SIZE, OR COLOR.

FOR ATHLETIC SOCKS, SHIRTS, AND HEADBANDS (U.S. CLS. 22 AND 39).  
KELLY TRUSILO, EXAMINING ATTORNEY

**CLASS 25—(Continued).**

SN 85-331,773. CRITCHLEY, ROBINA R., NAPA, CA. AND HAYNES, KRISTINA L., NAPA, CA. FILED 5-26-2011.



THE MARK CONSISTS OF THE STYLIZED TEXT "B4K", IN WHICH THERE IS A CROWN ON THE VERTICAL PART OF THE K. UNDER THIS TEXT IS THE STYLIZED TEXT "B4" WITH AN IMAGE OF A CROWN TO THE RIGHT. UNDERNEATH IN A SEMICIRCLE IS THE STYLIZED TEXT "BLING FOR THE KING", IN WHICH THERE IS A CROWN ON THE VERTICAL PART OF THE K.

FOR HATS; JACKETS; PANTS; SHIRTS; SHOES (U.S. CLS. 22 AND 39).

ALEX KEAM, EXAMINING ATTORNEY

SN 85-331,809. MURRAY, ALICIA, FT. LAUDERDALE, FL. AND MURRAY, CHRISTOPHER, FLORIDA, FL. FILED 5-26-2011.



THE MARK CONSISTS OF AN EYEBALL WITH THE STYLIZED TEXT "WITNESS" AND A CROSS AT THE END. FOR HATS; JACKETS; PANTS; SHIRTS; SHOES (U.S. CLS. 22 AND 39).

AMY HELLA, EXAMINING ATTORNEY

SN 85-331,954. KINGVIC FASHION CO., LIMITED, KL, HONG KONG, FILED 5-27-2011.

**TITIKAKA**

THE MARK CONSISTS OF STYLIZED LETTERS TITIKAKA.

FOR FOOTWEAR; BOOTS; HALF-BOOTS; LACE BOOTS; SPATS; GALOSHES; WOODEN SHOES; SANDALS; SHOES; SPORT SHOES (U.S. CLS. 22 AND 39).

CIMMERIAN COLEMAN, EXAMINING ATTORNEY

**CLASS 25—(Continued).**

SN 85-331,978. BUSHER, KELLY, CHARLOTTE, NC. FILED 5-27-2011.

**LIVE FREE AND DYE**

THE MARK CONSISTS OF STANDARD CHARACTERS WITHOUT CLAIM TO ANY PARTICULAR FONT, STYLE, SIZE, OR COLOR.

FOR CLOTHING, NAMELY, HATS SOCKS. T-SHIRTS, LONG SLEEVE SHIRTS, PANTS, SHORTS, SHOES, DRESSES, HOODED SWEATSHIRTS, SWEATERS, TANK-TOPS, DENIM (U.S. CLS. 22 AND 39).

JOHN HWANG, EXAMINING ATTORNEY

SN 85-332,053. STAGEONE SPORTS, REDONDO BEACH, CA. FILED 5-27-2011.

**StageOne**

THE MARK CONSISTS OF STANDARD CHARACTERS WITHOUT CLAIM TO ANY PARTICULAR FONT, STYLE, SIZE, OR COLOR.

FOR CYCLISTS' JERSEYS (U.S. CLS. 22 AND 39).

FIRST USE 1-1-2009; IN COMMERCE 1-1-2009.

SUNG IN, EXAMINING ATTORNEY

SN 85-332,087. FRASIER, TERRANCE, VIRGINIA BEACH, VA. FILED 5-27-2011.

**CAVANY**

THE MARK CONSISTS OF STANDARD CHARACTERS WITHOUT CLAIM TO ANY PARTICULAR FONT, STYLE, SIZE, OR COLOR.

FOR ATHLETIC APPAREL, NAMELY, SHIRTS, PANTS, JACKETS, FOOTWEAR, HATS AND CAPS, ATHLETIC UNIFORMS; BASEBALL CAPS AND HATS; CAPS; DRESS SHIRTS; HOODED SWEAT SHIRTS; LONG-SLEEVED SHIRTS; PANTS; SHIRTS; SHIRTS AND SHORT-SLEEVED SHIRTS; SHORT-SLEEVED SHIRTS; SPORT SHIRTS; SPORTS SHIRTS; SPORTS SHIRTS WITH SHORT SLEEVES; SWEAT PANTS; SWEAT SHIRTS; T-SHIRTS; TEE SHIRTS; TOPS; WEARABLE GARMENTS AND CLOTHING, NAMELY, SHIRTS; WOMEN'S CLOTHING, NAMELY, SHIRTS, DRESSES, SKIRTS, BLOUSES (U.S. CLS. 22 AND 39).

FIRST USE 1-1-2009; IN COMMERCE 6-26-2009.

JOHN WILKE, EXAMINING ATTORNEY

**CLASS 25—(Continued).**

SN 85-332,134. STANOJEVIC, DEJAN, DOWNEY, CA. FILED 5-27-2011.



THE MARK CONSISTS OF THE STYLIZED TEXT "R" IN A BOX.  
FOR HATS; SHIRTS; SHORTS; T-SHIRTS (U.S. CLS. 22 AND 39).  
KEVON CHISOLM, EXAMINING ATTORNEY

SN 85-332,143. TILLEY, JOHN, BILLERICA, MA. FILED 5-27-2011.

It's me against the world,  
and the world is  
outnumbered.

THE MARK CONSISTS OF STANDARD CHARACTERS WITHOUT CLAIM TO ANY PARTICULAR FONT, STYLE, SIZE, OR COLOR.  
FOR T-SHIRTS (U.S. CLS. 22 AND 39).  
KEVON CHISOLM, EXAMINING ATTORNEY

SN 85-332,148. FAYGO, BRAZIL, AKA ABDULLA TAFEEQ, WESTLAKE, OH. FILED 5-27-2011.

ADORADIVA

THE MARK CONSISTS OF STANDARD CHARACTERS WITHOUT CLAIM TO ANY PARTICULAR FONT, STYLE, SIZE, OR COLOR.  
FOR CAPS WITH VISORS; COLLARED SHIRTS; GLOVES; HATS; LADIES' UNDERWEAR; PANTS; POLO SHIRTS; ROBES; SCARVES; SHIRTS; SHIRTS FOR INFANTS, BABIES, TODDLERS AND CHILDREN; SHORTS; SKIRTS; SOCKS; STRETCH PANTS; SWEAT PANTS; SWEAT SHIRTS; T-SHIRTS; UNDERWEAR; WOMEN'S CLOTHING, NAMELY, SHIRTS, DRESSES, SKIRTS, BLOUSES; WOMEN'S HATS AND HOODS; WOMEN'S UNDERWEAR (U.S. CLS. 22 AND 39).  
KEVON CHISOLM, EXAMINING ATTORNEY

**CLASS 25—(Continued).**

SN 85-332,260. MORE THAN BIKES, INC., CARLSBAD, CA. FILED 5-27-2011.

SGX

THE MARK CONSISTS OF STANDARD CHARACTERS WITHOUT CLAIM TO ANY PARTICULAR FONT, STYLE, SIZE, OR COLOR.  
FOR CLOTHING, NAMELY, ARM WARMERS; SOCKS; T-SHIRTS; UNDERWEAR (U.S. CLS. 22 AND 39).  
DAVID H. STINE, EXAMINING ATTORNEY

SN 85-332,311. ALICE RITTER, NEW YORK, NY. FILED 5-27-2011.

PIPETTE

THE MARK CONSISTS OF STANDARD CHARACTERS WITHOUT CLAIM TO ANY PARTICULAR FONT, STYLE, SIZE, OR COLOR.  
THE ENGLISH TRANSLATION OF "PIPETTE" IN THE MARK IS "TALKATIVE".  
FOR BELTS; BRAS; CAMISOLES; COATS; DRESSES; HATS; JACKETS; LADIES' UNDERWEAR; LEGGINGS; PANTIES; PANTS; SCARVES; SHIRTS; SHOES; SHORTS; SKIRTS; SOCKS; SWEATERS; TOPS (U.S. CLS. 22 AND 39).  
NAKIA HENRY, EXAMINING ATTORNEY

SN 85-332,355. JORDAN R. QUIRICONI, NAPERVILLE, IL. FILED 5-27-2011.

Go Get Great

THE MARK CONSISTS OF STANDARD CHARACTERS WITHOUT CLAIM TO ANY PARTICULAR FONT, STYLE, SIZE, OR COLOR.  
FOR APPAREL, NAMELY, SHIRTS, PANTS, HATS, JACKETS, SHORTS (U.S. CLS. 22 AND 39).  
MARK SHINER, EXAMINING ATTORNEY

**CLASS 25—(Continued).**

SN 85-332,387. ARTEST MEDIA GROUP, LLC, BEVERLY HILLS, CA. FILED 5-27-2011.

# 7059

THE MARK CONSISTS OF STANDARD CHARACTERS WITHOUT CLAIM TO ANY PARTICULAR FONT, STYLE, SIZE, OR COLOR.

FOR JACKETS; JERSEYS; T-SHIRTS; WEARABLE GARMENTS AND CLOTHING, NAMELY, SHIRTS; WOMEN'S CLOTHING, NAMELY, SHIRTS, DRESSES, SKIRTS, BLOUSES (U.S. CLS. 22 AND 39).

KATHRYN COWARD, EXAMINING ATTORNEY

---

SN 85-332,565. CASA COUTURE, INC., OAKLAND PARK, FL. FILED 5-27-2011.

# CASA COUTURE

THE MARK CONSISTS OF STANDARD CHARACTERS WITHOUT CLAIM TO ANY PARTICULAR FONT, STYLE, SIZE, OR COLOR.

OWNER OF U.S. REG. NOS. 3,762,816 AND 3,914,107.

NO CLAIM IS MADE TO THE EXCLUSIVE RIGHT TO USE "COUTURE", APART FROM THE MARK AS SHOWN.

THE ENGLISH TRANSLATION OF "CASA" IN THE MARK IS "HOUSE".

FOR BELTS FOR CLOTHING; COATS; DRESSES; GLOVES; HATS; JACKETS; LEGGINGS; LINGERIE; NIGHTGOWNS; PANTS; SCARVES; SHIRTS; SHORTS; SKIRTS; SWEATERS; SWIM SUITS (U.S. CLS. 22 AND 39).

FIRST USE 8-13-2008; IN COMMERCE 8-13-2008.  
SIMON TENG, EXAMINING ATTORNEY

---

SN 85-332,701. LIZA CHRISTINA GARMENTS USA INC., LOS ANGELES, CA. FILED 5-27-2011.

# DONITA

THE MARK CONSISTS OF STANDARD CHARACTERS WITHOUT CLAIM TO ANY PARTICULAR FONT, STYLE, SIZE, OR COLOR.

FOR CLOTHING FOR GIRLS, NAMELY, DRESSES, BLOUSES, T-SHIRTS, JACKETS, SKIRTS, JEANS, TROUSERS, SHORTS, JUMPERS, SOCKS, SHOES AND UNDERWEAR (U.S. CLS. 22 AND 39).

FIRST USE 3-14-2011; IN COMMERCE 3-14-2011.  
ROSELLE HERRERA, EXAMINING ATTORNEY

**CLASS 25—(Continued).**

SN 85-332,792. HAMMOND, ISAAC, GRAPEVINE, TX. FILED 5-27-2011.



THE MARK CONSISTS OF A LABRADOR WITH THE STYLIZED TEXT "MAJOR PAIN" BELOW. TO THE RIGHT THERE IS THE STYLIZED TEXT "MAJOR PAIN BAD DOGS. GOOD TIMES".

FOR HATS; T-SHIRTS; TIES (U.S. CLS. 22 AND 39).  
SANI KHOURI, EXAMINING ATTORNEY

---

SN 85-332,945. WALKER, LOUQUAN, UTICA, NY. FILED 5-27-2011.

# YND (YUNG-N-DIP)

THE MARK CONSISTS OF STANDARD CHARACTERS WITHOUT CLAIM TO ANY PARTICULAR FONT, STYLE, SIZE, OR COLOR.

FOR CLOTHING, NAMELY, TOPS, BOTTOMS, SHIRTS, T-SHIRT, PANTS, SHORTS, BELTS, HATS (U.S. CLS. 22 AND 39).

REBECCA SMITH, EXAMINING ATTORNEY

---

SN 85-332,995. NOLAN, BRENDAN, UXBRIDGE, MA. AND NOLAN, NOLAN, UXBRIDGE, MA. FILED 5-27-2011.

# Straight Fly

THE MARK CONSISTS OF STANDARD CHARACTERS WITHOUT CLAIM TO ANY PARTICULAR FONT, STYLE, SIZE, OR COLOR.

FOR HATS; T-SHIRTS (U.S. CLS. 22 AND 39).  
MARCIE MILONE, EXAMINING ATTORNEY

**CLASS 25—(Continued).**

SN 85-333,037. NAUTIYACHTIES LLC, HONOLULU, HI.  
FILED 5-28-2011.

## Nauti Yachties

THE MARK CONSISTS OF STANDARD CHARACTERS WITHOUT CLAIM TO ANY PARTICULAR FONT, STYLE, SIZE, OR COLOR.

FOR BOTTOMS; BUSTIERS; COVERUPS; HOODED SWEATSHIRTS; LINGERIE; NIGHTIES; SWIMWEAR; TOPS (U.S. CLS. 22 AND 39).

BRENDAN REGAN, EXAMINING ATTORNEY

SN 85-333,132. LIMBERS, THERESE, BLOOMINGDALE, IL.  
FILED 5-28-2011.

Think you've got it BAD?  
Try sitting in my DIAPER!

THE MARK CONSISTS OF STANDARD CHARACTERS WITHOUT CLAIM TO ANY PARTICULAR FONT, STYLE, SIZE, OR COLOR.

FOR CLOTHING FOR BABIES, TODDLERS AND CHILDREN, TREATED WITH FIRE AND HEAT RETARDANTS, NAMELY, PAJAMAS, JACKETS, SHIRTS, PANTS, AND JUMPERS (U.S. CLS. 22 AND 39).

ANDREA HACK, EXAMINING ATTORNEY

SN 85-333,171. ZACHEIS, CRAIG, C, SAN DIEGO, CA. AND HOWES, WILLIAM, R. TORRANCE, CA. AND NIELSEN, SOREN, K, DK8300 ODDER, DENMARK, FILED 5-28-2011.

## OLLO

THE MARK CONSISTS OF STANDARD CHARACTERS WITHOUT CLAIM TO ANY PARTICULAR FONT, STYLE, SIZE, OR COLOR.

FOR ATHLETIC APPAREL, NAMELY, SHIRTS, PANTS, JACKETS, FOOTWEAR, HATS AND CAPS, ATHLETIC UNIFORMS; BEANIES; FOOTWEAR; HOODED PULLOVERS; HOODED SWEATSHIRTS; IN-SOLES FOR FOOTWEAR; SOCKS; SWEAT BANDS; SWEAT PANTS; SWEAT SHIRTS; T-SHIRTS; WRIST-BANDS (U.S. CLS. 22 AND 39).

SKYE YOUNG, EXAMINING ATTORNEY

**CLASS 25—(Continued).**

SN 85-333,315. EASEPAL ENTERPRISES LTD, FUJIAN PROVINCE, CHINA, FILED 5-30-2011.



THE MARK CONSISTS OF THE STYLIZED WORD KNINK ON THE LEFT, AND TWO CHINESE CHARACTERS WHICH TRANSLITERATE INTO YIN KE ON THE RIGHT. THE WORDING KNINK HAS NO MEANING IN A FOREIGN LANGUAGE.

THE NON-LATIN CHARACTERS IN THE MARK TRANSLITERATE TO YIN; KE AND THIS MEANS STAMP; GUEST IN ENGLISH.

FOR APRONS; BATH SLIPPERS; BOOTS; CAMISOLES; CAPS; COATS; FOOTWEAR; GLOVES; HOSIERY; LEATHER BELTS; SANDALS; SCARVES; SHOULDER WRAPS; SPORTS JERSEYS; SWIMSUITS; TEE SHIRTS; TURBANS; UNDER GARMENTS (U.S. CLS. 22 AND 39).

BARBARA BROWN, EXAMINING ATTORNEY

SN 85-333,320. GUANGZHOU NAIDA SHOES CO., LTD., PANYU ZONE, GUANGZHOU, CHINA, FILED 5-30-2011.



## GODE

THE MARK CONSISTS OF A PROFILE OF A MAN ENCIRCLED BY A VINE ABOVE THE WORD "GODE".

FOR SHOES (U.S. CLS. 22 AND 39).

TOBY BULLOFF, EXAMINING ATTORNEY

**CLASS 25—(Continued).**

SN 85-333,372. C&T 413 LLC, SOUTHFIELD, MI. FILED 5-30-2011.

She Hoops

THE MARK CONSISTS OF STANDARD CHARACTERS WITHOUT CLAIM TO ANY PARTICULAR FONT, STYLE, SIZE, OR COLOR.

FOR A-SHIRTS; APPAREL FOR DANCERS, NAMELY, TEE SHIRTS, SWEATSHIRTS, PANTS, LEGGINGS, SHORTS AND JACKETS; ATHLETIC APPAREL, NAMELY, SHIRTS, PANTS, JACKETS, FOOTWEAR, HATS AND CAPS, ATHLETIC UNIFORMS; BODY SHIRTS; BUTTON DOWN SHIRTS; BUTTON-FRONT ALOHA SHIRTS; CAMOUFLAGE SHIRTS; CAMP SHIRTS; CLOTHING FOR ATHLETIC USE, NAMELY, PADDED SHIRTS; CLOTHING FOR BABIES, TODDLERS AND CHILDREN, TREATED WITH FIRE AND HEAT RETARDANTS, NAMELY, PAJAMAS, JACKETS, SHIRTS, PANTS, JUMPERS; CLOTHING SHIELDS, NAMELY, PADS APPLIED TO THE UNDERARMS OF SHIRTS, BLOUSES AND SWEATERS; COLLARED SHIRTS; DRESS SHIRTS; FISHING SHIRTS; GOLF PANTS, SHIRTS AND SKIRTS; GOLF SHIRTS; HOODED SWEAT SHIRTS; HUNTING SHIRTS; KNIT SHIRTS; LEATHER SHIRTS; LONG-SLEEVED SHIRTS; MOISTURE-WICKING SPORTS SHIRTS; NIGHT SHIRTS; OPEN-NECKED SHIRTS; OVER SHIRTS; PIQUE SHIRTS; POLO SHIRTS; RUGBY SHIRTS; SCIENTIFIC AND TECHNOLOGICAL APPAREL, NAMELY, SHIRTS, PANTS, JACKETS, FOOTWEAR, HATS AND CAPS, UNIFORMS; SHIRT FRONTS; SHIRT INSERTS, NAMELY, DICKIES; SHIRT YOKES; SHIRTS; SHIRTS AND SHORT-SLEEVED SHIRTS; SHIRTS AND SLIPS; SHIRTS FOR INFANTS, BABIES, TODDLERS AND CHILDREN; SHIRTS FOR SUITS; SHORT-SLEEVED OR LONG-SLEEVED T-SHIRTS; SHORT-SLEEVED SHIRTS; SLEEP SHIRTS; SLEEVES WORN SEPARATE AND APART FROM BLOUSES, SHIRTS AND OTHER TOPS; SNAP CROTCH SHIRTS FOR INFANTS AND TODDLERS; SPORT SHIRTS; SPORTS SHIRTS; SPORTS SHIRTS WITH SHORT SLEEVES; SWEAT SHIRTS; T-SHIRTS; TEE SHIRTS; TRIATHLON CLOTHING, NAMELY, TRIATHLON TIGHTS, TRIATHLON SHORTS, TRIATHLON SINGLET, TRIATHLON SHIRTS, TRIATHLON SUITS; TURTLE NECK SHIRTS; WEARABLE GARMENTS AND CLOTHING, NAMELY, SHIRTS; WIND SHIRTS; WOMEN'S CLOTHING, NAMELY, SHIRTS, DRESSES, SKIRTS, BLOUSES; YOGA SHIRTS (U.S. CLS. 22 AND 39).

JAY FLOWERS, EXAMINING ATTORNEY

**CLASS 25—(Continued).**

SN 85-333,375. C&T 413 LLC, SOUTHFIELD, MI. FILED 5-30-2011.

HΦH

THE MARK CONSISTS OF THE MARK CONSISTS OF THE LETTER H, GREEK SYMBOL FOR "PHI", AND ANOTHER LETTER H.

FOR A-SHIRTS; APPAREL FOR DANCERS, NAMELY, TEE SHIRTS, SWEATSHIRTS, PANTS, LEGGINGS, SHORTS AND JACKETS; ATHLETIC APPAREL, NAMELY, SHIRTS, PANTS, JACKETS, FOOTWEAR, HATS AND CAPS, ATHLETIC UNIFORMS; BODY SHIRTS; BUTTON DOWN SHIRTS; BUTTON-FRONT ALOHA SHIRTS; CAMOUFLAGE SHIRTS; CAMP SHIRTS; CLOTHING FOR ATHLETIC USE, NAMELY, PADDED SHIRTS; CLOTHING FOR BABIES, TODDLERS AND CHILDREN, TREATED WITH FIRE AND HEAT RETARDANTS, NAMELY, PAJAMAS, JACKETS, SHIRTS, PANTS, JUMPERS; CLOTHING SHIELDS, NAMELY, PADS APPLIED TO THE UNDERARMS OF SHIRTS, BLOUSES AND SWEATERS; COLLARED SHIRTS; DRESS SHIRTS; FISHING SHIRTS; GOLF PANTS, SHIRTS AND SKIRTS; GOLF SHIRTS; HOODED SWEAT SHIRTS; HUNTING SHIRTS; KNIT SHIRTS; LEATHER SHIRTS; LONG-SLEEVED SHIRTS; MOISTURE-WICKING SPORTS SHIRTS; NIGHT SHIRTS; OPEN-NECKED SHIRTS; OVER SHIRTS; PIQUE SHIRTS; POLO SHIRTS; RUGBY SHIRTS; SCIENTIFIC AND TECHNOLOGICAL APPAREL, NAMELY, SHIRTS, PANTS, JACKETS, FOOTWEAR, HATS AND CAPS, UNIFORMS; SHIRT FRONTS; SHIRT INSERTS, NAMELY, DICKIES; SHIRT YOKES; SHIRTS; SHIRTS AND SHORT-SLEEVED SHIRTS; SHIRTS AND SLIPS; SHIRTS FOR INFANTS, BABIES, TODDLERS AND CHILDREN; SHIRTS FOR SUITS; SHORT-SLEEVED OR LONG-SLEEVED T-SHIRTS; SHORT-SLEEVED SHIRTS; SLEEP SHIRTS; SLEEVES WORN SEPARATE AND APART FROM BLOUSES, SHIRTS AND OTHER TOPS; SNAP CROTCH SHIRTS FOR INFANTS AND TODDLERS; SPORT SHIRTS; SPORTS SHIRTS; SPORTS SHIRTS WITH SHORT SLEEVES; SWEAT SHIRTS; T-SHIRTS; TEE SHIRTS; TRIATHLON CLOTHING, NAMELY, TRIATHLON TIGHTS, TRIATHLON SHORTS, TRIATHLON SINGLET, TRIATHLON SHIRTS, TRIATHLON SUITS; TURTLE NECK SHIRTS; WEARABLE GARMENTS AND CLOTHING, NAMELY, SHIRTS; WIND SHIRTS; WOMEN'S CLOTHING, NAMELY, SHIRTS, DRESSES, SKIRTS, BLOUSES; YOGA SHIRTS (U.S. CLS. 22 AND 39).

JAY FLOWERS, EXAMINING ATTORNEY



**CLASS 25—(Continued).**

SN 85-333,381. C&T 413 LLC, SOUTHFIELD, MI. FILED 5-30-2011.



THE MARK CONSISTS OF THE WORD "HOOP" AS IN "BASKETBALL HOOP" IS USED TWICE IN THE MARK. THE GREEK SYMBOL FOR "PHI" IS USED IN THE MARK. THE WHOLE PHRASE IN THE MARK IS HOOP (GREEK SYMBOL) HOOP.

FOR A-SHIRTS; APPAREL FOR DANCERS, NAMELY, TEE SHIRTS, SWEATSHIRTS, PANTS, LEGGINGS, SHORTS AND JACKETS; ATHLETIC APPAREL, NAMELY, SHIRTS, PANTS, JACKETS, FOOTWEAR, HATS AND CAPS, ATHLETIC UNIFORMS; BODY SHIRTS; BUTTON DOWN SHIRTS; BUTTON-FRONT ALOHA SHIRTS; CAMOUFLAGE SHIRTS; CAMP SHIRTS; CLOTHING FOR ATHLETIC USE, NAMELY, PADDED SHIRTS; CLOTHING FOR BABIES, TODDLERS AND CHILDREN, TREATED WITH FIRE AND HEAT RETARDANTS, NAMELY, PAJAMAS, JACKETS, SHIRTS, PANTS, JUMPERS; CLOTHING SHIELDS, NAMELY, PADS APPLIED TO THE UNDERARMS OF SHIRTS, BLOUSES AND SWEATERS; COLLARED SHIRTS; DRESS SHIRTS; FISHING SHIRTS; GOLF PANTS, SHIRTS AND SKIRTS; GOLF SHIRTS; HOODED SWEAT SHIRTS; HUNTING SHIRTS; KNIT SHIRTS; LEATHER SHIRTS; LONG-SLEEVED SHIRTS; MOISTURE-WICKING SPORTS SHIRTS; NIGHT SHIRTS; OPEN-NECKED SHIRTS; OVER SHIRTS; PIQUE SHIRTS; POLO SHIRTS; RUGBY SHIRTS; SCIENTIFIC AND TECHNOLOGICAL APPAREL, NAMELY, SHIRTS, PANTS, JACKETS, FOOTWEAR, HATS AND CAPS, UNIFORMS; SHIRT FRONTS; SHIRT INSERTS, NAMELY, DICKIES; SHIRT YOKES; SHIRTS; SHIRTS AND SHORT-SLEEVED SHIRTS; SHIRTS AND SLIPS; SHIRTS FOR INFANTS, BABIES, TODDLERS AND CHILDREN; SHIRTS FOR SUITS; SHORT-SLEEVED OR LONG-SLEEVED T-SHIRTS; SHORT-SLEEVED SHIRTS; SLEEP SHIRTS; SLEEVES WORN SEPARATE AND APART FROM BLOUSES, SHIRTS AND OTHER TOPS; SNAP CROTCH SHIRTS FOR INFANTS AND TODDLERS; SPORT SHIRTS; SPORTS SHIRTS; SPORTS SHIRTS WITH SHORT SLEEVES; SWEAT SHIRTS; T-SHIRTS; TEE SHIRTS; TRIATHLON CLOTHING, NAMELY, TRIATHLON TIGHTS, TRIATHLON SHORTS, TRIATHLON SINGLETTS, TRIATHLON SHIRTS, TRIATHLON SUITS; TURTLE NECK SHIRTS; WEARABLE GARMENTS AND CLOTHING, NAMELY, SHIRTS; WIND SHIRTS; WOMEN'S CLOTHING, NAMELY, SHIRTS, DRESSES, SKIRTS, BLOUSES; YOGA SHIRTS (U.S. CLS. 22 AND 39).

JAY FLOWERS, EXAMINING ATTORNEY

**CLASS 25—(Continued).**

SN 85-333,570. ISMAIL LUKARCANIN, CLIFTON, NJ. FILED 5-31-2011.

## MODOLOGIJA

THE MARK CONSISTS OF STANDARD CHARACTERS WITHOUT CLAIM TO ANY PARTICULAR FONT, STYLE, SIZE, OR COLOR.

FOR CLOTHING, NAMELY, T-SHIRTS, SHIRTS, CAPS AND HATS, PANTS, SWEATERS, UNDERWEAR, SOCKS, BELTS AND WRIST BANDS (U.S. CLS. 22 AND 39).

DAVID YONTEF, EXAMINING ATTORNEY

SN 85-333,582. HROMADA, STEPHEN, WHEATLEY HEIGHTS, NY. FILED 5-31-2011.

## SURE THING KNOCKOUTS

THE MARK CONSISTS OF STANDARD CHARACTERS WITHOUT CLAIM TO ANY PARTICULAR FONT, STYLE, SIZE, OR COLOR.

FOR SHIRTS; T-SHIRTS (U.S. CLS. 22 AND 39).

LINDA ORNDORFF, EXAMINING ATTORNEY

SN 85-333,596. RAFFERTY, DUSTIN, CHULA VISTA, CA. FILED 5-31-2011.

## Pure Entrepreneur

THE MARK CONSISTS OF STANDARD CHARACTERS WITHOUT CLAIM TO ANY PARTICULAR FONT, STYLE, SIZE, OR COLOR.

FOR HATS; JACKETS; LONG-SLEEVED SHIRTS; SHIRTS; SWEATSHIRTS; T-SHIRTS (U.S. CLS. 22 AND 39).

WENDY GOODMAN, EXAMINING ATTORNEY

**CLASS 25—(Continued).**

SN 85-333,673. MCINTOSH, PAULA JOY BALASCH, INVERNESS, FL. FILED 5-31-2011.

**NO TIME FOR HATERS**

THE MARK CONSISTS OF STANDARD CHARACTERS WITHOUT CLAIM TO ANY PARTICULAR FONT, STYLE, SIZE, OR COLOR.

FOR HEADGEAR, NAMELY, HATS AND CAPS; BOXER SHORTS; FLIP FLOPS; JACKETS; PANTS; SHIRTS; SHOES; SHORTS; SWEAT PANTS; SWEATSHIRTS; T-SHIRTS; UNDERWEAR (U.S. CLS. 22 AND 39).

FIRST USE 5-18-2011; IN COMMERCE 5-18-2011.  
WANDA KAY PRICE, EXAMINING ATTORNEY

SN 85-333,704. BELL, WILLIAM, FT. COLLINS, CO. FILED 5-31-2011.



THE MARK CONSISTS OF THE STYLIZED TEXT "S" IN THE CENTER OF A STAR.

FOR CAPS; DRESSES; PANTS; SHIRTS; SHORTS; T-SHIRTS; TIES (U.S. CLS. 22 AND 39).  
APRIL HESIK, EXAMINING ATTORNEY

SN 85-333,750. CHAPPELL, CASANDRA, ATLANTA, GA. FILED 5-31-2011.



THE MARK CONSISTS OF THE STYLIZED TEXT "SF" INSIDE A STYLIZED TEXT "SF". BELOW THERE IS THE STYLIZED TEXT "SAVED FOLK SEEK FIRST".

FOR SHORTS; SWEATSHIRTS; T-SHIRTS (U.S. CLS. 22 AND 39).  
FIRST USE 10-11-2009; IN COMMERCE 2-2-2011.  
GINA FINK, EXAMINING ATTORNEY

**CLASS 25—(Continued).**

SN 85-333,814. HARD RIGHT LLC, DELAFIELD, WI. FILED 5-31-2011.

**FAR LEFT**

THE MARK CONSISTS OF STANDARD CHARACTERS WITHOUT CLAIM TO ANY PARTICULAR FONT, STYLE, SIZE, OR COLOR.

FOR BELTS; CAPS; FOOTWEAR; HATS; HEADBANDS; JACKETS; LONG-SLEEVED SHIRTS; PANTS; POLO SHIRTS; SHORT-SLEEVED SHIRTS; SHORTS; SWEAT SHIRTS; T-SHIRTS; TIES; UNDERWEAR; WEARABLE GARMENTS AND CLOTHING, NAMELY, SHIRTS (U.S. CLS. 22 AND 39).

FIRST USE 2-15-2011; IN COMMERCE 2-15-2011.  
AMY KERTGATE, EXAMINING ATTORNEY

SN 85-333,914. NEW ENGLAND FOOTWEAR, LLC, NEW-MARKET, NH. FILED 5-31-2011.

**ROCK ABSORBER**

THE MARK CONSISTS OF STANDARD CHARACTERS WITHOUT CLAIM TO ANY PARTICULAR FONT, STYLE, SIZE, OR COLOR.

FOR FOOTWEAR (U.S. CLS. 22 AND 39).  
HOWARD SMIGA, EXAMINING ATTORNEY

SN 85-333,925. NEW ENGLAND FOOTWEAR, LLC, NEW-MARKET, NH. FILED 5-31-2011.

**ZERO IMPACT**

THE MARK CONSISTS OF STANDARD CHARACTERS WITHOUT CLAIM TO ANY PARTICULAR FONT, STYLE, SIZE, OR COLOR.

FOR FOOTWEAR (U.S. CLS. 22 AND 39).  
HOWARD SMIGA, EXAMINING ATTORNEY

**CLASS 25—(Continued).**

SN 85-334,018. CHA, JUN, CULVER CITY, CA. FILED 5-31-2011.

# LUX AETERNA

THE MARK CONSISTS OF STANDARD CHARACTERS WITHOUT CLAIM TO ANY PARTICULAR FONT, STYLE, SIZE, OR COLOR.

THE ENGLISH TRANSLATION OF "LUX AETERNA" IN THE MARK IS "ETERNAL LIGHT".

FOR HATS; JACKETS; SHIRTS; T-SHIRTS (U.S. CLS. 22 AND 39).

TAMARA FRAZIER, EXAMINING ATTORNEY

SN 85-334,060. TAGORDA, RICHARD, ALEXANDRIA, VA. AND BADLEY, BASIL, ALEXANDRIA, VA. AND TAGORDA, KRISTINE, ALEXANDRIA, VA. AND BADLEY, LEILANI, ALEXANDRIA, VA. AND TAGORDA, REYNOLD, ALEXANDRIA, VA. AND TAGORDA, JORDAN, ALEXANDRIA, VA. FILED 5-31-2011.

# Das Cherry

THE MARK CONSISTS OF STANDARD CHARACTERS WITHOUT CLAIM TO ANY PARTICULAR FONT, STYLE, SIZE, OR COLOR.

FOR BOARD SHORTS; HATS; PANTS; SHIRTS; SHORTS; SWIM SUITS (U.S. CLS. 22 AND 39).

FRED CARL, EXAMINING ATTORNEY

SN 85-334,080. FERRELL, CHARLES, TROY, OH. FILED 5-31-2011.



THE MARK CONSISTS OF THE TEXT "SKULL13" WRITTEN ABOVE A SKULL WITHOUT A JAW BONE, AND THE NUMBER "13" BELOW.

FOR HATS; JACKETS; SCARVES; SHIRTS (U.S. CLS. 22 AND 39).

FIRST USE 7-0-2008; IN COMMERCE 11-13-2010. EDWARD FENNESSY, EXAMINING ATTORNEY

**CLASS 25—(Continued).**

SN 85-334,218. HOLDEN LLC, PORTLAND, OR. FILED 5-31-2011.

# THANK YOU FOR BEING YOU

THE MARK CONSISTS OF STANDARD CHARACTERS WITHOUT CLAIM TO ANY PARTICULAR FONT, STYLE, SIZE, OR COLOR.

FOR CLOTHING, NAMELY, JACKETS, SWEATERS, SWEATSHIRTS, PANTS, T-SHIRTS, SHIRTS, VESTS AND OUTERWEAR, NAMELY, SNOW PANTS, SNOW JACKETS, SNOW SUITS, INSULATED AND THERMAL PANTS, JACKETS, AND SHIRTS; HEADGEAR, NAMELY, HATS, CAPS; FOOTWEAR; SNOWBOARDING BOOTS (U.S. CLS. 22 AND 39).

FIRST USE 0-0-2006; IN COMMERCE 0-0-2006.

ANGELA M. MICHELI, EXAMINING ATTORNEY

SN 85-334,255. FLORES, SERGIO, MENIFEE, CA. FILED 5-31-2011.



THE COLOR(S) PINK, YELLOW IS/ARE CLAIMED AS A FEATURE OF THE MARK.

THE MARK CONSISTS OF THE IMAGE OF A HEART IN PINK COLOR AT THE CENTER OF A DESIGN WITH EIGHT RAYS LIKE FIGURES IN YELLOW AND PINK COMBINATION COMING OUT WITH A STAR IN PINK COLOR OUTLINED WITH YELLOW AT THE TOP LEFT, RIGHT AND BOTTOM AS SHOWN IN THE MARK.

FOR CLOTHING, NAMELY, TOPS, BOTTOMS, T-SHIRTS, SWEAT PANTS, SWEAT SHIRTS, SHORTS, SOCKS, BELTS, TANK TOPS, SHIRTS (U.S. CLS. 22 AND 39).

MELISSA VALLILLO, EXAMINING ATTORNEY

**CLASS 25—(Continued).**

SN 85-334,265. NOVUS, INC., GUAYNABO, PUERTO RICO, FILED 5-31-2011.

## Marco Moretti

THE MARK CONSISTS OF STANDARD CHARACTERS WITHOUT CLAIM TO ANY PARTICULAR FONT, STYLE, SIZE, OR COLOR.

THE NAME(S), PORTRAIT(S), AND/OR SIGNATURE(S) SHOWN IN THE MARK DOES NOT IDENTIFY A PARTICULAR LIVING INDIVIDUAL.

FOR MEN'S SHOES (U.S. CLS. 22 AND 39).

CIMMERIAN COLEMAN, EXAMINING ATTORNEY

---

SN 85-334,274. KHALIL RAFATI, MALIBU, CA. FILED 5-31-2011.



THE MARK CONSISTS OF A SIDEWAYS (HORIZONTAL) IMAGE OF THE NUMBER 2 WITH STYLIZED LETTERS UNDERNEATH SPELLING THE WORD "LIBERATE".

FOR ATHLETIC APPAREL, NAMELY, SHIRTS, PANTS, JACKETS, FOOTWEAR, HATS AND CAPS, ATHLETIC UNIFORMS; BELTS; BOTTOMS; HATS; JACKETS; LEATHER BELTS; SWEATPANTS; SWEATSHIRTS; TOPS; WEARABLE GARMENTS AND CLOTHING, NAMELY, SHIRTS; WOMEN'S CLOTHING, NAMELY, SHIRTS, DRESSES, SKIRTS, BLOUSES (U.S. CLS. 22 AND 39).

WILLIAM P. SHANAHAN, EXAMINING ATTORNEY

---

SN 85-334,338. NOEL APPAREL GROUP, INC, DELRAY BEACH, FL. FILED 5-31-2011.

## LIVE INS

THE MARK CONSISTS OF STANDARD CHARACTERS WITHOUT CLAIM TO ANY PARTICULAR FONT, STYLE, SIZE, OR COLOR.

FOR BELTS; HATS; PANTS; SHIRTS; SHOES; SNEAKERS; SOCKS; UNDERWEAR (U.S. CLS. 22 AND 39).

FIRST USE 9-1-2000; IN COMMERCE 9-1-2000.

ANGELA M. MICHELI, EXAMINING ATTORNEY

**CLASS 25—(Continued).**

SN 85-334,345. MARTIN, KRIS, ELKHART, IN. FILED 5-31-2011.

## fly gang

THE MARK CONSISTS OF STANDARD CHARACTERS WITHOUT CLAIM TO ANY PARTICULAR FONT, STYLE, SIZE, OR COLOR.

FOR CLOTHING, NAMELY, T-SHIRTS, JACKET, SHORT-SLEEVED OR LONG-SLEEVED T-SHIRTS, V-NECK SHIRTS, HOODED SWEATSHIRTS, HATS, AND CAPS (U.S. CLS. 22 AND 39).

B. PARADEWELAI, EXAMINING ATTORNEY

---

SN 85-334,383. KELLWOOD COMPANY, CHESTERFIELD, MO. FILED 5-31-2011.

## MELISSA HARPER

THE MARK CONSISTS OF STANDARD CHARACTERS WITHOUT CLAIM TO ANY PARTICULAR FONT, STYLE, SIZE, OR COLOR.

OWNER OF U.S. REG. NO. 1,640,586.

THE NAME(S), PORTRAIT(S), AND/OR SIGNATURE(S) SHOWN IN THE MARK DOES NOT IDENTIFY A PARTICULAR LIVING INDIVIDUAL.

FOR BOTTOMS; JACKETS; PANTS; SHORTS; TOPS (U.S. CLS. 22 AND 39).

FIRST USE 5-23-2011; IN COMMERCE 5-23-2011.

ANDREW RHIM, EXAMINING ATTORNEY

---

SN 85-334,409. MASKEW, GENEVIEVE, LAWRENCEVILLE, GA. FILED 5-31-2011.



FOR HATS; SHIRTS (U.S. CLS. 22 AND 39).

WENDY JUN, EXAMINING ATTORNEY

**CLASS 25—(Continued).**

SN 85-334,481. SELLES MORRIS, CHICAGO, IL. FILED 5-31-2011.

I am strung out like a  
crack whore in spandex

THE MARK CONSISTS OF STANDARD CHARACTERS WITHOUT CLAIM TO ANY PARTICULAR FONT, STYLE, SIZE, OR COLOR.  
FOR SHORT-SLEEVED OR LONG-SLEEVED T-SHIRTS; T-SHIRTS (U.S. CLS. 22 AND 39).  
HANNO RITTNER, EXAMINING ATTORNEY

SN 85-334,485. MAJOROS, ANTHONY, CYPRESS, CA. FILED 5-31-2011.



THE MARK CONSISTS OF A ROBOT WITH THE STYLIZED TEXT "NTOSR".  
FOR CLOTHING, NAMELY, JACKETS, JACKET LINERS, HEADWRAPS, AND GLOVES (U.S. CLS. 22 AND 39).  
HANNO RITTNER, EXAMINING ATTORNEY

**CLASS 25—(Continued).**

SN 85-334,559. LAWANDA J. ABEL, BRONX, NY. FILED 5-31-2011.

rock my good

THE MARK CONSISTS OF STANDARD CHARACTERS WITHOUT CLAIM TO ANY PARTICULAR FONT, STYLE, SIZE, OR COLOR.

FOR ATHLETIC APPAREL, NAMELY, SHIRTS, PANTS, JACKETS, FOOTWEAR, HATS AND CAPS, ATHLETIC UNIFORMS; BELTS; BOTTOMS; BUTTON DOWN SHIRTS; CAPRI PANTS; CARGO PANTS; COLLARED SHIRTS; DENIMS; DRESS PANTS; DRESS SHIRTS; FOOTWEAR; FOOTWEAR FOR MEN AND WOMEN; GLOVES; HATS; HEAD SCARVES; HEAD SWEATBANDS; HEAD WEAR; HEADBANDS; HOODS; JACKETS; JERSEYS; JOGGING PANTS; LINGERIE; PANTS; POLO SHIRTS; SHIRTS; SOCKS; SWEAT SHIRTS; T-SHIRTS; TIES; TOPS; UNDERWEAR; WAIST BANDS; WEARABLE GARMENTS AND CLOTHING, NAMELY, SHIRTS; WOMEN'S CLOTHING, NAMELY, SHIRTS, DRESSES, SKIRTS, BLOUSES; WRIST BANDS (U.S. CLS. 22 AND 39).

FIRST USE 5-29-2011; IN COMMERCE 5-29-2011.  
KELLY TRUSILO, EXAMINING ATTORNEY

SN 85-334,637. ALEX & ELI, LLC, NEW YORK, NY. FILED 5-31-2011.

ALEX & ELI

THE MARK CONSISTS OF STANDARD CHARACTERS WITHOUT CLAIM TO ANY PARTICULAR FONT, STYLE, SIZE, OR COLOR.

FOR CLOTHING, NAMELY, BLAZERS, PANTS, SHIRTS, COATS, SKIRTS, DRESSES, AND SCARVES (U.S. CLS. 22 AND 39).

FIRST USE 2-15-2009; IN COMMERCE 2-15-2009.  
BARNEY CHARLON, EXAMINING ATTORNEY

**CLASS 25—(Continued).**

SN 85-334,651. CAMARILLO, DAVID, PLEASANTON, CA. FILED 6-1-2011.



NO CLAIM IS MADE TO THE EXCLUSIVE RIGHT TO USE "ZOMBIE", APART FROM THE MARK AS SHOWN.

THE MARK CONSISTS OF CREST CONTAINING WORDS, GUERRILLA ZOMBIE OPS, OVER ASSAULT RIFLE, ZOMBIE HAND AND GURKHA KNIFE.

FOR BASEBALL CAPS; BEANIES; HOODED SWEATSHIRTS; LONG-SLEEVED SHIRTS; MARTIAL ARTS UNIFORMS, NAMELY, GIs; SHIRTS; SPORT SHIRTS; SWEATSHIRTS (U.S. CLS. 22 AND 39).

JENNIFER MARTIN, EXAMINING ATTORNEY

**CLASS 25—(Continued).**

SN 85-334,881. EXCLUSIVELY.IN INC., NEW YORK, NY. FILED 6-1-2011.



THE MARK CONSISTS OF A CRICKET PLAYER IN FULL UNIFORM IN THE BATSMAN STANCE GETTING READY TO HIT A CRICKET BALL. THE CRICKET BAT HE IS HOLDING HAS 2 STRIPES ON IT AND BINDING DETAIL ON THE HANDLE. THE CRICKET BALL IS ABOUT TO CONNECT WITH THE CRICKET BAT. THE WICKET, WHICH CONSISTS OF 3 STUMPS AND 2 BAILS (WITH BARREL DETAIL), ARE TO THE LEFT OF THE BATSMAN IN PROPER POSITION OF A CRICKET STANCE. THE BATSMAN IS WEARING A CRICKET HELMET, LEG PADS, GLOVES, AND CRICKET SHOES WITH LACES AND A JOHNNY COLLAR CRICKET SHIRT WITH THE DOUBLE LETTER "S" MONOGRAM (FOR SHER SINGH) ON THE CHEST.

FOR BLOUSES; CLOTHING, NAMELY, BASE LAYERS; JACKETS; JERSEYS; MEN'S AND WOMEN'S JACKETS, COATS, TROUSERS, VESTS; POLO SHIRTS; SHORT-SLEEVED OR LONG-SLEEVED T-SHIRTS; SHORTS; WEARABLE GARMENTS AND CLOTHING, NAMELY, SHIRTS; WOMEN'S CLOTHING, NAMELY, SHIRTS, DRESSES, SKIRTS, BLOUSES (U.S. CLS. 22 AND 39).

RONALD MCMORROW, EXAMINING ATTORNEY

SN 85-334,832. ERNEST D. GAY, BROOKSVILLE, FL. FILED 6-1-2011.

**BLOW WHEELS**

THE MARK CONSISTS OF STANDARD CHARACTERS WITHOUT CLAIM TO ANY PARTICULAR FONT, STYLE, SIZE, OR COLOR.

FOR ATHLETIC APPAREL, NAMELY, SHIRTS, PANTS, JACKETS, FOOTWEAR, HATS AND CAPS, ATHLETIC UNIFORMS (U.S. CLS. 22 AND 39).

ODESSA BIBBINS, EXAMINING ATTORNEY

SN 85-334,883. GEORGE, MELISSA D., SALISBURY, PA. FILED 6-1-2011.

**High Heels Two Wheels**

THE MARK CONSISTS OF STANDARD CHARACTERS WITHOUT CLAIM TO ANY PARTICULAR FONT, STYLE, SIZE, OR COLOR.

FOR CLOTHING, NAMELY, HATS, SHIRTS, PANTS, JACKETS, AND SCARVES (U.S. CLS. 22 AND 39).

RONALD MCMORROW, EXAMINING ATTORNEY

**CLASS 25—(Continued).**

SN 85-334,889. ZOHNER, JACOB, CLEARFIELD, UT. FILED 6-1-2011.

# THORAZINE

THE MARK CONSISTS OF STANDARD CHARACTERS WITHOUT CLAIM TO ANY PARTICULAR FONT, STYLE, SIZE, OR COLOR.

FOR COATS; SWEATERS; T-SHIRTS (U.S. CLS. 22 AND 39).

RONALD MCMORROW, EXAMINING ATTORNEY

**CLASS 25—(Continued).**

SN 85-334,984. AMERICAN WEST INTERNATIONAL TRADES, LLC, SALT LAKE CITY, UT. FILED 6-1-2011.



THE MARK CONSISTS OF A SLASHING FLYING ARROW.

FOR ATHLETIC FOOTWEAR (U.S. CLS. 22 AND 39). COURTNEY ALVAREZ, EXAMINING ATTORNEY

SN 85-334,930. LAKIOTES, NICHOLAS, BROOKLYN, NY. FILED 6-1-2011.

# The Back Weeds

THE MARK CONSISTS OF STANDARD CHARACTERS WITHOUT CLAIM TO ANY PARTICULAR FONT, STYLE, SIZE, OR COLOR.

FOR T-SHIRTS (U.S. CLS. 22 AND 39). WENDY GOODMAN, EXAMINING ATTORNEY

SN 85-335,018. SELLES MORRIS, CHICAGO, IL. FILED 6-1-2011.

There are a lot of cats in  
the alley but there is  
only one bull.

THE MARK CONSISTS OF STANDARD CHARACTERS WITHOUT CLAIM TO ANY PARTICULAR FONT, STYLE, SIZE, OR COLOR.

FOR SHORT-SLEEVED OR LONG-SLEEVED T-SHIRTS; T-SHIRTS (U.S. CLS. 22 AND 39).

HANNO RITTNER, EXAMINING ATTORNEY

SN 85-334,945. DOVER SADDLERY, INC., LITTLETON, MA. FILED 6-1-2011.

# HUNTFIELD'S

THE MARK CONSISTS OF STANDARD CHARACTERS WITHOUT CLAIM TO ANY PARTICULAR FONT, STYLE, SIZE, OR COLOR.

FOR BOOTS (U.S. CLS. 22 AND 39). FIRST USE 1-0-1999; IN COMMERCE 1-0-1999. GIANCARLO CASTRO, EXAMINING ATTORNEY

SN 85-335,112. BOTTOMS UP GROUP, LLC, MOUNT PLEASANT, SC. FILED 6-1-2011.



# cutey booty

OWNER OF U.S. REG. NO. 3,962,542.

THE MARK CONSISTS OF THE PHRASE CUTEY BOOTY DEPICTED UNDERNEATH THE FACE OF A BABY OR YOUNG CHILD.

FOR CHILDREN'S CLOTHING, NAMELY, BLOOMERS, BOXERS, PANTS, ROMPERS, TOPS, AND DIAPER COVERS (U.S. CLS. 22 AND 39).

FIRST USE 1-21-2010; IN COMMERCE 1-21-2010. ROBIN MITTLER, EXAMINING ATTORNEY

**CLASS 25—(Continued).**

SN 85-335,118. SKINNYSHIRT LLC, GLEN HEAD, NY. FILED 6-1-2011.

**COLLARCAMI**

THE MARK CONSISTS OF STANDARD CHARACTERS WITHOUT CLAIM TO ANY PARTICULAR FONT, STYLE, SIZE, OR COLOR.

FOR FOUNDATION GARMENTS; UNDERGARMENTS; GIRDLES; CLOTHING, NAMELY, SHIRTS, BODY SHAPERS, CAMISOLES, AND LINGERIE; SHAPEWEAR, NAMELY, FOUNDATION GARMENTS INTEGRATED WITH SHIRT ELEMENTS, DESIGNED TO BE WORN UNDER CLOTHING WITH SHIRT ELEMENTS EXPOSED TO SIMULATE AN ENTIRE SHIRT; FOUNDATION GARMENTS WORN AROUND THE TORSO TO SUPPORT AND COMPRESS BODY TO CREATE A SLIMMING EFFECT (U.S. CLS. 22 AND 39).

KRISTIN CARLSON, EXAMINING ATTORNEY

SN 85-335,196. BINNS, MICHEAL L., ARLINGTON, VA. FILED 6-1-2011.

**I'M COOL WITH THAT**

THE MARK CONSISTS OF STANDARD CHARACTERS WITHOUT CLAIM TO ANY PARTICULAR FONT, STYLE, SIZE, OR COLOR.

FOR ATHLETIC APPAREL, NAMELY, SHIRTS, PANTS, JACKETS, FOOTWEAR, HATS AND CAPS, ATHLETIC UNIFORMS (U.S. CLS. 22 AND 39).

PAUL MORENO, EXAMINING ATTORNEY

SN 85-335,337. HALE, HAL DAVIS, HOUSTON, TX. FILED 6-1-2011.

**cougars dig me**

THE MARK CONSISTS OF STANDARD CHARACTERS WITHOUT CLAIM TO ANY PARTICULAR FONT, STYLE, SIZE, OR COLOR.

FOR T-SHIRTS (U.S. CLS. 22 AND 39).

C. DIONNE CLYBURN, EXAMINING ATTORNEY

**CLASS 25—(Continued).**

SN 85-335,505. GARVEY, JOSEPH, HAMPTON BAYS, NY. AND GARVEY, BETHNEY, HAMPTON BAYS, NY. FILED 6-1-2011.

**TRAFFIC JAM**

THE MARK CONSISTS OF STANDARD CHARACTERS WITHOUT CLAIM TO ANY PARTICULAR FONT, STYLE, SIZE, OR COLOR.

FOR T-SHIRTS (U.S. CLS. 22 AND 39).

DAVID HOFFMAN, EXAMINING ATTORNEY

SN 85-335,529. HALE, HAL DAVIS, HOUSTON, TX. FILED 6-1-2011.

**cougars love me**

THE MARK CONSISTS OF STANDARD CHARACTERS WITHOUT CLAIM TO ANY PARTICULAR FONT, STYLE, SIZE, OR COLOR.

FOR BABY BIBS NOT OF PAPER; BIB OVERALLS; CLOTHING FOR BABIES, TODDLERS AND CHILDREN, TREATED WITH FIRE AND HEAT RETARDANTS, NAMELY, PAJAMAS, JACKETS, SHIRTS, PANTS, JUMPERS; HATS; T-SHIRTS (U.S. CLS. 22 AND 39).

C. DIONNE CLYBURN, EXAMINING ATTORNEY

SN 85-335,585. VIRGINIAK, MICHAEL T., BUNNELL, FL. AND VIRGINIAK, THERESE, BUNNELL, FL. FILED 6-1-2011.

**Mud Hound**

THE MARK CONSISTS OF STANDARD CHARACTERS WITHOUT CLAIM TO ANY PARTICULAR FONT, STYLE, SIZE, OR COLOR.

FOR HATS; T-SHIRTS (U.S. CLS. 22 AND 39).

GRETTA YAO, EXAMINING ATTORNEY



**CLASS 25—(Continued).**

SN 85-335,588. NEWMAN, JULIA C., NEW YORK, NY.  
FILED 6-1-2011.

Enjoy it while it lasts.

THE MARK CONSISTS OF STANDARD CHARACTERS  
WITHOUT CLAIM TO ANY PARTICULAR FONT, STYLE,  
SIZE, OR COLOR.  
FOR T-SHIRTS (U.S. CLS. 22 AND 39).  
GRETTA YAO, EXAMINING ATTORNEY

SN 85-335,608. WAKSMACKI, CATHERINE, LIGHTHOUSE  
POINT, FL. FILED 6-1-2011.

FLATITUDE

THE MARK CONSISTS OF STANDARD CHARACTERS  
WITHOUT CLAIM TO ANY PARTICULAR FONT, STYLE,  
SIZE, OR COLOR.  
FOR HATS; T-SHIRTS (U.S. CLS. 22 AND 39).  
DORITT L. CARROLL, EXAMINING ATTORNEY

SN 85-335,648. BROWN, DEDDRICK, MEMPHIS, TN. FILED  
6-1-2011.

Brown Chocolate Diva

THE MARK CONSISTS OF STANDARD CHARACTERS  
WITHOUT CLAIM TO ANY PARTICULAR FONT, STYLE,  
SIZE, OR COLOR.  
FOR BATHING SUITS; BELTS; BLOUSES; BRAS;  
COATS; DRESSES; HATS; LINGERIE; PANTIES; PANTS;  
SHOES; SHORTS; STOCKINGS; SUITS; SWEATERS;  
SWEATSUITS; THONGS; UNDERWEAR; UNDERWEAR,  
NAMELY, BOY SHORTS (U.S. CLS. 22 AND 39).  
JUDITH HELFMAN, EXAMINING ATTORNEY

**CLASS 25—(Continued).**

SN 85-335,672. JACOB KENIGSBERG, GREAT NECK, NY.  
FILED 6-1-2011.

coupleof

THE MARK CONSISTS OF STANDARD CHARACTERS  
WITHOUT CLAIM TO ANY PARTICULAR FONT, STYLE,  
SIZE, OR COLOR.

FOR BEACH SHOES; CANVAS SHOES; LEATHER  
SHOES; SANDALS AND BEACH SHOES; SHOES; WO-  
MEN'S SHOES (U.S. CLS. 22 AND 39).  
FIRST USE 8-1-2010; IN COMMERCE 8-1-2010.  
PAUL MORENO, EXAMINING ATTORNEY

SN 85-335,774. ARTFULLY DISHEVELED, CINCINNATI,  
OH. FILED 6-1-2011.

Artfully Disheveled

THE MARK CONSISTS OF STANDARD CHARACTERS  
WITHOUT CLAIM TO ANY PARTICULAR FONT, STYLE,  
SIZE, OR COLOR.

FOR ASCOTS; BANDANAS; BATHROBES; BELTS;  
BELTS FOR CLOTHING; BELTS MADE OUT OF CLOTH;  
BOW TIES; HEAD SCARVES; NECKERCHIEFS; NECK-  
ERCHIEVES; NECKTIES; NECKWEAR; POCKET KER-  
CHIEFS; POCKET SQUARES; SCARFS; SCARVES;  
SHOULDER SCARVES; SHOULDER WRAPS; SILK  
SCARVES; TIES (U.S. CLS. 22 AND 39).  
FIRST USE 10-1-2009; IN COMMERCE 11-1-2010.  
CHRISTOPHER BUONGIORNO, EXAMINING ATTOR-  
NEY

SN 85-335,784. BARRETT, NATASHA, SHERMAN OAKS, CA.  
FILED 6-1-2011.

CURIO+KIND

THE MARK CONSISTS OF STANDARD CHARACTERS  
WITHOUT CLAIM TO ANY PARTICULAR FONT, STYLE,  
SIZE, OR COLOR.

FOR CLOTHING, NAMELY, TOPS, BOTTOMS, BELTS,  
DRAWERS, SHIRTS, PANTS, SHORTS, SKIRTS, JACK-  
ETS, COATS, T-SHIRTS, BLOUSES, UNDERWEAR,  
SOCKS, HATS, SWEATERS, SWEATSHIRTS, PAJAMAS;  
CHILDREN'S AND INFANT'S APPAREL, NAMELY,  
JUMPERS, OVERALL SLEEPWEAR, PAJAMAS, ROM-  
PERS AND ONE-PIECE GARMENTS (U.S. CLS. 22 AND  
39).

FIRST USE 1-1-2011; IN COMMERCE 5-1-2011.  
SUNG IN, EXAMINING ATTORNEY

**CLASS 25—(Continued).**

SN 85-335,846. LOLA KIMONI INC., SANTA MONICA, CA. FILED 6-1-2011.

# KIMONI

THE MARK CONSISTS OF STANDARD CHARACTERS WITHOUT CLAIM TO ANY PARTICULAR FONT, STYLE, SIZE, OR COLOR.

FOR BEACH COVER-UPS; DRESSES (U.S. CLS. 22 AND 39).

AISHA CLARKE, EXAMINING ATTORNEY

**CLASS 25—(Continued).**

SN 85-335,984. PANAEGIS, LLC, OLIVETTE, MO. FILED 6-2-2011.

# Newtity

SN 85-335,902. TAL, LIAN, NEW YORK, NY. FILED 6-2-2011.



THE MARK CONSISTS OF A STYLIZED IMAGE OF A WOMAN HANGING WITH ONE ARM ON A POLE, WHICH RISES FROM THE TOP OF THE CAPITAL LETTERS "BP", WITH A "+" ON TOP OF THE LETTERS IN THE MIDDLE OF THE LETTERS, ABOVE THE WORDS "BODY & POLE"; THE SQUARE IS BACKGROUND AND NOT A PART OF THE MARK.

FOR CLOTHING, NAMELY, SHIRTS, T-SHIRTS, TANK TOPS, SWEATERS, SWEATSHIRTS, HOODED SWEAT SHIRTS, SWEAT SUITS, TRACK SUITS, PANTS, SHORTS, SWEAT PANTS, LEGGINGS, SOCKS, HATS, CAPS, VISORS, AND UNDERWEAR (U.S. CLS. 22 AND 39).

FIRST USE 2-15-2008; IN COMMERCE 2-15-2008.  
APRIL ROACH, EXAMINING ATTORNEY

SN 85-335,958. SREEHARI GOPALAKRISHNAN, LAKE-  
LAND, FL. FILED 6-2-2011.

# My Life Is My Style

THE MARK CONSISTS OF STANDARD CHARACTERS WITHOUT CLAIM TO ANY PARTICULAR FONT, STYLE, SIZE, OR COLOR.

FOR APPAREL, NAMELY SHIRTS, PANTS, JACKETS, FOOTWEAR, SOCKS, HATS, CAPS, WRISTBANDS AND HEADBANDS (U.S. CLS. 22 AND 39).

MARK T. MULLEN, EXAMINING ATTORNEY

THE MARK CONSISTS OF STANDARD CHARACTERS WITHOUT CLAIM TO ANY PARTICULAR FONT, STYLE, SIZE, OR COLOR.

FOR A-SHIRTS; ATHLETIC APPAREL, NAMELY, SHIRTS, PANTS, JACKETS, FOOTWEAR, HATS AND CAPS, ATHLETIC UNIFORMS; BUTTON DOWN SHIRTS; CAPS; COATS FOR MEN AND WOMEN; COATS MADE OF COTTON; COATS OF DENIM; COL-  
LARED SHIRTS; DENIMS; DRESS PANTS; DRESS SHIRTS; FLEECE PULLOVERS; FLEECE VESTS; FOOT-  
TIES; FOOTWEAR; FOOTWEAR; FOOTWEAR FOR MEN; FOOTWEAR FOR MEN AND WOMEN; FOOT-  
WEAR FOR WOMEN; FOOTWEAR NOT FOR SPORTS;  
GOLF CAPS; GOLF PANTS, SHIRTS AND SKIRTS;  
GOLF SHIRTS; GOLF SHOES; GOLF SHORTS; GOLF SPIKES; GOLF TROUSERS; GYM PANTS; GYM SHORTS; GYM SUITS; HATS; HATS FOR INFANTS, BABIES, TODDLERS AND CHILDREN; HEAD WEAR; HEAVY COATS; HEAVY JACKETS; HOODED PULL-  
OVERS; HOODED SWEAT SHIRTS; HOODED SWEAT-  
SHIRTS; JACKETS; JACKETS AND SOCKS; JOGGING OUTFITS; JOGGING PANTS; JOGGING SUITS; KNIT JACKETS; KNIT SHIRTS; KNIT TOPS; KNITTED CAPS; KNITTED UNDERWEAR; LONG SLEEVE PULLOVERS; LOUNGE PANTS; LOUNGEWEAR; MEN'S AND WOMEN'S JACKETS, COATS, TROUSERS, VESTS; MEN'S DRESS SOCKS; MEN'S SOCKS; MEN'S UNDERWEAR; MOISTURE-WICKING SPORTS PANTS; MOISTURE-  
WICKING SPORTS SHIRTS; NIGHT SHIRTS; NIGHT-  
WEAR; OPEN-NECKED SHIRTS; OVER SHIRTS; PAJA-  
MA BOTTOMS; PAJAMAS; PANTS; PIQUE SHIRTS; POLO KNIT TOPS; POLO SHIRTS; PULLOVERS; RUGBY SHIRTS; RUNNING SUITS; SHIRTS; SHIRTS AND SHORT-SLEEVED SHIRTS; SHIRTS FOR INFANTS, BABIES, TODDLERS AND CHILDREN; SHORT-  
SLEEVED OR LONG-SLEEVED T-SHIRTS; SHORT-  
SLEEVED SHIRTS; SHORTS; SKIRTS; SKIRTS AND DRESSES; SKULL CAPS; SKULLIES; SLACKS; SLEEP PANTS; SLEEP SHIRTS; SLEEPING GARMENTS; SLEEP-  
WEAR; SOCKS; SOCKS AND STOCKINGS; SPORT SHIRTS; SPORTS CAPS AND HATS; SPORTS JACKETS; SPORTS PANTS; SPORTS SHIRTS; SPORTS SHIRTS WITH SHORT SLEEVES; SWEAT JACKETS; SWEAT PANTS; SWEAT SHIRTS; SWEAT SHORTS; SWEAT SUITS; SWEATPANTS; SWEATSHIRTS; SWEATSUITS; SWIM SUITS; SWIM TRUNKS; SWIM WEAR; SWIM WEAR FOR GENTLEMEN AND LADIES; SWIMMING TRUNKS; SWIMSUITS; SWIMWEAR; T-SHIRTS; TANK TOPS; TANK-TOPS; TEE SHIRTS; TOPS; TRACK JACKETS; TRACK PANTS; TRACK SUITS; TRACKSUITS; TROUSERS; TROUSERS FOR SWEATING; UNDER GARMENTS; UNDERCLOTHES; UNDERGARMENTS; UNDERPANTS; UNDERSHIRTS; UNDERWEAR; WALKING SHORTS; WARM UP OUTFITS; WARM UP SUITS; WARM-UP SUITS; WEARABLE GARMENTS AND CLOTHING, NAMELY, SHIRTS; WIND PANTS; WIND RESISTANT JACKETS; WIND-JACKETS; WOMEN'S UNDERWEAR (U.S. CLS. 22 AND 39).

JESSICA A. POWERS, EXAMINING ATTORNEY

**CLASS 25—(Continued).**

SN 85-336,011. MONTES, IGNACIO, ORANGE, CA. FILED 6-2-2011.

## Juice County

THE MARK CONSISTS OF STANDARD CHARACTERS WITHOUT CLAIM TO ANY PARTICULAR FONT, STYLE, SIZE, OR COLOR.

FOR HATS; JACKETS; SHIRTS (U.S. CLS. 22 AND 39).  
HENRY S. ZAK, EXAMINING ATTORNEY

SN 85-336,023. COOMBS, LISA, BLOOMINGTON, IN. FILED 6-2-2011.



THE STIPPLING IS FOR SHADING PURPOSES ONLY.  
THE MARK CONSISTS OF AN OUTLINED CHICKEN WITH POLKA DOTS PECKING A CUPCAKE, WHICH IS SITTING ON A STRIPED STAND. THE CUPCAKE HAS FROSTING WITH SPRINKLES, WITH A PALE WRAPPER. IT IS SITTING ON A STRIPED STAND. THE STAND IS WIDER AT BOTH THE TOP AND THE BOTTOM, AND IS ROUNDED OUT IN THE MIDDLE. THE WORDS "MARK'D WITH LOVE" ARE WRITTEN ACROSS THE TOP OF THE IMAGE.

FOR BOTTOMS; CLOTH DIAPERS; DRESSES; INFANT DIAPER COVERS; ONE-PIECE GARMENTS FOR CHILDREN; ROMPERS; SLEEPWEAR; TEXTILE DIAPERS; TOPS (U.S. CLS. 22 AND 39).

HENRY S. ZAK, EXAMINING ATTORNEY

SN 85-336,088. KOVESDI JR, JANOS, CATHEDRAL CITY, CA. FILED 6-2-2011.

## Ur Mad

THE MARK CONSISTS OF STANDARD CHARACTERS WITHOUT CLAIM TO ANY PARTICULAR FONT, STYLE, SIZE, OR COLOR.

FOR HATS; SWEATSHIRTS; T-SHIRTS (U.S. CLS. 22 AND 39).

PAUL E. FAHRENKOPF, EXAMINING ATTORNEY

**CLASS 25—(Continued).**

SN 85-336,177. PANAEGIS, LLC, OLIVETTE, MO. FILED 6-2-2011.

## NewtiTee

THE MARK CONSISTS OF STANDARD CHARACTERS WITHOUT CLAIM TO ANY PARTICULAR FONT, STYLE, SIZE, OR COLOR.

FOR SHIRTS; SHIRTS AND SHORT-SLEEVED SHIRTS; SHORT-SLEEVED OR LONG-SLEEVED T-SHIRTS; SHORT-SLEEVED SHIRTS; T-SHIRTS; TEE SHIRTS (U.S. CLS. 22 AND 39).

JESSICA A. POWERS, EXAMINING ATTORNEY

SN 85-336,178. SAETEURN, SOU FOU, OAKLAND, CA. FILED 6-2-2011.

## UnderHanger

THE MARK CONSISTS OF STANDARD CHARACTERS WITHOUT CLAIM TO ANY PARTICULAR FONT, STYLE, SIZE, OR COLOR.

FOR BOXER BRIEFS; BOXER SHORTS; BRIEFS; PAJAMAS; SHORTS; TRUNKS; UNDERGARMENTS; UNDERWEAR (U.S. CLS. 22 AND 39).

REBECCA SMITH, EXAMINING ATTORNEY

SN 85-336,405. R&amp;R ELITE MANAGEMENT LLC, BEVERLY HILLS, CA. FILED 6-2-2011.

## BALL STREET

THE MARK CONSISTS OF STANDARD CHARACTERS WITHOUT CLAIM TO ANY PARTICULAR FONT, STYLE, SIZE, OR COLOR.

FOR MEN'S, WOMEN'S AND CHILDREN'S CLOTHING, NAMELY, PANTS, SHIRTS, T-SHIRTS, SWEATSHIRTS, JACKETS, SUITS, DRESSES, COATS, TOPS, BOTTOMS, UNDERWEAR, SHOES, SOCKS, SLIPPERS, HEADWEAR, HATS, CAPS, SCARVES, SWEATERS, SWIMWEAR, SLEEPWEAR (U.S. CLS. 22 AND 39).

CHARLES L. JENKINS, EXAMINING ATTORNEY

**CLASS 25—(Continued).**

SN 85-336,700. PACIFIC SUNWEAR OF CALIFORNIA, INC., ANAHEIM, CA. FILED 6-2-2011.

**TILTED SEVEN**

THE MARK CONSISTS OF STANDARD CHARACTERS WITHOUT CLAIM TO ANY PARTICULAR FONT, STYLE, SIZE, OR COLOR.

FOR CLOTHING, NAMELY, SHIRTS, T-SHIRTS, WOMEN SHIRTS, FLANNEL SHIRTS, KNIT TOPS, TANK TOPS, DRESSES, SKIRTS, SWEATSHIRTS, SWEAT PANTS, PANTS, JEANS, LEGGINGS, SHORTS, JACKETS, SWEATERS, PAJAMAS, UNDER GARMENTS, SWIM SUITS, SWIM WEAR, SCARVES, SHAWLS, BELTS, GLOVES, MITTENS, SOCKS; FOOTWEAR NAMELY, ATHLETIC FOOTWEAR, SHOES, SANDALS, SLIPPERS, BOOTS, BEACH FOOTWEAR; HEADGEAR, NAMELY, HATS, CAPS, VISORS, BEANIES AND HEAD BANDS (U.S. CLS. 22 AND 39).

JEFF DEFORD, EXAMINING ATTORNEY

SN 85-336,755. EVO1 LLC, JAMAICA, NY. FILED 6-2-2011.

THE MARK CONSISTS OF THE LETTERS AND NUMBER "EVO1OVE", AND EXTENDING FROM THE RIGHT SIDE OF THE 'V' IS A HALF OF HEART.

FOR T-SHIRTS (U.S. CLS. 22 AND 39).  
JENNIFER MARTIN, EXAMINING ATTORNEY

SN 85-336,757. SCHIPILLITI, GREGORY, PARAMUS, NJ. FILED 6-2-2011.

THE MARK CONSISTS OF STANDARD CHARACTERS WITHOUT CLAIM TO ANY PARTICULAR FONT, STYLE, SIZE, OR COLOR.

FOR BLOUSES; BOXER BRIEFS; CAPS; GLOVES; HATS; HEADBANDS; HOODED SWEATSHIRTS; JACKETS; PANTS; SCARVES; SHIRTS; SHOES; SHORTS; SLIPPERS; SOCKS; SWEATBANDS; SWEATERS; T-SHIRTS; UNDERWEAR (U.S. CLS. 22 AND 39).

MAUREEN DALL, EXAMINING ATTORNEY

**CLASS 25—(Continued).**

SN 85-336,777. PIPES & SHAW LLC, NEW YORK, NY. FILED 6-2-2011.

**VERONICA BEARD**

THE MARK CONSISTS OF STANDARD CHARACTERS WITHOUT CLAIM TO ANY PARTICULAR FONT, STYLE, SIZE, OR COLOR.

FOR BLAZERS; BLOUSES; COATS; JACKETS; PANTS; SHORTS; SWEATERS (U.S. CLS. 22 AND 39).  
FIRST USE 7-10-2010; IN COMMERCE 7-10-2010.  
MARC LEIPZIG, EXAMINING ATTORNEY

SN 85-336,823. HANDSAROUND LLC, NEW YORK, NY. FILED 6-2-2011.

**SEYRIG**

THE MARK CONSISTS OF STANDARD CHARACTERS WITHOUT CLAIM TO ANY PARTICULAR FONT, STYLE, SIZE, OR COLOR.

FOR CLOTHING, NAMELY, SHIRTS, SWEATERS, SCARVES, DRESSES, SKIRTS AND PANTS (U.S. CLS. 22 AND 39).

AISHA CLARKE, EXAMINING ATTORNEY

SN 85-336,896. DLA DESIGNS LLC, AGOURA HILLS, CA. FILED 6-2-2011.

**UNDERGROUND SOCIETY**

THE MARK CONSISTS OF STANDARD CHARACTERS WITHOUT CLAIM TO ANY PARTICULAR FONT, STYLE, SIZE, OR COLOR.

FOR CLOTHING, NAMELY, KHAKIS; HEADGEAR, NAMELY, HATS, CAPS AND SKULLIES; HOODED SWEATSHIRTS; JEANS; POLO SHIRTS; RUGBY SHIRTS; SHIRTS; SHORT-SLEEVED OR LONG-SLEEVED T-SHIRTS; SHORTS; SWEAT JACKETS; SWEAT PANTS; SWEAT SHIRTS; T-SHIRTS; TANK-TOPS (U.S. CLS. 22 AND 39).

JOHN SCHUYLER YARD, EXAMINING ATTORNEY

**CLASS 25—(Continued).**

SN 85-336,928. SUMMIT ENTERTAINMENT, LLC, SANTA MONICA, CA. FILED 6-2-2011.

# ISLE ESME

THE MARK CONSISTS OF STANDARD CHARACTERS WITHOUT CLAIM TO ANY PARTICULAR FONT, STYLE, SIZE, OR COLOR.

FOR CLOTHING, NAMELY, T-SHIRTS, SWEAT-SHIRTS, SHIRTS, INFANTWEAR, JACKETS, LOUNGEWEAR, TANK TOPS, AND VESTS; AND HEADWEAR (U.S. CLS. 22 AND 39).

ASMAT KHAN, EXAMINING ATTORNEY

SN 85-337,202. POWELL, SONYA, LOS ANGELES, CA. FILED 6-3-2011.

# Snow Sugar

THE MARK CONSISTS OF STANDARD CHARACTERS WITHOUT CLAIM TO ANY PARTICULAR FONT, STYLE, SIZE, OR COLOR.

FOR BOOT ACCESSORIES, NAMELY, FITTED DECORATIVE COVERS FOR BOOTS; CLOTHING, NAMELY, BASE LAYERS; GLOVES; HEADWEAR; JACKETS; LEGGINGS; NECK GAITERS; PANTS; SHIRTS; SKIRTS; SOCKS; THERMAL UNDERWEAR; UNDERGARMENTS (U.S. CLS. 22 AND 39).

JILL C. ALT, EXAMINING ATTORNEY

SN 85-337,234. KATHRYN GAGE, KNOXVILLE, TN. FILED 6-3-2011.



THE MARK CONSISTS OF THE STYLIZED WORDS FLYING FEATHERS STRUT YOUR TEE BELOW A DESIGN INCLUDING TWO FEATHERS.

FOR SHIRTS; TOPS (U.S. CLS. 22 AND 39).

COLLEEN DOMBROW, EXAMINING ATTORNEY

**CLASS 25—(Continued).**

SN 85-337,317. FLEX GEER, LLC, BALTIMORE, MD. FILED 6-3-2011.



THE MARK CONSISTS OF AN ELLIPTICAL CIRCLE AROUND THE LETTER "X". BELOW THERE IS THE STYLIZED TEXT "FLEX".

FOR ATHLETIC APPAREL, NAMELY, SHIRTS, PANTS, SHORTS, SHOES, GLOVES, JACKETS, SOCKS, HATS, SWEAT BANDS, AND WRAPS (U.S. CLS. 22 AND 39).

JEFF DEFORD, EXAMINING ATTORNEY

SN 85-337,334. KYRA LAWTON, DARTMOUTH, MA. FILED 6-3-2011.



THE MARK CONSISTS OF THE WORDS GIRLS RUN WITH AN ASTERISK OVER THE I IN GIRLS AND THE WORDS ARE CONTAINED IN A RECTANGULAR BOX THAT IS SITUATED AT A SLIGHT ANGLE OVER SIX STYLIZED FLOWER PETALS IN WHICH FIVE OF THE FLOWER PETALS CONTAIN DEPICTIONS OF STYLIZED FOOTWEAR AND THE SIXTH PETAL CONTAINS A DEPICTION OF A STYLIZED FOOT.

FOR ATHLETIC APPAREL, NAMELY, SHIRTS, PANTS, JACKETS, FOOTWEAR, HATS AND CAPS, ATHLETIC UNIFORMS; BASEBALL CAPS AND HATS; CAP VISORS; CAPS; CAPS WITH VISORS; SKULL CAPS; SPORTS CAPS AND HATS (U.S. CLS. 22 AND 39).

FIRST USE 6-3-2011; IN COMMERCE 6-3-2011.

WILLIAM BRECKENFELD, EXAMINING ATTORNEY

**CLASS 25—(Continued).**

SN 85-337,487. CREATING ART FOR KIDS EVERYWHERE, LLC, CHICAGO, IL. FILED 6-3-2011.

when fish ride bicycles

THE MARK CONSISTS OF STANDARD CHARACTERS WITHOUT CLAIM TO ANY PARTICULAR FONT, STYLE, SIZE, OR COLOR.

FOR BANDANAS; HATS; HOODED SWEAT SHIRTS; SHIRTS; SHORT-SLEEVED OR LONG-SLEEVED T-SHIRTS (U.S. CLS. 22 AND 39).

JUDITH HELFMAN, EXAMINING ATTORNEY

SN 85-337,593. AOKI, STEVE, HOLLYWOOD, CA. FILED 6-3-2011.

D1M MAK

THE MARK CONSISTS OF STANDARD CHARACTERS WITHOUT CLAIM TO ANY PARTICULAR FONT, STYLE, SIZE, OR COLOR.

OWNER OF U.S. REG. NO. 3,312,474.

FOR CLOTHING, NAMELY, BLAZERS; BELTS, BLOUSES; BLOUSONS; BOLEROS; BOTTOMS; CAMISOLES; CAMP SHIRTS; CAPRI PANTS; CAPRIS; CARDIGANS; CARGO PANTS; COATS; COATS MADE OF COTTON; COATS OF DENIM; COVERALLS; CROP TOPS; DENIM JACKETS; DENIMS; DRESSES; DUSTERS; FOOTWEAR, HEADWEAR, INTIMATE APPAREL, NAMELY, BRAS, UNDERWEAR, LINGERIE; JACKETS; JEANS; JUMPERS; JUMPSUITS; LADIES' SUITS; LONG JACKETS; LONG SLEEVED VESTS; MEN'S AND WOMEN'S JACKETS, COATS, TROUSERS, VESTS; MINISKIRTS; MOCK TURTLE-NECK SWEATERS; PANTS; PANTSUITS; PEDAL PUSHERS; PULLOVERS; SARONGS; SHAWLS AND STOLE; SHIFTS; SHIRTS; SHIRTS FOR SUITS; SHORT SETS; SHORT TROUSERS; SHORT-SLEEVED OR LONG-SLEEVED T-SHIRTS; SHORT-SLEEVED SHIRTS; SHORTALLS; SHORTS; SHRUGS; SLEEPWEAR, SLEEVED OR SLEEVELESS JACKETS; SLEEVELESS JERSEYS; SMOCKS; SMOKING JACKETS; SWEAT PANTS; SWEAT SHIRTS; SUSPENDERS, SWEAT SUITS; SWEATERS; SWIMWEAR, TANK TOPS; TANKINIS; TEDDIES; TROUSERS; TUNICS; TURTLENECK SWEATERS; TURTLENECKS; V-NECK SWEATERS; VESTS; WALKING SHORTS; YOGA PANTS; YOGA SHIRTS (U.S. CLS. 22 AND 39).

KATHERINE STOIDES, EXAMINING ATTORNEY

**CLASS 25—(Continued).**

SN 85-337,624. TRUMEDIA NETWORKS, INC., BROOKLINE, MA. FILED 6-3-2011.

SAWXHEADS

THE MARK CONSISTS OF STANDARD CHARACTERS WITHOUT CLAIM TO ANY PARTICULAR FONT, STYLE, SIZE, OR COLOR.

FOR HATS; POLO SHIRTS; SWEAT SHIRTS; T-SHIRTS (U.S. CLS. 22 AND 39).

HOWARD B. LEVINE, EXAMINING ATTORNEY

SN 85-337,633. TRUMEDIA NETWORKS, INC., BROOKLINE, MA. FILED 6-3-2011.

SAWXHEADS.COM

THE MARK CONSISTS OF STANDARD CHARACTERS WITHOUT CLAIM TO ANY PARTICULAR FONT, STYLE, SIZE, OR COLOR.

FOR HATS; POLO SHIRTS; SWEAT SHIRTS; T-SHIRTS (U.S. CLS. 22 AND 39).

HOWARD B. LEVINE, EXAMINING ATTORNEY

SN 85-337,643. QUITUGUA, VINCE, LOS ALAMITOS, CA. FILED 6-3-2011.

Shoyoroll

THE MARK CONSISTS OF STANDARD CHARACTERS WITHOUT CLAIM TO ANY PARTICULAR FONT, STYLE, SIZE, OR COLOR.

FOR BASEBALL CAPS AND HATS; HOODED SWEATSHIRTS; MARTIAL ARTS UNIFORMS, NAMELY, GIS; RASH GUARDS; T-SHIRTS (U.S. CLS. 22 AND 39).

FIRST USE 11-29-1999; IN COMMERCE 12-18-2000.

IRA J. GOODSaid, EXAMINING ATTORNEY

**CLASS 25—(Continued).**

SN 85-338,004. FRANCO LLC, SEATTLE, WA. FILED 6-3-2011.

**GO HARD. SUPERSTAR.**

THE MARK CONSISTS OF STANDARD CHARACTERS WITHOUT CLAIM TO ANY PARTICULAR FONT, STYLE, SIZE, OR COLOR.

FOR CLOTHING, NAMELY, T-SHIRTS, SHIRTS, PANTS, JEANS, SHORTS, TANK-TOPS, BELTS, VESTS, SHOES, LONG SLEEVE SHIRTS, DRESS SHIRTS, DRESSES, HOODED SWEATSHIRTS, SWEATERS, SWEATSHIRTS, UNDERWEAR, BEACHWEAR (U.S. CLS. 22 AND 39).

FIRST USE 4-27-2011; IN COMMERCE 4-27-2011.  
AMY ALFIERI, EXAMINING ATTORNEY

SN 85-338,018. MORRISON, CHASE, BUTTE, MT. FILED 6-3-2011.



THE MARK CONSISTS OF THE STYLIZED TEXT "SEVENKINGS".

FOR BEANIES; HATS; HOODED SWEATSHIRTS; JACKETS; POLO SHIRTS; SHIRTS; SOCKS; SWEATSHIRTS (U.S. CLS. 22 AND 39).

SOPHIA S. KIM, EXAMINING ATTORNEY

SN 85-338,058. CHICK APPROVED, INC., HEALDSBURG, CA. FILED 6-3-2011.



THE MARK CONSISTS OF A DOUBLE CIRCLE FRONTED BY A SLANTED RECTANGLE WITH THE WORD CHICK IN THE UPPER PORTION OF THE CIRCLE, THE WORD APPROVED IN THE RECTANGLE, AND THE WORDS SHARE YOUR STYLE IN THE LOWER PORTION OF THE CIRCLE WITH ALL LETTERING IN STYLIZED FONT.

FOR CLOTHING, NAMELY, T-SHIRTS, SWEATPANTS, AND HATS (U.S. CLS. 22 AND 39).

FIRST USE 5-23-2011; IN COMMERCE 5-23-2011.  
BILL DAWE, EXAMINING ATTORNEY

**CLASS 25—(Continued).**

SN 85-338,111. UNDERWOOD, MARVEL D, DBA DEFINED GENIUS, SAN DIEGO, CA. FILED 6-4-2011.



THE MARK CONSISTS OF A FROWNING GHOST WITH MOUTH OPENED AND TONGUE OUT AND TWO ARMS.

FOR BASEBALL CAPS AND HATS; BEANIES; FLEECE PULLOVERS; FOOTWEAR; HATS; HOODED PULLOVERS; HOODED SWEATSHIRTS; JACKETS; JEANS; LONG SLEEVE PULLOVERS; PULLOVERS; SHORT-SLEEVED OR LONG-SLEEVED T-SHIRTS; SWEATSHIRTS; T-SHIRTS (U.S. CLS. 22 AND 39).

FIRST USE 1-10-2009; IN COMMERCE 1-10-2009.  
CHARLES L. JENKINS, EXAMINING ATTORNEY

SN 85-338,115. FAHRTMEISTER, LLC, LUTZ, FL. FILED 6-4-2011.

**FAHRTMEISTER**

THE MARK CONSISTS OF STANDARD CHARACTERS WITHOUT CLAIM TO ANY PARTICULAR FONT, STYLE, SIZE, OR COLOR.

THE ENGLISH TRANSLATION OF "FAHRTMEISTER" IN THE MARK IS "TRIP MASTER".

FOR HATS; HOODED SWEATSHIRTS (U.S. CLS. 22 AND 39).

FIRST USE 3-1-2011; IN COMMERCE 6-1-2011.  
SHAILA SETTLES, EXAMINING ATTORNEY

SN 85-338,157. ANAKA, IKENNA N, AKA IKE LOVE, BROOKLYN, NY. FILED 6-4-2011.

**Every Hour I'm Alive is a  
Happy Hour**

THE MARK CONSISTS OF STANDARD CHARACTERS WITHOUT CLAIM TO ANY PARTICULAR FONT, STYLE, SIZE, OR COLOR.

FOR WEARABLE GARMENTS AND CLOTHING, NAMELY, SHIRTS (U.S. CLS. 22 AND 39).

FRED CARL, EXAMINING ATTORNEY

**CLASS 25—(Continued).**

SN 85-338,179. COASTAL SAILS, LLC, FRISCO, TX. FILED 6-4-2011.

## Coastal Sails

THE MARK CONSISTS OF STANDARD CHARACTERS WITHOUT CLAIM TO ANY PARTICULAR FONT, STYLE, SIZE, OR COLOR.

FOR BELTS; BOAT SHOES; BUTTON DOWN SHIRTS; CAPS; COLLARED SHIRTS; DRESS SHIRTS; JEANS; PANTS; SHIRTS; SHORTS; SWEAT SHIRTS; T-SHIRTS (U.S. CLS. 22 AND 39).

KIMBERLY PERRY, EXAMINING ATTORNEY

---

SN 85-338,214. SILVA, JOHAN J, NATIONAL CITY, CA. FILED 6-4-2011.

## Don't Doubt Da Dirk

THE MARK CONSISTS OF STANDARD CHARACTERS WITHOUT CLAIM TO ANY PARTICULAR FONT, STYLE, SIZE, OR COLOR.

FOR ANKLE SOCKS; APPAREL FOR DANCERS, NAMELY, TEE SHIRTS, SWEATSHIRTS, PANTS, LEGGINGS, SHORTS AND JACKETS; ATHLETIC APPAREL, NAMELY, SHIRTS, PANTS, JACKETS, FOOTWEAR, HATS AND CAPS, ATHLETIC UNIFORMS; BANDANAS; BASEBALL CAPS AND HATS; BEANIES; BOXER SHORTS; COLLARED SHIRTS; GYM SHORTS; HAT BANDS; HATS; HATS FOR INFANTS, BABIES, TODDLERS AND CHILDREN; HEADBANDS; HEADBANDS AGAINST SWEATING; HEADBANDS FOR CLOTHING; HOODED SWEATSHIRTS; JERSEYS; MEN'S DRESS SOCKS; MEN'S SOCKS; SHORT-SLEEVED OR LONG-SLEEVED T-SHIRTS; SLEEVELESS JERSEYS; SOCKS; SPORTS CAPS AND HATS; SPORTS JERSEYS; SWEAT-PANTS; SWEATSHIRTS; T-SHIRTS; WOMEN'S HATS AND HOODS; WRISTBANDS (U.S. CLS. 22 AND 39).

SIMON TENG, EXAMINING ATTORNEY

---

SN 85-338,312. BOYS NIGHT OUT, LLC, SANTA MONICA, CA. FILED 6-5-2011.

## NEW NORMAL MUSIC

THE MARK CONSISTS OF STANDARD CHARACTERS WITHOUT CLAIM TO ANY PARTICULAR FONT, STYLE, SIZE, OR COLOR.

FOR CLOTHING, NAMELY, T-SHIRTS (U.S. CLS. 22 AND 39).

FIRST USE 12-0-2010; IN COMMERCE 12-0-2010.  
CHRIS WELLS, EXAMINING ATTORNEY

**CLASS 25—(Continued).**

SN 85-338,316. BOYS NIGHT OUT, LLC, SANTA MONICA, CA. FILED 6-5-2011.



THE MARK CONSISTS OF THE WORDS NEW NORMAL MUSIC IN STYLIZED FONT SUPERIMPOSED ON A BANNER-SHAPED DESIGN.

FOR CLOTHING, NAMELY, T-SHIRTS (U.S. CLS. 22 AND 39).

FIRST USE 2-0-2011; IN COMMERCE 2-0-2011.

CHRIS WELLS, EXAMINING ATTORNEY

---

SN 85-338,352. BOYS NIGHT OUT, LLC, SANTA MONICA, CA. FILED 6-5-2011.

## NEW NORMAL ROCK

THE MARK CONSISTS OF STANDARD CHARACTERS WITHOUT CLAIM TO ANY PARTICULAR FONT, STYLE, SIZE, OR COLOR.

FOR CLOTHING, NAMELY, T-SHIRTS AND SWEATSHIRTS (U.S. CLS. 22 AND 39).

FIRST USE 5-0-2011; IN COMMERCE 5-0-2011.  
CHRIS WELLS, EXAMINING ATTORNEY



**CLASS 25—(Continued).**

SN 85-338,355. BOYS NIGHT OUT, LLC, SANTA MONICA, CA. FILED 6-5-2011.



THE MARK CONSISTS OF A DIAMOND SHAPE, WITH THE WORDS NEW AND NORMAL INSIDE THE DIAMOND IN THE TOP AND BOTTOM POSITION, AND THE WORD ROCK INSIDE THE DIAMOND IN THE MIDDLE POSITION WITH THE EDGES OF THE "R" AND "K" EXTENDING SLIGHTLY BEYOND THE BORDERS OF THE DIAMOND.

FOR CLOTHING, NAMELY, T-SHIRTS AND SWEATSHIRTS (U.S. CLS. 22 AND 39).

FIRST USE 5-1-2011; IN COMMERCE 5-1-2011.  
CHRIS WELLS, EXAMINING ATTORNEY

SN 85-338,366. PANAEGIS, LLC, OLIVETTE, MO. FILED 6-5-2011.



THE MARK CONSISTS OF A STYLIZED REPRESENTATION OF A NEWT IN A HORIZONTAL BODY POSITION, INCLUDING A CURLED TAIL, CURVED BODY, OUTSTRETCHED LIMBS, FLARED TOES AND EYES IN A CONTRASTING SHADE AS IS USED TO DEPICT THE NEWT'S BODY.

FOR A-SHIRTS; ATHLETIC APPAREL, NAMELY, SHIRTS, PANTS, JACKETS, FOOTWEAR, HATS AND CAPS, ATHLETIC UNIFORMS; ATHLETIC UNIFORMS; BUTTON DOWN SHIRTS; CAPS; CAPS WITH VISORS; COATS FOR MEN AND WOMEN; COATS MADE OF COTTON; COATS OF DENIM; COLLARED SHIRTS; DENIMS; DRESS PANTS; DRESS SHIRTS; FLEECE PULLOVERS; FLEECE VESTS; FOOTIES; FOOTWEAR; FOOTWEAR; FOOTWEAR FOR MEN; FOOTWEAR FOR MEN AND WOMEN; FOOTWEAR FOR WOMEN; FOOTWEAR NOT FOR SPORTS; GOLF CAPS; GOLF PANTS, SHIRTS AND SKIRTS; GOLF SHIRTS; GOLF SHOES; GOLF SHORTS; GOLF SPIKES; GOLF TROUSERS; GYM PANTS; GYM SHORTS; GYM SUITS; HATS; HATS FOR INFANTS, BABIES, TODDLERS AND CHILDREN; HEAD WEAR; HEAVY COATS; HEAVY JACKETS; HOODED PULLOVERS; HOODED SWEAT SHIRTS; HOODED SWEATSHIRTS; JACKETS; JACKETS AND SOCKS; JOGGING OUTFITS; JOGGING PANTS; JOGGING SUITS; KNIT JACKETS; KNIT SHIRTS; KNIT TOPS; KNITTED CAPS; KNITTED UNDERWEAR; LONG SLEEVE PULLOVERS; LONG-SLEEVED SHIRTS; LOUNGE PANTS; LOUNGEWEAR; MEN'S AND WOMEN'S JACKETS, COATS, TROUSERS, VESTS; MEN'S DRESS SOCKS; MEN'S SOCKS; MEN'S UNDERWEAR;

**CLASS 25—(Continued).**

MOISTURE-WICKING SPORTS PANTS; MOISTURE-WICKING SPORTS SHIRTS; NIGHT SHIRTS; NIGHTSHIRTS; NIGHTWEAR; OPEN-NECKED SHIRTS; OVER SHIRTS; PAJAMA BOTTOMS; PAJAMAS; PANTS; PIQUE SHIRTS; POLO KNIT TOPS; POLO SHIRTS; PULL-OVERS; RUGBY SHIRTS; RUNNING SUITS; SHIRTS; SHIRTS AND SHORT-SLEEVED SHIRTS; SHIRTS FOR INFANTS, BABIES, TODDLERS AND CHILDREN; SHORT-SLEEVED OR LONG-SLEEVED T-SHIRTS; SHORT-SLEEVED SHIRTS; SHORTS; SKIRTS; SKIRTS AND DRESSES; SKULL CAPS; SKULLIES; SLACKS; SLEEP PANTS; SLEEP SHIRTS; SLEEPING GARMENTS; SLEEPWEAR; SOCKS; SOCKS AND STOCKINGS; SPORT SHIRTS; SPORTS CAPS AND HATS; SPORTS JACKETS; SPORTS PANTS; SPORTS SHIRTS; SPORTS SHIRTS WITH SHORT SLEEVES; SWEAT JACKETS; SWEAT PANTS; SWEAT SHIRTS; SWEAT SHORTS; SWEAT SUITS; SWEATPANTS; SWEATSHIRTS; SWEATSUITS; SWIM SUITS; SWIM TRUNKS; SWIM WEAR; SWIM WEAR FOR GENTLEMEN AND LADIES; SWIMMING TRUNKS; SWIMSUITS; SWIMWEAR; T-SHIRTS; TANK TOPS; TANK-TOPS; TEE SHIRTS; TOPS; TRACK JACKETS; TRACK PANTS; TRACK SUITS; TRACKSUITS; TROUSERS; TROUSERS FOR SWEATING; UNDER GARMENTS; UNDERCLOTHES; UNDERGARMENTS; UNDERPANTS; UNDERSHIRTS; UNDERWEAR; WALKING SHORTS; WARM UP OUTFITS; WARM UP SUITS; WARM-UP SUITS; WEARABLE GARMENTS AND CLOTHING, NAMELY, SHIRTS; WIND PANTS; WIND RESISTANT JACKETS; WIND-JACKETS; WOMEN'S UNDERWEAR (U.S. CLS. 22 AND 39).

JESSICA A. POWERS, EXAMINING ATTORNEY

SN 85-338,400. PROMAKER SPORT PTY LTD, MANLY, AUSTRALIA, FILED 6-6-2011.

# BYOSS

THE MARK CONSISTS OF STANDARD CHARACTERS WITHOUT CLAIM TO ANY PARTICULAR FONT, STYLE, SIZE, OR COLOR.

FOR ANKLE SOCKS; CLOTHING FOR ATHLETIC USE, NAMELY, PADDED PANTS; CLOTHING FOR ATHLETIC USE, NAMELY, PADDED SHIRTS; CLOTHING ITEMS, NAMELY, ADHESIVE POCKETS THAT MAY BE AFFIXED DIRECTLY TO THE INSIDE OF CLOTHING FOR STORAGE AND SAFEKEEPING OF PERSONAL ITEMS; CLOTHING SHIELDS, NAMELY, PADS APPLIED TO THE UNDERARMS OF SHIRTS, BLOUSES AND SWEATERS; CLOTHING, NAMELY, ATHLETIC SLEEVES; CLOTHING, NAMELY, BASE LAYERS; GLOVES AS CLOTHING; HEADBANDS FOR CLOTHING; MEN'S DRESS SOCKS; MEN'S SOCKS; MOISTURE-WICKING SPORTS BRAS; MOISTURE-WICKING SPORTS PANTS; MOISTURE-WICKING SPORTS SHIRTS; PERSPIRATION ABSORBENT UNDERWEAR CLOTHING; POCKET SQUARES; SLIPPER SOCKS; SOCKS; SPORT COATS; SPORT SHIRTS; SPORTS JACKETS; SPORTS JERSEYS; SPORTS JERSEYS AND BREECHES FOR SPORTS; SPORTS PANTS; SPORTS SHIRTS; SPORTS SHIRTS WITH SHORT SLEEVES (U.S. CLS. 22 AND 39).

KATHERINE E. HALMEN, EXAMINING ATTORNEY

**CLASS 25—(Continued).**

SN 85-338,587. TRANSLUCENT VISIONS LLC, SHELTON, CT. FILED 6-6-2011.

## Roll A Bone

THE MARK CONSISTS OF STANDARD CHARACTERS WITHOUT CLAIM TO ANY PARTICULAR FONT, STYLE, SIZE, OR COLOR.

FOR ATHLETIC APPAREL, NAMELY, SHIRTS, PANTS, JACKETS, FOOTWEAR, HATS AND CAPS, ATHLETIC UNIFORMS (U.S. CLS. 22 AND 39).  
LINDA M. KING, EXAMINING ATTORNEY

**CLASS 25—(Continued).**

SN 85-338,687. STANDSTALL, AVALON, MELBOURNE, FL. FILED 6-6-2011.



---

SN 85-338,646. MITCHELL, MARK, LOUISVILLE, KY. FILED 6-6-2011.

## FAITH IN GOD

THE MARK CONSISTS OF STANDARD CHARACTERS WITHOUT CLAIM TO ANY PARTICULAR FONT, STYLE, SIZE, OR COLOR.

FOR BANDANAS; HATS; HEADWEAR; PANTS; SHIRTS; SWEATSHIRTS; WRISTBANDS (U.S. CLS. 22 AND 39).  
DOUGLAS LEE, EXAMINING ATTORNEY

THE MARK CONSISTS OF THE STYLIZED TEXT "TREE LIFE" WITH A LEAF ON TOP OF THE LEFT SIDE OF THE TEXT.

FOR HATS; SHIRTS (U.S. CLS. 22 AND 39).  
ANDREA HACK, EXAMINING ATTORNEY

---

SN 85-338,659. THOMAS, GLEN, SUWANEE, GA. AND DEWEY, ANDREA, SUWANEE, GA. FILED 6-6-2011.

## Buzzhunters

THE MARK CONSISTS OF STANDARD CHARACTERS WITHOUT CLAIM TO ANY PARTICULAR FONT, STYLE, SIZE, OR COLOR.

FOR HATS; JACKETS; PANTS; SHIRTS; SOCKS (U.S. CLS. 22 AND 39).  
GIANCARLO CASTRO, EXAMINING ATTORNEY

---

SN 85-338,699. LUNDE, PETER, SETAUKET, NY. FILED 6-6-2011.

WHATEVER YOU CHOOSE, JUST  
KEEP MOVING!

THE MARK CONSISTS OF STANDARD CHARACTERS WITHOUT CLAIM TO ANY PARTICULAR FONT, STYLE, SIZE, OR COLOR.

FOR T-SHIRTS (U.S. CLS. 22 AND 39).  
GIANCARLO CASTRO, EXAMINING ATTORNEY

**CLASS 25—(Continued).**

SN 85-338,831. MOSHE COHEN, NEW YORK, NY. FILED 6-6-2011.

**SPORTIER**

THE MARK CONSISTS OF STANDARD CHARACTERS WITHOUT CLAIM TO ANY PARTICULAR FONT, STYLE, SIZE, OR COLOR.

FOR A-SHIRTS; ATHLETIC APPAREL, NAMELY, SHIRTS, PANTS, JACKETS, FOOTWEAR, HATS AND CAPS, ATHLETIC UNIFORMS; BOARD SHORTS; BOMBER JACKETS; BOTTOMS; BOXER SHORTS; BUTTON DOWN SHIRTS; CARGO PANTS; CHILDREN'S AND INFANT'S APPAREL, NAMELY, JUMPERS, OVERALL SLEEPWEAR, PAJAMAS, ROMPERS AND ONE-PIECE GARMENTS; CHILDREN'S HEADWEAR; COATS FOR MEN AND WOMEN; COLLARED SHIRTS; DENIM JACKETS; DENIMS; DOWN JACKETS; DRESS SHIRTS; FLEECE BOTTOMS; FLEECE PULLOVERS; FLEECE SHORTS; FLEECE TOPS; FOOTWEAR; GOLF SHIRTS; GOLF SHORTS; GYM SHORTS; HATS; HOODED SWEAT SHIRTS; JACKETS; JEANS; JOGGING PANTS; KNIT BOTTOMS; KNIT SHIRTS; KNIT TOPS; LEATHER COATS; LOUNGE PANTS; MEN'S AND WOMEN'S JACKETS, COATS, TROUSERS, VESTS; ONE-PIECE GARMENTS FOR CHILDREN; OVER COATS; PANTIES, SHORTS AND BRIEFS; PANTS; PLAY SUITS; POLO KNIT TOPS; POLO SHIRTS; RAIN COATS; RAIN JACKETS; SHIRTS; SHIRTS FOR INFANTS, BABIES, TODDLERS AND CHILDREN; SHORT SETS; SHORTS; SPORT COATS; SPORT SHIRTS; SPORTS PANTS; SUIT COATS; SWEAT PANTS; SWEAT SHORTS; SWEAT SUITS; SWEATSHIRTS; T-SHIRTS; TANK TOPS; UNDERWEAR (U.S. CLS. 22 AND 39).

FIRST USE 2-6-2004; IN COMMERCE 2-6-2004.  
CHRISTINE COOPER, EXAMINING ATTORNEY

SN 85-338,889. BOWERS, TY, AKA RED ACE, LOS ANGELES, CA. FILED 6-6-2011.

**RED ACE**

THE MARK CONSISTS OF STANDARD CHARACTERS WITHOUT CLAIM TO ANY PARTICULAR FONT, STYLE, SIZE, OR COLOR.

FOR BELTS; BOTTOMS; CHILDREN'S AND INFANTS' CLOTH BIBS; CHILDREN'S CLOTH EATING BIBS; CLOTHING, NAMELY, KHAKIS; EYESHADES; GLOVES AS CLOTHING; HOODS; JACKETS; JERSEYS; LEATHER BELTS; NON-DISPOSABLE CLOTH TRAINING PANTS; PARTS OF CLOTHING, NAMELY, GUSSETS FOR TIGHTS, GUSSETS FOR STOCKINGS, GUSSETS FOR BATHING SUITS, GUSSETS FOR UNDERWEAR, GUSSETS FOR LEOTARDS AND GUSSETS FOR FOOTLETS; PARTS OF CLOTHING, NAMELY, UNDERARM GUSSETS; SHORT SETS; TIES; TOPS; TRAVEL CLOTHING CONTAINED IN A PACKAGE COMPRISING REVERSIBLE JACKETS, PANTS, SKIRTS, TOPS AND A BELT OR SCARF; WEARABLE GARMENTS AND CLOTHING, NAMELY, SHIRTS; WOMEN'S CLOTHING, NAMELY, SHIRTS, DRESSES, SKIRTS, BLOUSES (U.S. CLS. 22 AND 39).

FIRST USE 12-1-2010; IN COMMERCE 4-15-2011.  
PAM WILLIS, EXAMINING ATTORNEY

**CLASS 25—(Continued).**

SN 85-338,943. ALVAREZ, ROBERTO, CHICAGO, IL. FILED 6-6-2011.

**robdachi**

THE MARK CONSISTS OF THE STYLIZED TEXT "ROB-DECHI".

FOR HOODED SWEATSHIRTS; JEANS; SCARVES (U.S. CLS. 22 AND 39).

APRIL ROACH, EXAMINING ATTORNEY

SN 85-338,971. DLA DESIGNS LLC, AGOURA HILLS, CA. FILED 6-6-2011.



THE MARK CONSISTS OF STYLIZED WORD "UNDERGROUND" AT THE TOP OF THE RECTANGLE AND STYLIZED WORD "SOCIETY" AT THE BOTTOM OF THE RECTANGLE, WITH A KEYHOLE IN THE CENTER, AGAINST A BACKDROP OF WOODGRAIN.

FOR CLOTHING, NAMELY, KHAKIS; HEADGEAR, NAMELY, HATS, CAPS AND SKULLIES; HOODED SWEATSHIRTS; JEANS; POLO SHIRTS; RUGBY SHIRTS; SHIRTS; SHORT-SLEEVED OR LONG-SLEEVED T-SHIRTS; SHORTS; SWEAT JACKETS; SWEAT PANTS; T-SHIRTS; TANK-TOPS (U.S. CLS. 22 AND 39).

JOHN SCHUYLER YARD, EXAMINING ATTORNEY

**CLASS 25—(Continued).**

SN 85-339,033. DLA DESIGNS LLC, AGOURA HILLS, CA.  
FILED 6-6-2011.



THE MARK CONSISTS OF A KEYHOLE IN THE CENTER WITH A VIEW OF WOODGRAIN IN THE BACKGROUND OVER TWO CROSSED KEYS WITH THE LETTERS "U" ON THE LEFT AND "S" ON THE RIGHT AND THE STYLIZED WORD "UNDERGROUND" IN A CURVE OVER THE TOP OF THE KEYHOLE AND THE STYLIZED WORD "SOCIETY" STRAIGHT ACROSS BENEATH THE KEYHOLE.

FOR CLOTHING, NAMELY, KHAKIS; HEADGEAR, NAMELY, HATS, CAPS AND SKULLIES; HOODED SWEATSHIRTS; JEANS; POLO SHIRTS; RUGBY SHIRTS; SHIRTS; SHORT-SLEEVED OR LONG-SLEEVED T-SHIRTS; SHORTS; SWEAT JACKETS; SWEAT PANTS; SWEAT SHIRTS; T-SHIRTS; TANK-TOPS (U.S. CLS. 22 AND 39).

JOHN SCHUYLER YARD, EXAMINING ATTORNEY

SN 85-339,235. DAVID JOHN REYNOLDS, SANTA CRUZ,  
CA. FILED 6-6-2011.



THE MARK CONSISTS OF THE WORD THIEVES IN STYLIZED TEXT WITH A BRUSH STROKE UNDERLINE.

FOR CLOTHING, NAMELY, SHIRTS, SPORTS SHIRTS, PANTS, SHORT PANTS, STRETCH PANTS, JEANS, FOOTWEAR, SHOES, SANDALS, FOOT SOCKS, SLEEVED OR SLEEVELESS JACKETS, SPORTS JACKETS, SPORTS PANTS, SOCKS, AND BELTS; HEADGEAR, NAMELY, HATS AND CAPS; ATHLETIC APPAREL, NAMELY, ATHLETIC UNIFORMS, ATHLETIC FOOTWEAR, ATHLETIC SHOES, ATHLETIC SANDALS, ATHLETIC SOCKS, SHORT-SLEEVED OR LONG-SLEEVED T-SHIRTS, RUNNING SHORTS, JOGGING PANTS, SKATEBOARD SHORT PANTS, SWIM SUITS, SKI JACKETS, SKI PANTS, SNOW PANTS, SNOWBOARD PANTS, SNOWBOARD JACKETS, YOGA PANTS AND TOPS, SWEATPANTS, SWEATSHIRTS, AND HEADGEAR; MOTORCYCLE JACKETS; RAIN JACKETS; RAINPROOF JACKETS; SHELL JACKETS; WATERPROOF JACKETS AND PANTS; WIND RESISTANT JACKETS; AND WIND-JACKETS (U.S. CLS. 22 AND 39).

PAUL E. FAHRENKOPF, EXAMINING ATTORNEY

**CLASS 25—(Continued).**

SN 85-339,256. DAVID JOHN REYNOLDS, SANTA CRUZ,  
CA. FILED 6-6-2011.



THE MARK CONSISTS OF THE WORD THIEVES IN STYLIZED TEXT PLACED ABOVE A CROWBAR IMAGE.

FOR CLOTHING, NAMELY, SHIRTS, SPORTS SHIRTS, PANTS, SHORT PANTS, STRETCH PANTS, JEANS, FOOTWEAR, SHOES, SANDALS, FOOT SOCKS, SLEEVED OR SLEEVELESS JACKETS, SPORTS JACKETS, SPORTS PANTS, SOCKS, AND BELTS; HEADGEAR, NAMELY, HATS AND CAPS; ATHLETIC APPAREL, NAMELY, ATHLETIC UNIFORMS, ATHLETIC FOOTWEAR, ATHLETIC SHOES, ATHLETIC SANDALS, ATHLETIC SOCKS, SHORT-SLEEVED OR LONG-SLEEVED T-SHIRTS, RUNNING SHORTS, JOGGING PANTS, SKATEBOARD SHORT PANTS, SWIM SUITS, SKI JACKETS, SKI PANTS, SNOW PANTS, SNOWBOARD PANTS, SNOWBOARD JACKETS, YOGA PANTS AND TOPS, SWEATPANTS, SWEATSHIRTS, AND HEADGEAR; MOTORCYCLE JACKETS; RAIN JACKETS; RAINPROOF JACKETS; SHELL JACKETS; WATERPROOF JACKETS AND PANTS; WIND RESISTANT JACKETS; AND WIND-JACKETS (U.S. CLS. 22 AND 39).

PAUL E. FAHRENKOPF, EXAMINING ATTORNEY

SN 85-339,297. TCL INTERNATIONAL BUSINESS LLC,  
EDISON, NJ. FILED 6-6-2011.



THE MARK CONSISTS OF THE STYLIZED TEXT "V-DELIGHT".

FOR BRASSIERES; LINGERIE (U.S. CLS. 22 AND 39).  
INGA ERVIN, EXAMINING ATTORNEY

**CLASS 25—(Continued).**

SN 85-339,338. MOTORFIST, LLC, IDAHO FALLS, ID. FILED 6-6-2011.



OWNER OF U.S. REG. NO. 3,897,819.  
THE MARK CONSISTS OF A FOREARM AND A FIST WITH A CIRCULAR ELEMENT AT THE BASE OF THE FOREARM.

FOR CLOTHING, NAMELY, COATS, PARKAS, JACKETS, SNOW BIBS, PANTS, SHIRTS, UNDERWEAR, JERSEYS, T-SHIRTS, PULLOVERS, HOODED SWEATSHIRTS, SWEATERS, SWEATSHIRTS, GLOVES; FOOTWEAR; HEADWEAR (U.S. CLS. 22 AND 39).

FIRST USE 11-4-2009; IN COMMERCE 11-4-2009.  
JESSICA A. POWERS, EXAMINING ATTORNEY

SN 85-339,343. LATOS, GEORGE, COTO DE CAZA, CA. FILED 6-6-2011.

**CODE64SEVEN**

THE MARK CONSISTS OF STANDARD CHARACTERS WITHOUT CLAIM TO ANY PARTICULAR FONT, STYLE, SIZE, OR COLOR.

FOR CLOTHING FOR MEN AND WOMEN, NAMELY, SHIRTS, T-SHIRTS, WOVEN SHIRTS, TOPS, TANK-TOPS, SWEATSHIRTS, HOODED SWEATSHIRTS, JACKETS, BOTTOMS, SHORTS, VESTS, AND BELTS; HEADGEAR, NAMELY, CAPS (U.S. CLS. 22 AND 39).

SARA BENJAMIN, EXAMINING ATTORNEY

**CLASS 25—(Continued).**

SN 85-339,397. NINGBO SKYTEX IMPORT AND EXPORT CO.,LTD., NINGBO, ZHEJIANG, CHINA, FILED 6-6-2011.

**BLACKGATEONE**

THE MARK CONSISTS OF THE STYLIZED WORD BLACKGATEONE WHERE THE THIRD LETTER A IS INVERTED.

THE WORDING BLACKGATEONE HAS NO MEANING IN A FOREIGN LANGUAGE.

FOR BABY LAYETTES FOR CLOTHING; DRESSES; FOOTWEAR; HOSIERY; JACKETS; LEATHER BELTS; PANTS; SHIRTS; T-SHIRTS; TROUSERS (U.S. CLS. 22 AND 39).

PAUL MORENO, EXAMINING ATTORNEY

SN 85-339,404. NINGBO SKYTEX IMPORT AND EXPORT CO.,LTD., NINGBO, ZHEJIANG, CHINA, FILED 6-6-2011.



THE MARK CONSISTS OF THE STYLIZED WORD BLK ON THE LEFT, THE STYLIZED WORD GATEONE LAY VERTICALLY ON THE LEFT, ALL WITHIN A RECTANGULAR BACKGROUND.

THE WORDING BLK GATEONE HAS NO MEANING IN A FOREIGN LANGUAGE.

FOR BABY LAYETTES FOR CLOTHING; DRESSES; FOOTWEAR; HOSIERY; JACKETS; LEATHER BELTS; PANTS; SHIRTS; T-SHIRTS; TROUSERS (U.S. CLS. 22 AND 39).

PAUL MORENO, EXAMINING ATTORNEY

SN 85-339,424. GADABOUT, INC., KIRTLAND, OH. FILED 6-7-2011.

**PIN-UP DARLING**

THE MARK CONSISTS OF STANDARD CHARACTERS WITHOUT CLAIM TO ANY PARTICULAR FONT, STYLE, SIZE, OR COLOR.

FOR ADHESIVE BRAS; ANKLE BOOTS; ANKLE SOCKS; ANKLETS; ANORAK; ANORAKS; ARTIFICIAL FLOWER HEADDRESSES; BATH SLIPPERS; BATHING COSTUMES; BATHING COSTUMES FOR WOMEN; BATHING SUITS; BEACH COVER-UPS; BEACH COVER-UPS; BEACH FOOTWEAR; BEACH SHOES; BEACHWEAR; BELTS; BELTS FOR CLOTHING; BELTS MADE FROM IMITATION LEATHER; BELTS MADE OF LEATHER; BELTS MADE OUT OF CLOTH; BELTS OF TEXTILE; BELTS THAT ARE DESIGNED TO ACCOMMODATE PREGNANCY SIZE CHANGES; BERETS; BIB OVERALLS; BIB OVERALLS FOR HUNTING; BIKINIS; BLAZERS; BLOOMERS; BLOUSES; BLOUSONS; BODICES; BODY LINEN; BODY SHAPERS; BODY

**CLASS 25—(Continued).**

SHIRTS; BODY STOCKINGS; BODY SUITS; BOLEROS; BOTTOMS; BOXER BRIEFS; BRALETTES; BRAS; BRASIERES; BRIEFS; BUSTIERS; BUTTON DOWN SHIRTS; CAGOULES; CAMISETTES; CAMISOLES; CAPELETS; CAPES; CAPRI PANTS; CAPRIS; CARDIGANS; CARGO PANTS; CAT SUITS; CATSUITS; CHEMISES; CHEMISSETTES; CLOAKS; COATS; COATS FOR MEN AND WOMEN; COATS MADE OF COTTON; COATS OF DENIM; COLLARED SHIRTS; COLLARS; CORSELETS; CORSETS; COVERALLS; COVERUPS; DANCE COSTUMES; DENIM JACKETS; DENIMS; DO RAGS; DOWN JACKETS; DRESS PANTS; DRESS SHIRTS; DRESS SUITS; DRESSES; DRESSES THAT MAY ALSO BE USED AS TOWELS; DRESSING GOWNS; DRESSING GOWNS AND BATH ROBES; DUNGAREES; DUST COATS; DUSTERS; ESPADRILLES; EVENING DRESSES; EVENING GOWNS; FABRIC BELTS; FINGERLESS GLOVES; FITTED SWIMMING COSTUMES WITH BRA CUPS; FLEECE BOTTOMS; FLEECE PULLOVERS; FLEECE SHORTS; FLEECE TOPS; FLEECE VESTS; FLIGHT SUITS; FLIP FLOPS; FLOOD PANTS; FOOTWEAR; FOOTWEAR FOR WOMEN; FOOTWEAR NOT FOR SPORTS; FOOTWEAR, NAMELY, PUMPS; FOULARDS; FOUNDATION GARMENTS; FOUNDATION GARMENTS WORN AROUND THE MIDSECTION OR THIGHS TO KEEP THE STOMACH IN AND CREATE A SLIMMING EFFECT; FROCKS; G-STRINGS; GARTER BELTS; GARTERS; GAUCHOS; GILETS; GIRDLES; GLOVES; GLOVES AS CLOTHING; GLOVES FOR APPAREL; GOWNS; GYM PANTS; GYM SHORTS; GYM SUITS; HALLOWEEN COSTUMES; HALLOWEEN COSTUMES AND MASKS SOLD IN CONNECTION THEREWITH; HALTER TOPS; HATS; HEAD SCARVES; HEAD WEAR; HEADBANDS; HEADWEAR; HEAVY COATS; HEAVY JACKETS; HEEL INSERTS; HEELS; HOODED PULLOVERS; HOODED SWEAT SHIRTS; HOODED SWEATSHIRTS; HOSIERY; HOUSECOATS; INSOLES FOR FOOTWEAR; JACKETS; JANDALS; JEANS; JEGGINGS, NAMELY, PANTS THAT ARE PARTIALLY JEANS AND PARTIALLY LEGGINGS; JODHPURS; JOGGING OUTFITS; JOGGING PANTS; JOGGING SUITS; KNEE HIGHS; KNEE-HIGH STOCKINGS; KNIT BOTTOMS; KNIT DRESSES; KNIT JACKETS; KNIT SHIRTS; KNIT SKIRTS; KNIT TOPS; KNITTED CAPS; KNITTED GLOVES; LADIES' BOOTS; LADIES' SUITS; LADIES' UNDERWEAR; LEG SHAPERS; LEG WARMERS; LEG WARMERS; LEGGINGS; LEGGINS; LINGERIE; LINGERIE ACCESSORIES, NAMELY, REMOVABLE SILICONE BREAST ENHANCER PADS USED IN A BRA; LONG JACKETS; LONG SLEEVE PULLOVERS; LONG SLEEVED VESTS; LONG-SLEEVED SHIRTS; LOUNGE PANTS; LOUNGEWEAR; MAILLOTS; MASQUERADE COSTUMES; MASQUERADE COSTUMES AND MASKS SOLD IN CONNECTION THEREWITH; MEN'S AND WOMEN'S JACKETS, COATS, TROUSERS, VESTS; MEN'S SUITS, WOMEN'S SUITS; MILLINERY, NAMELY, FASCINATORS; MINISKIRTS; NECK BANDS; NECKERCHIEFS; NECKERCHIEVES; NECKWEAR; NEGLIGEEES; NIGHT GOWNS; NIGHT SHIRTS; NIGHT-DRESSES; NIGHTIES; NIGHTSHIRTS; NIGHTWEAR; NIPPLE COVERS, NAMELY, PASTIES; OBIS; ONE-PIECE PLAY SUITS; OPEN-NECKED SHIRTS; OUTER JACKETS; OVER COATS; OVER SHIRTS; OVERALLS; PAJAMAS; PANTALOONS; PANTIES; PANTIES, SHORTS AND BRIEFS; PANTS; PANTSUITS; PANTYHOSE; PAREOS; PAREU; PAREUS; PARKAS; PEACOATS; PEDAL PUSHERS; PEIGNOIRS; PELERINES; PETTI-PANTS; PETTICOATS; PINAFORES; PLAY SUITS; POLO KNIT TOPS; POLO SHIRTS; PULLOVERS; PUMPS; RAIN WEAR; RAINCOATS; ROBES; ROMPERS; SALOPETTES; SANDALS; SANDALS AND BEACH SHOES; SARONGS; SASHES; SCARFS; SCARVES; SHAWLS; SHAWLS AND HEADSCARVES; SHAWLS AND STOLEES; SHIRTS; SHIRTS; SHIRTS AND SHORT-SLEEVED SHIRTS; SHIRTS AND SLIPS; SHIRTS FOR SUITS; SHOES; SHORT PETTICOATS; SHORT-SLEEVED OR LONG-SLEEVED T-SHIRTS; SHORT-SLEEVED SHIRTS; SHORTALLS; SHORTS; SHOULDER WRAPS; SHOULDER WRAPS FOR CLOTHING; SHRUGS; SINGLETS; SKIRT SUITS; SKIRTS; SKIRTS AND DRESSES; SKOOTERS; SKORTS; SLACKS; SLEEP MASKS; SLEEP PANTS; SLEEP SHIRTS; SLEEPING GARMENTS; SLEEPWEAR; SLEEVED OR SLEEVELESS JACKETS; SLEEVES WORN SEPARATE AND APART FROM BLOUSES, SHIRTS AND OTHER TOPS; SLIPPERS; SLIPS; SOCKS AND STOCKINGS; SPATS; SPORTS BRA; SPORTS BRAS; STILETTO HEELS; STOCKING SUSPENDERS; STOCK-

**CLASS 25—(Continued).**

INGS; STRAPLESS BRAS; STRAPS FOR BRAS; STRETCH PANTS; SUIT COATS; SUITS; SUNDRESSES; SWIM SUITS; SWIM WEAR; SWIMMING COSTUMES; SWIMSUITS; SWIMWEAR; T-SHIRTS; TAILLEURS; TAMS; TEDDIES; TEE SHIRTS; THONGS; TIGHTS; TOP COATS; TOPCOATS; TOPS; TROUSERS; TUBE TOPS; TUNICS; TURTLE NECK SHIRTS; TURTLENECK PULLOVERS; TURTLENECK SWEATERS; TURTLENECKS; UNDER GARMENTS; UNDERCLOTHES; UNDERGARMENTS; UNDERSHIRTS; UNDERSKIRTS; UNDERWEAR; UNDERWEAR, NAMELY, BOY SHORTS; UNITARDS; V-NECK SWEATERS; VESTED SUITS; WAIST BANDS; WAIST BELTS; WAIST CINCHERS; WINTER BOOTS; WOMEN'S ATHLETIC TOPS WITH BUILT-IN BRAS; WOMEN'S CLOTHING, NAMELY, SHIRTS, DRESSES, SKIRTS, BLOUSES; WOMEN'S HATS AND HOODS; WOMEN'S SHOES; WOMEN'S UNDERWEAR; WOVEN BOTTOMS; WOVEN DRESSES; WOVEN OR KNITTED UNDERWEAR; WOVEN SKIRTS; WOVEN TOPS; WRAPS; YOGA PANTS; YOGA SHIRTS (U.S. CLS. 22 AND 39).

CIMMERIAN COLEMAN, EXAMINING ATTORNEY

SN 85-339,438. COLVARD, RON, DBA RIDICULOUS RON COLVARD, NEWARK, CA. FILED 6-7-2011.

**RIDICULOUS RON COLVARD**

THE MARK CONSISTS OF STANDARD CHARACTERS WITHOUT CLAIM TO ANY PARTICULAR FONT, STYLE, SIZE, OR COLOR.

THE NAME SHOWN IN THE MARK IDENTIFIES A LIVING INDIVIDUAL WHOSE CONSENT IS OF RECORD.

FOR CLOTHING, NAMELY, SHOES, SOCKS, T-SHIRTS, POLO SHIRTS, SWEATSHIRTS, SWEATPANTS, SHORTS, SHORT PANTS, SWIM TRUNKS, MEN'S UNDERWEAR, WOMEN'S UNDERWEAR, LINGERIE, HATS, JACKETS, BIKINIS, SWEATERS, BLOUSES (U.S. CLS. 22 AND 39).

FIRST USE 2-11-2011; IN COMMERCE 3-23-2011.

HAI-LY LAM, EXAMINING ATTORNEY

**CLASS 25—(Continued).**

SN 85-339,446. LEONARD G. DAVIS, NEWPORT BEACH, CA. FILED 6-7-2011.

**FEAR THE FORK**

THE MARK CONSISTS OF STANDARD CHARACTERS WITHOUT CLAIM TO ANY PARTICULAR FONT, STYLE, SIZE, OR COLOR.

FOR APPAREL FOR DANCERS, NAMELY, TEE SHIRTS, SWEATSHIRTS, PANTS, LEGGINGS, SHORTS AND JACKETS; ATHLETIC APPAREL, NAMELY, SHIRTS, PANTS, JACKETS, FOOTWEAR, HATS AND CAPS, ATHLETIC UNIFORMS; CHILDREN'S AND INFANT'S APPAREL, NAMELY, JUMPERS, OVERALL SLEEPWEAR, PAJAMAS, ROMPERS AND ONE-PIECE GARMENTS; CHILDREN'S AND INFANTS' APPAREL TREATED WITH FIRE AND HEAT RETARDANTS, NAMELY, JUMPERS, OVERALL SLEEPWEAR, PAJAMAS, ROMPERS AND ONE-PIECE GARMENTS; CLOTHING FOR WEAR IN JUDO PRACTICES; CLOTHING FOR WEAR IN WRESTLING GAMES; GLOVES FOR APPAREL; HEAD WEAR; INFANT WEAR; RAIN WEAR; SCIENTIFIC AND TECHNOLOGICAL APPAREL, NAMELY, SHIRTS, PANTS, JACKETS, FOOTWEAR, HATS AND CAPS, UNIFORMS; SHOE COVERS FOR USE WHEN WEARING SHOES; SKI WEAR; SURF WEAR; SWIM WEAR; SWIM WEAR FOR GENTLEMEN AND LADIES; TENNIS WEAR (U.S. CLS. 22 AND 39).  
STEVEN PEREZ, EXAMINING ATTORNEY

SN 85-339,460. CHEN CHENGKAI, BAIYUN AREA, GUANGZHOU, CHINA, FILED 6-7-2011.



THE MARK CONSISTS OF THE STYLIZED WORD BS ABOVE TWO CHINESE CHARACTERS WHICH TRANSLITERATE INTO BAO; SHEN AND THE STYLIZED WORD BAOSHEN.

THE WORDING BS HAS NO MEANING IN A FOREIGN LANGUAGE.

THE NON-LATIN CHARACTERS IN THE MARK TRANSLITERATE TO BAO; SHEN AND THIS MEANS TREASURE; GENTLEMAN IN ENGLISH.

FOR DRESSES; FOOTWEAR; HEADWEAR; JACKETS; NECKTIES; PAJAMAS; SHIRTS; T-SHIRTS; TROUSERS; UNDERWEAR (U.S. CLS. 22 AND 39).

FIRST USE 1-1-2010; IN COMMERCE 12-5-2010.

DORITT L. CARROLL, EXAMINING ATTORNEY

**CLASS 25—(Continued).**

SN 85-339,557. I BELIEVE ME, LLC, DBA I BELIEVE ME, DE PERE, WI. FILED 6-7-2011.



THE MARK CONSISTS OF A HUMAN EYE AND PUPIL ON THE LEFT SIDE ADJACENT TO AND SLIGHTLY OVERLAPPING A STYLIZED LETTER B IN THE MIDDLE WHICH IS ADJACENT TO AND SLIGHTLY OVERLAPPING A LEAF WITH VEINS THAT SPELL OUT THE STYLIZED WORD "ME" ON THE RIGHT.

FOR T-SHIRTS (U.S. CLS. 22 AND 39).

FIRST USE 6-12-2010; IN COMMERCE 5-24-2011.

MIDGE BUTLER, EXAMINING ATTORNEY

SN 85-339,594. BERNARD HOPKINS BOXING, INC., ISELIN, NJ. FILED 6-7-2011.

**BHOP**

THE MARK CONSISTS OF STANDARD CHARACTERS WITHOUT CLAIM TO ANY PARTICULAR FONT, STYLE, SIZE, OR COLOR.

FOR HOODED SWEATSHIRTS; JACKETS; JEANS; JERSEYS; SHIRTS FOR INFANTS, BABIES, TODDLERS AND CHILDREN; SHORTS; SWEATPANTS; SWEATSHIRTS; T-SHIRTS; TANK TOPS (U.S. CLS. 22 AND 39).

CHRISTOPHER BUONGIORNO, EXAMINING ATTORNEY

SN 85-339,781. INDUSTRIAS DE CALZADO SANTINI S.A. DE C.V., LEON, GUANAJUATO, MEXICO, FILED 6-7-2011.

**SANTINI**shoox

THE MARK CONSISTS OF THE WORDS SANTINI SHOOX IN CAPITAL STYLIZED LETTERS.

THE WORDING SHOOX HAS NO MEANING IN A FOREIGN LANGUAGE.

FOR BELTS; BLOUSES; CAPS; FOOTWEAR; HATS; HEADWEAR; JACKETS; PANTS; SHIRTS; SHOES; SKIRTS AND DRESSES; SOCKS AND STOCKINGS; SWEATSHIRTS; T-SHIRTS; UNDERWEAR (U.S. CLS. 22 AND 39).

INGA ERVIN, EXAMINING ATTORNEY

**CLASS 25—(Continued).**

SN 85-340,031. MCGURREN, JEFFREY, HAVERHILL, MA. FILED 6-7-2011.

**AIRSTRIKE**

THE MARK CONSISTS OF THE STYLIZED TEXT "AIRSTRIKE" WITH THE LETTER "A" RESEMBLING A MISSILE-LIKE IMAGE.

FOR BANDANAS; BELTS; COATS; DRESS SHIRTS; FOOTWEAR; GLOVES; HATS; JACKETS; PANTS; SHIRTS; SHORTS; SOCKS; SUITS; SWEATERS; SWEATSHIRTS; SWIMWEAR; T-SHIRTS; UNDERWEAR; VESTS (U.S. CLS. 22 AND 39).

Laurie Mayes, Examining Attorney

**CLASS 25—(Continued).**

SN 85-340,256. ALLY'S LITTLE ANGELS, INC., LOS ANGELES, CA. FILED 6-7-2011.

**CUSTARD N JELLY**

THE MARK CONSISTS OF STANDARD CHARACTERS WITHOUT CLAIM TO ANY PARTICULAR FONT, STYLE, SIZE, OR COLOR.

FOR HATS; HOODED SWEATSHIRTS; SHIRTS; SWEATSHIRTS; T-SHIRTS; TUNICS (U.S. CLS. 22 AND 39).

Barbara Brown, Examining Attorney

SN 85-340,100. THOMPSON, CONNOR, HOLLYWOOD, FL. FILED 6-7-2011.

**KUSH & CHAMPAGNE**

THE MARK CONSISTS OF STANDARD CHARACTERS WITHOUT CLAIM TO ANY PARTICULAR FONT, STYLE, SIZE, OR COLOR.

FOR JACKETS; JEANS; PANTS; SHIRTS; SHOES; SWEATSHIRTS (U.S. CLS. 22 AND 39).

William Verhosek, Examining Attorney

SN 85-340,303. SOBEL WESTEX, LAS VEGAS, NV. FILED 6-7-2011.

**URBANA**

THE MARK CONSISTS OF STANDARD CHARACTERS WITHOUT CLAIM TO ANY PARTICULAR FONT, STYLE, SIZE, OR COLOR.

THE ENGLISH TRANSLATION OF "URBANA" IN THE MARK IS "CITY".

FOR ROBES (U.S. CLS. 22 AND 39).

Wendy Goodman, Examining Attorney

SN 85-340,158. MARCEAU & MARCEAU INC., GLENDALE, CA. FILED 6-7-2011.

**MONCEAU**

THE MARK CONSISTS OF STANDARD CHARACTERS WITHOUT CLAIM TO ANY PARTICULAR FONT, STYLE, SIZE, OR COLOR.

THE ENGLISH TRANSLATION OF "MONCEAU" IN THE MARK IS "HEAP" OR "PILE".

FOR CLOTHING, NAMELY, PANTS, JEANS, SHIRTS, SWEATSHIRTS, T-SHIRTS, SHORTS, SKIRTS, JACKETS, HATS, CAPS, FOOTWEAR, DRESSES, BLOUSES, COATS, SWEATERS, SWEATPANTS, TANK TOPS, LEGGINGS, SWIMWEAR, ROBES, UNDERWEAR AND UNDERGARMENTS (U.S. CLS. 22 AND 39).

Sara Benjamin, Examining Attorney

SN 85-340,308. CORLEY-RYAN, WENDY, MANTECA, CA. FILED 6-7-2011.

**Teachers the Next  
Endangered Species**

THE MARK CONSISTS OF STANDARD CHARACTERS WITHOUT CLAIM TO ANY PARTICULAR FONT, STYLE, SIZE, OR COLOR.

FOR SWEATSHIRTS; T-SHIRTS; TANK TOPS (U.S. CLS. 22 AND 39).

FIRST USE 4-25-2011; IN COMMERCE 4-25-2011.

Benjamin Okeke, Examining Attorney



**CLASS 25—(Continued).**

SN 85-340,371. ANDREWS, JACK, CLEVELAND, OK. FILED 6-7-2011.



THE MARK CONSISTS OF THE STYLIZED TEXT "ZAP JACK" WITH THE LETTER "Z" MAKING A LIGHTNING BOLT ON THE TAIL.

FOR HATS; HOODED SWEAT SHIRTS; JEANS; SHIRTS; SHOES (U.S. CLS. 22 AND 39).  
REBECCA POVARCHUK, EXAMINING ATTORNEY

---

SN 85-340,493. CALIDOCIOUS, INC., SUNNYVALE, CA. FILED 6-7-2011.

# FUGEZI

THE MARK CONSISTS OF STANDARD CHARACTERS WITHOUT CLAIM TO ANY PARTICULAR FONT, STYLE, SIZE, OR COLOR.

FOR HATS, CAPS AND VISORS (U.S. CLS. 22 AND 39).  
FIRST USE 6-3-2011; IN COMMERCE 6-3-2011.  
SHARON MEIER, EXAMINING ATTORNEY

---

SN 85-340,515. FARRELL-JAVITS MARK, DBA FAIR DESIGNS, BROOKLYN, NY. FILED 6-7-2011.

# FairDesigns

THE MARK CONSISTS OF STANDARD CHARACTERS WITHOUT CLAIM TO ANY PARTICULAR FONT, STYLE, SIZE, OR COLOR.

FOR ATHLETIC APPAREL, NAMELY, SHIRTS, PANTS, JACKETS, FOOTWEAR, HATS AND CAPS, ATHLETIC UNIFORMS; BUTTON DOWN SHIRTS; COLLARED SHIRTS; DRESS SHIRTS; GOLF SHIRTS; HOODED SWEAT SHIRTS; KNIT SHIRTS; LONG-SLEEVED SHIRTS; OPEN-NECKED SHIRTS; POLO SHIRTS; RUGBY SHIRTS; SHIRT FRONTS; SHIRTS; SHIRTS AND SHORT-SLEEVED SHIRTS; SHORT-SLEEVED OR LONG-SLEEVED T-SHIRTS; SPORTS SHIRTS; SWEAT SHIRTS; T-SHIRTS; TEE SHIRTS; WEARABLE GARMENTS AND CLOTHING, NAMELY, SHIRTS; WOMEN'S CLOTHING, NAMELY, SHIRTS, DRESSES, SKIRTS, BLOUSES (U.S. CLS. 22 AND 39).  
NORA BUCHANAN WILL, EXAMINING ATTORNEY

**CLASS 25—(Continued).**

SN 85-340,553. FOUR STRIPES PTY LTD, MULLUMBIMBY NSW 2482, AUSTRALIA, FILED 6-7-2011.

# Paper Wings

THE MARK CONSISTS OF STANDARD CHARACTERS WITHOUT CLAIM TO ANY PARTICULAR FONT, STYLE, SIZE, OR COLOR.

OWNER OF AUSTRALIA REG. NO. 1069324, DATED 8-10-2005, EXPIRES 8-10-2015.

FOR CLOTHING, NAMELY JACKETS, SHIRTS, BLOUSES, VESTS, SWEATERS, SMOCKS, TUNICS, ROMPERS, TROUSERS, PANTS, SHORTS, DRESSES AND SKIRTS (U.S. CLS. 22 AND 39).

TAMARA FRAZIER, EXAMINING ATTORNEY

---

SN 85-341,141. CHANG, MARGARET W, SOUTH EL MONTE, CA. FILED 6-8-2011.



THE MARK CONSISTS OF OUTLINE OF THE "QUEEN" CHESS PIECE WITH THREE LAYERED WINGS ON BOTH SIDES OF CHESS PIECE WITH THE WORD MARK VERPOSH.

FOR SANDALS; SHIRTS; SHIRTS FOR INFANTS, BABIES, TODDLERS AND CHILDREN; SHORT-SLEEVED OR LONG-SLEEVED T-SHIRTS; SHORT-SLEEVED SHIRTS; STILETTO HEELS; SWEAT SHIRTS; T-SHIRTS; TEE SHIRTS; WEARABLE GARMENTS AND CLOTHING, NAMELY, SHIRTS; WOMEN'S CLOTHING, NAMELY, SHIRTS, DRESSES, SKIRTS, BLOUSES; WOMEN'S SHOES (U.S. CLS. 22 AND 39).

JACQUELINE A. LAVINE, EXAMINING ATTORNEY

**CLASS 25—(Continued).**

SN 85-341,232. VIZZINI, JOHN, ANNAPOLIS, MD. FILED 6-8-2011.



THE MARK CONSISTS OF A STYLIZED LETTER B THAT LOOKS LIKE A RABBIT.

FOR JACKETS; PANTS; SHIRTS; SWEATSHIRTS (U.S. CLS. 22 AND 39).

DOMINICK J. SALEMI, EXAMINING ATTORNEY

SN 85-341,258. BYRNE, SHANNON, WESTBROOK, CT. FILED 6-8-2011.

## Pickle Pea

THE MARK CONSISTS OF STANDARD CHARACTERS WITHOUT CLAIM TO ANY PARTICULAR FONT, STYLE, SIZE, OR COLOR.

FOR BLOOMERS; CHILDREN'S AND INFANT'S APPAREL, NAMELY, JUMPERS, OVERALL SLEEPWEAR, PAJAMAS, ROMPERS AND ONE-PIECE GARMENTS; CLOTH BIBS; DRESSES; FOOTWEAR; GOWNS; HATS; HOODED SWEATSHIRTS; INFANT AND TODDLER ONE PIECE CLOTHING; JEANS; KNIT TOPS; LEGGINGS; PANTS; ROMPERS; SHIRTS; SHORT-SLEEVED OR LONG-SLEEVED T-SHIRTS; SHORTS; SKIRTS; SLEEPWEAR; SOCKS; SWEATERS; SWEATSHIRTS; UNDERWEAR (U.S. CLS. 22 AND 39).

DOMINICK J. SALEMI, EXAMINING ATTORNEY

SN 85-341,381. PULIDO, LUIS A., SANTA ANA, CA. FILED 6-8-2011.

## Salt Creek

THE MARK CONSISTS OF STANDARD CHARACTERS WITHOUT CLAIM TO ANY PARTICULAR FONT, STYLE, SIZE, OR COLOR.

FOR BOARD SHORTS; HATS; JACKETS; JEANS; SHIRTS; T-SHIRTS (U.S. CLS. 22 AND 39).

ALICIA COLLINS, EXAMINING ATTORNEY

**CLASS 25—(Continued).**

SN 85-341,461. GRANDE PRODUCTS LLC, NOKOMIS, FL. FILED 6-8-2011.

## Live Pawsitive

THE MARK CONSISTS OF STANDARD CHARACTERS WITHOUT CLAIM TO ANY PARTICULAR FONT, STYLE, SIZE, OR COLOR.

FOR ADULT NOVELTY GAG CLOTHING ITEM, NAMELY, SOCKS; BABY LAYETTES FOR CLOTHING; BELTS; BELTS FOR CLOTHING; BELTS MADE OUT OF CLOTH; BIBS NOT OF CLOTH OR PAPER; BOTTOMS; CHILDREN'S AND INFANTS' CLOTH BIBS; CHILDREN'S CLOTH EATING BIBS; CLOTH BIBS; CLOTH BIBS FOR ADULT DINERS; CLOTH BIBS FOR USE BY SENIOR CITIZENS OR PHYSICALLY- OR MENTALLY-CHALLENGED PERSONS; CLOTH DIAPERS; CLOTHING EXTENSION USED TO EXTEND THE NORMAL SIZE RANGE OF CLOTHING ITEMS TO ACCOMMODATE PREGNANCY SIZE CHANGES; CLOTHING FOR ATHLETIC USE, NAMELY, PADDED ELBOW COMPRESSION SLEEVES BEING PART OF AN ATHLETIC GARMENT; CLOTHING FOR ATHLETIC USE, NAMELY, PADDED PANTS; CLOTHING FOR ATHLETIC USE, NAMELY, PADDED SHIRTS; CLOTHING FOR ATHLETIC USE, NAMELY, PADDED SHORTS; CLOTHING FOR BABIES, TODDLERS AND CHILDREN, TREATED WITH FIRE AND HEAT RETARDANTS, NAMELY, PAJAMAS, JACKETS, SHIRTS, PANTS, JUMPERS; CLOTHING FOR WEAR IN JUDO PRACTICES; CLOTHING FOR WEAR IN WRESTLING GAMES; CLOTHING ITEMS, NAMELY, ADHESIVE POCKETS THAT MAY BE AFFIXED DIRECTLY TO THE BODY AS A DECORATIVE PIECE OF CLOTHING WITH UTILITY; CLOTHING ITEMS, NAMELY, ADHESIVE POCKETS THAT MAY BE AFFIXED DIRECTLY TO THE INSIDE OF CLOTHING FOR STORAGE AND SAFEKEEPING OF PERSONAL ITEMS; CLOTHING ITEMS, NAMELY, BLINDFOLDS WORN OVER THE EYES; CLOTHING ITEMS, NAMELY, GAGS WORN OVER THE MOUTH; CLOTHING SHIELDS, NAMELY, PADS APPLIED TO THE UNDERARMS OF SHIRTS, BLOUSES AND SWEATERS; CLOTHING, NAMELY, ARM WARMERS; CLOTHING, NAMELY, ATHLETIC SLEEVES; CLOTHING, NAMELY, BASE LAYERS; CLOTHING, NAMELY, COWLS AND SMOKE RING SCARVES; CLOTHING, NAMELY, CROPS; CLOTHING, NAMELY, FOLK COSTUMES; CLOTHING, NAMELY, HAND-WARMERS; CLOTHING, NAMELY, KHAKIS; CLOTHING, NAMELY, KNEE WARMERS; CLOTHING, NAMELY, MATERNITY BANDS; CLOTHING, NAMELY, NECK TUBES; CLOTHING, NAMELY, THOBES; CLOTHING, NAMELY, WRAP-AROUNDS; CORSETS; DUSTERS; EYESHADES; FABRIC SOLD AS AN INTEGRAL COMPONENT OF FINISHED CLOTHING ITEMS, NAMELY, SCARVES; FIGURE SKATING CLOTHING, NAMELY, SKIRTS, DRESSES, BLOUSES, SHIRTS; FOULARDS; GLOVES AS CLOTHING; HEADBANDS FOR CLOTHING; HOODS; INFANT AND TODDLER ONE PIECE CLOTHING; INFANT CLOTH DIAPERS; INSERTS SPECIALLY ADAPTED FOR CLOTH DIAPERS MADE OF BAMBOO; INSERTS SPECIALLY ADAPTED FOR CLOTH DIAPERS MADE OF HEMP; INSERTS SPECIALLY ADAPTED FOR CLOTH DIAPERS MADE OF MICROFIBER; JACKETS; JERSEYS; LEATHER BELTS; MANTLES; MATERNITY CLOTHING, NAMELY, SHIRTS, DRESSES, BLOUSES; MUFFLERS; NON-DISPOSABLE CLOTH TRAINING PANTS; PAPER HATS FOR USE AS CLOTHING ITEMS; PARTS OF CLOTHING, NAMELY, GUSSETS FOR TIGHTS, GUSSETS FOR STOCKINGS, GUSSETS FOR BATHING SUITS, GUSSETS FOR UNDERWEAR, GUSSETS FOR LEOTARDS AND GUSSETS FOR FOOTLETS; PARTS OF CLOTHING, NAMELY, UNDERARM GUSSETS; PARTY HATS; PERSPIRATION ABSORBENT UNDERWEAR CLOTHING; POCKET SQUARES; SHIRTS; SHORT SETS; SHOULDER WRAPS; SHOULDER WRAPS FOR CLOTHING; SUN PROTECTIVE CLOTHING, NAMELY, HATS, SHIRTS,

**CLASS 25—(Continued).**

JACKETS, BLOUSES, SCARVES, VISORS, GLOVES, PANTS, SHORTS; SWADDLING CLOTHES; TIES; TOPS; TRAVEL CLOTHING CONTAINED IN A PACKAGE COMPRISING REVERSIBLE JACKETS, PANTS, SKIRTS, TOPS AND A BELT OR SCARF; TRIATHLON CLOTHING, NAMELY, TRIATHLON TIGHTS, TRIATHLON SHORTS, TRIATHLON SINGLETS, TRIATHLON SHIRTS, TRIATHLON SUITS; UNDERARM CLOTHING SHIELDS; WEARABLE GARMENTS AND CLOTHING, NAMELY, SHIRTS; WOMEN'S CLOTHING, NAMELY, SHIRTS, DRESSES, SKIRTS, BLOUSES; WRAPS (U.S. CLS. 22 AND 39).

H. M. FISHER, EXAMINING ATTORNEY

SN 85-341,475. SANTOS CABALLERO, MARIA ISABEL, MEDELLIN, COLOMBIA, AND MARROQUIN SANTOS, JUAN SEBASTIAN, MEDELLIN, COLOMBIA, AND MARROQUIN SANTOS, JUANA MANUELA, MEDELLIN, COLOMBIA, FILED 6-8-2011.



Pablo Emilio Escobar Gaviria

OWNER OF COLOMBIA REG. NO. 409437, DATED 9-28-2010, EXPIRES 9-28-2020.

THE NAME(S), PORTRAIT(S), AND/OR SIGNATURE(S) SHOWN IN THE MARK DOES NOT IDENTIFY A PARTICULAR LIVING INDIVIDUAL.

THE MARK CONSISTS OF AN UNREADABLE SIGNATURE FOLLOWED BY A FINGERPRINT AND BELOW THEM THE WORDS PABLO EMILIO ESCOBAR GAVIRIA.

FOR DRESS SUITS; DRESSES; FOOTWEAR; HEADGEAR, NAMELY, HATS AND CAPS; HEADWEAR; HOODED PULLOVERS; HOODED SWEATSHIRTS; JACKETS; JEANS; LEATHER HEADWEAR; PANTS; SHIRTS; SHOES; SKIRTS; SUITS; T-SHIRTS (U.S. CLS. 22 AND 39).

SHANNON TWOHIG, EXAMINING ATTORNEY

SN 85-341,563. LAUREN AND WENDY LLC, PACIFIC PALISADES, CA. FILED 6-8-2011.

**LAUREN AND WENDY**

THE MARK CONSISTS OF STANDARD CHARACTERS WITHOUT CLAIM TO ANY PARTICULAR FONT, STYLE, SIZE, OR COLOR.

FOR BATHING SUITS; BELTS; BLOUSES; BOTTOMS; DRESSES; EVENING DRESSES; HEADWEAR; JACKETS; JUMPSUITS; NECKWEAR; PANTS; SCARVES; SHIRTS; SKIRTS; SWEATPANTS; T-SHIRTS; TOPS (U.S. CLS. 22 AND 39).

SUE LAWRENCE, EXAMINING ATTORNEY

**CLASS 25—(Continued).**

SN 85-341,587. GARDNER, MATTHEW, PAYNESVILLE, MN. FILED 6-8-2011.



THE MARK CONSISTS OF THE STYLIZED "M" WITH AN 8 POINT BUCK SKULL BEHIND THE "M" WITH THE ANTLERS WRAPING AROUND THE "M". ALONG WITH THE STYLIZED "M" ARE THE STYLIZED TEXT "MIDWEST MAYHEM".

FOR CAPS; GLOVES; HATS; JACKETS; PANTS; POLO SHIRTS; STOCKINGS; SWEATSHIRTS; T-SHIRTS; UNDERWEAR (U.S. CLS. 22 AND 39).

TOBY BULLOFF, EXAMINING ATTORNEY

SN 85-341,622. REPUBLIC CLOTHING CORPORATION, NEW YORK, NY. FILED 6-8-2011.

**FOURTH & JANE**

THE MARK CONSISTS OF STANDARD CHARACTERS WITHOUT CLAIM TO ANY PARTICULAR FONT, STYLE, SIZE, OR COLOR.

FOR WOMEN'S APPAREL, NAMELY, TOPS, BOTTOMS, JACKETS, SWEATERS, PANTS, SHIRTS, SHORTS (U.S. CLS. 22 AND 39).

MARK T. MULLEN, EXAMINING ATTORNEY

**CLASS 25—(Continued).**

SN 85-341,908. MARTINEZ, MATTHEW, MADERA, CA. AND GOMEZ, ANTONIO, MADERA, CA. FILED 6-9-2011.



THE MARK CONSISTS OF AN IMAGE OF A SHIELD WITH WINGS AND CURVED EMBELLISHMENTS AROUND THE BORDER. THREE SMALL CIRCLES BORDER THE UPPER SIDE OF THE SHIELD AND A CIRCLE IS POSITIONED AT EACH OF THE THREE LOWER CORNERS. A FLEUR-DE-LIS IS POSITIONED AT THE TOP OF THE SHIELD. THE STYLIZED LETTERS "T L" ARE IN THE CENTER OF THE SHIELD WITH THE "T" POSITIONED HIGHER AND TO THE LEFT OF THE "L".

FOR BEANIES; DRESS SHIRTS; HATS; SWEATSHIRTS; T-SHIRTS (U.S. CLS. 22 AND 39).  
JULIE GUTTADAURO, EXAMINING ATTORNEY

SN 85-342,067. FITSOK, LLC, CHANHASSEN, MN. FILED 6-9-2011.

**FLOWTEK**

THE MARK CONSISTS OF STANDARD CHARACTERS WITHOUT CLAIM TO ANY PARTICULAR FONT, STYLE, SIZE, OR COLOR.

FOR SOCKS (U.S. CLS. 22 AND 39).  
FIRST USE 3-7-2008; IN COMMERCE 3-7-2008.  
KELLY TRUSILO, EXAMINING ATTORNEY

SN 85-345,367. DANIEL D'ARCO, POTTSVILLE, PA. FILED 6-14-2011.

**ELDERITE**

THE MARK CONSISTS OF STANDARD CHARACTERS WITHOUT CLAIM TO ANY PARTICULAR FONT, STYLE, SIZE, OR COLOR.

FOR CAPS, HATS, HEAD WEAR, SHIRTS, T-SHIRTS, SLEEPWEAR, SWEATPANTS, TIES, UNDERWEAR, SHOES (U.S. CLS. 22 AND 39).  
SANI KHOURI, EXAMINING ATTORNEY

**CLASS 25—(Continued).**

SN 85-346,941. PACIFIC SUNWEAR OF CALIFORNIA, INC., ANAHEIM, CA. FILED 6-15-2011.

**REDWIND**

THE MARK CONSISTS OF STANDARD CHARACTERS WITHOUT CLAIM TO ANY PARTICULAR FONT, STYLE, SIZE, OR COLOR.

FOR CLOTHING, NAMELY, SHIRTS, T-SHIRTS, WOVEN SHIRTS, FLANNEL SHIRTS, KNIT TOPS, TANK TOPS, DRESSES, SKIRTS, SWEATSHIRTS, SWEAT PANTS, PANTS, JEANS, LEGGINGS, SHORTS, JACKETS, SWEATERS, PAJAMAS, UNDER GARMENTS, SWIM SUITS, SWIM WEAR, SCARVES, SHAWLS, BELTS, GLOVES, MITTENS, SOCKS; FOOTWEAR NAMELY, ATHLETIC FOOTWEAR, SHOES, SANDALS, SLIPPERS, BOOTS, BEACH FOOTWEAR; HEADGEAR, NAMELY, HATS, CAPS, VISORS, BEANIES AND HEAD BANDS (U.S. CLS. 22 AND 39).

JEFF DEFORD, EXAMINING ATTORNEY

SN 85-347,523. BELING, JOEL L, DBA SUPA CHARACTERS PTY LTD, DALLAS, VICTORIA, AUSTRALIA, FILED 6-16-2011.

Heavenly Bodies, Star Sign  
Superstars and Zone of the  
Zodiac: Capricorn the Goat,  
Aquario the Water-Bearer,  
Pisces the Fish, Aries the  
Ram, Taurus the Bull,  
Gemini Twins, Cancer the  
Crab, Leo and Leo the  
Lion, Virgo and Virgo the  
Virgin, Libra the Balancer,  
Scorpio and Scorpio the  
Scorpion, Sagittario the  
Archer. What's your star  
sign?

THE MARK CONSISTS OF STANDARD CHARACTERS WITHOUT CLAIM TO ANY PARTICULAR FONT, STYLE, SIZE, OR COLOR.

FOR ADULT NOVELTY GAG CLOTHING ITEM, NAMELY, SOCKS; BABY TOPS; BELTS; BOTTOMS; CHILDREN'S AND INFANTS' CLOTH BIBS; CLOTHING FOR ATHLETIC USE, NAMELY, PADDED PANTS; CLOTHING FOR ATHLETIC USE, NAMELY, PADDED SHIRTS; CLOTHING FOR ATHLETIC USE, NAMELY, PADDED SHORTS; CLOTHING FOR BABIES, TODDLERS AND CHILDREN, TREATED WITH FIRE AND HEAT RETARDANTS, NAMELY, PAJAMAS, JACKETS, SHIRTS, PANTS, JUMPERS; CLOTHING, NAMELY, ARM WARMERS; CLOTHING, NAMELY, ATHLETIC SLEEVES; CLOTHING, NAMELY, BASE LAYERS; CLOTHING, NAMELY, COWLS AND SMOKE RING SCARVES; CLOTHING, NAMELY, CROPS; CLOTHING, NAMELY, FOLK COSTUMES; CLOTHING, NAMELY, HAND-WARMERS; CLOTHING, NAMELY, KHAKIS; CLOTHING, NAMELY, KNEE WARMERS; CLOTHING, NAMELY, MATERNITY BANDS; CLOTHING, NAMELY, NECK TUBES; CLOTHING, NAMELY, THOBES; CLOTHING, NAMELY, WRAP-AROUNDS; COSTUMES FOR USE IN CHILDREN'S DRESS UP PLAY; COSTUMES FOR USE IN ROLE-PLAYING GAMES; COSTUMES FOR USE IN THE AMUSEMENT INDUSTRY; DANCE COSTUMES; FITTED SWIMMING COSTUMES WITH BRA CUPS; HALLOWEEN COSTUMES; HALLOWEEN COSTUMES AND MASKS SOLD IN CONNECTION THEREWITH; HATS; HEADBANDS FOR CLOTHING; HOODS; INFANT AND TODDLER ONE PIECE CLOTHING; INFANT CLOTH DIAPERS; INSERTS SPECIALLY

**CLASS 25—(Continued).**

ADAPTED FOR CLOTH DIAPERS MADE OF BAMBOO; INSERTS SPECIALLY ADAPTED FOR CLOTH DIAPERS MADE OF HEMP; INSERTS SPECIALLY ADAPTED FOR CLOTH DIAPERS MADE OF MICROFIBER; JACKETS; JERSEYS; LEATHER BELTS; MASQUERADE COSTUMES; MASQUERADE COSTUMES AND MASKS SOLD IN CONNECTION THEREWITH; MEN'S AND WOMEN'S JACKETS, COATS, TROUSERS, VESTS; MEN'S DRESS SOCKS; MEN'S SOCKS; MEN'S SUITS; MEN'S SUITS, WOMEN'S SUITS; MEN'S UNDERWEAR; MUFFLERS; PARTS OF CLOTHING, NAMELY, GUSSETS FOR TIGHTS, GUSSETS FOR STOCKINGS, GUSSETS FOR BATHING SUITS, GUSSETS FOR UNDERWEAR, GUSSETS FOR LEOTARDS AND GUSSETS FOR FOOTLETS; PARTS OF CLOTHING, NAMELY, UNDERARM GUSSETS; PARTY HATS; PERSPIRATION ABSORBENT UNDERWEAR CLOTHING; SHOES; SHORT SETS; SWIMMING COSTUMES; TIES; TOPS; WOMEN'S CLOTHING, NAMELY, SHIRTS, DRESSES, SKIRTS, BLOUSES; WRAPS (U.S. CLS. 22 AND 39).

KATINA MISTER, EXAMINING ATTORNEY

SN 85-349,227. ROKAB, SYLVIANE "SYLVIE", PACIFIC PALISADES, CA. FILED 6-17-2011.

## Love Thy Nature

THE MARK CONSISTS OF STANDARD CHARACTERS WITHOUT CLAIM TO ANY PARTICULAR FONT, STYLE, SIZE, OR COLOR.

FOR T-SHIRTS, SWEAT SHIRTS (U.S. CLS. 22 AND 39).

KATHERINE E. HALMEN, EXAMINING ATTORNEY

SN 85-349,370. BERNARD HOPKINS BOXING, INC., ISELIN, NJ. FILED 6-17-2011.

## I AM THE MACHINE

THE MARK CONSISTS OF STANDARD CHARACTERS WITHOUT CLAIM TO ANY PARTICULAR FONT, STYLE, SIZE, OR COLOR.

FOR HOODED SWEATSHIRTS; JACKETS; JEANS; JERSEYS; SHIRTS FOR INFANTS, BABIES, TODDLERS AND CHILDREN; SHORTS; SWEATPANTS; SWEATSHIRTS; T-SHIRTS (U.S. CLS. 22 AND 39).

CHRISTOPHER BUONGIORNO, EXAMINING ATTORNEY

**CLASS 25—(Continued).**

SN 85-349,390. BERNARD HOPKINS BOXING, INC., ISELIN, NJ. FILED 6-17-2011.

## THE EXECUTIONER

THE MARK CONSISTS OF STANDARD CHARACTERS WITHOUT CLAIM TO ANY PARTICULAR FONT, STYLE, SIZE, OR COLOR.

FOR HOODED SWEATSHIRTS; JACKETS; JEANS; JERSEYS; SHIRTS FOR INFANTS, BABIES, TODDLERS AND CHILDREN; SHORTS; SWEATPANTS; SWEATSHIRTS; T-SHIRTS; TANK TOPS (U.S. CLS. 22 AND 39).

CHRISTOPHER BUONGIORNO, EXAMINING ATTORNEY

SN 85-349,802. GRANDE PRODUCTS LLC, NOKOMIS, FL. FILED 6-18-2011.

## NO WAKE ZONE

THE MARK CONSISTS OF STANDARD CHARACTERS WITHOUT CLAIM TO ANY PARTICULAR FONT, STYLE, SIZE, OR COLOR.

FOR A-SHIRTS; ADULT NOVELTY GAG CLOTHING ITEM, NAMELY, SOCKS; ANKLE SOCKS; ANKLETS; ANTI-PERSPIRANT SOCKS; APPAREL FOR DANCERS, NAMELY, TEE SHIRTS, SWEATSHIRTS, PANTS, LEGGINGS, SHORTS AND JACKETS; ATHLETIC APPAREL, NAMELY, SHIRTS, PANTS, JACKETS, FOOTWEAR, HATS AND CAPS, ATHLETIC UNIFORMS; BASEBALL CAPS AND HATS; BELTS; BELTS FOR CLOTHING; BELTS MADE FROM IMITATION LEATHER; BELTS MADE OF LEATHER; BELTS MADE OUT OF CLOTH; BELTS OF TEXTILE; BELTS THAT ARE DESIGNED TO ACCOMMODATE PREGNANCY SIZE CHANGES; BERMUDA SHORTS; BIB SHORTS; BOARD SHORTS; BODY SHIRTS; BOXER SHORTS; BOXING SHORTS; BUTTON DOWN SHIRTS; BUTTON-FRONT ALOHA SHIRTS; CAMOUFLAGE SHIRTS; CAMP SHIRTS; CHEF'S HATS; CLOTHING FOR ATHLETIC USE, NAMELY, PADDED SHIRTS; CLOTHING FOR ATHLETIC USE, NAMELY, PADDED SHORTS; CLOTHING FOR BABIES, TODDLERS AND CHILDREN, TREATED WITH FIRE AND HEAT RETARDANTS, NAMELY, PAJAMAS, JACKETS, SHIRTS, PANTS, JUMPERS; CLOTHING SHIELDS, NAMELY, PADS APPLIED TO THE UNDERARMS OF SHIRTS, BLOUSES AND SWEATERS; COLLARED SHIRTS; COMPRESSION GARMENTS FOR ATHLETIC OR OTHER NON-MEDICAL USE, NAMELY, UNDERWEAR; CYCLING SHORTS; DRESS SHIRTS; FABRIC BELTS; FISHING SHIRTS; FLEECE SHORTS; FUR HATS; GARTER BELTS; GOLF PANTS, SHIRTS AND SKIRTS; GOLF SHIRTS; GOLF SHORTS; GYM SHORTS; HAT BANDS; HATS; HATS FOR INFANTS, BABIES, TODDLERS AND CHILDREN; HEADGEAR, NAMELY, HATS; HOODED SWEAT SHIRTS; HUNTING SHIRTS; JACKETS AND SOCKS; JAPANESE STYLE SOCKS (TABI COVERS); JAPANESE STYLE SOCKS (TABI); KNIT SHIRTS; KNIT SKIRTS; LEATHER BELTS; LEATHER HATS; LEATHER SHIRTS; LEATHER SKIRTS; LONG-SLEEVED SHIRTS; MATERNITY CLOTHING, NAMELY, SHIRTS; MEN'S DRESS SOCKS; MEN'S SOCKS; MOISTURE-WICKING SPORTS SHIRTS; MONEY BELTS; NIGHT SHIRTS; NON-SLIP SOCKS; OPEN-NECKED SHIRTS; OVER SHIRTS; PANTIES, SHORTS AND BRIEFS; PAPER HATS FOR USE AS CLOTHING ITEMS; PAPER SHOES USED WHEN GOING THROUGH METAL

**CLASS 25—(Continued).**

DETECTORS TO KEEP FEET AND SOCKS CLEAN; PARTY HATS; PERSPIRATION ABSORBENT STRAP TO BE USED IN THE BILL OF A HAT; PIQUE SHIRTS; PLEATED SKIRTS FOR FORMAL KIMONOS (HAKAMA); POLO SHIRTS; RACE NUMBER BELTS THAT HOLD A PAPER NUMBER ON THE RACE PARTICIPANT'S FRONT OR BACK DURING COMPETITION; RAIN HATS; RUGBY SHIRTS; RUGBY SHORTS; SCIENTIFIC AND TECHNOLOGICAL APPAREL, NAMELY, SHIRTS, PANTS, JACKETS, FOOTWEAR, HATS AND CAPS, UNIFORMS; SEDGE HATS (SUGE-GASA); SHIRT FRONTS; SHIRT INSERTS, NAMELY, DICKIES; SHIRT YOKES; SHIRTS; SHIRTS AND SHORT-SLEEVED SHIRTS; SHIRTS AND SLIPS; SHIRTS FOR INFANTS, BABIES, TODDLERS AND CHILDREN; SHIRTS FOR SUITS; SHORT OVERCOAT FOR KIMONO (HAORI); SHORT PETTICOATS; SHORT SETS; SHORT TROUSERS; SHORT-SLEEVED OR LONG-SLEEVED T-SHIRTS; SHORT-SLEEVED SHIRTS; SHORTS; SKIRT SUITS; SKIRTS; SKIRTS AND DRESSES; SLEEP SHIRTS; SLEEVES WORN SEPARATE AND APART FROM BLOUSES, SHIRTS AND OTHER TOPS; SLIDING SHORTS; SLIPPER SOCKS; SMALL HATS; SNAP CROTCH SHIRTS FOR INFANTS AND TODDLERS; SOCK SUSPENDERS; SOCKS; SOCKS AND STOCKINGS; SPORT SHIRTS; SPORTS CAPS AND HATS; SPORTS SHIRTS; SPORTS SHIRTS WITH SHORT SLEEVES; SUN PROTECTIVE CLOTHING, NAMELY, T-SHIRTS; SUSPENDER BELTS; SUSPENDER BELTS FOR MEN; SUSPENDER BELTS FOR WOMEN; SWEAT SHIRTS; SWEAT SHORTS; T-SHIRTS; T-SHIRTS FOR MEN, WOMEN, CHILDREN, BABIES; TEE SHIRTS; THERMAL SOCKS; TOBOGGAN HATS, PANTS AND CAPS; TRAVEL CLOTHING CONTAINED IN A PACKAGE COMPRISING REVERSIBLE JACKETS, PANTS, SKIRTS, TOPS AND A BELT OR SCARF; TRIATHLON CLOTHING, NAMELY, TRIATHLON TIGHTS, TRIATHLON SHORTS, TRIATHLON SINGLET, TRIATHLON SHIRTS, TRIATHLON SUITS; TURTLE NECK SHIRTS; TUXEDO BELTS; UNDERWEAR, NAMELY, BOY SHORTS; WAIST BELTS; WALKING SHORTS; WATER SOCKS; WEARABLE GARMENTS AND CLOTHING, NAMELY, SHIRTS; WIND SHIRTS; WOMEN'S CLOTHING, NAMELY, SHIRTS, DRESSES, SKIRTS, BLOUSES; WOMEN'S HATS AND HOODS; WOOLLEN SOCKS; WOOLLY HATS; WOVEN SKIRTS; WRAP BELTS FOR KIMONOS (DATEMAKI); YOGA SHIRTS (U.S. CLS. 22 AND 39).

H. M. FISHER, EXAMINING ATTORNEY

SN 85-353,407. NAUTIYACHTIES LLC, HONOLULU, HI. FILED 6-22-2011.

**NACHTIE YACHTIES**

THE MARK CONSISTS OF STANDARD CHARACTERS WITHOUT CLAIM TO ANY PARTICULAR FONT, STYLE, SIZE, OR COLOR.

FOR BOTTOMS; BUSTIERS; COVERUPS; HOODED SWEATSHIRTS; LINGERIE; NIGHTIES; SWIMWEAR; TOPS (U.S. CLS. 22 AND 39).

BRENDAN REGAN, EXAMINING ATTORNEY

**CLASS 25—(Continued).**

SN 85-356,297. HAFABROWNDDESIGNS, VACAVILLE, CA. FILED 6-25-2011.

**hafabrowndesigns**

THE MARK CONSISTS OF STANDARD CHARACTERS WITHOUT CLAIM TO ANY PARTICULAR FONT, STYLE, SIZE, OR COLOR.

THE ENGLISH TRANSLATION OF THE WORD "HAFA" IN THE MARK IS THE GREETING "HELLO" AND "WHAT'S UP".

FOR ATHLETIC APPAREL, NAMELY, SHIRTS, PANTS, JACKETS, FOOTWEAR, HATS AND CAPS, ATHLETIC UNIFORMS (U.S. CLS. 22 AND 39).

H. M. FISHER, EXAMINING ATTORNEY

SN 85-356,301. HAFABROWNDDESIGNS, VACAVILLE, CA. FILED 6-25-2011.

**hafagirldesigns**

THE MARK CONSISTS OF STANDARD CHARACTERS WITHOUT CLAIM TO ANY PARTICULAR FONT, STYLE, SIZE, OR COLOR.

THE ENGLISH TRANSLATION OF THE WORD "HAFA" IN THE MARK IS THE GREETING "HELLO" AND "WHAT'S UP".

FOR ATHLETIC APPAREL, NAMELY, SHIRTS, PANTS, JACKETS, FOOTWEAR, HATS AND CAPS, ATHLETIC UNIFORMS (U.S. CLS. 22 AND 39).

H. M. FISHER, EXAMINING ATTORNEY

SN 85-356,909. FINDING MY MUCHNESS, L.L.C., TEANECK, NJ. FILED 6-27-2011.

**MUCHNESS**

THE MARK CONSISTS OF STANDARD CHARACTERS WITHOUT CLAIM TO ANY PARTICULAR FONT, STYLE, SIZE, OR COLOR.

FOR HEADBANDS; SCARVES; WRISTBANDS (U.S. CLS. 22 AND 39).

JOHN HWANG, EXAMINING ATTORNEY

**CLASS 25—(Continued).**

SN 85-356,936. GAP (APPAREL), LLC, SAN FRANCISCO, CA. FILED 6-27-2011.

**PIM + LARKIN**

THE MARK CONSISTS OF STANDARD CHARACTERS WITHOUT CLAIM TO ANY PARTICULAR FONT, STYLE, SIZE, OR COLOR.

FOR CLOTHING, NAMELY, SHIRTS, BLOUSES, SWEATERS, SWEATSHIRTS, TOPS, BOTTOMS, PANTS, SHORTS, JEANS, SKIRTS, DRESSES, JACKETS, BLAZERS, COATS, HOSIERY, SOCKS, HEADWEAR, SCARVES, GLOVES, BELTS, FOOTWEAR (U.S. CLS. 22 AND 39).

BRENDAN MCCAULEY, EXAMINING ATTORNEY

SN 85-362,927. JOE SCARALLO JR., NORTH LINDENHURST, NY. FILED 7-5-2011.

**braggadocious**

THE MARK CONSISTS OF STANDARD CHARACTERS WITHOUT CLAIM TO ANY PARTICULAR FONT, STYLE, SIZE, OR COLOR.

FOR BOTTOMS; CLOTH BIBS; CLOTH BIBS FOR ADULT DINERS; CLOTHING, NAMELY, ATHLETIC SLEEVES; CLOTHING, NAMELY, BASE LAYERS; GLOVES AS CLOTHING; HEADBANDS FOR CLOTHING; HOODED SWEATSHIRTS; HOODS; JACKETS; JERSEYS; MATERNITY CLOTHING, NAMELY, T-SHIRT; RACE NUMBER BELTS THAT HOLD A PAPER NUMBER ON THE RACE PARTICIPANT'S FRONT OR BACK DURING COMPETITION; SHORT-SLEEVED OR LONG-SLEEVED T-SHIRTS; SWEATSHIRTS; T-SHIRTS; TOPS; WEARABLE GARMENTS AND CLOTHING, NAMELY, SHIRTS; WOMEN'S CLOTHING, NAMELY, SHIRTS, DRESSES, SKIRTS, BLOUSES (U.S. CLS. 22 AND 39).

LAURIE MAYES, EXAMINING ATTORNEY

SN 85-363,523. EMORY MARKETING SYSTEMS, LLC, TEMPLE HILLS, MD. FILED 7-5-2011.

**12P**

THE MARK CONSISTS OF STANDARD CHARACTERS WITHOUT CLAIM TO ANY PARTICULAR FONT, STYLE, SIZE, OR COLOR.

FOR T-SHIRTS, SHIRTS, UNIFORMS, NAMELY FOR MIXED MARTIAL ARTS, GRAPPLING, BRAZILIAN JIU JITSU UNIFORMS, GIS, KIMONOS (U.S. CLS. 22 AND 39).

FIRST USE 6-1-2009; IN COMMERCE 6-1-2009.  
WENDY JUN, EXAMINING ATTORNEY

**CLASS 25—(Continued).**

SN 85-364,303. MAIDENFORM, INC., ISELIN, NJ. FILED 7-6-2011.

**STAY THERE POWER**

THE MARK CONSISTS OF STANDARD CHARACTERS WITHOUT CLAIM TO ANY PARTICULAR FONT, STYLE, SIZE, OR COLOR.

FOR FEATURE OF FOUNDATION GARMENTS, WOMEN'S UNDERGARMENTS, LINGERIE, AND WOMEN'S INTIMATE APPAREL, NAMELY, A GRIPPING, STRETCHABLE BAND ATTACHED TO A BRA TO PREVENT THE BRA FROM SLIPPING OR MOVING FROM ITS PROPER POSITION ON THE BODY (U.S. CLS. 22 AND 39).

FIRST USE 0-0-2003; IN COMMERCE 0-0-2007.  
INGRID C. EULIN, EXAMINING ATTORNEY

SN 85-371,650. GEOFFREY BEENE, LLC, NEW YORK, NY. FILED 7-14-2011.

**BEENE BAG**

THE MARK CONSISTS OF STANDARD CHARACTERS WITHOUT CLAIM TO ANY PARTICULAR FONT, STYLE, SIZE, OR COLOR.

FOR CLOTHING, NAMELY, SHIRTS, BLOUSES, SWEATERS, SLACKS, KNITWEAR TOPS, KNITWEAR BOTTOMS, PANTS, JACKETS, COATS, DRESSES, VESTS, BELTS, SCARVES, SUITS, T-SHIRTS, LOUNGEWEAR, AND FOOTWEAR (U.S. CLS. 22 AND 39).

YAT SYE, LEE, EXAMINING ATTORNEY

SN 85-371,974. R&R ELITE MANAGEMENT LLC, BEVERLY HILLS, CA. FILED 7-14-2011.



THE MARK CONSISTS OF A TRIANGLE WITH TWO LINES RUNNING DOWN THE MIDDLE OF THE TRIANGLE.

FOR MEN'S, WOMEN'S AND CHILDREN'S CLOTHING, NAMELY, PANTS, SHIRTS, T-SHIRTS, SWEATSHIRTS, JACKETS, SUITS, DRESSES, COATS, TOPS, BOTTOMS, UNDERWEAR, SHOES, SOCKS, SLIPPERS, HEADWEAR, HATS, CAPS, SCARVES, SWEATERS, SWIMWEAR, SLEEPWEAR (U.S. CLS. 22 AND 39).

CHARLES L. JENKINS, EXAMINING ATTORNEY

**CLASS 25—(Continued).**

SN 85-373,881. R&R ELITE MANAGEMENT LLC, BEVERLY HILLS, CA. FILED 7-18-2011.

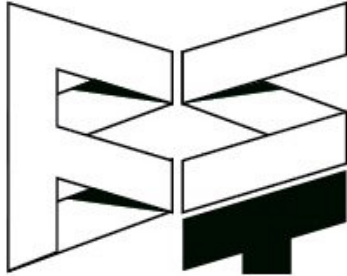

THE MARK CONSISTS OF THE LETTERS "B", "S" AND "T" IN A STYLIZED FORM WITH THE "B" ON THE LEFT HAND SIDE AND THE "S" AND "T" ON THE RIGHT HAND SIDE.

FOR MEN'S, WOMEN'S AND CHILDREN'S CLOTHING, NAMELY, PANTS, SHIRTS, T-SHIRTS, SWEATSHIRTS, JACKETS, SUITS, DRESSES, COATS, TOPS, BOTTOMS, UNDERWEAR, SHOES, SOCKS, SLIPPERS, HEADWEAR, HATS, CAPS, SCARVES, SWEATERS, SWIMWEAR, SLEEPWEAR (U.S. CLS. 22 AND 39).  
CHARLES L. JENKINS, EXAMINING ATTORNEY

SN 85-373,925. INC INTERNATIONAL COMPANY, KENNETT SQUARE, PA. FILED 7-18-2011.

**SOXX**

THE MARK CONSISTS OF STANDARD CHARACTERS WITHOUT CLAIM TO ANY PARTICULAR FONT, STYLE, SIZE, OR COLOR.  
FOR RUNNING SHOES; SHOE SOLES; SHOES (U.S. CLS. 22 AND 39).  
GRETTA YAO, EXAMINING ATTORNEY

**CLASS 25—(Continued).**

SN 85-374,407. FRANCO LLC, SEATTLE, WA. FILED 7-18-2011.



THE MARK CONSISTS OF A FIGURE THAT COMBINES THE LETTER "F" AND THE AMPERSAND SYMBOL, WITH A PERIOD IN THE LOWER RIGHT HAND CORNER AS SHOWN IN THE MARK.

FOR CLOTHING, NAMELY, T-SHIRTS, SHIRTS, PANTS, JEANS, SHORTS, TANK-TOPS, BELTS, VESTS, SHOES, LONG SLEEVE SHIRTS, DRESS SHIRTS, DRESSES, HOODED SWEATSHIRTS, SWEATERS, SWEATSHIRTS, UNDERWEAR, BEACHWEAR, JACKETS, LEATHER JACKETS (U.S. CLS. 22 AND 39).  
FIRST USE 4-27-2011; IN COMMERCE 4-27-2011.  
AMY ALFIERI, EXAMINING ATTORNEY

SN 85-374,940. KELLWOOD COMPANY, CHESTERFIELD, MO. FILED 7-19-2011.

**LAMB CHOP**

THE MARK CONSISTS OF STANDARD CHARACTERS WITHOUT CLAIM TO ANY PARTICULAR FONT, STYLE, SIZE, OR COLOR.

FOR BABY TOPS; BELTS; BLOUSES; BOXER BRIEFS; BOXER SHORTS; BRAS; CAPRI PANTS; CHILDREN'S AND INFANT'S APPAREL, NAMELY, JUMPERS, OVERALL SLEEPWEAR, PAJAMAS, ROMPERS AND ONE-PIECE GARMENTS; CHILDREN'S AND INFANTS' CLOTH BIBS; CHILDREN'S HEADWEAR; CLOTHING, NAMELY, ARM WARMERS; COATS; DENIMS; DRESSES; EAR MUFFS; FLEECE TOPS; FOOTWEAR; GLOVES; HATS FOR INFANTS, BABIES, TODDLERS AND CHILDREN; HEADBANDS; HOODED SWEATSHIRTS FOR CHILDREN; JACKETS; KNIT TOPS; LEG WARMERS; LEGGINGS; LONG UNDERWEAR; MITTENS; MUFFS; ONE PIECE GARMENT FOR INFANTS AND TODDLERS; ONE-PIECE GARMENTS FOR CHILDREN; PANTIES, SHORTS AND BRIEFS; PANTS; POLO KNIT TOPS; SCARVES; SHIRTS; SHIRTS FOR INFANTS, BABIES, TODDLERS AND CHILDREN; SHORTS; SKIRTS; SNAP CROTCH SHIRTS FOR INFANTS AND TODDLERS; SOCKS; SWEAT SHIRTS; SWEATERS; SWEATPANTS; SWEATSHIRTS FOR CHILDREN; SWIMWEAR; T-SHIRTS; T-SHIRTS FOR CHILDREN; TANK TOPS; TIGHTS; TOPS; UNDERWEAR; VESTS; WOVEN TOPS (U.S. CLS. 22 AND 39).  
ANDREW RHIM, EXAMINING ATTORNEY



**CLASS 25—(Continued).**

SN 85-375,242. CONSOLIDATED SHOE COMPANY, INC.,  
LYNCHBURG, VA. FILED 7-19-2011.

# ADALA

THE MARK CONSISTS OF STANDARD CHARACTERS  
WITHOUT CLAIM TO ANY PARTICULAR FONT, STYLE,  
SIZE, OR COLOR.

FOR FOOTWEAR (U.S. CLS. 22 AND 39).  
KATHERINE CONNOLLY, EXAMINING ATTORNEY

SN 85-378,122. DILLARD'S, LITTLE ROCK, AR. FILED 7-22-  
2011.

# Mr. Bingle

THE MARK CONSISTS OF STANDARD CHARACTERS  
WITHOUT CLAIM TO ANY PARTICULAR FONT, STYLE,  
SIZE, OR COLOR.

OWNER OF U.S. REG. NOS. 535,774, 3,273,141 AND  
OTHERS.

FOR BOXER SHORTS; ROBES; SLEEP PANTS; SLEEP  
SHIRTS; T-SHIRTS (U.S. CLS. 22 AND 39).  
ANGELA M. MICHELI, EXAMINING ATTORNEY

SN 85-385,140. PURTHREAD TECHNOLOGIES, INC., SAN  
FRANCISCO, CA. FILED 7-29-2011.

# SABIYA

THE MARK CONSISTS OF STANDARD CHARACTERS  
WITHOUT CLAIM TO ANY PARTICULAR FONT, STYLE,  
SIZE, OR COLOR.

FOR APPAREL, NAMELY SOCKS, HOSIERY, SHIRTS,  
SHOES, PANTS, SWEATSHIRTS; OUTERWEAR,  
NAMELY JACKETS AND VESTS; COMMERCIAL UN-  
IFORMS; ATHLETIC APPAREL, NAMELY, SHIRTS,  
PANTS, SHORTS, SOCKS, JACKETS, FOOTWEAR,  
HATS, CAPS AND ATHLETIC UNIFORMS; UNDER  
GARMENTS; LINGERIE; INTIMATE APPAREL,  
NAMELY UNDERWEAR, ATHLETIC BRAS, BODY SHA-  
PERS, BODYSUITS, CAMISOLES, BRAS, PANTIES AND  
SLIPS; SLEEPWEAR; BATHING SUITS (U.S. CLS. 22  
AND 39).

MARTHA FROMM, EXAMINING ATTORNEY

**CLASS 25—(Continued).**

SN 85-387,789. COASTAL SAILS, LLC, FRISCO, TX. FILED 8-  
3-2011.



THE COLOR(S) BLUE, AND CYAN IS/ARE CLAIMED AS  
A FEATURE OF THE MARK.

THE MARK CONSISTS OF THE WORDING COASTAL  
SAILS IN THE COLOR BLUE. THE C IN COASTAL SAILS IS  
A FISHING HOOK THAT REPRESENTS THE LETTER C. A  
BILLFISH TO THE RIGHT OF COASTAL SAILS THAT IS  
BLUE AND CYAN.

FOR BUTTON DOWN SHIRTS; LONG-SLEEVED  
SHIRTS; POLO SHIRTS; SHIRTS; SHIRTS AND SHORT-  
SLEEVED SHIRTS; SHORTS; T-SHIRTS (U.S. CLS. 22  
AND 39).

KIMBERLY PERRY, EXAMINING ATTORNEY

SN 85-388,693. ALVAREZ, ROBERTO, CHICAGO, IL. FILED  
8-3-2011.



THE MARK CONSISTS OF SYMMETRICAL STRAIGHT  
LINES AND CURVES THAT LOOK LIKE A "U" THAT IS  
LAYING ON ITS SIDE. THE STYLIZED TEXT "ROBDECHI"  
IS INSIDE.

FOR HATS; JEANS; SCARVES (U.S. CLS. 22 AND 39).  
APRIL ROACH, EXAMINING ATTORNEY

**CLASS 25—(Continued).**

SN 85-391,490. SHIMANO AMERICAN CORPORATION, IRVINE, CA. FILED 8-6-2011.



THE COLOR(S) BLUE, GRAY AND WHITE IS/ARE CLAIMED AS A FEATURE OF THE MARK.

THE MARK CONSISTS OF A GEAR DESIGN APPEARING IN GRAY INCLUDING THREE CONCENTRIC CIRCLES WITH A CENTRAL OPENING IN THE INNERMOST CIRCLE AND CIRCULAR OPENINGS BETWEEN THE TWO OUTERMOST CONCENTRIC CIRCLES. THE GEAR DESIGN APPEARS TO THE LEFT OF A BLUE RECTANGLE CONTAINING THE WHITE STYLIZED LETTERS "SSC" APPEARING ABOVE THE WHITE STYLIZED WORDING "SHIMANO SERVICE CENTER". THE MARK APPEARS ON A TRANSPARENT BACKGROUND.

FOR COLLARED SHIRTS; SHIRTS; SHORT-SLEEVED SHIRTS; TOPS (U.S. CLS. 22 AND 39).

BRIAN NEVILLE, EXAMINING ATTORNEY

SN 85-391,802. U.S. MARINE CORPS, A COMPONENT OF THE U.S. DEPARTMENT OF THE NAVY, WASHINGTON, DC. FILED 8-8-2011.

**MARINE WEEK**

THE MARK CONSISTS OF STANDARD CHARACTERS WITHOUT CLAIM TO ANY PARTICULAR FONT, STYLE, SIZE, OR COLOR.

FOR BASEBALL CAPS AND HATS; SHIRTS; T-SHIRTS (U.S. CLS. 22 AND 39).

FIRST USE 6-20-2011; IN COMMERCE 6-20-2011.

WENDY JUN, EXAMINING ATTORNEY

SN 85-392,544. SKECHERS U.S.A., INC. II, MANHATTAN BEACH, CA. FILED 8-8-2011.

**ALL GO**

THE MARK CONSISTS OF STANDARD CHARACTERS WITHOUT CLAIM TO ANY PARTICULAR FONT, STYLE, SIZE, OR COLOR.

FOR FOOTWEAR (U.S. CLS. 22 AND 39).

JOHN GARTNER, EXAMINING ATTORNEY

**CLASS 25—(Continued).**

SN 85-392,861. W. L. GORE & ASSOCIATES, INC., NEWARK, DE. FILED 8-9-2011.

**GORE RUNNING WEAR**

THE MARK CONSISTS OF STANDARD CHARACTERS WITHOUT CLAIM TO ANY PARTICULAR FONT, STYLE, SIZE, OR COLOR.

OWNER OF U.S. REG. NOS. 1,804,547, 2,035,841 AND 2,374,361.

NO CLAIM IS MADE TO THE EXCLUSIVE RIGHT TO USE "RUNNING WEAR", APART FROM THE MARK AS SHOWN.

FOR SHIRTS, TIGHTS, JACKETS, VESTS, SHORTS, HEADWEAR, ARM WARMERS, LEG WARMERS, SINGLET, CROP TOPS, GLOVES AND MITTENS (U.S. CLS. 22 AND 39).

FIRST USE 2-28-2011; IN COMMERCE 2-28-2011.

DOUGLAS LEE, EXAMINING ATTORNEY

SN 85-394,882. ANVIL KNITWEAR, INC., NEW YORK, NY. FILED 8-10-2011.



OWNER OF U.S. REG. NOS. 1,659,008, 3,083,117 AND OTHERS.

THE COLOR(S) BLACK AND RED IS/ARE CLAIMED AS A FEATURE OF THE MARK.

THE MARK CONSISTS OF THE WORD "ANVIL" IN BLACK WITH A RED LINE BELOW. THE WORDS "NOT JUST A T-SHIRT" APPEAR IN BLACK BENEATH THE RED LINE.

FOR CLOTHING, NAMELY, SHIRTS, T-SHIRTS; SHORT-SLEEVED AND LONG-SLEEVED T-SHIRTS; POLO SHIRTS; SWEATSHIRTS; HOODED SWEATSHIRTS; ROBES; FLEECE PULLOVERS; SPORT SHIRTS; HEADWEAR, CAPS, VISORS; SHORTS; TURTLENECKS (U.S. CLS. 22 AND 39).

EMILY CARLSEN, EXAMINING ATTORNEY

SN 85-399,388. SKECHERS U.S.A., INC. II, MANHATTAN BEACH, CA. FILED 8-16-2011.

**V STRIDE**

THE MARK CONSISTS OF STANDARD CHARACTERS WITHOUT CLAIM TO ANY PARTICULAR FONT, STYLE, SIZE, OR COLOR.

FOR FOOTWEAR (U.S. CLS. 22 AND 39).

JOHN GARTNER, EXAMINING ATTORNEY

**CLASS 25—(Continued).**

SN 85-401,482. BROWN SHOE COMPANY, INC., ST. LOUIS, MO. FILED 8-18-2011.

**PALOMA**

THE MARK CONSISTS OF STANDARD CHARACTERS WITHOUT CLAIM TO ANY PARTICULAR FONT, STYLE, SIZE, OR COLOR.

OWNER OF U.S. REG. NOS. 2,993,403, 3,100,693 AND 3,501,767.

THE ENGLISH TRANSLATION OF "PALOMA" IN THE MARK IS "DOVE"

FOR CLOTHING, NAMELY, SHIRTS, BLOUSES, PANTS, DRESSES, SKIRTS, SHORTS, JACKETS, COATS, UNDERGARMENTS, HOSIERY; BELTS; FOOTWEAR; HEADWEAR (U.S. CLS. 22 AND 39).

LINDA ESTRADA, EXAMINING ATTORNEY

SN 85-405,976. U.S. MARINE CORPS, A COMPONENT OF THE U.S. DEPARTMENT OF THE NAVY, WASHINGTON, DC. FILED 8-24-2011.

**EARNED. NEVER GIVEN.**

THE MARK CONSISTS OF STANDARD CHARACTERS WITHOUT CLAIM TO ANY PARTICULAR FONT, STYLE, SIZE, OR COLOR.

FOR T-SHIRTS (U.S. CLS. 22 AND 39).

FIRST USE 9-1-2010; IN COMMERCE 9-1-2010.

WENDY JUN, EXAMINING ATTORNEY

SN 85-975,143. DAVID, NICOL, 11600 PENANG, MALAYSIA, AND KEESEY, DEBBIE, GARDENA, CA. FILED 8-7-2010.



THE NAME SHOWN IN THE MARK IDENTIFIES "NICOL DAVID" WHOSE CONSENT IS MADE OF RECORD.

THE COLOR(S) DARK BROWN, LIGHT BROWN, MID-BROWN, WARM GRAY AND COOL GRAY IS/ARE CLAIMED AS A FEATURE OF THE MARK.

THE MARK CONSISTS OF DARK BROWN TILTED OVAL

**CLASS 25—(Continued).**

OR ELLIPSE WITH LOWER CASE LETTER "N" IN LIGHT BROWN COLOR WITH COOL GRAY COLOR DOT IN CENTER OF "N"; DIRECTLY BELOW (VERTICAL) THE "N" IS LOWER CASE "D" IN MID-BROWN COLOR WITH COOL GRAY DOT IN CENTER OF "D"; THE RIGHT SIDE OF THE "N" IS CONNECTED BY THE UPPER STEM OF THE "D"; THE UPPER STEM OF THE "D" IS IN WARM GRAY COLOR; THE OVAL IS FOLLOWED BY THE LETTERS/WORDS IN LOWER CASE "NICOL DAVID" IN WARM GRAY COLOR IN STYLIZED FONT.

FOR ATHLETIC FOOTWEAR (U.S. CLS. 22 AND 39).

FIRST USE 9-1-2010; IN COMMERCE 9-1-2010.

BRENDAN REGAN, EXAMINING ATTORNEY

SN 85-975,607. MARTIN BELL PRODUCTIONS, LLC, LOS ANGELES, CA. FILED 2-20-2011.

**J OFF R**

THE MARK CONSISTS OF STANDARD CHARACTERS WITHOUT CLAIM TO ANY PARTICULAR FONT, STYLE, SIZE, OR COLOR.

FOR SHIRTS, T-SHIRTS AND SCARVES (U.S. CLS. 22 AND 39).

FIRST USE 2-0-2011; IN COMMERCE 2-0-2011.

NORA BUCHANAN WILL, EXAMINING ATTORNEY

SN 85-975,633. MARTIN BELL PRODUCTIONS, LLC, LOS ANGELES, CA. FILED 2-20-2011.

**JUST OFF RODEO**

THE MARK CONSISTS OF STANDARD CHARACTERS WITHOUT CLAIM TO ANY PARTICULAR FONT, STYLE, SIZE, OR COLOR.

FOR SHIRTS, T-SHIRTS AND SCARVES (U.S. CLS. 22 AND 39).

FIRST USE 2-0-2011; IN COMMERCE 2-0-2011.

NORA BUCHANAN WILL, EXAMINING ATTORNEY

**CLASS 25—(Continued).**

SN 85-975,651. MARTIN BELL PRODUCTIONS, LLC, LOS ANGELES, CA. FILED 2-20-2011.



THE MARK CONSISTS OF THE WORDS "JUST OFF RODEO" IN STYLIZED LETTERING, WITH A LINE UNDER THE WORD "OFF", ALL ENCLOSED WITHIN A DOUBLE SQUARE DESIGN.

FOR SHIRTS, T-SHIRTS AND SCARVES (U.S. CLS. 22 AND 39).

FIRST USE 2-0-2011; IN COMMERCE 2-0-2011.  
NORA BUCHANAN WILL, EXAMINING ATTORNEY

**CLASS 26—FANCY GOODS**

SN 85-176,288. JACKSON, SEAN WESLEY, DBA TRITATS, OVERLAND PARK, KS. FILED 11-14-2010.



THE COLOR(S) RED AND WHITE IS/ARE CLAIMED AS A FEATURE OF THE MARK.

THE MARK CONSISTS OF A RED SQUARE AND WITHIN IT THE STYLIZED WHITE LETTERS "TRITAT" ON TWO LINES WITH THE "S" IN "TATS" BEING OUTSIDE THE SQUARE AND IN THE COLOR RED; THE BOTTOM RIGHT CORNER IS SHOWN WITH GRAY SHADING THAT IS NOT PART OF THE MARK, BUT IS TO DEMONSTRATE A LIFTING OR PEELING OFF MOTION WHICH REVEALS THE LETTER "S" IN RED.

FOR COMPETITORS' NUMBERS NOT OF TEXTILE (U.S. CLS. 37, 39, 40, 42 AND 50).

FIRST USE 1-9-2010; IN COMMERCE 1-14-2010.  
TRICIA SONNEBORN, EXAMINING ATTORNEY

**CLASS 26—(Continued).**

SN 85-207,142. NAMASTE LABORATORIES, L.L.C., BLUE ISLAND, IL. FILED 12-29-2010.

**YOUR WEAVE PRESCRIPTION**

THE MARK CONSISTS OF STANDARD CHARACTERS WITHOUT CLAIM TO ANY PARTICULAR FONT, STYLE, SIZE, OR COLOR.

OWNER OF U.S. REG. NO. 3,864,983.

NO CLAIM IS MADE TO THE EXCLUSIVE RIGHT TO USE "WEAVE", APART FROM THE MARK AS SHOWN.

FOR ADD-IN AND ADD-ON HAIR ACCESSORIES CONSTRUCTED PRIMARILY OF SYNTHETIC AND/OR HUMAN HAIR (U.S. CLS. 37, 39, 40, 42 AND 50).

KATHRYN COWARD, EXAMINING ATTORNEY

SN 85-321,059. HARRY B. HUDICK, PASADENA, CA. FILED 5-14-2011.

# DAMMITS

THE MARK CONSISTS OF STANDARD CHARACTERS WITHOUT CLAIM TO ANY PARTICULAR FONT, STYLE, SIZE, OR COLOR.

FOR FASTENERS FOR AFFIXING BADGES, INSIGNIA AND NAMETAGS TO CLOTHING (U.S. CLS. 37, 39, 40, 42 AND 50).

FIRST USE 8-29-2009; IN COMMERCE 8-29-2009.  
DAVID TOOLEY, EXAMINING ATTORNEY

SN 85-324,176. MAZYCK, DARREN C, MIRAMAR, FL. FILED 5-18-2011.

**THE MAGIC THIMBLE**

THE MARK CONSISTS OF STANDARD CHARACTERS WITHOUT CLAIM TO ANY PARTICULAR FONT, STYLE, SIZE, OR COLOR.

NO CLAIM IS MADE TO THE EXCLUSIVE RIGHT TO USE "THIMBLE", APART FROM THE MARK AS SHOWN.

FOR THIMBLES (U.S. CLS. 37, 39, 40, 42 AND 50).  
RON FAIRBANKS, EXAMINING ATTORNEY

**CLASS 26—(Continued).**

SN 85-324,832. DEBORAH A. CRAGG, DBA THE ROSEY BEAR BOUTIQUE, ROCHESTER, NY. FILED 5-19-2011.

# RoseyBow

THE MARK CONSISTS OF STANDARD CHARACTERS WITHOUT CLAIM TO ANY PARTICULAR FONT, STYLE, SIZE, OR COLOR.

OWNER OF U.S. REG. NO. 3,897,292.

FOR HAIR ACCESSORIES, NAMELY, HAIR ORNAMENTS MADE TO RESEMBLE FLOWERS; HAIR BARRETTES; HAIR BOWS; HAIR CLIPS; HAIR ORNAMENTS; HAIR RIBBONS; ORNAMENTS FOR THE HAIR (U.S. CLS. 37, 39, 40, 42 AND 50).

FIRST USE 1-29-2011; IN COMMERCE 5-19-2011.  
CORY BOONE, EXAMINING ATTORNEY

**CLASS 26—(Continued).**

SN 85-334,096. WILSON, SHEILA, DBA MEESHE HAIR, DETROIT, MI. FILED 5-31-2011.

# MEESHE

THE MARK CONSISTS OF STANDARD CHARACTERS WITHOUT CLAIM TO ANY PARTICULAR FONT, STYLE, SIZE, OR COLOR.

THE NAME(S), PORTRAIT(S), AND/OR SIGNATURE(S) SHOWN IN THE MARK DOES NOT IDENTIFY A PARTICULAR LIVING INDIVIDUAL.

THE WORDING MEESHE HAS NO MEANING IN A FOREIGN LANGUAGE.

FOR HAIR ACCESSORIES, NAMELY, SNAP CLIPS; HAIR BANDS; HAIR BARRETES; HAIR EXTENSIONS; HAIR PIECES (U.S. CLS. 37, 39, 40, 42 AND 50).  
DAVID C. REIHNER, EXAMINING ATTORNEY

SN 85-333,900. HALLMARK LICENSING, INC., KANSAS CITY, MO. FILED 5-31-2011.

# BLOOMING EXPRESSIONS

THE MARK CONSISTS OF STANDARD CHARACTERS WITHOUT CLAIM TO ANY PARTICULAR FONT, STYLE, SIZE, OR COLOR.

FOR ARTIFICIAL FLOWERS (U.S. CLS. 37, 39, 40, 42 AND 50).

LINDA M. KING, EXAMINING ATTORNEY

SN 85-336,929. SUMMIT ENTERTAINMENT, LLC, SANTA MONICA, CA. FILED 6-2-2011.

# ISLE ESME

THE MARK CONSISTS OF STANDARD CHARACTERS WITHOUT CLAIM TO ANY PARTICULAR FONT, STYLE, SIZE, OR COLOR.

FOR ORNAMENTAL NOVELTY BUTTONS OR PINS; AND EMBROIDERED OR CLOTH PATCHES FOR CLOTHING (U.S. CLS. 37, 39, 40, 42 AND 50).

ASMAT KHAN, EXAMINING ATTORNEY

SN 85-333,911. TAYLOR BRANDS, LLC, KINGSPORT, TN. FILED 5-31-2011.

# WESTERN EDGE

THE MARK CONSISTS OF STANDARD CHARACTERS WITHOUT CLAIM TO ANY PARTICULAR FONT, STYLE, SIZE, OR COLOR.

FOR BELT BUCKLES (U.S. CLS. 37, 39, 40, 42 AND 50).  
STEVEN R. FINE, EXAMINING ATTORNEY

SN 85-337,297. SAHIN, NEDIM T, LA JOLLA, CA. FILED 6-3-2011.

# Power Plant

THE MARK CONSISTS OF STANDARD CHARACTERS WITHOUT CLAIM TO ANY PARTICULAR FONT, STYLE, SIZE, OR COLOR.

FOR ARTIFICIAL PLANTS (U.S. CLS. 37, 39, 40, 42 AND 50).

PAUL E. FAHRENKOPF, EXAMINING ATTORNEY

**CLASS 26—(Continued).**

SN 85-340,001. SUN TAIYANG CO., LTD., CARLSTADT, NJ. FILED 6-7-2011.

## WAVETREND

THE MARK CONSISTS OF STANDARD CHARACTERS WITHOUT CLAIM TO ANY PARTICULAR FONT, STYLE, SIZE, OR COLOR.

FOR HAIR PIECES; HAIR PIECES AND WIGS; WIG CAPS; WIGS; WIGS, HAIRPIECES, AND ADD-IN AND ADD-ON HAIR ACCESSORIES CONSTRUCTED PRIMARILY OF SYNTHETIC AND/OR HUMAN HAIR (U.S. CLS. 37, 39, 40, 42 AND 50).

NELSON SNYDER, EXAMINING ATTORNEY

**CLASS 27—(Continued).**

SN 85-293,645. STAPLES THE OFFICE SUPERSTORE, LLC., FRAMINGHAM, MA. FILED 4-13-2011.



NO CLAIM IS MADE TO THE EXCLUSIVE RIGHT TO USE "PROFESSIONAL", APART FROM THE MARK AS SHOWN.

THE MARK CONSISTS OF A CIRCLE COMPRISED OF 4 CRESCENTS OVER THE WORDS "BRIGHTON PROFESSIONAL".

FOR FLOOR MATS AND FLOOR MATS FOR USE IN RESTROOMS (U.S. CLS. 19, 20, 37, 42 AND 50).

GIANCARLO CASTRO, EXAMINING ATTORNEY

**CLASS 27—FLOOR COVERINGS**

SN 85-174,638. CHARTIER AND ASSOCIATES, INC., MANDEVILLE, LA. FILED 11-11-2010.

## Avenue Rugs

THE MARK CONSISTS OF STANDARD CHARACTERS WITHOUT CLAIM TO ANY PARTICULAR FONT, STYLE, SIZE, OR COLOR.

NO CLAIM IS MADE TO THE EXCLUSIVE RIGHT TO USE "RUGS", APART FROM THE MARK AS SHOWN.

FOR CARPETS AND RUGS (U.S. CLS. 19, 20, 37, 42 AND 50).

FIRST USE 8-1-2010; IN COMMERCE 8-1-2010.

FLORENTINA BLANDU, EXAMINING ATTORNEY

SN 85-334,849. FLOORTEX EUROPE LIMITED, GLOUCESTERSHIREGL208DN, UNITED KINGDOM, FILED 6-1-2011.

## REVOLUTIONMAT

THE MARK CONSISTS OF STANDARD CHARACTERS WITHOUT CLAIM TO ANY PARTICULAR FONT, STYLE, SIZE, OR COLOR.

FOR FLOOR PROTECTION, NAMELY, FLOOR MATS (U.S. CLS. 19, 20, 37, 42 AND 50).

FIRST USE 11-0-2010; IN COMMERCE 11-0-2010.

NORA BUCHANAN WILL, EXAMINING ATTORNEY

SN 85-293,080. LOLLIPROPS INC., NEW YORK, NY. FILED 4-12-2011.

## Tempaper By You

THE MARK CONSISTS OF STANDARD CHARACTERS WITHOUT CLAIM TO ANY PARTICULAR FONT, STYLE, SIZE, OR COLOR.

OWNER OF U.S. REG. NOS. 3,555,451 AND 3,909,404.

FOR NON DECORATIVE WALL CANVAS IN THE NATURE OF ROOM SIZE ADHESIVE WALL COVERINGS (U.S. CLS. 19, 20, 37, 42 AND 50).

FIRST USE 3-23-2011; IN COMMERCE 4-1-2011.

GRETTA YAO, EXAMINING ATTORNEY

SN 85-337,520. SOUTHWEST GREENS INTERNATIONAL, LLC, ROSWELL, GA. FILED 6-3-2011.

## JOHN SMOLTZ

THE MARK CONSISTS OF STANDARD CHARACTERS WITHOUT CLAIM TO ANY PARTICULAR FONT, STYLE, SIZE, OR COLOR.

THE NAME(S), PORTRAIT(S), AND/OR SIGNATURE(S) SHOWN IN THE MARK IDENTIFIES JOHN SMOLTZ, WHOSE CONSENT(S) TO REGISTER IS MADE OF RECORD.

FOR SYNTHETIC TURF USED FOR PUTTING GREENS, DRIVING RANGES, ATHLETIC COURTS, BASEBALL DIAMONDS AND FIELDS, SOFTBALL DIAMONDS AND FIELDS, BACKYARD PLAY AREAS, LAWNS, AND RECREATIONAL SURFACES (U.S. CLS. 19, 20, 37, 42 AND 50).

MARK SPARACINO, EXAMINING ATTORNEY

**CLASS 27—(Continued).**

SN 85-337,903. PBH TRADE, AUSTIN, TX. FILED 6-3-2011.

**YERRA**

THE MARK CONSISTS OF THE LETTER Y, FOLLOWED BY THE LETTER E, FOLLOWED BY THE LETTER R, FOLLOWED BY THE LETTER A.

THE ENGLISH TRANSLATION OF "YERRA" IN THE MARK IS "BRANDING".

FOR AREA RUGS; CARPETS AND RUGS; FUR RUGS; RUGS; RUGS, NAMELY, FLOOR RUNNERS (U.S. CLS. 19, 20, 37, 42 AND 50).

FIRST USE 2-1-2007; IN COMMERCE 2-1-2007.  
GRETTA YAO, EXAMINING ATTORNEY

**CLASS 28—(Continued).**

SN 77-960,671. BEAT ME THE CLOWN, DBA INTELLIGENT ENTERTAINMENT, ZEPHYR COVE, NV. FILED 3-16-2010.

**Beat Me the Clown**

THE MARK CONSISTS OF STANDARD CHARACTERS WITHOUT CLAIM TO ANY PARTICULAR FONT, STYLE, SIZE, OR COLOR.

NO CLAIM IS MADE TO THE EXCLUSIVE RIGHT TO USE "CLOWN", APART FROM THE MARK AS SHOWN.

FOR TALKING DOLLS (U.S. CLS. 22, 23, 38 AND 50).  
SEAN CROWLEY, EXAMINING ATTORNEY

SN 85-340,775. KIDZ ON SAFARI NEW YORK, INC., BROOKLYN, NY. FILED 6-8-2011.

**BAMINGO**

THE MARK CONSISTS OF STANDARD CHARACTERS WITHOUT CLAIM TO ANY PARTICULAR FONT, STYLE, SIZE, OR COLOR.

FOR WALL PAPER (U.S. CLS. 19, 20, 37, 42 AND 50).  
JESSICA A. POWERS, EXAMINING ATTORNEY

SN 78-837,340. TIMME, JEFFREY, FRIENDSWOOD, TX. FILED 3-15-2006.

**BIG O**

THE MARK CONSISTS OF STANDARD CHARACTERS WITHOUT CLAIM TO ANY PARTICULAR FONT, STYLE, SIZE, OR COLOR.

FOR GOLF BALLS (U.S. CLS. 22, 23, 38 AND 50).  
JOHN KELLY, EXAMINING ATTORNEY

**CLASS 28—TOYS AND SPORTING GOODS**

SN 76-707,314. SPIN-BALLS, LLC, FORT LAUDERDALE, FL. FILED 4-18-2011.

**Spin-balls**

NO CLAIM IS MADE TO THE EXCLUSIVE RIGHT TO USE "SPIN-BALLS", APART FROM THE MARK AS SHOWN.

THE MARK CONSISTS OF THE STYLIZED WORDING "SPIN-BALLS" WITH BALLS CONNECTED BY A LINE FORMING EACH "S".

FOR JUGGLING TOYS, NAMELY, BALLS (U.S. CLS. 22, 23, 38 AND 50).

FIRST USE 12-21-2010; IN COMMERCE 12-21-2010.  
JASON TURNER, EXAMINING ATTORNEY

SN 79-094,000. JORDI CALVET TORRAS, E-08016 BARCELONA, SPAIN, FILED 1-17-2011.

**LOF**

THE MARK CONSISTS OF STANDARD CHARACTERS WITHOUT CLAIM TO ANY PARTICULAR FONT, STYLE, SIZE, OR COLOR.

OWNER OF INTERNATIONAL REGISTRATION 1068229 DATED 1-17-2011, EXPIRES 1-17-2021.

THE WORDING "LOF" HAS NO MEANING IN A FOREIGN LANGUAGE.

FOR SPORTS GLOVES FOR CYCLING, BODY BUILDING, SKIING (U.S. CLS. 22, 23, 38 AND 50).

KIM SAITO, EXAMINING ATTORNEY

**CLASS 28—(Continued).**

SN 85-020,051. AUSTRALIA ZOO PTY LTD., BEERWAH QLD, AUSTRALIA, FILED 4-21-2010.



OWNER OF AUSTRALIA REG. NO. 1197826, DATED 9-6-2007, EXPIRES 9-6-2017.

OWNER OF U.S. REG. NOS. 2,870,033, 3,665,963 AND OTHERS.

NO CLAIM IS MADE TO THE EXCLUSIVE RIGHT TO USE "AUSTRALIA" AND THE OUTLINE OF AUSTRALIA, APART FROM THE MARK AS SHOWN.

THE MARK CONSISTS OF THE MAP OF AUSTRALIA WITH THE WORDS "AUSTRALIA ZOO HOME OF THE CROCODILE HUNTER".

FOR GAMES AND PLAYTHINGS, NAMELY, BOARD GAMES, PUZZLE GAMES, TRIVIA CARD GAMES, CARD GAMES, PLAYING CARDS, TOY BUILDING BLOCK GAMES, PLAY BALLOONS, HOBBY CRAFT KITS FOR GAMES COMPRISING PLAYING PIECES REPLICATING WILDLIFE IN THE NATURE OF ACTION FIGURES, HOBBY CRAFT KITS FOR PLAYTHINGS COMPRISING DOLLS, MODELED PLASTIC TOY FIGURINES, TOY MODEL ANIMALS AND TOY MODEL WILDLIFE HABITATS, GAME TABLES, ARCADE GAMES, PARLOR GAMES, ARCADE-TYPE ELECTRONIC VIDEO GAMES, COIN-OPERATED AMUSEMENT MACHINES, OUTDOORS PLAY EQUIPMENT IN THE NATURE OF SWINGS AND SLIDES, AMUSEMENT PARK RIDES, AND PLAY ARTICLES IN THE NATURE OF SWIM FLOATS FOR RECREATIONAL USE IN SWIMMING POOLS; TOYS, NAMELY, PLUSH TOYS, DOLLS, ACCESSORIES FOR DOLLS, ACTION FIGURES, FLYING DISCS, KALEIDOSCOPES, KITES, REELS FOR KITES, MARIONETTE PUPPETS, TOY MOBILES, SNOW GLOBES, TOY ANIMALS, PUPPETS, TEDDY BEARS, TOY JEWELRY, TOY MASKS, TOYS FOR DOMESTIC PETS, TOY SOAP BUBBLES FEATURING WAND AND SOLUTION, SPINNING TOPS, DARTS, TARGETS, SHUTTLECOCKS FOR BADMINTON, SKITTLES, PLAYING CARDS, AND YO-YOS; SPORTING ARTICLES IN THIS CLASS AND ACCESSORIES THEREFORE IN THIS CLASS, NAMELY, BATS FOR GAMES, SPORT BALLS, GOLF CLUBS, SURF BOARDS, FISHING TACKLE, GYMNASIAC APPARATUS AND BAGS AND FITTED COVERS SPECIFICALLY ADAPTED FOR SPORTS EQUIPMENT; DECORATIONS IN THIS CLASS, NAMELY, DECORATIONS FOR CHRISTMAS TREES; NOVELTIES FOR PARTIES, NAMELY, CONFETTI, MAGIC TRICKS AND PINATAS (U.S. CLS. 22, 23, 38 AND 50).

ROBERT STRUCK, EXAMINING ATTORNEY

**CLASS 28—(Continued).**

SN 85-114,738. MERMIS, JAMES J., COLUMBUS, OH. FILED 8-24-2010.

# HitchGym

THE MARK CONSISTS OF STANDARD CHARACTERS WITHOUT CLAIM TO ANY PARTICULAR FONT, STYLE, SIZE, OR COLOR.

FOR PORTABLE FITNESS APPARATUS, NAMELY, MANUALLY-OPERATED EXERCISE EQUIPMENT FOR BODY WEIGHT EXERCISES; PORTABLE EXERCISE MACHINES (U.S. CLS. 22, 23, 38 AND 50).

PAUL MORENO, EXAMINING ATTORNEY

SN 85-167,591. HOPBET, INC., HENDERSON, NV. FILED 11-2-2010.

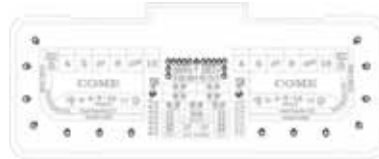

OWNER OF U.S. REG. NO. 2,875,551.

THE MARK CONSISTS OF THE CONFIGURATION OF A CRAPS GAME TABLE, WITH FLAMING CIRCLES APPEARING BEHIND THE PASS LINE AND AROUND THE CENTER PROPOSITION BET BOX, AND THE GLOBES ADJACENT TO THE PROPOSITION BET BOX. THE MATERIAL SHOWN IN DOTTED LINES ON THE CRAPS GAME TABLE IS NOT CLAIMED AS A FEATURE OF THE MARK. SEC. 2(F).

FOR GAMING EQUIPMENT, NAMELY, CRAPS TABLES (U.S. CLS. 22, 23, 38 AND 50).

FIRST USE 8-12-2003; IN COMMERCE 8-12-2003.

LEIGH CAROLINE CASE, EXAMINING ATTORNEY

SN 85-168,306. BACKCOUNTRY GARAGE, LLC, KETCHUM, ID. FILED 11-3-2010.

# MTNAPPROACH

THE MARK CONSISTS OF STANDARD CHARACTERS WITHOUT CLAIM TO ANY PARTICULAR FONT, STYLE, SIZE, OR COLOR.

FOR SKIS (U.S. CLS. 22, 23, 38 AND 50).

KRISTIN CARLSON, EXAMINING ATTORNEY



**CLASS 28—(Continued).**

SN 85-173,357. INDIAN INDUSTRIES, INC., EVANSVILLE, IN. FILED 11-10-2010.



THE COLOR(S) ORANGE IS/ARE CLAIMED AS A FEATURE OF THE MARK.

THE MARK CONSISTS OF A STYLIZED "G" IN ORANGE. FOR SPORTS TRAINING EQUIPMENT, NAMELY, NET GOALS, REBOUNTING NETS, HITTING TRAINERS, FOOTBALL BLOCKING DUMMIES, SPORTS TRAINING BALLS, AND APPARATUSES FOR REBOUNTING, CATCHING AND STOPPING BALLS (U.S. CLS. 22, 23, 38 AND 50).

RONALD AIKENS, EXAMINING ATTORNEY

SN 85-182,256. O'NEIL, ERIK, WHITE BEAR TOWNSHIP, MN. FILED 11-22-2010.

NO CLAIM IS MADE TO THE EXCLUSIVE RIGHT TO USE "DOME", APART FROM THE MARK AS SHOWN.

THE MARK CONSISTS OF THE WORDING "HOME DOME" WITH A LINE ABOVE THE WORDING IN WHICH THE LINE IS CURVED ABOVE THE WORDING "HOME" AND IT IS STRAIGHT ABOVE THE WORDING "DOME". THE LETTERS "O'S IN "HOME" AND "DOME" EACH HAVE TWO CIRCLES WITH THE OUTER CIRCLE HAVING A PROTRUDING POINT TO THE RIGHT.

FOR INFLATABLE DOME THAT CHILDREN PLAY IN AND UNDER (U.S. CLS. 22, 23, 38 AND 50).

JENNY PARK, EXAMINING ATTORNEY

**CLASS 28—(Continued).**

SN 85-186,044. TOY-TOON CREATIONS, INC., WATERFORD, MI. FILED 11-29-2010.

**BUGGY BABIES**

THE MARK CONSISTS OF STANDARD CHARACTERS WITHOUT CLAIM TO ANY PARTICULAR FONT, STYLE, SIZE, OR COLOR.

NO CLAIM IS MADE TO THE EXCLUSIVE RIGHT TO USE "BABIES", APART FROM THE MARK AS SHOWN.

FOR BATTERY OPERATED ACTION TOYS; COLLECTABLE TOY FIGURES; DOLLS AND DOLL ACCESSORIES, NAMELY, CLOTHING FOR DOLLS, DOLL ROOMS, DOLL BEDS, DOLL HOUSES, TOY FABRICS AND LINENS FOR DOLLS AND STROLLERS FOR DOLLS; FANTASY CHARACTER TOYS; MODELED PLASTIC TOY FIGURINES; PLASTIC CHARACTER TOYS; PLAY HOUSES AND TOY ACCESSORIES THEREFOR; POSITIONABLE TOY FIGURES; PUSH TOYS; ROLE PLAYING TOYS IN THE NATURE OF PLAY SETS FOR CHILDREN TO IMITATE REAL LIFE OCCUPATIONS; SOFT SCULPTURE PLUSH TOYS; STUFFED AND PLUSH TOYS; TALKING ELECTRONIC PRESS-DOWN TOY; TALKING TOYS; TOY ANIMALS AND ACCESSORIES THEREFOR; TOY HOUSES; TWO AND THREE DIMENSIONAL POSITIONABLE FIGURES SOLD AS AN INTEGRAL COMPONENT OF TOYS; TWO AND THREE DIMENSIONAL POSITIONABLE TOY FIGURES SOLD AS A UNIT WITH OTHER TOYS (U.S. CLS. 22, 23, 38 AND 50).

TINA BROWN, EXAMINING ATTORNEY

SN 85-188,361. RAWLINGS SPORTING GOODS COMPANY, INC., ST. LOUIS, MO. FILED 12-1-2010.

**RAWLINGS**

THE MARK CONSISTS OF STANDARD CHARACTERS WITHOUT CLAIM TO ANY PARTICULAR FONT, STYLE, SIZE, OR COLOR.

OWNER OF U.S. REG. NOS. 412,343, 802,164 AND 1,149,932.

SEC. 2(F).

FOR BASEBALL BATTING TEES; SOFTBALL BATTING TEES; BASEBALL TRAINING PLATES, NAMELY, HOME PLATES, PITCHERS PLATES; SOFTBALL TRAINING PLATES, NAMELY, HOME PLATES, PITCHERS PLATES; SPORTS KNEE PADS; SPORTS ELBOW PADS; BASEBALL PITCHBACKS, NAMELY, BALL REBOUNTING SCREENS; SOFTBALL PITCHBACKS, NAMELY, BALL REBOUNTING SCREENS; FOOTBALL PITCHBACKS, NAMELY, BALL REBOUNTING SCREENS; BASES FOR BASEBALL; BASES FOR SOFTBALL; PRACTICE NETS FOR SPORTS, NAMELY, THROWING NETS FOR BASEBALL; THROWING NETS FOR SOFTBALL; THROWING NETS FOR FOOTBALL; HITTING NETS FOR BASEBALL; HITTING NETS FOR SOFTBALL; HITTING NETS FOR FOOTBALL; SOCCER BALLS; PUMPS ESPECIALLY ADAPTED FOR USE WITH BALLS FOR GAMES; PROTECTIVE PADDING FOR SPORTS IN THE NATURE OF SHIN SLEEVES; SPORTS SHIN GUARDS; SOCCER GOALS; PRACTICE NETS FOR SPORTS, NAMELY, SOCCER REBOUNDERS; SPORTS FIELD EQUIPMENT, NAMELY, SPORTS MARKER CONES; SPORTS GOAL NETS; VOLLEYBALLS; SPORTS FIELD EQUIPMENT, NAMELY, COACHES STANDS; SPIKE TRAINERS, NAMELY, BLOCKING DUMMIES;

**CLASS 28—(Continued).**

BUNGEE BLOCKERS FOR FOOTBALL; SPORTS NET STORAGE RACKS; SPORTS BALL STORAGE RACKS; SPORTS FIELD EQUIPMENT, NAMELY, REFEREE STANDS; SPORTS FIELD EQUIPMENT, NAMELY, FOOTBALL LINESMAN FLAGS; BASEBALL TARGET TRAINERS; SOFTBALL TARGET TRAINERS; FOOTBALL TARGET TRAINERS; BASKETBALLS; PRACTICE NETS FOR SPORTS, NAMELY, BASEBALL BALL RETURN NETS, SOFTBALL BALL RETURN NETS, FOOTBALL BALL RETURN NETS; BASEBALL NETS; SOFTBALL NETS; FOOTBALL NETS; SOCCER NETS; FOOTBALL KICK TEES; PROTECTIVE PADDING FOR FOOTBALL FIELD GOALS; PRACTICE NETS FOR SPORTS, NAMELY, FOOTBALL KICK NETS; FOOTBALL SHOULDER PAD STORAGE RACKS; BASEBALL HELMET STORAGE RACKS; SOFTBALL HELMET STORAGE RACKS; FOOTBALL HELMET STORAGE RACKS; FOOTBALL FACEGUARD REMOVAL TOOLS; FOOTBALL SHOULDER PAD LACES FOR ATHLETIC USE; FOOTBALL BLOCKING PADS FOR FOOTBALL PRACTICE; FOOTBALL TACKLING SHIELDS; FOOTBALL AGILITY BLOCKING DUMMIES; FOOTBALL PULL SLEDS; FOOTBALL FOREARM PADS; BAGS SPECIALLY ADAPTED FOR SPORTS BALLS; SPORTS FIELD EQUIPMENT, NAMELY, SPORTS PYLONS, FOOTBALL DOWN BOXES, DOWN CHAINS, HOCKEY PENALTY FLAGS, FOOTBALL SIDELINE MARKERS, HOCKEY SIDELINE MARKERS, FOOTBALL SIDELINE FLAGS, SOCCER SIDELINE FLAGS; TRAMPOLINES; TOY SCOOTERS; STREET HOCKEY EQUIPMENT, NAMELY, HOCKEY NETS, ATHLETIC PROTECTIVE PADS; HOCKEY STICKS; BALLS FOR PLAYING STREET HOCKEY; PORTABLE BASKETBALL HOOPS; SKATE BOARDS; PROTECTIVE PADS FOR SKATEBOARDING (U.S. CLS. 22, 23, 38 AND 50).  
LEIGH LOWRY, EXAMINING ATTORNEY

SN 85-188,387. RAWLINGS SPORTING GOODS COMPANY, INC., ST. LOUIS, MO. FILED 12-1-2010.



OWNER OF U.S. REG. NOS. 412,343, 802,164 AND 1,149,932.

THE MARK CONSISTS OF THE STYLIZED WORD "RAWLINGS" OUTLINED BY A SINGLE LINE.

SEC. 2(F).

FOR BASEBALL BATTING TEES; SOFTBALL BATTING TEES; BASEBALL TRAINING PLATES, NAMELY, HOME PLATES, PITCHERS PLATES; SOFTBALL TRAINING PLATES, NAMELY, HOME PLATES, PITCHERS PLATES; SPORTS KNEE PADS; SPORTS ELBOW PADS; BASEBALL PITCHBACKS, NAMELY, BALL REBOUNDING SCREENS; SOFTBALL PITCHBACKS, NAMELY, BALL REBOUNDING SCREENS; FOOTBALL PITCHBACKS, NAMELY, BALL REBOUNDING SCREENS; BASES FOR BASEBALL; BASES FOR SOFTBALL; PRACTICE NETS FOR SPORTS, NAMELY, THROWING NETS FOR BASEBALL; THROWING NETS FOR SOFTBALL; THROWING NETS FOR FOOTBALL; HITTING NETS FOR BASEBALL; HITTING NETS FOR SOFTBALL; HITTING NETS FOR FOOTBALL; SOCCER BALLS; PUMPS ESPECIALLY ADAPTED FOR USE WITH BALLS FOR GAMES; PROTECTIVE PADDING FOR SPORTS IN THE NATURE OF SHIN SLEEVES; SPORTS SHIN GUARDS; SOCCER GOALS; PRACTICE NETS FOR SPORTS, NAMELY, SOCCER REBOUNDERS; SPORTS FIELD EQUIPMENT, NAMELY, SPORTS MARKER CONES; SPORTS GOAL NETS; VOLLEYBALLS; SPORTS FIELD EQUIPMENT, NAMELY, COACHES STANDS; SPIKE TRAINERS, NAMELY, BLOCKING DUMMIES; BUNGEE BLOCKERS FOR FOOTBALL; SPORTS NET STORAGE RACKS; SPORTS BALL STORAGE RACKS; SPORTS FIELD EQUIPMENT, NAMELY, REFEREE STANDS; SPORTS FIELD EQUIPMENT, NAMELY, FOOTBALL LINESMAN FLAGS; BASEBALL TARGET TRAINERS; SOFTBALL TARGET TRAINERS; FOOTBALL TARGET TRAINERS; BASKETBALLS; PRACTICE NETS FOR SPORTS, NAMELY, BASEBALL BALL RETURN NETS, SOFTBALL BALL RETURN NETS, FOOTBALL BALL RETURN NETS; BASEBALL NETS;

**CLASS 28—(Continued).**

SOFTBALL NETS; FOOTBALL NETS; SOCCER NETS; FOOTBALL KICK TEES; PROTECTIVE PADDING FOR FOOTBALL FIELD GOALS; PRACTICE NETS FOR SPORTS, NAMELY, FOOTBALL KICK NETS; FOOTBALL SHOULDER PAD STORAGE RACKS; BASEBALL HELMET STORAGE RACKS; SOFTBALL HELMET STORAGE RACKS; FOOTBALL HELMET STORAGE RACKS; FOOTBALL FACEGUARD REMOVAL TOOLS; FOOTBALL SHOULDER PAD LACES FOR ATHLETIC USE; FOOTBALL BLOCKING PADS FOR FOOTBALL PRACTICE; FOOTBALL TACKLING SHIELDS; FOOTBALL AGILITY BLOCKING DUMMIES; FOOTBALL PULL SLEDS; FOOTBALL FOREARM PADS; BAGS SPECIALLY ADAPTED FOR SPORTS BALLS; SPORTS FIELD EQUIPMENT, NAMELY, SPORTS PYLONS, FOOTBALL DOWN BOXES, DOWN CHAINS, HOCKEY PENALTY FLAGS, FOOTBALL SIDELINE MARKERS, HOCKEY SIDELINE MARKERS, FOOTBALL SIDELINE FLAGS, SOCCER SIDELINE FLAGS; TRAMPOLINES; TOY SCOOTERS; STREET HOCKEY EQUIPMENT, NAMELY, HOCKEY NETS, ATHLETIC PROTECTIVE PADS; HOCKEY STICKS; BALLS FOR PLAYING STREET HOCKEY; PORTABLE BASKETBALL HOOPS; SKATE BOARDS; PROTECTIVE PADS FOR SKATEBOARDING (U.S. CLS. 22, 23, 38 AND 50).  
LEIGH LOWRY, EXAMINING ATTORNEY

SN 85-189,309. VI HOLDINGS LLC, WILMINGTON, DE. FILED 12-2-2010.

**PRYSMOS**

THE MARK CONSISTS OF STANDARD CHARACTERS WITHOUT CLAIM TO ANY PARTICULAR FONT, STYLE, SIZE, OR COLOR.

FOR TOY ACTION FIGURES AND ACCESSORIES THEREFOR; TOY VEHICLES AND ACCESSORIES THEREFOR (U.S. CLS. 22, 23, 38 AND 50).

DEZMONA MIZELLE, EXAMINING ATTORNEY

SN 85-189,320. VI HOLDINGS LLC, WILMINGTON, DE. FILED 12-2-2010.

**LEORIC**

THE MARK CONSISTS OF STANDARD CHARACTERS WITHOUT CLAIM TO ANY PARTICULAR FONT, STYLE, SIZE, OR COLOR.

FOR TOY ACTION FIGURES AND ACCESSORIES THEREFOR; TOY VEHICLES AND ACCESSORIES THEREFOR (U.S. CLS. 22, 23, 38 AND 50).

DEZMONA MIZELLE, EXAMINING ATTORNEY

**CLASS 28—(Continued).**

SN 85-189,337. VI HOLDINGS LLC, WILMINGTON, DE.  
FILED 12-2-2010.

# FERYL

THE MARK CONSISTS OF STANDARD CHARACTERS WITHOUT CLAIM TO ANY PARTICULAR FONT, STYLE, SIZE, OR COLOR.  
FOR TOY ACTION FIGURES AND ACCESSORIES THEREFOR; TOY VEHICLES AND ACCESSORIES THEREFOR (U.S. CLS. 22, 23, 38 AND 50).  
DEZMONA MIZELLE, EXAMINING ATTORNEY

**CLASS 28—(Continued).**

SN 85-203,034. VI HOLDINGS LLC, WILMINGTON, DE.  
FILED 12-21-2010.

# THE AGE OF MAGIC

THE MARK CONSISTS OF STANDARD CHARACTERS WITHOUT CLAIM TO ANY PARTICULAR FONT, STYLE, SIZE, OR COLOR.  
FOR TOY ACTION FIGURES AND ACCESSORIES THEREFOR; TOY VEHICLES AND ACCESSORIES THEREFOR (U.S. CLS. 22, 23, 38 AND 50).  
RONALD DELGIZZI, EXAMINING ATTORNEY

SN 85-189,349. VI HOLDINGS LLC, WILMINGTON, DE.  
FILED 12-2-2010.

# WITTERQUICK

THE MARK CONSISTS OF STANDARD CHARACTERS WITHOUT CLAIM TO ANY PARTICULAR FONT, STYLE, SIZE, OR COLOR.  
FOR TOY ACTION FIGURES AND ACCESSORIES THEREFOR; TOY VEHICLES AND ACCESSORIES THEREFOR (U.S. CLS. 22, 23, 38 AND 50).  
DEZMONA MIZELLE, EXAMINING ATTORNEY

SN 85-203,057. VI HOLDINGS LLC, WILMINGTON, DE.  
FILED 12-21-2010.

# THE AGE OF SCIENCE

THE MARK CONSISTS OF STANDARD CHARACTERS WITHOUT CLAIM TO ANY PARTICULAR FONT, STYLE, SIZE, OR COLOR.  
FOR TOY ACTION FIGURES AND ACCESSORIES THEREFOR; TOY VEHICLES AND ACCESSORIES THEREFOR (U.S. CLS. 22, 23, 38 AND 50).  
RONALD DELGIZZI, EXAMINING ATTORNEY

SN 85-198,052. VI HOLDINGS LLC, WILMINGTON, DE.  
FILED 12-15-2010.

# DARKLING LORDS

THE MARK CONSISTS OF STANDARD CHARACTERS WITHOUT CLAIM TO ANY PARTICULAR FONT, STYLE, SIZE, OR COLOR.  
FOR TOY ACTION FIGURES AND ACCESSORIES THEREFOR; TOY VEHICLES AND ACCESSORIES THEREFOR (U.S. CLS. 22, 23, 38 AND 50).  
RONALD DELGIZZI, EXAMINING ATTORNEY

SN 85-203,124. VI HOLDINGS LLC, WILMINGTON, DE.  
FILED 12-21-2010.

# VALARAK

THE MARK CONSISTS OF STANDARD CHARACTERS WITHOUT CLAIM TO ANY PARTICULAR FONT, STYLE, SIZE, OR COLOR.  
THE WORDING "VALARAK" HAS NO MEANING IN A FOREIGN LANGUAGE.  
FOR TOY ACTION FIGURES AND ACCESSORIES THEREFOR; TOY VEHICLES AND ACCESSORIES THEREFOR (U.S. CLS. 22, 23, 38 AND 50).  
RONALD DELGIZZI, EXAMINING ATTORNEY

**CLASS 28—(Continued).**

SN 85-213,143. PAT ACQUISITION, LLC, NASHVILLE, TN. FILED 1-7-2011.

**SCRAPE BOMB**

THE MARK CONSISTS OF STANDARD CHARACTERS WITHOUT CLAIM TO ANY PARTICULAR FONT, STYLE, SIZE, OR COLOR.

OWNER OF U.S. REG. NO. 3,034,387.

NO CLAIM IS MADE TO THE EXCLUSIVE RIGHT TO USE "SCRAPE", APART FROM THE MARK AS SHOWN.

FOR APPARATUS FOR THE DISPERSAL OF SCENT LURES FOR HUNTING (U.S. CLS. 22, 23, 38 AND 50).  
KATHERINE CONNOLLY, EXAMINING ATTORNEY

**CLASS 28—(Continued).**

SN 85-213,988. RHYTHM, LLC, BOSTON, MA. FILED 1-10-2011.



THE MARK CONSISTS OF A STYLIZED DRAWING OF A TREBLE CLEF MUSICAL SYMBOL.

FOR SNOWBOARDS (U.S. CLS. 22, 23, 38 AND 50).

FIRST USE 9-15-2006; IN COMMERCE 12-15-2006.

WENDY GOODMAN, EXAMINING ATTORNEY

SN 85-213,602. VERNA GILLIS, ACCORD, NY. FILED 1-9-2011.

**kick butt ball**

THE MARK CONSISTS OF STANDARD CHARACTERS WITHOUT CLAIM TO ANY PARTICULAR FONT, STYLE, SIZE, OR COLOR.

NO CLAIM IS MADE TO THE EXCLUSIVE RIGHT TO USE "BALL", APART FROM THE MARK AS SHOWN.

FOR BUTTOCKS SHAPED BALL USED FOR ANGER MANAGEMENT, FUN, EXERCISE (U.S. CLS. 22, 23, 38 AND 50).

TIMOTHY FINNEGAN, EXAMINING ATTORNEY

SN 85-215,313. CEPIA, LLC, ST. LOUIS, MO. FILED 1-11-2011.

**DAGEDAR**

SN 85-213,603. SINGLETEASE LLC, WASHINGTON, DC. FILED S.R. 1-9-2011; AM. P.R. 9-7-2011.

**minglematch**

FOR PARTY GAMES (U.S. CLS. 22, 23, 38 AND 50).  
FIRST USE 12-6-2010; IN COMMERCE 12-19-2010.  
NAAKWAMA ANKRAH, EXAMINING ATTORNEY

THE MARK CONSISTS OF STANDARD CHARACTERS WITHOUT CLAIM TO ANY PARTICULAR FONT, STYLE, SIZE, OR COLOR.

FOR COLLECTIBLE TOY BALLS, NAMELY, RACING TOY BALLS COMPRISED OF WEIGHTED BALL BEARINGS; TOY TRACK COURSES FOR USE WITH RACING TOY BALLS; TRACK SETS COMPRISED OF TOY TRACK COURSES AND RACING TOY BALLS FOR USE ON THE TRACK COURSES; SPINNERS FOR SPINNING RACING TOY BALLS; CARRYING CASES FOR RACING TOY BALLS (U.S. CLS. 22, 23, 38 AND 50).

INGRID C. EULIN, EXAMINING ATTORNEY

**CLASS 28—(Continued).**

SN 85-225,741. SPOTSPORTS PROMOTIONS, CORAL GABLES, FL. FILED 1-25-2011.



THE MARK CONSISTS OF THE WORDS SPOTSPORTS, WITH THE "S" IN CAPITAL LETTERS, WITH A SERIES OF SPOTS OF VARIOUS SIZES SURROUNDING A BIGGER SPOT THAT IS IN THE CENTER.

FOR TENNIS BALLS (U.S. CLS. 22, 23, 38 AND 50).  
FIRST USE 8-0-2010; IN COMMERCE 8-0-2010.  
WILLIAM ROSSMAN, EXAMINING ATTORNEY

SN 85-232,067. VI HOLDINGS LLC, WILMINGTON, DE. FILED 2-2-2011.

**JADE MOUNTAIN**

THE MARK CONSISTS OF STANDARD CHARACTERS WITHOUT CLAIM TO ANY PARTICULAR FONT, STYLE, SIZE, OR COLOR.

FOR TOY ACTION FIGURES AND ACCESSORIES THEREFOR; TOY VEHICLES AND ACCESSORIES THEREFOR (U.S. CLS. 22, 23, 38 AND 50).  
RONALD DELGIZZI, EXAMINING ATTORNEY

SN 85-232,094. VI HOLDINGS LLC, WILMINGTON, DE. FILED 2-2-2011.

**ZODIACUS**

THE MARK CONSISTS OF STANDARD CHARACTERS WITHOUT CLAIM TO ANY PARTICULAR FONT, STYLE, SIZE, OR COLOR.

FOR TOY ACTION FIGURES AND ACCESSORIES THEREFOR; TOY VEHICLES AND ACCESSORIES THEREFOR (U.S. CLS. 22, 23, 38 AND 50).  
RONALD DELGIZZI, EXAMINING ATTORNEY

**CLASS 28—(Continued).**

SN 85-234,354. GORMAN, DONNA M., BARRINGTON, NH. AND ROBINSON, PAUL G., WAXHAW, NC. AND GORMAN, ROBERT M., BARRINGTON, NH. AND ROBINSON, REBECCA A., WAXHAW, NC. FILED 2-4-2011.

**MOLLY, THE MAGIC PEACH!!  
I AM, I AM**

THE MARK CONSISTS OF STANDARD CHARACTERS WITHOUT CLAIM TO ANY PARTICULAR FONT, STYLE, SIZE, OR COLOR.

NO CLAIM IS MADE TO THE EXCLUSIVE RIGHT TO USE "PEACH", APART FROM THE MARK AS SHOWN.

FOR FANTASY CHARACTER TOYS (U.S. CLS. 22, 23, 38 AND 50).

TINA L. SNAPP, EXAMINING ATTORNEY

SN 85-238,957. PROGRESSIVE INNOVATIONS, INC., DBA GLOBAL TOUR GOLF, VISTA, CA. FILED 2-10-2011.

**TATERGRIP**

OWNER OF U.S. REG. NO. 3,931,910.

THE MARK CONSISTS OF A STYLIZED VERSION OF THE WORD "TATERGRIP".

FOR BASEBALL AND SOFTBALL BAT GRIP; TENNIS RACKET GRIP; HOCKEY STICK GRIP; LACROSSE GRIP; FISHING ROD GRIP (U.S. CLS. 22, 23, 38 AND 50).

FIRST USE 8-10-2010; IN COMMERCE 8-10-2010.  
MICHAEL SOUDERS, EXAMINING ATTORNEY

SN 85-239,238. BICI VIDA LIMITED, ALBANY, NEW ZEALAND, FILED 2-10-2011.

**PUREBLACK  
RACING**

PRIORITY CLAIMED UNDER SEC. 44(D) ON NEW ZEALAND APPLICATION NO. 828979, FILED 8-17-2010, REG. NO. 828979, DATED 8-17-2010, EXPIRES 8-17-2020.

NO CLAIM IS MADE TO THE EXCLUSIVE RIGHT TO USE "RACING", APART FROM THE MARK AS SHOWN.

THE MARK CONSISTS OF THE WORDS "PURE BLACK RACING" IN STYLIZED FONT.

FOR EXERCISING APPARATUS AND EQUIPMENT, NAMELY, STATIONARY EXERCISE BICYCLES; SPORTING ARTICLES, NAMELY, ELBOW GUARDS, KNEE GUARDS, SHIN GUARDS, ALL FOR ATHLETIC USE; SPORTING EQUIPMENT AND APPARATUS, NAMELY, BASKET BALLS, BEACH BALLS, BOWLING BALLS, FOOTBALLS, SOCCER BALLS AND SPORTS BALLS; GAMES, NAMELY, ACTION SKILL GAMES, CARD GAMES; AND PLAYTHINGS, NAMELY, BASKET BALLS, BEACH BALLS, BOWLING BALLS, FOOTBALLS, SOCCER BALLS, TOYS, NAMELY, PUZZLES, JIGSAW PUZZLES, INFLATABLE TOYS, INFLATABLE TOY BALLS, INFLATABLE TOY CARS, DOLLS, TOY MONEY BANKS, TOY CARS AND CAR PARTS, TOY BICYCLES AND BICYCLE PARTS, NOT FOR TRANSPORT (U.S. CLS. 22, 23, 38 AND 50).

SARA BENJAMIN, EXAMINING ATTORNEY

**CLASS 28—(Continued).**

SN 85-243,129. DERRICK, PATRICIA AHLEEN, DBA ANIMALATIONS LLC, LAS VEGAS, NV. FILED 2-15-2011.

# Brainpaths

THE MARK CONSISTS OF STANDARD CHARACTERS WITHOUT CLAIM TO ANY PARTICULAR FONT, STYLE, SIZE, OR COLOR.

FOR BOARD GAMES; MANIPULATIVE GAMES (U.S. CLS. 22, 23, 38 AND 50).  
FIRST USE 1-8-2008; IN COMMERCE 1-8-2008.  
GRETTA YAO, EXAMINING ATTORNEY

---

SN 85-243,733. MARVEL CHARACTERS, INC., MANHATTAN BEACH, CA. FILED 2-16-2011.

# KA-ZAR

THE MARK CONSISTS OF STANDARD CHARACTERS WITHOUT CLAIM TO ANY PARTICULAR FONT, STYLE, SIZE, OR COLOR.

OWNER OF U.S. REG. NO. 3,944,780.  
FOR ACTION FIGURES AND ACCESSORIES THEREFOR; ARCADE GAMES; BALLOONS; BALLS FOR GAMES; BATTERY OPERATED ACTION TOYS; BEAN BAG DOLLS; BENDABLE TOYS; BOARD GAMES; BOBBLE HEAD DOLLS; CARD GAMES; CHESS SETS; CHILDREN'S MULTIPLE ACTIVITY TOYS; CHRISTMAS TREE DECORATIONS; COIN-OPERATED VIDEO GAMES; DOLLS AND ACCESSORIES THEREFOR; FLYING DISCS; GAME TABLES; HAND HELD UNITS FOR PLAYING VIDEO GAMES OTHER THAN THOSE ADAPTED FOR USE WITH AN EXTERNAL DISPLAY SCREEN OR MONITOR; INFLATABLE BOP BAGS; INFLATABLE POOLS FOR RECREATIONAL USE; INFLATABLE TOYS; JIGSAW PUZZLES; JUMP ROPES; KITES; MECHANICAL ACTION TOYS; PINBALL GAMES; PINBALL-TYPE GAMES; PLAYING CARDS; PLAYSETS FOR USE WITH TOY ACTION FIGURES AND FOR MAKE BELIEVE PLAY BATTLE OR ADVENTURE ACTIVITIES; PLUSH TOYS; PUPPETS; RADIO CONTROLLED TOY VEHICLES; RIDE-ON TOYS; RIDEABLE TOY VEHICLES; ROLE PLAYING GAMES; ROLLER SKATES; RUBBER BALLS; SNOW BOARDS; SNOW SLEDS FOR RECREATIONAL USE; SOFT SCULPTURE TOYS; STUFFED TOY ANIMALS; SURF BOARDS; SURF FINS; SWIM BOARDS FOR RECREATIONAL USE; SWIM FINS; TARGET GAMES; TOY ACTION FIGURES AND ACCESSORIES THEREFOR; TOY MASKS; TOY MODEL HOBBYCRAFT KITS; TOY VEHICLES; TOY WATCHES; TOY WEAPONS; WATER SQUIRTING TOYS; YO-YOS (U.S. CLS. 22, 23, 38 AND 50).  
ROSELLE HERRERA, EXAMINING ATTORNEY

**CLASS 28—(Continued).**

SN 85-261,912. MARCO SKATES LIMITED, CHAIWAN, HONG KONG, FILED 3-9-2011.



THE MARK CONSISTS OF THE WORD "SEBA" IN STYLIZED FONT, WITH THE LETTERS "S" AND "E" CONNECTED, AND THE LETTERS "B" AND "A" CONNECTED.

THE WORDING "SEBA" HAS NO MEANING IN A FOREIGN LANGUAGE.

FOR SPORTING ARTICLES, NAMELY, FOOTBALLS, BASKETBALLS, VOLLEYBALLS, SOCCER BALLS, BASEBALLS, GOLF BALLS, TENNIS BALLS; HOCKEY STICKS; ICE SKATES; ROLLER SKATES; SKATING BOOTS WITH SKATES ATTACHED; IN-LINE ROLLER SKATES; IN-LINE SKATES; BRAKING DEVICES AND REPLACEMENT BRAKE PADS ADAPTED FOR USE WITH SKATES, WHEELS BEING PART FOR SKATES; SPORTS GUARDS IN THE NATURE OF GUARDS FOR THE MOUTH, SPORTS GUARDS IN THE NATURE OF GUARDS FOR THE NOSE, SPORTS GUARDS IN THE NATURE OF GUARDS FOR THE CHIN; WRIST GUARDS FOR ATHLETIC USE, ATHLETIC WRIST SUPPORTS; ELBOW GUARDS FOR ATHLETIC USE; ELBOW GUARDS FOR USE IN SKATEBOARDING; KNEE PADS ADAPTED FOR USE WHILST PLAYING SPORTS; GLOVES MADE SPECIFICALLY FOR USE IN PLAYING SPORTS, NAMELY, WORKOUT GLOVES, HOCKEY GLOVES, GOLF GLOVES, SKATING GLOVES (U.S. CLS. 22, 23, 38 AND 50).

FIRST USE 12-31-2003; IN COMMERCE 6-30-2009.  
HELENE LIWINSKI, EXAMINING ATTORNEY

---

SN 85-261,972. POWERTEC, INC., DBA POWERTEC FITNESS, INC., CARSON, CA. FILED 3-9-2011.

# POWERDRIVE

THE MARK CONSISTS OF STANDARD CHARACTERS WITHOUT CLAIM TO ANY PARTICULAR FONT, STYLE, SIZE, OR COLOR.

FOR EXERCISE MACHINES, NAMELY, WEIGHT LIFTING MACHINES (U.S. CLS. 22, 23, 38 AND 50).  
DOMINIC J. FERRAIUOLO, EXAMINING ATTORNEY

**CLASS 28—(Continued).**

SN 85-265,976. MORIBER, TOM, NEW YORK, NY. FILED 3-14-2011.

## Furever Furs, Inc.

THE MARK CONSISTS OF STANDARD CHARACTERS WITHOUT CLAIM TO ANY PARTICULAR FONT, STYLE, SIZE, OR COLOR.

NO CLAIM IS MADE TO THE EXCLUSIVE RIGHT TO USE "FURS, INC.", APART FROM THE MARK AS SHOWN.

FOR HOBBY CRAFT KITS COMPRISING FUR CUTTERS, KNIVES, BLADES, NEEDLE NOSE PLIERS, AWLS, SCISSORS, MARKING PEN, TAILOR'S MARKING CRAYON, LEATHER BAG, MAGNETS, PINS, NEEDLES, THREAD, THIMBLE, PATTERNS, PRESS ON GLUE FABRIC, DVD AND INSTRUCTIONAL BOOK FOR TRANSFORMING RECYCLED ANIMAL FURS INTO RESTYLED BIODEGRADABLE REFURBISHED FURS, ALL SOLD AS A UNIT (U.S. CLS. 22, 23, 38 AND 50).

FIRST USE 11-10-2010; IN COMMERCE 3-9-2011.  
CHARISMA HAMPTON, EXAMINING ATTORNEY

**CLASS 28—(Continued).**

SN 85-288,046. SOFT PLAY, L.L.C., HUNTERSVILLE, NC. FILED 4-6-2011.

## TOT BLOBS

THE MARK CONSISTS OF STANDARD CHARACTERS WITHOUT CLAIM TO ANY PARTICULAR FONT, STYLE, SIZE, OR COLOR.

NO CLAIM IS MADE TO THE EXCLUSIVE RIGHT TO USE "TOT", APART FROM THE MARK AS SHOWN.

FOR PLAYGROUND EQUIPMENT, IN THE NATURE OF MODULAR PLAYGROUND COMPONENTS, NAMELY, CLIMBING COMPONENTS, BALANCE COMPONENTS, SPINNING COMPONENTS, DISCOVERY COMPONENTS, CRAWL-THROUGH COMPONENTS, CRAWL-ON COMPONENTS, GLIDING COMPONENTS, ROLLING COMPONENTS, SITTING COMPONENTS, AND GATHERING AREAS; PLAY SYSTEMS AND PLAY-ENVIRONMENTS COMPRISED OF ONE OR MORE OF THE LISTED COMPONENTS (U.S. CLS. 22, 23, 38 AND 50).

ALLISON HOLTZ, EXAMINING ATTORNEY

---

SN 85-282,985. HOFFART, JORDAN, SAN MARCOS, CA. FILED 3-31-2011.

## BEASTMODE SB

THE MARK CONSISTS OF STANDARD CHARACTERS WITHOUT CLAIM TO ANY PARTICULAR FONT, STYLE, SIZE, OR COLOR.

NO CLAIM IS MADE TO THE EXCLUSIVE RIGHT TO USE "SB", APART FROM THE MARK AS SHOWN.

FOR SKATEBOARD ACCESSORIES, NAMELY SKATEBOARD GRIP TAPES, SKATEBOARD WHEELS, SKATEBOARD BUSHINGS, SKATEBOARD RISER PADS, SKATEBOARD BEARINGS, SKATEBOARD WAX, AND SKATEBOARD HARDWARE, NAMELY SKATEBOARD DECKS (U.S. CLS. 22, 23, 38 AND 50).

MICHELE SWAIN, EXAMINING ATTORNEY

---

SN 85-290,930. HAMPTON FITNESS PRODUCTS, VENTURA, CA. FILED 4-9-2011.

## DURA-BELL

THE MARK CONSISTS OF STANDARD CHARACTERS WITHOUT CLAIM TO ANY PARTICULAR FONT, STYLE, SIZE, OR COLOR.

FOR DUMBBELLS (U.S. CLS. 22, 23, 38 AND 50).

FIRST USE 7-22-1998; IN COMMERCE 7-22-1998.

EVELYN BRADLEY, EXAMINING ATTORNEY

**CLASS 28—(Continued).**

SN 85-295,902. ABSOLUTE INTERNATIONAL PTY LTD,  
DAISY HILL QLD, AUSTRALIA, FILED 4-15-2011.



NO CLAIM IS MADE TO THE EXCLUSIVE RIGHT TO USE "AUSTRALIA", APART FROM THE MARK AS SHOWN.

THE MARK CONSISTS OF THE STYLIZED WORDING "PENNY, AUSTRALIA" FEATURED WITHIN A CIRCLE, WITH THE WORD "PENNY" APPEARING IN LARGE FONT ABOVE THE WORDING "AUSTRALIA" APPEARING IN SMALLER FONT, AND WITH A SMALL QUADRILATERAL APPEARING BEFORE THE WORDING "AUSTRALIA".

FOR SKATEBOARD DECKS; SKATEBOARD RISER PADS; SKATEBOARD TRUCKS; SKATEBOARD WHEELS; SKATEBOARDS (U.S. CLS. 22, 23, 38 AND 50).

KATHERINE CONNOLLY, EXAMINING ATTORNEY

SN 85-298,140. THE LITTLE TIKES COMPANY, VAN NUYS,  
CA. FILED 4-18-2011.

**BIG ADVENTURES**

THE MARK CONSISTS OF STANDARD CHARACTERS WITHOUT CLAIM TO ANY PARTICULAR FONT, STYLE, SIZE, OR COLOR.

OWNER OF U.S. REG. NO. 3,313,456.

FOR ACTION FIGURES AND PLAYSETS THEREFOR, ACTION SKILL GAMES, ARCADE GAMES, ATHLETIC PROTECTIVE PADS, NAMELY, ARM PADS, KNEE PADS, ELBOW PADS AND WRIST PADS FOR CYCLING, SKATING AND SKATEBOARDING, BOARD GAMES, CARD GAMES, CHRISTMAS TREE ORNAMENTS, EXCEPT CONFECTIONERY OR ILLUMINATION ARTICLES, DOLLS, DOLL CLOTHING, DOLL ACCESSORIES, HAND HELD UNIT FOR PLAYING ELECTRONIC GAMES OTHER THAN THOSE ADAPTED FOR USE WITH AN EXTERNAL DISPLAY SCREEN OR MONITOR, KITES, MOBILES FOR CHILDREN, PARTY FAVORS IN THE NATURE OF CRACKERS AND NOISEMAKERS, PLAYGROUND BALLS, PLAYING CARDS, PLUSH TOYS, PUPPETS, PUZZLES, SKATEBOARDS, TOY VEHICLES AND PLAYSETS THEREFOR, TOY SCOOTERS, WIND-UP TOYS, AND YO-YOS (U.S. CLS. 22, 23, 38 AND 50).

JULIE GUTTADAURO, EXAMINING ATTORNEY

**CLASS 28—(Continued).**

SN 85-298,975. THE LITTLE TIKES COMPANY, VAN NUYS,  
CA. FILED 4-19-2011.

**TIKES TOUGH**

THE MARK CONSISTS OF STANDARD CHARACTERS WITHOUT CLAIM TO ANY PARTICULAR FONT, STYLE, SIZE, OR COLOR.

OWNER OF U.S. REG. NOS. 1,055,661, 3,063,998 AND OTHERS.

FOR ACTION FIGURES AND PLAYSETS THEREFOR, ACTION SKILL GAMES, ARCADE GAMES, ATHLETIC PROTECTIVE PADS, NAMELY, ARM PADS, KNEE PADS, ELBOW PADS AND WRIST PADS FOR CYCLING, SKATING AND SKATEBOARDING, BALLOONS, BASEBALLS, BASEBALL GLOVES, BASKETBALLS, BEACH BALLS, BEAN BAG DOLLS, BOARD GAMES, BODY BOARDS, CARD GAMES, CHILDREN'S PLAY COSMETICS, CHRISTMAS TREE ORNAMENTS, EXCEPT CONFECTIONERY OR ILLUMINATION ARTICLES, CRAFT SETS FOR DECORATING BALLOONS, DOLLS, DOLL CLOTHING, DOLL ACCESSORIES, FLYING DISCS, FOOTBALLS, HAND HELD UNIT FOR PLAYING ELECTRONIC GAMES OTHER THAN THOSE ADAPTED FOR USE WITH AN EXTERNAL DISPLAY SCREEN OR MONITOR, IN-LINE SKATES, KITES, MOBILES FOR CHILDREN, PARTY FAVORS IN THE NATURE OF CRACKERS AND NOISEMAKERS, PLAYGROUND BALLS, PLAYING CARDS, PLUSH TOYS, PUPPETS, PUZZLES, ROLLER SKATES, SKATEBOARDS, SKIM BOARDS, SNOW SLEDS FOR RECREATIONAL USE, SOCCER BALLS, SWIM FLOATS FOR RECREATIONAL USE, SWIM FINS, TOY ACTION FIGURES AND ACCESSORIES THEREFOR, TOY VEHICLES AND PLAYSETS THEREFOR, TOY SCOOTERS, VOLLEYBALLS, WATER WING SWIM AIDS FOR RECREATIONAL USE, WIND-UP TOYS, AND YO-YOS (U.S. CLS. 22, 23, 38 AND 50).

JULIE GUTTADAURO, EXAMINING ATTORNEY

SN 85-299,499. FISH GUARDIAN, LLC, GILBERTSVILLE,  
KY. FILED 4-20-2011.



NO CLAIM IS MADE TO THE EXCLUSIVE RIGHT TO USE "FISH", APART FROM THE MARK AS SHOWN.

THE MARK CONSISTS OF THE LITERAL ELEMENTS "FISH GUARDIAN" WHEREIN THE WORD "FISH" IS PLACED ABOVE THE WORD "GUARDIAN" HAVING GROMMETS ON THE WORDINGS TO LOOK LIKE THE SHIELD AND A SHIELD HAVING GROMMETS ON IT CONSISTS OF A BASS FISH INSIDE THE SHIELD, PLACED ABOVE THE WORD "GUARDIAN" AS SHOWN IN THE MARK.

FOR FISHING ACCESSORY, NAMELY, A DEVICE SOLD EMPTY THAT DISPENSES LIQUID LIVE RELEASE FORMULA INTO A BOAT LIVEWELL WITH THE PUSH OF A BUTTON FOR THE PURPOSE OF PROLONGING THE LIFE OF GAME FISH (U.S. CLS. 22, 23, 38 AND 50).

FIRST USE 3-28-2011; IN COMMERCE 4-2-2011.

CIMMERIAN COLEMAN, EXAMINING ATTORNEY



**CLASS 28—(Continued).**

SN 85-299,909. PROCAPS L.P., VILLE ST-LAURENT, CANADA, FILED 4-20-2011.

# RECSPORT

THE MARK CONSISTS OF STANDARD CHARACTERS WITHOUT CLAIM TO ANY PARTICULAR FONT, STYLE, SIZE, OR COLOR.

OWNER OF U.S. REG. NO. 3,179,400.

SEC. 2(F).

FOR PAINTBALLS (U.S. CLS. 22, 23, 38 AND 50).

FIRST USE 10-1-2008; IN COMMERCE 10-1-2008.

MARK SPARACINO, EXAMINING ATTORNEY

---

SN 85-305,137. STROTTMAN INTERNATIONAL, IRVINE, CA. FILED 4-26-2011.



NO CLAIM IS MADE TO THE EXCLUSIVE RIGHT TO USE "LINKS", APART FROM THE MARK AS SHOWN.

THE MARK CONSISTS OF A CLOUD OR THOUGHT BUBBLE FEATURING THE STYLIZED WORDS "SMARTLINKS", WHERE "SMART" IS ABOVE "LINKS" THE BOTTOM OF THE "K" IN "LINKS" EXTENDS OUT AND THE "S" SITS ON TOP OF IT. THERE IS A BAR OR LINE BELOW "LINKS" IN WHICH THE WORDING "BUILD. PLAY. REPEAT." APPEARS IN THE NEGATIVE SPACE.

FOR BUILDING GAMES; PLAYSET BUILDINGS; PUZZLE GAMES; PUZZLES; TOY BUILDING BLOCKS CAPABLE OF INTERCONNECTION; TOY BUILDINGS AND ACCESSORIES THEREFOR (U.S. CLS. 22, 23, 38 AND 50).

FIRST USE 1-3-2011; IN COMMERCE 1-3-2011.

STEVEN R. FINE, EXAMINING ATTORNEY

**CLASS 28—(Continued).**

SN 85-307,037. CREATIVE CEDAR DESIGNS, INC., LAKE SUCCESS, NY. FILED 4-28-2011.



NO CLAIM IS MADE TO THE EXCLUSIVE RIGHT TO USE "CEDAR DESIGNS", APART FROM THE MARK AS SHOWN.

THE MARK CONSISTS OF THE WORDING "CREATIVE CEDAR DESIGNS" AND THE DESIGN OF A CEDAR TREE WITH A GIRL SWINGING FROM A LOW HANGING BRANCH ON THE RIGHT SIDE OF THE TREE, AND TWO ADIRONDACK CHAIRS NESTLED ON GRASS ON THE LEFT SIDE OF THE TREE.

FOR OUTDOOR PLAYGROUND EQUIPMENT AND OUTDOOR PLAY GYMS, NAMELY, PLAY YARDS, SWING SET, PLAY HOUSE, TEETER TOTTER IN THE NATURE OF OUTDOOR PLAYS STRUCTURES (U.S. CLS. 22, 23, 38 AND 50).

FIRST USE 10-1-2009; IN COMMERCE 10-1-2009.

MARGARET POWER, EXAMINING ATTORNEY

---

SN 85-309,361. JIN HONG EU, TAMPA, FL. FILED 5-1-2011.



NO CLAIM IS MADE TO THE EXCLUSIVE RIGHT TO USE "PRO FISHING", APART FROM THE MARK AS SHOWN.

THE MARK CONSISTS OF THE WORDING "HYTAC", WITH THE LETTER "H" INSIDE A DESIGN OF A FISH. THE WORDING "PRO FISHING" IS UNDERNEATH THE LETTERS "TAC" IN SMALLER LETTERS.

FOR SPORTING EQUIPMENT FOR FISHING, NAMELY, RODS, ROD BLANKS, REELS, HOOKS, LINES AND LURES; FISHING ACCESSORIES, NAMELY, TACKLE BOXES AND FISHING TERMINAL (U.S. CLS. 22, 23, 38 AND 50).

JANET LEE, EXAMINING ATTORNEY

**CLASS 28—(Continued).**

SN 85-311,597. SHANDONG REALLEADER FITNESS CO., LTD, XINTAI CITY, SHANDONG, CHINA, FILED 5-3-2011.



THE MARK CONSISTS OF THE STYLIZED WORDING, "GOOD LIFE" WITH THE LETTER "G" ENCLOSED IN A CIRCLE AND THE LETTER "L" FORMED BY A CURVED BAND.

FOR BODY-TRAINING APPARATUS; BODY-TRAINING APPARATUS AND DEVICES FOR PHYSICAL EXERCISES, NAMELY, BASEBALL BATS AND BASEBALL SWING TRAINING DEVICES; CHEST EXPANDERS; DUMB-BELLS; ELLIPTICAL EXERCISE MACHINES; EXERCISE EQUIPMENT, NAMELY, CHEST PULLS; EXERCISE TABLES; EXERCISING EQUIPMENT, NAMELY, WEIGHT LIFTING MACHINES; SPORTING GOODS, NAMELY, A SPORTS TRAINING DEVICE TO IMPROVE STRENGTH, TONING, CONDITIONING, BALANCE, AND PROPRIOCEPTION; STATIONARY EXERCISE BICYCLES (U.S. CLS. 22, 23, 38 AND 50).

JESSICA A. POWERS, EXAMINING ATTORNEY

**CLASS 28—(Continued).**

SN 85-316,485. HADDEN, JOHN DAVID T, SAN MARCOS, CA. FILED 5-10-2011.

**ASSAULT SKATEBOARDS**

THE MARK CONSISTS OF STANDARD CHARACTERS WITHOUT CLAIM TO ANY PARTICULAR FONT, STYLE, SIZE, OR COLOR.

NO CLAIM IS MADE TO THE EXCLUSIVE RIGHT TO USE "SKATEBOARDS", APART FROM THE MARK AS SHOWN.

FOR SKATEBOARDS (U.S. CLS. 22, 23, 38 AND 50).

FIRST USE 2-1-2011; IN COMMERCE 2-1-2011.

GIANCARLO CASTRO, EXAMINING ATTORNEY

SN 85-316,742. JUNIOR LEARNING, INC., DBA JUNIOR LEARNING, INC., HUNTINGTON BEACH, CA. FILED 5-10-2011.

SN 85-316,407. FASHION BRANDS HOLDING CORPORATION, CARSON CITY, NV. FILED 5-9-2011.



NO CLAIM IS MADE TO THE EXCLUSIVE RIGHT TO USE "YOGA", APART FROM THE MARK AS SHOWN.

THE NAME(S), PORTRAIT(S), AND/OR SIGNATURE(S) SHOWN IN THE MARK IDENTIFIES "MICHELE BOHBOT", WHOSE CONSENT(S) TO REGISTER IS MADE OF RECORD.

THE COLOR(S) BLACK, TURQUOISE BLUE, AND BRIGHT PINK IS/ARE CLAIMED AS A FEATURE OF THE MARK.

THE MARK CONSISTS OF THE WORDS "ELECTRIC" AND "YOGA" IN BLACK. THE NAME "MICHELE BOHBOT" IS DISPLAYED IN SMALLER TEXT BELOW. THE WORDS "ELECTRIC" AND "YOGA" AND "MICHELE" AND "BOHBOT" ARE SEPARATED BY A CUSTOM DRAWN LIGHTNING BOLT DISPLAYED IN THE CENTER. THE LIGHTNING BOLT IS OUTLINED ON THE LEFT SIDE WITH TURQUOISE BLUE AND ON THE RIGHT SIDE IT IS OUTLINED BRIGHT PINK WITH THE BODY OF THE LIGHTNING BOLT IS FILLED IN WITH BLACK.

FOR YOGA MATS (U.S. CLS. 22, 23, 38 AND 50).

GEORGE LORENZO, EXAMINING ATTORNEY



NO CLAIM IS MADE TO THE EXCLUSIVE RIGHT TO USE "LEARNING", APART FROM THE MARK AS SHOWN.

THE COLOR(S) RED AND WHITE IS/ARE CLAIMED AS A FEATURE OF THE MARK.

THE MARK CONSISTS OF THE WORDING "JUNIOR LEARNING" IN RED IN A ROUNDED SANS SERIF FONT WITH A CARTOON IMAGE OF A YOUNG BOY'S FACE AND HANDS IN RED AND WHITE PEERING OVER THE WORD. A SINGLE-LINE RED OUTLINE IN A SLOPED PARALLELOGRAM SHAPE SURROUNDS THE WORDING AND DESIGN. THE WHITE BACKGROUND INSIDE THE PARALLELOGRAM IS PART OF THE MARK, BUT THE WHITE BACKGROUND OUTSIDE THE PARALLELOGRAM IS NOT PART OF THE MARK.

FOR EDUCATIONAL TOYS, GAMES AND TEACHING MATERIALS FOR SCHOOL AGE CHILDREN, FOR TEACHING MATHEMATICS AND READING IN THE NATURE OF PLASTIC SHAPE BOARD GAMES, PLASTIC SHAPE MANIPULATIVE GAMES, PLASTIC SHAPED EDUCATIONAL TOYS AND PRINTED TEACHING AIDS (U.S. CLS. 22, 23, 38 AND 50).

FIRST USE 4-7-2010; IN COMMERCE 1-1-2011.

MICHAEL ENGEL, EXAMINING ATTORNEY

**CLASS 28—(Continued).**

SN 85-319,918. KGK GROUP INC., SOUTH EL MONTE, CA.  
FILED 5-13-2011.

**MetalTac**

THE MARK CONSISTS OF STANDARD CHARACTERS WITHOUT CLAIM TO ANY PARTICULAR FONT, STYLE, SIZE, OR COLOR.

FOR TOY GUNS, TOY PISTOLS, PAINTBALL GUNS, PAINTBALLS, TACTICAL GEARS, AIRSOFT GUNS, AIRSOFT GUN ACCESSORIES AND PARTS, NAMELY, SLINGS, GEARS, SPRINGS, MAGAZINES, AMMUNITION, LOADER, SIGHTS, GEARBOX DESIGNED TO BE USED BY ADULTS FOR RECREATIONAL PURPOSES (U.S. CLS. 22, 23, 38 AND 50).  
NAKIA HENRY, EXAMINING ATTORNEY

**CLASS 28—(Continued).**

SN 85-323,197. LORBER, ERIC, STEVENSON RANCH, CA.  
AND KOTISH, STEPHEN, STEVENSON RANCH, CA.  
FILED 5-17-2011.

**Ah-Too-Kee**

THE MARK CONSISTS OF STANDARD CHARACTERS WITHOUT CLAIM TO ANY PARTICULAR FONT, STYLE, SIZE, OR COLOR.

THE WORDING "AH-TOO-KEE" HAS NO MEANING IN A FOREIGN LANGUAGE.

FOR CHILDREN'S MULTIPLE ACTIVITY TOYS SOLD AS A UNIT WITH PRINTED BOOKS; SOFT SCULPTURE PLUSH TOYS; TOY FIGURES, PARTS AND ACCESSORIES THEREFOR; TOY ANIMALS, CRITTERS, CREATURES, MONSTERS, SPACE ALIENS, FANTASY FIGURES, PEOPLE AND CHARACTERS AND PARTS AND ACCESSORIES THEREFOR (U.S. CLS. 22, 23, 38 AND 50).

B. PARADEWELAI, EXAMINING ATTORNEY

SN 85-324,659. OL'GLORY AMERICA'S BEER, LLC, OKLAHOMA CITY, OK. FILED 5-19-2011.

**HULLY GULLY**

THE MARK CONSISTS OF STANDARD CHARACTERS WITHOUT CLAIM TO ANY PARTICULAR FONT, STYLE, SIZE, OR COLOR.

FOR CARD GAMES (U.S. CLS. 22, 23, 38 AND 50).

FIRST USE 5-18-2011; IN COMMERCE 5-18-2011.

ASMAT KHAN, EXAMINING ATTORNEY

SN 85-324,709. OL'GLORY AMERICA'S BEER, LLC, OKLAHOMA CITY, OK. FILED 5-19-2011.

**BIG MONEY BLACKJACK**

THE MARK CONSISTS OF STANDARD CHARACTERS WITHOUT CLAIM TO ANY PARTICULAR FONT, STYLE, SIZE, OR COLOR.

OWNER OF U.S. REG. NO. 3,213,845.

NO CLAIM IS MADE TO THE EXCLUSIVE RIGHT TO USE "MONEY BLACKJACK", APART FROM THE MARK AS SHOWN.

FOR GAMES, NAMELY, CASINO CARD GAMES, GAMING TABLES, HAND HELD UNITS FOR PLAYING ELECTRONIC CARD GAMES OTHER THAN THOSE ADAPTED FOR USE WITH AN EXTERNAL DISPLAY SCREEN OR MONITOR, AND STAND-ALONE VIDEO GAME MACHINES FOR PLAYING CARD GAMES (U.S. CLS. 22, 23, 38 AND 50).

FIRST USE 12-20-2002; IN COMMERCE 12-20-2002.

KAPIL BHANOT, EXAMINING ATTORNEY



THE MARK CONSISTS OF THE TERMS "OL' GLORY PRESENTS" ABOVE THE WORDS "HULLY GULLY." THE TERMS "OL' GLORY" ARE POSITIONED ON TOP OF A HORIZONTAL OVAL. THE TERM "PRESENTS" IS POSITIONED INSIDE THE HORIZONTAL OVAL NEAR THE BOTTOM AND UNDERNEATH THE TERMS "OL' GLORY."

**CLASS 28—(Continued).**

A HEAD OF A BALD EAGLE IS CONNECTED TO A WAVING AMERICAN FLAG. THE HEAD OF THE BALD EAGLE AND THE WAVING FLAG ARE POSITIONED ON THE LEFT SIDE OF THE HORIZONTAL OVAL AND TO THE LEFT OF THE TERMS "OL' GLORY." THE TERMS "HULLY GULLY" ARE PRESENTED IN A CIRCULAR FASHION AROUND A BUST OF A CLOWN WEARING A CROWN. THE ACRONYM "HG" IS WRITTEN ON THE CROWN OF THE CLOWN. THE LETTER "U" OF THE TERM "HULLY" AND THE LETTER "U" OF THE TERM "GULLY" ARE DISPLAYED AS HORSESHOES.

FOR CARD GAMES (U.S. CLS. 22, 23, 38 AND 50).  
FIRST USE 5-18-2011; IN COMMERCE 5-18-2011.  
ROBIN CHOSID, EXAMINING ATTORNEY

---

SN 85-324,836. SHOWBALL, INC., POWDER SPRINGS, GA.  
FILED 5-19-2011.

## SHOWBALL

THE MARK CONSISTS OF STANDARD CHARACTERS WITHOUT CLAIM TO ANY PARTICULAR FONT, STYLE, SIZE, OR COLOR.

FOR SPORTS MEMORABILIA TOY NOVELTY ITEMS, NAMELY, REPLICAS OF BASEBALLS, FOOTBALLS, BASKETBALLS, SOCCER BALLS, VOLLEYBALLS, TENNIS BALLS, GOLF BALLS, SOFTBALLS, BOXING GLOVES, HOCKEY PUCKS, MEGAPHONES, SPORTS HELMETS, AND RACE CAR WHEELS (U.S. CLS. 22, 23, 38 AND 50).

FIRST USE 11-0-1991; IN COMMERCE 12-0-1993.  
HOWARD B. LEVINE, EXAMINING ATTORNEY

---

SN 85-326,696. CUSTOM PRO SPORTS, INC., SMYRNA, GA.  
FILED 5-21-2011.

## TransformerEAS

THE MARK CONSISTS OF STANDARD CHARACTERS WITHOUT CLAIM TO ANY PARTICULAR FONT, STYLE, SIZE, OR COLOR.

FOR BADMINTON RACKETS; HANDLE GRIPS FOR SPORTING EQUIPMENT; OUTDOOR ACTIVITY GAME EQUIPMENT IN THE NATURE OF RACKETS FOR TENNIS, BADMINTON, SQUASH, HOCKEY; SQUASH RACKETS; TENNIS RACQUETS; TENNIS RACQUETS, BASEBALL BATS, CRICKET BATS, GOLF CLUBS AND HOCKEY STICKS (U.S. CLS. 22, 23, 38 AND 50).

LINDSEY RUBIN, EXAMINING ATTORNEY

**CLASS 28—(Continued).**

SN 85-327,540. BATTAT, INC., PLATTSBURGH, NY. FILED 5-23-2011.

## PUCCI PUPS WORLD

THE MARK CONSISTS OF STANDARD CHARACTERS WITHOUT CLAIM TO ANY PARTICULAR FONT, STYLE, SIZE, OR COLOR.

OWNER OF U.S. REG. NO. 2,923,964.

NO CLAIM IS MADE TO THE EXCLUSIVE RIGHT TO USE "PUPS", APART FROM THE MARK AS SHOWN.

FOR TOYS, NAMELY, PLUSH TOY DOGS; TOY CLOTHING FOR TOY DOGS; TOY FURNITURE FOR TOY DOGS; TOY DOG HOUSE AND CARRYING CASE FOR TOY DOGS; TOY GROOMING SALON FOR TOY DOGS; AND TOY DOLL HOUSE FOR TOY DOGS (U.S. CLS. 22, 23, 38 AND 50).

CAROLYN CATALDO, EXAMINING ATTORNEY

---

SN 85-328,453. POLLARD, SHERRI, FORT COLLINS, CO.  
FILED 5-24-2011.

## Red State Blue State

THE MARK CONSISTS OF STANDARD CHARACTERS WITHOUT CLAIM TO ANY PARTICULAR FONT, STYLE, SIZE, OR COLOR.

FOR BOARD GAMES (U.S. CLS. 22, 23, 38 AND 50).

DOMINICK J. SALEMI, EXAMINING ATTORNEY

---

SN 85-330,088. SUN MOUNTAIN SPORTS, INC., MISSOULA, MT. FILED 5-25-2011.

## KG:2

THE MARK CONSISTS OF STANDARD CHARACTERS WITHOUT CLAIM TO ANY PARTICULAR FONT, STYLE, SIZE, OR COLOR.

FOR GOLF BAGS; GOLF CLUB BAGS (U.S. CLS. 22, 23, 38 AND 50).

C. DIONNE CLYBURN, EXAMINING ATTORNEY

**CLASS 28—(Continued).**

SN 85-330,090. PODUNK IDEAS, LLC, BENTON, KY. FILED 5-25-2011.

**SNAKE N DA BRUSH**

THE MARK CONSISTS OF STANDARD CHARACTERS WITHOUT CLAIM TO ANY PARTICULAR FONT, STYLE, SIZE, OR COLOR.

FOR FISHING TACKLE, SNAGLESS FLEXIBLE FISHING WEIGHTS (U.S. CLS. 22, 23, 38 AND 50).

C. DIONNE CLYBURN, EXAMINING ATTORNEY

**CLASS 28—(Continued).**

SN 85-331,983. INTEX SYNDICATE LTD., HUNGHOM, KOWLOON, HONG KONG, FILED 5-27-2011.

**CAN OF WORMS**

THE MARK CONSISTS OF STANDARD CHARACTERS WITHOUT CLAIM TO ANY PARTICULAR FONT, STYLE, SIZE, OR COLOR.

FOR PARLOR GAMES (U.S. CLS. 22, 23, 38 AND 50).

JOHN HWANG, EXAMINING ATTORNEY

SN 85-330,749. THE ORVIS COMPANY, INC., SUNDERLAND, VT. FILED 5-26-2011.

**ENCOUNTER**

THE MARK CONSISTS OF STANDARD CHARACTERS WITHOUT CLAIM TO ANY PARTICULAR FONT, STYLE, SIZE, OR COLOR.

FOR FISHING TACKLE, FLY FISHING RODS, FLY FISHING REELS (U.S. CLS. 22, 23, 38 AND 50).

KRISTIN CARLSON, EXAMINING ATTORNEY

SN 85-331,984. INTEX SYNDICATE LTD., HUNGHOM, KOWLOON, HONG KONG, FILED 5-27-2011.

**GO BANANAS**

THE MARK CONSISTS OF STANDARD CHARACTERS WITHOUT CLAIM TO ANY PARTICULAR FONT, STYLE, SIZE, OR COLOR.

FOR PARLOR GAMES (U.S. CLS. 22, 23, 38 AND 50).

JOHN HWANG, EXAMINING ATTORNEY

SN 85-330,942. JB DESIGN, LLC, MESA, AZ. FILED 5-26-2011.

**DEEP SEA CLIPPER**

THE MARK CONSISTS OF STANDARD CHARACTERS WITHOUT CLAIM TO ANY PARTICULAR FONT, STYLE, SIZE, OR COLOR.

OWNER OF U.S. REG. NOS. 3,796,965 AND 3,896,263.

FOR FISHING EQUIPMENT, NAMELY, A DEVICE USED TO SECURE FISHING TACKLE TO A FISHING ROD (U.S. CLS. 22, 23, 38 AND 50).

KIMBERLY PERRY, EXAMINING ATTORNEY

SN 85-332,054. CYI, INC., CHATSWORTH, CA. FILED 5-27-2011.

**BUBBLEIZER**

THE MARK CONSISTS OF STANDARD CHARACTERS WITHOUT CLAIM TO ANY PARTICULAR FONT, STYLE, SIZE, OR COLOR.

FOR BUBBLE PRODUCING TOY, BUBBLE MAKING SOLUTION (U.S. CLS. 22, 23, 38 AND 50).

FIRST USE 3-8-2010; IN COMMERCE 3-8-2010.

ADA HAN, EXAMINING ATTORNEY

**CLASS 28—(Continued).**

SN 85-332,236. MATTEL, INC., EL SEGUNDO, CA. FILED 5-27-2011.

**TORALEI STRIPE**

THE MARK CONSISTS OF STANDARD CHARACTERS WITHOUT CLAIM TO ANY PARTICULAR FONT, STYLE, SIZE, OR COLOR.

FOR DOLLS, DOLL CLOTHING AND DOLL ACCESSORIES (U.S. CLS. 22, 23, 38 AND 50).

LESLIE RICHARDS, EXAMINING ATTORNEY

**CLASS 28—(Continued).**

SN 85-334,672. ARTISAN REPURPOSED LLC, CARBONDALE, CO. FILED 6-1-2011.

**viola studio**

THE MARK CONSISTS OF STANDARD CHARACTERS WITHOUT CLAIM TO ANY PARTICULAR FONT, STYLE, SIZE, OR COLOR.

FOR DOLLS; STUFFED DOLLS AND ANIMALS (U.S. CLS. 22, 23, 38 AND 50).

FIRST USE 11-30-2008; IN COMMERCE 11-30-2008.

DEIRDRE ROBERTSON, EXAMINING ATTORNEY

SN 85-332,748. SKIP HOP, INC., NEW YORK, NY. FILED 5-27-2011.

**HUG & HIDE**

THE MARK CONSISTS OF STANDARD CHARACTERS WITHOUT CLAIM TO ANY PARTICULAR FONT, STYLE, SIZE, OR COLOR.

FOR INFANT DEVELOPMENT TOYS; PLUSH TOYS; STUFFED TOYS (U.S. CLS. 22, 23, 38 AND 50).

FIRST USE 10-25-2010; IN COMMERCE 10-26-2010.

DEBRA LEE, EXAMINING ATTORNEY

SN 85-335,160. HALLMARK LICENSING, INC., KANSAS CITY, MO. FILED 6-1-2011.

**MY FIRST WORDS**

THE MARK CONSISTS OF STANDARD CHARACTERS WITHOUT CLAIM TO ANY PARTICULAR FONT, STYLE, SIZE, OR COLOR.

FOR PLUSH TOYS (U.S. CLS. 22, 23, 38 AND 50).

LINDA M. KING, EXAMINING ATTORNEY

SN 85-334,379. BALLOU, VIRGINIA, HAILEY, ID. FILED 5-31-2011.



THE MARK CONSISTS OF A SINGLE DIAMOND INSIDE EACH LETTER "D" IN "DIGNIFIEDESIGNS", AND TWO DOTS BETWEEN "CONNECT THE PIECES" AND "CONNECT THE LIVES".

FOR JIGSAW PUZZLES FOR THOSE WITH DEMENTIA OR ALZHEIMER'S (U.S. CLS. 22, 23, 38 AND 50).

FIRST USE 11-1-2009; IN COMMERCE 11-1-2009.  
VERNA BETH RIRIE, EXAMINING ATTORNEY

SN 85-335,474. HAGEST, RON, HUMBLE, TX. FILED 6-1-2011.



THE COLOR(S) BLUE, WHITE IS/ARE CLAIMED AS A FEATURE OF THE MARK.

THE MARK CONSISTS OF THE LITERAL ELEMENTS IHC IN WHITE COLOR WITH A BLUE OUTLINE INSIDE A SHIELD IN BLUE COLOR WITH A WHITE OUTLINE AS SHOWN IN THE MARK.

FOR TOY MODEL TRAIN SETS (U.S. CLS. 22, 23, 38 AND 50).

LINDA M. KING, EXAMINING ATTORNEY

**CLASS 28—(Continued).**

SN 85-335,654. MATTHEW J. FRIEDMAN, ENCINITAS, CA.  
FILED 6-1-2011.

**LIFTSUP**

THE MARK CONSISTS OF STANDARD CHARACTERS WITHOUT CLAIM TO ANY PARTICULAR FONT, STYLE, SIZE, OR COLOR.

FOR HANDLE GRIPS FOR SPORTING EQUIPMENT; HANDLE GRIPS FOR STAND UP PADDLE SURFBOARDS AND STAND UP PADDLEBOARDS (U.S. CLS. 22, 23, 38 AND 50).

FIRST USE 4-7-2011; IN COMMERCE 4-7-2011.  
KATHERINE CHANG, EXAMINING ATTORNEY

**CLASS 28—(Continued).**

SN 85-335,937. WINNING MOVES INC., DANVERS, MA.  
FILED 6-2-2011.

**SCRIBBO**

THE MARK CONSISTS OF STANDARD CHARACTERS WITHOUT CLAIM TO ANY PARTICULAR FONT, STYLE, SIZE, OR COLOR.

FOR BOARD GAMES; PARLOR GAMES (U.S. CLS. 22, 23, 38 AND 50).

DAVID C. REIHNER, EXAMINING ATTORNEY

SN 85-335,660. BB NOVELTY, LLC, VINCENNES, IN. FILED  
6-1-2011.

**SQUIRKY**

THE MARK CONSISTS OF STANDARD CHARACTERS WITHOUT CLAIM TO ANY PARTICULAR FONT, STYLE, SIZE, OR COLOR.

FOR STUFFED AND PLUSH DOLLS; STUFFED AND PLUSH TOY ANIMALS; STUFFED AND PLUSH TOY NOVELTIES (U.S. CLS. 22, 23, 38 AND 50).

KATHERINE CHANG, EXAMINING ATTORNEY

SN 85-336,254. NICHOLS, DONALD GREGORY, LAGUNA  
BEACH, CA. FILED 6-2-2011.

**JOY TOY**

THE MARK CONSISTS OF STANDARD CHARACTERS WITHOUT CLAIM TO ANY PARTICULAR FONT, STYLE, SIZE, OR COLOR.

FOR SURFBOARDS (U.S. CLS. 22, 23, 38 AND 50).  
FIRST USE 0-0-1968; IN COMMERCE 0-0-1968.

LAURIE KAUFMAN, EXAMINING ATTORNEY

SN 85-335,803. FRANKLIN SPORTS, INC., STOUGHTON,  
MA. FILED 6-1-2011.

**TAILSPIN**

THE MARK CONSISTS OF STANDARD CHARACTERS WITHOUT CLAIM TO ANY PARTICULAR FONT, STYLE, SIZE, OR COLOR.

FOR FOOTBALLS (U.S. CLS. 22, 23, 38 AND 50).  
ELLEN PERKINS, EXAMINING ATTORNEY

SN 85-336,409. SQUIRE BOONE CAVERNS, INC., NEW  
ALBANY, IN. FILED 6-2-2011.

**HITCHERS**

THE MARK CONSISTS OF STANDARD CHARACTERS WITHOUT CLAIM TO ANY PARTICULAR FONT, STYLE, SIZE, OR COLOR.

FOR STUFFED AND PLUSH TOYS (U.S. CLS. 22, 23, 38 AND 50).

FIRST USE 11-30-2010; IN COMMERCE 6-2-2011.  
HOWARD SMIGA, EXAMINING ATTORNEY

**CLASS 28—(Continued).**

SN 85-337,177. HORIZON HOBBY, INC., CHAMPAIGN, IL.  
FILED 6-3-2011.

**SCIMITAR**

THE MARK CONSISTS OF STANDARD CHARACTERS WITHOUT CLAIM TO ANY PARTICULAR FONT, STYLE, SIZE, OR COLOR.

FOR REMOTE CONTROLLED HOBBY MODEL AIRCRAFT AND PARTS AND ACCESSORIES THEREFOR (U.S. CLS. 22, 23, 38 AND 50).

HOWARD SMIGA, EXAMINING ATTORNEY

SN 85-337,211. SULLIVAN, ROYCE, STANTON, CA. FILED 6-3-2011.



THE MARK CONSISTS OF THE STYLIZED TEXT "AVALANCHE", DEPICTING AN AVALANCHE ON A MOUNTAIN WHERE THE LETTERS, STARTING WITH "A" ARE GRADUALLY INCREASE IN SIZE.

FOR AMUSEMENT GAME MACHINES (U.S. CLS. 22, 23, 38 AND 50).

FIRST USE 4-16-2011; IN COMMERCE 4-16-2011.  
SUSAN RICHARDS, EXAMINING ATTORNEY

SN 85-337,551. KIDZ ON SAFARI NEW YORK, INC.,  
BROOKLYN, NY. FILED 6-3-2011.

**BAMINGO**

THE MARK CONSISTS OF STANDARD CHARACTERS WITHOUT CLAIM TO ANY PARTICULAR FONT, STYLE, SIZE, OR COLOR.

FOR CRIB MOBILES; MOBILES FOR CHILDREN; PLAY MATS CONTAINING INFANT TOYS; PLUSH TOYS (U.S. CLS. 22, 23, 38 AND 50).

JESSICA A. POWERS, EXAMINING ATTORNEY

**CLASS 28—(Continued).**

SN 85-337,559. BYRON BUTLER, MURRIETA, CA. FILED 6-3-2011.

**SLIPPER**

THE MARK CONSISTS OF STANDARD CHARACTERS WITHOUT CLAIM TO ANY PARTICULAR FONT, STYLE, SIZE, OR COLOR.

FOR FITTED HEAD COVERS FOR GOLF CLUBS; HEAD COVERS FOR GOLF CLUBS (U.S. CLS. 22, 23, 38 AND 50).

FIRST USE 2-1-2002; IN COMMERCE 2-1-2002.  
ROBIN CHOSID, EXAMINING ATTORNEY

SN 85-338,443. BURBANK TRAWL MAKERS, INC., DBA  
BURBANK SPORT NETS, FERNANDINA BEACH, FL.  
FILED 6-6-2011.

**UDR2**

THE MARK CONSISTS OF STANDARD CHARACTERS WITHOUT CLAIM TO ANY PARTICULAR FONT, STYLE, SIZE, OR COLOR.

FOR NETS FOR BALL GAMES; NETS FOR SPORTS (U.S. CLS. 22, 23, 38 AND 50).

ERNEST SHOSHO, EXAMINING ATTORNEY

SN 85-338,671. ANDREA LOMBARDI, CHELSEA, MA.  
FILED 6-6-2011.

**PAUL REBEAR**

THE MARK CONSISTS OF STANDARD CHARACTERS WITHOUT CLAIM TO ANY PARTICULAR FONT, STYLE, SIZE, OR COLOR.

FOR STUFFED AND PLUSH TOYS (U.S. CLS. 22, 23, 38 AND 50).

WENDY GOODMAN, EXAMINING ATTORNEY



**CLASS 28—(Continued).**

SN 85-339,569. FOTORAMA USA, LLC, CUPERTINO, CA. FILED 6-7-2011.

# FLUSH!

THE MARK CONSISTS OF STANDARD CHARACTERS WITHOUT CLAIM TO ANY PARTICULAR FONT, STYLE, SIZE, OR COLOR.  
FOR PARLOR GAMES (U.S. CLS. 22, 23, 38 AND 50).  
FLORENTINA BLANDU, EXAMINING ATTORNEY

---

SN 85-339,571. FOTORAMA USA, LLC, CUPERTINO, CA. FILED 6-7-2011.

# JOHNNY THE SKULL

THE MARK CONSISTS OF STANDARD CHARACTERS WITHOUT CLAIM TO ANY PARTICULAR FONT, STYLE, SIZE, OR COLOR.  
FOR ELECTRIC ACTION TOYS; ACTION TARGET GAMES; PARLOR GAMES (U.S. CLS. 22, 23, 38 AND 50).  
FLORENTINA BLANDU, EXAMINING ATTORNEY

---

SN 85-339,831. LANGER, ALEXANDER, FRAMINGHAM, MA. FILED 6-7-2011.

# ROTOTAIL

THE MARK CONSISTS OF STANDARD CHARACTERS WITHOUT CLAIM TO ANY PARTICULAR FONT, STYLE, SIZE, OR COLOR.  
FOR FISHING LURES (U.S. CLS. 22, 23, 38 AND 50).  
CHRISTINA SOBRAL, EXAMINING ATTORNEY

**CLASS 28—(Continued).**

SN 85-339,834. CALLAWAY GOLF COMPANY, CARLSBAD, CA. FILED 6-7-2011.

# BLACKWORKS

THE MARK CONSISTS OF STANDARD CHARACTERS WITHOUT CLAIM TO ANY PARTICULAR FONT, STYLE, SIZE, OR COLOR.  
FOR GLOVES FOR GOLF; GOLF BAGS; GOLF BALLS; GOLF CLUBS; HEAD COVERS FOR GOLF CLUBS (U.S. CLS. 22, 23, 38 AND 50).  
LEIGH LOWRY, EXAMINING ATTORNEY

---

SN 85-339,840. CALLAWAY GOLF COMPANY, CARLSBAD, CA. FILED 6-7-2011.

# FIT TO FLY

THE MARK CONSISTS OF STANDARD CHARACTERS WITHOUT CLAIM TO ANY PARTICULAR FONT, STYLE, SIZE, OR COLOR.  
FOR GLOVES FOR GOLF; GOLF BAGS; GOLF BALLS; GOLF CLUBS; HEAD COVERS FOR GOLF CLUBS (U.S. CLS. 22, 23, 38 AND 50).  
LEIGH LOWRY, EXAMINING ATTORNEY

---

SN 85-340,131. SMITH, FLOYD TOM, ANAHEIM, CA. FILED 6-7-2011.

# PROTOOL

THE MARK CONSISTS OF STANDARD CHARACTERS WITHOUT CLAIM TO ANY PARTICULAR FONT, STYLE, SIZE, OR COLOR.  
FOR EXERCISE EQUIPMENT, NAMELY, GYROSCOPIC WRIST EXERCISERS; MANUALLY-OPERATED EXERCISE EQUIPMENT (U.S. CLS. 22, 23, 38 AND 50).  
FIRST USE 6-7-2011; IN COMMERCE 6-7-2011.  
LOURDES AYALA, EXAMINING ATTORNEY

**CLASS 28—(Continued).**

SN 85-340,365. EMIRIMAGE CORPORATION, HIALEAH, FL. FILED 6-7-2011.

**DOUBLE HORSE**

THE MARK CONSISTS OF STANDARD CHARACTERS WITHOUT CLAIM TO ANY PARTICULAR FONT, STYLE, SIZE, OR COLOR.

FOR ELECTRONIC TOY VEHICLES; ELECTRONICALLY OPERATED TOY MOTOR VEHICLES; RADIO CONTROLLED TOY VEHICLES; REMOTE CONTROL TOYS, NAMELY, HELICOPTERS AND PLANES; TOY AIRPLANES (U.S. CLS. 22, 23, 38 AND 50).

FIRST USE 11-14-2008; IN COMMERCE 11-14-2008.  
ROBIN CHOSID, EXAMINING ATTORNEY

**CLASS 28—(Continued).**

SN 85-341,233. MITCHELL GOLF EQUIPMENT COMPANY, DBA MITCHELL GOLF EQUIPMENT COMPANY, DAYTON, OH. FILED 6-8-2011.



THE MARK CONSISTS OF THE NAME MITCHELL AND INCORPORATES A STYLIZED M.

FOR GOLF CLUB SWING AIDS, NAMELY, MACHINES FOR ADJUSTING LOFT AND LIE ANGLES OF IRONS, WOODS, HYBRIDS AND PUTTERS (U.S. CLS. 22, 23, 38 AND 50).

FIRST USE 1-1-1999; IN COMMERCE 1-1-1999.  
DOMINICK J. SALEMI, EXAMINING ATTORNEY

SN 85-340,375. INTERACTIVE TOY CONCEPTS LTD., TORONTO, CANADA, FILED 6-7-2011.



THE MARK CONSISTS OF STANDARD CHARACTERS WITHOUT CLAIM TO ANY PARTICULAR FONT, STYLE, SIZE, OR COLOR.

FOR MECHANICAL ACTION TOYS; PLAY SETS FOR ACTION FIGURES; REMOTE CONTROL TOYS, NAMELY, CARS, HELICOPTERS, AIRPLANES, BOATS, OFF-ROAD VEHICLES, AND MOTORCYCLES; TOY VEHICLES (U.S. CLS. 22, 23, 38 AND 50).

REBECCA POVARCHUK, EXAMINING ATTORNEY

SN 85-341,481. SISTERS 2, INC., PERKASIE, PA. FILED 6-8-2011.



THE MARK CONSISTS OF STANDARD CHARACTERS WITHOUT CLAIM TO ANY PARTICULAR FONT, STYLE, SIZE, OR COLOR.

OWNER OF U.S. REG. NOS. 3,370,122 AND 3,431,805.  
FOR PARTY GAME (U.S. CLS. 22, 23, 38 AND 50).

JASON TURNER, EXAMINING ATTORNEY

SN 85-341,137. STECK, NATHAN, SAN FRANCISCO, CA. FILED 6-8-2011.

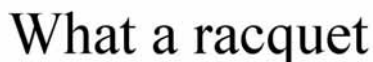

THE MARK CONSISTS OF STANDARD CHARACTERS WITHOUT CLAIM TO ANY PARTICULAR FONT, STYLE, SIZE, OR COLOR.

FOR TENNIS RACQUETS (U.S. CLS. 22, 23, 38 AND 50).

WENDY GOODMAN, EXAMINING ATTORNEY

SN 85-342,154. BORG UNLIMITED INC., MONTEREY PARK, CA. FILED 6-9-2011.



THE MARK CONSISTS OF STANDARD CHARACTERS WITHOUT CLAIM TO ANY PARTICULAR FONT, STYLE, SIZE, OR COLOR.

FOR SPORTING EQUIPMENT, NAMELY, A FOOTBALL RUNNING BACK TRAINING AIDE IN THE NATURE OF A MECHANICAL DEVICE FEATURING A SWIVELING ARM ON WHICH A FOOTBALL IS PLACED FOR USE IN HAND-OFF PRACTICE (U.S. CLS. 22, 23, 38 AND 50).

ANDREA K. NADELMAN, EXAMINING ATTORNEY

**CLASS 28—(Continued).**

SN 85-349,592. BASS PRO INTELLECTUAL PROPERTY,  
L.L.C., SPRINGFIELD, MO. FILED 6-17-2011.

BATTLE-READY, TESTED TOUGH  
ON BIG FISH!

THE MARK CONSISTS OF STANDARD CHARACTERS  
WITHOUT CLAIM TO ANY PARTICULAR FONT, STYLE,  
SIZE, OR COLOR.

FOR FISHING REELS (U.S. CLS. 22, 23, 38 AND 50).  
FIRST USE 1-0-2011; IN COMMERCE 1-0-2011.  
ELLEN BURNS, EXAMINING ATTORNEY

SN 85-354,372. BALIUS, LLC, DENISON, TX. FILED 6-23-  
2011.

A GYM IN THE PALM OF YOUR  
HAND

THE MARK CONSISTS OF STANDARD CHARACTERS  
WITHOUT CLAIM TO ANY PARTICULAR FONT, STYLE,  
SIZE, OR COLOR.

FOR MANUALLY-OPERATED EXERCISE EQUIP-  
MENT (U.S. CLS. 22, 23, 38 AND 50).  
NORA BUCHANAN WILL, EXAMINING ATTORNEY

SN 85-354,410. SHIMANO AMERICAN CORPORATION,  
IRVINE, CA. FILED 6-23-2011.

**ZELES**

THE MARK CONSISTS OF STANDARD CHARACTERS  
WITHOUT CLAIM TO ANY PARTICULAR FONT, STYLE,  
SIZE, OR COLOR.

FOR FISHING POLES; FISHING REELS; FISHING  
RODS; FISHING TACKLE (U.S. CLS. 22, 23, 38 AND 50).  
BRIAN NEVILLE, EXAMINING ATTORNEY

**CLASS 28—(Continued).**

SN 85-356,402. TRUGLO, INC., RICHARDSON, TX. FILED 6-  
26-2011.

**GAME CHANGER**

THE MARK CONSISTS OF STANDARD CHARACTERS  
WITHOUT CLAIM TO ANY PARTICULAR FONT, STYLE,  
SIZE, OR COLOR.

FOR ARCHERY EQUIPMENT, NAMELY, NON-TELE-  
SCOPIC BOW SIGHTS; ARCHERY EQUIPMENT,  
NAMELY, OPEN BOW SIGHTS; ARCHERY QUIVERS  
(U.S. CLS. 22, 23, 38 AND 50).

KATHLEEN LORENZO, EXAMINING ATTORNEY

SN 85-357,581. FRANKLIN SPORTS, INC., STOUGHTON,  
MA. FILED 6-27-2011.

**PITCH-N-HIT**

THE MARK CONSISTS OF STANDARD CHARACTERS  
WITHOUT CLAIM TO ANY PARTICULAR FONT, STYLE,  
SIZE, OR COLOR.

FOR BALL PITCHING MACHINES (U.S. CLS. 22, 23, 38  
AND 50).

ELLEN PERKINS, EXAMINING ATTORNEY

SN 85-359,920. NISTEVO SPORT MANUFACTURING COR-  
PORATION, LACEY, WA. FILED 6-29-2011.

**atom armor**

OWNER OF U.S. REG. NO. 3,768,324.

THE MARK CONSISTS OF THE WORD ATOM ABOVE  
THE WORD ARMOR, BOTH IN STYLIZED FONT, WHERE  
THE LETTER M IN ATOM EXTENDS DOWN TO FORM  
PART OF THE LETTER M IN ARMOR.

FOR PROTECTIVE GEAR FOR ATHLETIC USE,  
NAMELY ELBOW PADS, KNEE PADS, WRIST GUARDS,  
SHIN GUARDS (U.S. CLS. 22, 23, 38 AND 50).

ZACHARY BELLO, EXAMINING ATTORNEY

**CLASS 28—(Continued).**

SN 85-370,230. WINNING MOVES INC., DANVERS, MA.  
FILED 7-13-2011.

**BRAIN BLOCKS**

THE MARK CONSISTS OF STANDARD CHARACTERS WITHOUT CLAIM TO ANY PARTICULAR FONT, STYLE, SIZE, OR COLOR.

NO CLAIM IS MADE TO THE EXCLUSIVE RIGHT TO USE "BLOCKS", APART FROM THE MARK AS SHOWN, FOR MANIPULATIVE PUZZLES (U.S. CLS. 22, 23, 38 AND 50).

DAVID C. REIHNER, EXAMINING ATTORNEY

SN 85-393,959. WILKINSON, WILLIAM T., DBA INNOVATION INDUSTRIES, MEDIA, PA. FILED 8-10-2011.

**POWER GEAR**

THE MARK CONSISTS OF STANDARD CHARACTERS WITHOUT CLAIM TO ANY PARTICULAR FONT, STYLE, SIZE, OR COLOR.

NO CLAIM IS MADE TO THE EXCLUSIVE RIGHT TO USE "GEAR", APART FROM THE MARK AS SHOWN.

FOR FITNESS MACHINES AND EQUIPMENT, NAMELY, WEIGHTS, TREADMILLS, ROWING MACHINES, STAIR STEPPING MACHINES, RESISTANCE MACHINES, STATIONARY CYCLES (U.S. CLS. 22, 23, 38 AND 50).

GIANCARLO CASTRO, EXAMINING ATTORNEY

SN 85-394,779. BATTENFELD TECHNOLOGIES, INC., COLOMBIA, MO. FILED 8-10-2011.

**BANANA PEEL**

THE MARK CONSISTS OF STANDARD CHARACTERS WITHOUT CLAIM TO ANY PARTICULAR FONT, STYLE, SIZE, OR COLOR.

FOR PRINTED TARGETS FOR FIREARMS SHOOTING (U.S. CLS. 22, 23, 38 AND 50).

KATHERINE CHANG, EXAMINING ATTORNEY

**CLASS 28—(Continued).**

SN 85-408,457. OSRAM SYLVANIA INC., DANVERS, MA.  
FILED 8-26-2011.

**SYLVANIA**

THE MARK CONSISTS OF STANDARD CHARACTERS WITHOUT CLAIM TO ANY PARTICULAR FONT, STYLE, SIZE, OR COLOR.

OWNER OF U.S. REG. NOS. 434,729, 3,687,126 AND OTHERS.

FOR PRE-LIT ARTIFICIAL CHRISTMAS TREES (U.S. CLS. 22, 23, 38 AND 50).

FIRST USE 4-0-2007; IN COMMERCE 4-0-2007.

HEATHER THOMPSON, EXAMINING ATTORNEY

**CLASS 29—MEATS AND PROCESSED FOODS**

SN 76-707,372. B & E POULTRY INC., FREDERICKSBURG, PA. FILED 4-25-2011.



THE COLOR(S) RED, WHITE, BLUE, GREEN, AND YELLOW IS/ARE CLAIMED AS A FEATURE OF THE MARK.

THE MARK IS CHARACTERIZED BY A MEDIUM BLUE RING CONTAINING WHITE STARS CIRCUMSCRIBING A SERIES OF MEDIUM RED AND WHITE HORIZONTALLY ALTERNATING STRIPES. A PARTIALLY HUSKED EAR OF YELLOW CORN AND GREEN HUSK AND GREEN SOY BEAN PODS ARE SUPERIMPOSED ON THE STRIPES AND THE RING.

FOR DRESSED FRESH AND FROZEN POULTRY PRODUCED FROM DOMESTICALLY GROWN ORGANIC FEEDSTOCKS (U.S. CL. 46).

FIRST USE 12-31-2008; IN COMMERCE 12-31-2008.

MARK SPARACINO, EXAMINING ATTORNEY

**CLASS 29—(Continued).**

SN 77-565,738. THE DANNON COMPANY, INC., WHITE PLAINS, NY. FILED 9-9-2008.

# CRUSH CUP

THE MARK CONSISTS OF STANDARD CHARACTERS WITHOUT CLAIM TO ANY PARTICULAR FONT, STYLE, SIZE, OR COLOR.

NO CLAIM IS MADE TO THE EXCLUSIVE RIGHT TO USE "CUP", APART FROM THE MARK AS SHOWN.

FOR YOGURT, YOGURT-BASED BEVERAGES, DAIRY-BASED SNACK FOODS EXCLUDING ICE CREAM, ICE MILK AND FROZEN YOGURT; DAIRY-BASED BEVERAGES, DAIRY PRODUCTS EXCLUDING ICE CREAM, ICE MILK AND FROZEN YOGURT SOLD IN PLASTIC PACKAGING (U.S. CL. 46).

WENDY GOODMAN, EXAMINING ATTORNEY

SN 77-899,685. KOWA USA, INC., HUNTINGTON BEACH, CA. FILED 12-22-2009.



NO CLAIM IS MADE TO THE EXCLUSIVE RIGHT TO USE "USA INC." AND "CA U.S.A." AND "WILD ABALONE PRODUCT OF MEXICO", APART FROM THE MARK AS SHOWN.

THE COLOR(S) RED AND WHITE IS/ARE CLAIMED AS A FEATURE OF THE MARK.

THE MARK CONSISTS OF "TWO DIFFERENT RED CIRCLES: AN INNER CIRCLE AND AN OUTER CIRCLE. IN BETWEEN THE TWO CIRCLES ON THE LOWER PART ARE THE WORDS "KOWA USA INC., CA U.S.A." IN RED COLOR; ON THE UPPER PART, IN BETWEEN THE TWO CIRCLES ON THE LOWER PART ARE THE WORDS "WILD ABALONE PRODUCT OF MEXICO" IN RED COLOR. IN THE INNER CIRCLE THERE ARE TWO BIG RED STARS OFFSET FROM EACH OTHER. SUPERIMPOSED ONTO THE TWO STARS ARE TWO SETS OF THE WORDS "CALSTAR" IN RED COLOR, THE ONE IN THE MIDDLE OF THE INNER CIRCLE ARE IN BIGGER PRINT THAN THE ONE ABOVE IT. THE DESIGN AND THE WORDING ARE ALL ON A WHITE BACKGROUND.

FOR ABALONE, SEAFOOD (U.S. CL. 46).  
FIRST USE 4-20-2009; IN COMMERCE 4-20-2009.  
INGA ERVIN, EXAMINING ATTORNEY

**CLASS 29—(Continued).**

SN 79-092,097. RIAZOR - AZEITES E ÓLEOS VEGETAIS, S.A., PORTUGAL, FILED 12-20-2010.

# CAPITOA

THE MARK CONSISTS OF STANDARD CHARACTERS WITHOUT CLAIM TO ANY PARTICULAR FONT, STYLE, SIZE, OR COLOR.

OWNER OF INTERNATIONAL REGISTRATION 1063825 DATED 12-20-2010, EXPIRES 12-20-2020.

THE ENGLISH TRANSLATION OF "CAPITOA" IN THE MARK IS "FEMALE CAPTAIN".  
FOR OLIVE OIL FOR FOOD; PRESERVED OLIVES (U.S. CL. 46).

LIEF MARTIN, EXAMINING ATTORNEY

SN 79-093,914. EXCELLENT PARTNERS INC., JAPAN, FILED 10-7-2010.

# a c c h e

THE MARK CONSISTS OF STANDARD CHARACTERS WITHOUT CLAIM TO ANY PARTICULAR FONT, STYLE, SIZE, OR COLOR.

PRIORITY DATE OF 8-17-2010 IS CLAIMED.

OWNER OF INTERNATIONAL REGISTRATION 1068076 DATED 10-7-2010, EXPIRES 10-7-2020.

FOR FOOD SUPPLEMENTS NOT FOR MEDICAL PURPOSES CONSISTING OF CORAL CALCIUM IN FORMS OF CAPSULE AND LIQUID; FOOD SUPPLEMENTS NOT FOR MEDICAL PURPOSES CONSISTING OF CALCIUM DERIVED FROM DAIRY PRODUCTS, IN FORMS OF CAPSULE AND LIQUID (U.S. CL. 46).

CHRISTOPHER BUONGIORNO, EXAMINING ATTORNEY

SN 79-098,339. BARHAN GIDA SANAYI VE TICARET ANONIM SIRKETI, BURSA, TURKEY, FILED 4-13-2011.

# FRUPPA

THE MARK CONSISTS OF STANDARD CHARACTERS WITHOUT CLAIM TO ANY PARTICULAR FONT, STYLE, SIZE, OR COLOR.

OWNER OF INTERNATIONAL REGISTRATION 1079849 DATED 4-13-2011, EXPIRES 4-13-2021.

THE WORDING "FRUPPA" HAS NO MEANING IN A FOREIGN LANGUAGE.

FOR JAMS, FROZEN FRUIT, FRUIT PULP, MARMALADE (U.S. CL. 46).

ALYSSA STEEL, EXAMINING ATTORNEY

**CLASS 29—(Continued).**

SN 79-098,345. AFOI TSATSOULI ABEE, GR-671 00 XANTHI, GREECE, FILED 1-28-2011.



PRIORITY DATE OF 11-29-2010 IS CLAIMED. OWNER OF INTERNATIONAL REGISTRATION 1079867 DATED 1-28-2011, EXPIRES 1-28-2021.

THE COLOR(S) DARK BLUE AND LIGHT BLUE IS/ARE CLAIMED AS A FEATURE OF THE MARK.

THE MARK CONSISTS OF THE STYLIZED WORDING "ROYAL TSATSOULIS" IN DARK BLUE OVER A STYLIZED LEAF IN LIGHT BLUE.

THE WORDING "TSATSOULIS" HAS NO MEANING IN A FOREIGN LANGUAGE.

FOR PRESERVED VEGETABLES AND OLIVES IN VINEGAR AND SALT SOLUTION ALL SOLD AS A UNIT, NAMELY, PICKLES, HUNGARIAN SALAD, MIX PICKLES, OLIVE PASTE, CUCUMBERS, CAPSICUMS IN THE NATURE OF PROCESSED CAPSICUM PEPPERS, BEETROOTS IN THE NATURE OF PROCESSED BEETS, CAPERS, VINE LEAF IN THE NATURE OF PROCESSED VINE LEAVES, PROCESSED OLIVES, TOMATOES IN THE NATURE OF TOMATO PRESERVES, AUBERGINE IN THE NATURE OF AUBERGINE PUREE, GREEN VEGETABLES IN THE NATURE OF PRESERVED GREEN VEGETABLES, PROCESSED ASPARAGUS IN SALT SOLUTION, CHEESE IN OIL, SUN-DRIED TOMATOES IN THE NATURE OF PRESERVED SUN-DRIED TOMATOES (U.S. CL. 46).

JAMES STEIN, EXAMINING ATTORNEY

**CLASS 29—(Continued).**

CORNER OF THE RECTANGLE IS A STYLIZED DESIGN OF A GOLD GLOBE WITH POINTS AROUND THE CIRCUMFERENCE, AND A RED BANNER WITH THE WORDS "COMMITTED TO QUALITY" IN WHITE LETTERS AND A BLUE RIBBON EXTENDING FROM THE BOTTOM OF THE GLOBE. ABOVE THE RECTANGLE ARE THE WORDS "GENUINE GOLD LABEL" IN WHITE LETTERS, AND BELOW THE RECTANGLE ARE TWO CIRCULAR DESIGNS IN WHITE ABOVE THE WORDS "MIDWESTERN BRAND" IN WHITE LETTERS.

SEC. 2(F) AS TO "MIDWESTERN". FOR PROCESSED POULTRY SOLD IN PORTIONS; FULLY COOKED ENTREES CONSISTING PRIMARILY OF POULTRY (U.S. CL. 46).

FIRST USE 8-1-2009; IN COMMERCE 8-1-2009. KELLY TRUSILO, EXAMINING ATTORNEY

SN 85-023,067. QUANTUM FOODS, LLC, BOLINGBROOK, IL. FILED 4-26-2010.



SN 85-023,056. QUANTUM FOODS, LLC, BOLINGBROOK, IL. FILED 4-26-2010.

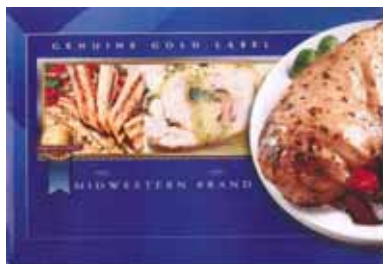

OWNER OF U.S. REG. NOS. 2,246,190, 3,245,334 AND OTHERS.

NO CLAIM IS MADE TO THE EXCLUSIVE RIGHT TO USE "BRAND" AND THE DEPICTION OF POULTRY, APART FROM THE MARK AS SHOWN.

THE COLOR(S) GREEN, BLACK, TAN, BROWN, BLUE, RED, WHITE, GOLD AND GRAY IS/ARE CLAIMED AS A FEATURE OF THE MARK.

THE MARK CONSISTS OF TRADE DRESS APPLIED TO THE FRONT OF PACKAGING FOR PROCESSED POULTRY PRODUCTS, NAMELY, BLUE BACKGROUND COLORS WHICH VARY FROM DARKER TO LIGHTER HUES AND RUN CONTINUOUSLY IN A RANDOM PATTERN. THE RIGHT SIDE OF THE PACKAGE SHOWS A PICTURE OF THE LEFT SIDE OF A WHITE PLATE WITH A PORTION OF TAN, BROWN AND BLACK COOKED CHICKEN AND RED AND GREEN VEGETABLES. WITHIN A GOLD AND GRAY RECTANGULAR BORDER RUNNING FROM THE LEFT SIDE ARE PICTURES OF TAN AND BROWN COOKED STRIPS OF CHICKEN ON THE LEFT WITH RED AND GREEN VEGETABLES AND A WHITE COOKED SLICE OF CHICKEN IN THE CENTER. IN THE LOWER LEFT

OWNER OF U.S. REG. NOS. 2,246,190, 3,245,334 AND OTHERS.

NO CLAIM IS MADE TO THE EXCLUSIVE RIGHT TO USE "BUTCHER'S FINEST PORK" AND "BRAND" AND THE DEPICTION OF PORK, APART FROM THE MARK AS SHOWN.

THE COLOR(S) BROWN, BLUE, YELLOW, BLACK, RED, WHITE, GOLD AND GRAY IS/ARE CLAIMED AS A FEATURE OF THE MARK.

THE MARK CONSISTS OF TRADE DRESS APPLIED TO THE FRONT OF PACKAGING FOR PROCESSED PORK PRODUCTS, NAMELY, YELLOW BACKGROUND COLORS WHICH VARY FROM DARKER TO LIGHTER HUES AND RUN CONTINUOUSLY IN A RANDOM PATTERN. WITHIN BLACK, GRAY, GOLD, AND BLACK RECTANGULAR BORDERS IS A PICTURE OF MULTIPLE BROWN PORK CHOPS OVER RED FLAMES, AND BELOW THE PORK CHOPS ON A BLACK BACKGROUND ARE THE WORDS "BUTCHER'S FINEST PORK" IN GOLD LETTERS. CENTERED IN THE RECTANGLE IS A STYLIZED DESIGN OF A GOLD GLOBE WITH POINTS AROUND THE CIRCUMFERENCE, AND A RED BANNER WITH THE WORDS "COMMITTED TO QUALITY" IN WHITE LETTERS AND A BLUE RIBBON EXTENDING FROM THE BOTTOM OF THE GLOBE. ABOVE THE RECTANGLE ARE THE WORDS "GENUINE GOLD LABEL" IN GOLD LETTERS, AND BELOW THE RECTANGLE ARE THE WORDS "MIDWESTERN BRAND" IN GOLD LETTERS. ABOVE THE WORDS "MIDWESTERN BRAND" ARE TWO CIRCULAR DESIGNS IN GOLD COLOR, AND A CIRCULAR DESIGN WITH GOLD COLOR IN THE BOTTOM LEFT AND BOTTOM RIGHT CORNERS OF THE PACKAGE.

SEC. 2(F) AS TO "MIDWESTERN". FOR PROCESSED PORK SOLD IN PORTIONS; FULLY COOKED ENTREES CONSISTING PRIMARILY OF PORK (U.S. CL. 46).

FIRST USE 8-1-2009; IN COMMERCE 8-1-2009. KELLY TRUSILO, EXAMINING ATTORNEY

**CLASS 29—(Continued).**

SN 85-136,997. FRESH EXPRESS INCORPORATED, SALINAS, CA. FILED 9-23-2010.



OWNER OF U.S. REG. NOS. 3,028,912, 3,482,338 AND OTHERS.

NO CLAIM IS MADE TO THE EXCLUSIVE RIGHT TO USE "FRESH", "KIT", OR "PARISIENNE", APART FROM THE MARK AS SHOWN.

THE MARK CONSISTS OF THE WORDS "FRESH EXPRESS" IN A TRAPEZOID SURMOUNTED BY TWO STYLIZED LEAVES ABOVE THE WORDS "KIT PARISIENNE SUPREME" SUPERIMPOSED ON A RIBBON DESIGN.

THE ENGLISH TRANSLATION OF "PARISIENNE" IN THE MARK IS "A WOMAN BORN OR LIVING IN PARIS" AND "PARISIAN".

FOR SALAD KIT CONSISTING OF PACKAGED PRECUT VEGETABLES, SALAD DRESSING, DRIED FRUIT, PROCESSED EDIBLE SEEDS AND NUTS, CHEESE (U.S. CL. 46).

JULIE VEPPUMTHARA, EXAMINING ATTORNEY

SN 85-160,290. DAIRY FARMERS OF AMERICA, INC., KANSAS CITY, MO. FILED 10-25-2010.

## FALFURRIAS

THE MARK CONSISTS OF STANDARD CHARACTERS WITHOUT CLAIM TO ANY PARTICULAR FONT, STYLE, SIZE, OR COLOR.

OWNER OF U.S. REG. NO. 1,636,562.  
SEC. 2(F).

FOR BUTTER (U.S. CL. 46).

FIRST USE 0-0-1909; IN COMMERCE 0-0-1909.  
MARTHA FROMM, EXAMINING ATTORNEY

**CLASS 29—(Continued).**

SN 85-163,528. SANTINI FOODS, INC., SAN LORENZO, CA. FILED 10-28-2010.

## SAVINI

THE MARK CONSISTS OF STANDARD CHARACTERS WITHOUT CLAIM TO ANY PARTICULAR FONT, STYLE, SIZE, OR COLOR.

THE WORDING "SAVINI" HAS NO ENGLISH TRANSLATION.

SEC. 2(F).

FOR EDIBLE OILS; OLIVE OIL (U.S. CL. 46).

FIRST USE 2-1-1990; IN COMMERCE 2-1-1999.

SUSAN STIGLITZ, EXAMINING ATTORNEY

SN 85-195,886. ABREU FOODS, INC., DBA ABREU FOODS, INC., CHICAGO, IL. FILED 12-11-2010.

## LAS 3 MARIAS

THE MARK CONSISTS OF STANDARD CHARACTERS WITHOUT CLAIM TO ANY PARTICULAR FONT, STYLE, SIZE, OR COLOR.

FOR BAKED BEANS; BEAN DIP; BROTH; CANNED BEANS; CANNED COOKED MEAT; CANNED FISH; CANNED FRUITS; CANNED FRUITS AND VEGETABLES; CANNED OR BOTTLED FRUITS; CANNED OR BOTTLED VEGETABLES; CANNED PORK AND BEANS; CANNED PROCESSED OLIVES; CANNED TOMATOES; CANNED VEGETABLES; CHILI; DRIED BEANS; DRINKABLE SOUPS; EXTRACTS FOR SOUPS; INSTANT OR PRE-COOKED SOUP; MATZO BALL SOUP; MIXES FOR MAKING SOUP; PREPARATIONS FOR MAKING SOUP; PREPARATIONS FOR MAKING SOUPS; PREPARED ENTREES CONSISTING PRIMARILY OF VEGETABLES, SOUPS, FRUIT SALADS AND VEGETABLE SALADS; PROCESSED BEANS; REFRIED BEANS; SLICED FRUITS; SLICED VEGETABLES; SOUP CONCENTRATES; SOUP MIXES; SOUP PASTES; SOUPS; SOUPS AND PREPARATIONS FOR MAKING SOUPS; SOY BEAN OIL (U.S. CL. 46).

FIRST USE 7-15-2010; IN COMMERCE 9-16-2010.

MARGERY A. TIERNEY, EXAMINING ATTORNEY

SN 85-202,725. KELLOGG NORTH AMERICA COMPANY, BATTLE CREEK, MI. FILED 12-21-2010.

## BEANATURAL

THE MARK CONSISTS OF STANDARD CHARACTERS WITHOUT CLAIM TO ANY PARTICULAR FONT, STYLE, SIZE, OR COLOR.

FOR BEAN CHIPS MADE IN WHOLE OR SUBSTANTIAL PART OF BEANS (U.S. CL. 46).

BARBARA A. GOLD, EXAMINING ATTORNEY

**CLASS 29—(Continued).**

SN 85-212,413. DISNEY ENTERPRISES, INC., BURBANK, CA. FILED 1-6-2011.

# D23

THE MARK CONSISTS OF STANDARD CHARACTERS WITHOUT CLAIM TO ANY PARTICULAR FONT, STYLE, SIZE, OR COLOR.

OWNER OF U.S. REG. NOS. 3,825,617, 3,912,333 AND OTHERS.

FOR FRUIT PRESERVES; FRUIT-BASED SNACK FOODS; JAMS; JELLIES; POTATO CHIPS; PROCESSED NUTS; MILK AND MILK PRODUCTS EXCLUDING ICE CREAM, ICE MILK AND FROZEN YOGURT; MEAT, POULTRY, FRUITS, VEGETABLES; PREPARED OR PACKAGED MEALS CONSISTING PRIMARILY OF MEAT, FISH, POULTRY AND PROCESSED VEGETABLES (U.S. CL. 46).

SOPHIA S. KIM, EXAMINING ATTORNEY

SN 85-221,929. BUNGE OILS, INC., ST. LOUIS, MO. FILED 1-20-2011.



OWNER OF U.S. REG. NO. 3,784,761.

THE MARK CONSISTS OF THE DESIGN OF BEAN WITH THREE BEAN PODS FEATURED INSIDE AND A STYLIZED FLOWERING PLANT ALL ENCASED WITHIN A SQUARE WITH ROUNDED EDGES.

FOR EDIBLE FATS; EDIBLE OILS; MARGARINE (U.S. CL. 46).

FIRST USE 9-27-2010; IN COMMERCE 9-27-2010.

KATHLEEN LORENZO, EXAMINING ATTORNEY

**CLASS 29—(Continued).**

SN 85-246,240. SANTINI FOODS, INC., SAN LORENZO, CA. FILED S.R. 2-18-2011; AM. P.R. 9-7-2011.

# MILK VALLEY

THE MARK CONSISTS OF STANDARD CHARACTERS WITHOUT CLAIM TO ANY PARTICULAR FONT, STYLE, SIZE, OR COLOR.

NO CLAIM IS MADE TO THE EXCLUSIVE RIGHT TO USE "MILK", APART FROM THE MARK AS SHOWN.

FOR CONDENSED MILK; MILK; MILK BEVERAGES WITH HIGH MILK CONTENT (U.S. CL. 46).

MARK SPARACINO, EXAMINING ATTORNEY

SN 85-267,699. EDWARD JOSEPH POZZI, AKA POZZI RANCH, BODEGA, CA. FILED 3-15-2011.

# Pozzi Ranch Lamb

THE MARK CONSISTS OF STANDARD CHARACTERS WITHOUT CLAIM TO ANY PARTICULAR FONT, STYLE, SIZE, OR COLOR.

NO CLAIM IS MADE TO THE EXCLUSIVE RIGHT TO USE "RANCH LAMB", APART FROM THE MARK AS SHOWN.

SEC. 2(F).

FOR FRESH LAMB MEAT; LAMB MEAT; PROCESSED MEAT, NAMELY, LAMB (U.S. CL. 46).

FIRST USE 4-6-1990; IN COMMERCE 4-6-1990.

MICHAEL GAAFAR, EXAMINING ATTORNEY

SN 85-273,079. OASIS FALAFEL LLC, DBA OASIS FALAFEL, IOWA CITY, IA. FILED 3-22-2011.

# Hummus Where the Heart Is

THE MARK CONSISTS OF STANDARD CHARACTERS WITHOUT CLAIM TO ANY PARTICULAR FONT, STYLE, SIZE, OR COLOR.

FOR HUMMUS; PROCESSED CABBAGE; FALAFEL; HUMMUS CHICK PEA PASTE; PREPARED ENTREES CONSISTING PRIMARILY OF MEAT, FISH, POULTRY OR VEGETABLES; PREPARED MEALS CONSISTING PRIMARILY OF MEAT, FISH, POULTRY OR VEGETABLES (U.S. CL. 46).

FIRST USE 6-1-2007; IN COMMERCE 10-1-2007.

KATHERINE E. HALMEN, EXAMINING ATTORNEY



**CLASS 29—(Continued).**

SN 85-279,593. HALSEY FOODSERVICE, HUNTSVILLE, AL. FILED 3-29-2011.



NO CLAIM IS MADE TO THE EXCLUSIVE RIGHT TO USE "PREMIUM MEAT COMPANY", APART FROM THE MARK AS SHOWN.

THE MARK CONSISTS OF A STYLIZED GEOMETRIC DESIGN OF A DIAMOND APPEARING OVER A FIVE-POINTED STAR DESIGN. TO THE RIGHT OF THE DESIGN IS THE STACKED WORDING "DIAMOND", "STAR" AND "PREMIUM MEAT COMPANY".

FOR COMBINATION MEAL CONSISTING PRIMARILY OF A MEAT OR VEGETABLE-BASED ENTREE AND A SOUP OR SALAD FOR CONSUMPTION ON OR OFF THE PREMISES; DRIED MEAT; FOOD PACKAGE COMBINATIONS CONSISTING PRIMARILY OF CHEESE, MEAT AND/OR PROCESSED FRUIT; FRANKFURTERS; FRESH MEAT; HAMBURGER; HEAD CHEESE; HOT DOGS; LUNCHEON MEATS; MARINATED MEATS, NAMELY, PORK, BEEF, POULTRY, GAME; MEAT; MEAT; MEAT, FISH, POULTRY AND GAME; MEAT, FROZEN; MEAT, POULTRY AND GAME; MEAT-BASED SNACK FOODS; PACKAGED MEATS; PRE-PACKAGED DINNERS CONSISTING OF, NAMELY, OF MEATS, PORK, BEEF OR POULTRY; PREPARED FOOD KITS COMPOSED OF MEAT, POULTRY, FISH, SEAFOOD, AND/OR VEGETABLES AND ALSO INCLUDING SAUCES OR SEASONINGS, READY FOR COOKING AND ASSEMBLY AS A MEAL; PREPARED MEAT; PRESERVED MEATS AND SAUSAGES; PROCESSED MEAT; REFRIGERATED FOOD PACKAGE COMBINATIONS CONSISTING PRIMARILY OF MEAT, CHEESE OR PROCESSED VEGETABLES FOR PURPOSES OF CREATING A SANDWICH; SALTED MEAT; SEASONED MEATS, NAMELY, BEEF, PORK, POULTRY; SLICED MEAT (U.S. CL. 46).

FIRST USE 3-1-2011; IN COMMERCE 3-1-2011.  
PAULA MAHONEY, EXAMINING ATTORNEY

SN 85-285,423. SNIKIDDY, LLC, BOULDER, CO. FILED 4-4-2011.



THE COLOR(S) RED, MAROON, WHITE, BLACK, ORANGE, DARK ORANGE, AND YELLOW IS/ARE CLAIMED AS A FEATURE OF THE MARK.

THE MARK CONSISTS OF THE WORD "SNIKIDDY" IN WHITE OUTLINED IN RED AND MAROON SUPERIMPOSED ON A SWIRL IN THE COLORS ORANGE, YELLOW, DARK ORANGE, AND BLACK.

FOR VEGETABLE-BASED SNACK FOODS (U.S. CL. 46).

CHARLOTTE CORWIN, EXAMINING ATTORNEY

**CLASS 29—(Continued).**

SN 85-296,259. LERNER, DIEGO JOSE, BUENOS AIRES, ARGENTINA, FILED 4-15-2011.

# LEUFU

THE MARK CONSISTS OF STANDARD CHARACTERS WITHOUT CLAIM TO ANY PARTICULAR FONT, STYLE, SIZE, OR COLOR.

OWNER OF ARGENTINA REG. NO. 2880532, DATED 11-20-2009, EXPIRES 11-20-2019.

THE ENGLISH TRANSLATION OF "LEUFU" IN THE MARK IS "RIVER".

FOR JAMS AND MARMALADES (U.S. CL. 46).  
TOBY BULLOFF, EXAMINING ATTORNEY

SN 85-296,428. WAYNE BAILEY, INC., FORMERLY W.E. BAILEY AND SON, INC., CHADBOURN, NC. FILED 4-15-2011.



NO CLAIM IS MADE TO THE EXCLUSIVE RIGHT TO USE "FOODS", APART FROM THE MARK AS SHOWN.

THE MARK CONSISTS OF THE STYLIZED WORDING "GEORGE FOODS" APPEARING INSIDE A SHADED OVAL WITH THREE WISPY LINES COMING DOWN FROM THE TOP RIGHT EDGE OF THE OVAL; THE WISPY LINES ARE WIDER AT THE EDGE OF THE OVAL AND GRADUALLY BECOME THINNER AS THEY APPROACH THE CENTER PORTION OF THE OVAL, STOPPING AT A POINT ABOVE THE WORD "GEORGE" WHICH APPEARS IN A SCRIPT FONT.

FOR PROCESSED SWEET POTATOES (U.S. CL. 46).  
FIRST USE 8-14-2007; IN COMMERCE 8-14-2007.  
HEATHER THOMPSON, EXAMINING ATTORNEY

**CLASS 29—(Continued).**

SN 85-299,623. BEST CHEESE CORP., MOUNT KISCO, NY.  
FILED 4-20-2011.

**HOLLANDSE HONEY BZZZ CHEVRE**

THE MARK CONSISTS OF STANDARD CHARACTERS WITHOUT CLAIM TO ANY PARTICULAR FONT, STYLE, SIZE, OR COLOR.

NO CLAIM IS MADE TO THE EXCLUSIVE RIGHT TO USE "HOLLANDSE HONEY" AND "CHEVRE", APART FROM THE MARK AS SHOWN.

THE ENGLISH TRANSLATION OF "HOLLANDSE" IN THE MARK IS "DUTCH".

FOR CHEESE FROM THE NETHERLANDS FEATURING HONEY AND GOAT'S MILK (U.S. CL. 46).

MARTHA FROMM, EXAMINING ATTORNEY

SN 85-302,001. DEBORAH MILLER, DENHOFF, ND. AND  
RANDY MILLER, DENHOFF, ND. FILED 4-22-2011.

**FLAX JACKS**

THE MARK CONSISTS OF STANDARD CHARACTERS WITHOUT CLAIM TO ANY PARTICULAR FONT, STYLE, SIZE, OR COLOR.

NO CLAIM IS MADE TO THE EXCLUSIVE RIGHT TO USE "FLAX", APART FROM THE MARK AS SHOWN.

FOR PROCESSED EDIBLE FLAX, NAMELY, EDIBLE MILLED FLAXSEED, EDIBLE COLD MILLED FLAXSEED, EDIBLE WHOLE SEED FLAXSEED, EDIBLE PRE-GROUND FLAXSEED, AND EDIBLE FLAX LIGNANS; EDIBLE FLAXSEED OIL (U.S. CL. 46).

JIM RINGLE, EXAMINING ATTORNEY

SN 85-302,847. IMBRIALE, VINCE, REDONDO BEACH, CA.  
FILED 4-23-2011.

**THE GRUMPY PALATE**

THE MARK CONSISTS OF STANDARD CHARACTERS WITHOUT CLAIM TO ANY PARTICULAR FONT, STYLE, SIZE, OR COLOR.

FOR MEAT AND PROCESSED FOOD CONSISTING OF PORTION CUT STEAKS, BEEF CUTS, PORK CHOPS, ELK CHOPS, VENISON CHOPS, WAGYU KOBE BEEF, HOT DOG MEAT, SAUSAGES, PATE, TURKEY, DUCK, CORNISH HEN, FROZEN PRE-PACKAGED ENTREES CONSISTING PRIMARILY OF SEAFOOD (U.S. CL. 46).

EMILY CARLSEN, EXAMINING ATTORNEY

**CLASS 29—(Continued).**

SN 85-302,881. PEACOCK HOLDINGS, LLC, MACOMB, MI.  
FILED 4-23-2011.

**Julian's Go Bar**

THE MARK CONSISTS OF STANDARD CHARACTERS WITHOUT CLAIM TO ANY PARTICULAR FONT, STYLE, SIZE, OR COLOR.

NO CLAIM IS MADE TO THE EXCLUSIVE RIGHT TO USE "BAR", APART FROM THE MARK AS SHOWN.

FOR FRUIT-BASED, HIGH NUTRITION, SNACK FOODS (U.S. CL. 46).

FIRST USE 5-11-2007; IN COMMERCE 5-11-2007.

ANGELA M. MICHELI, EXAMINING ATTORNEY

SN 85-306,859. HAYEL SAEED ANAM & CO., TAIZ, YEMEN,  
FILED 4-28-2011.



OWNER OF YEMEN REG. NO. 2034, DATED 10-4-1986,  
EXPIRES 4-1-2016.

THE COLOR(S) RED AND WHITE IS/ARE CLAIMED AS A FEATURE OF THE MARK.

THE MARK CONSISTS OF TWO RED RECTANGLES THAT EACH HAVE A WHITE BORDER ON THEIR INNER EDGE. THE WORD "ALMOMTAZ" APPEARS IN WHITE IN ENGLISH AND ARABIC ON EACH RECTANGLE.

THE NON-LATIN CHARACTERS IN THE MARK TRANSLITERATE TO "AL MOMTAZ" AND THIS MEANS "THE PERFECT" OR "THE EXCELLENT" IN ENGLISH.

FOR MILK AND MILK PRODUCTS EXCLUDING ICE CREAM, ICE MILK AND FROZEN YOGURT, EDIBLE OILS AND FATS, MEAT EXTRACTS, FATTY SUBSTANCES FOR THE MANUFACTURE OF EDIBLE FATS (U.S. CL. 46).

DOMINICK J. SALEMI, EXAMINING ATTORNEY

**CLASS 29—(Continued).**

SN 85-309,509. KABUSHIKI KAISHA YAKULT HONSHA, MINATO-KU, TOKYO, JAPAN, FILED 5-2-2011.

養樂多

OWNER OF JAPAN REG. NO. 5399501, DATED 3-18-2011, EXPIRES 3-18-2021.

OWNER OF U.S. REG. NO. 3,556,197.

THE MARK CONSISTS OF CHINESE LETTERS THAT TRANSLITERATE TO "YO-RAKU-TA."

THE NON-LATIN CHARACTERS IN THE MARK TRANSLITERATE TO "YO-RAKU-TA" AND THIS HAS NO MEANING IN A FOREIGN LANGUAGE.

FOR DAIRY PRODUCTS EXCLUDING ICE CREAM, ICE MILK, AND FROZEN YOGURT (U.S. CL. 46).

JASON BLAIR, EXAMINING ATTORNEY

SN 85-316,073. SWANSON, RUSSELL, SAN ANGELO, TX. AND SWANSON, SHERRY, SAN ANGELO, TX. FILED 5-9-2011.

Ro-Jo's

THE MARK CONSISTS OF STANDARD CHARACTERS WITHOUT CLAIM TO ANY PARTICULAR FONT, STYLE, SIZE, OR COLOR.

THE WORDING "RO-JO'S" HAS NO MEANING IN A FOREIGN LANGUAGE.

FOR FRIED POTATOES (U.S. CL. 46).

FIRST USE 6-17-1971; IN COMMERCE 6-17-1971.

AMY C. KEAN, EXAMINING ATTORNEY

SN 85-318,282. CSC BRANDS LP, CAMDEN, NJ. FILED 5-11-2011.

AUTHENTIC NOURISHMENT

THE MARK CONSISTS OF STANDARD CHARACTERS WITHOUT CLAIM TO ANY PARTICULAR FONT, STYLE, SIZE, OR COLOR.

NO CLAIM IS MADE TO THE EXCLUSIVE RIGHT TO USE "NOURISHMENT", APART FROM THE MARK AS SHOWN.

FOR BROTH; CHILI; PROCESSED BEANS; SOUPS; PACKAGED MEALS CONSISTING PRIMARILY OF MEAT, FISH, POULTRY OR VEGETABLES (U.S. CL. 46).

AMY HELLA, EXAMINING ATTORNEY

**CLASS 29—(Continued).**

SN 85-319,933. ZHEJIANG QIANDAOHU FUNDAY AQUATIC PRODUCTS CO., LTD, CHUN'AN, ZHEJIANG, CHINA, FILED 5-13-2011.



FOR CANNED FISH; FISH; FISH FILLETS; LOBSTERS; PICKLED FISH; PRAWNS, NOT LIVE; PRESERVED FISH; PROCESSED FISH; SHELLFISH, NOT LIVE; SHRIMPS, NOT LIVE (U.S. CL. 46).

FIRST USE 9-1-2009; IN COMMERCE 1-23-2010.

DEBRA LEE, EXAMINING ATTORNEY

SN 85-320,107. PATENDIS, TIM, FRESNO, CA. FILED 5-13-2011.

Alena Foods

NO CLAIM IS MADE TO THE EXCLUSIVE RIGHT TO USE "FOODS", APART FROM THE MARK AS SHOWN.

THE MARK CONSISTS OF THE STYLIZED TEXT "ALENA FOODS" WITH LEAVES COMING OUT OF THE LETTER "D".

FOR FISH; MEAT (U.S. CL. 46).

FIRST USE 9-21-2001; IN COMMERCE 9-21-2001.

WILLIAM P. SHANAHAN, EXAMINING ATTORNEY

SN 85-321,129. SALAMA, REBECCA, HUNTINGTON WOODS, MI. FILED 5-14-2011.

MACARONI MAGIC

THE MARK CONSISTS OF STANDARD CHARACTERS WITHOUT CLAIM TO ANY PARTICULAR FONT, STYLE, SIZE, OR COLOR.

NO CLAIM IS MADE TO THE EXCLUSIVE RIGHT TO USE "MACARONI", APART FROM THE MARK AS SHOWN.

FOR CHEESE POWDER (U.S. CL. 46).

HEATHER THOMPSON, EXAMINING ATTORNEY

**CLASS 29—(Continued).**

SN 85-321,393. LOEB'S FOODS, LLC, DEERFIELD BEACH, FL. FILED 5-16-2011.

CRISPY, CRUNCHY, YUM, YUM,  
YUM!

THE MARK CONSISTS OF STANDARD CHARACTERS WITHOUT CLAIM TO ANY PARTICULAR FONT, STYLE, SIZE, OR COLOR.

NO CLAIM IS MADE TO THE EXCLUSIVE RIGHT TO USE "CRISPY" AND "CRUNCHY", APART FROM THE MARK AS SHOWN.

FOR PROCESSED ONIONS (U.S. CL. 46).

FIRST USE 12-27-2010; IN COMMERCE 12-27-2010.

JAY FLOWERS, EXAMINING ATTORNEY

**CLASS 29—(Continued).**

SN 85-325,128. WISCONSIN CHEESE GROUP, INC., MONROE, WI. FILED 5-19-2011.

CHALCO

THE MARK CONSISTS OF STANDARD CHARACTERS WITHOUT CLAIM TO ANY PARTICULAR FONT, STYLE, SIZE, OR COLOR.

OWNER OF U.S. REG. NO. 1,804,641.

FOR DAIRY-BASED BEVERAGES AND CHORIZO (U.S. CL. 46).

JASON TURNER, EXAMINING ATTORNEY

SN 85-323,147. FUJI FOOD PRODUCTS, INC., SANTA FE SPRINGS, CA. FILED 5-17-2011.

Wandering Gourmet

THE MARK CONSISTS OF STANDARD CHARACTERS WITHOUT CLAIM TO ANY PARTICULAR FONT, STYLE, SIZE, OR COLOR.

NO CLAIM IS MADE TO THE EXCLUSIVE RIGHT TO USE "GOURMET", APART FROM THE MARK AS SHOWN.

FOR FRESH OR FROZEN PREPARED MEALS, ENTREES, AND SIDE DISHES CONSISTING PRIMARILY OF MEAT, FISH, POULTRY, OR VEGETABLES (U.S. CL. 46).

ANDREA HACK, EXAMINING ATTORNEY

SN 85-325,627. MATOSANTOS COMMERCIAL CORP., VEGA BAJA, PUERTO RICO, FILED 5-20-2011.

Fresh from the Fields

THE MARK CONSISTS OF STANDARD CHARACTERS WITHOUT CLAIM TO ANY PARTICULAR FONT, STYLE, SIZE, OR COLOR.

FOR FROZEN FRUITS, FROZEN VEGETABLES, CANNED FRUITS, CANNED VEGETABLES (U.S. CL. 46).

FIRST USE 4-0-2010; IN COMMERCE 4-0-2010.

WILLIAM BRECKENFELD, EXAMINING ATTORNEY

SN 85-323,683. TUTUNDJIAN, HAGOP, PORTER RANCH, CA. FILED 5-18-2011.

Nuits

THE MARK CONSISTS OF STANDARD CHARACTERS WITHOUT CLAIM TO ANY PARTICULAR FONT, STYLE, SIZE, OR COLOR.

THE ENGLISH TRANSLATION OF THE WORD "NUITS" IN THE MARK IS "NIGHTS".

FOR FRUITS AND NUT BASED SNACK FOODS (U.S. CL. 46).

APRIL HESIK, EXAMINING ATTORNEY

SN 85-325,659. MATOSANTOS COMMERCIAL CORP., VEGA BAJA, PUERTO RICO, FILED 5-20-2011.

Moonlight Serenade

THE MARK CONSISTS OF STANDARD CHARACTERS WITHOUT CLAIM TO ANY PARTICULAR FONT, STYLE, SIZE, OR COLOR.

FOR FROZEN WHOLE BLUEBERRIES (U.S. CL. 46).

WILLIAM BRECKENFELD, EXAMINING ATTORNEY

**CLASS 29—(Continued).**

SN 85-325,663. MATOSANTOS COMMERCIAL CORP., VEGA BAJA, PUERTO RICO, FILED 5-20-2011.

## Sunrise Delight

THE MARK CONSISTS OF STANDARD CHARACTERS WITHOUT CLAIM TO ANY PARTICULAR FONT, STYLE, SIZE, OR COLOR.

FOR MIXTURE OF FROZEN MANGO CHUNKS, SLICED STRAWBERRIES AND SLICED PEACHES (U.S. CL. 46).

WILLIAM BRECKENFELD, EXAMINING ATTORNEY

**CLASS 29—(Continued).**

SN 85-329,859. J.R. SIMPLOT COMPANY, BOISE, ID. FILED 5-25-2011.

## SPUD BROS.

THE MARK CONSISTS OF STANDARD CHARACTERS WITHOUT CLAIM TO ANY PARTICULAR FONT, STYLE, SIZE, OR COLOR.

OWNER OF U.S. REG. NOS. 3,477,839 AND 3,558,570. NO CLAIM IS MADE TO THE EXCLUSIVE RIGHT TO USE "SPUD", APART FROM THE MARK AS SHOWN.

FOR PROCESSED POTATOES; PROCESSED SWEET POTATOES; PROCESSED POTATO AND VEGETABLE COMBINATIONS (U.S. CL. 46).

JOHN WILKE, EXAMINING ATTORNEY

SN 85-326,843. CACIQUE, INC., CITY OF INDUSTRY, CA. FILED 5-22-2011.

## CACIQUE GO AUTENTICO

THE MARK CONSISTS OF STANDARD CHARACTERS WITHOUT CLAIM TO ANY PARTICULAR FONT, STYLE, SIZE, OR COLOR.

OWNER OF U.S. REG. NOS. 2,915,613, 3,909,161 AND OTHERS.

THE ENGLISH TRANSLATION OF THE WORD "AUTENTICO" IN THE MARK IS "AUTHENTIC".

FOR DAIRY PRODUCTS EXCLUDING ICE CREAM, ICE MILK AND FROZEN YOGURT; PRESERVED MEATS AND SAUSAGES (U.S. CL. 46).

FIRST USE 5-0-2011; IN COMMERCE 5-0-2011.

KATHERINE M. DUBRAY, EXAMINING ATTORNEY

SN 85-330,011. COLONNA BROTHERS, INC., NORTH BERGEN, NJ. FILED 5-25-2011.

## RISPARMIO

THE MARK CONSISTS OF STANDARD CHARACTERS WITHOUT CLAIM TO ANY PARTICULAR FONT, STYLE, SIZE, OR COLOR.

THE ENGLISH TRANSLATION OF RISPARMIO IN THE MARK IS SAVING.

FOR BROTH; BRUSCHETTA TOPPINGS; CHEESE; CHEESE SUBSTITUTES; EDIBLE OIL; OLIVE OIL; POULTRY; PRESERVED FRUIT AND VEGETABLES; PROCESSED MEAT; PROCESSED SEAFOOD, NAMELY, FISH; SAUSAGES; SOUPS; TEXTURED VEGETABLE PROTEIN BITS HAVING A BACON FLAVOR (U.S. CL. 46).

KELLY BOULTON, EXAMINING ATTORNEY

SN 85-328,797. TROPICAL TRADITIONS, INC., WEST BEND, WI. FILED 5-24-2011.

## GOLD LABEL

THE MARK CONSISTS OF STANDARD CHARACTERS WITHOUT CLAIM TO ANY PARTICULAR FONT, STYLE, SIZE, OR COLOR.

FOR COCONUT OIL (U.S. CL. 46).

FIRST USE 11-30-2007; IN COMMERCE 11-30-2007.

KATINA MISTER, EXAMINING ATTORNEY

SN 85-330,473. SALLY'S SMART FOODS, INC., SANTA MONICA, CA. FILED 5-25-2011.



THE MARK CONSISTS OF THE STYLIZED WORDS, "SALLY'S SMART" UNDER AN EYEBROW ARCH OF VERTICAL SCALE-LIKE TICK MARKS. THE INTERNAL LOOP OF THE LOWER CASE "A" EMBODIED WITHIN THE WORD "SMART" IS HEART SHAPED.

FOR FLAVORED NUTS (U.S. CL. 46).

FIRST USE 7-1-2010; IN COMMERCE 7-13-2010.

KATHERINE STOIDES, EXAMINING ATTORNEY

**CLASS 29—(Continued).**

SN 85-331,182. STEVE MARTIN, FRESNO, CA. FILED 5-26-2011.

# Renegades

THE MARK CONSISTS OF STANDARD CHARACTERS WITHOUT CLAIM TO ANY PARTICULAR FONT, STYLE, SIZE, OR COLOR.

FOR DRIED FRUITS; RAISINS (U.S. CL. 46).  
JEFF DEFORD, EXAMINING ATTORNEY

SN 85-332,111. CSC BRANDS LP, CAMDEN, NJ. FILED 5-27-2011.



OWNER OF U.S. REG. NOS. 48,461, 804,371 AND OTHERS. NO CLAIM IS MADE TO THE EXCLUSIVE RIGHT TO USE "THE DEPICTION OF SOUP", APART FROM THE MARK AS SHOWN.

THE MARK CONSISTS OF A RECTANGLE WITH THE STYLIZED WORD "CAMPBELL'S" ON A SLANT APPEARING ON A SHADED BACKGROUND. AN IMAGE OF A BOWL OF SOUP INSIDE A THREE-SIDED PORTION OF A SQUARE APPEARS ON THE RIGHT SIDE.

FOR SOUPS (U.S. CL. 46).  
AMY HELLA, EXAMINING ATTORNEY

SN 85-332,117. CSC BRANDS LP, CAMDEN, NJ. FILED 5-27-2011.



OWNER OF U.S. REG. NOS. 48,461, 804,371 AND OTHERS. NO CLAIM IS MADE TO THE EXCLUSIVE RIGHT TO USE "THE DEPICTION OF SOUP", APART FROM THE MARK AS SHOWN.

THE COLOR(S) RED, TAN, WHITE, BROWN AND LIGHT BROWN IS/ARE CLAIMED AS A FEATURE OF THE MARK.

THE MARK CONSISTS OF A TAN RECTANGLE WITH THE STYLIZED WORD "CAMPBELL'S" IN RED ON A SLANT APPEARING ON THE RECTANGLE. AN IMAGE OF A BROWN AND TAN BOWL OF LIGHT BROWN SOUP APPEARS ON THE RIGHT SIDE INSIDE A WHITE THREE-SIDED PORTION OF A SQUARE.

FOR SOUPS (U.S. CL. 46).  
AMY HELLA, EXAMINING ATTORNEY

**CLASS 29—(Continued).**

SN 85-332,407. OFF THE DOCK FRESH SEAFOOD, INC., MEMPHIS, TN. FILED 5-27-2011.

# OFF THE DOCK

THE MARK CONSISTS OF STANDARD CHARACTERS WITHOUT CLAIM TO ANY PARTICULAR FONT, STYLE, SIZE, OR COLOR.

FOR PROCESSED SEAFOOD, NAMELY, FISH; SEAFOOD; SEAFOOD, NAMELY, FISH AND SHELLFISH (U.S. CL. 46).

FIRST USE 1-31-1992; IN COMMERCE 1-31-1992.  
NORA BUCHANAN WILL, EXAMINING ATTORNEY

SN 85-332,477. STEVE MARTIN, FRESNO, CA. FILED 5-27-2011.



THE MARK CONSISTS OF A BACKWARDS CHARACTER "R" IN STYLIZED FONT, DIRECTLY TO THE RIGHT OF THE BACKWARDS "R" IS AN ADDITIONAL CHARACTER "R" IN STYLIZED FONT AND IN NORMAL SYNTAX (FACING FORWARD).

FOR DRIED FRUITS; RAISINS (U.S. CL. 46).  
JEFF DEFORD, EXAMINING ATTORNEY

SN 85-333,451. HOWARD, RAVEN, MIDLAND, TX. AND KLEINBACH, JOSHUA KARL, MIDLAND, TX. AND HOWARD, ALANA CAROL, MIDLAND, TX. AND HAWKINS, WILLIE LEE, MIDLAND, TX. FILED 5-30-2011.

# All Good Things

THE MARK CONSISTS OF STANDARD CHARACTERS WITHOUT CLAIM TO ANY PARTICULAR FONT, STYLE, SIZE, OR COLOR.

FOR BEVERAGES MADE WITH YOGHURT; FRUIT-BASED FOOD BEVERAGE (U.S. CL. 46).

JENNIFER MARTIN, EXAMINING ATTORNEY

**CLASS 29—(Continued).**

SN 85-334,069. ALEXANDER OLIVE OIL, INC., WILMINGTON, DE. FILED 5-31-2011.

# ALEXANDER

THE MARK CONSISTS OF STANDARD CHARACTERS WITHOUT CLAIM TO ANY PARTICULAR FONT, STYLE, SIZE, OR COLOR.

FOR OLIVE OIL (U.S. CL. 46).  
EMILY CARLSEN, EXAMINING ATTORNEY

---

SN 85-334,757. GROOMS GROUP, LLC, MADISON, IN. FILED 6-1-2011.

# MOTHER'S GRILLED WINGS

THE MARK CONSISTS OF STANDARD CHARACTERS WITHOUT CLAIM TO ANY PARTICULAR FONT, STYLE, SIZE, OR COLOR.

NO CLAIM IS MADE TO THE EXCLUSIVE RIGHT TO USE "GRILLED WINGS", APART FROM THE MARK AS SHOWN.

FOR CHICKEN (U.S. CL. 46).  
AISHA CLARKE, EXAMINING ATTORNEY

---

SN 85-335,401. RUGGIERO, BETHNEY, BABYLON, NY. FILED 6-1-2011.

# JAMMED UP

THE MARK CONSISTS OF STANDARD CHARACTERS WITHOUT CLAIM TO ANY PARTICULAR FONT, STYLE, SIZE, OR COLOR.

FOR JAMS; JAMS AND MARMALADES; JELLIES AND JAMS; JELLIES, JAMS; MARMALADES AND JAMS; MEAT, FRUIT AND VEGETABLE JELLIES, JAMS; MEAT, FRUIT AND VEGETABLE JELLIES, JAMS, EGGS (U.S. CL. 46).  
JULIE VEPPUMTHARA, EXAMINING ATTORNEY

**CLASS 29—(Continued).**

SN 85-336,436. BANGKOK 96 FOODS, DEARBORN, MI. FILED 6-2-2011.

# THAI FEAST

THE MARK CONSISTS OF STANDARD CHARACTERS WITHOUT CLAIM TO ANY PARTICULAR FONT, STYLE, SIZE, OR COLOR.

NO CLAIM IS MADE TO THE EXCLUSIVE RIGHT TO USE "THAI", APART FROM THE MARK AS SHOWN.

FOR FROZEN PRE-PACKAGED ENTREES CONSISTING PRIMARILY OF SEAFOOD; FROZEN ENTREES CONSISTING PRIMARILY OF MEAT, FISH, POULTRY OR VEGETABLES (U.S. CL. 46).

KEVIN CORWIN, EXAMINING ATTORNEY

---

SN 85-337,309. WERNER GOURMET MEAT SNACKS, INC., TILLAMOOK, OR. FILED 6-3-2011.

# GET YOUR MOVE ON

THE MARK CONSISTS OF STANDARD CHARACTERS WITHOUT CLAIM TO ANY PARTICULAR FONT, STYLE, SIZE, OR COLOR.

FOR MEAT-BASED SNACK FOODS (U.S. CL. 46).  
JEFF DEFORD, EXAMINING ATTORNEY

---

SN 85-337,513. MARFOOD USA, INC., TAYLOR, MI. FILED 6-3-2011.

# AUTHENTIC. HONEST. FOOD.

THE MARK CONSISTS OF STANDARD CHARACTERS WITHOUT CLAIM TO ANY PARTICULAR FONT, STYLE, SIZE, OR COLOR.

FOR BEEF; BEEF JERKY; MEAT; MEAT-BASED SNACK FOODS; PORK; POULTRY (U.S. CL. 46).  
MARK SPARACINO, EXAMINING ATTORNEY

**CLASS 29—(Continued).**

SN 85-337,523. COMERCIALIZADORA IMPULSA Y PRODUCE, S.A. DE C.V., IRAPUATO, MEXICO, FILED 6-3-2011.

# ZANIX

THE MARK CONSISTS OF STANDARD CHARACTERS WITHOUT CLAIM TO ANY PARTICULAR FONT, STYLE, SIZE, OR COLOR.

FOR DEHYDRATED FRUIT SNACKS; PRESERVED FRUIT AND VEGETABLES; VEGETABLE-BASED SNACK FOODS (U.S. CL. 46).

FIRST USE 12-14-2009; IN COMMERCE 5-31-2011.

MARK SPARACINO, EXAMINING ATTORNEY

SN 85-337,926. DIAGEO IRELAND, DUBLIN, IRELAND, FILED 6-3-2011.



OWNER OF U.S. REG. NOS. 3,573,883, 3,921,827 AND OTHERS.

THE MARK CONSISTS OF A HARP.  
FOR SOUPS; FROZEN, PREPARED OR PACKAGED ENTREES CONSISTING PRIMARILY OF MEAT, FISH, POULTRY OR VEGETABLES (U.S. CL. 46).

GRETTA YAO, EXAMINING ATTORNEY

**CLASS 29—(Continued).**

SN 85-337,984. ALFELD, BEVERALY, DBA JAMLADY, CRYSTAL LAKE, IL. AND ALFELD, TIMOTHY, CRYSTAL LAKE, IL. FILED 6-3-2011.

# JAMLADY

THE MARK CONSISTS OF STANDARD CHARACTERS WITHOUT CLAIM TO ANY PARTICULAR FONT, STYLE, SIZE, OR COLOR.

OWNER OF U.S. REG. NO. 2,881,316.

FOR CANNED FRUITS; CANNED FRUITS AND VEGETABLES; FRUIT JELLIES; FRUIT PASTE; FRUIT PECTIN; FRUIT PRESERVES; FRUIT PUREES; FRUIT SPREADS; PICKLED FRUITS; PICKLED VEGETABLES; PICKLES; PREPARED NUTS; PRESERVED FRUITS; PRESERVED FRUITS AND VEGETABLES; PRESERVED VEGETABLES; PROCESSED NUTS; TOMATO PRESERVES (U.S. CL. 46).

FIRST USE 12-31-1988; IN COMMERCE 12-31-1988.

VIVIAN MICZNIK FIRST, EXAMINING ATTORNEY

SN 85-339,369. FAITHFUL TO FOODS, INC., RYE, NY. FILED 6-6-2011.

## Food the way it is supposed to taste.

THE MARK CONSISTS OF STANDARD CHARACTERS WITHOUT CLAIM TO ANY PARTICULAR FONT, STYLE, SIZE, OR COLOR.

FOR JELLIES AND JAMS; OLIVE OIL; VEGETABLE-BASED SPREADS (U.S. CL. 46).

EMILY CARLSEN, EXAMINING ATTORNEY

SN 85-339,377. FAITHFUL TO FOODS, INC., RYE, NY. FILED 6-6-2011.

## Small Farms. Big Taste!

THE MARK CONSISTS OF STANDARD CHARACTERS WITHOUT CLAIM TO ANY PARTICULAR FONT, STYLE, SIZE, OR COLOR.

FOR JELLIES AND JAMS; OLIVE OIL; VEGETABLE-BASED SPREADS (U.S. CL. 46).

EMILY CARLSEN, EXAMINING ATTORNEY



**CLASS 29—(Continued).**

SN 85-343,564. BIG IDEA HOLDINGS, LLC, SALINAS, CA. FILED 6-10-2011.



NO CLAIM IS MADE TO THE EXCLUSIVE RIGHT TO USE "GREENS", APART FROM THE MARK AS SHOWN.

THE COLOR(S) RED, GREEN AND ORANGE IS/ARE CLAIMED AS A FEATURE OF THE MARK.

THE MARK CONSISTS OF THE WORDING "GREAT GREENS!" IN STYLIZED LETTERING. THE WORD "GREAT" APPEARS IN RED. THE WORDING "GREENS!" APPEARS IN GREEN. THE WORD "GREAT" APPEARS INSIDE OF AN ORANGE COMIC BLAST DESIGN FORMED BY A RECTANGULAR SHAPE HAVING JAGGED EDGES.

FOR PACKAGED PROCESSED FRESH VEGETABLES (U.S. CL. 46).

DEBRA LEE, EXAMINING ATTORNEY

SN 85-344,464. OTIS MCALLISTER INC., SAN FRANCISCO, CA. FILED 6-13-2011.



THE MARK CONSISTS OF A WINGED ANGEL PLAYING A STRINGED INSTRUMENT ABOVE THE WORD ANGELITA IN STYLIZED FONT.

FOR CANNED TOMATOES AND OLIVE OIL (U.S. CL. 46).

SOPHIA S. KIM, EXAMINING ATTORNEY

SN 85-355,470. MARFOOD USA, INC., TAYLOR, MI. FILED 6-24-2011.

PEMMICANBALANCE

THE MARK CONSISTS OF STANDARD CHARACTERS WITHOUT CLAIM TO ANY PARTICULAR FONT, STYLE, SIZE, OR COLOR.

OWNER OF U.S. REG. NOS. 2,767,517, 3,858,913 AND OTHERS.

FOR MEAT AND POULTRY BASED SNACK FOODS CONTAINING GRAINS, NUTS AND FRUITS (U.S. CL. 46).

MARK SPARACINO, EXAMINING ATTORNEY

**CLASS 29—(Continued).**

SN 85-355,483. MARFOOD USA, INC., TAYLOR, MI. FILED 6-24-2011.



OWNER OF U.S. REG. NOS. 2,767,517, 3,858,913 AND OTHERS.

THE MARK CONSISTS OF THE WORDS "PEMMICAN-BALANCE" WITHIN AN ANGLED PARALLELOGRAM THAT CONTAINS A STYLIZED CIRCLE BEHIND THE WORD "BALANCE".

FOR MEAT AND POULTRY BASED SNACK FOODS CONTAINING GRAINS, NUTS AND FRUITS (U.S. CL. 46).

MARK SPARACINO, EXAMINING ATTORNEY

SN 85-358,644. MONAVIE LLC, SOUTH JORDAN, UT. FILED 6-28-2011.

MONA · VIE

THE MARK CONSISTS OF STANDARD CHARACTERS WITHOUT CLAIM TO ANY PARTICULAR FONT, STYLE, SIZE, OR COLOR.

OWNER OF U.S. REG. NOS. 3,106,147, 3,691,549 AND OTHERS.

FOR PROTEIN BASED, NUTRIENT-DENSE SNACK BARS (U.S. CL. 46).

FIRST USE 12-24-2010; IN COMMERCE 12-24-2010.

FRED CARL, EXAMINING ATTORNEY

SN 85-358,741. MONAVIE LLC, SOUTH JORDAN, UT. FILED 6-28-2011.

RVL

THE MARK CONSISTS OF STANDARD CHARACTERS WITHOUT CLAIM TO ANY PARTICULAR FONT, STYLE, SIZE, OR COLOR.

FOR PROTEIN BASED, NUTRIENT-DENSE SNACK BARS (U.S. CL. 46).

FIRST USE 12-24-2010; IN COMMERCE 12-24-2010.

FRED CARL, EXAMINING ATTORNEY

**CLASS 29—(Continued).**

SN 85-398,962. MARFOOD USA, INC., TAYLOR, MI. FILED 8-16-2011.

**PEMMICAN-FLEXPACK**

THE MARK CONSISTS OF STANDARD CHARACTERS WITHOUT CLAIM TO ANY PARTICULAR FONT, STYLE, SIZE, OR COLOR.

OWNER OF U.S. REG. NOS. 2,730,120, 3,102,839 AND OTHERS.

FOR MEAT; MEAT-BASED SNACK FOODS (U.S. CL. 46).

MARK SPARACINO, EXAMINING ATTORNEY

SN 85-402,628. PETALUMA ACQUISITION, LLC, PETALUMA, CA. FILED 8-19-2011.

**TRACE OUR TRACKS**

THE MARK CONSISTS OF STANDARD CHARACTERS WITHOUT CLAIM TO ANY PARTICULAR FONT, STYLE, SIZE, OR COLOR.

FOR CHICKEN (U.S. CL. 46).

FIRST USE 7-1-2011; IN COMMERCE 7-21-2011.

DANNEAN HETZEL, EXAMINING ATTORNEY

SN 85-402,630. PETALUMA ACQUISITION, LLC, PETALUMA, CA. FILED 8-19-2011.



THE MARK CONSISTS OF THE STYLIZED WORDS "TRACE OUR TRACKS" IN VERTICAL ALIGNMENT WITH "TRACE" AT THE TOP, "OUR" IN THE MIDDLE AND "TRACKS" AT THE BOTTOM, AND THE DESIGN OF BIRDS TRACKS TO THE RIGHT OF THE STYLIZED WORDS.

FOR CHICKEN (U.S. CL. 46).

FIRST USE 7-1-2011; IN COMMERCE 7-21-2011.

DANNEAN HETZEL, EXAMINING ATTORNEY

**CLASS 30—STAPLE FOODS**

SN 76-690,180. VICTORIA FINE FOODS, LLC, BROOKLYN, NY. FILED 6-2-2008.



OWNER OF U.S. REG. NOS. 1,149,967, 3,703,873 AND OTHERS.

NO CLAIM IS MADE TO THE EXCLUSIVE RIGHT TO USE "COLLECTION" AND "GOURMET PASTA SAUCE-S" AND THE PICTORIAL REPRESENTATION OF A DISH OF PASTA WITH SAUCE, APART FROM THE MARK AS SHOWN.

THE COLOR(S) WHITE, BLACK, RED, GOLD, YELLOW, GREEN AND SILVER IS/ARE CLAIMED AS A FEATURE OF THE MARK.

THE MARK CONSISTS OF THE COLOR WHITE APPEARS IN THE BACKGROUND OF THE ENTIRE MARK, AND IN THE PLATE UNDER THE PASTA. THE COLOR BLACK APPEARS IN THE STYLIZED WORDING "WHITE LINEN COLLECTION" AND IN THE WORD "BY". THE COLOR RED APPEARS IN THE STYLIZED WORDING "GOURMET PASTA SAUCES" AND "VICTORIA" AND ALSO IN THE SAUCE ON TOP OF THE DISH OF PASTA. THE COLOR GOLD APPEARS IN THE TWO HORIZONTAL LINES AT THE TOP AND BOTTOM OF THE MARK. THE COLOR YELLOW APPEARS IN THE PASTA. THE COLOR GREEN APPEARS IN THE PIECE OF BASIL ON TOP OF THE PASTA. THE COLOR SILVER APPEARS IN THE FLATWARE ON EITHER SIDE OF THE PLATE.

FOR PASTA SAUCES, NAMELY, MARINARA SAUCE, VODKA SAUCE, SPICY VODKA SAUCE, FRADIIVOLO SAUCE, ROASTED GARLIC SAUCE, TOMATO BASIL SAUCE, PUTTANESCA SAUCE, MUSHROOMS SAUCE, EGGPLANT SAUCE, ARTICHOKE SAUCE AND PESTO SAUCE; PASTA SAUCES WITH MEAT, NAMELY, CRUMBLLED SAUSAGE PASTA SAUCE, SAUSAGE SLICES SAUCE, BOLOGNESE SAUCE, MINI MEAT-BALLS SAUCE AND ROASTED WHITE CHICKEN SAUCE; ORGANIC PASTA SAUCE; COOKING SAUCES; PEPPER SAUCES; VINEGARS, NAMELY, BALSAMIC VINEGAR, RED WINE VINEGAR, PURE WHITE WINE VINEGAR AND DISTILLED VINEGAR; SALSAS; CAPERS; SALAD DRESSINGS; SPICES, NAMELY, BLACK PEPPER, CRUSHED RED PEPPER, BASIL, NUTMEG, BAY LEAVES, GARLIC, CHILI POWDER, CINNAMON, WHOLE CLOVES, CUMIN, CURRY POWDER, FENNEL SEEDS, ITALIAN SEASONING, OREGANO, PAPRIKA, PARSLEY, THYME, CHIVES AND LEMON PEPPER SEASONING (U.S. CL. 46).

FIRST USE 3-6-2006; IN COMMERCE 6-28-2006.

MARCIE MILONE, EXAMINING ATTORNEY

**CLASS 30—(Continued).**

SN 76-707,145. CARBONARO, GREGORY, LUTZ, FL. FILED 4-7-2011.



OWNER OF U.S. REG. NO. 3,346,375.  
NO CLAIM IS MADE TO THE EXCLUSIVE RIGHT TO USE "BEST NEW YORK PIZZA" AND "BEST N.Y. PIZZA", APART FROM THE MARK AS SHOWN.

THE MARK CONSISTS OF THE WORDING "BEST NEW YORK PIZZA" WITHIN AN OVAL DESIGN AND THE WORKING "BEST N.Y. PIZZA" WITHIN A CIRCULAR DESIGN ADJACENT TO THE TERM "PIZZA".

FOR PIZZA FOR CONSUMPTION ON OR OFF PREMISES (U.S. CL. 46).

FIRST USE 1-20-2005; IN COMMERCE 1-20-2005.  
KAREN BRACEY, EXAMINING ATTORNEY

**CLASS 30—(Continued).**

SN 76-707,197. MCCLINTOCK, CATHY-ANNE, LONG BEACH, CA. FILED 4-11-2011.



NO CLAIM IS MADE TO THE EXCLUSIVE RIGHT TO USE "COOKIES", "SUGAR" OR "HOMEMADE SUGAR COOKIES", APART FROM THE MARK AS SHOWN.

THE MARK CONSISTS OF THE STYLIZED WORDING "LIL MISS SUGAR" WITH AN OVERLINE AND UNDERLINE, ABOVE THE STYLIZED WORDING "HOMEMADE SUGAR COOKIES.". ABOVE THESE IS THE DESIGN OF A COOKIE JAR WITH THE WORDING "COOKIES" AND A HEART-SHAPE DESIGN THEREON WITH TWO PLANT DECORATIONS ON BOTH SIDES OF THE COOKIE JAR. BELOW THE WORDINGS OF THE MARK ARE TWO SIMILAR PLANT DECORATIONS.

FOR COOKIES (U.S. CL. 46).  
FIRST USE 3-0-2011; IN COMMERCE 3-0-2011.  
DAWN HAN, EXAMINING ATTORNEY

SN 76-707,195. MCCLINTOCK, CATHY-ANNE, LONG BEACH, CA. FILED 4-11-2011.

**LIL MISS SUGAR**

THE MARK CONSISTS OF STANDARD CHARACTERS WITHOUT CLAIM TO ANY PARTICULAR FONT, STYLE, SIZE, OR COLOR.

NO CLAIM IS MADE TO THE EXCLUSIVE RIGHT TO USE "SUGAR", APART FROM THE MARK AS SHOWN.

FOR COOKIES (U.S. CL. 46).  
FIRST USE 3-0-2011; IN COMMERCE 3-0-2011.  
DAWN HAN, EXAMINING ATTORNEY

SN 76-707,762. J. PHILIP BROYLES, NAPLES, FL. AND BARBARA J. BROYLES, NAPLES, FL. FILED 5-26-2011.

**PLAY BETTER GOLF**

THE MARK CONSISTS OF STANDARD CHARACTERS WITHOUT CLAIM TO ANY PARTICULAR FONT, STYLE, SIZE, OR COLOR.

FOR ITEMS OF FOOD, BEING BARS OF CANDY (U.S. CL. 46).

CHARLOTTE CORWIN, EXAMINING ATTORNEY

**CLASS 30—(Continued).**

SN 77-737,938. CARNIVAL PONY L.L.C., LAS VEGAS, NV.  
FILED 5-15-2009.

INDIE  
TEA

NO CLAIM IS MADE TO THE EXCLUSIVE RIGHT TO USE "INDIE TEA", APART FROM THE MARK AS SHOWN. THE MARK CONSISTS OF THE STYLIZED TEXT "INDIE TEA" IN A STACKED FORMATION AND A SILHOUETTE OF A LITTLE BIRD DOTTING THE SECOND "I" OF THE WORD "INDIE".

FOR COFFEE AND TEA (U.S. CL. 46).  
JERI J. FICKES, EXAMINING ATTORNEY

SN 77-763,799. HERSHEY CHOCOLATE & CONFECTION-  
ERY CORPORATION, WHEAT RIDGE, CO. FILED 6-19-  
2009.

CRUNCHFUSION

THE MARK CONSISTS OF STANDARD CHARACTERS WITHOUT CLAIM TO ANY PARTICULAR FONT, STYLE, SIZE, OR COLOR.

FOR CANDY (U.S. CL. 46).  
ELIZABETH KAJUBI, EXAMINING ATTORNEY

**CLASS 30—(Continued).**

SN 79-085,790. OBSHESTVO S OGRANICHENNOI OT-  
VETSTVENNOSTYU "COFFEE COMPANY "HORS", RU-  
103104 MOSCOW, RUSSIAN FED., FILED 5-14-2010.

CARACTÈRE

THE MARK CONSISTS OF STANDARD CHARACTERS WITHOUT CLAIM TO ANY PARTICULAR FONT, STYLE, SIZE, OR COLOR.

OWNER OF INTERNATIONAL REGISTRATION 1046943  
DATED 5-14-2010, EXPIRES 5-14-2020.

THE ENGLISH TRANSLATION OF THE FOREIGN  
WORD IN THE MARK IS "CHARACTER".

FOR COFFEE; TEA; COCOA; SUGAR; TAPIOCA;  
SAGO; ARTIFICIAL COFFEE; FLOUR AND PREPARA-  
TIONS MADE FROM CEREALS, NAMELY, MUESLI  
AND PASTA; MALT FOR FOOD PURPOSES; PRO-  
CESSED CEREALS AND READY TO EAT CEREALS;  
BREAD; PASTRY AND CONFECTIONARY, NAMELY,  
SWEETS, CANDIES, MARZIPAN, COOKIES, CAKES  
AND HALVA; FROZEN CONFECTIONARY; CONFE-  
CTIONARY MADE OF SUGAR; ICES, NAMELY, FRUIT  
ICES AND FLAVORED ICES; TREACLE; YEAST; BAK-  
ING POWDER; SALT; MUSTARD; VINEGAR; CONDI-  
MENTS, NAMELY, SAUCES; SEASONING FOR SOUPS;  
PASTRIES; PASTRY MEAT DISHES; SEASONINGS FOR  
MEAT, FISH AND POULTRY AND FOR MEAT, FISH  
AND POULTRY DISHES; SPICES; AND ICE (U.S. CL. 46).

MARY I. SPARROW, EXAMINING ATTORNEY

SN 79-090,809. AUSWORLD IMPORTS & EXPORTS PTY  
LTD, AUSTRALIA, FILED 11-9-2010.



OWNER OF INTERNATIONAL REGISTRATION 1044154  
DATED 6-8-2010, EXPIRES 6-8-2020.

NO CLAIM IS MADE TO THE EXCLUSIVE RIGHT TO USE "BISCOTTO" AND "WAFER STICKS", APART FROM THE MARK AS SHOWN.

THE MARK CONSISTS OF THE WORDING "BISCOTTO" INSIDE A RECTANGLE HAVING SMALL CIRCLES AROUND ITS BORDER. THE ABOVE IS SET AGAINST A DESIGN OF THREE RECTANGLES THAT ARE SET INSIDE ONE ANOTHER. THE OUTER RECTANGLE BEARS DESIGNS OF MULTIPLE DECORATIVE LOOPS. THE CENTER RECTANGLE FEATURES ONE OF THE DECORATIVE LOOP DESIGNS AND IS SET AGAINST THREE CONCENTRIC INCOMPLETE CIRCLES. TOWARDS THE BOTTOM OF THE RECTANGLES IS THE WORDING "WAFER STICKS".

FOR BISCUITS; WAFER BISCUITS; WAFERS; WAFER  
STICKS; SWEET BISCUITS FOR HUMAN CONSUMP-  
TION; COOKIES (U.S. CL. 46).

HAI-LY LAM, EXAMINING ATTORNEY

**CLASS 30—(Continued).**

SN 79-093,486. SIMPLY HONEST FOODS PTY LTD, AUSTRALIA, FILED 11-19-2010.

# Simply Honest

THE MARK CONSISTS OF STANDARD CHARACTERS WITHOUT CLAIM TO ANY PARTICULAR FONT, STYLE, SIZE, OR COLOR.

OWNER OF INTERNATIONAL REGISTRATION 1067318 DATED 11-19-2010, EXPIRES 11-19-2020.

FOR HOT CHOCOLATE; BREAKFAST CEREALS; COFFEE; COFFEE BEANS; GROUND COFFEE; PASTA SAUCE; VINEGAR; CONDIMENTS; SPICES; MARIANADES; CAKES; SNACK BARS CONTAINING A MIXTURE OF GRAINS, NUTS AND DRIED FRUIT; BISCUITS; TOASTS; SNACK BARS CONTAINING DRIED FRUITS; SNACK BARS CONTAINING GRAINS; SNACK BARS CONTAINING NUTS; SHERBETS; SORBETS; ICE CREAM; FUDGE; BREAD; BREADSTICKS; GARLIC BREAD; CANDY, OTHER THAN FOR MEDICAL PURPOSES; SEASONED SALT FOR COOKING; SPICED SALT; CROUTONS; CRACKERS; FROZEN YOGURT; CHOCOLATE MOUSSES; PIZZAS; DRIED PASTA; FRESH PASTA; SALAD DRESSINGS; DRIED HERBS; POPCORN; HONEYS; SUGAR; RISOTTO; RICE; MAYONNAISE; FREEZE-DRIED COFFEE; COFFEE BEVERAGES; MIXTURES OF COFFEE ESSENCES AND COFFEE EXTRACTS; UNROASTED COFFEE (U.S. CL. 46).

RAUL CORDOVA, EXAMINING ATTORNEY

SN 85-030,489. RIKA BAKERIES, INC., HIALEAH, FL. FILED 5-5-2010.

# LA AURORA

THE MARK CONSISTS OF STANDARD CHARACTERS WITHOUT CLAIM TO ANY PARTICULAR FONT, STYLE, SIZE, OR COLOR.

FOR CRACKERS AND CRACKER MEAL (U.S. CL. 46). FIRST USE 2-18-1964; IN COMMERCE 2-18-1964.

REBECCA SMITH, EXAMINING ATTORNEY

SN 85-070,025. RADEMAEKERS, JONATHAN, BOULDER, CO. FILED 6-23-2010.

# J J'S COCOMELS

THE MARK CONSISTS OF STANDARD CHARACTERS WITHOUT CLAIM TO ANY PARTICULAR FONT, STYLE, SIZE, OR COLOR.

OWNER OF U.S. REG. NO. 4,020,198.

FOR CANDY (U.S. CL. 46).

FIRST USE 4-3-2010; IN COMMERCE 4-3-2010.

PAUL E. FAHRENKOPF, EXAMINING ATTORNEY

**CLASS 30—(Continued).**

SN 85-083,721. TYSON FOODS, INC., SPRINGDALE, AR. FILED 7-13-2010.

# CRISPITOS

THE MARK CONSISTS OF STANDARD CHARACTERS WITHOUT CLAIM TO ANY PARTICULAR FONT, STYLE, SIZE, OR COLOR.

OWNER OF U.S. REG. NO. 2,822,371.

FOR TORTILLAS FILLED WITH EGG, PORK AND CHEESE (U.S. CL. 46).

FIRST USE 7-0-2005; IN COMMERCE 7-0-2005.

DAVID ELTON, EXAMINING ATTORNEY

SN 85-098,436. BAROODY, MEGHAN ELIZABETH, ALEXANDRIA, VA. FILED 8-2-2010.

# Meggroll

THE MARK CONSISTS OF STANDARD CHARACTERS WITHOUT CLAIM TO ANY PARTICULAR FONT, STYLE, SIZE, OR COLOR.

FOR EGGROLL CREATIONS INCORPORATING A DIVERSITY OF FILLINGS, NAMELY, BREAKFAST, LUNCH, DINNER, DESSERT, AND ETHNIC FOOD FILLINGS (U.S. CL. 46).

FIRST USE 2-1-2010; IN COMMERCE 5-1-2010.

KATINA MISTER, EXAMINING ATTORNEY

SN 85-143,846. HACIENDA SAN JOSE DE MIRAVALLE S. DE R.L. DE C.V., ZAPOPAN, JALISCO, MEXICO, FILED 10-3-2010.

# Agavia

THE MARK CONSISTS OF STANDARD CHARACTERS WITHOUT CLAIM TO ANY PARTICULAR FONT, STYLE, SIZE, OR COLOR.

FOR NATURAL SWEETENER (U.S. CL. 46).

FIRST USE 1-15-2010; IN COMMERCE 1-15-2010.

JOHN DALIER, EXAMINING ATTORNEY

**CLASS 30—(Continued).**

SN 85-167,051. PT SARI INCOFOOD CORPORATION, SUMATERA UTARA, INDONESIA, FILED 11-2-2010.

# JIAJIA

THE MARK CONSISTS OF STANDARD CHARACTERS WITHOUT CLAIM TO ANY PARTICULAR FONT, STYLE, SIZE, OR COLOR.

OWNER OF INDONESIA REG. NO. IDM000081937, DATED 7-20-2006, EXPIRES 6-21-2016.

OWNER OF U.S. REG. NOS. 3,539,367 AND 3,649,301.

THE ENGLISH TRANSLATION OF "JIAJIA" IN THE MARK IS VERY GOOD.

FOR COFFEE, TEA, PROCESSED CACAO, SUGAR, RICE, TAPIOCA, SAGO, COFFEE SUBSTITUTE, FLOUR PREPARATIONS FROM CEREAL, NAMELY, BREAD, BISCUIT, CAKES; SWEETS, NAMELY, CANDY; ICE, HONEY, CORN SYRUP, YEAST, BAKING POWDER FOR MAKING BREAD, SALT, MUSTARD, PEPPER, VINEGAR, SAUCES, SPICES, ICE CREAM, CORN FLOUR, WHEAT FLOUR, CHOCOLATE, POPCORN, KETCHUP SWEET, KETCHUP SALTED, MACARONI, TOMATO SAUCES, MILK-BASED BEVERAGES CONTAINING CHOCOLATE (U.S. CL. 46).

TIMOTHY FINNEGAN, EXAMINING ATTORNEY

SN 85-171,428. HERSHEY CHOCOLATE & CONFECTIONERY CORPORATION, WHEAT RIDGE, CO. FILED 11-8-2010.



OWNER OF U.S. REG. NOS. 1,074,163, 3,601,728 AND OTHERS.

NO CLAIM IS MADE TO THE EXCLUSIVE RIGHT TO USE "MILK CHOCOLATE" AND THE REPRESENTATION OF THE CANDY, APART FROM THE MARK AS SHOWN.

THE COLOR(S) BROWN, ORANGE, YELLOW, WHITE AND LIGHT BROWN IS/ARE CLAIMED AS A FEATURE OF THE MARK.

THE MARK CONSISTS OF THE WORDING "REESE'S", "BIG CUP" AND "PEANUT BUTTER LOVERS CUP" IN YELLOW LETTERS OUTLINED IN THE COLOR BROWN WITH THE WORDING "BIG CUP" AND "LOVERS" HAVING THE COLOR WHITE AT THE TOP PORTION OF EACH LETTER, THE WORDING "MILK CHOCOLATE" IN BROWN APPEARING ABOVE THE WORDING "REESE'S", THE IMAGE OF THE PARTIALLY BITTEN CHOCOLATE COVERED CANDY IS BROWN WITH LIGHT BROWN FILLING, THE WORDING "PEANUT BUTTER LOVERS CUP" APPEARS IN THE LIGHT BROWN FILLING PART OF THE CANDY, AND THE ENTIRE MARK APPEARS AN ORANGE BACKGROUND. THE MATTER SHOWN IN DOTTED LINES SHOWS POSITIONING OF THE MARK AND IS NOT PART OF THE MARK.

SEC. 2(F) AS TO "BIG CUP".

FOR CANDY (U.S. CL. 46).

FIRST USE 7-31-2003; IN COMMERCE 7-31-2003.

JENNY PARK, EXAMINING ATTORNEY

**CLASS 30—(Continued).**

SN 85-173,563. KELLOGG NORTH AMERICA COMPANY, BATTLE CREEK, MI. FILED 11-10-2010.

# CHOCO ZUCARITAS

THE MARK CONSISTS OF STANDARD CHARACTERS WITHOUT CLAIM TO ANY PARTICULAR FONT, STYLE, SIZE, OR COLOR.

THE TERM "ZUCARITAS", IS A COINED TERM THAT HAS NO LITERAL ENGLISH TRANSLATION.

FOR PROCESSED CEREAL-BASED FOOD TO BE USED AS A BREAKFAST FOOD, SNACK FOOD OR INGREDIENT FOR MAKING OTHER FOODS (U.S. CL. 46).

BARBARA A. GOLD, EXAMINING ATTORNEY

SN 85-173,571. KELLOGG NORTH AMERICA COMPANY, BATTLE CREEK, MI. FILED 11-10-2010.

# ZUCARITAS

THE MARK CONSISTS OF STANDARD CHARACTERS WITHOUT CLAIM TO ANY PARTICULAR FONT, STYLE, SIZE, OR COLOR.

THE TERM "ZUCARITAS", IS A COINED TERM THAT HAS NO LITERAL ENGLISH TRANSLATION.

FOR PROCESSED CEREAL-BASED FOOD TO BE USED AS A BREAKFAST FOOD, SNACK FOOD OR INGREDIENT FOR MAKING OTHER FOODS (U.S. CL. 46).

BARBARA A. GOLD, EXAMINING ATTORNEY

SN 85-173,858. HERSHEY CHOCOLATE & CONFECTIONERY CORPORATION, WHEAT RIDGE, CO. FILED 11-10-2010.



OWNER OF U.S. REG. NOS. 1,074,163, 3,601,728 AND OTHERS.

NO CLAIM IS MADE TO THE EXCLUSIVE RIGHT TO USE "PEANUT BUTTER CUPS", "MILK CHOCOLATE", "ACTUAL SIZE", "CONVENIENTLY UNWRAPPED MINI CUPS" AND THE REPRESENTATION OF THE CANDY, APART FROM THE MARK AS SHOWN.

THE COLOR(S) ORANGE, YELLOW, WHITE, BROWN AND LIGHT BROWN IS/ARE CLAIMED AS A FEATURE OF THE MARK.

THE MARK CONSISTS OF THE WORDING "MILK CHOCOLATE" IN BROWN APPEARING ABOVE THE WORDING "REESE'S" IN YELLOW OUTLINED IN THE COLOR BROWN, BELOW THE WORDING "REESE'S" IS THE WORDING "PEANUT BUTTER CUPS" IN YELLOW OUTLINED IN THE COLOR BROWN AND APPEARING

**CLASS 30—(Continued).**

INSIDE A BROWN RECTANGULAR DESIGN WITH WEDGES, THE WORDING "MINIS" IN THE COLOR WHITE OUTLINED IN THE COLOR BROWN; A STYLIZED DESIGN LOGO OF A PARTIAL ELONGATED SIDE OF A CUP LIKE SHAPED BROWN CANDY WITH THE BROWN WORDING "ACTUAL SIZE!" APPEARING ABOVE THE CANDY ON THE LEFT AND A PARTIALLY BITTEN CHOCOLATE COVERED CANDY WITH THE LIGHT BROWN FILLING TO THE RIGHT, THE BROWN WORDING "CONVENIENTLY UNWRAPPED MINI CUPS" APPEARING BELOW THE WORDING "MINIS," AND THE ENTIRE MARK APPEARS ON AN ORANGE BACKGROUND. THE MATTER SHOWN IN DOTTED LINES SHOWS POSITIONING OF THE MARK AND IS NOT PART OF THE MARK.

FOR CANDY (U.S. CL. 46).

FIRST USE 3-31-2010; IN COMMERCE 3-31-2010.

JENNY PARK, EXAMINING ATTORNEY

**CLASS 30—(Continued).**

SN 85-177,164. HERSHEY CHOCOLATE & CONFECTIONERY CORPORATION, WHEAT RIDGE, CO. FILED 11-15-2010.



OWNER OF U.S. REG. NOS. 2,256,226 AND 3,492,642.

THE COLOR(S) ORANGE AND BROWN IS/ARE CLAIMED AS A FEATURE OF THE MARK.

THE MARK CONSISTS OF SIX BROWN SEMI CIRCLES WITH ZIG ZAG BORDERS APPEARING ON AN ORANGE BACKGROUND. THE MATTER SHOWN IN DOTTED LINES SHOWS POSITIONING OF THE MARK AND IS NOT PART OF THE MARK.

FOR CANDY (U.S. CL. 46).

FIRST USE 1-31-2010; IN COMMERCE 1-31-2010.

JENNY PARK, EXAMINING ATTORNEY

SN 85-174,045. HERSHEY CHOCOLATE & CONFECTIONERY CORPORATION, WHEAT RIDGE, CO. FILED 11-10-2010.



OWNER OF U.S. REG. NOS. 1,074,163, 3,601,728 AND OTHERS.

NO CLAIM IS MADE TO THE EXCLUSIVE RIGHT TO USE "MILK CHOCOLATE", "FILLED WITH", "PEANUT BUTTER" AND THE REPRESENTATION OF THE CANDY, APART FROM THE MARK AS SHOWN.

THE COLOR(S) ORANGE, YELLOW, BROWN, WHITE, BLUE, AND LIGHT BROWN IS/ARE CLAIMED AS A FEATURE OF THE MARK.

THE MARK CONSISTS OF THE WORDING "MILK CHOCOLATE" IN BROWN APPEARING ABOVE THE WORDING "REESE'S" IN YELLOW OUTLINED IN THE COLOR BROWN, BELOW THE WORDING "REESE'S" IS THE WORDING "FILLED WITH REESE'S PEANUT BUTTER" IN WHITE ON A BLUE BANNER, THE IMAGE OF A PARTIALLY BITTEN CHOCOLATE PIECE WITH THE IMPRINTED WORDING "REESE'S" IN BROWN AND THE FILLING OF THE CANDY IN LIGHT BROWN, AND THE ENTIRE MARK APPEARS ON AN ORANGE BACKGROUND. THE MATTER SHOWN IN DOTTED LINES SHOWS POSITIONING OF THE MARK AND IS NOT PART OF THE MARK.

FOR CANDY (U.S. CL. 46).

FIRST USE 4-30-2008; IN COMMERCE 4-30-2008.

JENNY PARK, EXAMINING ATTORNEY

SN 85-178,483. WHOLESOME FOOD SOLUTIONS LLC, GLENDALE, CA. FILED 11-16-2010.

**ZEN MONKEY**

THE MARK CONSISTS OF STANDARD CHARACTERS WITHOUT CLAIM TO ANY PARTICULAR FONT, STYLE, SIZE, OR COLOR.

FOR READY-TO-EAT CEREAL BASED MEAL CONTAINING OATS, YOGURT AND/OR FRUITS (U.S. CL. 46).

ANTHONY RINKER, EXAMINING ATTORNEY

SN 85-179,832. LAND OF THOUSAND HILLS COFFEE COMPANY, INC., ROSWELL, GA. FILED 11-18-2010.

**Land of a Thousand Hills**

THE MARK CONSISTS OF STANDARD CHARACTERS WITHOUT CLAIM TO ANY PARTICULAR FONT, STYLE, SIZE, OR COLOR.

FOR BEVERAGES MADE OF COFFEE; COFFEE; COFFEE; COFFEE BASED BEVERAGES; COFFEE BEANS; GROUND COFFEE BEANS (U.S. CL. 46).

FIRST USE 12-1-2005; IN COMMERCE 12-1-2005.

TEJBIR SINGH, EXAMINING ATTORNEY

**CLASS 30—(Continued).**

SN 85-179,944. PRODUCTOS DAMEL, S.L., CREVILLENTE (ALICANTE), SPAIN, FILED 11-18-2010.

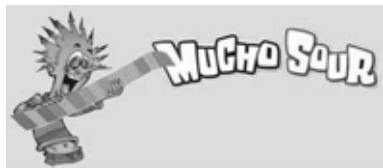

NO CLAIM IS MADE TO THE EXCLUSIVE RIGHT TO USE "SOUR", APART FROM THE MARK AS SHOWN.

THE MARK CONSISTS OF THE WORDING "MUCHO SOUR" WITH THE DESIGN OF A PERSON TO THE LEFT OF THE WORDING HOLDING A PIECE OF CANDY.

THE ENGLISH TRANSLATION OF THE WORD "MUCHO" IN THE MARK IS "MUCH".

FOR CONFECTIONERY MADE OF SUGAR; CANDY; CHEWING GUM; LICORICE; AND EDIBLE ICE (U.S. CL. 46).

FIRST USE 5-0-2010; IN COMMERCE 5-0-2010.  
AISHA SALEM, EXAMINING ATTORNEY

---

SN 85-180,175. THE TOPPS COMPANY, INC., NEW YORK, NY. FILED 11-18-2010.

**SWEET TWEETS**

THE MARK CONSISTS OF STANDARD CHARACTERS WITHOUT CLAIM TO ANY PARTICULAR FONT, STYLE, SIZE, OR COLOR.

FOR CANDY SOLD AFFIXED TO NOTE CARDS USED TO WRITE PERSONAL MESSAGES (U.S. CL. 46).

ANGELA M. MICHELI, EXAMINING ATTORNEY

---

SN 85-180,422. LAND OF THOUSAND HILLS COFFEE COMPANY, INC., ROSWELL, GA. FILED 11-18-2010.

**Drink Coffee. Do Good.**

THE MARK CONSISTS OF STANDARD CHARACTERS WITHOUT CLAIM TO ANY PARTICULAR FONT, STYLE, SIZE, OR COLOR.

FOR BEVERAGES MADE OF COFFEE; COFFEE; COFFEE; COFFEE BASED BEVERAGES; COFFEE BEANS; GROUND COFFEE BEANS (U.S. CL. 46).

FIRST USE 3-1-2005; IN COMMERCE 3-1-2005.  
TEJBIR SINGH, EXAMINING ATTORNEY

**CLASS 30—(Continued).**

SN 85-181,507. SKYCREPERS LLC, BELLINGHAM, MA. FILED 11-19-2010.

**CINNILLA**

THE MARK CONSISTS OF STANDARD CHARACTERS WITHOUT CLAIM TO ANY PARTICULAR FONT, STYLE, SIZE, OR COLOR.

FOR CREPES, PANCAKES; FRIED CREPE STRIPS; FRIED DOUGH; CONFECTIONERIES, NAMELY, SNACK FOODS, NAMELY, CHOCOLATE; SNACK FOODS, NAMELY, CHOCOLATE-BASED SNACK FOODS; BAKERY GOODS AND DESSERT ITEMS (U.S. CL. 46).

LOURDES AYALA, EXAMINING ATTORNEY

---

SN 85-188,966. CADBURY UK LIMITED, BIRMINGHAM, UNITED KINGDOM, FILED 12-2-2010.

**ROYAL DARK**

THE MARK CONSISTS OF STANDARD CHARACTERS WITHOUT CLAIM TO ANY PARTICULAR FONT, STYLE, SIZE, OR COLOR.

NO CLAIM IS MADE TO THE EXCLUSIVE RIGHT TO USE "DARK", APART FROM THE MARK AS SHOWN.

FOR CHOCOLATE (U.S. CL. 46).

FIRST USE 12-31-2003; IN COMMERCE 12-31-2003.

PAUL MORENO, EXAMINING ATTORNEY

---

SN 85-188,975. LY BROTHERS CORPORATION, DBA SUGAR BOWL BAKERY, HAYWARD, CA. FILED 12-2-2010.

**OLD FASHIONED GEMS**

THE MARK CONSISTS OF STANDARD CHARACTERS WITHOUT CLAIM TO ANY PARTICULAR FONT, STYLE, SIZE, OR COLOR.

NO CLAIM IS MADE TO THE EXCLUSIVE RIGHT TO USE "OLD FASHIONED", APART FROM THE MARK AS SHOWN.

FOR BAKERY GOODS (U.S. CL. 46).

FIRST USE 10-15-2010; IN COMMERCE 10-15-2010.

KATHLEEN LORENZO, EXAMINING ATTORNEY



**CLASS 30—(Continued).**

SN 85-203,009. KELLOGG NORTH AMERICA COMPANY, BATTLE CREEK, MI. FILED 12-21-2010.

NUTRI-GRAIN FRUIT FUSION

THE MARK CONSISTS OF STANDARD CHARACTERS WITHOUT CLAIM TO ANY PARTICULAR FONT, STYLE, SIZE, OR COLOR.

OWNER OF U.S. REG. NOS. 1,255,456, 3,389,446 AND OTHERS.

NO CLAIM IS MADE TO THE EXCLUSIVE RIGHT TO USE "FRUIT", APART FROM THE MARK AS SHOWN.

FOR GRAIN-BASED SNACK FOOD BAR; GRAIN-BASED SNACK FOOD BAR ALSO CONTAINING FRUIT; CEREAL-BASED SNACK FOOD BAR (U.S. CL. 46).

BARBARA A. GOLD, EXAMINING ATTORNEY

**CLASS 30—(Continued).**

SN 85-216,861. IMERMAN CAKE COMPANY LLC, BLOOMFIELD HILLS, MI. FILED 1-13-2011.



NO CLAIM IS MADE TO THE EXCLUSIVE RIGHT TO USE "CAKE COMPANY", APART FROM THE MARK AS SHOWN.

THE MARK CONSISTS OF THE TERMS "IMERMAN CAKE COMPANY" IN A CIRCLE WITH THE TERM "IMERMAN" AT THE TOP OF THE CIRCLE, THE TERM "CAKE" IN THE MIDDLE UNDER THE TERM "IMERMAN" AND THE TERM "COMPANY" AT THE BOTTOM OF THE CIRCLE UNDER THE TERM "CAKE".

FOR CAKES (U.S. CL. 46).

ALICE BENMAMAN, EXAMINING ATTORNEY

SN 85-217,021. LUIS FERNANDO ANDRADE, DOWNEY, CA. FILED S.R. 1-13-2011; AM. P.R. 7-6-2011.

Actígabe

THE MARK CONSISTS OF STANDARD CHARACTERS WITHOUT CLAIM TO ANY PARTICULAR FONT, STYLE, SIZE, OR COLOR.

FOR NATURAL SWEETENER MADE FROM BLUE WEBER AGAVE NECTAR; NATURAL FRUCTAN INULIN POWDER MADE FROM BLUE WEBER AGAVE FOR USE AS A FOOD STARCH (U.S. CL. 46).

MICHAEL SOUDERS, EXAMINING ATTORNEY

SN 85-212,315. YANABAH TEA, LLC, MESA, AZ. FILED 1-6-2011.

YANABAH

THE MARK CONSISTS OF STANDARD CHARACTERS WITHOUT CLAIM TO ANY PARTICULAR FONT, STYLE, SIZE, OR COLOR.

THE NAME(S), PORTRAIT(S), AND/OR SIGNATURE(S) SHOWN IN THE MARK DOES NOT IDENTIFY A PARTICULAR LIVING INDIVIDUAL.

FOR HERBAL TEA; TEA (U.S. CL. 46).

FIRST USE 12-1-2007; IN COMMERCE 12-1-2007.

ODESSA BIBBINS, EXAMINING ATTORNEY

SN 85-220,830. HORMEL FOODS, LLC, AUSTIN, MN. FILED 1-19-2011.

ENERGY WRAPS

THE MARK CONSISTS OF STANDARD CHARACTERS WITHOUT CLAIM TO ANY PARTICULAR FONT, STYLE, SIZE, OR COLOR.

NO CLAIM IS MADE TO THE EXCLUSIVE RIGHT TO USE "WRAPS", APART FROM THE MARK AS SHOWN.

FOR SANDWICHES MADE OF MEAT, POULTRY AND/OR CHEESE (U.S. CL. 46).

HENRY S. ZAK, EXAMINING ATTORNEY

**CLASS 30—(Continued).**

SN 85-225,757. BUNGE OILS, INC., ST. LOUIS, MO. FILED 1-25-2011.



OWNER OF U.S. REG. NOS. 2,374,882, 2,426,989 AND 3,834,087.

NO CLAIM IS MADE TO THE EXCLUSIVE RIGHT TO USE "GARLIC" AND THE PICTORIAL REPRESENTATION OF GARLIC, APART FROM THE MARK AS SHOWN.

THE MARK CONSISTS OF A REPRESENTATION OF A GLOBE OF THE WORLD SHOWING THE EASTERN HEMISPHERE AND WITH A BANNER LOCATED ABOVE THE GLOBE CONTAINING THE WORDS "OLD WORLD" AND A BANNER ACROSS THE BOTTOM OF THE GLOBE CONTAINING THE WORD "GARLIC". LOCATED ON EACH SIDE OF THE BOTTOM BANNER ARE TWO GARLIC CLOVES.

FOR PROCESSED GARLIC FOR USE AS SEASONING; MINCED GARLIC, REHYDRATED GARLIC; POWDERED GARLIC (U.S. CL. 46).

KATHLEEN LORENZO, EXAMINING ATTORNEY

**CLASS 30—(Continued).**

SN 85-246,351. NAEGELIN'S BAKERY, INC., NEW BRAUNFELS, TX. FILED 2-18-2011.

**NAEGELIN'S BAKERY**

THE MARK CONSISTS OF STANDARD CHARACTERS WITHOUT CLAIM TO ANY PARTICULAR FONT, STYLE, SIZE, OR COLOR.

NO CLAIM IS MADE TO THE EXCLUSIVE RIGHT TO USE "BAKERY", APART FROM THE MARK AS SHOWN.

SEC. 2(F).  
FOR BAKED GOODS, NAMELY, COOKIES, CAKES, STRUDEL, MUFFINS, CUPCAKES, AND PIES (U.S. CL. 46).

FIRST USE 12-31-1868; IN COMMERCE 12-31-1868.

KELLY BOULTON, EXAMINING ATTORNEY

SN 85-257,714. LEAF BRANDS, LLC, IRVINE, CA. FILED 3-4-2011.

SN 85-237,665. FIGUEROA, MELVIN, NEW YORK, NY. FILED 2-9-2011.

**IMPERIAL YUCATAN HONEY**

THE MARK CONSISTS OF STANDARD CHARACTERS WITHOUT CLAIM TO ANY PARTICULAR FONT, STYLE, SIZE, OR COLOR.

NO CLAIM IS MADE TO THE EXCLUSIVE RIGHT TO USE "HONEY", APART FROM THE MARK AS SHOWN.

FOR HONEY (U.S. CL. 46).  
KEVON CHISOLM, EXAMINING ATTORNEY



THE COLOR(S) GREEN AND WHITE IS/ARE CLAIMED AS A FEATURE OF THE MARK.

THE MARK CONSISTS OF CONCENTRIC RECTANGLE IN GREEN COLOR WITH WHITE COLOR OUTLINE AND THE WORDS "LEAF" IS WRITTEN IN THE CENTER IN WHITE COLOR. THERE IS AN IMAGE OF LEAF IN THE SPACE PROVIDED BETWEEN THE LETTER "L" AND "E" AS SHOWN IN THE MARK.

FOR STAPLE FOODS, NAMELY, CANDY, POPCORN AND CHEWING GUM (U.S. CL. 46).

JOHN WILKE, EXAMINING ATTORNEY

**CLASS 30—(Continued).**

SN 85-258,123. FERMENTACIONES MEXICANAS, S.A. DE C.V., TOLUCA, ESTADO DE MEX., MEXICO, FILED 3-4-2011.



OWNER OF MEXICO REG. NO. 1113225, DATED 7-31-2009, EXPIRES 6-10-2019.

OWNER OF U.S. REG. NO. 2,923,766.

THE COLOR(S) BLUE AND GREEN IS/ARE CLAIMED AS A FEATURE OF THE MARK.

THE MARK CONSISTS OF THE WORD "AZTECA" IN GREEN BELOW A STYLIZED BLUE STAR FEATURING A GREEN SPIRAL DESIGN INSIDE THE STAR. A BLUE FLOWER APPEARS IN THE LEFT UPPER CORNER OF THE MARK AND A GREEN CIRCLE APPEARS TO THE CENTER RIGHT OF THE STYLIZED STAR.

THE ENGLISH TRANSLATION OF "AZTECA" IN THE MARK IS "AZTEC".

FOR YEAST (U.S. CL. 46).

DANNEAN HETZEL, EXAMINING ATTORNEY

SN 85-259,012. KALICK, MARK, NEWPORT, KY. FILED 3-5-2011.

## GayScout Cookies

THE MARK CONSISTS OF STANDARD CHARACTERS WITHOUT CLAIM TO ANY PARTICULAR FONT, STYLE, SIZE, OR COLOR.

NO CLAIM IS MADE TO THE EXCLUSIVE RIGHT TO USE "COOKIES", APART FROM THE MARK AS SHOWN.

FOR COOKIES (U.S. CL. 46).

JOHN DALIER, EXAMINING ATTORNEY

SN 85-266,594. DYNAMIC CHOCOLATES, ULC, DELTA, BC, CANADA, FILED 3-14-2011.

## COCOA THERAPY

THE MARK CONSISTS OF STANDARD CHARACTERS WITHOUT CLAIM TO ANY PARTICULAR FONT, STYLE, SIZE, OR COLOR.

NO CLAIM IS MADE TO THE EXCLUSIVE RIGHT TO USE "COCOA", APART FROM THE MARK AS SHOWN.

FOR CHOCOLATE AND CHOCOLATES (U.S. CL. 46).

KAPIL BHANOT, EXAMINING ATTORNEY

**CLASS 30—(Continued).**

SN 85-275,764. PIAST MEATS & PROVISIONS, INC., GARFIELD, NJ. FILED 3-24-2011.

## PIEROGI IN A BOX

THE MARK CONSISTS OF STANDARD CHARACTERS WITHOUT CLAIM TO ANY PARTICULAR FONT, STYLE, SIZE, OR COLOR.

NO CLAIM IS MADE TO THE EXCLUSIVE RIGHT TO USE "PIEROGI", APART FROM THE MARK AS SHOWN.

SEC. 2(F).

FOR KITS COMPRISING INGREDIENTS FOR MAKING PIEORGI (U.S. CL. 46).

FIRST USE 12-31-1991; IN COMMERCE 12-31-1991.

DAWN HAN, EXAMINING ATTORNEY

SN 85-280,491. WAGNER TORRES, JULIAN MARCELO, NUEVO LEON, MEXICO, FILED 3-29-2011.

## SALVATIERRA

THE MARK CONSISTS OF STANDARD CHARACTERS WITHOUT CLAIM TO ANY PARTICULAR FONT, STYLE, SIZE, OR COLOR.

FOR COFFEE, SUGAR, ROASTED COFFEE BEANS, AND GREEN COFFEE (U.S. CL. 46).

HAI-LY LAM, EXAMINING ATTORNEY

SN 85-282,194. LOWE, ASHLEY A., CHICAGO, IL. FILED 3-31-2011.

## THE NAKED BAKER

THE MARK CONSISTS OF STANDARD CHARACTERS WITHOUT CLAIM TO ANY PARTICULAR FONT, STYLE, SIZE, OR COLOR.

NO CLAIM IS MADE TO THE EXCLUSIVE RIGHT TO USE "BAKER", APART FROM THE MARK AS SHOWN.

FOR BAKERY GOODS; BROWNIES; COOKIES (U.S. CL. 46).

ASMAT KHAN, EXAMINING ATTORNEY

**CLASS 30—(Continued).**

SN 85-284,772. KONA RISING COFFEE COMPANY, KEA-LAKEKUA, HI. FILED 4-3-2011.

**Kona Rising Coffee Company**

THE MARK CONSISTS OF STANDARD CHARACTERS WITHOUT CLAIM TO ANY PARTICULAR FONT, STYLE, SIZE, OR COLOR.

NO CLAIM IS MADE TO THE EXCLUSIVE RIGHT TO USE "KONA" AND "COFFEE COMPANY", APART FROM THE MARK AS SHOWN.

FOR COFFEE; COFFEE BEANS; GROUND COFFEE BEANS; ROASTED COFFEE BEANS (U.S. CL. 46).

FIRST USE 11-4-2010; IN COMMERCE 11-24-2010.  
SCOTT BIBB, EXAMINING ATTORNEY

SN 85-285,418. SNIKIDDY, LLC, BOULDER, CO. FILED 4-4-2011.



THE COLOR(S) RED, MAROON, WHITE, BLACK, ORANGE, DARK ORANGE, AND YELLOW IS/ARE CLAIMED AS A FEATURE OF THE MARK.

THE MARK CONSISTS OF THE WORD "SNIKIDDY", IN WHITE AND OUTLINED IN RED, SUPERIMPOSED OVER A SWIRL DESIGN IN THE COLORS ORANGE, YELLOW, DARK ORANGE, AND BLACK.

FOR CORN-BASED SNACK FOODS; GRAIN-BASED SNACK FOODS (U.S. CL. 46).

FIRST USE 3-0-2009; IN COMMERCE 3-0-2009.  
PAULA MAHONEY, EXAMINING ATTORNEY

SN 85-288,018. BRIDGE BRANDS, SAN FRANCISCO, CA. FILED 4-6-2011.

**GOT DARK? CHOCOLATE**

THE MARK CONSISTS OF STANDARD CHARACTERS WITHOUT CLAIM TO ANY PARTICULAR FONT, STYLE, SIZE, OR COLOR.

NO CLAIM IS MADE TO THE EXCLUSIVE RIGHT TO USE "DARK" AND "CHOCOLATE", APART FROM THE MARK AS SHOWN.

FOR CHOCOLATE (U.S. CL. 46).  
REBECCA SMITH, EXAMINING ATTORNEY

**CLASS 30—(Continued).**

SN 85-289,043. BENISH'S BAKERY, LLC, KANSAS CITY, MO. FILED 4-7-2011.

**Bob's Biscotti**

THE MARK CONSISTS OF STANDARD CHARACTERS WITHOUT CLAIM TO ANY PARTICULAR FONT, STYLE, SIZE, OR COLOR.

NO CLAIM IS MADE TO THE EXCLUSIVE RIGHT TO USE "BISCOTTI", APART FROM THE MARK AS SHOWN.

FOR BAKERY DESSERTS; BAKERY GOODS; BAKERY GOODS, NAMELY, BISCOTTI; BAKERY PRODUCTS; BAKERY PRODUCTS, NAMELY, SWEET BAKERY GOODS (U.S. CL. 46).

FIRST USE 12-21-2007; IN COMMERCE 12-21-2007.  
DAWN HAN, EXAMINING ATTORNEY

SN 85-290,206. MEDICAL DIAGNOSTIC LABORATORIES LLC, HAMILTON, NJ. FILED 4-8-2011.

**SEXUALLY TRANSMITTED  
COOKIES**

THE MARK CONSISTS OF STANDARD CHARACTERS WITHOUT CLAIM TO ANY PARTICULAR FONT, STYLE, SIZE, OR COLOR.

NO CLAIM IS MADE TO THE EXCLUSIVE RIGHT TO USE "COOKIES", APART FROM THE MARK AS SHOWN.

FOR COOKIES (U.S. CL. 46).  
JACQUELINE A. LAVINE, EXAMINING ATTORNEY

SN 85-303,748. ESY'S SASSY SAUCE, INC., TROY, MI. FILED 4-25-2011.

**ESY'S SASSY SAUCE**

THE MARK CONSISTS OF STANDARD CHARACTERS WITHOUT CLAIM TO ANY PARTICULAR FONT, STYLE, SIZE, OR COLOR.

NO CLAIM IS MADE TO THE EXCLUSIVE RIGHT TO USE "SAUCE", APART FROM THE MARK AS SHOWN.

FOR SAUCE FOR MARINATING, TENDERIZING, SEASONING AND ENHANCING THE FLAVOR OF FOOD (U.S. CL. 46).

FIRST USE 7-25-2008; IN COMMERCE 9-29-2008.  
LIEF MARTIN, EXAMINING ATTORNEY

**CLASS 30—(Continued).**

SN 85-303,843. CHECKERS DRIVE-IN RESTAURANTS, INC., TAMPA, FL. FILED 4-25-2011.

# AUSSIE

THE MARK CONSISTS OF STANDARD CHARACTERS WITHOUT CLAIM TO ANY PARTICULAR FONT, STYLE, SIZE, OR COLOR.

FOR HAMBURGER SANDWICHES FOR CONSUMPTION ON OR OFF THE PREMISES (U.S. CL. 46).  
TRACY CROSS, EXAMINING ATTORNEY

**CLASS 30—(Continued).**

SN 85-308,806. RAINDANCER COFFEE, LLC, PORTLAND, OR. FILED 4-29-2011.

# RAINDANCER COFFEE

THE MARK CONSISTS OF STANDARD CHARACTERS WITHOUT CLAIM TO ANY PARTICULAR FONT, STYLE, SIZE, OR COLOR.

NO CLAIM IS MADE TO THE EXCLUSIVE RIGHT TO USE "COFFEE", APART FROM THE MARK AS SHOWN.  
FOR COFFEE (U.S. CL. 46).  
FIRST USE 3-1-2011; IN COMMERCE 3-1-2011.  
MICHAEL TANNER, EXAMINING ATTORNEY

SN 85-305,237. KIKKOMAN CORPORATION, NODA CITY, CHIBA, JAPAN, FILED 4-26-2011.



THE MARK CONSISTS OF TWO JAPANESE KANJI CHARACTERS SET AGAINST A LIGHTLY DARKENED SQUARE.

THE ENGLISH TRANSLATION OF "SEISHO" IN THE MARK IS "GREEN PINE".

THE NON-LATIN CHARACTERS IN THE MARK TRANSLITERATE TO SEISHO AND THIS MEANS GREEN PINE IN ENGLISH.

FOR RICE FLAVORED GRAIN VINEGAR FOR USE IN CONNECTION WITH SUSHI, DRESSING TYPE SEASONING, SOUP, AND MARINADE (U.S. CL. 46).

B. PARADEWELAI, EXAMINING ATTORNEY

SN 85-309,188. SPENCER & FLEETWOOD LIMITED, SURREY, UNITED KINGDOM, FILED 4-30-2011.

SN 85-305,705. LITTLE BRITTLE CANDY COMPANY, LLC, CANTON, OH. FILED 4-27-2011.

# LITTLE BRITTLE CANDY COMPANY

THE MARK CONSISTS OF STANDARD CHARACTERS WITHOUT CLAIM TO ANY PARTICULAR FONT, STYLE, SIZE, OR COLOR.

NO CLAIM IS MADE TO THE EXCLUSIVE RIGHT TO USE "BRITTLE CANDY COMPANY", APART FROM THE MARK AS SHOWN.

FOR CANDY (U.S. CL. 46).

BRIAN CALLAGHAN, EXAMINING ATTORNEY

THE MARK CONSISTS OF THE WORDS "KISS WITH CONFIDENCE" IN STYLIZED LETTERS.

FOR PEPPERMINT SWEETS (U.S. CL. 46).

FIRST USE 11-19-2008; IN COMMERCE 11-19-2008.

SUE LAWRENCE, EXAMINING ATTORNEY

**CLASS 30—(Continued).**

SN 85-309,685. FAUSTINOS, GABRIEL, INGLEWOOD, CA. FILED 5-2-2011.



NO CLAIM IS MADE TO THE EXCLUSIVE RIGHT TO USE "CHILE FAMILIAR", APART FROM THE MARK AS SHOWN.

THE MARK CONSISTS OF A DESIGN OF A FLAG POLE WITH FLAG OVER AND TO THE LEFT OF THE STYLIZED TEXT "FELICITA CHILE FAMILIAR" WITH THE TERM "CHILE FAMILIAR" OVER THE "CITA" IN "FELICITA", AN UNDERLINE UNDER THE TERM "FELICITA", ALL ENCLOSED IN A RECTANGLE.

THE ENGLISH TRANSLATION OF "CHILE FAMILIAR" IN THE MARK IS "FAMILY CHILI".

FOR SALSA; SAUCES (U.S. CL. 46).  
TARA PATE, EXAMINING ATTORNEY

SN 85-309,788. SWAIN CREATIONS, INC., DBA JER'S CHOCOLATES, SOLANA BEACH, CA. FILED 5-2-2011.

**JER'S SQUARES**

THE MARK CONSISTS OF STANDARD CHARACTERS WITHOUT CLAIM TO ANY PARTICULAR FONT, STYLE, SIZE, OR COLOR.

FOR CANDY (U.S. CL. 46).  
MATTHEW PAPPAS, EXAMINING ATTORNEY

SN 85-309,866. PATRICIA MERSCHDORF, KAILUA KONA, HI. FILED 5-2-2011.

**MONGOOSE BALLS**

THE MARK CONSISTS OF STANDARD CHARACTERS WITHOUT CLAIM TO ANY PARTICULAR FONT, STYLE, SIZE, OR COLOR.

FOR CHOCOLATE COVERED ROASTED COFFEE BEANS (U.S. CL. 46).  
EDWARD NELSON, EXAMINING ATTORNEY

**CLASS 30—(Continued).**

SN 85-310,734. POST FOODS, LLC, ST. LOUIS, MO. FILED 5-3-2011.

**POST NATURAL ADVANTAGE**

THE MARK CONSISTS OF STANDARD CHARACTERS WITHOUT CLAIM TO ANY PARTICULAR FONT, STYLE, SIZE, OR COLOR.

OWNER OF U.S. REG. NOS. 655,328, 3,959,714 AND OTHERS.

NO CLAIM IS MADE TO THE EXCLUSIVE RIGHT TO USE "NATURAL", APART FROM THE MARK AS SHOWN.

FOR BREAKFAST CEREALS MADE IN WHOLE OR SUBSTANTIAL PART OF NATURAL INGREDIENTS (U.S. CL. 46).

FIRST USE 1-1-2010; IN COMMERCE 1-1-2010.  
JULIE WATSON, EXAMINING ATTORNEY

SN 85-311,537. WAH FONG TEA COMPANY LIMITED, HONG KONG, HONG KONG, FILED 5-3-2011.



PRIORITY CLAIMED UNDER SEC. 44(D) ON HONG KONG APPLICATION NO. 301808901, FILED 1-12-2011, REG. NO. 301808901, DATED 1-12-2011, EXPIRES 1-11-2021.

THE MARK CONSISTS OF STYLIZED LETTERS "C" AND "T".

FOR TEA; TEA BAGS (U.S. CL. 46).  
ANGELA DUONG, EXAMINING ATTORNEY

SN 85-311,543. WAH FONG TEA COMPANY LIMITED, HONG KONG, HONG KONG, FILED 5-3-2011.

**CAMELLIA TREASURES**

THE MARK CONSISTS OF STANDARD CHARACTERS WITHOUT CLAIM TO ANY PARTICULAR FONT, STYLE, SIZE, OR COLOR.

PRIORITY CLAIMED UNDER SEC. 44(D) ON HONG KONG APPLICATION NO. 301808910, FILED 1-12-2011, REG. NO. 301808910, DATED 1-12-2011, EXPIRES 1-11-2021.

NO CLAIM IS MADE TO THE EXCLUSIVE RIGHT TO USE "CAMELLIA", APART FROM THE MARK AS SHOWN.

FOR TEA; TEA BAGS (U.S. CL. 46).  
ANGELA DUONG, EXAMINING ATTORNEY

**CLASS 30—(Continued).**

SN 85-315,250. CORNER DELI MANAGEMENT LLC, NEW YORK, NY. FILED 5-8-2011.



THE MARK CONSISTS OF THE WORDS "LA ESQUINA" ALONGSIDE A MASK OR STATUE'S FACE. THE ENGLISH TRANSLATION OF "LA ESQUINA" IN THE MARK IS "THE CORNER".  
FOR SALSA (U.S. CL. 46).  
FIRST USE 4-30-2011; IN COMMERCE 4-30-2011.  
HEATHER THOMPSON, EXAMINING ATTORNEY

SN 85-315,345. ADVANCEPIERRE FOODS, INC., CINCINNATI, OH. FILED 5-9-2011.

**BUTCHER BLOCK DELI**

THE MARK CONSISTS OF STANDARD CHARACTERS WITHOUT CLAIM TO ANY PARTICULAR FONT, STYLE, SIZE, OR COLOR.  
NO CLAIM IS MADE TO THE EXCLUSIVE RIGHT TO USE "DELI", APART FROM THE MARK AS SHOWN.  
FOR SANDWICHES. NOT FOR SALE IN THE FOOD SERVICES CHANNELS OF TRADE (U.S. CL. 46).  
FIRST USE 11-0-2008; IN COMMERCE 11-0-2008.  
CIMMERIAN COLEMAN, EXAMINING ATTORNEY

SN 85-316,203. FROSTING CUPCAKES LLC, SPOKANE, WA. FILED 5-9-2011.



NO CLAIM IS MADE TO THE EXCLUSIVE RIGHT TO USE "SWEET FROSTINGS", APART FROM THE MARK AS SHOWN.  
THE MARK CONSISTS OF A STYLIZED BORDER AROUND THE STYLIZED TEXT "SWEET FROSTINGS."  
FOR BAKERY GOODS (U.S. CL. 46).  
KATHERINE M. DUBRAY, EXAMINING ATTORNEY

**CLASS 30—(Continued).**

SN 85-316,778. ZEUS SPICE COMPANY, DAYTON, OH. FILED 5-10-2011.

**Zeus Spice**

THE MARK CONSISTS OF STANDARD CHARACTERS WITHOUT CLAIM TO ANY PARTICULAR FONT, STYLE, SIZE, OR COLOR.  
NO CLAIM IS MADE TO THE EXCLUSIVE RIGHT TO USE "SPICE", APART FROM THE MARK AS SHOWN.  
FOR SPICE BLENDS (U.S. CL. 46).  
MARIA-VICTORIA SUAREZ, EXAMINING ATTORNEY

SN 85-316,864. VITAMIZER ICE CO., GLADWYNE, PA. FILED 5-10-2011.

**Vita ice**

THE MARK CONSISTS OF STANDARD CHARACTERS WITHOUT CLAIM TO ANY PARTICULAR FONT, STYLE, SIZE, OR COLOR.  
NO CLAIM IS MADE TO THE EXCLUSIVE RIGHT TO USE "ICE", APART FROM THE MARK AS SHOWN.  
FOR FROZEN VITAMIN-ENHANCED NOVELTY SNACKS, NAMELY, EDIBLE ICES (U.S. CL. 46).  
KEVIN CORWIN, EXAMINING ATTORNEY

SN 85-316,967. CELESTIAL SEASONINGS, INC., BOULDER, CO. FILED 5-10-2011.

**ZINGER ICE**

THE MARK CONSISTS OF STANDARD CHARACTERS WITHOUT CLAIM TO ANY PARTICULAR FONT, STYLE, SIZE, OR COLOR.  
OWNER OF U.S. REG. NOS. 1,390,142, 3,231,654 AND OTHERS.  
NO CLAIM IS MADE TO THE EXCLUSIVE RIGHT TO USE "ICE", APART FROM THE MARK AS SHOWN.  
FOR TEAS (U.S. CL. 46).  
FIRST USE 1-0-2010; IN COMMERCE 1-0-2010.  
PAUL E. FAHRENKOPF, EXAMINING ATTORNEY

**CLASS 30—(Continued).**

SN 85-318,499. MONTAÑA DEL ARCO IRIS, S.A., SAN JOSE, COSTA RICA, FILED 5-11-2011.

MONDAISA



THE COLOR(S) BLUE, DARK BLUE, YELLOW, ORANGE, GREEN, RED, WHITE, AND BLACK IS/ARE CLAIMED AS A FEATURE OF THE MARK.

THE MARK CONSISTS OF A CIRCLE, INSIDE OF WHICH APPEARS A BLUE RIVER BETWEEN TWO MOUNTAINS AND IN THE BACKGROUND AREA A SUN APPEARS IN THE HORIZON, A RAINBOW AND THE SKY WITH TWO CLOUDS. IN THE LEFT FOREGROUND AREA OF THE CIRCLE APPEARS AN ASIAN GAZEBO. THE COLOR BLUE APPEARS IN THE SKY, IN THE RIVER AND IN THE RAINBOW. THE COLOR YELLOW APPEARS IN THE RAINBOW, IN THE ASIAN GAZEBO, IN THE SUN AND IN THE RING FORMING THE CIRCLE. THE COLOR GREEN APPEARS IN THE MOUNTAINS. THE COLOR DARK BLUE APPEARS IN THE RAINBOW. THE COLORS ORANGE AND RED APPEAR IN THE RAINBOW. THE COLOR BLACK APPEARS IN THE WORD MONDAISA AND IN THE OUTER AND INNER BORDER OF THE RING THAT FORMS THE CIRCLE. THE COLOR WHITE APPEARS IN THE CLOUDS.

THE WORDING MONDAISA HAS NO MEANING IN A FOREIGN LANGUAGE.

FOR BAKERY DESSERTS; BAKING POWDERS; BREAD; CAKES; CANDIES; CEREAL-BASED SNACK FOODS; COCOA; COFFEE; COFFEE SUBSTITUTES; FLOUR; HONEY; ICE; ICE CREAMS; MOLASSES SYRUP; MUSTARD; PASTRIES; PROCESSED CEREALS; READY-TO-EAT CEREALS; RICE; SAGO; SALT; SAUCES; SEASONINGS; SPICES; SUGAR; TAPIOCA; TEA; VINEGAR; YEAST (U.S. CL. 46).

PAM WILLIS, EXAMINING ATTORNEY

**CLASS 30—(Continued).**

SN 85-318,518. GUPTA, SURENDER, DBA DULISONS FOODS, MUMBAI 400 059, INDIA, FILED 5-11-2011.



THE COLOR(S) BLUE AND YELLOW IS/ARE CLAIMED AS A FEATURE OF THE MARK.

THE MARK CONSISTS OF THE WORD "DUNAR", IN BLUE, BENEATH A FLOWERING PLANT, IN YELLOW WITHIN A RECTANGULAR BANDED FRAME IN BLUE AND YELLOW WITH A CURVED TOP.

FOR BAKING POWDER; BAKING SPICES; BREAD; BREAD AND PASTRY; CEREAL-BASED SNACK FOODS; CHILI OIL FOR USE AS A SEASONING OR CONDIMENT; CHUTNEYS; COCOA-BASED INGREDIENT IN CONFECTIONERY PRODUCTS; COFFEE; CONDIMENT, NAMELY, PEPPER SAUCE; CONFECTIONERY CHIPS FOR BAKING; EDIBLE SPICES; FLOUR; FROZEN CONFECTIONERY; FRUIT JELLIES; HONEY; MASALA POWDER AND SPICES; MUSTARD; PICKLED GINGER; PIMIENTO USED AS A CONDIMENT; PREPARATIONS MADE FROM CEREALS, NAMELY, BREAD, PASTRY AND CONFECTIONERY; PREPARED HORSE RADISH; PROCESSED CEREAL-BASED FOOD TO BE USED AS A BREAKFAST FOOD, SNACK FOOD OR INGREDIENT FOR MAKING OTHER FOODS; PROCESSED CEREALS; PROTEIN REDUCED AND GLUTEN FREE FLOUR AND BREAD; READY-MADE SAUCES; RICE; SALT; SAUCES; SOYA BEAN PASTE; SPICES; TEA; VINEGAR; YEAST, BAKING POWDER AND FLAVOURINGS (U.S. CL. 46).

RAUL CORDOVA, EXAMINING ATTORNEY

SN 85-319,225. SUNNYLAND BULGUR WHEAT, INC., FRESNO, CA. FILED 5-12-2011.



OWNER OF U.S. REG. NOS. 1,329,936, 2,161,513 AND 4,005,495.

NO CLAIM IS MADE TO THE EXCLUSIVE RIGHT TO USE "BULGHUR CO. WHEAT PRODUCTS" OR "SUPERIOR QUALITY SINCE 1935", APART FROM THE MARK AS SHOWN.

THE MARK CONSISTS OF THE WORDING "SUNNYLAND BULGHUR CO." ABOVE A HORIZONTAL OVAL; INSIDE THE OVAL AND AT OPPOSING ENDS APPEARS A TWO-TONED WHEAT SEED HEAD; BEHIND THE SEED HEADS IS A COUNTRY LANDSCAPE OF THREE ROLLING HILLS WITH TREES AND SUN RAYS IN THE BACKGROUND; A TRACTOR APPEARS ATOP OF THE MIDDLE AND FOREMOST HILL; BELOW THE TRACTOR ARE THREE SHEAVES OF WHEAT; BELOW THE OVAL IS THE WORDING "WHEAT PRODUCTS"; AND BENEATH IS A BANNER BEARING THE WORDING "SUPERIOR QUALITY SINCE 1935".

FOR PROCESSED WHEAT (U.S. CL. 46).

FIRST USE 3-15-2011; IN COMMERCE 3-15-2011.

KIM MONINGHOFF, EXAMINING ATTORNEY



**CLASS 30—(Continued).**

SN 85-319,889. BURKE, TIMOTHY W.C., DBA BONITA VALLEY FOODS, BONITA, CA. FILED 5-12-2011.

**Macho Mango Salsa**

THE MARK CONSISTS OF STANDARD CHARACTERS WITHOUT CLAIM TO ANY PARTICULAR FONT, STYLE, SIZE, OR COLOR.

NO CLAIM IS MADE TO THE EXCLUSIVE RIGHT TO USE "MANGO SALSA", APART FROM THE MARK AS SHOWN.

FOR SALSA (U.S. CL. 46).  
BENJAMIN OKEKE, EXAMINING ATTORNEY

**CLASS 30—(Continued).**

SN 85-323,580. SOUTHWEST SPECIALTY FOOD, INC., GOODYEAR, AZ. FILED 5-18-2011.

**I LOST MY ASS IN LAS VEGAS**

THE MARK CONSISTS OF STANDARD CHARACTERS WITHOUT CLAIM TO ANY PARTICULAR FONT, STYLE, SIZE, OR COLOR.

FOR HOT SAUCE (U.S. CL. 46).  
FIRST USE 8-6-1998; IN COMMERCE 8-6-1998.  
MARK SHINER, EXAMINING ATTORNEY

SN 85-323,247. THE FUSION FOOD FACTORY, SAN DIEGO, CA. FILED 5-17-2011.

**bread for health**

THE MARK CONSISTS OF STANDARD CHARACTERS WITHOUT CLAIM TO ANY PARTICULAR FONT, STYLE, SIZE, OR COLOR.

NO CLAIM IS MADE TO THE EXCLUSIVE RIGHT TO USE "BREAD", APART FROM THE MARK AS SHOWN.

FOR BAGELS; BAGUETTES; BREAD; BREADSTICKS; BUNS; CAKES; CROISSANTS; MUFFINS; PASTRIES; PIZZA CRUST; ROLLS (U.S. CL. 46).

KAREN BRACEY, EXAMINING ATTORNEY

SN 85-325,067. PASSAGE CREEK FARM, FORT VALLEY, VA. FILED 5-19-2011.

**Firefly Hot Sauce**

THE MARK CONSISTS OF STANDARD CHARACTERS WITHOUT CLAIM TO ANY PARTICULAR FONT, STYLE, SIZE, OR COLOR.

NO CLAIM IS MADE TO THE EXCLUSIVE RIGHT TO USE "HOT SAUCE", APART FROM THE MARK AS SHOWN.

FOR HOT SAUCE (U.S. CL. 46).  
FIRST USE 10-3-2009; IN COMMERCE 10-3-2009.  
MARK SHINER, EXAMINING ATTORNEY

SN 85-323,290. RICKER, ANDREW H., PORTLAND, OR. FILED 5-17-2011.

**POK POK SOM**

THE MARK CONSISTS OF STANDARD CHARACTERS WITHOUT CLAIM TO ANY PARTICULAR FONT, STYLE, SIZE, OR COLOR.

NO CLAIM IS MADE TO THE EXCLUSIVE RIGHT TO USE "SOM", APART FROM THE MARK AS SHOWN.

THE ENGLISH TRANSLATION OF THE WORD "SOM" IN THE MARK IS "ORANGE".

THE WORDING "POK POK" HAS NO MEANING IN A FOREIGN LANGUAGE.

FOR FLAVORED VINEGAR (U.S. CL. 46).  
FIRST USE 12-20-2010; IN COMMERCE 12-20-2010.  
EMILY CARLSEN, EXAMINING ATTORNEY

SN 85-325,137. WISCONSIN CHEESE GROUP, INC., MON-ROE, WI. FILED 5-19-2011.

**CHALCO**

THE MARK CONSISTS OF STANDARD CHARACTERS WITHOUT CLAIM TO ANY PARTICULAR FONT, STYLE, SIZE, OR COLOR.

OWNER OF U.S. REG. NO. 1,804,641.  
FOR SPICES AND TOSTADAS (U.S. CL. 46).  
JASON TURNER, EXAMINING ATTORNEY

**CLASS 30—(Continued).**

SN 85-325,494. LA TAPATIA TORTILLERIA, INC., FRESNO, CA. FILED 5-19-2011.

**OPCIONES MAS SALUDABLES**

THE MARK CONSISTS OF STANDARD CHARACTERS WITHOUT CLAIM TO ANY PARTICULAR FONT, STYLE, SIZE, OR COLOR.

NO CLAIM IS MADE TO THE EXCLUSIVE RIGHT TO USE "SALUDABLES", APART FROM THE MARK AS SHOWN.

THE ENGLISH TRANSLATION OF "OPCIONES MAS SALUDABLES" IN THE MARK IS "MORE HEALTHY OPTIONS".

FOR TORTILLAS AND TORTILLA CHIPS (U.S. CL. 46).

ELLEN PERKINS, EXAMINING ATTORNEY

**CLASS 30—(Continued).**

SN 85-327,783. HOMEFREE, LLC, WINDHAM, NH. FILED 5-23-2011.

**HOMEFREE**

THE MARK CONSISTS OF STANDARD CHARACTERS WITHOUT CLAIM TO ANY PARTICULAR FONT, STYLE, SIZE, OR COLOR.

FOR BAKED GOODS, NAMELY COOKIES AND CAKES (U.S. CL. 46).

FIRST USE 8-27-2008; IN COMMERCE 8-27-2008.

KELLY TRUSILO, EXAMINING ATTORNEY

SN 85-327,788. HOMEFREE, LLC, WINDHAM, NH. FILED 5-23-2011.

**TREATS YOU CAN TRUST**

SN 85-326,482. EXPRESS IT WITH CHOCOLATE, LLC, CAMARILLO, CA. FILED 5-20-2011.



NO CLAIM IS MADE TO THE EXCLUSIVE RIGHT TO USE "HANDWRAPPED CHOCOLATES" AND "PERSONALIZED FOR YOU", APART FROM THE MARK AS SHOWN.

THE MARK CONSISTS OF AN ABSTRACT DESIGN WITH THE STYLIZED TEXT "EXPRESS IT WITH CHOCOLATE" IN THE MIDDLE. BELOW THERE IS AN OVAL WITH THE STYLIZED TEXT "HANDWRAPPED CHOCOLATE" ON THE TOP AND A SMALL BANNER AT THE BOTTOM RIGHT CORNER WITH THE STYLIZED TEXT "PERSONALIZED FOR YOU".

FOR GIFT SETS CONSISTING PRIMARILY OF CHOCOLATE AND A GREETING CARD (U.S. CL. 46).

INGRID C. EULIN, EXAMINING ATTORNEY

THE MARK CONSISTS OF STANDARD CHARACTERS WITHOUT CLAIM TO ANY PARTICULAR FONT, STYLE, SIZE, OR COLOR.

FOR BAKED GOODS, NAMELY COOKIES AND CAKES (U.S. CL. 46).

FIRST USE 8-27-2008; IN COMMERCE 8-27-2008.

KELLY TRUSILO, EXAMINING ATTORNEY

SN 85-328,191. COVINGTON JR, LARRY P, NORWALK, CA. FILED 5-24-2011.



THE COLOR(S) RED, YELLOW, GREEN, BLUE, ORANGE IS/ARE CLAIMED AS A FEATURE OF THE MARK.

THE MARK CONSISTS OF THE WORDS "GOOEY GOODIES" WHEREIN THE WORD "GOOEY" IS WRITTEN IN RED COLOR AND OUTLINED IN YELLOW COLOR. THE LETTERS "OO" OF GOOEY DEPICTS AN EYE WITH A MOUTH IN GREEN AND BLUE COLOR. THE WORD "GOODIES" IS WRITTEN BELOW GOOEY IN SHADES OF GREEN AND YELLOW WHICH IS OUTLINED IN BLUE AND ORANGE COLOR AS SHOWN IN THE MARK.

FOR CARAMEL COVERED APPLE, POPCORN, CARAMEL POPCORN, KETTLE POPCORN, CUP CAKES, CAKES (U.S. CL. 46).

MICHAEL WIENER, EXAMINING ATTORNEY

**CLASS 30—(Continued).**

SN 85-329,811. PERFETTI VAN MELLE BENELUX B.V., 4815 HK BREDA, NETHERLANDS, FILED 5-25-2011.

two flavors, one pack, you  
decide

THE MARK CONSISTS OF STANDARD CHARACTERS WITHOUT CLAIM TO ANY PARTICULAR FONT, STYLE, SIZE, OR COLOR.

FOR CONFECTIONERY PRODUCTS, NAMELY, CHEWING GUM, BUBBLE GUM AND CANDIES (U.S. CL. 46).

RAUL CORDOVA, EXAMINING ATTORNEY

**CLASS 30—(Continued).**

SN 85-330,228. HARO, DINO PAUL, APPLE VALLEY, CA. FILED 5-25-2011.



THE COLOR(S) RED, YELLOW, BLACK, GREY AND BROWN IS/ARE CLAIMED AS A FEATURE OF THE MARK.

THE MARK CONSISTS OF THE WORD 'SEMPERIFIC' IN RED LETTERING SHADOWED IN BLACK IN A SLIGHT ARCH. BELOW THIS ARE TWO CROSSED GRAY & BROWN SWORDS. THE SWORDS ARE BEHIND A RED DIAMOND THAT IS OUTLINED IN BLACK WITH A YELLOW 'S' OUTLINED IN BLACK INSIDE OF THE DIAMOND. UNDERNEATH THE SWORDS & DIAMOND THERE IS A RED BANNER OUTLINED IN BLACK WITH TWO FLEUR DE LIS-TYPE BLACK SHAPES ON EACH SIDE. INSIDE THE BOTTOM BANNER ARE THE WORDS 'ALWAYS TERRIFIC' IN YELLOW.

FOR BARBEQUE SAUCE; CHILI SAUCE; HOT CHILI PEPPER SAUCE; HOT SAUCE; STEAK SAUCE (U.S. CL. 46).

ELLEN BURNS, EXAMINING ATTORNEY

SN 85-329,842. GRIFFIN FOODS LIMITED, AUCKLAND, NEW ZEALAND, FILED 5-25-2011.

HUNTLEY & PALMERS

THE MARK CONSISTS OF STANDARD CHARACTERS WITHOUT CLAIM TO ANY PARTICULAR FONT, STYLE, SIZE, OR COLOR.

OWNER OF NEW ZEALAND REG. NO. 54638, DATED 4-6-1954, EXPIRES 4-6-2017.

FOR CRACKERS (U.S. CL. 46).

CIMMERIAN COLEMAN, EXAMINING ATTORNEY

SN 85-330,695. COMPAGNIE GERVAIS DANONE, PARIS, FRANCE, FILED 5-26-2011.

ACTIVIA

SN 85-330,019. COLONNA BROTHERS, INC., NORTH BERGEN, NJ. FILED 5-25-2011.

RISPARMIO

THE MARK CONSISTS OF STANDARD CHARACTERS WITHOUT CLAIM TO ANY PARTICULAR FONT, STYLE, SIZE, OR COLOR.

THE ENGLISH TRANSLATION OF "RISPARMIO" IN THE MARK IS "SAVING".

FOR ALIMENTARY PASTA; BAKERY PRODUCTS; BREAD CRUMBS; BREADSTICKS; CANDY; CANNOLI; CHEESE SAUCE; CONDIMENT, NAMELY, PEPPER SAUCE; MACARONI; MARINADES; PANETTONE; PASTA; RAVIOLI; READY-MADE SAUCES; RICE; RISOTTO; SALSA; SALT; SAUCES; SEASONINGS; SPICE RUBS; SPICES; VINEGAR (U.S. CL. 46).

KELLY BOULTON, EXAMINING ATTORNEY

THE MARK CONSISTS OF STANDARD CHARACTERS WITHOUT CLAIM TO ANY PARTICULAR FONT, STYLE, SIZE, OR COLOR.

OWNER OF U.S. REG. NOS. 2,613,732, 3,334,867 AND OTHERS.

FOR EDIBLE ICES; EDIBLE ICES MADE OF YOGURT; ICE CREAM; EDIBLE WATER ICES; FROZEN YOGURT; FLAVORED ICES (U.S. CL. 46).

PAUL E. FAHRENKOPF, EXAMINING ATTORNEY

**CLASS 30—(Continued).**

SN 85-330,701. JEFFREY GLAZER, MARLBORO, NJ. FILED 5-26-2011.

# AMAZEN

THE MARK CONSISTS OF STANDARD CHARACTERS WITHOUT CLAIM TO ANY PARTICULAR FONT, STYLE, SIZE, OR COLOR.

FOR GRAIN-BASED SNACK FOODS; MULTIGRAIN-BASED SNACK FOODS; PUFFED CORN SNACKS; RICE-BASED SNACK FOODS (U.S. CL. 46).  
PAUL E. FAHRENKOPF, EXAMINING ATTORNEY

---

SN 85-330,739. WHITEBOARD COMMUNICATIONS, LLC, CINCINNATI, OH. FILED 5-26-2011.

# QUACKERS

THE MARK CONSISTS OF STANDARD CHARACTERS WITHOUT CLAIM TO ANY PARTICULAR FONT, STYLE, SIZE, OR COLOR.

FOR COOKIES AND CRACKERS (U.S. CL. 46).  
WENDY GOODMAN, EXAMINING ATTORNEY

---

SN 85-330,806. OSMANSKI, JOHN M, MILWAUKEE, WI. FILED 5-26-2011.

# Candy Sunshine

THE MARK CONSISTS OF STANDARD CHARACTERS WITHOUT CLAIM TO ANY PARTICULAR FONT, STYLE, SIZE, OR COLOR.

NO CLAIM IS MADE TO THE EXCLUSIVE RIGHT TO USE "CANDY", APART FROM THE MARK AS SHOWN.  
FOR CANDY (U.S. CL. 46).  
DAWN HAN, EXAMINING ATTORNEY

**CLASS 30—(Continued).**

SN 85-330,824. SANDALS RESORTS INTERNATIONAL 2000 LIMITED, NASSAU, BAHAMAS, FILED 5-26-2011.



NO CLAIM IS MADE TO THE EXCLUSIVE RIGHT TO USE "SCOTCH BONNET PEPPER SAUCE", APART FROM THE MARK AS SHOWN.

THE MARK CONSISTS OF A STYLIZED RECTANGLE OUTLINING THE STYLIZED TERMS BLAZE FIAH SCOTCH BONNET PEPPER SAUCE APPEARING ABOVE AN IMAGE OF STYLIZED FLAMES.

FOR SAUCES (U.S. CL. 46).  
LINDA POWELL, EXAMINING ATTORNEY

---

SN 85-330,853. PIZZA INN, INC., THE COLONY, TX. FILED 5-26-2011.

# p3

THE MARK CONSISTS OF STANDARD CHARACTERS WITHOUT CLAIM TO ANY PARTICULAR FONT, STYLE, SIZE, OR COLOR.

FOR PIZZA (U.S. CL. 46).  
KAREN BRACEY, EXAMINING ATTORNEY

---

SN 85-331,100. KASHMIR CROWN BAKING, LLC, LINDEN, NJ. FILED 5-26-2011.



NO CLAIM IS MADE TO THE EXCLUSIVE RIGHT TO USE "CRISPY RUSK", APART FROM THE MARK AS SHOWN.

THE COLOR(S) RED, YELLOW, WHITE AND BLUE IS/ ARE CLAIMED AS A FEATURE OF THE MARK.

THE MARK CONSISTS OF THE STYLIZED WORD "CRISPY" IN WHITE ON A RED BANNER WITH A YELLOW OUTLINE APPEARING ABOVE THE STYLIZED WORD "RUSK" IN BLUE.

FOR RUSKS (U.S. CL. 46).  
FIRST USE 1-0-2009; IN COMMERCE 1-0-2009.  
KEVON CHISOLM, EXAMINING ATTORNEY

**CLASS 30—(Continued).**

SN 85-331,212. KELLY ANNE C. O'CONNOR, BEDFORD, MA. FILED 5-26-2011.

## Dirty Hot Cookies

THE MARK CONSISTS OF STANDARD CHARACTERS WITHOUT CLAIM TO ANY PARTICULAR FONT, STYLE, SIZE, OR COLOR.

NO CLAIM IS MADE TO THE EXCLUSIVE RIGHT TO USE "HOT COOKIES", APART FROM THE MARK AS SHOWN.

FOR COOKIES (U.S. CL. 46).  
LYDIA BELZER, EXAMINING ATTORNEY

**CLASS 30—(Continued).**

SN 85-331,807. PREECE DESIGNER CHOCOLATE LLC, MERIDIAN, ID. FILED 5-26-2011.

## Kiss'ums

THE MARK CONSISTS OF STANDARD CHARACTERS WITHOUT CLAIM TO ANY PARTICULAR FONT, STYLE, SIZE, OR COLOR.

FOR MARSHMALLOW TREATS COVERED IN CARAMEL AND CHOCOLATE (U.S. CL. 46).

FIRST USE 8-1-2010; IN COMMERCE 8-1-2010.  
AMY HELLA, EXAMINING ATTORNEY

SN 85-333,111. UMEVILLE FOOD CO., LTD., CHANGHUA COUNTY, TAIWAN, FILED 5-28-2011.

SN 85-331,473. AMERICAN LICORICE CO., BEND, OR. FILED 5-26-2011.

## PUNCHIES

THE MARK CONSISTS OF STANDARD CHARACTERS WITHOUT CLAIM TO ANY PARTICULAR FONT, STYLE, SIZE, OR COLOR.

OWNER OF U.S. REG. NOS. 2,736,530, 3,368,294 AND OTHERS.

FOR CANDY (U.S. CL. 46).  
JAY BESCH, EXAMINING ATTORNEY



NO CLAIM IS MADE TO THE EXCLUSIVE RIGHT TO USE "FOOD", APART FROM THE MARK AS SHOWN.

THE MARK CONSISTS OF A CHINESE CHARACTER WITHIN A PINWHEEL LIKE CONTOUR ADJACENT CHINESE CHARACTERS ABOVE THE WORDS "UMEVILLE FOOD".

THE NON-LATIN CHARACTERS IN THE MARK TRANSLITERATE TO MEI HUA CHANG RONG AND THIS MEANS PLUM FLOWER ALWAYS BLOSSOM IN ENGLISH. FOR RICE CAKES; RICE BALLS; PUDDING (U.S. CL. 46).

FIRST USE 5-27-2009; IN COMMERCE 5-27-2009.  
CHERYL CLAYTON, EXAMINING ATTORNEY

SN 85-333,153. MARSEE, MICHAEL W, SILVERTON, CO. FILED 5-28-2011.

## Jimmy Crack Korn

SN 85-331,707. CREATIVE FUNDRAISING IDEAS, INC., GLENVIEW, IL. FILED 5-26-2011.

## Mom's Secret Recipe

THE MARK CONSISTS OF STANDARD CHARACTERS WITHOUT CLAIM TO ANY PARTICULAR FONT, STYLE, SIZE, OR COLOR.

FOR FROZEN COOKIE DOUGH (U.S. CL. 46).  
FIRST USE 8-0-2001; IN COMMERCE 8-0-2001.  
CHARLES L. JENKINS, EXAMINING ATTORNEY

THE MARK CONSISTS OF STANDARD CHARACTERS WITHOUT CLAIM TO ANY PARTICULAR FONT, STYLE, SIZE, OR COLOR.

FOR CANDY COATED POPCORN; CANDY WITH CARAMEL; CARAMEL POPCORN; CHOCOLATE COVERED POPCORN; FLAVOR-COATED POPPED POPCORN; GLAZED POPCORN; POPCORN; POPPED POPCORN; SNACK MIX CONSISTING PRIMARILY OF CRACKERS, PRETZELS AND/OR POPPED POPCORN (U.S. CL. 46).

LEIGH LOWRY, EXAMINING ATTORNEY

**CLASS 30—(Continued).**

SN 85-333,290. FLAVOURTECH SARL, MEGRINE, TUNIS, TUNISIA, FILED 5-30-2011.

# Boni

THE MARK CONSISTS OF STANDARD CHARACTERS WITHOUT CLAIM TO ANY PARTICULAR FONT, STYLE, SIZE, OR COLOR.

THE ENGLISH TRANSLATION OF "BONI" IN THE MARK IS "BONUS".

FOR FLAVOR ENHANCERS USED IN FOOD AND BEVERAGE PRODUCTS; FLAVOURINGS AND SEASONINGS; FOOD FLAVORINGS; FOOD SEASONINGS (U.S. CL. 46).

SUSAN LESLIE DUBOIS, EXAMINING ATTORNEY

SN 85-333,293. FLAVOURTECH SARL, MEGRINE, TUNIS, TUNISIA, FILED 5-30-2011.



THE COLOR(S) RED, PINK, BLUE, AND WHITE IS/ARE CLAIMED AS A FEATURE OF THE MARK.

THE MARK CONSISTS OF THE WORD, BONI, IN WHITE LETTERS, OUTLINED IN RED AND BELOW A STYLISTIC FLOWER IN PINK AND RED; ALL SET WITHIN 3 CONCENTRIC, OVERLAPPING HEARTS, LAYING ON THEIR LEFT SIDES IN COLORS OF PINK, RED, AND BLUE, FROM INNERMOST TO OUTERMOST.

THE ENGLISH TRANSLATION OF "BONI" IN THE MARK IS "BONUS".

FOR FLAVOR ENHANCERS USED IN FOOD AND BEVERAGE PRODUCTS; FLAVOURINGS AND SEASONINGS; FOOD FLAVORINGS; FOOD SEASONINGS (U.S. CL. 46).

SUSAN LESLIE DUBOIS, EXAMINING ATTORNEY

**CLASS 30—(Continued).**

SN 85-333,411. DR. HESS, MARKUS, G, EGLISAU, SWITZERLAND, FILED 5-30-2011.

# Choco Letter

THE MARK CONSISTS OF STANDARD CHARACTERS WITHOUT CLAIM TO ANY PARTICULAR FONT, STYLE, SIZE, OR COLOR.

FOR ARRANGEMENTS OF CUT FRUIT COMPRISED OF FRESH FRUITS CUT INTO FLOWER SHAPES AND AT LEAST PARTIALLY COATED WITH CHOCOLATE; BAKED GOODS, NAMELY, CRUMBLES; BAKERY DESERTS; BAKERY GOODS; BAKERY GOODS AND DESERT ITEMS, NAMELY, CHEESECAKES FOR RETAIL AND WHOLESALE DISTRIBUTION AND CONSUMPTION ON OR OFF THE PREMISES; BAKERY GOODS, NAMELY, CHOCOLATE RELATED; BAKERY PRODUCTS; BAKERY PRODUCTS, NAMELY, SWEET BAKERY GOODS; BEVERAGES WITH A CHOCOLATE BASE; BROWN SUGAR; BROWNIE MIXES; BROWNIES; CANDIES; CANDY; CANDY BARS; CANDY CAKE DECORATIONS; CANDY COATED POPCORN; CANDY CONTAINING ALCOHOLIC BEVERAGE CONTENT AND FLAVOR; CANDY DECORATIONS FOR CAKES; CANDY FOR FOOD; CANDY MINTS; CANDY SPRINKLES; CANDY WITH CARAMEL; CANDY WITH COCOA; CANDY, NAMELY, DRAGEES; CEREAL BASED SNACK FOOD; CEREAL-BASED SNACK FOODS; CHEWING GUM; CHEWING GUM WITH VITAMINS; CHEWING GUM, NOT FOR MEDICAL PURPOSES; CHEWING GUMS; CHOCOLATE; CHOCOLATE AND CHOCOLATES; CHOCOLATE BARK CONTAINING GROUND COFFEE BEANS; CHOCOLATE BARS; CHOCOLATE BASED INGREDIENT FOR USE IN CHOCOLATE; CHOCOLATE CANDIES; CHOCOLATE CHIPS; CHOCOLATE CONFECTIONS; CHOCOLATE CONFECTIONS, NAMELY, CHOCOLATE CANDY; CHOCOLATE COVERED COCOA NIBS; CHOCOLATE COVERED COOKIES; CHOCOLATE COVERED FRUIT; CHOCOLATE COVERED NUTS; CHOCOLATE COVERED POPCORN; CHOCOLATE COVERED PRETZELS; CHOCOLATE COVERED RAISINS; CHOCOLATE COVERED ROASTED COFFEE BEANS; CHOCOLATE FONDUE; CHOCOLATE FOOD BEVERAGES NOT BEING DAIRY-BASED OR VEGETABLE BASED; CHOCOLATE FOR CONFECTIONERY AND BREAD; CHOCOLATE FOR TOPPINGS; CHOCOLATE MOUSSE; CHOCOLATE PASTES; CHOCOLATE POWDER; CHOCOLATE SAUCE; CHOCOLATE SYRUP; CHOCOLATE TOPPED PRETZELS; CHOCOLATE TOPPING; CHOCOLATE TRUFFLES; CHOCOLATE-BASED BEVERAGES WITH MILK; CHOCOLATE-BASED FILLINGS FOR CAKES AND PIES; CHOCOLATE-BASED READY-TO-EAT FOOD BARS; CHOCOLATE-COVERED POTATO CHIPS; CHOCOLATES AND CHOCOLATE BASED READY TO EAT CANDIES AND SNACKS; CHOCOLATES CONTAINING NUTRIENTS; COCOA; COCOA; COCOA BEVERAGES WITH MILK; COCOA EXTRACTS FOR HUMAN CONSUMPTION; COCOA MIXES; COCOA POWDER; COCOA SPREADS; COCOA-BASED BEVERAGES; COCOA-BASED CONDIMENTS AND SEASONINGS FOR FOOD AND DRINK; COCOA-BASED INGREDIENT IN CONFECTIONERY PRODUCTS; COCONUT SUGAR; COCONUT-BASED FRUIT ICE; COFFEE; COFFEE; COFFEE AND ARTIFICIAL COFFEE; COFFEE AND COFFEE SUBSTITUTES; COFFEE AND TEA; COFFEE BASED BEVERAGES; COFFEE BEANS; COFFEE BEVERAGES WITH MILK; COFFEE CAPSULES CONTAINING COFFEE FOR BREWING; COFFEE ESSENCES; COFFEE ESSENCES FOR USE AS SUBSTITUTES FOR COFFEE; COFFEE EXTRACTS; COFFEE EXTRACTS FOR USE AS SUBSTITUTES FOR COFFEE; COFFEE FLAVORED SYRUP USED IN MAKING FOOD BEVERAGES; COFFEE PODS; COFFEE SUBSTITUTES; COFFEE SUBSTITUTES; COFFEE-BASED BEVERAGE CONTAINING MILK; COFFEE-BASED BEVERAGES; CONES FOR ICE CREAM; CONES FOR ICECREAM; CONFECTIONER'S COATINGS IN THE NATURE OF EDIBLE SHELLAC COATINGS FOR FOODS; CONFECTIONERIES,

**CLASS 30—(Continued).**

NAMELY, SNACK FOODS, NAMELY, CHOCOLATE; CONFECTIONERY CHIPS FOR BAKING; CONFECTIONERY MADE OF SUGAR; CONFECTIONERY, NAMELY, PASTILLES; COOKIES; COOKIES AND CRACKERS; DANISH PASTRIES; DOUGHNUTS; FILLED CHOCOLATE; FRESH FRUITS CUT INTO FLOWER SHAPES AND AT LEAST PARTIALLY COATED WITH CHOCOLATE; FROZEN APPETIZERS CONSISTING PRIMARILY OF CORNMEAL; FROZEN BREADS; FROZEN CASHEW-BASED DESSERTS; FROZEN CONFECTIONERY; FROZEN CONFECTIONS; FROZEN CONFECTIONS, NAMELY, FREEZER BARS; FROZEN CONFECTIONS, NAMELY, FREEZER POPS; FROZEN CONFECTIONS, NAMELY, ICES; FROZEN COOKIE DOUGH; FROZEN COOKIE, BROWNIE AND BISCOTTI DOUGH; FROZEN CUSTARDS; FROZEN DESSERT CONSISTING OF FRUIT AND CREAM OR CREAM SUBSTITUTES; FROZEN DESSERTS CONSISTING OF FLAVORED ICE BLOCKS WITH TOPPINGS; FROZEN JUICE BARS; FROZEN SOY-BASED DESSERTS; FROZEN YOGHURT; FROZEN YOGURT; FROZEN YOGURT CONFECTIONS; FROZEN YOGURT MIXES; FROZEN YOGURT PIES AND CAKES; FRUCTOSE FOR FOOD; FRUIT BREADS; FRUIT CAKES; FRUIT COBBLERS; FRUIT ICE; FRUIT ICE BAR; FRUIT ICES; FRUIT JELLIES; GELATO; GIFT BASKETS CONTAINING CANDY; GRAIN-BASED FOOD BARS ALSO CONTAINING CHOCOLATE; HOT CHOCOLATE; ICE CANDIES; ICE CREAM; ICE CREAM DESSERTS; ICE CREAM DRINKS; ICE CREAM FLOATS; ICE CREAM MIXES; ICE CREAM POWDER; ICE CREAM SANDWICHES; ICE CREAM SUBSTITUTE; ICE CREAMS; ICE MILK BARS; ICE-CREAM; ICE-CREAM CAKES; MARZIPAN; MARZIPAN SUBSTITUTES; MILK CHOCOLATE; MUESLI; MUESLI BARS; MUFFINS; NOUGAT; PASTRIES; PASTRIES WITH FRUIT; PASTRIES, NAMELY, PASTIES; PASTRY; PASTRY MIXES; PRALINES; PROCESSED CACAO; PROCESSED CEREAL-BASED FOOD TO BE USED AS A BREAKFAST FOOD, SNACK FOOD OR INGREDIENT FOR MAKING OTHER FOODS; PROCESSED CEREALS; ROLLS; SNACK FOODS, NAMELY, CHOCOLATE-BASED SNACK FOODS; SPREAD CONTAINING CHOCOLATE AND NUTS; ZWIEBACK (U.S. CL. 46).

ANDREW LEASER, EXAMINING ATTORNEY

SN 85-333,723. CHOCOLATE MOMOTOMBO S.A., MIAMI, FL. FILED 5-31-2011.

**FABRICA DE CHOCOLATE  
MOMOTOMBO**

THE MARK CONSISTS OF STANDARD CHARACTERS WITHOUT CLAIM TO ANY PARTICULAR FONT, STYLE, SIZE, OR COLOR.

NO CLAIM IS MADE TO THE EXCLUSIVE RIGHT TO USE "CHOCOLATE", APART FROM THE MARK AS SHOWN.

THE ENGLISH TRANSLATION OF "FABRICA DE CHOCOLATE MOMOTOMBO" IN THE MARK IS "THE MOMOTOMBO CHOCOLATE FACTORY".

SEC. 2(F).

FOR CHOCOLATE AND CHOCOLATES (U.S. CL. 46).  
FIRST USE 12-1-2005; IN COMMERCE 12-1-2005.

EMILY CARLSEN, EXAMINING ATTORNEY

**CLASS 30—(Continued).**

SN 85-333,883. K.C. CONFECTIONERY, LTD., COUVA, TRINIDAD/TOBAGO, FILED 5-31-2011.

**MAKE EVERY MOMENT SWEETER**

THE MARK CONSISTS OF STANDARD CHARACTERS WITHOUT CLAIM TO ANY PARTICULAR FONT, STYLE, SIZE, OR COLOR.

FOR CONFECTIONERY, NAMELY, CANDY (U.S. CL. 46).

DEZMONA MIZELLE, EXAMINING ATTORNEY

SN 85-333,997. KOI GROUP, INC., LAS VEGAS, CA. FILED 5-31-2011.

**Koi**

THE MARK CONSISTS OF STANDARD CHARACTERS WITHOUT CLAIM TO ANY PARTICULAR FONT, STYLE, SIZE, OR COLOR.

OWNER OF U.S. REG. NOS. 2,950,303, 2,970,473 AND OTHERS.

FOR RICE; STEAMED RICE (U.S. CL. 46).  
FIRST USE 4-30-2011; IN COMMERCE 4-30-2011.

JOHN DALIER, EXAMINING ATTORNEY

SN 85-334,107. CE DE CANDY, INC., UNION, NJ. FILED 5-31-2011.

**SMARTIES 'N CREME**

THE MARK CONSISTS OF STANDARD CHARACTERS WITHOUT CLAIM TO ANY PARTICULAR FONT, STYLE, SIZE, OR COLOR.

FOR CANDY (U.S. CL. 46).

KATHERINE CONNOLLY, EXAMINING ATTORNEY

**CLASS 30—(Continued).**

SN 85-334,156. MCKASKLE, STEPHEN F., DBA MCKASKLE FAMILY FARM, BRAGGADOCIO, MO. FILED 5-31-2011.

**BRAGGADOCIO**

THE MARK CONSISTS OF STANDARD CHARACTERS WITHOUT CLAIM TO ANY PARTICULAR FONT, STYLE, SIZE, OR COLOR.  
FOR RICE AND POPCORN (U.S. CL. 46).  
FIRST USE 3-0-2010; IN COMMERCE 3-0-2010.  
HELENE LIWINSKI, EXAMINING ATTORNEY

**CLASS 30—(Continued).**

SN 85-334,331. PROSTAR SERVICES, INC, DBA PARKS COFFEE, CARROLLTON, TX. FILED 5-31-2011.

**Nutty Aunt Hazel**

THE MARK CONSISTS OF STANDARD CHARACTERS WITHOUT CLAIM TO ANY PARTICULAR FONT, STYLE, SIZE, OR COLOR.  
FOR COFFEE (U.S. CL. 46).  
FIRST USE 9-1-2009; IN COMMERCE 9-1-2009.  
ANGELA M. MICHELI, EXAMINING ATTORNEY

SN 85-334,296. PROSTAR SERVICES, INC, DBA PARKS COFFEE, CARROLLTON, TX. FILED 5-31-2011.

**Eiffel Power**

THE MARK CONSISTS OF STANDARD CHARACTERS WITHOUT CLAIM TO ANY PARTICULAR FONT, STYLE, SIZE, OR COLOR.  
FOR COFFEE (U.S. CL. 46).  
FIRST USE 9-1-2009; IN COMMERCE 9-1-2009.  
ANGELA M. MICHELI, EXAMINING ATTORNEY

SN 85-334,770. HARBAR, LLC, CANTON, MA. FILED 6-1-2011.

**THE NATURAL TASTE OF  
QUALITY**

THE MARK CONSISTS OF STANDARD CHARACTERS WITHOUT CLAIM TO ANY PARTICULAR FONT, STYLE, SIZE, OR COLOR.  
FOR TORTILLAS, WRAPS AND FLATBREADS (U.S. CL. 46).  
FIRST USE 0-0-2002; IN COMMERCE 0-0-2002.  
HEATHER THOMPSON, EXAMINING ATTORNEY

SN 85-334,325. PROSTAR SERVICES, INC, DBA PARKS COFFEE, CARROLLTON, TX. FILED 5-31-2011.

**Southern Belle Pecan**

THE MARK CONSISTS OF STANDARD CHARACTERS WITHOUT CLAIM TO ANY PARTICULAR FONT, STYLE, SIZE, OR COLOR.  
NO CLAIM IS MADE TO THE EXCLUSIVE RIGHT TO USE "PECAN", APART FROM THE MARK AS SHOWN.  
FOR COFFEE (U.S. CL. 46).  
FIRST USE 9-1-2009; IN COMMERCE 9-1-2009.  
ANGELA M. MICHELI, EXAMINING ATTORNEY

SN 85-335,020. RATHLE, SIMONE M., MCLEAN, VA. FILED 6-1-2011.

**Porkorn**

THE MARK CONSISTS OF STANDARD CHARACTERS WITHOUT CLAIM TO ANY PARTICULAR FONT, STYLE, SIZE, OR COLOR.  
FOR CARAMEL POPCORN; POPPED POPCORN; SNACK MIX CONSISTING PRIMARILY OF CRACKERS; PRETZELS AND/OR POPPED POPCORN (U.S. CL. 46).  
FIRST USE 5-2-2010; IN COMMERCE 10-20-2010.  
MAUREEN DALL, EXAMINING ATTORNEY



**CLASS 30—(Continued).**

SN 85-335,208. WHITEBOARD COMMUNICATIONS, LLC,  
CINCINNATI, OH. FILED 6-1-2011.

# MOONS

THE MARK CONSISTS OF STANDARD CHARACTERS  
WITHOUT CLAIM TO ANY PARTICULAR FONT, STYLE,  
SIZE, OR COLOR.  
FOR COOKIES AND CRACKERS (U.S. CL. 46).  
WENDY GOODMAN, EXAMINING ATTORNEY

**CLASS 30—(Continued).**

SN 85-336,180. CANINO, CAROLYN, STATEN ISLAND, NY.  
FILED 6-2-2011.

# Snips

THE MARK CONSISTS OF STANDARD CHARACTERS  
WITHOUT CLAIM TO ANY PARTICULAR FONT, STYLE,  
SIZE, OR COLOR.  
FOR ICE CREAM; ICE CREAM DESSERTS (U.S. CL.  
46).  
GRETCHEN ULRICH, EXAMINING ATTORNEY

SN 85-335,736. OLÉ MEXICAN FOODS, INC., NORCROSS,  
GA. FILED 6-1-2011.

# LA CASERITA

THE MARK CONSISTS OF STANDARD CHARACTERS  
WITHOUT CLAIM TO ANY PARTICULAR FONT, STYLE,  
SIZE, OR COLOR.  
THE ENGLISH TRANSLATION OF "LA CASERITA" IN  
THE MARK IS "THE LITTLE LANDLADY".  
FOR TORTILLAS; TOSTADAS (U.S. CL. 46).  
JEFFREY LOOK, EXAMINING ATTORNEY

SN 85-336,197. SALVATORE RAO, BROOKLYN, NY. FILED  
6-2-2011.

# WHEN LIFE GAVE US LEMONS WE MADE COOKIES

THE MARK CONSISTS OF STANDARD CHARACTERS  
WITHOUT CLAIM TO ANY PARTICULAR FONT, STYLE,  
SIZE, OR COLOR.  
FOR BAKERY GOODS; BAKERY PRODUCTS; COO-  
KIE DOUGH; COOKIES; FROZEN COOKIE DOUGH;  
MIXES FOR BAKERY GOODS (U.S. CL. 46).  
JESSICA A. POWERS, EXAMINING ATTORNEY

SN 85-336,157. JD'S SALSA SEASONING, LLC, COON  
RAPIDS, MN. FILED 6-2-2011.

# JD'S SALSA

THE MARK CONSISTS OF STANDARD CHARACTERS  
WITHOUT CLAIM TO ANY PARTICULAR FONT, STYLE,  
SIZE, OR COLOR.  
NO CLAIM IS MADE TO THE EXCLUSIVE RIGHT TO  
USE "SALSA", APART FROM THE MARK AS SHOWN.  
FOR SALSA SEASONING MIX (U.S. CL. 46).  
FIRST USE 1-1-2011; IN COMMERCE 2-15-2011.  
JENNIFER DIXON, EXAMINING ATTORNEY

SN 85-336,386. DSD PARTNERS INC., MIDLOTHIAN, VA.  
FILED 6-2-2011.

# HEAVENLY SENT

THE MARK CONSISTS OF STANDARD CHARACTERS  
WITHOUT CLAIM TO ANY PARTICULAR FONT, STYLE,  
SIZE, OR COLOR.  
FOR BAKERY GOODS; BAKERY PRODUCTS (U.S. CL.  
46).  
MICHELE SWAIN, EXAMINING ATTORNEY

**CLASS 30—(Continued).**

SN 85-336,401. DSD PARTNERS INC., MIDLOTHIAN, VA.  
FILED 6-2-2011.

**HEAVENLY SCENT**

THE MARK CONSISTS OF STANDARD CHARACTERS  
WITHOUT CLAIM TO ANY PARTICULAR FONT, STYLE,  
SIZE, OR COLOR.

FOR BAKERY GOODS; BAKERY PRODUCTS (U.S. CL.  
46).

MICHELE SWAIN, EXAMINING ATTORNEY

SN 85-336,465. AJINOMOTO CO., INC., CHUO-KU, TOKYO,  
JAPAN, FILED 6-2-2011.

**AJI-AROMA**

THE MARK CONSISTS OF STANDARD CHARACTERS  
WITHOUT CLAIM TO ANY PARTICULAR FONT, STYLE,  
SIZE, OR COLOR.

OWNER OF U.S. REG. NO. 2,952,115.  
FOR SEASONINGS; MIXED SEASONINGS; FOOD  
FLAVORINGS; FLAVOR ENHANCER USED IN FOOD  
AND BEVERAGE PRODUCTS (U.S. CL. 46).

CHARLES L. JENKINS, EXAMINING ATTORNEY

SN 85-336,798. COLLECTIVE CUISINE LLC, MARINA DEL  
REY, CA. FILED 6-2-2011.

**Beetchup**

THE MARK CONSISTS OF STANDARD CHARACTERS  
WITHOUT CLAIM TO ANY PARTICULAR FONT, STYLE,  
SIZE, OR COLOR.

FOR KETCHUP (U.S. CL. 46).

RONALD DELGIZZI, EXAMINING ATTORNEY

**CLASS 30—(Continued).**

SN 85-336,893. PASHEN CORPORATION, DBA PASHEN,  
MINNEAPOLIS, MN. FILED 6-2-2011.



NO CLAIM IS MADE TO THE EXCLUSIVE RIGHT TO  
USE "RAW", "HEALTHY", "DELICIOUS", AND "SNACK",  
APART FROM THE MARK AS SHOWN.

THE COLOR(S) CREAM, BLUE, RED, PURPLE, GREEN,  
YELLOW, AND BLACK IS/ARE CLAIMED AS A FEATURE  
OF THE MARK.

THE MARK CONSISTS OF THE LOWERCASE WORD  
"PASHEN" IN CREAM WITH STYLIZED LETTERS "P" AND  
"H" AND AN UPSIDE-DOWN LETTER "E". UNDERNEATH  
THE WORD "PASHEN" IS THE WORD "RAW" IN BLUE,  
FOLLOWED BY A PLUS SYMBOL IN RED, FOLLOWED BY  
THE WORD "HEALTHY" IN PURPLE, FOLLOWED BY A  
PLUS SYMBOL IN GREEN, AND FOLLOWED BY THE  
WORDS "DELICIOUS SNACK" IN YELLOW. THE BACK-  
GROUND IS BLACK.

THE WORDING PASHEN WITH AN UPSIDE-DOWN "E"  
HAS NO MEANING IN A FOREIGN LANGUAGE.

FOR GRANOLA SNACKS; GRANOLA-BASED SNACK  
BARS (U.S. CL. 46).

FIRST USE 4-18-2011; IN COMMERCE 4-18-2011.

CHERYL CLAYTON, EXAMINING ATTORNEY

SN 85-337,129. DAVID BADER, ERWINNA, PA. FILED 6-3-  
2011.

**Parvelous**

THE MARK CONSISTS OF STANDARD CHARACTERS  
WITHOUT CLAIM TO ANY PARTICULAR FONT, STYLE,  
SIZE, OR COLOR.

FOR KOSHER BAKERY PRODUCTS (U.S. CL. 46).

LINDA ESTRADA, EXAMINING ATTORNEY

**CLASS 30—(Continued).**

SN 85-337,725. LIU, CHIEN, FAIRFAX, VA. FILED 6-3-2011.

**TEABEA**

THE MARK CONSISTS OF STANDARD CHARACTERS WITHOUT CLAIM TO ANY PARTICULAR FONT, STYLE, SIZE, OR COLOR.

FOR COFFEE; TEA (U.S. CL. 46).  
MICHELE SWAIN, EXAMINING ATTORNEY

SN 85-338,012. FORT, MARK, CHINO, CA. FILED 6-3-2011.

**Bayou Bliss**

THE MARK CONSISTS OF STANDARD CHARACTERS WITHOUT CLAIM TO ANY PARTICULAR FONT, STYLE, SIZE, OR COLOR.

FOR BARBEQUE SAUCE (U.S. CL. 46).  
KATHRYN COWARD, EXAMINING ATTORNEY

SN 85-338,129. ARIOLA FOODS INC, FARMINGDALE, NY. FILED 6-4-2011.



THE MARK CONSISTS OF TWO ANIMATED CANNOLI SHELLS WITH SMILEY FACES, LEGS AND ARMS, AND DANCING. ONE LARGE AND ONE SMALL. ONE SMALL FEMALE AND ONE LARGER MALE. THE FEMALE HAS A BOW IN HER HEAD. THERE ARE MUSICAL NOTES AROUND THEM. THEY ARE ORIGINAL CARTOON CHARACTERS CREATED FROM CANNOLI, AN ITALIAN PASTRY.

FOR CANNOLI; PASTRY CREAM (U.S. CL. 46).  
FIRST USE 11-0-2010; IN COMMERCE 11-0-2010.  
KIM SAITO, EXAMINING ATTORNEY

**CLASS 30—(Continued).**

SN 85-338,280. THIS, LLC, MADISON, CT. FILED 6-5-2011.

**SMORNAMENT**

THE MARK CONSISTS OF STANDARD CHARACTERS WITHOUT CLAIM TO ANY PARTICULAR FONT, STYLE, SIZE, OR COLOR.

FOR PACKAGED ASSORTMENT OF PRODUCTS SOLD AS A UNIT CONSISTING OF CANDY BAR, GRAHAM CRACKERS, MARSHMALLOWS AND PRINTED INSTRUCTIONS (U.S. CL. 46).  
JOHN E. MICHOS, EXAMINING ATTORNEY

SN 85-338,294. WOLF, MARC E., NEW YORK, NY. FILED 6-5-2011.

**LOSE THE CONE**

THE MARK CONSISTS OF STANDARD CHARACTERS WITHOUT CLAIM TO ANY PARTICULAR FONT, STYLE, SIZE, OR COLOR.

FOR ICE CREAM; ICE CREAM DESSERTS; ICE CREAM SANDWICHES; ICE-CREAM CAKES (U.S. CL. 46).

FIRST USE 7-2-2011; IN COMMERCE 7-2-2011.  
DANIEL CAPSHAW, EXAMINING ATTORNEY

SN 85-338,597. NAVARRO, CHARLES J., CERRITOS, CA. FILED 6-6-2011.

**Salsabrosa**

THE MARK CONSISTS OF STANDARD CHARACTERS WITHOUT CLAIM TO ANY PARTICULAR FONT, STYLE, SIZE, OR COLOR.

FOR SALSA (U.S. CL. 46).  
NICHOLAS ALTREE, EXAMINING ATTORNEY

**CLASS 30—(Continued).**

SN 85-339,669. DFO, LLC, SPARTANBURG, SC. FILED 6-7-2011.

# Chillychino

THE MARK CONSISTS OF STANDARD CHARACTERS WITHOUT CLAIM TO ANY PARTICULAR FONT, STYLE, SIZE, OR COLOR.

FOR BEVERAGES WITH A COFFEE BASE; COFFEE BASED BEVERAGES; COFFEE BEVERAGES WITH MILK; ICED COFFEE (U.S. CL. 46).

KEVIN CORWIN, EXAMINING ATTORNEY

**CLASS 30—(Continued).**

SN 85-340,356. PRODUCTOS ZAM-FRE, S.A. DE C.V., MÉXICO, DF, MEXICO, FILED 6-7-2011.

# CHOCOZERO

THE MARK CONSISTS OF STANDARD CHARACTERS WITHOUT CLAIM TO ANY PARTICULAR FONT, STYLE, SIZE, OR COLOR.

OWNER OF MEXICO REG. NO. 1129671, DATED 11-6-2009, EXPIRES 10-26-2019.

FOR CHOCOLATE (U.S. CL. 46).

TINA BROWN, EXAMINING ATTORNEY

SN 85-339,687. IVEY, LOYD L, WINSLOW, IL. FILED 6-7-2011.

# Cool Blue

THE MARK CONSISTS OF STANDARD CHARACTERS WITHOUT CLAIM TO ANY PARTICULAR FONT, STYLE, SIZE, OR COLOR.

FOR SAUCES; SALAD DRESSINGS; SEASONINGS; AND MARINADES (U.S. CL. 46).

HENRY S. ZAK, EXAMINING ATTORNEY

SN 85-341,054. RUGER, LLC, CHEVY CHASE, MD. FILED 6-8-2011.

# MUSIC TO YOUR MOUTH

THE MARK CONSISTS OF STANDARD CHARACTERS WITHOUT CLAIM TO ANY PARTICULAR FONT, STYLE, SIZE, OR COLOR.

FOR WAFERS (U.S. CL. 46).

JOHN SCHUYLER YARD, EXAMINING ATTORNEY

SN 85-340,345. PETYBON, S.A. DE C.V., MÉXICO, DF, MEXICO, FILED 6-7-2011.

# NUTRIENERGY

THE MARK CONSISTS OF STANDARD CHARACTERS WITHOUT CLAIM TO ANY PARTICULAR FONT, STYLE, SIZE, OR COLOR.

OWNER OF MEXICO REG. NO. 734126, DATED 2-11-2002, EXPIRES 12-18-2011.

FOR GRAIN-BASED FOOD BARS ALSO CONTAINING COCONUT, DRIED FRUIT OR AMARANTH; READY TO EAT, CEREAL DERIVED FOOD BARS (U.S. CL. 46).

ALICIA COLLINS, EXAMINING ATTORNEY

SN 85-341,569. GINDO'S SPICE OF LIFE, LOS ANGELES, CA. FILED 6-8-2011.

# Gindo's Spice Of Life

THE MARK CONSISTS OF STANDARD CHARACTERS WITHOUT CLAIM TO ANY PARTICULAR FONT, STYLE, SIZE, OR COLOR.

FOR HOT SAUCE (U.S. CL. 46).

FIRST USE 4-20-2010; IN COMMERCE 4-20-2010.

KATHERINE CHANG, EXAMINING ATTORNEY

**CLASS 30—(Continued).**

SN 85-344,176. LEU, MEI, SAN FRANCISCO, CA. FILED 6-13-2011.

PRECIOUS AND RARE

THE MARK CONSISTS OF STANDARD CHARACTERS WITHOUT CLAIM TO ANY PARTICULAR FONT, STYLE, SIZE, OR COLOR.  
FOR CHOCOLATE, CANDY (U.S. CL. 46).  
FONG HSU, EXAMINING ATTORNEY

SN 85-351,816. PRECISION FOODS, INC., ST. LOUIS, MO. FILED 6-21-2011.

Asian Passport

THE MARK CONSISTS OF STANDARD CHARACTERS WITHOUT CLAIM TO ANY PARTICULAR FONT, STYLE, SIZE, OR COLOR.  
NO CLAIM IS MADE TO THE EXCLUSIVE RIGHT TO USE "ASIAN", APART FROM THE MARK AS SHOWN.  
FOR FOOD SEASONINGS; DRY MIXES FOR SAUCES AND SALSA (U.S. CL. 46).  
MEGHAN REINHART, EXAMINING ATTORNEY

SN 85-351,860. PRECISION FOODS, INC., ST. LOUIS, MO. FILED 6-21-2011.

Latin Passport

THE MARK CONSISTS OF STANDARD CHARACTERS WITHOUT CLAIM TO ANY PARTICULAR FONT, STYLE, SIZE, OR COLOR.  
NO CLAIM IS MADE TO THE EXCLUSIVE RIGHT TO USE "LATIN", APART FROM THE MARK AS SHOWN.  
FOR FOOD SEASONINGS; DRY MIXES FOR SAUCES AND SALSA (U.S. CL. 46).  
MEGHAN REINHART, EXAMINING ATTORNEY

**CLASS 30—(Continued).**

SN 85-362,822. UNILEVER SUPPLY CHAIN, INC., CLINTON, CT. FILED 7-5-2011.

LAYERZ

THE MARK CONSISTS OF STANDARD CHARACTERS WITHOUT CLAIM TO ANY PARTICULAR FONT, STYLE, SIZE, OR COLOR.  
FOR ICE CREAMS; FROZEN CONFECTIONERY (U.S. CL. 46).  
PRISCILLA MILTON, EXAMINING ATTORNEY

SN 85-362,825. UNILEVER SUPPLY CHAIN, INC., CLINTON, CT. FILED 7-5-2011.

TORPEDO

THE MARK CONSISTS OF STANDARD CHARACTERS WITHOUT CLAIM TO ANY PARTICULAR FONT, STYLE, SIZE, OR COLOR.  
FOR ICE CREAMS; FROZEN CONFECTIONERY (U.S. CL. 46).  
PRISCILLA MILTON, EXAMINING ATTORNEY

SN 85-365,465. HENRI BENDEL, INC., NEW YORK, NY. FILED 7-7-2011.

GRAHAMAR RULES

THE MARK CONSISTS OF STANDARD CHARACTERS WITHOUT CLAIM TO ANY PARTICULAR FONT, STYLE, SIZE, OR COLOR.  
FOR GRAHAM CRACKERS COVERED IN CHOCOLATE (U.S. CL. 46).  
FONG HSU, EXAMINING ATTORNEY

**CLASS 30—(Continued).**

SN 85-365,692. AMERICAN LICORICE CO., BEND, OR.  
FILED 7-7-2011.

**AMERICAN LICORICE**

THE MARK CONSISTS OF STANDARD CHARACTERS WITHOUT CLAIM TO ANY PARTICULAR FONT, STYLE, SIZE, OR COLOR.

NO CLAIM IS MADE TO THE EXCLUSIVE RIGHT TO USE "LICORICE", APART FROM THE MARK AS SHOWN. SEC. 2(F).

FOR CANDY (U.S. CL. 46).

FIRST USE 12-0-1970; IN COMMERCE 12-0-1970.  
JAY BESCH, EXAMINING ATTORNEY

**CLASS 30—(Continued).**

SN 85-375,702. DAVID MICHAEL & CO., INC., PHILADELPHIA, PA. FILED 7-20-2011.

**MICHAELCAP**

THE MARK CONSISTS OF STANDARD CHARACTERS WITHOUT CLAIM TO ANY PARTICULAR FONT, STYLE, SIZE, OR COLOR.

OWNER OF U.S. REG. NO. 3,043,587.

FOR NON-NUTRITIONAL FOOD ADDITIVES IN THE NATURE OF MICROENCAPSULATED FLAVORINGS USED FOR FOOD AND BEVERAGES (U.S. CL. 46).

JOHN DALIER, EXAMINING ATTORNEY

SN 85-368,369. CALIDOCIOUS, INC., SUNNYVALE, CA.  
FILED 7-11-2011.

**ZOOTS**

THE MARK CONSISTS OF STANDARD CHARACTERS WITHOUT CLAIM TO ANY PARTICULAR FONT, STYLE, SIZE, OR COLOR.

FOR CANDY (U.S. CL. 46).

FIRST USE 6-19-2011; IN COMMERCE 6-19-2011.  
SHARON MEIER, EXAMINING ATTORNEY

SN 85-376,450. PROSTAR SERVICES, INC, DBA PARKS COFFEE, CARROLLTON, TX. FILED 7-20-2011.

**Everything Nice**

THE MARK CONSISTS OF STANDARD CHARACTERS WITHOUT CLAIM TO ANY PARTICULAR FONT, STYLE, SIZE, OR COLOR.

FOR COFFEE (U.S. CL. 46).

FIRST USE 6-1-2009; IN COMMERCE 6-1-2009.

ANGELA M. MICHELI, EXAMINING ATTORNEY

SN 85-375,123. CALIDOCIOUS, INC., SUNNYVALE, CA.  
FILED 7-19-2011.

**FUGEZI**

THE MARK CONSISTS OF STANDARD CHARACTERS WITHOUT CLAIM TO ANY PARTICULAR FONT, STYLE, SIZE, OR COLOR.

FOR COOKIES (U.S. CL. 46).

FIRST USE 7-18-2011; IN COMMERCE 7-18-2011.  
SHARON MEIER, EXAMINING ATTORNEY

SN 85-388,504. PERFETTI VAN MELLE BENELUX B.V., 4815 HK BREDA, NETHERLANDS, FILED 8-3-2011.

**2 FLAVORS, 1 PACK, YOU DECIDE**

THE MARK CONSISTS OF STANDARD CHARACTERS WITHOUT CLAIM TO ANY PARTICULAR FONT, STYLE, SIZE, OR COLOR.

FOR CONFECTIONERY PRODUCTS, NAMELY, CHEWING GUM, BUBBLE GUM AND CANDIES (U.S. CL. 46).

FIRST USE 5-12-2011; IN COMMERCE 5-12-2011.

RAUL CORDOVA, EXAMINING ATTORNEY

**CLASS 30—(Continued).**

SN 85-396,217. THE QUAKER OATS COMPANY, CHICAGO, IL. FILED 8-12-2011.

**COUNTRY APPLE WALNUT**

THE MARK CONSISTS OF STANDARD CHARACTERS WITHOUT CLAIM TO ANY PARTICULAR FONT, STYLE, SIZE, OR COLOR.

NO CLAIM IS MADE TO THE EXCLUSIVE RIGHT TO USE "APPLE" OR "WALNUT", APART FROM THE MARK AS SHOWN.

FOR BREAKFAST CEREALS (U.S. CL. 46).  
SUSAN RICHARDS, EXAMINING ATTORNEY

**CLASS 31—NATURAL AGRICULTURAL PRODUCTS**

SN 76-705,644. HAAS OUTDOORS, INC., WEST POINT, MS. FILED 12-10-2010.

**BIO LOGIC WHITETAIL PROBIOTIC**

THE MARK CONSISTS OF STANDARD CHARACTERS WITHOUT CLAIM TO ANY PARTICULAR FONT, STYLE, SIZE, OR COLOR.

OWNER OF U.S. REG. NOS. 2,278,961, 3,609,081 AND OTHERS.

NO CLAIM IS MADE TO THE EXCLUSIVE RIGHT TO USE "WHITETAIL PROBIOTIC", APART FROM THE MARK AS SHOWN.

SEC. 2(F) AS TO "BIO LOGIC".  
FOR PLANT SEED FOR GROWING PLANTS INTENDED AND DESIGNED FOR CONSUMPTION BY WILDLIFE (U.S. CLS. 1 AND 46).

KEVIN CORWIN, EXAMINING ATTORNEY

SN 85-397,656. THE COCA-COLA COMPANY, ATLANTA, GA. FILED 8-15-2011.



THE MARK CONSISTS OF A STYLIZED "O" RESEMBLING STEAM.

FOR COFFEE; COFFEE BASED BEVERAGES (U.S. CL. 46).

GEOFFREY FOSDICK, EXAMINING ATTORNEY

SN 77-205,891. MARS, INCORPORATED, MCLEAN, VA. FILED 6-14-2007.

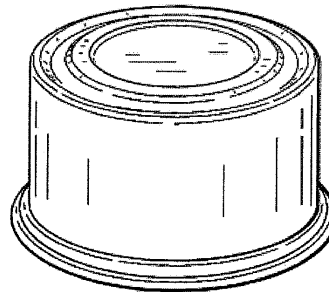

THE MARK CONSISTS OF A THREE-DIMENSIONAL CONFIGURATION OF PACKAGING FOR PET FOOD THAT CONSISTS OF A ROUND, INVERTED AND LACQUERED PET FOOD CONTAINER. THE TOP OF THE CONTAINER IS ROUNDED WITH TWO CONCENTRIC RIDGES THAT FORM THE INNER AND OUTER LIP OF THE TOP OF THE CONTAINER. THE BOTTOM OF THE CONTAINER HAS A WIDER RIDGED LIP. THE INVERTED NATURE OF THE CONTAINER AND THE LACQUERED FINISH ARE CLAIMED AS FEATURES OF THE MARK.

FOR PET FOOD (U.S. CLS. 1 AND 46).

CHARISMA HAMPTON, EXAMINING ATTORNEY

**CLASS 31—(Continued).**

SN 79-090,786. STIMULAN B.V., NETHERLANDS, FILED 11-5-2010.

# PAVO

OWNER OF INTERNATIONAL REGISTRATION 0639946 DATED 7-4-1995, EXPIRES 7-4-2015.

THE ENGLISH TRANSLATION OF "PAVO" IN THE MARK IS "TURKEY, USELESS, PEACOCK OR DANGEROUS".

FOR HORSE FEED (U.S. CLS. 1 AND 46).  
SARA BENJAMIN, EXAMINING ATTORNEY

SN 85-167,871. EVANS AG GP, INC., LOS ANGELES, CA. FILED 11-3-2010.

# AIR SWEET

THE MARK CONSISTS OF STANDARD CHARACTERS WITHOUT CLAIM TO ANY PARTICULAR FONT, STYLE, SIZE, OR COLOR.

OWNER OF U.S. REG. NOS. 1,704,344, 2,479,825 AND OTHERS.

NO CLAIM IS MADE TO THE EXCLUSIVE RIGHT TO USE "SWEET", APART FROM THE MARK AS SHOWN.

FOR FRESH FRUIT, NAMELY, ORANGES (U.S. CLS. 1 AND 46).

FIRST USE 2-0-2011; IN COMMERCE 2-0-2011.  
JOHN SCHUYLER YARD, EXAMINING ATTORNEY

SN 85-171,013. INTEGRACOLOR, MESQUITE, TX. FILED 11-7-2010.



The logo for LandscapeGarden features the word "Landscape" in a white, sans-serif font and "Garden" in a bold, white, sans-serif font, both set against a dark green rectangular background. A small green leaf icon is positioned above the letter "d" in "Garden".

NO CLAIM IS MADE TO THE EXCLUSIVE RIGHT TO USE "GARDEN", APART FROM THE MARK AS SHOWN.

THE COLOR(S) LIGHT GREEN, DARK GREEN, AND WHITE IS/ARE CLAIMED AS A FEATURE OF THE MARK.

THE MARK CONSISTS OF THE STYLIZED WORDING "LANDSCAPE" IN THE COLOR WHITE AND THE WORDING "GARDEN" IN BOLDER WHITE FEATURING A SHADED GREEN LEAF ON THE "G" IN "GARDEN" ALL ON A DARK GREEN RECTANGULAR BACKGROUND THAT IS OUTLINED IN A LIGHT GREEN COLOR.

FOR LIVING PLANTS (U.S. CLS. 1 AND 46).  
FIRST USE 5-30-2010; IN COMMERCE 5-30-2010.  
BERYL GARDNER, EXAMINING ATTORNEY

**CLASS 31—(Continued).**

SN 85-173,919. DRISCOLL STRAWBERRY ASSOCIATES, INC., WATSONVILLE, CA. FILED 11-10-2010.



THE MARK CONSISTS OF A REPRESENTATION OF A BLUEBERRY.

FOR FRESH BLUEBERRIES (U.S. CLS. 1 AND 46).  
SARA BENJAMIN, EXAMINING ATTORNEY

SN 85-173,944. DRISCOLL STRAWBERRY ASSOCIATES, INC., WATSONVILLE, CA. FILED 11-10-2010.



THE MARK CONSISTS OF A REPRESENTATION OF A RASPBERRY.

FOR FRESH RASPBERRIES (U.S. CLS. 1 AND 46).  
SARA BENJAMIN, EXAMINING ATTORNEY

SN 85-184,334. IPA TRADING GROUP, HIDALGO, TX. FILED 11-24-2010.

# GOLDEN DRAGON

THE MARK CONSISTS OF STANDARD CHARACTERS WITHOUT CLAIM TO ANY PARTICULAR FONT, STYLE, SIZE, OR COLOR.

FOR AGRICULTURAL PRODUCTS, NAMELY, FRESH MANGOS AND FRESH ASIAN VEGETABLES (U.S. CLS. 1 AND 46).

STEVEN PEREZ, EXAMINING ATTORNEY



**CLASS 31—(Continued).**

SN 85-186,100. EUROFRESH, INC., WILLCOX, AZ. FILED 11-29-2010.

**PRODUSEAL**

THE MARK CONSISTS OF STANDARD CHARACTERS WITHOUT CLAIM TO ANY PARTICULAR FONT, STYLE, SIZE, OR COLOR.  
FOR FRESH PRODUCE, NAMELY, FRESH FRUITS AND VEGETABLES (U.S. CLS. 1 AND 46).  
LINDA ORNDORFF, EXAMINING ATTORNEY

SN 85-187,415. THE GRACIOUS LIVING GROUP, LLC, YORBA LINDA, CA. FILED 11-30-2010.

**LIVING SALAD**

THE MARK CONSISTS OF STANDARD CHARACTERS WITHOUT CLAIM TO ANY PARTICULAR FONT, STYLE, SIZE, OR COLOR.  
NO CLAIM IS MADE TO THE EXCLUSIVE RIGHT TO USE "SALAD", APART FROM THE MARK AS SHOWN.  
FOR LIVE FISH FOR FOOD PURPOSES; LIVE PLANTS, NAMELY, LETTUCE, SPINACH, ARUGULA, GREENS, NAMELY, CRESS, ENDIVE, ESCAROLE, MICRO-GREENS, SPROUTS, WHEATGRASS, MUSTARD GREENS, CHARD, BROCCOLI, FRESH HERBS, CARROTS, TOMATOES, VEGETABLES, NAMELY, CARROTS, CUCUMBERS, SQUASH, PEAS, BEANS, EGGPLANTS, ZUCCHINI, PEPPERS, AND CABBAGES; LIVE LOBSTERS; LIVE OYSTERS; LIVE SHRIMP; UNPROCESSED ANCHOVIES; UNPROCESSED APPLES; UNPROCESSED APRICOTS; UNPROCESSED ARTICHOKE; UNPROCESSED ASPARAGUS; UNPROCESSED AVOCADOS; UNPROCESSED BEAN SPROUTS; UNPROCESSED BEANS; UNPROCESSED BEETS; UNPROCESSED BLUEBERRIES; UNPROCESSED CABBAGE; UNPROCESSED COLLARD GREENS; UNPROCESSED CORN; UNPROCESSED DATES; UNPROCESSED FRUITS; UNPROCESSED GINGER; UNPROCESSED HEARTS OF PALM; UNPROCESSED HERBS; UNPROCESSED LETTUCE; UNPROCESSED MUSHROOMS; UNPROCESSED OLIVES; UNPROCESSED ONIONS; UNPROCESSED ORANGES; UNPROCESSED PEACHES; UNPROCESSED PEPPERS; UNPROCESSED POTATOES; UNPROCESSED TOMATOES; UNPROCESSED VEGETABLES; UNPROCESSED ZUCCHINI (U.S. CLS. 1 AND 46).  
KATHLEEN M. VANSTON, EXAMINING ATTORNEY

**CLASS 31—(Continued).**

SN 85-189,976. S. STAMOULES, INC., MENDOTA, CA. FILED 12-3-2010.



THE MARK CONSISTS OF THE LETTERS "S","S" WITH THE LETTERS SEPARATED BY A DESIGN OF 2 "S"'S ENTER TWINED.  
FOR FRESH FRUIT AND VEGETABLES (U.S. CLS. 1 AND 46).  
FIRST USE 7-26-1927; IN COMMERCE 7-26-1927.  
IRA J. GOODSAD, EXAMINING ATTORNEY

SN 85-190,795. TIMOTHY P. SCHIPPER, DBA SCHIPPER & COMPANY, GREENWICH, CT. FILED 12-4-2010.

**BLOOMSDAY**

THE MARK CONSISTS OF STANDARD CHARACTERS WITHOUT CLAIM TO ANY PARTICULAR FONT, STYLE, SIZE, OR COLOR.  
FOR FLOWER BULBS SOLD WHOLESALE TO THOSE IN THE FLOWER INDUSTRY (U.S. CLS. 1 AND 46).  
FIRST USE 6-30-2009; IN COMMERCE 6-30-2009.  
JOHN E. MICHOS, EXAMINING ATTORNEY

SN 85-194,363. FAIRY GARDENING, INC., LOVELAND, CO. FILED 12-9-2010.

**Fairy Flowers**

THE MARK CONSISTS OF STANDARD CHARACTERS WITHOUT CLAIM TO ANY PARTICULAR FONT, STYLE, SIZE, OR COLOR.  
NO CLAIM IS MADE TO THE EXCLUSIVE RIGHT TO USE "FLOWERS", APART FROM THE MARK AS SHOWN.  
FOR LIVING PLANTS (U.S. CLS. 1 AND 46).  
FIRST USE 8-23-2010; IN COMMERCE 10-20-2010.  
ARETHA SOMERVILLE, EXAMINING ATTORNEY

**CLASS 31—(Continued).**

SN 85-238,891. AGRÍCOLA MAAS, S.A. DE C.V., LA PIEDAD, MICHOACÁN, MEXICO, FILED 2-10-2011.

**RED SUNSHINE**

THE MARK CONSISTS OF STANDARD CHARACTERS WITHOUT CLAIM TO ANY PARTICULAR FONT, STYLE, SIZE, OR COLOR.

NO CLAIM IS MADE TO THE EXCLUSIVE RIGHT TO USE "RED", APART FROM THE MARK AS SHOWN.

FOR FRESH FRUITS; FRESH VEGETABLES (U.S. CLS. 1 AND 46).

FIRST USE 7-0-2010; IN COMMERCE 7-0-2010.

NAAKWAMA ANKRAH, EXAMINING ATTORNEY

---

SN 85-245,911. RAY MARKS CO. LLC, NEW YORK, NY, FILED 2-18-2011.

**Rachael Ray Nutrish Soup Bones**

THE MARK CONSISTS OF STANDARD CHARACTERS WITHOUT CLAIM TO ANY PARTICULAR FONT, STYLE, SIZE, OR COLOR.

OWNER OF U.S. REG. NOS. 3,628,092, 3,640,637 AND OTHERS.

NO CLAIM IS MADE TO THE EXCLUSIVE RIGHT TO USE "SOUP BONE", APART FROM THE MARK AS SHOWN.

THE NAME(S), PORTRAIT(S), AND/OR SIGNATURE(S) SHOWN IN THE MARK IDENTIFIES "RACHAEL RAY", WHOSE CONSENT(S) TO REGISTER IS MADE OF RECORD.

FOR PET FOOD, NAMELY, PET TREATS (U.S. CLS. 1 AND 46).

ALYSSA STEEL, EXAMINING ATTORNEY

---

SN 85-321,876. FARMING TECHNOLOGY, INC., HOUSTON, TX, FILED 5-16-2011.

**KING RUSTICS**

THE MARK CONSISTS OF STANDARD CHARACTERS WITHOUT CLAIM TO ANY PARTICULAR FONT, STYLE, SIZE, OR COLOR.

OWNER OF U.S. REG. NO. 4,003,110.

FOR FRESH POTATOES; RAW POTATOES; UNPROCESSED POTATOES (U.S. CLS. 1 AND 46).

CAROLINE WOOD, EXAMINING ATTORNEY

**CLASS 31—(Continued).**

SN 85-323,963. COREY NUTRITION COMPANY INC., FREDERICTON, NB, CANADA, FILED 5-18-2011.



THE MARK CONSISTS OF A STONE FIGURE.

FOR PET FOOD (U.S. CLS. 1 AND 46).

FIRST USE 10-13-2006; IN COMMERCE 11-0-2006.

ARETHA SOMERVILLE, EXAMINING ATTORNEY

---

SN 85-324,354. TRACTOR SUPPLY CO. OF TEXAS, LP, BRENTWOOD, TN, FILED 5-18-2011.



OWNER OF U.S. REG. NOS. 3,144,624 AND 3,253,811.

THE MARK CONSISTS OF THE WORD GROUNDWORK IN A STYLIZED FONT APPEARING WITHIN A SLIGHTLY ARCHED RECTANGLE BANNER WITH A SEMI CIRCLE PROTRUSION AT THE TOP CENTER. CENTERED ABOVE THE WORD GROUNDWORK AND WITHIN THE SEMI CIRCLE PROTRUSION APPEARS THE IMAGE OF THREE LEAVES.

FOR GRASS SEEDS (U.S. CLS. 1 AND 46).

REGINA DRUMMOND, EXAMINING ATTORNEY

---

SN 85-328,708. BESSIE LOU BAD DOG, LLC, SAN ANTONIO, TX, FILED 5-24-2011.

**BESSIE LOU BAD DOG**

THE MARK CONSISTS OF STANDARD CHARACTERS WITHOUT CLAIM TO ANY PARTICULAR FONT, STYLE, SIZE, OR COLOR.

FOR DOG BISCUITS, DOG FOOD AND DOG TREATS (U.S. CLS. 1 AND 46).

ALLISON SCHRODY, EXAMINING ATTORNEY

**CLASS 31—(Continued).**

SN 85-333,591. THE IAMS COMPANY, CINCINNATI, OH.  
FILED 5-31-2011.

**IAMS SPORTING 29/18**

THE MARK CONSISTS OF STANDARD CHARACTERS  
WITHOUT CLAIM TO ANY PARTICULAR FONT, STYLE,  
SIZE, OR COLOR.  
OWNER OF U.S. REG. NOS. 1,317,225, 3,851,517 AND  
OTHERS.  
FOR PET FOOD (U.S. CLS. 1 AND 46).  
MAYUR VAGHANI, EXAMINING ATTORNEY

SN 85-333,977. THE IAMS COMPANY, CINCINNATI, OH.  
FILED 5-31-2011.

**NOT JUST FOOD. NUTRITION  
FOR LIFE.**

THE MARK CONSISTS OF STANDARD CHARACTERS  
WITHOUT CLAIM TO ANY PARTICULAR FONT, STYLE,  
SIZE, OR COLOR.  
FOR PET FOOD (U.S. CLS. 1 AND 46).  
MAYUR VAGHANI, EXAMINING ATTORNEY

SN 85-334,006. SAWAYA, MARGARET ANN NICOLE, DBA  
SUNBUDSFARM, WILLITS, CA. FILED 5-31-2011.

**SunBudsFarm**

THE MARK CONSISTS OF STANDARD CHARACTERS  
WITHOUT CLAIM TO ANY PARTICULAR FONT, STYLE,  
SIZE, OR COLOR.  
FOR NATURAL PLANTS AND FLOWERS (U.S. CLS. 1  
AND 46).  
MIDGE BUTLER, EXAMINING ATTORNEY

**CLASS 31—(Continued).**

SN 85-334,396. TANIMURA & ANTLE FRESH FOODS, INC.,  
SALINAS, CA. FILED 5-31-2011.

**EVERYDAY ARTISAN**

THE MARK CONSISTS OF STANDARD CHARACTERS  
WITHOUT CLAIM TO ANY PARTICULAR FONT, STYLE,  
SIZE, OR COLOR.  
FOR FRESH VEGETABLES (U.S. CLS. 1 AND 46).  
KATHERINE E. HALMEN, EXAMINING ATTORNEY

SN 85-336,645. SOCIETE DES PRODUITS NESTLE S.A.,  
VEVEY, SWITZERLAND, FILED 6-2-2011.

**PURE NATURE**

THE MARK CONSISTS OF STANDARD CHARACTERS  
WITHOUT CLAIM TO ANY PARTICULAR FONT, STYLE,  
SIZE, OR COLOR.  
FOR ANIMAL LITTER (U.S. CLS. 1 AND 46).  
VIVIAN MICZNIK FIRST, EXAMINING ATTORNEY

SN 85-336,649. SOCIETE DES PRODUITS NESTLE S.A.,  
VEVEY, SWITZERLAND, FILED 6-2-2011.

**COOKOUT CLASSICS**

THE MARK CONSISTS OF STANDARD CHARACTERS  
WITHOUT CLAIM TO ANY PARTICULAR FONT, STYLE,  
SIZE, OR COLOR.  
FOR PET FOOD (U.S. CLS. 1 AND 46).  
FIRST USE 6-20-2011; IN COMMERCE 6-20-2011.  
VIVIAN MICZNIK FIRST, EXAMINING ATTORNEY

SN 85-336,980. CANIDAE CORPORATION, SAN LUIS OBIS-  
PO, CA. FILED 6-2-2011.

**SUIDAE**

THE MARK CONSISTS OF STANDARD CHARACTERS  
WITHOUT CLAIM TO ANY PARTICULAR FONT, STYLE,  
SIZE, OR COLOR.  
FOR PIG FEED (U.S. CLS. 1 AND 46).  
HEATHER BIDDULPH, EXAMINING ATTORNEY

**CLASS 31—(Continued).**

SN 85-337,096. DARRY DAWG'S DOG BAKERY LLC, LAS VEGAS, NV. FILED 6-3-2011.



NO CLAIM IS MADE TO THE EXCLUSIVE RIGHT TO USE "GRAIN FREE DOG BISCUITS MADE FRESH DAILY", APART FROM THE MARK AS SHOWN.

THE COLOR(S) RED, BLUE, BEIGE, BROWN, BLACK AND WHITE IS/ARE CLAIMED AS A FEATURE OF THE MARK.

THE MARK CONSISTS OF THE WORDS DARRY DAWG'S IN BLACK AND OUTLINED IN WHITE AND THE WORDS GRAIN FREE IN RED AND DOG BISCUITS IN WHITE OUTLINED IN BLACK WITH THE DESIGN OF A BEIGE AND BROWN DOG WEARING A BLUE COLLAR WITH A RED TAG ALL SUPERIMPOSED ON A BLUE CIRCLE OUTLINED IN BLACK WHICH IS SUPERIMPOSED ON A BEIGE CIRCLE AND THE WORDS MADE FRESH DAILY IN BLACK PLACED AT THE BOTTOM OF THE BEIGE CIRCLE.

FOR DOG BISCUITS (U.S. CLS. 1 AND 46).  
LEIGH CAROLINE CASE, EXAMINING ATTORNEY

SN 85-337,289. JACK D. HERNANDEZ, BOYNTON BEACH, FL. FILED 6-3-2011.

## moviefruits

THE MARK CONSISTS OF STANDARD CHARACTERS WITHOUT CLAIM TO ANY PARTICULAR FONT, STYLE, SIZE, OR COLOR.

FOR FRESH FRUIT; FRESH FRUIT AND VEGETABLES; FRESH FRUITS (U.S. CLS. 1 AND 46).  
FIRST USE 5-15-2011; IN COMMERCE 5-15-2011.  
JACLYN KIDWELL WALKER, EXAMINING ATTORNEY

**CLASS 31—(Continued).**

SN 85-337,652. PIONEER PET PRODUCTS, LLC, CEDARBURG, WI. FILED 6-3-2011.

## THE GOOD EARTH

THE MARK CONSISTS OF STANDARD CHARACTERS WITHOUT CLAIM TO ANY PARTICULAR FONT, STYLE, SIZE, OR COLOR.

FOR CAT LITTER AND LITTER FOR SMALL ANIMALS (U.S. CLS. 1 AND 46).  
KATHERINE CHANG, EXAMINING ATTORNEY

SN 85-338,583. FIRESTEED CORPORATION, SEATTLE, WA. FILED 6-6-2011.

## ERRATIC OAKS

THE MARK CONSISTS OF STANDARD CHARACTERS WITHOUT CLAIM TO ANY PARTICULAR FONT, STYLE, SIZE, OR COLOR.

FOR FRESH FRUITS (U.S. CLS. 1 AND 46).  
LAURIE KAUFMAN, EXAMINING ATTORNEY

SN 85-338,664. GREEN FUSE BOTANICALS, INC., SANTA MONICA, CA. FILED 6-6-2011.

## DOUBLE UP

THE MARK CONSISTS OF STANDARD CHARACTERS WITHOUT CLAIM TO ANY PARTICULAR FONT, STYLE, SIZE, OR COLOR.

FOR LIVE PLANTS, NAMELY IMPATIENS (U.S. CLS. 1 AND 46).  
FIRST USE 10-1-2002; IN COMMERCE 10-1-2002.  
ALLISON HOLTZ, EXAMINING ATTORNEY

**CLASS 31—(Continued).**

SN 85-339,352. WHOLESUM FAMILY FARMS, INC., NO-GALES, AZ. FILED 6-6-2011.

**WHOLESUM HARVEST**

THE MARK CONSISTS OF STANDARD CHARACTERS WITHOUT CLAIM TO ANY PARTICULAR FONT, STYLE, SIZE, OR COLOR.

NO CLAIM IS MADE TO THE EXCLUSIVE RIGHT TO USE "WHOLESOME", APART FROM THE MARK AS SHOWN.

FOR FRESH FRUITS AND FRESH VEGETABLES (U.S. CLS. 1 AND 46).

FIRST USE 10-1-2010; IN COMMERCE 10-1-2010.  
JAY FLOWERS, EXAMINING ATTORNEY

**CLASS 31—(Continued).**

SN 85-347,683. KALMBACH FEEDS, INC., UPPER SANDUSKY, OH. FILED 6-16-2011.

**FEED THE ADDICTION**

THE MARK CONSISTS OF STANDARD CHARACTERS WITHOUT CLAIM TO ANY PARTICULAR FONT, STYLE, SIZE, OR COLOR.

FOR ANIMAL FEED; WILDLIFE SEED MIXTURES (U.S. CLS. 1 AND 46).

PATRICIA EVANKO, EXAMINING ATTORNEY

SN 85-341,558. PRODUCEERS REFINED OILSEED COMPANY, LLC, OKLAHOMA CITY, OK. FILED 6-8-2011.

**PROCO**

THE MARK CONSISTS OF STANDARD CHARACTERS WITHOUT CLAIM TO ANY PARTICULAR FONT, STYLE, SIZE, OR COLOR.

FOR CANOLA MEAL FOR ANIMAL FEED; UNPROCESSED SEEDS FOR AGRICULTURAL USE; AGRICULTURAL SEEDS (U.S. CLS. 1 AND 46).

WENDY JUN, EXAMINING ATTORNEY

SN 85-347,685. KALMBACH FEEDS, INC., UPPER SANDUSKY, OH. FILED 6-16-2011.

**AUTUMN ADDICTION**

THE MARK CONSISTS OF STANDARD CHARACTERS WITHOUT CLAIM TO ANY PARTICULAR FONT, STYLE, SIZE, OR COLOR.

FOR ANIMAL FEED; WILDLIFE SEED MIXTURES (U.S. CLS. 1 AND 46).

PATRICIA EVANKO, EXAMINING ATTORNEY

SN 85-341,933. BIG IDEA HOLDINGS, LLC, SALINAS, CA. FILED 6-9-2011.



NO CLAIM IS MADE TO THE EXCLUSIVE RIGHT TO USE "GREENS", APART FROM THE MARK AS SHOWN. THE COLOR(S) RED, GREEN AND ORANGE IS/ARE CLAIMED AS A FEATURE OF THE MARK.

THE MARK CONSISTS OF THE WORDING "GREAT GREENS!" IN STYLIZED LETTERING. THE WORD "GREAT" APPEARS IN RED. THE WORDING "GREENS!" APPEARS IN GREEN. THE WORD "GREAT" APPEARS INSIDE OF AN ORANGE COMIC BLAST DESIGN FORMED BY A RECTANGULAR SHAPE HAVING JAGGED EDGES.

FOR FRESH VEGETABLES (U.S. CLS. 1 AND 46).  
DEBRA LEE, EXAMINING ATTORNEY

SN 85-363,189. THE IAMS COMPANY, CINCINNATI, OH. FILED 7-5-2011.

**DOING THE WORK FROM THE  
INSIDE OUT**

THE MARK CONSISTS OF STANDARD CHARACTERS WITHOUT CLAIM TO ANY PARTICULAR FONT, STYLE, SIZE, OR COLOR.

FOR PET FOOD (U.S. CLS. 1 AND 46).

FIRST USE 5-12-2011; IN COMMERCE 5-12-2011.  
MAYUR VAGHANI, EXAMINING ATTORNEY

**CLASS 31—(Continued).**

SN 85-404,618. BALL HORTICULTURAL COMPANY, WEST CHICAGO, IL. FILED 8-23-2011.



OWNER OF U.S. REG. NOS. 2,664,474, 2,848,076 AND OTHERS.

THE COLOR(S) PINK IS/ARE CLAIMED AS A FEATURE OF THE MARK.

THE MARK CONSISTS OF THE STYLIZED PINK WORD "WAVE", WITH THE DESIGN OF A WAVE UNDERNEATH. FOR LIVING PLANTS; PLANT SEEDS (U.S. CLS. 1 AND 46).

DAVID TOOLEY, EXAMINING ATTORNEY

**CLASS 32—(Continued).**

SN 79-090,161. NORTH WINDS BREWING CORPORATION, NEW YORK, NY. FILED 6-4-2010.



OWNER OF INTERNATIONAL REGISTRATION 1058809 DATED 6-4-2010, EXPIRES 6-4-2020.

THE COLOR(S) RED, WHITE, BLACK AND GRAY IS/ARE CLAIMED AS A FEATURE OF THE MARK.

THE MARK CONSISTS OF ANIMAL TEETH IN WHITE ABOVE THE WORDING "GORILLA" IN WHITE TO THE LEFT OF FOUR JAGGED ARCS IN RED ABOVE ANIMAL TEETH IN WHITE ABOVE THE WORDING "GORILLA" IN WHITE. THE BACKGROUND IS GRAY AND BLACK IN A GRAINY PATTERN.

FOR MINERAL AND AERATED WATERS AND OTHER NON-ALCOHOLIC DRINKS, NAMELY, ISOTONIC NON-ALCOHOLIC DRINKS, ENERGY DRINKS, NON-ALCOHOLIC COCKTAILS; FRUIT DRINKS AND FRUIT JUICES; SYRUPS AND OTHER PREPARATIONS FOR MAKING BEVERAGES, NAMELY, FRUIT DRINKS AND NON-ALCOHOLIC COCKTAILS, ENERGY DRINKS; NON-ALCOHOLIC ISOTONIC BEVERAGES (U.S. CLS. 45, 46 AND 48).

BERNICE MIDDLETON, EXAMINING ATTORNEY

**CLASS 32—LIGHT BEVERAGES**

SN 77-761,812. NAMIBIA BREWERIES LIMITED, WINDHOEK, NAMIBIA, FILED 6-17-2009.

**WINDHOEK LAGER**

SN 79-091,716. INBEV BELGIUM S.A., BELGIUM, FILED 11-23-2010.

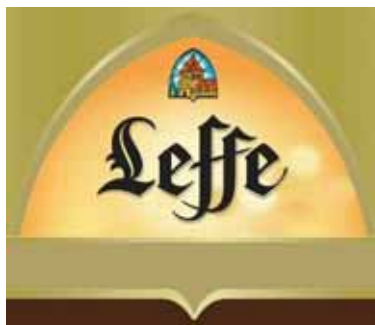

PRIORITY DATE OF 8-13-2010 IS CLAIMED.

OWNER OF INTERNATIONAL REGISTRATION 1062761 DATED 11-23-2010, EXPIRES 11-23-2020.

OWNER OF U.S. REG. NOS. 1,344,905, 3,488,893 AND OTHERS.

THE COLOR(S) BLACK, YELLOW, GREEN, BLUE, RED, ORANGE, WHITE, BROWN, GOLD AND BEIGE IS/ARE CLAIMED AS A FEATURE OF THE MARK.

THE MARK CONSISTS OF A RECTANGLE BORDER WITH A THICK BAND OF BROWN ACROSS THE BOTTOM OF THE RECTANGLE. A THIN BAND OF GOLD IS ABOVE THE BROWN BAND, WITH AN INDENTATION IN THE CENTER GOING INTO THE BROWN BAND. ABOVE THE

THE MARK CONSISTS OF STANDARD CHARACTERS WITHOUT CLAIM TO ANY PARTICULAR FONT, STYLE, SIZE, OR COLOR.

OWNER OF NAMIBIA REG. NO. 83/1276, DATED 12-6-1983, EXPIRES 12-6-2013.

NO CLAIM IS MADE TO THE EXCLUSIVE RIGHT TO USE "LAGER", APART FROM THE MARK AS SHOWN. FOR BEERS (U.S. CLS. 45, 46 AND 48).

ANGELA M. MICHELI, EXAMINING ATTORNEY

**CLASS 32—(Continued).**

GOLD BAND IS A LARGE BAND OF BEIGE. ABOVE THE GOLD BAND IS AN ARCH COMPOSED OF THIN GOLD AND BEIGE BANDS. INSIDE THE ARCH, ON A GOLD, YELLOW AND ORANGE BACKGROUND IS THE WORD "LEFFE" IN STYLIZED BROWN LETTERING, OUTLINED IN BEIGE. ABOVE THE WORDING IS A SMALL ARCH OUTLINED IN BROWN CONTAINING A BLUE AND WHITE WINDOW, A GREEN TREE, AND A BLACK, RED AND GOLD DESIGN OF AN ABBEY. THE UPPER PORTION OF THE RECTANGLE BORDER IS GOLD.

SEC. 2(F) "LEFFE".

FOR BEERS (U.S. CLS. 45, 46 AND 48).

ANDREA K. NADELMAN, EXAMINING ATTORNEY

SN 79-092,003. OBCHTCHESTVO S OGRANITCHENNOY OTVETSTVENNOSTYU "STRATEGUIYA", RUSSIAN FED., FILED 11-29-2010.

**ЖИГУЛИ**

OWNER OF INTERNATIONAL REGISTRATION 1063546 DATED 11-29-2010, EXPIRES 11-29-2020.

THE MARK CONSISTS OF CYRILLIC CHARACTERS THAT TRANSLITERATE INTO ZHIGULI.

THE ENGLISH TRANSLATION OF THE FOREIGN WORD(S) IN THE MARK IS: ZHIGULI

THE NON-LATIN CHARACTERS IN THE MARK TRANSLITERATE TO ZHIGULI AND THIS MEANS ZHIGULI IN ENGLISH.

FOR BEER (U.S. CLS. 45, 46 AND 48).

TASNEEM HUSSAIN, EXAMINING ATTORNEY

SN 79-095,508. LA GALVANINA S.P.A., ITALY, FILED 1-28-2011.

**GALVANINA**  
**FRU.IT**

PRIORITY DATE OF 1-27-2011 IS CLAIMED.  
OWNER OF INTERNATIONAL REGISTRATION 1072318 DATED 1-28-2011, EXPIRES 1-28-2021.

OWNER OF U.S. REG. NOS. 1,671,988 AND 2,787,547.

NO CLAIM IS MADE TO THE EXCLUSIVE RIGHT TO USE "FRUIT", APART FROM THE MARK AS SHOWN.

FOR FRUIT JUICES, GARDEN HERB AND VEGETABLE JUICES, NON-ALCOHOLIC BEVERAGES, NAMELY, FLAVORED DRINKING WATER, FLAVORED MINERAL WATER AND SOFT DRINKS (U.S. CLS. 45, 46 AND 48).

APRIL ROACH, EXAMINING ATTORNEY

**CLASS 32—(Continued).**

SN 79-096,520. NEVIOT-NATURE OF GALILEE LTD., ISRAEL, FILED 12-30-2010.



OWNER OF INTERNATIONAL REGISTRATION 1074777 DATED 12-30-2010, EXPIRES 12-30-2020.

THE MARK CONSISTS OF WAVE DESIGNS THAT FORM AN INCOMPLETE CIRCLE.

FOR MINERAL WATER (U.S. CLS. 45, 46 AND 48).

COURTNEY ALVAREZ, EXAMINING ATTORNEY

SN 79-096,839. GEROLSTEINER BRUNNEN GMBH & CO. KG, FED REP GERMANY, FILED 4-8-2011.

**GEROLSTEINER**  

OWNER OF INTERNATIONAL REGISTRATION 1075583 DATED 4-8-2011, EXPIRES 4-8-2021.

OWNER OF U.S. REG. NO. 2,490,217.

THE COLOR(S) BLUE, RED, BLACK, WHITE IS/ARE CLAIMED AS A FEATURE OF THE MARK.

THE MARK CONSISTS OF THE WORDING "GEROLSTEINER" IN STYLIZED BLUE TEXT, ABOVE THE DESIGN OF A STAR IN RED, WHITE AND BLACK, WITH A BLUE STYLIZED LION WITHIN THE STAR.

THE ENGLISH TRANSLATION OF "GEROLSTEINER" IN THE MARK IS "THING OR PERSON ORIGINATING FROM THE TOWN OF "GEROLSTEIN".

SEC. 2(F) AS TO "GEROLSTEINER".

FOR MINERAL WATER AND AERATED WATER, FLAVORED MINERAL WATER, MINERAL WATER WITH NATURAL AND ARTIFICIAL FLAVOR ADDITIVES, NON-ALCOHOLIC FRUIT AND MINT-FLAVORED BEVERAGES; ISOTONIC BEVERAGES; LEMONADES; ENERGY DRINKS AND SPORTS DRINKS; NON-ALCOHOLIC FRUIT BEVERAGES FOR STABILISING ENERGY BALANCE; FRUIT DRINKS AND FRUIT JUICES (U.S. CLS. 45, 46 AND 48).

JAMES MACFARLANE, EXAMINING ATTORNEY



**CLASS 32—(Continued).**

SN 79-098,042. DERIVADOS CÍTRICOS, S.A, SPAIN, FILED 5-31-2011.

**QUICKLEMON**

THE MARK CONSISTS OF STANDARD CHARACTERS WITHOUT CLAIM TO ANY PARTICULAR FONT, STYLE, SIZE, OR COLOR.

OWNER OF INTERNATIONAL REGISTRATION 1079164 DATED 5-31-2011, EXPIRES 5-31-2021.

FOR NON-ALCOHOLIC BEVERAGES, NAMELY, LEMON JUICE (U.S. CLS. 45, 46 AND 48).

SHANNON TWOHIG, EXAMINING ATTORNEY

**CLASS 32—(Continued).**

SN 85-047,624. DANK ENERGY DRINKS LTD., LANGLEY, B.C., CANADA, FILED 5-25-2010.

GET A BUZZ WITHOUT THE FUZZ

SN 85-021,342. NUTRITION 53, INC, LAFAYETTE, CA. FILED 4-23-2010.

**FOCUS1**

THE MARK CONSISTS OF STANDARD CHARACTERS WITHOUT CLAIM TO ANY PARTICULAR FONT, STYLE, SIZE, OR COLOR.

OWNER OF U.S. REG. NOS. 3,367,709, 3,475,805 AND 3,476,294.

FOR LIGHT BEVERAGES, NAMELY, BEERS; MINERAL AND AERATED WATERS; FRUIT DRINKS AND FRUIT JUICES; SYRUPS FOR MAKING BEVERAGES FOR CONSUMERS; SOFT DRINKS (U.S. CLS. 45, 46 AND 48).

ALEXANDER L. POWERS, EXAMINING ATTORNEY

THE MARK CONSISTS OF STANDARD CHARACTERS WITHOUT CLAIM TO ANY PARTICULAR FONT, STYLE, SIZE, OR COLOR.

OWNER OF CANADA REG. NO. 805972, DATED 9-2-2011, EXPIRES 9-2-2026.

FOR NON-ALCOHOLIC BEVERAGES, NAMELY, ENERGY DRINKS (U.S. CLS. 45, 46 AND 48).

BILL DAWE, EXAMINING ATTORNEY

SN 85-039,323. GREEN MOUNTAIN COFFEE ROASTERS, INC., WATERBURY, VT. FILED 5-14-2010.

**VITAMIN BURST**

THE MARK CONSISTS OF STANDARD CHARACTERS WITHOUT CLAIM TO ANY PARTICULAR FONT, STYLE, SIZE, OR COLOR.

NO CLAIM IS MADE TO THE EXCLUSIVE RIGHT TO USE "VITAMIN", APART FROM THE MARK AS SHOWN.

FOR FRUIT-BASED BEVERAGES CONTAINING VITAMINS (U.S. CLS. 45, 46 AND 48).

SALLY SHIH, EXAMINING ATTORNEY

SN 85-112,557. REVITALIVE HEALTH & WELLNESS, LLC, NEWBURYPORT, MA. FILED 8-20-2010.

**REVITACLEANSE**

THE MARK CONSISTS OF STANDARD CHARACTERS WITHOUT CLAIM TO ANY PARTICULAR FONT, STYLE, SIZE, OR COLOR.

FOR COCONUT JUICE; FRUIT JUICES; PREPARED ENTREES CONSISTING OF FRUIT DRINKS AND FRUIT JUICES, FRUIT-BASED BEVERAGES, NON-ALCOHOLIC BEVERAGES CONTAINING FRUIT JUICES, NON-ALCOHOLIC FRUIT EXTRACTS USED IN THE PREPARATION OF BEVERAGES, NON-ALCOHOLIC FRUIT JUICE BEVERAGES, VEGETABLE JUICES, VEGETABLE-FRUIT JUICES AND SMOOTHIES; VEGETABLE JUICE (U.S. CLS. 45, 46 AND 48).

FIRST USE 8-15-2010; IN COMMERCE 8-15-2010.

JENNIFER MARTIN, EXAMINING ATTORNEY



**CLASS 32—(Continued).**

SN 85-130,131. FASISCA, NEW ORLEANS, LA. FILED 9-15-2010.



NO CLAIM IS MADE TO THE EXCLUSIVE RIGHT TO USE "WATER" AND "NATURAL SPRING WATER", APART FROM THE MARK AS SHOWN.

THE STIPPLING IS A FEATURE OF THE MARK.

THE MARK CONSISTS OF THE WORD "FASISCA" IN STYLIZED STIPPLED FONT ORIENTED VERTICALLY TO THE LEFT OF A STIPPLED IMAGE OF SPLASHING WATER. ABOVE THE DESIGN IS THE WORDING "THE WORLD'S SEXIEST WATER" IN STYLIZED FONT AND BELOW THE DESIGN IS THE WORDING "NATURAL SPRING WATER" IN STYLIZED FONT. SCATTERED STIPPLING/SMUDGES INTENDED AS A FEATURE OF THE MARK ALSO APPEAR AMID THE WORDING ALONG THE LEFT AND TOP OF THE MARK.

THE WORDING "FASISCA" HAS NO MEANING IN A FOREIGN LANGUAGE.

FOR NATURAL SPRING WATER BEVERAGES (U.S. CLS. 45, 46 AND 48).

STEVEN PEREZ, EXAMINING ATTORNEY

**CLASS 32—(Continued).**

SN 85-181,766. POMODORO LLC, SAN DIEGO, CA. FILED 11-20-2010.

# COCO POW

THE MARK CONSISTS OF STANDARD CHARACTERS WITHOUT CLAIM TO ANY PARTICULAR FONT, STYLE, SIZE, OR COLOR.

NO CLAIM IS MADE TO THE EXCLUSIVE RIGHT TO USE "COCO", APART FROM THE MARK AS SHOWN.

FOR COCONUT WATER (U.S. CLS. 45, 46 AND 48).

TARA PATE, EXAMINING ATTORNEY

SN 85-183,076. FRESH MATTERS, LLC, SANTA FE, NM. FILED 11-23-2010.

# PRESSTEURIZED

THE MARK CONSISTS OF STANDARD CHARACTERS WITHOUT CLAIM TO ANY PARTICULAR FONT, STYLE, SIZE, OR COLOR.

FOR LIGHT BEVERAGE PRODUCTS, NAMELY, FRUIT JUICE BEVERAGES, FRUIT JUICES, FRUIT AND VEGETABLE JUICE DRINKS, NON-ALCOHOLIC FRUIT JUICE BEVERAGES AND VEGETABLE JUICES FOR CONSUMERS OF ALL AGES (U.S. CLS. 45, 46 AND 48).

B. PARADEWELAI, EXAMINING ATTORNEY

SN 85-168,149. 2156775 ONTARIO INC., DBA D'ANGELO BRANDS, MISSISSAUGA, ONTARIO, CANADA, FILED 11-3-2010.

# CHEETAH

THE MARK CONSISTS OF STANDARD CHARACTERS WITHOUT CLAIM TO ANY PARTICULAR FONT, STYLE, SIZE, OR COLOR.

OWNER OF U.S. REG. NO. 3,602,563.

FOR NON-ALCOHOLIC BEVERAGES, NAMELY, FRUIT DRINKS, FRUIT JUICES, SPORTS DRINKS, ENERGY DRINKS, AND SOFT DRINKS (U.S. CLS. 45, 46 AND 48).

GEOFFREY FOSDICK, EXAMINING ATTORNEY

SN 85-193,787. LOGIN BEVERAGE CO., LTD., GOYANG-SI, GYEONGGI-DO, REPUBLIC OF KOREA, FILED 12-9-2010.

# Login Logsoo DMZ

THE MARK CONSISTS OF STANDARD CHARACTERS WITHOUT CLAIM TO ANY PARTICULAR FONT, STYLE, SIZE, OR COLOR.

THE WORDING "LOGIN LOGSOO DMZ" HAS NO MEANING IN A FOREIGN LANGUAGE.

FOR MINERAL WATER; PREPARATION FOR MAKING MINERAL WATER, NAMELY, ESSENCES AND SYRUPS FOR MAKING FLAVORED MINERAL WATERS; LITHIA WATER; NON-AERATED WATER; WATER BEVERAGES; TABLE WATER; MINERAL WATER BEVERAGES; DRINKING WATER; SPRING WATER (U.S. CLS. 45, 46 AND 48).

BERNICE MIDDLETON, EXAMINING ATTORNEY

**CLASS 32—(Continued).**

SN 85-199,095. WINERY EXCHANGE, INC., NOVATO, CA.  
FILED 12-15-2010.

**PORT REPUBLIC**

THE MARK CONSISTS OF STANDARD CHARACTERS  
WITHOUT CLAIM TO ANY PARTICULAR FONT, STYLE,  
SIZE, OR COLOR.

FOR BEER (U.S. CLS. 45, 46 AND 48).  
FIRST USE 4-0-2011; IN COMMERCE 4-0-2011.  
GRETTA YAO, EXAMINING ATTORNEY

SN 85-202,379. SIMKO LLC, HERMOSA BEACH, CA. FILED  
12-21-2010.

**Hermosa Brunette**

THE MARK CONSISTS OF STANDARD CHARACTERS  
WITHOUT CLAIM TO ANY PARTICULAR FONT, STYLE,  
SIZE, OR COLOR.

THE ENGLISH TRANSLATION OF THE WORD "HER-  
MOSA" IN THE MARK IS "BEAUTIFUL".  
FOR BEER (U.S. CLS. 45, 46 AND 48).  
ELISSA GARBER KON, EXAMINING ATTORNEY

SN 85-222,867. CHIVAS HOLDINGS (IP) LIMITED, RE-  
NFREWSHIRE, UNITED KINGDOM, FILED 1-21-2011.

**100 PIPERS**

THE MARK CONSISTS OF STANDARD CHARACTERS  
WITHOUT CLAIM TO ANY PARTICULAR FONT, STYLE,  
SIZE, OR COLOR.

OWNER OF ERPN CMNTY TM OFC REG. NO. 008468365,  
DATED 1-21-2010, EXPIRES 8-3-2019.

OWNER OF U.S. REG. NO. 806,464.  
FOR BEERS; MINERAL AND AERATED WATERS;  
OTHER NON-ALCOHOLIC DRINKS, NAMELY, CARBO-  
NATED BEVERAGES, PUNCH, SOFT DRINKS, AND  
NON-ALCOHOLIC COCKTAILS; FRUIT DRINKS AND  
FRUIT JUICES; SYRUPS FOR MAKING BEVERAGES;  
AND OTHER PREPARATIONS FOR MAKING BEV-  
ERAGES, NAMELY, CONCENTRATES AND POWDERS  
USED IN THE PREPARATION OF NON-ALCOHOLIC  
CARBONATED BEVERAGES, SOFT DRINKS AND  
FRUIT-FLAVORED BEVERAGES (U.S. CLS. 45, 46 AND  
48).

MICHAEL TANNER, EXAMINING ATTORNEY

**CLASS 32—(Continued).**

SN 85-243,696. HOG'S BREATH INTERNATIONAL, INC.,  
DESTIN, FL. FILED 2-16-2011.



OWNER OF U.S. REG. NOS. 1,292,830, 1,331,992 AND  
OTHERS.

NO CLAIM IS MADE TO THE EXCLUSIVE RIGHT TO  
USE "BEER", APART FROM THE MARK AS SHOWN.

THE MARK CONSISTS OF THE WORDS "HOG'S  
BREATH BEER" INSIDE AN OVAL WITH THE DESIGN  
OF A HOG HEAD IN THE CENTER.

FOR BEER AND ALE (U.S. CLS. 45, 46 AND 48).  
FIRST USE 4-1-1990; IN COMMERCE 4-1-1990.  
SUE LAWRENCE, EXAMINING ATTORNEY

SN 85-247,295. SUPER BAKERY INC., PITTSBURGH, PA.  
FILED 2-21-2011.

**THE POWER OF COCOA**

THE MARK CONSISTS OF STANDARD CHARACTERS  
WITHOUT CLAIM TO ANY PARTICULAR FONT, STYLE,  
SIZE, OR COLOR.

NO CLAIM IS MADE TO THE EXCLUSIVE RIGHT TO  
USE "COCOA", APART FROM THE MARK AS SHOWN.

FOR SPORTS DRINKS CONTAINING COCOA (U.S.  
CLS. 45, 46 AND 48).

FIRST USE 1-11-2011; IN COMMERCE 1-11-2011.  
KAREN BRACEY, EXAMINING ATTORNEY

**CLASS 32—(Continued).**

SN 85-259,750. EVOLUTION FRESH, INC., SAN BERNARDINO, CA. FILED 3-7-2011.

## Truth in Juice

THE MARK CONSISTS OF STANDARD CHARACTERS WITHOUT CLAIM TO ANY PARTICULAR FONT, STYLE, SIZE, OR COLOR.

NO CLAIM IS MADE TO THE EXCLUSIVE RIGHT TO USE "JUICE", APART FROM THE MARK AS SHOWN.

FOR ALOE JUICE BEVERAGES; APPLE JUICE BEVERAGES; COCONUT-BASED BEVERAGES; COCONUT-BASED NON-ALCOHOLIC BEVERAGES; FRUIT-BASED BEVERAGES; GRAPE JUICE BEVERAGES; ISOTONIC NON-ALCOHOLIC DRINKS; NON-ALCOHOLIC BEVERAGES CONTAINING FRUIT JUICES; NON-ALCOHOLIC COCKTAIL BASES; NON-ALCOHOLIC COCKTAIL MIXES; NON-ALCOHOLIC COCKTAILS; NON-ALCOHOLIC FRUIT JUICE BEVERAGES; NON-ALCOHOLIC HONEY-BASED BEVERAGES; ORANGE JUICE BEVERAGES; PINEAPPLE JUICE BEVERAGES; TOMATO JUICE BEVERAGES; VEGETABLE JUICES (U.S. CLS. 45, 46 AND 48).

NICHOLAS COLEMAN, EXAMINING ATTORNEY

SN 85-266,973. GENEVE FOOD CORP, PROVIDENCE, RI. FILED 3-15-2011.

## LA KOLA REAL

THE MARK CONSISTS OF STANDARD CHARACTERS WITHOUT CLAIM TO ANY PARTICULAR FONT, STYLE, SIZE, OR COLOR.

NO CLAIM IS MADE TO THE EXCLUSIVE RIGHT TO USE "COLA", APART FROM THE MARK AS SHOWN.

THE ENGLISH TRANSLATION OF THE WORD "LA" IN THE MARK IS "THE".

FOR NON-ALCOHOLIC FRUIT JUICE BEVERAGES; NON-ALCOHOLIC BEVERAGES, NAMELY, CARBONATED BEVERAGES; BOTTLED WATER; MINERAL WATER; VEGETABLE JUICES (U.S. CLS. 45, 46 AND 48).

CHARLES L. JENKINS, EXAMINING ATTORNEY

SN 85-284,491. LIN, DAVID, HONOLULU, HI. FILED 4-2-2011.

## waiola

THE MARK CONSISTS OF STANDARD CHARACTERS WITHOUT CLAIM TO ANY PARTICULAR FONT, STYLE, SIZE, OR COLOR.

THE ENGLISH TRANSLATION OF "WAIOLA" IN THE MARK IS "WATER OF LIFE".

FOR COCONUT WATER (U.S. CLS. 45, 46 AND 48). FIRST USE 3-1-2011; IN COMMERCE 3-15-2011.

MEGHAN REINHART, EXAMINING ATTORNEY

**CLASS 32—(Continued).**

SN 85-290,266. PHOENIX BEVERAGES LIMITED, PHOENIX, MAURITIUS, FILED 4-8-2011.



NO CLAIM IS MADE TO THE EXCLUSIVE RIGHT TO USE "PHOENIX BEER", APART FROM THE MARK AS SHOWN.

THE COLOR(S) BLACK, YELLOW, RED, WHITE AND BLUE IS/ARE CLAIMED AS A FEATURE OF THE MARK.

THE MARK CONSISTS OF A BLACK PHOENIX ON TOP OF A RED BANNER, OUTLINED IN WHITE AND YELLOW, WITH THE WORD "PHOENIX" APPEARING IN WHITE, WITH A SMALLER BLUE BANNER UNDERNEATH WITH THE WORD "BEER" APPEARING IN WHITE; THE UNDERSIDE OF THE LARGE RED BANNER IS SHADED WITH YELLOW AND BLUE.

FOR BEERS, ALES, STOUTS AND PORTERS (U.S. CLS. 45, 46 AND 48).

BARBARA A. GOLD, EXAMINING ATTORNEY

SN 85-299,222. ORANGE LIFE, LLC, RENTON, WA. FILED 4-19-2011.



NO CLAIM IS MADE TO THE EXCLUSIVE RIGHT TO USE "JUST SQUEEZED", APART FROM THE MARK AS SHOWN.

THE COLOR(S) YELLOW, ORANGE, GREEN, BROWN, BLUE, RED, BLACK, WHITE IS/ARE CLAIMED AS A FEATURE OF THE MARK.

THE MARK CONSISTS OF THE WORDS "JUST SQUEEZED" IN BLACK OUTLINED IN WHITE. THE WORDS ARE SUPERIMPOSED OVER AN OBLONG RECTANGLE DESIGN WHICH CONTAINS SHADED AREAS OF GREEN, YELLOW, AND ORANGE WITH AN ORANGE LIQUID DROP DESIGN AT ONE END. BETWEEN THE WORDS, AND ALSO SUPERIMPOSED OVER THE RECTANGLE, IS THE DESIGN OF AN ORANGE WITH GREEN LEAVES ON A BROWN STEM AT THE TOP OF THE ORANGE; WHITE, BLUE, AND BLACK EYES; WHITE TEETH, RED TONGUE, BLACK IN THE INTERIOR OF A MOUTH; AND WHITE AND BLACK HANDS. THE COLORS ARE CLAIMED AS A FEATURE OF THE MARK. THE COLORS ARE ORANGE: YELLOW (ORANGE): C:0 M:18 Y:100 K:0; LT YELLOW (ORANGE): C:0 M:9 Y:53 K:0; ORANGE (ORANGE): C:0 M:39 Y:100 K:0; MED ORANGE (ORANGE): C:0 M:68 Y:86 K:40; DRK ORANGE (ORANGE): C:0 M:63 Y:100 K:16; STEM: GREEN (ORANGE): C:80 M:0 Y:100 K:20; DRK GREEN (ORANGE): C:80 M:0 Y:100 K:39; BROWN (ORANGE): C:40 M:70 Y:100 K:50; EYES: BLUE

**CLASS 32—(Continued).**

(ORANGE): C:100 M:72 Y:0 K:30; DRK BLUE (ORANGE): C:100 M:81 Y:0 K:68; HANDS: LT BLUE (ORANGE): C:70 M:15 Y:0 K:0; MOUTH: RED (ORANGE): C:15 M:100 Y:90 K:10; DRK RED (ORANGE): C:50 M:70 Y:80 K:70. FONT IS ANGELINA (REGULAR), BLACK LETTERS WITH WHITE OUTLINE, JUST., ON A BANNERED BACKGROUND OF CMYK GREEN (GRADIENT): C:91 M:0 Y:100 K:0 AND, SQUEEZED, ON A BANNERED BACKGROUND OF CMYK YELLOW (GRADIENT): C:0 M:18 Y:100 K:0 AND ORANGE (GRADIENT): C:0 M:57 Y:100 K:0.

FOR FRESH NATURAL ORANGE JUICE SQUEEZED IN SECONDS FROM AN AUTOMATED FRUIT VENDING MACHINE OR EQUIPMENT (U.S. CLS. 45, 46 AND 48).

FIRST USE 2-20-2011; IN COMMERCE 3-1-2011.  
MATTHEW EINSTEIN, EXAMINING ATTORNEY

SN 85-308,217. STOKELY-VAN CAMP, INC., CHICAGO, IL.  
FILED 4-29-2011.

**G SERIES PERFORM**

THE MARK CONSISTS OF STANDARD CHARACTERS WITHOUT CLAIM TO ANY PARTICULAR FONT, STYLE, SIZE, OR COLOR.

OWNER OF U.S. REG. NOS. 3,767,941, 3,855,002 AND OTHERS.

NO CLAIM IS MADE TO THE EXCLUSIVE RIGHT TO USE "SERIES", APART FROM THE MARK AS SHOWN.

FOR NON-ALCOHOLIC, NON-CARBONATED FRUIT FLAVORED BEVERAGES (U.S. CLS. 45, 46 AND 48).

BRENDAN REGAN, EXAMINING ATTORNEY

SN 85-308,226. STOKELY-VAN CAMP, INC., CHICAGO, IL.  
FILED 4-29-2011.

**G SERIES RECOVER**

THE MARK CONSISTS OF STANDARD CHARACTERS WITHOUT CLAIM TO ANY PARTICULAR FONT, STYLE, SIZE, OR COLOR.

OWNER OF U.S. REG. NOS. 3,767,941, 3,929,887 AND OTHERS.

NO CLAIM IS MADE TO THE EXCLUSIVE RIGHT TO USE "SERIES", APART FROM THE MARK AS SHOWN.

FOR NON-ALCOHOLIC, NON-CARBONATED FRUIT FLAVORED BEVERAGES (U.S. CLS. 45, 46 AND 48).

BRENDAN REGAN, EXAMINING ATTORNEY

**CLASS 32—(Continued).**

SN 85-311,399. EPARTNERSCW5, INC., CHICAGO, IL. FILED 5-3-2011.



NO CLAIM IS MADE TO THE EXCLUSIVE RIGHT TO USE "COCO", "HYDRATING PERFORMANCE DRINK", AND "COCONUT WATER", APART FROM THE MARK AS SHOWN.

THE MARK CONSISTS OF A VERTICALLY WRITTEN WORD "COCO" WHICH APPEARS TO THE LEFT OF A ARABIC NUMERAL "5"; BOTH THE WORD "COCO" AND NUMBER "5" ARE ABOVE AN IMAGE OF WATER SPLASHING, WITH THE WATER ALSO SPLASHING BETWEEN THE WORD "COCO" AND NUMBER "5"; A BROKEN HALF OF A COCONUT ABOVE THE WORD "COCO" AND NUMBER "5"; AND THE PHRASE "HYDRATING PERFORMANCE DRINK FUELED BY PURE COCONUT WATER" WRITTEN BELOW THE SPLASHING WATER.

FOR COCONUT WATER (U.S. CLS. 45, 46 AND 48).  
DANNEAN HETZEL, EXAMINING ATTORNEY

SN 85-311,671. THE CORN SQUEEZIN COMPANY, LLC,  
LOUISA, KY. FILED 5-4-2011.



OWNER OF U.S. REG. NO. 3,950,302.

NO CLAIM IS MADE TO THE EXCLUSIVE RIGHT TO USE "CORN", APART FROM THE MARK AS SHOWN.

THE COLOR(S) YELLOW, BLUE, BLACK, LIGHT BROWN, RED, LIGHT BEIGE AND DARK BROWN IS/ ARE CLAIMED AS A FEATURE OF THE MARK.

THE MARK CONSISTS OF A MALE HILLBILLY FIGURE WITH A YELLOW BEARD AND HAIR, WEARING A LIGHT BROWN HAT AND BLUE OVERALLS WITHOUT A SHIRT WITH LIGHT BEIGE SKIN, HOLDING A DARK AND LIGHT BROWN TWO-TONE JUG IN HIS RIGHT HAND,

**CLASS 32—(Continued).**

WITH A LIGHT BEIGE DOG WEARING A LIGHT BROWN HAT AND RED COLLAR SITTING AT THE MAN'S FEET. THE MAN IS SUPPORTING A LIGHT BROWN WOODEN SIGN DISPLAYING THE WORDS "CORN SQUEEZIN" IN ALL UPPERCASE LETTERS IN THE COLOR YELLOW EACH LETTER OUTLINED IN BLACK, AND WITH A BALLOON COMMENT APPEARING IN THE RIGHT SIDE OF THE MARK WITH THE WORDS "HAVE A SWIG" IN RED UPPERCASE LETTERS WITH A YELLOW BACKGROUND AND OUTLINED IN BLACK.

FOR SOFT DRINKS; SOFT DRINKS, NAMELY, CARBONATED, CITRUS FLAVORED SOFT DRINKS (U.S. CLS. 45, 46 AND 48).

FIRST USE 7-14-2009; IN COMMERCE 7-14-2009.  
DAVID HOFFMAN, EXAMINING ATTORNEY

**CLASS 32—(Continued).**

SN 85-321,916. CLEMENTS, MAYLING WOO, LAGUNA NIGUEL, CA. FILED 5-16-2011.

**Coco The Cow**

THE MARK CONSISTS OF STANDARD CHARACTERS WITHOUT CLAIM TO ANY PARTICULAR FONT, STYLE, SIZE, OR COLOR.

NO CLAIM IS MADE TO THE EXCLUSIVE RIGHT TO USE "COCO", APART FROM THE MARK AS SHOWN.

FOR COCONUT-BASED BEVERAGES (U.S. CLS. 45, 46 AND 48).

WILLIAM VERHOSEK, EXAMINING ATTORNEY

SN 85-314,967. WIERENGA, AARON JOHN, SAN FRANCISCO, CA. FILED 5-6-2011.

**MORNING BEER**

THE MARK CONSISTS OF STANDARD CHARACTERS WITHOUT CLAIM TO ANY PARTICULAR FONT, STYLE, SIZE, OR COLOR.

NO CLAIM IS MADE TO THE EXCLUSIVE RIGHT TO USE "BEER", APART FROM THE MARK AS SHOWN.

FOR BEER (U.S. CLS. 45, 46 AND 48).

ELLEN PERKINS, EXAMINING ATTORNEY

SN 85-323,144. FRONTERA FOODS, INC, CHICAGO, IL. FILED 5-17-2011.

SN 85-320,399. DZL PRODUCTIONS, LLC, TROY, NY. FILED 5-13-2011.

**SNACK SIPS WITH REAL FRUIT SLICES**

THE MARK CONSISTS OF STANDARD CHARACTERS WITHOUT CLAIM TO ANY PARTICULAR FONT, STYLE, SIZE, OR COLOR.

NO CLAIM IS MADE TO THE EXCLUSIVE RIGHT TO USE "SNACK" OR "WITH REAL FRUIT SLICES", APART FROM THE MARK AS SHOWN.

FOR FRUIT JUICES (U.S. CLS. 45, 46 AND 48).

KATHERINE CHANG, EXAMINING ATTORNEY

NO CLAIM IS MADE TO THE EXCLUSIVE RIGHT TO USE "LATIN STYLE WHITE ALE", APART FROM THE MARK AS SHOWN.

THE COLOR(S) RED, YELLOW-ORANGE, PURPLE AND WHITE IS/ARE CLAIMED AS A FEATURE OF THE MARK.

THE MARK CONSISTS OF THE WORDS "MARISOL LATIN STYLE WHITE ALE" IN WHITE UPPERCASE LETTERS SUPERIMPOSED ON A SERIES OF 15 WAVY RINGS ARRANGED CONCENTRICALLY; THE RINGS ARE MULTICOLORED AND PROGRESS AROUND THE CIRCLE FROM RED THROUGH YELLOW-ORANGE TO PURPLE BACK THROUGH YELLOW-ORANGE AND ENDING WITH RED.

FOR BEER (U.S. CLS. 45, 46 AND 48).

FIRST USE 10-0-2010; IN COMMERCE 10-0-2010.

MATTHEW KLINE, EXAMINING ATTORNEY



**CLASS 32—(Continued).**

SN 85-323,592. GLAS, ROBERT, WALKER VALLEY, NY. AND YOVANE, GREGORY, CORTLANDT MANOR, NY. FILED 5-18-2011.

**Beer Water The Responsible  
Alternative**

THE MARK CONSISTS OF STANDARD CHARACTERS WITHOUT CLAIM TO ANY PARTICULAR FONT, STYLE, SIZE, OR COLOR.

NO CLAIM IS MADE TO THE EXCLUSIVE RIGHT TO USE "BEER WATER", APART FROM THE MARK AS SHOWN.

FOR BOTTLED WATER (U.S. CLS. 45, 46 AND 48).  
KAREN K. BUSH, EXAMINING ATTORNEY

SN 85-323,709. TROPICAL PARADISE, INC., BEDFORD, MA. FILED 5-18-2011.



OWNER OF U.S. REG. NO. 2,159,021.  
THE COLOR(S) DARK BLUE, TEAL BLUE, WHITE AND RED IS/ARE CLAIMED AS A FEATURE OF THE MARK.

THE MARK CONSISTS OF THE WORD "COOL" IN DARK BLUE CURSIVE WITH A TEAL BLUE BORDER SHADOWED IN WHITE AND RED WITH A STRAW WITH RED AND WHITE STRIPES AND OUTLINED IN DARK BLUE RUNNING THROUGH THE SECOND "O" AND THE WORD "TROPICS" IN DARK BLUE WITH A TEAL BLUE OUTLINE AND SHADOWED IN WHITE AND RED.

FOR CONCENTRATES FOR MAKING FRUIT DRINKS; FROZEN FRUIT BEVERAGES; FROZEN FRUIT-BASED BEVERAGES; FRUIT DRINKS; FRUIT-BASED BEVERAGES; FRUIT-FLAVORED BEVERAGES; NON-ALCOHOLIC BEVERAGES CONTAINING FRUIT JUICES; NON-ALCOHOLIC FRUIT JUICE BEVERAGES; PREPARATIONS FOR MAKING BEVERAGES, NAMELY, FRUIT DRINKS (U.S. CLS. 45, 46 AND 48).  
FIRST USE 5-1-1997; IN COMMERCE 5-1-1997.

BARBARA RUTLAND, EXAMINING ATTORNEY

**CLASS 32—(Continued).**

SN 85-324,376. VANBERG & DEWULF CO., INC., COOPERTOWN, NY. FILED 5-18-2011.

**POSCA RUSTICA**

THE MARK CONSISTS OF STANDARD CHARACTERS WITHOUT CLAIM TO ANY PARTICULAR FONT, STYLE, SIZE, OR COLOR.

THE ENGLISH TRANSLATION OF "RUSTICA" IN THE MARK IS "RUSTIC".

FOR ALE (U.S. CLS. 45, 46 AND 48).  
DEBRA LEE, EXAMINING ATTORNEY

SN 85-327,804. THE LIVING WELL BREWERY, LLC, CHICAGO, IL. FILED 5-23-2011.

**ARIZE**

THE MARK CONSISTS OF STANDARD CHARACTERS WITHOUT CLAIM TO ANY PARTICULAR FONT, STYLE, SIZE, OR COLOR.

FOR NON-ALCOHOLIC BEVERAGES WITH TEA FLAVOR (U.S. CLS. 45, 46 AND 48).

KATHERINE E. HALMEN, EXAMINING ATTORNEY

SN 85-333,930. THE COCA-COLA COMPANY, ATLANTA, GA. FILED 5-31-2011.

**FLEUR**

THE MARK CONSISTS OF STANDARD CHARACTERS WITHOUT CLAIM TO ANY PARTICULAR FONT, STYLE, SIZE, OR COLOR.

THE ENGLISH TRANSLATION OF "FLEUR" IN THE MARK IS "FLOWER".

FOR FLAVORED WATERS (U.S. CLS. 45, 46 AND 48).  
GEOFFREY FOSDICK, EXAMINING ATTORNEY

**CLASS 32—(Continued).**

SN 85-334,731. ROY-PITZ BREWING CO., LLC, CHAMBERS-BURG, PA. FILED 6-1-2011.

# Liquid Art

THE MARK CONSISTS OF STANDARD CHARACTERS WITHOUT CLAIM TO ANY PARTICULAR FONT, STYLE, SIZE, OR COLOR.

FOR BEER; BEER, ALE AND LAGER; FLAVORED BEERS (U.S. CLS. 45, 46 AND 48).

FIRST USE 1-30-2008; IN COMMERCE 1-30-2008.

HEATHER THOMPSON, EXAMINING ATTORNEY

---

SN 85-334,752. ROY-PITZ BREWING CO., LLC, CHAMBERS-BURG, PA. FILED 6-1-2011.

# Ludwig's Revenge

THE MARK CONSISTS OF STANDARD CHARACTERS WITHOUT CLAIM TO ANY PARTICULAR FONT, STYLE, SIZE, OR COLOR.

FOR BEER; BEER, ALE AND LAGER (U.S. CLS. 45, 46 AND 48).

FIRST USE 1-30-2008; IN COMMERCE 1-30-2008.

HEATHER THOMPSON, EXAMINING ATTORNEY

---

SN 85-334,762. ROY-PITZ BREWING CO., LLC, CHAMBERS-BURG, PA. FILED 6-1-2011.

# Daddy Fat Sacks

THE MARK CONSISTS OF STANDARD CHARACTERS WITHOUT CLAIM TO ANY PARTICULAR FONT, STYLE, SIZE, OR COLOR.

FOR BEER; BEER, ALE AND LAGER (U.S. CLS. 45, 46 AND 48).

FIRST USE 1-30-2008; IN COMMERCE 1-30-2008.

HEATHER THOMPSON, EXAMINING ATTORNEY

**CLASS 32—(Continued).**

SN 85-334,771. ROY-PITZ BREWING CO., LLC, CHAMBERS-BURG, PA. FILED 6-1-2011.

# Old Jail

THE MARK CONSISTS OF STANDARD CHARACTERS WITHOUT CLAIM TO ANY PARTICULAR FONT, STYLE, SIZE, OR COLOR.

FOR BEER; BEER, ALE AND LAGER (U.S. CLS. 45, 46 AND 48).

FIRST USE 1-30-2008; IN COMMERCE 1-30-2008.

HEATHER THOMPSON, EXAMINING ATTORNEY

---

SN 85-334,925. ALL NATURAL HEALTH AND BEAUTY CENTER, INC., SIMPSONVILLE, SC. FILED 6-1-2011.



NO CLAIM IS MADE TO THE EXCLUSIVE RIGHT TO USE "WATER", APART FROM THE MARK AS SHOWN.

THE COLOR(S) BLUE AND WHITE IS/ARE CLAIMED AS A FEATURE OF THE MARK.

THE MARK CONSISTS OF A BLUE OVAL CONTAINING THE STYLIZED WORD OXYIONIC IN WHITE AND BLUE. THE STYLIZED WORD WATER IN BLUE APPEARS SLIGHTLY INSIDE THE BOTTOM OF THE OVAL. A BLUE SWIRL WITH BLUE AND WHITE BUBBLES APPEARS THROUGH THE MIDDLE OF THE OVAL AND EXTENDS ABOVE AND BELOW THE OVAL.

FOR BOTTLED WATER (U.S. CLS. 45, 46 AND 48).

PAUL E. FAHRENKOPF, EXAMINING ATTORNEY



**CLASS 32—(Continued).**

SN 85-335,191. WK FOODS, DBA WUNDERSMOOTHIE, BROOKLINE, MA. FILED 6-1-2011.



NO CLAIM IS MADE TO THE EXCLUSIVE RIGHT TO USE "SMOOTHIE", APART FROM THE MARK AS SHOWN.

THE COLOR(S) DARK GREEN AND LIGHT GREEN IS/ARE CLAIMED AS A FEATURE OF THE MARK.

THE MARK CONSISTS OF THE WORD WUNDERSMOOTHIE STACKED ACROSS 2 LINES IN A DARK GREEN COLOR SURROUNDED BY A STYLISED LIGHT GREEN KEYLINE. THE KEYLINE INCLUDES A SHOOTING STAR ABOVE THE LETTERS U AND N, A RISING SUN ABOVE THE LETTER D, A SWIRL WITHIN THE LETTER D, A HEART WITHIN BOTH LETTERS O, A SILHOUETTE STAR ABOVE THE LETTER H AND THE LETTER I, AND 5 LIGHT GREEN STARS.

THE ENGLISH TRANSLATION OF "WUNDER" IN THE MARK IS "WONDER".

FOR SMOOTHIES (U.S. CLS. 45, 46 AND 48).

FIRST USE 9-17-2010, THE MARK WAS FIRST USED ANYWHERE IN A DIFFERENT FORM OTHER THAN THAT SOUGHT TO BE REGISTERED AT LEAST AS EARLY AS 09/17/2010; IN COMMERCE 9-17-2010, THE MARK WAS FIRST USED IN COMMERCE IN A DIFFERENT FORM OTHER THAN THAT SOUGHT TO BE REGISTERED AT LEAST AS EARLY AS 09/17/2010.

IRA J. GOODSaid, EXAMINING ATTORNEY

SN 85-335,848. GREGORY G. PLUMMER, PORTLAND, OR. FILED 6-1-2011.

## VITATAK

THE MARK CONSISTS OF STANDARD CHARACTERS WITHOUT CLAIM TO ANY PARTICULAR FONT, STYLE, SIZE, OR COLOR.

FOR ENERGY DRINKS; SPORTS DRINKS; SPORTS DRINKS CONTAINING ELECTROLYTES; SPORTS DRINKS, NAMELY, ENERGY DRINKS (U.S. CLS. 45, 46 AND 48).

SUNG IN, EXAMINING ATTORNEY

SN 85-336,108. PURBLU BEVERAGES, INC., PITTSBURGH, PA. FILED 6-2-2011.

## GIVE

THE MARK CONSISTS OF STANDARD CHARACTERS WITHOUT CLAIM TO ANY PARTICULAR FONT, STYLE, SIZE, OR COLOR.

OWNER OF U.S. REG. NOS. 3,541,103 AND 3,803,768.

FOR FRUIT AND VEGETABLE JUICE (U.S. CLS. 45, 46 AND 48).

FLORENTINA BLANDU, EXAMINING ATTORNEY

**CLASS 32—(Continued).**

SN 85-336,337. FENWAY HOLDINGS, LLC, DALLAS, TX. FILED 6-2-2011.

## How Do?

THE MARK CONSISTS OF STANDARD CHARACTERS WITHOUT CLAIM TO ANY PARTICULAR FONT, STYLE, SIZE, OR COLOR.

FOR BEER (U.S. CLS. 45, 46 AND 48).

CHRISTINE COOPER, EXAMINING ATTORNEY

SN 85-337,471. LAWSON, MATTHEW R, RALEIGH, NC. FILED 6-3-2011.

## SNICKLEFRITZ

THE MARK CONSISTS OF STANDARD CHARACTERS WITHOUT CLAIM TO ANY PARTICULAR FONT, STYLE, SIZE, OR COLOR.

FOR CARBONATED AND NON-CARBONATED FRUIT BEVERAGES, POWDERS AND CONCENTRATES FOR MAKING CARBONATED AND NON-CARBONATED FRUIT BEVERAGES (U.S. CLS. 45, 46 AND 48).

JUDITH HELFMAN, EXAMINING ATTORNEY

SN 85-338,339. PRICE, SCOTT WESLEY, AKA E55DU13, TEMPE, AZ. FILED 6-5-2011.

## VASO LOCO

THE MARK CONSISTS OF STANDARD CHARACTERS WITHOUT CLAIM TO ANY PARTICULAR FONT, STYLE, SIZE, OR COLOR.

THE ENGLISH TRANSLATION OF "VASO LOCO" IN THE MARK IS "CRAZY GLASS".

FOR BEER (U.S. CLS. 45, 46 AND 48).

TINA BROWN, EXAMINING ATTORNEY



**CLASS 32—(Continued).**

SN 85-338,523. SPANGLER, SHANNON, SANTA MONICA, CA. FILED 6-6-2011.

# Shanimal

THE MARK CONSISTS OF STANDARD CHARACTERS WITHOUT CLAIM TO ANY PARTICULAR FONT, STYLE, SIZE, OR COLOR.

FOR ALL-NATURAL ENERGY DRINK USING LIVER DETOXIFYING HERBS, SPECIFICALLY MILK THISTLE (U.S. CLS. 45, 46 AND 48).

GRETCHEN ULRICH, EXAMINING ATTORNEY

---

SN 85-338,681. BOOMERANG BOB'S, LLC, TERRE HAUTE, IN. FILED 6-6-2011.



THE NAME(S), PORTRAIT(S), AND/OR SIGNATURE(S) SHOWN IN THE MARK DOES NOT IDENTIFY A PARTICULAR LIVING INDIVIDUAL.

THE MARK CONSISTS OF A SWEEPING LINE DESIGN AND BOOMERANG BOB'S IN STYLIZED LETTERING.

FOR NON-ALCOHOLIC COCKTAIL BASES; NON-ALCOHOLIC COCKTAIL MIXES (U.S. CLS. 45, 46 AND 48). FIRST USE 12-1-2010; IN COMMERCE 2-28-2011.

WILLIAM BRECKENFELD, EXAMINING ATTORNEY

---

SN 85-339,217. LULU FRUIT COMPANY, LLC, LOS ANGELES, CA. FILED 6-6-2011.

# Wild Poppy

THE MARK CONSISTS OF STANDARD CHARACTERS WITHOUT CLAIM TO ANY PARTICULAR FONT, STYLE, SIZE, OR COLOR.

FOR NON-ALCOHOLIC BEVERAGES CONTAINING FRUIT JUICES (U.S. CLS. 45, 46 AND 48).

FIRST USE 5-25-2011; IN COMMERCE 5-25-2011.

ODESSA BIBBINS, EXAMINING ATTORNEY

**CLASS 32—(Continued).**

SN 85-339,398. MILLENNIUM PRODUCTS, INC., VERNON, CA. FILED 6-6-2011.

# SYNERGY

THE MARK CONSISTS OF STANDARD CHARACTERS WITHOUT CLAIM TO ANY PARTICULAR FONT, STYLE, SIZE, OR COLOR.

OWNER OF U.S. REG. NO. 3,946,879.

FOR FUNCTIONAL BEVERAGES, NAMELY, COCONUT WATER, FRUIT JUICES, FRUIT DRINKS, AND ENERGY DRINKS (U.S. CLS. 45, 46 AND 48).

EMILY CARLSEN, EXAMINING ATTORNEY

---

SN 85-340,010. UINTA BREWING COMPANY, SALT LAKE CITY, UT. FILED 6-7-2011.

# YARD SALE

THE MARK CONSISTS OF STANDARD CHARACTERS WITHOUT CLAIM TO ANY PARTICULAR FONT, STYLE, SIZE, OR COLOR.

FOR BEER (U.S. CLS. 45, 46 AND 48).

GRETCHEN ULRICH, EXAMINING ATTORNEY

---

SN 85-340,151. UINTA BREWING COMPANY, SALT LAKE CITY, UT. FILED 6-7-2011.

# BIRTHDAY SUIT

THE MARK CONSISTS OF STANDARD CHARACTERS WITHOUT CLAIM TO ANY PARTICULAR FONT, STYLE, SIZE, OR COLOR.

FOR BEER (U.S. CLS. 45, 46 AND 48).

GRETCHEN ULRICH, EXAMINING ATTORNEY

**CLASS 32—(Continued).**

SN 85-340,458. LAS OLEADAS LLC, ASPEN, CO. FILED 6-7-2011.

# OLEADA

THE MARK CONSISTS OF STANDARD CHARACTERS WITHOUT CLAIM TO ANY PARTICULAR FONT, STYLE, SIZE, OR COLOR.

THE ENGLISH TRANSLATION OF "OLEADA" IN THE MARK IS "SWELL; SURGE; BILLOW; MOMENTUM OR ENERGY BEHIND A WAVE; MOVEMENT OF A WAVE; A FIGURATIVE WAVE, SUCH AS A 'WAVE OF PROTESTS'".  
FOR WATER BEVERAGES (U.S. CLS. 45, 46 AND 48).  
FIRST USE 11-1-2010; IN COMMERCE 11-1-2010.  
CHERYL CLAYTON, EXAMINING ATTORNEY

**CLASS 32—(Continued).**

SN 85-352,763. THE COCA-COLA COMPANY, ATLANTA, GA. FILED 6-22-2011.

# FANTA FRUITIZZ

THE MARK CONSISTS OF STANDARD CHARACTERS WITHOUT CLAIM TO ANY PARTICULAR FONT, STYLE, SIZE, OR COLOR.

OWNER OF U.S. REG. NOS. 513,565, 3,011,381 AND OTHERS.  
FOR FRUIT JUICES AND FRUIT DRINKS; PREPARATIONS FOR MAKING BEVERAGES, NAMELY, SYRUPS AND CONCENTRATES FOR MAKING FRUIT DRINKS AND FRUIT JUICES (U.S. CLS. 45, 46 AND 48).  
GEOFFREY FOSDICK, EXAMINING ATTORNEY

SN 85-341,685. JAY ZACHARY ZUPPARDO, MORENO VALLEY, CA. FILED 6-8-2011.

# Manyk

THE MARK CONSISTS OF STANDARD CHARACTERS WITHOUT CLAIM TO ANY PARTICULAR FONT, STYLE, SIZE, OR COLOR.

FOR ENERGY DRINKS (U.S. CLS. 45, 46 AND 48).  
GEOFFREY FOSDICK, EXAMINING ATTORNEY

SN 85-357,225. THE COCA-COLA COMPANY, ATLANTA, GA. FILED 6-27-2011.

# BE UNCONTAINABLE

THE MARK CONSISTS OF STANDARD CHARACTERS WITHOUT CLAIM TO ANY PARTICULAR FONT, STYLE, SIZE, OR COLOR.

FOR SOFT DRINKS (U.S. CLS. 45, 46 AND 48).  
GEOFFREY FOSDICK, EXAMINING ATTORNEY

SN 85-341,690. JAY ZACHARY ZUPPARDO, MORENO VALLEY, CA. FILED 6-8-2011.

# MANYK MINDSET

THE MARK CONSISTS OF STANDARD CHARACTERS WITHOUT CLAIM TO ANY PARTICULAR FONT, STYLE, SIZE, OR COLOR.

FOR ENERGY DRINKS (U.S. CLS. 45, 46 AND 48).  
GEOFFREY FOSDICK, EXAMINING ATTORNEY

SN 85-359,412. ANHEUSER-BUSCH, INCORPORATED, ST. LOUIS, MO. FILED 6-29-2011.

# YOU'RE GOLDEN

THE MARK CONSISTS OF STANDARD CHARACTERS WITHOUT CLAIM TO ANY PARTICULAR FONT, STYLE, SIZE, OR COLOR.

FOR BEER (U.S. CLS. 45, 46 AND 48).  
FIRST USE 7-31-2010; IN COMMERCE 7-31-2010.  
AMY KERTGATE, EXAMINING ATTORNEY

**CLASS 32—(Continued).**

SN 85-363,231. BOOMERANG BOB'S, LLC, TERRE HAUTE, IN. FILED 7-5-2011.



THE MARK CONSISTS OF A SWEEPING LINE DESIGN AND BOOMERANG BAY IN STYLIZED LETTERING.  
FOR NON-ALCOHOLIC COCKTAIL BASES; NON-ALCOHOLIC COCKTAIL MIXES (U.S. CLS. 45, 46 AND 48).  
WILLIAM BRECKENFELD, EXAMINING ATTORNEY

SN 85-366,360. THE COCA-COLA COMPANY, ATLANTA, GA. FILED 7-8-2011.

# ZENZERO

THE MARK CONSISTS OF STANDARD CHARACTERS WITHOUT CLAIM TO ANY PARTICULAR FONT, STYLE, SIZE, OR COLOR.  
FOR SOFT DRINKS (U.S. CLS. 45, 46 AND 48).  
GEOFFREY FOSDICK, EXAMINING ATTORNEY

SN 85-372,277. THE COCA-COLA COMPANY, ATLANTA, GA. FILED 7-15-2011.

# DESIGNED TO MAKE A DIFFERENCE

THE MARK CONSISTS OF STANDARD CHARACTERS WITHOUT CLAIM TO ANY PARTICULAR FONT, STYLE, SIZE, OR COLOR.  
FOR BOTTLED DRINKING WATER (U.S. CLS. 45, 46 AND 48).  
FIRST USE 4-1-2011; IN COMMERCE 4-1-2011.  
GEOFFREY FOSDICK, EXAMINING ATTORNEY

**CLASS 32—(Continued).**

SN 85-375,791. U.S. MARINE CORPS, A COMPONENT OF THE U.S. DEPARTMENT OF THE NAVY, WASHINGTON, DC. FILED 7-20-2011.

# MARINE WEEK

THE MARK CONSISTS OF STANDARD CHARACTERS WITHOUT CLAIM TO ANY PARTICULAR FONT, STYLE, SIZE, OR COLOR.

FOR NON-ALCOHOLIC BEVERAGES, NAMELY, CARBONATED BEVERAGES (U.S. CLS. 45, 46 AND 48).  
FIRST USE 6-20-2011; IN COMMERCE 6-20-2011.  
WENDY JUN, EXAMINING ATTORNEY

SN 85-377,360. DIAGEO IRELAND, DUBLIN, IRELAND, FILED 7-21-2011.

# BOLDEST FAN

THE MARK CONSISTS OF STANDARD CHARACTERS WITHOUT CLAIM TO ANY PARTICULAR FONT, STYLE, SIZE, OR COLOR.

FOR BEER (U.S. CLS. 45, 46 AND 48).  
GRETTA YAO, EXAMINING ATTORNEY

SN 85-377,373. DIAGEO IRELAND, DUBLIN, IRELAND, FILED 7-21-2011.

# ONLY FOR THE BOLDEST FANS

THE MARK CONSISTS OF STANDARD CHARACTERS WITHOUT CLAIM TO ANY PARTICULAR FONT, STYLE, SIZE, OR COLOR.

FOR BEER (U.S. CLS. 45, 46 AND 48).  
GRETTA YAO, EXAMINING ATTORNEY

**CLASS 32—(Continued).**

SN 85-384,081. INTELLECTUAL PROPERTY DEVELOPMENT CORPORATION PTY LTD, MELBOURNE, AUSTRALIA, FILED 7-28-2011.

**WE DO BEER DIFFERENTLY**

THE MARK CONSISTS OF STANDARD CHARACTERS WITHOUT CLAIM TO ANY PARTICULAR FONT, STYLE, SIZE, OR COLOR.

PRIORITY CLAIMED UNDER SEC. 44(D) ON AUSTRALIA APPLICATION NO. 1433694, FILED 6-29-2011.

FOR BEER; BEER MAKING KIT (U.S. CLS. 45, 46 AND 48).

LYDIA BELZER, EXAMINING ATTORNEY

---

SN 85-388,725. THE CONCENTRATE MANUFACTURING COMPANY OF IRELAND, HAMILTON, BERMUDA, FILED 8-3-2011.

**ICEBOLT MO MOCHA**

THE MARK CONSISTS OF STANDARD CHARACTERS WITHOUT CLAIM TO ANY PARTICULAR FONT, STYLE, SIZE, OR COLOR.

OWNER OF U.S. REG. NO. 3,412,283.

NO CLAIM IS MADE TO THE EXCLUSIVE RIGHT TO USE "MOCHA", APART FROM THE MARK AS SHOWN.

FOR NON-CARBONATED, NON-ALCOHOLIC FROZEN FLAVORED BEVERAGES (U.S. CLS. 45, 46 AND 48).

DOUGLAS LEE, EXAMINING ATTORNEY

---

SN 85-388,732. THE CONCENTRATE MANUFACTURING COMPANY OF IRELAND, HAMILTON, BERMUDA, FILED 8-3-2011.

**ICEBOLT ORANGE FROST**

THE MARK CONSISTS OF STANDARD CHARACTERS WITHOUT CLAIM TO ANY PARTICULAR FONT, STYLE, SIZE, OR COLOR.

OWNER OF U.S. REG. NO. 3,412,283.

NO CLAIM IS MADE TO THE EXCLUSIVE RIGHT TO USE "ORANGE", APART FROM THE MARK AS SHOWN.

FOR NON-CARBONATED, NON-ALCOHOLIC FROZEN FLAVORED BEVERAGES (U.S. CLS. 45, 46 AND 48).

DOUGLAS LEE, EXAMINING ATTORNEY

**CLASS 32—(Continued).**

SN 85-388,736. THE CONCENTRATE MANUFACTURING COMPANY OF IRELAND, HAMILTON, BERMUDA, FILED 8-3-2011.

**ICEBOLT POTENT PEACH**

THE MARK CONSISTS OF STANDARD CHARACTERS WITHOUT CLAIM TO ANY PARTICULAR FONT, STYLE, SIZE, OR COLOR.

OWNER OF U.S. REG. NO. 3,412,283.

NO CLAIM IS MADE TO THE EXCLUSIVE RIGHT TO USE "PEACH", APART FROM THE MARK AS SHOWN.

FOR NON-CARBONATED, NON-ALCOHOLIC FROZEN FLAVORED BEVERAGES (U.S. CLS. 45, 46 AND 48).

DOUGLAS LEE, EXAMINING ATTORNEY

---

SN 85-388,831. THE CONCENTRATE MANUFACTURING COMPANY OF IRELAND, HAMILTON, BERMUDA, FILED 8-3-2011.

**ICEBOLT VANILLACCINO**

THE MARK CONSISTS OF STANDARD CHARACTERS WITHOUT CLAIM TO ANY PARTICULAR FONT, STYLE, SIZE, OR COLOR.

OWNER OF U.S. REG. NO. 3,412,283.

FOR NON-CARBONATED, NON-ALCOHOLIC FROZEN FLAVORED BEVERAGES (U.S. CLS. 45, 46 AND 48).

DOUGLAS LEE, EXAMINING ATTORNEY

---

SN 85-390,736. THE COCA-COLA COMPANY, ATLANTA, GA. FILED 8-5-2011.

**HANDHELD**

THE MARK CONSISTS OF STANDARD CHARACTERS WITHOUT CLAIM TO ANY PARTICULAR FONT, STYLE, SIZE, OR COLOR.

FOR NON-ALCOHOLIC BEVERAGES, NAMELY SOFT DRINKS (U.S. CLS. 45, 46 AND 48).

GEOFFREY FOSDICK, EXAMINING ATTORNEY

**CLASS 32—(Continued).**

SN 85-397,798. RAINFOREST BEVERAGES, LLC, FT. LAUDERDALE, FL. FILED 8-15-2011.

**RAINFOREST CITRUS**

THE MARK CONSISTS OF STANDARD CHARACTERS WITHOUT CLAIM TO ANY PARTICULAR FONT, STYLE, SIZE, OR COLOR.

NO CLAIM IS MADE TO THE EXCLUSIVE RIGHT TO USE "CITRUS", APART FROM THE MARK AS SHOWN, FOR SOFT DRINKS CONTAINING CITRUS FLAVORING (U.S. CLS. 45, 46 AND 48).

MATTHEW MCDOWELL, EXAMINING ATTORNEY

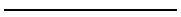

SN 85-412,325. MILLERCOORS LLC, CHICAGO, IL. FILED 8-31-2011.

**COLD ZONE**

THE MARK CONSISTS OF STANDARD CHARACTERS WITHOUT CLAIM TO ANY PARTICULAR FONT, STYLE, SIZE, OR COLOR.

FOR BEER (U.S. CLS. 45, 46 AND 48).  
SUSAN RICHARDS, EXAMINING ATTORNEY



SN 85-413,309. MILLERCOORS LLC, CHICAGO, IL. FILED 9-1-2011.

**FROST ZONE**

THE MARK CONSISTS OF STANDARD CHARACTERS WITHOUT CLAIM TO ANY PARTICULAR FONT, STYLE, SIZE, OR COLOR.

FOR BEER (U.S. CLS. 45, 46 AND 48).  
SUSAN RICHARDS, EXAMINING ATTORNEY

**CLASS 33—WINES AND SPIRITS**

SN 76-707,789. OFFICER, MICHAEL R., SANTA ROSA, CA. AND OFFICER, KENDALL H., SANTA ROSA, CA. FILED 5-31-2011.

**THE DERIVATIVE**

THE MARK CONSISTS OF STANDARD CHARACTERS WITHOUT CLAIM TO ANY PARTICULAR FONT, STYLE, SIZE, OR COLOR.

FOR WINE (U.S. CLS. 47 AND 49).  
ESTHER BELENKER, EXAMINING ATTORNEY



SN 77-644,048. GLOBEFILL INCORPORATED, KINGSTON, ONTARIO, CANADA, FILED 1-6-2009.

**CRYSTAL SKULL**

THE MARK CONSISTS OF STANDARD CHARACTERS WITHOUT CLAIM TO ANY PARTICULAR FONT, STYLE, SIZE, OR COLOR.

PRIORITY CLAIMED UNDER SEC. 44(D) ON CANADA APPLICATION NO. 1416350, FILED 10-29-2008, REG. NO. TMA766372, DATED 5-11-2010, EXPIRES 5-11-2025.

FOR ALCOHOLIC BEVERAGES, NAMELY, VODKA (U.S. CLS. 47 AND 49).  
ANGELA DUONG, EXAMINING ATTORNEY



SN 77-782,462. VAMPT BEVERAGE CORP., KELOWNA, BC, CANADA, FILED 7-16-2009.

**VAMPT**

THE MARK CONSISTS OF STANDARD CHARACTERS WITHOUT CLAIM TO ANY PARTICULAR FONT, STYLE, SIZE, OR COLOR.

PRIORITY CLAIMED UNDER SEC. 44(D) ON CANADA APPLICATION NO. 1435647, FILED 4-23-2009.

FOR ALCOHOLIC BEVERAGES, NAMELY, PREMIXED COCKTAILS AND TEQUILA-BASED COOLERS; ALCOHOLIC COCKTAIL MIXES (U.S. CLS. 47 AND 49).  
ESTHER A. BORSUK, EXAMINING ATTORNEY

**CLASS 33—(Continued).**

SN 77-824,838. RUSSIAN STANDARD INTELLECTUAL PROPERTY HOLDING AG, CHAM, SWITZERLAND, AND ROUST INCORPORATED, SAINT-PETERSBURG, RUSSIAN FED., FILED 9-11-2009.

# ИМПЕРИЯ

OWNER OF U.S. REG. NO. 2,998,580.  
THE MARK CONSISTS OF CYRILLIC CHARACTERS. THE NON-LATIN CHARACTERS IN THE MARK TRANSLITERATE TO "IMPERIYA," AND THIS MEANS "EMPIRE" IN ENGLISH  
FOR ALCOHOLIC BEVERAGES, NAMELY, VODKA (U.S. CLS. 47 AND 49).  
HEATHER BIDDULPH, EXAMINING ATTORNEY

SN 77-834,425. VAMPT BEVERAGE CORP., KELOWNA, BC, CANADA, FILED 9-24-2009.

# GET VAMPT

THE MARK CONSISTS OF STANDARD CHARACTERS WITHOUT CLAIM TO ANY PARTICULAR FONT, STYLE, SIZE, OR COLOR.

PRIORITY CLAIMED UNDER SEC. 44(D) ON CANADA APPLICATION NO. 1452142, FILED 9-17-2009.

FOR ALCOHOLIC BEVERAGES, NAMELY, PREMIXED COCKTAILS AND TEQUILA-BASED COOLERS; ALCOHOLIC COCKTAIL MIXES (U.S. CLS. 47 AND 49).  
JOHN WILKE, EXAMINING ATTORNEY

SN 77-954,452. CHASE DISTILLERY LIMITED, HEREFORD, UNITED KINGDOM, FILED 3-9-2010.



THE NAME(S), PORTRAIT(S), AND/OR SIGNATURE(S) SHOWN IN THE MARK DOES NOT IDENTIFY A PARTICULAR LIVING INDIVIDUAL.

THE MARK CONSISTS OF THE WORDS "WILLIAMS WC CHASE" SURROUNDED BY A STYLIZED OVAL DESIGN WITH A VINE AND LEAF DESIGN SURROUNDING THE OVAL.

FOR VODKA; GIN; AND FRUIT LIQUORS (U.S. CLS. 47 AND 49).

WANDA KAY PRICE, EXAMINING ATTORNEY

**CLASS 33—(Continued).**

SN 79-070,283. ADOLPH HUESGEN, DBA WINE INTERNATIONAL ADOLPH HUESGEN E. K., FED REP GERMANY, FILED 6-3-2009.

# Villa Huesgen

THE MARK CONSISTS OF STANDARD CHARACTERS WITHOUT CLAIM TO ANY PARTICULAR FONT, STYLE, SIZE, OR COLOR.

PRIORITY DATE OF 5-26-2009 IS CLAIMED.

OWNER OF INTERNATIONAL REGISTRATION 1006253 DATED 6-3-2009, EXPIRES 6-3-2019.

FOR WINES (U.S. CLS. 47 AND 49).

JAMES STEIN, EXAMINING ATTORNEY

SN 79-090,414. CAVICCHIOLI U. E FIGLI S.R.L., I-41030 SAN PROSPERO (MO), ITALY, FILED 10-29-2010.

# CAVICCHIOLI

THE MARK CONSISTS OF STANDARD CHARACTERS WITHOUT CLAIM TO ANY PARTICULAR FONT, STYLE, SIZE, OR COLOR.

PRIORITY DATE OF 10-22-2010 IS CLAIMED.

OWNER OF INTERNATIONAL REGISTRATION 1059699 DATED 10-29-2010, EXPIRES 10-29-2020.

OWNER OF U.S. REG. NO. 3,387,406.

FOR WINES, SPARKLING WINES AND ALCOHOLIC BEVERAGES EXCEPT BEERS (U.S. CLS. 47 AND 49).

SCOTT BIBB, EXAMINING ATTORNEY

SN 79-090,756. SOCIETE D'EXPLOITATION DU CHATEAU SOUTARD, FRANCE, FILED 11-10-2010.



PRIORITY DATE OF 6-11-2010 IS CLAIMED.

OWNER OF INTERNATIONAL REGISTRATION 1060509 DATED 11-10-2010, EXPIRES 11-10-2020.

NO CLAIM IS MADE TO THE EXCLUSIVE RIGHT TO USE "CHATEAU" AND "GRAND CRU CLASSE SAINT-EMILION 2008", APART FROM THE MARK AS SHOWN.

THE COLOR(S) CREAM, GOLD, AND GRAY IS/ARE CLAIMED AS A FEATURE OF THE MARK.

THE MARK CONSISTS OF A CREAM RECTANGLE WITH A GRAY AND CREAM BORDER WITHIN WHICH APPEARS A DESIGN OF A MANSION IN CREAM AND

**CLASS 33—(Continued).**

GRAY WITHIN AN OVAL WITH A CREAM BACKGROUND AND GRAY DECORATIVE BORDER ITSELF PLACED OVER A GRAY RECTANGLE WITH A BORDER OF CREAM AND GRAY. THIS DESIGN APPEARS ABOVE THE WORDING "CHATEAU SOUTARD" IN GRAY, WHICH IS ABOVE THE WORDING "GRAND CRU CLASSE" IN GOLD, WHICH IS ABOVE THE WORDING "SAINT-EMILION" IN GRAY. THIS APPEARS ABOVE AN OVAL BORDERED IN GRAY CIRCLES WITHIN WHICH APPEARS "2008" IN GOLD.

THE ENGLISH TRANSLATION OF THE WORD "CLASSE" IN THE MARK IS CLASSIFICATION. THE WORDING "SOUTARD" HAS NO MEANING IN A FOREIGN LANGUAGE.

FOR WINES WITH A REGISTERED DESIGNATION OF ORIGIN, NAMELY, AOC WINES (U.S. CLS. 47 AND 49).

ANDREA HACK, EXAMINING ATTORNEY

SN 79-091,035. CHIVAS HOLDINGS (IP) LIMITED, UNITED KINGDOM, FILED 11-30-2010.

**JAMES & JOHN**

THE MARK CONSISTS OF STANDARD CHARACTERS WITHOUT CLAIM TO ANY PARTICULAR FONT, STYLE, SIZE, OR COLOR.

PRIORITY DATE OF 10-13-2010 IS CLAIMED.

OWNER OF INTERNATIONAL REGISTRATION 1061225 DATED 11-30-2010, EXPIRES 11-30-2020.

FOR ALCOHOLIC BEVERAGES EXCEPT BEERS (U.S. CLS. 47 AND 49).

COLLEEN DOMBROW, EXAMINING ATTORNEY

SN 79-092,398. CHIVAS HOLDINGS (IP) LIMITED, UNITED KINGDOM, FILED 11-30-2010.



PRIORITY DATE OF 10-13-2010 IS CLAIMED.  
OWNER OF INTERNATIONAL REGISTRATION 1064625 DATED 11-30-2010, EXPIRES 11-30-2020.

THE COLOR(S) BROWN AND GREY IS/ARE CLAIMED AS A FEATURE OF THE MARK.

THE MARK CONSISTS OF THE STYLIZED TERMS "JAMES JOHN" WITH THE STYLIZED LETTERS "J & J" LOCATED IN BETWEEN THE "JAMES JOHN" WORDING. THE WORDING "JAMES" "JOHN" AND BOTH "J" LETTERS APPEAR IN THE COLOR GREY. THE AMPERSAND SYMBOL APPEARS IN THE COLOR BROWN. THE TWO "J" LETTERS ARE OFFSET SO THAT THE SECOND "J" LETTER BEGINS AT THE MIDPOINT OF THE FIRST "J" LETTER AND THE AMPERSAND SYMBOL INTERTWINES BOTH "J" LETTERS.

FOR ALCOHOLIC BEVERAGES EXCEPT BEERS (U.S. CLS. 47 AND 49).

MICHAEL TANNER, EXAMINING ATTORNEY

**CLASS 33—(Continued).**

SN 79-093,531. BRUICHLADDICH DISTILLERY COMPANY LIMITED, UNITED KINGDOM, FILED 2-1-2011.

**RENEGADE**

THE MARK CONSISTS OF STANDARD CHARACTERS WITHOUT CLAIM TO ANY PARTICULAR FONT, STYLE, SIZE, OR COLOR.

OWNER OF INTERNATIONAL REGISTRATION 1067383 DATED 2-1-2011, EXPIRES 2-1-2021.

FOR RUM (U.S. CLS. 47 AND 49).

MARY BOAGNI, EXAMINING ATTORNEY

SN 79-094,105. OTKRYTOE AKTSIONERNOE OBSHESTVO "MORDOVSPIRT", RUSSIAN FED., FILED 12-9-2010.

**МЛЕЧНЫЙ ПУТЬ**

OWNER OF INTERNATIONAL REGISTRATION 1068528 DATED 12-9-2010, EXPIRES 12-9-2020.

THE MARK CONSISTS OF RUSSIAN CHARACTERS THAT TRANSLITERATE TO MLECHNYI PUT WHICH MEANS MILKY WAY IN ENGLISH.

THE NON-LATIN CHARACTERS IN THE MARK TRANSLITERATE TO "MLECHNYI PUT" AND THIS MEANS "MILKY WAY" IN ENGLISH.

FOR ALCOHOLIC BEVERAGES EXCEPT BEERS, APERITIFS; ARAK; BRANDY; WINE; PIQUETTE; WHISKY; VODKA; GIN; DIGESTIFS, NAMELY, LIQUEURS AND SPIRITS; PREPARED ALCOHOLIC COCKTAILS; LIQUEURS; ALCOHOLIC BEVERAGES CONTAINING FRUIT; SPIRITS; DISTILLED BEVERAGES, NAMELY, DISTILLED SPIRITS; HYDROMEL IN THE NATURE OF MEAD; PEPPERMINT LIQUEURS; ALCOHOLIC BITTERS; RUM; SAKE; HARD CIDER; RICE ALCOHOL, NAMELY, DISTILLED SPIRITS OF RICE; ALCOHOLIC EXTRACTS; ALCOHOLIC FRUIT EXTRACTS; ALCOHOLIC ESSENCES (U.S. CLS. 47 AND 49).

HAI-LY LAM, EXAMINING ATTORNEY

SN 79-094,117. BOUGRIER SA, FRANCE, FILED 2-1-2011.

**DOUCE FRANCE**

THE MARK CONSISTS OF STANDARD CHARACTERS WITHOUT CLAIM TO ANY PARTICULAR FONT, STYLE, SIZE, OR COLOR.

PRIORITY DATE OF 8-4-2010 IS CLAIMED.

OWNER OF INTERNATIONAL REGISTRATION 1068571 DATED 2-1-2011, EXPIRES 2-1-2021.

NO CLAIM IS MADE TO THE EXCLUSIVE RIGHT TO USE "FRANCE", APART FROM THE MARK AS SHOWN.

FOR ALCOHOLIC BEVERAGES EXCEPT BEER (U.S. CLS. 47 AND 49).

MARY BOAGNI, EXAMINING ATTORNEY

**CLASS 33—(Continued).**

SN 79-094,712. PRZEDSIĘBIORSTWO HANDLOWO-PRODUKCYJNE WAWRZYNIAK WIESLAW, POLAND, FILED 1-27-2011.

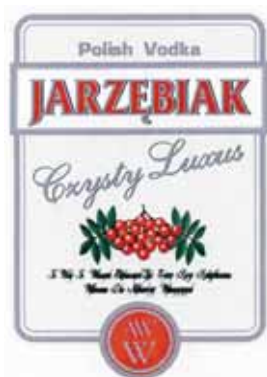

PRIORITY DATE OF 7-28-2010 IS CLAIMED.  
OWNER OF INTERNATIONAL REGISTRATION 1070075  
DATED 1-27-2011, EXPIRES 1-27-2021.

NO CLAIM IS MADE TO THE EXCLUSIVE RIGHT TO USE "POLISH VODKA", "CZYSTY LUXUS" OR "Z WODY Z WŁASNYCH GLEBINOWYCH UJEC. CZTERY RAZY REKTYFIKOWANA WYKONANA DLA NAJBARDZIEJ WYMAGAJACYCH", APART FROM THE MARK AS SHOWN.

THE COLOR(S) WHITE, SILVER, LIGHT GREY, RED, BLACK AND GREEN IS/ARE CLAIMED AS A FEATURE OF THE MARK.

THE MARK CONSISTS OF A LIGHT GREY VERTICAL RECTANGLE WITH ROUNDED CORNERS, OUTLINED BY TWO SILVER LINES WITH A LIGHT GRAY INTERIOR. THE TERM "POLISH VODKA" IN SILVER LETTERS APPEARS AT THE TOP. BELOW IN WHITE HORIZONTAL RECTANGLE SURROUNDED BY SILVER CONTOUR LINES THAT IS THE WORD "JARZEBIAK" IN RED WITH A SILVER CONTOUR LINE AND A BLACK SHADOW. BENEATH THAT IS THE TERM "CZYSTY LUXUS" IN SILVER SLANTING LETTERS WITH A BLACK SHADOW; IN THE CENTRAL PART OF THE RECTANGLE IS THE DESIGN OF A RED BUNCH OF ROWANBERRIES WITH WHITE HIGHLIGHTS, GREEN LEAVES AND BLACK TWIGS; BELOW THAT IS THE BLACK INSCRIPTION: "Z WODY Z WŁASNYCH GLEBINOWYCH UJEC. CZTERY RAZY REKTYFIKOWANA WYKONANA DLA NAJBARDZIEJ WYMAGAJACYCH"; AND ON THE BOTTOM IS A RED CREST WITH THE SILVER LETTERS "AW" AND "W", SURROUNDED IN TURN BY SILVER, RED AND SILVER LINES.

THE ENGLISH TRANSLATION OF THE FOREIGN WORDS IN THE MARK IS POLISH VODKA ROWAN VODKA CLEAR LUXURY FROM WATER FROM OWN DEEP WATER RECOURSES; FOUR TIMES RECTIFIED MADE FOR THE MOST DEMANDING AW W.

FOR LIQUEURS, VODKA, ALCOHOLIC BEVERAGES EXCEPT BEER (U.S. CLS. 47 AND 49).

SUSAN LESLIE DUBOIS, EXAMINING ATTORNEY

**CLASS 33—(Continued).**

SN 79-095,654. CANEI S.R.L., ITALY, FILED 3-21-2011.



PRIORITY DATE OF 2-16-2011 IS CLAIMED.  
OWNER OF INTERNATIONAL REGISTRATION 1072718  
DATED 3-21-2011, EXPIRES 3-21-2021.

OWNER OF U.S. REG. NOS. 2,201,553, 3,793,231 AND OTHERS.

NO CLAIM IS MADE TO THE EXCLUSIVE RIGHT TO USE "VINO FRIZZANTE", APART FROM THE MARK AS SHOWN.

THE MARK CONSISTS OF THE WORDING "C CANEI VINO FRIZZANTE"; THE WORD "CANEI" APPEARS WITHIN THE LETTER "C"; TO THE LEFT OF THE "C" IS AN DECORATIVE DESIGN; THE ENTIRE MARK APPEARS WITHIN A RECTANGLE WITH A CURVED TOP; A CREST DESIGN APPEARS ABOVE THE LETTER "NE".

THE ENGLISH TRANSLATION OF "VINO FRIZZANTE" IN THE MARK IS "SPARKLING WINE".

FOR WINE, SPARKLING WINE (U.S. CLS. 47 AND 49).  
SKYE YOUNG, EXAMINING ATTORNEY

SN 79-096,426. MHCS, F-51200 EPERNAY, FRANCE, FILED 3-23-2011.

**YOU NEVER FORGET YOUR FIRST TASTE OF  
KRUG**

THE MARK CONSISTS OF STANDARD CHARACTERS WITHOUT CLAIM TO ANY PARTICULAR FONT, STYLE, SIZE, OR COLOR.

PRIORITY DATE OF 9-24-2010 IS CLAIMED.  
OWNER OF INTERNATIONAL REGISTRATION 1074533  
DATED 3-23-2011, EXPIRES 3-23-2021.

OWNER OF U.S. REG. NOS. 1,228,687, 3,608,119 AND OTHERS.

FOR CHAMPAGNES, AND SPARKLING WINES (U.S. CLS. 47 AND 49).

DAVID HOFFMAN, EXAMINING ATTORNEY



**CLASS 33—(Continued).**

SN 79-096,825. DISBER, S.L., SPAIN, FILED 1-27-2011.



OWNER OF INTERNATIONAL REGISTRATION 1075547  
DATED 1-27-2011, EXPIRES 1-27-2021.

NO CLAIM IS MADE TO THE EXCLUSIVE RIGHT TO  
USE "VIÑAS", APART FROM THE MARK AS SHOWN.

THE COLOR(S) BLUE, GRAY AND WHITE IS/ARE  
CLAIMED AS A FEATURE OF THE MARK.

THE MARK CONSISTS OF A WHITE SAIL OUTLINED IN  
GRAY, WITH THE WORDING "VIÑAS DE CALLES" IN  
BLUE AND TWO BRUSH STROKES, ONE IN BLUE AND  
ONE IN GRAY.

THE ENGLISH TRANSLATION OF "VIÑAS DE CALLES"  
IN THE MARK IS "VINEYARDS OF STREETS".

FOR WINE PRODUCED UNDER THE PROTECTED  
DENOMINATION OF ORIGIN 'VALENCIA' (U.S. CLS. 47  
AND 49).

MICHAEL WIENER, EXAMINING ATTORNEY

**CLASS 33—(Continued).**SN 79-097,247. FOSHAN JILI TRADING CO., LTD., CHINA,  
FILED 4-11-2011.

OWNER OF INTERNATIONAL REGISTRATION 1011480  
DATED 7-31-2009, EXPIRES 7-31-2019.

THE MARK CONSISTS OF CHINESE CHARACTERS.

THE ENGLISH TRANSLATION OF THE FOREIGN  
WORD(S) IN THE MARK IS: CENTURIES CONFUSED.

THE TRANSLITERATION OF THE NON-LATIN CHAR-  
ACTERS IN THE MARK IS: BAI NIAN HU TU.

FOR ARAK; FRUIT EXTRACTS, ALCOHOLIC; DIS-  
TILLED BEVERAGES, NAMELY, DISTILLED SPIRITS;  
WINE; SPIRITS BEING BEVERAGES; RICE ALCOHOL;  
ALCOHOLIC BEVERAGES CONTAINING FRUIT (U.S.  
CLS. 47 AND 49).

APRIL ROACH, EXAMINING ATTORNEY

SN 79-096,917. SANFRANCESCO S.R.L. - SOCIETA' AGRI-  
COLA, ITALY, FILED 3-10-2011.

# DOROVERDE

THE MARK CONSISTS OF STANDARD CHARACTERS  
WITHOUT CLAIM TO ANY PARTICULAR FONT, STYLE,  
SIZE, OR COLOR.

PRIORITY DATE OF 3-4-2011 IS CLAIMED.

OWNER OF INTERNATIONAL REGISTRATION 1075841  
DATED 3-10-2011, EXPIRES 3-10-2021.

THE WORDING "DOROVERDE" HAS NO MEANING IN  
A FOREIGN LANGUAGE.

FOR ALCOHOLIC BEVERAGES EXCEPT BEERS (U.S.  
CLS. 47 AND 49).

JESSICA FATHY, EXAMINING ATTORNEY

SN 79-097,914. MHCS, F-51200 EPERNAY, FRANCE, FILED  
3-23-2011.

## CREATE YOUR OWN VERSION OF HAPPINESS

THE MARK CONSISTS OF STANDARD CHARACTERS  
WITHOUT CLAIM TO ANY PARTICULAR FONT, STYLE,  
SIZE, OR COLOR.

PRIORITY DATE OF 9-24-2010 IS CLAIMED.

OWNER OF INTERNATIONAL REGISTRATION 1078774  
DATED 3-23-2011, EXPIRES 3-23-2021.

FOR CHAMPAGNES; SPARKLING WINES (U.S. CLS.  
47 AND 49).

MICHAEL WIENER, EXAMINING ATTORNEY

**CLASS 33—(Continued).**

SN 79-098,389. FUJI SHUZOU GOUSHI GAISHA, JAPAN, FILED 5-27-2011.



PRIORITY DATE OF 3-10-2011 IS CLAIMED.  
OWNER OF INTERNATIONAL REGISTRATION 1079968 DATED 5-27-2011, EXPIRES 5-27-2021.

THE TRANSLITERATION OF THE NON-LATIN CHARACTERS IN THE MARK IS: IZUMOFUJI.

FOR ALCOHOLIC BEVERAGES, NAMELY LIQUEURS, SAKE, JAPANESE WHITE LIQUOR (SHOCHU) (U.S. CLS. 47 AND 49).

KATHERINE STOIDES, EXAMINING ATTORNEY

SN 79-099,817. MAISON PRUNIER, FRANCE, FILED 6-7-2011.

# PRUNIER

THE MARK CONSISTS OF STANDARD CHARACTERS WITHOUT CLAIM TO ANY PARTICULAR FONT, STYLE, SIZE, OR COLOR.

PRIORITY DATE OF 1-21-2011 IS CLAIMED.

OWNER OF INTERNATIONAL REGISTRATION 1083643 DATED 6-7-2011, EXPIRES 7-30-2022.

THE ENGLISH TRANSLATION OF THE FOREIGN WORD(S) IN THE MARK IS: PLUM-TREE.

FOR COGNAC, BRANDY, ORANGE LIQUEUR, LIQUEUR WINES WITH THE PROTECTED APPELLATION OF ORIGIN PINEAU DES CHARENTES (U.S. CLS. 47 AND 49).

ROSELLE HERRERA, EXAMINING ATTORNEY

SN 85-026,507. DIAGEO NORTH AMERICA, INC., NORWALK, CT. FILED 4-29-2010.

## PERFECTLY SMOOTH

THE MARK CONSISTS OF STANDARD CHARACTERS WITHOUT CLAIM TO ANY PARTICULAR FONT, STYLE, SIZE, OR COLOR.

NO CLAIM IS MADE TO THE EXCLUSIVE RIGHT TO USE "SMOOTH", APART FROM THE MARK AS SHOWN.

FOR ALCOHOLIC BEVERAGES EXCEPT BEERS (U.S. CLS. 47 AND 49).

FIRST USE 7-31-2010; IN COMMERCE 7-31-2010.

BARNEY CHARLON, EXAMINING ATTORNEY

**CLASS 33—(Continued).**

SN 85-030,170. VIÑA SANTA CAROLINA S.A., SANTIAGO, CHILE, FILED 5-4-2010.



OWNER OF U.S. REG. NO. 1,153,350.

NO CLAIM IS MADE TO THE EXCLUSIVE RIGHT TO USE "SINCE 1875", "CHILE", "RESERVA", "CABERNET SAUVIGNON" AND "D.O. VALLE DE COLCHAGUA", APART FROM THE MARK AS SHOWN.

THE COLOR(S) BROWN, GREEN, BLUE, WHITE, GOLD, BLACK AND RED IS/ARE CLAIMED AS A FEATURE OF THE MARK.

THE MARK CONSISTS OF A GREEN WINE BOTTLE WRAPPED IN A VINE BRANCH WITH BARK AND BRANCHES IN SHADES OF BROWN AND LEAVES IN SHADES OF GREEN. THE FOIL AT THE TOP OF THE WINE BOTTLE IS RED. ACROSS THE FRONT OF THE BOTTLE IS A WHITE LABEL. ON THE LABEL, APPEARING FROM TOP TO BOTTOM, IS THE WORDING "SINCE 1875" IN BLACK WITH A MULTI-POINTED RED AND GOLD STAR APPEARING BETWEEN THE WORDS, THE WORDING "SANTA CAROLINA", IN BLACK, THE WORD "CHILE" IN GOLD WITH GOLD LINES EXTENDING FROM EITHER SIDE OF THE WORD "CHILE", THE WORD "RESERVA" IN GOLD AND SURROUNDED BY A RECTANGLE COMPRISED OF DOUBLE BLACK LINES, AND THE WORDING "CABERNET SAUVIGNON" AND "D.O. VALLE DE COLCHAGUA", IN BLACK WITH BLACK LINES APPEARING BEFORE, BETWEEN AND AFTER THE WORDING. THE BOTTLE IS RESTING ON GROUND IN SHADES OF BROWN AND SET AGAINST A BACKGROUND OF VINEYARDS IN GREEN AND BROWN AND MOUNTAINS IN SHADES OF BLUE WITH WHITE PATCHES OF SNOW. GREEN TREES APPEAR AT THE BACK OF THE VINEYARD. THE SKY IS BLUE WITH PATCHES OF WHITE CLOUDS.

THE ENGLISH TRANSLATION OF "RESERVA" IN THE MARK IS "RESERVE" AND THE ENGLISH TRANSLATION OF "VALLE DE COLCHAGUA" MEANS "COLCHAGUA VALLEY".

FOR WINES (U.S. CLS. 47 AND 49).

MARTHA FROMM, EXAMINING ATTORNEY

SN 85-082,611. THE WINE GROUP LLC, TRACY, CA. FILED 7-12-2010.

## TOTAL CHAOS

THE MARK CONSISTS OF STANDARD CHARACTERS WITHOUT CLAIM TO ANY PARTICULAR FONT, STYLE, SIZE, OR COLOR.

FOR LIQUEURS; PREPARED ALCOHOLIC COCKTAIL; PREPARED WINE COCKTAILS; SPIRITS; WINE; WINE-BASED DRINKS (U.S. CLS. 47 AND 49).

JIM RINGLE, EXAMINING ATTORNEY

**CLASS 33—(Continued).**

SN 85-106,314. KATANA VODKA LLC, OAKTON, VA. FILED 8-12-2010.



NO CLAIM IS MADE TO THE EXCLUSIVE RIGHT TO USE THE NECK AND TOP OF THE BOTTLE EXCLUDING THE FOIL OR CAPSULE, APART FROM THE MARK AS SHOWN.

THE MARK CONSISTS OF THE THREE-DIMENSIONAL CONFIGURATION OF THE CONTAINER FOR THE GOODS IN THE FORM OF A BOTTLE THAT IS BISECTED BY AN INCLINED PLANE WITH THE TWO HALVES SLIGHTLY OFFSET, SO AS TO APPEAR THAT THE BOTTLE HAS BEEN CUT AS IF BY A SWORD.

FOR ALCOHOLIC BEVERAGES EXCEPT BEERS (U.S. CLS. 47 AND 49).

KAREN K. BUSH, EXAMINING ATTORNEY

SN 85-161,000. MONTES S.A., HUECHURABA, CHILE, FILED 10-26-2010.

**KAIKEN MAI**

THE MARK CONSISTS OF STANDARD CHARACTERS WITHOUT CLAIM TO ANY PARTICULAR FONT, STYLE, SIZE, OR COLOR.

OWNER OF CHILE REG. NO. 908.315, DATED 6-26-2011, EXPIRES 1-21-2021.

OWNER OF U.S. REG. NO. 3,061,001.

THE ENGLISH TRANSLATION OF "KAIKEN MAI" IN THE MARK IS "FIRST GEESE".

FOR WINE (U.S. CLS. 47 AND 49).

JAMES STEIN, EXAMINING ATTORNEY

**CLASS 33—(Continued).**

SN 85-167,738. WHITE ROCK DISTILLERIES, INC., LEWISTON, ME. FILED 11-3-2010.

**CHOCOLATE VALLEY VINEYARDS**

THE MARK CONSISTS OF STANDARD CHARACTERS WITHOUT CLAIM TO ANY PARTICULAR FONT, STYLE, SIZE, OR COLOR.

NO CLAIM IS MADE TO THE EXCLUSIVE RIGHT TO USE "VINEYARDS", APART FROM THE MARK AS SHOWN.

FOR WINES AND LIQUEURS (U.S. CLS. 47 AND 49).  
RUSS HERMAN, EXAMINING ATTORNEY

SN 85-169,052. GRUPO INDUSTRIAL MUYAAD S.A. DE C.V., TONALA, JALISCO, MEXICO, FILED 11-4-2010.



THE COLOR(S) RED IS/ARE CLAIMED AS A FEATURE OF THE MARK.

THE MARK CONSISTS OF A TRIDIMENSIONAL SHAPE OF A BULL IN RED COLOR, WHICH WILL BE USED AS THE BOTTLE FOR THE PRODUCTS.

FOR ALCOHOLIC BEVERAGES EXCEPT BEERS (U.S. CLS. 47 AND 49).

LESLEY LAMOTHE, EXAMINING ATTORNEY

SN 85-170,336. MAST-JAEGERMEISTER SE, 38296 WOLFENBUETTEL, FED REP GERMANY, FILED 11-5-2010.

**JÄGER BOMB**

THE MARK CONSISTS OF STANDARD CHARACTERS WITHOUT CLAIM TO ANY PARTICULAR FONT, STYLE, SIZE, OR COLOR.

OWNER OF FED REP GERMANY REG. NO. 302010058723, DATED 11-16-2010, EXPIRES 10-31-2020.

OWNER OF U.S. REG. NO. 3,008,995.

THE ENGLISH TRANSLATION OF "JÄGER" IN THE MARK IS "HUNTER".

FOR LIQUEURS, NAMELY, HERBAL LIQUEURS; ALCOHOLIC MIXED BEVERAGES EXCEPT BEERS; SPIRITS (U.S. CLS. 47 AND 49).

MICHAEL ENGEL, EXAMINING ATTORNEY

**CLASS 33—(Continued).**

SN 85-172,779. COLLINS, LANCE, BEVERLY HILLS, CA. FILED 11-9-2010.

# Dos Caminos

THE MARK CONSISTS OF STANDARD CHARACTERS WITHOUT CLAIM TO ANY PARTICULAR FONT, STYLE, SIZE, OR COLOR.

THE ENGLISH TRANSLATION OF "DOS CAMINOS" IN THE MARK IS "TWO ROADS".

FOR ALCOHOLIC BEVERAGES EXCEPT BEERS (U.S. CLS. 47 AND 49).

DOUGLAS LEE, EXAMINING ATTORNEY

**CLASS 33—(Continued).**

SN 85-185,104. AXIAL GLOBALIZACIÓN DE VINOS S.L., ZARAGOZA, SPAIN, FILED 11-24-2010.

# CONSPIRACIÓN

PRIORITY CLAIMED UNDER SEC. 44(D) ON ERPNTY TM OFC APPLICATION NO. 009137159, FILED 5-27-2010, REG. NO. 009137159, DATED 10-14-2010, EXPIRES 5-27-2020.

THE ENGLISH TRANSLATION OF "CONSPIRACIÓN" IN THE MARK IS "CONSPIRACY".

FOR SPANISH WINES (U.S. CLS. 47 AND 49).

SIMON TENG, EXAMINING ATTORNEY

SN 85-184,706. TEQUILA ORENDAIN DE JALISCO, S.A. DE C.V., CP 45017 JALISCO, MEXICO, FILED 11-24-2010.

# ALMENDRADO ORENDAIN

THE MARK CONSISTS OF STANDARD CHARACTERS WITHOUT CLAIM TO ANY PARTICULAR FONT, STYLE, SIZE, OR COLOR.

OWNER OF U.S. REG. NO. 2,063,773.

THE ENGLISH TRANSLATION OF "ALMENDRADO" IN THE MARK IS "ALMOND-SHAPED". THE WORDING "ORENDAIN" HAS NO MEANING IN A FOREIGN LANGUAGE.

FOR LIQUOR; SPIRITS (U.S. CLS. 47 AND 49).

JENNIFER MARTIN, EXAMINING ATTORNEY

SN 85-185,759. ALANA BERISH, NEW YORK, NY. FILED 11-28-2010.

# Henri d'Ussé

SN 85-184,707. TEQUILA ORENDAIN DE JALISCO, S.A. DE C.V., CP 45017 JALISCO, MEXICO, FILED 11-24-2010.

# ORENDAIN OLLITAS

THE MARK CONSISTS OF STANDARD CHARACTERS WITHOUT CLAIM TO ANY PARTICULAR FONT, STYLE, SIZE, OR COLOR.

OWNER OF U.S. REG. NO. 2,063,773.

THE ENGLISH TRANSLATION OF "OLLITAS" IN THE MARK IS "POTS". THE WORDING "ORENDAIN" HAS NO MEANING IN A FOREIGN LANGUAGE.

FOR LIQUOR; SPIRITS (U.S. CLS. 47 AND 49).

JENNIFER MARTIN, EXAMINING ATTORNEY

THE MARK CONSISTS OF STANDARD CHARACTERS WITHOUT CLAIM TO ANY PARTICULAR FONT, STYLE, SIZE, OR COLOR.

PRIORITY CLAIMED UNDER SEC. 44(D) ON FRANCE APPLICATION NO. 10/3779891, FILED 11-5-2010.

THE NAME(S), PORTRAIT(S), AND/OR SIGNATURE(S) SHOWN IN THE MARK DOES NOT IDENTIFY A PARTICULAR LIVING INDIVIDUAL.

THE ENGLISH TRANSLATION OF "HENRI D'USSE" IN THE MARK IS "HENRY OF D'USSE". THE WORDING "HENRI D'USSE" HAS NO MEANING IN A FOREIGN LANGUAGE.

FOR (BASED ON INTENT TO USE) COGNAC (BASED ON 44(D) PRIORITY APPLICATION) COGNAC (U.S. CLS. 47 AND 49).

DAVID TAYLOR, EXAMINING ATTORNEY

**CLASS 33—(Continued).**

SN 85-188,479. VIÑA UNDURRAGA S.A., SANTIAGO, CHILE, FILED 12-1-2010.

BODEGA VOLCANES DE CHILE

THE MARK CONSISTS OF STANDARD CHARACTERS WITHOUT CLAIM TO ANY PARTICULAR FONT, STYLE, SIZE, OR COLOR.

NO CLAIM IS MADE TO THE EXCLUSIVE RIGHT TO USE "BODEGA" AND "CHILE", APART FROM THE MARK AS SHOWN.

THE ENGLISH TRANSLATION OF "BODEGA VOLCANES DE CHILE" IN THE MARK IS "THE VOLCANO WINERY OF CHILE".

FOR WINES (U.S. CLS. 47 AND 49).

FRANK LATTUCA, EXAMINING ATTORNEY

SN 85-200,624. GRUPO OSBORNE, S.A, CADIZ, SPAIN, FILED 12-17-2010.

OSBORNE

THE MARK CONSISTS OF STANDARD CHARACTERS WITHOUT CLAIM TO ANY PARTICULAR FONT, STYLE, SIZE, OR COLOR.

OWNER OF U.S. REG. NOS. 3,003,980, 3,046,546 AND 3,060,159.

SEC. 2(F).

FOR BRANDY; LIQUEURS; SHERRY; WINES (U.S. CLS. 47 AND 49).

FIRST USE 3-3-1959; IN COMMERCE 3-3-1959.

APRIL HESIK, EXAMINING ATTORNEY

SN 85-205,338. DOTSON, LESLIE, CARSON, CA. FILED 12-23-2010.

Bonsai Saki Beer

THE MARK CONSISTS OF STANDARD CHARACTERS WITHOUT CLAIM TO ANY PARTICULAR FONT, STYLE, SIZE, OR COLOR.

NO CLAIM IS MADE TO THE EXCLUSIVE RIGHT TO USE "SAKI" AND "BEER", APART FROM THE MARK AS SHOWN.

FOR ALCOHOLIC BEVERAGE, NAMELY, A COMBINATION JAPANESE SAKI AND JAPANESE BEER BEVERAGE (U.S. CLS. 47 AND 49).

KATINA MISTER, EXAMINING ATTORNEY

**CLASS 33—(Continued).**

SN 85-226,524. COX-MARTINI 2006 REVOCABLE TRUST, ST. HELENA, CA. FILED 1-26-2011.

CASTLEVALE

THE MARK CONSISTS OF STANDARD CHARACTERS WITHOUT CLAIM TO ANY PARTICULAR FONT, STYLE, SIZE, OR COLOR.

FOR WINES (U.S. CLS. 47 AND 49).

JANICE KIM, EXAMINING ATTORNEY

SN 85-229,187. 1872 HOLDINGS, V.O.F., TORTOLA, BR.VIRGIN ISLANDS, FILED 1-28-2011.

PATICRUZADO

THE MARK CONSISTS OF STANDARD CHARACTERS WITHOUT CLAIM TO ANY PARTICULAR FONT, STYLE, SIZE, OR COLOR.

THE ENGLISH TRANSLATION OF "PATICRUZADO" IN THE MARK IS "CROSS LEGGED".

FOR RUM; ALCOHOLIC BEVERAGES CONTAINING RUM (U.S. CLS. 47 AND 49).

GIANCARLO CASTRO, EXAMINING ATTORNEY

SN 85-234,420. DOLCE CO. INVEST INC., TORTOLA, BR.VIRGIN ISLANDS, FILED 2-4-2011.



NO CLAIM IS MADE TO THE EXCLUSIVE RIGHT TO USE "GREEN", APART FROM THE MARK AS SHOWN.

THE COLOR(S) BLACK AND GREEN IS/ARE CLAIMED AS A FEATURE OF THE MARK.

THE MARK CONSISTS OF THE WORD "GO" IN BLACK LETTERING ABOVE THE WORD "GREEN" IN BLACK LETTERING WITH GREEN GRASS FEATURED INSIDE OF THE LETTER "O".

FOR WINES (U.S. CLS. 47 AND 49).

STEVEN JACKSON, EXAMINING ATTORNEY

**CLASS 33—(Continued).**

SN 85-252,190. DYNASTY SPIRITS, LLC, LANTANA, TX.  
FILED 2-25-2011.

**NUE VODKA**

THE MARK CONSISTS OF STANDARD CHARACTERS WITHOUT CLAIM TO ANY PARTICULAR FONT, STYLE, SIZE, OR COLOR.

NO CLAIM IS MADE TO THE EXCLUSIVE RIGHT TO USE "VODKA", APART FROM THE MARK AS SHOWN.

THE ENGLISH TRANSLATION OF "NUE" IN THE MARK IS "QUICK" OR "FORWARD" IN POLISH.

FOR ALCOHOLIC BEVERAGES, NAMELY, VODKA AND FLAVORED VODKA (U.S. CLS. 47 AND 49).

TIMOTHY FINNEGAN, EXAMINING ATTORNEY

---

SN 85-261,180. WATERSHED DISTILLERY, LLC, COLUMBUS, OH. FILED 3-8-2011.

**WATERSHED DISTILLERY**

THE MARK CONSISTS OF STANDARD CHARACTERS WITHOUT CLAIM TO ANY PARTICULAR FONT, STYLE, SIZE, OR COLOR.

NO CLAIM IS MADE TO THE EXCLUSIVE RIGHT TO USE "DISTILLERY", APART FROM THE MARK AS SHOWN.

FOR BLENDED SPIRITS; DISTILLED SPIRITS; SPIRITS; SPIRITS AND LIQUEURS (U.S. CLS. 47 AND 49).

NAAKWAMA ANKRAH, EXAMINING ATTORNEY

---

SN 85-273,137. ANTTILA, MATTI C., PALM BEACH, FL.  
FILED 3-22-2011.

**Hunter Baltimore Rye**

THE MARK CONSISTS OF STANDARD CHARACTERS WITHOUT CLAIM TO ANY PARTICULAR FONT, STYLE, SIZE, OR COLOR.

NO CLAIM IS MADE TO THE EXCLUSIVE RIGHT TO USE "BALTIMORE RYE", APART FROM THE MARK AS SHOWN.

FOR ALCOHOLIC BEVERAGES EXCEPT BEERS (U.S. CLS. 47 AND 49).

LINDA ORNDORFF, EXAMINING ATTORNEY

**CLASS 33—(Continued).**

SN 85-280,702. CRYSTAL SPIRITS LLC, DAYTON, OH.  
FILED 3-30-2011.

**The Spirit of Ohio**

THE MARK CONSISTS OF STANDARD CHARACTERS WITHOUT CLAIM TO ANY PARTICULAR FONT, STYLE, SIZE, OR COLOR.

NO CLAIM IS MADE TO THE EXCLUSIVE RIGHT TO USE "OHIO", APART FROM THE MARK AS SHOWN.

FOR VODKA (U.S. CLS. 47 AND 49).

WILLIAM VERHOSEK, EXAMINING ATTORNEY

---

SN 85-281,219. GEMTREE VINEYARDS, PTY. LTD., MCLAREN VALE, AUSTRALIA, FILED 3-30-2011.

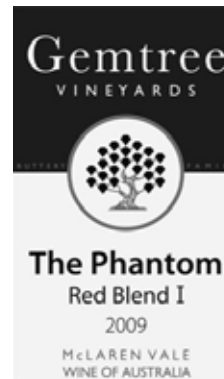

OWNER OF U.S. REG. NO. 3,141,433.  
NO CLAIM IS MADE TO THE EXCLUSIVE RIGHT TO USE "VINEYARDS" "FAMILY" "RED BLEND I" "2009" "MCLAREN VALE" AND "WINE OF AUSTRALIA", APART FROM THE MARK AS SHOWN.

THE MARK CONSISTS OF A RECTANGLE WHICH INCLUDES A DESIGN OF A GEM TREE IN THE MIDDLE WITHIN A CIRCLE, AND THE TEXT "GEMTREE VINEYARDS" ABOVE, "BUTTERY FAMILY" ON THE LINE DIVIDING THE RECTANGLE, AND "THE PHANTOM" "RED BLEND I" "2009" "MCLAREN VALE" "WINE OF AUSTRALIA" STACKED BELOW.

FOR WINE (U.S. CLS. 47 AND 49).

CARYN GLASSER, EXAMINING ATTORNEY

**CLASS 33—(Continued).**

SN 85-285,767. 21ST CENTRUY SPIRITS, LLC, CITY OF COMMERCE, CA. FILED 4-4-2011.



OWNER OF U.S. REG. NO. 276,132.  
 THE MARK CONSISTS OF A STYLIZED LETTER "G" WITH A STALK OF GRAIN AT THE TOP RIGHT OF THE LETTER "G" AND A DOT UNDERNEATH WITH THE STYLIZED WORDING "BLUE ICE" BELOW THE DOT.  
 FOR ALCOHOLIC BEVERAGES, NAMELY, VODKA (U.S. CLS. 47 AND 49).  
 SUNG IN, EXAMINING ATTORNEY

SN 85-288,076. RE:WINED LLC, PETALUMA, CA. FILED 4-6-2011.

**DECO**

THE MARK CONSISTS OF STANDARD CHARACTERS WITHOUT CLAIM TO ANY PARTICULAR FONT, STYLE, SIZE, OR COLOR.  
 FOR WINE (U.S. CLS. 47 AND 49).  
 FIRST USE 12-16-1994; IN COMMERCE 1-23-1995.  
 RUSS HERMAN, EXAMINING ATTORNEY

**CLASS 33—(Continued).**

SN 85-290,754. PERNOD RICARD ITALIA S.P.A., MILANO, ITALY, FILED 4-8-2011.



OWNER OF ERPN CMNTY TM OFC REG. NO. 008598351, DATED 4-5-2010, EXPIRES 10-7-2019.  
 NO CLAIM IS MADE TO THE EXCLUSIVE RIGHT TO USE "AMARO", "CASA FONDATA NEL 1815", AND "SPECIALITA DELLA DITTA", APART FROM THE MARK AS SHOWN.

THE NAME(S), PORTRAIT(S), AND/OR SIGNATURE(S) SHOWN IN THE MARK DOES NOT IDENTIFY A PARTICULAR LIVING INDIVIDUAL.

THE COLOR(S) RED, DARK BLUE, WHITE AND GOLD IS/ARE CLAIMED AS A FEATURE OF THE MARK.

THE MARK CONSISTS OF A RECTANGULAR LABEL THAT IS COMPOSED OF A SMALLER DARK BLUE RECTANGLE AT THE TOP AND A MUCH LARGER RED RECTANGLE BELOW. IN THE UPPER DARK BLUE RECTANGLE IS THE WORD "RAMAZZOTTI" IN LARGE WHITE LETTERS, SURROUNDED BY A THIN WHITE RECTANGULAR OUTLINE THAT PARALLELS THE EDGE OF THE DARK BLUE RECTANGLE, CREATING AN OUTER DARK BLUE BORDER. THE RED RECTANGLE BELOW IS DIVIDED INTO THREE SECTIONS. THE LARGEST SECTION, IN THE MIDDLE OF THE LABEL, IS DELINEATED BY A THIN GOLD RECTANGULAR OUTLINE THAT ENCLOSES APPROXIMATELY 80% OF THE RED RECTANGLE AND CREATES A NARROW OUTER RED BORDER AROUND THE LARGE CENTRAL RED RECTANGLE. BELOW THAT, A NARROW DARK BLUE STRIPE EXTENDS HORIZONTALLY ACROSS MOST OF THE LABEL NEAR THE BOTTOM OF THE RED RECTANGLE, BUT LEAVES A NARROW BAND OF RED ON EITHER SIDE THAT CORRESPONDS TO THE NARROW RED BORDER LEFT BY THE GOLD OUTLINE. BELOW THAT IS A SECOND THIN GOLD RECTANGULAR OUTLINE AT THE VERY BOTTOM OF THE LABEL THAT CREATES A RED BORDER AROUND A NARROW RED RECTANGLE. CENTERED ON THE DARK BLUE STRIPE IS A GOLD OUTLINE AROUND A DARK BLUE CARTOUCHE-LIKE SHAPE WITH SEMI-CIRCULAR PROTRUSIONS ABOVE AND BELOW THE CENTER OF THE CARTOUCHE. THE PROTRUSIONS CONTAIN DECORATIVE SCROLLWORK LINES IN WHITE ON THE TOP AND WHITE AND GOLD ON THE BOTTOM. THE GOLD OUTLINES SURROUNDING THE RED SECTIONS OF THE LABEL JUST ABOVE AND JUST BELOW THE CARTOUCHE ARE BROKEN AND THEN CURVED TO PARALLEL THE OUTLINE OF THE CARTOUCHE INCLUDING THE UPPER AND LOWER PROTRUSIONS, AND THE GOLD OUTLINE DIRECTLY ABOVE THE UPPER PROTRUSION OF THE CARTOUCHE RISES TO FIVE SHORT LINES AT THE CENTER, TWO POINTING DIAGONALLY UPWARDS TO THE LEFT, TWO POINTING DIAGONALLY UPWARDS TO THE RIGHT, AND THE ONE IN THE CENTER POINTING VERTICALLY UPRIGHT. THERE ARE ALSO SMALLER SEMI-CIRCULAR PROTRUSIONS ON EITHER SIDE OF THE CARTOUCHE. WITHIN THE LARGE CENTRAL RED RECTANGLE, FROM TOP TO BOTTOM, ARE THE WORD "AMARO" IN WHITE, THEN BELOW THAT, THE WORDS "FRATELLI RAMAZZOTTI" IN WHITE, AND BELOW THAT LINKED SCRIPT INITIALS "FR" IN GOLD WITH A STRAIGHT WHITE LINE AND THEN A WAVY WHITE FLOURISH ON EITHER SIDE OF THE INITIALS. BELOW THAT ARE THE WORDS "CASA FONDATA NEL 1815" IN WHITE, AND BELOW THAT AN



**CLASS 33—(Continued).**

ORNATE SHIELD DESIGN IN WHITE, RED AND GOLD. THE SHIELD IS WHITE WITH AN OUTER GOLD BORDER OUTLINE, THEN MOVING INWARDS, A THIN RED BORDER, A THICKER WHITE BORDER, AND THEN A THIN RED LINE THAT OUTLINES A SHIELD SHAPE DIVIDED INTO QUARTERS BY CROSSING RED LINES. IN THE UPPER LEFT QUARTER OF THE SHIELD DESIGN IS A SMALL SHIELD, DIVIDED INTO QUARTERS, IN RED AND WHITE AND WITH A RED CROWN ON TOP ON A WHITE GROUND; IN THE UPPER RIGHT QUARTER IS A STAR OUTLINED IN RED AND WITH RED SHADING ON A WHITE GROUND; IN THE LOWER LEFT QUARTER ARE THE INITIALS "FR" IN RED SCRIPT ON A WHITE GROUND; AND THE LOWER RIGHT QUARTER IS ENTIRELY FILLED WITH A RED CROSS ON A WHITE GROUND. ON EITHER SIDE OF THE LARGE SHIELD ARE ORNATE DESIGNS IN WHITE THAT RESEMBLE WHEELS WHOSE INNER EDGES ARE MASKED BY THE EDGE OF THE SHIELD. THE WHEEL-LIKE FIGURES ARE LINKED TO THE SHIELD BY LINES THAT CURVE OUT FROM THE SIDES OF THE SHIELD ABOVE AND BELOW THE "WHEELS" AND JOIN TOGETHER ON THE OUTER SIDE OF THE WHEELS, EXTENDING PAST THE "WHEELS" IN LONG CURVES THAT RESEMBLE PLUMES. BELOW THE LARGE SHIELD A WHITE LINE EXTENDS OUT ON EITHER SIDE AND CURVES AROUND BELOW TO ENCLOSE THE WORDS "SPECIALITA DELLA DITTA" IN WHITE. BELOW THESE WORDS ARE THE WORDS "FRATELLI RAMAZZOTTI" IN WHITE SCRIPT WITH FLOURISHES THAT GIVE THE WORDS THE APPEARANCE OF A SIGNATURE

THE ENGLISH TRANSLATION OF THE WORDING "AMARO" IS "BITTER," THE WORDING "FRATELLI" IS "BROTHERS," THE WORDING "CASA FONDATA NEL" IS "ESTABLISHMENT FOUNDED IN," AND THE WORDING "SPECIALITA DELLA DITTA" IS "SPECIALTY OF THE COMPANY."

FOR ALCOHOLIC BEVERAGES EXCEPT BEERS, NAMELY, BITTER LIQUEURS (U.S. CLS. 47 AND 49).  
JENNY PARK, EXAMINING ATTORNEY

**CLASS 33—(Continued).**

SN 85-308,444. BLAC BRANDS, LLC, LA MESA, CA. FILED 4-29-2011.



NO CLAIM IS MADE TO THE EXCLUSIVE RIGHT TO USE "TEA", APART FROM THE MARK AS SHOWN.

THE MARK CONSISTS OF A PLANT WITH THREE LEAVES SURROUNDED BY A CIRCLE ABOVE THE WORD "SAK" WHICH IS DIRECTLY OVER THE WORD "TEA".

FOR ALCOHOLIC TEA BASED BEVERAGE (U.S. CLS. 47 AND 49).

FIRST USE 2-17-2003; IN COMMERCE 3-10-2005.  
MARY BOAGNI, EXAMINING ATTORNEY

SN 85-298,510. BEVERAGE INTERNATIONAL INC., INDIAN HEAD PARK, IL. FILED 4-19-2011.



NO CLAIM IS MADE TO THE EXCLUSIVE RIGHT TO USE "MARGARITA", APART FROM THE MARK AS SHOWN.

THE MARK CONSISTS OF A RECTANGLE WITH AN AGAVE PLANT AND THE STYLIZED TEXT "MARGARITA VIVA".

THE ENGLISH TRANSLATION OF "VIVA" IN THE MARK IS "LONG LIVE" OR "HOORAY".

FOR PREPARED ALCOHOLIC COCKTAIL (U.S. CLS. 47 AND 49).  
DAVID I, EXAMINING ATTORNEY

SN 85-310,608. GROUPEMENT FONCIER AGRICOLE DU CHATEAU ANDRON BLANQUET, 33180 SAINT-ESTEPHE, FRANCE, FILED 5-3-2011.

CHATEAU ANDRON BLANQUET

THE MARK CONSISTS OF STANDARD CHARACTERS WITHOUT CLAIM TO ANY PARTICULAR FONT, STYLE, SIZE, OR COLOR.

NO CLAIM IS MADE TO THE EXCLUSIVE RIGHT TO USE "CHATEAU", APART FROM THE MARK AS SHOWN. THE NAME(S), PORTRAIT(S), AND/OR SIGNATURE(S) SHOWN IN THE MARK DOES NOT IDENTIFY A PARTICULAR LIVING INDIVIDUAL.

FOR WINES (U.S. CLS. 47 AND 49).  
FIRST USE 1-0-1972; IN COMMERCE 1-0-1972.  
STEVEN JACKSON, EXAMINING ATTORNEY



**CLASS 33—(Continued).**

SN 85-313,955. PACIFIC EDGE MARKETING GROUP, INC., AGOURA HILLS, CA. FILED 5-6-2011.

# GVORI

THE MARK CONSISTS OF STANDARD CHARACTERS WITHOUT CLAIM TO ANY PARTICULAR FONT, STYLE, SIZE, OR COLOR.

OWNER OF U.S. REG. NO. 3,094,384.  
FOR VODKA (U.S. CLS. 47 AND 49).  
FIRST USE 9-30-1999; IN COMMERCE 9-30-1999.  
ESTHER BELENKER, EXAMINING ATTORNEY

SN 85-314,413. INVESTORS OF AMERICA, LP, DBA THREE SAINTS VINEYARD, CLAYTON, MO. FILED 5-6-2011.

# THREE SAINTS

THE MARK CONSISTS OF STANDARD CHARACTERS WITHOUT CLAIM TO ANY PARTICULAR FONT, STYLE, SIZE, OR COLOR.

FOR WINE (U.S. CLS. 47 AND 49).  
FIRST USE 12-31-2003; IN COMMERCE 12-31-2003.  
MATTHEW PAPPAS, EXAMINING ATTORNEY

SN 85-315,775. ASCENTIA WINE ESTATES, LLC, HEALDSBURG, CA. FILED 5-9-2011.

# LITTLE RED

THE MARK CONSISTS OF STANDARD CHARACTERS WITHOUT CLAIM TO ANY PARTICULAR FONT, STYLE, SIZE, OR COLOR.

NO CLAIM IS MADE TO THE EXCLUSIVE RIGHT TO USE "RED", APART FROM THE MARK AS SHOWN.  
FOR WINE (U.S. CLS. 47 AND 49).  
JOHN GARTNER, EXAMINING ATTORNEY

**CLASS 33—(Continued).**

SN 85-315,953. ATLANTIC BOTTLING LLC, OCEAN, NJ. FILED 5-9-2011.

## Western Flavored Whiskey

THE MARK CONSISTS OF STANDARD CHARACTERS WITHOUT CLAIM TO ANY PARTICULAR FONT, STYLE, SIZE, OR COLOR.

NO CLAIM IS MADE TO THE EXCLUSIVE RIGHT TO USE "FLAVORED WHISKEY", APART FROM THE MARK AS SHOWN.

FOR LIQUOR (U.S. CLS. 47 AND 49).  
FIRST USE 4-1-2011; IN COMMERCE 4-1-2011.  
NAPOLEON SHARMA, EXAMINING ATTORNEY

SN 85-318,417. CBTL EXPORTS, NEW YORK, NY. FILED 5-11-2011.



THE MARK CONSISTS OF A STYLIZED ANTHROPO-MORPHIZED DEPICTION OF THE SUN CONTAINING TWO EYES AND MOUTH.

FOR ALCOHOLIC BEVERAGES EXCEPT BEERS; ALCOHOLIC BEVERAGES, NAMELY, RUM WITH SPICED TROPICAL ROOT, TREE BARK, LEAVES AND HERBS; LIQUOR AND LIQUEUR BEVERAGES, NAMELY, RUM WITH SPICED TROPICAL ROOTS, TREE BARK, LEAVES AND HERBS; RUM; SPIRITS (U.S. CLS. 47 AND 49).

ALICIA COLLINS, EXAMINING ATTORNEY

SN 85-319,458. DEPARTMENT28, INC, PALATINE, IL. FILED 5-12-2011.

## TRAVELLER28 VODKA

THE MARK CONSISTS OF STANDARD CHARACTERS WITHOUT CLAIM TO ANY PARTICULAR FONT, STYLE, SIZE, OR COLOR.

NO CLAIM IS MADE TO THE EXCLUSIVE RIGHT TO USE "VODKA", APART FROM THE MARK AS SHOWN.  
FOR VODKA (U.S. CLS. 47 AND 49).  
DAVID ELTON, EXAMINING ATTORNEY

**CLASS 33—(Continued).**

SN 85-322,067. RARE BREED DISTILLING LLC, SAN FRANCISCO, CA. FILED 5-16-2011.

**WILD  
TURKEY**

OWNER OF U.S. REG. NOS. 513,549, 1,670,450 AND OTHERS.

THE MARK CONSISTS OF THE WORDING "WILD TURKEY" IN STYLIZED FONT.  
FOR DISTILLED SPIRITS (U.S. CLS. 47 AND 49).  
ANDREW RHIM, EXAMINING ATTORNEY

SN 85-323,868. HIGHWAY I LIMITED PARTNERSHIP, DEWEY BEACH, DE. FILED 5-18-2011.

**THE DEWEY DEVIL**

THE MARK CONSISTS OF STANDARD CHARACTERS WITHOUT CLAIM TO ANY PARTICULAR FONT, STYLE, SIZE, OR COLOR.

FOR PREPARED ALCOHOLIC COCKTAIL (U.S. CLS. 47 AND 49).  
FIRST USE 12-31-1984; IN COMMERCE 12-31-1984.  
TRACY FLETCHER, EXAMINING ATTORNEY

SN 85-324,028. SHADYBROOK ESTATE, LLC, NEWPORT BEACH, CA. FILED 5-18-2011.

**Shadybrook Estate**

THE MARK CONSISTS OF STANDARD CHARACTERS WITHOUT CLAIM TO ANY PARTICULAR FONT, STYLE, SIZE, OR COLOR.

NO CLAIM IS MADE TO THE EXCLUSIVE RIGHT TO USE "ESTATE", APART FROM THE MARK AS SHOWN.  
FOR WINE (U.S. CLS. 47 AND 49).  
JACQUELINE A. LAVINE, EXAMINING ATTORNEY

**CLASS 33—(Continued).**

SN 85-324,316. HIWASSEE ACRES LLC, DBA ADAMS COUNTY WINERY, ORRTANNA, PA. FILED 5-18-2011.

**Tears of Gettysburg**

THE MARK CONSISTS OF STANDARD CHARACTERS WITHOUT CLAIM TO ANY PARTICULAR FONT, STYLE, SIZE, OR COLOR.

NO CLAIM IS MADE TO THE EXCLUSIVE RIGHT TO USE "GETTYSBURG", APART FROM THE MARK AS SHOWN.

FOR WINE (U.S. CLS. 47 AND 49).  
FIRST USE 7-4-1988; IN COMMERCE 7-4-1988.  
MAYUR VAGHANI, EXAMINING ATTORNEY

SN 85-325,367. VIÑAS DEL CENIT, S.L., MADRID, SPAIN, FILED 5-19-2011.

**CENIT ALEO**

THE MARK CONSISTS OF STANDARD CHARACTERS WITHOUT CLAIM TO ANY PARTICULAR FONT, STYLE, SIZE, OR COLOR.

THE ENGLISH TRANSLATION OF THE SPANISH WORDING "CENIT" IS "ZENITH".

FOR WINE (U.S. CLS. 47 AND 49).  
JUDITH HELFMAN, EXAMINING ATTORNEY

SN 85-327,527. SPEED PUBLICIDAD S.A.C.I.F., BUENOS AIRES, ARGENTINA, FILED 5-23-2011.

**LIVENZA**

THE MARK CONSISTS OF STANDARD CHARACTERS WITHOUT CLAIM TO ANY PARTICULAR FONT, STYLE, SIZE, OR COLOR.

OWNER OF U.S. REG. NO. 1,669,669.  
THE WORDING "LIVENZA" HAS NO MEANING IN A FOREIGN LANGUAGE.

FOR APERITIF WINES (U.S. CLS. 47 AND 49).  
CAROLINE WOOD, EXAMINING ATTORNEY

**CLASS 33—(Continued).**

SN 85-328,325. RED ROCKET SPIRITS, LLC, BOISE, ID. FILED 5-24-2011.

# NVS VODKA

THE MARK CONSISTS OF STANDARD CHARACTERS WITHOUT CLAIM TO ANY PARTICULAR FONT, STYLE, SIZE, OR COLOR.

NO CLAIM IS MADE TO THE EXCLUSIVE RIGHT TO USE "VODKA", APART FROM THE MARK AS SHOWN. FOR DISTILLED SPIRITS (U.S. CLS. 47 AND 49).  
LESLIE RICHARDS, EXAMINING ATTORNEY

SN 85-329,900. TERESA GIUDICE LLC, TOWACO, NJ. FILED 5-25-2011.

# FABELLINI

THE MARK CONSISTS OF STANDARD CHARACTERS WITHOUT CLAIM TO ANY PARTICULAR FONT, STYLE, SIZE, OR COLOR.

FOR ALCOHOLIC COCKTAIL MIXES (U.S. CLS. 47 AND 49).  
ERIN FALK, EXAMINING ATTORNEY

SN 85-330,792. AFTON VINEYARDS & WINERY, LLC, AFTON, VA. FILED 5-26-2011.



THE MARK CONSISTS OF A STYLIZED HEAD ADORNED WITH GRAPES AND GRAPE LEAVES. FOR WINE (U.S. CLS. 47 AND 49).  
FIRST USE 10-31-2009; IN COMMERCE 10-31-2009.  
JAMES LOVELACE, EXAMINING ATTORNEY

**CLASS 33—(Continued).**

SN 85-331,018. SX BRAND TRIBE, INC., FORT LAUDERDALE, FL. FILED 5-26-2011.

# SXBLANCO

THE MARK CONSISTS OF STANDARD CHARACTERS WITHOUT CLAIM TO ANY PARTICULAR FONT, STYLE, SIZE, OR COLOR.

FOR DISTILLED SPIRITS (U.S. CLS. 47 AND 49).  
DOMINIC FATHY, EXAMINING ATTORNEY

SN 85-331,021. SX BRAND TRIBE, INC., FORT LAUDERDALE, FL. FILED 5-26-2011.

# SXVERDE

THE MARK CONSISTS OF STANDARD CHARACTERS WITHOUT CLAIM TO ANY PARTICULAR FONT, STYLE, SIZE, OR COLOR.

FOR DISTILLED SPIRITS (U.S. CLS. 47 AND 49).  
DOMINIC FATHY, EXAMINING ATTORNEY

SN 85-331,024. SX BRAND TRIBE, INC., FORT LAUDERDALE, FL. FILED 5-26-2011.

# SXNEGRO

THE MARK CONSISTS OF STANDARD CHARACTERS WITHOUT CLAIM TO ANY PARTICULAR FONT, STYLE, SIZE, OR COLOR.

FOR DISTILLED SPIRITS (U.S. CLS. 47 AND 49).  
DOMINIC FATHY, EXAMINING ATTORNEY

SN 85-331,026. SX BRAND TRIBE, INC., FORT LAUDERDALE, FL. FILED 5-26-2011.

# SXAZUL

THE MARK CONSISTS OF STANDARD CHARACTERS WITHOUT CLAIM TO ANY PARTICULAR FONT, STYLE, SIZE, OR COLOR.

FOR DISTILLED SPIRITS (U.S. CLS. 47 AND 49).  
DOMINIC FATHY, EXAMINING ATTORNEY

**CLASS 33—(Continued).**

SN 85-331,030. SX BRAND TRIBE, INC., FORT LAUDERDALE, FL. FILED 5-26-2011.

# SXROSA

THE MARK CONSISTS OF STANDARD CHARACTERS WITHOUT CLAIM TO ANY PARTICULAR FONT, STYLE, SIZE, OR COLOR.  
FOR DISTILLED SPIRITS (U.S. CLS. 47 AND 49).  
DOMINIC FATHY, EXAMINING ATTORNEY

---

SN 85-331,125. BALO VINEYARDS, LLC, CHARLOTTE, NC. FILED 5-26-2011.

# BALO

THE MARK CONSISTS OF STANDARD CHARACTERS WITHOUT CLAIM TO ANY PARTICULAR FONT, STYLE, SIZE, OR COLOR.  
FOR ALCOHOLIC BEVERAGES EXCEPT BEERS (U.S. CLS. 47 AND 49).  
FIRST USE 12-31-2005; IN COMMERCE 12-31-2005.  
DOMINIC FATHY, EXAMINING ATTORNEY

---

SN 85-332,079. SCHNEIDER SELECTIONS, LLC, NEW YORK, NY. FILED 5-27-2011.

# Vina Mayu

THE MARK CONSISTS OF STANDARD CHARACTERS WITHOUT CLAIM TO ANY PARTICULAR FONT, STYLE, SIZE, OR COLOR.  
THE ENGLISH TRANSLATION OF "VINA MAYU" IN THE MARK IS "MILKY WAY".  
FOR WINE (U.S. CLS. 47 AND 49).  
RAUL CORDOVA, EXAMINING ATTORNEY

**CLASS 33—(Continued).**

SN 85-332,562. MICHAEL SKURNIK WINES, INC., SYOSSET, NY. FILED 5-27-2011.

# THE PINOT PROJECT

THE MARK CONSISTS OF STANDARD CHARACTERS WITHOUT CLAIM TO ANY PARTICULAR FONT, STYLE, SIZE, OR COLOR.  
NO CLAIM IS MADE TO THE EXCLUSIVE RIGHT TO USE "PINOT", APART FROM THE MARK AS SHOWN.  
FOR WINES (U.S. CLS. 47 AND 49).  
FIRST USE 9-27-2010; IN COMMERCE 9-27-2010.  
SIMON TENG, EXAMINING ATTORNEY

---

SN 85-332,663. PAN AMERICAN PROPERTIES CORP., GUAYNABO, PUERTO RICO, FILED 5-27-2011.

# IPouch

THE MARK CONSISTS OF STANDARD CHARACTERS WITHOUT CLAIM TO ANY PARTICULAR FONT, STYLE, SIZE, OR COLOR.  
FOR PREPARED ALCOHOLIC COCKTAILS (U.S. CLS. 47 AND 49).  
JIM RINGLE, EXAMINING ATTORNEY

---

SN 85-332,751. CAKEBREAD CELLARS, RUTHERFORD, CA. FILED 5-27-2011.

# CAKEBREAD

THE MARK CONSISTS OF STANDARD CHARACTERS WITHOUT CLAIM TO ANY PARTICULAR FONT, STYLE, SIZE, OR COLOR.  
OWNER OF U.S. REG. NO. 1,493,450.  
FOR ALCOHOLIC BEVERAGES EXCEPT BEERS (U.S. CLS. 47 AND 49).  
FIRST USE 7-27-1976; IN COMMERCE 7-1-1977.  
DEBRA LEE, EXAMINING ATTORNEY

**CLASS 33—(Continued).**

SN 85-332,804. PRIME BRANDS DUTY FREE, S.A. DE C.V., LERMA, MEXICO, FILED 5-27-2011.

# BOTICA

THE MARK CONSISTS OF STANDARD CHARACTERS WITHOUT CLAIM TO ANY PARTICULAR FONT, STYLE, SIZE, OR COLOR.

THE ENGLISH TRANSLATION OF "BOTICA" IN THE MARK IS "PHARMACY".

FOR ALCOHOLIC BEVERAGES EXCEPT BEERS; MEZCAL; TEQUILA (U.S. CLS. 47 AND 49).  
KYLE PEETE, EXAMINING ATTORNEY

---

SN 85-332,971. WALKENHORST, ROBERT, JOPLIN, MO. FILED 5-27-2011.

# SPAA

THE MARK CONSISTS OF THE STYLIZED TEXT "SPAA". FOR ALCOHOLIC BEVERAGE PRODUCED FROM A BREWED MALT BASE WITH NATURAL FLAVORS (U.S. CLS. 47 AND 49).

ESTHER A. BORSUK, EXAMINING ATTORNEY

---

SN 85-333,447. HINDLE, BONNIE, LUBBOCK, TX. FILED 5-30-2011.

# Chilton

THE MARK CONSISTS OF STANDARD CHARACTERS WITHOUT CLAIM TO ANY PARTICULAR FONT, STYLE, SIZE, OR COLOR.

FOR ALCOHOLIC BEVERAGES CONTAINING FRUIT; ALCOHOLIC BEVERAGES EXCEPT BEERS; ALCOHOLIC CARBONATED BEVERAGES, EXCEPT BEER; ALCOHOLIC COCKTAIL MIXES; ALCOHOLIC MIXED BEVERAGES EXCEPT BEERS; PREPARED ALCOHOLIC COCKTAIL (U.S. CLS. 47 AND 49).

PAM WILLIS, EXAMINING ATTORNEY

**CLASS 33—(Continued).**

SN 85-333,529. R. SEAN MANNING, INC., ST. PETE BEACH, FL. FILED 5-31-2011.

# SEANPAGNE

THE MARK CONSISTS OF STANDARD CHARACTERS WITHOUT CLAIM TO ANY PARTICULAR FONT, STYLE, SIZE, OR COLOR.

FOR WINES (U.S. CLS. 47 AND 49).

KATHERINE CONNOLLY, EXAMINING ATTORNEY

---

SN 85-333,891. LADER VINEYARDS, LLC, ANGWIN, CA. FILED 5-31-2011.

# TIMBERLINE

THE MARK CONSISTS OF STANDARD CHARACTERS WITHOUT CLAIM TO ANY PARTICULAR FONT, STYLE, SIZE, OR COLOR.

FOR WINES (U.S. CLS. 47 AND 49).

LINDA M. KING, EXAMINING ATTORNEY

---

SN 85-333,984. C&N CORPORATION, DBA DOOR PENINSULA WINERY, STURGEON BAY, WI. FILED 5-31-2011.

# DISTILLING THE SPIRIT OF DOOR COUNTY

THE MARK CONSISTS OF STANDARD CHARACTERS WITHOUT CLAIM TO ANY PARTICULAR FONT, STYLE, SIZE, OR COLOR.

FOR SPIRITS AND LIQUEURS (U.S. CLS. 47 AND 49).

APRIL HESIK, EXAMINING ATTORNEY

---

SN 85-334,461. SIMONT ENTERPRISES, LLC, WEST HOLLYWOOD, CA. FILED 5-31-2011.

# SLEÉQ

THE MARK CONSISTS OF STANDARD CHARACTERS WITHOUT CLAIM TO ANY PARTICULAR FONT, STYLE, SIZE, OR COLOR.

FOR DISTILLED SPIRITS; SPIRITS AND LIQUEURS (U.S. CLS. 47 AND 49).

LINDA ORNDORFF, EXAMINING ATTORNEY

**CLASS 33—(Continued).**

SN 85-334,506. DOUG OFFENBACHER, SANTA ROSA, CA.  
FILED 5-31-2011.

**WARM SPRINGS**

THE MARK CONSISTS OF STANDARD CHARACTERS  
WITHOUT CLAIM TO ANY PARTICULAR FONT, STYLE,  
SIZE, OR COLOR.

FOR ALCOHOLIC BEVERAGES EXCEPT BEERS (U.S.  
CLS. 47 AND 49).  
H. M. FISHER, EXAMINING ATTORNEY

SN 85-334,572. RBZ VINEYARDS, LLC, SANTA BARBARA,  
CA. FILED 5-31-2011.

**MIRAGE**

THE MARK CONSISTS OF STANDARD CHARACTERS  
WITHOUT CLAIM TO ANY PARTICULAR FONT, STYLE,  
SIZE, OR COLOR.

FOR WINE; WINES (U.S. CLS. 47 AND 49).  
TINA MAI, EXAMINING ATTORNEY

SN 85-334,577. RBZ VINEYARDS, LLC, SANTA BARBARA,  
CA. FILED 5-31-2011.

**SUNMIRAGE**

THE MARK CONSISTS OF STANDARD CHARACTERS  
WITHOUT CLAIM TO ANY PARTICULAR FONT, STYLE,  
SIZE, OR COLOR.

FOR WINE; WINES (U.S. CLS. 47 AND 49).  
TINA MAI, EXAMINING ATTORNEY

SN 85-334,652. LJ PRODUCTIONS, LLC, SAN FRANCISCO,  
CA. FILED 6-1-2011.

**MAMA CHARLOTTE'S**

THE MARK CONSISTS OF STANDARD CHARACTERS  
WITHOUT CLAIM TO ANY PARTICULAR FONT, STYLE,  
SIZE, OR COLOR.

FOR LIQUEURS; PREPARED ALCOHOLIC COCK-  
TAIL; SPIRITS; WINE (U.S. CLS. 47 AND 49).  
CARYN GLASSER, EXAMINING ATTORNEY

**CLASS 33—(Continued).**

SN 85-334,794. ASTOR HOME LTD., EAST RUTHERFORD,  
NJ. FILED 6-1-2011.



THE MARK CONSISTS OF A DIAMOND SHAPE IN-  
SCRIBED INSIDE ANOTHER DIAMOND SHAPE WITH  
BOTH DIAMOND SHAPES COMPRISED OF AN AR-  
RANGEMENT OF 4 LETTER PS PLACED HEAD TO TOE.

FOR WINES (U.S. CLS. 47 AND 49).  
MICHELE SWAIN, EXAMINING ATTORNEY

SN 85-335,104. RASA VINEYARDS, LLC, RANDOLPH, NJ.  
FILED 6-1-2011.

**THE LYRICIST**

THE MARK CONSISTS OF STANDARD CHARACTERS  
WITHOUT CLAIM TO ANY PARTICULAR FONT, STYLE,  
SIZE, OR COLOR.

FOR WINES (U.S. CLS. 47 AND 49).  
FIRST USE 3-31-2011; IN COMMERCE 3-31-2011.  
KEVON CHISOLM, EXAMINING ATTORNEY

SN 85-335,155. WHITECLIFF VINEYARD & WINERY LLC,  
GARDINER, NY. FILED 6-1-2011.

**Red Trail**

THE MARK CONSISTS OF STANDARD CHARACTERS  
WITHOUT CLAIM TO ANY PARTICULAR FONT, STYLE,  
SIZE, OR COLOR.

FOR GRAPE WINE; RED WINE; RED WINES; STILL  
WINES; WINE; WINES; WINES AND FORTIFIED WINES  
(U.S. CLS. 47 AND 49).

C. DIONNE CLYBURN, EXAMINING ATTORNEY

**CLASS 33—(Continued).**

SN 85-335,230. BICKING, VIRGINIA H., SANTA ROSA, CA.  
FILED 6-1-2011.

**GRINDSTONE**

THE MARK CONSISTS OF STANDARD CHARACTERS  
WITHOUT CLAIM TO ANY PARTICULAR FONT, STYLE,  
SIZE, OR COLOR.  
FOR WINE (U.S. CLS. 47 AND 49).  
BERYL GARDNER, EXAMINING ATTORNEY

SN 85-335,432. DECORADOS Y SATINADOS MEXICANOS  
S.A DE C.V., LERMA, MEXICO, FILED 6-1-2011.

**PRATIVA**

THE MARK CONSISTS OF STANDARD CHARACTERS  
WITHOUT CLAIM TO ANY PARTICULAR FONT, STYLE,  
SIZE, OR COLOR.  
FOR ALCOHOLIC BEVERAGES EXCEPT BEER; VOD-  
KA (U.S. CLS. 47 AND 49).  
KHANH LE, EXAMINING ATTORNEY

SN 85-335,714. ROJAS GONZALEZ, PEDRO, VILAGARCIA  
DE AROUSA, SPAIN, FILED 6-1-2011.

**BENITO SANTOS**

THE MARK CONSISTS OF STANDARD CHARACTERS  
WITHOUT CLAIM TO ANY PARTICULAR FONT, STYLE,  
SIZE, OR COLOR.  
THE ENGLISH TRANSLATION OF "BENITO SANTOS" IN  
THE MARK IS "BLESSED SAINTS".  
FOR WINES AND LIQUEURS (U.S. CLS. 47 AND 49).  
SHAUNIA CARLYLE, EXAMINING ATTORNEY

**CLASS 33—(Continued).**

SN 85-335,839. RYAN R. HARRIS, MIRAFLORES, LIMA -18,  
PERU, FILED 6-1-2011.

**FLOATING BOAT**

THE MARK CONSISTS OF STANDARD CHARACTERS  
WITHOUT CLAIM TO ANY PARTICULAR FONT, STYLE,  
SIZE, OR COLOR.  
FOR POTABLE SPIRITS; WINE (U.S. CLS. 47 AND 49).  
AISHA CLARKE, EXAMINING ATTORNEY

SN 85-335,930. INDUSTRIAS VINICOLAS PEDRO DOMEQ,  
S.A. DE C.V., CUAJIMALPA, MEXICO D.F, MEXICO,  
FILED 6-2-2011.

**LOS REYES**

THE MARK CONSISTS OF STANDARD CHARACTERS  
WITHOUT CLAIM TO ANY PARTICULAR FONT, STYLE,  
SIZE, OR COLOR.  
OWNER OF MEXICO REG. NO. 156422, DATED 3-6-1969,  
EXPIRES 3-6-2014.  
OWNER OF U.S. REG. NOS. 1,248,581 AND 2,952,275.  
THE ENGLISH TRANSLATION OF "LOS REYES" IN THE  
MARK IS "THE KINGS".  
FOR POTABLE DISTILLED SPIRITS (U.S. CLS. 47  
AND 49).  
KATHRYN COWARD, EXAMINING ATTORNEY

SN 85-336,219. ANGEL FIRE LIQUORS, INC., WIMBERLEY,  
TX. FILED 6-2-2011.

**ANGEL FIRE LIQUORS**

THE MARK CONSISTS OF STANDARD CHARACTERS  
WITHOUT CLAIM TO ANY PARTICULAR FONT, STYLE,  
SIZE, OR COLOR.  
NO CLAIM IS MADE TO THE EXCLUSIVE RIGHT TO  
USE "LIQUORS", APART FROM THE MARK AS SHOWN.  
FOR ALCOHOLIC BEVERAGES EXCEPT BEERS (U.S.  
CLS. 47 AND 49).  
LAURIE KAUFMAN, EXAMINING ATTORNEY

**CLASS 33—(Continued).**

SN 85-336,251. ENTERPRISES INTERNATIONAL, INC., HOQUIAM, WA. FILED 6-2-2011.

**DEACON SEAT**

THE MARK CONSISTS OF STANDARD CHARACTERS WITHOUT CLAIM TO ANY PARTICULAR FONT, STYLE, SIZE, OR COLOR.

FOR ALCOHOLIC BEVERAGES EXCEPT BEERS; DISTILLED SPIRITS (U.S. CLS. 47 AND 49).

KIM MONINGHOFF, EXAMINING ATTORNEY

**CLASS 33—(Continued).**

SN 85-336,336. CAPSTONE INTERNATIONAL INC., ST. PETERSBURG, FL. FILED 6-2-2011.

**BLACK COLIN**

THE MARK CONSISTS OF STANDARD CHARACTERS WITHOUT CLAIM TO ANY PARTICULAR FONT, STYLE, SIZE, OR COLOR.

FOR SCOTCH WHISKY (U.S. CLS. 47 AND 49).

CHRISTINE COOPER, EXAMINING ATTORNEY

SN 85-336,255. ANGEL FIRE LIQUORS, INC., WIMBERLEY, TX. FILED 6-2-2011.

**ANGEL FIRE SPIRITS**

THE MARK CONSISTS OF STANDARD CHARACTERS WITHOUT CLAIM TO ANY PARTICULAR FONT, STYLE, SIZE, OR COLOR.

NO CLAIM IS MADE TO THE EXCLUSIVE RIGHT TO USE "SPIRITS", APART FROM THE MARK AS SHOWN.

FOR ALCOHOLIC BEVERAGES EXCEPT BEERS (U.S. CLS. 47 AND 49).

LAURIE KAUFMAN, EXAMINING ATTORNEY

SN 85-336,842. PEJU PROVINCE, RUTHERFORD, CA. FILED 6-2-2011.

**GATEWAY**

THE MARK CONSISTS OF STANDARD CHARACTERS WITHOUT CLAIM TO ANY PARTICULAR FONT, STYLE, SIZE, OR COLOR.

FOR ALCOHOLIC BEVERAGES EXCEPT BEERS (U.S. CLS. 47 AND 49).

WENDY GOODMAN, EXAMINING ATTORNEY

SN 85-336,328. CAPSTONE INTERNATIONAL INC., ST. PETERSBURG, FL. FILED 6-2-2011.

**BLACK COLIN OF LOCH AWE**

THE MARK CONSISTS OF STANDARD CHARACTERS WITHOUT CLAIM TO ANY PARTICULAR FONT, STYLE, SIZE, OR COLOR.

FOR SCOTCH WHISKY (U.S. CLS. 47 AND 49).

CHRISTINE COOPER, EXAMINING ATTORNEY

SN 85-337,161. BIAGIO CRU & ESTATE WINES, LLC, ROSLYN HEIGHTS, NY. FILED 6-3-2011.

**JUST PEACHY**

THE MARK CONSISTS OF STANDARD CHARACTERS WITHOUT CLAIM TO ANY PARTICULAR FONT, STYLE, SIZE, OR COLOR.

FOR SPIRITS; WINES (U.S. CLS. 47 AND 49).

JERI J. FICKES, EXAMINING ATTORNEY



**CLASS 33—(Continued).**

SN 85-337,639. BLACKWATER DISTILLING, INC., STEVENSVILLE, MD. FILED 6-3-2011.

**BLACKWATER DISTILLING**

THE MARK CONSISTS OF STANDARD CHARACTERS WITHOUT CLAIM TO ANY PARTICULAR FONT, STYLE, SIZE, OR COLOR.

NO CLAIM IS MADE TO THE EXCLUSIVE RIGHT TO USE "DISTILLING", APART FROM THE MARK AS SHOWN.

FOR LIQUOR (U.S. CLS. 47 AND 49).  
INGA ERVIN, EXAMINING ATTORNEY

**CLASS 33—(Continued).**

SN 85-338,083. SIMONT ENTERPRISES, LLC, DBA PRÉVU, WEST HOLLYWOOD, CA. FILED 6-3-2011.

**PRÉVU**

THE MARK CONSISTS OF STANDARD CHARACTERS WITHOUT CLAIM TO ANY PARTICULAR FONT, STYLE, SIZE, OR COLOR.

FOR SPARKLING LIQUEUR (U.S. CLS. 47 AND 49).  
LINDA ORNDORFF, EXAMINING ATTORNEY

SN 85-337,957. MARIMAR TORRES ESTATE CORP., SEBAS-  
TOPOL, CA. FILED 6-3-2011.

**MARIMAR ESTATE**

THE MARK CONSISTS OF STANDARD CHARACTERS WITHOUT CLAIM TO ANY PARTICULAR FONT, STYLE, SIZE, OR COLOR.

OWNER OF U.S. REG. NO. 1.659.241.  
NO CLAIM IS MADE TO THE EXCLUSIVE RIGHT TO USE "ESTATE", APART FROM THE MARK AS SHOWN.

FOR WINE (U.S. CLS. 47 AND 49).  
FIRST USE 5-1-2005, THE MARK WAS FIRST USED ANYWHERE IN A DIFFERENT FORM OTHER THAN THAT SOUGHT TO BE REGISTERED AT LEAST AS EARLY AS 03/15/1991; IN COMMERCE 5-1-2005, THE MARK WAS FIRST USED IN COMMERCE IN A DIFFERENT FORM OTHER THAN THAT SOUGHT TO BE REGISTERED AT LEAST AS EARLY AS 03/15/1991.

DORITT L. CARROLL, EXAMINING ATTORNEY

SN 85-338,285. ALEXANDRIA NICOLE CELLARS, LLC,  
PROSSER, WA. FILED 6-5-2011.

**SHEPHERDS MARK**

THE MARK CONSISTS OF STANDARD CHARACTERS WITHOUT CLAIM TO ANY PARTICULAR FONT, STYLE, SIZE, OR COLOR.

FOR WINES (U.S. CLS. 47 AND 49).  
FIRST USE 12-13-2004; IN COMMERCE 2-1-2005.

JOHN E. MICHOS, EXAMINING ATTORNEY

SN 85-337,965. SPRING 44 DISTILLING, LLC, DENVER, CO.  
FILED 6-3-2011.

**Get Stung**

THE MARK CONSISTS OF STANDARD CHARACTERS WITHOUT CLAIM TO ANY PARTICULAR FONT, STYLE, SIZE, OR COLOR.

FOR ALCOHOLIC BEVERAGES, NAMELY VODKA AND GIN (U.S. CLS. 47 AND 49).  
JEFFREY LOOK, EXAMINING ATTORNEY

SN 85-338,337. PRICE, SCOTT WESLEY, AKA E55DU13,  
TEMPE, AZ. FILED 6-5-2011.

**VASO LOCO**

THE MARK CONSISTS OF STANDARD CHARACTERS WITHOUT CLAIM TO ANY PARTICULAR FONT, STYLE, SIZE, OR COLOR.

THE ENGLISH TRANSLATION OF "VASO LOCO" IN THE MARK IS "CRAZY GLASS".  
FOR TEQUILA (U.S. CLS. 47 AND 49).  
TINA BROWN, EXAMINING ATTORNEY

**CLASS 33—(Continued).**

SN 85-338,572. FIRESTEED CORPORATION, SEATTLE, WA. FILED 6-6-2011.

**BALLARD ROAD**

THE MARK CONSISTS OF STANDARD CHARACTERS WITHOUT CLAIM TO ANY PARTICULAR FONT, STYLE, SIZE, OR COLOR.  
FOR WINE (U.S. CLS. 47 AND 49).  
LAURIE KAUFMAN, EXAMINING ATTORNEY

**CLASS 33—(Continued).**

SN 85-339,670. INTERNATIONAL SPIRITS, LLC, JACKSONVILLE, FL. FILED 6-7-2011.

**IVANABITCH**

THE MARK CONSISTS OF STANDARD CHARACTERS WITHOUT CLAIM TO ANY PARTICULAR FONT, STYLE, SIZE, OR COLOR.  
FOR SPIRITS, NAMELY, FLAVORED VODKA, GIN, FRENCH BRANDY (U.S. CLS. 47 AND 49).  
FIRST USE 12-31-2009; IN COMMERCE 12-31-2009.  
RAMONA ORTIGA, EXAMINING ATTORNEY

SN 85-339,205. MANUCCI WINERY, INC., DBA WILD COYOTE WINERY, PASO ROBLES, CA. FILED 6-6-2011.

**House-Of-Reds**

THE MARK CONSISTS OF STANDARD CHARACTERS WITHOUT CLAIM TO ANY PARTICULAR FONT, STYLE, SIZE, OR COLOR.  
FOR WINE (U.S. CLS. 47 AND 49).  
FIRST USE 4-15-2000; IN COMMERCE 5-1-2001.  
MEGHAN REINHART, EXAMINING ATTORNEY

SN 85-339,722. VOLI SPIRITS, LLC, LOS ANGELES, CA. FILED 6-7-2011.

**KEEP IT LIGHT**

THE MARK CONSISTS OF STANDARD CHARACTERS WITHOUT CLAIM TO ANY PARTICULAR FONT, STYLE, SIZE, OR COLOR.  
FOR VODKA (U.S. CLS. 47 AND 49).  
LINDA MICKLEBURGH, EXAMINING ATTORNEY

SN 85-339,624. VINTNERS EDGE, INC., WILLIAMSVILLE, NY. FILED 6-7-2011.

**COURTNEY & WOODS**

THE MARK CONSISTS OF STANDARD CHARACTERS WITHOUT CLAIM TO ANY PARTICULAR FONT, STYLE, SIZE, OR COLOR.  
OWNER OF U.S. REG. NO. 2,750,938.  
FOR SPIRITS (U.S. CLS. 47 AND 49).  
INGA ERVIN, EXAMINING ATTORNEY

SN 85-339,878. VERA, ARTURO, MURRIETTA, CA. FILED 6-7-2011.

**EL TRAGUITO**

THE MARK CONSISTS OF STANDARD CHARACTERS WITHOUT CLAIM TO ANY PARTICULAR FONT, STYLE, SIZE, OR COLOR.  
THE ENGLISH TRANSLATION OF "EL TRAGUITO" IN THE MARK IS "THE LITTLE DRINK OF ALCOHOL".  
FOR TEQUILA (U.S. CLS. 47 AND 49).  
RUSS HERMAN, EXAMINING ATTORNEY

**CLASS 33—(Continued).**

SN 85-339,982. FORTUNATUS, REDWOOD CITY, CA. FILED 6-7-2011.

# BIG JUGS

THE MARK CONSISTS OF STANDARD CHARACTERS WITHOUT CLAIM TO ANY PARTICULAR FONT, STYLE, SIZE, OR COLOR.

NO CLAIM IS MADE TO THE EXCLUSIVE RIGHT TO USE "BIG", APART FROM THE MARK AS SHOWN.

FOR WINE (U.S. CLS. 47 AND 49).  
FIRST USE 2-1-2011; IN COMMERCE 2-1-2011.  
ERNEST SHOSHO, EXAMINING ATTORNEY

**CLASS 33—(Continued).**

SN 85-344,460. ENTERPRISES INTERNATIONAL, INC., HOQUIAM, WA. FILED 6-13-2011.

# THOUGHTFULLY MADE

THE MARK CONSISTS OF STANDARD CHARACTERS WITHOUT CLAIM TO ANY PARTICULAR FONT, STYLE, SIZE, OR COLOR.

FOR ALCOHOLIC BEVERAGES EXCEPT BEERS; DISTILLED SPIRITS (U.S. CLS. 47 AND 49).  
KIM MONINGHOFF, EXAMINING ATTORNEY

SN 85-344,606. ASCENTIA WINE ESTATES, LLC, HEALDSBURG, CA. FILED 6-13-2011.

SN 85-340,495. PHELPS, JOSH, SAINT HELENA, CA. FILED 6-7-2011.

# COMPLICATED

THE MARK CONSISTS OF STANDARD CHARACTERS WITHOUT CLAIM TO ANY PARTICULAR FONT, STYLE, SIZE, OR COLOR.

FOR WINE (U.S. CLS. 47 AND 49).  
SHARON MEIER, EXAMINING ATTORNEY

# LI'L RED

THE MARK CONSISTS OF STANDARD CHARACTERS WITHOUT CLAIM TO ANY PARTICULAR FONT, STYLE, SIZE, OR COLOR.

NO CLAIM IS MADE TO THE EXCLUSIVE RIGHT TO USE "RED", APART FROM THE MARK AS SHOWN.

FOR WINE (U.S. CLS. 47 AND 49).  
JOHN GARTNER, EXAMINING ATTORNEY

SN 85-345,377. DELICATO VINEYARDS, MANTECA, CA. FILED 6-14-2011.

SN 85-342,684. SX BRAND TRIBE, INC., FORT LAUDERDALE, FL. FILED 6-9-2011.

# SXCAFEDOBLE

THE MARK CONSISTS OF STANDARD CHARACTERS WITHOUT CLAIM TO ANY PARTICULAR FONT, STYLE, SIZE, OR COLOR.

FOR DISTILLED SPIRITS; SPIRITS AND LIQUEURS (U.S. CLS. 47 AND 49).  
DOMINIC FATHY, EXAMINING ATTORNEY

# Hi Jinx

THE MARK CONSISTS OF STANDARD CHARACTERS WITHOUT CLAIM TO ANY PARTICULAR FONT, STYLE, SIZE, OR COLOR.

FOR APERITIF WINES; APERITIFS WITH A WINE BASE; COOKING WINE; FORTIFIED WINES; FRUIT WINE; GRAPE WINE; HONEY WINE; KITS FOR MAKING WINE; NATURAL SPARKLING WINES; PORT WINES; PREPARED WINE COCKTAILS; RED WINE; RED WINES; ROSE WINE; SPARKLING FRUIT WINE; SPARKLING GRAPE WINE; SPARKLING WINES; STILL WINES; STRAWBERRY WINE; SWEET WINES; TABLE WINES; TONIC SWEET GRAPE WINE CONTAINING EXTRACTS FROM GINSENG AND CONCHONA BARK (NINJIN-KINATETSU WINE); WHITE WINE; WINE; WINE COOLERS; WINE PUNCH; WINE PUNCHES; WINE-BASED BEVERAGE, NAMELY, PIQUETTE; WINE-BASED DRINKS; WINES; WINES AND FORTIFIED WINES; WINES AND LIQUEURS; WINES AND SPARKLING WINES; WINES DERIVED FROM GRAPES GROWN IN CALIFORNIA, LABELED AND ADVERTISED IN COMPLIANCE WITH USA LAWS FOR WINES (U.S. CLS. 47 AND 49).  
BARBARA BROWN, EXAMINING ATTORNEY

**CLASS 33—(Continued).**

SN 85-345,741. RBZ VINEYARDS, LLC, SANTA BARBARA, CA. FILED 6-14-2011.

**ZINGRIA**

THE MARK CONSISTS OF STANDARD CHARACTERS WITHOUT CLAIM TO ANY PARTICULAR FONT, STYLE, SIZE, OR COLOR.

FOR WINE; WINES (U.S. CLS. 47 AND 49).  
TINA MAI, EXAMINING ATTORNEY

**CLASS 33—(Continued).**

SN 85-350,415. PAN AMERICAN PROPERTIES CORP., GUAYNABO, PUERTO RICO, FILED 6-20-2011.

**I Like!**

THE MARK CONSISTS OF STANDARD CHARACTERS WITHOUT CLAIM TO ANY PARTICULAR FONT, STYLE, SIZE, OR COLOR.

FOR PREPARED ALCOHOLIC COCKTAILS (U.S. CLS. 47 AND 49).  
JIM RINGLE, EXAMINING ATTORNEY

SN 85-348,994. SX BRAND TRIBE, INC., FORT LAUDERDALE, FL. FILED 6-17-2011.

**Sexier**

THE MARK CONSISTS OF WORD SEXIER, IN WHICH LETTER "X" IS REPRESENTED BY INTERSECTING STYLIZED LETTERS "S" AND "X".

FOR DISTILLED SPIRITS; SPIRITS AND LIQUEURS (U.S. CLS. 47 AND 49).  
DOMINIC FATHY, EXAMINING ATTORNEY

SN 85-352,576. ASTOR HOME LTD., EAST RUTHERFORD, NJ. FILED 6-22-2011.

**TALA**

THE MARK CONSISTS OF STANDARD CHARACTERS WITHOUT CLAIM TO ANY PARTICULAR FONT, STYLE, SIZE, OR COLOR.

FOR WINES (U.S. CLS. 47 AND 49).  
MICHELE SWAIN, EXAMINING ATTORNEY

SN 85-348,999. SX BRAND TRIBE, INC., FORT LAUDERDALE, FL. FILED 6-17-2011.

**SEXIER**

THE MARK CONSISTS OF STANDARD CHARACTERS WITHOUT CLAIM TO ANY PARTICULAR FONT, STYLE, SIZE, OR COLOR.

FOR DISTILLED SPIRITS; SPIRITS AND LIQUEURS (U.S. CLS. 47 AND 49).  
DOMINIC FATHY, EXAMINING ATTORNEY

SN 85-353,856. BILLY BARRACUDA, LLC, VIRGINIA BEACH, VA. FILED 6-23-2011.



THE MARK CONSISTS OF A FISH WITH A HAT AND JACKET OVER THE WORDS "BILLY BARRACUDA".

FOR ALCOHOLIC COCKTAIL MIXES; BRANDY; RUM; SPIRITS AND LIQUEURS; TEQUILA; VODKA; WHISKEY (U.S. CLS. 47 AND 49).  
ODESSA BIBBINS, EXAMINING ATTORNEY

**CLASS 33—(Continued).**

SN 85-355,527. BILLY BARRACUDA, LLC, VIRGINIA BEACH, VA. FILED 6-24-2011.

**CLASS 33—(Continued).**

SN 85-372,917. GENGHIS GRILL FRANCHISE CONCEPTS, LP, DALLAS, TX. FILED 7-15-2011.

**BILLY BARRACUDA**

**KHANGARITAS**

THE MARK CONSISTS OF STANDARD CHARACTERS WITHOUT CLAIM TO ANY PARTICULAR FONT, STYLE, SIZE, OR COLOR.

FOR ALCOHOLIC COCKTAIL MIXES; BRANDY; RUM; SPIRITS AND LIQUEURS; TEQUILA; VODKA; WHISKEY (U.S. CLS. 47 AND 49).  
ODESSA BIBBINS, EXAMINING ATTORNEY

THE MARK CONSISTS OF STANDARD CHARACTERS WITHOUT CLAIM TO ANY PARTICULAR FONT, STYLE, SIZE, OR COLOR.

FOR PREPARED ALCOHOLIC COCKTAIL (U.S. CLS. 47 AND 49).  
CHRISTINE COOPER, EXAMINING ATTORNEY

SN 85-366,007. RASA VINEYARDS, LLC, RANDOLPH, NJ. FILED 7-7-2011.

SN 85-372,940. GENGHIS GRILL FRANCHISE CONCEPTS, LP, DALLAS, TX. FILED 7-15-2011.

**IN ORDER TO FORM A MORE  
PERFECT UNION**

**WARRIORITA**

THE MARK CONSISTS OF STANDARD CHARACTERS WITHOUT CLAIM TO ANY PARTICULAR FONT, STYLE, SIZE, OR COLOR.

FOR WINES (U.S. CLS. 47 AND 49).  
KEVON CHISOLM, EXAMINING ATTORNEY

THE MARK CONSISTS OF STANDARD CHARACTERS WITHOUT CLAIM TO ANY PARTICULAR FONT, STYLE, SIZE, OR COLOR.

FOR PREPARED ALCOHOLIC COCKTAIL (U.S. CLS. 47 AND 49).  
CHRISTINE COOPER, EXAMINING ATTORNEY

SN 85-366,017. RASA VINEYARDS, LLC, RANDOLPH, NJ. FILED 7-7-2011.

SN 85-373,172. MONTAUK U.S.A., LLC, NEW YORK, NY. FILED 7-16-2011.

**PLUS ONE**

**SLOPOLOGY**

THE MARK CONSISTS OF STANDARD CHARACTERS WITHOUT CLAIM TO ANY PARTICULAR FONT, STYLE, SIZE, OR COLOR.

FOR WINES (U.S. CLS. 47 AND 49).  
KEVON CHISOLM, EXAMINING ATTORNEY

THE MARK CONSISTS OF STANDARD CHARACTERS WITHOUT CLAIM TO ANY PARTICULAR FONT, STYLE, SIZE, OR COLOR.

FOR ALCOHOLIC BEVERAGES EXCEPT BEERS (U.S. CLS. 47 AND 49).  
GISELLE AGOSTO, EXAMINING ATTORNEY

**CLASS 33—(Continued).**

SN 85-384,676. VAMPT BEVERAGE CORP., KELOWNA, BC, CANADA, FILED 7-29-2011.

**B 21+**

THE MARK CONSISTS OF STANDARD CHARACTERS WITHOUT CLAIM TO ANY PARTICULAR FONT, STYLE, SIZE, OR COLOR.

FOR ALCOHOLIC BEVERAGES, NAMELY, PRE-MIXED COCKTAILS AND TEQUILA BASED COOLERS; FLAVORED ALCOHOLIC MALT COOLERS PRODUCED FROM BREWED MALT BASE WITH NATURAL FLAVORS (U.S. CLS. 47 AND 49).  
DOMINIC FATHY, EXAMINING ATTORNEY

**CLASS 33—(Continued).**

SN 85-416,545. JOHNNY CUBA, INC., MIAMI, FL. FILED 9-7-2011.

**JOHNNY CUBA**

THE MARK CONSISTS OF STANDARD CHARACTERS WITHOUT CLAIM TO ANY PARTICULAR FONT, STYLE, SIZE, OR COLOR.

OWNER OF U.S. REG. NO. 3,038,104.  
THE NAME(S), PORTRAIT(S), AND/OR SIGNATURE(S) SHOWN IN THE MARK DOES NOT IDENTIFY A PARTICULAR LIVING INDIVIDUAL.

FOR ALCOHOLIC BEVERAGES EXCEPT BEERS (U.S. CLS. 47 AND 49).  
DAVID C. REIHNER, EXAMINING ATTORNEY

SN 85-397,242. SPARKLING TEQUILA, LLC, DBA SPARKLING TEQUILA, LLC, ENCINO, CA. FILED 8-12-2011.

**Teqava**

THE MARK CONSISTS OF STANDARD CHARACTERS WITHOUT CLAIM TO ANY PARTICULAR FONT, STYLE, SIZE, OR COLOR.

FOR DISTILLED SPIRITS (U.S. CLS. 47 AND 49).  
KIMBERLY PERRY, EXAMINING ATTORNEY

**CLASS 34—SMOKERS' ARTICLES**

SN 76-707,673. STARCO IMPEX, INC., BEAUMONT, TX. FILED 5-20-2011.

**KICKBACK**

THE MARK CONSISTS OF THE STYLIZED WORD "KICKBACK" WITH A BAR EXTENDING OUT FROM THE BOTTOM OF THE FIRST LETTER "K" UNDER THE REST OF THE WORD, THE BAR CONTAINS A STYLIZED DESIGN CENTERED UNDER THE LETTERS "ICKBACK".

FOR CIGARS, FILTER CIGARS, CIGARILLOS AND BLUNTS (U.S. CLS. 2, 8, 9 AND 17).  
JEFF DEFORD, EXAMINING ATTORNEY

SN 85-407,829. SPARKLING TEQUILA, LLC, ENCINO, CA. FILED 8-25-2011.

**Teqave**

THE MARK CONSISTS OF STANDARD CHARACTERS WITHOUT CLAIM TO ANY PARTICULAR FONT, STYLE, SIZE, OR COLOR.

FOR SPIRITS AND LIQUEURS (U.S. CLS. 47 AND 49).  
KIMBERLY PERRY, EXAMINING ATTORNEY

SN 77-262,426. CIGARS INTERNATIONAL, INC., BETHLEHEM, PA. FILED S.R. 8-23-2007; AM. P.R. 11-17-2008.

**MEGA-SAMPLER**

THE MARK CONSISTS OF STANDARD CHARACTERS WITHOUT CLAIM TO ANY PARTICULAR FONT, STYLE, SIZE, OR COLOR.

SEC. 2(F).  
FOR CIGARS (U.S. CLS. 2, 8, 9 AND 17).  
FIRST USE 8-12-2004; IN COMMERCE 8-12-2004.  
EVELYN BRADLEY, EXAMINING ATTORNEY

**CLASS 34—(Continued).**

SN 77-629,524. NAT SHERMAN, INC., FORT LEE, NJ. FILED 12-9-2008.

PHANTOM BY NAT SHERMAN

THE MARK CONSISTS OF STANDARD CHARACTERS WITHOUT CLAIM TO ANY PARTICULAR FONT, STYLE, SIZE, OR COLOR.

OWNER OF U.S. REG. NOS. 2,019,294, 2,864,445 AND OTHERS.

THE NAME(S), PORTRAIT(S), AND/OR SIGNATURE(S) SHOWN IN THE MARK DOES NOT IDENTIFY A PARTICULAR LIVING INDIVIDUAL.

FOR CIGARETTES (U.S. CLS. 2, 8, 9 AND 17).  
BRIAN NEVILLE, EXAMINING ATTORNEY

**CLASS 34—(Continued).**

SN 85-203,281. DARIER & CLEEF GMBH, HAMBURG, FED REP GERMANY, FILED 12-21-2010.

Campo Verde

THE MARK CONSISTS OF STANDARD CHARACTERS WITHOUT CLAIM TO ANY PARTICULAR FONT, STYLE, SIZE, OR COLOR.

PRIORITY CLAIMED UNDER SEC. 44(D) ON ERPNTY TM OFC APPLICATION NO. 009198011, FILED 6-23-2010, REG. NO. 009198011, DATED 10-19-2010, EXPIRES 6-23-2020.

THE ENGLISH TRANSLATION OF "CAMPO VERDE" IN THE MARK IS "GREEN FIELD".

FOR ASHTRAYS; CIGAR CUTTERS; CIGARETTES; CIGARILLOS; CIGARS; MATCHES; PIPE TOBACCO; TOBACCO (U.S. CLS. 2, 8, 9 AND 17).

COLLEEN KEARNEY, EXAMINING ATTORNEY

SN 85-179,589. YAMMINE FADY KAMIL, DBA YAMMINE FADY KAMIL, BEIRUT, LEBANON, FILED 11-18-2010.

SheeCool

THE MARK CONSISTS OF STANDARD CHARACTERS WITHOUT CLAIM TO ANY PARTICULAR FONT, STYLE, SIZE, OR COLOR.

FOR HOOKAH TOBACCO: HOOKAHS; SMOKERS' ARTICLES, NAMELY, HOOKAH CHARCOAL (U.S. CLS. 2, 8, 9 AND 17).

FIRST USE 1-1-2007; IN COMMERCE 9-21-2007.  
ELIZABETH KAJUBI, EXAMINING ATTORNEY

SN 85-311,990. FUMO DESIGN, LLC, BOCA RATON, FL. FILED 5-4-2011.

FUMO

THE MARK CONSISTS OF STANDARD CHARACTERS WITHOUT CLAIM TO ANY PARTICULAR FONT, STYLE, SIZE, OR COLOR.

THE ENGLISH TRANSLATION OF "FUMO" IN THE MARK IS "SMOKE".

FOR HOOKAHS; TOBACCO WATER PIPES; SMOKER'S ARTICLES, NAMELY, JARS, PODS, TANKS, HOSES, POD STANDS, COAL SCREENS, COAL TRAYS, HOLE PLUGS, BOWLS, DOWNSTEMS, MOUTHPIECES, WINDGUARDS, HOSE INSERT FITTINGS, HOSE ADAPTERS, HOSE VALVES, CONNECTING STEMS, CARRYING CASES, ALL FOR USE WITH HOOKAHS OR TOBACCO WATER PIPES (U.S. CLS. 2, 8, 9 AND 17).

FIRST USE 12-17-2009; IN COMMERCE 12-17-2009.  
FRANK LATTUCA, EXAMINING ATTORNEY

SN 85-195,457. PATEL, RAKESH, BONITA SPRINGS, FL. FILED 12-10-2010.

ROCKY PATEL LATTE

THE MARK CONSISTS OF STANDARD CHARACTERS WITHOUT CLAIM TO ANY PARTICULAR FONT, STYLE, SIZE, OR COLOR.

OWNER OF U.S. REG. NOS. 3,023,623, 3,909,101 AND OTHERS.

NO CLAIM IS MADE TO THE EXCLUSIVE RIGHT TO USE "LATTE", APART FROM THE MARK AS SHOWN.

THE NAME(S), PORTRAIT(S), AND/OR SIGNATURE(S) SHOWN IN THE MARK IDENTIFIES RAKESH "PATEL", WHOSE CONSENT(S) TO REGISTER IS MADE OF RECORD.

FOR CIGARS (U.S. CLS. 2, 8, 9 AND 17).  
VIVIAN MICZNIK FIRST, EXAMINING ATTORNEY

SN 85-321,543. NAZARI, NADER, SAN DIEGO, CA. FILED 5-16-2011.

AIRSTREAM

THE MARK CONSISTS OF THE STYLIZED TEXT "AIRSTREAM" WITH A FLAME ON TOP OF THE LETTER "I".

FOR ELECTRONIC CIGARETTES; ELECTRONIC CIGARETTE REFILL CARTRIDGES; ELECTRONICS CIGARETTE REFILL LIQUIDS (U.S. CLS. 2, 8, 9 AND 17).  
EMILY CHUO, EXAMINING ATTORNEY

**CLASS 34—(Continued).**

SN 85-324,413. TMS INTERNATIONAL CORP, TARZANA, CA. FILED 5-18-2011.

**BANZAI**

THE MARK CONSISTS OF STANDARD CHARACTERS WITHOUT CLAIM TO ANY PARTICULAR FONT, STYLE, SIZE, OR COLOR.

THE ENGLISH TRANSLATION OF THE WORD "BANZAI" IN THE MARK IS "TEN THOUSAND YEARS".

FOR SMOKERS' ARTICLES, NAMELY, HOOKAH CHARCOAL (U.S. CLS. 2, 8, 9 AND 17).

FIRST USE 4-30-2010; IN COMMERCE 4-30-2010.  
DORITT L. CARROLL, EXAMINING ATTORNEY



SN 85-331,435. GOLD STANDARD ENTERPRISES, INC., CHICAGO, IL. FILED 5-26-2011.

**EL SEÑOR**

THE MARK CONSISTS OF STANDARD CHARACTERS WITHOUT CLAIM TO ANY PARTICULAR FONT, STYLE, SIZE, OR COLOR.

FOR CIGARS (U.S. CLS. 2, 8, 9 AND 17).  
JAY BESCH, EXAMINING ATTORNEY



SN 85-333,106. ARIZONA INVESTMENT & TRADING, LLC, SCOTTSDALE, AZ. FILED 5-28-2011.

**REVE**

THE MARK CONSISTS OF STANDARD CHARACTERS WITHOUT CLAIM TO ANY PARTICULAR FONT, STYLE, SIZE, OR COLOR.

FOR CIGARETTES (U.S. CLS. 2, 8, 9 AND 17).  
SOPHIA S. KIM, EXAMINING ATTORNEY

**CLASS 34—(Continued).**

SN 85-333,110. ARIZONA INVESTMENT & TRADING, LLC, SCOTTSDALE, AZ. FILED 5-28-2011.

**VIGNIA**

THE MARK CONSISTS OF STANDARD CHARACTERS WITHOUT CLAIM TO ANY PARTICULAR FONT, STYLE, SIZE, OR COLOR.

FOR CIGARETTES (U.S. CLS. 2, 8, 9 AND 17).  
SOPHIA S. KIM, EXAMINING ATTORNEY



SN 85-333,114. ARIZONA INVESTMENT & TRADING, LLC, SCOTTSDALE, AZ. FILED 5-28-2011.

**VIRGINIA20**

THE MARK CONSISTS OF STANDARD CHARACTERS WITHOUT CLAIM TO ANY PARTICULAR FONT, STYLE, SIZE, OR COLOR.

FOR CIGARETTES (U.S. CLS. 2, 8, 9 AND 17).  
SOPHIA S. KIM, EXAMINING ATTORNEY



SN 85-333,115. ARIZONA INVESTMENT & TRADING, LLC, SCOTTSDALE, AZ. FILED 5-28-2011.



THE MARK CONSISTS OF THE TRADEMARK LETTERS HG ON A SHIELD, WHERE H IS LIGHT AND G IS DARK, AND THE BACKGROUND SECTIONS OF THE SHIELD ARE DARK AND LIGHT, RESPECTIVELY, WHERE THE SHIELD IS BELOW A CROWN AND SIDED BY STYLIZED LIONS AND ABOVE SIX LEAVES AND FIVE CURVED RECTANGULAR BARS.

FOR CIGARETTES (U.S. CLS. 2, 8, 9 AND 17).  
SOPHIA S. KIM, EXAMINING ATTORNEY



**CLASS 34—(Continued).**

SN 85-333,860. CHEYENNE INTERNATIONAL, LLC, GROVER, NC. FILED 5-31-2011.

# AVENTURO

THE MARK CONSISTS OF STANDARD CHARACTERS WITHOUT CLAIM TO ANY PARTICULAR FONT, STYLE, SIZE, OR COLOR.

THE ENGLISH TRANSLATION OF "AVENTURO" IN THE MARK IS "TO DARE OR TO TAKE A RISK".  
FOR CIGARS (U.S. CLS. 2, 8, 9 AND 17).  
JOHN DWYER, EXAMINING ATTORNEY

---

SN 85-334,934. MOUNTAIN VAPOR, HENDERSONVILLE, NC. FILED 6-1-2011.

# Mountain Vapor

THE MARK CONSISTS OF STANDARD CHARACTERS WITHOUT CLAIM TO ANY PARTICULAR FONT, STYLE, SIZE, OR COLOR.

FOR LIQUIDS FOR ELECTRONIC CIGARETTES (U.S. CLS. 2, 8, 9 AND 17).  
FIRST USE 4-1-2011; IN COMMERCE 4-1-2011.  
ZHALEH DELANEY, EXAMINING ATTORNEY

---

SN 85-335,057. SHERRY, ROBERT, ST. CHARLES, IL. AND SHERRY, PATRICIA, ST. CHARLES, IL. FILED 6-1-2011.

# WEDGIE

THE MARK CONSISTS OF STANDARD CHARACTERS WITHOUT CLAIM TO ANY PARTICULAR FONT, STYLE, SIZE, OR COLOR.

FOR HOLDERS FOR CIGARS AND CIGARETTES (U.S. CLS. 2, 8, 9 AND 17).  
JOSETTE BEVERLY, EXAMINING ATTORNEY

**CLASS 34—(Continued).**

SN 85-336,833. SAHARA HOOKAH, LLC, SACRAMENTO, CA. FILED 6-2-2011.

# STORM

THE MARK CONSISTS OF STANDARD CHARACTERS WITHOUT CLAIM TO ANY PARTICULAR FONT, STYLE, SIZE, OR COLOR.

FOR HOOKAH TOBACCO; MOLASSES TOBACCO (U.S. CLS. 2, 8, 9 AND 17).  
AISHA CLARKE, EXAMINING ATTORNEY

---

SN 85-337,335. THOMPSON & CO. OF TAMPA, INC., TAMPA, FL. FILED 6-3-2011.

# MAGNA CARTA

THE MARK CONSISTS OF STANDARD CHARACTERS WITHOUT CLAIM TO ANY PARTICULAR FONT, STYLE, SIZE, OR COLOR.

FOR CIGARS (U.S. CLS. 2, 8, 9 AND 17).  
WILLIAM BRECKENFELD, EXAMINING ATTORNEY

---

SN 85-337,630. DORANS IV, JOHN, SAN DIEGO, CA. FILED 6-3-2011.

# SMASHTRAY TAP THIS

THE MARK CONSISTS OF STANDARD CHARACTERS WITHOUT CLAIM TO ANY PARTICULAR FONT, STYLE, SIZE, OR COLOR.

FOR ASHTRAYS (U.S. CLS. 2, 8, 9 AND 17).  
FIRST USE 2-1-2011; IN COMMERCE 5-1-2011.  
TRACY FLETCHER, EXAMINING ATTORNEY

---

SN 85-340,029. CHIUSANO, JOSEPH V, SARASOTA, FL. FILED 6-7-2011.

# Roll Back

THE MARK CONSISTS OF STANDARD CHARACTERS WITHOUT CLAIM TO ANY PARTICULAR FONT, STYLE, SIZE, OR COLOR.

FOR CIGARS (U.S. CLS. 2, 8, 9 AND 17).  
LAURIE MAYES, EXAMINING ATTORNEY

**CLASS 34—(Continued).**

SN 85-340,673. THOMPSON & CO. OF TAMPA, INC., TAMPA, FL. FILED 6-8-2011.

# MOXEY

THE MARK CONSISTS OF STANDARD CHARACTERS WITHOUT CLAIM TO ANY PARTICULAR FONT, STYLE, SIZE, OR COLOR.

FOR CIGARS (U.S. CLS. 2, 8, 9 AND 17).

WILLIAM BRECKENFELD, EXAMINING ATTORNEY

---

SN 85-365,435. SANTA CLARA, INC., BURLINGTON, NC. FILED 7-7-2011.

# Brick & Mortar

THE MARK CONSISTS OF STANDARD CHARACTERS WITHOUT CLAIM TO ANY PARTICULAR FONT, STYLE, SIZE, OR COLOR.

FOR CIGARS (U.S. CLS. 2, 8, 9 AND 17).

KATHY DE JONGE, EXAMINING ATTORNEY

---

SN 85-387,671. ANTILLIAN CIGAR CORPORATION, MIAMI, FL. FILED 8-2-2011.

# Royal Honduras

THE MARK CONSISTS OF STANDARD CHARACTERS WITHOUT CLAIM TO ANY PARTICULAR FONT, STYLE, SIZE, OR COLOR.

NO CLAIM IS MADE TO THE EXCLUSIVE RIGHT TO USE "HONDURAS", APART FROM THE MARK AS SHOWN.

FOR CIGARS (U.S. CLS. 2, 8, 9 AND 17).

KAPIL BHANOT, EXAMINING ATTORNEY

**CLASS 34—(Continued).**

SN 85-396,404. SANTA CLARA, INC., BURLINGTON, NC. FILED 8-12-2011.

# Lew's Handmade Smokers

THE MARK CONSISTS OF STANDARD CHARACTERS WITHOUT CLAIM TO ANY PARTICULAR FONT, STYLE, SIZE, OR COLOR.

NO CLAIM IS MADE TO THE EXCLUSIVE RIGHT TO USE "HANDMADE SMOKERS", APART FROM THE MARK AS SHOWN.

FOR HANDMADE CIGARS (U.S. CLS. 2, 8, 9 AND 17).

FIRST USE 10-1-1997; IN COMMERCE 10-1-1997.

KATHY DE JONGE, EXAMINING ATTORNEY

---

SN 85-418,922. FUENTE MARKETING LTD., PROVIDENCIALES, TURKS/CAICOS IS., FILED 9-9-2011.



THE PORTRAIT IN THE MARK DOES NOT IDENTIFY A LIVING INDIVIDUAL.

THE MARK CONSISTS OF A DRAWING OF THE HEAD AND SHOULDERS OF A NATIVE AMERICAN INDIAN GIRL IN NATIVE DRESS.

FOR CIGARS (U.S. CLS. 2, 8, 9 AND 17).

KATHLEEN M. VANSTON, EXAMINING ATTORNEY

CLASS 35—(Continued).

CLASS 35—(Continued).

SN 76-707,765. GABRIEL BROS, INC, NEW YORK, NY.  
FILED 5-27-2011.

SERVICE MARKS

CLASS 35—ADVERTISING AND BUSINESS

SN 76-702,585. THE HAMILTON CO., LAWRENCEVILLE, NJ.  
FILED 4-22-2010.



ENGAGED

THE MARK CONSISTS OF STANDARD CHARACTERS WITHOUT CLAIM TO ANY PARTICULAR FONT, STYLE, SIZE, OR COLOR.  
FOR DISTRIBUTORSHIP SERVICES IN THE FIELD OF JEWELRY (U.S. CLS. 100, 101 AND 102).  
FIRST USE 5-26-2011; IN COMMERCE 5-26-2011.  
KATHERINE STOIDES, EXAMINING ATTORNEY

OWNER OF U.S. REG. NO. 3,589,469.  
NO CLAIM IS MADE TO THE EXCLUSIVE RIGHT TO USE "FAMILY-OWNED SINCE 1912", "PRINCETON", "LAWRENCEVILLE", "RED BANK", "PALM BEACH" AND "PALM BEACH GARDENS", APART FROM THE MARK AS SHOWN.

THE MARK CONSISTS OF A DESIGN OF A CREST AND THE WORDS "HAMILTON FAMILY-OWNED SINCE 1912 PRINCETON LAWRENCEVILLE RED BANK PALM BEACH PALM BEACH GARDENS 1-800-5-HAMILTON WWW.HAMILTONJEWELERS.COM".

FOR RETAIL STORE SERVICES FEATURING JEWELRY (U.S. CLS. 100, 101 AND 102).

FIRST USE 1-1-1925; IN COMMERCE 1-1-1925.  
FLORENTINA BLANDU, EXAMINING ATTORNEY

SN 77-298,443. BIG SCREEN NETWORK PRODUCTIONS, INC., WESTLAKE VILLAGE, CA. FILED 10-8-2007.

SN 76-707,764. GABRIEL BROS, INC, NEW YORK, NY.  
FILED 5-27-2011.

BSN COMMUNICATIONS

REDEFINING ENGAGED

THE MARK CONSISTS OF STANDARD CHARACTERS WITHOUT CLAIM TO ANY PARTICULAR FONT, STYLE, SIZE, OR COLOR.

FOR DISTRIBUTORSHIP SERVICES IN THE FIELD OF JEWELRY (U.S. CLS. 100, 101 AND 102).

FIRST USE 5-26-2011; IN COMMERCE 5-26-2011.  
KATHERINE STOIDES, EXAMINING ATTORNEY

THE MARK CONSISTS OF STANDARD CHARACTERS WITHOUT CLAIM TO ANY PARTICULAR FONT, STYLE, SIZE, OR COLOR.

NO CLAIM IS MADE TO THE EXCLUSIVE RIGHT TO USE "COMMUNICATIONS", APART FROM THE MARK AS SHOWN.

FOR ADVERTISING, MARKETING AND PROMOTION SERVICES; DEVELOPMENT OF MARKETING STRATEGIES AND CONCEPTS; ADVERTISING AND PUBLICITY SERVICES, NAMELY, PROMOTING THE GOODS, SERVICES, BRAND IDENTITY AND COMMERCIAL INFORMATION AND NEWS OF THIRD PARTIES THROUGH PRINT, AUDIO, VIDEO, DIGITAL AND ONLINE MEDIUM (U.S. CLS. 100, 101 AND 102).

JOHN E. MICHOS, EXAMINING ATTORNEY

**CLASS 35—(Continued).**

SN 77-317,569. GLOBAL ELECTRIC ELECTRONIC PROCESSING INC., BARRIE, CANADA, FILED 10-31-2007.



NO CLAIM IS MADE TO THE EXCLUSIVE RIGHT TO USE "GLOBAL ELECTRIC ELECTRONIC PROCESSING", APART FROM THE MARK AS SHOWN.

THE MARK CONSISTS OF THE WORDING "GEEP GLOBAL ELECTRIC ELECTRONIC PROCESSING" AND A DESIGN TO THE LEFT OF THE WORDING CONSISTING OF A GLOBE SURROUNDED BY TWO SHADED ROTATIONAL ARROWS.

FOR BUSINESS MANAGEMENT; BUSINESS MANAGEMENT IN THE FIELD OF WASTE DISPOSAL AND RECYCLING/RECOVERY MATTERS, INDUSTRIAL MANAGEMENT ASSISTANCE, RESALE OF REUSABLE SCRAP ELECTRIC AND ELECTRONICS ITEMS, NAMELY, COMPUTER, LAPTOP COMPUTERS, COMPUTER PERIPHERALS, AND COMPUTER ACCESSORIES AND PARTS THEREOF; PROMOTING PUBLIC AWARENESS OF THE NEED FOR ADEQUATE ELECTRIC AND ELECTRONIC MATERIAL DISPOSAL AND RECYCLING/RECOVERY; TRACKING AND FACILITATION OF THE SHIPMENT OF ELECTRIC AND ELECTRONIC MATERIALS; PROMOTING PUBLIC AWARENESS OF ZERO LANDFILL OBJECTIVES, LANDFILL RECOVERY, AND WASTE DIVERSION PROCESSING (U.S. CLS. 100, 101 AND 102).

MARK PILARO, EXAMINING ATTORNEY

SN 77-593,905. NOOR CLOTHING INC, CHULA VISTA, CA. FILED 10-16-2008.

## Homiegear.com

THE MARK CONSISTS OF STANDARD CHARACTERS WITHOUT CLAIM TO ANY PARTICULAR FONT, STYLE, SIZE, OR COLOR.

FOR ON-LINE RETAIL STORE SERVICES FEATURING SLIPPERS (U.S. CLS. 100, 101 AND 102).

FIRST USE 6-1-2008; IN COMMERCE 6-1-2008.

LEIGH LOWRY, EXAMINING ATTORNEY

**CLASS 35—(Continued).**

SN 77-812,422. JETRO HOLDINGS, LLC, FLUSHING, NY. FILED 8-25-2009.



NO CLAIM IS MADE TO THE EXCLUSIVE RIGHT TO USE "STORE" AND ".COM", APART FROM THE MARK AS SHOWN.

THE COLOR(S) BLUE, YELLOW, ORANGE, WHITE AND BLACK IS/ARE CLAIMED AS A FEATURE OF THE MARK.

THE MARK CONSISTS OF THE STYLIZED WORDING "THERDSTORE.COM". THE WORDING "THE" AND "STORE" APPEARS IN THE COLOR BLUE. THE WORDING "RD" APPEARS IN THE COLOR YELLOW. A DESIGN OF AN ORANGE TAG ATTACHED TO A BLACK STRING CONTAINS THE WORDING ".COM". THE WORDING ".COM" APPEARS IN THE COLOR WHITE. THE WORDING "RDSTORE" IS DISPLAYED ON A REFLECTIVE SURFACE CREATING A BLUE AND YELLOW MIRROR IMAGE OF THE WORDING.

FOR ONLINE WHOLESALE DISTRIBUTORSHIP SERVICES IN THE FIELD OF GROCERIES AND RESTAURANT SUPPLIES AND EQUIPMENT (U.S. CLS. 100, 101 AND 102).

CIMMERIAN COLEMAN, EXAMINING ATTORNEY

SN 77-837,934. PARFUMS CARLO CORINTO PARIS, S.A.R.L., PARIS 75008, FRANCE, FILED 9-30-2009.

## CARLO CORINTO

THE MARK CONSISTS OF STANDARD CHARACTERS WITHOUT CLAIM TO ANY PARTICULAR FONT, STYLE, SIZE, OR COLOR.

PRIORITY CLAIMED UNDER SEC. 44(D) ON MEXICO APPLICATION NO. 1037186, FILED 9-29-2009, REG. NO. 1155146, DATED 4-27-2010, EXPIRES 9-29-2019.

OWNER OF U.S. REG. NOS. 1,386,458, 3,473,587 AND OTHERS.

THE NAME(S), PORTRAIT(S), AND/OR SIGNATURE(S) SHOWN IN THE MARK DOES NOT IDENTIFY A PARTICULAR LIVING INDIVIDUAL.

FOR ON-LINE RETAIL STORE, ON-LINE WHOLESALE STORE AND ON-LINE ORDERING SERVICES IN THE FIELDS INCLUDING DRESSING, FOOTWEAR, GLASSES, KEY RINGS, CLOCKS, PENS, CAPS, AND HEADGEAR (U.S. CLS. 100, 101 AND 102).

NAPOLEON SHARMA, EXAMINING ATTORNEY

**CLASS 35—(Continued).**

SN 77-842,803. UNICORN MEDIA, INC., TEMPE, AZ. FILED 10-6-2009.

UNICORNMEDIA

THE MARK CONSISTS OF STANDARD CHARACTERS WITHOUT CLAIM TO ANY PARTICULAR FONT, STYLE, SIZE, OR COLOR.

FOR BUSINESS MONITORING SERVICES, NAMELY, TRACKING WEB SITES OF OTHERS TO PROVIDE DETAILS ABOUT VISITS TO WEB SITES AND THE USE OF DATA OR AUDIO VISUAL IMAGES DISPLAYED AND DISTRIBUTED ON THOSE WEB SITES AND PREPARING BUSINESS AND MARKET REPORTS WITH RESPECT TO THAT INFORMATION (U.S. CLS. 100, 101 AND 102).

SETH A. RAPPAPORT, EXAMINING ATTORNEY

SN 77-865,696. BRYANT, JULIE, FORT WORTH, TX. FILED 11-5-2009.



NO CLAIM IS MADE TO THE EXCLUSIVE RIGHT TO USE "SISTERHOOD", APART FROM THE MARK AS SHOWN.

THE STIPPLING IS FOR SHADING PURPOSES ONLY.

THE MARK CONSISTS OF A DEPICTION OF THE BUST OF A YOUNG WOMAN WEARING A COWBOY HAT, WITH A SMALL HEART JUST BELOW HER LEFT EYE. TO THE RIGHT OF THIS DEPICTION IS THE WORDING "YEEHAW SISTERHOOD". THE "A" OF "YEEHAW" HAS A SPLATTER EFFECT IN THE "HOLE" OF THE "A", THE "I" OF "SISTERHOOD" IS ELONGATED, AND THERE APPEARS TO BE A HORIZONTAL LINE THROUGH "SISTERHOOD".

FOR CLUB SERVICES, NAMELY, PROMOTING THE INTERESTS OF WOMEN IN THE WESTERN LIFESTYLE (U.S. CLS. 100, 101 AND 102).

NANCY CLARKE, EXAMINING ATTORNEY

**CLASS 35—(Continued).**

SN 77-916,105. KIMAYA USA, INC., SECAUCUS, NJ. FILED 1-20-2010.

AYAMIK  
DARE TO BE YOU

THE MARK CONSISTS OF STANDARD CHARACTERS WITHOUT CLAIM TO ANY PARTICULAR FONT, STYLE, SIZE, OR COLOR.

THE WORD "AYAMIK" IS KIMAYA SPELLED BACKWARDS, AND HAS NO MEANING IN A FOREIGN LANGUAGE.

FOR ADVERTISING, MARKETING AND PROMOTION OF THE PRODUCTS OF OTHERS (U.S. CLS. 100, 101 AND 102).

JASON BLAIR, EXAMINING ATTORNEY

SN 77-941,106. CORDLESS NETWORK SERVICES, INC., STERLING, VA. FILED 2-22-2010.



NO CLAIM IS MADE TO THE EXCLUSIVE RIGHT TO USE "FRAME DISPLAYS.COM", APART FROM THE MARK AS SHOWN.

THE MARK CONSISTS OF THE WORD "FRAME" IN STYLIZED, LOWERCASE TYPE APPEARING ABOVE THE WORD "DISPLAYS" IN LOWERCASE, STYLIZED TYPE. THE LETTERS "F" AND "D" ARE SLIGHTLY OFFSET FROM THE WORDS "FRAME" AND "DISPLAY" AND ARE OUTLINED TO APPEAR IN NEGATIVE SPACE. THE DESCENDER OF THE LETTER "F" AND THE ASCENDER OF THE LETTER "D" APPEAR SIDE BY SIDE AND GIVE THE IMPRESSION OF FITTING TOGETHER. THE FINAL LETTER "S" IN THE WORD "DISPLAYS" APPEARS SMALLER THAN THE OTHER LETTERS. THE TERM ".COM" APPEARS UNDER THE FINAL LETTER "S" IN THE WORD "DISPLAYS".

FOR ONLINE RETAIL AND WHOLESALE STORE SERVICES FEATURING EYEWEAR DISPLAYS, FURNITURE FOR OPHTHALMIC DISPENSING PROFESSIONALS, DISPLAYS FOR SUNGLASSES, OPTICAL DISPLAYS, WALL MOUNT OPTICAL DISPLAYS, SLATWALL OPTICAL DISPLAYS, WALL RACKS FOR SUNGLASSES, OPTICAL FRAME RODS, ROTATING AND STANDING OPTICAL DISPLAYS, MIRRORS, OPTICAL DISPENSING MIRRORS, ACCESSORIES AND REPLACEMENT PARTS FOR OPTICAL DISPLAYS, CHAIRS, TABLES, DESKS, STOOLS, EYEWEAR BAGS, EYEWEAR STORAGE CONTAINERS, ULTRASONIC CLEANING MACHINES, OPTICAL AND OPHTHALMIC LABORATORY AND EXAMINATION INSTRUMENTS AND EQUIPMENT; ELECTRONIC CATALOG SERVICES AND MAIL ORDER SERVICES FEATURING EYEWEAR DISPLAYS, FURNITURE FOR OPHTHALMIC DISPENSING PROFESSIONALS, DISPLAYS FOR SUNGLASSES, OPTICAL DISPLAYS, WALL MOUNT OPTICAL DISPLAYS, SLATWALL OPTICAL DISPLAYS, WALL RACKS FOR SUNGLASSES, OPTICAL FRAME RODS, ROTATING AND STANDING OPTICAL DISPLAYS,

**CLASS 35—(Continued).**

MIRRORS, OPTICAL DISPENSING MIRRORS, ACCESSORIES AND REPLACEMENT PARTS FOR OPTICAL DISPLAYS, CHAIRS, TABLES, DESKS, STOOLS, EYEWEAR BAGS, EYEWEAR STORAGE CONTAINERS, ULTRASONIC CLEANING MACHINES, OPTICAL AND OPHTHALMIC LABORATORY AND EXAMINATION INSTRUMENTS AND EQUIPMENT; PHONE ORDERING SERVICES FEATURING EYEWEAR DISPLAYS, FURNITURE FOR OPHTHALMIC DISPENSING PROFESSIONALS, DISPLAYS FOR SUNGLASSES, OPTICAL DISPLAYS, WALL MOUNT OPTICAL DISPLAYS, SLAT-WALL OPTICAL DISPLAYS, WALL RACKS FOR SUNGLASSES, OPTICAL FRAME RODS, ROTATING AND STANDING OPTICAL DISPLAYS, MIRRORS, OPTICAL DISPENSING MIRRORS, ACCESSORIES AND REPLACEMENT PARTS FOR OPTICAL DISPLAYS, CHAIRS, TABLES, DESKS, STOOLS, EYEWEAR BAGS, EYEWEAR STORAGE CONTAINERS, ULTRASONIC CLEANING MACHINES, OPTICAL AND OPHTHALMIC LABORATORY AND EXAMINATION INSTRUMENTS AND EQUIPMENT (U.S. CLS. 100, 101 AND 102).

FIRST USE 9-21-2005. THE MARK WAS FIRST USED ANYWHERE IN A DIFFERENT FORM OTHER THAN THAT SOUGHT TO BE REGISTERED AT LEAST AS EARLY AS 04/30/2004; IN COMMERCE 9-21-2005. THE MARK WAS FIRST USED IN COMMERCE IN A DIFFERENT FORM OTHER THAN THAT SOUGHT TO BE REGISTERED AT LEAST AS EARLY AS 04/30/2004.

LINDA ORNDORFF, EXAMINING ATTORNEY

**CLASS 35—(Continued).**

SN 78-750,860. SAFARI SHIRT CO., STAYTON, OR. FILED 11-9-2005.

## What Fuels You?

THE MARK CONSISTS OF STANDARD CHARACTERS WITHOUT CLAIM TO ANY PARTICULAR FONT, STYLE, SIZE, OR COLOR.

NO CLAIM IS MADE TO THE EXCLUSIVE RIGHT TO USE "FUEL", APART FROM THE MARK AS SHOWN.

FOR RETAIL STORE SERVICES FEATURING SURFING, SKATEBOARDING, SNOWBOARDING AND MOTOCROSS CLOTHING AND ACTIVE-WEAR (U.S. CLS. 100, 101 AND 102).

FIRST USE 10-27-2004; IN COMMERCE 10-27-2004.  
SUSAN RICHARDS, EXAMINING ATTORNEY

SN 79-101,247. STEFAN GRAEFE, AUSTRALIA, FILED 5-30-2011.

# HuTrust

THE MARK CONSISTS OF STANDARD CHARACTERS WITHOUT CLAIM TO ANY PARTICULAR FONT, STYLE, SIZE, OR COLOR.

OWNER OF INTERNATIONAL REGISTRATION 1087242 DATED 5-30-2011, EXPIRES 5-14-2022.

FOR ADVERTISING; BUSINESS MANAGEMENT; BRAND MANAGEMENT AND STRATEGY, CONSUMER RESEARCH, BUSINESS ADMINISTRATION; OFFICE FUNCTIONS (U.S. CLS. 100, 101 AND 102).

KRISTINA MORRIS, EXAMINING ATTORNEY

SN 77-964,785. ARCTIC ORIGINALS, INC., ANCHORAGE, AK. FILED 3-22-2010.



NO CLAIM IS MADE TO THE EXCLUSIVE RIGHT TO USE "BERING SEA ORIGINALS", APART FROM THE MARK AS SHOWN.

THE MARK CONSISTS OF TWO POLAR BEARS RUNNING ON MOUNTAINOUS TERRAIN WITH MOUNTAIN SCENERY IN THE BACKGROUND WITH THE WORDS "BERING SEA ORIGINALS" APPEARING UNDERNEATH. FOR ON-LINE RETAIL GIFT SHOPS (U.S. CLS. 100, 101 AND 102).

FIRST USE 3-1-1976; IN COMMERCE 3-1-1976.  
ANDREA BUTLER, EXAMINING ATTORNEY

SN 85-003,777. COOKIE'S, INC., DBA COOKIES CLOTHING CO., HONOLULU, HI. FILED 4-1-2010.

## COOKIE'S CLOTHING CO.

THE MARK CONSISTS OF STANDARD CHARACTERS WITHOUT CLAIM TO ANY PARTICULAR FONT, STYLE, SIZE, OR COLOR.

NO CLAIM IS MADE TO THE EXCLUSIVE RIGHT TO USE "CLOTHING CO.", APART FROM THE MARK AS SHOWN.

FOR RETAIL CLOTHING STORES (U.S. CLS. 100, 101 AND 102).

FIRST USE 7-7-2005; IN COMMERCE 12-13-2008.  
DAVID MURRAY, EXAMINING ATTORNEY

**CLASS 35—(Continued).**

SN 85-007,301. EVOFURNITURE, LLC, HAWORTH, NJ. FILED 4-6-2010.

# MOD WIKI

THE MARK CONSISTS OF STANDARD CHARACTERS WITHOUT CLAIM TO ANY PARTICULAR FONT, STYLE, SIZE, OR COLOR.

NO CLAIM IS MADE TO THE EXCLUSIVE RIGHT TO USE "WIKI", APART FROM THE MARK AS SHOWN.

FOR PROVIDING CONSUMER INFORMATION REGARDING FURNITURE COMPOSITION AND THE SELECTION AND PURCHASE OF FURNITURE (U.S. CLS. 100, 101 AND 102).

STEVEN R. FINE, EXAMINING ATTORNEY

SN 85-008,821. SK TELECOM CO., LTD., SEOUL, REPUBLIC OF KOREA, FILED 4-7-2010.



PRIORITY CLAIMED UNDER SEC. 44(D) ON REPUBLIC OF KOREA APPLICATION NO. 41-2010-0004, FILED 2-25-2010.

OWNER OF REPUBLIC OF KOREA REG. NO. 0210169, DATED 5-9-2011, EXPIRES 5-9-2021.

THE COLOR(S) GREY, PINK, BLACK AND WHITE IS/ ARE CLAIMED AS A FEATURE OF THE MARK.

THE MARK CONSISTS OF TWO STYLIZED EYES, THE RIGHT EYE LARGER THAN OVERLAPPING THE LEFT EYE. EACH EYE HAS A WHITE CIRCLE, A BLACK CIRCLE, A PINK CIRCLE, AND A GREY OUTLINE. BENEATH BOTH OF THE EYES IS A GREY LINE.

FOR ADVERTISEMENT SERVICES; NEWS CLIPPING SERVICES; DATA SEARCH IN COMPUTER FILES FOR OTHERS, NAMELY, DATA FILE MANAGEMENT AND SEARCHING FOR BUSINESS FILES AND RECORDS; SYSTEMIZATION OF INFORMATION INTO COMPUTER DATABASES; MANAGEMENT AND COMPILATION OF COMPUTERIZED DATABASES; COMPILATION OF INFORMATION INTO COMPUTER DATABASES; RETAIL STORE SERVICES AND ON-LINE RETAIL STORE SERVICES FEATURING PORTABLE TELEPHONES, PERSONAL DIGITAL ASSISTANT DEVICES, AND COMPUTERS; RETAIL STORE SERVICES AND ON-LINE RETAIL STORE SERVICES FEATURING CONSUMER ELECTRONIC APPLIANCES (U.S. CLS. 100, 101 AND 102).

DEBRA LEE, EXAMINING ATTORNEY

**CLASS 35—(Continued).**

SN 85-019,229. DUTY FREE AMERICAS, INC., HOLLYWOOD, FL. FILED 4-21-2010.



OWNER OF U.S. REG. NOS. 2,940,956 AND 2,984,726. NO CLAIM IS MADE TO THE EXCLUSIVE RIGHT TO USE "DUTY FREE INTERNATIONAL", APART FROM THE MARK AS SHOWN.

THE MARK CONSISTS OF THE LETTERS "DFI" WITHIN A DIAMOND WITH THE WORDS "DUTY FREE INTERNATIONAL" BELOW.

FOR RETAIL STORE SERVICES FEATURING DUTY FREE GOODS, NAMELY, FRAGRANCES, COSMETICS, TOBACCO PRODUCTS AND SMOKERS' ARTICLES, ALCOHOLIC BEVERAGES, FOOD, CONFECTION AND BEVERAGE PRODUCTS, APPAREL, EYEWEAR, PURSES AND HANDBAGS, SMALL LEATHER GOODS, WATCHES AND CLOCKS, JEWELRY, WRITING INSTRUMENTS, NOVELTY GIFTS AND SOUVENIRS, POSTCARDS, ELECTRONICS, CAMERAS, CALCULATORS, COMPUTERS, BATTERIES, AND TRAVEL RELATED PRODUCTS AND INFLIGHT COMFORT ITEMS (U.S. CLS. 100, 101 AND 102).

KRISTINA MORRIS, EXAMINING ATTORNEY

SN 85-019,765. MONROE COUNTY TOURIST DEVELOPMENT COUNCIL, KEY WEST, FL. FILED 4-21-2010.

# Key West

Close To Perfect - Far From Normal

OWNER OF U.S. REG. NOS. 2,056,046, 3,253,572 AND OTHERS.

NO CLAIM IS MADE TO THE EXCLUSIVE RIGHT TO USE "KEY WEST", APART FROM THE MARK AS SHOWN. FOR CHAMBER OF COMMERCE SERVICES, NAMELY, PROMOTING BUSINESS AND TOURISM IN THE MONROE COUNTY, FLORIDA AREA (U.S. CLS. 100, 101 AND 102).

FIRST USE 1-4-2010; IN COMMERCE 1-4-2010.

TAMARA FRAZIER, EXAMINING ATTORNEY

**CLASS 35—(Continued).**

SN 85-031,411. NEUSCHAEFER, GABRIELE, ATLANTA, GA. FILED 5-6-2010.

**Think Ambience**

THE MARK CONSISTS OF STANDARD CHARACTERS WITHOUT CLAIM TO ANY PARTICULAR FONT, STYLE, SIZE, OR COLOR.

FOR ADVERTISING AGENCY SPECIALIZING IN THE DESIGN AND EXECUTION OF WORD OF MOUTH, VIRAL, BUZZ AND EXPERIENTIAL MARKETING PROGRAMS; ADVERTISING AND BUSINESS SERVICES, NAMELY, PROVIDING AN ONLINE WEBSITE WHERE ADVERTISERS, MARKETERS, AND CONTENT PROVIDERS CAN INTERACT WITH USERS FOR ADVERTISING, BRANDING, AND PROMOTING KNOWLEDGE, PRODUCTS, AND SERVICES, AND TRADESHOWS, ON BEHALF OF THEMSELVES AND OTHERS, AND FOR EVALUATING AND RATING THE SAME, ALL THE FOREGOING RELEVANT TO HUMAN ACTIVITIES AFFECTING CLIMATE CHANGE AND RELATED FIELDS; ADVERTISING AND MARKETING; ADVERTISING AND MARKETING CONSULTANCY; ADVERTISING AND MARKETING SERVICES, NAMELY, PROMOTING THE GOODS AND SERVICES OF OTHERS; ADVERTISING SERVICES, NAMELY, PROMOTING AND MARKETING THE GOODS AND SERVICES OF OTHERS THROUGH ALL PUBLIC COMMUNICATION MEANS; ADVERTISING, MARKETING AND PROMOTION SERVICES; ARRANGING AND CONDUCTING MARKETING PROMOTIONAL EVENTS FOR OTHERS; ASSISTANCE, ADVISORY SERVICES AND CONSULTANCY WITH REGARD TO BUSINESS PLANNING, BUSINESS ANALYSIS, BUSINESS MANAGEMENT, BUSINESS ORGANIZATION, MARKETING AND CUSTOMER ANALYSIS; BUSINESS MARKETING CONSULTING SERVICES; BUSINESS MARKETING SERVICES; COLLECTION OF MARKET RESEARCH INFORMATION; CONSULTING SERVICES IN THE FIELD OF INTERNET MARKETING; CONSULTING SERVICES IN THE FIELD OF MARKETING OF EDUCATIONAL TRAINING; CONSUMER MARKETING RESEARCH AND CONSULTING RELATED THERETO; CREATION OF MARKETING TOOLS DESIGNED TO INCREASE A CLIENT COMPANY'S KNOWLEDGE OF CUSTOMER NEEDS, AND ITS COMPETITORS' PRODUCTS AND SERVICES, PRICING, ADVERTISING STRATEGY AND SALES STRATEGY; IMPLEMENTATION AND FOLLOW-UP OF ADVICE IN THE FIELDS OF MARKETING; INFORMATION OR ENQUIRIES ON BUSINESS AND MARKETING; MARKET RESEARCH CONSULTATION; MARKET RESEARCH SERVICES; MARKET RESEARCH STUDIES; MARKETING RESEARCH SERVICES; MARKETING SERVICES, NAMELY, PROVIDING INFORMATIONAL WEB PAGES DESIGNED TO GENERATE SALES TRAFFIC VIA HYPERLINKS TO OTHER WEB SITES; ON-LINE ADVERTISING AND MARKETING SERVICES; PROMOTING THE GOODS AND SERVICES OF OTHERS BY MEANS OF WORD-OF-MOUTH AND NONTRADITIONAL MARKETING PROGRAMS; PROMOTING, ADVERTISING AND MARKETING OF THE ON-LINE WEB SITES OF OTHERS; PROMOTION AND MARKETING SERVICES AND RELATED CONSULTING; PROVIDING A WEBSITE FEATURING INFORMATION ON MULTI-LEVEL MARKETING BUSINESS SERVICES; PROVIDING BUSINESS MARKETING INFORMATION; PROVIDING MARKETING AND PROMOTION OF SPECIAL EVENTS; THE BRINGING TOGETHER, FOR THE BENEFIT OF OTHERS, OF A VARIETY OF GOODS AND SERVICES, ENABLING CUSTOMERS TO CONVENIENTLY VIEW AND PURCHASE THOSE GOODS AND SERVICES FROM AN INTERNET WEB SITE PARTICULARLY SPECIALIZING IN THE MARKETING OF THE SALE OF GOODS AND SERVICES OF OTHERS (U.S. CLS. 100, 101 AND 102).

FIRST USE 5-5-2010; IN COMMERCE 5-5-2010.

HENRY S. ZAK, EXAMINING ATTORNEY

**CLASS 35—(Continued).**

SN 85-039,969. SHELUVSTECH ENTERPRISES INC., VANCOUVER, CANADA, FILED 5-17-2010.

**SHELUVSTECH**

THE MARK CONSISTS OF STANDARD CHARACTERS WITHOUT CLAIM TO ANY PARTICULAR FONT, STYLE, SIZE, OR COLOR.

PRIORITY CLAIMED UNDER SEC. 44(D) ON CANADA APPLICATION NO. 1481119, FILED 5-14-2010, REG. NO. TMA796663, DATED 5-4-2011, EXPIRES 5-4-2026.

FOR ON-LINE RETAIL STORE SERVICES FEATURING A WIDE VARIETY OF CONSUMER GOODS OF OTHERS (U.S. CLS. 100, 101 AND 102).

MORGAN WYNNE, EXAMINING ATTORNEY

SN 85-075,946. HEALTH CARE TRANSITIONS, LLC, DBA HEALTH CARE TRANSITIONS, AURORA, CO. FILED 7-1-2010.

**Health Care Transitions**

THE MARK CONSISTS OF STANDARD CHARACTERS WITHOUT CLAIM TO ANY PARTICULAR FONT, STYLE, SIZE, OR COLOR.

SEC. 2(F).

FOR BUSINESS CONSULTATION IN THE FIELD OF HEALTH CARE SERVICES (U.S. CLS. 100, 101 AND 102). FIRST USE 7-0-1988; IN COMMERCE 7-0-1988.

BERNICE MIDDLETON, EXAMINING ATTORNEY

SN 85-076,280. HEALTH CARE TRANSITIONS, LLC, DBA HEALTH CARE TRANSITIONS, AURORA, CO. FILED 7-1-2010.



THE COLOR(S) RED, WHITE, LIGHT BLUE AND DARK BLUE IS/ARE CLAIMED AS A FEATURE OF THE MARK.

THE MARK CONSISTS OF THE WORDS "HEALTH CARE TRANSITIONS", IN DARK BLUE TO THE RIGHT OF A DESIGN ELEMENT. THE DESIGN ELEMENT IS COMPRISED OF AN UPPER AND LOWER TRIANGLE SEPARATE BY RED CURVED ARROWS, WITH THE HEAD OF EACH ARROW POINTING TO THE TAIL OF THE OTHER ARROW AND THE APEX OF THE TRIANGLES POSITIONED SUCH THAT THEY ARE ADJACENT TO THE



**CLASS 35—(Continued).**

ARROWS. THE UPPER TRIANGLE IS INVERTED, IS LARGER THAN THE LOWER TRIANGLE AND IS BIFURCATED BY TWO HORIZONTAL WHITE LINES. THE UPPER TRIANGLE IS INVERTED, IS LARGER THAN THE LOWER TRIANGLE AND IS BIFURCATED BY TWO HORIZONTAL WHITE LINES. THE UPPER TRIANGLE FADES FROM A LIGHT BLUE AT ITS BASE TO A DARK BLUE AT THE APEX, WHILE THE SMALLER TRIANGLE FADES FROM A DARK BLUE AT THE APEX TO A LIGHT BLUE AT THE BASE.

SEC. 2(F).

FOR BUSINESS CONSULTATION IN THE FIELD OF HEALTH CARE SERVICES (U.S. CLS. 100, 101 AND 102).

FIRST USE 2-0-1995; IN COMMERCE 2-0-1995.

BERNICE MIDDLETON, EXAMINING ATTORNEY

---

SN 85-083,361. SMITH, ZEE MILLER, THOUSAND OAKS, CA. FILED 7-13-2010.



NO CLAIM IS MADE TO THE EXCLUSIVE RIGHT TO USE "BABY SITTERS", APART FROM THE MARK AS SHOWN.

THE COLOR(S) BLUE AND GRAY IS/ARE CLAIMED AS A FEATURE OF THE MARK.

THE MARK CONSISTS OF THE LETTERS "NJBS" IN CAPITAL FORM AND IN THE COLOR BLUE. THE MARK CONSISTS OF ONE ADULT AND TWO CHILDREN OUTLINED IN THE COLOR GREY AND POSITIONED BETWEEN THE "J" AND "B" IN "NJBS". THERE IS A BLUE LINE UNDERLINING THE FOLLOWING "NJBS" WITH THE AFOREMENTIONED GREY PEOPLE BETWEEN THE "J" AND "B". THE CAPITAL LETTER "J", DIPPING BELOW THE BLUE LINE. THE WORDS "NOT JUST BABY SITTERS" IN GREY BELOW THE BLUE LINE WITH THE CAPITAL LETTER "J" DIPPING BELOW THE GREY LINE ABOVE TO BE A PART OF THE WORD "JUST" LOCATED BELOW THE GREY LINE.

FOR EMPLOYMENT AGENCY SERVICES, NAMELY, FILLING THE TEMPORARY AND PERMANENT STAFFING NEEDS OF BUSINESSES; EMPLOYMENT STAFFING CONSULTATION SERVICES; PROFESSIONAL STAFFING AND RECRUITING SERVICES (U.S. CLS. 100, 101 AND 102).

FIRST USE 1-1-2007; IN COMMERCE 1-1-2007.

KAREN K. BUSH, EXAMINING ATTORNEY

**CLASS 35—(Continued).**

SN 85-085,687. AUI MANAGEMENT GROUP, INC., HENDERSON, NV. FILED 7-15-2010.

## PARASITE PARASITE AND ASSOCIATES

THE MARK CONSISTS OF STANDARD CHARACTERS WITHOUT CLAIM TO ANY PARTICULAR FONT, STYLE, SIZE, OR COLOR.

FOR COMPUTERIZED ON-LINE ORDERING FEATURING GENERAL MERCHANDISE AND GENERAL CONSUMER GOODS; ON-LINE RETAIL STORE SERVICES FEATURING PHYSICAL AND VIRTUAL MERCHANDISE FOR USE BY MEMBERS OF AN ON-LINE COMMUNITY IN CONNECTION WITH A DESIGNATED WEBSITE FEATURING FICTIONAL CHARACTERS; ON-LINE RETAIL STORE SERVICES FEATURING HATS, SHIRTS, CALENDARS, MUGS, AND POSTERS (U.S. CLS. 100, 101 AND 102).

JERI J. FICKES, EXAMINING ATTORNEY

---

SN 85-097,113. INETAGENT INC., NEWMARKET, ON, CANADA, FILED 7-30-2010.



OWNER OF CANADA REG. NO. TMA787396, DATED 1-17-2011, EXPIRES 1-17-2026.

THE COLOR(S) BLACK, GREEN, WHITE, ORANGE AND BLUE IS/ARE CLAIMED AS A FEATURE OF THE MARK.

THE MARK CONSISTS OF A DESIGN OF ROOFTOPS AND CHIMNEYS ABOVE THE WORD "INETAGENT.COM". THE LETTERS IN THE WORDS "NET" AND "AGENT" HAVE BLACK OUTLINES. THE ROOFTOPS AND CHIMNEYS, THE BODY AND HEAD OF THE PERSON THAT REPRESENTS THE LETTER "I" [ LOWERCASE LETTER "I" ], AND THE TEXT OF ".COM" ARE BLACK. THE "I" OF THE PERSON [ REPRESENTED BY LOWERCASE LETTER "I" ] IS GREEN, WITH A WHITE DOT ON THE HEAD. THE OUTLINE OF THE PERSON [ REPRESENTED BY LOWERCASE LETTER "I" ] IS ORANGE. THE TEXT OF THE WORD "NET" IS BLUE. THE TEXT OF THE WORD "AGENT" IS ORANGE.

FOR ADVERTISING OF COMMERCIAL, INDUSTRIAL, INVESTMENT OR RESIDENTIAL REAL ESTATE; MATCHING CONSUMERS WITH REAL ESTATE PROFESSIONALS IN THE FIELD OF REAL ESTATE SERVICES VIA COMPUTER NETWORK; PROVIDING AN INTERACTIVE REAL ESTATE WEBSITE WHICH PROMOTES HOUSING, COMMERCIAL, INDUSTRIAL AND INVESTMENT PROPERTIES THROUGH OFFERING PROSPECTIVE PURCHASERS OR TENANTS VIDEO WALK THROUGH, PROPERTY DESCRIPTIONS, TEXT, PRICE, LOCATION, MAPS AND OTHER INFORMATION THAT WOULD BE INFLUENTIAL TO A PROSPECTIVE PURCHASER OR TENANT IN MAKING A DECISION TO PURCHASE, RENT OR LEASE; REAL ESTATE ADVERTISING SERVICES (U.S. CLS. 100, 101 AND 102).

MICHAEL ENGEL, EXAMINING ATTORNEY

**CLASS 35—(Continued).**

SN 85-100,282. BRANDTRUST, INC., CHICAGO, IL. FILED 8-4-2010.

SHOPPING INQUIRY

THE MARK CONSISTS OF STANDARD CHARACTERS WITHOUT CLAIM TO ANY PARTICULAR FONT, STYLE, SIZE, OR COLOR.

OWNER OF U.S. REG. NO. 2,941,463.

NO CLAIM IS MADE TO THE EXCLUSIVE RIGHT TO USE "SHOPPING", APART FROM THE MARK AS SHOWN. FOR MARKET RESEARCH (U.S. CLS. 100, 101 AND 102).

MATTHEW EINSTEIN, EXAMINING ATTORNEY

SN 85-139,127. DARK TIMBERS, RANCHO SANTA FE, CA. FILED 9-27-2010.



THE MARK CONSISTS OF A MOUNTAIN OUTLINE CONTAINED WITHIN CURVED BRACKETS ACCOMPANIED BY THE STYLIZED WORDING "DARK TIMBERS", WITH THE LETTER "A" CUSTOMIZED TO BE MISSING THE LINE THAT CONNECTS THE UPSIDE DOWN "V" THAT WOULD OTHERWISE CHARACTERIZE THE LETTER "A".

FOR MEDIA PRODUCTION LOCATION SCOUTING SERVICES FOR ADVERTISING PURPOSES; PROMOTION USING AUDIOVISUAL MEDIA (U.S. CLS. 100, 101 AND 102).

DANIEL CAPSHAW, EXAMINING ATTORNEY

**CLASS 35—(Continued).**

SN 85-146,118. BOARD OF LAKE COUNTY COMMISSIONERS, PAINESVILLE, OH. FILED 10-6-2010.



NO CLAIM IS MADE TO THE EXCLUSIVE RIGHT TO USE "1840", APART FROM THE MARK AS SHOWN.

THE COLOR(S) BLACK, WHITE, BLUE AND GREEN IS/ARE CLAIMED AS A FEATURE OF THE MARK.

THE MARK CONSISTS OF THE WORD "LAKE" IN WHICH THE LETTERS "L" AND "K" ARE BLACK WITH A BLUE SAILBOAT FORMING THE LETTER "A" AND A BLUE FISH FORMING THE LETTER "E". BEHIND THE LETTER "L" IS A GREEN TREE. THERE IS A LIGHTHOUSE WHICH IS WHITE WITH A BLACK BAND AND THE TOP HAS THE COLORS BLACK AND BLUE. TO THE RIGHT IS THE BLACK NUMBER "1840".

FOR INFORMATION IN THE FIELD OF GOVERNMENT AFFAIRS (U.S. CLS. 100, 101 AND 102).

FIRST USE 3-11-2003; IN COMMERCE 3-11-2003.

RAMONA ORTIGA, EXAMINING ATTORNEY

SN 85-147,186. AXIS41, INC., SALT LAKE CITY, UT. FILED 10-7-2010.



THE COLOR(S) DARK GREY AND REDDISH-ORANGE IS/ARE CLAIMED AS A FEATURE OF THE MARK.

THE MARK CONSISTS OF THE WORD "AXIS" IN DARK GREY IN LOWER CASE WITH THE NUMBER "41" IN REDDISH-ORANGE AND BOLD IMMEDIATELY FOLLOWING. NO SPACE BETWEEN "AXIS" AND "41".

FOR ADVERTISING SERVICES, PUBLIC RELATIONS AND MARKETING SERVICES, NAMELY, PROMOTING AND MARKETING THE GOODS AND SERVICES OF OTHERS THROUGH ALL PUBLIC COMMUNICATION MEANS (U.S. CLS. 100, 101 AND 102).

FIRST USE 4-27-2001; IN COMMERCE 4-27-2001.

EMILY CHUO, EXAMINING ATTORNEY

**CLASS 35—(Continued).**

SN 85-154,017. IRON GM, LLC, DUPONT, WA. FILED 10-15-2010.

## Iron GM

THE MARK CONSISTS OF STANDARD CHARACTERS WITHOUT CLAIM TO ANY PARTICULAR FONT, STYLE, SIZE, OR COLOR.

NO CLAIM IS MADE TO THE EXCLUSIVE RIGHT TO USE "GM", APART FROM THE MARK AS SHOWN.

FOR ARRANGING AND CONDUCTING SPECIAL EVENTS FOR COMMERCIAL, PROMOTIONAL OR ADVERTISING PURPOSES (U.S. CLS. 100, 101 AND 102).

FIRST USE 9-0-2010; IN COMMERCE 10-0-2010.  
DARRYL SPRUILL, EXAMINING ATTORNEY

**CLASS 35—(Continued).**

SN 85-162,679. MICHEL EDOUARD ROGER CELAYETA, DISTRITO FEDERAL, MEXICO, FILED 10-27-2010.



OWNER OF MEXICO REG. NO. 1170332, DATED 7-27-2010, EXPIRES 7-27-2020.

THE COLOR(S) RED, BLUE, LIGHT BLUE AND YELLOW IS/ARE CLAIMED AS A FEATURE OF THE MARK.

THE MARK CONSISTS OF THE TERM "BABIES" IN YELLOW, "&" AND "TO BE" IN RED, "PARENTS" IN BLUE WITH A LIGHT BLUE CIRCLE CARRIER.

FOR (BASED ON USE IN COMMERCE) ADVERTISING AND MARKETING (BASED ON 44(E)) ADVERTISING AND MARKETING (U.S. CLS. 100, 101 AND 102).

FIRST USE 7-27-2010; IN COMMERCE 7-27-2010.  
SAIMA MAKHDOOM, EXAMINING ATTORNEY

SN 85-155,152. ALFALFA'S MARKET, INC., BOULDER, CO. FILED 10-18-2010.

## Alfalfa's

THE MARK CONSISTS OF STANDARD CHARACTERS WITHOUT CLAIM TO ANY PARTICULAR FONT, STYLE, SIZE, OR COLOR.

FOR RETAIL GROCERY STORE SERVICES, SPECIALIZING IN HEALTH FOODS AND NATURAL FOODS (U.S. CLS. 100, 101 AND 102).

FIRST USE 8-1-2010; IN COMMERCE 8-1-2010.  
RAUL CORDOVA, EXAMINING ATTORNEY

SN 85-165,546. HOLISTIC MBA, LLC, SAN FRANCISCO, CA. FILED 10-30-2010.

SN 85-156,842. FLORISTS' TRANSWORLD DELIVERY, INC., DOWNERS GROVE, IL. FILED 10-20-2010.

## 12 DEALS OF CHRISTMAS

THE MARK CONSISTS OF STANDARD CHARACTERS WITHOUT CLAIM TO ANY PARTICULAR FONT, STYLE, SIZE, OR COLOR.

FOR ONLINE RETAIL STORE SERVICES FEATURING FLOWERS AND GIFTS, AND PROMOTING THE RETAIL STORE SERVICES OF MEMBER FLORISTS (U.S. CLS. 100, 101 AND 102).

FIRST USE 12-12-2010; IN COMMERCE 12-12-2010.  
ANNE MADDEN, EXAMINING ATTORNEY

## Get 10 Clients In 30 Days

THE MARK CONSISTS OF STANDARD CHARACTERS WITHOUT CLAIM TO ANY PARTICULAR FONT, STYLE, SIZE, OR COLOR.

FOR CREATION OF MARKETING TOOLS DESIGNED TO INCREASE A CLIENT COMPANY'S KNOWLEDGE OF CUSTOMER NEEDS, AND ITS COMPETITORS' PRODUCTS AND SERVICES, PRICING, ADVERTISING STRATEGY AND SALES STRATEGY (U.S. CLS. 100, 101 AND 102).

FIRST USE 6-28-2010; IN COMMERCE 7-11-2010.  
ROBERT STRUCK, EXAMINING ATTORNEY

**CLASS 35—(Continued).**

SN 85-167,622. LINKED UP MOMMY, BRONX, NY. FILED 11-2-2010.



THE COLOR(S) PINK, BLUE, LIGHT BLUE, AND TAN IS/ARE CLAIMED AS A FEATURE OF THE MARK.

THE MARK CONSISTS OF A TAN BABY OUTLINED IN PINK WITH A LIGHT BLUE DIAPER OUTLINED IN BLUE. THE WORDS "LINKED UP MOMMY" WITH "LINKED" AND "MOMMY" IN BLUE AND "UP" IN PINK, "WWW.LINKEDUPMOMMY.COM" IN PINK LETTERS.

FOR PROVIDING A FEE BASED WEBSITE WHERE USERS CAN POST AND UPLOAD PHOTOGRAPHS OF BABY ITEMS FOR SALE THROUGH ON-LINE CLASSIFIED ADVERTISEMENTS (U.S. CLS. 100, 101 AND 102). AMEEN IMAM, EXAMINING ATTORNEY

SN 85-167,778. JESTER COMMUNICATIONS, LLC, HILTON HEAD ISLAND, SC. FILED 11-3-2010.

## Personal Marketing Experience

THE MARK CONSISTS OF STANDARD CHARACTERS WITHOUT CLAIM TO ANY PARTICULAR FONT, STYLE, SIZE, OR COLOR.

NO CLAIM IS MADE TO THE EXCLUSIVE RIGHT TO USE "PERSONAL MARKETING", APART FROM THE MARK AS SHOWN.

FOR ADVERTISEMENT FOR OTHERS ON THE INTERNET; ADVERTISING AND BUSINESS SERVICES, NAMELY, PROVIDING AN ONLINE WEBSITE WHERE ADVERTISERS, MARKETERS, AND CONTENT PROVIDERS CAN INTERACT WITH USERS FOR ADVERTISING, BRANDING, AND PROMOTING KNOWLEDGE, PRODUCTS, AND SERVICES, AND TRADE SHOWS, ON BEHALF OF THEMSELVES AND OTHERS, AND FOR EVALUATING AND RATING THE SAME, ALL THE FOREGOING RELEVANT TO HUMAN ACTIVITIES AFFECTING CLIMATE CHANGE AND RELATED FIELDS; ADVERTISING AND COMMERCIAL INFORMATION SERVICES, VIA THE INTERNET; ADVERTISING AND MARKETING; ADVERTISING AND MARKETING CONSULTANCY; ADVERTISING AND MARKETING SERVICES PROVIDED BY MEANS OF INDIRECT METHODS OF MARKETING COMMUNICATIONS, NAMELY, SOCIAL MEDIA, SEARCH ENGINE MARKETING, INQUIRY MARKETING, INTERNET MARKETING, MOBILE MARKETING, BLOGGING AND OTHER FORMS OF PASSIVE, SHARABLE OR VIRAL COMMUNICATIONS CHANNELS; ADVERTISING AND MARKETING SERVICES, NAMELY, PROMOTING THE GOODS AND SERVICES OF OTHERS; ADVERTISING BY TRANSMISSION OF ON-LINE PUBLICITY FOR THIRD PARTIES THROUGH ELECTRONIC COMMUNICATIONS NETWORKS; ADVERTISING ON THE INTERNET FOR OTHERS; ADVERTISING SERVICES, NAMELY, PROMOTING AND MARKETING THE GOODS AND SERVICES OF OTHERS IN THE FIELD OF UPSCALE CHOICES SUCH AS CULTURAL EVENTS, RESTAURANTS, SHOPPING, AND TRAVEL VIA PRINT AND ELECTRONIC MEDIA; ADVERTISING SERVICES, NAMELY, PROMOTING AND MARKETING THE GOODS AND SERVICES OF OTHERS THROUGH ALL PUBLIC COMMUNICATION MEANS; ADVERTISING SERVICES, PUBLIC RELATIONS AND MARKET-

**CLASS 35—(Continued).**

ING SERVICES, NAMELY, PROMOTING AND MARKETING THE GOODS AND SERVICES OF OTHERS THROUGH ALL PUBLIC COMMUNICATION MEANS; ADVERTISING THROUGH ALL PUBLIC COMMUNICATION MEANS; ADVERTISING VIA ELECTRONIC MEDIA AND SPECIFICALLY THE INTERNET; ADVERTISING, MARKETING AND PROMOTION SERVICES; ADVERTISING, MARKETING AND PROMOTIONAL SERVICES RELATED TO ALL INDUSTRIES FOR THE PURPOSE OF FACILITATING NETWORKING AND SOCIALIZING OPPORTUNITIES FOR BUSINESS PURPOSES; ADVERTISING, PROMOTION, AND MARKETING SERVICES IN THE NATURE OF PERSONALIZED INTERNET BASED MARKETING FOR MOBILE DEVICES; ANALYSIS OF MARKET RESEARCH DATA AND STATISTICS; ARRANGING AND CONDUCTING MARKETING PROMOTIONAL EVENTS FOR OTHERS; BUSINESS ADVICE AND ANALYSIS OF MARKETS; BUSINESS CONSULTATION AND MANAGEMENT REGARDING MARKETING ACTIVITIES AND LAUNCHING OF NEW PRODUCTS; BUSINESS MANAGEMENT CONSULTING WITH RELATION TO STRATEGY, MARKETING, SALES, OPERATION, PRODUCT DESIGN PARTICULARLY SPECIALIZING IN THE USE OF ANALYTIC AND STATISTIC MODELS FOR THE UNDERSTANDING AND PREDICTING OF CONSUMERS, BUSINESSES, AND MARKET TRENDS AND ACTIONS; BUSINESS MARKETING AND DIRECT MAIL CONSULTING SERVICES; BUSINESS MARKETING CONSULTING SERVICES; BUSINESS MARKETING SERVICES; BUSINESS MONITORING AND CONSULTING SERVICES, NAMELY, TRACKING WEB SITES AND APPLICATIONS OF OTHERS TO PROVIDE STRATEGY, INSIGHT, MARKETING, SALES, OPERATION, PRODUCT DESIGN, PARTICULARLY SPECIALIZING IN THE USE OF ANALYTIC AND STATISTIC MODELS FOR THE UNDERSTANDING AND PREDICTING OF CONSUMERS, BUSINESSES, AND MARKET TRENDS AND ACTIONS; BUSINESS TO BUSINESS DIRECT MARKETING SERVICES; COLLECTION OF MARKET RESEARCH INFORMATION; COMPUTERIZED MARKET RESEARCH SERVICES; CONDUCTING MARKETING STUDIES; CONSULTING SERVICES IN THE FIELD OF INTERNET MARKETING; CONSUMER STRATEGY BUSINESS CONSULTING IN THE FIELDS OF MARKETING, SALES, OPERATION, AND PRODUCT DESIGN PARTICULARLY SPECIALIZING IN THE USE OF ANALYTIC MODELS FOR THE UNDERSTANDING AND PREDICTING OF CONSUMER, BUSINESS, AND RETAIL MARKET TRENDS AND ACTIONS; COOPERATIVE ADVERTISING AND MARKETING; COOPERATIVE ADVERTISING AND MARKETING SERVICES BY WAY OF SOLICITATION, CUSTOMER SERVICE AND PROVIDING MARKETING INFORMATION VIA WEB SITES ON A GLOBAL COMPUTER NETWORK; CREATIVE MARKETING DESIGN SERVICES; DESIGN OF INTERNET ADVERTISING; DEVELOPMENT OF MARKETING STRATEGIES AND CONCEPTS; DEVELOPMENT OF MARKETING STRATEGIES, CONCEPTS AND TACTICS, NAMELY, AUDIENCE DEVELOPMENT, BRAND AWARENESS, CUSTOMER RELATIONS, ON-LINE COMMUNITY BUILDING AND DIGITAL WORD OF MOUTH COMMUNICATIONS; DIRECT MARKETING; DIRECT MARKETING ADVERTISING FOR OTHERS; DIRECT MARKETING CONSULTING SERVICES; DISSEMINATION OF ADVERTISING FOR OTHERS VIA AN ON-LINE COMMUNICATIONS NETWORK ON THE INTERNET; DISSEMINATION OF ADVERTISING FOR OTHERS VIA THE INTERNET; EVENT PLANNING AND MANAGEMENT FOR MARKETING, BRANDING, PROMOTING OR ADVERTISING THE GOODS AND SERVICES OF OTHERS; GENERAL BUSINESS MERCHANDISING SERVICES, NAMELY, MARKETING; INFORMATION, ADVISORY, CONSULTING, BUSINESS RESEARCH AND PLANNING SERVICES RELATING TO PUBLICITY, MARKETING COMMUNICATIONS, REPUTATION MANAGEMENT OR BUSINESS ADMINISTRATION, INCLUDING SUCH SERVICES PROVIDED ONLINE OR VIA THE INTERNET; INTERNET ADVERTISING SERVICES; MARKET ANALYSIS; MARKET ANALYSIS AND RESEARCH SERVICES; MARKET ASSESSMENT SERVICES; MARKET RESEARCH SERVICES; MARKETING AND BRANDING SERVICES, NAMELY, PERFORMING CONSUMER INSIGHT AND BRAND STRATEGY OF COMPANY LOGOS; MARKETING AND BRANDING SERVICES, NAMELY, PROVIDING CUSTOMIZED COM-

**CLASS 35—(Continued).**

MUNICATION PROGRAMS TO OBTAIN CONSUMER INSIGHTS AND DEVELOP BRANDING STRATEGIES; MARKETING AND CONSULTING SERVICES IN THE FIELD OF PROMOTING AND TRACKING THE GOODS, SERVICES, AND BRANDS OF OTHERS THROUGH ALL PUBLIC COMMUNICATION MEANS, PARTICULARLY SPECIALIZING IN THE USE OF MOBILE, SOCIAL, AND PRINT MEDIA TO DRIVE CONSUMER INTEREST, ENGAGEMENT AND ACTION; MARKETING CONSULTATION IN THE FIELD OF MOBILE DEVICES; MARKETING RESEARCH SERVICES; ON-LINE ADVERTISING AND MARKETING SERVICES; ON-LINE ADVERTISING ON COMPUTER COMMUNICATION NETWORKS; ONLINE MEDIA MONITORING SERVICES USING COMPUTER SOFTWARE TO AUTOMATICALLY MONITOR INTERNET WEBSITES AND ONLINE PUBLICATIONS FOR CUSTOMER-SPECIFIED TOPICS AND TO CAPTURE RELEVANT CONTENT ON THOSE TOPICS, AND PROVIDING DOCUMENTATION AND ANALYSIS OF THAT ONLINE CONTENT TO OTHERS FOR BUSINESS PURPOSES; PROMOTING THE GOODS AND SERVICES OF OTHERS BY MEANS OF DISTRIBUTING ADVERTISING ON THE INTERNET; PROVIDING ADVERTISING SERVICE TO DISTRIBUTE ADVERTISEMENTS FOR DISPLAY ON INTERNET, NAMELY, IN WEBSITES, SOCIAL CONVERSATIONS OVER THE INTERNET, E-MAILS, MICROBLOGS, BLOGS, ELECTRONIC MESSAGES, INSTANT MESSAGES, TEXT MESSAGES, MULTIMEDIA MESSAGES, SOCIAL NETWORKS, STATUS UPDATES, FORUMS, ELECTRONIC BULLETIN BOARDS; PROVIDING ADVERTISING, MARKETING AND PROMOTIONAL SERVICES, NAMELY, DEVELOPMENT OF ADVERTISING CAMPAIGNS FOR CLIENTS (U.S. CLS. 100, 101 AND 102).

FIRST USE 10-10-2009; IN COMMERCE 10-25-2010.  
RUDY R. SINGLETON, EXAMINING ATTORNEY

SN 85-168,007. NORTHPOINTE CONSULTING, LLC,  
SPRINGFIELD, IL. FILED 11-3-2010.



THE MARK CONSISTS OF A TRIANGLE SHAPE, WITH AN "N" ACROSS THE MIDDLE, AND A WATER CRES-CENT AS PART OF ITS TINT.

FOR BUSINESS SERVICES, NAMELY, STRATEGIC PLANNING AND MANAGEMENT ADVISORY SERVICES FOR BUSINESSES (U.S. CLS. 100, 101 AND 102).

FIRST USE 5-4-2010; IN COMMERCE 5-4-2010.  
RUSS HERMAN, EXAMINING ATTORNEY

**CLASS 35—(Continued).**

SN 85-168,913. QUATTRO JOHN A, FLEMINGTON, NJ.  
FILED 11-4-2010.

**DIABETES INTERVENTION**

THE MARK CONSISTS OF STANDARD CHARACTERS WITHOUT CLAIM TO ANY PARTICULAR FONT, STYLE, SIZE, OR COLOR.

NO CLAIM IS MADE TO THE EXCLUSIVE RIGHT TO USE "DIABETES", APART FROM THE MARK AS SHOWN.

FOR ASSOCIATION SERVICES, NAMELY, PROMOTING THE INTERESTS OF MEMBER ORGANIZATIONS ENGAGED IN CHARITABLE FUND RAISING FOR HEALTH AND HUMAN SERVICES AGENCIES, PATIENTS AND BUSINESSES (U.S. CLS. 100, 101 AND 102).  
LINDA M. KING, EXAMINING ATTORNEY

SN 85-168,922. ST@RS, LLC, DORADO, PUERTO RICO,  
FILED 11-4-2010.



THE COLOR(S) BLACK, WHITE, AND GREEN IS/ARE CLAIMED AS A FEATURE OF THE MARK.

THE MARK CONSISTS OF THE WORD "CROFERS" AND CONSISTS OF A CIRCLE, WITH THE LEFT HALF IN BLACK AND THE RIGHT HALF IN GREEN. THE CIRCLE IS DIVIDED BY TWO CIRCLES. THE BOTTOM LEFT CIRCLE IS GREEN WITH BLACK BORDER, AND THE TOP RIGHT CIRCLE IS BLACK WITH GREEN BORDER. THE WHITE APPEARS IN THE BREAKS IN THE CIRCLE AND SURROUNDING THE BLACK AND GREEN CIRCLES. THE WORD "CROFERS" IN BLACK LETTERS FOLLOW.

FOR PROMOTING THE GOODS AND SERVICES OF OTHERS BY OPERATING AN ON-LINE MARKET-PLACE FOR CONNECTING BUYERS OF GOODS AND SERVICES WITH SELLERS OF GOODS AND SERVICES VIA A GLOBAL COMPUTER NETWORK (U.S. CLS. 100, 101 AND 102).

LOURDES AYALA, EXAMINING ATTORNEY



**CLASS 35—(Continued).**

SN 85-168,937. QUATTRO JOHN A, FLEMINGTON, NJ.  
FILED 11-4-2010.

## ALZHEIMER'S DISEASE INTERVENTION

THE MARK CONSISTS OF STANDARD CHARACTERS WITHOUT CLAIM TO ANY PARTICULAR FONT, STYLE, SIZE, OR COLOR.

NO CLAIM IS MADE TO THE EXCLUSIVE RIGHT TO USE "ALZHEIMER'S DISEASE", APART FROM THE MARK AS SHOWN.

FOR ASSOCIATION SERVICES, NAMELY, PROMOTING THE INTERESTS OF MEMBER ORGANIZATIONS ENGAGED IN CHARITABLE FUND RAISING FOR HEALTH AND HUMAN SERVICES AGENCIES, PATIENTS AND BUSINESSES (U.S. CLS. 100, 101 AND 102).  
LINDA M. KING, EXAMINING ATTORNEY

---

SN 85-168,957. QUATTRO JOHN A, FLEMINGTON, NJ.  
FILED 11-4-2010.

## PROSTATE CANCER INTERVENTION

THE MARK CONSISTS OF STANDARD CHARACTERS WITHOUT CLAIM TO ANY PARTICULAR FONT, STYLE, SIZE, OR COLOR.

NO CLAIM IS MADE TO THE EXCLUSIVE RIGHT TO USE "PROSTATE CANCER", APART FROM THE MARK AS SHOWN.

FOR ASSOCIATION SERVICES, NAMELY, PROMOTING THE INTERESTS OF MEMBER ORGANIZATIONS ENGAGED IN CHARITABLE FUND RAISING FOR HEALTH AND HUMAN SERVICES AGENCIES, PATIENTS AND BUSINESSES (U.S. CLS. 100, 101 AND 102).  
LINDA M. KING, EXAMINING ATTORNEY

---

SN 85-169,102. QUATTRO JOHN A, FLEMINGTON, NJ.  
FILED 11-4-2010.

## HEART ATTACK INTERVENTION

THE MARK CONSISTS OF STANDARD CHARACTERS WITHOUT CLAIM TO ANY PARTICULAR FONT, STYLE, SIZE, OR COLOR.

NO CLAIM IS MADE TO THE EXCLUSIVE RIGHT TO USE "HEART ATTACK", APART FROM THE MARK AS SHOWN.

FOR ASSOCIATION SERVICES, NAMELY, PROMOTING THE INTERESTS OF MEMBER ORGANIZATIONS ENGAGED IN CHARITABLE FUND RAISING FOR HEALTH AND HUMAN SERVICES, PATIENTS AND BUSINESSES (U.S. CLS. 100, 101 AND 102).  
LINDA M. KING, EXAMINING ATTORNEY

**CLASS 35—(Continued).**

SN 85-169,116. QUATTRO JOHN A, FLEMINGTON, NJ.  
FILED 11-4-2010.

## LUNG CANCER INTERVENTION

THE MARK CONSISTS OF STANDARD CHARACTERS WITHOUT CLAIM TO ANY PARTICULAR FONT, STYLE, SIZE, OR COLOR.

NO CLAIM IS MADE TO THE EXCLUSIVE RIGHT TO USE "LUNG CANCER", APART FROM THE MARK AS SHOWN.

FOR ASSOCIATION SERVICES, NAMELY, PROMOTING THE INTERESTS OF MEMBER ORGANIZATIONS ENGAGED IN CHARITABLE FUND RAISING FOR HEALTH AND HUMAN SERVICES AGENCIES, PATIENTS AND BUSINESSES (U.S. CLS. 100, 101 AND 102).  
LINDA M. KING, EXAMINING ATTORNEY

---

SN 85-169,505. SHIP MY BID, L.L.C., MANSON, IA. FILED  
11-4-2010.

## SHIP MY BID

THE MARK CONSISTS OF STANDARD CHARACTERS WITHOUT CLAIM TO ANY PARTICULAR FONT, STYLE, SIZE, OR COLOR.

FOR TRANSPORTATION LOGISTIC SERVICES, NAMELY, CONNECTING BUYERS AND SELLERS OF GENERAL CONSUMER GOODS TO ARRANGE THE SHIPMENT OF GOODS AT A GIVEN PRICE AND PROVIDING INCENTIVES IN THE FORM OF DISCOUNTS ON FUTURE SHIPMENTS (U.S. CLS. 100, 101 AND 102).

JULIE VEPPUMTHARA, EXAMINING ATTORNEY

**CLASS 35—(Continued).**

SN 85-169,901. WANG, PO-CHUNG, ZHUBEI CITY, HSNCHU C, TAIWAN, FILED 11-5-2010.

# Ledionopto

THE MARK CONSISTS OF STANDARD CHARACTERS WITHOUT CLAIM TO ANY PARTICULAR FONT, STYLE, SIZE, OR COLOR.

FOR RETAIL STORE AND WHOLESALE STORE SERVICES BOTH FEATURING ELECTRON MATERIALS; RETAIL AND WHOLESALE STORE SERVICES BOTH FEATURING INTERIOR DECORATIONS; RETAIL AND WHOLESALE STORE SERVICES BOTH FEATURING ELECTRIC APPLIANCES; LAYOUT SERVICES FOR EXHIBITIONS FOR ADVERTISING PURPOSES; ORGANIZATION OF TRADE FAIRS AND EXHIBITIONS FOR COMMERCIAL OR ADVERTISING PURPOSES; ORGANIZATION OF EXHIBITIONS FOR ENTERPRISES; IMPORT AND EXPORT AGENCIES; PROCUREMENT SERVICES, NAMELY, PURCHASING GOODS AND SERVICES, NAMELY, LIGHT EMITTING DIODES, LIGHT EMITTING DIODE INDICATOR LIGHTS, LIGHT EMITTING DIODE DISPLAYS, SEMICONDUCTOR ELEMENTS, SEMICONDUCTOR DEVICES, SENSORS FOR THE DETERMINATION OF TEMPERATURES, POSITIONS AND DISTANCES, LIGHT SENSORS, ELECTRONICAL SENSORS FOR MEASURING SOLAR RADIATION, MOTION DETECTORS, FIRE AND SMOKE DETECTORS, METAL DETECTORS, ELECTRONIC TOUCH SENSITIVE SWITCHES, ELECTRONIC LIGHT CONTROLLERS, ENERGY SAVING LIGHT BULBS, ELECTRO-OPTICAL SWITCHES, LIGHTING APPARATUS FOR OUTDOOR AND INDOOR, LED LIGHT APPARATUS, LIGHT EMITTING DIODE LIGHTING FIXTURES, PENDENT LAMPS, DESK LAMPS, DOWN LIGHTS, WALL LIGHTS, DECORATIVE LIGHTS, THEATRICAL STAGE LIGHTING APPARATUS, FLOOR LAMPS, PROJECT LIGHTS, LIGHT BULBS, PICTURE LIGHTS, TABLE LAMPS, ELECTRIC LAMPS, BURNERS FOR LAMPS, SOCKETS FOR ELECTRIC LIGHTS, HALOGEN LIGHTS, LIGHTING APPARATUS FOR USE IN AUTOMOBILES, LIGHTING APPARATUS FOR VEHICLES, SENSOR LIGHTS, YARD LAMPS, CEILING LIGHTS, DOOR LIGHTS, GUIDE LIGHTS, GLOW LAMPS, PENDENT LAMP HOLDERS, SPOTLIGHTS, EMERGENCY LIGHTS, DIRECTION INDICATOR LIGHTS, EXIT LIGHTS, SEARCHLIGHTS, LIGHT DIFFUSERS AND CAST LIGHTS FOR THE BUSINESS OF OTHERS; ADMINISTRATIVE PROCESSING OF PURCHASE ORDERS; ONLINE AUCTION SERVICES; ADMINISTRATIVE PROCESSING OF PURCHASE ORDERS BY TELEPHONE AND THE INTERNET (U.S. CLS. 100, 101 AND 102).

LINDA E. BLOHM, EXAMINING ATTORNEY

**CLASS 35—(Continued).**

SN 85-175,657. EBAY INC., SAN JOSE, CA. FILED 11-12-2010.



THE MARK CONSISTS OF A DOG.

FOR INTERNET SEARCH ENGINE SERVICES IN THE NATURE OF SHOPPING FACILITATION SERVICES, NAMELY, PROVIDING AN ONLINE COMPARISON-SHOPPING SEARCH ENGINE FOR OBTAINING PURCHASING INFORMATION; CONSUMER PRODUCT RESEARCH SERVICES, NAMELY, PROVIDING A SEARCHABLE ONLINE ADVERTISING WEBSITE AND GUIDE FEATURING THE GOODS AND SERVICES OF OTHERS AND OF OTHER RETAIL STORES ON THE INTERNET; PROMOTING THE GOODS AND SERVICES OF OTHERS BY PROVIDING A SEARCHABLE WEBSITE FEATURING PRODUCT INFORMATION, PRODUCT INVENTORY AND AVAILABILITY, PRICE-COMPARISON INFORMATION, PRODUCT REVIEWS, DISCOUNT INFORMATION, LINKS TO RETAIL WEBSITES OF OTHERS, AND MAPS WITH LOCATIONS OF STORES (U.S. CLS. 100, 101 AND 102).

FIRST USE 10-21-2008; IN COMMERCE 10-21-2008.

KELLEY WELLS, EXAMINING ATTORNEY

SN 85-175,669. EBAY INC., SAN JOSE, CA. FILED 11-12-2010.

# MILO

THE MARK CONSISTS OF STANDARD CHARACTERS WITHOUT CLAIM TO ANY PARTICULAR FONT, STYLE, SIZE, OR COLOR.

FOR INTERNET SEARCH ENGINE SERVICES IN THE NATURE OF SHOPPING FACILITATION SERVICES, NAMELY, PROVIDING AN ONLINE COMPARISON-SHOPPING SEARCH ENGINE FOR OBTAINING PURCHASING INFORMATION; CONSUMER PRODUCT RESEARCH SERVICES, NAMELY, PROVIDING A SEARCHABLE ONLINE ADVERTISING WEBSITE AND GUIDE FEATURING THE GOODS AND SERVICES OF OTHERS AND OF OTHER RETAIL STORES ON THE INTERNET; PROMOTING THE GOODS AND SERVICES OF OTHERS BY PROVIDING A SEARCHABLE WEBSITE FEATURING PRODUCT INFORMATION, PRODUCT INVENTORY AND AVAILABILITY, PRICE-COMPARISON INFORMATION, PRODUCT REVIEWS, DISCOUNT INFORMATION, LINKS TO RETAIL WEBSITES OF OTHERS, AND MAPS WITH LOCATIONS OF STORES (U.S. CLS. 100, 101 AND 102).

FIRST USE 10-21-2008; IN COMMERCE 10-21-2008.

KELLEY WELLS, EXAMINING ATTORNEY

**CLASS 35—(Continued).**

SN 85-175,796. LOGIC AQUATIC AND PET, LLC, TEMECULA, CA. FILED 11-12-2010.

**LOGIC AQUATIC & PET**

THE MARK CONSISTS OF STANDARD CHARACTERS WITHOUT CLAIM TO ANY PARTICULAR FONT, STYLE, SIZE, OR COLOR.

NO CLAIM IS MADE TO THE EXCLUSIVE RIGHT TO USE "AQUATIC & PET", APART FROM THE MARK AS SHOWN.

FOR WHOLESALE DISTRIBUTORSHIP SERVICES FEATURING PET AND AQUARIUM SUPPLIES (U.S. CLS. 100, 101 AND 102).

JOHN SCHUYLER YARD, EXAMINING ATTORNEY

SN 85-176,517. HARTER HOUSE - GLENSTONE, INC., SPRINGFIELD, MO. FILED 11-15-2010.

**Harter House**

THE MARK CONSISTS OF STANDARD CHARACTERS WITHOUT CLAIM TO ANY PARTICULAR FONT, STYLE, SIZE, OR COLOR.

NO CLAIM IS MADE TO THE EXCLUSIVE RIGHT TO USE "HOUSE", APART FROM THE MARK AS SHOWN. SEC. 2(F).

FOR GROCERY STORES OFFERING RETAIL AND ONLINE SERVICES (U.S. CLS. 100, 101 AND 102).

FIRST USE 11-1-1973; IN COMMERCE 11-1-1973.

JOHN WILKE, EXAMINING ATTORNEY

SN 85-176,737. NATIONAL DEFAULT SERVICING, LLC, GLASTONBURY, CT. FILED 11-15-2010.

**NDS NATIONAL DEFAULT SERVICING**

THE MARK CONSISTS OF STANDARD CHARACTERS WITHOUT CLAIM TO ANY PARTICULAR FONT, STYLE, SIZE, OR COLOR.

OWNER OF U.S. REG. NO. 3,380,854.

NO CLAIM IS MADE TO THE EXCLUSIVE RIGHT TO USE "NATIONAL DEFAULT SERVICING", APART FROM THE MARK AS SHOWN.

FOR OUTSOURCING IN THE FIELD OF REO (REAL ESTATE OWNED) PROPERTIES (U.S. CLS. 100, 101 AND 102).

FIRST USE 6-30-2004; IN COMMERCE 6-30-2004.

C. DIONNE CLYBURN, EXAMINING ATTORNEY

**CLASS 35—(Continued).**

SN 85-179,665. PRESSURE PARTS, LLC, WELLFORD, SC. FILED 11-18-2010.



NO CLAIM IS MADE TO THE EXCLUSIVE RIGHT TO USE "PRESSURE PARTS, LLC", APART FROM THE MARK AS SHOWN.

THE MARK CONSISTS OF A RECTANGLE CONTAINING THE WORDING "PRESSURE PARTS, LLC" WHERE THE WORDING "PARTS, LLC" APPEARS CENTERED BELOW THE WORD "PRESSURE" AND THE TWO LETTER "PS" ARE INTERLOCKING AT THE TOP PORTIONS. THE WORDING "PARTS, LLC" IS UNDERLINED BY TWO PARALLEL VERTICAL BANDS. THERE IS A SILHOUETTE OF A BOILER SYSTEM TO THE RIGHT OF THE RECTANGLE CONTAINING THE WORDING. THE RECTANGLE CONTAINING THE WORDING AND THE SILHOUETTE OF THE BOILER SYSTEM ARE CONTAINED WITHIN A SINGLE RECTANGLE.

FOR RETAIL STORE SERVICES, ONLINE RETAIL STORE SERVICES AND DISTRIBUTORSHIP IN THE FIELD OF PARTS FOR BOILER SYSTEMS (U.S. CLS. 100, 101 AND 102).

FIRST USE 2-22-2007; IN COMMERCE 2-22-2007.

TINA BROWN, EXAMINING ATTORNEY

SN 85-179,807. INNOVENTIVE POWER LLC, SOUTH ORANGE, NJ. FILED 11-18-2010.

**DRCC**

THE MARK CONSISTS OF STANDARD CHARACTERS WITHOUT CLAIM TO ANY PARTICULAR FONT, STYLE, SIZE, OR COLOR.

OWNER OF U.S. REG. NOS. 3,993,137 AND 3,993,138.

FOR BUSINESS CONSULTING SERVICES FOR THE ELECTRIC ENERGY INDUSTRY; CONSULTING SERVICES IN THE FIELD OF ENERGY USAGE MANAGEMENT AND ENERGY EFFICIENCY; BUSINESS SERVICES, NAMELY, MONITORING ENERGY USAGE AND COORDINATING ELECTRICITY LOAD SHIFTING AND LOAD CURTAILMENT AMONG UTILITY PROVIDERS; PROVIDING A WEB-BASED ON-LINE PORTAL THAT PROVIDES CUSTOMER ACCESS TO THEIR ENERGY USAGE PATTERN INFORMATION, ENERGY LOAD-SHIFTING AND LOAD-CURTALMENT INFORMATION, AND ENERGY CONSUMPTION AND USAGE DATA, FOR PURPOSES OF UTILITY ACCOUNT BUSINESS MANAGEMENT AND ENERGY USAGE MANAGEMENT (U.S. CLS. 100, 101 AND 102).

CHARLES L. JENKINS, EXAMINING ATTORNEY



**CLASS 35—(Continued).**

SN 85-181,692. BENTLY HOLDINGS CORPORATION, SAN FRANCISCO, CA. FILED 11-19-2010.

**A COMMON GREEN**

THE MARK CONSISTS OF STANDARD CHARACTERS WITHOUT CLAIM TO ANY PARTICULAR FONT, STYLE, SIZE, OR COLOR.

NO CLAIM IS MADE TO THE EXCLUSIVE RIGHT TO USE "GREEN", APART FROM THE MARK AS SHOWN.

FOR PROMOTING PUBLIC AWARENESS OF THE NEED FOR ENVIRONMENTAL, GREEN AND SUSTAINABILITY PRACTICES THROUGH THE ORGANIZING AND HOSTING OF MEETINGS (U.S. CLS. 100, 101 AND 102).

FIRST USE 7-22-2009; IN COMMERCE 7-22-2009.  
ESTHER A. BORSUK, EXAMINING ATTORNEY

---

SN 85-182,015. SCOTTSDALE ART AUCTION, LLC, SCOTTSDALE, AZ. FILED 11-22-2010.

**SCOTTSDALE ART AUCTION**

THE MARK CONSISTS OF STANDARD CHARACTERS WITHOUT CLAIM TO ANY PARTICULAR FONT, STYLE, SIZE, OR COLOR.

NO CLAIM IS MADE TO THE EXCLUSIVE RIGHT TO USE "ART AUCTION", APART FROM THE MARK AS SHOWN.

SEC. 2(F).

FOR ARRANGING AND CONDUCTION OF AUCTION SALES IN THE FIELD OF ART (U.S. CLS. 100, 101 AND 102).

FIRST USE 1-1-2005; IN COMMERCE 4-2-2005.  
MARK SPARACINO, EXAMINING ATTORNEY

**CLASS 35—(Continued).**

SN 85-184,133. BONILLA SR., JOSE E., SANTA ANA, CA. FILED 11-23-2010.



THE MARK CONSISTS OF A RAMPANT BULL UNDER THE LETTERING OF THE WORDS "EL TORO" WITHIN TWO CONCENTRIC CIRCLES WITH ASTIC SYMBOLS BETWEEN THEM.

THE ENGLISH TRANSLATION OF "EL TORO" IN THE MARK IS "THE BULL".

FOR RETAIL SUPERMARKET GROCERY STORES FEATURING BEER, WINE, AND OTHER PACKAGED ALCOHOLIC BEVERAGES; RETAIL DELICATESSEN SERVICES; RETAIL BAKERY SHOPS; RETAIL PHARMACY SERVICES (U.S. CLS. 100, 101 AND 102).

FIRST USE 6-14-1977; IN COMMERCE 6-14-1977.  
JOHN DWYER, EXAMINING ATTORNEY

---

SN 85-184,279. KIM, BYUNG YOON, MILL VALLEY, CA. FILED 11-24-2010.

**PNC WORLD CORP**

THE MARK CONSISTS OF STANDARD CHARACTERS WITHOUT CLAIM TO ANY PARTICULAR FONT, STYLE, SIZE, OR COLOR.

NO CLAIM IS MADE TO THE EXCLUSIVE RIGHT TO USE "WORLD CORP", APART FROM THE MARK AS SHOWN.

FOR ADVERTISING AND BUSINESS CONSULTATION SERVICES IN THE FIELD OF IMPORT AND EXPORT TRADE OF GENERAL GOODS; EXPORT AND IMPORT AGENCY (U.S. CLS. 100, 101 AND 102).

TRACY WHITTAKER-BROWN, EXAMINING ATTORNEY

**CLASS 35—(Continued).**

SN 85-184,725. SLIGHTLY HEROIC MARKETING, LLC, HICKORY, NC. FILED 11-24-2010.

**ARMORMAN**

THE MARK CONSISTS OF STANDARD CHARACTERS WITHOUT CLAIM TO ANY PARTICULAR FONT, STYLE, SIZE, OR COLOR.

FOR ADVERTISING AND MARKETING (U.S. CLS. 100, 101 AND 102).

FIRST USE 2-1-2010; IN COMMERCE 2-1-2010.  
 NAPOLEON SHARMA, EXAMINING ATTORNEY

---

SN 85-184,730. LUMBERMENS MERCHANDISING CORPORATION, WAYNE, PA. FILED 11-24-2010.

**LMC**

THE MARK CONSISTS OF STANDARD CHARACTERS WITHOUT CLAIM TO ANY PARTICULAR FONT, STYLE, SIZE, OR COLOR.

FOR BUSINESS SERVICES, NAMELY, COMBINED STRATEGIC GOODS OR SERVICES SOURCING AND COOPERATIVE PURCHASING FOR OTHERS IN THE FIELD OF LUMBER, BUILDING MATERIALS AND HARDWARE; COOPERATIVE ADVERTISING AND MARKETING IN THE FIELD OF LUMBER, BUILDING MATERIALS AND HARDWARE; MANAGEMENT AND BUSINESS CONSULTING SERVICES IN THE FIELD OF LUMBER, BUILDING MATERIALS AND HARDWARE; MARKETING CONSULTATION IN THE FIELD OF LUMBER, BUILDING MATERIALS AND HARDWARE (U.S. CLS. 100, 101 AND 102).

FIRST USE 1-1-1975; IN COMMERCE 1-1-1975.  
 JOSETTE BEVERLY, EXAMINING ATTORNEY

---

SN 85-184,769. AMAZON TECHNOLOGIES, INC., RENO, NV. FILED 11-24-2010.

**SHELFARI**

THE MARK CONSISTS OF STANDARD CHARACTERS WITHOUT CLAIM TO ANY PARTICULAR FONT, STYLE, SIZE, OR COLOR.

OWNER OF U.S. REG. NO. 3,742,741.  
 FOR ON-LINE RETAIL STORE SERVICES FEATURING BOOKS, MUSIC, MOVIES, PERIODICALS AND OTHER MEDIA; OPERATING ON-LINE MARKETPLACES FOR SELLERS OF GOODS AND SERVICES; PROMOTING, ADVERTISING AND MARKETING THE ON-LINE WEBSITES OF OTHERS AND THE GOODS AND SERVICES OF OTHERS (U.S. CLS. 100, 101 AND 102).

PAULA MAHONEY, EXAMINING ATTORNEY

**CLASS 35—(Continued).**

SN 85-184,821. LARSON, APRIL, LOS ANGELES, CA. FILED 11-24-2010.

**IF THE EARTH HAD HANDS**

THE MARK CONSISTS OF STANDARD CHARACTERS WITHOUT CLAIM TO ANY PARTICULAR FONT, STYLE, SIZE, OR COLOR.

FOR PROMOTING PUBLIC AWARENESS OF ENVIRONMENTAL ISSUES AND INITIATIVES TO CHILDREN; CHARITABLE SERVICES, NAMELY, ORGANIZING AND DEVELOPING PROJECTS TO PROMOTE AWARENESS OF ENVIRONMENTAL CONSERVATION; CHARITABLE SERVICES, NAMELY, ORGANIZING AND CONDUCTING VOLUNTEER PROGRAMS AND COMMUNITY SERVICE PROJECTS AIMED AT INCREASING SUPPORT FOR ENVIRONMENTAL CONSERVATION INITIATIVES (U.S. CLS. 100, 101 AND 102).

FIRST USE 3-1-2010; IN COMMERCE 3-1-2010.  
 RONALD AIKENS, EXAMINING ATTORNEY

---

SN 85-186,639. STUMP PRINTING CO., INC., SOUTH WHITLEY, IN. FILED 11-29-2010.

**AMERICAN PROM**

THE MARK CONSISTS OF STANDARD CHARACTERS WITHOUT CLAIM TO ANY PARTICULAR FONT, STYLE, SIZE, OR COLOR.

OWNER OF U.S. REG. NO. 3,012,378.  
 NO CLAIM IS MADE TO THE EXCLUSIVE RIGHT TO USE "PROM", APART FROM THE MARK AS SHOWN.

SEC. 2(F).  
 FOR MAIL ORDER SERVICES FEATURING ALL-OCCASION AND PROM FAVORS, INVITATIONS, COSTUMES, DECORATIONS, CANDLES, GLASSWARE, TABLEWARE, SUPPLIES AND EVENT PLANNING INFORMATION, ALL PROVIDED BY MEANS OF PRINTED MATERIALS AND THE INTERNET (U.S. CLS. 100, 101 AND 102).

FIRST USE 11-8-2004; IN COMMERCE 11-8-2004.  
 MARC LEIPZIG, EXAMINING ATTORNEY

**CLASS 35—(Continued).**

SN 85-186,677. DEAL DOG, LLC, PERRYSBURG, OH. FILED 11-29-2010.



NO CLAIM IS MADE TO THE EXCLUSIVE RIGHT TO USE DESCRIPTIVE WORDING "DEAL", APART FROM THE MARK AS SHOWN.

THE MARK CONSISTS OF HIGHLY-STYLIZED CARTOON DOG WITH SHADED NOSE, EYES, BANDANNA/COLLAR, AND EARS SITTING OVER TEXT "DEAL DOG".

FOR ADMINISTRATION OF A PROGRAM FOR ENABLING PARTICIPANTS TO OBTAIN DISCOUNTS ON GOODS AND RECEIVE IMPROVED SERVICES; ADMINISTRATION OF A PROGRAM FOR ENABLING PARTICIPANTS TO OBTAIN DISCOUNTS ON PRODUCTS AND SERVICES; ONLINE SERVICE FOR CONNECTING SOCIAL NETWORK USERS WITH RETAILERS FOR THE PURPOSE OF FACILITATING DISCOUNTED PURCHASES; PROMOTING THE GOODS OF OTHERS, NAMELY, PROVIDING COUPONS, REBATES AND VOUCHERS FOR THE GOODS OF OTHERS; PROMOTING THE SALE OF GOODS AND SERVICES OF OTHERS THROUGH ELECTRONIC COUPONING, PROMOTIONS AND DISCOUNTS (U.S. CLS. 100, 101 AND 102).

FIRST USE 6-21-2010; IN COMMERCE 6-21-2010.  
MARC LEIPZIG, EXAMINING ATTORNEY

SN 85-188,113. DISTANCE, INCORPORATED, OMAHA, NE. FILED 12-1-2010.

# Deal Garden

THE MARK CONSISTS OF STANDARD CHARACTERS WITHOUT CLAIM TO ANY PARTICULAR FONT, STYLE, SIZE, OR COLOR.

NO CLAIM IS MADE TO THE EXCLUSIVE RIGHT TO USE "DEAL", APART FROM THE MARK AS SHOWN.

FOR PROMOTING THE GOODS AND SERVICES OF OTHERS BY PROVIDING A WEBSITE FEATURING COUPONS, REBATES, PRICE-COMPARISON INFORMATION, PRODUCT REVIEWS, LINKS TO THE RETAIL WEBSITES OF OTHERS, AND DISCOUNT INFORMATION (U.S. CLS. 100, 101 AND 102).

FIRST USE 11-24-2010; IN COMMERCE 11-24-2010.  
WILLIAM P. SHANAHAN, EXAMINING ATTORNEY

**CLASS 35—(Continued).**

SN 85-189,105. WINE ACADEMY SUPERSTORES INC., WILMINGTON, DE. FILED 12-2-2010.

# WINE ACADEMY

THE MARK CONSISTS OF STANDARD CHARACTERS WITHOUT CLAIM TO ANY PARTICULAR FONT, STYLE, SIZE, OR COLOR.

NO CLAIM IS MADE TO THE EXCLUSIVE RIGHT TO USE "WINE", APART FROM THE MARK AS SHOWN.

FOR ON-LINE RETAIL STORE SERVICES FEATURING WINE, BEER AND SPIRITS (U.S. CLS. 100, 101 AND 102).

INGA ERVIN, EXAMINING ATTORNEY

SN 85-189,125. WINE ACADEMY SUPERSTORES INC., WILMINGTON, DE. FILED 12-2-2010.

# WINE ACADEMY

THE MARK CONSISTS OF STANDARD CHARACTERS WITHOUT CLAIM TO ANY PARTICULAR FONT, STYLE, SIZE, OR COLOR.

NO CLAIM IS MADE TO THE EXCLUSIVE RIGHT TO USE "WINE", APART FROM THE MARK AS SHOWN.

FOR IMPORT AGENCIES FEATURING THE IMPORTATION OF WINE, BEER AND LIQUOR (U.S. CLS. 100, 101 AND 102).

INGA ERVIN, EXAMINING ATTORNEY

SN 85-189,140. WINE ACADEMY SUPERSTORES INC., WILMINGTON, DE. FILED 12-2-2010.

# WINE ACADEMY

THE MARK CONSISTS OF STANDARD CHARACTERS WITHOUT CLAIM TO ANY PARTICULAR FONT, STYLE, SIZE, OR COLOR.

NO CLAIM IS MADE TO THE EXCLUSIVE RIGHT TO USE "WINE", APART FROM THE MARK AS SHOWN.

FOR WHOLESALE DISTRIBUTORSHIPS FEATURING WINE, BEER AND LIQUOR (U.S. CLS. 100, 101 AND 102).

INGA ERVIN, EXAMINING ATTORNEY

**CLASS 35—(Continued).**

SN 85-189,321. KASAWORKS, LLC, COLUMBUS, OH. FILED 12-2-2010.

# KasaWorks

THE MARK CONSISTS OF STANDARD CHARACTERS WITHOUT CLAIM TO ANY PARTICULAR FONT, STYLE, SIZE, OR COLOR.

FOR BUSINESS CONSULTING, MANAGEMENT, PLANNING AND SUPERVISION (U.S. CLS. 100, 101 AND 102).

FIRST USE 7-1-2008; IN COMMERCE 7-1-2008.  
SCOTT BIBB, EXAMINING ATTORNEY

SN 85-189,341. KASAWORKS, LLC, COLUMBUS, OH. FILED 12-2-2010.

# Workation

THE MARK CONSISTS OF STANDARD CHARACTERS WITHOUT CLAIM TO ANY PARTICULAR FONT, STYLE, SIZE, OR COLOR.

FOR BUSINESS CONSULTING, MANAGEMENT, PLANNING AND SUPERVISION (U.S. CLS. 100, 101 AND 102).

FIRST USE 10-1-2010; IN COMMERCE 10-1-2010.  
SCOTT BIBB, EXAMINING ATTORNEY

SN 85-189,691. CONTENT ED NET COMMUNICATIONS S.L., MADRID, SPAIN, FILED 12-2-2010.



NO CLAIM IS MADE TO THE EXCLUSIVE RIGHT TO USE "CONTENT", "NET" AND "INTERNATIONAL MEDICAL PUBLISHING SOLUTIONS", APART FROM THE MARK AS SHOWN.

THE COLOR(S) BLUE, LIGHT BLUE IS/ARE CLAIMED AS A FEATURE OF THE MARK.

THE MARK CONSISTS OF A DARK BLUE GLOBE WITH LIGHT BLUE CONTINENTS SURROUNDED BY A LIGHT-BLUE TEARDROP-SHAPED FIELD SHADING TO LIGHTER BLUE NEXT TO THE GLOBE, NEXT TO THE WORDING "CONTENT ED NET" IN DARK BLUE AND THE WORDING "INTERNATIONAL MEDICAL PUBLISHING SOLUTIONS" IN LIGHT BLUE.

FOR RESELLER SERVICES, NAMELY, DISTRIBUTORSHIP SERVICES IN THE FIELD OF MEDICAL PUBLICATIONS REPRINTS (U.S. CLS. 100, 101 AND 102).

FIRST USE 1-1-2002; IN COMMERCE 1-1-2002.  
AMY HELLA, EXAMINING ATTORNEY

**CLASS 35—(Continued).**

SN 85-191,040. ALBASOLAR S.L., MADRID, SPAIN, FILED 12-6-2010.



NO CLAIM IS MADE TO THE EXCLUSIVE RIGHT TO USE "SOLAR", APART FROM THE MARK AS SHOWN.

THE MARK CONSISTS OF THE COLORS DARK BLUE AND LIGHT BLUE ARE CLAIMED AS A FEATURE WORDING "ALBA SOLAR" IN DARK BLUE, WITH A DESIGN CONSISTING OF A CURVED LINE WITH A SEMI-CIRCLE ATTACHED TO THE CURVED LINE APPEARING NEAR THE MIDWAY POINT OF THE CURVED LINE, ALL APPEARING IN LIGHT BLUE, BETWEEN THE WORDS "ALBA" AND "SOLAR".

FOR WHOLESALE DISTRIBUTORSHIP SERVICES FEATURING SOLAR PRODUCTS FOR INSTALLERS AND RESELLERS (U.S. CLS. 100, 101 AND 102).

FIRST USE 10-1-2008; IN COMMERCE 10-1-2009.  
MARK PILARO, EXAMINING ATTORNEY

SN 85-191,556. FAN JOY, DBA VINTAGE JOY, SAN FRANCISCO, CA. FILED 12-6-2010.



THE MARK CONSISTS OF A HANGING CRYSTAL CHANDELIER WITH TEARDROP SHAPE CRYSTALS HELD FROM THE CEILING WITH A CHAIN THAT INCLUDES A STYLIZED "V" AND "J" IN THE CENTER OF THE CHANDELIER.

FOR ON-LINE RETAIL STORE SERVICES FEATURING CLOTHING AND ACCESSORIES; ON-LINE WHOLESALE AND RETAIL STORE SERVICES FEATURING CLOTHING AND ACCESSORIES; RETAIL APPAREL STORES; RETAIL CLOTHING BOUTIQUES; RETAIL STORE AND ON-LINE RETAIL STORE SERVICES FEATURING CLOTHING AND ACCESSORIES (U.S. CLS. 100, 101 AND 102).

FIRST USE 10-1-2010; IN COMMERCE 10-1-2010.  
BILL DAWE, EXAMINING ATTORNEY

**CLASS 35—(Continued).**

SN 85-192,088. WEST STREET WINES AND SPIRITS, LLC,  
NEW YORK, NY. FILED 12-7-2010.

**VINTRY FINE WINES**

THE MARK CONSISTS OF STANDARD CHARACTERS  
WITHOUT CLAIM TO ANY PARTICULAR FONT, STYLE,  
SIZE, OR COLOR.

NO CLAIM IS MADE TO THE EXCLUSIVE RIGHT TO  
USE "FINE WINES", APART FROM THE MARK AS  
SHOWN.

FOR RETAIL STORES FEATURING WINE (U.S. CLS.  
100, 101 AND 102).

VIVIAN MICZNIK FIRST, EXAMINING ATTORNEY

---

SN 85-192,212. FUAGNEM INC., SAN ANTONIO, TX. FILED  
12-7-2010.

**Seizure Solutions**

THE MARK CONSISTS OF STANDARD CHARACTERS  
WITHOUT CLAIM TO ANY PARTICULAR FONT, STYLE,  
SIZE, OR COLOR.

NO CLAIM IS MADE TO THE EXCLUSIVE RIGHT TO  
USE "SEIZURE", APART FROM THE MARK AS SHOWN.

FOR PROVIDING A WEBSITE FEATURING COM-  
MERCIAL INFORMATION IN THE NATURE OF LIST-  
INGS AND REFERRAL INFORMATION OF LEGAL  
SERVICE PROVIDERS, MEDICAL SERVICE PROVI-  
DERS, EDUCATIONAL SERVICE PROVIDERS, SOCIAL  
WORK PROVIDERS, AND FINANCIAL ADVISORS PRI-  
MARILY FOR FAMILIES WITH MEMBERS HAVING  
SEIZURE DISORDERS, EPILEPSY, AND BRAIN INJURY  
(U.S. CLS. 100, 101 AND 102).

RUSS HERMAN, EXAMINING ATTORNEY

---

SN 85-192,682. COONS, JAIME, TOPANGA, CA. FILED 12-7-  
2010.

**YOU WERE BORN TO BE SPOILED**

THE MARK CONSISTS OF STANDARD CHARACTERS  
WITHOUT CLAIM TO ANY PARTICULAR FONT, STYLE,  
SIZE, OR COLOR.

FOR ON-LINE RETAIL STORE SERVICES FEATUR-  
ING STREAMING AND DOWNLOADABLE MUSIC AND  
RINGTONES, PHONORECORDS AND COMPACT DISCS  
FEATURING MUSIC, AND ACCESSORIES, NAMELY,  
CLOTHING, MUGS, TOTE BAGS, CALENDARS, AND  
JEWELRY; ON-LINE ADVERTISING, AND MARKET-  
ING SERVICES (U.S. CLS. 100, 101 AND 102).

FIRST USE 12-6-2010; IN COMMERCE 12-6-2010.  
JAMES LOVELACE, EXAMINING ATTORNEY

**CLASS 35—(Continued).**

SN 85-192,922. SUPREME COUNCIL COLUMBIETTES,  
MINEOLA, NY. FILED 12-8-2010.

**SUPREME COUNCIL  
COLUMBIETTES**

THE MARK CONSISTS OF STANDARD CHARACTERS  
WITHOUT CLAIM TO ANY PARTICULAR FONT, STYLE,  
SIZE, OR COLOR.

NO CLAIM IS MADE TO THE EXCLUSIVE RIGHT TO  
USE "COUNCIL", APART FROM THE MARK AS SHOWN.

FOR CHARITABLE SERVICES, NAMELY, ORGANIZ-  
ING WOMEN'S GROUPS TO UNDERTAKE PROJECTS  
WHICH BENEFIT THE HOMELESS, ABUSED, AT RISK  
WOMEN AND WOMEN IN TRANSITION AND IN PAIN,  
WHILE ENCOURAGING EMPOWERMENT AMONG  
WOMEN OF ALL AGES AND ETHNICITIES (U.S. CLS.  
100, 101 AND 102).

FIRST USE 0-0-1939; IN COMMERCE 0-0-1940.

RUDY R. SINGLETON, EXAMINING ATTORNEY

---

SN 85-196,305. TALLWAVE MEDIA, INC., SCOTTSDALE,  
AZ. FILED 12-13-2010.

**ethosystem**

THE MARK CONSISTS OF STANDARD CHARACTERS  
WITHOUT CLAIM TO ANY PARTICULAR FONT, STYLE,  
SIZE, OR COLOR.

FOR ANALYZING AND COMPILING DATA FOR  
MEASURING PERFORMANCE OF OTHER BUSI-  
NESSES' DIGITAL MARKETING (U.S. CLS. 100, 101  
AND 102).

H. M. FISHER, EXAMINING ATTORNEY

**CLASS 35—(Continued).**

SN 85-196,392. ARES SCIENTIFIC LLC, BROOKLYN, NY. FILED 12-13-2010.

**ARES SCIENTIFIC**

THE MARK CONSISTS OF STANDARD CHARACTERS WITHOUT CLAIM TO ANY PARTICULAR FONT, STYLE, SIZE, OR COLOR.

NO CLAIM IS MADE TO THE EXCLUSIVE RIGHT TO USE "SCIENTIFIC", APART FROM THE MARK AS SHOWN.

FOR INDEPENDENT SALES REPRESENTATIVES IN THE FIELD OF LABORATORY EQUIPMENT; MANUFACTURER REPRESENTATIVES IN THE FIELD OF LABORATORY EQUIPMENT; OPERATING, ASSISTING AND OUTSOURCING THE OPERATION OF A DISTRIBUTION CENTER OR WAREHOUSE FACILITY CONTAINING DISTRIBUTION INVENTORY; PROVIDING AN ON-LINE SHOWROOM FOR THE GOODS OF OTHERS IN THE FIELD OF LABORATORY EQUIPMENT; RESELLER SERVICES, NAMELY, DISTRIBUTORSHIP SERVICES IN THE FIELD OF LABORATORY EQUIPMENT; RETAIL SERVICES THROUGH DIRECT SOLICITATION BY SALESPERSONS DIRECTED TO END-USERS FEATURING LABORATORY EQUIPMENT; RETAIL SERVICES THROUGH DIRECT SOLICITATION BY DISTRIBUTORS DIRECTED TO END-USERS FEATURING LABORATORY EQUIPMENT; WHOLESALE DISTRIBUTORSHIPS FEATURING LABORATORY EQUIPMENT (U.S. CLS. 100, 101 AND 102).

FIRST USE 6-1-2009; IN COMMERCE 7-1-2009.  
CHRISTOPHER BUONGIORNO, EXAMINING ATTORNEY

SN 85-196,986. XCESSORY INTERNATIONAL, NEW YORK, NY. FILED 12-14-2010.

**BUILD A BOX WORKSHOP**

THE MARK CONSISTS OF STANDARD CHARACTERS WITHOUT CLAIM TO ANY PARTICULAR FONT, STYLE, SIZE, OR COLOR.

NO CLAIM IS MADE TO THE EXCLUSIVE RIGHT TO USE "WORKSHOP", APART FROM THE MARK AS SHOWN.

FOR RETAIL STORES FEATURING TOYS, TOY BOXES, COSTUMES AND CLOTHING (U.S. CLS. 100, 101 AND 102).

TIMOTHY FINNEGAN, EXAMINING ATTORNEY

**CLASS 35—(Continued).**

SN 85-199,154. EYELEVEL INTERACTIVE, LLC, GREENBORO, GA. FILED 12-16-2010.

**"WE'VE GOT YOUR BACK"**

THE MARK CONSISTS OF STANDARD CHARACTERS WITHOUT CLAIM TO ANY PARTICULAR FONT, STYLE, SIZE, OR COLOR.

FOR ADVERTISING SERVICES, PUBLIC RELATIONS AND MARKETING SERVICES, NAMELY, PROMOTING AND MARKETING THE GOODS AND SERVICES OF OTHERS THROUGH ALL PUBLIC COMMUNICATION MEANS; ADVERTISING SERVICES, PUBLIC RELATIONS AND MARKETING SERVICES, NAMELY, PROMOTING AND MARKETING GOODS AND SERVICES OF OTHERS ON INTERACTIVE SWITCHABLE PANELS MADE OF REMOVABLE CLOTH AND DIGITAL PANELS AFFIXED TO UNIFORMS AND CLOTHING (U.S. CLS. 100, 101 AND 102).

SKYE YOUNG, EXAMINING ATTORNEY

SN 85-201,657. IGLTA, INC., FORT LAUDERDALE, FL. FILED 12-20-2010.



NO CLAIM IS MADE TO THE EXCLUSIVE RIGHT TO USE "INTERNATIONAL GAY & LESBIAN TRAVEL ASSOCIATION", APART FROM THE MARK AS SHOWN.

THE COLOR(S) RED, ORANGE, YELLOW, GREEN, BLUE, PURPLE, BLACK IS/ARE CLAIMED AS A FEATURE OF THE MARK.

THE MARK CONSISTS OF THE STYLIZED WORDING "IGLTA" IN A RAINBOW GRADIENT WHERE THE LETTERS GRADUALLY CHANGE FROM RED TO ORANGE TO YELLOW TO GREEN TO BLUE TO PURPLE FROM LEFT TO RIGHT. BELOW IS THE WORDING "INTERNATIONAL GAY & LESBIAN TRAVEL ASSOCIATION" IN BLACK

FOR ASSOCIATION SERVICES, NAMELY, PROMOTING THE INTERESTS OF TRAVEL BUSINESSES MARKETING THEMSELVES TO LGBT CONSUMERS.; BUSINESS MANAGEMENT OF THE NONPROFIT CORPORATIONS AND TRADE ASSOCIATIONS OF OTHERS (U.S. CLS. 100, 101 AND 102).

FIRST USE 10-1-2007; IN COMMERCE 10-1-2007.  
BERNICE MIDDLETON, EXAMINING ATTORNEY

**CLASS 35—(Continued).**

SN 85-203,822. WPP PROPERTIES, NEW YORK, NY. FILED 12-22-2010.

**OGILVY FUSION**

THE MARK CONSISTS OF STANDARD CHARACTERS WITHOUT CLAIM TO ANY PARTICULAR FONT, STYLE, SIZE, OR COLOR.

OWNER OF U.S. REG. NOS. 2,276,623, 3,366,964 AND OTHERS.

FOR ADVERTISING AGENCY SERVICES; PUBLIC RELATIONS SERVICES; DIRECT MARKETING ADVERTISING SERVICES FOR OTHERS; MARKETING CONSULTING; MARKET RESEARCH, SURVEYS AND ANALYSIS; MEDIA PLANNING AND BUYING SERVICES, NAMELY, CONSULTING AND ADVISING ON THE APPROPRIATE MEDIA TO ADVERTISE IN, AND PURCHASING MEDIA TIME AND SPACE; PLACING ADVERTISEMENTS FOR OTHERS; SALES PROMOTION SERVICES; NAMELY, PROMOTING THE GOODS AND SERVICES OF VARIOUS INDUSTRIES THROUGH THE DISTRIBUTION OF PROMOTIONAL MATERIALS AND BY RENDERING SALES PROMOTION ADVICE; CUSTOMER RELATIONSHIP MANAGEMENT SERVICES; BUSINESS AND MARKETING CONSULTING SERVICES RELATED TO ADVERTISING, MARKETING AND BRAND DEVELOPMENT; EVENT MARKETING, NAMELY, ARRANGING AND CONDUCTING MARKETING PROMOTIONAL EVENTS FOR OTHERS; BUSINESS MARKETING CONSULTING SERVICES RELATING TO BRANDS AND BRAND DEVELOPMENT, ASSESSMENT, ANALYSIS, EXPLOITATION AND PROMOTION (U.S. CLS. 100, 101 AND 102).

LINDA ORNDORFF, EXAMINING ATTORNEY

SN 85-204,718. COTTERWEB ENTERPRISES, INC., MENDOTA HEIGHTS, MN. FILED 12-23-2010.



THE MARK CONSISTS OF AN ANIMATED MONETARY BILL WITH ARMS, FEET AND A SMILEY FACE, WHICH IS LEANING ON ITS LEFT FOOT.

FOR CUSTOMER LOYALTY SERVICES FOR COMMERCIAL, PROMOTIONAL AND/OR ADVERTISING PURPOSES WHICH REWARDS CONSUMERS FOR READING EMAIL ADVERTISED MESSAGES AND COMPLETING ONLINE ACTIVITIES INCLUDING, ONLINE SHOPPING, MARKET RESEARCH SURVEYS AND PLAYING ONLINE GAMES; ONLINE ADVERTISING AND MARKETING SERVICES (U.S. CLS. 100, 101 AND 102).

SANJEEV VOHRA, EXAMINING ATTORNEY

**CLASS 35—(Continued).**

SN 85-204,719. COTTERWEB ENTERPRISES, INC., MENDOTA HEIGHTS, MN. FILED 12-23-2010.

**THE ONLINE REWARDS CLUB THAT PAYS**

THE MARK CONSISTS OF STANDARD CHARACTERS WITHOUT CLAIM TO ANY PARTICULAR FONT, STYLE, SIZE, OR COLOR.

NO CLAIM IS MADE TO THE EXCLUSIVE RIGHT TO USE "ONLINE REWARDS CLUB", APART FROM THE MARK AS SHOWN.

FOR CUSTOMER LOYALTY SERVICES FOR COMMERCIAL, PROMOTIONAL AND/OR ADVERTISING PURPOSES WHICH REWARDS CONSUMERS FOR READING EMAIL ADVERTISED MESSAGES AND COMPLETING ONLINE ACTIVITIES INCLUDING, ONLINE SHOPPING, MARKET RESEARCH SURVEYS AND PLAYING ONLINE GAMES; ONLINE ADVERTISING AND MARKETING SERVICES (U.S. CLS. 100, 101 AND 102).

SANJEEV VOHRA, EXAMINING ATTORNEY

SN 85-205,816. AGRO TRADE INTERNATIONAL B.V., AMSTERDAM, NETHERLANDS, FILED 12-27-2010.

**O'KEY**

THE MARK CONSISTS OF STANDARD CHARACTERS WITHOUT CLAIM TO ANY PARTICULAR FONT, STYLE, SIZE, OR COLOR.

PRIORITY CLAIMED UNDER SEC. 44(D) ON BENELUX APPLICATION NO. 1205654, FILED 6-29-2010, REG. NO. 0885568, DATED 11-10-2010, EXPIRES 6-29-2020.

FOR WHOLESALE AND RETAIL STORE SERVICES FEATURING A WIDE VARIETY OF CONSUMER GOODS OF OTHERS; SUPERMARKETS; ONLINE RETAIL STORE SERVICES FEATURING A WIDE VARIETY OF CONSUMER GOODS OF OTHERS; IMPORT-EXPORT AGENCIES; COST PRICE ANALYSIS; RENTAL OF ADVERTISING SPACE; ACCOUNTING; INVOICING; DEMONSTRATION OF GOODS; CONDUCTING MARKETING STUDIES; COMMERCIAL INFORMATION AND ADVICE FOR CONSUMERS (CONSUMER ADVICE SHOP); BUSINESS INVESTIGATIONS; MARKETING RESEARCH; BUSINESS MANAGEMENT AND ORGANIZATION CONSULTANCY; MANAGEMENT AND OPERATION ASSISTANCE TO COMMERCIAL BUSINESSES, NAMELY, IN THE FIELD OF WHOLESALE AND RETAIL STORES; MANAGEMENT ASSISTANCE IN THE FIELD OF WHOLESALE AND RETAIL STORES; PROFESSIONAL BUSINESS CONSULTANCY; ORGANIZATION OF EXHIBITIONS FOR COMMERCIAL OR ADVERTISING PURPOSES; ORGANIZATION OF TRADE FAIRS FOR COMMERCIAL OR ADVERTISING PURPOSES; SHOP WINDOW DRESSING AND DISPLAY ARRANGEMENT SERVICE; BUSINESS APPRAISALS; PAYROLL PREPARATION; BUSINESS ADMINISTRATION; BUSINESS MANAGEMENT ASSISTANCE; ASSISTANCE IN MANAGEMENT OF BUSINESS ACTIVITIES IN THE FIELD OF WHOLESALE AND RETAIL STORES; ASSISTANCE TO INDUSTRIAL OR COMMERCIAL ENTERPRISES IN THE RUNNING OF THEIR BUSINESS IN THE FIELD OF WHOLESALE AND RETAIL STORES; COMMERCIAL AND INDUSTRIAL MANAGEMENT ASSISTANCE; PRESENTATION OF GOODS ON COMMUNICATION MEDIA, FOR RETAIL PURPOSES; AUCTIONEERING; SALES PROMOTION FOR OTHERS;

**CLASS 35—(Continued).**

SALES PROMOTION FOR OTHERS, NAMELY, WHOLESALE AND RETAIL STORE SERVICES; SALES PROMOTION FOR OTHERS, NAMELY, PROMOTION SERVICES PROVIDED TO RETAIL STORES AND WHOLESALE OUTLETS THROUGH MAIL ORDER CATALOGUES AND BY MEANS OF ELECTRONIC MEDIA, WEB SITES, TELEVISION SHOPPING PROGRAMS; DISTRIBUTION OF SAMPLES; DISSEMINATION OF ADVERTISING MATTER; ADVERTISING; ON-LINE ADVERTISING ON A COMPUTER NETWORK; THE BRINGING TOGETHER, FOR THE BENEFIT OF OTHERS, OF A VARIETY OF GOODS, EXCLUDING THE TRANSPORT THEREOF, ENABLING CUSTOMERS TO CONVENIENTLY VIEW AND PURCHASE THOSE GOODS IN THE FIELD OF FOOD AND DRINK PRODUCTS AND INGREDIENTS; THE BRINGING TOGETHER, FOR THE BENEFIT OF OTHERS, OF A VARIETY OF GOODS, EXCLUDING THE TRANSPORT THEREOF ENABLING CUSTOMERS TO CONVENIENTLY VIEW AND PURCHASE THOSE GOODS MAIL ORDER CATALOGUES OR BY AN INTERNET WEBSITE OR ONLINE CATALOGUE OR TELEVISION SHOPPING PROGRAM; ADMINISTRATIVE ACCOUNTING SERVICES, NAMELY, DRAWING UP OF STATEMENTS OF ACCOUNTS; COMMERCIAL ADMINISTRATION OF THE LICENSING OF THE GOODS AND SERVICES OF OTHERS; ADMINISTRATIVE PROCESSING OF PURCHASE ORDERS; MODELING FOR ADVERTISING OR SALES PROMOTION; PRICE COMPARISON SERVICES; PROCUREMENT SERVICES FOR OTHERS, NAMELY, PURCHASING GOODS AND SERVICES FOR OTHER BUSINESS IN THE FIELD OF FOOD AND DRINK PRODUCTS; OUTSOURCING SERVICES; EFFICIENCY EXPERTS; FRANCHISING, NAMELY, OFFERING BUSINESS MANAGEMENT ASSISTANCE IN THE ESTABLISHMENT AND/OR OPERATION OF SUPERMARKETS AND DEPARTMENT STORES (U.S. CLS. 100, 101 AND 102).

PAULA MAHONEY, EXAMINING ATTORNEY

---

SN 85-206,612. MOTHERS AGAINST DRUNK DRIVING, IRVING, TX. FILED 12-28-2010.

**TONIGHT, I'M DD**

THE MARK CONSISTS OF STANDARD CHARACTERS WITHOUT CLAIM TO ANY PARTICULAR FONT, STYLE, SIZE, OR COLOR.

FOR ASSOCIATION SERVICES, NAMELY, PROMOTING THE INTERESTS OF INDIVIDUALS OPPOSED TO DRUNK DRIVING (U.S. CLS. 100, 101 AND 102).

TRACY FLETCHER, EXAMINING ATTORNEY

**CLASS 35—(Continued).**

SN 85-207,080. GUITAR CENTER, INC., WESTLAKE VILLAGE, CA. FILED 12-29-2010.

**BE WHO U WANT PLAY WHAT U WANT**

THE MARK CONSISTS OF STANDARD CHARACTERS WITHOUT CLAIM TO ANY PARTICULAR FONT, STYLE, SIZE, OR COLOR.

FOR RETAIL STORE SERVICES FEATURING MUSICAL INSTRUMENTS; ON-LINE RETAIL STORE SERVICES FEATURING MUSICAL INSTRUMENTS; RETAIL SERVICES FEATURING INSTRUMENTS BY DIRECT SOLICITATION OF SALES AGENTS; RETAIL STORE SERVICES FEATURING MUSICAL INSTRUMENTS IN THE NATURE OF CONTRACT SALES (U.S. CLS. 100, 101 AND 102).

KELLY BOULTON, EXAMINING ATTORNEY

---

SN 85-207,131. I PROMOTIONS INC., ST. LOUIS, MO. FILED 12-29-2010.

**I-PROMOTIONS**

THE MARK CONSISTS OF STANDARD CHARACTERS WITHOUT CLAIM TO ANY PARTICULAR FONT, STYLE, SIZE, OR COLOR.

OWNER OF U.S. REG. NO. 2,916,300.

FOR WHOLESALE DISTRIBUTORSHIPS FEATURING EYE CARE SUPPLIES AND IMPRINTED PROMOTIONAL ITEMS TO MEDICAL PROFESSIONAL AND HEALTH CARE ORGANIZATIONS (U.S. CLS. 100, 101 AND 102).

FIRST USE 8-31-1995; IN COMMERCE 8-31-1995.

ALICIA COLLINS, EXAMINING ATTORNEY

---

SN 85-209,508. ARMSTRONG GARDEN CENTERS, INC., GLENDORA, CA. FILED 1-3-2011.

**ARMSTRONG NURSERIES**

THE MARK CONSISTS OF STANDARD CHARACTERS WITHOUT CLAIM TO ANY PARTICULAR FONT, STYLE, SIZE, OR COLOR.

NO CLAIM IS MADE TO THE EXCLUSIVE RIGHT TO USE "NURSERIES", APART FROM THE MARK AS SHOWN.

SEC. 2(F) AS TO "ARMSTRONG".

FOR RETAIL LAWN, GARDEN AND NURSERY STORES (U.S. CLS. 100, 101 AND 102).

SUSAN RICHARDS, EXAMINING ATTORNEY



**CLASS 35—(Continued).**

SN 85-209,981. NATIONAL REGISTRY OF EMERGENCY MEDICAL TECHNICIANS, COLUMBUS, OH. FILED 1-4-2011.

## THE NATION'S EMS CERTIFICATION

THE MARK CONSISTS OF STANDARD CHARACTERS WITHOUT CLAIM TO ANY PARTICULAR FONT, STYLE, SIZE, OR COLOR.

OWNER OF U.S. REG. NO. 3,018,816.

NO CLAIM IS MADE TO THE EXCLUSIVE RIGHT TO USE "CERTIFICATION", APART FROM THE MARK AS SHOWN.

SEC. 2(F).

FOR MAINTAINING A REGISTRY OF CERTIFIED PRACTITIONERS OF EMERGENCY MEDICAL SERVICES; TESTING SERVICES, NAMELY, CONDUCTING WRITTEN AND PRACTICAL EXAMINATIONS OF CANDIDATES TO EVALUATE THEIR QUALIFICATION AND COMPETENCY FOR THE PRACTICE OF EMERGENCY MEDICAL SERVICES BASED ON ESTABLISHED REQUIREMENTS AND ISSUING A CERTIFICATE TO INDIVIDUALS WHO SATISFY THE ESTABLISHED REQUIREMENTS (U.S. CLS. 100, 101 AND 102).

FIRST USE 9-0-2004; IN COMMERCE 9-0-2004.  
MARY ROSSMAN, EXAMINING ATTORNEY

**CLASS 35—(Continued).**

SN 85-215,557. BAILOWICH, SHANNON, BALTIMORE, MD. FILED 1-12-2011.

## HIGH REVVERS MC

THE MARK CONSISTS OF STANDARD CHARACTERS WITHOUT CLAIM TO ANY PARTICULAR FONT, STYLE, SIZE, OR COLOR.

NO CLAIM IS MADE TO THE EXCLUSIVE RIGHT TO USE "MC", APART FROM THE MARK AS SHOWN.

FOR MOTORCYCLE CLUB SERVICES, NAMELY, PROMOTING THE INTERESTS OF MOTORCYCLE RIDERS (U.S. CLS. 100, 101 AND 102).

ESTHER A. BORSUK, EXAMINING ATTORNEY

SN 85-215,638. JERVIS BENNETT HOUGH, SUNNY ISLES BEACH, FL. FILED 1-12-2011.



NO CLAIM IS MADE TO THE EXCLUSIVE RIGHT TO USE "COMPLIANCE SERVICES EXCHANGE", APART FROM THE MARK AS SHOWN.

THE COLOR(S) BLACK, BLUE, GREY IS/ARE CLAIMED AS A FEATURE OF THE MARK.

THE MARK CONSISTS OF A DIAMOND-TYPE SHAPE COMPRISED OF FOUR SMALLER DIAMONDS. THE TOP DIAMOND IS OF A BLACK COLOR. THE LEFT AND RIGHT DIAMONDS ARE OF A BLUE COLOR. THE BOTTOM DIAMOND IS A GREY GRADIENT. TO THE LEFT OF THE DIAMOND ON ONE LINE ARE THE LETTERS "CSE". ON A SECOND LINE, THE WORD "COMPLIANCE SERVICES EXCHANGE". "COMPLIANCE" IS IN BLUE AND "SERVICES EXCHANGE" IS IN BLACK.

FOR ARRANGING AND CONDUCTING AUCTIONS; ARRANGING AND CONDUCTING AUCTIONS IN THE FIELD OF COMPLIANCE AND BROKER/AGENT SERVICES; AUCTIONEERING PROVIDED ON THE INTERNET; AUCTIONING VIA TELECOMMUNICATION NETWORKS; ON-LINE AUCTION SERVICES; ON-LINE AUCTION SERVICES FEATURING COMPLIANCE AND BROKER/AGENT SERVICES; ON-LINE AUCTION SERVICES FOR BROKER/AGENTS; ON-LINE AUCTIONEERING SERVICES VIA THE INTERNET; PROVIDING A WEB SITE THAT FEATURES AN ON-LINE MARKET FOR USERS TO LIST OFFERED OR WANTED PERSONAL AND BUSINESS ASSETS AND SKILLS FOR HIRE, RENT, SALE OR AUCTION TRANSACTED ON THE BASIS OF PREDEFINED PERFORMANCE AND CLOSING TERMS AND CONDITIONS; PROVIDING ON-LINE AUCTION SERVICES (U.S. CLS. 100, 101 AND 102).

SUZANNE BLANE, EXAMINING ATTORNEY

SN 85-215,143. KIM, DO KYUN, LOS ANGELES, CA. FILED 1-11-2011.

## TOM N TOMS

THE MARK CONSISTS OF STANDARD CHARACTERS WITHOUT CLAIM TO ANY PARTICULAR FONT, STYLE, SIZE, OR COLOR.

OWNER OF U.S. REG. NO. 3,530,315.

FOR RETAIL STORES FEATURING COFFEE, PASTRIES, BAGELS, AND PRETZELS (U.S. CLS. 100, 101 AND 102).

FIRST USE 12-1-2010; IN COMMERCE 12-1-2010.

ALICIA COLLINS, EXAMINING ATTORNEY

**CLASS 35—(Continued).**

SN 85-219,252. SISTERHOOD OF SURVIVORS, PINEDALE, CA. FILED 1-17-2011.



THE COLOR(S) BLUE, GREEN, YELLOW, BLACK, ORANGE, PINK, PURPLE AND WHITE IS/ARE CLAIMED AS A FEATURE OF THE MARK.

THE MARK CONSISTS OF 6 STYLIZED WHITE FEMALE FIGURES TRIMMED IN BLACK AND DRESSED IN CLOTHING OF THE FOLLOWING COLORS MOVING LEFT TO RIGHT: GREEN, PINK AND GREEN, ORANGE AND PINK, YELLOW AND BLUE, PINK AND PURPLE, AND GREEN. THE TERMS "INSPIRATION FOR EACH OTHER" ARE IN BLACK STYLIZED SCRIPT LETTERS BELOW THE FEMALE FIGURES.

FOR CHARITABLE SERVICES, NAMELY, PROMOTING PUBLIC AWARENESS OF THE NEED FOR FUNDING TO FIGHT BREAST CANCER AND TO AID IN SURVIVOR RECOVERY (U.S. CLS. 100, 101 AND 102).

FIRST USE 5-30-2002; IN COMMERCE 5-30-2002.  
MARK T. MULLEN, EXAMINING ATTORNEY

**CLASS 35—(Continued).**

SN 85-220,840. HOME TEAM MARKETING, CLEVELAND, OH. FILED 1-19-2011.



**HOME TEAM MARKETING**

NO CLAIM IS MADE TO THE EXCLUSIVE RIGHT TO USE "HOME TEAM MARKETING", APART FROM THE MARK AS SHOWN.

THE MARK CONSISTS OF CONCENTRIC CIRCLES WITH THE STYLIZED LETTERS "HTM" IN THE CENTER; BELOW THE CONCENTRIC CIRCLES IS THE STYLIZED WORDING "HOME TEAM MARKETING".

FOR SPORTS MARKETING SERVICES, NAMELY, MARKETING AND ADVERTISING SERVICES FOR HIGH SCHOOLS, STATE HIGH SCHOOL ATHLETIC ASSOCIATIONS AND COLLEGES; DISPLAYING ADVERTISEMENTS AT HIGH SCHOOL ATHLETIC EVENTS (U.S. CLS. 100, 101 AND 102).

FIRST USE 1-15-2001; IN COMMERCE 5-15-2001.  
MARY CRAWFORD, EXAMINING ATTORNEY

SN 85-220,625. PARENTPOW LLC, AKA PARENT POW!, CHARLESTON, SC. FILED 1-19-2011.

The new parent involvement

THE MARK CONSISTS OF STANDARD CHARACTERS WITHOUT CLAIM TO ANY PARTICULAR FONT, STYLE, SIZE, OR COLOR.

NO CLAIM IS MADE TO THE EXCLUSIVE RIGHT TO USE "NEW PARENT", APART FROM THE MARK AS SHOWN.

FOR PROVIDING AN INTERACTIVE WEBSITE FEATURING A CHARTING SERVICE IN THE NATURE OF AN ADMINISTRATIVE RECORD KEEPING SERVICE FOR PARENTS, CAREGIVERS, AND STUDENTS TO TRACK LEARNING AND SKILL PROGRESS IN SCHOOL (U.S. CLS. 100, 101 AND 102).

FIRST USE 1-19-2011; IN COMMERCE 1-19-2011.  
KRISTINA MORRIS, EXAMINING ATTORNEY

SN 85-221,861. THE ELECTRIC BIKE SHOP, LLC, SACRAMENTO, CA. FILED 1-20-2011.



NO CLAIM IS MADE TO THE EXCLUSIVE RIGHT TO USE "THE ELECTRIC BIKE SHOP", APART FROM THE MARK AS SHOWN.

THE MARK CONSISTS OF THE DESIGN OF A BICYCLE ON THE UPPER PORTION OF AN INTERSTATE HIGHWAY CREST SYMBOL WITH ELECTRICAL CHORDS FOR WHEELS AND HAVING LIGHTING BOLTS ON EITHER SIDE. BELOW THE BICYCLE DESIGN IS A FANCIFUL GRILL DESIGN WING ELEMENT, WITHIN WHICH APPEARS THE WORDING "THE ELECTRIC BIKE SHOP".

FOR RETAIL STORE SERVICES FEATURING BICYCLE AND SCOOTER ACCESSORIES (U.S. CLS. 100, 101 AND 102).

GEOFFREY FOSDICK, EXAMINING ATTORNEY

**CLASS 35—(Continued).**

SN 85-225,660. MEMPHIS CHAMPIONSHIP BARBECUE COMMISSARY, INC., LAS VEGAS, NV. FILED 1-25-2011.



OWNER OF U.S. REG. NOS. 2,256,568, 3,317,387 AND OTHERS.

NO CLAIM IS MADE TO THE EXCLUSIVE RIGHT TO USE "MEMPHIS" AND "BARBECUE", APART FROM THE MARK AS SHOWN.

THE MARK CONSISTS OF THE TERM "MEMPHIS" DISPLAYED WITHIN A BORDERED ARC, THE TERM "BARBECUE" DISPLAYED BENEATH AND WITHIN A BORDERED ARC, THE TERM "CHAMPIONSHIP" IN SCRIPT BETWEEN THE TWO OTHER TERMS AND WITHIN A STYLIZED, HORIZONTALLY ALIGNED RIBBON, AND SMALL STAR SYMBOLS FLANKING THE TERM "CHAMPIONSHIP".

SEC. 2(F) AS TO "MEMPHIS CHAMPIONSHIP BARBECUE".

FOR ONLINE RETAIL STORE SERVICES, MAIL ORDER SERVICES, AND ELECTRONIC CATALOG SERVICES FEATURING FOODS AND BEVERAGES; RETAIL STORE SERVICES, MAIL ORDER SERVICES AND ONLINE RETAIL STORE SERVICES FEATURING FOODS AND BEVERAGES, NAMELY, MEATS, FISH, POULTRY, BEEF, STEAK, SAUSAGES, BARBECUE RIBS, BARBECUE CHICKEN, BARBECUE STEAK, BARBECUE PORK, BABY BACK RIBS, PORK, CHICKEN, HAM, TURKEY, SMOKED PRIME RIB AND TURKEY, BAKED BEANS, COLESLAW, CAESAR SALADS, GARDEN SALADS, PRE-CUT VEGETABLE SALADS, POTATO CHIPS, FRENCH FRIED POTATOES, POTATO-BASED SNACK FOODS, SANDWICH SPREADS, NAMELY, FRUIT BASED SPREADS, POTATO SALADS, FRUIT SALADS, CHILI, SOUPS, STEWS, FRESH AND COOKED VEGETABLES, OMELETS, ONION RINGS, PICKLES, GUACAMOLE, SOUR CREAM, BUTTER AND HONEY BUTTER, BARBECUE SAUCES AND SPICES, FOOD SAUCES, FOOD SPICES, FOOD SEASONINGS, RELISHES, SALAD DRESSINGS, BREAD, RICE, CORN CHIPS, PUFFED CORN SNACKS, CEREAL, RICE AND WHEAT-BASED SNACK FOODS, ICED TEA, BREWED TEA, COFFEE, SALAD DRESSINGS AND ALL PURPOSE SALAD DRESSING, ALL PURPOSE FOOD SEASONINGS, HONEY MUSTARD SAUCE, CHILI POWDER, SALSA, NACHOS, CHILI SAUCE, SANDWICHES, REUBEN SANDWICHES, TURKEY AND CHICKEN SANDWICHES, STEAK AND MEAT SANDWICHES, HAMBURGERS CHEESEBURGERS, GRAVY, BURRITOS, GARLIC BREAD, ROLLS, CORN BREAD, CORN MUFFINS, MACARONI, PASTA, SWEET POTATO PIE, STRAWBERRY SHORTCAKE, AND PIES, LEMONADE, SOFT DRINKS, SODA WATER, AND ROOT BEER; ONLINE RETAIL STORE SERVICES AND MAIL ORDER SERVICES FEATURING CLOTHING, T-SHIRTS, SHIRTS, HATS, CAPS, SWEATERS, JACKETS, SWEATSHIRTS, AND APRONS, MUGS, BEER

**CLASS 35—(Continued).**

MUGS, COFFEE MUGS, CUPS, DISHES, JUGS, PEANUT BUCKETS, ICE BUCKETS, DRINKING GLASSES, GLASS BOWLS, BEVERAGE GLASSWARE, BRUSHES FOR BASTING MEAT, POT CLEANING BRUSHES, CRUMB BRUSHES, WOOD BASKETS, AND GIFT BASKETS OF WICKER AND WOOD SOLD EMPTY, PAPER ARTICLES, NAMELY, NAPKINS, MENUS AND CATALOGS IN THE FIELD OF FOODS AND RESTAURANTS, PRINTED MATERIALS, NAMELY, PUBLICATIONS, NEWSLETTERS, HEALTH AND NUTRITION BULLETINS AND INFORMATION SHEETS ALL RELATING TO FOOD AND RESTAURANTS, PAPER SHOPPING BAGS, PRINTED WALL CHARTS, PRINTED COOKING AND RECIPE SHEETS, COLORING BOOKS AND GIFT CARDS; COMPUTERIZED ONLINE ORDERING FEATURING CONSUMER FOOD PRODUCTS AND GENERAL CONSUMER MERCHANDISE; AND PROVIDING ONLINE RETAIL STORE SERVICES FEATURING FOODS, BEVERAGES, CLOTHING, DRINK WARE AND GENERAL CONSUMER MERCHANDISE (U.S. CLS. 100, 101 AND 102).

FIRST USE 1-15-1998; IN COMMERCE 1-15-1998.  
TARA PATE, EXAMINING ATTORNEY

SN 85-226,107. GOOD SOURCE SOLUTIONS, INC., CARLSBAD, CA. FILED 1-25-2011.



OWNER OF U.S. REG. NOS. 2,459,561 AND 3,065,081.

NO CLAIM IS MADE TO THE EXCLUSIVE RIGHT TO USE "SPECIAL BUY" AND "LIMITED QUANTITIES AVAILABLE", APART FROM THE MARK AS SHOWN.

THE MARK CONSISTS OF THE WORDING "GOOD SOURCE SPECIAL BUY LIMITED QUANTITIES AVAILABLE" BENEATH A STAR WITHIN A CONCENTRIC CIRCLE.

FOR WHOLESALE DISTRIBUTORSHIP SERVICES IN THE FIELD OF DISCOUNT SECONDARY MARKET FOOD AND BEVERAGE PRODUCTS (U.S. CLS. 100, 101 AND 102).

FIRST USE 0-0-1989; IN COMMERCE 0-0-1989.  
KATHERINE M. DUBRAY, EXAMINING ATTORNEY

**CLASS 35—(Continued).**

SN 85-229,966. FLEMING, CRAIG A., ORLANDO, FL. FILED 1-31-2011.

# Tired Walls

THE MARK CONSISTS OF STANDARD CHARACTERS WITHOUT CLAIM TO ANY PARTICULAR FONT, STYLE, SIZE, OR COLOR.

FOR ARRANGING AND CONDUCTING TRADE SHOW EXHIBITIONS IN THE FIELD OF ART; ARRANGING AND CONDUCTING TRADE SHOWS IN THE FIELD OF ART; ART GALLERIES; ART GALLERY SERVICES; COMMISSIONING OF WORKS OF ART; CONDUCTING TRADE SHOWS IN THE FIELD OF ART; MAINTAINING A REGISTRY OF SPORTS MEMORABILIA AND WORKS OF ART; ON-LINE ART GALLERIES; PROMOTING AND CONDUCTING TRADE SHOWS IN THE FIELD OF ART; PROMOTING THE GRAPHIC ARTS DESIGN SERVICES OF OTHERS BY MEANS OF A WEBSITE FEATURING GRAPHIC ARTWORK SUBMITTED BY GRAPHIC ART DESIGNERS; PROMOTING VISUAL AND PERFORMING ARTS EVENTS BY MEANS OF PROVIDING AN ONLINE EVENTS CALENDAR, ORIGINAL ARTICLES, INTERVIEWS, AND INFORMATION ABOUT ART, ARTISTS AND ARTS EVENTS VIA AN INTERNET WEB SITE, ALL FOR PROMOTIONAL PURPOSES; PROVIDING AN INTERNET WEB SITE FOR CLASSIFIED ADVERTISING TO BUY AND SELL UKRAINIAN RELATED WARES, ART, ANTIQUES, BOOKS, EMBROIDERY, COSTUMES, COLLECTIBLES, INSTRUMENTS, MEMORABILIA AND OTHER ONE-OF-A-KIND ITEMS (U.S. CLS. 100, 101 AND 102).

FIRST USE 1-1-2011; IN COMMERCE 1-1-2011.  
DOUGLAS LEE, EXAMINING ATTORNEY

SN 85-230,416. LIFE CARE COMPANIES LLC, DES MOINES, IA. FILED 1-31-2011.

## CHANGING LIFESTYLES. CHANGING LIVES.

THE MARK CONSISTS OF STANDARD CHARACTERS WITHOUT CLAIM TO ANY PARTICULAR FONT, STYLE, SIZE, OR COLOR.

FOR BUSINESS MANAGEMENT OF RESIDENTIAL COMMUNITIES, CONTINUING CARE COMMUNITIES, ASSISTED LIVING COMMUNITIES AND RETIREMENT COMMUNITIES; BUSINESS DEVELOPMENT OF RESIDENTIAL, CONTINUING CARE, ASSISTED LIVING COMMUNITIES AND RETIREMENT COMMUNITIES; BUSINESS MANAGEMENT AND OPERATION OF CONTINUING CARE RETIREMENT COMMUNITIES (U.S. CLS. 100, 101 AND 102).

BRENDAN MCCAULEY, EXAMINING ATTORNEY

**CLASS 35—(Continued).**

SN 85-230,435. JEFFERSON STREET SIGNAGE DISTRICT, LLC, PHOENIX, AZ. FILED 1-31-2011.

## LEGENDS ENTERTAINMENT DISTRICT

THE MARK CONSISTS OF STANDARD CHARACTERS WITHOUT CLAIM TO ANY PARTICULAR FONT, STYLE, SIZE, OR COLOR.

NO CLAIM IS MADE TO THE EXCLUSIVE RIGHT TO USE "ENTERTAINMENT" AND "DISTRICT", APART FROM THE MARK AS SHOWN.

FOR PROVIDING ADVERTISING SPACE ON BILLBOARDS AND ELECTRONIC MEDIA WITHIN A DESIGNATED MARKETING COMPLEX WHICH MARKET THE GOODS AND SERVICES OF OTHERS (U.S. CLS. 100, 101 AND 102).

FIRST USE 11-1-2010; IN COMMERCE 11-1-2010.  
LINDA MICKLEBURGH, EXAMINING ATTORNEY

SN 85-230,531. JEFFERSON STREET SIGNAGE DISTRICT, LLC, PHOENIX, AR. FILED 1-31-2011.



NO CLAIM IS MADE TO THE EXCLUSIVE RIGHT TO USE "LEGENDS", "ENTERTAINMENT", "DISTRICT", "PHOENIX", "ARIZONA" AND "EST. 2010", APART FROM THE MARK AS SHOWN.

THE COLOR(S) BLACK, WHITE, GRAY, RED, ORANGE, TAN, AND TEAL IS/ARE CLAIMED AS A FEATURE OF THE MARK.

THE MARK CONSISTS OF A DRAWING OF PORTIONS OF DOWNTOWN PHOENIX, ARIZONA IN BLACK AND TAN, WITH A BLUE AND BLACK GUITAR, GRAY AND BLACK MICROPHONE, ORANGE AND BLACK BASKETBALL, WHITE AND RED BASEBALL, BROWN AND BLACK BASEBALL GLOVE, AND TAN AND BLACK BASEBALL BAT ABOVE IT SURROUNDED BY RED AND ORANGE FLAMES. THE WORDS "LEGENDS ENTERTAINMENT DISTRICT" SURROUNDED BY THE WORDS "EST. 2010" ARE IN WHITE ABOVE THE WORDS "PHOENIX ARIZONA" IN ORANGE, SEPARATED BY A WHITE STAR. ALL WORDS ARE DEPICTED ON A BLACK AND TEAL PLATFORM.

FOR PROVIDING ADVERTISING SPACE ON BILLBOARDS AND ELECTRONIC MEDIA WITHIN A DESIGNATED MARKETING COMPLEX WHICH MARKET THE GOODS AND SERVICES OF OTHERS (U.S. CLS. 100, 101 AND 102).

FIRST USE 11-1-2010; IN COMMERCE 11-1-2010.  
LINDA MICKLEBURGH, EXAMINING ATTORNEY

**CLASS 35—(Continued).**

SN 85-231,034. HIGH PERFORMANCE SPORTS LIMITED, TSMISHATSUI, KOWLOON,, HONG KONG, FILED 2-1-2011.

羽  
絨  
城

OWNER OF HONG KONG REG. NO. 2000B11141, DATED 5-31-1993, EXPIRES 5-31-2014.

THE MARK CONSISTS OF THE CHINESE CHARACTERS, WHICH TRANSLITERATE TO "YU RONG CHENG".

THE NON-LATIN CHARACTERS IN THE MARK TRANSLITERATE TO YU RONG CHENG AND THIS MEANS DOWN CITY IN ENGLISH.

FOR RETAIL STORE SERVICES FEATURING CLOTHING, FOOTWEAR, HEADGEAR, SLEEPING BAGS, SPORTS AND RECREATION EQUIPMENT (U.S. CLS. 100, 101 AND 102).

KATHERINE E. HALMEN, EXAMINING ATTORNEY

**CLASS 35—(Continued).**

SN 85-232,737. LBV HOLDINGS, LLC, ATLANTA, GA. FILED 2-2-2011.

La Belle Vie

THE MARK CONSISTS OF STANDARD CHARACTERS WITHOUT CLAIM TO ANY PARTICULAR FONT, STYLE, SIZE, OR COLOR.

THE ENGLISH TRANSLATION OF "LA BELLE VIE" IN THE MARK IS "THE BEAUTIFUL LIFE".

FOR WHOLESALE AND RETAIL STORE SERVICES FEATURING CLOTHING (U.S. CLS. 100, 101 AND 102).

FIRST USE 1-5-2011; IN COMMERCE 2-7-2011.

JEFF DEFORD, EXAMINING ATTORNEY

SN 85-231,497. BOTICA COMERCIAL FARMACEUTICA LTDA, S. JOSE DOS PINHAIS PR, BRAZIL, FILED 2-1-2011.

EUDORA

THE MARK CONSISTS OF STANDARD CHARACTERS WITHOUT CLAIM TO ANY PARTICULAR FONT, STYLE, SIZE, OR COLOR.

FOR RETAIL STORE SERVICES, MAIL ORDER CATALOG SERVICES, INTERACTIVE RETAIL STORE SERVICES RENDERED BY MEANS OF A GLOBAL COMPUTER INFORMATION NETWORK, RETAIL SERVICES BY DIRECT SOLICITATION BY SALES REPRESENTATIVES ALL IN THE FIELD OF COSMETICS, PERFUMERY, ACCESSORIES, SOAPS, SHAMPOOS, ESSENTIAL OILS, DENTIFRICES, CLOTHING, FOOTWEAR, HEADGEAR, HANDBAGS, SMALL LEATHER GOODS (U.S. CLS. 100, 101 AND 102).

CAROLINE WOOD, EXAMINING ATTORNEY

SN 85-233,440. DUN & BRADSTREET, INC., SHORT HILLS, NJ. FILED 2-3-2011.

SLMi

THE MARK CONSISTS OF STANDARD CHARACTERS WITHOUT CLAIM TO ANY PARTICULAR FONT, STYLE, SIZE, OR COLOR.

FOR BUSINESS SERVICES, NAMELY, BUSINESS INFORMATION, ADVICE, AND CONSULTATION IN THE FIELD OF SUPPLY LIFECYCLE MANAGEMENT PROCESSES AND FUNCTIONAL NEEDS IN THE AREAS OF SUPPLIER RISK, COMPLIANCE, DIVERSITY AND INFORMATION MANAGEMENT (U.S. CLS. 100, 101 AND 102).

PATRICIA EVANKO, EXAMINING ATTORNEY

**CLASS 35—(Continued).**

SN 85-235,091. AVERBUG, ANDRE, POTOMAC, MD. FILED 2-5-2011.



THE MARK CONSISTS OF A STYLIZED FROG DRAWING/ICON, NEXT TO THE WORD "RANKPAD".

FOR PROVIDING AN INTERACTIVE WEB SITE FOR USERS TO RANK, LIST, RATE, RECOMMEND AND REVIEW PRODUCTS, SERVICES, BUSINESSES, BRANDS, EXPERIENCES, PEOPLE, PLACES, CONTENT AND THINGS; PROVIDING INFORMATION IN THE FIELD OF PUBLIC OPINIONS VIA THE INTERNET; PROVIDING AN ONLINE COMPUTER DATABASE IN THE FIELD OF CONSUMER PRODUCT AND SERVICE REVIEWS, AS WELL AS RANKS AND CLASSIFICATIONS OF BUSINESSES, BRANDS, EXPERIENCES, PEOPLE, PLACES, CONTENT AND THINGS; PROVIDING AN ONLINE COMPUTER DATABASE FOR THE PROVISION OF BUSINESS INTELLIGENCE SERVICES; PROVIDING MARKETING, PROMOTION AND ADVERTISING SERVICES; DISPLAYING ADVERTISEMENTS FOR OTHERS; ELECTRONIC COMMERCE SERVICES, NAMELY, PROVIDING INFORMATION ON PRODUCTS, SERVICES, BUSINESSES, EXPERIENCES, PEOPLE, PLACES, CONTENT AND THINGS VIA THE INTERNET OR OTHER COMPUTER OR COMMUNICATIONS NETWORKS FOR ADVERTISING AND SALES PURPOSES; PROVIDING CONSUMER INFORMATION REGARDING THE SELECTION OF GOODS, SERVICES AND OTHER CONTENT VIA MOBILE TELEPHONES AND DESKTOP AND LAPTOP COMPUTERS; PROVIDING A SEARCHABLE DATABASE IN THE NATURE OF AN ONLINE ADVERTISING GUIDE FEATURING THE GOODS, SERVICES AND OTHER CONTENT OF OTHERS VIA THE INTERNET OR OTHER COMPUTER, MOBILE OR COMMUNICATIONS NETWORKS (U.S. CLS. 100, 101 AND 102).

C. DIONNE CLYBURN, EXAMINING ATTORNEY

SN 85-236,060. VICTOR, KRISTEN L., SAN DIEGO, CA. FILED 2-7-2011.

## Sustainability Matters

THE MARK CONSISTS OF STANDARD CHARACTERS WITHOUT CLAIM TO ANY PARTICULAR FONT, STYLE, SIZE, OR COLOR.

NO CLAIM IS MADE TO THE EXCLUSIVE RIGHT TO USE "SUSTAINABILITY", APART FROM THE MARK AS SHOWN.

FOR PROCUREMENT, NAMELY, PURCHASING ENVIRONMENTALLY FRIENDLY, RENEWABLE BUILDING MATERIALS FOR OTHERS; BUSINESS CONSULTING SERVICE TO THE BUILDING INDUSTRY IN THE FIELD OF IDENTIFICATION, ANALYSIS AND GRADING OF ENVIRONMENTALLY FRIENDLY, RENEWABLE BUILDING MATERIALS, AND OF THEIR MANUFACTURERS AND SUPPLIERS; PROVIDING A DATABASE OF INFORMATION TO THE BUILDING INDUSTRY PERTAINING TO SOURCING ENVIRONMENTALLY FRIENDLY, RENEWABLE BUILDING MATERIALS AND THEIR MANUFACTURERS (U.S. CLS. 100, 101 AND 102).

FIRST USE 11-25-2009; IN COMMERCE 11-25-2009.  
SEAN CROWLEY, EXAMINING ATTORNEY

**CLASS 35—(Continued).**

SN 85-236,451. ENCORE TAX INC, SANTA ANA, CA. FILED 2-8-2011.



NO CLAIM IS MADE TO THE EXCLUSIVE RIGHT TO USE "SOLUTIONS" AND "THE DIRECT SELLERS' TAX EXPERT", APART FROM THE MARK AS SHOWN.

THE MARK CONSISTS OF THE STYLIZED TEXT "A" INSIDE THE LETTER "A". TO THE RIGHT THERE IS THE STYLIZED TEXT "ACCOUNTABLE SOLUTIONS THE DIRECT SELLERS' TAX EXPERT".

FOR ACCOUNTING SERVICES; AUDIT SUPPORT SERVICES, NAMELY, REVIEW AND ANALYSIS OF A COMPANY'S SALES, AS WELL AS THE PREPARATION, ORGANIZATION AND PRESENTATION OF THE DOCUMENTS AND DATA REQUESTED BY A GOVERNMENT BODY, AND ADVICE ON GOVERNMENT AUDIT PROCESSES, POLICIES AND STRATEGY; BOOKKEEPING; PAYROLL PROCESSING SERVICES; TAX PREPARATION (U.S. CLS. 100, 101 AND 102).

FIRST USE 12-15-2010; IN COMMERCE 12-15-2010.  
ADA HAN, EXAMINING ATTORNEY

SN 85-238,624. MARKETING RESEARCH ASSOCIATION, INC., GLASTONBURY, CT. FILED 2-10-2011.

## Marketing Research Association

THE MARK CONSISTS OF STANDARD CHARACTERS WITHOUT CLAIM TO ANY PARTICULAR FONT, STYLE, SIZE, OR COLOR.

OWNER OF U.S. REG. NO. 3,804,737.

NO CLAIM IS MADE TO THE EXCLUSIVE RIGHT TO USE "ASSOCIATION", APART FROM THE MARK AS SHOWN.

SEC. 2(F).

FOR ASSOCIATION SERVICES, NAMELY, PROMOTING THE INTERESTS OF INDIVIDUALS, BUSINESSES AND FIRMS INVOLVED IN THE MARKETING RESEARCH FIELD AND MARKETING SURVEY AND MARKETING OPINION RESEARCH FIELDS (U.S. CLS. 100, 101 AND 102).

FIRST USE 0-0-1973; IN COMMERCE 0-0-1973.

BERNICE MIDDLETON, EXAMINING ATTORNEY

**CLASS 35—(Continued).**

SN 85-240,036. TAYLORSTRIDES, LLC, LITTLE ROCK, AR. FILED 2-11-2011.

**GO! RUNNING**

THE MARK CONSISTS OF STANDARD CHARACTERS WITHOUT CLAIM TO ANY PARTICULAR FONT, STYLE, SIZE, OR COLOR.

FOR RETAIL STORE SERVICES FEATURING ATHLETIC SPORTSWEAR FOR MEN, WOMEN, AND CHILDREN, ATHLETIC SHORTS AND SHIRTS, ATHLETIC WARM-UPS, ATHLETIC SOCKS, SHOES, SANDALS, SPORTS WATCHES, TIMERS, ATHLETIC HEADWEAR, GLOVES, HYDRATION EQUIPMENT, BOOKS IN THE FIELD OF ATHLETICS AND NUTRITION, NUTRITION AND HIGH ENERGY FOOD PRODUCTS, AND ATHLETIC THERAPY EQUIPMENT (U.S. CLS. 100, 101 AND 102).

FIRST USE 4-1-2010; IN COMMERCE 4-1-2010.  
DAVID H. STINE, EXAMINING ATTORNEY

SN 85-245,351. THE SAINT AUGUSTINE LIGHTHOUSE AND MUSEUM, INC., ST. AUGUSTINE, FL. FILED 2-17-2011.

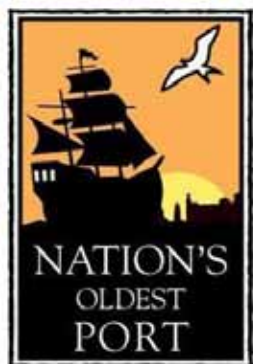

NO CLAIM IS MADE TO THE EXCLUSIVE RIGHT TO USE "NATION'S OLDEST PORT", APART FROM THE MARK AS SHOWN.

THE COLOR(S) BLACK, WHITE, ORANGE AND YELLOW IS/ARE CLAIMED AS A FEATURE OF THE MARK.

THE MARK CONSISTS OF A SILHOUETTE OF A HISTORICAL SHIP APPEARING IN BLACK AND WHITE SAILING TOWARDS A FORT APPEARING IN THE COLOR BLACK, WITH A RISING SUN APPEARING IN THE COLOR YELLOW IN THE BACKGROUND, AND TO THE RIGHT APPEARS A SILHOUETTE OF A FLYING BIRD IN WHITE OUTLINED IN BLACK, AND BELOW THE HISTORICAL SHIP APPEARS THE WORDING "NATION'S OLDEST PORT" IN WHITE AGAINST A BLACK BACKGROUND, ALL APPEARING AGAINST AN ORANGE BACKGROUND AND CONTAINED WITHIN A DOUBLE-SIDED BLACK AND WHITE RECTANGULAR CARRIER.

FOR PROMOTING RECREATION AND TOURISM IN ST. AUGUSTINE, FLORIDA; MARKETING, ADVERTISING AND PROMOTING THE GOODS AND SERVICES OF OTHERS IN THE FIELDS OF TRAVEL, TOURISM, MARITIME, ARCHEOLOGY AND LOCAL HISTORY; RETAIL STORE SERVICES AND ONLINE RETAIL STORE SERVICES FEATURING GIFTS AND SPECIALTY ITEMS, CLOTHING AND SOUVENIRS (U.S. CLS. 100, 101 AND 102).

APRIL HESIK, EXAMINING ATTORNEY

**CLASS 35—(Continued).**

SN 85-246,374. NAEGELIN'S BAKERY, INC., SAN ANTONIO, TX. FILED 2-18-2011.

**NAEGELIN'S BAKERY**

THE MARK CONSISTS OF STANDARD CHARACTERS WITHOUT CLAIM TO ANY PARTICULAR FONT, STYLE, SIZE, OR COLOR.

NO CLAIM IS MADE TO THE EXCLUSIVE RIGHT TO USE "BAKERY", APART FROM THE MARK AS SHOWN.

SEC. 2(F).  
FOR RETAIL AND ONLINE SHOP FEATURING BAKED GOODS (U.S. CLS. 100, 101 AND 102).

FIRST USE 12-31-1868; IN COMMERCE 12-31-1868.  
KELLY BOULTON, EXAMINING ATTORNEY

SN 85-247,035. COONS, JOHN D, WASHINGTON, DC. FILED 2-20-2011.

**DogMayor**

THE MARK CONSISTS OF STANDARD CHARACTERS WITHOUT CLAIM TO ANY PARTICULAR FONT, STYLE, SIZE, OR COLOR.

FOR ADVERTISING, PROMOTION, AND MARKETING SERVICES IN THE NATURE OF WEB BASED ADVERTISING FOR PET RELATED PRODUCTS AND PET INSURANCE; PROVIDING AN ON-LINE SHOWROOM FOR THE GOODS OF OTHERS IN THE FIELD OF DOGS; SPECIALTY MERCHANDISING SERVICES, NAMELY, PROMOTING THE GOODS AND SERVICES OF OTHERS THROUGH THE DISTRIBUTION OF CUSTOMIZED ADVERTISING MATERIALS, NAMELY, WEBSITE ADVERTISING BANNERS AND WEBSITE ADVERTISING LINKS (U.S. CLS. 100, 101 AND 102).

TINA L. SNAPP, EXAMINING ATTORNEY



**CLASS 35—(Continued).**

SN 85-249,497. PREMIER CONCEPTS, BENTONVILLE, AR. FILED 2-23-2011.



THE COLOR(S) BLUE AND YELLOW ORANGE IS/ARE CLAIMED AS A FEATURE OF THE MARK.

THE MARK CONSISTS OF THE WORD "SMARTCOM" ALL IN LOWERCASE WITH NO SPACE BETWEEN THE "T" AND THE "C". THE WORD "SMART" IS BLUE. THE WORD "COM" IS YELLOW ORANGE. FIVE ARCHES WITH TAPERED ENDS EXTEND HORIZONTALLY FROM BOTH SIDES OF THE TOP OF THE "T" WITH EACH ARCH PROGRESSIVELY LARGER AS IT EXTENDS OUTWARD TO GIVE THE APPEARANCE OF RADIO WAVES. THESE ARCHES ARE ALSO IN BLUE.

FOR CONSUMER STRATEGY BUSINESS CONSULTING IN THE FIELDS OF MARKETING, SALES, OPERATION, AND PRODUCT DESIGN PARTICULARLY SPECIALIZING IN THE USE OF ANALYTIC MODELS FOR THE UNDERSTANDING AND PREDICTING OF CONSUMER, BUSINESS, AND RETAIL MARKET TRENDS AND ACTIONS; CUSTOMER SERVICE, NAMELY, PROVIDING SALES ANALYSIS AND IN-STORE MERCHANDISING SUPPORT FOR PRODUCT MANUFACTURERS (U.S. CLS. 100, 101 AND 102).

FIRST USE 10-1-2010; IN COMMERCE 10-1-2010.  
ANNE MADDEN, EXAMINING ATTORNEY

SN 85-250,422. DIGECOR, DBA MILL CREEK SHOPPE, SEATTLE, WA. FILED 2-24-2011.

## Mill Creek Shoppe

THE MARK CONSISTS OF STANDARD CHARACTERS WITHOUT CLAIM TO ANY PARTICULAR FONT, STYLE, SIZE, OR COLOR.

NO CLAIM IS MADE TO THE EXCLUSIVE RIGHT TO USE "SHOPPE", APART FROM THE MARK AS SHOWN.

FOR IN-FLIGHT ON-LINE RETAIL STORE SERVICES, FEATURING APPAREL, JEWELRY, WATCHES, PURSES, WALLET, COMPUTERS, ELECTRONICS, ART, FOOD, FURNITURE, GARDEN DÉCOR, HEALTH AND BEAUTY PRODUCTS, HOME DÉCOR, KITCHEN, PET PRODUCTS, TOYS AND GAMES, HAWAIIAN-THEMED GOODS, LUGGAGE, TRAVEL ACCESSORIES, AUTOMOTIVE, SPORTS, AND GIFTS (U.S. CLS. 100, 101 AND 102).

FIRST USE 9-1-2010; IN COMMERCE 9-1-2010.  
ROBERT C. CLARK JR., EXAMINING ATTORNEY

**CLASS 35—(Continued).**

SN 85-252,196. PIZZA HUT, INC., PLANO, TX. FILED 2-25-2011.

## PIZZA HUT PERKS

THE MARK CONSISTS OF STANDARD CHARACTERS WITHOUT CLAIM TO ANY PARTICULAR FONT, STYLE, SIZE, OR COLOR.

OWNER OF U.S. REG. NOS. 729,847, 3,975,582 AND OTHERS.

NO CLAIM IS MADE TO THE EXCLUSIVE RIGHT TO USE "PERKS", APART FROM THE MARK AS SHOWN.

FOR CUSTOMER LOYALTY SERVICES FOR COMMERCIAL, PROMOTIONAL AND/OR ADVERTISING PURPOSES; PROVIDING INCENTIVE AWARD PROGRAMS FOR CUSTOMERS AND EMPLOYEES THROUGH THE DISTRIBUTION OF PREPAID STORED VALUE CARDS FOR THE PURPOSE OF PROMOTING AND REWARDING LOYALTY; PROVIDING INCENTIVE AWARD PROGRAMS FOR CUSTOMERS THROUGH THE ISSUANCE AND PROCESSING OF LOYALTY COUPONS FOR FREQUENT USE OF PARTICIPATING BUSINESSES (U.S. CLS. 100, 101 AND 102).

MICHAEL KEATING, EXAMINING ATTORNEY

SN 85-252,916. LAB313 CORPORATION, CHEYENNE, WY. FILED 2-28-2011.

## EWORXZ

THE MARK CONSISTS OF STANDARD CHARACTERS WITHOUT CLAIM TO ANY PARTICULAR FONT, STYLE, SIZE, OR COLOR.

FOR BUSINESS PROCESS MANAGEMENT ASSISTANCE (U.S. CLS. 100, 101 AND 102).

HENRY S. ZAK, EXAMINING ATTORNEY

SN 85-255,885. LAPKOSOFT, INC., DBA STROLLER VILLAGE, LINCOLN, NE. FILED 3-2-2011.

## Stroller Village

THE MARK CONSISTS OF STANDARD CHARACTERS WITHOUT CLAIM TO ANY PARTICULAR FONT, STYLE, SIZE, OR COLOR.

NO CLAIM IS MADE TO THE EXCLUSIVE RIGHT TO USE "STROLLER", APART FROM THE MARK AS SHOWN.

FOR ON-LINE RETAIL STORE SERVICES FEATURING INFANTS' AND CHILDREN'S TOYS AND GEAR INCLUDING STROLLERS, BIKE TRAILERS, CAR SEATS, BABY CARRIERS, HIGH CHAIRS AND FURNITURE (U.S. CLS. 100, 101 AND 102).

FIRST USE 2-21-2008; IN COMMERCE 2-21-2008.  
KATHERINE CHANG, EXAMINING ATTORNEY



**CLASS 35—(Continued).**

SN 85-257,324. YOUNGIVEGOODS, LLC, MORISTOWN, NJ. FILED 3-3-2011.

**YouGiveGoods**

THE MARK CONSISTS OF STANDARD CHARACTERS WITHOUT CLAIM TO ANY PARTICULAR FONT, STYLE, SIZE, OR COLOR.

FOR OPERATING A WEBSITE TO PROMOTE PUBLIC AWARENESS OF THE NEEDS OF CHARITABLE ORGANIZATIONS FOR DONATIONS OF GOODS SUCH AS CLOTHING, FOOD, BLANKETS, ANIMAL PRODUCTS, BABY SUPPLIES AND SIMILAR ITEMS (U.S. CLS. 100, 101 AND 102).

LIEF MARTIN, EXAMINING ATTORNEY



SN 85-257,332. YOUNGIVEGOODS, LLC, MORISTOWN, NJ. FILED 3-3-2011.

**YouGiveGoods**

THE MARK CONSISTS OF STANDARD CHARACTERS WITHOUT CLAIM TO ANY PARTICULAR FONT, STYLE, SIZE, OR COLOR.

FOR OPERATING A WEBSITE WHICH PROVIDES A SERVICE WHEREBY USERS MAY PURCHASE ITEMS ONLINE FOR DELIVERY TO CHARITABLE ORGANIZATIONS, NAMELY, AN ONLINE RETAIL STORE SERVICE FEATURING CANNED FOODS, BLANKETS, BABY PRODUCTS, ANIMAL FOOD, AND CLOTHING (U.S. CLS. 100, 101 AND 102).

LIEF MARTIN, EXAMINING ATTORNEY



SN 85-257,348. YOUNGIVEGOODS, LLC, MORISTOWN, NJ. FILED 3-3-2011.

**YGG**

THE MARK CONSISTS OF STANDARD CHARACTERS WITHOUT CLAIM TO ANY PARTICULAR FONT, STYLE, SIZE, OR COLOR.

FOR OPERATING A WEBSITE TO PROMOTE PUBLIC AWARENESS OF THE NEEDS OF CHARITABLE ORGANIZATIONS FOR DONATIONS OF GOODS SUCH AS CLOTHING, FOOD, BLANKETS, ANIMAL PRODUCTS, BABY SUPPLIES AND SIMILAR ITEMS (U.S. CLS. 100, 101 AND 102).

LIEF MARTIN, EXAMINING ATTORNEY

**CLASS 35—(Continued).**

SN 85-257,355. YOUNGIVEGOODS, LLC, MORISTOWN, NJ. FILED 3-3-2011.

**YGG**

THE MARK CONSISTS OF STANDARD CHARACTERS WITHOUT CLAIM TO ANY PARTICULAR FONT, STYLE, SIZE, OR COLOR.

FOR OPERATING A WEBSITE WHICH PROVIDES A SERVICE WHEREBY USERS MAY PURCHASE ITEMS ONLINE FOR DELIVERY TO CHARITABLE ORGANIZATIONS, NAMELY, AN ONLINE RETAIL STORE SERVICE FEATURING CANNED FOODS, BLANKETS, BABY PRODUCTS, ANIMAL FOOD, AND CLOTHING (U.S. CLS. 100, 101 AND 102).

LIEF MARTIN, EXAMINING ATTORNEY



SN 85-259,438. MIRIAM CARRIAZO, LOWELL, MA. FILED 3-7-2011.

**CARRIAZO TALENT**

THE MARK CONSISTS OF STANDARD CHARACTERS WITHOUT CLAIM TO ANY PARTICULAR FONT, STYLE, SIZE, OR COLOR.

NO CLAIM IS MADE TO THE EXCLUSIVE RIGHT TO USE "TALENT", APART FROM THE MARK AS SHOWN.

FOR EVENT PLANNING AND MANAGEMENT FOR MARKETING, BRANDING, PROMOTING OR ADVERTISING THE GOODS AND SERVICES OF OTHERS; MODELING AGENCY SERVICES; PROMOTING THE PARTIES AND SPECIAL EVENTS OF OTHERS (U.S. CLS. 100, 101 AND 102).

DEBRA LEE, EXAMINING ATTORNEY

**CLASS 35—(Continued).**

SN 85-259,456. CITIZENS SOLDIERS, INC., JOHNSON CITY, TN. FILED 3-7-2011.



NO CLAIM IS MADE TO THE EXCLUSIVE RIGHT TO USE "SOLDIERS", APART FROM THE MARK AS SHOWN. THE STIPLING IS FOR SHADING PURPOSES ONLY.

THE COLOR(S) RED, WHITE, BLUE, BROWN, GOLD, GREEN, GRAY AND BLACK IS/ARE CLAIMED AS A FEATURE OF THE MARK.

THE MARK CONSISTS OF THE FOLLOWING: A STYLIZED DESIGN OF A BALD EAGLE WITH DOG TAGS AND AN OLIVE BRANCH IN ITS BEAK APPEARING UNDER A BANNER WITH THE WORDS "CITIZENS SOLDIERS"; THE EAGLE'S WINGS ARE FORMED BY A STYLIZED FLAG DESIGN WITH WHITE STARS AND BLUE FEATHERS APPEARING ON THE EAGLE'S RIGHT WING AND WHITE AND RED STRIPES APPEARING ON THE EAGLE'S LEFT WING; THE EAGLE HAS WHITE FEATHERS ON ITS HEAD, BROWN FEATHERS ON THE TOP OF ITS RIGHT WING, AND A YELLOW EYE AND YELLOW BEAK; THE EAGLE IS HOLDING A GREEN OLIVE BRANCH AND TWO GRAY DOG TAGS IN ITS BEAK; THE DOG TAG ON THE LEFT HAS THE WORD "SOLDIERS" IN BLACK, AND THE DOG TAG ON THE RIGHT HAS THE WORD "CITIZENS" IN BLACK; THE EAGLE APPEARS ON A BLACK BACKGROUND WITH A WHITE SINGLE LINE INSET BORDER; THE BANNER ABOVE THE EAGLE IS BLACK AND HAS THE WORDS "CITIZENS SOLDIERS" IN WHITE AND A SINGLE LINE INSET RED BORDER.

FOR CHARITABLE SERVICES, NAMELY, ORGANIZING AND CONDUCTING VOLUNTEER PROGRAMS AND COMMUNITY SERVICE PROJECTS AIMED AT INCREASING SUPPORT AND MORALE OF FAMILIES OF HOMELESS WAR VETERANS, WAR VETERANS, CURRENT MEMBERS AND FUTURE MEMBERS OF THE U.S. MILITARY (U.S. CLS. 100, 101 AND 102).

FIRST USE 3-25-2010; IN COMMERCE 3-25-2010.

DAVID ELTON, EXAMINING ATTORNEY

**CLASS 35—(Continued).**

SN 85-262,820. HOMEAWAY.COM, INC., AUSTIN, TX. FILED 3-9-2011.



OWNER OF U.S. REG. NOS. 3,385,395, 3,596,173 AND 3,596,175.

THE MARK CONSISTS OF BLACK AND WHITE BIRDHOUSE.

FOR PROVIDING AN INTERACTIVE WEBSITE THAT PROMOTES REAL ESTATE PROPERTIES THROUGH OFFERING PROSPECTIVE TENANTS AND BUYERS PHOTOGRAPHS, PROPERTY DESCRIPTIONS, TEXT, PRICE, LOCATION, MAPS AND OTHER INFORMATION TO BE CONSIDERED BY A PROSPECTIVE TENANT OR BUYER IN MAKING A RENTAL OR PURCHASE DECISION; PROVIDING AN INTERACTIVE WEBSITE FOR ADVERTISING SPECIALS, OFFERING OF COUPONS, REBATES, DISCOUNTS AND SPECIAL OFFERINGS PROMOTING THE SERVICES OF OTHERS, AND RESPONDING TO CUSTOMER INQUIRIES FOR OTHERS IN THE FIELD OF REAL ESTATE; ON-LINE ADVERTISING AND MARKETING SERVICES RELATED TO THE RENTAL OR SALE OF REAL PROPERTY; REAL ESTATE MARKETING SERVICES IN THE FIELD OF TEMPORARY ACCOMMODATIONS (U.S. CLS. 100, 101 AND 102).

FIRST USE 7-12-2006; IN COMMERCE 7-12-2006.

RON FAIRBANKS, EXAMINING ATTORNEY

SN 85-263,306. EHOFF INTERNATIONAL, INC., NOT-FOR-PROFIT, PARK RIDGE, IL. FILED 3-10-2011.

## Atlas Awards

THE MARK CONSISTS OF STANDARD CHARACTERS WITHOUT CLAIM TO ANY PARTICULAR FONT, STYLE, SIZE, OR COLOR.

NO CLAIM IS MADE TO THE EXCLUSIVE RIGHT TO USE "AWARDS", APART FROM THE MARK AS SHOWN.

FOR ORGANIZING, PROMOTING AND CONDUCTING EXHIBITIONS, TRADESHOWS AND EVENTS FOR BUSINESS PURPOSES (U.S. CLS. 100, 101 AND 102).

SUE LAWRENCE, EXAMINING ATTORNEY

**CLASS 35—(Continued).**

SN 85-263,541. OH MY GAUZE, INC., SARASOTA, FL. FILED 3-10-2011.



OWNER OF U.S. REG. NO. 2,233,557.  
THE MARK CONSISTS OF DESIGN OF THE WORDS "OH MY GAUZE" IN A STYLIZED FONT WITH AN EXCLAMATION POINT AT THE END OF THE WORDS.  
FOR WHOLESALE AND RETAIL STORE SERVICES FEATURING COTTON GAUZE CLOTHING AND ACCESSORIES (U.S. CLS. 100, 101 AND 102).  
FIRST USE 1-1-1995; IN COMMERCE 1-1-1995.  
ALLISON SCHRODY, EXAMINING ATTORNEY

---

SN 85-265,206. THE CLOROX COMPANY, OAKLAND, CA. FILED 3-11-2011.

SEASONS OF WHITE

THE MARK CONSISTS OF STANDARD CHARACTERS WITHOUT CLAIM TO ANY PARTICULAR FONT, STYLE, SIZE, OR COLOR.  
FOR PROVIDING CONSUMER INFORMATION ONLINE THROUGH GLOBAL COMPUTER NETWORKS ABOUT LAUNDRY CARE AND STAIN REMOVER ADVICE (U.S. CLS. 100, 101 AND 102).  
FIRST USE 1-21-2011; IN COMMERCE 1-21-2011.  
TAMARA FRAZIER, EXAMINING ATTORNEY

---

SN 85-265,580. CONSORCIO COMEX, S.A. DE C.V., MEXICO, D.F., MEXICO, FILED 3-13-2011.

COMEX

THE MARK CONSISTS OF STANDARD CHARACTERS WITHOUT CLAIM TO ANY PARTICULAR FONT, STYLE, SIZE, OR COLOR.  
OWNER OF MEXICO REG. NO. 809275, DATED 10-10-2003, EXPIRES 8-13-2013.  
OWNER OF U.S. REG. NOS. 1,958,222, 2,909,357 AND OTHERS.  
FOR ADVERTISING SERVICES, COMMERCIAL BUSINESS MANAGEMENT; COMMERCIAL BUSINESS ADMINISTRATION ASSISTANCE; PROVIDING OFFICE FUNCTIONS (U.S. CLS. 100, 101 AND 102).  
MARK T. MULLEN, EXAMINING ATTORNEY

**CLASS 35—(Continued).**

SN 85-266,416. NICO COMMODITIES, S.A. DE C.V., AKA NICO ALIMENTOS, MAZATLAN, MEXICO, FILED 3-14-2011.



NO CLAIM IS MADE TO THE EXCLUSIVE RIGHT TO USE "ALIMENTOS", APART FROM THE MARK AS SHOWN.

THE MARK CONSISTS OF THE WORDING "NICO" STYLIZED WITH A LEAF DESIGN OVER THE LETTER "O" AND THE WORDING "ALIMENTOS" BELOW "NICO".

THE ENGLISH TRANSLATION OF "ALIMENTOS" IN THE MARK IS "FOOD".

FOR DISTRIBUTORSHIP SERVICES IN THE FIELD OF FOOD; EXPORT AND IMPORT AGENCIES; EXPORT AND IMPORT AGENCIES IN THE FIELD OF FOOD; RESELLER SERVICES, NAMELY, DISTRIBUTORSHIP SERVICES IN THE FIELD OF FOOD; WHOLESALE FOOD DISTRIBUTORSHIP SERVICES (U.S. CLS. 100, 101 AND 102).

FIRST USE 1-22-2010; IN COMMERCE 12-8-2010.  
ALICE BENMAMAN, EXAMINING ATTORNEY

---

SN 85-266,539. GROUPON, INC., CHICAGO, IL. FILED 3-14-2011.



THE MARK CONSISTS OF A STYLIZED LETTER "G".  
FOR PROMOTING THE GOODS AND SERVICES OF OTHERS BY PROVIDING A WEBSITE FEATURING COUPONS, REBATES, PRICE-COMPARISON INFORMATION, PRODUCT REVIEWS, LINKS TO THE RETAIL WEBSITES OF OTHERS, AND DISCOUNT INFORMATION (U.S. CLS. 100, 101 AND 102).  
CHERYL CLAYTON, EXAMINING ATTORNEY

**CLASS 35—(Continued).**

SN 85-266,548. GROUPON, INC., CHICAGO, IL. FILED 3-14-2011.



OWNER OF U.S. REG. NOS. 3,513,882 AND 3,685,954.  
THE MARK CONSISTS OF THE WORD "GROUPON" INSIDE A TRAPEZIUM THAT IS SURROUNDED BY A BORDER.

FOR PROMOTING THE GOODS AND SERVICES OF OTHERS BY PROVIDING A WEBSITE FEATURING COUPONS, REBATES, PRICE-COMPARISON INFORMATION, PRODUCT REVIEWS, LINKS TO THE RETAIL WEBSITES OF OTHERS, AND DISCOUNT INFORMATION (U.S. CLS. 100, 101 AND 102).

CHERYL CLAYTON, EXAMINING ATTORNEY

---

SN 85-266,992. THE GOODYEAR TIRE & RUBBER COMPANY, AKRON, OH. FILED 3-15-2011.

## MAXXCARE

THE MARK CONSISTS OF STANDARD CHARACTERS WITHOUT CLAIM TO ANY PARTICULAR FONT, STYLE, SIZE, OR COLOR.

FOR ADMINISTRATION OF CUSTOMER LOYALTY PROGRAM THAT ENABLES PARTICIPANTS TO OBTAIN DISCOUNTED OR FREE PRODUCTS AND SERVICES FOR TIRES, TRUCK PARTS AND TRUCK REPAIR AND MAINTENANCE SERVICES (U.S. CLS. 100, 101 AND 102).

TRACY CROSS, EXAMINING ATTORNEY

---

SN 85-276,844. SMITH, MATTHEW, W., N. LAS VEGAS, NV. FILED 3-25-2011.

## READING IT'S NEVER TOO EARLY

THE MARK CONSISTS OF STANDARD CHARACTERS WITHOUT CLAIM TO ANY PARTICULAR FONT, STYLE, SIZE, OR COLOR.

FOR PROMOTING PUBLIC AWARENESS OF THE IMPORTANCE OF READING TO AND WITH CHILDREN (U.S. CLS. 100, 101 AND 102).

FIRST USE 3-10-2009; IN COMMERCE 9-1-2009.

APRIL HESIK, EXAMINING ATTORNEY

**CLASS 35—(Continued).**

SN 85-277,244. AMERICAN MEDICAL SERVICES, INC., ROCHESTER HILLS, MI. FILED 3-25-2011.

## FOR YOUR LEGS

THE MARK CONSISTS OF STANDARD CHARACTERS WITHOUT CLAIM TO ANY PARTICULAR FONT, STYLE, SIZE, OR COLOR.

SEC. 2(F).

FOR RETAIL AND ONLINE RETAIL STORE SERVICES FEATURING SOCKS, SUPPORT STOCKINGS AND FOOT ACCESSORIES, NAMELY, FOOTWEAR, ORTHOTICS FOR THE FEET, MEDICAL HOSIERY, MEDICATED FOOT CREAMS AND NON-MEDICATED FOOT CREAMS (U.S. CLS. 100, 101 AND 102).

FIRST USE 3-0-2004; IN COMMERCE 5-0-2005.

PAM WILLIS, EXAMINING ATTORNEY

---

SN 85-277,338. VISIONS FOR CHANGE, INC., SYRACUSE, NY. FILED 3-25-2011.

## VISIONSFORCHANGE

THE MARK CONSISTS OF THE STYLIZED WORDING "VISIONSFORCHANGE".

FOR CHARITABLE SERVICES, NAMELY, ORGANIZING AND DEVELOPING PROJECTS FOR FOSTERING COLLABORATION AND PARTNERSHIP AMONG COMMUNITY ORGANIZATIONS AND INDIVIDUALS THAT AIM TO IMPROVE THE LIVES OF UNDERPRIVILEGED AND IMPOVERISHED PEOPLE BY IMPROVING AND SUSTAINING QUALITY OF LIFE AND REDUCING POVERTY (U.S. CLS. 100, 101 AND 102).

FIRST USE 3-31-2010; IN COMMERCE 3-31-2010.

AMY C. KEAN, EXAMINING ATTORNEY

**CLASS 35—(Continued).**

SN 85-277,531. AMPEGY, LLC, HOUSTON, TX. FILED 3-25-2011.

AMPEGY More Markets. More  
Opportunity.

THE MARK CONSISTS OF STANDARD CHARACTERS WITHOUT CLAIM TO ANY PARTICULAR FONT, STYLE, SIZE, OR COLOR.

FOR MARKETING OF ENERGY RELATED SERVICES TO RESIDENTIAL AND COMMERCIAL CUSTOMERS, NAMELY, MARKETING SERVICES IN THE NATURE OF PROMOTING OR ADVERTISING THE ELECTRICITY AND NATURAL GAS SUPPLY SERVICES OF OTHERS TO RESIDENTIAL AND COMMERCIAL CUSTOMERS THROUGH IN PERSON SOLICITATION BY SALES PEOPLE; ON-LINE ENERGY MANAGEMENT SERVICES, NAMELY, PROVIDING AN ONLINE SERVICE THAT ALLOWS RESIDENTIAL AND COMMERCIAL CUSTOMERS TO PURCHASE ENERGY NAMELY, ELECTRICITY, NATURAL GAS AND RENEWABLE ENERGY, FROM VARIOUS ENERGY PROVIDERS; MULTILEVEL MARKETING BUSINESS SERVICES, IN THE NATURE OF PROVIDING MARKETING AND INCOME OPPORTUNITIES TO OTHERS IN THE FIELDS OF ELECTRICITY, NATURAL GAS, RENEWABLE ENERGY, DIGITAL PHONE SERVICE, WIRELESS COMMUNICATIONS, LOCAL AND LONG DISTANCE TELECOMMUNICATIONS SERVICES, DIGITAL TELEVISION TRANSMISSION SERVICES, SATELLITE TELEVISION SERVICES AND INTERNET ACCESS, AND THROUGH THE DEVELOPMENT OF MARKETING ORGANIZATIONS (U.S. CLS. 100, 101 AND 102).

FIRST USE 2-24-2011; IN COMMERCE 2-24-2011.  
DEZMONA MIZELLE, EXAMINING ATTORNEY

SN 85-278,866. USM, INC., NORWALK, CT. FILED 3-28-2011.

TOWER CLEANING SYSTEMS

THE MARK CONSISTS OF STANDARD CHARACTERS WITHOUT CLAIM TO ANY PARTICULAR FONT, STYLE, SIZE, OR COLOR.

OWNER OF U.S. REG. NO. 1,807,863.

NO CLAIM IS MADE TO THE EXCLUSIVE RIGHT TO USE "CLEANING SYSTEMS", APART FROM THE MARK AS SHOWN.

FOR FRANCHISING, NAMELY, OFFERING BUSINESS MANAGEMENT ASSISTANCE IN THE ESTABLISHMENT AND/OR OPERATION OF COMPANIES THAT CLEAN COMMERCIAL AND INDUSTRIAL PROPERTIES, NAMELY, SHOPPING CENTERS, STORES, OFFICES, FACTORIES AND WAREHOUSES (U.S. CLS. 100, 101 AND 102).

FIRST USE 11-9-1989; IN COMMERCE 11-9-1989.  
MICHAEL TANNER, EXAMINING ATTORNEY

**CLASS 35—(Continued).**

SN 85-280,295. BELLISSIMO, JOSEPH, DBA LOCALBABY.COM, HIDDEN HILLS, CA. FILED 3-29-2011.

localbaby

THE MARK CONSISTS OF STANDARD CHARACTERS WITHOUT CLAIM TO ANY PARTICULAR FONT, STYLE, SIZE, OR COLOR.

FOR COMMERCIAL INFORMATION AND DIRECTORY AGENCY; COMPILATION OF BUSINESS DIRECTORIES; ON-LINE BUSINESS DIRECTORIES FEATURING BABY AND NEW PARENT RELATED RETAILERS, GOODS, DISCOUNTS, COUPONS AND SERVICES; PROVIDING AN ON-LINE COMMERCIAL INFORMATION DIRECTORY ON THE INTERNET; PROVIDING AN ON-LINE DIRECTORY INFORMATION SERVICE FEATURING INFORMATION REGARDING BABY AND NEW PARENT RELATED RETAILERS, GOODS, DISCOUNTS, COUPONS AND SERVICES; PROVIDING ON-LINE DIRECTORY INFORMATION SERVICES ALSO FEATURING HYPERLINKS TO OTHER WEB SITES (U.S. CLS. 100, 101 AND 102).

RAMONA ORTIGA, EXAMINING ATTORNEY

SN 85-281,248. KURT T. DAUL, NEW LONDON, WI. FILED 3-30-2011.

BIG BOY TOYZ

THE MARK CONSISTS OF STANDARD CHARACTERS WITHOUT CLAIM TO ANY PARTICULAR FONT, STYLE, SIZE, OR COLOR.

FOR RETAIL STORES SERVICES AND ONLINE RETAIL STORE SERVICES FEATURING REFURBISHED MOTORIZED VEHICLES, NAMELY, MOTOR VEHICLES, OUTDOOR POWER PRODUCTS, RECREATIONAL PRODUCTS, AGRICULTURAL EQUIPMENT, INDUSTRIAL EQUIPMENT, TRAILERS, RECREATIONAL VEHICLES, CAMPING EQUIPMENT, MOTORCYCLES, MARINE PRODUCTS, TRACTORS, MOPEDS, LAWN AND GARDEN EQUIPMENT, FOOD PLOT EQUIPMENT, GOLF CARTS AND ELECTRIC SCOOTERS (U.S. CLS. 100, 101 AND 102).

KELLEY WELLS, EXAMINING ATTORNEY

**CLASS 35—(Continued).**

SN 85-281,568. EHOFF INTERNATIONAL, INC., NOT-FOR-PROFIT, PARK RIDGE, IL. FILED 3-30-2011.

# Roll Call

THE MARK CONSISTS OF STANDARD CHARACTERS WITHOUT CLAIM TO ANY PARTICULAR FONT, STYLE, SIZE, OR COLOR.

FOR ON-LINE BUSINESS DIRECTORIES FEATURING INTERNATIONAL BUSINESSES IN THE FIELD OF ENTREPRENEURSHIP (U.S. CLS. 100, 101 AND 102).  
SUE LAWRENCE, EXAMINING ATTORNEY

SN 85-281,613. HOME ANALYZERS DEVELOPMENT COMPANY LLC, GERMANTOWN, TN. FILED 3-30-2011.

## HOME ANALYZERS

THE MARK CONSISTS OF STANDARD CHARACTERS WITHOUT CLAIM TO ANY PARTICULAR FONT, STYLE, SIZE, OR COLOR.

OWNER OF U.S. REG. NO. 3,284,876.  
NO CLAIM IS MADE TO THE EXCLUSIVE RIGHT TO USE "HOME", APART FROM THE MARK AS SHOWN.

FOR FRANCHISING, NAMELY, OFFERING BUSINESS MANAGEMENT ASSISTANCE IN THE ESTABLISHMENT AND/OR OPERATION OF HOUSE AND HOME INSPECTION SERVICES (U.S. CLS. 100, 101 AND 102).

FIRST USE 1-6-2006; IN COMMERCE 2-18-2006.  
SHARON MEIER, EXAMINING ATTORNEY

**CLASS 35—(Continued).**

SN 85-283,217. EMB DESIGNS, INC., COLDWATER, OH. FILED 3-31-2011.

## LOVE YOUR BRAND.

THE MARK CONSISTS OF STANDARD CHARACTERS WITHOUT CLAIM TO ANY PARTICULAR FONT, STYLE, SIZE, OR COLOR.

FOR BRANDING SERVICES, NAMELY, CONSULTING, DEVELOPMENT, MANAGEMENT AND MARKETING OF BRANDS FOR BUSINESSES; ADVERTISING, MARKETING AND PROMOTION SERVICES; BUSINESS MARKETING CONSULTING SERVICES; CREATIVE MARKETING DESIGN SERVICES; MARKETING ANALYSIS SERVICES; ON-LINE RETAIL STORE SERVICES FEATURING A WIDE VARIETY OF CONSUMER GOODS OF OTHERS; PROVIDING INFORMATION IN THE FIELD OF MARKETING AND ON-LINE MARKETING MEDIA VIA THE INTERNET; ADVERTISING SERVICES, NAMELY, CREATING PROMOTIONAL PRINTED BUSINESS PRODUCTS ADVERTISING THE GOODS AND SERVICES OF OTHERS, NAMELY, SIGNS, BANNERS, EMBROIDERY AND SCREEN PRINTING ON COMPANY AND TEAM APPAREL; PROVIDING WEB SITES FEATURING ADVERTISEMENTS FOR THE GOODS AND SERVICES OF OTHERS; CONSULTING SERVICES IN THE FIELD OF INTERNET MARKETING (U.S. CLS. 100, 101 AND 102).

SUE LAWRENCE, EXAMINING ATTORNEY

SN 85-283,960. WABI SABI SHOP LLC, PLYMOUTH, MN. FILED 4-1-2011.

## WABI SABI SHOP

THE MARK CONSISTS OF STANDARD CHARACTERS WITHOUT CLAIM TO ANY PARTICULAR FONT, STYLE, SIZE, OR COLOR.

NO CLAIM IS MADE TO THE EXCLUSIVE RIGHT TO USE "SHOP", APART FROM THE MARK AS SHOWN.

FOR RETAIL CONSIGNMENT STORE FEATURING FURNITURE, NAMELY, SOFAS, LOVE SEATS, RECLINERS, CHAIRS, BEDS, NIGHTSTANDS, TABLES, CHESTS, DESKS, BOOKCASES, MEDIA CONSOLES, AREA RUGS, ANTIQUES, VASES, WALL HANGINGS, MIRRORS, CLOCKS, TABLE LINENS, AND OUTDOOR FURNISHINGS, NAMELY, PATIO AND LAWN FURNITURE (U.S. CLS. 100, 101 AND 102).

FIRST USE 6-30-2009; IN COMMERCE 6-30-2009.  
NATALIE POLZER, EXAMINING ATTORNEY

**CLASS 35—(Continued).**

SN 85-284,790. EHOFF INTERNATIONAL, INC., NOT-FOR-PROFIT, PARK RIDGE, IL. FILED 4-3-2011.

## Atlas Business Incubator

THE MARK CONSISTS OF STANDARD CHARACTERS WITHOUT CLAIM TO ANY PARTICULAR FONT, STYLE, SIZE, OR COLOR.

NO CLAIM IS MADE TO THE EXCLUSIVE RIGHT TO USE "BUSINESS INCUBATOR", APART FROM THE MARK AS SHOWN.

FOR INCUBATION SERVICES, NAMELY, PROVIDING WORK SPACE CONTAINING BUSINESS EQUIPMENT TO FREELANCERS, START-UPS, EXISTING BUSINESSES AND NON-PROFITS (U.S. CLS. 100, 101 AND 102).

SUE LAWRENCE, EXAMINING ATTORNEY

SN 85-287,243. MCROBERTS SALES CO., INC., RUSKIN, FL. FILED 4-5-2011.



NO CLAIM IS MADE TO THE EXCLUSIVE RIGHT TO USE "SALES CO., INC. SINCE 1968", APART FROM THE MARK AS SHOWN.

THE STIPPLING IS FOR SHADING PURPOSES ONLY. THE NAME(S), PORTRAIT(S), AND/OR SIGNATURE(S) SHOWN IN THE MARK DOES NOT IDENTIFY A PARTICULAR LIVING INDIVIDUAL.

THE MARK CONSISTS OF THE STYLIZED TEXT "MM" WITH A FISH JUMPING. TO THE RIGHT THERE IS THE STYLIZED TEXT "MCROBERTS SALES CO., INC. SINCE 1968".

FOR WHOLESALE DISTRIBUTORSHIPS FEATURING SEAFOOD FOR ANIMAL CONSUMPTION AT PARKS, AQUARIUMS, AND ZOOS (U.S. CLS. 100, 101 AND 102).

FIRST USE 11-1-2008; IN COMMERCE 11-1-2008.  
GRETTA YAO, EXAMINING ATTORNEY

SN 85-287,772. HUGEDOMAINS.COM, DENVER, CO. FILED 4-6-2011.

## HugeDomains

THE MARK CONSISTS OF STANDARD CHARACTERS WITHOUT CLAIM TO ANY PARTICULAR FONT, STYLE, SIZE, OR COLOR.

FOR OPERATING AN ONLINE MARKETPLACE FEATURING DOMAIN NAMES, NAMELY, PROVIDING INTELLECTUAL PROPERTY RIGHTS ON AFTER-MARKET DOMAIN NAMES FOR POSSIBLE ACQUISITION (U.S. CLS. 100, 101 AND 102).

FIRST USE 11-1-2005; IN COMMERCE 11-1-2005.  
DORITT L. CARROLL, EXAMINING ATTORNEY

**CLASS 35—(Continued).**

SN 85-287,834. POINT TO POINT, CLEVELAND, OH. FILED 4-6-2011.

## Pinhole Marketing

THE MARK CONSISTS OF STANDARD CHARACTERS WITHOUT CLAIM TO ANY PARTICULAR FONT, STYLE, SIZE, OR COLOR.

NO CLAIM IS MADE TO THE EXCLUSIVE RIGHT TO USE "MARKETING", APART FROM THE MARK AS SHOWN.

FOR ADVERTISEMENT AND PUBLICITY SERVICES BY TELEVISION, RADIO, MAIL; ADVERTISEMENT FOR OTHERS ON THE INTERNET; ADVERTISING AND ADVERTISEMENT SERVICES; ADVERTISING AND BUSINESS SERVICES, NAMELY, SECURING AIR-TIME ON ALL FORMS OF MEDIA COMMUNICATIONS STATIONS, SYSTEMS, NETWORKS, AND SERVICES FOR THE PURPOSE OF PROMOTING THE GOODS AND SERVICES OF OTHERS; ADVERTISING AND MARKETING; ADVERTISING AND MARKETING SERVICES PROVIDED BY MEANS OF INDIRECT METHODS OF MARKETING COMMUNICATIONS, NAMELY, SOCIAL MEDIA, SEARCH ENGINE MARKETING, INQUIRY MARKETING, INTERNET MARKETING, MOBILE MARKETING, BLOGGING AND OTHER FORMS OF PASSIVE, SHARABLE OR VIRAL COMMUNICATIONS CHANNELS; ADVERTISING CONSULTATION; ADVERTISING SERVICES; ADVERTISING, PROMOTION AND MARKETING SERVICES IN THE NATURE OF E-MAIL BLAST CAMPAIGNS FOR OTHERS; ANALYSIS OF ADVERTISING RESPONSE; BUSINESS MARKETING SERVICES; BUSINESS TO BUSINESS DIRECT MARKETING SERVICES; DEVELOPMENT OF MARKETING STRATEGIES AND CONCEPTS; DEVELOPMENT OF MARKETING STRATEGIES, CONCEPTS AND TACTICS, NAMELY, AUDIENCE DEVELOPMENT, BRAND AWARENESS, CUSTOMER RELATIONS, ONLINE COMMUNITY BUILDING AND DIGITAL WORD OF MOUTH COMMUNICATIONS; DEVELOPMENT OF MARKETING STRATEGIES, CONCEPTS AND TACTICS, NAMELY, AUDIENCE DEVELOPMENT, BRAND AWARENESS, ONLINE COMMUNITY BUILDING AND DIGITAL WORD OF MOUTH COMMUNICATIONS; INTERNET ADVERTISING SERVICES; MARKETING AND BRANDING SERVICES, NAMELY, PERFORMING CONSUMER INSIGHT AND BRAND STRATEGY OF COMPANY LOGOS; MARKETING AND BRANDING SERVICES, NAMELY, PROVIDING CUSTOMIZED COMMUNICATION PROGRAMS TO OBTAIN CONSUMER INSIGHTS AND DEVELOP BRANDING STRATEGIES; MARKETING CONSULTING; MARKETING SERVICES, NAMELY, CONSUMER MARKETING RESEARCH; MARKETING SERVICES, NAMELY, PROMOTING OR ADVERTISING THE GOODS AND SERVICES OF OTHERS; MEDIA BUYING ADVICE, NAMELY, ADVISING THE CLIENT HOW MUCH MEDIA TIME, AND AT WHAT TIMES THE CLIENT SHOULD BE PURCHASING ADVERTISING; MEDIA PLANNING, NAMELY, ADVISING THE CLIENT ON THE CORRECT TIMES AND STATIONS TO ADVERTISE BASED ON MEDIA ANALYSIS OF THE MARKET FOR THAT MEDIA; ON-LINE ADVERTISING AND MARKETING SERVICES; PROVIDING ADVERTISING AND ADVERTISEMENT SERVICES; PROVIDING BUSINESS MARKETING INFORMATION (U.S. CLS. 100, 101 AND 102).

FIRST USE 1-15-2011; IN COMMERCE 4-1-2011.  
JIM RINGLE, EXAMINING ATTORNEY

**CLASS 35—(Continued).**

SN 85-288,066. SLEEPY HOLLOW, INC., DBA RUNWAY FASHION EXCHANGE, IDAHO FALLS, ID. FILED 4-6-2011.



NO CLAIM IS MADE TO THE EXCLUSIVE RIGHT TO USE "RUNWAY FASHION EXCHANGE", APART FROM THE MARK AS SHOWN.

THE MARK CONSISTS OF A STYLIZED LETTER "R" WITH A STAR WITHIN A STAR IN THE UPPER PORTION OF THE "R" AND AN EXTENDING TAIL FROM THE "R". IT INCLUDES A STYLIZED "UNWAY". WITHIN THE EXTENDED TAIL OF THE "R" ARE THE STYLIZED WORDS "FASHION EXCHANGE" UNDERNEATH THE STYLIZED "UNWAY".

FOR FRANCHISE SERVICES, NAMELY, OFFERING BUSINESS MANAGEMENT ASSISTANCE IN THE ESTABLISHMENT AND OPERATION OF RETAIL STORES IN THE FIELD OF CLOTHING AND ACCESSORIES (U.S. CLS. 100, 101 AND 102).

FIRST USE 4-1-2010; IN COMMERCE 4-1-2010.  
LOURDES AYALA, EXAMINING ATTORNEY

**CLASS 35—(Continued).**

SN 85-289,310. METADYNAMICS, INC., TROY, MI. FILED 4-7-2011.



THE COLOR(S) BLUE AND GOLD IS/ARE CLAIMED AS A FEATURE OF THE MARK.

THE MARK CONSISTS OF THE PHRASE "META DYNAMICS" IN BLUE WITH TWO CONCENTRIC CIRCLES SHADED IN GOLD DISPOSED BETWEEN "META DYNAMICS". THE INNER CONCENTRIC CIRCLE INCLUDES THREE INTERLOCKING BLUE ARCUATE LINES. THE COLOR WHITE REPRESENTS TRANSPARENT AREAS AND IS NOT CLAIMED AS A FEATURE OF THE MARK.

FOR BUSINESS CONSULTATION SERVICES, NAMELY, PROVIDING CONSULTATION IN SYSTEM-WIDE ORGANIZATIONAL CHANGE, LEADERSHIP DEVELOPMENT, AND TEAM BUILDING (U.S. CLS. 100, 101 AND 102).

FIRST USE 7-30-1997; IN COMMERCE 7-30-1997.  
KATHERINE M. DUBRAY, EXAMINING ATTORNEY

SN 85-289,473. LRK PARTNERS, L.L.C., FRISCO, TX. FILED 4-7-2011.

SN 85-289,141. NETEXPONENT LLC, NEW YORK, NY. FILED 4-7-2011.



THE MARK CONSISTS OF THE STYLIZED WORD "NET" TO THE LEFT OF A BLACK CIRCLE WITH A STYLIZED "X" IN WHITE INSIDE THE CIRCLE.

FOR ADVERTISING AND MARKETING SERVICES, NAMELY, DISSEMINATION OF ADVERTISING FOR OTHERS; BUSINESS MARKETING CONSULTING SERVICES; DIRECT MARKETING ADVERTISING SERVICES; PROMOTING THE GOODS AND SERVICES OF OTHERS VIA DISTRIBUTING ADVERTISING ON THE INTERNET (U.S. CLS. 100, 101 AND 102).

FIRST USE 3-16-2011; IN COMMERCE 3-16-2011.  
DAWN FELDMAN, EXAMINING ATTORNEY

**TIMBERHORN HEALTHCARE SOLUTIONS**

THE MARK CONSISTS OF STANDARD CHARACTERS WITHOUT CLAIM TO ANY PARTICULAR FONT, STYLE, SIZE, OR COLOR.

NO CLAIM IS MADE TO THE EXCLUSIVE RIGHT TO USE "HEALTHCARE SOLUTIONS", APART FROM THE MARK AS SHOWN.

FOR EMPLOYMENT STAFFING IN THE FIELD OF HEALTH CARE; EMPLOYMENT AGENCY SERVICES, NAMELY, FILLING THE TEMPORARY AND PERMANENT STAFFING NEEDS OF BUSINESSES; EMPLOYMENT STAFFING CONSULTATION SERVICES; EMPLOYMENT HIRING, RECRUITING, PLACEMENT, STAFFING AND CAREER NETWORKING SERVICES; PROFESSIONAL STAFFING AND RECRUITING SERVICES (U.S. CLS. 100, 101 AND 102).

FIRST USE 2-1-2010; IN COMMERCE 2-1-2010.  
MARK SPARACINO, EXAMINING ATTORNEY



**CLASS 35—(Continued).**

SN 85-289,487. LRK PARTNERS, L.L.C., FRISCO, TX. FILED 4-7-2011.

**CLASS 35—(Continued).**

SN 85-291,410. VIP BUSINESS SOLUTIONS LLC, FLORHAM PARK, NJ. FILED 4-11-2011.

**TIMBERHORN SPECIALTY SERVICES**

**VIP Business Solutions LLC**

THE MARK CONSISTS OF STANDARD CHARACTERS WITHOUT CLAIM TO ANY PARTICULAR FONT, STYLE, SIZE, OR COLOR.

NO CLAIM IS MADE TO THE EXCLUSIVE RIGHT TO USE "SPECIALTY SERVICES", APART FROM THE MARK AS SHOWN.

FOR EMPLOYMENT STAFFING IN THE FIELD OF PROFESSIONAL BUSINESS SERVICES, NAMELY, SALES, MARKETING, BRAND MANAGEMENT, FINANCE, ACCOUNTING, HUMAN RESOURCES, SUPPLY CHAIN MANAGEMENT, MANUFACTURING, AND LEGAL SERVICES; EMPLOYMENT AGENCY SERVICES, NAMELY, FILLING THE TEMPORARY AND PERMANENT STAFFING NEEDS OF BUSINESSES; EMPLOYMENT STAFFING CONSULTATION SERVICES; EMPLOYMENT HIRING, RECRUITING, PLACEMENT, STAFFING AND CAREER NETWORKING SERVICES; PROFESSIONAL STAFFING AND RECRUITING SERVICES (U.S. CLS. 100, 101 AND 102).

FIRST USE 2-1-2010; IN COMMERCE 2-1-2010.  
MARK SPARACINO, EXAMINING ATTORNEY

THE MARK CONSISTS OF STANDARD CHARACTERS WITHOUT CLAIM TO ANY PARTICULAR FONT, STYLE, SIZE, OR COLOR.

NO CLAIM IS MADE TO THE EXCLUSIVE RIGHT TO USE "BUSINESS SOLUTIONS LLC", APART FROM THE MARK AS SHOWN.

FOR BUSINESS DEVELOPMENT SERVICES; BUSINESS MANAGEMENT (U.S. CLS. 100, 101 AND 102).  
SETH A. RAPPAPORT, EXAMINING ATTORNEY

SN 85-292,386. WOODHOUSE, SHEILA, ATLANTA, GA. FILED 4-12-2011.

SN 85-290,005. CREATIVE EDUCATION FOUNDATION, AMHERST, MA. FILED 4-8-2011.

**WHERE BRAINSTORMING BEGAN**



THE MARK CONSISTS OF STANDARD CHARACTERS WITHOUT CLAIM TO ANY PARTICULAR FONT, STYLE, SIZE, OR COLOR.

NO CLAIM IS MADE TO THE EXCLUSIVE RIGHT TO USE "BRAINSTORMING", APART FROM THE MARK AS SHOWN.

FOR BUSINESS CONSULTATION SERVICES IN THE FIELD OF CREATIVE PROBLEM SOLVING OF BUSINESS PROBLEMS (U.S. CLS. 100, 101 AND 102).

FIRST USE 1-7-2007; IN COMMERCE 1-7-2007.  
ANDREA HACK, EXAMINING ATTORNEY

THE COLOR(S) BLACK, WHITE AND RED IS/ARE CLAIMED AS A FEATURE OF THE MARK.

THE MARK CONSISTS OF THE LITERAL ELEMENTS "SENTIKON" IN BLACK COLOR WITH TWO IMAGES OF FLOATING HEARTS IN RED COLOR CREATING THE LETTER "S" IN WHITE COLOR PLACED ABOVE THE WORD "SENTIKON" AS SHOWN IN THE MARK.

FOR BUSINESS CONSULTING SERVICES IN THE FIELDS OF HEALTHCARE, CORPORATE AND GOVERNMENT (U.S. CLS. 100, 101 AND 102).

MELISSA VALLILLO, EXAMINING ATTORNEY

**CLASS 35—(Continued).**

SN 85-292,774. WAVE ELECTRONICS, INC., HOUSTON, TX. FILED 4-12-2011.



NO CLAIM IS MADE TO THE EXCLUSIVE RIGHT TO USE "ELECTRONICS", APART FROM THE MARK AS SHOWN.

THE COLOR(S) PURPLE, GREEN, AND LIGHT GREEN IS/ARE CLAIMED AS A FEATURE OF THE MARK.

THE MARK CONSISTS OF THE WORD "WAVE" IN PURPLE ABOVE THE WORD "ELECTRONICS" IN GREEN, IN FRONT OF TWO HORIZONTAL "S" SHAPED WAVES IN GREEN, AND BEHIND A SINGLE HORIZONTAL "S" SHAPED WAVE IN LIGHT GREEN, WHERE THE LIGHT GREEN WAVE IS IN BETWEEN THE TWO GREEN WAVES.

FOR WHOLESALE DISTRIBUTORSHIPS FEATURING CONSUMER ELECTRONICS AND HOME AUTOMATION/INTEGRATION PRODUCTS (U.S. CLS. 100, 101 AND 102).

FIRST USE 2-1-2002; IN COMMERCE 3-1-2002.  
RENEE MCCRAY, EXAMINING ATTORNEY

---

SN 85-294,062. RONES, SEAN, SAN DIEGO, CA. FILED 4-13-2011.

## SHOPSTICKS

THE MARK CONSISTS OF STANDARD CHARACTERS WITHOUT CLAIM TO ANY PARTICULAR FONT, STYLE, SIZE, OR COLOR.

FOR ON-LINE RETAIL STORE SERVICES FEATURING IMPORTED PRODUCTS FROM ASIA, NAMELY, KITCHEN GADGETS, WINE ACCESSORIES, HEALTH AND BEAUTY AIDS, HOME FURNISHINGS, CONSUMER ELECTRONICS, SPORTING GOODS, AUTOMOTIVE ACCESSORIES, CLOTHING AND APPAREL, AND HAND HELD APPLIANCES (U.S. CLS. 100, 101 AND 102).  
MEGHAN REINHART, EXAMINING ATTORNEY

**CLASS 35—(Continued).**

SN 85-295,431. NEXT JUMP, INC., NEW YORK, NY. FILED 4-14-2011.

## OVERWHELMING OFFERS

THE MARK CONSISTS OF STANDARD CHARACTERS WITHOUT CLAIM TO ANY PARTICULAR FONT, STYLE, SIZE, OR COLOR.

NO CLAIM IS MADE TO THE EXCLUSIVE RIGHT TO USE "OFFERS", APART FROM THE MARK AS SHOWN.

FOR DEVELOPING, IMPLEMENTING, ADMINISTERING AND SUPERVISING REWARDS, LOYALTY, INCENTIVE AND AFFINITY PROGRAMS FOR BUSINESSES WHO OFFER SUCH PROGRAMS TO OTHERS; DEVELOPING, IMPLEMENTING, ADMINISTERING AND SUPERVISING ADVERTISING AND MARKETING CAMPAIGNS FOR OTHERS (U.S. CLS. 100, 101 AND 102).

FIRST USE 5-31-2010; IN COMMERCE 5-31-2010.  
SANI KHOURI, EXAMINING ATTORNEY

---

SN 85-296,103. NEWBERY, ROBERT C., LIVINGSTON, NJ. FILED 4-15-2011.

## CAMP NOBLE CAUSE

THE MARK CONSISTS OF STANDARD CHARACTERS WITHOUT CLAIM TO ANY PARTICULAR FONT, STYLE, SIZE, OR COLOR.

NO CLAIM IS MADE TO THE EXCLUSIVE RIGHT TO USE "CAMP", APART FROM THE MARK AS SHOWN.

FOR CHARITABLE SERVICES, NAMELY, ORGANIZING AND CONDUCTING VOLUNTEER PROGRAMS AND COMMUNITY SERVICE PROJECTS AIMED AT INCREASING SUPPORT AND MORALE OF MEMBERS OF THE U.S. MILITARY (U.S. CLS. 100, 101 AND 102).

FIRST USE 4-30-2008; IN COMMERCE 4-30-2008.  
DOMINIC FATHY, EXAMINING ATTORNEY

---

SN 85-296,480. MITCHELL MANUFACTURING L.L.C., MITCHELL, SD. FILED 4-15-2011.

## Unexcelled Fishing

THE MARK CONSISTS OF STANDARD CHARACTERS WITHOUT CLAIM TO ANY PARTICULAR FONT, STYLE, SIZE, OR COLOR.

NO CLAIM IS MADE TO THE EXCLUSIVE RIGHT TO USE "FISHING", APART FROM THE MARK AS SHOWN.

FOR MAIL ORDER CATALOG SERVICES FEATURING FISHING AND MARINE ACCESSORIES; ON-LINE RETAIL STORE SERVICES FEATURING FISHING AND MARINE ACCESSORIES (U.S. CLS. 100, 101 AND 102).

FIRST USE 0-0-2006; IN COMMERCE 0-0-2006.  
BARBARA A. GOLD, EXAMINING ATTORNEY

**CLASS 35—(Continued).**

SN 85-298,945. OMX, INC., NAPERVILLE, IL. FILED 4-19-2011.



THE MARK CONSISTS OF BALL FORMED OF A PLURALITY OF RUBBER BANDS.  
FOR RETAIL STORE SERVICES AND ONLINE RETAIL STORE SERVICES FEATURING OFFICE SUPPLIES, OFFICE FURNITURE, COMPUTER SUPPLIES AND ACCESSORIES, COPYING SERVICES, NAMELY, COPYING DOCUMENTS (U.S. CLS. 100, 101 AND 102).  
FIRST USE 6-0-2006; IN COMMERCE 6-0-2006.  
JULIE WATSON, EXAMINING ATTORNEY

**CLASS 35—(Continued).**

SN 85-300,481. SOLES4SOULS, INC., OLD HICKORY, TN. FILED 4-20-2011.

# HOPE4SOULS

THE MARK CONSISTS OF STANDARD CHARACTERS WITHOUT CLAIM TO ANY PARTICULAR FONT, STYLE, SIZE, OR COLOR.  
OWNER OF U.S. REG. NOS. 3,338,146, 3,346,912 AND OTHERS.  
FOR COORDINATION OF THE PROCUREMENT AND DISTRIBUTION OF MEDICAL MATERIALS, TOYS, NON-PERISHABLE FOOD, AND OTHER PROVISIONS FROM MANUFACTURERS, WHOLESALERS, RETAILERS, AND INDIVIDUALS TO ORGANIZATIONS PROVIDING FREE ITEMS TO NEEDY PEOPLE (U.S. CLS. 100, 101 AND 102).  
FIRST USE 4-5-2011; IN COMMERCE 4-5-2011.  
ANDREW LEASER, EXAMINING ATTORNEY

SN 85-300,483. SOLES4SOULS, INC., OLD HICKORY, TN. FILED 4-20-2011.

SN 85-299,326. RLC BUSINESS PERFORMANCE LLC, BONNAIRE, GA. FILED 4-19-2011.

## RLC Business Performance

THE MARK CONSISTS OF STANDARD CHARACTERS WITHOUT CLAIM TO ANY PARTICULAR FONT, STYLE, SIZE, OR COLOR.  
NO CLAIM IS MADE TO THE EXCLUSIVE RIGHT TO USE "BUSINESS PERFORMANCE", APART FROM THE MARK AS SHOWN.  
FOR CONSULTING IN THE FIELD OF BUSINESS ORGANIZATIONAL PERFORMANCE THROUGH INTERVIEWING, DISTRIBUTING QUESTIONNAIRES, AND STATISTICAL ANALYSIS; CONSULTING IN THE FIELD OF SALES PERFORMANCES THROUGH INTEGRATION OF FUNDAMENTAL CONCEPTS WITH THE OUTPUT OF ORGANIZATIONAL ANALYSIS (U.S. CLS. 100, 101 AND 102).  
WANDA KAY PRICE, EXAMINING ATTORNEY



OWNER OF U.S. REG. NOS. 3,338,146, 3,346,912 AND OTHERS.  
THE MARK CONSISTS OF A HEART DESIGN WITH A HALO ENCIRCLING THE TOP OF THE HEART AND THE WORDS "HOPE4SOULS" INSIDE THE HEART DESIGN.  
FOR COORDINATION OF THE PROCUREMENT AND DISTRIBUTION OF MEDICAL MATERIALS, TOYS, NON-PERISHABLE FOOD, AND OTHER PROVISIONS FROM MANUFACTURERS, WHOLESALERS, RETAILERS, AND INDIVIDUALS TO ORGANIZATIONS PROVIDING FREE ITEMS TO NEEDY PEOPLE (U.S. CLS. 100, 101 AND 102).  
FIRST USE 4-5-2011; IN COMMERCE 4-5-2011.  
ANDREW LEASER, EXAMINING ATTORNEY

**CLASS 35—(Continued).**

SN 85-300,698. MONSTER VISION, LLC, ORLANDO, FL. FILED 4-21-2011.

**MONSTER MOBILE**

THE MARK CONSISTS OF STANDARD CHARACTERS WITHOUT CLAIM TO ANY PARTICULAR FONT, STYLE, SIZE, OR COLOR.

OWNER OF U.S. REG. NO. 3,058,680.  
NO CLAIM IS MADE TO THE EXCLUSIVE RIGHT TO USE "MOBILE", APART FROM THE MARK AS SHOWN.  
FOR ADVERTISING SERVICES, NAMELY, DISSEMINATION OF ADVERTISING FOR OTHERS USING MOBILE COMMUNICATIONS; ADVERTISING SERVICES, NAMELY, DISSEMINATION OF ADVERTISING FOR OTHERS (U.S. CLS. 100, 101 AND 102).  
KAELIE KUNG, EXAMINING ATTORNEY

**CLASS 35—(Continued).**

SN 85-303,112. TIN-VA LATIN, LLC LIMITED LIABILITY COMPANY, PLAYA VISTA, CA. FILED 4-24-2011.

**DO IT AND FEEL LIKE A DANCE STAR!**

THE MARK CONSISTS OF STANDARD CHARACTERS WITHOUT CLAIM TO ANY PARTICULAR FONT, STYLE, SIZE, OR COLOR.

FOR ADVERTISING AND MARKETING SERVICES PROVIDED BY MEANS OF INDIRECT METHODS OF MARKETING COMMUNICATIONS, NAMELY, SOCIAL MEDIA, SEARCH ENGINE MARKETING, INQUIRY MARKETING, INTERNET MARKETING, MOBILE MARKETING, BLOGGING AND OTHER FORMS OF PASSIVE, SHARABLE OR VIRAL COMMUNICATIONS CHANNELS (U.S. CLS. 100, 101 AND 102).  
FIRST USE 1-15-2007; IN COMMERCE 12-15-2008.  
ERIN FALK, EXAMINING ATTORNEY

SN 85-303,107. QUANTUM MEDICAL LLC, DENVER, CO. FILED 4-24-2011.

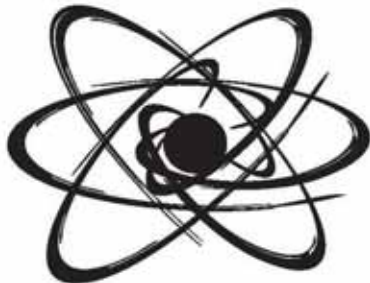

THE MARK CONSISTS OF THE DESIGN OF SWIRLY LINES AND OPEN OVALS, CROSSING OVER EACH OTHER, WITH A FILLED CIRCLE IN THE CENTER.

FOR DISTRIBUTORSHIP SERVICES IN THE FIELD OF MEDICAL DEVICES; BUSINESS CONSULTING SERVICES IN THE FIELD OF MEDICAL DEVICES (U.S. CLS. 100, 101 AND 102).

FIRST USE 2-0-2007; IN COMMERCE 2-0-2007.  
DAWN HAN, EXAMINING ATTORNEY

SN 85-303,161. TIN-VA LATIN, LLC LIMITED LIABILITY COMPANY, PLAYA VISTA, CA. FILED 4-25-2011.

**LATINVA**

THE MARK CONSISTS OF STANDARD CHARACTERS WITHOUT CLAIM TO ANY PARTICULAR FONT, STYLE, SIZE, OR COLOR.

OWNER OF U.S. REG. NO. 3,547,840.  
THE WORDING "LATINVA" HAS NO MEANING IN A FOREIGN LANGUAGE.

FOR ADVERTISING AND MARKETING SERVICES PROVIDED BY MEANS OF INDIRECT METHODS OF MARKETING COMMUNICATIONS, NAMELY, SOCIAL MEDIA, SEARCH ENGINE MARKETING, INQUIRY MARKETING, INTERNET MARKETING, MOBILE MARKETING, BLOGGING AND OTHER FORMS OF PASSIVE, SHARABLE OR VIRAL COMMUNICATIONS CHANNELS (U.S. CLS. 100, 101 AND 102).

FIRST USE 1-15-2007; IN COMMERCE 12-15-2008.  
ERIN FALK, EXAMINING ATTORNEY

**CLASS 35—(Continued).**

SN 85-303,937. LYNCHPIN BIOMEDIA, LLC, MARTINSBURG, WV. FILED 4-25-2011.



THE COLOR(S) GREEN AND BLACK IS/ARE CLAIMED AS A FEATURE OF THE MARK.

THE MARK CONSISTS OF THE WORD "LYNCHPIN" WITH AN UPPERCASE "L" AND THE REMAINING LETTERS IN LOWERCASE ALL LETTERS IN SAID WORD IN BLACK, ABOVE AND TO THE LEFT OF THE WORD "BIOMEDIA" WITH THE LETTERS "B" AND "M" IN UPPERCASE AND THE REMAINING LETTERS IN LOWERCASE ALL LETTERS IN SAID WORD IN GREEN, WITH A SERIES OF GREEN LINES IN A SEMI-CIRCLE RUNNING FROM BELOW THE "E" IN "BIOMEDIA" TO THE RIGHT AND TO THE TOP OF THE FINAL "N" IN "LYNCHPIN".

FOR ADVERTISING SERVICES, PUBLIC RELATIONS AND MARKETING SERVICES, NAMELY, PROMOTING AND MARKETING THE GOODS AND SERVICES OF OTHERS THROUGH ALL PUBLIC COMMUNICATION MEANS; BRANDING SERVICES, NAMELY, CONSULTING, DEVELOPMENT, MANAGEMENT AND MARKETING OF BRANDS FOR BUSINESSES; DEVELOPMENT OF MARKETING STRATEGIES AND CONCEPTS; MARKETING CONSULTATION IN THE FIELD OF HEALTH (U.S. CLS. 100, 101 AND 102).

DOUGLAS LEE, EXAMINING ATTORNEY

**CLASS 35—(Continued).**

SN 85-304,552. SB MUNICIPAL LLC, HOLLYWOOD, FL. FILED 4-26-2011.

# LienBase

THE MARK CONSISTS OF STANDARD CHARACTERS WITHOUT CLAIM TO ANY PARTICULAR FONT, STYLE, SIZE, OR COLOR.

FOR TAX LIEN MANAGEMENT SERVICES, NAMELY, PURCHASING, SERVICING AND MANAGING MUNICIPAL TAX LIENS; PROVIDING A WEB-BASED SYSTEM FOR THE SERVICING, REPORTING AND MANAGEMENT OF MUNICIPAL TAX LIENS (U.S. CLS. 100, 101 AND 102).

FIRST USE 10-12-2009; IN COMMERCE 10-12-2009.

JOHN WILKE, EXAMINING ATTORNEY

SN 85-307,183. CHAROEN POKPHAND GROUP CO., LTD., BANGKOK 10500, THAILAND, FILED 4-28-2011.

SN 85-303,946. NATIONAL ASSOCIATION OF CHAIN DRUG STORES, INC., ALEXANDRIA, VA. FILED 4-25-2011.



## TOTAL STORE EXPO

THE MARK CONSISTS OF STANDARD CHARACTERS WITHOUT CLAIM TO ANY PARTICULAR FONT, STYLE, SIZE, OR COLOR.

NO CLAIM IS MADE TO THE EXCLUSIVE RIGHT TO USE "STORE EXPO", APART FROM THE MARK AS SHOWN.

FOR ASSOCIATION SERVICES, NAMELY, PROMOTING THE INTERESTS OF COMMUNITY RETAIL PHARMACIES THROUGH TRADE SHOWS (U.S. CLS. 100, 101 AND 102).

FIRST USE 5-1-2011; IN COMMERCE 5-1-2011.

GIANCARLO CASTRO, EXAMINING ATTORNEY

OWNER OF U.S. REG. NOS. 3,693,119, 3,884,431 AND OTHERS.

NO CLAIM IS MADE TO THE EXCLUSIVE RIGHT TO USE "FRESH MART", APART FROM THE MARK AS SHOWN.

THE MARK CONSISTS OF THE STYLIZED WORDING "CP FRESHMART", WITH "CP" ENCLOSED IN A CIRCLE AT THE LEFT, AND "FRESHMART" IN SCRIPT, ALL UNDERLINED WITH A SOLID HORIZONTAL LINE REACHING A POINT AT BOTH ENDS, AND THE THAI EQUIVALENT OF "CP FRESHMART" IN THE UPPER RIGHT CORNER.

THE NON-LATIN CHARACTERS IN THE MARK TRANSLITERATE TO "CP FRESHMART" AND THIS HAS NO MEANING IN A FOREIGN LANGUAGE.

FOR RETAIL GROCERY STORES (U.S. CLS. 100, 101 AND 102).

ESTHER A. BORSUK, EXAMINING ATTORNEY

**CLASS 35—(Continued).**

SN 85-307,798. BIG DEAL CORPORATION, BELLEVUE, WA. FILED 4-28-2011.

**DEAL ZOO**

THE MARK CONSISTS OF STANDARD CHARACTERS WITHOUT CLAIM TO ANY PARTICULAR FONT, STYLE, SIZE, OR COLOR.

OWNER OF U.S. REG. NO. 3,430,216.

NO CLAIM IS MADE TO THE EXCLUSIVE RIGHT TO USE "DEAL", APART FROM THE MARK AS SHOWN.

FOR ADVERTISING AND PROMOTIONAL SERVICES; PROMOTING THE GOODS AND SERVICES OF OTHERS BY PROVIDING A WEBSITE FEATURING SPECIAL OFFERS, PRODUCT AND SERVICE REVIEWS, LINKS TO THE RETAIL WEBSITES OF OTHERS, AND DISCOUNT INFORMATION (U.S. CLS. 100, 101 AND 102).

GRETTA YAO, EXAMINING ATTORNEY

SN 85-307,884. MTB INNOVATIONS, ATLANTA, GA. FILED 4-28-2011.



NO CLAIM IS MADE TO THE EXCLUSIVE RIGHT TO USE "PUPS", APART FROM THE MARK AS SHOWN.

THE MARK CONSISTS OF TWO DOGS SITTING IN FRONT OF THE ATLANTA SKYLINE. ON THE UPPER RIGHT CORNER THERE IS THE STYLIZED TEXT "UPTOWN PUPS".

FOR RETAIL STORE AND ON-LINE RETAIL STORE SERVICES FEATURING PET PRODUCTS AND SUPPLIES (U.S. CLS. 100, 101 AND 102).

FIRST USE 8-31-2010; IN COMMERCE 11-1-2010.

MICHELE SWAIN, EXAMINING ATTORNEY

SN 85-308,266. SUSAN GOUVEIA, GRASS VALLEY, CA. FILED 4-29-2011.

**Society of Garden Goddesses**

THE MARK CONSISTS OF STANDARD CHARACTERS WITHOUT CLAIM TO ANY PARTICULAR FONT, STYLE, SIZE, OR COLOR.

NO CLAIM IS MADE TO THE EXCLUSIVE RIGHT TO USE "SOCIETY", APART FROM THE MARK AS SHOWN.

FOR CLUB SERVICES, NAMELY, PROMOTING THE INTERESTS OF WOMEN IN ORGANIC SUSTAINABLE GARDENING (U.S. CLS. 100, 101 AND 102).

GIANCARLO CASTRO, EXAMINING ATTORNEY

**CLASS 35—(Continued).**

SN 85-308,787. CANADA PRESCRIPTION SERVICE, BOISE, ID. FILED 4-29-2011.

**UNIVERSAL PRESCRIPTION**

THE MARK CONSISTS OF STANDARD CHARACTERS WITHOUT CLAIM TO ANY PARTICULAR FONT, STYLE, SIZE, OR COLOR.

NO CLAIM IS MADE TO THE EXCLUSIVE RIGHT TO USE "PRESCRIPTION", APART FROM THE MARK AS SHOWN.

FOR MAIL ORDER PHARMACY SERVICES; PHARMACEUTICAL SERVICES, NAMELY, PROCESSING ON-LINE AND TELEPHONE PRESCRIPTION ORDERS IN RETAIL AND CENTRAL FILL PHARMACIES (U.S. CLS. 100, 101 AND 102).

FIRST USE 2-2-2011; IN COMMERCE 2-14-2011.

PAM WILLIS, EXAMINING ATTORNEY

SN 85-309,609. HOLOMAR, INC., DBA WORXRITE.COM, SUGAR LAND, TX. FILED 5-2-2011.

**SEARCH2FIT**

THE MARK CONSISTS OF STANDARD CHARACTERS WITHOUT CLAIM TO ANY PARTICULAR FONT, STYLE, SIZE, OR COLOR.

FOR PROMOTING THE GOODS OF OTHERS BY ALLOWING PROSPECTIVE CUSTOMERS TO USE 2-D AND 3-D COMPUTER-GENERATED MODELS OF THE GOODS OF OTHERS TO EVALUATE THE GOODS OF OTHERS BEFORE PURCHASING; OPERATING ON-LINE MARKETPLACES FOR SELLERS OF GOODS AND/OR SERVICES (U.S. CLS. 100, 101 AND 102).

HOWARD B. LEVINE, EXAMINING ATTORNEY

SN 85-309,612. HOLOMAR, INC., DBA WORXRITE.COM, SUGAR LAND, TX. FILED 5-2-2011.

**WORXRITE**

THE MARK CONSISTS OF STANDARD CHARACTERS WITHOUT CLAIM TO ANY PARTICULAR FONT, STYLE, SIZE, OR COLOR.

FOR PROMOTING THE GOODS OF OTHERS BY ALLOWING PROSPECTIVE CUSTOMERS TO USE 2-D AND 3-D COMPUTER-GENERATED MODELS OF THE GOODS OF OTHERS TO EVALUATE THE GOODS OF OTHERS BEFORE PURCHASING; OPERATING ON-LINE MARKETPLACES FOR SELLERS OF GOODS AND/OR SERVICES (U.S. CLS. 100, 101 AND 102).

HOWARD B. LEVINE, EXAMINING ATTORNEY

**CLASS 35—(Continued).**

SN 85-309,769. PATSCHULL, GREG, SAN PEDRO, CA. FILED 5-2-2011.

**OCTAGON NATION**

THE MARK CONSISTS OF STANDARD CHARACTERS WITHOUT CLAIM TO ANY PARTICULAR FONT, STYLE, SIZE, OR COLOR.

FOR RETAIL STORE SERVICES FEATURING MIXED MARTIAL ARTS SPORTS GEAR, AND OCTAGON FIGHTING CAGES; ONLINE RETAIL STORE SERVICES FEATURING MIXED MARTIAL ARTS SPORTS GEAR, AND OCTAGON FIGHTING CAGES (U.S. CLS. 100, 101 AND 102).

PRISCILLA MILTON, EXAMINING ATTORNEY

SN 85-310,155. CENTRIC GROUP, LLC, ST. LOUIS, MO. FILED 5-2-2011.

**COMMISSARY PLUS**

THE MARK CONSISTS OF STANDARD CHARACTERS WITHOUT CLAIM TO ANY PARTICULAR FONT, STYLE, SIZE, OR COLOR.

NO CLAIM IS MADE TO THE EXCLUSIVE RIGHT TO USE "COMMISSARY", APART FROM THE MARK AS SHOWN.

FOR COMPUTERIZED ON-LINE ORDERING FEATURING GENERAL MERCHANDISE AND GENERAL CONSUMER GOODS (U.S. CLS. 100, 101 AND 102).

BRIAN NEVILLE, EXAMINING ATTORNEY

SN 85-310,202. THE JG PRESS, INC., EMMAUS, PA. FILED 5-2-2011.

**BIOCYCLE'S  
FINDACOMPOSTER.COM**

THE MARK CONSISTS OF STANDARD CHARACTERS WITHOUT CLAIM TO ANY PARTICULAR FONT, STYLE, SIZE, OR COLOR.

NO CLAIM IS MADE TO THE EXCLUSIVE RIGHT TO USE "FINDACOMPOSTER.COM", APART FROM THE MARK AS SHOWN.

FOR ADVERTISING AND DIRECTORY SERVICES, NAMELY, PROMOTING THE SERVICES OF COMPOSTING FACILITIES BY PROVIDING A WEB PAGE FEATURING LINKS TO THE WEBSITES, ADDRESSES, TELEPHONE NUMBERS, FAXES AND/OR E-MAIL ADDRESSES OF SUCH FACILITIES (U.S. CLS. 100, 101 AND 102).

FIRST USE 12-1-2007; IN COMMERCE 12-1-2007.

WILLIAM P. SHANAHAN, EXAMINING ATTORNEY

**CLASS 35—(Continued).**

SN 85-310,376. HOME GARDENS TO GO, PLEASANT GROVE, UT. FILED 5-2-2011.

**Home Gardens To Go**

THE MARK CONSISTS OF STANDARD CHARACTERS WITHOUT CLAIM TO ANY PARTICULAR FONT, STYLE, SIZE, OR COLOR.

NO CLAIM IS MADE TO THE EXCLUSIVE RIGHT TO USE "HOME GARDENS", APART FROM THE MARK AS SHOWN.

FOR ON-LINE RETAIL STORE SERVICES FEATURING SQUARE FOOT GARDENING PRODUCTS (U.S. CLS. 100, 101 AND 102).

FIRST USE 3-5-2009; IN COMMERCE 3-0-2011.

ANTHONY RINKER, EXAMINING ATTORNEY

SN 85-310,893. TYLER, NICOLE, RICHMOND, VA. AND LOCKLEY, BENNIKA, RICHMOND, VA. FILED 5-3-2011.

**Shoeicide**

THE MARK CONSISTS OF STANDARD CHARACTERS WITHOUT CLAIM TO ANY PARTICULAR FONT, STYLE, SIZE, OR COLOR.

FOR RETAIL STORE AND ON-LINE RETAIL STORE SERVICES FEATURING WOMEN'S SHOES (U.S. CLS. 100, 101 AND 102).

THEODORE MCBRIDE, EXAMINING ATTORNEY

SN 85-311,083. PATRICK ULMER, LEESBURG, VA. FILED 5-3-2011.



NO CLAIM IS MADE TO THE EXCLUSIVE RIGHT TO USE "MMA BRANDED", APART FROM THE MARK AS SHOWN.

THE MARK CONSISTS OF "CAGEMADE MMA BRANDED", WITH THE SECOND LETTER AND SIXTH LETTER OF THE FIRST WORD APPEARING AS AN INVERTED "V". THE WORD "CAGEMADE" HAS THE SIZE OF THE LETTERS GROWING LARGER IN HEIGHT FROM "EM" TO THE END LETTERS "C" AND "E".

FOR ON-LINE RETAIL AND WHOLESALE STORE SERVICES FEATURING T-SHIRTS, SWEATSHIRTS, SHIRTS, TANK TOPS, SWEATERS, HOODED SWEATSHIRTS, PULLOVERS, VESTS, PAJAMAS, SHORTS, PANTS, SWEATPANTS, SOCKS, HATS, CAPS, SKULL CAPS, BEANIES, BELTS, WRISTBANDS, HEADBANDS, AND JACKETS (U.S. CLS. 100, 101 AND 102).

MARGERY A. TIERNEY, EXAMINING ATTORNEY



**CLASS 35—(Continued).**

SN 85-311,852. RED CARPET DATABASE LLC, LAS VEGAS, NV. FILED 5-4-2011.

**RED CARPET DATABASE**

THE MARK CONSISTS OF STANDARD CHARACTERS WITHOUT CLAIM TO ANY PARTICULAR FONT, STYLE, SIZE, OR COLOR.

NO CLAIM IS MADE TO THE EXCLUSIVE RIGHT TO USE "DATABASE", APART FROM THE MARK AS SHOWN. FOR BUSINESS SERVICES, NAMELY, MANAGEMENT AND COMPILATION OF A DATABASE FEATURING FASHION AND CELEBRITIES; PROVIDING WEBSITE ADVERTISING PRODUCTS AND SERVICES FOR OTHERS (U.S. CLS. 100, 101 AND 102).  
DAVID I, EXAMINING ATTORNEY

SN 85-311,927. TEAM ALLIANCE INC., FAIRFIELD, NJ. FILED 5-4-2011.



THE COLOR(S) BLACK, NAVY, TURQUOISE, AND GRAY IS/ARE CLAIMED AS A FEATURE OF THE MARK.

THE MARK CONSISTS OF A CIRCLE WITH AN INVERTED "V" WITHIN THE CIRCLE. THE INVERTED "V" IS IN GRAY, AND OUTSIDE THE "V" IS NAVY AND INSIDE THE "V" IS TURQUOISE. THE WORDS "TEAM ALLIANCE AFFILIATE OF KMM" ARE WRITTEN IN BLACK TO THE RIGHT OF AND BELOW THE CIRCLE DESIGN. THE LETTERS "KMM" HAVE A CURVE THAT SLOPES UP TO THE RIGHT HAND SIDE OF THE LETTERS AND CUTS THROUGH ALL THREE OF THE LETTERS AND ENDS WITH A BLACK SLOPING LINE ABOVE THE SECOND "M."

FOR SUPPLY CHAIN INTEGRATION AND LOGISTICS SERVICES FOR TELECOMMUNICATION CARRIERS AND ORIGINAL EQUIPMENT MANUFACTURERS, NAMELY, BUSINESS CONSULTING AND SUPPLY CHAIN MANAGEMENT SERVICES REGARDING SOURCING OF PRODUCTS AND SERVICES, CONTRACT MANAGEMENT, INVENTORY PLANNING AND PROCUREMENT, TELECOMMUNICATION MATERIAL SUPPLY MANAGEMENT AND DEPLOYMENT, WAREHOUSING OF SUPPLIES AND MATERIALS, CABLE-CUTTING SERVICES, AND INFORMATION TECHNOLOGY SYSTEMS INTEGRATION AND PROJECT MANAGEMENT (U.S. CLS. 100, 101 AND 102).

FIRST USE 3-11-2011; IN COMMERCE 4-12-2011.  
LINDSEY RUBIN, EXAMINING ATTORNEY

**CLASS 35—(Continued).**

SN 85-312,147. WOOHOO ONLINE, LLC, LOS ANGELES, CA. FILED 5-4-2011.



THE COLOR(S) BLUE AND BLACK IS/ARE CLAIMED AS A FEATURE OF THE MARK.

THE MARK CONSISTS OF THE STYLIZED LETTERS "A" AND "M" IN A CIRCLE, AND THE STYLIZED PHRASE "AUTOMATEDMAN". THE OUTSIDE OF THE CIRCLE AND THE STYLIZED LETTERS "A" AND "M" APPEAR IN BLUE. THE INSIDE OF THE CIRCLE APPEARS IN BLACK. THE PHRASE "AUTOMATEDMAN" APPEARS IN BLACK WITH THE TERM "MAN" APPEARING IN BOLD.

FOR ONLINE RETAIL STORE SERVICES FEATURING MEN'S GROOMING AND TOILETRY PRODUCTS OF OTHERS IN THE NATURE OF RAZOR BLADES, AFTERSHAVES, SHAMPOOS, HAIR CONDITIONERS, HAIR GELS, HAIR FORMING CREAMS, MOUTH WASH, DEODORANTS, COTTON SWABS, SUN BLOCK, LIP BALMS, TOOTHPASTES, DENTAL FLOSS, SOAP BARS, BODY WASH, SHAVE CREAMS, SHAVE GELS, AFTER SHAVE BALMS, PRE-SHAVE TOWELS, FACIAL CLEANSERS, FACIAL MOISTURIZERS, FACIAL CREAMS, AND CONDOMS, AND ADDITIONAL PRODUCTS OF OTHERS IN THE NATURE OF T-SHIRTS, KEY CHAINS, MUGS, GROOMING AND TOILETRY KITS, AND TOILETRY BAGS, THROUGH A WEB SITE (U.S. CLS. 100, 101 AND 102).

FIRST USE 1-13-2011; IN COMMERCE 1-13-2011.

JACLYN KIDWELL WALKER, EXAMINING ATTORNEY

SN 85-312,832. SUGAR RUSH, INC., LITTLETON, CO. FILED 5-5-2011.



OWNER OF U.S. REG. NO. 3,821,787.

THE COLOR(S) BROWN AND PINK IS/ARE CLAIMED AS A FEATURE OF THE MARK.

THE MARK CONSISTS OF PINK CIRCLE WITH A BROWN SWIRL.

FOR RETAIL CANDY STORES; RETAIL STORE AND ON-LINE RETAIL STORE SERVICES FEATURING CANDIES AND CONFECTIONARIES (U.S. CLS. 100, 101 AND 102).

FIRST USE 5-20-2009; IN COMMERCE 5-20-2009.

FONG HSU, EXAMINING ATTORNEY



**CLASS 35—(Continued).**

SN 85-313,050. BONNER, DALE E., LOS ANGELES, CA.  
FILED 5-5-2011.

Cal-Infra Advisors, Inc.

THE MARK CONSISTS OF STANDARD CHARACTERS WITHOUT CLAIM TO ANY PARTICULAR FONT, STYLE, SIZE, OR COLOR.

NO CLAIM IS MADE TO THE EXCLUSIVE RIGHT TO USE "ADVISORS" AND "INC.", APART FROM THE MARK AS SHOWN.

FOR BUSINESS ADVISORY SERVICES, CONSULTANCY AND INFORMATION (U.S. CLS. 100, 101 AND 102).

ERIN FALK, EXAMINING ATTORNEY

SN 85-313,343. PARTS FOR A CAUSE, INC., SUWANEE, GA.  
FILED 5-5-2011.

PARTS FOR A CAUSE

THE MARK CONSISTS OF STANDARD CHARACTERS WITHOUT CLAIM TO ANY PARTICULAR FONT, STYLE, SIZE, OR COLOR.

NO CLAIM IS MADE TO THE EXCLUSIVE RIGHT TO USE "PARTS", APART FROM THE MARK AS SHOWN.

FOR ONLINE RETAIL AND WHOLESALE DISTRIBUTORSHIP SERVICES IN THE FIELD OF AUTOMOBILE AND LIGHT TRUCK REPLACEMENT PARTS AND ACCESSORIES; ELECTRONIC, MAIL ORDER, AND WEB BASED CATALOG SERVICES IN THE FIELD OF AUTOMOBILE AND LIGHT TRUCK REPLACEMENT PARTS AND ACCESSORIES (U.S. CLS. 100, 101 AND 102).

COLLEEN DOMBROW, EXAMINING ATTORNEY

**CLASS 35—(Continued).**

SN 85-313,834. PAVESA CARLOS CESAR, CIUDAD DE BUENOS AIRES, ARGENTINA, FILED 5-5-2011.



OWNER OF ARGENTINA REG. NO. 1926441, DATED 5-13-2003, EXPIRES 5-13-2013.

THE MARK CONSISTS OF THERE APPEARS THE WORD "ENGORMIX.COM" WITH THE LETTER "E" ABOVE IT, BOTH IN LOWER CASE. THERE APPEAR THE SHAPE OF A COW ON THE UPPER LEFT SIDE OF THE LETTER "E", HALF THE SHAPE OF A PIG ON THE LOWER LEFT SIDE OF THE LETTER "E", THE SHAPE OF A ROOSTER ON THE UPPER RIGHT SIDE NEXT TO THE COW, AND A RABBIT ON THE LOWER RIGHT SIDE OF THE LETTER "E". THE LETTER "E" IS BIGGER THAN "ENGORMIX.COM".

FOR ADVERTISEMENT FOR OTHERS ON THE INTERNET; ADVERTISING AND COMMERCIAL INFORMATION SERVICES, VIA THE INTERNET; ADVERTISING AND MARKETING SERVICES PROVIDED BY MEANS OF INDIRECT METHODS OF MARKETING COMMUNICATIONS, NAMELY, SOCIAL MEDIA, SEARCH ENGINE MARKETING, INQUIRY MARKETING, INTERNET MARKETING, MOBILE MARKETING, BLOGGING AND OTHER FORMS OF PASSIVE, SHARABLE OR VIRAL COMMUNICATIONS CHANNELS; ADVERTISING ON THE INTERNET FOR OTHERS; ADVERTISING SERVICES, NAMELY, PROMOTING PROPERTIES FOR SALE BY OWNER VIA THE INTERNET; ADVERTISING VIA ELECTRONIC MEDIA AND SPECIFICALLY THE INTERNET; ADVICE AND INFORMATION ABOUT CUSTOMER SERVICES AND PRODUCT MANAGEMENT AND PRICES ON INTERNET SITES IN CONNECTION WITH PURCHASES MADE OVER THE INTERNET; BUSINESS ADMINISTRATION SERVICES FOR PROCESSING SALES MADE ON THE INTERNET; BUSINESS MANAGEMENT CONSULTANCY, ALSO VIA THE INTERNET; COMPILATION OF ADVERTISEMENTS FOR USE AS WEB PAGES ON THE INTERNET; DESIGN OF INTERNET ADVERTISING; DISSEMINATION OF ADVERTISING FOR OTHERS VIA AN ON-LINE COMMUNICATIONS NETWORK ON THE INTERNET; DISSEMINATION OF ADVERTISING FOR OTHERS VIA THE INTERNET; INFORMATION, ADVISORY AND CONSULTANCY SERVICES RELATING TO BUSINESS AND MANAGEMENT OR BUSINESS ADMINISTRATION, INCLUDING SUCH SERVICES PROVIDED ON LINE OR VIA THE INTERNET; INFORMATION, ADVISORY, CONSULTING, BUSINESS RESEARCH AND PLANNING SERVICES RELATING TO PUBLICITY, MARKETING COMMUNICATIONS, REPUTATION MANAGEMENT OR BUSINESS ADMINISTRATION, INCLUDING SUCH SERVICES PROVIDED ONLINE OR VIA THE INTERNET; INTERNET ADVERTISING SERVICES; ON-LINE BUSINESS RESEARCH SERVICE THAT ALLOWS THE USER TO ANALYZE OPINION TRENDS CONTAINED IN DOCUMENTS ON THE INTERNET; PROMOTING THE GOODS AND SERVICES OF OTHERS BY MEANS OF DISTRIBUTING ADVERTISING ON THE INTERNET; PROVIDING A SEARCHABLE INTERNET DATABASE OF POTENTIAL HOME BUYERS WITH THE PURPOSE OF MATCHING HOME BUYERS WITH HOME SELLERS; PROVIDING A SEARCHABLE ON-LINE ADVERTISING WEBSITE AND GUIDE FEATURING THE GOODS AND SERVICES OF OTHER VENDORS VIA THE INTERNET; PROVIDING A SEARCHABLE ONLINE

**CLASS 35—(Continued).**

ADVERTISING GUIDE FEATURING THE GOODS AND SERVICES OF OTHER ON-LINE VENDORS ON THE INTERNET; PROVIDING A SECURED ACCESS DATABASE VIA THE INTERNET THROUGH WHICH DOCUMENTS AND IMAGES CAN BE VIEWED, COPIED, AND PRINTED FOR PURPOSES OF CONDUCTING CORPORATE TRANSACTIONS; PROVIDING AN INTERNET WEBSITE FEATURING NEWS AND INFORMATION IN THE FIELD OF NATIONAL AND INTERNATIONAL POLITICS; PROVIDING AN INTERNET WEBSITE FEATURING NEWS AND INFORMATION IN THE FIELD OF NATURAL RESOURCE MANAGEMENT RELATING TO THE ENVIRONMENT AND PUBLIC LANDS; PROVIDING AN INTERNET WEBSITE PORTAL FEATURING PROMOTION AND ADVERTISING FOR HOME SERVICE PROVIDERS AND PRODUCT MANUFACTURERS; PROVIDING AN ON-LINE COMMERCIAL INFORMATION DIRECTORY ON THE INTERNET; PROVIDING AND RENTAL OF ADVERTISING SPACE ON THE INTERNET; PROVIDING BUSINESS INFORMATION, ALSO VIA INTERNET, THE CABLE NETWORK OR OTHER FORMS OF DATA TRANSFER; PROVIDING BUSINESS INFORMATION, NAMELY, COMMERCIAL CORPORATE AND STATISTICAL INFORMATION PROVIDED ON-LINE FROM A COMPUTER DATABASE OR THE INTERNET; PROVIDING INFORMATION IN THE FIELD OF MARKETING AND ON-LINE MARKETING MEDIA VIA THE INTERNET; PROVIDING INFORMATION PERTAINING TO PROCUREMENT, BUYING, SELLING AND TENDERING INFORMATION AND OPPORTUNITIES RELATING TO GOODS, SERVICES, AND CONSTRUCTION VIA COMPUTER, COMPUTER NETWORKS, TELEPHONE, THE INTERNET OR ELECTRONIC MAIL; THE BRINGING TOGETHER, FOR THE BENEFIT OF OTHERS, OF A VARIETY OF GOODS AND SERVICES, ENABLING CUSTOMERS TO CONVENIENTLY VIEW AND PURCHASE THOSE GOODS AND SERVICES FROM AN INTERNET WEB SITE PARTICULARLY SPECIALIZING IN THE MARKETING OF THE SALE OF GOODS AND SERVICES OF OTHERS (U.S. CLS. 100, 101 AND 102).

JAMES A. RAUEN, EXAMINING ATTORNEY

SN 85-313,951. WOOP MEDIA, PARIS, FRANCE, FILED 5-6-2011.

**BONUS BRIGADE**

THE MARK CONSISTS OF STANDARD CHARACTERS WITHOUT CLAIM TO ANY PARTICULAR FONT, STYLE, SIZE, OR COLOR.

NO CLAIM IS MADE TO THE EXCLUSIVE RIGHT TO USE "BONUS", APART FROM THE MARK AS SHOWN.

FOR PROVIDING AN ON-LINE WEBSITE FOR PRICE COMPARISON INFORMATION; PROMOTING THE GOODS AND SERVICES OF OTHERS BY PROVIDING A WEB SITE FEATURING COUPONS, REBATES, PRICE-COMPARISON INFORMATION, PRODUCT REVIEWS, LINKS TO THE RETAIL WEB SITES OF OTHERS, AND DISCOUNT INFORMATION; MARKETING AND ADVERTISING CONSULTING SERVICES (U.S. CLS. 100, 101 AND 102).

ESTHER BELENKER, EXAMINING ATTORNEY

**CLASS 35—(Continued).**

SN 85-314,068. JENI'S SPLENDID ICE CREAMS, LLC, COLUMBUS, OH. FILED 5-6-2011.

**ART · IS · AN ICE CREAM**

THE MARK CONSISTS OF STANDARD CHARACTERS WITHOUT CLAIM TO ANY PARTICULAR FONT, STYLE, SIZE, OR COLOR.

NO CLAIM IS MADE TO THE EXCLUSIVE RIGHT TO USE "ICE CREAM", APART FROM THE MARK AS SHOWN.

FOR ON-LINE WHOLESALE AND RETAIL STORE SERVICES FEATURING ICE CREAM, SORBET AND FROZEN YOGURT; WHOLESALE AND RETAIL STORE SERVICES FEATURING ICE CREAM, SORBET AND FROZEN YOGURT (U.S. CLS. 100, 101 AND 102).

FIRST USE 3-31-2008; IN COMMERCE 3-31-2008.

JILL C. ALT, EXAMINING ATTORNEY

SN 85-314,153. LED SOURCE LLC, WELLINGTON, FL. FILED 5-6-2011.



OWNER OF U.S. REG. NOS. 3,713,570 AND 3,951,763. NO CLAIM IS MADE TO THE EXCLUSIVE RIGHT TO USE "LED SOURCE", APART FROM THE MARK AS SHOWN.

THE MARK CONSISTS OF THE WORD "LED" APPEARING OVER THE WORD "SOURCE" WITH A STYLIZED CHARACTER OF AN "LED" BULB APPEARING OVER THE WORD "SOURCE".

FOR FRANCHISING, NAMELY, OFFERING BUSINESS MANAGEMENT ASSISTANCE IN THE ESTABLISHMENT AND/OR OPERATION OF LED LIGHTING DISTRIBUTORSHIPS AND LED LIGHTING DESIGN SERVICES (U.S. CLS. 100, 101 AND 102).

FIRST USE 12-1-2009; IN COMMERCE 12-1-2009.

KELLEY WELLS, EXAMINING ATTORNEY

**CLASS 35—(Continued).**

SN 85-314,271. BUYOLOGY, INC., NEW YORK, NY. FILED 5-6-2011.

# MindLink

THE MARK CONSISTS OF STANDARD CHARACTERS WITHOUT CLAIM TO ANY PARTICULAR FONT, STYLE, SIZE, OR COLOR.

FOR MARKETING RESEARCH SERVICES; CONSUMER MARKETING RESEARCH AND CONSULTING RELATED THERETO; MARKETING AND BRANDING SERVICES, NAMELY, PERFORMING RESEARCH AND CONSULTATION ON CONSUMER INSIGHTS, BRAND STRATEGY AND RELATIONSHIPS, NAMELY, CONSUMER INSIGHTS INTO BRAND IDENTIFICATION (U.S. CLS. 100, 101 AND 102).

FIRST USE 3-17-2011; IN COMMERCE 3-17-2011.  
MARLENE BELL, EXAMINING ATTORNEY

**CLASS 35—(Continued).**

SN 85-316,457. SPICY HOME PARTIES LLC, CLEARWATER, FL. FILED 5-10-2011.

# SPICY PARTY

THE MARK CONSISTS OF STANDARD CHARACTERS WITHOUT CLAIM TO ANY PARTICULAR FONT, STYLE, SIZE, OR COLOR.

NO CLAIM IS MADE TO THE EXCLUSIVE RIGHT TO USE "PARTY", APART FROM THE MARK AS SHOWN.

FOR DISTRIBUTORSHIPS IN THE FIELD OF ADULT SEXUAL AIDS AND SEX TOYS; ON-LINE RETAIL STORE SERVICES FEATURING ADULT SEXUAL AIDS AND SEX TOYS; RETAIL SHOP-AT-HOME PARTY SERVICES IN THE FIELD OF ADULT SEXUAL AIDS AND SEX TOYS; SHOP-AT-HOME PARTIES FEATURING ADULT SEXUAL AIDS AND SEX TOYS (U.S. CLS. 100, 101 AND 102).

FIRST USE 0-0-2009; IN COMMERCE 0-0-2009.  
MARY CRAWFORD, EXAMINING ATTORNEY

SN 85-314,682. TOWER 18 MARKETING, INC., HUNTINGTON BEACH, CA. FILED 5-6-2011.

# TOWER 18 marketing

NO CLAIM IS MADE TO THE EXCLUSIVE RIGHT TO USE "MARKETING", APART FROM THE MARK AS SHOWN.

THE MARK CONSISTS OF THE STYLIZED WORDS "TOWER 18" ABOVE THE WORD "MARKETING" IN LOWERCASE STYLIZED FONT.

FOR ADVERTISING AND PROMOTION SERVICES AND RELATED CONSULTING; BRANDING SERVICES, NAMELY, CONSULTING, DEVELOPMENT, MANAGEMENT AND MARKETING OF BRANDS FOR BUSINESSES; CREATIVE MARKETING DESIGN SERVICES; DEVELOPING PROMOTIONAL CAMPAIGNS FOR BUSINESS; PROVIDING ADVERTISING, MARKETING AND PROMOTIONAL SERVICES, NAMELY, DEVELOPMENT OF ADVERTISING CAMPAIGNS FOR PRINT, INTERNET, RADIO, AND TELEVISION (U.S. CLS. 100, 101 AND 102).

FIRST USE 4-0-2009; IN COMMERCE 4-0-2009.  
INGRID C. EULIN, EXAMINING ATTORNEY

SN 85-316,458. SPICY HOME PARTIES LLC, CLEARWATER, FL. FILED 5-10-2011.

# SPICY HOME PARTIES

THE MARK CONSISTS OF STANDARD CHARACTERS WITHOUT CLAIM TO ANY PARTICULAR FONT, STYLE, SIZE, OR COLOR.

NO CLAIM IS MADE TO THE EXCLUSIVE RIGHT TO USE "HOME PARTIES", APART FROM THE MARK AS SHOWN.

FOR DISTRIBUTORSHIPS IN THE FIELD OF ADULT SEXUAL AIDS AND SEX TOYS; ON-LINE RETAIL STORE SERVICES FEATURING ADULT SEXUAL AIDS AND SEX TOYS; RETAIL SHOP-AT-HOME PARTY SERVICES IN THE FIELD OF ADULT SEXUAL AIDS AND SEX TOYS; SHOP-AT-HOME PARTIES FEATURING ADULT SEXUAL AIDS AND SEX TOYS (U.S. CLS. 100, 101 AND 102).

FIRST USE 0-0-2009; IN COMMERCE 0-0-2009.  
MARY CRAWFORD, EXAMINING ATTORNEY

**CLASS 35—(Continued).**

SN 85-317,476. SOILAND CO., INC., SANTA ROSA, CA. FILED 5-10-2011.

**GRAB N' GROW**

THE MARK CONSISTS OF STANDARD CHARACTERS WITHOUT CLAIM TO ANY PARTICULAR FONT, STYLE, SIZE, OR COLOR.

OWNER OF U.S. REG. NOS. 3,111,003 AND 3,130,471. FOR WHOLESALE AND RETAIL STORE SERVICES FEATURING SALE OF SOIL AND COMPOST FOR AGRICULTURAL USE AND LANDSCAPING USE (U.S. CLS. 100, 101 AND 102).

FIRST USE 9-30-2010; IN COMMERCE 9-30-2010. ALICIA COLLINS, EXAMINING ATTORNEY

**CLASS 35—(Continued).**

SN 85-317,899. FLUENT, INC., NEW YORK, NY. FILED 5-11-2011.

**PushAds**

THE MARK CONSISTS OF STANDARD CHARACTERS WITHOUT CLAIM TO ANY PARTICULAR FONT, STYLE, SIZE, OR COLOR.

FOR ADVERTISING AND MARKETING SERVICES, NAMELY, PROMOTING THE GOODS AND SERVICES OF OTHERS (U.S. CLS. 100, 101 AND 102).

DAVID COLLIER, EXAMINING ATTORNEY

SN 85-317,514. BUDGETDOC LLC, CONVERSE, TX. FILED 5-10-2011.



THE MARK CONSISTS OF TWO FIGURES ATTACHED TO EACH OTHER WITH A PLUS SIGN IN THE MIDDLE. TO THE RIGHT THERE IS THE STYLIZED TEXT "BUDGETDOC".

FOR PROVIDING A WEB SITE AT WHICH MEDICAL DOCTORS CAN ADVERTISE AND OFFER DISCOUNTS ON THEIR SERVICES TO PERSPECTIVE PATIENTS WHO MAY THEN SELECT A DOCTOR AND SCHEDULE MEDICAL APPOINTMENTS (U.S. CLS. 100, 101 AND 102).

BILL DAWE, EXAMINING ATTORNEY

SN 85-318,015. ESPINAL, SERGIO, WEST HEMPSTEAD, NY. FILED 5-11-2011.

**SUPER COMPARE FOODS MARKETPLACE**

THE MARK CONSISTS OF STANDARD CHARACTERS WITHOUT CLAIM TO ANY PARTICULAR FONT, STYLE, SIZE, OR COLOR.

NO CLAIM IS MADE TO THE EXCLUSIVE RIGHT TO USE "FOODS MARKETPLACE", APART FROM THE MARK AS SHOWN.

FOR RETAIL STORE SERVICES FEATURING FOOD; SUPERMARKETS (U.S. CLS. 100, 101 AND 102).

SKYE YOUNG, EXAMINING ATTORNEY

SN 85-317,582. FUNCHES, CEDRICK, DBA FLIPPO INTERACTIVE, SAN DIEGO, CA. FILED 5-10-2011.

**MOTHERS MONTH**

NO CLAIM IS MADE TO THE EXCLUSIVE RIGHT TO USE "MOTHERS", APART FROM THE MARK AS SHOWN. THE COLOR(S) PINK IS/ARE CLAIMED AS A FEATURE OF THE MARK.

THE MARK CONSISTS OF THE STYLIZED WORDING "MOTHERS MONTH" IN THE COLOR PINK.

FOR CHARITABLE SERVICES, NAMELY, ORGANIZING WOMEN'S GROUPS TO UNDERTAKE PROJECTS WHICH BENEFIT THE HOMELESS, ABUSED, AT RISK WOMEN AND WOMEN IN TRANSITION AND IN PAIN, WHILE ENCOURAGING EMPOWERMENT AMONG WOMEN OF ALL AGES AND ETHNICITIES (U.S. CLS. 100, 101 AND 102).

FIRST USE 9-10-2007; IN COMMERCE 1-1-2011. ADA HAN, EXAMINING ATTORNEY

SN 85-318,377. SIMON ROOFING AND SHEET METAL CORPORATION, BOARDMAN, OH. FILED 5-11-2011.

**S.T.A.M.P.**

THE MARK CONSISTS OF STANDARD CHARACTERS WITHOUT CLAIM TO ANY PARTICULAR FONT, STYLE, SIZE, OR COLOR.

FOR ASSOCIATION SERVICES, NAMELY, PROMOTING THE INTEREST OF SMALL BUSINESSES IN THE CONSTRUCTION INDUSTRY WHICH ARE OWNED BY MINORITIES, VETERANS, WOMEN AND THE DISADVANTAGED (U.S. CLS. 100, 101 AND 102).

FIRST USE 2-3-2011; IN COMMERCE 2-3-2011. BILL DAWE, EXAMINING ATTORNEY

**CLASS 35—(Continued).**

SN 85-318,653. ALLENTUS PHARMACY, INC., LIBERTY, MO. FILED 5-11-2011.



NO CLAIM IS MADE TO THE EXCLUSIVE RIGHT TO USE "PHARMACY" AND "RX", APART FROM THE MARK AS SHOWN.

THE COLOR(S) ROYAL BLUE, LIGHT GREY AND DARK GREY IS/ARE CLAIMED AS A FEATURE OF THE MARK.

THE MARK CONSISTS OF THE WORD "ALLENTUS" IN ROYAL BLUE TYPE UNDERLINED BY A ROYAL BLUE HORIZONTAL ELLIPSE; THE WORD "PHARMACY" IN ROYAL BLUE TYPE UNDERNEATH THE HORIZONTAL ELLIPSE; ONE LIGHT GREY AND ONE DARK GREY PARALLEL BAR BEGINNING UNDERNEATH THE LETTERS "TU" ABOVE THE ELLIPSE AND CONTINUING BEHIND THE LETTER "U" AND INTERSECTING WITH A SOLID DARK GREY CIRCLE CONTAINING THE LETTERS "RX" IN LIGHT GREY TYPE.

FOR INSTITUTIONAL RETAIL PHARMACY SERVICES (U.S. CLS. 100, 101 AND 102).

CHRISTINE COOPER, EXAMINING ATTORNEY

SN 85-319,890. ROBERTS, RICHARD V, DBA DISOMO, VASHON, WA. FILED 5-12-2011.

# DISOMO

THE MARK CONSISTS OF STANDARD CHARACTERS WITHOUT CLAIM TO ANY PARTICULAR FONT, STYLE, SIZE, OR COLOR.

FOR ADVERTISING AND BUSINESS SERVICES, NAMELY, PROVIDING AN ONLINE WEBSITE WHERE ADVERTISERS, MARKETERS, AND CONTENT PROVIDERS CAN INTERACT WITH USERS FOR ADVERTISING, BRANDING, AND PROMOTING KNOWLEDGE, PRODUCTS, AND SERVICES, AND TRADESHOWS, ON BEHALF OF THEMSELVES AND OTHERS, AND FOR EVALUATING AND RATING THE SAME, ALL THE FOREGOING RELEVANT TO HUMAN ACTIVITIES AFFECTING CLIMATE CHANGE AND RELATED FIELDS; ADVERTISING AND MARKETING; ADVERTISING AND MARKETING CONSULTANCY; ADVERTISING AND MARKETING SERVICES PROVIDED BY MEANS OF INDIRECT METHODS OF MARKETING COMMUNICATIONS, NAMELY, SOCIAL MEDIA, SEARCH ENGINE MARKETING, INQUIRY MARKETING, INTERNET MARKETING, MOBILE MARKETING, BLOGGING AND OTHER FORMS OF PASSIVE, SHARABLE OR VIRAL COMMUNICATIONS CHANNELS; ADVERTISING AND MARKETING SERVICES, NAMELY, PROMOTING THE GOODS AND SERVICES OF OTHERS; ADVERTISING SERVICES, NAMELY, PROMOTING AND MARKETING THE GOODS AND SERVICES OF OTHERS IN THE FIELD OF UPSCALE CHOICES SUCH AS CULTURAL EVENTS, RESTAURANTS, SHOPPING, AND TRAVEL VIA PRINT AND ELECTRONIC MEDIA; ADVERTISING SERVICES, NAMELY, PROMOTING AND MARKETING THE GOODS AND SERVICES OF OTHERS THROUGH ALL PUBLIC COMMUNICATION MEANS; ADVERTISING SERVICES, PUBLIC RELATIONS AND MARKETING

**CLASS 35—(Continued).**

SERVICES, NAMELY, PROMOTING AND MARKETING THE GOODS AND SERVICES OF OTHERS THROUGH ALL PUBLIC COMMUNICATION MEANS; ADVERTISING, MARKETING AND PROMOTION SERVICES; ADVERTISING, MARKETING AND PROMOTION SERVICES, NAMELY, PROMOTING THE GOODS AND SERVICES OF OTHERS BY PROVIDING CUSTOMIZED EXHIBITS; ADVERTISING, MARKETING AND PROMOTIONAL SERVICES FOR AUTOMOTIVE DEALERSHIPS; ADVERTISING, MARKETING AND PROMOTIONAL SERVICES FOR LIGHT AND HEAVY EQUIPMENT DEALERSHIPS; ADVERTISING, MARKETING AND PROMOTIONAL SERVICES FOR THE DONATION OF HUMAN BLOOD THAT EXACTLY MATCHES THE BLOOD TYPE OF INDIVIDUALS NEEDING TRANSFUSIONS; ADVERTISING, MARKETING AND PROMOTIONAL SERVICES RELATED TO ALL INDUSTRIES FOR THE PURPOSE OF FACILITATING NETWORKING AND SOCIALIZING OPPORTUNITIES FOR BUSINESS PURPOSES; ADVICE IN THE FIELD OF BUSINESS MANAGEMENT AND MARKETING; ANALYSIS OF MARKET RESEARCH DATA AND STATISTICS; ARRANGING AND CONDUCTING MARKETING PROMOTIONAL EVENTS FOR OTHERS; ASSISTANCE, ADVISORY SERVICES AND CONSULTANCY WITH REGARD TO BUSINESS PLANNING, BUSINESS ANALYSIS, BUSINESS MANAGEMENT, BUSINESS ORGANIZATION, MARKETING AND CUSTOMER ANALYSIS; BRANDING SERVICES, NAMELY, CONSULTING, DEVELOPMENT, MANAGEMENT AND MARKETING OF BRANDS FOR BUSINESSES; BUSINESS CONSULTATION AND MANAGEMENT REGARDING MARKETING ACTIVITIES AND LAUNCHING OF NEW PRODUCTS; BUSINESS MANAGEMENT AND CONSULTING SERVICES FOR THE HEALTH CARE INDUSTRY, NAMELY, CUSTOMER SERVICE, ACCOUNTING SERVICES, AND MARKETING SERVICES; BUSINESS MANAGEMENT AND CONSULTING SERVICES FOR THE HEALTH CARE INDUSTRY, NAMELY, CUSTOMER SERVICE, ACCOUNTING SERVICES, AND WEB-BASED ADVERTISING AND MARKETING SERVICES; BUSINESS MANAGEMENT CONSULTING WITH RELATION TO STRATEGY, FINANCING, MARKETING, PRODUCTION, PERSONNEL AND SALE MATTERS FOR COMPANIES INVOLVED WITH THIN FILM AND NANO TECHNOLOGIES AND PLASMA PROCESSES; BUSINESS MANAGEMENT CONSULTING WITH RELATION TO STRATEGY, MARKETING, PRODUCTION, PERSONNEL AND RETAIL SALE MATTERS; BUSINESS MANAGEMENT CONSULTING WITH RELATION TO STRATEGY, MARKETING, SALES, OPERATION, PRODUCT DESIGN PARTICULARLY SPECIALIZING IN THE USE OF ANALYTIC AND STATISTIC MODELS FOR THE UNDERSTANDING AND PREDICTING OF CONSUMERS, BUSINESSES, AND MARKET TRENDS AND ACTIONS; BUSINESS MARKETING AND DIRECT MAIL CONSULTING SERVICES; BUSINESS MARKETING CONSULTING SERVICES; BUSINESS MARKETING CONSULTING SERVICES TO CHILDCARE ORGANIZATIONS; BUSINESS MONITORING AND CONSULTING SERVICES, NAMELY, TRACKING WEB SITES AND APPLICATIONS OF OTHERS TO PROVIDE STRATEGY, INSIGHT, MARKETING, SALES, OPERATION, PRODUCT DESIGN, PARTICULARLY SPECIALIZING IN THE USE OF ANALYTIC AND STATISTIC MODELS FOR THE UNDERSTANDING AND PREDICTING OF CONSUMERS, BUSINESSES, AND MARKET TRENDS AND ACTIONS; BUSINESS TO BUSINESS DIRECT MARKETING SERVICES; COLLECTION OF MARKET RESEARCH INFORMATION; COMMERCIAL INFORMATION AGENCIES; COMPILING FINANCIAL, SECURITIES, STOCK EXCHANGE, TRADE AND QUOTE, INDEX VALUE AND OTHER FINANCIAL MARKET INFORMATION FOR BUSINESS PURPOSES; CONDUCTING BUSINESS AND MARKET RESEARCH SURVEYS; CONDUCTING MARKET SURVEYS; CONDUCTING MARKETING STUDIES; CONSIGNMENT SERVICES, NAMELY, PROMOTING AND MARKETING THE HORSES OF OTHERS; CONSULTATION SERVICES, NAMELY, CREATIVE AND STRATEGIC CONSULTATION REGARDING DEVELOPMENT AND PRODUCTION OF MARKETING CAMPAIGNS FOR OTHERS; CONSULTING SERVICES IN THE FIELD OF INTERNET MARKETING; CONSULTING SERVICES IN THE FIELD OF MARKETING OF EDUCATIONAL TRAINING; CON-

**CLASS 35—(Continued).**

SUMER MARKETING RESEARCH AND CONSULTING RELATED THERETO; CONSUMER STRATEGY BUSINESS CONSULTING IN THE FIELDS OF MARKETING, SALES, OPERATION, AND PRODUCT DESIGN PARTICULARLY SPECIALIZING IN THE USE OF ANALYTIC MODELS FOR THE UNDERSTANDING AND PREDICTING OF CONSUMER, BUSINESS, AND RETAIL MARKET TRENDS AND ACTIONS; COOPERATIVE ADVERTISING AND MARKETING; COOPERATIVE ADVERTISING AND MARKETING SERVICES BY WAY OF SOLICITATION, CUSTOMER SERVICE AND PROVIDING MARKETING INFORMATION VIA WEB SITES ON A GLOBAL COMPUTER NETWORK; COOPERATIVE ADVERTISING AND MARKETING SERVICES, NAMELY, OFFERING DISCOUNTS TO CLIENTS THROUGH THE JOINT PARTICIPATION OF MEMBER BEAUTY SALONS; CREATION OF MARKETING TOOLS DESIGNED TO INCREASE A CLIENT COMPANY'S KNOWLEDGE OF CUSTOMER NEEDS, AND ITS COMPETITORS' PRODUCTS AND SERVICES, PRICING, ADVERTISING STRATEGY AND SALES STRATEGY; CUSTOM WRITING SERVICES COMPRISING PUBLIC RELATIONS AND MARKETING MATERIALS FOR THE AUDIO, VIDEO AND TECHNOLOGY INDUSTRIES; DEVELOPMENT OF MARKETING STRATEGIES AND CONCEPTS; DEVELOPMENT OF MARKETING STRATEGIES, CONCEPTS AND TACTICS, NAMELY, AUDIENCE DEVELOPMENT, BRAND AWARENESS, CUSTOMER RELATIONS, ONLINE COMMUNITY BUILDING AND DIGITAL WORD OF MOUTH COMMUNICATIONS; DEVELOPMENT OF MARKETING STRATEGIES, CONCEPTS AND TACTICS, NAMELY, AUDIENCE DEVELOPMENT, BRAND AWARENESS, ONLINE COMMUNITY BUILDING AND DIGITAL WORD OF MOUTH COMMUNICATIONS; DIRECT MARKETING; DIRECT MARKETING ADVERTISING FOR OTHERS; DIRECT MARKETING CONSULTING SERVICES; ENTERTAINMENT MARKETING SERVICES, NAMELY, MARKETING, PROMOTION AND ADVERTISING FOR RECORDING AND PERFORMING ARTISTS; EVENT PLANNING AND MANAGEMENT FOR MARKETING, BRANDING, PROMOTING OR ADVERTISING THE GOODS AND SERVICES OF OTHERS; GENERAL BUSINESS MERCHANDISING SERVICES, NAMELY, MARKETING; IMPLEMENTATION AND FOLLOW-UP OF ADVICE IN THE FIELDS OF MARKETING; INFORMATION OR ENQUIRIES ON BUSINESS AND MARKETING; INFORMATION, ADVISORY, CONSULTING, BUSINESS RESEARCH AND PLANNING SERVICES RELATING TO PUBLICITY, MARKETING COMMUNICATIONS, REPUTATION MANAGEMENT OR BUSINESS ADMINISTRATION, INCLUDING SUCH SERVICES PROVIDED ONLINE OR VIA THE INTERNET; INTERNATIONAL BUSINESS CONSULTING SERVICES RELATING TO MERCHANDISE TRADING, HUMAN RESOURCE INTERCHANGE, MANAGEMENT SUPPORT, MARKETING, ADVERTISING, PROMOTION, AND DOMESTIC AND INTERNATIONAL MARKET RESEARCH AND DEVELOPMENT; MARKET ANALYSIS; MARKET ANALYSIS AND RESEARCH SERVICES; MARKET OPINION POLLING STUDIES; MARKET REPORTS AND STUDIES; MARKET RESEARCH; MARKET RESEARCH AND BUSINESS ANALYSES; MARKET RESEARCH AND MARKET INTELLIGENCE SERVICES; MARKET RESEARCH CONSULTATION; MARKET RESEARCH SERVICES; MARKET RESEARCH STUDIES; MARKET SEGMENTATION CONSULTATION; MARKET STUDY AND ANALYSIS OF MARKET STUDIES; MARKETING ANALYSIS SERVICES; MARKETING AND ADVERTISING SERVICES FOR AUTOMOBILE DEALERSHIPS; MARKETING AND BRANDING SERVICES, NAMELY, PERFORMING CONSUMER INSIGHT AND BRAND STRATEGY OF COMPANY LOGOS; MARKETING AND BRANDING SERVICES, NAMELY, PROVIDING CUSTOMIZED COMMUNICATION PROGRAMS TO OBTAIN CONSUMER INSIGHTS AND DEVELOP BRANDING STRATEGIES; MARKETING AND CONSULTING SERVICES IN THE FIELD OF PROMOTING AND TRACKING THE GOODS, SERVICES, AND BRANDS OF OTHERS THROUGH ALL PUBLIC COMMUNICATION MEANS, PARTICULARLY SPECIALIZING IN THE USE OF MOBILE, SOCIAL, AND PRINT MEDIA TO DRIVE CONSUMER INTEREST, ENGAGEMENT AND ACTION; MARKETING CONSULTATION

**CLASS 35—(Continued).**

IN THE FIELD OF ADVERTISING; MARKETING CONSULTING; MARKETING CONSULTING SERVICES RELATING TO LONG-TERM BUSINESS STRATEGY DEVELOPMENT FOR NON-PROFIT ORGANIZATIONS; MARKETING PLAN DEVELOPMENT; MARKETING RESEARCH IN THE FIELDS OF COSMETICS, PERFUMERY AND BEAUTY PRODUCTS; MARKETING RESEARCH SERVICES; MARKETING SERVICES, NAMELY, CONDUCTING CONSUMER TRACKING BEHAVIOR RESEARCH AND CONSUMER TREND ANALYSIS; MARKETING SERVICES, NAMELY, CONSUMER MARKETING RESEARCH; MARKETING SERVICES, NAMELY, PROMOTING OR ADVERTISING THE GOODS AND SERVICES OF OTHERS; MARKETING SERVICES, NAMELY, PROMOTIONAL SERVICES IN THE FIELD OF PLANNED-GIVING FOR NON-PROFIT AND CHARITABLE ORGANIZATIONS; MARKETING SERVICES, NAMELY, PROVIDING INFORMATIONAL WEB PAGES DESIGNED TO GENERATE SALES TRAFFIC VIA HYPERLINKS TO OTHER WEB SITES; MARKETING SERVICES, NAMELY, PROVIDING ON-LINE NON-DOWNLOADABLE VIDEOS TO PROMOTE DOCTORS AND MEDICAL PRACTICES; MARKETING SERVICES, NAMELY, PROVIDING VIDEOS TO PROMOTE THE PRODUCTS AND SERVICES OF RETAIL STORES; MARKETING SERVICES, NAMELY, RETAIL STORE SERVICES IN THE FIELD OF POINT OF SALE DISPLAYS, DIGITAL SIGNAGE AND OTHER IN-STORE MARKETING STRATEGIES; MARKETING, ADVERTISING AND PROMOTING THE GOODS AND SERVICES OF OTHERS IN THE FIELD OF TRAVEL AND TOURISM, NAMELY, PROVIDING INFORMATION VIA MAIL AND ELECTRONIC MAIL; MARKETING, ADVERTISING, AND PROMOTING THE RETAIL GOODS AND SERVICES OF OTHERS TO WIRELESS ELECTRONIC DEVICES; MARKETING, PROMOTIONAL AND ADVERTISING SERVICES PROVIDED BY MOBILE TELEPHONE CONNECTIONS; MEDIA PLANNING, NAMELY, ADVISING THE CLIENT ON THE CORRECT TIMES AND STATIONS TO ADVERTISE BASED ON MEDIA ANALYSIS OF THE MARKET FOR THAT MEDIA; MEMBERSHIP CLUB SERVICES, NAMELY, PROVIDING ON-LINE INFORMATION TO MEMBERS IN THE FIELDS OF BRANDING, BUSINESS DEVELOPMENT, BUSINESS MARKETING, AND MARKETING; MULTI-LEVEL MARKETING BUSINESS SERVICES; ON-LINE ADVERTISING AND MARKETING SERVICES; PLANNING, DESIGN, DEVELOPMENT, MAINTENANCE, TRACKING AND REPORTING OF ONLINE MARKETING ACTIVITIES FOR THIRD PARTIES; PROMOTING AND MARKETING THE GOODS AND SERVICES OF OTHERS BY DISTRIBUTING ADVERTISING MATERIAL, COUPONS AND DISCOUNT OFFERS VIA TEXT MESSAGES; PROMOTING THE GOODS AND SERVICES OF OTHERS BY MEANS OF WORD-OF-MOUTH AND NONTRADITIONAL MARKETING PROGRAMS; PROMOTING, ADVERTISING AND MARKETING OF THE BRANDS, PRODUCTS, SERVICES OR ONLINE WEBSITES OF INDIVIDUALS, BUSINESSES AND NONPROFIT ORGANIZATIONS; PROMOTING, ADVERTISING AND MARKETING OF THE ON-LINE WEB SITES OF OTHERS; PROMOTING, ADVERTISING AND MARKETING THE ON-LINE DATABASES AND ELECTRONIC PUBLICATIONS OF OTHERS; PROMOTING, MARKETING AND ADVERTISING THE BRANDS AND GOODS OF OTHERS RELATED TO ALL INDUSTRIES, THROUGH ALL PUBLIC AND PRIVATE COMMUNICATION MEANS, NAMELY, PROMOTING THE BRANDS AND GOODS OF OTHERS MADE IN THE UNITED STATES; PROMOTION AND MARKETING SERVICES AND RELATED CONSULTING; PROMOTION, ADVERTISING AND MARKETING OF ON-LINE WEBSITES; PROMOTIONAL MARKETING AND REPRESENTATION SERVICES FOR SALES TO THE PUBLIC SECTOR; PROMOTIONAL MARKETING SERVICES USING AUDIOVISUAL MEDIA; PROMOTIONAL SERVICES, NAMELY, GUERRILLA MARKETING SERVICES; PROVIDING A WEB SITE FEATURING A DIRECTORY OF MARKET RESEARCH PANELS FOR CONSUMERS; PROVIDING A WEBSITE FEATURING CONTENT ON NEWS RELATING TO PHILANTHROPY MARKETING STRATEGIES, COVERING MONETARY GIVING TRENDS AND STATISTICS, VOLUNTEER/CAREER OPPORTUNITIES AND BEST PRACTICES FOR SUCCESSFUL DIGITAL PHILANTHROPY EFFORTS; PROVIDING A WEBSITE FEATURING INFORMATION AND LINKS RELATING TO THE MUSIC INDUSTRY,

**CLASS 35—(Continued).**

NAMELY, PROMOTION, MARKETING AND BUSINESS ADVICE TO MUSICIANS; PROVIDING A WEBSITE FEATURING INFORMATION ON MULTI-LEVEL MARKETING BUSINESS SERVICES; PROVIDING ADVERTISING, MARKETING AND PROMOTIONAL SERVICES FOR THE PHARMACEUTICAL AND MEDICAL INDUSTRY; PROVIDING ADVERTISING, MARKETING AND PROMOTIONAL SERVICES FOR THE PHARMACEUTICAL AND MEDICAL PRODUCTS OF OTHERS; PROVIDING ADVERTISING, MARKETING AND PROMOTIONAL SERVICES, NAMELY, DEVELOPMENT OF ADVERTISING CAMPAIGNS FOR BROADCAST, PRINT, OUTDOOR SIGNAGE, INTERNET, MOBILE COMMUNICATION; PROVIDING ADVERTISING, MARKETING AND PROMOTIONAL SERVICES, NAMELY, DEVELOPMENT OF ADVERTISING CAMPAIGNS PROVIDED THROUGH CABLE TELEVISION BROADCAST, WEB CASTS, RADIO BROADCASTS, NEWSPAPERS, MAGAZINES, ONLINE BANNERS, OUTDOOR BILLBOARDS, WILD POSTINGS, BUS AND SUBWAY ADS; PROVIDING AN ONLINE MARKETING COLLABORATION NETWORK FOR SOCIAL MEDIA AND ONLINE MARKETING PROFESSIONALS FOR THE PURPOSE OF SYNDICATING CONTENT THROUGH THE NETWORK TO BE SHARED BY OTHERS; PROVIDING BUSINESS MARKETING INFORMATION; PROVIDING BUSINESS PLANNING AND MARKETING SOLUTIONS FOR REAL ESTATE PROFESSIONALS; PROVIDING INFORMATION IN THE FIELD OF MARKETING AND ON-LINE MARKETING MEDIA VIA THE INTERNET; PROVIDING MARKETING AND PROMOTION OF SPECIAL EVENTS; PROVIDING MARKETING SOLUTIONS FOR RETAIL STORES, NATIONAL CHAIN RETAIL STORES, DEPARTMENT STORES; PROVIDING PROMOTIONAL MARKETING SERVICES TO BUSINESSES IN THE BROADBAND AND MEDIA INDUSTRIES; PROVIDING PUBLIC SECTOR GO-TO-MARKET ADVICE AND STRATEGIES; PROVIDING REAL ESTATE VIDEO TOURS FOR MARKETING PURPOSES; PROVISION OF MARKETING REPORTS; PUBLIC RELATIONS, ADVERTISING AND MARKETING SERVICES FOR THE TOURISM AND CONVENTION INDUSTRY, NAMELY, ORGANIZING AND HOSTING SITE INSPECTIONS AND FAMILIARIZATION TOURS FOR WHOLESALERS, TOUR OPERATORS, TRAVEL AGENTS, MEETING AND INCENTIVE TRAVEL PLANNERS AND TRAVEL MEDIA; REAL ESTATE MARKETING ANALYSIS; REAL ESTATE MARKETING SERVICES IN THE FIELD OF APARTMENTS, RESIDENTIAL HOMES, AND COMMERCIAL BUILDINGS; REAL ESTATE MARKETING SERVICES, NAMELY, ON-LINE SERVICES FEATURING THE PROMOTION OF RESIDENTIAL NEW CONSTRUCTION, WHICH ALSO CONTAINS BACK OFFICE SOLUTIONS FOR BUILDERS; REAL ESTATE MARKETING SERVICES, NAMELY, ON-LINE SERVICES FEATURING TOURS OF RESIDENTIAL AND COMMERCIAL REAL ESTATE; SOCIAL MEDIA STRATEGY AND MARKETING CONSULTANCY FOCUSING ON HELPING CLIENTS CREATE AND EXTEND THEIR PRODUCT AND BRAND STRATEGIES BY BUILDING VIRALLY ENGAGING MARKETING SOLUTIONS (U.S. CLS. 100, 101 AND 102).

BENJAMIN OKEKE, EXAMINING ATTORNEY

**CLASS 35—(Continued).**

SN 85-319,981. GRAPETRIP LLC, NEW YORK, NY. FILED 5-13-2011.



The logo for GrapeTrip features the word "GrapeTrip" in a stylized, rounded font. "Grape" is in a dark purple color, and "Trip" is in a lighter pink color. A small globe icon is positioned above the letter 'i' in "Trip". The letters have a slight drop shadow effect.

NO CLAIM IS MADE TO THE EXCLUSIVE RIGHT TO USE "BLACK, WHITE AND GRAY", APART FROM THE MARK AS SHOWN.

THE STIPPLING IS FOR SHADING PURPOSES ONLY.

THE COLOR(S) PURPLE AND PINK IS/ARE CLAIMED AS A FEATURE OF THE MARK.

THE MARK CONSISTS OF THE WORDING GRAPE IN PURPLE, THE WORDING TRIP IN PINK, A WORLD GLOBE ON THE I OF TRIP.

FOR PROVIDING A SEARCHABLE WEBSITE FEATURING THE GOODS AND SERVICES OF OTHER VENDORS (U.S. CLS. 100, 101 AND 102).

FIRST USE 5-1-2011; IN COMMERCE 5-1-2011.

JACQUELINE A. LAVINE, EXAMINING ATTORNEY

SN 85-319,992. SHAKHIN ANTUAN, LONDON, UNITED KINGDOM, FILED 5-13-2011.



The logo for bompare features the word "bompare" in a lowercase, serif font. The letters are black and have a slightly irregular, hand-drawn appearance.

THE MARK CONSISTS OF STANDARD CHARACTERS WITHOUT CLAIM TO ANY PARTICULAR FONT, STYLE, SIZE, OR COLOR.

THE WORDING "BOMPARE" HAS NO MEANING IN A FOREIGN LANGUAGE.

FOR COMPARISON SHOPPING SERVICES; PROVIDING A SEARCHABLE WEBSITE FEATURING THE GOODS AND SERVICES OF OTHER VENDORS; PROVIDING A WEB SITE WHERE USERS CAN POST RATINGS, REVIEWS AND RECOMMENDATIONS ON PRODUCTS AND SERVICES FOR COMMERCIAL PURPOSES; PROVIDING CONSUMER PRODUCT INFORMATION VIA THE INTERNET (U.S. CLS. 100, 101 AND 102).

CHRISTINA SOBRAL, EXAMINING ATTORNEY



**CLASS 35—(Continued).**

SN 85-320,056. TWO WEST, INC., KANSAS CITY, MO. FILED 5-13-2011.



The logo for "Retail Archetypes" features the word "retail" in a bold, lowercase, sans-serif font, with a vertical bar through the letter "i". Below it, the word "archetypes" is written in a similar font, also in lowercase.

NO CLAIM IS MADE TO THE EXCLUSIVE RIGHT TO USE "RETAIL", APART FROM THE MARK AS SHOWN.

THE MARK CONSISTS OF THE WORDS "RETAIL ARCHETYPES" IN STYLIZED FORM; THE "I" IN THE WORD "RETAIL" IS SURROUNDED BY A RECTANGLE AND THE LETTER "L" IN THE WORD "RETAIL" IS SLANTED OUTWARDS WITH A FAINT SHADOW BEHIND.

FOR MARKETING AND BRANDING, NAMELY, PERFORMING CONSUMER INSIGHT AND BRANDING STRATEGIES IN THE AREAS OF SPATIAL COMMERCIAL LAYOUT AND SHOPPING ENVIRONMENTS; BRAND CONCEPT AND BRAND DEVELOPMENT IN THE AREA OF SPATIAL COMMERCIAL LAYOUT AND DESIGN OF SHOPPING ENVIRONMENTS TO PROMOTE THE EXPERIENCE, GOODS, SERVICES, BRAND IDENTITY AND COMMERCIAL INFORMATION OF THIRD PARTIES; BRAND IMAGERY CONSULTING SERVICES (U.S. CLS. 100, 101 AND 102).

NAAKWAMA ANKRAH, EXAMINING ATTORNEY

SN 85-320,198. NOLAND, DEEANN, CHERRY VALLEY, CA. FILED 5-13-2011.



The logo for "Noble Hearts Pembroke Welsh Corgis" features the words "Noble Hearts Pembroke" stacked above "Welsh Corgis" in a serif font.

THE MARK CONSISTS OF STANDARD CHARACTERS WITHOUT CLAIM TO ANY PARTICULAR FONT, STYLE, SIZE, OR COLOR.

NO CLAIM IS MADE TO THE EXCLUSIVE RIGHT TO USE "PEMBROKE WELSH CORGIS", APART FROM THE MARK AS SHOWN.

FOR RETAIL STORE SERVICES FEATURING PETS (U.S. CLS. 100, 101 AND 102).

FIRST USE 1-1-2003; IN COMMERCE 3-28-2003.

MIDGE BUTLER, EXAMINING ATTORNEY

SN 85-320,324. WONDER PET EXPO LLC, GILBERT, AZ. FILED 5-13-2011.

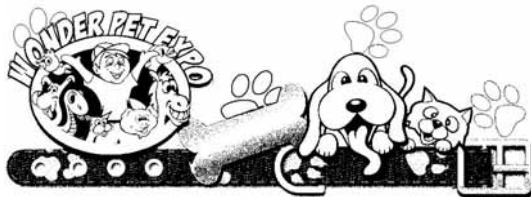

NO CLAIM IS MADE TO THE EXCLUSIVE RIGHT TO USE "PET EXPO", APART FROM THE MARK AS SHOWN.

THE MARK CONSISTS OF A CIRCLE AROUND A CARTOON CAT, A CARTOON DOG, A CARTOON HORSE, A CARTOON BIRD, A CARTOON PIG, A CARTOON SNAKE, A CARTOON FISH AND CARTOON BOY WITH

**CLASS 35—(Continued).**

HANDS IN THE AIR. THE STYLIZED TEXT "WONDER PET EXPO" CURVES ABOVE THE CIRCLE. A LEASH EXTENDS ACROSS TO THE RIGHT WITH FOUR HOLES IN IT, A BUCKLE AT THE END, AND A LOOP IN THE MIDDLE. A CARTOON DOG WITH A LONG TONGUE HANGING OUT OF HIS MOUTH AND A CARTOON CAT WITH ITS MOUTH OPEN AND EYES CLOSED HANG OVER THE LEASH. A BONE IS ANGLED ACROSS THE LEASH TOWARD THE DOG'S MOUTH. THERE ARE PAW MARKS IN THE BACKGROUND AND SCATTERED ON THE LEASH.

FOR ARRANGING AND CONDUCTING TRADE SHOWS IN THE FIELD OF PET PRODUCTS AND SERVICES (U.S. CLS. 100, 101 AND 102).

FIRST USE 12-1-2010; IN COMMERCE 12-1-2010.

CHRISTOPHER BUONGIORNO, EXAMINING ATTORNEY

SN 85-320,357. SHS OF TN, LLC, MADISON, TN. FILED 5-13-2011.



NO CLAIM IS MADE TO THE EXCLUSIVE RIGHT TO USE "SUPER HOME SURPLUS", APART FROM THE MARK AS SHOWN.

THE MARK CONSISTS OF THE LETTER "S" SUPERIMPOSED OVER THE SHAPE OF A COAT OF ARMS. THE COAT OF ARMS HAS STARS AT THE TOP AND STRIPES AT THE BOTTOM; THE WORDS "SUPER HOME SURPLUS" APPEAR TO THE RIGHT OF THIS DESIGN.

FOR RETAIL HOME SUPPLY STORE SERVICES, FEATURING HOME FURNISHINGS, HOME ACCESSORIES AND BUILDING MATERIALS (U.S. CLS. 100, 101 AND 102).

FIRST USE 1-4-2007; IN COMMERCE 11-1-2008.

DAWN FELDMAN, EXAMINING ATTORNEY

SN 85-320,364. THE CEMENTWORKS, LLC, NEW YORK, NY. FILED 5-13-2011.



The logo for "The CementBloc" features the words "the cementbloc" in a lowercase, sans-serif font, followed by a graphic of a cement block with a shadow.

OWNER OF U.S. REG. NOS. 3,982,592 AND 3,999,449.

THE MARK CONSISTS OF A FOUR TIERED UPWARD FACING CEMENT BLOCK WITH THE LOWEST TIER OF THE CEMENT BLOCK PARTIALLY SHOWN. THE CEMENT BLOCK IS POSITIONED PARTIALLY IN FRONT OF THE LOWER RIGHT HAND PORTION OF A SQUARE WHICH SERVES AS A BACKDROP FOR THE TOP THREE TIERS OF THE CEMENT BLOCK. TO THE LEFT OF THE CEMENT BLOCK AND THE SQUARE BACKDROP IS THE WORDING "THE CEMENTBLOC" IN LOWERCASE STYLIZED LETTERS.

FOR PROVIDING ADVERTISING AGENCY SERVICES, PUBLIC RELATIONS AND PROMOTIONAL MARKETING SERVICES IN THE PHARMACEUTICAL AND HEALTHCARE INDUSTRIES THROUGH ALL PUBLIC COMMUNICATIONS MEANS (U.S. CLS. 100, 101 AND 102).

FIRST USE 4-1-2010; IN COMMERCE 4-1-2010.

DAWN FELDMAN, EXAMINING ATTORNEY



**CLASS 35—(Continued).**

SN 85-320,512. DI FAZIO CIGARS CORP., AVENTURA, FL.  
FILED 5-13-2011.



OWNER OF U.S. REG. NOS. 3,581,957 AND 3,617,414.  
NO CLAIM IS MADE TO THE EXCLUSIVE RIGHT TO  
USE "CIGAR", APART FROM THE MARK AS SHOWN.  
THE NAME(S), PORTRAIT(S), AND/OR SIGNATURE(S)  
SHOWN IN THE MARK IDENTIFIES CARMELO "DI  
FAZIO", WHOSE CONSENT(S) TO REGISTER IS MADE  
OF RECORD.

THE MARK CONSISTS OF THE WORD "DI FAZIO"  
STYLIZED WITHIN A RECTANGLE THE WORDS "CIGAR  
HOUSE" BELOW.

FOR RETAIL STORE SERVICES FEATURING CI-  
GARS, CIGAR HUMIDORS, LIGHTERS, LIGHTER  
FLUID, CUTTERS, ASH TRAYS (U.S. CLS. 100, 101  
AND 102).

FIRST USE 4-1-2011; IN COMMERCE 4-1-2011.  
ZACHARY BELLO, EXAMINING ATTORNEY

SN 85-320,667. NATIONAL MULTI HOUSING COUNCIL,  
WASHINGTON, DC. FILED 5-13-2011.



NO CLAIM IS MADE TO THE EXCLUSIVE RIGHT TO  
USE "NATIONAL STUDENT HOUSING COUNCIL", APART  
FROM THE MARK AS SHOWN.

THE MARK CONSISTS OF THE LETTERS "NSHC"  
ABOVE THE WORDS "NATIONAL STUDENT HOUSING  
COUNCIL" AND NEXT TO A STYLIZED ABSTRACT  
REPRESENTATION OF A STUDENT HOUSING APART-  
MENT COMPRISED OF THREE ROWS OF EIGHT BOXES  
EACH AND A STRAIGHT LINE ABOVE THE SAME.

FOR ASSOCIATION SERVICES, NAMELY, PROMOT-  
ING PUBLIC AWARENESS OF AND PUBLIC INTEREST  
IN PRIVATELY OWNED STUDENT HOUSING (U.S.  
CLS. 100, 101 AND 102).

FIRST USE 5-13-2011; IN COMMERCE 5-13-2011.  
WENDY GOODMAN, EXAMINING ATTORNEY

**CLASS 35—(Continued).**

SN 85-320,680. HOSPITAL CARE CONSULTANTS, INC.,  
DALLAS, TX. FILED 5-13-2011.



NO CLAIM IS MADE TO THE EXCLUSIVE RIGHT TO  
USE "HOSPITAL CARE CONSULTANTS", APART FROM  
THE MARK AS SHOWN.

THE COLOR(S) BURNT ORANGE AND BLACK IS/ARE  
CLAIMED AS A FEATURE OF THE MARK.

THE MARK CONSISTS OF THE LETTERING "HCC"  
ABOVE THE WORDING "HOSPITAL CARE CONSUL-  
TANTS". THE LETTER "H" AND THE SECOND LETTER  
"C" ARE BLACK. THE MIDDLE LETTER "C" IS BURNT  
ORANGE. THE WORDING "HOSPITAL CARE CONSUL-  
TANTS" IS BURNT ORANGE. A DESIGN OF A BURNT  
ORANGE RIGHT-POINTING ARROW APPEARS TO THE  
LEFT OF THE WORDING. THE COLOR WHITE REPRESENTS  
BACKGROUND AND IS NOT A FEATURE OF THE  
MARK.

FOR EMPLOYMENT STAFFING IN THE FIELD OF  
MEDICINE, NAMELY, PHYSICIAN STAFFING; MEDI-  
CAL CLAIMS MANAGEMENT SERVICES, NAMELY,  
RECEIVING, DATA ENTERING, AND RE-PRICING OF  
TRANSACTIONS THAT ARE ORIGINATED BY PHYSI-  
CIANS, HOSPITALS, AND ANCILLARY MEDICAL  
CARE PROVIDERS (U.S. CLS. 100, 101 AND 102).

FIRST USE 9-14-2005; IN COMMERCE 9-14-2005.  
WENDY GOODMAN, EXAMINING ATTORNEY

SN 85-320,712. AMERICAN PATHOLOGY PARTNERS, INC.,  
BRENTWOOD, TN. FILED 5-13-2011.

APP

THE MARK CONSISTS OF STANDARD CHARACTERS  
WITHOUT CLAIM TO ANY PARTICULAR FONT, STYLE,  
SIZE, OR COLOR.

OWNER OF U.S. REG. NO. 4,002,757.  
FOR BUSINESS MANAGEMENT SERVICES,  
NAMELY, SUPERVISION, DEVELOPMENT, OPERA-  
TION, OVERSIGHT, AND DIRECTION OF PATHOLOGY  
LABORATORIES AND PATHOLOGY PRACTICES (U.S.  
CLS. 100, 101 AND 102).

FIRST USE 5-13-2011; IN COMMERCE 5-13-2011.  
WENDY GOODMAN, EXAMINING ATTORNEY

**CLASS 35—(Continued).**

SN 85-320,840. IMAGINECHILDHOOD.COM LLC, CASTLE ROCK, CO. FILED 5-13-2011.

## Imagine Childhood

THE MARK CONSISTS OF STANDARD CHARACTERS WITHOUT CLAIM TO ANY PARTICULAR FONT, STYLE, SIZE, OR COLOR.

OWNER OF U.S. REG. NO. 3,747,534.

FOR ON-LINE RETAIL STORE SERVICES FEATURING SOCIALLY AND/OR ENVIRONMENTALLY CONSCIOUS TOYS, GAMES, ACTIVITIES, BOOKS, CRAFTS, KITS, EDUCATIONAL PRODUCTS, OUTDOOR EQUIPMENT, SPORTS EQUIPMENT, CREATIVE PLAY PRODUCTS, STORYTELLING PRODUCTS, NAMELY, AUDIO BOOKS AND, VIDEOS THAT PROMOTE UNSTRUCTURED PLAY AND EXPLORATION OF THE NATURAL WORLD AND RELATED ACCESSORIES FOR THE ABOVE GOODS (U.S. CLS. 100, 101 AND 102).

FIRST USE 9-16-2008; IN COMMERCE 11-13-2008.  
CHARLES L. JENKINS, EXAMINING ATTORNEY

---

SN 85-321,019. DELIGHTFUL COLLECTIONS, LLC, PLAINSBORO, NJ. FILED 5-13-2011.

## DELIGHTFUL COLLECTIONS Naturally Thankful

THE MARK CONSISTS OF STANDARD CHARACTERS WITHOUT CLAIM TO ANY PARTICULAR FONT, STYLE, SIZE, OR COLOR.

NO CLAIM IS MADE TO THE EXCLUSIVE RIGHT TO USE "COLLECTIONS", APART FROM THE MARK AS SHOWN.

FOR ADVERTISING AND MARKETING SERVICES, NAMELY, PROMOTING THE GOODS AND SERVICES OF OTHERS; RETAIL STORE SERVICES FEATURING HANDMADE GIFTS, NAMELY, CERAMICS, PORCELAIN, AND WOOD GIFTS ITEMS; AND ON-LINE RETAIL GIFT SHOP (U.S. CLS. 100, 101 AND 102).

JOHN DWYER, EXAMINING ATTORNEY

---

SN 85-321,062. HEARD, CLARENCE, MOBILE, AL. FILED 5-14-2011.

## NEW PRODUCTS GALORE

THE MARK CONSISTS OF STANDARD CHARACTERS WITHOUT CLAIM TO ANY PARTICULAR FONT, STYLE, SIZE, OR COLOR.

NO CLAIM IS MADE TO THE EXCLUSIVE RIGHT TO USE "NEW PRODUCTS", APART FROM THE MARK AS SHOWN.

FOR RETAIL STORE AND ON-LINE RETAIL STORE SERVICES FEATURING ELECTRONICS (U.S. CLS. 100, 101 AND 102).

DAVID TOOLEY, EXAMINING ATTORNEY

**CLASS 35—(Continued).**

SN 85-321,271. USADATA, INC., NEW YORK, NY. FILED 5-15-2011.

## Salesleads360

THE MARK CONSISTS OF STANDARD CHARACTERS WITHOUT CLAIM TO ANY PARTICULAR FONT, STYLE, SIZE, OR COLOR.

OWNER OF U.S. REG. NOS. 4,015,908 AND 4,015,910.  
FOR PREPARING MAILING LISTS (U.S. CLS. 100, 101 AND 102).

FIRST USE 1-1-2008; IN COMMERCE 1-1-2009.  
JERI J. FICKES, EXAMINING ATTORNEY

---

SN 85-321,515. PUBLIX ASSET MANAGEMENT COMPANY, LAKELAND, FL. FILED 5-16-2011.

PUBLIX  
GreenWise  
MARKET

OWNER OF U.S. REG. NOS. 2,520,594, 2,843,303 AND OTHERS.

NO CLAIM IS MADE TO THE EXCLUSIVE RIGHT TO USE "MARKET", APART FROM THE MARK AS SHOWN.

THE MARK CONSISTS OF THE WORDS "PUBLIX GREENWISE MARKET", WITH THE WORD "GREENWISE" IN ONE STYLIZED FONT AND THE WORDS "PUBLIX" AND "MARKET" BOTH IN ANOTHER STYLIZED FONT.

FOR RETAIL GROCERY STORE SERVICES (U.S. CLS. 100, 101 AND 102).

FIRST USE 3-14-2001; IN COMMERCE 3-14-2001.  
EMILY CHUO, EXAMINING ATTORNEY

**CLASS 35—(Continued).**

SN 85-321,562. PUBLIX ASSET MANAGEMENT COMPANY, LAKELAND, FL. FILED 5-16-2011.

P U B L I X  
**GreenWise**  
 M A R K E T

OWNER OF U.S. REG. NOS. 2,520,594, 2,843,303 AND OTHERS.

NO CLAIM IS MADE TO THE EXCLUSIVE RIGHT TO USE "MARKET", APART FROM THE MARK AS SHOWN.

THE COLOR(S) GREEN AND BROWN IS/ARE CLAIMED AS A FEATURE OF THE MARK.

THE MARK CONSISTS OF THE WORD PUBLIX IN BROWN IN A STYLIZED FONT, ABOVE THE WORD GREENWISE IN GREEN IN A DIFFERENT STYLIZED FONT, ABOVE THE WORD MARKET IN BROWN IN THE SAME STYLIZED FONT AS THE WORD PUBLIX.

FOR RETAIL GROCERY STORE SERVICES (U.S. CLS. 100, 101 AND 102).

FIRST USE 9-0-2007; IN COMMERCE 9-0-2007.

EMILY CHUO, EXAMINING ATTORNEY

**CLASS 35—(Continued).**

SN 85-321,839. REDLINE STAFFING, INC., RALEIGH, NC. FILED 5-16-2011.

REDLINE STAFFING

THE MARK CONSISTS OF STANDARD CHARACTERS WITHOUT CLAIM TO ANY PARTICULAR FONT, STYLE, SIZE, OR COLOR.

NO CLAIM IS MADE TO THE EXCLUSIVE RIGHT TO USE "STAFFING", APART FROM THE MARK AS SHOWN.

FOR EMPLOYMENT AGENCY SERVICES, NAMELY, FILLING THE TEMPORARY AND PERMANENT STAFFING NEEDS OF BUSINESSES; EMPLOYMENT HIRING, RECRUITING, PLACEMENT, STAFFING AND CAREER NETWORKING SERVICES; EMPLOYMENT RECRUITING AND STAFFING SERVICES PROVIDED VIA TEXT MESSAGING; EMPLOYMENT STAFFING CONSULTATION SERVICES; EMPLOYMENT STAFFING IN THE FIELD OF PROMOTIONAL STAFFING FOR THE EVENTS OF OTHER COMPANIES; PROFESSIONAL STAFFING AND RECRUITING SERVICES (U.S. CLS. 100, 101 AND 102).

FIRST USE 10-1-2008; IN COMMERCE 10-1-2008.

EDWARD FENNESSY, EXAMINING ATTORNEY

SN 85-321,920. PORTFOLIO RETHINK LLC, ENGLEWOOD, CO. FILED 5-16-2011.

Portfolio Rethink



GRABYT

THE MARK CONSISTS OF A HAND ABOVE OVER THE STYLIZED TEXT "GRABYT".

FOR PROMOTING THE GOODS AND SERVICES OF OTHERS BY PROVIDING A WEB SITE FEATURING THE DAILY DEALS OF ONLINE RETAILERS IN MULTIPLE CITY LOCATIONS (U.S. CLS. 100, 101 AND 102).

GIANCARLO CASTRO, EXAMINING ATTORNEY

THE MARK CONSISTS OF STANDARD CHARACTERS WITHOUT CLAIM TO ANY PARTICULAR FONT, STYLE, SIZE, OR COLOR.

NO CLAIM IS MADE TO THE EXCLUSIVE RIGHT TO USE "PORTFOLIO", APART FROM THE MARK AS SHOWN.

FOR ANALYZING AND COMPILING DATA FOR MEASURING THE PERFORMANCE OF FINANCIAL MARKETS; COMPILING FINANCIAL, SECURITIES, STOCK EXCHANGE, TRADE AND QUOTE, INDEX VALUE AND OTHER FINANCIAL MARKET INFORMATION FOR BUSINESS PURPOSES; PROVIDING AND UPDATING A FINANCIAL INDEX OF SECURITIES VALUES AND CLASSIFICATION, ANALYSIS, AND REPORTING THEREOF; PROVIDING FINANCIAL INDICES BASED ON SELECTED GROUPS OF SECURITIES; PROVIDING FINANCIAL INDICES OF SELECT SECURITIES TO ENABLE CONSUMERS TO EVALUATE INVESTMENTS AND MARKET TRENDS IN THE SECURITIES MARKET (U.S. CLS. 100, 101 AND 102).

MICHAEL TANNER, EXAMINING ATTORNEY

**CLASS 35—(Continued).**

SN 85-321,926. STREAM GAS & ELECTRIC, LTD., DALLAS, TX. FILED 5-16-2011.

**ROLLING PLAINS ENERGY**

THE MARK CONSISTS OF STANDARD CHARACTERS WITHOUT CLAIM TO ANY PARTICULAR FONT, STYLE, SIZE, OR COLOR.

NO CLAIM IS MADE TO THE EXCLUSIVE RIGHT TO USE "ENERGY", APART FROM THE MARK AS SHOWN.

FOR RETAIL ENERGY PROVIDER SERVICES, NAMELY, PROVIDING A SERVICE THAT ALLOWS CUSTOMERS TO PURCHASE ENERGY, NAMELY, ELECTRICITY, NATURAL GAS, AND RENEWABLE ENERGY (U.S. CLS. 100, 101 AND 102).

ANTHONY RINKER, EXAMINING ATTORNEY

---

SN 85-322,183. J. CREW INTERNATIONAL, INC., WILMINGTON, DE. FILED 5-16-2011.

**J. CREW**

THE MARK CONSISTS OF STANDARD CHARACTERS WITHOUT CLAIM TO ANY PARTICULAR FONT, STYLE, SIZE, OR COLOR.

OWNER OF U.S. REG. NOS. 2,351,667, 3,622,997 AND OTHERS.

FOR PROMOTING PUBLIC AWARENESS OF SOCIALLY RESPONSIBLE BUSINESS PRACTICES; PROVIDING INFORMATION ON-LINE RELATING TO SOCIALLY RESPONSIBLE BUSINESS PRACTICES (U.S. CLS. 100, 101 AND 102).

DOMINIC J. FERRAIUOLO, EXAMINING ATTORNEY

---

SN 85-322,203. MICHAEL T. MOTLEY, DAVIS, CA. FILED 5-16-2011.

**Clarity Police**

THE MARK CONSISTS OF STANDARD CHARACTERS WITHOUT CLAIM TO ANY PARTICULAR FONT, STYLE, SIZE, OR COLOR.

FOR PUBLIC RELATIONS CONSULTING IN THE FIELD OF PUBLIC COMMUNICATION (U.S. CLS. 100, 101 AND 102).

FIRST USE 8-14-2009; IN COMMERCE 8-14-2009.  
SIMON TENG, EXAMINING ATTORNEY

**CLASS 35—(Continued).**

SN 85-322,240. PASTOR-VILLAREAL INC., LYNWOOD, CA. FILED 5-16-2011.



NO CLAIM IS MADE TO THE EXCLUSIVE RIGHT TO USE "NATURAL", APART FROM THE MARK AS SHOWN.

THE MARK CONSISTS OF THE STYLIZED TEXT "INNOVACION NATURAL" IN AN OUTLINE FONT. "INNOVACION" IS POSITIONED ABOVE AND SLIGHTLY TO THE LEFT OF "NATURAL". A BIRD OF PARADISE FLOWER IS TO THE LEFT OF "NATURAL" AND BEHIND "INNOVACION". A SECOND, SMALLER BIRD OF PARADISE IS ABOVE "NATURAL" AND TO THE RIGHT OF "INNOVACION".

THE ENGLISH TRANSLATION OF "INNOVACION NATURAL" IN THE MARK IS "NATURAL INNOVATION".

FOR RETAIL STORE AND ON-LINE RETAIL STORE SERVICES FEATURING NUTRITIONAL SUPPLEMENTS IN LIQUID, CAPSULE AND POWDER FORMS, AND NATURAL BEAUTY SUPPLIES IN SOAP, SHAMPOO AND ACCESSORY FORMS (U.S. CLS. 100, 101 AND 102).

FIRST USE 7-10-2010; IN COMMERCE 10-1-2010.

PAM WILLIS, EXAMINING ATTORNEY

---

SN 85-322,674. EXTRA BLAST MARKETING LLC, SCARSDALE, NY. FILED 5-17-2011.

**EXTRA BLAST Marketing**

THE MARK CONSISTS OF STANDARD CHARACTERS WITHOUT CLAIM TO ANY PARTICULAR FONT, STYLE, SIZE, OR COLOR.

NO CLAIM IS MADE TO THE EXCLUSIVE RIGHT TO USE "MARKETING", APART FROM THE MARK AS SHOWN.

FOR ADVERTISING AND MARKETING SERVICES, NAMELY, PROMOTING THE GOODS AND SERVICES OF OTHERS (U.S. CLS. 100, 101 AND 102).

FIRST USE 3-14-2010; IN COMMERCE 3-14-2010.  
KEVIN DINALLO, EXAMINING ATTORNEY

**CLASS 35—(Continued).**

SN 85-322,937. SERVICEMAGIC, INC., GOLDEN, CO. FILED 5-17-2011.

# Share a Pro

THE MARK CONSISTS OF STANDARD CHARACTERS WITHOUT CLAIM TO ANY PARTICULAR FONT, STYLE, SIZE, OR COLOR.

OWNER OF U.S. REG. NO. 3,667,146.

FOR ADVERTISING AND DIRECTORY SERVICES AVAILABLE VIA THE INTERNET AND MOBILE PHONE NETWORKS, NAMELY, GENERAL BUSINESS NETWORKING REFERRAL SERVICES, NAMELY, PROMOTING THE GOODS AND SERVICES OF OTHERS BY PASSING BUSINESS LEADS, AND REFERRALS AMONG GROUP MEMBERS, PROMOTING THE SERVICES OF OTHERS BY PROVIDING COMMERCIAL INFORMATION OF LOCAL AND NATIONAL SERVICE PROVIDERS, MATCHING CONSUMERS AND COMMERCIAL ENTITIES WITH LOCAL AND NATIONAL SERVICE PROVIDERS FOR COMMERCIAL PURPOSES, AND PROVIDING AN ONLINE MARKETPLACE FEATURING THE SERVICES OF OTHERS (U.S. CLS. 100, 101 AND 102).

FIRST USE 5-8-2011; IN COMMERCE 5-8-2011.

TINA MAI, EXAMINING ATTORNEY

---

SN 85-323,025. GUITAR CENTER, INC., WESTLAKE VIL-  
LAGE, CA. FILED 5-17-2011.

## THE RECORDING EXPERIENCE

THE MARK CONSISTS OF STANDARD CHARACTERS WITHOUT CLAIM TO ANY PARTICULAR FONT, STYLE, SIZE, OR COLOR.

NO CLAIM IS MADE TO THE EXCLUSIVE RIGHT TO USE "RECORDING", APART FROM THE MARK AS SHOWN.

FOR RETAIL STORE SERVICES AND ONLINE RETAIL STORE SERVICES FEATURING RECORDING STUDIO EQUIPMENT PACKAGES FOR THE AT-HOME MUSICIAN CONSISTING OF COMPUTER SOFTWARE, AUDIO INTERFACE, COMPUTER MONITOR, RECORDING MICROPHONE AND STAND, HEADPHONES, COMPUTER HARD DRIVE, DESK, KEYBOARD, POWER CONDITIONER AND MONITOR ISOLATION (U.S. CLS. 100, 101 AND 102).

FIRST USE 9-1-2010; IN COMMERCE 9-1-2010.

JAMES LOVELACE, EXAMINING ATTORNEY

**CLASS 35—(Continued).**

SN 85-323,026. COLORTYME, INC., PLANO, TX. FILED 5-17-2011.



OWNER OF U.S. REG. NOS. 3,341,976 AND 3,341,977.

NO CLAIM IS MADE TO THE EXCLUSIVE RIGHT TO USE "CUSTOM WHEELS AND TIRES", APART FROM THE MARK AS SHOWN.

THE MARK CONSISTS OF THE STYLIZED WORD "RIMTYME" PARTIALLY SUPERIMPOSED OVER AN IMAGE OF A WHEEL RIM WITH A FLAMING TIRE, AND THE WORDS "CUSTOM WHEELS AND TIRES" UNDERNEATH.

FOR RETAIL STORE SERVICES FEATURING TIRES AND WHEEL RIMS (U.S. CLS. 100, 101 AND 102).

FIRST USE 10-0-2006; IN COMMERCE 10-0-2006.

PAUL E. FAHRENKOPF, EXAMINING ATTORNEY

---

SN 85-323,086. IT'S ALL GOOD AUTO SALES, INC., MEM-  
PHIS, TN. FILED 5-17-2011.

## IT'S ALL GOOD AUTO SALES

THE MARK CONSISTS OF STANDARD CHARACTERS WITHOUT CLAIM TO ANY PARTICULAR FONT, STYLE, SIZE, OR COLOR.

NO CLAIM IS MADE TO THE EXCLUSIVE RIGHT TO USE "AUTO SALES", APART FROM THE MARK AS SHOWN.

FOR AUTOMOBILE DEALERSHIPS (U.S. CLS. 100, 101 AND 102).

FIRST USE 11-15-1996; IN COMMERCE 11-15-1996.

KEVIN DINALLO, EXAMINING ATTORNEY

**CLASS 35—(Continued).**

SN 85-323,091. IT'S ALL GOOD AUTO SALES, INC., MEMPHIS, TN. FILED 5-17-2011.

I DON'T CARE ABOUT YOUR  
CREDIT I CARE ABOUT YOU

THE MARK CONSISTS OF STANDARD CHARACTERS WITHOUT CLAIM TO ANY PARTICULAR FONT, STYLE, SIZE, OR COLOR.  
FOR AUTOMOBILE DEALERSHIPS (U.S. CLS. 100, 101 AND 102).  
FIRST USE 12-0-2002; IN COMMERCE 12-0-2002.  
KEVIN DINALLO, EXAMINING ATTORNEY

SN 85-323,216. SILVA, CHRISTOPHER, BOSTON, MA. FILED 5-17-2011.

creating industry solutions

THE MARK CONSISTS OF STANDARD CHARACTERS WITHOUT CLAIM TO ANY PARTICULAR FONT, STYLE, SIZE, OR COLOR.  
NO CLAIM IS MADE TO THE EXCLUSIVE RIGHT TO USE "INDUSTRY SOLUTIONS", APART FROM THE MARK AS SHOWN.  
FOR BUSINESS MANAGEMENT CONSULTING AND ADVISORY SERVICES (U.S. CLS. 100, 101 AND 102).  
LAKEISHA LEWIS, EXAMINING ATTORNEY

SN 85-323,939. DOLLAR GENERAL CORPORATION, GOODLETTSVILLE, TN. FILED 5-18-2011.

**DOLLAR GENERAL**  
**market**

OWNER OF U.S. REG. NOS. 2,912,893, 3,159,752 AND OTHERS.  
NO CLAIM IS MADE TO THE EXCLUSIVE RIGHT TO USE "MARKET", APART FROM THE MARK AS SHOWN.  
THE MARK CONSISTS OF THE WORDS "DOLLAR GENERAL" ON A RECTANGULAR BACKGROUND ABOVE THE WORD "MARKET". THE LETTER "R" IN "MARKET" FEATURES A LEAF DESIGN.  
FOR RETAIL STORE SERVICES IN THE FIELD OF GENERAL MERCHANDISE; RETAIL GROCERY STORE SERVICES (U.S. CLS. 100, 101 AND 102).  
FIRST USE 10-0-2009; IN COMMERCE 5-2-2010.  
HOWARD SMIGA, EXAMINING ATTORNEY

**CLASS 35—(Continued).**

SN 85-324,046. NATURALLY FINE FOODS, INC., CARMEL, IN. FILED 5-18-2011.



NO CLAIM IS MADE TO THE EXCLUSIVE RIGHT TO USE "BUTCHER SHOP" AND "FISH MARKET", APART FROM THE MARK AS SHOWN.

THE MARK CONSISTS OF THE WORD "JOE'S" IN A BANNER OVER THE WORDS "BUTCHER SHOP" OVER A CROSSED KNIFE AND CLEAVER OVER THE WORDS "FISH MARKET", ALL WITHIN A 13 SIDED SYMMETRICAL BOX.

FOR BUTCHER SHOPS; RETAIL MARKETS FEATURING MEATS, FISH, SEAFOOD, GOURMET GROCERIES, BREAD, CHEESE, WINE, BEER, AND BUTCHER SERVICES; RETAIL STORES FEATURING MEATS, FISH, SEAFOOD, GOURMET GROCERIES, BREAD, CHEESE, WINE, BEER, AND BUTCHER SERVICES (U.S. CLS. 100, 101 AND 102).

FIRST USE 8-1-2005; IN COMMERCE 8-1-2005.  
HEATHER THOMPSON, EXAMINING ATTORNEY

SN 85-324,079. EYHOMI MUSIC GROUP LLC, TEANECK, NJ. FILED 5-18-2011.

EYHOMI MUSIC GROUP

THE MARK CONSISTS OF STANDARD CHARACTERS WITHOUT CLAIM TO ANY PARTICULAR FONT, STYLE, SIZE, OR COLOR.

NO CLAIM IS MADE TO THE EXCLUSIVE RIGHT TO USE "MUSIC GROUP", APART FROM THE MARK AS SHOWN.

FOR BUSINESS MANAGEMENT SERVICES IN THE ENTERTAINMENT INDUSTRY, NAMELY, PROMOTING INDIVIDUAL ARTISTS AND GROUPS, CREATING AND MANAGING PUBLICITY, AND SCHEDULING AND ARRANGING PERSONAL APPEARANCES (U.S. CLS. 100, 101 AND 102).

FIRST USE 5-20-1999; IN COMMERCE 5-20-1999.  
ALYSSA STEEL, EXAMINING ATTORNEY

**CLASS 35—(Continued).**

SN 85-324,377. GUZU INC, DEER PARK, NY. FILED 5-18-2011.

# Guzu

THE MARK CONSISTS OF STANDARD CHARACTERS WITHOUT CLAIM TO ANY PARTICULAR FONT, STYLE, SIZE, OR COLOR.

FOR ELECTRONIC COMMERCE SERVICES, NAMELY, OPERATING ON-LINE MARKETPLACES FOR SELLERS AND TRADERS OF GOODS VIA A GLOBAL COMPUTER NETWORK (U.S. CLS. 100, 101 AND 102).

FIRST USE 2-9-2011; IN COMMERCE 2-9-2011.  
TRACY FLETCHER, EXAMINING ATTORNEY

---

SN 85-324,403. TGSTR, LLC, EDEN PRAIRIE, MN. FILED 5-18-2011.

# tgstr

THE MARK CONSISTS OF STANDARD CHARACTERS WITHOUT CLAIM TO ANY PARTICULAR FONT, STYLE, SIZE, OR COLOR.

FOR ONLINE MEDIA MONITORING SERVICES USING COMPUTER SOFTWARE TO AUTOMATICALLY MONITOR INTERNET WEBSITES AND ONLINE PUBLICATIONS FOR CUSTOMER-SPECIFIED TOPICS AND TO CAPTURE RELEVANT CONTENT ON THOSE TOPICS, AND PROVIDING DOCUMENTATION AND ANALYSIS OF THAT ONLINE CONTENT TO OTHERS FOR BUSINESS PURPOSES (U.S. CLS. 100, 101 AND 102).

SKYE YOUNG, EXAMINING ATTORNEY

---

SN 85-324,406. NEVADA GENERAL INSURANCE COMPANY, LAS VEGAS, NV. FILED 5-18-2011.

# DRIVE LESS PAY LESS

THE MARK CONSISTS OF STANDARD CHARACTERS WITHOUT CLAIM TO ANY PARTICULAR FONT, STYLE, SIZE, OR COLOR.

FOR ADMINISTRATION OF A PROGRAM FOR ENABLING CUSTOMERS TO OBTAIN PREMIUM DISCOUNTS ON THE COST OF AUTO INSURANCE POLICIES (U.S. CLS. 100, 101 AND 102).

SKYE YOUNG, EXAMINING ATTORNEY

**CLASS 35—(Continued).**

SN 85-324,479. MARINEMAX, INC., CLEARWATER, FL. FILED 5-18-2011.

# MARINEMAX BOATING GEAR CENTER

THE MARK CONSISTS OF STANDARD CHARACTERS WITHOUT CLAIM TO ANY PARTICULAR FONT, STYLE, SIZE, OR COLOR.

OWNER OF U.S. REG. NOS. 2,401,921, 2,618,170 AND OTHERS.

NO CLAIM IS MADE TO THE EXCLUSIVE RIGHT TO USE "BOATING GEAR CENTER", APART FROM THE MARK AS SHOWN.

FOR RETAIL STORE SERVICES FEATURING MARINE EQUIPMENT AND SUPPLIES (U.S. CLS. 100, 101 AND 102).

FIRST USE 10-1-2004; IN COMMERCE 10-1-2004.  
CYNTHIA TRIPI, EXAMINING ATTORNEY

---

SN 85-324,794. REED ELSEVIER PROPERTIES INC., WILMINGTON, DE. FILED 5-19-2011.

# MYJCKSHOWPLANNER

THE MARK CONSISTS OF STANDARD CHARACTERS WITHOUT CLAIM TO ANY PARTICULAR FONT, STYLE, SIZE, OR COLOR.

OWNER OF U.S. REG. NOS. 2,112,292, 3,753,719 AND OTHERS.

FOR PROMOTING, ARRANGING AND CONDUCTING TRADESHOWS, EXHIBITIONS, EXPOSITIONS AND BUSINESS CONFERENCES IN THE FIELD OF JEWELRY; PROVIDING ONLINE DIRECTORIES AND GUIDES FOR TRADESHOW EXHIBITIONS THE FIELD OF JEWELRY AND FASHION ACCESSORIES (U.S. CLS. 100, 101 AND 102).

FIRST USE 1-31-2011; IN COMMERCE 1-31-2011.  
ANNE FARRELL, EXAMINING ATTORNEY

**CLASS 35—(Continued).**

SN 85-324,989. WIOFFER, LLC, SUFFERN, NY. FILED 5-19-2011.



THE MARK CONSISTS OF A CIRCULAR DESIGN WITH MULTIPLE OUTER CIRCLE LAYERS AND THE STYLIZED LETTERS CAPITAL "W" LOWERCASE "i" AND CAPITAL "O" LOCATED IN THE CENTER CIRCLE.

FOR ADVERTISING AND MARKETING SERVICES PROVIDED BY MEANS OF INDIRECT METHODS OF MARKETING COMMUNICATIONS, NAMELY, SOCIAL MEDIA, SEARCH ENGINE MARKETING, INQUIRY MARKETING, INTERNET MARKETING, MOBILE MARKETING, BLOGGING AND OTHER FORMS OF PASSIVE, SHARABLE OR VIRAL COMMUNICATIONS CHANNELS (U.S. CLS. 100, 101 AND 102).

FIRST USE 12-1-2010; IN COMMERCE 1-1-2011.  
KRISTIN CARLSON, EXAMINING ATTORNEY

**CLASS 35—(Continued).**

SN 85-325,302. SAFEGUARD PROPERTIES, LLC, VALLEY VIEW, OH. FILED 5-19-2011.

**UTILITY PLUS**

THE MARK CONSISTS OF STANDARD CHARACTERS WITHOUT CLAIM TO ANY PARTICULAR FONT, STYLE, SIZE, OR COLOR.

NO CLAIM IS MADE TO THE EXCLUSIVE RIGHT TO USE "UTILITY", APART FROM THE MARK AS SHOWN.

FOR AUDITING UTILITY RATES FOR OTHERS; PROCUREMENT SERVICES, NAMELY, NEGOTIATING ENERGY RATES AND SERVICES FOR OTHERS; BILLING, NAMELY, PROCESSING UTILITY INVOICES FOR THIRD PARTIES; ENERGY-USAGE MANAGEMENT; UTILITY-BILL MANAGEMENT SERVICES, NAMELY, TRACKING, REPORTING, ANALYZING, AND DELIVERING ENERGY INFORMATION IN THE FORM OF UTILITY BILLS AND UTILITY METER DATA RATE SCHEDULES REGARDING THE REAL-ESTATE PROPERTIES OF OTHERS; CONSULTING SERVICES IN THE FIELD OF ENERGY MEASUREMENT TO IMPROVE ENERGY EFFICIENCY WITHIN RESIDENCES (U.S. CLS. 100, 101 AND 102).

HOWARD SMIGA, EXAMINING ATTORNEY

SN 85-325,267. GTF INVESTMENTS, LTD., DBA FOSSIL CREEK LIQUOR, FORT WORTH, TX. FILED 5-19-2011.

**Fossil Creek Liquor**

THE MARK CONSISTS OF STANDARD CHARACTERS WITHOUT CLAIM TO ANY PARTICULAR FONT, STYLE, SIZE, OR COLOR.

NO CLAIM IS MADE TO THE EXCLUSIVE RIGHT TO USE "LIQUOR", APART FROM THE MARK AS SHOWN.

FOR RETAIL AND WHOLESALE STORE SERVICES FEATURING BEER, WINE AND SPIRITS; RETAIL AND WHOLESALE LIQUOR STORE SERVICES (U.S. CLS. 100, 101 AND 102).

FIRST USE 4-6-2001; IN COMMERCE 4-6-2001.  
JIM RINGLE, EXAMINING ATTORNEY

SN 85-325,401. UNIFIED GROCERS, INC., COMMERCE, CA. FILED 5-19-2011.

**MORE WAYS TO MARKET YOUR MARKET**

THE MARK CONSISTS OF STANDARD CHARACTERS WITHOUT CLAIM TO ANY PARTICULAR FONT, STYLE, SIZE, OR COLOR.

OWNER OF U.S. REG. NOS. 3,190,184 AND 3,245,964.  
FOR DISTRIBUTORSHIP AND ONLINE DISTRIBUTORSHIP SERVICES IN THE FIELD OF GROCERY AND HOUSEHOLD PRODUCTS (U.S. CLS. 100, 101 AND 102).  
ANNE MADDEN, EXAMINING ATTORNEY



**CLASS 35—(Continued).**

SN 85-326,000. PASSIVE HOUSE MATERIALS LLC, CHAPEL HILL, NC. FILED 5-20-2011.



NO CLAIM IS MADE TO THE EXCLUSIVE RIGHT TO USE "PASSIVE HOUSE MATERIALS.COM SUPPLIES FOR THE ENERGY-EFFICIENT BUILDER", APART FROM THE MARK AS SHOWN.

THE MARK CONSISTS OF A HOUSE WITH SHED ROOF ENCOMPASSING OF THE STYLIZED TEXT "PASSIVE HOUSE MATERIALS". THERE IS A HALF CIRCLE ON THE LEFT SIDE OF THE STYLIZED TEXT "PASSIVE HOUSE MATERIALS". AN ARROW APPEARS RIGHT BEFORE THE STYLIZED TEXT "HOUSE". BELOW THERE IS THE STYLIZED TEXT ".COM SUPPLIES FOR THE ENERGY-EFFICIENT BUILDER".

FOR DISTRIBUTORSHIP SERVICES IN THE FIELD OF ENERGY EFFICIENT BUILDING MATERIALS AND PRODUCTS (U.S. CLS. 100, 101 AND 102).  
WENDY JUN, EXAMINING ATTORNEY

SN 85-326,273. PERFUME EMPORIUM INC., SANTA ANA, CA. FILED 5-20-2011.

## Beauty Bucks

THE MARK CONSISTS OF STANDARD CHARACTERS WITHOUT CLAIM TO ANY PARTICULAR FONT, STYLE, SIZE, OR COLOR.

NO CLAIM IS MADE TO THE EXCLUSIVE RIGHT TO USE "BEAUTY", APART FROM THE MARK AS SHOWN.

FOR ON-LINE RETAIL STORE SERVICES FEATURING COSMETICS (U.S. CLS. 100, 101 AND 102).

FIRST USE 1-1-1999; IN COMMERCE 1-1-1999.  
HOWARD SMIGA, EXAMINING ATTORNEY

**CLASS 35—(Continued).**

SN 85-326,394. TOKUSAKU INCORPORATED, SEATTLE, WA. FILED 5-20-2011.

## TokuSaku

THE MARK CONSISTS OF STANDARD CHARACTERS WITHOUT CLAIM TO ANY PARTICULAR FONT, STYLE, SIZE, OR COLOR.

THE ENGLISH TRANSLATION OF THE MARK IS "A GOOD PLAN".

FOR BUSINESS MANAGEMENT CONSULTANCY SERVICES; BUSINESS MANAGEMENT CONSULTATION; BUSINESS MANAGEMENT CONSULTING (U.S. CLS. 100, 101 AND 102).

FIRST USE 1-1-2008; IN COMMERCE 1-1-2008.  
ANDREW LEASER, EXAMINING ATTORNEY

SN 85-326,791. ASTRALCOM, LLC, LAKEWOOD, CA. FILED 5-21-2011.

## ASTRALCOM Your Digital Business Partner

THE MARK CONSISTS OF STANDARD CHARACTERS WITHOUT CLAIM TO ANY PARTICULAR FONT, STYLE, SIZE, OR COLOR.

FOR E-COMMERCE BUSINESS CONSULTING OR BUSINESS CONSULTING SERVICES (U.S. CLS. 100, 101 AND 102).

FIRST USE 10-1-1997; IN COMMERCE 10-7-1997.  
CHERYL CLAYTON, EXAMINING ATTORNEY

SN 85-326,942. HARRY WILLIAM JERNIGAN IV, DBA MEDICAL FOR YOU, EVANS, GA. FILED 5-22-2011.



THE COLOR(S) BLUE, GREEN, AND WHITE IS/ARE CLAIMED AS A FEATURE OF THE MARK.

THE MARK CONSISTS OF MEDICAL FOR YOU WRITTEN IN WHITE IN A BLUE SKY OVER A GREEN GRASS HILL WITH A BLUE CIRCLE TO THE LEFT WITH A WHITE DIGITAL IMAGE OF A PERSON RUNNING A WHITE WHEELCHAIR WITH SLANTED GREEN CROSS IN THE WHEEL IN THE BLUE CIRCLE.

FOR ON-LINE RETAIL STORE SERVICES FEATURING A WIDE VARIETY OF CONSUMER GOODS OF OTHERS (U.S. CLS. 100, 101 AND 102).

FIRST USE 9-1-2009; IN COMMERCE 9-1-2009.

DOMINICK J. SALEMI, EXAMINING ATTORNEY

**CLASS 35—(Continued).**

SN 85-327,205. THE INTERGROW GROUP, LLC, WARREN, NJ. FILED 5-23-2011.

**THE INTERGROW GROUP**

THE MARK CONSISTS OF STANDARD CHARACTERS WITHOUT CLAIM TO ANY PARTICULAR FONT, STYLE, SIZE, OR COLOR.

NO CLAIM IS MADE TO THE EXCLUSIVE RIGHT TO USE "GROUP", APART FROM THE MARK AS SHOWN.

FOR BUSINESS DEVELOPMENT CONSULTING SERVICES; BUSINESS MANAGEMENT CONSULTING; BUSINESS ORGANIZATION AND MANAGEMENT CONSULTING (U.S. CLS. 100, 101 AND 102).  
ALICIA COLLINS, EXAMINING ATTORNEY

**CLASS 35—(Continued).**

SN 85-327,676. BETTENCOURT GREEN BUILDING SUPPLIES, NEW YORK, NY. FILED 5-23-2011.

**ECOSUPPLY**

THE MARK CONSISTS OF STANDARD CHARACTERS WITHOUT CLAIM TO ANY PARTICULAR FONT, STYLE, SIZE, OR COLOR.

FOR DISTRIBUTORSHIPS IN THE FIELD OF ARCHITECTURAL MATERIALS AND SUPPLIES; ON-LINE RETAIL STORE SERVICES FEATURING ARCHITECTURAL MATERIALS AND SUPPLIES; RETAIL SHOPS FEATURING ARCHITECTURAL MATERIALS AND SUPPLIES (U.S. CLS. 100, 101 AND 102).

FIRST USE 8-1-2009; IN COMMERCE 8-1-2009.  
ALLISON HOLTZ, EXAMINING ATTORNEY

SN 85-327,704. GUITAR CENTER, INC., WESTLAKE VILLAGE, CA. FILED 5-23-2011.

**GC PRO**

THE MARK CONSISTS OF STANDARD CHARACTERS WITHOUT CLAIM TO ANY PARTICULAR FONT, STYLE, SIZE, OR COLOR.

NO CLAIM IS MADE TO THE EXCLUSIVE RIGHT TO USE "PRO", APART FROM THE MARK AS SHOWN.

FOR PROCUREMENT, NAMELY, PURCHASING OF INSTALLATION PROVIDERS, SYSTEM INTEGRATION PROVIDERS AND TECHNICAL SERVICE PROVIDERS FOR CUSTOMERS IN NEED OF AUDIO RECORDING EQUIPMENT FOR RECORDING STUDIOS, LIVE SOUND VENUES, NAMELY, CONGREGATIONS, SCHOOLS, DANCE CLUBS AND CONCERT HALLS, AND POST FACILITIES; BUSINESS MANAGEMENT SUPERVISION OF INSTALLATION PROVIDERS, SYSTEM INTEGRATION PROVIDERS AND TECHNICAL SERVICE PROVIDERS FOR CUSTOMERS IN NEED OF AUDIO RECORDING EQUIPMENT FOR RECORDING STUDIOS, LIVE SOUND VENUES, NAMELY, CONGREGATIONS, SCHOOLS, DANCE CLUBS AND CONCERT HALLS, AND POST FACILITIES; ONLINE RETAIL STORE SERVICES FEATURING AUDIO EQUIPMENT, NAMELY, AMPLIFIERS, SPEAKERS, MIXERS, RECORDING CONSOLES, MIXER CASES, LIGHTS, CONTROLLERS FOR LIGHTS, MICROPHONES, STANDS FOR MICROPHONES, AMPLIFIER RACKS, SPEAKER STANDS, CABLES, FOG MACHINES, SOFTWARE FOR COMPOSING AND WRITING MUSIC; RETAIL STORE SERVICES FEATURING AUDIO EQUIPMENT, NAMELY, AMPLIFIERS, SPEAKERS, MIXERS, RECORDING CONSOLES, MIXER CASES, LIGHTS, CONTROLLERS FOR LIGHTS, MICROPHONES, STANDS FOR MICROPHONES, AMPLIFIER RACKS, SPEAKER STANDS, CABLES, FOG MACHINES, SOFTWARE FOR COMPOSING AND WRITING MUSIC (U.S. CLS. 100, 101 AND 102).

FIRST USE 4-1-2001; IN COMMERCE 4-1-2001.  
JAMES LOVELACE, EXAMINING ATTORNEY

SN 85-327,577. EXTRA BLAST MARKETING LLC, SCARSDALE, NY. FILED 5-23-2011.

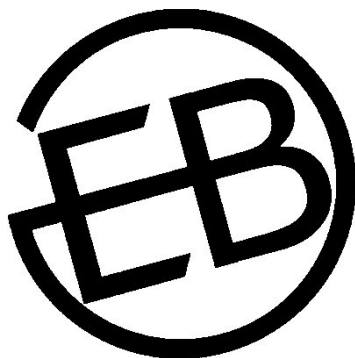

THE MARK CONSISTS OF THE LETTERS "EB" ON A SLIGHT ANGLE, INSIDE BUT ATTACHED TO AN INCOMPLETE CIRCLE WITH THE CURVED PART OF THE "B".

FOR ADVERTISING AND MARKETING SERVICES, NAMELY, PROMOTING THE GOODS AND SERVICES OF OTHERS (U.S. CLS. 100, 101 AND 102).

FIRST USE 5-14-2010; IN COMMERCE 5-14-2010.  
KEVIN DINALLO, EXAMINING ATTORNEY

**CLASS 35—(Continued).**

SN 85-327,844. GUITAR CENTER, INC., WESTLAKE VIL-  
LAGE, IL. FILED 5-23-2011.

# GOPRO

FOR PROCUREMENT, NAMELY, PURCHASING OF INSTALLATION PROVIDERS, SYSTEM INTEGRATION PROVIDERS AND TECHNICAL SERVICE PROVIDERS FOR CUSTOMERS IN NEED OF AUDIO RECORDING EQUIPMENT FOR RECORDING STUDIOS, LIVE SOUND VENUES, NAMELY, CONGREGATIONS, SCHOOLS, DANCE CLUBS AND CONCERT HALLS, AND POST FACILITIES; BUSINESS MANAGEMENT SUPERVISION OF INSTALLATION PROVIDERS, SYSTEM INTEGRATION PROVIDERS AND TECHNICAL SERVICE PROVIDERS FOR CUSTOMERS IN NEED OF AUDIO RECORDING EQUIPMENT FOR RECORDING STUDIOS, LIVE SOUND VENUES, NAMELY, CONGREGATIONS, SCHOOLS, DANCE CLUBS AND CONCERT HALLS, AND POST FACILITIES; ONLINE RETAIL STORE SERVICES FEATURING AUDIO EQUIPMENT, NAMELY, AMPLIFIERS, SPEAKERS, MIXERS, RECORDING CONSOLES, MIXER CASES, LIGHTS, CONTROLLERS FOR LIGHTS, MICROPHONES, STANDS FOR MICROPHONES, AMPLIFIER RACKS, SPEAKER STANDS, CABLES, FOG MACHINES, SOFTWARE FOR COMPOSING AND WRITING MUSIC; RETAIL STORE SERVICES FEATURING AUDIO EQUIPMENT, NAMELY, AMPLIFIERS, SPEAKERS, MIXERS, RECORDING CONSOLES, MIXER CASES, LIGHTS, CONTROLLERS FOR LIGHTS, MICROPHONES, STANDS FOR MICROPHONES, AMPLIFIER RACKS, SPEAKER STANDS, CABLES, FOG MACHINES, SOFTWARE FOR COMPOSING AND WRITING MUSIC (U.S. CLS. 100, 101 AND 102).

FIRST USE 4-1-2001; IN COMMERCE 4-1-2001.  
JAMES LOVELACE, EXAMINING ATTORNEY

SN 85-328,420. NV BEKAERT SA, ZWEVEGEM, BELGIUM,  
FILED 5-24-2011.

# FILMHANDLER

THE MARK CONSISTS OF STANDARD CHARACTERS WITHOUT CLAIM TO ANY PARTICULAR FONT, STYLE, SIZE, OR COLOR.

PRIORITY CLAIMED UNDER SEC. 44(D) ON BENELUX APPLICATION NO. 1224308, FILED 4-28-2011, REG. NO. 0900362, DATED 4-28-2011, EXPIRES 4-28-2021.

FOR HELP IN THE MANAGEMENT OF BUSINESS AFFAIRS OR FUNCTIONS OF COMMERCIAL ENTERPRISES; SALES PROMOTION; DISTRIBUTION OF ADVERTISING MATERIAL (U.S. CLS. 100, 101 AND 102).

KARANENDRA S. CHHINA, EXAMINING ATTORNEY

**CLASS 35—(Continued).**

SN 85-328,597. HARTFORD FIRE INSURANCE COMPANY,  
HARTFORD, CT. FILED 5-24-2011.

MEASURE. COACH. IMPROVE.

THE MARK CONSISTS OF STANDARD CHARACTERS WITHOUT CLAIM TO ANY PARTICULAR FONT, STYLE, SIZE, OR COLOR.

FOR BUSINESS RISK MANAGEMENT (U.S. CLS. 100, 101 AND 102).

FIRST USE 4-18-2011; IN COMMERCE 4-18-2011.

SAIMA MAKHDOOM, EXAMINING ATTORNEY

SN 85-328,961. STEVEN GORDON, NEW YORK, NY. FILED  
5-24-2011.

# ZIPFOODIE.COM

THE MARK CONSISTS OF STANDARD CHARACTERS WITHOUT CLAIM TO ANY PARTICULAR FONT, STYLE, SIZE, OR COLOR.

FOR ON-LINE ORDERING SERVICES IN THE FIELD OF RESTAURANT TAKE-OUT AND DELIVERY; PROMOTIONAL SERVICES, NAMELY, PROMOTING THE GOODS OF OTHERS BY MEANS OF PROVIDING ON-LINE RESTAURANT MENUS; PROVIDING A WEBSITE WHERE USERS CAN POST RATINGS, REVIEWS AND RECOMMENDATIONS ON RESTAURANTS, FOOD AND WINE FOR COMMERCIAL PURPOSES (U.S. CLS. 100, 101 AND 102).

CHARLES L. JENKINS, EXAMINING ATTORNEY

**CLASS 35—(Continued).**

SN 85-328,994. THE WOMAN'S BODY SHOPP, INC., AKA THE WOMAN'S WORKOUT COMPANY, HYANNIS, MA. FILED 5-24-2011.



THE MARK CONSISTS OF THE WORD "FAT" WITH THE WORD "TAX" BELOW IT, BOTH INSIDE A CIRCLE WITH A LINE BISECTING THE CIRCLE ON A DIAGONAL FROM THE UPPER RIGHT TO THE LOWER LEFT. OVERLAPPING THE BOTTOM RIGHT OF THE CIRCLE IS A RECTANGLE BEARING THE WORDS "THE MORE YOU WORKOUT THE LESS YOU PAY!" AND APPEARING TO HAVE A PAINTBRUSH STROKE DESIGN BEHIND THE TOP, BOTTOM AND RIGHT-HAND EDGES OF THE RECTANGLE.

FOR CONDUCTING AND ADMINISTERING A PROGRAM FOR PARTICIPATING HEALTH AND FITNESS CLUBS FEATURING DISCOUNTS ON CLUB MEMBERSHIP FOR ACCESS TO THE CLUBS TO PROGRAM MEMBERS; ADMINISTRATION OF A PROGRAM FOR ENABLING PARTICIPANTS TO OBTAIN DISCOUNTS ON PRODUCTS AND SERVICES IN THE FIELD OF PHYSICAL FITNESS (U.S. CLS. 100, 101 AND 102).

H. M. FISHER, EXAMINING ATTORNEY

**CLASS 35—(Continued).**

SN 85-329,725. WRITEMINDS, WHITE PLAINS, NY. FILED 5-25-2011.



THE MARK CONSISTS OF A THOUGHT BUBBLE WITH AN ABSTRACT TEXT INSIDE IT AND THREE SMALL BUBBLES FORMING THE TAIL, ALL TO THE RIGHT OF THE TEXT "WRITEMINDSMEDIA", AND THE TEXT "WHERE TRADITIONAL AND NEW MEDIA CONVERGE" BELOW "WRITEMINDSMEDIA".

FOR MARKETING AND CONSULTING SERVICES IN THE FIELD OF PROMOTING AND TRACKING THE GOODS, SERVICES, AND BRANDS OF OTHERS THROUGH ALL PUBLIC COMMUNICATION MEANS, PARTICULARLY SPECIALIZING IN THE USE OF MOBILE, SOCIAL, AND PRINT MEDIA TO DRIVE CONSUMER INTEREST, ENGAGEMENT AND ACTION (U.S. CLS. 100, 101 AND 102).

FIRST USE 1-1-2009; IN COMMERCE 4-9-2010.

PAM WILLIS, EXAMINING ATTORNEY

SN 85-329,572. HATCH, INC., WINSTON-SALEM, NC. FILED 5-25-2011.



*The Early Learning Experts*

OWNER OF U.S. REG. NO. 3,618,574.

NO CLAIM IS MADE TO THE EXCLUSIVE RIGHT TO USE "THE EARLY LEARNING EXPERTS", APART FROM THE MARK AS SHOWN.

THE MARK CONSISTS OF THE STYLIZED WORD "HATCH" WITH THE LETTER "T" INSIDE OF AN OVAL. BEGINNING UNDER THE "H" ARE THE WORDS "THE EARLY LEARNING EXPERTS" IN GRAY UPPERCASE AND LOWERCASE LETTERS.

FOR DIRECT MARKETING TO SCHOOLS; MAIL ORDER CATALOG SERVICES AND ON-LINE RETAIL STORE SERVICES IN THE FIELD OF COMPUTER HARDWARE AND SOFTWARE, CLASSROOM EQUIPMENT, CLASSROOM FURNITURE, AND TEACHING AIDS, GAMES, BOOKS AND EDUCATIONAL KITS; CONDUCTING TRADE SHOW EXHIBITIONS IN THE FIELD OF COMPUTER HARDWARE AND SOFTWARE, CLASSROOM EQUIPMENT, CLASSROOM FURNITURE, AND TEACHING AIDS, GAMES, BOOKS AND EDUCATIONAL KITS (U.S. CLS. 100, 101 AND 102).

FIRST USE 5-9-2011; IN COMMERCE 5-9-2011.

STEVEN R. FINE, EXAMINING ATTORNEY

SN 85-330,493. COSTPRESS, INCORPORATED, FRANKLIN, TN. FILED 5-25-2011.

**CostPress**

THE MARK CONSISTS OF STANDARD CHARACTERS WITHOUT CLAIM TO ANY PARTICULAR FONT, STYLE, SIZE, OR COLOR.

FOR BUYING CLUB SERVICES IN THE FIELD OF CONSUMER SERVICES AND RETAIL PRODUCTS (U.S. CLS. 100, 101 AND 102).

FIRST USE 5-23-2011; IN COMMERCE 5-23-2011.

KATHERINE STOIDES, EXAMINING ATTORNEY

**CLASS 35—(Continued).**

SN 85-330,602. WHITCOMB, JON, NEW CANAAN, CT. FILED 5-26-2011.

**KINDERGREEN**

THE MARK CONSISTS OF STANDARD CHARACTERS WITHOUT CLAIM TO ANY PARTICULAR FONT, STYLE, SIZE, OR COLOR.

FOR RETAIL STORE SERVICES AND RETAIL STORE SERVICES AVAILABLE THROUGH THE INTERNET AND INTERACTIVE TELEVISION, ALL FEATURING HEALTH AND BEAUTY AIDS, COSMETICS, PERFUMERY, HAIR CARE AND STYLING PREPARATIONS, DIETARY AND NUTRITIONAL SUPPLEMENTS, HERBAL REMEDIES, BEVERAGES, EXERCISE EQUIPMENT AND PRODUCTS, AND CLEANING PRODUCTS; TELEMARKETING (U.S. CLS. 100, 101 AND 102).

MARCIE MILONE, EXAMINING ATTORNEY

SN 85-330,659. SHWEKY, ISAAC H., CHESHIRE, CT. AND GARCIA, JESSE, ROUND LAKE BEACH, IL. FILED 5-26-2011.

**VORTEX MAN**

THE MARK CONSISTS OF STANDARD CHARACTERS WITHOUT CLAIM TO ANY PARTICULAR FONT, STYLE, SIZE, OR COLOR.

FOR PROMOTING PUBLIC AWARENESS OF ENVIRONMENTAL ISSUES AND INITIATIVES (U.S. CLS. 100, 101 AND 102).

ELLEN PERKINS, EXAMINING ATTORNEY

SN 85-331,070. ALPHA I MARKETING CORP., WHITE PLAINS, NY. FILED 5-26-2011.

**C TOWN**

THE MARK CONSISTS OF STANDARD CHARACTERS WITHOUT CLAIM TO ANY PARTICULAR FONT, STYLE, SIZE, OR COLOR.

OWNER OF U.S. REG. NOS. 1,210,785 AND 1,273,978.

FOR PROMOTING THE GOODS AND SERVICES OF OTHERS BY MEANS OF AN INTERACTIVE WEBSITE FEATURING COUPONS AND RECIPES, INFORMATION IN THE FIELDS OF FOOD AND BEVERAGES, DIET, FITNESS AND HEALTH, AND EVENTS OF INTEREST TO THE COMMUNITY AT LARGE; RETAIL CONVENIENCE STORES; RETAIL GROCERY STORES; SUPERMARKETS (U.S. CLS. 100, 101 AND 102).

FIRST USE 6-0-1975; IN COMMERCE 6-0-1975.

STEVEN R. FINE, EXAMINING ATTORNEY

**CLASS 35—(Continued).**

SN 85-331,160. HUDSON SHUFFLEBOARDS LLC, SANTA ANA, CA. FILED 5-26-2011.

**World Series of Shuffleboard**

THE MARK CONSISTS OF STANDARD CHARACTERS WITHOUT CLAIM TO ANY PARTICULAR FONT, STYLE, SIZE, OR COLOR.

FOR ADVERTISING AND MARKETING (U.S. CLS. 100, 101 AND 102).

KIMBERLY PERRY, EXAMINING ATTORNEY

SN 85-331,337. ERIC PELLY SPORTS EDUCATION FUND, ALLISON PARK, PA. FILED 5-26-2011.

**"Never Give Up" EP**

THE MARK CONSISTS OF STANDARD CHARACTERS WITHOUT CLAIM TO ANY PARTICULAR FONT, STYLE, SIZE, OR COLOR.

FOR CHARITABLE SERVICES, NAMELY, PROMOTING PUBLIC AWARENESS OF SPORTS SAFETY AND THE PREVENTION OF CONCUSSIONS AND OTHER HEAD INJURIES (U.S. CLS. 100, 101 AND 102).

FIRST USE 3-31-2007; IN COMMERCE 3-31-2007.

MARILYN IZZI, EXAMINING ATTORNEY

SN 85-331,505. MKM RESOURCES, INC., RANCHO CUCAMONGA, CA. FILED 5-26-2011.

**MKMRESOURCES**

THE MARK CONSISTS OF STANDARD CHARACTERS WITHOUT CLAIM TO ANY PARTICULAR FONT, STYLE, SIZE, OR COLOR.

FOR TEMPORARY PLACEMENT SERVICES FOR PHYSICAL, OCCUPATIONAL, SPEECH AND RESPIRATORY THERAPISTS, NURSES, AND ALLIED MEDICAL PROFESSIONALS (U.S. CLS. 100, 101 AND 102).

FIRST USE 12-8-2008; IN COMMERCE 12-8-2008.

JULIE VEPPUMTHARA, EXAMINING ATTORNEY

**CLASS 35—(Continued).**

SN 85-331,814. MR. MARKETING GROUP, INC., BOCA RATON, FL. FILED 5-26-2011.

**CONSUMER NEWS NATION**

THE MARK CONSISTS OF STANDARD CHARACTERS WITHOUT CLAIM TO ANY PARTICULAR FONT, STYLE, SIZE, OR COLOR.

NO CLAIM IS MADE TO THE EXCLUSIVE RIGHT TO USE "CONSUMER NEWS", APART FROM THE MARK AS SHOWN.

FOR OPERATING ON-LINE MARKETPLACE FOR SELLERS OF GOODS AND SERVICES; DISSEMINATION OF ADVERTISING FOR THE GOODS AND SERVICES OF OTHERS ON A GLOBAL COMPUTER NETWORK (U.S. CLS. 100, 101 AND 102).

SHANNON TWOHIG, EXAMINING ATTORNEY

SN 85-331,926. OUTWEST PROMOTIONS INC., NINE MILES FALLS, WA. FILED 5-26-2011.



THE MARK CONSISTS OF THE WORDS "FILL UP" APPEAR OVER THE WORDS "SPLASH DOWN" IN A RECTANGULAR FORM WITH AN AMPERSAND SIGN IN THE CENTER. WAVE DESIGNS APPEAR AT THE BOTTOM OF THE LOGO AND THE CENTER OF THE LOGO FEATURES CURVED SWOOPING RIBBON STYLE DESIGNS THAT ARE WIDER AT THE CENTER AND TAPER AT THE ENDS.

FOR ADVERTISING AND MARKETING SERVICES, NAMELY, PROMOTING THE GOODS AND SERVICES OF OTHERS; INCENTIVE AWARD PROGRAMS TO PROMOTE THE SALE OF PRODUCTS AND SERVICES OF OTHERS; PROMOTING THE SALE OF GOODS AND SERVICES OF OTHERS THROUGH THE DISTRIBUTION OF PRINTED MATERIAL AND PROMOTIONAL CONTESTS (U.S. CLS. 100, 101 AND 102).

SHARON MEIER, EXAMINING ATTORNEY

**CLASS 35—(Continued).**

SN 85-331,934. GOOLSBY, TERRY P., UPPER MARLBORO, MD. FILED 5-26-2011.

**CLOZYNERGY**

THE MARK CONSISTS OF STANDARD CHARACTERS WITHOUT CLAIM TO ANY PARTICULAR FONT, STYLE, SIZE, OR COLOR.

FOR CHARITABLE SERVICES, NAMELY, PROMOTING ENVIRONMENTAL AWARENESS TO CHILDREN (U.S. CLS. 100, 101 AND 102).

FIRST USE 5-24-2011; IN COMMERCE 5-24-2011.

HEATHER THOMPSON, EXAMINING ATTORNEY

SN 85-332,099. EASTBAY, INC., WAUSAU, WI. FILED 5-27-2011.

**Where Athletes Are**

THE MARK CONSISTS OF STANDARD CHARACTERS WITHOUT CLAIM TO ANY PARTICULAR FONT, STYLE, SIZE, OR COLOR.

FOR ADVERTISING THROUGH ALL PUBLIC COMMUNICATION MEANS; CATALOG ORDERING SERVICE FEATURING CLOTHING, FOOTWEAR AND ACCESSORIES; ELECTRONIC CATALOG SERVICES FEATURING CLOTHING, FOOTWEAR AND ACCESSORIES (U.S. CLS. 100, 101 AND 102).

JEFFERY COWARD, EXAMINING ATTORNEY

SN 85-332,155. FASTENAL IP COMPANY, WINONA, MN. FILED 5-27-2011.

**THE MACHINE BEHIND THE MACHINE**

THE MARK CONSISTS OF STANDARD CHARACTERS WITHOUT CLAIM TO ANY PARTICULAR FONT, STYLE, SIZE, OR COLOR.

FOR MOBILE VENDING SERVICES IN THE FIELDS OF MAINTENANCE, REPAIR AND OPERATION SUPPLIES AND OFFICE SUPPLIES (U.S. CLS. 100, 101 AND 102).

FIRST USE 12-10-2010; IN COMMERCE 12-10-2010.

NAKWAMA ANKRAH, EXAMINING ATTORNEY

**CLASS 35—(Continued).**

SN 85-332,165. VALEN TECHNOLOGIES, INC., DBA VALEN TECHNOLOGIES, INC., DENVER, CO. FILED 5-27-2011.

# ITVRight

THE MARK CONSISTS OF STANDARD CHARACTERS WITHOUT CLAIM TO ANY PARTICULAR FONT, STYLE, SIZE, OR COLOR.

FOR BUSINESS MANAGEMENT CONSULTING WITH RELATION TO STRATEGY, MARKETING, SALES, OPERATION, PRODUCT DESIGN PARTICULARLY SPECIALIZING IN THE USE OF ANALYTIC AND STATISTIC MODELS FOR THE UNDERSTANDING AND PREDICTING OF CONSUMERS, BUSINESSES, AND MARKET TRENDS AND ACTIONS (U.S. CLS. 100, 101 AND 102).

GRETTA YAO, EXAMINING ATTORNEY

SN 85-332,197. MC CORMICK, THOMAS, SOUTH BEND, IN. AND MC CORMICK, MARY A, SOUTH BEND, IN. FILED 5-27-2011.

**1800 GOT  CARS.com**

THE STIPPLING IS FOR SHADING PURPOSES ONLY. THE MARK CONSISTS OF THE STYLIZED TEXT "1800GOTECARS.COM" WITH THE "E" LEANING FORWARD SLIGHTLY WITH TWO LITTLE WHEELS AT THE BOTTOM OF THE CAPITAL LETTER E.

FOR ON-LINE RETAIL STORE SERVICES FEATURING AUTOMOBILES (U.S. CLS. 100, 101 AND 102).

FIRST USE 1-11-2011; IN COMMERCE 2-1-2011.

DAVID ELTON, EXAMINING ATTORNEY

**CLASS 35—(Continued).**

SN 85-332,286. BELLENZA, INC., STEVENSON RANCH, CA. FILED 5-27-2011.

# BELLENZA

THE MARK CONSISTS OF STANDARD CHARACTERS WITHOUT CLAIM TO ANY PARTICULAR FONT, STYLE, SIZE, OR COLOR.

FOR CATALOG ORDERING SERVICE FEATURING PERSONALIZED AND NON-PERSONALIZED WEDDING AND BRIDAL SHOWER GIFTWARE, ACCESSORIES, KEEPSAKES, MEMENTOS, FAVORS, DECORATIONS AND SUPPLIES; COMPUTERIZED ON-LINE ORDERING SERVICES IN THE FIELD OF PERSONALIZED AND NON-PERSONALIZED WEDDING AND BRIDAL SHOWER GIFTWARE, ACCESSORIES, KEEPSAKES, MEMENTOS, FAVORS, DECORATIONS AND SUPPLIES; COMPUTERIZED ON-LINE RETAIL STORE SERVICES IN THE FIELD OF PERSONALIZED AND NON-PERSONALIZED WEDDING AND BRIDAL SHOWER GIFTWARE, ACCESSORIES, KEEPSAKES, MEMENTOS, FAVORS, DECORATIONS AND SUPPLIES; FACSIMILE ORDERING SERVICES IN THE FIELD OF PERSONALIZED AND NON-PERSONALIZED WEDDING AND BRIDAL SHOWER GIFTWARE, ACCESSORIES, KEEPSAKES, MEMENTOS, FAVORS, DECORATIONS AND SUPPLIES; MAIL ORDER CATALOG SERVICES FEATURING PERSONALIZED AND NON-PERSONALIZED WEDDING AND BRIDAL SHOWER GIFTWARE, ACCESSORIES, KEEPSAKES, MEMENTOS, FAVORS, DECORATIONS AND SUPPLIES; ON-LINE ORDERING SERVICES FEATURING PERSONALIZED AND NON-PERSONALIZED WEDDING AND BRIDAL SHOWER GIFTWARE, ACCESSORIES, KEEPSAKES, MEMENTOS, FAVORS, DECORATIONS AND SUPPLIES (U.S. CLS. 100, 101 AND 102).

FIRST USE 3-5-2004; IN COMMERCE 3-5-2004.

JOHN DWYER, EXAMINING ATTORNEY

SN 85-332,337. CITYVIEW VISION LLC, DALLAS, TX. FILED 5-27-2011.

# EYEMAX

THE MARK CONSISTS OF STANDARD CHARACTERS WITHOUT CLAIM TO ANY PARTICULAR FONT, STYLE, SIZE, OR COLOR.

FOR ON-LINE RETAIL STORE SERVICES FEATURING OPTICAL GOODS, EYEGLASSES, SUNGLASSES, EYEGLASS FRAMES, CORRECTIVE AND NON-CORRECTIVE EYEGLASS LENSES, CONTACT LENSES, EYECARE PRODUCTS, EYECARE AND OPTICAL ACCESSORIES, CLOTHING, APPAREL, HEADWEAR, CLOTHING ACCESSORIES, BAGS; RETAIL STORE SERVICES FEATURING OPTICAL GOODS, EYEGLASSES, SUNGLASSES, EYEGLASS FRAMES, CORRECTIVE AND NON-CORRECTIVE EYEGLASS LENSES, CONTACT LENSES, EYECARE PRODUCTS, EYECARE AND OPTICAL ACCESSORIES, CLOTHING, APPAREL, HEADWEAR, CLOTHING ACCESSORIES, BAGS; RETAIL OPTICAL STORES (U.S. CLS. 100, 101 AND 102).

JEAN IM, EXAMINING ATTORNEY

**CLASS 35—(Continued).**

SN 85-332,358. CASA COUTURE, INC., OAKLAND PARK, FL. FILED 5-27-2011.

**CASA COUTURE**

THE MARK CONSISTS OF STANDARD CHARACTERS WITHOUT CLAIM TO ANY PARTICULAR FONT, STYLE, SIZE, OR COLOR.

OWNER OF U.S. REG. NOS. 3,762,816 AND 3,914,107.

NO CLAIM IS MADE TO THE EXCLUSIVE RIGHT TO USE "COUTURE", APART FROM THE MARK AS SHOWN. THE ENGLISH TRANSLATION OF "CASA" IN THE MARK IS "HOUSE".

FOR ON-LINE RETAIL STORE SERVICES FEATURING FOOTWEAR, HANDBAGS, EARRINGS, BRACELETS, RINGS, NECKLACES, BROACHES, HAIR ACCESSORIES, SUNGLASSES, BELTS, HATS, SCARVES, COATS, JACKETS, DRESSES, PANTS, SHIRTS, SHORTS, SKIRTS, SLEEPWEAR (U.S. CLS. 100, 101 AND 102).

SIMON TENG, EXAMINING ATTORNEY

**CLASS 35—(Continued).**

SN 85-332,517. ADVANCED DATA SYSTEMS CORPORATION, AKA ADS, PARAMUS, NJ. FILED 5-27-2011.

**MedicsDocAssistant**

THE MARK CONSISTS OF STANDARD CHARACTERS WITHOUT CLAIM TO ANY PARTICULAR FONT, STYLE, SIZE, OR COLOR.

FOR PROVIDING AN INTERNET-BASED DATABASE OF PATIENT MEDICAL INFORMATION DESIGNED TO FACILITATE PATIENT-AUTHORIZED, HIPAA-COMPLIANT SHARING AND MAINTENANCE OF PATIENT MEDICAL INFORMATION AMONGST A PATIENT'S DOCTORS SUCH THAT THIS INFORMATION CAN BE DIRECTLY INSERTED INTO THE DOCTOR'S MEDICAL REPORTS AS A MEANS OF INCREASING MEDICAL RECORD GENERATION EFFICIENCY AND ACCURACY (U.S. CLS. 100, 101 AND 102).

FIRST USE 4-1-2002; IN COMMERCE 4-1-2002.

SIMON TENG, EXAMINING ATTORNEY

SN 85-332,428. DOMEDIA, LLC, COLUMBUS, OH. FILED 5-27-2011.

**DOBUY**

THE MARK CONSISTS OF STANDARD CHARACTERS WITHOUT CLAIM TO ANY PARTICULAR FONT, STYLE, SIZE, OR COLOR.

OWNER OF U.S. REG. NOS. 3,722,234, 3,840,223 AND OTHERS.

FOR BUSINESS INTERMEDIARY AND ADVISORY SERVICES IN THE FIELDS OF BUYING AND SELLING ALTERNATIVE MEDIA; PROVIDING AN ONLINE COMPUTER DATABASE IN THE FIELD OF ALTERNATIVE MEDIA FOR USE IN ADVERTISING (U.S. CLS. 100, 101 AND 102).

KAREN SEVERSON, EXAMINING ATTORNEY

SN 85-332,561. SHIMMER & SHINE PRODUCTIONS, INC., ALPHARETTA, GA. FILED 5-27-2011.

**Know Better Do Better**

THE MARK CONSISTS OF STANDARD CHARACTERS WITHOUT CLAIM TO ANY PARTICULAR FONT, STYLE, SIZE, OR COLOR.

FOR ADMINISTRATION OF A PROGRAM TO PROMOTE COMMUNITY SERVICE; CHARITABLE SERVICES, NAMELY, ORGANIZING YOUTH GROUPS TO UNDERTAKE PROJECTS TO BENEFIT THE NEEDY AND THE COMMUNITY TO ENCOURAGE LEADERSHIP, CHARACTER, COMPASSION, AND GOOD CITIZENSHIP (U.S. CLS. 100, 101 AND 102).

JASON BLAIR, EXAMINING ATTORNEY

SN 85-332,473. CIRCA60, LLC, WEEHAWKEN, NJ. FILED 5-27-2011.

**circa60**

THE MARK CONSISTS OF STANDARD CHARACTERS WITHOUT CLAIM TO ANY PARTICULAR FONT, STYLE, SIZE, OR COLOR.

FOR SECOND HAND DEALERSHIPS FEATURING FURNITURE (U.S. CLS. 100, 101 AND 102).

FIRST USE 9-1-2007; IN COMMERCE 9-15-2007.

JACQUELINE A. LAVINE, EXAMINING ATTORNEY

SN 85-332,800. FILL MORE BOWLS, LLC, SAN FRANCISCO, CA. FILED 5-27-2011.

**(\*\*\*\*)  
fillmorebowls**

THE MARK CONSISTS OF THE STYLIZED SYMBOLS AND WORDS "FILLMOREBOWLS (\*\*\*\*)". THE SYMBOLS "(\*\*\*\*)" IS PLACE ABOVE THE TEXT.

FOR MOBILE STREET VENDOR SERVICES FEATURING FOOD AND DRINK (U.S. CLS. 100, 101 AND 102).

JAMES A. RAUEN, EXAMINING ATTORNEY



**CLASS 35—(Continued).**

SN 85-332,824. ANOKAH-SAN LLC, OLD BRIDGE, NJ. FILED 5-27-2011.

Cuff Cakes, Sweet Treats  
for Your Feet

THE MARK CONSISTS OF STANDARD CHARACTERS WITHOUT CLAIM TO ANY PARTICULAR FONT, STYLE, SIZE, OR COLOR.

FOR ON-LINE RETAIL STORE SERVICES FEATURING HEADBANDS, BOOT CUFFS, BRACELETS, AND OTHER FASHION ACCESSORIES (U.S. CLS. 100, 101 AND 102).

MICHELE SWAIN, EXAMINING ATTORNEY

**CLASS 35—(Continued).**

SN 85-333,072. VONCHURCH SAN FRANCISCO, INC., SAN FRANCISCO, CA. FILED 5-28-2011.



THE MARK CONSISTS OF A LETTER "V" WITH A SMALL "SHELF" OFF OF THE TOP LEFT SIDE OF THE LETTER.

FOR PROFESSIONAL STAFFING AND RECRUITING SERVICES (U.S. CLS. 100, 101 AND 102). FIRST USE 8-1-2008; IN COMMERCE 8-1-2008.

ARETHA SOMERVILLE, EXAMINING ATTORNEY

SN 85-332,923. HOUSE OF ANTIQUE HARDWARE, INC., PORTLAND, OR. FILED 5-27-2011.



THE MARK CONSISTS OF TWO STYLIZED "H" LETTERS CONNECTED TOGETHER.

FOR ONLINE RETAIL STORE SERVICES FEATURING DOOR HARDWARE, WINDOW HARDWARE, ELECTRICAL SWITCHES, ELECTRICAL SWITCH PLATES, ELECTRICAL SWITCH PLATE COVERS, ELECTRICAL SWITCH HOUSINGS, ELECTRICAL OUTLET COVERS, AND BATH ACCESSORIES (U.S. CLS. 100, 101 AND 102).

FIRST USE 3-7-2006; IN COMMERCE 3-7-2006. REBECCA EISINGER, EXAMINING ATTORNEY

SN 85-333,100. LOVINGECO, INC., DBA LOVINGECO, LOS ANGELES, CA. FILED 5-28-2011.

LovingEco

THE MARK CONSISTS OF STANDARD CHARACTERS WITHOUT CLAIM TO ANY PARTICULAR FONT, STYLE, SIZE, OR COLOR.

FOR ON-LINE CONSIGNMENT SERVICES WHEREBY GOODS ARE RECEIVED ON CONSIGNMENT IN ON-LINE RETAIL STORES FEATURING WOMEN'S CLOTHING, KIDS CLOTHING, BEAUTY PRODUCTS (U.S. CLS. 100, 101 AND 102).

FIRST USE 1-1-2011; IN COMMERCE 5-1-2011. JACQUELINE A. LAVINE, EXAMINING ATTORNEY

SN 85-333,113. FAMILY BUSINESS WIKI, LLC, ANN ARBOR, MI. FILED 5-28-2011.

fb2fb

THE MARK CONSISTS OF STANDARD CHARACTERS WITHOUT CLAIM TO ANY PARTICULAR FONT, STYLE, SIZE, OR COLOR.

FOR ON-LINE BUSINESS DIRECTORIES FEATURING FAMILY BUSINESSES (U.S. CLS. 100, 101 AND 102). FIRST USE 1-17-2010; IN COMMERCE 1-19-2011.

CHERYL CLAYTON, EXAMINING ATTORNEY

**CLASS 35—(Continued).**

SN 85-333,139. ORENDORFF, JAY E, SAN FRANCISCO, CA. FILED 5-28-2011.

## A Quiet Drink

THE MARK CONSISTS OF STANDARD CHARACTERS WITHOUT CLAIM TO ANY PARTICULAR FONT, STYLE, SIZE, OR COLOR.

FOR ADVERTISING, MARKETING AND PROMOTION SERVICES (U.S. CLS. 100, 101 AND 102). FIRST USE 9-11-2010; IN COMMERCE 4-1-2011. TRACY FLETCHER, EXAMINING ATTORNEY

---

SN 85-333,162. LOVE SHOPPING MIAMI, LLC, SUNNY ISLES BEACH, FL. FILED 5-28-2011.

## LSM

THE COLOR(S) GRAY IS/ARE CLAIMED AS A FEATURE OF THE MARK.

THE MARK CONSISTS OF STYLIZED CAPITAL LETTERS LSM IN COLOR GRAY.

FOR RETAIL APPAREL STORES (U.S. CLS. 100, 101 AND 102).

SKYE YOUNG, EXAMINING ATTORNEY

---

SN 85-333,247. MR. MARKETING, INC., BOCA RATON, FL. FILED 5-29-2011.

## Live Smart America

THE MARK CONSISTS OF STANDARD CHARACTERS WITHOUT CLAIM TO ANY PARTICULAR FONT, STYLE, SIZE, OR COLOR.

NO CLAIM IS MADE TO THE EXCLUSIVE RIGHT TO USE "AMERICA", APART FROM THE MARK AS SHOWN.

FOR OPERATING ON-LINE MARKETPLACE FOR SELLERS OF GOODS AND SERVICES; DISSEMINATION OF ADVERTISING FOR THE GOODS AND SERVICES OF OTHERS ON A GLOBAL COMPUTER NETWORK (U.S. CLS. 100, 101 AND 102).

JULIE VEPPUMTHARA, EXAMINING ATTORNEY

**CLASS 35—(Continued).**

SN 85-333,338. HANNICO LLC, NAPA, CA. FILED 5-30-2011.

## Vinotype

THE MARK CONSISTS OF STANDARD CHARACTERS WITHOUT CLAIM TO ANY PARTICULAR FONT, STYLE, SIZE, OR COLOR.

FOR PROVIDING A WEB-BASED SYSTEM AND ON-LINE PORTALS IN THE FIELD OF CONSUMER-TO-BUSINESS COMMERCE FOR CONSUMERS TO ENTER, MANAGE AND MODIFY THEIR CONSUMER PREFERENCE INFORMATION FOR USE BY MERCHANTS TO CREATE AND MANAGE OFFERS FOR DELIVERY TO CONSUMERS; PROVIDING A WEBSITE WHERE USERS CAN POST RATINGS, REVIEWS AND RECOMMENDATIONS ON RESTAURANTS, FOOD AND WINE FOR COMMERCIAL PURPOSES (U.S. CLS. 100, 101 AND 102). ANDREA HACK, EXAMINING ATTORNEY

---

SN 85-333,353. HANNICO LLC, NAPA, CA. FILED 5-30-2011.

## YumYuk

THE MARK CONSISTS OF STANDARD CHARACTERS WITHOUT CLAIM TO ANY PARTICULAR FONT, STYLE, SIZE, OR COLOR.

FOR PROVIDING A WEB SITE WHERE USERS CAN POST RATINGS, REVIEWS AND RECOMMENDATIONS ON PRODUCTS AND SERVICES FOR COMMERCIAL PURPOSES; PROVIDING A WEB-BASED SYSTEM AND ONLINE PORTALS IN THE FIELD OF CONSUMER-TO-BUSINESS COMMERCE FOR CONSUMERS TO ENTER, MANAGE AND MODIFY THEIR CONSUMER PREFERENCE INFORMATION FOR USE BY MERCHANTS TO CREATE AND MANAGE OFFERS FOR DELIVERY TO CONSUMERS; PROVIDING A WEBSITE FOR USERS WITH SPECIFIC INFORMED RECOMMENDATIONS OF SPECIFIC CONSUMER PRODUCTS AND SERVICES VALIDATED BY THE USERS' INPUTTED PREFERENCES AND SOCIAL NETWORK (U.S. CLS. 100, 101 AND 102).

FIRST USE 2-10-2000; IN COMMERCE 12-3-2007.

ANDREA HACK, EXAMINING ATTORNEY

**CLASS 35—(Continued).**

SN 85-333,377. MIKEN HOLDINGS, LLC, TULSA, OK. FILED 5-30-2011.



NO CLAIM IS MADE TO THE EXCLUSIVE RIGHT TO USE "FROZEN YOGURT", APART FROM THE MARK AS SHOWN.

THE MARK CONSISTS OF THE WORDS YOLOTTI FROZEN YOGURT. THE WORD YOLOTTI IS IN BOLDER CHARACTERS AND IS ON TOP OF THE WORDS FROZEN YOGURT. THERE IS A STYLIZED YOGURT SWIRL ABOVE THE SECOND "O" IN THE WORD YOLOTTI.

FOR SELF-SERVE FROZEN YOGURT SHOP SERVICES (U.S. CLS. 100, 101 AND 102).

FIRST USE 5-6-2011; IN COMMERCE 5-6-2011.  
KRISTINA MORRIS, EXAMINING ATTORNEY

**CLASS 35—(Continued).**

SN 85-333,588. FASTENAL IP COMPANY, WINONA, MN. FILED 5-31-2011.

GROWTH THROUGH CUSTOMER  
SERVICE

THE MARK CONSISTS OF STANDARD CHARACTERS WITHOUT CLAIM TO ANY PARTICULAR FONT, STYLE, SIZE, OR COLOR.

FOR WHOLESALE DISTRIBUTORSHIP AND WHOLESALE OUTLET STORES FEATURING FASTENERS, ELECTRICAL TOOLS AND WIRING, GLOVES, PROTECTIVE EYEWEAR, FIRST AID PRODUCTS, BUILDING CONSTRUCTION TOOLS AND EQUIPMENT USED FOR PLUMBING PURPOSES, JANITORIAL EQUIPMENT AND SUPPLIES USED FOR INDUSTRIAL, INSTITUTIONAL AND COMMERCIAL PURPOSES; BUSINESS MANAGEMENT CONSULTING SERVICES IN THE BUILDING CONSTRUCTION TOOLS INDUSTRY (U.S. CLS. 100, 101 AND 102).

FIRST USE 0-0-1995; IN COMMERCE 0-0-1995.  
NAAKWAMA ANKRAH, EXAMINING ATTORNEY

SN 85-333,630. LINDSEY, MARK, NEW YORK, NY. FILED 5-31-2011.

Where Producers Are King!

SN 85-333,399. WINTRISS, MARC V., SALT LAKE CITY, UT. FILED 5-30-2011.

CLEAREXCHANGE

THE MARK CONSISTS OF STANDARD CHARACTERS WITHOUT CLAIM TO ANY PARTICULAR FONT, STYLE, SIZE, OR COLOR.

FOR ADVERTISING, MARKETING AND PROMOTION SERVICES (U.S. CLS. 100, 101 AND 102).

JOHN GARTNER, EXAMINING ATTORNEY

SN 85-333,645. ZORCH INTERNATIONAL, INC., CHICAGO, IL. FILED 5-31-2011.



THE MARK CONSISTS OF STANDARD CHARACTERS WITHOUT CLAIM TO ANY PARTICULAR FONT, STYLE, SIZE, OR COLOR.

FOR EXCHANGE SERVICES, NAMELY, BARTERING OF GOODS FOR OTHERS; ON-LINE TRADING SERVICES IN WHICH SELLER POSTS PRODUCTS TO BE AUCTIONED AND BIDDING IS DONE VIA THE INTERNET; PROVIDING A WEBSITE FEATURING AN ON-LINE MARKETPLACE FOR EXCHANGING GOODS AND SERVICES WITH OTHER USERS (U.S. CLS. 100, 101 AND 102).

ANDREA HACK, EXAMINING ATTORNEY

OWNER OF U.S. REG. NOS. 2,993,947, 3,643,391 AND 3,825,612.

THE MARK CONSISTS OF THE WORD "ZORCH" IN STYLIZED FONT.

FOR SOURCING AND PURCHASING BRANDED PROMOTIONAL PRODUCTS AND CORPORATE IDENTITY MERCHANDISE FOR OTHERS (U.S. CLS. 100, 101 AND 102).

FIRST USE 10-31-2003; IN COMMERCE 10-31-2003.  
JOHN GARTNER, EXAMINING ATTORNEY

**CLASS 35—(Continued).**

SN 85-333,734. GUIDEWELL, INC., JACKSONVILLE, FL.  
FILED 5-31-2011.

**Happier.Healthier.Simplified.**

THE MARK CONSISTS OF STANDARD CHARACTERS WITHOUT CLAIM TO ANY PARTICULAR FONT, STYLE, SIZE, OR COLOR.

FOR PROVIDING A WEBSITE PROMOTING THE HEALTH-RELATED GOODS AND SERVICES OF OTHERS (U.S. CLS. 100, 101 AND 102).  
LAURA KOVALSKY, EXAMINING ATTORNEY

---

SN 85-333,796. REMEMBER THE WILD, LLC, AUSTIN, TX.  
FILED 5-31-2011.

**Remember the Wild**

THE MARK CONSISTS OF STANDARD CHARACTERS WITHOUT CLAIM TO ANY PARTICULAR FONT, STYLE, SIZE, OR COLOR.

FOR PROVIDING AN INTERNET WEBSITE FEATURING NEWS AND INFORMATION IN THE FIELD OF NATURAL RESOURCE MANAGEMENT RELATING TO THE ENVIRONMENT AND PUBLIC LANDS (U.S. CLS. 100, 101 AND 102).

FIRST USE 5-27-2010; IN COMMERCE 10-7-2010.  
TRICIA SONNEBORN, EXAMINING ATTORNEY

---

SN 85-333,841. XL MACHINERY SALES, INC., STUART, FL.  
FILED 5-31-2011.

**Tombstonecity**

THE MARK CONSISTS OF STANDARD CHARACTERS WITHOUT CLAIM TO ANY PARTICULAR FONT, STYLE, SIZE, OR COLOR.

FOR RETAIL STORE SERVICES FEATURING CAST IRON BLOCKS FOR HORIZONTAL MACHINES CENTER DESIGNED TO HOLD VARIOUS WORK PIECES DURING THE MACHINE PROCESS (U.S. CLS. 100, 101 AND 102).

FIRST USE 1-1-2004; IN COMMERCE 1-1-2004.  
JAMES LOVELACE, EXAMINING ATTORNEY

**CLASS 35—(Continued).**

SN 85-333,852. QUALITY SUPPLY CHAIN CO-OP, INC., DUBLIN, OH. FILED 5-31-2011.

**We Are You**

THE MARK CONSISTS OF STANDARD CHARACTERS WITHOUT CLAIM TO ANY PARTICULAR FONT, STYLE, SIZE, OR COLOR.

FOR PROCUREMENT SERVICES, NAMELY, PROCURING SUPPLY CHAIN CONTRACTS FOR OTHERS FOR THE PURCHASE OF GOODS IN THE FOOD SERVICE INDUSTRY; SUPPLY CHAIN MANAGEMENT SERVICES IN THE FOOD SERVICE INDUSTRY; BUSINESS MANAGEMENT SERVICES IN THE NATURE OF MANAGING LOGISTICS, SUPPLY CHAIN SERVICES, SUPPLY CHAIN VISIBILITY AND SYNCHRONIZATION, SUPPLY AND DEMAND FORECASTING AND PRODUCT DISTRIBUTION PROCESSES FOR OTHERS IN THE FOOD SERVICE INDUSTRY; ELECTRONIC DATA COLLECTION FOR BUSINESS PURPOSES IN THE FOOD SERVICE INDUSTRY; PREPARING BUSINESS AND FINANCIAL REPORTS FOR OTHERS IN THE FOOD SERVICE INDUSTRY (U.S. CLS. 100, 101 AND 102).

JOHN HWANG, EXAMINING ATTORNEY

---

SN 85-333,858. WEALTHTOUCH, INC., DENVER, CO. FILED 5-31-2011.

**WEALTHTOUCH**

THE MARK CONSISTS OF STANDARD CHARACTERS WITHOUT CLAIM TO ANY PARTICULAR FONT, STYLE, SIZE, OR COLOR.

FOR ACCOUNTING SERVICES; EXPENSE MANAGEMENT SERVICES; PROVIDING INFORMATION AGGREGATION AND REPORTING SERVICES FOR HIGH NET WORTH INDIVIDUALS AND ADVISORS; INVESTMENT REPORTING SERVICES (U.S. CLS. 100, 101 AND 102).

FIRST USE 12-31-2001; IN COMMERCE 12-31-2001.  
JOHN HWANG, EXAMINING ATTORNEY

**CLASS 35—(Continued).**

SN 85-333,874. LOVINGECO, INC., DBA LOVINGECO, LOS ANGELES, CA. FILED 5-31-2011.

# Style for Change

THE MARK CONSISTS OF STANDARD CHARACTERS WITHOUT CLAIM TO ANY PARTICULAR FONT, STYLE, SIZE, OR COLOR.

FOR ON-LINE CONSIGNMENT SERVICES WHEREBY GOODS ARE RECEIVED ON CONSIGNMENT IN ON-LINE RETAIL STORES FEATURING WOMEN'S CLOTHING, KIDS CLOTHING, BEAUTY PRODUCTS (U.S. CLS. 100, 101 AND 102).

FIRST USE 10-7-2010; IN COMMERCE 5-1-2011.  
JACQUELINE A. LAVINE, EXAMINING ATTORNEY

SN 85-333,922. XUBA, LLC, OMAHA, NE. FILED 5-31-2011.

# BLOOM

THE MARK CONSISTS OF STANDARD CHARACTERS WITHOUT CLAIM TO ANY PARTICULAR FONT, STYLE, SIZE, OR COLOR.

FOR ON-LINE RETAIL STORE SERVICES FEATURING HEALTH AND BEAUTY PRODUCTS; PROVIDING A WEBSITE WHERE USERS CAN POST RATINGS, REVIEWS AND RECOMMENDATIONS ON HEALTH AND BEAUTY PRODUCTS (U.S. CLS. 100, 101 AND 102).

JENNIFER VASQUEZ, EXAMINING ATTORNEY

SN 85-333,934. BUY AND SHIP, LLC, DANA POINT, CA. FILED 5-31-2011.



THE MARK CONSISTS OF STYLIZED THICK AND THIN INTERWOVEN CURVED LINES.

FOR RETAIL STORE SERVICES FEATURING ADULT ENTERTAINMENT PRODUCTS (U.S. CLS. 100, 101 AND 102).

GEOFFREY FOSDICK, EXAMINING ATTORNEY

**CLASS 35—(Continued).**

SN 85-333,937. XUBA, LLC, OMAHA, NE. FILED 5-31-2011.

# BLOOM.COM

THE MARK CONSISTS OF STANDARD CHARACTERS WITHOUT CLAIM TO ANY PARTICULAR FONT, STYLE, SIZE, OR COLOR.

FOR ON-LINE RETAIL STORE SERVICES FEATURING HEALTH AND BEAUTY PRODUCTS; PROVIDING A WEBSITE WHERE USERS CAN POST RATINGS, REVIEWS AND RECOMMENDATIONS ON HEALTH AND BEAUTY PRODUCTS (U.S. CLS. 100, 101 AND 102).

JENNIFER VASQUEZ, EXAMINING ATTORNEY

SN 85-333,949. RODRIGUEZ, JOSE A., DBA JR MEDIA COMPANY, DALLAS, TX. FILED 5-31-2011.

# Mouponz

THE MARK CONSISTS OF STANDARD CHARACTERS WITHOUT CLAIM TO ANY PARTICULAR FONT, STYLE, SIZE, OR COLOR.

FOR PROMOTING AND MARKETING THE GOODS AND SERVICES OF OTHERS BY DISTRIBUTING ADVERTISING MATERIAL, COUPONS AND DISCOUNT OFFERS VIA TEXT MESSAGES (U.S. CLS. 100, 101 AND 102).

NAAKWAMA ANKRAH, EXAMINING ATTORNEY

SN 85-334,040. PABLO MARCO CEBALLOS, BUENOS AIRES, ARGENTINA, FILED 5-31-2011.



OWNER OF ARGENTINA REG. NO. 2419766, DATED 1-21-2011. EXPIRES 1-21-2021.

NO CLAIM IS MADE TO THE EXCLUSIVE RIGHT TO USE "MARKETING CONSULTANTS", APART FROM THE MARK AS SHOWN.

THE COLOR(S) BLUE AND BLACK IS/ARE CLAIMED AS A FEATURE OF THE MARK.

THE MARK CONSISTS OF THE WORD "MARCO MARKETING CONSULTANTS" WITH THE WORD "MARCO" IN UPPER CASE AND BLACK LETTER ABOVE THE WORDS "MARKETING CONSULTANTS" IN LOWER CASE AND LIGHT BLUE LETTER AND THE FOREGOING IS TO THE RIGHT OF A STYLIZED PARTIAL CAPITAL LETTER "M" IN WHITE ON A LIGHT BLUE BACKGROUND.

FOR MARKET RESEARCH AND MARKET INTELLIGENCE SERVICES, MARKET RESEARCH CONSULTATION, BUSINESS MANAGEMENT AND MARKETING STRATEGY DEVELOPMENT AND IMPLEMENTATION (U.S. CLS. 100, 101 AND 102).

ROSELLE HERRERA, EXAMINING ATTORNEY

**CLASS 35—(Continued).**

SN 85-334,059. DELUXE ENTERPRISE OPERATIONS, INC., SHOREVIEW, MN. FILED 5-31-2011.

## MARKETSTART

THE MARK CONSISTS OF STANDARD CHARACTERS WITHOUT CLAIM TO ANY PARTICULAR FONT, STYLE, SIZE, OR COLOR.

FOR BUSINESS CONSULTING SERVICES IN THE FIELD OF BUSINESS STRATEGY, NAMELY, BUSINESS OPERATIONAL EFFECTIVENESS, REVENUE GENERATION AND COST MANAGEMENT; IMPROVING CLIENT SERVICES, NAMELY, CUSTOMER SATISFACTION AND RETENTION, CUSTOMER REFERRALS; BUSINESS AND CONSULTING SERVICES RELATING TO ADVERTISING, PROMOTING AND MARKETING (U.S. CLS. 100, 101 AND 102).

FIRST USE 12-0-2010; IN COMMERCE 12-0-2010.  
BARBARA BROWN, EXAMINING ATTORNEY

SN 85-334,121. BETTENCOURT GREEN BUILDING SUPPLIES, LLC, GARDEN CITY, NY. FILED 5-31-2011.



The logo for Ecosupply features the word "ecosupply" in a lowercase, sans-serif font. The "eco" is in black and the "supply" is in a light brown color. A thin, curved line arches over the text, and a white highlight is visible on the top of the "eco" portion.

THE COLOR(S) BLACK, WHITE AND LIGHT BROWN IS/ARE CLAIMED AS A FEATURE OF THE MARK.

THE MARK CONSISTS OF THE STYLIZED WORDS "ECOSUPPLY" WITH "ECO" IN BLACK AND "SUPPLY" IN LIGHT BROWN WITH A BROKEN CURVED LINE GOING OVER THE STYLIZED MARK IN LIGHT BROWN AND A HIGHLIGHT OF WHITE ON THE LIGHT BROWN CURVED LINE.

FOR DISTRIBUTORSHIPS IN THE FIELD OF ARCHITECTURAL MATERIALS AND SUPPLIES; ON-LINE RETAIL STORE SERVICES FEATURING ARCHITECTURAL MATERIALS AND SUPPLIES; RETAIL SHOPS FEATURING ARCHITECTURAL MATERIALS AND SUPPLIES (U.S. CLS. 100, 101 AND 102).

FIRST USE 8-1-2009; IN COMMERCE 8-1-2009.  
KATHERINE CONNOLLY, EXAMINING ATTORNEY

**CLASS 35—(Continued).**

SN 85-334,151. ACCUFORM MANUFACTURING, INC., BROOKSVILLE, FL. FILED 5-31-2011.



OWNER OF U.S. REG. NO. 3,746,505.

NO CLAIM IS MADE TO THE EXCLUSIVE RIGHT TO USE "SIGNS", APART FROM THE MARK AS SHOWN.

THE MARK CONSISTS OF A DESIGN ELEMENT COMPRISING A SQUARE WITH ROUNDED CORNERS AND A STYLIZED "A" LOCATED WITHIN THE SQUARE, AN "ACCUFORM" TERM LOCATED TO THE RIGHT OF THE DESIGN ELEMENT AND A "SIGNS" TERM LOCATED BELOW THIS "ACCUFORM" TERM AND TO THE RIGHT OF THE DESIGN ELEMENT.

FOR RETAIL STORE AND ON-LINE RETAIL STORE SERVICES FEATURING SIGNS, TAGS, LABELS, MARKERS, AND BARRIERS (U.S. CLS. 100, 101 AND 102).

FIRST USE 5-20-2011; IN COMMERCE 5-20-2011.

KATHLEEN LORENZO, EXAMINING ATTORNEY

SN 85-334,165. JAYNE EHRLICH, DBA HOMETOWN NANNIES PLUS, WESTPORT, CT. FILED 5-31-2011.

## Malibu Mamas

THE MARK CONSISTS OF STANDARD CHARACTERS WITHOUT CLAIM TO ANY PARTICULAR FONT, STYLE, SIZE, OR COLOR.

FOR (BASED ON USE IN COMMERCE) EMPLOYMENT AGENCIES; EMPLOYMENT AGENCY SERVICES; EMPLOYMENT AGENCY SERVICES, NAMELY, TEMPORARY PLACEMENT OF CHILD CARE PROVIDERS (BASED ON INTENT TO USE) EMPLOYMENT AGENCY SERVICES, NAMELY, FILLING THE TEMPORARY AND PERMANENT STAFFING NEEDS OF BUSINESSES (U.S. CLS. 100, 101 AND 102).

FIRST USE 4-1-1988; IN COMMERCE 6-1-1995.

HOWARD B. LEVINE, EXAMINING ATTORNEY

**CLASS 35—(Continued).**

SN 85-334,201. MAYE, JEROME, LOS ANGELES, CA. FILED 5-31-2011.

## PROFITRICITY

THE MARK CONSISTS OF STANDARD CHARACTERS WITHOUT CLAIM TO ANY PARTICULAR FONT, STYLE, SIZE, OR COLOR.

FOR PROVIDING AN INTERNET WEBSITE PORTAL FEATURING PROMOTION OF LOCAL MERCHANTS, NON-PROFITS, AND MEDIA ALIGNING AND AGREEING TO SHARE REVENUE GENERATED BY INDIVIDUALS PARTICIPATING IN A COST PER ACTION PRICING MODEL (U.S. CLS. 100, 101 AND 102).

ZACHARY BELLO, EXAMINING ATTORNEY

SN 85-334,336. KM FINE ARTS, LLC, CHICAGO, IL. FILED 5-31-2011.



NO CLAIM IS MADE TO THE EXCLUSIVE RIGHT TO USE "FINE ARTS", APART FROM THE MARK AS SHOWN.

THE MARK CONSISTS OF THE LETTERS "K" AND "M" APPEAR IN BLOCK LETTERS, WITH THE WORDS "FINE ARTS" APPEARING IN CAPITAL LETTERS UNDERNEATH. SHADING AROUND THE "K" IS DARKER THAN THE SHADING SURROUNDING THE "M". COLOR IS NOT CLAIMED IN THIS MARK.

FOR ART GALLERY SPECIALIZING IN THE SALE AND ACQUISITION OF FINE WORKS OF ART (U.S. CLS. 100, 101 AND 102).

FIRST USE 5-23-2011; IN COMMERCE 5-23-2011.  
LYDIA BELZER, EXAMINING ATTORNEY

SN 85-334,341. BOLD PRODUCTION, LLC, CORONA DEL MAR, CA. FILED 5-31-2011.

## Next: Fulfillment Beyond Retirement

THE MARK CONSISTS OF STANDARD CHARACTERS WITHOUT CLAIM TO ANY PARTICULAR FONT, STYLE, SIZE, OR COLOR.

FOR PROVIDING EMPLOYMENT COUNSELING INFORMATION ON HOW TO SUCCESSFULLY TRANSITION JOBS FOR MATURE WORKERS (U.S. CLS. 100, 101 AND 102).

JENNIFER MARTIN, EXAMINING ATTORNEY

**CLASS 35—(Continued).**

SN 85-334,343. KM FINE ARTS, LLC, CHICAGO, IL. FILED 5-31-2011.

## KM FINE ARTS

THE MARK CONSISTS OF STANDARD CHARACTERS WITHOUT CLAIM TO ANY PARTICULAR FONT, STYLE, SIZE, OR COLOR.

NO CLAIM IS MADE TO THE EXCLUSIVE RIGHT TO USE "FINE ARTS", APART FROM THE MARK AS SHOWN.

FOR ART GALLERY SPECIALIZING IN THE SALE AND ACQUISITION OF FINE WORKS OF ART (U.S. CLS. 100, 101 AND 102).

FIRST USE 5-23-2011; IN COMMERCE 5-23-2011.  
LYDIA BELZER, EXAMINING ATTORNEY

SN 85-334,369. TRASH TALK EXCHANGE, LLC, CALABASAS, CA. FILED 5-31-2011.

## Trash Talk eXchange

THE MARK CONSISTS OF STANDARD CHARACTERS WITHOUT CLAIM TO ANY PARTICULAR FONT, STYLE, SIZE, OR COLOR.

FOR MARKETING RESEARCH SERVICES (U.S. CLS. 100, 101 AND 102).

B. PARADEWELAI, EXAMINING ATTORNEY

SN 85-334,386. PRINCESS OF TIDES, LLC, CHARLESTON, SC. FILED 5-31-2011.

## Princess of Tides

THE MARK CONSISTS OF STANDARD CHARACTERS WITHOUT CLAIM TO ANY PARTICULAR FONT, STYLE, SIZE, OR COLOR.

FOR RETAIL STORE SELLING CHILDREN'S GIFTS AND TOYS (U.S. CLS. 100, 101 AND 102).

FIRST USE 10-1-2009; IN COMMERCE 10-1-2009.  
VERNA BETH RIRIE, EXAMINING ATTORNEY

**CLASS 35—(Continued).**

SN 85-334,400. RESURGENT ENERGY, LLC, HOUSTON, TX.  
FILED 5-31-2011.



THE MARK CONSISTS OF AN IMAGE OF A SQUIRREL WEARING A HAT, VEST, SHIRT, AND TIE. THE SQUIRREL HOLDS A MAGNIFYING GLASS IN HIS RIGHT HAND AND A LIGHT BULB UNDER HIS LEFT ARM. TO THE LEFT OF THE MAGNIFYING GLASS ARE THREE LIGHTNING BOLTS. TO THE LEFT OF THESE IMAGES IS THE STYLIZED TEXT "BIDAWATT".

FOR ENERGY MANAGEMENT SERVICES, NAMELY, PROVIDING A SERVICE THAT ALLOWS CUSTOMERS TO PURCHASE ENERGY, NAMELY, ELECTRICITY, NATURAL GAS AND RENEWABLE ENERGY, AT A FIXED PRICE (U.S. CLS. 100, 101 AND 102).

FIRST USE 3-15-2011; IN COMMERCE 3-15-2011.  
HOWARD SMIGA, EXAMINING ATTORNEY

---

SN 85-334,533. AVID TRANSLATION, SAN MATEO, CA.  
FILED 5-31-2011.

**AVID TRANSLATION**

THE MARK CONSISTS OF STANDARD CHARACTERS WITHOUT CLAIM TO ANY PARTICULAR FONT, STYLE, SIZE, OR COLOR.

NO CLAIM IS MADE TO THE EXCLUSIVE RIGHT TO USE "TRANSLATION", APART FROM THE MARK AS SHOWN.

FOR PROJECT MANAGEMENT SERVICES FOR OTHERS IN THE FIELDS OF LANGUAGE TRANSLATION, CUSTOM WRITING, TEXT ADAPTATION, INTERPRETING AND PROOFREADING (U.S. CLS. 100, 101 AND 102).

FIRST USE 4-20-2005; IN COMMERCE 10-15-2005.  
NAAKWAMA ANKRAH, EXAMINING ATTORNEY

---

SN 85-334,537. MASTRANDONAS, ANDREW, MIAMI BEACH, FL. AND GITLIN, PRESTON, MIAMI BEACH, FL. FILED 5-31-2011.

**WORLD MAKERS**

THE MARK CONSISTS OF STANDARD CHARACTERS WITHOUT CLAIM TO ANY PARTICULAR FONT, STYLE, SIZE, OR COLOR.

FOR RETAIL STORE AND ON-LINE RETAIL STORE SERVICES FEATURING CHOCOLATE, COFFEE, WOOD PRODUCTS, SOAPS, LOTIONS, T-SHIRTS, SOCKS, SLIPPERS, SCARVES AND STUFFED ANIMALS (U.S. CLS. 100, 101 AND 102).

NAAKWAMA ANKRAH, EXAMINING ATTORNEY

**CLASS 35—(Continued).**

SN 85-334,545. SECK, TIMOTHY H, MORRIS PLAINS, NJ.  
FILED 5-31-2011.

**DEATH ANGEL****SOCIETY**

NO CLAIM IS MADE TO THE EXCLUSIVE RIGHT TO USE "SOCIETY", APART FROM THE MARK AS SHOWN.

THE STIPPLING IS FOR SHADING PURPOSES ONLY.

THE MARK CONSISTS OF AN IMAGE DEPICTING A DEATH ANGEL WITH ANGELIC TYPE WINGS, WITH A SKELETON LIKE FACE, AND WITH SKELETON LIKE BONE HANDS, HOLDING A LINKED CHAIN IN BOTH HANDS WITH A WRIST SHACKLE ATTACHED TO THE END OF CHAIN. THERE ARE TWO SKULL HEADS, ONE ON TOP OF EACH WING LEFT AND RIGHT. THERE ARE SKULL HEADS SPREAD OUT ALL ALONG THE BOTTOM OF DEATH ANGELS FEET AREA. THE DEATH ANGEL IS WEARING A CLOAK /ROBE WITH SKULL IMAGES SUPER IMPOSED/ PRINTED ON FRONT. TO THE RIGHT OF THE DEATH ANGEL THERE IS A DIAMOND SHAPED FIGURE WITH THE STYLIZED TEXT "SOCIETY". OVER THE TOP OF THE IMAGE OF THE DEATH ANGEL THERE IS THE STYLIZED TEXT "DEATH ANGEL" AND ON THE BOTTOM OF THE DEATH ANGEL IMAGE THERE IS THE STYLIZED TEXT "SOCIETY".

FOR CLUB SERVICES, NAMELY, PROMOTING THE INTERESTS OF MOTORCYCLE ENTHUSIASTS (U.S. CLS. 100, 101 AND 102).

FIRST USE 1-13-2010; IN COMMERCE 5-15-2010.  
JANET LEE, EXAMINING ATTORNEY

---

SN 85-334,635. TRANSPPLACE MEXICO, LLC, FRISCO, TX.  
FILED 5-31-2011.

**CLEARDIRECT**

THE MARK CONSISTS OF STANDARD CHARACTERS WITHOUT CLAIM TO ANY PARTICULAR FONT, STYLE, SIZE, OR COLOR.

FOR PROVIDING BUSINESS INTELLIGENCE SERVICES; CUSTOMS CLEARANCE SERVICES; PROVIDING ONLINE BUSINESS INTELLIGENCE AND CUSTOMS CLEARANCE SERVICES (U.S. CLS. 100, 101 AND 102).

KRISTINA MORRIS, EXAMINING ATTORNEY



**CLASS 35—(Continued).**

SN 85-334,650. INTERIOR ILLUSIONS, INC., WEST HOLLYWOOD, CA. FILED 6-1-2011.

## Interior Illusions

THE MARK CONSISTS OF STANDARD CHARACTERS WITHOUT CLAIM TO ANY PARTICULAR FONT, STYLE, SIZE, OR COLOR.

NO CLAIM IS MADE TO THE EXCLUSIVE RIGHT TO USE "INTERIOR", APART FROM THE MARK AS SHOWN.

FOR RETAIL STORE SERVICES IN THE FIELD OF FURNITURE; RETAIL STORE SERVICES FEATURING INTERIOR DECORATING AND HOME DECOR PRODUCTS; ONLINE RETAIL STORE SERVICES IN THE FIELD OF FURNITURE; ONLINE RETAIL STORE SERVICES FEATURING INTERIOR DECORATING AND HOME DECOR PRODUCTS (U.S. CLS. 100, 101 AND 102).

FIRST USE 1-1-1999; IN COMMERCE 1-1-1999.  
LAURA HAMMEL, EXAMINING ATTORNEY

**CLASS 35—(Continued).**

SN 85-334,948. W.K. KELLOGG FOUNDATION, EAST BATTLE CREEK, MI. FILED 6-1-2011.



THE MARK CONSISTS OF THREE CIRCLES REPRESENTING THREE FACES SHOWING ONLY EYES AND HAIR, THE FIRST CIRCLE HAS TWO DOTTED EYES AND THREE LINES EXTENDING FROM THE TOP TO REPRESENT HAIR, THE SECOND CIRCLE HAS TWO DOTTED EYES AND A SINGLE CURLED LINE TO REPRESENT HAIR, AND THE THIRD CIRCLE HAS TWO DOTTED EYES AND HAIR EXTENDED DOWN FROM THE TOP OF THE CIRCLE TOWARDS THE EYES WITH A V CUT PART OVER ONE OF THE EYES.

FOR PROMOTING PUBLIC AWARENESS OF THE NEED FOR EARLY CHILDHOOD EDUCATION, LEARNING, AND EARLY CHILDHOOD PROGRAMS (U.S. CLS. 100, 101 AND 102).

JOHN SCHUYLER YARD, EXAMINING ATTORNEY

SN 85-334,724. SOCIALPAKT, LLC, NEW YORK, NY. FILED 6-1-2011.

## SOCIALPAKT

THE MARK CONSISTS OF STANDARD CHARACTERS WITHOUT CLAIM TO ANY PARTICULAR FONT, STYLE, SIZE, OR COLOR.

FOR PROMOTING THE GOODS AND SERVICES OF OTHERS BY PROVIDING A WEBSITE FEATURING COUPONS, REBATES AND DISCOUNTS FOR GOODS AND/OR SERVICES FROM PARTICIPATING MERCHANTS TO MEMBERS WHERE A PERCENTAGE OF THE PURCHASE PRICE IS DONATED TO SELECTED CHARITIES AND NONPROFITS (U.S. CLS. 100, 101 AND 102).

GRETTA YAO, EXAMINING ATTORNEY

SN 85-334,955. EMPOWERING YOU, INC., EVANSVILLE, IN. FILED 6-1-2011.

## EMPOWERING YOU

THE MARK CONSISTS OF STANDARD CHARACTERS WITHOUT CLAIM TO ANY PARTICULAR FONT, STYLE, SIZE, OR COLOR.

FOR BUSINESS CONSULTING AND INFORMATION SERVICES (U.S. CLS. 100, 101 AND 102).

FIRST USE 3-16-2009; IN COMMERCE 3-16-2009.  
JOHN KELLY, EXAMINING ATTORNEY

**CLASS 35—(Continued).**

SN 85-334,968. AFTERSTEPS, INC., NEW YORK, NY. FILED 6-1-2011.

# AfterSteps

THE MARK CONSISTS OF STANDARD CHARACTERS WITHOUT CLAIM TO ANY PARTICULAR FONT, STYLE, SIZE, OR COLOR.

FOR (BASED ON USE IN COMMERCE) ESTATE MANAGEMENT, NAMELY, ASSISTANCE IN THE GATHERING AND ORGANIZATION OF PERSONAL VITAL AND FINANCIAL RECORDS IN CONJUNCTION WITH INSTRUCTIONS FOR HANDLING OF SUCH DOCUMENTS BY OTHERS, INCLUDING EXECUTORS AND ATTORNEYS, UPON DEATH OR WHEN OTHERWISE NECESSARY; RECORDS MANAGEMENT SERVICES, NAMELY, DOCUMENT INDEXING FOR OTHERS (BASED ON INTENT TO USE) PROVIDING A SEARCHABLE ONLINE ADVERTISING WEBSITE AND INFORMATIONAL GUIDE FEATURING THE GOODS AND SERVICES OF OTHER VENDORS VIA THE INTERNET IN THE FIELD OF DEATH PLANNING, ESTATE PLANNING, FUNERARY PLANNING, OR RELATED END-OF-LIFE PLANNING (U.S. CLS. 100, 101 AND 102).

FIRST USE 12-16-2010; IN COMMERCE 1-23-2011.  
STEPHANIE ALI, EXAMINING ATTORNEY

---

SN 85-335,045. KILWIN'S CHOCOLATES FRANCHISE, INC., PETOSKEY, MI. FILED 6-1-2011.



THE MARK CONSISTS OF SCROLLWORK AND FLOURISH DESIGN.

FOR RETAIL STORE SERVICES FEATURING CANDY, CONFECTIONS AND ICE CREAM (U.S. CLS. 100, 101 AND 102).

FIRST USE 5-26-2011; IN COMMERCE 5-26-2011.  
KATHY DE JONGE, EXAMINING ATTORNEY

---

SN 85-335,114. UNE BELLE VIE MEMORIAL URNS LLC, ENGLEWOOD, CO. FILED 6-1-2011.

CELEBRATE A BEAUTIFUL LIFE

THE MARK CONSISTS OF STANDARD CHARACTERS WITHOUT CLAIM TO ANY PARTICULAR FONT, STYLE, SIZE, OR COLOR.

FOR RETAIL STORE SERVICES AND ONLINE RETAIL STORE SERVICES IN THE FIELD OF MEMORIAL PRODUCTS (U.S. CLS. 100, 101 AND 102).

FIRST USE 2-25-2010; IN COMMERCE 2-25-2010.  
KATHERINE E. HALMEN, EXAMINING ATTORNEY

**CLASS 35—(Continued).**

SN 85-335,249. CHARLES T. ALMOND, ATLANTA, GA. FILED 6-1-2011.

# TAXCLOSURE

THE MARK CONSISTS OF STANDARD CHARACTERS WITHOUT CLAIM TO ANY PARTICULAR FONT, STYLE, SIZE, OR COLOR.

OWNER OF U.S. REG. NO. 3,957,876.

FOR PROVIDING NONLEGAL ADVICE TO TAXPAYERS WITH RESPECT TO INTERNAL REVENUE SERVICE MATTERS, IN CLASS 35 (U.S. CLS. 100, 101 AND 102).

FIRST USE 6-1-2011; IN COMMERCE 6-1-2011.

WILLIAM P. SHANAHAN, EXAMINING ATTORNEY

---

SN 85-335,275. CHARLES T. ALMOND, ATLANTA, GA. FILED 6-1-2011.

# ONE CALL TO RESOLVE

THE MARK CONSISTS OF STANDARD CHARACTERS WITHOUT CLAIM TO ANY PARTICULAR FONT, STYLE, SIZE, OR COLOR.

FOR PROVIDING NONLEGAL ADVICE TO TAXPAYERS WITH RESPECT TO INTERNAL REVENUE SERVICE MATTERS, IN CLASS 35 (U.S. CLS. 100, 101 AND 102).

FIRST USE 1-1-2011; IN COMMERCE 1-1-2011.

WILLIAM P. SHANAHAN, EXAMINING ATTORNEY

**CLASS 35—(Continued).**

SN 85-335,280. HAGGLETEAM CORPORATION, MISSISSAUGA, ONTARIO, CANADA, FILED 6-1-2011.



THE MARK CONSISTS OF A CIRCULAR DESIGN WITH INTERNAL AND EXTERNAL BORDERS COMPRISED OF A FULL SMALLER CIRCLE INSIDE. THREE VARIOUS SHADED FISTS, HOLDING OUTLINES OF CASH MONEY. THE INTERNET ADDRESS HAGGLETEAM.COM IS PLACED IN THE LOWER HALF OF THE DESIGN IN A SHORT SEMI CIRCLE. WITH THE SLOGAN BELOW "THE BUYING POWER OF PEOPLE!"

FOR ONLINE SERVICE FOR CONNECTING SOCIAL NETWORK USERS WITH RETAILERS FOR THE PURPOSE OF FACILITATING DISCOUNTED PURCHASES (U.S. CLS. 100, 101 AND 102).

WILLIAM P. SHANAHAN, EXAMINING ATTORNEY

SN 85-335,412. DON DIXON, DBA LIFESTYLE MARKETING GROUP, ATLANTA, GA. AND MARK ROTHENBERG, DBA LIFESTYLE MARKETING GROUP, ATLANTA, GA. FILED 6-1-2011.

**LIFESTYLE MARKETING GROUP**

THE MARK CONSISTS OF STANDARD CHARACTERS WITHOUT CLAIM TO ANY PARTICULAR FONT, STYLE, SIZE, OR COLOR.

NO CLAIM IS MADE TO THE EXCLUSIVE RIGHT TO USE "MARKETING GROUP", APART FROM THE MARK AS SHOWN.

FOR BUSINESS CONSULTING SERVICES IN THE FIELD OF SPORTS AND ENTERTAINMENT MARKETING, EVENT MARKETING AND MANAGEMENT, LICENSING AND SPONSORING SALES AND PROMOTIONS (U.S. CLS. 100, 101 AND 102).

FIRST USE 0-0-1987; IN COMMERCE 0-0-1987.

MARIA-VICTORIA SUAREZ, EXAMINING ATTORNEY

**CLASS 35—(Continued).**

SN 85-335,434. GRABCAD, INC., BOSTON, MA. FILED 6-1-2011.

**GRABCAD**

THE MARK CONSISTS OF STANDARD CHARACTERS WITHOUT CLAIM TO ANY PARTICULAR FONT, STYLE, SIZE, OR COLOR.

FOR PROVIDING ON-LINE EMPLOYMENT PLACEMENT SERVICES, NAMELY MATCHING ENGINEERING PROFESSIONALS AND POTENTIAL EMPLOYERS VIA A GLOBAL COMPUTER NETWORK (U.S. CLS. 100, 101 AND 102).

FIRST USE 11-0-2010; IN COMMERCE 11-0-2010.  
GISELLE AGOSTO, EXAMINING ATTORNEY

SN 85-335,506. GOLDBUG GROUP, LLC, MARCO ISLAND, FL. FILED 6-1-2011.

**GoldBug Group**

THE MARK CONSISTS OF STANDARD CHARACTERS WITHOUT CLAIM TO ANY PARTICULAR FONT, STYLE, SIZE, OR COLOR.

NO CLAIM IS MADE TO THE EXCLUSIVE RIGHT TO USE "GROUP", APART FROM THE MARK AS SHOWN.

FOR BUSINESS CONSULTATION; SOCIAL MEDIA STRATEGY AND MARKETING CONSULTANCY FOCUSING ON HELPING CLIENTS CREATE AND EXTEND THEIR PRODUCT AND BRAND STRATEGIES BY BUILDING VIRALLY ENGAGING MARKETING SOLUTIONS (U.S. CLS. 100, 101 AND 102).

FIRST USE 9-0-2006; IN COMMERCE 10-0-2006.  
KAREN BRACEY, EXAMINING ATTORNEY

SN 85-335,531. WORLD OF GREEN, LLC, DEERFIELD BEACH, FL. FILED 6-1-2011.

**Daffodeals**

THE MARK CONSISTS OF STANDARD CHARACTERS WITHOUT CLAIM TO ANY PARTICULAR FONT, STYLE, SIZE, OR COLOR.

FOR ADVERTISING SERVICES VIA THE INTERNET; PROMOTING THE ECO-FRIENDLY GOODS AND SERVICES OF OTHERS THROUGH THE ADVERTISING, PROMOTION AND DISTRIBUTION OF DISCOUNT OFFERS, SPECIAL PRICING PROMOTIONS, COUPONS OR REBATES (U.S. CLS. 100, 101 AND 102).

ASMAT KHAN, EXAMINING ATTORNEY

**CLASS 35—(Continued).**

SN 85-335,748. OLY ROLLERS, OLYMPIA, WA. FILED 6-1-2011.



NO CLAIM IS MADE TO THE EXCLUSIVE RIGHT TO USE "ROLLERS", APART FROM THE MARK AS SHOWN.

THE MARK CONSISTS OF THE WORDS OLY ROLLERS WITH STARS SHOOTING UP BEHIND THE WORDS.

FOR ASSOCIATION SERVICES, NAMELY, PROMOTING THE INTERESTS OF INDIVIDUALS, TEAMS, AND LEAGUES THAT PARTICIPATE IN ORGANIZED COMPETITIONS; COORDINATION OF RECREATIONAL SPORTING OPPORTUNITIES FOR INDIVIDUALS WHO WISH TO PARTICIPATE IN TEAM LEAGUE SPORTS (U.S. CLS. 100, 101 AND 102).

FIRST USE 1-1-2006; IN COMMERCE 1-1-2006.  
MARILYN IZZI, EXAMINING ATTORNEY

**CLASS 35—(Continued).**

SN 85-335,933. CELLHUB.COM LLC, LONG ISLAND CITY, NY. FILED 6-2-2011.

# CELLHUB

THE MARK CONSISTS OF STANDARD CHARACTERS WITHOUT CLAIM TO ANY PARTICULAR FONT, STYLE, SIZE, OR COLOR.

FOR ONLINE RETAIL STORE SERVICES FEATURING CELLULAR AND TELECOMMUNICATION APPARATUS, CELLULAR AND TELECOMMUNICATIONS SERVICE PLANS AND SUBSCRIPTIONS, PRE-PAID CELLULAR CALLING AND DATA CARDS AND CELLULAR AND MOBILE TELEPHONES AND PERSONAL DATA ASSISTANT ACCESSORIES, NAMELY, CHARGERS, HEADSETS, BATTERIES, DATA CABLES, PERSONAL DIGITAL ASSISTANTS, HANDHELD WIRELESS DEVICES, MICROPHONES, EARPIECES, CAMERAS, CARRYING AND STORAGE CASES, AND SOFTWARE ALL FOR USE WITH CELLULAR AND TELECOMMUNICATION APPARATUS (U.S. CLS. 100, 101 AND 102).

FIRST USE 10-13-2010; IN COMMERCE 10-13-2010.  
STEVEN PEREZ, EXAMINING ATTORNEY

SN 85-335,969. GLOBAL YIELD INTERNATIONAL LIMITED, TST, KOWLOON, HONG KONG, FILED 6-2-2011.

SN 85-335,785. PEOPLE GEAR INCORPORATED, CHICAGO, IL. FILED 6-1-2011.



## Stay Mobile. Be Social.

THE MARK CONSISTS OF STANDARD CHARACTERS WITHOUT CLAIM TO ANY PARTICULAR FONT, STYLE, SIZE, OR COLOR.

FOR ON-LINE RETAIL STORE SERVICES FEATURING ELECTRONIC AND MOBILE ELECTRONIC ACCESSORIES, CLOTHING, ATHLETIC CLOTHING AND GEAR, FITNESS CLOTHING AND GEAR, AND CYCLING CLOTHING AND GEAR, AS WELL AS RELATED ACCESSORIES (U.S. CLS. 100, 101 AND 102).

SUNG IN, EXAMINING ATTORNEY

THE MARK CONSISTS OF THE STYLIZED TEXT "COUP-PIE" WITH THE STYLIZED TEXT "YOU KNOW YOU LOVE ME" DIRECTLY BELOW. THERE IS A CARTOON CHARACTER ON THE LEFT OF THE TEXT.

FOR PROCESSING MANUFACTURER'S COUPONS; PROMOTING THE GOODS OF OTHERS, NAMELY, PROVIDING COUPONS, REBATES AND VOUCHERS FOR THE GOODS OF OTHERS; PROMOTIONAL SERVICES, NAMELY, PROMOTING THE GOODS OF OTHERS BY MEANS OF PROVIDING ONLINE COUPONS (U.S. CLS. 100, 101 AND 102).

FIRST USE 6-21-2010; IN COMMERCE 6-21-2010.  
PAM WILLIS, EXAMINING ATTORNEY

**CLASS 35—(Continued).**

SN 85-335,987. THE NEIMAN MARCUS GROUP, INC.,  
DALLAS, TX. FILED 6-2-2011.

**NM On the Go**

THE MARK CONSISTS OF STANDARD CHARACTERS  
WITHOUT CLAIM TO ANY PARTICULAR FONT, STYLE,  
SIZE, OR COLOR.

FOR ADVERTISING, MARKETING AND PROMO-  
TION SERVICES IN THE FIELD OF CLOTHING (U.S.  
CLS. 100, 101 AND 102).

GRETTA YAO, EXAMINING ATTORNEY

SN 85-335,993. BACKCHANNELMEDIA, INC., SUMMIT, NJ.  
FILED 6-2-2011.

**HAZZOO**

THE MARK CONSISTS OF STANDARD CHARACTERS  
WITHOUT CLAIM TO ANY PARTICULAR FONT, STYLE,  
SIZE, OR COLOR.

FOR PROMOTING THE GOODS AND SERVICES OF  
OTHERS BY PROVIDING A WEBSITE FEATURING  
COUPONS, REBATES, PRICE-COMPARISON INFORMA-  
TION, PRODUCT REVIEWS, LINKS TO THE RETAIL  
WEBSITES OF OTHERS, AND DISCOUNT INFORMA-  
TION (U.S. CLS. 100, 101 AND 102).

FIRST USE 3-28-2011; IN COMMERCE 3-28-2011.  
LAURA KOVALSKY, EXAMINING ATTORNEY

SN 85-336,006. ECHO SERVICES, INC., DBA CALLING ALL  
CARS, OMAHA, NE. FILED 6-2-2011.

**Calling All Cars**

THE MARK CONSISTS OF STANDARD CHARACTERS  
WITHOUT CLAIM TO ANY PARTICULAR FONT, STYLE,  
SIZE, OR COLOR.

NO CLAIM IS MADE TO THE EXCLUSIVE RIGHT TO  
USE "CARS", APART FROM THE MARK AS SHOWN.

FOR ADVERTISING AND MARKETING SERVICES,  
NAMELY, PROMOTING THE GOODS AND SERVICES  
OF OTHERS (U.S. CLS. 100, 101 AND 102).

FIRST USE 1-28-1997; IN COMMERCE 1-28-1997.  
HENRY S. ZAK, EXAMINING ATTORNEY

**CLASS 35—(Continued).**

SN 85-336,080. THE RED PROJECT COLLECTIVE, INC.,  
CHICAGO, IL. FILED 6-2-2011.

**ROCK THE RED PUMP**

THE MARK CONSISTS OF STANDARD CHARACTERS  
WITHOUT CLAIM TO ANY PARTICULAR FONT, STYLE,  
SIZE, OR COLOR.

FOR CHARITABLE SERVICES, NAMELY, PROMOT-  
ING PUBLIC AWARENESS ABOUT THE IMPACT OF  
HIV/AIDS ON WOMEN AND GIRLS; CHARITABLE  
SERVICES, NAMELY, ORGANIZING AND DEVELOP-  
ING PROJECTS TO PROMOTE AWARENESS ABOUT  
THE IMPACT OF HIV/AIDS ON WOMEN AND GIRLS  
(U.S. CLS. 100, 101 AND 102).

FIRST USE 3-2-2009; IN COMMERCE 3-2-2009.  
CARRIE GENOVESE, EXAMINING ATTORNEY

SN 85-336,200. GOGRO SOLUTIONS LLC, CHARLOTTE, NC.  
FILED 6-2-2011.

**GROCIERGE**

THE MARK CONSISTS OF STANDARD CHARACTERS  
WITHOUT CLAIM TO ANY PARTICULAR FONT, STYLE,  
SIZE, OR COLOR.

FOR RETAIL AND ON-LINE GROCERY STORE SER-  
VICES FEATURING HOME DELIVERY SERVICE (U.S.  
CLS. 100, 101 AND 102).

BENJAMIN OKEKE, EXAMINING ATTORNEY

SN 85-336,257. ALBERTSON'S LLC, BOISE, ID. FILED 6-2-  
2011.

**SUPER SAVER**

THE MARK CONSISTS OF STANDARD CHARACTERS  
WITHOUT CLAIM TO ANY PARTICULAR FONT, STYLE,  
SIZE, OR COLOR.

OWNER OF U.S. REG. NO. 933,392.

SEC. 2(F).

FOR RETAIL GROCERY STORE SERVICES (U.S. CLS.  
100, 101 AND 102).

FIRST USE 10-18-1967; IN COMMERCE 10-18-1967.

MARK T. MULLEN, EXAMINING ATTORNEY

**CLASS 35—(Continued).**

SN 85-336,457. LAS VEGAS CONVENTION AND VISITORS AUTHORITY, LAS VEGAS, NV. FILED 6-2-2011.

**STAY AND PLAY HERE**

THE MARK CONSISTS OF STANDARD CHARACTERS WITHOUT CLAIM TO ANY PARTICULAR FONT, STYLE, SIZE, OR COLOR.

FOR PROMOTION OF THE LAS VEGAS, NEVADA AREA AS A DESTINATION FOR LEISURE AND BUSINESS ACTIVITIES (U.S. CLS. 100, 101 AND 102).

FIRST USE 5-10-2009; IN COMMERCE 5-10-2009.  
EMILY CHUO, EXAMINING ATTORNEY

SN 85-336,523. DARKHORSE MULTIMEDIA, INC., SAVANNAH, GA. FILED 6-2-2011.

**CRIMESCAPE**

THE MARK CONSISTS OF STANDARD CHARACTERS WITHOUT CLAIM TO ANY PARTICULAR FONT, STYLE, SIZE, OR COLOR.

FOR RETAIL BOOK STORE SERVICES (U.S. CLS. 100, 101 AND 102).

NAAKWAMA ANKRAH, EXAMINING ATTORNEY

SN 85-336,571. REALESTATEXP LLC, NEW YORK, NY. FILED 6-2-2011.

**ZUZZUZ**

THE MARK CONSISTS OF STANDARD CHARACTERS WITHOUT CLAIM TO ANY PARTICULAR FONT, STYLE, SIZE, OR COLOR.

FOR ADVERTISING AND BUSINESS SERVICES, NAMELY, PROVIDING AN ONLINE WEBSITE WHERE ADVERTISERS, MARKETERS, AND CONTENT PROVIDERS CAN INTERACT WITH USERS FOR ADVERTISING, BRANDING, AND PROMOTING KNOWLEDGE, PRODUCTS, AND SERVICES, AND TRADESHOWS, ON BEHALF OF THEMSELVES AND OTHERS, AND FOR EVALUATING AND RATING THE SAME, ALL THE FOREGOING RELEVANT TO HUMAN ACTIVITIES AFFECTING CLIMATE CHANGE AND RELATED FIELDS; ADVERTISING AND DIRECTORY SERVICES, NAMELY, PROMOTING THE SERVICES OF OTHERS BY PROVIDING A WEB PAGE FEATURING LINKS TO THE WEBSITES OF OTHERS; ADVERTISING AND MARKETING; ADVERTISING AND MARKETING SERVICES PROVIDED BY MEANS OF INDIRECT METHODS OF MARKETING COMMUNICATIONS, NAMELY, SOCIAL MEDIA, SEARCH ENGINE MARKETING, INQUIRY MARKETING, INTERNET MARKETING, MOBILE MARKETING, BLOGGING AND OTHER FORMS OF PASSIVE, SHARABLE OR VIRAL COMMUNICATIONS CHANNELS; ADVERTISING AND MAR-

**CLASS 35—(Continued).**

KETING SERVICES, NAMELY, PROMOTING THE GOODS AND SERVICES OF OTHERS; ADVERTISING AND PROMOTIONAL SERVICES; ADVERTISING OF COMMERCIAL OR RESIDENTIAL REAL ESTATE; ADVERTISING ON THE INTERNET FOR OTHERS; ADVERTISING SERVICES; ADVERTISING THE SERVICES OF OTHERS VIA WEB PAGES OPTIMIZED FOR ONLINE SEARCH ENGINES; ANALYSIS OF ADVERTISING RESPONSE; CREATION OF MARKETING TOOLS DESIGNED TO INCREASE A CLIENT COMPANY'S KNOWLEDGE OF CUSTOMER NEEDS, AND ITS COMPETITORS' PRODUCTS AND SERVICES, PRICING, ADVERTISING STRATEGY AND SALES STRATEGY; DISSEMINATION OF ADVERTISING FOR OTHERS VIA PUBLIC AND PRIVATE WIRELESS NETWORKS FOR DISPLAY ON MOBILE DEVICES; DISSEMINATION OF ADVERTISING FOR OTHERS VIA THE INTERNET; INTERNET ADVERTISING SERVICES; ON-LINE ADVERTISING AND MARKETING SERVICES; ONLINE ADVERTISING AND PROMOTIONAL SERVICES; PROMOTING, ADVERTISING AND MARKETING OF THE ON-LINE WEB SITES OF OTHERS; PROMOTING, ADVERTISING AND MARKETING THE ON-LINE DATABASES AND ELECTRONIC PUBLICATIONS OF OTHERS; PROMOTION, ADVERTISING AND MARKETING OF ON-LINE WEBSITES; PROVIDING A SEARCHABLE ON-LINE ADVERTISING WEBSITE AND GUIDE FEATURING THE GOODS AND SERVICES OF OTHER VENDORS VIA THE INTERNET; PROVIDING A SEARCHABLE ONLINE ADVERTISING GUIDE FEATURING THE GOODS AND SERVICES OF ONLINE VENDORS; PROVIDING A SEARCHABLE ONLINE ADVERTISING GUIDE FEATURING THE GOODS AND SERVICES OF OTHER ON-LINE VENDORS ON THE INTERNET; PROVIDING A SEARCHABLE ONLINE ADVERTISING WEBSITE AND INFORMATIONAL GUIDE FEATURING THE GOODS AND SERVICES OF OTHER VENDORS VIA THE INTERNET IN THE FIELD OF FURNITURE, HOME FURNISHINGS, PAINT, FLOORING, WALL COVERINGS, WINDOW DRESSINGS, HOME APPLIANCES, ARTWORK FOR THE HOME, LIGHTING, AREA RUGS, MIRRORS, HOME EXERCISE EQUIPMENT, ELECTRONIC EQUIPMENT FOR THE HOME, MOLDINGS, RAILINGS, HOME SECURITY SYSTEMS, SOLAR PANELS, ARCHITECTURAL GRILLES, PLUMBING FIXTURES, BEDDING, WINDOWS AND DOORS, KITCHEN CABINETS, KITCHEN COUNTER TOPS, OUTSIDE DECKING, HAVC ITEMS, FENCE PRODUCTS; PROVIDING ADVERTISING SERVICES USING 3D AND ANIMATION DESIGNS; PROVIDING AN INTERACTIVE REAL ESTATE WEBSITE WHICH PROMOTES HOUSING AND APARTMENT PROPERTIES THROUGH OFFERING PROSPECTIVE TENANTS VIDEO WALK THROUGHs, PROPERTY DESCRIPTIONS, TEXT, PRICE, LOCATION, MAPS AND OTHER INFORMATION THAT WOULD BE INFLUENTIAL TO A PROSPECTIVE TENANT IN MAKING A RENTAL DECISION; PROVIDING AN INTERNET WEBSITE PORTAL FEATURING PROMOTION AND ADVERTISING FOR HOME SERVICE PROVIDERS AND PRODUCT MANUFACTURERS; PROVIDING AND RENTAL OF ADVERTISING SPACE ON THE INTERNET; PROVIDING REAL ESTATE VIDEO TOURS FOR MARKETING PURPOSES; PROVISION OF SPACE ON WEBSITES FOR ADVERTISING GOODS AND SERVICES; REAL ESTATE MARKETING SERVICES, NAMELY, ON-LINE SERVICES FEATURING TOURS OF RESIDENTIAL AND COMMERCIAL REAL ESTATE (U.S. CLS. 100, 101 AND 102).

SKYE YOUNG, EXAMINING ATTORNEY

**CLASS 35—(Continued).**

SN 85-336,609. DUCKWALL-ALCO STORES, INC., ABILENE, KS. FILED 6-2-2011.

**Shop Smart. Save Smart.**

THE MARK CONSISTS OF STANDARD CHARACTERS WITHOUT CLAIM TO ANY PARTICULAR FONT, STYLE, SIZE, OR COLOR.

FOR ADVERTISING SERVICES, NAMELY, PROMOTING AND MARKETING THE GOODS AND SERVICES OF OTHERS IN THE FIELD OF RETAIL SALES VIA PRINT AND ELECTRONIC MEDIA (U.S. CLS. 100, 101 AND 102).

SKYE YOUNG, EXAMINING ATTORNEY

SN 85-336,616. REALESTATEXP LLC, NEW YORK, NY. FILED 6-2-2011.

**RealEstateXP**

THE MARK CONSISTS OF STANDARD CHARACTERS WITHOUT CLAIM TO ANY PARTICULAR FONT, STYLE, SIZE, OR COLOR.

FOR ADVERTISING OF COMMERCIAL OR RESIDENTIAL REAL ESTATE; ADVERTISING SERVICES, NAMELY, PROMOTING PROPERTIES FOR SALE BY OWNER VIA THE INTERNET; MATCHING CONSUMERS WITH REAL ESTATE PROFESSIONALS IN THE FIELD OF REAL ESTATE SERVICES VIA COMPUTER NETWORK; PROVIDING REAL ESTATE LEADS FOR PROSPECTIVE PURCHASERS; REAL ESTATE ADVERTISING SERVICES; REAL ESTATE MARKETING SERVICES, NAMELY, ON-LINE SERVICES FEATURING THE PROMOTION OF RESIDENTIAL NEW CONSTRUCTION, WHICH ALSO CONTAINS BACK OFFICE SOLUTIONS FOR BUILDERS; REAL ESTATE MARKETING SERVICES, NAMELY, ON-LINE SERVICES FEATURING TOURS OF RESIDENTIAL AND COMMERCIAL REAL ESTATE (U.S. CLS. 100, 101 AND 102).

SKYE YOUNG, EXAMINING ATTORNEY

SN 85-336,749. CIERANT CORPORATION, DANBURY, CT. FILED 6-2-2011.

**CampaignRx**

THE MARK CONSISTS OF STANDARD CHARACTERS WITHOUT CLAIM TO ANY PARTICULAR FONT, STYLE, SIZE, OR COLOR.

FOR ADVERTISING AND MARKETING SERVICES, NAMELY, PROMOTING THE GOODS AND SERVICES OF OTHERS (U.S. CLS. 100, 101 AND 102).

FIRST USE 4-16-2011; IN COMMERCE 4-16-2011.

JERI J. FICKES, EXAMINING ATTORNEY

**CLASS 35—(Continued).**

SN 85-336,754. CONSUMERBELL INC., NEW YORK, NY. FILED 6-2-2011.

**MAKING SAFETY EASIER**

THE MARK CONSISTS OF STANDARD CHARACTERS WITHOUT CLAIM TO ANY PARTICULAR FONT, STYLE, SIZE, OR COLOR.

FOR PROVIDING A WEBSITE FEATURING INFORMATION IN THE FIELD OF PRODUCT RECALLS (U.S. CLS. 100, 101 AND 102).

FIRST USE 12-30-2010; IN COMMERCE 3-24-2011.

JENNIFER MARTIN, EXAMINING ATTORNEY

SN 85-337,140. ELECTRIC AVENUE, INC., MIAMI, FL. FILED 6-3-2011.

**THE POWER IS ON**

THE MARK CONSISTS OF STANDARD CHARACTERS WITHOUT CLAIM TO ANY PARTICULAR FONT, STYLE, SIZE, OR COLOR.

FOR RETAIL STORE SERVICES FEATURING CONSUMER ELECTRONICS (U.S. CLS. 100, 101 AND 102).

FIRST USE 2-11-2011; IN COMMERCE 2-11-2011.

HEATHER SAPP, EXAMINING ATTORNEY

SN 85-337,250. ACACIA ENERGY, LLC, HOUSTON, TX. FILED 6-3-2011.

**ACACIA ENERGY**

THE MARK CONSISTS OF STANDARD CHARACTERS WITHOUT CLAIM TO ANY PARTICULAR FONT, STYLE, SIZE, OR COLOR.

NO CLAIM IS MADE TO THE EXCLUSIVE RIGHT TO USE "ENERGY", APART FROM THE MARK AS SHOWN.

FOR RETAIL ELECTRICITY PROVIDER SERVICES THAT ALLOW CUSTOMERS TO PURCHASE ELECTRICITY (U.S. CLS. 100, 101 AND 102).

JEFF DEFORD, EXAMINING ATTORNEY

**CLASS 35—(Continued).**

SN 85-337,304. NETMASONS INCORPORATED, ANDERSON, IN. FILED 6-3-2011.

## Bonusbox

THE MARK CONSISTS OF STANDARD CHARACTERS WITHOUT CLAIM TO ANY PARTICULAR FONT, STYLE, SIZE, OR COLOR.

FOR PROVIDING INCENTIVE AWARD PROGRAMS FOR CUSTOMERS THROUGH ISSUANCE AND PROCESSING OF LOYALTY POINTS FOR ON-LINE PURCHASE OF COMPANY'S GOODS AND SERVICES (U.S. CLS. 100, 101 AND 102).

FIRST USE 2-7-2008; IN COMMERCE 7-13-2010.  
JEFF DEFORD, EXAMINING ATTORNEY

SN 85-337,318. ACACIA ENERGY, LLC, HOUSTON, TX. FILED 6-3-2011.



NO CLAIM IS MADE TO THE EXCLUSIVE RIGHT TO USE "ENERGY", APART FROM THE MARK AS SHOWN.

THE COLOR(S) BLACK, GREEN AND LIGHT GREEN IS/ ARE CLAIMED AS A FEATURE OF THE MARK.

THE MARK CONSISTS OF A STYLIZED RING OF GREEN AND LIGHT GREEN LEAVES SUSPENDED ABOVE THE WORDING ACACIA WRITTEN IN BLACK AND THE TERM ENERGY WRITTEN IN GREEN LOCATED BENEATH ACACIA IN THE LOWER RIGHT HAND PORTION OF THE MARK.

FOR RETAIL ELECTRICITY PROVIDER SERVICES THAT ALLOW CUSTOMERS TO PURCHASE ELECTRICITY (U.S. CLS. 100, 101 AND 102).

JEFF DEFORD, EXAMINING ATTORNEY

**CLASS 35—(Continued).**

SN 85-337,338. SELECT INTELLECTUAL, LLC, PITTSBURGH, PA. FILED 6-3-2011.

## SAFETYFIT

THE MARK CONSISTS OF STANDARD CHARACTERS WITHOUT CLAIM TO ANY PARTICULAR FONT, STYLE, SIZE, OR COLOR.

FOR BUSINESS SERVICES, NAMELY, PROVIDING PERSONNEL SELECTION AND ASSESSMENT SERVICES BY IDENTIFYING, AND SCREENING OF SAFETY ATTITUDES AND BEHAVIOR OF EMPLOYEES, INDEPENDENT CONTRACTORS AND EMPLOYEE CANDIDATES (U.S. CLS. 100, 101 AND 102).

MORGAN WYNNE, EXAMINING ATTORNEY

SN 85-337,359. BREAD LABS, INC., SAN MATEO, CA. FILED 6-3-2011.

## TOAST

THE MARK CONSISTS OF STANDARD CHARACTERS WITHOUT CLAIM TO ANY PARTICULAR FONT, STYLE, SIZE, OR COLOR.

FOR ON-LINE ADVERTISING AND MARKETING SERVICES, NAMELY PROVIDING CONSUMER AND PRODUCT INFORMATION VIA THE INTERNET; PROMOTING THE GOODS AND SERVICES OF OTHERS BY PROVIDING HYPERTEXT LINKS TO THE WEBSITES OF OTHERS; PROVIDING SPACE ON WEBSITES FOR PROMOTING THE GOODS AND SERVICES OF OTHERS; PROMOTING THE CHARITABLE SERVICES OF OTHERS, NAMELY, PROVIDING INDIVIDUALS WITH INFORMATION FOR THE PURPOSE OF MAKING DONATIONS TO CHARITIES (U.S. CLS. 100, 101 AND 102).

FIRST USE 5-1-2011; IN COMMERCE 5-1-2011.  
WILLIAM BRECKENFELD, EXAMINING ATTORNEY

SN 85-337,390. FOCUS ON THE FAMILY, COLORADO SPRINGS, CO. FILED 6-3-2011.

## Day of Dialogue

THE MARK CONSISTS OF STANDARD CHARACTERS WITHOUT CLAIM TO ANY PARTICULAR FONT, STYLE, SIZE, OR COLOR.

FOR PROMOTING PUBLIC AWARENESS OF THE BENEFIT OF OPEN CONVERSATION REGARDING THE EXERCISE OF FREE SPEECH AND RELIGIOUS LIBERTY IN COMMUNICATING A RELIGIOUS PERSPECTIVE ON CURRENT ISSUES, INCLUDING SEXUALITY, SEXUAL ORIENTATION, GENDER IDENTITY AND MARRIAGE (U.S. CLS. 100, 101 AND 102).

FIRST USE 11-17-2010; IN COMMERCE 11-17-2010.  
BRIAN CALLAGHAN, EXAMINING ATTORNEY



**CLASS 35—(Continued).**

SN 85-337,527. HENDY ASSET MANAGEMENT, INC., CINCINNATI, OH. FILED 6-3-2011.

# ElderStrong

THE MARK CONSISTS OF STANDARD CHARACTERS WITHOUT CLAIM TO ANY PARTICULAR FONT, STYLE, SIZE, OR COLOR.

FOR PROMOTING THE INTERESTS OF PEOPLE CONCERNED WITH HEALTH, COMMUNITY AND ENVIRONMENTAL SUSTAINABILITY ISSUES (U.S. CLS. 100, 101 AND 102).

FIRST USE 6-20-2010; IN COMMERCE 9-8-2010.  
MARK SPARACINO, EXAMINING ATTORNEY

SN 85-337,591. STONEDONUT, BEDFORD, OH. FILED 6-3-2011.



THE MARK CONSISTS OF THE STYLIZED WORD "STONE" THAT SITS ABOVE A HORIZONTAL LINE IN LARGER TEXT THAN THE STYLIZED WORD "DONUT", WHICH SITS BELOW THE HORIZONTAL LINE IN SMALLER TEXT AND IS SPACED OUT EVENLY BELOW THE HORIZONTAL LINE. FURTHER, THE LETTER "O" IN THE WORD "STONE" IS A SWIRLING LETTER O THAT OVERLAPS THE LETTER "N" IN THE WORD "STONE" JUST SLIGHTLY AT THE TOP LEFT OF THE LETTER. THE SWIRLING O ALSO CROSSES THE HORIZONTAL LINE SLIGHTLY TO THE LEFT OF THE LETTER "N" IN THE WORD "DONUT".

FOR BUSINESS CONSULTATION SERVICES, NAMELY, BUSINESS PROCESS IMPROVEMENT AND ENTERPRISE ARCHITECTURE DESIGN; BUSINESS PROCESS RE-ENGINEERING SERVICES (U.S. CLS. 100, 101 AND 102).

FIRST USE 1-1-2003; IN COMMERCE 1-1-2003.  
KATHLEEN LORENZO, EXAMINING ATTORNEY

SN 85-337,599. OPERATION INSIDE INFORMATION, LLC, RIVERWOODS, IL. FILED 6-3-2011.

# OPERATION INSIDE INFORMATION

THE MARK CONSISTS OF STANDARD CHARACTERS WITHOUT CLAIM TO ANY PARTICULAR FONT, STYLE, SIZE, OR COLOR.

FOR PHYSICIAN REFERRALS (U.S. CLS. 100, 101 AND 102).

FIRST USE 9-5-2010; IN COMMERCE 9-7-2010.  
APRIL ROACH, EXAMINING ATTORNEY

**CLASS 35—(Continued).**

SN 85-337,666. STUDY ABROAD COMPASS, LLC, ALTA-MONTE SPRINGS, FL. FILED 6-3-2011.



NO CLAIM IS MADE TO THE EXCLUSIVE RIGHT TO USE "STUDY ABROAD", APART FROM THE MARK AS SHOWN.

THE COLOR(S) GRAY, BLUE AND RED IS/ARE CLAIMED AS A FEATURE OF THE MARK.

THE MARK CONSISTS OF STYLIZED BLUE AND GRAY COMPASS WITH A RED NEEDLE; TO THE RIGHT IS STUDYABROAD IN GRAY STYLIZED FONT AND COMPASS IN BLUE STYLIZED FONT.

FOR ADMINISTERING STUDY ABROAD PROGRAMS FOR COLLEGE STUDENTS (U.S. CLS. 100, 101 AND 102).

FIRST USE 3-0-2011; IN COMMERCE 3-0-2011.  
KAREN BRACEY, EXAMINING ATTORNEY

SN 85-337,692. PROSOFT SYSTEMS INC., SANTA CLARA, CA. FILED 6-3-2011.



THE COLOR(S) SKY BLUE, GREEN, DARK BLUE IS/ARE CLAIMED AS A FEATURE OF THE MARK.

THE MARK CONSISTS OF THE LITERAL ELEMENTS MEDANTEX UNDERLINED IN GREEN COLOR WHEREIN THE IMAGE CONSISTS OF A CIRCLE TO THE LEFT OF LITERAL ELEMENTS IN HALF SKY BLUE AND HALF GREEN COLOR CUT IN THE MIDDLE IN A ZIGZAG MANNER, THE LETTERS MED IS IN DARK BLUE COLOR AND THE LETTERS ANTE IS IN SKY BLUE COLOR, THE LETTER X IS HALF SKY BLUE AND HALF GREEN COLOR AS SHOWN IN THE MARK.

FOR MEDICAL TRANSCRIPTION SERVICES; MEDICAL BILLING SUPPORT SERVICES; MEDICAL BILLING OUTSOURCING SERVICES (U.S. CLS. 100, 101 AND 102).

FIRST USE 5-31-2011; IN COMMERCE 5-31-2011.  
KATHERINE STOIDES, EXAMINING ATTORNEY

**CLASS 35—(Continued).**

SN 85-337,731. REED AND BARTON CORPORATION, TAUNTON, MA. FILED 6-3-2011.

**REEDANDBARTON.COM**

THE MARK CONSISTS OF STANDARD CHARACTERS WITHOUT CLAIM TO ANY PARTICULAR FONT, STYLE, SIZE, OR COLOR.

OWNER OF U.S. REG. NOS. 516,256, 2,500,505 AND 2,681,878.

FOR ONLINE RETAIL STORE SERVICES FEATURING SILVERWARE, FLATWARE, TABLEWARE, HOLLOWWARE, CRYSTAL, STEMWARE, BARWARE, GLASSWARE, SERVEWARE, HOLIDAY ORNAMENTS, CANDLESTICKS, CANDLE HOLDERS, GIFTWARE, PICTURE FRAMES AND STORAGE BOXES; PROVIDING INFORMATION TO ASSIST IN THE PURCHASING OF SILVERWARE, FLATWARE, TABLEWARE, HOLLOWWARE, CRYSTAL, STEMWARE, BARWARE, GLASSWARE, SERVEWARE, HOLIDAY ORNAMENTS, CANDLESTICKS, CANDLE HOLDERS, GIFTWARE, PICTURE FRAMES AND STORAGE BOXES, ALL BY MEANS OF AN INTERNET WEB SITE (U.S. CLS. 100, 101 AND 102).

DANNEAN HETZEL, EXAMINING ATTORNEY

SN 85-337,865. MAZEL MOMENTS, INC., NEW YORK, NY. FILED 6-3-2011.



THE MARK CONSISTS OF THE WORDING MAZELMOMENTS WHERE BOTH "E" CHARACTERS ARE SLANTED, AND A HAMSA PENDANT IS HANGING FROM THE "S".

FOR PROVIDING ON-LINE DIRECTORY INFORMATION SERVICES ALSO FEATURING HYPERLINKS TO OTHER WEB SITES (U.S. CLS. 100, 101 AND 102).

JAMES A. RAUEN, EXAMINING ATTORNEY

SN 85-337,967. SEAN SOLO, LLC, DENVER, CO. FILED 6-3-2011.

**BIZCON**

THE MARK CONSISTS OF STANDARD CHARACTERS WITHOUT CLAIM TO ANY PARTICULAR FONT, STYLE, SIZE, OR COLOR.

FOR PROMOTING THE GOODS AND SERVICES OF OTHERS BY PROVIDING A WEBSITE FEATURING COUPONS, REBATES, PRICE-COMPARISON INFORMATION, PRODUCT REVIEWS, LINKS TO THE RETAIL WEBSITES OF OTHERS, AND DISCOUNT INFORMATION (U.S. CLS. 100, 101 AND 102).

JEFFREY LOOK, EXAMINING ATTORNEY

**CLASS 35—(Continued).**

SN 85-337,985. NEEDS MARKET, L.L.C., BOSSIER CITY, LA. FILED 6-3-2011.



NO CLAIM IS MADE TO THE EXCLUSIVE RIGHT TO USE "DRIVE-THRU MARKET", APART FROM THE MARK AS SHOWN.

THE COLOR(S) IVORY, GREEN, AND DARK GREEN IS/ARE CLAIMED AS A FEATURE OF THE MARK.

THE MARK CONSISTS OF THE WORD "NEEDS" WRITTEN IN LARGE, IVORY-COLORED SERIF FONT; THE PHRASE "- DRIVE-THRU MARKET -" WRITTEN BELOW IN GREEN IN A SMALLER SIZE, ALL CAPS; AND AN ILLUSTRATION OF A LEAF IN A LIGHT GREEN COLOR OVER THE CENTER OF THE WORD "NEEDS," ALL ON A DARK GREEN RECTANGULAR BACKGROUND AND OUTLINED IN AN IVORY AND GREEN BORDER.

FOR RETAIL GROCERY STORES FEATURING DRIVE-THROUGH SERVICE (U.S. CLS. 100, 101 AND 102).

VIVIAN MICZNIK FIRST, EXAMINING ATTORNEY

SN 85-338,013. CALENDAR HOLDINGS LLC, AUSTIN, TX. FILED 6-3-2011.

**GO! CALENDARS**

THE MARK CONSISTS OF STANDARD CHARACTERS WITHOUT CLAIM TO ANY PARTICULAR FONT, STYLE, SIZE, OR COLOR.

OWNER OF U.S. REG. NOS. 2,791,814, 3,881,995 AND OTHERS.

NO CLAIM IS MADE TO THE EXCLUSIVE RIGHT TO USE "CALENDARS", APART FROM THE MARK AS SHOWN.

FOR RETAIL STORE AND ON-LINE RETAIL STORE SERVICES FEATURING CALENDARS, BOARD GAMES, ELECTRONIC GAMES, GAMES OF CHANCE, COLLECTIBLE CARDS, TOYS AND GAME RELATED MERCHANDISE (U.S. CLS. 100, 101 AND 102).

DANIEL CAPSHAW, EXAMINING ATTORNEY

**CLASS 35—(Continued).**

SN 85-338,017. SWALLOW, TRACIE, MURRIETA, CA. FILED 6-3-2011.

**THE SWALLOW'S NEST**

THE MARK CONSISTS OF STANDARD CHARACTERS WITHOUT CLAIM TO ANY PARTICULAR FONT, STYLE, SIZE, OR COLOR.  
FOR RETAIL VARIETY STORE (U.S. CLS. 100, 101 AND 102).  
TIMOTHY FINNEGAN, EXAMINING ATTORNEY



SN 85-338,105. DAMIANOS, HELAYNE, HEAD OF THE HARBOR, NY. FILED 6-4-2011.

**THX2MYX**

THE MARK CONSISTS OF STANDARD CHARACTERS WITHOUT CLAIM TO ANY PARTICULAR FONT, STYLE, SIZE, OR COLOR.  
FOR ON-LINE RETAIL STORE SERVICES FEATURING T-SHIRTS, MUGS, DOORMATS, HOUSEHOLD AND NOVELTY ITEMS (U.S. CLS. 100, 101 AND 102).  
JOHN E. MICHOS, EXAMINING ATTORNEY



SN 85-338,256. MATYJASIK, ERIC A, TUCSON, AZ. AND MATYJASIK, GREGORY M, TUCSON, AZ. FILED 6-5-2011.

**WOLFMOBILE**

THE MARK CONSISTS OF STANDARD CHARACTERS WITHOUT CLAIM TO ANY PARTICULAR FONT, STYLE, SIZE, OR COLOR.  
FOR DISPLAYING ADVERTISEMENTS FOR OTHERS; OUT-OF-HOME ADVERTISING SERVICES, NAMELY, RENTAL OF ADVERTISING SPACE, AND PREPARING AND PLACING ADVERTISEMENTS FOR OTHERS; RENTAL OF ADVERTISING SPACE (U.S. CLS. 100, 101 AND 102).  
ERIN FALK, EXAMINING ATTORNEY

**CLASS 35—(Continued).**

SN 85-338,325. DON'T LET ME FALL FOUNDATION, INC., DBA DON'T LET ME FALL, LANHAM, MD. FILED 6-5-2011.

**Don't Let Me Fall**

THE MARK CONSISTS OF STANDARD CHARACTERS WITHOUT CLAIM TO ANY PARTICULAR FONT, STYLE, SIZE, OR COLOR.  
FOR ADMINISTRATION OF A PROGRAM TO PROMOTE COMMUNITY SERVICE; CHARITABLE SERVICES, NAMELY, COORDINATION OF NON-MONETARY CONTRIBUTIONS TO CHARITIES AND NON-PROFITS; CHARITABLE SERVICES, NAMELY, ORGANIZING AND CONDUCTING VOLUNTEER PROGRAMS AND COMMUNITY SERVICE PROJECTS (U.S. CLS. 100, 101 AND 102).  
COLLEEN DOMBROW, EXAMINING ATTORNEY

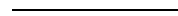

SN 85-338,340. WATERSTONE HOSPITALITY, LLC, COLUMBIA, SC. FILED 6-5-2011.

**Gas-A-Go-Go**

THE MARK CONSISTS OF STANDARD CHARACTERS WITHOUT CLAIM TO ANY PARTICULAR FONT, STYLE, SIZE, OR COLOR.  
FOR ADVERTISEMENT FOR OTHERS ON THE INTERNET; ADVERTISING AND COMMERCIAL INFORMATION SERVICES, VIA THE INTERNET; ADVERTISING AND MARKETING SERVICES PROVIDED BY MEANS OF INDIRECT METHODS OF MARKETING COMMUNICATIONS, NAMELY, SOCIAL MEDIA, SEARCH ENGINE MARKETING, INQUIRY MARKETING, INTERNET MARKETING, MOBILE MARKETING, BLOGGING AND OTHER FORMS OF PASSIVE, SHARABLE OR VIRAL COMMUNICATIONS CHANNELS; DISSEMINATION OF ADVERTISING FOR OTHERS VIA THE INTERNET; PROVIDING A SEARCHABLE ONLINE ADVERTISING WEBSITE AND INFORMATIONAL GUIDE FEATURING THE GOODS AND SERVICES OF OTHER VENDORS VIA THE INTERNET IN THE FIELD OF AUTOMOBILE TRAVEL; PROVIDING CONSUMER PRODUCT INFORMATION VIA THE INTERNET; PROVIDING INFORMATION PERTAINING TO PROCUREMENT, BUYING, SELLING AND TENDERING INFORMATION AND OPPORTUNITIES RELATING TO GOODS, SERVICES, AND CONSTRUCTION VIA COMPUTER, COMPUTER NETWORKS, TELEPHONE, THE INTERNET OR ELECTRONIC MAIL; THE BRINGING TOGETHER, FOR THE BENEFIT OF OTHERS, OF A VARIETY OF GOODS AND SERVICES, ENABLING CUSTOMERS TO CONVENIENTLY VIEW AND PURCHASE THOSE GOODS AND SERVICES FROM AN INTERNET WEB SITE PARTICULARLY SPECIALIZING IN THE MARKETING OF THE SALE OF GOODS AND SERVICES OF OTHERS (U.S. CLS. 100, 101 AND 102).  
TINA BROWN, EXAMINING ATTORNEY

**CLASS 35—(Continued).**

SN 85-338,402. YAWARITH FOUNDATION, DBA HATCH-HOPE FOR HUMANITY, FALLS CHURCH, VA. FILED 6-6-2011.

# HatchHope

THE MARK CONSISTS OF STANDARD CHARACTERS WITHOUT CLAIM TO ANY PARTICULAR FONT, STYLE, SIZE, OR COLOR.

FOR MARKETING SERVICES, NAMELY, PROMOTIONAL SERVICES IN THE FIELD OF PLANNED-GIVING FOR NON-PROFIT AND CHARITABLE ORGANIZATIONS (U.S. CLS. 100, 101 AND 102).

FIRST USE 6-2-2011; IN COMMERCE 6-2-2011.  
RAMONA ORTIGA, EXAMINING ATTORNEY

SN 85-338,434. ROTHERY, LOUISE, MARBLEHEAD, MA. FILED 6-6-2011.

# SEAWORDY

THE MARK CONSISTS OF STANDARD CHARACTERS WITHOUT CLAIM TO ANY PARTICULAR FONT, STYLE, SIZE, OR COLOR.

FOR ADVERTISING AND MARKETING SERVICES PROVIDED BY MEANS OF INDIRECT METHODS OF MARKETING COMMUNICATIONS, NAMELY, SOCIAL MEDIA, SEARCH ENGINE MARKETING, INQUIRY MARKETING, INTERNET MARKETING, MOBILE MARKETING, BLOGGING AND OTHER FORMS OF PASSIVE, SHARABLE OR VIRAL COMMUNICATIONS CHANNELS; ON-LINE RETAIL GIFT SHOPS; PROMOTIONAL SERVICES, NAMELY, CONDUCTING LAUNCH PARTIES TO INTRODUCE A NEW BOOK, AUTHOR, BOOK PUBLISHER OR RETAILER; RETAIL APPAREL STORES; RETAIL BOOK STORE SERVICES; RETAIL CLOTHING STORES; RETAIL GIFT SHOPS; RETAIL SHOPS FEATURING CLOTHING AND GIFT ITEMS; RETAIL STORE SERVICES FEATURING CLOTHING AND GIFT ITEMS; RETAIL STORE SERVICES FEATURING CLOTHING AND GIFT ITEMS ACCESSIBLE ONLINE AND BY TELEPHONE, FACSIMILE AND MAIL ORDER; RETAIL STORES FEATURING CLOTHING AND GIFT ITEMS (U.S. CLS. 100, 101 AND 102).

FIRST USE 7-6-2009; IN COMMERCE 7-6-2009.  
MARK SPARACINO, EXAMINING ATTORNEY

**CLASS 35—(Continued).**

SN 85-338,465. SIP RIGHTS, LLC, BOCA RATON, FL. FILED 6-6-2011.

## CELEBRATE ALABAMA

THE MARK CONSISTS OF STANDARD CHARACTERS WITHOUT CLAIM TO ANY PARTICULAR FONT, STYLE, SIZE, OR COLOR.

OWNER OF U.S. REG. NOS. 2,367,898 AND 3,127,690.

NO CLAIM IS MADE TO THE EXCLUSIVE RIGHT TO USE "ALABAMA", APART FROM THE MARK AS SHOWN. FOR CHAMBER OF COMMERCE SERVICES, NAMELY, PROMOTING BUSINESS AND TOURISM IN ALABAMA (U.S. CLS. 100, 101 AND 102).

MICHAEL ENGEL, EXAMINING ATTORNEY

SN 85-338,525. EPSILON DATA MANAGEMENT, LLC, PLANO, TX. FILED 6-6-2011.

# EMOCIAL

THE MARK CONSISTS OF STANDARD CHARACTERS WITHOUT CLAIM TO ANY PARTICULAR FONT, STYLE, SIZE, OR COLOR.

FOR ADVERTISING AND MARKETING CONSULTANCY; ADVERTISING AND MARKETING SERVICES PROVIDED BY MEANS OF INDIRECT METHODS OF MARKETING COMMUNICATIONS, NAMELY, SOCIAL MEDIA, SEARCH ENGINE MARKETING, INQUIRY MARKETING, INTERNET MARKETING, MOBILE MARKETING, BLOGGING AND OTHER FORMS OF PASSIVE, SHARABLE OR VIRAL COMMUNICATIONS CHANNELS; SOCIAL MEDIA STRATEGY AND MARKETING CONSULTANCY FOCUSING ON HELPING CLIENTS CREATE AND EXTEND THEIR PRODUCT AND BRAND STRATEGIES BY BUILDING VIRALLY ENGAGING MARKETING SOLUTIONS (U.S. CLS. 100, 101 AND 102).

GRETCHEN ULRICH, EXAMINING ATTORNEY

SN 85-338,626. LCD ADVISORS, SOUTHFIELD, MI. FILED 6-6-2011.

## MyCapitalCoach.com Learn Today. Profit Tomorrow.

THE MARK CONSISTS OF STANDARD CHARACTERS WITHOUT CLAIM TO ANY PARTICULAR FONT, STYLE, SIZE, OR COLOR.

FOR BUSINESS MARKETING CONSULTING SERVICES; CONSULTING SERVICES IN THE FIELD OF INTERNET MARKETING (U.S. CLS. 100, 101 AND 102).

SUE LAWRENCE, EXAMINING ATTORNEY

**CLASS 35—(Continued).**

SN 85-338,762. ALTHEA RUSSELL, SYLMAR, CA. FILED 6-6-2011.

REMEDY FOR THE SOUL

THE MARK CONSISTS OF STANDARD CHARACTERS WITHOUT CLAIM TO ANY PARTICULAR FONT, STYLE, SIZE, OR COLOR.

FOR ON-LINE WHOLESALE AND RETAIL STORE SERVICES FEATURING GUM POWDER, BOWEL CLEANSER, AND BEAUTY CLEANSING PRODUCTS; WHOLESALE AND RETAIL STORE SERVICES FEATURING GUM POWDER, BOWEL CLEANSER, BEAUTY CLEANSING PRODUCTS (U.S. CLS. 100, 101 AND 102).

FIRST USE 5-0-2010; IN COMMERCE 5-0-2010.  
ESTHER BELENKER, EXAMINING ATTORNEY

SN 85-338,909. MARTOPIA, INC., ST. CHARLES, IL. FILED 6-6-2011.

M  
MARTOPIA

THE MARK CONSISTS OF THE LETTER "M" ABOVE AND THE WORD "MARTOPIA" BELOW IT.

FOR BANNER ADVERTISING; BRANDING SERVICES, NAMELY, CONSULTING, DEVELOPMENT, MANAGEMENT AND MARKETING OF BRANDS FOR BUSINESSES; BUSINESS MARKETING SERVICES; PUBLIC RELATIONS (U.S. CLS. 100, 101 AND 102).

FIRST USE 4-1-2002; IN COMMERCE 4-1-2002.  
ESTHER BELENKER, EXAMINING ATTORNEY

**CLASS 35—(Continued).**

SN 85-339,047. TRACTOR SUPPLY CO. OF TEXAS, LP, BRENTWOOD, TN. FILED 6-6-2011.



OWNER OF U.S. REG. NOS. 884,786, 3,968,287 AND OTHERS.

THE COLOR(S) RED IS/ARE CLAIMED AS A FEATURE OF THE MARK.

THE MARK CONSISTS OF A RED TRAPEZIUM. FOR RETAIL STORE SERVICES, ON-LINE RETAIL STORE SERVICES, AND MAIL ORDER CATALOG SERVICES, ALL FEATURING HARDWARE, HAND TOOLS, POWER TOOLS, AUTOMOTIVE SUPPLIES, HOUSEHOLD SUPPLIES, APPAREL, PET FOODS AND PET SUPPLIES, LAWN AND GARDEN TOOLS AND PRODUCTS, SWIMMING POOL SUPPLIES, LAWN CARE EQUIPMENT, ELECTRICAL AND GAS HEATERS, PAINTS AND PAINTER'S SUPPLIES, AIR COMPRESSORS, WELDERS AND WELDING SUPPLIES, FARM EQUIPMENT, AND FARM SUPPLIES IN THE NATURE OF FENCING, LIVESTOCK FEEDS, MINERAL SUPPLEMENTS, LIVESTOCK FEEDERS AND WATERERS, VETERINARY SUPPLIES, ROPE AND TWINE, SPRAYERS, AND PUMPS (U.S. CLS. 100, 101 AND 102).

REGINA DRUMMOND, EXAMINING ATTORNEY

SN 85-339,148. PETROHG LIMITED, DUBAI, UNITED ARAB EMIR., FILED 6-6-2011.

PETROHG

THE MARK CONSISTS OF STANDARD CHARACTERS WITHOUT CLAIM TO ANY PARTICULAR FONT, STYLE, SIZE, OR COLOR.

FOR BUSINESS CONSULTING SERVICES, NAMELY IDENTIFICATION OF STRATEGIC BUSINESS OPPORTUNITIES AND BUSINESS RELATIONSHIPS FOR OTHERS; BUSINESS INFORMATION SERVICES, NAMELY, PROVIDING INFORMATION ON BUSINESS OPPORTUNITIES, ECONOMIC CONDITIONS AND BUSINESS DEVELOPMENT IN FOREIGN MARKETS (U.S. CLS. 100, 101 AND 102).

KELLY TRUSILO, EXAMINING ATTORNEY

**CLASS 35—(Continued).**

SN 85-339,154. THETA XI FRATERNITY, ST. LOUIS, MO. FILED 6-6-2011.



OWNER OF U.S. REG. NOS. 636,955 AND 636,956.  
 THE MARK CONSISTS OF THE GREEK ALPHABET LETTERS "THETA" AND "XI".  
 FOR ASSOCIATION SERVICES, NAMELY, ORGANIZING CHAPTERS OF A FRATERNITY AND PROMOTING THE INTERESTS OF THE MEMBERS THEREOF (U.S. CLS. 100, 101 AND 102).  
 FIRST USE 0-0-1864; IN COMMERCE 0-0-1864.  
 FLORENTINA BLANDU, EXAMINING ATTORNEY

SN 85-339,194. SOSBUZZ, INC, GLENDALE, CA. FILED 6-6-2011.

**CONSCIENTIOUS SHOPPERS  
 CELEBRATE**

THE MARK CONSISTS OF STANDARD CHARACTERS WITHOUT CLAIM TO ANY PARTICULAR FONT, STYLE, SIZE, OR COLOR.  
 FOR ONLINE ADVERTISING AND MARKETING SERVICES (U.S. CLS. 100, 101 AND 102).  
 FIRST USE 5-23-2011; IN COMMERCE 5-23-2011.  
 BRENDAN MCCAULEY, EXAMINING ATTORNEY

SN 85-339,201. FOURTH ESTATE PRESS, INC., DBA SUS OPINIONES, SANTA MONICA, CA. FILED 6-6-2011.

**Sus Opiniones**

THE MARK CONSISTS OF STANDARD CHARACTERS WITHOUT CLAIM TO ANY PARTICULAR FONT, STYLE, SIZE, OR COLOR.  
 THE ENGLISH TRANSLATION OF "SUS OPINIONES" IN THE MARK IS "YOUR OPINIONS".  
 SEC. 2(F).  
 FOR ONLINE BUSINESS RESEARCH SERVICES THAT ALLOW USERS TO SHARE OPINIONS WITH A MARKETING RESEARCH COMPANY RELATED TO EVERYDAY CONSUMER PRODUCTS AND SERVICES (U.S. CLS. 100, 101 AND 102).  
 FIRST USE 10-13-2006; IN COMMERCE 10-13-2006.  
 JANICE L. MCMORROW, EXAMINING ATTORNEY

**CLASS 35—(Continued).**

SN 85-339,259. H.O.A. ASSISTANT, LLC, LAKE WORTH, FL. FILED 6-6-2011.

**CAMassistant**

THE MARK CONSISTS OF STANDARD CHARACTERS WITHOUT CLAIM TO ANY PARTICULAR FONT, STYLE, SIZE, OR COLOR.  
 FOR PROVIDING A WEB-BASED SYSTEM TO AID COMMUNITY ASSOCIATIONS WITH VENDOR SELECTION (U.S. CLS. 100, 101 AND 102).  
 JOHN WILKE, EXAMINING ATTORNEY

SN 85-339,276. SECURE DENT, INC., CYPRESS, TX. FILED 6-6-2011.

**SECUREDENT**

THE MARK CONSISTS OF STANDARD CHARACTERS WITHOUT CLAIM TO ANY PARTICULAR FONT, STYLE, SIZE, OR COLOR.  
 FOR DENTAL COST MANAGEMENT, NAMELY, PROVIDING AND ADMINISTERING DISCOUNT DENTAL CARE MEMBERSHIP PROGRAMS TO ENABLE PARTICIPANT MEMBERS TO OBTAIN DISCOUNTS ON DENTAL CARE RELATED GOODS AND SERVICES FROM CONTRACTED DENTAL CARE PROVIDERS (U.S. CLS. 100, 101 AND 102).  
 FIRST USE 6-1-2003; IN COMMERCE 7-15-2003.  
 GRETCHEN ULRICH, EXAMINING ATTORNEY

**CLASS 35—(Continued).**

SN 85-339,368. MITCH HUHEM, SAN DIEGO, CA. FILED 6-6-2011.

**MOBATHON**

THE MARK CONSISTS OF STANDARD CHARACTERS WITHOUT CLAIM TO ANY PARTICULAR FONT, STYLE, SIZE, OR COLOR.

FOR ADVERTISING AND MARKETING SERVICES PROVIDED BY MEANS OF INDIRECT METHODS OF MARKETING COMMUNICATIONS, NAMELY, SOCIAL MEDIA, SEARCH ENGINE MARKETING, INQUIRY MARKETING, INTERNET MARKETING, MOBILE MARKETING, BLOGGING AND OTHER FORMS OF PASSIVE, SHARABLE OR VIRAL COMMUNICATIONS CHANNELS; ADVERTISING ON THE INTERNET FOR OTHERS; AN INTERACTIVE WEB SITE FOR USERS TO REVIEW AND RATE INTERNET CONTENT, PEOPLE, COMPANIES, PRODUCTS AND/OR SERVICES UTILIZING A SOFTWARE APPLICATION TO AWARD POINTS WHEREBY WEB SITE USERS ARE ELIGIBLE TO EXCHANGE POINTS EARNED FOR PROMOTIONAL ITEMS CONSISTING OF COUPONS, REBATES, DISCOUNTS OR SPECIAL OFFERINGS ON GOODS AND/OR SERVICE PROVIDED BY WEB SITE SPONSORS; PROMOTING AND MARKETING THE GOODS AND SERVICES OF OTHERS BY DISTRIBUTING ADVERTISING MATERIAL, COUPONS AND DISCOUNT OFFERS VIA TEXT MESSAGES; PROMOTING THE GOODS AND SERVICES OF OTHERS BY MEANS OF DISTRIBUTING ADVERTISING ON THE INTERNET; PROMOTING THE GOODS OF OTHERS, NAMELY, PROVIDING INFORMATION REGARDING DISCOUNTS, COUPONS, REBATES, VOUCHERS AND SPECIAL OFFERS FOR THE GOODS OF OTHERS (U.S. CLS. 100, 101 AND 102).

MELISSA VALLILLO, EXAMINING ATTORNEY

SN 85-339,693. BOARDROOM INC., STAMFORD, CT. FILED 6-7-2011.

**BOTTOM LINE STORES**

THE MARK CONSISTS OF STANDARD CHARACTERS WITHOUT CLAIM TO ANY PARTICULAR FONT, STYLE, SIZE, OR COLOR.

OWNER OF U.S. REG. NOS. 1,240,265, 3,299,121 AND OTHERS.

NO CLAIM IS MADE TO THE EXCLUSIVE RIGHT TO USE "STORES", APART FROM THE MARK AS SHOWN.

FOR ONLINE RETAIL STORE FEATURING BOOKS, NEWSLETTERS, MAGAZINES, VITAMINS, DIETARY SUPPLEMENTS, MEDICAL DEVICES AND CONSUMER ELECTRONICS (U.S. CLS. 100, 101 AND 102).

FIRST USE 6-3-2011; IN COMMERCE 6-3-2011.  
KIMBERLY FRYE, EXAMINING ATTORNEY

**CLASS 35—(Continued).**

SN 85-339,788. XANTI MEDIA LLC, RUTHERFORD, NJ. FILED 6-7-2011.

**FIZZIN**

THE MARK CONSISTS OF STANDARD CHARACTERS WITHOUT CLAIM TO ANY PARTICULAR FONT, STYLE, SIZE, OR COLOR.

FOR PROMOTING THE GOODS AND SERVICES OF OTHERS BY PROVIDING A WEBSITE FEATURING COUPONS, REBATES, PRICE-COMPARISON INFORMATION, PRODUCT REVIEWS, LINKS TO THE RETAIL WEBSITES OF OTHERS, AND DISCOUNT INFORMATION; PROMOTING THE GOODS OF OTHERS, NAMELY, PROVIDING COUPONS, REBATES AND VOUCHERS FOR THE GOODS OF OTHERS; PROMOTING THE GOODS OF OTHERS, NAMELY, PROVIDING INFORMATION REGARDING DISCOUNTS, COUPONS, REBATES, VOUCHERS AND SPECIAL OFFERS FOR THE GOODS OF OTHERS; PROMOTIONAL SERVICES, NAMELY, PROMOTING THE GOODS OF OTHERS BY MEANS OF PROVIDING ONLINE COUPONS (U.S. CLS. 100, 101 AND 102).

LINDA MICKLEBURGH, EXAMINING ATTORNEY

SN 85-339,882. SIDESHOW ENTERTAINMENT, INC., ALAMEDA, CA. FILED 6-7-2011.

**Viewpon**

THE MARK CONSISTS OF STANDARD CHARACTERS WITHOUT CLAIM TO ANY PARTICULAR FONT, STYLE, SIZE, OR COLOR.

FOR PROMOTING THE GOODS AND SERVICES OF OTHERS BY PROVIDING A WEBSITE FEATURING COUPONS, REBATES, PRICE-COMPARISON INFORMATION, PRODUCT REVIEWS, LINKS TO THE RETAIL WEBSITES OF OTHERS, AND DISCOUNT INFORMATION (U.S. CLS. 100, 101 AND 102).

FIRST USE 3-0-2011; IN COMMERCE 3-0-2011.  
HOWARD B. LEVINE, EXAMINING ATTORNEY

**CLASS 35—(Continued).**

SN 85-340,020. FORD, TABORIS, LAWRENCEVILLE, GA. FILED 6-7-2011.



THE MARK CONSISTS OF THE LITERAL ELEMENTS K O K WHEREIN THE IMAGE CONSISTS OF A CROWN ON WHICH THE LITERAL ELEMENTS ARE WRITTEN IN THE FRONT SIDE AND THE CROWN IS WITH A TRIBAL DESIGN ALL OVER IT AS SHOWN IN THE MARK.

FOR ADVERTISING, MARKETING AND PROMOTION SERVICES IN THE FIELD OF MUSIC (U.S. CLS. 100, 101 AND 102).

CARRIE GENOVESE, EXAMINING ATTORNEY

SN 85-340,119. MONAD CORPORATION, DBA MONAD, WILMINGTON, DE. FILED 6-7-2011.

# MONAD

THE MARK CONSISTS OF STANDARD CHARACTERS WITHOUT CLAIM TO ANY PARTICULAR FONT, STYLE, SIZE, OR COLOR.

FOR ADVERTISING AND MARKETING; ADVERTISING AND MARKETING SERVICES, NAMELY, PROMOTING THE GOODS AND SERVICES OF OTHERS; ADVERTISING SERVICES; ADVERTISING, MARKETING AND PROMOTION SERVICES; ADVERTISING, PROMOTION, AND MARKETING SERVICES IN THE NATURE OF VIRAL MARKETING FOR ONLINE USERS; INTERNET ADVERTISING SERVICES; ON-LINE ADVERTISING SERVICES FOR OTHERS; ONLINE ADVERTISEMENTS; ONLINE ADVERTISING AND PROMOTIONAL SERVICES; PROMOTING THE GOODS AND SERVICES OF OTHERS BY MEANS OF DISTRIBUTING ADVERTISING ON THE INTERNET (U.S. CLS. 100, 101 AND 102).

FIRST USE 7-13-2010; IN COMMERCE 10-19-2010.  
ESTHER BELENKER, EXAMINING ATTORNEY

**CLASS 35—(Continued).**

SN 85-340,133. WOWNOW NUTRITIONALS, INC., HENDERSON, NV. FILED 6-7-2011.

# HERBWORKS

THE MARK CONSISTS OF STANDARD CHARACTERS WITHOUT CLAIM TO ANY PARTICULAR FONT, STYLE, SIZE, OR COLOR.

FOR RETAIL STORE AND ON-LINE RETAIL STORE SERVICES FEATURING HERBAL AND NUTRITIONAL SUPPLEMENTS (U.S. CLS. 100, 101 AND 102).

HAI-LY LAM, EXAMINING ATTORNEY

SN 85-340,174. LAUNCHSQUAD, LLC, SAN FRANCISCO, CA. FILED 6-7-2011.

# LAUNCHSQUAD

THE MARK CONSISTS OF STANDARD CHARACTERS WITHOUT CLAIM TO ANY PARTICULAR FONT, STYLE, SIZE, OR COLOR.

FOR BUSINESS MARKETING CONSULTING SERVICES; PUBLIC RELATIONS (U.S. CLS. 100, 101 AND 102).

FIRST USE 5-1-2000; IN COMMERCE 5-25-2000.

CHARLES L. JENKINS, EXAMINING ATTORNEY

SN 85-340,193. DONEGAL MUTUAL INSURANCE COMPANY, MARIETTA, PA. FILED 6-7-2011.

# COMPAY

THE MARK CONSISTS OF STANDARD CHARACTERS WITHOUT CLAIM TO ANY PARTICULAR FONT, STYLE, SIZE, OR COLOR.

FOR ADMINISTRATION SERVICES FOR PREMIUM PAYROLL DEDUCTIONS FOR WORKERS COMPENSATION POLICIES OF OTHERS, AND PREMIUM PAYMENT SERVICES (U.S. CLS. 100, 101 AND 102).

FRED CARL, EXAMINING ATTORNEY



**CLASS 35—(Continued).**

SN 85-340,275. MAKE-A-WISH FOUNDATION OF AMERICA, PHOENIX, AZ. FILED 6-7-2011.

**WISHES IN FLIGHT**

THE MARK CONSISTS OF STANDARD CHARACTERS WITHOUT CLAIM TO ANY PARTICULAR FONT, STYLE, SIZE, OR COLOR.

OWNER OF U.S. REG. NOS. 1,565,443, 3,674,652 AND OTHERS.

FOR CHARITABLE SERVICES, NAMELY, COORDINATION OF THE PROCUREMENT AND DISTRIBUTION OF AIRLINE MILES AND AIRLINE TICKETS FROM THE GENERAL PUBLIC TO CHILDREN WITH LIFE THREATENING ILLNESSES AND THEIR FAMILIES (U.S. CLS. 100, 101 AND 102).

FIRST USE 3-31-2011; IN COMMERCE 3-31-2011.

BARBARA BROWN, EXAMINING ATTORNEY

**CLASS 35—(Continued).**

SN 85-340,442. AIRDEX INTERNATIONAL, INC., HENDERSON, NV. FILED 6-7-2011.

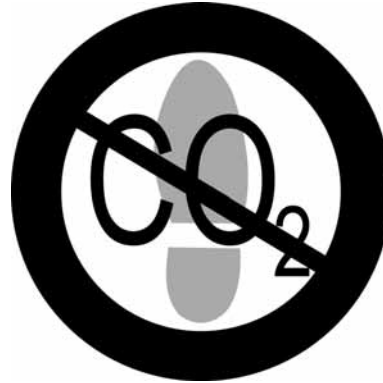

THE MARK CONSISTS OF A CIRCLE HAVING A FOOTPRINT IN A SUBSTANTIALLY VERTICAL DIRECTION INSIDE THE CIRCLE, WITH THE WORD CO2 WRITTEN ACROSS THE FACE OF THE FOOTPRINT AND A LINE DIVIDING THE CIRCLE AND THE WORD CO2 SUBSTANTIALLY DIAGONALLY.

FOR BUSINESS MANAGEMENT IN THE FIELD OF ENVIRONMENTAL MANAGEMENT; BUSINESS MANAGEMENT SERVICES IN THE FIELD OF ENVIRONMENTAL MANAGEMENT, NAMELY, ADVISING BUSINESSES AND INDIVIDUALS ON ISSUES OF ENVIRONMENTAL IMPACT, CONSERVATION, PRESERVATION AND PROTECTION, AND ECONOMIC ANALYSIS FOR BUSINESS PURPOSES; BUSINESS MANAGEMENT IN THE AREA OF ADVERTISING CAMPAIGNS GEARED TOWARD ENVIRONMENTAL ISSUES; BUSINESS CONSULTING AND ADVISORY SERVICES IN THE AREA OF ADVERTISING CAMPAIGNS GEARED TOWARD ENVIRONMENTAL ISSUES; BUSINESS CONSULTING AND ADVISORY SERVICES IN THE FIELD OF ENVIRONMENTAL MANAGEMENT; PROMOTING PUBLIC AWARENESS OF ENVIRONMENTAL MATTERS; BUSINESS CONSULTING IN THE FIELD OF ENVIRONMENTAL MANAGEMENT, NAMELY, ADVISING BUSINESSES AND INDIVIDUALS ON ISSUES OF ENVIRONMENTAL IMPACT, CONSERVATION, PRESERVATION AND PROTECTION, AND ECONOMIC ANALYSIS FOR BUSINESS PURPOSES; BUSINESS CONSULTING AND ADVISORY SERVICES IN THE FIELD OF ENERGY CONSERVATION; PROMOTING PUBLIC AWARENESS OF ENERGY CONSERVATION; BUSINESS MANAGEMENT SERVICES IN THE AREA OF DEVELOPING ADVERTISING CAMPAIGNS GEARED TOWARD ENVIRONMENTAL ISSUES; BUSINESS CONSULTING IN THE AREA OF DEVELOPING ADVERTISING CAMPAIGNS FOR OTHERS GEARED TOWARD ENVIRONMENTAL ISSUES; BUSINESS MANAGEMENT SERVICES IN THE AREA OF DEVELOPING ADVERTISING CAMPAIGNS GEARED TOWARD ENERGY CONSERVATION; BUSINESS MANAGEMENT IN THE FIELD OF ENERGY CONSERVATION (U.S. CLS. 100, 101 AND 102).

SAMUEL E. SHARPER JR., EXAMINING ATTORNEY

SN 85-340,313. PATRICK ALEXANDER, INC., SAN DIEGO, CA. FILED 6-7-2011.

**HOMEbate**

THE MARK CONSISTS OF STANDARD CHARACTERS WITHOUT CLAIM TO ANY PARTICULAR FONT, STYLE, SIZE, OR COLOR.

FOR ADVERTISING AND MARKETING SERVICES, NAMELY, PROMOTING THE GOODS AND SERVICES OF OTHERS; PROMOTING THE GOODS AND SERVICES OF OTHERS BY PROVIDING A WEBSITE FEATURING COUPONS, REBATES, PRICE-COMPARISON INFORMATION, LINKS TO THE RETAIL WEBSITES OF OTHERS, AND DISCOUNT INFORMATION FOR GOODS AND SERVICES IN THE REAL ESTATE INDUSTRY (U.S. CLS. 100, 101 AND 102).

FIRST USE 5-23-2011; IN COMMERCE 5-23-2011.

RON FAIRBANKS, EXAMINING ATTORNEY

**CLASS 35—(Continued).**

SN 85-340,909. PATRICK ALEXANDER, INC., SAN DIEGO, CA. FILED 6-8-2011.



THE MARK CONSISTS OF A STYLIZED DRAWING OF A HOUSE FOLLOWED BY THE LITERAL ELEMENT "HOME-BATE".

FOR ADVERTISING AND MARKETING SERVICES, NAMELY, PROMOTING THE GOODS AND SERVICES OF OTHERS; PROMOTING THE GOODS AND SERVICES OF OTHERS BY PROVIDING A WEBSITE FEATURING COUPONS, REBATES, PRICE-COMPARISON INFORMATION, LINKS TO THE RETAIL WEBSITES OF OTHERS, AND DISCOUNT INFORMATION FOR GOODS AND SERVICES IN THE REAL ESTATE INDUSTRY (U.S. CLS. 100, 101 AND 102).

FIRST USE 5-23-2011; IN COMMERCE 5-23-2011.  
RON FAIRBANKS, EXAMINING ATTORNEY

---

SN 85-341,068. COREPSYCH LLC, VIRGINIA BEACH, VA. FILED 6-8-2011.

**CoreNutrients**

THE MARK CONSISTS OF STANDARD CHARACTERS WITHOUT CLAIM TO ANY PARTICULAR FONT, STYLE, SIZE, OR COLOR.

FOR RETAIL STORE AND ON-LINE RETAIL STORE SERVICES FEATURING VITAMINS, SUPPLEMENTS, AND MEDICATION (U.S. CLS. 100, 101 AND 102).

FIRST USE 4-0-2011; IN COMMERCE 4-11-2011.  
THEODORE MCBRIDE, EXAMINING ATTORNEY

**CLASS 35—(Continued).**

SN 85-341,412. GASLAMP QUARTER ASSOCIATION, INC., SAN DIEGO, CA. FILED 6-8-2011.

**GASLAMP QUARTER ASSOCIATION**

THE MARK CONSISTS OF STANDARD CHARACTERS WITHOUT CLAIM TO ANY PARTICULAR FONT, STYLE, SIZE, OR COLOR.

NO CLAIM IS MADE TO THE EXCLUSIVE RIGHT TO USE "ASSOCIATION", APART FROM THE MARK AS SHOWN.

SEC. 2(F).

FOR ADVERTISING AND BUSINESS SERVICES, NAMELY, SECURING AIRTIME ON ALL FORMS OF MEDIA COMMUNICATIONS STATIONS, SYSTEMS, NETWORKS, AND SERVICES FOR THE PURPOSE OF PROMOTING THE GOODS AND SERVICES OF OTHERS; ADVERTISING, MARKETING AND PROMOTIONAL SERVICES RELATED TO ALL INDUSTRIES FOR THE PURPOSE OF FACILITATING NETWORKING AND SOCIALIZING OPPORTUNITIES FOR BUSINESS PURPOSES; BUSINESS DEVELOPMENT SERVICES; BUSINESS SERVICES FOR FUNDRAISING PROGRAMS, NAMELY, DEVELOPING FUNDRAISING PROGRAM CATALOGS, BROCHURES, PRICE SHEETS, ORDER FORMS, AND OTHER DOCUMENTS FOR NOT-FOR-PROFIT ORGANIZATIONS; CHAMBER OF COMMERCE SERVICES, NAMELY, PROMOTING BUSINESS AND TOURISM IN THE SOUTHERN CALIFORNIA AREA; GENERAL BUSINESS MERCHANDISING SERVICES, NAMELY, MARKETING; INFORMATION SERVICES RELATING TO BUSINESS MATTERS; INFORMATION, ADVISORY AND CONSULTANCY SERVICES RELATING TO BUSINESS AND MANAGEMENT OR BUSINESS ADMINISTRATION, INCLUDING SUCH SERVICES PROVIDED ON LINE OR VIA THE INTERNET; ON-LINE BUSINESS NETWORKING SERVICES; PROMOTING, ADVERTISING AND MARKETING OF THE BRANDS, PRODUCTS, SERVICES AND ONLINE WEBSITES OF INDIVIDUALS, BUSINESSES AND NONPROFIT ORGANIZATIONS; PROVIDING INFORMATION ABOUT AND MAKING REFERRALS IN THE FIELD OF CONSUMER PRODUCTS AND SERVICES FOR RETAIL SERVICES CONCERNING PRODUCTS, SERVICES, EVENTS, ACTIVITIES, ATTRACTIONS AND FACILITIES IN PARTICULAR GEOGRAPHIC LOCATIONS (U.S. CLS. 100, 101 AND 102).

FIRST USE 1-1-1983; IN COMMERCE 1-1-1983.

EVELYN BRADLEY, EXAMINING ATTORNEY

---

SN 85-341,530. MICHAEL SALTZ, BAKERSFIELD, CA. FILED 6-8-2011.

**MORE THAN A TOY STORE**

THE MARK CONSISTS OF STANDARD CHARACTERS WITHOUT CLAIM TO ANY PARTICULAR FONT, STYLE, SIZE, OR COLOR.

FOR ON-LINE RETAIL STORE SERVICES FEATURING TOYS; RETAIL STORE SERVICES FEATURING TOYS (U.S. CLS. 100, 101 AND 102).

MARY BOAGNI, EXAMINING ATTORNEY

**CLASS 35—(Continued).**

SN 85-341,532. SIXTHMAN, LLC, ATLANTA, GA. FILED 6-8-2011.

# SIXTHMAN

THE MARK CONSISTS OF STANDARD CHARACTERS WITHOUT CLAIM TO ANY PARTICULAR FONT, STYLE, SIZE, OR COLOR.

FOR PROMOTION OF CONCERTS OF OTHERS; PROMOTION OF MUSICIANS AND MUSICAL GROUPS BY DISSEMINATION OF ADVERTISING MATTER; AND LOGISTICS MANAGEMENT IN THE FIELD OF CONCERT TOURS FOR MUSICIANS AND MUSICAL GROUPS (U.S. CLS. 100, 101 AND 102).

FIRST USE 1-1-2001; IN COMMERCE 1-1-2001.  
ALICIA COLLINS, EXAMINING ATTORNEY

**CLASS 35—(Continued).**

SN 85-341,673. BRICKTWN LLC, MIAMI, FL. FILED 6-8-2011.

# BrickTWN

THE MARK CONSISTS OF STANDARD CHARACTERS WITHOUT CLAIM TO ANY PARTICULAR FONT, STYLE, SIZE, OR COLOR.

FOR CLASSIFIED ADVERTISING SERVICES; PROVIDING A WEB SITE WHERE USERS CAN POST ITEMS FOR SALE THROUGH ON-LINE CLASSIFIED ADVERTISEMENTS (U.S. CLS. 100, 101 AND 102).

FIRST USE 4-27-2011; IN COMMERCE 5-1-2011.  
JEFFREY LOOK, EXAMINING ATTORNEY

SN 85-341,536. RICHARD AWN, NEW YORK, NY. FILED 6-8-2011.

# MARKET SHARE

THE MARK CONSISTS OF STANDARD CHARACTERS WITHOUT CLAIM TO ANY PARTICULAR FONT, STYLE, SIZE, OR COLOR.

FOR INCUBATION SERVICES, NAMELY, PROVIDING WORK SPACE CONTAINING BUSINESS EQUIPMENT TO FREELANCERS, START-UPS, EXISTING BUSINESSES AND NON-PROFITS; RETAIL MARKETS FEATURING BAKED GOODS, BREAD, PASTRY, DESSERTS, SANDWICHES, SOUPS, SALADS, SIDES, ENTREES, CHEESE, MEAT, SNACK FOODS, AND GOURMET FOODS (U.S. CLS. 100, 101 AND 102).

KAPIL BHANOT, EXAMINING ATTORNEY

SN 85-342,910. HOOVER'S, INC., AUSTIN, TX. FILED 6-10-2011.

# BAL PRO

THE MARK CONSISTS OF STANDARD CHARACTERS WITHOUT CLAIM TO ANY PARTICULAR FONT, STYLE, SIZE, OR COLOR.

FOR BUSINESS INFORMATION SERVICES; BUSINESS AND CONTACT LIST CREATION, MAINTENANCE, AND ENHANCEMENT SERVICES (U.S. CLS. 100, 101 AND 102).

HEATHER BIDDULPH, EXAMINING ATTORNEY

SN 85-341,661. ETS EXPRESS, INC., OXNARD, CA. FILED 6-8-2011.

# THE EXPRESS LINE

THE MARK CONSISTS OF STANDARD CHARACTERS WITHOUT CLAIM TO ANY PARTICULAR FONT, STYLE, SIZE, OR COLOR.

FOR CATALOG ORDERING SERVICE FEATURING CUPS, MUGS, BOTTLES, GLASSWARE; MAIL ORDER CATALOG SERVICES FEATURING CUPS, MUGS, GLASSWARE, BOTTLES; MAIL ORDER SERVICES FEATURING CUPS, MUGS, GLASSWARE, BOTTLES; ON-LINE WHOLESALE AND RETAIL STORE SERVICES FEATURING BOTTLES, CUPS, MUGS GLASSWARE; WEB-BASED CATALOG SERVICES FEATURING CUPS, MUGS, BOTTLES, GLASSWARE (U.S. CLS. 100, 101 AND 102).

FIRST USE 6-1-1986; IN COMMERCE 6-1-1986.  
ALICE BENMAMAN, EXAMINING ATTORNEY

SN 85-347,763. REED ELSEVIER PROPERTIES INC., WILMINGTON, DE. FILED 6-16-2011.

# STADIUMONE2ONE

THE MARK CONSISTS OF STANDARD CHARACTERS WITHOUT CLAIM TO ANY PARTICULAR FONT, STYLE, SIZE, OR COLOR.

FOR ORGANIZING AND CONDUCTING TRADE SHOWS IN THE FIELD OF STADIUM AND ARENA PROPERTY AND VENUE MANAGEMENT, ARRANGING AND CONDUCTING BUSINESS CONFERENCES IN THE FIELD OF STADIUM AND ARENA PROPERTY AND VENUE MANAGEMENT (U.S. CLS. 100, 101 AND 102).

ANNE FARRELL, EXAMINING ATTORNEY

**CLASS 35—(Continued).**

SN 85-347,807. REED ELSEVIER PROPERTIES INC., WILMINGTON, DE. FILED 6-16-2011.

**ARENAONE2ONE**

THE MARK CONSISTS OF STANDARD CHARACTERS WITHOUT CLAIM TO ANY PARTICULAR FONT, STYLE, SIZE, OR COLOR.

FOR ORGANIZING AND CONDUCTING TRADE SHOWS IN THE FIELD OF STADIUM AND ARENA PROPERTY AND VENUE MANAGEMENT, ARRANGING AND CONDUCTING BUSINESS CONFERENCES IN THE FIELD OF STADIUM AND ARENA PROPERTY AND VENUE MANAGEMENT (U.S. CLS. 100, 101 AND 102).

ANNE FARRELL, EXAMINING ATTORNEY

---

SN 85-349,030. TASCA AUTOMOTIVE GROUP, INC., CRANSTON, RI. FILED 6-17-2011.

**YOU WILL BE SATISFIED**

THE MARK CONSISTS OF STANDARD CHARACTERS WITHOUT CLAIM TO ANY PARTICULAR FONT, STYLE, SIZE, OR COLOR.

FOR AUTOMOBILE DEALERSHIPS (U.S. CLS. 100, 101 AND 102).

MORGAN WYNNE, EXAMINING ATTORNEY

---

SN 85-349,074. SEARS BRANDS, LLC, HOFFMAN ESTATES, IL. FILED 6-17-2011.

**TURF WARS**

THE MARK CONSISTS OF STANDARD CHARACTERS WITHOUT CLAIM TO ANY PARTICULAR FONT, STYLE, SIZE, OR COLOR.

FOR RETAIL STORE SERVICES AND ONLINE RETAIL STORE SERVICES FEATURING LAWN AND GARDEN EQUIPMENT AND OUTDOOR POWER EQUIPMENT (U.S. CLS. 100, 101 AND 102).

FIRST USE 3-20-2011; IN COMMERCE 3-20-2011.

JANICE KIM, EXAMINING ATTORNEY

**CLASS 35—(Continued).**

SN 85-349,574. FIGUEROA, ERIC J., AVENTURA, FL. FILED 6-17-2011.

**Yeah Baby**

THE MARK CONSISTS OF STANDARD CHARACTERS WITHOUT CLAIM TO ANY PARTICULAR FONT, STYLE, SIZE, OR COLOR.

FOR ADVERTISING AGENCIES, NAMELY, PROMOTING THE GOODS AND SERVICES OF OTHERS; ADVERTISING AND MARKETING SERVICES, NAMELY, PROMOTING THE GOODS AND SERVICES OF OTHERS; ADVERTISING AND PUBLICITY SERVICES, NAMELY, PROMOTING THE GOODS, SERVICES, BRAND IDENTITY AND COMMERCIAL INFORMATION AND NEWS OF THIRD PARTIES THROUGH PRINT, AUDIO, VIDEO, DIGITAL AND ON-LINE MEDIUM (U.S. CLS. 100, 101 AND 102).

FIRST USE 8-22-2010; IN COMMERCE 8-22-2010.

TINA BROWN, EXAMINING ATTORNEY

---

SN 85-355,688. FLORIDA ENERGY CONSERVATION ADVISORS, INC., PALM HARBOR, FL. FILED 6-24-2011.

**"Welcome To A Greener Cleaner World"**

THE MARK CONSISTS OF STANDARD CHARACTERS WITHOUT CLAIM TO ANY PARTICULAR FONT, STYLE, SIZE, OR COLOR.

FOR DISTRIBUTORSHIP SERVICES IN THE FIELD OF WINDOW FILM, INSULATION, POWER CORRECTOR DEVICES, THERMONOMICS, PROGRAMMABLE THERMOSTATS, WINDOW AND DOOR REFURBISHMENTS; ENERGY AUDITING (U.S. CLS. 100, 101 AND 102).

FIRST USE 4-1-2009; IN COMMERCE 4-1-2009.

STEPHANIE ALI, EXAMINING ATTORNEY

---

SN 85-357,804. DEERE & COMPANY, MOLINE, IL. FILED 6-28-2011.

**PRU**

THE MARK CONSISTS OF STANDARD CHARACTERS WITHOUT CLAIM TO ANY PARTICULAR FONT, STYLE, SIZE, OR COLOR.

FOR ORDER FULFILLMENT SERVICES (U.S. CLS. 100, 101 AND 102).

FIRST USE 10-16-2009; IN COMMERCE 10-16-2009.

SKYE YOUNG, EXAMINING ATTORNEY

**CLASS 35—(Continued).**

SN 85-361,724. TRACFONE WIRELESS, INC., MIAMI, FL. FILED 7-1-2011.

**EVERYWHERENESS**

THE MARK CONSISTS OF STANDARD CHARACTERS WITHOUT CLAIM TO ANY PARTICULAR FONT, STYLE, SIZE, OR COLOR.

FOR ONLINE RETAIL STORE SERVICES FEATURING CELLULAR TELEPHONES, PREPAID WIRELESS AIR TIME CARDS, CELLULAR TELEPHONE ACCESSORIES AND WIRELESS SERVICES; DISTRIBUTORSHIP SERVICES FEATURING CELLULAR TELEPHONES, PREPAID AIR TIME CELLULAR TELEPHONE AND PREPAID AIR TIME DEBIT CARDS AND SOFTWARE FOR CONTROLLING AND MONITORING PREPAID AIR TIME CELLULAR SERVICE (U.S. CLS. 100, 101 AND 102).

PAUL E. FAHRENKOPF, EXAMINING ATTORNEY

SN 85-370,078. DALTON MOUNTAIN GEAR, LLC, TELLURIDE, CO. FILED 7-13-2011.

**JAGGED EDGE**

THE MARK CONSISTS OF STANDARD CHARACTERS WITHOUT CLAIM TO ANY PARTICULAR FONT, STYLE, SIZE, OR COLOR.

FOR RETAIL STORE SERVICES FEATURING CLOTHING, OUTERWEAR, HEADWEAR, FOOTWEAR, ACCESSORIES, EYEWEAR, BAGS, ATHLETIC EQUIPMENT, CAMPING EQUIPMENT, CLIMBING EQUIPMENT, HIKING EQUIPMENT, SPORTING EQUIPMENT, WATER SPORTS EQUIPMENT, BACKPACKS, SLEEPING BAGS, TENTS; RETAIL STORE SERVICES ACCESSIBLE ONLINE AND BY TELEPHONE FEATURING CLOTHING, OUTERWEAR, HEADWEAR, FOOTWEAR, ACCESSORIES, EYEWEAR, BAGS, ATHLETIC EQUIPMENT, CAMPING EQUIPMENT, CLIMBING EQUIPMENT, HIKING EQUIPMENT, SPORTING EQUIPMENT, WATER SPORTS EQUIPMENT, BACKPACKS, SLEEPING BAGS, TENTS (U.S. CLS. 100, 101 AND 102).

KATHERINE CHANG, EXAMINING ATTORNEY

**CLASS 35—(Continued).**

SN 85-370,236. LSPACE AMERICA, LLC., LAKE FOREST, CA. FILED 7-13-2011.

**WISH YOU WERE HERE**

THE MARK CONSISTS OF STANDARD CHARACTERS WITHOUT CLAIM TO ANY PARTICULAR FONT, STYLE, SIZE, OR COLOR.

FOR ADVERTISING AND MARKETING SERVICES PROVIDED BY MEANS OF INDIRECT METHODS OF MARKETING COMMUNICATIONS, NAMELY, SOCIAL MEDIA, SEARCH ENGINE MARKETING, INQUIRY MARKETING, INTERNET MARKETING, MOBILE MARKETING, BLOGGING AND OTHER FORMS OF PASSIVE, SHARABLE OR VIRAL COMMUNICATIONS CHANNELS (U.S. CLS. 100, 101 AND 102).

CURTIS FRENCH, EXAMINING ATTORNEY

SN 85-371,687. DEBAUN DEVELOPMENT INC., NEW YORK, NY. FILED 7-14-2011.

**ROGANIC**

THE MARK CONSISTS OF STANDARD CHARACTERS WITHOUT CLAIM TO ANY PARTICULAR FONT, STYLE, SIZE, OR COLOR.

FOR ON-LINE RETAIL STORE SERVICES FEATURING HEALTH, BEAUTY, SKIN CARE PRODUCTS, DIETARY SUPPLEMENTS, MAKE-UP PRODUCTS, HAIR COLORS, HAIR LOTIONS, PREPARATIONS AND SHAMPOOS, CLOTHING, FOOD, BEVERAGES, BABY PRODUCTS, HOME FURNISHINGS, BED SHEETS, TOWELS, PUBLICATIONS, BOOKS, DVDS (U.S. CLS. 100, 101 AND 102).

BENJAMIN OKEKE, EXAMINING ATTORNEY

SN 85-372,367. SIDESHOW ENTERTAINMENT, INC., ALAMEDA, CA. FILED 7-15-2011.

**Viewpon.TV**

THE MARK CONSISTS OF STANDARD CHARACTERS WITHOUT CLAIM TO ANY PARTICULAR FONT, STYLE, SIZE, OR COLOR.

FOR PROMOTING THE GOODS AND SERVICES OF OTHERS BY PROVIDING A WEBSITE FEATURING COUPONS, REBATES, PRICE-COMPARISON INFORMATION, PRODUCT REVIEWS, LINKS TO THE RETAIL WEBSITES OF OTHERS, AND DISCOUNT INFORMATION (U.S. CLS. 100, 101 AND 102).

FIRST USE 3-0-2011; IN COMMERCE 3-0-2011.

HOWARD B. LEVINE, EXAMINING ATTORNEY

**CLASS 35—(Continued).**

SN 85-372,371. SIDESHOW ENTERTAINMENT, INC., ALAMEDA, CA. FILED 7-15-2011.

## Viewpon.com

THE MARK CONSISTS OF STANDARD CHARACTERS WITHOUT CLAIM TO ANY PARTICULAR FONT, STYLE, SIZE, OR COLOR.

FOR PROMOTING THE GOODS AND SERVICES OF OTHERS BY PROVIDING A WEBSITE FEATURING COUPONS, REBATES, PRICE-COMPARISON INFORMATION, PRODUCT REVIEWS, LINKS TO THE RETAIL WEBSITES OF OTHERS, AND DISCOUNT INFORMATION (U.S. CLS. 100, 101 AND 102).

HOWARD B. LEVINE, EXAMINING ATTORNEY

**CLASS 35—(Continued).**

SN 85-384,709. EXACTTARGET, INC., INDIANAPOLIS, IN. FILED 7-29-2011.

## CONNECTIONS

THE MARK CONSISTS OF STANDARD CHARACTERS WITHOUT CLAIM TO ANY PARTICULAR FONT, STYLE, SIZE, OR COLOR.

FOR ARRANGING AND CONDUCTING A YEARLY BUSINESS CONFERENCE FOR INTERACTIVE MARKETING PROFESSIONALS (U.S. CLS. 100, 101 AND 102).

FIRST USE 6-30-2007; IN COMMERCE 6-30-2007.

CHARLOTTE CORWIN, EXAMINING ATTORNEY

SN 85-379,661. SOCIALPAKT LLC, NEW YORK, NY. FILED 7-25-2011.

## SOCIALPAKT

THE MARK CONSISTS OF STANDARD CHARACTERS WITHOUT CLAIM TO ANY PARTICULAR FONT, STYLE, SIZE, OR COLOR.

FOR ON-LINE RETAIL STORE SERVICES FEATURING CLOTHING (U.S. CLS. 100, 101 AND 102).

GRETTA YAO, EXAMINING ATTORNEY

SN 85-385,736. PROGRESSIVE CASUALTY INSURANCE COMPANY, MAYFIELD VILLAGE, OH. FILED 8-1-2011.

## PROGRESSIVE PLUS

THE MARK CONSISTS OF STANDARD CHARACTERS WITHOUT CLAIM TO ANY PARTICULAR FONT, STYLE, SIZE, OR COLOR.

FOR ADMINISTRATION OF A PROGRAM FOR ENABLING PARTICIPANTS TO OBTAIN DISCOUNTS ON PRODUCTS AND SERVICES (U.S. CLS. 100, 101 AND 102).

GINA FINK, EXAMINING ATTORNEY

SN 85-384,265. ADVERTISING SPECIALTY INSTITUTE, INC., TREVOSE, PA. FILED 7-29-2011.

## ASI SMARTSALES

THE MARK CONSISTS OF STANDARD CHARACTERS WITHOUT CLAIM TO ANY PARTICULAR FONT, STYLE, SIZE, OR COLOR.

OWNER OF U.S. REG. NOS. 1,176,093, 1,932,477 AND OTHERS.

FOR PROVIDING ON-LINE SERVICES, NAMELY, A DATABASE FOR DISTRIBUTORS FOR STORING CUSTOMER INFORMATION, INCLUDING CONTACT INFORMATION, SALES HISTORY, TASK MANAGEMENT, SALES FORCE AUTOMATION AND ELECTRONIC TERRITORY MANAGEMENT, CLIENT PROFILING AND TARGETING, INFORMATION MANAGEMENT, ANALYSIS, SYNCHRONIZATION AND SUPPORT OF SALES OPPORTUNITIES FOR DISTRIBUTORS IN THE ADVERTISING SPECIALTY/PROMOTIONAL PRODUCTS INDUSTRY (U.S. CLS. 100, 101 AND 102).

MIDGE BUTLER, EXAMINING ATTORNEY

SN 85-388,741. THE NEIMAN MARCUS GROUP, INC., DALLAS, TX. FILED 8-3-2011.

## Last Call Studio by Neiman Marcus

THE MARK CONSISTS OF STANDARD CHARACTERS WITHOUT CLAIM TO ANY PARTICULAR FONT, STYLE, SIZE, OR COLOR.

OWNER OF U.S. REG. NOS. 934,177, 1,774,545 AND OTHERS.

FOR RETAIL DEPARTMENT STORE SERVICES (U.S. CLS. 100, 101 AND 102).

FIRST USE 12-1-2010; IN COMMERCE 12-1-2010.

GRETTA YAO, EXAMINING ATTORNEY

**CLASS 35—(Continued).**

SN 85-389,359. MJCM, LLC, DBA PINNACLE FINANCIAL STRATEGIES, HOUSTON, TX. FILED 8-4-2011.

**INTEREST COUNTS**

THE MARK CONSISTS OF STANDARD CHARACTERS WITHOUT CLAIM TO ANY PARTICULAR FONT, STYLE, SIZE, OR COLOR.

FOR BUSINESS CONSULTATION SERVICES; BUSINESS MARKETING CONSULTING SERVICES; BUSINESS MARKETING SERVICES; PROMOTION AND MARKETING SERVICES AND RELATED CONSULTING (U.S. CLS. 100, 101 AND 102).

MARIA-VICTORIA SUAREZ, EXAMINING ATTORNEY

**CLASS 35—(Continued).**

SN 85-389,758. LENOX CORPORATION, BRISTOL, PA. FILED 8-4-2011.

**DANSK**

THE MARK CONSISTS OF STANDARD CHARACTERS WITHOUT CLAIM TO ANY PARTICULAR FONT, STYLE, SIZE, OR COLOR.

OWNER OF U.S. REG. NOS. 661,778, 2,225,220 AND OTHERS.

THE ENGLISH TRANSLATION OF "DANSK" IN THE MARK IS "DANISH".

SEC. 2(F).

FOR RETAIL AND WHOLESALE STORE SERVICES, DISTRIBUTORSHIPS, DIRECT RESPONSE RETAIL SERVICES IN THE NATURE OF CATALOG ORDERING, AND ON-LINE RETAIL STORE SERVICES, ALL FEATURING DINNERWARE, STEMWARE, BEVERAGE GLASSWARE, FLATWARE, HOME DECOR, COLLECTIBLE FIGURINES, ORNAMENTS, AND A WIDE VARIETY OF CONSUMER GIFTWARE GOODS; AND PROVIDING CONSUMER PRODUCT INFORMATION VIA THE INTERNET OR OTHER COMPUTER OR COMMUNICATIONS NETWORKS (U.S. CLS. 100, 101 AND 102).

FIRST USE 7-28-1954; IN COMMERCE 7-28-1954.

DOMINIC FATHY, EXAMINING ATTORNEY

SN 85-389,413. MJCM, LLC, DBA PINNACLE FINANCIAL STRATEGIES, HOUSTON, TX. FILED 8-4-2011.

**TRUST COUNTS**

THE MARK CONSISTS OF STANDARD CHARACTERS WITHOUT CLAIM TO ANY PARTICULAR FONT, STYLE, SIZE, OR COLOR.

FOR BUSINESS CONSULTATION SERVICES; BUSINESS MARKETING CONSULTING SERVICES; BUSINESS MARKETING SERVICES; PROMOTION AND MARKETING SERVICES AND RELATED CONSULTING (U.S. CLS. 100, 101 AND 102).

MARIA-VICTORIA SUAREZ, EXAMINING ATTORNEY

SN 85-391,397. PERRY, BOB, LAS VEGAS, NV. FILED 8-6-2011.



THE MARK CONSISTS OF THE TEXT "ROLLING STRONG" PRINTED OVER A HIGHWAY SIGN SYMBOL WITH A BAR WITH THREE TIRES ON BOTH ENDS.

FOR MARKETING CONSULTING (U.S. CLS. 100, 101 AND 102).

FIRST USE 6-15-2011; IN COMMERCE 6-23-2011.

STEPHANIE ALI, EXAMINING ATTORNEY

**CLASS 35—(Continued).**

SN 85-392,367. SELECT INTELLECTUAL, LLC, PITTSBURGH, PA. FILED 8-8-2011.

**SAFETYMIRROR**

THE MARK CONSISTS OF STANDARD CHARACTERS WITHOUT CLAIM TO ANY PARTICULAR FONT, STYLE, SIZE, OR COLOR.

FOR BUSINESS SERVICES, NAMELY, PROVIDING PERSONNEL SELECTION AND ASSESSMENT SERVICES BY IDENTIFYING, AND SCREENING OF SAFETY ATTITUDES AND BEHAVIOR OF EMPLOYEES, INDEPENDENT CONTRACTORS AND EMPLOYEE CANDIDATES (U.S. CLS. 100, 101 AND 102).  
MORGAN WYNNE, EXAMINING ATTORNEY

---

SN 85-399,480. BRITISH SWIM CENTERS, LLC, SUNRISE, FL. FILED 8-16-2011.

**SWIM SCHOOL IN-A-BOX JUST ADD WATER**

THE MARK CONSISTS OF STANDARD CHARACTERS WITHOUT CLAIM TO ANY PARTICULAR FONT, STYLE, SIZE, OR COLOR.

NO CLAIM IS MADE TO THE EXCLUSIVE RIGHT TO USE "SWIM SCHOOL", APART FROM THE MARK AS SHOWN.

FOR FRANCHISE SERVICES, NAMELY, OFFERING BUSINESS MANAGEMENT ASSISTANCE IN THE ESTABLISHMENT AND OPERATION OF LOCAL SWIMMING INSTRUCTION BUSINESSES (U.S. CLS. 100, 101 AND 102).

FIRST USE 1-31-2011; IN COMMERCE 1-31-2011.  
EMILY CARLSEN, EXAMINING ATTORNEY

---

SN 85-401,102. U.S. MARINE CORPS, A COMPONENT OF THE U.S. DEPARTMENT OF THE NAVY, WASHINGTON, DC. FILED 8-18-2011.

**EARNED. NEVER GIVEN.**

THE MARK CONSISTS OF STANDARD CHARACTERS WITHOUT CLAIM TO ANY PARTICULAR FONT, STYLE, SIZE, OR COLOR.

FOR EMPLOYMENT COUNSELING AND RECRUITING; EMPLOYMENT COUNSELING IN THE FIELD(S) OF CAREERS IN THE MILITARY; EMPLOYMENT RECRUITING CONSULTATION; EMPLOYMENT STAFFING IN THE FIELD OF CAREERS IN THE MILITARY (U.S. CLS. 100, 101 AND 102).

FIRST USE 12-31-2003; IN COMMERCE 12-31-2003.  
WENDY JUN, EXAMINING ATTORNEY

**CLASS 35—(Continued).**

SN 85-402,636. PETALUMA ACQUISITION, LLC, PETALUMA, CA. FILED 8-19-2011.

**TRACE OUR TRACKS**

THE MARK CONSISTS OF STANDARD CHARACTERS WITHOUT CLAIM TO ANY PARTICULAR FONT, STYLE, SIZE, OR COLOR.

FOR PROMOTING PUBLIC AWARENESS OF THE NEED FOR SUPPORTING LOCAL FARMERS, PURCHASING LOCALLY GROWN FOOD AND FOOD PRODUCTS OF OTHERS, FOOD SUSTAINABILITY AND CRUELTY FREE FARMING; PROVIDING CONSUMER PRODUCT INFORMATION REGARDING THE SOURCE OR ORIGINATION OF POULTRY AND POULTRY PRODUCTS (U.S. CLS. 100, 101 AND 102).

FIRST USE 7-1-2011; IN COMMERCE 7-21-2011.  
DANNEAN HETZEL, EXAMINING ATTORNEY

---

SN 85-402,641. PETALUMA ACQUISITION, LLC, PETALUMA, CA. FILED 8-19-2011.



THE MARK CONSISTS OF THE STYLIZED WORDS "TRACE OUR TRACKS" IN VERTICAL ALIGNMENT WITH "TRACE" AT THE TOP, "OUR" IN THE MIDDLE AND "TRACKS" AT THE BOTTOM, AND THE DESIGN OF BIRDS TRACKS TO THE RIGHT OF THE STYLIZED WORDS.

FOR PROMOTING PUBLIC AWARENESS OF THE NEED FOR SUPPORTING LOCAL FARMERS, PURCHASING LOCALLY GROWN FOOD AND FOOD PRODUCTS OF OTHERS, FOOD SUSTAINABILITY AND CRUELTY FREE FARMING; PROVIDING CONSUMER PRODUCT INFORMATION REGARDING THE SOURCE OR ORIGINATION OF POULTRY AND POULTRY PRODUCTS (U.S. CLS. 100, 101 AND 102).

FIRST USE 7-1-2011; IN COMMERCE 7-21-2011.  
DANNEAN HETZEL, EXAMINING ATTORNEY



**CLASS 35—(Continued).**

SN 85-404,677. XANTI MEDIA LLC, RUTHERFORD, NJ. FILED 8-23-2011.

# MAKE IT FIZZ

THE MARK CONSISTS OF STANDARD CHARACTERS WITHOUT CLAIM TO ANY PARTICULAR FONT, STYLE, SIZE, OR COLOR.

FOR PROMOTING THE GOODS AND SERVICES OF OTHERS BY PROVIDING A WEBSITE FEATURING COUPONS, REBATES, PRICE-COMPARISON INFORMATION, PRODUCT REVIEWS, LINKS TO THE RETAIL WEBSITES OF OTHERS, AND DISCOUNT INFORMATION; PROMOTING THE GOODS OF OTHERS, NAMELY, PROVIDING COUPONS, REBATES AND VOUCHERS FOR THE GOODS OF OTHERS; PROMOTING THE GOODS OF OTHERS, NAMELY, PROVIDING INFORMATION REGARDING DISCOUNTS, COUPONS, REBATES, VOUCHERS AND SPECIAL OFFERS FOR THE GOODS OF OTHERS; PROMOTIONAL SERVICES, NAMELY, PROMOTING THE GOODS OF OTHERS BY MEANS OF PROVIDING ONLINE COUPONS (U.S. CLS. 100, 101 AND 102).

LINDA MICKLEBURGH, EXAMINING ATTORNEY

SN 85-975,652. KAJABI, LLC, TUSTIN, CA. FILED 3-23-2011.

# KAJABI

THE MARK CONSISTS OF STANDARD CHARACTERS WITHOUT CLAIM TO ANY PARTICULAR FONT, STYLE, SIZE, OR COLOR.

THE ENGLISH TRANSLATION OF "KAJABI" IN THE MARK IS "TO TAKE FLIGHT".

FOR GENERAL BUSINESS NETWORKING REFERRAL SERVICES, NAMELY, PROMOTING THE GOODS AND SERVICES OF OTHERS BY PASSING BUSINESS LEADS AND REFERRALS AMONG GROUP MEMBERS; ON-LINE BUSINESS NETWORKING SERVICES; PROVIDING DEMAND CREATION AND LEAD GENERATION ACTIVITIES AND SERVICES; SALES PROMOTION SERVICES (U.S. CLS. 100, 101 AND 102).

STEVEN PEREZ, EXAMINING ATTORNEY

**CLASS 36—INSURANCE AND FINANCIAL**

SN 76-464,379. JANUS INTERNATIONAL HOLDING COMPANY, RENO, NV. FILED 11-4-2002.

# JANUS WORLD FUNDS

NO CLAIM IS MADE TO THE EXCLUSIVE RIGHT TO USE "WORLD FUNDS", APART FROM THE MARK AS SHOWN.

FOR INVESTING THE FUNDS OF OTHERS; MUTUAL FUND INVESTMENT AND INVESTMENT ADVISORY SERVICES (U.S. CLS. 100, 101 AND 102).

FIRST USE 7-31-2001; IN COMMERCE 7-31-2001.

HENRY S. ZAK, EXAMINING ATTORNEY

SN 76-704,132. NEW YORK CITY REGIONAL CENTER, LLC, NEW YORK, NY. FILED 8-16-2010.



NO CLAIM IS MADE TO THE EXCLUSIVE RIGHT TO USE "NEW YORK CITY REGIONAL CENTER", APART FROM THE MARK AS SHOWN.

THE COLOR(S) RED, BLUE AND BLACK IS/ARE CLAIMED AS A FEATURE OF THE MARK.

THE MARK CONSISTS OF THE LETTERS "NYCRC" WITH THE LETTERS "NYC" IN BLUE AND LETTERS "RC" IN RED, THE WORDS "NEW YORK CITY REGIONAL CENTER" ARE IN BLACK AND THE CURVED LINES TO THE LEFT OF THE LETTERS "NYC" ARE IN RED.

FOR PROVIDING ADVICE AND ASSISTANCE TO NON-UNITED STATES RESIDENTS AND CITIZENS AS TO INVESTING IN UNITED STATES BUSINESSES IN ACCORDANCE WITH UNITED STATES GOVERNMENT PROGRAMS (U.S. CLS. 100, 101 AND 102).

FIRST USE 12-0-2008; IN COMMERCE 6-0-2009.

EDWARD NELSON, EXAMINING ATTORNEY

SN 76-707,066. AMERIFLEX, LLC, MOUNT LAUREL, NJ. FILED 4-1-2011.

# AFC COBRA

THE MARK CONSISTS OF STANDARD CHARACTERS WITHOUT CLAIM TO ANY PARTICULAR FONT, STYLE, SIZE, OR COLOR.

NO CLAIM IS MADE TO THE EXCLUSIVE RIGHT TO USE "COBRA", APART FROM THE MARK AS SHOWN.

FOR INSURANCE ADMINISTRATION UNDER THE CONSOLIDATED OMNIBUS RECONCILIATION ACT (U.S. CLS. 100, 101 AND 102).

SUE LAWRENCE, EXAMINING ATTORNEY

**CLASS 36—(Continued).**

SN 76-707,077. AMERIFLEX, LLC, MOUNT LAUREL, NJ. FILED 4-1-2011.

**AFC INVOICE MANAGER**

THE MARK CONSISTS OF STANDARD CHARACTERS WITHOUT CLAIM TO ANY PARTICULAR FONT, STYLE, SIZE, OR COLOR.

NO CLAIM IS MADE TO THE EXCLUSIVE RIGHT TO USE "INVOICE MANAGER", APART FROM THE MARK AS SHOWN.

FOR ADMINISTRATION OF PRE-PAID HEALTH CARE PLANS; ADMINISTRATION OF EMPLOYEE BENEFIT PLANS (U.S. CLS. 100, 101 AND 102).

SUE LAWRENCE, EXAMINING ATTORNEY

---

SN 76-707,593. GRIFFIN LABORATORIES, TEMECULA, CA. FILED 5-13-2011.

**DROP & SOAK**

THE MARK CONSISTS OF STANDARD CHARACTERS WITHOUT CLAIM TO ANY PARTICULAR FONT, STYLE, SIZE, OR COLOR.

FOR PROVIDING EXTENDED WARRANTY SERVICES FOR VOICE-RELATED DEVICES, NAMELY, ELECTROLARYNX AND AUDIO AMPLIFIER DEVICES (U.S. CLS. 100, 101 AND 102).

FIRST USE 1-31-2005; IN COMMERCE 1-31-2005.

MIDGE BUTLER, EXAMINING ATTORNEY

---

SN 77-333,611. LEXICON MARKETING, LLC, LOS ANGELES, CA. FILED 11-19-2007.

**CASA SIN BARRERAS**

THE MARK CONSISTS OF STANDARD CHARACTERS WITHOUT CLAIM TO ANY PARTICULAR FONT, STYLE, SIZE, OR COLOR.

OWNER OF U.S. REG. NOS. 1,627,082, 3,252,247 AND OTHERS.

THE FOREIGN WORDING IN THE MARK TRANSLATES INTO ENGLISH AS HOUSE WITHOUT BORDERS.

FOR MORTGAGE BROKERAGE; MORTGAGE LENDING; REAL ESTATE BROKERAGE; REAL ESTATE CONSULTATION; REAL ESTATE LENDING SERVICES; REAL ESTATE LISTING (U.S. CLS. 100, 101 AND 102).

MATTHEW EINSTEIN, EXAMINING ATTORNEY

**CLASS 36—(Continued).**

SN 77-372,345. LINCOLN FUNDS INTERNATIONAL, INC., COSTA MESA, CA. FILED 1-15-2008.

**EFX CAPITAL**

THE MARK CONSISTS OF STANDARD CHARACTERS WITHOUT CLAIM TO ANY PARTICULAR FONT, STYLE, SIZE, OR COLOR.

NO CLAIM IS MADE TO THE EXCLUSIVE RIGHT TO USE "CAPITAL", APART FROM THE MARK AS SHOWN.

FOR CURRENCY EXCHANGE AND ADVICE; FINANCIAL EXCHANGE; FINANCIAL INFORMATION IN THE NATURE OF RATES OF EXCHANGE; FINANCIAL SERVICES, NAMELY, PROVIDING FOR THE EXCHANGE OF FOREIGN CURRENCY, COMMODITIES, FINANCIAL DERIVATIVES, AND EQUITIES VIA THE INTERNET AND INTRANET SYSTEMS; FOREIGN EXCHANGE INFORMATION SERVICES; FOREIGN EXCHANGE TRANSACTIONS (U.S. CLS. 100, 101 AND 102).

FIRST USE 6-0-2007; IN COMMERCE 8-0-2007.

STEVEN JACKSON, EXAMINING ATTORNEY

---

SN 77-483,847. THE WARRANTY GROUP, INC., CHICAGO, IL. FILED 5-27-2008.



NO CLAIM IS MADE TO THE EXCLUSIVE RIGHT TO USE "WARRANTY", APART FROM THE MARK AS SHOWN.

THE MARK CONSISTS OF THE WORDING "MAIN ST." THE "T" IN "ST." IS A DESIGN ELEMENT OF AN OUTDOOR LAMP POST. BELOW THE WORDING "MAIN ST." PLUS DESIGN IS THE WORDING "WARRANTY". A STRAIGHT LINE SEPARATES THE TOP AND BOTTOM WORDINGS.

FOR PROVIDING EXTENDED WARRANTIES, EITHER INDIVIDUALLY OR IN COMBINATION, RELATING TO HOME HEATING SYSTEMS, AIR CONDITIONING UNITS, DUCT WORK, ELECTRICAL AND PLUMBING, WATER HEATERS, DISHWASHERS, OVENS, COOKTOPS, APPLIANCES, WASHERS AND DRYERS, ICE MAKERS, FREEZERS, REFRIGERATORS, TRASH COMPACTORS, WELL PUMPS, SEPTIC SYSTEMS, SWIMMING POOLS AND POOL SPAS (U.S. CLS. 100, 101 AND 102).

WENDY JUN, EXAMINING ATTORNEY

**CLASS 36—(Continued).**

SN 77-976,039. KEY RISK MANAGEMENT SERVICES, INC., GREENSBORO, NC. FILED 12-4-2007.

**CLASS 36—(Continued).**

SN 79-092,096. GOLD BUYERS INTERNATIONAL PTY LTD, CROYDON VIC 3136, AUSTRALIA, FILED 12-15-2010.

**MASTERKEY CONNECTS**

THE MARK CONSISTS OF STANDARD CHARACTERS WITHOUT CLAIM TO ANY PARTICULAR FONT, STYLE, SIZE, OR COLOR.

FOR PROVIDING A WEB SITE WITH ACCESS TO ONLINE INFORMATION IN THE FIELD OF INSURANCE EXCLUDING MEDICAL, AUTO, AND RENTAL INSURANCE FOR TRAVELERS, EXTENDED WARRANTY, AND TRAVEL ASSISTANCE INSURANCE; PROVIDING INSURANCE ADMINISTRATION SERVICES VIA A WEB SITE ALLOWING INDIVIDUALS TO MONITOR INFORMATION, ACCESS DOCUMENTS AND GENERATE REPORTS RELATED TO BILLING, LOSS CONTROL AND CLAIMS INFORMATION, ALL IN THE FIELD OF INSURANCE EXCLUDING MEDICAL, AUTO, AND RENTAL INSURANCE FOR TRAVELERS, EXTENDED WARRANTY, AND TRAVEL ASSISTANCE INSURANCE (U.S. CLS. 100, 101 AND 102).

FIRST USE 2-29-2008; IN COMMERCE 3-6-2008.  
ELIZABETH KAJUBI, EXAMINING ATTORNEY



SN 79-091,003. INTELECTIA CAPITAL LUXEMBOURG S.A.R.L., LUXEMBOURG, FILED 11-3-2010.

**INTELECTIA**  
capital

PRIORITY DATE OF 8-2-2010 IS CLAIMED.  
OWNER OF INTERNATIONAL REGISTRATION 1061114 DATED 11-3-2010, EXPIRES 11-3-2020.

NO CLAIM IS MADE TO THE EXCLUSIVE RIGHT TO USE "CAPITAL", APART FROM THE MARK AS SHOWN.  
THE COLOR(S) BLUE AND GRAY IS/ARE CLAIMED AS A FEATURE OF THE MARK.

THE MARK CONSISTS OF THE WORDING "INTELECTIA CAPITAL" AND THE WORD "INTELECTIA" IS IN BLUE AND "CAPITAL" IS IN GRAY.

THE WORDING "INTELECTIA" HAS NO MEANING IN A FOREIGN LANGUAGE.

FOR INSURANCE SERVICES, NAMELY, UNDERWRITING AND BROKERAGE OF LIFE, HEALTH, ANNUITY, FIRE, PROPERTY AND CASUALTY INSURANCE, BANKING; FINANCIAL AFFAIRS AND MONETARY AFFAIRS, NAMELY, FINANCIAL INFORMATION, MANAGEMENT AND ANALYSIS SERVICES; REAL ESTATE AGENCIES, MUTUAL FUNDS AND CAPITAL INVESTMENT, ELECTRONIC FUNDS TRANSFER (U.S. CLS. 100, 101 AND 102).

LOURDES AYALA, EXAMINING ATTORNEY

PRIORITY DATE OF 9-2-2010 IS CLAIMED.  
OWNER OF INTERNATIONAL REGISTRATION 1063822 DATED 12-15-2010, EXPIRES 12-15-2020.

THE MARK CONSISTS OF THE STYLIZED LETTERS "GB" APPEARING ABOVE THE DEPICTION OF AN UPWARDLY CURVING LINE.

FOR VALUATION SERVICES, NAMELY, APPRAISALS OF JEWELRY; VALUATION OF ASSETS, NAMELY, COIN APPRAISAL; VALUATION SERVICES, NAMELY, APPRAISALS OF VALUABLES IN THE NATURE OF COINS, JEWELRY, PRECIOUS METALS AND PRECIOUS STONES; COMMODITIES, GOLD, MERCANTILE, MONETARY AND SECURITY EXCHANGES, NAMELY, MONETARY EXCHANGE, COMMODITIES EXCHANGE SERVICES, FINANCIAL SECURITIES EXCHANGE SERVICES; JEWELRY APPRAISAL; COMMODITIES, PRECIOUS METALS, MERCANTILE, MONETARY AND SECURITY EXCHANGES, NAMELY, MONETARY EXCHANGE, BROKERAGE IN THE FIELD OF PRECIOUS METALS, COMMODITIES EXCHANGE SERVICES, FINANCIAL SECURITIES EXCHANGE SERVICES; PRECIOUS METALS BROKERAGE SERVICES; PURCHASE OF GOLD, SILVER, PLATINUM AND PRECIOUS METALS, NAMELY, BROKERAGE IN THE FIELD OF GOLD, SILVER, PLATINUM AND PRECIOUS METALS (U.S. CLS. 100, 101 AND 102).

MICHAEL TANNER, EXAMINING ATTORNEY

**CLASS 36—(Continued).**

SN 79-093,999. SOCIETE GENERALE, F-75009 PARIS, FRANCE, FILED 12-28-2010.

TEAM SPIRIT  SOCIETE GENERALE

PRIORITY DATE OF 11-24-2010 IS CLAIMED.  
OWNER OF INTERNATIONAL REGISTRATION 1068228 DATED 12-28-2010, EXPIRES 12-28-2020.  
OWNER OF U.S. REG. NOS. 1,723,648, 3,318,419 AND OTHERS.

NO CLAIM IS MADE TO THE EXCLUSIVE RIGHT TO USE "SOCIETE", APART FROM THE MARK AS SHOWN.  
THE COLOR(S) RED, BLACK AND WHITE IS/ARE CLAIMED AS A FEATURE OF THE MARK.

THE MARK CONSISTS OF THE FOLLOWING: THE WORDING "TEAM SPIRIT SOCIETE GENERALE" IN BLACK AND THE COLOR RED APPEARING IN THE TOP PORTION OF THE SQUARE, THE COLOR WHITE APPEARING IN THE STRIP GOING THROUGH A PORTION OF THE CENTER OF THE SQUARE, WHILE THE COLOR BLACK APPEARS IN THE BOTTOM PORTION OF THE SQUARE.

FOR BANKING; FINANCIAL AFFAIRS, NAMELY, FINANCING SERVICES; MONETARY AFFAIRS, NAMELY, MONETARY EXCHANGE; REAL ESTATE AFFAIRS, NAMELY, REAL ESTATE BROKERAGE; CREDIT BUREAU; FINANCIAL SPONSORSHIP OF CULTURAL EVENTS, ENTERTAINMENT EVENTS, SPORTING EVENTS, SPORTS TEAMS, COMMUNITY CENTERED EVENTS, PUBLIC INTEREST PROGRAMS AND ACTIVITIES, EDUCATIONAL PROGRAMS AND ACTIVITIES, CHARITABLE EVENTS AND CHARITIES; DEBT COLLECTION AGENCIES; FINANCIAL ANALYSIS; INSURANCE UNDERWRITING IN THE FIELD HEALTH, ACCIDENT AND FIRE; LIFE INSURANCE UNDERWRITING; INSURANCE CONSULTANCY; SAVINGS BANKS; CREDIT CARD SERVICES; DEBIT CARD SERVICES; SURETY SERVICES; RAISING CAPITAL; FINANCIAL CONSULTANCY; REAL ESTATE APPRAISAL; APARTMENT HOUSE MANAGEMENT; STOCK EXCHANGE QUOTATIONS; SECURITIES BROKERAGE; INSURANCE BROKERAGE; CREDIT, NAMELY, CREDIT AGENCY SERVICES AND CREDIT CONSULTATION; HIRE-PURCHASE FINANCING; DEPOSITS OF VALUABLES; SECURITIES MANAGEMENT; ISSUING OF TRAVELERS' CHECKS; SAVINGS, NAMELY, SAVINGS AND LOAN SERVICES AND ADMINISTRATION OF SAVINGS ACCOUNTS; FINANCIAL EVALUATION; FINANCING SERVICES; MUTUAL FUNDS; MUTUAL INVESTMENT FUNDS; UNDERTAKINGS FOR COLLECTIVE INVESTMENT IN SECURITIES; FINANCIAL INFORMATION; INSURANCE INFORMATION; HOME BANKING; CAPITAL INVESTMENTS; EXCHANGING MONEY; FINANCIAL TRUST OPERATIONS; MONETARY OPERATIONS, NAMELY, MONETARY EXCHANGE SERVICES; PAYMENT BY INSTALLMENTS; FUND PAYMENTS, NAMELY, ELECTRONIC FUNDS TRANSFER SERVICES AND MONEY ORDER PAYMENT GUARANTEE SERVICES; PROVIDING CONSUMER LOANS; PAWN BROKERAGE; FINANCIAL TRANSACTIONS, NAMELY, INVESTMENT FUNDS TRANSFER AND ASSISTING OTHERS WITH THE COMPLETION OF FINANCIAL TRANSACTIONS FOR STOCKS, BONDS, SECURITIES AND EQUITIES; ELECTRONIC FUNDS TRANSFER; CHECK VERIFICATIONS; FINANCIAL AND BANKING MANAGEMENT; RESEARCH AND PROSPECTING OF FINANCIAL MARKETS AND MANAGEMENT OF SECURITIES, FINANCIAL INDICES AND FINANCIAL INDEXING; ALL THESE SERVICES MAY BE PROVIDED VIA THE INTERNET (U.S. CLS. 100, 101 AND 102).

KEVON CHISOLM, EXAMINING ATTORNEY

**CLASS 36—(Continued).**

SN 85-008,830. SK TELECOM CO., LTD., SEOUL, REPUBLIC OF KOREA, FILED 4-7-2010.

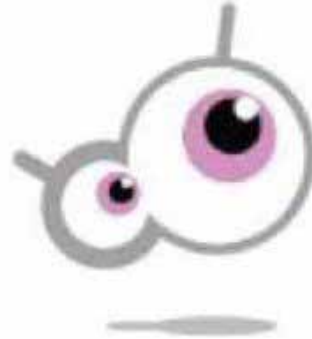

PRIORITY CLAIMED UNDER SEC. 44(D) ON REPUBLIC OF KOREA APPLICATION NO. 41-2010-0004, FILED 2-25-2010, REG. NO. 0210164, DATED 5-9-2011, EXPIRES 5-9-2021.  
THE COLOR(S) GREY, PINK, BLACK AND WHITE IS/ARE CLAIMED AS A FEATURE OF THE MARK.

THE MARK CONSISTS OF TWO STYLIZED EYES, THE RIGHT EYE LARGER THUS OVERLAPPING THE LEFT EYE. EACH EYE HAS A WHITE CIRCLE, A BLACK CIRCLE, A PINK CIRCLE, AND A GREY OUTLINE. BENEATH BOTH OF THE EYES IS A GREY LINE.

FOR BANKING, ELECTRONIC PAYMENT PROCESSING SERVICES, NAMELY, PAYMENT AND RECEIPT OF MONEY AS AGENT ACCESSIBLE THROUGH TELECOM DEVICES AND SERVICES; PROVISION OF INFORMATION RELATING TO FINANCE VIA WIRELESS COMMUNICATIONS; STOCK BROKERAGE VIA WIRELESS COMMUNICATIONS; ELECTRONIC PAYMENT PROCESSING SERVICES THROUGH MOBILE PHONES; ELECTRONIC PAYMENT PROCESSING SERVICES THROUGH THE INTERNET; ELECTRONIC PAYMENT PROCESSING SERVICES THROUGH COMPUTER NETWORKS; HOME BANKING SERVICES THROUGH COMMUNICATION NETWORKS; BILL PAYMENT SERVICES THROUGH COMMUNICATION NETWORKS; CERTIFIED FINANCIAL EXCHANGE AND PAYMENT PROCESSING SERVICES THROUGH AN ONLINE CONNECTION; PROVISION OF INFORMATION IN THE FIELD OF REAL ESTATE VIA THE INTERNET THROUGH TELECOM DEVICES; PROVISION OF INFORMATION RELATING TO INSURANCE THROUGH TELECOM DEVICES; PROVISION OF INFORMATION RELATING TO FINANCIAL AFFAIRS THROUGH TELECOM DEVICES (U.S. CLS. 100, 101 AND 102).

DEBRA LEE, EXAMINING ATTORNEY

SN 85-014,789. TIMBERVEST, LLC, ATLANTA, GA. FILED 4-15-2010.

# Timbervest

THE MARK CONSISTS OF STANDARD CHARACTERS WITHOUT CLAIM TO ANY PARTICULAR FONT, STYLE, SIZE, OR COLOR.

FOR INVESTMENT ADVISORY SERVICES; REAL ESTATE INVESTMENT SERVICES (U.S. CLS. 100, 101 AND 102).

FIRST USE 8-1-2000; IN COMMERCE 8-1-2000.  
JOSETTE BEVERLY, EXAMINING ATTORNEY

**CLASS 36—(Continued).**

SN 85-014,954. TIMBERVEST, LLC, ATLANTA, GA. FILED 4-15-2010.



THE COLOR(S) BLUE AND GREEN IS/ARE CLAIMED AS A FEATURE OF THE MARK.

THE MARK CONSISTS OF A GREEN TREE SHAPE WITH TWO OTHER LIKE COLOR POLYGONS, ONE TO THE LEFT AND ONE TO THE RIGHT, REPRESENTING ADDITIONAL TREES IN THE DISTANCE BEHIND IT AND THE WORD "TIMBERVEST" WRITTEN IN BLUE. THE ACTUAL COLORS ARE PANTONE 397 FOR THE GREEN AND PANTONE 293 FOR THE BLUE.

FOR INVESTMENT ADVISORY SERVICES; REAL ESTATE INVESTMENT SERVICES (U.S. CLS. 100, 101 AND 102).

FIRST USE 3-1-2003; IN COMMERCE 3-1-2003.  
JOSETTE BEVERLY, EXAMINING ATTORNEY

SN 85-019,247. L2L ENTERPRISES, INC., DBA IBEAN COFFEE, INC., COLORADO SPRINGS, CO. FILED 4-21-2010.



NO CLAIM IS MADE TO THE EXCLUSIVE RIGHT TO USE "BEAN COFFEE", APART FROM THE MARK AS SHOWN.

THE COLOR(S) WHITE, BLACK, AND RED IS/ARE CLAIMED AS A FEATURE OF THE MARK.

THE MARK CONSISTS OF THE COLOR RED IN THE RECTANGULAR BACKGROUND, WITH ROUNDED EDGES, THE COLOR BLACK IN THE COFFEE BEAN DESIGN AND THE WORDING "BEAN COFFEE", AND THE COLOR WHITE IN THE STYLIZED "I" AND THE EDGES BEYOND THE ROUNDED CORNERS OF THE RECTANGULAR BACKGROUND.

FOR CHARITABLE FUNDRAISING SERVICES BY MEANS OF SELLING COFFEE TO RAISE FUNDS FOR EDUCATIONAL INSTITUTIONS, SPORTS CLUBS, RELIGIOUS MINISTRIES, AND NONPROFIT ORGANIZATIONS; FUNDRAISING SERVICES, NAMELY, ORGANIZING FUNDRAISERS FOR SCHOOLS AND OTHER GROUPS (U.S. CLS. 100, 101 AND 102).

FIRST USE 8-1-2003; IN COMMERCE 7-15-2004.  
FRED CARL, EXAMINING ATTORNEY

**CLASS 36—(Continued).**

SN 85-059,414. REPUBLIC MORTGAGE HOME LOANS, LLC, MURRAY, UT. FILED 6-10-2010.

CHOICEHOMELOANS.COM

THE MARK CONSISTS OF STANDARD CHARACTERS WITHOUT CLAIM TO ANY PARTICULAR FONT, STYLE, SIZE, OR COLOR.

FOR MORTGAGE LENDING (U.S. CLS. 100, 101 AND 102).

PAULA MAHONEY, EXAMINING ATTORNEY

SN 85-090,195. T THEORY FOUNDATION, INC., NANTUCKET, MA. FILED 7-22-2010.

T Theory

THE MARK CONSISTS OF STANDARD CHARACTERS WITHOUT CLAIM TO ANY PARTICULAR FONT, STYLE, SIZE, OR COLOR.

FOR FINANCIAL EVALUATION, TRACKING, ANALYSIS, FORECASTING, CONSULTANCY, ADVISORY AND RESEARCH SERVICES RELATING TO SECURITIES AND OTHER FINANCIAL INSTRUMENTS (U.S. CLS. 100, 101 AND 102).

FIRST USE 7-18-1973; IN COMMERCE 12-3-1998.  
REBECCA SMITH, EXAMINING ATTORNEY

SN 85-118,128. DIRECT EDGE HOLDINGS LLC, JERSEY CITY, NJ. FILED 8-28-2010.

CPI

THE MARK CONSISTS OF STANDARD CHARACTERS WITHOUT CLAIM TO ANY PARTICULAR FONT, STYLE, SIZE, OR COLOR.

FOR FINANCIAL SERVICES IN THE NATURE OF TRADING IN SECURITIES AND SHARE PRICE INFORMATION SERVICES NOT INVOLVED IN OR BASED ON THE CONSUMER PRICE INDEX (U.S. CLS. 100, 101 AND 102).

CHRISIE B. KING, EXAMINING ATTORNEY

**CLASS 36—(Continued).**

SN 85-125,661. NATIONAL WARRANTY ADMINISTRATION NETWORK LLC, STRONGSVILLE, OH. FILED 9-9-2010.

**WARRANTY FOREVER**

THE MARK CONSISTS OF STANDARD CHARACTERS WITHOUT CLAIM TO ANY PARTICULAR FONT, STYLE, SIZE, OR COLOR.

NO CLAIM IS MADE TO THE EXCLUSIVE RIGHT TO USE "WARRANTY", APART FROM THE MARK AS SHOWN.

FOR PROVIDING EXTENDED WARRANTIES ON AUTOMOTIVE POWERTRAIN COMPONENTS (U.S. CLS. 100, 101 AND 102).

FIRST USE 5-10-2006; IN COMMERCE 5-10-2006.  
TRACY CROSS, EXAMINING ATTORNEY

---

SN 85-153,085. TRANSPORT FUNDING, LLC, KANSAS CITY, MO. FILED 10-14-2010.

**TRANSPORT FUNDING**

THE MARK CONSISTS OF STANDARD CHARACTERS WITHOUT CLAIM TO ANY PARTICULAR FONT, STYLE, SIZE, OR COLOR.

NO CLAIM IS MADE TO THE EXCLUSIVE RIGHT TO USE "FUNDING", APART FROM THE MARK AS SHOWN.

SEC. 2(F).  
FOR USED TRUCK FINANCING (U.S. CLS. 100, 101 AND 102).

FIRST USE 0-0-1998; IN COMMERCE 0-0-1998.  
MARK SPARACINO, EXAMINING ATTORNEY

---

SN 85-154,656. MARCO ISLAND VACATION PROPERTIES, INC., MARCO ISLAND, FL. FILED 10-18-2010.

**MARCO ISLAND VACATION PROPERTIES**

THE MARK CONSISTS OF STANDARD CHARACTERS WITHOUT CLAIM TO ANY PARTICULAR FONT, STYLE, SIZE, OR COLOR.

OWNER OF U.S. REG. NO. 2,902,558.  
NO CLAIM IS MADE TO THE EXCLUSIVE RIGHT TO USE "VACATION PROPERTIES", APART FROM THE MARK AS SHOWN.

SEC. 2(F) AS TO "MARCO ISLAND".  
FOR REAL ESTATE RENTAL SERVICES, NAMELY, RENTAL OF VACATION PROPERTIES (U.S. CLS. 100, 101 AND 102).

FIRST USE 5-8-1995; IN COMMERCE 5-8-1995.  
NAKIA HENRY, EXAMINING ATTORNEY

**CLASS 36—(Continued).**

SN 85-165,818. THE HANOVER INSURANCE GROUP, INC., WORCESTER, MA. FILED 11-1-2010.



THE MARK CONSISTS OF THE LITERAL ELEMENT "EIA" APPEARING OVER A TRIANGLE DESIGN.

FOR INSURANCE SERVICES, NAMELY, UNDERWRITING, ISSUANCE AND ADMINISTRATION OF PROPERTY AND CASUALTY INSURANCE (U.S. CLS. 100, 101 AND 102).

FIRST USE 9-15-2010; IN COMMERCE 9-15-2010.  
MORGAN WYNNE, EXAMINING ATTORNEY

---

SN 85-171,459. VISIUM ASSET MANAGEMENT, LP, NEW YORK, NY. FILED 11-8-2010.

**TAX ALPHA**

THE MARK CONSISTS OF STANDARD CHARACTERS WITHOUT CLAIM TO ANY PARTICULAR FONT, STYLE, SIZE, OR COLOR.

NO CLAIM IS MADE TO THE EXCLUSIVE RIGHT TO USE "TAX", APART FROM THE MARK AS SHOWN.

FOR FINANCIAL SERVICES, NAMELY, MANAGEMENT OF AN INVESTMENT FUND (U.S. CLS. 100, 101 AND 102).

MICHELE SWAIN, EXAMINING ATTORNEY

---

SN 85-171,527. THE TRAVELERS INDEMNITY COMPANY, HARTFORD, CT. FILED 11-8-2010.

**SOLARPAK**

THE MARK CONSISTS OF STANDARD CHARACTERS WITHOUT CLAIM TO ANY PARTICULAR FONT, STYLE, SIZE, OR COLOR.

FOR PROPERTY AND CASUALTY INSURANCE UNDERWRITING SERVICES (U.S. CLS. 100, 101 AND 102).

KATINA MISTER, EXAMINING ATTORNEY

**CLASS 36—(Continued).**

SN 85-171,807. NEW YORK LIFE INSURANCE COMPANY, NEW YORK, NY. FILED 11-8-2010.

WE WANT TO GIVE AMERICANS  
THEIR PENSIONS BACK

THE MARK CONSISTS OF STANDARD CHARACTERS WITHOUT CLAIM TO ANY PARTICULAR FONT, STYLE, SIZE, OR COLOR.

FOR FINANCIAL ANALYSIS AND CONSULTING SERVICES; FINANCIAL PLANNING SERVICES; INVESTMENT ADVISORY SERVICES; MUTUAL FUND INVESTMENT SERVICES; MUTUAL FUND DISTRIBUTION; FUND INVESTMENT CONSULTATION; INVESTMENT MANAGEMENT; ANNUITY UNDERWRITING (U.S. CLS. 100, 101 AND 102).

HEATHER BIDDULPH, EXAMINING ATTORNEY

**CLASS 36—(Continued).**

SN 85-171,948. CASHEDGE, INC., NEW YORK, NY. FILED 11-8-2010.



OWNER OF U.S. REG. NOS. 3,848,688 AND 3,867,315. THE MARK CONSISTS OF THE WORD "POP" WITH CIRCULAR ARROWS ABOVE AND BELOW.

FOR FINANCIAL SERVICES FOR USE BY BANKS AND ONLINE BANKING CUSTOMERS IN BANKING TRANSACTIONS, NAMELY, ELECTRONIC FUNDS TRANSFER AND ELECTRONIC PAYMENT PROCESSING SERVICES NOT INCLUDING PAPER CHECK CONVERSIONS; FINANCIAL SERVICES FOR USE BY BANKS AND ONLINE BANKING CUSTOMERS IN BANKING TRANSACTIONS, NAMELY, DIRECT ELECTRONIC DEBIT TRANSACTIONS, PEER TO PEER ELECTRONIC PAYMENTS, AND PEER-TO-PEER MONEY TRANSFERS; FINANCIAL SERVICES, NAMELY, PEER TO PEER ELECTRONIC PAYMENTS AND PEER-TO-PEER MONEY TRANSFERS (U.S. CLS. 100, 101 AND 102).

HANNO RITTNER, EXAMINING ATTORNEY

SN 85-171,820. NEW YORK LIFE INSURANCE COMPANY, NEW YORK, NY. FILED 11-8-2010.

GIVING AMERICANS BACK  
THEIR PENSIONS

THE MARK CONSISTS OF STANDARD CHARACTERS WITHOUT CLAIM TO ANY PARTICULAR FONT, STYLE, SIZE, OR COLOR.

FOR FINANCIAL ANALYSIS AND CONSULTING SERVICES; FINANCIAL PLANNING SERVICES; INVESTMENT ADVISORY SERVICES; MUTUAL FUND INVESTMENT SERVICES; MUTUAL FUND DISTRIBUTION; FUND INVESTMENT CONSULTATION; INVESTMENT MANAGEMENT; ANNUITY UNDERWRITING (U.S. CLS. 100, 101 AND 102).

HEATHER BIDDULPH, EXAMINING ATTORNEY

SN 85-173,578. NORTH BY NORTHWEST CAPITAL CORPORATION, ST. LOUIS, MO. FILED 11-10-2010.

NORTH BY NORTHWEST CAPITAL

THE MARK CONSISTS OF STANDARD CHARACTERS WITHOUT CLAIM TO ANY PARTICULAR FONT, STYLE, SIZE, OR COLOR.

NO CLAIM IS MADE TO THE EXCLUSIVE RIGHT TO USE "CAPITAL", APART FROM THE MARK AS SHOWN.

FOR FINANCIAL ANALYSIS AND CONSULTATION SERVICES; CREDIT RATING SERVICES, NAMELY, FINANCIAL ASSESSMENT SERVICES FOR MUNICIPAL BORROWERS AND LENDERS IN THE NATURE OF ASSESSMENTS OF LOAN FINANCING FOR PURPOSES OF DETERMINING ELIGIBILITY FOR TAX CREDITS; FINANCIAL PORTFOLIO ANALYSIS SERVICES IN THE NATURE OF QUALITATIVE AND QUANTITATIVE MEASUREMENTS FOR ISSUER AND BORROWER SPECIFIC CREDIT RISKS; INVESTMENT CONSULTING SERVICES (U.S. CLS. 100, 101 AND 102).

KAELIE KUNG, EXAMINING ATTORNEY

**CLASS 36—(Continued).**

SN 85-174,621. SOUTH OF THE BORDER CONSULTING, LLC, BALTIMORE, MD. FILED 11-11-2010.

**RED MERCHANT**

THE MARK CONSISTS OF STANDARD CHARACTERS WITHOUT CLAIM TO ANY PARTICULAR FONT, STYLE, SIZE, OR COLOR.

NO CLAIM IS MADE TO THE EXCLUSIVE RIGHT TO USE "MERCHANT", APART FROM THE MARK AS SHOWN.

FOR FINANCING SERVICES (U.S. CLS. 100, 101 AND 102).

DAWN FELDMAN, EXAMINING ATTORNEY

---

SN 85-174,635. SOUTH OF THE BORDER CONSULTING, LLC, BALTIMORE, MD. FILED 11-11-2010.

**MY RED MERCHANT**

THE MARK CONSISTS OF STANDARD CHARACTERS WITHOUT CLAIM TO ANY PARTICULAR FONT, STYLE, SIZE, OR COLOR.

NO CLAIM IS MADE TO THE EXCLUSIVE RIGHT TO USE "MERCHANT", APART FROM THE MARK AS SHOWN.

FOR FINANCING SERVICES (U.S. CLS. 100, 101 AND 102).

DAWN FELDMAN, EXAMINING ATTORNEY

---

SN 85-178,210. NEW YORK LIFE INSURANCE COMPANY, NEW YORK, NY. FILED 11-16-2010.

**CLASS 36—(Continued).**

SN 85-178,223. NEW YORK LIFE INSURANCE COMPANY, NEW YORK, NY. FILED 11-16-2010.

**RETIREMENT INCOME FRONTIER**

THE MARK CONSISTS OF STANDARD CHARACTERS WITHOUT CLAIM TO ANY PARTICULAR FONT, STYLE, SIZE, OR COLOR.

NO CLAIM IS MADE TO THE EXCLUSIVE RIGHT TO USE "RETIREMENT INCOME", APART FROM THE MARK AS SHOWN.

FOR INVESTMENT ADVISORY SERVICES; INVESTMENT ADVISORY SERVICES RELATED TO THE EFFICIENT WITHDRAWAL OF ASSETS DURING RETIREMENT; INVESTMENT CONSULTATION; INVESTMENT MANAGEMENT (U.S. CLS. 100, 101 AND 102).

HEATHER BIDDULPH, EXAMINING ATTORNEY

---

SN 85-180,484. WORLD RELIEF CORPORATION OF NATIONAL ASSOCIATION OF EVANGELICALS, BALTIMORE, MD. FILED 11-18-2010.

**WORLD RELIEF****RETIREMENT OUTCOME FRONTIER**

THE MARK CONSISTS OF STANDARD CHARACTERS WITHOUT CLAIM TO ANY PARTICULAR FONT, STYLE, SIZE, OR COLOR.

NO CLAIM IS MADE TO THE EXCLUSIVE RIGHT TO USE "RETIREMENT", APART FROM THE MARK AS SHOWN.

FOR INVESTMENT ADVISORY SERVICES; INVESTMENT ADVISORY SERVICES RELATED TO THE EFFICIENT WITHDRAWAL OF ASSETS DURING RETIREMENT; INVESTMENT CONSULTATION; INVESTMENT MANAGEMENT (U.S. CLS. 100, 101 AND 102).

HEATHER BIDDULPH, EXAMINING ATTORNEY

THE MARK CONSISTS OF STANDARD CHARACTERS WITHOUT CLAIM TO ANY PARTICULAR FONT, STYLE, SIZE, OR COLOR.

OWNER OF U.S. REG. NO. 1,938,375.

NO CLAIM IS MADE TO THE EXCLUSIVE RIGHT TO USE "RELIEF", APART FROM THE MARK AS SHOWN.

SEC. 2(F).

FOR CHARITABLE FUND-RAISING SERVICES (U.S. CLS. 100, 101 AND 102).

FIRST USE 0-0-1950; IN COMMERCE 0-0-1950.

KATHERINE E. HALMEN, EXAMINING ATTORNEY



**CLASS 36—(Continued).**

SN 85-180,523. TEMASEK HOLDINGS (PRIVATE) LIMITED, SINGAPORE, SINGAPORE, FILED 11-18-2010.

**TEMASEK BONDS**

THE MARK CONSISTS OF STANDARD CHARACTERS WITHOUT CLAIM TO ANY PARTICULAR FONT, STYLE, SIZE, OR COLOR.

OWNER OF U.S. REG. NO. 3,187,580.

NO CLAIM IS MADE TO THE EXCLUSIVE RIGHT TO USE "BONDS", APART FROM THE MARK AS SHOWN.

FOR FINANCIAL SERVICES, NAMELY, FINANCIAL PLANNING, FINANCIAL RESEARCH, FINANCIAL MANAGEMENT, FINANCIAL CONSULTATION; INVESTMENT SERVICES, NAMELY, MUTUAL FUND INVESTMENT; FINANCIAL CONSULTANCY SERVICES; FINANCIAL MANAGEMENT SERVICES; FUND INVESTMENTS; CAPITAL INVESTMENTS; MUTUAL FUNDS, NAMELY, MUTUAL FUND DISTRIBUTION AND ESTABLISHING MUTUAL FUNDS FOR OTHERS; FINANCIAL INFORMATION; STOCK EXCHANGE QUOTATIONS; INSURANCE INFORMATION; FINANCIAL EVALUATION FOR INSURANCE PURPOSES; CHARITABLE COLLECTIONS IN THE NATURE OF FUNDRAISING; PROVISION OF INFORMATION RELATING TO THE REAL ESTATE PROPERTY MARKET IN THE FIELD OF REAL ESTATE VALUES; PRICING INFORMATION SERVICES, NAMELY, QUOTATION OF STOCK MARKET PRICES; INVESTMENT INFORMATION SERVICES; INFORMATION ABOUT STOCK BROKING SERVICES; PROVISION OF INFORMATION RELATING TO SHARES PRICES, AND CORPORATE SAVINGS ACCOUNT SERVICES; PROVISION OF INFORMATION RELATING TO REAL ESTATE AND REAL PROPERTY IN THE FIELD OF EVALUATION OF REAL PROPERTY; COMPUTERIZED FINANCIAL INFORMATION RELATING TO COMMODITIES AND SECURITIES; COMPUTERIZED FINANCIAL SERVICES FOR RETAIL BUSINESSES; PROVISION OF FINANCIAL INFORMATION RELATING TO RATES OF EXCHANGE; REAL ESTATE PROPERTY APPRAISAL SERVICES; REAL ESTATE PROPERTY BROKERAGE SERVICES; REAL ESTATE PROPERTY CONSULTANCY SERVICES; REAL ESTATE PROPERTY EVALUATION SERVICES; REAL ESTATE PROPERTY FINANCING SERVICES; REAL ESTATE PROPERTY INVESTMENT SERVICES; REAL ESTATE RENTAL PROPERTY MANAGEMENT SERVICES; COMMERCIAL PROPERTY INVESTMENT SERVICES; ESTATE TRUST MANAGEMENT SERVICES RELATING TO REAL ESTATE AND PROPERTY; FINANCIAL SERVICES RELATING TO THE ACQUISITION AND SALE OF PROPERTY, NAMELY, REAL ESTATE MORTGAGE BROKERAGE; COLLECTION OF CREDIT SALES BEING CREDIT RECOVERY AND COLLECTION SERVICES; COLLECTION OF PAYMENT BEING RENT; FINANCIAL ADMINISTRATION OF STOCK EXCHANGE TRADING OF SHARES IN FINANCIAL MARKETS; BROKERAGE OF SHARES; COMPUTERIZED INFORMATION SERVICES RELATING TO SHARE PRICES; FINANCIAL MANAGEMENT OF SHARES; FINANCIAL INFORMATION RELATING TO SHARES; FINANCIAL SERVICES, NAMELY, THE TRADING OF SHARES; AUTOMATED BANKING SERVICES RELATING TO ELECTRONIC CHARGE CARD AND CREDIT CARD TRANSACTIONS; COMPUTERIZED INFORMATION SERVICES RELATING TO BANKING MATTERS; PROVIDING INFORMATION ABOUT BANKING SERVICES; PROVISION OF FINANCIAL NEWS (U.S. CLS. 100, 101 AND 102).

LINDA ESTRADA, EXAMINING ATTORNEY

**CLASS 36—(Continued).**

SN 85-184,510. GLOBAL INDEMNITY, PLC, DUBLIN 2, IRELAND, FILED 11-24-2010.



**GLOBAL INDEMNITY PLC**  
*Insurance & Reinsurance*

NO CLAIM IS MADE TO THE EXCLUSIVE RIGHT TO USE "GLOBAL INDEMNITY PLC" AND "INSURANCE & REINSURANCE", APART FROM THE MARK AS SHOWN.

THE MARK CONSISTS OF A MAN HOLDING A GLOBE ABOVE HIS HEAD AND THE WORDS "GLOBAL INDEMNITY PLC INSURANCE & REINSURANCE".

FOR INSURANCE AND REINSURANCE UNDERWRITING IN THE FIELDS OF PROPERTY, CASUALTY AND MARINE INSURANCE (U.S. CLS. 100, 101 AND 102).

JIM RINGLE, EXAMINING ATTORNEY

SN 85-188,202. THE PNC FINANCIAL SERVICES GROUP, INC., PITTSBURGH, PA. FILED 12-1-2010.

**PNC BusinessOptions**

THE MARK CONSISTS OF STANDARD CHARACTERS WITHOUT CLAIM TO ANY PARTICULAR FONT, STYLE, SIZE, OR COLOR.

OWNER OF U.S. REG. NOS. 1,416,898, 1,863,311 AND 2,508,843.

NO CLAIM IS MADE TO THE EXCLUSIVE RIGHT TO USE "BUSINESS OPTIONS", APART FROM THE MARK AS SHOWN.

FOR CREDIT CARD SERVICES (U.S. CLS. 100, 101 AND 102).

FIRST USE 11-30-2009; IN COMMERCE 11-30-2009.  
SUSAN LESLIE DUBOIS, EXAMINING ATTORNEY

**CLASS 36—(Continued).**

SN 85-190,351. THE EH FOUNDATION (U.S.), ARLINGTON, VA. FILED 12-3-2010.

**BEYOND CAPITAL FUND**

THE MARK CONSISTS OF STANDARD CHARACTERS WITHOUT CLAIM TO ANY PARTICULAR FONT, STYLE, SIZE, OR COLOR.

NO CLAIM IS MADE TO THE EXCLUSIVE RIGHT TO USE "CAPITAL FUND", APART FROM THE MARK AS SHOWN.

FOR PHILANTHROPIC IMPACT INVESTMENTS TO ENABLE SOCIAL ENTREPRENEURS AND THEIR RESPECTIVE ENTERPRISES TO CONDUCT AND/OR EXPAND ACTIVITIES THAT MITIGATE THE STRESSES OF POVERTY, COMBAT COMMUNITY DETERIORATION AND PROMOTE ECONOMIC DEVELOPMENT AND PROSPERITY IN DEVELOPING AREAS OF THE WORLD (U.S. CLS. 100, 101 AND 102).

FIRST USE 3-12-2010; IN COMMERCE 3-12-2010.  
THOMAS MANOR, EXAMINING ATTORNEY

SN 85-191,246. CLINES, DARRYL, SAINT LOUIS, MO. FILED 12-6-2010.

**Direct Lines Global**

THE MARK CONSISTS OF STANDARD CHARACTERS WITHOUT CLAIM TO ANY PARTICULAR FONT, STYLE, SIZE, OR COLOR.

NO CLAIM IS MADE TO THE EXCLUSIVE RIGHT TO USE "GLOBAL", APART FROM THE MARK AS SHOWN.

FOR INSURANCE BROKERAGE IN THE FIELD OF PERSON-TO-PERSON PROVIDER OF ASSURANCE CONTRACTS, INCLUDING VEHICLE SERVICE CONTRACTS, PAY-AS-YOU-GO VEHICLE SERVICE CONTRACTS, MECHANICAL BREAKDOWN INSURANCE, PRODUCT WARRANTIES AND FUTURE MARKET ADAPTED NAME CLASSIFICATION, HOME OWNER'S INSURANCE PLANS, AND POLICY INSURANCE PLANS (U.S. CLS. 100, 101 AND 102).

CHARLOTTE CORWIN, EXAMINING ATTORNEY

**CLASS 36—(Continued).**

SN 85-191,334. LAMPO LICENSING, LLC, BRENTWOOD, TN. FILED 12-6-2010.

**THE MOMENTUM THEOREM**

THE MARK CONSISTS OF STANDARD CHARACTERS WITHOUT CLAIM TO ANY PARTICULAR FONT, STYLE, SIZE, OR COLOR.

OWNER OF U.S. REG. NO. 3,446,941.

FOR FINANCIAL ADVICE RELATING TO FINANCIAL MANAGEMENT FOR RELIGIOUS INSTITUTIONS (U.S. CLS. 100, 101 AND 102).

FIRST USE 10-14-2007; IN COMMERCE 10-14-2007.

CIMMERIAN COLEMAN, EXAMINING ATTORNEY

SN 85-192,489. NEW YORK LIFE INSURANCE COMPANY, NEW YORK, NY. FILED 12-7-2010.

**LET'S GIVE AMERICANS THEIR PENSIONS BACK**

THE MARK CONSISTS OF STANDARD CHARACTERS WITHOUT CLAIM TO ANY PARTICULAR FONT, STYLE, SIZE, OR COLOR.

FOR FINANCIAL ANALYSIS AND CONSULTING SERVICES; FINANCIAL PLANNING SERVICES; INVESTMENT ADVISORY SERVICES; MUTUAL FUND INVESTMENT SERVICES; MUTUAL FUND DISTRIBUTION; FUND INVESTMENT CONSULTATION; INVESTMENT MANAGEMENT; ANNUITY UNDERWRITING (U.S. CLS. 100, 101 AND 102).

HEATHER BIDDULPH, EXAMINING ATTORNEY

SN 85-193,875. HCC INSURANCE HOLDINGS, INC., HOUSTON, TX. FILED 12-9-2010.

**PERICO LIFE**

THE MARK CONSISTS OF STANDARD CHARACTERS WITHOUT CLAIM TO ANY PARTICULAR FONT, STYLE, SIZE, OR COLOR.

NO CLAIM IS MADE TO THE EXCLUSIVE RIGHT TO USE "LIFE", APART FROM THE MARK AS SHOWN.

SEC. 2(F).

FOR LIFE, HEALTH, AND DISABILITY INSURANCE UNDERWRITING SERVICES; INSURANCE CLAIMS ADJUSTMENT AND SETTLEMENT SERVICES; INSURANCE ADMINISTRATION (U.S. CLS. 100, 101 AND 102).

FIRST USE 1-0-2006, THE MARK WAS FIRST USED ANYWHERE IN A DIFFERENT FORM OTHER THAN THAT SOUGHT TO BE REGISTERED AT LEAST AS EARLY AS 11/08/1988; IN COMMERCE 1-0-2006, THE MARK WAS FIRST USED IN COMMERCE IN A DIFFERENT FORM OTHER THAN THAT SOUGHT TO BE REGISTERED AT LEAST AS EARLY AS 11/08/1988.

WILLIAM ROSSMAN, EXAMINING ATTORNEY

**CLASS 36—(Continued).**

SN 85-196,769. TENANT ADVISORS, INC, SCHAUMBURG, IL. FILED 12-13-2010.



NO CLAIM IS MADE TO THE EXCLUSIVE RIGHT TO USE "TENANT ADVISORS", APART FROM THE MARK AS SHOWN.

THE MARK CONSISTS OF THE WORDING "TENANT-ADVISORS" NEXT TO A DESIGN OF A RECTANGLE AND TWO POLYGONS WITH A GENERALLY RECTANGULAR SHAPE.

FOR COMMERCIAL REAL ESTATE BROKERAGE SERVICES (U.S. CLS. 100, 101 AND 102).

FIRST USE 4-1-2004; IN COMMERCE 4-1-2004.

MATTHEW EINSTEIN, EXAMINING ATTORNEY

---

SN 85-200,157. FPDUGAN, LLC, DBA FPDUGAN, MINNEAPOLIS, MN. FILED 12-16-2010.



THE MARK CONSISTS OF AN ARRANGEMENT OF THE LETTERS "F" AND "P" SURROUNDED BY A HEXAGON SHAPED SHIELD.

FOR FINANCIAL ADVISORY AND CONSULTANCY SERVICES (U.S. CLS. 100, 101 AND 102).

FIRST USE 1-1-2010; IN COMMERCE 1-1-2010.

DANIEL CAPSHAW, EXAMINING ATTORNEY

**CLASS 36—(Continued).**

SN 85-200,892. INNOVATIVE RETIREMENT INCOME SOLUTIONS (IRIS), LLC, ST. PETERSBURG, FL. FILED 12-17-2010.



THE MARK CONSISTS OF AN ILLUSTRATED IRIS FLOWER WITH THE DESIGNATION "I.R.I.S." ARCHED UNDER THE FLOWER.

FOR PROVIDING INFORMATION AND ADVICE IN THE FIELD OF FINANCE, FINANCIAL INVESTMENTS, AND THE FINANCIAL ASPECTS OF RETIREMENT; FINANCIAL PLANNING AND INVESTMENT ADVISORY SERVICES, NAMELY, ANALYSIS OF PERSONAL FINANCES AND DEVELOPMENT OF A CUSTOMIZED FINANCIAL PLAN TO MEET FISCAL GOALS, NAMELY, ESTATE PLANNING, RETIREMENT PLANNING, BUSINESS FINANCE PLANNING, INVESTMENT PLANNING, AND PLANNING FOR EDUCATION COSTS; FINANCIAL ADVISORY AND CONSULTANCY SERVICES, NAMELY, THE CREATION OF PERSONALIZED STRATEGIES TO ACHIEVE FINANCIAL INDEPENDENCE OR RETIREMENT; ESTATE PLANNING; ADVISORY SERVICES IN THE FIELD OF EMPLOYEE BENEFITS FOR GROUP HEALTHCARE AND BUSINESS INSURANCE OFFERED TO EMPLOYEES SUCH AS MEDICAL, DENTAL, LIFE INSURANCE, SHORT TERM DISABILITY, LONG TERM DISABILITY, ACCIDENTAL DEATH AND DISMEMBERMENT; CONSULTING AND INFORMATION CONCERNING INSURANCE, NAMELY, CONSULTING ON INSURANCE PRODUCTS DESIGNED TO MANAGE THE RISKS OF PREMATURE DEATH, DISABILITY AND HEALTH CARE (U.S. CLS. 100, 101 AND 102).

FIRST USE 11-0-2009; IN COMMERCE 11-0-2009.

TINA MAI, EXAMINING ATTORNEY

---

SN 85-205,099. NEW YORK LIFE INSURANCE COMPANY, NEW YORK, NY. FILED 12-23-2010.

**ADVANCED INCOME SOLUTIONS**

THE MARK CONSISTS OF STANDARD CHARACTERS WITHOUT CLAIM TO ANY PARTICULAR FONT, STYLE, SIZE, OR COLOR.

NO CLAIM IS MADE TO THE EXCLUSIVE RIGHT TO USE "INCOME SOLUTIONS", APART FROM THE MARK AS SHOWN.

FOR INVESTMENT ADVISORY SERVICES; INVESTMENT ADVISORY SERVICES RELATED TO THE EFFICIENT WITHDRAWAL OF ASSETS DURING RETIREMENT; INVESTMENT CONSULTATION; INVESTMENT MANAGEMENT (U.S. CLS. 100, 101 AND 102).

HEATHER BIDDULPH, EXAMINING ATTORNEY

**CLASS 36—(Continued).**

SN 85-212,128. FEDERAL RESERVE BANKS COMPOSED OF FEDERAL RESERVE BANK OF ATLANTA, FEDERAL RESERVE BANK OF NEW YORK, FEDERAL RESERVE BANK OF BOSTON, FEDERAL RESERVE BANK OF CHICAGO, FEDERAL RESERVE BANK OF CLEVELAND, FEDERAL RESERVE BANK OF DALLAS, FEDERAL RESERVE BANK OF KANSAS CITY, FEDERAL RESERVE BANK OF MINNEAPOLIS, FEDERAL RESERVE BANK OF PHILADELPHIA, FEDERAL RESERVE BANK OF RICHMOND, FEDERAL RESERVE BANK OF ST. LOUIS, FEDERAL RESERVE BANK OF SAN FRANCISCO, CHICAGO, IL. FILED 1-6-2011.

**FEDCOMPLETE**

THE MARK CONSISTS OF STANDARD CHARACTERS WITHOUT CLAIM TO ANY PARTICULAR FONT, STYLE, SIZE, OR COLOR.

FOR BANKING SERVICES, NAMELY, BANK ACCOUNT SERVICES; BANKING AND FINANCIAL SERVICES, NAMELY, CHECKING PROCESSING, ACH PROCESSING AND ELECTRONIC FUNDS TRANSFERS PROVIDED VIA AN ELECTRONIC ACCESS SYSTEM (U.S. CLS. 100, 101 AND 102).

KAELIE KUNG, EXAMINING ATTORNEY

---

SN 85-225,803. HENDRIE, ALYSSA BELLE, TUJUNGA, CA. AND HENDRIE, TESSA MARIE, TUJUNGA, CA. FILED 1-25-2011.

**Bitchin' Beach House**

THE MARK CONSISTS OF STANDARD CHARACTERS WITHOUT CLAIM TO ANY PARTICULAR FONT, STYLE, SIZE, OR COLOR.

NO CLAIM IS MADE TO THE EXCLUSIVE RIGHT TO USE "BEACH HOUSE", APART FROM THE MARK AS SHOWN.

FOR LEASING OF REAL PROPERTY; REAL ESTATE MANAGEMENT OF VACATION HOMES; REAL ESTATE SERVICE, NAMELY, RENTAL PROPERTY MANAGEMENT; REAL ESTATE SERVICES, NAMELY, RENTAL OF VACATION HOMES; REAL ESTATE SERVICES, NAMELY, RENTAL OF VACATION HOMES, CONDOMINIUMS, CABINS, AND VILLAS USING PAY PER CLICK ADVERTISING ON A GLOBAL COMPUTER NETWORK; REAL ESTATE SERVICES, NAMELY, VACATION HOME RENTAL MANAGEMENT SERVICES; VACATION REAL ESTATE TIME SHARE EXCHANGE SERVICES (U.S. CLS. 100, 101 AND 102).

FIRST USE 12-15-2010; IN COMMERCE 12-15-2010.  
KIM SAITO, EXAMINING ATTORNEY

**CLASS 36—(Continued).**

SN 85-249,890. HDC INC., PROVIDENCE, RI. FILED 2-23-2011.

**hope for housing**

THE MARK CONSISTS OF STANDARD CHARACTERS WITHOUT CLAIM TO ANY PARTICULAR FONT, STYLE, SIZE, OR COLOR.

NO CLAIM IS MADE TO THE EXCLUSIVE RIGHT TO USE "HOUSING", APART FROM THE MARK AS SHOWN.

FOR MORTGAGE COMPLIANCE CONSULTING SERVICES CONCERNING FINANCIAL REQUIREMENTS FOR MORTGAGES FOR MORTGAGE LENDERS AND SERVICERS AND MORTGAGE BROKERS (U.S. CLS. 100, 101 AND 102).

FIRST USE 12-15-2009; IN COMMERCE 8-10-2010.  
ZACHARY BELLO, EXAMINING ATTORNEY

---

SN 85-250,049. ROBERT HAY HOLDINGS, LLC, DALLAS, TX. FILED 2-23-2011.

**Dream As If You'll Live Forever.**

THE MARK CONSISTS OF STANDARD CHARACTERS WITHOUT CLAIM TO ANY PARTICULAR FONT, STYLE, SIZE, OR COLOR.

FOR FINANCIAL INVESTMENT IN THE FIELDS OF ENTERTAINMENT MEDIA, PRODUCTION, DISTRIBUTION, EXHIBITION AND PERFORMANCE (U.S. CLS. 100, 101 AND 102).

CHRISTOPHER BUONGIORNO, EXAMINING ATTORNEY

**CLASS 36—(Continued).**

SN 85-252,964. MANTIS CAPITAL INVESTMENTS LIMITED, ALEXANDRA, NEW ZEALAND, FILED 2-28-2011.

MANTIS

THE MARK CONSISTS OF STANDARD CHARACTERS WITHOUT CLAIM TO ANY PARTICULAR FONT, STYLE, SIZE, OR COLOR.

PRIORITY CLAIMED UNDER SEC. 44(D) ON NEW ZEALAND APPLICATION NO. 835747, FILED 1-12-2011, REG. NO. 835747, DATED 1-12-2011, EXPIRES 1-12-2021.

FOR FINANCIAL AND MONETARY AFFAIRS, NAMELY, FINANCIAL INFORMATION, MANAGEMENT AND ANALYSIS SERVICES; FINANCIAL SERVICES, NAMELY, FINANCIAL TRADING, CAPITAL INVESTMENT SERVICES; BROKERAGE SERVICES FOR STOCKS, BONDS, CAPITAL INVESTMENTS, CURRENCIES AND COMMODITIES AND THEIR DERIVATIVES; ADVISORY, CONSULTANCY AND INFORMATION SERVICES IN THE FIELDS OF FINANCIAL MATTERS, BROKERAGE OF STOCKS, BONDS, CAPITAL INVESTMENTS, CURRENCIES, COMMODITIES AND THEIR DERIVATIVES (U.S. CLS. 100, 101 AND 102).

JORDAN BAKER, EXAMINING ATTORNEY

**CLASS 36—(Continued).**

SN 85-257,816. INSTINET HOLDINGS INCORPORATED, NEW YORK, NY. FILED 3-4-2011.

**INSTINET**  
POWERFORWARD 

THE MARK CONSISTS OF "INSTINET POWERFORWARD" WITH ARROW DESIGN.

FOR FINANCIAL SERVICES, NAMELY, FINANCIAL INVESTMENT BROKERAGE SERVICES AND SECURITY BROKERAGE SERVICES; ELECTRONIC FINANCIAL TRADING AND BROKERAGE SERVICES, NAMELY, FINANCIAL SERVICES IN THE NATURE OF TRADING OF SECURITIES BY ELECTRONIC MEANS VIA A GLOBAL NETWORK; FINANCIAL MANAGEMENT AND FINANCIAL PORTFOLIO MANAGEMENT SERVICES (U.S. CLS. 100, 101 AND 102).

FIRST USE 4-4-2011; IN COMMERCE 4-4-2011.

JAY FLOWERS, EXAMINING ATTORNEY

SN 85-258,036. INSTINET HOLDINGS INCORPORATED, NEW YORK, NY. FILED 3-4-2011.

SN 85-255,507. MARKET HARBINGER INSTITUTE, LLC, LEHI, UT. FILED 3-2-2011.

MUSCLESTOCKS



THE MARK CONSISTS OF STANDARD CHARACTERS WITHOUT CLAIM TO ANY PARTICULAR FONT, STYLE, SIZE, OR COLOR.

FOR PROVIDING ONLINE FINANCIAL INFORMATION AND FINANCIAL ADVICE RELATING TO STOCK AND EXCHANGE-TRADED FUND INVESTMENTS IN THE FIELD OF INVESTMENT TRADING (U.S. CLS. 100, 101 AND 102).

FIRST USE 3-1-2011; IN COMMERCE 3-1-2011.

SETH A. RAPPAPORT, EXAMINING ATTORNEY

THE MARK CONSISTS OF DOUBLE ARROWS.

FOR FINANCIAL SERVICES, NAMELY, FINANCIAL INVESTMENT BROKERAGE SERVICES AND SECURITY BROKERAGE SERVICES; ELECTRONIC FINANCIAL TRADING AND BROKERAGE SERVICES, NAMELY, FINANCIAL SERVICES IN THE NATURE OF TRADING OF SECURITIES BY ELECTRONIC MEANS VIA A GLOBAL NETWORK; FINANCIAL MANAGEMENT AND FINANCIAL PORTFOLIO MANAGEMENT SERVICES (U.S. CLS. 100, 101 AND 102).

FIRST USE 4-4-2011; IN COMMERCE 4-4-2011.

JAY FLOWERS, EXAMINING ATTORNEY

**CLASS 36—(Continued).**

SN 85-258,842. ABC APPRAISAL MANAGEMENT COMPANY, PLLC, GARDEN RIDGE, TX. FILED S.R. 3-5-2011; AM. P.R. 7-12-2011.

## ABC Appraisal Management Company

THE MARK CONSISTS OF STANDARD CHARACTERS WITHOUT CLAIM TO ANY PARTICULAR FONT, STYLE, SIZE, OR COLOR.

NO CLAIM IS MADE TO THE EXCLUSIVE RIGHT TO USE "APPRAISAL MANAGEMENT COMPANY", APART FROM THE MARK AS SHOWN.

FOR APPRAISAL AND EVALUATION OF REAL ESTATE; APPRAISAL OF REAL ESTATE; REAL ESTATE APPRAISAL; REAL ESTATE APPRAISAL AND VALUATION (U.S. CLS. 100, 101 AND 102).

FIRST USE 9-8-2008; IN COMMERCE 10-1-2008.  
CHARLES L. JENKINS, EXAMINING ATTORNEY

---

SN 85-267,003. CUNA MUTUAL INSURANCE SOCIETY, MADISON, WI. FILED 3-15-2011.

## DEBT PROTECTION PATH

THE MARK CONSISTS OF STANDARD CHARACTERS WITHOUT CLAIM TO ANY PARTICULAR FONT, STYLE, SIZE, OR COLOR.

NO CLAIM IS MADE TO THE EXCLUSIVE RIGHT TO USE "DEBT PROTECTION", APART FROM THE MARK AS SHOWN.

FOR FINANCIAL SERVICES, NAMELY, DEBT DEFERMENT OR ELIMINATION UPON OCCURRENCE OF CERTAIN EVENTS TO BORROWER SUCH AS UNEMPLOYMENT, DISABILITY, AND DEATH WHEREBY THE LENDER MAY OR MAY NOT ELECT TO INSURE THE RELATED CONTRACTUAL RISK (U.S. CLS. 100, 101 AND 102).

FIRST USE 5-3-2010; IN COMMERCE 5-3-2010.  
CHRIS WELLS, EXAMINING ATTORNEY

---

SN 85-274,238. REAL ESTATE STRATEGIES CORPORATION, SOMERSET, NJ. FILED 3-23-2011.

## CFO Studio

THE MARK CONSISTS OF STANDARD CHARACTERS WITHOUT CLAIM TO ANY PARTICULAR FONT, STYLE, SIZE, OR COLOR.

NO CLAIM IS MADE TO THE EXCLUSIVE RIGHT TO USE "CFO", APART FROM THE MARK AS SHOWN.

FOR PROVIDING INFORMATION IN THE FIELD OF FINANCE THROUGH TAPED INTERVIEWS WITH FINANCE INDUSTRY EXECUTIVES AVAILABLE ONLINE (U.S. CLS. 100, 101 AND 102).

FIRST USE 8-6-2010; IN COMMERCE 8-6-2010.  
PAULA MAHONEY, EXAMINING ATTORNEY

**CLASS 36—(Continued).**

SN 85-274,369. NORTHWEST BANK AND TRUST COMPANY, DAVENPORT, IA. FILED 3-23-2011.



NO CLAIM IS MADE TO THE EXCLUSIVE RIGHT TO USE "BANK MANAGER SOLUTIONS", APART FROM THE MARK AS SHOWN.

THE MARK CONSISTS OF TWO ARROWS FORMING A CIRCULAR MOTION TO THE LEFT OF THE WORDING "BANK MANAGER SOLUTIONS".

FOR FINANCIAL SERVICES TO ASSIST FINANCIAL INSTITUTIONS, NAMELY, FINANCIAL MANAGEMENT AND FINANCIAL ADMINISTRATION OF IN-HOUSE SWEEP ACCOUNTS, COLLATERALIZED DEPOSITS, LOAN PRICING, LOAN ADMINISTRATION, AND BANK OPERATIONS IN THE NATURE OF TURN-KEY PACKAGES (U.S. CLS. 100, 101 AND 102).

FIRST USE 2-20-2011; IN COMMERCE 2-20-2011.  
TINA L. SNAPP, EXAMINING ATTORNEY

---

SN 85-274,469. CASEY RESEARCH, LLC, ASPEN, CO. FILED 3-23-2011.

## CASEY RESEARCH

THE MARK CONSISTS OF STANDARD CHARACTERS WITHOUT CLAIM TO ANY PARTICULAR FONT, STYLE, SIZE, OR COLOR.

NO CLAIM IS MADE TO THE EXCLUSIVE RIGHT TO USE "RESEARCH", APART FROM THE MARK AS SHOWN.

FOR FINANCIAL CONSULTATION IN THE FIELD OF INVESTMENT ADVICE AND INFORMATION RELATING TO FINANCIAL INVESTMENT, FINANCIAL ANALYSIS, GLOBAL FINANCIAL TRENDS, GEOPOLITICAL ISSUES, NATURAL RESOURCES AND EMERGING INVESTMENT OPPORTUNITIES (U.S. CLS. 100, 101 AND 102).

JOSETTE BEVERLY, EXAMINING ATTORNEY

**CLASS 36—(Continued).**

SN 85-283,060. SENIOR INSURANCE SPECIALISTS, LLC, JOPLIN, MO. FILED 3-31-2011.



NO CLAIM IS MADE TO THE EXCLUSIVE RIGHT TO USE "SENIOR INSURANCE SPECIALISTS, LLC", APART FROM THE MARK AS SHOWN.

THE MARK CONSISTS OF A HALF SUN OVER THE TEXT "SENIOR INSURANCE SPECIALISTS, LLC". THERE IS A SWIRL UNDERNEATH THE TEXT, SYMBOLIZING AN OCEAN WAVE. BESIDE THE TEXT, THERE IS A COUPLE OF PALM TREES.

FOR INSURANCE AGENCIES (U.S. CLS. 100, 101 AND 102).

FIRST USE 8-1-2010; IN COMMERCE 8-1-2010.

VERNA BETH RIRIE, EXAMINING ATTORNEY

**CLASS 36—(Continued).**

SN 85-289,674. MIB GROUP, INC., BRAINTREE, MA. FILED 4-7-2011.



NO CLAIM IS MADE TO THE EXCLUSIVE RIGHT TO USE "RISK REVEALED", APART FROM THE MARK AS SHOWN.

THE COLOR(S) WHITE, BLACK AND TEAL GREEN IS/ ARE CLAIMED AS A FEATURE OF THE MARK.

THE MARK CONSISTS OF THE LETTERS "MIB" ARE WRITTEN IN WHITE BLOCK LETTERS OVER A BLACK BACKGROUND, AND THE "I" IS DOTTED IN A TEAL GREEN. UNDERNEATH "MIB" ARE THE WORDS "RISK REVEALED" WRITTEN IN WHITE IN A STYLISTIC FORM OVER A TEAL GREEN BACKGROUND.

FOR COMPILING AND ANALYZING ACTUARIAL DATA IN THE NATURE OF MORTALITY, MORBIDITY AND POLICYHOLDER BEHAVIOR INFORMATION TO DETERMINE INSURANCE RISK ASSESSMENTS FOR THE LIFE AND HEALTH INSURANCE INDUSTRY (U.S. CLS. 100, 101 AND 102).

RUSS HERMAN, EXAMINING ATTORNEY

SN 85-293,768. JAGEX LIMITED, CAMBRIDGE, UNITED KINGDOM, FILED 4-13-2011.

# JCOINS

SN 85-287,020. AFRICAN LEADERSHIP, INC., BRENTWOOD, TN. FILED 4-5-2011.

## African Leadership

THE MARK CONSISTS OF STANDARD CHARACTERS WITHOUT CLAIM TO ANY PARTICULAR FONT, STYLE, SIZE, OR COLOR.

SEC. 2(F).

FOR CHARITABLE FUND RAISING SERVICES, NAMELY, PROVIDING FINANCIAL SUPPORT TO INDIVIDUALS IN FOREIGN COUNTRIES FOR THE PURPOSE OF FACILITATING EDUCATION, HEALTHCARE AND WELFARE BY MEANS OF RUNNING EVENTS AND SELLING GOODS TO RAISE FUNDS (U.S. CLS. 100, 101 AND 102).

FIRST USE 11-1-2000; IN COMMERCE 11-1-2000.

ANNE FARRELL, EXAMINING ATTORNEY

THE MARK CONSISTS OF STANDARD CHARACTERS WITHOUT CLAIM TO ANY PARTICULAR FONT, STYLE, SIZE, OR COLOR.

PRIORITY CLAIMED UNDER SEC. 44(D) ON UNITED KINGDOM APPLICATION NO. 2561612, FILED 10-15-2010, REG. NO. 2561612, DATED 1-14-2011, EXPIRES 10-15-2020.

FOR FINANCIAL SERVICES, NAMELY, PROVIDING A VIRTUAL CURRENCY FOR USE BY MEMBERS OF AN ON-LINE COMMUNITY VIA A GLOBAL COMPUTER NETWORK; FINANCIAL EXCHANGE SERVICES; CURRENCY SERVICES, NAMELY, CURRENCY EXCHANGE SERVICES AND CURRENCY TRADING SERVICES; FINANCIAL SERVICES AND FINANCIAL EXCHANGE SERVICES AND CURRENCY SERVICES PROVIDED TO USERS OF INTERACTIVE GAMES SOFTWARE, NAMELY, PROVIDING A VIRTUAL CURRENCY FOR USE BY MEMBERS OF AN ON-LINE COMMUNITY VIA A GLOBAL COMPUTER NETWORK; ELECTRONIC COMMERCE PAYMENT AND EXCHANGE SERVICES, NAMELY, ELECTRONIC COMMERCE PAYMENT SERVICES, NAMELY, ESTABLISHING FUNDED ACCOUNTS USED TO PURCHASE GOODS AND SERVICES ON THE INTERNET, AND FINANCIAL EXCHANGE SERVICES; ONLINE PAYMENT AND EXCHANGE SERVICES, NAMELY, ELECTRONIC COMMERCE PAYMENT SERVICES, NAMELY, ESTABLISHING FUNDED ACCOUNTS USED TO PURCHASE GOODS AND SERVICES ON THE INTERNET, AND FINANCIAL EXCHANGE SERVICES; VIRTUAL CURRENCY SERVICES, NAMELY, FINANCIAL SERVICES, NAMELY, PROVIDING A VIRTUAL CURRENCY FOR USE BY MEMBERS OF AN ON-LINE COMMUNITY VIA A GLOBAL COMPUTER NETWORK (U.S. CLS. 100, 101 AND 102).

LINDSEY RUBIN, EXAMINING ATTORNEY

**CLASS 36—(Continued).**

SN 85-299,154. STEPSTONE GROUP, LLC, SAN DIEGO, CA. FILED 4-19-2011.



OWNER OF U.S. REG. NO. 3,515,030.

NO CLAIM IS MADE TO THE EXCLUSIVE RIGHT TO USE "PRIVATE MARKETS", APART FROM THE MARK AS SHOWN.

THE COLOR(S) BLUE, GREEN, YELLOW, ORANGE AND BLACK IS/ARE CLAIMED AS A FEATURE OF THE MARK. THE MARK CONSISTS OF A RING DESIGN IN BLUE, GREEN, YELLOW AND ORANGE, WITH THE WORDING "STEPSTONE" IN LARGE, UPPER CASE BLACK LETTERS, AND THE WORDING "INSIDE PRIVATE MARKETS" IN SMALLER, LOWER CASE BLACK LETTERS.

FOR CAPITAL INVESTMENT CONSULTING; CAPITAL INVESTMENT SERVICES; EQUITY CAPITAL INVESTMENT; INVESTMENT ADVICE; INVESTMENT ADVISORY SERVICES; INVESTMENT BANKING SERVICES; INVESTMENT CONSULTANCY; INVESTMENT CONSULTATION; INVESTMENT MANAGEMENT; INVESTMENT SERVICES, NAMELY, ASSET ACQUISITION, CONSULTATION, DEVELOPMENT AND MANAGEMENT SERVICES; MANAGEMENT OF A CAPITAL INVESTMENT FUND (U.S. CLS. 100, 101 AND 102).

FIRST USE 3-2-2011; IN COMMERCE 4-6-2011.  
JAMES A. RAUEN, EXAMINING ATTORNEY

---

SN 85-300,713. VISIONARY HORIZONS, LLC, DBA VISIONARY HORIZONS WEALTH MANAGEMENT, KNOXVILLE, TN. FILED 4-21-2011.

## Community Family Office

THE MARK CONSISTS OF STANDARD CHARACTERS WITHOUT CLAIM TO ANY PARTICULAR FONT, STYLE, SIZE, OR COLOR.

NO CLAIM IS MADE TO THE EXCLUSIVE RIGHT TO USE "FAMILY OFFICE", APART FROM THE MARK AS SHOWN.

FOR FINANCIAL SERVICES, NAMELY, WEALTH MANAGEMENT SERVICES (U.S. CLS. 100, 101 AND 102).

FIRST USE 4-20-2011; IN COMMERCE 4-20-2011.  
SHANNON TWOHIG, EXAMINING ATTORNEY

**CLASS 36—(Continued).**

SN 85-301,378. PROVIDENT BANK, MONTEBELLO, NY. FILED 4-21-2011.

## YOUR CONNECTION

THE MARK CONSISTS OF STANDARD CHARACTERS WITHOUT CLAIM TO ANY PARTICULAR FONT, STYLE, SIZE, OR COLOR.

FOR FINANCIAL SERVICES THROUGH A NETWORK OF BRANCHES AND VIA ON-LINE BANKING THROUGH THE INTERNET, NAMELY, CHECKING ACCOUNT, SAVINGS ACCOUNT, DEBIT CARD, CASH MANAGEMENT, AND MONEY LENDING SERVICES FOR INDIVIDUAL AND BUSINESS CUSTOMERS (U.S. CLS. 100, 101 AND 102).

FIRST USE 2-14-2011; IN COMMERCE 2-14-2011.  
SANI KHOURI, EXAMINING ATTORNEY

---

SN 85-301,385. PROVIDENT BANK, MONTEBELLO, NY. FILED 4-21-2011.

## PBNY BANK

THE MARK CONSISTS OF STANDARD CHARACTERS WITHOUT CLAIM TO ANY PARTICULAR FONT, STYLE, SIZE, OR COLOR.

OWNER OF U.S. REG. NO. 4,004,693. NO CLAIM IS MADE TO THE EXCLUSIVE RIGHT TO USE "BANK", APART FROM THE MARK AS SHOWN.

FOR FINANCIAL SERVICES THROUGH A NETWORK OF BRANCHES AND VIA ON-LINE BANKING THROUGH THE INTERNET, NAMELY, CHECKING ACCOUNT, SAVINGS ACCOUNT, DEBIT CARD, CASH MANAGEMENT, AND MONEY LENDING SERVICES FOR INDIVIDUAL AND BUSINESS CUSTOMERS (U.S. CLS. 100, 101 AND 102).

SANI KHOURI, EXAMINING ATTORNEY

---

SN 85-302,858. UNITED ATHLETES OF AMERICA, INC., OAK PARK, CA. FILED 4-23-2011.

## UNITED ATHLETES OF AMERICA, INC.

THE MARK CONSISTS OF STANDARD CHARACTERS WITHOUT CLAIM TO ANY PARTICULAR FONT, STYLE, SIZE, OR COLOR.

NO CLAIM IS MADE TO THE EXCLUSIVE RIGHT TO USE "ATHLETES OF AMERICA, INC.", APART FROM THE MARK AS SHOWN.

FOR CHARITABLE FUNDRAISING SERVICES, NAMELY, RAISING FUNDS FOR SPORTS AND ATHLETIC TEAMS (U.S. CLS. 100, 101 AND 102).

EMILY CARLSEN, EXAMINING ATTORNEY



**CLASS 36—(Continued).**

SN 85-304,562. AMERICAN CAPITAL, LTD., BETHESDA, MD. FILED 4-26-2011.



OWNER OF U.S. REG. NOS. 3,258,097, 3,696,273 AND OTHERS.

NO CLAIM IS MADE TO THE EXCLUSIVE RIGHT TO USE "CAPITAL AGENCY", APART FROM THE MARK AS SHOWN.

THE MARK CONSISTS OF THE WORDS "AMERICAN CAPITAL AGENCY" ADJACENT TO A STYLIZED TRIANGLE SHAPE.

SEC. 2(F) AS TO "AMERICAN CAPITAL".

FOR FINANCIAL AND INVESTMENT SERVICES RENDERED TO BUSINESSES AND ENTITIES AND INDIVIDUALS ASSOCIATED THEREWITH, NAMELY, FINANCIAL ANALYSIS AND CONSULTATION, REAL ESTATE INVESTMENT SERVICES, REAL ESTATE INVESTMENT TRUST ADVISORY AND MANAGEMENT SERVICES, AND MORTGAGE-RELATED INVESTMENT SERVICES (U.S. CLS. 100, 101 AND 102).

FIRST USE 12-0-2008; IN COMMERCE 12-0-2008.

DANIEL CAPSHAW, EXAMINING ATTORNEY

**CLASS 36—(Continued).**

CONSULTATION AND INVESTMENT OF FUNDS FOR OTHERS, INCLUDING PRIVATE AND PUBLIC EQUITY AND DEBT INVESTMENT SERVICES; LEVERAGED BUY OUTS AND INVESTMENTS IN FINANCIALLY DISTRESSED OR UNDERPERFORMING COMPANIES; MANAGEMENT OF PRIVATE EQUITY FUNDS; PRIVATE EQUITY CONSULTANT SERVICES; PRIVATE EQUITY FUND INVESTMENT SERVICES; PRIVATE PLACEMENTS OF HEDGE FUNDS, PRIVATE EQUITY FUNDS, SECURITIES AND DERIVATIVES FOR OTHERS; PROVIDING INFORMATION IN THE FIELD OF FINANCIAL STOCK AND EQUITY MARKETS; PROVIDING VENTURE CAPITAL, DEVELOPMENT CAPITAL, PRIVATE EQUITY AND INVESTMENT FUNDING; VENTURE CAPITAL ADVISORY SERVICES; VENTURE CAPITAL FINANCING; VENTURE CAPITAL FUND MANAGEMENT; VENTURE CAPITAL FUNDING SERVICES TO EMERGING AND START-UP COMPANIES; VENTURE CAPITAL SERVICES, NAMELY, PROVIDING FINANCING TO EMERGING AND START-UP COMPANIES (U.S. CLS. 100, 101 AND 102).

FIRST USE 1-1-2007; IN COMMERCE 1-1-2007.

MARIA-VICTORIA SUAREZ, EXAMINING ATTORNEY

SN 85-309,445. ENNOVANCE CAPITAL, LLC, PHILADELPHIA, PA. FILED 5-2-2011.



**ENNOVANCE CAPITAL**

NO CLAIM IS MADE TO THE EXCLUSIVE RIGHT TO USE "CAPITAL", APART FROM THE MARK AS SHOWN.

FOR BUSINESS BROKERAGE SERVICES AND RELATED CONSULTING PERTAINING TO BUSINESS SALES, MERGERS, ACQUISITIONS AND BUSINESS VALUATIONS; BUSINESS EQUITY RESEARCH; CAPITAL INVESTMENT CONSULTING; CAPITAL INVESTMENT SERVICES; EQUITY CAPITAL INVESTMENT; EVALUATION OF THE CREDIT WORTHINESS OF COMPANIES AND PRIVATE INDIVIDUALS; FINANCIAL CONSULTING AND ADVISING IN THE FIELD OF MERGERS AND ACQUISITIONS; FINANCIAL RESEARCH AND EQUITY RESEARCH BROKERAGE SERVICES; FINANCIAL SERVICES, NAMELY, A TOTAL PORTFOLIO OFFERING FOR HIGH NET WORTH CLIENTS CONSISTING OF BOTH SEPARATE ACCOUNTS AND MUTUAL FUNDS FOR EQUITY AND FIXED INCOME INVESTMENTS; FINANCIAL SERVICES, NAMELY, ADMINISTRATION OF TRANSACTIONS INVOLVING FUNDS DRAWN FROM SECURITIES, STOCKS, FUNDS, EQUITIES, BONDS, CASH, OR OTHER TYPES OF FINANCIAL INVESTMENTS IN RETIREMENT PLANS USING A CHECK OR NEGOTIABLE ORDER OF WITHDRAWAL OVER A GLOBAL DATA NETWORK; FINANCIAL SERVICES, NAMELY, ADMINISTRATION OF TRANSACTIONS INVOLVING FUNDS DRAWN FROM SECURITIES, STOCKS, FUNDS, EQUITIES, BONDS, CASH, OR OTHER TYPES OF FINANCIAL INVESTMENTS IN RETIREMENT PLANS USING A CREDIT OR DEBIT CARD OVER A GLOBAL DATA NETWORK; FINANCIAL SERVICES, NAMELY, ASSISTING OTHERS WITH THE COMPLETION OF FINANCIAL TRANSACTIONS FOR STOCKS, BONDS, SECURITIES AND EQUITIES;

SN 85-309,420. ENNOVANCE CAPITAL, LLC, PHILADELPHIA, PA. FILED 5-2-2011.

**Ennovance**

THE MARK CONSISTS OF STANDARD CHARACTERS WITHOUT CLAIM TO ANY PARTICULAR FONT, STYLE, SIZE, OR COLOR.

FOR BUSINESS BROKERAGE SERVICES AND RELATED CONSULTING PERTAINING TO BUSINESS SALES, MERGERS, ACQUISITIONS AND BUSINESS VALUATIONS; BUSINESS EQUITY RESEARCH; EQUITY CAPITAL INVESTMENT; EVALUATION OF THE CREDIT WORTHINESS OF COMPANIES AND PRIVATE INDIVIDUALS; FINANCIAL RESEARCH AND EQUITY RESEARCH BROKERAGE SERVICES; FINANCIAL SERVICES, NAMELY, ADMINISTRATION OF TRANSACTIONS INVOLVING FUNDS DRAWN FROM SECURITIES, STOCKS, FUNDS, EQUITIES, BONDS, CASH, OR OTHER TYPES OF FINANCIAL INVESTMENTS IN RETIREMENT PLANS USING A CREDIT OR DEBIT CARD OVER A GLOBAL DATA NETWORK; FINANCIAL SERVICES, NAMELY, ASSISTING OTHERS WITH THE COMPLETION OF FINANCIAL TRANSACTIONS FOR STOCKS, BONDS, SECURITIES AND EQUITIES; FINANCIAL SERVICES, NAMELY, INVESTMENT ADVICE, INVESTMENT MANAGEMENT, INVESTMENT

**CLASS 36—(Continued).**

FINANCIAL SERVICES, NAMELY, DEALING IN SECURITIES AS A MARKET MAKER AND IN TRADING COMMODITIES, SECURITIES, OPTIONS, FUTURES, EQUITIES AND FIXED INCOME PRODUCTS IN THE U.S. AND OVERSEAS MARKET SECURITIES; FINANCIAL SERVICES, NAMELY, INVESTMENT ADVICE, INVESTMENT MANAGEMENT, INVESTMENT CONSULTATION AND INVESTMENT OF FUNDS FOR OTHERS, INCLUDING PRIVATE AND PUBLIC EQUITY AND DEBT INVESTMENT SERVICES; FINANCIAL SERVICES, NAMELY, RAISING DEBT AND EQUITY CAPITAL FOR OTHERS; LEVERAGED BUY OUTS AND INVESTMENTS IN FINANCIALLY DISTRESSED OR UNDERPERFORMING COMPANIES; MANAGEMENT OF A CAPITAL INVESTMENT FUND; MANAGEMENT OF PRIVATE EQUITY FUNDS; MUTUAL FUNDS AND CAPITAL INVESTMENT; PRIVATE EQUITY CONSULTANT SERVICES; PRIVATE EQUITY FUND INVESTMENT SERVICES; PRIVATE PLACEMENTS OF HEDGE FUNDS, PRIVATE EQUITY FUNDS, SECURITIES AND DERIVATIVES FOR OTHERS; PROVIDING INFORMATION IN THE FIELD OF FINANCIAL STOCK AND EQUITY MARKETS; PROVIDING VENTURE CAPITAL, DEVELOPMENT CAPITAL, PRIVATE EQUITY AND INVESTMENT FUNDING; PUBLIC EQUITY INVESTMENT MANAGEMENT (U.S. CLS. 100, 101 AND 102).

FIRST USE 1-1-2007; IN COMMERCE 1-1-2007.  
MARIA-VICTORIA SUAREZ, EXAMINING ATTORNEY

**CLASS 36—(Continued).**

SN 85-310,009. ARCH CAPITAL GROUP (U.S.) INC., NEW YORK, NY. FILED 5-2-2011.

**ARCH ESSENTIAL ENHANCEMENT ENDORSEMENT**

THE MARK CONSISTS OF STANDARD CHARACTERS WITHOUT CLAIM TO ANY PARTICULAR FONT, STYLE, SIZE, OR COLOR.

OWNER OF U.S. REG. NOS. 3,116,619, 3,784,744 AND OTHERS.

NO CLAIM IS MADE TO THE EXCLUSIVE RIGHT TO USE "ENHANCEMENT ENDORSEMENT", APART FROM THE MARK AS SHOWN.

FOR INSURANCE UNDERWRITING SERVICES IN THE FIELD OF DIRECTORS AND OFFICERS LIABILITY (U.S. CLS. 100, 101 AND 102).

FRANK LATTUCA, EXAMINING ATTORNEY

SN 85-309,458. WHITE-HART & ASSOCIATES, INC., ATLANTA, GA. FILED 5-2-2011.



NO CLAIM IS MADE TO THE EXCLUSIVE RIGHT TO USE "ASSOCIATES" AND "MULTI-LINE INSURANCE ADJUSTERS", APART FROM THE MARK AS SHOWN.

THE MARK CONSISTS OF AN OVAL SHAPED LOGO, CONTAINING THE CHARACTER "W" IN THE LEFT HALF AND THE CHARACTER "H" IN THE RIGHT HALF; THE UPPER OUTER BORDER OF THE LOGO CONTAINS THE WORDS "WHITE-HART & ASSOCIATES" AND THE LOWER OUTER BORDER CONTAINS THE WORDS "MULTI-LINE INSURANCE ADJUSTERS".

FOR CLAIMS ADJUSTMENT IN THE FIELD OF INSURANCE; APPRAISALS FOR INSURANCE CLAIMS OF PERSONAL PROPERTY AND REAL PROPERTY (U.S. CLS. 100, 101 AND 102).

FIRST USE 1-1-2006; IN COMMERCE 1-1-2006.  
MARIA-VICTORIA SUAREZ, EXAMINING ATTORNEY

SN 85-313,079. FOWLKES, CLAYTON, HUEYTOWN, AL. FILED 5-5-2011.



NO CLAIM IS MADE TO THE EXCLUSIVE RIGHT TO USE "MINERS BROTHERHOOD", "AL", "M.C.", APART FROM THE MARK AS SHOWN.

THE MARK CONSISTS OF A PATCH WITH A CROSSED PICK AND SHOVEL WITH THE NUMBER 13 IN THE CENTER OF THE PICK AND SHOVEL ALSO HAS A CROSS BENEATH IT. AROUND THE PATCH THERE IS THE LETTERS "IN MEMORY OF OUR FALLEN BROTHERS". TO THE RIGHT AND LEFT THERE IS A RECTANGLE WITH THE LETTERS "A L" AND "M.C." ON THE TOP AND AT THE BOTTOM THERE IS A BANNER WITH THE STYLIZED TEXT "MINERS" AND "BROTHERHOOD".

FOR CHARITABLE FUNDRAISING TO SUPPORT COAL MINERS AND THEIR FAMILIES; CHARITABLE FOUNDATION SERVICES, NAMELY, PROVIDING FINANCIAL ASSISTANCE FOR COAL MINERS AND THEIR FAMILIES (U.S. CLS. 100, 101 AND 102).

FIRST USE 10-26-2010; IN COMMERCE 10-26-2010.  
HELENE LIWINSKI, EXAMINING ATTORNEY

**CLASS 36—(Continued).**

SN 85-314,770. (EM2L)2, LAKE OSWEGO, OR. FILED 5-6-2011.

(Em2L)2 We Make Green Do  
More.

THE MARK CONSISTS OF STANDARD CHARACTERS WITHOUT CLAIM TO ANY PARTICULAR FONT, STYLE, SIZE, OR COLOR.

FOR CHARITABLE FUNDRAISING TO SUPPORT SOLAR ENERGY INSTALLATION IN SCHOOLS AND FOR EDUCATIONAL PROGRAMS (U.S. CLS. 100, 101 AND 102).

FIRST USE 1-1-2006; IN COMMERCE 1-1-2006.  
SUSAN STIGLITZ, EXAMINING ATTORNEY

---

SN 85-315,268. FREDERIKSEN, PATRICIA A. AKA SMARTER WOMEN COLORADO, GOLDEN, CO. FILED 5-8-2011.

Smarter Women Colorado

THE MARK CONSISTS OF STANDARD CHARACTERS WITHOUT CLAIM TO ANY PARTICULAR FONT, STYLE, SIZE, OR COLOR.

NO CLAIM IS MADE TO THE EXCLUSIVE RIGHT TO USE "WOMEN COLORADO", APART FROM THE MARK AS SHOWN.

FOR INSURANCE AND FINANCIAL INFORMATION AND CONSULTANCY SERVICES (U.S. CLS. 100, 101 AND 102).

FIRST USE 2-3-2011; IN COMMERCE 2-3-2011.  
GISELLE AGOSTO, EXAMINING ATTORNEY

---

SN 85-317,388. CANOPY INVESTMENT ADVISORS LLC, PLYMOUTH MEETING, PA. FILED 5-10-2011.

Canopy Investment Advisors  
LLC

THE MARK CONSISTS OF STANDARD CHARACTERS WITHOUT CLAIM TO ANY PARTICULAR FONT, STYLE, SIZE, OR COLOR.

NO CLAIM IS MADE TO THE EXCLUSIVE RIGHT TO USE "INVESTMENT ADVISORS, LLC", APART FROM THE MARK AS SHOWN.

FOR FINANCIAL AND INVESTMENT SERVICES, NAMELY, ASSET AND INVESTMENT ACQUISITION, CONSULTATION, ADVISORY AND DEVELOPMENT; REAL ESTATE FUNDS INVESTMENT SERVICES (U.S. CLS. 100, 101 AND 102).

SAMUEL E. SHARPER JR., EXAMINING ATTORNEY

**CLASS 36—(Continued).**

SN 85-317,408. PRIVATE OCEAN LLC, SAN RAFAEL, CA. FILED 5-10-2011.

BETA PLUS

THE MARK CONSISTS OF STANDARD CHARACTERS WITHOUT CLAIM TO ANY PARTICULAR FONT, STYLE, SIZE, OR COLOR.

NO CLAIM IS MADE TO THE EXCLUSIVE RIGHT TO USE "BETA", APART FROM THE MARK AS SHOWN.

FOR FINANCIAL SERVICES, NAMELY, INVESTMENT MANAGEMENT AND ADVICE; FISCAL VALUATIONS AND ASSESSMENTS; CASH MANAGEMENT; FINANCIAL ANALYSIS; CONSULTING IN THE FIELDS OF FINANCE, REAL ESTATE INVESTMENTS, CAPITAL INVESTMENTS, INVESTMENT SECURITIES, FINANCIAL PLANNING, WEALTH MANAGEMENT AND ASSET MANAGEMENT (U.S. CLS. 100, 101 AND 102).

ESTHER A. BORSUK, EXAMINING ATTORNEY

---

SN 85-317,881. REALTY CAPITAL SECURITIES, LLC, BOSTON, MA. FILED 5-11-2011.



NO CLAIM IS MADE TO THE EXCLUSIVE RIGHT TO USE "SECURITIES", APART FROM THE MARK AS SHOWN.

THE MARK CONSISTS OF A CAPITAL LETTER "R" THAT OVERLAPS A SLIGHTLY SMALLER CAPITAL LETTER "C", WITH THE TERM "SECURITIES" SHOWN IN SMALLER CAPITAL LETTERS BENEATH THE LETTERS "R" AND "C".

FOR ADVICE RELATING TO INVESTMENTS; BROKERAGE OF SHARES OR STOCKS AND OTHER SECURITIES; REAL ESTATE INVESTMENT SERVICES (U.S. CLS. 100, 101 AND 102).

FIRST USE 12-0-2007; IN COMMERCE 12-0-2007.  
DAVID COLLIER, EXAMINING ATTORNEY

**CLASS 36—(Continued).**

SN 85-319,993. VERIBANC, INC., WAKEFIELD, MA. FILED 5-13-2011.

**VERIBANC**

THE MARK CONSISTS OF STANDARD CHARACTERS WITHOUT CLAIM TO ANY PARTICULAR FONT, STYLE, SIZE, OR COLOR.

OWNER OF U.S. REG. NO. 1,605,939.  
FOR FINANCIAL INFORMATION AND EVALUATIONS (U.S. CLS. 100, 101 AND 102).  
FIRST USE 11-20-1989; IN COMMERCE 11-20-1989.  
MATTHEW PAPPAS, EXAMINING ATTORNEY



SN 85-320,090. SPECIAL AGENTS MUTUAL BENEFITS ASSOCIATION, ROCKVILLE, MD. FILED 5-13-2011.



THE MARK CONSISTS OF A STYLIZED OWL DESIGN WHERE THE OWL IS WEARING A COAT WITH A NAME TAG ON THE LEFT LAPEL, AND SHIRT AND TIE; AROUND THE OWL'S NECK IS A STETHOSCOPE; THE OWL IS ALSO WEARING GLASSES AND HOLDING A CLIPBOARD IN HIS LEFT HAND, WITH AN OUTSTRETCHED RIGHT HAND; BENEATH THE OWL IS A SHADED SHADOW EFFECT.

FOR INSURANCE SERVICES, NAMELY, UNDERWRITING, ISSUANCE AND ADMINISTRATION OF HEALTH BENEFIT PLANS FOR FEDERAL EMPLOYEES (U.S. CLS. 100, 101 AND 102).  
FIRST USE 11-0-2008; IN COMMERCE 11-0-2008.  
BENJAMIN OKEKE, EXAMINING ATTORNEY

**CLASS 36—(Continued).**

SN 85-320,097. SPECIAL AGENTS MUTUAL BENEFITS ASSOCIATION, ROCKVILLE, MD. FILED 5-13-2011.



THE MARK CONSISTS OF A STYLIZED OWL DESIGN WHERE THE OWL IS WEARING A COAT WITH A NAME TAG ON THE LEFT LAPEL, AND SHIRT AND TIE; AROUND THE OWL'S NECK IS A STETHOSCOPE; THE OWL IS ALSO WEARING GLASSES; THE OWL'S ARMS ARE OUTSTRETCHED; BENEATH THE OWL IS A SHADED SHADOW EFFECT.

FOR INSURANCE SERVICES, NAMELY, UNDERWRITING, ISSUANCE AND ADMINISTRATION OF HEALTH BENEFITS PLANS FOR FEDERAL EMPLOYEES (U.S. CLS. 100, 101 AND 102).  
FIRST USE 11-0-2009; IN COMMERCE 11-0-2009.  
BENJAMIN OKEKE, EXAMINING ATTORNEY



SN 85-320,102. SPECIAL AGENTS MUTUAL BENEFITS ASSOCIATION, ROCKVILLE, MD. FILED 5-13-2011.



THE MARK CONSISTS OF A STYLIZED OWL DESIGN WHERE THE OWL IS WEARING A SUIT WITH A NAME TAG ON THE LEFT LAPEL, AND SHIRT AND TIE AND SHOES; THE OWL IS ALSO WEARING EYEGASSES; THE OWL'S RIGHT ARM IS OUTSTRETCHED.

FOR INSURANCE SERVICES, NAMELY, UNDERWRITING, ISSUANCE AND ADMINISTRATION OF HEALTH BENEFIT PLANS FOR FEDERAL EMPLOYEES (U.S. CLS. 100, 101 AND 102).  
FIRST USE 11-0-2009; IN COMMERCE 11-0-2009.  
BENJAMIN OKEKE, EXAMINING ATTORNEY

**CLASS 36—(Continued).**

SN 85-320,411. STOCKBRIDGE PARTNERS LLC, BOSTON, MA. FILED 5-13-2011.

**STOCKBRIDGE INVESTORS**

THE MARK CONSISTS OF STANDARD CHARACTERS WITHOUT CLAIM TO ANY PARTICULAR FONT, STYLE, SIZE, OR COLOR.

OWNER OF U.S. REG. NOS. 3,818,941 AND 3,907,111.

NO CLAIM IS MADE TO THE EXCLUSIVE RIGHT TO USE "INVESTORS", APART FROM THE MARK AS SHOWN. FOR FINANCIAL SERVICES, NAMELY, INVESTMENT ADVICE, INVESTMENT MANAGEMENT, INVESTMENT CONSULTATION AND INVESTMENT OF FUNDS FOR OTHERS; HEDGE FUND INVESTMENT SERVICES (U.S. CLS. 100, 101 AND 102).

FIRST USE 4-30-2010; IN COMMERCE 4-30-2010.

KATHERINE CHANG, EXAMINING ATTORNEY

SN 85-321,067. R.K. HAMMER, THOUSAND OAKS, CA. FILED 5-14-2011.

**CARD KNOWLEDGE FACTORY**

THE MARK CONSISTS OF STANDARD CHARACTERS WITHOUT CLAIM TO ANY PARTICULAR FONT, STYLE, SIZE, OR COLOR.

NO CLAIM IS MADE TO THE EXCLUSIVE RIGHT TO USE "CARD KNOWLEDGE", APART FROM THE MARK AS SHOWN.

FOR FINANCIAL CONSULTING AND RESEARCH SERVICES IN THE FIELD OF BANK CARDS (U.S. CLS. 100, 101 AND 102).

TRACY FLETCHER, EXAMINING ATTORNEY

**CLASS 36—(Continued).**

SN 85-321,169. ENDURING WEALTH ADVISORS, FORMERLY JENICLYN, INC., TEMECULA, CA. FILED 5-14-2011.



NO CLAIM IS MADE TO THE EXCLUSIVE RIGHT TO USE "WEALTH ADVISORS", APART FROM THE MARK AS SHOWN.

THE COLOR(S) GOLD AND GREEN IS/ARE CLAIMED AS A FEATURE OF THE MARK.

THE MARK CONSISTS OF THE WORDING "ENDURING WEALTH ADVISORS" APPEARS IN GREEN WITH A STYLIZED LETTER "E" CONTAINING A BRANCH OF WHEAT. FOUR ASCENDING GOLD BARS PRECEDE THE STYLIZED "E" AND ARE CROSSED BY THE BRANCH OF WHEAT. THE BRANCH OF WHEAT APPEARS IN GOLD WHILE THE WHEAT BERRIES APPEAR IN GREEN.

FOR ADVICE RELATING TO INVESTMENTS; AGENCIES FOR BROKERAGE OF SECURITIES TRADING IN OVERSEAS SECURITIES MARKETS AND OF TRANSACTIONS ON COMMISSION OF OVERSEAS MARKET SECURITIES FUTURES; AGENCIES IN THE FIELD OF BONDS AND OTHER SECURITIES; AGENCIES OR BROKERAGE FOR TRADING OF SECURITIES, SECURITIES INDEX FUTURES, SECURITIES OPTIONS, AND OVERSEAS MARKET SECURITIES FUTURES; BROKERAGE OF SHARES AND OTHER SECURITIES; BROKERAGE OF SHARES OR STOCKS AND OTHER SECURITIES; BROKERAGE SERVICES IN THE FIELD OF SECURITIES AND COMMODITIES INVESTING; COMMODITY INVESTMENT ADVICE; CREDIT AND FINANCIAL CONSULTATION; FINANCIAL ADVICE; FINANCIAL ADVISORY AND CONSULTANCY SERVICES; FINANCIAL AND INVESTMENT SERVICES, NAMELY, ASSET AND INVESTMENT ACQUISITION, CONSULTATION, ADVISORY AND DEVELOPMENT; FINANCIAL AND INVESTMENT SERVICES, NAMELY, MANAGEMENT AND BROKERAGE IN THE FIELDS OF STOCKS, BONDS, OPTIONS, COMMODITIES, FUTURES AND OTHER SECURITIES, AND THE INVESTMENT OF FUNDS OF OTHERS; FINANCIAL EVALUATION FOR INSURANCE PURPOSES; FINANCIAL INVESTMENT BROKERAGE; FINANCIAL INVESTMENT BROKERAGE SERVICES; FINANCIAL INVESTMENT IN THE FIELD OF SECURITIES; FINANCIAL PLANNING; FINANCIAL PLANNING AND INVESTMENT ADVISORY SERVICES; FINANCIAL PLANNING CONSULTATION; FINANCIAL PLANNING FOR RETIREMENT; FINANCIAL PORTFOLIO ANALYSIS SERVICES; FINANCIAL PORTFOLIO MANAGEMENT; FINANCIAL SERVICES, NAMELY, A TOTAL PORTFOLIO OFFERING FOR HIGH NET WORTH CLIENTS CONSISTING OF BOTH SEPARATE ACCOUNTS AND MUTUAL FUNDS FOR EQUITY AND FIXED INCOME INVESTMENTS; FINANCIAL SERVICES, NAMELY, BROKER/DEALER SERVICES ON SECURITIES EXCHANGES AND OVER-THE-COUNTER MARKETS; FINANCIAL SERVICES, NAMELY, COMMODITY TRADING AND MANAGED FUTURES ADVISORY AND MANAGEMENT SERVICES; FINANCIAL SERVICES, NAMELY, COORDINATION, WITHIN A SINGLE ACCOUNT, OF AN INVESTMENT PORTFOLIO'S MAINTENANCE, TRADING, REBALAN-

**CLASS 36—(Continued).**

CING, AND TAX MANAGEMENT NEEDS; FINANCIAL SERVICES, NAMELY, INVESTMENT ADVICE, INVESTMENT MANAGEMENT, INVESTMENT CONSULTATION AND INVESTMENT OF FUNDS FOR OTHERS, INCLUDING PRIVATE AND PUBLIC EQUITY AND DEBT INVESTMENT SERVICES; FINANCIAL SERVICES, NAMELY, WEALTH MANAGEMENT SERVICES; INVESTMENT ADVICE; INVESTMENT ADVISORY SERVICES; INVESTMENT OF FUNDS FOR OTHERS; MANAGEMENT OF PORTFOLIOS COMPRISING SECURITIES; MANAGEMENT OF PORTFOLIOS OF TRANSFERABLE SECURITIES; MANAGEMENT OF SECURITIES PORTFOLIOS; MUTUAL FUND INVESTMENT; MUTUAL FUNDS AND CAPITAL INVESTMENT; PRIVATE EQUITY FUND INVESTMENT SERVICES; PRIVATE PLACEMENTS OF HEDGE FUNDS, PRIVATE EQUITY FUNDS, SECURITIES AND DERIVATIVES FOR OTHERS; SECURITIES BROKERAGE; SECURITIES BROKERAGE SERVICES; SECURITY BROKERAGE; TRADING IN SECURITIES (U.S. CLS. 100, 101 AND 102).

FIRST USE 5-11-2011; IN COMMERCE 5-11-2011.  
NATALIE POLZER, EXAMINING ATTORNEY

SN 85-321,250. CUMBERLAND VALLEY FINANCIAL CORPORATION, LONDON, KY. FILED 5-15-2011.

# Y BANK

THE MARK CONSISTS OF STANDARD CHARACTERS WITHOUT CLAIM TO ANY PARTICULAR FONT, STYLE, SIZE, OR COLOR.

NO CLAIM IS MADE TO THE EXCLUSIVE RIGHT TO USE "BANK", APART FROM THE MARK AS SHOWN.

FOR BANKING SERVICES; ELECTRONIC BANKING VIA A GLOBAL COMPUTER NETWORK; BANKING SERVICES PROVIDED BY MOBILE TELEPHONE CONNECTIONS; ELECTRONIC PAYMENT SERVICES, NAMELY, ELECTRONIC PROCESSING AND TRANSMISSION OF BILL PAYMENT DATA (U.S. CLS. 100, 101 AND 102).

LOURDES AYALA, EXAMINING ATTORNEY

SN 85-321,560. EQIS HOLDINGS, INC, SAN RAFAEL, CA. FILED 5-16-2011.

# EQIS

THE MARK CONSISTS OF STANDARD CHARACTERS WITHOUT CLAIM TO ANY PARTICULAR FONT, STYLE, SIZE, OR COLOR.

OWNER OF U.S. REG. NO. 3,391,211.

THE WORDING "EQIS" HAS NO MEANING IN A FOREIGN LANGUAGE.

FOR FINANCIAL SERVICES, NAMELY, A TOTAL PORTFOLIO OFFERING FOR HIGH NET WORTH CLIENTS CONSISTING OF BOTH SEPARATE ACCOUNTS AND MUTUAL FUNDS FOR EQUITY AND FIXED INCOME INVESTMENTS (U.S. CLS. 100, 101 AND 102).

FIRST USE 7-26-2010; IN COMMERCE 7-26-2010.  
EMILY CHUO, EXAMINING ATTORNEY

**CLASS 36—(Continued).**

SN 85-321,624. MERK INVESTMENTS, LLC, PALO ALTO, CA. FILED 5-16-2011.

# MERK FUNDS

THE MARK CONSISTS OF STANDARD CHARACTERS WITHOUT CLAIM TO ANY PARTICULAR FONT, STYLE, SIZE, OR COLOR.

OWNER OF U.S. REG. NOS. 3,050,409, 3,813,429 AND OTHERS.

NO CLAIM IS MADE TO THE EXCLUSIVE RIGHT TO USE "FUNDS", APART FROM THE MARK AS SHOWN.

SEC. 2(F) AS TO "MERK".

FOR INVESTMENT MANAGEMENT (U.S. CLS. 100, 101 AND 102).

FIRST USE 5-31-2005; IN COMMERCE 5-31-2005.

JAMES LOVELACE, EXAMINING ATTORNEY

SN 85-321,690. CYSTIC FIBROSIS FOUNDATION, BETHESDA, MD. FILED 5-16-2011.

# BLOW AWAY CYSTIC FIBROSIS

THE MARK CONSISTS OF STANDARD CHARACTERS WITHOUT CLAIM TO ANY PARTICULAR FONT, STYLE, SIZE, OR COLOR.

NO CLAIM IS MADE TO THE EXCLUSIVE RIGHT TO USE "CYSTIC FIBROSIS", APART FROM THE MARK AS SHOWN.

FOR CHARITABLE FUNDRAISING SERVICES (U.S. CLS. 100, 101 AND 102).

ROBIN MITTLER, EXAMINING ATTORNEY

SN 85-322,136. CHRISTIAN COOK, DBA PROJECT SPARK, DENVER, CO. FILED 5-16-2011.

# Play For Parkinsons

THE MARK CONSISTS OF STANDARD CHARACTERS WITHOUT CLAIM TO ANY PARTICULAR FONT, STYLE, SIZE, OR COLOR.

NO CLAIM IS MADE TO THE EXCLUSIVE RIGHT TO USE "PARKINSON'S", APART FROM THE MARK AS SHOWN.

FOR CHARITABLE SERVICES, NAMELY, ORGANIZING FUNDRAISING SERVICES AND EVENTS TO RAISE FUNDS IN THE FIELD OF PARKINSON'S DISEASE RESEARCH (U.S. CLS. 100, 101 AND 102).

FIRST USE 8-0-2009; IN COMMERCE 8-0-2009.

JIM RINGLE, EXAMINING ATTORNEY

**CLASS 36—(Continued).**

SN 85-322,199. NORTHSTAR CREDIT UNION, WARREN-VILLE, IL. FILED 5-16-2011.

**FOCUSED ON YOUR FUTURE**

THE MARK CONSISTS OF STANDARD CHARACTERS WITHOUT CLAIM TO ANY PARTICULAR FONT, STYLE, SIZE, OR COLOR.

FOR BANKING AND FINANCING SERVICES; CREDIT UNION SERVICES; FINANCIAL ADVICE AND CONSULTANCY SERVICES (U.S. CLS. 100, 101 AND 102).  
FIRST USE 9-25-2004; IN COMMERCE 9-25-2004.  
SIMON TENG, EXAMINING ATTORNEY

**CLASS 36—(Continued).**

SN 85-323,068. ABC IP HOLDINGS, LLC, CORAL SPRINGS, FL. FILED 5-17-2011.

**JUST A CLICK OF THE MOUSE  
AND WE'RE AT YOUR HOUSE**

THE MARK CONSISTS OF STANDARD CHARACTERS WITHOUT CLAIM TO ANY PARTICULAR FONT, STYLE, SIZE, OR COLOR.

FOR PREPAID PREVENTIVE MAINTENANCE SERVICE PLANS FOR HEATING, VENTILATING AND AIR CONDITIONING SYSTEMS, INSTALLATION AND REPAIR OF AIR CONDITIONING APPARATUS (U.S. CLS. 100, 101 AND 102).  
RICHARD WHITE, EXAMINING ATTORNEY

SN 85-322,247. AMIS/ALLIANCE MARKETING & INSURANCE SERVICES, SAN MARCOS, CA. FILED 5-16-2011.



THE MARK CONSISTS OF THE TEXT "AMIS" INSIDE AN OVAL.

THE ENGLISH TRANSLATION OF THE WORD "AMIS" IN THE MARK IS "FRIENDS".  
FOR INSURANCE AGENCIES (U.S. CLS. 100, 101 AND 102).  
FIRST USE 1-1-2000; IN COMMERCE 1-1-2000.  
HELENE LIWINSKI, EXAMINING ATTORNEY

SN 85-323,072. ABC IP HOLDINGS, LLC, CORAL SPRINGS, FL. FILED 5-17-2011.

**JUST CLICK THE MOUSE AND  
WE'RE AT YOUR HOUSE**

THE MARK CONSISTS OF STANDARD CHARACTERS WITHOUT CLAIM TO ANY PARTICULAR FONT, STYLE, SIZE, OR COLOR.

FOR PREPAID PREVENTIVE MAINTENANCE SERVICE PLANS FOR HEATING, VENTILATING AND AIR CONDITIONING SYSTEMS, INSTALLATION AND REPAIR OF AIR CONDITIONING APPARATUS (U.S. CLS. 100, 101 AND 102).  
RICHARD WHITE, EXAMINING ATTORNEY

SN 85-323,041. LOYAL LOANS HOLDING CO., L.L.C., SHAWNEE, OK. FILED 5-17-2011.

**LOYAL LOANS**

THE MARK CONSISTS OF STANDARD CHARACTERS WITHOUT CLAIM TO ANY PARTICULAR FONT, STYLE, SIZE, OR COLOR.

NO CLAIM IS MADE TO THE EXCLUSIVE RIGHT TO USE "LOANS", APART FROM THE MARK AS SHOWN.  
FOR FINANCING SERVICES, NAMELY, PERSONAL INSTALLMENT LOANS (U.S. CLS. 100, 101 AND 102).  
MIDGE BUTLER, EXAMINING ATTORNEY

SN 85-323,561. ABC IP HOLDINGS, LLC, CORAL SPRINGS, FL. FILED 5-18-2011.

**CLICK THE MOUSE AND WE'RE  
AT YOUR HOUSE**

THE MARK CONSISTS OF STANDARD CHARACTERS WITHOUT CLAIM TO ANY PARTICULAR FONT, STYLE, SIZE, OR COLOR.

FOR PREPAID PREVENTIVE MAINTENANCE SERVICE PLANS FOR HEATING, VENTILATING AND AIR CONDITIONING SYSTEMS, INSTALLATION AND REPAIR OF AIR CONDITIONING APPARATUS (U.S. CLS. 100, 101 AND 102).  
RICHARD WHITE, EXAMINING ATTORNEY

**CLASS 36—(Continued).**

SN 85-323,870. WOODMEN OF THE WORLD LIFE INSURANCE SOCIETY AND / OR OMAHA WOODMEN LIFE INSURANCE SOCIETY, OMAHA, NE. FILED 5-18-2011.

**WOODMEN PROVIDER**

THE MARK CONSISTS OF STANDARD CHARACTERS WITHOUT CLAIM TO ANY PARTICULAR FONT, STYLE, SIZE, OR COLOR.

OWNER OF U.S. REG. NOS. 2,767,582, 3,559,362 AND OTHERS.

NO CLAIM IS MADE TO THE EXCLUSIVE RIGHT TO USE "PROVIDER", APART FROM THE MARK AS SHOWN.

FOR INSURANCE SERVICES, NAMELY, UNDERWRITING, ISSUING AND ADMINISTRATION OF LIFE INSURANCE (U.S. CLS. 100, 101 AND 102).

JOHN SCHUYLER YARD, EXAMINING ATTORNEY

SN 85-324,017. DARREN L. NANTZ, DBA NANTZ INSURANCE AND THE INSURANCE BUTLER, GAINESVILLE, FL. FILED 5-18-2011.



NO CLAIM IS MADE TO THE EXCLUSIVE RIGHT TO USE "INSURANCE" AND "SOLUTIONS AND RESOURCES FOR RISK MANAGEMENT", APART FROM THE MARK AS SHOWN.

THE COLOR(S) BLUE AND WHITE IS/ARE CLAIMED AS A FEATURE OF THE MARK.

THE MARK CONSISTS OF A DESIGN OF A BUTLER LEANING OVER WITH AN EXTENDED ARM IN WHITE AND THE WORDING "THE INSURANCE BUTLER SOLUTIONS AND RESOURCES FOR RISK MANAGEMENT" IN WHITE AGAINST A BLUE BACKGROUND.

FOR INSURANCE PRODUCTS, NAMELY, UNDERWRITING LIFE, HOME, AUTOMOBILE, ACCIDENT, ANNUITIES AND FIRE INSURANCE; INSURANCE AGENCY; FINANCIAL PRODUCTS, NAMELY, INDIVIDUAL RETIREMENT ACCOUNT SERVICES AND FINANCIAL PLANNING FOR RETIREMENT (U.S. CLS. 100, 101 AND 102).

FIRST USE 0-0-2010; IN COMMERCE 0-0-2010.  
KATHY DE JONGE, EXAMINING ATTORNEY

**CLASS 36—(Continued).**

SN 85-324,795. REALTY CAPITAL SECURITIES, LLC, BOSTON, MA. FILED 5-19-2011.



NO CLAIM IS MADE TO THE EXCLUSIVE RIGHT TO USE "SECURITIES", APART FROM THE MARK AS SHOWN.

THE COLOR(S) GOLD, LIGHT BLUE AND WHITE IS/ARE CLAIMED AS A FEATURE OF THE MARK.

THE MARK CONSISTS OF A GOLD UPPERCASE LETTER "R" TO THE LEFT OF A LIGHT BLUE UPPERCASE LETTER "C" ALL ABOVE THE TERM "SECURITIES" IN WHITE UPPERCASE LETTER. THE BLACK OUTLINE OF THE LETTERS IN THE TERM "SECURITIES" IS NOT PART OF THE MARK AND IS ONLY USED TO DEFINE THE LETTERS AGAINST THE BACKGROUND.

FOR ADVICE RELATING TO INVESTMENTS; BROKERAGE OF SHARES OR STOCKS AND OTHER SECURITIES; REAL ESTATE INVESTMENT SERVICES (U.S. CLS. 100, 101 AND 102).

FIRST USE 12-0-2007; IN COMMERCE 12-0-2007.  
DAVID COLLIER, EXAMINING ATTORNEY

SN 85-325,235. CENTREVILLE SAVINGS BANK, WEST WARWICK, RI. FILED 5-19-2011.

**CENTREVILLE BANK**

THE MARK CONSISTS OF STANDARD CHARACTERS WITHOUT CLAIM TO ANY PARTICULAR FONT, STYLE, SIZE, OR COLOR.

NO CLAIM IS MADE TO THE EXCLUSIVE RIGHT TO USE "BANK", APART FROM THE MARK AS SHOWN.

SEC. 2(F).

FOR ATM BANKING SERVICES; BANKING; BANKING AND FINANCING SERVICES; ON-LINE BANKING SERVICES (U.S. CLS. 100, 101 AND 102).

FIRST USE 3-0-2006; IN COMMERCE 3-0-2006.

DORITT L. CARROLL, EXAMINING ATTORNEY



**CLASS 36—(Continued).**

SN 85-326,017. GEORGIA'S OWN CREDIT UNION, ATLANTA, GA. FILED 5-20-2011.

GEORGIA'S OWN RESOLUTION  
CHECKING

THE MARK CONSISTS OF STANDARD CHARACTERS WITHOUT CLAIM TO ANY PARTICULAR FONT, STYLE, SIZE, OR COLOR.

OWNER OF U.S. REG. NOS. 3,499,492 AND 3,505,746.

NO CLAIM IS MADE TO THE EXCLUSIVE RIGHT TO USE "GEORGIA'S" AND "CHECKING", APART FROM THE MARK AS SHOWN.

FOR CHECKING ACCOUNT SERVICES (U.S. CLS. 100, 101 AND 102).

WENDY JUN, EXAMINING ATTORNEY

SN 85-326,429. FALLEN SAINTS MC, HOPKINSVILLE, KY. FILED 5-20-2011.

Fallen Saints MC

THE MARK CONSISTS OF STANDARD CHARACTERS WITHOUT CLAIM TO ANY PARTICULAR FONT, STYLE, SIZE, OR COLOR.

FOR FUNDRAISING SERVICES, NAMELY, ORGANIZING, ARRANGING AND CONDUCTING FUNDRAISING PROGRAMS FOR THE BENEFIT OF SCHOOLS AND NON-PROFIT ORGANIZATIONS (U.S. CLS. 100, 101 AND 102).

LINDA E. BLOHM, EXAMINING ATTORNEY

SN 85-326,543. STORE CAPITAL ADVISORS, LLC, PARADISE VALLEY, AZ. FILED 5-20-2011.



NO CLAIM IS MADE TO THE EXCLUSIVE RIGHT TO USE "CAPITAL", APART FROM THE MARK AS SHOWN.

THE COLOR(S) GOLD, WHITE, AND DARK BLUE IS/ARE CLAIMED AS A FEATURE OF THE MARK.

THE MARK CONSISTS OF THE WORD "STORE" IN DARK BLUE UPPER CASE LETTERS, WITH EACH LETTER OF THE WORD "STORE" SEPARATED BY DARK BLUE VERTICAL LINES OF THE SAME CHARACTER HEIGHT. THE WORD "CAPITAL" IS IN GOLD LOWER CASE

**CLASS 36—(Continued).**

LETTERS AND IS RIGHT-ALIGNED BENEATH THE WORD "STORE". A STYLIZED BOX IS PLACED DIRECTLY TO THE RIGHT OF THE WORDS "STORE" AND "CAPITAL", AND IS THE SAME HEIGHT AS THE COMBINED TWO LINES OF TEXT. THE STYLIZED BOX CONSISTS OF A GOLD, LEFT-POINTED APEX WHICH IS SHADOWED ON THE UPPER ANGLE, AND A DARK BLUE, RIGHT-POINTED APEX WHICH IS SHADOWED ON THE LOWER ANGLE. THE GOLD AND BLUE APEXES ARE SEPARATED BY WHITE SPACE.

FOR FINANCIAL SERVICES, NAMELY, REAL ESTATE ASSET MANAGEMENT, REAL ESTATE INVESTMENT, AND MORTGAGE LENDING (U.S. CLS. 100, 101 AND 102).

MEGHAN REINHART, EXAMINING ATTORNEY

SN 85-327,948. NEVADA GENERAL INSURANCE COMPANY, LAS VEGAS, NV. FILED 5-23-2011.

PAY MY WAY

THE MARK CONSISTS OF STANDARD CHARACTERS WITHOUT CLAIM TO ANY PARTICULAR FONT, STYLE, SIZE, OR COLOR.

FOR BILL PAYMENT SERVICES, NAMELY, PROVIDING AN AUTO INSURANCE POLICY PREMIUM PAYMENT PROGRAM (U.S. CLS. 100, 101 AND 102).

FIRST USE 3-0-2011; IN COMMERCE 3-0-2011.

SKYE YOUNG, EXAMINING ATTORNEY

SN 85-328,322. UNLIMITED 1 ADJUSTMENTS, LLC, PORT CHESTER, NY. FILED 5-24-2011.



THE MARK CONSISTS OF A CIRCLE WITH A STYLIZED "A" HOVERING TO THE TOP RIGHT OF A STYLIZED "U". BOTH LETTERS ARE CUT OUT OF THE CIRCLE AND PIERCE THE BORDER OF THE CIRCLE. THE RIGHT SIDE OF THE "U" IS SPLIT AND FORMS A STYLIZED NUMBER "1" WHICH DOUBLES AS THE CROSSBAR IN THE "A".

FOR CLAIMS ADJUSTMENT IN THE FIELD OF INSURANCE (U.S. CLS. 100, 101 AND 102).

RUDY R. SINGLETON, EXAMINING ATTORNEY

**CLASS 36—(Continued).**

SN 85-328,506. VALUEWEALTH SERVICES, LLC, DUNKIRK, MD. FILED 5-24-2011.

**VALUEWEALTH**

THE MARK CONSISTS OF STANDARD CHARACTERS WITHOUT CLAIM TO ANY PARTICULAR FONT, STYLE, SIZE, OR COLOR.

FOR INVESTMENT ADVISORY AND WEALTH MANAGEMENT CONSULTING (U.S. CLS. 100, 101 AND 102).  
CHERYL CLAYTON, EXAMINING ATTORNEY

SN 85-331,558. OFFICE DEPOT FOUNDATION, INC., BOCA RATON, FL. FILED 5-26-2011.



THE MARK CONSISTS OF AN ARROW POINTING DOWN TOWARD A RECEPTACLE USED FOR CHANGE COLLECTION. THE WORDS "CHANGE CAN" ARE ON THE ARROW AND THE WORDS "MAKE A DIFFERENCE" ARE BELOW THE CHANGE RECEPTACLE. THE "C" IS "CHANGE" IS A CENT SIGN.

FOR CHARITABLE FUNDRAISING SERVICES (U.S. CLS. 100, 101 AND 102).  
INGRID C. EULIN, EXAMINING ATTORNEY

SN 85-332,081. HOME ENTERTAINMENT DISTRIBUTORS, INC., DBA INSURERS WORLD, CANTON, MA. FILED 5-27-2011.



THE COLOR(S) BLACK AND RED IS/ARE CLAIMED AS A FEATURE OF THE MARK.

THE MARK CONSISTS OF THE WORD "VOX" MADE WITH A RED CAPITAL V, A BLACK SPEAKER SYMBOL ACTING AS THE LETTER O, A BLACK LOWERCASE X; AND THE WORD "SCOPE" WITH A RED CAPITAL S FOLLOWED BY BLACK LOWERCASE C, O, P, E.

FOR INSURANCE ADMINISTRATION SERVICES, NAMELY, ASSISTING OTHERS WITH ADJUSTING INSURANCE CLAIMS (U.S. CLS. 100, 101 AND 102).

HEATHER BIDDULPH, EXAMINING ATTORNEY

**CLASS 36—(Continued).**

SN 85-332,089. HOME ENTERTAINMENT DISTRIBUTORS, INC., DBA INSURERS WORLD, CANTON, MA. FILED 5-27-2011.

**VoxScope**

THE MARK CONSISTS OF STANDARD CHARACTERS WITHOUT CLAIM TO ANY PARTICULAR FONT, STYLE, SIZE, OR COLOR.

FOR INSURANCE ADMINISTRATION SERVICES, NAMELY, ASSISTING OTHERS WITH ADJUSTING INSURANCE CLAIMS (U.S. CLS. 100, 101 AND 102).  
HEATHER BIDDULPH, EXAMINING ATTORNEY

SN 85-332,377. DAYMARK REALTY ADVISORS, INC., SANTA ANA, CA. FILED 5-27-2011.

**Get Fit Stay Fit**

THE MARK CONSISTS OF STANDARD CHARACTERS WITHOUT CLAIM TO ANY PARTICULAR FONT, STYLE, SIZE, OR COLOR.

FOR LEASING OF APARTMENTS; MANAGEMENT OF APARTMENTS; REAL ESTATE SERVICES, NAMELY, PROPERTY MANAGEMENT SERVICES FOR CONDOMINIUM ASSOCIATIONS, HOMEOWNER ASSOCIATIONS AND APARTMENT BUILDINGS; RENTAL OF APARTMENTS IN AN APARTMENT COMMUNITY (U.S. CLS. 100, 101 AND 102).

FIRST USE 5-20-2011; IN COMMERCE 5-20-2011.  
LYDIA BELZER, EXAMINING ATTORNEY

SN 85-333,122. HARBORONE CREDIT UNION, BROCKTON, MA. FILED 5-28-2011.

**Embrace the Difference**

THE MARK CONSISTS OF STANDARD CHARACTERS WITHOUT CLAIM TO ANY PARTICULAR FONT, STYLE, SIZE, OR COLOR.

FOR CREDIT UNION SERVICES; CONSUMER AND MORTGAGE LENDING SERVICES; DEPOSIT ACCOUNT SERVICES; BANKING SERVICES; INSURANCE BROKERAGE SERVICES IN THE FIELDS OF LIFE, LONG-TERM CARE AND FIXED ANNUITIES; INVESTMENT MANAGEMENT SERVICES; AND FINANCIAL PLANNING SERVICES (U.S. CLS. 100, 101 AND 102).

SOPHIA S. KIM, EXAMINING ATTORNEY

**CLASS 36—(Continued).**

SN 85-333,127. DYLAN-HYDE, TYLER M., SAN DIEGO, CA. AND DYLAN-HYDE, ANTHONY D., SAN DIEGO, CA. FILED 5-28-2011.

**ADVANCING COMPASSION**

THE MARK CONSISTS OF STANDARD CHARACTERS WITHOUT CLAIM TO ANY PARTICULAR FONT, STYLE, SIZE, OR COLOR.

FOR CHARITABLE FOUNDATION SERVICES, NAMELY, PROVIDING FINANCIAL ASSISTANCE FOR PROGRAMS AND SERVICES OF OTHERS; CHARITABLE FOUNDATION SERVICES, NAMELY, PROVIDING FUNDRAISING ACTIVITIES, SUPPLEMENTAL FUNDING, CAPITAL IMPROVEMENT FUNDING, SCHOLARSHIPS AND FINANCIAL ASSISTANCE FOR PROGRAMS AND SERVICES OF OTHERS; CHARITABLE FUNDRAISING SERVICES (U.S. CLS. 100, 101 AND 102).

SOPHIA S. KIM, EXAMINING ATTORNEY

**CLASS 36—(Continued).**

SN 85-333,208. MEHDI MOUTAHIR, PROVIDENCE, RI. FILED 5-29-2011.

**weowe**

THE MARK CONSISTS OF STANDARD CHARACTERS WITHOUT CLAIM TO ANY PARTICULAR FONT, STYLE, SIZE, OR COLOR.

FOR COLLEGE CONSULTING SERVICES, NAMELY, ASSISTING STUDENTS IN APPLYING FOR SCHOLARSHIPS AND FINANCIAL AID; DEBT COUNSELING SERVICES; DEBT MANAGEMENT CONSULTATION; DEBT MANAGEMENT SERVICES; FINANCIAL SERVICES, NAMELY, FUNDING ONLINE CASH ACCOUNTS FROM PREPAID CASH CARDS, BANK ACCOUNTS AND CREDIT CARD ACCOUNTS; PROVIDING STUDENT LOAN INFORMATION; PROVIDING STUDENT LOANS; STUDENT LOAN SERVICES; FINANCIAL SERVICES, NAMELY, PROVIDING INCENTIVE STUDENT DEBT REPAYMENT PROGRAMS FOR STUDENT DEBT FOR CHILDREN AND ADULTS (U.S. CLS. 100, 101 AND 102).

FIRST USE 12-15-2009; IN COMMERCE 12-15-2009.  
DANIEL CAPSHAW, EXAMINING ATTORNEY

SN 85-333,133. FIGHTERS FOR THE WORLD, SAN CLEMENTE, CA. FILED 5-28-2011.



THE MARK CONSISTS OF THE TEXT "FW" WITH ONE BAR ABOVE THE "FW" AND ONE BELOW, THE WORD "FIGHTERS" WRITTEN IN THE TOP BAR, AND THE WORDS "FOR THE WORLD" WRITTEN IN THE BOTTOM BAR.

FOR CHARITABLE FUNDRAISING SERVICES BY MEANS OF ORGANIZING AND CONDUCTING SPECIAL EVENTS (U.S. CLS. 100, 101 AND 102).

FIRST USE 2-1-2011; IN COMMERCE 2-1-2011.  
CHERYL CLAYTON, EXAMINING ATTORNEY

SN 85-333,501. US BANKCARD SERVICES, INC, DBA US BANKCARD SERVICES, INC, CITY OF INDUSTRY, CA. FILED 5-31-2011.



THE MARK CONSISTS OF AN ACORN STYLIZED SHIELD, AN OUTLINE OF THE SHIELD, 3 INNER SHADED RECTANGULAR ODD SHAPED BOXES MERGING INTO THE TOP, BOTTOM AND LEFT SIDES OF THE INNER SHIELD.

FOR CREDIT CARD PAYMENT PROCESSING SERVICES; CREDIT CARD TRANSACTION PROCESSING SERVICES; PAYMENT PROCESSING SERVICES, NAMELY, CREDIT CARD AND DEBIT CARD TRANSACTION PROCESSING SERVICES (U.S. CLS. 100, 101 AND 102).

KIM SAITO, EXAMINING ATTORNEY

**CLASS 36—(Continued).**

SN 85-333,693. LOUISVILLE COMPREHENSIVE CARE MULTIPLE SCLEROSIS CENTER, INC., DBA THE MS CENTER, LOUISVILLE, KY. FILED 5-31-2011.



NO CLAIM IS MADE TO THE EXCLUSIVE RIGHT TO USE "MS", APART FROM THE MARK AS SHOWN.

THE MARK CONSISTS OF THE STYLIZED TEXT "MS" WITH THE "S" IN THE SHAPE OF THE LETTER "S" COMBINED WITH A HEART SHAPE.

FOR CHARITABLE FUND RAISING SERVICES (U.S. CLS. 100, 101 AND 102).

FIRST USE 7-15-2005; IN COMMERCE 7-15-2005.  
HEATHER THOMPSON, EXAMINING ATTORNEY

---

SN 85-333,721. HENDERSON A'S, PHOENIX, AZ. FILED 5-31-2011.



THE MARK CONSISTS OF THE STYLIZED WORDS "HENDERSON A'S". AN IMAGE OF MAN RUNNING TO THE LEFT OF THE TEXT.

FOR CHARITABLE FUNDRAISING SERVICES BY MEANS OF AN ENTERTAINMENT EVENT (U.S. CLS. 100, 101 AND 102).

JACQUELINE A. LAVINE, EXAMINING ATTORNEY

---

SN 85-333,755. AON CORPORATION, CHICAGO, IL. FILED 5-31-2011.

## Aon Hewitt Navigators

THE MARK CONSISTS OF STANDARD CHARACTERS WITHOUT CLAIM TO ANY PARTICULAR FONT, STYLE, SIZE, OR COLOR.

OWNER OF U.S. REG. NOS. 1,496,123, 3,254,615 AND OTHERS.

FOR HEALTH INSURANCE CONSULTING, INFORMATION AND BROKERAGE (U.S. CLS. 100, 101 AND 102).

RONALD AIKENS, EXAMINING ATTORNEY

**CLASS 36—(Continued).**

SN 85-333,996. MODULUS INFORMATICS, INC., SCOTTSDALE, AZ. FILED 5-31-2011.



NO CLAIM IS MADE TO THE EXCLUSIVE RIGHT TO USE "WALL ST", APART FROM THE MARK AS SHOWN.

THE COLOR(S) WHITE, BLUE, ORANGE, YELLOW AND BLACK IS/ARE CLAIMED AS A FEATURE OF THE MARK.

THE MARK CONSISTS OF THE WORDING "WALL ST BIRDS" WITH THE WORDS "WALL ST" APPEARING INSIDE OF A STREET SIGN. THE WORDS "WALL ST" APPEAR IN THE COLOR WHITE, THE WORD "BIRDS" APPEARS IN THE COLOR BLUE, AND THE STREET SIGN APPEARS IN THE COLOR BLUE WITH ITS RIGHT SIDE FORMING THE BLUE LETTER "B" IN "BIRDS". A BLUE BIRD HAVING A WHITE CHEST, AN ORANGE AND YELLOW BEAK, ORANGE LEGS AND FEET AND A BLACK DOT FOR AN EYE APPEARS OVER THE LETTER I IN THE WORD "BIRDS".

FOR COMPUTER ANALYSES OF STOCK EXCHANGE INFORMATION; PROVISION OF INFORMATION AND DATA CONCERNING STOCK EXCHANGES; PROVISION OF STOCK MARKET INFORMATION (U.S. CLS. 100, 101 AND 102).

ZHALEH DELANEY, EXAMINING ATTORNEY

---

SN 85-334,074. ROTARY CLUB OF ROSEVILLE, CALIFORNIA, ROSEVILLE, CA. FILED 5-31-2011.

## A TASTE OF ROSEVILLE

THE MARK CONSISTS OF STANDARD CHARACTERS WITHOUT CLAIM TO ANY PARTICULAR FONT, STYLE, SIZE, OR COLOR.

NO CLAIM IS MADE TO THE EXCLUSIVE RIGHT TO USE "ROSEVILLE", APART FROM THE MARK AS SHOWN.

FOR CHARITABLE FUNDRAISING SERVICES, NAMELY, ORGANIZING AND CONDUCTING MUSICAL ENTERTAINMENT EVENTS FEATURING FOOD AND WINE (U.S. CLS. 100, 101 AND 102).

EDWARD FENNESSY, EXAMINING ATTORNEY

**CLASS 36—(Continued).**

SN 85-334,768. AKRO ADVISORS, INC., MIAMI, FL. FILED 6-1-2011.



NO CLAIM IS MADE TO THE EXCLUSIVE RIGHT TO USE "CONSULTING", APART FROM THE MARK AS SHOWN.

THE COLOR(S) BLUE AND SILVER IS/ARE CLAIMED AS A FEATURE OF THE MARK.

THE MARK CONSISTS OF A STYLIZED WORD AKRO, WHERE "A" AND "K" ARE ATTACHED AND THE "AK" AND "RO" ARE INTERSECTED BY AN ARCH-LIKE SYMBOL. A STYLIZED WORD "CONSULTING" APPEARS UNDER THE SPACE BETWEEN THE LETTERS "K" AND "R" IN "AKRO" AND PAST THE LETTER "O" IN "AKRO". THE WORDS "AKRO" AND "CONSULTING" ARE IN BLUE AND THE ARCH-LIKE SYMBOL IS IN SILVER.

THE ENGLISH TRANSLATION OF "AKRO" IN THE MARK IS "PINNACLE".

FOR FINANCIAL PLANNING AND INVESTMENT ADVISORY SERVICES; FINANCIAL PLANNING CONSULTATION; FINANCIAL SERVICES, NAMELY, WEALTH MANAGEMENT SERVICES (U.S. CLS. 100, 101 AND 102).

FIRST USE 1-1-2010; IN COMMERCE 1-1-2010.

HEATHER THOMPSON, EXAMINING ATTORNEY

SN 85-334,785. AKRO ADVISORS, INC., MIAMI, FL. FILED 6-1-2011.



NO CLAIM IS MADE TO THE EXCLUSIVE RIGHT TO USE "GROUP", APART FROM THE MARK AS SHOWN.

THE COLOR(S) BLUE AND SILVER IS/ARE CLAIMED AS A FEATURE OF THE MARK.

THE MARK CONSISTS OF A STYLIZED WORD AKRO, WHERE "A" AND "K" ARE ATTACHED AND THE "AK" AND "RO" ARE INTERSECTED BY AN ARCH-LIKE SYMBOL. A STYLIZED WORD "GROUP" APPEARS UNDER THE LETTER "R" IN "AKRO" AND TO THE LETTER "O" IN "AKRO". THE WORDS "AKRO" AND "GROUP" ARE IN BLUE AND THE ARCH-LIKE SYMBOL IS IN SILVER.

FOR FINANCIAL CONSULTATION; FINANCIAL PLANNING AND INVESTMENT ADVISORY SERVICES; FINANCIAL SERVICES, NAMELY, WEALTH MANAGEMENT SERVICES (U.S. CLS. 100, 101 AND 102).

FIRST USE 1-1-2010; IN COMMERCE 1-1-2010.

TINA BROWN, EXAMINING ATTORNEY

**CLASS 36—(Continued).**

SN 85-335,164. WELLS FARGO & COMPANY, MINNEAPOLIS, MN. FILED 6-1-2011.

# WAY2SAVE

THE MARK CONSISTS OF STANDARD CHARACTERS WITHOUT CLAIM TO ANY PARTICULAR FONT, STYLE, SIZE, OR COLOR.

OWNER OF U.S. REG. NOS. 3,509,656 AND 3,624,145.

FOR BANKING SERVICES, NAMELY, CHECKING AND SAVINGS ACCOUNT SERVICES; EDUCATIONAL SAVINGS ACCOUNTS; RETIREMENT SAVINGS ACCOUNTS; CREDIT CARD AND DEBIT CARD SERVICES; STORED VALUE CARD SERVICES; PRE-PAID PURCHASE CARD SERVICES, NAMELY, PROCESSING ELECTRONIC PAYMENTS THROUGH PRE-PAID CARDS; PROVIDING ELECTRONIC PROCESSING OF ELECTRONIC FUNDS TRANSFER, CREDIT CARD, DEBIT CARD, ELECTRONIC CHECK AND ELECTRONIC PAYMENTS; MONEY TRANSFER SERVICES; FINANCIAL TRANSACTION SERVICES, NAMELY, PROVIDING PAYMENT OPTIONS USING A MOBILE DEVICE AT A POINT OF SALE; PROVIDING INFORMATION AND ADVICE IN THE FIELD OF FINANCE, FINANCIAL INVESTMENTS, FINANCIAL VALUATIONS, AND THE FINANCIAL ASPECTS OF RETIREMENT; INDIVIDUAL RETIREMENT ACCOUNT SERVICES (U.S. CLS. 100, 101 AND 102).

ALLISON SCHRODY, EXAMINING ATTORNEY

SN 85-335,441. SOUTHERN CONSIDERATION, LLC, LAKE CHARLES, LA. FILED 6-1-2011.

# SOUTHERN CONSIDERATION

THE MARK CONSISTS OF STANDARD CHARACTERS WITHOUT CLAIM TO ANY PARTICULAR FONT, STYLE, SIZE, OR COLOR.

FOR FINANCIAL INVESTMENT IN THE FIELD OF REAL ESTATE; REAL ESTATE INVESTMENT SERVICES (U.S. CLS. 100, 101 AND 102).

DAVID HOFFMAN, EXAMINING ATTORNEY

**CLASS 36—(Continued).**

SN 85-335,448. SANTOS, CLAUDIA, LAREDO, TX. FILED 6-1-2011.

# Listingslive

THE MARK CONSISTS OF STANDARD CHARACTERS WITHOUT CLAIM TO ANY PARTICULAR FONT, STYLE, SIZE, OR COLOR.

FOR PROVIDING INFORMATION IN THE FIELD OF REAL ESTATE VIA THE INTERNET; PROVIDING REAL ESTATE LISTINGS AND REAL ESTATE INFORMATION VIA THE INTERNET; PROVIDING REAL ESTATE LISTINGS VIA THE INTERNET (U.S. CLS. 100, 101 AND 102).  
KYLE PEETE, EXAMINING ATTORNEY

SN 85-335,525. MONASSEBIAN, JEFF, GREAT NECK, NY. FILED 6-1-2011.

# CAPITALNEXION

THE MARK CONSISTS OF STANDARD CHARACTERS WITHOUT CLAIM TO ANY PARTICULAR FONT, STYLE, SIZE, OR COLOR.

FOR BANKING AND FINANCING SERVICES; FINANCIAL SERVICES, NAMELY, MONEY LENDING; MORTGAGE BANKING SERVICES, NAMELY, ORIGINATION, ACQUISITION, SERVICING, SECURITIZATION AND BROKERAGE OF MORTGAGE LOANS; MORTGAGE SERVICES, NAMELY, BUYER PRE-QUALIFICATION OF MORTGAGES FOR MORTGAGE BROKERS AND BANKS (U.S. CLS. 100, 101 AND 102).  
C. DIONNE CLYBURN, EXAMINING ATTORNEY

SN 85-335,702. INDEPENDENT STOCK MARKET, DBA INDEPENDENT STOCK MARKET, BOUNTIFUL, UT. FILED 6-1-2011.

# Get up and move your assets

THE MARK CONSISTS OF STANDARD CHARACTERS WITHOUT CLAIM TO ANY PARTICULAR FONT, STYLE, SIZE, OR COLOR.

FOR AGENCIES FOR BROKERAGE OF SECURITIES TRADING IN OVERSEAS SECURITIES MARKETS AND OF TRANSACTIONS ON COMMISSION OF OVERSEAS MARKET SECURITIES FUTURES; AGENCIES OR BROKERAGE FOR TRADING OF SECURITIES, SECURITIES INDEX FUTURES, SECURITIES OPTIONS, AND OVERSEAS MARKET SECURITIES FUTURES; BROKERAGE HOUSES IN THE FIELD OF STOCKS, COMMODITIES, AND FUTURES; BROKERAGE OF SHARES OR STOCKS AND OTHER SECURITIES; BROKERAGE SERVICES FOR STOCKS AND BONDS; BUSINESS, STOCK OPTION AND PENSION VALUATION SERVICES; COMPUTER ANALYSES OF STOCK EXCHANGE INFORMATION; EMPLOYEE STOCK PLAN

**CLASS 36—(Continued).**

ADMINISTRATION SERVICES; FINANCIAL ADMINISTRATION OF STOCK EXCHANGE TRADING OF SHARES AND OTHER FINANCIAL SECURITIES IN FINANCIAL MARKETS; FINANCIAL AND INVESTMENT SERVICES, NAMELY, MANAGEMENT AND BROKERAGE IN THE FIELDS OF STOCKS, BONDS, OPTIONS, COMMODITIES, FUTURES AND OTHER SECURITIES, AND THE INVESTMENT OF FUNDS OF OTHERS; FINANCIAL INVESTMENT ANALYSIS AND STOCK RESEARCH; FINANCIAL SERVICES, NAMELY, ADMINISTRATION OF TRANSACTIONS INVOLVING FUNDS DRAWN FROM SECURITIES, STOCKS, FUNDS, EQUITIES, BONDS, CASH, OR OTHER TYPES OF FINANCIAL INVESTMENTS IN RETIREMENT PLANS USING A CHECK OR NEGOTIABLE ORDER OF WITHDRAWAL OVER A GLOBAL DATA NETWORK; FINANCIAL SERVICES, NAMELY, ADMINISTRATION OF TRANSACTIONS INVOLVING FUNDS DRAWN FROM SECURITIES, STOCKS, FUNDS, EQUITIES, BONDS, CASH, OR OTHER TYPES OF FINANCIAL INVESTMENTS IN RETIREMENT PLANS USING A CREDIT OR DEBIT CARD OVER A GLOBAL DATA NETWORK; FINANCIAL SERVICES, NAMELY, ASSISTING OTHERS WITH THE COMPLETION OF FINANCIAL TRANSACTIONS FOR STOCKS, BONDS, SECURITIES AND EQUITIES; FINANCIAL SERVICES, NAMELY, BROKER/DEALER SERVICES ON SECURITIES EXCHANGES AND OVER-THE-COUNTER MARKETS; FINANCIAL SERVICES, NAMELY, DEALING IN SECURITIES AS A MARKET MAKER AND IN TRADING COMMODITIES, SECURITIES, OPTIONS, FUTURES, EQUITIES AND FIXED INCOME PRODUCTS IN THE U.S. AND OVERSEAS MARKET SECURITIES; FINANCIAL SERVICES, NAMELY, PROPRIETARY TRADING IN COMMODITIES, SECURITIES, OPTIONS, FUTURES, EQUITIES AND FIXED INCOME PRODUCTS IN THE U.S. AND OVERSEAS MARKET SECURITIES; INVESTMENT BANKING SERVICES IN THE FIELD OF EMPLOYEE STOCK OWNERSHIP PLANS (ESOP); ON-LINE TRADING OF OPTIONS ON THE OPTIONS EXCHANGE MARKET; ORGANIZATION OF ONLINE STOCK EXCHANGES FOR THE BENEFIT OF THE TRADE OF STOCKS AND OTHER FINANCIAL SECURITIES; ORGANIZATION OF STOCK EXCHANGES FOR THE BENEFIT OF THE TRADE OF STOCKS AND OTHER FINANCIAL VALUES; PROVIDING A WEB SITE THAT FEATURES INFORMATION ON THE OPTIONS MARKETS; PROVIDING A WEB SITE WHERE USERS CAN POST RATINGS, REVIEWS AND RECOMMENDATIONS ON STOCKS, BONDS, MUTUAL FUNDS AND OTHER FINANCIAL INSTRUMENTS; PROVIDING AN ON-LINE COMPUTER DATABASE IN THE FIELD OF STOCK/SECURITIES MARKET INFORMATION; PROVIDING FINANCIAL SERVICES WITH RESPECT TO SECURITIES AND OTHER FINANCIAL INSTRUMENTS AND PRODUCTS, NAMELY, PROVIDING FINANCIAL MARKET NEWS AND COMMENTARY; PROVIDING INFORMATION IN THE FIELD OF FINANCIAL STOCK AND EQUITY MARKETS; PROVIDING STOCK MARKET INFORMATION; PROVIDING STOCK/SECURITIES MARKET INFORMATION; PROVISION OF INFORMATION AND DATA CONCERNING STOCK EXCHANGES; PROVISION OF STOCK MARKET INFORMATION; QUOTATION OF STOCK MARKET PRICES; STOCK BROKERAGE; STOCK BROKING SERVICES; STOCK EXCHANGE INFORMATION SERVICES; STOCK EXCHANGE PRICE QUOTATIONS; STOCK EXCHANGE QUOTATION AND LISTING SERVICES; STOCK EXCHANGE QUOTATIONS (U.S. CLS. 100, 101 AND 102).  
ALICE BENMAMAN, EXAMINING ATTORNEY

**CLASS 36—(Continued).**

SN 85-335,757. FIRST BUSEY CORPORATION, URBANA, IL. FILED 6-1-2011.

**SIGNATURE SOLUTIONS**

THE MARK CONSISTS OF STANDARD CHARACTERS WITHOUT CLAIM TO ANY PARTICULAR FONT, STYLE, SIZE, OR COLOR.  
FOR CAPITAL INVESTMENT SERVICES (U.S. CLS. 100, 101 AND 102).  
FIRST USE 4-4-2011; IN COMMERCE 4-4-2011.  
WILLIAM P. SHANAHAN, EXAMINING ATTORNEY

SN 85-335,851. ANTUNA, EDWARD A., LAS VEGAS, NV. FILED 6-1-2011.

**SugarFree Kids**

THE MARK CONSISTS OF STANDARD CHARACTERS WITHOUT CLAIM TO ANY PARTICULAR FONT, STYLE, SIZE, OR COLOR.  
NO CLAIM IS MADE TO THE EXCLUSIVE RIGHT TO USE "KIDS", APART FROM THE MARK AS SHOWN.  
FOR CHARITABLE FUNDRAISING TO SUPPORT CHILDREN WITH DIABETES (U.S. CLS. 100, 101 AND 102).  
SUNG IN, EXAMINING ATTORNEY

**CLASS 36—(Continued).**

SN 85-335,868. ESSENTIA FINANCIAL SERVICES LLC, FORT WORTH, TX. FILED 6-2-2011.



THE COLOR(S) BLUE AND ORANGE IS/ARE CLAIMED AS A FEATURE OF THE MARK.  
THE MARK CONSISTS OF THE WORD "CHARGE" IN BLUE LETTERS, THE WORD "IT" IN ORANGE LETTERS WITH A SERIES OF FADING PLUS SIGNS FOLLOWING THE LETTER T, AND THE WORD "PLUS" IN BLUE LETTERS WITH A BLUE ARROW PARTIALLY ENCIRCLING IT.  
FOR CREDIT AND LOAN SERVICES; PROVIDING PERSONAL LOANS AND LINES OF CREDIT (U.S. CLS. 100, 101 AND 102).  
FIRST USE 10-1-2010; IN COMMERCE 10-1-2010.  
KATHERINE STOIDES, EXAMINING ATTORNEY

SN 85-335,888. THE FACTOR SOURCE, LLC, COLORADO SPRINGS, CO. FILED 6-2-2011.

**FACTORSOURCE**

THE MARK CONSISTS OF STANDARD CHARACTERS WITHOUT CLAIM TO ANY PARTICULAR FONT, STYLE, SIZE, OR COLOR.  
FOR COMMERCIAL FINANCING BROKERAGE SERVICES (U.S. CLS. 100, 101 AND 102).  
JOHN E. MICHOS, EXAMINING ATTORNEY

SN 85-335,982. PAN-MASSACHUSETTS CHALLENGE, INC., DBA PMC, NEEDHAM, MA. FILED 6-2-2011.

**PMC**

THE MARK CONSISTS OF STANDARD CHARACTERS WITHOUT CLAIM TO ANY PARTICULAR FONT, STYLE, SIZE, OR COLOR.  
OWNER OF U.S. REG. NOS. 3,232,853 AND 3,279,594.  
FOR CHARITABLE FUNDRAISING (U.S. CLS. 100, 101 AND 102).  
FIRST USE 8-1-1980; IN COMMERCE 8-1-1980.  
MEGHAN REINHART, EXAMINING ATTORNEY

**CLASS 36—(Continued).**

SN 85-335,983. FIVE PEAKS, LLC, BOCA RATON, FL. FILED 6-2-2011.

## FIVE PEAKS

THE MARK CONSISTS OF STANDARD CHARACTERS WITHOUT CLAIM TO ANY PARTICULAR FONT, STYLE, SIZE, OR COLOR.

FOR PROVIDING RESEARCH SERVICES IN THE FIELD OF FINANCE AND INVESTMENT (U.S. CLS. 100, 101 AND 102).

MEGHAN REINHART, EXAMINING ATTORNEY

SN 85-336,241. INDEPENDENT STOCK MARKET, DBA INDEPENDENT STOCK MARKET, BOUNTIFUL, UT. FILED 6-2-2011.

## Move your assets

THE MARK CONSISTS OF STANDARD CHARACTERS WITHOUT CLAIM TO ANY PARTICULAR FONT, STYLE, SIZE, OR COLOR.

FOR AGENCIES FOR BROKERAGE OF SECURITIES TRADING IN OVERSEAS SECURITIES MARKETS AND OF TRANSACTIONS ON COMMISSION OF OVERSEAS MARKET SECURITIES FUTURES; AGENCIES OR BROKERAGE FOR TRADING OF SECURITIES, SECURITIES INDEX FUTURES, SECURITIES OPTIONS, AND OVERSEAS MARKET SECURITIES FUTURES; BROKERAGE HOUSES IN THE FIELD OF STOCKS, COMMODITIES, AND FUTURES; BROKERAGE OF SHARES OR STOCKS AND OTHER SECURITIES; BROKERAGE SERVICES FOR STOCKS AND BONDS; BUSINESS, STOCK OPTION AND PENSION VALUATION SERVICES; COMPUTER ANALYSES OF STOCK EXCHANGE INFORMATION; EMPLOYEE STOCK PLAN ADMINISTRATION SERVICES; FINANCIAL ADMINISTRATION OF STOCK EXCHANGE TRADING OF SHARES AND OTHER FINANCIAL SECURITIES IN FINANCIAL MARKETS; FINANCIAL AND INVESTMENT SERVICES, NAMELY, MANAGEMENT AND BROKERAGE IN THE FIELDS OF STOCKS, BONDS, OPTIONS, COMMODITIES, FUTURES AND OTHER SECURITIES, AND THE INVESTMENT OF FUNDS OF OTHERS; FINANCIAL INVESTMENT ANALYSIS AND STOCK RESEARCH; FINANCIAL SERVICES, NAMELY, ADMINISTRATION OF TRANSACTIONS INVOLVING FUNDS DRAWN FROM SECURITIES, STOCKS, FUNDS, EQUITIES, BONDS, CASH, OR OTHER TYPES OF FINANCIAL INVESTMENTS IN RETIREMENT PLANS USING A CHECK OR NEGOTIABLE ORDER OF WITHDRAWAL OVER A GLOBAL DATA NETWORK; FINANCIAL SERVICES, NAMELY, ADMINISTRATION OF TRANSACTIONS INVOLVING FUNDS DRAWN FROM SECURITIES, STOCKS, FUNDS, EQUITIES, BONDS, CASH, OR OTHER TYPES OF FINANCIAL INVESTMENTS IN RETIREMENT PLANS USING A CREDIT OR DEBIT CARD OVER A GLOBAL DATA NETWORK; FINANCIAL SERVICES, NAMELY, ASSISTING OTHERS WITH THE COMPLETION OF FINANCIAL TRANSACTIONS FOR STOCKS, BONDS, SECURITIES AND EQUITIES; FINANCIAL SERVICES, NAMELY, BROKER/DEALER SERVICES ON SECURITIES EXCHANGES AND OVER-THE-COUNTER MARKETS; FINANCIAL SERVICES, NAMELY, DEALING IN SECURITIES AS A MARKET MAKER AND IN TRADING COMMODITIES, SECURITIES, OPTIONS, FUTURES, EQUITIES AND

**CLASS 36—(Continued).**

FIXED INCOME PRODUCTS IN THE U.S. AND OVERSEAS MARKET SECURITIES; FINANCIAL SERVICES, NAMELY, PROPRIETARY TRADING IN COMMODITIES, SECURITIES, OPTIONS, FUTURES, EQUITIES AND FIXED INCOME PRODUCTS IN THE U.S. AND OVERSEAS MARKET SECURITIES; INVESTMENT BANKING SERVICES IN THE FIELD OF EMPLOYEE STOCK OWNERSHIP PLANS (ESOP); ON-LINE TRADING OF OPTIONS ON THE OPTIONS EXCHANGE MARKET; ORGANIZATION OF ONLINE STOCK EXCHANGES FOR THE BENEFIT OF THE TRADE OF STOCKS AND OTHER FINANCIAL SECURITIES; ORGANIZATION OF STOCK EXCHANGES FOR THE BENEFIT OF THE TRADE OF STOCKS AND OTHER FINANCIAL VALUES; PROVIDING A WEB SITE THAT FEATURES INFORMATION ON THE OPTIONS MARKETS; PROVIDING A WEB SITE WHERE USERS CAN POST RATINGS, REVIEWS AND RECOMMENDATIONS ON STOCKS, BONDS, MUTUAL FUNDS AND OTHER FINANCIAL INSTRUMENTS; PROVIDING AN ON-LINE COMPUTER DATABASE IN THE FIELD OF STOCK/SECURITIES MARKET INFORMATION; PROVIDING FINANCIAL SERVICES WITH RESPECT TO SECURITIES AND OTHER FINANCIAL INSTRUMENTS AND PRODUCTS, NAMELY, PROVIDING FINANCIAL MARKET NEWS AND COMMENTARY; PROVIDING INFORMATION IN THE FIELD OF FINANCIAL STOCK AND EQUITY MARKETS; PROVIDING STOCK MARKET INFORMATION; PROVIDING STOCK/SECURITIES MARKET INFORMATION; PROVISION OF INFORMATION AND DATA CONCERNING STOCK EXCHANGES; PROVISION OF STOCK MARKET INFORMATION; QUOTATION OF STOCK MARKET PRICES; STOCK BROKERAGE; STOCK BROKING SERVICES; STOCK EXCHANGE INFORMATION SERVICES; STOCK EXCHANGE PRICE QUOTATIONS; STOCK EXCHANGE QUOTATION AND LISTING SERVICES; STOCK EXCHANGE QUOTATIONS (U.S. CLS. 100, 101 AND 102).

ALICE BENMAMAN, EXAMINING ATTORNEY

SN 85-336,482. CAPRETZ, TAYLOR, LAGUNA BEACH, CA. AND CAPRETZ, RYAN, LAGUNA BEACH, CA. AND CAPRETZ, CINDY, LAGUNA BEACH, CA. FILED 6-2-2011.

## RED for Life

THE MARK CONSISTS OF STANDARD CHARACTERS WITHOUT CLAIM TO ANY PARTICULAR FONT, STYLE, SIZE, OR COLOR.

FOR CHARITABLE FUNDRAISING SERVICES FOR THE SUPPORT OF WOMEN AND CHILDREN INFECTED WITH HIV AIDS (U.S. CLS. 100, 101 AND 102).

DAVID ELTON, EXAMINING ATTORNEY

SN 85-336,519. OFFICE DEPOT FOUNDATION, INC., BOCA RATON, FL. FILED 6-2-2011.



THE MARK CONSISTS OF THE WORDS "GOT CHANGE" WITH A QUESTION MARK AT THE END. THE "C" IN "CHANGE" IS A CENT SIGN.

FOR CHARITABLE FUNDRAISING SERVICES (U.S. CLS. 100, 101 AND 102).

INGRID C. EULIN, EXAMINING ATTORNEY



**CLASS 36—(Continued).**

SN 85-336,594. INTERNET PAWN, INC., CENTENNIAL, CO.  
FILED 6-2-2011.

# PAWNGO

THE MARK CONSISTS OF STANDARD CHARACTERS WITHOUT CLAIM TO ANY PARTICULAR FONT, STYLE, SIZE, OR COLOR.

FOR ARRANGING OF LOANS; CREDIT AND LOAN SERVICES; ELECTRONIC LOAN ORIGINATION SERVICES; ELECTRONIC LOAN PREPARATION SERVICES; INSTALLMENT LOANS; PAWN BROKERAGE; PAWN SHOPS; PROVIDING TEMPORARY LOANS; TEMPORARY LOANS (U.S. CLS. 100, 101 AND 102).

FIRST USE 5-18-2011; IN COMMERCE 5-18-2011.

CIMMERIAN COLEMAN, EXAMINING ATTORNEY

**CLASS 36—(Continued).**

SN 85-336,752. LIVE IN REVERSE, INC., MINEOLA, NY.  
FILED 6-2-2011.



THE STIPPLING IS FOR SHADING PURPOSES ONLY.  
THE MARK CONSISTS OF THE TEXT "LIVE IN REVERSE" WITH A BACKWARDS FACING "R" IN "REVERSE" AND A REVERSE MIRROR IMAGE OF THE WORDS "LIVE IN REVERSE" ABOVE IT. ABOVE THAT THERE IS AN ARCH AND 4 SQUARES WITH A ROOF OVER THE TOP. THIS SYMBOL REPRESENTS A HOUSE.

FOR FINANCIAL SERVICES, NAMELY, MORTGAGE PLANNING (U.S. CLS. 100, 101 AND 102).

FIRST USE 3-1-2009; IN COMMERCE 3-1-2009.

JENNIFER MARTIN, EXAMINING ATTORNEY

SN 85-336,598. OFFICE DEPOT FOUNDATION, INC., BOCA RATON, FL. FILED 6-2-2011.

Helping Makes  
**Cents**

THE MARK CONSISTS OF THE WORDS "HELPING MAKES" OVER THE WORD "CENTS". THE "C" IN "CENTS" IS A CENT SIGN.

FOR CHARITABLE FUNDRAISING SERVICES (U.S. CLS. 100, 101 AND 102).

INGRID C. EULIN, EXAMINING ATTORNEY

SN 85-337,179. GFI GROUP, INC., NEW YORK, NY. FILED 6-3-2011.

# MARGINMATCH

THE MARK CONSISTS OF STANDARD CHARACTERS WITHOUT CLAIM TO ANY PARTICULAR FONT, STYLE, SIZE, OR COLOR.

FOR FINANCIAL MANAGEMENT; FINANCIAL AND INVESTMENT SERVICES, NAMELY, PROVIDING PRICING, MARKET AND TRADING INFORMATION FOR SECURITIES, DERIVATIVES OR SIMILAR INSTRUMENTS BY ELECTRONIC MEANS VIA VOICE BROKERS, DOMESTIC AND GLOBAL COMPUTER NETWORK FOR USE BY FINANCIAL INSTITUTIONS, PROFESSIONALS, AND TRADERS; EXECUTION OF TRANSACTIONS INVOLVING SECURITIES, DERIVATIVES OR SIMILAR INSTRUMENTS BY ELECTRONIC MEANS VIA GLOBAL COMPUTER NETWORK FOR USE BY FINANCIAL INSTITUTIONS, PROFESSIONALS AND TRADERS (U.S. CLS. 100, 101 AND 102).

MAYUR VAGHANI, EXAMINING ATTORNEY

SN 85-336,698. OFFICE DEPOT FOUNDATION, INC., BOCA RATON, FL. FILED 6-2-2011.



THE MARK CONSISTS OF THE WORDS "LET'S CHANGE IT UP!" ABOVE A COIN BEING INSERTED INTO A COIN RECEPTACLE FORMED BY THREE CIRCLES OF DIFFERENT SIZES, ONE INSIDE THE OTHER. THE "C" IN "CHANGE" IS A CENT SIGN.

FOR CHARITABLE FUNDRAISING SERVICES (U.S. CLS. 100, 101 AND 102).

INGRID C. EULIN, EXAMINING ATTORNEY

SN 85-337,227. MBT FINANCIAL CORP., MONROE, MI.  
FILED 6-3-2011.

# Checking...with Benefits!

THE MARK CONSISTS OF STANDARD CHARACTERS WITHOUT CLAIM TO ANY PARTICULAR FONT, STYLE, SIZE, OR COLOR.

FOR CHECKING ACCOUNT SERVICES (U.S. CLS. 100, 101 AND 102).

FIRST USE 5-31-2011; IN COMMERCE 5-31-2011.

WILLIAM ROSSMAN, EXAMINING ATTORNEY

**CLASS 36—(Continued).**

SN 85-337,241. CDOC, INC., CARMEL, IN. FILED 6-3-2011.

**ACCIDENTASSURE**

THE MARK CONSISTS OF STANDARD CHARACTERS WITHOUT CLAIM TO ANY PARTICULAR FONT, STYLE, SIZE, OR COLOR.

FOR BROKERAGE, UNDERWRITING AND ADMINISTRATION OF INSURANCE SERVICES, NAMELY, UNDERWRITING SUPPLEMENTAL HEALTH INSURANCE (U.S. CLS. 100, 101 AND 102).

FIRST USE 4-1-2011; IN COMMERCE 4-1-2011.  
GRETTA YAO, EXAMINING ATTORNEY

**CLASS 36—(Continued).**

SN 85-337,744. PRESTONE PRODUCTS GROUP, DANBURY, CT. FILED 6-3-2011.

**OWN IT FOR GOOD**

THE MARK CONSISTS OF STANDARD CHARACTERS WITHOUT CLAIM TO ANY PARTICULAR FONT, STYLE, SIZE, OR COLOR.

FOR CHARITABLE FUNDRAISING SERVICES BY MEANS OF ORGANIZING AND CONDUCTING SPECIAL EVENTS (U.S. CLS. 100, 101 AND 102).

ESTHER BELENKER, EXAMINING ATTORNEY

SN 85-337,266. ROCKWOOD ASSET MANAGEMENT, LLC, GREENWICH, CT. FILED 6-3-2011.

**ROCKWOOD**

THE MARK CONSISTS OF STANDARD CHARACTERS WITHOUT CLAIM TO ANY PARTICULAR FONT, STYLE, SIZE, OR COLOR.

FOR INVESTMENT MANAGEMENT AND ADVISORY SERVICES FOR PRIVATE INSTITUTIONAL FUNDS AND INSTITUTIONAL CLIENTS (U.S. CLS. 100, 101 AND 102).

FIRST USE 6-28-1994; IN COMMERCE 6-28-1994.  
THOMAS MANOR, EXAMINING ATTORNEY

SN 85-338,797. PROFOUNDER FINANCIAL, INC., AKA PROFOUNDER, WEST HOLLYWOOD, CA. FILED 6-6-2011.

**ProFounder**

THE MARK CONSISTS OF STANDARD CHARACTERS WITHOUT CLAIM TO ANY PARTICULAR FONT, STYLE, SIZE, OR COLOR.

FOR ON-LINE BUSINESS FUNDRAISING SERVICES (U.S. CLS. 100, 101 AND 102).

FIRST USE 12-0-2009; IN COMMERCE 12-0-2009.  
ELISSA GARBER KON, EXAMINING ATTORNEY

SN 85-337,481. FUNDS TRANSFER ALLIANCE, LLC, AKA THE FTA, PHOENIX, AZ. FILED 6-3-2011.

**banking is BORING**

THE MARK CONSISTS OF STANDARD CHARACTERS WITHOUT CLAIM TO ANY PARTICULAR FONT, STYLE, SIZE, OR COLOR.

FOR CASH ADVANCE SERVICES FOR BUSINESSES AND MERCHANTS; MERCHANT BANKING SERVICES; MERCHANT SERVICES, NAMELY, PAYMENT TRANSACTION PROCESSING SERVICES (U.S. CLS. 100, 101 AND 102).

JUDITH HELFMAN, EXAMINING ATTORNEY

SN 85-339,011. SEQUOIA EQUITIES, INC., WALNUT CREEK, CA. FILED 6-6-2011.



THE MARK CONSISTS OF A ROUND RECTANGLE WITH THE STYLIZED TEXT "DON'T GET CHESTER'D".

FOR REAL ESTATE SERVICE, NAMELY, RENTAL PROPERTY MANAGEMENT; RENTAL OF APARTMENTS (U.S. CLS. 100, 101 AND 102).

KATHERINE STOIDES, EXAMINING ATTORNEY

**CLASS 36—(Continued).**

SN 85-339,215. YAKIMA VALLEY CREDIT UNION, YAKIMA, WA. FILED 6-6-2011.

# SOLARITY

THE MARK CONSISTS OF STANDARD CHARACTERS WITHOUT CLAIM TO ANY PARTICULAR FONT, STYLE, SIZE, OR COLOR.

FOR CREDIT UNION SERVICES (U.S. CLS. 100, 101 AND 102).

ODESSA BIBBINS, EXAMINING ATTORNEY

---

SN 85-339,229. PAN-AMERICAN LIFE INSURANCE COMPANY, NEW ORLEANS, LA. FILED 6-6-2011.

# VIDA SIMPLE LIFE

THE MARK CONSISTS OF STANDARD CHARACTERS WITHOUT CLAIM TO ANY PARTICULAR FONT, STYLE, SIZE, OR COLOR.

NO CLAIM IS MADE TO THE EXCLUSIVE RIGHT TO USE "VIDA" AND "LIFE", APART FROM THE MARK AS SHOWN.

THE ENGLISH TRANSLATION OF VIDA IN THE MARK IS LIFE.

FOR TERM LIFE INSURANCE UNDERWRITING AND ADMINISTRATION SERVICES (U.S. CLS. 100, 101 AND 102).

VIVIAN MICZNIK FIRST, EXAMINING ATTORNEY

---

SN 85-339,696. ONEGATE CAPITAL, LLC, NEW YORK, NY. FILED 6-7-2011.

# ONEGATE

THE MARK CONSISTS OF STANDARD CHARACTERS WITHOUT CLAIM TO ANY PARTICULAR FONT, STYLE, SIZE, OR COLOR.

FOR FINANCIAL SERVICES, NAMELY, PRIVATE EQUITY INVESTMENT MANAGEMENT AND CONSULTING SERVICES RELATED THERETO (U.S. CLS. 100, 101 AND 102).

FIRST USE 4-0-2010; IN COMMERCE 4-0-2010.

HEATHER BIDDULPH, EXAMINING ATTORNEY

**CLASS 36—(Continued).**

SN 85-339,713. ONEGATE CAPITAL, LLC, NEW YORK, NY. FILED 6-7-2011.

# ONEGATE CAPITAL

THE MARK CONSISTS OF STANDARD CHARACTERS WITHOUT CLAIM TO ANY PARTICULAR FONT, STYLE, SIZE, OR COLOR.

NO CLAIM IS MADE TO THE EXCLUSIVE RIGHT TO USE "CAPITAL", APART FROM THE MARK AS SHOWN.

FOR FINANCIAL SERVICES, NAMELY, PRIVATE EQUITY INVESTMENT MANAGEMENT AND CONSULTING SERVICES RELATED THERETO (U.S. CLS. 100, 101 AND 102).

FIRST USE 4-0-2010; IN COMMERCE 4-0-2010.

HEATHER BIDDULPH, EXAMINING ATTORNEY

---

SN 85-339,907. NUVO BANK & TRUST COMPANY, SPRINGFIELD, MA. FILED 6-7-2011.



THE MARK CONSISTS OF AN UPPERCASE "O" DESIGN CONFIGURATION SPLIT INTO TWO HALVES RESEMBLING PARENTHESES AND HAVING ON THE OUTSIDE EDGES OF EACH HALF SYMMETRICAL TABS OR CIRCULAR PROTRUSIONS.

FOR RETAIL AND COMMERCIAL BANKING SERVICES (U.S. CLS. 100, 101 AND 102).

FIRST USE 7-1-2008; IN COMMERCE 7-1-2008.

CURTIS FRENCH, EXAMINING ATTORNEY

**CLASS 36—(Continued).**

SN 85-340,014. HARTFORD FIRE INSURANCE COMPANY, HARTFORD, CT. FILED 6-7-2011.

**The Hartford's Saver Max**

THE MARK CONSISTS OF STANDARD CHARACTERS WITHOUT CLAIM TO ANY PARTICULAR FONT, STYLE, SIZE, OR COLOR.

SEC. 2(F) AS TO "THE HARTFORD".  
FOR OFFERING, ADMINISTERING, AND UNDERWRITING OF A FIXED ANNUITY (U.S. CLS. 100, 101 AND 102).

FIRST USE 3-31-2010; IN COMMERCE 3-31-2010.  
SAIMA MAKHDOOM, EXAMINING ATTORNEY

**CLASS 36—(Continued).**

SN 85-340,399. CROSS COUNTRY HOME SERVICES, INC., FT. LAUDERDALE, FL. FILED 6-7-2011.

**SYSTEMS MD**

THE MARK CONSISTS OF STANDARD CHARACTERS WITHOUT CLAIM TO ANY PARTICULAR FONT, STYLE, SIZE, OR COLOR.

FOR PROVIDING EXTENDED WARRANTY AND HOME SERVICE CONTRACTS IN THE FIELDS OF HOME HEATING, COOLING, VENTILATION, ELECTRICAL AND PLUMBING SYSTEMS AND ON HOME APPLIANCES (U.S. CLS. 100, 101 AND 102).

LAURIE MAYES, EXAMINING ATTORNEY

SN 85-340,287. MIDFLORIDA CREDIT UNION, LAKELAND, FL. FILED 6-7-2011.

**PAY A PERSON**

THE MARK CONSISTS OF STANDARD CHARACTERS WITHOUT CLAIM TO ANY PARTICULAR FONT, STYLE, SIZE, OR COLOR.

FOR CREDIT UNION SERVICES (U.S. CLS. 100, 101 AND 102).

ANN E. SAPPENFIELD, EXAMINING ATTORNEY

SN 85-341,482. SOPHOSYNE MALTHUSIAN MANAGEMENT, LLC, NEW YORK, NY. FILED 6-8-2011.

**MALTHUSIAN**

THE MARK CONSISTS OF STANDARD CHARACTERS WITHOUT CLAIM TO ANY PARTICULAR FONT, STYLE, SIZE, OR COLOR.

FOR FUND INVESTMENT CONSULTATION; FUNDS INVESTMENT; MANAGEMENT OF A CAPITAL INVESTMENT FUND; MUTUAL FUND INVESTMENT (U.S. CLS. 100, 101 AND 102).

FIRST USE 1-30-2011; IN COMMERCE 1-30-2011.  
KATHERINE CHANG, EXAMINING ATTORNEY

SN 85-340,309. FRANCISCO JAVIER ARTALOITIA CISCOMANI, HILDAGO, C.P. 11810, MEXICO, FILED 6-7-2011.

**MONTE PROVIDENCIA**

THE MARK CONSISTS OF STANDARD CHARACTERS WITHOUT CLAIM TO ANY PARTICULAR FONT, STYLE, SIZE, OR COLOR.

THE ENGLISH TRANSLATION OF MONTE PROVIDENCIA IN THE MARK IS MOUNT PROVIDENCE.

FOR FINANCIAL GUARANTEE AND SURETY (U.S. CLS. 100, 101 AND 102).

BENJAMIN OKEKE, EXAMINING ATTORNEY

SN 85-342,236. UNITED RENTALS, INC., GREENWICH, CT. FILED 6-9-2011.

**UNITED GUARD**

THE MARK CONSISTS OF STANDARD CHARACTERS WITHOUT CLAIM TO ANY PARTICULAR FONT, STYLE, SIZE, OR COLOR.

FOR EXTENDED WARRANTY SERVICES, NAMELY, SERVICE CONTRACTS (U.S. CLS. 100, 101 AND 102).

FIRST USE 0-0-1999; IN COMMERCE 0-0-1999.  
KAREN SEVERSON, EXAMINING ATTORNEY

**CLASS 36—(Continued).**

SN 85-342,275. COMPASSION4, INC., LAKE JACKSON, TX.  
FILED 6-9-2011.

## COMPASSION4

THE MARK CONSISTS OF STANDARD CHARACTERS WITHOUT CLAIM TO ANY PARTICULAR FONT, STYLE, SIZE, OR COLOR.

FOR CHARITABLE SERVICES, NAMELY, PROVIDING FINANCIAL SUPPORT TO DISADVANTAGED INDIVIDUALS AND SMALL BUSINESSES IN OTHER COUNTRIES FOR THE PURPOSE OF FACILITATING HEALTH, WELLNESS AND ECONOMIC DEVELOPMENT (U.S. CLS. 100, 101 AND 102).

FLORENTINA BLANDU, EXAMINING ATTORNEY

SN 85-346,879. HULL & COMPANY, INC., TAMPA, FL.  
FILED 6-15-2011.



THE MARK CONSISTS OF A DESIGN OF A HUMAN FIGURE.

FOR INSURANCE UNDERWRITING, BROKERAGE AND ADMINISTRATION SERVICES IN THE FIELD OF PROPERTY AND CASUALTY (U.S. CLS. 100, 101 AND 102).

FIRST USE 0-0-1963; IN COMMERCE 0-0-1963.  
SHARON MEIER, EXAMINING ATTORNEY

SN 85-346,904. HULL & COMPANY, INC., TAMPA, FL.  
FILED 6-15-2011.

## HULL

THE MARK CONSISTS OF STANDARD CHARACTERS WITHOUT CLAIM TO ANY PARTICULAR FONT, STYLE, SIZE, OR COLOR.

FOR INSURANCE UNDERWRITING, BROKERAGE AND ADMINISTRATION SERVICES IN THE FIELD OF PROPERTY AND CASUALTY (U.S. CLS. 100, 101 AND 102).

FIRST USE 0-0-1963; IN COMMERCE 0-0-1963.  
SHARON MEIER, EXAMINING ATTORNEY

**CLASS 36—(Continued).**

SN 85-358,111. RADIAN GROUP INC., PHILADELPHIA, PA.  
FILED 6-28-2011.

## POWERPAK

THE MARK CONSISTS OF STANDARD CHARACTERS WITHOUT CLAIM TO ANY PARTICULAR FONT, STYLE, SIZE, OR COLOR.

FOR REAL ESTATE MORTGAGE INSURANCE UNDERWRITING SERVICES (U.S. CLS. 100, 101 AND 102).

LESLEY LAMOTHE, EXAMINING ATTORNEY

SN 85-359,376. RADIAN GROUP INC., PHILADELPHIA, PA.  
FILED 6-29-2011.

## MAAC

THE MARK CONSISTS OF STANDARD CHARACTERS WITHOUT CLAIM TO ANY PARTICULAR FONT, STYLE, SIZE, OR COLOR.

FOR FINANCIAL GUARANTEE AND SURETY UNDERWRITING SERVICES (U.S. CLS. 100, 101 AND 102).

LESLEY LAMOTHE, EXAMINING ATTORNEY

SN 85-360,924. ARCH CAPITAL GROUP (U.S.) INC., NEW YORK, NY. FILED 6-30-2011.

## POWERING SPECIALTY RISK SOLUTIONS

THE MARK CONSISTS OF STANDARD CHARACTERS WITHOUT CLAIM TO ANY PARTICULAR FONT, STYLE, SIZE, OR COLOR.

NO CLAIM IS MADE TO THE EXCLUSIVE RIGHT TO USE "SPECIALTY RISK SOLUTIONS", APART FROM THE MARK AS SHOWN.

FOR INSURANCE UNDERWRITING IN THE FIELDS OF PROPERTY AND CASUALTY, ERRORS AND OMISSION, ENERGY, EXECUTIVE ASSURANCE, FIDUCIARY LIABILITY, EMPLOYMENT PRACTICES LIABILITY, PROFESSIONAL LIABILITY, DIRECTORS AND OFFICERS LIABILITY, CRIME AND FIDELITY, MANAGEMENT LIABILITY, INSURANCE UNDERWRITING CONSULTING SERVICES, AND REINSURANCE UNDERWRITING SERVICES (U.S. CLS. 100, 101 AND 102).

FIRST USE 6-22-2011; IN COMMERCE 6-22-2011.  
FRANK LATTUCA, EXAMINING ATTORNEY

**CLASS 36—(Continued).**

SN 85-361,247. HARBORONE CREDIT UNION, BROCKTON, MA. FILED 6-30-2011.

**Embracing Difference**

THE MARK CONSISTS OF STANDARD CHARACTERS WITHOUT CLAIM TO ANY PARTICULAR FONT, STYLE, SIZE, OR COLOR.

FOR CREDIT UNION SERVICES; CONSUMER AND MORTGAGE LENDING SERVICES; DEPOSIT ACCOUNT SERVICES; BANKING SERVICES; INSURANCE BROKERAGE SERVICES IN THE FIELDS OF LIFE, LONG-TERM CARE AND FIXED ANNUITIES; INVESTMENT MANAGEMENT SERVICES; AND FINANCIAL PLANNING SERVICES (U.S. CLS. 100, 101 AND 102).

SOPHIA S. KIM, EXAMINING ATTORNEY

---

SN 85-361,470. IPAYMENT, INC., NASHVILLE, TN. FILED 7-1-2011.

**IADVANTAGE**

THE MARK CONSISTS OF STANDARD CHARACTERS WITHOUT CLAIM TO ANY PARTICULAR FONT, STYLE, SIZE, OR COLOR.

FOR CREDIT CARD PAYMENT PROCESSING SERVICES; MERCHANT SERVICES, NAMELY, PAYMENT TRANSACTION PROCESSING SERVICES (U.S. CLS. 100, 101 AND 102).

JASON TURNER, EXAMINING ATTORNEY

---

SN 85-361,473. IPAYMENT, INC., NASHVILLE, TN. FILED 7-1-2011.

**SOLUTIONSOURCE**

THE MARK CONSISTS OF STANDARD CHARACTERS WITHOUT CLAIM TO ANY PARTICULAR FONT, STYLE, SIZE, OR COLOR.

FOR CREDIT CARD PAYMENT PROCESSING SERVICES; MERCHANT SERVICES, NAMELY, PAYMENT TRANSACTION PROCESSING SERVICES (U.S. CLS. 100, 101 AND 102).

JASON TURNER, EXAMINING ATTORNEY

**CLASS 36—(Continued).**

SN 85-366,617. LOCASTIC, INC., CAMBRIDGE, MA. FILED 7-8-2011.

**PUNCHEY**

THE MARK CONSISTS OF STANDARD CHARACTERS WITHOUT CLAIM TO ANY PARTICULAR FONT, STYLE, SIZE, OR COLOR.

FOR MERCHANT SERVICES, NAMELY, PAYMENT TRANSACTION PROCESSING SERVICES; FINANCIAL SERVICES, NAMELY, CREDIT AND DEBIT CARD SERVICES; PRE-PAID CARD SERVICES, NAMELY, PROCESSING ELECTRONIC PAYMENTS THROUGH PREPAID CARDS, AND STORED VALUE CARD SERVICES; PREPAID STORED VALUE CARD RELOAD SERVICES; BILL PAYMENT SERVICES; FUNDS REMITTANCE SERVICES; MOBILE FINANCIAL SERVICES, NAMELY, MOBILE BANKING, PAYMENTS AND ELECTRONIC FUNDS TRANSFERS; ON-LINE FINANCIAL SERVICES, NAMELY, ONLINE BANKING AND PROVIDING FINANCIAL ACCOUNT INFORMATION; AND LOAN FINANCING AND MONEY LENDING SERVICES (U.S. CLS. 100, 101 AND 102).

PAUL MORENO, EXAMINING ATTORNEY

---

SN 85-375,025. APOLLO GROUP, INC., PHOENIX, CA. FILED 7-19-2011.

**FOCUS TO THE FINISH**

THE MARK CONSISTS OF STANDARD CHARACTERS WITHOUT CLAIM TO ANY PARTICULAR FONT, STYLE, SIZE, OR COLOR.

FOR PROVIDING EDUCATIONAL SCHOLARSHIPS AT THE POST-SECONDARY LEVEL (U.S. CLS. 100, 101 AND 102).

DEZMONA MIZELLE, EXAMINING ATTORNEY

---

SN 85-378,425. MYSTIC SEAPORT MUSEUM, INC., MYSTIC, CT. FILED 7-22-2011.

**THE 38TH VOYAGE**

THE MARK CONSISTS OF STANDARD CHARACTERS WITHOUT CLAIM TO ANY PARTICULAR FONT, STYLE, SIZE, OR COLOR.

FOR CHARITABLE FUNDRAISING; CHARITABLE FUNDRAISING TO SUPPORT RESTORATION OF AN HISTORIC WHALING SHIP (U.S. CLS. 100, 101 AND 102).

FIRST USE 6-23-2011; IN COMMERCE 6-23-2011.  
LINDA E. BLOHM, EXAMINING ATTORNEY

**CLASS 36—(Continued).**

SN 85-378,445. MYSTIC SEAPORT MUSEUM, INC., MYSTIC, CT. FILED 7-22-2011.

**SPIRIT OF AMERICAN  
ENTERPRISE**

THE MARK CONSISTS OF STANDARD CHARACTERS WITHOUT CLAIM TO ANY PARTICULAR FONT, STYLE, SIZE, OR COLOR.

FOR CHARITABLE FUNDRAISING; CHARITABLE FUNDRAISING TO SUPPORT RESTORATION OF AN HISTORIC WHALING SHIP (U.S. CLS. 100, 101 AND 102).  
FIRST USE 6-23-2011; IN COMMERCE 6-23-2011.  
LINDA E. BLOHM, EXAMINING ATTORNEY

**CLASS 36—(Continued).**

SN 85-380,135. SANTANDER CONSUMER USA, INC., DALLAS, TX. AND BANCO SANTANDER, S.A., MADRID, SPAIN, FILED 7-25-2011.

**HelpingLoan**

THE MARK CONSISTS OF STANDARD CHARACTERS WITHOUT CLAIM TO ANY PARTICULAR FONT, STYLE, SIZE, OR COLOR.

FOR FINANCIAL SERVICES, NAMELY, FINANCING AUTOMOBILE LOANS AND VEHICLE TITLE LOANS (U.S. CLS. 100, 101 AND 102).  
HEATHER THOMPSON, EXAMINING ATTORNEY

SN 85-380,075. SANTANDER CONSUMER USA, INC., DALLAS, TX. AND BANCO SANTANDER, S.A., MADRID, SPAIN, FILED 7-25-2011.

**HelpingLoan.com**

THE MARK CONSISTS OF STANDARD CHARACTERS WITHOUT CLAIM TO ANY PARTICULAR FONT, STYLE, SIZE, OR COLOR.

FOR FINANCIAL SERVICES, NAMELY, FINANCING AUTOMOBILE LOANS AND VEHICLE TITLE LOANS (U.S. CLS. 100, 101 AND 102).  
HEATHER THOMPSON, EXAMINING ATTORNEY

SN 85-381,943. SANTANDER CONSUMER USA, INC., DALLAS, TX. AND BANCO SANTANDER, S.A., MADRID, SPAIN, FILED 7-27-2011.

**HelpingLoans.com**

THE MARK CONSISTS OF STANDARD CHARACTERS WITHOUT CLAIM TO ANY PARTICULAR FONT, STYLE, SIZE, OR COLOR.

FOR FINANCIAL SERVICES, NAMELY, FINANCING AUTOMOBILE LOANS AND VEHICLE TITLE LOANS (U.S. CLS. 100, 101 AND 102).  
FIRST USE 3-1-2011; IN COMMERCE 3-1-2011.  
HEATHER THOMPSON, EXAMINING ATTORNEY

SN 85-380,118. SANTANDER CONSUMER USA, INC., DALLAS, TX. AND BANCO SANTANDER, S.A., MADRID, SPAIN, FILED 7-25-2011.

**HelpingLoans**

THE MARK CONSISTS OF STANDARD CHARACTERS WITHOUT CLAIM TO ANY PARTICULAR FONT, STYLE, SIZE, OR COLOR.

FOR FINANCIAL SERVICES, NAMELY, FINANCING AUTOMOBILE LOANS AND VEHICLE TITLE LOANS (U.S. CLS. 100, 101 AND 102).  
HEATHER THOMPSON, EXAMINING ATTORNEY

SN 85-382,993. FIRST BUSEY CORPORATION, URBANA, IL. FILED 7-27-2011.

**YOUR DREAM, OUR PROMISE**

THE MARK CONSISTS OF STANDARD CHARACTERS WITHOUT CLAIM TO ANY PARTICULAR FONT, STYLE, SIZE, OR COLOR.

FOR BANKING (U.S. CLS. 100, 101 AND 102).  
WILLIAM P. SHANAHAN, EXAMINING ATTORNEY

**CLASS 36—(Continued).**

SN 85-393,581. INDEPENDENT STOCK MARKET, DBA INDEPENDENT STOCK MARKET, BOUNTIFUL, UT. FILED 8-9-2011.

## Stop Trading. Start Investing

THE MARK CONSISTS OF STANDARD CHARACTERS WITHOUT CLAIM TO ANY PARTICULAR FONT, STYLE, SIZE, OR COLOR.

FOR ADVICE RELATING TO INVESTMENTS; AGENCIES FOR BROKERAGE OF SECURITIES TRADING IN OVERSEAS SECURITIES MARKETS AND OF TRANSACTIONS ON COMMISSION OF OVERSEAS MARKET SECURITIES FUTURES; AGENCIES OR BROKERAGE FOR TRADING OF SECURITIES, SECURITIES INDEX FUTURES, SECURITIES OPTIONS, AND OVERSEAS MARKET SECURITIES FUTURES; BROKERAGE HOUSES IN THE FIELD OF STOCKS, COMMODITIES, AND FUTURES; BROKERAGE OF SHARES OR STOCKS AND OTHER SECURITIES; BROKERAGE SERVICES FOR STOCKS AND BONDS; ELECTRONIC FINANCIAL TRADING SERVICES; FINANCIAL ADMINISTRATION OF STOCK EXCHANGE TRADING OF SHARES AND OTHER FINANCIAL SECURITIES IN FINANCIAL MARKETS; FINANCIAL AND INVESTMENT SERVICES, NAMELY, MANAGEMENT AND BROKERAGE IN THE FIELDS OF STOCKS, BONDS, OPTIONS, COMMODITIES, FUTURES AND OTHER SECURITIES, AND THE INVESTMENT OF FUNDS OF OTHERS; FINANCIAL INVESTMENT BROKERAGE; FINANCIAL INVESTMENT BROKERAGE SERVICES; FINANCIAL PLANNING AND INVESTMENT ADVISORY SERVICES; FINANCIAL SERVICES IN THE NATURE OF AN INVESTMENT SECURITY; FINANCIAL SERVICES, NAMELY, ADMINISTRATION OF TRANSACTIONS INVOLVING FUNDS DRAWN FROM SECURITIES, STOCKS, FUNDS, EQUITIES, BONDS, CASH, OR OTHER TYPES OF FINANCIAL INVESTMENTS IN RETIREMENT PLANS USING A CHECK OR NEGOTIABLE ORDER OF WITHDRAWAL OVER A GLOBAL DATA NETWORK; FINANCIAL SERVICES, NAMELY, DEALING IN SECURITIES AS A MARKET MAKER AND IN TRADING COMMODITIES, SECURITIES, OPTIONS, FUTURES, EQUITIES AND FIXED INCOME PRODUCTS IN THE U.S. AND OVERSEAS MARKET SECURITIES; INVESTMENT BROKERAGE; INVESTMENT BY ELECTRONIC MEANS; INVESTMENT CLUBS; LEVERAGED BUY OUTS AND INVESTMENTS IN FINANCIALLY DISTRESSED OR UNDERPERFORMING COMPANIES; ON-LINE TRADING OF FINANCIAL INSTRUMENTS, SHARES, OPTIONS AND OTHER DERIVATIVE PRODUCTS; ON-LINE TRADING OF OPTIONS ON THE OPTIONS EXCHANGE MARKET; ORGANIZATION OF ONLINE STOCK EXCHANGES FOR THE BENEFIT OF THE TRADE OF STOCKS AND OTHER FINANCIAL SECURITIES; ORGANIZATION OF STOCK EXCHANGES FOR THE BENEFIT OF THE TRADE OF STOCKS AND OTHER FINANCIAL VALUES; PROVIDING A WEB SITE WHERE USERS CAN POST RATINGS, REVIEWS AND RECOMMENDATIONS ON STOCKS, BONDS, MUTUAL FUNDS AND OTHER FINANCIAL INSTRUMENTS; PROVIDING AN ON-LINE COMPUTER DATABASE IN THE FIELD OF STOCK/SECURITIES MARKET INFORMATION; PROVIDING INFORMATION AND RESEARCH IN THE FIELD OF FINANCE AND FINANCIAL INVESTMENTS; PROVIDING INFORMATION IN THE FIELD OF FINANCIAL STOCK AND EQUITY MARKETS; PROVIDING STOCK MARKET INFORMATION; PROVISION OF A FINANCIAL EXCHANGE FOR THE TRADING OF SECURITIES, SHARES AND OPTIONS AND OTHER DERIVATIVE PRODUCTS; STOCK EXCHANGE INFORMATION SERVICES; STOCK EXCHANGE QUOTATION AND LISTING SERVICES; TRADING IN SECURITIES (U.S. CLS. 100, 101 AND 102).

FIRST USE 6-17-2011; IN COMMERCE 6-17-2011.  
ALICE BENMAMAN, EXAMINING ATTORNEY

**CLASS 36—(Continued).**

SN 85-393,800. CLARITY IN NUMBERS, LLC, CHICAGO, IL. FILED 8-9-2011.

## TOP LAW

THE MARK CONSISTS OF STANDARD CHARACTERS WITHOUT CLAIM TO ANY PARTICULAR FONT, STYLE, SIZE, OR COLOR.

NO CLAIM IS MADE TO THE EXCLUSIVE RIGHT TO USE "LAW", APART FROM THE MARK AS SHOWN.

FOR ACTUARIAL SERVICES; FINANCIAL ADMINISTRATION OF RETIREMENT PLANS (U.S. CLS. 100, 101 AND 102).

IRA J. GOODSaid, EXAMINING ATTORNEY

SN 85-393,805. CLARITY IN NUMBERS, LLC, CHICAGO, IL. FILED 8-9-2011.

## TOP MD

THE MARK CONSISTS OF STANDARD CHARACTERS WITHOUT CLAIM TO ANY PARTICULAR FONT, STYLE, SIZE, OR COLOR.

NO CLAIM IS MADE TO THE EXCLUSIVE RIGHT TO USE "MD", APART FROM THE MARK AS SHOWN.

FOR ACTUARIAL SERVICES; FINANCIAL ADMINISTRATION OF RETIREMENT PLANS (U.S. CLS. 100, 101 AND 102).

IRA J. GOODSaid, EXAMINING ATTORNEY

SN 85-393,807. CLARITY IN NUMBERS, LLC, CHICAGO, IL. FILED 8-9-2011.

## TOP PROFESSIONAL

THE MARK CONSISTS OF STANDARD CHARACTERS WITHOUT CLAIM TO ANY PARTICULAR FONT, STYLE, SIZE, OR COLOR.

NO CLAIM IS MADE TO THE EXCLUSIVE RIGHT TO USE "PROFESSIONAL", APART FROM THE MARK AS SHOWN.

FOR ACTUARIAL SERVICES; FINANCIAL ADMINISTRATION OF RETIREMENT PLANS (U.S. CLS. 100, 101 AND 102).

IRA J. GOODSaid, EXAMINING ATTORNEY



**CLASS 36—(Continued).**

SN 85-393,812. CLARITY IN NUMBERS, LLC, CHICAGO, IL. FILED 8-9-2011.

**TOP DENTIST**

THE MARK CONSISTS OF STANDARD CHARACTERS WITHOUT CLAIM TO ANY PARTICULAR FONT, STYLE, SIZE, OR COLOR.

NO CLAIM IS MADE TO THE EXCLUSIVE RIGHT TO USE "DENTIST", APART FROM THE MARK AS SHOWN.

FOR ACTUARIAL SERVICES; FINANCIAL ADMINISTRATION OF RETIREMENT PLANS (U.S. CLS. 100, 101 AND 102).

IRA J. GOODSaid, EXAMINING ATTORNEY

---

SN 85-394,108. SMILE BRANDS INC., IRVINE, CA. FILED 8-10-2011.

**SMILES FOR EVERYONE**

THE MARK CONSISTS OF STANDARD CHARACTERS WITHOUT CLAIM TO ANY PARTICULAR FONT, STYLE, SIZE, OR COLOR.

FOR FINANCIAL SERVICES, NAMELY, ADMINISTERING RETAIL INSTALLMENT CONTRACTS (U.S. CLS. 100, 101 AND 102).

JOHN DALIER, EXAMINING ATTORNEY

**CLASS 37—CONSTRUCTION AND REPAIR**

SN 76-707,678. MULCHING MANIA, LLC, LITTLE FALLS, MN. FILED 5-20-2011.

**MULCHING MANIA**

NO CLAIM IS MADE TO THE EXCLUSIVE RIGHT TO USE "MULCHING", APART FROM THE MARK AS SHOWN.

FOR BRUSH AND LAND CLEARING SERVICES, STUMP AND BRUSH REMOVAL, FOOD PLOTTING, AND PROPERTY LINES CLEARING (U.S. CLS. 100, 103 AND 106).

FIRST USE 3-1-2010; IN COMMERCE 3-1-2010.  
ODESSA BIBBINS, EXAMINING ATTORNEY

**CLASS 37—(Continued).**

SN 77-622,489. HANDY DAN, INC., LAS VEGAS, NV. FILED 11-26-2008.



THE MARK CONSISTS OF THE WORDING "HANDY DAN" IN STYLIZED FONT WITH DESIGN ELEMENTS. THE LETTER "H" INCLUDES THE DESIGN OF A HAMMER. THE LOWER PORTION OF LETTER "Y" CURVES TO BECOME A HOSE OR PIPE ENDING WITH A DRIPPING SPIGOT. TO THE RIGHT OF THE WORDING IS A STYLIZED REPRESENTATION OF A MAN IN WORK CLOTHES AND HARD HAT HOLDING A PAINT ROLLER AND A POWER DRILL. THE CORD OF WHICH EXTENDS TO AN OUTLET WITHIN THE LETTER "A" IN "DAN".

FOR BUILDING REPAIR AND MAINTENANCE SERVICES FOR RESIDENTIAL AND COMMERCIAL STRUCTURES (U.S. CLS. 100, 103 AND 106).

FIRST USE 1-1-2007; IN COMMERCE 1-1-2007.  
STEVEN PEREZ, EXAMINING ATTORNEY

---

SN 77-963,947. GREAN GEAR BICYCLE CENTER LLC, ALISO VIEJO, CA. FILED 3-19-2010.

**GREEN GEAR BICYCLE CENTER**

THE MARK CONSISTS OF STANDARD CHARACTERS WITHOUT CLAIM TO ANY PARTICULAR FONT, STYLE, SIZE, OR COLOR.

NO CLAIM IS MADE TO THE EXCLUSIVE RIGHT TO USE "BICYCLE CENTER", APART FROM THE MARK AS SHOWN.

FOR REPAIR AND MAINTENANCE OF BICYCLES FOR OTHERS (U.S. CLS. 100, 103 AND 106).

FIRST USE 7-1-2009; IN COMMERCE 10-15-2009.  
JAY FLOWERS, EXAMINING ATTORNEY

**CLASS 37—(Continued).**

SN 85-169,293. MAC WINDOW SYSTEMS, LLC, FAIRFIELD, NJ. FILED 11-4-2010.



THE COLOR(S) YELLOW, BLACK, WHITE AND BLUE IS/ARE CLAIMED AS A FEATURE OF THE MARK.

THE MARK CONSISTS OF THE WORDS "DOORS2FIT.COM" IN BLACK LETTERS, WITH THE "T" IN THE WORD "FIT" HAS AN ARROW POINTING TO THE RIGHT, LOCATED ABOVE THE WORD "COM". THE WORDS ARE CONTAINED WITHIN A RECTANGULAR BOX, THE TOP OF THE BOX IS SHADED IN WHITE, THE REMAINING RECTANGLE IS SHADED IN YELLOW. THE RECTANGLE IS OUTLINED IN BLACK AND SET ON A ROYAL BLUE BACKGROUND.

FOR INSTALLATION OF INTERIOR DOORS, EXTERIORS DOORS, CLOSET DOORS, FRENCH DOORS, WOOD DOORS, GLASS DOORS, BIFOLD DOORS, SLIDING DOORS, HARDWARE AND WINDOWS (U.S. CLS. 100, 103 AND 106).

FIRST USE 6-1-2009; IN COMMERCE 9-1-2009.  
KEVON CHISOLM, EXAMINING ATTORNEY

SN 85-198,579. M. LEUZZI, JR. & V. LEUZZI CEMENT CONTRACTORS, LLC, PHILADELPHIA, PA. FILED 12-15-2010.

THE NAME "MARK LEUZZI" IDENTIFIES A LIVING INDIVIDUAL WHOSE CONSENT IS OF RECORD.

THE COLOR(S) RED IS/ARE CLAIMED AS A FEATURE OF THE MARK.

THE MARK CONSISTS OF THE WORD MARK WITH A BACKWARD LETTER "K" ABOVE THE WORDS "LEUZZI & SONS", ALL IN THE COLOR RED.

FOR CONSTRUCTION AND INSTALLATION OF MASONRY WALLS AND STRUCTURES; CONSTRUCTION SERVICES, NAMELY, CONCRETE PAVING, SITE CLEARING, EXCAVATION, PAD PREPARATION, GRADING, AND ASPHALT PAVING SERVICES; MASONRY SERVICES; PAVING CONTRACTOR SERVICES (U.S. CLS. 100, 103 AND 106).

FIRST USE 0-0-1990; IN COMMERCE 0-0-1990.  
ANNE MADDEN, EXAMINING ATTORNEY

**CLASS 37—(Continued).**

SN 85-207,194. MARCK INDUSTRIES INC, CASSVILLE, MO. FILED 12-29-2010.



NO CLAIM IS MADE TO THE EXCLUSIVE RIGHT TO USE "GREEN", "RECYCLING", "417-RECYCLE" AND "417-732-9253", APART FROM THE MARK AS SHOWN.

THE COLOR(S) GREEN, BLACK, AND WHITE IS/ARE CLAIMED AS A FEATURE OF THE MARK.

THE MARK CONSISTS OF A STYLIZED MONSTER FACE IN GREEN WITH LARGE EYES WITH BLACK PUPILS AND WHITE IRIS ON A GREEN BACKGROUND. AT THE TOP OF THE HEAD IS A BAND IN BLACK AND UNDERNEATH A WHITE WAVY LINE. THERE IS A SPEECH BUBBLE IN THE UPPER LEFT WITH THE WORDING "ME LIKE ALL PAPER." BELOW THE GREEN FACE SURROUNDED BY STYLIZED WHITE TEETH IS THE WORDING FEED THE GREEN MONSTER WITH THE WORDING FEED THE MONSTER IN BLACK AND THE WORD GREEN IN THE COLOR GREEN. BELOW THAT WORDING IS MARCK RECYCLING IN BLACK, AND 417-RECYCLE AND WWW.MARCK.NET IN BLACK WITH THE TELEPHONE NUMBER (417-732-9253) IN GREEN.

FOR PAPER AND CARDBOARD COLLECTION FOR RECYCLING (U.S. CLS. 100, 103 AND 106).

FIRST USE 10-1-2010; IN COMMERCE 10-1-2010.  
LESLEY LAMOTHE, EXAMINING ATTORNEY

SN 85-207,618. MARCK INDUSTRIES INC, CASSVILLE, MO. FILED 12-29-2010.



NO CLAIM IS MADE TO THE EXCLUSIVE RIGHT TO USE "GREEN", "RECYCLING", "417-RECYCLE" AND "417-732-9253", APART FROM THE MARK AS SHOWN.

THE COLOR(S) GREEN, BLACK, WHITE, GOLDEN YELLOW, RED IS/ARE CLAIMED AS A FEATURE OF THE MARK.

THE MARK CONSISTS OF A STYLIZED MOUTH IN BLACK WITH WHITE TEETH ON A GREEN BACKGROUND WITH A SPEECH BUBBLE ON THE LEFT WITH THE WORDING "ME LIKE ALL PAPER". BELOW IS A WHITE JAGGED CIRCLE INSIDE OF WHICH IS THE

**CLASS 37—(Continued).**

WORDING "FEED THE GREEN MONSTER" WITH THE WORDING "FEED THE MONSTER" IN BLACK AND THE WORD "GREEN" IN THE COLOR GREEN. TO THE RIGHT OF THAT IS A SMALL GOLDEN YELLOW CREATURE OUTLINED IN BLACK WITH BLACK FEET WITH A RED MOUTH OUTLINED IN BLACK POINTING UP. BELOW THAT IS THE WORDING "MARCK RECYCLING 417-RECYCLE WWW.MARCK.NET" IN WHITE AND BELOW THAT THE TELEPHONE NUMBER "(417-732-9253)" IN BLACK.

FOR PAPER AND CARDBOARD COLLECTION FOR RECYCLING (U.S. CLS. 100, 103 AND 106).

FIRST USE 10-1-2010; IN COMMERCE 10-1-2010.  
LESLEY LAMOTHE, EXAMINING ATTORNEY

SN 85-207,628. MARCK INDUSTRIES INC, CASSVILLE, MO.  
FILED 12-29-2010.



NO CLAIM IS MADE TO THE EXCLUSIVE RIGHT TO USE "GREEN", "RECYCLING", "417-RECYCLE" AND "417-732-9253", APART FROM THE MARK AS SHOWN.

THE COLOR(S) GREEN, BLACK, WHITE, LIME GREEN, RED IS/ARE CLAIMED AS A FEATURE OF THE MARK.

THE MARK CONSISTS OF A STYLIZED MOUTH IN BLACK WITH WHITE TEETH ON A GREEN BACKGROUND WITH A SPEECH BUBBLE ON THE LEFT WITH THE WORDING "ME LIKE ALL PAPER". BELOW IS A WHITE JAGGED CIRCLE INSIDE OF WHICH IS THE WORDING "FEED THE GREEN MONSTER" WITH THE WORDING "FEED THE MONSTER" IN BLACK AND THE WORD "GREEN" IN THE COLOR GREEN. TO THE RIGHT OF THAT IS A SMALL LIME GREEN HORNED CREATURE OUTLINED IN BLACK WITH BLACK FEET AND A RED MOUTH WITH TWO WHITE FANGS WITH ITS LEFT ARM POINTING UP. BELOW THAT IS THE WORDING "MARCK RECYCLING 417-RECYCLE WWW.MARCK.NET" IN WHITE AND BELOW THAT THE TELEPHONE NUMBER "(417-732-9253)" IN BLACK.

FOR PAPER AND CARDBOARD COLLECTION FOR RECYCLING (U.S. CLS. 100, 103 AND 106).

FIRST USE 10-1-2010; IN COMMERCE 10-1-2010.  
LESLEY LAMOTHE, EXAMINING ATTORNEY

SN 85-208,490. MARYLAND MOBILITY LIFTS, LLC, FORMERLY MARYLAND MOBILITY SOLUTIONS, LLC, OWINGS, MD. FILED 12-31-2010.



NO CLAIM IS MADE TO THE EXCLUSIVE RIGHT TO USE "MOBILITY LIFTS", APART FROM THE MARK AS SHOWN.

THE MARK CONSISTS OF THE STYLIZED TEXT "MOBILITY LIFTS" WHEREIN THE WORD "MOBILITY" APPEARS IN LARGE STYLIZED TEXT WITH THE LETTER

**CLASS 37—(Continued).**

"O" OVERLAPPING THE LETTERS "M" AND "B" AND THE LETTERS ARE SEPARATED BY A THIN WHITE SPACE TO DIFFERENTIATE THE LETTERS; THE FIRST LETTER "I" HAS AN ARROWHEAD AT THE BOTTOM OF THE LETTER WHICH EXTENDS BELOW THE REST OF THE TEXT; THE LETTER "L" HAS AN ARROWHEAD EXTENDING FROM THE RIGHT END OF THE BOTTOM OF THE LETTER WHERE THE ARROWHEAD EXTENDS INTO THE BASE OF THE LETTER "T"; THE SECOND LETTER "I" HAS ITS BOTTOM RESTING ON THE TOP OF THE LETTER "L" AND THE TOP OF THE SECOND LETTER "I" HAS AN ARROWHEAD WHICH EXTENDS ABOVE THE REST OF THE TEXT; THE LETTERS "T" AND "Y" ARE JOINED TOGETHER AT THE TOP SO THAT THE TOP OF THE LETTER "T" FLOWS INTO THE TOP OF THE LETTER "Y" WITH NO SEPARATION BETWEEN; THE WORD "LIFTS" APPEARS IN A SUBSTANTIALLY SMALLER STYLIZED TEXT BELOW THE WORD "MOBILITY" SUCH THAT THE BEGINNING OF THE WORD "LIFTS" BEGINS AT THE BASE OF THE LETTER "T" AND ENDS AT THE BASE OF THE LETTER "Y".

FOR INSTALLATION AND REPAIR OF EQUIPMENT DESIGNED TO ASSIST INDIVIDUALS WHO REQUIRE ASSISTANCE WITH MOBILITY WITHIN AND ABOUT THEIR HOMES; INSTALLATION OF TRAMS, WHEELCHAIR LIFTS, RAMPS, AND STRAIGHT AND CURVED STAIRLIFTS (U.S. CLS. 100, 103 AND 106).

FIRST USE 7-15-2011; IN COMMERCE 7-15-2011.  
LINDA ESTRADA, EXAMINING ATTORNEY

SN 85-212,572. SIGNATURE FLIGHT SUPPORT UK REGIONS, LUTON, BEDFORDSHIRE, UNITED KINGDOM, FILED 1-7-2011.



OWNER OF U.S. REG. NOS. 1,998,482 AND 2,032,400.

NO CLAIM IS MADE TO THE EXCLUSIVE RIGHT TO USE "AIRCRAFT MAINTENANCE", APART FROM THE MARK AS SHOWN.

THE MARK CONSISTS OF A PARTIAL CIRCLE WITH AN X IN THE MIDDLE SHOWN ON THE LEFT HAND SIDE OF THE WORDS "SIGNATURE TECHNICAIR AIRCRAFT MAINTENANCE".

FOR MAINTENANCE AND REPAIR OF AIRCRAFT (U.S. CLS. 100, 103 AND 106).

ALEXANDER L. POWERS, EXAMINING ATTORNEY

**CLASS 37—(Continued).**

SN 85-231,083. KONICA MINOLTA MEDICAL & GRAPHIC, INC., HINO, TOKYO, JAPAN, FILED 2-1-2011.

**AEROREMOTE**

THE MARK CONSISTS OF STANDARD CHARACTERS WITHOUT CLAIM TO ANY PARTICULAR FONT, STYLE, SIZE, OR COLOR.

FOR REMOTE MAINTENANCE AND REPAIR OF X-RAY APPARATUS AND INSTRUMENTS USED FOR MEDICAL DIAGNOSTIC PURPOSES, AND THEIR PERIPHERAL DEVICES; REMOTE MAINTENANCE AND REPAIR OF COMPUTED RADIOGRAPHY SYSTEMS; REMOTE MAINTENANCE AND REPAIR OF DIGITAL RADIOGRAPHY SYSTEMS; REMOTE MAINTENANCE AND REPAIR OF INTENSIFYING SCREENS FOR X-RAY FILMS USED FOR MEDICAL X-RAY APPARATUS (U.S. CLS. 100, 103 AND 106).

DEBRA LEE, EXAMINING ATTORNEY

SN 85-265,892. SERVE MANAGEMENT GROUP, INC., CUMMING, GA. FILED 3-14-2011.

**MISSION SERVE**

THE MARK CONSISTS OF STANDARD CHARACTERS WITHOUT CLAIM TO ANY PARTICULAR FONT, STYLE, SIZE, OR COLOR.

OWNER OF U.S. REG. NOS. 3,247,365, 3,247,367 AND 3,247,372.

FOR CHARITABLE SERVICES, NAMELY, RENOVATING HOMES FOR LOW INCOME FAMILIES (U.S. CLS. 100, 103 AND 106).

FIRST USE 10-0-2005; IN COMMERCE 10-0-2005.  
RONALD DELGIZZI, EXAMINING ATTORNEY

SN 85-291,941. KAB MANAGEMENT CONSULTANTS, INC., DBA GADGET GURU, OWINGS MILLS, MD. FILED 4-11-2011.

**GADGET GURU**

THE MARK CONSISTS OF STANDARD CHARACTERS WITHOUT CLAIM TO ANY PARTICULAR FONT, STYLE, SIZE, OR COLOR.

NO CLAIM IS MADE TO THE EXCLUSIVE RIGHT TO USE "GADGET", APART FROM THE MARK AS SHOWN.

FOR INSTALLATION, MAINTENANCE AND REPAIR OF CELL PHONE RELATED HARDWARE; REPAIR OF GAME MACHINES AND APPARATUS (U.S. CLS. 100, 103 AND 106).

FIRST USE 4-11-2011; IN COMMERCE 4-11-2011.  
LESLIE RICHARDS, EXAMINING ATTORNEY

**CLASS 37—(Continued).**

SN 85-295,840. UTSTARCOM, INC., ALAMEDA, CA. FILED 4-14-2011.



OWNER OF U.S. REG. NOS. 3,257,655, 3,259,483 AND 3,406,764.

THE MARK CONSISTS OF THE LETTERS "UT" IN AN INCOMPLETE CIRCLE, FOLLOWED BY THE LETTERS "STARCOM", WITH THE OPEN SPACE IN THE LETTER "A" REPRESENTED BY A FOUR-POINTED STAR.

THE WORDING "UTSTARCOM" HAS NO MEANING IN A FOREIGN LANGUAGE.

FOR INSTALLATION, MAINTENANCE AND REPAIR OF COMPUTER HARDWARE; INSTALLATION, MAINTENANCE AND REPAIR OF ETHERNET AND WIRELESS NETWORKING HARDWARE; MAINTENANCE AND REPAIR OF TELECOMMUNICATIONS NETWORKING HARDWARE, APPARATUS, AND INSTRUMENTS; TELEPHONE INSTALLATION AND REPAIR (U.S. CLS. 100, 103 AND 106).

ALLISON HOLTZ, EXAMINING ATTORNEY

SN 85-302,419. OIL CHANGER, PLEASANTON, CA. FILED 4-22-2011.



NO CLAIM IS MADE TO THE EXCLUSIVE RIGHT TO USE "OIL CHANGERS", APART FROM THE MARK AS SHOWN.

THE MARK CONSISTS OF THE STYLIZED WORDING "OIL CHANGERS 3000". THE WORDING "OIL CHANGERS" IS UNDERSCORED BY PARALLEL LINES CURVING BACK UPON THEMSELVES FROM LEFT TO RIGHT. THE WORDING "3000" IS DEPICTED AS A VEHICLE ODOMETER.

FOR AUTOMOTIVE MAINTENANCE AND REPAIR; REPAIR AND MAINTENANCE OF VEHICLES; REPAIR OR MAINTENANCE OF AUTOMOBILES (U.S. CLS. 100, 103 AND 106).

FIRST USE 1-1-1997; IN COMMERCE 1-1-1997.

CIMMERIAN COLEMAN, EXAMINING ATTORNEY

**CLASS 37—(Continued).**

SN 85-314,049. DAVID CAVILL, SEMINOLE, FL. FILED 5-6-2011.

**Renewit! Don't Replace It!  
Fall In Love With Your Car  
All Over Again!**

THE MARK CONSISTS OF STANDARD CHARACTERS WITHOUT CLAIM TO ANY PARTICULAR FONT, STYLE, SIZE, OR COLOR.

FOR VEHICLE PAINTING (U.S. CLS. 100, 103 AND 106).

FIRST USE 1-12-1992; IN COMMERCE 1-12-1992.  
TINA MAI, EXAMINING ATTORNEY

---

SN 85-316,629. CAVALIER CONSTRUCTION, LLC, AKA VETCON, GEORGETOWN, TX. FILED 5-10-2011.

**Customer First Construction**

THE MARK CONSISTS OF STANDARD CHARACTERS WITHOUT CLAIM TO ANY PARTICULAR FONT, STYLE, SIZE, OR COLOR.

NO CLAIM IS MADE TO THE EXCLUSIVE RIGHT TO USE "CONSTRUCTION", APART FROM THE MARK AS SHOWN.

FOR CLIENT FOCUSED PROFESSIONAL COMMERCIAL CONSTRUCTION PROJECT MANAGEMENT SERVICES (U.S. CLS. 100, 103 AND 106).

FIRST USE 2-19-2011; IN COMMERCE 2-19-2011.  
TIMOTHY FINNEGAN, EXAMINING ATTORNEY

---

SN 85-316,685. NARDON, RAFFAEL, MIAMI, FL. FILED 5-10-2011.

**MADAM PLUS**

THE MARK CONSISTS OF STANDARD CHARACTERS WITHOUT CLAIM TO ANY PARTICULAR FONT, STYLE, SIZE, OR COLOR.

FOR MAID SERVICES, REAL ESTATE PROPERTY CLEANING, REPAIR AND MAINTENANCE SERVICES (U.S. CLS. 100, 103 AND 106).

CIMMERIAN COLEMAN, EXAMINING ATTORNEY

**CLASS 37—(Continued).**

SN 85-317,005. MCM CUSTOM VEHICLES, LLC, TRUSSVILLE, AL. FILED 5-10-2011.

**MCX**

THE MARK CONSISTS OF STANDARD CHARACTERS WITHOUT CLAIM TO ANY PARTICULAR FONT, STYLE, SIZE, OR COLOR.

FOR AUTOMOBILE AND TRUCK CONVERSION IN THE NATURE OF SPECIALTY AUTOMOTIVE EQUIPMENT INSTALLATION, CUSTOMIZATION AND ACCESSORY INSTALLATION SERVICES; AUTOMOBILE PAINTING, NAMELY, CUSTOM DESIGNED AUTOMOBILE PAINT SCHEMES (U.S. CLS. 100, 103 AND 106).

FIRST USE 3-16-2009; IN COMMERCE 3-16-2009.  
SHANNON TWOHIG, EXAMINING ATTORNEY

---

SN 85-317,687. CLEAN FACILITIES GROUP, INC., WALTHAM, MA. FILED 5-11-2011.



NO CLAIM IS MADE TO THE EXCLUSIVE RIGHT TO USE "CLEAN FACILITIES GROUP, INC.", APART FROM THE MARK AS SHOWN.

THE COLOR(S) GREEN, BLUE AND WHITE IS/ARE CLAIMED AS A FEATURE OF THE MARK.

THE MARK CONSISTS OF A CIRCLE IN BLUE AND GREEN WHICH CONTAINS THE STYLIZED LETTERS "CFG" IN WHITE. A CURVED LINE IN WHITE APPEARS TO GO THROUGH THE LETTER "G". FOUR INTERSECTING LINES IN WHITE FORM AN EIGHT POINTED STAR WHICH TOUCHES THE TOP OF THE CURVED LINE AND APPEARS TO THE RIGHT OF THE LETTER "C" IN "CFG". TO THE RIGHT OF THE CIRCLE ARE THE BLUE STYLIZED WORDS "CLEAN FACILITIES GROUP INC." ABOVE A GREEN LINE.

FOR BUILDING MAINTENANCE AND REPAIR; JANITORIAL SERVICES; LAUNDRY SERVICES (U.S. CLS. 100, 103 AND 106).

NELSON SNYDER, EXAMINING ATTORNEY

**CLASS 37—(Continued).**

SN 85-317,823. NESTORE, ROBERT, DBA DCCS DAYCARE CLEANING SERVICES, MARLTON, NJ. FILED 5-11-2011.



NO CLAIM IS MADE TO THE EXCLUSIVE RIGHT TO USE "DAYCARE CLEANING SERVICES" AND "HEALTHCARE CLEANING FOR SCHOOLS", APART FROM THE MARK AS SHOWN.

THE MARK CONSISTS OF A DEPICTION OF THE WORLD GLOBE, WITH THE LETTERS "DCCS" IMPOSED IN THE PACIFIC OCEAN AREA, ALSO CONTAINING THE WORD "DAYCARE" ABOVE A HORIZONTAL LINE, BELOW WHICH APPEAR THE WORDS "CLEANING SERVICES HEALTHCARE CLEANING FOR SCHOOLS".

FOR JANITORIAL SERVICES (U.S. CLS. 100, 103 AND 106).

ELI HELLMAN, EXAMINING ATTORNEY

SN 85-318,309. MAALOUF, KARLO G, DBA MR. ANTENNA, LAS VEGAS, NV. FILED 5-11-2011.

## Mr. Antenna

THE MARK CONSISTS OF STANDARD CHARACTERS WITHOUT CLAIM TO ANY PARTICULAR FONT, STYLE, SIZE, OR COLOR.

NO CLAIM IS MADE TO THE EXCLUSIVE RIGHT TO USE "ANTENNA", APART FROM THE MARK AS SHOWN.

FOR ANTENNA INSTALLATION AND REPAIR (U.S. CLS. 100, 103 AND 106).

FIRST USE 1-29-2011; IN COMMERCE 1-29-2011.

PAM WILLIS, EXAMINING ATTORNEY

SN 85-320,469. THE CAMBER GROUP CONSULTANTS, LLC, NEW BERLIN, WI. FILED 5-13-2011.



NO CLAIM IS MADE TO THE EXCLUSIVE RIGHT TO USE "GROUP", APART FROM THE MARK AS SHOWN.

THE COLOR(S) DARK YELLOW, MAROON, DARK BLUE, AND FOREST GREEN IS/ARE CLAIMED AS A FEATURE OF THE MARK.

THE MARK CONSISTS OF THE WORDS THE CAMBER GROUP, IN DARK BLUE, CENTERED VERTICALLY BETWEEN TWO DARK BLUE HORIZONTAL LINES, IS RIGHT-JUSTIFIED BEGINNING AT LEFT OF CENTER OF A 4-CRESCENT SPIRAL AND THE WORDS THE CAMBER GROUP OVERLAY THE 4-CRESCENT SPIRAL SO THAT THE 4-CRESCENT SPIRAL IS NOT SEEN IN THE AREAS OF OVERLAP; THE WORDS THE CAMBER GROUP

**CLASS 37—(Continued).**

ARE IN ALL-CAPS WITH THE FIRST-LETTER "C" OF CAMBER AND "G" OF GROUP SLIGHTLY LARGER THAN THE REST OF THE TEXT; THE "U" IN THE WORD "GROUP" IS AN ASYMMETRIC DARK YELLOW PARABOLA WITH THE RIGHT SIDE HIGHER THAN THE LEFT SIDE WHILE BOTH POINTS OF THE "U" ARE CAPPED WITH SMALL HORIZONTAL LINES VISUALLY SIMILAR TO SERIFS; THE 4-CRESCENT SPIRAL HAS AN ELLIPTICAL CENTER AND IS ARRANGED TO FORM A CLOCKWISE SPIRAL CENTERED TO THE LEFT OF THE WORDS THE CAMBER GROUP; THE FIRST CRESCENT IS DARK YELLOW, IS PREDOMINANTLY SYMMETRIC, LIES ABOVE THE VERTICAL CENTER OF THE DESIGN, AND IS ORIENTATED SO THAT THE CRESCENT, WITH HORNS LOWER THAN THE CENTER CURVE, TILTS UPWARD FROM LEFT-TO-RIGHT AT A 45 DEGREE ANGLE SO THAT THE LEFT HORN ENDS AT HORIZONTAL CENTER OF THE DESIGN WHILE THE RIGHT HORN ENDS AT THE VERTICAL CENTER OF THE MIDPOINT BETWEEN THE HORIZONTAL CENTER AND THE TOP OF THE DESIGN; THE SECOND CRESCENT IS MAROON, ASYMMETRIC WITH THE LOWER HORN LONGER THAN THE UPPER HORN, AND IS ORIENTATED SO THE LEFT HORN ENDS AT BELOW THE CENTER OF THE DARK YELLOW CRESCENT WHILE THE RIGHT HORN ENDS JUST BELOW THE MIDPOINT BETWEEN THE VERTICAL CENTER AND THE BOTTOM OF THE DESIGN; THE THIRD CRESCENT IS DARK BLUE, LIES BELOW THE VERTICAL CENTER OF THE DESIGN, IS PREDOMINANTLY SYMMETRIC AND MIRRORS THE DARK YELLOW CRESCENT IN SHAPE WHILE BEING INVERTED RELATIVE TO THE DARK YELLOW CRESCENT, AND IS ORIENTATED SO THE CRESCENT TILTS AT A 45 DEGREE ANGLE SO THAT THE RIGHT HORN ENDS TO THE LEFT OF THE MAROON CRESCENT CURVE CENTER AND SO THAT THE LEFT HORN ENDS A SMALL DISTANCE FROM THE LEFT EDGE OF THE DESIGN AND VERTICALLY POSITIONED AT THE FIRST THIRD BELOW THE VERTICAL CENTER OF THE DESIGN; THE FOURTH CRESCENT IS FOREST GREEN, ASYMMETRIC WITH THE UPPER HORN LONGER THAN THE LOWER HORN, MIRRORS THE MAROON CRESCENT IN SHAPE WHILE INVERTED RELATIVE TO THE MAROON CRESCENT, AND IS ORIENTATED SO THE UPPER HORN ENDS ABOVE THE DARK YELLOW CRESCENT, JUST ABOVE THE MIDPOINT BETWEEN THE VERTICAL CENTER AND THE TOP OF THE DESIGN.

FOR CONSTRUCTION MANAGEMENT SERVICES, NAMELY, CONSTRUCTION PLANNING AND CONSTRUCTION SUPERVISION FOR EDUCATION, HEALTHCARE, HOSPITALITY, OFFICE AND MIXED-USE CONSTRUCTION; CONSTRUCTION CONSULTATION SERVICES; CONSTRUCTION MANAGEMENT SERVICES FOR SOLAR AND WIND PROJECTS; CONSULTING SERVICES IN THE FIELD OF INSTALLATION FOR GEOTHERMAL HEAT PUMP TECHNOLOGY (U.S. CLS. 100, 103 AND 106).

FIRST USE 5-3-2010; IN COMMERCE 5-3-2010.

JAY FLOWERS, EXAMINING ATTORNEY



**CLASS 37—(Continued).**

SN 85-321,584. NARPRO, LLC, SCOTTSDALE, AZ. FILED 5-16-2011.



NO CLAIM IS MADE TO THE EXCLUSIVE RIGHT TO USE "PRO", APART FROM THE MARK AS SHOWN.

THE COLOR(S) GRAY/SILVER, WHITE, BLUE, AND RED IS/ARE CLAIMED AS A FEATURE OF THE MARK.

THE MARK CONSISTS OF A SILVER/GRAY CIRCLE WITH 11 SQUARE TUCKS AROUND IT. THE INNER PART OF THE CIRCLE IS WHITE. THE TEXT "NARPRO" IS LOCATED INSIDE OF THE WHITE CIRCLE. THE LETTERS "NAR" ARE IN A DARK BLUE COLOR AND THE LETTERS "PRO" ARE IN RED.

FOR VEHICLE MAINTENANCE AND REPAIR (U.S. CLS. 100, 103 AND 106).

FIRST USE 9-1-2004; IN COMMERCE 9-1-2004.  
STEPHANIE ALI, EXAMINING ATTORNEY

SN 85-321,636. OLD GUYS RESTORATION, TUCSON, AZ. FILED 5-16-2011.

"Building Your Dream Car"

THE MARK CONSISTS OF STANDARD CHARACTERS WITHOUT CLAIM TO ANY PARTICULAR FONT, STYLE, SIZE, OR COLOR.

FOR RESTORATION IN THE FIELD OF CLASSIC AUTOMOBILES (U.S. CLS. 100, 103 AND 106).

FIRST USE 5-24-2010; IN COMMERCE 5-24-2010.  
MICHAEL WIENER, EXAMINING ATTORNEY

**CLASS 37—(Continued).**

SN 85-322,189. MOSQUITO SHIELD, INC., NORTH ATTLEBORO, MA. FILED 5-16-2011.



OWNER OF U.S. REG. NO. 3,636,568.

NO CLAIM IS MADE TO THE EXCLUSIVE RIGHT TO USE "TICK", APART FROM THE MARK AS SHOWN.

THE MARK CONSISTS OF THE TEXT "TICK SHIELD" AND A REPRESENTATION OF A TICK UNDER TWO CONCENTRIC DOTTED CIRCLES ON A SHIELD DESIGN. FOR PEST CONTROL AND EXTERMINATION OTHER THAN FOR AGRICULTURAL PURPOSES (U.S. CLS. 100, 103 AND 106).

FIRST USE 4-1-2011; IN COMMERCE 4-1-2011.  
SIMON TENG, EXAMINING ATTORNEY

SN 85-322,205. MOSQUITO SHIELD, INC., NORTH ATTLEBORO, MA. FILED 5-16-2011.

TICK SHIELD

THE MARK CONSISTS OF STANDARD CHARACTERS WITHOUT CLAIM TO ANY PARTICULAR FONT, STYLE, SIZE, OR COLOR.

OWNER OF U.S. REG. NO. 3,636,568.

NO CLAIM IS MADE TO THE EXCLUSIVE RIGHT TO USE "TICK", APART FROM THE MARK AS SHOWN.

FOR PEST CONTROL AND EXTERMINATION OTHER THAN FOR AGRICULTURAL PURPOSES (U.S. CLS. 100, 103 AND 106).

FIRST USE 4-1-2011; IN COMMERCE 4-1-2011.  
SIMON TENG, EXAMINING ATTORNEY

SN 85-323,083. SEVEN SUN WINDOWS, NEW BRITAIN, CT. FILED 5-17-2011.



NO CLAIM IS MADE TO THE EXCLUSIVE RIGHT TO USE "WINDOWS", APART FROM THE MARK AS SHOWN. THE COLOR(S) DARK ORANGE AND DARK BLUE IS/ARE CLAIMED AS A FEATURE OF THE MARK.

THE MARK CONSISTS OF ONE DARK ORANGE AND THREE DARK BLUE SQUARES ON THE LEFT SIDE OF THE MARK FOLLOWED BY THE WORDS "SEVEN SUN" IN DARK ORANGE ABOVE THE WORD "WINDOWS" IN DARK BLUE. A THIN DARK BLUE LINE RUNS ACROSS THE MARK AND SEPARATES THE "SEVEN SUN" AND "WINDOWS" WORDS.

FOR INSTALLATION OF DOORS AND WINDOWS; INSTALLING SIDING (U.S. CLS. 100, 103 AND 106).

FIRST USE 3-7-2009; IN COMMERCE 3-7-2009.  
MARK SHINER, EXAMINING ATTORNEY

**CLASS 37—(Continued).**

SN 85-324,020. MOSQUITO SHIELD, INC., NORTH ATTLEBORO, MA. FILED 5-18-2011.



OWNER OF U.S. REG. NO. 3,636,568.

NO CLAIM IS MADE TO THE EXCLUSIVE RIGHT TO USE "MOSQUITO", APART FROM THE MARK AS SHOWN. THE MARK CONSISTS OF THE TEXT "MOSQUITO SHIELD" AND A DEPICTION OF A MOSQUITO UNDERNEATH TWO CONCENTRIC DOTTED CIRCLES ON THE FACE OF A SHIELD.

FOR PEST CONTROL AND EXTERMINATION OTHER THAN FOR AGRICULTURAL PURPOSES (U.S. CLS. 100, 103 AND 106).

FIRST USE 4-1-2011; IN COMMERCE 4-1-2011.  
SIMON TENG, EXAMINING ATTORNEY

SN 85-324,083. TRAFIX, INC., MALDEN, MA. FILED 5-18-2011.



THE MARK CONSISTS OF THE WORD "TRAFIX" IN ALL CAPS BOLD ITALICIZED STYLIZED FONT. DOUBLE PARALLEL LINES ARE SHOWN IN PERSPECTIVE IN A DOWNWARD DIRECTION STARTING FROM BEHIND THE LETTER "F" AND END BEYOND THE LETTER "X".

FOR PAVEMENT MARKING SERVICES (U.S. CLS. 100, 103 AND 106).

FIRST USE 1-1-2011; IN COMMERCE 1-1-2011.  
RUSS HERMAN, EXAMINING ATTORNEY

SN 85-324,680. WASTE STREAM SOLUTIONS CALIFORNIA LLC, POMONA, CA. FILED 5-19-2011.



NO CLAIM IS MADE TO THE EXCLUSIVE RIGHT TO USE "WASTE STREAM SOLUTIONS", APART FROM THE MARK AS SHOWN.

THE MARK CONSISTS OF A MODIFIED UNIVERSAL SYMBOL FOR MEDICINE TO THE LEFT, THE STYLE HAS GRADIENT FADING AND PATTERNED CROSS SECTIONS, AND THE TEXT "WASTE STREAM SOLUTIONS" TO THE RIGHT.

FOR WASTE DISPOSAL FOR OTHERS (U.S. CLS. 100, 103 AND 106).

FIRST USE 1-1-2009; IN COMMERCE 7-1-2009.  
ROBIN CHOSID, EXAMINING ATTORNEY

**CLASS 37—(Continued).**

SN 85-325,204. UNKUK, INC., FORT WORTH, TX. FILED 5-19-2011.

**JETT EXPRESS**

THE MARK CONSISTS OF STANDARD CHARACTERS WITHOUT CLAIM TO ANY PARTICULAR FONT, STYLE, SIZE, OR COLOR.

NO CLAIM IS MADE TO THE EXCLUSIVE RIGHT TO USE "EXPRESS", APART FROM THE MARK AS SHOWN.

FOR CAR WASHING (U.S. CLS. 100, 103 AND 106).

FIRST USE 6-1-2007; IN COMMERCE 6-1-2007.  
DAWN FELDMAN, EXAMINING ATTORNEY

SN 85-325,319. JONES, JOSHUAH, DALEVILLE, AL. FILED 5-19-2011.



OWNER OF U.S. REG. NO. 3,563,821.

NO CLAIM IS MADE TO THE EXCLUSIVE RIGHT TO USE "CUSTOMER ORIENTED PEST SERVICES", APART FROM THE MARK AS SHOWN.

THE MARK CONSISTS OF A STENCILED LOOKING FONT WITH A BUG (SPECIFICALLY A BOLL WEEVIL) IN THE "O" OF "C.O.P.S.", AND "CUSTOMER ORIENTED PEST SERVICES" BELOW.

FOR PEST CONTROL AND EXTERMINATION OTHER THAN FOR AGRICULTURAL PURPOSES; TERMITE AND PEST CONTROL (U.S. CLS. 100, 103 AND 106).

FIRST USE 1-14-2011; IN COMMERCE 1-21-2011.  
GEOFFREY FOSDICK, EXAMINING ATTORNEY

SN 85-325,389. ERWIN, WILLIAM, ENCINITAS, CA. FILED 5-19-2011.



NO CLAIM IS MADE TO THE EXCLUSIVE RIGHT TO USE "DRY" AND "RESTORATION", APART FROM THE MARK AS SHOWN.

THE MARK CONSISTS OF THE STYLIZED TEXT "ENERDRY RESTORATION" WRITTEN IN TWO LINES. THERE IS A WATER DROP SEPARATING THE TEXT "ENER" AND "DRY".

FOR RESTORATION SERVICES IN THE FIELD OF WATER, SMOKE AND FIRE DAMAGE (U.S. CLS. 100, 103 AND 106).

FIRST USE 12-1-2010; IN COMMERCE 12-1-2010.  
TOBY BULLOFF, EXAMINING ATTORNEY



**CLASS 37—(Continued).**

SN 85-325,900. ARW ROOFING, INC., WONDER LAKE, IL.  
FILED 5-20-2011.



THE COLOR(S) RED, WHITE, BLUE IS/ARE CLAIMED AS A FEATURE OF THE MARK.

THE MARK CONSISTS OF VERTICAL DIAMOND OUTLINED IN BLUE, WITH INTERIOR OUTLINE OF WHITE, AND RED, FOLLOWED BY ANOTHER OUTLINE OF BLUE. INTERIOR OF DIAMOND IS RED. CENTERED VERTICALLY IN DIAMOND ARE THE CAPITAL LETTERS RTS.

FOR ROOFING CONTRACTING (U.S. CLS. 100, 103 AND 106).

FIRST USE 0-0-1990; IN COMMERCE 0-0-1990.  
BENJAMIN OKEKE, EXAMINING ATTORNEY

SN 85-328,715. LIBERTY AFFORDABLE HOUSING, INC.,  
ROME, NY. FILED 5-24-2011.

Better lives through  
better housing

THE MARK CONSISTS OF STANDARD CHARACTERS WITHOUT CLAIM TO ANY PARTICULAR FONT, STYLE, SIZE, OR COLOR.

FOR CHARITABLE SERVICES, NAMELY, RENOVATING AND CONSTRUCTING HOMES FOR LOW INCOME FAMILIES; CHARITABLE SERVICES, NAMELY, RENOVATING HOMES FOR LOW INCOME FAMILIES; HOUSING SERVICES, NAMELY, DEVELOPMENT OF REAL PROPERTY, NAMELY, REPAIR, IMPROVEMENT, AND NEW CONSTRUCTION; HOUSING SERVICES, NAMELY, REPAIR, IMPROVEMENT, AND CONSTRUCTION OF RESIDENTIAL REAL PROPERTY; REAL ESTATE DEVELOPMENT; RENOVATION IN THE FIELD OF RESIDENTIAL HOUSING (U.S. CLS. 100, 103 AND 106).

FIRST USE 1-1-2003; IN COMMERCE 6-1-2010.  
JOHN KELLY, EXAMINING ATTORNEY

**CLASS 37—(Continued).**

SN 85-330,471. ADVANCED SERVICES, INC., AUGUSTA,  
GA. FILED 5-25-2011.

# BUGBABES

THE MARK CONSISTS OF STANDARD CHARACTERS WITHOUT CLAIM TO ANY PARTICULAR FONT, STYLE, SIZE, OR COLOR.

FOR INSTALLATION OF INSULATING MATERIALS; TERMITE AND PEST CONTROL (U.S. CLS. 100, 103 AND 106).

FIRST USE 1-0-2006; IN COMMERCE 1-0-2006.  
JOSETTE BEVERLY, EXAMINING ATTORNEY

SN 85-330,869. SHAWCOR LTD., TORONTO, CANADA,  
FILED 5-26-2011.

# BRIGDEN

THE MARK CONSISTS OF STANDARD CHARACTERS WITHOUT CLAIM TO ANY PARTICULAR FONT, STYLE, SIZE, OR COLOR.

FOR PIPE COATING SERVICES FOR THE OIL AND GAS INDUSTRY (U.S. CLS. 100, 103 AND 106).

FIRST USE 3-0-2010; IN COMMERCE 3-0-2010.  
JOHN WILKE, EXAMINING ATTORNEY

SN 85-331,192. ALL FLOORS & MORE, TOMBALL, TX.  
FILED 5-26-2011.

# All Floors & More

THE MARK CONSISTS OF STANDARD CHARACTERS WITHOUT CLAIM TO ANY PARTICULAR FONT, STYLE, SIZE, OR COLOR.

NO CLAIM IS MADE TO THE EXCLUSIVE RIGHT TO USE "FLOORS", APART FROM THE MARK AS SHOWN.

FOR INSTALLATION AND MAINTENANCE OF BLINDS, CARPETS, GRANITE COUNTERTOPS, LAMINATE FLOORING, TILE, AND HARDWOOD FLOORING; INSTALLATION AND REPAIR OF BLINDS; INSTALLING CARPET; INSTALLING FLOOR TILE; INSTALLING WOOD FLOORING; LAYING OF CARPET; TILE INSTALLATION SERVICES; WINDOW BLIND INSTALLATION AND REPAIR (U.S. CLS. 100, 103 AND 106).

FIRST USE 1-1-2005; IN COMMERCE 1-1-2005.  
ALLISON HOLTZ, EXAMINING ATTORNEY

**CLASS 37—(Continued).**

SN 85-333,833. HOT SERRANO, LLC, DBA SOREO SELECT, TUCSON, AZ. FILED 5-31-2011.

# SOREO

THE MARK CONSISTS OF STANDARD CHARACTERS WITHOUT CLAIM TO ANY PARTICULAR FONT, STYLE, SIZE, OR COLOR.

FOR CLEANING OF CLOTHING; CLEANING OF RESIDENTIAL HOUSES; HOUSING SERVICES, NAMELY, REPAIR, IMPROVEMENT, AND CONSTRUCTION OF RESIDENTIAL REAL PROPERTY (U.S. CLS. 100, 103 AND 106).

FIRST USE 4-30-2011; IN COMMERCE 4-30-2011.  
HAI-LY LAM, EXAMINING ATTORNEY

---

SN 85-334,887. LARRY HAIGHT'S RESIDENTIAL ROOFING, REDMOND, WA. FILED 6-1-2011.

## Experience the Difference

THE MARK CONSISTS OF STANDARD CHARACTERS WITHOUT CLAIM TO ANY PARTICULAR FONT, STYLE, SIZE, OR COLOR.

FOR ROOFING SERVICES (U.S. CLS. 100, 103 AND 106).

FIRST USE 2-0-2010; IN COMMERCE 9-0-2010.  
RONALD MCMORROW, EXAMINING ATTORNEY

---

SN 85-335,078. JIFFY LUBE INTERNATIONAL, INC., HOUSTON, TX. FILED 6-1-2011.

## YOUR VOICE, YOUR CHOICE

THE MARK CONSISTS OF STANDARD CHARACTERS WITHOUT CLAIM TO ANY PARTICULAR FONT, STYLE, SIZE, OR COLOR.

FOR VEHICLE PREVENTATIVE SERVICES, NAMELY CHANGING VEHICLE OIL (U.S. CLS. 100, 103 AND 106).

FIRST USE 10-25-2010; IN COMMERCE 10-25-2010.  
KATHERINE M. DUBRAY, EXAMINING ATTORNEY

**CLASS 37—(Continued).**

SN 85-335,343. MOYER, JOHN, DBA PREMIUM PROTECTIVE COATINGS, PALMYRA, PA. FILED 6-1-2011.

# MaxGrip

THE MARK CONSISTS OF STANDARD CHARACTERS WITHOUT CLAIM TO ANY PARTICULAR FONT, STYLE, SIZE, OR COLOR.

FOR APPLYING PROTECTIVE COATINGS TO TRUCK BEDS (U.S. CLS. 100, 103 AND 106).

FIRST USE 6-30-2008; IN COMMERCE 6-30-2008.  
MICHAEL ENGEL, EXAMINING ATTORNEY

---

SN 85-335,413. XINERGY CORP, KNOXVILLE, TN. FILED 6-1-2011.

# Xinergy

THE MARK CONSISTS OF STANDARD CHARACTERS WITHOUT CLAIM TO ANY PARTICULAR FONT, STYLE, SIZE, OR COLOR.

FOR COAL MINING EXTRACTION SERVICES (U.S. CLS. 100, 103 AND 106).

FIRST USE 4-1-2008; IN COMMERCE 4-1-2008.  
C. DIONNE CLYBURN, EXAMINING ATTORNEY

---

SN 85-335,512. XINERGY CORP, KNOXVILLE, TN. FILED 6-1-2011.



THE MARK CONSISTS OF A SWOOPING MARK COMING FROM BEHIND THE X AT THE BEGINNING OF THE WORD XINERGY AND COMING AROUND THE TOP OF THE X OVER TOWARD THE LETTER I TO VISUALLY LOOK AS IF IT IS DOTTING THE LETTER I.

FOR COAL MINING EXTRACTION SERVICES (U.S. CLS. 100, 103 AND 106).

FIRST USE 4-1-2008; IN COMMERCE 4-1-2008.  
C. DIONNE CLYBURN, EXAMINING ATTORNEY

**CLASS 37—(Continued).**

SN 85-338,360. LORRIS-GANNING, LLC, MOUNT WASHINGTON, KY. FILED 6-5-2011.



THE MARK CONSISTS OF TWO TRIANGLES IN A DIAGONAL DESIGN, ONE IN THE TOP LEFT CORNER AND THE OTHER IN THE BOTTOM RIGHT CORNER. BETWEEN THE TWO TRIANGLES IS THE NAME OF THE COMPANY LORRIS GANNING WRITTEN DIAGONALLY FROM BOTTOM LEFT CORNER TO UPPER RIGHT CORNER WITH LORRIS AND THE TOP OF THE WORD GANNING AND EXTENDING OUT PAST THE TRIANGLES.

FOR REPAIR OR MAINTENANCE OF COMPUTERS (U.S. CLS. 100, 103 AND 106).  
CHRIS WELLS, EXAMINING ATTORNEY

SN 85-338,905. KBA, INC., BELLEVUE, WA. FILED 6-6-2011.

**SMART & STRATEGIC**

THE MARK CONSISTS OF STANDARD CHARACTERS WITHOUT CLAIM TO ANY PARTICULAR FONT, STYLE, SIZE, OR COLOR.  
FOR CONSTRUCTION PROJECT MANAGEMENT SERVICES (U.S. CLS. 100, 103 AND 106).  
FIRST USE 3-17-2010; IN COMMERCE 3-17-2010.  
JEFFERY COWARD, EXAMINING ATTORNEY

**CLASS 37—(Continued).**

SN 85-341,561. CAFFERYTOWN LTD, HOUSTON, TX. FILED 6-8-2011.

**CAFFERYTOWN**

THE MARK CONSISTS OF STANDARD CHARACTERS WITHOUT CLAIM TO ANY PARTICULAR FONT, STYLE, SIZE, OR COLOR.

FOR BUILDING CONSTRUCTION SUPERVISION; CONSTRUCTION PLANNING; CONSTRUCTION SERVICES, NAMELY, PLANNING, LAYING OUT AND CONSTRUCTION OF A PLANNED RESIDENTIAL COMMUNITY; CONSTRUCTION SERVICES, NAMELY, PLANNING, LAYING OUT AND CONSTRUCTION OF RESIDENTIAL AND COMMERCIAL COMMUNITIES; CONSTRUCTION SERVICES, NAMELY, PLANNING, LAYING OUT AND CUSTOM CONSTRUCTION OF COMMERCIAL BUILDINGS; CONSTRUCTION SERVICES, NAMELY, PLANNING, LAYING OUT AND CUSTOM CONSTRUCTION OF RESIDENTIAL AND COMMERCIAL COMMUNITIES; HOUSING SERVICES, NAMELY, DEVELOPMENT OF REAL PROPERTY, NAMELY, REPAIR, IMPROVEMENT, AND NEW CONSTRUCTION; LAND DEVELOPMENT SERVICES, NAMELY, PLANNING AND LAYING OUT OF COMMERCIAL BUILDINGS; LAND DEVELOPMENT SERVICES, NAMELY, PLANNING AND LAYING OUT OF RESIDENTIAL AND/OR COMMERCIAL COMMUNITIES; PLANNING AND LAYING OUT OF RESIDENTIAL COMMUNITIES; REAL ESTATE DEVELOPMENT; REAL ESTATE DEVELOPMENT AND CONSTRUCTION OF COMMERCIAL, RESIDENTIAL AND HOTEL PROPERTY; REAL ESTATE DEVELOPMENT SERVICES IN THE FIELD OF RETIREMENT COMMUNITIES; REAL ESTATE PROPERTY CLEANING, REPAIR AND MAINTENANCE SERVICES; REAL ESTATE SITE SELECTION (U.S. CLS. 100, 103 AND 106).  
FIRST USE 11-0-2007; IN COMMERCE 11-0-2007.  
SUE LAWRENCE, EXAMINING ATTORNEY

SN 85-342,411. GENERAL ELECTRIC COMPANY, FAIRFIELD, CT. FILED 6-9-2011.

**CBM-R**

THE MARK CONSISTS OF STANDARD CHARACTERS WITHOUT CLAIM TO ANY PARTICULAR FONT, STYLE, SIZE, OR COLOR.  
FOR GAS TURBINE MAINTENANCE SERVICES AND GAS TURBINE REPAIR SERVICES (U.S. CLS. 100, 103 AND 106).  
REBECCA SMITH, EXAMINING ATTORNEY

**CLASS 38—COMMUNICATION**

SN 75-575,331. ENVOYWORLDWIDE, INC., BEDFORD, MA. FILED 10-21-1998.

**MESSAGEBLASTER**

FOR ELECTRONIC MAIL AND VOICE MAIL SERVICES; DELIVERY OF MESSAGES BY ELECTRONIC TRANSMISSION; ELECTRONIC MAIL SERVICES; ELECTRONIC TRANSMISSION OF DATA AND DOCUMENTS VIA COMPUTER TERMINALS (U.S. CLS. 100, 101 AND 104).

DAVID TAYLOR, EXAMINING ATTORNEY

SN 76-707,196. PRAECO SYSTEMS, LLC, ARLINGTON, TX. FILED 4-11-2011.

**PRAECO**

THE MARK CONSISTS OF STANDARD CHARACTERS WITHOUT CLAIM TO ANY PARTICULAR FONT, STYLE, SIZE, OR COLOR.

FOR ELECTRONIC VOICE MESSAGING, NAMELY, THE RECORDING AND SUBSEQUENT TRANSMISSION OF VOICE MESSAGES BY TELEPHONE TO AN IDENTIFIED CLASS OF RECIPIENTS; ELECTRONIC VOICE MESSAGING, NAMELY, THE RECORDING AND SUBSEQUENT TRANSMISSION OF VIDEO MESSAGES TO AN IDENTIFIED CLASS OF RECIPIENTS VIA WEB-BASED INTERFACES; COMPUTER-AIDED TRANSMISSION OF TEXT MESSAGES TO AN IDENTIFIED CLASS OF RECIPIENTS VIA WEB-BASED INTERFACES; DELIVERY OF OUTBOUND VIDEO, TEXT AND AUDIO ANNOUNCEMENT MESSAGES BY ELECTRONIC TRANSMISSION VIA INTERNET HYPERLINKS OR TEXT MESSAGES TO AN IDENTIFIED CLASS OF RECIPIENTS TO INFORM THEM OF AVAILABLE MESSAGES FOR RETRIEVAL VIA INBOUND TELEPHONE CALLS OR WEB-BASED INTERFACES (U.S. CLS. 100, 101 AND 104).

DAWN HAN, EXAMINING ATTORNEY

SN 77-736,592. IGENETIX CORPORATION, KINGSTON, CANADA, FILED 5-14-2009.

**VideoChatr**

THE MARK CONSISTS OF STANDARD CHARACTERS WITHOUT CLAIM TO ANY PARTICULAR FONT, STYLE, SIZE, OR COLOR.

OWNER OF CANADA REG. NO. TMA805,892, DATED 9-1-2011, EXPIRES 9-1-2026.

FOR COMMUNICATION SERVICES, NAMELY, PROVIDING MULTIPLE USER ACCESS TO A GLOBAL COMPUTER NETWORK AND PROVIDING MULTIPLE USER ACCESS TO VIDEO, AUDIO, AND TEXT BROADCAST TRANSMISSION OVER A GLOBAL COMPUTER NETWORK (U.S. CLS. 100, 101 AND 104).

LINDA MICKLEBURGH, EXAMINING ATTORNEY

**CLASS 38—(Continued).**

SN 77-840,490. PAPPAS TELECASTING COMPANIES, VISA-LIA, CA. FILED 10-2-2009.

**NTV NEWS**

THE MARK CONSISTS OF STANDARD CHARACTERS WITHOUT CLAIM TO ANY PARTICULAR FONT, STYLE, SIZE, OR COLOR.

NO CLAIM IS MADE TO THE EXCLUSIVE RIGHT TO USE "NEWS", APART FROM THE MARK AS SHOWN.

FOR TELEVISION BROADCASTING (U.S. CLS. 100, 101 AND 104).

FIRST USE 1-1-1985; IN COMMERCE 1-1-1985.

SUNG IN, EXAMINING ATTORNEY

SN 78-862,060. MARSHALL MILES, FALLS VILLAGE, CT. AND JILL GOODMAN, FALLS VILLAGE, CT. FILED 4-14-2006.



THE COLOR(S) YELLOW AND GREEN IS/ARE CLAIMED AS A FEATURE OF THE MARK.

THE MARK CONSISTS OF "ROBINHOODRADIO.COM" IN YELLOW LOWER CASE LETTERS ON A GREEN BACKGROUND.

SEC. 2(F).

FOR RADIO BROADCASTING; BROADCASTING PROGRAMS VIA A GLOBAL COMPUTER NETWORK (U.S. CLS. 100, 101 AND 104).

FIRST USE 4-15-2006; IN COMMERCE 4-15-2006.

PAUL E. FAHRENKOPF, EXAMINING ATTORNEY

SN 79-092,672. KT CORPORATION, KYEONGGI-DO, REPUBLIC OF KOREA, FILED 11-30-2010.

**olleh**

OWNER OF INTERNATIONAL REGISTRATION 1065431 DATED 11-30-2010, EXPIRES 11-30-2020.

THE WORD(S) "OLLEH" HAS NO MEANING IN A FOREIGN LANGUAGE.

FOR SATELLITE TRANSMISSION AND TELEVISION BROADCASTING SERVICES; TELECOMMUNICATION SERVICES, NAMELY, PERSONAL COMMUNICATIONS SERVICES; PAY-TELEPHONE COMMUNICATION SERVICES; OPERATION OF BROADBAND TELECOMMUNICATION NETWORKS; COMMUNICATIONS BY FIBER OPTIC NETWORKS; TRANSMISSION OF INFORMATION ON OPTICAL TELECOMMUNICATION NETWORKS; TRANSMISSION OF INFORMATION VIA NATIONAL AND INTERNATIONAL NETWORKS; INTERNATIONAL TELEPHONE CALL SERVICES; OPERATION OF LOCAL AREA NETWORKS, NAMELY,

**CLASS 38—(Continued).**

PROVIDING A HIGH SPEED ACCESS TO LOCAL AREA NETWORKS; LEASING OF LOCAL AREA NETWORKS EQUIPMENT; RENTAL OF ACCESS TIME TO GLOBAL COMPUTER NETWORKS; TRANSMISSION OF NEWS; TRANSMISSION OF SHORT MESSAGES; PROVIDING ACCESS TO DATABASES; RENTAL OF DATA COMMUNICATIONS INSTALLATIONS; DATA COMMUNICATION SERVICES PROVIDED BY DATA SWITCHES; PAGING SERVICES, NAMELY, RADIO AND TELEPHONE PAGING; COMMUNICATIONS BY RADIO, TELEPHONE, TELEGRAPH; MESSAGE SENDING SERVICES; RENTAL OF MESSAGE SENDING APPARATUS; LEASING OF MESSAGE STORAGE APPARATUS; RENTAL OF MODEMS; WIRELESS BROADBAND COMMUNICATIONS SERVICES; RADIO COMMUNICATIONS OF DATA; COMMUNICATIONS BY WIRELESS LOCAL AREA NETWORKS; PROVIDING ACCESS TO WIRELESS INTERNET; TELECOMMUNICATION SERVICES, NAMELY, WIRELESS TELEPHONE SERVICES; WIRELESS TELEPHONE COMMUNICATION; VAN (VALUE ADDED NETWORK) COMMUNICATIONS SERVICES, NAMELY, VOICE COMMUNICATION SERVICES; SECURE E-MAIL SERVICES; PROVIDING ACCESS TO ONLINE DATABASES IN THE FIELDS OF MARKETING; REMOTE SCREEN COMMUNICATION, NAMELY, AUDIO TELECONFERENCING SERVICES AND VIDEO TELECONFERENCING SERVICES; TRANSMISSION OF DATA, SOUND AND IMAGES BY SATELLITE; WIRE COMMUNICATIONS SERVICES, NAMELY, PROVIDING WIRELESS INTERNET ACCESS TO OTHERS; VOICE MAIL SERVICES; MOBILE RADIO COMMUNICATIONS; TELECOMMUNICATIONS BY MOBILE PHONES; PROVIDING E-MAIL SERVICES; TELECONFERENCING VIA SATELLITE; PROVIDING INSTANT MESSENGER SERVICES VIA THE INTERNET; PROVIDING MULTIPLE-USER ACCESS TO A GLOBAL COMPUTER INFORMATION NETWORK; PROVIDING INTERNET CHAT-ROOMS; INFORMATION TRANSMISSION SERVICES USING DATA COMMUNICATIONS VIA THE INTERNET; TRANSMISSION OF MOVING PICTURES VIA THE INTERNET; TRANSMISSION OF MESSAGES AND IMAGES VIA THE INTERNET; TRANSMISSION OF IMAGES AND VOICE VIA THE INTERNET; PROVIDING USER ACCESS TO A GLOBAL COMPUTER NETWORK (SERVICE PROVIDERS); INTERNET TELEPHONE SERVICES; PROVIDING TELECOMMUNICATIONS CONNECTIONS TO A GLOBAL COMPUTER NETWORK; RENTAL OF TELECOMMUNICATION EQUIPMENT; INFORMATION ABOUT TELECOMMUNICATION; SENDING OF TELEGRAMS; TELEGRAPH SERVICES; TRANSMISSION OF TELEGRAMS; COMMUNICATIONS BY TELEGRAMS; TELECOMMUNICATIONS SERVICES, NAMELY, ELECTRONIC BULLETIN BOARD SERVICES; COMMUNICATION SERVICES FOR THE ELECTRONIC TRANSMISSION OF DATA; ELECTRONIC MESSAGE SENDING; ELECTRONIC MAIL; RENTAL OF TELEPHONE EXCHANGE APPARATUS; RENTAL OF TELEPHONES; PROVIDING TELEPHONE DIRECTORY INFORMATION; MOBILE TELEPHONE SERVICES; COMMUNICATIONS BY TELEPHONE; COMPUTER DATA TRANSMISSION SERVICES, NAMELY, ELECTRONIC EXCHANGE OF DATA STORED IN A DATABASE ACCESSIBLE VIA A TELECOMMUNICATIONS NETWORK; COMPUTER AIDED TRANSMISSION OF MESSAGES AND IMAGES; COMMUNICATION BY COMPUTER TERMINALS; COMMUNICATIONS BY TELEVISION FOR MEETING; PROVIDING TELECOMMUNICATION CHANNELS FOR TEleshopping SERVICES; ELECTRONIC DATA TRANSMISSION, NAMELY, TELEX SERVICES; TELECOMMUNICATIONS ROUTING AND JUNCTION SERVICES; RENTAL OF TELECOMMUNICATION MACHINES AND APPARATUS; TRANSMISSION OF STOCK MARKET INFORMATION WITH THE HELP OF TELECOMMUNICATION MEDIA; TRANSMISSION AND RECEPTION (TRANSMISSION) OF DATABASE INFORMATION VIA THE TELECOMMUNICATION NETWORK; NEWS AGENCIES; RENTAL OF FACSIMILE APPARATUS; FACSIMILE TRANSMISSION; CELLULAR TELEPHONE COMMUNICATION; RENTAL OF VIDEOPHONES; TELECONFERENCING SERVICES; EDUCATION BROADCASTING, NAMELY, TELEVISION AND RADIO BROADCASTING SERVICES FEATURING EDUCATIONAL PROGRAMS; TRAFFIC BROADCASTING; DIGITAL RADIO BROADCASTING; DIGITAL TELEVISION BROADCASTING; RADIO BROADCASTING; WIRELESS INTERNET BROADCASTING; RENTAL

**CLASS 38—(Continued).**

OF BROADCASTING EQUIPMENT; DIGITAL RADIO BROADCASTING BY SATELLITE; DIGITAL TELEVISION BROADCASTING BY SATELLITE; SATELLITE RADIO BROADCASTING; RENTAL OF SATELLITE BROADCAST RECEIVING AERIALS; SATELLITE TELEVISION BROADCASTING; CABLE TELEVISION BROADCASTING; INTERNET EDUCATION BROADCASTING; INTERNET RADIO BROADCASTING; INTERNET BROADCASTING SERVICES; ON-DEMAND RADIO BROADCASTING; VIDEO-ON-DEMAND BROADCASTING; ON-DEMAND CABLE TELEVISION BROADCASTING; ON-DEMAND TELEVISION BROADCASTING; TELEVISION BROADCASTING (U.S. CLS. 100, 101 AND 104).

FLORENTINA BLANDU, EXAMINING ATTORNEY

SN 85-148,460. PAX CATHOLIC COMMUNICATIONS, INC., MIAMI, FL. FILED 10-8-2010.

# RADIO PAZ

THE MARK CONSISTS OF STANDARD CHARACTERS WITHOUT CLAIM TO ANY PARTICULAR FONT, STYLE, SIZE, OR COLOR.

OWNER OF U.S. REG. NO. 2,327,772.

NO CLAIM IS MADE TO THE EXCLUSIVE RIGHT TO USE "RADIO", APART FROM THE MARK AS SHOWN.

THE ENGLISH TRANSLATION OF "PAZ" IN THE MARK IS "PEACE".

FOR RADIO BROADCASTING (U.S. CLS. 100, 101 AND 104).

FIRST USE 3-1-1993; IN COMMERCE 3-1-1993.

KIMBERLY PERRY, EXAMINING ATTORNEY

SN 85-181,422. OTHON GONZÁLEZ RUIZ, JOSÉ, XALAPA, VERACRUZ, MEXICO, FILED 11-19-2010.



THE MARK CONSISTS OF THE WORD "CABLEVER" WITH THE LETTER "C" DIRECTLY ABOVE IT. THE LETTER "C" CONTAINS A DOT IN THE MIDDLE AND A HEART DESIGN TO THE IMMEDIATE RIGHT THEREOF.

THE WORDING "CABLEVER" HAS NO MEANING IN A FOREIGN LANGUAGE.

FOR CABLE TELEVISION BROADCASTING; CABLE TELEVISION TRANSMISSION; COMMUNICATION VIA TELEVISION TRANSMISSIONS (U.S. CLS. 100, 101 AND 104).

KATHERINE CHANG, EXAMINING ATTORNEY

**CLASS 38—(Continued).**

SN 85-184,264. DVMMY LIMITED, HONG KONG, HONG KONG, FILED 11-24-2010.

# QFFERS

THE MARK CONSISTS OF STANDARD CHARACTERS WITHOUT CLAIM TO ANY PARTICULAR FONT, STYLE, SIZE, OR COLOR.

FOR TELECOMMUNICATION SERVICES, NAMELY, PROVIDING ACCESS TO THE INTERNET, GLOBAL COMPUTER NETWORKS, WIRELESS NETWORKS, OR OTHER ELECTRONIC COMMUNICATIONS NETWORKS; COMPUTER TRANSMISSION OF INFORMATION FOR ONLINE-BASED SERVICES IN RELATION TO COMMENTS, RECOMMENDATIONS, RATINGS, REVIEWS, BLOGS, DISCUSSIONS, OR ANY COMBINATION THEREOF, VIA THE INTERNET OR OTHER COMPUTER AND ELECTRONIC COMMUNICATIONS NETWORKS; COMPUTER TRANSMISSION OF INFORMATION FOR ONLINE-BASED SERVICES IN RELATION TO PROMOTIONS, MARKETING CAMPAIGNS, ADVERTISEMENTS, OR ANY COMBINATION THEREOF, VIA THE INTERNET OR OTHER COMPUTER AND ELECTRONIC COMMUNICATIONS NETWORKS; COMPUTER TRANSMISSION OF INFORMATION FOR ONLINE-BASED SERVICES IN RELATION TO RETAIL AND COMMERCIAL ITEMS, GOODS, SERVICES, SELLERS, OFFERS, DEALS, COUPONS, DISCOUNTS, OR ANY COMBINATION THEREOF, VIA THE INTERNET OR OTHER COMPUTER AND ELECTRONIC COMMUNICATIONS NETWORKS; PROVISION OF TELECOMMUNICATION CONNECTIVITY SERVICES AND ACCESS TO ELECTRONIC COMMUNICATIONS NETWORKS FOR TRANSMISSION OR RECEPTION OF ONLINE-BASED SERVICES IN RELATION TO COMMENTS, RECOMMENDATIONS, RATINGS, REVIEWS, BLOGS, DISCUSSIONS, OR ANY COMBINATION THEREOF; PROVISION OF TELECOMMUNICATION CONNECTIVITY SERVICES AND ACCESS TO ELECTRONIC COMMUNICATIONS NETWORKS FOR TRANSMISSION OR RECEPTION OF ONLINE-BASED SERVICES IN RELATION TO PROMOTIONS, MARKETING CAMPAIGNS, ADVERTISEMENTS, OR ANY COMBINATION THEREOF; PROVISION OF TELECOMMUNICATION CONNECTIVITY SERVICES AND ACCESS TO ELECTRONIC COMMUNICATIONS NETWORKS FOR TRANSMISSION OR RECEPTION OF ONLINE-BASED SERVICES IN RELATION TO RETAIL AND COMMERCIAL ITEMS, GOODS, SERVICES, SELLERS, OFFERS, DEALS, COUPONS, DISCOUNTS, OR ANY COMBINATION THEREOF; COMPUTER TRANSMISSION OF ONLINE BASED SERVICES ACCESSED VIA A NETWORK REFERENCE, NAMELY, A URI, VISUAL CODE, NAMELY, BAR-CODES, TAG, NAMELY, RFID, TERMINAL, NAMELY PC OR MOBILE DEVICE, OR ANY COMBINATION THEREOF (U.S. CLS. 100, 101 AND 104).

DOUGLAS LEE, EXAMINING ATTORNEY

**CLASS 38—(Continued).**

SN 85-189,707. KODIAK KENAI CABLE COMPANY, LLC, SEATTLE, WA. FILED 12-2-2010.

## NORTHERN FIBER OPTIC LINK

THE MARK CONSISTS OF STANDARD CHARACTERS WITHOUT CLAIM TO ANY PARTICULAR FONT, STYLE, SIZE, OR COLOR.

NO CLAIM IS MADE TO THE EXCLUSIVE RIGHT TO USE "FIBER OPTIC LINK", APART FROM THE MARK AS SHOWN.

FOR DIGITAL TRANSMISSION OF VOICE, VIDEO AND DATA THROUGH HIGH CAPACITY BROADBAND MEDIA PROTOCOLS (U.S. CLS. 100, 101 AND 104).

KARANENDRA S. CHHINA, EXAMINING ATTORNEY

SN 85-194,605. 98SECONDS, INC., SAN FRANCISCO, CA. FILED 12-9-2010.



THE MARK CONSISTS OF A BALLOON WITH CURVED STRIPES TO THE UPPER RIGHT OF WHICH IS A CIRCLE WHICH TOGETHER FORM A STYLIZED BEE TO THE RIGHT OF WHICH ARE THE LETTERS "SHOPBEE".

FOR ELECTRONIC TRANSMISSION OF MESSAGES AND DATA, NAMELY, ADVERTISING CONTENT OF OTHERS TO COMPUTERS, MOBILE TELEPHONES AND OTHER MOBILE DIGITAL DEVICES (U.S. CLS. 100, 101 AND 104).

SUSAN STIGLITZ, EXAMINING ATTORNEY

SN 85-244,811. XCHANGE TELECOM CORP., BROOKLYN, NY. FILED 2-17-2011.



THE COLOR(S) BLACK, BLUE AND ORANGE IS/ARE CLAIMED AS A FEATURE OF THE MARK.

THE MARK CONSISTS OF THE WORDING "CELLTHRU" BELOW THE DESIGN OF A GLOBE WITH AN ARROW

**CLASS 38—(Continued).**

WRAPPED AROUND IT. THE COLOR BLACK APPEARS IN THE OUTLINE OF THE GLOBE, IN THE OUTLINE OF THE LAND MASSES ON THE GLOBE, AND IN THE ARROW. THE COLOR ORANGE APPEARS IN THE LAND MASSES ON THE GLOBE AND IN THE WORD "THRU" IN THE MARK. THE COLOR BLUE APPEARS IN THE AREA REPRESENTING WATER IN THE GLOBE DESIGN AND IN THE WORD "CELL" IN THE MARK. THE WHITE IN THE DRAWING REPRESENTS BACKGROUND AREAS ONLY AND IS NOT PART OF THE MARK.

FOR CELLULAR TELEPHONE SERVICES; COMMUNICATION BY MOBILE TELEPHONE; COMMUNICATIONS BY TELEPHONE; INTERNATIONAL TELEPHONE SERVICES; INTERSTATE TELEPHONE SERVICES; MOBILE TELEPHONE SERVICES; TELECOMMUNICATION SERVICES IN THE NATURE OF PROVIDING TELEPHONE FEATURES, NAMELY, CALL WAITING, CALL IDENTIFICATION, CALL FORWARDING, AND MESSAGE WAITING; TELECOMMUNICATION SERVICES IN THE NATURE OF PROVIDING TELEPHONE SERVICES WITH VARIOUS TELEPHONE FEATURES, NAMELY, A DEDICATED TOLL-FREE NUMBER, VOICEMAIL, MULTIPLE MAILBOX EXTENSIONS, TELEPHONE MESSAGE NOTIFICATION, FAX CAPABILITIES, DETAILED CALL REPORTS, CALL WAITING, CALL IDENTIFICATION, CALL FORWARDING, AND MESSAGE WAITING; TELEPHONE COMMUNICATION SERVICES (U.S. CLS. 100, 101 AND 104).

FIRST USE 10-17-2002; IN COMMERCE 10-17-2002.  
MAUREEN DALL, EXAMINING ATTORNEY

---

SN 85-245,306. COX COMMUNICATIONS, INC., ATLANTA, GA. FILED 2-17-2011.

## COX DIGEEZ

THE MARK CONSISTS OF STANDARD CHARACTERS WITHOUT CLAIM TO ANY PARTICULAR FONT, STYLE, SIZE, OR COLOR.

OWNER OF U.S. REG. NOS. 2,189,184, 3,831,749 AND OTHERS.

FOR COMMUNICATION SERVICES, NAMELY, TRANSMISSION OF VOICE, AUDIO, VISUAL IMAGES AND DATA BY DIGITAL TELECOMMUNICATIONS NETWORKS, WIRELESS COMMUNICATION NETWORKS, THE INTERNET, INFORMATION SERVICES NETWORKS AND DATA NETWORKS (U.S. CLS. 100, 101 AND 104).

NELSON SNYDER, EXAMINING ATTORNEY

**CLASS 38—(Continued).**

SN 85-253,139. INTELEPEER, INC., SAN MATEO, CA. FILED 2-28-2011.

## CloudWorx

THE MARK CONSISTS OF STANDARD CHARACTERS WITHOUT CLAIM TO ANY PARTICULAR FONT, STYLE, SIZE, OR COLOR.

FOR TELECOMMUNICATION SERVICES, NAMELY, VOICE TELEPHONY SERVICES, VOICE OVER INTERNET PROTOCOL (VOIP) TELEPHONY SERVICES, ROUTING CALLS USING VOIP SERVICES, TELEPHONE COMMUNICATION, USING SECURE MULTI-CARRIER DATABASES FOR MAPPING OF STANDARD PSTN TELEPHONE NUMBERS TO RESOLVABLE INTERNET PROTOCOL (IP) ADDRESSES, NAMELY, TELEPHONE COMMUNICATION USING THE LATEST INTERNATIONAL PUBLIC TELECOMMUNICATION NUMBERING PLAN; DIGITAL TELEPHONY SERVICES; IP TELEPHONY SERVICES; INTELLIGENT ROUTING GATEWAY SERVICES, NAMELY, TELECOMMUNICATIONS ROUTING AND JUNCTION SERVICES; CLICK-TO-CALL SERVICES, NAMELY, TELEPHONY COMMUNICATION SERVICES INITIATED VIA WEB LINKS ON COMPUTERS OR MOBILE DEVICES; VIDEO COMMUNICATIONS SERVICES, NAMELY, TRANSMISSION OF INFORMATION THROUGH VIDEO COMMUNICATIONS SYSTEMS, AUTO VIDEO AND AUDIO CONFERENCE SERVICES, VIDEO AND AUDIO CONFERENCE-ON-DEMAND SERVICES; BLAST CALLING SERVICES; BRIDGE TO CONNECT SERVICES FOR AUDIO AND VIDEO CONFERENCE; VOICE PEERING NETWORK SERVICES CONNECTING CARRIERS TO TRANSPORT CALLS ANYTIME AND TO ANYWHERE; INTELLIGENT NETWORK SERVICES, NAMELY, PROVIDING A NETWORK ARCHITECTURE FOR FIXED AND MOBILE TELECOM NETWORKS HAVING FEATURES SUCH AS CALLER IDENTIFICATION, PRE-PAYMENT AND CALL ANSWER; SERVICES TO FACILITATE INTERWORKING BETWEEN THE PUBLIC TELEPHONE NETWORK AND INTERNET PROTOCOL NETWORKS; MANAGED COMPUTER AND COMMUNICATIONS GATEWAY AND NETWORK CONNECTION SERVICES; INTELLIGENT ROUTING SERVICES FEATURING MANAGED DIRECTORY IDENTIFICATION AND ADDRESS RESOLUTION (U.S. CLS. 100, 101 AND 104).

KEVIN CORWIN, EXAMINING ATTORNEY

---

SN 85-266,396. ADELMAN TRAVEL SYSTEMS, INC., MILWAUKEE, WI. FILED 3-14-2011.

## VIDEOTRAVEL

THE MARK CONSISTS OF STANDARD CHARACTERS WITHOUT CLAIM TO ANY PARTICULAR FONT, STYLE, SIZE, OR COLOR.

FOR VIDEO CONFERENCE SERVICES AND CONSULTING SERVICES RELATED TO VIDEOCONFERENCE; PROVIDING TECHNICAL SUPPORT SERVICES REGARDING THE USAGE OF VIDEOCONFERENCE EQUIPMENT (U.S. CLS. 100, 101 AND 104).

KEVON CHISOLM, EXAMINING ATTORNEY

**CLASS 38—(Continued).**

SN 85-272,688. AVI YROSHALMIANE, LOS ANGELES, CA. FILED 3-21-2011.



NO CLAIM IS MADE TO THE EXCLUSIVE RIGHT TO USE "HABLA CON MEXICO", APART FROM THE MARK AS SHOWN.

THE COLOR(S) RED, WHITE, AND GREEN IS/ARE CLAIMED AS A FEATURE OF THE MARK.

THE MARK CONSISTS OF RECTANGLE CARRYING THE WORD "LLAMÉX", WITH THE "LLA" IN GREEN, THE "M" IN WHITE, AND THE "EX" IN RED, ALL IN LARGE FONT ABOVE THE WORDING "HABLA CON MEXICO!" IN SMALLER FONT IN THE COLOR WHITE; THE COLOR BLACK REPRESENTS TRANSPARENT AREA AND IS NOT A FEATURE OF THE MARK.

THE ENGLISH TRANSLATION OF "LLAMÉX HABLA CON MEXICO" IN THE MARK IS "LLAMÉX SPEAK WITH MEXICO". THE WORDING "LLAMÉX" HAS NO MEANING IN A FOREIGN LANGUAGE.

FOR PROVIDING ACCESS TO TELECOMMUNICATION NETWORKS; TELECOMMUNICATION ACCESS SERVICES; TELECOMMUNICATION SERVICES, NAMELY, LOCAL AND LONG DISTANCE TRANSMISSION OF VOICE, DATA, GRAPHICS AND VIDEO BY MEANS OF BROADBAND OPTICAL OR WIRELESS NETWORKS (U.S. CLS. 100, 101 AND 104).

FIRST USE 9-1-2010; IN COMMERCE 1-1-2011.  
HEATHER BIDDULPH, EXAMINING ATTORNEY

---

SN 85-277,560. AMPEGY, LLC, HOUSTON, TX. FILED 3-25-2011.

**AMPEGY More Markets. More Opportunity.**

THE MARK CONSISTS OF STANDARD CHARACTERS WITHOUT CLAIM TO ANY PARTICULAR FONT, STYLE, SIZE, OR COLOR.

FOR TELECOMMUNICATIONS SERVICES, NAMELY, LOCAL AND LONG DISTANCE TELEPHONE SERVICES, CELLULAR TELEPHONE SERVICES, WIRELESS TELECOMMUNICATIONS SERVICES IN THE NATURE OF WIRELESS TELEPHONE SERVICES, WIRELESS TELECOMMUNICATIONS SERVICES IN THE NATURE OF TRANSMISSION OF VOICE, DATA, GRAPHICS, SOUND AND VIDEO BY MEANS OF WIRELESS NETWORKS, PERSONAL COMMUNICATION SERVICES, LOCAL AND LONG DISTANCE TRANSMISSION OF VOICE AND DATA BY MEANS OF BROADBAND, COPPER AND OPTICAL OR WIRELESS NETWORKS, AUDIO AND VIDEO TELECONFERENCING SERVICES, AND PROVIDING ACCESS TO THE INTERNET; TELECOMMUNICATIONS RESELLER SERVICES THROUGH MULTILEVEL MARKETING, NAMELY, PROVIDING LOCAL AND LONG DISTANCE DIGITAL TELEPHONE SERVICE, WIRELESS TELEPHONE TELECOMMUNICATIONS SERVICES, TELECOMMUNICATIONS SERVICES IN THE NATURE OF LOCAL AND LONG DISTANCE TRANSMISSION OF VOICE, DATA, GRAPHICS AND VIDEO BY MEANS OF BROADBAND, COPPER AND OPTICAL OR WIRELESS NETWORKS, DIGITAL TELEVISION TRANSMISSION SERVICES, SATELLITE TRANSMISSION SERVICES AND PROVIDING INTERNET ACCESS (U.S. CLS. 100, 101 AND 104).

DEZMONA MIZELLE, EXAMINING ATTORNEY

**CLASS 38—(Continued).**

SN 85-283,123. PORTABLE WINDOW, LLC, RALEIGH, NC. FILED 3-31-2011.



NO CLAIM IS MADE TO THE EXCLUSIVE RIGHT TO USE "PORTABLE", APART FROM THE MARK AS SHOWN.

THE MARK CONSISTS OF THE STYLIZED WORDING "PORTABLE WINDOW A BETTER VIEW" WITH THE WORDING "PORTABLE WINDOW" APPEARING IN RELATIVELY LARGER FONT ABOVE THE WORDING "A BETTER VIEW" AND WITH ALL THE WORDING APPEARING WITHIN A RECTANGULAR FRAME CREATED BY TWO CONCENTRIC RECTANGLES.

FOR TRANSMISSION OF HIGH DEFINITION VIDEO TO PLAYBACK SYSTEMS LOCATED IN THE PLACES OF BUSINESS OF SUBSCRIBING CLIENTS (U.S. CLS. 100, 101 AND 104).

FIRST USE 7-30-2010; IN COMMERCE 7-30-2010.  
NICHOLAS ALTREE, EXAMINING ATTORNEY

---

SN 85-290,196. LIFENEXUS, INC., SANDPOINT, ID. FILED 4-8-2011.

**ICHIP APP GALLERY**

THE MARK CONSISTS OF STANDARD CHARACTERS WITHOUT CLAIM TO ANY PARTICULAR FONT, STYLE, SIZE, OR COLOR.

NO CLAIM IS MADE TO THE EXCLUSIVE RIGHT TO USE "APP", APART FROM THE MARK AS SHOWN.

FOR ELECTRONIC TRANSMISSION OF DATA VIA THE INTERNET, GLOBAL COMPUTER NETWORKS, WIRELESS NETWORKS AND ELECTRONIC COMMUNICATION NETWORKS; PROVIDING ACCESS TO GLOBAL COMPUTER NETWORKS, WIRELESS NETWORKS AND ELECTRONIC COMMUNICATIONS NETWORKS FOR TRANSMISSION OR RECEIPT OF DATA (U.S. CLS. 100, 101 AND 104).

ANTHONY RINKER, EXAMINING ATTORNEY



**CLASS 38—(Continued).**

SN 85-295,701. X-SANGUINE, LLC, SAN DIEGO, CA. FILED 4-14-2011.

**ZDN**  
**Zombie Defense**  
**Network**

THE MARK CONSISTS OF STANDARD CHARACTERS WITHOUT CLAIM TO ANY PARTICULAR FONT, STYLE, SIZE, OR COLOR.

NO CLAIM IS MADE TO THE EXCLUSIVE RIGHT TO USE "NETWORK", APART FROM THE MARK AS SHOWN. FOR CHAT ROOM SERVICES FOR SOCIAL NETWORKING (U.S. CLS. 100, 101 AND 104).

DAWN HAN, EXAMINING ATTORNEY

SN 85-295,844. UTSTARCOM, INC., ALAMEDA, CA. FILED 4-14-2011.



OWNER OF U.S. REG. NOS. 3,257,655, 3,259,483 AND 3,406,764.

THE MARK CONSISTS OF THE LETTERS "UT" IN AN INCOMPLETE CIRCLE, FOLLOWED BY THE LETTERS "STARCOM", WITH THE OPEN SPACE IN THE LETTER A REPRESENTED BY A FOUR-POINTED STAR.

THE WORDING "UTSTARCOM" HAS NO MEANING IN A FOREIGN LANGUAGE.

FOR COMMUNICATIONS BY TELEPHONE; CONSULTING IN THE FIELD OF TELECOMMUNICATION SERVICES, NAMELY, TRANSMISSION OF VOICE, DATA, AND DOCUMENTS VIA TELECOMMUNICATIONS NETWORKS; INFORMATION ABOUT TELECOMMUNICATION; PROVIDING TELECOMMUNICATIONS CONNECTIONS TO A GLOBAL COMPUTER NETWORK; TELECOMMUNICATION CONSULTATION IN THE NATURE OF TECHNICAL CONSULTING IN THE FIELD OF AUDIO, TEXT AND VISUAL DATA TRANSMISSION AND COMMUNICATION (U.S. CLS. 100, 101 AND 104).

ALLISON HOLTZ, EXAMINING ATTORNEY

SN 85-313,383. COHASSET COMMUNITY TELEVISION, INC., COHASSET, MA. FILED 5-5-2011.

**143 TV**

THE MARK CONSISTS OF STANDARD CHARACTERS WITHOUT CLAIM TO ANY PARTICULAR FONT, STYLE, SIZE, OR COLOR.

NO CLAIM IS MADE TO THE EXCLUSIVE RIGHT TO USE "TV", APART FROM THE MARK AS SHOWN.

FOR CABLE TELEVISION BROADCASTING SERVICES (U.S. CLS. 100, 101 AND 104).

FIRST USE 1-1-2011; IN COMMERCE 1-1-2011.

CHERYL CLAYTON, EXAMINING ATTORNEY

**CLASS 38—(Continued).**

SN 85-314,567. SPEEDNET, LLC, SAGINAW, MI. FILED 5-6-2011.



**HIGH-SPEED WIRELESS INTERNET & TELEPHONE**

OWNER OF U.S. REG. NO. 3,935,822.

NO CLAIM IS MADE TO THE EXCLUSIVE RIGHT TO USE "HIGH-SPEED WIRELESS INTERNET & TELEPHONE", APART FROM THE MARK AS SHOWN.

THE MARK CONSISTS OF THE TERM SPEEDCONNECT AS A SINGLE TERM, THE LETTER "D" IS CONNECTED TO THE LETTER "C". A STIPPLED CIRCLE IS PLACED IN THE CENTER OF THE LETTER "C" AND SOUND OR ELECTRONIC WAVES SURROUND THE OPEN PORTION OF THE LETTER "C" AND INTERSECTS THE FOLLOWING LETTER "O". THE TERM "HIGH-SPEED WIRELESS INTERNET & TELEPHONE" APPEARS BELOW THE TERM "SPEEDCONNECT".

FOR COMMUNICATION SERVICES, NAMELY, PROVIDING HIGH SPEED INTERNET ACCESS (U.S. CLS. 100, 101 AND 104).

HENRY S. ZAK, EXAMINING ATTORNEY

**CLASS 38—(Continued).**

SN 85-316,351. THE INTERNET CORNER, S.L., MADRID, SPAIN, FILED 5-9-2011.



PRIORITY CLAIMED UNDER SEC. 44(D) ON ERP N CMNTY TM OFC APPLICATION NO. 009930661, FILED 4-29-2011, REG. NO. 009930661, DATED 8-19-2011, EXPIRES 4-29-2021.

THE COLOR(S) GREEN AND WHITE IS/ARE CLAIMED AS A FEATURE OF THE MARK.

THE MARK CONSISTS OF THE LETTER "K" IN WHITE INSIDE A GREEN RECTANGLE.

FOR TELECOMMUNICATION SERVICES, NAMELY, PROVIDING ONLINE AND TELECOMMUNICATION FACILITIES FOR REAL-TIME INTERACTION BETWEEN AND AMONG USERS OF COMPUTERS, MOBILE AND HANDHELD COMPUTERS, AND WIRED AND WIRELESS COMMUNICATION DEVICES CONCERNING TOPICS OF GENERAL INTEREST; ENABLING INDIVIDUALS TO SEND AND RECEIVE MESSAGES VIA EMAIL, INSTANT MESSAGING OR A WEBSITE ON THE INTERNET IN THE FIELD OF GENERAL INTEREST; PROVIDING ON-LINE CHAT ROOMS AND ELECTRONIC BULLETIN BOARDS FOR TRANSMISSION OF MESSAGES CONCERNING COLLEGIATE LIFE, GENERAL INTEREST CLASSIFIEDS, VIRTUAL COMMUNITY, SOCIAL NETWORKING, PHOTO SHARING, AND TRANSMISSION OF PHOTOGRAPHIC IMAGES; PROVIDING AN ONLINE COMMUNITY FORUM FOR REGISTERED USERS TO SHARE INFORMATION, PHOTOS, AUDIO AND VIDEO CONTENT THEMSELVES, THEIR LIKES AND DISLIKES AND DAILY ACTIVITIES, TO GET FEEDBACK FROM THEIR PEERS, TO FORM VIRTUAL COMMUNITIES, AND TO ENGAGE IN SOCIAL NETWORKING; PROVIDING OF ON-LINE FORUMS FOR COMMUNICATIONS ON TOPICS OF GENERAL INTEREST (U.S. CLS. 100, 101 AND 104).

JAMES LOVELACE, EXAMINING ATTORNEY

**CLASS 38—(Continued).**

SN 85-317,835. AMERICAN NETWORK, INC., NEW YORK, NY, FILED 5-11-2011.



NO CLAIM IS MADE TO THE EXCLUSIVE RIGHT TO USE "PHONECAPTION", APART FROM THE MARK AS SHOWN.

THE COLOR(S) LIGHT BLUE AND DARK BLUE IS/ARE CLAIMED AS A FEATURE OF THE MARK.

THE MARK CONSISTS OF THE WORDING "PHONECAPTION" WITH THE WORD "PHONE" IN DARK BLUE AND THE WORD "CAPTION" IN LIGHT BLUE. SURROUNDING THE LETTER "C" IS A DARK BLUE STYLIZED "C" WITH A POINT EXTENDING FROM THE BOTTOM THEREOF.

FOR CAPTIONED TELEPHONE SERVICES FOR INDIVIDUALS WHO ARE DEAF, HARD OF HEARING OR SPEECH IMPAIRED; COMMUNICATION SERVICES, NAMELY, ELECTRONIC TRANSMISSION OF MESSAGES VIA GLOBAL COMPUTER NETWORKS (U.S. CLS. 100, 101 AND 104).

FIRST USE 4-21-2011; IN COMMERCE 4-21-2011.  
TINA MAI, EXAMINING ATTORNEY

SN 85-318,495. ADASIM INC., CULVER CITY, CA. FILED 5-11-2011.



*For you*  
...The Stupid Simple Way To Instantly Reach Your Customers!

NO CLAIM IS MADE TO THE EXCLUSIVE RIGHT TO USE "TEXT", APART FROM THE MARK AS SHOWN.

THE MARK CONSISTS OF THE STYLIZED WORDS "YEP TEXT" ARRANGED ONE ON TOP OF THE OTHER, SURROUNDED BY A SPEECH BUBBLE. TO THE RIGHT IS THE STYLIZED TEXT "...THE STUPID SIMPLE WAY FOR YOU TO INSTANTLY REACH YOUR CUSTOMERS!". THE "FOR YOU" IS POSITIONED ABOVE THE REST OF THE LINE AND IS INSERTED WITH AN ARROW BETWEEN "WAY" AND "TO".

FOR TEXT AND NUMERIC WIRELESS DIGITAL MESSAGING SERVICES (U.S. CLS. 100, 101 AND 104).

FIRST USE 1-1-2011; IN COMMERCE 3-20-2011.  
BRIAN PINO, EXAMINING ATTORNEY

**CLASS 38—(Continued).**

SN 85-320,941. DELLOSO, MICHELLE, IVINS, UT. FILED 5-13-2011.

## Rim to Rim Club

THE MARK CONSISTS OF STANDARD CHARACTERS WITHOUT CLAIM TO ANY PARTICULAR FONT, STYLE, SIZE, OR COLOR.

OWNER OF U.S. REG. NO. 3,956,195.  
NO CLAIM IS MADE TO THE EXCLUSIVE RIGHT TO USE "CLUB", APART FROM THE MARK AS SHOWN.  
FOR PROVIDING AN ONLINE FORUM FOR EXCHANGING AND TRANSMISSION OF INFORMATION AND EXPERIENCES ABOUT HIKING (U.S. CLS. 100, 101 AND 104).

KHANH LE, EXAMINING ATTORNEY

SN 85-329,067. HTC CORPORATION, TAOYUAN CITY, TAIWAN, FILED 5-24-2011.

## INNOVATION INSPIRED BY YOU

THE MARK CONSISTS OF STANDARD CHARACTERS WITHOUT CLAIM TO ANY PARTICULAR FONT, STYLE, SIZE, OR COLOR.

OWNER OF U.S. REG. NO. 3,750,693.  
FOR TELECOMMUNICATION ACCESS SERVICES; TELECOMMUNICATION SERVICES, NAMELY, PROVIDING INTERNET ACCESS VIA BROADBAND OPTICAL OR WIRELESS NETWORKS; TELECOMMUNICATION SERVICES, NAMELY, TRANSMISSION OF VOICE, AUDIO, VISUAL IMAGES AND DATA BY TELECOMMUNICATIONS NETWORKS, WIRELESS COMMUNICATION NETWORKS, THE INTERNET, INFORMATION SERVICES NETWORKS AND DATA NETWORKS (U.S. CLS. 100, 101 AND 104).

AMY C. KEAN, EXAMINING ATTORNEY

SN 85-330,872. CREATIVE RESOURCES GROUP, PLYMOUTH, MA. FILED 5-26-2011.



THE MARK CONSISTS OF THE STYLIZED TEXT "ICASTING WORKS.COM" WITH A SWOOSH OVER THE LETTER "I".

FOR INTERNET BROADCASTING SERVICES (U.S. CLS. 100, 101 AND 104).  
FIRST USE 6-11-2009; IN COMMERCE 7-15-2009.  
CARYN GLASSER, EXAMINING ATTORNEY

**CLASS 38—(Continued).**

SN 85-331,075. YOUMICRO, S.L., MADRID, SPAIN, FILED 5-26-2011.

## AUDIOSTATUS

THE MARK CONSISTS OF STANDARD CHARACTERS WITHOUT CLAIM TO ANY PARTICULAR FONT, STYLE, SIZE, OR COLOR.

FOR AUDIO AND VIDEO BROADCASTING SERVICES OVER THE INTERNET; BROADCASTING OF VIDEO AND AUDIO PROGRAMMING OVER THE INTERNET; COMMUNICATION SERVICES, NAMELY, TRANSMISSION OF VOICE, AUDIO, VISUAL IMAGES AND DATA BY TELECOMMUNICATIONS NETWORKS, WIRELESS COMMUNICATION NETWORKS, THE INTERNET, INFORMATION SERVICES NETWORKS AND DATA NETWORKS; ELECTRONIC TRANSMISSION OF INFORMATION POSTED TO USENET NEWSGROUPS AND DISCUSSION GROUPS VIA A GLOBAL COMPUTER NETWORK; INFORMATION TRANSMISSION VIA ELECTRONIC COMMUNICATIONS NETWORKS; TELECOMMUNICATION CONSULTATION IN THE NATURE OF TECHNICAL CONSULTING IN THE FIELD OF AUDIO, TEXT AND VISUAL DATA TRANSMISSION AND COMMUNICATION; TELECOMMUNICATION SERVICES, NAMELY, TRANSMISSION OF VOICE, DATA, GRAPHICS, IMAGES, AUDIO AND VIDEO BY MEANS OF TELECOMMUNICATIONS NETWORKS, WIRELESS COMMUNICATION NETWORKS, AND THE INTERNET; VIDEO BROADCASTING SERVICES OVER THE INTERNET OR OTHER COMMUNICATIONS NETWORK FEATURING THE UPLOADED, POSTED AND TAGGED VIDEOS OF OTHERS (U.S. CLS. 100, 101 AND 104).

STEVEN R. FINE, EXAMINING ATTORNEY

SN 85-331,979. VELOCITY INTERNATIONAL, INC., PITTSBURGH, PA. FILED 5-27-2011.

## HD2U

THE MARK CONSISTS OF STANDARD CHARACTERS WITHOUT CLAIM TO ANY PARTICULAR FONT, STYLE, SIZE, OR COLOR.

FOR AUDIO AND VIDEO BROADCASTING SERVICES OVER THE INTERNET; AUDIO AND VIDEO BROADCASTING SERVICES OVER THE INTERNET IN THE FIELD OF PRIVATE EVENT BROADCASTING; BROADCASTING PROGRAMS VIA A GLOBAL COMPUTER NETWORK; INTERNET BROADCASTING SERVICES; VIDEO BROADCASTING; WEBCASTING SERVICES (U.S. CLS. 100, 101 AND 104).

DORITT L. CARROLL, EXAMINING ATTORNEY

**CLASS 38—(Continued).**

SN 85-332,042. SORENSON COMMUNICATIONS, INC., SALT LAKE CITY, UT. FILED 5-27-2011.



THE MARK CONSISTS OF CLUSTER OF CIRCLES WITH THE LETTERS SN TO THE RIGHT AND THE WORD SIGNETWORK BELOW THE LETTERS.

FOR INTERNET BROADCASTING SERVICES (U.S. CLS. 100, 101 AND 104).  
MATTHEW EINSTEIN, EXAMINING ATTORNEY

---

SN 85-333,043. SANSONE, ALISON, IRVINE, CA. FILED 5-28-2011.

## webtime stories

THE MARK CONSISTS OF STANDARD CHARACTERS WITHOUT CLAIM TO ANY PARTICULAR FONT, STYLE, SIZE, OR COLOR.

NO CLAIM IS MADE TO THE EXCLUSIVE RIGHT TO USE "STORIES", APART FROM THE MARK AS SHOWN.

FOR TRANSMISSION OF SOUND, VIDEO AND INFORMATION FROM WEB CAMS, ALL FEATURING LIVE OR RECORDED MATERIALS (U.S. CLS. 100, 101 AND 104).

FIRST USE 10-1-2010; IN COMMERCE 12-1-2010.  
TINA BROWN, EXAMINING ATTORNEY

---

SN 85-334,352. PREMIERE RADIO NETWORKS, INC., SAN ANTONIO, TX. FILED 5-31-2011.

## DITTOHEAD NATION

THE MARK CONSISTS OF STANDARD CHARACTERS WITHOUT CLAIM TO ANY PARTICULAR FONT, STYLE, SIZE, OR COLOR.

OWNER OF U.S. REG. NOS. 3,005,851 AND 3,088,658. FOR RADIO BROADCASTING (U.S. CLS. 100, 101 AND 104).

FIRST USE 4-11-2011; IN COMMERCE 4-11-2011.  
DOMINICK J. SALEMI, EXAMINING ATTORNEY

**CLASS 38—(Continued).**

SN 85-334,523. EVERLOOP, INC., DANVILLE, CA. FILED 5-31-2011.

## WHO'S IN YOUR LOOP?

THE MARK CONSISTS OF STANDARD CHARACTERS WITHOUT CLAIM TO ANY PARTICULAR FONT, STYLE, SIZE, OR COLOR.

FOR COMMUNICATION SERVICES, NAMELY, ELECTRONIC TRANSMISSION OF AUDIO, MESSAGES, VIDEO AND OTHER DATA; PROVIDING ON-LINE CHAT ROOMS AND ELECTRONIC BULLETIN BOARDS FOR TRANSMISSION OF MESSAGES AMONG USERS IN THE FIELD OF GENERAL INTEREST (U.S. CLS. 100, 101 AND 104).

CHRISTINA SOBRAL, EXAMINING ATTORNEY

---

SN 85-335,329. CMPPLY, INC., NEW YORK, NY. FILED 6-1-2011.

## CMP.LY

THE MARK CONSISTS OF STANDARD CHARACTERS WITHOUT CLAIM TO ANY PARTICULAR FONT, STYLE, SIZE, OR COLOR.

FOR COMMUNICATION SERVICES, NAMELY ELECTRONIC AND DIGITAL TRANSMISSION OF TEXT, CONTENT, NOTIFICATIONS, SHORT MESSAGING SERVICES (SMS), MULTIMEDIA MESSAGING SERVICES (MMS), INSTANT MESSAGING SERVICES AND ELECTRONIC TRANSMISSION OF OTHER DIGITAL AND INTERACTIVE INFORMATION, VIA GLOBAL DIGITAL, BROADBAND AND WIRELESS COMMUNICATION NETWORKS (U.S. CLS. 100, 101 AND 104).

FIRST USE 10-6-2009; IN COMMERCE 10-15-2009.  
BRIAN NEVILLE, EXAMINING ATTORNEY

**CLASS 38—(Continued).**

SN 85-336,558. ATE MY HEART INC., LOS ANGELES, CA. FILED 6-2-2011.

**LITTLE MONSTERS**

THE MARK CONSISTS OF STANDARD CHARACTERS WITHOUT CLAIM TO ANY PARTICULAR FONT, STYLE, SIZE, OR COLOR.

FOR STREAMING OF AUDIO AND VIDEO MATERIAL ON THE INTERNET; PROVIDING ONLINE CHAT ROOMS AND ELECTRONIC BULLETIN BOARDS FOR TRANSMISSION OF MESSAGES AMONG USERS CONCERNING A MUSICAL ARTIST, HER RECORDINGS, PERSONAL APPEARANCES AND OTHER ACTIVITIES; PROVIDING ON-LINE FACILITIES FOR REAL-TIME INTERACTION WITH OTHER COMPUTER USERS CONCERNING A MUSICAL ARTIST, HER RECORDINGS, PERSONAL APPEARANCES AND OTHER ACTIVITIES (U.S. CLS. 100, 101 AND 104).

NICHOLAS ALTREE, EXAMINING ATTORNEY

SN 85-336,596. INTERNET PAWN, INC., CENTENNIAL, CO. FILED 6-2-2011.

**PAWNGO**

THE MARK CONSISTS OF STANDARD CHARACTERS WITHOUT CLAIM TO ANY PARTICULAR FONT, STYLE, SIZE, OR COLOR.

FOR ELECTRONIC DELIVERY OF LOAN DOCUMENTS (U.S. CLS. 100, 101 AND 104).

FIRST USE 5-18-2011; IN COMMERCE 5-18-2011.

CIMMERIAN COLEMAN, EXAMINING ATTORNEY

SN 85-337,098. VIANETTV INC., TORONTO, ONTARIO, CANADA, FILED 6-3-2011.

**ViaNetTV**

THE MARK CONSISTS OF STANDARD CHARACTERS WITHOUT CLAIM TO ANY PARTICULAR FONT, STYLE, SIZE, OR COLOR.

FOR COMMUNICATION SERVICES, NAMELY, TRANSMISSION OF VOICE, AUDIO, VISUAL IMAGES AND DATA BY TELECOMMUNICATIONS NETWORKS, WIRELESS COMMUNICATION NETWORKS, THE INTERNET, INFORMATION SERVICES NETWORKS AND DATA NETWORKS; INTERNET BROADCASTING SERVICES; PROVIDING VOICE COMMUNICATION SERVICES VIA THE INTERNET (U.S. CLS. 100, 101 AND 104).

FIRST USE 1-26-2009; IN COMMERCE 1-26-2009.

CHARLOTTE CORWIN, EXAMINING ATTORNEY

**CLASS 38—(Continued).**

SN 85-337,193. VOTELA, INC, ANNAPOLIS, MD. FILED 6-3-2011.



THE MARK CONSISTS OF A SQUARED BACKGROUND WITH A CLOUD AND THE TEXT "VOTELA" IN THE MIDDLE.

FOR VOICE OVER IP SERVICES (U.S. CLS. 100, 101 AND 104).

LINDA ESTRADA, EXAMINING ATTORNEY

SN 85-337,612. BELLEVUE RADIO, INC., BELLEVUE, WA. FILED 6-3-2011.

**MUSIC AS COOL NOW AS IT WAS THEN!**

THE MARK CONSISTS OF STANDARD CHARACTERS WITHOUT CLAIM TO ANY PARTICULAR FONT, STYLE, SIZE, OR COLOR.

FOR RADIO BROADCASTING SERVICES (U.S. CLS. 100, 101 AND 104).

FIRST USE 4-6-2009; IN COMMERCE 4-6-2009.

DOUGLAS LEE, EXAMINING ATTORNEY

SN 85-338,463. NORTHERN KENTUCKY UNIVERSITY, HIGHLAND HEIGHTS, KY. FILED 6-6-2011.

**WNKU**

THE MARK CONSISTS OF STANDARD CHARACTERS WITHOUT CLAIM TO ANY PARTICULAR FONT, STYLE, SIZE, OR COLOR.

FOR RADIO BROADCASTING SERVICES (U.S. CLS. 100, 101 AND 104).

FIRST USE 0-0-1985; IN COMMERCE 0-0-1985.

JENNIFER DIXON, EXAMINING ATTORNEY

**CLASS 38—(Continued).**

SN 85-338,929. MOBILE INFOWARE, LLC, ANDOVER, MA. FILED 6-6-2011.

# ZYMAP

THE MARK CONSISTS OF STANDARD CHARACTERS WITHOUT CLAIM TO ANY PARTICULAR FONT, STYLE, SIZE, OR COLOR.

FOR PROVIDING ONLINE ELECTRONIC BULLETIN BOARDS FOR TRANSMISSION OF MESSAGES AMONG COMPUTER USERS CONCERNING RANKINGS, RATINGS, REVIEWS, REFERRALS, AND RECOMMENDATIONS RELATING TO BUSINESS ORGANIZATIONS, SERVICE PROVIDERS AND SOCIAL NETWORKING (U.S. CLS. 100, 101 AND 104).

KIM MONINGHOFF, EXAMINING ATTORNEY

SN 85-339,227. LIQUID SPINS, INC., FORMERLY MALE-MARK, INC., COLORADO SPRINGS, CO. FILED 6-6-2011.

# Liquid Spins

THE MARK CONSISTS OF STANDARD CHARACTERS WITHOUT CLAIM TO ANY PARTICULAR FONT, STYLE, SIZE, OR COLOR.

FOR DELIVERY OF DIGITAL MUSIC BY ELECTRONIC TRANSMISSION; PROVIDING ACCESS TO DIGITAL MUSIC WEBSITES ON THE INTERNET (U.S. CLS. 100, 101 AND 104).

FIRST USE 8-2-2010; IN COMMERCE 8-10-2010.  
SHANNON TWOHIG, EXAMINING ATTORNEY

SN 85-339,241. NET2VU INC., WILMINGTON, DE. FILED 6-6-2011.



**Net2Vu**  
VIEW THE WORLD

THE MARK CONSISTS OF THE STYLIZED TEXT "NET2-VU" IN WHICH THERE ARE THREE SEMI CIRCLES ABOVE THE LETTER "V". THE STYLIZED TEXT "VIEW THE WORLD" IS BELOW IN SMALLER TYPE.

FOR INTERNET PROTOCOL TELEVISION (IPTV) TRANSMISSION SERVICES (U.S. CLS. 100, 101 AND 104).  
FIRST USE 4-2-2009; IN COMMERCE 10-1-2009.

VIVIAN MICZNIK FIRST, EXAMINING ATTORNEY

**CLASS 38—(Continued).**

SN 85-340,409. EARLY BIRD ALERT, INC., SAN RAFAEL, CA. FILED 6-7-2011.



THE MARK CONSISTS OF BIRD HEAD LOGO. FOR TELECOMMUNICATION SERVICES, NAMELY, ELECTRONIC AND DIGITAL TRANSMISSION OF VOICE, DATA, SIGNALS AND MESSAGES FOR PROVIDING COMMUNICATION BETWEEN USERS OF THE SERVICE AND HEALTHCARE PROVIDERS (U.S. CLS. 100, 101 AND 104).

HEATHER THOMPSON, EXAMINING ATTORNEY

SN 85-341,617. TWENTIETH CENTURY FOX FILM CORPORATION, LOS ANGELES, CA. FILED 6-8-2011.

## FOX SPORTS GAME CONNECT

THE MARK CONSISTS OF STANDARD CHARACTERS WITHOUT CLAIM TO ANY PARTICULAR FONT, STYLE, SIZE, OR COLOR.

OWNER OF U.S. REG. NOS. 3,001,993, 3,032,760 AND OTHERS.

NO CLAIM IS MADE TO THE EXCLUSIVE RIGHT TO USE "SPORTS GAME CONNECT", APART FROM THE MARK AS SHOWN.

FOR PROVIDING ON-LINE CHAT ROOMS FOR TRANSMISSION OF MESSAGES AMONG USERS IN THE FIELD OF VARIOUS SUBJECT MATTER INCLUDING ENTERTAINMENT AND SPORTS (U.S. CLS. 100, 101 AND 104).

FIRST USE 4-6-2011; IN COMMERCE 4-6-2011.  
CAROLINE WOOD, EXAMINING ATTORNEY

**CLASS 38—(Continued).**

SN 85-344,159. MONAD CORPORATION, DBA MONAD, WILMINGTON, DE. FILED 6-13-2011.

# MONAD

THE MARK CONSISTS OF STANDARD CHARACTERS WITHOUT CLAIM TO ANY PARTICULAR FONT, STYLE, SIZE, OR COLOR.

FOR DELIVERY OF MESSAGES BY ELECTRONIC TRANSMISSION; ELECTRONIC MESSAGING; ELECTRONIC TRANSMISSION OF MESSAGES; ELECTRONIC TRANSMISSION OF MESSAGES AND DATA; MESSAGE SENDING AND RECEIVING SERVICES; MESSAGE SENDING VIA A WEBSITE; PROVIDING E-MAIL AND INSTANT MESSAGING SERVICES; PROVIDING ON-LINE CHAT ROOMS AND ELECTRONIC BULLETIN BOARDS FOR TRANSMISSION OF MESSAGES AMONG USERS IN THE FIELD OF GENERAL INTEREST; TELECOMMUNICATION SERVICES, NAMELY, PROVIDING ELECTRONIC MESSAGE ALERTS VIA THE INTERNET; TELECOMMUNICATION SERVICES, NAMELY, TRANSMISSION OF WEBCASTS; TELECOMMUNICATIONS BY E-MAIL; TRANSMISSION OF MESSAGES; TRANSMISSION OF MESSAGES OVER ELECTRONIC MEDIA; WEB MESSAGING (U.S. CLS. 100, 101 AND 104).

ESTHER BELENKER, EXAMINING ATTORNEY

**CLASS 38—(Continued).**

SN 85-365,284. MONAVIE LLC, SOUTH JORDAN, UT. FILED 7-7-2011.

# MLN

THE MARK CONSISTS OF STANDARD CHARACTERS WITHOUT CLAIM TO ANY PARTICULAR FONT, STYLE, SIZE, OR COLOR.

FOR AUDIO AND VIDEO BROADCASTING SERVICES OVER THE INTERNET; AUDIO BROADCASTING; BROADCAST OF CABLE TELEVISION PROGRAMMES; BROADCASTING OF RADIO AND TELEVISION PROGRAMMES; BROADCASTING OF RADIO PROGRAMMES; BROADCASTING OF TELEVISION PROGRAMMES; BROADCASTING OF VIDEO AND AUDIO PROGRAMMING OVER THE INTERNET; BROADCASTING PROGRAMS VIA A GLOBAL COMPUTER NETWORK; BROADCASTING SERVICES AND PROVISION OF TELECOMMUNICATION ACCESS TO FILMS AND TELEVISION PROGRAMMES PROVIDED VIA A VIDEO-ON-DEMAND SERVICE; BROADCASTING SERVICES AND PROVISION OF TELECOMMUNICATION ACCESS TO VIDEO AND AUDIO CONTENT PROVIDED VIA A VIDEO-ON-DEMAND SERVICE VIA THE INTERNET; CABLE TELEVISION BROADCASTING; CABLE TELEVISION BROADCASTING SERVICES; INTERNET BROADCASTING SERVICES; INTERNET RADIO BROADCASTING SERVICES; RADIO PROGRAM BROADCASTING; SATELLITE TELEVISION BROADCASTING; SATELLITE TRANSMISSION SERVICES, TELEVISION AND RADIO BROADCASTING SERVICES; SUBSCRIPTION TELEVISION BROADCASTING; TELEVISION BROADCASTING; VIDEO BROADCASTING; VIDEO BROADCASTING AND TRANSMISSION SERVICES VIA THE INTERNET, FEATURING FILMS AND MOVIES; VIDEO BROADCASTING SERVICES VIA THE INTERNET (U.S. CLS. 100, 101 AND 104).

FRED CARL, EXAMINING ATTORNEY

SN 85-361,727. TRACFONE WIRELESS, INC., MIAMI, FL. FILED 7-1-2011.

# EVERYWHERENESS

THE MARK CONSISTS OF STANDARD CHARACTERS WITHOUT CLAIM TO ANY PARTICULAR FONT, STYLE, SIZE, OR COLOR.

FOR CELLULAR TELEPHONE COMMUNICATIONS SERVICES; CELLULAR TELEPHONE TELECOMMUNICATIONS SERVICES PROVIDED VIA PREPAID AIR TIME CELLULAR TELEPHONES AND PREPAID AIR TIME CELLULAR TELEPHONE CALLING CARD SERVICES (U.S. CLS. 100, 101 AND 104).

PAUL E. FAHRENKOPF, EXAMINING ATTORNEY

**CLASS 38—(Continued).**

SN 85-370,757. GOGO LLC, ITASCA, IL. FILED 7-13-2011.

**GOGO VISION**

THE MARK CONSISTS OF STANDARD CHARACTERS WITHOUT CLAIM TO ANY PARTICULAR FONT, STYLE, SIZE, OR COLOR.

OWNER OF U.S. REG. NOS. 3,499,843 AND 3,680,364.

FOR BROADBAND AND NARROWBAND COMMUNICATION SERVICES ONBOARD AIRCRAFTS TO ENABLE USERS TO TRANSMIT AND RECEIVE VOICE, VIDEO, AND DATA WITHIN THE AIRCRAFTS, BETWEEN THE AIRCRAFTS, BETWEEN THE AIRCRAFTS AND THE GROUND, AND BETWEEN THE GROUND AND THE AIRCRAFTS; BROADBAND AND NARROWBAND COMMUNICATION SERVICES TO INTERCONNECT USERS, LOCATED ONBOARD AN AIRCRAFT, WITH USERS LOCATED ONBOARD ANOTHER AIRCRAFT, TO INTERCONNECT USERS LOCATED ONBOARD AN AIRCRAFT WITH USERS AND DESTINATIONS ON THE GROUND, TO INTERCONNECT USERS AND DESTINATIONS ON THE GROUND WITH USERS ONBOARD THE AIRCRAFTS, AND TO INTERCONNECT USERS LOCATED ONBOARD AN AIRCRAFT; PROVISION OF ACCESS TO VIDEO AND AUDIO CONTENT VIA VIDEO-ON-DEMAND SERVICES (U.S. CLS. 100, 101 AND 104).

ELLEN B. AWRICH, EXAMINING ATTORNEY

SN 85-383,702. PREMIERE RADIO NETWORKS, INC., SAN ANTONIO, TX. FILED 7-28-2011.

**ELECTRIC SOUND STAGE**

THE MARK CONSISTS OF STANDARD CHARACTERS WITHOUT CLAIM TO ANY PARTICULAR FONT, STYLE, SIZE, OR COLOR.

FOR BROADCASTING SERVICES VIA THE INTERNET AND WORLDWIDE WEB; DIGITAL AUDIO BROADCASTING AND PODCASTING SERVICES PROVIDED VIA A GLOBAL COMMUNICATIONS NETWORK; TELECOMMUNICATIONS SERVICES, NAMELY, PROVIDING TRANSMISSION OF VOICE, DATA, VIDEO, AND MEDIA CONTENT VIA A GLOBAL COMMUNICATIONS NETWORK (U.S. CLS. 100, 101 AND 104).

DOMINICK J. SALEMI, EXAMINING ATTORNEY

**CLASS 38—(Continued).**

SN 85-391,864. SPRINT COMMUNICATIONS COMPANY L.P., OVERLAND PARK, KS. FILED 8-8-2011.

**Business Share Plus Plans**

THE MARK CONSISTS OF STANDARD CHARACTERS WITHOUT CLAIM TO ANY PARTICULAR FONT, STYLE, SIZE, OR COLOR.

NO CLAIM IS MADE TO THE EXCLUSIVE RIGHT TO USE "BUSINESS SHARE" AND "PLANS", APART FROM THE MARK AS SHOWN.

FOR WIRELESS TELEPHONE TELECOMMUNICATIONS SERVICES, NAMELY, WIRELESS MOBILE TELEPHONE CALLING PLANS (U.S. CLS. 100, 101 AND 104).

JAY BESCH, EXAMINING ATTORNEY

**CLASS 39—TRANSPORTATION AND STORAGE**

SN 77-955,561. BERG ADVENTURES INTERNATIONAL, INC., CANMORE, ALBERTA, CANADA, FILED 3-10-2010.

**BAI**

THE MARK CONSISTS OF STANDARD CHARACTERS WITHOUT CLAIM TO ANY PARTICULAR FONT, STYLE, SIZE, OR COLOR.

FOR TRAVEL SERVICES, NAMELY, ARRANGING AND CONDUCTING INTERNATIONAL ADVENTURE, LUXURY AND CULTURAL TOURS (U.S. CLS. 100 AND 105).

FIRST USE 11-1-2001; IN COMMERCE 11-1-2001.

KATHERINE E. HALMEN, EXAMINING ATTORNEY



**CLASS 39—(Continued).**

SN 79-093,074. GZL INTRNATIONAL TRAVEL SERVICE LTD., GUANGDONG, CHINA, FILED 1-21-2011.



OWNER OF INTERNATIONAL REGISTRATION 1066570 DATED 1-21-2011, EXPIRES 1-21-2021.

NO CLAIM IS MADE TO THE EXCLUSIVE RIGHT TO USE THE NON-LATIN CHARACTERS THAT TRANSLITERATE TO LU, APART FROM THE MARK AS SHOWN.

THE MARK CONSISTS OF THE STYLIZED CHINESE CHARACTERS GUANG ZHI LU ABOVE THE STYLIZED LETTERS "CGZL". TO THE LEFT OF THE LETTERS APPEARS A STYLIZED FLOWER DESIGN ABOVE A CURVED LINE.

THE CHINESE SYMBOLS IN THE MARK TRANSLITERATE TO GUANG ZHI LU. GUANG MEANS WIDE IN ENGLISH. ZHI MEANS OF IN ENGLISH. LU MEANS TRIP OR TRAVEL IN ENGLISH. WHEN USED IN COMBINATION, THE SYMBOLS HAVE NO MEANING IN ENGLISH.

FOR TRAVEL AGENCY SERVICES, EXCLUDING HOTEL RESERVATIONS, NAMELY, ARRANGING FOR TRAVEL VISAS, PASSPORTS AND TRAVEL DOCUMENTS FOR PERSONS TRAVELING ABROAD, ARRANGING TRAVEL TOURS, BOOKING OF SEATS FOR TRAVEL; ESCORTING OF TRAVELLERS; ARRANGING OF CRUISES; ORGANIZATIONS OF SIGHTSEEING TOURS; ARRANGING OF TOURS; BOOKING OF SEATS FOR TRAVEL; TRAVEL RESERVATION, NAMELY, BOOKING OF SEATS FOR TRAVEL (U.S. CLS. 100 AND 105).

ELI HELLMAN, EXAMINING ATTORNEY

**CLASS 39—(Continued).**

SN 85-008,855. SK TELECOM CO., LTD., SEOUL, REPUBLIC OF KOREA, FILED 4-7-2010.

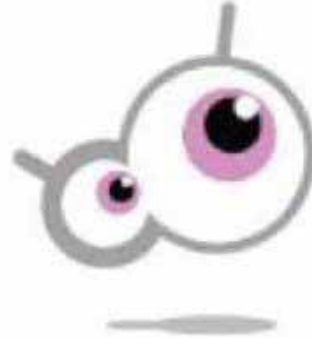

PRIORITY CLAIMED UNDER SEC. 44(D) ON REPUBLIC OF KOREA APPLICATION NO. 41-2010-0004, FILED 2-25-2010, REG. NO. 0210180, DATED 5-9-2011, EXPIRES 5-9-2021.

THE COLOR(S) GREY, PINK, BLACK AND WHITE IS/ARE CLAIMED AS A FEATURE OF THE MARK.

THE MARK CONSISTS OF TWO STYLIZED EYES, THE RIGHT EYE LARGER THUS OVERLAPPING THE LEFT EYE. EACH EYE HAS A WHITE CIRCLE, A BLACK CIRCLE, A PINK CIRCLE, AND A GREY OUTLINE. BENEATH BOTH OF THE EYES IS A GREY LINE.

FOR PROVIDING ROAD AND TRAFFIC INFORMATION THROUGH TELECOM DEVICES; PROVIDING TRANSPORTATION INFORMATION THROUGH TELECOM DEVICES; PROVIDING A WEBSITE AND WEBSITE LINKS TO GEOGRAPHIC INFORMATION, MAP IMAGES, NAVIGATION, TRAFFIC, TRAVEL AND PUBLIC TRANSPORT INFORMATION VIA TELECOMMUNICATION NETWORKS, WIRELESS LOCAL AREA NETWORKS, MOBILE TELEPHONES AND COMMUNICATION EQUIPMENT, WIRELESS NAVIGATION DEVICES AND HANDHELD COMPUTERS; PROVIDING GEOGRAPHIC LOCATION, TRANSPORTATION AND NAVIGATION INFORMATION RELATING TO RECREATIONAL SERVICES VIA TELECOMMUNICATION NETWORKS, WIRELESS LOCAL AREA NETWORKS, MOBILE TELEPHONES AND COMMUNICATION EQUIPMENT, WIRELESS NAVIGATION DEVICES AND HANDHELD COMPUTERS (U.S. CLS. 100 AND 105).

DEBRA LEE, EXAMINING ATTORNEY

SN 85-029,692. GLOBAL MAIL, INC., WESTON, FL. FILED 5-4-2010.

**DHL SMARTMAIL PHARMA SELECT**

THE MARK CONSISTS OF STANDARD CHARACTERS WITHOUT CLAIM TO ANY PARTICULAR FONT, STYLE, SIZE, OR COLOR.

NO CLAIM IS MADE TO THE EXCLUSIVE RIGHT TO USE "PHARMA SELECT", APART FROM THE MARK AS SHOWN.

FOR TRANSPORTATION AND DELIVERY SERVICES BY AIR, ROAD, RAIL AND SEA (U.S. CLS. 100 AND 105).

BARBARA A. GOLD, EXAMINING ATTORNEY

**CLASS 39—(Continued).**

SN 85-065,513. CINTAS HOLDINGS, INC., MASON, OH.  
FILED 6-17-2010.

# DVX

THE MARK CONSISTS OF STANDARD CHARACTERS WITHOUT CLAIM TO ANY PARTICULAR FONT, STYLE, SIZE, OR COLOR.

FOR DIGITAL AND ELECTRONIC DOCUMENT STORAGE SERVICES (U.S. CLS. 100 AND 105).

FIRST USE 1-31-2010; IN COMMERCE 1-31-2010.  
ODESSA BIBBINS, EXAMINING ATTORNEY

**CLASS 39—(Continued).**

SN 85-134,310. AMBIT ENERGY HOLDINGS, L.L.C., DALLAS, TX. FILED 9-21-2010.

# AMBIT ADVANTAGES

THE MARK CONSISTS OF STANDARD CHARACTERS WITHOUT CLAIM TO ANY PARTICULAR FONT, STYLE, SIZE, OR COLOR.

OWNER OF U.S. REG. NOS. 3,389,005, 3,443,624 AND 3,786,848.

NO CLAIM IS MADE TO THE EXCLUSIVE RIGHT TO USE "ADVANTAGES", APART FROM THE MARK AS SHOWN.

FOR DISTRIBUTION OF ENERGY, NAMELY, PROVIDING ELECTRICAL ENERGY AND NATURAL GAS TO RESIDENTIAL AND COMMERCIAL USERS (U.S. CLS. 100 AND 105).

LINDA MICKLEBURGH, EXAMINING ATTORNEY

SN 85-097,654. DANCER FLEET, INC., MIAMI LAKES, FL.  
FILED 8-1-2010.



OWNER OF U.S. REG. NOS. 3,653,398 AND 3,662,634.  
NO CLAIM IS MADE TO THE EXCLUSIVE RIGHT TO USE "FLEET", APART FROM THE MARK AS SHOWN.

THE COLOR(S) WHITE, BLUE AND BLACK IS/ARE CLAIMED AS A FEATURE OF THE MARK.

THE MARK CONSISTS OF A DESIGN COMPRISED OF BLACK SILHOUETTES OF TWO AQUATIC DIVERS ON AN OVAL BLUE AND WHITE FIELD OF THE WESTERN HEMISPHERE OF THE EARTH, BORDERED BY THE WORDS "OCEAN MINDED DANCER FLEET" IN BLACK.

FOR CONDUCTING DIVING CHARTERS (U.S. CLS. 100 AND 105).

FIRST USE 1-1-1989; IN COMMERCE 1-1-1989.  
KAELIE KUNG, EXAMINING ATTORNEY

SN 85-168,483. CITY OF CHICAGO, CHICAGO, IL. FILED 11-3-2010.

# The Purple Airplane

THE COLOR(S) PURPLE IS/ARE CLAIMED AS A FEATURE OF THE MARK.

THE MARK CONSISTS OF THE WORDS "THE PURPLE AIRPLANE" WHERE THE WORD "PURPLE" IS SHOWN IN THE COLOR PURPLE. THE COLOR BLACK IS NOT BEING CLAIMED AS A COLOR IN THE MARK. THE COLOR BLACK REPRESENTS BACKGROUND, OUTLINING, SHADING AND/OR TRANSPARENT AREAS AND IS NOT PART OF THE MARK.

FOR TRAVEL ASSISTANCE PROGRAMS AND SERVICES AT AIRPORT FACILITIES, NAMELY, PROVIDING TRAVEL INFORMATION TO PERSONS WITH DISABILITIES (U.S. CLS. 100 AND 105).

FIRST USE 4-16-2010; IN COMMERCE 4-16-2010.  
AISHA SALEM, EXAMINING ATTORNEY

**CLASS 39—(Continued).**

SN 85-170,606. SOUTHWEST AIRLINES CO., DALLAS, TX. FILED 11-5-2010.

**CLASS 39—(Continued).**

SN 85-233,555. AMERICAN EXPRESS MARKETING & DEVELOPMENT CORP., NEW YORK, NY. FILED 2-3-2011.

## International Connect

THE MARK CONSISTS OF STANDARD CHARACTERS WITHOUT CLAIM TO ANY PARTICULAR FONT, STYLE, SIZE, OR COLOR.

NO CLAIM IS MADE TO THE EXCLUSIVE RIGHT TO USE "INTERNATIONAL", APART FROM THE MARK AS SHOWN.

FOR ON-LINE TRANSPORTATION RESERVATION AND TRAVEL TICKET RESERVATION SERVICES; TRANSPORTATION RESERVATION SERVICES (U.S. CLS. 100 AND 105).

JAY BESCH, EXAMINING ATTORNEY



SN 85-209,932. SPAN PACKAGING SERVICES LLC, GREENVILLE, SC. FILED 1-4-2011.



THE MARK CONSISTS OF FOUR ARCH SHAPED DESIGNS APPEARING ON A SQUARE BACKGROUND DESIGN, WITH ONE ARCH FACING UP, ONE FACING DOWN, ONE FACING LEFT AND ONE FACING RIGHT, WITH ONE EACH OF THE LEGS INTERLOCKING IN THE MIDDLE OF THE FORMED DESIGN.

FOR CONTRACT PACKAGING SERVICES, NAMELY, PACKAGING TOWELETTES, LIQUIDS, CREAMS AND LOTIONS TO THE ORDER AND SPECIFICATION OF OTHERS (U.S. CLS. 100 AND 105).

FIRST USE 11-0-2008; IN COMMERCE 11-0-2008.  
JULIE GUTTADAURO, EXAMINING ATTORNEY

OWNER OF U.S. REG. NOS. 3,157,593, 3,473,542 AND OTHERS.

THE MARK CONSISTS OF THE TERM "BLISSTORIAN", STEPS AND EYES WITHIN A CIRCLE. THE BACKGROUND OF THE CIRCLE IS COVERED IN LETTERS SPELLING "AMERICAN EXPRESS".

FOR ARRANGING TRAVEL TOURS FEATURING A CUSTOMIZED MYSTERY TRIP BASED ON RESPONSES TO A QUIZ; ARRANGING A CUSTOMIZED MYSTERY TRIP BASED ON RESPONSES TO A QUIZ, NAMELY, MAKING RESERVATIONS AND BOOKINGS FOR TRANSPORTATION (U.S. CLS. 100 AND 105).

KYLE PEETE, EXAMINING ATTORNEY

**CLASS 39—(Continued).**

SN 85-262,825. HOMEAWAY.COM, INC., AUSTIN, TX. FILED 3-9-2011.



OWNER OF U.S. REG. NOS. 3,385,395, 3,596,173 AND 3,596,175.

THE MARK CONSISTS OF BLACK AND WHITE BIRD-HOUSE.

FOR PROVIDING A WEBSITE FOR THE ARRANGEMENT AND BOOKING OF ECO-TRAVEL AND ECO-TOURS; PROVIDING A WEB SITE AND WEB SITE LINKS TO GEOGRAPHIC INFORMATION, MAP IMAGES, AND TRIP ROUTING; PROVIDING A WEB SITE FEATURING TRAVEL INFORMATION AND COMMENTARY; PROVIDING AN ON-LINE COMPUTER DATABASE IN THE FIELD OF TRAVEL INFORMATION SERVICES; PROVIDING AN ON-LINE SEARCHABLE COMPUTER DATABASE FEATURING INFORMATION ON TRAVEL; PROVIDING INFORMATION, NEWS AND COMMENTARY IN THE FIELD OF TRAVEL; PROVIDING LINKS TO WEB SITES OF OTHERS FEATURING TRAVEL; PROVIDING REVIEWS OF TRAVEL SERVICE PROVIDERS; TRAVEL GUIDE AND TRAVEL INFORMATION SERVICES (U.S. CLS. 100 AND 105).

FIRST USE 7-12-2006; IN COMMERCE 7-12-2006.  
RON FAIRBANKS, EXAMINING ATTORNEY

SN 85-263,630. COX, ANTHONY, J, SAINT LOUIS, MO. FILED 3-10-2011.



THE COLOR(S) ORANGE, GREEN, BLACK AND GRAY IS/ARE CLAIMED AS A FEATURE OF THE MARK.

THE MARK CONSISTS OF THE WORDS "PITCH IT & FORGET IT" CASCADING INTO A WASTE CAN; THE WORDS "PITCH IT & FORGET IT" ARE ORANGE AND OUTLINED IN BLACK AND THE WASTE CAN IS GREEN WITH GRAY LINES AND A BLACK OPENING AT THE TOP.

FOR JUNK, TRASH AND DEBRIS REMOVAL (U.S. CLS. 100 AND 105).

FIRST USE 12-0-2010; IN COMMERCE 2-0-2011.  
DAVID ELTON, EXAMINING ATTORNEY

**CLASS 39—(Continued).**

SN 85-265,409. VERSATILE TRANSPORT, ROGERS, MN. FILED 3-12-2011.



NO CLAIM IS MADE TO THE EXCLUSIVE RIGHT TO USE "VERSATILE TRANSPORT, LLC", APART FROM THE MARK AS SHOWN.

THE MARK CONSISTS OF "VT VERSATILE TRANSPORT, LLC" IN STYLIZED FONT AND A DESIGN OF A BROKEN ROAD LINE.

FOR TRUCKING SERVICES, NAMELY, HAULING OF GENERAL COMMODITIES ; WAREHOUSING SERVICES, NAMELY, STORAGE, DISTRIBUTION, PICK-UP, AND PACKING FOR SHIPMENT OF DOCUMENTS, PACKAGES, RAW MATERIALS, AND OTHER FREIGHT FOR OTHERS ; TRANSPORTATION AND STORAGE OF GOODS IN REFRIGERATED CONDITIONS (U.S. CLS. 100 AND 105).

FIRST USE 3-1-2009; IN COMMERCE 3-1-2009.  
APRIL HESIK, EXAMINING ATTORNEY

SN 85-275,673. STREETSMART CAR RENTAL, LLC, BOGART, GA. FILED 3-24-2011.

## StreetSmart Car Rental

THE MARK CONSISTS OF STANDARD CHARACTERS WITHOUT CLAIM TO ANY PARTICULAR FONT, STYLE, SIZE, OR COLOR.

NO CLAIM IS MADE TO THE EXCLUSIVE RIGHT TO USE "CAR RENTAL", APART FROM THE MARK AS SHOWN.

FOR CAR RENTAL (U.S. CLS. 100 AND 105).  
FIRST USE 11-1-2010; IN COMMERCE 11-1-2010.  
ALYSSA STEEL, EXAMINING ATTORNEY

SN 85-287,866. REEBIE STORAGE & MOVING COMPANY, INC., FRANKLIN PARK, IL. FILED 4-6-2011.



NO CLAIM IS MADE TO THE EXCLUSIVE RIGHT TO USE "STORE YOUR THINGS", APART FROM THE MARK AS SHOWN.

THE MARK CONSISTS OF A PARTIAL CUBE WITH ONE OF THE CORNER EDGES FACING THE VIEWER. THE PORTIONS OF THE CUBE VISIBLE TO THE VIEWER ARE A TOP SQUARE, A LEFT SQUARE AND A RIGHT SQUARE. THERE IS A PADLOCK ON THE RIGHT SQUARE, WHICH

**CLASS 39—(Continued).**

PADLOCK APPEARS TO GO THROUGH THE RIGHT SQUARE (AS IF LOCKING THE RIGHT SQUARE AS THE FRONT OF A STORAGE UNIT). THE PADLOCK CONTAINS A KEY HOLE. TO THE LEFT OF THE PARTIAL CUBE IS THE STYLIZED WORD "STORE". UNDER THE PARTIAL CUBE AND UNDER THE WORD "STORE" BEGINNING AT THE LETTER "R" IN THE WORD "STORE", ARE THE STYLIZED WORDS "YOUR THINGS". THUS, THE LITERAL ELEMENTS OF THE MARK CONSIST OF THE STYLIZED WORDS "STORE YOUR THINGS".

FOR PROVIDING SELF-STORAGE FACILITIES FOR OTHERS (U.S. CLS. 100 AND 105).

FIRST USE 3-0-2005; IN COMMERCE 3-0-2005.  
DOUGLAS LEE, EXAMINING ATTORNEY

---

SN 85-293,564. MOHR, JEFF, MALIBU, CA. FILED 4-13-2011.

**HOLLYWOOD PICTURE CARS**

THE MARK CONSISTS OF STANDARD CHARACTERS WITHOUT CLAIM TO ANY PARTICULAR FONT, STYLE, SIZE, OR COLOR.

NO CLAIM IS MADE TO THE EXCLUSIVE RIGHT TO USE "CARS", APART FROM THE MARK AS SHOWN. SEC. 2(F).

FOR RENTAL OF CARS FOR USE IN MOTION PICTURE PRODUCTION (U.S. CLS. 100 AND 105).

FIRST USE 9-16-2000; IN COMMERCE 9-16-2000.  
HAI-LY LAM, EXAMINING ATTORNEY

---

SN 85-299,528. TRAVEL TRADE MARKETING, INC., FORT LAUDERDALE, FL. FILED 4-20-2011.

**TOURTRACKERPRO**

THE MARK CONSISTS OF STANDARD CHARACTERS WITHOUT CLAIM TO ANY PARTICULAR FONT, STYLE, SIZE, OR COLOR.

FOR TRAVEL AND TOUR INFORMATION SERVICE (U.S. CLS. 100 AND 105).

FIRST USE 4-15-2011; IN COMMERCE 4-15-2011.  
INGRID C. EULIN, EXAMINING ATTORNEY

**CLASS 39—(Continued).**

SN 85-308,184. MOORHEAD PUBLIC SERVICE, MOORHEAD, MN. FILED 4-29-2011.

**THRIFTY WATTS**

THE MARK CONSISTS OF STANDARD CHARACTERS WITHOUT CLAIM TO ANY PARTICULAR FONT, STYLE, SIZE, OR COLOR.

NO CLAIM IS MADE TO THE EXCLUSIVE RIGHT TO USE "WATTS", APART FROM THE MARK AS SHOWN.

FOR PUBLIC UTILITY SERVICES IN THE NATURE OF ELECTRICITY DISTRIBUTION AND TRANSMISSION (U.S. CLS. 100 AND 105).

LOURDES AYALA, EXAMINING ATTORNEY

---

SN 85-311,522. MULTISPORT JOURNEYS, LLC, RIDGWAY, CO. FILED 5-3-2011.



OWNER OF U.S. REG. NO. 3,987,059.

THE MARK CONSISTS OF THE STYLIZED INITIALS "MSJ" WITH A DESIGN OF A BIKER TO THE LEFT, A DESIGN OF A ROWER ABOVE, AND A DESIGN OF A HIKER TO THE RIGHT OF "MSJ". THE STACKED STYLIZED WORDING "WWW.MULTISPORTJOURNEYS.COM" AND "LIVE TO PLAY ANOTHER DAY" ARE CENTERED AT THE BOTTOM OF THE MARK.

FOR TRAVEL GUIDE AND TRAVEL INFORMATION SERVICES (U.S. CLS. 100 AND 105).

PAULA MAHONEY, EXAMINING ATTORNEY

---

SN 85-314,747. RAHN BAHIA MAR L.L.C., NEW YORK, NY. FILED 5-6-2011.

**Bahia Mar Beach Resort & Yachting Center**

THE MARK CONSISTS OF STANDARD CHARACTERS WITHOUT CLAIM TO ANY PARTICULAR FONT, STYLE, SIZE, OR COLOR.

OWNER OF U.S. REG. NO. 3,156,648.

NO CLAIM IS MADE TO THE EXCLUSIVE RIGHT TO USE "BEACH RESORT & YACHTING CENTER", APART FROM THE MARK AS SHOWN.

FOR MARINA SERVICES (U.S. CLS. 100 AND 105).

FIRST USE 1-1-1966; IN COMMERCE 1-1-1966.  
RAMONA ORTIGA, EXAMINING ATTORNEY

**CLASS 39—(Continued).**

SN 85-318,767. COMMERCELOG BUSINESS GROUP INC, HIALEAH, FL. FILED 5-12-2011.



THE COLOR(S) BLUE, BLACK, RED, WHITE, AND BROWN IS/ARE CLAIMED AS A FEATURE OF THE MARK.

THE MARK CONSISTS OF A BLUE AND BLACK POSTAL BOX INSIDE A BROWN BOX WITH THE STYLIZED TEXT "USA2SHIP.COM" APPEARING ON THE OUTSIDE OF THE BOX. THE TERM "USA" APPEARS IN RED OUTLINED IN WHITE, THE NUMBER "2" APPEARS IN WHITE OUTLINED IN BLACK, THE TERM "SHIP" APPEARS IN BLUE OUTLINED IN WHITE, AND THE TERM ".COM" APPEARS IN RED.

FOR FREIGHT FORWARDING; FREIGHT FORWARDING SERVICES; POSTAL SERVICES, NAMELY, PARCEL DELIVERY, PACKAGING ARTICLES FOR TRANSPORTATION, RENTAL OF MAILBOXES (U.S. CLS. 100 AND 105).

FIRST USE 5-1-2011; IN COMMERCE 5-1-2011.  
GEOFFREY FOSDICK, EXAMINING ATTORNEY

SN 85-324,640. GURSPAN, PAUL, DBA WHYWASTE?, JAMIACA PLAIN, MA. FILED 5-19-2011.



NO CLAIM IS MADE TO THE EXCLUSIVE RIGHT TO USE "GREEN HAULING", APART FROM THE MARK AS SHOWN.

THE COLOR(S) GREEN IS/ARE CLAIMED AS A FEATURE OF THE MARK.

THE MARK CONSISTS OF A STYLIZED LETTER "W" WITH A LEAF AS THE CENTER STROKE, THE PHRASE "WHYWASTE?" AND THE WORDS "GREEN HAULING", ALL OF THE ABOVE IN THE COLOR GREEN; THE COLOR WHITE REPRESENTS BACKGROUND AND IS NOT PART OF THE MARK.

FOR JUNK, TRASH AND DEBRIS REMOVAL PROVIDED IN AN ENVIRONMENTALLY RESPONSIBLE MANNER (U.S. CLS. 100 AND 105).

FIRST USE 3-15-2009; IN COMMERCE 3-15-2009.  
TRICIA SONNEBORN, EXAMINING ATTORNEY

**CLASS 39—(Continued).**

SN 85-327,952. NUMAAN INCORPORATED, DBA NASBUS, EAST MEADOW, NY. FILED 5-23-2011.

## NASBUS

THE MARK CONSISTS OF STANDARD CHARACTERS WITHOUT CLAIM TO ANY PARTICULAR FONT, STYLE, SIZE, OR COLOR.

FOR BUS CHARTERING; BUS TRANSPORT; TRANSPORTATION SERVICES, NAMELY, PROVIDING SHUTTLE SERVICES BY BUS (U.S. CLS. 100 AND 105).

FIRST USE 2-1-2011; IN COMMERCE 3-1-2011.  
DEIRDRE ROBERTSON, EXAMINING ATTORNEY

SN 85-330,485. AMPRO VACATIONS INC., IRVINE, CA. FILED 5-25-2011.

## Happiness Assurance

THE MARK CONSISTS OF STANDARD CHARACTERS WITHOUT CLAIM TO ANY PARTICULAR FONT, STYLE, SIZE, OR COLOR.

FOR ARRANGING AND COORDINATING TRAVEL ARRANGEMENTS FOR INDIVIDUALS AND GROUPS, NAMELY, DESTINATIONS STAYS, HONEYMOONS, FAMILY VACATIONS, AND DESTINATION WEDDINGS (U.S. CLS. 100 AND 105).

FIRST USE 1-5-2011; IN COMMERCE 3-7-2011.  
KATHERINE STOIDES, EXAMINING ATTORNEY

SN 85-331,753. SOUTHWEST AIRLINES CO., DALLAS, TX. FILED 5-26-2011.

## Meet Your Shipmates

THE MARK CONSISTS OF STANDARD CHARACTERS WITHOUT CLAIM TO ANY PARTICULAR FONT, STYLE, SIZE, OR COLOR.

FOR AIR FREIGHT SHIPPING SERVICES; AIR TRANSPORT SERVICES; CARGO HANDLING; DELIVERY OF GOODS BY AIR (U.S. CLS. 100 AND 105).

FIRST USE 9-1-2010; IN COMMERCE 9-1-2010.  
ALEX KEAM, EXAMINING ATTORNEY

**CLASS 39—(Continued).**

SN 85-333,854. KHM CONSULTING INC., DBA KHM TRAVEL GROUP, BRUNSWICK, OH. FILED 5-31-2011.

Luxevo

THE MARK CONSISTS OF STANDARD CHARACTERS WITHOUT CLAIM TO ANY PARTICULAR FONT, STYLE, SIZE, OR COLOR.  
FOR TRAVEL CLUBS (U.S. CLS. 100 AND 105).  
DEBRA LEE, EXAMINING ATTORNEY

SN 85-333,884. HOT SERRANO, LLC, DBA SOREO SELECT, TUCSON, AZ. FILED 5-31-2011.

SOREO

THE MARK CONSISTS OF STANDARD CHARACTERS WITHOUT CLAIM TO ANY PARTICULAR FONT, STYLE, SIZE, OR COLOR.  
FOR PASSENGER TRANSPORT; TRANSPORT OF PERSONS; TRANSPORT OF PERSONS AND GOODS (U.S. CLS. 100 AND 105).  
FIRST USE 4-30-2011; IN COMMERCE 4-30-2011.  
HAI-LY LAM, EXAMINING ATTORNEY

SN 85-334,290. FRANK SCHINNERER, ASTENET, BELGIUM, FILED 5-31-2011.

decocarts

THE MARK CONSISTS OF STANDARD CHARACTERS WITHOUT CLAIM TO ANY PARTICULAR FONT, STYLE, SIZE, OR COLOR.  
FOR VEHICLE RENTAL (U.S. CLS. 100 AND 105).  
FIRST USE 3-20-2003; IN COMMERCE 3-20-2003.  
SHANNON TWOHIG, EXAMINING ATTORNEY

**CLASS 39—(Continued).**

SN 85-335,197. COMP OPTIONS INSURANCE COMPANY, INC., JACKSONVILLE, FL. FILED 6-1-2011.

CIRCANA

THE MARK CONSISTS OF STANDARD CHARACTERS WITHOUT CLAIM TO ANY PARTICULAR FONT, STYLE, SIZE, OR COLOR.  
FOR PROVIDING SERVICES TO INDIVIDUALS, BOTH FOREIGNERS AND UNITED STATES RESIDENTS, WITH ASSISTANCE IN MAKING RESERVATIONS AND BOOKINGS FOR TRANSPORTATION RELATED TO SECURING MEDICAL CARE OUTSIDE THEIR HOME COUNTRY (U.S. CLS. 100 AND 105).  
CAROLINE WOOD, EXAMINING ATTORNEY

SN 85-337,149. DOLPHIN CRUISES, INC., ORANGE BEACH, AL. FILED 6-3-2011.

COLD MIL

THE MARK CONSISTS OF STANDARD CHARACTERS WITHOUT CLAIM TO ANY PARTICULAR FONT, STYLE, SIZE, OR COLOR.  
FOR ARRANGING OF TOURS AND CRUISES; BOAT CRUISES; PLEASURE BOAT CRUISES (U.S. CLS. 100 AND 105).  
FIRST USE 4-1-1997; IN COMMERCE 4-1-1997.  
JENNIFER VASQUEZ, EXAMINING ATTORNEY

SN 85-338,182. JAMES SIEWERT, DBA TANK TOPPERS, RIDGEFIELD, CT. FILED 6-4-2011.

Tank Toppers

THE MARK CONSISTS OF STANDARD CHARACTERS WITHOUT CLAIM TO ANY PARTICULAR FONT, STYLE, SIZE, OR COLOR.  
FOR FUEL DELIVERY SERVICES FEATURING GASOLINE (U.S. CLS. 100 AND 105).  
KIMBERLY PERRY, EXAMINING ATTORNEY

**CLASS 39—(Continued).**

SN 85-338,550. ESTES EXPRESS LINES, RICHMOND, VA. FILED 6-6-2011.

**EFW**

THE MARK CONSISTS OF STANDARD CHARACTERS WITHOUT CLAIM TO ANY PARTICULAR FONT, STYLE, SIZE, OR COLOR.  
FOR FREIGHT FORWARDING SERVICES (U.S. CLS. 100 AND 105).  
FIRST USE 2-1-2011; IN COMMERCE 2-1-2011.  
DOMINIC J. FERRAIUOLO, EXAMINING ATTORNEY

SN 85-339,230. DAVIGNON, DANIEL, LAKE HAVASU CITY, AZ. FILED 6-6-2011.

**You Fly to Live; We Live  
to Fly**

THE MARK CONSISTS OF STANDARD CHARACTERS WITHOUT CLAIM TO ANY PARTICULAR FONT, STYLE, SIZE, OR COLOR.  
FOR AIRCRAFT AMBULANCE TRANSPORT (U.S. CLS. 100 AND 105).  
PAUL MORENO, EXAMINING ATTORNEY

SN 85-355,058. ESTES EXPRESS LINES, RICHMOND, VA. FILED 6-24-2011.



THE MARK CONSISTS OF A CHECK MARK IN A CIRCLE WITH THE WORDS ESTES SUREMOVE.  
FOR MOVING AND STORAGE OF GOODS; MOVING COMPANY SERVICES; TRANSPORTATION OF HOUSEHOLD GOODS OF OTHERS (U.S. CLS. 100 AND 105).  
DOMINIC J. FERRAIUOLO, EXAMINING ATTORNEY

**CLASS 39—(Continued).**

SN 85-355,110. ESTES EXPRESS LINES, RICHMOND, VA. FILED 6-24-2011.

**ESTES SUREMOVE**

THE MARK CONSISTS OF STANDARD CHARACTERS WITHOUT CLAIM TO ANY PARTICULAR FONT, STYLE, SIZE, OR COLOR.  
FOR MOVING AND STORAGE OF GOODS; MOVING COMPANY SERVICES; TRANSPORTATION OF HOUSEHOLD GOODS OF OTHERS (U.S. CLS. 100 AND 105).  
DOMINIC J. FERRAIUOLO, EXAMINING ATTORNEY

SN 85-399,095. ERA GROUP INC., LAKE CHARLES, LA. FILED 8-16-2011.

**Flying is our Passion,  
Safety is our Mission**

THE MARK CONSISTS OF STANDARD CHARACTERS WITHOUT CLAIM TO ANY PARTICULAR FONT, STYLE, SIZE, OR COLOR.  
FOR AIR TRANSPORTATION SERVICES, NAMELY, HELICOPTER AND AIRPLANE CHARTER SERVICES, SCHEDULED AIRLINE SERVICES AND TRANSPORTATION OF PASSENGERS AND GOODS BY AIR (U.S. CLS. 100 AND 105).  
TINA BROWN, EXAMINING ATTORNEY

**CLASS 40—MATERIAL TREATMENT**

SN 77-567,373. BLUE OCEAN PRESS, INC., FORT LAUDERDALE, FL. FILED 9-11-2008.

**GREEN BY CHOICE**

THE MARK CONSISTS OF STANDARD CHARACTERS WITHOUT CLAIM TO ANY PARTICULAR FONT, STYLE, SIZE, OR COLOR.  
NO CLAIM IS MADE TO THE EXCLUSIVE RIGHT TO USE "GREEN", APART FROM THE MARK AS SHOWN.  
FOR CUSTOM MANUFACTURE OF PROMOTIONAL GOODS OF OTHERS SUCH AS COFFEE MUGS, KEY CHAINS, T-SHIRTS AND PENS, PRINTED MATTER, NAMELY, BOOKS, BROCHURES, MANUALS, LETTERHEAD, STATIONARY, AND BUSINESS CARDS USING ENVIRONMENTALLY FRIENDLY MANUFACTURING PROCESSES (U.S. CLS. 100, 103 AND 106).  
EVELYN BRADLEY, EXAMINING ATTORNEY



**CLASS 40—(Continued).**

SN 79-090,951. VIWATEQ B.V., NETHERLANDS, FILED 11-10-2010.

# Viwateq

THE MARK CONSISTS OF STANDARD CHARACTERS WITHOUT CLAIM TO ANY PARTICULAR FONT, STYLE, SIZE, OR COLOR.

PRIORITY DATE OF 5-17-2010 IS CLAIMED.

OWNER OF INTERNATIONAL REGISTRATION 1060970 DATED 11-10-2010, EXPIRES 11-10-2020.

THE WORDING "VIWATEQ" HAS NO MEANING IN A FOREIGN LANGUAGE.

FOR TREATMENT OF MATERIALS, NAMELY, SURFACE TREATMENT OF METALS, PLASTICS AND RUBBER (U.S. CLS. 100, 103 AND 106).

ANDREA HACK, EXAMINING ATTORNEY

---

SN 85-091,707. PARAMOUNT INDUSTRIES, INC., LANGHORNE, PA. FILED 7-23-2010.

# CLS

THE MARK CONSISTS OF STANDARD CHARACTERS WITHOUT CLAIM TO ANY PARTICULAR FONT, STYLE, SIZE, OR COLOR.

FOR CUSTOM MANUFACTURE OF COMPONENTS MADE USING ADDITIVE MANUFACTURING TECHNOLOGIES (U.S. CLS. 100, 103 AND 106).

RONALD AIKENS, EXAMINING ATTORNEY

---

SN 85-093,065. DILLON, JOHN C., OZARK, MO. FILED 7-26-2010.

# Daredevil Distillery

THE MARK CONSISTS OF STANDARD CHARACTERS WITHOUT CLAIM TO ANY PARTICULAR FONT, STYLE, SIZE, OR COLOR.

NO CLAIM IS MADE TO THE EXCLUSIVE RIGHT TO USE "DISTILLERY", APART FROM THE MARK AS SHOWN.

FOR SPIRITS DISTILLERY SERVICES (U.S. CLS. 100, 103 AND 106).

ALYSSA STEEL, EXAMINING ATTORNEY

**CLASS 40—(Continued).**

SN 85-178,560. RAMLER INDUSTRIES, HIAWATHA, IA. FILED 11-17-2010.

# Shuttle Trike

THE MARK CONSISTS OF STANDARD CHARACTERS WITHOUT CLAIM TO ANY PARTICULAR FONT, STYLE, SIZE, OR COLOR.

NO CLAIM IS MADE TO THE EXCLUSIVE RIGHT TO USE "TRIKE", APART FROM THE MARK AS SHOWN.

FOR CUSTOM BUILDING OF MOTORCYCLES (U.S. CLS. 100, 103 AND 106).

KIMBERLY PERRY, EXAMINING ATTORNEY

---

SN 85-189,281. AEROCLAVE, LLC, MAITLAND, FL. FILED 12-2-2010.

# eHP

THE MARK CONSISTS OF STANDARD CHARACTERS WITHOUT CLAIM TO ANY PARTICULAR FONT, STYLE, SIZE, OR COLOR.

THE WORD(S) "EHP" HAS NO MEANING IN A FOREIGN LANGUAGE.

FOR DECONTAMINATION SERVICES, NAMELY, BIOLOGICAL DECONTAMINATION SERVICES (U.S. CLS. 100, 103 AND 106).

MARK PILARO, EXAMINING ATTORNEY

---

SN 85-195,106. SUMNER, MICHAEL D, GASTONIA, NC. FILED 12-10-2010.

# MATTAMUSKEET GOOSE CLUB

THE MARK CONSISTS OF STANDARD CHARACTERS WITHOUT CLAIM TO ANY PARTICULAR FONT, STYLE, SIZE, OR COLOR.

FOR IMPRINTING MESSAGES ON WEARING APPAREL, ACCESSORIES, AND MUGS (U.S. CLS. 100, 103 AND 106).

FIRST USE 12-1-2008; IN COMMERCE 12-1-2008.

TOBY BULLOFF, EXAMINING ATTORNEY

**CLASS 40—(Continued).**

SN 85-216,038. B&D LITHO OF ARIZONA, INC., PHOENIX, AZ. FILED 1-12-2011.



NO CLAIM IS MADE TO THE EXCLUSIVE RIGHT TO USE "LITHO", APART FROM THE MARK AS SHOWN.  
 THE MARK CONSISTS OF A SETTING SUN WITH "B&D" IN FRONT OF THE SETTING SUN AND THE WORD "LITHO" IN FRONT OF THE LETTER "D".  
 FOR DESIGN PRINTING FOR OTHERS; PRINTING SERVICES (U.S. CLS. 100, 103 AND 106).  
 FIRST USE 12-31-1960; IN COMMERCE 12-31-1960.  
 KATHLEEN M. VANSTON, EXAMINING ATTORNEY

---

SN 85-245,471. HALLMARK METALS, INC., GLENDORA, CA. FILED 2-17-2011.

## Hallmark Metals

THE MARK CONSISTS OF STANDARD CHARACTERS WITHOUT CLAIM TO ANY PARTICULAR FONT, STYLE, SIZE, OR COLOR.  
 NO CLAIM IS MADE TO THE EXCLUSIVE RIGHT TO USE "METALS", APART FROM THE MARK AS SHOWN.  
 FOR MACHINE SHOP SERVICES, NAMELY, MACHINING PARTS FOR OTHERS; MANUFACTURING SERVICES FOR OTHERS IN THE FIELD OF SHEET METAL, METAL CANS, AND METAL CONTAINERS; METAL STAMPING (U.S. CLS. 100, 103 AND 106).  
 FIRST USE 12-1-1959; IN COMMERCE 12-1-1959.  
 DAWN FELDMAN, EXAMINING ATTORNEY

---

SN 85-264,754. ALL JETTING TECHNOLOGIES, INC., PALM CITY, FL. FILED 3-11-2011.

## ALL JETTING TECHNOLOGIES, INC.

THE MARK CONSISTS OF STANDARD CHARACTERS WITHOUT CLAIM TO ANY PARTICULAR FONT, STYLE, SIZE, OR COLOR.  
 NO CLAIM IS MADE TO THE EXCLUSIVE RIGHT TO USE "JETTING TECHNOLOGIES, INC.", APART FROM THE MARK AS SHOWN.  
 FOR MANUFACTURE OF MACHINE REPLACEMENT PARTS, NOZZLES AND HOSE FITTINGS TO ORDER AND/OR SPECIFICATION OF OTHERS (U.S. CLS. 100, 103 AND 106).  
 FIRST USE 7-0-2001; IN COMMERCE 7-0-2001.  
 CHARISMA HAMPTON, EXAMINING ATTORNEY

**CLASS 40—(Continued).**

SN 85-305,244. COMPOSITE EFFECTS, LLC, AKA CFX, BATON ROUGE, LA. FILED 4-26-2011.



NO CLAIM IS MADE TO THE EXCLUSIVE RIGHT TO USE "DERMAL SYNTHETICS", APART FROM THE MARK AS SHOWN.  
 THE MARK CONSISTS OF THE WORDS "DERMAL SYNTHETICS" WITHIN A PARALLELOGRAM, WHEREIN THE CAPITAL "D" INCLUDES A FACIAL PROFILE, AND WHEREIN THE CAPITAL "S" INCLUDES HANDS.  
 FOR CUSTOM MANUFACTURING OF PROSTHETIC AND ANATOMICAL SIMULATION PRODUCTS TO ORDER (U.S. CLS. 100, 103 AND 106).  
 MARK SPARACINO, EXAMINING ATTORNEY

---

SN 85-308,114. COBRA PLASTICS, INC., MACEDONIA, OH. FILED 4-29-2011.

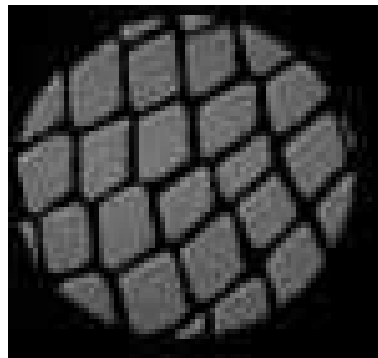

THE MARK CONSISTS OF A CIRCLE WITH A SNAKE-SKIN DESIGN INSIDE A SQUARE BORDER.  
 FOR MANUFACTURE OF PLASTIC CAPS TO ORDER AND/OR SPECIFICATION OF OTHERS (U.S. CLS. 100, 103 AND 106).  
 FIRST USE 6-16-1995; IN COMMERCE 6-16-1995.  
 REBECCA SMITH, EXAMINING ATTORNEY

**CLASS 40—(Continued).**

SN 85-308,136. COBRA PLASTICS, INC., MACEDONIA, OH. FILED 4-29-2011.

**COBRA PLASTICS**

THE MARK CONSISTS OF STANDARD CHARACTERS WITHOUT CLAIM TO ANY PARTICULAR FONT, STYLE, SIZE, OR COLOR.

NO CLAIM IS MADE TO THE EXCLUSIVE RIGHT TO USE "PLASTICS", APART FROM THE MARK AS SHOWN.

FOR MANUFACTURE OF PLASTIC CAPS TO ORDER AND/OR SPECIFICATION OF OTHERS (U.S. CLS. 100, 103 AND 106).

FIRST USE 6-16-1995; IN COMMERCE 6-16-1995.  
REBECCA SMITH, EXAMINING ATTORNEY

SN 85-308,144. COBRA PLASTICS, INC., MACEDONIA, OH. FILED 4-29-2011.



NO CLAIM IS MADE TO THE EXCLUSIVE RIGHT TO USE "PLASTICS, INC.", APART FROM THE MARK AS SHOWN.

THE MARK CONSISTS OF A CIRCLE WITH A SNAKE-SKIN DESIGN TO THE LEFT OF THE TERMS "COBRA" AND "PLASTICS, INC." WHERE THE TERM "PLASTICS, INC." IS SITUATED BELOW THE TERM "COBRA".

FOR MANUFACTURE OF PLASTIC CAPS TO ORDER AND/OR SPECIFICATION OF OTHERS (U.S. CLS. 100, 103 AND 106).

FIRST USE 6-16-1995; IN COMMERCE 6-16-1995.  
REBECCA SMITH, EXAMINING ATTORNEY

SN 85-312,838. PARAGON MOTOR YACHTS INC., DBA PARAGON MOTOR YACHTS, COSTA MESA, CA. FILED 5-5-2011.



NO CLAIM IS MADE TO THE EXCLUSIVE RIGHT TO USE "MOTOR YACHTS", APART FROM THE MARK AS SHOWN.

THE COLOR(S) BLUE AND BLACK IS/ARE CLAIMED AS A FEATURE OF THE MARK.

THE MARK CONSISTS OF THE WORDING "PARAGON" IN BLACK ON TOP WITH THE WORDING "MOTOR YACHTS" IN BLACK BELOW SEPARATED BY A SINGLE BLUE HORIZONTAL LINE WITH THREE BLUE WAVY LINES ON THE RIGHT HAND SIDE.

FOR YACHT BUILDING TO THE ORDER AND SPECIFICATION OF OTHERS (U.S. CLS. 100, 103 AND 106).

FIRST USE 1-12-2001; IN COMMERCE 4-3-2001.  
FONG HSU, EXAMINING ATTORNEY

**CLASS 40—(Continued).**

SN 85-318,882. PYE, MARK, RICHMOND, VA. FILED 5-12-2011.



NO CLAIM IS MADE TO THE EXCLUSIVE RIGHT TO USE "WHEELS", APART FROM THE MARK AS SHOWN.

THE MARK CONSISTS OF THE FIRST WORD ("HAREM") ON TOP, THE SECOND WORD ("WHEELS") ON BOTTOM, AND ONE PAIR OF EYES IN THE MIDDLE. THE MARK IS IN BETWEEN TWO LINES: ONE ABOVE THE WORD "HAREM", AND ONE BELOW THE WORD "WHEELS".

FOR CUSTOM MANUFACTURE OF BICYCLE WHEELS TO THE ORDER AND SPECIFICATION OF OTHERS (U.S. CLS. 100, 103 AND 106).

FIRST USE 6-0-2010; IN COMMERCE 2-0-2011.  
INGA ERVIN, EXAMINING ATTORNEY

SN 85-320,669. C2SK, INC., OTTAWA, IL. FILED 5-13-2011.



NO CLAIM IS MADE TO THE EXCLUSIVE RIGHT TO USE "GENUINE MERCHANDISE", APART FROM THE MARK AS SHOWN.

THE COLOR(S) WHITE, BLUE AND RED IS/ARE CLAIMED AS A FEATURE OF THE MARK.

THE MARK CONSISTS OF THE WORDING "GEN-U-WIN MERCHANDISE" IN WHITE STYLIZED LETTERING INSIDE A BLUE TITLE BOX WHICH TURNS INTO A FIVE POINT STAR ON THE RIGHT SIDE. THE STAR IS RED IN THE CENTER WITH A WHITE BORDER FOLLOWED BY A BLUE OUTSIDE BORDER.

FOR IMPRINTING MESSAGES ON WEARING APPAREL, ACCESSORIES AND MUGS (U.S. CLS. 100, 103 AND 106).

FIRST USE 10-8-2010; IN COMMERCE 10-8-2010.  
WENDY GOODMAN, EXAMINING ATTORNEY

SN 85-321,657. ROYSTER, E. ROBERT, DETROIT, MI. FILED 5-16-2011.

**Karved'N'Stone**

THE MARK CONSISTS OF STANDARD CHARACTERS WITHOUT CLAIM TO ANY PARTICULAR FONT, STYLE, SIZE, OR COLOR.

FOR INSPIRATIONAL ENGRAVING FOR THE FUNERAL INDUSTRY (U.S. CLS. 100, 103 AND 106).

WILLIAM P. SHANAHAN, EXAMINING ATTORNEY

**CLASS 40—(Continued).**

SN 85-324,408. SIGN CITY, INC., COLUMBUS, OH. FILED 5-18-2011.



NO CLAIM IS MADE TO THE EXCLUSIVE RIGHT TO USE "SIGN", APART FROM THE MARK AS SHOWN. THE COLOR(S) RED, BLACK, ORANGE AND GRAY IS/ARE CLAIMED AS A FEATURE OF THE MARK.

THE MARK CONSISTS OF THE STYLIZED WORDS "SIGN" IN RED OUTLINED IN GRAY AND "CITY" IN ORANGE OUTLINED IN GRAY. THE WORDS ARE SEPARATED BY THE ARTISTIC RENDERING OF TWO BUILDINGS IN BLACK FADING INTO SHADES OF GRAY.

FOR PRINTING SERVICES (U.S. CLS. 100, 103 AND 106).  
SKYE YOUNG, EXAMINING ATTORNEY

**CLASS 40—(Continued).**

SN 85-331,289. ECOSPAN, LLC, GREENBRAE, CA. FILED 5-26-2011.



THE MARK CONSISTS OF THE WORD ECOSPAN IN A STYLIZED FORMAT PLUS PARTIAL CONCENTRIC OVAL SHAPES.

FOR MANUFACTURE OF PLASTICS TO SPECIFICATION OF OTHERS (U.S. CLS. 100, 103 AND 106).  
ALLISON SCHRODY, EXAMINING ATTORNEY

SN 85-330,346. THE CENTERS FOR HABILITATION/TCH, TEMPE, AZ. FILED 5-25-2011.

**ASDD**

THE MARK CONSISTS OF STANDARD CHARACTERS WITHOUT CLAIM TO ANY PARTICULAR FONT, STYLE, SIZE, OR COLOR.

FOR DOCUMENT DESTRUCTION; DOCUMENT SHREDDING SERVICES (U.S. CLS. 100, 103 AND 106).  
FIRST USE 5-13-2011; IN COMMERCE 5-13-2011.  
GEORGE LORENZO, EXAMINING ATTORNEY

SN 85-332,275. ZYME BY DESIGN LLC, DUBLIN, OH. FILED 5-27-2011.

**Your Memories on Canvas**

THE MARK CONSISTS OF STANDARD CHARACTERS WITHOUT CLAIM TO ANY PARTICULAR FONT, STYLE, SIZE, OR COLOR.

FOR PRINTING OF PHOTOGRAPHIC IMAGES FROM DIGITAL MEDIA (U.S. CLS. 100, 103 AND 106).  
FIRST USE 9-29-2010; IN COMMERCE 4-22-2011.  
MIDGE BUTLER, EXAMINING ATTORNEY

SN 85-330,401. THE CENTERS FOR HABILITATION/TCH, TEMPE, AZ. FILED 5-25-2011.

**Predator Protection**

THE MARK CONSISTS OF STANDARD CHARACTERS WITHOUT CLAIM TO ANY PARTICULAR FONT, STYLE, SIZE, OR COLOR.

FOR DOCUMENT DESTRUCTION; DOCUMENT SHREDDING SERVICES (U.S. CLS. 100, 103 AND 106).  
FIRST USE 4-25-2011; IN COMMERCE 4-25-2011.  
GEORGE LORENZO, EXAMINING ATTORNEY

SN 85-333,213. WARD R CARAPETAN, RIDGEWOOD, NJ. FILED 5-29-2011.

**Compromise is Planned Failure**

THE MARK CONSISTS OF STANDARD CHARACTERS WITHOUT CLAIM TO ANY PARTICULAR FONT, STYLE, SIZE, OR COLOR.

FOR IMPRINTING MESSAGES ON T-SHIRTS; IMPRINTING MESSAGES ON WEARING APPAREL, ACCESSORIES AND MUGS (U.S. CLS. 100, 103 AND 106).  
KIMBERLY FRYE, EXAMINING ATTORNEY

**CLASS 40—(Continued).**

SN 85-335,601. THE CENTERS FOR HABILITATION/TCH, TEMPE, AZ. FILED 6-1-2011.



THE MARK CONSISTS OF A WOLF'S HEAD, BEARING ITS TEETH.

FOR DOCUMENT DESTRUCTION; DOCUMENT SHREDDING SERVICES (U.S. CLS. 100, 103 AND 106). FIRST USE 5-13-2011; IN COMMERCE 5-13-2011. GEORGE LORENZO, EXAMINING ATTORNEY

SN 85-337,080. BO-WITT PRODUCTS, INC., EDINBURGH, IN. FILED 6-3-2011.

INNOVATION THAT BREAKS THE MOLD

THE MARK CONSISTS OF STANDARD CHARACTERS WITHOUT CLAIM TO ANY PARTICULAR FONT, STYLE, SIZE, OR COLOR.

FOR CUSTOM MANUFACTURE OF INSULATORS MADE OF THERMOSET, PHENOLIC, BULK MOLDING COMPOUND OR SHEET MOLDING COMPOUND, TO THE ORDER AND SPECIFICATION OF OTHERS (U.S. CLS. 100, 103 AND 106).

FIRST USE 2-0-2011; IN COMMERCE 2-0-2011. LINDA ESTRADA, EXAMINING ATTORNEY

SN 85-337,953. YAN, KE (KENT), WALNUT, CA. AND SONG, TAO (TOM), WALNUT, CA. FILED 6-3-2011.

Overlord

THE MARK CONSISTS OF STANDARD CHARACTERS WITHOUT CLAIM TO ANY PARTICULAR FONT, STYLE, SIZE, OR COLOR.

FOR CONTRACT MANUFACTURING IN THE FIELD OF AUTOMOBILES; CUSTOM BUILDING OF AUTOMOBILE ENGINES; CUSTOM BUILDING OF AUTOMOBILES; MANUFACTURE OF GENERAL PRODUCT LINES IN THE FIELD OF AUTOMOBILES TO THE ORDER AND SPECIFICATION OF OTHERS (U.S. CLS. 100, 103 AND 106).

MARK SHINER, EXAMINING ATTORNEY

**CLASS 40—(Continued).**

SN 85-338,108. NEOGI, SUNEETA, TEMECULA, CA. FILED 6-4-2011.

MIDAS TOUCH

THE MARK CONSISTS OF STANDARD CHARACTERS WITHOUT CLAIM TO ANY PARTICULAR FONT, STYLE, SIZE, OR COLOR.

FOR TREATMENT OF SILVER ARTICLES (U.S. CLS. 100, 103 AND 106).

CHARLES L. JENKINS, EXAMINING ATTORNEY

SN 85-338,492. STOKES, ANNETTE, GARY, IN. FILED 6-6-2011.



THE STIPPLING IS FOR SHADING PURPOSES ONLY. THE MARK CONSISTS OF THE IMAGE OF A ZIPPER MADE INTO A STYLIZED LETTER "Z". ACROSS THE "Z" IS THE STYLIZED TEXT "ZIP IT" ABOVE A STYLIZED NUMBER "2". UNDER THE "2" IS THE STYLIZED TEXT "ME".

FOR SEWING SERVICES (U.S. CLS. 100, 103 AND 106). ERNEST SHOSHO, EXAMINING ATTORNEY

SN 85-338,724. LITE TECH LLC, ALTAMONTE SPRINGS, FL. FILED 6-6-2011.

CORSA

THE MARK CONSISTS OF STANDARD CHARACTERS WITHOUT CLAIM TO ANY PARTICULAR FONT, STYLE, SIZE, OR COLOR.

THE ENGLISH TRANSLATION OF CORSA IN THE MARK IS "RACE."

FOR MANUFACTURE OF GREEN BUILDING PRODUCTS, NAMELY, LIGHTWEIGHT CONCRETE WALL SYSTEMS, TO ORDER AND/OR SPECIFICATION OF OTHERS (U.S. CLS. 100, 103 AND 106).

COURTNEY ALVAREZ, EXAMINING ATTORNEY

**CLASS 40—(Continued).**

SN 85-394,320. INVISTA NORTH AMERICA S.A R.L., WICHITA, KS. FILED 8-10-2011.



THE MARK CONSISTS OF DIFFERENT SIZE BALLS APPEARING IN A PINWHEEL FASHION, AND THE WORDS PRECISION AND CONCEPTS SEPARATED BY A LINE.

FOR MACHINE SHOP SERVICES, NAMELY, MACHINING PARTS FOR OTHERS (U.S. CLS. 100, 103 AND 106).

NAAKWAMA ANKRAH, EXAMINING ATTORNEY

**CLASS 41—EDUCATION AND ENTERTAINMENT**

SN 76-702,547. NATIONAL CHAMPIONSHIP CHUCKWAGON RACE, INC., CLINTON, AR. FILED 4-19-2010.



THE MARK CONSISTS OF A DESIGN OF A COWBOY RIDING A HORSE-DRAWN COVERED WAGON LEAD BY TWO HORSES ON A PATCH OF GRASS; ON THE SIDE OF THE COVERED WAGON IS THE WORDING "OF RANCH", OVER THE LETTER "O" IS A HORIZONTAL LINE.

FOR ENTERTAINMENT IN THE NATURE OF HORSE RACES (U.S. CLS. 100, 101 AND 107).

FIRST USE 0-0-1995; IN COMMERCE 0-0-1995.

CHRISTINA SOBRAL, EXAMINING ATTORNEY

SN 76-703,378. GROUP KAITU, LLC, RICHMOND, VA. FILED 6-15-2010.

SN 85-402,311. CRABAR/GBF, INC., MIDLOTHIAN, TX. FILED 8-19-2011.

**ATLAS TAG & LABEL**

THE MARK CONSISTS OF STANDARD CHARACTERS WITHOUT CLAIM TO ANY PARTICULAR FONT, STYLE, SIZE, OR COLOR.

OWNER OF U.S. REG. NO. 2,293,871.

NO CLAIM IS MADE TO THE EXCLUSIVE RIGHT TO USE "TAG & LABEL", APART FROM THE MARK AS SHOWN.

FOR PRINTING SERVICES (U.S. CLS. 100, 103 AND 106).

FIRST USE 5-31-1980; IN COMMERCE 5-31-1980.  
WENDY GOODMAN, EXAMINING ATTORNEY

**EROS MOBILE**

THE MARK CONSISTS OF STANDARD CHARACTERS WITHOUT CLAIM TO ANY PARTICULAR FONT, STYLE, SIZE, OR COLOR.

OWNER OF U.S. REG. NOS. 2,793,831, 3,134,894 AND OTHERS.

NO CLAIM IS MADE TO THE EXCLUSIVE RIGHT TO USE "MOBILE", APART FROM THE MARK AS SHOWN.

FOR ENTERTAINMENT SERVICES, NAMELY, PROVIDING INFORMATION ABOUT ENTERTAINERS AND PROVIDING MARKET SPECIFIC INFORMATION ON ENTERTAINERS IN THE FIELD OF ADULT-THEMED ENTERTAINMENT VIA MOBILE AND WIRELESS DEVICES; ENTERTAINMENT SERVICES, NAMELY, NON-DOWNLOADABLE TEXT AND IMAGES CONTAINING INFORMATION ABOUT ENTERTAINERS AND THEIR GEOGRAPHIC LOCATION AS PRESENTED TO MOBILE COMMUNICATIONS DEVICES VIA A GLOBAL COMPUTER NETWORK AND WIRELESS NETWORKS; ENTERTAINMENT SERVICES, NAMELY, NON-DOWNLOADABLE AUDIO RECORDINGS IN THE NATURE OF VOICE RECORDINGS AS PRESENTED TO MOBILE COMMUNICATIONS DEVICES VIA A GLOBAL COMPUTER NETWORK AND WIRELESS NETWORKS (U.S. CLS. 100, 101 AND 107).

AMEEN IMAM, EXAMINING ATTORNEY

**CLASS 41—(Continued).**

SN 76-705,725. GEOWHIZ UNIVERSE, LLC, PLANO, TX. FILED 12-20-2010.



THE COLOR(S) CYAN, BLUE AND GREEN IS/ARE CLAIMED AS A FEATURE OF THE MARK.

THE MARK CONSISTS OF A STYLIZED VERSION OF THE WORD "GEOWHIZ" WITH A GLOBAL SPHERE SERVING AS THE "O" IN "GEOWHIZ". THE LETTERS ARE COLORED AS FOLLOWS: THE LETTER "G" IS COLORED CYAN, THE LETTER "E" AND THE GLOBAL SPHERE SERVING AS THE "O" ARE COLORED BLUE, AND THE LETTERS "W", "H", "I" AND "Z" ARE COLORED GREEN. THE COLOR WHITE IN THE LINES ON THE GLOBE DESIGN REPRESENTS BACKGROUND AND IS NOT CLAIMED AS A FEATURE OF THE MARK.

FOR EDUCATIONAL AND ENTERTAINMENT SERVICES, NAMELY, PROVIDING ON-LINE INTERACTIVE COMPUTER GAME (U.S. CLS. 100, 101 AND 107).  
MARILYN IZZI, EXAMINING ATTORNEY

SN 76-706,540. BRIARD CLUB OF AMERICA, DETROIT, MI. FILED 2-24-2011.

**RASSEMBLEMENT**

THE MARK CONSISTS OF STANDARD CHARACTERS WITHOUT CLAIM TO ANY PARTICULAR FONT, STYLE, SIZE, OR COLOR.

THE ENGLISH TRANSLATION OF "RASSEMBLEMENT" IN THE MARK IS "GATHERING; RALLY".  
SEC. 2(F).

FOR EDUCATIONAL AND ENTERTAINMENT SERVICES, NAMELY, PROVIDING NONCOMPETITIVE EVENTS, NAMELY, ANIMAL EXHIBITIONS FOR THE EVALUATION OF INDIVIDUAL BRIARDS ENTERED IN THE EVENT, SUCH EVALUATIONS PERFORMED BY A BRIARD BREED EXPERT ACCORDING TO RECOGNIZED BRIARD BREED STANDARDS AND PUBLISHING THE EVALUATIONS OF THE INDIVIDUAL BRIARDS ENTERED IN THE EVENT, AND PROVIDING EDUCATIONAL SEMINARS CONCERNING THE BRIARD BREED (U.S. CLS. 100, 101 AND 107).

FIRST USE 0-0-1974; IN COMMERCE 0-0-1974.  
SUSAN STIGLITZ, EXAMINING ATTORNEY

**CLASS 41—(Continued).**

SN 76-706,761. HAAS OUTDOORS, INC., WEST POINT, MS. FILED 3-11-2011.



NO CLAIM IS MADE TO THE EXCLUSIVE RIGHT TO USE "OUTDOOR NEWS EXPRESS", APART FROM THE MARK AS SHOWN.

THE COLOR(S) BLACK, WHITE AND YELLOW IS/ARE CLAIMED AS A FEATURE OF THE MARK.

THE MARK CONSISTS OF A YELLOW RECTANGLE WITH A SHADED WHITE AREA AT THE TOP THAT CREATES THE OUTLINE FOR A CURVED BAND; SUPERIMPOSED OVER THE RECTANGLE AND CURVED BAND IS THE WORDING "ONX" IN BLACK ABOVE THE WORDING "OUTDOOR NEWS EXPRESS", ALSO IN BLACK.

FOR ENTERTAINMENT IN THE NATURE OF ONGOING TELEVISION PROGRAMS IN THE FIELD OF HUNTING AND THE OUTDOORS ACCESSIBLE BY TELEVISION AND COMPUTER NETWORKS (U.S. CLS. 100, 101 AND 107).

FIRST USE 1-10-2011; IN COMMERCE 1-10-2011.  
SHAILA SETTLES, EXAMINING ATTORNEY

SN 76-707,627. PSYCHOLOGICAL ASSOCIATES, INC., ST. LOUIS, MO. FILED 5-16-2011.

**WHAT YOU NEED TO LEAD**

THE MARK CONSISTS OF STANDARD CHARACTERS WITHOUT CLAIM TO ANY PARTICULAR FONT, STYLE, SIZE, OR COLOR.

FOR EDUCATIONAL SERVICES, NAMELY, CONDUCTING SEMINARS IN THE FIELD OF BUSINESS MANAGEMENT AND EMPLOYEE PERFORMANCE, AND DEVELOPING AND CONDUCTING MOTIVATIONAL SEMINARS AND WORKSHOPS IN THE APPLICATION OF PSYCHOLOGICAL PRINCIPLES TO THE PROBLEMS OF BUSINESS ORGANIZATION (U.S. CLS. 100, 101 AND 107).

FIRST USE 3-5-2009; IN COMMERCE 8-25-2009.  
ALYSSA STEEL, EXAMINING ATTORNEY

SN 76-707,766. INTERNATIONAL MARCH OF THE LIVING, INC, NEW YORK, NY. FILED 5-27-2011.

**MARCH OF REMEMBRANCE AND HOPE**

THE MARK CONSISTS OF STANDARD CHARACTERS WITHOUT CLAIM TO ANY PARTICULAR FONT, STYLE, SIZE, OR COLOR.

FOR EDUCATIONAL SERVICES, NAMELY, CONDUCTING CLASSES, SEMINARS, LECTURES, CONFERENCES, WORKSHOPS AND FIELD TRIPS IN THE FIELD OF HOLOCAUST STUDIES (U.S. CLS. 100, 101 AND 107).

FIRST USE 6-0-1993; IN COMMERCE 6-0-1993.  
KATHERINE STOIDES, EXAMINING ATTORNEY



**CLASS 41—(Continued).**

SN 76-708,077. SMITHSONIAN INSTITUTION, WASHINGTON, DC. FILED 6-21-2011.



THE COLOR(S) PURPLE, ORANGE AND GREEN IS/ARE CLAIMED AS A FEATURE OF THE MARK.

THE MARK CONSISTS OF A DESIGN OF AN EXCLAMATION POINT IN GREEN, ORANGE BARS REPRESENTING THE ARMS AND LEGS, AND A PURPLE CIRCLE WITH RAYS ON TOP OF THE ARMS REPRESENTING THE HEAD. THE COLOR WHITE REPRESENTS BACKGROUND AREAS AND IS NOT PART OF THE MARK.

FOR MUSEUM SERVICES AND EDUCATIONAL SERVICES; NAMELY, OPERATING INTERACTIVE ACTIVITY CENTERS, EDUCATIONAL WORKSHOPS AND PUBLIC PROGRAMS IN THE FIELD OF INVENTIONS AND INNOVATIONS AND THEIR RELATED HISTORIES (U.S. CLS. 100, 101 AND 107).

FIRST USE 5-0-2008; IN COMMERCE 11-0-2008.

RAUL CORDOVA, EXAMINING ATTORNEY

SN 77-429,989. JACQUELINE WADDELL, BEVERLY HILLS, CA. FILED 3-24-2008.

## TEN TRAINING

THE MARK CONSISTS OF STANDARD CHARACTERS WITHOUT CLAIM TO ANY PARTICULAR FONT, STYLE, SIZE, OR COLOR.

NO CLAIM IS MADE TO THE EXCLUSIVE RIGHT TO USE "TRAINING", APART FROM THE MARK AS SHOWN.

FOR PROVIDING FITNESS AND EXERCISE FACILITIES, PHYSICAL FITNESS INSTRUCTIONS, PHYSICAL FITNESS CONSULTATION, PHYSICAL FITNESS CONDITIONING, PERSONAL TRAINING SERVICES (U.S. CLS. 100, 101 AND 107).

BERYL GARDNER, EXAMINING ATTORNEY

**CLASS 41—(Continued).**

SN 77-775,457. TRUSTEES OF CLARK UNIVERSITY, WORCESTER, MA. FILED 7-7-2009.

## CLARK UNIVERSITY

THE MARK CONSISTS OF STANDARD CHARACTERS WITHOUT CLAIM TO ANY PARTICULAR FONT, STYLE, SIZE, OR COLOR.

NO CLAIM IS MADE TO THE EXCLUSIVE RIGHT TO USE "UNIVERSITY", APART FROM THE MARK AS SHOWN.

FOR EDUCATIONAL SERVICES, NAMELY, PROVIDING INSTRUCTION AND TRAINING IN THE FIELDS OF ANCIENT CIVILIZATION, ART HISTORY, ASIAN STUDIES, BIOCHEMISTRY AND MOLECULAR BIOLOGY, BIOINFORMATICS, BIOLOGY, CHEMISTRY, COMMUNICATION AND CULTURE, COMPARATIVE LITERATURE, COMPUTER SCIENCE, ECONOMICS, EDUCATION, ENGINEERING, ENGLISH, ENVIRONMENTAL SCIENCE, ETHICS AND PUBLIC POLICY, FOREIGN LANGUAGES AND LITERATURES, GEOGRAPHIC INFORMATION SCIENCES, GEOGRAPHY, GLOBAL ENVIRONMENTAL STUDIES, HISTORY, HOLOCAUST AND GENOCIDE STUDIES, INNOVATION AND ENTREPRENEURSHIP, INTERNATIONAL DEVELOPMENT, COMMUNITY AND ENVIRONMENT, INTERNATIONAL DEVELOPMENT AND SOCIAL CHANGE, INTERNATIONAL STUDIES, JEWISH STUDIES, LAW AND SOCIETY, MANAGEMENT, MATHEMATICS AND COMPUTER SCIENCE, MUSIC, PEACE STUDIES, PHILOSOPHY, PHYSICS, POLITICAL SCIENCE, PREHEALTH, PRELAW, PSYCHOLOGY, RACE AND ETHNIC RELATIONS, SCIENCES, SCREEN STUDIES, SOCIOLOGY, STUDIO ART, THEATER, URBAN DEVELOPMENT AND SOCIAL CHANGE, VISUAL AND PERFORMING ARTS, WOMEN'S AND GENDER STUDIES PROGRAMS, WRITING, AT THE SECONDARY, UNDERGRADUATE, GRADUATE, AND POST-GRADUATE LEVEL; EDUCATIONAL SERVICES, NAMELY, CONDUCTING WORKSHOPS TO PROMOTE INVOLVEMENT IN COMMUNITY SERVICE AND ARRANGING AND CONDUCTING EDUCATIONAL CONFERENCES AND SEMINARS IN THE FIELD OF ANCIENT CIVILIZATION, ART HISTORY, ASIAN STUDIES, BIOCHEMISTRY AND MOLECULAR BIOLOGY, BIOINFORMATICS, BIOLOGY, CHEMISTRY, COMMUNICATION AND CULTURE, COMPARATIVE LITERATURE, COMPUTER SCIENCE, ECONOMICS, EDUCATION, ENGINEERING, ENGLISH, ENVIRONMENTAL SCIENCE, ETHICS AND PUBLIC POLICY, FOREIGN LANGUAGES AND LITERATURES, GEOGRAPHIC INFORMATION SCIENCES, GEOGRAPHY, GLOBAL ENVIRONMENTAL STUDIES, HISTORY, HOLOCAUST AND GENOCIDE STUDIES, INNOVATION AND ENTREPRENEURSHIP, INTERNATIONAL DEVELOPMENT, COMMUNITY AND ENVIRONMENT, INTERNATIONAL DEVELOPMENT AND SOCIAL CHANGE, INTERNATIONAL STUDIES, JEWISH STUDIES, LAW AND SOCIETY, MANAGEMENT, MATHEMATICS AND COMPUTER SCIENCE, MUSIC, PEACE STUDIES, PHILOSOPHY, PHYSICS, POLITICAL SCIENCE, PREHEALTH, PRELAW, PSYCHOLOGY, RACE AND ETHNIC RELATIONS, SCIENCES, SCREEN STUDIES, SOCIOLOGY, STUDIO ART, THEATER, URBAN DEVELOPMENT AND SOCIAL CHANGE, VISUAL AND PERFORMING ARTS, WOMEN'S AND GENDER STUDIES PROGRAMS, WRITING; PHYSICAL EDUCATION SERVICES, NAMELY, CONDUCTING INTRAMURAL AND INTERCOLLEGIATE ATHLETIC COMPETITIONS (U.S. CLS. 100, 101 AND 107).

FIRST USE 3-31-1887; IN COMMERCE 3-31-1887.

YAT SYE, LEE, EXAMINING ATTORNEY



**CLASS 41—(Continued).**

SN 77-806,358. TRIUMPH INTERNATIONAL, INC., ATLANTA, GA. FILED 8-17-2009.

**MICHAEL JACKSON**

THE MARK CONSISTS OF STANDARD CHARACTERS WITHOUT CLAIM TO ANY PARTICULAR FONT, STYLE, SIZE, OR COLOR.

OWNER OF U.S. REG. NO. 1,908,209.  
THE NAME "MICHAEL JACKSON" DOES NOT IDENTIFY A LIVING INDIVIDUAL.

FOR ENTERTAINMENT SERVICES, NAMELY, LIVE AND TELEVISED PERFORMANCES FEATURING MUSICAL, DANCE, DRAMATIC, AND COMEDIC PRESENTATIONS; ENTERTAINMENT SERVICES, NAMELY, AN ONGOING SERIES FEATURING MUSIC AND DANCE PROVIDED THROUGH THE INTERNET, TELEVISION, SATELLITE, AND AUDIO MEDIA; FILM, THEATER, RADIO, VIDEOTAPE AND TELEVISION PROGRAM PRODUCTION SERVICES; ENTERTAINMENT IN THE NATURE OF A CONTINUING TELEVISION DRAMA SERIES, ENTERTAINMENT IN THE NATURE OF A CONTINUING TELEVISION COMEDY SERIES; ENTERTAINMENT IN THE NATURE OF TELEVISION NEWS SHOWS; MUSIC PUBLISHING SERVICES; SONG WRITING SERVICES; AUDIO RECORDING AND PRODUCTION; RECORD AND MUSIC PRODUCTION; RECORDING STUDIO SERVICES; MAGAZINE PUBLICATION SERVICES; PROVIDING RECREATIONAL ACTIVITIES FACILITIES FOR OTHERS; RECREATIONAL CAMPS; RECREATIONAL PARK SERVICES; AMUSEMENT PARKS; ART EXHIBITIONS; DANCE INSTRUCTION; ENTERTAINMENT SERVICES, NAMELY, OPERATING A MUSEUM AND PROVIDING GUIDED TOURS OF THE MUSEUM; PROVIDING THEME PARK SERVICES; DANCE EVENTS; DANCE SCHOOLS; DANCE STUDIOS; MUSEUMS; ENTERTAINMENT SERVICES, NAMELY, PROVIDING PODCASTS IN THE FIELD OF MUSIC; ENTERTAINMENT SERVICES, NAMELY, PROVIDING INFORMATION AND COMMENTARY ONLINE IN THE FIELD OF MUSIC; PROVIDING NEWSLETTERS IN THE FIELD OF MUSIC VIA E-MAIL; ENTERTAINMENT SERVICES, NAMELY, PROVIDING PRE-RECORDED MUSIC, VIDEO AND GRAPHICS, PROVIDING INFORMATION IN THE FIELD OF MUSIC, AND COMMENTARY AND ARTICLES ABOUT MUSIC, ALL ON-LINE; PROVIDING AN INTERNET WEBSITE PORTAL FEATURING MUSICAL PERFORMANCES, MUSICAL VIDEOS, FILM CLIPS, PHOTOGRAPHS AND OTHER MULTIMEDIA MATERIALS; FAN CLUB SERVICES; EDUCATIONAL SERVICES, NAMELY, CONDUCTING CLASSES, SEMINARS, CONFERENCES, AND WORKSHOPS IN THE FIELD OF MUSIC AND ENTERTAINMENT (U.S. CLS. 100, 101 AND 107).

HEATHER THOMPSON, EXAMINING ATTORNEY

**CLASS 41—(Continued).**

SN 77-806,397. TRIUMPH INTERNATIONAL, INC., ATLANTA, GA. FILED 8-17-2009.



OWNER OF U.S. REG. NO. 1,908,209.  
THE NAME "MICHAEL JACKSON" DOES NOT IDENTIFY A LIVING INDIVIDUAL.

THE MARK CONSISTS OF THE NAME "MICHAEL JACKSON" WRITTEN IN STYLIZED FORM WHEN THE END OF THE LETTER "N" HAS A VERTICAL LINE UP AND AT THE PEAK HAS A SLIGHTLY CURVED LINE DOWN ENDING WITH A STYLIZED STARBURST.

FOR ENTERTAINMENT SERVICES, NAMELY, LIVE AND TELEVISED PERFORMANCES FEATURING MUSICAL, DANCE, DRAMATIC, AND COMEDIC PRESENTATIONS; ENTERTAINMENT SERVICES, NAMELY, AN ONGOING SERIES FEATURING MUSIC AND DANCE PROVIDED THROUGH THE INTERNET, TELEVISION, SATELLITE, AND AUDIO MEDIA; FILM, THEATER, RADIO, VIDEOTAPE AND TELEVISION PROGRAM PRODUCTION SERVICES; ENTERTAINMENT IN THE NATURE OF A CONTINUING TELEVISION DRAMA SERIES, ENTERTAINMENT IN THE NATURE OF A CONTINUING TELEVISION COMEDY SERIES; ENTERTAINMENT IN THE NATURE OF TELEVISION NEWS SHOWS; MUSIC PUBLISHING SERVICES; SONG WRITING SERVICES; AUDIO RECORDING AND PRODUCTION; RECORD AND MUSIC PRODUCTION; RECORDING STUDIO SERVICES; MAGAZINE PUBLICATION SERVICES; PROVIDING RECREATIONAL ACTIVITIES FACILITIES FOR OTHERS; RECREATIONAL CAMPS; RECREATIONAL PARK SERVICES; AMUSEMENT PARKS; ART EXHIBITIONS; DANCE INSTRUCTION; ENTERTAINMENT SERVICES, NAMELY, OPERATING A MUSEUM AND PROVIDING GUIDED TOURS OF THE MUSEUM; PROVIDING THEME PARK SERVICES; DANCE EVENTS; DANCE SCHOOLS; DANCE STUDIOS; MUSEUMS; ENTERTAINMENT SERVICES, NAMELY, PROVIDING PODCASTS IN THE FIELD OF MUSIC; ENTERTAINMENT SERVICES, NAMELY, PROVIDING INFORMATION AND COMMENTARY ONLINE IN THE FIELD OF MUSIC; PROVIDING NEWSLETTERS IN THE FIELD OF MUSIC VIA E-MAIL; ENTERTAINMENT SERVICES, NAMELY, PROVIDING PRE-RECORDED MUSIC, VIDEO AND GRAPHICS, PROVIDING INFORMATION IN THE FIELD OF MUSIC, AND COMMENTARY AND ARTICLES ABOUT MUSIC, ALL ON-LINE; PROVIDING AN INTERNET WEBSITE PORTAL FEATURING MUSICAL PERFORMANCES, MUSICAL VIDEOS, FILM CLIPS, PHOTOGRAPHS AND OTHER MULTIMEDIA MATERIALS; FAN CLUB SERVICES; EDUCATIONAL SERVICES, NAMELY, CONDUCTING CLASSES, SEMINARS, CONFERENCES, AND WORKSHOPS IN THE FIELD OF MUSIC AND ENTERTAINMENT (U.S. CLS. 100, 101 AND 107).

HEATHER THOMPSON, EXAMINING ATTORNEY

**CLASS 41—(Continued).**

SN 77-877,482. EDUCATION NORTHWEST, PORTLAND, OR. FILED 11-20-2009.



NO CLAIM IS MADE TO THE EXCLUSIVE RIGHT TO USE "EDUCATION", APART FROM THE MARK AS SHOWN.

THE MARK CONSISTS OF THE WORDS "EDUCATION NORTHWEST" ADJACENT TO A SQUARE INCORPORATING TWO RIGHT ANGLES ON THE UPPER PORTION OF THE SQUARE.

SEC. 2(F) AS TO "EDUCATION NORTHWEST".

FOR EDUCATION SERVICES, NAMELY, PROVIDING INFORMATION, TRAINING ACTIVITIES, AND TECHNICAL ASSISTANCE IN THE FIELDS OF CONDUCTING PRESCHOOL, PRIMARY, ELEMENTARY, AND SECONDARY SCHOOL EDUCATION; EDUCATION SERVICES, NAMELY, PROVIDING INFORMATION, TRAINING ACTIVITIES, AND TECHNICAL ASSISTANCE IN THE FIELDS OF POLICYMAKING AND ADMINISTRATION OF PRESCHOOL, PRIMARY, ELEMENTARY, AND SECONDARY SCHOOL EDUCATION; EDUCATION SERVICES, NAMELY, PROVIDING INFORMATION, TRAINING ACTIVITIES, AND TECHNICAL ASSISTANCE IN THE FIELDS OF FAMILY AND COMMUNITY ENGAGEMENT WITH EDUCATION SYSTEMS, VOLUNTEERISM, AND YOUTH MENTORING; EDUCATION SERVICES, NAMELY, CONDUCTING AND DISSEMINATING RESEARCH IN THE FIELDS OF PRESCHOOL, PRIMARY, ELEMENTARY, AND SECONDARY SCHOOL EDUCATION; EDUCATION SERVICES, NAMELY, CONDUCTING AND DISSEMINATING RESEARCH IN THE FIELDS OF POLICYMAKING AND ADMINISTRATION OF PRESCHOOL, PRIMARY, ELEMENTARY, AND SECONDARY SCHOOL EDUCATION; EDUCATION SERVICES, NAMELY, CONDUCTING AND DISSEMINATING RESEARCH IN THE FIELDS OF FAMILY AND COMMUNITY ENGAGEMENT WITH EDUCATION SYSTEMS, VOLUNTEERISM, AND YOUTH MENTORING; EDUCATION SERVICES, NAMELY, PROVIDING WEB-BASED INFORMATION AND TRAINING FOR PROFESSIONAL DEVELOPMENT OF EDUCATIONAL PRACTITIONERS, POLICY MAKERS, AND COMMUNITY ORGANIZATIONS; EDUCATION SERVICES, NAMELY, PROVIDING EVALUATION AND ASSESSMENTS FOR EDUCATIONAL PROGRAMS; PUBLICATION OF RESEARCH REPORTS, BOOKS, MAGAZINES, AND TRAINING MATERIALS IN BOTH PRINT AND ELECTRONIC MEDIA (U.S. CLS. 100, 101 AND 107).

FIRST USE 9-1-2009; IN COMMERCE 9-1-2009.  
BRIAN NEVILLE, EXAMINING ATTORNEY

**CLASS 41—(Continued).**

SN 77-883,211. GROMS, INC., HERMOSA BEACH, CA. FILED 12-1-2009.

## GROMS COVE

THE MARK CONSISTS OF STANDARD CHARACTERS WITHOUT CLAIM TO ANY PARTICULAR FONT, STYLE, SIZE, OR COLOR.

NO CLAIM IS MADE TO THE EXCLUSIVE RIGHT TO USE "GROMS", APART FROM THE MARK AS SHOWN.

FOR ENTERTAINMENT SERVICES, NAMELY, PROVIDING ON-LINE COMPUTER GAMES AND PROVIDING A WEBSITE FEATURING ELECTRONIC MEDIA, MULTIMEDIA CONTENT, VIDEOS, MOVIES, PICTURES, IMAGES, TEXT, PHOTOS, AUDIO CONTENT, AND RELATED INFORMATION IN THE FIELD OF ACTION SPORTS (U.S. CLS. 100, 101 AND 107).

LINDSEY RUBIN, EXAMINING ATTORNEY

SN 77-965,016. TOYODA, SHIGEHARU, KOBE CITY HYOGO PREF., JAPAN, FILED 3-22-2010.

## Araki Mujinsai Ryu Iaido

THE MARK CONSISTS OF STANDARD CHARACTERS WITHOUT CLAIM TO ANY PARTICULAR FONT, STYLE, SIZE, OR COLOR.

NO CLAIM IS MADE TO THE EXCLUSIVE RIGHT TO USE "RYU IAIDO", APART FROM THE MARK AS SHOWN.

THE NAME "ARAKI MUJINSAI" DOES NOT IDENTIFY A LIVING INDIVIDUAL.

"ARAKI MUJINSAI" IS THE NAME OF THE FOUNDER OF THIS TYPE OF MARTIAL ARTS. THE WORD "RYU" TRANSLATES TO "SCHOOL OF" AND THE WORD "IAIDO" IS A TRADITIONAL FORM OF JAPANESE MARTIAL ARTS, IN WHICH SWORDS ARE USED.

SEC. 2(F).

FOR MARTIAL ARTS INSTRUCTION; OPERATING OF MARTIAL ARTS' SCHOOLS (U.S. CLS. 100, 101 AND 107).

FIRST USE 2-23-1987; IN COMMERCE 2-23-1987.  
HOWARD B. LEVINE, EXAMINING ATTORNEY

**CLASS 41—(Continued).**

SN 77-969,411. RIAT, DEBORAH L., NASHVILLE, TN. FILED 3-26-2010.

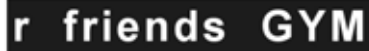

NO CLAIM IS MADE TO THE EXCLUSIVE RIGHT TO USE "GYM", APART FROM THE MARK AS SHOWN.

THE MARK CONSISTS OF STYLIZED WORDING "R FRIENDS GYM" INSIDE OF A RECTANGLE.

FOR PROVIDING FITNESS AND EXERCISE FACILITIES (U.S. CLS. 100, 101 AND 107).

FIRST USE 3-26-2010; IN COMMERCE 3-26-2010.  
SCOTT BIBB, EXAMINING ATTORNEY

---

SN 77-982,452. LAUREATE EDUCATION, INC., BALTIMORE, MD. FILED 12-8-2009.

**MOTIVATING TODAY'S LEARNER**

THE MARK CONSISTS OF STANDARD CHARACTERS WITHOUT CLAIM TO ANY PARTICULAR FONT, STYLE, SIZE, OR COLOR.

FOR (BASED ON USE IN COMMERCE) EDUCATIONAL SERVICES, NAMELY, CONDUCTING GRADUATE-LEVEL COURSES ON TEACHING STRATEGIES FOR K-12 TEACHERS; (BASED ON INTENT TO USE) EDUCATIONAL SERVICES, NAMELY, CONDUCTING ONLINE COURSES AND PROVIDING PODCASTS AND VIDEOCASTS IN THE FIELD OF TEACHING STRATEGIES FOR K-12 TEACHERS (U.S. CLS. 100, 101 AND 107).

FIRST USE 0-0-1996; IN COMMERCE 0-0-1996.  
KIMBERLY FRYE, EXAMINING ATTORNEY

---

SN 78-498,546. WORLD WRESTLING ENTERTAINMENT, INC., STAMFORD, CT. FILED 10-12-2004.

**EYE SCREAM MAN**

THE MARK CONSISTS OF STANDARD CHARACTERS WITHOUT CLAIM TO ANY PARTICULAR FONT, STYLE, SIZE, OR COLOR.

THE NAME IN THE MARK DOES NOT IDENTIFY A LIVING INDIVIDUAL.

FOR ENTERTAINMENT SERVICES, NAMELY, THE PRODUCTION AND DISTRIBUTION OF MOTION PICTURES (U.S. CLS. 100, 101 AND 107).

KIM SAITO, EXAMINING ATTORNEY

**CLASS 41—(Continued).**

SN 79-094,751. PHDR. PAVEL HORÁK, PH.D., HRADEC KRÁLOVÉ, CZECH REPUBLIC, FILED 11-19-2010.

**ČESKÝ CHLAPECKÝ SBOR BONI PUERI**

THE MARK CONSISTS OF STANDARD CHARACTERS WITHOUT CLAIM TO ANY PARTICULAR FONT, STYLE, SIZE, OR COLOR.

OWNER OF INTERNATIONAL REGISTRATION 1070194 DATED 11-19-2010, EXPIRES 11-19-2020.

NO CLAIM IS MADE TO THE EXCLUSIVE RIGHT TO USE "CESKY CHLAPECKY SBOR", APART FROM THE MARK AS SHOWN.

THE ENGLISH TRANSLATION OF "CESKY CHLAPECKY SBOR" IS CZECH BOYS CHOIR. THE WORDING "BONI PUERI" HAS NO MEANING IN A FOREIGN LANGUAGE.

FOR ORGANIZING AND ARRANGEMENT OF LIVE MUSIC CONCERTS AND MUSICAL CHOIR COMPETITIONS, AUDIO AND VIDEO RECORDING SERVICES, RENTAL OF AUDIO AND VIDEO RECORDINGS, EDUCATION SERVICES, NAMELY, PROVIDING CLASSES, SEMINARS, AND WORKSHOPS IN THE FIELD OF CHOIR SINGING (U.S. CLS. 100, 101 AND 107).

ADA HAN, EXAMINING ATTORNEY

---

SN 79-095,851. ANHEUSER-BUSCH INBEV (SOCIÉTÉ ANONYME), BELGIUM, FILED 3-17-2011.



PRIORITY DATE OF 10-11-2010 IS CLAIMED.  
OWNER OF INTERNATIONAL REGISTRATION 1073246 DATED 3-17-2011, EXPIRES 3-17-2021.

NO CLAIM IS MADE TO THE EXCLUSIVE RIGHT TO USE "GLOBAL BEER RESPONSIBLE DAY", APART FROM THE MARK AS SHOWN.

THE COLOR(S) YELLOW, WHITE, ORANGE, AND RED IS/ARE CLAIMED AS A FEATURE OF THE MARK.

THE MARK CONSISTS OF A SHADED RECTANGLE WITH THE COLORS GRADATING RIGHT TO LEFT FROM YELLOW AND ORANGE TO RED, INSIDE OF THE RECTANGLE IS THE WORDING "GLOBAL" IN YELLOW, "BEER" WITH "BE" IN WHITE, AND "ER" IN YELLOW, "RESPONSIBLE" IN WHITE, AND "DAY" IN YELLOW.

FOR EDUCATION NAMELY, PROVIDING CLASSES, SEMINARS, WORKSHOPS AND PROVIDING OF TRAINING IN THE FIELDS OF PUBLIC ALCOHOL AWARENESS AND RESPONSIBLE DRINKING; ORGANIZING COMMUNITY SPORTING AND CULTURAL EVENTS (U.S. CLS. 100, 101 AND 107).

SCOTT BIBB, EXAMINING ATTORNEY

**CLASS 41—(Continued).**

SN 85-003,114. SHIGEHARU TOYODA, KOBE CITY, JAPAN,  
FILED 3-31-2010.

荒  
木  
無  
人  
齋  
流  
居  
合  
道

NO CLAIM IS MADE TO THE EXCLUSIVE RIGHT TO USE THE NON-LATIN CHARACTERS THAT TRANSLITERATE TO RYU IAIDO, APART FROM THE MARK AS SHOWN.

THE NAME ARAKI MUJINSAI DOES NOT IDENTIFY A LIVING INDIVIDUAL.

THE MARK CONSISTS OF JAPANESE CHARACTERS TRANSLITERATING TO: ARAKI MUJINSAI RYU IAIDO.

"ARAKI MUJINSAI" IS THE NAME OF THE FOUNDER OF THE IAIDO MARTIAL ARTS. THE ENGLISH TRANSLATION OF "RYU IAIDO" IS "A SCHOOL OF A TRADITIONAL FORM OF JAPANESE MARTIAL ARTS, IN WHICH SWORDS ARE USED".

THE JAPANESE CHARACTERS IN THE MARK TRANSLITERATE TO ARAKI MUJINSAI RYU IAIDO.

SEC. 2(F).

FOR MARTIAL ARTS INSTRUCTION; OPERATING OF MARTIAL ARTS' SCHOOLS (U.S. CLS. 100, 101 AND 107).

FIRST USE 4-1-1985; IN COMMERCE 11-21-1986.

CHRISIE B. KING, EXAMINING ATTORNEY

SN 85-003,156. SHIGEHARU TOYODA, KOBE CITY, JAPAN,  
FILED 3-31-2010.

荒  
木  
無  
人  
齋  
流  
居  
合  
道

NO CLAIM IS MADE TO THE EXCLUSIVE RIGHT TO USE THE NON-LATIN CHARACTERS THAT TRANSLITERATE TO RYU IAIDO, APART FROM THE MARK AS SHOWN.

THE NAME ARAKI MUJINSAI DOES NOT IDENTIFY A LIVING INDIVIDUAL.

THE MARK CONSISTS OF JAPANESE CHARACTERS TRANSLITERATING TO: ARAKI MUJINSAI RYU IAIDO.

"ARAKI MUJINSAI" IS THE NAME OF THE FOUNDER OF THE IAIDO MARTIAL ARTS. THE ENGLISH TRANSLATION OF "RYU IAIDO" IS "A SCHOOL OF A TRADITIONAL FORM OF JAPANESE MARTIAL ARTS, IN WHICH SWORDS ARE USED".

THE JAPANESE CHARACTERS IN THE MARK TRANSLITERATE TO ARAKI MUJINSAI RYU IAIDO.

SEC. 2(F).

FOR MARTIAL ARTS INSTRUCTION; OPERATING OF MARTIAL ARTS' SCHOOLS (U.S. CLS. 100, 101 AND 107).

FIRST USE 4-1-1985; IN COMMERCE 11-21-1986.

CHRISIE B. KING, EXAMINING ATTORNEY

**CLASS 41—(Continued).**

SN 85-004,900. HANGOUT INDUSTRIES, INC., BOSTON,  
MA. FILED 4-2-2010.

FASHION CITY

THE MARK CONSISTS OF STANDARD CHARACTERS WITHOUT CLAIM TO ANY PARTICULAR FONT, STYLE, SIZE, OR COLOR.

NO CLAIM IS MADE TO THE EXCLUSIVE RIGHT TO USE "FASHION", APART FROM THE MARK AS SHOWN.

FOR PROVISION OF AN ONLINE VIDEO GAME (U.S. CLS. 100, 101 AND 107).

PAM WILLIS, EXAMINING ATTORNEY

SN 85-004,904. HANGOUT INDUSTRIES, INC., BOSTON,  
MA. FILED 4-2-2010.

DANCE BEAT

THE MARK CONSISTS OF STANDARD CHARACTERS WITHOUT CLAIM TO ANY PARTICULAR FONT, STYLE, SIZE, OR COLOR.

NO CLAIM IS MADE TO THE EXCLUSIVE RIGHT TO USE "DANCE", APART FROM THE MARK AS SHOWN.

FOR PROVISION OF AN ONLINE VIDEO GAME (U.S. CLS. 100, 101 AND 107).

PAM WILLIS, EXAMINING ATTORNEY

**CLASS 41—(Continued).**

SN 85-008,871. SK TELECOM CO., LTD., SEOUL, REPUBLIC OF KOREA, FILED 4-7-2010.

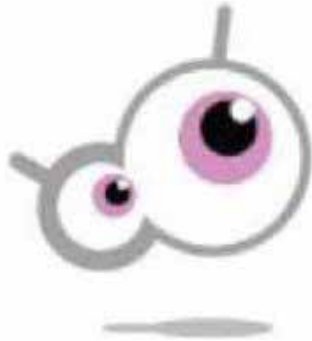

PRIORITY CLAIMED UNDER SEC. 44(D) ON REPUBLIC OF KOREA APPLICATION NO. 41-2010-0004, FILED 2-25-2010, REG. NO. 0210183, DATED 5-9-2011, EXPIRES 5-9-2021.

THE COLOR(S) GREY, PINK, BLACK AND WHITE IS/ARE CLAIMED AS A FEATURE OF THE MARK.

THE MARK CONSISTS OF TWO STYLIZED EYES, THE RIGHT EYE LARGER THAN OVERLAPPING THE LEFT EYE. EACH EYE HAS A WHITE CIRCLE, A BLACK CIRCLE, A PINK CIRCLE, AND A GREY OUTLINE. BENEATH BOTH OF THE EYES IS A GREY LINE.

FOR ENTERTAINMENT SERVICES IN THE NATURE OF PROVIDING ON-LINE VIDEO GAMES AND PROVIDING A CONTINUING RADIO PROGRAM IN THE FIELD OF NEWS AND IN THE FIELDS OF ENTERTAINMENT, SPORTS, LEISURE AND RECREATION ACTIVITIES, MUSIC, WEATHER INFORMATION, COMMENTARY IN THE FIELD OF ENTERTAINMENT, SPORTS, LEISURE AND RECREATION ACTIVITIES, CELEBRITIES DELIVERED VIA THE INTERNET; ENTERTAINMENT IN THE NATURE OF VISUAL AND AUDIO PERFORMANCES, AND MUSICAL, VARIETY, NEWS AND COMEDY SHOWS; PROVIDING NEWS AND INFORMATION IN THE FIELD OF MUSIC, FILM, TELEVISION, CELEBRITIES, AND OTHER ENTERTAINMENT EVENTS; PRODUCTION AND DISTRIBUTION OF FILMS AND VIDEO; PROVIDING INFORMATION, NEWS AND COMMENTARY IN THE FIELD OF RECREATION AND LEISURE ACTIVITIES; ARRANGING AND CONDUCTING SPORTING COMPETITIONS; TICKET AGENCY SERVICES FOR ENTERTAINMENT AND SPORTING EVENTS; PROVIDING NEWS IN THE NATURE OF CURRENT EVENT REPORTING; PROVIDING NEWS AND INFORMATION IN THE FIELD OF SPORTS (U.S. CLS. 100, 101 AND 107).

DEBRA LEE, EXAMINING ATTORNEY

**CLASS 41—(Continued).**

SN 85-028,934. TUTORING RESOURCES OF ARKANSAS, INC., ROGERS, AR. FILED 5-3-2010.



NO CLAIM IS MADE TO THE EXCLUSIVE RIGHT TO USE "TUTORING RESOURCES OF ARKANSAS, INC.", APART FROM THE MARK AS SHOWN.

THE MARK CONSISTS OF THE LETTERS "TRA" BY A WOMAN STANDING BEHIND A STUDENT AND ABOVE THE WORDS "TUTORING RESOURCES OF ARKANSAS, INC."

FOR EDUCATIONAL SERVICES, NAMELY, DEVELOPING AND CONDUCTING CLASSES, WORKSHOPS, INDIVIDUAL GROUP INSTRUCTION AND SMALL GROUP INSTRUCTION IN THE NATURE OF COURSES AT THE GRADE SCHOOL LEVEL AND UNIVERSITY LEVEL AND DISTRIBUTION OF PRINTED MATERIALS IN CONNECTION THEREWITH IN HARD COPY OR ELECTRONIC FORMAT ON THE SAME TOPICS (U.S. CLS. 100, 101 AND 107).

VERNA BETH RIRIE, EXAMINING ATTORNEY

SN 85-029,532. SAFARI RUN, SAN MATEO, CA. FILED 5-4-2010.



OWNER OF U.S. REG. NOS. 3,273,381 AND 3,273,382.

THE MARK CONSISTS OF A CIRCLE WITH THE STYLIZED WORDING "SAFARI RUN" CURVED AT THE TOP OF THE CIRCLE AND WITH A GIRL AND BOY WEARING JUNGLE PRINT BATHING SUITS SWINGING ON A VINE IN THE CENTER OF THE CIRCLE. THERE ARE PALM TREES BEHIND THE TOP OF THE CIRCLE AND THERE ARE A LION, A TOUCAN, AN ELEPHANT AND A SNAKE BELOW THE BOY AND GIRL INSIDE THE BOTTOM OF THE CIRCLE. UNDER THE CIRCLE IS A CURVED BANNER FOLLOWING THE LINE OF THE CIRCLE WITH THE STYLIZED WORDING "WHERE KIDS PARTY LIKE ANIMALS" INSIDE THE BANNER.

FOR ARRANGING, ORGANIZING, CONDUCTING AND HOSTING BIRTHDAY PARTIES; ENTERTAINMENT SERVICES, NAMELY, CONDUCTING PARTIES; PHYSICAL FITNESS CONDITIONING CLASSES; PROVISION OF PLAY FACILITIES FOR CHILDREN; RECREATIONAL CAMPS (U.S. CLS. 100, 101 AND 107).

FIRST USE 9-10-2006; IN COMMERCE 9-10-2006.

KELLEY WELLS, EXAMINING ATTORNEY

**CLASS 41—(Continued).**

SN 85-030,942. OREGON ZOO AND METRO, PORTLAND, OR. FILED 5-5-2010.



NO CLAIM IS MADE TO THE EXCLUSIVE RIGHT TO USE "PREDATORS OF THE SERENGETI", APART FROM THE MARK AS SHOWN.

THE COLOR(S) BLACK, RED, YELLOW AND GREEN IS/ARE CLAIMED AS A FEATURE OF THE MARK.

THE MARK CONSISTS OF THE FOLLOWING: A DESIGN OF A LION IN AFRICAN MOTIF OF THE COLORS BLACK, RED, YELLOW AND GREEN OVER THE WORDING "PREDATORS OF THE SERENGETI" IN BLACK.

FOR ANIMAL EXHIBITIONS; ANIMAL EXHIBITIONS AND TRAINING OF ANIMALS; ANIMAL TRAINING (U.S. CLS. 100, 101 AND 107).

FIRST USE 12-20-2007; IN COMMERCE 7-25-2008.

LINDA M. KING, EXAMINING ATTORNEY

SN 85-036,368. OKLAHOMA CITY NATIONAL MEMORIAL INSTITUTE FOR THE PREVENTION OF TERRORISM, DBA MIPT, OKLAHOMA CITY, OK. FILED 5-12-2010.



THE COLOR(S) BLUE, BLACK, GRAY, WHITE, AND RED IS/ARE CLAIMED AS A FEATURE OF THE MARK.

THE MARK CONSISTS OF THE TERM "INCOP" IN A BLUE STYLIZED FONT AND ON TOP OF A BROKEN BLACK HORIZONTAL LINE. BELOW THE TERM IS THE WORDING "MIPT INFORMATION COLLECTION ON PATROL" IN BLACK. ABOVE THE LINE AND TO THE LEFT OF "INCOP" IS A GRAPHIC OF A GRAY PUZZLE PIECE WITH BLACK CONTINENTS ON IT. THE PUZZLE PIECE IS ENCLOSED IN AN OUTLINE OF A RED CIRCLE. THE ENTIRE MARK IS ENCLOSED IN A BLACK RECTANGLE. THE INSIDE OF THE RECTANGLE IS WHITE.

FOR TRAINING SERVICES IN THE FIELD OF POLICE WORK (U.S. CLS. 100, 101 AND 107).

FIRST USE 4-9-2009; IN COMMERCE 4-9-2009.

ALYSSA STEEL, EXAMINING ATTORNEY

**CLASS 41—(Continued).**

SN 85-037,019. WARNER BROS. ENTERTAINMENT INC., BURBANK, CA. FILED 5-12-2010.

**MOVIEPOP.COM**

THE MARK CONSISTS OF STANDARD CHARACTERS WITHOUT CLAIM TO ANY PARTICULAR FONT, STYLE, SIZE, OR COLOR.

FOR ENTERTAINMENT SERVICES, NAMELY, THE PROVISION OF NON-DOWNLOADABLE INTERACTIVE ENTERTAINMENT TRIVIA GAMES WHICH ARE ACCESSED AND DISTRIBUTED OVER A GLOBAL COMPUTER NETWORK, A COMPUTER NETWORK, VIDEO-ON-DEMAND, ELECTRONIC SELL-THROUGH, DOWNLOADABLE VIDEO RECORDINGS AND OTHER ELECTRONIC MEDIA ENVIRONMENTS; ENTERTAINMENT SERVICES IN THE NATURE OF LIVE-ACTION, COMEDY, DRAMA, ANIMATED, AND REALITY TELEVISION SERIES; PRODUCTION OF LIVE-ACTION, COMEDY, DRAMA, ANIMATED AND REALITY TELEVISION SERIES; DISTRIBUTION AND THE DISPLAY FOR VIEWING OF LIVE-ACTION, COMEDY, DRAMA AND ANIMATED MOTION PICTURE THEATRICAL FILMS; PRODUCTION OF LIVE-ACTION, COMEDY, DRAMA AND ANIMATED MOTION PICTURE THEATRICAL FILMS; THEATRICAL PERFORMANCES BOTH ANIMATED AND LIVE ACTION; ENTERTAINMENT SERVICES, NAMELY, PROVIDING INFORMATION RELATING SPECIFICALLY TO MOVIES, AND TELEVISION VIA AN ELECTRONIC GLOBAL COMPUTER NETWORK; PROVIDING NEWS ABOUT CURRENT EVENTS AND ENTERTAINMENT, AND INFORMATION RELATED TO EDUCATION AND CULTURAL EVENTS, VIA A GLOBAL COMPUTER NETWORK; AND PROVIDING ACTUAL ENTERTAINMENT VIA AN ELECTRONIC GLOBAL COMMUNICATIONS NETWORK IN THE NATURE OF LIVE-ACTION, COMEDY, DRAMA AND ANIMATED PROGRAMS; AND PRODUCTION AND CREATION OF LIVE-ACTION, COMEDY, DRAMA AND ANIMATED MOTION PICTURE FILMS FOR DISTRIBUTION VIA A GLOBAL COMPUTER NETWORK (U.S. CLS. 100, 101 AND 107).

LESLEY LAMOTHE, EXAMINING ATTORNEY

SN 85-044,942. DIANE JARMOLOW, DBA BALLROOM DANCE TEACHERS COLLEGE, OAKLAND, CA. FILED 5-21-2010.

**TEACH LIKE A PRO**

THE MARK CONSISTS OF STANDARD CHARACTERS WITHOUT CLAIM TO ANY PARTICULAR FONT, STYLE, SIZE, OR COLOR.

FOR EDUCATIONAL SERVICES, NAMELY, CONDUCTING EDUCATIONAL SEMINARS IN THE FIELD OF BALLROOM DANCE AND DISTRIBUTION OF COURSE MATERIALS IN CONNECTION THEREWITH (U.S. CLS. 100, 101 AND 107).

PAUL E. FAHRENKOPF, EXAMINING ATTORNEY

**CLASS 41—(Continued).**

SN 85-052,146. RENAISSANCE PICTURES LTD., BEVERLY HILLS, CA. FILED 6-1-2010.

# EVIL DEAD

THE MARK CONSISTS OF STANDARD CHARACTERS WITHOUT CLAIM TO ANY PARTICULAR FONT, STYLE, SIZE, OR COLOR.

FOR ENTERTAINMENT IN THE NATURE OF THEATER PRODUCTIONS; ENTERTAINMENT MEDIA PRODUCTION SERVICES FOR MOTION PICTURES, TELEVISION AND INTERNET; MOTION PICTURE FILM PRODUCTION (U.S. CLS. 100, 101 AND 107).

FIRST USE 12-1-1981; IN COMMERCE 12-1-1981.  
REBECCA EISINGER, EXAMINING ATTORNEY

**CLASS 41—(Continued).**

SN 85-082,011. BEATNOMICS PRODUCTION, TAMARAC, FL. FILED 7-10-2010.



THE COLOR(S) BLACK, BLUE, AND WHITE IS/ARE CLAIMED AS A FEATURE OF THE MARK.

THE MARK CONSISTS OF A BLUE CAPITALIZED "B" WITH WHITE OUTLINE, WITH SEVEN EVENLY DOTTED BLUE ARROWS ON BOTH SIDES OF THE CAPITAL "B", WHICH IS ABOVE THE BLUE WORD "BEATNOMICS", WITH A LIGHT BLUE FLAME IN THE BACKGROUND BEHIND THE CAPITAL "B", WITH A BLACK BACKGROUND.

FOR MUSIC PRODUCTION SERVICES; MUSIC PUBLISHING SERVICES (U.S. CLS. 100, 101 AND 107).

FIRST USE 1-15-2005; IN COMMERCE 1-15-2005.  
MARK SPARACINO, EXAMINING ATTORNEY

SN 85-084,994. SHIPLEY BUSINESS DEVELOPMENT SERVICES, INC., DBA SHIPLEY ASSOCIATES, KAYSVILLE, UT. FILED 7-15-2010.

# SHIPLEY ASSOCIATES

THE MARK CONSISTS OF STANDARD CHARACTERS WITHOUT CLAIM TO ANY PARTICULAR FONT, STYLE, SIZE, OR COLOR.

NO CLAIM IS MADE TO THE EXCLUSIVE RIGHT TO USE "ASSOCIATES", APART FROM THE MARK AS SHOWN.

SEC. 2(F).

FOR DEVELOPMENT AND DISSEMINATION OF EDUCATIONAL MATERIALS OF OTHERS IN THE FIELD OF BUSINESS DEVELOPMENT, SALES, COMMUNICATION SKILLS, PROPOSAL DEVELOPMENT, AND CAPTURE PLANNING; EDUCATION SERVICES, NAMELY, PROVIDING ON-LINE WEBINARS, COURSES, AND DISCUSSIONS IN THE FIELD OF PROPOSAL DEVELOPMENT, PROPOSAL WRITING, CAPTURE PLANNING, AND SELLING TO THE GOVERNMENT; EDUCATION SERVICES, NAMELY, CONDUCTING CLASSES, SEMINARS, CONFERENCES, AND WORKSHOPS IN THE FIELD OF PROPOSAL DEVELOPMENT, SALES, CAPTURE PLANNING, BUSINESS DEVELOPMENT, AND PRICE TO WIN IN THE FIELD OF BUSINESS DEVELOPMENT; EDUCATIONAL SERVICES, NAMELY, CONDUCTING ONLINE AND CLASSROOM CLASSES, WORKSHOPS, SEMINARS, AND WEB-BASED TRAINING COURSES IN THE FIELD OF PROPOSAL DEVELOPMENT, SALES, CAPTURE PLANNING, WRITING AND MANAGING PROPOSALS, BUSINESS DEVELOPMENT, PROCESS IMPROVEMENT AND DISTRIBUTION OF PRINTED MATERIALS IN CONNECTION THEREWITH IN HARD COPY OR ELECTRONIC FORMAT ON THE SAME TOPICS (U.S. CLS. 100, 101 AND 107).

FIRST USE 12-0-1976; IN COMMERCE 12-0-1976.  
ESTHER A. BORSUK, EXAMINING ATTORNEY

SN 85-080,980. CABLE NEWS NETWORK, INC., ATLANTA, GA. FILED 7-9-2010.

# EATOCRACY

THE MARK CONSISTS OF STANDARD CHARACTERS WITHOUT CLAIM TO ANY PARTICULAR FONT, STYLE, SIZE, OR COLOR.

FOR ENTERTAINMENT SERVICES, NAMELY, PROVIDING A WEBSITE THAT FEATURES ONLINE JOURNALS, NAMELY, BLOGS FEATURING COMMENTARY ON FOOD, COOKING, RECIPES, MEAL PLANNING, DINING AND RESTAURANTS (U.S. CLS. 100, 101 AND 107).

FIRST USE 6-17-2010; IN COMMERCE 6-17-2010.  
DOMINIC FATHY, EXAMINING ATTORNEY

**CLASS 41—(Continued).**

SN 85-091,449. FOSHEE, GOLSON, MONTGOMERY, AL. FILED 7-23-2010.



NO CLAIM IS MADE TO THE EXCLUSIVE RIGHT TO USE "MONTGOMERY CIVIL RIGHTS TRAIL", APART FROM THE MARK AS SHOWN.

THE MARK CONSISTS OF THE WORDING "THE MONTGOMERY" APPEARING IN ALL SMALL-SIZE CAPS, CENTERED AT THE TOP OF THE MARK. BELOW THE WORDING "THE MONTGOMERY" ARE THE WORDS "CIVIL RIGHTS" IN ALL LARGE-SIZE CAPS AND THE WORD "TRAIL" IN ALL LARGE-SIZE CAPS APPEARS BELOW THE LETTERING "IGHTS." TO THE LEFT OF THE WORD "TRAIL" IS A PICTURE OF A STYLIZED BRICK-LINED TRAIL.

FOR EDUCATIONAL AND ENTERTAINMENT SERVICES, NAMELY, PROVIDING EDUCATIONAL GUIDED TOURS AND SELF GUIDED TOURS OF A HISTORICALLY SIGNIFICANT GEOGRAPHIC AREA IN ORDER TO RAISE AWARENESS IN THE FIELD OF CIVIL RIGHTS EVENTS IN MONTGOMERY, ALABAMA AND THE DISTRIBUTION OF COURSE MATERIALS IN CONNECTION THEREWITH (U.S. CLS. 100, 101 AND 107).

PAULA MAHONEY, EXAMINING ATTORNEY

---

SN 85-104,046. TELEVISION FOOD NETWORK, G.P., NEW YORK, NY. FILED 8-10-2010.

**KELSEY'S ESSENTIALS**

THE MARK CONSISTS OF STANDARD CHARACTERS WITHOUT CLAIM TO ANY PARTICULAR FONT, STYLE, SIZE, OR COLOR.

THE NAME(S), PORTRAIT(S), AND/OR SIGNATURE(S) SHOWN IN THE MARK IDENTIFIES KELSEY NIXON, WHOSE CONSENT(S) TO REGISTER IS MADE OF RECORD.

FOR EDUCATIONAL AND ENTERTAINMENT SERVICES, NAMELY, A CONTINUING PROGRAM ABOUT FOOD AND COOKING, ACCESSIBLE BY RADIO, TELEVISION, CABLE, FIBER OPTIC NETWORKS, WIRELESS NETWORKS, SATELLITE, AUDIO VIDEO, AND COMPUTER NETWORKS (U.S. CLS. 100, 101 AND 107).

ALLISON HOLTZ, EXAMINING ATTORNEY

**CLASS 41—(Continued).**

SN 85-104,273. SCRIPPS NETWORKS, LLC, KNOXVILLE, TN. FILED 8-10-2010.

**DESTINATION RENOVATION**

THE MARK CONSISTS OF STANDARD CHARACTERS WITHOUT CLAIM TO ANY PARTICULAR FONT, STYLE, SIZE, OR COLOR.

NO CLAIM IS MADE TO THE EXCLUSIVE RIGHT TO USE "RENOVATION", APART FROM THE MARK AS SHOWN.

FOR EDUCATIONAL AND ENTERTAINMENT SERVICES, NAMELY, A CONTINUING PROGRAM ABOUT HOME DESIGN, INTERIOR DESIGN AND DECORATING, ACCESSIBLE BY RADIO, TELEVISION, CABLE, FIBER OPTIC NETWORKS, WIRELESS NETWORKS, SATELLITE, AUDIO VIDEO, AND COMPUTER NETWORKS (U.S. CLS. 100, 101 AND 107).

TRACY WHITTAKER-BROWN, EXAMINING ATTORNEY

---

SN 85-106,400. SCRIPPS NETWORKS, LLC, KNOXVILLE, TN. FILED 8-12-2010.

**AMERICA'S WORST DIY'ER**

THE MARK CONSISTS OF STANDARD CHARACTERS WITHOUT CLAIM TO ANY PARTICULAR FONT, STYLE, SIZE, OR COLOR.

FOR EDUCATIONAL AND ENTERTAINMENT SERVICES, NAMELY, A CONTINUING PROGRAM ABOUT INDIVIDUAL'S FAILED HOME IMPROVEMENT AND HOME REPAIR PROJECTS ACCESSIBLE BY RADIO, TELEVISION, CABLE, FIBER OPTIC NETWORKS, WIRELESS NETWORKS, SATELLITE, AUDIO VIDEO, AND COMPUTER NETWORKS (U.S. CLS. 100, 101 AND 107).

MARK SHINER, EXAMINING ATTORNEY

---

SN 85-111,702. GODDARD, MELINDA K. M., THE VALLEY, ANGUILLA, FILED 8-19-2010.

**ANGUILLA PRIDE**

THE MARK CONSISTS OF STANDARD CHARACTERS WITHOUT CLAIM TO ANY PARTICULAR FONT, STYLE, SIZE, OR COLOR.

PRIORITY CLAIMED UNDER SEC. 44(D) ON ANGUILLA APPLICATION NO. 4920, FILED 7-29-2010.

NO CLAIM IS MADE TO THE EXCLUSIVE RIGHT TO USE "ANGUILLA", APART FROM THE MARK AS SHOWN, FOR BUSINESS TRAINING (U.S. CLS. 100, 101 AND 107).

FIRST USE 7-18-2009; IN COMMERCE 8-13-2010.

KARANENDRA S. CHHINA, EXAMINING ATTORNEY



**CLASS 41—(Continued).**

SN 85-130,247. SIDE STREET KIDS, INC., BRONX, NY.  
FILED 9-15-2010.

## SIDE STREET KIDS

THE MARK CONSISTS OF STANDARD CHARACTERS WITHOUT CLAIM TO ANY PARTICULAR FONT, STYLE, SIZE, OR COLOR.

NO CLAIM IS MADE TO THE EXCLUSIVE RIGHT TO USE "KIDS", APART FROM THE MARK AS SHOWN.

FOR EDUCATIONAL AND CHARITABLE SERVICES, NAMELY, PROVIDING GROUP COACHING AND LEADERSHIP DEVELOPMENT FOR YOUTH WITHIN THE FIELD OF DANCE (U.S. CLS. 100, 101 AND 107).

FIRST USE 10-0-1997; IN COMMERCE 10-0-1997.

MARLENE BELL, EXAMINING ATTORNEY

**CLASS 41—(Continued).**

SN 85-146,527. TREE HOME MEDIA, VALLEY VILLAGE, CA. FILED 10-6-2010.

## TreeLiving

THE MARK CONSISTS OF STANDARD CHARACTERS WITHOUT CLAIM TO ANY PARTICULAR FONT, STYLE, SIZE, OR COLOR.

FOR EDUCATIONAL SERVICES, NAMELY, SEMINARS AND WORKSHOPS PROVIDING INFORMATION WHICH PROMOTES GREEN LIVING, GREEN TECHNOLOGY, CONSERVATION, THE ENVIRONMENT, HEALTH AND WELLBEING, AND HOME AND GARDEN IMPROVEMENT (U.S. CLS. 100, 101 AND 107).

FIRST USE 7-1-2010; IN COMMERCE 7-1-2010.

GRETTA YAO, EXAMINING ATTORNEY

SN 85-144,871. PERSONAL HEALTH PRODUCT DEVELOPMENT, GREENVILLE, DE. FILED 10-5-2010.



NO CLAIM IS MADE TO THE EXCLUSIVE RIGHT TO USE "PH", APART FROM THE MARK AS SHOWN.

THE COLOR(S) PURPLE, GREEN AND BLUE IS/ARE CLAIMED AS A FEATURE OF THE MARK.

THE MARK CONSISTS OF LETTER "P" AND "H" IN PURPLE COLOR ENCIRCLED BY LETTER "C" WHEREIN THE INNER PART OF LETTER "C" IS IN GREEN COLOR AND OUTER PART IS IN BLUE COLOR AS SHOWN IN THE MARK.

FOR EDUCATION SERVICES, NAMELY, PROVIDING CLASSES AND SEMINARS IN THE FIELD OF HEALTH (U.S. CLS. 100, 101 AND 107).

ERIN FALK, EXAMINING ATTORNEY

SN 85-151,783. WISE BUY NOW, LLC, FRAZEYSBURG, OH. FILED 10-13-2010.

## Cheat Masters

THE MARK CONSISTS OF STANDARD CHARACTERS WITHOUT CLAIM TO ANY PARTICULAR FONT, STYLE, SIZE, OR COLOR.

NO CLAIM IS MADE TO THE EXCLUSIVE RIGHT TO USE "CHEAT", APART FROM THE MARK AS SHOWN.

SEC. 2(F).

FOR PROVIDING A WEBSITE IN THE FIELD OF PLAYING COMPUTER GAMES THAT FEATURES COMPUTER AND VIDEO GAME CHEATS, GAME HINTS, AND CHEAT CODES; PROVIDING A WEBSITE FEATURING COMPUTER AND VIDEO GAME INFORMATION AND NEWS, GAME PLAY STRATEGIES AND FREQUENTLY ASKED QUESTIONS ABOUT GAME HINTS, CHEATS, CHEAT CODES, AND COMPUTER AND VIDEO GAMES; ON-LINE JOURNALS, NAMELY, BLOGS FEATURING INFORMATION RELATED TO CHEATS, CHEAT CODES, GAME HINTS, AND COMPUTER AND VIDEO GAMES; ENTERTAINMENT SERVICES, NAMELY, CONDUCTING CONTESTS (U.S. CLS. 100, 101 AND 107).

FIRST USE 9-4-2001; IN COMMERCE 9-4-2001.

ALICE BENMAMAN, EXAMINING ATTORNEY

**CLASS 41—(Continued).**

SN 85-151,887. SOLPUGID PRODUCTIONS, PORTLAND, OR. FILED 10-13-2010.



NO CLAIM IS MADE TO THE EXCLUSIVE RIGHT TO USE "BUG", APART FROM THE MARK AS SHOWN.

THE MARK CONSISTS OF THE STYLIZED WORDING "THE BUG CHICKS" WITH A DEPICTION OF DRAGONFLY BELOW THE WORDS "BUG CHICKS" AND A STYLIZED DRAWING OF THE HEAD AND SHOULDERS OF TWO WOMEN FACING FORWARD.

FOR PROVIDING A WEB SITE FEATURING PHOTOGRAPHIC, AUDIO, VIDEO AND PROSE PRESENTATIONS FEATURING EDUCATIONAL INFORMATION IN THE ACADEMIC FIELD OF ENTOMOLOGY FOR THE PURPOSE OF ACADEMIC STUDY; PROVIDING A WEB SITE FEATURING NON-DOWNLOADABLE INSTRUCTIONAL VIDEOS IN THE ACADEMIC FIELD OF ENTOMOLOGY FOR THE PURPOSE OF ACADEMIC STUDY AND ENTERTAINMENT; ENTERTAINMENT SERVICES, NAMELY, PROVIDING A WEB SITE FEATURING AUDIO, VIDEO AND PROSE PRESENTATIONS IN THE NATURE OF AN ON-GOING VIDEO PROGRAMS IN THE FIELD OF ENTOMOLOGY; PROVIDING A WEBSITE FEATURING AUDIO, VIDEO AND PROSE PRESENTATIONS IN THE NATURE OF NON-DOWNLOADABLE ONGOING TELEVISION PROGRAMS IN THE FIELD OF ENTOMOLOGY (U.S. CLS. 100, 101 AND 107).

FIRST USE 12-15-2010; IN COMMERCE 1-20-2011.  
CYNTHIA TRIPI, EXAMINING ATTORNEY

SN 85-153,813. THE COACHES TRAINING INSTITUTE, SAN RAFAEL, CA. FILED 10-15-2010.

**CO-ACTIVE COACHING**

THE MARK CONSISTS OF STANDARD CHARACTERS WITHOUT CLAIM TO ANY PARTICULAR FONT, STYLE, SIZE, OR COLOR.

NO CLAIM IS MADE TO THE EXCLUSIVE RIGHT TO USE "COACHING", APART FROM THE MARK AS SHOWN.

FOR PROVIDING PROFESSIONAL COACHING SERVICES AND TRAINING COURSES IN THE FIELD OF PROFESSIONAL COACHING (U.S. CLS. 100, 101 AND 107).

FIRST USE 5-0-2007; IN COMMERCE 5-0-2007.  
JANICE KIM, EXAMINING ATTORNEY

**CLASS 41—(Continued).**

SN 85-154,637. POST UNIVERSITY, INC., WATERBURY, CT. FILED 10-18-2010.

**POST UNIVERSITY PARTNERS  
IN EDUCATION**

THE MARK CONSISTS OF STANDARD CHARACTERS WITHOUT CLAIM TO ANY PARTICULAR FONT, STYLE, SIZE, OR COLOR.

OWNER OF U.S. REG. NOS. 3,183,102, 3,214,920 AND 3,232,314.

NO CLAIM IS MADE TO THE EXCLUSIVE RIGHT TO USE "EDUCATION", APART FROM THE MARK AS SHOWN.

FOR EDUCATIONAL SERVICES, NAMELY, PROVIDING INSTRUCTION AND TRAINING AT THE GRADUATE, POST-GRADUATE AND PROFESSIONAL LEVELS, AND DISTRIBUTION OF COURSE MATERIALS IN CONNECTION THEREWITH (U.S. CLS. 100, 101 AND 107).

FIRST USE 1-13-2006; IN COMMERCE 1-13-2006.  
MICHAEL WIENER, EXAMINING ATTORNEY

SN 85-154,875. AMSTER-YOUNG, KAREN, NEW YORK, NY. AND GODWIN, PAMELA, NEW YORK, NY. FILED 10-18-2010.

**THE 52 WEEKS**

THE MARK CONSISTS OF STANDARD CHARACTERS WITHOUT CLAIM TO ANY PARTICULAR FONT, STYLE, SIZE, OR COLOR.

FOR (BASED ON USE IN COMMERCE): PROVIDING A WEBSITE(S) FEATURING ONLINE PUBLICATIONS IN THE NATURE OF BLOGS AND ARTICLES ADDED ON A WEEKLY OR OTHER FREQUENT PERIODIC BASIS, IN THE FIELDS OF DO-IT-YOURSELF, FACING CHALLENGES, FACING FEARS, OVERCOMING ADDICTIONS, CULTURE, WELL-BEING, RELATIONSHIPS, MOTIVATION, VOLUNTEERING, INSPIRATION, LOVE, FAMILY AND PARENTING (BASED ON INTENT TO USE) EDUCATIONAL AND ENTERTAINMENT SERVICES, NAMELY, PROVIDING SPEAKING SERVICES, AND PUBLICATION AND ONLINE PUBLICATION OF BOOKS AND OTHER PRINTED MATERIALS, IN THE FIELDS OF DO-IT-YOURSELF, FACING CHALLENGES, FACING FEARS, OVERCOMING ADDICTIONS, CULTURE, WELL-BEING, RELATIONSHIPS, MOTIVATION, VOLUNTEERING, INSPIRATION, LOVE, FAMILY AND PARENTING (U.S. CLS. 100, 101 AND 107).

FIRST USE 4-0-2010; IN COMMERCE 6-28-2010.  
GRETTA YAO, EXAMINING ATTORNEY

**CLASS 41—(Continued).**

SN 85-157,769. COMPANY PICTURES, LONDON, UNITED KINGDOM, FILED 10-21-2010.

# SKINS

THE MARK CONSISTS OF STANDARD CHARACTERS WITHOUT CLAIM TO ANY PARTICULAR FONT, STYLE, SIZE, OR COLOR.

FOR PROVIDING ONLINE INFORMATION IN THE FIELD OF ENTERTAINMENT CONCERNING TELEVISION PROGRAMS (U.S. CLS. 100, 101 AND 107).  
LIEF MARTIN, EXAMINING ATTORNEY

**CLASS 41—(Continued).**

SN 85-160,898. TRIFIND, LLC, CAPE CORAL, FL. FILED 10-26-2010.

# SUPERTRI

THE MARK CONSISTS OF STANDARD CHARACTERS WITHOUT CLAIM TO ANY PARTICULAR FONT, STYLE, SIZE, OR COLOR.

FOR ORGANIZING, ARRANGING, AND CONDUCTING TRIATHLON EVENTS (U.S. CLS. 100, 101 AND 107).  
AMY C. KEAN, EXAMINING ATTORNEY

SN 85-159,367. VARIANT EVENTS LLC, RICHMOND, VA. FILED 10-22-2010.

## RICHMOND INTERNATIONAL WINE EXCURSION

THE MARK CONSISTS OF STANDARD CHARACTERS WITHOUT CLAIM TO ANY PARTICULAR FONT, STYLE, SIZE, OR COLOR.

NO CLAIM IS MADE TO THE EXCLUSIVE RIGHT TO USE "RICHMOND INTERNATIONAL WINE", APART FROM THE MARK AS SHOWN.

FOR ENTERTAINMENT AND EDUCATIONAL SERVICES, NAMELY, CONDUCTING WINE TASTINGS, LUNCHESES, DINNERS, SYMPOSIUMS, SEMINARS, CLASSES, CONFERENCES AND WORKSHOPS IN THE FIELD OF ENOLOGY AND VINICULTURE (U.S. CLS. 100, 101 AND 107).  
LAKEISHA LEWIS, EXAMINING ATTORNEY

SN 85-162,476. CASE CONSULTING SERVICES, INC., RESTON, VA. FILED 10-27-2010.

## THE SIX "I'S" OF FUNDRAISING

SN 85-159,379. VARIANT EVENTS LLC, RICHMOND, VA. FILED 10-22-2010.

## WINE EXCURSION

THE MARK CONSISTS OF STANDARD CHARACTERS WITHOUT CLAIM TO ANY PARTICULAR FONT, STYLE, SIZE, OR COLOR.

NO CLAIM IS MADE TO THE EXCLUSIVE RIGHT TO USE "WINE", APART FROM THE MARK AS SHOWN.

FOR ENTERTAINMENT AND EDUCATIONAL SERVICES, NAMELY, CONDUCTING WINE TASTING, LUNCHESES, DINNERS, SYMPOSIUMS, SEMINARS, CLASSES, CONFERENCES AND WORKSHOPS IN THE FIELD OF THE ENOLOGY AND VINICULTURE (U.S. CLS. 100, 101 AND 107).  
LAKEISHA LEWIS, EXAMINING ATTORNEY

THE MARK CONSISTS OF STANDARD CHARACTERS WITHOUT CLAIM TO ANY PARTICULAR FONT, STYLE, SIZE, OR COLOR.

NO CLAIM IS MADE TO THE EXCLUSIVE RIGHT TO USE "FUNDRAISING", APART FROM THE MARK AS SHOWN.

FOR PROFESSIONAL COACHING AND TRAINING SERVICES IN THE FIELD OF FUNDRAISING (U.S. CLS. 100, 101 AND 107).  
DORITT L. CARROLL, EXAMINING ATTORNEY

**CLASS 41—(Continued).**

SN 85-165,398. ESSANDOH, JUSTIN, CROWNSVILLE, MD. FILED 10-29-2010.

# D.King

THE MARK CONSISTS OF STANDARD CHARACTERS WITHOUT CLAIM TO ANY PARTICULAR FONT, STYLE, SIZE, OR COLOR.

THE NAME(S), PORTRAIT(S), AND/OR SIGNATURE(S) SHOWN IN THE MARK IDENTIFIES "D. KING", WHOSE CONSENT(S) TO REGISTER IS MADE OF RECORD.

FOR CONDUCTING ENTERTAINMENT EXHIBITIONS IN THE NATURE OF CONCERTS, PRODUCTION OF TV PROGRAMS AND MOVIES; ENTERTAINMENT IN THE NATURE OF AN ON-GOING SPECIAL VARIETY, NEWS, MUSIC OR COMEDY SHOWS FEATURING RECORDING ARTIST BROADCAST OVER TELEVISION, SATELLITE, AUDIO, AND VIDEO MEDIA; ENTERTAINMENT IN THE NATURE OF LIVE PERFORMANCES BY A RECORDING ARTIST; ENTERTAINMENT IN THE NATURE OF LIVE RADIO PERSONALITY PERFORMANCES; ENTERTAINMENT IN THE NATURE OF LIVE STAGE PERFORMANCES IN THE NATURE OF MUSICAL CONCERTS AND LECTURES IN THE FIELD OF THE MUSIC BUSINESS BY AN INDIVIDUAL; ENTERTAINMENT IN THE NATURE OF VISUAL AND AUDIO PERFORMANCES, AND MUSICAL, VARIETY, NEWS AND COMEDY SHOWS; ENTERTAINMENT IN THE NATURE OF VISUAL AND AUDIO PERFORMANCES, NAMELY, MUSICAL BAND, ROCK GROUP, GYMNASTIC, DANCE, AND BALLET PERFORMANCES (U.S. CLS. 100, 101 AND 107).

DAVID C. REIHNER, EXAMINING ATTORNEY

SN 85-166,648. OFF-LEASH K9 TRAINING, WOODBRIDGE, VA. FILED 11-1-2010.



NO CLAIM IS MADE TO THE EXCLUSIVE RIGHT TO USE "OFF LEASH K9 TRAINING, LLC", APART FROM THE MARK AS SHOWN.

THE MARK CONSISTS OF THE DESIGN OF A COLLAR AND A LEASH WRAPPED AROUND THE WORDING "OFF LEASH". BELOW IS THE UNDERLINED WORDING "K9 TRAINING, LLC" WITH A DOG STANDING TO THE LEFT OF "K9 TRAINING, LLC". FURTHER BELOW IS THE WORDING "'LET THE BOND WITH YOUR K9 BE UNLEASHED'".

FOR DOG TRAINING (U.S. CLS. 100, 101 AND 107).  
FIRST USE 3-10-2010; IN COMMERCE 3-10-2010.  
BERNICE MIDDLETON, EXAMINING ATTORNEY

**CLASS 41—(Continued).**

SN 85-167,367. ST. CLOUD STATE UNIVERSITY, ST. CLOUD, MN. FILED 11-2-2010.

# UCHOOSE

THE MARK CONSISTS OF STANDARD CHARACTERS WITHOUT CLAIM TO ANY PARTICULAR FONT, STYLE, SIZE, OR COLOR.

FOR EDUCATIONAL SERVICES, NAMELY, PROVIDING WORKSHOPS, CLASSES AND TRAININGS IN THE FIELD OF RESPONSIBLE ALCOHOL CONSUMPTION, AND PROVIDING PRINTED COURSE MATERIALS IN CONNECTION THEREWITH (U.S. CLS. 100, 101 AND 107).

FIRST USE 9-0-2007; IN COMMERCE 9-0-2007.  
JESSICA A. POWERS, EXAMINING ATTORNEY

SN 85-167,600. MOBILE PARTY CONCEPTS, LLC, SCOTTSDALE, AZ. FILED 11-2-2010.



NO CLAIM IS MADE TO THE EXCLUSIVE RIGHT TO USE "GAMES ON WHEELS", APART FROM THE MARK AS SHOWN.

THE MARK CONSISTS OF A RING WITH THE STYLIZED TEXT "GAMEZ ON WHEELZ".

FOR MOBILE VIDEO ARCADE SERVICES (U.S. CLS. 100, 101 AND 107).

FIRST USE 2-1-2009; IN COMMERCE 5-1-2009.  
ALICE BENMAMAN, EXAMINING ATTORNEY

SN 85-167,893. SGT VENTURE GROUP, LLC, TALLAHASSEE, FL. FILED 11-3-2010.

# BODYTRAC

THE MARK CONSISTS OF STANDARD CHARACTERS WITHOUT CLAIM TO ANY PARTICULAR FONT, STYLE, SIZE, OR COLOR.

FOR PERSONAL FITNESS TRAINING SERVICES AND CONSULTANCY; PHYSICAL FITNESS CONDITIONING CLASSES; PHYSICAL FITNESS CONSULTATION; PHYSICAL FITNESS INSTRUCTION (U.S. CLS. 100, 101 AND 107).

FIRST USE 6-6-2005; IN COMMERCE 6-6-2005.  
RONALD MCMORROW, EXAMINING ATTORNEY

**CLASS 41—(Continued).**

SN 85-169,483. COURTROOM TELEVISION NETWORK LLC,  
NEW YORK, NY. FILED 11-4-2010.

TRUTV PRESENTS: WORLD'S  
DUMBEST...

THE MARK CONSISTS OF STANDARD CHARACTERS WITHOUT CLAIM TO ANY PARTICULAR FONT, STYLE, SIZE, OR COLOR.

OWNER OF U.S. REG. NOS. 3,493,740, 3,669,937 AND OTHERS.

FOR ENTERTAINMENT SERVICES, NAMELY, CONTINUING SCRIPTED AND UNSCRIPTED TELEVISION PROGRAM SERIES IN THE FIELD OF COMEDY, DRAMA, ACTION, ADVENTURE AND/OR REALITY PROVIDED THROUGH CABLE TELEVISION, BROADCAST TELEVISION, INTERNET, VIDEO-ON-DEMAND, AND THROUGH OTHER DISTRIBUTION PLATFORMS; PROVIDING INFORMATION, NAMELY, ENTERTAINMENT INFORMATION OVER THE INTERNET (U.S. CLS. 100, 101 AND 107).

TAMARA FRAZIER, EXAMINING ATTORNEY

SN 85-171,108. ORRICO DE LA ROSA, DOLORES ALEJANDRA, MEXICO CITY, MEXICO, FILED 11-8-2010.



NO CLAIM IS MADE TO THE EXCLUSIVE RIGHT TO USE "EN ESPAÑOL", APART FROM THE MARK AS SHOWN.

THE COLOR(S) SILVER, WHITE, GRAY, BLACK, BLUE, GREEN, ORANGE AND PINK IS/ARE CLAIMED AS A FEATURE OF THE MARK.

THE MARK CONSISTS OF THE LITERAL ELEMENTS "THE BEST OF SL EN ESPANOL" ARRANGED IN VERTICAL CONFIGURATION WRITTEN IN WHITE AND GRAY COLOR ON A BLACK RECTANGULAR BACKGROUND WITH A SILVER BORDER. THERE ARE FOUR SQUARES IN BLUE, GREEN, ORANGE AND PINK HAVING THE LETTERS "S", "L", "B" AND "O" IN BLACK INSIDE THEM AS SHOWN IN THE MARK.

THE ENGLISH TRANSLATION OF "EN ESPAÑOL" IN THE MARK IS "IN SPANISH".

FOR NON-DOWNLOADABLE ONLINE MAGAZINES AND ONLINE VIRTUAL WORLD MAGAZINE IN THE FIELD OF GENERAL INTEREST AND ADVERTISING (U.S. CLS. 100, 101 AND 107).

CARYN GLASSER, EXAMINING ATTORNEY

**CLASS 41—(Continued).**

SN 85-171,159. SHULTZ, ASHLEY, LH, DBA MISS PINK,  
BEVERLY, MA. FILED 11-8-2010.

## Miss Pink Pageant

THE MARK CONSISTS OF STANDARD CHARACTERS WITHOUT CLAIM TO ANY PARTICULAR FONT, STYLE, SIZE, OR COLOR.

NO CLAIM IS MADE TO THE EXCLUSIVE RIGHT TO USE "PAGEANT", APART FROM THE MARK AS SHOWN. FOR ENTERTAINMENT IN THE NATURE OF BEAUTY PAGEANTS (U.S. CLS. 100, 101 AND 107).

FIRST USE 4-16-2010; IN COMMERCE 4-16-2010.  
KAREN BRACEY, EXAMINING ATTORNEY

SN 85-171,597. VOLLMECKE, ERIC W, DBA TOSA GROUP,  
GREAT FALLS, VA. FILED 11-8-2010.

## FarmFit

THE MARK CONSISTS OF STANDARD CHARACTERS WITHOUT CLAIM TO ANY PARTICULAR FONT, STYLE, SIZE, OR COLOR.

FOR PROVIDING ASSISTANCE, PERSONAL TRAINING AND PHYSICAL FITNESS CONSULTATION TO CORPORATE CLIENTS TO HELP THEIR EMPLOYEES MAKE PHYSICAL FITNESS, STRENGTH, CONDITIONING, AND EXERCISE ALTERATIONS IN THEIR DAILY LIVING (U.S. CLS. 100, 101 AND 107).

ANNE FARRELL, EXAMINING ATTORNEY

SN 85-174,012. MODORCEA MIHAELA, NEW YORK, NY,  
FILED 11-10-2010.

## WICKED CLONE

THE MARK CONSISTS OF STANDARD CHARACTERS WITHOUT CLAIM TO ANY PARTICULAR FONT, STYLE, SIZE, OR COLOR.

FOR ENTERTAINMENT IN THE NATURE OF VISUAL AND AUDIO PERFORMANCES BY MUSICAL BANDS, ACTORS, WRITERS, AND DANCERS; ENTERTAINMENT IN THE NATURE OF FASHION SHOWS; MUSIC PRODUCTION SERVICES (U.S. CLS. 100, 101 AND 107).

BARBARA A. GOLD, EXAMINING ATTORNEY

**CLASS 41—(Continued).**

SN 85-176,058. DOTFIT, LLC, LAFAYETTE, CA. FILED 11-12-2010.

## Fitness Intelligence Technology

THE MARK CONSISTS OF STANDARD CHARACTERS WITHOUT CLAIM TO ANY PARTICULAR FONT, STYLE, SIZE, OR COLOR.

NO CLAIM IS MADE TO THE EXCLUSIVE RIGHT TO USE "FITNESS" AND "TECHNOLOGY", APART FROM THE MARK AS SHOWN.

FOR PROVIDING A WEBSITE FEATURING INFORMATION ON EXERCISE AND FITNESS AND LINKS RELATING TO FITNESS, ALL TO HELP PEOPLE ACHIEVE THEIR FITNESS GOALS (U.S. CLS. 100, 101 AND 107).

FIRST USE 8-1-2009; IN COMMERCE 8-1-2009.  
JOHN GARTNER, EXAMINING ATTORNEY

**CLASS 41—(Continued).**

SN 85-177,083. MATRIX ENERGETICS INTERNATIONAL INC., LYNNWOOD, WA. FILED 11-15-2010.

## RICHARD BARTLETT'S ME

THE MARK CONSISTS OF STANDARD CHARACTERS WITHOUT CLAIM TO ANY PARTICULAR FONT, STYLE, SIZE, OR COLOR.

THE NAME(S), PORTRAIT(S), AND/OR SIGNATURE(S) SHOWN IN THE MARK IDENTIFIES "RICHARD BARTLETT", WHOSE CONSENT(S) TO REGISTER IS MADE OF RECORD.

FOR EDUCATIONAL SERVICES, NAMELY, CONDUCTING CLASSES, SEMINARS, CONFERENCES AND WORKSHOPS IN THE FIELDS OF HEALTH CARE, PHYSICAL, MENTAL AND EMOTIONAL WELLNESS, MEDITATION, SPIRITUALITY, SELF-AWARENESS, INTUITION AND CONSCIOUSNESS DEVELOPMENT, AND AUDIO, VIDEO AND PRINTED EDUCATIONAL COURSE MATERIALS PROVIDED IN CONNECTION THEREWITH; CONDUCTING SEMINARS IN THE FIELD OF VIRTUAL TRANSFORMATION, HEALING AND PERSONAL WELL-BEING (U.S. CLS. 100, 101 AND 107).

REBECCA EISINGER, EXAMINING ATTORNEY

SN 85-176,268. DUFF, KERRY C, SAN ANSELMO, CA. FILED 11-14-2010.

## CEOoftheHouse Chief Entertainer and Organizer of the House

THE MARK CONSISTS OF STANDARD CHARACTERS WITHOUT CLAIM TO ANY PARTICULAR FONT, STYLE, SIZE, OR COLOR.

FOR PROVIDING A WEBSITE FEATURING INFORMATION IN THE FIELDS OF EDUCATION AND ENTERTAINMENT FOR CHILDREN (U.S. CLS. 100, 101 AND 107).

MICHAEL WEBSTER, EXAMINING ATTORNEY

SN 85-178,200. ENTWELL CO., LTD., GEUMCHEON-GU, SEOUL, REPUBLIC OF KOREA, FILED 11-16-2010.

## COREONLINE

THE MARK CONSISTS OF STANDARD CHARACTERS WITHOUT CLAIM TO ANY PARTICULAR FONT, STYLE, SIZE, OR COLOR.

FOR MULTI-PLAYER GAME SERVICES, NAMELY, PROVIDING AN ON-LINE COMPUTER GAME ELECTRONICALLY VIA A GLOBAL COMPUTER NETWORK AND WIRELESS COMMUNICATION DEVICES (U.S. CLS. 100, 101 AND 107).

DOMINICK J. SALEMI, EXAMINING ATTORNEY

**CLASS 41—(Continued).**

SN 85-178,742. D&N IPROPERTIES LLC, WINTER PARK, FL. FILED 11-17-2010.



NO CLAIM IS MADE TO THE EXCLUSIVE RIGHT TO USE "NATIONAL ACADEMY OF BEST-SELLING AUTHORS", APART FROM THE MARK AS SHOWN.

THE MARK CONSISTS OF A FEATHER SURROUNDED BY A LINE IN THE SHAPE OF A CIRCLE, WITH THE WORDS "NATIONAL ACADEMY OF BEST-SELLING AUTHORS" APPEARING AT THE BOTTOM RIGHT PORTION OF THE FEATHER.

FOR EDUCATIONAL SERVICES, NAMELY, PROVIDING INCENTIVES TO PEOPLE TO DEMONSTRATE EXCELLENCE IN THE FIELD OF WRITING AND BOOK PUBLISHING THROUGH A SELECTIVE MEMBERSHIP DIRECTORY AND ISSUANCE OF AWARDS; EDUCATIONAL SERVICES, NAMELY, PROMOTING INTEREST, PROGRESS, AND DISTINGUISHED ACHIEVEMENT IN WRITING AND BOOK PUBLISHING THROUGH THE ISSUANCE OF AWARDS; PROVIDING AN AWARDS PROGRAM AT AN ANNUAL EVENT FOR THE PRESENTATION OF AWARDS IN RECOGNITION OF DISTINGUISHED ACHIEVEMENT IN THE FIELDS OF WRITING AND BOOK PUBLISHING; PROVIDING A WEBSITE FEATURING NEWS, INFORMATION, MULTIMEDIA CONTENT, AND A MEMBERSHIP DIRECTORY IN THE FIELDS OF WRITING AND BOOK PUBLISHING (U.S. CLS. 100, 101 AND 107).

FIRST USE 5-1-2009; IN COMMERCE 7-1-2009.  
EDWARD FENNESSY, EXAMINING ATTORNEY

SN 85-179,161. AOL INC., DULLES, VA. FILED 11-17-2010.

# AUTOBLOG

THE MARK CONSISTS OF STANDARD CHARACTERS WITHOUT CLAIM TO ANY PARTICULAR FONT, STYLE, SIZE, OR COLOR.

OWNER OF U.S. REG. NOS. 3,892,424 AND 3,892,425. SEC. 2(F).

FOR INTERACTIVE ONLINE WEB JOURNALS FEATURING MOTOR VEHICLES, MOTOR VEHICLE RACING, AND THE MOTOR VEHICLE INDUSTRY; PROVIDING A WEBSITE FEATURING ENTERTAINMENT INFORMATION OF INTEREST TO MOTOR VEHICLE ENTHUSIASTS; PROVIDING A WEBSITE FEATURING EDUCATIONAL INFORMATION OF INTEREST TO MOTOR VEHICLE ENTHUSIASTS, NAMELY, MOTOR VEHICLE RACING AND EXHIBITIONS; PROVIDING ONLINE INFORMATION IN THE FIELD OF MOTOR VEHICLE RACING AND EXHIBITIONS (U.S. CLS. 100, 101 AND 107).

FIRST USE 5-0-2004; IN COMMERCE 5-0-2004.  
ALLISON SCHRODY, EXAMINING ATTORNEY

**CLASS 41—(Continued).**

SN 85-179,289. HENRY PARRA, MIAMI, FL. FILED 11-17-2010.

# La Mejor Edad

THE MARK CONSISTS OF STANDARD CHARACTERS WITHOUT CLAIM TO ANY PARTICULAR FONT, STYLE, SIZE, OR COLOR.

THE ENGLISH TRANSLATION OF "LA MEJOR EDAD" IN THE MARK IS "THE BEST AGE".

FOR ENTERTAINMENT SERVICES, NAMELY, THE PROVISION OF CONTINUING SHOW FEATURING ELDERLY LIFESTYLES, HEALTH EDUCATION AND SOCIAL EVENTS DELIVERED BY TELEVISION, SATELLITE AND THE INTERNET (U.S. CLS. 100, 101 AND 107).

FIRST USE 11-1-2010; IN COMMERCE 11-1-2010.  
TRACY CROSS, EXAMINING ATTORNEY

SN 85-180,375. CDC PUBLISHING. LLC, VERO BEACH, FL. FILED 11-18-2010.



NO CLAIM IS MADE TO THE EXCLUSIVE RIGHT TO USE "RAIL PROJECT GUIDE", APART FROM THE MARK AS SHOWN.

THE COLOR(S) RED, WHITE AND GREY IS/ARE CLAIMED AS A FEATURE OF THE MARK.

THE MARK CONSISTS OF A SQUARE OUTLINED IN THE COLOR RED WITH A CHECKERED PATTERN INSIDE IN WHITE AND SHADES OF GREY AND THE LETTERS "RPG" IN THE COLOR RED, ALL WITH THE TERM "RAILPROJECTGUIDE" BENEATH IT, THE LETTERS "RAIL" IN THE COLOR RED, THE LETTERS "PROJECT" IN THE COLOR GREY, AND THE LETTERS "GUIDE" IN A LIGHTER SHADE OF GREY.

FOR BUSINESS INFORMATION SERVICES, NAMELY, PROVIDING A SUBSCRIPTION-BASED ONLINE NON-DOWNLOADABLE DAILY REPORT OF RAILROAD CONSTRUCTION PROJECTS AND RAILROAD PROJECT BID ADVERTISEMENTS (U.S. CLS. 100, 101 AND 107).

FIRST USE 9-15-2010; IN COMMERCE 9-15-2010.  
LAURIE MAYES, EXAMINING ATTORNEY

**CLASS 41—(Continued).**

SN 85-180,517. WORLD RELIEF CORPORATION OF NATIONAL ASSOCIATION OF EVANGELICALS, BALTIMORE, MD. FILED 11-18-2010.



OWNER OF U.S. REG. NOS. 2,251,349 AND 2,270,515.  
THE MARK CONSISTS OF FOUR STYLIZED HAND SYMBOLS THAT CREATE A PINWHEEL DESIGN.

FOR CHARITABLE SERVICES, NAMELY, PROVIDING TRAINING FOR NEEDY PEOPLE IN THE FIELD OF HIV/AIDS AND HEALTH PRACTICES; CHARITABLE SERVICES, NAMELY, PROVIDING NEEDY PEOPLE WITH EMPLOYMENT TRAINING IN THE FIELD OF BASIC SKILLS NEEDED TO FIND ENTRY-LEVEL JOBS AND MANUAL LABOR JOBS; CHARITABLE SERVICES, NAMELY, PROVIDING NEEDY PEOPLE WITH TRAINING IN THE FIELD OF AGRICULTURE AND SUSTAINABLE ECONOMIC DEVELOPMENT; PROVIDING TRAINING FOR REFUGEES REGARDING THE UNITED STATES IMMIGRATION PROCESS (U.S. CLS. 100, 101 AND 107).

FIRST USE 9-18-2010; IN COMMERCE 9-18-2010.  
KATHERINE E. HALMEN, EXAMINING ATTORNEY

SN 85-181,096. WORLD RELIEF CORPORATION OF NATIONAL ASSOCIATION OF EVANGELICALS, BALTIMORE, MD. FILED 11-19-2010.

**STAND/FOR THE VULNERABLE**

THE MARK CONSISTS OF THE WORDS "STAND/FOR THE VULNERABLE" IN A STYLIZED FORMAT WITH AN UPSIDE DOWN "V" FOR THE "A" IN "STAND".

FOR CHARITABLE SERVICES, NAMELY, PROVIDING TRAINING FOR NEEDY PEOPLE IN THE FIELD OF HIV/AIDS AND HEALTH PRACTICES; CHARITABLE SERVICES, NAMELY, PROVIDING NEEDY PEOPLE WITH EMPLOYMENT TRAINING IN THE FIELD OF BASIC SKILLS NEEDED TO FIND ENTRY-LEVEL JOBS AND MANUAL LABOR JOBS; CHARITABLE SERVICES, NAMELY, PROVIDING NEEDY PEOPLE WITH TRAINING IN THE FIELD OF AGRICULTURE AND SUSTAINABLE ECONOMIC DEVELOPMENT; PROVIDING TRAINING FOR REFUGEES REGARDING THE UNITED STATES IMMIGRATION PROCESS (U.S. CLS. 100, 101 AND 107).

FIRST USE 9-18-2010; IN COMMERCE 9-18-2010.  
KATHERINE E. HALMEN, EXAMINING ATTORNEY

**CLASS 41—(Continued).**

SN 85-181,229. HARRIS PUBLICATIONS, INC., NEW YORK, NY. FILED 11-19-2010.

**EXTREME MUSCLE**

THE MARK CONSISTS OF STANDARD CHARACTERS WITHOUT CLAIM TO ANY PARTICULAR FONT, STYLE, SIZE, OR COLOR.

NO CLAIM IS MADE TO THE EXCLUSIVE RIGHT TO USE "MUSCLE", APART FROM THE MARK AS SHOWN.

FOR PROVIDING ON-LINE MAGAZINES IN THE FIELD OF BODYBUILDING, FITNESS, DIET, NUTRITION, AND EXERCISE (U.S. CLS. 100, 101 AND 107).

ELI HELLMAN, EXAMINING ATTORNEY

SN 85-181,415. CITY OF HOPE, DUARTE, CA. FILED 11-19-2010.

**CANSWER**

THE MARK CONSISTS OF STANDARD CHARACTERS WITHOUT CLAIM TO ANY PARTICULAR FONT, STYLE, SIZE, OR COLOR.

FOR ORGANIZING AND CONDUCTING A WALKING AND MARATHON RACE EVENT THE PROCEEDS OF WHICH ARE DONATED TO CHARITY (U.S. CLS. 100, 101 AND 107).

MARY CRAWFORD, EXAMINING ATTORNEY

SN 85-181,438. DIETERLY, DOUGLAS K., LAKEVILLE, IN. AND DIETERLY, DEBRA A., LAKEVILLE, IN. FILED 11-19-2010.

**D3**

THE MARK CONSISTS OF STANDARD CHARACTERS WITHOUT CLAIM TO ANY PARTICULAR FONT, STYLE, SIZE, OR COLOR.

FOR ENTERTAINMENT SERVICES IN THE NATURE OF LIVE PERFORMANCES BY A MUSICAL GROUP (U.S. CLS. 100, 101 AND 107).

FIRST USE 7-25-2002; IN COMMERCE 7-25-2002.  
KATHERINE CHANG, EXAMINING ATTORNEY



**CLASS 41—(Continued).**

SN 85-181,506. SMUGGLER'S EVENT MANAGEMENT, LLC,  
PUNTA GORDA, FL. FILED 11-19-2010.



NO CLAIM IS MADE TO THE EXCLUSIVE RIGHT TO  
USE "SERIES", APART FROM THE MARK AS SHOWN.

THE MARK CONSISTS OF THE STYLIZED WORDING  
"FLATSMASTERS SERIES" AND A STYLIZED FISH.  
SEC. 2(F).

FOR ORGANIZING AND CONDUCTING FISHING  
TOURNAMENTS (U.S. CLS. 100, 101 AND 107).

FIRST USE 1-1-2001; IN COMMERCE 1-1-2001.  
LOURDES AYALA, EXAMINING ATTORNEY

---

SN 85-183,065. OCHOA JR, JOSE G, PHOENIX, AZ. FILED 11-  
23-2010.

**LUPE OCHOA "EL MONARCA"**

THE MARK CONSISTS OF STANDARD CHARACTERS  
WITHOUT CLAIM TO ANY PARTICULAR FONT, STYLE,  
SIZE, OR COLOR.

THE NAME(S), PORTRAIT(S), AND/OR SIGNATURE(S)  
SHOWN IN THE MARK IDENTIFIES JOSE OCHOA, WHOSE  
CONSENT(S) TO REGISTER IS MADE OF RECORD.

THE ENGLISH TRANSLATION OF "EL MONARCA" IN  
THE MARK IS "THE MONARCH".

FOR ENTERTAINMENT SERVICES IN THE NATURE  
OF LIVE MUSICAL PERFORMANCES (U.S. CLS. 100, 101  
AND 107).

GISELLE AGOSTO, EXAMINING ATTORNEY

---

SN 85-183,913. BUSY BOUNCING, LLC, ENGLEWOOD, OH.  
FILED 11-23-2010.

**BUSY BOUNCING**

THE MARK CONSISTS OF STANDARD CHARACTERS  
WITHOUT CLAIM TO ANY PARTICULAR FONT, STYLE,  
SIZE, OR COLOR.

FOR RENTAL OF INFLATABLE TOY STRUCTURES  
(U.S. CLS. 100, 101 AND 107).

FIRST USE 8-1-2006; IN COMMERCE 8-1-2006.  
RENEE MCCRAY, EXAMINING ATTORNEY

**CLASS 41—(Continued).**

SN 85-184,021. DJ ASHBA, WEST HOLLYWOOD, CA. FILED  
11-23-2010.

**DJ ASHBA**

THE MARK CONSISTS OF STANDARD CHARACTERS  
WITHOUT CLAIM TO ANY PARTICULAR FONT, STYLE,  
SIZE, OR COLOR.

FOR ENTERTAINMENT SERVICES, NAMELY, PRO-  
VIDING A WEB SITE FEATURING INFORMATION  
RELATING TO LIVE PERFORMANCES, MUSICAL  
AND VIDEO RECORDINGS AND PHOTOGRAPHS; PRO-  
DUCTION OF SOUND RECORDINGS; SONG WRITING  
SERVICES; MUSIC COMPOSITION FOR OTHERS; EDIT-  
ING OF SOUND RECORDINGS; AND LIVE PERFOR-  
MANCES IN THE NATURE OF AN INDIVIDUAL  
PROVIDING MUSICAL PERFORMANCES (U.S. CLS.  
100, 101 AND 107).

GIANCARLO CASTRO, EXAMINING ATTORNEY

---

SN 85-185,737. EDMUND JOHN MESSINA, HASLETT, MI.  
FILED 11-28-2010.

**Intellivideo**

THE MARK CONSISTS OF STANDARD CHARACTERS  
WITHOUT CLAIM TO ANY PARTICULAR FONT, STYLE,  
SIZE, OR COLOR.

FOR PROVIDING EDUCATIONAL PROGRAMS IN  
THE FIELD OF ELEMENTARY THROUGH HIGH  
SCHOOL COURSEWORK (U.S. CLS. 100, 101 AND 107).

FIRST USE 11-28-2010; IN COMMERCE 11-28-2010.  
SHAUNIA CARLYLE, EXAMINING ATTORNEY

**CLASS 41—(Continued).**

SN 85-186,077. WHARTON KING LLC, DALLAS, TX. FILED 11-29-2010.

## PINK PURSE INTERNATIONAL

THE MARK CONSISTS OF STANDARD CHARACTERS WITHOUT CLAIM TO ANY PARTICULAR FONT, STYLE, SIZE, OR COLOR.

NO CLAIM IS MADE TO THE EXCLUSIVE RIGHT TO USE "INTERNATIONAL", APART FROM THE MARK AS SHOWN.

FOR EDUCATION AND ENTERTAINMENT SERVICES, NAMELY, PROVIDING RADIO SEMINARS, ON-LINE SEMINARS, AND TELEVISED SEMINARS IN THE FIELDS SPORTS, FOOD, FASHION, ENTERTAINMENT, AND WOMEN'S INTERESTS; ARRANGING AND CONDUCTING SPECIAL EVENTS FOR SOCIAL ENTERTAINMENT PURPOSES; ENTERTAINMENT, NAMELY, A CONTINUING WOMEN'S INTEREST SHOW BROADCAST OVER THE INTERNET; ON-LINE JOURNALS, NAMELY, BLOGS FEATURING SPORTS, FOOD, FASHION, AND ENTERTAINMENT; PROVIDING ON-LINE MAGAZINES IN THE FIELD OF SPORTS, FOOD, FASHION, ENTERTAINMENT, AND WOMEN'S INTERESTS (U.S. CLS. 100, 101 AND 107).

FIRST USE 1-7-2010; IN COMMERCE 2-9-2010.  
CAROLINE WOOD, EXAMINING ATTORNEY

**CLASS 41—(Continued).**

SN 85-187,324. THIRDSREEL, INC., LOS ANGELES, CA. FILED 11-30-2010.

## THIRDSREEL

THE MARK CONSISTS OF STANDARD CHARACTERS WITHOUT CLAIM TO ANY PARTICULAR FONT, STYLE, SIZE, OR COLOR.

FOR DIGITAL VIDEO, AUDIO, AND MULTIMEDIA PUBLISHING SERVICES; ENTERTAINMENT AND EDUCATIONAL SERVICES IN THE NATURE OF ON-LINE COMPETITIONS IN THE FIELD OF ENTERTAINMENT, EDUCATION, CULTURE, SPORTS, AND OTHER NON-BUSINESS AND NON-COMMERCIAL FIELDS; ENTERTAINMENT AND EDUCATIONAL SERVICES, NAMELY, PROVIDING A WEBSITE THAT DISPLAYS VARIOUS REQUESTS, REVIEWS, RECOMMENDATIONS, RANKINGS, TRACKINGS, VOTES, AND INFORMATION RELATING TO UNCREATED, UNRELEASED, NEW, SPECIAL, POPULAR, AND RARE PRODUCTS, SERVICES, AND EVENTS IN THE FIELDS OF POP CULTURE, ENTERTAINMENT, EDUCATION, AND SPORTS, ALL EXCLUSIVELY FOR NON-BUSINESS AND NON-COMMERCIAL TRANSACTIONS AND PURPOSES; ENTERTAINMENT INFORMATION; ENTERTAINMENT SERVICES, NAMELY, PLANNING AND CONDUCTING A SERIES OF FILM FESTIVALS; ENTERTAINMENT SERVICES, NAMELY, PROVIDING ON-LINE REVIEWS OF FILMS; FILM DISTRIBUTION; PROVIDING A WEB SITE WHERE USERS CAN POST RATINGS, REVIEWS AND RECOMMENDATIONS ON EVENTS AND ACTIVITIES IN THE FIELD OF ENTERTAINMENT AND EDUCATION; PROVIDING A WEBSITE FEATURING ENTERTAINMENT INFORMATION; PROVIDING A WEBSITE FOR ENTERTAINMENT PURPOSES WHERE USERS CAN VIEW AND POST FILMS FEATURING FEATURE LENGTH FILMS, SHORT FILMS, DOCUMENTARIES, MUSIC VIDEOS, ANIMATION, AND DEMONSTRATION REELS; PROVIDING RECOGNITION AND INCENTIVES BY THE WAY OF AWARDS AND CONTESTS TO DEMONSTRATE EXCELLENCE IN THE FIELD OF FILM MAKING (U.S. CLS. 100, 101 AND 107).

KELLY TRUSILO, EXAMINING ATTORNEY

---

SN 85-186,444. CLUB SPEED, INC., IRVINE, CA. FILED 11-29-2010.

## RPM

THE MARK CONSISTS OF STANDARD CHARACTERS WITHOUT CLAIM TO ANY PARTICULAR FONT, STYLE, SIZE, OR COLOR.

FOR MEASUREMENT EVALUATIONS IN THE FIELD OF RACE TIMING FOR MOTORIZED KARTS (U.S. CLS. 100, 101 AND 107).

FIRST USE 9-15-2006; IN COMMERCE 9-30-2006.  
ESTHER A. BORSUK, EXAMINING ATTORNEY

**CLASS 41—(Continued).**

SN 85-188,697. JAMES DONALD SCANLON, LITTLE SILVER, NJ. FILED 12-1-2010.

**ONE SHOT BILLY**

THE MARK CONSISTS OF STANDARD CHARACTERS WITHOUT CLAIM TO ANY PARTICULAR FONT, STYLE, SIZE, OR COLOR.

FOR ENTERTAINMENT SERVICES IN THE NATURE OF LIVE MUSICAL PERFORMANCES; ENTERTAINMENT IN THE NATURE OF MUSICAL PLAY PERFORMANCES; ENTERTAINMENT SERVICES, NAMELY, DISTRIBUTION OF MOTION PICTURE FILMS; ENTERTAINMENT IN THE NATURE OF AN ONGOING TELEVISION PROGRAM FEATURING MOTION PICTURE FILMS; LIVE THEATRICAL AND MUSICAL PERFORMANCES; PRODUCTION OF MOTION PICTURE FILMS; ENTERTAINMENT, NAMELY, PROVIDING LIVE MUSICAL PERFORMANCES; ENTERTAINMENT, NAMELY, PROVIDING LIVE MUSICAL PERFORMANCES FEATURING SINGERS; ENTERTAINMENT IN THE NATURE OF AUDIO AND VISUAL PERFORMANCES BY AN ACTOR; PRODUCTION OF ENTERTAINMENT SHOWS, NAMELY, PLAYS, SHOWS, AND MUSIC VIDEOS ACCESSIBLE VIA TELEVISION, CABLE, SATELLITE, AUDIO, VIDEO AND COMPUTER NETWORKS; PROVIDING INFORMATION IN THE FIELD OF ENTERTAINMENT VIA COMMUNICATION AND COMPUTER NETWORKS (U.S. CLS. 100, 101 AND 107).  
JOHN SCHUYLER YARD, EXAMINING ATTORNEY

SN 85-188,834. LAWSON, JULIANNE PATRICE, CHAPEL HILL, NC. FILED 12-2-2010.

**Julianne Patrice**

THE MARK CONSISTS OF STANDARD CHARACTERS WITHOUT CLAIM TO ANY PARTICULAR FONT, STYLE, SIZE, OR COLOR.

THE NAME "JULIANNE PATRICE" IDENTIFIES A LIVING INDIVIDUAL WHOSE CONSENT IS OF RECORD.

FOR ENTERTAINMENT IN THE NATURE OF VISUAL AND AUDIO PERFORMANCES BY AN ACTOR (U.S. CLS. 100, 101 AND 107).

MICHAEL SOUDERS, EXAMINING ATTORNEY

**CLASS 41—(Continued).**

SN 85-188,868. EDUCATIONAL CYBERPLAYGROUND, INC., CONSHOHOCKEN, PA. FILED 12-2-2010.

**EDUCATIONAL CYBERPLAYGROUND**

THE MARK CONSISTS OF STANDARD CHARACTERS WITHOUT CLAIM TO ANY PARTICULAR FONT, STYLE, SIZE, OR COLOR.

NO CLAIM IS MADE TO THE EXCLUSIVE RIGHT TO USE "EDUCATIONAL", APART FROM THE MARK AS SHOWN.

FOR EDUCATIONAL SERVICES, NAMELY, PROVIDING A WEBSITE FEATURING NON-DOWNLOADABLE PUBLICATIONS IN THE NATURE OF EDUCATIONAL BOOKS IN THE FIELD OF K-12 CURRICULUM, TEACHING INSTRUCTION GUIDES, TEACHER RESOURCES; INTERACTIVE WEBSITE AND INTERNET WEBSITE PORTAL FEATURING INFORMATION AND LINKS RELATED TO K-12 CURRICULUM, RESOURCES AND INSTRUCTION (U.S. CLS. 100, 101 AND 107).

FIRST USE 6-9-1998; IN COMMERCE 6-9-1998.

ADA HAN, EXAMINING ATTORNEY

SN 85-191,585. YSIDRO, STACIE, APOLLO BEACH, FL. FILED 12-6-2010.

**Talia Amour**

THE MARK CONSISTS OF STANDARD CHARACTERS WITHOUT CLAIM TO ANY PARTICULAR FONT, STYLE, SIZE, OR COLOR.

THE NAME(S), PORTRAIT(S), AND/OR SIGNATURE(S) SHOWN IN THE MARK IDENTIFIES STACIE YSIDRO, WHOSE CONSENT(S) TO REGISTER IS MADE OF RECORD.

FOR ENTERTAINMENT SERVICES, NAMELY, LIVE, TELEVISED AND MOVIE APPEARANCES BY A PROFESSIONAL ENTERTAINER/MODEL (U.S. CLS. 100, 101 AND 107).

FIRST USE 9-14-2010; IN COMMERCE 9-14-2010.

GISELLE AGOSTO, EXAMINING ATTORNEY

**CLASS 41—(Continued).**

SN 85-191,751. TOASTMASTERS INTERNATIONAL, RANCHO SANTA MARGARITA, CA. FILED 12-6-2010.

**TABLE TOPICS**

THE MARK CONSISTS OF STANDARD CHARACTERS WITHOUT CLAIM TO ANY PARTICULAR FONT, STYLE, SIZE, OR COLOR.

NO CLAIM IS MADE TO THE EXCLUSIVE RIGHT TO USE "TOPICS", APART FROM THE MARK AS SHOWN.

FOR EDUCATIONAL SERVICES, NAMELY, CONDUCTING INFORMAL PROGRAMS IN THE FIELD OF PUBLIC SPEAKING, LEADERSHIP AND COMMUNICATION SKILLS (U.S. CLS. 100, 101 AND 107).

ROBERT C. CLARK JR., EXAMINING ATTORNEY

---

SN 85-191,783. IIAMS, FREDERICK, SAN PEDRO, CA. FILED S.R. 12-6-2010; AM. P.R. 9-7-2011.

**Funkalicious**

THE MARK CONSISTS OF STANDARD CHARACTERS WITHOUT CLAIM TO ANY PARTICULAR FONT, STYLE, SIZE, OR COLOR.

FOR ENTERTAINMENT, NAMELY, LIVE PERFORMANCES BY A MUSICAL BAND (U.S. CLS. 100, 101 AND 107).

FIRST USE 10-16-2005; IN COMMERCE 10-16-2005.

BARNEY CHARLON, EXAMINING ATTORNEY

---

SN 85-193,626. ART KIDS RULE, RUTHERFORD, NJ. FILED 12-8-2010.

**Art Kids Rule**

THE MARK CONSISTS OF STANDARD CHARACTERS WITHOUT CLAIM TO ANY PARTICULAR FONT, STYLE, SIZE, OR COLOR.

NO CLAIM IS MADE TO THE EXCLUSIVE RIGHT TO USE "ART KIDS", APART FROM THE MARK AS SHOWN.

FOR EDUCATION SERVICES, NAMELY, PROVIDING CLASSES IN THE FIELD OF ART; EDUCATIONAL SERVICES, NAMELY, CONDUCTING PROGRAMS IN THE FIELD OF ART (U.S. CLS. 100, 101 AND 107).

FIRST USE 11-1-2010; IN COMMERCE 11-30-2010.

APRIL ROACH, EXAMINING ATTORNEY

**CLASS 41—(Continued).**

SN 85-193,750. ENOVATIVEPIANO, LLC, LAFAYETTE, LA. FILED 12-8-2010.



THE MARK CONSISTS OF A LETTER "E" FORMING THE KEYS OF A PIANO TO THE LEFT OF THE WORDING "ENOVATIVEPIANO" IN STYLIZED FONT INSIDE OF A RECTANGULAR BACKGROUND.

FOR PIANO INSTRUCTION; PROVIDING A WEBSITE FEATURING RESOURCES, NAMELY, NON-DOWNLOADABLE PUBLICATIONS IN THE NATURE OF INSTRUCTIONAL AUDIO AND VIDEO PRESENTATIONS IN THE FIELD OF PIANO INSTRUCTION (U.S. CLS. 100, 101 AND 107).

FIRST USE 1-3-2009; IN COMMERCE 2-1-2009.

TINA BROWN, EXAMINING ATTORNEY

---

SN 85-195,489. PT DEVELOPMENT FLORIDA LLC, SARASOTA, FL. FILED 12-10-2010.

**AmaZing!**

THE MARK CONSISTS OF THE WORD "AMAZING" WITH THE FIRST LETTER "A" AND THE LETTER "Z" CAPITALIZED ENDING WITH AN EXCLAMATION MARK.

FOR BUSINESS TRAINING CONSULTANCY SERVICES IN THE FIELD OF BUSINESS MANAGEMENT FOR BUSINESSES PROVIDING PHYSICAL THERAPY SERVICES, NAMELY, EMPLOYEE TRAINING IN THE FIELD OF CUSTOMER SERVICES (U.S. CLS. 100, 101 AND 107).

FIRST USE 5-31-2009; IN COMMERCE 6-30-2009.

JENNIFER VASQUEZ, EXAMINING ATTORNEY

**CLASS 41—(Continued).**

SN 85-195,643. WHOOP, INC., LOS ANGELES, CA. FILED 12-10-2010.

**LIL' WHOOP PRODUCTIONS**

THE MARK CONSISTS OF STANDARD CHARACTERS WITHOUT CLAIM TO ANY PARTICULAR FONT, STYLE, SIZE, OR COLOR.

NO CLAIM IS MADE TO THE EXCLUSIVE RIGHT TO USE "PRODUCTIONS", APART FROM THE MARK AS SHOWN.

FOR ENTERTAINMENT AND EDUCATIONAL SERVICES IN THE NATURE OF PRODUCTION OF ENTERTAINMENT AND EDUCATIONAL MOTION PICTURE FILMS AND TELEVISION PROGRAMS WITH OR WITHOUT MUSIC ON A WIDE VARIETY OF THEMES INCLUDING COMEDY, DRAMA, ACTION, ADVENTURE AND/OR ANIMATION IN ALL MEDIA; PRODUCTION OF AUDIO AND VIDEO RECORDINGS IN ALL MEDIA ON A WIDE VARIETY OF THEMES; AND MUSIC PRODUCTION (U.S. CLS. 100, 101 AND 107).

WILLIAM VERHOSEK, EXAMINING ATTORNEY

---

SN 85-203,459. DHX MEDIA USA, INC., BEVERLY HILLS, CA. FILED 12-21-2010.

**THE MERCHANT OF VENICE**

THE MARK CONSISTS OF STANDARD CHARACTERS WITHOUT CLAIM TO ANY PARTICULAR FONT, STYLE, SIZE, OR COLOR.

FOR PRODUCTION AND DISTRIBUTION OF TELEVISION PROGRAMS VIA BROADCAST TELEVISION, THE INTERNET, BROADBAND AND OTHER MEDIA; ENTERTAINMENT SERVICES IN THE NATURE OF ONGOING TELEVISION PROGRAMS IN THE FIELD OF COMEDY AND VARIETY DOCUMENTARY TELEVISION PROGRAMMING (U.S. CLS. 100, 101 AND 107).

ALEXANDER L. POWERS, EXAMINING ATTORNEY

---

SN 85-203,747. MORRIS, WILLIE, HYANNIS, MA. FILED 12-22-2010.

**BUHD**

THE MARK CONSISTS OF STANDARD CHARACTERS WITHOUT CLAIM TO ANY PARTICULAR FONT, STYLE, SIZE, OR COLOR.

THE NAME SHOWN IN THE MARK IDENTIFIES THE NICKNAME OF WILLIE MORRIS, WHOSE CONSENT TO REGISTER IS MADE OF RECORD.

FOR ENTERTAINMENT IN THE NATURE OF LIVE PERFORMANCES BY A MUSICAL ARTIST (U.S. CLS. 100, 101 AND 107).

LINDSEY RUBIN, EXAMINING ATTORNEY

**CLASS 41—(Continued).**

SN 85-208,719. INMAN GROUP, INC., DBA INMAN NEWS, ALAMEDA, CA. FILED 12-31-2010.

**Where Real Estate & Technology Connect**

THE MARK CONSISTS OF STANDARD CHARACTERS WITHOUT CLAIM TO ANY PARTICULAR FONT, STYLE, SIZE, OR COLOR.

OWNER OF U.S. REG. NO. 3,692,146.

NO CLAIM IS MADE TO THE EXCLUSIVE RIGHT TO USE "REAL ESTATE & TECHNOLOGY", APART FROM THE MARK AS SHOWN.

FOR NEWS AGENCIES, NAMELY, GATHERING AND DISSEMINATION OF NEWS (U.S. CLS. 100, 101 AND 107).

FIRST USE 5-4-2006; IN COMMERCE 5-4-2006.

TINA MAI, EXAMINING ATTORNEY

---

SN 85-208,727. SOCIAL ESQUIRE, MIAMI, FL. FILED 12-31-2010.

**Social Esquire**

THE MARK CONSISTS OF STANDARD CHARACTERS WITHOUT CLAIM TO ANY PARTICULAR FONT, STYLE, SIZE, OR COLOR.

FOR EDUCATIONAL SERVICES, NAMELY, PROVIDING SEMINARS, WORKSHOPS, MENTORING, AND MOTIVATIONAL SPEAKING SERVICES FOR WOMEN IN THE FIELDS OF WOMANHOOD, HEALTH, FITNESS, WORK LIFE BALANCE, CONFIDENCE, SELF ESTEEM, INDIVIDUALITY, AND ACHIEVING DREAMS AND GOALS; ARRANGING AND CONDUCTING SPECIAL EVENTS FOR SOCIAL ENTERTAINMENT PURPOSES; PROVIDING ONGOING RADIO AND TELEVISION PROGRAMS IN THE FIELDS OF WOMEN'S HEALTH, WORK LIFE BALANCE, CONFIDENCE, SELF ESTEEM, INDIVIDUALITY, AND ACHIEVING DREAMS AND GOALS (U.S. CLS. 100, 101 AND 107).

FIRST USE 9-8-2008; IN COMMERCE 9-8-2008.

KIMBERLY FRYE, EXAMINING ATTORNEY

**CLASS 41—(Continued).**

SN 85-210,474. INMAN GROUP, INC., DBA INMAN NEWS, ALAMEDA, CA. FILED 1-4-2011.

**FUTURE OF REAL ESTATE  
MARKETING**

THE MARK CONSISTS OF STANDARD CHARACTERS WITHOUT CLAIM TO ANY PARTICULAR FONT, STYLE, SIZE, OR COLOR.

OWNER OF U.S. REG. NO. 3,692,146.

NO CLAIM IS MADE TO THE EXCLUSIVE RIGHT TO USE "REAL ESTATE MARKETING", APART FROM THE MARK AS SHOWN.

FOR ON-LINE JOURNALS, NAMELY, BLOGS FEATURING REAL ESTATE AND TECHNOLOGY, INCLUDING THE INTERNET, SOCIAL MEDIA AND MOBILE TECHNOLOGY (U.S. CLS. 100, 101 AND 107).

FIRST USE 4-28-2006; IN COMMERCE 4-28-2006.

TINA MAI, EXAMINING ATTORNEY

**CLASS 41—(Continued).**

SN 85-218,534. WOODLAND PARK ZOOLOGICAL SOCIETY, SEATTLE, WA. FILED 1-14-2011.



NO CLAIM IS MADE TO THE EXCLUSIVE RIGHT TO USE "WOODLAND PARK ZOO", APART FROM THE MARK AS SHOWN.

THE MARK CONSISTS THE WORDING "WOODLAND PARK ZOO" BENEATH A PARTIALLY SHADED RECTANGLE CONTAINING A STYLIZATION OF ZEBRA STRIPES.

FOR ZOO SERVICES, NAMELY, PROVIDING FOR PUBLIC VIEWING OF ANIMAL LIFE, PARK FACILITIES AND GARDENS (U.S. CLS. 100, 101 AND 107).

FIRST USE 5-1-2011; IN COMMERCE 5-1-2011.

JOHN DWYER, EXAMINING ATTORNEY

SN 85-220,016. UMUADA NDI-IGBO IN DIASPORA, INC., RIVERSIDE, CA. FILED 1-18-2011.



NO CLAIM IS MADE TO THE EXCLUSIVE RIGHT TO USE "UMUADA NDI-IGBO" AND "INC.", APART FROM THE MARK AS SHOWN.

THE COLOR(S) BLUE, BROWN, ORANGE, RED, BLACK, WHITE, SILVER AND YELLOW IS/ARE CLAIMED AS A FEATURE OF THE MARK.

THE MARK CONSISTS OF THE FOLLOWING: THE WORDS "UMUADA NDI-IGBO" APPEAR IN THE COLOR BLACK ON A YELLOW BANNER AND BETWEEN SILVER AND WHITE LINES AT THE TOP OF THE LOGO, WHILE THE WORDS "IN DIASPORA, INC." APPEAR IN THE COLOR BLACK ON A YELLOW BANNER AND BETWEEN SILVER AND WHITE LINES AT THE BOTTOM OF THE LOGO; THE DESIGN CONSISTS OF A GLOBE APPEARING IN THE COLORS BLUE, YELLOW AND WHITE WITHIN A HEART OF CHECKERED RED LINED, YELLOW, WHITE, BROWN AND ORANGE SMALL BOXES AND STARS TO DEPICT A SPARKLING EFFECT APPEAR-

SN 85-211,394. BORZINI, JARROD J, GREENFIELD, CA. FILED 1-5-2011.

**JAY B**

THE MARK CONSISTS OF STANDARD CHARACTERS WITHOUT CLAIM TO ANY PARTICULAR FONT, STYLE, SIZE, OR COLOR.

THE NAME(S), PORTRAIT(S), AND/OR SIGNATURE(S) SHOWN IN THE MARK IDENTIFIES JARROD J BORZINI, WHOSE CONSENT(S) TO REGISTER IS MADE OF RECORD.

FOR ENTERTAINMENT SERVICES IN THE NATURE OF PRESENTING LIVE MUSICAL PERFORMANCES (U.S. CLS. 100, 101 AND 107).

FIRST USE 0-0-2009; IN COMMERCE 0-0-2009.

JORDAN BAKER, EXAMINING ATTORNEY

**CLASS 41—(Continued).**

ING IN THE COLOR WHITE; THERE ARE TWO ARMS APPEARING IN THE COLORS BROWN, RED AND BLUE AT THE BOTTOM OF THE HEART SHAKING HANDS; TO THE LEFT SIDE OF THE GLOBE AND ABOVE THE SHAKING HANDS BUT WITHIN THE HEART APPEAR THE WORDS "PEACE", "UNITY" AND "LOVE" IN THE COLOR BLACK, AND TO THE RIGHT OF THE GLOBE ABOVE THE SHAKING HANDS BUT WITHIN THE HEART APPEAR THE WORDS "RESPECT" AND "EMPOWERMENT" IN THE COLOR BLACK.

THE ENGLISH TRANSLATION OF "UMUADA NDI-IGBO IN DIASPORA" IN THE MARK IS "WOMEN OF THE IGBO TRIBE OF NIGERIA IN DIASPORA".

FOR PROVIDING CULTURAL AWARENESS PROGRAMS ABOUT AFRICAN WOMEN IN THE AREA OF LANGUAGE, LIFESTYLE, AND PERSONAL GROWTH (U.S. CLS. 100, 101 AND 107).

RONALD AIKENS, EXAMINING ATTORNEY

SN 85-220,249. BIG HISTORY PROJECT, LLC, KIRKLAND, WA. FILED 1-18-2011.

**BIG HISTORY PROJECT**

THE MARK CONSISTS OF STANDARD CHARACTERS WITHOUT CLAIM TO ANY PARTICULAR FONT, STYLE, SIZE, OR COLOR.

NO CLAIM IS MADE TO THE EXCLUSIVE RIGHT TO USE "HISTORY PROJECT", APART FROM THE MARK AS SHOWN.

FOR EDUCATION AND ENTERTAINMENT SERVICES, NAMELY, LECTURES, CLASSES, SEMINARS AND OTHER PRESENTATIONS IN THE FIELDS OF HISTORY AND SCIENCE CONDUCTED LIVE, VIA THE INTERNET, RADIO AND TELEVISION AND DEVELOPMENT AND DISTRIBUTION OF COURSE MATERIALS IN CONNECTION THEREWITH (U.S. CLS. 100, 101 AND 107).

RICHARD WHITE, EXAMINING ATTORNEY

SN 85-220,517. THE MUSEUM OF MARIJUANA LLC, DBA THE MUSEUM OF MARIJUANA, DENVER, CO. FILED 1-18-2011.



NO CLAIM IS MADE TO THE EXCLUSIVE RIGHT TO USE "THE MUSEUM OF MARIJUANA" AND THE ROMAN NUMERALS "IV-XX-MMXI", APART FROM THE MARK AS SHOWN.

THE COLOR(S) GREEN AND WHITE IS/ARE CLAIMED AS A FEATURE OF THE MARK.

THE MARK CONSISTS OF A SHIELD DIVIDED INTO QUADRANTS. TWO OF THE FOUR QUADRANTS ARE DIAGONALLY OPPOSITE OF EACH OTHER AND CON-

**CLASS 41—(Continued).**

TAIN A GREEN AND WHITE CHECKERED PATTERN. THE REMAINING TWO QUADRANTS ARE ALSO DIAGONALLY OPPOSITE OF EACH OTHER AND CONTAIN A GREEN BACKGROUND THAT USES NEGATIVE WHITE SPACE TO REPRESENT A MARIJUANA LEAF. ON THE LEFT AND RIGHT SIDE OF THE SHIELD, THERE IS AN INCOMPLETE, GREEN MARIJUANA LEAF. THE ROMAN NUMERALS "IV-XX-MMXI" APPEAR IN GREEN ABOVE THE SHIELD AND THE WORDING "THE MUSEUM OF MARIJUANA" APPEARS IN GREEN BELOW THE SHIELD.

FOR MUSEUMS (U.S. CLS. 100, 101 AND 107).

LINDSEY RUBIN, EXAMINING ATTORNEY

SN 85-223,889. BUENA VISTA UNIVERSITY, STORM LAKE, IA. FILED 1-23-2011.



OWNER OF U.S. REG. NO. 2,697,679.

THE MARK CONSISTS OF THE WORDS "BUENA VISTA" WITH BLACK OUTLINE AND A LARGE "V".

SEC. 2(F).

FOR ARRANGING AND CONDUCTING ATHLETIC COMPETITIONS AT THE UNIVERSITY LEVEL (U.S. CLS. 100, 101 AND 107).

FIRST USE 0-0-2002; IN COMMERCE 0-0-2002.

DOUGLAS LEE, EXAMINING ATTORNEY

SN 85-224,397. HOWARD FALCO, DBA TRUTH SERUM LLC, SCOTTSDALE, AZ. FILED 1-24-2011.

**Master Your Reality**

THE MARK CONSISTS OF STANDARD CHARACTERS WITHOUT CLAIM TO ANY PARTICULAR FONT, STYLE, SIZE, OR COLOR.

FOR EDUCATIONAL AND ENTERTAINMENT SERVICES, NAMELY, MOTIVATIONAL AND EDUCATIONAL SPEAKERS; AND PROVIDING CLASSES AND SEMINARS IN THE FIELD OF PERSONAL GROWTH (U.S. CLS. 100, 101 AND 107).

FIRST USE 11-1-2008; IN COMMERCE 11-1-2008.

DORITT L. CARROLL, EXAMINING ATTORNEY

**CLASS 41—(Continued).**

SN 85-226,166. UNITED STATES DEPARTMENT OF ENERGY, WASHINGTON, DC. FILED 1-26-2011.

## National Science Bowl

THE MARK CONSISTS OF STANDARD CHARACTERS WITHOUT CLAIM TO ANY PARTICULAR FONT, STYLE, SIZE, OR COLOR.

NO CLAIM IS MADE TO THE EXCLUSIVE RIGHT TO USE "SCIENCE BOWL", APART FROM THE MARK AS SHOWN.

SEC. 2(F).

FOR ARRANGING AND CONDUCTING ACADEMIC COMPETITIONS IN SCIENCE AND MATHEMATICS (U.S. CLS. 100, 101 AND 107).

FIRST USE 7-26-1990; IN COMMERCE 7-26-1990.  
EDWARD NELSON, EXAMINING ATTORNEY

---

SN 85-226,545. HOLYPOP.COM LLC, DBA HOLYPOP, WINTER SPRINGS, FL. FILED 1-26-2011.

## Holypop

THE MARK CONSISTS OF STANDARD CHARACTERS WITHOUT CLAIM TO ANY PARTICULAR FONT, STYLE, SIZE, OR COLOR.

FOR PROVIDING ON-LINE RELIGIOUS INSTRUCTION PROMOTING CHRISTIAN AND FAMILY VALUES (U.S. CLS. 100, 101 AND 107).

FIRST USE 11-10-2009; IN COMMERCE 11-10-2009.  
KAELIE KUNG, EXAMINING ATTORNEY

---

SN 85-227,948. COMMUNITY MAIN STREET, DBA COMMUNITY MAIN STREET, CEDAR FALLS, IA. FILED 1-27-2011.

## Holiday Hoopla

THE MARK CONSISTS OF STANDARD CHARACTERS WITHOUT CLAIM TO ANY PARTICULAR FONT, STYLE, SIZE, OR COLOR.

NO CLAIM IS MADE TO THE EXCLUSIVE RIGHT TO USE "HOLIDAY", APART FROM THE MARK AS SHOWN.

FOR ORGANIZING COMMUNITY FESTIVALS FEATURING PRIMARILY LIVE MUSICAL PERFORMANCES AND STREET PERFORMERS, AND ALSO PROVIDING VARIOUS GAMES AND CONTESTS RELATING TO THE HOLIDAY SEASON (U.S. CLS. 100, 101 AND 107).

FIRST USE 10-1-2009; IN COMMERCE 10-1-2009.  
BARBARA BROWN, EXAMINING ATTORNEY

**CLASS 41—(Continued).**

SN 85-228,686. FESTIVALS DC LTD., WASHINGTON, DC. FILED 1-28-2011.

## JAZZ IN THE 'HOODS

THE MARK CONSISTS OF STANDARD CHARACTERS WITHOUT CLAIM TO ANY PARTICULAR FONT, STYLE, SIZE, OR COLOR.

NO CLAIM IS MADE TO THE EXCLUSIVE RIGHT TO USE "JAZZ", APART FROM THE MARK AS SHOWN.

FOR MUSIC PRODUCTION SERVICES; ENTERTAINMENT SERVICES, NAMELY, ORGANIZING, CONDUCTING, PRODUCING AND PRESENTING MUSIC CONCERTS AND FESTIVALS; PRODUCTION OF SOUND AND MUSIC VIDEO RECORDINGS; EDUCATION SERVICES, NAMELY, CONDUCTING CLASSES, WORKSHOPS AND MASTER CLASSES IN THE FIELD OF MUSIC; INSTRUCTION IN THE FIELD OF MUSIC; PROVIDING AN INTERNET WEBSITE FEATURING NEWS AND INFORMATION IN THE FIELD OF MUSIC (U.S. CLS. 100, 101 AND 107).

FIRST USE 9-0-2005; IN COMMERCE 9-0-2005.  
CARRIE GENOVESE, EXAMINING ATTORNEY

---

SN 85-228,694. FESTIVALS DC LTD., WASHINGTON, DC. FILED 1-28-2011.

## JAZZ 'N FAMILIES FUN DAY

THE MARK CONSISTS OF STANDARD CHARACTERS WITHOUT CLAIM TO ANY PARTICULAR FONT, STYLE, SIZE, OR COLOR.

NO CLAIM IS MADE TO THE EXCLUSIVE RIGHT TO USE "JAZZ" OR "FAMILIES", APART FROM THE MARK AS SHOWN.

FOR MUSIC PRODUCTION SERVICES; ENTERTAINMENT SERVICES, NAMELY, ORGANIZING, CONDUCTING, PRODUCING AND PRESENTING MUSIC CONCERTS AND FESTIVALS; PRODUCTION OF SOUND AND MUSIC VIDEO RECORDINGS; EDUCATION SERVICES, NAMELY CONDUCTING CLASSES, WORKSHOPS AND MASTER CLASSES IN THE FIELD OF MUSIC; INSTRUCTION IN THE FIELD OF MUSIC; PROVIDING AN INTERNET WEBSITE FEATURING NEWS AND INFORMATION IN THE FIELD OF MUSIC (U.S. CLS. 100, 101 AND 107).

FIRST USE 9-0-2005; IN COMMERCE 9-0-2005.  
CARRIE GENOVESE, EXAMINING ATTORNEY



**CLASS 41—(Continued).**

SN 85-228,979. MARVEL CHARACTERS, INC., MANHATTAN BEACH, CA. FILED 1-28-2011.

**NEW WARRIORS**

THE MARK CONSISTS OF STANDARD CHARACTERS WITHOUT CLAIM TO ANY PARTICULAR FONT, STYLE, SIZE, OR COLOR.

OWNER OF U.S. REG. NO. 3,148,820.  
FOR ENTERTAINMENT SERVICES, NAMELY, PROVIDING ONLINE NON-DOWNLOADABLE COMIC BOOKS AND GRAPHIC NOVELS FEATURING FICTIONAL ACTION ADVENTURE STORIES AND CHARACTERS (U.S. CLS. 100, 101 AND 107).  
FIRST USE 11-13-2007; IN COMMERCE 11-13-2007.  
ROSELLE HERRERA, EXAMINING ATTORNEY

**CLASS 41—(Continued).**

SN 85-229,131. MARVEL CHARACTERS, INC., MANHATTAN BEACH, CA. FILED 1-28-2011.

**MACHINE TEEN**

THE MARK CONSISTS OF STANDARD CHARACTERS WITHOUT CLAIM TO ANY PARTICULAR FONT, STYLE, SIZE, OR COLOR.

OWNER OF U.S. REG. NO. 3,142,286.  
FOR ENTERTAINMENT SERVICES, NAMELY, PROVIDING ONLINE NON-DOWNLOADABLE COMIC BOOKS AND GRAPHIC NOVELS FEATURING FICTIONAL ACTION ADVENTURE STORIES AND CHARACTERS (U.S. CLS. 100, 101 AND 107).  
FIRST USE 11-13-2007; IN COMMERCE 11-13-2007.  
ROSELLE HERRERA, EXAMINING ATTORNEY

SN 85-229,108. MARVEL CHARACTERS, INC., MANHATTAN BEACH, CA. FILED 1-28-2011.

**ETERNALS**

THE MARK CONSISTS OF STANDARD CHARACTERS WITHOUT CLAIM TO ANY PARTICULAR FONT, STYLE, SIZE, OR COLOR.

OWNER OF U.S. REG. NO. 3,523,873.  
FOR ENTERTAINMENT SERVICES, NAMELY, PROVIDING ONLINE NON-DOWNLOADABLE COMIC BOOKS AND GRAPHIC NOVELS FEATURING FICTIONAL ACTION ADVENTURE STORIES AND CHARACTERS (U.S. CLS. 100, 101 AND 107).  
FIRST USE 11-13-2007; IN COMMERCE 11-13-2007.  
ROSELLE HERRERA, EXAMINING ATTORNEY

SN 85-229,135. MARVEL CHARACTERS, INC., MANHATTAN BEACH, CA. FILED 1-28-2011.

**MS. MARVEL**

THE MARK CONSISTS OF STANDARD CHARACTERS WITHOUT CLAIM TO ANY PARTICULAR FONT, STYLE, SIZE, OR COLOR.

OWNER OF U.S. REG. NO. 3,708,691.  
FOR ENTERTAINMENT SERVICES, NAMELY, PROVIDING ONLINE NON-DOWNLOADABLE COMIC BOOKS AND GRAPHIC NOVELS FEATURING FICTIONAL ACTION ADVENTURE STORIES AND CHARACTERS (U.S. CLS. 100, 101 AND 107).  
FIRST USE 11-13-2007; IN COMMERCE 11-13-2007.  
ROSELLE HERRERA, EXAMINING ATTORNEY

SN 85-229,115. MARVEL CHARACTERS, INC., MANHATTAN BEACH, CA. FILED 1-28-2011.

**NOVA**

THE MARK CONSISTS OF STANDARD CHARACTERS WITHOUT CLAIM TO ANY PARTICULAR FONT, STYLE, SIZE, OR COLOR.

OWNER OF U.S. REG. NO. 1,099,494.  
FOR ENTERTAINMENT SERVICES, NAMELY, PROVIDING ONLINE NON-DOWNLOADABLE COMIC BOOKS AND GRAPHIC NOVELS FEATURING FICTIONAL ACTION ADVENTURE STORIES AND CHARACTERS (U.S. CLS. 100, 101 AND 107).  
FIRST USE 12-3-2007; IN COMMERCE 12-3-2007.  
ROSELLE HERRERA, EXAMINING ATTORNEY

SN 85-229,144. MARVEL CHARACTERS, INC., MANHATTAN BEACH, CA. FILED 1-28-2011.

**BIG HERO 6**

THE MARK CONSISTS OF STANDARD CHARACTERS WITHOUT CLAIM TO ANY PARTICULAR FONT, STYLE, SIZE, OR COLOR.

FOR ENTERTAINMENT SERVICES, NAMELY, PROVIDING ONLINE NON-DOWNLOADABLE COMIC BOOKS AND GRAPHIC NOVELS FEATURING FICTIONAL ACTION ADVENTURE STORIES AND CHARACTERS (U.S. CLS. 100, 101 AND 107).  
FIRST USE 4-9-2009; IN COMMERCE 4-9-2009.  
ROSELLE HERRERA, EXAMINING ATTORNEY

**CLASS 41—(Continued).**

SN 85-229,700. SUSOIX LLC, NEW YORK, NY. FILED 1-30-2011.



NO CLAIM IS MADE TO THE EXCLUSIVE RIGHT TO USE "RACING", APART FROM THE MARK AS SHOWN.

THE COLOR(S) BLACK AND RED IS/ARE CLAIMED AS A FEATURE OF THE MARK.

THE MARK CONSISTS OF THE WORDS "SPIKEBOARD RACING" IN BLACK WHERE THE LETTERS "S", "B" AND "R" ARE CAPITALIZED, WHERE THE WORD "RACING" IS IN ITALICS AND BOLD AND IS SET BELOW THE WORD "SPIKEBOARD" AND WHERE A RED FLASH EXTENDS OUT OF THE LETTER "K".

FOR ARRANGING AND CONDUCTING ATHLETIC COMPETITIONS (U.S. CLS. 100, 101 AND 107).

DOUGLAS LEE, EXAMINING ATTORNEY

SN 85-231,926. BALTIMORE MARTIAL ARTS ACADEMY INC, CATONSVILLE, MD. FILED 2-2-2011.

**BALTIMORE MARTIAL ARTS**

THE MARK CONSISTS OF STANDARD CHARACTERS WITHOUT CLAIM TO ANY PARTICULAR FONT, STYLE, SIZE, OR COLOR.

NO CLAIM IS MADE TO THE EXCLUSIVE RIGHT TO USE "MARTIAL ARTS", APART FROM THE MARK AS SHOWN.

SEC. 2(F).

FOR MARTIAL ARTS INSTRUCTION; OPERATING OF MARTIAL ARTS' SCHOOLS; PROVIDING CLASSES, WORKSHOPS, SEMINARS IN THE FIELDS OF FITNESS, EXERCISE, AND MARTIAL ARTS (U.S. CLS. 100, 101 AND 107).

FIRST USE 1-1-1995; IN COMMERCE 1-1-1995.

ELLEN PERKINS, EXAMINING ATTORNEY

**CLASS 41—(Continued).**

SN 85-234,660. JUNKIN HOLDINGS, LLC, CORONA DEL MAR, CA. FILED 2-4-2011.

**TURNING VIEWERS INTO PARTICIPANTS**

THE MARK CONSISTS OF STANDARD CHARACTERS WITHOUT CLAIM TO ANY PARTICULAR FONT, STYLE, SIZE, OR COLOR.

FOR ENTERTAINMENT SERVICES IN THE NATURE OF PROVIDING INTERACTIVE FANTASY SPORTS SCORES AND OTHER SPORTS INFORMATION THAT CAN BE USED IN CONJUNCTION WITH USER PARTICIPATION IN FANTASY SPORTS GAMES; ENTERTAINMENT SERVICES IN THE NATURE OF CONDUCTING ONLINE CONTESTS AND PROVIDING ONLINE VIDEO, COMPUTER, ELECTRONIC, CARD, AND BOARD GAMES THAT PROVIDE INTERACTIVE VIEWER PARTICIPATION; PROVIDING NEWS AND INFORMATION ON SPORTS, GAMES AND ENTERTAINMENT; ENTERTAINMENT SERVICES, NAMELY, PROVIDING VIRTUAL ENVIRONMENTS IN WHICH USERS CAN INTERACT FOR RECREATIONAL, LEISURE OR ENTERTAINMENT PURPOSES; ENTERTAINMENT SERVICES, NAMELY, PROVIDING ON-LINE COMPUTER GAMES, ELECTRONIC GAMES AND VIDEO GAMES (U.S. CLS. 100, 101 AND 107).

KAREN BRACEY, EXAMINING ATTORNEY

SN 85-235,097. FINSTON CONSULTING LLC, WASHINGTON, DC. FILED 2-5-2011.

**BALTIMORE MARTIAL ARTS**

NO CLAIM IS MADE TO THE EXCLUSIVE RIGHT TO USE "WASHINGTON EMBASSY NETWORK", APART FROM THE MARK AS SHOWN.

THE COLOR(S) BLUE, BLACK, WHITE IS/ARE CLAIMED AS A FEATURE OF THE MARK.

THE MARK CONSISTS OF RECTANGULAR BAR IN NAVY BLUE WITH FOLLOWING WORDS IN WHITE, SMALL CAPS: "WASHINGTON EMBASSY NETWORK" INITIALS ABOVE THE BLUE BAR IN BLACK: "WEN" (BLOCK LETTERS) GLOBE AT AN ANGLE AND FADING OUT BEHIND IN BLUE AND WHITE ON A WHITE FIELD.

FOR ARRANGING AND CONDUCTING EDUCATIONAL CONFERENCES; ORGANIZATION OF EVENTS FOR CULTURAL PURPOSES (U.S. CLS. 100, 101 AND 107).

FIRST USE 12-15-2010; IN COMMERCE 12-15-2010.

C. DIONNE CLYBURN, EXAMINING ATTORNEY

**CLASS 41—(Continued).**

SN 85-245,300. THE SAINT AUGUSTINE LIGHTHOUSE AND MUSEUM, INC., ST. AUGUSTINE, FL. FILED 2-17-2011.

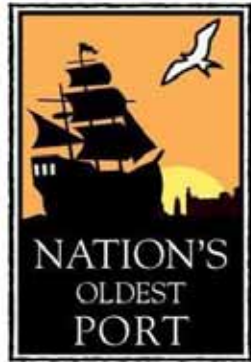

NO CLAIM IS MADE TO THE EXCLUSIVE RIGHT TO USE "NATION'S OLDEST PORT", APART FROM THE MARK AS SHOWN.

THE COLOR(S) BLACK, WHITE, ORANGE AND YELLOW IS/ARE CLAIMED AS A FEATURE OF THE MARK.

THE MARK CONSISTS OF A SILHOUETTE OF A HISTORICAL SHIP APPEARING IN BLACK AND WHITE SAILING TOWARDS A FORT APPEARING IN THE COLOR BLACK, WITH A RISING SUN APPEARING IN THE COLOR YELLOW IN THE BACKGROUND, AND TO THE RIGHT APPEARS A SILHOUETTE OF A FLYING BIRD IN WHITE OUTLINED IN BLACK, AND BELOW THE HISTORICAL SHIP APPEARS THE WORDING "NATION'S OLDEST PORT" IN WHITE AGAINST A BLACK BACKGROUND, ALL APPEARING AGAINST AN ORANGE BACKGROUND AND CONTAINED WITHIN A DOUBLE-SIDED BLACK AND WHITE RECTANGULAR CARRIER.

FOR EDUCATION SERVICES, NAMELY, PROVIDING CLASSES, SEMINARS, WORKSHOPS, EXHIBITIONS, PRESENTATIONS AND INFORMATION IN THE FIELD OF TOURISM, TRAVEL, MARITIME, ARCHEOLOGY AND LOCAL HISTORY; EDUCATIONAL SERVICES, NAMELY, CONDUCTING PROGRAMS IN THE FIELD OF TOURISM, TRAVEL, MARITIME, ARCHEOLOGY AND LOCAL HISTORY; MUSEUM SERVICES (U.S. CLS. 100, 101 AND 107).

APRIL HESIK, EXAMINING ATTORNEY

**CLASS 41—(Continued).**

SN 85-249,035. EDUCATION MASTERS, LLC, DEERFIELD, IL. FILED 2-23-2011.



THE MARK CONSISTS OF THE LETTERS "EM" WITHIN A LAPTOP COMPUTER IMAGE WITH A FOUR POINTED HAT WITH A TASSEL.

FOR EDUCATION SERVICES, NAMELY, PROVIDING ONLINE TUTORING UTILIZING WEB-BASED SOFTWARE IN THE FIELD OF ACADEMIC SUBJECTS (U.S. CLS. 100, 101 AND 107).

FIRST USE 8-30-2010; IN COMMERCE 8-30-2010.  
MICHELE SWAIN, EXAMINING ATTORNEY

SN 85-250,155. MEDINA, BOBBY JOSEPH, DBA VIP BATTING, HAWAIIAN GARDENS, CA. FILED 2-24-2011.

## Punishers

THE MARK CONSISTS OF STANDARD CHARACTERS WITHOUT CLAIM TO ANY PARTICULAR FONT, STYLE, SIZE, OR COLOR.

FOR ENTERTAINMENT SERVICES IN THE NATURE OF COMPETITIONS IN THE SPORT OF SOFTBALL AND BASEBALL (U.S. CLS. 100, 101 AND 107).

FIRST USE 11-16-2003; IN COMMERCE 12-31-2004.  
NELSON SNYDER, EXAMINING ATTORNEY

**CLASS 41—(Continued).**

SN 85-256,968. CRICKETS CORP., SACRAMENTO, CA.  
FILED 3-3-2011.

**LOS ANGELES ROYALS**

THE MARK CONSISTS OF STANDARD CHARACTERS WITHOUT CLAIM TO ANY PARTICULAR FONT, STYLE, SIZE, OR COLOR.

NO CLAIM IS MADE TO THE EXCLUSIVE RIGHT TO USE "LOS ANGELES", APART FROM THE MARK AS SHOWN.

FOR ENTERTAINMENT SERVICES IN THE NATURE OF CONDUCTING PROFESSIONAL SPORTING EVENTS, NAMELY, CRICKET EXHIBITIONS, BASEBALL EXHIBITIONS, HOCKEY EXHIBITIONS, FOOTBALL EXHIBITIONS, BASKETBALL EXHIBITIONS; ENTERTAINMENT SERVICES IN THE FORM OF PROFESSIONAL CRICKET GAMES, PROFESSIONAL BASEBALL GAMES, PROFESSIONAL HOCKEY GAMES, PROFESSIONAL FOOTBALL GAMES AND PROFESSIONAL BASKETBALL GAMES; ENTERTAINMENT AND INFORMATION SERVICES, NAMELY, ORGANIZING AND CONDUCTING PROFESSIONAL SPORTING EVENTS, COMPETITIONS AND EXHIBITIONS RENDERED LIVE AND RECORDED FOR THE PURPOSE OF DISTRIBUTION THROUGH BROADCAST MEDIA INCLUDING TELEVISION AND RADIO AND VIA A GLOBAL COMPUTER NETWORK OR A COMMERCIAL ON-LINE SERVICE; PROVIDING INFORMATION IN THE FIELD OF PROFESSIONAL SPORTS AND ENTERTAINMENT; ENTERTAINMENT AND EDUCATIONAL SERVICES IN THE NATURE OF ONGOING TELEVISION AND RADIO PROGRAMS IN THE FIELD OF PROFESSIONAL PREVIOUSLY RECORDED AND LIVE SPORTING EVENTS, NAMELY, CRICKET GAMES, BASEBALL GAMES, FOOTBALL GAMES, HOCKEY GAMES AND BASKETBALL GAMES AND EXHIBITIONS; THE PRODUCTION AND DISTRIBUTION OF RADIO AND TELEVISION SHOWS FEATURING PROFESSIONAL CRICKET, BASEBALL, FOOTBALL, HOCKEY AND BASKETBALL GAMES; CONDUCTING AND ARRANGING CRICKET, BASEBALL, FOOTBALL, HOCKEY AND BASKETBALL CLINICS AND CAMPS, COACHES CLINICS AND CAMPS, DANCE TEAM CLINICS AND CAMPS; ENTERTAINMENT SERVICES IN THE NATURE OF PERSONAL APPEARANCES BY A COSTUMED MASCOT OR DANCE TEAM AT PROFESSIONAL BASKETBALL GAMES AND EXHIBITIONS, CLINICS, CAMPS, PROMOTIONS, AND OTHER PROFESSIONAL CRICKET, BASEBALL, FOOTBALL, HOCKEY AND BASKETBALL-RELATED EVENTS, SPECIAL EVENTS AND PARTIES; FAN CLUB SERVICES; ENTERTAINMENT SERVICES, NAMELY, PROVIDING A WEBSITE FEATURING NON-DOWNLOADABLE MULTIMEDIA MATERIAL IN THE NATURE OF VIDEO RECORDINGS, VIDEO STREAM RECORDINGS ALL FEATURING TELEVISION SPORTS HIGHLIGHTS AND INTERACTIVE TELEVISION SPORTS HIGHLIGHTS, INTERACTIVE VIDEO SPORTS HIGHLIGHT SELECTIONS, AND AUDIENCE RECORDINGS IN THE NATURE OF RADIO PROGRAMS, RADIO HIGHLIGHTS IN THE FIELD OF PROFESSIONAL CRICKET, BASEBALL, FOOTBALL, HOCKEY, BASKETBALL; PROVIDING NEWS AND INFORMATION IN THE NATURE OF PLAYER AND TEAM STATISTICS AND TRIVIA IN THE FIELD OF PROFESSIONAL CRICKET, BASEBALL, FOOTBALL, HOCKEY, BASKETBALL; ON-LINE NON-DOWNLOADABLE GAMES, NAMELY, COMPUTER GAMES, VIDEO GAMES, INTERACTIVE VIDEO

**CLASS 41—(Continued).**

GAMES, ACTION SKILL GAMES, ARCADE GAMES, ADULTS' AND CHILDREN'S PARTY GAMES, BOARD GAMES, PUZZLES, AND TRIVIA GAMES; ELECTRONIC PUBLISHING SERVICES, NAMELY, PUBLICATION OF MAGAZINES, GUIDES, NEWSLETTERS, COLORING BOOKS, AND GAME SCHEDULES OF OTHERS ON-LINE THROUGH THE INTERNET, ALL IN THE FIELD OF PROFESSIONAL BASKETBALL; PROVIDING AN ONLINE COMPUTER DATABASE IN THE FIELD OF PROFESSIONAL CRICKET, BASEBALL, FOOTBALL, HOCKEY BASKETBALL GAMES AND COMPETITIONS (U.S. CLS. 100, 101 AND 107).  
ELLEN PERKINS, EXAMINING ATTORNEY

SN 85-260,412. RAAK LLC, CHANDLER, AZ. FILED 3-7-2011.



THE MARK CONSISTS OF TWO STYLIZED RUNNERS FACING LEFT, IN FRONT OF A STYLIZED SUN AND ON TOP OF A CONVEX ARC. THE DESIGN OF A SOLID LINE APPEARS IN THE RUNNERS FROM THE CHEST DOWN TO THE RUNNERS' KNEES.

FOR ON-LINE JOURNALS, NAMELY, BLOGS FEATURING USER DEFINED CONTENT (U.S. CLS. 100, 101 AND 107).

GILBERT SWIFT, EXAMINING ATTORNEY

SN 85-260,749. ALBERE, PATRICIA D. DBA EVOLUTIONARY COLLECTIVE, BOULDER, CO. FILED 3-8-2011.



THE COLOR(S) ORANGE, YELLOW, GREEN, LIGHT BLUE, PURPLE IS/ARE CLAIMED AS A FEATURE OF THE MARK.

THE MARK CONSISTS OF WORDS "EVOLUTIONARY COLLECTIVE" IN ORANGE, FOUR CIRCLES TO LEFT WITH RAINBOW PATTERNS OF YELLOW, GREEN, ORANGE, LIGHT BLUE, PURPLE EXTENDING WITHIN.

FOR SOCIAL NETWORKING COURSES (U.S. CLS. 100, 101 AND 107).

FIRST USE 1-1-2007; IN COMMERCE 1-1-2007.

JOHN HWANG, EXAMINING ATTORNEY

**CLASS 41—(Continued).**

SN 85-262,688. LINDER, MAURICE B., WASHINGTON, DC. AND BROOKS, NORBERT D., WASHINGTON, DC. FILED 3-9-2011.

**S.M.I.L.E. Self Motivation  
& Inspiration of Life  
Experiences**

THE MARK CONSISTS OF STANDARD CHARACTERS WITHOUT CLAIM TO ANY PARTICULAR FONT, STYLE, SIZE, OR COLOR.

FOR PROVIDE ON-LINE RESOURCE GUIDES FOR THE COMMUNITY CONCERNING CHILDREN IN THE FIELDS OF EDUCATION, RECREATION, AND ENTERTAINMENT; PROVIDE EDUCATIONAL MENTORING, AND LIFE COACHING SERVICES; EDUCATIONAL COUNSELING SERVICES TO ASSIST STUDENTS IN PLANNING AND PREPARING FOR FURTHER EDUCATION; AND EDUCATION SERVICES, NAMELY, PROVIDING MOTIVATIONAL SPEAKING SERVICES, MENTORING, TUTORING, CLASSES, SEMINARS AND WORKSHOPS ALL IN THE FIELDS OF SELF-AWARENESS AND SELF-IMPROVEMENT (U.S. CLS. 100, 101 AND 107).

SKYE YOUNG, EXAMINING ATTORNEY

**CLASS 41—(Continued).**

SN 85-262,942. FRESH ONE PRODUCTIONS LIMITED, LONDON, UNITED KINGDOM, FILED 3-10-2011.

**DREAM SCHOOL**

THE MARK CONSISTS OF STANDARD CHARACTERS WITHOUT CLAIM TO ANY PARTICULAR FONT, STYLE, SIZE, OR COLOR.

FOR EDUCATIONAL AND ENTERTAINMENT SERVICES IN THE NATURE OF AN ON-GOING REALITY BASED TELEVISION PROGRAM DELIVERED BY TELEVISION, RADIO, SATELLITE, THE INTERNET, LIVE OR MOBILE COMMUNICATIONS; EDUCATIONAL AND ENTERTAINMENT SERVICES IN THE NATURE OF A CONTINUING OBSERVATIONAL DOCUMENTARY DELIVERED BY TELEVISION, RADIO, SATELLITE, THE INTERNET, LIVE OR MOBILE COMMUNICATIONS; ENTERTAINMENT SERVICES, NAMELY, PROVIDING DIGITIZED PRINT AND VISUAL INFORMATION ABOUT A TELEVISION SERIES FEATURING REALITY VIA A GLOBAL COMPUTER NETWORK (U.S. CLS. 100, 101 AND 107).

ODESSA BIBBINS, EXAMINING ATTORNEY

SN 85-262,834. HOMEAWAY.COM, INC., AUSTIN, TX. FILED 3-9-2011.



OWNER OF U.S. REG. NOS. 3,385,395, 3,596,173 AND 3,596,175.

THE MARK CONSISTS OF BLACK AND WHITE BIRD-HOUSE.

FOR PROVIDING ONLINE NEWSLETTERS FEATURING LODGING, TRAVEL INFORMATION, FEATURED DESTINATIONS, REVIEWS, AND OTHER INFORMATION RELATED TO LODGING AND TRAVEL PROVIDERS; CONDUCTING WORKSHOPS AND SEMINARS IN THE FIELD OF VACATION PROPERTY RENTAL (U.S. CLS. 100, 101 AND 107).

FIRST USE 7-12-2006; IN COMMERCE 7-12-2006.  
RON FAIRBANKS, EXAMINING ATTORNEY

SN 85-264,369. COMMUNICATE & NEGOTIATE, LLC, DBA PTCOURSES.COM, TEMPLE, TX. FILED 3-11-2011.



NO CLAIM IS MADE TO THE EXCLUSIVE RIGHT TO USE "PT COURSES.COM" AND "EST. 1996", APART FROM THE MARK AS SHOWN.

THE MARK CONSISTS OF A HUMAN FIGURE STRETCHING TO TOUCH TWO EDGES OF A SEMI-CIRCLE, TO THE RIGHT OF WHICH ARE THE WORDS "PT COURSES.COM" AND A CURVING LINE. BELOW THE "PT" ARE THE WORDS "EST. 1996".

FOR EDUCATIONAL SERVICES, NAMELY, DEVELOPING, ARRANGING AND CONDUCTING PROFESSIONAL WORKSHOPS, TRAINING, CONFERENCES, PROGRAMS, AND CONTINUING EDUCATION COURSES IN THE FIELDS OF CARE AND REHABILITATION; EDUCATIONAL SERVICES, NAMELY, PROVIDING TRAINING AT THE PROFESSIONAL OR CONTINUING EDUCATION LEVEL RELATED TO CARE AND REHABILITATION ON-LINE, VIA MAIL, AND VIA E-MAIL (U.S. CLS. 100, 101 AND 107).

FIRST USE 6-29-2011; IN COMMERCE 6-29-2011.  
PRISCILLA MILTON, EXAMINING ATTORNEY

**CLASS 41—(Continued).**

SN 85-264,779. PERFECT TUTORS, LLC, OVERLAND PARK, KS. FILED 3-11-2011.

## Perfect Tutors

THE MARK CONSISTS OF STANDARD CHARACTERS WITHOUT CLAIM TO ANY PARTICULAR FONT, STYLE, SIZE, OR COLOR.

NO CLAIM IS MADE TO THE EXCLUSIVE RIGHT TO USE "TUTORS", APART FROM THE MARK AS SHOWN.

FOR EDUCATION SERVICES, NAMELY, PROVIDING TUTORING IN THE FIELDS OF ELEMENTARY THROUGH HIGH SCHOOL SUBJECTS (U.S. CLS. 100, 101 AND 107).

FIRST USE 1-7-2011; IN COMMERCE 1-7-2011.  
RON FAIRBANKS, EXAMINING ATTORNEY

---

SN 85-266,409. GALLEGO COMMUNICATION AND MARKETING, LLC, ABERDEEN, NJ. FILED 3-14-2011.

## Toward0

THE MARK CONSISTS OF STANDARD CHARACTERS WITHOUT CLAIM TO ANY PARTICULAR FONT, STYLE, SIZE, OR COLOR.

FOR PROVIDING INFORMATION ABOUT THE GREEN AND ENVIRONMENTALLY-CONSCIOUS MOVEMENT, NAMELY, PROVIDING ON-LINE NEWSLETTERS AND AN INTERNET NEWS PORTAL FEATURING LINKS TO NEWS STORIES ALL IN THE FIELDS OF ENVIRONMENTALLY-CONSCIOUS AND GREEN PRODUCTS, SERVICES AND INVENTIONS (U.S. CLS. 100, 101 AND 107).

CHARISMA HAMPTON, EXAMINING ATTORNEY

---

SN 85-267,721. REMEMBER ALEX BROWN FOUNDATION, WELLMAN, TX. FILED 3-15-2011.

## REMEMBER ALEX BROWN

THE MARK CONSISTS OF STANDARD CHARACTERS WITHOUT CLAIM TO ANY PARTICULAR FONT, STYLE, SIZE, OR COLOR.

THE NAME(S), PORTRAIT(S), AND/OR SIGNATURE(S) SHOWN IN THE MARK DOES NOT IDENTIFY A PARTICULAR LIVING INDIVIDUAL.

FOR EDUCATIONAL SERVICES, NAMELY, CONDUCTING CLASSES, SEMINARS, CONFERENCES, WORKSHOPS, AND TRAINING COURSES IN THE FIELD OF PREVENTING TEXTING WHILE DRIVING AND DISTRIBUTION OF TRAINING MATERIAL IN CONNECTION THEREWITH (U.S. CLS. 100, 101 AND 107).

FIRST USE 11-15-2009; IN COMMERCE 11-15-2009.  
SUNG IN, EXAMINING ATTORNEY

**CLASS 41—(Continued).**

SN 85-267,756. CHEYENNE FRONTIER DAYS PROPERTIES, INC., CHEYENNE, WY. FILED 3-15-2011.

## Frontier Nights

THE MARK CONSISTS OF STANDARD CHARACTERS WITHOUT CLAIM TO ANY PARTICULAR FONT, STYLE, SIZE, OR COLOR.

FOR ARRANGING FOR TICKET RESERVATIONS FOR SHOWS AND OTHER ENTERTAINMENT EVENTS; ENTERTAINMENT IN THE NATURE OF AN ON-GOING SPECIAL VARIETY, NEWS, MUSIC OR COMEDY SHOW FEATURING GUEST APPEARANCES BY CELEBRITIES IN FRONT OF A LIVE AUDIENCE BROADCAST LIVE OR RECORDED VIA TELEVISION, SATELLITE, AUDIO, AND VIDEO MEDIA; ENTERTAINMENT SERVICES IN THE NATURE OF LIVE MUSICAL PERFORMANCES; ENTERTAINMENT SERVICES IN THE NATURE OF PRESENTING LIVE MUSICAL PERFORMANCES; ENTERTAINMENT, NAMELY, LIVE MUSIC CONCERTS; ENTERTAINMENT, NAMELY, LIVE PERFORMANCES BY A MUSICAL BAND; ENTERTAINMENT, NAMELY, LIVE PERFORMANCES BY MUSICAL BANDS; PRESENTATION OF LIVE COMEDY SHOWS; PROVIDING A WEBSITE FEATURING INFORMATION IN THE FIELD OF MUSIC AND ENTERTAINMENT (U.S. CLS. 100, 101 AND 107).

FIRST USE 9-8-1999; IN COMMERCE 9-8-1999.  
SUNG IN, EXAMINING ATTORNEY

---

SN 85-270,159. CHRISTINA AROKIASAMY, KENT, WA. FILED 3-17-2011.

## THE SPICE MERCHANT'S DAUGHTER

THE MARK CONSISTS OF STANDARD CHARACTERS WITHOUT CLAIM TO ANY PARTICULAR FONT, STYLE, SIZE, OR COLOR.

FOR EDUCATIONAL SERVICES, NAMELY, INSTRUCTION IN THE NATURE OF CLASSES, COURSES, AND DEMONSTRATIONS IN THE FIELD OF CULINARY ARTS (U.S. CLS. 100, 101 AND 107).

LINDA POWELL, EXAMINING ATTORNEY

**CLASS 41—(Continued).**

SN 85-270,472. SACCA TONY J, LAS VEGAS, NV. FILED 3-18-2011.

## Vegas The Story

THE MARK CONSISTS OF STANDARD CHARACTERS WITHOUT CLAIM TO ANY PARTICULAR FONT, STYLE, SIZE, OR COLOR.

NO CLAIM IS MADE TO THE EXCLUSIVE RIGHT TO USE "VEGAS", APART FROM THE MARK AS SHOWN.

FOR ENTERTAINMENT SERVICES, NAMELY, PRODUCTION OF LIVE VARIETY, STAGE, AND THEATER SHOWS, PRODUCTION OF LIVE MUSICAL CONCERTS; ENTERTAINMENT SERVICES, NAMELY, THE PROVISION OF CONTINUING SHOWS FEATURING COMEDY AND MUSIC DELIVERED BY THE INTERNET OR LIVE (U.S. CLS. 100, 101 AND 107).

KIMBERLY FRYE, EXAMINING ATTORNEY

**CLASS 41—(Continued).**

SN 85-270,625. MARVEL CHARACTERS, INC., MANHATTAN BEACH, CA. FILED 3-18-2011.

## MARVEL ARCADE

THE MARK CONSISTS OF STANDARD CHARACTERS WITHOUT CLAIM TO ANY PARTICULAR FONT, STYLE, SIZE, OR COLOR.

OWNER OF U.S. REG. NOS. 1,741,813, 3,602,028 AND OTHERS.

NO CLAIM IS MADE TO THE EXCLUSIVE RIGHT TO USE "ARCADE", APART FROM THE MARK AS SHOWN.

FOR ENTERTAINMENT SERVICES, NAMELY, PROVIDING ON-LINE INTERACTIVE COMPUTER GAME OVER AN ELECTRONIC NETWORK FOR USE NETWORK-WIDE BY NETWORK USERS; PROVIDING ON-LINE COMPUTER GAMES; PROVIDING WEBSITES IN THE FIELD OF ENTERTAINMENT RELATING TO COMIC BOOKS AND VIDEO GAMES; PROVIDING NEWS AND INFORMATION IN THE FIELD OF ENTERTAINMENT RELATING TO COMIC BOOKS AND VIDEO GAMES OVER AN ELECTRONIC NETWORK (U.S. CLS. 100, 101 AND 107).

WILLIAM VERHOSEK, EXAMINING ATTORNEY

SN 85-270,566. JASMIN, RICHARD, HOMESTEAD, FL. FILED 3-18-2011.

## PRINSIP

THE MARK CONSISTS OF STANDARD CHARACTERS WITHOUT CLAIM TO ANY PARTICULAR FONT, STYLE, SIZE, OR COLOR.

THE ENGLISH TRANSLATION OF THE WORD "PRINSIP" IN THE MARK IS GOOD MANNERS.

FOR ENTERTAINMENT SERVICES IN THE NATURE OF LIVE MUSICAL PERFORMANCES (U.S. CLS. 100, 101 AND 107).

DAVID COLLIER, EXAMINING ATTORNEY

SN 85-271,351. ALEXANDER, JOSEPH, RALEIGH, NC. FILED 3-18-2011.



THE MARK CONSISTS OF THE WORDING "URBAN SPIDER" WITH THE DESIGN OF A SPIDER APPEARING BETWEEN THE WORDS.

FOR PHYSICAL FITNESS CONSULTATION; PHYSICAL FITNESS INSTRUCTION (U.S. CLS. 100, 101 AND 107).

FIRST USE 6-9-2010; IN COMMERCE 6-10-2010.  
MARTHA FROMM, EXAMINING ATTORNEY

**CLASS 41—(Continued).**

SN 85-274,475. CASEY RESEARCH, LLC, ASPEN, CO. FILED 3-23-2011.

**CASEY RESEARCH**

THE MARK CONSISTS OF STANDARD CHARACTERS WITHOUT CLAIM TO ANY PARTICULAR FONT, STYLE, SIZE, OR COLOR.

NO CLAIM IS MADE TO THE EXCLUSIVE RIGHT TO USE "RESEARCH", APART FROM THE MARK AS SHOWN. FOR PROVIDING ON-LINE PUBLICATIONS IN THE NATURE OF NEWSLETTERS IN THE FIELD OF FINANCIAL INVESTMENT, FINANCIAL ANALYSIS, GLOBAL FINANCIAL TRENDS, GEOPOLITICAL ISSUES, NATURAL RESOURCES AND EMERGING INVESTMENT OPPORTUNITIES (U.S. CLS. 100, 101 AND 107).

FIRST USE 4-1-2004; IN COMMERCE 4-1-2004.  
JOSETTE BEVERLY, EXAMINING ATTORNEY

**CLASS 41—(Continued).**

SN 85-277,000. ART & SOUL PRODUCTIONS, LLC, BOULDER, CO. FILED 3-25-2011.

**THE WHEEL OF CREATIVITY**

THE MARK CONSISTS OF STANDARD CHARACTERS WITHOUT CLAIM TO ANY PARTICULAR FONT, STYLE, SIZE, OR COLOR.

NO CLAIM IS MADE TO THE EXCLUSIVE RIGHT TO USE "CREATIVITY", APART FROM THE MARK AS SHOWN.

FOR EDUCATIONAL SERVICES, NAMELY, CONDUCTING CLASSES, SEMINARS, RETREATS, AND LECTURES IN THE FIELDS OF PERSONAL IMPROVEMENT, DEVELOPMENT AND EMPOWERMENT, SPIRITUALITY, AND SELF-HELP; ONLINE JOURNALS, NAMELY, BLOGS CONCERNING PERSONAL IMPROVEMENT, DEVELOPMENT AND EMPOWERMENT, SPIRITUALITY, AND SELF-HELP (U.S. CLS. 100, 101 AND 107).

FIRST USE 6-1-2010; IN COMMERCE 6-1-2010.  
KATHLEEN M. VANSTON, EXAMINING ATTORNEY

SN 85-276,917. CHEYENNE FRONTIER DAYS PROPERTIES, INC, CHEYENNE, WY. FILED 3-25-2011.

**Cheyenne Frontier Nights**

THE MARK CONSISTS OF STANDARD CHARACTERS WITHOUT CLAIM TO ANY PARTICULAR FONT, STYLE, SIZE, OR COLOR.

NO CLAIM IS MADE TO THE EXCLUSIVE RIGHT TO USE "CHEYENNE", APART FROM THE MARK AS SHOWN. FOR ARRANGING AND CONDUCTING SPECIAL EVENTS FOR SOCIAL ENTERTAINMENT PURPOSES; ARRANGING FOR TICKET RESERVATIONS FOR SHOWS AND OTHER ENTERTAINMENT EVENTS; ENTERTAINMENT SERVICES IN THE NATURE OF LIVE MUSICAL PERFORMANCES; ENTERTAINMENT SERVICES IN THE NATURE OF PRESENTING LIVE MUSICAL PERFORMANCES; ENTERTAINMENT, NAMELY, LIVE MUSIC CONCERTS; ENTERTAINMENT, NAMELY, LIVE PERFORMANCES BY MUSICAL BANDS (U.S. CLS. 100, 101 AND 107).

FIRST USE 7-1-1993; IN COMMERCE 1-1-2011.  
SUNG IN, EXAMINING ATTORNEY

SN 85-277,489. ART & SOUL PRODUCTIONS, LLC, BOULDER, CO. FILED 3-25-2011.

**THE WHEEL OF CREATIVITY**

THE MARK CONSISTS OF STANDARD CHARACTERS WITHOUT CLAIM TO ANY PARTICULAR FONT, STYLE, SIZE, OR COLOR.

NO CLAIM IS MADE TO THE EXCLUSIVE RIGHT TO USE "CREATIVITY", APART FROM THE MARK AS SHOWN.

FOR EDUCATIONAL AND ENTERTAINMENT SERVICES, NAMELY, PROVIDING WEBINARS, WEBCASTS, CONTINUING RADIO PROGRAMS, PODCASTS, REALITY TELEVISION SERIES, AND AUDIO AND VIDEO PODCASTS FEATURING DOCUMENTARIES, ALL IN THE FIELDS OF PERSONAL IMPROVEMENT AND EMPOWERMENT, SPIRITUALITY AND SELF-HELP (U.S. CLS. 100, 101 AND 107).

KATHLEEN M. VANSTON, EXAMINING ATTORNEY



**CLASS 41—(Continued).**

SN 85-279,370. PLAY PLANET, LLC, TITUSVILLE, FL. FILED 3-29-2011.



THE COLOR(S) BLUE, GREEN, TAN, ORANGE, YELLOW, AND BLACK IS/ARE CLAIMED AS A FEATURE OF THE MARK.

THE MARK CONSISTS OF BLUE AND GREEN GLOBE, A BOY'S HEAD WITH TAN SKIN AND ORANGE HAIR, A GIRL WITH TAN SKIN AND YELLOW HAIR, AND THE WORDING "PLAYPLANET" IN YELLOW. THE BOY, GIRL, AND WORDING ARE OUTLINED IN BLACK. THE COLOR WHITE APPEARS AS SHADING AND IS NOT PART OF THE MARK.

FOR CHILDREN'S ENTERTAINMENT AND AMUSEMENT CENTERS, NAMELY, INTERACTIVE PLAY AREAS (U.S. CLS. 100, 101 AND 107).

FIRST USE 11-12-2010; IN COMMERCE 2-4-2011.

PAUL MORENO, EXAMINING ATTORNEY

**CLASS 41—(Continued).**

SN 85-282,590. IRBY, JOYCE, JONESBORO, GA. FILED 3-31-2011.

# The Sing Bling

THE MARK CONSISTS OF STANDARD CHARACTERS WITHOUT CLAIM TO ANY PARTICULAR FONT, STYLE, SIZE, OR COLOR.

NO CLAIM IS MADE TO THE EXCLUSIVE RIGHT TO USE "SING", APART FROM THE MARK AS SHOWN.

FOR ENTERTAINMENT SERVICES IN THE NATURE OF A CONTINUING TELEVISION TALENT SHOW (U.S. CLS. 100, 101 AND 107).

DAWN HAN, EXAMINING ATTORNEY

SN 85-284,092. BILINGUAL BUDS, LLC, MAPLEWOOD, NJ. FILED 4-1-2011.



OWNER OF U.S. REG. NO. 3,198,283. NO CLAIM IS MADE TO THE EXCLUSIVE RIGHT TO USE "BILINGUAL" AND "IMMERSION SCHOOL FOR CHILDREN" AND "EST. 2005" AND "MANDARIN CHINESE" AND THE CHARACTERS WHICH TRANSLITERATE TO "MANDARIN CHINESE", APART FROM THE MARK AS SHOWN.

THE COLOR(S) GREEN, YELLOW, WHITE, PINKISH-WHITE DARK BROWN, BROWN, LIGHT BROWN AND RED IS/ARE CLAIMED AS A FEATURE OF THE MARK.

THE MARK CONSISTS OF THE WORDS "BILINGUAL BUDS IMMERSION SCHOOL FOR CHILDREN EST. 2005" WITHIN THREE CONCENTRIC CIRCLES. THE TERMS "BILINGUAL BUDS" ARE ARCHED ON THE TOP OF THE MARK WITHIN THE MAIN CIRCLE AND THE TERMS "IMMERSION SCHOOL FOR CHILDREN" ARE ARCHED UPWARD FROM THE BOTTOM OF THE MAIN CIRCLE. THE TERMS "EST. 2005" ARE CENTERED ON THE BOTTOM OF THE MAIN CIRCLE. ALL THE WORDING IS IN GREEN AND THE THREE CONCENTRIC CIRCLES OUTLINES ARE IN GREEN. THE WORDS "MANDARIN CHINESE" AND THE CORRESPONDING CHINESE CHARACTERS ARE ALL GREEN AND ARE CENTERED AT THE BASE OF THE MARK UNDER THE CIRCLES, WITH THE CHINESE CHARACTERS CENTERED UNDER THE WORDS "MANDARIN CHINESE". THE AREA BETWEEN

SN 85-282,579. IRBY, JOYCE, JONESBORO, GA. FILED 3-31-2011.

# America's Next Teen Superstar

THE MARK CONSISTS OF STANDARD CHARACTERS WITHOUT CLAIM TO ANY PARTICULAR FONT, STYLE, SIZE, OR COLOR.

NO CLAIM IS MADE TO THE EXCLUSIVE RIGHT TO USE "AMERICA'S" OR "TEEN", APART FROM THE MARK AS SHOWN.

FOR ENTERTAINMENT SERVICES IN THE NATURE OF A CONTINUING TELEVISION TALENT SHOW (U.S. CLS. 100, 101 AND 107).

DAWN HAN, EXAMINING ATTORNEY

**CLASS 41—(Continued).**

THE TWO OUTER CONCENTRIC CIRCLES IS YELLOW AND THE AREA IN THE MIDDLE OF THE INNER CONCENTRIC CIRCLE IS WHITE. IN THE MIDDLE OF THE INNER CIRCLE ARE TWO STEMS IN GREEN, WITH THE FACE OF A GIRL ON THE TOP OF THE LEFT STEM. THE GIRL'S FACE IS PINKISH-WHITE WITH DARK BROWN HAIR, BROWN EYES AND RED LIPS. THERE IS A FACE OF A BOY ON THE TOP OF THE RIGHT STEM. THE BOY'S FACE IS PINKISH-WHITE WITH LIGHT BROWN HAIR, BROWN EYES AND RED LIPS.

THE ENGLISH TRANSLATION OF THE CHINESE CHARACTERS IN THE MARK IS "MANDARIN CHINESE".

THE NON-LATIN CHARACTERS IN THE MARK TRANSLITERATE TO ZHONG WEN PU TONG WHA AND THIS MEANS "MANDARIN CHINESE" IN ENGLISH.

FOR EDUCATIONAL SERVICES, NAMELY, EARLY CHILDHOOD DEVELOPMENT, ELEMENTARY SCHOOL AND AFTER SCHOOL CLASSES IN THE FIELDS OF LANGUAGE, MATH, SPELLING, READING, AND WRITING (U.S. CLS. 100, 101 AND 107).

FIRST USE 6-0-2009; IN COMMERCE 6-0-2009.

PAULA MAHONEY, EXAMINING ATTORNEY

---

SN 85-285,217. MANSFIELD, TANICK & COHEN, P.A., MINNEAPOLIS, MN. FILED 4-4-2011.

**WORKPLACE WATCH**

THE MARK CONSISTS OF STANDARD CHARACTERS WITHOUT CLAIM TO ANY PARTICULAR FONT, STYLE, SIZE, OR COLOR.

NO CLAIM IS MADE TO THE EXCLUSIVE RIGHT TO USE "WORKPLACE", APART FROM THE MARK AS SHOWN.

FOR EMPLOYMENT-RELATED COUNSELING SERVICES AND RESOURCES, NAMELY, PROVIDING ONLINE NEWSLETTERS, TRAINING AND SEMINARS RELATED TO EMPLOYMENT AND WORK PLACE ISSUES (U.S. CLS. 100, 101 AND 107).

FIRST USE 4-0-1997; IN COMMERCE 4-0-1997.

ELIZABETH KAJUBI, EXAMINING ATTORNEY

---

SN 85-285,840. WORTH THE HURT, INC., SAN FRANCISCO, CA. FILED 4-4-2011.

**WORTH THE HURT**

THE MARK CONSISTS OF STANDARD CHARACTERS WITHOUT CLAIM TO ANY PARTICULAR FONT, STYLE, SIZE, OR COLOR.

FOR ORGANIZING SPORTING EVENTS, NAMELY, FOOT RACES; ENTERTAINMENT SERVICES, NAMELY, ORGANIZING AND CONDUCTING RUNNING AND WALKING EVENTS FOR ADULTS AND CHILDREN; PROVIDING ENTERTAINMENT IN THE FORM OF ONLINE ADVICE IN THE AREA OF SPORTS TRAINING, SPECIFICALLY RUNNING, MARATHON TRAINING AND RELATED AREAS (U.S. CLS. 100, 101 AND 107).

FIRST USE 11-0-2009; IN COMMERCE 11-0-2009.

MARK PILARO, EXAMINING ATTORNEY

**CLASS 41—(Continued).**

SN 85-285,874. BEST LITTLE SITES, LLC, OREM, UT. FILED 4-4-2011.

**ComicBookMovie.com**

THE MARK CONSISTS OF STANDARD CHARACTERS WITHOUT CLAIM TO ANY PARTICULAR FONT, STYLE, SIZE, OR COLOR.

SEC. 2(F).

FOR PROVIDING A WEBSITE FEATURING INFORMATION, NEWS AND COMMENTARY IN THE FIELD OF ENTERTAINMENT (U.S. CLS. 100, 101 AND 107).

FIRST USE 1-25-2003; IN COMMERCE 1-25-2003.

CIMMERIAN COLEMAN, EXAMINING ATTORNEY

---

SN 85-286,954. CENTRAL WASHINGTON UNIVERSITY, ELLENSBURG, WA. FILED 4-5-2011.

**CENTRAL WASHINGTON UNIVERSITY**

THE MARK CONSISTS OF STANDARD CHARACTERS WITHOUT CLAIM TO ANY PARTICULAR FONT, STYLE, SIZE, OR COLOR.

OWNER OF U.S. REG. NOS. 2,544,320 AND 3,623,504.

NO CLAIM IS MADE TO THE EXCLUSIVE RIGHT TO USE "UNIVERSITY", APART FROM THE MARK AS SHOWN.

SEC. 2(F).

FOR EDUCATIONAL SERVICES, NAMELY, PROVIDING COURSES OF INSTRUCTION AT THE UNIVERSITY LEVEL (U.S. CLS. 100, 101 AND 107).

FIRST USE 0-0-1977; IN COMMERCE 0-0-1977.

WANDA KAY PRICE, EXAMINING ATTORNEY

---

SN 85-288,627. VICKERS, LARRY A., FAYETTEVILLE, NC. FILED 4-7-2011.

**VICKERS TACTICAL**

THE MARK CONSISTS OF STANDARD CHARACTERS WITHOUT CLAIM TO ANY PARTICULAR FONT, STYLE, SIZE, OR COLOR.

NO CLAIM IS MADE TO THE EXCLUSIVE RIGHT TO USE "TACTICAL", APART FROM THE MARK AS SHOWN.

FOR DEVELOPING TRAINING SYSTEMS FOR OTHERS; TRAINING IN THE USE AND OPERATION OF FIREARMS; TRAINING SERVICES IN THE FIELD OF TECHNIQUES FOR USE OF FIREARMS; CONDUCTING CLASSES AND COURSES IN SAFE AND PROFICIENT USE OF FIREARMS (U.S. CLS. 100, 101 AND 107).

FIRST USE 5-0-2007; IN COMMERCE 5-0-2007.

JOSETTE BEVERLY, EXAMINING ATTORNEY

**CLASS 41—(Continued).**

SN 85-288,909. ROBERTS, CLAIRE, CENTENNIAL, WY. FILED 4-7-2011.



NO CLAIM IS MADE TO THE EXCLUSIVE RIGHT TO USE "BEST 303 SOUNDS", APART FROM THE MARK AS SHOWN.

THE STIPLING IS FOR SHADING PURPOSES ONLY. THE PORTRAIT IN THE MARK IDENTIFIES "CLAIRE ROBERTS", A LIVING INDIVIDUAL WHOSE CONSENT IS OF RECORD.

THE MARK CONSISTS OF THE STYLIZED TEXT "BEST 303 SOUNDS" AND PART OF THE FACE OF A FEMALE IN THE BACKGROUND. ALL ELEMENTS OF THE MARK ARE SHOWN WITHIN A SQUARE.

FOR ENTERTAINMENT SERVICES, NAMELY, PROVIDING NONDOWNLOADABLE PRERECORDED MUSIC, INFORMATION IN THE FIELD OF MUSIC, AND COMMENTARY AND ARTICLES ABOUT MUSIC, ALL ON-LINE VIA A GLOBAL COMPUTER NETWORK (U.S. CLS. 100, 101 AND 107).  
LINDA ESTRADA, EXAMINING ATTORNEY

SN 85-289,554. YELLOWSTONE LANGUAGE INSTITUTE LLC, TEN SLEEP, WY. FILED 4-7-2011.

**YELLOWSTONE LANGUAGE  
INSTITUTE**

THE MARK CONSISTS OF STANDARD CHARACTERS WITHOUT CLAIM TO ANY PARTICULAR FONT, STYLE, SIZE, OR COLOR.

NO CLAIM IS MADE TO THE EXCLUSIVE RIGHT TO USE "LANGUAGE INSTITUTE", APART FROM THE MARK AS SHOWN.

FOR EDUCATIONAL SERVICES, NAMELY, CONDUCTING ON-LINE PROGRAMS IN THE FIELD OF LANGUAGE INSTRUCTION, NAMELY, ENGLISH (U.S. CLS. 100, 101 AND 107).

FIRST USE 6-3-2010; IN COMMERCE 6-3-2010.  
MICHAEL SOUDERS, EXAMINING ATTORNEY

**CLASS 41—(Continued).**

SN 85-289,812. FUSION MASSAGE & WELLNESS, BARTLESVILLE, OK. FILED 4-8-2011.

**GET FIT BARTLESVILLE**

THE MARK CONSISTS OF STANDARD CHARACTERS WITHOUT CLAIM TO ANY PARTICULAR FONT, STYLE, SIZE, OR COLOR.

NO CLAIM IS MADE TO THE EXCLUSIVE RIGHT TO USE "BARTLESVILLE", APART FROM THE MARK AS SHOWN.

FOR EDUCATIONAL SERVICES, NAMELY, PROVIDING CLASSES IN THE FIELD OF NUTRITION AND WELLNESS; PROVIDING GROUP COACHING IN THE FIELD OF NUTRITION (U.S. CLS. 100, 101 AND 107).

MICHAEL KEATING, EXAMINING ATTORNEY

SN 85-290,414. THE TRAVEL CHANNEL, L.L.C., CHEVY CHASE, MD. FILED 4-8-2011.

**SAND MASTERS**

THE MARK CONSISTS OF STANDARD CHARACTERS WITHOUT CLAIM TO ANY PARTICULAR FONT, STYLE, SIZE, OR COLOR.

NO CLAIM IS MADE TO THE EXCLUSIVE RIGHT TO USE "SAND", APART FROM THE MARK AS SHOWN.

FOR ENTERTAINMENT SERVICES IN THE NATURE OF A CONTINUING NON-FICTION PROGRAM ABOUT RUNNING A BUSINESS, TRAVELLING THE WORLD, INTERPERSONAL RELATIONSHIPS AND THE CONSTRUCTION OF SCULPTURES AND ARCHITECTURAL STRUCTURES MADE OF SAND FOR OTHERS, ACCESSIBLE BY RADIO, TELEVISION, CABLE, FIBER OPTIC NETWORKS, WIRELESS NETWORKS, SATELLITE, AUDIO VIDEO, AND COMPUTER NETWORKS (U.S. CLS. 100, 101 AND 107).

DAVID I, EXAMINING ATTORNEY

SN 85-293,351. SHARK EATING DOG, LLC, LOS ANGELES, CA. FILED 4-12-2011.

**TROUBLEMAKERS**

THE MARK CONSISTS OF THE STYLIZED WORDS "TROUBLEMAKERS".

FOR FAN CLUBS (U.S. CLS. 100, 101 AND 107).

FIRST USE 7-4-2010; IN COMMERCE 7-4-2010.

BRENDAN REGAN, EXAMINING ATTORNEY

**CLASS 41—(Continued).**

SN 85-294,587. SOUTHWESTERN UNIVERSITY, GEORGETOWN, TX. FILED 4-13-2011.

# NITLE

THE MARK CONSISTS OF STANDARD CHARACTERS WITHOUT CLAIM TO ANY PARTICULAR FONT, STYLE, SIZE, OR COLOR.

FOR EDUCATIONAL SERVICES, NAMELY, CONDUCTING CONFERENCES AND TRAINING DEALING WITH THE SUBJECT OF USING TECHNOLOGY EFFECTIVELY TO FURTHER UNDERGRADUATE EDUCATION AT COLLEGES, UNIVERSITIES AND EDUCATIONAL ORGANIZATIONS (U.S. CLS. 100, 101 AND 107).

FIRST USE 6-1-2002; IN COMMERCE 6-1-2002.  
ALEX KEAM, EXAMINING ATTORNEY

---

SN 85-295,320. UTGR, INC., LINCOLN, RI. FILED 4-14-2011.



NO CLAIM IS MADE TO THE EXCLUSIVE RIGHT TO USE "CASINO", APART FROM THE MARK AS SHOWN.

THE COLOR(S) GREEN AND BLUE IS/ARE CLAIMED AS A FEATURE OF THE MARK.

THE MARK CONSISTS OF THE WORD "TWIN" IN GREEN ABOVE AND TO THE LEFT OF THE WORD "RIVER". THE LETTER "I" IN "TWIN" IS REPLACED WITH A BLUE WAVY VERTICAL LINE THAT EXTENDS ABOVE AND BELOW THE WORD "TWIN". THE WORD "RIVER" IN BLUE BELOW THE WORD "TWIN" BEGINNING BENEATH THE LETTER "W" IN THE WORD "TWIN". THE LETTER "I" IN "RIVER" IS REPLACED WITH A GREEN WAVY VERTICAL LINE THAT EXTENDS ABOVE AND BELOW THE WORD "RIVER". THE WORD "CASINO" IN GREEN IN SMALLER FONT THAN THE FONT USED FOR THE WORDS "TWIN RIVER" BEGINS BELOW THE WORD "RIVER", BEGINNING BENEATH AND TO THE RIGHT OF THE WAVY GREEN LINE CONSTITUTING THE "I" IN THE WORD "RIVER" ABOVE. A BLUE LINE UNDERSCORES THE WORD "CASINO" BEGINNING BENEATH THE FIRST LETTER OF THE WORD "TWIN" AND ENDING AT THE END OF THE WORD "CASINO". THE WORDS "SO MUCH. SO CLOSE!" IN BLUE ARE UNDER THE BLUE LINE.

FOR PARI-MUTUEL BETTING AND WAGERING SERVICES; LOTTERY SERVICES, NAMELY, VIDEO LOTTERY SERVICES, CASINO GAMING AND GAMBLING SERVICES; ENTERTAINMENT SERVICES, NAMELY, ARRANGING AND CONDUCTING EXHIBITIONS AND COMPETITIONS IN GAMES OF CHANCE, PRODUCTION OF LIVE MUSICAL, ATHLETIC AND DANCE PERFORMANCES; NIGHT CLUB SERVICES; LIVE MUSIC CONCERTS; SPECIAL EVENT PLANNING FOR SOCIAL ENTERTAINMENT PURPOSES; COMEDY CLUB SERVICES (U.S. CLS. 100, 101 AND 107).

FIRST USE 4-16-2009; IN COMMERCE 4-16-2009.  
MATTHEW KLINE, EXAMINING ATTORNEY

**CLASS 41—(Continued).**

SN 85-295,694. CHRISTELLE CHOPARD, DBA DHARMI / LIFE CREATION INC., MIAMI, FL. FILED 4-14-2011.

# DHARMI Yoga

THE MARK CONSISTS OF STANDARD CHARACTERS WITHOUT CLAIM TO ANY PARTICULAR FONT, STYLE, SIZE, OR COLOR.

OWNER OF U.S. REG. NO. 3,741,845.  
NO CLAIM IS MADE TO THE EXCLUSIVE RIGHT TO USE "YOGA", APART FROM THE MARK AS SHOWN.

FOR YOGA INSTRUCTION (U.S. CLS. 100, 101 AND 107).

FIRST USE 3-10-2011; IN COMMERCE 3-10-2011.  
DAWN HAN, EXAMINING ATTORNEY

---

SN 85-296,224. M3 MEDIA, INC., CARSON CITY, NV. FILED 4-15-2011.



THE MARK CONSISTS OF THE LETTER "M" ON THE SURFACE OF THREE SIDES OF A SQUARE BOX ABOVE THE WORD "MILLENNIUM".

FOR DISTRIBUTION OF MOTION PICTURE FILMS; MOTION PICTURE FILM PRODUCTION; MOTION PICTURE SONG PRODUCTION; PRODUCTION AND DISTRIBUTION OF MOTION PICTURES (U.S. CLS. 100, 101 AND 107).

FIRST USE 3-1-2011; IN COMMERCE 3-1-2011.  
ROBIN MITTLER, EXAMINING ATTORNEY

**CLASS 41—(Continued).**

SN 85-298,156. BATTILLO, PATRICK, TEMPE, AZ. FILED 4-18-2011.



THE STIPPLING IS FOR SHADING PURPOSES ONLY.  
THE NAME "MR. ORNG" IS THE PSEUDONYM OF PATRICK JASON BATTILLO AND IDENTIFIES A LIVING INDIVIDUAL WHOSE CONSENT IS OF RECORD.  
THE MARK CONSISTS OF A PERSON WEARING A HEAD BAND WITH THE STYLIZED TEXT "MR. ORNG". HE IS HOLDING A BALL AND THE STYLIZED TEXT "MR. ORNG" APPEARS BELOW.  
FOR ENTERTAINMENT IN THE NATURE OF LIVE PERFORMANCES BY PROFESSIONAL ENTERTAINER (U.S. CLS. 100, 101 AND 107).  
FIRST USE 5-18-2010; IN COMMERCE 5-24-2010.  
ANDREA HACK, EXAMINING ATTORNEY

SN 85-298,159. BARSHOTZ, INC, TORRANCE, CA. FILED 4-18-2011.

THE MARK CONSISTS OF THE STYLIZED TEXT "BARSHOTZ" WITH A CAMERA LENS IN PLACE OF THE LETTER "O".  
FOR ENTERTAINMENT SERVICES, NAMELY, PROVIDING A WEBSITE FEATURING NON-DOWNLOADABLE PHOTOGRAPHS OF BARS AND PATRONS (U.S. CLS. 100, 101 AND 107).  
FIRST USE 1-15-2011; IN COMMERCE 1-15-2011.  
JENNIFER VASQUEZ, EXAMINING ATTORNEY

**CLASS 41—(Continued).**

SN 85-299,635. THERAPEEDS, INC., DAVIE, FL. FILED 4-20-2011.

**FUNNER SCHOOL**

THE MARK CONSISTS OF STANDARD CHARACTERS WITHOUT CLAIM TO ANY PARTICULAR FONT, STYLE, SIZE, OR COLOR.

NO CLAIM IS MADE TO THE EXCLUSIVE RIGHT TO USE "SCHOOL", APART FROM THE MARK AS SHOWN, FOR EDUCATION SERVICES, NAMELY, A SUMMER CAMP FOR CHILDREN WITH SPECIAL NEEDS (U.S. CLS. 100, 101 AND 107).

FIRST USE 3-0-2010; IN COMMERCE 3-0-2010.  
GRETTA YAO, EXAMINING ATTORNEY

SN 85-299,688. GANDLEY, STEPHEN, HACKETTSTOWN, NJ. FILED 4-20-2011.

**Legacy In Lyrics**

THE MARK CONSISTS OF STANDARD CHARACTERS WITHOUT CLAIM TO ANY PARTICULAR FONT, STYLE, SIZE, OR COLOR.

FOR CUSTOM WRITING SERVICES, NAMELY, ASSISTING OTHERS IN WRITING NARRATIVES ABOUT THE IMPORTANCE OF A PARTICULAR SELECTION OF SONGS IN THEIR LIFETIME; CONSULTATION AND ADVICE REGARDING MUSICAL SELECTIONS FOR SOUND RECORDINGS; AUDIO RECORDING AND PRODUCTION (U.S. CLS. 100, 101 AND 107).

AMY KERTGATE, EXAMINING ATTORNEY

SN 85-300,001. JOAN SINGER, NEW YORK, NY. FILED 4-20-2011.

**BICYCLE SPANISH**

THE MARK CONSISTS OF STANDARD CHARACTERS WITHOUT CLAIM TO ANY PARTICULAR FONT, STYLE, SIZE, OR COLOR.

NO CLAIM IS MADE TO THE EXCLUSIVE RIGHT TO USE "SPANISH", APART FROM THE MARK AS SHOWN.

FOR SPANISH LANGUAGE INSTRUCTION (U.S. CLS. 100, 101 AND 107).  
STEVEN R. FINE, EXAMINING ATTORNEY

**CLASS 41—(Continued).**

SN 85-300,103. BIG SUR FOOD AND WINE FESTIVAL, LLC, BIG SUR, CA. FILED 4-20-2011.



NO CLAIM IS MADE TO THE EXCLUSIVE RIGHT TO USE "BIG SUR FOOD & WINE FESTIVAL", APART FROM THE MARK AS SHOWN.

THE COLOR(S) PURPLE AND BLACK IS/ARE CLAIMED AS A FEATURE OF THE MARK.

THE MARK CONSISTS OF A STYLIZED WINE GLASS OUTLINED IN BLACK WITH PURPLE WINE SPILLING FROM THE SIDE OF THE GLASS INTO THE SHAPE OF MOUNTAINS, AND THE WORDS "BIG SUR" IN BLACK APPEARING ABOVE THE WORDS "FOOD & WINE FESTIVAL" IN BLACK.

FOR ENTERTAINMENT SERVICES, NAMELY, CONDUCTING ENTERTAINMENT EXHIBITIONS IN THE NATURE OF FOOD AND WINE FESTIVALS (U.S. CLS. 100, 101 AND 107).

FIRST USE 3-0-2009; IN COMMERCE 3-0-2009.  
TARA PATE, EXAMINING ATTORNEY

SN 85-300,781. JANET SCLAROFF, CHERRY HILL, NJ. FILED 4-21-2011.

**SONNY MAXWELL THEATER**

THE MARK CONSISTS OF STANDARD CHARACTERS WITHOUT CLAIM TO ANY PARTICULAR FONT, STYLE, SIZE, OR COLOR.

NO CLAIM IS MADE TO THE EXCLUSIVE RIGHT TO USE "THEATER", APART FROM THE MARK AS SHOWN.

THE NAME(S), PORTRAIT(S), AND/OR SIGNATURE(S) SHOWN IN THE MARK DOES NOT IDENTIFY A PARTICULAR LIVING INDIVIDUAL.

FOR EDUCATION AND ENTERTAINMENT SERVICES, NAMELY, PRODUCTION OF THEATRICAL PERFORMANCES AND PRODUCTION OF TELEVISION PROGRAMS; PRODUCTION OF DVDS AND VIDEOS FEATURING THEATRICAL PERFORMANCES (U.S. CLS. 100, 101 AND 107).

MARC LEIPZIG, EXAMINING ATTORNEY

**CLASS 41—(Continued).**

SN 85-301,129. BREATH OF LIFE RECORDS, LLC, VAN NUYS, CA. FILED 4-21-2011.

**Breath of Life Records**

THE MARK CONSISTS OF STANDARD CHARACTERS WITHOUT CLAIM TO ANY PARTICULAR FONT, STYLE, SIZE, OR COLOR.

NO CLAIM IS MADE TO THE EXCLUSIVE RIGHT TO USE "RECORDS", APART FROM THE MARK AS SHOWN.

FOR PRODUCTION OF SOUND AND MUSIC VIDEO RECORDINGS (U.S. CLS. 100, 101 AND 107).

AMY C. KEAN, EXAMINING ATTORNEY

SN 85-301,680. MOTIONNET.COM, INC., DBA USD MEDIA, VANCOUVER, WA. FILED 4-21-2011.



NO CLAIM IS MADE TO THE EXCLUSIVE RIGHT TO USE "MEDIA", APART FROM THE MARK AS SHOWN.

THE COLOR(S) BLUE, RED, WHITE, BLACK AND GRAY IS/ARE CLAIMED AS A FEATURE OF THE MARK.

THE MARK CONSISTS OF A STYLIZED EAGLE HEAD RENDERED WITH A BLUE BEAK AND A HEAD REPRESENTED BY FIVE STRIPS OF RED AND WHITE, FLOATING OVER THE WORDING "USD MEDIA" IN BLACK, WITH A GRAY SHADOW DESIGN ABOVE THE WORDING.

FOR PROVIDING NEWS, INFORMATION AND COMMENTARY IN THE FIELD OF CURRENT EVENTS RELATED TO RELIGION, POLITICS, THE MEDIA, ENTERTAINMENT, BUSINESS, HEALTH, LIVING AND LIFESTYLE, WELLNESS, ENVIRONMENTAL ISSUES, FOOD, TECHNOLOGY, TRAVEL, EDUCATION, CALENDAR OF EVENTS, ACTIVITIES, LOCAL SITES OF INTEREST, NEIGHBORHOODS, OBITUARIES, CLASSIFIEDS, AND JOB POSTINGS; ENTERTAINMENT SERVICES, NAMELY, MULTIMEDIA PRODUCTION SERVICES IN THE FIELD OF CURRENT EVENTS RELATED TO RELIGION, POLITICS, THE MEDIA, ENTERTAINMENT, BUSINESS, HEALTH, LIVING AND LIFESTYLE, WELLNESS, ENVIRONMENTAL ISSUES, FOOD, TECHNOLOGY, TRAVEL, EDUCATION, CALENDAR OF EVENTS, ACTIVITIES, LOCAL SITES OF INTEREST, NEIGHBORHOODS, OBITUARIES, CLASSIFIEDS, AND JOB POSTINGS (U.S. CLS. 100, 101 AND 107).

HEATHER THOMPSON, EXAMINING ATTORNEY

**CLASS 41—(Continued).**

SN 85-302,172. EFFECTIVE COMMUNICATIONS LLC, DBA THE COLOR OF HAPPINESS, COLORADO SPRINGS, CO. FILED 4-22-2011.

THE COLOR OF HAPPINESS

THE MARK CONSISTS OF STANDARD CHARACTERS WITHOUT CLAIM TO ANY PARTICULAR FONT, STYLE, SIZE, OR COLOR.

FOR EDUCATIONAL SERVICES, NAMELY, MOTIVATIONAL SPEAKING, LECTURING AND CONDUCTING SEMINARS, WORKSHOPS AND CLASSES IN THE FIELD OF SELF-AWARENESS AND SELF-IMPROVEMENT AND DISTRIBUTION OF PRINTED MATERIALS IN CONNECTION THEREWITH; EDUCATIONAL SERVICES, NAMELY, MENTORING IN THE FIELD OF SELF-AWARENESS AND SELF-IMPROVEMENT; LIFE COACHING IN THE FIELD OF SELF-AWARENESS AND SELF-IMPROVEMENT (U.S. CLS. 100, 101 AND 107).

LESLEY LAMOTHE, EXAMINING ATTORNEY

**CLASS 41—(Continued).**

SN 85-303,137. PETERSON, LAUREN RAY, DBA ELLANESQUE WEDDING AND EVENT PLANNING, SPRING, TX. FILED 4-24-2011.

ellanesque

THE MARK CONSISTS OF STANDARD CHARACTERS WITHOUT CLAIM TO ANY PARTICULAR FONT, STYLE, SIZE, OR COLOR.

FOR CONSULTATION IN THE FIELD OF SPECIAL EVENT PLANNING FOR SOCIAL ENTERTAINMENT PURPOSES; WEDDING PLANNING AND COORDINATION SERVICES (U.S. CLS. 100, 101 AND 107).

FIRST USE 9-30-2010; IN COMMERCE 12-10-2010.

PATRICIA EVANKO, EXAMINING ATTORNEY

SN 85-303,546. FAMILY BOOTCAMP, LLC, BOWIE, MD. FILED 4-25-2011.

SN 85-302,840. KEMBEL, INES, GLENDALE, CA. FILED 4-23-2011.



THE MARK CONSISTS OF THE WORD "MATERIALISE" POSITIONED ON TOP OF THE WORD "DREAMS", WITH A LARGE STAR RIGHT OF THE PHRASE, A SMALL STAR ABOVE THE LETTER "I", AND A MEDIUM SIZED STAR ABOVE AND TO THE RIGHT OF THE SMALL STAR (THE SOLID PART OF THE STARS ARE SHOWING).

FOR EDUCATIONAL AND ENTERTAINMENT SERVICES, NAMELY, CONDUCTING CLASSES, SEMINARS, WEBINARS, AND WORKSHOPS IN THE FIELD OF ENTERTAINMENT BUSINESS AND DISTRIBUTION OF COURSE MATERIALS IN CONNECTION THEREWITH, AND EDUCATION CONSULTING RELATED THERETO; ON-LINE ELECTRONIC NEWSLETTERS DELIVERED BY E-MAIL IN THE FIELD OF ENTERTAINMENT BUSINESS; PROVIDING A WEBSITE FEATURING INFORMATION IN THE FIELD OF MUSIC AND ENTERTAINMENT (U.S. CLS. 100, 101 AND 107).

FIRST USE 3-15-2011; IN COMMERCE 4-15-2011.

MARK T. MULLEN, EXAMINING ATTORNEY



THE MARK CONSISTS OF A RECTANGLE BOX. WITHIN THE BOX IS AN IMAGE OF SOMEONE STANDING IN A PAIR OF LACED MILITARY BOOTS WITH MILITARY/FATIGUE PANTS TUCKED IN THE BOOTS. THE IMAGE START FROM MID SHIN DOWNWARD. ALSO WITHIN THE BOX, BENEATH THE SOLES OF THE BOOTS, IS THE WORD "BOOTCAMP" IN ALL CAPS STENCIL FONT. DIRECTLY ABOVE THE BOX IS THE WORD "FAMILY" IN ALL CAPS STENCIL FONT.

SEC. 2(F) AS TO "FAMILY BOOTCAMP".

FOR EDUCATIONAL SERVICES, NAMELY, CONDUCTING CLASSES, SEMINARS, CONFERENCES, AND WORKSHOPS IN THE FIELD OF MARRIAGE, RELATIONSHIPS, FAMILY TRAINING AND COACHING AND DISTRIBUTION OF COURSE MATERIAL IN CONNECTION THEREWITH (U.S. CLS. 100, 101 AND 107).

FIRST USE 5-1-2002; IN COMMERCE 5-1-2002.

MARK T. MULLEN, EXAMINING ATTORNEY

**CLASS 41—(Continued).**

SN 85-304,039. EXALT EDUCATION, INC., LITTLE ROCK, AR. FILED 4-25-2011.

## Exalt Academy

THE MARK CONSISTS OF STANDARD CHARACTERS WITHOUT CLAIM TO ANY PARTICULAR FONT, STYLE, SIZE, OR COLOR.

NO CLAIM IS MADE TO THE EXCLUSIVE RIGHT TO USE "ACADEMY", APART FROM THE MARK AS SHOWN. FOR EDUCATIONAL SERVICES, NAMELY, PROVIDING COURSES OF INSTRUCTION AT THE EARLY CHILDHOOD, ELEMENTARY, MIDDLE AND SECONDARY GRADE LEVELS (U.S. CLS. 100, 101 AND 107).

AISHA CLARKE, EXAMINING ATTORNEY

**CLASS 41—(Continued).**

SN 85-305,480. TAIT, GERON A, DBA GKEYS, WINTER PARK, FL. FILED 4-26-2011.



THE COLOR(S) GOLD AND BLACK IS/ARE CLAIMED AS A FEATURE OF THE MARK.

THE MARK CONSISTS OF A 3D IMAGE OF THE LETTER "G" IN GOLD AND BLACK WITH GOLD AND BLACK WINGS AND FIVE BLACK STARS ON THE LEFT SIDE OF THE LETTER "G". THE WORD "HEROES" IN BLACK IS ENGRAVED ON THE LETTER "G" AT THE BOTTOM.

FOR ENTERTAINMENT SERVICES BY A MUSICAL ARTIST AND PRODUCER, NAMELY, MUSICAL COMPOSITION FOR OTHERS AND PRODUCTION OF MUSICAL SOUND RECORDINGS (U.S. CLS. 100, 101 AND 107).

FIRST USE 4-1-2011; IN COMMERCE 4-1-2011.

ANDREW RHIM, EXAMINING ATTORNEY

SN 85-304,350. GILL-OCHAL, JOHN E, DBA THE BLACK SHIPS, AMSTERDAM, NY. FILED 4-25-2011.

## The Black Ships

THE MARK CONSISTS OF STANDARD CHARACTERS WITHOUT CLAIM TO ANY PARTICULAR FONT, STYLE, SIZE, OR COLOR.

FOR ENTERTAINMENT IN THE NATURE OF VISUAL AND AUDIO PERFORMANCES BY THE BLACK SHIPS; ENTERTAINMENT IN THE NATURE OF VISUAL AND AUDIO PERFORMANCES, NAMELY, MUSICAL BAND, ROCK GROUP, DANCE PERFORMANCES; ENTERTAINMENT, NAMELY, LIVE PERFORMANCES BY A MUSICAL BAND; PROVIDING A WEBSITE FOR ENTERTAINMENT PURPOSES WHERE USERS CAN VIEW AND POST MUSIC, VIDEOS, IMAGES FEATURING THE BLACK SHIPS (U.S. CLS. 100, 101 AND 107).

FIRST USE 4-8-2005; IN COMMERCE 1-5-2008.

JEFFREY LOOK, EXAMINING ATTORNEY

SN 85-305,866. TUTORIA LATINA, LLC, CHICAGO, IL. FILED 4-27-2011.



NO CLAIM IS MADE TO THE EXCLUSIVE RIGHT TO USE "TUTORIA LATINA", APART FROM THE MARK AS SHOWN.

THE COLOR(S) BLUE, RED, BLACK AND YELLOW IS/ARE CLAIMED AS A FEATURE OF THE MARK.

THE MARK CONSISTS OF THE WORD "TUTORIA" IN BLACK, BOLD FACE ALL CAP LETTERS, UNDERLINED IN BLUE, FOLLOWED BY THE WORD "LATINA" IN BLACK, BOLD FACE ALL CAP LETTERS, UNDERLINED IN RED, FRAMING A SHADOWED IMAGE OF A TUTOR OR TEACHER LOOKING OVER THE SHOULDER OF A CHILD READING, ALL IN BLACK, WITH RAINBOW IN YELLOW.

THE ENGLISH TRANSLATION OF "TUTORIA LATINA" IN THE MARK IS "LATINO TUTORING".

FOR EDUCATION SERVICES, NAMELY, PROVIDING TUTORING IN THE FIELDS OF MATH, READING AND SCIENCE (U.S. CLS. 100, 101 AND 107).

JESSICA A. POWERS, EXAMINING ATTORNEY



**CLASS 41—(Continued).**

SN 85-305,885. MOONFLOSS PRODUCTIONS, INC., DBA CELEBRATEGREECE.COM, SANTA BARBARA, CA. FILED 4-27-2011.

**CLASS 41—(Continued).**

SN 85-305,954. BIY BUILD IT YOURSELF RENOVATION LEARNING CENTER INC., TORONTO, ONTARIO, CANADA, FILED 4-27-2011.



## Goddess and the Geek

THE MARK CONSISTS OF STANDARD CHARACTERS WITHOUT CLAIM TO ANY PARTICULAR FONT, STYLE, SIZE, OR COLOR.

FOR ENTERTAINMENT SERVICES, NAMELY, THEATRICAL PRESENTATIONS AND ONGOING SHOWS BROADCAST OVER INTERNET, TELEVISION, SATELLITE, RADIO, AIRWAVES, AND AUDIO AND VIDEO MEDIA FEATURING HUMOROUS, EDUCATIONAL, CULTURAL, HISTORICAL, POLITICAL AND INSPIRATIONAL CONTENT AND SUBJECT MATTER, NAMELY, COOKING, ROMANCE, RELATIONSHIPS, WELLNESS, FOOD, HISTORY, TRAVEL, CULTURE, DRAMA, COMEDY, SPORTS, POLITICS, NEWS, DOCUMENTARIES, MOVIES, TELEVISION, BROADCAST, INTERNET, ENTERTAINMENT, INTERVIEWS AND STOCK FOOTAGE OF GREECE; ENTERTAINMENT SERVICES, NAMELY, PROVIDING A INTERNET WEBSITE FEATURING PHOTOGRAPHIC, AUDIO, VIDEO, AND PROSE PRESENTATIONS FEATURING HUMOROUS, EDUCATIONAL, CULTURAL, HISTORICAL, POLITICAL AND INSPIRATIONAL CONTENT AND SUBJECT MATTER, NAMELY, COOKING, ROMANCE, RELATIONSHIPS, WELLNESS, FOOD, HISTORY, TRAVEL, CULTURE, DRAMA, COMEDY, SPORTS, POLITICS, NEWS, DOCUMENTARIES, MOVIES, TELEVISION, BROADCAST, INTERNET, INTERVIEWS, ENTERTAINMENT, INTERVIEWS AND STOCK FOOTAGE OF GREECE; ENTERTAINMENT SERVICES, NAMELY, ONLINE JOURNALS FEATURING PHOTOGRAPHIC, AUDIO, VIDEO, AND PROSE PRESENTATIONS FEATURING HUMOROUS, EDUCATIONAL, CULTURAL, HISTORICAL, POLITICAL AND INSPIRATIONAL CONTENT AND SUBJECT MATTER, NAMELY, COOKING, ROMANCE, RELATIONSHIPS, WELLNESS, FOOD, HISTORY, TRAVEL, CULTURE, DRAMA, COMEDY, SPORTS, POLITICS, NEWS, DOCUMENTARIES, MOVIES, TELEVISION, BROADCAST, INTERNET, ENTERTAINMENT, INTERVIEWS AND STOCK FOOTAGE OF GREECE (U.S. CLS. 100, 101 AND 107).

FIRST USE 4-18-2005; IN COMMERCE 4-18-2005.

LOURDES AYALA, EXAMINING ATTORNEY

PRIORITY CLAIMED UNDER SEC. 44(D) ON CANADA APPLICATION NO. 1523947, FILED 4-15-2011.

NO CLAIM IS MADE TO THE EXCLUSIVE RIGHT TO USE "BIY", "BUILD IT YOURSELF.", "LEARNING CENTERS", AND "WE TEACH YOU HOW TO DO-IT-YOURSELF", APART FROM THE MARK AS SHOWN.

THE MARK CONSISTS OF THE LETTERS "BIY" IN A STYLIZED FONT UNDER A ROOF LINE DESIGN WHICH EXTENDS FROM THE LETTER "Y" AND WHERE THE DOT OVER THE LETTER "I" IS REPLACED WITH THE DESIGN OF A MAPLE LEAF, ALL TO THE RIGHT OF THE STYLIZED WORDING "BUILD IT YOURSELF.", "LEARNING CENTERS" AND "WE TEACH YOU HOW TO DO-IT-YOURSELF".

FOR EDUCATION AND TRAINING SERVICES, NAMELY, ORGANIZING, PRESENTING, CONDUCTING, PROVIDING AND STAGING CONFERENCES, TRAINING SESSIONS, SEMINARS, COURSES, WORKSHOPS AND CONVENTIONS IN THE FIELD OF HOME IMPROVEMENT AND RENOVATION, HOME DESIGN, BUILDING MAINTENANCE, ARCHITECTURE, HEATING AND VENTILATING, ELECTRICAL, TILING, BUILDING CONSTRUCTION, CONSTRUCTION OF RESIDENTIAL BUILDINGS; EDUCATION AND TRAINING SERVICES, NAMELY, ORGANIZING, PRESENTING, CONDUCTING, PROVIDING AND STAGING CONFERENCES, TRAINING SESSIONS, SEMINARS, COURSES, WORKSHOPS AND CONVENTIONS IN THE FIELD OF HOME IMPROVEMENT AND RENOVATION, HOME DESIGN, BUILDING MAINTENANCE, ARCHITECTURE, HEATING AND VENTILATING, ELECTRICAL, TILING, BUILDING CONSTRUCTION, CONSTRUCTION OF RESIDENTIAL BUILDINGS, AND DISTRIBUTION OF PRINTED EDUCATIONAL PUBLICATIONS IN CONNECTION THEREWITH; PUBLISHING SERVICES FOR PUBLICATIONS OF AN EDUCATIONAL TRAINING NATURE, NAMELY, CONFERENCE, SEMINAR, COURSE, WORKSHOP AND CONVENTION MATERIALS; EDUCATIONAL SERVICES, NAMELY, PROVIDING ONLINE CLASSES, SEMINARS AND WORKSHOPS IN THE FIELD OF PROJECT PLANNING ASSISTANCE, HOME IMPROVEMENT AND RENOVATION, HOME DESIGN, BUILDING MAINTENANCE, ARCHITECTURE, HEATING AND VENTILATING, ELECTRICAL, TILING, BUILDING CONSTRUCTION, CONSTRUCTION OF RESIDENTIAL BUILDINGS; PROVIDING A WEBSITE FEATURING BLOGS AND NON-DOWNLOADABLE PUBLICATIONS IN THE NATURE OF ARTICLES ON TOPICS OF GENERAL INTEREST REGARDING HOME IMPROVEMENT AND RENOVATIONS; PROVIDING A WEB SITE WHERE USERS CAN POST RATINGS, REVIEWS AND RECOMMENDATIONS ON EVENTS AND ACTIVITIES IN THE FIELD OF HOME IMPROVEMENT AND DESIGN; PRODUCTION OF RADIO AND TELEVISION PROGRAMS AND FILMS; PRODUCTION OF VIDEO DISCS AND VIDEO TAPES, TELEVISION PROGRAMS AND TELEVISION VIDEOS IN THE FIELD OF HOME IMPROVEMENT AND RENOVATION; VIDEO TAPE RECORDING FOR OTHERS IN THE FIELD OF HOME IMPROVEMENT AND RENOVATION (U.S. CLS. 100, 101 AND 107).

CHRISTINE COOPER, EXAMINING ATTORNEY

**CLASS 41—(Continued).**

SN 85-306,328. FAMILY DYNAMICS INSTITUTE, INC., AKA FAMILY DYNAMICS, FRANKLIN, TN. FILED 4-27-2011.

**MARRIAGE BY THE BOOK**

THE MARK CONSISTS OF STANDARD CHARACTERS WITHOUT CLAIM TO ANY PARTICULAR FONT, STYLE, SIZE, OR COLOR.

FOR EDUCATION, NAMELY, SEMINARS, CLASSES, AND WORKSHOPS AND TRAINING SERVICES FOR TROUBLED MARRIAGES AND FAMILY INTERACTION SOCIAL SKILLS AND DISTRIBUTION OF ASSOCIATED COURSE MATERIALS IN CONNECTION THEREWITH (U.S. CLS. 100, 101 AND 107).

FIRST USE 12-1-2009; IN COMMERCE 12-1-2009.  
PATRICIA EVANKO, EXAMINING ATTORNEY

SN 85-306,810. PROVEN PUBLICATIONS, LLC, VIRGINIA BEACH, VA. FILED 4-28-2011.



NO CLAIM IS MADE TO THE EXCLUSIVE RIGHT TO USE "PUBLICATIONS", APART FROM THE MARK AS SHOWN.

THE COLOR(S) RED, GREY, BLACK, AND YELLOW IS/ ARE CLAIMED AS A FEATURE OF THE MARK.

THE MARK CONSISTS OF THE STYLIZED, INTERLOCKING LETTERS "PP" WITH THE FIRST "P" IN RED OUTLINED IN GREY, AND THE SECOND "P" IN BLACK OUTLINED IN GRAY, WITH THE "PP" APPEARING AGAINST A YELLOW CIRCLE WITH A ZIGZAG EDGE, THE FOREGOING INSIDE TWO CONCENTRIC GREY CIRCLES, AND THIS DESIGN IS ALMOST COMPLETELY ENCIRCLED BY A BORDER MADE OF GREY LEAVES THAT TURNS TO GREY DASHED LINES THAT MEET AT A YELLOW 5-POINT STAR AT THE TOP, AND AT THE VERY BOTTOM OF THE MARK APPEARS THE STYLIZED WORDING "PROVEN PUBLICATIONS" IN BLACK. THE COLOR WHITE APPEARING IN THE MARK REPRESENTS BACKGROUND AND/OR TRANSPARENT AREAS AND IS NOT CLAIMED AS A FEATURE OF THE MARK.

FOR MAGAZINE PUBLISHING; MULTIMEDIA PUBLISHING OF BOOKS, MAGAZINES, JOURNALS, SOFTWARE, GAMES, MUSIC, AND ELECTRONIC PUBLICATIONS (U.S. CLS. 100, 101 AND 107).

FIRST USE 5-1-2008; IN COMMERCE 5-1-2008.  
ANDREW LEASER, EXAMINING ATTORNEY

**CLASS 41—(Continued).**

SN 85-307,152. HUMAN CAPITAL INSTITUTE, INC., WHITE RIVER JUNCTION, VT. FILED 4-28-2011.

**HUMAN CAPITAL SUMMIT**

THE MARK CONSISTS OF STANDARD CHARACTERS WITHOUT CLAIM TO ANY PARTICULAR FONT, STYLE, SIZE, OR COLOR.

OWNER OF U.S. REG. NO. 3,263,395.

NO CLAIM IS MADE TO THE EXCLUSIVE RIGHT TO USE "SUMMIT", APART FROM THE MARK AS SHOWN. SEC. 2(F).

FOR ARRANGING, ORGANIZING, AND CONDUCTING EXHIBITIONS, SEMINARS AND CONFERENCES FEATURING SPEAKERS, VENDOR BOOTHS, SOCIAL EVENTS AND EDUCATIONAL CLASSES IN THE FIELD OF HUMAN RESOURCES, NOT FOR BUSINESS PURPOSES (U.S. CLS. 100, 101 AND 107).

FIRST USE 4-0-2006; IN COMMERCE 4-0-2006.

JOHN HWANG, EXAMINING ATTORNEY

SN 85-307,181. CHAD ZADINA, WELLINGTON, CO. FILED 4-28-2011.

**Dr. Pawz**

THE MARK CONSISTS OF STANDARD CHARACTERS WITHOUT CLAIM TO ANY PARTICULAR FONT, STYLE, SIZE, OR COLOR.

FOR EDUCATIONAL SERVICES, NAMELY, PROVIDING LIVE WEBINARS IN THE FIELDS OF PETS AND PET OWNERSHIP (U.S. CLS. 100, 101 AND 107).

FIRST USE 4-20-2011; IN COMMERCE 4-20-2011.

REBECCA SMITH, EXAMINING ATTORNEY

SN 85-307,200. THE ERGO BABY CARRIER, INC., MAKAWAO, HI. FILED 4-28-2011.



THE MARK CONSISTS OF THE LETTER "E" SLIGHTLY ABOVE THE LETTER "P" ALL WITHIN A CIRCLE WITH A DARK BACKGROUND FOLLOWED BY THE PHRASE "ERGOPARENT".

FOR PROVIDING AN ON-LINE, NON-DOWNLOADABLE MAGAZINE IN THE FIELDS OF CHILD CARE, PARENTING, BABYWEARING, CHILD DEVELOPMENT, PARENTING PRODUCTS AND SERVICES, EXPERT OPINION, RESEARCH AND OTHER INFORMATION RELATED TO PARENTING AND THE RAISING OF YOUNG CHILDREN (U.S. CLS. 100, 101 AND 107).

FIRST USE 9-8-2010; IN COMMERCE 9-8-2010.

B. PARADEWELAI, EXAMINING ATTORNEY

**CLASS 41—(Continued).**

SN 85-307,899. LORI A. GETTIS, DBA THE SPEAKER BOUTIQUE, NEW HOPE, PA. FILED 4-28-2011.

The Speaker Boutique

THE MARK CONSISTS OF STANDARD CHARACTERS WITHOUT CLAIM TO ANY PARTICULAR FONT, STYLE, SIZE, OR COLOR.

NO CLAIM IS MADE TO THE EXCLUSIVE RIGHT TO USE "SPEAKER", APART FROM THE MARK AS SHOWN.

FOR EDUCATIONAL AND ENTERTAINMENT SERVICES, NAMELY, PROVIDING MOTIVATIONAL AND EDUCATIONAL SPEAKERS FOR A SPEAKERS BUREAU (U.S. CLS. 100, 101 AND 107).

MICHELE SWAIN, EXAMINING ATTORNEY

**CLASS 41—(Continued).**

SN 85-308,553. GLOBAL ENTERTAINMENT PRODUCTIONS, LTD., BROOKLYN, NY. FILED 4-29-2011.



NO CLAIM IS MADE TO THE EXCLUSIVE RIGHT TO USE "CLOWN THEATER", APART FROM THE MARK AS SHOWN.

THE NAME(S), PORTRAIT(S), AND/OR SIGNATURE(S) SHOWN IN THE MARK DOES NOT IDENTIFY A PARTICULAR LIVING INDIVIDUAL.

THE MARK CONSISTS OF THE TEXT "MIMIRICHI" DIVIDED INTO "MIM" (IN A BOX), "I", AND "RICHI" (IN A BOX); "CLOWN" IS ABOVE THE BOX CONTAINING "MIM", AND "THEATER" IS BELOW THE BOX CONTAINING "RICHI". IN THE CENTER BEHIND THE WORDS IS A THEATRICAL MASK WITH THE NOSE, WHICH IS ALSO A PART OF LETTER "I".

FOR ENTERTAINMENT IN THE NATURE OF THEATER PRODUCTIONS (U.S. CLS. 100, 101 AND 107).

FIRST USE 4-0-1993; IN COMMERCE 4-0-1993.

GIANCARLO CASTRO, EXAMINING ATTORNEY

SN 85-308,179. MELINCHOCK, JOHN, PHILADELPHIA, PA. FILED 4-29-2011.

The Fabulous Philadelphia  
Mojo Kings Dance Band

THE MARK CONSISTS OF STANDARD CHARACTERS WITHOUT CLAIM TO ANY PARTICULAR FONT, STYLE, SIZE, OR COLOR.

NO CLAIM IS MADE TO THE EXCLUSIVE RIGHT TO USE "PHILADELPHIA" AND "DANCE BAND", APART FROM THE MARK AS SHOWN.

FOR ENTERTAINMENT, NAMELY, LIVE PERFORMANCES BY A MUSICAL BAND (U.S. CLS. 100, 101 AND 107).

LOURDES AYALA, EXAMINING ATTORNEY

SN 85-308,623. THE NEW TEACHER PROJECT, INC., BROOKLYN, NY. FILED 4-29-2011.



NO CLAIM IS MADE TO THE EXCLUSIVE RIGHT TO USE "TEACHING", APART FROM THE MARK AS SHOWN.

THE MARK CONSISTS OF A COIL FORMED OF DOTS AND TWO ARROWS WITH THE WORDS "TEACHING FOR RESULTS" OVERLAYING PART OF THE COIL.

FOR EDUCATIONAL SERVICES, NAMELY, TRAINING INDIVIDUALS TO TEACH CLASSES IN PRIMARY AND SECONDARY PUBLIC SCHOOLS IN THE FIELDS OF READING, WRITING, SPELLING, GRAMMAR, LANGUAGES, GEOGRAPHY, SOCIAL STUDIES, MATHEMATICS, SCIENCE, NUTRITION, HEALTH, PHYSICAL EDUCATION, COMPUTER AND INFORMATION TECHNOLOGY, MUSIC, ART AND LITERATURE AND DISTRIBUTION OF TRAINING MATERIAL IN CONNECTION THEREWITH (U.S. CLS. 100, 101 AND 107).

FIRST USE 3-0-2009; IN COMMERCE 3-0-2009.

LEIGH CAROLINE CASE, EXAMINING ATTORNEY

**CLASS 41—(Continued).**

SN 85-309,026. GASTON, ERNEST, ONTARIO, CA. AND NGO, GREG, ONTARIO, CA. AND UNITE, ANTHONY, ONTARIO, CA. AND RAMOS JR., RODOLFO A., ONTARIO, CA. FILED 4-29-2011.

## Guns at the Bar

THE MARK CONSISTS OF STANDARD CHARACTERS WITHOUT CLAIM TO ANY PARTICULAR FONT, STYLE, SIZE, OR COLOR.

FOR ENTERTAINMENT IN THE NATURE OF VISUAL AND AUDIO PERFORMANCES BY A MUSICAL BAND (U.S. CLS. 100, 101 AND 107).

FIRST USE 11-0-2010; IN COMMERCE 11-0-2010.  
LOURDES AYALA, EXAMINING ATTORNEY

---

SN 85-309,359. MURPHY, KIMBERLY M, AKA KIM DURPHY, RENTON, WA. FILED 5-1-2011.

## We Make Frugal Fancy

THE MARK CONSISTS OF STANDARD CHARACTERS WITHOUT CLAIM TO ANY PARTICULAR FONT, STYLE, SIZE, OR COLOR.

FOR PROVIDING A WEBSITE FEATURING COMMENTARY AND ADVICE IN THE FIELD OF SAVING MONEY (U.S. CLS. 100, 101 AND 107).

FIRST USE 2-1-2011; IN COMMERCE 2-1-2011.  
DAVID TOOLEY, EXAMINING ATTORNEY

---

SN 85-310,073. TO KNOW JOY, INC., RAYMORE, MO. FILED 5-2-2011.

## HONOR YOUR AUTHENTICITY

THE MARK CONSISTS OF STANDARD CHARACTERS WITHOUT CLAIM TO ANY PARTICULAR FONT, STYLE, SIZE, OR COLOR.

FOR LIFE COACHING SERVICES IN THE FIELD OF PERSONAL AND PROFESSIONAL PLANNING, GROWTH, DEVELOPMENT, AND IMPROVEMENT; EDUCATIONAL SERVICES, NAMELY, CONDUCTING INDIVIDUALIZED AND GROUP PROGRAMS, CLASSES, WORKSHOPS AND SEMINARS IN THE FIELD OF PERSONAL AND PROFESSIONAL PLANNING, GROWTH, DEVELOPMENT, AND IMPROVEMENT (U.S. CLS. 100, 101 AND 107).

FIRST USE 5-31-2010; IN COMMERCE 5-31-2010.  
CAROLINE WOOD, EXAMINING ATTORNEY

**CLASS 41—(Continued).**

SN 85-310,485. ADVANCED PRODUCTIONS & ENTERTAINMENT, INC., HOLLYWOOD, FL. FILED 5-3-2011.

## FUN SHOP

THE MARK CONSISTS OF STANDARD CHARACTERS WITHOUT CLAIM TO ANY PARTICULAR FONT, STYLE, SIZE, OR COLOR.

FOR EDUCATIONAL SERVICES, NAMELY, CONDUCTING PROGRAMS THAT TEACH KIDS MOTOR SKILLS, COMMUNICATION SKILLS, SOCIAL SKILLS, AND PROMOTES PHYSICAL ACTIVITY, THROUGH THE USE OF GAMES, CRAFTS, INTERACTIVE SHOWS, WORKSHEETS, AND ASSIGNMENTS (U.S. CLS. 100, 101 AND 107).

FIRST USE 12-4-2008; IN COMMERCE 1-2-2010.  
ELLEN PERKINS, EXAMINING ATTORNEY

---

SN 85-310,638. SOUTHERN CALIFORNIA PUBLIC RADIO, PASADENA, CA. FILED 5-3-2011.

## ONCENTRAL

THE MARK CONSISTS OF STANDARD CHARACTERS WITHOUT CLAIM TO ANY PARTICULAR FONT, STYLE, SIZE, OR COLOR.

FOR PROVIDING AN INTERNET NEWS PORTAL FEATURING CURRENT EVENT NEWS ABOUT POLITICS, THE ENVIRONMENT, BUSINESS, ARTS, CULTURE AND EDUCATION (U.S. CLS. 100, 101 AND 107).

FIRST USE 4-0-2011; IN COMMERCE 4-0-2011.  
EMILY CARLSEN, EXAMINING ATTORNEY

---

SN 85-311,618. JOHNSON, SHAWNA M, DBA SPINELATES, COSTA MESA, CA. FILED 5-4-2011.

## Spinelates

THE MARK CONSISTS OF STANDARD CHARACTERS WITHOUT CLAIM TO ANY PARTICULAR FONT, STYLE, SIZE, OR COLOR.

THE WORDING "SPINELATES" HAS NO MEANING IN A FOREIGN LANGUAGE.

FOR PROVIDING FITNESS AND EXERCISE STUDIO SERVICES, NAMELY, PILATES INSTRUCTION AND TRAINING (U.S. CLS. 100, 101 AND 107).

FIRST USE 2-2-2011; IN COMMERCE 3-27-2011.  
BENJAMIN OKEKE, EXAMINING ATTORNEY

**CLASS 41—(Continued).**

SN 85-311,877. ECKARD, HEIDI, SANTA MONICA, CA.  
FILED 5-4-2011.



THE MARK CONSISTS OF THE STYLIZED TEXT "KUMIKO'S KALEIDOSCOPE" IN A WAVE FORM AND ALL LETTERS IN A SEPARATE BOX.

FOR EDUCATIONAL AND ENTERTAINMENT SERVICES, NAMELY, A CONTINUING PROGRAM FEATURING EDUCATIONAL TOPICS IN A GENERAL PRE-KINDERGARTEN THROUGH 12TH GRADE CURRICULUM FOR CHILDREN ACCESSIBLE BY RADIO, TELEVISION, SATELLITE, AUDIO, VIDEO AND COMPUTER NETWORKS (U.S. CLS. 100, 101 AND 107).  
ELLEN PERKINS, EXAMINING ATTORNEY

---

SN 85-311,958. DEHOYOS, RAMON, MELBOURNE, FL.  
FILED 5-4-2011.

**World Champion Duckwalker**

THE MARK CONSISTS OF STANDARD CHARACTERS WITHOUT CLAIM TO ANY PARTICULAR FONT, STYLE, SIZE, OR COLOR.

NO CLAIM IS MADE TO THE EXCLUSIVE RIGHT TO USE "DUCKWALKER", APART FROM THE MARK AS SHOWN.

FOR ENTERTAINMENT SERVICES IN THE NATURE OF NOVELTY WALKING EXHIBITIONS; PROVIDING A WEBSITE FEATURING INFORMATION ON NOVELTY WALKING (U.S. CLS. 100, 101 AND 107).

FIRST USE 1-9-2011; IN COMMERCE 1-9-2011.  
JOHN WILKE, EXAMINING ATTORNEY

---

SN 85-312,253. ENERGY BUSINESS NETWORK, WASHINGTON, DC. FILED 5-4-2011.

**SHALE REVOLUTION**

THE MARK CONSISTS OF STANDARD CHARACTERS WITHOUT CLAIM TO ANY PARTICULAR FONT, STYLE, SIZE, OR COLOR.

NO CLAIM IS MADE TO THE EXCLUSIVE RIGHT TO USE "SHALE", APART FROM THE MARK AS SHOWN.

FOR ON-LINE PUBLICATIONS, NAMELY, A NEWSLETTER ON THE SUBJECT OF ENERGY RESOURCES; EDUCATIONAL SERVICES, NAMELY, PROVIDING WEBINAR PRESENTATIONS ON THE SUBJECT OF ENERGY RESOURCES VIA AN ONLINE WEB SITE (U.S. CLS. 100, 101 AND 107).

FIRST USE 8-18-2010; IN COMMERCE 9-14-2010.  
EDWARD NELSON, EXAMINING ATTORNEY

**CLASS 41—(Continued).**

SN 85-312,583. URBAN TOUCH, LLC, CEDAR HILL, TX.  
FILED 5-4-2011.

**URBAN TOUCH**

THE MARK CONSISTS OF STANDARD CHARACTERS WITHOUT CLAIM TO ANY PARTICULAR FONT, STYLE, SIZE, OR COLOR.

FOR EDUCATION AND ENTERTAINMENT SERVICES, NAMELY, PRODUCTION AND DISTRIBUTION OF TELEVISION PROGRAMMING IN THE FIELD OF CHRISTIAN AND ETHNIC SERVICES AND MINISTRIES; ENTERTAINMENT, NAMELY, A CONTINUING SHOW IN THE FIELD OF CHRISTIAN AND ETHNIC SERVICES AND MINISTRIES BROADCAST OVER TELEVISION, SATELLITE, AUDIO, AND VIDEO MEDIA (U.S. CLS. 100, 101 AND 107).

FIRST USE 5-3-2011; IN COMMERCE 5-3-2011.  
ANGELA M. MICHELI, EXAMINING ATTORNEY

---

SN 85-313,149. AWAKEN HIGHER BRAIN LIVING LLC, GREENFIELD, WI. FILED 5-5-2011.

**HIGHER BRAIN LIVING**

THE MARK CONSISTS OF STANDARD CHARACTERS WITHOUT CLAIM TO ANY PARTICULAR FONT, STYLE, SIZE, OR COLOR.

NO CLAIM IS MADE TO THE EXCLUSIVE RIGHT TO USE "HIGHER BRAIN", APART FROM THE MARK AS SHOWN.

FOR EDUCATIONAL SERVICES, NAMELY, PROVIDING CLASSES, LECTURES, SEMINARS, WEB SITES, ARTICLES, VIDEOS, IN THE FIELD OF SPIRITUALITY, AND LIFE IMPROVEMENT (U.S. CLS. 100, 101 AND 107).

FIRST USE 8-1-2007; IN COMMERCE 3-7-2009.  
JEFF DEFORD, EXAMINING ATTORNEY

**CLASS 41—(Continued).**

SN 85-313,983. BAKER COLLEGE, FLINT, MI. FILED 5-6-2011.

**ELDON BAKER UNIVERSITY**

THE MARK CONSISTS OF STANDARD CHARACTERS WITHOUT CLAIM TO ANY PARTICULAR FONT, STYLE, SIZE, OR COLOR.

OWNER OF U.S. REG. NOS. 2,992,069, 3,658,017 AND OTHERS.

NO CLAIM IS MADE TO THE EXCLUSIVE RIGHT TO USE "UNIVERSITY", APART FROM THE MARK AS SHOWN.

THE NAME(S), PORTRAIT(S), AND/OR SIGNATURE(S) SHOWN IN THE MARK DOES NOT IDENTIFY A PARTICULAR LIVING INDIVIDUAL.

FOR EDUCATIONAL SERVICES, NAMELY, PROVIDING COURSES OF INSTRUCTION AT THE COLLEGE AND UNIVERSITY LEVEL AND DISTRIBUTION OF COURSE MATERIAL IN CONNECTION THEREWITH (U.S. CLS. 100, 101 AND 107).

ROBERT C. CLARK JR., EXAMINING ATTORNEY

**CLASS 41—(Continued).**

SN 85-314,504. BODY OF PURPOSE, CASTLE ROCK, CO. FILED 5-6-2011.

**Lifetime Physique**

THE MARK CONSISTS OF STANDARD CHARACTERS WITHOUT CLAIM TO ANY PARTICULAR FONT, STYLE, SIZE, OR COLOR.

FOR PERSONAL FITNESS TRAINING SERVICES; LIFE COACHING SERVICES IN THE FIELD OF NUTRITION AND FITNESS (U.S. CLS. 100, 101 AND 107).

FIRST USE 3-1-2011; IN COMMERCE 3-1-2011.

MAYUR VAGHANI, EXAMINING ATTORNEY

SN 85-314,589. UNITED SOCIAL SPORTS INC., WASHINGTON, DC. FILED 5-6-2011.

SN 85-314,170. MASTER GAMES INTERNATIONAL INC., PIPECREEK, TX. FILED 5-6-2011.

**GEARSCORE**

THE MARK CONSISTS OF STANDARD CHARACTERS WITHOUT CLAIM TO ANY PARTICULAR FONT, STYLE, SIZE, OR COLOR.

FOR ELECTRONIC GAMES SERVICES PROVIDED BY MEANS OF THE INTERNET; ENTERTAINMENT INFORMATION; ENTERTAINMENT SERVICES, NAMELY, PROVIDING AN ON-LINE COMPUTER GAME; ENTERTAINMENT SERVICES, NAMELY, PROVIDING ON-LINE COMPUTER GAMES; ENTERTAINMENT SERVICES, NAMELY, PROVIDING ONLINE ELECTRONIC GAMES; ENTERTAINMENT SERVICES, NAMELY, PROVIDING ONLINE VIDEO GAMES; ENTERTAINMENT SERVICES, NAMELY, PROVIDING TEMPORARY USE OF NON-DOWNLOADABLE COMPUTER GAMES; ENTERTAINMENT SERVICES, NAMELY, PROVIDING TEMPORARY USE OF NON-DOWNLOADABLE ELECTRONIC GAMES; ENTERTAINMENT SERVICES, NAMELY, PROVIDING TEMPORARY USE OF NON-DOWNLOADABLE INTERACTIVE GAMES; ENTERTAINMENT SERVICES, NAMELY, PROVIDING TEMPORARY USE OF NON-DOWNLOADABLE VIDEO GAMES; PROVIDING A WEB SITE THROUGH WHICH PEOPLE LOCATE INFORMATION ABOUT TOURNAMENTS, EVENTS, AND COMPETITIONS IN THE VIDEO GAME FIELD; PROVIDING A WEB-BASED SYSTEM AND ON-LINE PORTAL FOR CUSTOMERS TO PARTICIPATE IN ON-LINE GAMING, OPERATION AND COORDINATION OF GAME TOURNAMENTS, LEAGUES AND TOURS; PROVIDING INFORMATION ON-LINE RELATING TO COMPUTER GAMES AND COMPUTER ENHANCEMENTS FOR GAMES; PROVISION OF INFORMATION RELATING TO ELECTRONIC COMPUTER GAMES PROVIDED VIA THE INTERNET (U.S. CLS. 100, 101 AND 107).

FIRST USE 1-16-2009; IN COMMERCE 1-16-2009.

ANDREA BUTLER, EXAMINING ATTORNEY



NO CLAIM IS MADE TO THE EXCLUSIVE RIGHT TO USE "DC KICKBALL", "KICKING BALLS" AND "EST. 2004", APART FROM THE MARK AS SHOWN.

THE COLOR(S) RED, WHITE AND BLACK IS/ARE CLAIMED AS A FEATURE OF THE MARK.

THE MARK CONSISTS OF THE STYLIZED WORDING "DC KICKBALL" IN BLACK TEXT WITH "DC" IMPOSED ON A RED CIRCULAR BALL AND "KICKBALL" BELOW THE BALL; A RED BAND SURROUNDS THE OUTER PERIMETER AND INCLUDES THE WHITE TEXT "KICKING BALLS & FLIPPING CUPS EST. 2004".

FOR ENTERTAINMENT IN THE NATURE OF COMPETITIONS IN THE FIELD OF SOCIAL AND LEAGUE GAMES; ENTERTAINMENT IN THE NATURE OF KICKBALL GAMES; ENTERTAINMENT SERVICES, NAMELY, ARRANGING AND CONDUCTING OF COMPETITIONS FOR KICKBALL GAMES; PROVIDING A WEBSITE FOR ENTERTAINMENT PURPOSES WHERE USERS CAN VIEW AND POST LEAGUE AND COMPETITION INFORMATION FEATURING KICKBALL EVENTS; PROVIDING RECOGNITION AND INCENTIVES BY THE WAY OF AWARDS TO DEMONSTRATE EXCELLENCE IN THE FIELD OF KICKBALL (U.S. CLS. 100, 101 AND 107).

FIRST USE 1-1-2004; IN COMMERCE 1-1-2004.

KATINA MISTER, EXAMINING ATTORNEY

**CLASS 41—(Continued).**

SN 85-314,781. HARKINS REEL DEALS, LLC, SCOTTSDALE, AZ. FILED 5-6-2011.

**MOVIE GEEK**

THE MARK CONSISTS OF STANDARD CHARACTERS WITHOUT CLAIM TO ANY PARTICULAR FONT, STYLE, SIZE, OR COLOR.

NO CLAIM IS MADE TO THE EXCLUSIVE RIGHT TO USE "MOVIE", APART FROM THE MARK AS SHOWN.

FOR PROVIDING A WEB SITE FEATURING CONTESTS RELATING TO MOVIE TRIVIA (U.S. CLS. 100, 101 AND 107).

SANI KHOURI, EXAMINING ATTORNEY

SN 85-314,803. HARKINS REEL DEALS, LLC, SCOTTSDALE, AZ. FILED 5-6-2011.

**FILM GEEK**

THE MARK CONSISTS OF STANDARD CHARACTERS WITHOUT CLAIM TO ANY PARTICULAR FONT, STYLE, SIZE, OR COLOR.

NO CLAIM IS MADE TO THE EXCLUSIVE RIGHT TO USE "FILM", APART FROM THE MARK AS SHOWN.

FOR PROVIDING A WEB SITE FEATURING CONTESTS RELATING TO MOVIE TRIVIA (U.S. CLS. 100, 101 AND 107).

SANI KHOURI, EXAMINING ATTORNEY

**CLASS 41—(Continued).**

SN 85-315,443. JOYRIDE CYCLE STUDIO, LLC, WESTPORT, CT. FILED 5-9-2011.



NO CLAIM IS MADE TO THE EXCLUSIVE RIGHT TO USE "CYCLING STUDIO", APART FROM THE MARK AS SHOWN.

THE MARK CONSISTS OF A CIRCULAR TIRE THAT RESEMBLES THE SUN. THE WORDS UNDER IT ARE "JOYRIDE" (TOP LINE) AND "CYCLING STUDIO" (BOTTOM LINE) IN STYLIZED TEXT.

FOR PROVIDING PHYSICAL FITNESS AND EXERCISE SERVICE, NAMELY, INDOOR CYCLING; PHYSICAL FITNESS STUDIO SERVICES, NAMELY, PROVIDING EXERCISE CLASSES, BODY SCULPTING CLASSES, AND GROUP FITNESS CLASSES; PHYSICAL FITNESS INSTRUCTION; PROVIDING FITNESS AND EXERCISE STUDIO SERVICES, NAMELY, PILATES INSTRUCTION AND TRAINING (U.S. CLS. 100, 101 AND 107).

FIRST USE 12-1-2010; IN COMMERCE 3-15-2011.

LESLEY LAMOTHE, EXAMINING ATTORNEY

SN 85-315,938. FENWAY HIGH SCHOOL CORPORATION, DBA FENWAY HIGH SCHOOL, BOSTON, MA. FILED 5-9-2011.

**Work Hard. Be Yourself. Do  
the Right Thing.**

THE MARK CONSISTS OF STANDARD CHARACTERS WITHOUT CLAIM TO ANY PARTICULAR FONT, STYLE, SIZE, OR COLOR.

FOR PROVIDING COURSES OF INSTRUCTION AT THE HIGH SCHOOL LEVEL (U.S. CLS. 100, 101 AND 107).

FIRST USE 9-1-2001; IN COMMERCE 9-1-2001.

RONALD AIKENS, EXAMINING ATTORNEY

**CLASS 41—(Continued).**

SN 85-316,822. A BREED APART LIMITED LIABILITY COMPANY, MORRIS PLAINS, NJ. FILED 5-10-2011.

## Training in a Flash

THE MARK CONSISTS OF STANDARD CHARACTERS WITHOUT CLAIM TO ANY PARTICULAR FONT, STYLE, SIZE, OR COLOR.

NO CLAIM IS MADE TO THE EXCLUSIVE RIGHT TO USE "TRAINING", APART FROM THE MARK AS SHOWN. FOR PROVIDING ADVICE IN THE FIELD OF DOG TRAINING, AND DISTRIBUTION OF EDUCATION MATERIALS IN CONNECTION THEREWITH (U.S. CLS. 100, 101 AND 107).

JASON BLAIR, EXAMINING ATTORNEY

**CLASS 41—(Continued).**

SN 85-317,818. LOUKA TACTICAL TRAINING LLC, BELLEVILLE, MI. FILED 5-11-2011.

## LOUKA TACTICAL

THE MARK CONSISTS OF STANDARD CHARACTERS WITHOUT CLAIM TO ANY PARTICULAR FONT, STYLE, SIZE, OR COLOR.

NO CLAIM IS MADE TO THE EXCLUSIVE RIGHT TO USE "TACTICAL", APART FROM THE MARK AS SHOWN.

FOR TRAINING IN THE USE AND OPERATION OF FIREARMS; TRAINING SERVICES IN THE FIELD OF TECHNIQUES FOR USE OF FIREARMS; CONDUCTING CLASSES AND COURSES IN SAFE AND PROFICIENT USE OF FIREARMS; PERSONAL FITNESS TRAINING SERVICES AND CONSULTANCY; EDUCATIONAL SERVICES, NAMELY, CONDUCTING CLASSES, SEMINARS, CONFERENCES, WORKSHOPS IN THE FIELDS OF FIREARMS TRAINING AND TACTICS, BICYCLE SAFETY AND TACTICS, DEFENSIVE TACTICS, AND PERSONAL FITNESS AND DISTRIBUTION OF TRAINING MATERIALS IN CONNECTION THEREWITH (U.S. CLS. 100, 101 AND 107).

FIRST USE 1-0-1999; IN COMMERCE 1-0-1999.

BRIAN CALLAGHAN, EXAMINING ATTORNEY

SN 85-317,853. THE 21 MINUTE WORKOUT LLC, WAYNESBORO, NC. FILED 5-11-2011.



NO CLAIM IS MADE TO THE EXCLUSIVE RIGHT TO USE "THE 21 MINUTE WORKOUT", APART FROM THE MARK AS SHOWN.

THE COLOR(S) BLACK, GRAY, RED AND WHITE IS/ARE CLAIMED AS A FEATURE OF THE MARK.

THE MARK CONSISTS OF A BLACK, GRAY AND WHITE STOP WATCH WITH "21 MINUTE" IN RED STYLIZED LETTERS OVERLAID ON THE WATCH; "THE" AND "WORKOUT" APPEAR IN BLACK STYLIZED LETTERS AND ABOVE AND BELOW THE WATCH.

FOR CONSULTING SERVICES IN THE FIELDS OF FITNESS AND EXERCISE; PERSONAL FITNESS TRAINING SERVICES AND CONSULTANCY; PHYSICAL FITNESS INSTRUCTION (U.S. CLS. 100, 101 AND 107).

FIRST USE 12-0-2010; IN COMMERCE 12-0-2010.

DAVID COLLIER, EXAMINING ATTORNEY

SN 85-317,803. ANDERSON UNIVERSITY, INC., ANDERSON, IN. FILED 5-11-2011.



NO CLAIM IS MADE TO THE EXCLUSIVE RIGHT TO USE "UNIVERSITY", APART FROM THE MARK AS SHOWN.

THE MARK CONSISTS OF A FLAME OVER A CURVEY LINE WITH THE WORDS "ANDERSON UNIVERSITY" UNDERNEATH THE LINE.

FOR EDUCATIONAL SERVICES IN THE NATURE OF COURSES AT THE UNIVERSITY LEVEL AND DISTRIBUTION OF MULTI-MEDIA TRAINING MATERIALS IN CONNECTION THEREWITH; ENTERTAINMENT SERVICES, NAMELY, ARRANGING AND CONDUCTING CONCERTS (U.S. CLS. 100, 101 AND 107).

ZHALEH DELANEY, EXAMINING ATTORNEY



**CLASS 41—(Continued).**

SN 85-317,858. LOUKA TACTICAL TRAINING LLC, BELLEVILLE, MI. FILED 5-11-2011.



NO CLAIM IS MADE TO THE EXCLUSIVE RIGHT TO USE "PUBLIC SAFETY BICYCLE TRAINING", APART FROM THE MARK AS SHOWN.

THE COLOR(S) BLACK AND BLUE IS/ARE CLAIMED AS A FEATURE OF THE MARK.

THE MARK CONSISTS OF A BLUE OUTLINE OF A SHIELD AT LEAST PARTIALLY SURROUNDING A BLACK BICYCLE RIDER GOING DOWN A BLACK STAIRCASE WITH THE WORDS "PUBLIC SAFETY BICYCLE TRAINING" IN BLACK SURROUNDING PORTIONS OF THE SHIELD OUTLINE.

FOR EDUCATIONAL SERVICES, NAMELY, CONDUCTING BICYCLE SAFETY AND TACTICS CLASSES, COURSES, AND WORKSHOPS AND DISTRIBUTION OF TRAINING MATERIALS IN CONNECTION THEREWITH (U.S. CLS. 100, 101 AND 107).

FIRST USE 4-0-2011; IN COMMERCE 4-0-2011.

BRIAN CALLAGHAN, EXAMINING ATTORNEY

SN 85-317,865. LOUKA TACTICAL TRAINING LLC, BELLEVILLE, MI. FILED 5-11-2011.

**BUILDING WARRIOR WOMEN**

THE MARK CONSISTS OF STANDARD CHARACTERS WITHOUT CLAIM TO ANY PARTICULAR FONT, STYLE, SIZE, OR COLOR.

NO CLAIM IS MADE TO THE EXCLUSIVE RIGHT TO USE "WOMEN", APART FROM THE MARK AS SHOWN.

FOR TRAINING IN THE USE AND OPERATION OF FIREARMS; TRAINING SERVICES IN THE FIELD OF TECHNIQUES FOR USE OF FIREARMS; CONDUCTING CLASSES AND COURSES IN SAFE AND PROFICIENT USE OF FIREARMS; PERSONAL FITNESS TRAINING SERVICES AND CONSULTANCY; EDUCATIONAL SERVICES, NAMELY, CONDUCTING CLASSES, SEMINARS, CONFERENCES, WORKSHOPS IN THE FIELDS OF FIREARMS TRAINING AND TACTICS, BICYCLE SAFETY AND TACTICS, DEFENSIVE TACTICS, AND PERSONAL FITNESS AND DISTRIBUTION OF TRAINING MATERIALS IN CONNECTION THEREWITH (U.S. CLS. 100, 101 AND 107).

BRIAN CALLAGHAN, EXAMINING ATTORNEY

**CLASS 41—(Continued).**

SN 85-318,164. RACOSKY, RICHARD J., BOULDER, CO. FILED 5-11-2011.

**JUST 2 CHOICES**

THE MARK CONSISTS OF STANDARD CHARACTERS WITHOUT CLAIM TO ANY PARTICULAR FONT, STYLE, SIZE, OR COLOR.

OWNER OF U.S. REG. NO. 3,865,890.

SEC. 2(F).

FOR EDUCATIONAL AND ENTERTAINMENT SERVICES, NAMELY, CONDUCTING LIVE SEMINARS, CONFERENCES, TELESEMINARS, WEBINARS, WORKSHOPS, AND PERSONAL COACHING IN THE FIELD OF SELF-IMPROVEMENT AND DISTRIBUTION OF COURSE MATERIALS IN CONNECTION THEREWITH, AND EDUCATION CONSULTING RELATED THERETO; EDUCATIONAL AND ENTERTAINMENT SERVICES, NAMELY, PROVIDING MOTIVATIONAL AND EDUCATIONAL SPEAKERS IN THE FIELD OF SELF- AND PERSONAL IMPROVEMENT; LIFE COACHING SERVICES IN THE FIELD OF SELF-IMPROVEMENT (U.S. CLS. 100, 101 AND 107).

GIANCARLO CASTRO, EXAMINING ATTORNEY

SN 85-318,654. OC AIR SHOW, LLC, COCOA BEACH, FL. FILED 5-11-2011.



NO CLAIM IS MADE TO THE EXCLUSIVE RIGHT TO USE "OC AIR SHOW", APART FROM THE MARK AS SHOWN.

THE MARK CONSISTS OF SIX AIRCRAFT WITH MOTION LINES FLYING UPWARDS AND FANNING OUTWARD FROM A CENTER POINT COMPRISING WAVES ALL ABOVE THE STYLIZED TEXT "OC AIR SHOW".

FOR ENTERTAINMENT IN THE NATURE OF AIR SHOWS (U.S. CLS. 100, 101 AND 107).

FIRST USE 2-1-2008; IN COMMERCE 2-1-2008.

CHRISTINE COOPER, EXAMINING ATTORNEY

**CLASS 41—(Continued).**

SN 85-318,656. HARKINS REEL DEALS, LLC, SCOTTSDALE, AZ. FILED 5-11-2011.

**ULTIMATE MOVIEGOING**

THE MARK CONSISTS OF STANDARD CHARACTERS WITHOUT CLAIM TO ANY PARTICULAR FONT, STYLE, SIZE, OR COLOR.

OWNER OF U.S. REG. NO. 3,081,012.

NO CLAIM IS MADE TO THE EXCLUSIVE RIGHT TO USE "MOVIEGOING", APART FROM THE MARK AS SHOWN.

SEC. 2(F).

FOR MOVIE THEATER SERVICES (U.S. CLS. 100, 101 AND 107).

FIRST USE 1-6-2005; IN COMMERCE 5-13-2005.

SANI KHOURI, EXAMINING ATTORNEY

---

SN 85-318,893. ALEXANDER, HILLARY, NOVATO, CA. FILED 5-12-2011.

**Hillary's Hounds Day  
Training Program**

THE MARK CONSISTS OF STANDARD CHARACTERS WITHOUT CLAIM TO ANY PARTICULAR FONT, STYLE, SIZE, OR COLOR.

NO CLAIM IS MADE TO THE EXCLUSIVE RIGHT TO USE "HOUNDS DAY TRAINING PROGRAM", APART FROM THE MARK AS SHOWN.

FOR DOG TRAINING (U.S. CLS. 100, 101 AND 107).

FIRST USE 6-1-2008; IN COMMERCE 6-1-2008.

CHRIS WELLS, EXAMINING ATTORNEY

**CLASS 41—(Continued).**

SN 85-318,894. OTTAWA AREA INTERMEDIATE SCHOOL DISTRICT, HOLLAND, MI. FILED 5-12-2011.



NO CLAIM IS MADE TO THE EXCLUSIVE RIGHT TO USE "MATH" AND "RTI PROGRAM", APART FROM THE MARK AS SHOWN.

THE MARK CONSISTS OF DESIGN OF AN INCOMPLETE CIRCLE AROUND THE WORDS "DELTA MATH" WHERE "DELTA MATH" APPEARS IN BLOCK LETTERS AND THE "A" IN EACH WORD IS A TRIANGLE AND THE WORDS "RTI PROGRAM" IN SMALLER BLOCK LETTERS BENEATH. THE LETTER "T" IN "RTI" IS LOWER CASE.

FOR EDUCATIONAL SERVICES, NAMELY, PROVIDING ONLINE ASSESSMENTS, TRAINING PROGRAMS, AND CONSULTATION THAT ASSIST SCHOOL TEACHERS AND ADMINISTRATORS IN ASSESSING STUDENT PROGRESS IN MATHEMATICS (U.S. CLS. 100, 101 AND 107).

FIRST USE 10-1-2010; IN COMMERCE 10-1-2010.

CHRIS WELLS, EXAMINING ATTORNEY

---

SN 85-318,946. JDM GOLF, LLC, PHOENIX, AZ. FILED 5-12-2011.

**HYBRID GOLF OUTINGS**

THE MARK CONSISTS OF STANDARD CHARACTERS WITHOUT CLAIM TO ANY PARTICULAR FONT, STYLE, SIZE, OR COLOR.

NO CLAIM IS MADE TO THE EXCLUSIVE RIGHT TO USE "GOLF OUTINGS", APART FROM THE MARK AS SHOWN.

FOR PROVIDING FACILITIES FOR RECREATIONAL ACTIVITIES, NAMELY, SKILLS CHALLENGES (U.S. CLS. 100, 101 AND 107).

FIRST USE 4-1-2011; IN COMMERCE 4-1-2011.

TOBY BULLOFF, EXAMINING ATTORNEY

**CLASS 41—(Continued).**

SN 85-319,042. ZINN, JEFF W, ORLEANS, MA. FILED 5-12-2011.

# W.H.A.T.

THE MARK CONSISTS OF STANDARD CHARACTERS WITHOUT CLAIM TO ANY PARTICULAR FONT, STYLE, SIZE, OR COLOR.

FOR CINEMA THEATERS; DINNER THEATERS; ENTERTAINMENT IN THE NATURE OF THEATER PRODUCTIONS; MOTION PICTURE THEATERS; MOVIE THEATERS; PROVIDING THEATER LISTINGS (U.S. CLS. 100, 101 AND 107).

FIRST USE 8-1-1985; IN COMMERCE 8-1-1985.  
AMY KERTGATE, EXAMINING ATTORNEY

---

SN 85-319,271. KLOSER, CHRISTINE, RED LION, FL. FILED 5-12-2011.

## TRANSFORMATIONAL AUTHOR EXPERIENCE

THE MARK CONSISTS OF STANDARD CHARACTERS WITHOUT CLAIM TO ANY PARTICULAR FONT, STYLE, SIZE, OR COLOR.

NO CLAIM IS MADE TO THE EXCLUSIVE RIGHT TO USE "AUTHOR", APART FROM THE MARK AS SHOWN.

FOR PROFESSIONAL COACHING SERVICES IN THE FIELDS OF BOOK WRITING, BOOK PROMOTION, AND SELF-HELP, EMOTIONAL HEALING AND MOTIVATION WITH RESPECT TO BOOK WRITING AND BOOK PROMOTION; EDUCATIONAL SERVICES, NAMELY, CONDUCTING WORKSHOPS, TRAINING, SEMINARS AND RETREATS IN THE FIELDS OF BOOK WRITING, BOOK PROMOTION, SELF-HELP, EMOTIONAL HEALING AND MOTIVATION AND DISTRIBUTION OF TRAINING MATERIALS IN CONNECTION THEREWITH; PERSONAL COACHING SERVICES IN THE FIELDS OF BOOK WRITING, BOOK PROMOTION, AND SELF-HELP, EMOTIONAL HEALING AND MOTIVATION WITH RESPECT TO BOOK WRITING AND BOOK PROMOTION; PROVIDING NEWSLETTERS IN THE FIELDS OF BOOK WRITING, BOOK PROMOTION, SELF-HELP AND MOTIVATION FOR PROFESSIONAL AND SPIRITUAL DEVELOPMENT OF AUTHORS VIA E-MAIL (U.S. CLS. 100, 101 AND 107).

FIRST USE 4-0-2011; IN COMMERCE 5-9-2011.  
SETH A. RAPPAPORT, EXAMINING ATTORNEY

**CLASS 41—(Continued).**

SN 85-319,439. FLECK, LLC, OKLAHOMA CITY, OK. FILED 5-12-2011.

# CROWN

THE MARK CONSISTS OF STANDARD CHARACTERS WITHOUT CLAIM TO ANY PARTICULAR FONT, STYLE, SIZE, OR COLOR.

FOR EDUCATIONAL AND ENTERTAINMENT SERVICES, NAMELY, PROVIDING MOTIVATIONAL AND EDUCATIONAL SPEAKERS; EDUCATIONAL AND ENTERTAINMENT SERVICES, NAMELY, PROVIDING MOTIVATIONAL AND EDUCATIONAL SPEAKERS IN THE FIELD OF SELF- AND PERSONAL IMPROVEMENT (U.S. CLS. 100, 101 AND 107).

FIRST USE 5-4-2011; IN COMMERCE 5-4-2011.  
ESTHER BELENKER, EXAMINING ATTORNEY

---

SN 85-319,792. MONDO MEDIA, INC., SAN FRANCISCO, CA. FILED 5-12-2011.

## MONDO MINI SHOWS

THE MARK CONSISTS OF STANDARD CHARACTERS WITHOUT CLAIM TO ANY PARTICULAR FONT, STYLE, SIZE, OR COLOR.

OWNER OF U.S. REG. NOS. 1,954,622 AND 2,955,219.  
NO CLAIM IS MADE TO THE EXCLUSIVE RIGHT TO USE "MINI SHOWS", APART FROM THE MARK AS SHOWN.

FOR ENTERTAINMENT SERVICES, NAMELY, PRODUCTION OF AN ANIMATED CARTOON SERIES FEATURED ON THE GLOBAL COMPUTER NETWORK (U.S. CLS. 100, 101 AND 107).

FIRST USE 8-1-1998; IN COMMERCE 8-1-1998.  
H. M. FISHER, EXAMINING ATTORNEY

**CLASS 41—(Continued).**

SN 85-319,802. MONDO MEDIA, INC., SAN FRANCISCO, CA. FILED 5-12-2011.

**HAPPY TREE FRIENDS**

THE MARK CONSISTS OF STANDARD CHARACTERS WITHOUT CLAIM TO ANY PARTICULAR FONT, STYLE, SIZE, OR COLOR.

FOR ENTERTAINMENT AND ANIMATION PRODUCTION SERVICES, NAMELY, PRODUCING AN ANIMATED CARTOON SERIES FEATURED ON TELEVISION AND ON A WEB SITE ON THE INTERNET; ENTERTAINMENT SERVICES IN THE NATURE OF LIVE-ACTION, COMEDY AND DRAMA TELEVISION PROGRAMS; PRODUCTION OF LIVE-ACTION COMEDY, DRAMA AND ANIMATED MOTION PICTURE THEATRICAL FILMS; ENTERTAINMENT IN THE NATURE OF LIVE ACTION THEATRICAL PERFORMANCES; PROVIDING A WEB SITE FEATURING INFORMATION ABOUT MOVIES, CARTOONS, AND RELATED ENTERTAINMENT INDUSTRY INFORMATION (U.S. CLS. 100, 101 AND 107).

FIRST USE 1-1-1999; IN COMMERCE 1-1-1999.

H. M. FISHER, EXAMINING ATTORNEY

**CLASS 41—(Continued).**

SN 85-319,973. HORROR ENTERTAINMENT, LLC, LOS ANGELES, CA. FILED 5-13-2011.

**FEARFUL FIRST FIVE**

THE MARK CONSISTS OF STANDARD CHARACTERS WITHOUT CLAIM TO ANY PARTICULAR FONT, STYLE, SIZE, OR COLOR.

FOR ENTERTAINMENT SERVICES, NAMELY, PROVIDING NON-DOWNLOADABLE AUDIOVISUAL CONTENT VIA THE INTERNET FEATURING PORTIONS OF HORROR MOVIES AND TELEVISION PROGRAMS (U.S. CLS. 100, 101 AND 107).

EMILY CARLSEN, EXAMINING ATTORNEY

SN 85-320,261. REVVED UP KIDS, LLC, ALPHARETTA, GA. FILED 5-13-2011.

**Revved Up Kids**  
Be Smart ⇒ Be Strong ⇒ Be Safe

SN 85-319,891. ALLEN, ROSIE L., MCLEAN, VA. AND JAMES, ANTHONY L., MCLEAN, VA. FILED 5-12-2011.



**International Protocol and Etiquette Services**

NO CLAIM IS MADE TO THE EXCLUSIVE RIGHT TO USE "INTERNATIONAL PROTOCOL AND ETIQUETTE SERVICES", APART FROM THE MARK AS SHOWN.

THE MARK CONSISTS OF THE STYLIZED TEXT "IPES" SUPERIMPOSED OVER A SHADED GLOBE DESIGN SET IN A SQUARE BOX WITH ROUNDED CORNERS; BENEATH THIS DESIGN PORTION AND IN STYLIZED FONT IS THE PHRASE "INTERNATIONAL PROTOCOL AND ETIQUETTE SERVICES".

FOR TRAINING SERVICES IN THE FIELD OF INTERNATIONAL PROTOCOL, BUSINESS ETIQUETTE AND PROTOCOL, AND IMAGING (U.S. CLS. 100, 101 AND 107).

FIRST USE 3-7-2011; IN COMMERCE 3-30-2011.

BENJAMIN OKEKE, EXAMINING ATTORNEY

THE MARK CONSISTS OF THE WORDS "REVVED UP KIDS", WITH AN ARROW POINTING VERTICALLY UP FROM THE "U" IN "UP", UNDERNEATH WHICH APPEAR, IN SMALLER LETTERS, THE IMPERATIVE PHRASES "BE SMART", "BE STRONG", AND "BE SAFE", CONNECTED WITH HORIZONTAL ARROWS.

FOR EDUCATIONAL AND ENTERTAINMENT SERVICES, NAMELY, CONDUCTING CONFERENCES, WORKSHOPS, SEMINARS, AND CLASSES IN THE FIELD OF PERSONAL SAFETY, ABDUCTION PREVENTION, AND SELF-DEFENSE FOR CHILDREN AND DISTRIBUTION OF COURSE MATERIALS IN CONNECTION THEREWITH, AND EDUCATION CONSULTING RELATED THERETO; EDUCATIONAL SERVICES, NAMELY, CONDUCTING CONFERENCES, WORKSHOPS, SEMINARS, AND CLASSES IN THE FIELD OF PERSONAL SAFETY, ABDUCTION PREVENTION, AND SELF-DEFENSE FOR CHILDREN AND DISTRIBUTION OF PRINTED MATERIALS IN CONNECTION THEREWITH IN HARD COPY OR ELECTRONIC FORMAT ON THE SAME TOPICS; EDUCATIONAL SERVICES, NAMELY, CONDUCTING CONFERENCES, WORKSHOPS, SEMINARS, AND CLASSES IN THE FIELD OF PERSONAL SAFETY, ABDUCTION PREVENTION, AND SELF-DEFENSE FOR CHILDREN AND DISTRIBUTION OF EDUCATIONAL MATERIALS IN CONNECTION THEREWITH; EDUCATIONAL SERVICES, NAMELY, DEVELOPING CURRICULUM FOR OTHERS IN THE FIELD OF PERSONAL SAFETY, ABDUCTION PREVENTION, AND SELF-DEFENSE FOR CHILDREN; INSTRUCTION IN THE FIELD OF PERSONAL SAFETY, ABDUCTION PREVENTION, AND SELF-DEFENSE FOR CHILDREN (U.S. CLS. 100, 101 AND 107).

FIRST USE 10-29-2010; IN COMMERCE 11-0-2010.

LINDA E. BLOHM, EXAMINING ATTORNEY

**CLASS 41—(Continued).**

SN 85-320,464. COOKING BY THE BOOK INC., NEW YORK, NY. FILED 5-13-2011.

**COOKING BY THE BOOK**

THE MARK CONSISTS OF STANDARD CHARACTERS WITHOUT CLAIM TO ANY PARTICULAR FONT, STYLE, SIZE, OR COLOR.

FOR EDUCATIONAL AND ENTERTAINMENT SERVICES, NAMELY, PROVIDING COOKING CLASSES AND MULTI-DIMENSIONAL CULINARY ARTS PROGRAMS FOR COMPANIES, PROFESSIONALS, AND INDIVIDUALS, CONDUCTING COOKING CLASSES AND CULINARY ARTS PROGRAMS DIRECTED TO TEAM-BUILDING; ENTERTAINMENT SERVICES AND EDUCATIONAL SERVICES, NAMELY, CONDUCTING LIVE INTERACTIVE GAMES AS PART OF CULINARY ARTS PROGRAMS DIRECTED TO TEAM-BUILDING; ENTERTAINMENT SERVICES, NAMELY, CONDUCTING FOOD AND WINE TASTINGS; RENTAL OF FACILITIES FOR PARTIES; RENTAL OF FACILITIES FOR VIDEO AND PHOTO SHOOTS (U.S. CLS. 100, 101 AND 107).

FIRST USE 11-9-1989; IN COMMERCE 11-9-1989.  
JAY FLOWERS, EXAMINING ATTORNEY

---

SN 85-320,589. STATE FAIR OF TEXAS, DALLAS, TX. FILED 5-13-2011.

**SUMMER ADVENTURES IN FAIR PARK**

THE MARK CONSISTS OF STANDARD CHARACTERS WITHOUT CLAIM TO ANY PARTICULAR FONT, STYLE, SIZE, OR COLOR.

NO CLAIM IS MADE TO THE EXCLUSIVE RIGHT TO USE "FAIR PARK", APART FROM THE MARK AS SHOWN.

FOR ARRANGING AND CONDUCTING ENTERTAINMENT AND AMUSEMENT SERVICES, NAMELY, SHOWS, RIDES AND GAMES; ARRANGING AND CONDUCTING EDUCATIONAL SERVICES IN THE NATURE OF PUBLIC EXHIBITS AND PRESENTATIONS FEATURING ACHIEVEMENTS IN THE ARTS AND SCIENCES (U.S. CLS. 100, 101 AND 107).

EMILY CARLSEN, EXAMINING ATTORNEY

**CLASS 41—(Continued).**

SN 85-320,642. INTERNET PRODUCT DEVELOPMENT GROUP INC., WASHINGTON, DC. FILED 5-13-2011.

**EIN NEWS**

THE MARK CONSISTS OF STANDARD CHARACTERS WITHOUT CLAIM TO ANY PARTICULAR FONT, STYLE, SIZE, OR COLOR.

OWNER OF U.S. REG. NO. 3,717,564.

NO CLAIM IS MADE TO THE EXCLUSIVE RIGHT TO USE "NEWS", APART FROM THE MARK AS SHOWN.

FOR NEWS AGENCIES, NAMELY, GATHERING AND DISSEMINATION OF NEWS (U.S. CLS. 100, 101 AND 107).

FIRST USE 4-12-2002; IN COMMERCE 4-12-2002.  
PATRICIA EVANKO, EXAMINING ATTORNEY

---

SN 85-320,725. ACTION BASED LEARNING LAB LLC, MURPHY, TX. FILED 5-13-2011.

**NEURONASIUM**

THE MARK CONSISTS OF STANDARD CHARACTERS WITHOUT CLAIM TO ANY PARTICULAR FONT, STYLE, SIZE, OR COLOR.

FOR EDUCATIONAL SERVICES, NAMELY, CONDUCTING PROGRAMS IN THE FIELD OF PHYSICAL EXERCISE AND ACADEMIC ACHIEVEMENT BASED ON THE NEUROSCIENCE LINKING MOVEMENT AND EXERCISE TO LEARNING (U.S. CLS. 100, 101 AND 107).

IRA J. GOODSaid, EXAMINING ATTORNEY

---

SN 85-320,857. ACTION BASED LEARNING LAB LLC, MURPHY, TX. FILED 5-13-2011.



THE GRAY IN THE MARK IS FOR SHADING PURPOSES ONLY, AND DOES NOT REPRESENT COLOR.

THE MARK CONSISTS OF A STYLIZED BRAIN DESIGN FROM WHICH ELECTRICITY CHARGES EMANATE AND THE TERM "NEURONASIUM" APPEARS INSIDE.

FOR EDUCATIONAL SERVICES, NAMELY, CONDUCTING PROGRAMS IN THE FIELD OF PHYSICAL EXERCISE AND ACADEMIC ACHIEVEMENT BASED ON THE NEUROSCIENCE LINKING MOVEMENT AND EXERCISE TO LEARNING (U.S. CLS. 100, 101 AND 107).

IRA J. GOODSaid, EXAMINING ATTORNEY

**CLASS 41—(Continued).**

SN 85-320,871. LEE TAYLOR DESIGN, LLC, MAITLAND, FL. FILED 5-13-2011.

## Pane in the Glass

THE MARK CONSISTS OF STANDARD CHARACTERS WITHOUT CLAIM TO ANY PARTICULAR FONT, STYLE, SIZE, OR COLOR.

FOR ON-LINE JOURNALS, NAMELY, BLOGS FEATURING INFORMATION ABOUT GLASS ARTWORKS, GLASS STUDIOS, FUSED GLASS, STAINED GLASS, GLASS DESIGN, ART SHOWS AND GALLERIES (U.S. CLS. 100, 101 AND 107).

FIRST USE 6-4-2010; IN COMMERCE 5-8-2011.

BARBARA A. GOLD, EXAMINING ATTORNEY

**CLASS 41—(Continued).**

SN 85-321,113. SPARKLING EVENTS & DESIGNS, LLC., STONE RIDGE, VA. FILED 5-14-2011.



The logo for Sparkling Events & Designs features the word "Sparkling" in a large, elegant, cursive script. Below it, the words "Events & Designs" are written in a smaller, simpler cursive font. A small decorative flourish is positioned at the bottom right of the logo.

NO CLAIM IS MADE TO THE EXCLUSIVE RIGHT TO USE "EVENTS & DESIGNS", APART FROM THE MARK AS SHOWN.

THE MARK CONSISTS OF THE WORDS "SPARKLING EVENTS & DESIGNS" IN STYLIZED LETTERS, SHOWN WITH A CALLIGRAPHIC FLOURISH CENTERED UNDERNEATH.

FOR CONSULTATION IN THE FIELD OF SPECIAL EVENT PLANNING FOR SOCIAL ENTERTAINMENT PURPOSES; PARTY AND WEDDING PLANNING, COORDINATION AND CONSULTATION SERVICES; PROVIDING INFORMATION IN THE FIELD OF WEDDING PARTY PLANNING (U.S. CLS. 100, 101 AND 107).

FIRST USE 7-21-2009; IN COMMERCE 7-21-2009.

KRISTIN CARLSON, EXAMINING ATTORNEY

SN 85-320,903. BRING IT BOOTCAMP LLC, MIAMI, FL. FILED 5-13-2011.



The logo for Bring It Bootcamp features the words "BRING IT" in a bold, sans-serif font. To the right of "IT" is a stylized arrow pointing to the right. Below "BRING IT" are six horizontal bars of varying lengths, followed by the word "BOOTCAMP" in a smaller, bold, sans-serif font.

NO CLAIM IS MADE TO THE EXCLUSIVE RIGHT TO USE "BOOTCAMP", APART FROM THE MARK AS SHOWN.

THE MARK CONSISTS OF "BRING IT" IN BOLD LETTERING AND AN ARROW POINTING TO THE RIGHT HAND SIDE AT THE END OF IT; BELOW ARE 6 BARS GETTING SMALLER, THEN FOLLOWED BY "BOOTCAMP" IN THE SAME LETTERING AS "BRING IT".

FOR PROVIDING CAMPS IN THE FIELDS OF FITNESS, AND EXERCISE (U.S. CLS. 100, 101 AND 107).

FIRST USE 4-21-2010; IN COMMERCE 4-21-2010.

MICHAEL WEBSTER, EXAMINING ATTORNEY

SN 85-321,501. LIRON MELLER, DBA MY COOKING PARTY, BLOOMFIELD, NJ. FILED 5-16-2011.

## My Cooking Party

THE MARK CONSISTS OF STANDARD CHARACTERS WITHOUT CLAIM TO ANY PARTICULAR FONT, STYLE, SIZE, OR COLOR.

NO CLAIM IS MADE TO THE EXCLUSIVE RIGHT TO USE "COOKING PARTY", APART FROM THE MARK AS SHOWN.

FOR ARRANGING AND CONDUCTING SPECIAL EVENTS FOR SOCIAL ENTERTAINMENT PURPOSES; EDUCATION SERVICES, NAMELY, PROVIDING CLASSES IN THE FIELD OF COOKING; ENTERTAINMENT IN THE NATURE OF COMPETITIONS IN THE FIELD OF COOKING; ENTERTAINMENT SERVICES, NAMELY, ARRANGING AND CONDUCTING OF COMPETITIONS FOR COOKING; ENTERTAINMENT SERVICES, NAMELY, CONDUCTING PARTIES; ENTERTAINMENT SERVICES, NAMELY, WINE AND FOOD TASTINGS; ENTERTAINMENT SERVICES, NAMELY, WINE TASTINGS (U.S. CLS. 100, 101 AND 107).

FIRST USE 5-1-2005; IN COMMERCE 5-1-2005.

EDWARD NELSON, EXAMINING ATTORNEY

**CLASS 41—(Continued).**

SN 85-321,891. BRUNSON, RICKEY, WAUKEGAN, IL. AND BANKS, EUGENE, WAUKEGAN, IL. FILED 5-16-2011.



NO CLAIM IS MADE TO THE EXCLUSIVE RIGHT TO USE "PRODUCTION", APART FROM THE MARK AS SHOWN.

THE MARK CONSISTS OF WEIGHTS BENDING ON BOTH ENDS OF A BENCH PRESSING BAR, WITH THE WORDS "POUND PUSHA" SITTING ABOVE AND "PRODUCTION" BELOW THE BAR.

FOR MULTIMEDIA ENTERTAINMENT SERVICES IN THE NATURE OF RECORDING, PRODUCTION AND POST-PRODUCTION SERVICES IN THE FIELDS OF MUSIC, VIDEO, AND FILMS (U.S. CLS. 100, 101 AND 107).

EDWARD FENNESSY, EXAMINING ATTORNEY

SN 85-321,934. AL-MONITOR LLC, HOUSTON, TX. FILED 5-16-2011.

## THE PULSE OF THE MIDDLE EAST

THE MARK CONSISTS OF STANDARD CHARACTERS WITHOUT CLAIM TO ANY PARTICULAR FONT, STYLE, SIZE, OR COLOR.

NO CLAIM IS MADE TO THE EXCLUSIVE RIGHT TO USE "MIDDLE EAST", APART FROM THE MARK AS SHOWN.

FOR ONLINE NON-DOWNLOADABLE PUBLICATIONS FEATURING MIDDLE EASTERN POLITICAL AND BUSINESS NEWS, NAMELY, ARTICLES AND ARTICLES IN THE NATURE OF EDITORIALS, TRANSLATED FROM ARABIC TO ENGLISH, AND ALSO FEATURING NON-DOWNLOADABLE SOFTWARE WHICH ENABLES SUBSCRIBERS TO POST COMMENTS ONLINE RELATIVE TO THE SAME (U.S. CLS. 100, 101 AND 107).

JEAN IM, EXAMINING ATTORNEY

**CLASS 41—(Continued).**

SN 85-321,937. AL-MONITOR LLC, HOUSTON, TX. FILED 5-16-2011.

## AL-MONITOR

THE MARK CONSISTS OF STANDARD CHARACTERS WITHOUT CLAIM TO ANY PARTICULAR FONT, STYLE, SIZE, OR COLOR.

FOR ONLINE NON-DOWNLOADABLE PUBLICATIONS FEATURING MIDDLE EASTERN POLITICAL AND BUSINESS NEWS, NAMELY, ARTICLES AND ARTICLES IN THE NATURE OF EDITORIALS, TRANSLATED FROM ARABIC TO ENGLISH, AND ALSO FEATURING NON-DOWNLOADABLE SOFTWARE WHICH ENABLES SUBSCRIBERS TO POST COMMENTS ONLINE RELATIVE TO THE SAME (U.S. CLS. 100, 101 AND 107).

JEAN IM, EXAMINING ATTORNEY

SN 85-321,990. UNIVERSITY OF IDAHO, MOSCOW, ID. FILED 5-16-2011.

## OPERATION EDUCATION

THE MARK CONSISTS OF STANDARD CHARACTERS WITHOUT CLAIM TO ANY PARTICULAR FONT, STYLE, SIZE, OR COLOR.

NO CLAIM IS MADE TO THE EXCLUSIVE RIGHT TO USE "EDUCATION", APART FROM THE MARK AS SHOWN.

FOR EDUCATIONAL COUNSELING SERVICES TO ASSIST STUDENTS IN PLANNING AND PREPARING FOR FURTHER EDUCATION (U.S. CLS. 100, 101 AND 107).

FIRST USE 1-31-2007; IN COMMERCE 1-31-2007.  
KIM MONINGHOFF, EXAMINING ATTORNEY

SN 85-322,165. SOUL LIGHTENING INTERNATIONAL, LOS ALTOS, CA. FILED 5-16-2011.

## Acupressure for Anyone

THE MARK CONSISTS OF STANDARD CHARACTERS WITHOUT CLAIM TO ANY PARTICULAR FONT, STYLE, SIZE, OR COLOR.

NO CLAIM IS MADE TO THE EXCLUSIVE RIGHT TO USE "ACUPRESSURE", APART FROM THE MARK AS SHOWN.

FOR EDUCATIONAL SERVICES, NAMELY, CONDUCTING WORKSHOPS IN THE FIELDS OF ACUPRESSURE METHODS AND DISTRIBUTION OF TRAINING MATERIALS IN CONNECTION THEREWITH (U.S. CLS. 100, 101 AND 107).

FIRST USE 9-2-2009; IN COMMERCE 1-17-2010.  
DARRYL SPRUILL, EXAMINING ATTORNEY

**CLASS 41—(Continued).**

SN 85-322,202. ACTION BASED LEARNING LAB LLC, MURPHY, TX. FILED 5-16-2011.

**BODY BRAIN ADVENTURE**

THE MARK CONSISTS OF STANDARD CHARACTERS WITHOUT CLAIM TO ANY PARTICULAR FONT, STYLE, SIZE, OR COLOR.

FOR EDUCATIONAL SERVICES, NAMELY, CONDUCTING PROGRAMS IN THE FIELD OF PHYSICAL EXERCISE AND ACADEMIC ACHIEVEMENT BASED ON THE NEUROSCIENCE LINKING MOVEMENT AND EXERCISE TO LEARNING; EDUCATIONAL SERVICES, NAMELY, CONDUCTING CLASSES, SEMINARS AND WORKSHOPS IN THE FIELD OF HOW LEARNING TAKES PLACE AND KINESTHETIC TEACHING STRATEGIES, DISTRIBUTION OF COURSE MATERIALS IN CONNECTION THEREWITH, AND EDUCATION CONSULTING RELATED THERETO (U.S. CLS. 100, 101 AND 107).

IRA J. GOODSaid, EXAMINING ATTORNEY

SN 85-322,825. INTERACTIVE SPORT, LLC, DAUPHIN, AL. FILED 5-17-2011.

**ISLE COACH**

THE MARK CONSISTS OF STANDARD CHARACTERS WITHOUT CLAIM TO ANY PARTICULAR FONT, STYLE, SIZE, OR COLOR.

NO CLAIM IS MADE TO THE EXCLUSIVE RIGHT TO USE "COACH", APART FROM THE MARK AS SHOWN.

FOR ENTERTAINMENT SERVICES, NAMELY, PROVIDING AN ON-LINE COMPUTER GAME (U.S. CLS. 100, 101 AND 107).

CHRISTINE COOPER, EXAMINING ATTORNEY

SN 85-323,023. LIVE 2 BOUNCE LLC, SYRACUSE, NY. FILED 5-17-2011.



NO CLAIM IS MADE TO THE EXCLUSIVE RIGHT TO USE "BOUNCE", APART FROM THE MARK AS SHOWN.

THE MARK CONSISTS OF THE STYLIZED TEXT "LIVE 2 BOUNCE" WHERE THE "2" IS SLIGHTLY HIGHER THAN "LIVE" AND "BOUNCE".

FOR CHILDREN'S ENTERTAINMENT AND AMUSEMENT CENTERS, NAMELY, INTERACTIVE PLAY AREAS (U.S. CLS. 100, 101 AND 107).

FIRST USE 2-1-2010; IN COMMERCE 3-1-2010.

NAKIA HENRY, EXAMINING ATTORNEY

**CLASS 41—(Continued).**

SN 85-323,132. GUITAR CENTER, INC., WESTLAKE VILLAGES, CA. FILED 5-17-2011.

**RAPID RENTALS**

THE MARK CONSISTS OF STANDARD CHARACTERS WITHOUT CLAIM TO ANY PARTICULAR FONT, STYLE, SIZE, OR COLOR.

NO CLAIM IS MADE TO THE EXCLUSIVE RIGHT TO USE "RENTALS", APART FROM THE MARK AS SHOWN.

FOR ONLINE BAND AND ORCHESTRA MUSICAL INSTRUMENT RENTAL SERVICES (U.S. CLS. 100, 101 AND 107).

JAMES LOVELACE, EXAMINING ATTORNEY

SN 85-323,199. BODYSTAR FITNESS, INC., WILMETTE, IL. FILED 5-17-2011.

**BODYSTAR**

THE MARK CONSISTS OF STANDARD CHARACTERS WITHOUT CLAIM TO ANY PARTICULAR FONT, STYLE, SIZE, OR COLOR.

FOR PROVIDING A WEB SITE FEATURING NON-DOWNLOADABLE INSTRUCTIONAL VIDEOS IN THE FIELD OF PHYSICAL EXERCISE (U.S. CLS. 100, 101 AND 107).

SHARON MEIER, EXAMINING ATTORNEY

SN 85-323,323. TAMMY APPLETON, AKA WICKED FITNESS, MURRELLS INLET, SC. FILED S.R. 5-17-2011; AM. P.R. 9-8-2011.

**Wicked Fitness Pollet**

THE MARK CONSISTS OF STANDARD CHARACTERS WITHOUT CLAIM TO ANY PARTICULAR FONT, STYLE, SIZE, OR COLOR.

NO CLAIM IS MADE TO THE EXCLUSIVE RIGHT TO USE "FITNESS", APART FROM THE MARK AS SHOWN.

FOR PHYSICAL FITNESS CONDITIONING CLASSES (U.S. CLS. 100, 101 AND 107).

FIRST USE 8-5-2010; IN COMMERCE 9-1-2010.

MATTHEW KLINE, EXAMINING ATTORNEY



**CLASS 41—(Continued).**

SN 85-323,335. TAYLOR, LILLIE DAWN, DBA VIRGINIA THUNDER, NORFOLK, VA. FILED 5-17-2011.

**VIRGINIA THUNDER**

THE MARK CONSISTS OF STANDARD CHARACTERS WITHOUT CLAIM TO ANY PARTICULAR FONT, STYLE, SIZE, OR COLOR.

NO CLAIM IS MADE TO THE EXCLUSIVE RIGHT TO USE "VIRGINIA", APART FROM THE MARK AS SHOWN.

FOR ENTERTAINMENT IN THE NATURE OF DANCE PERFORMANCES (U.S. CLS. 100, 101 AND 107).

FIRST USE 10-15-2005; IN COMMERCE 10-15-2005.

ADA HAN, EXAMINING ATTORNEY

**CLASS 41—(Continued).**

SN 85-323,583. ELK RIVER EXTREME MOTOR PARK, INC., ELK RIVER, MN. FILED 5-18-2011.

**BEATERCROSS**

THE MARK CONSISTS OF STANDARD CHARACTERS WITHOUT CLAIM TO ANY PARTICULAR FONT, STYLE, SIZE, OR COLOR.

FOR ENTERTAINMENT SERVICES IN THE NATURE OF COMPETITIONS IN THE FIELD OF DEMOLITION DERBY CONTESTS, MOTOCROSS AND MOTOR SPORTS EVENTS (U.S. CLS. 100, 101 AND 107).

FIRST USE 7-1-2010; IN COMMERCE 7-1-2010.

SAMUEL E. SHARPER JR., EXAMINING ATTORNEY

SN 85-323,387. AMERICAN COLLEGE OF BRAZILIAN STUDIES, LLC, DBA AMBRA, ORLANDO, FL. FILED 5-17-2011.

**Ambra**

THE MARK CONSISTS OF STANDARD CHARACTERS WITHOUT CLAIM TO ANY PARTICULAR FONT, STYLE, SIZE, OR COLOR.

THE ENGLISH TRANSLATION OF THE WORD "AMBRA" IN THE MARK IS "AMBER".

FOR EDUCATIONAL SERVICES, NAMELY, CONDUCTING DISTANCE LEARNING INSTRUCTION AT THE SECONDARY, COLLEGE AND GRADUATE LEVELS (U.S. CLS. 100, 101 AND 107).

FIRST USE 1-6-2010; IN COMMERCE 2-0-2010.

MATTHEW KLINE, EXAMINING ATTORNEY

SN 85-323,585. ELK RIVER EXTREME MOTOR PARK, INC., ELK RIVER, MN. FILED 5-18-2011.

**BEATER-X**

THE MARK CONSISTS OF STANDARD CHARACTERS WITHOUT CLAIM TO ANY PARTICULAR FONT, STYLE, SIZE, OR COLOR.

FOR ENTERTAINMENT SERVICES IN THE NATURE OF COMPETITIONS IN THE FIELD OF DEMOLITION DERBY CONTESTS, MOTOCROSS AND MOTOR SPORTS EVENTS (U.S. CLS. 100, 101 AND 107).

FIRST USE 7-1-2010; IN COMMERCE 7-1-2010.

SAMUEL E. SHARPER JR., EXAMINING ATTORNEY

SN 85-323,483. ROWE, JENNY, PALO ALTO, CA. FILED 5-18-2011.

**XERCISE LAB**

THE MARK CONSISTS OF STANDARD CHARACTERS WITHOUT CLAIM TO ANY PARTICULAR FONT, STYLE, SIZE, OR COLOR.

NO CLAIM IS MADE TO THE EXCLUSIVE RIGHT TO USE "EXERCISE", APART FROM THE MARK AS SHOWN.

FOR EDUCATION AND ENTERTAINMENT SERVICES, NAMELY, A CHOREOGRAPHED GROUP FITNESS PROGRAM FOR CHILDREN AND ADULTS (U.S. CLS. 100, 101 AND 107).

KAREN SEVERSON, EXAMINING ATTORNEY

SN 85-323,676. THE ALBRIGHTS, DBA THE ALBRIGHTS BAND, BUFFALO, NY. FILED 5-18-2011.



THE COLOR(S) YELLOW, BLACK, AND WHITE IS/ARE CLAIMED AS A FEATURE OF THE MARK.

THE MARK CONSISTS OF THE STYLIZED WORDING "THE ALBRIGHTS" WITH "THE" IN YELLOW WITH BLACK OUTLINING AND "ALBRIGHTS" IN WHITE WITH BLACK OUTLINING AND STYLIZED BLACK DOTS.

FOR ENTERTAINMENT SERVICES IN THE NATURE OF LIVE MUSICAL PERFORMANCES (U.S. CLS. 100, 101 AND 107).

FIRST USE 3-11-2011; IN COMMERCE 5-17-2011.

BARBARA RUTLAND, EXAMINING ATTORNEY

**CLASS 41—(Continued).**

SN 85-323,867. PEERFIT, INC., GAINESVILLE, FL. FILED 5-18-2011.

peerFit

THE MARK CONSISTS OF STANDARD CHARACTERS WITHOUT CLAIM TO ANY PARTICULAR FONT, STYLE, SIZE, OR COLOR.

FOR PROVIDING A WEBSITE FEATURING COLLECTED, ORGANIZED AND DISTRIBUTED USER-PROVIDED INFORMATION IN THE FIELD OF PHYSICAL FITNESS ACTIVITIES (U.S. CLS. 100, 101 AND 107).

FIRST USE 5-15-2011; IN COMMERCE 5-15-2011.  
TRACY FLETCHER, EXAMINING ATTORNEY

**CLASS 41—(Continued).**

SN 85-324,010. HIGH NOON PRODUCTIONS, LLC, DENVER, CO. FILED 5-18-2011.

High Noon Productions

THE MARK CONSISTS OF STANDARD CHARACTERS WITHOUT CLAIM TO ANY PARTICULAR FONT, STYLE, SIZE, OR COLOR.

OWNER OF U.S. REG. NOS. 3,173,426 AND 3,746,530.

NO CLAIM IS MADE TO THE EXCLUSIVE RIGHT TO USE "PRODUCTIONS", APART FROM THE MARK AS SHOWN.

FOR PRODUCTION OF TELEVISION PROGRAMS ACROSS ALL MEDIA AND DISTRIBUTION OF TELEVISION PROGRAMS, EXCLUDING VIDEO PRODUCTION FOR TELEVISION COMMERCIALS ON BROADCAST, CABLE AND SATELLITE, AND EXCLUDING CORPORATE VIDEO FOR NON-BROADCAST DISTRIBUTION ONLY (U.S. CLS. 100, 101 AND 107).

FIRST USE 2-4-1997; IN COMMERCE 2-4-1997.  
ALEXANDER L. POWERS, EXAMINING ATTORNEY

SN 85-323,869. BONNIER ACTIVE MEDIA, INC., WINTER PARK, FL. FILED 5-18-2011.

Devise and Conquer

THE MARK CONSISTS OF STANDARD CHARACTERS WITHOUT CLAIM TO ANY PARTICULAR FONT, STYLE, SIZE, OR COLOR.

FOR PROVIDING AN INTERNET WEBSITE PORTAL IN THE FIELD OF ENTERTAINMENT AND SPORTING EVENTS FEATURING PROGRAMS IN THE FIELD OF WAKEBOARDING COMPETITIONS; EDUCATION AND ENTERTAINMENT SERVICES, NAMELY, PRODUCTION AND DISTRIBUTION OF TELEVISION PROGRAMS IN THE FIELD OF WAKEBOARDING RELATED COMPETITIONS; ENTERTAINMENT SERVICES, NAMELY, PROVIDING AN ON-GOING TELEVISION PROGRAM IN THE FIELD OF WAKEBOARDING COMPETITIONS VIA A GLOBAL COMPUTER NETWORK (U.S. CLS. 100, 101 AND 107).

FIRST USE 4-1-2011; IN COMMERCE 5-17-2011.  
ANGELA M. MICHELI, EXAMINING ATTORNEY

SN 85-324,189. METTA YOGA & BODYWORK COMPANY, BATAVIA, IL. FILED 5-18-2011.

METTA YOGA

THE MARK CONSISTS OF STANDARD CHARACTERS WITHOUT CLAIM TO ANY PARTICULAR FONT, STYLE, SIZE, OR COLOR.

NO CLAIM IS MADE TO THE EXCLUSIVE RIGHT TO USE "YOGA", APART FROM THE MARK AS SHOWN.

FOR EDUCATION SERVICES; NAMELY, CONDUCTING YOGA, MEDITATION AND WELLNESS INSTRUCTION, CLASSES, SEMINARS, CONFERENCES, WORKSHOPS, RETREATS, YOGA TEACHER TRAININGS, AND EDUCATIONAL MATERIALS DISTRIBUTED IN CONNECTION THEREWITH (U.S. CLS. 100, 101 AND 107).

FIRST USE 12-10-2003; IN COMMERCE 12-10-2003.  
TRACY WHITTAKER-BROWN, EXAMINING ATTORNEY

**CLASS 41—(Continued).**

SN 85-324,217. UNIVISION COMMUNICATIONS INC., LOS ANGELES, CA. FILED 5-18-2011.

**50 MILLONES DICEN**

THE MARK CONSISTS OF STANDARD CHARACTERS WITHOUT CLAIM TO ANY PARTICULAR FONT, STYLE, SIZE, OR COLOR.

THE ENGLISH TRANSLATION OF "MILLONES DICEN" IN THE MARK IS "MILLION SAY".

FOR ENTERTAINMENT SERVICES, NAMELY, AN ONGOING TELEVISION GAME SHOW (U.S. CLS. 100, 101 AND 107).

ALLISON SCHRODY, EXAMINING ATTORNEY

SN 85-324,300. BURDETTE, JON, SPRINGFIELD, MO. AND BURDETTE, NINA, SPRINGFIELD, MO. AND BURDETTE, GENE, SPRINGFIELD, MO. AND RIPLEY, JAMES, SPRINGFIELD, MO. FILED 5-18-2011.



NO CLAIM IS MADE TO THE EXCLUSIVE RIGHT TO USE "AIRSOFT", APART FROM THE MARK AS SHOWN.

THE MARK CONSISTS OF THE WORDING "SO GO AIRSOFT" IN A STYLIZED FONT WITH "SO GO" ON THE TOP LINE AND "AIRSOFT" ON THE SECOND LINE AND A DESIGN THAT CONSISTS OF A CROSS-HAIR TARGET LOCATED AT THE BEGINNING OF THE WORDING.

FOR PROVIDING FACILITIES FOR RECREATIONAL ACTIVITIES, NAMELY, AIRSOFT GAMES (U.S. CLS. 100, 101 AND 107).

FIRST USE 8-1-2007; IN COMMERCE 8-15-2007.  
RENEE MCCRAY, EXAMINING ATTORNEY

SN 85-324,396. ZAP.MEDIA ENTERTAINMENT, INC., BEVERLY HILLS, CA. FILED 5-18-2011.

**ZAP.me**

THE MARK CONSISTS OF STANDARD CHARACTERS WITHOUT CLAIM TO ANY PARTICULAR FONT, STYLE, SIZE, OR COLOR.

FOR ENTERTAINMENT SERVICES IN THE NATURE OF DEVELOPMENT, CREATION, PRODUCTION AND POST-PRODUCTION SERVICES OF MULTIMEDIA ENTERTAINMENT CONTENT; FILM DISTRIBUTION AND DISTRIBUTION OF TELEVISION SHOWS (U.S. CLS. 100, 101 AND 107).

SKYE YOUNG, EXAMINING ATTORNEY

**CLASS 41—(Continued).**

SN 85-324,776. LOUKA TACTICAL TRAINING LLC, BELLEVILLE, MI. FILED 5-19-2011.



NO CLAIM IS MADE TO THE EXCLUSIVE RIGHT TO USE "POLICE FITNESS", APART FROM THE MARK AS SHOWN.

THE COLOR(S) BLACK, BLUE, RED AND WHITE IS/ARE CLAIMED AS A FEATURE OF THE MARK.

THE MARK CONSISTS OF THE WORD "FITNESS" POSITIONED WITHIN A CROSSHAIRS IMAGE FORMED BY TWO INTERSECTING BLACK LINES AND A CIRCLE FORMED BY A SINGLE BLACK LINE AND SPLIT INTO FOUR WHITE QUADRANTS, THE WORD "POLICE" POSITIONED ABOVE THE CROSSHAIRS IMAGE, AND THE PHRASE "TAKE AIM!" POSITIONED BELOW THE CROSSHAIRS IMAGE; THE LETTERS OF THE WORD "POLICE" ARE BLUE WITH A BLACK OUTLINE, THE LETTERS OF THE WORD "FITNESS" ARE RED WITH A BLACK OUTLINE, AND THE LETTERS OF THE PHRASE "TAKE AIM!" ARE BLUE.

FOR TRAINING IN THE USE AND OPERATION OF FIREARMS; TRAINING SERVICES IN THE FIELD OF TECHNIQUES FOR USE OF FIREARMS; CONDUCTING CLASSES AND COURSES IN SAFE AND PROFICIENT USE OF FIREARMS; PERSONAL FITNESS TRAINING SERVICES AND CONSULTANCY; EDUCATIONAL SERVICES, NAMELY, CONDUCTING CLASSES, SEMINARS, CONFERENCES, WORKSHOPS IN THE FIELDS OF FIREARMS TRAINING AND TACTICS, BICYCLE SAFETY AND TACTICS, DEFENSIVE TACTICS, AND PERSONAL FITNESS AND DISTRIBUTION OF TRAINING MATERIALS IN CONNECTION THEREWITH (U.S. CLS. 100, 101 AND 107).

FIRST USE 6-0-2007; IN COMMERCE 6-0-2007.  
BRIAN CALLAGHAN, EXAMINING ATTORNEY

**CLASS 41—(Continued).**

SN 85-324,818. WILLIAM J. LOWE, DBA CLARION TECHNICAL CONFERENCES, HOUSTON, TX. FILED 5-19-2011.



NO CLAIM IS MADE TO THE EXCLUSIVE RIGHT TO USE "TECHNICAL CONFERENCES", APART FROM THE MARK AS SHOWN.

THE COLOR(S) RED, WHITE, AND BLACK IS/ARE CLAIMED AS A FEATURE OF THE MARK.

THE MARK CONSISTS OF A RECTANGULAR BOX WITH THE WORD "CLARION" IN CAPITAL LETTERS AND THE WORDS "TECHNICAL CONFERENCES" IN SMALLER CAPITALS BELOW. "CLARION" IS DISPLAYED IN WHITE, OUTLINED IN BLACK, OVER A RED BACKGROUND. "TECHNICAL CONFERENCES" IS DISPLAYED IN BLACK OVER A WHITE BACKGROUND.

FOR EDUCATIONAL SERVICES, NAMELY, CONDUCTING COURSES, SEMINARS, CONFERENCES IN THE FIELDS OF ENGINEERING AND DISTRIBUTION OF TRAINING MATERIALS IN CONNECTION THEREWITH; EDUCATIONAL SERVICES, NAMELY, CONDUCTING COURSES, SEMINARS, CONFERENCES IN THE FIELD OF ENGINEERING AND DISTRIBUTION OF COURSE MATERIAL IN CONNECTION THEREWITH; EDUCATIONAL SERVICES, NAMELY, CONDUCTING COURSES, SEMINARS, CONFERENCES IN THE FIELD OF ENGINEERING AND DISTRIBUTION OF TRAINING MATERIAL IN CONNECTION THEREWITH; EDUCATIONAL SERVICES, NAMELY, CONDUCTING COURSES, SEMINARS, CONFERENCES IN THE FIELD OF ENGINEERING AND DISTRIBUTION OF COURSE AND EDUCATIONAL MATERIALS IN CONNECTION THEREWITH; EDUCATIONAL SERVICES, NAMELY, DEVELOPING, ARRANGING, AND CONDUCTING EDUCATIONAL CONFERENCES AND PROGRAMS AND PROVIDING COURSES OF INSTRUCTION IN THE FIELD OF ENGINEERING (U.S. CLS. 100, 101 AND 107).

FIRST USE 11-1-1997; IN COMMERCE 11-1-1997.  
PRISCILLA MILTON, EXAMINING ATTORNEY

SN 85-324,821. HOFFA, JARED, CHICAGO, IL. FILED 5-19-2011.

**VGTV VIDEO GAME TELEVISION**

THE MARK CONSISTS OF STANDARD CHARACTERS WITHOUT CLAIM TO ANY PARTICULAR FONT, STYLE, SIZE, OR COLOR.

NO CLAIM IS MADE TO THE EXCLUSIVE RIGHT TO USE "VIDEO GAME TELEVISION", APART FROM THE MARK AS SHOWN.

FOR ENTERTAINMENT, NAMELY, A CONTINUING GAMING AND ELECTRONIC NEWS SHOW BROADCAST OVER INTERNET (U.S. CLS. 100, 101 AND 107).

FIRST USE 2-1-2011; IN COMMERCE 4-1-2011.  
HOWARD B. LEVINE, EXAMINING ATTORNEY

**CLASS 41—(Continued).**

SN 85-324,904. YOGA ROBIN, MILL VALLEY, CA. FILED 5-19-2011.



NO CLAIM IS MADE TO THE EXCLUSIVE RIGHT TO USE "YOGA", APART FROM THE MARK AS SHOWN.

THE NAME "ROBIN" IDENTIFIES A LIVING INDIVIDUAL WHOSE CONSENT IS OF RECORD.

THE COLOR(S) PURPLE, LIGHT PURPLE, LIGHT GREY, AND DARK GREY IS/ARE CLAIMED AS A FEATURE OF THE MARK.

THE MARK CONSISTS OF A DESIGN THAT DEPICTS A PERSON PERFORMING A YOGA POSE IN THE COLOR OF PURPLE. BEHIND THE PERSON ARE SWIRLS IN THE COLOR OF LIGHT PURPLE. WITHIN THE LOWER-LEFT PORTION OF THE MARK FEATURES THE WORDING "YOGA ROBIN" IN STYLIZED FONT IN THE SHADING OF LIGHT GREY TO DARK GREY. THE COLOR WHITE WITHIN THE BACKGROUND OF THE MARK IS NOT CLAIMED AS A FEATURE OF THE MARK.

FOR YOGA INSTRUCTION (U.S. CLS. 100, 101 AND 107).

FIRST USE 2-10-2011; IN COMMERCE 2-28-2011.  
BARBARA RUTLAND, EXAMINING ATTORNEY

SN 85-325,046. HOT YOGA AT MILL CREEK TOWNCENTER, INC., BELLEVUE, WA. FILED 5-19-2011.



NO CLAIM IS MADE TO THE EXCLUSIVE RIGHT TO USE "HOT YOGA", APART FROM THE MARK AS SHOWN.

THE MARK CONSISTS OF A CIRCLE OF A YIN/YANG AND WITH THE STYLIZED TEXT "HOT YOGA" INSIDE.

FOR YOGA INSTRUCTION (U.S. CLS. 100, 101 AND 107).  
FIRST USE 7-30-2009; IN COMMERCE 7-30-2009.  
APRIL ROACH, EXAMINING ATTORNEY

**CLASS 41—(Continued).**

SN 85-325,055. HOT YOGA AT MILL CREEK TOWNCENTER, INC., BELLEVUE, WA. FILED 5-19-2011.

10 CLASSES FOR \$10 YES,  
IT'S REALLY TRUE!

THE MARK CONSISTS OF STANDARD CHARACTERS WITHOUT CLAIM TO ANY PARTICULAR FONT, STYLE, SIZE, OR COLOR.

NO CLAIM IS MADE TO THE EXCLUSIVE RIGHT TO USE "10 CLASSES FOR \$10", APART FROM THE MARK AS SHOWN.

FOR YOGA INSTRUCTION (U.S. CLS. 100, 101 AND 107).

FIRST USE 1-1-2004; IN COMMERCE 1-1-2004.  
APRIL ROACH, EXAMINING ATTORNEY

SN 85-325,321. JONES, TODD, ENCINO, CA. FILED 5-19-2011.

GOSSIP GUM

THE MARK CONSISTS OF STANDARD CHARACTERS WITHOUT CLAIM TO ANY PARTICULAR FONT, STYLE, SIZE, OR COLOR.

NO CLAIM IS MADE TO THE EXCLUSIVE RIGHT TO USE "GOSSIP", APART FROM THE MARK AS SHOWN.

FOR ENTERTAINMENT IN THE NATURE OF ONGOING TELEVISION PROGRAMS IN THE FIELD OF CELEBRITY GOSSIP; ENTERTAINMENT SERVICES, NAMELY, PROVIDING WEBCASTS IN THE FIELD OF CELEBRITY GOSSIP (U.S. CLS. 100, 101 AND 107).

ALEX KEAM, EXAMINING ATTORNEY

SN 85-325,835. TAL, LIAN, NEW YORK, NY. FILED 5-20-2011.

Body & Pole

THE MARK CONSISTS OF STANDARD CHARACTERS WITHOUT CLAIM TO ANY PARTICULAR FONT, STYLE, SIZE, OR COLOR.

NO CLAIM IS MADE TO THE EXCLUSIVE RIGHT TO USE "POLE", APART FROM THE MARK AS SHOWN.

FOR DANCE, ACROBATICS, AND FITNESS STUDIOS; PROVIDING FITNESS AND EXERCISE FACILITIES; INSTRUCTION IN THE FIELD OF DANCE, FITNESS, AND ACROBATICS; ENTERTAINMENT IN THE NATURE OF DANCE AND ACROBATIC PERFORMANCES (U.S. CLS. 100, 101 AND 107).

FIRST USE 2-15-2008; IN COMMERCE 2-15-2008.  
APRIL ROACH, EXAMINING ATTORNEY

**CLASS 41—(Continued).**

SN 85-325,973. TAL, LIAN, NEW YORK, NY. FILED 5-20-2011.



NO CLAIM IS MADE TO THE EXCLUSIVE RIGHT TO USE "POLE", APART FROM THE MARK AS SHOWN.

THE MARK CONSISTS OF A STYLIZED IMAGE OF A WOMAN HANGING WITH ONE ARM ON A POLE, WHICH RISES FROM THE TOP OF THE CAPITAL LETTERS "BP", WITH A "+" ON TOP OF THE LETTERS IN THE MIDDLE OF THE LETTERS, ABOVE THE WORDS "BODY & POLE"; THE SQUARE IS BACKGROUND AND NOT A PART OF THE MARK.

FOR DANCE, ACROBATICS, AND FITNESS STUDIOS; PROVIDING FITNESS AND EXERCISE FACILITIES; INSTRUCTION IN THE FIELD OF DANCE, FITNESS, AND ACROBATICS; ENTERTAINMENT IN THE NATURE OF DANCE AND ACROBATIC PERFORMANCES (U.S. CLS. 100, 101 AND 107).

FIRST USE 4-14-2011; IN COMMERCE 4-14-2011.  
APRIL ROACH, EXAMINING ATTORNEY

SN 85-325,980. PINALES, AYDA, MIAMI, FL. FILED 5-20-2011.

Momo Records

THE MARK CONSISTS OF STANDARD CHARACTERS WITHOUT CLAIM TO ANY PARTICULAR FONT, STYLE, SIZE, OR COLOR.

NO CLAIM IS MADE TO THE EXCLUSIVE RIGHT TO USE "RECORDS", APART FROM THE MARK AS SHOWN.

FOR MULTIMEDIA ENTERTAINMENT SERVICES IN THE NATURE OF RECORDING, PRODUCTION AND POST-PRODUCTION SERVICES IN THE FIELDS OF MUSIC, VIDEO, AND FILMS; VIDEO EDITING (U.S. CLS. 100, 101 AND 107).

FIRST USE 1-12-2011; IN COMMERCE 1-12-2011.  
KEVIN DINALLO, EXAMINING ATTORNEY

**CLASS 41—(Continued).**

SN 85-326,297. FITNESS CONSULTING GROUP, LLC, ELIZABETHTOWN, KY. FILED 5-20-2011.

**FITYUMMYMUMMY**

THE MARK CONSISTS OF STANDARD CHARACTERS WITHOUT CLAIM TO ANY PARTICULAR FONT, STYLE, SIZE, OR COLOR.

FOR EDUCATIONAL SERVICES FOR ADULTS IN THE NATURE OF CLASSES, WORKSHOPS, AND COACHING SESSIONS IN ORDER TO PROMOTE OPTIMAL WEIGHT, PHYSICAL FITNESS AND ATHLETIC PERFORMANCE; PROVIDING INFORMATION ABOUT PHYSICAL FITNESS TRAINING FOR USE IN WEIGHT LOSS (U.S. CLS. 100, 101 AND 107).

FIRST USE 6-10-2007; IN COMMERCE 9-25-2007.

JANICE L. MCMORROW, EXAMINING ATTORNEY

**CLASS 41—(Continued).**

SN 85-326,674. GLOBAL CHRISTIAN EVENT NETWORK INC., BROOKLYN, NY. FILED 5-21-2011.

**NIGHT OF GOSPEL LAUGHS**

THE MARK CONSISTS OF STANDARD CHARACTERS WITHOUT CLAIM TO ANY PARTICULAR FONT, STYLE, SIZE, OR COLOR.

FOR ENTERTAINMENT SERVICES, NAMELY, ONGOING SEASONAL STAND UP COMEDY SHOWS INFUSED WITH PERFORMANCES SUCH AS DRAMAS, DOCUMENTARIES, NEWS, COMEDY PERFORMANCES THROUGH THE MEDIUM OF LIVE STAGE PERFORMANCES, CABLE TELEVISION, BROADCAST TELEVISION, BROADCAST RADIO AND THE INTERNET (U.S. CLS. 100, 101 AND 107).

FIRST USE 5-29-2010; IN COMMERCE 5-29-2010.

COLLEEN KEARNEY, EXAMINING ATTORNEY

SN 85-326,424. TELEVISA, S.A. DE C.V., SANTA FE, MEXICO, FILED 5-20-2011.



OWNER OF MEXICO REG. NO. 831918, DATED 1-5-2004, EXPIRES 1-5-2014.

THE MARK CONSISTS OF "LA ESCUELITA VIP", WITH PENCIL DESIGN BEHIND THE "LA" PORTION OF THE MARK, RABBIT EARS OVER THE "A" IN "ESCUELITA", RULER DESIGN UNDER "ESCUELITA" AND STAR DESIGN BEHIND THE "VIP" PORTION OF THE MARK.

THE ENGLISH TRANSLATION OF "LA ESCUELITA" IN THE MARK IS "THE LITTLE SCHOOL".

FOR ENTERTAINMENT SERVICES IN THE NATURE OF A CONTINUING COMEDY SHOW BROADCAST OVER THE INTERNET AND AN ONGOING COMEDY TELEVISION PROGRAM (U.S. CLS. 100, 101 AND 107).

JACLYN KIDWELL WALKER, EXAMINING ATTORNEY

SN 85-326,730. GARRET T HANSEN, DBA DAKOTA ENTERTAINMENT, SIOUX FALLS, SD. AND REID, SCOTT, TODD ENTERPRISES, INC., DBA DAKOTA ENTERTAINMENT, SIOUX FALLS, SD. FILED 5-21-2011.



NO CLAIM IS MADE TO THE EXCLUSIVE RIGHT TO USE "CLUB", APART FROM THE MARK AS SHOWN.

THE MARK CONSISTS OF "CLUB CRAZE" LOGO CONSISTS OF THE WORDS "CLUB CRAZE", WITH "CLUB" ON TOP OF "CRAZE" WITH AN IMAGE OF DANCING INDIVIDUALS IN BETWEEN THE WORDS.

FOR DISC JOCKEY SERVICES; DISC JOCKEYS FOR PARTIES AND SPECIAL EVENTS (U.S. CLS. 100, 101 AND 107).

FIRST USE 4-1-2011; IN COMMERCE 4-1-2011.

ANTHONY RINKER, EXAMINING ATTORNEY

**CLASS 41—(Continued).**

SN 85-326,862. LASSITER, KIMBERLY, UPLAND, CA. FILED 5-22-2011.

## Under the Twinfluence

THE MARK CONSISTS OF STANDARD CHARACTERS WITHOUT CLAIM TO ANY PARTICULAR FONT, STYLE, SIZE, OR COLOR.

FOR ON-LINE JOURNALS, NAMELY, BLOGS FEATURING INFORMATION ABOUT PARENTING AND MARRIAGE (U.S. CLS. 100, 101 AND 107).

TAMARA FRAZIER, EXAMINING ATTORNEY

---

SN 85-327,144. MORRIS, DARRON L, DBA MOGUL FILMS, FAIRFAX, VA. FILED 5-23-2011.

## MOGUL FILMS

THE MARK CONSISTS OF STANDARD CHARACTERS WITHOUT CLAIM TO ANY PARTICULAR FONT, STYLE, SIZE, OR COLOR.

NO CLAIM IS MADE TO THE EXCLUSIVE RIGHT TO USE "FILMS", APART FROM THE MARK AS SHOWN.

FOR MOTION PICTURE FILM PRODUCTION (U.S. CLS. 100, 101 AND 107).

FIRST USE 6-1-2011; IN COMMERCE 6-1-2011.

JACQUELINE A. LAVINE, EXAMINING ATTORNEY

---

SN 85-327,961. BUILDING CHAMPIONS, INC., LAKE OSWEGO, OR. FILED 5-23-2011.

## THE CORE FOUR SUCCESS PUZZLE

THE MARK CONSISTS OF STANDARD CHARACTERS WITHOUT CLAIM TO ANY PARTICULAR FONT, STYLE, SIZE, OR COLOR.

OWNER OF U.S. REG. NO. 2,956,624.

FOR EDUCATIONAL SERVICES, NAMELY, CONDUCTING INDIVIDUAL AND GROUP TRAINING, TEACHING AND MENTORING SESSIONS IN THE FIELD OF SELF-IMPROVEMENT, AND JOB PERFORMANCE, INCLUDING THE DISTRIBUTION OF COURSE MATERIALS IN CONNECTION THEREWITH (U.S. CLS. 100, 101 AND 107).

FIRST USE 10-23-2008; IN COMMERCE 10-23-2008.

INGA ERVIN, EXAMINING ATTORNEY

**CLASS 41—(Continued).**

SN 85-327,964. BUILDING CHAMPIONS, INC., LAKE OSWEGO, OR. FILED 5-23-2011.

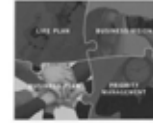

OWNER OF U.S. REG. NO. 2,956,624.

THE MARK CONSISTS OF A PUZZLE GRAPHIC SHOWING FOUR PUZZLE PIECES CONTAINING THE WORDS LIFE PLAN, BUSINESS VISION, BUSINESS PLAN AND PRIORITY MANAGEMENT.

FOR EDUCATIONAL SERVICES, NAMELY, CONDUCTING INDIVIDUAL AND GROUP TRAINING, TEACHING AND MENTORING SESSIONS IN THE FIELD OF SELF-IMPROVEMENT, AND JOB PERFORMANCE, INCLUDING THE DISTRIBUTION OF COURSE MATERIALS IN CONNECTION THEREWITH (U.S. CLS. 100, 101 AND 107).

FIRST USE 10-23-2008; IN COMMERCE 10-23-2008.

INGA ERVIN, EXAMINING ATTORNEY

---

SN 85-327,986. CHALMERS, NATHAN, D, DALLAS, TX. FILED 5-23-2011.

## C.O.D. Cash On Delivery

THE MARK CONSISTS OF STANDARD CHARACTERS WITHOUT CLAIM TO ANY PARTICULAR FONT, STYLE, SIZE, OR COLOR.

FOR PRODUCTION AND DISTRIBUTION OF TELEVISION SHOWS AND MOVIES; TELEVISION PROGRAM SYNDICATION (U.S. CLS. 100, 101 AND 107).

SANJEEV VOHRA, EXAMINING ATTORNEY

---

SN 85-328,441. THE STUDER GROUP, LLC, GULF BREEZE, FL. FILED 5-24-2011.

## AIDET

THE MARK CONSISTS OF STANDARD CHARACTERS WITHOUT CLAIM TO ANY PARTICULAR FONT, STYLE, SIZE, OR COLOR.

FOR TRAINING AND COACHING SERVICES IN THE FIELD OF HEALTH CARE TO IMPROVE COMMUNICATION BETWEEN HEALTHCARE PROFESSIONALS AND PATIENTS (U.S. CLS. 100, 101 AND 107).

FIRST USE 10-26-1999; IN COMMERCE 10-26-1999.

DOMINICK J. SALEMI, EXAMINING ATTORNEY

**CLASS 41—(Continued).**

SN 85-328,494. DEBETTENCOURT, KELLEY, VINEYARD HAVEN, MA. FILED 5-24-2011.



THE MARK CONSISTS OF A DESIGN OF A SMILING FURRY CREATURE WITH ARMS AND LEGS THAT IS HOLDING A FORK AND A KNIFE. HE IS LICKING HIS LIPS AND WEARING SHOES. TO THE RIGHT IS THE STYLIZED TEXT "HUNGRY NATIVE".

FOR ON-LINE JOURNALS, NAMELY, BLOGS FEATURING FOOD RELATED TOPICS LIKE RESTAURANTS, FESTIVALS, PRODUCTS, RECIPES, COOKBOOKS, AND GENERAL FOOD TOPICS (U.S. CLS. 100, 101 AND 107).

FIRST USE 3-5-2011; IN COMMERCE 3-5-2011.  
MARCIE MILONE, EXAMINING ATTORNEY

**CLASS 41—(Continued).**

SN 85-329,444. HOPKINS, CHRISTOPHER, JUDSONIA, AR. FILED 5-25-2011.

**SPIRIT LED**

THE MARK CONSISTS OF STANDARD CHARACTERS WITHOUT CLAIM TO ANY PARTICULAR FONT, STYLE, SIZE, OR COLOR.

FOR ENTERTAINMENT RENDERED BY A MUSICAL ARTISTS, NAMELY, ENTERTAINMENT IN THE NATURE OF VISUAL AND AUDIO PERFORMANCES BY A MUSICAL ACT; LIVE PERFORMANCES BY A MUSICAL ACT; MULTIMEDIA ENTERTAINMENT SERVICES IN THE NATURE OF RECORDING, PRODUCTION AND POST-PRODUCTION SERVICES IN THE FIELD OF MUSIC AND VIDEO; ENTERTAINMENT SERVICES BY A MUSICAL ARTIST, NAMELY, MUSICAL COMPOSITION AND PRODUCTION OF MUSICAL SOUND RECORDINGS (U.S. CLS. 100, 101 AND 107).

CYNTHIA TRIPI, EXAMINING ATTORNEY

SN 85-329,581. BROKEN COMPLEX LLC, NORTH HILLS, CA. FILED 5-25-2011.

SN 85-328,799. TWENTIETH CENTURY FOX FILM CORPORATION, LOS ANGELES, CA. FILED 5-24-2011.

**FOX SPORTS HOT TRAX****BROKENCOMPLEX**

THE MARK CONSISTS OF STANDARD CHARACTERS WITHOUT CLAIM TO ANY PARTICULAR FONT, STYLE, SIZE, OR COLOR.

OWNER OF U.S. REG. NOS. 3,001,993, 3,032,760 AND OTHERS.

NO CLAIM IS MADE TO THE EXCLUSIVE RIGHT TO USE "SPORTS", APART FROM THE MARK AS SHOWN.

FOR ENTERTAINMENT SERVICES IN THE NATURE OF PROVIDING SPORTS VIDEO FOOTAGE FOR TELEVISION BROADCASTS (U.S. CLS. 100, 101 AND 107).

CAROLINE WOOD, EXAMINING ATTORNEY

THE MARK CONSISTS OF THE STYLIZED LETTERS "BC BROKEN COMPLEX". THE LETTERS "BC" INSIDE A CIRCLE TURNED SIDEWAYS.

FOR ENTERTAINMENT SERVICES IN THE NATURE OF RECORDING, PRODUCTION AND POST-PRODUCTION SERVICES IN THE FIELD OF MUSIC (U.S. CLS. 100, 101 AND 107).

FIRST USE 9-1-2004; IN COMMERCE 9-1-2004.  
SHAUNIA CARLYLE, EXAMINING ATTORNEY



**CLASS 41—(Continued).**

SN 85-329,869. BLOCKI FLUTE METHOD LLC, GIBSONIA, PA. FILED 5-25-2011.

# KinderFlute

THE MARK CONSISTS OF STANDARD CHARACTERS WITHOUT CLAIM TO ANY PARTICULAR FONT, STYLE, SIZE, OR COLOR.

FOR EDUCATIONAL SERVICES, NAMELY, TEACHER TRAINING AND CONDUCTING CLASSES IN THE FIELD OF MUSICAL INSTRUMENTS, NAMELY, THE FLUTE AND DISTRIBUTION OF COURSE MATERIAL IN CONNECTION THEREWITH (U.S. CLS. 100, 101 AND 107).

FIRST USE 3-30-2011; IN COMMERCE 3-30-2011.  
NELSON SNYDER, EXAMINING ATTORNEY

SN 85-329,939. BROWN ESTATE VINEYARDS, LLC, ST. HELENA, CA. FILED 5-25-2011.

# ZINAPALOOZA

THE MARK CONSISTS OF STANDARD CHARACTERS WITHOUT CLAIM TO ANY PARTICULAR FONT, STYLE, SIZE, OR COLOR.

FOR ENTERTAINMENT SERVICES, NAMELY, WINE AND FOOD TASTINGS (U.S. CLS. 100, 101 AND 107).  
MICHELLE DUBOIS, EXAMINING ATTORNEY

SN 85-330,210. SHAWN GEE, BALA CYNWYD, PA. AND JULIUS ERVING III, NEW YORK, NY. AND TROY CARTER, BALA CYNWYD, PA. FILED 5-25-2011.

# CLOSER TO MY DREAMS TOUR

THE MARK CONSISTS OF STANDARD CHARACTERS WITHOUT CLAIM TO ANY PARTICULAR FONT, STYLE, SIZE, OR COLOR.

NO CLAIM IS MADE TO THE EXCLUSIVE RIGHT TO USE "TOUR", APART FROM THE MARK AS SHOWN.

FOR ENTERTAINMENT, NAMELY, LIVE MUSIC CONCERTS (U.S. CLS. 100, 101 AND 107).  
DAVID ELTON, EXAMINING ATTORNEY

**CLASS 41—(Continued).**

SN 85-330,530. DO GOOD LABS, INC., SAN FRANCISCO, CA. FILED 5-26-2011.

# SAVEUP

THE MARK CONSISTS OF STANDARD CHARACTERS WITHOUT CLAIM TO ANY PARTICULAR FONT, STYLE, SIZE, OR COLOR.

FOR ENTERTAINMENT SERVICES, NAMELY, PROVIDING ONLINE COMPUTER GAMES THAT HELP TO ACHIEVE A SET OF FINANCIAL GOALS (U.S. CLS. 100, 101 AND 107).

SHANNON TWOHIG, EXAMINING ATTORNEY

SN 85-330,780. COVERSMART, INC., LOWELL, MA. FILED 5-26-2011.

# COVERSMART

THE MARK CONSISTS OF STANDARD CHARACTERS WITHOUT CLAIM TO ANY PARTICULAR FONT, STYLE, SIZE, OR COLOR.

FOR PROVIDING A WEBSITE FEATURING INFORMATION IN THE FIELD OF MUSIC, ART, AND ENTERTAINMENT; PROVIDING A WEBSITE FEATURING INTERACTIVE TRIVIA GAMES; ENTERTAINMENT SERVICES, NAMELY, ORGANIZING AND CONDUCTING TRIVIA GAMES; ENTERTAINMENT SERVICES, NAMELY, CONDUCTING CONTESTS; ENTERTAINMENT AND EDUCATION SERVICES, NAMELY THE PROVISION OF INTERACTIVE AND EDUCATIONAL TRIVIA GAMES AND CONTESTS (U.S. CLS. 100, 101 AND 107).

PAUL E. FAHRENKOPF, EXAMINING ATTORNEY

SN 85-330,923. SAMUELS, SKYLER, BEVERLY HILLS, CA. FILED 5-26-2011.

# SKYLER SAMUELS

THE MARK CONSISTS OF STANDARD CHARACTERS WITHOUT CLAIM TO ANY PARTICULAR FONT, STYLE, SIZE, OR COLOR.

THE NAME "SKYLER SAMUELS" IDENTIFIES A LIVING INDIVIDUAL WHOSE CONSENT IS OF RECORD.

FOR ENTERTAINMENT SERVICES, NAMELY, ACTING SERVICES, AND PERSONAL APPEARANCES BY A MOTION PICTURE AND TELEVISION CELEBRITY (U.S. CLS. 100, 101 AND 107).

FIRST USE 0-0-2000; IN COMMERCE 0-0-2000.

JACQUELINE A. LAVINE, EXAMINING ATTORNEY

**CLASS 41—(Continued).**

SN 85-331,309. LINGUALINX LANGUAGE SOLUTIONS, INC., COHOES, NY. FILED 5-26-2011.



OWNER OF U.S. REG. NO. 3,724,758.  
THE COLOR(S) BLACK AND BLUE IS/ARE CLAIMED AS A FEATURE OF THE MARK.

THE MARK CONSISTS OF THE WORD LINGUALINX IN BLACK STYLIZED LOWER CASE LETTERS WITH A BLUE GEOMETRIC SHAPE CENTERED ABOVE THE N.

FOR BRAILLE TRANSCRIPTION; BRAILLE TRANSLATION; DESKTOP PUBLISHING FOR OTHERS; LANGUAGE INTERPRETATION; TRANSLATION SERVICES (U.S. CLS. 100, 101 AND 107).

CAROLINE WOOD, EXAMINING ATTORNEY

---

SN 85-331,867. EISENMAN, DIANE L., PASADENA, CA. FILED 5-26-2011.

## Radiant Soul Salon

THE MARK CONSISTS OF STANDARD CHARACTERS WITHOUT CLAIM TO ANY PARTICULAR FONT, STYLE, SIZE, OR COLOR.

FOR EDUCATION SERVICES, NAMELY, PROVIDING LIVE AND ON-LINE CLASSES, SEMINARS, WORKSHOPS AND MENTORING IN THE FIELDS OF MENTAL HEALTH AND SPIRITUALITY (U.S. CLS. 100, 101 AND 107).

STEVEN JACKSON, EXAMINING ATTORNEY

---

SN 85-331,964. CURRAH MEDIA, LLC, DBA SAVORY SWEET LIFE, SEATTLE, WA. FILED 5-27-2011.

## Savory Sweet Life

THE MARK CONSISTS OF STANDARD CHARACTERS WITHOUT CLAIM TO ANY PARTICULAR FONT, STYLE, SIZE, OR COLOR.

FOR ON-LINE JOURNALS, NAMELY, BLOGS FEATURING ARTICLES AND RECIPES; PROVIDING A WEBSITE FEATURING BLOGS AND NON-DOWNLOADABLE PUBLICATIONS IN THE NATURE OF ARTICLES AND RECIPES IN THE FIELD(S) OF FOOD AND PERSONAL OPINION (U.S. CLS. 100, 101 AND 107).

FIRST USE 2-0-2009; IN COMMERCE 3-0-2009.  
SUNG IN, EXAMINING ATTORNEY

**CLASS 41—(Continued).**

SN 85-331,974. ROBERTO KALB, AVENTURA, FL. FILED 5-27-2011.



NO CLAIM IS MADE TO THE EXCLUSIVE RIGHT TO USE "NEW ENGLAND METROPOLITAN ORCHESTRA", APART FROM THE MARK AS SHOWN.

THE COLOR(S) BLACK, GRAY, RED IS/ARE CLAIMED AS A FEATURE OF THE MARK.

THE MARK CONSISTS OF LETTERS DELINEATING "NEMO". THE REGULAR "E" IS REPLACED BY A MORE CIRCULAR FIGURE SIMILAR TO A CELLO AND THE LETTER "E". BENEATH IS WRITTEN "THE NEW ENGLAND METROPOLITAN ORCHESTRA" THE LAST "O" OF "NEMO" IS RED AND THE WORD "ORCHESTRA" IS RED ALSO. THE REST OF THE LOGO IS DARK GRAY.

FOR ENTERTAINMENT IN THE NATURE OF SYMPHONY ORCHESTRA PERFORMANCES (U.S. CLS. 100, 101 AND 107).

JOHN HWANG, EXAMINING ATTORNEY

---

SN 85-331,991. DEAN MIUCCIO PRODUCTIONS, LLC, LIBERTY TOWNSHIP, OH. FILED 5-27-2011.

## CINCINNALITY

THE MARK CONSISTS OF STANDARD CHARACTERS WITHOUT CLAIM TO ANY PARTICULAR FONT, STYLE, SIZE, OR COLOR.

FOR ENTERTAINMENT, NAMELY, A CONTINUING VARIETY AND COMEDY SHOW BROADCAST OVER TELEVISION, RADIO, INTERNET, SATELLITE, AUDIO, AND/OR VIDEO MEDIA (U.S. CLS. 100, 101 AND 107).

DANNEAN HETZEL, EXAMINING ATTORNEY

---

SN 85-332,056. TICKET SOFTWARE, LLC, VERNON, CT. FILED 5-27-2011.

## SUPERBOLETERÍA

THE MARK CONSISTS OF STANDARD CHARACTERS WITHOUT CLAIM TO ANY PARTICULAR FONT, STYLE, SIZE, OR COLOR.

FOR TICKET AGENCIES IN THE FIELD OF CONCERTS, THEATERS, ENTERTAINMENT AND SPORTING EVENTS (U.S. CLS. 100, 101 AND 107).

FIRST USE 7-1-2010; IN COMMERCE 7-1-2010.  
SUNG IN, EXAMINING ATTORNEY

**CLASS 41—(Continued).**

SN 85-332,093. CLEARCORRECT HOLDINGS, INC., HOUSTON, TX. FILED 5-27-2011.

**CLEARLY...**

THE MARK CONSISTS OF STANDARD CHARACTERS WITHOUT CLAIM TO ANY PARTICULAR FONT, STYLE, SIZE, OR COLOR.

FOR ON-LINE JOURNALS, NAMELY, BLOGS FEATURING NEWS AND COMMENTS ABOUT DENTAL AND ORTHODONTIC PRACTICE, PRODUCTS AND INDUSTRY (U.S. CLS. 100, 101 AND 107).

FIRST USE 5-27-2011; IN COMMERCE 5-27-2011.  
HEATHER BIDDULPH, EXAMINING ATTORNEY

**CLASS 41—(Continued).**

SN 85-332,192. NEW WAVE PILATES, COSTA MESA, CA. FILED 5-27-2011.

**MARATHON MAT**

THE MARK CONSISTS OF STANDARD CHARACTERS WITHOUT CLAIM TO ANY PARTICULAR FONT, STYLE, SIZE, OR COLOR.

NO CLAIM IS MADE TO THE EXCLUSIVE RIGHT TO USE "MAT", APART FROM THE MARK AS SHOWN.

FOR DEVELOPING EDUCATIONAL MANUALS FOR OTHERS IN THE FIELD OF EXERCISE, FITNESS, WELLNESS, MOVEMENT; EDUCATIONAL SERVICES, NAMELY, PROVIDING CLASSES, SEMINARS, AND WORKSHOPS IN THE FIELD OF EXERCISE, FITNESS, WELLNESS, MOVEMENT; EDUCATIONAL SERVICES, NAMELY, PROVIDING CONTINUING PROFESSIONAL EDUCATION COURSES IN THE FIELD OF EXERCISE, FITNESS, WELLNESS, MOVEMENT; EDUCATIONAL SERVICES, NAMELY, PROVIDING COURSES OF INSTRUCTION AT THE CONTINUING PROFESSIONAL EDUCATION LEVEL; PHYSICAL FITNESS TRAINING SERVICES; PROVIDING A WEBSITE FEATURING INFORMATION ON EXERCISE AND FITNESS; PROVIDING FITNESS AND EXERCISE FACILITIES; PROVIDING FITNESS AND EXERCISE STUDIO SERVICES, NAMELY, PILATES INSTRUCTION AND TRAINING (U.S. CLS. 100, 101 AND 107).

FIRST USE 11-22-2008; IN COMMERCE 11-22-2008.  
MARK SPARACINO, EXAMINING ATTORNEY

SN 85-332,283. SHERRY L. MCKILLOP, DBA FOLLOW YOUR COMPASS, NAPA, CA. FILED 5-27-2011.

**Follow Your Compass**

THE MARK CONSISTS OF STANDARD CHARACTERS WITHOUT CLAIM TO ANY PARTICULAR FONT, STYLE, SIZE, OR COLOR.

FOR ARRANGING PROFESSIONAL WORKSHOP AND TRAINING COURSES; BUSINESS EDUCATION AND TRAINING SERVICES, NAMELY, DEVELOPING AND FACILITATING CUSTOMIZED LEADERSHIP AND EXECUTIVE DEVELOPMENT PROGRAMS, PROVIDING EXECUTIVE COACHING SERVICES, AND PROVIDING BUSINESS EDUCATION PROGRAMS TO EMPLOYEES AND EXECUTIVES; BUSINESS EDUCATION AND TRAINING SERVICES, NAMELY, DEVELOPING, AND FACILITATING CUSTOMIZED IN-COMPANY LEADERSHIP AND EXECUTIVE DEVELOPMENT PROGRAMS, PROVIDING EXECUTIVE COACHING SERVICES, AND PROVIDING PUBLIC AND IN-COMPANY KEYNOTE PRESENTATIONS TO BUSINESS LEADERS; BUSINESS TRAINING; BUSINESS TRAINING CONSULTANCY SERVICES; CHARITABLE SERVICES, NAMELY, PROVIDING VOCATIONAL EDUCATION IN THE FIELDS OF CONSTRUCTION AND FLIGHT TRAINING TO OBTAIN PILOT'S LICENSE, PROVIDING CAREER GUIDANCE, AND PROVIDING GROUP COACHING IN THE FIELD OF LEADERSHIP DEVELOPMENT TO DISADVANTAGED YOUTH; DEVELOPING TRAINING SYSTEMS AND LEARNING METHODOLOGIES FOR OTHERS; EDUCATIONAL SERVICES, NAMELY, CONDUCTING CLASSES, SEMINARS, CONFERENCES, WORKSHOPS, RETREATS, CAMPS AND FIELD TRIPS IN THE FIELD OF PERSONAL AND PROFESSIONAL DEVELOPMENT AND DISTRIBUTION OF TRAINING

SN 85-332,139. SHIMMER & SHINE PRODUCTIONS, INC., ALPHARETTA, GA. FILED 5-27-2011.

**The Know Better Effect**

THE MARK CONSISTS OF STANDARD CHARACTERS WITHOUT CLAIM TO ANY PARTICULAR FONT, STYLE, SIZE, OR COLOR.

FOR ENTERTAINMENT, NAMELY, PRODUCTION OF A TELEVISION PROGRAM SERIES FEATURING CHILDREN EXPLORING THEIR COMMUNITY AND SURROUNDING NEIGHBORHOODS AND GAINING AN UNDERSTANDING OF WORLD ISSUES BY LEARNING HOW OTHERS LIVE AND WHAT IT MEANS TO HELP THOSE IN NEED (U.S. CLS. 100, 101 AND 107).

FIRST USE 11-6-2010; IN COMMERCE 1-24-2011.  
JASON BLAIR, EXAMINING ATTORNEY

**CLASS 41—(Continued).**

MATERIAL IN CONNECTION THEREWITH; EDUCATIONAL SERVICES, NAMELY, CONDUCTING CLASSES, WORKSHOPS, SEMINARS, CONFERENCES, AND RETREATS IN THE FIELDS OF PERSONAL AND PROFESSIONAL DEVELOPMENT AND DISTRIBUTION OF TRAINING MATERIALS IN CONNECTION THEREWITH; EDUCATIONAL SERVICES, NAMELY, CONDUCTING CLASSES, WORKSHOPS, SEMINARS, CONFERENCES, AND RETREATS IN THE FIELD OF PERSONAL AND PROFESSIONAL DEVELOPMENT AND DISTRIBUTION OF TRAINING MATERIAL IN CONNECTION THEREWITH; EDUCATIONAL SERVICES, NAMELY, DEVELOPING AND CONDUCTING TRAINING COURSES AND DISTRIBUTION OF TRAINING MATERIALS IN CONNECTION THEREWITH FOR SUBJECT MATTERS AS REQUESTED BY CUSTOMERS; LIFE COACHING SERVICES IN THE FIELD OF PERSONAL AND PROFESSIONAL DEVELOPMENT; PERSONAL COACHING SERVICES IN THE FIELD OF PERSONAL AND PROFESSIONAL DEVELOPMENT; PROFESSIONAL COACHING SERVICES IN THE FIELD OF PERSONAL AND PROFESSIONAL DEVELOPMENT; PROVIDING GROUP COACHING AND LEARNING FORUMS IN THE FIELD OF LEADERSHIP DEVELOPMENT; PROVIDING GROUP COACHING IN THE FIELD OF PERSONAL AND PROFESSIONAL DEVELOPMENT; TRAINING SERVICES IN THE FIELD OF PERSONAL AND PROFESSIONAL DEVELOPMENT (U.S. CLS. 100, 101 AND 107).

FIRST USE 4-30-2005; IN COMMERCE 4-30-2005.  
JOHN DWYER, EXAMINING ATTORNEY

SN 85-332,481. ARTEST MEDIA GROUP, LLC, BEVERLY HILLS, CA. FILED 5-27-2011.

# ITUP

THE MARK CONSISTS OF STANDARD CHARACTERS WITHOUT CLAIM TO ANY PARTICULAR FONT, STYLE, SIZE, OR COLOR.

FOR PRODUCTION AND DISTRIBUTION OF TELEVISION SHOWS AND MOVIES (U.S. CLS. 100, 101 AND 107).

KATHRYN COWARD, EXAMINING ATTORNEY

SN 85-332,708. SHORTBURST MEDIA, LLC, CARLSBAD, CA. FILED 5-27-2011.

# edgehogs

THE MARK CONSISTS OF STANDARD CHARACTERS WITHOUT CLAIM TO ANY PARTICULAR FONT, STYLE, SIZE, OR COLOR.

FOR PROVIDING A WEB SITE FEATURING THE AGGREGATION OF PREDICTIONS OF SPORTING AND OTHER EVENTS, AN ALGORITHMIC RATING SYSTEM FOR EXPERTS MAKING PREDICTIONS, SPORTS NEWS AND OTHER NEWS, VIDEOS OF PREDICTIONS, AND A GAMING LADDER SYSTEM FOR PREDICTION CONTESTS (U.S. CLS. 100, 101 AND 107).

ROSELLE HERRERA, EXAMINING ATTORNEY

**CLASS 41—(Continued).**

SN 85-332,888. THE MUSEUM OF MODERN ART, NEW YORK, NY. FILED 5-27-2011.

# MOMA PS1

THE MARK CONSISTS OF STANDARD CHARACTERS WITHOUT CLAIM TO ANY PARTICULAR FONT, STYLE, SIZE, OR COLOR.

FOR ENTERTAINMENT IN THE NATURE OF ART, MUSIC AND ARCHITECTURE; ENTERTAINMENT IN THE NATURE OF ART EXHIBITIONS; ENTERTAINMENT IN THE NATURE OF ARCHITECTURAL EXHIBITIONS; ENTERTAINMENT IN THE NATURE OF DIS AND LIVE MUSIC PERFORMANCES; ENTERTAINMENT IN THE NATURE OF COMPETITIONS FOR ARCHITECTS (U.S. CLS. 100, 101 AND 107).

FIRST USE 5-20-2010; IN COMMERCE 5-20-2010.  
HEATHER SAPP, EXAMINING ATTORNEY

SN 85-332,933. JOHN R. ESLICH, HUDSON, OH. FILED 5-27-2011.

# 4saken

THE MARK CONSISTS OF STANDARD CHARACTERS WITHOUT CLAIM TO ANY PARTICULAR FONT, STYLE, SIZE, OR COLOR.

FOR AMUSEMENT ARCADES; AMUSEMENT CENTERS; AMUSEMENT PARK AND THEME PARK SERVICES; AMUSEMENT PARKS; ENTERTAINMENT SERVICES IN THE NATURE OF AN AMUSEMENT PARK ATTRACTION, NAMELY, A THEMED AREA; ENTERTAINMENT SERVICES IN THE NATURE OF AN AMUSEMENT PARK SHOW; ENTERTAINMENT SERVICES, NAMELY, ARRANGING AND CONDUCTING SPECIAL EVENTS AT AN AMUSEMENT PARK; PROVIDING AMUSEMENT ARCADE SERVICES; PROVIDING AMUSEMENT FACILITIES; PROVISION OF INFORMATION RELATING TO AMUSEMENT PARK SHOWS (U.S. CLS. 100, 101 AND 107).

FIRST USE 5-27-2011; IN COMMERCE 5-27-2011.  
JESSICA A. POWERS, EXAMINING ATTORNEY

SN 85-333,174. HOLT, ARON CAMERON, NORMAN, OK. FILED 5-28-2011.

# Mama Sweet

THE MARK CONSISTS OF STANDARD CHARACTERS WITHOUT CLAIM TO ANY PARTICULAR FONT, STYLE, SIZE, OR COLOR.

FOR ENTERTAINMENT SERVICES IN THE NATURE OF LIVE MUSICAL PERFORMANCES (U.S. CLS. 100, 101 AND 107).

FIRST USE 5-1-2002; IN COMMERCE 5-1-2002.  
SKYE YOUNG, EXAMINING ATTORNEY

**CLASS 41—(Continued).**

SN 85-333,337. MOOSHELLI INC., DBA STUDIO PULSE, REDONDO BEACH, CA. FILED 5-30-2011.

## Precision at Play

THE MARK CONSISTS OF STANDARD CHARACTERS WITHOUT CLAIM TO ANY PARTICULAR FONT, STYLE, SIZE, OR COLOR.

FOR HEALTH CLUB SERVICES, NAMELY, PROVIDING INSTRUCTION AND EQUIPMENT IN THE FIELD OF PHYSICAL EXERCISE (U.S. CLS. 100, 101 AND 107).  
SIMON TENG, EXAMINING ATTORNEY

SN 85-333,628. GUINNESS WORLD RECORDS LIMITED, LONDON, NW1 3HP, UNITED KINGDOM, FILED 5-31-2011.

## RECORDPLAYER

THE MARK CONSISTS OF STANDARD CHARACTERS WITHOUT CLAIM TO ANY PARTICULAR FONT, STYLE, SIZE, OR COLOR.

FOR ENTERTAINMENT SERVICES, NAMELY, PROVIDING A WEB SITE FEATURING NON-DOWNLOADABLE VIDEOS AND FILM CLIPS IN THE FIELD OF RECORD BREAKING ACHIEVEMENTS AND ATTEMPTS (U.S. CLS. 100, 101 AND 107).  
JENNIFER MARTIN, EXAMINING ATTORNEY

SN 85-333,642. COZZINI, ADAM, CHICAGO, IL. FILED 5-31-2011.

## THE YOUNGBLOOD RAMBLERS

THE MARK CONSISTS OF STANDARD CHARACTERS WITHOUT CLAIM TO ANY PARTICULAR FONT, STYLE, SIZE, OR COLOR.

FOR ENTERTAINMENT, NAMELY, LIVE PERFORMANCES BY MUSICAL BANDS (U.S. CLS. 100, 101 AND 107).

JOHN GARTNER, EXAMINING ATTORNEY

**CLASS 41—(Continued).**

SN 85-333,706. CASTLE BUILDERS (IL) LTD., RAMAT-GAN, 52596, ISRAEL, FILED 5-31-2011.

## BooClips

THE MARK CONSISTS OF STANDARD CHARACTERS WITHOUT CLAIM TO ANY PARTICULAR FONT, STYLE, SIZE, OR COLOR.

FOR EDUCATIONAL AND ENTERTAINMENT SERVICES, NAMELY, PROVIDING ON-LINE INTERACTIVE CHILDREN'S STORIES (U.S. CLS. 100, 101 AND 107).  
FIRST USE 4-24-2011; IN COMMERCE 4-24-2011.  
ALEXANDER L. POWERS, EXAMINING ATTORNEY

SN 85-333,756. COMET TECHNOLOGIES, LLC, MAYFIELD HEIGHTS, OH. FILED 5-31-2011.

## SPORTADORE

THE MARK CONSISTS OF STANDARD CHARACTERS WITHOUT CLAIM TO ANY PARTICULAR FONT, STYLE, SIZE, OR COLOR.

FOR PROVIDING AN INTERNET WEBSITE PORTAL IN THE FIELD OF ENTERTAINMENT, CULTURAL AND SPORTING EVENTS (U.S. CLS. 100, 101 AND 107).  
FIRST USE 11-1-2010; IN COMMERCE 5-15-2011.  
RONALD AIKENS, EXAMINING ATTORNEY

SN 85-333,777. OBAS, GERGHINIO, LAUDERDALE LAKES, FL. FILED 5-31-2011.



THE STIPPLING IS FOR SHADING PURPOSES ONLY.  
THE MARK CONSISTS OF THE STYLIZED TEXT "THAT'S CLASIK! MEGATAINMENT" WITH TWO SPEAKERS ON THE SIDE.

FOR AUDIO AND VIDEO RECORDING SERVICES; AUDIO RECORDING AND PRODUCTION; VIDEO PRODUCTION SERVICES (U.S. CLS. 100, 101 AND 107).

ASMAT KHAN, EXAMINING ATTORNEY

**CLASS 41—(Continued).**

SN 85-333,827. SHANE HARRINGTON, LINCOLN, NE.  
FILED 5-31-2011.

**SMOOTH**

THE MARK CONSISTS OF STANDARD CHARACTERS WITHOUT CLAIM TO ANY PARTICULAR FONT, STYLE, SIZE, OR COLOR.

FOR NIGHTS-CLUBS (U.S. CLS. 100, 101 AND 107).  
JOHN HWANG, EXAMINING ATTORNEY

SN 85-334,098. HAMERMAN, ELIOT, PLANO, TX. FILED 5-31-2011.



THE MARK CONSISTS OF A CIRCULAR CASINO CHIP THAT HAS THE LETTER "E" WITH THE NUMBERS "1" AND "3" INSIDE THE LETTER. THE BORDER OF THE CHIP HAS 13 ROUNDED RECTANGULAR BARS GOING AROUND THE CHIP.

FOR GAMBLING SERVICES; GAMING SERVICES IN THE NATURE OF CASINO GAMING (U.S. CLS. 100, 101 AND 107).

MORGAN WYNNE, EXAMINING ATTORNEY

SN 85-334,163. EMORY MARKETING SYSTEMS, LLC,  
TEMPLE HILLS, MD. FILED 5-31-2011.

**MY MMA BLUEPRINT**

THE MARK CONSISTS OF STANDARD CHARACTERS WITHOUT CLAIM TO ANY PARTICULAR FONT, STYLE, SIZE, OR COLOR.

NO CLAIM IS MADE TO THE EXCLUSIVE RIGHT TO USE "MMA", APART FROM THE MARK AS SHOWN.

FOR CONDUCTING WORKSHOPS AND SEMINARS IN THE FIELD OF SELF-IMPROVEMENT VIA MARTIAL ARTS TRAINING AND DISTRIBUTION OF TRAINING MATERIALS IN CONNECTION THEREWITH (U.S. CLS. 100, 101 AND 107).

FIRST USE 6-1-2010; IN COMMERCE 6-1-2010.

WENDY JUN, EXAMINING ATTORNEY

**CLASS 41—(Continued).**

SN 85-334,356. GREATIST, INC., SAN FRANCISCO, CA.  
FILED 5-31-2011.

**GREATIST**

THE MARK CONSISTS OF STANDARD CHARACTERS WITHOUT CLAIM TO ANY PARTICULAR FONT, STYLE, SIZE, OR COLOR.

FOR PROVIDING A WEBSITE AND A BLOG FEATURING AUDIO, VIDEO, TEXT, AND MULTIMEDIA MATERIALS AND ARTICLES IN THE FIELD OF HEALTH, WELLNESS, AND HAPPINESS FOR ENTERTAINMENT PURPOSES; ELECTRONIC PUBLISHING SERVICES, NAMELY, PUBLICATION OF AUDIO, VIDEO, TEXT, AND MULTIMEDIA WORKS OF OTHERS ONLINE FEATURING INFORMATION IN THE FIELD OF HEALTH, WELLNESS AND HAPPINESS; PROVIDING A WEBSITE AT WHICH THE GENERAL PUBLIC CAN RECEIVE ADVICE FROM AN INDIVIDUAL OR ENTITY CONCERNING HAPPINESS FOR ENTERTAINMENT PURPOSES (U.S. CLS. 100, 101 AND 107).

DOMINICK J. SALEMI, EXAMINING ATTORNEY

SN 85-334,358. TADDA'S FITNESS CAMP, LLC, LITHONIA,  
GA. FILED 5-31-2011.

**CAN I GET IT**

THE MARK CONSISTS OF STANDARD CHARACTERS WITHOUT CLAIM TO ANY PARTICULAR FONT, STYLE, SIZE, OR COLOR.

FOR CONDUCTING FITNESS CLASSES; PHYSICAL FITNESS CONSULTATION; PHYSICAL FITNESS TRAINING SERVICES; PHYSICAL FITNESS STUDIO SERVICES, NAMELY, PROVIDING GROUP EXERCISE INSTRUCTION, EQUIPMENT, AND FACILITIES (U.S. CLS. 100, 101 AND 107).

FIRST USE 0-0-2008; IN COMMERCE 0-0-2009.

DOMINICK J. SALEMI, EXAMINING ATTORNEY

SN 85-334,384. EMORY MARKETING SYSTEMS, LLC,  
TEMPLE HILLS, MD. FILED 5-31-2011.

**METRO MONEY MAKERS**

THE MARK CONSISTS OF STANDARD CHARACTERS WITHOUT CLAIM TO ANY PARTICULAR FONT, STYLE, SIZE, OR COLOR.

FOR CONDUCTING WORKSHOPS AND SEMINARS IN THE FIELD OF MARKETING ONLINE, NAMELY, DIRECT RESPONSE MARKETING, AND DISTRIBUTION OF TRAINING MATERIALS IN CONNECTION THEREWITH (U.S. CLS. 100, 101 AND 107).

FIRST USE 3-1-2006; IN COMMERCE 3-1-2006.

WENDY JUN, EXAMINING ATTORNEY

**CLASS 41—(Continued).**

SN 85-334,406. FAIRVIEW HEALTH SERVICES, BURNSVILLE, MN. FILED 5-31-2011.

## Caring Out Loud

THE MARK CONSISTS OF STANDARD CHARACTERS WITHOUT CLAIM TO ANY PARTICULAR FONT, STYLE, SIZE, OR COLOR.

FOR TRAINING SERVICES IN THE FIELD OF NURSING CARE AS IT PERTAINS TO PATIENT EXPERIENCE (U.S. CLS. 100, 101 AND 107).

ELI HELLMAN, EXAMINING ATTORNEY

---

SN 85-334,441. KOG CO., LTD, DAEGU, REPUBLIC OF KOREA, FILED 5-31-2011.

## ELSWORD

THE MARK CONSISTS OF STANDARD CHARACTERS WITHOUT CLAIM TO ANY PARTICULAR FONT, STYLE, SIZE, OR COLOR.

FOR ENTERTAINMENT SERVICES, NAMELY, PROVIDING ON-LINE COMPUTER GAMES (U.S. CLS. 100, 101 AND 107).

FIRST USE 10-13-2006; IN COMMERCE 2-13-2011.  
PATRICIA EVANKO, EXAMINING ATTORNEY

---

SN 85-334,464. GRIFFIN, LATOYA L, ARLINGTON, TX. FILED 5-31-2011.

## The Gospelnista

THE MARK CONSISTS OF STANDARD CHARACTERS WITHOUT CLAIM TO ANY PARTICULAR FONT, STYLE, SIZE, OR COLOR.

FOR ON-LINE JOURNALS, NAMELY, BLOGS FEATURING INSPIRATIONAL STORIES AND FASHION (U.S. CLS. 100, 101 AND 107).

FIRST USE 10-0-2010; IN COMMERCE 10-0-2010.  
HANNO RITTNER, EXAMINING ATTORNEY

**CLASS 41—(Continued).**

SN 85-334,472. BUSINESS WOMEN RISING, INC., NEWPORT BEACH, CA. FILED 5-31-2011.

## Alta Vista

THE MARK CONSISTS OF STANDARD CHARACTERS WITHOUT CLAIM TO ANY PARTICULAR FONT, STYLE, SIZE, OR COLOR.

THE ENGLISH TRANSLATION OF ALTA IN THE MARK IS HIGH.

FOR BUSINESS EDUCATION AND TRAINING SERVICES, NAMELY, DEVELOPING, AND FACILITATING CUSTOMIZED IN-COMPANY LEADERSHIP AND EXECUTIVE DEVELOPMENT PROGRAMS, PROVIDING EXECUTIVE COACHING SERVICES, AND PROVIDING PUBLIC AND IN-COMPANY KEYNOTE PRESENTATIONS TO BUSINESS LEADERS; EDUCATION SERVICES, NAMELY, ONE-ON-ONE MENTORING IN THE FIELD OF MANAGEMENT, LEADERSHIP AND EXECUTIVE DEVELOPMENT; PEER TO PEER COACHING SERVICES IN THE FIELD OF MANAGEMENT, LEADERSHIP AND EXECUTIVE DEVELOPMENT; PROVIDING EDUCATIONAL MENTORING SERVICES AND PROGRAMS IN THE FIELD OF MANAGEMENT, LEADERSHIP AND EXECUTIVE DEVELOPMENT; PROVIDING GROUP COACHING AND LEARNING FORUMS IN THE FIELD OF LEADERSHIP DEVELOPMENT (U.S. CLS. 100, 101 AND 107).

FIRST USE 12-20-2010; IN COMMERCE 1-10-2011.  
HANNO RITTNER, EXAMINING ATTORNEY

---

SN 85-334,566. EVERLOOP, INC., DANVILLE, CA. FILED 5-31-2011.

## WHO'S IN YOUR LOOP?

THE MARK CONSISTS OF STANDARD CHARACTERS WITHOUT CLAIM TO ANY PARTICULAR FONT, STYLE, SIZE, OR COLOR.

FOR ENTERTAINMENT SERVICES, NAMELY, PROVIDING TEMPORARY USE OF NON-DOWNLOADABLE VIDEO GAMES (U.S. CLS. 100, 101 AND 107).

CHRISTINA SOBRAL, EXAMINING ATTORNEY

**CLASS 41—(Continued).**

SN 85-334,568. TEENWRITE, LLC, DBA TEENWRITE, DUVALL, WA. FILED 5-31-2011.

---

## TeenWrite

THE MARK CONSISTS OF STANDARD CHARACTERS WITHOUT CLAIM TO ANY PARTICULAR FONT, STYLE, SIZE, OR COLOR.

FOR EDUCATION SERVICES, NAMELY, PROVIDING MENTORING, TUTORING, CLASSES, SEMINARS AND WORKSHOPS IN THE FIELD OF WRITING AND ACTING (U.S. CLS. 100, 101 AND 107).

FIRST USE 10-16-2010; IN COMMERCE 10-16-2010.

DAVID TOOLEY, EXAMINING ATTORNEY

---

SN 85-334,748. KOCH DEVELOPMENT CORPORATION, SANTA CLAUS, IN. FILED 6-1-2011.

## HoliWood Nights

THE MARK CONSISTS OF STANDARD CHARACTERS WITHOUT CLAIM TO ANY PARTICULAR FONT, STYLE, SIZE, OR COLOR.

FOR AMUSEMENT PARK AND THEME PARK SERVICES; AMUSEMENT PARKS; ENTERTAINMENT IN THE NATURE OF AN AMUSEMENT PARK RIDE; ENTERTAINMENT SERVICES IN THE NATURE OF AN AMUSEMENT PARK ATTRACTION, NAMELY, A THEMED AREA; ENTERTAINMENT SERVICES IN THE NATURE OF AN AMUSEMENT PARK SHOW; ENTERTAINMENT SERVICES, NAMELY, ARRANGING AND CONDUCTING SPECIAL EVENTS AT AN AMUSEMENT PARK; ENTERTAINMENT SERVICES, NAMELY, ARRANGING FOR TICKET RESERVATIONS FOR AMUSEMENT PARK ATTRACTIONS; PROVIDING AMUSEMENT PARKS; PROVIDING THEME PARK SERVICES; PROVISION OF INFORMATION RELATING TO AMUSEMENT PARK SHOWS (U.S. CLS. 100, 101 AND 107).

FIRST USE 11-1-2005; IN COMMERCE 11-1-2005.

AISHA CLARKE, EXAMINING ATTORNEY

**CLASS 41—(Continued).**

SN 85-334,758. WGBH EDUCATIONAL FOUNDATION, BOSTON, MA. FILED 6-1-2011.

## Dot Diva

THE MARK CONSISTS OF STANDARD CHARACTERS WITHOUT CLAIM TO ANY PARTICULAR FONT, STYLE, SIZE, OR COLOR.

FOR ENTERTAINMENT SERVICES, NAMELY, PROVIDING A WEB SITE FEATURING PHOTOGRAPHIC, VIDEO AND PROSE PRESENTATIONS FEATURING INFORMATION ABOUT CAREERS IN COMPUTING FOR GIRLS; PROVIDING INFORMATION ON-LINE RELATING TO EDUCATIONAL OPPORTUNITIES (U.S. CLS. 100, 101 AND 107).

FIRST USE 3-8-2010; IN COMMERCE 3-8-2010.

AISHA CLARKE, EXAMINING ATTORNEY

---

SN 85-334,856. SMITHSONIAN INSTITUTION, WASHINGTON, DC. FILED 6-1-2011.

## SERIOUSLY AMAZING

THE MARK CONSISTS OF STANDARD CHARACTERS WITHOUT CLAIM TO ANY PARTICULAR FONT, STYLE, SIZE, OR COLOR.

FOR EDUCATION AND MUSEUM SERVICES, NAMELY, PROVIDING LIVE AND ON-LINE EXHIBITIONS, PROGRAMS, LECTURES, GAMES AND ACTIVITIES IN THE FIELDS OF SCIENCE, HISTORY, ART, MUSIC, CULTURE AND EDUCATION (U.S. CLS. 100, 101 AND 107).

RAUL CORDOVA, EXAMINING ATTORNEY

---

SN 85-334,862. BRIAN SHNIPPER, LOS ANGELES, CA. FILED 6-1-2011.

## STANDING ON CEREMONY

THE MARK CONSISTS OF STANDARD CHARACTERS WITHOUT CLAIM TO ANY PARTICULAR FONT, STYLE, SIZE, OR COLOR.

FOR ENTERTAINMENT IN THE NATURE OF THEATRICAL PRODUCTIONS AND DISTRIBUTION OF THEATRICAL MATERIALS IN CONNECTION THEREWITH; PRODUCTION OF PLAYS; PROVISION OF INFORMATION RELATING TO THEATER PRODUCTIONS (U.S. CLS. 100, 101 AND 107).

FIRST USE 9-12-2009; IN COMMERCE 9-12-2009.

FLORENTINA BLANDU, EXAMINING ATTORNEY



**CLASS 41—(Continued).**

SN 85-334,882. SUZANNE SUMMERWILL, CORALVILLE, IA. FILED 6-1-2011.

**SUZANNE SUMMERWILL**

THE MARK CONSISTS OF STANDARD CHARACTERS WITHOUT CLAIM TO ANY PARTICULAR FONT, STYLE, SIZE, OR COLOR.

THE NAME(S), PORTRAIT(S), AND/OR SIGNATURE(S) SHOWN IN THE MARK IDENTIFIES SUZANNE SUMMERWILL, WHOSE CONSENT(S) TO REGISTER IS MADE OF RECORD.

FOR EDUCATIONAL AND ENTERTAINMENT SERVICES, NAMELY, CONDUCTING CLASSES, SEMINARS, CONFERENCES, CONFERENCES AND WORKSHOPS IN THE FIELD OF CAREER DEVELOPMENT, NEW POSITION ENVISIONING AND STRATEGIES, CAREER AND LIFE TRANSITION PLANNING AND SUPPORT, RELATIONSHIP ENHANCEMENT, PERSONAL GROWTH, LIFESTYLE MANAGEMENT, LIFE BALANCE, ADDRESSING RESISTANCE, DECISION MAKING, AND ACHIEVEMENT OF SHORT-TERM AND LONG-TERM GOALS AND DISTRIBUTION OF COURSE MATERIALS IN CONNECTION THEREWITH, AND EDUCATION CONSULTING RELATED THERETO; EDUCATIONAL AND ENTERTAINMENT SERVICES, NAMELY, PROVIDING MOTIVATIONAL SPEAKING SERVICES IN THE FIELD OF CAREER DEVELOPMENT, NEW POSITION ENVISIONING AND STRATEGIES, CAREER AND LIFE TRANSITION PLANNING AND SUPPORT, RELATIONSHIP ENHANCEMENT, PERSONAL GROWTH, LIFESTYLE MANAGEMENT, LIFE BALANCE, ADDRESSING RESISTANCE, DECISION MAKING, AND ACHIEVEMENT OF SHORT-TERM AND LONG-TERM GOALS; LIFE COACHING SERVICES IN THE FIELD OF CAREER DEVELOPMENT, NEW POSITION ENVISIONING AND STRATEGIES, CAREER AND LIFE TRANSITION PLANNING AND SUPPORT, RELATIONSHIP ENHANCEMENT, PERSONAL GROWTH, LIFESTYLE MANAGEMENT, LIFE BALANCE, ADDRESSING RESISTANCE, DECISION MAKING, AND ACHIEVEMENT OF SHORT-TERM AND LONG-TERM GOALS; PROVIDING A WEBSITE FEATURING BLOGS AND NON-DOWNLOADABLE PUBLICATIONS IN THE NATURE OF ARTICLES, BROCHURES, BLOG ENTRIES IN THE FIELD(S) OF CAREER DEVELOPMENT, NEW POSITION ENVISIONING AND STRATEGIES, CAREER AND LIFE TRANSITION PLANNING AND SUPPORT, RELATIONSHIP ENHANCEMENT, PERSONAL GROWTH, LIFESTYLE MANAGEMENT, LIFE BALANCE, ADDRESSING RESISTANCE, DECISION MAKING, AND ACHIEVEMENT OF SHORT-TERM AND LONG-TERM GOALS; PROVIDING ON-LINE PUBLICATIONS IN THE NATURE OF AN E-BOOK IN THE FIELD OF CAREER DEVELOPMENT, NEW POSITION ENVISIONING AND STRATEGIES, CAREER AND LIFE TRANSITION PLANNING AND SUPPORT, RELATIONSHIP ENHANCEMENT, PERSONAL GROWTH, LIFESTYLE MANAGEMENT, LIFE BALANCE, ADDRESSING RESISTANCE, DECISION MAKING, AND ACHIEVEMENT OF SHORT-TERM AND LONG-TERM GOALS (U.S. CLS. 100, 101 AND 107).

FIRST USE 6-1-1983; IN COMMERCE 3-1-2011.  
MAYUR VAGHANI, EXAMINING ATTORNEY

**CLASS 41—(Continued).**

SN 85-334,892. 9 CLOUDS, INC., SIOUX FALLS, SD. FILED 6-1-2011.



NO CLAIM IS MADE TO THE EXCLUSIVE RIGHT TO USE "A PLACE FOR DIGITAL LEARNING", APART FROM THE MARK AS SHOWN.

THE MARK CONSISTS OF THE WORD "SANDBOX" IN LOWER CASE LETTERS, WITH A SHOVEL WITH THE BLADE AND A PORTION OF THE SHAFT INSIDE THE LETTER "O" AND THE REMAINING PORTION OF THE SHAFT AND THE HANDLE OUTSIDE THE LETTER "O". THE SHOVEL IS ANGLED DIAGONALLY TO THE RIGHT. THE PHRASE "A PLACE FOR DIGITAL LEARNING" IN LOWER CASE LETTERS BELOW THE WORD "SANDBOX" IN A SMALLER FONT SIZE AND RIGHT ALIGNED WITH THE WORD "SANDBOX".

FOR EDUCATION SERVICES, NAMELY, CONDUCTING ONLINE TRAINING IN THE FIELD OF SOCIAL MEDIA AND DIGITAL TOOLS (U.S. CLS. 100, 101 AND 107).

FIRST USE 3-11-2011; IN COMMERCE 3-11-2011.  
TOBY BULLOFF, EXAMINING ATTORNEY

SN 85-334,902. MANOWITZ, BRIAN, ORLANDO, FL. FILED 6-1-2011.

**Forever Dawn**

THE MARK CONSISTS OF STANDARD CHARACTERS WITHOUT CLAIM TO ANY PARTICULAR FONT, STYLE, SIZE, OR COLOR.

FOR ENTERTAINMENT, NAMELY, LIVE PERFORMANCES BY A MUSICAL BAND (U.S. CLS. 100, 101 AND 107).

FIRST USE 1-1-2004; IN COMMERCE 1-1-2004.  
BARBARA A. GOLD, EXAMINING ATTORNEY

SN 85-334,908. NELSON, ADAM, ROCK HILL, SC. FILED 6-1-2011.

**The Jupiter Tide**

THE MARK CONSISTS OF STANDARD CHARACTERS WITHOUT CLAIM TO ANY PARTICULAR FONT, STYLE, SIZE, OR COLOR.

FOR ENTERTAINMENT, NAMELY, LIVE PERFORMANCES BY A MUSICAL BAND (U.S. CLS. 100, 101 AND 107).

FIRST USE 2-20-2010; IN COMMERCE 2-20-2010.  
BARBARA A. GOLD, EXAMINING ATTORNEY

**CLASS 41—(Continued).**

SN 85-334,994. ZOELJA BOY ENTERTAINMENT INC., BOCA RATON, FL. FILED 6-1-2011.

# Zo'Mega

THE MARK CONSISTS OF STANDARD CHARACTERS WITHOUT CLAIM TO ANY PARTICULAR FONT, STYLE, SIZE, OR COLOR.

FOR ENTERTAINMENT IN THE NATURE OF LIVE RADIO PERSONALITY PERFORMANCES; ENTERTAINMENT IN THE NATURE OF VISUAL AND AUDIO PERFORMANCES, AND MUSICAL, VARIETY, NEWS AND COMEDY SHOWS; ENTERTAINMENT SERVICES BY A MUSICAL ARTIST AND PRODUCER, NAMELY, MUSICAL COMPOSITION FOR OTHERS AND PRODUCTION OF MUSICAL SOUND RECORDINGS; ENTERTAINMENT SERVICES IN THE NATURE OF LIVE MUSICAL PERFORMANCES; ENTERTAINMENT SERVICES IN THE NATURE OF PRESENTING LIVE MUSICAL PERFORMANCES; ENTERTAINMENT SERVICES IN THE NATURE OF RECORDING, PRODUCTION AND POST-PRODUCTION SERVICES IN THE FIELD OF MUSIC; ENTERTAINMENT SERVICES, NAMELY, DANCE EVENTS BY A RECORDING ARTIST; ENTERTAINMENT SERVICES, NAMELY, MULTIMEDIA PRODUCTION SERVICES; ENTERTAINMENT, NAMELY, LIVE MUSIC CONCERTS; MULTIMEDIA ENTERTAINMENT SERVICES IN THE NATURE OF DEVELOPMENT, PRODUCTION AND POST-PRODUCTION SERVICES IN THE FIELDS OF VIDEO AND FILMS; MULTIMEDIA ENTERTAINMENT SERVICES IN THE NATURE OF RECORDING, PRODUCTION AND POST-PRODUCTION SERVICES IN THE FIELDS OF MUSIC, VIDEO, AND FILMS; MUSIC COMPOSITION FOR OTHERS; MUSIC PRODUCTION SERVICES; PRODUCTION OF MUSICAL SOUND RECORDING; PRODUCTION OF MUSICAL VIDEOS; PRODUCTION OF SOUND AND MUSIC VIDEO RECORDINGS (U.S. CLS. 100, 101 AND 107).

TRACY FLETCHER, EXAMINING ATTORNEY

SN 85-335,073. BOSS, TODD, DBA MOTIONPOEMS, ST. PAUL, MN. FILED 6-1-2011.

# MOTIONPOEMS

THE MARK CONSISTS OF STANDARD CHARACTERS WITHOUT CLAIM TO ANY PARTICULAR FONT, STYLE, SIZE, OR COLOR.

FOR MULTIMEDIA ENTERTAINMENT SERVICES IN THE NATURE OF DEVELOPMENT, PRODUCTION AND POST-PRODUCTION SERVICES IN THE FIELDS OF VIDEO AND FILMS; ENTERTAINMENT SERVICES, NAMELY, DISPLAYING A SERIES OF ANIMATED FILMS VIA THE INTERNET (U.S. CLS. 100, 101 AND 107).

FIRST USE 11-1-2009; IN COMMERCE 11-1-2009.  
ELLEN B. AWRICH, EXAMINING ATTORNEY

**CLASS 41—(Continued).**

SN 85-335,086. MADSEN, HARRY B., ARLINGTON HEIGHTS, IL. FILED 6-1-2011.

# ISSUES, ETC.

THE MARK CONSISTS OF STANDARD CHARACTERS WITHOUT CLAIM TO ANY PARTICULAR FONT, STYLE, SIZE, OR COLOR.

FOR PRODUCTION AND DISTRIBUTION OF RADIO PROGRAMS (U.S. CLS. 100, 101 AND 107).

FIRST USE 6-30-2008; IN COMMERCE 6-30-2008.

DOMINICK J. SALEMI, EXAMINING ATTORNEY

SN 85-335,122. BEY, MALIK R., LILBURN, GA. FILED 6-1-2011.

NO CLAIM IS MADE TO THE EXCLUSIVE RIGHT TO USE "HOLLYWOOD", APART FROM THE MARK AS SHOWN.

THE MARK CONSISTS OF THE LETTERS N AND H CONNECTED AND IN BLACK WITH WHITE BACKGROUND ALONG WITH NEW UNDERNEATH THE CONNECTED N AND H AND HOLLYWOOD UNDER THE WORD NEW. ALL THE LETTERING IS BLACK WITH A WHITE BACKGROUND.

FOR ENTERTAINMENT MEDIA PRODUCTION SERVICES FOR MOTION PICTURES, TELEVISION AND INTERNET; ENTERTAINMENT SERVICES IN THE NATURE OF RECORDING, PRODUCTION AND POST-PRODUCTION SERVICES IN THE FIELD OF MUSIC (U.S. CLS. 100, 101 AND 107).

FIRST USE 12-26-2010; IN COMMERCE 12-26-2010.  
ROBIN MITTLER, EXAMINING ATTORNEY

**CLASS 41—(Continued).**

SN 85-335,133. SXSWS, INC., AUSTIN, TX. FILED 6-1-2011.

**SXSWECS**

THE MARK CONSISTS OF STANDARD CHARACTERS WITHOUT CLAIM TO ANY PARTICULAR FONT, STYLE, SIZE, OR COLOR.

OWNER OF U.S. REG. NOS. 2,043,596, 3,773,290 AND OTHERS.

FOR EDUCATIONAL AND ENTERTAINMENT SERVICES, NAMELY CONDUCTING CONFERENCES AND SEMINARS CONCERNING ENVIRONMENTAL ISSUES AND SOLUTIONS (U.S. CLS. 100, 101 AND 107).

JUSTINE D. PARKER, EXAMINING ATTORNEY

---

SN 85-335,193. STOPLIGHT MUSIC LLC, DBA THE 3 DUDES, SULLIVANS ISLAND, SC. FILED 6-1-2011.

**THE 3 DUDES**

THE MARK CONSISTS OF STANDARD CHARACTERS WITHOUT CLAIM TO ANY PARTICULAR FONT, STYLE, SIZE, OR COLOR.

FOR ENTERTAINMENT, NAMELY, LIVE MUSIC CONCERTS (U.S. CLS. 100, 101 AND 107).

FIRST USE 11-9-2008; IN COMMERCE 11-9-2008.

JAY BESCH, EXAMINING ATTORNEY

---

SN 85-335,349. JOHNSON, DAVID MICHAEL, TEMPE, AZ. FILED 6-1-2011.

**SUMOSOMMELIER**

THE MARK CONSISTS OF STANDARD CHARACTERS WITHOUT CLAIM TO ANY PARTICULAR FONT, STYLE, SIZE, OR COLOR.

FOR ON-LINE JOURNALS, NAMELY, BLOGS FEATURING INFORMATION ON WINE, SPIRITS AND FOOD; PROVIDING A WEBSITE FEATURING BLOGS AND NON-DOWNLOADABLE PUBLICATIONS IN THE NATURE OF ARTICLES IN THE FIELD(S) OF WINE, SPIRITS AND FOOD (U.S. CLS. 100, 101 AND 107).

FIRST USE 3-0-2000; IN COMMERCE 3-0-2000.

PRISCILLA MILTON, EXAMINING ATTORNEY

**CLASS 41—(Continued).**

SN 85-335,455. THE WASHINGTON TIMES LLC, WASHINGTON, DC. FILED 6-1-2011.

**TIMES247**

THE MARK CONSISTS OF STANDARD CHARACTERS WITHOUT CLAIM TO ANY PARTICULAR FONT, STYLE, SIZE, OR COLOR.

FOR ONLINE PUBLICATIONS, NAMELY, ONLINE GENERAL INTEREST NEWSPAPERS (U.S. CLS. 100, 101 AND 107).

MAUREEN DALL, EXAMINING ATTORNEY

---

SN 85-335,472. TRIBUNE MEDIA SERVICES, INC., CHICAGO, IL. FILED 6-1-2011.



THE COLOR(S) WHITE, RED AND BLUE IS/ARE CLAIMED AS A FEATURE OF THE MARK.

THE MARK CONSISTS OF THE LETTERS "POP" IN WHITE, THE NUMBER "2" IN RED AND THE LETTERS "IT" IN WHITE WITH BLUE BLACK GROUND.

FOR PROVIDING ENTERTAINMENT NEWS AND INFORMATION, OVER THE INTERNET AND/OR TO CONNECTED DEVICES, ABOUT TELEVISION PROGRAMMING, MOVIE SYNOPSSES, MOVIE SHOW TIMES, TELEVISION LISTINGS, CURRENT EVENTS, CULTURAL EVENTS, THEATRE LISTINGS AND THEATRE INFORMATION, GLOBAL, NATIONAL, LOCAL, GENERAL AND ENTERTAINMENT NEWS, AND GLOBAL, NATIONAL, LOCAL AND REGIONAL LIVE ENTERTAINMENT INFORMATION; PROVIDING ON-LINE AND/OR INTERACTIVE EDITORIAL COLUMNS, BLOGS, AND ON-LINE PERIODIC ARTICLES REGARDING THE ENTERTAINMENT INDUSTRY AND INTERVIEWS, PROFILES, AND REVIEWS OF BOOKS, MUSIC, FILM, THEATRICAL PRODUCTIONS, MOVIES AND TELEVISION IN THE ENTERTAINMENT FIELD (U.S. CLS. 100, 101 AND 107).

FIRST USE 11-30-2010; IN COMMERCE 11-30-2010.

KEVON CHISOLM, EXAMINING ATTORNEY

**CLASS 41—(Continued).**

SN 85-335,486. ICONOSYS, INC., LAGUNA NIGUEL, CA. FILED 6-1-2011.

**ZOMBIE SLASHER**

THE MARK CONSISTS OF STANDARD CHARACTERS WITHOUT CLAIM TO ANY PARTICULAR FONT, STYLE, SIZE, OR COLOR.

FOR ENTERTAINMENT SERVICES, NAMELY, PROVIDING ON-LINE COMPUTER GAMES; ENTERTAINMENT SERVICES, NAMELY, PROVIDING ONLINE ELECTRONIC GAMES; ENTERTAINMENT SERVICES, NAMELY, PROVIDING ONLINE VIDEO GAMES; ENTERTAINMENT SERVICES, NAMELY, PROVIDING TEMPORARY USE OF NON-DOWNLOADABLE COMPUTER GAMES; ENTERTAINMENT SERVICES, NAMELY, PROVIDING TEMPORARY USE OF NON-DOWNLOADABLE COMPUTER LEARNING GAMES; ENTERTAINMENT SERVICES, NAMELY, PROVIDING TEMPORARY USE OF NON-DOWNLOADABLE ELECTRONIC GAMES; ENTERTAINMENT SERVICES, NAMELY, PROVIDING TEMPORARY USE OF NON-DOWNLOADABLE INTERACTIVE GAMES; ENTERTAINMENT SERVICES, NAMELY, PROVIDING TEMPORARY USE OF NON-DOWNLOADABLE VIDEO GAMES; PROVIDING ONLINE AUGMENTED REALITY GAMES; PROVIDING ONLINE NON-DOWNLOADABLE COMIC BOOKS AND GRAPHIC NOVELS (U.S. CLS. 100, 101 AND 107).

LINDA MICKLEBURGH, EXAMINING ATTORNEY

SN 85-335,582. RIVERCARD COMPANY, INC., ESCONDIDO, CA. FILED 6-1-2011.

**RIVERCARD**

THE MARK CONSISTS OF STANDARD CHARACTERS WITHOUT CLAIM TO ANY PARTICULAR FONT, STYLE, SIZE, OR COLOR.

FOR CONDUCTING AND PROVIDING FACILITIES FOR SPECIAL EVENTS FEATURING CASINO AND GAMING CONTESTS AND TOURNAMENTS (U.S. CLS. 100, 101 AND 107).

FIRST USE 5-15-2011; IN COMMERCE 5-15-2011.

GRETTA YAO, EXAMINING ATTORNEY

**CLASS 41—(Continued).**

SN 85-335,593. BIKERS AGAINST CHILD ABUSE, OZARK, MO. FILED 6-1-2011.

**Bikers & Babes At The Beach**

THE MARK CONSISTS OF STANDARD CHARACTERS WITHOUT CLAIM TO ANY PARTICULAR FONT, STYLE, SIZE, OR COLOR.

FOR ORGANIZING SPORTING EVENTS, NAMELY, MOTORCYCLE RALLYS (U.S. CLS. 100, 101 AND 107).

FIRST USE 6-0-2005; IN COMMERCE 8-0-2005.

GRETTA YAO, EXAMINING ATTORNEY

SN 85-335,611. GENEVA COLLEGE, BEAVER FALLS, PA. FILED 6-1-2011.

**GENEVA COLLEGE**

THE MARK CONSISTS OF STANDARD CHARACTERS WITHOUT CLAIM TO ANY PARTICULAR FONT, STYLE, SIZE, OR COLOR.

NO CLAIM IS MADE TO THE EXCLUSIVE RIGHT TO USE "COLLEGE", APART FROM THE MARK AS SHOWN.

FOR EDUCATIONAL SERVICES, NAMELY, PROVIDING COURSES OF INSTRUCTION AT THE UNDERGRADUATE AND POST-GRADUATE LEVEL AND DISTRIBUTION OF COURSE MATERIAL IN CONNECTION THEREWITH (U.S. CLS. 100, 101 AND 107).

FIRST USE 0-0-1873; IN COMMERCE 0-0-1873.

JENNIFER MARTIN, EXAMINING ATTORNEY

SN 85-335,759. SJ FOUNDATION, AUSTIN, TX. FILED 6-1-2011.

**MAN UP CHECK 'EM**

THE MARK CONSISTS OF STANDARD CHARACTERS WITHOUT CLAIM TO ANY PARTICULAR FONT, STYLE, SIZE, OR COLOR.

FOR PROVIDING EDUCATIONAL MENTORING SERVICES AND PROGRAMS IN THE FIELD OF TESTICULAR CANCER (U.S. CLS. 100, 101 AND 107).

FIRST USE 2-1-2011; IN COMMERCE 4-1-2011.

MATTHEW KLINE, EXAMINING ATTORNEY

**CLASS 41—(Continued).**

SN 85-335,787. LABARBERA, JASON, LIVERMORE, CA. FILED 6-1-2011.

## Talent Wars

THE MARK CONSISTS OF STANDARD CHARACTERS WITHOUT CLAIM TO ANY PARTICULAR FONT, STYLE, SIZE, OR COLOR.

FOR ENTERTAINMENT SERVICES IN THE NATURE OF AN ON-GOING REALITY BASED TELEVISION PROGRAM (U.S. CLS. 100, 101 AND 107).  
SUNG IN, EXAMINING ATTORNEY

---

SN 85-335,834. FEINBERG, LEONARD, NEW YORK, NY. FILED 6-1-2011.

## GARMENTAL

THE MARK CONSISTS OF STANDARD CHARACTERS WITHOUT CLAIM TO ANY PARTICULAR FONT, STYLE, SIZE, OR COLOR.

FOR ENTERTAINMENT SERVICES IN THE NATURE OF AN ON-GOING REALITY BASED TELEVISION PROGRAM (U.S. CLS. 100, 101 AND 107).  
MARGARET POWER, EXAMINING ATTORNEY

---

SN 85-336,106. SHUSHTARI, J. KEVIN, FARMINGTON, CT. FILED 6-2-2011.

## Secrets From Back Home

THE MARK CONSISTS OF STANDARD CHARACTERS WITHOUT CLAIM TO ANY PARTICULAR FONT, STYLE, SIZE, OR COLOR.

FOR MEDIA PRODUCTION SERVICES, NAMELY, VIDEO AND FILM PRODUCTION (U.S. CLS. 100, 101 AND 107).  
INGRID C. EULIN, EXAMINING ATTORNEY

**CLASS 41—(Continued).**

SN 85-336,215. NATIONAL CONFERENCE FOR COMMUNITY AND JUSTICE OF CONNECTICUT AND WESTERN MASSACHUSETTS, INC., WINDSOR, CT. FILED 6-2-2011.

## YES! Youth Establishing Strength

THE MARK CONSISTS OF STANDARD CHARACTERS WITHOUT CLAIM TO ANY PARTICULAR FONT, STYLE, SIZE, OR COLOR.

FOR EDUCATIONAL AND ENTERTAINMENT SERVICES, NAMELY, PROVIDING PRESENTATIONS, SEMINARS, DISCUSSION GROUPS AND INTERACTIVE AND COLLABORATIVE ACTIVITIES IN THE FIELD OF BULLYING AND CYBERBULLYING (U.S. CLS. 100, 101 AND 107).  
JANICE L. MCMORROW, EXAMINING ATTORNEY

---

SN 85-336,231. BIDEAWEE, INC., NEW YORK, NY. FILED 6-2-2011.

## ANIMAL PEOPLE FOR PEOPLE WHO LOVE ANIMALS

THE MARK CONSISTS OF STANDARD CHARACTERS WITHOUT CLAIM TO ANY PARTICULAR FONT, STYLE, SIZE, OR COLOR.

FOR EDUCATIONAL SERVICES, NAMELY, ARRANGING AND CONDUCTING PROGRAMS, SEMINARS, CLASSES, AND CONFERENCES ON THE SUBJECT OF ANIMAL CARE, WELFARE AND PROTECTION; ANIMAL TRAINING SERVICES; ANIMAL SHELTER SERVICES, NAMELY, KENNEL SERVICES FOR ANIMALS IN THE NATURE OF DOG TRAINING SERVICES (U.S. CLS. 100, 101 AND 107).  
FIRST USE 5-23-2011; IN COMMERCE 5-23-2011.  
KIMBERLY PERRY, EXAMINING ATTORNEY

---

SN 85-336,297. GOFF, ANGELA, HERNDON, VA. FILED 6-2-2011.

## OH MY GOFF

THE MARK CONSISTS OF STANDARD CHARACTERS WITHOUT CLAIM TO ANY PARTICULAR FONT, STYLE, SIZE, OR COLOR.

FOR ON-LINE JOURNALS, NAMELY, BLOGS FEATURING GENERAL INTEREST STORIES FOR ENTERTAINMENT PURPOSES; NEWS REPORTERS SERVICES; NEWS REPORTER SERVICES IN THE NATURE OF NEWS ANALYSIS AND NEWS COMMENTARY (U.S. CLS. 100, 101 AND 107).  
FRED CARL, EXAMINING ATTORNEY

**CLASS 41—(Continued).**

SN 85-336,426. CHILDS, VICTORIA, PASADENA, CA. FILED 6-2-2011.

## FISSIONchicks

THE MARK CONSISTS OF STANDARD CHARACTERS WITHOUT CLAIM TO ANY PARTICULAR FONT, STYLE, SIZE, OR COLOR.

FOR PEER TO PEER COACHING SERVICES IN THE FIELD OF BUSINESS ENTREPRENEURSHIP; PROFESSIONAL COACHING SERVICES IN THE FIELD OF BUSINESS ENTREPRENEURSHIP; PROVIDING GROUP COACHING IN THE FIELD OF BUSINESS ENTREPRENEURSHIP (U.S. CLS. 100, 101 AND 107).

WILLIAM VERHOSEK, EXAMINING ATTORNEY

SN 85-336,587. INTERNET PAWN, INC., CENTENNIAL, CO. FILED 6-2-2011.

## PAWNGO

THE MARK CONSISTS OF STANDARD CHARACTERS WITHOUT CLAIM TO ANY PARTICULAR FONT, STYLE, SIZE, OR COLOR.

FOR PROVIDING ON-LINE DOCUMENTS FOR APPLICATIONS CONCERNING COLLATERALIZED LOANS (U.S. CLS. 100, 101 AND 107).

CIMMERIAN COLEMAN, EXAMINING ATTORNEY

SN 85-336,591. ASVATHAA INC., NORTHRIDGE, CA. FILED 6-2-2011.

## KARMA KINGDOM

THE MARK CONSISTS OF STANDARD CHARACTERS WITHOUT CLAIM TO ANY PARTICULAR FONT, STYLE, SIZE, OR COLOR.

FOR ENTERTAINMENT SERVICES, NAMELY, PROVIDING TEMPORARY USE OF NON-DOWNLOADABLE ELECTRONIC GAMES BY MEANS OF THE INTERNET OR OTHER WIRED OR WIRELESS NETWORKS (U.S. CLS. 100, 101 AND 107).

CIMMERIAN COLEMAN, EXAMINING ATTORNEY

**CLASS 41—(Continued).**

SN 85-336,625. ERGOCARE, INC., RIVERSIDE, CA. FILED 6-2-2011.

## TECHNOLOGY THAT MOVES

THE MARK CONSISTS OF STANDARD CHARACTERS WITHOUT CLAIM TO ANY PARTICULAR FONT, STYLE, SIZE, OR COLOR.

FOR TRAINING SERVICES IN THE FIELD OF MEDICINE, NAMELY, TRAINING OTHERS IN THE PROPER TRANSFER OF PATIENTS ONTO AIR MATTRESSES (U.S. CLS. 100, 101 AND 107).

FIRST USE 10-11-2004; IN COMMERCE 10-11-2004.

SKYE YOUNG, EXAMINING ATTORNEY

SN 85-336,642. HOLMES, AMBER, SALT LAKE CITY, UT. FILED 6-2-2011.

## XAVII

THE MARK CONSISTS OF STANDARD CHARACTERS WITHOUT CLAIM TO ANY PARTICULAR FONT, STYLE, SIZE, OR COLOR.

THE WORDING "XAVII" HAS NO MEANING IN A FOREIGN LANGUAGE.

FOR EDUCATION SERVICES, NAMELY, PROVIDING LIVE AND ON-LINE CLASSES, SEMINARS, WORKSHOPS AND MEETINGS IN THE FIELD OF NETWORKING, IMPROVING YOUR KNOWLEDGE AND PROFESSIONAL SKILLS AND OVERALL SUCCESS; LIFE COACHING SERVICES IN THE FIELD OF NETWORKING, IMPROVING YOUR KNOWLEDGE AND PROFESSIONAL SKILLS AND OVERALL SUCCESS (U.S. CLS. 100, 101 AND 107).

TINA BROWN, EXAMINING ATTORNEY

SN 85-336,646. THE GLASS ROOSTER, INC., CHICAGO, IL. FILED 6-2-2011.

## The Glass Rooster

THE MARK CONSISTS OF STANDARD CHARACTERS WITHOUT CLAIM TO ANY PARTICULAR FONT, STYLE, SIZE, OR COLOR.

FOR EDUCATIONAL SERVICES, NAMELY, CONDUCTING LIVE AND ON-LINE COURSES AND WORKSHOPS IN THE FIELD OF FOOD PRESERVATION AND CANNING TECHNIQUES AND DISTRIBUTION OF PRINTED MATERIALS IN CONNECTION THEREWITH IN HARD COPY OR ELECTRONIC FORMAT ON THE SAME TOPICS (U.S. CLS. 100, 101 AND 107).

FIRST USE 11-11-2008; IN COMMERCE 5-31-2010.

JEAN IM, EXAMINING ATTORNEY

**CLASS 41—(Continued).**

SN 85-336,656. TRACKS MEDIA INC., NEW YORK, NY.  
FILED 6-2-2011.



THE MARK CONSISTS OF A STYLIZED QUOTATION-LIKE BUBBLE WITH A CIRCULAR HOLE IN THE MIDDLE AND A SMALLER CIRCLE BELOW.

FOR ONLINE ELECTRONIC PUBLISHING OF DIGITAL MEDIA WORKS OF OTHERS TO CREATE DIGITAL MEDIA STORIES (U.S. CLS. 100, 101 AND 107).  
FIRST USE 5-24-2011; IN COMMERCE 5-24-2011.  
ALLISON SCHRODY, EXAMINING ATTORNEY

SN 85-336,679. AMERICAN ROAD AND TRANSPORTATION BUILDERS ASSOCIATION, WASHINGTON, DC. FILED 6-2-2011.

## TransOvation

THE MARK CONSISTS OF STANDARD CHARACTERS WITHOUT CLAIM TO ANY PARTICULAR FONT, STYLE, SIZE, OR COLOR.

FOR EDUCATIONAL SERVICES, NAMELY, PROVIDING WORKSHOPS AND EXHIBITS FOCUSED ON INNOVATION AND DEVELOPED SPECIFICALLY FOR YOUNG EXECUTIVES IN THE TRANSPORTATION AND CONSTRUCTION INDUSTRY (U.S. CLS. 100, 101 AND 107).

FIRST USE 6-2-2011; IN COMMERCE 6-2-2011.  
ALLISON SCHRODY, EXAMINING ATTORNEY

**CLASS 41—(Continued).**

SN 85-336,762. FERRELL, AMELIA, WENATCHEE, WA.  
FILED 6-2-2011.

## Da Vincineers

THE MARK CONSISTS OF STANDARD CHARACTERS WITHOUT CLAIM TO ANY PARTICULAR FONT, STYLE, SIZE, OR COLOR.

FOR EDUCATION SERVICES, NAMELY, PROVIDING CLASSES IN THE FIELDS OF SCIENCE, LITERACY, AND MATH INTEGRATED INTO ART (U.S. CLS. 100, 101 AND 107).

MAUREEN DALL, EXAMINING ATTORNEY

SN 85-336,780. TERRI O, INC., SCOTTSDALE, AZ. FILED 6-2-2011.

## Super Simple

THE MARK CONSISTS OF STANDARD CHARACTERS WITHOUT CLAIM TO ANY PARTICULAR FONT, STYLE, SIZE, OR COLOR.

OWNER OF U.S. REG. NOS. 3,915,017 AND 3,915,018.  
FOR LIVE AND PRERECORDED ENTERTAINMENT SERVICES IN THE NATURE OF TELEVISION PROGRAMMING CONTAINING EDUCATIONAL INSTRUCTION AND DEMONSTRATIONS IN THE FIELDS OF CRAFTS, FASHION, THE DOMESTIC ARTS AND SOCIAL GRACES (U.S. CLS. 100, 101 AND 107).

FIRST USE 4-1-2009; IN COMMERCE 1-8-2011.  
TINA BROWN, EXAMINING ATTORNEY

SN 85-336,905. EVANOFF, CAROL, PORT LUDLOW, WA.  
FILED 6-2-2011.

## Errai2 The Next North Star

THE MARK CONSISTS OF STANDARD CHARACTERS WITHOUT CLAIM TO ANY PARTICULAR FONT, STYLE, SIZE, OR COLOR.

FOR TRAINING SERVICES IN THE FIELD OF BUSINESS AND PROFESSIONAL DEVELOPMENT (U.S. CLS. 100, 101 AND 107).

TRICIA SONNEBORN, EXAMINING ATTORNEY

**CLASS 41—(Continued).**

SN 85-336,910. METRO-GOLDWYN-MAYER LION CORP., BEVERLY HILLS, CA. FILED 6-2-2011.



OWNER OF U.S. REG. NOS. 1,911,153, 3,027,476 AND OTHERS.

THE STIPPLING IS A FEATURE OF THE MARK AND DOES NOT INDICATE COLOR; THE STIPPLING IS FOR SHADING PURPOSES ONLY.

THE MARK CONSISTS OF THE DEPICTION OF A ROARING LION ENCIRCLED BY FILM STRIP WITH THE WORDS ARS GRATIA ARTIS ON THE TOP OF THE FILM STRIP, AND A FACE DESIGN BELOW THE LION ENCIRCLED BY LAUREL LEAVES, AND THE LETTERS MGM BELOW THE DESIGN.

THE ENGLISH TRANSLATION OF ARS GRATIA ARTIS IN THE MARK IS ART FOR ART'S SAKE.

FOR DISTRIBUTION OF MOTION PICTURE FILMS (U.S. CLS. 100, 101 AND 107).

TRACY FLETCHER, EXAMINING ATTORNEY

SN 85-337,033. CRANEY, JOE, PHOENIX, AZ. FILED 6-3-2011.

**WICKED SMART CENTRAL**

THE MARK CONSISTS OF STANDARD CHARACTERS WITHOUT CLAIM TO ANY PARTICULAR FONT, STYLE, SIZE, OR COLOR.

FOR CONDUCTING WORKSHOPS AND SEMINARS IN BUSINESS TOPICS AND TEACHING INDIVIDUALS HOW TO MODIFY THEIR BEHAVIORS BY UNDERSTANDING HOW EMOTIONS AND STIMULI CAUSE REACTIONS (U.S. CLS. 100, 101 AND 107).

CHARLOTTE CORWIN, EXAMINING ATTORNEY

SN 85-337,075. FUN FACTORY, INC., KAPOLEI, HI. FILED 6-3-2011.

**TED TOKEN**

THE MARK CONSISTS OF STANDARD CHARACTERS WITHOUT CLAIM TO ANY PARTICULAR FONT, STYLE, SIZE, OR COLOR.

FOR AMUSEMENT ARCADE SERVICES (U.S. CLS. 100, 101 AND 107).

PRISCILLA MILTON, EXAMINING ATTORNEY

**CLASS 41—(Continued).**

SN 85-337,077. FUN FACTORY, INC., KAPOLEI, HI. FILED 6-3-2011.



THE MARK CONSISTS OF A ROUND TOKEN MAN WITH AN OPEN MOUTH, ROUND EYES AND ARMS OUTSTRETCHED AND WEARING SHOES AND A CAP.

FOR AMUSEMENT ARCADE SERVICES (U.S. CLS. 100, 101 AND 107).

PRISCILLA MILTON, EXAMINING ATTORNEY

SN 85-337,092. COMMITTEE FOR THE FANDEMONEUM MUSEUM, INC., SHREWSBURY, MA. FILED 6-3-2011.

**FANDEMONEUM**

THE MARK CONSISTS OF STANDARD CHARACTERS WITHOUT CLAIM TO ANY PARTICULAR FONT, STYLE, SIZE, OR COLOR.

FOR MUSEUM SERVICES (U.S. CLS. 100, 101 AND 107).

TAMARA FRAZIER, EXAMINING ATTORNEY

SN 85-337,313. FLORES, ARTURO, LOS ANGELES, CA. FILED 6-3-2011.

**BACKYARD ESKRIMA**

THE MARK CONSISTS OF STANDARD CHARACTERS WITHOUT CLAIM TO ANY PARTICULAR FONT, STYLE, SIZE, OR COLOR.

NO CLAIM IS MADE TO THE EXCLUSIVE RIGHT TO USE "ESKRIMA", APART FROM THE MARK AS SHOWN.

FOR MARTIAL ARTS INSTRUCTION; OPERATING OF MARTIAL ARTS' SCHOOLS; OPERATING OF MARTIAL ARTS' STUDIOS (U.S. CLS. 100, 101 AND 107).

JEFF DEFORD, EXAMINING ATTORNEY



**CLASS 41—(Continued).**

SN 85-337,443. AMERICAN BROADCASTING COMPANIES, INC., NEW YORK, NY. FILED 6-3-2011.

### EXTREME MAKEOVER HOME EDITION

THE MARK CONSISTS OF STANDARD CHARACTERS WITHOUT CLAIM TO ANY PARTICULAR FONT, STYLE, SIZE, OR COLOR.

OWNER OF U.S. REG. NOS. 3,125,624 AND 3,534,134.

NO CLAIM IS MADE TO THE EXCLUSIVE RIGHT TO USE "MAKEOVER HOME EDITION", APART FROM THE MARK AS SHOWN.

FOR ENTERTAINMENT IN THE NATURE OF A REALITY TELEVISION SERIES; ENTERTAINMENT SERVICES, NAMELY, A SERIES OF TELEVISION PROGRAMS IN THE FIELDS OF ARCHITECTURE, CARPENTRY, CONSTRUCTION, REMODELING, DESIGN, LANDSCAPING, OR WISH FULFILLMENT OR COMBINATION THEREOF (U.S. CLS. 100, 101 AND 107).

FIRST USE 12-3-2003; IN COMMERCE 12-3-2003.  
LESLEY LAMOTHE, EXAMINING ATTORNEY

SN 85-337,543. MAXIMUM CHANGE, INC., MURFREESBORO, TN. FILED 6-3-2011.

### Maximum Change

THE MARK CONSISTS OF STANDARD CHARACTERS WITHOUT CLAIM TO ANY PARTICULAR FONT, STYLE, SIZE, OR COLOR.

FOR BUSINESS EDUCATION AND TRAINING SERVICES, NAMELY, DEVELOPING AND FACILITATING CUSTOMIZED LEADERSHIP AND EXECUTIVE DEVELOPMENT PROGRAMS, PROVIDING EXECUTIVE COACHING SERVICES, AND PROVIDING BUSINESS EDUCATION PROGRAMS TO EMPLOYEES AND EXECUTIVES; BUSINESS EDUCATION AND TRAINING SERVICES, NAMELY, DEVELOPING, AND FACILITATING CUSTOMIZED IN-COMPANY LEADERSHIP AND EXECUTIVE DEVELOPMENT PROGRAMS, PROVIDING EXECUTIVE COACHING SERVICES, AND PROVIDING PUBLIC AND IN-COMPANY KEYNOTE PRESENTATIONS TO BUSINESS LEADERS; LIFE COACHING SERVICES IN THE FIELD OF GENERAL LIFE ISSUE; PERSONAL COACHING SERVICES IN THE FIELD OF GENERAL LIFE ISSUES; PROFESSIONAL COACHING SERVICES IN THE FIELD OF LEADERSHIP; PROVIDING GROUP COACHING AND LEARNING FORUMS IN THE FIELD OF LEADERSHIP DEVELOPMENT; PROVIDING GROUP COACHING IN THE FIELD OF LEADERSHIP (U.S. CLS. 100, 101 AND 107).

FIRST USE 6-1-2005; IN COMMERCE 6-1-2005.

WILLIAM ROSSMAN, EXAMINING ATTORNEY

**CLASS 41—(Continued).**

SN 85-337,695. JOHNSTON, LYNWOOD, BOZEMAN, MT. FILED 6-3-2011.

### THE TWO-STEP OUTLAWS

THE MARK CONSISTS OF STANDARD CHARACTERS WITHOUT CLAIM TO ANY PARTICULAR FONT, STYLE, SIZE, OR COLOR.

FOR ENTERTAINMENT SERVICES IN THE NATURE OF LIVE MUSICAL PERFORMANCES (U.S. CLS. 100, 101 AND 107).

GRETCHEN ULRICH, EXAMINING ATTORNEY

SN 85-337,751. RANDALL LINDAMOOD, TYRON, NC. AND ROGER LINDAMOOD, TYRON, NC. AND LYNN RONZELLO, TYRON, NC. AND RALPH RONZELLO, TYRON, NC. FILED 6-3-2011.

### Color Me Gone

THE MARK CONSISTS OF STANDARD CHARACTERS WITHOUT CLAIM TO ANY PARTICULAR FONT, STYLE, SIZE, OR COLOR.

FOR ENTERTAINMENT SERVICES, NAMELY, PARTICIPATION IN AUTO RACES AND AUTO SHOWS WITH RESTORED AUTOMOBILES (U.S. CLS. 100, 101 AND 107).

FIRST USE 2-15-1991; IN COMMERCE 2-15-1991.

KATHY DE JONGE, EXAMINING ATTORNEY

SN 85-337,798. UBIQUITY BROADCASTING CORPORATION, IRVINE, CA. FILED 6-3-2011.

### UNCAGED

THE MARK CONSISTS OF STANDARD CHARACTERS WITHOUT CLAIM TO ANY PARTICULAR FONT, STYLE, SIZE, OR COLOR.

FOR ENTERTAINMENT IN THE NATURE OF AN ON-GOING SPECIAL VARIETY, NEWS, MUSIC OR COMEDY SHOW FEATURING REALITY BASED TELEVISION PROGRAMS AND SEMI SCRIPTED, SCRIPTED, EPISODIC, SHORT FORM AND LONG FORM PROGRAMMING IN THE FIELD OF ACTION SPORTS BROADCAST OVER TELEVISION, SATELLITE, AUDIO, AND VIDEO MEDIA; ENTERTAINMENT IN THE NATURE OF ON-GOING SEMI SCRIPTED, SCRIPTED, EPISODIC, SHORT FORM AND LONG FORM REALITY BASED TELEVISION PROGRAMS; ENTERTAINMENT SERVICES, NAMELY, PROVIDING ON-GOING REALITY BASED TELEVISION PROGRAMS AND SEMI SCRIPTED, SCRIPTED, EPISODIC, SHORT FORM AND LONG FORM TELEVISION PROGRAMS IN THE FIELD OF ACTION SPORTS VIA A GLOBAL COMPUTER NETWORK; ENTERTAINMENT, NAMELY, A CONTINUING REALITY BASED TELEVISION PROGRAM AND SEMI

**CLASS 41—(Continued).**

SCRIPTED, SCRIPTED, EPISODIC, SHORT FORM AND LONG FORM PROGRAMMING SHOW IN THE FIELD OF ACTION SPORTS BROADCAST OVER TELEVISION, SATELLITE, AUDIO, AND VIDEO MEDIA; ENTERTAINMENT, NAMELY, A CONTINUING REALITY BASED TELEVISION PROGRAM AND SEMI SCRIPTED, SCRIPTED, EPISODIC, SHORT FORM AND LONG FORM PROGRAMMING SHOW IN THE FIELD OF ACTION SPORTS BROADCAST OVER GLOBAL COMPUTER NETWORK; ENTERTAINMENT, NAMELY, PRODUCTION OF REALITY, SEMI SCRIPTED, SCRIPTED, EPISODIC, SHORT FORM AND LONG FORM TELEVISION PROGRAMS; OPERATION OF VIDEO EQUIPMENT OR AUDIO EQUIPMENT ETC. FOR PRODUCTION OF RADIO OR TELEVISION PROGRAMS; PRODUCTION AND DISTRIBUTION OF TELEVISION SHOWS AND MOVIES; PRODUCTION OF DVDS, VIDEOTAPES AND TELEVISION PROGRAMS FEATURING REALITY BASED TELEVISION PROGRAMS AND SEMI SCRIPTED, SCRIPTED, EPISODIC, SHORT FORM AND LONG FORM TELEVISION SHOWS IN THE FIELD OF ACTION SPORTS (U.S. CLS. 100, 101 AND 107).

FIRST USE 6-1-2011; IN COMMERCE 6-1-2011.

ANNE E. GUSTASON, EXAMINING ATTORNEY

SN 85-337,822. NATURALLY FIT LLC, AUSTIN, TX. FILED 6-3-2011.

## Naturally Fit

THE MARK CONSISTS OF STANDARD CHARACTERS WITHOUT CLAIM TO ANY PARTICULAR FONT, STYLE, SIZE, OR COLOR.

FOR PRESENTATION OF LIVE SHOW PERFORMANCES (U.S. CLS. 100, 101 AND 107).

FIRST USE 5-30-2011; IN COMMERCE 5-30-2011.

KAPIL BHANOT, EXAMINING ATTORNEY

SN 85-337,916. ANDREW WOJTOWICZ, CHICAGO, IL. FILED 6-3-2011.

## JERZY

THE MARK CONSISTS OF STANDARD CHARACTERS WITHOUT CLAIM TO ANY PARTICULAR FONT, STYLE, SIZE, OR COLOR.

FOR AUDIO AND VIDEO RECORDING SERVICES; AUDIO RECORDING AND PRODUCTION; EDITING OR RECORDING OF SOUNDS AND IMAGES; ENTERTAINMENT IN THE NATURE OF LIVE PERFORMANCES BY DJ; ENTERTAINMENT IN THE NATURE OF VISUAL AND AUDIO PERFORMANCES BY DJ; ENTERTAINMENT IN THE NATURE OF DJ; ENTERTAINMENT SERVICES IN THE NATURE OF LIVE MUSICAL PERFORMANCES; ENTERTAINMENT, NAMELY, LIVE MUSIC CONCERTS; PRESENTATION OF LIVE SHOW PERFORMANCES; PRESENTATION OF MUSICAL PERFORMANCE; PRODUCTION OF AUDIO RECORDING (U.S. CLS. 100, 101 AND 107).

FIRST USE 10-1-2004; IN COMMERCE 10-1-2004.

SHAILA SETTLES, EXAMINING ATTORNEY

**CLASS 41—(Continued).**

SN 85-337,922. ESLICH JOHN R, LOUISVILLE, OH. FILED 6-3-2011.

## SCREAMING IS ONLY THE BEGINNING

THE MARK CONSISTS OF STANDARD CHARACTERS WITHOUT CLAIM TO ANY PARTICULAR FONT, STYLE, SIZE, OR COLOR.

FOR AMUSEMENT CENTERS; PROVIDING AMUSEMENT FACILITIES (U.S. CLS. 100, 101 AND 107).

FIRST USE 6-3-2011; IN COMMERCE 6-3-2011.

SUSAN RICHARDS, EXAMINING ATTORNEY

SN 85-338,063. APOLLO GROUP, INC., PHOENIX, AL. FILED 6-3-2011.

## PHOENIXMATH

THE MARK CONSISTS OF STANDARD CHARACTERS WITHOUT CLAIM TO ANY PARTICULAR FONT, STYLE, SIZE, OR COLOR.

FOR ONLINE NON-DOWNLOADABLE EDUCATIONAL MATERIAL IN THE FIELD OF MATHEMATICS (U.S. CLS. 100, 101 AND 107).

FIRST USE 8-1-2011; IN COMMERCE 8-1-2011.

DEZMONA MIZELLE, EXAMINING ATTORNEY

SN 85-338,070. GOGHGO, INC., SCOTTSDALE, AZ. FILED 6-3-2011.

## GOGOTRAINING

THE MARK CONSISTS OF STANDARD CHARACTERS WITHOUT CLAIM TO ANY PARTICULAR FONT, STYLE, SIZE, OR COLOR.

FOR PROVIDING ON-LINE TRAINING IN THE FORM OF COURSES, PODCASTS, SEMINARS, WORKSHOPS AND SELF STUDY IN THE FIELD OF INFORMATION TECHNOLOGY AND MANAGEMENT (U.S. CLS. 100, 101 AND 107).

FIRST USE 12-20-2010; IN COMMERCE 12-20-2010.

HELENE LIWINSKI, EXAMINING ATTORNEY

**CLASS 41—(Continued).**

SN 85-338,274. SEA WORLD LLC, ORLANDO, FL. FILED 6-5-2011.



OWNER OF U.S. REG. NO. 1,181,571.  
 THE MARK CONSISTS OF A STYLIZED LETTER "O" INCORPORATING A WHALE AND WATER.  
 FOR ENTERTAINMENT SERVICES IN THE NATURE OF AN AMUSEMENT PARK SHOW (U.S. CLS. 100, 101 AND 107).  
 SUSAN LESLIE DUBOIS, EXAMINING ATTORNEY

SN 85-338,315. "WE ALWAYS SWING," INC., COLUMBIA, MO. FILED 6-5-2011.

"WE ALWAYS SWING"

THE MARK CONSISTS OF STANDARD CHARACTERS WITHOUT CLAIM TO ANY PARTICULAR FONT, STYLE, SIZE, OR COLOR.

FOR MUSICAL EVENT BOOKING SERVICES; CONCERT BOOKING SERVICES; ORGANIZING, ARRANGING, AND CONDUCTING LIVE MUSICAL CONCERTS AND PERFORMANCES (U.S. CLS. 100, 101 AND 107).  
 FIRST USE 7-0-1995; IN COMMERCE 7-0-1995.  
 MARILYN IZZI, EXAMINING ATTORNEY

**CLASS 41—(Continued).**

SN 85-338,358. SYNAPTIC SUCCESS, INC., BOCA RATON, FL. FILED 6-5-2011.

# Mindfluence

THE MARK CONSISTS OF STANDARD CHARACTERS WITHOUT CLAIM TO ANY PARTICULAR FONT, STYLE, SIZE, OR COLOR.

FOR BUSINESS EDUCATION AND TRAINING SERVICES, NAMELY, DEVELOPING AND FACILITATING CUSTOMIZED LEADERSHIP AND EXECUTIVE DEVELOPMENT PROGRAMS, PROVIDING EXECUTIVE COACHING SERVICES, AND PROVIDING BUSINESS EDUCATION PROGRAMS TO EMPLOYEES AND EXECUTIVES; BUSINESS TRAINING; BUSINESS TRAINING CONSULTANCY SERVICES; DEVELOPING TRAINING SYSTEMS AND LEARNING METHODOLOGIES FOR OTHERS; EDUCATIONAL SERVICES, NAMELY, PROVIDING ONLINE INSTRUCTION IN THE FIELD OF SELF-HELP, BUSINESS TRAINING, MIND CONTROL, PERSONAL DEVELOPMENT VIA AN ONLINE WEBSITE; INTERACTIVE ON-LINE TRAINING SERVICES IN THE FIELD OF SELF-HELP, BUSINESS TRAINING, MIND CONTROL, PERSONAL DEVELOPMENT; TRAINING COURSES IN STRATEGIC PLANNING RELATING TO ADVERTISING, PROMOTION, MARKETING AND BUSINESS; TRAINING IN THE FIELD OF DESIGN, ADVERTISING AND COMMUNICATION TECHNOLOGIES; TRAINING SERVICES IN THE FIELD OF SELF-HELP, BUSINESS TRAINING, MIND CONTROL, PERSONAL DEVELOPMENT (U.S. CLS. 100, 101 AND 107).

FIRST USE 4-5-2010; IN COMMERCE 4-5-2010.  
 CHRIS WELLS, EXAMINING ATTORNEY

SN 85-338,479. MICHIGAN CARDIOVASCULAR INSTITUTE FOUNDATION, SAGINAW, MI. FILED 6-6-2011.

# Shocks and Saves

THE MARK CONSISTS OF STANDARD CHARACTERS WITHOUT CLAIM TO ANY PARTICULAR FONT, STYLE, SIZE, OR COLOR.

FOR ENTERTAINMENT IN THE NATURE OF HOCKEY GAMES (U.S. CLS. 100, 101 AND 107).  
 FIRST USE 3-1-2008; IN COMMERCE 3-1-2008.  
 CAROLINE WOOD, EXAMINING ATTORNEY

**CLASS 41—(Continued).**

SN 85-338,487. HAIL MARY PRODUCTIONS, LLC, ATLANTA, GA. FILED 6-6-2011.

**HAIL MARY PRODUCTIONS**

THE MARK CONSISTS OF STANDARD CHARACTERS WITHOUT CLAIM TO ANY PARTICULAR FONT, STYLE, SIZE, OR COLOR.

NO CLAIM IS MADE TO THE EXCLUSIVE RIGHT TO USE "PRODUCTIONS", APART FROM THE MARK AS SHOWN.

FOR PRODUCTION AND DISTRIBUTION OF TELEVISION SHOWS AND MOVIES (U.S. CLS. 100, 101 AND 107).

ERNEST SHOSHO, EXAMINING ATTORNEY

SN 85-338,606. MARC ANGELL, VENTURA, CA. FILED 6-6-2011.

**YOUCLOUD**

THE MARK CONSISTS OF STANDARD CHARACTERS WITHOUT CLAIM TO ANY PARTICULAR FONT, STYLE, SIZE, OR COLOR.

FOR PROVIDING A WEBSITE FOR ENTERTAINMENT PURPOSES WHERE USERS CAN VIEW AND POST PHOTOS, VIDEOS, ELECTRONIC MEDIA, MOVIES, TEXT, AUDIO CONTENT, AND RELATED INFORMATION FEATURING A WIDE VARIETY OF SUBJECTS (U.S. CLS. 100, 101 AND 107).

NAPOLEON SHARMA, EXAMINING ATTORNEY

SN 85-338,666. WERNER, CHRISTOPHER, GILBERT, AZ. FILED 6-6-2011.

**The Proven Pitch**

THE MARK CONSISTS OF STANDARD CHARACTERS WITHOUT CLAIM TO ANY PARTICULAR FONT, STYLE, SIZE, OR COLOR.

FOR PERSONAL COACHING SERVICES IN THE FIELD OF SALES TECHNIQUES (U.S. CLS. 100, 101 AND 107).

GIANCARLO CASTRO, EXAMINING ATTORNEY

**CLASS 41—(Continued).**

SN 85-338,733. NINTENDO OF AMERICA INC., REDMOND, WA. FILED 6-6-2011.

**POKÉDEX**

THE MARK CONSISTS OF STANDARD CHARACTERS WITHOUT CLAIM TO ANY PARTICULAR FONT, STYLE, SIZE, OR COLOR.

FOR ENTERTAINMENT SERVICES, NAMELY, PROVIDING AN ON-LINE NON-DOWNLOADABLE INTERACTIVE ENCYCLOPEDIA OF ANIMATED AND VIDEO GAME CHARACTERS; ENTERTAINMENT SERVICES, NAMELY, PROVIDING ELECTRONIC IMAGES AND TEXT FEATURING ANIMATED AND VIDEO GAME CHARACTERS ON-LINE; ENTERTAINMENT IN THE NATURE OF PROVIDING AN INFORMATIONAL AND ENTERTAINMENT WEBSITE IN THE FIELD OF ANIMATED AND VIDEO GAME CHARACTERS; ENTERTAINMENT INFORMATION PROVIDED ON-LINE FROM A COMPUTER DATABASE OR THE INTERNET; ON-LINE INTERACTIVE ENCYCLOPEDIA IN THE FIELD OF ANIMATED AND VIDEO GAME CHARACTERS; ENTERTAINMENT SERVICES, NAMELY, PROVIDING AN ONLINE DATABASE FEATURING INFORMATION ABOUT ANIMATED AND VIDEO GAME CHARACTERS; ENTERTAINMENT SERVICES, NAMELY, PROVIDING A WEB SITE FEATURING IMAGES, VIDEOS, MOVIES, MUSIC AND SOUND IN THE FIELDS OF VIDEO GAMES, COMPUTER GAMES, ANIMATED AND VIDEO GAME CHARACTERS VIA WIRELESS COMMUNICATION AND THE INTERNET; NON-DOWNLOADABLE ELECTRONIC PUBLICATIONS IN THE NATURE OF MAGAZINES, MANUALS, AND NEWSLETTERS IN THE FIELDS OF VIDEO GAMES, COMPUTER GAMES AND ANIMATED AND VIDEO GAME CHARACTERS VIA WIRELESS COMMUNICATION AND THE INTERNET; PROVIDING A WEBSITE FEATURING INFORMATION IN THE FIELDS OF VIDEO GAMES, COMPUTER GAMES AND ANIMATED AND VIDEO GAME CHARACTERS VIA WIRELESS COMMUNICATION AND THE INTERNET (U.S. CLS. 100, 101 AND 107).

B. PARADEWELAI, EXAMINING ATTORNEY

SN 85-338,968. AUDIOENGINE, LLC, PHOENIX, AZ. FILED 6-6-2011.

THE COLOR(S) RED, BLACK AND WHITE IS/ARE CLAIMED AS A FEATURE OF THE MARK.

THE MARK CONSISTS OF THE WORD BROAD DIRECTLY ABOVE THE WORD CASTERS IN A SAN SERIF FONT, ALL LOWER CASE LETTERING WITH THE LETTERING IN BLACK AGAINST A WHITE BACKGROUND EXCEPT THE "O" IN BROAD AND THE "T" IN CASTERS (WHICH ARE IN LINE VERTICALLY) ARE IN RED AND JOINED TO FORM THE SCIENTIFIC SYMBOL FOR FEMALE.

FOR AUDIO AND VIDEO EDITING AND MASTERING SERVICES; PRODUCTION OF AUDIO AND VIDEO RECORDINGS (U.S. CLS. 100, 101 AND 107).

FIRST USE 1-15-2011; IN COMMERCE 6-1-2011.

JOHN DALIER, EXAMINING ATTORNEY

**CLASS 41—(Continued).**

SN 85-339,200. WHITE HAT VENTURES, LLC, AKRON, OH.  
FILED 6-6-2011.

# AZDELA

THE MARK CONSISTS OF STANDARD CHARACTERS WITHOUT CLAIM TO ANY PARTICULAR FONT, STYLE, SIZE, OR COLOR.

FOR EDUCATIONAL SERVICES, NAMELY, CONDUCTING AND PROVIDING ELEMENTARY, JUNIOR HIGH, AND HIGH SCHOOL CLASSES AND EDUCATION COURSES THROUGH MEANS OF TELECOMMUNICATIONS AND COMPUTER NETWORKS (U.S. CLS. 100, 101 AND 107).

JANICE L. MCMORROW, EXAMINING ATTORNEY

---

SN 85-339,243. WARNER BROS. ENTERTAINMENT INC.,  
BURBANK, CA. FILED 6-6-2011.

# HARDLY NEWS

THE MARK CONSISTS OF STANDARD CHARACTERS WITHOUT CLAIM TO ANY PARTICULAR FONT, STYLE, SIZE, OR COLOR.

OWNER OF U.S. REG. NO. 3,444,993.  
FOR CONTINUING TELEVISION SERIES FEATURING FUNNY NEWS STORIES, CURRENT EVENTS, POLITICS AND POP CULTURE; AND AN ONLINE INTERACTIVE WEBSITE QUIZ SHOW FEATURING FUNNY NEWS STORIES, CURRENT EVENTS, POLITICS AND POP CULTURE (U.S. CLS. 100, 101 AND 107).

DEIRDRE ROBERTSON, EXAMINING ATTORNEY

---

SN 85-339,249. CORPORACIÓN FRANCISCO EL HOMBRE  
CORP, MIAMI, FL. FILED 6-6-2011.



NO CLAIM IS MADE TO THE EXCLUSIVE RIGHT TO USE "FESTIVAL", APART FROM THE MARK AS SHOWN.

THE COLOR(S) ORANGE, YELLOW, WHITE AND BLACK IS/ARE CLAIMED AS A FEATURE OF THE MARK.

THE MARK CONSISTS OF WORDING "FESTIVAL FRANCISCO EL HOMBRE" IN THE CENTER OF A BLACK BACKGROUND WITH AN ACCORDION SHAPE. THE LETTERS "FRANCISCO" AND "HOMBRE" APPEAR IN WHITE COLOR, THE WORDS "FESTIVAL", AND "EL" APPEAR IN ORANGE COLOR, A HAT IS DEPICTED WITH YELLOW AND WHITE STRIPES IN THE UPPER RIGHT

**CLASS 41—(Continued).**

CORNER OF THE LOGO, EACH SIDE OF THE LOGO IS AN END OF A YELLOW ACCORDION SHAPE, THE WORD "FESTIVAL" IS ALSO LOCATED ON THE TOP LEFT OF THE LOGO, THERE IS A YELLOW LINE LOCATED BELOW THE WORD "EL HOMBRE" EXTENDING FROM BELOW THE LETTER "E" ENDING IN A YELLOW SWIRL BELOW THE LETTERS "ER". ANOTHER YELLOW LINE IS PRESENT ON THE TOP OF THE LOGO EXTENDING FROM THE LEFT SIDE OF THE HAT AND ENDING IN A YELLOW SWIRL ABOVE THE LETTER "I" IN "FESTIVAL".

THE ENGLISH TRANSLATION OF "EL HOMBRE" IN THE MARK IS "THE MAN".

FOR PUBLICATION OF MAGAZINES, JOURNALS, NEWSPAPER, BROCHURES AND PRINTED MATTER; ENTERTAINMENT MEDIA PRODUCTION SERVICES FOR TELEVISION AND INTERNET; ENTERTAINMENT SERVICES IN THE NATURE OF PRESENTING LIVE MUSICAL PERFORMANCES; ORGANIZING COMMUNITY FESTIVALS FEATURING CULTURAL EVENTS; PUBLICATION AND EDITING OF PRINTED MATTERS (U.S. CLS. 100, 101 AND 107).

Laurie Mayes, Examining Attorney

---

SN 85-339,266. HOLLEY, DEANNA, DOUGLASVILLE, GA.  
FILED 6-6-2011.

# spectical

THE MARK CONSISTS OF STANDARD CHARACTERS WITHOUT CLAIM TO ANY PARTICULAR FONT, STYLE, SIZE, OR COLOR.

FOR ENTERTAINMENT SERVICES IN THE NATURE OF LIVE MUSICAL PERFORMANCES BY A PERFORMER; ENTERTAINMENT SERVICES IN THE NATURE OF DEVELOPMENT, CREATION, PRODUCTION AND POST-PRODUCTION SERVICES OF MULTIMEDIA ENTERTAINMENT CONTENT (U.S. CLS. 100, 101 AND 107).

AMY ALFIERI, EXAMINING ATTORNEY

**CLASS 41—(Continued).**

SN 85-339,357. ENVIROVILLAGE, PORTLAND, OR. FILED 6-6-2011.

## Envirovillage

THE MARK CONSISTS OF STANDARD CHARACTERS WITHOUT CLAIM TO ANY PARTICULAR FONT, STYLE, SIZE, OR COLOR.

FOR CONDUCTING EDUCATIONAL EXHIBITIONS IN THE NATURE OF SOCIAL AND ENVIRONMENTAL RESPONSIBILITY; DEVELOPMENT AND DISSEMINATION OF EDUCATIONAL MATERIALS OF OTHERS IN THE FIELD OF SOCIAL AND ENVIRONMENTAL RESPONSIBILITY; EDUCATION SERVICES, NAMELY, PROVIDING KINDERGARTEN THROUGH 12TH GRADE (K-12) CLASSROOM INSTRUCTION; EDUCATION SERVICES, NAMELY, PROVIDING SUMMER CAMPS IN THE FIELD OF SOCIAL AND ENVIRONMENTAL RESPONSIBILITY; EDUCATIONAL AND ENTERTAINMENT SERVICES FOR CHILDREN, NAMELY, PROVIDING INTERACTIVE PLAY AREAS, INSTRUCTIONAL CLASSES IN THE FIELD OF SOCIAL AND ENVIRONMENTAL RESPONSIBILITY AND SOCIAL GATHERINGS FOR CHILDREN; EDUCATIONAL DEMONSTRATIONS; EDUCATIONAL SERVICES, NAMELY, CONDUCTING CLASSROOM WORKSHOPS IN THE FIELD OF SOCIAL AND ENVIRONMENTAL RESPONSIBILITY AND DISTRIBUTION OF PRINTED MATERIALS IN CONNECTION THEREWITH IN HARD COPY OR ELECTRONIC FORMAT ON THE SAME TOPICS; EDUCATIONAL SERVICES, NAMELY, PROVIDING EDUCATIONAL SPEAKERS IN THE FIELD OF SOCIAL AND ENVIRONMENTAL RESPONSIBILITY; PROVIDING AFTER SCHOOL EDUCATIONAL PROGRAMS IN THE FIELD OF SOCIAL AND ENVIRONMENTAL RESPONSIBILITY AND PLAY FACILITIES FOR CHILDREN (U.S. CLS. 100, 101 AND 107).

FIRST USE 12-13-2010; IN COMMERCE 12-14-2010.  
JAY FLOWERS, EXAMINING ATTORNEY

SN 85-339,444. QUACKHOUSE, LLC, NEW YORK, NY. FILED 6-7-2011.

## DUCKY

THE MARK CONSISTS OF STANDARD CHARACTERS WITHOUT CLAIM TO ANY PARTICULAR FONT, STYLE, SIZE, OR COLOR.

FOR ENTERTAINMENT SERVICES IN THE NATURE OF LIVE MUSICAL PERFORMANCES; PRODUCING MUSICAL AUDIO AND VIDEO RECORDINGS; DISC JOCKEY SERVICES; PROVIDING A WEBSITE FEATURING INFORMATION, BLOGS, AND NON-DOWNLOADABLE RECORDINGS IN THE FIELD OF MUSIC AND ENTERTAINMENT (U.S. CLS. 100, 101 AND 107).

FIRST USE 11-6-2005; IN COMMERCE 11-6-2005.  
BERNICE MIDDLETON, EXAMINING ATTORNEY

**CLASS 41—(Continued).**

SN 85-339,482. GLENN H. REYNOLDS, KNOXVILLE, TN. FILED 6-7-2011.

## INSTAPUNDIT

THE MARK CONSISTS OF STANDARD CHARACTERS WITHOUT CLAIM TO ANY PARTICULAR FONT, STYLE, SIZE, OR COLOR.

FOR AN ONLINE JOURNAL, NAMELY, A WEBLOG FEATURING COMMENTARY AND INFORMATION IN THE FIELDS OF ADVANCED TECHNOLOGIES, INDIVIDUAL LIBERTY AND POPULAR CULTURE (U.S. CLS. 100, 101 AND 107).

FIRST USE 8-8-2001; IN COMMERCE 8-8-2001.  
CHRISTINA SOBRAL, EXAMINING ATTORNEY

SN 85-339,533. SABATIER, MICHAEL, LAS VEGAS, NV. FILED 6-7-2011.

## HAMMOCKING

THE MARK CONSISTS OF STANDARD CHARACTERS WITHOUT CLAIM TO ANY PARTICULAR FONT, STYLE, SIZE, OR COLOR.

FOR PERSONAL FITNESS TRAINING SERVICES FEATURING AEROBIC AND ANAEROBIC ACTIVITIES COMBINED WITH RESISTANCE AND FLEXIBILITY TRAINING; PHYSICAL FITNESS INSTRUCTION; PHYSICAL FITNESS TRAINING OF INDIVIDUALS AND GROUPS; PHYSICAL FITNESS TRAINING SERVICES (U.S. CLS. 100, 101 AND 107).

JAMES STEIN, EXAMINING ATTORNEY

SN 85-339,615. DUST JACKET, YUKON, OK. FILED 6-7-2011.

## DustJacket

THE MARK CONSISTS OF STANDARD CHARACTERS WITHOUT CLAIM TO ANY PARTICULAR FONT, STYLE, SIZE, OR COLOR.

FOR BOOK PUBLISHING (U.S. CLS. 100, 101 AND 107).  
FIRST USE 1-1-2009; IN COMMERCE 1-1-2009.  
HANNO RITTNER, EXAMINING ATTORNEY

**CLASS 41—(Continued).**

SN 85-339,864. RACHEL LANZEROTTI, SAN FRANCISCO, CA. FILED 6-7-2011.

# Five Rivers

THE MARK CONSISTS OF STANDARD CHARACTERS WITHOUT CLAIM TO ANY PARTICULAR FONT, STYLE, SIZE, OR COLOR.

FOR ARRANGING PROFESSIONAL WORKSHOP AND TRAINING COURSES; CONDUCTING WORKSHOPS AND SEMINARS IN PERSONAL AWARENESS; EDUCATIONAL SERVICES, NAMELY, CONDUCTING CLASSES, SEMINARS, CONFERENCES, WORKSHOPS, RETREATS, CAMPS AND FIELD TRIPS IN THE FIELD OF SELF-AWARENESS AND HEALTH AND DISTRIBUTION OF TRAINING MATERIAL IN CONNECTION THEREWITH; EDUCATIONAL SERVICES, NAMELY, CONDUCTING SEMINARS, LECTURES, TELESEMINARS, TELECLASSES, AND WORKSHOPS IN PERSONAL AWARENESS; WORKSHOPS AND SEMINARS IN THE FIELD OF SELF-AWARENESS AND HEALTH; YOGA INSTRUCTION (U.S. CLS. 100, 101 AND 107).

FIRST USE 11-1-2010; IN COMMERCE 1-15-2011.  
ALICE BENMAMAN, EXAMINING ATTORNEY

SN 85-339,865. GLEA, LLC, IRVING, TX. FILED 6-7-2011.

# LIKE MONEY

THE MARK CONSISTS OF STANDARD CHARACTERS WITHOUT CLAIM TO ANY PARTICULAR FONT, STYLE, SIZE, OR COLOR.

FOR ENTERTAINMENT SERVICES, NAMELY, CONDUCTING CONTESTS (U.S. CLS. 100, 101 AND 107).

FIRST USE 4-15-2011; IN COMMERCE 4-15-2011.  
ARETHA SOMERVILLE, EXAMINING ATTORNEY

SN 85-339,871. HYDENTRA, L.P., SANTA MONICA, CA. FILED 6-7-2011.

# SEXART

THE MARK CONSISTS OF STANDARD CHARACTERS WITHOUT CLAIM TO ANY PARTICULAR FONT, STYLE, SIZE, OR COLOR.

FOR ENTERTAINMENT SERVICES, NAMELY, PROVIDING A WEBSITE FEATURING ADULT-THEMED PHOTOGRAPHS AND VIDEOS; ONLINE MAGAZINES WITH SUBJECT MATTER RELATED TO ADULT ENTERTAINMENT AND ADULT-THEMED TOPICS (U.S. CLS. 100, 101 AND 107).

ARETHA SOMERVILLE, EXAMINING ATTORNEY

**CLASS 41—(Continued).**

SN 85-340,023. RUNRIGHT LLC, FORT WORTH, TX. FILED 6-7-2011.

# RunRight

THE MARK CONSISTS OF STANDARD CHARACTERS WITHOUT CLAIM TO ANY PARTICULAR FONT, STYLE, SIZE, OR COLOR.

FOR PROVIDING A WEB SITE FEATURING INFORMATION ON EXERCISE AND FITNESS (U.S. CLS. 100, 101 AND 107).

FIRST USE 2-1-2011; IN COMMERCE 2-15-2011.  
DANIEL CAPSHAW, EXAMINING ATTORNEY

SN 85-340,099. TRICOASTAL, LLC, CHICAGO, IL. FILED 6-7-2011.

# TRICOASTAL

THE MARK CONSISTS OF STANDARD CHARACTERS WITHOUT CLAIM TO ANY PARTICULAR FONT, STYLE, SIZE, OR COLOR.

FOR ENTERTAINMENT IN THE NATURE OF VISUAL AND AUDIO PERFORMANCES, NAMELY, MUSICAL BAND, ROCK GROUP, RAPPING, DANCE PERFORMANCES; ENTERTAINMENT INFORMATION SERVICES, NAMELY, PROVIDING INFORMATION AND NEWS RELEASES ABOUT A MUSICAL ARTIST; ENTERTAINMENT SERVICES BY A MUSICAL ARTIST AND PRODUCER, NAMELY, MUSICAL COMPOSITION FOR OTHERS AND PRODUCTION OF MUSICAL SOUND RECORDINGS, AND ASSOCIATED PROMOTIONAL WORK (U.S. CLS. 100, 101 AND 107).

RICHARD WHITE, EXAMINING ATTORNEY

SN 85-340,130. GILBERT PERFORMANCE DESIGN, SAN CLEMENTE, CA. FILED 6-7-2011.

# prosynk

THE MARK CONSISTS OF STANDARD CHARACTERS WITHOUT CLAIM TO ANY PARTICULAR FONT, STYLE, SIZE, OR COLOR.

FOR GOLF CLUB SERVICES; FITTING OF GOLF CLUBS TO INDIVIDUAL USERS; PROVIDING NEWS AND INFORMATION ON THE SPORT OF GOLF; PROVIDING A WEBSITE FEATURING INFORMATION ON GOLF AND GOLF INSTRUCTION; PROVIDING A WEBSITE FEATURING EDUCATIONAL INFORMATION IN THE FIELD OF GOLF CLUBS, GOLF CLUB FITTING, GOLF GAME STRATEGY, AND GOLF SWING MECHANICS (U.S. CLS. 100, 101 AND 107).

KATHERINE CONNOLLY, EXAMINING ATTORNEY

**CLASS 41—(Continued).**

SN 85-340,153. LEVERETT, JAMEY L, WEBSTER, NY. AND LEVERETT, TIMOTHY D, WEBSTER, NY. FILED 6-7-2011.

## The Blood Countess

THE MARK CONSISTS OF STANDARD CHARACTERS WITHOUT CLAIM TO ANY PARTICULAR FONT, STYLE, SIZE, OR COLOR.

FOR ENTERTAINMENT IN THE NATURE OF BALLET PERFORMANCES; ENTERTAINMENT IN THE NATURE OF DANCE PERFORMANCES; ENTERTAINMENT IN THE NATURE OF VISUAL AND AUDIO PERFORMANCES BY DANCERS, ACTORS, AND MUSICIANS (U.S. CLS. 100, 101 AND 107).

FIRST USE 4-1-2010; IN COMMERCE 5-15-2010.  
GRETCHEN ULRICH, EXAMINING ATTORNEY

---

SN 85-340,440. CHECKPOINT HR HOLDINGS CORPORATION, EDISON, NJ. FILED 6-7-2011.

## BENELERT

THE MARK CONSISTS OF STANDARD CHARACTERS WITHOUT CLAIM TO ANY PARTICULAR FONT, STYLE, SIZE, OR COLOR.

FOR ON-LINE ELECTRONIC NEWSLETTERS DELIVERED BY E-MAIL IN THE FIELD OF HUMAN RESOURCES, EMPLOYEE BENEFITS AND INSURANCE (U.S. CLS. 100, 101 AND 107).

FIRST USE 11-3-2010; IN COMMERCE 11-3-2010.  
JOHN DWYER, EXAMINING ATTORNEY

---

SN 85-341,095. LAUNCHUP.ORG, LEHI, UT. FILED 6-8-2011.

## LAUNCHUP

THE MARK CONSISTS OF STANDARD CHARACTERS WITHOUT CLAIM TO ANY PARTICULAR FONT, STYLE, SIZE, OR COLOR.

FOR EDUCATIONAL SERVICES, NAMELY, PROVIDING MEETUPS, CLASSES, FORUMS, CLINICS, WORKSHOPS, SEMINARS AND MENTORING IN THE FIELDS OF BUSINESS, ENTREPRENEURSHIP, MARKETING, DESIGN, TECHNOLOGY, AND LAW (U.S. CLS. 100, 101 AND 107).

FIRST USE 1-25-2009; IN COMMERCE 1-25-2009.  
DARRYL SPRUILL, EXAMINING ATTORNEY

**CLASS 41—(Continued).**

SN 85-341,240. DEAD KINGS LLC, LOS ANGELES, CA. FILED 6-8-2011.

## Dead Kings

THE MARK CONSISTS OF STANDARD CHARACTERS WITHOUT CLAIM TO ANY PARTICULAR FONT, STYLE, SIZE, OR COLOR.

FOR ENTERTAINMENT SERVICES BY A MUSICAL ARTIST AND PRODUCER, NAMELY, MUSICAL COMPOSITION FOR OTHERS AND PRODUCTION OF MUSICAL SOUND RECORDINGS (U.S. CLS. 100, 101 AND 107).

DOMINICK J. SALEMI, EXAMINING ATTORNEY

---

SN 85-341,613. TWENTIETH CENTURY FOX FILM CORPORATION, LOS ANGELES, CA. FILED 6-8-2011.

## FOX SPORTS GAME CONNECT

THE MARK CONSISTS OF STANDARD CHARACTERS WITHOUT CLAIM TO ANY PARTICULAR FONT, STYLE, SIZE, OR COLOR.

OWNER OF U.S. REG. NOS. 3,001,993, 3,032,760 AND OTHERS.

NO CLAIM IS MADE TO THE EXCLUSIVE RIGHT TO USE "SPORTS GAME", APART FROM THE MARK AS SHOWN.

FOR PROVIDING ON-LINE INFORMATION IN THE FIELD OF SPORTS AND ENTERTAINMENT (U.S. CLS. 100, 101 AND 107).

FIRST USE 4-6-2011; IN COMMERCE 4-6-2011.  
CAROLINE WOOD, EXAMINING ATTORNEY



**CLASS 41—(Continued).**

SN 85-344,449. MR. MARKETING GROUP, INC., BOCA RATON, FL. FILED 6-13-2011.

**CELEBRITY GURUS**

THE MARK CONSISTS OF STANDARD CHARACTERS WITHOUT CLAIM TO ANY PARTICULAR FONT, STYLE, SIZE, OR COLOR.

NO CLAIM IS MADE TO THE EXCLUSIVE RIGHT TO USE "CELEBRITY", APART FROM THE MARK AS SHOWN.

FOR ENTERTAINMENT IN THE NATURE OF ONGOING TELEVISION PROGRAMS COVERING AND PROVIDING NEWS, TRENDS, PROFILES AND INTERVIEWS, KNOW-HOW, SUCCESS TIPS AND ADVICE IN THE FIELDS OF CONSUMER, BUSINESS, LIFESTYLE, POPULAR CULTURE, SELF-HELP, AND CELEBRITY INFORMATION; ENTERTAINMENT SERVICES IN THE NATURE OF AN AMUSEMENT PARK ATTRACTION, NAMELY, A THEMED AREA; PROVIDING A WEBSITE FEATURING ON-LINE JOURNALS, NAMELY, BLOGS COVERING AND PROVIDING NEWS, TRENDS, PROFILES AND INTERVIEWS, KNOW-HOW, SUCCESS TIPS AND ADVICE IN THE FIELDS OF CONSUMER, BUSINESS, LIFESTYLE, POPULAR CULTURE, SELF-HELP, AND CELEBRITY INFORMATION; ENTERTAINMENT SERVICES, NAMELY, PROVIDING CONTINUING ON-LINE RADIO AND TELEVISION COMPUTER TALK SHOWS AND INTERVIEWS WITH CELEBRITIES, EXPERTS AND INNOVATORS IN THE FIELDS OF CONSUMER, BUSINESS, LIFESTYLE, POPULAR CULTURE, SELF-HELP, AND CELEBRITY INFORMATION; PROVIDING ON-LINE COMPUTER GAMES, CONTESTS AND SWEEPSTAKES (U.S. CLS. 100, 101 AND 107).

SHANNON TWOHIG, EXAMINING ATTORNEY

SN 85-344,963. METRO-GOLDWYN-MAYER LION CORP., BEVERLY HILLS, CA. FILED 6-13-2011.



OWNER OF U.S. REG. NOS. 1,911,153, 3,027,476 AND OTHERS.

NO CLAIM IS MADE TO THE EXCLUSIVE RIGHT TO USE "TRADE MARK", APART FROM THE MARK AS SHOWN.

THE STIPPLING IS FOR SHADING PURPOSES ONLY.

THE MARK CONSISTS OF THE DEPICTION OF A ROARING LION ENCIRCLED BY FILM STRIP WITH THE WORDS ARS GRATIA ARTIS ON THE TOP OF THE FILM STRIP, THE WORDS TRADE AND MARK TO THE LEFT AND RIGHT OF THE FILM STRIP AND A FACE DESIGN BELOW THE LION ENCIRCLED BY LAUREL LEAVES AND THE LETTERS MGM BELOW THE DESIGN.

THE ENGLISH TRANSLATION OF ARS GRATIA ARTIS IN THE MARK IS ART FOR ART'S SAKE.

FOR DISTRIBUTION OF MOTION PICTURE FILMS (U.S. CLS. 100, 101 AND 107).

TRACY FLETCHER, EXAMINING ATTORNEY

**CLASS 41—(Continued).**

SN 85-345,691. STRATUM SECURITY, LLC, HERNDON, VA. FILED 6-14-2011.

**SpearTraining**

THE MARK CONSISTS OF STANDARD CHARACTERS WITHOUT CLAIM TO ANY PARTICULAR FONT, STYLE, SIZE, OR COLOR.

FOR IT TRAINING SERVICES (U.S. CLS. 100, 101 AND 107).

FIRST USE 6-14-2011; IN COMMERCE 6-14-2011.

PRISCILLA MILTON, EXAMINING ATTORNEY

SN 85-345,869. NATIONAL CONSORTIUM FOR ACADEMICS AND SPORTS, ORLANDO, FL. FILED 6-14-2011.



THE MARK CONSISTS OF A BAR CODE WITH THE WORDS BRANDED A LEADER PRINTED UNDERNEATH. FOR EDUCATION SERVICES, NAMELY, PROVIDING WORKSHOPS IN THE FIELDS OF LEADERSHIP (U.S. CLS. 100, 101 AND 107).

FIRST USE 8-20-2008; IN COMMERCE 8-20-2008.

HEATHER THOMPSON, EXAMINING ATTORNEY

SN 85-347,327. TELEVISA, S.A. DE C.V., SANTA FE, MEXICO, FILED 6-15-2011.

**123 X MÉXICO**

THE MARK CONSISTS OF STANDARD CHARACTERS WITHOUT CLAIM TO ANY PARTICULAR FONT, STYLE, SIZE, OR COLOR.

OWNER OF MEXICO REG. NO. 1220273, DATED 1-25-2011. EXPIRES 1-25-2021.

NO CLAIM IS MADE TO THE EXCLUSIVE RIGHT TO USE "MÉXICO", APART FROM THE MARK AS SHOWN.

FOR ENTERTAINMENT SERVICES IN THE NATURE OF A CONTINUING GAME SHOW REGARDING CULTURAL, GASTRONOMIC, GEOGRAPHICAL AND GENERAL INFORMATION ABOUT MEXICO BROADCAST OVER THE INTERNET AND A CONTINUING TELEVISION SERIES GAME SHOW REGARDING CULTURAL, GASTRONOMIC, GEOGRAPHICAL AND GENERAL INFORMATION ABOUT MEXICO (U.S. CLS. 100, 101 AND 107).

JACLYN KIDWELL WALKER, EXAMINING ATTORNEY

**CLASS 41—(Continued).**

SN 85-351,973. MAUI TOYS, INC., YOUNGSTOWN, OH. FILED 6-21-2011.

**GROVER DRIVE**

THE MARK CONSISTS OF STANDARD CHARACTERS WITHOUT CLAIM TO ANY PARTICULAR FONT, STYLE, SIZE, OR COLOR.

FOR MEDIA PRODUCTION SERVICES, NAMELY VIDEO AND FILM PRODUCTION; ENTERTAINMENT SERVICES IN THE NATURE OF LIVE SHOW AND MUSICAL PERFORMANCES; ENTERTAINMENT SERVICES, NAMELY ORGANIZATION OF SPORTS EVENTS AND COMPETITIONS (U.S. CLS. 100, 101 AND 107).

KEVON CHISOLM, EXAMINING ATTORNEY

---

SN 85-359,437. JOHNSON & JOHNSON, NEW BRUNSWICK, NJ. FILED 6-29-2011.

**SEE WHAT COULD BE**

THE MARK CONSISTS OF STANDARD CHARACTERS WITHOUT CLAIM TO ANY PARTICULAR FONT, STYLE, SIZE, OR COLOR.

OWNER OF U.S. REG. NO. 3,781,896.  
FOR HEALTH EDUCATION PROGRAM REGARDING EYE CARE AND EYE HEALTH (U.S. CLS. 100, 101 AND 107).

ALEXANDER L. POWERS, EXAMINING ATTORNEY

---

SN 85-359,879. DISCOVERY COMMUNICATIONS, LLC, SILVER SPRING, MD. FILED 6-29-2011.

**QUESTION EVERYTHING**

THE MARK CONSISTS OF STANDARD CHARACTERS WITHOUT CLAIM TO ANY PARTICULAR FONT, STYLE, SIZE, OR COLOR.

FOR ENTERTAINMENT SERVICES IN THE NATURE OF AUDIO-VISUAL PROGRAMMING AND CONTENT, NAMELY, ON-GOING NON-FICTION SHOWS FEATURING SUBJECTS RELATING TO SCIENCE, RESEARCH, INVENTIONS, TECHNOLOGY, ANIMALS, NATURE, COSMOLOGY, HISTORY, CULTURE AND HUMAN ACHIEVEMENT, DISTRIBUTED THROUGH AUDIO AND VIDEO MEDIA, NAMELY, TELEVISION, SATELLITE, WIRELESS, FIBER OPTICS, CABLE, RADIO AND A GLOBAL COMPUTER NETWORK; INFORMATION REGARDING THE SAME PROVIDED VIA A GLOBAL COMPUTER NETWORK (U.S. CLS. 100, 101 AND 107).

HOWARD FRIEDMAN, EXAMINING ATTORNEY

**CLASS 41—(Continued).**

SN 85-372,719. PINNACLE ENTERTAINMENT, INC., LAS VEGAS, NV. FILED 7-15-2011.

**BONTOMPS**

THE MARK CONSISTS OF STANDARD CHARACTERS WITHOUT CLAIM TO ANY PARTICULAR FONT, STYLE, SIZE, OR COLOR.

THE WORDING "BONTOMPS" HAS NO MEANING IN A FOREIGN LANGUAGE.

FOR ENTERTAINMENT IN THE NATURE OF CASINO SERVICES (U.S. CLS. 100, 101 AND 107).

JENNY PARK, EXAMINING ATTORNEY

---

SN 85-373,949. SMITHSONIAN INSTITUTION, WASHINGTON, DC. FILED 7-18-2011.

**SI:Q**

THE MARK CONSISTS OF STANDARD CHARACTERS WITHOUT CLAIM TO ANY PARTICULAR FONT, STYLE, SIZE, OR COLOR.

FOR EDUCATION AND MUSEUM SERVICES, NAMELY, PROVIDING LIVE AND ON-LINE EXHIBITIONS, PROGRAMS, LECTURES, GAMES AND ACTIVITIES IN THE FIELDS OF SCIENCE, HISTORY, ART, MUSIC, CULTURE AND EDUCATION (U.S. CLS. 100, 101 AND 107).

RAUL CORDOVA, EXAMINING ATTORNEY

**CLASS 41—(Continued).**

SN 85-376,668. PINNACLE ENTERTAINMENT, INC., LAS VEGAS, NV. FILED 7-20-2011.



THE MARK CONSISTS OF THE DRAWING OF THE SIDE OF A BASS DRUM WITHIN THE CENTER OF WHICH IS FEATURED A FLEUR-DE-LIS ABOVE WHICH IS THE WORD BONTOMPS IN STYLIZED FORM. THE WORDS EAT DRINK GOOD TIMES ARE FEATURED BELOW THE FLEUR-DE-LIS WHERE THE WORDS EAT AND DRINK AND GOOD ARE EACH SEPARATED BY A BULLET POINT.

THE WORDING BONTOMPS HAS NO MEANING IN A FOREIGN LANGUAGE.

FOR ENTERTAINMENT IN THE NATURE OF CASINO SERVICES (U.S. CLS. 100, 101 AND 107).

JENNY PARK, EXAMINING ATTORNEY

SN 85-377,876. LAWANDA J. ABEL, BRONX, NY. FILED 7-21-2011.

rock my good

THE MARK CONSISTS OF STANDARD CHARACTERS WITHOUT CLAIM TO ANY PARTICULAR FONT, STYLE, SIZE, OR COLOR.

FOR CONDUCTING WORKSHOPS AND SEMINARS IN PERSONAL AWARENESS; EDUCATION SERVICES, NAMELY, PROVIDING CLASSES, SEMINARS, WORKSHOPS, TUTORING, AND MENTORING IN THE FIELD OF MIDDLE AND HIGH SCHOOL REFORM; EDUCATION SERVICES, NAMELY, PROVIDING MENTORING, TUTORING, CLASSES, SEMINARS AND WORKSHOPS IN THE FIELD OF PERSONAL DEVELOPMENT, JOB READINESS, LIFE SKILLS; EDUCATIONAL SERVICES, NAMELY, CONDUCTING SEMINARS, LECTURES, TELESEMINARS, TELECLASSES, AND WORKSHOPS IN PERSONAL AWARENESS; ENTERTAINMENT AND EDUCATIONAL SERVICES, NAMELY, THE PRESENTATION OF SEMINARS, LECTURES, WORKSHOPS AND PANEL DISCUSSIONS, AND ONGOING TELEVISION AND RADIO TALK SHOWS ALL IN THE FIELD OF PUBLIC INTEREST CONCERNING PERSONAL DEVELOPMENT, JOB READINESS, LIFE SKILLS (U.S. CLS. 100, 101 AND 107).

FIRST USE 5-29-2011; IN COMMERCE 5-29-2011.

KELLY TRUSILO, EXAMINING ATTORNEY

**CLASS 41—(Continued).**

SN 85-381,528. WARM SPRINGS PRODUCTIONS, LLC, MISSOULA, MT. FILED 7-26-2011.

RIVER RATS

THE MARK CONSISTS OF STANDARD CHARACTERS WITHOUT CLAIM TO ANY PARTICULAR FONT, STYLE, SIZE, OR COLOR.

NO CLAIM IS MADE TO THE EXCLUSIVE RIGHT TO USE "RIVER", APART FROM THE MARK AS SHOWN.

FOR ENTERTAINMENT IN THE NATURE OF ONGOING TELEVISION PROGRAMS IN THE FIELD OF DOCUMENTING THE LIVES OF PEOPLE WHO LIVE AND WORK IN CERTAIN AREAS OF THE UNITED STATES NEAR BODIES OF WATER; ENTERTAINMENT SERVICES IN THE NATURE OF AN ON-GOING REALITY BASED TELEVISION PROGRAM (U.S. CLS. 100, 101 AND 107).

DOUGLAS LEE, EXAMINING ATTORNEY

SN 85-384,214. HOME BOX OFFICE, INC., NEW YORK, NY. FILED 7-29-2011.

MOREMAX

THE MARK CONSISTS OF STANDARD CHARACTERS WITHOUT CLAIM TO ANY PARTICULAR FONT, STYLE, SIZE, OR COLOR.

OWNER OF U.S. REG. NO. 2,319,052.

FOR PAY OR PREMIUM TELEVISION PROGRAMMING SERVICES (U.S. CLS. 100, 101 AND 107).

FIRST USE 6-1-1998; IN COMMERCE 6-1-1998.

SUSAN RICHARDS, EXAMINING ATTORNEY

SN 85-384,369. HOME BOX OFFICE, INC., NEW YORK, NY. FILED 7-29-2011.

ACTIONMAX

THE MARK CONSISTS OF STANDARD CHARACTERS WITHOUT CLAIM TO ANY PARTICULAR FONT, STYLE, SIZE, OR COLOR.

OWNER OF U.S. REG. NO. 2,470,873.

FOR PAY OR PREMIUM TELEVISION PROGRAMMING SERVICES (U.S. CLS. 100, 101 AND 107).

FIRST USE 6-1-1998; IN COMMERCE 6-1-1998.

SUSAN RICHARDS, EXAMINING ATTORNEY

**CLASS 41—(Continued).**

SN 85-385,614. PRETTY BIRD PICTURES, INC., CULVER CITY, CA. FILED 7-31-2011.

**PRETTYBIRD**

THE MARK CONSISTS OF STANDARD CHARACTERS WITHOUT CLAIM TO ANY PARTICULAR FONT, STYLE, SIZE, OR COLOR.

FOR ENTERTAINMENT MEDIA PRODUCTION SERVICES FOR MOTION PICTURES, TELEVISION AND INTERNET; ENTERTAINMENT SERVICES IN THE NATURE OF DEVELOPMENT, CREATION, PRODUCTION AND POST-PRODUCTION SERVICES OF MULTIMEDIA ENTERTAINMENT CONTENT; MULTIMEDIA ENTERTAINMENT SERVICES IN THE NATURE OF DEVELOPMENT, PRODUCTION AND POST-PRODUCTION SERVICES IN THE FIELDS OF VIDEO AND FILMS; ENTERTAINMENT SERVICES, NAMELY, PRODUCTION OF SPECIAL EFFECTS INCLUDING MODEL-MAKING SERVICES, COMPUTER-GENERATED IMAGERY AND COMPUTER-GENERATED GRAPHICS FOR THE PRODUCTION OF MOTION PICTURES AND VIDEOS; PROVISION OF INFORMATION RELATING TO TELEVISION, MOTION PICTURE, AND FILM; AND FILM AND VIDEO PRODUCTION CONSULTING SERVICES (U.S. CLS. 100, 101 AND 107).

FIRST USE 1-0-2008; IN COMMERCE 1-0-2008.  
FRED CARL, EXAMINING ATTORNEY

SN 85-389,598. TRIAD SHAKTI CORPORATION, HUNTINGTON BEACH, CA. FILED 8-4-2011.

**YOGA SHAKTI**

THE MARK CONSISTS OF STANDARD CHARACTERS WITHOUT CLAIM TO ANY PARTICULAR FONT, STYLE, SIZE, OR COLOR.

OWNER OF U.S. REG. NO. 3,212,232.

NO CLAIM IS MADE TO THE EXCLUSIVE RIGHT TO USE "YOGA", APART FROM THE MARK AS SHOWN.

THE ENGLISH TRANSLATION OF "SHAKTI" IN THE MARK IS "DIVINE POWER AND ENERGY".

FOR YOGA INSTRUCTION CONSISTING OF CLASSES, COURSES, WORKSHOPS, INTENSIVES, LECTURES, PERFORMANCES, TEACHER TRAINING PROGRAMS AND RETREATS (U.S. CLS. 100, 101 AND 107).

FIRST USE 5-18-2002; IN COMMERCE 5-18-2002.  
ELISSA GARBER KON, EXAMINING ATTORNEY

**CLASS 41—(Continued).**

SN 85-389,651. CLOUDCO, INC., CLEVELAND, OH. FILED 8-4-2011.

**THOSE DARNED SOCKS**

THE MARK CONSISTS OF STANDARD CHARACTERS WITHOUT CLAIM TO ANY PARTICULAR FONT, STYLE, SIZE, OR COLOR.

FOR ENTERTAINMENT SERVICES IN THE NATURE OF ON-GOING TELEVISION PROGRAMS IN THE FIELD OF CHILDREN'S ENTERTAINMENT; ENTERTAINMENT SERVICES PROVIDED VIA A GLOBAL COMPUTER NETWORK WEB SITE FEATURING ONLINE COMPUTER GAMES AND VIDEOS IN THE NATURE OF ANIMATION IN THE FIELD OF CHILDREN'S ENTERTAINMENT; PROVIDING NON-DOWNLOADABLE ONLINE INTERACTIVE COMPUTER GAMES (U.S. CLS. 100, 101 AND 107).

WENDY GOODMAN, EXAMINING ATTORNEY

SN 85-393,591. SEA WORLD LLC, ORLANDO, FL. FILED 8-9-2011.

**ANTARCTICA**

THE MARK CONSISTS OF STANDARD CHARACTERS WITHOUT CLAIM TO ANY PARTICULAR FONT, STYLE, SIZE, OR COLOR.

FOR ENTERTAINMENT SERVICES IN THE NATURE OF AN AMUSEMENT PARK ATTRACTION; ENTERTAINMENT SERVICES IN THE NATURE OF AN AMUSEMENT PARK ATTRACTION, NAMELY, A THEMED AREA (U.S. CLS. 100, 101 AND 107).

SUSAN LESLIE DUBOIS, EXAMINING ATTORNEY

SN 85-396,906. SEA WORLD LLC, ORLANDO, FL. FILED 8-12-2011.

**SNOWWORLD**

THE MARK CONSISTS OF STANDARD CHARACTERS WITHOUT CLAIM TO ANY PARTICULAR FONT, STYLE, SIZE, OR COLOR.

FOR ENTERTAINMENT SERVICES IN THE NATURE OF AN AMUSEMENT PARK ATTRACTION, NAMELY, A THEMED AREA; ENTERTAINMENT SERVICES IN THE NATURE OF AN AMUSEMENT PARK ATTRACTION (U.S. CLS. 100, 101 AND 107).

SUSAN LESLIE DUBOIS, EXAMINING ATTORNEY

**CLASS 41—(Continued).**

SN 85-397,162. PINNACLE ENTERTAINMENT, INC., LAS VEGAS, NV. FILED 8-12-2011.

**iWin  
@  
BOOMTOWN**

OWNER OF U.S. REG. NO. 1,866,988.

THE MARK CONSISTS OF THE STYLIZED WORD "IWIN" WHICH IS CENTERED OVER THE SYMBOL "@" WHICH IS SUPERIMPOSED OVER A SQUARE WHICH IS CENTERED OVER THE STYLIZED WORD "BOOMTOWN".

FOR ARRANGING FOR TICKET RESERVATIONS FOR SHOWS AND OTHER ENTERTAINMENT EVENTS; ENTERTAINMENT IN THE NATURE OF CASINO SERVICES, AND LIVE PERFORMANCES FEATURING MUSICIANS AND SINGERS, DANCERS, MAGICIANS, ACTORS, ACROBATS, COMEDIANS AND PRE-RECORDED MUSIC AND VIDEO, NAMELY, LIVE PERFORMANCES FEATURING PRERECORDED MUSIC PERFORMANCES VIEWED ON A BIG SCREEN; PROVIDING CASINO SERVICES FEATURING A CASINO PLAYERS REWARDS PROGRAM (U.S. CLS. 100, 101 AND 107).

JENNY PARK, EXAMINING ATTORNEY

SN 85-400,880. BURGER KING CORPORATION, MIAMI, FL. FILED 8-18-2011.

**BK CROWN**

THE MARK CONSISTS OF STANDARD CHARACTERS WITHOUT CLAIM TO ANY PARTICULAR FONT, STYLE, SIZE, OR COLOR.

OWNER OF U.S. REG. NOS. 2,790,924, 3,534,987 AND OTHERS.

FOR ENTERTAINMENT SERVICES, NAMELY, PROVIDING ON-LINE COMPUTER GAMES FOR CHILDREN (U.S. CLS. 100, 101 AND 107).

ZACHARY BELLO, EXAMINING ATTORNEY

SN 85-402,398. AXA EQUITABLE LIFE INSURANCE COMPANY, NEW YORK, NY. FILED 8-19-2011.

**PASS IT ON!**

THE MARK CONSISTS OF STANDARD CHARACTERS WITHOUT CLAIM TO ANY PARTICULAR FONT, STYLE, SIZE, OR COLOR.

FOR ENTERTAINMENT SERVICES, NAMELY, PROVIDING AN ON-LINE COMPUTER GAME (U.S. CLS. 100, 101 AND 107).

CURTIS FRENCH, EXAMINING ATTORNEY

**CLASS 41—(Continued).**

SN 85-975,528. BNP MEDIA II, LLC, TROY, MI. FILED 8-25-2010.

**INDUSTRIA ALIMENTICIA**

THE MARK CONSISTS OF STANDARD CHARACTERS WITHOUT CLAIM TO ANY PARTICULAR FONT, STYLE, SIZE, OR COLOR.

OWNER OF U.S. REG. NO. 2,379,015.

THE ENGLISH TRANSLATION OF "INDUSTRIA ALIMENTICIA" IN THE MARK IS "FOOD INDUSTRY".

SEC. 2(F).

FOR PROVIDING ONLINE PUBLICATIONS IN THE NATURE OF ARTICLES, COLUMNS, MAGAZINES, AND NEWSLETTERS IN THE FIELD OF FOOD PROCESSING THAT ARE OF INTEREST TO THOSE IN THE FOOD PROCESSING INDUSTRY; PROVIDING ONLINE JOURNALS, NAMELY, BLOGS, FEATURING TOPICS OF INTEREST TO THOSE IN THE FOOD PROCESSING INDUSTRY (U.S. CLS. 100, 101 AND 107).

FIRST USE 2-23-2001; IN COMMERCE 2-23-2001.

MICHELLE DUBOIS, EXAMINING ATTORNEY

SN 85-975,682. AERIALISTA, INC., NEW YORK, NY. FILED 5-4-2011.

**FLOAT**

THE MARK CONSISTS OF STANDARD CHARACTERS WITHOUT CLAIM TO ANY PARTICULAR FONT, STYLE, SIZE, OR COLOR.

FOR CONDUCTING FITNESS CLASSES; PHYSICAL FITNESS CONDITIONING CLASSES; PHYSICAL FITNESS STUDIO SERVICES, NAMELY, PROVIDING GROUP EXERCISE INSTRUCTION, EQUIPMENT, AND FACILITIES; PHYSICAL FITNESS TRAINING OF INDIVIDUALS AND GROUPS; PROVIDING A WEB SITE FEATURING INFORMATION ON EXERCISE AND FITNESS; PROVIDING ASSISTANCE, PERSONAL TRAINING AND PHYSICAL FITNESS CONSULTATION TO INDIVIDUALS TO HELP THEM MAKE PHYSICAL FITNESS, STRENGTH, CONDITIONING, AND EXERCISE IMPROVEMENT IN THEIR DAILY LIVING; YOGA INSTRUCTION (U.S. CLS. 100, 101 AND 107).

FIRST USE 9-1-2008; IN COMMERCE 9-1-2008.

DEBRA LEE, EXAMINING ATTORNEY

**CLASS 41—(Continued).**

SN 85-975,708. INKBALL, LLC, ASPEN, CO. FILED 5-23-2011.

**I AM WHO I AM**

THE MARK CONSISTS OF STANDARD CHARACTERS WITHOUT CLAIM TO ANY PARTICULAR FONT, STYLE, SIZE, OR COLOR.

FOR BOOK PUBLISHING AND ENTERTAINMENT SERVICES, NAMELY, DOCUMENTARY SERIES OF PRINTED PUBLICATIONS AND PROGRAMS FEATURING ATHLETES AND THEIR LIFE STORIES ON TELEVISION, FOR THE GLOBAL COMPUTER NETWORK AND OTHER MEDIA (U.S. CLS. 100, 101 AND 107).

PRISCILLA MILTON, EXAMINING ATTORNEY

**CLASS 42—(Continued).**

SN 77-607,131. CROWE HORWATH LLP, SOUTH BEND, IN. FILED 11-4-2008.

**CARS**

THE MARK CONSISTS OF STANDARD CHARACTERS WITHOUT CLAIM TO ANY PARTICULAR FONT, STYLE, SIZE, OR COLOR.

FOR PROVIDING TEMPORARY USE OF A NON-DOWNLOADABLE FINANCIAL TRANSACTION MONITORING SYSTEM, NAMELY, SOFTWARE IN THE NATURE OF A STEP BY STEP ACTIVITY REVIEW PROCESS FOR THE REVIEW OF TRANSACTIONS BY FINANCIAL SERVICE PROVIDERS (U.S. CLS. 100 AND 101).

FIRST USE 5-13-2008; IN COMMERCE 5-13-2008.  
MARY CRAWFORD, EXAMINING ATTORNEY

**CLASS 42—SCIENTIFIC AND COMPUTER SERVICES**

SN 76-707,267. ENDPLAY, INC., LOS ANGELES, CA. FILED 4-14-2011.

**EndPlay** 

THE MARK CONSISTS OF A CIRCULAR DESIGN FORMED BY GEOMETRIC PAISLEY-LIKE SHAPES WHICH FORM A HUMAN PERSON. TO THE LEFT OF THE DESIGN IS THE WORDING "ENDPLAY".

FOR SOFTWARE, INFRASTRUCTURE AND TECHNICAL OPERATIONS SERVICE PROVIDER, NAMELY, HOSTING, MANAGING, DEVELOPING, AND MAINTAINING APPLICATIONS, SOFTWARE, AND WEB SITES, IN THE FIELDS OF PRODUCTIVITY, COMMUNICATION, INFORMATION ACCESS, AND REMOTE DATA MANAGEMENT FOR DELIVERY OF CONTENT TO COMPUTERS, MOBILE DEVICES, AND HOSTING COMPUTER SOFTWARE APPLICATIONS OF OTHERS (U.S. CLS. 100 AND 101).

FIRST USE 4-11-2011; IN COMMERCE 4-11-2011.  
JANICE KIM, EXAMINING ATTORNEY

SN 77-788,472. BURWEN, DANIEL, DBA GAMESTEPPER, OAKLAND, CA. FILED 7-23-2009.



NO CLAIM IS MADE TO THE EXCLUSIVE RIGHT TO USE "GAME", APART FROM THE MARK AS SHOWN.

THE COLOR(S) PINK, WHITE, BLACK AND GREY IS/ARE CLAIMED AS A FEATURE OF THE MARK.

THE MARK CONSISTS OF THE FOLLOWING: THE COLOR PINK APPEARS IN THE WORDING "STEPPER" AND IN THE BOX DESIGN. THE COLOR BLACK APPEARS IN THE BOX DESIGN AND AS A RECTANGULAR BACKGROUND FOR THE ENTIRE MARK. THE COLOR WHITE APPEARS IN THE WORDING "GAME" AND THE BOX DESIGN. THE COLOR GREY APPEARS IN THE WORDING "STEP UP YOUR GAME" AND IN THE BOX DESIGN.

FOR HOSTING AN ONLINE WEBSITE FEATURING INTERACTION BETWEEN STUDENTS AND GAME COMPANIES FOR THE CREATION OF BETTER GAMES (U.S. CLS. 100 AND 101).

FIRST USE 2-1-2008; IN COMMERCE 2-1-2008.  
TIMOTHY FINNEGAN, EXAMINING ATTORNEY

**CLASS 42—(Continued).**

SN 77-816,608. PATHWAY GENOMICS CORPORATION, SAN DIEGO, CA. FILED 8-31-2009.

# eDoc

THE MARK CONSISTS OF STANDARD CHARACTERS WITHOUT CLAIM TO ANY PARTICULAR FONT, STYLE, SIZE, OR COLOR.

FOR PROVIDING SCIENTIFIC ANALYSIS BASED UPON RESULTS OF LABORATORY TESTING IN THE FIELD OF GENETICS; PROVIDING ONLINE COMPUTER DATABASES FEATURING INFORMATION BASED ON AGGREGATED RESULTS OF GENOTYPING; APPLICATION SERVICE PROVIDER (ASP) FEATURING SOFTWARE FOR PROVIDING ACCESS TO MULTIPLE DATABASES THAT CONTAIN AGGREGATED RESULTS OF GENOTYPING; APPLICATION SERVICE PROVIDER (ASP) FEATURING SOFTWARE FOR USE IN DATA MANAGEMENT, DATA STORAGE, DATA ANALYSIS, USER IDENTIFICATION, AND MEMBERSHIP IDENTIFICATION, ALL IN THE FIELDS OF GENETICS, GENETIC TESTING, AND PERSONALIZED MEDICINE; SCIENTIFIC RESEARCH IN THE FIELDS OF GENETICS, GENETIC TESTING, GENETIC SCREENING, GENOTYPING, PHENOTYPING, MOLECULAR ANALYTICS, AND ANCESTRY (U.S. CLS. 100 AND 101).

DAVID ELTON, EXAMINING ATTORNEY

SN 78-725,897. INNOVATA BIOMED LIMITED, EDINBURGH EH2 1JX, UNITED KINGDOM, FILED 10-4-2005.

# INNOVATA

THE MARK CONSISTS OF STANDARD CHARACTERS WITHOUT CLAIM TO ANY PARTICULAR FONT, STYLE, SIZE, OR COLOR.

PRIORITY CLAIMED UNDER SEC. 44(D) ON ERP CMNTY TM OFC APPLICATION NO. 004619664, FILED 9-5-2005, REG. NO. 004619664, DATED 1-26-2011, EXPIRES 9-5-2015.

FOR LICENSING OF INTELLECTUAL PROPERTY IN RELATION TO PHARMACEUTICAL PRODUCTS FOR DELIVERY VIA THE PULMONARY ROUTE, INHALATION DEVICES AND INHALERS, PHARMACEUTICAL RESEARCH AND DEVELOPMENT IN THE AREA OF INHALATION DEVICES, INHALERS AND PHARMACEUTICAL PRODUCTS FOR DELIVERY VIA THE PULMONARY ROUTE (U.S. CLS. 100 AND 101).

LINDA E. BLOHM, EXAMINING ATTORNEY

**CLASS 42—(Continued).**

SN 85-000,035. GUSKY, JEFFREY, DALLAS, TX. FILED 3-27-2010.

## OLMSTED NATURAL FRONTIER

THE MARK CONSISTS OF STANDARD CHARACTERS WITHOUT CLAIM TO ANY PARTICULAR FONT, STYLE, SIZE, OR COLOR.

NO CLAIM IS MADE TO THE EXCLUSIVE RIGHT TO USE "NATURAL", APART FROM THE MARK AS SHOWN.

FOR NATURAL AREA DEVELOPMENT AND PRESERVATION SERVICES, NAMELY, MONITORING, TESTING AND ANALYZING ECOLOGICAL SUCCESS IN THE FIELD OF ENVIRONMENTALLY SENSITIVE HABITAT CONSERVATION AND PRESERVATION OF NATURAL TOPOGRAPHIC FEATURES, VEGETATION AND WILDLIFE; LANDSCAPE ARCHITECTURAL SERVICES INCLUDING DESIGNATING HISTORICAL LANDMARKS IN URBAN CENTRAL CITIES AND SUBURBS RELATED TO NATURAL FEATURES FOR PRESERVATION (U.S. CLS. 100 AND 101).

ESTHER BELENKER, EXAMINING ATTORNEY

SN 85-008,879. SK TELECOM CO., LTD., SEOUL, REPUBLIC OF KOREA, FILED 4-7-2010.



PRIORITY CLAIMED UNDER SEC. 44(D) ON REPUBLIC OF KOREA APPLICATION NO. 41-2010-0004, FILED 2-25-2010.

OWNER OF REPUBLIC OF KOREA REG. NO. 0210189, DATED 5-9-2011, EXPIRES 5-9-2021.

THE COLOR(S) GREY, PINK, BLACK AND WHITE IS/ARE CLAIMED AS A FEATURE OF THE MARK.

THE MARK CONSISTS OF TWO STYLIZED EYES, THE RIGHT EYE LARGER THUS OVERLAPPING THE LEFT EYE. EACH EYE HAS A WHITE CIRCLE, A BLACK CIRCLE, A PINK CIRCLE, AND A GREY OUTLINE. BENEATH BOTH OF THE EYES IS A GREY LINE.

FOR DEVELOPMENT OF GAME SOFTWARE; CREATING AND MAINTAINING WEB SITES FOR OTHERS; MAINTENANCE OF WEB SITES FOR ELECTRONIC COMMERCE; HOSTING COMPUTER SITES; PROVIDING SEARCH ENGINES FOR THE INTERNET; MANAGEMENT OF WEB SITES FOR ELECTRONIC COMMERCE; COMPUTER PROGRAMMING FOR ELECTRONIC COMMERCE; DATA CONVERSION OF COMPUTER PROGRAMS AND DATA; ADVISORY AND DEVELOPMENT SERVICES RELATING TO COMPUTER SOFTWARE; UPDATING OF COMPUTER SOFTWARE; MAINTENANCE OF COMPUTER SOFTWARE; RETRIEVING INFORMATION AVAILABLE ON COMPUTER NETWORKS FOR OTHERS (U.S. CLS. 100 AND 101).

DEBRA LEE, EXAMINING ATTORNEY

**CLASS 42—(Continued).**

SN 85-021,490. AON BENFIELD GLOBAL, INC., CHICAGO, IL. FILED 4-23-2010.

# PathWise

THE MARK CONSISTS OF STANDARD CHARACTERS WITHOUT CLAIM TO ANY PARTICULAR FONT, STYLE, SIZE, OR COLOR.

OWNER OF CANADA REG. NO. TMA804566, DATED 8-16-2011, EXPIRES 8-16-2026.

FOR PROVIDING TEMPORARY USE OF ON-LINE NON-DOWNLOADABLE SOFTWARE FOR USE AS AN ANALYTICAL PLATFORM, FOR MODELING, HEDGING, AND CALCULATING ANNUITY PRICING AND RISK FACTORS IN THE FIELD OF INSURANCE AND ANNUITY UNDERWRITING (U.S. CLS. 100 AND 101).

EDWARD FENNESSY, EXAMINING ATTORNEY

---

SN 85-097,615. GUILHERME CARDOSO DE CARDOSO, AKA BILL CARDOSO, CARLSBAD, CA. FILED 8-1-2010.

# Creative Electron

THE MARK CONSISTS OF STANDARD CHARACTERS WITHOUT CLAIM TO ANY PARTICULAR FONT, STYLE, SIZE, OR COLOR.

FOR RESEARCH AND DEVELOPMENT OF TECHNOLOGY IN THE FIELD OF RADIATION DETECTION, CHEMISTRY, X-RAY INSPECTION (U.S. CLS. 100 AND 101).

FIRST USE 6-6-2008; IN COMMERCE 6-6-2008.  
ANDREW LEASER, EXAMINING ATTORNEY

---

SN 85-103,316. LIFELEGACY FOUNDATION, TUCSON, AZ. FILED 8-9-2010.

# LIFELEGACY FOUNDATION

THE MARK CONSISTS OF STANDARD CHARACTERS WITHOUT CLAIM TO ANY PARTICULAR FONT, STYLE, SIZE, OR COLOR.

NO CLAIM IS MADE TO THE EXCLUSIVE RIGHT TO USE "FOUNDATION", APART FROM THE MARK AS SHOWN.

FOR ORGAN AND TISSUE BANK SERVICES, NAMELY, PROCURING AND PROVIDING ORGAN AND TISSUE DONATIONS FOR THE PURPOSE OF MEDICAL AND SCIENTIFIC RESEARCH (U.S. CLS. 100 AND 101).

FIRST USE 12-1-1997; IN COMMERCE 12-1-1997.  
ANN E. SAPPENFIELD, EXAMINING ATTORNEY

**CLASS 42—(Continued).**

SN 85-107,018. SZTABZYB, JAVIER, LAUDERHILL, FL. FILED 8-13-2010.

# nadanu

THE MARK CONSISTS OF STANDARD CHARACTERS WITHOUT CLAIM TO ANY PARTICULAR FONT, STYLE, SIZE, OR COLOR.

FOR PROVIDING A WEB HOSTING PLATFORM FOR ENABLING NON-PROFITS, EDUCATIONAL INSTITUTIONS, CAMPAIGN FUNDRAISERS AND BUSINESSES TO INCREASE INTERACTION, AWARENESS AND SUPPORT, VIA A GLOBAL COMPUTER NETWORK (U.S. CLS. 100 AND 101).

FIRST USE 6-11-2010; IN COMMERCE 6-11-2010.  
HOWARD B. LEVINE, EXAMINING ATTORNEY

---

SN 85-146,674. ROMAN MEAD, NEW YORK, NY. FILED 10-6-2010.

# SQURL

THE MARK CONSISTS OF STANDARD CHARACTERS WITHOUT CLAIM TO ANY PARTICULAR FONT, STYLE, SIZE, OR COLOR.

FOR APPLICATION SERVICE PROVIDER (ASP) SERVICES, NAMELY, HOSTING COMPUTER SOFTWARE APPLICATIONS OF OTHERS; APPLICATION SERVICE PROVIDER (ASP) FEATURING SOFTWARE TO ENABLE OR FACILITATE THE UPLOADING, DOWNLOADING, STREAMING, POSTING, DISPLAYING, BLOGGING, LINKING, SHARING OR OTHERWISE PROVIDING ELECTRONIC MEDIA OR INFORMATION OVER COMMUNICATION NETWORKS; PROVIDING AN ONLINE NETWORK SERVICE THAT ENABLES USERS TO TRANSFER PERSONAL IDENTITY DATA TO AND SHARE PERSONAL IDENTITY DATA WITH AND AMONG MULTIPLE WEBSITES; PROVIDING A WEB SITE FEATURING TECHNOLOGY THAT ENABLES ONLINE USERS TO CREATE PERSONAL PROFILES FEATURING SOCIAL NETWORKING INFORMATION AND TO TRANSFER AND SHARE SUCH INFORMATION AMONG MULTIPLE WEBSITES; PROVIDING TEMPORARY USE OF NON-DOWNLOADABLE SOFTWARE APPLICATIONS FOR SOCIAL NETWORKING, CREATING A VIRTUAL COMMUNITY, AND TRANSMISSION OF AUDIO, VIDEO, PHOTOGRAPHIC IMAGES, TEXT, GRAPHICS AND DATA; COMPUTER SERVICES IN THE NATURE OF PROVIDING CUSTOMIZED WEB PAGES FEATURING USER-DEFINED OR SPECIFIED INFORMATION, PERSONAL PROFILES, AUDIO, VIDEO, PHOTOGRAPHIC IMAGES, TEXT, GRAPHICS AND DATA, AND FOR POSTING AND READING CLASSIFIEDS, FOR CREATING AND MAINTAINING VIRTUAL COMMUNITIES, FOR SOCIAL NETWORKING, PHOTO SHARING, VIDEO SHARING, AND TRANSMISSION OF PHOTOGRAPHIC IMAGES (U.S. CLS. 100 AND 101).

JUDITH HELFMAN, EXAMINING ATTORNEY



**CLASS 42—(Continued).**

SN 85-148,005. ACCURATE VIDEO SERVICES, INC., DBA MIVNET, VERO BEACH, FL. FILED 10-7-2010.

## Earth Search

THE MARK CONSISTS OF STANDARD CHARACTERS WITHOUT CLAIM TO ANY PARTICULAR FONT, STYLE, SIZE, OR COLOR.

NO CLAIM IS MADE TO THE EXCLUSIVE RIGHT TO USE "SEARCH", APART FROM THE MARK AS SHOWN.

FOR PROVIDING ON-LINE NON-DOWNLOADABLE COMPUTER SOFTWARE TO ENABLE USERS TO ACCESS TEXT AND GRAPHIC INFORMATION, NAMELY, MAPS, TO LOCATE AVAILABLE VIDEO CONFERENCING FACILITIES IN GEOGRAPHIC LOCATIONS THROUGHOUT THE WORLD (U.S. CLS. 100 AND 101).

FIRST USE 1-31-2006; IN COMMERCE 1-31-2006.  
GINA HAYES, EXAMINING ATTORNEY

---

SN 85-156,947. BLACK DUCK SOFTWARE, INC., WALTHAM, MA. FILED 10-20-2010.

## OHLOH

THE MARK CONSISTS OF STANDARD CHARACTERS WITHOUT CLAIM TO ANY PARTICULAR FONT, STYLE, SIZE, OR COLOR.

FOR PROVIDING A WEBSITE THAT FEATURES INFORMATION ON COMPUTER TECHNOLOGY AND PROGRAMMING DIRECTED TO OPEN SOURCE PROGRAMMERS AND DEVELOPERS (U.S. CLS. 100 AND 101).

FIRST USE 7-15-2006; IN COMMERCE 7-15-2006.  
SARA BENJAMIN, EXAMINING ATTORNEY

---

SN 85-168,355. AKILITEK, L3C, CANTON, MA. FILED 11-3-2010.

## akilitek

THE MARK CONSISTS OF STANDARD CHARACTERS WITHOUT CLAIM TO ANY PARTICULAR FONT, STYLE, SIZE, OR COLOR.

FOR COMPUTER SOFTWARE DEVELOPMENT IN THE FIELD OF MOBILE APPLICATIONS; COMPUTER SOFTWARE DEVELOPMENT IN THE FIELD OF HEALTH CARE (U.S. CLS. 100 AND 101).

FIRST USE 10-8-2010; IN COMMERCE 10-8-2010.  
BARBARA RUTLAND, EXAMINING ATTORNEY

**CLASS 42—(Continued).**

SN 85-170,389. AOL INC., DULLES, VA. FILED 11-5-2010.

## QUICK BAR

THE MARK CONSISTS OF STANDARD CHARACTERS WITHOUT CLAIM TO ANY PARTICULAR FONT, STYLE, SIZE, OR COLOR.

NO CLAIM IS MADE TO THE EXCLUSIVE RIGHT TO USE "BAR", APART FROM THE MARK AS SHOWN.

FOR COMPUTER SERVICES, NAMELY, A FEATURE OF ONLINE NON-DOWNLOADABLE COMPUTER INTERFACE SOFTWARE THAT PROVIDES A UNIFIED INTERFACE FOR E-MAIL, TEXT, SOCIAL NETWORKING, REAL-TIME COMMUNICATIONS APPLICATIONS AND OTHER APPLICATIONS (U.S. CLS. 100 AND 101).

ALLISON SCHRODY, EXAMINING ATTORNEY

---

SN 85-172,468. BRISTOL-MYERS SQUIBB COMPANY, NEW YORK, NY. FILED 11-9-2010.



THE MARK CONSISTS OF STYLIZED STARS, A HUMAN LIKE FIGURE ABOVE THE LETTER "I" AND A SWIRL DESIGN WITH THE LETTERS AND WORDS "VIK VERY IMPORTANT KIDS".

FOR MEDICAL AND SCIENTIFIC RESEARCH, NAMELY, CONDUCTING CLINICAL TRIALS RELATING TO PHARMACEUTICAL PREPARATIONS FOR HUMAN USE (U.S. CLS. 100 AND 101).

MIDGE BUTLER, EXAMINING ATTORNEY

**CLASS 42—(Continued).**

SN 85-173,730. H2P, LLC, SOUTHLAKE, TX. FILED 11-10-2010.

**GO AHEAD, HELP YOURSELF**

THE MARK CONSISTS OF STANDARD CHARACTERS WITHOUT CLAIM TO ANY PARTICULAR FONT, STYLE, SIZE, OR COLOR.

FOR APPLICATION SERVICE PROVIDER (ASP) FEATURING SOFTWARE FOR USE IN ENABLING OR ASSISTING OTHERS WITH TROUBLESHOOTING BY DIAGNOSING PROBLEMS WITH COMPUTER SYSTEMS OR EQUIPMENT AND IDENTIFYING POSSIBLE CAUSES AND SOLUTIONS; COMPUTER SERVICES IN THE FIELD OF INFORMATION TECHNOLOGY SUPPORT SERVICES, NAMELY, SERVICE DESK SERVICES (U.S. CLS. 100 AND 101).

FIRST USE 10-18-2010; IN COMMERCE 10-18-2010.  
TRACY FLETCHER, EXAMINING ATTORNEY

**CLASS 42—(Continued).**

SN 85-179,010. HUBSPOT, INC., CAMBRIDGE, MA. FILED 11-17-2010.

**SOCIAL INBOX**

THE MARK CONSISTS OF STANDARD CHARACTERS WITHOUT CLAIM TO ANY PARTICULAR FONT, STYLE, SIZE, OR COLOR.

NO CLAIM IS MADE TO THE EXCLUSIVE RIGHT TO USE "SOCIAL", APART FROM THE MARK AS SHOWN.

FOR COMPUTER SERVICES, NAMELY, PROVIDING AN INTERACTIVE WEB SITE THAT ALLOWS USERS TO CONSOLIDATE AND MANAGE SOCIAL NETWORKS, ACCOUNTS, AND CONNECTIONS TO EXISTING AND EMERGING APPLICATION PROGRAMMING INTERFACES (APIS) (U.S. CLS. 100 AND 101).

FIRST USE 9-27-2010; IN COMMERCE 9-27-2010.  
JASON TURNER, EXAMINING ATTORNEY

SN 85-177,337. CONCEPT MEDICAL INC., TWINSBURG, OH. FILED 11-15-2010.



NO CLAIM IS MADE TO THE EXCLUSIVE RIGHT TO USE "MEDICAL", APART FROM THE MARK AS SHOWN.

THE COLOR(S) BLUE AND GRAY IS/ARE CLAIMED AS A FEATURE OF THE MARK.

THE MARK CONSISTS OF TWO BLUE AND ONE BLUE-GRAY ARROWED SWOOSH MARKS FORMING A ROLLING CIRCLE ON WHITE WHICH REPRESENTS BACKGROUND, SURMOUNTING THE WORD "CONCEPT" IN BLUE AND IN SMALL CASE LETTERS, WHICH SURMOUNTS THE WORD "MEDICAL" IN BLUE-GRAY AND IN SMALL CASE LETTERS.

FOR MEDICAL AND SCIENTIFIC RESEARCH IN THE FIELD OF CARDIOVASCULAR CATHETERS, STENTS, AND DRUG DELIVERY SYSTEMS (U.S. CLS. 100 AND 101).

FIRST USE 4-1-2009; IN COMMERCE 4-1-2009.  
NAAKWAMA ANKRAH, EXAMINING ATTORNEY

SN 85-179,282. HEALTHPER, INC., PRINCETON, NJ. FILED 11-17-2010.

**HEALTHNGAGE**

THE MARK CONSISTS OF STANDARD CHARACTERS WITHOUT CLAIM TO ANY PARTICULAR FONT, STYLE, SIZE, OR COLOR.

FOR PLATFORM AS A SERVICE (PAAS) FEATURING COMPUTER SOFTWARE PLATFORMS FOR ENABLING ONLINE, SOCIAL NETWORKING-BASED INTERACTION BETWEEN EMPLOYERS AND HEALTH PLAN PROVIDERS, INCENTIVE SPONSORS, PARTICIPATING USERS AND COMMUNITY MEMBERS FOR THE PURPOSE OF ENCOURAGING USER PARTICIPATION IN HEALTH AND WELLNESS PROGRAMS (U.S. CLS. 100 AND 101).

FIRST USE 9-1-2010; IN COMMERCE 9-1-2010.  
TRACY CROSS, EXAMINING ATTORNEY

**CLASS 42—(Continued).**

SN 85-183,537. NETARX LLC, AUBURN HILLS, MI. FILED 11-23-2010.

# Netarx

THE MARK CONSISTS OF STANDARD CHARACTERS WITHOUT CLAIM TO ANY PARTICULAR FONT, STYLE, SIZE, OR COLOR.

FOR COMPUTER NETWORK CONFIGURATION SERVICES; COMPUTER NETWORK DESIGN FOR OTHERS; COMPUTER SECURITY CONSULTANCY IN THE FIELD OF SCANNING AND PENETRATION TESTING OF COMPUTERS AND NETWORKS TO ASSESS INFORMATION SECURITY VULNERABILITY; COMPUTER SERVICE, NAMELY, ACTING AS AN APPLICATION SERVICE PROVIDER IN THE FIELD OF KNOWLEDGE MANAGEMENT TO HOST COMPUTER APPLICATION SOFTWARE FOR SEARCHING AND RETRIEVING INFORMATION FROM DATABASES AND COMPUTER NETWORKS; COMPUTER SERVICES, NAMELY, INTEGRATION OF COMPUTER SOFTWARE INTO MULTIPLE SYSTEMS AND NETWORKS; COMPUTER SYSTEMS INTEGRATION SERVICES; DESIGN AND DEVELOPMENT OF WIRELESS COMPUTER NETWORKS; HOSTING THE WEB SITES OF OTHERS ON A COMPUTER SERVER FOR A GLOBAL COMPUTER NETWORK; INTEGRATION OF COMPUTER SYSTEMS AND NETWORKS; PROFESSIONAL COMPUTER SERVICES, NAMELY, NETWORK ANALYSIS, LAN/WAN DESIGN, WIRELESS ENGINEERING, VIRTUALIZATION AND COMPUTER PROJECT MANAGEMENT; REMOTE COMPUTER NETWORK TECHNICAL MONITORING AND SOFTWARE MAINTENANCE SERVICES (U.S. CLS. 100 AND 101).

FIRST USE 10-1-1999; IN COMMERCE 10-1-1999.  
IRA J. GOODSaid, EXAMINING ATTORNEY

SN 85-185,041. ONYX PHARMACEUTICALS, INC., SOUTH SAN FRANCISCO, CA. FILED 11-24-2010.



OWNER OF U.S. REG. NOS. 2,791,902, 3,063,997 AND OTHERS.

NO CLAIM IS MADE TO THE EXCLUSIVE RIGHT TO USE "PHARMACEUTICALS", APART FROM THE MARK AS SHOWN.

THE MARK CONSISTS OF TWO CURVED LINES THAT PARTIALLY INTERSECT AT ONE POINT WITH THE WORDS "ONYX PHARMACEUTICALS" TO THE RIGHT OF THE CURVED LINES.

FOR PHARMACEUTICAL RESEARCH AND DEVELOPMENT; MEDICAL AND SCIENTIFIC RESEARCH, NAMELY, CONDUCTING CLINICAL TRIALS; MEDICAL AND SCIENTIFIC RESEARCH IN THE FIELDS OF TREATMENT FOR CANCER AND ONCOLOGY, AND IN THE FIELDS OF TREATMENT OF INFLAMMATION AND AUTOIMMUNE DISEASES (U.S. CLS. 100 AND 101).

ELI HELLMAN, EXAMINING ATTORNEY

**CLASS 42—(Continued).**

SN 85-187,611. INMOTION HOSTING, INC., MARINA DEL REY, CA. FILED S.R. 11-30-2010; AM. P.R. 9-9-2011.

# INMOTION HOSTING

THE MARK CONSISTS OF STANDARD CHARACTERS WITHOUT CLAIM TO ANY PARTICULAR FONT, STYLE, SIZE, OR COLOR.

NO CLAIM IS MADE TO THE EXCLUSIVE RIGHT TO USE "HOSTING", APART FROM THE MARK AS SHOWN.

FOR PROVIDING A WEB HOSTING PLATFORM FOR HOSTING OF DIGITAL CONTENT ON A GLOBAL COMPUTER NETWORK, NAMELY, THE HOSTING OF WEB SITES, ELECTRONIC MAIL, DOMAIN NAMES AND DATABASE CONTENT FOR OTHERS ON A SERVER SYSTEM THAT IS COUPLED TO A GLOBAL COMPUTER NETWORK (U.S. CLS. 100 AND 101).

FIRST USE 1-27-2003; IN COMMERCE 1-27-2003.  
ALICIA COLLINS, EXAMINING ATTORNEY

SN 85-187,705. SKINNY SCORE, LLC, BAY HARBOR, FL. FILED 11-30-2010.

# SKINNY SCORE

THE MARK CONSISTS OF STANDARD CHARACTERS WITHOUT CLAIM TO ANY PARTICULAR FONT, STYLE, SIZE, OR COLOR.

FOR PROVIDING TEMPORARY USE OF A NON-DOWNLOADABLE WEB-BASED COMPUTER SOFTWARE APPLICATION THAT RATES USERS CLOTHING CHOICES (U.S. CLS. 100 AND 101).

DAVID H. STINE, EXAMINING ATTORNEY

SN 85-187,783. BLACK SKY, INC., REDONDO BEACH, CA. FILED 11-30-2010.

# SkyNet

THE MARK CONSISTS OF STANDARD CHARACTERS WITHOUT CLAIM TO ANY PARTICULAR FONT, STYLE, SIZE, OR COLOR.

FOR PROVIDING VIRTUAL COMPUTER SYSTEMS AND VIRTUAL COMPUTER ENVIRONMENTS THROUGH CLOUD COMPUTING (U.S. CLS. 100 AND 101).

FIRST USE 11-30-2010; IN COMMERCE 11-30-2010.  
SALLY SHIH, EXAMINING ATTORNEY

**CLASS 42—(Continued).**

SN 85-190,808. FRANCE, DIANE LINDA, LAPORTE, CO. FILED 12-4-2010.

**Bone Detective**

THE MARK CONSISTS OF STANDARD CHARACTERS WITHOUT CLAIM TO ANY PARTICULAR FONT, STYLE, SIZE, OR COLOR.

FOR CONSULTING SERVICES IN THE FIELDS OF FORENSIC SCIENCE (U.S. CLS. 100 AND 101).

FIRST USE 7-9-2005; IN COMMERCE 7-9-2005.  
NATALIE POLZER, EXAMINING ATTORNEY

SN 85-194,652. CLAIMSMADEEZ, INC., CHAMPLIN, MN. FILED 12-9-2010.

**CLAIMSMADEEZ**

THE MARK CONSISTS OF STANDARD CHARACTERS WITHOUT CLAIM TO ANY PARTICULAR FONT, STYLE, SIZE, OR COLOR.

FOR PROVIDING A WEBSITE FEATURING TECHNOLOGY THAT ENABLES USERS TO PROACTIVELY IDENTIFY, CATEGORIZE AND ORGANIZE HOME AND BUSINESS INVENTORY FOR INSURANCE CLAIMS PURPOSES (U.S. CLS. 100 AND 101).

CHRISTINE MARTIN, EXAMINING ATTORNEY

SN 85-194,763. CRUSH REPUBLIC, LLC, CINCINNATI, OH. FILED 12-10-2010.

**BACKPAT**

THE MARK CONSISTS OF STANDARD CHARACTERS WITHOUT CLAIM TO ANY PARTICULAR FONT, STYLE, SIZE, OR COLOR.

FOR PROVIDING ON-LINE NON-DOWNLOADABLE SOFTWARE FOR DATABASE MANAGEMENT AND TRACKING OF PERFORMANCE FOR USE IN THE FIELD OF EMPLOYEE REWARDS AND RECOGNITIONS FOR JOB PERFORMANCE (U.S. CLS. 100 AND 101).

AISHA CLARKE, EXAMINING ATTORNEY

**CLASS 42—(Continued).**

SN 85-194,956. BLAZE PORTFOLIO SYSTEMS LLC, CHICAGO, IL. FILED 12-10-2010.

**BLAZEPORTFOLIO**

THE MARK CONSISTS OF STANDARD CHARACTERS WITHOUT CLAIM TO ANY PARTICULAR FONT, STYLE, SIZE, OR COLOR.

FOR TECHNICAL CONSULTING SERVICES IN THE FIELD OF INFORMATION TECHNOLOGY FEATURING INVESTMENT AND PORTFOLIO MANAGEMENT AND TRADING; AND DESIGN, DEVELOPMENT, INSTALLATION, TECHNICAL SUPPORT AND MAINTENANCE OF COMPUTER SOFTWARE (U.S. CLS. 100 AND 101).

TINA MAI, EXAMINING ATTORNEY

SN 85-197,310. REACH CALL, INC., AUGUSTA, GA. FILED 12-14-2010.



THE MARK CONSISTS OF A EQUILATERAL CROSS INCLUDING A JAGGED DIAGONAL PATH, FOLLOWED BY THE WORDING "REACH".

FOR SOFTWARE AS A SERVICE (SAAS) SERVICES FEATURING SOFTWARE FOR REMOTE MEDICAL CONSULTATION IN THE FIELD OF TELEMEDICINE (U.S. CLS. 100 AND 101).

TOBY BULLOFF, EXAMINING ATTORNEY

SN 85-197,326. REACH CALL, INC., AUGUSTA, GA. FILED 12-14-2010.

**REACH HEALTH**

THE MARK CONSISTS OF STANDARD CHARACTERS WITHOUT CLAIM TO ANY PARTICULAR FONT, STYLE, SIZE, OR COLOR.

NO CLAIM IS MADE TO THE EXCLUSIVE RIGHT TO USE "HEALTH", APART FROM THE MARK AS SHOWN.

FOR SOFTWARE AS A SERVICE (SAAS) SERVICES FEATURING SOFTWARE FOR REMOTE MEDICAL CONSULTATION IN THE FIELD OF TELEMEDICINE (U.S. CLS. 100 AND 101).

TOBY BULLOFF, EXAMINING ATTORNEY

**CLASS 42—(Continued).**

SN 85-197,885. CONVERTRO, INC., SANTA MONICA, CA.  
FILED 12-14-2010.

**convertro**

THE MARK CONSISTS OF STANDARD CHARACTERS WITHOUT CLAIM TO ANY PARTICULAR FONT, STYLE, SIZE, OR COLOR.

THE WORDING "CONVERTRO" HAS NO MEANING IN A FOREIGN LANGUAGE.

FOR COMPUTER SERVICE, NAMELY, ACTING AS AN APPLICATION SERVICE PROVIDER IN THE FIELD OF INFORMATION MANAGEMENT TO HOST COMPUTER APPLICATION SOFTWARE FOR THE PURPOSE OF TRACKING, ANALYZING, EVALUATING AND ADVISING OTHERS REGARDING WEBSITE MARKETING PERFORMANCE (U.S. CLS. 100 AND 101).

FIRST USE 6-1-2009; IN COMMERCE 6-1-2009.  
NATALIE POLZER, EXAMINING ATTORNEY

---

SN 85-204,239. PHAZ2, LOS ANGELES, CA. FILED 12-22-2010.

**stiletto<sup>B</sup>**

THE MARK CONSISTS OF THE WORD "STILETTO" FOLLOWED BY THE LETTER "P" AND THE NUMBER "2".

FOR PLATFORM AS A SERVICE (PAAS) FEATURING COMPUTER SOFTWARE PLATFORM FOR COMMUNICATION OF WIRELESS CONTENT WITH USERS OF HANDHELD COMPUTERS AND OTHER MOBILE DEVICES (U.S. CLS. 100 AND 101).

FIRST USE 8-26-2010; IN COMMERCE 8-26-2010.  
EMILY CHUO, EXAMINING ATTORNEY

**CLASS 42—(Continued).**

SN 85-210,502. LAURA FOXMAN, LAKE OSWEGO, OR.  
FILED S.R. 1-4-2011; AM. P.R. 8-17-2011.

**WE ARE ALL COLLAGE**

THE MARK CONSISTS OF STANDARD CHARACTERS WITHOUT CLAIM TO ANY PARTICULAR FONT, STYLE, SIZE, OR COLOR.

FOR ARCHITECTURAL CONSULTATION; ARCHITECTURAL DESIGN; ARCHITECTURAL RESEARCH; COMPUTER PROGRAMMING AND SOFTWARE DESIGN; COMPUTER SOFTWARE DESIGN, COMPUTER PROGRAMMING, OR MAINTENANCE OF COMPUTER SOFTWARE; CONSULTING SERVICES IN THE FIELD OF ARCHITECTURAL DESIGN; CREATING, DESIGNING AND MAINTAINING WEB SITES; DESIGN AND DEVELOPMENT OF MULTIMEDIA PRODUCTS; DESIGN OF INFORMATION GRAPHICS AND DATA VISUALIZATION MATERIALS; DESIGN OF INTERIOR DECOR; DESIGN, DEVELOPMENT AND IMPLEMENTATION OF SOFTWARE; DESIGNING AND DEVELOPING WEBPAGES ON THE INTERNET; FURNITURE DESIGN SERVICES; GRAPHIC ART DESIGN; GRAPHIC DESIGN; INDUSTRIAL DESIGN; INDUSTRIAL DESIGN SERVICES; LANDSCAPE ARCHITECTURAL DESIGN; MULTIDISCIPLINARY GRAPHIC DESIGN SERVICES; MULTIDISCIPLINARY VISUAL DESIGN SERVICES; PLANNING AND LAYOUT DESIGN FOR THE INTERIOR SPACE OF RETAIL BUSINESS ESTABLISHMENTS; PROVIDING A WEBSITE FEATURING INFORMATION IN THE FIELD OF INTERIOR DESIGN AND ARCHITECTURE FOR USE BY INTERIOR DESIGNERS AND ARCHITECTS; RESIDENTIAL BUILDING DESIGN; SOFTWARE DESIGN AND DEVELOPMENT; URBAN DESIGN PLANNING SERVICES; VISUAL DESIGN SERVICES IN THE NATURE OF DESIGNING VISUAL ELEMENTS FOR ON-LINE, BROADCAST, PRINT, OUTDOOR AND OTHER COMMUNICATION MEDIA; WEB SITE DESIGN (U.S. CLS. 100 AND 101).

WILLIAM ROSSMAN, EXAMINING ATTORNEY

---

SN 85-211,893. BORTA QOE CONSULTING, PLC, DBA QOE CONSULTING PLC, LANSING, MI. FILED 1-6-2011.

**QoE**  
CONSULTING

NO CLAIM IS MADE TO THE EXCLUSIVE RIGHT TO USE "CONSULTING", APART FROM THE MARK AS SHOWN.

THE MARK CONSISTS OF STYLIZED LETTERS "QOE" OVER THE WORD "CONSULTING".

FOR TRANSPORTATION AND TRAFFIC PLANNING SERVICES, NAMELY, PLANNING AND ENGINEERING IN THE FIELD OF TRANSPORTATION, INFRASTRUCTURE AND AIRPORT DEVELOPMENT (U.S. CLS. 100 AND 101).

KRISTIN DAHLING, EXAMINING ATTORNEY

**CLASS 42—(Continued).**

SN 85-215,228. A2SIX, INC., LISLE, IL. FILED 1-11-2011.

**INSUREVIEW**

THE MARK CONSISTS OF STANDARD CHARACTERS WITHOUT CLAIM TO ANY PARTICULAR FONT, STYLE, SIZE, OR COLOR.

FOR CONDUCTING ELECTRONIC DISCOVERY SERVICES VIA GLOBAL COMPUTER NETWORKS FOR LAWYERS AND CORPORATIONS; CONSULTING SERVICES IN THE FIELD OF THE DESIGN OF DOCUMENT REVIEW SYSTEMS; CONVERSION OF DATA OR DOCUMENTS FROM PHYSICAL TO ELECTRONIC MEDIA; DATA CONVERSION OF ELECTRONIC INFORMATION; DESIGN AND DEVELOPMENT OF ELECTRONIC DATA SECURITY SYSTEMS; ELECTRONIC LEGAL DISCOVERY CONSULTING SERVICES; ELECTRONIC SCANNING OF DOCUMENTS FOR DOCUMENT REVIEW, INDEXING, CONSULTING AND E-DISCOVERY FOR BUSINESSES AND LAW FIRMS; IT CONSULTING SERVICES; IT INTEGRATION SERVICES; PLATFORM AS A SERVICE (PAAS) FEATURING COMPUTER SOFTWARE PLATFORMS FOR DOCUMENT REVIEW AND INDEXING; PROVIDING A WEBSITE FEATURING TECHNOLOGY THAT ENABLES USERS TO SPECIALIZE IN DOCUMENT REVIEW, INDEXING, CONSULTING AND E-DISCOVERY FOR BUSINESSES, LAW FIRMS AND INSURANCE INDUSTRY; PROVIDING AN ONLINE NETWORK SERVICE THAT ENABLES USERS TO SHARE DATA IN THE FIELD OF E-DISCOVERY FOR BUSINESSES AND LAW FIRMS; PROVIDING AN ONLINE NON-DOWNLOADABLE INTERNET-BASED SYSTEM APPLICATION FEATURING TECHNOLOGY ENABLING USERS TO REVIEW E-DISCOVERY (U.S. CLS. 100 AND 101).

CURTIS FRENCH, EXAMINING ATTORNEY

**CLASS 42—(Continued).**

SN 85-218,505. LEADER TECHNOLOGIES INCORPORATED, LEWIS CENTER, OH. FILED 1-14-2011.

**LEADER**

THE MARK CONSISTS OF STANDARD CHARACTERS WITHOUT CLAIM TO ANY PARTICULAR FONT, STYLE, SIZE, OR COLOR.

OWNER OF U.S. REG. NOS. 2,743,664, 3,947,212 AND OTHERS.

FOR COMPUTER SERVICES, NAMELY, PROVIDING AN ONLINE NON-DOWNLOADABLE SUITE OF COMPUTER SOFTWARE FOR USE IN TELECOMMUNICATIONS THAT ENABLES COLLABORATION THROUGH TRACKING, CONTEXT, AND STORAGE COMPONENTS OF TECHNOLOGY WITHIN A WEB-BASED SYSTEM, ENABLES MANAGEMENT OF TASKS, ENABLES MANAGEMENT OF COMMUNICATIONS, NAMELY, TRACKING OF INCOMING AND OUTGOING WRITTEN, ELECTRONIC, AND TELEPHONIC COMMUNICATIONS, ENABLES FILE TRANSFERS, ENABLES USE OF USER-DEFINED TOOLS, NAMELY, NEWS INTERFACES, AND ESCALATIONS OF ALERT NOTIFICATION THAT ENHANCE THE PRODUCTIVITY OF THE USER, ENABLES TEAMWORK AMONG THE USERS, ENABLES ACCESS TO USER-GENERATED DATA, AND ENABLES THE USER TO LEVERAGE ENTERPRISE KNOWLEDGE; APPLICATION SERVICE PROVIDER (ASP) FEATURING SOFTWARE TO ENABLE OR FACILITATE THE UPLOADING, DOWNLOADING, STREAMING, POSTING, DISPLAYING, BLOGGING, LINKING, SHARING OR OTHERWISE PROVIDING ELECTRONIC MEDIA OR INFORMATION OVER COMMUNICATION NETWORKS; PROVIDING A WEB SITE FEATURING TECHNOLOGY THAT ENABLES ONLINE USERS TO CREATE PERSONAL PROFILES FEATURING SOCIAL NETWORKING INFORMATION AND TO TRANSFER AND SHARE SUCH INFORMATION AMONG MULTIPLE WEBSITES (U.S. CLS. 100 AND 101).

CARYN GLASSER, EXAMINING ATTORNEY

---

SN 85-223,477. B7 INTERACTIVE, LLC, COLORADO SPRINGS, CO. FILED 1-21-2011.

**IntelliSuggest**

THE MARK CONSISTS OF STANDARD CHARACTERS WITHOUT CLAIM TO ANY PARTICULAR FONT, STYLE, SIZE, OR COLOR.

FOR SOFTWARE AS A SERVICE (SAAS) SERVICES FEATURING SEARCH ENGINE SOFTWARE THAT RECOMMENDS ITEMS AND OPTIMIZES SEARCH RESULTS BASED ON USER SHOPPING BEHAVIOR (U.S. CLS. 100 AND 101).

FIRST USE 1-5-2009; IN COMMERCE 1-5-2009.

ANDREA K. NADELMAN, EXAMINING ATTORNEY

**CLASS 42—(Continued).**

SN 85-225,958. IMC2, LLC, DBA IMC\*, DALLAS, TX. FILED 1-25-2011.



OWNER OF U.S. REG. NO. 3,943,346.  
THE COLOR(S) PURPLE AND WHITE IS/ARE CLAIMED AS A FEATURE OF THE MARK.

THE MARK CONSISTS OF A PURPLE RECTANGLE THAT IS CONVEX AND ROUNDED AT THE TOP AND BOTTOM, WITH "IMC\*" WRITTEN ACROSS IT IN WHITE.

FOR COMPUTER SOFTWARE DEVELOPMENT IN THE FIELD OF MOBILE APPLICATIONS; PLANNING, DESIGN, DEVELOPMENT, MAINTENANCE AND OPTIMIZATION OF ONLINE WEBSITES FOR THIRD PARTIES; WEBSITE DESIGN AND DEVELOPMENT FOR OTHERS; WEBSITE USABILITY TESTING SERVICES (U.S. CLS. 100 AND 101).

FIRST USE 1-2-1995; IN COMMERCE 1-2-1995.  
JAMES LOVELACE, EXAMINING ATTORNEY

---

SN 85-238,304. WEBTRENDS, INC., MENLO PARK, CA. FILED 2-9-2011.

## WEBTRENDS

THE MARK CONSISTS OF STANDARD CHARACTERS WITHOUT CLAIM TO ANY PARTICULAR FONT, STYLE, SIZE, OR COLOR.

OWNER OF U.S. REG. NOS. 2,740,900, 3,834,343 AND OTHERS.

FOR COMPUTER SOFTWARE DEVELOPMENT IN THE FIELD OF MOBILE APPLICATIONS; COMPUTER SERVICES, NAMELY, SEARCH ENGINE OPTIMIZATION; COMPUTER SERVICES, NAMELY, DATA-DRIVEN OPTIMIZATION OF ONLINE SEARCHES AND WEBSITE MANAGEMENT FOR OTHERS; COMPUTER SERVICES, NAMELY, COMPUTER CONSULTATION; COMPUTER SOFTWARE DESIGN FOR OTHERS; COMPUTER SERVICES, NAMELY, TECHNICAL CONSULTATION IN THE FIELDS OF SEARCH ENGINE PLACEMENT AND INCREASING INTERNET TRAFFIC FOR THE WEBSITES OF OTHERS; CUSTOMIZED SOFTWARE DEVELOPMENT SERVICES; CONSULTATION SERVICES IN THE FIELD OF SEARCH ENGINE OPTIMIZATION (U.S. CLS. 100 AND 101).

GRETCHEN ULRICH, EXAMINING ATTORNEY

**CLASS 42—(Continued).**

SN 85-239,191. REVENUEWIRE INC., VICTORIA BC, CANADA, FILED 2-10-2011.

OWNER OF U.S. REG. NOS. 3,404,926 AND 3,711,889.  
THE MARK CONSISTS OF THE TERM "SAFECART" WITH AN INVERTED ARC SPANNING UNDERNEATH THE "CART" PORTION OF THE MARK.

FOR PROVIDING TEMPORARY USE OF NON-DOWNLOADABLE CREDIT CARD TRANSACTION PROCESSING SOFTWARE IN THE FIELD OF E-COMMERCE SUPPORT USED TO PROVIDE SECURE MULTI-CURRENCY PAYMENT SERVICES FOR TRANSACTIONS CONDUCTED IN ELECTRONIC COMMERCE, NAMELY, ESTABLISHING FUNDED ACCOUNTS USED TO PURCHASE GOODS AND SERVICES ON THE INTERNET; PROVIDING TEMPORARY USE OF NON-DOWNLOADABLE CREDIT CARD TRANSACTION PROCESSING SOFTWARE FEATURING TOOLS FOR MONITORING WEBSITE TRANSACTIONS, MANAGING ACCOUNTS, MANAGING CATALOG OF PRODUCTS, ORDER MANAGEMENT AND PRODUCT SEARCHING AND PERFORMANCE REPORTING (U.S. CLS. 100 AND 101).

GENE MACIOL, EXAMINING ATTORNEY

---

SN 85-243,381. THE TRUSTEES OF INDIANA UNIVERSITY, BLOOMINGTON, IN. FILED 2-16-2011.

## GLOBALNOC

THE MARK CONSISTS OF STANDARD CHARACTERS WITHOUT CLAIM TO ANY PARTICULAR FONT, STYLE, SIZE, OR COLOR.

SEC. 2(F).

FOR ONLINE SERVICES, NAMELY, PROVIDING COMPUTER NETWORK OPERATIONS SERVICES TO MANAGE THE INTERNATIONAL NETWORK CONNECTIONS OF ADVANCED RESEARCH AND EDUCATION NETWORKS IN ORDER TO FACILITATE INTERNATIONAL COLLABORATION IN RESEARCH AND EDUCATION (U.S. CLS. 100 AND 101).

FIRST USE 10-4-2000; IN COMMERCE 10-4-2000.  
WANDA KAY PRICE, EXAMINING ATTORNEY

**CLASS 42—(Continued).**

SN 85-243,383. THE TRUSTEES OF INDIANA UNIVERSITY, BLOOMINGTON, IN. FILED 2-16-2011.



THE MARK CONSISTS OF A SERIES OF RECTANGULAR SHAPES IN THE SHAPE OF A GLOBE WHICH APPEARS TO BE MOVING FORWARD.

FOR ONLINE SERVICES, NAMELY, PROVIDING COMPUTER NETWORK OPERATIONS SERVICES TO MANAGE THE INTERNATIONAL NETWORK CONNECTIONS OF ADVANCED RESEARCH AND EDUCATION NETWORKS IN ORDER TO FACILITATE INTERNATIONAL COLLABORATION IN RESEARCH AND EDUCATION (U.S. CLS. 100 AND 101).

FIRST USE 11-13-2010; IN COMMERCE 11-13-2010.  
WANDA KAY PRICE, EXAMINING ATTORNEY

SN 85-243,847. HUMIGEN, LLC, HAMILTON, NJ. FILED 2-16-2011.



NO CLAIM IS MADE TO THE EXCLUSIVE RIGHT TO USE "INSTITUTE FOR GENETIC IMMUNOLOGY", APART FROM THE MARK AS SHOWN.

THE MARK CONSISTS OF THE LITERAL ELEMENTS "THE INSTITUTE FOR GENETIC IMMUNOLOGY HUMIGEN" AND A STYLIZED ELEMENT DEPICTING AN ANTIBODY ENTWINED BY A DNA DOUBLE-HELIX IN FRONT OF AN OVAL DEPICTING A CELL; THE OVAL CONSISTS OF AN OUTER OVAL AND AN INNER OVAL; THE INNER OVAL CONTAINS A DEPICTION OF CELLULAR COMPONENTS; THE LITERAL ELEMENTS "THE INSTITUTE FOR GENETIC IMMUNOLOGY" ARCH ABOVE THE STYLIZED ELEMENT AND THE LITERAL TERM "HUMIGEN" APPEARS BELOW THE STYLIZED ELEMENT.

FOR RESEARCH AND DEVELOPMENT IN THE PHARMACEUTICAL AND BIOTECHNOLOGY FIELDS (U.S. CLS. 100 AND 101).

WILLIAM BRECKENFELD, EXAMINING ATTORNEY

**CLASS 42—(Continued).**

SN 85-244,046. HUMIGEN, LLC, HAMILTON, NJ. FILED 2-16-2011.



NO CLAIM IS MADE TO THE EXCLUSIVE RIGHT TO USE "INSTITUTE FOR GENETIC IMMUNOLOGY", APART FROM THE MARK AS SHOWN.

THE COLOR(S) BLACK, BLUE, GREEN, YELLOW AND VIOLET IS/ARE CLAIMED AS A FEATURE OF THE MARK.

THE MARK CONSISTS OF THE LITERAL ELEMENTS "THE INSTITUTE FOR GENETIC IMMUNOLOGY HUMIGEN" AND A STYLIZED ELEMENT DEPICTING AN ANTIBODY ENTWINED BY A DNA DOUBLE-HELIX IN FRONT OF AN OVAL DEPICTING A CELL; THE OVAL CONSISTS OF AN OUTER OVAL AND AN INNER OVAL; THE INNER OVAL CONTAINS A DEPICTION OF CELLULAR COMPONENTS; THE LITERAL ELEMENTS "THE INSTITUTE FOR GENETIC IMMUNOLOGY" ARCH ABOVE THE STYLIZED ELEMENT AND THE LITERAL TERM "HUMIGEN" APPEARS BELOW THE STYLIZED ELEMENT; THE COLOR BLACK APPEARS IN THE LITERAL ELEMENTS "THE INSTITUTE FOR GENETIC IMMUNOLOGY HUMIGEN"; THE COLOR BLUE APPEARS IN THE DEPICTION OF THE ANTIBODY; THE COLOR YELLOW APPEARS IN THE DEPICTION OF THE DNA DOUBLE-HELIX; THE COLOR GREEN APPEARS IN THE OUTER OVAL; THE COLOR VIOLET APPEARS IN THE INNER OVAL.

FOR RESEARCH AND DEVELOPMENT IN THE PHARMACEUTICAL AND BIOTECHNOLOGY FIELDS (U.S. CLS. 100 AND 101).

WILLIAM BRECKENFELD, EXAMINING ATTORNEY

SN 85-246,390. SELMAN AND ASSOCIATES, LTD., HOUSTON, TX. FILED 2-18-2011.

**ACQUIREIT**

THE MARK CONSISTS OF STANDARD CHARACTERS WITHOUT CLAIM TO ANY PARTICULAR FONT, STYLE, SIZE, OR COLOR.

FOR PROVIDING TEMPORARY USE OF ON-LINE NON-DOWNLOADABLE SOFTWARE IN THE FIELD OF GEOLOGY FOR USE TO CAPTURE, CATEGORIZE, AND DISPLAY SURFACE LOG INFORMATION FOR WELLS (U.S. CLS. 100 AND 101).

FIRST USE 10-24-2003; IN COMMERCE 10-24-2003.  
GIANCARLO CASTRO, EXAMINING ATTORNEY



**CLASS 42—(Continued).**

SN 85-246,666. CASELLI, NICHOLAS G, DBA ALPENGLO MAPPING, SEATTLE, WA. FILED 2-18-2011.

# Alpenglo

THE MARK CONSISTS OF STANDARD CHARACTERS WITHOUT CLAIM TO ANY PARTICULAR FONT, STYLE, SIZE, OR COLOR.

FOR COMPUTER GRAPHICS DESIGN SERVICES, NAMELY, CREATING OF STATIC, DYNAMIC, AND INTERACTIVE FOR USE IN PRINT AND DIGITAL MEDIA MAPS; PROVIDING AN ON-LINE SEARCHABLE DATABASE IN THE FIELD OF GEOGRAPHIC MAPS FOR SCIENTIFIC RESEARCH PURPOSES; ANALYSIS OF GEOGRAPHIC DATA (U.S. CLS. 100 AND 101).

FIRST USE 4-3-2008; IN COMMERCE 7-1-2009.  
RONALD AIKENS, EXAMINING ATTORNEY

---

SN 85-247,763. ENVISZEN, LLC, CHICAGO, IL. FILED 2-21-2011.

# enviszen

THE MARK CONSISTS OF STANDARD CHARACTERS WITHOUT CLAIM TO ANY PARTICULAR FONT, STYLE, SIZE, OR COLOR.

FOR COMPUTER SOFTWARE DEVELOPMENT; COMPUTER SOFTWARE DEVELOPMENT AND COMPUTER PROGRAMMING DEVELOPMENT FOR OTHERS; COMPUTER SOFTWARE DEVELOPMENT IN THE FIELD OF MOBILE APPLICATIONS; CREATION, DESIGN, DEVELOPMENT AND MAINTENANCE OF WEB SITES FOR THIRD PARTIES; IT CONSULTING SERVICES; WEB SITE DEVELOPMENT FOR OTHERS (U.S. CLS. 100 AND 101).

BRENDAN REGAN, EXAMINING ATTORNEY

---

SN 85-252,720. NETWORK OPTIX, INC., GLENDALE, CA. FILED 2-26-2011.

# HD Unleashed

THE MARK CONSISTS OF STANDARD CHARACTERS WITHOUT CLAIM TO ANY PARTICULAR FONT, STYLE, SIZE, OR COLOR.

NO CLAIM IS MADE TO THE EXCLUSIVE RIGHT TO USE "HD", APART FROM THE MARK AS SHOWN.

FOR COMPUTER SOFTWARE DEVELOPMENT (U.S. CLS. 100 AND 101).

BARBARA BROWN, EXAMINING ATTORNEY

**CLASS 42—(Continued).**

SN 85-257,913. COREY, JAMES, PAINTED POST, NY. FILED 3-4-2011.



NO CLAIM IS MADE TO THE EXCLUSIVE RIGHT TO USE "CRYSTAL CITY" AND "COMPUTING", APART FROM THE MARK AS SHOWN.

THE STIPPLING IS A FEATURE OF THE MARK.

THE MARK CONSISTS OF THE LETTER "C" WITHIN A STIPPLED CIRCLE SURROUNDED BY A RING, BENEATH WHICH APPEARS THE STYLIZED TEXT "CRYSTAL CITY COMPUTING" WITH A RECTANGULAR CARRIER AROUND "COMPUTING".

FOR CUSTOMIZATION OF COMPUTER HARDWARE AND SOFTWARE; MAINTENANCE AND UPGRADING OF COMPUTER SOFTWARE; REPAIR OF COMPUTER SOFTWARE (U.S. CLS. 100 AND 101).

FIRST USE 1-1-2011; IN COMMERCE 2-20-2011.  
SUSAN STIGLITZ, EXAMINING ATTORNEY

---

SN 85-260,054. FIFTH THIRD PROCESSING SOLUTIONS, LLC, CINCINNATI, OH. FILED 3-7-2011.

# E-SIMILATE

THE MARK CONSISTS OF STANDARD CHARACTERS WITHOUT CLAIM TO ANY PARTICULAR FONT, STYLE, SIZE, OR COLOR.

FOR PROVIDING A WEBSITE FEATURING ON-LINE NON-DOWNLOADABLE SOFTWARE DEVELOPMENT TOOLS, NAMELY, AN APPLICATION PROGRAMMING INTERFACE, SAMPLE CODE, SAMPLE APPLICATIONS, AND DEVELOPER SANDBOX; COMPUTER TECHNOLOGY SUPPORT SERVICES, NAMELY, HELP DESK SERVICES (U.S. CLS. 100 AND 101).

FIRST USE 2-16-2011; IN COMMERCE 2-16-2011.

FLORENTINA BLANDU, EXAMINING ATTORNEY

**CLASS 42—(Continued).**

SN 85-262,842. HOMEAWAY.COM, INC., AUSTIN, TX. FILED 3-9-2011.



OWNER OF U.S. REG. NOS. 3,385,395, 3,596,173 AND 3,596,175.

THE MARK CONSISTS OF BLACK AND WHITE BIRD-HOUSE.

FOR COMPUTER SERVICES FOR PROVIDING A REAL ESTATE SEARCH PLATFORM CONFIGURED TO ALLOW USERS TO REQUEST AND RECEIVE CONTENT FROM A WEBSITE; APPLICATION SERVICE PROVIDER (ASP) FEATURING SOFTWARE IN THE FIELD OF RENTALS AND SALES RELATED TO REAL ESTATE; ASP FEATURING SOFTWARE FOR USE BY REAL ESTATE AND TRAVEL BASED COMPANIES TO ADVERTISE SPECIALS, MAKE RESERVATIONS, OFFER COUPONS, SPECIALS, DISCOUNTS, AND DIRECTIONS AND FOR USE IN INTERACTIVE CUSTOMER SERVICES RELATED TO THE RENTAL OR PURCHASE OF REAL ESTATE; PROVIDING INFORMATION SERVICES IN THE FIELD OF ASP FEATURING SOFTWARE FOR REAL ESTATE RENTAL OR SALES; ASP FEATURING SOFTWARE FOR USE BY COMPANIES AND INDIVIDUALS TO ADVERTISE SPECIALS, MAKE RESERVATIONS, OFFER COUPONS, OFFER SPECIALS, OFFER DISCOUNTS, SELL REAL ESTATE, PROVIDE DIRECTIONS, AND FOR USE IN ACCESSING INTERACTIVE CUSTOMER SERVICES OF OTHERS; DESIGN AND DEVELOPMENT OF VISUALIZATION TECHNOLOGIES FOR ADVERTISEMENT OF REAL-ESTATE AND BUSINESS OF OTHERS; APPLICATION SERVICE PROVIDER, NAMELY, HOSTING, MANAGING, DEVELOPING, ANALYZING, AND MAINTAINING APPLICATIONS, SOFTWARE, AND WEB SITES, OF OTHERS IN THE FIELDS OF ADVERTISING AND MARKETING; COMPUTER SERVICE, NAMELY, ACTING AS AN APPLICATION SERVICE PROVIDER IN THE FIELD OF KNOWLEDGE MANAGEMENT TO HOST COMPUTER APPLICATION SOFTWARE FOR CREATING SEARCHABLE DATABASES OF INFORMATION AND DATA; COMPUTER SERVICE, NAMELY, ACTING AS AN APPLICATION SERVICE PROVIDER IN THE FIELD OF KNOWLEDGE MANAGEMENT TO HOST COMPUTER APPLICATION SOFTWARE FOR SEARCHING AND RETRIEVING INFORMATION FROM DATABASES AND COMPUTER NETWORKS; COMPUTER SERVICES IN THE NATURE OF CUSTOMIZED WEB PAGES FEATURING USER-DEFINED INFORMATION AND PERSONAL PROFILES; COMPUTER SERVICES, NAMELY, PROVIDING SEARCH ENGINES FOR OBTAINING DATA ON A GLOBAL COMPUTER NETWORK; PROVIDING A WEBSITE THAT GIVES USERS THE ABILITY TO CREATE CUSTOMIZED WEB PAGES FEATURING USER-DEFINED INFORMATION (U.S. CLS. 100 AND 101).

FIRST USE 7-12-2006; IN COMMERCE 7-12-2006.  
RON FAIRBANKS, EXAMINING ATTORNEY

**CLASS 42—(Continued).**

SN 85-269,020. NANO LIVING SYSTEM, LTD., AMERSHAM, UNITED KINGDOM, FILED 3-16-2011.

# @Connect

THE MARK CONSISTS OF A STYLIZED AT SYMBOL CONTAINING THE LETTER "E" FOLLOWED AT THE RIGHT THE WORDING "CONNECT".

FOR COMPUTER SERVICES, NAMELY, CREATING AN ON-LINE COMMUNITY FOR REGISTERED USERS TO SHOWCASE THEIR VEHICLES, PARTICIPATE IN COMPETITIONS, GET FEEDBACK FROM THEIR PEERS, FORM VIRTUAL COMMUNITIES, AND ENGAGE IN SOCIAL NETWORKING (U.S. CLS. 100 AND 101).

SAMUEL E. SHARPER JR., EXAMINING ATTORNEY

SN 85-272,716. INTERNATIONAL DOWN AND FEATHER TESTING LABORATORY, SALT LAKE CITY, UT. FILED 3-21-2011.



THE MARK CONSISTS OF AN OUTLINE OF A GLOBE WITH MULTIPLE LATITUDE AND LONGITUDE LINES WITH THE LETTERS "IDFL" EXTENDING ACROSS THE EQUATOR REGION OF THE GLOBE. THE LETTERS "IDFL" SEPARATE THE LONGITUDE LINES AT THE EQUATOR REGION AND THE OUTLINE OF THE GLOBE AT THE EQUATOR REGION.

FOR TESTING, INSPECTION, OR RESEARCH OF TEXTILES, FILLED TEXTILES, SYNTHETIC FILLS, NATURAL FILLS, DOWN AND FEATHERS, AND OTHER TEXTILE-RELATED PRODUCTS; CONSULTING IN THE FIELDS OF CONSUMER PRODUCT SAFETY, QUALITY CONTROL, MANUFACTURING, AND DESIGN CONSULTING FOR THE TEXTILES, FILLED TEXTILES, SYNTHETIC FILLS, NATURAL FILLS, DOWN AND FEATHERS, AND OTHER TEXTILE-RELATED PRODUCTS INDUSTRIES; CONSUMER PRODUCT SAFETY TESTING FOR TEXTILES, FILLED TEXTILES, SYNTHETIC FILLS, NATURAL FILLS, DOWN AND FEATHERS, AND OTHER TEXTILE-RELATED PRODUCTS; QUALITY CONTROL FOR OTHERS IN THE FIELDS OF TEXTILES, FILLED TEXTILES, SYNTHETIC FILLS, NATURAL FILLS, DOWN AND FEATHERS, AND OTHER TEXTILE-RELATED PRODUCTS (U.S. CLS. 100 AND 101).

FIRST USE 10-1-1978; IN COMMERCE 10-1-1978.  
SUNG IN, EXAMINING ATTORNEY

**CLASS 42—(Continued).**

SN 85-272,720. INTERNATIONAL DOWN AND FEATHER TESTING LABORATORY, SALT LAKE CITY, UT. FILED 3-21-2011.

# IDFL

THE MARK CONSISTS OF STANDARD CHARACTERS WITHOUT CLAIM TO ANY PARTICULAR FONT, STYLE, SIZE, OR COLOR.

FOR TESTING, INSPECTION, OR RESEARCH OF TEXTILES, FILLED TEXTILES, SYNTHETIC FILLS, NATURAL FILLS, DOWN AND FEATHERS, AND OTHER TEXTILE-RELATED PRODUCTS; CONSULTING IN THE FIELDS OF CONSUMER PRODUCT SAFETY, QUALITY CONTROL, MANUFACTURING, AND DESIGN CONSULTING FOR THE TEXTILES, FILLED TEXTILES, SYNTHETIC FILLS, NATURAL FILLS, DOWN AND FEATHERS, AND OTHER TEXTILE-RELATED PRODUCTS INDUSTRIES; CONSUMER PRODUCT SAFETY TESTING FOR TEXTILES, FILLED TEXTILES, SYNTHETIC FILLS, NATURAL FILLS, DOWN AND FEATHERS, AND OTHER TEXTILE-RELATED PRODUCTS; QUALITY CONTROL FOR OTHERS IN THE FIELDS OF TEXTILES, FILLED TEXTILES, SYNTHETIC FILLS, NATURAL FILLS, DOWN AND FEATHERS, AND OTHER TEXTILE-RELATED PRODUCTS (U.S. CLS. 100 AND 101).

FIRST USE 10-1-1978; IN COMMERCE 10-1-1978.  
SUNG IN, EXAMINING ATTORNEY

SN 85-275,195. KAJABI, LLC, TUSTIN, CA. FILED 3-23-2011.

# KAJABI

THE MARK CONSISTS OF STANDARD CHARACTERS WITHOUT CLAIM TO ANY PARTICULAR FONT, STYLE, SIZE, OR COLOR.

THE ENGLISH TRANSLATION OF "KAJABI" IN THE MARK IS "TO TAKE FLIGHT".

FOR APPLICATION SERVICE PROVIDER, NAMELY, HOSTING, MANAGING, DEVELOPING, ANALYZING, AND MAINTAINING APPLICATIONS, SOFTWARE, AND WEB SITES, OF OTHERS IN THE FIELDS OF ADVERTISING AND MARKETING; COMPUTER SERVICES, NAMELY, CREATING AN ON-LINE COMMUNITY FOR REGISTERED USERS TO PARTICIPATE IN DISCUSSIONS, GET FEEDBACK FROM THEIR PEERS, FORM VIRTUAL COMMUNITIES, AND ENGAGE IN SOCIAL NETWORKING; COMPUTER SERVICES, NAMELY, CREATING, MAINTAINING, DESIGNING AND IMPLEMENTING WEB SITES FOR OTHERS AND HOSTING THE WEB SITES OF OTHERS ON A COMPUTER SERVER FOR A GLOBAL COMPUTER NETWORK; COMPUTER SERVICES, NAMELY, HOSTING AND MAINTAINING AN ON-LINE WEB SITE FOR OTHERS TO CREATE AND OPERATE CUSTOMIZABLE WEB

**CLASS 42—(Continued).**

PAGES FOR MARKETING AND DELIVERING MEMBERSHIP-BASED CONTENT PROVIDER SERVICES; COMPUTER SERVICES, NAMELY, HOSTING ON-LINE WEB FACILITIES FOR OTHERS FOR ORGANIZING AND CONDUCTING ONLINE MEETINGS, GATHERINGS, AND INTERACTIVE DISCUSSIONS; COMPUTER SERVICES, NAMELY, INTERACTIVE HOSTING SERVICES WHICH ALLOW THE USER TO PUBLISH AND SHARE THEIR OWN CONTENT AND IMAGES ON-LINE; HOSTING AN ONLINE WEBSITE FEATURING AN ON-LINE SOFTWARE PLATFORM ENABLING USERS TO CREATE AND OPERATE CUSTOMIZABLE WEB PAGES FOR MARKETING AND DELIVERING MEMBERSHIP-BASED CONTENT PROVIDER SERVICES; HOSTING OF DIGITAL CONTENT ON THE INTERNET; HOSTING THE WEB SITES OF OTHERS; PROVIDING A WEB HOSTING PLATFORM FOR USERS TO CREATE AND OPERATE CUSTOMIZABLE WEB PAGES FOR MARKETING AND DELIVERING MEMBERSHIP-BASED CONTENT PROVIDER SERVICES (U.S. CLS. 100 AND 101).

FIRST USE 3-15-2010; IN COMMERCE 6-4-2010.  
STEVEN PEREZ, EXAMINING ATTORNEY

SN 85-277,609. ROOFING CONTRACTOR SOLUTIONS INC., BOTHELL, WA. FILED 3-25-2011.

# ProjecTracker

THE MARK CONSISTS OF STANDARD CHARACTERS WITHOUT CLAIM TO ANY PARTICULAR FONT, STYLE, SIZE, OR COLOR.

FOR COMPUTER SERVICES, NAMELY, PROVIDING SEARCH ENGINES FOR OBTAINING ROOFING ESTIMATES ON A GLOBAL COMPUTER NETWORK (U.S. CLS. 100 AND 101).

FIRST USE 5-1-2009; IN COMMERCE 5-1-2009.  
INGA ERVIN, EXAMINING ATTORNEY

SN 85-279,178. 7144849 CANADA LIMITED, MONTREAL, CANADA, FILED 3-28-2011.

# Porn Gun

THE MARK CONSISTS OF STANDARD CHARACTERS WITHOUT CLAIM TO ANY PARTICULAR FONT, STYLE, SIZE, OR COLOR.

NO CLAIM IS MADE TO THE EXCLUSIVE RIGHT TO USE "PORN", APART FROM THE MARK AS SHOWN.

FOR PROVIDING A WEB SITE FEATURING TEMPORARY USE OF NON-DOWNLOADABLE SOFTWARE ALLOWING WEB SITE USERS TO UPLOAD, POST AND DISPLAY ONLINE VIDEOS AND PICTURES FOR SHARING WITH OTHERS FOR ENTERTAINMENT PURPOSES (U.S. CLS. 100 AND 101).

CORY BOONE, EXAMINING ATTORNEY

**CLASS 42—(Continued).**

SN 85-283,934. JAY GULOTTA, N. BARRINGTON, IL. FILED 4-1-2011.

**MUSIC UNITED**

THE MARK CONSISTS OF STANDARD CHARACTERS WITHOUT CLAIM TO ANY PARTICULAR FONT, STYLE, SIZE, OR COLOR.

NO CLAIM IS MADE TO THE EXCLUSIVE RIGHT TO USE "MUSIC", APART FROM THE MARK AS SHOWN.

FOR COMPUTER SERVICES, NAMELY, HOSTING ONLINE WEB FACILITIES FOR OTHERS FOR ORGANIZING AND CONDUCTING ONLINE MEETINGS, GATHERINGS, AND INTERACTIVE DISCUSSIONS; AND COMPUTER SERVICES IN THE NATURE OF CUSTOMIZED WEB PAGES FEATURING USER-DEFINED INFORMATION, PERSONAL PROFILES AND INFORMATION; COMPUTER SERVICES, NAMELY, CREATING AN ON-LINE COMMUNITY FOR REGISTERED USERS TO PARTICIPATE IN DISCUSSION, GET FEEDBACK FROM THEIR PEERS, FORM VIRTUAL COMMUNITIES, AND ENGAGE IN SOCIAL NETWORKING; PEER-TO-BROWSER PHOTO SHARING SERVICES, NAMELY, PROVIDING A WEBSITE FEATURING TECHNOLOGY ENABLING USERS TO UPLOAD, VIEW AND DOWNLOAD DIGITAL PHOTOS AND MUSIC (U.S. CLS. 100 AND 101).

HOWARD B. LEVINE, EXAMINING ATTORNEY

SN 85-285,543. GREEN ENERGY CORP., DENVER, CO. FILED 4-4-2011.

**GREENBUS**

THE MARK CONSISTS OF STANDARD CHARACTERS WITHOUT CLAIM TO ANY PARTICULAR FONT, STYLE, SIZE, OR COLOR.

FOR COMPUTER SOFTWARE DEVELOPMENT AND COMPUTER PROGRAMMING DEVELOPMENT FOR OTHERS; PLATFORM AS A SERVICE (PAAS) FEATURING COMPUTER SOFTWARE PLATFORMS FOR UTILITY DATA MANAGEMENT AND ANALYSIS (U.S. CLS. 100 AND 101).

FIRST USE 4-0-2010; IN COMMERCE 1-0-2011.

MARIA-VICTORIA SUAREZ, EXAMINING ATTORNEY

**CLASS 42—(Continued).**

SN 85-288,694. RPX CORPORATION, SAN FRANCISCO, CA. FILED 4-7-2011.

**PRIORSMART**

THE MARK CONSISTS OF STANDARD CHARACTERS WITHOUT CLAIM TO ANY PARTICULAR FONT, STYLE, SIZE, OR COLOR.

FOR COMPUTER SERVICES, NAMELY, PROVIDING SEARCH ENGINES FOR OBTAINING DATA ON A GLOBAL COMPUTER NETWORK; SEARCHING AND RETRIEVING INFORMATION, SITES, AND OTHER RESOURCES AVAILABLE ON COMPUTER NETWORKS FOR OTHERS (U.S. CLS. 100 AND 101).

KELLY TRUSILO, EXAMINING ATTORNEY

SN 85-289,490. NATIONAL RISK SERVICES, INC., GLEN ROCK, NJ. FILED 4-7-2011.

**Adjuster Assistant**

THE MARK CONSISTS OF STANDARD CHARACTERS WITHOUT CLAIM TO ANY PARTICULAR FONT, STYLE, SIZE, OR COLOR.

NO CLAIM IS MADE TO THE EXCLUSIVE RIGHT TO USE "ADJUSTER", APART FROM THE MARK AS SHOWN.

FOR PROVIDING TEMPORARY USE OF ONLINE NON-DOWNLOADABLE SOFTWARE FOR CONTRACTED CLAIMS MANAGEMENT (U.S. CLS. 100 AND 101).

FIRST USE 11-22-2010; IN COMMERCE 1-21-2011.

MARK SPARACINO, EXAMINING ATTORNEY

SN 85-289,994. ADVERTAS, LLC, HOUSTON, TX. FILED 4-8-2011.

**FileSpring**

THE MARK CONSISTS OF STANDARD CHARACTERS WITHOUT CLAIM TO ANY PARTICULAR FONT, STYLE, SIZE, OR COLOR.

FOR PROVIDING A SECURED-ACCESS MEMBERS ONLY WEBSITE FEATURING TECHNOLOGY THAT GIVES REGISTERED INTERNET USERS THE ABILITY TO VIEW, DOWNLOAD, AND UPLOAD FILES OF ANY TYPE AND SIZE FOR THE PURPOSE OF SHARING INFORMATION ABOUT AN ENTERPRISE, WHERE THE ACCESS PRIVILEGES FOR ANY INDIVIDUAL USER OR GROUPS OF USERS MAY BE SYSTEMATICALLY SET THROUGH A WEBSITE ADMINISTRATION TOOL (U.S. CLS. 100 AND 101).

FIRST USE 3-16-2011; IN COMMERCE 3-16-2011.

ERIN FALK, EXAMINING ATTORNEY

**CLASS 42—(Continued).**

SN 85-291,319. YALE UNIVERSITY, NEW HAVEN, CT.  
FILED 4-11-2011.

# Play2Prevent

THE MARK CONSISTS OF STANDARD CHARACTERS WITHOUT CLAIM TO ANY PARTICULAR FONT, STYLE, SIZE, OR COLOR.

FOR VIDEO GAME DESIGN AND DEVELOPMENT SERVICES (U.S. CLS. 100 AND 101).

FIRST USE 9-0-2010; IN COMMERCE 9-0-2010.  
SHARON MEIER, EXAMINING ATTORNEY

**CLASS 42—(Continued).**

SN 85-294,366. CONCERNTRAK, LLC, RICHMOND, VA.  
FILED 4-13-2011.

# ConcernTrak

THE MARK CONSISTS OF STANDARD CHARACTERS WITHOUT CLAIM TO ANY PARTICULAR FONT, STYLE, SIZE, OR COLOR.

FOR PROVIDING TEMPORARY USE OF ONLINE NON-DOWNLOADABLE SOFTWARE FOR TRACKING FREIGHT AND FOR MONITORING THE PERFORMANCE BY SUPPLIERS OF A WIDE VARIETY OF PRODUCTS (U.S. CLS. 100 AND 101).

FIRST USE 4-30-2010; IN COMMERCE 4-30-2010.  
MARK SPARACINO, EXAMINING ATTORNEY

SN 85-293,040. SYNDICIT SERVICES CORPORATION, WIMBERLEY, TX. FILED 4-12-2011.



NO CLAIM IS MADE TO THE EXCLUSIVE RIGHT TO USE "LEASE", APART FROM THE MARK AS SHOWN.

THE COLOR(S) BLACK, WHITE, SILVER AND YELLOW IS/ARE CLAIMED AS A FEATURE OF THE MARK.

THE MARK CONSISTS OF THE WORDING "LEASE" IN LOWER CASE BLACK LETTERS WITH THE "L" CAPITALIZED AND THE WORDING "IT" IN UPPER CASE WHITE LETTERS SURROUNDED BY A CIRCLE IN VARYING SHADES OF SILVER, ALL OF WHICH IS SURROUNDED BY A YELLOW RECTANGLE WITH CURVED CORNERS.

FOR COMPUTER PROGRAMMING SERVICES, NAMELY, FOR APPLICATION SERVICE PROVIDER (ASP) FEATURING A DIGITAL LEASE LIBRARY AND LEASE DOCUMENT PREPARATION AND MANAGEMENT SYSTEM FOR RESIDENTIAL RENTAL PROPERTY OPERATORS (U.S. CLS. 100 AND 101).

FIRST USE 2-10-2010; IN COMMERCE 11-8-2010.  
SUSAN STIGLITZ, EXAMINING ATTORNEY

SN 85-295,847. UTSTARCOM, INC., ALAMEDA, CA. FILED 4-14-2011.



OWNER OF U.S. REG. NOS. 3,257,655, 3,259,483 AND 3,406,764.

THE MARK CONSISTS OF THE LETTERS "UT" IN AN INCOMPLETE CIRCLE, FOLLOWED BY THE LETTERS "STARCOM", WITH THE OPEN SPACE IN THE LETTER "A" REPRESENTED BY A FOUR-POINTED STAR.

THE WORDING "UTSTARCOM" HAS NO MEANING IN A FOREIGN LANGUAGE.

FOR COMPUTER SOFTWARE CONSULTANCY; COMPUTER SOFTWARE DESIGN; CONSULTATION SERVICES IN THE FIELDS OF SELECTION, IMPLEMENTATION AND USE OF COMPUTER HARDWARE AND SOFTWARE SYSTEMS FOR OTHERS; DESIGN OF TELECOMMUNICATIONS APPARATUS AND EQUIPMENT; HOSTING THE WEB SITES OF OTHERS ON A COMPUTER SERVER FOR A GLOBAL COMPUTER NETWORK; INSTALLATION OF COMPUTER SOFTWARE (U.S. CLS. 100 AND 101).

ALLISON HOLTZ, EXAMINING ATTORNEY

**CLASS 42—(Continued).**

SN 85-297,637. ACCREDITATION SERVICES BUREAU, DBA INSPECTION SERVICES ACCREDITATION BUREAU, FORT WAYNE, IN. FILED 4-18-2011.



NO CLAIM IS MADE TO THE EXCLUSIVE RIGHT TO USE "INSPECTION SERVICES ACCREDITATION BUREAU", APART FROM THE MARK AS SHOWN.

THE COLOR(S) RED AND BLACK IS/ARE CLAIMED AS A FEATURE OF THE MARK.

THE MARK CONSISTS OF A DESIGN OF A ROUND MAGNIFYING GLASS WITH A HANDLE, THE MAGNIFYING GLASS IS IN BLACK WITH AN INNER HALF CIRCLE WITHIN THE RIGHT SECTION OF THE EYEPIECE IN RED. THE HANDLE OF THE MAGNIFYING GLASS IS BLACK WITH EACH END OF THE HANDLE IN RED. THE WORDS "INSPECTION SERVICES ACCREDITATION BUREAU" ARE IN BLACK. THE COLOR WHITE REPRESENTS BACKGROUND AND IS NOT PART OF THE MARK.

FOR ACCREDITATION SERVICES, NAMELY, EVALUATING ORGANIZATIONS TO DETERMINE WHETHER THE ORGANIZATIONS CONFORM TO AN ESTABLISHED STANDARD (U.S. CLS. 100 AND 101).

FIRST USE 4-1-2011; IN COMMERCE 4-1-2011.

BRIAN NEVILLE, EXAMINING ATTORNEY

---

SN 85-299,699. ROCKFISH INTERACTIVE CORPORATION, ROGERS, AR. FILED 4-20-2011.

||||| COUPONFACTORY

THE MARK CONSISTS OF SEVEN VERTICAL LINES THAT SYMBOLIZE A BAR CODE WITH THE WORD "COUPONFACTORY" TO THE IMMEDIATE RIGHT OF THE VERTICAL LINES.

FOR PROVIDING AN ONLINE DIGITAL PORTAL FEATURING TECHNOLOGY THAT ALLOWS USERS TO CREATE, MANAGE, ANALYZE AND DISTRIBUTE PROMOTIONAL OFFERS, COUPONS AND DISCOUNTS THROUGH ELECTRONIC AND WIRELESS CHANNELS (U.S. CLS. 100 AND 101).

FIRST USE 3-20-2011; IN COMMERCE 3-20-2011.

ANNE FARRELL, EXAMINING ATTORNEY

**CLASS 42—(Continued).**

SN 85-299,713. TAPIT PARTNERS LLC, HEALDSBURG, CA. FILED 4-20-2011.

**captina**

THE MARK CONSISTS OF STANDARD CHARACTERS WITHOUT CLAIM TO ANY PARTICULAR FONT, STYLE, SIZE, OR COLOR.

FOR PROVIDING AN ONLINE NON-DOWNLOADABLE INTERNET-BASED SYSTEM APPLICATION FEATURING TECHNOLOGY ENABLING USERS TO MANAGE AND OPERATE A SMALL BUSINESS, NAMELY, GENERATION AND TRACKING OF REVENUE, MARKETING, INVENTORY, CUSTOMER RELATIONSHIP MANAGEMENT, CUSTOMER SERVICE, EMPLOYEE TRACKING AND TIME KEEPING, BUSINESS AND RELATED REPORTING, ORDER FULFILLMENT, AND PAYMENT PROCESSING (U.S. CLS. 100 AND 101).

FIRST USE 5-18-2010; IN COMMERCE 5-18-2010.

SAMUEL E. SHARPER JR., EXAMINING ATTORNEY

---

SN 85-300,502. BENTLEY 3 TECHNOLOGIES, INC., ENCINITAS, CA. FILED 4-20-2011.

**BLAST POWER FACTOR**

THE MARK CONSISTS OF STANDARD CHARACTERS WITHOUT CLAIM TO ANY PARTICULAR FONT, STYLE, SIZE, OR COLOR.

FOR COMPUTER SERVICES, NAMELY, MONITORING THE PERFORMANCE OF PARTICIPANTS AT SPORTING EVENTS BY TRACKING A COMPUTER CHIP WORN BY A SPORTING PARTICIPANT; MEASUREMENT EVALUATIONS IN THE FIELD OF MOTION TRACKING, POSITION AND ORIENTATION SENSING (U.S. CLS. 100 AND 101).

WON TEAK OH, EXAMINING ATTORNEY

---

SN 85-300,513. BENTLEY 3 TECHNOLOGIES, INC., ENCINITAS, CA. FILED 4-20-2011.

**BLAST POWER NUMBER**

THE MARK CONSISTS OF STANDARD CHARACTERS WITHOUT CLAIM TO ANY PARTICULAR FONT, STYLE, SIZE, OR COLOR.

FOR COMPUTER SERVICES, NAMELY, MONITORING THE PERFORMANCE OF PARTICIPANTS AT SPORTING EVENTS BY TRACKING A COMPUTER CHIP WORN BY A SPORTING PARTICIPANT; MEASUREMENT EVALUATIONS IN THE FIELD OF MOTION TRACKING, POSITION AND ORIENTATION SENSING (U.S. CLS. 100 AND 101).

WON TEAK OH, EXAMINING ATTORNEY

**CLASS 42—(Continued).**

SN 85-301,526. MCGIBNEY, JAMES, LAS VEGAS, NV. FILED 4-21-2011.

**Cheaterville.com - look  
who's getting caught with  
their pants down**

THE MARK CONSISTS OF STANDARD CHARACTERS WITHOUT CLAIM TO ANY PARTICULAR FONT, STYLE, SIZE, OR COLOR.

FOR COMPUTER SERVICES, NAMELY, CREATING AN ON-LINE COMMUNITY FOR REGISTERED USERS TO PARTICIPATE IN DISCUSSIONS, GET FEEDBACK FROM THEIR PEERS, FORM VIRTUAL COMMUNITIES, AND ENGAGE IN SOCIAL NETWORKING (U.S. CLS. 100 AND 101).

JESSICA FATHY, EXAMINING ATTORNEY

SN 85-301,861. PUBLISHING RESOURCES INC., CRANBURY, NJ. FILED 4-22-2011.

**shipmentHQ**

THE COLOR(S) BLACK, BLUE, AND LIGHT BLUE IS/ARE CLAIMED AS A FEATURE OF THE MARK.

THE MARK CONSISTS OF THE WORDING "SHIPMENTHQ" IN STYLIZED FORM WITH THE LETTERS "SHIPMENT" IN BLACK, THE SECOND "H" IN BLUE, AND THE "Q" IN LIGHT BLUE.

FOR PROVIDING A WEB SITE FEATURING TEMPORARY USE OF NON-DOWNLOADABLE SOFTWARE FOR ANALYTICS, REPORTING, AND AUDITING OF SHIPMENTS; PROVIDING TEMPORARY USE OF A WEB-BASED SOFTWARE APPLICATION FOR ANALYTICS, REPORTING, AND AUDITING OF SHIPMENTS (U.S. CLS. 100 AND 101).

FIRST USE 1-0-2010; IN COMMERCE 1-0-2010.  
ALLISON HOLTZ, EXAMINING ATTORNEY

SN 85-303,116. DAY, JAMES R, DBA CYBERTRONICS, NEW BOSTON, TX. FILED 4-24-2011.

**Cybertronics**

THE MARK CONSISTS OF STANDARD CHARACTERS WITHOUT CLAIM TO ANY PARTICULAR FONT, STYLE, SIZE, OR COLOR.

THE WORDING "CYBERTRONICS" HAS NO MEANING IN A FOREIGN LANGUAGE.

FOR DESIGN, CREATION, HOSTING, MAINTENANCE OF WEBSITES FOR OTHERS; REMOTE ONLINE BACKUP OF COMPUTER DATA (U.S. CLS. 100 AND 101).

FIRST USE 5-6-1996; IN COMMERCE 5-6-1996.  
ERIN FALK, EXAMINING ATTORNEY

**CLASS 42—(Continued).**

SN 85-303,188. SCIENTIFIC CONSERVATION INC., ATLANTA, GA. FILED 4-25-2011.

**SCITRACK**

THE MARK CONSISTS OF STANDARD CHARACTERS WITHOUT CLAIM TO ANY PARTICULAR FONT, STYLE, SIZE, OR COLOR.

FOR REPORTING AND ANALYTICS FEATURE OF SOFTWARE AS A SERVICE (SAAS) SERVICES FEATURING SOFTWARE FOR AUTOMATIC FINANCIAL AND COST DATA COLLECTION, TRACKING AND ANALYTICS IN THE FIELD OF ENERGY-EFFICIENCY AND SYSTEM-OPTIMIZATION FOR THE COMMERCIAL BUILDING MARKET (U.S. CLS. 100 AND 101).

KEVIN CORWIN, EXAMINING ATTORNEY

SN 85-303,189. SCIENTIFIC CONSERVATION INC., ATLANTA, GA. FILED 4-25-2011.

**SCITRACK PLUS**

THE MARK CONSISTS OF STANDARD CHARACTERS WITHOUT CLAIM TO ANY PARTICULAR FONT, STYLE, SIZE, OR COLOR.

FOR REPORTING AND ANALYTICS FEATURE OF SOFTWARE AS A SERVICE (SAAS) SERVICES FEATURING SOFTWARE FOR AUTOMATIC FINANCIAL AND COST DATA COLLECTION, TRACKING AND ANALYTICS IN THE FIELD OF ENERGY-EFFICIENCY AND SYSTEM-OPTIMIZATION FOR THE COMMERCIAL BUILDING MARKET (U.S. CLS. 100 AND 101).

KEVIN CORWIN, EXAMINING ATTORNEY

SN 85-303,190. SCIENTIFIC CONSERVATION INC., ATLANTA, GA. FILED 4-25-2011.

**SCIAUDIT**

THE MARK CONSISTS OF STANDARD CHARACTERS WITHOUT CLAIM TO ANY PARTICULAR FONT, STYLE, SIZE, OR COLOR.

FOR REPORTING AND ANALYTICS FEATURE OF SOFTWARE AS A SERVICE (SAAS) SERVICES FEATURING SOFTWARE FOR AUTOMATIC FINANCIAL AND COST DATA COLLECTION, TRACKING AND ANALYTICS IN THE FIELD OF ENERGY-EFFICIENCY AND SYSTEM-OPTIMIZATION FOR THE COMMERCIAL BUILDING MARKET (U.S. CLS. 100 AND 101).

KEVIN CORWIN, EXAMINING ATTORNEY



**CLASS 42—(Continued).**

SN 85-304,819. COMFORT REVOLUTION, LLC, EATON-TOWN, NJ. FILED 4-26-2011.

---

REVOLUTIONARY THINK TANK

THE MARK CONSISTS OF STANDARD CHARACTERS WITHOUT CLAIM TO ANY PARTICULAR FONT, STYLE, SIZE, OR COLOR.

FOR RESEARCH AND DEVELOPMENT IN THE FIELD OF SLEEP PRODUCTS (U.S. CLS. 100 AND 101).  
DOUGLAS LEE, EXAMINING ATTORNEY

---

SN 85-306,838. ERNEST, PAUL, MCKINNEY, TX. FILED 4-28-2011.

TELL PEOPLE YOU KNOW

THE MARK CONSISTS OF STANDARD CHARACTERS WITHOUT CLAIM TO ANY PARTICULAR FONT, STYLE, SIZE, OR COLOR.

FOR PROVIDING A WEBSITE FEATURING NON-DOWNLOADABLE SOFTWARE FOR CREATING ADVERTISING AND MARKETING MATERIALS (U.S. CLS. 100 AND 101).

FIRST USE 4-0-2008; IN COMMERCE 4-0-2008.  
LOURDES AYALA, EXAMINING ATTORNEY

---

SN 85-308,182. HARDWOOD PLYWOOD AND VENEER ASSOCIATION, RESTON, VA. FILED 4-29-2011.



OWNER OF U.S. REG. NOS. 3,355,888, 3,387,930 AND OTHERS.

THE MARK CONSISTS OF TWO CONCENTRIC CIRCLES. INSIDE THE UPPER PORTION OF THE RING BETWEEN THE TWO CIRCLES IS THE STYLIZED TEXT "ANSI/HPVA" AND IN THE BOTTOM PORTION OF THE RING IS THE STYLIZED TEXT "EF 2011". INSIDE BOTH SIDES OF THE RING AT 3 O'CLOCK AND 9 O'CLOCK IS A STAR. INSIDE THE INNER CIRCLE IS A STYLIZED HARDWOOD TREE.

FOR TESTING, ANALYSIS, AND EVALUATION OF THE ENGINEERED WOOD FLOORING OF OTHERS FOR THE PURPOSE OF CERTIFICATION (U.S. CLS. 100 AND 101).

DEIRDRE ROBERTSON, EXAMINING ATTORNEY

**CLASS 42—(Continued).**

SN 85-308,252. CASTLE CONSULTING PLLC, AUSTIN, TX. FILED 4-29-2011.

# SolidBox

THE MARK CONSISTS OF STANDARD CHARACTERS WITHOUT CLAIM TO ANY PARTICULAR FONT, STYLE, SIZE, OR COLOR.

FOR CUSTOMIZATION OF COMPUTER HARDWARE AND SOFTWARE; ENGINEERING; INSTALLATION, MAINTENANCE AND REPAIR OF COMPUTER SOFTWARE (U.S. CLS. 100 AND 101).

FIRST USE 10-27-2009; IN COMMERCE 10-27-2009.  
JOHN GARTNER, EXAMINING ATTORNEY

---

SN 85-309,824. FREEFIND.COM, SANTA CRUZ, CA. FILED 5-2-2011.

# FREEFIND

THE MARK CONSISTS OF STANDARD CHARACTERS WITHOUT CLAIM TO ANY PARTICULAR FONT, STYLE, SIZE, OR COLOR.

FOR COMPUTER SERVICES, NAMELY, PROVIDING ONLINE NON-DOWNLOADABLE SOFTWARE FOR USE IN CREATING SEARCH ENGINES AND SITE MAPS FOR SEARCHING THE WEB SITES OF OTHERS, PROVIDING SEARCH ENGINES FOR OBTAINING DATA ON A GLOBAL COMPUTER NETWORK, MAINTAINING WEB SITES FOR OTHERS, IMPLEMENTING WEB SITES FOR OTHERS, AND HOSTING THE WEB SITES OF OTHERS ON A COMPUTER SERVER FOR A GLOBAL COMPUTER NETWORK (U.S. CLS. 100 AND 101).

FIRST USE 5-14-1998; IN COMMERCE 5-14-1998.  
SAIMA MAKHDOOM, EXAMINING ATTORNEY

---

SN 85-309,908. ANTOINETTE AGUILAR, AKA TOINE AGUILAR, WASHINGTON, DC. FILED 5-2-2011.



NO CLAIM IS MADE TO THE EXCLUSIVE RIGHT TO USE "FASHIONS", APART FROM THE MARK AS SHOWN.

THE COLOR(S) PINK, BLACK IS/ARE CLAIMED AS A FEATURE OF THE MARK.

THE MARK CONSISTS OF THE LETTERS "AMA"



**CLASS 42—(Continued).**

SPELLED OUT, IN THE MIDDLE THE "M" IS COMBINED WITH A HEART AND THE "M" IS FILLED WITH THE COLOR PINK. THE BOTTOM OF THE HEART IS FILLED WITH BLACK DIRECTLY UNDERNEATH THE "M". UNDERNEATH THE "AMA" TOWARD THE BOTTOM RIGHT HAND SIDE THE WORD "FASHIONS" IS SPELLED OUT IN BLACK AND OUTLINED WITH PINK. THE WHITE BACKGROUND, INCLUDING THE WHITE CENTER OF THE HEART DESIGN, IS NOT CLAIMED AS PART OF THE MARK.

FOR CUSTOM DESIGN OF APPAREL BASED ON PERSONAL SELECTIONS MADE BY THE CUSTOMER (U.S. CLS. 100 AND 101).

DORITT L. CARROLL, EXAMINING ATTORNEY

**CLASS 42—(Continued).**

SN 85-312,817. FORRST, LLC, NEW YORK, NY. FILED 5-5-2011.



THE MARK CONSISTS OF THE WORD "FORRST" APPEARING TO THE RIGHT OF A TRIANGULAR TREE WITH A TRUNK.

FOR PROVIDING A WEBSITE FEATURING INFORMATION IN THE FIELD OF DEVELOPMENT AND DESIGN OF WEBSITES AND OF SOFTWARE; COMPUTER SERVICES, NAMELY, CREATING AN ON-LINE COMMUNITY FOR REGISTERED USERS TO PARTICIPATE IN DISCUSSIONS, GET FEEDBACK FROM THEIR PEERS, FORM VIRTUAL COMMUNITIES, AND ENGAGE IN SOCIAL NETWORKING IN THE FIELD OF DEVELOPMENT AND DESIGN OF WEBSITES AND OF SOFTWARE (U.S. CLS. 100 AND 101).

FIRST USE 2-1-2010; IN COMMERCE 5-1-2010.  
FONG HSU, EXAMINING ATTORNEY

SN 85-310,317. P. R. B. CORP., COLORADO SPRINGS, CO. FILED 5-2-2011.

## Springs Hosting

THE MARK CONSISTS OF STANDARD CHARACTERS WITHOUT CLAIM TO ANY PARTICULAR FONT, STYLE, SIZE, OR COLOR.

NO CLAIM IS MADE TO THE EXCLUSIVE RIGHT TO USE "HOSTING", APART FROM THE MARK AS SHOWN.

FOR COMPUTER SERVICE, NAMELY, ACTING AS AN APPLICATION SERVICE PROVIDER IN THE FIELD OF KNOWLEDGE MANAGEMENT TO HOST COMPUTER APPLICATION SOFTWARE FOR CREATING SEARCHABLE DATABASES OF INFORMATION AND DATA; COMPUTER SERVICES, NAMELY, MANAGING WEB SITES FOR OTHERS; HOSTING OF DIGITAL CONTENT ON THE INTERNET; HOSTING THE WEB SITES OF OTHERS ON A COMPUTER SERVER FOR A GLOBAL COMPUTER NETWORK; RENTAL OF WEB SERVERS; WEB SITE HOSTING SERVICES (U.S. CLS. 100 AND 101).

FIRST USE 1-15-2006; IN COMMERCE 1-15-2006.  
KELLY TRUSILO, EXAMINING ATTORNEY

SN 85-313,585. MINUS -10 SOFTWARE, LLC, CINCINNATI, OH. FILED 5-5-2011.



SN 85-311,906. QUIRING MONUMENTS, INC., SEATTLE, WA. FILED 5-4-2011.

## LIVING HEADSTONE

THE MARK CONSISTS OF STANDARD CHARACTERS WITHOUT CLAIM TO ANY PARTICULAR FONT, STYLE, SIZE, OR COLOR.

NO CLAIM IS MADE TO THE EXCLUSIVE RIGHT TO USE "HEADSTONE", APART FROM THE MARK AS SHOWN.

FOR DESIGNING, CREATING, MAINTAINING AND HOSTING PERSONAL MEMORIAL WEB PAGES FOR OTHERS (U.S. CLS. 100 AND 101).

AMY HELLA, EXAMINING ATTORNEY

NO CLAIM IS MADE TO THE EXCLUSIVE RIGHT TO USE "SOFTWARE", APART FROM THE MARK AS SHOWN.

THE MARK CONSISTS OF THE ROMAN NUMERALS 0 AND X IN LARGE PRINT, WITH THE WORDING "MINUS -10" ABOVE AND THE WORDING "SOFTWARE" BELOW THE ROMAN NUMERALS AND WITH BARS OR LINES ABOVE AND BELOW EACH OF THE WORDINGS.

FOR DESIGN, DEVELOPMENT, AND CONSULTING SERVICES RELATED THERETO IN THE FIELD OF SOFTWARE FOR FILING BANKRUPTCY FORMS (U.S. CLS. 100 AND 101).

FIRST USE 5-8-2008; IN COMMERCE 10-18-2009.  
JENNIFER MARTIN, EXAMINING ATTORNEY

**CLASS 42—(Continued).**

SN 85-313,604. MILLCREEK ENGINEERING COMPANY, SALT LAKE CITY, UT. FILED 5-5-2011.

**MILLCREEK ENGINEERING**

THE MARK CONSISTS OF STANDARD CHARACTERS WITHOUT CLAIM TO ANY PARTICULAR FONT, STYLE, SIZE, OR COLOR.

NO CLAIM IS MADE TO THE EXCLUSIVE RIGHT TO USE "ENGINEERING", APART FROM THE MARK AS SHOWN.

SEC. 2(F).

FOR ENGINEERING SERVICES IN THE FIELD OF MECHANICAL, ELECTRICAL AND PLUMBING DESIGN FOR COMMERCIAL AND INDUSTRIAL PROJECTS (U.S. CLS. 100 AND 101).

FIRST USE 7-21-1997; IN COMMERCE 7-21-1997.  
EDWARD FENNESSY, EXAMINING ATTORNEY

SN 85-314,166. LED SOURCE LLC, WELLINGTON, FL. FILED 5-6-2011.



OWNER OF U.S. REG. NOS. 3,713,570 AND 3,951,763.  
NO CLAIM IS MADE TO THE EXCLUSIVE RIGHT TO USE "LED SOURCE", APART FROM THE MARK AS SHOWN.

THE MARK CONSISTS OF THE WORD "LED" APPEARING ABOVE THE WORD "SOURCE" WITH A STYLIZED CHARACTER OF AN "LED" BULB ALSO APPEARING ABOVE THE WORD "SOURCE".

FOR LIGHTING DESIGN SERVICES RELATING TO THE DESIGN OF LED LIGHTING SYSTEMS IN BOTH NEW CONSTRUCTION AND RETROFIT APPLICATIONS (U.S. CLS. 100 AND 101).

FIRST USE 12-1-2009; IN COMMERCE 12-1-2009.  
KELLEY WELLS, EXAMINING ATTORNEY

**CLASS 42—(Continued).**

SN 85-314,582. MARKETALKNOW.COM, HAYMARKET, VA. FILED 5-6-2011.

**MarketTalkNow**

THE MARK CONSISTS OF STANDARD CHARACTERS WITHOUT CLAIM TO ANY PARTICULAR FONT, STYLE, SIZE, OR COLOR.

FOR PROVIDING A MEDIA RELATIONS WEBSITE FOR REGISTERED USERS, NAMELY, JOURNALISTS AND FINANCIAL INDUSTRY SOURCES, FEATURING TECHNOLOGY THAT ENABLES USERS TO CONNECT WITH EACH OTHER FOR INTERVIEWS (U.S. CLS. 100 AND 101).

GINA FINK, EXAMINING ATTORNEY

SN 85-315,439. BANDIT SOFTWARE, LLC, NASHVILLE, TN. FILED 5-9-2011.



THE MARK CONSISTS OF A CIRCLE, RINGED BY SQUARES. LOOKS A LITTLE LIKE A SUN OR A FLOWER, OR CHAIRS SEATED AROUND A ROUND TABLE FROM ABOVE. STYLIZED TEXT "LEANKIT" ALONGSIDE.

FOR PROVIDING TEMPORARY USE OF A WEB-BASED SOFTWARE APPLICATION FOR USE IN PROJECT MANAGEMENT (U.S. CLS. 100 AND 101).

FIRST USE 4-1-2009; IN COMMERCE 4-4-2011.  
PAM WILLIS, EXAMINING ATTORNEY

SN 85-319,244. THEOREM CLINICAL RESEARCH, INC., KING OF PRUSSIA, PA. FILED 5-12-2011.



NO CLAIM IS MADE TO THE EXCLUSIVE RIGHT TO USE "CLINICAL RESEARCH", APART FROM THE MARK AS SHOWN.

THE MARK CONSISTS OF THE WORDING "THEOREM" OVER A BAR DEVICE OVER THE WORDING "THEOREM CLINICAL RESEARCH", ALL OF THE WORDING IN STYLIZED UPPER CASE LETTERING.

FOR PROVIDING CLINICAL TRIAL SERVICES FOR OTHERS IN THE FIELD OF PHARMACEUTICALS, BIOTECHNOLOGY, AND MEDICAL DEVICE RESEARCH (U.S. CLS. 100 AND 101).

FIRST USE 6-16-2011; IN COMMERCE 6-16-2011.  
JENNY PARK, EXAMINING ATTORNEY

**CLASS 42—(Continued).**

SN 85-320,182. TENORIO DESIGN, INC., COOPER CITY, FL. FILED 5-13-2011.

# TENORIO

THE MARK CONSISTS OF STANDARD CHARACTERS WITHOUT CLAIM TO ANY PARTICULAR FONT, STYLE, SIZE, OR COLOR.

THE ENGLISH TRANSLATION OF "TENORIO" IN THE MARK IS "LADY KILLER" OR "WOMANIZER".

FOR INTERIOR AND ARCHITECTURAL DESIGN SERVICES (U.S. CLS. 100 AND 101).

MATTHEW PAPPAS, EXAMINING ATTORNEY

**CLASS 42—(Continued).**

SN 85-321,754. SMT—RAIL CORP., FREMONT, CA. FILED 5-16-2011.

SN 85-321,519. INHIBRX, LLC, LA JOLLA, CA. FILED 5-16-2011.

# INHIBRX

# *SMT* *Rail*

THE MARK CONSISTS OF STANDARD CHARACTERS WITHOUT CLAIM TO ANY PARTICULAR FONT, STYLE, SIZE, OR COLOR.

FOR RESEARCH AND DEVELOPMENT OF THERAPEUTIC ANTIBODIES AND PHARMACEUTICALS, AND RESEARCH AND DEVELOPMENT OF TECHNOLOGY IN THE FIELD OF THERAPEUTIC ANTIBODIES AND PHARMACEUTICALS (U.S. CLS. 100 AND 101).

FIRST USE 11-5-2009; IN COMMERCE 11-5-2009.

SAMUEL E. SHARPER JR., EXAMINING ATTORNEY

SN 85-321,526. INHIBRX, LLC, LA JOLLA, CA. FILED 5-16-2011.

# IDEA TO DRUG

THE MARK CONSISTS OF STANDARD CHARACTERS WITHOUT CLAIM TO ANY PARTICULAR FONT, STYLE, SIZE, OR COLOR.

FOR RESEARCH AND DEVELOPMENT OF THERAPEUTIC ANTIBODIES AND PHARMACEUTICALS, AND RESEARCH AND DEVELOPMENT OF TECHNOLOGY IN THE FIELD OF THERAPEUTIC ANTIBODIES AND PHARMACEUTICALS (U.S. CLS. 100 AND 101).

FIRST USE 12-0-2010; IN COMMERCE 12-0-2010.

SAMUEL E. SHARPER JR., EXAMINING ATTORNEY

NO CLAIM IS MADE TO THE EXCLUSIVE RIGHT TO USE "RAIL", APART FROM THE MARK AS SHOWN.

THE MARK CONSISTS OF THE STYLIZED TEXT "SMT" A DESIGN OF A RAIL AND THE WORD "RAIL".

FOR ENGINEERING SERVICES IN THE FIELD OF MASS TRANSIT; ARCHITECTURAL DESIGN SERVICES IN THE FIELD OF MASS TRANSIT; STRUCTURAL ENGINEERING DESIGN SERVICES RELATED TO MASS TRANSIT (U.S. CLS. 100 AND 101).

TAMARA FRAZIER, EXAMINING ATTORNEY

**CLASS 42—(Continued).**

SN 85-322,164. MYTIMESCORE, INC., DBA MYTIMESCORE, PLANO, TX. FILED 5-16-2011.



THE MARK CONSISTS OF THE WORDING "MYTIMESCORE" IN A STYLIZED FONT. IT HAS CLOCK HANDS AS PART OF THE "M" IN "MY", CLOCK HANDS FOR THE "T" IN "TIME", AND "SCORE". THE WORDING SHOWS A CLOCK WHOSE CLOCK HANDS ARE THE "T", AND CLOCK SHOWS ONLY THE NUMBERS "3", "6", "9", AND "12".

FOR APPLICATION SERVICE PROVIDER (ASP) FEATURING SOFTWARE FOR USE IN COLLECTION, RECORDING, VERIFICATION, AGGREGATION, ANALYSIS, AND REPORTING AND/OR COMMUNICATION OF TIME, ACTIVITY, INTERESTS, EXPENSES, APPOINTMENTS, AND ALL RELATED INFORMATION, IN PROVIDING AN ON-LINE DATABASE IN THE FIELD OF TRANSACTION PROCESSING TO UPLOAD TRANSACTIONAL DATA, PROVIDE STATISTICAL ANALYSIS, AND PRODUCE NOTIFICATIONS AND REPORTS; CLOUD COMPUTING FEATURING SOFTWARE FOR USE IN COLLECTION, RECORDING, VERIFICATION, AGGREGATION, ANALYSIS, AND REPORTING AND/OR COMMUNICATION OF TIME, ACTIVITY, INTERESTS, EXPENSES, APPOINTMENTS, AND ALL RELATED INFORMATION, IN PROVIDING AN ON-LINE DATABASE IN THE FIELD OF TRANSACTION PROCESSING TO UPLOAD TRANSACTIONAL DATA, PROVIDE STATISTICAL ANALYSIS, AND PRODUCE NOTIFICATIONS AND REPORTS; CONSULTING SERVICES IN THE FIELD OF HOSTING COMPUTER SOFTWARE APPLICATIONS; CONSULTING SERVICES IN THE FIELD OF SOFTWARE AS A SERVICE (SAAS); PROVIDING A WEBSITE FEATURING TECHNOLOGY THAT ENABLES USERS TO ENABLE COMPANIES AND ORGANIZATIONS TO ADMINISTER AND MANAGE MEMBER INCENTIVE AWARD PROGRAMS AND TO PROMOTE PRODUCTIVITY, PERFORMANCE, RECOGNITION AND MORALE.; SOFTWARE AS A SERVICE (SAAS) SERVICES, NAMELY, HOSTING SOFTWARE FOR USE BY OTHERS FOR USE IN COLLECTION, RECORDING, VERIFICATION, AGGREGATION, ANALYSIS, AND REPORTING AND/OR COMMUNICATION OF TIME, ACTIVITY, INTERESTS, EXPENSES, APPOINTMENTS, AND ALL RELATED INFORMATION (U.S. CLS. 100 AND 101).

FIRST USE 5-6-2011; IN COMMERCE 5-6-2011.  
DOMINIC J. FERRAIUOLO, EXAMINING ATTORNEY

**CLASS 42—(Continued).**

SN 85-322,321. WEBTECH OMEGA, LLC, NEENAH, WI. FILED 5-16-2011.



THE MARK CONSISTS OF THE STYLIZED LETTERS "WO". THE "W" IS CONNECTED TO THE "O" BY A LINE AT THE TOP OF THE LETTERS. THE "O" HAS A CIRCULAR DESIGN IN THE MIDDLE LIKE A ROLL OF PAPER, AND HAS A LINE COMING FROM THE RIGHT SIDE LIKE SOME OF THE PAPER HAS UNROLLED. THE LETTERS ARE FRAMED ON THE LEFT AND BOTTOM BY A LINE.

FOR CONSULTING IN THE FIELD OF ENGINEERING (U.S. CLS. 100 AND 101).  
JAMES GRIFFIN, EXAMINING ATTORNEY

SN 85-322,332. RED I WEAR, LLC, SAN DIEGO, CA. FILED 5-16-2011.



THE MARK CONSISTS OF STYLIZED LETTER "I" COMPRISED OF DESIGN OF AN EYEBALL CONSISTING OF THREE CIRCLES ON TOP, AN OVERALL RECTANGLE SHAPE WITH A PARTIAL CIRCLE IN THE MIDDLE AND A SMALL TRAY-LIKE RECTANGLE ON THE BOTTOM.

FOR HOSTING AN ON-LINE COMMUNITY WEB SITE FEATURING NETWORKING, COMPETING AND RANKINGS IN THE FIELD OF GAMES AND SOCIAL BENCHMARK BETWEEN MEMBERS; PROVIDING A WEB SITE FEATURING TECHNOLOGY THAT ENABLES INTERNET USERS TO SHARE DOCUMENTS, IMAGES AND VIDEOS; PROVIDING A WEBSITE THAT GIVES USERS THE ABILITY TO CREATE CUSTOMIZED WEB PAGES FEATURING USER-DEFINED INFORMATION; PROVIDING A WEBSITE THAT GIVES USERS THE ABILITY TO CREATE CUSTOMIZED WEB PAGES FEATURING USER-DEFINED PROFILES (U.S. CLS. 100 AND 101).

SALLY SHIH, EXAMINING ATTORNEY

**CLASS 42—(Continued).**

SN 85-322,421. VCN MEDIA LLC, BUFFALO GROVE, IL.  
FILED 5-17-2011.

# XVerify

THE MARK CONSISTS OF STANDARD CHARACTERS WITHOUT CLAIM TO ANY PARTICULAR FONT, STYLE, SIZE, OR COLOR.

FOR PROVIDING A WEBSITE THAT ENABLES COMPUTER USERS TO VERIFY VIA ONLINE NON-DOWNLOADABLE SOFTWARE THE LEGITIMACY AND AUTHENTICITY OF E-MAIL ADDRESSES, TELEPHONE NUMBERS, POSTAL ADDRESSES, PERSONAL NAMES, AND IP ADDRESSES, AND ALSO ENABLES COMPUTER USERS TO IDENTIFY OR VERIFY THE IDENTITY OF PARTICIPANTS IN TRANSACTIONS CONDUCTED OVER LOCAL, WIDE AREA, OR GLOBAL COMPUTER AND DATA STORAGE NETWORKS (U.S. CLS. 100 AND 101).

FIRST USE 2-1-2011; IN COMMERCE 2-1-2011.  
ZHALEH DELANEY, EXAMINING ATTORNEY

---

SN 85-322,791. PARTNERS HEALTHCARE SYSTEM, INC.,  
BOSTON, MA. FILED 5-17-2011.



OWNER OF U.S. REG. NO. 2,394,819.  
NO CLAIM IS MADE TO THE EXCLUSIVE RIGHT TO USE "COLLABORATION", APART FROM THE MARK AS SHOWN.

THE MARK CONSISTS OF THE WORDS "CIMIT COLLABORATION" ON A RECTANGULAR BACKGROUND, A HORIZONTAL LINE BETWEEN THE TWO WORDS, AND A VERTICAL LINE TO THE LEFT OF "COLLABORATION", WITH "COL", "LAB" AND "ORATION" EACH SHOWN AS A VISUALLY DISTINCT PORTION OF THAT WORD.

FOR COMPUTER SERVICES, NAMELY, CREATING AN ON-LINE COMMUNITY FOR REGISTERED USERS TO COMMUNICATE WITH EACH OTHER AND TO OBTAIN AND PROVIDE INFORMATION RELATING TO THE DISCOVERY, DEVELOPMENT AND IMPLEMENTATION OF INNOVATIVE TECHNOLOGIES IN THE FIELD OF HEALTH CARE; SOFTWARE AS A SERVICE (SAAS) SERVICES FEATURING SOFTWARE IN THE FIELD OF SOCIAL MEDIA FOR USE BY HEALTH CARE PROVIDERS, CLINICAL RESEARCHERS, TECHNOLOGISTS AND INNOVATORS TO EXCHANGE INFORMATION AND WORK TOGETHER WITH A VIEW TOWARD IMPROVING HEALTH CARE EFFICIENCY, QUALITY AND ACCESS (U.S. CLS. 100 AND 101).

JORDAN BAKER, EXAMINING ATTORNEY

**CLASS 42—(Continued).**

SN 85-323,186. TEAM CUMMINS, LLC, SAN ANTONIO, TX.  
FILED 5-17-2011.

# LeadFrog

THE MARK CONSISTS OF STANDARD CHARACTERS WITHOUT CLAIM TO ANY PARTICULAR FONT, STYLE, SIZE, OR COLOR.

FOR PROVIDING A MEMBERS-ONLY WEBSITE FEATURING TECHNOLOGY WHICH PROVIDES MEMBERS WITH THE ABILITY TO DESIGN, PLAN, IMPLEMENT AND TRACK BUSINESS AND PERSONAL GOALS WHILE EXTRACTING METRICS FOR THE ANALYSIS OF PERFORMANCE MANAGEMENT AND DEVELOPMENT; PROVIDING A WEBSITE THAT GIVES COMPUTER USERS THE ABILITY TO DESIGN, PLAN, IMPLEMENT AND TRACK BUSINESS AND PERSONAL GOALS WHILE EXTRACTING METRICS FOR THE ANALYSIS OF PERFORMANCE MANAGEMENT AND DEVELOPMENT; PROVIDING AN INTERACTIVE WEBSITE FEATURING TECHNOLOGY THAT ALLOWS USERS TO DESIGN, PLAN, IMPLEMENT AND TRACK BUSINESS AND PERSONAL GOALS WHILE EXTRACTING METRICS FOR THE ANALYSIS OF PERFORMANCE MANAGEMENT AND DEVELOPMENT (U.S. CLS. 100 AND 101).

FIRST USE 2-1-2011; IN COMMERCE 3-1-2011.  
MATTHEW KLINE, EXAMINING ATTORNEY

---

SN 85-323,306. CLOUDABILITY INC., PORTLAND, OR.  
FILED 5-17-2011.

# cloudability

THE MARK CONSISTS OF STANDARD CHARACTERS WITHOUT CLAIM TO ANY PARTICULAR FONT, STYLE, SIZE, OR COLOR.

FOR SOFTWARE AS A SERVICE (SAAS) SERVICES FEATURING SOFTWARE IN THE FIELD OF AGGREGATING, ANALYZING, AND REPORTING COST AND SPENDING INFORMATION OF BUSINESSES USING THE INTERNET (U.S. CLS. 100 AND 101).

FIRST USE 2-23-2011; IN COMMERCE 5-16-2011.  
BRIAN PINO, EXAMINING ATTORNEY

**CLASS 42—(Continued).**

SN 85-323,696. AMERICAN TECHNOLOGY SOLUTIONS INTERNATIONAL, FREDERICKSBURG, VA. FILED 5-18-2011.



NO CLAIM IS MADE TO THE EXCLUSIVE RIGHT TO USE "AMERICAN TECHNOLOGY SOLUTIONS INTERNATIONAL CORP.", APART FROM THE MARK AS SHOWN.

THE MARK CONSISTS OF THE TEXT "ATSI" AND "AMERICAN TECHNOLOGY SOLUTIONS INTERNATIONAL CORP." STACKED UNDERNEATH WITH THE WORD "AMERICAN" WITHIN A RECTANGULAR BACKGROUND AND TWO CURVED LINES ON THE LEFT.

FOR CONSULTING IN THE FIELD OF IT PROJECT MANAGEMENT; IT CONSULTING SERVICES; IT INTEGRATION SERVICES; TECHNICAL CONSULTING SERVICES IN THE FIELDS OF DATACENTER ARCHITECTURE, PUBLIC AND PRIVATE CLOUD COMPUTING SOLUTIONS, AND EVALUATION AND IMPLEMENTATION OF INTERNET TECHNOLOGY AND SERVICES (U.S. CLS. 100 AND 101).

FIRST USE 12-1-2010; IN COMMERCE 12-22-2010.  
CARYN GLASSER, EXAMINING ATTORNEY

SN 85-323,815. DIAZ, JUAN, BROOKLYN, NY. FILED 5-18-2011.

## IMAGE AXIS

THE MARK CONSISTS OF STANDARD CHARACTERS WITHOUT CLAIM TO ANY PARTICULAR FONT, STYLE, SIZE, OR COLOR.

NO CLAIM IS MADE TO THE EXCLUSIVE RIGHT TO USE "IMAGE", APART FROM THE MARK AS SHOWN.

FOR GRAPHIC DESIGN OF ADVERTISEMENTS, BROCHURES, BOOKLETS AND BUSINESS CARDS (U.S. CLS. 100 AND 101).

FONG HSU, EXAMINING ATTORNEY

**CLASS 42—(Continued).**

SN 85-324,381. OMNISENT LLC, PALM SPRINGS, CA. FILED 5-18-2011.

## Omnisent

THE MARK CONSISTS OF STANDARD CHARACTERS WITHOUT CLAIM TO ANY PARTICULAR FONT, STYLE, SIZE, OR COLOR.

FOR SCIENTIFIC RESEARCH AND DEVELOPMENT (U.S. CLS. 100 AND 101).

MARK RADEMACHER, EXAMINING ATTORNEY

SN 85-324,814. STRAUSS, JOSHUA, DBA POLARFORCE CREATIVE, LOS ANGELES, CA. FILED 5-19-2011.

## POLARFORCE CREATIVE

THE MARK CONSISTS OF STANDARD CHARACTERS WITHOUT CLAIM TO ANY PARTICULAR FONT, STYLE, SIZE, OR COLOR.

NO CLAIM IS MADE TO THE EXCLUSIVE RIGHT TO USE "CREATIVE", APART FROM THE MARK AS SHOWN. FOR GRAPHIC DESIGN (U.S. CLS. 100 AND 101).

HOWARD SMIGA, EXAMINING ATTORNEY

SN 85-326,227. INTERNATIONAL ART & ANTIQUES RESEARCH ASSOCIATION, INC., LAS VEGAS, NV. FILED 5-20-2011.

## YI'S 4-IN-1

THE MARK CONSISTS OF STANDARD CHARACTERS WITHOUT CLAIM TO ANY PARTICULAR FONT, STYLE, SIZE, OR COLOR.

NO CLAIM IS MADE TO THE EXCLUSIVE RIGHT TO USE "4-IN-1", APART FROM THE MARK AS SHOWN.

FOR TESTING, ANALYSIS AND EVALUATION OF THE GOODS OF OTHERS FOR THE PURPOSE OF CERTIFICATION (U.S. CLS. 100 AND 101).

APRIL ROACH, EXAMINING ATTORNEY

**CLASS 42—(Continued).**

SN 85-327,223. OPENDNS, INC., SAN FRANCISCO, CA.  
FILED 5-23-2011.

**DNS-0-MATIC**

THE MARK CONSISTS OF STANDARD CHARACTERS WITHOUT CLAIM TO ANY PARTICULAR FONT, STYLE, SIZE, OR COLOR.

FOR DOMAIN NAME SYSTEM (DNS) MANAGEMENT AND MAINTENANCE SERVICES, NAMELY, UPDATING DYNAMIC IP ADDRESSES WITH MULTIPLE DNS SERVICES ON BEHALF OF A USER VIA THE INTERNET; COMPUTER SERVICES, NAMELY, REDIRECTING ELECTRONIC MAIL TO CHANGED PERSONAL ELECTRONIC ADDRESSES BY UPDATING DYNAMIC IP ADDRESSES WITH MULTIPLE DNS SERVICES ON BEHALF OF A USER VIA THE INTERNET; ON-LINE BATCH COMPUTER SERVICES, NAMELY, UPDATING DYNAMIC IP ADDRESSES WITH MULTIPLE DNS SERVICES ON BEHALF OF A USER VIA THE INTERNET (U.S. CLS. 100 AND 101).

FIRST USE 12-2-2007; IN COMMERCE 12-2-2007.  
TRACY CROSS, EXAMINING ATTORNEY

---

SN 85-327,304. ELECTRONIC INK, INC., PHILADELPHIA, PA. FILED 5-23-2011.

**ENABLING TECHNOLOGY BY DESIGN**

THE MARK CONSISTS OF STANDARD CHARACTERS WITHOUT CLAIM TO ANY PARTICULAR FONT, STYLE, SIZE, OR COLOR.

FOR COMPUTER SOFTWARE, SOFTWARE SYSTEM, AND WEBSITE DEVELOPMENT FOR OTHERS (U.S. CLS. 100 AND 101).

FIRST USE 2-0-2011; IN COMMERCE 2-0-2011.  
RICHARD WHITE, EXAMINING ATTORNEY

---

SN 85-327,308. ELECTRONIC INK, INC., PHILADELPHIA, PA. FILED 5-23-2011.

**SERVING THE GREATER GOOD BY DESIGN**

THE MARK CONSISTS OF STANDARD CHARACTERS WITHOUT CLAIM TO ANY PARTICULAR FONT, STYLE, SIZE, OR COLOR.

FOR COMPUTER SOFTWARE, SOFTWARE SYSTEM, AND WEBSITE DEVELOPMENT FOR OTHERS (U.S. CLS. 100 AND 101).

FIRST USE 2-0-2011; IN COMMERCE 2-0-2011.  
RICHARD WHITE, EXAMINING ATTORNEY

**CLASS 42—(Continued).**

SN 85-327,309. ELECTRONIC INK, INC., PHILADELPHIA, PA. FILED 5-23-2011.

**GROWING INVESTMENTS BY DESIGN**

THE MARK CONSISTS OF STANDARD CHARACTERS WITHOUT CLAIM TO ANY PARTICULAR FONT, STYLE, SIZE, OR COLOR.

FOR COMPUTER SOFTWARE, SOFTWARE SYSTEM, AND WEBSITE DEVELOPMENT FOR OTHERS (U.S. CLS. 100 AND 101).

FIRST USE 2-0-2011; IN COMMERCE 2-0-2011.  
RICHARD WHITE, EXAMINING ATTORNEY

---

SN 85-328,155. CORREA, CARLOS D, DUBLIN, CA. FILED 5-24-2011.

**flixense**

THE MARK CONSISTS OF STANDARD CHARACTERS WITHOUT CLAIM TO ANY PARTICULAR FONT, STYLE, SIZE, OR COLOR.

FOR PROVIDING A WEB SITE FEATURING TECHNOLOGY THAT ENABLES INTERNET USERS TO SHARE DOCUMENTS, IMAGES AND VIDEOS; PROVIDING A WEB SITE FEATURING TECHNOLOGY THAT ENABLES USERS TO CREATE MOSAIC IMAGES FROM UPLOADED VIDEOS; PROVIDING A WEBSITE FEATURING TECHNOLOGY THAT ENABLES USERS TO UPLOAD AND SHARE USER-GENERATED VIDEOS ON A WIDE VARIETY OF TOPICS AND SUBJECTS (U.S. CLS. 100 AND 101).

PAUL E. FAHRENKOPF, EXAMINING ATTORNEY

**CLASS 42—(Continued).**

SN 85-328,539. GARAGE FUSE LLC, SADDLE RIVER, NJ. FILED 5-24-2011.



THE COLOR(S) BLACK, WHITE, YELLOW AND SILVER IS/ARE CLAIMED AS A FEATURE OF THE MARK.

THE MARK CONSISTS OF BLACK BACKGROUND WITH A YELLOW, BLACK, WHITE AND SILVER CAR WITH GARAGE IN WHITE STYLIZED LETTERS BELOW AND FUSE IN YELLOW STYLIZED LETTERS TO THE RIGHT OF GARAGE.

FOR PROVIDING A WEBSITE FEATURING TECHNOLOGY THAT ENABLES USERS TO CREATE 3 DIMENSIONAL MODELS OF AUTOMOBILES THAT ARE LINKED TO THEIR OWN ENVIRONMENT ONLINE (U.S. CLS. 100 AND 101).

BARBARA RUTLAND, EXAMINING ATTORNEY

SN 85-328,550. GARAGE FUSE LLC, SADDLE RIVER, NJ. FILED 5-24-2011.



THE COLOR(S) WHITE, BLACK, SILVER, GRAY AND YELLOW IS/ARE CLAIMED AS A FEATURE OF THE MARK.

THE MARK CONSISTS OF WHITE BACKGROUND WITH A YELLOW, BLACK, SILVER AND WHITE CAR WITH GARAGE IN GRAY STYLIZED LETTERS BELOW AND FUSE IN YELLOW STYLIZED LETTERS TO THE RIGHT OF GARAGE.

FOR PROVIDING A WEBSITE FEATURING TECHNOLOGY THAT ENABLES USERS TO CREATE 3 DIMENSIONAL MODELS OF AUTOMOBILES THAT ARE LINKED TO THEIR OWN ENVIRONMENT ONLINE (U.S. CLS. 100 AND 101).

BARBARA RUTLAND, EXAMINING ATTORNEY

**CLASS 42—(Continued).**

SN 85-328,716. VECTORTUNES, NORTH HILLS, CA. FILED 5-24-2011.

**VECTOR-CODE**

THE MARK CONSISTS OF STANDARD CHARACTERS WITHOUT CLAIM TO ANY PARTICULAR FONT, STYLE, SIZE, OR COLOR.

FOR DESIGN AND DEVELOPMENT OF COMPUTER SOFTWARE (U.S. CLS. 100 AND 101).

ALLISON SCHRODY, EXAMINING ATTORNEY

SN 85-330,022. ESEIS, INC., HOUSTON, TX. FILED 5-25-2011.

**QX**

THE MARK CONSISTS OF STANDARD CHARACTERS WITHOUT CLAIM TO ANY PARTICULAR FONT, STYLE, SIZE, OR COLOR.

OWNER OF U.S. REG. NO. 2,951,583.

FOR CONSULTING SERVICES, NAMELY, INTERPRETATION OF SEISMIC DATA BY THE APPLICATION OF PROPRIETARY ALGORITHMS TO EXTRACT PORE PRESSURE INFORMATION FROM SEISMIC FREQUENCY VARIATIONS FOR THE EVALUATION OF MINERAL RESERVES AND TO AID IN PLANNING WELLS (U.S. CLS. 100 AND 101).

FIRST USE 10-28-2002; IN COMMERCE 10-28-2002.

KELLY BOULTON, EXAMINING ATTORNEY

SN 85-330,334. VANNESSA D. EGGLESTON, DBA THEN COMES PAPER, EDINBURG, TX. AND SARAH G. FARLEY, DBA THEN COMES PAPER, EDINBURG, TX. FILED 5-25-2011.

**First Comes Love Then Comes Paper**

THE MARK CONSISTS OF STANDARD CHARACTERS WITHOUT CLAIM TO ANY PARTICULAR FONT, STYLE, SIZE, OR COLOR.

NO CLAIM IS MADE TO THE EXCLUSIVE RIGHT TO USE "PAPER", APART FROM THE MARK AS SHOWN.

FOR DESIGN FOR OTHERS IN THE FIELD OF PAPER GOODS NAMELY, NOTEPADS, STATIONERY, CARDS, GREETING CARDS, NOTE CARDS, GIFT CARDS, GREETING CARDS, ANNOUNCEMENTS, INVITATIONS, BLANK NOTE CARDS, POST CARDS; GRAPHIC DESIGN SERVICES (U.S. CLS. 100 AND 101).

FIRST USE 5-1-2011; IN COMMERCE 5-1-2011.

KAELIE KUNG, EXAMINING ATTORNEY



**CLASS 42—(Continued).**

SN 85-330,531. DO GOOD LABS, INC., SAN FRANCISCO, CA. FILED 5-26-2011.

# SAVEUP

THE MARK CONSISTS OF STANDARD CHARACTERS WITHOUT CLAIM TO ANY PARTICULAR FONT, STYLE, SIZE, OR COLOR.

FOR APPLICATION SERVICE PROVIDER (ASP) FEATURING COMPUTER GAME SOFTWARE FOCUSING ON ACHIEVING A SET OF FINANCIAL GOALS (U.S. CLS. 100 AND 101).

SHANNON TWOHIG, EXAMINING ATTORNEY

**CLASS 42—(Continued).**

SN 85-331,906. WALTER DORWIN TEAGUE ASSOCIATES INCORPORATED, SEATTLE, WA. FILED 5-26-2011.

# DESIGN THIS DAY

THE MARK CONSISTS OF STANDARD CHARACTERS WITHOUT CLAIM TO ANY PARTICULAR FONT, STYLE, SIZE, OR COLOR.

FOR ENGINEERING SERVICES IN THE FIELD OF SYSTEMS ENGINEERING; INDUSTRIAL DESIGN; INDUSTRIAL DESIGN SERVICES (U.S. CLS. 100 AND 101).

FIRST USE 2-15-2009; IN COMMERCE 2-15-2009. JASON BLAIR, EXAMINING ATTORNEY

SN 85-331,524. BOLD GROUP, INC., NEWPORT BEACH, CA. FILED 5-26-2011.

# NotaryNow

THE MARK CONSISTS OF STANDARD CHARACTERS WITHOUT CLAIM TO ANY PARTICULAR FONT, STYLE, SIZE, OR COLOR.

FOR PROVIDING A WEBSITE FEATURING NON-DOWNLOADABLE SOFTWARE FOR ELECTRONICALLY AUTHENTICATING DOCUMENTS; PROVIDING AN INTERACTIVE WEBSITE FEATURING TECHNOLOGY THAT ENABLES USERS TO ELECTRONICALLY AUTHENTICATE DOCUMENTS (U.S. CLS. 100 AND 101).

LAURIE MAYES, EXAMINING ATTORNEY

SN 85-331,966. KRUTHOFF, TROY, ROSEVILLE, CA. FILED 5-27-2011.

# FITHUB

THE MARK CONSISTS OF STANDARD CHARACTERS WITHOUT CLAIM TO ANY PARTICULAR FONT, STYLE, SIZE, OR COLOR.

FOR PROVIDING A WEB SITE FEATURING TECHNOLOGY THAT ENABLES USERS TO VIEW, TRACK, STORE, MANAGE, AND SHARE FITNESS ACTIVITIES AND DATA (U.S. CLS. 100 AND 101).

FIRST USE 5-24-2011; IN COMMERCE 5-24-2011. JENNY PARK, EXAMINING ATTORNEY

SN 85-331,550. BOLD GROUP, INC., NEWPORT BEACH, CA. FILED 5-26-2011.

# SignNow

THE MARK CONSISTS OF STANDARD CHARACTERS WITHOUT CLAIM TO ANY PARTICULAR FONT, STYLE, SIZE, OR COLOR.

FOR PROVIDING A WEBSITE FEATURING NON-DOWNLOADABLE SOFTWARE FOR ELECTRONICALLY AUTHENTICATING DOCUMENTS; PROVIDING AN INTERACTIVE WEBSITE FEATURING TECHNOLOGY THAT ENABLES USERS TO ELECTRONICALLY AUTHENTICATE DOCUMENTS (U.S. CLS. 100 AND 101).

LAURIE MAYES, EXAMINING ATTORNEY

SN 85-331,986. PEIFER, JOSEPH L, LANCASTER, PA. FILED 5-27-2011.

# READYBIT

THE MARK CONSISTS OF STANDARD CHARACTERS WITHOUT CLAIM TO ANY PARTICULAR FONT, STYLE, SIZE, OR COLOR.

FOR REMOTE ONLINE BACKUP OF COMPUTER DATA (U.S. CLS. 100 AND 101).

FIRST USE 5-24-2011; IN COMMERCE 5-24-2011. JOHN HWANG, EXAMINING ATTORNEY

**CLASS 42—(Continued).**

SN 85-332,102. MOTIONSOFT, INC., ROCKVILLE, MD.  
FILED 5-27-2011.

Get them. Keep them.  
Know them.

THE MARK CONSISTS OF STANDARD CHARACTERS WITHOUT CLAIM TO ANY PARTICULAR FONT, STYLE, SIZE, OR COLOR.

FOR APPLICATION SERVICE PROVIDER (ASP) FEATURING SOFTWARE FOR USE IN DATABASE MANAGEMENT, MEMBERSHIP MANAGEMENT, BILLING AND ACCOUNT MANAGEMENT, DATA MINING, AND BUSINESS INTELLIGENCE IN HEALTH CLUBS, GYMS, AND OTHER FITNESS FACILITIES (U.S. CLS. 100 AND 101).

FIRST USE 5-23-2011; IN COMMERCE 5-23-2011.  
MATTHEW EINSTEIN, EXAMINING ATTORNEY

---

SN 85-332,177. QUEWEY, INC., PHILADELPHIA, PA. FILED  
5-27-2011.



THE MARK CONSISTS OF THE STYLIZED WORD "QUEWEY".  
FOR CREATING AN ON-LINE COMMUNITY FOR BUSINESS PROFESSIONALS (U.S. CLS. 100 AND 101).  
KHANH LE, EXAMINING ATTORNEY

---

SN 85-332,515. MITEK SYSTEMS, INC., SAN DIEGO, CA.  
FILED 5-27-2011.

POINT.SHOOT.SEARCH.

THE MARK CONSISTS OF STANDARD CHARACTERS WITHOUT CLAIM TO ANY PARTICULAR FONT, STYLE, SIZE, OR COLOR.

FOR PROVIDING TEMPORARY USE OF ON-LINE NON-DOWNLOADABLE COMPUTER SOFTWARE FOR DOCUMENT IMAGING, INTELLIGENT CHARACTER AND IMAGE RECOGNITION, AND DOCUMENT ANALYSIS (U.S. CLS. 100 AND 101).

LEIGH LOWRY, EXAMINING ATTORNEY

**CLASS 42—(Continued).**

SN 85-332,534. MITEK SYSTEMS, INC., SAN DIEGO, CA.  
FILED 5-27-2011.

POINT.SHOOT.SHARE.

THE MARK CONSISTS OF STANDARD CHARACTERS WITHOUT CLAIM TO ANY PARTICULAR FONT, STYLE, SIZE, OR COLOR.

FOR PROVIDING TEMPORARY USE OF ON-LINE NON-DOWNLOADABLE COMPUTER SOFTWARE FOR DOCUMENT IMAGING, INTELLIGENT CHARACTER AND IMAGE RECOGNITION, AND DOCUMENT ANALYSIS (U.S. CLS. 100 AND 101).

LEIGH LOWRY, EXAMINING ATTORNEY

---

SN 85-332,643. SAVAGE, JOSHUA, MADISON, WI. FILED 5-  
27-2011.



THE MARK CONSISTS OF STANDARD CHARACTERS WITHOUT CLAIM TO ANY PARTICULAR FONT, STYLE, SIZE, OR COLOR.

FOR COMPUTER SERVICES, NAMELY, HOSTING ON-LINE INTERACTIVE CALENDARS THAT ALLOW MULTIPLE PARTICIPANTS TO FIND, POST AND SHARE PRIVATE AND PUBLIC EVENTS, MAKE RESERVATIONS AND PURCHASE EVENT TICKETS (U.S. CLS. 100 AND 101).

FIRST USE 1-13-2007; IN COMMERCE 10-1-2009.  
KATHERINE M. DUBRAY, EXAMINING ATTORNEY

**CLASS 42—(Continued).**

SN 85-332,973. VULCAN INC., SEATTLE, WA. FILED 5-27-2011.

**(ai)<sup>2</sup>**

THE MARK CONSISTS OF THE LETTERS "A" AND "I" ENCLOSED BY STANDARD BRACKETS WITH A NUMERICAL "2" IN SUPERSCRIPIT IN UPPER RIGHT CORNER.

FOR COMPUTER PROGRAMMING SERVICES FOR THE DEVELOPMENT OF INTELLIGENT AGENT DEVICES; PROVIDING SCIENTIFIC INFORMATION IN THE FIELD OF SEARCH AND RETRIEVAL OF DATA, KNOWLEDGE MANAGEMENT AND THE STUDY AND DESIGN OF INTELLIGENT AGENTS; RESEARCH AND DEVELOPMENT FOR NEW PRODUCTS FOR OTHERS; RESEARCH AND DEVELOPMENT IN THE FIELD OF KNOWLEDGE MANAGEMENT AND THE STUDY AND DESIGN OF INTELLIGENT AGENTS; SCIENTIFIC RESEARCH AND DEVELOPMENT; SCIENTIFIC STUDY AND RESEARCH IN THE FIELDS OF KNOWLEDGE MANAGEMENT AND THE STUDY AND DESIGN OF INTELLIGENT AGENTS (U.S. CLS. 100 AND 101).

JANICE L. MCMORROW, EXAMINING ATTORNEY

**CLASS 42—(Continued).**

SN 85-333,036. WISEGATE, INC., AUSTIN, TX. FILED 5-28-2011.

**Wisegate**

THE MARK CONSISTS OF STANDARD CHARACTERS WITHOUT CLAIM TO ANY PARTICULAR FONT, STYLE, SIZE, OR COLOR.

FOR COMPUTER SERVICES, NAMELY, CREATING AN ON-LINE COMMUNITY FOR REGISTERED USERS TO PARTICIPATE IN DISCUSSIONS, GET FEEDBACK FROM THEIR PEERS, FORM VIRTUAL COMMUNITIES, AND ENGAGE IN SOCIAL NETWORKING (U.S. CLS. 100 AND 101).

FIRST USE 6-15-2010; IN COMMERCE 6-15-2010.  
BRENDAN REGAN, EXAMINING ATTORNEY

SN 85-332,987. VULCAN INC., SEATTLE, WA. FILED 5-27-2011.

**AI2**

THE MARK CONSISTS OF STANDARD CHARACTERS WITHOUT CLAIM TO ANY PARTICULAR FONT, STYLE, SIZE, OR COLOR.

FOR COMPUTER PROGRAMMING SERVICES FOR THE DEVELOPMENT OF INTELLIGENT AGENT DEVICES; PROVIDING SCIENTIFIC INFORMATION IN THE FIELD OF SEARCH AND RETRIEVAL OF DATA, KNOWLEDGE MANAGEMENT AND THE STUDY AND DESIGN OF INTELLIGENT AGENTS; RESEARCH AND DEVELOPMENT FOR NEW PRODUCTS FOR OTHERS; RESEARCH AND DEVELOPMENT IN THE FIELD OF KNOWLEDGE MANAGEMENT AND THE STUDY AND DESIGN OF INTELLIGENT AGENTS; SCIENTIFIC RESEARCH AND DEVELOPMENT; SCIENTIFIC STUDY AND RESEARCH IN THE FIELDS OF KNOWLEDGE MANAGEMENT AND THE STUDY AND DESIGN OF INTELLIGENT AGENTS (U.S. CLS. 100 AND 101).

JANICE L. MCMORROW, EXAMINING ATTORNEY

SN 85-333,095. ELIZABETH GADWA, DBA YES EXACTLY, GREENFIELD, MA. FILED 5-28-2011.

**Yes Exactly**

THE MARK CONSISTS OF STANDARD CHARACTERS WITHOUT CLAIM TO ANY PARTICULAR FONT, STYLE, SIZE, OR COLOR.

FOR COMPUTER SERVICES, NAMELY, DESIGNING AND IMPLEMENTING WEB SITES FOR OTHERS (U.S. CLS. 100 AND 101).

FIRST USE 1-5-2011; IN COMMERCE 1-5-2011.

MARGERY A. TIERNEY, EXAMINING ATTORNEY

**CLASS 42—(Continued).**

SN 85-333,098. ELIZABETH GADWA, DBA YES EXACTLY, GREENFIELD, NH. FILED 5-28-2011.



THE COLOR(S) GREEN, BLUE-GREEN, PURPLE, RED, ORANGE AND WHITE IS/ARE CLAIMED AS A FEATURE OF THE MARK.

THE MARK CONSISTS OF A GREEN LETTER X, ON WHICH IS SUPERIMPOSED A GREEN DASH, AND SUPERIMPOSED ON ALL OF WHICH AT THE CENTER ARE 5 CONCENTRIC AND DECREASING SIZE FIVE POINTED STARS, IN ORDER FROM SMALLEST TO LARGEST WHITE, ORANGE, RED, PURPLE, BLUE-GREEN, AND THE STAR POINTS BECOMING MORE ROUNDED FROM SMALLEST TO LARGEST.

FOR COMPUTER SERVICES, NAMELY, DESIGNING AND IMPLEMENTING WEB PAGES FOR OTHERS (U.S. CLS. 100 AND 101).

FIRST USE 1-5-2011; IN COMMERCE 1-5-2011.

MARGERIE A. TIERNEY, EXAMINING ATTORNEY

---

SN 85-333,157. DIGITAL TROOPER INC, CHARLOTTE, NC. FILED 5-28-2011.

**brynk**

THE MARK CONSISTS OF STANDARD CHARACTERS WITHOUT CLAIM TO ANY PARTICULAR FONT, STYLE, SIZE, OR COLOR.

FOR SOFTWARE AS A SERVICE (SAAS) SERVICES FEATURING SOFTWARE FOR EMAIL MARKETING, WEBSITE MANAGEMENT, E-COMMERCE, EVENT MANAGEMENT AND ONLINE ADVERTISING (U.S. CLS. 100 AND 101).

FIRST USE 3-17-2011; IN COMMERCE 3-17-2011.

SUNG IN, EXAMINING ATTORNEY

**CLASS 42—(Continued).**

SN 85-333,259. CONHOLDATE PTE LTD, EQUITY PLAZA, SINGAPORE, FILED 5-29-2011.

**Banckle**

THE MARK CONSISTS OF STANDARD CHARACTERS WITHOUT CLAIM TO ANY PARTICULAR FONT, STYLE, SIZE, OR COLOR.

FOR SOFTWARE AS A SERVICE (SAAS) SERVICES FEATURING SOFTWARE FOR ONLINE MEETING, LIVE CHAT, REMOTE COMPUTER ACCESS, FILE SHARING, GROUP CHAT, EMAIL SERVER, AND FEEDBACK CAPTURE (U.S. CLS. 100 AND 101).

FIRST USE 10-1-2010; IN COMMERCE 10-1-2010.

LINDA ORNDORFF, EXAMINING ATTORNEY

---

SN 85-333,329. THOMAS RUSSELL HOWARD, DBA REFINED REDNECK, PASADENA, MD. FILED 5-30-2011.

**Refined Redneck**

THE MARK CONSISTS OF STANDARD CHARACTERS WITHOUT CLAIM TO ANY PARTICULAR FONT, STYLE, SIZE, OR COLOR.

FOR TOOL DESIGN (U.S. CLS. 100 AND 101).

SIMON TENG, EXAMINING ATTORNEY

---

SN 85-333,586. EXACTTARGET, INC., INDIANAPOLIS, IN. FILED 5-31-2011.

**EXACTTARGET GEARS**

THE MARK CONSISTS OF STANDARD CHARACTERS WITHOUT CLAIM TO ANY PARTICULAR FONT, STYLE, SIZE, OR COLOR.

OWNER OF U.S. REG. NOS. 2,624,201 AND 3,157,611.

FOR PROVIDING TEMPORARY USE OF ON-LINE NON-DOWNLOADABLE SOFTWARE FOR BUILDING AND PUBLISHING SELECT PIECES OF CONTENT ON WEB PAGES (U.S. CLS. 100 AND 101).

CHARLOTTE CORWIN, EXAMINING ATTORNEY

**CLASS 42—(Continued).**

SN 85-333,651. FARRAGUT SYSTEMS, INC., DURHAM, NC. FILED 5-31-2011.

**BIG IDEAS, SMALL DEVICES**

THE MARK CONSISTS OF STANDARD CHARACTERS WITHOUT CLAIM TO ANY PARTICULAR FONT, STYLE, SIZE, OR COLOR.

FOR DESIGN AND DEVELOPMENT OF COMPUTER SOFTWARE; COMPUTER SOFTWARE CONSULTING (U.S. CLS. 100 AND 101).

FIRST USE 1-14-2011; IN COMMERCE 1-14-2011.  
HOWARD SMIGA, EXAMINING ATTORNEY

SN 85-333,743. COONS, KRISTIN, MANHATTAN BEACH, CA. FILED 5-31-2011.

**My Own Little Story**

THE MARK CONSISTS OF STANDARD CHARACTERS WITHOUT CLAIM TO ANY PARTICULAR FONT, STYLE, SIZE, OR COLOR.

FOR DESIGN OF CUSTOMIZED BOOKS (U.S. CLS. 100 AND 101).

FIRST USE 5-23-2007; IN COMMERCE 3-1-2010.  
ALICE BENMAMAN, EXAMINING ATTORNEY

SN 85-333,763. JOSTLE CORPORATION, SURREY, B.C. V4A9K5, CANADA, FILED 5-31-2011.

**Tame Organizational Complexity**

THE MARK CONSISTS OF STANDARD CHARACTERS WITHOUT CLAIM TO ANY PARTICULAR FONT, STYLE, SIZE, OR COLOR.

FOR SOFTWARE AS A SERVICE (SAAS) SERVICES FEATURING SOFTWARE FOR USE BY ORGANIZATIONS, THEIR MEMBERS AND ASSOCIATES, FOR COLLABORATIVELY SHARING, RETRIEVING, EXCHANGING AND ACCESSING DATA ABOUT THEMSELVES, THEIR ACTIVITIES AND THEIR RELATIONSHIPS THROUGH VISUALIZATIONS AND VISUAL DEPICTIONS (U.S. CLS. 100 AND 101).

RONALD AIKENS, EXAMINING ATTORNEY

**CLASS 42—(Continued).**

SN 85-333,766. CURTIS, RONALD, BERKELEY, CA. FILED 5-31-2011.



THE MARK CONSISTS OF A MAN YELLING INTO A MEGAPHONE WEARING A SUIT. THE STYLIZED TEXT "UVOYCIT" IS LABELED ON THE MEGAPHONE.

FOR PROVIDING CUSTOMIZED ON-LINE WEB PAGES AND DATA FEEDS FEATURING USER-DEFINED INFORMATION, WHICH INCLUDES BLOG POSTS, NEW MEDIA CONTENT, OTHER ON-LINE CONTENT, AND ON-LINE WEB LINKS TO OTHER WEBSITES (U.S. CLS. 100 AND 101).

RONALD AIKENS, EXAMINING ATTORNEY

SN 85-333,769. CYBERSPACE TO PARADISE, INC., DE- LAND, FL. FILED 5-31-2011.



THE MARK CONSISTS OF THE STYLIZED TEXT "FRIENDCHECKER" WITH A CHECK MARK AND A DOT IN BETWEEN THE LETTER "N" AND "D".

FOR ONLINE SECURITY SERVICES, NAMELY, SEXUAL OFFENDER REGISTRY AND LOCATOR SERVICE USED IN SCREENING VIRTUAL COMMUNITIES (U.S. CLS. 100 AND 101).

FIRST USE 5-1-2011; IN COMMERCE 5-1-2011.  
RONALD AIKENS, EXAMINING ATTORNEY

SN 85-333,863. WEALTHTOUCH, INC., DENVER, CO. FILED 5-31-2011.

**WEALTHTOUCH VERIDIUM**

THE MARK CONSISTS OF STANDARD CHARACTERS WITHOUT CLAIM TO ANY PARTICULAR FONT, STYLE, SIZE, OR COLOR.

FOR COMPUTER SERVICES, NAMELY, PROVIDING A WEB-BASED SYSTEM AND ONLINE PORTAL FEATURING ON-LINE NON-DOWNLOADABLE SOFTWARE THAT ENABLES USERS TO ACCESS, TRACK, ANALYZE, REVIEW AND CREATE REPORTS ON INVESTMENTS (U.S. CLS. 100 AND 101).

JOHN HWANG, EXAMINING ATTORNEY

**CLASS 42—(Continued).**

SN 85-333,885. JABFAB INC., VIENNA, VA. FILED 5-31-2011.

**JABFAB**

THE MARK CONSISTS OF STANDARD CHARACTERS WITHOUT CLAIM TO ANY PARTICULAR FONT, STYLE, SIZE, OR COLOR.

FOR COMPUTER SERVICES, NAMELY, CREATING AN ON-LINE COMMUNITY FOR REGISTERED USERS TO PARTICIPATE IN DISCUSSIONS, GET FEEDBACK FROM THEIR PEERS, FORM VIRTUAL COMMUNITIES, AND ENGAGE IN SOCIAL NETWORKING SERVICES IN THE FIELD OF CONSUMER SENTIMENT, EXPERIENCES, RATINGS, AND OPINIONS RELATING TO BUSINESS ORGANIZATIONS, SERVICE PROVIDERS, AND CONSUMER PRODUCTS; PROVIDING A WEB SITE THAT GIVES COMPUTER USERS THE ABILITY TO UPLOAD, EXCHANGE AND SHARE PHOTOS, VIDEOS AND VIDEO LOGS (U.S. CLS. 100 AND 101).

TINA BROWN, EXAMINING ATTORNEY

SN 85-333,931. XUBA, LLC, OMAHA, NE. FILED 5-31-2011.

**BLOOM**

THE MARK CONSISTS OF STANDARD CHARACTERS WITHOUT CLAIM TO ANY PARTICULAR FONT, STYLE, SIZE, OR COLOR.

FOR COMPUTER SERVICES, NAMELY, CREATING AN ON-LINE COMMUNITY FOR REGISTERED USERS TO PARTICIPATE IN DISCUSSIONS, GET FEEDBACK FROM THEIR PEERS, FORM VIRTUAL COMMUNITIES, AND ENGAGE IN SOCIAL NETWORKING IN THE FIELDS OF HEALTH AND BEAUTY PRODUCTS (U.S. CLS. 100 AND 101).

JENNIFER VASQUEZ, EXAMINING ATTORNEY

SN 85-334,085. XLHEALTH CORPORATION, BALTIMORE, MD. FILED 5-31-2011.

**XL CARE**

THE MARK CONSISTS OF STANDARD CHARACTERS WITHOUT CLAIM TO ANY PARTICULAR FONT, STYLE, SIZE, OR COLOR.

FOR PROVIDING ON-LINE NON-DOWNLOADABLE SOFTWARE FEATURING A SECURE WEB-BASED PLATFORM THAT ENABLES THE ENTRY, ANALYSIS AND REPORTING OF DATA FOR THE PROVISION AND MANAGEMENT OF HEALTHCARE SERVICES (U.S. CLS. 100 AND 101).

EDWARD FENNESSY, EXAMINING ATTORNEY

**CLASS 42—(Continued).**

SN 85-334,148. SYNCHRONET LLC, HOUSTON, TX. FILED 5-31-2011.

**StormCloud**

THE MARK CONSISTS OF STANDARD CHARACTERS WITHOUT CLAIM TO ANY PARTICULAR FONT, STYLE, SIZE, OR COLOR.

FOR REMOTE COMPUTER BACKUP SERVICES; REMOTE ONLINE BACKUP OF COMPUTER DATA (U.S. CLS. 100 AND 101).

FIRST USE 5-1-2011; IN COMMERCE 5-1-2011.

KATHERINE CONNOLLY, EXAMINING ATTORNEY

SN 85-334,149. DELUXE ENTERPRISE OPERATIONS, INC., SHOREVIEW, MN. FILED 5-31-2011.

**BRANDTEGRITY**

THE MARK CONSISTS OF STANDARD CHARACTERS WITHOUT CLAIM TO ANY PARTICULAR FONT, STYLE, SIZE, OR COLOR.

FOR SOFTWARE AS A SERVICE (SAAS) SERVICES, NAMELY, HOSTING SOFTWARE FOR USE BY OTHERS FOR USE BY OTHERS TO CREATE, OPERATE AND MAINTAIN AN ELECTRONIC COMMERCE WEBSITE (U.S. CLS. 100 AND 101).

FIRST USE 12-17-2010; IN COMMERCE 12-17-2010.

BARBARA BROWN, EXAMINING ATTORNEY

SN 85-334,155. BOLTNET, INC., SAN FRANCISCO, CA. FILED 5-31-2011.



THE MARK CONSISTS OF A STYLIZED DRAWING OF THE PROFILE OF AN ELEPHANT'S HEAD WITH A LIGHTNING BOLT.

FOR SOFTWARE AS A SERVICE (SAAS) SERVICES FEATURING SOFTWARE FOR CUSTOMIZING WEB PAGE CONTENT AND DISTRIBUTING WEB PAGE CONTENT THROUGH SOCIAL NETWORKS IN THE FIELD OF MARKETING (U.S. CLS. 100 AND 101).

HELENE LIWINSKI, EXAMINING ATTORNEY

**CLASS 42—(Continued).**

SN 85-334,242. CATAPULT SYSTEMS, INC., AUSTIN, TX.  
FILED 5-31-2011.



THE MARK CONSISTS OF THREE SPHERES JOINED BY THREE LINES, ALL FORMING A TRIANGULAR SHAPE SUGGESTING A MOLECULE, ADJACENT THREE ARCHES EMANATING FROM THE MOLECULE DESIGN.

FOR DESIGN, DEVELOPMENT, AND DEPLOYMENT OF MOBILE WEBSITES AND MOBILE APPLICATIONS FOR OTHERS (U.S. CLS. 100 AND 101).

ODESSA BIBBINS, EXAMINING ATTORNEY

---

SN 85-334,516. LOCAL OFFICE SPACE, LLC, SCOTTSDALE, AZ. FILED 5-31-2011.

## SpaceMonkey

THE MARK CONSISTS OF STANDARD CHARACTERS WITHOUT CLAIM TO ANY PARTICULAR FONT, STYLE, SIZE, OR COLOR.

FOR PROVIDING AN INTERACTIVE WEBSITE FEATURING TECHNOLOGY THAT PROVIDES A PLATFORM FOR CONNECTING SMALL BUSINESS OWNERS INTERESTED IN LEASING OR PURCHASING COMMERCIAL OFFICE, RETAIL OR INDUSTRIAL SPACE WITH THE OWNERS OR "LANDLORDS" OF THAT PROPERTY (U.S. CLS. 100 AND 101).

FIRST USE 2-20-2011; IN COMMERCE 5-5-2011.

JOHN DWYER, EXAMINING ATTORNEY

**CLASS 42—(Continued).**

SN 85-334,552. ADOBE SYSTEMS INCORPORATED, SAN JOSE, CA. FILED 5-31-2011.

# ADOBE

THE MARK CONSISTS OF STANDARD CHARACTERS WITHOUT CLAIM TO ANY PARTICULAR FONT, STYLE, SIZE, OR COLOR.

OWNER OF U.S. REG. NOS. 1,475,793, 1,988,712 AND OTHERS.

FOR COMPUTER SERVICES, NAMELY, PROVIDING TEMPORARY USE OF ON-LINE, NON-DOWNLOADABLE SOFTWARE FOR WORD PROCESSING, FOR CREATING, EDITING, LAYING OUT, PRINTING, ORGANIZING, MANAGING, SHARING AND ACCESS CONTROL OF DOCUMENTS, AND FOR COLLABORATIVE AUTHORING, EDITING AND REVIEWING OF MULTIMEDIA DOCUMENTS, TABLES, PRESENTATIONS, DESIGN PROJECTS, SCRIPTS AND SCREENPLAYS; PROVIDING TEMPORARY USE OF ON-LINE NON-DOWNLOADABLE SOFTWARE FOR USE IN CREATING, EDITING, ANNOTATING, VIEWING, SHARING, STORING AND DISTRIBUTING INTERACTIVE ELECTRONIC DOCUMENTS, NAMELY, PORTABLE DOCUMENT FORMAT (PDF) FILES; COMPUTER SERVICES, NAMELY, HOSTING ON-LINE WEB FACILITIES FOR OTHERS FOR ORGANIZING AND CONDUCTING ON-LINE, REAL-TIME MEETINGS, INTERACTIVE DISCUSSIONS AND PRESENTATIONS, FEATURING ELECTRONIC DATA SHARING, DOCUMENT SHARING, APPLICATION SHARING, COMPUTER SCREEN SHARING AND TEXT CHAT; PROVIDING TEMPORARY USE OF ON-LINE, NON-DOWNLOADABLE SOFTWARE FOR COLLABORATIVE SCREENWRITING AND STREAMLINING THE FLOW OF SCRIPT DATA INTO VIDEO PRODUCTIONS; PROVIDING TEMPORARY USE OF ON-LINE, NON-DOWNLOADABLE SOFTWARE FOR PREVIEWING AND TESTING WEB PAGES AND WEB PAGE CONTENT IN MULTIPLE WEB BROWSERS AND OPERATING SYSTEMS (U.S. CLS. 100 AND 101).

FIRST USE 1-15-2007; IN COMMERCE 1-15-2007.

JAMES MACFARLANE, EXAMINING ATTORNEY

---

SN 85-334,556. EVERLOOP, INC., DANVILLE, CA. FILED 5-31-2011.

## WHO'S IN YOUR LOOP?

THE MARK CONSISTS OF STANDARD CHARACTERS WITHOUT CLAIM TO ANY PARTICULAR FONT, STYLE, SIZE, OR COLOR.

FOR PROVIDING AND HOSTING AN INTERACTIVE WEBSITE ALLOWING USERS THE ABILITY TO UPLOAD, EXCHANGE AND SHARE PHOTOS, VIDEOS, MUSIC AND OTHER DATA; FILE SHARING SERVICES, NAMELY, PROVIDING A WEBSITE FEATURING TECHNOLOGY ENABLING USERS TO UPLOAD AND DOWNLOAD ELECTRONIC FILES (U.S. CLS. 100 AND 101).

CHRISTINA SOBRAL, EXAMINING ATTORNEY

**CLASS 42—(Continued).**

SN 85-334,565. ADOBE SYSTEMS INCORPORATED, SAN JOSE, CA. FILED 5-31-2011.



OWNER OF U.S. REG. NOS. 1,988,710, 3,032,288 AND OTHERS.

THE MARK CONSISTS OF A STYLIZED LETTER A IN A SQUARE FORM.

FOR COMPUTER SERVICES, NAMELY, PROVIDING TEMPORARY USE OF ON-LINE, NON-DOWNLOADABLE SOFTWARE FOR WORD PROCESSING, FOR CREATING, EDITING, LAYING OUT, PRINTING, ORGANIZING, MANAGING, SHARING AND ACCESS CONTROL OF DOCUMENTS, AND FOR COLLABORATIVE AUTHORING, EDITING AND REVIEWING OF MULTIMEDIA DOCUMENTS, TABLES, PRESENTATIONS, DESIGN PROJECTS, SCRIPTS AND SCREENPLAYS; PROVIDING TEMPORARY USE OF ON-LINE NON-DOWNLOADABLE SOFTWARE FOR USE IN CREATING, EDITING, ANNOTATING, VIEWING, SHARING, STORING AND DISTRIBUTING INTERACTIVE ELECTRONIC DOCUMENTS, NAMELY, PORTABLE DOCUMENT FORMAT (PDF) FILES; COMPUTER SERVICES, NAMELY, HOSTING ON-LINE WEB FACILITIES FOR OTHERS FOR ORGANIZING AND CONDUCTING ON-LINE, REAL-TIME MEETINGS, INTERACTIVE DISCUSSIONS AND PRESENTATIONS, FEATURING ELECTRONIC DATA SHARING, DOCUMENT SHARING, APPLICATION SHARING, COMPUTER SCREEN SHARING AND TEXT CHAT; PROVIDING TEMPORARY USE OF ON-LINE, NON-DOWNLOADABLE SOFTWARE FOR COLLABORATIVE SCREENWRITING AND STREAMLINING THE FLOW OF SCRIPT DATA INTO VIDEO PRODUCTIONS; PROVIDING TEMPORARY USE OF ON-LINE, NON-DOWNLOADABLE SOFTWARE FOR PREVIEWING AND TESTING WEB PAGES AND WEB PAGE CONTENT IN MULTIPLE WEB BROWSERS AND OPERATING SYSTEMS (U.S. CLS. 100 AND 101).

FIRST USE 1-15-2007; IN COMMERCE 1-15-2007.

JAMES MACFARLANE, EXAMINING ATTORNEY

**CLASS 42—(Continued).**

SN 85-334,639. INTERIOR ILLUSIONS, INC., WEST HOLLYWOOD, CA. FILED 5-31-2011.

## Interior Illusions

THE MARK CONSISTS OF STANDARD CHARACTERS WITHOUT CLAIM TO ANY PARTICULAR FONT, STYLE, SIZE, OR COLOR.

NO CLAIM IS MADE TO THE EXCLUSIVE RIGHT TO USE "INTERIOR", APART FROM THE MARK AS SHOWN.

FOR DESIGN OF INTERIOR DECOR; HOME STAGING CONSULTATION, NAMELY, TEMPORARY INTERIOR AND EXTERIOR HOME DECORATION CONSULTATION FOR THE PURPOSE OF MAKING HOMES MORE APPEALING TO PROSPECTIVE BUYERS; INTERIOR DECORATING; INTERIOR DECORATION CONSULTATION; INTERIOR DESIGN SERVICES; INTERIOR DESIGN SERVICES INCLUDING SPACE PLANNING, FURNITURE SELECTION, MATERIAL AND SURFACE SELECTION; PAINT MATCHING, NAMELY, COLOR ANALYSIS TO DETERMINE PROPER PAINT MIXTURE FOR MATCHING COLORS FOR INTERIOR DECORATING PURPOSES; PROVIDING A WEBSITE FEATURING INFORMATION IN THE FIELD OF INTERIOR DESIGN AND HOME STAGING (U.S. CLS. 100 AND 101).

FIRST USE 1-1-1999; IN COMMERCE 1-1-1999.

LAURA HAMMEL, EXAMINING ATTORNEY

SN 85-335,030. INNOVATRIX MARKETING LLC, DEERFIELD, IL. FILED 6-1-2011.

## MEMORY-ART-PRINT

THE MARK CONSISTS OF STANDARD CHARACTERS WITHOUT CLAIM TO ANY PARTICULAR FONT, STYLE, SIZE, OR COLOR.

FOR COMPUTER AIDED GRAPHIC DESIGN; COMPUTER GRAPHICS DESIGN SERVICES; COMPUTER GRAPHICS DESIGN SERVICES, NAMELY, CREATING OF CUSTOM AND NON-CUSTOM PHOTOGRAPHS, PAINTINGS, COLLAGES, PRINTS, WORKS OF ART, GIFTS; COMPUTER SERVICES, NAMELY, ELECTRONIC DIGITIZING OF CUSTOM AND NON-CUSTOM PHOTOGRAPHS, PAINTINGS, COLLAGES, PRINTS, WORKS OF ART, GIFTS; COMPUTER SERVICES, NAMELY, ELECTRONIC IMAGING OF CUSTOM AND NON-CUSTOM PHOTOGRAPHS, PAINTINGS, COLLAGES, PRINTS, WORKS OF ART, GIFTS; CUSTOM DESIGN AND DEVELOPMENT OF CUSTOM AND NON-CUSTOM PHOTOGRAPHS, PAINTINGS, COLLAGES, PRINTS, WORKS OF ART, GIFTS; CUSTOM DESIGN AND ENGINEERING OF CUSTOM AND NON-CUSTOM PHOTOGRAPHS, PAINTINGS, COLLAGES, PRINTS, WORKS OF ART, GIFTS; CUSTOM DESIGN OF CUSTOM AND NON-CUSTOM PHOTOGRAPHS, PAINTINGS, COLLAGES, PRINTS, WORKS OF ART, GIFTS BASED ON PERSONAL SELECTIONS MADE BY THE CUSTOMER; DESIGN AND DEVELOPMENT OF MULTIMEDIA PRODUCTS; DESIGN OF CUSTOM PAINTINGS; GRAPHIC DESIGN SERVICES FOR CUSTOM AND



**CLASS 42—(Continued).**

NON-CUSTOM PHOTOGRAPHS, PAINTINGS, COLLAGES, PRINTS, WORKS OF ART, GIFTS; GRAPHIC ILLUSTRATION AND DRAWING SERVICES, NAMELY, CUSTOM AND NON-CUSTOM PHOTOGRAPHS, PAINTINGS, COLLAGES, PRINTS, WORKS OF ART, GIFTS; GRAPHIC ILLUSTRATION SERVICES FOR OTHERS; PROVIDING A WEB SITE THAT GIVES MULTIPLE COMPUTER USERS SIMULTANEOUSLY THE ABILITY TO UPLOAD, CREATE AND EDIT DOCUMENTS, PRINTED PUBLICATIONS, ONLINE PUBLICATIONS, PHOTOGRAPHS, PRODUCT PACKAGING AND ADVERTISEMENTS; PROVIDING A WEBSITE FEATURING ON-LINE NON-DOWNLOADABLE SOFTWARE THAT ENABLES USERS TO CUSTOM AND NON-CUSTOM PHOTOGRAPHS, PAINTINGS, COLLAGES, PRINTS, WORKS OF ART, GIFTS; PROVIDING A WEBSITE FEATURING ON-LINE NON-DOWNLOADABLE SOFTWARE TOOLS FOR IMAGE EDITING; PROVIDING GRAPHIC AND MULTIMEDIA DESIGN SERVICES FOR THE PURPOSE OF PROMOTING THE GOODS AND SERVICES OF OTHERS (U.S. CLS. 100 AND 101).

KEVON CHISOLM, EXAMINING ATTORNEY

**CLASS 42—(Continued).**

OF ART, GIFTS; GRAPHIC ILLUSTRATION SERVICES FOR OTHERS; PROVIDING A WEB SITE THAT GIVES MULTIPLE COMPUTER USERS SIMULTANEOUSLY THE ABILITY TO UPLOAD, CREATE AND EDIT DOCUMENTS, PRINTED PUBLICATIONS, ONLINE PUBLICATIONS, PHOTOGRAPHS, PRODUCT PACKAGING AND ADVERTISEMENTS; PROVIDING A WEBSITE FEATURING ON-LINE NON-DOWNLOADABLE SOFTWARE THAT ENABLES USERS TO CUSTOM AND NON-CUSTOM PHOTOGRAPHS, PAINTINGS, COLLAGES, PRINTS, WORKS OF ART, GIFTS; PROVIDING A WEBSITE FEATURING ON-LINE NON-DOWNLOADABLE SOFTWARE TOOLS FOR IMAGE EDITING; PROVIDING A WEBSITE THAT GIVES USERS THE ABILITY TO REVIEW VARIOUS PRINT, PHOTOGRAPHIC, GRAPHIC IMAGE, AND AUDIO AND VIDEO CONTENT AND UTILIZE A CUSTOM TEMPLATE TO PROVIDE INPUT, LIKES, DISLIKES, EDITS, CHANGES, MODIFICATIONS, OPINIONS, SUGGESTIONS, AND COMMENTS AND ENGAGE IN SOCIAL, BUSINESS AND COMMUNITY NETWORKING (U.S. CLS. 100 AND 101).

KEVON CHISOLM, EXAMINING ATTORNEY

---

SN 85-335,107. INNOVATRIX MARKETING LLC, DEERFIELD, IL. FILED 6-1-2011.

**HAPPINESS GUARANTEE**

THE MARK CONSISTS OF STANDARD CHARACTERS WITHOUT CLAIM TO ANY PARTICULAR FONT, STYLE, SIZE, OR COLOR.

NO CLAIM IS MADE TO THE EXCLUSIVE RIGHT TO USE "GUARANTEE", APART FROM THE MARK AS SHOWN.

FOR COMPUTER AIDED GRAPHIC DESIGN; COMPUTER GRAPHICS DESIGN SERVICES; COMPUTER GRAPHICS DESIGN SERVICES, NAMELY, CREATING OF CUSTOM AND NON-CUSTOM PHOTOGRAPHS, PAINTINGS, COLLAGES, PRINTS, WORKS OF ART, GIFTS; COMPUTER GRAPHICS SERVICES; CUSTOM DESIGN AND DEVELOPMENT OF PHOTOGRAPHS, PAINTINGS, COLLAGES, PRINTS, WORKS OF ART, GIFTS; CUSTOM DESIGN AND ENGINEERING OF PHOTOGRAPHS, PAINTINGS, COLLAGES, PRINTS, WORKS OF ART, GIFTS; CUSTOM DESIGN OF PHOTOGRAPHS, PAINTINGS, COLLAGES, PRINTS, WORKS OF ART, GIFTS BASED ON PERSONAL SELECTIONS MADE BY THE CUSTOMER; DESIGN AND DEVELOPMENT OF CUSTOM AND NON-CUSTOM PHOTOGRAPHS, PAINTINGS, COLLAGES, PRINTS, WORKS OF ART, GIFTS; DESIGN OF CUSTOM PAINTINGS; DESIGNING CUSTOM AND NON-CUSTOM PHOTOGRAPHS, PAINTINGS, COLLAGES, PRINTS, WORKS OF ART, GIFTS; ELECTRONIC SCANNING OF CUSTOM AND NON-CUSTOM PHOTOGRAPHS, PAINTINGS, COLLAGES, PRINTS, WORKS OF ART, GIFTS; GRAPHIC ARTS DESIGNING; GRAPHIC DESIGN; GRAPHIC DESIGN SERVICES; GRAPHIC DESIGN SERVICES FOR CUSTOM AND NON-CUSTOM PHOTOGRAPHS, PAINTINGS, COLLAGES, PRINTS, WORKS OF ART, GIFTS; GRAPHIC ILLUSTRATION AND DRAWING SERVICES, NAMELY, PROVIDING GRAPHIC ILLUSTRATIONS AND DRAWINGS OF COMMERCIAL AND INDUSTRIAL BUILDING DESIGNS, AND CONVERTING BUILDING DESIGNS OR MARKUPS TO ELECTRONIC CAD DRAWINGS; GRAPHIC ILLUSTRATION AND DRAWING SERVICES, NAMELY, CUSTOM AND NON-CUSTOM PHOTOGRAPHS, PAINTINGS, COLLAGES, PRINTS, WORKS

---

SN 85-335,142. NEWTEK BUSINESS SERVICES, INC., NEW YORK, NY. FILED 6-1-2011.

**CLOUD AUTHORITY**

THE MARK CONSISTS OF STANDARD CHARACTERS WITHOUT CLAIM TO ANY PARTICULAR FONT, STYLE, SIZE, OR COLOR.

OWNER OF U.S. REG. NO. 3,955,632.

NO CLAIM IS MADE TO THE EXCLUSIVE RIGHT TO USE "CLOUD", APART FROM THE MARK AS SHOWN.

FOR COMPUTER SERVICES, NAMELY, CLOUD HOSTING PROVIDER SERVICES; COMPUTER SERVICES, NAMELY, CLOUD HOSTING PROVIDER SERVICES FOR DATA AND APPLICATIONS; TECHNICAL SUPPORT SERVICES, NAMELY, REMOTE SERVICES FOR MONITORING, ADMINISTRATION AND MANAGEMENT OF CLOUD COMPUTING IT AND APPLICATIONS (U.S. CLS. 100 AND 101).

WILLIAM ROSSMAN, EXAMINING ATTORNEY

**CLASS 42—(Continued).**

SN 85-335,148. NEWTEK BUSINESS SERVICES, INC., NEW YORK, NY. FILED 6-1-2011.

**THE CLOUD AUTHORITY**

THE MARK CONSISTS OF STANDARD CHARACTERS WITHOUT CLAIM TO ANY PARTICULAR FONT, STYLE, SIZE, OR COLOR.

OWNER OF U.S. REG. NO. 3,955,632.

NO CLAIM IS MADE TO THE EXCLUSIVE RIGHT TO USE "CLOUD", APART FROM THE MARK AS SHOWN.

FOR COMPUTER SERVICES, NAMELY, CLOUD HOSTING PROVIDER SERVICES; COMPUTER SERVICES, NAMELY, CLOUD HOSTING PROVIDER SERVICES FOR DATA AND APPLICATIONS; TECHNICAL SUPPORT SERVICES, NAMELY, REMOTE SERVICES FOR MONITORING, ADMINISTRATION AND MANAGEMENT OF CLOUD COMPUTING IT AND APPLICATIONS (U.S. CLS. 100 AND 101).

FIRST USE 3-0-2011; IN COMMERCE 3-0-2011.

WILLIAM ROSSMAN, EXAMINING ATTORNEY

SN 85-335,159. NEWTEK BUSINESS SERVICES, INC., NEW YORK, NY. FILED 6-1-2011.



OWNER OF U.S. REG. NO. 3,955,632.  
NO CLAIM IS MADE TO THE EXCLUSIVE RIGHT TO USE "CLOUD", APART FROM THE MARK AS SHOWN.

THE MARK CONSISTS OF THE WORDING THE CLOUD AUTHORITY APPEARING IN A RECTANGULAR BOX.

FOR COMPUTER SERVICES, NAMELY, CLOUD HOSTING PROVIDER SERVICES; COMPUTER SERVICES, NAMELY, CLOUD HOSTING PROVIDER SERVICES FOR DATA AND APPLICATIONS; TECHNICAL SUPPORT SERVICES, NAMELY, REMOTE SERVICES FOR MONITORING, ADMINISTRATION AND MANAGEMENT OF CLOUD COMPUTING IT AND APPLICATIONS (U.S. CLS. 100 AND 101).

FIRST USE 3-0-2011; IN COMMERCE 3-0-2011.

WILLIAM ROSSMAN, EXAMINING ATTORNEY

**CLASS 42—(Continued).**

SN 85-335,217. NEWTEK BUSINESS SERVICES, INC., NEW YORK, NY. FILED 6-1-2011.

**A NEW WAY TO THINK ABOUT  
SMALL-BUSINESS IT**

THE MARK CONSISTS OF STANDARD CHARACTERS WITHOUT CLAIM TO ANY PARTICULAR FONT, STYLE, SIZE, OR COLOR.

FOR COMPUTER SERVICES, NAMELY, CLOUD HOSTING PROVIDER SERVICES; COMPUTER SERVICES, NAMELY, CLOUD HOSTING PROVIDER SERVICES FOR DATA AND APPLICATIONS; TECHNICAL SUPPORT SERVICES, NAMELY, REMOTE SERVICES FOR MONITORING, ADMINISTRATION AND MANAGEMENT OF CLOUD COMPUTING IT AND APPLICATIONS (U.S. CLS. 100 AND 101).

FIRST USE 3-0-2011; IN COMMERCE 3-0-2011.

WILLIAM ROSSMAN, EXAMINING ATTORNEY

SN 85-335,361. TABULA, INC., SANTA CLARA, CA. FILED 6-1-2011.

**ASAP**

THE MARK CONSISTS OF STANDARD CHARACTERS WITHOUT CLAIM TO ANY PARTICULAR FONT, STYLE, SIZE, OR COLOR.

FOR DESIGN OF APPLICATION SPECIFIC STANDARD PRODUCTS, NAMELY, SEMICONDUCTOR DEVICES, FOR OTHERS (U.S. CLS. 100 AND 101).

MICHELE SWAIN, EXAMINING ATTORNEY

SN 85-335,392. BOLTNET, INC., SAN FRANCISCO, CA. FILED 6-1-2011.

**GETBOLT**

THE MARK CONSISTS OF STANDARD CHARACTERS WITHOUT CLAIM TO ANY PARTICULAR FONT, STYLE, SIZE, OR COLOR.

FOR COMPUTER SERVICES, NAMELY, AN ON-LINE COMMUNITY FOR PROFESSIONALS AND CONSUMERS TO FIND INFORMATION, CONNECT WITH PEERS, PARTICIPATE IN DISCUSSIONS, AND ENGAGE IN SOCIAL NETWORKING FEATURING TOPICS ON WEB PAGE CUSTOMIZATION THROUGH SOCIAL NETWORKS IN THE FIELD OF MARKETING (U.S. CLS. 100 AND 101).

HELENE LIWINSKI, EXAMINING ATTORNEY

**CLASS 42—(Continued).**

SN 85-335,424. GRABCAD, INC., BOSTON, MA. FILED 6-1-2011.

# GRABCAD

THE MARK CONSISTS OF STANDARD CHARACTERS WITHOUT CLAIM TO ANY PARTICULAR FONT, STYLE, SIZE, OR COLOR.

FOR SOFTWARE AS A SERVICE (SAAS) FEATURING SOFTWARE THAT ENABLES ENGINEERING PROFESSIONALS AND THEIR CURRENT AND PROSPECTIVE CLIENTS TO COMMUNICATE AND SHARE DATA (U.S. CLS. 100 AND 101).

GISELLE AGOSTO, EXAMINING ATTORNEY

SN 85-335,511. PRIVEAZY, INC., CORINTH, TX. FILED 6-1-2011.

# Priveazy

THE MARK CONSISTS OF STANDARD CHARACTERS WITHOUT CLAIM TO ANY PARTICULAR FONT, STYLE, SIZE, OR COLOR.

FOR PROVIDING A WEBSITE FEATURING RESOURCES, NAMELY, NON-DOWNLOADABLE SOFTWARE FOR EDUCATING USERS ABOUT ONLINE PRIVACY AND SAFETY (U.S. CLS. 100 AND 101).

C. DIONNE CLYBURN, EXAMINING ATTORNEY

SN 85-335,561. CINTEL SYSTEMS INC, PLEASANTON, CA. FILED 6-1-2011.

# CintelTime

THE MARK CONSISTS OF STANDARD CHARACTERS WITHOUT CLAIM TO ANY PARTICULAR FONT, STYLE, SIZE, OR COLOR.

FOR PROVIDING AN INTERNET WEBSITE PORTAL IN THE FIELDS OF TECHNOLOGY AND SOFTWARE DEVELOPMENT (U.S. CLS. 100 AND 101).

FIRST USE 4-1-2011; IN COMMERCE 4-1-2011.

REGINA DRUMMOND, EXAMINING ATTORNEY

**CLASS 42—(Continued).**

SN 85-335,780. SENSPIRE LLC, PALO ALTO, CA. FILED 6-1-2011.



THE COLOR(S) GRAY, BLUE, AND WHITE IS/ARE CLAIMED AS A FEATURE OF THE MARK.

THE MARK CONSISTS OF THE VERBAL ELEMENT SENSPIRE IN GRAY WITH THE SECOND S IN WHITE SURROUNDED BY A HEXAGON FILLED IN BLUE.

FOR PROVIDING ON-LINE NON-DOWNLOADABLE SOFTWARE FOR ENHANCING AND INSPIRING CREATIVITY BY REVEALING MATHEMATICAL PATTERNS IN NATURE (U.S. CLS. 100 AND 101).

PAM WILLIS, EXAMINING ATTORNEY

SN 85-335,825. JUST4FRIENDS INC, GREENWOOD VILLAGE, CO. FILED 6-1-2011.

# JUST4FRIENDS

THE MARK CONSISTS OF STANDARD CHARACTERS WITHOUT CLAIM TO ANY PARTICULAR FONT, STYLE, SIZE, OR COLOR.

FOR COMPUTER SERVICES, NAMELY, CREATING AN ON-LINE COMMUNITY FOR REGISTERED USERS TO PARTICIPATE IN DISCUSSIONS, GET FEEDBACK FROM THEIR PEERS, FORM VIRTUAL COMMUNITIES, AND ENGAGE IN SOCIAL NETWORKING (U.S. CLS. 100 AND 101).

DORITT L. CARROLL, EXAMINING ATTORNEY

SN 85-336,424. K. HOV IP, II, INC., RED BANK, NJ. FILED 6-2-2011.

# STYLESUITE

THE MARK CONSISTS OF STANDARD CHARACTERS WITHOUT CLAIM TO ANY PARTICULAR FONT, STYLE, SIZE, OR COLOR.

FOR PROVIDING A WEBSITE FEATURING ON-LINE NON-DOWNLOADABLE SOFTWARE THAT ENABLES USERS TO SEARCH, REVIEW AND SELECT INTERIOR AND EXTERIOR HOME FINISHES AND DÉCOR; INTERIOR DESIGN SERVICES, NAMELY, ON-LINE INFORMATION AND ADVICE FOR INTERIOR AND EXTERIOR HOME FINISHES AND DÉCOR (U.S. CLS. 100 AND 101).

SAMUEL E. SHARPER JR., EXAMINING ATTORNEY

**CLASS 42—(Continued).**

SN 85-336,590. ATE MY HEART INC., LOS ANGELES, CA. FILED 6-2-2011.

**LITTLE MONSTERS**

THE MARK CONSISTS OF STANDARD CHARACTERS WITHOUT CLAIM TO ANY PARTICULAR FONT, STYLE, SIZE, OR COLOR.

FOR PROVIDING A WEB SITE FEATURING TEMPORARY USE OF NON-DOWNLOADABLE SOFTWARE ALLOWING USERS TO UPLOAD, POST AND DISPLAY ONLINE VIDEOS FOR SHARING WITH OTHERS FOR ENTERTAINMENT PURPOSES; PROVIDING A WEBSITE ALLOWING USERS TO UPLOAD AND DOWNLOAD MUSIC AND MUSIC VIDEOS; PROVIDING A WEB SITE THAT GIVES USERS THE ABILITY TO UPLOAD, EXCHANGE AND SHARE PHOTOS AND VIDEOS (U.S. CLS. 100 AND 101).

NICHOLAS ALTREE, EXAMINING ATTORNEY

SN 85-336,632. MENEZES, DEELIP CHARLES, ALTO PORVORIM, GOA, INDIA, FILED 6-2-2011.

**DEELIP.COM**

THE MARK CONSISTS OF STANDARD CHARACTERS WITHOUT CLAIM TO ANY PARTICULAR FONT, STYLE, SIZE, OR COLOR.

FOR PROVIDING A WEBSITE FEATURING NEWS, INFORMATION, ANALYSIS, AND COMMENTARY ON THE COMPUTER AIDED DESIGN INDUSTRY (U.S. CLS. 100 AND 101).

FIRST USE 8-1-2006; IN COMMERCE 8-1-2006.  
NAKIA HENRY, EXAMINING ATTORNEY

SN 85-336,639. SMACK DAB STUDIOS, LLC, SAVANNAH, GA. FILED 6-2-2011.

**RAPPIDAPP**

THE MARK CONSISTS OF STANDARD CHARACTERS WITHOUT CLAIM TO ANY PARTICULAR FONT, STYLE, SIZE, OR COLOR.

FOR SOFTWARE AS A SERVICE (SAAS) SERVICES FEATURING SOFTWARE FOR USE IN THE DEVELOPMENT AND MANAGEMENT OF MOBILE APPLICATIONS (U.S. CLS. 100 AND 101).

FIRST USE 4-12-2011; IN COMMERCE 4-12-2011.  
STEVEN PEREZ, EXAMINING ATTORNEY

**CLASS 42—(Continued).**

SN 85-337,198. GDSX, LTD., ALLEN, TX. FILED 6-3-2011.

**TripLink**

THE MARK CONSISTS OF STANDARD CHARACTERS WITHOUT CLAIM TO ANY PARTICULAR FONT, STYLE, SIZE, OR COLOR.

FOR PROVIDING A NON-DOWNLOADABLE PROPRIETARY SOFTWARE SOLUTION, NAMELY, A TRAVEL DATA REPOSITORY THAT ALLOWS OTHERS TO CONSOLIDATE DATA ORIGINATING FROM WITHIN A GLOBAL DISTRIBUTION SYSTEM (GDS) WITH NON-GDS ORIGINATED DATA IN THE FIELD OF CORPORATE TRAVEL MANAGEMENT (U.S. CLS. 100 AND 101).

JILL C. ALT, EXAMINING ATTORNEY

SN 85-337,760. GOLF PIGEON, INC., EDMOND, OK. FILED 6-3-2011.

**OBSESSED? WE ARE TOO!**

THE MARK CONSISTS OF STANDARD CHARACTERS WITHOUT CLAIM TO ANY PARTICULAR FONT, STYLE, SIZE, OR COLOR.

FOR COMPUTER SERVICES, NAMELY, CREATING AN ON-LINE COMMUNITY FOR REGISTERED USERS TO PARTICIPATE IN DISCUSSIONS, OBTAIN NEWS AND INFORMATION, FORM VIRTUAL COMMUNITIES, AND ENGAGE IN SOCIAL NETWORKING (U.S. CLS. 100 AND 101).

FIRST USE 12-6-2010; IN COMMERCE 12-6-2010.  
CAROLINE WOOD, EXAMINING ATTORNEY

SN 85-338,003. TABJUICE, LLC, SAN DIEGO, CA. FILED 6-3-2011.

**TabJuice**

THE MARK CONSISTS OF STANDARD CHARACTERS WITHOUT CLAIM TO ANY PARTICULAR FONT, STYLE, SIZE, OR COLOR.

FOR SOFTWARE AS A SERVICE (SAAS) SERVICES FEATURING SOFTWARE FOR SELLING GOODS AND SERVICES ONLINE THROUGH SOCIAL MEDIA PLATFORMS (U.S. CLS. 100 AND 101).

FIRST USE 5-31-2011; IN COMMERCE 5-31-2011.  
BRENDAN MCCAULEY, EXAMINING ATTORNEY

**CLASS 42—(Continued).**

SN 85-338,701. SANCHEZ, SANDRA, ALBUQUERQUE, NM.  
FILED 6-6-2011.

# MexiChanic

THE MARK CONSISTS OF STANDARD CHARACTERS WITHOUT CLAIM TO ANY PARTICULAR FONT, STYLE, SIZE, OR COLOR.

FOR COMPUTER SERVICES, NAMELY, CREATING AN ON-LINE COMMUNITY FOR REGISTERED USERS TO PARTICIPATE IN DISCUSSIONS, GET FEEDBACK FROM THEIR PEERS, FORM VIRTUAL COMMUNITIES, UPLOAD AND EXCHANGE PHOTOS, AND ENGAGE IN SOCIAL NETWORKING FEATURING DO-IT-YOURSELF ADVICE FROM DO-IT-YOURSELF INDIVIDUALS (U.S. CLS. 100 AND 101).

GIANCARLO CASTRO, EXAMINING ATTORNEY

**CLASS 42—(Continued).**

SN 85-338,872. INSURANCE DATA PROCESSING, INC.,  
WYNCOTE, PA. FILED 6-6-2011.

# INSURASPHERE

THE MARK CONSISTS OF STANDARD CHARACTERS WITHOUT CLAIM TO ANY PARTICULAR FONT, STYLE, SIZE, OR COLOR.

FOR SOFTWARE AS A SERVICE (SAAS) SERVICES FOR INSURANCE CARRIERS; MANAGING GENERAL AGENTS AND INSURANCE AGENTS, NAMELY, HOSTING SOFTWARE FOR USE BY OTHERS FOR DATABASE MANAGEMENT, DOCUMENT MANAGEMENT, INSURANCE POLICY ADMINISTRATION, INSURANCE CLAIMS PROCESSING AND SERVICES, INSURANCE POLICY BILLING, ACCOUNTING AND PAYMENT FUNCTIONS, CUSTOMER RELATIONSHIP MANAGEMENT AND CUSTOMER COMMUNICATIONS; COMPUTER SERVICES, NAMELY, CREATING AND MAINTAINING WEB SITES FOR OTHERS; COMPUTER TECHNICAL SUPPORT SERVICES, NAMELY, 24/7 SERVICE DESK/HELP DESK SERVICES FOR IT INFRASTRUCTURE, OPERATING SYSTEMS, DATABASE SYSTEMS, AND WEB APPLICATIONS (U.S. CLS. 100 AND 101).

JOHN WILKE, EXAMINING ATTORNEY

SN 85-339,077. BRAWERMAN MARSH, LLC, ATLANTA, GA.  
FILED 6-6-2011.

# TERRAIN

THE MARK CONSISTS OF STANDARD CHARACTERS WITHOUT CLAIM TO ANY PARTICULAR FONT, STYLE, SIZE, OR COLOR.

FOR SOFTWARE AS A SERVICE THAT DELIVERS A PROPRIETARY ANALYTICS SOLUTION TO MEASURE THE EFFECTIVENESS OF THE IN-STORE PROMOTION INVESTMENT (U.S. CLS. 100 AND 101).

FLORENTINA BLANDU, EXAMINING ATTORNEY

SN 85-338,741. BROWSIUM, INC., REDMOND, WA. FILED 6-6-2011.

# Browsium

THE MARK CONSISTS OF STANDARD CHARACTERS WITHOUT CLAIM TO ANY PARTICULAR FONT, STYLE, SIZE, OR COLOR.

FOR COMPUTER SOFTWARE DEVELOPMENT (U.S. CLS. 100 AND 101).

FIRST USE 10-1-2010; IN COMMERCE 10-1-2010.  
BRIAN CALLAGHAN, EXAMINING ATTORNEY

SN 85-339,361. ZOOT ENTERPRISES, INC., BOZEMAN, MT.  
FILED 6-6-2011.

# ZINITIATE

THE MARK CONSISTS OF STANDARD CHARACTERS WITHOUT CLAIM TO ANY PARTICULAR FONT, STYLE, SIZE, OR COLOR.

FOR PROVIDING TEMPORARY USE OF ON-LINE NON-DOWNLOADABLE SOFTWARE FOR INSTANT EVALUATION OF DEMAND DEPOSIT ACCOUNT (DDA) OR CHECKING ACCOUNT APPLICATIONS (U.S. CLS. 100 AND 101).

FIRST USE 3-30-2011; IN COMMERCE 3-30-2011.  
H. M. FISHER, EXAMINING ATTORNEY

**CLASS 42—(Continued).**

SN 85-339,390. SGDR INDUSTRIES, LLC, RESEARCH TRIANGLE PARK, NC. FILED 6-6-2011.

# ADITAP

THE MARK CONSISTS OF STANDARD CHARACTERS WITHOUT CLAIM TO ANY PARTICULAR FONT, STYLE, SIZE, OR COLOR.

FOR PROVIDING A WEB SITE FEATURING TEMPORARY USE OF NON-DOWNLOADABLE SOFTWARE ALLOWING WEB SITE USERS TO UPLOAD, POST AND DISPLAY ONLINE VIDEOS AND PICTURES FOR SHARING WITH OTHERS FOR ENTERTAINMENT PURPOSES (U.S. CLS. 100 AND 101).

CIMMERIAN COLEMAN, EXAMINING ATTORNEY

---

SN 85-339,472. SHANTI SOLUTIONS, LLC, SALINE, MI. FILED 6-7-2011.

# TherapyNudge

THE MARK CONSISTS OF STANDARD CHARACTERS WITHOUT CLAIM TO ANY PARTICULAR FONT, STYLE, SIZE, OR COLOR.

FOR PROVIDING ON-LINE NON-DOWNLOADABLE SOFTWARE FOR THERAPISTS AND OTHER PROFESSIONAL SERVICE PROVIDERS TO SET AND SEND REMINDER MESSAGES TO CLIENTS AT PARTICULAR DATES AND TIMES BY EMAIL AND TEXT MESSAGING (U.S. CLS. 100 AND 101).

THEODORE MCBRIDE, EXAMINING ATTORNEY

---

SN 85-339,613. VATISSI CORPORATION, CHEHALIS, WA. FILED 6-7-2011.



The logo for VATISSI features a large, stylized blue letter 'V' on the left, followed by the word 'ATISSI' in a smaller, blue, sans-serif font.

THE NAME(S), PORTRAIT(S), AND/OR SIGNATURE(S) SHOWN IN THE MARK DOES NOT IDENTIFY A PARTICULAR LIVING INDIVIDUAL.

THE COLOR(S) BLUE IS/ARE CLAIMED AS A FEATURE OF THE MARK.

THE MARK CONSISTS OF VATISSI IN BLUE STYLIZED LETTERS.

FOR RESEARCH AND DEVELOPMENT IN THE FIELD OF LIFE SCIENCES (U.S. CLS. 100 AND 101).

FIRST USE 6-3-2011; IN COMMERCE 6-3-2011.

HANNO RITTNER, EXAMINING ATTORNEY

**CLASS 42—(Continued).**

SN 85-341,209. NUBIFER INC., SAN DIEGO, CA. FILED 6-8-2011.

# NUBIFER

THE MARK CONSISTS OF STANDARD CHARACTERS WITHOUT CLAIM TO ANY PARTICULAR FONT, STYLE, SIZE, OR COLOR.

FOR CLOUD COMPUTING FEATURING SOFTWARE FOR USE IN MONITORING AND AUDITING ENTERPRISE SYSTEM CONFIGURATIONS AND DATA STORAGE AND REPORTING; COMPUTER SERVICES, NAMELY, CLOUD HOSTING PROVIDER SERVICES; CONSULTING SERVICES IN THE FIELD OF CLOUD COMPUTING; CONSULTING SERVICES IN THE FIELD OF SOFTWARE AS A SERVICE (SAAS); PLATFORM AS A SERVICE (PAAS) FEATURING COMPUTER SOFTWARE PLATFORMS FOR CUSTOMER RESOURCE MANAGEMENT AND HUMAN RESOURCE INFORMATION SYSTEMS; SOFTWARE AS A SERVICE (SAAS) SERVICES FEATURING SOFTWARE IN THE FIELD OF CUSTOMER RESOURCE MANAGEMENT AND HUMAN RESOURCE INFORMATION SYSTEMS; TECHNICAL SUPPORT SERVICES, NAMELY, REMOTE AND ON-SITE INFRASTRUCTURE MANAGEMENT SERVICES FOR MONITORING, ADMINISTRATION AND MANAGEMENT OF PUBLIC AND PRIVATE CLOUD COMPUTING IT AND APPLICATION SYSTEMS (U.S. CLS. 100 AND 101).

FIRST USE 12-2-2008; IN COMMERCE 1-1-2009.

JOHN SCHUYLER YARD, EXAMINING ATTORNEY

---

SN 85-341,498. BELL, JEFFREY MICHAEL, DBA TECHANALIA, SAN BRUNO, CA. FILED 6-8-2011.

# Techanalia

THE MARK CONSISTS OF STANDARD CHARACTERS WITHOUT CLAIM TO ANY PARTICULAR FONT, STYLE, SIZE, OR COLOR.

FOR COMPUTER SERVICES, NAMELY, CREATING AN ON-LINE COMMUNITY FOR REGISTERED USERS TO SUBMIT AND ANSWER TECHNICAL QUESTIONS (U.S. CLS. 100 AND 101).

ELISSA GARBER KON, EXAMINING ATTORNEY

**CLASS 42—(Continued).**

SN 85-341,646. M2 SOFTWARE, INC., LOS ANGELES, CA. FILED 6-8-2011.

M2

THE MARK CONSISTS OF STANDARD CHARACTERS WITHOUT CLAIM TO ANY PARTICULAR FONT, STYLE, SIZE, OR COLOR.

OWNER OF U.S. REG. NO. 1,931,182.

SEC. 2(F).

FOR DEVELOPMENT, UPDATING AND MAINTENANCE OF SOFTWARE AND DATA BASES; TECHNICAL SUPPORT SERVICES, NAMELY, TROUBLESHOOTING OF COMPUTER SOFTWARE PROBLEMS (U.S. CLS. 100 AND 101).

FIRST USE 10-23-1991; IN COMMERCE 1-10-1992.

DORITT L. CARROLL, EXAMINING ATTORNEY

**CLASS 42—(Continued).**

SN 85-357,408. HARDWOOD PLYWOOD AND VENEER ASSOCIATION, RESTON, VA. FILED 6-27-2011.



OWNER OF U.S. REG. NOS. 3,355,888, 3,387,930 AND OTHERS.

THE MARK CONSISTS OF TWO CONCENTRIC CIRCLES. INSIDE THE UPPER PORTION OF THE RING BETWEEN THE TWO CIRCLES IS THE STYLIZED TEXT "ANSI/HPVA" AND IN THE BOTTOM PORTION OF THE RING IS THE STYLIZED TEXT "HP-1-2011". INSIDE BOTH SIDES OF THE RING AT 3 O'CLOCK AND 9 O'CLOCK IS A STAR. INSIDE THE INNER CIRCLE IS A STYLIZED HARDWOOD TREE.

FOR TESTING, ANALYSIS AND EVALUATION OF THE GOODS OF OTHERS FOR THE PURPOSE OF CERTIFICATION (U.S. CLS. 100 AND 101).

DEIRDRE ROBERTSON, EXAMINING ATTORNEY

SN 85-352,277. TEIKOKU PHARMA USA, INC., SAN JOSE, CA. FILED 6-21-2011.

TEIKOKU PHARMA USA

THE MARK CONSISTS OF STANDARD CHARACTERS WITHOUT CLAIM TO ANY PARTICULAR FONT, STYLE, SIZE, OR COLOR.

NO CLAIM IS MADE TO THE EXCLUSIVE RIGHT TO USE "PHARMA USA", APART FROM THE MARK AS SHOWN.

THE ENGLISH TRANSLATION OF "TEIKOKU" IN THE MARK IS EMPIRE.

FOR PHARMACEUTICAL RESEARCH AND DEVELOPMENT (U.S. CLS. 100 AND 101).

FIRST USE 12-31-2010; IN COMMERCE 12-31-2010.

VERNA BETH RIRIE, EXAMINING ATTORNEY

SN 85-359,208. ADVERTISING SPECIALTY INSTITUTE, INC., TREVOSE, PA. FILED 6-29-2011.

ASKASI.COM

THE MARK CONSISTS OF STANDARD CHARACTERS WITHOUT CLAIM TO ANY PARTICULAR FONT, STYLE, SIZE, OR COLOR.

OWNER OF U.S. REG. NOS. 1,917,420, 1,932,477 AND 2,990,827.

FOR TECHNICAL SUPPORT SERVICES, NAMELY, PROVIDING ON A GLOBAL COMPUTER NETWORK INFORMATION AND ADVICE ON THE USE OF COMPUTER SYSTEMS, COMPUTER SOFTWARE, AND DATA BASES; AND PROVIDING UPDATES AND PATCHES AND ENHANCEMENTS FOR COMPUTER SOFTWARE AND DATA BASE (U.S. CLS. 100 AND 101).

FIRST USE 3-0-2000; IN COMMERCE 3-0-2000.

MIDGE BUTLER, EXAMINING ATTORNEY

**CLASS 42—(Continued).**

SN 85-363,121. BLUE ZONES, LLC, MINNEAPOLIS, MN. FILED 7-5-2011.

**BLUE ZONES**

THE MARK CONSISTS OF STANDARD CHARACTERS WITHOUT CLAIM TO ANY PARTICULAR FONT, STYLE, SIZE, OR COLOR.

FOR ACCREDITATION SERVICES, NAMELY, DEVELOPING, EVALUATING, AND TESTING STANDARDS FOR HEALTHY ENVIRONMENTS AND LIFESTYLES, HAPPINESS AND LONGEVITY FOR THE PURPOSE OF ACCREDITATION; ARCHITECTURAL DESIGN; ARCHITECTURAL RESEARCH; DESIGN OF FACTORY BUILDINGS; DESIGN, DEVELOPMENT, AND TESTING SERVICES FOR OTHERS IN THE FIELDS OF NEW FOOD PRODUCTS AND NEW MENUS; DEVELOPMENT AND ESTABLISHMENT OF TESTING SPECIFICATIONS AND PROCEDURES IN THE FIELD OF HEALTHY ENVIRONMENTS AND LIFESTYLES, HAPPINESS AND LONGEVITY; INTERIOR DESIGN SERVICES; PLANNING AND DESIGN OF RESIDENTIAL, INSTITUTIONAL, COMMERCIAL AND OFFICE SPACES; PLANNING AND LAYOUT DESIGN SERVICES FOR ENVIRONMENTS AND INTERIOR SPACES THAT PROMOTE HEALTHY LIFESTYLES, HAPPINESS AND LONGEVITY; PRODUCT DESIGN AND DEVELOPMENT IN THE FIELD OF HEALTHY ENVIRONMENTS AND LIFESTYLES, HAPPINESS AND LONGEVITY; PROVIDING A WEBSITE FEATURING INFORMATION IN THE FIELD OF INTERIOR DESIGN AND ARCHITECTURE FOR USE BY INTERIOR DESIGNERS AND ARCHITECTS; RESEARCH AND DEVELOPMENT AND CONSULTATION RELATED THERETO IN THE FIELD OF HEALTHY ENVIRONMENTS AND LIFESTYLES, HAPPINESS AND LONGEVITY; RESEARCH ON BUILDING CONSTRUCTION OR CITY PLANNING; URBAN DESIGN PLANNING SERVICES (U.S. CLS. 100 AND 101).

JILL C. ALT, EXAMINING ATTORNEY

SN 85-377,152. MITEK SYSTEMS, INC., SAN DIEGO, CA. FILED 7-21-2011.

**SHOOT.SEND.DONE.**

THE MARK CONSISTS OF STANDARD CHARACTERS WITHOUT CLAIM TO ANY PARTICULAR FONT, STYLE, SIZE, OR COLOR.

FOR PROVIDING TEMPORARY USE OF ON-LINE NON-DOWNLOADABLE COMPUTER SOFTWARE FOR DOCUMENT IMAGING, INTELLIGENT CHARACTER AND IMAGE RECOGNITION, AND DOCUMENT ANALYSIS (U.S. CLS. 100 AND 101).

LEIGH LOWRY, EXAMINING ATTORNEY

**CLASS 42—(Continued).**

SN 85-378,327. SKYBOARD, LLC, METAIRIE, LA. FILED 7-22-2011.

**Zingboard**

THE MARK CONSISTS OF STANDARD CHARACTERS WITHOUT CLAIM TO ANY PARTICULAR FONT, STYLE, SIZE, OR COLOR.

FOR COMPUTER SERVICES, NAMELY, PROVIDING SEARCH PLATFORMS TO ALLOW USERS TO CONNECT STUDENTS, PARENTS, AND SCHOOLS AROUND STUDENT ACCOMPLISHMENTS (U.S. CLS. 100 AND 101).

LAURA HAMMEL, EXAMINING ATTORNEY

SN 85-378,622. ESEIS, INC., HOUSTON, TX. FILED 7-22-2011.

**V-BASED**

THE MARK CONSISTS OF STANDARD CHARACTERS WITHOUT CLAIM TO ANY PARTICULAR FONT, STYLE, SIZE, OR COLOR.

OWNER OF U.S. REG. NO. 3,030,350.

FOR CONSULTING SERVICES, NAMELY, INTERPRETATION OF SEISMIC DATA BY THE APPLICATION OF PROPRIETARY ALGORITHMS TO EXTRACT PORE PRESSURE INFORMATION FROM SEISMIC INTERVAL VELOCITIES FOR THE EVALUATION OF MINERAL RESERVES AND TO AID IN PLANNING WELLS (U.S. CLS. 100 AND 101).

FIRST USE 10-16-2002; IN COMMERCE 10-16-2002.

KELLY BOULTON, EXAMINING ATTORNEY

SN 85-378,681. ESEIS, INC., HOUSTON, TX. FILED 7-22-2011.

**Q-BASED**

THE MARK CONSISTS OF STANDARD CHARACTERS WITHOUT CLAIM TO ANY PARTICULAR FONT, STYLE, SIZE, OR COLOR.

OWNER OF U.S. REG. NO. 3,030,349.

FOR CONSULTING SERVICES, NAMELY, INTERPRETATION OF SEISMIC DATA BY THE APPLICATION OF PROPRIETARY ALGORITHMS TO EXTRACT PORE PRESSURE INFORMATION FROM SEISMIC FREQUENCY VARIATIONS FOR THE EVALUATION OF MINERAL RESERVES AND TO AID IN PLANNING WELLS (U.S. CLS. 100 AND 101).

FIRST USE 9-13-2002; IN COMMERCE 9-13-2002.

KELLY BOULTON, EXAMINING ATTORNEY



**CLASS 42—(Continued).**

SN 85-378,915. AOL INC., DULLES, VA. FILED 7-22-2011.

**CLASS 42—(Continued).**

SN 85-383,636. DYAX CORP., CAMBRIDGE, MA. FILED 7-28-2011.

EDITORS ROOM



THE MARK CONSISTS OF STANDARD CHARACTERS WITHOUT CLAIM TO ANY PARTICULAR FONT, STYLE, SIZE, OR COLOR.

FOR PROVIDING A WEBSITE FEATURING TECHNOLOGY THAT PROCESSES VIDEO CONTENT, NAMELY, ASSIGNS METADATA, ORGANIZES METADATA, AND CATEGORIZES THE VIDEO CONTENT; COMPUTER SOFTWARE SERVICES, NAMELY, DESIGNING, PROGRAMMING, AND PROVIDING ONLINE NONDOWNLOADABLE SOFTWARE IN THE NATURE OF ONLINE WIDGETS FOR THE DISPLAY OF VIDEO CONTENT; PROVIDING ONLINE NONDOWNLOADABLE SOFTWARE FOR STREAMING VIDEOS; PROVIDING ONLINE NONDOWNLOADABLE SOFTWARE IN THE NATURE OF AN ONLINE VIDEO PLAYER; PROVIDING TEMPORARY USE OF ONLINE NON-DOWNLOADABLE SOFTWARE FOR DISPLAYING, SHARING, AND PUBLISHING VIDEO CONTENT VIA COMPUTER AND COMMUNICATIONS NETWORKS; PROVIDING TEMPORARY USE OF ONLINE NON-DOWNLOADABLE SOFTWARE FOR THE INTEGRATION OF VIDEO CONTENT ONTO THE WEBSITES OF OTHERS; PROVIDING COMPUTER PROGRAMMING SERVICES TO CUSTOMERS THAT ENABLES THEM TO PROVIDE VIDEO CONTENT ON THEIR WEBSITES (U.S. CLS. 100 AND 101).

AMY KERTGATE, EXAMINING ATTORNEY

OWNER OF U.S. REG. NOS. 2,186,240 AND 2,710,452.  
NO CLAIM IS MADE TO THE EXCLUSIVE RIGHT TO USE "PHAGE DISPLAY", APART FROM THE MARK AS SHOWN.

THE MARK CONSISTS OF THE WORDS DYAX PHAGE DISPLAY AND THE DESIGN OF A CURVED LINE WHICH IS TAPERED TO A POINT ON ONE END AND BROAD AT THE OTHER END, WITH TWO SMALLER SHAPES WHICH ARE ROUGHLY TRIANGULAR.

FOR APPLICATION SERVICE PROVIDER (ASP) FEATURING SOFTWARE FOR USE DATABASE RESEARCH IN THE FIELD OF ANTIBODIES, PEPTIDES AND PROTEINS BY MEANS OF A SECURED-ACCESS WEB SITE; MEDICAL AND SCIENTIFIC RESEARCH INFORMATION IN THE FIELD OF PHAGES, PHAGE DISPLAY AND DRUG DISCOVERY; PHARMACEUTICAL RESEARCH SERVICES; PROVIDING AN ON-LINE SEARCHABLE DATABASE IN THE FIELD OF BIOTECHNOLOGY FOR SCIENTIFIC RESEARCH PURPOSES; PROVIDING ON-LINE NON-DOWNLOADABLE SOFTWARE FOR DATABASE MANAGEMENT IN THE FIELDS OF BIOTECHNOLOGY, PHARMACEUTICALS AND SCIENCE; PROVIDING ON-LINE NON-DOWNLOADABLE SOFTWARE FOR DATABASE RESEARCH IN THE FIELD OF ANTIBODIES, PEPTIDES AND PROTEINS FOR THE PURPOSE OF IDENTIFYING POSSIBLE THERAPEUTIC COMPOUNDS; PROVIDING SCIENTIFIC INFORMATION IN THE FIELD OF ANTIBODIES, PEPTIDES AND PROTEINS FOR THE PURPOSE OF IDENTIFYING POSSIBLE THERAPEUTIC COMPOUNDS; RESEARCH IN THE FIELD OF BIOTECHNOLOGY; SCIENTIFIC RESEARCH (U.S. CLS. 100 AND 101).

PRISCILLA MILTON, EXAMINING ATTORNEY

**CLASS 42—(Continued).**

SN 85-383,672. DYAX CORP., CAMBRIDGE, MA. FILED 7-28-2011.

### DYAX LIBRARIES - BILLIONS OF POSSIBILITIES

THE MARK CONSISTS OF STANDARD CHARACTERS WITHOUT CLAIM TO ANY PARTICULAR FONT, STYLE, SIZE, OR COLOR.

OWNER OF U.S. REG. NOS. 2,186,240 AND 2,710,452.  
NO CLAIM IS MADE TO THE EXCLUSIVE RIGHT TO USE "LIBRARIES", APART FROM THE MARK AS SHOWN.  
FOR APPLICATION SERVICE PROVIDER (ASP) FEATURING SOFTWARE FOR USE DATABASE RESEARCH IN THE FIELD OF ANTIBODIES, PEPTIDES AND PROTEINS BY MEANS OF A SECURED-ACCESS WEB SITE; MEDICAL AND SCIENTIFIC RESEARCH INFORMATION IN THE FIELD OF PHAGES, PHAGE DISPLAY AND DRUG DISCOVERY; PHARMACEUTICAL RESEARCH SERVICES; PROVIDING AN ON-LINE SEARCHABLE DATABASE IN THE FIELD OF BIOTECHNOLOGY FOR SCIENTIFIC RESEARCH PURPOSES; PROVIDING ON-LINE NON-DOWNLOADABLE SOFTWARE FOR DATABASE MANAGEMENT IN THE FIELDS OF BIOTECHNOLOGY, PHARMACEUTICALS AND SCIENCE; PROVIDING ON-LINE NON-DOWNLOADABLE SOFTWARE FOR DATABASE RESEARCH IN THE FIELD OF ANTIBODIES, PEPTIDES AND PROTEINS FOR THE PURPOSE OF IDENTIFYING POSSIBLE THERAPEUTIC COMPOUNDS; PROVIDING SCIENTIFIC INFORMATION IN THE FIELD OF ANTIBODIES, PEPTIDES AND PROTEINS FOR THE PURPOSE OF IDENTIFYING POSSIBLE THERAPEUTIC COMPOUNDS; RESEARCH IN THE FIELD OF BIOTECHNOLOGY; SCIENTIFIC RESEARCH (U.S. CLS. 100 AND 101).

PRISCILLA MILTON, EXAMINING ATTORNEY

SN 85-390,160. ADOBE SYSTEMS INCORPORATED, SAN JOSE, CA. FILED 8-4-2011.

### ECHOSIGN

THE MARK CONSISTS OF STANDARD CHARACTERS WITHOUT CLAIM TO ANY PARTICULAR FONT, STYLE, SIZE, OR COLOR.

OWNER OF U.S. REG. NO. 3,928,167.  
FOR COMPUTER SERVICES, NAMELY, PROVIDING TEMPORARY USE OF WEB-BASED, NON-DOWNLOADABLE COMPUTER SOFTWARE FOR AUTOMATING AND SYSTEMATIZING CONTRACT EXECUTION AND ELECTRONIC DOCUMENT EXCHANGE AND MANAGEMENT; PROVIDING TEMPORARY USE OF WEB-BASED, NON-DOWNLOADABLE COMPUTER SOFTWARE FOR SENDING, ROUTING AND DIGITALLY SIGNING ELECTRONIC DOCUMENTS AND TRANSCRIBING, DISTRIBUTING, REGISTERING, VIEWING, TRACKING, FILING, SHARING AND STORING EXECUTED ELECTRONIC DOCUMENTS AND DATA; DESIGN, DEVELOPMENT, AND IMPLEMENTATION OF SOFTWARE FOR AUTOMATING AND SYSTEMATIZING ELECTRONIC DOCUMENT REVIEW AND APPROVAL, CONTRACT EXECUTION AND ELECTRONIC DOCUMENT EXCHANGE AND MANAGEMENT (U.S. CLS. 100 AND 101).

FIRST USE 1-0-2006; IN COMMERCE 1-0-2006.

JAMES MACFARLANE, EXAMINING ATTORNEY

**CLASS 42—(Continued).**

SN 85-397,780. MITEK SYSTEMS, INC., SAN DIEGO, CA. FILED 8-15-2011.

### POINT.SHOOT.TRANSER.

THE MARK CONSISTS OF STANDARD CHARACTERS WITHOUT CLAIM TO ANY PARTICULAR FONT, STYLE, SIZE, OR COLOR.

FOR PROVIDING TEMPORARY USE OF ON-LINE NON-DOWNLOADABLE COMPUTER SOFTWARE FOR DOCUMENT IMAGING, INTELLIGENT CHARACTER AND IMAGE RECOGNITION, AND DOCUMENT ANALYSIS (U.S. CLS. 100 AND 101).

LEIGH LOWRY, EXAMINING ATTORNEY

SN 85-398,988. CARLA DAVID DESIGN, LLC, SAVAGE, MD. FILED 8-16-2011.

### The Black Bench

THE MARK CONSISTS OF STANDARD CHARACTERS WITHOUT CLAIM TO ANY PARTICULAR FONT, STYLE, SIZE, OR COLOR.

FOR GRAPHIC DESIGN SERVICES (U.S. CLS. 100 AND 101).

ALICE BENMAMAN, EXAMINING ATTORNEY

SN 85-399,019. CARLA DAVID DESIGN, LLC, SAVAGE, MD. FILED 8-16-2011.

### Designing the details that style life's special moments

THE MARK CONSISTS OF STANDARD CHARACTERS WITHOUT CLAIM TO ANY PARTICULAR FONT, STYLE, SIZE, OR COLOR.

FOR DESIGN FOR OTHERS IN THE FIELD OF INVITATIONS (U.S. CLS. 100 AND 101).

ALICE BENMAMAN, EXAMINING ATTORNEY

**CLASS 42—(Continued).**

SN 85-399,056. CARLA DAVID DESIGN, LLC, SAVAGE, MD.  
FILED 8-16-2011.

**Styling Events with Paper**

THE MARK CONSISTS OF STANDARD CHARACTERS WITHOUT CLAIM TO ANY PARTICULAR FONT, STYLE, SIZE, OR COLOR.

FOR GRAPHIC DESIGN SERVICES (U.S. CLS. 100 AND 101).

ALICE BENMAMAN, EXAMINING ATTORNEY

SN 85-415,722. MITEK SYSTEMS, INC., SAN DIEGO, CA.  
FILED 9-6-2011.

**POINT.SHOOT.TRANSFER.**

THE MARK CONSISTS OF STANDARD CHARACTERS WITHOUT CLAIM TO ANY PARTICULAR FONT, STYLE, SIZE, OR COLOR.

FOR PROVIDING TEMPORARY USE OF ON-LINE NON-DOWNLOADABLE COMPUTER SOFTWARE FOR DOCUMENT IMAGING, INTELLIGENT CHARACTER AND IMAGE RECOGNITION, AND DOCUMENT ANALYSIS (U.S. CLS. 100 AND 101).

LEIGH LOWRY, EXAMINING ATTORNEY

SN 85-975,551. INTELLIGENT SOFTWARE SOLUTIONS, INC., COLORADO SPRINGS, CO. FILED 12-17-2010.

**WEBTAS FX**

THE MARK CONSISTS OF STANDARD CHARACTERS WITHOUT CLAIM TO ANY PARTICULAR FONT, STYLE, SIZE, OR COLOR.

NO CLAIM IS MADE TO THE EXCLUSIVE RIGHT TO USE "WEBTAS", APART FROM THE MARK AS SHOWN.

SEC. 2(F).

FOR SOFTWARE AS A SERVICE (SAAS) SERVICES FEATURING SOFTWARE FOR A WEB 2.0 BASED SOFTWARE TOOLKIT PROVIDING VISUALIZATION, INTEGRATION AND ANALYSIS OF DISPARATE DATA, EXCLUDING FINANCIAL EXCHANGE DATA, IN A SERVICE ORIENTED ARCHITECTURE (SOA) COMPLIANT PLATFORM (U.S. CLS. 100 AND 101).

FIRST USE 9-0-2009; IN COMMERCE 9-0-2009.

JAMES MACFARLANE, EXAMINING ATTORNEY

**CLASS 43—HOTEL AND RESTAURANT SERVICES**

SN 76-702,263. PRIMARY HOSPITALITY GROUP LLC, CHICAGO, IL. FILED 3-29-2010.

**GRAHAM ELLIOT**

THE MARK CONSISTS OF STANDARD CHARACTERS WITHOUT CLAIM TO ANY PARTICULAR FONT, STYLE, SIZE, OR COLOR.

THE NAME "GRAHAM ELLIOT" IDENTIFIES A LIVING INDIVIDUAL WHOSE CONSENT IS OF RECORD.

FOR FULL SERVICE RESTAURANT (U.S. CLS. 100 AND 101).

FIRST USE 5-30-2008; IN COMMERCE 5-30-2008.

EVELYN BRADLEY, EXAMINING ATTORNEY

SN 77-878,644. PUB GROUP INVESTMENTS, LLC, CINCINNATI, OH. FILED 11-23-2009.

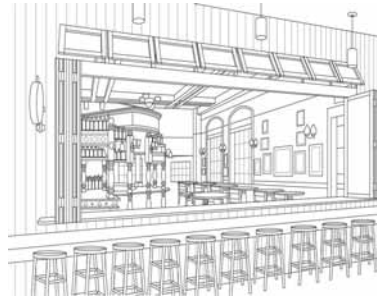

THE MARK CONSISTS OF THE CONFIGURATION OF THE INTERIOR DESIGN OF A BAR RESTAURANT EVOKING THE LOOK AND FEEL REMINISCENT OF A TRADITIONAL URBAN BRITISH PUB THROUGH THE COMBINATION OF A CENTER COVERED BAR WITH COLUMNS, CHANDELIER, A COFFERED CEILING, MULTI-PANED GLASS LONG WINDOWS WITH TRANSOM WINDOW, WALL SCONES, FRAMED ART AND BAR MIRRORS ON THE WALLS, HIGH-TOP BAR TABLES AND CHAIRS, OUTSIDE BAR AREA WITH RETRACTABLE WINDOWS AND AWNING WINDOWS AND BAR STOOLS, OUTDOOR PENDANT LIGHTING, AND CIRCULAR DECORATIVE SIGNAGE ON OUTSIDE WALL.

SEC. 2(F).

FOR RESTAURANT SERVICES; BAR SERVICES (U.S. CLS. 100 AND 101).

FIRST USE 12-0-2001; IN COMMERCE 12-0-2001.

WILLIAM VERHOSEK, EXAMINING ATTORNEY

SN 77-893,996. PUB GROUP INVESTMENTS, LLC, CINCINNATI, OH. FILED 12-15-2009.



NO CLAIM IS MADE TO THE EXCLUSIVE RIGHT TO USE "THE PUB", APART FROM THE MARK AS SHOWN.

THE MARK CONSISTS OF THE CONFIGURATION OF

**CLASS 43—(Continued).**

THE EXTERIOR BUILDING OF A BAR RESTAURANT EVOKING THE LOOK AND FEEL REMINISCENT OF A TRADITIONAL URBAN BRITISH PUB FEATURING CLASSIC ARCHITECTURAL DETAILS, MULTI-PANED GLASS LONG WINDOWS WITH TRANSOM WINDOW THROUGHOUT, MULTIPLE DOWNWARD CUPPED LIGHTING THROUGHOUT, MOLDING BETWEEN THE UPPER AND LOWER PORTIONS OF THE RESTAURANT, DOUBLE GLASS ENTRANCE DOORS WITH OUTDOOR LIGHTING ON EACH SIDE, THE WORDS "THE PUB" CENTERED ABOVE THE ENTRANCE, EXTERIOR CLOCK TO THE RIGHT OF THE WORDING, MULTIPLE FLAGS ABOVE THE WORDING, AND AN OUTDOOR DINING PATIO AREA WITH FENCING AND OUTDOOR LIGHTING AND A SIDE ENTRY PANED GLASS DOOR.

SEC. 2(F).

FOR RESTAURANT SERVICES; BAR SERVICES (U.S. CLS. 100 AND 101).

FIRST USE 12-0-2001; IN COMMERCE 12-0-2001.

WILLIAM VERHOSEK, EXAMINING ATTORNEY

---

SN 79-085,329. GLOBALIA EXPLOTACIONES HOTELERAS, S.L., E-38400 PUERTO DE LA CRUZ (TENERIFE), SPAIN, FILED 6-4-2010.

**BE-LIVE HOTELS**

THE MARK CONSISTS OF STANDARD CHARACTERS WITHOUT CLAIM TO ANY PARTICULAR FONT, STYLE, SIZE, OR COLOR.

PRIORITY DATE OF 6-2-2010 IS CLAIMED.

OWNER OF INTERNATIONAL REGISTRATION 1045735 DATED 6-4-2010, EXPIRES 6-4-2020.

NO CLAIM IS MADE TO THE EXCLUSIVE RIGHT TO USE "HOTELS", APART FROM THE MARK AS SHOWN.

FOR TRAVEL AGENCY SERVICES, NAMELY, MAKING RESERVATIONS AND BOOKING FOR TEMPORARY LODGING; MAKING HOTEL RESERVATIONS FOR OTHERS; HOTEL SERVICES (U.S. CLS. 100 AND 101).

KIMBERLY PERRY, EXAMINING ATTORNEY

---

SN 85-004,408. CITY OF PIGEON FORGE, PIGEON FORGE, TN. FILED 4-1-2010.

**LECONTE CENTER OF PIGEON FORGE**

THE MARK CONSISTS OF STANDARD CHARACTERS WITHOUT CLAIM TO ANY PARTICULAR FONT, STYLE, SIZE, OR COLOR.

OWNER OF U.S. REG. NOS. 2,071,322, 2,071,324 AND OTHERS.

NO CLAIM IS MADE TO THE EXCLUSIVE RIGHT TO USE "CENTER" AND "PIGEON FORGE", APART FROM THE MARK AS SHOWN.

FOR ARENA SERVICES, NAMELY, PROVIDING FACILITIES FOR SPORTS, CONCERTS, BUSINESS EVENTS, CONSUMER AND TRADE SHOWS, EDUCATIONAL EVENTS, AND EXHIBITIONS (U.S. CLS. 100 AND 101).

TRACY WHITTAKER-BROWN, EXAMINING ATTORNEY

**CLASS 43—(Continued).**

SN 85-006,199. CIRIELLO, JOSEPH, NEW YORK, NY. FILED 4-5-2010.

**DIRTY BIRD TO GO**

THE MARK CONSISTS OF STANDARD CHARACTERS WITHOUT CLAIM TO ANY PARTICULAR FONT, STYLE, SIZE, OR COLOR.

NO CLAIM IS MADE TO THE EXCLUSIVE RIGHT TO USE "TO GO", APART FROM THE MARK AS SHOWN.

SEC. 2(F).

FOR CARRY-OUT RESTAURANTS; RESTAURANT SERVICES; RESTAURANT SERVICES FEATURING CHICKEN (U.S. CLS. 100 AND 101).

FIRST USE 4-13-2006; IN COMMERCE 4-13-2006.

INGRID C. EULIN, EXAMINING ATTORNEY

---

SN 85-011,334. DAVID DEDVUKAJ INVESTMENTS LLC, DBA FRESCO WOOD OVEN PIZZERIA, ROCHESTER, MI. FILED 4-12-2010.

**FRESCO WOOD OVEN PIZZERIA**

THE MARK CONSISTS OF STANDARD CHARACTERS WITHOUT CLAIM TO ANY PARTICULAR FONT, STYLE, SIZE, OR COLOR.

NO CLAIM IS MADE TO THE EXCLUSIVE RIGHT TO USE "WOOD OVEN PIZZERIA", APART FROM THE MARK AS SHOWN.

FOR BAR AND RESTAURANT SERVICES; CAFE AND RESTAURANT SERVICES; CARRY-OUT RESTAURANTS; PIZZA PARLORS; RESTAURANT; RESTAURANT SERVICES; RESTAURANTS; TAKE-OUT RESTAURANT SERVICES (U.S. CLS. 100 AND 101).

FIRST USE 3-9-2010; IN COMMERCE 3-9-2010.

JEFFREY LOOK, EXAMINING ATTORNEY

---

SN 85-011,337. DAVID DEDVUKAJ INVESTMENTS LLC, DBA FRESCO WOOD OVEN PIZZERIA, ROCHESTER, MI. FILED 4-12-2010.

**750° F + 2 minutes = FRESCO**

THE MARK CONSISTS OF STANDARD CHARACTERS WITHOUT CLAIM TO ANY PARTICULAR FONT, STYLE, SIZE, OR COLOR.

NO CLAIM IS MADE TO THE EXCLUSIVE RIGHT TO USE "750° F + 2 MIN =", APART FROM THE MARK AS SHOWN.

FOR BAR AND RESTAURANT SERVICES; CAFE AND RESTAURANT SERVICES; CARRY-OUT RESTAURANTS; PIZZA PARLORS; RESTAURANT; RESTAURANT SERVICES; RESTAURANTS; TAKE-OUT RESTAURANT SERVICES (U.S. CLS. 100 AND 101).

FIRST USE 3-9-2010; IN COMMERCE 3-9-2010.

JEFFREY LOOK, EXAMINING ATTORNEY

**CLASS 43—(Continued).**

SN 85-072,054. FOODCONNECT MEDIA INC., VANCOUVER, CANADA, FILED 6-25-2010.



PRIORITY CLAIMED UNDER SEC. 44(D) ON CANADA APPLICATION NO. 1486506, FILED 6-25-2010, REG. NO. TMA804,312, DATED 8-11-2011, EXPIRES 8-11-2026.

THE MARK CONSISTS OF A STYLIZED SPOON DESIGN SHOW ABOVE A STYLIZED FORK DESIGN, BOTH OF WHICH ARE SHOWN INSIDE A SOLID SQUARE WITH ROUNDED CORNERS.

FOR PROVIDING AN INTERACTIVE WEBSITE FEATURING INFORMATION ABOUT DINING, RESTAURANT INFORMATION, FOOD, WINE, BEVERAGES, COOKING, BAKING AND RECIPES (U.S. CLS. 100 AND 101).

FIRST USE 11-0-2007; IN COMMERCE 12-31-2007.

CHARISMA HAMPTON, EXAMINING ATTORNEY

**CLASS 43—(Continued).**

SN 85-116,026. FOX, J.T., STUDIO CITY, CA. AND ROUSSEL, ERROL, STUDIO CITY, CA. FILED 8-25-2010.

# KITCHEN 24

THE MARK CONSISTS OF STANDARD CHARACTERS WITHOUT CLAIM TO ANY PARTICULAR FONT, STYLE, SIZE, OR COLOR.

NO CLAIM IS MADE TO THE EXCLUSIVE RIGHT TO USE "KITCHEN", APART FROM THE MARK AS SHOWN.

FOR BAR AND RESTAURANT SERVICES (U.S. CLS. 100 AND 101).

FIRST USE 1-1-2009; IN COMMERCE 6-1-2009.

JESSICA FATHY, EXAMINING ATTORNEY

SN 85-076,927. LORENZO FOOD GROUP, INC, NORTH BERGEN, NJ. FILED 7-2-2010.



NO CLAIM IS MADE TO THE EXCLUSIVE RIGHT TO USE "MARKET", APART FROM THE MARK AS SHOWN.

THE COLOR(S) YELLOW, GREEN AND WHITE IS/ARE CLAIMED AS A FEATURE OF THE MARK.

THE MARK CONSISTS OF A SQUARE BOARDER DESIGN WITH A GREEN BACKGROUND AND WHITE LINE ALONG THE INTERIOR OF THE BOARDER; A YELLOW STYLIZED FORK RESEMBLING A HIGHWAY LINE DIVIDER IS IN THE MIDDLE OF THE DESIGN; THE WORDING "YORK STREET MARKET" APPEARS BELOW THE FORK DESIGN IN THE COLOR WHITE.

FOR CATERING FOR THE PROVISION OF FOOD AND BEVERAGES (U.S. CLS. 100 AND 101).

DAVID TAYLOR, EXAMINING ATTORNEY

SN 85-125,959. DIROMIO INC., DBA DIROMIO'S PIZZA AND GRILL, CLERMONT, FL. FILED 9-9-2010.



NO CLAIM IS MADE TO THE EXCLUSIVE RIGHT TO USE "PIZZA AND GRILL", APART FROM THE MARK AS SHOWN.

THE COLOR(S) WHITE, RED, BLACK, BROWN AND TEAL IS/ARE CLAIMED AS A FEATURE OF THE MARK.

THE MARK CONSISTS OF THE WORDING "DIROMIO'S PIZZA & GRILL" IN WHITE ON A RED BACKGROUND WITH A TEAL AND BLACK BORDER. A GREEN ROMAN SOLDIER WITH A BROWN HELMET STANDING IN FRONT OF A TEAL, WHITE, AND RED ITALIAN FLAG. THE SOLDIER IS HOLDING A GREEN SHIELD AND A WHITE SWORD. TWO BLACK FLORAL DESIGNS SIT ON THE OUTSIDE OF THE MARK.

FOR PIZZA PARLORS (U.S. CLS. 100 AND 101).

FIRST USE 1-4-2005; IN COMMERCE 1-4-2005.

KEVON CHISOLM, EXAMINING ATTORNEY

**CLASS 43—(Continued).**

SN 85-149,450. REEF ASSETS, INC., FRANCIS RACHE, ST. VICTORIA, SEYCHELLES, FILED 10-11-2010.



OWNER OF U.S. REG. NOS. 2,330,449, 2,598,197 AND 2,844,146.

THE MARK CONSISTS OF THE DESIGN OF A BARTENDER HOLDING A COCKTAIL MIXER, WITH THREE BEVERAGE GLASSES IN FRONT OF HIM. BELOW THE DESIGN IS THE STYLIZED TEXT "DOWNTOWN".

FOR RESTAURANT SERVICES (U.S. CLS. 100 AND 101).

FIRST USE 3-1-1996; IN COMMERCE 3-1-1996.  
REBECCA EISINGER, EXAMINING ATTORNEY

SN 85-151,501. TORTOISE RESTAURANT GROUP INC., BURLINGTON, ONTARIO, CANADA, FILED 10-13-2010.

**FRATICELLI'S ITALIAN GRILL  
& LOUNGE**

THE MARK CONSISTS OF STANDARD CHARACTERS WITHOUT CLAIM TO ANY PARTICULAR FONT, STYLE, SIZE, OR COLOR.

OWNER OF CANADA REG. NO. TMA804508, DATED 8-16-2011, EXPIRES 8-16-2026.

NO CLAIM IS MADE TO THE EXCLUSIVE RIGHT TO USE "ITALIAN GRILL & LOUNGE", APART FROM THE MARK AS SHOWN.

FOR RESTAURANT AND BAR SERVICES (U.S. CLS. 100 AND 101).

ANNE MADDEN, EXAMINING ATTORNEY

SN 85-166,739. SAIGONTOURIST HOLDING COMPANY, HO CHI MINH CITY, VIETNAM, FILED 11-2-2010.



OWNER OF VIETNAM REG. NO. 52223, DATED 1-28-2004, EXPIRES 10-28-2012.

OWNER OF U.S. REG. NO. 2,888,854.  
NO CLAIM IS MADE TO THE EXCLUSIVE RIGHT TO USE "SAIGON TOURIST HOLDING COMPANY", APART FROM THE MARK AS SHOWN.

THE COLOR(S) BLUE AND YELLOW IS/ARE CLAIMED AS A FEATURE OF THE MARK.

THE MARK CONSISTS OF THE WORDS "SAIGONTOURIST HOLDING COMPANY" IN BLUE WITH A THE IMAGE OF A YELLOW FLOWER HAVING FIVE PETALS WITH A THIN BLUE LINE AS AN EXTERNAL BORDER AND A BLUE AND YELLOW CIRCLE IN THE MIDDLE WITH A BLUE GLOBE-LIKE CIRCLE INSIDE.

FOR HOTEL, RESTAURANT SERVICES (U.S. CLS. 100 AND 101).

BRIAN CALLAGHAN, EXAMINING ATTORNEY

**CLASS 43—(Continued).**

SN 85-168,851. YOBA INC., BEAVERCREEK, OH. FILED 11-4-2010.

**Yoba**

THE MARK CONSISTS OF STANDARD CHARACTERS WITHOUT CLAIM TO ANY PARTICULAR FONT, STYLE, SIZE, OR COLOR.

FOR FROZEN YOGURT SHOP SERVICES IN THE NATURE OF A RESTAURANT (U.S. CLS. 100 AND 101).

FIRST USE 9-1-2010; IN COMMERCE 9-1-2010.  
JAY FLOWERS, EXAMINING ATTORNEY

SN 85-174,609. P. LOWELL SANDERS HOLDING LLC, CHICAGO, IL. FILED 11-11-2010.



NO CLAIM IS MADE TO THE EXCLUSIVE RIGHT TO USE "HOTEL", APART FROM THE MARK AS SHOWN.

THE MARK CONSISTS OF A DECORATIVE BORDER AND THE WORDING "HOTEL BLUE" ABOVE THE TERMS "WHERE WE CELEBRATE YOU!" AND TWO DIAMOND AND LINE DESIGNS POINTING TOWARD THE WORDING.

FOR HOTEL AND MOTEL SERVICES (U.S. CLS. 100 AND 101).

REBECCA SMITH, EXAMINING ATTORNEY

SN 85-184,220. CLEAR HOPE ASSOCIATION, SANTA ANA, CA. FILED 11-23-2010.

**CLEAR HOPE ASSOCIATION**

THE MARK CONSISTS OF STANDARD CHARACTERS WITHOUT CLAIM TO ANY PARTICULAR FONT, STYLE, SIZE, OR COLOR.

NO CLAIM IS MADE TO THE EXCLUSIVE RIGHT TO USE "ASSOCIATION", APART FROM THE MARK AS SHOWN.

FOR PROVISION OF CONFERENCE FACILITIES (U.S. CLS. 100 AND 101).

INGA ERVIN, EXAMINING ATTORNEY

**CLASS 43—(Continued).**

SN 85-184,224. CLEAR HOPE ASSOCIATION, SANTA ANA, CA. FILED 11-23-2010.



NO CLAIM IS MADE TO THE EXCLUSIVE RIGHT TO USE "ASSOCIATION", APART FROM THE MARK AS SHOWN.

THE MARK CONSISTS OF THE WORDS "CLEAR HOPE ASSOCIATION" OVER A BAR STRIPE WITH A TILTED CROSS INTERSECTING THROUGH THE WORDS "HOPE" AND "ASSOCIATION" AND THE BAR STRIPE.

FOR PROVISION OF CONFERENCE FACILITIES (U.S. CLS. 100 AND 101).

INGA ERVIN, EXAMINING ATTORNEY

SN 85-187,627. TORIDOLL USA CORPORATION, HONOLULU, HI. FILED 11-30-2010.

丸亀製麺

NO CLAIM IS MADE TO THE EXCLUSIVE RIGHT TO USE THE NON-LATIN CHARACTERS WHICH TRANSLITERATE TO "SEIMEN", APART FROM THE MARK AS SHOWN.

THE MARK CONSISTS OF FOUR JAPANESE CHARACTERS.

THE NON-LATIN CHARACTERS IN THE MARK TRANSLITERATE TO MARUKAME SEIMEN AND THE WORDING MARUKAME HAS NO MEANING IN A FOREIGN LANGUAGE AND THE WORDING SEIMEN MEANS NOODLE MAKING IN ENGLISH.

FOR RESTAURANT AND CAFE SERVICES, NAMELY, RESTAURANTS AND CAFES THAT SERVE JAPANESE-STYLE NOODLES SUCH AS UDON; CATERING OF FOOD AND DRINKS; SNACK BAR AND CANTEEN SERVICES; SELF-SERVICE RESTAURANTS; MOBILE RESTAURANT SERVICES (U.S. CLS. 100 AND 101).

BILL DAWE, EXAMINING ATTORNEY

**CLASS 43—(Continued).**

SN 85-187,629. TORIDOLL USA CORPORATION, HONOLULU, HI. FILED 11-30-2010.

MARUKAME

THE MARK CONSISTS OF STANDARD CHARACTERS WITHOUT CLAIM TO ANY PARTICULAR FONT, STYLE, SIZE, OR COLOR.

THE WORDING "MARUKAME" HAS NO MEANING IN A FOREIGN LANGUAGE.

FOR RESTAURANT AND CAFE SERVICES, NAMELY, RESTAURANTS AND CAFES THAT SERVE JAPANESE-STYLE NOODLES SUCH AS UDON; CATERING OF FOOD AND DRINKS; SNACK BAR AND CANTEEN SERVICES; SELF-SERVICE RESTAURANTS; MOBILE RESTAURANT SERVICES (U.S. CLS. 100 AND 101).

BILL DAWE, EXAMINING ATTORNEY

SN 85-187,632. TORIDOLL USA CORPORATION, HONOLULU, HI. FILED 11-30-2010.



NO CLAIM IS MADE TO THE EXCLUSIVE RIGHT TO USE "JAPANESE NOODLE" OR "UDON" OR "TEMPURA OR MUSUBI" OR THE NON-LATIN CHARACTERS WHICH TRANSLITERATE TO SEIMEN, APART FROM THE MARK AS SHOWN.

THE MARK CONSISTS OF A SQUARE WHICH CONTAINS THE WORDING "JAPANESE NOODLE" FOLLOWED BY THE WORD "MARUKAME", SEPARATED TO HIGHLIGHT THE SYLLABLES "MA", "RU", "KA", AND "ME", PLUS FOUR JAPANESE CHARACTERS, ALONG WITH THE WORDS "UDON", "TEMPURA", AND "MUSUBI", AND AN ORNAMENTAL BACKGROUND SHOWING STYLIZED WAVES OF WATER.

THE WORDING "MA RU KA ME" HAS NO MEANING IN A FOREIGN LANGUAGE.

THE NON-LATIN CHARACTERS IN THE MARK TRANSLITERATE TO MARUKAME SEIMEN AND THE WORDING "MARUKAME" HAS NO MEANING IN A FOREIGN LANGUAGE AND THE WORDING SEIMEN MEANS NOODLE MAKING IN ENGLISH.

FOR RESTAURANT AND CAFE SERVICES, NAMELY, RESTAURANTS AND CAFES THAT SERVE JAPANESE-STYLE NOODLES SUCH AS UDON; CATERING OF FOOD AND DRINKS; SNACK BAR AND CANTEEN SERVICES; SELF-SERVICE RESTAURANTS; MOBILE RESTAURANT SERVICES (U.S. CLS. 100 AND 101).

BILL DAWE, EXAMINING ATTORNEY

**CLASS 43—(Continued).**

SN 85-190,292. CATHOLIC BISHOP OF CHICAGO, CHICAGO, IL. FILED 12-3-2010.

**EARTHSMART KITCHENS**

THE MARK CONSISTS OF STANDARD CHARACTERS WITHOUT CLAIM TO ANY PARTICULAR FONT, STYLE, SIZE, OR COLOR.

NO CLAIM IS MADE TO THE EXCLUSIVE RIGHT TO USE "KITCHENS", APART FROM THE MARK AS SHOWN. FOR FOOD SERVICES, NAMELY, OPERATION OF CAFETERIAS; FOOD PREPARATION; CHARITABLE SERVICES, NAMELY, PROVIDING FOOD TO NEEDY PERSONS (U.S. CLS. 100 AND 101).

CHARLOTTE CORWIN, EXAMINING ATTORNEY

SN 85-196,203. DINO KARTSONAKIS, HOLLISTER, MO. FILED 12-13-2010.



NO CLAIM IS MADE TO THE EXCLUSIVE RIGHT TO USE "CAKE COMPANY", APART FROM THE MARK AS SHOWN.

THE NAME DINO IDENTIFIES A LIVING INDIVIDUAL WHOSE CONSENT IS OF RECORD.

THE MARK CONSISTS OF THE WORDING "DINO'S 24 CAKE COMPANY" WITH A CARROT DESIGN BETWEEN THE WORDING "24" AND "CAKE".

FOR BAKERY RESTAURANT SERVICES, NAMELY, RESTAURANTS FEATURING BAKED GOODS; CAFE RESTAURANT SERVICES; COFFEE SHOP SERVICES (U.S. CLS. 100 AND 101).

FIRST USE 2-8-2008; IN COMMERCE 2-8-2008.

MEGHAN REINHART, EXAMINING ATTORNEY

SN 85-208,724. TROPICAL LIQUEURS CORP., COLUMBIA, MO. FILED 12-31-2010.

**Tropical Liqueurs**

THE MARK CONSISTS OF STANDARD CHARACTERS WITHOUT CLAIM TO ANY PARTICULAR FONT, STYLE, SIZE, OR COLOR.

NO CLAIM IS MADE TO THE EXCLUSIVE RIGHT TO USE "LIQUEURS", APART FROM THE MARK AS SHOWN. SEC. 2(F).

FOR BAR AND COCKTAIL LOUNGE SERVICES; BAR AND RESTAURANT SERVICES (U.S. CLS. 100 AND 101).

FIRST USE 10-17-1985; IN COMMERCE 10-17-1985.

MARK PILARO, EXAMINING ATTORNEY

**CLASS 43—(Continued).**

SN 85-215,187. PULIDO SALAS, JOSE, MONTERREY, N.L., MEXICO, FILED 1-11-2011.



NO CLAIM IS MADE TO THE EXCLUSIVE RIGHT TO USE "PISTO", APART FROM THE MARK AS SHOWN.

THE MARK CONSISTS OF THE DRAWING OF A MOUNTAIN RANGE BELOW OF WHICH APPEARS THE WORD "KARANCHO'S" IN PROMINENT STYLIZED LETTERS AND EXACTLY BELOW IT IN SMALLER STYLIZED LETTERS APPEAR THE WORDS "TOCADA & PISTO".

THE ENGLISH TRANSLATION OF "TOCADA & PISTO" IN THE MARK IS TOUCHED & STEW. THE WORDING "KARANCHO'S" HAS NO MEANING IN A FOREIGN LANGUAGE.

FOR RESTAURANT AND BAR SERVICES (U.S. CLS. 100 AND 101).

FIRST USE 4-17-2001; IN COMMERCE 4-17-2001.

ROBERT C. CLARK JR., EXAMINING ATTORNEY

SN 85-215,997. VASSALAT LLC, DBA VASSALAT LLC, HOUSTON, TX. FILED 1-12-2011.



NO CLAIM IS MADE TO THE EXCLUSIVE RIGHT TO USE "FOODS SUGAR & NUT FREE VEGAN RAW GLUTEN & SOY FREE", APART FROM THE MARK AS SHOWN.

THE COLOR(S) WHITE, BLACK, RED, AND GREEN IS/ ARE CLAIMED AS A FEATURE OF THE MARK.

THE MARK CONSISTS OF HEAD TO WAIST PROFILE OF A FEMALE SILHOUETTE IN BLACK WITH HAIR PASSING SHOULDER LEVEL HIGHLIGHTED BY WHITE. THE SILHOUETTED FEMALE HAS HER ARM BENT IN AN UPWARD GESTURE HER HAND TO HER MOUTH IS HOLDING A RED APPLE WITH BLACK OUTLINE WHICH HAS A GREEN LEAF ON THE TWIG OF THE APPLE AND A WHITE MARK INDICATING SHINE. THE FEMALE SILHOUETTE HAS RED LIPSTICK AND RED AND GREEN EARRINGS. SURROUNDING THE SILHOUETTE ARE TWO CONCENTRIC CIRCLES. INSIDE THE SPACE BETWEEN THE TWO CIRCLES ARE THE WORDS "JICKO FOODS SUGAR & NUT FREE VEGAN RAW GLUTEN & SOY FREE". THE BACKGROUND OF THE MARK IS TRANSPARENT.

FOR TAKE-OUT RESTAURANT SERVICES (U.S. CLS. 100 AND 101).

FIRST USE 10-1-2010; IN COMMERCE 10-1-2010.

MORGAN WYNNE, EXAMINING ATTORNEY



**CLASS 43—(Continued).**

SN 85-216,476. LI, SIZHI, DBA LEGEND RESTAURANT, NEWARK, NJ. AND CHEN, YAOFEI, DBA LEGEND RESTAURANT, JERSEY CITY, NJ. FILED 1-12-2011.



NO CLAIM IS MADE TO THE EXCLUSIVE RIGHT TO USE THE NON-LATIN CHARACTERS THAT TRANSLITERATE TO "SHU LIU", APART FROM THE MARK AS SHOWN.

THE MARK CONSISTS OF THE TRADITIONAL CHINESE FAN ON TOP OF THREE CHINESE CHARACTERS "SHU LIU XIANG". ON THE BOTTOM ARE STYLIZED LETTERS OF WORD "LEGEND".

THE NON-LATIN CHARACTERS IN THE MARK TRANSLITERATE TO SHU LIU XIANG AND THIS MEANS SICHUAN SPICE STAYS IN ENGLISH.

FOR BAR AND RESTAURANT SERVICES (U.S. CLS. 100 AND 101).

FIRST USE 9-10-2010; IN COMMERCE 9-10-2010.  
EUGENIA MARTIN, EXAMINING ATTORNEY

SN 85-241,659. MADISON SERVICES GROUP, LLC, ATLANTA, GA. FILED 2-14-2011.

**Arbor Terrace**

THE MARK CONSISTS OF STANDARD CHARACTERS WITHOUT CLAIM TO ANY PARTICULAR FONT, STYLE, SIZE, OR COLOR.

FOR PROVIDING ASSISTED LIVING FACILITIES FOR SENIORS (U.S. CLS. 100 AND 101).

FIRST USE 2-15-1991; IN COMMERCE 2-15-1991.  
DAVID ELTON, EXAMINING ATTORNEY

**CLASS 43—(Continued).**

SN 85-242,048. KIMURA, SHUJI, DBA SUSHISTOP, STUDIO CITY, CA. FILED 2-14-2011.



NO CLAIM IS MADE TO THE EXCLUSIVE RIGHT TO USE "SUSHI", APART FROM THE MARK AS SHOWN.

THE COLOR(S) WHITE, RED AND BLACK IS/ARE CLAIMED AS A FEATURE OF THE MARK.

THE MARK CONSISTS OF THE WORD "SUSHISTOP" WITH THE WORD "SUSHI" IN WHITE WITH A BLACK BORDER AND "STOP" IN RED WITH A BLACK BORDER. THE COLOR GRAY APPEARS IN THE BACKGROUND AND REPRESENTS TRANSPARENT AREAS AND IS NOT A FEATURE OF THE MARK.

FOR RESTAURANT (U.S. CLS. 100 AND 101).  
FIRST USE 11-11-2010; IN COMMERCE 11-11-2010.  
KRISTINA MORRIS, EXAMINING ATTORNEY

SN 85-251,591. MENDEZ, JUAN PABLO, DBA CABO SEAFOOD + BAR, SAN ANTONIO, TX. FILED 2-25-2011.

**CABO SEAFOOD + BAR**

THE MARK CONSISTS OF STANDARD CHARACTERS WITHOUT CLAIM TO ANY PARTICULAR FONT, STYLE, SIZE, OR COLOR.

NO CLAIM IS MADE TO THE EXCLUSIVE RIGHT TO USE "SEAFOOD + BAR", APART FROM THE MARK AS SHOWN.

THE ENGLISH TRANSLATION OF "CABO" IN THE MARK IS "CAPE".

FOR BAR AND RESTAURANT SERVICES (U.S. CLS. 100 AND 101).

PRISCILLA MILTON, EXAMINING ATTORNEY

SN 85-251,752. MENDEZ, JUAN PABLO, DBA CABO SEAFOOD + BAR, SAN ANTONIO, TX. FILED 2-25-2011.



NO CLAIM IS MADE TO THE EXCLUSIVE RIGHT TO USE "SEAFOOD + BAR", APART FROM THE MARK AS SHOWN.

THE MARK CONSISTS OF A STYLIZED DESIGN OF A FISH INCORPORATING VERTICAL BONES ALONG A CENTRAL SPINE TERMINATED BY HEAD AND TAIL SECTIONS SUPERIMPOSED OVER THE LETTER "A" IN THE WORD "CABO" PLACED ABOVE THE SUBTEXT "SEAFOOD + BAR".

THE ENGLISH TRANSLATION OF "CABO" IN THE MARK IS "CAPE".

FOR BAR AND RESTAURANT SERVICES (U.S. CLS. 100 AND 101).

PRISCILLA MILTON, EXAMINING ATTORNEY

**CLASS 43—(Continued).**

SN 85-258,729. GOLDEN ROAD FOOD SERVICES, L.L.C., REDONDO BEACH, CA. FILED 3-4-2011.

**FRESH THINKING FRESH PIZZA**

THE MARK CONSISTS OF STANDARD CHARACTERS WITHOUT CLAIM TO ANY PARTICULAR FONT, STYLE, SIZE, OR COLOR.

NO CLAIM IS MADE TO THE EXCLUSIVE RIGHT TO USE "FRESH PIZZA", APART FROM THE MARK AS SHOWN.

FOR RESTAURANTS AND CARRY-OUT RESTAURANTS PERTAINING TO AMERICAN FOOD, ITALIAN FOOD AND PIZZA PIES MADE TO ORDER, FOR HOME AND REMOTE LOCATION DELIVERY, FOR CONSUMPTION WITHIN THE RESTAURANT, AND BY CARRY-OUT (U.S. CLS. 100 AND 101).

FIRST USE 6-22-2008; IN COMMERCE 6-22-2008.  
CAROLINE WOOD, EXAMINING ATTORNEY

---

SN 85-259,063. MCQ, LLC, DBA IDAHO PIZZA COMPANY, KUNA, ID. FILED 3-5-2011.



OWNER OF U.S. REG. NOS. 3,899,660 AND 3,899,662.  
NO CLAIM IS MADE TO THE EXCLUSIVE RIGHT TO USE "IDAHO PIZZA COMPANY", APART FROM THE MARK AS SHOWN.

THE COLOR(S) BROWN, BLACK, LIGHT BROWN, KHA-KI, PINK, YELLOW AND WHITE IS/ARE CLAIMED AS A FEATURE OF THE MARK.

THE MARK CONSISTS OF A BROWN ELK WITH LIGHT BROWN HOOVES, ANTLERS, AND INNER EAR FUR, BLACK AND WHITE EYES AND NOSE, PINK TONGUE, WEARING A BLACK T-SHIRT WITH THE WORDS "SUMMIT" IN YELLOW ON THE RIGHT SIDE AND "IDAHO PIZZA COMPANY" AS PART OF A YELLOW LOGO ON THE LEFT SIDE, WITH KHAKI SHORTS, STANDING OVER A BLACK SHADOW.

FOR CAFE AND RESTAURANT SERVICES (U.S. CLS. 100 AND 101).

HANNO RITTNER, EXAMINING ATTORNEY

**CLASS 43—(Continued).**

SN 85-259,646. ILIOPOULOS ILIAS, GLYFADA, ATHENS, GREECE, FILED 3-7-2011.



NO CLAIM IS MADE TO THE EXCLUSIVE RIGHT TO USE "GELATERIA", APART FROM THE MARK AS SHOWN.

THE MARK CONSISTS OF A CONE-SHAPED BOTTOM JOINED BY FIVE ROUNDED CONTINUOUS TIPS WITH A CIRCULAR SHAPE UNDER THE WORDS "FRESCO GELATERIA".

THE ENGLISH TRANSLATION OF "FRESCO GELATERIA" IN THE MARK IS "FRESH ICE CREAM PARLOUR".

FOR ICE CREAM PARLORS; ICE CREAM SHOP SERVICES IN THE NATURE OF A RESTAURANT (U.S. CLS. 100 AND 101).

FLORENTINA BLANDU, EXAMINING ATTORNEY

---

SN 85-271,034. WIGMAN AND WIGNMAN, LLC, WEST BEND, WI. FILED 3-18-2011.



THE COLOR(S) RED, TAN, BLACK, BLUE, AND DARK TAN IS/ARE CLAIMED AS A FEATURE OF THE MARK.

THE MARK CONSISTS OF THE WORD "DADDY'S", IN RED CURVED ON THE TOP, A RED DOG HOUSE WITH A TAN ROOF AND DARKER TAN ROOF EDGE, THE

**CLASS 43—(Continued).**

CURVED BLACK WORD "YUMM" OVER THE DOG HOUSE DOOR WAY, A RED HOT DOG SHAPED DOG STICKING THROUGH THE DOG HOUSE, WITH TAIL WAGGING AND RED TONGUE HANGING OUT OF THE DOGS OPEN BLACK MOUTH, THE DOG HAVING A BLACK MOUTH, NOSE AND EYES, EARS UP, THE CURVED RED WORDS "DOG HOUSE" BELOW THE DOG AND DOG HOUSE, AND THE WORDS "WHERE "OUR DOGS SPEAK FOR THEMSELVES"" IN BLUE UNDERNEATH THE WORDS "DOG HOUSE".

SEC. 2(F).

FOR RESTAURANT AND BAR SERVICES, INCLUDING RESTAURANT CARRYOUT SERVICES; RESTAURANT SERVICES FEATURING SANDWICHES; RESTAURANT SERVICES, INCLUDING SIT-DOWN SERVICE OF FOOD AND TAKE-OUT RESTAURANT SERVICES; RESTAURANT SERVICES, NAMELY, PROVIDING OF FOOD AND BEVERAGES FOR CONSUMPTION ON AND OFF THE PREMISES (U.S. CLS. 100 AND 101).

FIRST USE 8-6-2003; IN COMMERCE 8-6-2003.

JOHN SCHUYLER YARD, EXAMINING ATTORNEY

**CLASS 43—(Continued).**

SN 85-271,708. VELASQUEZ, LILIANA, MASPETH, NY. FILED 3-20-2011.



NO CLAIM IS MADE TO THE EXCLUSIVE RIGHT TO USE "PATACON", APART FROM THE MARK AS SHOWN. THE COLOR(S) YELLOW, LIGHT BLUE, RED, GREEN, BLACK AND WHITE IS/ARE CLAIMED AS A FEATURE OF THE MARK.

THE MARK CONSISTS OF THE STYLIZED WORDING "PATACON" IN YELLOW COLOR OUTLINED IN BLACK, ABOVE SEVEN STARS IN LIGHT BLUE COLOR OUTLINED IN BLACK, ABOVE THE STYLIZED WORDING "EL VERDADERO SABOR" AND "DE LA COMIDA VENEZOLANA" IN TWO LINES IN RED COLOR ALL TO THE RIGHT OF A PERSONIFIED GREEN PLANTAIN WITH A RED MOUTH, BLACK AND WHITE EYES, WEARING WHITE GLOVES AND WHITE SHOES.

THE ENGLISH TRANSLATION OF "PATACON EL VERDADERO SABOR DE LA COMIDA VENEZOLANA" IS "PLANTAIN THE TRUE FLAVOR OF THE VENEZUELAN FOOD".

FOR FAST FOOD AND NON-STOP RESTAURANT SERVICES; MOBILE CAFE SERVICES FOR PROVIDING FOOD AND DRINK; MOBILE RESTAURANT SERVICES; RESTAURANT SERVICES, INCLUDING SIT-DOWN SERVICE OF FOOD AND TAKE-OUT RESTAURANT SERVICES; RESTAURANT SERVICES, NAMELY, PROVIDING OF FOOD AND BEVERAGES FOR CONSUMPTION ON AND OFF THE PREMISES; TAKE-OUT RESTAURANT SERVICES (U.S. CLS. 100 AND 101).

FIRST USE 7-27-2009; IN COMMERCE 7-27-2009.

LINDA POWELL, EXAMINING ATTORNEY

SN 85-271,278. BROTHER & BROTHER, LLC, DBA CRAVE CAFE, LARKSPUR, CO. FILED 3-18-2011.

**CRAVE REAL BURGERS**

THE MARK CONSISTS OF STANDARD CHARACTERS WITHOUT CLAIM TO ANY PARTICULAR FONT, STYLE, SIZE, OR COLOR.

NO CLAIM IS MADE TO THE EXCLUSIVE RIGHT TO USE "REAL BURGERS", APART FROM THE MARK AS SHOWN.

FOR RESTAURANT SERVICES (U.S. CLS. 100 AND 101).

FIRST USE 7-4-2010; IN COMMERCE 7-4-2010.

PAUL MORENO, EXAMINING ATTORNEY

SN 85-284,807. TIGER EXPRESS, LLC, ALBUQUERQUE, NM. FILED 4-3-2011.

**TIGER INDIA EXPRESS INDIAN CUISINE**

THE MARK CONSISTS OF STANDARD CHARACTERS WITHOUT CLAIM TO ANY PARTICULAR FONT, STYLE, SIZE, OR COLOR.

NO CLAIM IS MADE TO THE EXCLUSIVE RIGHT TO USE "INDIA" OR "EXPRESS INDIAN CUISINE", APART FROM THE MARK AS SHOWN.

FOR RESTAURANT SERVICES FEATURING EAST INDIAN CUISINE (U.S. CLS. 100 AND 101).

FIRST USE 12-28-2010; IN COMMERCE 12-28-2010.

SUSAN LESLIE DUBOIS, EXAMINING ATTORNEY

**CLASS 43—(Continued).**

SN 85-289,676. GORDON H. MILES, CARDIFF, CA. FILED 4-7-2011.

**SPIKE AFRICA'S FISH HOUSE**

THE MARK CONSISTS OF STANDARD CHARACTERS WITHOUT CLAIM TO ANY PARTICULAR FONT, STYLE, SIZE, OR COLOR.

NO CLAIM IS MADE TO THE EXCLUSIVE RIGHT TO USE "FISH HOUSE", APART FROM THE MARK AS SHOWN.

THE NAME(S), PORTRAIT(S), AND/OR SIGNATURE(S) SHOWN IN THE MARK DOES NOT IDENTIFY A PARTICULAR LIVING INDIVIDUAL.

FOR BAR AND RESTAURANT SERVICES; CAFE AND RESTAURANT SERVICES; RESTAURANT (U.S. CLS. 100 AND 101).

INGRID C. EULIN, EXAMINING ATTORNEY

SN 85-289,680. GORDON H. MILES, CARDIFF, CA. FILED 4-7-2011.

**SPIKE AFRICA'S FRESH FISH GRILL AND BAR**

THE MARK CONSISTS OF STANDARD CHARACTERS WITHOUT CLAIM TO ANY PARTICULAR FONT, STYLE, SIZE, OR COLOR.

NO CLAIM IS MADE TO THE EXCLUSIVE RIGHT TO USE "FRESH FISH GRILL AND BAR", APART FROM THE MARK AS SHOWN.

THE NAME(S), PORTRAIT(S), AND/OR SIGNATURE(S) SHOWN IN THE MARK DOES NOT IDENTIFY A PARTICULAR LIVING INDIVIDUAL.

FOR BAR AND RESTAURANT SERVICES; CAFE AND RESTAURANT SERVICES; RESTAURANT (U.S. CLS. 100 AND 101).

INGRID C. EULIN, EXAMINING ATTORNEY

SN 85-291,182. THOMAS JAMES LLC, DBA PENGUIN ICE CREAM, BERNARDSVILLE, NJ. FILED 4-10-2011.



NO CLAIM IS MADE TO THE EXCLUSIVE RIGHT TO USE "ICE CREAM", APART FROM THE MARK AS SHOWN. THE COLOR(S) BLACK, WHITE, RED, PINK, BROWN, DARK BLUE, LIGHT BLUE, TAN AND ORANGE IS/ARE CLAIMED AS A FEATURE OF THE MARK.

THE MARK CONSISTS OF THE WORDING "PENGUIN ICE CREAM" AND A STYLIZED DESIGN OF A PENGUIN.

**CLASS 43—(Continued).**

THE WORD "PENGUIN" IS RED AND OUTLINED IN WHITE. THE WORDING "ICE CREAM" IS WHITE AND OUTLINED IN LIGHT BLUE AND BLACK. THE PENGUIN IS MOSTLY DARK BLUE WITH A WHITE FACE AND WHITE STOMACH, BLACK EYES AND EYEBROWS, AND ORANGE BEAK AND FEET. THE PENGUIN IS HOLDING A BROWN CONE WITH PINK ICE CREAM IN ITS RIGHT FLIPPER, AND WEARING A RED BOW TIE AND A WHITE HAT WITH SEVEN DIAGONAL PINK STRIPES. ACROSS THE FRONT OF THE PENGUIN IS A TAN BANNER WITH THE WORD "PENGUIN" WRITTEN ON IT.

FOR ICE CREAM SHOP SERVICES IN THE NATURE OF A RESTAURANT (U.S. CLS. 100 AND 101).

FIRST USE 11-1-2009; IN COMMERCE 11-1-2009.

JOHN DWYER, EXAMINING ATTORNEY

SN 85-294,463. BO LING'S CHINESE RESTAURANT, INC., DBA BO LING'S, OVERLAND PARK, KS. FILED 4-13-2011.

**BO LINGS**  
chinese please!

OWNER OF U.S. REG. NO. 1,517,581.

THE NAME "BO LINGS" DOES NOT IDENTIFY A LIVING INDIVIDUAL.

THE MARK CONSISTS OF THE WORDING "BO LINGS" ABOVE THE WORDING "CHINESE PLEASE!" WITH ALL WORDING IN STYLIZED FONT.

THE WORDING "BO LINGS" HAS NO MEANING IN A FOREIGN LANGUAGE.

FOR RESTAURANT, BAR AND CATERING SERVICES (U.S. CLS. 100 AND 101).

FIRST USE 12-1-1999; IN COMMERCE 12-1-1999.

SUZANNE BLANE, EXAMINING ATTORNEY

SN 85-302,159. REAL BAR B Q, LLC, PLYMOUTH, MI. FILED 4-22-2011.



NO CLAIM IS MADE TO THE EXCLUSIVE RIGHT TO USE "BARBECUE" AND "WE SMOKE IT LOW AND SLOW", APART FROM THE MARK AS SHOWN.

THE MARK CONSISTS OF THE WORDS AND LETTERS "REAL BARBQ WE SMOKE IT LOW & SLOW". THE "R" IN "REAL" INCLUDING STYLIZED FLAMES, AND A LINE EXTENDING FROM THE "B" OF "BQ" TO UNDERLINE "BAR".

FOR RESTAURANT SERVICES (U.S. CLS. 100 AND 101).

FIRST USE 1-21-2011; IN COMMERCE 1-21-2011.

JOHN DWYER, EXAMINING ATTORNEY

**CLASS 43—(Continued).**

SN 85-307,232. GUILLERMO, OLGUIN, NEW YORK, NY. FILED 4-28-2011.

**OBRA NEGRA**

THE MARK CONSISTS OF STANDARD CHARACTERS WITHOUT CLAIM TO ANY PARTICULAR FONT, STYLE, SIZE, OR COLOR.

THE ENGLISH TRANSLATION OF "OBRA NEGRA" IN THE MARK IS "BLACK WORK".

FOR RESTAURANT SERVICES; BAR SERVICES (U.S. CLS. 100 AND 101).

ZHALEH DELANEY, EXAMINING ATTORNEY

SN 85-309,473. ABUNDANT BRANDS, L.L.C., AMERICAN FORK, UT. FILED 5-2-2011.



NO CLAIM IS MADE TO THE EXCLUSIVE RIGHT TO USE "TEXAS BBQ CATERING & PICK-UP", APART FROM THE MARK AS SHOWN.

THE MARK CONSISTS OF STYLIZED LETTERS FORMING THE WORDS "BIG AL'S TEXAS BBQ CATERING & PICK-UP" AND A STYLIZED DRAWING OF A BOW-LEGGED COWBOY WITH AN OVER-SIZED HEAD, LARGE NOSE AND MUSTACHE, LARGE HAT, AND OPEN HANDS FACING DOWNWARD, READY TO DRAW A PISTOL.

FOR CARRY-OUT RESTAURANTS; CATERING; CATERING FOR THE PROVISION OF FOOD AND BEVERAGES; CATERING OF FOOD AND DRINKS; CATERING SERVICES; TAKE-OUT RESTAURANT SERVICES (U.S. CLS. 100 AND 101).

FIRST USE 11-18-2005; IN COMMERCE 11-18-2005.

JENNIFER VASQUEZ, EXAMINING ATTORNEY

SN 85-309,826. YONGCHANG SHEN, BROOKLYN, NY. AND LINFENG JI, BROOKLYN, NY. FILED 5-2-2011.



NO CLAIM IS MADE TO THE EXCLUSIVE RIGHT TO USE "LICHEE NUT", APART FROM THE MARK AS SHOWN.

THE MARK CONSISTS OF TWO ALMOST OVERLAPPED RECTANGLES WITH WORDING "LICHEE NUT" IN THE FRONT RECTANGLE.

FOR RESTAURANTS; CAFE AND PROVIDING OF FOOD AND DRINK (U.S. CLS. 100 AND 101).

FIRST USE 10-7-1997; IN COMMERCE 10-7-1997.

ROSELLE HERRERA, EXAMINING ATTORNEY

**CLASS 43—(Continued).**

SN 85-312,484. KAATI FRESH FOODS, LLC, SAN JOSE, CA. FILED 5-4-2011.



NO CLAIM IS MADE TO THE EXCLUSIVE RIGHT TO USE "FRESH", "HEALTHY FOOD" AND "INDIAN FLAVOR", APART FROM THE MARK AS SHOWN.

THE COLOR(S) ORANGE AND GREEN IS/ARE CLAIMED AS A FEATURE OF THE MARK.

THE MARK CONSISTS OF THE LITERAL ELEMENT "KAATI" IN ORANGE, "FRESH" IN GREEN AND "HEALTHY FOOD INDIAN FLAVOR" IN ORANGE; A GREEN LEAF APPEARS ABOVE THE LETTER "S" IN "FRESH" AND A GREEN LEAF APPEARS BETWEEN "FOOD" AND "INDIAN".

FOR RESTAURANT SERVICES (U.S. CLS. 100 AND 101).

FIRST USE 6-16-2010; IN COMMERCE 6-16-2010.

INGA ERVIN, EXAMINING ATTORNEY

SN 85-312,851. WILSON, JOHN, CITRUS HEIGHTS, CA. AND WILSON, DENISE, CITRUS HEIGHTS, CA. FILED 5-5-2011.

**PARKER'S HOT DOGS OF SANTA CRUZ**

THE MARK CONSISTS OF STANDARD CHARACTERS WITHOUT CLAIM TO ANY PARTICULAR FONT, STYLE, SIZE, OR COLOR.

NO CLAIM IS MADE TO THE EXCLUSIVE RIGHT TO USE "HOTDOGS OF SANTA CRUZ", APART FROM THE MARK AS SHOWN.

SEC. 2(F).

FOR RESTAURANT SERVICES (U.S. CLS. 100 AND 101).

FIRST USE 8-17-1997; IN COMMERCE 8-17-1997.

TRACY WHITTAKER-BROWN, EXAMINING ATTORNEY

SN 85-314,510. NIEPARENT, DREW, NEW YORK, NY. FILED 5-6-2011.

**THE DAILY BURGER**

THE MARK CONSISTS OF STANDARD CHARACTERS WITHOUT CLAIM TO ANY PARTICULAR FONT, STYLE, SIZE, OR COLOR.

NO CLAIM IS MADE TO THE EXCLUSIVE RIGHT TO USE "BURGER", APART FROM THE MARK AS SHOWN.

FOR RESTAURANT SERVICES, NAMELY, PROVIDING OF FOOD AND BEVERAGES FOR CONSUMPTION ON AND OFF THE PREMISES (U.S. CLS. 100 AND 101).

MICHAEL KEATING, EXAMINING ATTORNEY

**CLASS 43—(Continued).**

SN 85-315,155. TWO DAUGHTERS, LLC, GREENVILLE, SC.  
FILED 5-7-2011.

## SNIFFER SOCIETY

THE MARK CONSISTS OF STANDARD CHARACTERS WITHOUT CLAIM TO ANY PARTICULAR FONT, STYLE, SIZE, OR COLOR.

NO CLAIM IS MADE TO THE EXCLUSIVE RIGHT TO USE "SOCIETY", APART FROM THE MARK AS SHOWN.

FOR WINE CLUB SERVICES FEATURING PERIODIC OFFERING OF SELECTIONS OF WINE TO MEMBERS FOR WINE APPRECIATION PURPOSES (U.S. CLS. 100 AND 101).

FIRST USE 2-7-2011; IN COMMERCE 2-7-2011.

PAUL E. FAHRENKOPF, EXAMINING ATTORNEY

SN 85-315,924. DEER CREEK COFFEE, INC., LADUE, MO.  
FILED 5-9-2011.

## DEER CREEK COFFEE

THE MARK CONSISTS OF STANDARD CHARACTERS WITHOUT CLAIM TO ANY PARTICULAR FONT, STYLE, SIZE, OR COLOR.

NO CLAIM IS MADE TO THE EXCLUSIVE RIGHT TO USE "COFFEE", APART FROM THE MARK AS SHOWN.

FOR PROVIDING COFFEE SHOP, CAFE, AND RESTAURANT SERVICES; PROVIDING CATERING SERVICES; AND PROVIDING CONFERENCE ROOMS (U.S. CLS. 100 AND 101).

FIRST USE 11-1-2010; IN COMMERCE 11-1-2010.

RONALD AIKENS, EXAMINING ATTORNEY

**CLASS 43—(Continued).**

SN 85-316,437. SDP ENTERPRISES, INC., MT. JULITE, TN.  
FILED 5-10-2011.



NO CLAIM IS MADE TO THE EXCLUSIVE RIGHT TO USE "NY NY PIZZA", APART FROM THE MARK AS SHOWN.

THE MARK CONSISTS OF A SHIELD OR CREST DESIGN WITH FIGURATIVE ELEMENTS CONTAINED THEREIN OR SUPERIMPOSED THEREON, NAMELY, IMAGES OF A PIZZA SLICE, A PIZZA PIE THE FACE OF THE STATUE OF LIBERTY, CITY BUILDINGS, STRUCTURES, TOWERS. ABOVE THE CREST DESIGN IS THE WORDING "NY NY". BELOW THE CREST IS THE WORDING "PIZZA".

FOR RESTAURANT AND CARRY OUT SERVICES (U.S. CLS. 100 AND 101).

FIRST USE 8-1-2008; IN COMMERCE 8-1-2008.

DANIEL CAPSHAW, EXAMINING ATTORNEY

SN 85-316,625. NARDON, RAFFAEL, MIAMI, FL. FILED 5-10-2011.

## EUROPEAN HOUSE OF SANDWICHES

THE MARK CONSISTS OF STANDARD CHARACTERS WITHOUT CLAIM TO ANY PARTICULAR FONT, STYLE, SIZE, OR COLOR.

NO CLAIM IS MADE TO THE EXCLUSIVE RIGHT TO USE "EUROPEAN" AND "SANDWICHES", APART FROM THE MARK AS SHOWN.

FOR RESTAURANT SERVICES FEATURING SANDWICHES (U.S. CLS. 100 AND 101).

CIMMERIAN COLEMAN, EXAMINING ATTORNEY



**CLASS 43—(Continued).**

SN 85-317,354. OFF AIR VENTURES, INC., ORO VALLEY, AZ. FILED 5-10-2011.

## Fruit Shack Smoothies & Yogurt

THE MARK CONSISTS OF STANDARD CHARACTERS WITHOUT CLAIM TO ANY PARTICULAR FONT, STYLE, SIZE, OR COLOR.

NO CLAIM IS MADE TO THE EXCLUSIVE RIGHT TO USE "FRUIT" AND "SMOOTHIES & YOGURT", APART FROM THE MARK AS SHOWN.

FOR RESTAURANT SERVICES FEATURING SMOOTHIES, FROZEN YOGURT, PRETZELS, SALADS AND SANDWICHES (U.S. CLS. 100 AND 101).

JOHN E. MICHOS, EXAMINING ATTORNEY

---

SN 85-320,294. CALIFORNIA TORTILLA GROUP, INC., DBA CALIFORNIA TORTILLA, ROCKVILLE, MD. FILED 5-13-2011.

## Burrito Elito

THE MARK CONSISTS OF STANDARD CHARACTERS WITHOUT CLAIM TO ANY PARTICULAR FONT, STYLE, SIZE, OR COLOR.

NO CLAIM IS MADE TO THE EXCLUSIVE RIGHT TO USE "BURRITO", APART FROM THE MARK AS SHOWN.

THE WORDING "ELITO" HAS NO MEANING IN A FOREIGN LANGUAGE.

FOR RESTAURANT SERVICES (U.S. CLS. 100 AND 101).

KATHERINE CONNOLLY, EXAMINING ATTORNEY

---

SN 85-320,727. BRC HOSPITALITY LLC, MIAMI, FL. FILED 5-13-2011.



OWNER OF U.S. REG. NO. 3,545,755.

NO CLAIM IS MADE TO THE EXCLUSIVE RIGHT TO USE "SINCE 1975" AND "FRESH" "CUBAN" "CAFE", APART FROM THE MARK AS SHOWN.

THE COLOR(S) RED AND BLACK IS/ARE CLAIMED AS A FEATURE OF THE MARK.

THE MARK CONSISTS OF THE WORDING "SERGIO'S" IN A FANCIFUL CURSIVE IN THE COLOR RED, THE WORDING "SINCE 1975" IN THE COLOR BLACK, AND THE WORDING "FRESH" "CUBAN" "CAFE" IN THE COLOR BLACK SEPARATED BY BLACK DOTS IN BETWEEN THE WORDS.

FOR RESTAURANT SERVICES (U.S. CLS. 100 AND 101).

FIRST USE 3-3-2011; IN COMMERCE 5-23-2011.

LESLIE RICHARDS, EXAMINING ATTORNEY

**CLASS 43—(Continued).**

SN 85-321,911. HLT DOMESTIC IP LLC, MCLEAN, VA. FILED 5-16-2011.

## TRUE WALDORF SERVICE

THE MARK CONSISTS OF STANDARD CHARACTERS WITHOUT CLAIM TO ANY PARTICULAR FONT, STYLE, SIZE, OR COLOR.

OWNER OF U.S. REG. NOS. 1,065,983, 2,527,138 AND OTHERS.

NO CLAIM IS MADE TO THE EXCLUSIVE RIGHT TO USE "SERVICE", APART FROM THE MARK AS SHOWN.

FOR HOTEL SERVICES (U.S. CLS. 100 AND 101).

MICHAEL WEBSTER, EXAMINING ATTORNEY

---

SN 85-322,869. CRAVEN, CHARLES H, OCEAN CITY, MD. FILED 5-17-2011.

## CRAVEN CHICKEN

THE MARK CONSISTS OF STANDARD CHARACTERS WITHOUT CLAIM TO ANY PARTICULAR FONT, STYLE, SIZE, OR COLOR.

NO CLAIM IS MADE TO THE EXCLUSIVE RIGHT TO USE "CHICKEN", APART FROM THE MARK AS SHOWN.

FOR RESTAURANT SERVICES, INCLUDING SIT-DOWN SERVICE OF FOOD AND TAKE-OUT RESTAURANT SERVICES (U.S. CLS. 100 AND 101).

MICHAEL WIENER, EXAMINING ATTORNEY

---

SN 85-323,166. WILSON, JOHN, CITRUS HEIGHTS, CA. AND WILSON, DENISE, CITRUS HEIGHTS, CA. FILED 5-17-2011.

## PARKER'S HOT DOGS

THE MARK CONSISTS OF STANDARD CHARACTERS WITHOUT CLAIM TO ANY PARTICULAR FONT, STYLE, SIZE, OR COLOR.

NO CLAIM IS MADE TO THE EXCLUSIVE RIGHT TO USE "HOTDOGS", APART FROM THE MARK AS SHOWN. SEC. 2(F).

FOR RESTAURANT SERVICES (U.S. CLS. 100 AND 101).

FIRST USE 8-17-1997; IN COMMERCE 8-17-1997.

TRACY WHITTAKER-BROWN, EXAMINING ATTORNEY

**CLASS 43—(Continued).**

SN 85-323,244. RICKER, ANDREW H., PORTLAND, OR.  
FILED 5-17-2011.

**POK POK**

THE MARK CONSISTS OF STANDARD CHARACTERS WITHOUT CLAIM TO ANY PARTICULAR FONT, STYLE, SIZE, OR COLOR.

THE WORDING "POK POK" HAS NO MEANING IN A FOREIGN LANGUAGE.

FOR RESTAURANT SERVICES, NAMELY, PROVIDING OF FOOD AND BEVERAGES FOR CONSUMPTION ON AND OFF THE PREMISES; BAR AND CATERING SERVICES (U.S. CLS. 100 AND 101).

FIRST USE 11-25-2005; IN COMMERCE 11-25-2005.

EMILY CARLSEN, EXAMINING ATTORNEY

**CLASS 43—(Continued).**

SN 85-323,893. JAIME OLIVAS, CEDAR PARK, UNITED STATES, FILED 5-18-2011.



NO CLAIM IS MADE TO THE EXCLUSIVE RIGHT TO USE "MARGARITAS", APART FROM THE MARK AS SHOWN.

THE MARK CONSISTS OF BUZZIN BLOND BEE GIRL HOLDING A MARGARITA SITTING ON "BUZZIN MARGARITAS" LETTERING ON A TROPICAL SCENERY OF HORIZON BACKGROUND WITH SUN SET AND PALM TREE LEAF AND TWO BIRDS FLYING IN THE HORIZON WITH "CHILL WITH US" SLOGAN.

FOR RENTAL OF DRINK DISPENSING MACHINES (U.S. CLS. 100 AND 101).

FIRST USE 9-19-2009; IN COMMERCE 9-19-2009.

ANNE MADDEN, EXAMINING ATTORNEY

SN 85-323,279. ANDREW H. RICKER, PORTLAND, OR.  
FILED 5-17-2011.

**POK POK NOI**

THE MARK CONSISTS OF STANDARD CHARACTERS WITHOUT CLAIM TO ANY PARTICULAR FONT, STYLE, SIZE, OR COLOR.

THE ENGLISH TRANSLATION OF THE WORD "NOI" IN THE MARK IS "LITTLE".

THE WORDING "POK POK" HAS NO MEANING IN A FOREIGN LANGUAGE.

FOR RESTAURANT SERVICES, NAMELY, PROVIDING OF FOOD AND BEVERAGES FOR CONSUMPTION ON AND OFF THE PREMISES; BAR AND CATERING SERVICES (U.S. CLS. 100 AND 101).

FIRST USE 3-26-2011; IN COMMERCE 3-26-2011.

EMILY CARLSEN, EXAMINING ATTORNEY

SN 85-324,021. CHICKEN ETCETERA, INC., SUGAR LAND, TX. FILED 5-18-2011.



NO CLAIM IS MADE TO THE EXCLUSIVE RIGHT TO USE "CHICKEN" AND "ROTISSERIE", APART FROM THE MARK AS SHOWN.

THE MARK CONSISTS OF AN OUTLINED CIRCLE WITH WINGS EXTENDING FROM EITHER SIDE AND THE STYLIZED WORDS "CHICKEN ETCETERA" AND "ROTISSERIE" WRITTEN AROUND THE INSIDE, WITH A RAISED DOT ON EACH SIDE OF THE TERM "ROTISSERIE". IN THE CENTER OF THE CIRCLE IS ANOTHER CIRCLE CONTAINING A GRAPHIC OF A CHICKEN.

FOR CATERING SERVICES; RESTAURANT SERVICES (U.S. CLS. 100 AND 101).

FIRST USE 11-0-1995; IN COMMERCE 11-0-1995.

ALYSSA STEEL, EXAMINING ATTORNEY



**CLASS 43—(Continued).**

SN 85-324,804. KIMBALL, JAMES, VANCOUVER, WA. FILED 5-19-2011.

# YoYumba

THE MARK CONSISTS OF STANDARD CHARACTERS WITHOUT CLAIM TO ANY PARTICULAR FONT, STYLE, SIZE, OR COLOR.

FOR FROZEN YOGURT SHOP SERVICES IN THE NATURE OF A RESTAURANT (U.S. CLS. 100 AND 101).  
GEORGE LORENZO, EXAMINING ATTORNEY

SN 85-325,373. MINIDIS, JAMES D, PALMDALE, CA. FILED 5-19-2011.

# Build It/Name It!

THE MARK CONSISTS OF STANDARD CHARACTERS WITHOUT CLAIM TO ANY PARTICULAR FONT, STYLE, SIZE, OR COLOR.

FOR RESTAURANT SERVICES, NAMELY, PROVIDING OF FOOD AND BEVERAGES FOR CONSUMPTION ON AND OFF THE PREMISES (U.S. CLS. 100 AND 101).  
FIRST USE 3-30-2010; IN COMMERCE 3-30-2010.  
ANN E. SAPPENFIELD, EXAMINING ATTORNEY

SN 85-325,469. ZULLAS, L.C., DBA CAFE ZUPAS, SANDY, UT. FILED 5-19-2011.

# IZUPAS BAR

THE MARK CONSISTS OF STANDARD CHARACTERS WITHOUT CLAIM TO ANY PARTICULAR FONT, STYLE, SIZE, OR COLOR.

NO CLAIM IS MADE TO THE EXCLUSIVE RIGHT TO USE "BAR", APART FROM THE MARK AS SHOWN.  
FOR RESTAURANT SERVICES FEATURING SUPPORT FOR PERSONAL ELECTRONIC DEVICES, INTERNET ACCESS, AND/OR ELECTRICAL OUTLETS (U.S. CLS. 100 AND 101).  
FIRST USE 2-1-2010; IN COMMERCE 2-1-2010.  
JAY FLOWERS, EXAMINING ATTORNEY

**CLASS 43—(Continued).**

SN 85-328,018. ZULLAS, L.C., DBA CAFE ZUPAS, SANDY, UT. FILED 5-23-2011.



OWNER OF U.S. REG. NO. 3,286,336.  
NO CLAIM IS MADE TO THE EXCLUSIVE RIGHT TO USE "CAFÉ", APART FROM THE MARK AS SHOWN.  
THE MARK CONSISTS OF THE WORD "CAFÉ" SURROUNDED BY AN OVAL AND THE WORD "ZUPAS" IN A LARGER FONT SIZE.

FOR RESTAURANT SERVICES (U.S. CLS. 100 AND 101).  
FIRST USE 7-25-2006; IN COMMERCE 7-25-2006.  
JAY FLOWERS, EXAMINING ATTORNEY

SN 85-330,231. GUCKENHEIMER ENTERPRISES, INC., REDWOOD SHORES, CA. FILED 5-25-2011.

# Nourishing Inspiration

THE MARK CONSISTS OF STANDARD CHARACTERS WITHOUT CLAIM TO ANY PARTICULAR FONT, STYLE, SIZE, OR COLOR.

FOR CONTRACT FOOD SERVICES (U.S. CLS. 100 AND 101).  
FIRST USE 7-0-2011; IN COMMERCE 8-1-2011.  
ELLEN BURNS, EXAMINING ATTORNEY

SN 85-331,237. DELI LLC, COLUMBIA, SC. FILED 5-26-2011.

# DIPRATO'S

THE MARK CONSISTS OF STANDARD CHARACTERS WITHOUT CLAIM TO ANY PARTICULAR FONT, STYLE, SIZE, OR COLOR.

FOR DELICATESSENS; RESTAURANT SERVICES (U.S. CLS. 100 AND 101).  
FIRST USE 5-30-2004; IN COMMERCE 5-30-2004.  
TRACY WHITTAKER-BROWN, EXAMINING ATTORNEY

**CLASS 43—(Continued).**

SN 85-331,319. FRONTERA GRILL, CHICAGO, IL. FILED 5-26-2011.

# XOCO

THE MARK CONSISTS OF STANDARD CHARACTERS WITHOUT CLAIM TO ANY PARTICULAR FONT, STYLE, SIZE, OR COLOR.  
FOR RESTAURANT SERVICES (U.S. CLS. 100 AND 101).  
FIRST USE 8-0-2009; IN COMMERCE 8-0-2009.  
CAROLINE WOOD, EXAMINING ATTORNEY

---

SN 85-331,366. COLE-SWANSON, LLC, DBA ONE2ONE RESTAURANT AND BAR, FRISCO, TX. FILED 5-26-2011.

# One2One

THE MARK CONSISTS OF STANDARD CHARACTERS WITHOUT CLAIM TO ANY PARTICULAR FONT, STYLE, SIZE, OR COLOR.  
FOR BAR AND RESTAURANT SERVICES (U.S. CLS. 100 AND 101).  
FIRST USE 11-30-2008; IN COMMERCE 8-9-2010.  
JAMES STEIN, EXAMINING ATTORNEY

---

SN 85-331,652. KAREN GOLDBERG, DBA TAMALPIE PIZZA, MILL VALLEY, CA. FILED 5-26-2011.

# TAMALPIE PIZZA

THE MARK CONSISTS OF STANDARD CHARACTERS WITHOUT CLAIM TO ANY PARTICULAR FONT, STYLE, SIZE, OR COLOR.  
NO CLAIM IS MADE TO THE EXCLUSIVE RIGHT TO USE "PIZZA", APART FROM THE MARK AS SHOWN.  
THE WORDING TAMALPIE HAS NO MEANING IN A FOREIGN LANGUAGE.  
FOR BAR AND RESTAURANT SERVICES; CAFE AND RESTAURANT SERVICES; CAFE-RESTAURANTS; CAFETERIA AND RESTAURANT SERVICES; CARRY-OUT RESTAURANTS; FAST-FOOD RESTAURANT SERVICES; FAST-FOOD RESTAURANTS; MOBILE RESTAURANT SERVICES; RESTAURANT; RESTAURANT SERVICES, NAMELY, PROVIDING OF FOOD AND BEVERAGES FOR CONSUMPTION ON AND OFF THE PREMISES (U.S. CLS. 100 AND 101).  
ROSELLE HERRERA, EXAMINING ATTORNEY

**CLASS 43—(Continued).**

SN 85-332,044. KO PROJECT CONSULTING INC., LOS ANGELES, CA. FILED 5-27-2011.

# Maize & Barley

THE MARK CONSISTS OF STANDARD CHARACTERS WITHOUT CLAIM TO ANY PARTICULAR FONT, STYLE, SIZE, OR COLOR.  
FOR RESTAURANT AND BAR SERVICES (U.S. CLS. 100 AND 101).  
SUNG IN, EXAMINING ATTORNEY

---

SN 85-332,160. HEALTHY HAVANAS, MIAMI, FL. FILED 5-27-2011.

# Healthy Havana's

THE MARK CONSISTS OF STANDARD CHARACTERS WITHOUT CLAIM TO ANY PARTICULAR FONT, STYLE, SIZE, OR COLOR.  
FOR FAST-FOOD RESTAURANT SERVICES (U.S. CLS. 100 AND 101).  
GRETTA YAO, EXAMINING ATTORNEY

---

SN 85-332,319. SUPERDAWG DRIVE-IN, INC., CHICAGO, IL. FILED 5-27-2011.

# SUPERDAWG

THE MARK CONSISTS OF STANDARD CHARACTERS WITHOUT CLAIM TO ANY PARTICULAR FONT, STYLE, SIZE, OR COLOR.  
OWNER OF U.S. REG. NO. 1,309,420.  
FOR RESTAURANT AND CATERING SERVICES (U.S. CLS. 100 AND 101).  
FIRST USE 0-0-1948; IN COMMERCE 0-0-1948.  
JEFFERY COWARD, EXAMINING ATTORNEY

**CLASS 43—(Continued).**

SN 85-332,497. METROVINO LLC, PORTLAND, OR. FILED 5-27-2011.

# Metrovino

THE MARK CONSISTS OF STANDARD CHARACTERS WITHOUT CLAIM TO ANY PARTICULAR FONT, STYLE, SIZE, OR COLOR.

FOR RESTAURANT AND BAR SERVICES (U.S. CLS. 100 AND 101).

FIRST USE 5-6-2009; IN COMMERCE 5-6-2009.

MARY CRAWFORD, EXAMINING ATTORNEY

---

SN 85-332,850. LOVE STYLE CORPORATION, FORT WORTH, TX. FILED 5-27-2011.

# THE WOODSHED

THE MARK CONSISTS OF STANDARD CHARACTERS WITHOUT CLAIM TO ANY PARTICULAR FONT, STYLE, SIZE, OR COLOR.

FOR RESTAURANT AND BAR SERVICES (U.S. CLS. 100 AND 101).

BRIAN CALLAGHAN, EXAMINING ATTORNEY

---

SN 85-333,248. CHATEAU CELESTE, INC., LOS ANGELES, CA. FILED 5-29-2011.

# CHATEAU CELESTE

THE MARK CONSISTS OF STANDARD CHARACTERS WITHOUT CLAIM TO ANY PARTICULAR FONT, STYLE, SIZE, OR COLOR.

THE ENGLISH TRANSLATION OF "CELESTE" IN THE MARK IS "HEAVENLY".

FOR BAR AND COCKTAIL LOUNGE SERVICES; HOTEL, RESTAURANT AND CATERING SERVICES; PROVIDING SOCIAL MEETING, BANQUET AND SOCIAL FUNCTION FACILITIES; PROVISION OF CONFERENCE, EXHIBITION AND MEETING FACILITIES (U.S. CLS. 100 AND 101).

LINDA E. BLOHM, EXAMINING ATTORNEY

**CLASS 43—(Continued).**

SN 85-333,417. NOAH HOMES, INC., SPRING VALLEY, CA. FILED 5-30-2011.



NO CLAIM IS MADE TO THE EXCLUSIVE RIGHT TO USE "HOMES", APART FROM THE MARK AS SHOWN.

THE MARK CONSISTS OF THE PHRASE "NOAH HOMES" WITH THE OUTLINE OF A BIRD WITH A BRANCH IN ITS BEAK CENTERED ABOVE THE PHRASE AND A REPRESENTATION OF A RAINBOW OVERARCHING THE BIRD AND PHRASE.

FOR PROVIDING TEMPORARY ACCOMMODATIONS, NAMELY, RESIDENTIAL HOMES AND HOUSING SERVICES FOR INDIVIDUALS WITH AUTISM AND OTHER DEVELOPMENTAL DISORDERS (U.S. CLS. 100 AND 101).

FIRST USE 0-0-1982; IN COMMERCE 0-0-1982.

GEORGE LORENZO, EXAMINING ATTORNEY

---

SN 85-333,691. EDWYN C. HUANG, NEW YORK, NY. FILED 5-31-2011.

# FRESH OFF THE BOAT

THE MARK CONSISTS OF STANDARD CHARACTERS WITHOUT CLAIM TO ANY PARTICULAR FONT, STYLE, SIZE, OR COLOR.

FOR RESTAURANT SERVICES (U.S. CLS. 100 AND 101).

FIRST USE 12-24-2009; IN COMMERCE 12-24-2009.

HEATHER THOMPSON, EXAMINING ATTORNEY

---

SN 85-333,718. ANTONIOS SIKOLAS, WEST HOLLYWOOD, CA. FILED 5-31-2011.

# Adonis Eat Like a God

THE MARK CONSISTS OF STANDARD CHARACTERS WITHOUT CLAIM TO ANY PARTICULAR FONT, STYLE, SIZE, OR COLOR.

FOR RESTAURANT SERVICES (U.S. CLS. 100 AND 101).

JACQUELINE A. LAVINE, EXAMINING ATTORNEY

**CLASS 43—(Continued).**

SN 85-333,941. HOT SERRANO, LLC, DBA SOREO SELECT, TUCSON, AZ. FILED 5-31-2011.

# SOREO

THE MARK CONSISTS OF STANDARD CHARACTERS WITHOUT CLAIM TO ANY PARTICULAR FONT, STYLE, SIZE, OR COLOR.

FOR FOOD PREPARATION SERVICES; FOOD PREPARATION SERVICES FEATURING FRESH, PROPERLY PROPORTIONED, HEALTHY MEALS DESIGNED TO FUEL METABOLISM AND BURN FAT AND MADE TO ORDER FOR DELIVERY OR PICK UP; PET DAY CARE SERVICES (U.S. CLS. 100 AND 101).

FIRST USE 4-30-2011; IN COMMERCE 4-30-2011.  
HAI-LY LAM, EXAMINING ATTORNEY

**CLASS 43—(Continued).**

SN 85-334,248. AMERICA'S BETTER BURGER, LLC, DBA TOM AND EDDIE'S, WOODRIDGE, IL. FILED 5-31-2011.

# WE PUT GOOD TASTE IN EVERYTHING WE DO

THE MARK CONSISTS OF STANDARD CHARACTERS WITHOUT CLAIM TO ANY PARTICULAR FONT, STYLE, SIZE, OR COLOR.

FOR RESTAURANT SERVICES (U.S. CLS. 100 AND 101).

FIRST USE 2-16-2010; IN COMMERCE 2-16-2010.  
DOMINICK J. SALEMI, EXAMINING ATTORNEY

SN 85-334,075. BLUE ZONES, LLC, MINNEAPOLIS, MN. FILED 5-31-2011.

# BLUE ZONES

THE MARK CONSISTS OF STANDARD CHARACTERS WITHOUT CLAIM TO ANY PARTICULAR FONT, STYLE, SIZE, OR COLOR.

FOR CAFES; CARRY-OUT RESTAURANTS; COFFEE BARS; JUICE BAR SERVICES; RESTAURANT SERVICES; TEA BARS; WINE BARS (U.S. CLS. 100 AND 101).  
JILL C. ALT, EXAMINING ATTORNEY

SN 85-334,654. LJ PRODUCTIONS, LLC, SAN FRANCISCO, CA. FILED 6-1-2011.

# MAMA CHARLOTTE'S

THE MARK CONSISTS OF STANDARD CHARACTERS WITHOUT CLAIM TO ANY PARTICULAR FONT, STYLE, SIZE, OR COLOR.

FOR BAR SERVICES; RESTAURANT SERVICES (U.S. CLS. 100 AND 101).

CARYN GLASSER, EXAMINING ATTORNEY

SN 85-334,133. DAVIDSON HOTEL COMPANY LLC, MEMPHIS, TN. FILED 5-31-2011.

# DELIVERING HOSPITALITY, CREATING VALUE ... EVERY CUSTOMER, EVERY TIME

THE MARK CONSISTS OF STANDARD CHARACTERS WITHOUT CLAIM TO ANY PARTICULAR FONT, STYLE, SIZE, OR COLOR.

FOR HOTELS; RESORT HOTELS (U.S. CLS. 100 AND 101).

FIRST USE 3-1-2007; IN COMMERCE 3-1-2007.  
HELENE LIWINSKI, EXAMINING ATTORNEY

SN 85-335,493. ZARAGOZA, ENNIO E, DOVER, DE. FILED 6-1-2011.

# LeLoLi

THE MARK CONSISTS OF STANDARD CHARACTERS WITHOUT CLAIM TO ANY PARTICULAR FONT, STYLE, SIZE, OR COLOR.

FOR CAFE (U.S. CLS. 100 AND 101).  
KHANH LE, EXAMINING ATTORNEY

**CLASS 43—(Continued).**

SN 85-335,909. COMP OPTIONS INSURANCE COMPANY, INC., JACKSONVILLE, FL. FILED 6-2-2011.

# CIRCANA

THE MARK CONSISTS OF STANDARD CHARACTERS WITHOUT CLAIM TO ANY PARTICULAR FONT, STYLE, SIZE, OR COLOR.

FOR PROVIDING SERVICES TO INDIVIDUALS, BOTH FOREIGNERS AND UNITED STATES RESIDENTS, WITH ASSISTANCE IN MAKING RESERVATIONS AND BOOKINGS FOR TEMPORARY LODGING AND MEALS RELATED TO SECURING MEDICAL CARE OUTSIDE THEIR HOME COUNTRY (U.S. CLS. 100 AND 101).

CAROLINE WOOD, EXAMINING ATTORNEY



SN 85-335,945. JLK II, INC., DBA SAGE WOODFIRE TAVERN, ALPHARETTA, GA. FILED 6-2-2011.

## CREATIVITY WITH PASSION

THE MARK CONSISTS OF STANDARD CHARACTERS WITHOUT CLAIM TO ANY PARTICULAR FONT, STYLE, SIZE, OR COLOR.

FOR BAR AND RESTAURANT SERVICES (U.S. CLS. 100 AND 101).

FIRST USE 10-19-2002; IN COMMERCE 10-19-2002.  
CHRISTINE COOPER, EXAMINING ATTORNEY



SN 85-336,118. AMERICA'S BETTER BURGER, LLC, DBA TOM AND EDDIE'S, WOODRIDGE, IL. FILED 6-2-2011.

## GOOD TASTE GUILD

THE MARK CONSISTS OF STANDARD CHARACTERS WITHOUT CLAIM TO ANY PARTICULAR FONT, STYLE, SIZE, OR COLOR.

FOR RESTAURANT SERVICES FEATURING AN INCENTIVE REWARD PROGRAM (U.S. CLS. 100 AND 101).

FIRST USE 8-27-2010; IN COMMERCE 8-27-2010.  
DOMINICK J. SALEMI, EXAMINING ATTORNEY

**CLASS 43—(Continued).**

SN 85-336,530. BILLY BARRACUDA, LLC, VIRGINIA BEACH, VA. FILED 6-2-2011.

# BILLY BARRACUDA

THE MARK CONSISTS OF STANDARD CHARACTERS WITHOUT CLAIM TO ANY PARTICULAR FONT, STYLE, SIZE, OR COLOR.

FOR RESTAURANT AND BAR SERVICES, INCLUDING RESTAURANT CARRYOUT SERVICES (U.S. CLS. 100 AND 101).

ODESSA BIBBINS, EXAMINING ATTORNEY



SN 85-336,675. SPECTRUM RETIREMENT COMMUNITIES, LLC, DENVER, CO. FILED 6-2-2011.

# HUGS

THE MARK CONSISTS OF STANDARD CHARACTERS WITHOUT CLAIM TO ANY PARTICULAR FONT, STYLE, SIZE, OR COLOR.

FOR RETIREMENT HOMES, NAMELY, PROVIDING ASSISTED LIVING FACILITIES AND CONGREGATE LIVING FACILITIES FOR SENIORS (U.S. CLS. 100 AND 101).

FIRST USE 3-31-2008; IN COMMERCE 3-31-2008.  
ZACHARY BELLO, EXAMINING ATTORNEY



SN 85-336,701. SPECTRUM RETIREMENT COMMUNITIES, LLC, DENVER, CO. FILED 6-2-2011.

## HUMANITY UNITED FOR GOOD

THE MARK CONSISTS OF STANDARD CHARACTERS WITHOUT CLAIM TO ANY PARTICULAR FONT, STYLE, SIZE, OR COLOR.

FOR RETIREMENT HOMES, NAMELY, PROVIDING ASSISTED LIVING FACILITIES AND CONGREGATE LIVING FACILITIES FOR SENIORS (U.S. CLS. 100 AND 101).

ZACHARY BELLO, EXAMINING ATTORNEY

**CLASS 43—(Continued).**

SN 85-336,828. PLATE & PITCHFORK, INC., PORTLAND, OR. FILED 6-2-2011.

**Plate & Pitchfork**

THE MARK CONSISTS OF STANDARD CHARACTERS WITHOUT CLAIM TO ANY PARTICULAR FONT, STYLE, SIZE, OR COLOR.

FOR RESTAURANT SERVICES; PREPARATION OF FOOD AND DRINK; PROVISION OF FOOD AND DRINK FOR PATRONS AND GUESTS AT FARMS, WINERIES AND OTHER AGRICULTURAL AND CULINARY ESTABLISHMENTS (U.S. CLS. 100 AND 101).

FIRST USE 7-17-2003; IN COMMERCE 7-17-2003.  
AISHA CLARKE, EXAMINING ATTORNEY

SN 85-336,930. SUMMIT ENTERTAINMENT, LLC, SANTA MONICA, CA. FILED 6-2-2011.

**ISLE ESME**

THE MARK CONSISTS OF STANDARD CHARACTERS WITHOUT CLAIM TO ANY PARTICULAR FONT, STYLE, SIZE, OR COLOR.

FOR HOTEL, RESTAURANT, AND CATERING SERVICES (U.S. CLS. 100 AND 101).

ASMAT KHAN, EXAMINING ATTORNEY

SN 85-337,055. CAULK, STEVE, TAMPA, FL. FILED 6-3-2011.

**BFAST**

THE MARK CONSISTS OF STANDARD CHARACTERS WITHOUT CLAIM TO ANY PARTICULAR FONT, STYLE, SIZE, OR COLOR.

FOR RESTAURANT SERVICES (U.S. CLS. 100 AND 101).

JASON TURNER, EXAMINING ATTORNEY

**CLASS 43—(Continued).**

SN 85-337,056. DRW FITZGERALD REAL PROPERTY LLC, RENO, NV. FILED 6-3-2011.

**HANG**

THE MARK CONSISTS OF STANDARD CHARACTERS WITHOUT CLAIM TO ANY PARTICULAR FONT, STYLE, SIZE, OR COLOR.

FOR HOTEL ACCOMMODATION SERVICES; BAR AND RESTAURANT SERVICES (U.S. CLS. 100 AND 101).  
NORA BUCHANAN WILL, EXAMINING ATTORNEY

SN 85-337,069. LAKEVIEW VILLAGE, LENEXA, KS. FILED 6-3-2011.

**AGE STRONG**

THE MARK CONSISTS OF STANDARD CHARACTERS WITHOUT CLAIM TO ANY PARTICULAR FONT, STYLE, SIZE, OR COLOR.

FOR RETIREMENT HOMES (U.S. CLS. 100 AND 101).  
CHRISTOPHER BUONGIORNO, EXAMINING ATTORNEY

SN 85-337,199. BILLY BARRACUDA, LLC, VIRGINIA BEACH, VA. FILED 6-3-2011.



THE MARK CONSISTS OF A FISH DRESSED IN A HAT AND SHIRT OVER THE WORDS "BILLY BARRACUDA".

FOR RESTAURANT AND BAR SERVICES, INCLUDING RESTAURANT CARRYOUT SERVICES (U.S. CLS. 100 AND 101).

ODESSA BIBBINS, EXAMINING ATTORNEY

**CLASS 43—(Continued).**

SN 85-337,781. SIP RIGHTS, LLC, BOCA RATON, FL. FILED 6-3-2011.

**CELEBRATE ALABAMA**

THE MARK CONSISTS OF STANDARD CHARACTERS WITHOUT CLAIM TO ANY PARTICULAR FONT, STYLE, SIZE, OR COLOR.

OWNER OF U.S. REG. NOS. 2,367,898 AND 3,127,690. NO CLAIM IS MADE TO THE EXCLUSIVE RIGHT TO USE "ALABAMA", APART FROM THE MARK AS SHOWN. FOR HOTELS, MOTELS; ECO-RESORT SERVICES, NAMELY, PROVIDING TEMPORARY ACCOMMODATIONS IN NATURAL HABITATS; PROVIDING CAMP-GROUND FACILITIES; TRAVEL AGENCY SERVICES, NAMELY, MAKING RESERVATIONS FOR TEMPORARY LODGING; AND RESTAURANT SERVICES (U.S. CLS. 100 AND 101).

MICHAEL ENGEL, EXAMINING ATTORNEY

SN 85-338,207. TIKIWHO, LLC, RICHMOND, KY. FILED 6-4-2011.

**TikiWho**

THE MARK CONSISTS OF STANDARD CHARACTERS WITHOUT CLAIM TO ANY PARTICULAR FONT, STYLE, SIZE, OR COLOR.

FOR BAR AND RESTAURANT SERVICES (U.S. CLS. 100 AND 101).

SIMON TENG, EXAMINING ATTORNEY

SN 85-338,403. CHATEAU CELESTE, INC., LOS ANGELES, CA. FILED 6-6-2011.



THE MARK CONSISTS OF PALM TREE LEAVES INSIDE AN ARCHED FRAME.

FOR BAR AND COCKTAIL LOUNGE SERVICES; HOTEL, RESTAURANT AND CATERING SERVICES; PROVIDING SOCIAL MEETING, BANQUET AND SOCIAL FUNCTION FACILITIES; PROVISION OF CONFERENCE, EXHIBITION AND MEETING FACILITIES (U.S. CLS. 100 AND 101).

FIRST USE 3-2-2001; IN COMMERCE 3-2-2001.  
LINDA E. BLOHM, EXAMINING ATTORNEY

**CLASS 43—(Continued).**

SN 85-339,211. CHOICE HOTELS INTERNATIONAL, INC., SILVER SPRING, MD. FILED 6-6-2011.

**YOUR SUITE SUCCESS**

THE MARK CONSISTS OF STANDARD CHARACTERS WITHOUT CLAIM TO ANY PARTICULAR FONT, STYLE, SIZE, OR COLOR.

FOR HOTEL AND MOTEL SERVICES (U.S. CLS. 100 AND 101).

FIRST USE 6-6-2011; IN COMMERCE 6-6-2011.  
CURTIS FRENCH, EXAMINING ATTORNEY

SN 85-339,213. CHOICE HOTELS INTERNATIONAL, INC., SILVER SPRING, MD. FILED 6-6-2011.

**TRULY YOURS**

THE MARK CONSISTS OF STANDARD CHARACTERS WITHOUT CLAIM TO ANY PARTICULAR FONT, STYLE, SIZE, OR COLOR.

FOR HOTEL AND MOTEL SERVICES (U.S. CLS. 100 AND 101).

FIRST USE 6-6-2011; IN COMMERCE 6-6-2011.  
CURTIS FRENCH, EXAMINING ATTORNEY

SN 85-339,866. EPICURE CATERING, LLC, LELAND, MI. FILED 6-7-2011.



THE MARK CONSISTS OF A CARICATURE OUTLINE OF A LEAPING PIG.

FOR SERVICES FOR PROVIDING FOOD AND DRINK, NAMELY SERVING FOOD AND DRINKS, PROVIDING OF FOOD AND DRINKS FOR GUESTS, CATERING OF FOOD AND DRINKS (U.S. CLS. 100 AND 101).

FIRST USE 8-31-2005; IN COMMERCE 8-31-2005.  
ALICE BENMAMAN, EXAMINING ATTORNEY

**CLASS 43—(Continued).**

SN 85-340,229. MARK R. NELSON, PLANO, IL. FILED 6-7-2011.

**BURRITOS GONE WILD**

THE MARK CONSISTS OF STANDARD CHARACTERS WITHOUT CLAIM TO ANY PARTICULAR FONT, STYLE, SIZE, OR COLOR.

NO CLAIM IS MADE TO THE EXCLUSIVE RIGHT TO USE "BURRITOS", APART FROM THE MARK AS SHOWN. FOR RESTAURANTS FEATURING DINE IN, DELIVERY AND MOBILE SERVICE (U.S. CLS. 100 AND 101). JOHN GARTNER, EXAMINING ATTORNEY

SN 85-345,039. LAS VEGAS CONVENTION AND VISITORS AUTHORITY, LAS VEGAS, NV. FILED 6-13-2011.

**LAS VEGAS CONVENTION CENTER**

THE MARK CONSISTS OF STANDARD CHARACTERS WITHOUT CLAIM TO ANY PARTICULAR FONT, STYLE, SIZE, OR COLOR.

NO CLAIM IS MADE TO THE EXCLUSIVE RIGHT TO USE "CONVENTION CENTER", APART FROM THE MARK AS SHOWN.

SEC. 2(F) AS TO "LAS VEGAS". FOR PROVISION OF CONFERENCE, EXHIBITION AND MEETING FACILITIES; PROVISION OF FACILITIES FOR CONVENTIONS (U.S. CLS. 100 AND 101). FIRST USE 1-1-1959; IN COMMERCE 1-1-1959. EMILY CHUO, EXAMINING ATTORNEY

SN 85-347,733. SWEET BEE, INC., RICHMOND, VA. FILED 6-16-2011.



NO CLAIM IS MADE TO THE EXCLUSIVE RIGHT TO USE "PREMIUM FROZEN YOGURT", APART FROM THE MARK AS SHOWN.

THE MARK CONSISTS OF THE WORDS "SWEET BEE" DIVIDED BY SHADED CIRCLES AND A HALF CIRCLE REPRESENTING A BOWL OF FRUITS AND BERRIES OVER THE WORDS "PREMIUM FROZEN YOGURT" IN AN OBLONG.

FOR FROZEN YOGURT SHOP SERVICES IN THE NATURE OF A RESTAURANT (U.S. CLS. 100 AND 101). DAVID C. REIHNER, EXAMINING ATTORNEY

**CLASS 43—(Continued).**

SN 85-352,994. OTG EXPERIENCE, LLC, CHALFONT, PA. FILED 6-22-2011.

**Southern Sow**

THE MARK CONSISTS OF STANDARD CHARACTERS WITHOUT CLAIM TO ANY PARTICULAR FONT, STYLE, SIZE, OR COLOR.

FOR RESTAURANT AND BAR SERVICES (U.S. CLS. 100 AND 101). ANNE FARRELL, EXAMINING ATTORNEY

SN 85-356,978. TACO BELL CORP., IRVINE, CA. FILED 6-27-2011.

**BIGGER JUST GOT BETTER**

THE MARK CONSISTS OF STANDARD CHARACTERS WITHOUT CLAIM TO ANY PARTICULAR FONT, STYLE, SIZE, OR COLOR.

FOR RESTAURANT SERVICES (U.S. CLS. 100 AND 101). JANICE KIM, EXAMINING ATTORNEY

SN 85-372,731. PINNACLE ENTERTAINMENT, INC., LAS VEGAS, NV. FILED 7-15-2011.

**BONTOMPS**

THE MARK CONSISTS OF STANDARD CHARACTERS WITHOUT CLAIM TO ANY PARTICULAR FONT, STYLE, SIZE, OR COLOR.

THE WORDING "BONTOMPS" HAS NO MEANING IN A FOREIGN LANGUAGE.

FOR BAR AND RESTAURANT SERVICES; COCKTAIL LOUNGE SERVICES (U.S. CLS. 100 AND 101). JENNY PARK, EXAMINING ATTORNEY



**CLASS 43—(Continued).**

SN 85-374,658. MCDONALD'S CORPORATION, OAK BROOK, IL. FILED 7-19-2011.

CHANGING. TOGETHER.

THE MARK CONSISTS OF STANDARD CHARACTERS WITHOUT CLAIM TO ANY PARTICULAR FONT, STYLE, SIZE, OR COLOR.

FOR RESTAURANT SERVICES (U.S. CLS. 100 AND 101).

FIRST USE 7-26-2011; IN COMMERCE 7-26-2011.  
REBECCA SMITH, EXAMINING ATTORNEY

**CLASS 43—(Continued).**

SN 85-376,692. PINNACLE ENTERTAINMENT, INC., LAS VEGAS, NV. FILED 7-20-2011.



THE MARK CONSISTS OF THE DRAWING OF THE SIDE OF A BASS DRUM WITHIN THE CENTER OF WHICH IS FEATURED A FLEUR-DE-LIS ABOVE WHICH IS THE WORD BONTOMPS IN STYLIZED FORM. THE WORDS EAT DRINK GOOD TIMES ARE FEATURED BELOW THE FLEUR-DE-LIS WHERE THE WORDS EAT AND DRINK AND GOOD ARE EACH SEPARATED BY A BULLET POINT.

THE WORDING BONTOMPS HAS NO MEANING IN A FOREIGN LANGUAGE.

FOR BAR AND RESTAURANT SERVICES; COCKTAIL LOUNGES (U.S. CLS. 100 AND 101).

JENNY PARK, EXAMINING ATTORNEY

SN 85-376,289. KOI GROUP INC., LAS VEGAS, NV. FILED 7-20-2011.

KOI

THE MARK CONSISTS OF STANDARD CHARACTERS WITHOUT CLAIM TO ANY PARTICULAR FONT, STYLE, SIZE, OR COLOR.

OWNER OF U.S. REG. NOS. 2,950,303, 2,976,272 AND OTHERS.

FOR RESTAURANT SERVICES FEATURING JAPANESE-INSPIRED CUISINE WITH CALIFORNIA ACCENTS (U.S. CLS. 100 AND 101).

FIRST USE 11-30-2001; IN COMMERCE 3-0-2002.  
JOHN DALIER, EXAMINING ATTORNEY

SN 85-381,050. ALTICOR INC., ADA, MI. FILED 7-26-2011.

NUTRILITE

THE MARK CONSISTS OF STANDARD CHARACTERS WITHOUT CLAIM TO ANY PARTICULAR FONT, STYLE, SIZE, OR COLOR.

OWNER OF U.S. REG. NOS. 1,303,954, 2,145,912 AND OTHERS.

FOR FOOD PREPARATION SERVICES FEATURING MEALS FOR DELIVERY OR PICK-UP; PROVIDING A DATABASE IN THE FIELD OF RECIPES, COOKING INFORMATION, AND FOOD AND BEVERAGE PREPARATION; PROVIDING ON-LINE INFORMATION IN THE FIELD OF RECIPES, COOKING INFORMATION, AND FOOD AND BEVERAGE PREPARATION; PROVIDING A WEBSITE WHERE USERS CAN SHARE RECIPES AND POST RATINGS, REVIEWS, AND RECOMMENDATIONS ON RECIPES, COOKING INFORMATION, AND FOOD AND BEVERAGE PREPARATION FOR FOOD AND BEVERAGE APPRECIATION PURPOSES (U.S. CLS. 100 AND 101).

JUSTINE D. PARKER, EXAMINING ATTORNEY

**CLASS 43—(Continued).**

SN 85-383,697. KELLY R DOTY, OVERLAND PARK, KS. FILED 7-28-2011.

share's bistro

THE MARK CONSISTS OF STANDARD CHARACTERS WITHOUT CLAIM TO ANY PARTICULAR FONT, STYLE, SIZE, OR COLOR.

NO CLAIM IS MADE TO THE EXCLUSIVE RIGHT TO USE "BISTRO", APART FROM THE MARK AS SHOWN.

FOR RESTAURANT (U.S. CLS. 100 AND 101).

PAUL E. FAHRENKOPF, EXAMINING ATTORNEY

SN 85-384,030. PINNACLE ENTERTAINMENT, INC., LAS VEGAS, NV. FILED 7-28-2011.

IWIN@BOOMTOWN

THE MARK CONSISTS OF STANDARD CHARACTERS WITHOUT CLAIM TO ANY PARTICULAR FONT, STYLE, SIZE, OR COLOR.

OWNER OF U.S. REG. NO. 1,866,988.

FOR BAR AND RESTAURANT SERVICES; RESORT HOTELS (U.S. CLS. 100 AND 101).

JENNY PARK, EXAMINING ATTORNEY

SN 85-387,621. GUCKENHEIMER ENTERPRISES, INC., REDWOOD SHORES, CA. FILED 8-2-2011.



OWNER OF U.S. REG. NOS. 2,438,182, 3,010,690 AND OTHERS.

THE MARK CONSISTS OF A GEOMETRIC FIGURE COMPOSED OF MULTIPLE CURVED LINES FORMING THE SHAPE OF A BOWL WITH THREE UPWARD SPIRALING WAVY LINES FORMING THE LOWERCASE LETTER "G" AND ALSO BEING A SIMULATIVE FOR THE APPEARANCE OF RISING VAPOR.

FOR CONTRACT FOOD SERVICES (U.S. CLS. 100 AND 101).

FIRST USE 7-0-2011; IN COMMERCE 8-1-2011.

ELLEN BURNS, EXAMINING ATTORNEY

**CLASS 43—(Continued).**

SN 85-387,626. GUCKENHEIMER ENTERPRISES, INC., REDWOOD SHORES, CA. FILED 8-2-2011.



OWNER OF U.S. REG. NOS. 1,698,166, 2,438,182 AND OTHERS.

THE MARK CONSISTS OF A GEOMETRIC FIGURE COMPOSED OF MULTIPLE CURVED LINES FORMING THE SHAPE OF A BOWL WITH THREE UPWARD SPIRALING WAVY LINES FORMING THE LOWERCASE LETTER "G" AND ALSO BEING A SIMULATIVE FOR THE APPEARANCE OF RISING VAPOR, ALONG WITH THE LETTERS "UCKENHEIMER" SO AS TO FORM THE NAME "GUCKENHEIMER".

FOR CONTRACT FOOD SERVICES (U.S. CLS. 100 AND 101).

FIRST USE 7-0-2011; IN COMMERCE 8-1-2011.

ELLEN BURNS, EXAMINING ATTORNEY

SN 85-389,812. MEADWESTVACO CORPORATION, RICHMOND, VA. FILED 8-4-2011.



NO CLAIM IS MADE TO THE EXCLUSIVE RIGHT TO USE "CUMBERLAND RIVER RETREAT EST. 1928", APART FROM THE MARK AS SHOWN.

THE MARK CONSISTS OF WORDS "CABIN BLUFF CUMBERLAND RIVER RETREAT EST. 1928", AND A SILHOUETTE OF A STANDING DOG.

FOR RESORT LODGING SERVICES; PROVISION OF CONFERENCE FACILITIES (U.S. CLS. 100 AND 101).

FIRST USE 12-28-2010; IN COMMERCE 12-28-2010.

DORITT L. CARROLL, EXAMINING ATTORNEY

**CLASS 43—(Continued).**

SN 85-392,870. KOCH DEVELOPMENT CORPORATION,  
SANTA CLAUS, IN. FILED 8-9-2011.

**HOLIDAY WORLD HOTEL**

THE MARK CONSISTS OF STANDARD CHARACTERS  
WITHOUT CLAIM TO ANY PARTICULAR FONT, STYLE,  
SIZE, OR COLOR.

NO CLAIM IS MADE TO THE EXCLUSIVE RIGHT TO  
USE "HOTEL", APART FROM THE MARK AS SHOWN.  
FOR HOTEL SERVICES (U.S. CLS. 100 AND 101).  
AISHA CLARKE, EXAMINING ATTORNEY

SN 85-397,178. PINNACLE ENTERTAINMENT, INC., LAS  
VEGAS, NV. FILED 8-12-2011.

**iWin**  
@  
**BOOMTOWN**

OWNER OF U.S. REG. NO. 1,866,988.  
THE MARK CONSISTS OF THE STYLIZED WORD  
"IWIN" WHICH IS CENTERED OVER THE SYMBOL "@"  
WHICH IS SUPERIMPOSED OVER A SQUARE WHICH IS  
CENTERED OVER THE STYLIZED WORD "BOOMTOWN".  
FOR BAR AND RESTAURANT SERVICES; RESORT  
HOTELS (U.S. CLS. 100 AND 101).  
JENNY PARK, EXAMINING ATTORNEY

**CLASS 44—MEDICAL, BEAUTY AND AGRICULTURAL SERVICES**

SN 76-704,241. AMERICAN HOME COMPANION, INC.,  
RENO, NV. FILED 8-25-2010.

**AMERICAN HOME COMPANION**

THE MARK CONSISTS OF STANDARD CHARACTERS  
WITHOUT CLAIM TO ANY PARTICULAR FONT, STYLE,  
SIZE, OR COLOR.

NO CLAIM IS MADE TO THE EXCLUSIVE RIGHT TO  
USE "AMERICAN", APART FROM THE MARK AS SHOWN.  
FOR RENTAL AND LEASING OF DURABLE MEDICAL  
EQUIPMENT AND MEDICAL OXYGEN TANKS  
(U.S. CLS. 100 AND 101).

FIRST USE 12-0-1999; IN COMMERCE 12-0-1999.  
CHARLOTTE CORWIN, EXAMINING ATTORNEY

**CLASS 44—(Continued).**

SN 76-704,918. SOMA SOLUTIONS, L.L.C., THE WOOD-  
LANDS, TX. FILED 10-15-2010.



NO CLAIM IS MADE TO THE EXCLUSIVE RIGHT TO  
USE "WELLNESS & NUTRITION CENTERS", APART  
FROM THE MARK AS SHOWN.

THE MARK CONSISTS OF THE WORDS "SOMA" AND  
"SOLUTIONS" IN ROUNDED STYLIZED FORM WITH A  
DRAWING OF A FIGURE IN A DANCING POSE AND THE  
WORDS "WELLNESS & NUTRITION CENTERS" IN THE  
MIDDLE.

FOR DIETARY AND NUTRITIONAL GUIDANCE;  
PROVIDING INFORMATION ABOUT DIETARY SUP-  
PLEMENTS AND NUTRITION; WEIGHT REDUCTION  
DIET PLANNING AND SUPERVISION (U.S. CLS. 100  
AND 101).

FIRST USE 6-7-2010; IN COMMERCE 6-7-2010.  
CARYN GLASSER, EXAMINING ATTORNEY

SN 76-707,828. EQUINE ORTHOCARE, LLC, PHOENIX, MD.  
FILED 6-3-2011.

**EQUINE ORTHOCARE**

THE MARK CONSISTS OF STANDARD CHARACTERS  
WITHOUT CLAIM TO ANY PARTICULAR FONT, STYLE,  
SIZE, OR COLOR.

NO CLAIM IS MADE TO THE EXCLUSIVE RIGHT TO  
USE "EQUINE", APART FROM THE MARK AS SHOWN.

FOR VETERINARY SERVICES, NAMELY, THE  
TREATMENT OF ARTHRITIS AND RELATED MUSCU-  
LOSKELETAL INJURY AND DISEASES IN HORSES  
THROUGH THE APPLICATION OF BIOELECTRIC  
TECHNOLOGIES (U.S. CLS. 100 AND 101).

SAMUEL E. SHARPER JR., EXAMINING ATTORNEY

SN 76-708,207. EQUINE ORTHOCARE, LLC, PHOENIX, MD.  
FILED 7-1-2011.



NO CLAIM IS MADE TO THE EXCLUSIVE RIGHT TO  
USE "EQUINE", APART FROM THE MARK AS SHOWN.  
FOR VETERINARY SERVICES, NAMELY, THE  
TREATMENT OF ARTHRITIS AND RELATED MUSCU-  
LOSKELETAL INJURY AND DISEASES IN HORSES  
THROUGH THE APPLICATION OF BIOELECTRIC  
TECHNOLOGIES (U.S. CLS. 100 AND 101).

SAMUEL E. SHARPER JR., EXAMINING ATTORNEY

**CLASS 44—(Continued).**

SN 77-184,403. BROW, GEORGES, GEORGETOWN, CANADA, FILED 5-18-2007.



PRIORITY CLAIMED UNDER SEC. 44(D) ON CANADA APPLICATION NO. 1,347,586, FILED 5-15-2007, REG. NO. 799,767, DATED 6-13-2011, EXPIRES 6-13-2026.

THE MARK CONSISTS OF A SMILEY FACE COMPRISED OF THE LETTER "U" FOR THE MOUTH AND TWO DIAMONDS FOR THE EYES, SURROUNDED BY A CIRCLE FOR THE OUTLINE OF THE FACE.

FOR OPERATION OF PUBLIC TOILETS (U.S. CLS. 100 AND 101).

COLLEEN KEARNEY, EXAMINING ATTORNEY

**CLASS 44—(Continued).**

SN 77-785,070. VALENTINO LOSAURO, DBA THE FRINGEY, FT MYERS, FL. FILED 7-20-2009.



THE NAME "VALENTINO" IDENTIFIES A LIVING INDIVIDUAL WHOSE CONSENT TO REGISTER HIS NAME AS A SERVICE MARK IS OF RECORD.

THE COLOR(S) PINK, BLACK, PURPLE, YELLOW, GREEN, ORANGE, BLUE, GRAY, MAUVE, AND BROWN IS/ARE CLAIMED AS A FEATURE OF THE MARK.

THE MARK CONSISTS OF THE WORDING "THE FRINGEY BY VALENTINO" WITH THE WORD "THE" IN PINK WITH BLACK PIPING, "FRINGEY" IN PURPLE WITH BLACK PIPING, AND EACH LETTER HIGHLIGHTED IN ONE OF THE COLORS PINK, YELLOW, GREEN, ORANGE, AND BLUE, AND "BY VALENTINO" IN BLACK; FANCIFUL WOMAN'S BLUE EYES WITH BLACK, GRAY, AND MAUVE MAKEUP, AND BROWN EYELASHES; AND BANGS IN THE COLORS BLUE, PURPLE, AND MAUVE.

FOR HAIR CUTTING (U.S. CLS. 100 AND 101).  
DAVID C. REIHNER, EXAMINING ATTORNEY

SN 77-602,118. UBM MEDICA LLC, JERSEY CITY, NJ. FILED 10-28-2008.



NO CLAIM IS MADE TO THE EXCLUSIVE RIGHT TO USE "SEARCH" AND "PROFESSIONAL MEDICAL SEARCH", APART FROM THE MARK AS SHOWN.

THE COLOR(S) BLACK, BLUE AND WHITE IS/ARE CLAIMED AS A FEATURE OF THE MARK.

THE MARK CONSISTS OF THE WORDING "SEARCH MEDICA" AND "PROFESSIONAL MEDICAL SEARCH" TO THE RIGHT OF A CIRCULAR DESIGN CONTAINING A PLUS SIGN COMPRISED OF TWO SQUARES FOR EACH PRONG OF THE PLUS SIGN. THE SQUARES OF THE PLUS SIGN APPEAR IN SHADES OF BLUE, LIGHT BLUE AND WHITE. THE CIRCULAR DESIGN AND THE WORDING "SEARCH MEDICA" APPEAR IN SHADES OF BLUE AND LIGHT BLUE, AND THE WORDING "PROFESSIONAL MEDICAL SEARCH" APPEARS IN THE COLOR BLACK.

FOR PROVIDING AN ONLINE COMPUTER DATABASE IN THE FIELD OF CLINICAL MEDICINE FOR USE BY MEDICAL PROFESSIONALS; PROVIDING ONLINE INFORMATION IN THE FIELD OF CLINICAL MEDICINE FOR USE BY MEDICAL PROFESSIONALS (U.S. CLS. 100 AND 101).

FIRST USE 10-0-2006; IN COMMERCE 10-0-2006.  
KATHRYN COWARD, EXAMINING ATTORNEY

SN 78-829,639. BIOTROPHIC NUTRIENTS CORPORATION, CLEARWATER, FL. FILED 3-6-2006.

## Galaxy Nutrients

THE MARK CONSISTS OF STANDARD CHARACTERS WITHOUT CLAIM TO ANY PARTICULAR FONT, STYLE, SIZE, OR COLOR.

NO CLAIM IS MADE TO THE EXCLUSIVE RIGHT TO USE "NUTRIENTS", APART FROM THE MARK AS SHOWN.

FOR PROVIDING INFORMATION IN THE FIELD OF HEALTH, NAMELY, INFORMATION ON INTERNAL CLEANSING, NUTRITIONAL SUPPLEMENTS, NATURAL DIET, NUTRITION AND DIETARY AND NUTRITIONAL GUIDANCE; PROVIDING A WEBSITE FEATURING HEALTH INFORMATION ON INTERNAL CLEANSING, NUTRITIONAL SUPPLEMENTS, NATURAL DIET, NUTRITION AND DIETARY AND NUTRITIONAL GUIDANCE (U.S. CLS. 100 AND 101).

FIRST USE 1-25-1999; IN COMMERCE 1-25-1999.  
LOURDES AYALA, EXAMINING ATTORNEY

**CLASS 44—(Continued).**

SN 79-097,943. MEDMOBILE MEDIZINTECHNIK GMBH, WIEN, AUSTRIA, FILED 1-12-2011.

medmobile

OWNER OF INTERNATIONAL REGISTRATION 1078865 DATED 1-12-2011, EXPIRES 1-12-2021.

THE COLOR(S) RED, GREY IS/ARE CLAIMED AS A FEATURE OF THE MARK.

THE MARK CONSISTS OF THE WORD "MEDMOBILE" WITH THE COLOR RED APPEARING IN THE WORD "MED" AND THE DOT OVER THE LETTER "I" AND THE COLOR GREY APPEARING IN THE WORD "MOBILE" EXCEPT FOR THE DOT OVER THE "I".

FOR BLOOD PRESSURE MONITORING SERVICES (U.S. CLS. 100 AND 101).

CARYN GLASSER, EXAMINING ATTORNEY

**CLASS 44—(Continued).**

SN 85-047,036. CAPTCO, INC., ADDISON, TX. FILED 5-25-2010.

## CAT TATTOO

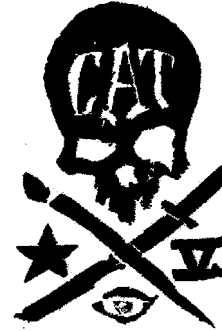

NO CLAIM IS MADE TO THE EXCLUSIVE RIGHT TO USE "TATTOO", APART FROM THE MARK AS SHOWN.

THE MARK CONSISTS OF A SKULL WITH THE WORD "CAT" ABOVE THE EYES AND A PAINTBRUSH CROSSED OVER A SWORD BELOW THE SKULL. THERE IS A STAR ON THE LEFT SIDE OF THE CROSSED PAINTBRUSH AND A SWORD AND A ROMAN NUMERAL FIVE ON THE RIGHT SIDE WITH AN EYE BELOW. ABOVE THE SKULL ARE THE WORDS "CAT TATTOO".

FOR BODY PIERCING AND TATTOOING SERVICES (U.S. CLS. 100 AND 101).

FIRST USE 1-1-2009; IN COMMERCE 1-1-2009.

KATHLEEN M. VANSTON, EXAMINING ATTORNEY

SN 85-047,060. CAPTCO, INC., ADDISON, TX. FILED 5-25-2010.

## STRAY CAT TATTOO



NO CLAIM IS MADE TO THE EXCLUSIVE RIGHT TO USE "TATTOO", APART FROM THE MARK AS SHOWN.

THE MARK CONSISTS OF A SKULL WITH THE WORD "STRAY" ABOVE THE EYES AND A PAINTBRUSH CROSSED OVER A SWORD BELOW THE SKULL. THERE IS A STAR ON THE LEFT SIDE OF THE CROSSED PAINTBRUSH AND A SWORD AND A ROMAN NUMERAL FIVE ON THE RIGHT SIDE WITH AN EYE BELOW. ABOVE THE SKULL ARE THE WORDS "STRAY CAT TATTOO".

FOR BODY PIERCING AND TATTOOING SERVICES (U.S. CLS. 100 AND 101).

FIRST USE 9-1-2009; IN COMMERCE 9-1-2009.

KATHLEEN M. VANSTON, EXAMINING ATTORNEY

SN 85-023,634. SAENZ, ANDREA, SANTA ANA, CA. FILED 4-26-2010.

PIXIE LOCKS

THE MARK CONSISTS OF STANDARD CHARACTERS WITHOUT CLAIM TO ANY PARTICULAR FONT, STYLE, SIZE, OR COLOR.

NO CLAIM IS MADE TO THE EXCLUSIVE RIGHT TO USE "LOCKS", APART FROM THE MARK AS SHOWN.

FOR IN-HOME LICE REMOVAL SERVICES FOR HUMANS AND ANIMALS (U.S. CLS. 100 AND 101).

FIRST USE 4-1-2005; IN COMMERCE 4-1-2005.

MATTHEW PAPPAS, EXAMINING ATTORNEY

**CLASS 44—(Continued).**

SN 85-110,113. PHYSICIANS & PATIENTS SOLUTIONS LLC,  
LAWRENCEVILLE, GA. FILED 8-18-2010.



NO CLAIM IS MADE TO THE EXCLUSIVE RIGHT TO USE THE REPRESENTATION OF THE CADUCEUS, APART FROM THE MARK AS SHOWN.

THE MARK CONSISTS OF A SHOPPING CART WITH A PHYSICIAN BAG WITH THE CADUCEUS ON THE PHYSICIANS BAG.

FOR PROVIDING A WEBSITE WHERE PATIENTS CAN SHOP FOR A MEDICAL SERVICE, MAKE APPOINTMENTS, AND CAN PURCHASE THE MEDICAL SERVICE ONLINE IN ADVANCE, SO THAT THEY CAN PRINT AND SUBMIT THE VOUCHER AT THE TIME OF APPOINTMENT (U.S. CLS. 100 AND 101).

FIRST USE 2-1-2010; IN COMMERCE 4-1-2010.  
MICHAEL KEATING, EXAMINING ATTORNEY

**CLASS 44—(Continued).**

SN 85-129,265. JOEL GELMAN, M.D., INC., DBA CENTER  
FOR RECONSTRUCTIVE UROLOGY, ORANGE, CA.  
FILED 9-14-2010.

CENTER FOR RECONSTRUCTIVE  
UROLOGY

THE MARK CONSISTS OF STANDARD CHARACTERS WITHOUT CLAIM TO ANY PARTICULAR FONT, STYLE, SIZE, OR COLOR.

SEC. 2(F).

FOR MEDICAL SERVICES, NAMELY, TREATMENT OF DISORDERS OF THE MALE URETHRA AND EXTERNAL GENITALIA; PROVIDING A WEB SITE INCLUDING MEDICAL INFORMATION (U.S. CLS. 100 AND 101).

FIRST USE 7-23-2001; IN COMMERCE 7-23-2001.  
KEVON CHISOLM, EXAMINING ATTORNEY

SN 85-123,921. HEALING WATERS, LC, WICHITA, KS.  
FILED 9-7-2010.



OWNER OF U.S. REG. NOS. 3,020,121, 3,027,284 AND 3,044,972.

NO CLAIM IS MADE TO THE EXCLUSIVE RIGHT TO USE "COSMETIC CLINIC", APART FROM THE MARK AS SHOWN.

THE MARK CONSISTS OF THE WORDS "HEALING WATERS" WRITTEN IN CURSIVE AND THE WORDS "COSMETIC CLINIC" IN TYPEWRITTEN FONT UNDER THE WORD "WATERS".

FOR AESTHETIC COSMETIC MEDICAL SERVICES, NAMELY, COSMETIC BODY CARE SERVICES; LASER HAIR REMOVAL; LASER SKIN RESURFACING AND ABLATION; LASER VEIN THERAPY; LASER WRINKLE AND SCAR REDUCTION; CELLULITE REDUCTION TREATMENTS USING LIGHT AND RADIO WAVE FREQUENCIES; FACIAL REJUVENATION THERAPY, NAMELY, MICRODERMABRASION, SCLEROTHERAPY, CHEMICAL PEELS FOR SKIN, SKIN PHOTOREJUVENATION; SKIN TREATMENTS, NAMELY, HYPODERMIC INJECTIONS OF COLLAGEN, HYALURONIC ACID OR ONABOTULINUMTOXINA TO REDUCE THE APPEARANCE OF FACIAL LINES AND WRINKLES; AND LASER LIPOLYSIS (U.S. CLS. 100 AND 101).

FIRST USE 11-16-2009; IN COMMERCE 11-16-2009.  
KATHLEEN LORENZO, EXAMINING ATTORNEY

SN 85-144,868. BALANCED ELEMENTAL MEDICINE LLC,  
SEBASTOPOL, CA. FILED 10-5-2010.

PEACE IN MEDICINE HEALING  
CENTER

THE MARK CONSISTS OF STANDARD CHARACTERS WITHOUT CLAIM TO ANY PARTICULAR FONT, STYLE, SIZE, OR COLOR.

NO CLAIM IS MADE TO THE EXCLUSIVE RIGHT TO USE "MEDICINE HEALING CENTER", APART FROM THE MARK AS SHOWN.

FOR ONLINE MEDICAL CANNABIS RESOURCES, NAMELY, PROVIDING ONLINE RESOURCES FEATURING MEDICAL INFORMATION PERTAINING TO MEDICINAL CANNABIS; PROVIDING MEDICAL INFORMATION IN THE FIELD OF MEDICINAL CANNABIS (U.S. CLS. 100 AND 101).

LINDSEY RUBIN, EXAMINING ATTORNEY

**CLASS 44—(Continued).**

SN 85-170,646. BAYCARE HEALTH SYSTEMS LLC, GREEN BAY, WI. FILED 11-5-2010.



**Green Bay Hand Center**  
BAYCARE CLINIC

OWNER OF U.S. REG. NOS. 2,793,431 AND 2,826,810.

NO CLAIM IS MADE TO THE EXCLUSIVE RIGHT TO USE "GREEN BAY HAND CENTER" AND "CLINIC", APART FROM THE MARK AS SHOWN.

THE COLOR(S) LIGHT GREEN, LIGHT BLUE, TAN, BLACK AND WHITE IS/ARE CLAIMED AS A FEATURE OF THE MARK.

THE MARK CONSISTS OF A LIGHT GREEN CROSS WITH A WHITE BORDER AND A THIN BLACK OUTLINE. WITHIN THE CROSS ARE THREE OVERLAPPING HAND SHAPES, WITH THE TAN HAND BEHIND, THE LIGHT BLUE HAND OVERLAPPING THAT, AND A SMALLER WHITE HAND IN FRONT. TO THE RIGHT OF THIS IS THE WORDING "GREEN BAY HAND CENTER" IN BLACK OVER A BLACK HORIZONTAL LINE, BENEATH WHICH IS THE WORDING "BAYCARE CLINIC" ALSO IN BLACK.

FOR HEALTH CARE SERVICES, NAMELY, MEDICAL DIAGNOSIS, PHYSICAL THERAPY, MASSAGE THERAPY AND SURGERY AND MEDICAL TREATMENT FOR HANDS AND OTHER UPPER EXTREMITIES (U.S. CLS. 100 AND 101).

FRED CARL, EXAMINING ATTORNEY

---

SN 85-172,100. ISAACS, GILLIAN, DANBURY, CT. FILED 11-9-2010.

**CONNECTICUT NURSING  
SERVICES, LLC**

THE MARK CONSISTS OF STANDARD CHARACTERS WITHOUT CLAIM TO ANY PARTICULAR FONT, STYLE, SIZE, OR COLOR.

NO CLAIM IS MADE TO THE EXCLUSIVE RIGHT TO USE "NURSING SERVICES, LLC", APART FROM THE MARK AS SHOWN.

SEC. 2(F).

FOR MEDICAL SERVICES, NAMELY, PRIVATE DUTY HOME HEALTH CARE AGENCY (U.S. CLS. 100 AND 101).

FIRST USE 11-10-2003; IN COMMERCE 1-1-2004.  
MARK SPARACINO, EXAMINING ATTORNEY

**CLASS 44—(Continued).**

SN 85-172,390. DEL MONTE SPA LLC, ROCHESTER, NY. FILED 11-9-2010.

**SPA AT THE DEL MONTE**

THE MARK CONSISTS OF STANDARD CHARACTERS WITHOUT CLAIM TO ANY PARTICULAR FONT, STYLE, SIZE, OR COLOR.

NO CLAIM IS MADE TO THE EXCLUSIVE RIGHT TO USE "SPA", APART FROM THE MARK AS SHOWN.

THE ENGLISH TRANSLATION OF "DEL MONTE" IN THE MARK IS "OF THE MOUNTAIN".

FOR BEAUTY SALON SERVICES; HEALTH SPA SERVICES FOR HEALTH AND WELLNESS OF THE BODY AND SPIRIT, NAMELY, PROVIDING MASSAGE, FACIAL AND BODY TREATMENT SERVICES, COSMETIC BODY CARE SERVICES (U.S. CLS. 100 AND 101).

FIRST USE 12-2-2004; IN COMMERCE 12-2-2004.  
MARK SPARACINO, EXAMINING ATTORNEY

---

SN 85-172,729. DEL MONTE SPA LLC, ROCHESTER, NY. FILED 11-9-2010.

**DEL MONTE SPA**

THE MARK CONSISTS OF STANDARD CHARACTERS WITHOUT CLAIM TO ANY PARTICULAR FONT, STYLE, SIZE, OR COLOR.

NO CLAIM IS MADE TO THE EXCLUSIVE RIGHT TO USE "SPA", APART FROM THE MARK AS SHOWN.

THE ENGLISH TRANSLATION OF "DEL MONTE" IN THE MARK IS "OF THE MOUNTAIN".

FOR BEAUTY SALON SERVICES; HEALTH SPA SERVICES FOR HEALTH AND WELLNESS OF THE BODY AND SPIRIT, NAMELY, PROVIDING MASSAGE, FACIAL AND BODY TREATMENT SERVICES, COSMETIC BODY CARE SERVICES (U.S. CLS. 100 AND 101).

MARK SPARACINO, EXAMINING ATTORNEY

---

SN 85-176,834. DRAYER PHYSICAL THERAPY INSTITUTE, LLC, HUMMELSTOWN, PA. FILED 11-15-2010.

**DRAYER**

THE MARK CONSISTS OF STANDARD CHARACTERS WITHOUT CLAIM TO ANY PARTICULAR FONT, STYLE, SIZE, OR COLOR.

OWNER OF U.S. REG. NO. 3,108,973.  
SEC. 2(F).

FOR OCCUPATIONAL THERAPY SERVICES; PHYSICAL REHABILITATION; PHYSICAL THERAPY; PROVIDING PHYSICAL REHABILITATION FACILITIES (U.S. CLS. 100 AND 101).

FIRST USE 10-1-2002; IN COMMERCE 10-1-2002.  
RAMONA ORTIGA, EXAMINING ATTORNEY

**CLASS 44—(Continued).**

SN 85-178,544. TYNET HEALTHCARE INC, ARLINGTON, TX. FILED 11-17-2010.

TYNET HEALTHCARE

THE MARK CONSISTS OF STANDARD CHARACTERS WITHOUT CLAIM TO ANY PARTICULAR FONT, STYLE, SIZE, OR COLOR.

NO CLAIM IS MADE TO THE EXCLUSIVE RIGHT TO USE "HEALTHCARE", APART FROM THE MARK AS SHOWN.

FOR MEDICAL SERVICES, NAMELY, PROVIDING HOME HEALTHCARE SERVICES FOR PRIVATE PAY PATIENTS AND PATIENTS COVERED UNDER INSURANCE PLANS; MEDICAL CONSULTING SERVICES FOR HEALTHCARE FACILITIES, NAMELY, HOME HEALTH AGENCIES, NURSING FACILITIES, AND HEALTHCARE ORGANIZATIONS WHICH FEATURE COMMUNITY BASED ALTERNATIVES, PRIMARY HOME CARE, RESIDENTIAL CARE, ASSISTED LIVING; PROVIDING MEDICAL SERVICES SUCH AS VITAL SIGNS AND GLUCOSE MONITORING, DISEASE MANAGEMENT, CATHETER CARE, ADMINISTRATION OF INJECTIONS, PAIN MANAGEMENT, INFUSION THERAPY, POST SURGICAL CARE, WOUND CARE, CARDIAC MONITORING, DIABETES MONITORING, HEART CARE MONITORING; SKILLED NURSING SERVICES (U.S. CLS. 100 AND 101).

FIRST USE 8-3-2006; IN COMMERCE 8-3-2006.  
ERNEST SHOSHO, EXAMINING ATTORNEY

**CLASS 44—(Continued).**

SN 85-179,433. LAWRENCE D. DAVANZO, SKILLMAN, NJ. FILED 11-17-2010.



NO CLAIM IS MADE TO THE EXCLUSIVE RIGHT TO USE "GARDEN STATE SLEEP CENTER", APART FROM THE MARK AS SHOWN.

THE COLOR(S) GREEN AND BLUE IS/ARE CLAIMED AS A FEATURE OF THE MARK.

THE MARK CONSISTS OF THE TOP SILHOUETTE LINE IS GREEN, THE WORDS "GARDEN STATE" ARE BLUE, THE WORDS "SLEEP CENTER" ARE GREEN AND THE BOTTOM CURVED LINE IS BLUE.

FOR DENTAL SERVICES, NAMELY, TREATMENT OF PATIENTS WITH SNORING, SLEEP APNEA AND TMJ (TEMPOROMANDIBULAR JOINT) DISORDERS; HEALTH ASSESSMENT SERVICES, NAMELY, PROVIDING A DATABASE IN THE FIELD OF SLEEP APNEA AND HOME SLEEP TESTING DIAGNOSTIC INFORMATION BASED ON COLLECTED DATA AND INFORMATION ALL FOR TREATMENT AND DIAGNOSTIC PURPOSES; HEALTHCARE SERVICES, NAMELY, TREATMENT OF PATIENTS WITH SNORING AND SLEEP APNEA DISORDERS; PROVIDING AN INTERNET WEB SITE FOR MEDICAL PROFESSIONALS AND MEDICAL PATIENTS RELATING TO SLEEP APNEA AND RELATED DIAGNOSTIC DATA INPUT FROM REMOTE LOCATIONS USING ELECTRONIC PATIENT MONITORING DEVICES THAT FEED INFORMATION TO THE WEB SITE FOR USE BY MEDICAL PROFESSIONALS FOR PURPOSES OF MONITORING AND DIAGNOSING MEDICAL CONDITIONS; PROVIDING INFORMATION IN THE FIELD OF SLEEP APNEA AND RELATED SLEEP DISORDERS FOR DOCTORS AND PATIENTS (U.S. CLS. 100 AND 101).

FIRST USE 1-1-2008; IN COMMERCE 5-1-2008.  
JASON TURNER, EXAMINING ATTORNEY



**CLASS 44—(Continued).**

SN 85-183,323. FISHER, GARTH, BEVERLY HILLS, CA. FILED 11-23-2010.

GARTH FISHER MD BIOMED SPA

THE MARK CONSISTS OF STANDARD CHARACTERS WITHOUT CLAIM TO ANY PARTICULAR FONT, STYLE, SIZE, OR COLOR.

NO CLAIM IS MADE TO THE EXCLUSIVE RIGHT TO USE "MD" OR "BIOMED SPA", APART FROM THE MARK AS SHOWN.

THE NAME(S), PORTRAIT(S), AND/OR SIGNATURE(S) SHOWN IN THE MARK IDENTIFIES "GARTH FISHER", WHOSE CONSENT(S) TO REGISTER IS MADE OF RECORD.

FOR MEDICAL SPA SERVICES, NAMELY, MINIMALLY AND NON-INVASIVE COSMETIC FACIAL AND BODY TREATMENTS; NON-INVASIVE COSMETIC MEDICAL PROCEDURES; INJECTION OF DERMAL FILLERS AND NEUROMUSCULAR BLOCKING AGENTS TO REDUCE THE APPEARANCE OF FACIAL FINE LINES AND WRINKLES; LASER TREATMENT OF THE SKIN FOR COSMETIC AND AESTHETIC PURPOSES; NON-INVASIVE BODY CONTOURING; HEALTH SPA SERVICES, NAMELY, COSMETIC BODY CARE SERVICES; PROVIDING HEALTHCARE INFORMATION AND MEDICAL CONSULTATION AND ADVISORY SERVICES IN CONNECTION WITH AESTHETIC AND COSMETIC MEDICAL PROCEDURES, SKINCARE, NUTRITION, SUPPLEMENTS, VITAMINS, HORMONE REPLACEMENT THERAPY, HEALTH AND WELLNESS (U.S. CLS. 100 AND 101).

TAMARA FRAZIER, EXAMINING ATTORNEY

SN 85-183,358. FISHER, GARTH, BEVERLY HILLS, CA. FILED 11-23-2010.

GARTH FISHER MD BIOMEDICAL SKIN TREATMENT INSTITUTE

THE MARK CONSISTS OF STANDARD CHARACTERS WITHOUT CLAIM TO ANY PARTICULAR FONT, STYLE, SIZE, OR COLOR.

NO CLAIM IS MADE TO THE EXCLUSIVE RIGHT TO USE "MD" OR "BIOMEDICAL SKIN TREATMENT INSTITUTE", APART FROM THE MARK AS SHOWN.

THE NAME(S), PORTRAIT(S), AND/OR SIGNATURE(S) SHOWN IN THE MARK IDENTIFIES "GARTH FISHER", WHOSE CONSENT(S) TO REGISTER IS MADE OF RECORD.

FOR MEDICAL SPA SERVICES, NAMELY, MINIMALLY AND NON-INVASIVE COSMETIC FACIAL AND BODY TREATMENTS; NON-INVASIVE COSMETIC MEDICAL PROCEDURES; INJECTION OF DERMAL FILLERS AND NEUROMUSCULAR BLOCKING AGENTS TO REDUCE THE APPEARANCE OF FACIAL FINE LINES AND WRINKLES; LASER TREATMENT OF THE SKIN FOR COSMETIC AND AESTHETIC PURPOSES; NON-INVASIVE BODY CONTOURING; HEALTH SPA SERVICES, NAMELY, COSMETIC BODY CARE SERVICES; PROVIDING HEALTHCARE INFORMATION AND MEDICAL CONSULTATION AND ADVISORY SERVICES IN CONNECTION WITH AESTHETIC AND COSMETIC MEDICAL PROCEDURES, SKINCARE, NUTRITION, SUPPLEMENTS, VITAMINS, HORMONE REPLACEMENT THERAPY, HEALTH AND WELLNESS (U.S. CLS. 100 AND 101).

TAMARA FRAZIER, EXAMINING ATTORNEY

**CLASS 44—(Continued).**

SN 85-193,902. BIOSCRIP, INC., ELMSFORD, NY. FILED 12-9-2010.



OWNER OF U.S. REG. NOS. 2,596,894, 3,506,138 AND OTHERS.

NO CLAIM IS MADE TO THE EXCLUSIVE RIGHT TO USE "SCRIP.COM", APART FROM THE MARK AS SHOWN.

THE MARK CONSISTS OF A GEOMETRICAL SHAPED DESIGN IN THE NATURE OF TWO OVERLAPPED ELONGATED PILLS PLACED BETWEEN THE "MYBIO" AND "SCRIP.COM", THE WORD "MY" BEING IN A SCRIPT STYLE AND "BIO" IN PLAIN TEXT, AND "SCRIP.COM" IN PLAIN TEXT.

FOR PROVIDING ONLINE INFORMATION RELATING TO PRESCRIPTION REFILL REMINDER AND MAKE UP PRESCRIPTION STATUS; ONLINE MEDICAL COUNSELING REAL-TIME INTERACTION ABOUT PERSONAL MEDICAL AND HEALTHCARE INFORMATION AND MEDICAL SERVICES FOR CONNECTING PATIENTS, CAREGIVERS, PRESCRIBING PHYSICIANS AND HEALTH PLAN PROVIDERS; MEDICAL ASSISTANCE SERVICES PROVIDED VIA A GLOBAL COMPUTER NETWORK FEATURING MEDICAL HEALTH MONITORING AND ALERT SERVICES FOR INDIVIDUALS CONCERNING MEDICATIONS, MEDICAL TREATMENTS, MEDICAL CONDITIONS, MEDICAL INFORMATION, AND MEDICAL SOLUTIONS (U.S. CLS. 100 AND 101).

SIMON TENG, EXAMINING ATTORNEY

SN 85-193,918. BIOSCRIP, INC., ELMSFORD, NY. FILED 12-9-2010.

myBioScrip

THE MARK CONSISTS OF STANDARD CHARACTERS WITHOUT CLAIM TO ANY PARTICULAR FONT, STYLE, SIZE, OR COLOR.

OWNER OF U.S. REG. NOS. 2,596,894, 3,506,138 AND OTHERS.

FOR PROVIDING ONLINE INFORMATION RELATING TO PRESCRIPTION REFILL REMINDER AND MAKE UP PRESCRIPTION STATUS; ONLINE MEDICAL COUNSELING REAL-TIME INTERACTION ABOUT PERSONAL MEDICAL AND HEALTHCARE INFORMATION AND MEDICAL SERVICES FOR CONNECTING PATIENTS, CAREGIVERS, PRESCRIBING PHYSICIANS AND HEALTH PLAN PROVIDERS; MEDICAL ASSISTANCE SERVICES PROVIDED VIA A GLOBAL COMPUTER NETWORK FEATURING MEDICAL HEALTH MONITORING AND ALERT SERVICES FOR INDIVIDUALS CONCERNING MEDICATIONS, MEDICAL TREATMENTS, MEDICAL CONDITIONS, MEDICAL INFORMATION, AND MEDICAL SOLUTIONS (U.S. CLS. 100 AND 101).

SIMON TENG, EXAMINING ATTORNEY

**CLASS 44—(Continued).**

SN 85-199,356. SICILIANO LANDSCAPE COMPANY, LLC,  
RED BANK, NJ. FILED 12-16-2010.



SICILIANO LANDSCAPE COMPANY, LLC

NO CLAIM IS MADE TO THE EXCLUSIVE RIGHT TO USE "LANDSCAPE COMPANY, LLC", APART FROM THE MARK AS SHOWN.

THE COLOR(S) RED, BLACK AND WHITE IS/ARE CLAIMED AS A FEATURE OF THE MARK.

THE MARK CONSISTS OF RED CIRCLE WITH WHITE CROSS PATTERN IN MIDDLE, CONSISTING OF ONE WHITE VERTICAL LINE AND THREE HORIZONTAL LINES. BENEATH THE CIRCLE ARE THE WORDS "SICILIANO LANDSCAPE COMPANY, LLC" IN BLACK LETTERS.

FOR LANDSCAPE GARDENING AND DESIGN SERVICES (U.S. CLS. 100 AND 101).

FIRST USE 1-1-1995; IN COMMERCE 1-1-1995.  
JANET LEE, EXAMINING ATTORNEY

SN 85-202,362. STUDIO BIJOUX, WESTLAKE VILLAGE, CA.  
FILED 12-21-2010.

STUDIO BIJOUX

THE MARK CONSISTS OF STANDARD CHARACTERS WITHOUT CLAIM TO ANY PARTICULAR FONT, STYLE, SIZE, OR COLOR.

NO CLAIM IS MADE TO THE EXCLUSIVE RIGHT TO USE "STUDIO", APART FROM THE MARK AS SHOWN.

FOR BEAUTY ANALYSIS TO DETERMINE COSMETICS THAT ARE BEST SUITED TO PARTICULAR INDIVIDUALS; BEAUTY CONSULTATION SERVICES; BEAUTY CONSULTATION SERVICES IN THE SELECTION AND USE OF COSMETICS, FRAGRANCES, BEAUTY AIDS, PERSONAL CARE PRODUCTS, AND BATH, BODY AND BEAUTY PRODUCTS; BEAUTY SALON SERVICES; BEAUTY SALONS; BEAUTY SPA SERVICES, NAMELY, COSMETIC BODY CARE; CHARITABLE SERVICES, NAMELY, PROVIDING BEAUTY AND HAIR CARE SERVICES TO PERSONS SEEKING EMPLOYMENT; HAIR COLOR SALON SERVICES; HAIR SALON SERVICES; HAIR SALON SERVICES, NAMELY, HAIR CUTTING, STYLING, COLORING, AND HAIR EXTENSION SERVICES; HAIR SALON SERVICES, NAMELY, TREATMENTS TO PROTECT HAIR FROM EFFECTS OF EXPOSURE TO SUNLIGHT, HEAT, HUMIDITY AND CHLORINATED WATER; HAIRDRES-

**CLASS 44—(Continued).**

SING SALONS; HYGIENIC AND BEAUTY CARE; MAKING RESERVATIONS AND BOOKINGS FOR OTHERS AT BEAUTY SALONS; MAKING RESERVATIONS AND BOOKINGS FOR OTHERS FOR PHYSICAL AND BEAUTY TREATMENTS AT HEALTH SPAS; MEDICAL, HYGIENIC AND BEAUTY CARE; MEDSPA SERVICES FOR HEALTH AND BEAUTY OF THE BODY AND SPIRIT; NAIL CARE SALONS; PROVIDING BEAUTY CARE INFORMATION ON HOW AUNTS CAN PAMPER AND TREAT THEMSELVES; PROVIDING INFORMATION ABOUT BEAUTY; PROVIDING NEWS AND INFORMATION IN THE FIELD OF PERSONAL BEAUTY; PROVIDING ON-SITE BEAUTY SERVICES, NAMELY, HAIR STYLING AND MAKE-UP APPLICATION SERVICES; RENTAL OF MACHINES AND APPARATUS FOR USE IN BEAUTY SALONS OR BARBERS' SHOPS; SALON SERVICES, NAMELY, FACIALS, MANICURES AND MESSAGES THAT ARE PROVIDED IN A TRAILER OUTFITTED WITH CHAIR, TABLE AND SINK ACCESSORIES; SKIN CARE SALONS; TANNING SALONS (U.S. CLS. 100 AND 101).

FIRST USE 1-2-2005; IN COMMERCE 1-2-2009.  
MELISSA VALLILLO, EXAMINING ATTORNEY

SN 85-206,828. ROSENBERG, JUDY, SHERMAN OAKS, CA.  
FILED 12-28-2010.

Dr. Judy

THE MARK CONSISTS OF STANDARD CHARACTERS WITHOUT CLAIM TO ANY PARTICULAR FONT, STYLE, SIZE, OR COLOR.

THE NAME IN THE MARK, "DR. JUDY", REFERS TO THE OWNER, "DR. JUDY" ROSENBERG, WHOSE CONSENT IS OF RECORD.

FOR PSYCHOLOGICAL ASSESSMENT SERVICES; PSYCHOLOGICAL CONSULTATION; PSYCHOLOGICAL COUNSELING (U.S. CLS. 100 AND 101).

FIRST USE 1-1-2009; IN COMMERCE 1-1-2009.  
RONALD DELGIZZI, EXAMINING ATTORNEY

SN 85-209,167. ATLANTICARE NURSING SERVICES, INC.,  
DELRAY BEACH, FL. FILED 1-3-2011.



NO CLAIM IS MADE TO THE EXCLUSIVE RIGHT TO USE "SENIOR HOME CARE", APART FROM THE MARK AS SHOWN.

THE MARK CONSISTS OF THE STYLIZED WORD "NAUTILUS" AND THE WORDING "SENIOR HOME CARE" UNDERNEATH WITH THE DESIGN OF A SPIRAL CONSISTING OF DOTS STARTING FROM THE "N" CIRCLING THROUGH THE CENTER OF THE WORDS.

FOR SENIOR HOME HEALTH CARE SERVICES (U.S. CLS. 100 AND 101).  
DOMINIC FATHY, EXAMINING ATTORNEY

**CLASS 44—(Continued).**

SN 85-210,296. ROSENBERG, JUDY, SHERMAN OAKS, CA.  
FILED 1-4-2011.



THE COLOR(S) WHITE AND THREE SHADES OF GREEN IS/ARE CLAIMED AS A FEATURE OF THE MARK.

THE MARK CONSISTS OF A DESIGN CONSISTING OF THREE INTERLOCKING CIRCLES EACH APPEARING IN A SLIGHTLY DIFFERENT SHADE OF THE COLOR GREEN WHEREIN PORTIONS OF THE THREE CIRCLES OVERLAP AND FORM THREE INTERSECTING ELLIPTICAL GEOMETRIC SHAPES AND A CENTER PORTION IN THE COLOR WHITE THAT DISTINGUISH THE THREE OVERLAPPING PORTIONS OF THE THREE CIRCLES.

FOR PSYCHOLOGICAL ASSESSMENT SERVICES; PSYCHOLOGICAL CONSULTATION; PSYCHOLOGICAL COUNSELING (U.S. CLS. 100 AND 101).

FIRST USE 1-1-2010; IN COMMERCE 1-1-2010.  
RONALD DELGIZZI, EXAMINING ATTORNEY

SN 85-216,083. TAMASA MEDICAL, PLLC, SCOTTSDALE, AZ. FILED 1-12-2011.

**PJ<sub>C</sub> ORTHOPEDICS**  
*Personalized Joint Care*

NO CLAIM IS MADE TO THE EXCLUSIVE RIGHT TO USE "ORTHOPEDICS" AND "PERSONALIZED JOINT CARE", APART FROM THE MARK AS SHOWN.

THE MARK CONSISTS OF THE WORDING "PJ<sub>C</sub> ORTHOPEDICS PERSONALIZED JOINT CARE; PJ<sub>C</sub>" IS CAPITALIZED AND IS SHOWN IN A DESCENDING ORDER FROM TOP TO BOTTOM, LEFT TO RIGHT IN A STAIR-STEP MANNER AND IS LOCATED TO THE LEFT OF THE WORD "ORTHOPEDICS"; THE LETTER "O" IN ORTHOPEDICS IS CAPITALIZED; "PERSONALIZED JOINT CARE" IS IN A SMALLER FONT SIZE IN ITALICS AND BELOW THE WORD "ORTHOPEDICS", AND THE LETTERS "P", "J" AND "C" ARE CAPITALIZED.

FOR HEALTHCARE SERVICES IN THE FIELD OF ORTHOPEDICS (U.S. CLS. 100 AND 101).

AISHA CLARKE, EXAMINING ATTORNEY

**CLASS 44—(Continued).**

SN 85-238,942. BUCHANAN, TIMOTHY, WESTERVILLE, OH. FILED 2-10-2011.

 **Buchanan**  
*medical arts*

NO CLAIM IS MADE TO THE EXCLUSIVE RIGHT TO USE "MEDICAL ARTS", APART FROM THE MARK AS SHOWN.

THE MARK CONSISTS OF A LARGE CAPITAL "B" RESEMBLING AN ABSTRACT HEART OVERLYING A SOLID RECTANGLE. ADJACENT TO THE RECTANGLE IS THE PHRASE "BUCHANAN MEDICAL ARTS".

FOR HEALTH CARE (U.S. CLS. 100 AND 101).  
FIRST USE 12-15-2002; IN COMMERCE 12-15-2002.  
WILLIAM BRECKENFELD, EXAMINING ATTORNEY

SN 85-245,745. BOWERS, MARK, ANN ARBOR, MI. FILED 2-18-2011.

**Sōsh**

THE MARK CONSISTS OF THE WORD "SOSH" WITH A MACRON APPEARING ABOVE THE LETTER "O".

FOR PSYCHOLOGICAL COUNSELING (U.S. CLS. 100 AND 101).

LINDA POWELL, EXAMINING ATTORNEY

SN 85-260,895. FAIRFAX RADIOLOGICAL CONSULTANTS, P.C., FAIRFAX, VA. FILED 3-8-2011.

**Make Time for Family. Make  
Time for Yourself. Every  
Year Make Time for Your  
Mammogram.**

THE MARK CONSISTS OF STANDARD CHARACTERS WITHOUT CLAIM TO ANY PARTICULAR FONT, STYLE, SIZE, OR COLOR.

NO CLAIM IS MADE TO THE EXCLUSIVE RIGHT TO USE "MAMMOGRAM", APART FROM THE MARK AS SHOWN.

FOR MEDICAL RADIOLOGY SERVICES (U.S. CLS. 100 AND 101).

FIRST USE 9-0-2007; IN COMMERCE 9-0-2007.  
DAWN HAN, EXAMINING ATTORNEY

**CLASS 44—(Continued).**

SN 85-261,160. FAIRFAX RADIOLOGICAL CONSULTANTS, P.C., FAIRFAX, VA. FILED 3-8-2011.

The Only Radiology  
Practice Your Family Will  
Ever Need

THE MARK CONSISTS OF STANDARD CHARACTERS WITHOUT CLAIM TO ANY PARTICULAR FONT, STYLE, SIZE, OR COLOR.

NO CLAIM IS MADE TO THE EXCLUSIVE RIGHT TO USE "RADIOLOGY PRACTICE", APART FROM THE MARK AS SHOWN.

FOR MEDICAL RADIOLOGY SERVICES (U.S. CLS. 100 AND 101).

FIRST USE 10-1-1999; IN COMMERCE 10-1-1999.  
DAWN HAN, EXAMINING ATTORNEY

SN 85-261,721. MERCY HEALTH SYSTEM - NORTHERN REGION, DBA MERCY HEALTH PARTNERS, TOLEDO, OH. FILED 3-9-2011.

TAKING THE OPEN OUT OF  
OPEN HEART

THE MARK CONSISTS OF STANDARD CHARACTERS WITHOUT CLAIM TO ANY PARTICULAR FONT, STYLE, SIZE, OR COLOR.

NO CLAIM IS MADE TO THE EXCLUSIVE RIGHT TO USE "OPEN HEART", APART FROM THE MARK AS SHOWN.

FOR HEALTHCARE SERVICES, NAMELY, PROVIDING HEALTH INFORMATION, MEDICAL INFORMATION, MEDICAL TESTING FOR CORONARY ARTERY BYPASS, HEART VALVE REPAIR OR REPLACEMENT, ATRIAL FIBRILLATION ABLATION, ATRIAL SEPTAL DEFECT CLOSURE AND CARDIAC TUMOR REMOVAL, CONDUCTING MEDICAL PHYSICAL EVALUATION, MEDICAL DIAGNOSTIC TESTING, MONITORING, AND REPORTING SERVICES, MEDICAL SERVICES, SURGERY SERVICES, AND HOSPITAL SERVICES (U.S. CLS. 100 AND 101).

SUZANNE BLANE, EXAMINING ATTORNEY

SN 85-278,061. MY MESSAGE LADY, HOUSTON, TX. FILED 3-27-2011.

My Massage Lady

THE MARK CONSISTS OF STANDARD CHARACTERS WITHOUT CLAIM TO ANY PARTICULAR FONT, STYLE, SIZE, OR COLOR.

NO CLAIM IS MADE TO THE EXCLUSIVE RIGHT TO USE "MESSAGE LADY", APART FROM THE MARK AS SHOWN.

FOR MASSAGE THERAPY SERVICES (U.S. CLS. 100 AND 101).

FIRST USE 12-21-2009; IN COMMERCE 12-21-2009.  
RUSS HERMAN, EXAMINING ATTORNEY

**CLASS 44—(Continued).**

SN 85-282,773. BRIAN B. TOORANI, D.D.S., INC., HUNTINGTON BEACH, CA. FILED 3-31-2011.



NO CLAIM IS MADE TO THE EXCLUSIVE RIGHT TO USE "DENTAL", APART FROM THE MARK AS SHOWN.

THE MARK CONSISTS OF THE WORDS "DENTAL" AND "OASIS" IN STYLIZED FONT WITH A PALM TREE LIKE DESIGN FOR THE LEFT SIDE OF THE "D".

FOR COSMETIC DENTISTRY; DENTIST SERVICES; DENTISTRY (U.S. CLS. 100 AND 101).

FIRST USE 1-1-2008; IN COMMERCE 1-1-2008.  
KATHERINE CONNOLLY, EXAMINING ATTORNEY

SN 85-288,822. EICHENLAUB, INC., PITTSBURGH, PA. FILED 4-7-2011.



EICHENLAUB

THE MARK CONSISTS OF CURVED LINES REPRESENTING WATER RIPPLES ABOVE A SHADOW WITH THE STYLIZED TEXT "EICHENLAUB" APPEARING BELOW.

FOR LANDSCAPE DESIGN (U.S. CLS. 100 AND 101).

FIRST USE 4-1-2011; IN COMMERCE 4-14-2011.

TARA PATE, EXAMINING ATTORNEY

SN 85-292,168. GREATER TULSA HEALTH ACCESS NETWORK, INC., TULSA, OK. FILED 4-11-2011.



NO CLAIM IS MADE TO THE EXCLUSIVE RIGHT TO USE "ACCESS NETWORK", APART FROM THE MARK AS SHOWN.

THE MARK CONSISTS OF FOUR DIAMONDS TOGETHER FORMING ONE LARGE DIAMOND AND "MY HEALTH ACCESS NETWORK".

FOR PROVIDING AN INTERNET-BASED DATABASE OF PATIENT MEDICAL INFORMATION DESIGNED TO FACILITATE HIPPA COMPLIANT SHARING AND MAINTENANCE OF PATIENT INFORMATION AMONG DOCTORS (U.S. CLS. 100 AND 101).

FIRST USE 3-13-2011; IN COMMERCE 3-13-2011.

WILLIAM BRECKENFELD, EXAMINING ATTORNEY

**CLASS 44—(Continued).**

SN 85-295,703. SILVERCARE CORPORATION, ROCKFORD, IL. FILED 4-14-2011.

**SILVERMARK**

THE MARK CONSISTS OF STANDARD CHARACTERS WITHOUT CLAIM TO ANY PARTICULAR FONT, STYLE, SIZE, OR COLOR.

OWNER OF U.S. REG. NO. 2,818,597.  
FOR MEDICAL SERVICES; NAMELY, TEMPORARY NURSING SERVICES IN HOME, NURSING HOMES, HOSPITALS, CLINICS, PHYSICIAN OFFICES AND INDEPENDENT CARE FACILITIES (U.S. CLS. 100 AND 101).

DAWN HAN, EXAMINING ATTORNEY

SN 85-300,583. ZO SKIN HEALTH, INC., DEL MAR, CA. FILED 4-20-2011.

**ZO**

THE MARK CONSISTS OF STANDARD CHARACTERS WITHOUT CLAIM TO ANY PARTICULAR FONT, STYLE, SIZE, OR COLOR.

OWNER OF U.S. REG. NOS. 3,443,711 AND 3,443,712.  
FOR BEAUTY SPAS SERVICES; NAMELY, COSMETIC BODY AND FACIAL CARE; COSMETIC AND PLASTIC SURGERY; COSMETIC SKIN CARE SERVICES; FACIAL TREATMENT SERVICES; NAMELY, COSMETIC PEELS; LASER AND INTENSE PULSE LIGHT SKIN ENHANCEMENT PROCEDURES; MEDICAL CLINICS; MEDICAL SKIN CARE SERVICES; PERMANENT HAIR REMOVAL AND REDUCTION SERVICES; PHYSICIAN SERVICES (U.S. CLS. 100 AND 101).

ELLEN PERKINS, EXAMINING ATTORNEY

SN 85-300,889. AMAZON TANS, FT LAUDERDALE, FL. FILED 4-21-2011.

**AMAZON TANS**

THE MARK CONSISTS OF STANDARD CHARACTERS WITHOUT CLAIM TO ANY PARTICULAR FONT, STYLE, SIZE, OR COLOR.

NO CLAIM IS MADE TO THE EXCLUSIVE RIGHT TO USE "TANS", APART FROM THE MARK AS SHOWN.

FOR MOBILE SKIN SPRAY TANNING SERVICES PROVIDING SPRAY TANS AT THE CLIENTS' LOCATION (U.S. CLS. 100 AND 101).

FIRST USE 3-20-2011; IN COMMERCE 3-20-2011.  
SOPHIA S. KIM, EXAMINING ATTORNEY

**CLASS 44—(Continued).**

SN 85-301,573. ARTHUR, MD, KRISTINE, NEWPORT BEACH, CA. AND ARTHUR, MICHAEL JAY, NEWPORT BEACH, CA. FILED 4-21-2011.

*Regeneration*  
anti-aging medicine

NO CLAIM IS MADE TO THE EXCLUSIVE RIGHT TO USE "REGENERATION ANTI-AGING MEDICINE", APART FROM THE MARK AS SHOWN.

THE MARK CONSISTS OF THE STYLIZED TEXT "REGENERATION ANTI-AGING MEDICINE" WITH AN INFINITY SYMBOL.

FOR ANTI-AGING MEDICAL CLINIC SERVICES PROVIDING HORMONE REPLACEMENT THERAPY, NUTRITION AND WEIGHT LOSS MANAGEMENT (U.S. CLS. 100 AND 101).

HANNO RITTNER, EXAMINING ATTORNEY

SN 85-302,332. UNIVERSITY OF ROCHESTER, ROCHESTER, NY. FILED 4-22-2011.

**EASTMAN DENTAL**

THE MARK CONSISTS OF STANDARD CHARACTERS WITHOUT CLAIM TO ANY PARTICULAR FONT, STYLE, SIZE, OR COLOR.

OWNER OF U.S. REG. NO. 2,405,330.  
NO CLAIM IS MADE TO THE EXCLUSIVE RIGHT TO USE "DENTAL", APART FROM THE MARK AS SHOWN. SEC. 2(F).

FOR PROVIDING DENTISTRY SERVICES; PROVIDING ORAL HEALTH SERVICES; PROVIDING MEDICAL SERVICES (U.S. CLS. 100 AND 101).

FIRST USE 6-0-2009; IN COMMERCE 6-0-2009.  
YAT SYE, LEE, EXAMINING ATTORNEY

**CLASS 44—(Continued).**

SN 85-303,092. RECORD BUCK FARMS, INC, HOWEY-IN-THE-HILLS, FL. FILED 4-24-2011.



NO CLAIM IS MADE TO THE EXCLUSIVE RIGHT TO USE "FARMS", APART FROM THE MARK AS SHOWN. THE MARK CONSISTS OF A DESIGN OF A SHIELD WITH THE WORDING "RECORD BUCK" IN THE TOP PORTION OF THE SHIELD AND THE WORDING "FARMS" IN THE BOTTOM PORTION OF THE SHIELD. A DESIGN OF A BUCK'S HEAD FACING LEFT APPEARS INSIDE THE SHIELD.

FOR TREE NURSERIES (U.S. CLS. 100 AND 101).  
FIRST USE 8-30-2001; IN COMMERCE 8-30-2001.  
SETH A. RAPPAPORT, EXAMINING ATTORNEY

SN 85-303,207. ALLIGATOR DENTAL, PLLC, SEGUIN, TX. FILED 4-25-2011.



THE COLOR(S) GREEN, LIGHT GREEN, DARK GREEN, BLACK, BLUE, LIGHT BLUE, ORANGE, DARK ORANGE AND WHITE IS/ARE CLAIMED AS A FEATURE OF THE MARK.

THE MARK CONSISTS OF AN ALLIGATOR IN GREEN AND LIGHT GREEN AND OUTLINED IN DARK GREEN, WITH WHITE EYES AND BLACK PUPILS, WHITE TEETH WITH A BLACK JAGGED LINE, WEARING A WHITE T-SHIRT OUTLINED IN BLACK, BLUE PANTS WITH LIGHT BLUE CUFFS OUTLINED IN BLACK, HOLDING AN ORANGE TOOTHBRUSH OUTLINED IN DARK ORANGE WITH WHITE BRISTLES OUTLINED IN BLACK, AND WITH A SHADOW.

FOR DENTIST SERVICES (U.S. CLS. 100 AND 101).  
FIRST USE 7-0-2009; IN COMMERCE 7-0-2009.  
TARA PATE, EXAMINING ATTORNEY

**CLASS 44—(Continued).**

SN 85-303,209. ALLIGATOR DENTAL, PLLC, SEGUIN, TX. FILED 4-25-2011.

**ALLIGATOR DENTAL**

THE MARK CONSISTS OF STANDARD CHARACTERS WITHOUT CLAIM TO ANY PARTICULAR FONT, STYLE, SIZE, OR COLOR.

NO CLAIM IS MADE TO THE EXCLUSIVE RIGHT TO USE "DENTAL", APART FROM THE MARK AS SHOWN. FOR DENTIST SERVICES (U.S. CLS. 100 AND 101).  
FIRST USE 7-0-2009; IN COMMERCE 7-0-2009.  
TARA PATE, EXAMINING ATTORNEY

SN 85-307,249. MOUNT CLEMENS REGIONAL MEDICAL CENTER, MOUNT CLEMENS, MI. FILED 4-28-2011.

**HEARTLINK**

THE MARK CONSISTS OF STANDARD CHARACTERS WITHOUT CLAIM TO ANY PARTICULAR FONT, STYLE, SIZE, OR COLOR.

FOR ONLINE HEALTH ASSESSMENTS, NAMELY, A SERIES OF HEALTH-RELATED QUESTIONS FOR RESPONSE FROM THE USER THAT RESULT IN A REPORT THAT PROVIDES HEALTH-RELATED INFORMATION IN THE FORM OF RECOMMENDED EDUCATIONAL RESOURCES AND TREATMENT INFORMATION IN THE FIELD OF CARDIAC DISEASE (U.S. CLS. 100 AND 101).

JESSICA A. POWERS, EXAMINING ATTORNEY

SN 85-311,989. MEDICAL CONSULT AND ADVOCACY SERVICES, A PROFESSIONAL CORPORATION, SAN FRANCISCO, CA. FILED 5-4-2011.

**GOOD MEDICINE**

THE MARK CONSISTS OF STANDARD CHARACTERS WITHOUT CLAIM TO ANY PARTICULAR FONT, STYLE, SIZE, OR COLOR.

FOR CONSULTING SERVICES IN THE FIELD OF MEDICAL CARE (U.S. CLS. 100 AND 101).  
ALYSSA STEEL, EXAMINING ATTORNEY

**CLASS 44—(Continued).**

SN 85-312,878. BEHAVIORAL HEALTH SYSTEMS, INC., BIRMINGHAM, AL. FILED 5-5-2011.

# SAFETY FIRST

THE MARK CONSISTS OF STANDARD CHARACTERS WITHOUT CLAIM TO ANY PARTICULAR FONT, STYLE, SIZE, OR COLOR.

OWNER OF U.S. REG. NO. 2,101,326.

FOR DRUG TESTING FOR SUBSTANCE ABUSE; DRUG USE SCREENING; HEALTHCARE SERVICES OFFERED BY A MEDICAL REVIEW OFFICER; RANDOM DRUG TESTING FOR SUBSTANCE ABUSE (U.S. CLS. 100 AND 101).

FIRST USE 12-1-1989; IN COMMERCE 12-1-1989.  
ELI HELLMAN, EXAMINING ATTORNEY

---

SN 85-317,370. BLOW LA, INC., BEVERLY HILLS, CA. FILED 5-10-2011.



THE COLOR(S) BLACK, GRAY AND ORANGE IS/ARE CLAIMED AS A FEATURE OF THE MARK.

THE MARK CONSISTS OF A BLACK RECTANGLE WITH THE WORDS "MY BLOW" IN GRAY. TO THE RIGHT OF THE WORDING IS AN ORANGE DESIGN OF A HAIR DRYER WITH SWIRLS REPRESENTING AIR AND A CORD WITH THE LETTERS "LA" IN THE CORD.

FOR HAIR COLOR SALON SERVICES; HAIR COLOURING SERVICES; HAIR SALON SERVICES; HAIR SALON SERVICES, NAMELY, HAIR CUTTING, STYLING, COLORING, AND HAIR EXTENSION SERVICES; HAIR SALON SERVICES, NAMELY, TREATMENTS TO PROTECT HAIR FROM EFFECTS OF EXPOSURE TO SUNLIGHT, HEAT, HUMIDITY AND CHLORINATED WATER; HAIR STYLING (U.S. CLS. 100 AND 101).

FIRST USE 7-1-2010; IN COMMERCE 7-1-2010.  
ESTHER A. BORSUK, EXAMINING ATTORNEY

**CLASS 44—(Continued).**

SN 85-319,327. HEALTHY TANNING TECHNOLOGIES INC., COCONUT CREEK, FL. FILED 5-12-2011.



NO CLAIM IS MADE TO THE EXCLUSIVE RIGHT TO USE "SPRAY TAN", APART FROM THE MARK AS SHOWN.

THE MARK CONSISTS OF A CIRCLE WITHIN WHICH SITS A SMALLER CIRCLE. THE WORD "SPRAY" SITS ATOP THE SMALLER CIRCLE AND IS CURVED AS PER THE CURVATURE OF THE CIRCLE. THE WORD "TAN" SITS BELOW THE SMALLER CIRCLE AND IS CURVED AS PER THE CURVATURE OF THE CIRCLE. THE LETTERS "BTC" ARE WRITTEN FROM LEFT TO RIGHT AND CUT THROUGH THE MIDPOINT OF THE TWO CIRCLES. THE SILHOUETTE OF A WOMAN'S FIGURE IS WITHIN THE LETTER "T".

FOR SPRAY TANNING SERVICE FOR HUMANS FOR COSMETIC PURPOSES (U.S. CLS. 100 AND 101).  
BARBARA BROWN, EXAMINING ATTORNEY

---

SN 85-319,333. ANACOT STEELE LLC, DBA TERES - A NAIL BAR, SCOTTSDALE, AZ. FILED 5-12-2011.

# teres

THE MARK CONSISTS OF THE STYLIZED TEXT "TERES" WITH A PAINT BRUSH OVER THE SECOND LETTER "E".

THE ENGLISH TRANSLATION OF THE WORD "TERES" IN THE MARK IS "SMOOTH", "POLISHED", "ELEGANT".  
FOR BEAUTY SALON SERVICES, NAIL CARE SERVICES AND BODY WAXING SERVICES (U.S. CLS. 100 AND 101).

JACQUELINE A. LAVINE, EXAMINING ATTORNEY

**CLASS 44—(Continued).**

SN 85-319,586. RUSSELL M. JAFFE, VIENNA, VA. FILED 5-12-2011.

## PERQUE INTEGRATIVE HEALTH

THE MARK CONSISTS OF STANDARD CHARACTERS WITHOUT CLAIM TO ANY PARTICULAR FONT, STYLE, SIZE, OR COLOR.

OWNER OF U.S. REG. NOS. 2,461,525, 3,642,666 AND OTHERS.

NO CLAIM IS MADE TO THE EXCLUSIVE RIGHT TO USE "INTEGRATIVE HEALTH", APART FROM THE MARK AS SHOWN.

FOR PROVIDING INFORMATION AND CONSULTING IN THE SELECTION AND USE OF DIETARY AND NUTRITIONAL SUPPLEMENTS (U.S. CLS. 100 AND 101).

FIRST USE 3-0-2011; IN COMMERCE 3-0-2011.  
MARTHA FROMM, EXAMINING ATTORNEY

SN 85-320,181. KELLY ENTERPRISES, LLC, OKLAHOMA CITY, OK. FILED 5-13-2011.



NO CLAIM IS MADE TO THE EXCLUSIVE RIGHT TO USE "OKLAHOMA PAIN CENTER", APART FROM THE MARK AS SHOWN.

THE MARK CONSISTS OF A CIRCLE WITH A RIBBON, MAKING THE SHAPE OF A PERSON. TO THE RIGHT THERE IS THE STYLIZED TEXT "OKLAHOMA PAIN CENTER".

FOR MEDICAL CLINICS (U.S. CLS. 100 AND 101).  
FIRST USE 3-1-2011; IN COMMERCE 3-1-2011.  
VERNA BETH RIRIE, EXAMINING ATTORNEY

SN 85-320,610. WESTERN CAROLINA MEDICAL SOCIETY FOUNDATION, ASHEVILLE, NC. FILED 5-13-2011.

## PROJECT ACCESS

THE MARK CONSISTS OF STANDARD CHARACTERS WITHOUT CLAIM TO ANY PARTICULAR FONT, STYLE, SIZE, OR COLOR.

NO CLAIM IS MADE TO THE EXCLUSIVE RIGHT TO USE "PROJECT", APART FROM THE MARK AS SHOWN.

FOR CHARITABLE SERVICES, NAMELY, COORDINATING CHARITY HEALTH CARE PROVIDED AT THE COMMUNITY LEVEL (U.S. CLS. 100 AND 101).

FIRST USE 8-0-1995; IN COMMERCE 8-0-1995.  
JEFF DEFORD, EXAMINING ATTORNEY

**CLASS 44—(Continued).**

SN 85-321,809. BAKER, ELAINE, CALABASAS, CA. FILED 5-16-2011.

## Sober Influencing

THE MARK CONSISTS OF STANDARD CHARACTERS WITHOUT CLAIM TO ANY PARTICULAR FONT, STYLE, SIZE, OR COLOR.

NO CLAIM IS MADE TO THE EXCLUSIVE RIGHT TO USE "SOBER", APART FROM THE MARK AS SHOWN.

FOR PSYCHOLOGICAL CONSULTATION (U.S. CLS. 100 AND 101).

MICHAEL WIENER, EXAMINING ATTORNEY

SN 85-322,235. METHODIST HEALTHCARE SYSTEM OF SAN ANTONIO, LTD., L.L.P., SAN ANTONIO, TX. FILED 5-16-2011.

## METHODIST TEXSAN HOSPITAL

THE MARK CONSISTS OF STANDARD CHARACTERS WITHOUT CLAIM TO ANY PARTICULAR FONT, STYLE, SIZE, OR COLOR.

OWNER OF U.S. REG. NOS. 2,921,636, 2,978,777 AND OTHERS.

NO CLAIM IS MADE TO THE EXCLUSIVE RIGHT TO USE "METHODIST" AND "HOSPITAL", APART FROM THE MARK AS SHOWN.

FOR HEALTH CARE (U.S. CLS. 100 AND 101).  
FIRST USE 1-0-2011; IN COMMERCE 1-0-2011.  
MICHAEL TANNER, EXAMINING ATTORNEY

SN 85-323,258. BLOSSOM, DANIEL, VASSAR, MI. FILED 5-17-2011.

## The Dream Diet

THE MARK CONSISTS OF STANDARD CHARACTERS WITHOUT CLAIM TO ANY PARTICULAR FONT, STYLE, SIZE, OR COLOR.

FOR PROVIDING WEIGHT LOSS PROGRAM SERVICES (U.S. CLS. 100 AND 101).

FIRST USE 2-15-2011; IN COMMERCE 3-26-2011.  
HELENE LIWINSKI, EXAMINING ATTORNEY



**CLASS 44—(Continued).**

SN 85-324,262. METASTAT, INC., THE WOODLANDS, TX. FILED 5-18-2011.

**METASTAT**

THE MARK CONSISTS OF STANDARD CHARACTERS WITHOUT CLAIM TO ANY PARTICULAR FONT, STYLE, SIZE, OR COLOR.

FOR MEDICAL TESTING SERVICES IN THE FIELD OF CANCER TREATMENT AND DIAGNOSIS (U.S. CLS. 100 AND 101).

MAUREEN DALL, EXAMINING ATTORNEY

SN 85-324,736. METABOLIC BLISS, LLC, VIRGINIA BEACH, VA. FILED 5-19-2011.



FOR DIETARY AND NUTRITIONAL GUIDANCE; GENETIC COUNSELING; NUTRITION COUNSELING; PROVIDING HEALTHY LIFESTYLE AND NUTRITION SERVICES, NAMELY, PERSONAL ASSESSMENTS, PERSONALIZED ROUTINES, MAINTENANCE SCHEDULES, AND COUNSELING (U.S. CLS. 100 AND 101).

FIRST USE 7-2-2010; IN COMMERCE 7-2-2010.

WENDY GOODMAN, EXAMINING ATTORNEY

SN 85-325,228. DOCTOR'S BEST IMMEDIATE MEDICAL CARE INC., DBA DOCTOR'S BEST IMMEDIATE MEDICAL CARE, BERWYN, PA. FILED 5-19-2011.



NO CLAIM IS MADE TO THE EXCLUSIVE RIGHT TO USE "DOCTOR'S BEST IMMEDIATE MEDICAL CARE", APART FROM THE MARK AS SHOWN.

THE COLOR(S) RED, BLUE, WHITE, BLACK AND GRAY IS/ARE CLAIMED AS A FEATURE OF THE MARK.

THE MARK CONSISTS OF A RED CIRCLE WITH A WHITE CROSS AND A BLACK SHADOW OUTLINED IN A GRAY CIRCLE. NEXT TO THE DESIGN ARE THE WORDS "DOCTOR'S" IN LIGHT AND DARK BLUE OUTLINED IN WHITE WITH A GRAY SHADOW, AND THE WORD "BEST" IN LIGHT AND DARK RED OUTLINED IN WHITE WITH A GRAY SHADOW. BELOW THIS ARE THE WORDS "IMMEDIATE MEDICAL CARE" IN DARK BLUE. THE WORDING IS ON A WHITE RECTANGULAR BACKGROUND WITH A ROUNDED EDGE OUTLINED IN GRAY.

FOR URGENT MEDICAL CARE CENTERS (U.S. CLS. 100 AND 101).

FIRST USE 5-11-2011; IN COMMERCE 5-11-2011.

FRANK LATTUCA, EXAMINING ATTORNEY

**CLASS 44—(Continued).**

SN 85-325,754. BASKIN, HILARY, DBA ALL ABOUT BRACES, LAKEWOOD, CO. FILED 5-20-2011.

**All About Braces**

THE MARK CONSISTS OF STANDARD CHARACTERS WITHOUT CLAIM TO ANY PARTICULAR FONT, STYLE, SIZE, OR COLOR.

NO CLAIM IS MADE TO THE EXCLUSIVE RIGHT TO USE "BRACES", APART FROM THE MARK AS SHOWN.

FOR ORTHODONTIC SERVICES (U.S. CLS. 100 AND 101).

WENDY JUN, EXAMINING ATTORNEY

SN 85-326,190. MATT JENSEN MARKETING, LLC, SIOUX FALLS, SD. FILED 5-20-2011.

**RELACS**

THE MARK CONSISTS OF STANDARD CHARACTERS WITHOUT CLAIM TO ANY PARTICULAR FONT, STYLE, SIZE, OR COLOR.

FOR MEDICAL AND SURGICAL EYE CARE SERVICES, NAMELY, LASER VISION SURGICAL SERVICES (U.S. CLS. 100 AND 101).

AMY C. KEAN, EXAMINING ATTORNEY

SN 85-331,339. ROSENTHAL, ROBERT, SOLANA BEACH, CA. FILED 5-26-2011.

**prostatehelper**

THE MARK CONSISTS OF STANDARD CHARACTERS WITHOUT CLAIM TO ANY PARTICULAR FONT, STYLE, SIZE, OR COLOR.

FOR PROVIDING A WEBSITE FEATURING DIETARY ADVICE, SELF ASSESSMENT QUESTIONS, AND HEALTH-RELATED INFORMATION IN THE FORM OF RECOMMENDED EDUCATIONAL RESOURCES AND TREATMENT INFORMATION, ALL RELATING TO CONTROLLING ENLARGED PROSTATES (U.S. CLS. 100 AND 101).

FIRST USE 7-22-2007; IN COMMERCE 7-22-2007.

WENDY JUN, EXAMINING ATTORNEY

**CLASS 44—(Continued).**

SN 85-331,380. PRIMP AND BLOW, L.L.C., SCOTTSDALE, AZ. FILED 5-26-2011.



THE MARK CONSISTS OF A SILHOUETTE OF A CHANDELIER.

FOR BEAUTY SALON SERVICES; BEAUTY SALONS; HAIR SALON SERVICES; HAIR STYLING; HAIRDRESSING SALONS (U.S. CLS. 100 AND 101).

FIRST USE 12-5-2010; IN COMMERCE 12-5-2010.  
JAMES STEIN, EXAMINING ATTORNEY

---

SN 85-332,133. ATA REVITALIZATION INSTITUTE, INC., EASTON, PA. FILED 5-27-2011.

ATA

THE MARK CONSISTS OF STANDARD CHARACTERS WITHOUT CLAIM TO ANY PARTICULAR FONT, STYLE, SIZE, OR COLOR.

FOR USE OF LASERS IN COMBINATION WITH TRADITIONAL THERAPY FOR (I) FAT REDUCTION AND BODY SLIMMING (II) PAIN CONTROL AND REDUCTION OF PAIN AND SWELLING AND (III) SKIN RESURFACING AND ANTI-AGING (U.S. CLS. 100 AND 101).

FIRST USE 3-1-2010; IN COMMERCE 3-1-2010.  
FRANK LATTUCA, EXAMINING ATTORNEY

---

SN 85-332,637. VAL-U-VET ANIMAL HEALTH, INC., DELAND, FL. FILED 5-27-2011.

We Love'em Like Our Own

THE MARK CONSISTS OF STANDARD CHARACTERS WITHOUT CLAIM TO ANY PARTICULAR FONT, STYLE, SIZE, OR COLOR.

FOR VETERINARY SERVICES (U.S. CLS. 100 AND 101).

FIRST USE 3-1-2009; IN COMMERCE 3-1-2009.  
KATHERINE M. DUBRAY, EXAMINING ATTORNEY

**CLASS 44—(Continued).**

SN 85-332,765. REVIVE LANDSCAPE DESIGN, SAN DIEGO, CA. FILED 5-27-2011.

REVIVE

THE MARK CONSISTS OF STANDARD CHARACTERS WITHOUT CLAIM TO ANY PARTICULAR FONT, STYLE, SIZE, OR COLOR.

FOR LANDSCAPE DESIGN; LANDSCAPE GARDENING; LANDSCAPE GARDENING DESIGN FOR OTHERS; CONSULTING SERVICES IN THE FIELD OF LANDSCAPE DESIGN, LANDSCAPE GARDENING, LANDSCAPE GARDENING DESIGN, GARDENING, LANDSCAPING, HORTICULTURE, AND ARBORICULTURE (U.S. CLS. 100 AND 101).

FIRST USE 1-1-2008; IN COMMERCE 1-1-2008.  
COLLEEN DOMBROW, EXAMINING ATTORNEY

---

SN 85-332,870. REVIVE LANDSCAPE DESIGN, SAN DIEGO, CA. FILED 5-27-2011.



THE MARK CONSISTS OF SIX TREES OF VARIOUS SHAPES AND SIZES.

FOR LANDSCAPE DESIGN; LANDSCAPE GARDENING; LANDSCAPE GARDENING DESIGN FOR OTHERS; CONSULTING SERVICES IN THE FIELD OF LANDSCAPE DESIGN, LANDSCAPE GARDENING, LANDSCAPE GARDENING DESIGN, GARDENING, LANDSCAPING, HORTICULTURE, AND ARBORICULTURE (U.S. CLS. 100 AND 101).

FIRST USE 1-29-2008; IN COMMERCE 1-29-2008.  
COLLEEN DOMBROW, EXAMINING ATTORNEY

**CLASS 44—(Continued).**

SN 85-332,904. REVIVE LANDSCAPE DESIGN, SAN DIEGO, CA. FILED 5-27-2011.



THE MARK CONSISTS OF A SINGLE TREE. FOR LANDSCAPE DESIGN; LANDSCAPE GARDENING; LANDSCAPE GARDENING DESIGN FOR OTHERS; CONSULTING SERVICES IN THE FIELD OF LANDSCAPE DESIGN, LANDSCAPE GARDENING, LANDSCAPE GARDENING DESIGN, GARDENING, LANDSCAPING, HORTICULTURE, AND ARBORICULTURE (U.S. CLS. 100 AND 101).

FIRST USE 1-29-2008; IN COMMERCE 1-29-2008.  
COLLEEN DOMBROW, EXAMINING ATTORNEY

SN 85-333,598. GUIDEWELL, INC., JACKSONVILLE, FL. FILED 5-31-2011.

**Happier.Healthier.Simplified.**

THE MARK CONSISTS OF STANDARD CHARACTERS WITHOUT CLAIM TO ANY PARTICULAR FONT, STYLE, SIZE, OR COLOR.

FOR PROVIDING A WEBSITE FEATURING INFORMATION ABOUT HEALTH, WELLNESS AND NUTRITION (U.S. CLS. 100 AND 101).  
LAURA KOVALSKY, EXAMINING ATTORNEY

SN 85-333,870. STC INVESTMENT GROUP, LLC, KNOXVILLE, TN. FILED 5-31-2011.

**LUMITAN**

THE MARK CONSISTS OF STANDARD CHARACTERS WITHOUT CLAIM TO ANY PARTICULAR FONT, STYLE, SIZE, OR COLOR.

FOR SKIN TANNING SERVICE FOR HUMANS FOR COSMETIC PURPOSES (U.S. CLS. 100 AND 101).  
FIRST USE 2-10-2011; IN COMMERCE 2-10-2011.  
KRISTIN CARLSON, EXAMINING ATTORNEY

**CLASS 44—(Continued).**

SN 85-333,985. HOT SERRANO, LLC, DBA SOREO SELECT, TUCSON, AZ. FILED 5-31-2011.

**SOREO**

THE MARK CONSISTS OF STANDARD CHARACTERS WITHOUT CLAIM TO ANY PARTICULAR FONT, STYLE, SIZE, OR COLOR.

FOR CONSULTING SERVICES IN THE FIELDS OF HEALTH AND NUTRITION; HOME HEALTH CARE SERVICES; MEDICAL ASSISTANCE SERVICES; MEDICAL, HYGIENIC AND BEAUTY CARE; REHABILITATION PATIENT CARE SERVICES (U.S. CLS. 100 AND 101).

FIRST USE 4-30-2011; IN COMMERCE 4-30-2011.  
HAI-LY LAM, EXAMINING ATTORNEY

SN 85-334,024. NAPPSTAR LLC, ODENTON, MD. FILED 5-31-2011.

**NAPPSTAR**

THE MARK CONSISTS OF STANDARD CHARACTERS WITHOUT CLAIM TO ANY PARTICULAR FONT, STYLE, SIZE, OR COLOR.

FOR HAIR STYLING; PROVIDING ADVICE AND INFORMATION OVER THE INTERNET IN THE FIELD OF HAIRSTYLING; PROVIDING INFORMATION IN THE FIELD OF HAIR STYLING; PROVIDING INFORMATION OVER THE INTERNET IN THE FIELD OF HAIRSTYLING; PROVIDING ON-SITE BEAUTY SERVICES, NAMELY, HAIR STYLING AND MAKE-UP APPLICATION SERVICES (U.S. CLS. 100 AND 101).

FIRST USE 7-25-2010; IN COMMERCE 7-25-2010.  
APRIL HESIK, EXAMINING ATTORNEY

SN 85-334,158. THE THREADING STATION INC., RIDGEWOOD, NJ. FILED 5-31-2011.



THE MARK CONSISTS OF AN EYE WITH 2 THREADS ON TOP OF EYEBROW, LOCATED RIGHT OF CENTER PUPIL.

FOR EYEBROW THREADING SERVICES (U.S. CLS. 100 AND 101).  
FIRST USE 1-2-2006; IN COMMERCE 1-2-2006.  
HELENE LIWINSKI, EXAMINING ATTORNEY

**CLASS 44—(Continued).**

SN 85-334,536. WESTERN CONNECTICUT HEALTHCARE, INC., DANBURY, CT. FILED 5-31-2011.



THE COLOR(S) ORANGE, PEACH, AND WHITE IS/ARE CLAIMED AS A FEATURE OF THE MARK.

THE MARK CONSISTS OF A STYLIZED ORB DESIGN MADE UP OF BANDS APPEARING IN THE COLORS ORANGE, PEACH AND WHITE.

FOR HEALTHCARE; HOME HEALTH CARE SERVICES; HOSPITALS; MEDICAL SERVICES; MENTAL HEALTH SERVICES; PSYCHIATRIC SERVICES; REHABILITATION PATIENT CARE SERVICES; SURGERY; URGENT MEDICAL CARE CENTERS (U.S. CLS. 100 AND 101).

FIRST USE 5-16-2011; IN COMMERCE 5-16-2011.  
JANET LEE, EXAMINING ATTORNEY

---

SN 85-335,312. DIETMATCH, INC., DELRAY BEACH, FL. FILED 6-1-2011.

# DIETMATCH

THE MARK CONSISTS OF STANDARD CHARACTERS WITHOUT CLAIM TO ANY PARTICULAR FONT, STYLE, SIZE, OR COLOR.

FOR CONSULTING SERVICES IN THE FIELD OF HEALTH; CONSULTING SERVICES IN THE FIELDS OF HEALTH AND NUTRITION; CONSULTING TO INDIVIDUALS AND COMMUNITIES ENGAGED IN GROUP WEIGHT LOSS PROGRAMS; COUNSELING SERVICES IN THE FIELDS OF HEALTH, HERBALISM, AND LIFESTYLE WELLNESS; COUNSELING SERVICES IN THE FIELDS OF HEALTH, NUTRITION AND LIFESTYLE WELLNESS; DIETARY AND NUTRITIONAL GUIDANCE; DIETETIC ADVISORY SERVICES; FOOD NUTRITION CONSULTATION; PROVIDING A WEB SITE FEATURING INFORMATION ON HEALTH AND NUTRITION (U.S. CLS. 100 AND 101).

ALICE BENMAMAN, EXAMINING ATTORNEY

**CLASS 44—(Continued).**

SN 85-335,422. SOUTH BROWARD HOSPITAL DISTRICT, HOLLYWOOD, FL. FILED 6-1-2011.

# U18

THE MARK CONSISTS OF STANDARD CHARACTERS WITHOUT CLAIM TO ANY PARTICULAR FONT, STYLE, SIZE, OR COLOR.

FOR PHYSICIAN SERVICES; PHYSICAL THERAPY EVALUATION, IDENTIFICATION, AND MANAGEMENT OF MOVEMENT DYSFUNCTION TO RESTORE, MAINTAIN, AND PROMOTE OPTIMAL PHYSICAL FUNCTION PREVENTING THE ONSET, SYMPTOMS AND PROGRESSION OF IMPAIRMENTS, FUNCTIONAL LIMITATIONS, AND DISABILITIES RESULTING FROM DISEASE, DISORDERS, CONDITIONS, OR INJURIES; PHYSICAL REHABILITATION SERVICES; MEDICAL EVALUATION SERVICES, NAMELY, PROVIDING FUNCTIONAL ASSESSMENT PROGRAMS FOR PATIENTS RECEIVING MEDICAL REHABILITATION SERVICES FOR PURPOSES OF GUIDING TREATMENT AND ASSESSING PROGRAM EFFECTIVENESS; OCCUPATIONAL THERAPY SERVICES (U.S. CLS. 100 AND 101).

FIRST USE 8-31-2009; IN COMMERCE 8-31-2009.  
MARIA-VICTORIA SUAREZ, EXAMINING ATTORNEY

---

SN 85-335,916. ANISTA CORPORATION, MIAMI BEACH, FL. FILED 6-2-2011.

# Anista

THE MARK CONSISTS OF STANDARD CHARACTERS WITHOUT CLAIM TO ANY PARTICULAR FONT, STYLE, SIZE, OR COLOR.

FOR MEDICAL CLINICS PROVIDING PRIMARY CARE, URGENT CARE AND MEDICAL AESTHETIC SERVICES (U.S. CLS. 100 AND 101).

JASON TURNER, EXAMINING ATTORNEY

**CLASS 44—(Continued).**

SN 85-335,959. FUNSENSE LLC, PRINCETON, NJ. FILED 6-2-2011.



THE MARK CONSISTS OF A SILHOUETTE DEPICTING A YOUNG PERSON REACHING UP AND JUMPING. FOR OCCUPATIONAL THERAPY SERVICES (U.S. CLS. 100 AND 101).

FIRST USE 2-15-2011; IN COMMERCE 2-15-2011.  
TRACY FLETCHER, EXAMINING ATTORNEY

**CLASS 44—(Continued).**

SN 85-336,602. MAKE A SMILE INC., FOLSOM, CA. FILED 6-2-2011.



THE MARK CONSISTS OF THE WORDING "MAKE A SMILE" WITH THE LETTER "M" CUSTOMIZED AS A TOOTH WITH EYES AND A SMILING MOUTH.

FOR COSMETIC DENTISTRY; DENTAL HYGIENIST SERVICES; DENTAL SERVICES, NAMELY, PERFORMING RESTORATIVE AND COSMETIC PROCEDURES; DENTAL SERVICES, NAMELY, TREATMENT OF PATIENTS WITH SNORING, SLEEP APNEA AND TMJ (TEMPOROMANDIBULAR JOINT) DISORDERS; DENTIST SERVICES; DENTISTRY; ORAL SURGERY AND DENTAL IMPLANT SERVICES; ORTHODONTIC SERVICES; PEDIATRIC HEALTH CARE SERVICES; PROVIDING A WEBSITE FEATURING INFORMATION FOR PATIENTS IN THE FIELD OF DENTAL HEALTH (U.S. CLS. 100 AND 101).

FIRST USE 1-1-2004; IN COMMERCE 1-1-2004.  
NICHOLAS ALTREE, EXAMINING ATTORNEY

SN 85-337,629. PROMETHEUS LABORATORIES INC., SAN DIEGO, CA. FILED 6-3-2011.



THE MARK CONSISTS OF AN ORB DESIGN INTERSECTED BY A LINE, ALL OF WHICH IS ABOVE A FAINT REFLECTION THEREOF.

FOR MEDICAL TESTING IN THE FIELD OF INFLAMMATORY BOWEL DISEASE AND CROHN'S DISEASE AND PROGNOSIS THEREOF; MEDICAL TESTING FOR TREATMENT PURPOSES; AND PROVIDING INFORMATION, REPORTS AND TEST RESULTS FOR MEDICAL TESTING, GENETIC TESTING, INFLAMMATORY BOWEL DISEASE TESTING, AND INFLAMMATORY BOWEL DISEASE PROGNOSIS (U.S. CLS. 100 AND 101).

FIRST USE 7-0-2010; IN COMMERCE 7-0-2010.  
ALLISON HOLTZ, EXAMINING ATTORNEY

SN 85-336,209. SMILE BRANDS INC., IRVINE, CA. FILED 6-2-2011.

# ESMILES

THE MARK CONSISTS OF STANDARD CHARACTERS WITHOUT CLAIM TO ANY PARTICULAR FONT, STYLE, SIZE, OR COLOR.

OWNER OF U.S. REG. NO. 3,822,884.  
FOR DENTIST SERVICES; DENTAL HYGIENIST SERVICES; DENTAL REMINDER SERVICES FOR REMINDING CLIENTS OF DENTAL APPOINTMENTS (U.S. CLS. 100 AND 101).

FIRST USE 5-18-2009; IN COMMERCE 5-18-2009.  
JOHN DALIER, EXAMINING ATTORNEY

**CLASS 44—(Continued).**

SN 85-337,635. PROMETHEUS LABORATORIES INC., SAN DIEGO, CA. FILED 6-3-2011.



OWNER OF U.S. REG. NO. 2,238,126.  
THE MARK CONSISTS OF THE WORD LOTRONEX ABOVE THE WORD CONNEX, WHERE A LINE INTERSECTS THE X IN BOTH WORDS.  
FOR PROVIDING MEDICAL INFORMATION; PROVIDING MEDICAL INFORMATION, CONSULTANCY AND ADVISORY SERVICES; PROVIDING MEDICAL INFORMATION IN THE FIELD OF BOWEL DISEASE AND TREATMENTS THEREFOR; PROVIDING A WEB SITE FEATURING MEDICAL INFORMATION (U.S. CLS. 100 AND 101).  
ALLISON HOLTZ, EXAMINING ATTORNEY

SN 85-338,292. SIMPLE CARE NORTH AMERICA, INC., LYNNFIELD, MA. FILED 6-5-2011.

**DESTINATION**

THE MARK CONSISTS OF STANDARD CHARACTERS WITHOUT CLAIM TO ANY PARTICULAR FONT, STYLE, SIZE, OR COLOR.  
FOR VETERINARY SERVICES (U.S. CLS. 100 AND 101).  
SHAILA SETTLES, EXAMINING ATTORNEY

**CLASS 44—(Continued).**

SN 85-338,553. PERFECT HEALTH TECHNOLOGIES, PUYALLUP, WA. FILED 6-6-2011.

**ResearchHCGSuccess**

THE MARK CONSISTS OF STANDARD CHARACTERS WITHOUT CLAIM TO ANY PARTICULAR FONT, STYLE, SIZE, OR COLOR.  
FOR MEDICAL CLINIC PROVIDING WEIGHT LOSS SOLUTIONS, SERVICES AND PROGRAMS, NUTRITION COUNSELING, HORMONE THERAPY, INCLUDING, BIOIDENTICAL HORMONE REPLACEMENT, ANTI AGING THERAPY, AND NATURAL HORMONE THERAPY, MEDICAL AESTHETIC PROCEDURES, INCLUDING, LASER HAIR REMOVAL, LASER PEELS, BOTULINUM TOXIN TREATMENTS, MICRODERMABRASION, LIPOSUCTION, VEIN TREATMENTS, VEIN THERAPY, CELLULITE TREATMENTS, BODY CONTOURING TREATMENTS, INJECTABLE FILLER TREATMENTS, FACIALS, AND SKIN CARE; MEDICAL CLINICS (U.S. CLS. 100 AND 101).  
JOHN DWYER, EXAMINING ATTORNEY

SN 85-338,663. BRIDGES TO RECOVERY INC., PACIFIC PALISADES, CA. FILED 6-6-2011.

**Bridges to Recovery**

THE MARK CONSISTS OF STANDARD CHARACTERS WITHOUT CLAIM TO ANY PARTICULAR FONT, STYLE, SIZE, OR COLOR.  
FOR MENTAL HEALTH SERVICES (U.S. CLS. 100 AND 101).  
FIRST USE 9-1-2002; IN COMMERCE 1-21-2003.  
GIANCARLO CASTRO, EXAMINING ATTORNEY

**CLASS 44—(Continued).**

SN 85-338,917. ARTHUR GLOSMAN, BEVERLY HILLS, CA.  
FILED 6-6-2011.

ARTHUR GLOSMAN DDS

THE MARK CONSISTS OF STANDARD CHARACTERS WITHOUT CLAIM TO ANY PARTICULAR FONT, STYLE, SIZE, OR COLOR.

NO CLAIM IS MADE TO THE EXCLUSIVE RIGHT TO USE "DDS", APART FROM THE MARK AS SHOWN.

THE NAME(S), PORTRAIT(S), AND/OR SIGNATURE(S) SHOWN IN THE MARK IDENTIFIES ARTHUR GLOSMAN, WHOSE CONSENT(S) TO REGISTER IS MADE OF RECORD.

FOR DENTAL SERVICES, NAMELY, PERFORMING RESTORATIVE AND COSMETIC PROCEDURES; PROVIDING A WEBSITE FEATURING INFORMATION FOR PATIENTS IN THE FIELD OF DENTAL HEALTH; TEETH WHITENING SERVICES (U.S. CLS. 100 AND 101).

FIRST USE 1-1-2000; IN COMMERCE 1-1-2000.  
SARA BENJAMIN, EXAMINING ATTORNEY

**CLASS 44—(Continued).**

SN 85-339,187. KEY REHABILITATION, INC., MURFREESBORO, TN. FILED 6-6-2011.

ReLive

THE MARK CONSISTS OF STANDARD CHARACTERS WITHOUT CLAIM TO ANY PARTICULAR FONT, STYLE, SIZE, OR COLOR.

FOR REHABILITATION PATIENT CARE SERVICES (U.S. CLS. 100 AND 101).

DANNEAN HETZEL, EXAMINING ATTORNEY

SN 85-339,951. BLOCHSTAMPFOR LLC, ST. CHARLES, MO.  
FILED 6-7-2011.

B.TAN

THE MARK CONSISTS OF STANDARD CHARACTERS WITHOUT CLAIM TO ANY PARTICULAR FONT, STYLE, SIZE, OR COLOR.

FOR AIRBRUSH SKIN TANNING SERVICES FOR HUMANS FOR COSMETIC PURPOSES; SKIN TANNING SERVICE FOR HUMANS FOR COSMETIC PURPOSES (U.S. CLS. 100 AND 101).

RUSS HERMAN, EXAMINING ATTORNEY

SN 85-339,178. BLUE ZONES, LLC, MINNEAPOLIS, MN.  
FILED 6-6-2011.

Power 9

THE MARK CONSISTS OF STANDARD CHARACTERS WITHOUT CLAIM TO ANY PARTICULAR FONT, STYLE, SIZE, OR COLOR.

FOR HEALTH CARE SERVICES, NAMELY, WELLNESS PROGRAMS; PROVIDING A WEBSITE FEATURING CONTENT REGARDING HEALTHY LIVING AND LIFESTYLE WELLNESS; WELLNESS AND HEALTH-RELATED CONSULTING SERVICES; PROVIDING CONSULTATION TO CORPORATE CLIENTS TO HELP THEIR EMPLOYEES MAKE HEALTH, WELLNESS AND NUTRITIONAL CHANGES IN THEIR DAILY LIVING TO IMPROVE HEALTH; PROVIDING ASSISTANCE AND CONSULTATION TO INDIVIDUALS TO HELP THEM MAKE HEALTH, WELLNESS AND NUTRITIONAL CHANGES IN THEIR DAILY LIVING TO IMPROVE HEALTH; ESTABLISHING, DEVELOPING AND PROVIDING RESIDENTIAL AND COMMERCIAL COMMUNITIES FOCUSED ON HEALTH, WELLNESS AND LONGEVITY; PUBLIC HEALTH PROGRAMS; HEALTH AWARENESS PROGRAMS; WELLNESS PROGRAMS; EXERCISE PROGRAMS; PREVENTATIVE HEALTH PROGRAMS; EMPLOYER SPONSORED HEALTH PROGRAMS; COMMUNITY SPONSORED HEALTH PROGRAMS; WELLNESS COMMUNITIES (U.S. CLS. 100 AND 101).

FIRST USE 1-5-2008; IN COMMERCE 1-5-2008.  
JILL C. ALT, EXAMINING ATTORNEY

SN 85-341,078. HEALTH2HOME, LLC, ROCKY MOUNT, NC.  
FILED 6-8-2011.

HealthCare2Home

THE MARK CONSISTS OF STANDARD CHARACTERS WITHOUT CLAIM TO ANY PARTICULAR FONT, STYLE, SIZE, OR COLOR.

FOR GERIATRIC HEALTH CARE MANAGEMENT SERVICES; HEALTH CARE; HOME HEALTH CARE SERVICES; MEDICAL SERVICES; MEDICAL, PHYSICAL REHABILITATION AND PHYSICAL THERAPY SERVICES; PROVIDING HEALTH CARE INFORMATION BY TELEPHONE AND THE INTERNET; PROVIDING HEALTH INFORMATION; PROVIDING IN-PERSON HOLISTIC HEALTH CARE SERVICES; WELLNESS AND HEALTH-RELATED CONSULTING SERVICES (U.S. CLS. 100 AND 101).

FIRST USE 12-21-2010; IN COMMERCE 12-22-2010.  
BARBARA BROWN, EXAMINING ATTORNEY

**CLASS 44—(Continued).**

SN 85-341,105. HEALTH2HOME, LLC, ROCKY MOUNT, NC. FILED 6-8-2011.

# HC2H

THE MARK CONSISTS OF STANDARD CHARACTERS WITHOUT CLAIM TO ANY PARTICULAR FONT, STYLE, SIZE, OR COLOR.

FOR CONSULTING SERVICES IN THE FIELD OF HEALTH; GERIATRIC HEALTH CARE MANAGEMENT SERVICES; HEALTHCARE; HOME HEALTH CARE SERVICES; MEDICAL SERVICES; MEDICAL, PHYSICAL REHABILITATION AND PHYSICAL THERAPY SERVICES; PROVIDING HEALTH CARE INFORMATION BY TELEPHONE AND THE INTERNET; PROVIDING HEALTH INFORMATION; PROVIDING IN-PERSON HOLISTIC HEALTH CARE SERVICES; WELLNESS AND HEALTH-RELATED CONSULTING SERVICES (U.S. CLS. 100 AND 101).

FIRST USE 12-21-2010; IN COMMERCE 12-21-2010.  
BARBARA BROWN, EXAMINING ATTORNEY

SN 85-341,599. L.B.L. INSURANCE SERVICES, INC., LOS ALAMITOS, CA. FILED 6-8-2011.

## LIVING A BETTER LIFESTYLE

THE MARK CONSISTS OF STANDARD CHARACTERS WITHOUT CLAIM TO ANY PARTICULAR FONT, STYLE, SIZE, OR COLOR.

FOR HEALTH CARE SERVICES; NAMELY, WELLNESS PROGRAMS (U.S. CLS. 100 AND 101).  
DAVID H. STINE, EXAMINING ATTORNEY

SN 85-362,781. ARISTACARE, LLC, SOUTH PLAINFIELD, NJ. FILED 7-5-2011.

# CAREPAIRS

THE MARK CONSISTS OF STANDARD CHARACTERS WITHOUT CLAIM TO ANY PARTICULAR FONT, STYLE, SIZE, OR COLOR.

FOR HEALTHCARE SERVICES, NAMELY, PROVIDING STAFF-PATIENT ONE-ON-ONE BONDING PROGRAMS FOR LONG-TERM CARE AND NURSING HOME PATIENTS (U.S. CLS. 100 AND 101).

FIRST USE 6-7-2011; IN COMMERCE 6-16-2011.  
JACLYN KIDWELL WALKER, EXAMINING ATTORNEY

**CLASS 44—(Continued).**

SN 85-374,963. EPICGENETICS CORPORATION, SANTA MONICA, CA. FILED 7-19-2011.

## Wastebasket Diagnosis

THE MARK CONSISTS OF STANDARD CHARACTERS WITHOUT CLAIM TO ANY PARTICULAR FONT, STYLE, SIZE, OR COLOR.

NO CLAIM IS MADE TO THE EXCLUSIVE RIGHT TO USE "DIAGNOSIS", APART FROM THE MARK AS SHOWN, FOR PERFORMING DIAGNOSIS OF DISEASES (U.S. CLS. 100 AND 101).

THOMAS MANOR, EXAMINING ATTORNEY

SN 85-386,068. BOEHRINGER INGELHEIM VETMEDICA, INC., ST. JOSEPH, MO. FILED 8-1-2011.

## MILK HEALTHY

THE MARK CONSISTS OF STANDARD CHARACTERS WITHOUT CLAIM TO ANY PARTICULAR FONT, STYLE, SIZE, OR COLOR.

FOR VETERINARIAN VACCINE INFORMATION SERVICES, PROVIDED VIA PRINT, MEDIA, LITERATURE, WEBSITES, AND OTHER MEDIA TO EDUCATE VETERINARIANS AND OTHER PERSONS ON THE PROTOCOL AND BENEFITS OF USING VACCINES TO RAISE HEALTHY BULLS AND HEIFERS, CATTLE AND LIVESTOCK IN THE DAIRY INDUSTRY (U.S. CLS. 100 AND 101).

JENNY PARK, EXAMINING ATTORNEY

**CLASS 45—PERSONAL AND LEGAL SERVICES**

SN 77-212,733. GLOBAL MARKETING STRATEGIES LLC, OGDEN, UT. FILED 6-22-2007.

## TRUST GUARD

THE MARK CONSISTS OF STANDARD CHARACTERS WITHOUT CLAIM TO ANY PARTICULAR FONT, STYLE, SIZE, OR COLOR.

FOR IDENTIFICATION VERIFICATION SERVICES, NAMELY, PROVIDING AUTHENTICATION OF PERSONAL AND BUSINESS IDENTIFICATION INFORMATION (U.S. CLS. 100 AND 101).

FIRST USE 8-1-2006; IN COMMERCE 8-17-2006.  
HEATHER THOMPSON, EXAMINING ATTORNEY



**CLASS 45—(Continued).**

SN 77-810,698. ANGEL MINISTRIES, RALEIGH, NC. FILED 8-22-2009.



NO CLAIM IS MADE TO THE EXCLUSIVE RIGHT TO USE "PURSUING MORE OF JESUS", APART FROM THE MARK AS SHOWN.

THE COLOR(S) BLUE, WHITE, PURPLE, AND BLACK IS/ARE CLAIMED AS A FEATURE OF THE MARK.

THE MARK CONSISTS OF THE WORDING "PURSUING MORE OF JESUS". THE WORDING "PURSUING" IS WHITE, THE WORDING "MORE OF" IS PURPLE, AND THE WORDING "JESUS" IS WHITE. THE BACKGROUND HAS BLUE ROCKS WITH A BLUE WATERFALL AND ON THE RIGHT SIDE IS A BLACK AREA.

SEC. 2(F).  
FOR CHRISTIAN MINISTRY SERVICES (U.S. CLS. 100 AND 101).

FIRST USE 6-1-2006; IN COMMERCE 6-1-2006.  
RAMONA ORTIGA, EXAMINING ATTORNEY

SN 79-096,778. ALGEMEEN OCTROOI- EN MERKENBUREAU, NETHERLANDS, FILED 2-2-2011.



PRIORITY DATE OF 8-27-2010 IS CLAIMED.  
OWNER OF INTERNATIONAL REGISTRATION 1075385 DATED 2-2-2011, EXPIRES 2-2-2021.

NO CLAIM IS MADE TO THE EXCLUSIVE RIGHT TO USE "EUROPE", APART FROM THE MARK AS SHOWN.

THE MARK CONSISTS OF THE STYLIZED WORDING "AIPEX" IN WHICH THE LETTERS "IP" ARE SET OFF IN A DIFFERENT SHADE THAN THE OTHER LETTERS WITH THE STYLIZED WORDING "EUROPE CONNECTED" UNDERNEATH AND A DESIGN ON THE RIGHT COMPRISED OF A GLOBE MADE OF PUZZLE PIECES WITH ONE SHADED PIECE LIFTED ABOVE THE REST.

FOR LEGAL SERVICES; ADVICE AND CONSULTATION SERVICES RELATING TO LEGAL SERVICES; ADVICE RELATING TO INTELLECTUAL PROPERTY, NAMELY, CONSULTING IN THE FIELD OF INTELLECTUAL PROPERTY LICENSING AND REGISTRATION AND RENEWAL OF INTELLECTUAL PROPERTY RIGHTS; LEGAL RESEARCH SERVICES IN THE FIELD OF INTELLECTUAL PROPERTY; CONSULTANCY RELATING TO LICENSING, NAMELY, EXPLOITATION AND TRANSFER OF INTELLECTUAL PROPERTY RIGHTS; ADVISORY SERVICES RELATING TO INTELLECTUAL PROPERTY LICENSING (U.S. CLS. 100 AND 101).

TASNEEM HUSSAIN, EXAMINING ATTORNEY

**CLASS 45—(Continued).**

SN 85-033,324. PROFESSIONAL MEDICAL SURGICAL SUPPLY, INC., NEW LENNOX, IL. FILED 5-7-2010.



OWNER OF U.S. REG. NO. 3,601,769.

THE COLOR(S) RED, GRAY, WHITE, YELLOW, ORANGE, BLACK AND PINK FLESH COLOR IS/ARE CLAIMED AS A FEATURE OF THE MARK.

THE MARK CONSISTS OF A PINK FLESH COLORED STRONG-BODIED CHARACTER WEARING A SUIT THAT IS RED, ORANGE AND YELLOW WITH A RED CHECK MARK INSIDE OF A WHITE CIRCULAR BACKGROUND. THE CHARACTER'S HAIR, EYES, AND EYEBROWS ARE BLACK, HIS TEETH ARE WHITE, HIS GLASSES ARE ORANGE AND RED, AND PART OF HIS CAPE IS OUTLINED IN BLACK. BELOW THE CHARACTER, THE WORDING "CAPTAIN COMPLIANCE" APPEARS IN WHITE AND GRAY AND OUTLINED IN RED. THERE IS ALSO A WHITE AND GRAY CHECK MARK INSIDE A WHITE AND GRAY CIRCULAR BORDER. THE CHECK MARK AND THE CIRCULAR BORDER ARE OUTLINED IN RED. THE REMAINING WHITE IN THE MARK IS BACKGROUND ONLY AND IS NOT INTENDED AS A FEATURE OF THE MARK.

FOR PROVIDING REGULATORY COMPLIANCE INFORMATION AND CONSULTING IN THE FIELD OF MEDICAL CARE (U.S. CLS. 100 AND 101).

KIM MONINGHOFF, EXAMINING ATTORNEY

SN 85-085,814. SIX DEGREES CAPITAL CORPORATION, SEATTLE, WA. FILED 7-15-2010.

**IPI**

THE MARK CONSISTS OF STANDARD CHARACTERS WITHOUT CLAIM TO ANY PARTICULAR FONT, STYLE, SIZE, OR COLOR.

FOR ON-LINE SOCIAL NETWORKING SERVICES (U.S. CLS. 100 AND 101).

ELIZABETH KAJUBI, EXAMINING ATTORNEY

**CLASS 45—(Continued).**

SN 85-159,780. MATCHSIGN.COM, LLC, STAMFORD, CT. FILED 10-24-2010.

# LIPSIGN

THE MARK CONSISTS OF STANDARD CHARACTERS WITHOUT CLAIM TO ANY PARTICULAR FONT, STYLE, SIZE, OR COLOR.

FOR ASTROLOGICAL FORECASTING; ASTROLOGY CONSULTATION; COMPUTER DATING SERVICES; DATING SERVICES, NAMELY, PROVIDING AN ON-LINE COMPUTER DATABASE FEATURING SINGLE PEOPLE INTERESTED IN MEETING OTHER SINGLE PEOPLE; HOROSCOPE CASTING; HOROSCOPE FORECASTING; HOROSCOPES; INTERNET-BASED DATING, SOCIAL INTRODUCTION AND SOCIAL NETWORKING SERVICES; MATCHMAKING SERVICES; ON-LINE GAY, LESBIAN AND BISEXUAL SOCIAL NETWORKING SERVICES; PROVIDING AN ON-LINE SEARCHABLE DATABASE FEATURING INFORMATION CONCERNING THE LIFESTYLES OF GAY, LESBIAN, BI-SEXUAL AND TRANSGENDER PEOPLE; PROVIDING HOROSCOPE INFORMATION VIA COMPUTER NETWORKS; PROVIDING ON-LINE COMPUTER DATABASES AND ON-LINE SEARCHABLE DATABASES IN THE FIELD OF SOCIAL NETWORKING; ZODIAC CONSULTATION (U.S. CLS. 100 AND 101).

FIRST USE 10-1-2010; IN COMMERCE 10-1-2010.  
DANIEL CAPSHAW, EXAMINING ATTORNEY

SN 85-163,215. CONTRACTOR COMPLIANCE SOLUTIONS, LLC, DIXON, CA. FILED 10-28-2010.

# COMPLY AND WIN

THE MARK CONSISTS OF STANDARD CHARACTERS WITHOUT CLAIM TO ANY PARTICULAR FONT, STYLE, SIZE, OR COLOR.

NO CLAIM IS MADE TO THE EXCLUSIVE RIGHT TO USE "COMPLY", APART FROM THE MARK AS SHOWN.

FOR REGULATORY COMPLIANCE CONSULTING IN THE FIELD OF CONSTRUCTION (U.S. CLS. 100 AND 101).

DAVID C. REIHNER, EXAMINING ATTORNEY

SN 85-174,480. DINSMORE & SHOHL LLP, CINCINNATI, OH. FILED 11-11-2010.

# Dinsmôre

THE MARK CONSISTS OF THE WORD "DINSMORE" WITH AN INVERTED "V" OVER THE LETTER "O".

SEC. 2(F).

FOR LEGAL SERVICES (U.S. CLS. 100 AND 101).  
CHERYL CLAYTON, EXAMINING ATTORNEY

**CLASS 45—(Continued).**

SN 85-188,556. KILPATRICK TOWNSEND & STOCKTON LLP, ATLANTA, GA. FILED 12-1-2010.



OWNER OF U.S. REG. NOS. 2,183,743 AND 2,620,666.  
THE MARK CONSISTS OF A SHADED BOX DESIGN FEATURING THE LETTERS "K", "T" AND THE STYLIZED WORDING "KILPATRICK TOWNSEND".

FOR LEGAL SERVICES (U.S. CLS. 100 AND 101).  
BERYL GARDNER, EXAMINING ATTORNEY

SN 85-191,675. LEWIS OPERATING CORP., UPLAND, CA. FILED 12-6-2010.



OWNER OF U.S. REG. NOS. 3,883,247 AND 3,897,585.  
THE MARK CONSISTS OF AN OVAL SHAPE; WITHIN THE SHAPE ARE A HOUSE, A TREE NEXT TO THE HOUSE, A MOUNTAIN RANGE IN THE BACKGROUND, OPEN FIELD IN FRONT OF THE HOUSE, FENCING AROUND THE FIELD, AND BOULDERS OUTSIDE THE FENCING.

FOR OBTAIN ENTITLEMENTS, NAMELY, GOVERNMENT AND REGULATORY PERMITS, LICENSES AND APPROVALS, FOR DEVELOPMENT AND BUILDING OF PLANNED RESIDENTIAL COMMUNITIES AND SHOPPING CENTERS FOR OTHERS (U.S. CLS. 100 AND 101).

FIRST USE 10-18-2010; IN COMMERCE 10-18-2010.  
KATHLEEN M. VANSTON, EXAMINING ATTORNEY

SN 85-254,651. FAITH HOSPICE CHARITY, INC., OKLAHOMA CITY, OK. FILED 3-1-2011.

# HOSPICE WISH FOUNDATION

THE MARK CONSISTS OF STANDARD CHARACTERS WITHOUT CLAIM TO ANY PARTICULAR FONT, STYLE, SIZE, OR COLOR.

NO CLAIM IS MADE TO THE EXCLUSIVE RIGHT TO USE "HOSPICE" OR "FOUNDATION", APART FROM THE MARK AS SHOWN.

FOR CHARITABLE SERVICES, NAMELY, GRANTING WISHES OF TERMINALLY ILL INDIVIDUALS (U.S. CLS. 100 AND 101).

KAELIE KUNG, EXAMINING ATTORNEY

**CLASS 45—(Continued).**

SN 85-256,890. OTTESON, JAMES C., EAST PALO ALTO, CA. FILED 3-3-2011.

## Agility IP Law

THE MARK CONSISTS OF STANDARD CHARACTERS WITHOUT CLAIM TO ANY PARTICULAR FONT, STYLE, SIZE, OR COLOR.

NO CLAIM IS MADE TO THE EXCLUSIVE RIGHT TO USE "IP LAW", APART FROM THE MARK AS SHOWN.

FOR LEGAL SERVICES (U.S. CLS. 100 AND 101).

FIRST USE 2-4-2010; IN COMMERCE 2-4-2010.

JOHN DWYER, EXAMINING ATTORNEY

SN 85-257,694. PROPHETESS LISA LOFTON, WELLINGTON, FL. AND PASTOR JAMES LOFTON, JR., WELLINGTON, FL. FILED 3-4-2011.



THE MARK CONSISTS OF A DOVE WITH BOTH WINGS OPEN HOLDING A RAM'S HORN IN HIS FEET. THERE ARE FLAMES BEHIND THE DOVE. UNDER THE DOVE IS A THREE SIDED SHIELD CONTAINING THE FOLLOWING IMAGES: A LION WITH A CROWN AROUND HIS FOREHEAD, FACING FRONT AND STEPPING ON A ROD WITH HIS FRONT TWO PAWS; DIRECTLY BELOW THE ROD AND AT THE BASE OF THE SHIELD IS A GOBLET OF GRAPES WITH LEAVES; THE EDGES OF THE SHIELD CONTAIN STYLIZED LETTERING WITH THE WORDS, "LION OF JUDAH", "CUP OF SUFFERING" AND "ROD OF MOSES". BEHIND THE LION AND THE GOBLET IS A GLOWING EFFECT. TWELVE NEEDLE STYLE BURSTS OF LIGHT ALSO SURROUND THE LION AND GOBLET OF GRAPES. THE BURSTS SHINE OUT FROM THE CENTER OF THE SHIELD TO THE EDGES OF THE SHIELD, WITH THE POINTS OF THE NEEDLE LIKE BURSTS CLOSE TO THE EDGES OF THE SHIELD.

FOR CHRISTIAN MINISTRY SERVICES; RELIGIOUS AND SPIRITUAL SERVICES, NAMELY, CONDUCTING RELIGIOUS WORSHIP, MARRIAGE CEREMONIES, BAPTISMAL CEREMONIES, BABY DEDICATIONS, BE-REAVEMENT CEREMONIES, AND RELIGIOUS COUNSELING (U.S. CLS. 100 AND 101).

FIRST USE 1-15-2011; IN COMMERCE 1-15-2011.

BRIAN NEVILLE, EXAMINING ATTORNEY

**CLASS 45—(Continued).**

SN 85-269,373. CLEARSTAR LOGISTICS, INC., DBA CLEARSTAR MEDICAL REVIEW OFFICE; CLEARSTAR MRO, CUMMING, GA. FILED 3-17-2011.

## WebCCF

THE MARK CONSISTS OF STANDARD CHARACTERS WITHOUT CLAIM TO ANY PARTICULAR FONT, STYLE, SIZE, OR COLOR.

FOR BACKGROUND INVESTIGATION AND RESEARCH SERVICES; BACKGROUND INVESTIGATION SERVICES; DETECTIVE INVESTIGATIONS; DMV RECORD INVESTIGATION SERVICES; DRUG, ALCOHOL AND DNA SCREENING FOR SECURITY AND EMPLOYMENT PURPOSES; EMPLOYEE MISCONDUCT INVESTIGATION SERVICES; EMPLOYMENT BACKGROUND SCREENING, NAMELY, BACKGROUND SCREENING OF CURRENT EMPLOYEES OF OTHERS; INVESTIGATION OF ASSETS, CREDIT REPORTS, FISCAL ASSESSMENTS, AND COLLECTION REPORTS FOR SECURITY OR AUTHENTICATION PURPOSES; INVESTIGATION OR SURVEILLANCE ON BACKGROUND PROFILES; INVESTIGATION SERVICES RELATED TO INSURANCE CLAIMS; MONITORING OF CREDIT REPORTS, THE INTERNET, AND PUBLIC RECORDS TO FACILITATE THE DETECTION AND PREVENTION OF IDENTITY THEFT AND FRAUD; ON-LINE IDENTITY RELIABILITY INVESTIGATION IN THE FIELD OF ON-LINE DATING AND CLAIMS MADE ABOUT AGE, GENDER; PERSONAL BACKGROUND INVESTIGATIONS; PRE-EMPLOYMENT BACKGROUND INVESTIGATION SERVICES; PRE-EMPLOYMENT BACKGROUND SCREENING; PRIVATE INVESTIGATION; PROVIDING AN INTERACTIVE WEB SITE THAT FACILITATES THE VERIFICATION OF A PERSON'S BACKGROUND CREDENTIALS; PUBLIC RECORD INVESTIGATION SERVICES (U.S. CLS. 100 AND 101).

FIRST USE 3-17-2011; IN COMMERCE 3-17-2011.

MICHAEL WIENER, EXAMINING ATTORNEY

SN 85-276,867. SHILOH, KALONA,, IA. FILED 3-25-2011.

# Shiloh

THE MARK CONSISTS OF THE STYLIZED WORD "SHILOH".

FOR CONDUCTING RELIGIOUS PRAYER SERVICES; MINISTERIAL SERVICES, NAMELY, HOLDING SPIRITUAL RETREATS TO ASSIST RELIGIOUS LEADERS, BOTH CLERGY AND LAY, TO DEVELOP AND ENHANCE THEIR SPIRITUAL LIVES; PROVIDING A WEBSITE FEATURING INFORMATION ABOUT RELIGIOUS BELIEF SYSTEMS; RELIGIOUS AND SPIRITUAL SERVICES, NAMELY, PROVIDING GATHERINGS AND RETREATS TO DEVELOP AND ENHANCE THE SPIRITUAL LIVES OF INDIVIDUALS (U.S. CLS. 100 AND 101).

FIRST USE 0-0-1991; IN COMMERCE 0-0-1991.

DAVID ELTON, EXAMINING ATTORNEY

**CLASS 45—(Continued).**

SN 85-281,787. DENNIS, THOMAS J., CHICAGO, IL. FILED 3-30-2011.

# Grief River

THE MARK CONSISTS OF STANDARD CHARACTERS WITHOUT CLAIM TO ANY PARTICULAR FONT, STYLE, SIZE, OR COLOR.

NO CLAIM IS MADE TO THE EXCLUSIVE RIGHT TO USE "GRIEF", APART FROM THE MARK AS SHOWN.

FOR GRIEF COUNSELING SERVICES, NAMELY, HELPING PEOPLE TO COPE WITH BEREAVEMENT AND OTHER SIGNIFICANT LOSSES USING A RIVER METAPHOR AS A FRAMEWORK FOR THERAPY (U.S. CLS. 100 AND 101).

FIRST USE 5-5-2008; IN COMMERCE 3-23-2009.

COLLEEN KEARNEY, EXAMINING ATTORNEY

---

SN 85-287,097. MARKETPLACE MINISTRIES INC., PLANO, TX. FILED 4-5-2011.



OWNER OF U.S. REG. NO. 3,625,007.

NO CLAIM IS MADE TO THE EXCLUSIVE RIGHT TO USE "RAILROAD CHAPLAINS", APART FROM THE MARK AS SHOWN.

THE MARK CONSISTS OF THE WORDS "RAILROAD CHAPLAINS" IN WHITE CAPITAL LETTERS AGAINST A BLACK BACKGROUND WITH A TRAIN TO THE LEFT OF THE WORDS WITH THE LETTERS "RRC" ON THE DOORS OF THE TRAIN, ALL CONTAINED INSIDE A RECTANGLE.

FOR MINISTERIAL SERVICES FOR RAILROAD WORKERS, FAMILIES, AND RELATED THIRD PARTIES (U.S. CLS. 100 AND 101).

FIRST USE 4-5-2011, THE MARK WAS FIRST USED ANYWHERE IN A DIFFERENT FORM OTHER THAN THAT SOUGHT TO BE REGISTERED AT LEAST AS EARLY AS 05/25/2006; IN COMMERCE 4-5-2011, THE MARK WAS FIRST USED IN COMMERCE IN A DIFFERENT FORM OTHER THAN THAT SOUGHT TO BE REGISTERED AT LEAST AS EARLY AS 05/25/2006.

ANNE FARRELL, EXAMINING ATTORNEY

**CLASS 45—(Continued).**

SN 85-289,632. MIB GROUP, INC., BRAINTREE, MA. FILED 4-7-2011.



NO CLAIM IS MADE TO THE EXCLUSIVE RIGHT TO USE "RISK REVEALED", APART FROM THE MARK AS SHOWN.

THE COLOR(S) WHITE, BLACK AND TEAL GREEN IS/ ARE CLAIMED AS A FEATURE OF THE MARK.

THE MARK CONSISTS OF THE LETTERS "MIB" ARE WRITTEN IN WHITE BLOCK LETTERS OVER A BLACK BACKGROUND, AND THE "I" IS DOTTED IN A TEAL GREEN. UNDERNEATH "MIB" ARE THE WORDS "RISK REVEALED" WRITTEN IN WHITE IN A STYLISTIC FORM OVER A TEAL GREEN BACKGROUND.

FOR COMPILING CONFIDENTIAL DATA ON INSURANCE POLICYHOLDERS AND SHARING SUCH DATA WITH MEMBER INSURANCE COMPANIES IN ORDER TO IMPROVE AN INSURER'S RISK MANAGEMENT BY DETECTING FRAUD ON THE PART OF APPLICANTS WHO OMIT OR SEEK TO CONCEAL FACTS THAT ARE ESSENTIAL TO THE UNDERWRITING PROCESS (U.S. CLS. 100 AND 101).

FIRST USE 3-11-2011; IN COMMERCE 3-11-2011.

RUSS HERMAN, EXAMINING ATTORNEY

---

SN 85-291,318. GREENWOOD, INC., DANVILLE, IL. FILED 4-11-2011.

## CREATIVE JUICES IDEA GROUP

THE MARK CONSISTS OF STANDARD CHARACTERS WITHOUT CLAIM TO ANY PARTICULAR FONT, STYLE, SIZE, OR COLOR.

NO CLAIM IS MADE TO THE EXCLUSIVE RIGHT TO USE "GROUP", APART FROM THE MARK AS SHOWN.

FOR CONSULTING SERVICES RELATING TO FUNERAL ARRANGEMENT SERVICES (U.S. CLS. 100 AND 101).

TRACY CROSS, EXAMINING ATTORNEY

**CLASS 45—(Continued).**

SN 85-295,417. MOTHER BRAND JEANS COMPANY, LLC, STAMFORD, CT. FILED 4-14-2011.

DIVORCEADVANTAGE.COM

THE MARK CONSISTS OF STANDARD CHARACTERS WITHOUT CLAIM TO ANY PARTICULAR FONT, STYLE, SIZE, OR COLOR.

FOR PROVIDING INTERNET-BASED SOCIAL NETWORKING SERVICES IN THE FIELD OF MARITAL DIVORCE AND SEPARATION (U.S. CLS. 100 AND 101).  
JAY FLOWERS, EXAMINING ATTORNEY

---

SN 85-297,188. JANNUZZO, JEFFREY A., AKA JANNUZZO LAW OFFICE, NEW YORK, NY. FILED 4-17-2011.

One against many . . . is  
good odds

THE MARK CONSISTS OF STANDARD CHARACTERS WITHOUT CLAIM TO ANY PARTICULAR FONT, STYLE, SIZE, OR COLOR.

FOR LEGAL SERVICES; LEGAL SERVICES, NAMELY, PROVIDING CUSTOMIZED INFORMATION, COUNSELING, ADVICE AND LITIGATION SERVICES IN ALL AREAS OF INTERNATIONAL LAW; LITIGATION CONSULTANCY; LITIGATION SERVICES (U.S. CLS. 100 AND 101).

FIRST USE 4-1-2011; IN COMMERCE 4-1-2011.  
SUZANNE BLANE, EXAMINING ATTORNEY

---

SN 85-301,167. MUNZNER, ROBERT F, SCHUYLER, VA. FILED 4-21-2011.

DOCTOR DEVICE

THE MARK CONSISTS OF STANDARD CHARACTERS WITHOUT CLAIM TO ANY PARTICULAR FONT, STYLE, SIZE, OR COLOR.

FOR REGULATORY COMPLIANCE CONSULTING IN THE FIELD OF MEDICAL DEVICES (U.S. CLS. 100 AND 101).

FIRST USE 6-1-1999; IN COMMERCE 6-1-1999.  
TARA PATE, EXAMINING ATTORNEY

**CLASS 45—(Continued).**

SN 85-304,615. KAY & GINGER, LLC, NEW ORLEANS, LA. FILED 4-26-2011.

THE OCCASIONAL WIFE

THE MARK CONSISTS OF STANDARD CHARACTERS WITHOUT CLAIM TO ANY PARTICULAR FONT, STYLE, SIZE, OR COLOR.

OWNER OF U.S. REG. NO. 3,568,991.  
FOR ORGANIZATIONAL SERVICES FOR HOME OR PERSONAL PURPOSES, NAMELY, ORGANIZING, DE-CLUTTERING, STAGING AND PLANNING CLOSETS, KITCHENS, GARAGES, OFFICES AND KIDS' ROOMS.; PERSONAL SHOPPING FOR OTHERS (U.S. CLS. 100 AND 101).

FIRST USE 4-1-2007; IN COMMERCE 4-1-2007.  
DANNEAN HETZEL, EXAMINING ATTORNEY

---

SN 85-307,333. JANE'S DUE PROCESS, INC., AUSTIN, TX. FILED 4-28-2011.

JANE'S DUE PROCESS

THE MARK CONSISTS OF STANDARD CHARACTERS WITHOUT CLAIM TO ANY PARTICULAR FONT, STYLE, SIZE, OR COLOR.

NO CLAIM IS MADE TO THE EXCLUSIVE RIGHT TO USE "DUE PROCESS", APART FROM THE MARK AS SHOWN.

FOR PROVIDING ADVICE AND INFORMATION IN THE FIELD OF THE LEGAL RIGHTS OF MINORS AND WOMEN; PROVIDING A WEBSITE FEATURING INFORMATION IN THE FIELD OF THE LEGAL RIGHTS OF MINORS AND WOMEN (U.S. CLS. 100 AND 101).

FIRST USE 1-11-2001; IN COMMERCE 1-11-2001.  
CHRISTINA SOBRAL, EXAMINING ATTORNEY

**CLASS 45—(Continued).**

SN 85-307,779. KERN, TRACY ANN, YACOLT, WA. FILED 4-28-2011.

**LOVESICK SINGLES**

THE MARK CONSISTS OF STANDARD CHARACTERS WITHOUT CLAIM TO ANY PARTICULAR FONT, STYLE, SIZE, OR COLOR.

NO CLAIM IS MADE TO THE EXCLUSIVE RIGHT TO USE "SINGLES", APART FROM THE MARK AS SHOWN.

FOR DATING SERVICES, NAMELY, PROVIDING AN ONLINE COMPUTER DATABASE FEATURING SINGLE PEOPLE AFFLICTED WITH MEDICAL CONDITIONS AND/OR ILLNESSES INTERESTED IN MEETING OTHER SINGLE PEOPLE WITH MEDICAL CONDITIONS AND/OR ILLNESSES; DATING SERVICES, NAMELY, PROVIDING AN ONLINE COMPUTER DATABASE FEATURING SINGLE PEOPLE INTERESTED IN MEETING OTHER SINGLE PEOPLE (U.S. CLS. 100 AND 101).

LEIGH CAROLINE CASE, EXAMINING ATTORNEY

SN 85-315,628. JOHNSON, JOHN W, SANTA ANA, CA. AND JOHNSON, LUCINDA M, SANTA ANA, CA. FILED 5-9-2011.



OWNER OF U.S. REG. NOS. 3,034,489 AND 3,053,261. THE MARK CONSISTS OF THE WORD "SAFER" WRITTEN OVER THE NUMERAL "3" WITH A SCRIBBLE PATTERN IN THE BACKGROUND. THIS IMAGE IS SURROUNDED BY A TRIANGLE, AND ON THE INSIDE OF EACH ARM OF THE TRIANGLE APPEARS THE PHRASES: "SAFER KIDS", "SAFER WATER", "SAFER RESPONSE", RESPECTIVELY. OUTSIDE OF EACH ARM OF THE TRIANGLE APPEARS A TADPOLE AND THE NAME "TIMMY TADPOLE" BELOW IT, A STARFISH AND THE NAME "SAMMY STARFISH" BELOW THE STARFISH, AND A GUPPY AND THE NAME "GILBERT GUPPY" BELOW IT.

FOR PROVIDING INFORMATION TO THE PUBLIC REGARDING POOL SAFETY AND DROWNING PREVENTION (U.S. CLS. 100 AND 101).

FIRST USE 10-23-2003; IN COMMERCE 10-23-2003. MARGARET POWER, EXAMINING ATTORNEY

**CLASS 45—(Continued).**

SN 85-316,624. BAUMGARDNER, LANE, PLEASANT VALLEY, NY. FILED 5-10-2011.



NO CLAIM IS MADE TO THE EXCLUSIVE RIGHT TO USE "SOCIAL", APART FROM THE MARK AS SHOWN.

THE MARK CONSISTS OF A CARTOON TYPE CELL PHONE THAT LOOKS LIKE A MAN. HE'S WEARING A COWBOY HAT, A POLICE BADGE, BOOTS AND HOLDING A CELLPHONES. THE MARK CONTAINS THE STYLIZED WORDING "SOCIAL GUARDIAN TEX CELLULAR SOCIAL COP".

FOR INTERNET-BASED PERSONAL SECURITY PROTECTION SERVICES THAT OFFERS CUSTOMERS PERSONAL SECURITY PROTECTION, NAMELY, BY THE USE OF TEXT MESSAGES, E-MAIL, AND CELL PHONE APPLICATIONS SENT AND STORED TO A CENTRAL LOCATION, CONFIRMING THE CUSTOMERS' CURRENT ACTIVITIES AND SOCIAL INTERACTIONS WITH OTHERS, IN ORDER TO ENHANCE THEIR SECURITY BY ESTABLISHING THROUGH A THIRD-PARTY THE IDENTITY OF THOSE WHO MAY TRY TO CAUSE HARM TO THE CUSTOMERS (U.S. CLS. 100 AND 101).

JOHN HWANG, EXAMINING ATTORNEY

SN 85-318,224. STARKS, TERRY B., NORCROSS, GA. FILED 5-11-2011.

**New Beginning Bible Institute**

THE MARK CONSISTS OF STANDARD CHARACTERS WITHOUT CLAIM TO ANY PARTICULAR FONT, STYLE, SIZE, OR COLOR.

NO CLAIM IS MADE TO THE EXCLUSIVE RIGHT TO USE "BIBLE INSTITUTE", APART FROM THE MARK AS SHOWN.

FOR MINISTERIAL SERVICES, NAMELY, HOLDING SPIRITUAL RETREATS TO ASSIST RELIGIOUS LEADERS, BOTH CLERGY AND LAY, TO DEVELOP AND ENHANCE THEIR SPIRITUAL LIVES; RELIGIOUS AND SPIRITUAL SERVICES, NAMELY, PROVIDING GATHERINGS AND RETREATS TO DEVELOP AND ENHANCE THE SPIRITUAL LIVES OF INDIVIDUALS; RELIGIOUS SERVICES, NAMELY, PRAYER MEETINGS (U.S. CLS. 100 AND 101).

C. DIONNE CLYBURN, EXAMINING ATTORNEY

**CLASS 45—(Continued).**

SN 85-319,442. TAX RITE, INC., ARLINGTON HEIGHTS, IL.  
FILED 5-12-2011.

## Thumbprint Lock

THE MARK CONSISTS OF STANDARD CHARACTERS WITHOUT CLAIM TO ANY PARTICULAR FONT, STYLE, SIZE, OR COLOR.

FOR CONSULTATION IN THE FIELD OF DATA THEFT AND IDENTITY THEFT; FINANCIAL IDENTITY MONITORING SERVICE; FRAUD AND IDENTITY THEFT PROTECTION SERVICES; MONITORING OF CREDIT REPORTS, THE INTERNET, AND PUBLIC RECORDS TO FACILITATE THE DETECTION AND PREVENTION OF IDENTITY THEFT AND FRAUD (U.S. CLS. 100 AND 101).

JACQUELINE A. LAVINE, EXAMINING ATTORNEY

SN 85-319,759. VON OECH, ROGER V., WOODSIDE, CA.  
FILED 5-12-2011.

## Wise Fool

THE MARK CONSISTS OF STANDARD CHARACTERS WITHOUT CLAIM TO ANY PARTICULAR FONT, STYLE, SIZE, OR COLOR.

FOR PROVIDING INFORMATION ON TECHNIQUES FOR IMPROVING PERSONAL CREATIVITY (U.S. CLS. 100 AND 101).

FIRST USE 3-3-2011; IN COMMERCE 3-3-2011.  
JAMES LOVELACE, EXAMINING ATTORNEY

SN 85-321,572. HAY, CHRISTOPHER A, CYPRESS, CA.  
FILED 5-16-2011.

## Zarephath Ministries

THE MARK CONSISTS OF STANDARD CHARACTERS WITHOUT CLAIM TO ANY PARTICULAR FONT, STYLE, SIZE, OR COLOR.

NO CLAIM IS MADE TO THE EXCLUSIVE RIGHT TO USE "MINISTRIES", APART FROM THE MARK AS SHOWN.

FOR MINISTERIAL SERVICES, NAMELY, HOLDING SPIRITUAL RETREATS TO ASSIST RELIGIOUS LEADERS, BOTH CLERGY AND LAY, TO DEVELOP AND ENHANCE THEIR SPIRITUAL LIVES (U.S. CLS. 100 AND 101).

FIRST USE 3-15-2009; IN COMMERCE 3-15-2009.  
JOHN GARTNER, EXAMINING ATTORNEY

**CLASS 45—(Continued).**

SN 85-323,250. DIGITAL CONCEALMENT SYSTEMS, LLC,  
PHENIX CITY, AL. FILED 5-17-2011.



NO CLAIM IS MADE TO THE EXCLUSIVE RIGHT TO USE "ADVANCED CONCEALMENT SYSTEM", APART FROM THE MARK AS SHOWN.

THE MARK CONSISTS OF THE LETTERS "ACS" ABOVE THE WORDS "ADVANCED CONCEALMENT SYSTEM" ALL TO THE LEFT OF A LETTER "T" OVER A SQUARE BLACK BACKGROUND.

FOR LICENSING OF INTELLECTUAL PROPERTY IN THE FIELD OF CAMOUFLAGE PATTERNS FOR DECORATING GOODS SOLD AND USED IN THE FIELDS OF MILITARY, LAW ENFORCEMENT, PARAMILITARY, RESCUE AND PUBLIC SAFETY (U.S. CLS. 100 AND 101).

MICHAEL ENGEL, EXAMINING ATTORNEY

SN 85-323,268. DIGITAL CONCEALMENT SYSTEMS, LLC,  
PHENIX CITY, AL. FILED 5-17-2011.



NO CLAIM IS MADE TO THE EXCLUSIVE RIGHT TO USE "ADVANCED CONCEALMENT SYSTEM", APART FROM THE MARK AS SHOWN.

THE MARK CONSISTS OF THE LETTERS "ACS" ABOVE THE WORDS "ADVANCED CONCEALMENT SYSTEM" ALL TO THE LEFT OF A LETTER "I" OVER A SQUARE BLACK BACKGROUND.

FOR LICENSING OF INTELLECTUAL PROPERTY IN THE FIELD OF CAMOUFLAGE PATTERNS FOR DECORATING GOODS SOLD AND USED IN THE FIELDS OF MILITARY, LAW ENFORCEMENT, PARAMILITARY, RESCUE AND PUBLIC SAFETY (U.S. CLS. 100 AND 101).

MICHAEL ENGEL, EXAMINING ATTORNEY

SN 85-323,283. DIGITAL CONCEALMENT SYSTEMS, LLC,  
PHENIX CITY, AL. FILED 5-17-2011.



NO CLAIM IS MADE TO THE EXCLUSIVE RIGHT TO USE "ADVANCED CONCEALMENT SYSTEM", APART FROM THE MARK AS SHOWN.

THE MARK CONSISTS OF THE LETTERS "ACS" ABOVE THE WORDS "ADVANCED CONCEALMENT SYSTEM" ALL TO THE LEFT OF A LETTER "A" OVER A SQUARE BLACK BACKGROUND.

FOR LICENSING OF INTELLECTUAL PROPERTY IN THE FIELD OF CAMOUFLAGE PATTERNS FOR DECORATING GOODS SOLD AND USED IN THE FIELDS OF MILITARY, LAW ENFORCEMENT, PARAMILITARY, RESCUE AND PUBLIC SAFETY (U.S. CLS. 100 AND 101).

MICHAEL ENGEL, EXAMINING ATTORNEY



**CLASS 45—(Continued).**

SN 85-329,303. THE ANDERSON-MCQUEEN COMPANY, ST. PETERSBURG, FL. FILED 5-24-2011.

WHERE THE HEALING BEGINS

THE MARK CONSISTS OF STANDARD CHARACTERS WITHOUT CLAIM TO ANY PARTICULAR FONT, STYLE, SIZE, OR COLOR.  
FOR FUNERAL HOMES (U.S. CLS. 100 AND 101).  
FIRST USE 5-20-2011; IN COMMERCE 5-20-2011.  
THEODORE MCBRIDE, EXAMINING ATTORNEY

SN 85-329,306. THE ANDERSON-MCQUEEN COMPANY, ST. PETERSBURG, FL. FILED 5-24-2011.

A LEGACY OF CARING

THE MARK CONSISTS OF STANDARD CHARACTERS WITHOUT CLAIM TO ANY PARTICULAR FONT, STYLE, SIZE, OR COLOR.  
FOR FUNERAL HOMES (U.S. CLS. 100 AND 101).  
FIRST USE 4-21-2011; IN COMMERCE 4-21-2011.  
THEODORE MCBRIDE, EXAMINING ATTORNEY

SN 85-331,284. SOUTH FLORIDA CENTER FOR FAMILY COUNSELING CORP., MIAMI, FL. FILED 5-26-2011.

YLC

THE MARK CONSISTS OF STANDARD CHARACTERS WITHOUT CLAIM TO ANY PARTICULAR FONT, STYLE, SIZE, OR COLOR.  
FOR PROVIDING COUNSELING AND EMOTIONAL SUPPORT SERVICES FOR YOUTH TRANSITIONING OUT OF THE FOSTER CARE SYSTEM (U.S. CLS. 100 AND 101).  
FIRST USE 7-1-2010; IN COMMERCE 7-1-2010.  
MICHAEL ENGEL, EXAMINING ATTORNEY

**CLASS 45—(Continued).**

SN 85-332,178. XPAL SOCIAL MEDIA CORPORATION, SUNNYVALE, CA. FILED 5-27-2011.

XPage

THE MARK CONSISTS OF STANDARD CHARACTERS WITHOUT CLAIM TO ANY PARTICULAR FONT, STYLE, SIZE, OR COLOR.  
FOR ON-LINE SOCIAL NETWORKING SERVICES (U.S. CLS. 100 AND 101).  
FIRST USE 5-16-2002; IN COMMERCE 4-15-2010.  
PATRICIA EVANKO, EXAMINING ATTORNEY

SN 85-333,269. THE WITNESS REVOLUTION, LLC, KING GEORGE, VA. FILED 5-29-2011.

the **WITNESS**  
Revolution

THE COLOR(S) RED, BLACK AND WHITE IS/ARE CLAIMED AS A FEATURE OF THE MARK.  
THE MARK CONSISTS OF THE STYLIZED WORDS THE WITNESS REVOLUTION IN RED AND BLACK WITH THE T IN WITNESS APPEARING AS A CROSS IN BLACK AND WHITE WITH A WHITE AND BLACK CLOTH DRAPED OVER THE CROSS.  
FOR MINISTERIAL SERVICES (U.S. CLS. 100 AND 101).  
FIRST USE 5-27-2011; IN COMMERCE 5-27-2011.  
RENEE MCCRAY, EXAMINING ATTORNEY

SN 85-333,426. XPAL SOCIAL MEDIA CORPORATION, SUNNYVALE, CA. FILED 5-30-2011.

XJOURNAL

THE MARK CONSISTS OF STANDARD CHARACTERS WITHOUT CLAIM TO ANY PARTICULAR FONT, STYLE, SIZE, OR COLOR.  
FOR ON-LINE SOCIAL NETWORKING SERVICES (U.S. CLS. 100 AND 101).  
FIRST USE 5-16-2002; IN COMMERCE 4-10-2010.  
PATRICIA EVANKO, EXAMINING ATTORNEY



**CLASS 45—(Continued).**

SN 85-333,429. XPAL SOCIAL MEDIA CORPORATION, AKA XPAL.COM, SUNNYVALE, CA. FILED 5-30-2011.

# XSEARCH

THE MARK CONSISTS OF STANDARD CHARACTERS WITHOUT CLAIM TO ANY PARTICULAR FONT, STYLE, SIZE, OR COLOR.

FOR ON-LINE SOCIAL NETWORKING SERVICES (U.S. CLS. 100 AND 101).  
FIRST USE 5-16-2002; IN COMMERCE 4-10-2010.  
PATRICIA EVANKO, EXAMINING ATTORNEY

---

SN 85-333,472. MYCHANGENOW LLC, HONOLULU, HI. FILED 5-30-2011.

# MyChangeNow

THE MARK CONSISTS OF STANDARD CHARACTERS WITHOUT CLAIM TO ANY PARTICULAR FONT, STYLE, SIZE, OR COLOR.

FOR ON-LINE SOCIAL NETWORKING SERVICES (U.S. CLS. 100 AND 101).  
JULIE GUTTADAURO, EXAMINING ATTORNEY

---

SN 85-333,557. AFM DIGITAL, LLC, GROSSE ILE, MI. FILED 5-31-2011.

# GUYFAX

THE MARK CONSISTS OF STANDARD CHARACTERS WITHOUT CLAIM TO ANY PARTICULAR FONT, STYLE, SIZE, OR COLOR.

FOR PROVIDING INTERNET-BASED BACKGROUND INVESTIGATION SERVICES, NAMELY, BACKGROUND CHECKS, SCREENING AND PERSONAL VERIFICATION SERVICES FOR PURPOSES OF COMPARATIVE DECISION-MAKING IN THE DATING INDUSTRY; DATING SERVICES; INTERNET-BASED SOCIAL NETWORKING, INTRODUCTION AND DATING SERVICES (U.S. CLS. 100 AND 101).  
CHARLES L. JENKINS, EXAMINING ATTORNEY

**CLASS 45—(Continued).**

SN 85-333,559. AFM DIGITAL, LLC, GROSSE ILE, MI. FILED 5-31-2011.

# GIRLFX

THE MARK CONSISTS OF STANDARD CHARACTERS WITHOUT CLAIM TO ANY PARTICULAR FONT, STYLE, SIZE, OR COLOR.

FOR PROVIDING INTERNET-BASED BACKGROUND INVESTIGATION SERVICES, NAMELY, BACKGROUND CHECKS, SCREENING AND PERSONAL VERIFICATION SERVICES FOR PURPOSES OF COMPARATIVE DECISION-MAKING IN THE DATING INDUSTRY; DATING SERVICES; INTERNET-BASED SOCIAL NETWORKING, INTRODUCTION AND DATING SERVICES (U.S. CLS. 100 AND 101).  
CHARLES L. JENKINS, EXAMINING ATTORNEY

---

SN 85-333,732. SWORD MINISTRIES, INC., SUWANEE, GA. FILED 5-31-2011.

# BREAKING THE STAINED GLASS CEILING

THE MARK CONSISTS OF STANDARD CHARACTERS WITHOUT CLAIM TO ANY PARTICULAR FONT, STYLE, SIZE, OR COLOR.

FOR CHRISTIAN MINISTRY SERVICES (U.S. CLS. 100 AND 101).  
TRACY FLETCHER, EXAMINING ATTORNEY

---

SN 85-333,760. LAW OFFICE OF CHRIS STEWART, P.C., AMARILLO, TX. FILED 5-31-2011.

# HOME OF THE HALF PRICE TRADEMARK

THE MARK CONSISTS OF STANDARD CHARACTERS WITHOUT CLAIM TO ANY PARTICULAR FONT, STYLE, SIZE, OR COLOR.

FOR LEGAL SERVICES (U.S. CLS. 100 AND 101).  
FIRST USE 5-20-2011; IN COMMERCE 5-20-2011.  
RONALD AIKENS, EXAMINING ATTORNEY

**CLASS 45—(Continued).**

SN 85-333,865. BRENT GUTEKUNST, SAN DIEGO, CA. FILED 5-31-2011.

## Your Connections Your Future

THE MARK CONSISTS OF STANDARD CHARACTERS WITHOUT CLAIM TO ANY PARTICULAR FONT, STYLE, SIZE, OR COLOR.  
FOR INTERNET-BASED SOCIAL NETWORKING SERVICES (U.S. CLS. 100 AND 101).  
FIRST USE 4-2-2011; IN COMMERCE 4-2-2011.  
PAUL MORENO, EXAMINING ATTORNEY

SN 85-334,388. MALLAVARUPU, NIRUPAMA, SUMMIT, NJ. FILED 5-31-2011.

## Howdyhood

THE MARK CONSISTS OF STANDARD CHARACTERS WITHOUT CLAIM TO ANY PARTICULAR FONT, STYLE, SIZE, OR COLOR.  
FOR PROVIDING A SOCIAL NETWORKING WEBSITE FOR COMMUNICATION AMONG NEIGHBORS (U.S. CLS. 100 AND 101).  
FIRST USE 5-15-2011; IN COMMERCE 5-15-2011.  
VERNA BETH RIRIE, EXAMINING ATTORNEY

SN 85-334,389. MORCOS, SAMIR, PASADENA, CA. FILED 5-31-2011.

**Harry**  
*meets*  
**Sally.com**

NO CLAIM IS MADE TO THE EXCLUSIVE RIGHT TO USE ".COM", APART FROM THE MARK AS SHOWN.  
THE MARK CONSISTS OF THE STYLIZED TEXT "HARRY MEETS SALLY .COM" WITH THE "M" IN "MEETS" IN THE SHAPE OF A HEART.  
FOR DATING SERVICES, NAMELY, PROVIDING AN ON-LINE COMPUTER DATABASE FEATURING SINGLE PEOPLE INTERESTED IN MEETING OTHER SINGLE PEOPLE; MATCHMAKING SERVICES (U.S. CLS. 100 AND 101).  
VERNA BETH RIRIE, EXAMINING ATTORNEY

**CLASS 45—(Continued).**

SN 85-334,465. EVERLOOP, INC., DANVILLE, CA. FILED 5-31-2011.

## WHO'S IN YOUR LOOP?

THE MARK CONSISTS OF STANDARD CHARACTERS WITHOUT CLAIM TO ANY PARTICULAR FONT, STYLE, SIZE, OR COLOR.  
FOR PROVIDING INTERNET-BASED SOCIAL NETWORKING SERVICES (U.S. CLS. 100 AND 101).  
CHRISTINA SOBRAL, EXAMINING ATTORNEY

SN 85-334,661. ROOT LAW GROUP, LOS ANGELES, CA. FILED 6-1-2011.

## No problem is unsolvable

THE MARK CONSISTS OF STANDARD CHARACTERS WITHOUT CLAIM TO ANY PARTICULAR FONT, STYLE, SIZE, OR COLOR.  
FOR LEGAL SERVICES; LEGAL SERVICES, NAMELY, PROVIDING CUSTOMIZED INFORMATION, COUNSELING, ADVICE AND LITIGATION SERVICES IN ALL AREAS OF IMMIGRATION LAW (U.S. CLS. 100 AND 101).  
FIRST USE 12-31-2001; IN COMMERCE 12-31-2001.  
ZHALEH DELANEY, EXAMINING ATTORNEY

SN 85-335,615. THE HOT CHILD LLC, NEW YORK, NY. FILED 6-1-2011.

## Dreammerge.com

THE MARK CONSISTS OF STANDARD CHARACTERS WITHOUT CLAIM TO ANY PARTICULAR FONT, STYLE, SIZE, OR COLOR.  
FOR DATING SERVICES, NAMELY, PROVIDING AN ON-LINE COMPUTER DATABASE FEATURING SINGLE PEOPLE INTERESTED IN MEETING OTHER SINGLE PEOPLE (U.S. CLS. 100 AND 101).  
JENNIFER MARTIN, EXAMINING ATTORNEY

**CLASS 45—(Continued).**

SN 85-335,833. INDIVIDUAL DIGITAL, INC., NEW YORK, NY. FILED 6-1-2011.

# REVJAM

THE MARK CONSISTS OF STANDARD CHARACTERS WITHOUT CLAIM TO ANY PARTICULAR FONT, STYLE, SIZE, OR COLOR.

FOR SOCIAL NETWORKING SERVICES IN THE FIELD OF ADVERTISING PROVIDED VIA THE INTERNET (U.S. CLS. 100 AND 101).

MARGARET POWER, EXAMINING ATTORNEY

---

SN 85-335,837. PAMELA CONDRON, ARMONK, NY. FILED 6-1-2011.

# WeHadAMoment

THE MARK CONSISTS OF STANDARD CHARACTERS WITHOUT CLAIM TO ANY PARTICULAR FONT, STYLE, SIZE, OR COLOR.

FOR INTERNET BASED SOCIAL NETWORKING, INTRODUCTION, AND DATING SERVICES; INTERNET-BASED SOCIAL NETWORKING SERVICES; ON-LINE SOCIAL NETWORKING SERVICES; ONLINE SOCIAL NETWORKING SERVICES IN THE FIELD OF CHANCE ENCOUNTERS BETWEEN MEMBERS PROVIDED VIA A WEBSITE; PROVIDING A SOCIAL NETWORKING WEBSITE FOR ENTERTAINMENT PURPOSES (U.S. CLS. 100 AND 101).

FIRST USE 5-13-2011; IN COMMERCE 5-13-2011.

AISHA CLARKE, EXAMINING ATTORNEY

---

SN 85-336,600. ATE MY HEART INC., LOS ANGELES, CA. FILED 6-2-2011.

# LITTLE MONSTERS

THE MARK CONSISTS OF STANDARD CHARACTERS WITHOUT CLAIM TO ANY PARTICULAR FONT, STYLE, SIZE, OR COLOR.

FOR ON-LINE SOCIAL NETWORKING SERVICES; PROVIDING A SOCIAL NETWORKING WEBSITE FOR ENTERTAINMENT PURPOSES; SOCIAL NETWORKING SERVICES IN THE FIELD OF MUSIC, FASHION, ENTERTAINMENT, ART, CULTURE AND LIFESTYLES PROVIDED VIA A WEBSITE (U.S. CLS. 100 AND 101).

NICHOLAS ALTREE, EXAMINING ATTORNEY

**CLASS 45—(Continued).**

SN 85-336,627. ERGOCARE, INC., RIVERSIDE, CA. FILED 6-2-2011.

# TECHNOLOGY THAT MOVES

THE MARK CONSISTS OF STANDARD CHARACTERS WITHOUT CLAIM TO ANY PARTICULAR FONT, STYLE, SIZE, OR COLOR.

FOR CONSULTING IN THE FIELD OF WORKPLACE SAFETY (U.S. CLS. 100 AND 101).

FIRST USE 1-8-2004; IN COMMERCE 1-8-2004.

SKYE YOUNG, EXAMINING ATTORNEY

---

SN 85-337,210. FABBRI, MICHAEL J., NEW YORK, NY. FILED 6-3-2011.

# mantherunway

THE MARK CONSISTS OF STANDARD CHARACTERS WITHOUT CLAIM TO ANY PARTICULAR FONT, STYLE, SIZE, OR COLOR.

FOR RENTAL OF CLOTHING (U.S. CLS. 100 AND 101).

SUSAN RICHARDS, EXAMINING ATTORNEY

---

SN 85-337,235. REED, ARNOLD E., FARMINGTON HILLS, MI. FILED 6-3-2011.

# When in Need, Call Reed

THE MARK CONSISTS OF STANDARD CHARACTERS WITHOUT CLAIM TO ANY PARTICULAR FONT, STYLE, SIZE, OR COLOR.

FOR LEGAL SERVICES (U.S. CLS. 100 AND 101).

FIRST USE 5-1-2000; IN COMMERCE 5-1-2000.

ELISSA GARBER KON, EXAMINING ATTORNEY

**CLASS 45—(Continued).**

SN 85-337,249. REED, ARNOLD E., FARMINGTON HILLS, MI. FILED 6-3-2011.

You Can't Go Wrong When  
You Go Right With Reed

THE MARK CONSISTS OF STANDARD CHARACTERS WITHOUT CLAIM TO ANY PARTICULAR FONT, STYLE, SIZE, OR COLOR.  
FOR LEGAL SERVICES (U.S. CLS. 100 AND 101).  
ELISSA GARBER KON, EXAMINING ATTORNEY

SN 85-337,602. SURVIVINGINFIDELITY.COM, THE WOODLANDS, TX. FILED 6-3-2011.

SURVIVINGINFIDELITY.COM

THE MARK CONSISTS OF STANDARD CHARACTERS WITHOUT CLAIM TO ANY PARTICULAR FONT, STYLE, SIZE, OR COLOR.  
FOR PROVIDING A WEBSITE FEATURING INFORMATION REGARDING INFIDELITY AND INTERACTIVE SUPPORT FOR THOSE AFFECTED BY INFIDELITY (U.S. CLS. 100 AND 101).  
FIRST USE 5-30-2002; IN COMMERCE 6-10-2002.  
SHAUNIA CARLYLE, EXAMINING ATTORNEY

SN 85-338,117. JAMES M. DENARO, POTOMAC, MD. FILED 6-4-2011.

CIPHERLAW

THE MARK CONSISTS OF STANDARD CHARACTERS WITHOUT CLAIM TO ANY PARTICULAR FONT, STYLE, SIZE, OR COLOR.  
FOR LEGAL SERVICES (U.S. CLS. 100 AND 101).  
FIRST USE 6-2-2011; IN COMMERCE 8-5-2011.  
RONALD DELGIZZI, EXAMINING ATTORNEY

**CLASS 45—(Continued).**

SN 85-338,428. CUPID PLC, EDINBURGH, UNITED KINGDOM, FILED 6-6-2011.

FLIRT

THE MARK CONSISTS OF STANDARD CHARACTERS WITHOUT CLAIM TO ANY PARTICULAR FONT, STYLE, SIZE, OR COLOR.  
FOR INTERNET-BASED DATING, SOCIAL INTRODUCTION AND SOCIAL NETWORKING SERVICES (U.S. CLS. 100 AND 101).  
FIRST USE 12-31-1997; IN COMMERCE 12-31-1997.  
IRA J. GOODSaid, EXAMINING ATTORNEY

SN 85-338,544. LASKY CAROL, BOSTON, MA. FILED 6-6-2011.

YOULO

THE MARK CONSISTS OF STANDARD CHARACTERS WITHOUT CLAIM TO ANY PARTICULAR FONT, STYLE, SIZE, OR COLOR.  
FOR ONLINE SOCIAL NETWORKING SERVICES IN THE FIELD OF PERSONALIZED MEMORIAL CELEBRATIONS (U.S. CLS. 100 AND 101).  
REBECCA POVARCHUK, EXAMINING ATTORNEY

SN 85-338,562. LASKY CAROL, BOSTON, MA. FILED 6-6-2011.

YOULO.GY

THE MARK CONSISTS OF STANDARD CHARACTERS WITHOUT CLAIM TO ANY PARTICULAR FONT, STYLE, SIZE, OR COLOR.  
FOR ONLINE SOCIAL NETWORKING SERVICES IN THE FIELD OF PERSONALIZED MEMORIAL CELEBRATIONS (U.S. CLS. 100 AND 101).  
REBECCA POVARCHUK, EXAMINING ATTORNEY

**CLASS 45—(Continued).**

SN 85-338,808. SPARK NETWORKS USA, LLC, BEVERLY HILLS, CA. FILED 6-6-2011.

**Find God's Match For You**

THE MARK CONSISTS OF STANDARD CHARACTERS WITHOUT CLAIM TO ANY PARTICULAR FONT, STYLE, SIZE, OR COLOR.

FOR PROVIDING ON-LINE PERSONAL INTRODUCTIONS THROUGH A WEBSITE, ACCESSED VIA INTERCONNECTED GLOBAL COMPUTER NETWORKS, FOR THE PURPOSE OF MAKING ACQUAINTANCES, FRIENDSHIP, AND LONG TERM RELATIONSHIPS (U.S. CLS. 100 AND 101).

FIRST USE 7-1-2010; IN COMMERCE 7-1-2010.  
MARIA-VICTORIA SUAREZ, EXAMINING ATTORNEY

**CLASS 45—(Continued).**

SN 85-341,275. SCHMIEDER LAW FIRM LLC, WOOD RIVER, IL. FILED 6-8-2011.

**compLEX**

THE MARK CONSISTS OF STANDARD CHARACTERS WITHOUT CLAIM TO ANY PARTICULAR FONT, STYLE, SIZE, OR COLOR.

THE ENGLISH TRANSLATION OF LEX IN THE MARK IS LAW.

FOR LEGAL SERVICES (U.S. CLS. 100 AND 101).  
FIRST USE 6-1-2011; IN COMMERCE 6-1-2011.  
INGA ERVIN, EXAMINING ATTORNEY

SN 85-339,809. REYNOLDS, LORI A., GOSHEN, KY. AND GRAHAM ROWLES, GEORGETOWN, KY. AND AMANDA SOKAN, LEXINGTON, KY. FILED 6-7-2011.

**OptimAging**

THE MARK CONSISTS OF STANDARD CHARACTERS WITHOUT CLAIM TO ANY PARTICULAR FONT, STYLE, SIZE, OR COLOR.

FOR IN-HOME SUPPORT SERVICES TO SENIOR PERSONS, NAMELY, GERIATRIC CARE MANAGEMENT SERVICES IN THE NATURE OF THE COORDINATION OF NECESSARY SERVICES AND PERSONAL CARE FOR OLDER INDIVIDUALS (U.S. CLS. 100 AND 101).

HOWARD B. LEVINE, EXAMINING ATTORNEY

SN 85-360,452. SCHLUMBERGER TECHNOLOGY CORPORATION, SUGAR LAND, TX. FILED 6-30-2011.

**FracDR**

THE MARK CONSISTS OF STANDARD CHARACTERS WITHOUT CLAIM TO ANY PARTICULAR FONT, STYLE, SIZE, OR COLOR.

FOR REGULATORY COMPLIANCE CONSULTING IN THE FIELD OF FRACTURING AND REPORTING CHEMICALS USED IN FRACTURING (U.S. CLS. 100 AND 101).

SKYE YOUNG, EXAMINING ATTORNEY

SN 85-341,235. HOUSE OF POSSIBILITIES, INC., NORTH EASTON, MA. FILED 6-8-2011.

**House of Possibilities**

THE MARK CONSISTS OF STANDARD CHARACTERS WITHOUT CLAIM TO ANY PARTICULAR FONT, STYLE, SIZE, OR COLOR.

FOR PROVIDING PERSONAL SUPPORT SERVICES FOR CAREGIVERS, PARTNERS, WIVES AND HUSBANDS OF THE CHRONICALLY ILL AND/OR DISABLED, NAMELY, COMPANIONSHIP AND EMOTIONAL SUPPORT (U.S. CLS. 100 AND 101).

FIRST USE 5-14-2003; IN COMMERCE 5-14-2003.  
DOMINICK J. SALEMI, EXAMINING ATTORNEY

SN 85-366,618. LOCASTIC, INC., CAMBRIDGE, MA. FILED 7-8-2011.

**PUNCHEY**

THE MARK CONSISTS OF STANDARD CHARACTERS WITHOUT CLAIM TO ANY PARTICULAR FONT, STYLE, SIZE, OR COLOR.

FOR ON-LINE SOCIAL NETWORKING SERVICES (U.S. CLS. 100 AND 101).

PAUL MORENO, EXAMINING ATTORNEY

SECTION 4.—PRIOR UNITED STATES CLASSIFICATION

APPLICATION IN ONE CLASS

COLLECTIVE MEMBERSHIP MARKS

CLASS 200—COLLECTIVE MEMBERSHIP  
SN 85-303,540. THE AMERICAN SOCIETY OF MECHANICAL ENGINEERS, NEW YORK, NY. FILED 4-25-2011.



OWNER OF U.S. REG. NO. 1,174,662.  
THE MARK CONSISTS OF THE LETTERS "A", "S", "M" AND "E" ARRANGED IN EACH LEAF OF A QUADRAFOIL DESIGN HAVING A CENTRAL CRUCIFORM MEMBER.  
FOR INDICATING MEMBERSHIP IN AN ORGANIZATION OF MECHANICAL ENGINEERS.  
FIRST USE 12-31-1925; IN COMMERCE 12-31-1925.  
DANIEL CAPSHAW, EXAMINING ATTORNEY

SUCH AS COLOR FASTNESS, SHRINKAGE OR OTHER DAMAGE TO WOOL FIBERS, PH LEVELS, AND OTHER CHARACTERISTICS TO ENSURE THE GOODS HAVE THE NECESSARY PROPERTIES TO WASH AND DRY WOOL AND WOOL BLEND PRODUCTS SAFELY WITHOUT DAMAGE IN THE NATURE OF COLOR CHANGE, SHRINKAGE AND/OR FELTING, AND THAT PERSONS AUTHORIZED BY CERTIFIER WILL MANUFACTURE THE GOODS IN ACCORDANCE WITH PROCESSES DEVELOPED BY CERTIFIER.

FOR LAUNDRY SOAPS AND DETERGENTS, LAUNDRY WASHING AND CLEANING PREPARATIONS FOR CLEANING CLOTHES AND LAUNDRY, EXCLUDING INDUSTRIAL AND MANUFACTURING PROCESSES AND MEDICAL USE; AND WASHING MACHINES FOR APPAREL AND CLOTHES DRYERS.  
CARRIE GENOVESE, EXAMINING ATTORNEY

SN 85-279,670. NATIONAL INTELLECTUAL PROPERTY CENTER OF GEORGIA - SAKPATENTI, 0108 TBILISI, REP OF GEORGIA, FILED 3-29-2011.

CERTIFICATION MARKS

CLASS A—GOODS

SN 85-243,829. WOOLMARK AMERICAS, INC., NEW YORK, NY. FILED 2-16-2011.



OWNER OF U.S. REG. NOS. 1,229,937, 2,338,440 AND OTHERS.

THE MARK CONSISTS OF OVERLAPPING CURVED LINES AND A STYLIZED SWIRL DESIGN WITH THE WORD "WOOLMARK".

THE CERTIFICATION MARK, AS INTENDED TO BE USED BY AUTHORIZED PERSONS, IS INTENDED TO CERTIFY THE NATURE AND QUALITY OF THE GOODS,

MANAVI

THE MARK CONSISTS OF STANDARD CHARACTERS WITHOUT CLAIM TO ANY PARTICULAR FONT, STYLE, SIZE, OR COLOR.

THE CERTIFICATION MARK, AS USED BY AUTHORIZED PERSONS, CERTIFIES THAT THE GOODS HAVE BEEN PRODUCED IN ACCORDANCE WITH PRODUCTION STANDARDS ESTABLISHED BY CERTIFIER AND THAT THE GOODS EMANATE FROM A SPECIFIC GEOGRAPHICAL REGION, NAMELY, THE PORTION OF OUTER KAKHETI THAT INCLUDES THE VILLAGES OF TOKHLIAURI, MANAVI, BURIANI, GIORGITSMINDA, ANTOKI, MARIAMJVARI, DIDI CHALILURI, PATARA CHAILURI, KAKABETI AND VERKHVIANI, AND OTHER LOCATIONS SPECIFIED IN THE STANDARDS, IN GEORGIA.

FOR WINE.

FIRST USE 0-0-2007; IN COMMERCE 0-0-2007.  
SUSAN HAYASH, EXAMINING ATTORNEY

SN 85-279,958. NATIONAL INTELLECTUAL PROPERTY CENTER OF GEORGIA - SAKPATENTI, 0108 TBILISI, REP OF GEORGIA, FILED 3-29-2011.

SN 85-158,033. WOODLARK CIRCLE, INC., BETHLEHEM, PA. FILED 10-21-2010.

# ATENI

# CSPHP

THE MARK CONSISTS OF STANDARD CHARACTERS WITHOUT CLAIM TO ANY PARTICULAR FONT, STYLE, SIZE, OR COLOR.

THE CERTIFICATION MARK, AS INTENDED TO BE USED BY AUTHORIZED PERSONS, IS INTENDED TO CERTIFY THAT THE GOODS HAVE BEEN PRODUCED IN ACCORDANCE WITH PRODUCTION STANDARDS ESTABLISHED BY THE CERTIFIER AND THAT THE GOODS EMANATE FROM A SPECIFIC GEOGRAPHIC REGION, NAMELY, THE ZONE OF "ATENI" LOCATED IN SHIDA KARTLI IN THE ADMINISTRATIVE DISTRICT OF GORI THAT INCLUDES THE VILLAGES OF PATARA "ATENI", GARDATENI AND DIDI "ATENI", AND OTHER LOCATIONS SPECIFIED IN THE STANDARDS, IN GEORGIA.

FOR WINE.  
SUSAN HAYASH, EXAMINING ATTORNEY

THE MARK CONSISTS OF STANDARD CHARACTERS WITHOUT CLAIM TO ANY PARTICULAR FONT, STYLE, SIZE, OR COLOR.

THE CERTIFICATION MARK, AS INTENDED TO BE USED BY AUTHORIZED PERSONS, IS INTENDED TO CERTIFY THAT THE CERTIFIED HEALTH CARE PROVIDER OR PROFESSIONAL MEETS SPECIFIC CRITERIA, ADHERES TO SPECIFIC STANDARDS AND QUALIFIES THROUGH COURSE WORK OR EXAMINATION TO SAFELY HANDLE AND TRANSPORT PATIENTS.

FOR PRACTICE OF SAFE PATIENT HANDLING, TRANSPORT AND MOVEMENT TECHNIQUES.  
CARYN GLASSER, EXAMINING ATTORNEY

SN 85-283,406. NATIONAL INTELLECTUAL PROPERTY CENTER OF GEORGIA - SAKPATENTI, 0108 TBILISI, REP OF GEORGIA, FILED 4-1-2011.

SN 85-185,418. GLOBAL PUBLIC HEALTH SERVICES, LLC, ORLANDO, FL. FILED 11-26-2010.

# KAKHURI

# Certified Public Health Supervisor - CPHS

THE MARK CONSISTS OF STANDARD CHARACTERS WITHOUT CLAIM TO ANY PARTICULAR FONT, STYLE, SIZE, OR COLOR.

THE ENGLISH TRANSLATION OF THE WORD "KAKHURI" IN THE MARK IS "FROM KAKHETI".

THE CERTIFICATION MARK, AS USED BY AUTHORIZED PERSONS, CERTIFIES THAT THE GOODS HAVE BEEN PRODUCED IN ACCORDANCE WITH PRODUCTION STANDARDS ESTABLISHED BY CERTIFIER AND THAT THE GOODS EMANATE FROM A SPECIFIC GEOGRAPHICAL REGION, NAMELY, THAT PORTION OF "KAKHETI" LOCATED IN THE SOUTHEASTERN PART OF GEORGIA IN THE BASIN OF THE RIVERS ALAZANI AND IORI, AND OTHER LOCATIONS SPECIFIED IN THE STANDARDS, IN GEORGIA.

FOR WINE.  
FIRST USE 0-0-2009; IN COMMERCE 0-0-2009.  
CHRISTINA SOBRAL, EXAMINING ATTORNEY

THE MARK CONSISTS OF STANDARD CHARACTERS WITHOUT CLAIM TO ANY PARTICULAR FONT, STYLE, SIZE, OR COLOR.

NO CLAIM IS MADE TO THE EXCLUSIVE RIGHT TO USE "CERTIFIED PUBLIC HEALTH SUPERVISOR", APART FROM THE MARK AS SHOWN.

THE CERTIFICATION MARK, AS USED BY AUTHORIZED PERSONS, CERTIFIES SPECIAL TRAINING TO ASSESS CONFORMITY WITH FEDERAL PUBLIC HEALTH PRINCIPLES, PRACTICES, PROCEDURES AND STANDARDS FOR PROTECTING THE TRAVELING PUBLIC IN THE FIELDS OF HYGIENE, MICROBIOLOGY, INFECTION CONTROL, HOUSEKEEPING AND FOOD AND WATER SAFETY.

FOR PROMOTION, TRAINING, IMPLEMENTATION AND ENFORCEMENT OF PROPER STANDARDS OF SANITATION AND HYGIENE IN PUBLIC AREAS TO PREVENT AND CONTROL THE INTRODUCTION, TRANSMISSION AND SPREAD OF INFECTIOUS AND CHRONIC ILLNESSES AND DISEASES.

HAI-LY LAM, EXAMINING ATTORNEY

CLASS B—SERVICES

SN 85-185,426. GLOBAL PUBLIC HEALTH SERVICES, LLC, ORLANDO, FL. FILED 11-26-2010.

### Certified Public Health Manager - CPHM

THE MARK CONSISTS OF STANDARD CHARACTERS WITHOUT CLAIM TO ANY PARTICULAR FONT, STYLE, SIZE, OR COLOR.

NO CLAIM IS MADE TO THE EXCLUSIVE RIGHT TO USE "CERTIFIED PUBLIC HEALTH MANAGER", APART FROM THE MARK AS SHOWN.

THE CERTIFICATION MARK, AS USED BY AUTHORIZED PERSONS, CERTIFIES SPECIAL TRAINING TO ASSESS CONFORMITY WITH FEDERAL PUBLIC HEALTH PRINCIPLES, PRACTICES, PROCEDURES AND STANDARDS FOR PROTECTING THE TRAVELING PUBLIC IN THE FIELDS OF HYGIENE, MICROBIOLOGY, INFECTION CONTROL, HOUSEKEEPING AND FOOD AND WATER SAFETY.

FOR PROMOTION, TRAINING, IMPLEMENTATION AND ENFORCEMENT OF PROPER STANDARDS OF SANITATION AND HYGIENE IN PUBLIC AREAS TO PREVENT AND CONTROL THE INTRODUCTION, TRANSMISSION AND SPREAD OF INFECTIOUS AND CHRONIC ILLNESSES AND DISEASES.

HAI-LY LAM, EXAMINING ATTORNEY

NO CLAIM IS MADE TO THE EXCLUSIVE RIGHT TO USE "QUALITY ASSURED" AND "HVAC", APART FROM THE MARK AS SHOWN.

THE MARK CONSISTS OF THE LETTERS "QA" OVER THE WORD "HVAC" THAT APPEARS IN A RECTANGULAR BOX, WITH THE WORDS "ACCA QUALITY ASSURED" FORMING THE LEFT HALF OF THE "Q".

THE CERTIFICATION MARK, AS INTENDED TO BE USED BY AUTHORIZED PERSONS, IS INTENDED TO CERTIFY THAT THE PERSONS DISPLAYING THE MARK HAVE DEMONSTRATED, THROUGH THE SUCCESSFUL COMPLETION OF AN EXAM AND SELF-ASSESSMENT PROCEDURES, THAT THEY SATISFY THE CERTIFIER'S REQUIREMENTS FOR KNOWLEDGE RELATIVE TO THE INSTALLATION, MAINTENANCE AND REPAIR OF HVAC SYSTEMS.

FOR HEATING VENTILATION AND AIR CONDITIONING (HVAC) CONTRACTING SERVICES, NAMELY, INSTALLATION, MAINTENANCE AND REPAIR OF HVAC SYSTEMS.

KYLE PEETE, EXAMINING ATTORNEY

SN 85-338,334. NATIONAL ASSOCIATION OF SOCIAL WORKERS, WASHINGTON, DC. FILED 6-5-2011.

SN 85-255,368. AIR CONDITIONING CONTRACTORS OF AMERICA, ARLINGTON, VA. FILED 3-2-2011.



OWNER OF U.S. REG. NOS. 1,222,147, 2,642,630 AND 2,931,446.

### DCSW

THE MARK CONSISTS OF STANDARD CHARACTERS WITHOUT CLAIM TO ANY PARTICULAR FONT, STYLE, SIZE, OR COLOR.

THE CERTIFICATION MARK, AS USED BY AUTHORIZED PERSONS, CERTIFIES THAT THE INDIVIDUALS PROVIDING THE SERVICES MEET THE MINIMUM LEVELS OF EDUCATION, TRAINING AND QUALIFICATIONS UNDER THE REQUIREMENTS AND STANDARDS ESTABLISHED BY THE NATIONAL ASSOCIATION OF SOCIAL WORKERS.

FOR BEHAVIORAL HEALTH CARE SERVICES.

FIRST USE 12-0-1986; IN COMMERCE 12-0-1986.

TINA BROWN, EXAMINING ATTORNEY



# TRADEMARK REGISTRATIONS ISSUED

## PRINCIPAL REGISTER

### SECTION 1.— INTERNATIONAL CLASSIFICATION

The short titles associated below with the international class numbers are terms designed merely for quick identification and are not an official part of the international classification. The full names of international classes are given in section 6.1 of the trademark rules of practice.

The designation "U.S. Cl." appearing in this section refers to the U.S. class in effect prior to Sep. 1, 1973 rather than the international class which applies to applications filed on or after that date. For adoption of international classification see notice in the OFFICIAL GAZETTE of Jun. 26, 1973 (911 O.G. TM 210).

#### CLASS 1—CHEMICALS

- 4,043,649. **MISCELLANEOUS DESIGN. SYSMEX CORPORATION**, MULTIPLE CLASS, (INT. CLS. 1, 3, 5, 9, 10, 37, 39, 42 AND 44), (U.S. CLS. 1, 4, 5, 6, 10, 18, 21, 23, 26, 36, 38, 39, 44, 46, 50, 51, 52, 100, 101, 103, 105 AND 106). SN 77-591,288. PUB. 8-9-2011. FILED 10-13-2008.
- 4,043,656. **WE BELIEVE THE POSSIBILITIES (STANDARD CHARACTER). SYSMEX CORPORATION**, MULTIPLE CLASS, (INT. CLS. 1, 3, 5, 9 AND 10), (U.S. CLS. 1, 4, 5, 6, 10, 18, 21, 23, 26, 36, 38, 39, 44, 46, 50, 51 AND 52). SN 77-623,859. PUB. 8-9-2011. FILED 12-1-2008.
- 4,043,658. **U.S. WATER SERVICES AND DESIGN. U.S. WATER SERVICES, INC.**, MULTIPLE CLASS, (INT. CLS. 1, 40 AND 42), (U.S. CLS. 1, 5, 6, 10, 26, 46, 100, 101, 103 AND 106). SN 77-629,464. PUB. 8-9-2011. FILED 12-9-2008.
- 4,043,665. **SCAN'DRY (STANDARD CHARACTER). DENTA-CO DENTALINDUSTRIE UND - MARKETING GMBH**, MULTIPLE CLASS, (INT. CLS. 1 AND 5), (U.S. CLS. 1, 5, 6, 10, 18, 26, 44, 46, 51 AND 52). SN 77-689,152. PUB. 5-3-2011. FILED 3-12-2009.
- 4,043,666. **HOBBYIST LEVEL (STANDARD CHARACTER). ADVANCED NUTRIENTS LTD.**, (U.S. CLS. 1, 5, 6, 10, 26 AND 46). SN 77-715,173. PUB. 7-12-2011. FILED 4-16-2009.
- 4,043,667. **GRAND MASTER GROWER LEVEL (STANDARD CHARACTER). ADVANCED NUTRIENTS LTD.**, (U.S. CLS. 1, 5, 6, 10, 26 AND 46). SN 77-715,199. PUB. 7-19-2011. FILED 4-16-2009.
- 4,043,672. **AMP (STANDARD CHARACTER). AGRIUO ADVANCED TECHNOLOGIES (U.S.) INC.**, (U.S. CLS. 1, 5, 6, 10, 26 AND 46). SN 77-730,050. PUB. 8-9-2011. FILED 5-6-2009.
- 4,043,713. **IGE IMMUNOCAP IS IT ALLERGY? AND DESIGN. PHADIA AB**, MULTIPLE CLASS, (INT. CLS. 1, 5, 9 AND 10), (U.S. CLS. 1, 5, 6, 10, 18, 21, 23, 26, 36, 38, 39, 44, 46, 51 AND 52). SN 77-916,576. PUB. 1-11-2011. FILED 1-21-2010.
- 4,043,722. **DAYTON SUPERIOR (STANDARD CHARACTER). DAYTON SUPERIOR CORPORATION**, MULTIPLE CLASS, (INT. CLS. 1, 2, 3, 6, 7, 8, 9, 17, 19 AND 42), (U.S. CLS. 1, 2, 4, 5, 6, 10, 11, 12, 13, 14, 16, 19, 21, 23, 25, 26, 28, 31, 33, 34, 35, 36, 38, 44, 46, 50, 51, 52, 100 AND 101). SN 77-944,787. PUB. 8-9-2011. FILED 2-25-2010.
- 4,043,744. **VINNACOAT (STANDARD CHARACTER). WACKER CHEMIE AG**, MULTIPLE CLASS, (INT. CLS. 1, 2 AND 17), (U.S. CLS. 1, 5, 6, 10, 11, 12, 13, 16, 26, 35, 46 AND 50). SN 79-073,676. PUB. 8-9-2011. FILED 6-17-2009.
- 4,043,766. **FOMA (STYLIZED). FOMA BOHEMIA, SPOL. S R.O.**, (U.S. CLS. 1, 5, 6, 10, 26 AND 46). SN 79-087,449. PUB. 8-9-2011. FILED 8-3-2010.
- 4,043,826. **ILSA (STANDARD CHARACTER). ILSA S.P.A.**, (U.S. CLS. 1, 5, 6, 10, 26 AND 46). SN 79-091,093. PUB. 8-9-2011. FILED 7-6-2010.
- 4,043,861. **CRESTAPOL (STYLIZED). SCOTT BADER COMPANY LIMITED**, (U.S. CLS. 1, 5, 6, 10, 26 AND 46). SN 79-096,687. PUB. 8-9-2011. FILED 4-5-2011.
- 4,043,932. **CELL BOOST (STANDARD CHARACTER). HYCLONE LABORATORIES, INC.**, (U.S. CLS. 1, 5, 6, 10, 26 AND 46). SN 85-090,711. PUB. 8-9-2011. FILED 7-22-2010.
- 4,044,025. **ZYALD (STANDARD CHARACTER). L'AIR LIQUIDE, SOCIÉTÉ ANONYME POUR L'ETUDE ET L'EXPLOITATION DES PROCÉDÉS GEORGES CLAUDE**, (U.S. CLS. 1, 5, 6, 10, 26 AND 46). SN 85-127,104. PUB. 8-9-2011. FILED 9-10-2010.
- 4,044,212. **LIGHTNING LINK (STANDARD CHARACTER). INNOVA BIOSCIENCES LIMITED**, MULTIPLE CLASS, (INT. CLS. 1 AND 5), (U.S. CLS. 1, 5, 6, 10, 18, 26, 44, 46, 51 AND 52). SN 85-217,292. PUB. 8-9-2011. FILED 1-13-2011.
- 4,044,570. **XINFU AND DESIGN. ZHEJIANG HANGZHOU XINFU PHARMACEUTICAL CO. LTD.**, (U.S. CLS. 1, 5, 6, 10, 26 AND 46). SN 85-265,740. PUB. 8-9-2011. FILED 3-14-2011.
- 4,044,669. **ROCKON (STANDARD CHARACTER). MULTICHEM GROUP, LLC**, (U.S. CLS. 1, 5, 6, 10, 26 AND 46). SN 85-273,999. PUB. 8-9-2011. FILED 3-22-2011.
- 4,044,695. **UREOCAL (STANDARD CHARACTER). PLANT FOOD SYSTEMS, INC.**, (U.S. CLS. 1, 5, 6, 10, 26 AND 46). SN 85-274,414. PUB. 8-9-2011. FILED 3-23-2011.
- 4,044,721. **GETTERMAX (STANDARD CHARACTER). RESEARCH CATALYSTS, INC.**, (U.S. CLS. 1, 5, 6, 10, 26 AND 46). SN 85-274,846. PUB. 8-9-2011. FILED 3-23-2011.
- 4,044,793. **IN COLOR AND DESIGN. TAGAWA GREENHOUSES, INC.**, (U.S. CLS. 1, 5, 6, 10, 26 AND 46). SN 85-275,896. PUB. 8-9-2011. FILED 3-24-2011.
- 4,044,840. **THE TUNE-UP FOR THE 21ST CENTURY (STANDARD CHARACTER). UVIEW ULTRAVIOLET SYSTEMS INC.**, (U.S. CLS. 1, 5, 6, 10, 26 AND 46). SN 85-276,569. PUB. 8-9-2011. FILED 3-25-2011.
- 4,044,856. **SEAL-ONCE (STANDARD CHARACTER). NEW IMAGE COATINGS, LLC**, (U.S. CLS. 1, 5, 6, 10, 26 AND 46). SN 85-276,815. PUB. 8-9-2011. FILED 3-25-2011.
- 4,044,896. **U-V-KILLER (STANDARD CHARACTER). ATSKO, INC.**, (U.S. CLS. 1, 5, 6, 10, 26 AND 46). SN 85-277,335. PUB. 8-9-2011. FILED 3-25-2011.
- 4,044,911. **INBOUNDS (STANDARD CHARACTER). AG SPECTRUM COMPANY**, (U.S. CLS. 1, 5, 6, 10, 26 AND 46). SN 85-277,477. PUB. 8-9-2011. FILED 3-25-2011.
- 4,045,013. **NEOMIX (STANDARD CHARACTER). CHENG CONCRETE LLC**, (U.S. CLS. 1, 5, 6, 10, 26 AND 46). SN 85-278,935. PUB. 8-9-2011. FILED 3-28-2011.
- 4,045,017. **D-FRC (STANDARD CHARACTER). CHENG CONCRETE LLC**, (U.S. CLS. 1, 5, 6, 10, 26 AND 46). SN 85-278,953. PUB. 8-9-2011. FILED 3-28-2011.
- 4,045,058. **WEDGE-SET (STANDARD CHARACTER). SHARP-ROCK TECHNOLOGIES, INC.**, (U.S. CLS. 1, 5, 6, 10, 26 AND 46). SN 85-279,445. PUB. 8-9-2011. FILED 3-29-2011.
- 4,045,249. **MAXSOL (STANDARD CHARACTER). RESOLUTE OIL, LLC**, (U.S. CLS. 1, 5, 6, 10, 26 AND 46). SN 85-282,017. PUB. 8-9-2011. FILED 3-31-2011.
- 4,045,250. **MAXSOLV (STANDARD CHARACTER). RESOLUTE OIL, LLC**, (U.S. CLS. 1, 5, 6, 10, 26 AND 46). SN 85-282,024. PUB. 8-9-2011. FILED 3-31-2011.
- 4,045,252. **MAXTRACT (STANDARD CHARACTER). RESOLUTE OIL, LLC**, (U.S. CLS. 1, 5, 6, 10, 26 AND 46). SN 85-282,032. PUB. 8-9-2011. FILED 3-31-2011.
- 4,045,337. **ELASTECHS (STANDARD CHARACTER). AMERICAN TEXTILE, LLC.**, (U.S. CLS. 1, 5, 6, 10, 26 AND 46). SN 85-283,055. PUB. 8-9-2011. FILED 3-31-2011.
- 4,045,366. **DURASTAT (STANDARD CHARACTER). POLYMER PRODUCTS COMPANY, INC.**, (U.S. CLS. 1, 5, 6, 10,

26 AND 46). SN 85-283,394. PUB. 8-9-2011. FILED 4-1-2011.  
 4,045,367. **AVANTRA (STANDARD CHARACTER)**. POLYMER PRODUCTS COMPANY, INC., (U.S. CLS. 1, 5, 6, 10, 26 AND 46). SN 85-283,414. PUB. 8-9-2011. FILED 4-1-2011.  
 4,045,556. **TOTELVYSION (STANDARD CHARACTER)**. ABBOTT LABORATORIES, (U.S. CLS. 1, 5, 6, 10, 26 AND 46). SN 85-309,513. PUB. 8-9-2011. FILED 5-2-2011.  
 4,045,558. **TELVYSION (STANDARD CHARACTER)**. ABBOTT LABORATORIES, (U.S. CLS. 1, 5, 6, 10, 26 AND 46). SN 85-309,781. PUB. 8-9-2011. FILED 5-2-2011.

## CLASS 2—PAINTS

4,043,722 ( *See Class 1 for this trademark*).  
 4,043,744 ( *See Class 1 for this trademark*).  
 4,044,086. **DEC A CAKE (STANDARD CHARACTER)**. ACH FOOD COMPANIES, INC., MULTIPLE CLASS, (INT. CLS. 2, 4, 21 AND 30), (U.S. CLS. 1, 2, 6, 11, 13, 15, 16, 23, 29, 30, 33, 40, 46 AND 50). SN 85-155,248. PUB. 8-9-2011. FILED 10-18-2010.  
 4,044,130. **SC JOHNSON PROFESSIONAL AND DESIGN**. S. C. JOHNSON & SON, INC., MULTIPLE CLASS, (INT. CLS. 2 AND 3), (U.S. CLS. 1, 4, 6, 11, 16, 50, 51 AND 52). SN 85-180,225. PUB. 8-9-2011. FILED 11-18-2010.  
 4,044,397. **COATMASTERS (STANDARD CHARACTER)**. IMRAE CORPORATION, DBA IMRAE CORPORATION, (U.S. CLS. 6, 11 AND 16). SN 85-258,777. PUB. 8-9-2011. FILED 3-5-2011.  
 4,044,715. **ZIRCOLOR (STANDARD CHARACTER)**. TANAKA DENTAL PRODUCTS, (U.S. CLS. 6, 11 AND 16). SN 85-274,729. PUB. 8-9-2011. FILED 3-23-2011.  
 4,044,717. **ZIRCHROME (STANDARD CHARACTER)**. TANAKA DENTAL PRODUCTS, (U.S. CLS. 6, 11 AND 16). SN 85-274,736. PUB. 8-9-2011. FILED 3-23-2011.  
 4,044,759. **MISCELLANEOUS DESIGN**. IMPRINTOR, INC., MULTIPLE CLASS, (INT. CLS. 2 AND 7), (U.S. CLS. 6, 11, 13, 16, 19, 21, 23, 31, 34 AND 35). SN 85-275,493. PUB. 8-9-2011. FILED 3-24-2011.  
 4,045,245. **ALL IN ONE (STANDARD CHARACTER)**. MARTIN, SCOTT, (U.S. CLS. 6, 11 AND 16). SN 85-282,003. PUB. 8-9-2011. FILED 3-31-2011.

## CLASS 3—COSMETICS AND CLEANING PREPARATIONS

4,043,625. **ABSOLUTELY FABULOUS (STANDARD CHARACTER)**. LAYCOCK, SUSAN S., (U.S. CLS. 1, 4, 6, 50, 51 AND 52). SN 76-706,698. PUB. 8-9-2011. FILED 3-8-2011.  
 4,043,649 ( *See Class 1 for this trademark*).  
 4,043,656 ( *See Class 1 for this trademark*).  
 4,043,657. **SSIS AND DESIGN**. UNITED COLORS INTERNATIONAL LIMITED, MULTIPLE CLASS, (INT. CLS. 3, 18, 25 AND 35), (U.S. CLS. 1, 2, 3, 4, 6, 22, 39, 41, 50, 51, 52, 100, 101 AND 102). SN 77-627,245. PUB. 8-9-2011. FILED 12-5-2008.  
 4,043,659. **MISCELLANEOUS DESIGN**. COTY US LLC, (U.S. CLS. 1, 4, 6, 50, 51 AND 52). SN 77-633,492. PUB. 8-9-2011. FILED 12-15-2008.  
 4,043,661. **WHOO ASH AND DESIGN**. SHEREE ELIZABETH LLC, (U.S. CLS. 1, 4, 6, 50, 51 AND 52). SN 77-662,756. PUB. 12-15-2009. FILED 2-3-2009.  
 4,043,688. **OPAL (STANDARD CHARACTER)**. PACIFIC BIOSCIENCE LABORATORIES, INC., (U.S. CLS. 1, 4, 6, 50, 51 AND 52). SN 77-825,671. PUB. 3-8-2011. FILED 9-14-2009.  
 4,043,689. **LES TROPÉZIENNES PAR M. BELARBI (STANDARD CHARACTER)**. BELARBI, MOHAMED, MULTIPLE CLASS, (INT. CLS. 3, 16, 24, 28, 32, 35, 38 AND 39), (U.S. CLS. 1, 2, 4, 5, 6, 22, 23, 29, 37, 38, 42, 45, 46, 48, 50, 51, 52, 100, 101, 102, 104 AND 105). SN 77-835,533. PUB. 5-17-2011. FILED 9-25-2009.  
 4,043,721. **THE YUM YUM SHOPPE (STANDARD CHARACTER)**. TALITHA ROSE LLC, DBA THE YUM-YUM SHOPPE, (U.S. CLS. 1, 4, 6, 50, 51 AND 52). SN 77-943,350.

PUB. 8-9-2011. FILED 2-24-2010.  
 4,043,722 ( *See Class 1 for this trademark*).  
 4,043,746. **GODBLISS (STANDARD CHARACTER)**. KARL-GEORG GLEHN, MULTIPLE CLASS, (INT. CLS. 3, 29, 30 AND 31), (U.S. CLS. 1, 4, 6, 46, 50, 51 AND 52). SN 79-076,833. PUB. 10-26-2010. FILED 11-5-2009.  
 4,043,748. **SAVI (STANDARD CHARACTER)**. QVSIP PTY LTD, MULTIPLE CLASS, (INT. CLS. 3, 8, 21 AND 26), (U.S. CLS. 1, 2, 4, 6, 13, 23, 28, 29, 30, 33, 37, 39, 40, 42, 44, 50, 51 AND 52). SN 79-078,783. PUB. 8-9-2011. FILED 1-8-2010.  
 4,043,753. **OLIVELIA MACROVITA AND DESIGN**. MACROVITA - A. & E. VASILAKAKI O.E., (U.S. CLS. 1, 4, 6, 50, 51 AND 52). SN 79-083,305. PUB. 8-9-2011. FILED 3-18-2010.  
 4,043,760. **RUFUS & COCO (STANDARD CHARACTER)**. RUFUS & COCO PTY LTD, MULTIPLE CLASS, (INT. CLS. 3 AND 5), (U.S. CLS. 1, 4, 6, 18, 44, 46, 50, 51 AND 52). SN 79-085,265. PUB. 5-3-2011. FILED 6-24-2010.  
 4,043,776. **RASAVEDA (STANDARD CHARACTER)**. DR. JUERGEN O. KIRCHNER, (U.S. CLS. 1, 4, 6, 50, 51 AND 52). SN 79-088,293. PUB. 8-9-2011. FILED 8-11-2010.  
 4,043,785. **TYCOONAIRE (STANDARD CHARACTER)**. TYCOONAIRE HOLDING SA, MULTIPLE CLASS, (INT. CLS. 3, 9, 12, 16, 24, 25, 28, 32, 34, 35, 36, 38, 41, 43 AND 45), (U.S. CLS. 1, 2, 4, 5, 6, 8, 9, 17, 19, 21, 22, 23, 26, 29, 31, 35, 36, 37, 38, 39, 42, 44, 45, 46, 48, 50, 51, 52, 100, 101, 102, 104 AND 107). SN 79-088,821. PUB. 8-9-2011. FILED 6-2-2010.  
 4,043,792. **SISCON (STYLIZED)**. LABORATOIRE CCD, MULTIPLE CLASS, (INT. CLS. 3, 5 AND 10), (U.S. CLS. 1, 4, 6, 18, 26, 39, 44, 46, 50, 51 AND 52). SN 79-089,099. PUB. 8-9-2011. FILED 7-13-2010.  
 4,043,831. **ACGLICOLIC (STYLIZED)**. SESDERMA, S.L., MULTIPLE CLASS, (INT. CLS. 3 AND 5), (U.S. CLS. 1, 4, 6, 18, 44, 46, 50, 51 AND 52). SN 79-091,505. PUB. 8-9-2011. FILED 8-4-2010.  
 4,043,855. **GALITZINE (STYLIZED)**. XINES S.R.L., MULTIPLE CLASS, (INT. CLS. 3, 9 AND 18), (U.S. CLS. 1, 2, 3, 4, 6, 21, 22, 23, 26, 36, 38, 41, 50, 51 AND 52). SN 79-096,233. PUB. 8-9-2011. FILED 1-25-2011.  
 4,043,860. **B (STYLIZED)**. HUGO BOSS TRADE MARK MANAGEMENT GMBH & CO. KG, MULTIPLE CLASS, (INT. CLS. 3, 9, 14, 18, 25 AND 35), (U.S. CLS. 1, 2, 3, 4, 6, 21, 22, 23, 26, 27, 28, 36, 38, 39, 41, 50, 51, 52, 100, 101 AND 102). SN 79-096,563. PUB. 8-9-2011. FILED 12-16-2010.  
 4,043,863. **SIBERRY (STANDARD CHARACTER)**. OBSHESTVO S OGRANICHENNOY OTVETSTVENNOSTYU "SPLAT-COSMETICA", (U.S. CLS. 1, 4, 6, 50, 51 AND 52). SN 79-097,021. PUB. 8-9-2011. FILED 3-24-2011.  
 4,043,867. **SPLAT DREAM (STANDARD CHARACTER)**. OBSHESTVO S OGRANICHENNOY OTVETSTVENNOSTYU "SPLAT-COSMETICA", (U.S. CLS. 1, 4, 6, 50, 51 AND 52). SN 79-097,482. PUB. 8-9-2011. FILED 3-24-2011.  
 4,043,870. **ESSENCE PURE SKIN (STANDARD CHARACTER)**. BORA CREATIONS S.L., MULTIPLE CLASS, (INT. CLS. 3, 5 AND 21), (U.S. CLS. 1, 2, 4, 6, 13, 18, 23, 29, 30, 33, 40, 44, 46, 50, 51 AND 52). SN 85-002,660. PUB. 3-1-2011. FILED 3-31-2010.  
 4,043,876. **GEL3OZONE AND DESIGN**. CRISTOBAL ORDONEZ, AND DIEGO ORDONEZ, MULTIPLE CLASS, (INT. CLS. 3 AND 5), (U.S. CLS. 1, 4, 6, 18, 44, 46, 50, 51 AND 52). SN 85-008,217. PUB. 8-9-2011. FILED 4-7-2010.  
 4,043,888. **MISCELLANEOUS DESIGN**. DEXCEL LTD., MULTIPLE CLASS, (INT. CLS. 3 AND 5), (U.S. CLS. 1, 4, 6, 18, 44, 46, 50, 51 AND 52). SN 85-034,179. PUB. 8-9-2011. FILED 5-10-2010.  
 4,043,889. **BMCARE AND DESIGN**. BIOSTIME, INC. (GUANGZHOU), (U.S. CLS. 1, 4, 6, 50, 51 AND 52). SN 85-039,490. PUB. 3-1-2011. FILED 5-15-2010.  
 4,043,902. **STOKO REFRESH (STANDARD CHARACTER)**. EVONIK STOCKHAUSEN GMBH, (U.S. CLS. 1, 4, 6, 50, 51 AND 52). SN 85-055,874. PUB. 5-24-2011. FILED 6-7-2010.  
 4,043,911. **SPLT MILK (STANDARD CHARACTER)**. KIRK, BRIDGETTE, (U.S. CLS. 1, 4, 6, 50, 51 AND 52). SN 85-058,896. PUB. 5-3-2011. FILED 6-9-2010.  
 4,043,921. **ECLAT MIRACLE (STANDARD CHARACTER)**. LANCOME PARFUMS ET BEAUTE & CIE, (U.S. CLS. 1, 4, 6, 50, 51 AND 52). SN 85-072,644. PUB. 8-9-2011. FILED 6-28-2010.  
 4,043,969. **STONEWALL KITCHEN (STANDARD CHARAC-**

- TER). STONEWALL KITCHEN, LLC, MULTIPLE CLASS, (INT. CLS. 3, 21, 24, 29, 30, 32, 35 AND 43), (U.S. CLS. 1, 2, 4, 6, 13, 23, 29, 30, 33, 40, 42, 45, 46, 48, 50, 51, 52, 100, 101 AND 102). SN 85-112,125. PUB. 8-9-2011. FILED 8-20-2010.
- 4,043,972. **MAJEUNESS AND DESIGN**. BERNADEAU, JACQUELINE, (U.S. CLS. 1, 4, 6, 50, 51 AND 52). SN 85-112,885. PUB. 8-9-2011. FILED 8-21-2010.
- 4,044,027. **NYX (STANDARD CHARACTER)**. NYX, LOS ANGELES INC., MULTIPLE CLASS, (INT. CLS. 3, 18, 21, 25 AND 35), (U.S. CLS. 1, 2, 3, 4, 6, 13, 22, 23, 29, 30, 33, 39, 40, 41, 50, 51, 52, 100, 101 AND 102). SN 85-127,145. PUB. 8-9-2011. FILED 9-10-2010.
- 4,044,044. **PS SCHERVEN (STANDARD CHARACTER)**. PS SCHERVEN LLC, (U.S. CLS. 1, 4, 6, 50, 51 AND 52). SN 85-136,835. PUB. 8-9-2011. FILED 9-23-2010.
- 4,044,052. **MAMA'S NO YUCK AND DESIGN**. MAMA'S NO YUCK, (U.S. CLS. 1, 4, 6, 50, 51 AND 52). SN 85-139,979. PUB. 8-9-2011. FILED 9-28-2010.
- 4,044,062. **COHBE (STANDARD CHARACTER)**. ADWIN USA, INC., DBA COHBE, (U.S. CLS. 1, 4, 6, 50, 51 AND 52). SN 85-142,559. PUB. 8-9-2011. FILED 9-30-2010.
- 4,044,072. **EZ-ON EZ-OFF (STANDARD CHARACTER)**. REBELPRO PRODUCTS, LLC, (U.S. CLS. 1, 4, 6, 50, 51 AND 52). SN 85-147,123. PUB. 8-9-2011. FILED 10-7-2010.
- 4,044,073. **SKINDULGE (STANDARD CHARACTER)**. THE TRUSTEES OF THE SHANTI INSURANCE TRUST, AKA SHANTI INSURANCE TRUST U/T/A DTD 3/1/07, (U.S. CLS. 1, 4, 6, 50, 51 AND 52). SN 85-150,173. PUB. 8-9-2011. FILED 10-12-2010.
- 4,044,106. **RETINOLMAX (STANDARD CHARACTER)**. SKINSCIENCE LABS, INC., (U.S. CLS. 1, 4, 6, 50, 51 AND 52). SN 85-166,971. PUB. 3-8-2011. FILED 11-2-2010.
- 4,044,127. **ANGELO GALASSO (STANDARD CHARACTER)**. AG HOLDING S.A., MULTIPLE CLASS, (INT. CLS. 3, 14, 18, 25 AND 35), (U.S. CLS. 1, 2, 3, 4, 6, 22, 27, 28, 39, 41, 50, 51, 52, 100, 101 AND 102). SN 85-179,442. PUB. 8-9-2011. FILED 11-17-2010.
- 4,044,130 ( *See Class 2 for this trademark*).
- 4,044,246. **SNUGGLE BEAR AND DESIGN**. THE SUN PRODUCTS CORPORATION, (U.S. CLS. 1, 4, 6, 50, 51 AND 52). SN 85-228,207. PUB. 8-9-2011. FILED 1-27-2011.
- 4,044,272. **HEIR ATELIER ULTIMATE MAKE UP PREP AND DESIGN**. HEIR ATELLIER, (U.S. CLS. 1, 4, 6, 50, 51 AND 52). SN 85-232,741. PUB. 8-9-2011. FILED 2-2-2011.
- 4,044,301. **LUMINESCENCE (STANDARD CHARACTER)**. CASTER, (U.S. CLS. 1, 4, 6, 50, 51 AND 52). SN 85-241,289. PUB. 7-12-2011. FILED 2-14-2011.
- 4,044,310. **H AND DESIGN**. HEIR ATELLIER, (U.S. CLS. 1, 4, 6, 50, 51 AND 52). SN 85-245,068. PUB. 8-9-2011. FILED 2-17-2011.
- 4,044,315. **ROSEMIRA ORGANICS (STANDARD CHARACTER)**. HERMAN, MIRA, DBA ROSEMIRA ORGANICS, MULTIPLE CLASS, (INT. CLS. 3 AND 5), (U.S. CLS. 1, 4, 6, 18, 44, 46, 50, 51 AND 52). SN 85-246,806. PUB. 8-9-2011. FILED 2-18-2011.
- 4,044,423. **ZERO AND DESIGN**. HAIR COLOR RESEARCH GROUP, INC., (U.S. CLS. 1, 4, 6, 50, 51 AND 52). SN 85-260,057. PUB. 8-9-2011. FILED 3-7-2011.
- 4,044,490. **THE TRUTH WILL SET YOU FREE (STANDARD CHARACTER)**. LANIAK, MAUREEN L., (U.S. CLS. 1, 4, 6, 50, 51 AND 52). SN 85-262,954. PUB. 8-9-2011. FILED 3-10-2011.
- 4,044,500. **JAASBEAUTY (STANDARD CHARACTER)**. JAAS BEAUTY PRODUCTS, (U.S. CLS. 1, 4, 6, 50, 51 AND 52). SN 85-263,252. PUB. 8-9-2011. FILED 3-10-2011.
- 4,044,509. **UNIQUE EXCELLENCE (STANDARD CHARACTER)**. SL MEREDITH, LLC, (U.S. CLS. 1, 4, 6, 50, 51 AND 52). SN 85-263,383. PUB. 8-9-2011. FILED 3-10-2011.
- 4,044,512. **UNIQUE EXCELLENCE AND DESIGN**. SL MEREDITH, LLC, (U.S. CLS. 1, 4, 6, 50, 51 AND 52). SN 85-263,481. PUB. 8-9-2011. FILED 3-10-2011.
- 4,044,519. **NUBAG (STANDARD CHARACTER)**. BEACH MARKETING, INC., DBA BEACH MARKETING, (U.S. CLS. 1, 4, 6, 50, 51 AND 52). SN 85-263,712. PUB. 8-9-2011. FILED 3-10-2011.
- 4,044,526. **SWEETY AND DESIGN**. SHON ANDY KI, (U.S. CLS. 1, 4, 6, 50, 51 AND 52). SN 85-263,992. PUB. 8-9-2011. FILED 3-10-2011.
- 4,044,532. **ELP ESSENTIAL AND DESIGN**. CIURO AESCHMANN, CRISTINA, (U.S. CLS. 1, 4, 6, 50, 51 AND 52). SN 85-264,151. PUB. 8-9-2011. FILED 3-11-2011.
- 4,044,558. **LUSTRASILK (STANDARD CHARACTER)**. ALLEGHANY PHARMACAL, (U.S. CLS. 1, 4, 6, 50, 51 AND 52). SN 85-265,291. PUB. 8-9-2011. FILED 3-11-2011.
- 4,044,658. **CHAPSTUFF (STANDARD CHARACTER)**. MAYRON'S GOODS, INC., (U.S. CLS. 1, 4, 6, 50, 51 AND 52). SN 85-273,873. PUB. 8-9-2011. FILED 3-22-2011.
- 4,044,707. **AQUANIL (STANDARD CHARACTER)**. CROFTGATE USA, LLC, (U.S. CLS. 1, 4, 6, 50, 51 AND 52). SN 85-274,631. PUB. 8-9-2011. FILED 3-23-2011.
- 4,044,772. **COAT ON A GOAT (STANDARD CHARACTER)**. ALPACA PASTURES OF VIRGINIA, INC., (U.S. CLS. 1, 4, 6, 50, 51 AND 52). SN 85-275,657. PUB. 8-9-2011. FILED 3-24-2011.
- 4,044,870. **BRILLIANTE (STANDARD CHARACTER)**. NVEN-TA INCORPORATED, (U.S. CLS. 1, 4, 6, 50, 51 AND 52). SN 85-276,984. PUB. 8-9-2011. FILED 3-25-2011.
- 4,044,888. **HYPAN AND DESIGN**. SHENG-TAI TECHNOLOGY CO., LTD., (U.S. CLS. 1, 4, 6, 50, 51 AND 52). SN 85-277,220. PUB. 8-9-2011. FILED 3-25-2011.
- 4,044,891. **HYPANIQUE AND DESIGN**. SHENG-TAI TECHNOLOGY CO., LTD., (U.S. CLS. 1, 4, 6, 50, 51 AND 52). SN 85-277,257. PUB. 8-9-2011. FILED 3-25-2011.
- 4,044,892. **JOUANY AND DESIGN**. WORLD SCENTS, LLC, (U.S. CLS. 1, 4, 6, 50, 51 AND 52). SN 85-277,278. PUB. 8-9-2011. FILED 3-25-2011.
- 4,044,910. **RGB (STANDARD CHARACTER)**. RGB COSMETICS, LLC, (U.S. CLS. 1, 4, 6, 50, 51 AND 52). SN 85-277,472. PUB. 8-9-2011. FILED 3-25-2011.
- 4,044,933. **SKILLFUL PAWS AND DESIGN**. SKILLFUL PAWS, MULTIPLE CLASS, (INT. CLS. 3 AND 44), (U.S. CLS. 1, 4, 6, 50, 51, 52, 100 AND 101). SN 85-277,814. PUB. 8-9-2011. FILED 3-26-2011.
- 4,045,116. **TEXTURE BLAST (STANDARD CHARACTER)**. SALLY HERSHBERGER PROFESSIONAL HAIR CARE LLC, (U.S. CLS. 1, 4, 6, 50, 51 AND 52). SN 85-280,274. PUB. 8-9-2011. FILED 3-29-2011.
- 4,045,120. **SUPREME VOLUME (STANDARD CHARACTER)**. SALLY HERSHBERGER PROFESSIONAL HAIR CARE LLC, (U.S. CLS. 1, 4, 6, 50, 51 AND 52). SN 85-280,343. PUB. 8-9-2011. FILED 3-29-2011.
- 4,045,122. **GLAM WAVES (STANDARD CHARACTER)**. SALLY HERSHBERGER PROFESSIONAL HAIR CARE LLC, (U.S. CLS. 1, 4, 6, 50, 51 AND 52). SN 85-280,376. PUB. 8-9-2011. FILED 3-29-2011.
- 4,045,134. **JEAN WATSON (STANDARD CHARACTER)**. JEAN WATSON, LLC, (U.S. CLS. 1, 4, 6, 50, 51 AND 52). SN 85-280,477. PUB. 8-9-2011. FILED 3-29-2011.
- 4,045,197. **THE SMART WAY TO CLEAN! (STANDARD CHARACTER)**. MIDLAB, INC., (U.S. CLS. 1, 4, 6, 50, 51 AND 52). SN 85-281,315. PUB. 8-9-2011. FILED 3-30-2011.
- 4,045,210. **LIVING IN LAVENDER (STANDARD CHARACTER)**. BELMONT, DAVE, (U.S. CLS. 1, 4, 6, 50, 51 AND 52). SN 85-281,516. PUB. 8-9-2011. FILED 3-30-2011.
- 4,045,225. **NUTRICHOL (STANDARD CHARACTER)**. BEVERLY HILLS HAIR RESTORATION, INC., (U.S. CLS. 1, 4, 6, 50, 51 AND 52). SN 85-281,783. PUB. 8-9-2011. FILED 3-30-2011.
- 4,045,241. **JAMBIANCE (STANDARD CHARACTER)**. PAUL RITCHIE, (U.S. CLS. 1, 4, 6, 50, 51 AND 52). SN 85-281,972. PUB. 8-9-2011. FILED 3-31-2011.
- 4,045,242. **CLEANCAF (STANDARD CHARACTER)**. URNEX BRANDS, INC., (U.S. CLS. 1, 4, 6, 50, 51 AND 52). SN 85-281,975. PUB. 8-9-2011. FILED 3-31-2011.
- 4,045,281. **WUNJAE (STANDARD CHARACTER)**. LOTTMEN, BILLY, (U.S. CLS. 1, 4, 6, 50, 51 AND 52). SN 85-282,378. PUB. 8-9-2011. FILED 3-31-2011.
- 4,045,282. **SECRET KISSES (STANDARD CHARACTER)**. SECRET KISSES, LLC., (U.S. CLS. 1, 4, 6, 50, 51 AND 52). SN 85-282,392. PUB. 8-9-2011. FILED 3-31-2011.
- 4,045,283. **PERFECT FINISH (STANDARD CHARACTER)**. APPLIED SCIENTIFIC INTERNATIONAL, LLC, (U.S. CLS. 1, 4, 6, 50, 51 AND 52). SN 85-282,408. PUB. 8-9-2011. FILED 3-31-2011.
- 4,045,310. **SEA HORSE AND DESIGN**. MATTA INT., INC., MULTIPLE CLASS, (INT. CLS. 3 AND 5), (U.S. CLS. 1, 4, 6,

- 18, 44, 46, 50, 51 AND 52). SN 85-282,736. PUB. 8-9-2011. FILED 3-31-2011.
- 4,045,316. **BLONDSHELL (STANDARD CHARACTER)**. COPOMON ENTERPRISES, LLC, (U.S. CLS. 1, 4, 6, 50, 51 AND 52). SN 85-282,832. PUB. 8-9-2011. FILED 3-31-2011.
- 4,045,412. **25° A (STANDARD CHARACTER)**. CRETAN HERBALCHEM S.A., (U.S. CLS. 1, 4, 6, 50, 51 AND 52). SN 85-283,958. PUB. 8-9-2011. FILED 4-1-2011.
- 4,045,419. **TRUE PROMISE BEAUTY ONE (STANDARD CHARACTER)**. TRUE PROMISE BEAUTY, INC., (U.S. CLS. 1, 4, 6, 50, 51 AND 52). SN 85-284,023. PUB. 8-9-2011. FILED 4-1-2011.
- 4,045,451. **EK (STYLIZED)**. EVA KENNOCHA LLC, (U.S. CLS. 1, 4, 6, 50, 51 AND 52). SN 85-284,410. PUB. 8-9-2011. FILED 4-1-2011.
- 4,045,512. **DOUBLE DOSE (STANDARD CHARACTER)**. SENSPA, LLC, (U.S. CLS. 1, 4, 6, 50, 51 AND 52). SN 85-288,174. PUB. 8-9-2011. FILED 4-6-2011.
- 4,045,520. **MERRY MAIDS (STANDARD CHARACTER)**. SERVICEMASTER BRANDS L.L.C., (U.S. CLS. 1, 4, 6, 50, 51 AND 52). SN 85-290,174. PUB. 8-9-2011. FILED 4-8-2011.
- 4,045,525. **A CURLY REVOLUTION (STANDARD CHARACTER)**. MIXED CHICKS LLC, MULTIPLE CLASS, (INT. CLS. 3 AND 21), (U.S. CLS. 1, 2, 4, 6, 13, 23, 29, 30, 33, 40, 50, 51 AND 52). SN 85-292,330. PUB. 8-9-2011. FILED 4-11-2011.
- 4,045,532. **BEING GUTSY (STANDARD CHARACTER)**. CONAIR CORPORATION, (U.S. CLS. 1, 4, 6, 50, 51 AND 52). SN 85-296,047. PUB. 8-9-2011. FILED 4-15-2011.

---

#### CLASS 4—LUBRICANTS AND FUELS

- 4,043,812. **COT CLEAN OIL TECHNOLOGY AND DESIGN**. COT-CLEAN OIL TECHNOLOGY AB, MULTIPLE CLASS, (INT. CLS. 4, 7, 11, 40 AND 42), (U.S. CLS. 1, 6, 13, 15, 19, 21, 23, 31, 34, 35, 100, 101, 103 AND 106). SN 79-090,205. PUB. 8-9-2011. FILED 8-3-2010.
- 4,044,086 ( *See Class 2 for this trademark*).
- 4,045,109. **STRIPES (STANDARD CHARACTER)**. STRIPES LLC, (U.S. CLS. 1, 6 AND 15). SN 85-280,233. PUB. 8-9-2011. FILED 3-29-2011.
- 4,045,246. **MAXNAP (STANDARD CHARACTER)**. RESOLUTE OIL, LLC, (U.S. CLS. 1, 6 AND 15). SN 85-282,007. PUB. 8-9-2011. FILED 3-31-2011.
- 4,045,248. **MAXPAR (STANDARD CHARACTER)**. RESOLUTE OIL, LLC, (U.S. CLS. 1, 6 AND 15). SN 85-282,010. PUB. 8-9-2011. FILED 3-31-2011.
- 4,045,251. **MAXSYN (STANDARD CHARACTER)**. RESOLUTE OIL, LLC, (U.S. CLS. 1, 6 AND 15). SN 85-282,028. PUB. 8-9-2011. FILED 3-31-2011.
- 4,045,320. **POWER-D (STYLIZED)**. CONOCOPHILLIPS COMPANY, (U.S. CLS. 1, 6 AND 15). SN 85-282,900. PUB. 8-9-2011. FILED 3-31-2011.
- 4,045,438. **THE MOODY HOUSEWIFE (STANDARD CHARACTER)**. DELP, THOMAS R, DBA THE MOODY HOUSEWIFE, (U.S. CLS. 1, 6 AND 15). SN 85-284,265. PUB. 8-9-2011. FILED 4-1-2011.
- 4,045,541. **ARTISANAL BEAUTY (STANDARD CHARACTER)**. NEDBOY, ROBIN L., (U.S. CLS. 1, 6 AND 15). SN 85-300,052. PUB. 8-9-2011. FILED 4-20-2011.

---

#### CLASS 5—PHARMACEUTICALS

- 4,043,613. **INCAGEN (STANDARD CHARACTER)**. PERUVIAN IMPORT COMPANY, INC, MULTIPLE CLASS, (INT. CLS. 5 AND 30), (U.S. CLS. 6, 18, 44, 46, 51 AND 52). SN 76-704,158. PUB. 8-9-2011. FILED 8-19-2010.
- 4,043,617. **CITRICHOLESS AND DESIGN**. NGUYEN, TUONG, (U.S. CLS. 6, 18, 44, 46, 51 AND 52). SN 76-705,240. PUB. 8-9-2011. FILED 11-8-2010.
- 4,043,628. **FELINEPROTECT (STANDARD CHARACTER)**. AWARENESS, CORPORATION, (U.S. CLS. 6, 18, 44, 46, 51 AND 52). SN 76-706,962. PUB. 8-9-2011. FILED 3-25-2011.
- 4,043,629. **CANINEPROTECT (STANDARD CHARACTER)**.

- AWARENESS, CORPORATION, (U.S. CLS. 6, 18, 44, 46, 51 AND 52). SN 76-706,963. PUB. 8-9-2011. FILED 3-25-2011.
- 4,043,639. **SQID (STANDARD CHARACTER)**. SQI DIAGNOSTICS SYSTEMS INC., (U.S. CLS. 6, 18, 44, 46, 51 AND 52). SN 77-213,178. PUB. 7-19-2011. FILED 6-22-2007.
- 4,043,649 ( *See Class 1 for this trademark*).
- 4,043,656 ( *See Class 1 for this trademark*).
- 4,043,665 ( *See Class 1 for this trademark*).
- 4,043,670. **GARGAX (STANDARD CHARACTER)**. GENOMMA LAB INTERNACIONAL, S.A.B. DE C.V., (U.S. CLS. 6, 18, 44, 46, 51 AND 52). SN 77-727,051. PUB. 8-9-2011. FILED 5-1-2009.
- 4,043,713 ( *See Class 1 for this trademark*).
- 4,043,750. **IVI AND DESIGN**. EQUIPO IVI, S.L., MULTIPLE CLASS, (INT. CLS. 5, 9, 41 AND 44), (U.S. CLS. 6, 18, 21, 23, 26, 36, 38, 44, 46, 51, 52, 100, 101 AND 107). SN 79-081,752. PUB. 3-8-2011. FILED 2-23-2010.
- 4,043,760 ( *See Class 3 for this trademark*).
- 4,043,792 ( *See Class 3 for this trademark*).
- 4,043,795. **VE AND DESIGN**. SANYPET S.P.A., MULTIPLE CLASS, (INT. CLS. 5 AND 31), (U.S. CLS. 1, 6, 18, 44, 46, 51 AND 52). SN 79-089,227. PUB. 8-9-2011. FILED 9-16-2010.
- 4,043,813. **BRISMARANT (STANDARD CHARACTER)**. PRONOVA BIOPHARMA NORGE AS, (U.S. CLS. 6, 18, 44, 46, 51 AND 52). SN 79-090,211. PUB. 8-9-2011. FILED 9-13-2010.
- 4,043,819. **FAMIPRO (STANDARD CHARACTER)**. MURTAZA LIAKATALI DATOO PARDAN, (U.S. CLS. 6, 18, 44, 46, 51 AND 52). SN 79-090,913. PUB. 5-3-2011. FILED 9-9-2010.
- 4,043,831 ( *See Class 3 for this trademark*).
- 4,043,853. **THUNDRION (STANDARD CHARACTER)**. BOEHRINGER INGELHEIM INTERNATIONAL GMBH, (U.S. CLS. 6, 18, 44, 46, 51 AND 52). SN 79-095,951. PUB. 8-9-2011. FILED 10-20-2010.
- 4,043,869. **ISASTER (STANDARD CHARACTER)**. IMS-INTERNATIONAL MEDICAL SERVICE S.R.L., (U.S. CLS. 6, 18, 44, 46, 51 AND 52). SN 79-098,433. PUB. 8-9-2011. FILED 9-21-2010.
- 4,043,870 ( *See Class 3 for this trademark*).
- 4,043,876 ( *See Class 3 for this trademark*).
- 4,043,888 ( *See Class 3 for this trademark*).
- 4,043,890. **BMCARE AND DESIGN**. BIOSTIME, INC. (-GUANGZHOU), (U.S. CLS. 6, 18, 44, 46, 51 AND 52). SN 85-039,496. PUB. 3-1-2011. FILED 5-15-2010.
- 4,043,903. **STOKO REFRESH (STANDARD CHARACTER)**. EVONIK STOCKHAUSEN GMBH, (U.S. CLS. 6, 18, 44, 46, 51 AND 52). SN 85-055,875. PUB. 5-10-2011. FILED 6-7-2010.
- 4,043,942. **ACTIVATED COLLAGEN (STANDARD CHARACTER)**. WOUND CARE INNOVATIONS, LLC, (U.S. CLS. 6, 18, 44, 46, 51 AND 52). SN 85-099,930. PUB. 8-9-2011. FILED 8-4-2010.
- 4,043,943. **CRX AND DESIGN**. WOUND CARE INNOVATIONS, LLC, (U.S. CLS. 6, 18, 44, 46, 51 AND 52). SN 85-099,934. PUB. 8-9-2011. FILED 8-4-2010.
- 4,043,970. **MOTIVE PURE (STANDARD CHARACTER)**. M HOLDINGS, LLC, MULTIPLE CLASS, (INT. CLS. 5 AND 32), (U.S. CLS. 6, 18, 44, 45, 46, 48, 51 AND 52). SN 85-112,453. PUB. 8-9-2011. FILED 8-20-2010.
- 4,043,983. **CHECKMATE (STANDARD CHARACTER)**. CHECK MATE TEST LLC, (U.S. CLS. 6, 18, 44, 46, 51 AND 52). SN 85-114,605. PUB. 2-8-2011. FILED 8-24-2010.
- 4,044,000. **NAUGHTYBITS (STANDARD CHARACTER)**. ARNSTON, CATHARINE V., DBA THE NAUGHTY NUTRITIONIST, (U.S. CLS. 6, 18, 44, 46, 51 AND 52). SN 85-119,071. PUB. 5-3-2011. FILED 8-30-2010.
- 4,044,008. **VITALOE (STANDARD CHARACTER)**. RBC LIFE SCIENCES, INC., (U.S. CLS. 6, 18, 44, 46, 51 AND 52). SN 85-121,099. PUB. 8-9-2011. FILED 9-1-2010.
- 4,044,029. **MAZU (STANDARD CHARACTER)**. NUVONYX INC, (U.S. CLS. 6, 18, 44, 46, 51 AND 52). SN 85-127,234. PUB. 8-9-2011. FILED 9-10-2010.
- 4,044,064. **LIFETRIENTS (STANDARD CHARACTER)**. NOURISHLIFE, (U.S. CLS. 6, 18, 44, 46, 51 AND 52). SN 85-144,350. PUB. 8-9-2011. FILED 10-4-2010.
- 4,044,118. **ENZYMEDICA (STANDARD CHARACTER)**. TOM BOHAGER, (U.S. CLS. 6, 18, 44, 46, 51 AND 52). SN 85-174,680. PUB. 8-9-2011. FILED 11-11-2010.
- 4,044,128. **GLUCOVERA (STANDARD CHARACTER)**. VORWALLER, JOHN A., (U.S. CLS. 6, 18, 44, 46, 51 AND 52). SN

- 85-179,997. PUB. 5-3-2011. FILED 11-18-2010.
- 4,044,136. **HIGIA (STANDARD CHARACTER)**. LABORATORIOS HIGIA, S.A., (U.S. CLS. 6, 18, 44, 46, 51 AND 52). SN 85-183,981. PUB. 8-9-2011. FILED 11-23-2010.
- 4,044,142. **A D N (STYLIZED)**. PAN, FUZHONG, (U.S. CLS. 6, 18, 44, 46, 51 AND 52). SN 85-185,542. PUB. 8-9-2011. FILED 11-26-2010.
- 4,044,143. **SPEED STRENGTH PERFORMANCE SSP NUTRITION AND DESIGN**. CIERI, DENNIS, (U.S. CLS. 6, 18, 44, 46, 51 AND 52). SN 85-186,192. PUB. 8-9-2011. FILED 11-29-2010.
- 4,044,164. **MISCELLANEOUS DESIGN**. GOLDEN BIOTECHNOLOGY CORPORATION, (U.S. CLS. 6, 18, 44, 46, 51 AND 52). SN 85-195,224. PUB. 8-9-2011. FILED 12-10-2010.
- 4,044,179. **C & E WILDLIFE PRODUCTS (STYLIZED)**. HORROCKS ENTERPRISES, LLC, (U.S. CLS. 6, 18, 44, 46, 51 AND 52). SN 85-206,051. PUB. 8-9-2011. FILED 12-27-2010.
- 4,044,212 ( *See Class 1 for this trademark*).
- 4,044,274. **GLUTEN-FREE REMEDIES BY INSTITUTE FOR SPECIALIZED MEDICINE AND DESIGN**. INSTITUTE FOR SPECIALIZED MEDICINE, INC, (U.S. CLS. 6, 18, 44, 46, 51 AND 52). SN 85-233,744. PUB. 8-9-2011. FILED 2-3-2011.
- 4,044,284. **CIRCU FORTE (STANDARD CHARACTER)**. OLALDE, JOSE, (U.S. CLS. 6, 18, 44, 46, 51 AND 52). SN 85-237,568. PUB. 8-9-2011. FILED 2-9-2011.
- 4,044,313. **BLING IT! (STANDARD CHARACTER)**. SCOTT ABRAHAM, (U.S. CLS. 6, 18, 44, 46, 51 AND 52). SN 85-246,305. PUB. 8-9-2011. FILED 2-18-2011.
- 4,044,315 ( *See Class 3 for this trademark*).
- 4,044,319. **SITAVIG (STANDARD CHARACTER)**. BIOALLIANCE PHARMA, (U.S. CLS. 6, 18, 44, 46, 51 AND 52). SN 85-247,490. PUB. 5-24-2011. FILED 2-21-2011.
- 4,044,326. **SEDUCE (STANDARD CHARACTER)**. CERTIS U.S.A. L.L.C., (U.S. CLS. 6, 18, 44, 46, 51 AND 52). SN 85-249,244. PUB. 8-9-2011. FILED 2-23-2011.
- 4,044,327. **DES-X (STANDARD CHARACTER)**. CERTIS U.S.A. L.L.C., (U.S. CLS. 6, 18, 44, 46, 51 AND 52). SN 85-249,246. PUB. 8-9-2011. FILED 2-23-2011.
- 4,044,502. **TD GOLD (STANDARD CHARACTER)**. TOTAL DIABETES, LLC, (U.S. CLS. 6, 18, 44, 46, 51 AND 52). SN 85-263,269. PUB. 8-9-2011. FILED 3-10-2011.
- 4,044,531. **GHS CORPORATION AND DESIGN**. GLOBAL HEALTH AND INFORMATION SERVICES CORPORATION, (U.S. CLS. 6, 18, 44, 46, 51 AND 52). SN 85-264,141. PUB. 8-9-2011. FILED 3-11-2011.
- 4,044,611. **CLICKSET (STANDARD CHARACTER)**. HOECHST GMBH, MULTIPLE CLASS, (INT. CLS. 5 AND 10), (U.S. CLS. 6, 18, 26, 39, 44, 46, 51 AND 52). SN 85-271,082. PUB. 8-9-2011. FILED 3-18-2011.
- 4,044,645. **FERMENT-AID (STANDARD CHARACTER)**. AGRARIAN MARKETING CORPORATION, (U.S. CLS. 6, 18, 44, 46, 51 AND 52). SN 85-273,697. PUB. 8-9-2011. FILED 3-22-2011.
- 4,044,653. **QUINTESSENTIAL (STANDARD CHARACTER)**. WATER AND WELLNESS SOLUTIONS INC., (U.S. CLS. 6, 18, 44, 46, 51 AND 52). SN 85-273,823. PUB. 8-9-2011. FILED 3-22-2011.
- 4,044,657. **CORTISLIM (STANDARD CHARACTER)**. NATIONAL MARKETING, INC., (U.S. CLS. 6, 18, 44, 46, 51 AND 52). SN 85-273,843. PUB. 8-9-2011. FILED 3-22-2011.
- 4,044,713. **ZAP-A-ROACH (STANDARD CHARACTER)**. HBC CHEMICAL INC., (U.S. CLS. 6, 18, 44, 46, 51 AND 52). SN 85-274,721. PUB. 8-9-2011. FILED 3-23-2011.
- 4,044,719. **REGENERECT (STANDARD CHARACTER)**. REGENECA INTERNATIONAL, INC., DBA REGENECA, (U.S. CLS. 6, 18, 44, 46, 51 AND 52). SN 85-274,839. PUB. 8-9-2011. FILED 3-23-2011.
- 4,044,810. **AFFIRM XL (STANDARD CHARACTER)**. AFFIRM XL, LLC, (U.S. CLS. 6, 18, 44, 46, 51 AND 52). SN 85-276,173. PUB. 8-9-2011. FILED 3-24-2011.
- 4,044,831. **ACUNOL (STANDARD CHARACTER)**. PLYMOUTH PHARMACEUTICALS INC., (U.S. CLS. 6, 18, 44, 46, 51 AND 52). SN 85-276,516. PUB. 8-9-2011. FILED 3-25-2011.
- 4,044,895. **OSTEOBLAX (STANDARD CHARACTER)**. K.-W. PFANNENSCHMIDT, (U.S. CLS. 6, 18, 44, 46, 51 AND 52). SN 85-277,325. PUB. 8-9-2011. FILED 3-25-2011.
- 4,044,972. **FASTSTAT (STANDARD CHARACTER)**. CAO GROUP, INC., (U.S. CLS. 6, 18, 44, 46, 51 AND 52). SN 85-278,381. PUB. 8-9-2011. FILED 3-28-2011.
- 4,044,973. **FASTFIX (STANDARD CHARACTER)**. CAO GROUP, INC., (U.S. CLS. 6, 18, 44, 46, 51 AND 52). SN 85-278,410. PUB. 8-9-2011. FILED 3-28-2011.
- 4,045,064. **DIAS SOLEADOS (STANDARD CHARACTER)**. S. C. JOHNSON & SON, INC., (U.S. CLS. 6, 18, 44, 46, 51 AND 52). SN 85-279,541. PUB. 8-9-2011. FILED 3-29-2011.
- 4,045,084. **WINN-50 (STANDARD CHARACTER)**. DYNAMIC SPORTS NUTRITION, LLC, (U.S. CLS. 6, 18, 44, 46, 51 AND 52). SN 85-279,863. PUB. 8-9-2011. FILED 3-29-2011.
- 4,045,099. **LIPH WE PUT THE PH IN LIFE AND DESIGN**. CISNE ENTERPRISES, INC., (U.S. CLS. 6, 18, 44, 46, 51 AND 52). SN 85-280,053. PUB. 8-9-2011. FILED 3-29-2011.
- 4,045,113. **2-DAY FAST FORMULA (STANDARD CHARACTER)**. BEACHBODY, LLC, (U.S. CLS. 6, 18, 44, 46, 51 AND 52). SN 85-280,249. PUB. 8-9-2011. FILED 3-29-2011.
- 4,045,198. **ZETPIL (STANDARD CHARACTER)**. CAFARELLI, DAVID, (U.S. CLS. 6, 18, 44, 46, 51 AND 52). SN 85-281,341. PUB. 8-9-2011. FILED 3-30-2011.
- 4,045,221. **RECOVERORS (STANDARD CHARACTER)**. WOMP WORKS LLC, (U.S. CLS. 6, 18, 44, 46, 51 AND 52). SN 85-281,736. PUB. 8-9-2011. FILED 3-30-2011.
- 4,045,222. **PREMIER N U T R I T I O N AND DESIGN**. PREMIER NUTRITION, INC., (U.S. CLS. 6, 18, 44, 46, 51 AND 52). SN 85-281,742. PUB. 8-9-2011. FILED 3-30-2011.
- 4,045,223. **CHOLEST FACTORS (STANDARD CHARACTER)**. ZWIRN, LAURENCE, (U.S. CLS. 6, 18, 44, 46, 51 AND 52). SN 85-281,745. PUB. 8-9-2011. FILED 3-30-2011.
- 4,045,310 ( *See Class 3 for this trademark*).
- 4,045,349. **GFA AND DESIGN**. GENUINE FIRST AID, MULTIPLE CLASS, (INT. CLS. 5 AND 10), (U.S. CLS. 6, 18, 26, 39, 44, 46, 51 AND 52). SN 85-283,255. PUB. 8-9-2011. FILED 3-31-2011.
- 4,045,476. **RUMEN ZEST (STANDARD CHARACTER)**. PROVIMI NORTH AMERICA, INC., (U.S. CLS. 6, 18, 44, 46, 51 AND 52). SN 85-285,573. PUB. 8-9-2011. FILED 4-4-2011.
- 4,045,487. **BE A STAR IN THE BEDROOM (STANDARD CHARACTER)**. BOLANOS FAMILY TRUST, (U.S. CLS. 6, 18, 44, 46, 51 AND 52). SN 85-285,892. PUB. 8-9-2011. FILED 4-4-2011.
- 4,045,494. **DMX (STANDARD CHARACTER)**. DYNAMAXX INTERNATIONAL LTD, (U.S. CLS. 6, 18, 44, 46, 51 AND 52). SN 85-286,555. PUB. 8-9-2011. FILED 4-5-2011.
- 4,045,508. **BIG BRAIN IMMUNE SYSTEM GROWTH AND DESIGN**. STONYFIELD FARM, INC., MULTIPLE CLASS, (INT. CLS. 5 AND 29), (U.S. CLS. 6, 18, 44, 46, 51 AND 52). SN 85-287,778. PUB. 8-9-2011. FILED 4-6-2011.
- 4,045,518. **MERRY MAIDS (STANDARD CHARACTER)**. SERVICEMASTER BRANDS L.L.C., (U.S. CLS. 6, 18, 44, 46, 51 AND 52). SN 85-290,155. PUB. 8-9-2011. FILED 4-8-2011.
- 4,045,529. **IMNOVID (STANDARD CHARACTER)**. CELGENE CORPORATION, (U.S. CLS. 6, 18, 44, 46, 51 AND 52). SN 85-294,895. PUB. 7-26-2011. FILED 4-14-2011.
- 4,045,535. **GAS-GON (STANDARD CHARACTER)**. AMJAD, AYNE, (U.S. CLS. 6, 18, 44, 46, 51 AND 52). SN 85-297,240. PUB. 8-9-2011. FILED 4-17-2011.
- 4,045,547. **MISCELLANEOUS DESIGN**. PROVIMI NORTH AMERICA, INC., (U.S. CLS. 6, 18, 44, 46, 51 AND 52). SN 85-304,845. PUB. 8-9-2011. FILED 4-26-2011.
- 4,045,550. **RESEARCH BASED SHOWING CONFIRMED AND DESIGN**. PROVIMI NORTH AMERICA, INC., MULTIPLE CLASS, (INT. CLS. 5 AND 31), (U.S. CLS. 1, 6, 18, 44, 46, 51 AND 52). SN 85-305,062. PUB. 8-9-2011. FILED 4-26-2011.
- 4,045,555. **TESTA-DRIVE (STANDARD CHARACTER)**. MARTEX NUTRITION, INC, (U.S. CLS. 6, 18, 44, 46, 51 AND 52). SN 85-308,550. PUB. 8-9-2011. FILED 4-29-2011.

---

## CLASS 6—METAL GOODS

- 4,043,654. **POWER CLICK (STANDARD CHARACTER)**. IMPRESS GROUP B.V., MULTIPLE CLASS, (INT. CLS. 6, 20 AND 21), (U.S. CLS. 2, 12, 13, 14, 22, 23, 25, 29, 30, 32, 33, 40 AND 50). SN 77-607,706. PUB. 7-20-2010. FILED 11-5-2008.

- 4,043,722 ( *See Class 1 for this trademark*).
- 4,043,749. **CUISINOX (STYLIZED)**. AMEFA FRANCE, MULTIPLE CLASS, (INT. CLS. 6, 8 AND 21), (U.S. CLS. 2, 12, 13, 14, 23, 25, 28, 29, 30, 33, 40, 44 AND 50). SN 79-079,543. PUB. 5-3-2011. FILED 9-28-2009.
- 4,043,798. **XI AND DESIGN**. LOTHAR COLLINI, MULTIPLE CLASS, (INT. CLS. 6, 11 AND 20), (U.S. CLS. 2, 12, 13, 14, 21, 22, 23, 25, 31, 32, 34 AND 50). SN 79-089,419. PUB. 8-9-2011. FILED 10-15-2010.
- 4,043,858. **SOLARX (STANDARD CHARACTER)**. OUTOKUMPU OYJ, (U.S. CLS. 2, 12, 13, 14, 23, 25 AND 50). SN 79-096,435. PUB. 8-9-2011. FILED 4-5-2011.
- 4,043,994. **SAFE WHEELS SECURED BY NORD-LOCK AND DESIGN**. NORD-LOCK INTERNATIONAL AB, (U.S. CLS. 2, 12, 13, 14, 23, 25 AND 50). SN 85-117,538. PUB. 8-9-2011. FILED 8-27-2010.
- 4,044,019. **CRYSTALEX (STANDARD CHARACTER)**. PRISMO ROAD MARKINGS LIMITED, MULTIPLE CLASS, (INT. CLS. 6, 9 AND 19), (U.S. CLS. 1, 2, 12, 13, 14, 21, 23, 25, 26, 33, 36, 38 AND 50). SN 85-125,724. PUB. 8-9-2011. FILED 9-9-2010.
- 4,044,131. **MSS MOBILE SHELTER SYSTEMS AND DESIGN**. MOBILE SHELTER SYSTEMS, INC., (U.S. CLS. 2, 12, 13, 14, 23, 25 AND 50). SN 85-180,459. PUB. 8-9-2011. FILED 11-18-2010.
- 4,044,352. **SS AND DESIGN**. SUPER SWEEP, INC., MULTIPLE CLASS, (INT. CLS. 6 AND 21), (U.S. CLS. 2, 12, 13, 14, 23, 25, 29, 30, 33, 40 AND 50). SN 85-253,110. PUB. 8-9-2011. FILED 2-28-2011.
- 4,044,511. **ERGO-LADDER (STANDARD CHARACTER)**. AXIOM MANUFACTURING, INC., (U.S. CLS. 2, 12, 13, 14, 23, 25 AND 50). SN 85-263,462. PUB. 8-9-2011. FILED 3-10-2011.
- 4,044,948. **FLUTAGON (STANDARD CHARACTER)**. ATLANTIC STEEL CORPORATION, (U.S. CLS. 2, 12, 13, 14, 23, 25 AND 50). SN 85-278,071. PUB. 8-9-2011. FILED 3-27-2011.
- 4,045,126. **YC (STANDARD CHARACTER)**. YOW CHERN CO., LTD., (U.S. CLS. 2, 12, 13, 14, 23, 25 AND 50). SN 85-280,449. PUB. 8-9-2011. FILED 3-29-2011.
- 
- CLASS 7—MACHINERY**
- 4,043,675. **W-GEARY (STANDARD CHARACTER)**. MOTOVARIO S.P.A., (U.S. CLS. 13, 19, 21, 23, 31, 34 AND 35). SN 77-763,221. PUB. 8-9-2011. FILED 6-18-2009.
- 4,043,687. **PUREWELD (STANDARD CHARACTER)**. WATSON-MARLOW LIMITED, MULTIPLE CLASS, (INT. CLS. 7, 9, 10 AND 17), (U.S. CLS. 1, 5, 12, 13, 19, 21, 23, 26, 31, 34, 35, 36, 38, 39, 44 AND 50). SN 77-824,398. PUB. 3-29-2011. FILED 9-11-2009.
- 4,043,722 ( *See Class 1 for this trademark*).
- 4,043,784. **MISCELLANEOUS DESIGN**. CLAAS KGAA MBH, MULTIPLE CLASS, (INT. CLS. 7, 9, 12, 35, 37 AND 42), (U.S. CLS. 13, 19, 21, 23, 26, 31, 34, 35, 36, 38, 44, 100, 101, 102, 103 AND 106). SN 79-088,820. PUB. 8-9-2011. FILED 3-27-2010.
- 4,043,794. **KOTL AND DESIGN**. JINLONG MACHINERY & ELECTRONICS CO., LTD., (U.S. CLS. 13, 19, 21, 23, 31, 34 AND 35). SN 79-089,192. PUB. 8-9-2011. FILED 9-14-2010.
- 4,043,800. **ENGINELIFE (STANDARD CHARACTER)**. SNECMA, MULTIPLE CLASS, (INT. CLS. 7, 35 AND 37), (U.S. CLS. 13, 19, 21, 23, 31, 34, 35, 100, 101, 102, 103 AND 106). SN 79-089,551. PUB. 8-9-2011. FILED 6-23-2010.
- 4,043,809. **SPARKY AND DESIGN**. "SPARKY GROUP" AD, (U.S. CLS. 13, 19, 21, 23, 31, 34 AND 35). SN 79-089,980. PUB. 8-9-2011. FILED 9-1-2010.
- 4,043,812 ( *See Class 4 for this trademark*).
- 4,043,817. **MISCELLANEOUS DESIGN**. ESSLOR INTERNATIONAL (COMPAGNIE GENERALE D'OPTIQUE), MULTIPLE CLASS, (INT. CLS. 7, 9 AND 44), (U.S. CLS. 13, 19, 21, 23, 26, 31, 34, 35, 36, 38, 100 AND 101). SN 79-090,462. PUB. 8-9-2011. FILED 10-14-2010.
- 4,043,832. **ZUPPER (STYLIZED)**. TAIZHOU JULI TOOLS CO., LTD., (U.S. CLS. 13, 19, 21, 23, 31, 34 AND 35). SN 79-091,700. PUB. 8-9-2011. FILED 9-15-2010.
- 4,043,835. **MISCELLANEOUS DESIGN**. BROADCROWN HOLDINGS PLC, MULTIPLE CLASS, (INT. CLS. 7 AND 37), (U.S. CLS. 13, 19, 21, 23, 31, 34, 35, 100, 103 AND 106). SN 79-092,590. PUB. 8-9-2011. FILED 11-24-2010.
- 4,043,864. **NAUTILUS (STANDARD CHARACTER)**. TOKYO ELECTRON LIMITED, (U.S. CLS. 13, 19, 21, 23, 31, 34 AND 35). SN 79-097,105. PUB. 8-9-2011. FILED 3-31-2011.
- 4,043,865. **POLARIS (STANDARD CHARACTER)**. INTERNATIONAL TOBACCO MACHINERY POLAND SP. Z O.O., (U.S. CLS. 13, 19, 21, 23, 31, 34 AND 35). SN 79-097,280. PUB. 8-9-2011. FILED 4-4-2011.
- 4,043,875. **O.S.K. AND DESIGN**. OSK LTD., (U.S. CLS. 13, 19, 21, 23, 31, 34 AND 35). SN 85-006,651. PUB. 8-9-2011. FILED 4-5-2010.
- 4,043,880. **INFINIA (STANDARD CHARACTER)**. INFINIA CORPORATION, (U.S. CLS. 13, 19, 21, 23, 31, 34 AND 35). SN 85-012,750. PUB. 8-9-2011. FILED 4-13-2010.
- 4,044,024. **DD AQUAFICIENT (STANDARD CHARACTER)**. LG ELECTRONICS INC., (U.S. CLS. 13, 19, 21, 23, 31, 34 AND 35). SN 85-126,404. PUB. 8-9-2011. FILED 9-9-2010.
- 4,044,235. **DRAGMASTER (STANDARD CHARACTER)**. KISER ARENA SPECIALISTS, INC., (U.S. CLS. 13, 19, 21, 23, 31, 34 AND 35). SN 85-226,016. PUB. 8-9-2011. FILED 1-25-2011.
- 4,044,237. **HI TORQUE (STANDARD CHARACTER)**. IMI PERFORMANCE PRODUCTS, INC., (U.S. CLS. 13, 19, 21, 23, 31, 34 AND 35). SN 85-226,990. PUB. 8-9-2011. FILED 1-26-2011.
- 4,044,294. **PTI (STANDARD CHARACTER)**. P.T. INTERNATIONAL CORP., (U.S. CLS. 13, 19, 21, 23, 31, 34 AND 35). SN 85-239,125. PUB. 8-9-2011. FILED 2-10-2011.
- 4,044,295. **P.T. INTERNATIONAL CORP. (STANDARD CHARACTER)**. P.T. INTERNATIONAL CORP., (U.S. CLS. 13, 19, 21, 23, 31, 34 AND 35). SN 85-239,165. PUB. 8-9-2011. FILED 2-10-2011.
- 4,044,299. **PTI AND DESIGN**. P.T. INTERNATIONAL CORP., (U.S. CLS. 13, 19, 21, 23, 31, 34 AND 35). SN 85-239,972. PUB. 8-9-2011. FILED 2-11-2011.
- 4,044,366. **NETSTAL (STANDARD CHARACTER)**. NETSTAL-MASCHINEN AG (NETSTAL-MACHINES S.A., NETSTAL-MACHINERY LTD.), (U.S. CLS. 13, 19, 21, 23, 31, 34 AND 35). SN 85-254,858. PUB. 8-9-2011. FILED 3-1-2011.
- 4,044,376. **ROTOFLO (STANDARD CHARACTER)**. MWI CORPORATION, (U.S. CLS. 13, 19, 21, 23, 31, 34 AND 35). SN 85-256,764. PUB. 8-9-2011. FILED 3-3-2011.
- 4,044,528. **APPLIED OPUS (STANDARD CHARACTER)**. APPLIED MATERIALS, INC., (U.S. CLS. 13, 19, 21, 23, 31, 34 AND 35). SN 85-264,000. PUB. 8-9-2011. FILED 3-10-2011.
- 4,044,585. **YOUR PRODUCTIVITY PROCESS PEOPLE (STANDARD CHARACTER)**. MESSER CUTTING SYSTEMS, INC., (U.S. CLS. 13, 19, 21, 23, 31, 34 AND 35). SN 85-266,989. PUB. 8-9-2011. FILED 3-15-2011.
- 4,044,593. **CRANE CAMS (STANDARD CHARACTER)**. CRANE ACQUISITION, LLC, MULTIPLE CLASS, (INT. CLS. 7 AND 9), (U.S. CLS. 13, 19, 21, 23, 26, 31, 34, 35, 36 AND 38). SN 85-267,775. PUB. 8-9-2011. FILED 3-15-2011.
- 4,044,670. **TURF BEAST (STANDARD CHARACTER)**. GXI OUTDOOR POWER LLC, (U.S. CLS. 13, 19, 21, 23, 31, 34 AND 35). SN 85-274,018. PUB. 8-9-2011. FILED 3-22-2011.
- 4,044,759 ( *See Class 2 for this trademark*).
- 4,044,868. **ROOT-N-ALL AND DESIGN**. H & W ATTACHMENTS, L.L.C., (U.S. CLS. 13, 19, 21, 23, 31, 34 AND 35). SN 85-276,952. PUB. 8-9-2011. FILED 3-25-2011.
- 4,044,901. **DK DYNAKING AND DESIGN**. DYNAKING CRANE, LLC, (U.S. CLS. 13, 19, 21, 23, 31, 34 AND 35). SN 85-277,361. PUB. 8-9-2011. FILED 3-25-2011.
- 4,045,016. **THE SILENT RIDER (STANDARD CHARACTER)**. QUAD FAB, INC., (U.S. CLS. 13, 19, 21, 23, 31, 34 AND 35). SN 85-278,951. PUB. 8-9-2011. FILED 3-28-2011.
- 4,045,043. **ISPRINT (STANDARD CHARACTER)**. APPLIED MATERIALS, INC., (U.S. CLS. 13, 19, 21, 23, 31, 34 AND 35). SN 85-279,221. PUB. 8-9-2011. FILED 3-28-2011.
- 4,045,050. **JCM (STANDARD CHARACTER)**. STRONG CONSTRUCTION MACHINERY CO., LTD., (U.S. CLS. 13, 19, 21, 23, 31, 34 AND 35). SN 85-279,323. PUB. 8-9-2011. FILED 3-29-2011.
- 4,045,232. **ORBOT (STYLIZED)**. HRUBY, JEFFREY THOMAS, (U.S. CLS. 13, 19, 21, 23, 31, 34 AND 35). SN 85-281,835. PUB. 8-9-2011. FILED 3-30-2011.
- 4,045,342. **SHUTREASE (STANDARD CHARACTER)**. THE

- ELP GROUP, LLC, (U.S. CLS. 13, 19, 21, 23, 31, 34 AND 35). SN 85-283,134. PUB. 8-9-2011. FILED 3-31-2011.
- 4,045,397. **NEOSYM (STANDARD CHARACTER)**. COFFIN CHARLES R, DBA CODRIVE, MULTIPLE CLASS, (INT. CLS. 7 AND 9), (U.S. CLS. 13, 19, 21, 23, 26, 31, 34, 35, 36 AND 38). SN 85-283,775. PUB. 8-9-2011. FILED 4-1-2011.
- 4,045,406. **USG (STANDARD CHARACTER)**. USG CORPORATION, (U.S. CLS. 13, 19, 21, 23, 31, 34 AND 35). SN 85-283,883. PUB. 8-9-2011. FILED 4-1-2011.
- 4,045,447. **POLY-SPHERE (STANDARD CHARACTER)**. EDT CORP., (U.S. CLS. 13, 19, 21, 23, 31, 34 AND 35). SN 85-284,380. PUB. 8-9-2011. FILED 4-1-2011.
- 4,045,519. **MERRY MAIDS (STANDARD CHARACTER)**. SERVICEMASTER BRANDS L.L.C., (U.S. CLS. 13, 19, 21, 23, 31, 34 AND 35). SN 85-290,164. PUB. 8-9-2011. FILED 4-8-2011.

---

### CLASS 8—HAND TOOLS

- 4,043,722 ( *See Class 1 for this trademark*).
- 4,043,748 ( *See Class 3 for this trademark*).
- 4,043,749 ( *See Class 6 for this trademark*).
- 4,043,752. **MANZANA NULES AND DESIGN**. RAMÓN MANZANA, S.L., (U.S. CLS. 23, 28 AND 44). SN 79-082,587. PUB. 8-9-2011. FILED 4-22-2010.
- 4,043,761. **LEYAT (STANDARD CHARACTER)**. LEYAT SÁRL, (U.S. CLS. 23, 28 AND 44). SN 79-085,768. PUB. 8-9-2011. FILED 7-19-2010.
- 4,043,896. **GREAT GATHERINGS (STANDARD CHARACTER)**. CONSOLIDATED PROPERTY HOLDINGS, INC., MULTIPLE CLASS, (INT. CLS. 8 AND 21), (U.S. CLS. 2, 13, 23, 28, 29, 30, 33, 40, 44 AND 50). SN 85-045,156. PUB. 8-9-2011. FILED 5-21-2010.
- 4,043,915. **EZSTRINGER (STYLIZED)**. INNOVATORS INC, (U.S. CLS. 23, 28 AND 44). SN 85-064,877. PUB. 8-9-2011. FILED 6-16-2010.
- 4,044,776. **MISCELLANEOUS DESIGN**. TRIPLE AUGHT DESIGN, LLC, (U.S. CLS. 23, 28 AND 44). SN 85-275,726. PUB. 8-9-2011. FILED 3-24-2011.
- 4,044,964. **SWIVEL-SWIRL (STANDARD CHARACTER)**. FRANK V. SCIGLIANO, JR., (U.S. CLS. 23, 28 AND 44). SN 85-278,258. PUB. 8-9-2011. FILED 3-28-2011.
- 4,045,008. **DIAMOND XTRACTOR (STANDARD CHARACTER)**. J.A.O. TOOL, INC., (U.S. CLS. 23, 28 AND 44). SN 85-278,864. PUB. 8-9-2011. FILED 3-28-2011.
- 4,045,127. **ECOSEURITY (STANDARD CHARACTER)**. ECOTENSIL, INC., (U.S. CLS. 23, 28 AND 44). SN 85-280,452. PUB. 8-9-2011. FILED 3-29-2011.
- 4,045,147. **S-CUT (STANDARD CHARACTER)**. ES EQUIPMENT, (U.S. CLS. 23, 28 AND 44). SN 85-280,598. PUB. 8-9-2011. FILED 3-29-2011.
- 4,045,160. **RUI AND DESIGN**. MARTINEZ ORTEGA, JOSE, (U.S. CLS. 23, 28 AND 44). SN 85-280,846. PUB. 8-9-2011. FILED 3-30-2011.

---

### CLASS 9—ELECTRICAL AND SCIENTIFIC APPARATUS

- 4,043,615. **NOBLECURE (STANDARD CHARACTER)**. HERAEUS NOBLELIGHT GMBH, MULTIPLE CLASS, (INT. CLS. 9 AND 11), (U.S. CLS. 13, 21, 23, 26, 31, 34, 36 AND 38). SN 76-704,481. PUB. 8-9-2011. FILED 9-14-2010.
- 4,043,618. **SOFTBSA (STANDARD CHARACTER)**. SOFT COMPUTER CONSULTANTS, INC., DBA SCC SOFT COMPUTER, (U.S. CLS. 21, 23, 26, 36 AND 38). SN 76-705,669. PUB. 8-9-2011. FILED 12-13-2010.
- 4,043,619. **SLICER (STANDARD CHARACTER)**. ROLAND CORPORATION, (U.S. CLS. 21, 23, 26, 36 AND 38). SN 76-705,768. PUB. 8-9-2011. FILED 12-23-2010.
- 4,043,620. **SPACE ECHO (STANDARD CHARACTER)**. ROLAND CORPORATION, (U.S. CLS. 21, 23, 26, 36 AND 38). SN 76-705,769. PUB. 8-9-2011. FILED 12-23-2010.
- 4,043,641. **EOVDSL ETHERNET OVER VDSL AND DESIGN**. RUGGEDCOM INC., MULTIPLE CLASS, (INT. CLS. 9, 35 AND 42), (U.S. CLS. 21, 23, 26, 36, 38, 100, 101 AND 102). SN 77-353,182. PUB. 8-9-2011. FILED 12-16-2007.
- 4,043,642. **HOLA, ¿QUÉ TAL? AND DESIGN**. SERVICIOS TECNOLÓGICOS SINGULARES, S.A., MULTIPLE CLASS, (INT. CLS. 9 AND 38), (U.S. CLS. 21, 23, 26, 36, 38, 100, 101 AND 104). SN 77-401,161. PUB. 1-18-2011. FILED 2-20-2008.
- 4,043,643. **THREAD (STANDARD CHARACTER)**. IZZO, JAMES, (U.S. CLS. 21, 23, 26, 36 AND 38). SN 77-552,903. PUB. 8-9-2011. FILED 8-21-2008.
- 4,043,649 ( *See Class 1 for this trademark*).
- 4,043,656 ( *See Class 1 for this trademark*).
- 4,043,660. **THE POWER OF SPEED (STANDARD CHARACTER)**. TYCO SAFETY PRODUCTS CANADA, LTD., (U.S. CLS. 21, 23, 26, 36 AND 38). SN 77-639,429. PUB. 8-9-2011. FILED 12-23-2008.
- 4,043,662. **CELINE DION V AND DESIGN**. CELINE DION, MULTIPLE CLASS, (INT. CLS. 9, 14 AND 20), (U.S. CLS. 2, 13, 21, 22, 23, 25, 26, 27, 28, 32, 36, 38 AND 50). SN 77-662,958. PUB. 8-9-2011. FILED 2-4-2009.
- 4,043,674. **CELAYIX (STANDARD CHARACTER)**. CELAYIX, INC., MULTIPLE CLASS, (INT. CLS. 9, 41 AND 42), (U.S. CLS. 21, 23, 26, 36, 38, 100, 101 AND 107). SN 77-760,466. PUB. 8-9-2011. FILED 6-16-2009.
- 4,043,684. **CARBON DESKTOP (STANDARD CHARACTER)**. CAMCO INTERNATIONAL LIMITED, MULTIPLE CLASS, (INT. CLS. 9, 16, 35, 36 AND 42), (U.S. CLS. 2, 5, 21, 22, 23, 26, 29, 36, 37, 38, 50, 100, 101 AND 102). SN 77-803,889. PUB. 1-18-2011. FILED 8-13-2009.
- 4,043,687 ( *See Class 7 for this trademark*).
- 4,043,695. **MISCELLANEOUS DESIGN**. ALIBABA GROUP HOLDING LIMITED, MULTIPLE CLASS, (INT. CLS. 9, 16, 35, 38, 41 AND 42), (U.S. CLS. 2, 5, 21, 22, 23, 26, 29, 36, 37, 38, 50, 100, 101, 102, 104 AND 107). SN 77-866,865. PUB. 8-9-2011. FILED 11-6-2009.
- 4,043,697. **ASCI (STANDARD CHARACTER)**. ARGUS MEDIA LIMITED, MULTIPLE CLASS, (INT. CLS. 9, 35, 36 AND 38), (U.S. CLS. 21, 23, 26, 36, 38, 100, 101, 102 AND 104). SN 77-875,825. PUB. 8-9-2011. FILED 11-18-2009.
- 4,043,698. **K-NET (STANDARD CHARACTER)**. KRAMER ELECTRONICS LTD., (U.S. CLS. 21, 23, 26, 36 AND 38). SN 77-876,635. PUB. 7-12-2011. FILED 11-19-2009.
- 4,043,700. **BLUE TOAD MURDER FILES AND DESIGN**. RELENTLESS SOFTWARE LIMITED, MULTIPLE CLASS, (INT. CLS. 9, 28 AND 41), (U.S. CLS. 21, 22, 23, 26, 36, 38, 50, 100, 101 AND 107). SN 77-882,185. PUB. 8-9-2011. FILED 11-30-2009.
- 4,043,701. **AMEE (STYLIZED)**. THE UNIVERSITY OF WESTERN ONTARIO O/A WORLDISCOVERIES, (U.S. CLS. 21, 23, 26, 36 AND 38). SN 77-883,661. PUB. 8-9-2011. FILED 12-1-2009.
- 4,043,706. **ANNIDIS (STANDARD CHARACTER)**. ANNIDIS HEALTH SYSTEMS CORP., MULTIPLE CLASS, (INT. CLS. 9, 10 AND 44), (U.S. CLS. 21, 23, 26, 36, 38, 39, 44, 100 AND 101). SN 77-903,386. PUB. 8-9-2011. FILED 12-31-2009.
- 4,043,707. **TCA TEXAS COUNSELING ASSOCIATION AND DESIGN**. TEXAS COUNSELING ASSOCIATION, (U.S. CLS. 21, 23, 26, 36 AND 38). SN 77-903,641. PUB. 8-9-2011. FILED 12-31-2009.
- 4,043,712. **TIC TAC TOUCH (STANDARD CHARACTER)**. FLIPSIDES INC., (U.S. CLS. 21, 23, 26, 36 AND 38). SN 77-916,505. PUB. 6-8-2010. FILED 1-21-2010.
- 4,043,713 ( *See Class 1 for this trademark*).
- 4,043,714. **SMARTSENDER (STANDARD CHARACTER)**. LISTMARKETER SOFTWARE, INC., (U.S. CLS. 21, 23, 26, 36 AND 38). SN 77-925,274. PUB. 1-18-2011. FILED 2-1-2010.
- 4,043,719. **JAGEX.COM (STANDARD CHARACTER)**. JAGEX LIMITED, MULTIPLE CLASS, (INT. CLS. 9, 16, 25, 28 AND 41), (U.S. CLS. 2, 5, 21, 22, 23, 26, 29, 36, 37, 38, 39, 50, 100, 101 AND 107). SN 77-937,941. PUB. 8-9-2011. FILED 2-17-2010.
- 4,043,722 ( *See Class 1 for this trademark*).
- 4,043,725. **DIAMONDPLUS (STANDARD CHARACTER)**. DE BEERS CENTENARY AG, (U.S. CLS. 21, 23, 26, 36 AND 38). SN 77-954,402. PUB. 2-1-2011. FILED 3-9-2010.
- 4,043,731. **BUCKLE DOWN ONLINE (STANDARD CHARACTER)**. TRIUMPH LEARNING, LLC, (U.S. CLS. 21, 23, 26, 36 AND 38). SN 77-969,923. PUB. 8-9-2011. FILED 3-26-2010.
- 4,043,747. **SMART TRADE TECHNOLOGIES (STANDARD CHARACTER)**. SMART TRADE TECHNOLOGIES, MUL-

- TIPLE CLASS, (INT. CLS. 9, 37, 38 AND 42), (U.S. CLS. 21, 23, 26, 36, 38, 100, 101, 103, 104 AND 106). SN 79-077,935. PUB. 5-3-2011. FILED 8-10-2009.
- 4,043,750 ( *See Class 5 for this trademark*).
- 4,043,763. **TONEBOOK (STYLIZED)**, ALIEN AFTER ALL SOCIÉTÉ PAR ACTIONS SIMPLIFIÉE, MULTIPLE CLASS, (INT. CLS. 9, 35 AND 41), (U.S. CLS. 21, 23, 26, 36, 38, 100, 101, 102 AND 107). SN 79-086,830. PUB. 8-9-2011. FILED 7-13-2010.
- 4,043,767. **INNOVARO (STANDARD CHARACTER)**, INNOVARO, INC., MULTIPLE CLASS, (INT. CLS. 9, 35 AND 42), (U.S. CLS. 21, 23, 26, 36, 38, 100, 101 AND 102). SN 79-087,584. PUB. 8-9-2011. FILED 8-13-2010.
- 4,043,768. **VGATE (STANDARD CHARACTER)**, SECURITY CODE LTD., MULTIPLE CLASS, (INT. CLS. 9 AND 42), (U.S. CLS. 21, 23, 26, 36, 38, 100 AND 101). SN 79-087,612. PUB. 8-9-2011. FILED 5-27-2010.
- 4,043,769. **INNOVARO AND DESIGN**, INNOVARO, INC., MULTIPLE CLASS, (INT. CLS. 9, 35 AND 42), (U.S. CLS. 21, 23, 26, 36, 38, 100, 101 AND 102). SN 79-087,723. PUB. 8-9-2011. FILED 8-13-2010.
- 4,043,773. **MISCELLANEOUS DESIGN**, WORKOUT FACTORY B.V., MULTIPLE CLASS, (INT. CLS. 9, 16, 25, 28, 35, 38, 41 AND 42), (U.S. CLS. 2, 5, 21, 22, 23, 26, 29, 36, 37, 38, 39, 50, 100, 101, 102, 104 AND 107). SN 79-088,083. PUB. 5-3-2011. FILED 4-6-2010.
- 4,043,774. **LEDIOC (STYLIZED)**, IWASAKI ELECTRIC CO., LTD., MULTIPLE CLASS, (INT. CLS. 9 AND 11), (U.S. CLS. 13, 21, 23, 26, 31, 34, 36 AND 38). SN 79-088,089. PUB. 8-9-2011. FILED 9-13-2010.
- 4,043,777. **CONQUEST OF THE AMERICAS (STANDARD CHARACTER)**, NITRO GAMES LTD, (U.S. CLS. 21, 23, 26, 36 AND 38). SN 79-088,392. PUB. 8-9-2011. FILED 8-6-2010.
- 4,043,779. **E5 AND DESIGN**, THE CROWN IN RIGHT OF THE STATE OF VICTORIA, REPRESENTED BY AND ACTING THROUGH THE DEPARTMENT, THE DEPARTMENT OF EDUCATION AND EARLY CHILDHOOD DEVELOPMENT, MULTIPLE CLASS, (INT. CLS. 9, 16 AND 41), (U.S. CLS. 2, 5, 21, 22, 23, 26, 29, 36, 37, 38, 50, 100, 101 AND 107). SN 79-088,620. PUB. 8-9-2011. FILED 7-14-2010.
- 4,043,780. **E5 AND DESIGN**, THE CROWN IN RIGHT OF THE STATE OF VICTORIA, REPRESENTED BY AND ACTING THROUGH THE DEPARTMENT, THE DEPARTMENT OF EDUCATION AND EARLY CHILDHOOD DEVELOPMENT, MULTIPLE CLASS, (INT. CLS. 9, 16 AND 41), (U.S. CLS. 2, 5, 21, 22, 23, 26, 29, 36, 37, 38, 50, 100, 101 AND 107). SN 79-088,623. PUB. 8-9-2011. FILED 7-14-2010.
- 4,043,781. **E5 AND DESIGN**, THE CROWN IN RIGHT OF THE STATE OF VICTORIA, REPRESENTED BY AND ACTING THROUGH THE DEPARTMENT, THE DEPARTMENT OF EDUCATION AND EARLY CHILDHOOD DEVELOPMENT, MULTIPLE CLASS, (INT. CLS. 9, 16 AND 41), (U.S. CLS. 2, 5, 21, 22, 23, 26, 29, 36, 37, 38, 50, 100, 101 AND 107). SN 79-088,624. PUB. 8-9-2011. FILED 7-14-2010.
- 4,043,784 ( *See Class 7 for this trademark*).
- 4,043,785 ( *See Class 3 for this trademark*).
- 4,043,788. **EDUN LIVE (STYLIZED)**, EDUN APPAREL LIMITED, MULTIPLE CLASS, (INT. CLS. 9, 18, 25, 35, 38 AND 41), (U.S. CLS. 1, 2, 3, 21, 22, 23, 26, 36, 38, 39, 41, 100, 101, 102, 104 AND 107). SN 79-088,934. PUB. 8-9-2011. FILED 9-16-2010.
- 4,043,791. **CORLIGHT (STANDARD CHARACTER)**, EWO SRL/GMBH, MULTIPLE CLASS, (INT. CLS. 9, 11 AND 42), (U.S. CLS. 13, 21, 23, 26, 31, 34, 36, 38, 100 AND 101). SN 79-089,089. PUB. 8-9-2011. FILED 8-24-2010.
- 4,043,793. **MST (STANDARD CHARACTER)**, KONINKLIJKE PHILIPS ELECTRONICS N.V., (U.S. CLS. 21, 23, 26, 36 AND 38). SN 79-089,187. PUB. 8-9-2011. FILED 8-20-2010.
- 4,043,796. **CASTLE OF HEROES AND DESIGN**, SUZHOU SNAIL ELECTRONIC CO., LTD., MULTIPLE CLASS, (INT. CLS. 9, 41 AND 42), (U.S. CLS. 21, 23, 26, 36, 38, 100, 101 AND 107). SN 79-089,234. PUB. 8-9-2011. FILED 4-13-2010.
- 4,043,797. **PETS VS. MONSTERS (STANDARD CHARACTER)**, FUNCOM GMBH, MULTIPLE CLASS, (INT. CLS. 9, 28 AND 41), (U.S. CLS. 21, 22, 23, 26, 36, 38, 50, 100, 101 AND 107). SN 79-089,323. PUB. 8-9-2011. FILED 7-13-2010.
- 4,043,799. **P CABLE AND DESIGN**, P-CABLE 3D SEISMIC AS, MULTIPLE CLASS, (INT. CLS. 9, 35, 37 AND 42), (U.S. CLS. 21, 23, 26, 36, 38, 100, 101, 102, 103 AND 106). SN 79-089,437. PUB. 8-9-2011. FILED 4-7-2010.
- 4,043,802. **BIONIC LOOP FAN (STANDARD CHARACTER)**, HEIKE SPIESS, (U.S. CLS. 21, 23, 26, 36 AND 38). SN 79-089,667. PUB. 8-9-2011. FILED 8-5-2010.
- 4,043,806. **DOMAIN SAMURAI (STANDARD CHARACTER)**, PERSISTENT CACHE PTY LTD AS TRUSTEE FOR PERSISTENT CACHE UNIT TRUST, MULTIPLE CLASS, (INT. CLS. 9, 16 AND 45), (U.S. CLS. 2, 5, 21, 22, 23, 26, 29, 36, 37, 38, 50, 100 AND 101). SN 79-089,848. PUB. 8-9-2011. FILED 10-15-2010.
- 4,043,814. **MIPS AND DESIGN**, MIPS AB, (U.S. CLS. 21, 23, 26, 36 AND 38). SN 79-090,319. PUB. 8-9-2011. FILED 10-19-2010.
- 4,043,815. **VISUM (STANDARD CHARACTER)**, PTV PLANUNG TRANSPORT VERKEHR AG, MULTIPLE CLASS, (INT. CLS. 9, 41 AND 42), (U.S. CLS. 21, 23, 26, 36, 38, 100, 101 AND 107). SN 79-090,367. PUB. 8-9-2011. FILED 11-9-2010.
- 4,043,817 ( *See Class 7 for this trademark*).
- 4,043,820. **AB AND DESIGN**, DA LIAN YA TU TOU ZI XUN YOU XIAN GONG SI, (U.S. CLS. 21, 23, 26, 36 AND 38). SN 79-090,927. PUB. 8-9-2011. FILED 12-1-2010.
- 4,043,821. **O AND DESIGN**, DA LIAN YA TU TOU ZI XUN YOU XIAN GONG SI, (U.S. CLS. 21, 23, 26, 36 AND 38). SN 79-090,934. PUB. 8-9-2011. FILED 12-1-2010.
- 4,043,822. **O AND DESIGN**, DA LIAN YA TU TOU ZI XUN YOU XIAN GONG SI, (U.S. CLS. 21, 23, 26, 36 AND 38). SN 79-090,935. PUB. 8-9-2011. FILED 12-1-2010.
- 4,043,823. **A AND DESIGN**, DA LIAN YA TU TOU ZI XUN YOU XIAN GONG SI, (U.S. CLS. 21, 23, 26, 36 AND 38). SN 79-090,936. PUB. 8-9-2011. FILED 12-1-2010.
- 4,043,825. **EMOTION3D (STANDARD CHARACTER)**, FLORIAN SEITNER, MULTIPLE CLASS, (INT. CLS. 9 AND 42), (U.S. CLS. 21, 23, 26, 36, 38, 100 AND 101). SN 79-090,966. PUB. 8-9-2011. FILED 9-28-2010.
- 4,043,830. **VISSIM (STANDARD CHARACTER)**, PTV PLANUNG TRANSPORT VERKEHR AG, MULTIPLE CLASS, (INT. CLS. 9, 41 AND 42), (U.S. CLS. 21, 23, 26, 36, 38, 100, 101 AND 107). SN 79-091,453. PUB. 8-9-2011. FILED 11-9-2010.
- 4,043,837. **RRR (STYLIZED)**, ZHEJIANG RRR OPTOELECTRONIC TECHNOLOGY CO., LTD., MULTIPLE CLASS, (INT. CLS. 9 AND 11), (U.S. CLS. 13, 21, 23, 26, 31, 34, 36 AND 38). SN 79-093,177. PUB. 8-9-2011. FILED 11-29-2010.
- 4,043,841. **LANCA (STANDARD CHARACTER)**, FRAUNHOFER-GESELLSCHAFT ZUR FÖRDERUNG DER ANGEWANDTEN FORSCHUNG E.V., MULTIPLE CLASS, (INT. CLS. 9, 41 AND 42), (U.S. CLS. 21, 23, 26, 36, 38, 100, 101 AND 107). SN 79-093,502. PUB. 8-9-2011. FILED 10-20-2010.
- 4,043,844. **OVASEAZ RECORDS (STANDARD CHARACTER)**, ALEXANDER LESLIE WILSON, (U.S. CLS. 21, 23, 26, 36 AND 38). SN 79-093,987. PUB. 8-9-2011. FILED 1-19-2011.
- 4,043,846. **NUSTAR (STYLIZED)**, BEIJING NUFONT MOBILE MULTIMEDIA TECHNOLOGY CO., LTD. (U.S. CLS. 21, 23, 26, 36 AND 38). SN 79-094,295. PUB. 5-3-2011. FILED 2-11-2011.
- 4,043,848. **TRUVIRTU TV AND DESIGN**, KATRIN MENGEL, AND THOMAS WINGERTER, MULTIPLE CLASS, (INT. CLS. 9, 14, 16, 18 AND 20), (U.S. CLS. 1, 2, 3, 5, 13, 21, 22, 23, 25, 26, 27, 28, 29, 32, 36, 37, 38, 41 AND 50). SN 79-094,937. PUB. 8-9-2011. FILED 11-25-2010.
- 4,043,855 ( *See Class 3 for this trademark*).
- 4,043,856. **OXDOG (STANDARD CHARACTER)**, 20TEN SPORTS S.R.O., MULTIPLE CLASS, (INT. CLS. 9, 25, 28 AND 35), (U.S. CLS. 21, 22, 23, 26, 36, 38, 39, 50, 100, 101 AND 102). SN 79-096,250. PUB. 8-9-2011. FILED 11-15-2010.
- 4,043,857. **VEGASWING (STANDARD CHARACTER)**, VEGA GRIESHABER KG, (U.S. CLS. 21, 23, 26, 36 AND 38). SN 79-096,434. PUB. 8-9-2011. FILED 3-30-2011.
- 4,043,860 ( *See Class 3 for this trademark*).
- 4,043,862. **VEGABAR (STANDARD CHARACTER)**, VEGA GRIESHABER KG, (U.S. CLS. 21, 23, 26, 36 AND 38). SN 79-096,760. PUB. 8-9-2011. FILED 3-30-2011.
- 4,043,879. **JINX (STANDARD CHARACTER)**, CORENSIC, INC., (U.S. CLS. 21, 23, 26, 36 AND 38). SN 85-012,445. PUB. 7-5-2011. FILED 4-13-2010.
- 4,043,881. **COSMAS (STANDARD CHARACTER)**, KENNEY, GERRARD FRANCIS, (U.S. CLS. 21, 23, 26, 36 AND 38). SN



- 85-015,986. PUB. 8-9-2011. FILED 4-16-2010.
- 4,043,882. **SPEEDLEDGER (STANDARD CHARACTER)**. SPEEDLEDGER AKTIEBOLAG, MULTIPLE CLASS, (INT. CLS. 9, 41 AND 42), (U.S. CLS. 21, 23, 26, 36, 38, 100, 101 AND 107). SN 85-019,263. PUB. 8-9-2011. FILED 4-21-2010.
- 4,043,886. **THE ESCAPE (STANDARD CHARACTER)**. THE ESCAPE BAND INC., FORMERLY REALITY STRICKEN INC., (U.S. CLS. 21, 23, 26, 36 AND 38). SN 85-029,422. PUB. 8-9-2011. FILED 5-4-2010.
- 4,043,893. **LOGENA AUTOMOTIVE AND DESIGN**. LOGENA AUTOMOTIVE LLC, MULTIPLE CLASS, (INT. CLS. 9, 12 AND 42), (U.S. CLS. 19, 21, 23, 26, 31, 35, 36, 38, 44, 100 AND 101). SN 85-042,134. PUB. 8-9-2011. FILED 5-19-2010.
- 4,043,895. **REVOLUTION PC, INC. AND DESIGN**. REVOLUTION PC, INC., (U.S. CLS. 21, 23, 26, 36 AND 38). SN 85-045,042. PUB. 8-9-2011. FILED 5-21-2010.
- 4,043,897. **X AND DESIGN**. FLEXIANT LIMITED, MULTIPLE CLASS, (INT. CLS. 9, 42 AND 45), (U.S. CLS. 21, 23, 26, 36, 38, 100 AND 101). SN 85-047,032. PUB. 7-19-2011. FILED 5-25-2010.
- 4,043,898. **FLEXISCALE (STANDARD CHARACTER)**. FLEXIANT LIMITED, MULTIPLE CLASS, (INT. CLS. 9, 42 AND 45), (U.S. CLS. 21, 23, 26, 36, 38, 100 AND 101). SN 85-047,053. PUB. 8-9-2011. FILED 5-25-2010.
- 4,043,904. **STOKO REFRESH (STANDARD CHARACTER)**. EVONIK STOCKHAUSEN GMBH, (U.S. CLS. 21, 23, 26, 36 AND 38). SN 85-055,877. PUB. 5-17-2011. FILED 6-7-2010.
- 4,043,914. **MISCELLANEOUS DESIGN**. BROWE, INC., (U.S. CLS. 21, 23, 26, 36 AND 38). SN 85-061,868. PUB. 8-9-2011. FILED 6-14-2010.
- 4,043,917. **ALIZILA (STANDARD CHARACTER)**. ALIBABA GROUP HOLDING LIMITED, MULTIPLE CLASS, (INT. CLS. 9, 16, 35, 38 AND 41), (U.S. CLS. 2, 5, 21, 22, 23, 26, 29, 36, 37, 38, 50, 100, 101, 102, 104 AND 107). SN 85-068,863. PUB. 8-9-2011. FILED 6-22-2010.
- 4,043,927. **AERO (STANDARD CHARACTER)**. AERO INSTRUMENTS, (U.S. CLS. 21, 23, 26, 36 AND 38). SN 85-082,652. PUB. 8-9-2011. FILED 7-12-2010.
- 4,043,934. **ACCELERATED CARE PLUS (STANDARD CHARACTER)**. ACCELERATED CARE PLUS CORP., MULTIPLE CLASS, (INT. CLS. 9, 10 AND 41), (U.S. CLS. 21, 23, 26, 36, 38, 39, 44, 100, 101 AND 107). SN 85-091,603. PUB. 5-3-2011. FILED 7-23-2010.
- 4,043,935. **HUCUSOL (STANDARD CHARACTER)**. HUCU SOLAR ESPANA, S.L., MULTIPLE CLASS, (INT. CLS. 9 AND 11), (U.S. CLS. 13, 21, 23, 26, 31, 34, 36 AND 38). SN 85-092,428. PUB. 8-9-2011. FILED 7-26-2010.
- 4,043,941. **AB AIRPORT BUTLER AND DESIGN**. MCDougALL-BENBOW, LORNA D, DBA TELMIWARE, INC, (U.S. CLS. 21, 23, 26, 36 AND 38). SN 85-099,601. PUB. 8-9-2011. FILED 8-4-2010.
- 4,043,949. **SO YOU WANT TO BE A FIGHTER! (STANDARD CHARACTER)**. ZUFFA, LLC, (U.S. CLS. 21, 23, 26, 36 AND 38). SN 85-102,299. PUB. 8-9-2011. FILED 8-6-2010.
- 4,043,951. **MIKROTIK (STANDARD CHARACTER)**. MIKROTIKLS, (U.S. CLS. 21, 23, 26, 36 AND 38). SN 85-102,762. PUB. 8-9-2011. FILED 8-9-2010.
- 4,043,953. **SO YOU WANNA BE A FIGHTER! (STANDARD CHARACTER)**. ZUFFA, LLC, (U.S. CLS. 21, 23, 26, 36 AND 38). SN 85-103,338. PUB. 8-9-2011. FILED 8-9-2010.
- 4,043,955. **REVO REMOTE PRO (STANDARD CHARACTER)**. REVO AMERICA CORPORATION, (U.S. CLS. 21, 23, 26, 36 AND 38). SN 85-104,244. PUB. 8-9-2011. FILED 8-10-2010.
- 4,043,956. **REVO MOBILE (STANDARD CHARACTER)**. REVO AMERICA CORPORATION, (U.S. CLS. 21, 23, 26, 36 AND 38). SN 85-104,267. PUB. 8-9-2011. FILED 8-10-2010.
- 4,043,958. **REVO ELITE (STANDARD CHARACTER)**. REVO AMERICA CORPORATION, (U.S. CLS. 21, 23, 26, 36 AND 38). SN 85-104,327. PUB. 8-9-2011. FILED 8-10-2010.
- 4,043,960. **THE ASIAN JOURNAL OF MATHEMATICS (STANDARD CHARACTER)**. INTERNATIONAL PRESS OF BOSTON, INC., (U.S. CLS. 21, 23, 26, 36 AND 38). SN 85-108,043. PUB. 8-9-2011. FILED 8-16-2010.
- 4,043,986. **STOPLIFT (STANDARD CHARACTER)**. STOP-LIFT, INC., DBA STOPLIFT CHECKOUT VISION SYSTEMS, (U.S. CLS. 21, 23, 26, 36 AND 38). SN 85-115,776. PUB. 8-9-2011. FILED 8-25-2010.
- 4,043,995. **STARGEN (STANDARD CHARACTER)**. GREENFIELD SOLAR CORP., (U.S. CLS. 21, 23, 26, 36 AND 38). SN 85-117,544. PUB. 8-9-2011. FILED 8-27-2010.
- 4,043,996. **GREENFIELD SOLAR (STANDARD CHARACTER)**. GREENFIELD SOLAR CORP., MULTIPLE CLASS, (INT. CLS. 9 AND 37), (U.S. CLS. 21, 23, 26, 36, 38, 100, 103 AND 106). SN 85-117,558. PUB. 8-9-2011. FILED 8-27-2010.
- 4,044,010. **TACTIPEDIA AND DESIGN**. ORBIS TECHNOLOGIES, INC., (U.S. CLS. 21, 23, 26, 36 AND 38). SN 85-121,491. PUB. 5-3-2011. FILED 9-2-2010.
- 4,044,011. **TACTIPEDIA (STANDARD CHARACTER)**. ORBIS TECHNOLOGIES, INC., (U.S. CLS. 21, 23, 26, 36 AND 38). SN 85-121,496. PUB. 5-3-2011. FILED 9-2-2010.
- 4,044,019 ( See Class 6 for this trademark).
- 4,044,021. **E-MT EASY MONEY TRANSFER AND DESIGN**. ABM TECHNOLOGIES, MULTIPLE CLASS, (INT. CLS. 9, 35, 36, 38, 42 AND 45), (U.S. CLS. 21, 23, 26, 36, 38, 100, 101, 102 AND 104). SN 85-125,995. PUB. 8-9-2011. FILED 9-9-2010.
- 4,044,030. **PYXIS CHSAFE (STANDARD CHARACTER)**. CAREFUSION 303, INC., (U.S. CLS. 21, 23, 26, 36 AND 38). SN 85-128,205. PUB. 8-9-2011. FILED 9-13-2010.
- 4,044,031. **PYXIS MEDSTATION (STANDARD CHARACTER)**. CAREFUSION 303, INC., (U.S. CLS. 21, 23, 26, 36 AND 38). SN 85-128,213. PUB. 8-9-2011. FILED 9-13-2010.
- 4,044,038. **ROLLINGHOT (STANDARD CHARACTER)**. ROLLINGHOT, LLC., (U.S. CLS. 21, 23, 26, 36 AND 38). SN 85-132,729. PUB. 8-9-2011. FILED 9-18-2010.
- 4,044,058. **SEMI\*CONSOLE (STANDARD CHARACTER)**. SELECTIVA SYSTEMS, INC., (U.S. CLS. 21, 23, 26, 36 AND 38). SN 85-141,497. PUB. 8-9-2011. FILED 9-29-2010.
- 4,044,071. **IRON GIRL (STANDARD CHARACTER)**. WORLD TRIATHLON CORPORATION, (U.S. CLS. 21, 23, 26, 36 AND 38). SN 85-146,149. PUB. 8-9-2011. FILED 10-6-2010.
- 4,044,074. **SOL2O (STYLIZED)**. SOL 2-O, LLC, MULTIPLE CLASS, (INT. CLS. 9 AND 11), (U.S. CLS. 13, 21, 23, 26, 31, 34, 36 AND 38). SN 85-150,413. PUB. 8-9-2011. FILED 10-12-2010.
- 4,044,078. **SAT-7 (STANDARD CHARACTER)**. SAT-7 MEDIA SERVICES LIMITED, (U.S. CLS. 21, 23, 26, 36 AND 38). SN 85-151,285. PUB. 8-9-2011. FILED 10-13-2010.
- 4,044,079. **SAT7 AND DESIGN**. SAT-7 MEDIA SERVICES LIMITED, (U.S. CLS. 21, 23, 26, 36 AND 38). SN 85-151,318. PUB. 8-9-2011. FILED 10-13-2010.
- 4,044,081. **S-UNNO (STANDARD CHARACTER)**. SPICE I2I LIMITED, MULTIPLE CLASS, (INT. CLS. 9 AND 38), (U.S. CLS. 21, 23, 26, 36, 38, 100, 101 AND 104). SN 85-152,213. PUB. 8-9-2011. FILED 10-13-2010.
- 4,044,082. **MEDIASTORM (STANDARD CHARACTER)**. MEDIASTORM, LLC, MULTIPLE CLASS, (INT. CLS. 9, 16, 38 AND 41), (U.S. CLS. 2, 5, 21, 22, 23, 26, 29, 36, 37, 38, 50, 100, 101, 104 AND 107). SN 85-153,080. PUB. 5-3-2011. FILED 10-14-2010.
- 4,044,090. **DIA RENEE 12.08.84 PURE CASA AND DESIGN**. RAMIREZ, RICHARD, (U.S. CLS. 21, 23, 26, 36 AND 38). SN 85-157,354. PUB. 8-9-2011. FILED 10-20-2010.
- 4,044,092. **SMART. SIMPLE. SENSIBLE. (STANDARD CHARACTER)**. SUPERIOR COMMUNICATIONS, INC., (U.S. CLS. 21, 23, 26, 36 AND 38). SN 85-161,753. PUB. 5-3-2011. FILED 10-26-2010.
- 4,044,095. **XTRACTINATOR (STANDARD CHARACTER)**. SUPPLY CHAIN SERVICES, (U.S. CLS. 21, 23, 26, 36 AND 38). SN 85-162,560. PUB. 8-9-2011. FILED 10-27-2010.
- 4,044,096. **C AND DESIGN**. CLIFF ELECTRONIC COMPONENTS LIMITED, (U.S. CLS. 21, 23, 26, 36 AND 38). SN 85-164,398. PUB. 8-9-2011. FILED 10-29-2010.
- 4,044,119. **SUPERSOURCE (STANDARD CHARACTER)**. BLACKMAGIC DESIGN PTY LTD, (U.S. CLS. 21, 23, 26, 36 AND 38). SN 85-175,032. PUB. 3-8-2011. FILED 11-11-2010.
- 4,044,145. **AXIOLOGIX EDUCATION AND DESIGN**. AXIOLOGIX EDUCATION CORPORATION, (U.S. CLS. 21, 23, 26, 36 AND 38). SN 85-187,852. PUB. 8-9-2011. FILED 12-1-2010.
- 4,044,158. **HUDSON (STANDARD CHARACTER)**. ORACLE AMERICA, INC., (U.S. CLS. 21, 23, 26, 36 AND 38). SN 85-193,459. PUB. 8-9-2011. FILED 12-8-2010.
- 4,044,165. **WINK (STANDARD CHARACTER)**. WIZARD INTERNATIONAL, INC., (U.S. CLS. 21, 23, 26, 36 AND 38). SN 85-197,916. PUB. 8-9-2011. FILED 12-14-2010.

- 4,044,171. **IKAS (STANDARD CHARACTER)**. KOGER, INC., (U.S. CLS. 21, 23, 26, 36 AND 38). SN 85-200,224. PUB. 5-3-2011. FILED 12-17-2010.
- 4,044,177. **QUICK-REQ (STANDARD CHARACTER)**. TELCOR INC., (U.S. CLS. 21, 23, 26, 36 AND 38). SN 85-205,153. PUB. 8-9-2011. FILED 12-23-2010.
- 4,044,184. **KORNIT AND DESIGN**. KORNIT DIGITAL LTD, (U.S. CLS. 21, 23, 26, 36 AND 38). SN 85-208,044. PUB. 8-9-2011. FILED 12-30-2010.
- 4,044,188. **MISCELLANEOUS DESIGN**. MIKE VAUGHN CUSTOM SPORTS, INC., MULTIPLE CLASS, (INT. CLS. 9, 18, 25 AND 28), (U.S. CLS. 1, 2, 3, 21, 22, 23, 26, 36, 38, 39, 41 AND 50). SN 85-208,937. PUB. 8-9-2011. FILED 1-3-2011.
- 4,044,189. **VAUGHN (STYLIZED)**. MIKE VAUGHN CUSTOM SPORTS, INC., MULTIPLE CLASS, (INT. CLS. 9, 18, 25 AND 28), (U.S. CLS. 1, 2, 3, 21, 22, 23, 26, 36, 38, 39, 41 AND 50). SN 85-208,938. PUB. 8-9-2011. FILED 1-3-2011.
- 4,044,191. **ITEACH (STANDARD CHARACTER)**. MOORECO, INC., (U.S. CLS. 21, 23, 26, 36 AND 38). SN 85-209,405. PUB. 5-3-2011. FILED 1-3-2011.
- 4,044,195. **THE SUPER STOCK SYSTEM (STANDARD CHARACTER)**. UNDER THE RADAR PICKS, LLC, MULTIPLE CLASS, (INT. CLS. 9 AND 41), (U.S. CLS. 21, 23, 26, 36, 38, 100, 101 AND 107). SN 85-209,570. PUB. 8-9-2011. FILED 1-3-2011.
- 4,044,201. **RESHAPING THE WAY THE WORLD SEES (STANDARD CHARACTER)**. C & E DISTRIBUTING, MULTIPLE CLASS, (INT. CLS. 9 AND 44), (U.S. CLS. 21, 23, 26, 36, 38, 100 AND 101). SN 85-210,959. PUB. 8-9-2011. FILED 1-5-2011.
- 4,044,205. **PROTEUS (STANDARD CHARACTER)**. TRIDENT SPACE AND DEFENSE, LLC, (U.S. CLS. 21, 23, 26, 36 AND 38). SN 85-212,323. PUB. 5-3-2011. FILED 1-6-2011.
- 4,044,207. **HURRICANE STRIKE! (STANDARD CHARACTER)**. UNIVERSITY CORPORATION FOR ATMOSPHERIC RESEARCH, (U.S. CLS. 21, 23, 26, 36 AND 38). SN 85-214,243. PUB. 8-9-2011. FILED 1-10-2011.
- 4,044,210. **CANTO (STANDARD CHARACTER)**. THE FONT BUREAU, INC., (U.S. CLS. 21, 23, 26, 36 AND 38). SN 85-216,290. PUB. 5-3-2011. FILED 1-12-2011.
- 4,044,215. **STARTSSL (STANDARD CHARACTER)**. START COMMERCIAL LTD., MULTIPLE CLASS, (INT. CLS. 9 AND 45), (U.S. CLS. 21, 23, 26, 36, 38, 100 AND 101). SN 85-219,498. PUB. 8-9-2011. FILED 1-18-2011.
- 4,044,226. **EMPOWERED (STANDARD CHARACTER)**. YONDER NEIGHBORHOODS, LLC, DBA YONDER INTERACTIVE NEIGHBORHOODS, (U.S. CLS. 21, 23, 26, 36 AND 38). SN 85-224,483. PUB. 8-9-2011. FILED 1-24-2011.
- 4,044,227. **EMPOWERED (STYLIZED)**. YONDER NEIGHBORHOODS, LLC, DBA YONDER INTERACTIVE NEIGHBORHOODS, (U.S. CLS. 21, 23, 26, 36 AND 38). SN 85-224,617. PUB. 8-9-2011. FILED 1-24-2011.
- 4,044,228. **STEALTHLINK AND DESIGN**. CHARGER CONNECTION, LLC, (U.S. CLS. 21, 23, 26, 36 AND 38). SN 85-224,708. PUB. 8-9-2011. FILED 1-24-2011.
- 4,044,276. **SCRAMBLER (STANDARD CHARACTER)**. ROCKET GAMING SYSTEMS, LLC, (U.S. CLS. 21, 23, 26, 36 AND 38). SN 85-233,824. PUB. 8-9-2011. FILED 2-3-2011.
- 4,044,305. **EARPLUGZPC BY E.A.R., INC. (STYLIZED)**. ENVIRONMENTAL ACOUSTICAL RESEARCH, INC., DBA E.A.R., INC., (U.S. CLS. 21, 23, 26, 36 AND 38). SN 85-242,848. PUB. 8-9-2011. FILED 2-15-2011.
- 4,044,308. **ULLUCUS HEAVEN (STYLIZED)**. ULLUCUS HEAVEN, INC., (U.S. CLS. 21, 23, 26, 36 AND 38). SN 85-244,612. PUB. 8-9-2011. FILED 2-17-2011.
- 4,044,323. **XEAL AND DESIGN**. ISTARUSA, INC., (U.S. CLS. 21, 23, 26, 36 AND 38). SN 85-247,792. PUB. 8-9-2011. FILED 2-21-2011.
- 4,044,331. **DR. QUANTUM (STANDARD CHARACTER)**. WOLF, FRED ALAN, (U.S. CLS. 21, 23, 26, 36 AND 38). SN 85-250,135. PUB. 8-9-2011. FILED 2-23-2011.
- 4,044,337. **HIVE (STYLIZED)**. DECODE SOLUTIONS LLC, (U.S. CLS. 21, 23, 26, 36 AND 38). SN 85-250,920. PUB. 8-9-2011. FILED 2-24-2011.
- 4,044,338. **MISCELLANEOUS DESIGN**. DECODE SOLUTIONS LLC, (U.S. CLS. 21, 23, 26, 36 AND 38). SN 85-250,980. PUB. 8-9-2011. FILED 2-24-2011.
- 4,044,369. **CHOCHMAH (STANDARD CHARACTER)**. FREDERICK ALLAN LEPOW, DBA CDP CONSULTANTS, (U.S. CLS. 21, 23, 26, 36 AND 38). SN 85-255,254. PUB. 8-9-2011. FILED 3-2-2011.
- 4,044,375. **DRUG DOSING & ADMINISTRATION DATABASE (STANDARD CHARACTER)**. WOLTERS KLUWER HEALTH, INC., (U.S. CLS. 21, 23, 26, 36 AND 38). SN 85-256,623. PUB. 8-9-2011. FILED 3-3-2011.
- 4,044,383. **J. W. FECKER (STANDARD CHARACTER)**. JOHN WU, (U.S. CLS. 21, 23, 26, 36 AND 38). SN 85-257,403. PUB. 8-9-2011. FILED 3-3-2011.
- 4,044,392. **S THE SAFE CIG AND DESIGN**. THE SAFE CIG, LLC, MULTIPLE CLASS, (INT. CLS. 9, 16 AND 34), (U.S. CLS. 2, 5, 8, 9, 17, 21, 22, 23, 26, 29, 36, 37, 38 AND 50). SN 85-258,477. PUB. 8-9-2011. FILED 3-4-2011.
- 4,044,393. **NAVIGATOR FAMILY (STANDARD CHARACTER)**. MIDRANGE PERFORMANCE GROUP, AKA MPG, (U.S. CLS. 21, 23, 26, 36 AND 38). SN 85-258,527. PUB. 8-9-2011. FILED 3-4-2011.
- 4,044,407. **ICE PACK . IN CASE OF EMERGENCY . IN CASE OF EMERGENCY AND DESIGN**. ASHBURY INTERNATIONAL GROUP INC., MULTIPLE CLASS, (INT. CLS. 9, 16 AND 41), (U.S. CLS. 2, 5, 21, 22, 23, 26, 29, 36, 37, 38, 50, 100, 101 AND 107). SN 85-259,329. PUB. 8-9-2011. FILED 3-7-2011.
- 4,044,422. **HDWORLDMEDIA GLOBAL MEDIA SOLUTIONS (STANDARD CHARACTER)**. HDWORLDMEDIA COMPANIES, LLC, (U.S. CLS. 21, 23, 26, 36 AND 38). SN 85-260,033. PUB. 8-9-2011. FILED 3-7-2011.
- 4,044,444. **P2 AND DESIGN**. ESYS CORPORATION, (U.S. CLS. 21, 23, 26, 36 AND 38). SN 85-261,145. PUB. 8-9-2011. FILED 3-8-2011.
- 4,044,457. **EYEGLASS STASH AND DESIGN**. MEEKS, JENNIFER, (U.S. CLS. 21, 23, 26, 36 AND 38). SN 85-261,710. PUB. 8-9-2011. FILED 3-9-2011.
- 4,044,469. **TURBODRAFT (STANDARD CHARACTER)**. SCHUTTE & KOERTING, LLC, (U.S. CLS. 21, 23, 26, 36 AND 38). SN 85-262,185. PUB. 8-9-2011. FILED 3-9-2011.
- 4,044,489. **THE SAFE CIG THE BLACK BATTERY (STANDARD CHARACTER)**. THE SAFE CIG, LLC, MULTIPLE CLASS, (INT. CLS. 9 AND 34), (U.S. CLS. 2, 8, 9, 17, 21, 23, 26, 36 AND 38). SN 85-262,892. PUB. 8-9-2011. FILED 3-10-2011.
- 4,044,499. **TAX-PI (STANDARD CHARACTER)**. REGIONAL ECONOMIC MODELS, INC., (U.S. CLS. 21, 23, 26, 36 AND 38). SN 85-263,224. PUB. 8-9-2011. FILED 3-10-2011.
- 4,044,520. **GALAXY X (STANDARD CHARACTER)**. CMI PRODUCTIONS LIMITED, (U.S. CLS. 21, 23, 26, 36 AND 38). SN 85-263,735. PUB. 8-9-2011. FILED 3-10-2011.
- 4,044,521. **BUBBLY (STANDARD CHARACTER)**. FAB APPS, INC., (U.S. CLS. 21, 23, 26, 36 AND 38). SN 85-263,752. PUB. 8-9-2011. FILED 3-10-2011.
- 4,044,546. **ISCAPE (STANDARD CHARACTER)**. HOME REVIVALS LLC, (U.S. CLS. 21, 23, 26, 36 AND 38). SN 85-264,660. PUB. 8-9-2011. FILED 3-11-2011.
- 4,044,549. **LAZY COUCH (STANDARD CHARACTER)**. JUST MOBILE LTD., (U.S. CLS. 21, 23, 26, 36 AND 38). SN 85-264,966. PUB. 8-9-2011. FILED 3-11-2011.
- 4,044,555. **PORTERMAX, INC. (STANDARD CHARACTER)**. PORTERMAX, INC., (U.S. CLS. 21, 23, 26, 36 AND 38). SN 85-265,132. PUB. 8-9-2011. FILED 3-11-2011.
- 4,044,565. **JACKPOT JUSTICE VILLAIN (STANDARD CHARACTER)**. ECLIPSE GAMING SYSTEMS, LLC, (U.S. CLS. 21, 23, 26, 36 AND 38). SN 85-265,606. PUB. 8-9-2011. FILED 3-13-2011.
- 4,044,566. **JACKPOT JUSTICE HERO (STANDARD CHARACTER)**. ECLIPSE GAMING SYSTEMS, LLC, (U.S. CLS. 21, 23, 26, 36 AND 38). SN 85-265,607. PUB. 8-9-2011. FILED 3-13-2011.
- 4,044,573. **NASCENT (STANDARD CHARACTER)**. NASCENT TECHNOLOGY, INC., (U.S. CLS. 21, 23, 26, 36 AND 38). SN 85-266,210. PUB. 8-9-2011. FILED 3-14-2011.
- 4,044,591. **NUCLEAR INTELLIGENCE WEEKLY (STANDARD CHARACTER)**. ENERGY INTELLIGENCE GROUP, INC., (U.S. CLS. 21, 23, 26, 36 AND 38). SN 85-267,472. PUB. 8-9-2011. FILED 3-15-2011.
- 4,044,593 ( *See Class 7 for this trademark*).
- 4,044,603. **VISCONNECT (STANDARD CHARACTER)**. DELAWARE CAPITAL FORMATION, INC., (U.S. CLS. 21, 23, 26, 36 AND 38). SN 85-269,555. PUB. 8-9-2011. FILED 3-17-2011.

- 4,044,608. **MINDFUL PARTNERSHIP ~ MINDFUL DIVORCE (STANDARD CHARACTER)**. BERGER, ILLANA, (U.S. CLS. 21, 23, 26, 36 AND 38). SN 85-270,146. PUB. 8-9-2011. FILED 3-17-2011.
- 4,044,617. **DIBBEM MUSIC (STANDARD CHARACTER)**. DIBBEM LICENSING, LLC, (U.S. CLS. 21, 23, 26, 36 AND 38). SN 85-272,046. PUB. 8-9-2011. FILED 3-21-2011.
- 4,044,623. **PMEXPRESS (STANDARD CHARACTER)**. PROJECT MANAGEMENT LEADERSHIP GROUP, INC., (U.S. CLS. 21, 23, 26, 36 AND 38). SN 85-273,355. PUB. 8-9-2011. FILED 3-22-2011.
- 4,044,625. **PRISPLUS! (STANDARD CHARACTER)**. RIMAGE CORPORATION, (U.S. CLS. 21, 23, 26, 36 AND 38). SN 85-273,369. PUB. 8-9-2011. FILED 3-22-2011.
- 4,044,627. **STARLING (STANDARD CHARACTER)**. THE FONT BUREAU INC., (U.S. CLS. 21, 23, 26, 36 AND 38). SN 85-273,385. PUB. 8-9-2011. FILED 3-22-2011.
- 4,044,629. **JULIANA (STANDARD CHARACTER)**. THE FONT BUREAU INC., (U.S. CLS. 21, 23, 26, 36 AND 38). SN 85-273,400. PUB. 8-9-2011. FILED 3-22-2011.
- 4,044,633. **MOVERS & SHAKERS (STANDARD CHARACTER)**. DAY-TIMERS, INC., (U.S. CLS. 21, 23, 26, 36 AND 38). SN 85-273,462. PUB. 8-9-2011. FILED 3-22-2011.
- 4,044,636. **NEWLIFE (STANDARD CHARACTER)**. K2 ENERGY SOLUTIONS, INC., (U.S. CLS. 21, 23, 26, 36 AND 38). SN 85-273,559. PUB. 8-9-2011. FILED 3-22-2011.
- 4,044,637. **NEXTWINDOW (STANDARD CHARACTER)**. NEXT HOLDINGS LIMITED, MULTIPLE CLASS, (INT. CLS. 9 AND 42), (U.S. CLS. 21, 23, 26, 36, 38, 100 AND 101). SN 85-273,595. PUB. 8-9-2011. FILED 3-22-2011.
- 4,044,640. **SWIT (STANDARD CHARACTER)**. SWIT ELECTRONICS CO., LTD., (U.S. CLS. 21, 23, 26, 36 AND 38). SN 85-273,619. PUB. 8-9-2011. FILED 3-22-2011.
- 4,044,659. **HUNGY (STANDARD CHARACTER)**. JOHN ROBERT HAAK, (U.S. CLS. 21, 23, 26, 36 AND 38). SN 85-273,878. PUB. 8-9-2011. FILED 3-22-2011.
- 4,044,665. **PUZ (STANDARD CHARACTER)**. SMART CHOICE MARKETING GROUP LLC, (U.S. CLS. 21, 23, 26, 36 AND 38). SN 85-273,969. PUB. 8-9-2011. FILED 3-22-2011.
- 4,044,672. **INTENSELY CURIOUS, FOCUSED ON FACTS (STANDARD CHARACTER)**. CASEY RESEARCH, LLC, (U.S. CLS. 21, 23, 26, 36 AND 38). SN 85-274,030. PUB. 8-9-2011. FILED 3-22-2011.
- 4,044,673. **LUNA SOPOR AND DESIGN**. LUNA SOPOR LLC., AKA LUNA SOPOR, MULTIPLE CLASS, (INT. CLS. 9 AND 41), (U.S. CLS. 21, 23, 26, 36, 38, 100, 101 AND 107). SN 85-274,062. PUB. 8-9-2011. FILED 3-22-2011.
- 4,044,674. **JUSTTIDE AND DESIGN**. SHENZHEN JUSTTIDE TECH CO., LTD., (U.S. CLS. 21, 23, 26, 36 AND 38). SN 85-274,063. PUB. 8-9-2011. FILED 3-22-2011.
- 4,044,675. **VRECOVERY (STANDARD CHARACTER)**. THINWARE, INC., (U.S. CLS. 21, 23, 26, 36 AND 38). SN 85-274,081. PUB. 8-9-2011. FILED 3-23-2011.
- 4,044,679. **DIGITALROUTE (STANDARD CHARACTER)**. DIGITAL ROUTE AB, MULTIPLE CLASS, (INT. CLS. 9, 38 AND 42), (U.S. CLS. 21, 23, 26, 36, 38, 100, 101 AND 104). SN 85-274,144. PUB. 8-9-2011. FILED 3-23-2011.
- 4,044,681. **PHANTOM (STANDARD CHARACTER)**. FORTRESS TECHNOLOGY, INC., (U.S. CLS. 21, 23, 26, 36 AND 38). SN 85-274,179. PUB. 8-9-2011. FILED 3-23-2011.
- 4,044,685. **SEQSOLVE (STANDARD CHARACTER)**. INTEGROMICS, S.L., (U.S. CLS. 21, 23, 26, 36 AND 38). SN 85-274,252. PUB. 8-9-2011. FILED 3-23-2011.
- 4,044,709. **BREEZY (STANDARD CHARACTER)**. BREEZY-PRINT CORPORATION, (U.S. CLS. 21, 23, 26, 36 AND 38). SN 85-274,660. PUB. 8-9-2011. FILED 3-23-2011.
- 4,044,710. **DAZMO (STANDARD CHARACTER)**. 9100-0554 QUÉBEC INC., AKA GROUPE DAZMO, (U.S. CLS. 21, 23, 26, 36 AND 38). SN 85-274,668. PUB. 8-9-2011. FILED 3-23-2011.
- 4,044,712. **BREEZY AND DESIGN**. BREEZYPRINT CORPORATION, (U.S. CLS. 21, 23, 26, 36 AND 38). SN 85-274,705. PUB. 8-9-2011. FILED 3-23-2011.
- 4,044,723. **COACHCOMM CONNEX AND DESIGN**. COACHCOMM, LLC, (U.S. CLS. 21, 23, 26, 36 AND 38). SN 85-274,862. PUB. 8-9-2011. FILED 3-23-2011.
- 4,044,739. **SILICA (STANDARD CHARACTER)**. IMMUNITY PRODUCTS, LLC, DBA IMMUNITY SOLUTIONS, (U.S. CLS. 21, 23, 26, 36 AND 38). SN 85-275,185. PUB. 8-9-2011. FILED 3-23-2011.
- 4,044,767. **CONVEX (STANDARD CHARACTER)**. ANALYSIS, INTEGRATION AND DESIGN, INC., (U.S. CLS. 21, 23, 26, 36 AND 38). SN 85-275,638. PUB. 8-9-2011. FILED 3-24-2011.
- 4,044,790. **HELP MORE PEOPLE SYSTEM (STANDARD CHARACTER)**. EVANS, SUZANNE, (U.S. CLS. 21, 23, 26, 36 AND 38). SN 85-275,845. PUB. 8-9-2011. FILED 3-24-2011.
- 4,044,796. **SCULPT MY DREAM (STANDARD CHARACTER)**. CANFIELD SCIENTIFIC, INC., (U.S. CLS. 21, 23, 26, 36 AND 38). SN 85-275,928. PUB. 8-9-2011. FILED 3-24-2011.
- 4,044,805. **MISCELLANEOUS DESIGN**. TENNRICH INTERNATIONAL CORP., (U.S. CLS. 21, 23, 26, 36 AND 38). SN 85-276,030. PUB. 8-9-2011. FILED 3-24-2011.
- 4,044,818. **NEER (STANDARD CHARACTER)**. QUALCOMM LABS, INC., (U.S. CLS. 21, 23, 26, 36 AND 38). SN 85-276,258. PUB. 8-9-2011. FILED 3-24-2011.
- 4,044,824. **ZEN TIMER (STANDARD CHARACTER)**. NOW & ZEN, INC., (U.S. CLS. 21, 23, 26, 36 AND 38). SN 85-276,385. PUB. 8-9-2011. FILED 3-24-2011.
- 4,044,852. **ZOONANZA (STANDARD CHARACTER)**. ADZOO LLC, MULTIPLE CLASS, (INT. CLS. 9, 16 AND 35), (U.S. CLS. 2, 5, 21, 22, 23, 26, 29, 36, 37, 38, 50, 100, 101 AND 102). SN 85-276,743. PUB. 8-9-2011. FILED 3-25-2011.
- 4,044,855. **NRS (STANDARD CHARACTER)**. NATIONAL RAILWAY SUPPLY, LLC, MULTIPLE CLASS, (INT. CLS. 9 AND 35), (U.S. CLS. 21, 23, 26, 36, 38, 100, 101 AND 102). SN 85-276,789. PUB. 8-9-2011. FILED 3-25-2011.
- 4,044,860. **SOUND TO GO (STANDARD CHARACTER)**. EDIFIER INTERNATIONAL, LTD., (U.S. CLS. 21, 23, 26, 36 AND 38). SN 85-276,837. PUB. 8-9-2011. FILED 3-25-2011.
- 4,044,876. **RUSHFIT (STANDARD CHARACTER)**. PIPELINE HEALTH INC., (U.S. CLS. 21, 23, 26, 36 AND 38). SN 85-277,065. PUB. 8-9-2011. FILED 3-25-2011.
- 4,044,879. **EXPRESSROOM (STANDARD CHARACTER)**. INDUSTRIAL MEDIUM LLC, (U.S. CLS. 21, 23, 26, 36 AND 38). SN 85-277,141. PUB. 8-9-2011. FILED 3-25-2011.
- 4,044,917. **ENSUITE (STANDARD CHARACTER)**. ENDIMENSIONS, LLC, DBA ENDIMENSIONS, (U.S. CLS. 21, 23, 26, 36 AND 38). SN 85-277,534. PUB. 8-9-2011. FILED 3-25-2011.
- 4,044,926. **VIGILENT (STANDARD CHARACTER)**. FEDERSPIEL CORPORATION, AKA FEDERSPIEL CONTROLS, (U.S. CLS. 21, 23, 26, 36 AND 38). SN 85-277,734. PUB. 8-9-2011. FILED 3-26-2011.
- 4,044,953. **TRILLIAN (STANDARD CHARACTER)**. CERULEAN STUDIOS, LLC, MULTIPLE CLASS, (INT. CLS. 9 AND 38), (U.S. CLS. 21, 23, 26, 36, 38, 100, 101 AND 104). SN 85-278,132. PUB. 8-9-2011. FILED 3-27-2011.
- 4,044,957. **ILUMEN (STANDARD CHARACTER)**. ILUMEN, INC., MULTIPLE CLASS, (INT. CLS. 9 AND 42), (U.S. CLS. 21, 23, 26, 36, 38, 100 AND 101). SN 85-278,199. PUB. 8-9-2011. FILED 3-28-2011.
- 4,044,967. **MISCELLANEOUS DESIGN**. INFUSION DEVELOPMENT, MULTIPLE CLASS, (INT. CLS. 9 AND 42), (U.S. CLS. 21, 23, 26, 36, 38, 100 AND 101). SN 85-278,278. PUB. 8-9-2011. FILED 3-28-2011.
- 4,045,000. **TECHSPIN (STANDARD CHARACTER)**. HELMER INC., (U.S. CLS. 21, 23, 26, 36 AND 38). SN 85-278,740. PUB. 8-9-2011. FILED 3-28-2011.
- 4,045,024. **SENGA (STANDARD CHARACTER)**. RUBY COLLINS, DBA SENG RECORDS, (U.S. CLS. 21, 23, 26, 36 AND 38). SN 85-279,017. PUB. 8-9-2011. FILED 3-28-2011.
- 4,045,051. **VADRUM (STANDARD CHARACTER)**. VADRUCI ANDREA, AKA VADRUM, (U.S. CLS. 21, 23, 26, 36 AND 38). SN 85-279,347. PUB. 8-9-2011. FILED 3-29-2011.
- 4,045,077. **VERBALLY (STANDARD CHARACTER)**. INTUARY, INC., (U.S. CLS. 21, 23, 26, 36 AND 38). SN 85-279,800. PUB. 8-9-2011. FILED 3-29-2011.
- 4,045,078. **MISCELLANEOUS DESIGN**. INTUARY, INC., (U.S. CLS. 21, 23, 26, 36 AND 38). SN 85-279,802. PUB. 8-9-2011. FILED 3-29-2011.
- 4,045,097. **SILVER APPS (STANDARD CHARACTER)**. LAVENDER, GERRY, R, DBA NETSOFT ENGINEERING, (U.S. CLS. 21, 23, 26, 36 AND 38). SN 85-280,012. PUB. 8-9-2011. FILED 3-29-2011.
- 4,045,100. **CE-VUE (STANDARD CHARACTER)**. WALTHER, JOHN, (U.S. CLS. 21, 23, 26, 36 AND 38). SN 85-280,061. PUB. 8-9-2011. FILED 3-29-2011.

- 4,045,155. **EASYROTATOR (STANDARD CHARACTER)**. MAGNETIC MARKETING & SERVICES, INC., (U.S. CLS. 21, 23, 26, 36 AND 38). SN 85-280,787. PUB. 8-9-2011. FILED 3-30-2011.
- 4,045,168. **PROTECTEDMOBILITY (STANDARD CHARACTER)**. PROTECTED MOBILITY, LLC, (U.S. CLS. 21, 23, 26, 36 AND 38). SN 85-280,943. PUB. 8-9-2011. FILED 3-30-2011.
- 4,045,171. **PROTECTED MOBILITY AND DESIGN**. PROTECTED MOBILITY, LLC, (U.S. CLS. 21, 23, 26, 36 AND 38). SN 85-280,943. PUB. 8-9-2011. FILED 3-30-2011.
- 4,045,173. **MISCELLANEOUS DESIGN**. PROTECTED MOBILITY, LLC, (U.S. CLS. 21, 23, 26, 36 AND 38). SN 85-280,981. PUB. 8-9-2011. FILED 3-30-2011.
- 4,045,174. **LOWAVZ AND DESIGN**. KALTMAN CREATIONS LLC, (U.S. CLS. 21, 23, 26, 36 AND 38). SN 85-280,984. PUB. 8-9-2011. FILED 3-30-2011.
- 4,045,177. **PROTECTEDSMS (STANDARD CHARACTER)**. PROTECTED MOBILITY, LLC, (U.S. CLS. 21, 23, 26, 36 AND 38). SN 85-280,998. PUB. 8-9-2011. FILED 3-30-2011.
- 4,045,179. **DPR (STANDARD CHARACTER)**. XTREME POWER INC., (U.S. CLS. 21, 23, 26, 36 AND 38). SN 85-281,026. PUB. 8-9-2011. FILED 3-30-2011.
- 4,045,181. **INFERNAEON (STANDARD CHARACTER)**. TRI-CYBER, (U.S. CLS. 21, 23, 26, 36 AND 38). SN 85-281,056. PUB. 8-9-2011. FILED 3-30-2011.
- 4,045,183. **BARNYARD BLITZ (STANDARD CHARACTER)**. PROTEC GAMES, INC., (U.S. CLS. 21, 23, 26, 36 AND 38). SN 85-281,094. PUB. 8-9-2011. FILED 3-30-2011.
- 4,045,188. **THE POWER TO CONTROL (STANDARD CHARACTER)**. XTREME POWER INC., (U.S. CLS. 21, 23, 26, 36 AND 38). SN 85-281,132. PUB. 8-9-2011. FILED 3-30-2011.
- 4,045,200. **CROSSOVER (STANDARD CHARACTER)**. CODE-WEAVERS, INC., (U.S. CLS. 21, 23, 26, 36 AND 38). SN 85-281,373. PUB. 8-9-2011. FILED 3-30-2011.
- 4,045,205. **QUIET COMPANY (STANDARD CHARACTER)**. QUIET COMPANY MUSIC, LLC, AKA QUIET COMPANY, MULTIPLE CLASS, (INT. CLS. 9 AND 41), (U.S. CLS. 21, 23, 26, 36, 38, 100, 101 AND 107). SN 85-281,436. PUB. 8-9-2011. FILED 3-30-2011.
- 4,045,219. **YCC (STYLIZED)**. YCC INTERNATIONAL, (U.S. CLS. 21, 23, 26, 36 AND 38). SN 85-281,703. PUB. 8-9-2011. FILED 3-30-2011.
- 4,045,244. **360TRAINING.COM (STANDARD CHARACTER)**. 360TRAINING.COM, INC., MULTIPLE CLASS, (INT. CLS. 9, 41 AND 42), (U.S. CLS. 21, 23, 26, 36, 38, 100, 101 AND 107). SN 85-281,988. PUB. 8-9-2011. FILED 3-31-2011.
- 4,045,260. **THE PRESIDENT'S OWN (STANDARD CHARACTER)**. U.S. MARINE CORPS, A COMPONENT OF THE U.S. DEPARTMENT OF THE NAVY, (U.S. CLS. 21, 23, 26, 36 AND 38). SN 85-282,088. PUB. 8-9-2011. FILED 3-31-2011.
- 4,045,265. **PLAYBACKPRO (STANDARD CHARACTER)**. DT VIDEOLABS LLC, (U.S. CLS. 21, 23, 26, 36 AND 38). SN 85-282,115. PUB. 8-9-2011. FILED 3-31-2011.
- 4,045,268. **DOUBLE DUTY (STANDARD CHARACTER)**. RADIAN, INC., (U.S. CLS. 21, 23, 26, 36 AND 38). SN 85-282,176. PUB. 8-9-2011. FILED 3-31-2011.
- 4,045,269. **SPYWAREFIGHTER (STANDARD CHARACTER)**. SPAMFIGHTER APS, (U.S. CLS. 21, 23, 26, 36 AND 38). SN 85-282,182. PUB. 8-9-2011. FILED 3-31-2011.
- 4,045,270. **FOAM SHIELD (STANDARD CHARACTER)**. RADIAN, INC., (U.S. CLS. 21, 23, 26, 36 AND 38). SN 85-282,191. PUB. 8-9-2011. FILED 3-31-2011.
- 4,045,272. **FEDEL (STANDARD CHARACTER)**. FEDELITY MUSIC, (U.S. CLS. 21, 23, 26, 36 AND 38). SN 85-282,227. PUB. 8-9-2011. FILED 3-31-2011.
- 4,045,274. **INVOICEASP AND DESIGN**. APPNOLA, LLC, (U.S. CLS. 21, 23, 26, 36 AND 38). SN 85-282,241. PUB. 8-9-2011. FILED 3-31-2011.
- 4,045,286. **TESTCENTRE (STANDARD CHARACTER)**. ARC TECHNOLOGY SOLUTIONS, (U.S. CLS. 21, 23, 26, 36 AND 38). SN 85-282,420. PUB. 8-9-2011. FILED 3-31-2011.
- 4,045,289. **INTELIKEY (STANDARD CHARACTER)**. E.P. RADIOLOGICAL SERVICES, (U.S. CLS. 21, 23, 26, 36 AND 38). SN 85-282,441. PUB. 8-9-2011. FILED 3-31-2011.
- 4,045,293. **CCMN (STANDARD CHARACTER)**. BELL, MICHAEL, (U.S. CLS. 21, 23, 26, 36 AND 38). SN 85-282,492. PUB. 8-9-2011. FILED 3-31-2011.
- 4,045,299. **IN4M AND DESIGN**. 4 OVER, INC., MULTIPLE CLASS, (INT. CLS. 9 AND 38), (U.S. CLS. 21, 23, 26, 36, 38, 100, 101 AND 104). SN 85-282,551. PUB. 8-9-2011. FILED 3-31-2011.
- 4,045,304. **SKY DRIVE (STANDARD CHARACTER)**. CANADIAN AUTOMOTIVE INSTRUMENTS LTD., (U.S. CLS. 21, 23, 26, 36 AND 38). SN 85-282,600. PUB. 8-9-2011. FILED 3-31-2011.
- 4,045,312. **ARBORLINE (STANDARD CHARACTER)**. ASPLUNDH INVESTMENTS, INC., (U.S. CLS. 21, 23, 26, 36 AND 38). SN 85-282,747. PUB. 8-9-2011. FILED 3-31-2011.
- 4,045,330. **THE DSC STANDARD (STANDARD CHARACTER)**. DESERT STAR CONSTRUCTION, INC., (U.S. CLS. 21, 23, 26, 36 AND 38). SN 85-282,984. PUB. 8-9-2011. FILED 3-31-2011.
- 4,045,344. **CLEARSCAN AND DESIGN**. IC TECHNOLOGIES, INC., (U.S. CLS. 21, 23, 26, 36 AND 38). SN 85-283,149. PUB. 8-9-2011. FILED 3-31-2011.
- 4,045,347. **VISITVIEW (STANDARD CHARACTER)**. MASTER-SOFT, INC., DBA VISITVIEW, (U.S. CLS. 21, 23, 26, 36 AND 38). SN 85-283,183. PUB. 8-9-2011. FILED 3-31-2011.
- 4,045,351. **FASHION STORY (STANDARD CHARACTER)**. TEAMLAVA, LLC, MULTIPLE CLASS, (INT. CLS. 9 AND 41), (U.S. CLS. 21, 23, 26, 36, 38, 100, 101 AND 107). SN 85-283,274. PUB. 8-9-2011. FILED 3-31-2011.
- 4,045,357. **ARRAYFORTH (STANDARD CHARACTER)**. GREENARRAYS, INC., (U.S. CLS. 21, 23, 26, 36 AND 38). SN 85-283,300. PUB. 8-9-2011. FILED 4-1-2011.
- 4,045,358. **DA CODE (STYLIZED)**. LIGHT IN THE BOX LIMITED, (U.S. CLS. 21, 23, 26, 36 AND 38). SN 85-283,322. PUB. 8-9-2011. FILED 4-1-2011.
- 4,045,364. **FULL-DISKFIGHTER (STANDARD CHARACTER)**. SPAMFIGHTER APS, (U.S. CLS. 21, 23, 26, 36 AND 38). SN 85-283,385. PUB. 8-9-2011. FILED 4-1-2011.
- 4,045,368. **GROOM-O-MATIC (STANDARD CHARACTER)**. OLIVE, BRADLEY, (U.S. CLS. 21, 23, 26, 36 AND 38). SN 85-283,455. PUB. 8-9-2011. FILED 4-1-2011.
- 4,045,383. **RESTPATCH (STYLIZED)**. REVCO INDUSTRIES, INC., (U.S. CLS. 21, 23, 26, 36 AND 38). SN 85-283,674. PUB. 8-9-2011. FILED 4-1-2011.
- 4,045,385. **BACKPATCH (STYLIZED)**. REVCO INDUSTRIES, INC., (U.S. CLS. 21, 23, 26, 36 AND 38). SN 85-283,684. PUB. 8-9-2011. FILED 4-1-2011.
- 4,045,397 ( *See Class 7 for this trademark.* )
- 4,045,407. **MISCELLANEOUS DESIGN**. HEALTHCARE INTERACTIVE, INC., MULTIPLE CLASS, (INT. CLS. 9, 41 AND 44), (U.S. CLS. 21, 23, 26, 36, 38, 100, 101 AND 107). SN 85-283,893. PUB. 8-9-2011. FILED 4-1-2011.
- 4,045,417. **EH-LINK (STANDARD CHARACTER)**. MICRO-STRAIN, INC., (U.S. CLS. 21, 23, 26, 36 AND 38). SN 85-284,000. PUB. 8-9-2011. FILED 4-1-2011.
- 4,045,433. **EVENTPILOT (STANDARD CHARACTER)**. ATIV SOLUTIONS LLC, DBA ATIV SOFTWARE, (U.S. CLS. 21, 23, 26, 36 AND 38). SN 85-284,199. PUB. 8-9-2011. FILED 4-1-2011.
- 4,045,441. **LOSA (STANDARD CHARACTER)**. FLUID ENERGY CONTROLS, INC., (U.S. CLS. 21, 23, 26, 36 AND 38). SN 85-284,305. PUB. 8-9-2011. FILED 4-1-2011.
- 4,045,468. **DOCCHOICE (STANDARD CHARACTER)**. KIK-KERIMOKA SOFTWARE INC, (U.S. CLS. 21, 23, 26, 36 AND 38). SN 85-285,070. PUB. 8-9-2011. FILED 4-4-2011.
- 4,045,484. **PIXELPIPE (STANDARD CHARACTER)**. PIXELPIPE, INC., (U.S. CLS. 21, 23, 26, 36 AND 38). SN 85-285,800. PUB. 8-9-2011. FILED 4-4-2011.
- 4,045,493. **READYSHIPPER AND DESIGN**. TRUESHIP LLC, (U.S. CLS. 21, 23, 26, 36 AND 38). SN 85-286,539. PUB. 8-9-2011. FILED 4-5-2011.
- 4,045,516. **VIDEOVIEW (STANDARD CHARACTER)**. ADT SERVICES AG, MULTIPLE CLASS, (INT. CLS. 9 AND 45), (U.S. CLS. 21, 23, 26, 36, 38, 100 AND 101). SN 85-289,964. PUB. 8-9-2011. FILED 4-8-2011.
- 4,045,528. **ZVELODB (STANDARD CHARACTER)**. ZVELO, INC., (U.S. CLS. 21, 23, 26, 36 AND 38). SN 85-293,864. PUB. 8-9-2011. FILED 4-13-2011.
- 4,045,534. **XZ XZ-LOOK (STYLIZED)**. GOLDEN STAR CORP, (U.S. CLS. 21, 23, 26, 36 AND 38). SN 85-297,142. PUB. 8-9-2011. FILED 4-16-2011.
- 4,045,539. **DESIGNIT (STANDARD CHARACTER)**. MICRO-SYSTEMS TECHNOLOGY, INC., (U.S. CLS. 21, 23, 26, 36

AND 38). SN 85-298,609. PUB. 8-9-2011. FILED 4-19-2011.  
 4,045,544. **ZOOM!** (STANDARD CHARACTER). CALIFORNIA CHARTER SCHOOLS ASSOCIATION, MULTIPLE CLASS, (INT. CLS. 9 AND 41), (U.S. CLS. 21, 23, 26, 36, 38, 100, 101 AND 107). SN 85-301,783. PUB. 8-9-2011. FILED 4-21-2011.  
 4,045,560. **PIRATE BEACH** (STANDARD CHARACTER). BALLY GAMING, INC., DBA BALLY TECHNOLOGIES, (U.S. CLS. 21, 23, 26, 36 AND 38). SN 85-312,631. PUB. 8-9-2011. FILED 5-4-2011.  
 4,045,562. **DOSE-MAP** (STANDARD CHARACTER). ISP INVESTMENTS INC., (U.S. CLS. 21, 23, 26, 36 AND 38). SN 85-313,581. PUB. 8-9-2011. FILED 5-5-2011.  
 4,045,566. **USRP** (STANDARD CHARACTER). NATIONAL INSTRUMENTS CORPORATION, (U.S. CLS. 21, 23, 26, 36 AND 38). SN 85-318,374. PUB. 8-9-2011. FILED 5-11-2011.  
 4,045,567. **USRP2** (STANDARD CHARACTER). NATIONAL INSTRUMENTS CORPORATION, (U.S. CLS. 21, 23, 26, 36 AND 38). SN 85-318,437. PUB. 8-9-2011. FILED 5-11-2011.  
 4,045,568. **TT AND DESIGN**. RIVER LIGHT V. L.P., (U.S. CLS. 21, 23, 26, 36 AND 38). SN 85-325,963. PUB. 8-9-2011. FILED S.R. 5-20-2011; AM. P.R. 5-27-2011.  
 4,045,569. **GAFCHROMIC** (STANDARD CHARACTER). ISP INVESTMENTS INC., (U.S. CLS. 21, 23, 26, 36 AND 38). SN 85-328,794. PUB. 8-9-2011. FILED 5-24-2011.  
 4,045,574. **REVOLUTIONIZING DOCUMENTATION. EQUIPPING PEOPLE FOR CARE.** (STANDARD CHARACTER). CARE CAM INNOVATIONS, LLC, (U.S. CLS. 21, 23, 26, 36 AND 38). SN 85-344,508. PUB. 8-9-2011. FILED 6-13-2011.  
 4,045,576. **WEBTAS** (STANDARD CHARACTER). INTELLIGENT SOFTWARE SOLUTIONS, INC., (U.S. CLS. 21, 23, 26, 36 AND 38). SN 85-975,315. PUB. 8-9-2011. FILED 12-9-2010.

---

#### CLASS 10—MEDICAL APPARATUS

4,043,608. **IULTRASOUND** (STANDARD CHARACTER). ISCIENCE INTERVENTIONAL CORPORATION, (U.S. CLS. 26, 39 AND 44). SN 76-697,730. PUB. 8-9-2011. FILED 6-3-2009.  
 4,043,644. **CONNECT HEARING ! C AND DESIGN**. SONOVA HOLDING AG, MULTIPLE CLASS, (INT. CLS. 10, 35, 41 AND 44), (U.S. CLS. 26, 39, 44, 100, 101, 102 AND 107). SN 77-554,801. PUB. 1-25-2011. FILED 8-25-2008.  
 4,043,649 ( *See Class 1 for this trademark* ).  
 4,043,656 ( *See Class 1 for this trademark* ).  
 4,043,687 ( *See Class 7 for this trademark* ).  
 4,043,706 ( *See Class 9 for this trademark* ).  
 4,043,713 ( *See Class 1 for this trademark* ).  
 4,043,765. **MEDI VACU VALVE** (STANDARD CHARACTER). MEDI GMBH & CO. KG, (U.S. CLS. 26, 39 AND 44). SN 79-087,350. PUB. 8-9-2011. FILED 7-9-2010.  
 4,043,775. **MEDI GENU SLEEVE** (STANDARD CHARACTER). MEDI GMBH & CO. KG, (U.S. CLS. 26, 39 AND 44). SN 79-088,236. PUB. 8-9-2011. FILED 7-9-2010.  
 4,043,790. **CIMA** (STANDARD CHARACTER). CORIN LIMITED, (U.S. CLS. 26, 39 AND 44). SN 79-088,947. PUB. 8-9-2011. FILED 10-6-2010.  
 4,043,792 ( *See Class 3 for this trademark* ).  
 4,043,810. **MASTER CAUTION** (STANDARD CHARACTER). YORAMOS LTD., (U.S. CLS. 26, 39 AND 44). SN 79-089,983. PUB. 5-3-2011. FILED 10-12-2010.  
 4,043,866. **FILBLOC** (STANDARD CHARACTER). ASSUT EUROPE S.P.A., (U.S. CLS. 26, 39 AND 44). SN 79-097,329. PUB. 8-9-2011. FILED 3-31-2011.  
 4,043,872. **THE AMPUTEE & PROSTHETIC CENTER AND DESIGN**. TMC ORTHOPEDIC, L.P., (U.S. CLS. 26, 39 AND 44). SN 85-004,460. PUB. 8-9-2011. FILED 4-1-2010.  
 4,043,873. **THE AMPUTEE & PROSTHETIC CENTER** (STANDARD CHARACTER). TMC ORTHOPEDIC, L.P., (U.S. CLS. 26, 39 AND 44). SN 85-004,532. PUB. 8-9-2011. FILED 4-1-2010.  
 4,043,878. **RADIANCE** (STANDARD CHARACTER). SAFCO DENTAL SUPPLY CO., (U.S. CLS. 26, 39 AND 44). SN 85-010,738. PUB. 8-9-2011. FILED 4-9-2010.  
 4,043,891. **BMCARE AND DESIGN**. BIOSTIME, INC. (-

GUANGZHOU), (U.S. CLS. 26, 39 AND 44). SN 85-039,502. PUB. 3-1-2011. FILED 5-15-2010.  
 4,043,934 ( *See Class 9 for this trademark* ).  
 4,044,063. **HEAD HONCHO** (STANDARD CHARACTER). CALIFORNIA EXOTIC NOVELTIES, LLC, (U.S. CLS. 26, 39 AND 44). SN 85-144,123. PUB. 8-9-2011. FILED 10-4-2010.  
 4,044,122. **VIVOLINE** (STANDARD CHARACTER). VIVOLINE MEDICAL AB, MULTIPLE CLASS, (INT. CLS. 10 AND 44), (U.S. CLS. 26, 39, 44, 100 AND 101). SN 85-175,756. PUB. 8-9-2011. FILED 11-12-2010.  
 4,044,242. **NOLAN HOOF PLATE** (STANDARD CHARACTER). GESUND, INC., DBA NOLAN HOOF HEALTH, (U.S. CLS. 26, 39 AND 44). SN 85-227,760. PUB. 8-9-2011. FILED 1-27-2011.  
 4,044,243. **PLATE THE HOOF. RESTORE THE HORSE.** (STANDARD CHARACTER). GESUND, INC., DBA NOLAN HOOF HEALTH, (U.S. CLS. 26, 39 AND 44). SN 85-227,778. PUB. 8-9-2011. FILED 1-27-2011.  
 4,044,300. **SENTINEL** (STANDARD CHARACTER). ALCOR SCIENTIFIC, INC., (U.S. CLS. 26, 39 AND 44). SN 85-240,145. PUB. 8-9-2011. FILED 2-11-2011.  
 4,044,378. **VERTALUX** (STANDARD CHARACTER). HENDRICKS ORTHOTIC PROSTHETIC ENTERPRISES, INC., (U.S. CLS. 26, 39 AND 44). SN 85-257,080. PUB. 8-9-2011. FILED 3-3-2011.  
 4,044,379. **ORTHOLUX** (STANDARD CHARACTER). HENDRICKS ORTHOTIC PROSTHETIC ENTERPRISES, INC., (U.S. CLS. 26, 39 AND 44). SN 85-257,087. PUB. 8-9-2011. FILED 3-3-2011.  
 4,044,380. **LUMBOLUX** (STANDARD CHARACTER). HENDRICKS ORTHOTIC PROSTHETIC ENTERPRISES, INC., (U.S. CLS. 26, 39 AND 44). SN 85-257,116. PUB. 8-9-2011. FILED 3-3-2011.  
 4,044,583. **MISCELLANEOUS DESIGN**. PREWITT, DR. MARY JULIA WIESS, AND PREWITT, DR. JAMES ROBINSON, (U.S. CLS. 26, 39 AND 44). SN 85-266,718. PUB. 8-9-2011. FILED 3-14-2011.  
 4,044,609. **BUNCHEES** (STANDARD CHARACTER). JONES, MONICA G, DBA RITZY BITZY DESIGNS, (U.S. CLS. 26, 39 AND 44). SN 85-270,679. PUB. 8-9-2011. FILED 3-18-2011.  
 4,044,611 ( *See Class 5 for this trademark* ).  
 4,044,714. **ABO** (STANDARD CHARACTER). CENTINEL SPINE, INC., (U.S. CLS. 26, 39 AND 44). SN 85-274,726. PUB. 8-9-2011. FILED 3-23-2011.  
 4,044,821. **REL-K** (STANDARD CHARACTER). RIZZOLI ORTOPEDIA S.P.A., (U.S. CLS. 26, 39 AND 44). SN 85-276,345. PUB. 8-9-2011. FILED 3-24-2011.  
 4,044,889. **IRRICLEAR** (STANDARD CHARACTER). NORTHSTAR LABORATORIES, (U.S. CLS. 26, 39 AND 44). SN 85-277,236. PUB. 8-9-2011. FILED 3-25-2011.  
 4,044,921. **LASER MESSIAH** (STANDARD CHARACTER). CHRISTIAN, JOHN G., DBA HAIR LASER HELMETS, (U.S. CLS. 26, 39 AND 44). SN 85-277,724. PUB. 8-9-2011. FILED 3-26-2011.  
 4,044,978. **VISCOTIP** (STANDARD CHARACTER). CAO GROUP, INC., (U.S. CLS. 26, 39 AND 44). SN 85-278,453. PUB. 8-9-2011. FILED 3-28-2011.  
 4,044,983. **LIQUATIP** (STANDARD CHARACTER). CAO GROUP, INC., (U.S. CLS. 26, 39 AND 44). SN 85-278,498. PUB. 8-9-2011. FILED 3-28-2011.  
 4,045,012. **FESCRUBTIP** (STANDARD CHARACTER). CAO GROUP, INC., (U.S. CLS. 26, 39 AND 44). SN 85-278,891. PUB. 8-9-2011. FILED 3-28-2011.  
 4,045,167. **PEDI-TIE** (STANDARD CHARACTER). PEPPER MEDICAL INCORPORATED, (U.S. CLS. 26, 39 AND 44). SN 85-280,920. PUB. 8-9-2011. FILED 3-30-2011.  
 4,045,349 ( *See Class 5 for this trademark* ).  
 4,045,379. **PRODUCTS FOR SERIOUS MESSAGE** (STANDARD CHARACTER). THUMPER MASSAGER, INC., (U.S. CLS. 26, 39 AND 44). SN 85-283,558. PUB. 8-9-2011. FILED 4-1-2011.  
 4,045,557. **RAD-SURE** (STANDARD CHARACTER). ISP INVESTMENTS INC., (U.S. CLS. 26, 39 AND 44). SN 85-309,678. PUB. 8-9-2011. FILED 5-2-2011.

**CLASS 11—ENVIRONMENTAL CONTROL APPARATUS**

- 4,043,605. **LAVA**. LAVA LITE, LLC, (U.S. CLS. 13, 21, 23, 31 AND 34). SN 76-124,415. PUB. 8-9-2011. FILED 9-8-2000.  
4,043,615 ( *See Class 9 for this trademark* ).
- 4,043,651. **POWDERREV (STANDARD CHARACTER)**. EN-WAVE CORPORATION, MULTIPLE CLASS, (INT. CLS. 11 AND 40), (U.S. CLS. 13, 21, 23, 31, 34, 100, 103 AND 106). SN 77-596,520. PUB. 7-12-2011. FILED 10-20-2008.
- 4,043,726. **CCI (STANDARD CHARACTER)**. COLEMAN CABLE, INC., (U.S. CLS. 13, 21, 23, 31 AND 34). SN 77-955,474. PUB. 7-5-2011. FILED 3-10-2010.
- 4,043,738. **ACCULITE (STANDARD CHARACTER)**. JUNO MANUFACTURING, LLC, (U.S. CLS. 13, 21, 23, 31 AND 34). SN 78-769,242. PUB. 8-9-2011. FILED 12-8-2005.
- 4,043,756. **KKDC (STANDARD CHARACTER)**. KKDC PTY LTD, (U.S. CLS. 13, 21, 23, 31 AND 34). SN 79-084,401. PUB. 8-9-2011. FILED 5-17-2010.
- 4,043,757. **KKDC AND DESIGN**. KKDC PTY LTD, (U.S. CLS. 13, 21, 23, 31 AND 34). SN 79-084,402. PUB. 8-9-2011. FILED 5-17-2010.
- 4,043,762. **DINAIR (STANDARD CHARACTER)**. DINAIR INDUSTRIES AB, (U.S. CLS. 13, 21, 23, 31 AND 34). SN 79-086,342. PUB. 8-9-2011. FILED 8-18-2010.
- 4,043,774 ( *See Class 9 for this trademark* ).
- 4,043,791 ( *See Class 9 for this trademark* ).
- 4,043,798 ( *See Class 6 for this trademark* ).
- 4,043,812 ( *See Class 4 for this trademark* ).
- 4,043,834. **GS GNUTTI SEBASTIANO & FIGLI AND DESIGN**. R.B.M. S.P.A., (U.S. CLS. 13, 21, 23, 31 AND 34). SN 79-092,554. PUB. 8-9-2011. FILED 11-8-2010.
- 4,043,837 ( *See Class 9 for this trademark* ).
- 4,043,905. **STOKO REFRESH (STANDARD CHARACTER)**. EVONIK STOCKHAUSEN GMBH, (U.S. CLS. 13, 21, 23, 31 AND 34). SN 85-055,881. PUB. 5-10-2011. FILED 6-7-2010.
- 4,043,916. **HYDRO R2 (STANDARD CHARACTER)**. MITSUBISHI ELECTRIC CORPORATION, (U.S. CLS. 13, 21, 23, 31 AND 34). SN 85-068,391. PUB. 8-9-2011. FILED 6-22-2010.
- 4,043,920. **EUROSMART (STANDARD CHARACTER)**. GROHE AG, (U.S. CLS. 13, 21, 23, 31 AND 34). SN 85-072,366. PUB. 2-22-2011. FILED 6-26-2010.
- 4,043,935 ( *See Class 9 for this trademark* ).
- 4,043,948. **J AND DESIGN**. ARTEMIS RUBBER TECHNOLOGY, INC., MULTIPLE CLASS, (INT. CLS. 11 AND 28), (U.S. CLS. 13, 21, 22, 23, 31, 34, 38 AND 50). SN 85-102,044. PUB. 8-9-2011. FILED 8-6-2010.
- 4,043,984. **MISCELLANEOUS DESIGN**. CHRYSLER GROUP LLC, MULTIPLE CLASS, (INT. CLS. 11 AND 12), (U.S. CLS. 13, 19, 21, 23, 31, 34, 35 AND 44). SN 85-115,180. PUB. 8-9-2011. FILED 8-25-2010.
- 4,044,074 ( *See Class 9 for this trademark* ).
- 4,044,139. **PLASMAGLOW (STANDARD CHARACTER)**. EUGENE OVERLINE, (U.S. CLS. 13, 21, 23, 31 AND 34). SN 85-184,648. PUB. 8-9-2011. FILED 11-24-2010.
- 4,044,175. **BADDASS BLOWER (STANDARD CHARACTER)**. ADVANCED NUTRIENTS LTD., (U.S. CLS. 13, 21, 23, 31 AND 34). SN 85-205,008. PUB. 7-26-2011. FILED 12-23-2010.
- 4,044,176. **MISCELLANEOUS DESIGN**. ADVANCED NUTRIENTS LTD., (U.S. CLS. 13, 21, 23, 31 AND 34). SN 85-205,026. PUB. 7-26-2011. FILED 12-23-2010.
- 4,044,238. **COZOC (STANDARD CHARACTER)**. COZOC GROUPS INC., MULTIPLE CLASS, (INT. CLS. 11, 12 AND 40), (U.S. CLS. 13, 19, 21, 23, 31, 34, 35, 44, 100, 103 AND 106). SN 85-227,289. PUB. 8-9-2011. FILED 1-27-2011.
- 4,044,247. **COZOC AND DESIGN**. COZOC GROUPS INC., MULTIPLE CLASS, (INT. CLS. 11, 12 AND 40), (U.S. CLS. 13, 19, 21, 23, 31, 34, 35, 44, 100, 103 AND 106). SN 85-228,371. PUB. 8-9-2011. FILED 1-28-2011.
- 4,044,256. **HOUSE OF MARLEY MARETT TSEHAI DAM AND DESIGN**. FIFTY-SIX HOPE ROAD MUSIC LIMITED, (U.S. CLS. 13, 21, 23, 31 AND 34). SN 85-230,791. PUB. 8-9-2011. FILED 2-1-2011.
- 4,044,280. **VERITAS (STANDARD CHARACTER)**. EGL COMPANY, INC, (U.S. CLS. 13, 21, 23, 31 AND 34). SN 85-235,279. PUB. 8-9-2011. FILED 2-7-2011.
- 4,044,359. **AQUASHIELD (STANDARD CHARACTER)**. NATIONAL PRODUCTS, INC., (U.S. CLS. 13, 21, 23, 31 AND 34). SN 85-253,953. PUB. 8-9-2011. FILED 2-28-2011.

- 4,044,381. **DRAGON FIRE THERMO RECOVERY FILTER AND DESIGN**. NATIONAL WHOLESALE SUPPLY, INC., DBA NATIONAL HOT WATER, (U.S. CLS. 13, 21, 23, 31 AND 34). SN 85-257,237. PUB. 8-9-2011. FILED 3-3-2011.
- 4,044,592. **PD AND DESIGN**. PARTYDRAGON LIMITED, (U.S. CLS. 13, 21, 23, 31 AND 34). SN 85-267,676. PUB. 8-9-2011. FILED 3-15-2011.
- 4,044,646. **SWIT (STANDARD CHARACTER)**. SWIT ELECTRONICS CO., LTD., (U.S. CLS. 13, 21, 23, 31 AND 34). SN 85-273,703. PUB. 8-9-2011. FILED 3-22-2011.
- 4,044,770. **AQUATOP AND DESIGN**. CHAI DAVE, (U.S. CLS. 13, 21, 23, 31 AND 34). SN 85-275,642. PUB. 8-9-2011. FILED 3-24-2011.
- 4,044,886. **HEPAQUIET (STANDARD CHARACTER)**. BLUE-AIR AB, (U.S. CLS. 13, 21, 23, 31 AND 34). SN 85-277,211. PUB. 8-9-2011. FILED 3-25-2011.
- 4,044,900. **ONE HOME ONE PURIFIER ONE CHOICE (STANDARD CHARACTER)**. BLUEAIR AB, (U.S. CLS. 13, 21, 23, 31 AND 34). SN 85-277,359. PUB. 8-9-2011. FILED 3-25-2011.
- 4,045,092. **ELLIPTI-FIN (STANDARD CHARACTER)**. EVAPCO, INC., (U.S. CLS. 13, 21, 23, 31 AND 34). SN 85-279,919. PUB. 8-9-2011. FILED 3-29-2011.

**CLASS 12—VEHICLES**

- 4,043,686. **EXTREME COLD (STANDARD CHARACTER)**. FIC, INC., (U.S. CLS. 19, 21, 23, 31, 35 AND 44). SN 77-821,419. PUB. 8-9-2011. FILED 9-8-2009.
- 4,043,772. **FACC AND DESIGN**. FACC AG, MULTIPLE CLASS, (INT. CLS. 12, 17 AND 42), (U.S. CLS. 1, 5, 12, 13, 19, 21, 23, 31, 35, 44, 50, 100 AND 101). SN 79-088,053. PUB. 8-9-2011. FILED 9-10-2010.
- 4,043,782. **GB (STYLIZED)**. GOODBABY CHILD PRODUCTS CO., LTD., MULTIPLE CLASS, (INT. CLS. 12, 20 AND 28), (U.S. CLS. 2, 13, 19, 21, 22, 23, 25, 31, 32, 35, 38, 44 AND 50). SN 79-088,641. PUB. 8-9-2011. FILED 2-10-2010.
- 4,043,784 ( *See Class 7 for this trademark* ).
- 4,043,785 ( *See Class 3 for this trademark* ).
- 4,043,838. **MIA ELECTRIC (STANDARD CHARACTER)**. MIA ELECTRIC GMBH, MULTIPLE CLASS, (INT. CLS. 12, 35 AND 37), (U.S. CLS. 19, 21, 23, 31, 35, 44, 100, 101, 102, 103 AND 106). SN 79-093,185. PUB. 8-9-2011. FILED 12-17-2010.
- 4,043,854. **VIRAGE (STANDARD CHARACTER)**. ASTON MARTIN LAGONDA LIMITED, MULTIPLE CLASS, (INT. CLS. 12 AND 37), (U.S. CLS. 19, 21, 23, 31, 35, 44, 100, 103 AND 106). SN 79-096,174. PUB. 8-9-2011. FILED 2-11-2011.
- 4,043,893 ( *See Class 9 for this trademark* ).
- 4,043,899. **BOMETEC AUTO AND DESIGN**. HU, JIAN, (U.S. CLS. 19, 21, 23, 31, 35 AND 44). SN 85-050,898. PUB. 5-3-2011. FILED 5-29-2010.
- 4,043,918. **MERCEDES GP PETRONAS (STANDARD CHARACTER)**. DAIMLER AG, MULTIPLE CLASS, (INT. CLS. 12, 14, 16, 18, 25, 35, 41 AND 43), (U.S. CLS. 1, 2, 3, 5, 19, 21, 22, 23, 27, 28, 29, 31, 35, 37, 38, 39, 41, 44, 50, 100, 101, 102 AND 107). SN 85-071,841. PUB. 8-9-2011. FILED 6-25-2010.
- 4,043,982. **MCK (STYLIZED)**. BEIJING CITY CHANGPING ZONE NORTHERN AUTOMOTIVE LEAF-SPRING FACTORY, (U.S. CLS. 19, 21, 23, 31, 35 AND 44). SN 85-114,148. PUB. 8-9-2011. FILED 8-24-2010.
- 4,043,984 ( *See Class 11 for this trademark* ).
- 4,044,138. **KARMAN AND DESIGN**. KARMAN HEALTHCARE INC., (U.S. CLS. 19, 21, 23, 31, 35 AND 44). SN 85-184,167. PUB. 8-9-2011. FILED 11-23-2010.
- 4,044,197. **TREBOL AND DESIGN**. FLYBIKES, S.L., (U.S. CLS. 19, 21, 23, 31, 35 AND 44). SN 85-209,918. PUB. 8-9-2011. FILED 1-4-2011.
- 4,044,238 ( *See Class 11 for this trademark* ).
- 4,044,247 ( *See Class 11 for this trademark* ).
- 4,044,340. **WHEELS NEXT (STANDARD CHARACTER)**. WHEELSNEXT INC, AKA WHEELSNEXT, (U.S. CLS. 19, 21, 23, 31, 35 AND 44). SN 85-251,105. PUB. 8-9-2011. FILED 2-24-2011.
- 4,044,396. **HEATHTECNA (STANDARD CHARACTER)**. HEATH TECNA INC., (U.S. CLS. 19, 21, 23, 31, 35 AND

- 44). SN 85-258,675. PUB. 8-9-2011. FILED 3-4-2011.
- 4,044,508. **UNI-CHASSIS AND DESIGN**. THEODORE, CHRIS P., (U.S. CLS. 19, 21, 23, 31, 35 AND 44). SN 85-263,377. PUB. 8-9-2011. FILED 3-10-2011.
- 4,044,618. **PEG-PÉREGO AND DESIGN**. PEG PEREGO U.S.A., INC., MULTIPLE CLASS, (INT. CLS. 12, 20 AND 28), (U.S. CLS. 2, 13, 19, 21, 22, 23, 25, 31, 32, 35, 38, 44 AND 50). SN 85-272,393. PUB. 8-9-2011. FILED 3-21-2011.
- 4,044,693. **OPTITRAC (STANDARD CHARACTER)**. THE GOODYEAR TIRE & RUBBER COMPANY, (U.S. CLS. 19, 21, 23, 31, 35 AND 44). SN 85-274,381. PUB. 8-9-2011. FILED 3-23-2011.
- 4,044,727. **ARTISAN (STANDARD CHARACTER)**. ARTISAN VEHICLE SYSTEMS, INC., (U.S. CLS. 19, 21, 23, 31, 35 AND 44). SN 85-274,927. PUB. 8-9-2011. FILED 3-23-2011.
- 4,044,833. **FLEXPORT (STANDARD CHARACTER)**. CATERPILLAR INC., (U.S. CLS. 19, 21, 23, 31, 35 AND 44). SN 85-276,529. PUB. 8-9-2011. FILED 3-25-2011.
- 4,044,906. **EDGE (STANDARD CHARACTER)**. DUBINSKIY, YURIY, AND GOROKHOVSKY, ALEXANDER, (U.S. CLS. 19, 21, 23, 31, 35 AND 44). SN 85-277,426. PUB. 8-9-2011. FILED 3-25-2011.
- 4,045,063. **NOVA RAY (STANDARD CHARACTER)**. ADVENT MARINE TECHNOLOGIES (MALAYSIA) SDN BHD, (U.S. CLS. 19, 21, 23, 31, 35 AND 44). SN 85-279,537. PUB. 8-9-2011. FILED 3-29-2011.
- 4,045,137. **STAATS (STANDARD CHARACTER)**. SOURCE SOLUTIONS INTL., LTD., (U.S. CLS. 19, 21, 23, 31, 35 AND 44). SN 85-280,506. PUB. 8-9-2011. FILED 3-29-2011.
- 4,045,139. **CIARI (STANDARD CHARACTER)**. SOURCE SOLUTIONS INTL., LTD., (U.S. CLS. 19, 21, 23, 31, 35 AND 44). SN 85-280,511. PUB. 8-9-2011. FILED 3-29-2011.
- 4,045,211. **SUNNYBROOK (STANDARD CHARACTER)**. WINNEBAGO OF INDIANA, LLC, (U.S. CLS. 19, 21, 23, 31, 35 AND 44). SN 85-281,600. PUB. 8-9-2011. FILED 3-30-2011.
- 4,045,323. **BUILT TO BE BETTER. (STANDARD CHARACTER)**. NORTHROCK BICYCLES, LLC, (U.S. CLS. 19, 21, 23, 31, 35 AND 44). SN 85-282,954. PUB. 8-9-2011. FILED 3-31-2011.
- 4,045,340. **MAF (STANDARD CHARACTER)**. ALVAREZ AUTOMOTRIZ, S.A. DE C.V., (U.S. CLS. 19, 21, 23, 31, 35 AND 44). SN 85-283,085. PUB. 8-9-2011. FILED 3-31-2011.
- 4,045,436. **REVENIO (STANDARD CHARACTER)**. RALEIGH AMERICA, INC., (U.S. CLS. 19, 21, 23, 31, 35 AND 44). SN 85-284,240. PUB. 8-9-2011. FILED 4-1-2011.
- 4,045,437. **RUSH HOUR (STANDARD CHARACTER)**. RALEIGH AMERICA, INC., (U.S. CLS. 19, 21, 23, 31, 35 AND 44). SN 85-284,264. PUB. 8-9-2011. FILED 4-1-2011.
- 4,045,506. **DRIVING INTELLIGENT VEHICLE SOLUTIONS (STANDARD CHARACTER)**. UTILIMASTER CORPORATION, (U.S. CLS. 19, 21, 23, 31, 35 AND 44). SN 85-287,514. PUB. 8-9-2011. FILED 4-6-2011.
- 4,045,517. **THE BEAST (STANDARD CHARACTER)**. SEAL AFTERMARKET PRODUCTS, LLC, (U.S. CLS. 19, 21, 23, 31, 35 AND 44). SN 85-290,008. PUB. 8-9-2011. FILED 4-8-2011.
- 4,043,843. **JUGGLE ANGELS (STANDARD CHARACTER)**. JUGGLE ANGELS, SOCIÉTÉ PRIVÉE À RESPONSABILITÉ LIMITÉE, MULTIPLE CLASS, (INT. CLS. 14, 25 AND 35), (U.S. CLS. 2, 22, 27, 28, 39, 50, 100, 101 AND 102). SN 79-093,927. PUB. 8-9-2011. FILED 12-21-2010.
- 4,043,848 ( *See Class 9 for this trademark*).
- 4,043,860 ( *See Class 3 for this trademark*).
- 4,043,918 ( *See Class 12 for this trademark*).
- 4,044,016. **MIDNIGHT STAR (STANDARD CHARACTER)**. COLOR JEWELS, INC, (U.S. CLS. 2, 27, 28 AND 50). SN 85-123,845. PUB. 8-9-2011. FILED 9-7-2010.
- 4,044,127 ( *See Class 3 for this trademark*).
- 4,044,203. **E AND DESIGN**. U.S. DEPARTMENT OF COMMERCE, INTERNATIONAL TRADE ADMINISTRATION, MULTIPLE CLASS, (INT. CLS. 14 AND 16), (U.S. CLS. 2, 5, 22, 23, 27, 28, 29, 37, 38 AND 50). SN 85-211,889. PUB. 8-9-2011. FILED 1-6-2011.
- 4,044,204. **E AND DESIGN**. U.S. DEPARTMENT OF COMMERCE, INTERNATIONAL TRADE ADMINISTRATION, MULTIPLE CLASS, (INT. CLS. 14 AND 16), (U.S. CLS. 2, 5, 22, 23, 27, 28, 29, 37, 38 AND 50). SN 85-211,890. PUB. 8-9-2011. FILED 1-6-2011.
- 4,044,257. **HOUSE OF MARLEY MARETT TSEHAI DAM AND DESIGN**. FIFTY-SIX HOPE ROAD MUSIC LIMITED, (U.S. CLS. 2, 27, 28 AND 50). SN 85-230,792. PUB. 8-9-2011. FILED 2-1-2011.
- 4,044,318. **WOODY (STANDARD CHARACTER)**. ERICKSEN, ADAM C., DBA UTAH IDAHO LEATHER LLC, MULTIPLE CLASS, (INT. CLS. 14 AND 18), (U.S. CLS. 1, 2, 3, 22, 27, 28, 41 AND 50). SN 85-247,124. PUB. 8-9-2011. FILED 2-20-2011.
- 4,044,455. **SPARKLING PINK (STANDARD CHARACTER)**. GUESS?, INC., (U.S. CLS. 2, 27, 28 AND 50). SN 85-261,524. PUB. 8-9-2011. FILED 3-8-2011.
- 4,044,505. **SUN SANDALS LLC AND DESIGN**. SUN SANDALS, LLC, (U.S. CLS. 2, 27, 28 AND 50). SN 85-263,316. PUB. 8-9-2011. FILED 3-10-2011.
- 4,044,806. **BERGIO (STANDARD CHARACTER)**. BERGIO INTERNATIONAL, INC., (U.S. CLS. 2, 27, 28 AND 50). SN 85-276,066. PUB. 8-9-2011. FILED 3-24-2011.
- 4,044,814. **MARK ZUNINO (STANDARD CHARACTER)**. ZUNINO, MARK, (U.S. CLS. 2, 27, 28 AND 50). SN 85-276,220. PUB. 8-9-2011. FILED 3-24-2011.
- 4,044,815. **MARK ZUNINO AND DESIGN**. ZUNINO, MARK, (U.S. CLS. 2, 27, 28 AND 50). SN 85-276,228. PUB. 8-9-2011. FILED 3-24-2011.
- 4,044,992. **GEMISTRY (STANDARD CHARACTER)**. ULTIMATE TRADING CORPORATION, (U.S. CLS. 2, 27, 28 AND 50). SN 85-278,605. PUB. 8-9-2011. FILED 3-28-2011.
- 4,045,236. **THE LOOKSY (STANDARD CHARACTER)**. LUCAS, LEE A, DBA THE LOOKSY, (U.S. CLS. 2, 27, 28 AND 50). SN 85-281,892. PUB. 8-9-2011. FILED 3-30-2011.
- 4,045,288. **AK AND DESIGN**. AUGELLO-COOK, ALICIA, MULTIPLE CLASS, (INT. CLS. 14, 25 AND 26), (U.S. CLS. 2, 22, 27, 28, 37, 39, 40, 42 AND 50). SN 85-282,430. PUB. 8-9-2011. FILED 3-31-2011.
- 4,045,375. **ACCESSORY CONNECTION (STANDARD CHARACTER)**. FACTORY CONNECTION, LLC, (U.S. CLS. 2, 27, 28 AND 50). SN 85-283,534. PUB. 8-9-2011. FILED 4-1-2011.
- 4,045,394. **8 AND DESIGN**. J WILLIAMS, DBA JJ NUMBER 8, INC., MULTIPLE CLASS, (INT. CLS. 14, 18 AND 25), (U.S. CLS. 1, 2, 3, 22, 27, 28, 39, 41 AND 50). SN 85-283,721. PUB. 8-9-2011. FILED 4-1-2011.
- 4,045,405. **STEWART/STAND (STANDARD CHARACTER)**. COCKROACH DESIGN, LLC, DBA STEWART/STAND, (U.S. CLS. 2, 27, 28 AND 50). SN 85-283,880. PUB. 8-9-2011. FILED 4-1-2011.
- 4,045,466. **BELLA FOREVER (STANDARD CHARACTER)**. BELLA FOREVER LIMITED, INC., (U.S. CLS. 2, 27, 28 AND 50). SN 85-284,813. PUB. 8-9-2011. FILED 4-3-2011.
- 4,045,479. **JEWELRY OF LEGENDS (STANDARD CHARACTER)**. EXCLUSIVE SOURCE INTERNATIONAL, INC., (U.S. CLS. 2, 27, 28 AND 50). SN 85-285,653. PUB. 8-9-2011. FILED 4-4-2011.

---

### CLASS 13—FIREARMS

- 4,044,885. **CIRCUIT JUDGE (STANDARD CHARACTER)**. BRAZTECH INTERNATIONAL, L.C., (U.S. CLS. 2 AND 9). SN 85-277,207. PUB. 8-9-2011. FILED 3-25-2011.
- 4,045,019. **CHAMBER CHECK BETTER GUN SAFETY AND DESIGN**. CAT5TACTICALLLC, (U.S. CLS. 2 AND 9). SN 85-278,961. PUB. 8-9-2011. FILED 3-28-2011.

---

### CLASS 14—JEWELRY

- 4,043,662 ( *See Class 9 for this trademark*).
- 4,043,702. **KIMAYA (STANDARD CHARACTER)**. KIMAYA FASHIONS PRIVATE LIMITED, (U.S. CLS. 2, 27, 28 AND 50). SN 77-886,127. PUB. 8-9-2011. FILED 12-4-2009.
- 4,043,771. **EDUN (STYLIZED)**. EDUN APPAREL LIMITED,

**CLASS 15—MUSICAL INSTRUMENTS**

- 4,044,486. **DYNAMICX DRUMS USA (STANDARD CHARACTER)**. BLACK SWAMP PERCUSSION, (U.S. CLS. 2, 21 AND 36). SN 85-262,772. PUB. 8-9-2011. FILED 3-9-2011.
- 4,044,527. **MR SCARY GUITARS (STANDARD CHARACTER)**. LYNCH, GEORGE M. AND LYNCH, DANICA J. (U.S. CLS. 2, 21 AND 36). SN 85-263,994. PUB. 8-9-2011. FILED 3-10-2011.
- 4,044,797. **E-PAD! (STANDARD CHARACTER)**. EBLEN, EDMUND L., (U.S. CLS. 2, 21 AND 36). SN 85-275,939. PUB. 8-9-2011. FILED 3-24-2011.
- 4,044,919. **GIRLS ROCK (STANDARD CHARACTER)**. BIG IDEA GUYS, INC., (U.S. CLS. 2, 21 AND 36). SN 85-277,596. PUB. 8-9-2011. FILED 3-25-2011.
- 4,045,129. **LOST TIMBRE (STANDARD CHARACTER)**. RUSSELL K. SCHAEFFER AND KARLA SCHAEFFER, (U.S. CLS. 2, 21 AND 36). SN 85-280,462. PUB. 8-9-2011. FILED 3-29-2011.
- 4,045,138. **LOST TIMBRE (STYLIZED)**. RUSSELL K. SCHAEFFER AND KARLA SCHAEFFER, (U.S. CLS. 2, 21 AND 36). SN 85-280,509. PUB. 8-9-2011. FILED 3-29-2011.

**CLASS 16—PAPER GOODS AND PRINTED MATTER**

- 4,043,611. **POWER SOLUTIONS (STYLIZED)**. STORAGE BATTERY SYSTEMS, INC., (U.S. CLS. 2, 5, 22, 23, 29, 37, 38 AND 50). SN 76-701,281. PUB. 8-9-2011. FILED 1-20-2010.
- 4,043,621. **FLOORTEX (STANDARD CHARACTER)**. FLOOR-TEX EUROPE LIMITED, MULTIPLE CLASS, (INT. CLS. 16 AND 27), (U.S. CLS. 2, 5, 19, 20, 22, 23, 29, 37, 38, 42 AND 50). SN 76-705,895. PUB. 5-3-2011. FILED 1-4-2011.
- 4,043,626. **CONKLIN THE CONKLIN PEN CO. EST. 1898 THE LEGENDARY NAME FOR FINE WRITING INSTRUMENTS AND DESIGN**. YAFA A PEN COMPANY INC., (U.S. CLS. 2, 5, 22, 23, 29, 37, 38 AND 50). SN 76-706,943. PUB. 8-9-2011. FILED 3-22-2011.
- 4,043,676. **THE COWL (STANDARD CHARACTER)**. HAMILTON, RICHARD A. (U.S. CLS. 2, 5, 22, 23, 29, 37, 38 AND 50). SN 77-769,196. PUB. 8-9-2011. FILED 6-26-2009.
- 4,043,684 ( *See Class 9 for this trademark*).
- 4,043,689 ( *See Class 3 for this trademark*).
- 4,043,694. **WHO'S PARKED IN YOUR HEART? (STANDARD CHARACTER)**. ILLUSIVE DREAMS, INC., MULTIPLE CLASS, (INT. CLS. 16, 21, 25 AND 28), (U.S. CLS. 2, 5, 13, 22, 23, 29, 30, 33, 37, 38, 39, 40 AND 50). SN 77-865,956. PUB. 8-9-2011. FILED 11-5-2009.
- 4,043,695 ( *See Class 9 for this trademark*).
- 4,043,705. **SF AIRLINES (STYLIZED)**. SF (IP) LIMITED, MULTIPLE CLASS, (INT. CLS. 16, 37 AND 39), (U.S. CLS. 2, 5, 22, 23, 29, 37, 38, 50, 100, 103, 105 AND 106). SN 77-896,348. PUB. 4-26-2011. FILED 12-17-2009.
- 4,043,719 ( *See Class 9 for this trademark*).
- 4,043,751. **NAOSTORE (STANDARD CHARACTER)**. ALDEBARAN ROBOTICS, MULTIPLE CLASS, (INT. CLS. 16, 35 AND 41), (U.S. CLS. 2, 5, 22, 23, 29, 37, 38, 50, 100, 101, 102 AND 107). SN 79-081,797. PUB. 8-9-2011. FILED 2-3-2010.
- 4,043,773 ( *See Class 9 for this trademark*).
- 4,043,779 ( *See Class 9 for this trademark*).
- 4,043,780 ( *See Class 9 for this trademark*).
- 4,043,781 ( *See Class 9 for this trademark*).
- 4,043,783. **SAVE FOOD SOLUTIONS FOR A WORLD AWARE OF ITS RESOURCES AND DESIGN**. MESSE DÜSSELDORF GMBH, MULTIPLE CLASS, (INT. CLS. 16, 35 AND 41), (U.S. CLS. 2, 5, 22, 23, 29, 37, 38, 50, 100, 101, 102 AND 107). SN 79-088,817. PUB. 8-9-2011. FILED 10-8-2010.
- 4,043,785 ( *See Class 3 for this trademark*).
- 4,043,806 ( *See Class 9 for this trademark*).
- 4,043,848 ( *See Class 9 for this trademark*).
- 4,043,871. **MISCELLANEOUS DESIGN**. THE UNIVERSITY OF TULSA, MULTIPLE CLASS, (INT. CLS. 16, 21, 22 AND 25), (U.S. CLS. 1, 2, 5, 7, 13, 19, 22, 23, 29, 30, 33, 37, 38, 39, 40, 42 AND 50). SN 85-002,804. PUB. 3-8-2011. FILED 3-31-2010.
- 4,043,877. **TECHNICITY (STANDARD CHARACTER)**. DAIMLER AG, (U.S. CLS. 2, 5, 22, 23, 29, 37, 38 AND 50). SN 85-010,575. PUB. 8-9-2011. FILED 4-9-2010.
- 4,043,884. **DEVELOPING THE NEXT GENERATION OF LATINO LEADERS (STANDARD CHARACTER)**. CONGRESSIONAL HISPANIC CAUCUS INSTITUTE, INC., MULTIPLE CLASS, (INT. CLS. 16, 35 AND 41), (U.S. CLS. 2, 5, 22, 23, 29, 37, 38, 50, 100, 101, 102 AND 107). SN 85-025,239. PUB. 8-9-2011. FILED 4-28-2010.
- 4,043,906. **STOKO REFRESH (STANDARD CHARACTER)**. EVONIK STOCKHAUSEN GMBH, (U.S. CLS. 2, 5, 22, 23, 29, 37, 38 AND 50). SN 85-055,882. PUB. 5-17-2011. FILED 6-7-2010.
- 4,043,917 ( *See Class 9 for this trademark*).
- 4,043,918 ( *See Class 12 for this trademark*).
- 4,044,028. **ATTICUS AND DESIGN**. ATTICUS, INC., MULTIPLE CLASS, (INT. CLS. 16, 35 AND 41), (U.S. CLS. 2, 5, 22, 23, 29, 37, 38, 50, 100, 101, 102 AND 107). SN 85-127,190. PUB. 8-9-2011. FILED 9-10-2010.
- 4,044,042. **PERSPECTIVES (STANDARD CHARACTER)**. LUCK STONE CORPORATION, (U.S. CLS. 2, 5, 22, 23, 29, 37, 38 AND 50). SN 85-135,543. PUB. 8-9-2011. FILED 9-22-2010.
- 4,044,054. **RUSSELL PETERS (STANDARD CHARACTER)**. JUST THE TIP, INC., (U.S. CLS. 2, 5, 22, 23, 29, 37, 38 AND 50). SN 85-141,433. PUB. 8-9-2011. FILED 9-29-2010.
- 4,044,055. **R RUSSELL PETERS AND DESIGN**. JUST THE TIP, INC., (U.S. CLS. 2, 5, 22, 23, 29, 37, 38 AND 50). SN 85-141,451. PUB. 8-9-2011. FILED 9-29-2010.
- 4,044,067. **QUP AND DESIGN**. LEO PAPER BAGS MANUFACTURING (1982) LIMITED, (U.S. CLS. 2, 5, 22, 23, 29, 37, 38 AND 50). SN 85-145,029. PUB. 8-9-2011. FILED 10-5-2010.
- 4,044,075. **WASATCH LIVIN (STANDARD CHARACTER)**. STILL LIVIN LLC, (U.S. CLS. 2, 5, 22, 23, 29, 37, 38 AND 50). SN 85-150,449. PUB. 8-9-2011. FILED 10-12-2010.
- 4,044,082 ( *See Class 9 for this trademark*).
- 4,044,114. **REEFNEWS (STANDARD CHARACTER)**. REEFNEWS, INC., (U.S. CLS. 2, 5, 22, 23, 29, 37, 38 AND 50). SN 85-172,143. PUB. 8-9-2011. FILED 11-9-2010.
- 4,044,203 ( *See Class 14 for this trademark*).
- 4,044,204 ( *See Class 14 for this trademark*).
- 4,044,206. **AMERICAN UNDERDOG (STANDARD CHARACTER)**. INSPIRATION & MOTIVATION, INC., MULTIPLE CLASS, (INT. CLS. 16 AND 41), (U.S. CLS. 2, 5, 22, 23, 29, 37, 38, 50, 100, 101 AND 107). SN 85-212,932. PUB. 5-3-2011. FILED 1-7-2011.
- 4,044,258. **HOUSE OF MARLEY MARETT TSEHAI DAM AND DESIGN**. FIFTY-SIX HOPE ROAD MUSIC LIMITED, (U.S. CLS. 2, 5, 22, 23, 29, 37, 38 AND 50). SN 85-230,794. PUB. 8-9-2011. FILED 2-1-2011.
- 4,044,278. **POCKET VIDEOS (STANDARD CHARACTER)**. POCKET VIDEOS, LLC, (U.S. CLS. 2, 5, 22, 23, 29, 37, 38 AND 50). SN 85-235,031. PUB. 8-9-2011. FILED 2-5-2011.
- 4,044,296. **OMAHA STORM CHASERS AND DESIGN**. OMAHA ROYALS LIMITED PARTNERSHIP, (U.S. CLS. 2, 5, 22, 23, 29, 37, 38 AND 50). SN 85-239,210. PUB. 8-9-2011. FILED 2-10-2011.
- 4,044,353. **OSCAR & OLLIE (STANDARD CHARACTER)**. AMANDA HOLT COREY CRAFTS, MULTIPLE CLASS, (INT. CLS. 16 AND 20), (U.S. CLS. 2, 5, 13, 22, 23, 25, 29, 32, 37, 38 AND 50). SN 85-253,298. PUB. 8-9-2011. FILED 2-28-2011.
- 4,044,372. **MSI AND DESIGN**. MAP SUPPLY, INC., (U.S. CLS. 2, 5, 22, 23, 29, 37, 38 AND 50). SN 85-255,454. PUB. 8-9-2011. FILED 3-2-2011.
- 4,044,392 ( *See Class 9 for this trademark*).
- 4,044,402. **THE ORIGINAL SILENT HEROES AUTOGRAPH BOOK AND DESIGN**. SILENT HEROES, (U.S. CLS. 2, 5, 22, 23, 29, 37, 38 AND 50). SN 85-259,279. PUB. 8-9-2011. FILED 3-6-2011.
- 4,044,407 ( *See Class 9 for this trademark*).
- 4,044,452. **COLORPRO TECHNOLOGY AND DESIGN**. HEWLETT-PACKARD DEVELOPMENT COMPANY, L.P., (U.S. CLS. 2, 5, 22, 23, 29, 37, 38 AND 50). SN 85-261,425. PUB. 8-9-2011. FILED 3-8-2011.
- 4,044,458. **5 FOLD MEDIA (STANDARD CHARACTER)**. 5 FOLD MEDIA, LLC, (U.S. CLS. 2, 5, 22, 23, 29, 37, 38 AND 50). SN 85-261,764. PUB. 8-9-2011. FILED 3-9-2011.
- 4,044,467. **FRAMED LEGACY (STANDARD CHARACTER)**. FRAMED LEGACY, INC., (U.S. CLS. 2, 5, 22, 23, 29, 37, 38



AND 50). SN 85-262,091. PUB. 8-9-2011. FILED 3-9-2011.

4,044,496. **ECOGREEN (STANDARD CHARACTER)**. HARLAND CLARKE CORP., (U.S. CLS. 2, 5, 22, 23, 29, 37, 38 AND 50). SN 85-263,216. PUB. 8-9-2011. FILED 3-10-2011.

4,044,498. **ELITE SELECT (STANDARD CHARACTER)**. HARLAND CLARKE CORP., (U.S. CLS. 2, 5, 22, 23, 29, 37, 38 AND 50). SN 85-263,222. PUB. 8-9-2011. FILED 3-10-2011.

4,044,533. **CONTROL TEMP BLUE AND DESIGN**. R.N.C. INDUSTRIES, INC., (U.S. CLS. 2, 5, 22, 23, 29, 37, 38 AND 50). SN 85-264,194. PUB. 8-9-2011. FILED 3-11-2011.

4,044,607. **MINDFUL PARTNERSHIP \* MINDFUL DIVORCE (STANDARD CHARACTER)**. BERGER, ILLANA, (U.S. CLS. 2, 5, 22, 23, 29, 37, 38 AND 50). SN 85-270,141. PUB. 8-9-2011. FILED 3-17-2011.

4,044,635. **DOC MILO (STANDARD CHARACTER)**. DOC MILO PRODUCTIONS, INC., (U.S. CLS. 2, 5, 22, 23, 29, 37, 38 AND 50). SN 85-273,503. PUB. 8-9-2011. FILED 3-22-2011.

4,044,667. **R.A.D.A.R. (STANDARD CHARACTER)**. MILLENNIUM LABORATORIES, INC., (U.S. CLS. 2, 5, 22, 23, 29, 37, 38 AND 50). SN 85-273,981. PUB. 8-9-2011. FILED 3-22-2011.

4,044,852 ( *See Class 9 for this trademark*).

4,044,862. **CREATE ON PURPOSE (STANDARD CHARACTER)**. THINKSHOP, INC., MULTIPLE CLASS, (INT. CLS. 16 AND 41), (U.S. CLS. 2, 5, 22, 23, 29, 37, 38, 50, 100, 101 AND 107). SN 85-276,900. PUB. 8-9-2011. FILED 3-25-2011.

4,044,890. **THE MIND TO LEAD (STANDARD CHARACTER)**. SUZANNE KRYDER, INC., (U.S. CLS. 2, 5, 22, 23, 29, 37, 38 AND 50). SN 85-277,251. PUB. 8-9-2011. FILED 3-25-2011.

4,044,898. **WINTERBORNE (STANDARD CHARACTER)**. WINTERBORNE, INC., (U.S. CLS. 2, 5, 22, 23, 29, 37, 38 AND 50). SN 85-277,352. PUB. 8-9-2011. FILED 3-25-2011.

4,044,915. **ZOO AND DESIGN**. SKIP HOP, INC., (U.S. CLS. 2, 5, 22, 23, 29, 37, 38 AND 50). SN 85-277,526. PUB. 8-9-2011. FILED 3-25-2011.

4,044,920. **SONGCOMPANION (STANDARD CHARACTER)**. SONGCOMPANION.COM, LLC, (U.S. CLS. 2, 5, 22, 23, 29, 37, 38 AND 50). SN 85-277,708. PUB. 8-9-2011. FILED 3-25-2011.

4,044,959. **VENTAJAS (STANDARD CHARACTER)**. VENTAJAS PUBLICATIONS LLC, (U.S. CLS. 2, 5, 22, 23, 29, 37, 38 AND 50). SN 85-278,230. PUB. 8-9-2011. FILED 3-28-2011.

4,045,044. **SCAMPS (STANDARD CHARACTER)**. BOSTON CHILDREN'S HEART FOUNDATION, INC., (U.S. CLS. 2, 5, 22, 23, 29, 37, 38 AND 50). SN 85-279,230. PUB. 8-9-2011. FILED 3-28-2011.

4,045,180. **MISCELLANEOUS DESIGN**. JESSICA JANSEN, DBA LITTLE LADY STUDIO, (U.S. CLS. 2, 5, 22, 23, 29, 37, 38 AND 50). SN 85-281,035. PUB. 8-9-2011. FILED 3-30-2011.

4,045,182. **THE EARLY ALERT (STANDARD CHARACTER)**. DOGS FOR DIABETICS, INC., (U.S. CLS. 2, 5, 22, 23, 29, 37, 38 AND 50). SN 85-281,065. PUB. 8-9-2011. FILED 3-30-2011.

4,045,189. **THE JOURNAL OF IRREPRODUCIBLE RESULTS (STANDARD CHARACTER)**. SPERLING, NORMAN, (U.S. CLS. 2, 5, 22, 23, 29, 37, 38 AND 50). SN 85-281,165. PUB. 8-9-2011. FILED 3-30-2011.

4,045,213. **THE PATTERN BOX (STANDARD CHARACTER)**. ROBIN RAMOS, (U.S. CLS. 2, 5, 22, 23, 29, 37, 38 AND 50). SN 85-281,621. PUB. 8-9-2011. FILED 3-30-2011.

4,045,309. **USMC (STANDARD CHARACTER)**. U.S. MARINE CORPS, A COMPONENT OF THE U.S. DEPARTMENT OF THE NAVY, (U.S. CLS. 2, 5, 22, 23, 29, 37, 38 AND 50). SN 85-282,712. PUB. 8-9-2011. FILED 3-31-2011.

4,045,311. **MODERN LIVING WITH MAN'S BEST FRIEND. (STANDARD CHARACTER)**. L+D PUBLISHING LLC, (U.S. CLS. 2, 5, 22, 23, 29, 37, 38 AND 50). SN 85-282,742. PUB. 8-9-2011. FILED 3-31-2011.

4,045,334. **THULS (STANDARD CHARACTER)**. MISSION INFORMATION RESOURCES, INC., (U.S. CLS. 2, 5, 22, 23, 29, 37, 38 AND 50). SN 85-283,030. PUB. 8-9-2011. FILED 3-31-2011.

4,045,400. **TG TALENTGUARD AND DESIGN**. TALENTGUARD, INC., MULTIPLE CLASS, (INT. CLS. 16, 35 AND 41), (U.S. CLS. 2, 5, 22, 23, 29, 37, 38, 50, 100, 101, 102 AND 107). SN 85-283,864. PUB. 8-9-2011. FILED 4-1-2011.

4,045,404. **USG (STANDARD CHARACTER)**. USG CORPORATION, (U.S. CLS. 2, 5, 22, 23, 29, 37, 38 AND 50). SN 85-283,878. PUB. 8-9-2011. FILED 4-1-2011.

4,045,460. **CANDY FAIRIES AND DESIGN**. BERNSTEIN, HELEN PERELMAN, TA PERELMAN, HELEN, (U.S. CLS. 2, 5, 22, 23, 29, 37, 38 AND 50). SN 85-284,586. PUB. 8-9-2011. FILED 4-2-2011.

4,045,542. **MISCELLANEOUS DESIGN**. SYDA FOUNDATION, (U.S. CLS. 2, 5, 22, 23, 29, 37, 38 AND 50). SN 85-300,057. PUB. 8-9-2011. FILED 4-20-2011.

4,045,565. **BATIQUE (STANDARD CHARACTER)**. MINTRA, AKA MISR FOR INDUSTRY AND TRADE, (U.S. CLS. 2, 5, 22, 23, 29, 37, 38 AND 50). SN 85-317,679. PUB. 8-9-2011. FILED 5-11-2011.

---

## CLASS 17—RUBBER GOODS

4,043,687 ( *See Class 7 for this trademark*).

4,043,722 ( *See Class 1 for this trademark*).

4,043,727. **MISCELLANEOUS DESIGN**. HANCOR, INC., (U.S. CLS. 1, 5, 12, 13, 35 AND 50). SN 77-957,475. PUB. 8-9-2011. FILED 3-12-2010.

4,043,744 ( *See Class 1 for this trademark*).

4,043,772 ( *See Class 12 for this trademark*).

4,043,808. **RBM AND DESIGN**. R.B.M. S.P.A., MULTIPLE CLASS, (INT. CLS. 17 AND 20), (U.S. CLS. 1, 2, 5, 12, 13, 22, 25, 32, 35 AND 50). SN 79-089,937. PUB. 8-9-2011. FILED 8-2-2010.

4,043,845. **DYMAT E (STANDARD CHARACTER)**. COVEME SPA, (U.S. CLS. 1, 5, 12, 13, 35 AND 50). SN 79-094,186. PUB. 8-9-2011. FILED 11-5-2010.

4,044,847. **INSULTEX HOUSE WRAP AND DESIGN**. INNOVATIVE DESIGNS, INC., (U.S. CLS. 1, 5, 12, 13, 35 AND 50). SN 85-276,665. PUB. 8-9-2011. FILED 3-25-2011.

4,045,195. **BUILDLOCK (STANDARD CHARACTER)**. BUILD-BLOCK BUILDING SYSTEMS, LLC, (U.S. CLS. 1, 5, 12, 13, 35 AND 50). SN 85-281,229. PUB. 8-9-2011. FILED 3-30-2011.

4,045,462. **CMF AND DESIGN**. CMF GLOBAL, INC., (U.S. CLS. 1, 5, 12, 13, 35 AND 50). SN 85-284,615. PUB. 8-9-2011. FILED 4-2-2011.

4,045,463. **CORRDRAIN AND DESIGN**. CMF GLOBAL, INC., (U.S. CLS. 1, 5, 12, 13, 35 AND 50). SN 85-284,621. PUB. 8-9-2011. FILED 4-2-2011.

---

## CLASS 18—LEATHER GOODS

4,043,657 ( *See Class 3 for this trademark*).

4,043,737. **BODY TALK (STANDARD CHARACTER)**. MILES-BRAMWELL EXECUTIVE SERVICES LIMITED, MULTIPLE CLASS, (INT. CLS. 18, 21, 28 AND 44), (U.S. CLS. 1, 2, 3, 13, 22, 23, 29, 30, 33, 38, 40, 41, 50, 100 AND 101). SN 78-677,185. PUB. 6-29-2010. FILED 7-25-2005.

4,043,771 ( *See Class 14 for this trademark*).

4,043,788 ( *See Class 9 for this trademark*).

4,043,848 ( *See Class 9 for this trademark*).

4,043,852. **MISCELLANEOUS DESIGN**. CHEN YUPING, (U.S. CLS. 1, 2, 3, 22 AND 41). SN 79-095,289. PUB. 8-9-2011. FILED 2-22-2011.

4,043,855 ( *See Class 3 for this trademark*).

4,043,860 ( *See Class 3 for this trademark*).

4,043,918 ( *See Class 12 for this trademark*).

4,043,937. **ECOLAB (STANDARD CHARACTER)**. ECOLAB USA INC., MULTIPLE CLASS, (INT. CLS. 18, 22, 25, 26, 27, 28 AND 30), (U.S. CLS. 1, 2, 3, 7, 19, 20, 22, 23, 37, 38, 39, 40, 41, 42, 46 AND 50). SN 85-094,844. PUB. 8-9-2011. FILED 7-28-2010.

4,044,003. **X AND DESIGN**. PACIFIC ENTERMARK VERTRIEBSGESELLSCHAFT MBH, MULTIPLE CLASS, (INT. CLS. 18, 25 AND 28), (U.S. CLS. 1, 2, 3, 22, 23, 38, 39, 41 AND 50). SN 85-120,235. PUB. 8-9-2011. FILED 8-31-2010.

4,044,027 ( *See Class 3 for this trademark*).

4,044,127 ( *See Class 3 for this trademark*).

4,044,188 ( *See Class 9 for this trademark*).

4,044,189 ( *See Class 9 for this trademark*).

4,044,214. **MISCELLANEOUS DESIGN**. LCS INTERNATIONAL B.V., MULTIPLE CLASS, (INT. CLS. 18, 25 AND

- 35), (U.S. CLS. 1, 2, 3, 22, 39, 41, 100, 101 AND 102). SN 85-218,962. PUB. 8-9-2011. FILED 1-17-2011.
- 4,044,259. **HOUSE OF MARLEY MARETT TSEHAI DAM AND DESIGN. FIFTY-SIX HOPE ROAD MUSIC LIMITED.** (U.S. CLS. 1, 2, 3, 22 AND 41). SN 85-230,795. PUB. 8-9-2011. FILED 2-1-2011.
- 4,044,318 ( *See Class 14 for this trademark.*).
- 4,044,428. **J WORLD CEO (STANDARD CHARACTER). J WORLD SPORTS, INC.,** (U.S. CLS. 1, 2, 3, 22 AND 41). SN 85-260,455. PUB. 8-9-2011. FILED 3-8-2011.
- 4,044,524. **DIAMONDBACK OUTDOORS (STANDARD CHARACTER). DIAMONDBACK OUTDOORS, LLC,** (U.S. CLS. 1, 2, 3, 22 AND 41). SN 85-263,859. PUB. 8-9-2011. FILED 3-10-2011.
- 4,044,789. **T.K GARMENT SUPPLY AND DESIGN. T.K. GARMENT SUPPLY CO., LTD.,** MULTIPLE CLASS, (INT. CLS. 18 AND 25), (U.S. CLS. 1, 2, 3, 22, 39 AND 41). SN 85-275,842. PUB. 8-9-2011. FILED 3-24-2011.
- 4,044,825. **CUTIE PAWTOOTIE (STANDARD CHARACTER). CUTIE PAWTOOTIE POOCHWARE, LLC,** (U.S. CLS. 1, 2, 3, 22 AND 41). SN 85-276,400. PUB. 8-9-2011. FILED 3-24-2011.
- 4,045,055. **KENSIEGIRL (STANDARD CHARACTER). WEST-COAST CONTEMPO FASHIONS LIMITED.** (U.S. CLS. 1, 2, 3, 22 AND 41). SN 85-279,424. PUB. 8-9-2011. FILED 3-29-2011.
- 4,045,284. **MISCELLANEOUS DESIGN. THOMAS, PAULA,** MULTIPLE CLASS, (INT. CLS. 18 AND 25), (U.S. CLS. 1, 2, 3, 22, 39 AND 41). SN 85-282,415. PUB. 8-9-2011. FILED 3-31-2011.
- 4,045,296. **ABT (STANDARD CHARACTER). BALLET THEATRE FOUNDATION, INC.,** (U.S. CLS. 1, 2, 3, 22 AND 41). SN 85-282,529. PUB. 8-9-2011. FILED 3-31-2011.
- 4,045,317. **THE DEFLECTOR AND DESIGN. WORLD IMPORT COMPANY,** (U.S. CLS. 1, 2, 3, 22 AND 41). SN 85-282,841. PUB. 8-9-2011. FILED 3-31-2011.
- 4,045,394 ( *See Class 14 for this trademark.*).
- 4,045,410. **STEWART/STAND (STANDARD CHARACTER). COCKROACH DESIGN, LLC, DBA STEWART/STAND,** (U.S. CLS. 1, 2, 3, 22 AND 41). SN 85-283,917. PUB. 8-9-2011. FILED 4-1-2011.
- 4,045,452. **BOBA (STANDARD CHARACTER). NAP, INC., DBA SLEEPY WRAP, INC.,** (U.S. CLS. 1, 2, 3, 22 AND 41). SN 85-284,469. PUB. 8-9-2011. FILED 4-2-2011.
- 4,045,483. **DOODY DANGLER AND DESIGN. IMAGINE THAT! CONSUMER PRODUCTS LLC,** (U.S. CLS. 1, 2, 3, 22 AND 41). SN 85-285,787. PUB. 8-9-2011. FILED 4-4-2011.
- 4,045,496. **BOSS HUGO BOSS (STYLIZED). HUGO BOSS TRADE MARK MANAGEMENT GMBH & CO. KG,** (U.S. CLS. 1, 2, 3, 22 AND 41). SN 85-286,775. PUB. 8-9-2011. FILED 4-5-2011.
- 4,045,546. **MISCELLANEOUS DESIGN. WAL-MART STORES, INC.,** MULTIPLE CLASS, (INT. CLS. 18 AND 28), (U.S. CLS. 1, 2, 3, 22, 23, 38, 41 AND 50). SN 85-302,661. PUB. 8-9-2011. FILED 4-22-2011.

#### CLASS 19—NON-METALLIC BUILDING MATERIALS

- 4,043,606. **STONEDGE (STANDARD CHARACTER). LES PIERRES STONEDGE INC.,** (U.S. CLS. 1, 12, 33 AND 50). SN 76-650,832. PUB. 8-28-2007. FILED 11-22-2005.
- 4,043,669. **THERMAX (STANDARD CHARACTER). MINERALKA D.O.O.,** (U.S. CLS. 1, 12, 33 AND 50). SN 77-726,009. PUB. 8-9-2011. FILED 4-30-2009.
- 4,043,722 ( *See Class 1 for this trademark.*).
- 4,043,829. **INFLATE AND DESIGN. TE KOOP LIMITED,** MULTIPLE CLASS, (INT. CLS. 19, 41 AND 42), (U.S. CLS. 1, 12, 33, 50, 100, 101 AND 107). SN 79-091,229. PUB. 8-9-2011. FILED 6-3-2010.
- 4,043,999. **EXPANDY LINER (STANDARD CHARACTER). PERMA-LINER INDUSTRIES, INC.,** (U.S. CLS. 1, 12, 33 AND 50). SN 85-118,783. PUB. 8-9-2011. FILED 8-30-2010.
- 4,044,006. **LOCATE LINER (STANDARD CHARACTER). PERMA-LINER INDUSTRIES, INC.,** (U.S. CLS. 1, 12, 33 AND 50). SN 85-120,737. PUB. 8-9-2011. FILED 9-1-2010.
- 4,044,007. **GROUNDGRAPHICS (STANDARD CHARACTER).**

- MICHAEL L. TANEL, SR., (U.S. CLS. 1, 12, 33 AND 50). SN 85-121,020. PUB. 8-9-2011. FILED 9-1-2010.
- 4,044,019 ( *See Class 6 for this trademark.*).
- 4,044,094. **TIMBERLINE (STANDARD CHARACTER). BUILDING MATERIALS INVESTMENT CORP.,** (U.S. CLS. 1, 12, 33 AND 50). SN 85-162,486. PUB. 8-9-2011. FILED 10-27-2010.
- 4,044,132. **ROMA STAIR PARTS (STANDARD CHARACTER). LNL BUILDING PRODUCTS, LLC,** (U.S. CLS. 1, 12, 33 AND 50). SN 85-180,628. PUB. 8-9-2011. FILED 11-19-2010.
- 4,044,148. **THRU-DRY ZIP-O-LOG MILLS, INC. AND DESIGN. ZIP-O-LOG MILLS, INC.,** (U.S. CLS. 1, 12, 33 AND 50). SN 85-189,292. PUB. 8-9-2011. FILED 12-2-2010.
- 4,044,151. **FLEXPLY (STANDARD CHARACTER). BUILDING MATERIALS INVESTMENT CORP.,** (U.S. CLS. 1, 12, 33 AND 50). SN 85-189,589. PUB. 8-9-2011. FILED 12-2-2010.
- 4,044,391. **WD 2000 (STANDARD CHARACTER). LONE STAR SPECIALTY PRODUCTS, LLC, DBA LONE STAR SPECIALTIES, LLC,** (U.S. CLS. 1, 12, 33 AND 50). SN 85-258,448. PUB. 8-9-2011. FILED 3-4-2011.
- 4,044,438. **HAVEN CUSTOM HOMES (STANDARD CHARACTER). THE HAVEN GROUP, INC.,** MULTIPLE CLASS, (INT. CLS. 19 AND 37), (U.S. CLS. 1, 12, 33, 50, 100, 103 AND 106). SN 85-260,915. PUB. 8-9-2011. FILED 3-8-2011.
- 4,044,523. **UI WALL (STANDARD CHARACTER). SWA HOLDING COMPANY, INC.,** (U.S. CLS. 1, 12, 33 AND 50). SN 85-263,853. PUB. 8-9-2011. FILED 3-10-2011.
- 4,044,743. **OLD VIRGINIA BRICK (STANDARD CHARACTER). OLD VIRGINIA BRICK COMPANY, INCORPORATED,** (U.S. CLS. 1, 12, 33 AND 50). SN 85-275,276. PUB. 8-9-2011. FILED 3-24-2011.
- 4,044,794. **MEL-ROL PRECON (STANDARD CHARACTER). W.R. MEADOWS, INC.,** (U.S. CLS. 1, 12, 33 AND 50). SN 85-275,900. PUB. 8-9-2011. FILED 3-24-2011.
- 4,045,015. **NEOMIX (STANDARD CHARACTER). CHENG CONCRETE LLC,** (U.S. CLS. 1, 12, 33 AND 50). SN 85-278,946. PUB. 8-9-2011. FILED 3-28-2011.
- 4,045,020. **D-FRC (STANDARD CHARACTER). CHENG CONCRETE LLC,** (U.S. CLS. 1, 12, 33 AND 50). SN 85-278,962. PUB. 8-9-2011. FILED 3-28-2011.
- 4,045,056. **NAPC AND DESIGN. NORTH AMERICAN PLYWOOD CORPORATION,** (U.S. CLS. 1, 12, 33 AND 50). SN 85-279,435. PUB. 8-9-2011. FILED 3-29-2011.
- 4,045,570. **WEEP-ARMOR (STANDARD CHARACTER). YORK MANUFACTURING, INC.,** (U.S. CLS. 1, 12, 33 AND 50). SN 85-339,984. PUB. 8-9-2011. FILED 6-7-2011.

#### CLASS 20—FURNITURE AND ARTICLES NOT OTHERWISE CLASSIFIED

- 4,043,654 ( *See Class 6 for this trademark.*).
- 4,043,662 ( *See Class 9 for this trademark.*).
- 4,043,782 ( *See Class 12 for this trademark.*).
- 4,043,798 ( *See Class 6 for this trademark.*).
- 4,043,808 ( *See Class 17 for this trademark.*).
- 4,043,848 ( *See Class 9 for this trademark.*).
- 4,044,015. **TOILETTREE AND DESIGN. TOILETTREE PRODUCTS, INC.,** (U.S. CLS. 2, 13, 22, 25, 32 AND 50). SN 85-122,975. PUB. 8-9-2011. FILED 9-3-2010.
- 4,044,221. **FILOSÁ (STANDARD CHARACTER). KOHBURG, INC.,** (U.S. CLS. 2, 13, 22, 25, 32 AND 50). SN 85-221,954. PUB. 8-9-2011. FILED 1-20-2011.
- 4,044,249. **JAZ (STANDARD CHARACTER). ONEUP INNOVATIONS, INC.,** (U.S. CLS. 2, 13, 22, 25, 32 AND 50). SN 85-230,073. PUB. 8-9-2011. FILED 1-31-2011.
- 4,044,260. **HOUSE OF MARLEY MARETT TSEHAI DAM AND DESIGN. FIFTY-SIX HOPE ROAD MUSIC LIMITED,** MULTIPLE CLASS, (INT. CLS. 20 AND 21), (U.S. CLS. 2, 13, 22, 23, 25, 29, 30, 32, 33, 40 AND 50). SN 85-230,796. PUB. 8-9-2011. FILED 2-1-2011.
- 4,044,307. **FISHCLIP (STANDARD CHARACTER). SHROCKIE LLC,** (U.S. CLS. 2, 13, 22, 25, 32 AND 50). SN 85-244,466. PUB. 8-9-2011. FILED 2-16-2011.
- 4,044,353 ( *See Class 16 for this trademark.*).
- 4,044,514. **CREATE-A-CRATE (STANDARD CHARACTER). SCHIFFMAYER SALES & ENGINEERING L.L.C.,** (U.S. CLS. 2, 13, 22, 25, 32 AND 50). SN 85-263,500. PUB. 8-9-2011.

- FILED 3-10-2011.  
 4,044,516. **STEMTRAK (STANDARD CHARACTER)**. SCHIFFMAYER SALES & ENGINEERING L.L.C., (U.S. CLS. 2, 13, 22, 25, 32 AND 50). SN 85-263,607. PUB. 8-9-2011. FILED 3-10-2011.  
 4,044,613. **TOOTHPASTE 2 GO AND DESIGN**. MCM INVENTIONS, INC., (U.S. CLS. 2, 13, 22, 25, 32 AND 50). SN 85-271,774. PUB. 8-9-2011. FILED 3-20-2011.  
 4,044,618 ( *See Class 12 for this trademark*).  
 4,044,744. **LIL' DICKENS (STANDARD CHARACTER)**. THE TJX COMPANIES, INC., MULTIPLE CLASS, (INT. CLS. 20 AND 24), (U.S. CLS. 2, 13, 22, 25, 32, 42 AND 50). SN 85-275,314. PUB. 8-9-2011. FILED 3-24-2011.  
 4,044,980. **P'ILLOPORTO (STANDARD CHARACTER)**. P'ILLOPORTO LLC, (U.S. CLS. 2, 13, 22, 25, 32 AND 50). SN 85-278,481. PUB. 8-9-2011. FILED 3-28-2011.  
 4,045,032. **WORK SMART (STANDARD CHARACTER)**. BLUMENTHAL DISTRIBUTING, INC., DBA OFFICE STAR PRODUCTS, (U.S. CLS. 2, 13, 22, 25, 32 AND 50). SN 85-279,110. PUB. 8-9-2011. FILED 3-28-2011.  
 4,045,038. **KAZZOINKS (STANDARD CHARACTER)**. NELSON, KEITH, (U.S. CLS. 2, 13, 22, 25, 32 AND 50). SN 85-279,172. PUB. 8-9-2011. FILED 3-28-2011.  
 4,045,052. **VILLAGESCAPE BY HESTIA (STANDARD CHARACTER)**. HESTIA CREATIONS, INC., (U.S. CLS. 2, 13, 22, 25, 32 AND 50). SN 85-279,355. PUB. 8-9-2011. FILED 3-29-2011.  
 4,045,104. **JESUSRX (STANDARD CHARACTER)**. WEB LINK ENTERPRISES, LLC, (U.S. CLS. 2, 13, 22, 25, 32 AND 50). SN 85-280,108. PUB. 8-9-2011. FILED 3-29-2011.  
 4,045,218. **SAP-SEAL (STANDARD CHARACTER)**. ORNULF ERNIE NESS, DBA SAP-SEAL, (U.S. CLS. 2, 13, 22, 25, 32 AND 50). SN 85-281,681. PUB. 8-9-2011. FILED 3-30-2011.  
 4,045,220. **TIES UP THE LINE THE TIE RACK FOR THE PERFECT PLACE IN YOUR CLOSET AND DESIGN**. COLE, DOUGLAS, (U.S. CLS. 2, 13, 22, 25, 32 AND 50). SN 85-281,706. PUB. 8-9-2011. FILED 3-30-2011.  
 4,045,418. **AAA, AMERICAN ALL ACCESSORIES AND DESIGN**. AMERICAN APPAREL ACCESSORIES, INC., DBA AAA HANGERS, (U.S. CLS. 2, 13, 22, 25, 32 AND 50). SN 85-284,019. PUB. 8-9-2011. FILED 4-1-2011.  
 4,045,429. **SONATA (STANDARD CHARACTER)**. THE WINDWARD DESIGN GROUP, INC., (U.S. CLS. 2, 13, 22, 25, 32 AND 50). SN 85-284,151. PUB. 8-9-2011. FILED 4-1-2011.  
 4,045,530. **EXPEDITION (STANDARD CHARACTER)**. BELL'S BREWERY, INC., MULTIPLE CLASS, (INT. CLS. 20, 25 AND 32), (U.S. CLS. 2, 13, 22, 25, 32, 39, 45, 46, 48 AND 50). SN 85-295,097. PUB. 8-9-2011. FILED 4-14-2011.  
 4,045,553. **HOTEL LIVING (STANDARD CHARACTER)**. CONAIR CORPORATION, (U.S. CLS. 2, 13, 22, 25, 32 AND 50). SN 85-307,560. PUB. 8-9-2011. FILED 4-28-2011.  
 4,044,068. **AUTOSEAL (STANDARD CHARACTER)**. IGNITE USA, LLC, (U.S. CLS. 2, 13, 23, 29, 30, 33, 40 AND 50). SN 85-145,127. PUB. 8-9-2011. FILED 10-5-2010.  
 4,044,086 ( *See Class 2 for this trademark*).  
 4,044,260 ( *See Class 20 for this trademark*).  
 4,044,277. **OREGON DUCKS (STANDARD CHARACTER)**. STATE OF OREGON ACTING BY AND THROUGH THE STATE BOARD OF HIGHER EDUCATION ON BEHALF OF THE UNIVERSITY OF OREGON, MULTIPLE CLASS, (INT. CLS. 21 AND 25), (U.S. CLS. 2, 13, 22, 23, 29, 30, 33, 40 AND 50). SN 85-233,867. PUB. 8-9-2011. FILED 2-3-2011.  
 4,044,352 ( *See Class 6 for this trademark*).  
 4,044,400. **MY INDOOR GARDEN (STANDARD CHARACTER)**. MY INDOOR GARDEN CORPORATION, (U.S. CLS. 2, 13, 23, 29, 30, 33, 40 AND 50). SN 85-259,110. PUB. 8-9-2011. FILED 3-6-2011.  
 4,044,518. **BELL BOTTOM BROOM (STANDARD CHARACTER)**. SCHIFFMAYER SALES & ENGINEERING L.L.C., (U.S. CLS. 2, 13, 23, 29, 30, 33, 40 AND 50). SN 85-263,699. PUB. 8-9-2011. FILED 3-10-2011.  
 4,044,586. **HARD WATER WAND (STANDARD CHARACTER)**. KALAN INDUSTRIES, INC., (U.S. CLS. 2, 13, 23, 29, 30, 33, 40 AND 50). SN 85-267,013. PUB. 8-9-2011. FILED 3-15-2011.  
 4,044,594. **BIOLUX-KERAMA (STANDARD CHARACTER)**. WS-INVENTION TRADE GMBH, (U.S. CLS. 2, 13, 23, 29, 30, 33, 40 AND 50). SN 85-267,974. PUB. 8-9-2011. FILED 3-15-2011.  
 4,044,639. **INSTA-MOUNT (STANDARD CHARACTER)**. ZHADANOV ELI, (U.S. CLS. 2, 13, 23, 29, 30, 33, 40 AND 50). SN 85-273,611. PUB. 8-9-2011. FILED 3-22-2011.  
 4,044,688. **VENUE (STANDARD CHARACTER)**. THE COLMAN GROUP, INC., (U.S. CLS. 2, 13, 23, 29, 30, 33, 40 AND 50). SN 85-274,276. PUB. 8-9-2011. FILED 3-23-2011.  
 4,044,703. **RATGUARD (STANDARD CHARACTER)**. HBC CHEMICAL INC., (U.S. CLS. 2, 13, 23, 29, 30, 33, 40 AND 50). SN 85-274,586. PUB. 8-9-2011. FILED 3-23-2011.  
 4,044,803. **REFRESH GLASS (STANDARD CHARACTER)**. REFRESH GLASS, LLC, (U.S. CLS. 2, 13, 23, 29, 30, 33, 40 AND 50). SN 85-275,975. PUB. 8-9-2011. FILED 3-24-2011.  
 4,044,918. **ZOO AND DESIGN**. SKIP HOP, INC., (U.S. CLS. 2, 13, 23, 29, 30, 33, 40 AND 50). SN 85-277,546. PUB. 8-9-2011. FILED 3-25-2011.  
 4,045,004. **M-CUPS (STANDARD CHARACTER)**. EASY ACES, INC., DBA FRED & FRIENDS, (U.S. CLS. 2, 13, 23, 29, 30, 33, 40 AND 50). SN 85-278,792. PUB. 8-9-2011. FILED 3-28-2011.  
 4,045,151. **COLLEGIATEKABOB (STANDARD CHARACTER)**. INNO-LABS LP, (U.S. CLS. 2, 13, 23, 29, 30, 33, 40 AND 50). SN 85-280,698. PUB. 8-9-2011. FILED 3-29-2011.  
 4,045,267. **GET WET (STANDARD CHARACTER)**. A.V.W. INC, DBA MAX PROFESSIONAL, (U.S. CLS. 2, 13, 23, 29, 30, 33, 40 AND 50). SN 85-282,124. PUB. 8-9-2011. FILED 3-31-2011.  
 4,045,403. **COMMANDER (STANDARD CHARACTER)**. CENTREX PLASTICS, LLC, (U.S. CLS. 2, 13, 23, 29, 30, 33, 40 AND 50). SN 85-283,874. PUB. 8-9-2011. FILED 4-1-2011.  
 4,045,525 ( *See Class 3 for this trademark*).

---

## CLASS 21—HOUSEWARES AND GLASS

- 4,043,654 ( *See Class 6 for this trademark*).  
 4,043,694 ( *See Class 16 for this trademark*).  
 4,043,736. **BRAWNY**. GEORGIA-PACIFIC CONSUMER PRODUCTS LP, (U.S. CLS. 2, 13, 23, 29, 30, 33, 40 AND 50). SN 78-307,174. PUB. 8-9-2011. FILED 9-30-2003.  
 4,043,737 ( *See Class 18 for this trademark*).  
 4,043,748 ( *See Class 3 for this trademark*).  
 4,043,749 ( *See Class 6 for this trademark*).  
 4,043,870 ( *See Class 3 for this trademark*).  
 4,043,871 ( *See Class 16 for this trademark*).  
 4,043,887. **9/11 MEMORIAL AND DESIGN**. NATIONAL SEPTEMBER 11 MEMORIAL & MUSEUM AT THE WORLD TRADE CENTER FOUNDATION, INC., (U.S. CLS. 2, 13, 23, 29, 30, 33, 40 AND 50). SN 85-032,948. PUB. 8-9-2011. FILED 5-7-2010.  
 4,043,896 ( *See Class 8 for this trademark*).  
 4,043,907. **STOKO REFRESH (STANDARD CHARACTER)**. EVONIK STOCKHAUSEN GMBH, (U.S. CLS. 2, 13, 23, 29, 30, 33, 40 AND 50). SN 85-055,883. PUB. 5-10-2011. FILED 6-7-2010.  
 4,043,969 ( *See Class 3 for this trademark*).  
 4,044,027 ( *See Class 3 for this trademark*).

---

## CLASS 22—CORDAGE AND FIBERS

- 4,043,871 ( *See Class 16 for this trademark*).  
 4,043,937 ( *See Class 18 for this trademark*).  
 4,043,964. **PERFORMANCE FIBERS (STANDARD CHARACTER)**. PERFORMANCE FIBERS, INC., (U.S. CLS. 1, 2, 7, 19, 22, 42 AND 50). SN 85-110,482. PUB. 8-9-2011. FILED 8-18-2010.  
 4,043,965. **PERFORMANCE FIBERS AND DESIGN**. PERFORMANCE FIBERS, INC., (U.S. CLS. 1, 2, 7, 19, 22, 42 AND 50). SN 85-110,498. PUB. 8-9-2011. FILED 8-18-2010.  
 4,044,416. **EVERGREEN BATTING (STANDARD CHARACTER)**. FAIRFIELD PROCESSING CORPORATION, (U.S. CLS. 1, 2, 7, 19, 22, 42 AND 50). SN 85-259,775. PUB. 8-9-2011. FILED 3-7-2011.  
 4,044,982. **IF YOU CAN IMAGINE IT, WE CAN SEW IT (STANDARD CHARACTER)**. D.S. SEWING, INC., (U.S. CLS. 1, 2, 7, 19, 22, 42 AND 50). SN 85-278,494. PUB. 8-9-

2011. FILED 3-28-2011.  
 4,045,163. **THE TWINERY (STANDARD CHARACTER)**. THE TWINERY, LLC, (U.S. CLS. 1, 2, 7, 19, 22, 42 AND 50). SN 85-280,901. PUB. 8-9-2011. FILED 3-30-2011.  
 4,045,262. **CYCLESHELTER (STANDARD CHARACTER)**. HARALD KOFLER, (U.S. CLS. 1, 2, 7, 19, 22, 42 AND 50). SN 85-282,107. PUB. 8-9-2011. FILED 3-31-2011.

---

### CLASS 23—YARNS AND THREADS

- 4,044,722. **ARTYARNS (STANDARD CHARACTER)**. ARTYARNS, INC., (U.S. CL. 43). SN 85-274,853. PUB. 8-9-2011. FILED 3-23-2011.  
 4,045,079. **CURLY Q (STANDARD CHARACTER)**. J. & P. COATS, LIMITED, (U.S. CL. 43). SN 85-279,817. PUB. 8-9-2011. FILED 3-29-2011.  
 4,045,082. **SPARK-A-DOODLE (STANDARD CHARACTER)**. J. & P. COATS, LIMITED, (U.S. CL. 43). SN 85-279,848. PUB. 8-9-2011. FILED 3-29-2011.  
 4,045,086. **BOUTIQUE CHANGES (STANDARD CHARACTER)**. J. & P. COATS, LIMITED, (U.S. CL. 43). SN 85-279,868. PUB. 8-9-2011. FILED 3-29-2011.  
 4,045,090. **BOUTIQUE ECLIPSE (STANDARD CHARACTER)**. J. & P. COATS, LIMITED, (U.S. CL. 43). SN 85-279,897. PUB. 8-9-2011. FILED 3-29-2011.  
 4,045,255. **RED HEART MYSTIC (STANDARD CHARACTER)**. J. & P. COATS, LIMITED, (U.S. CL. 43). SN 85-282,045. PUB. 8-9-2011. FILED 3-31-2011.  
 4,045,257. **BOUTIQUE SWIRL (STANDARD CHARACTER)**. J. & P. COATS, LIMITED, (U.S. CL. 43). SN 85-282,059. PUB. 8-9-2011. FILED 3-31-2011.  
 4,045,259. **BUTTERCUP (STANDARD CHARACTER)**. J. & P. COATS, LIMITED, (U.S. CL. 43). SN 85-282,064. PUB. 8-9-2011. FILED 3-31-2011.  
 4,045,263. **RED HEART HOLIDAY (STANDARD CHARACTER)**. J. & P. COATS, LIMITED, (U.S. CL. 43). SN 85-282,112. PUB. 8-9-2011. FILED 3-31-2011.

---

### CLASS 24—FABRICS

- 4,043,689 ( *See Class 3 for this trademark*).  
 4,043,785 ( *See Class 3 for this trademark*).  
 4,043,969 ( *See Class 3 for this trademark*).  
 4,044,049. **PROTECTYOU2 (STANDARD CHARACTER)**. MOXI ENTERPRISES, LLC, (U.S. CLS. 42 AND 50). SN 85-139,236. PUB. 8-9-2011. FILED 9-27-2010.  
 4,044,261. **HOUSE OF MARLEY MARETT TSEHAI DAM AND DESIGN**. FIFTY-SIX HOPE ROAD MUSIC LIMITED, (U.S. CLS. 42 AND 50). SN 85-230,799. PUB. 8-9-2011. FILED 2-1-2011.  
 4,044,716. **QZORGANIC (STANDARD CHARACTER)**. CLOUDS AND STARS, INC., (U.S. CLS. 42 AND 50). SN 85-274,733. PUB. 8-9-2011. FILED 3-23-2011.  
 4,044,744 ( *See Class 20 for this trademark*).  
 4,045,234. **CT AND DESIGN**. DRESAN INVESTMENTS B.V., (U.S. CLS. 42 AND 50). SN 85-281,865. PUB. 8-9-2011. FILED 3-30-2011.

---

### CLASS 25—CLOTHING

- 4,043,610. **SOUTHERN GZ AND DESIGN**. LEONARD DEMTRIOUS JONES, (U.S. CLS. 22 AND 39). SN 76-700,873. PUB. 8-9-2011. FILED 12-15-2009.  
 4,043,616. **NYLE JOSEF COUTURE (STANDARD CHARACTER)**. NYLE JOSEF COUTURE LLC, (U.S. CLS. 22 AND 39). SN 76-705,058. PUB. 8-9-2011. FILED 10-25-2010.  
 4,043,622. **STOP SHS AND DESIGN**. KESHA STOWE SPENCE, (U.S. CLS. 22 AND 39). SN 76-705,976. PUB. 8-9-2011. FILED 1-12-2011.  
 4,043,627. **BIRTH SKIRT (STANDARD CHARACTER)**. BINSI, INC., (U.S. CLS. 22 AND 39). SN 76-706,947. PUB. 8-9-2011.

- FILED 3-24-2011.  
 4,043,630. **JUDD WADDELL (STANDARD CHARACTER)**. JUDD WADDELL LLC, (U.S. CLS. 22 AND 39). SN 76-707,050. PUB. 8-9-2011. FILED 3-31-2011.  
 4,043,645. **GOJANE AND DESIGN**. PANG, TONY, (U.S. CLS. 22 AND 39). SN 77-557,269. PUB. 8-9-2011. FILED 8-27-2008.  
 4,043,647. **PANAMA CITY BEACH BIKE WEEK (STANDARD CHARACTER)**. BIGGS, W. JOSEPH, (U.S. CLS. 22 AND 39). SN 77-559,122. PUB. 1-20-2009. FILED 8-29-2008.  
 4,043,657 ( *See Class 3 for this trademark*).  
 4,043,694 ( *See Class 16 for this trademark*).  
 4,043,719 ( *See Class 9 for this trademark*).  
 4,043,741. **ICEPEAK (STANDARD CHARACTER)**. L-FASHION GROUP OY, (U.S. CLS. 22 AND 39). SN 78-936,511. PUB. 5-15-2007. FILED 7-24-2006.  
 4,043,773 ( *See Class 9 for this trademark*).  
 4,043,785 ( *See Class 3 for this trademark*).  
 4,043,787. **LUCIANO SOPRANI AND DESIGN**. LUCIANO SOPRANI S.R.L., (U.S. CLS. 22 AND 39). SN 79-088,889. PUB. 8-9-2011. FILED 8-4-2010.  
 4,043,788 ( *See Class 9 for this trademark*).  
 4,043,804. **W AND DESIGN**. FIVE SEASONS REAL ESTATE S.R.L., (U.S. CLS. 22 AND 39). SN 79-089,738. PUB. 8-9-2011. FILED 9-15-2010.  
 4,043,818. **MAGIFIT AND DESIGN**. TAYFAN TEKSTIL SANAYI VE TICARET LIMITED SIRKETI, (U.S. CLS. 22 AND 39). SN 79-090,765. PUB. 8-9-2011. FILED 6-28-2010.  
 4,043,843 ( *See Class 14 for this trademark*).  
 4,043,856 ( *See Class 9 for this trademark*).  
 4,043,860 ( *See Class 3 for this trademark*).  
 4,043,871 ( *See Class 16 for this trademark*).  
 4,043,901. **FORSYTH AND DESIGN**. FORSYTH OF CANADA, INC., (U.S. CLS. 22 AND 39). SN 85-055,222. PUB. 8-9-2011. FILED 6-4-2010.  
 4,043,918 ( *See Class 12 for this trademark*).  
 4,043,937 ( *See Class 18 for this trademark*).  
 4,043,947. **BUNNY TAILS (STANDARD CHARACTER)**. BUNNY TAILS, (U.S. CLS. 22 AND 39). SN 85-101,621. PUB. 1-25-2011. FILED 8-6-2010.  
 4,043,961. **ACADEMIA SANCHEZ CASAL (STANDARD CHARACTER)**. TENNIS AND FRIENDS S.L., MULTIPLE CLASS, (INT. CLS. 25 AND 41), (U.S. CLS. 22, 39, 100, 101 AND 107). SN 85-108,987. PUB. 8-9-2011. FILED 8-17-2010.  
 4,043,973. **MAD CHIC BOUTIQUE AND DESIGN**. PHILLIPS, MELISSA, DBA MAD CHIC BOUTIQUE, (U.S. CLS. 22 AND 39). SN 85-113,042. PUB. 8-9-2011. FILED 8-22-2010.  
 4,044,003 ( *See Class 18 for this trademark*).  
 4,044,018. **PIVOTSTAR AND DESIGN**. CROYS DILL, LUCY J, DBA PIVOT STAR DESIGNS, (U.S. CLS. 22 AND 39). SN 85-125,283. PUB. 2-22-2011. FILED 9-8-2010.  
 4,044,023. **AWG (STANDARD CHARACTER)**. ROBERSON, PAUL L., DBA AMERICAN WING GIRLS, (U.S. CLS. 22 AND 39). SN 85-126,273. PUB. 8-9-2011. FILED 9-9-2010.  
 4,044,027 ( *See Class 3 for this trademark*).  
 4,044,039. **GUY TAKAYAMA (STANDARD CHARACTER)**. GUY TAKAYAMA, DBA GUY TAKAYAMA, MULTIPLE CLASS, (INT. CLS. 25 AND 28), (U.S. CLS. 22, 23, 38, 39 AND 50). SN 85-134,528. PUB. 8-9-2011. FILED 9-21-2010.  
 4,044,045. **R.P.S ADDICT AND DESIGN**. PADMA TEXTILES, LTD., (U.S. CLS. 22 AND 39). SN 85-137,388. PUB. 8-9-2011. FILED 9-24-2010.  
 4,044,050. **JIU-JITSU NOVA UNIÃO U AND DESIGN**. NOVA UNIAO LLC, (U.S. CLS. 22 AND 39). SN 85-139,410. PUB. 8-9-2011. FILED 9-27-2010.  
 4,044,056. **RUSSELL PETERS (STANDARD CHARACTER)**. JUST THE TIP, INC., (U.S. CLS. 22 AND 39). SN 85-141,459. PUB. 8-9-2011. FILED 9-29-2010.  
 4,044,057. **R RUSSELL PETERS AND DESIGN**. JUST THE TIP, INC., (U.S. CLS. 22 AND 39). SN 85-141,468. PUB. 8-9-2011. FILED 9-29-2010.  
 4,044,066. **PEACE IN MEDICINE HEALING CENTER (STANDARD CHARACTER)**. BALANCED ELEMENTAL MEDICINE LLC, (U.S. CLS. 22 AND 39). SN 85-144,864. PUB. 8-9-2011. FILED 10-5-2010.  
 4,044,077. **FREEDMAN DENIM AND DESIGN**. NEW VINTAGE, INC., (U.S. CLS. 22 AND 39). SN 85-151,040. PUB. 8-9-2011. FILED 10-12-2010.  
 4,044,127 ( *See Class 3 for this trademark*).

- 4,044,166. **DANNY SHANE (STYLIZED)**. GOLF ETC. OF AMERICA, INC., (U.S. CLS. 22 AND 39). SN 85-197,945. PUB. 8-9-2011. FILED 12-14-2010.
- 4,044,167. **THREE-HEAT (STANDARD CHARACTER)**. WALIA, ROHIT, (U.S. CLS. 22 AND 39). SN 85-198,974. PUB. 5-3-2011. FILED 12-15-2010.
- 4,044,172. **LUMBERJACKS (STANDARD CHARACTER)**. BLUE OX HOCKEY, LLC, DBA MUSKEGON LUMBERJACKS, MULTIPLE CLASS, (INT. CLS. 25 AND 41), (U.S. CLS. 22, 39, 100, 101 AND 107). SN 85-200,256. PUB. 5-3-2011. FILED 12-17-2010.
- 4,044,178. **AYSHA (STANDARD CHARACTER)**. ASAR INDUSTRIES, INC., (U.S. CLS. 22 AND 39). SN 85-205,986. PUB. 8-9-2011. FILED 12-27-2010.
- 4,044,188 ( *See Class 9 for this trademark*).
- 4,044,189 ( *See Class 9 for this trademark*).
- 4,044,196. **ZAPPS (STANDARD CHARACTER)**. PAUL J. GERSTENBERGER, (U.S. CLS. 22 AND 39). SN 85-209,692. PUB. 8-9-2011. FILED 1-4-2011.
- 4,044,214 ( *See Class 18 for this trademark*).
- 4,044,217. **VALUCAP BY SPORTSMAN AND DESIGN**. PROMOTIONAL HEADWEAR INTERNATIONAL INC., DBA SPORTSMAN CAP NETWORK, (U.S. CLS. 22 AND 39). SN 85-219,652. PUB. 8-9-2011. FILED 1-18-2011.
- 4,044,262. **HOUSE OF MARLEY MARETT TSEHAI DAM AND DESIGN**. FIFTY-SIX HOPE ROAD MUSIC LIMITED, (U.S. CLS. 22 AND 39). SN 85-230,800. PUB. 8-9-2011. FILED 2-1-2011.
- 4,044,267. **DKNY ACTIVE (STANDARD CHARACTER)**. GABRIELLE STUDIO, INC., (U.S. CLS. 22 AND 39). SN 85-231,386. PUB. 8-9-2011. FILED 2-1-2011.
- 4,044,277 ( *See Class 21 for this trademark*).
- 4,044,285. **BAK'ATUS AND DESIGN**. BAKATUS, LLC, (U.S. CLS. 22 AND 39). SN 85-237,650. PUB. 8-9-2011. FILED 2-9-2011.
- 4,044,292. **OMAHA STORM CHASERS AND DESIGN**. OMAHA ROYALS LIMITED PARTNERSHIP, (U.S. CLS. 22 AND 39). SN 85-239,064. PUB. 8-9-2011. FILED 2-10-2011.
- 4,044,298. **HAI KARATE AFTER SHAVE AND DESIGN**. KAPLAN, JEFFREY, (U.S. CLS. 22 AND 39). SN 85-239,675. PUB. 8-9-2011. FILED 2-11-2011.
- 4,044,401. **VOLGA VERDI AND DESIGN**. PETER GREEN, DBA VOLGA CLOTHING, (U.S. CLS. 22 AND 39). SN 85-259,111. PUB. 8-9-2011. FILED 3-6-2011.
- 4,044,434. **LOVE SELF LOVE LIFE (STANDARD CHARACTER)**. DAVIS, SPENCER L, (U.S. CLS. 22 AND 39). SN 85-260,702. PUB. 8-9-2011. FILED 3-8-2011.
- 4,044,453. **CRANKY DUCK (STANDARD CHARACTER)**. LIVINGSTON, LAURIE, (U.S. CLS. 22 AND 39). SN 85-261,462. PUB. 8-9-2011. FILED 3-8-2011.
- 4,044,470. **BOBBY T GOODSON GOODSON'S ALL TERRAIN LOGGING INC. AND DESIGN**. GOODSON'S ALL TERRAIN LOGGING, INC., (U.S. CLS. 22 AND 39). SN 85-262,204. PUB. 8-9-2011. FILED 3-9-2011.
- 4,044,478. **ARISTOCRATIC: TO BE (STANDARD CHARACTER)**. GUIDO, RICHARD, (U.S. CLS. 22 AND 39). SN 85-262,610. PUB. 8-9-2011. FILED 3-9-2011.
- 4,044,560. **BE THE SPORT AND DESIGN**. JOHNSON, WAYNE R., (U.S. CLS. 22 AND 39). SN 85-265,410. PUB. 8-9-2011. FILED 3-12-2011.
- 4,044,576. **EST. 1979 BAD ASS CARS.COM AND DESIGN**. JOHNSON, ARRON, MULTIPLE CLASS, (INT. CLS. 25 AND 40), (U.S. CLS. 22, 39, 100, 103 AND 106). SN 85-266,439. PUB. 8-9-2011. FILED 3-14-2011.
- 4,044,597. **DON'T BE A "NOT-SEE" AND DESIGN**. PERKINS, ADAM L, (U.S. CLS. 22 AND 39). SN 85-268,800. PUB. 8-9-2011. FILED 3-16-2011.
- 4,044,624. **HIGH MEADOWS (STANDARD CHARACTER)**. CAROLINA HOSIERY MILLS, INC., (U.S. CLS. 22 AND 39). SN 85-273,359. PUB. 8-9-2011. FILED 3-22-2011.
- 4,044,641. **GJ (STYLIZED)**. DKG GROUP CORP., (U.S. CLS. 22 AND 39). SN 85-273,622. PUB. 8-9-2011. FILED 3-22-2011.
- 4,044,648. **SIRAK (STANDARD CHARACTER)**. ASIRAK LLC, (U.S. CLS. 22 AND 39). SN 85-273,742. PUB. 8-9-2011. FILED 3-22-2011.
- 4,044,661. **ODD FELLAS (STANDARD CHARACTER)**. CALIFORNIA SOURCING, INC., (U.S. CLS. 22 AND 39). SN 85-273,918. PUB. 8-9-2011. FILED 3-22-2011.
- 4,044,666. **IT'S ALL IN THE STROKE! IAITS AND DESIGN**. MESON BRO ENTERPRISE, (U.S. CLS. 22 AND 39). SN 85-273,972. PUB. 8-9-2011. FILED 3-22-2011.
- 4,044,668. **STAY HUMBLE AND REMAIN POSITIVE (STANDARD CHARACTER)**. MIDKIFF, COLE, (U.S. CLS. 22 AND 39). SN 85-273,984. PUB. 8-9-2011. FILED 3-22-2011.
- 4,044,671. **CLAYTIME (STANDARD CHARACTER)**. MICHAEL J WATERSTREET, AND RYAN D WATERSTREET, (U.S. CLS. 22 AND 39). SN 85-274,020. PUB. 8-9-2011. FILED 3-22-2011.
- 4,044,680. **WOODWIND (STANDARD CHARACTER)**. KILL-ETTE, ANDREW HOYT, MULTIPLE CLASS, (INT. CLS. 25 AND 28), (U.S. CLS. 22, 23, 38, 39 AND 50). SN 85-274,172. PUB. 8-9-2011. FILED 3-23-2011.
- 4,044,682. **10-8 (STANDARD CHARACTER)**. CAROLINA HOSIERY MILLS, INC., (U.S. CLS. 22 AND 39). SN 85-274,180. PUB. 8-9-2011. FILED 3-23-2011.
- 4,044,687. **FLING FLOPS (STANDARD CHARACTER)**. CHIC BIZOU, INC., (U.S. CLS. 22 AND 39). SN 85-274,271. PUB. 8-9-2011. FILED 3-23-2011.
- 4,044,702. **AUSTIN DILLON (STANDARD CHARACTER)**. DILLON, AUSTIN, MULTIPLE CLASS, (INT. CLS. 25 AND 41), (U.S. CLS. 22, 39, 100, 101 AND 107). SN 85-274,581. PUB. 8-9-2011. FILED 3-23-2011.
- 4,044,720. **WANALEI BOB AND DESIGN**. ZACCARDI, ROBERT J., (U.S. CLS. 22 AND 39). SN 85-274,844. PUB. 8-9-2011. FILED 3-23-2011.
- 4,044,732. **BABELAE (STYLIZED)**. NICK CHEN, (U.S. CLS. 22 AND 39). SN 85-275,060. PUB. 8-9-2011. FILED 3-23-2011.
- 4,044,738. **MISCELLANEOUS DESIGN**. TEE FURY LLC, MULTIPLE CLASS, (INT. CLS. 25 AND 35), (U.S. CLS. 22, 39, 100, 101 AND 102). SN 85-275,181. PUB. 8-9-2011. FILED 3-23-2011.
- 4,044,789 ( *See Class 18 for this trademark*).
- 4,044,811. **SIERRA EXPERIENCE (STANDARD CHARACTER)**. AMTAI IMPORTS, INC., (U.S. CLS. 22 AND 39). SN 85-276,178. PUB. 8-9-2011. FILED 3-24-2011.
- 4,044,822. **FIT TO FLICK (STANDARD CHARACTER)**. BOMZE, HANNAH, (U.S. CLS. 22 AND 39). SN 85-276,348. PUB. 8-9-2011. FILED 3-24-2011.
- 4,044,826. **DRO (STANDARD CHARACTER)**. PAUL ESPINO, (U.S. CLS. 22 AND 39). SN 85-276,409. PUB. 8-9-2011. FILED 3-24-2011.
- 4,044,904. **DEAR ALICE (STANDARD CHARACTER)**. HYE EUN LEE, DBA DEAR ALICE, (U.S. CLS. 22 AND 39). SN 85-277,401. PUB. 8-9-2011. FILED 3-25-2011.
- 4,044,908. **ZOO AND DESIGN**. SKIP HOP, INC., (U.S. CLS. 22 AND 39). SN 85-277,449. PUB. 8-9-2011. FILED 3-25-2011.
- 4,044,909. **URBAN FOLK ART (STANDARD CHARACTER)**. GOULD, MAX ADAM, MULTIPLE CLASS, (INT. CLS. 25 AND 35), (U.S. CLS. 22, 39, 100, 101 AND 102). SN 85-277,452. PUB. 8-9-2011. FILED 3-25-2011.
- 4,044,929. **MAKALUWEAR AND DESIGN**. MAKALU WEAR, LLC, (U.S. CLS. 22 AND 39). SN 85-277,786. PUB. 8-9-2011. FILED 3-26-2011.
- 4,044,936. **PICSHIRT (STANDARD CHARACTER)**. PICSHIRT, MULTIPLE CLASS, (INT. CLS. 25 AND 35), (U.S. CLS. 22, 39, 100, 101 AND 102). SN 85-277,868. PUB. 8-9-2011. FILED 3-26-2011.
- 4,044,951. **MISS VICTORIA (STANDARD CHARACTER)**. TANGO ARGENTINO PRODUCTIONS, LLC, (U.S. CLS. 22 AND 39). SN 85-278,117. PUB. 8-9-2011. FILED 3-27-2011.
- 4,044,974. **THE TIPSYP GOAT (STANDARD CHARACTER)**. THE TIPSYP GOAT LLC, MULTIPLE CLASS, (INT. CLS. 25 AND 43), (U.S. CLS. 22, 39, 100 AND 101). SN 85-278,411. PUB. 8-9-2011. FILED 3-28-2011.
- 4,044,976. **MUFFIN TOP STOPPER (STANDARD CHARACTER)**. MUFFIN TOP STOPPER, (U.S. CLS. 22 AND 39). SN 85-278,449. PUB. 8-9-2011. FILED 3-28-2011.
- 4,044,981. **LONG HAIR DONT CARE (STANDARD CHARACTER)**. TOP NOTCH LIVING LLC, (U.S. CLS. 22 AND 39). SN 85-278,493. PUB. 8-9-2011. FILED 3-28-2011.
- 4,045,011. **FEEL FOXY (STANDARD CHARACTER)**. FEEL FOXY, LLC, (U.S. CLS. 22 AND 39). SN 85-278,888. PUB. 8-9-2011. FILED 3-28-2011.
- 4,045,031. **GOT SOBER? (STYLIZED)**. ZAYAS, HECTOR, (U.S. CLS. 22 AND 39). SN 85-279,097. PUB. 8-9-2011. FILED 3-28-2011.

4,045,033. **823 (STANDARD CHARACTER)**. JOHNNY C CHOI, (U.S. CLS. 22 AND 39). SN 85-279,136. PUB. 8-9-2011. FILED 3-28-2011.

4,045,037. **BRDCST (STANDARD CHARACTER)**. BROADCAST LLC, MULTIPLE CLASS, (INT. CLS. 25 AND 28), (U.S. CLS. 22, 23, 38, 39 AND 50). SN 85-279,152. PUB. 8-9-2011. FILED 3-28-2011.

4,045,068. **LE (STYLIZED)**. LOYAL ELITE INC., (U.S. CLS. 22 AND 39). SN 85-279,613. PUB. 8-9-2011. FILED 3-29-2011.

4,045,125. **HANDSOME ME (STANDARD CHARACTER)**. JCW ENTERPRISES, INC., (U.S. CLS. 22 AND 39). SN 85-280,444. PUB. 8-9-2011. FILED 3-29-2011.

4,045,128. **LOADED BETTY (STANDARD CHARACTER)**. JOHNNY CHUN CHOI, (U.S. CLS. 22 AND 39). SN 85-280,455. PUB. 8-9-2011. FILED 3-29-2011.

4,045,130. **COODO (STYLIZED)**. NICK CHEN, (U.S. CLS. 22 AND 39). SN 85-280,466. PUB. 8-9-2011. FILED 3-29-2011.

4,045,131. **BEAUTIFUL ME (STANDARD CHARACTER)**. JCW ENTERPRISES, INC., (U.S. CLS. 22 AND 39). SN 85-280,468. PUB. 8-9-2011. FILED 3-29-2011.

4,045,132. **JOHNNY GOT HIS ... (STANDARD CHARACTER)**. JOHNNY CHUN CHOI, (U.S. CLS. 22 AND 39). SN 85-280,469. PUB. 8-9-2011. FILED 3-29-2011.

4,045,135. **FLYSIVE (STANDARD CHARACTER)**. JOHNNY CHUN CHOI, (U.S. CLS. 22 AND 39). SN 85-280,486. PUB. 8-9-2011. FILED 3-29-2011.

4,045,192. **PRDX (STANDARD CHARACTER)**. BOGARI HOLDINGS, INC., (U.S. CLS. 22 AND 39). SN 85-281,193. PUB. 8-9-2011. FILED 3-30-2011.

4,045,216. **STUNT QUEEN! AND DESIGN**. KRISTEN A. BITTNER, DBA STUNT QUEEN, AND CHRISTOPHER B. BITTNER, DBA STUNT QUEEN, (U.S. CLS. 22 AND 39). SN 85-281,645. PUB. 8-9-2011. FILED 3-30-2011.

4,045,229. **BUCK YEAH (STANDARD CHARACTER)**. BORDES, GREGORY A., (U.S. CLS. 22 AND 39). SN 85-281,815. PUB. 8-9-2011. FILED 3-30-2011.

4,045,239. **HIDAKI AND DESIGN**. GABAI, ILAN Y., (U.S. CLS. 22 AND 39). SN 85-281,915. PUB. 8-9-2011. FILED 3-31-2011.

4,045,254. **IF YOU BLOW IT, THEY WILL COME. (STANDARD CHARACTER)**. KILLETTE, ANDREW HOYT, MULTIPLE CLASS, (INT. CLS. 25 AND 28), (U.S. CLS. 22, 23, 38, 39 AND 50). SN 85-282,041. PUB. 8-9-2011. FILED 3-31-2011.

4,045,275. **T D AND DESIGN**. TONY DEMARIA ELECTRIC, INC., MULTIPLE CLASS, (INT. CLS. 25, 37, 41 AND 42), (U.S. CLS. 22, 39, 100, 101, 103, 106 AND 107). SN 85-282,270. PUB. 8-9-2011. FILED 3-31-2011.

4,045,284 ( *See Class 18 for this trademark*).

4,045,288 ( *See Class 14 for this trademark*).

4,045,292. **DAREALES (STANDARD CHARACTER)**. BRAY, CHRISTOPHER, (U.S. CLS. 22 AND 39). SN 85-282,490. PUB. 8-9-2011. FILED 3-31-2011.

4,045,303. **ABT (STANDARD CHARACTER)**. BALLET THEATRE FOUNDATION, INC., (U.S. CLS. 22 AND 39). SN 85-282,598. PUB. 8-9-2011. FILED 3-31-2011.

4,045,338. **FIVE BROTHER (STANDARD CHARACTER)**. TOPWIN CORPORATION, (U.S. CLS. 22 AND 39). SN 85-283,076. PUB. 8-9-2011. FILED 3-31-2011.

4,045,343. **PURSE & PULSE (STANDARD CHARACTER)**. SCOTT, STEWART, (U.S. CLS. 22 AND 39). SN 85-283,146. PUB. 8-9-2011. FILED 3-31-2011.

4,045,359. **DA CODE (STYLIZED)**. LIGHT IN THE BOX LIMITED, (U.S. CLS. 22 AND 39). SN 85-283,326. PUB. 8-9-2011. FILED 4-1-2011.

4,045,394 ( *See Class 14 for this trademark*).

4,045,408. **KUA (STANDARD CHARACTER)**. KIMBALL UNION ACADEMY, (U.S. CLS. 22 AND 39). SN 85-283,896. PUB. 8-9-2011. FILED 4-1-2011.

4,045,446. **FISH KID AND DESIGN**. FRASER, KEITH, (U.S. CLS. 22 AND 39). SN 85-284,348. PUB. 8-9-2011. FILED 4-1-2011.

4,045,450. **P N (STYLIZED)**. HEWITT, STEVE, AND HEWITT, TIFFANY, (U.S. CLS. 22 AND 39). SN 85-284,400. PUB. 8-9-2011. FILED 4-1-2011.

4,045,454. **HARD RIDER (STANDARD CHARACTER)**. RINALDI, FRANK JR., (U.S. CLS. 22 AND 39). SN 85-284,479. PUB. 8-9-2011. FILED 4-2-2011.

4,045,470. **DEAKI (STANDARD CHARACTER)**. FOGLIA, OMAR H., (U.S. CLS. 22 AND 39). SN 85-285,096. PUB. 8-

9-2011. FILED 4-4-2011.

4,045,489. **WORTH THE HURT (STANDARD CHARACTER)**. WORTH THE HURT, INC., (U.S. CLS. 22 AND 39). SN 85-285,940. PUB. 8-9-2011. FILED 4-4-2011.

4,045,490. **WTH (STANDARD CHARACTER)**. WORTH THE HURT, INC., (U.S. CLS. 22 AND 39). SN 85-285,943. PUB. 8-9-2011. FILED 4-4-2011.

4,045,530 ( *See Class 20 for this trademark*).

4,045,538. **ADD A LAYER OF MEANING (STANDARD CHARACTER)**. KATE SPADE LLC, (U.S. CLS. 22 AND 39). SN 85-298,486. PUB. 8-9-2011. FILED 4-19-2011.

4,045,540. **GAME OF THRONES AND DESIGN**. HOME BOX OFFICE, INC., (U.S. CLS. 22 AND 39). SN 85-298,788. PUB. 8-9-2011. FILED 4-19-2011.

4,045,564. **SURLY (STYLIZED)**. QUALITY BICYCLE PRODUCTS, INC., (U.S. CLS. 22 AND 39). SN 85-315,594. PUB. 8-9-2011. FILED 5-9-2011.

---

### CLASS 26—FANCY GOODS

4,043,748 ( *See Class 3 for this trademark*).

4,043,937 ( *See Class 18 for this trademark*).

4,044,156. **SHIMMER STRANDS AND DESIGN**. INNOVATIVE BEAUTY LABS, LLC, DBA SHIMMER STRANDS, (U.S. CLS. 37, 39, 40, 42 AND 50). SN 85-192,137. PUB. 8-9-2011. FILED 12-7-2010.

4,044,263. **HOUSE OF MARLEY MARETT TSEHAI DAM AND DESIGN**. FIFTY-SIX HOPE ROAD MUSIC LIMITED, (U.S. CLS. 37, 39, 40, 42 AND 50). SN 85-230,801. PUB. 8-9-2011. FILED 2-1-2011.

4,044,795. **MISCELLANEOUS DESIGN**. TRIPLE AUGHT DESIGN, LLC, (U.S. CLS. 37, 39, 40, 42 AND 50). SN 85-275,918. PUB. 8-9-2011. FILED 3-24-2011.

4,045,003. **USFRA (STANDARD CHARACTER)**. U.S. FARMERS & RANCHERS ALLIANCE, INC., (U.S. CLS. 37, 39, 40, 42 AND 50). SN 85-278,762. PUB. 8-9-2011. FILED 3-28-2011.

4,045,288 ( *See Class 14 for this trademark*).

4,045,448. **ONE INCH ROUND (STANDARD CHARACTER)**. ONE INCH ROUND INC., (U.S. CLS. 37, 39, 40, 42 AND 50). SN 85-284,397. PUB. 8-9-2011. FILED 4-1-2011.

---

### CLASS 27—FLOOR COVERINGS

4,043,621 ( *See Class 16 for this trademark*).

4,043,937 ( *See Class 18 for this trademark*).

---

### CLASS 28—TOYS AND SPORTING GOODS

4,043,689 ( *See Class 3 for this trademark*).

4,043,694 ( *See Class 16 for this trademark*).

4,043,700 ( *See Class 9 for this trademark*).

4,043,719 ( *See Class 9 for this trademark*).

4,043,733. **MISCELLANEOUS DESIGN**. CARROLL HALL SHELBY TRUST, (U.S. CLS. 22, 23, 38 AND 50). SN 77-981,499. PUB. 5-3-2011. FILED 12-19-2007.

4,043,737 ( *See Class 18 for this trademark*).

4,043,773 ( *See Class 9 for this trademark*).

4,043,782 ( *See Class 12 for this trademark*).

4,043,785 ( *See Class 3 for this trademark*).

4,043,797 ( *See Class 9 for this trademark*).

4,043,828. **POLIN AND DESIGN**. POLIN SU PARKLARI VE HAVUZ SISTEMLERI ANONIM SIRKETI, (U.S. CLS. 22, 23, 38 AND 50). SN 79-091,220. PUB. 8-9-2011. FILED 5-14-2010.

4,043,856 ( *See Class 9 for this trademark*).

4,043,937 ( *See Class 18 for this trademark*).

4,043,948 ( *See Class 11 for this trademark*).

4,043,950. **RENEGADE TARGETS (STANDARD CHARACTER)**. CORROSIVE LABS, INC., (U.S. CLS. 22, 23, 38 AND 50). SN 85-102,468. PUB. 8-9-2011. FILED 8-6-2010.

4,044,003 ( *See Class 18 for this trademark*).

- 4,044,039 ( *See Class 25 for this trademark.* )  
 4,044,188 ( *See Class 9 for this trademark.* )  
 4,044,189 ( *See Class 9 for this trademark.* )  
 4,044,264. **HOUSE OF MARLEY MARETT TSEHAI DAM AND DESIGN.** FIFTY-SIX HOPE ROAD MUSIC LIMITED, (U.S. CLS. 22, 23, 38 AND 50). SN 85-230,802. PUB. 8-9-2011. FILED 2-1-2011.  
 4,044,332. **SABALO (STANDARD CHARACTER).** ACELERANT INCORPORATED, DBA STINGRAY BRANDS, (U.S. CLS. 22, 23, 38 AND 50). SN 85-250,221. PUB. 8-9-2011. FILED 2-24-2011.  
 4,044,404. **ARCADE MFG (STANDARD CHARACTER).** CRUMP, ARTHUR S, DBA ARCADE MFG, (U.S. CLS. 22, 23, 38 AND 50). SN 85-259,300. PUB. 8-9-2011. FILED 3-7-2011.  
 4,044,446. **NEBULIS (STANDARD CHARACTER).** SENARIO LLC, (U.S. CLS. 22, 23, 38 AND 50). SN 85-261,265. PUB. 8-9-2011. FILED 3-8-2011.  
 4,044,447. **GALEX-Z (STANDARD CHARACTER).** SENARIO LLC, (U.S. CLS. 22, 23, 38 AND 50). SN 85-261,287. PUB. 8-9-2011. FILED 3-8-2011.  
 4,044,449. **TORRANT (STANDARD CHARACTER).** SENARIO LLC, (U.S. CLS. 22, 23, 38 AND 50). SN 85-261,356. PUB. 8-9-2011. FILED 3-8-2011.  
 4,044,491. **BABY JAVIER (STANDARD CHARACTER).** BABY ABUELITA PRODUCTIONS, LLC, (U.S. CLS. 22, 23, 38 AND 50). SN 85-263,063. PUB. 8-9-2011. FILED 3-10-2011.  
 4,044,587. **MONKEY DEPOT (STANDARD CHARACTER).** MONKEY DEPOT LLC, (U.S. CLS. 22, 23, 38 AND 50). SN 85-267,120. PUB. 8-9-2011. FILED 3-15-2011.  
 4,044,590. **SPEED WORM (STANDARD CHARACTER).** ZOOM BAIT COMPANY, INC., (U.S. CLS. 22, 23, 38 AND 50). SN 85-267,381. PUB. 8-9-2011. FILED 3-15-2011.  
 4,044,598. **DAVE DARINKO (STANDARD CHARACTER).** PRETTY UGLY LLC, AND HORVATH, DAVID, AND KIM, SUN-MIN, (U.S. CLS. 22, 23, 38 AND 50). SN 85-268,861. PUB. 8-9-2011. FILED 3-16-2011.  
 4,044,618 ( *See Class 12 for this trademark.* )  
 4,044,649. **IST & ROLL (STANDARD CHARACTER).** SMITH, EDWARD, (U.S. CLS. 22, 23, 38 AND 50). SN 85-273,744. PUB. 8-9-2011. FILED 3-22-2011.  
 4,044,656. **TOPRAIDER (STANDARD CHARACTER).** JOE BUCHER, (U.S. CLS. 22, 23, 38 AND 50). SN 85-273,839. PUB. 8-9-2011. FILED 3-22-2011.  
 4,044,678. **AIR HUNTERZ (STANDARD CHARACTER).** ZING TOYS, INC., (U.S. CLS. 22, 23, 38 AND 50). SN 85-274,142. PUB. 8-9-2011. FILED 3-23-2011.  
 4,044,680 ( *See Class 25 for this trademark.* )  
 4,044,704. **AUSTIN DILLON (STANDARD CHARACTER).** DILLON, AUSTIN, (U.S. CLS. 22, 23, 38 AND 50). SN 85-274,588. PUB. 8-9-2011. FILED 3-23-2011.  
 4,044,711. **HI HO CHERRY-O (STANDARD CHARACTER).** HASBRO, INC., (U.S. CLS. 22, 23, 38 AND 50). SN 85-274,702. PUB. 8-9-2011. FILED 3-23-2011.  
 4,044,757. **HXT AND DESIGN.** JAMES O. LUCAS, (U.S. CLS. 22, 23, 38 AND 50). SN 85-275,464. PUB. 8-9-2011. FILED 3-24-2011.  
 4,044,771. **CLUE (STANDARD CHARACTER).** HASBRO, INC., (U.S. CLS. 22, 23, 38 AND 50). SN 85-275,647. PUB. 8-9-2011. FILED 3-24-2011.  
 4,044,777. **MYSTIFYING ORACLE (STANDARD CHARACTER).** HASBRO, INC., (U.S. CLS. 22, 23, 38 AND 50). SN 85-275,735. PUB. 8-9-2011. FILED 3-24-2011.  
 4,044,784. **DON'T BREAK THE ICE (STANDARD CHARACTER).** HASBRO, INC., (U.S. CLS. 22, 23, 38 AND 50). SN 85-275,800. PUB. 8-9-2011. FILED 3-24-2011.  
 4,044,785. **OPERATION (STANDARD CHARACTER).** HASBRO, INC., (U.S. CLS. 22, 23, 38 AND 50). SN 85-275,807. PUB. 8-9-2011. FILED 3-24-2011.  
 4,044,839. **UMAREX USA (STYLIZED).** UMAREX SPORT-WAFFEN GMBH & CO. KG, (U.S. CLS. 22, 23, 38 AND 50). SN 85-276,566. PUB. 8-9-2011. FILED 3-25-2011.  
 4,044,864. **CANNONBALL (STANDARD CHARACTER).** BENNETT, MICHAEL, (U.S. CLS. 22, 23, 38 AND 50). SN 85-276,918. PUB. 8-9-2011. FILED 3-25-2011.  
 4,044,968. **THE LOOP WORKSHOP (STANDARD CHARACTER).** TUFTS, GEORGETTE, (U.S. CLS. 22, 23, 38 AND 50). SN 85-278,279. PUB. 8-9-2011. FILED 3-28-2011.  
 4,044,979. **ZOOCATIONAL (STANDARD CHARACTER).** SNLUSA, DBA CUDDLE BARN, (U.S. CLS. 22, 23, 38 AND 50). SN 85-278,480. PUB. 8-9-2011. FILED 3-28-2011.  
 4,045,022. **FIRECAST (STANDARD CHARACTER).** SORRELS WHOLESALE, INC., (U.S. CLS. 22, 23, 38 AND 50). SN 85-278,992. PUB. 8-9-2011. FILED 3-28-2011.  
 4,045,037 ( *See Class 25 for this trademark.* )  
 4,045,066. **MISCELLANEOUS DESIGN.** SPEEDWAY MOTORS, INC., MULTIPLE CLASS, (INT. CLS. 28 AND 35), (U.S. CLS. 22, 23, 38, 50, 100, 101 AND 102). SN 85-279,555. PUB. 8-9-2011. FILED 3-29-2011.  
 4,045,124. **R (STYLIZED).** RIVIERA GOLF & TENNIS, INC., (U.S. CLS. 22, 23, 38 AND 50). SN 85-280,427. PUB. 8-9-2011. FILED 3-29-2011.  
 4,045,190. **VSL (STANDARD CHARACTER).** R.L. WINSTON ROD COMPANY, (U.S. CLS. 22, 23, 38 AND 50). SN 85-281,185. PUB. 8-9-2011. FILED 3-30-2011.  
 4,045,193. **PASSPORT (STANDARD CHARACTER).** R.L. WINSTON ROD COMPANY, (U.S. CLS. 22, 23, 38 AND 50). SN 85-281,206. PUB. 8-9-2011. FILED 3-30-2011.  
 4,045,206. **VENOM (STANDARD CHARACTER).** MAYTUM, ZACK, (U.S. CLS. 22, 23, 38 AND 50). SN 85-281,475. PUB. 8-9-2011. FILED 3-30-2011.  
 4,045,254 ( *See Class 25 for this trademark.* )  
 4,045,305. **BOMBS AWAY (STANDARD CHARACTER).** XL GAMING, INC., DBA LITTLE BIG GAMES, (U.S. CLS. 22, 23, 38 AND 50). SN 85-282,647. PUB. 8-9-2011. FILED 3-31-2011.  
 4,045,345. **WARSTIC (STANDARD CHARACTER).** ONEFAST-BUFFALO CORP, (U.S. CLS. 22, 23, 38 AND 50). SN 85-283,165. PUB. 8-9-2011. FILED 3-31-2011.  
 4,045,395. **GIVE OR TAKE THE POT (STANDARD CHARACTER).** RUSING, STEPHEN E., (U.S. CLS. 22, 23, 38 AND 50). SN 85-283,736. PUB. 8-9-2011. FILED 4-1-2011.  
 4,045,502. **SQUIDO (STANDARD CHARACTER).** PETSPOUR USA, INC., (U.S. CLS. 22, 23, 38 AND 50). SN 85-287,199. PUB. 8-9-2011. FILED 4-5-2011.  
 4,045,503. **CRAZER (STANDARD CHARACTER).** PETSPOUR USA, INC., (U.S. CLS. 22, 23, 38 AND 50). SN 85-287,229. PUB. 8-9-2011. FILED 4-5-2011.  
 4,045,545. **MISCELLANEOUS DESIGN.** WAL-MART STORES, INC., (U.S. CLS. 22, 23, 38 AND 50). SN 85-302,644. PUB. 8-9-2011. FILED 4-22-2011.  
 4,045,546 ( *See Class 18 for this trademark.* )

---

**CLASS 29—MEATS AND PROCESSED FOODS**

- 4,043,742. **SUMMER SPLASH (STANDARD CHARACTER).** READY PAC PRODUCE, INC., (U.S. CL. 46). SN 78-965,851. PUB. 8-9-2011. FILED 9-1-2006.  
 4,043,746 ( *See Class 3 for this trademark.* )  
 4,043,770. **SUNON AND DESIGN.** AHCOF INDUSTRIAL DEVELOPMENT CO., LTD., AND AHCOF INTERNATIONAL DEVELOPMENT CO., LTD., AND ANHUI CEREALS, OILS & FOODSTUFFS IMPORT & EXPORT (GROUP) CORPORATION, MULTIPLE CLASS, (INT. CLS. 29 AND 31), (U.S. CLS. 1 AND 46). SN 79-087,833. PUB. 8-9-2011. FILED 9-14-2010.  
 4,043,778. **LABORATORIO TORTELLINI AND DESIGN.** SURGITAL S.P.A., MULTIPLE CLASS, (INT. CLS. 29 AND 30), (U.S. CL. 46). SN 79-088,504. PUB. 8-9-2011. FILED 7-6-2010.  
 4,043,868. **FUMAGALLI AND DESIGN.** FUMAGALLI INDUSTRIA ALIMENTARI S.P.A., (U.S. CL. 46). SN 79-097,865. PUB. 8-9-2011. FILED 4-4-2011.  
 4,043,929. **INNOCENT (STANDARD CHARACTER).** FRESH TRADING LIMITED, MULTIPLE CLASS, (INT. CLS. 29, 30 AND 32), (U.S. CLS. 45, 46 AND 48). SN 85-084,711. PUB. 4-12-2011. FILED 7-14-2010.  
 4,043,930. **TAZAKI AND DESIGN.** TAZAKI FOODS LIMITED, MULTIPLE CLASS, (INT. CLS. 29, 30, 31, 32 AND 33), (U.S. CLS. 1, 45, 46, 47, 48 AND 49). SN 85-088,711. PUB. 6-21-2011. FILED 7-20-2010.  
 4,043,969 ( *See Class 3 for this trademark.* )  
 4,043,981. **ALGOOD (STANDARD CHARACTER).** ALGOOD FOOD COMPANY, (U.S. CL. 46). SN 85-114,019. PUB. 8-9-

2011. FILED 8-23-2010.
- 4,043,988. **MISCELLANEOUS DESIGN**. HAOXIANGNI JU-JUBE INDUSTRY CO., LTD., (U.S. CL. 46). SN 85-116,859. PUB. 8-9-2011. FILED 8-26-2010.
- 4,044,004. **GREEN VALLEY OLIVE (STANDARD CHARACTER)**. AISONNE HOLDINGS, LLC, (U.S. CL. 46). SN 85-120,405. PUB. 8-9-2011. FILED 8-31-2010.
- 4,044,061. **BLUE FLAG BRAND AND DESIGN**. KABUSHIKI KAISHA NAKASHIMATO SHOTEN, ALSO TRADING AS NAKASHIMATO CO., LTD., MULTIPLE CLASS, (INT. CLS. 29 AND 30), (U.S. CL. 46). SN 85-141,937. PUB. 8-9-2011. FILED 9-30-2010.
- 4,044,105. **ALGAE TO OMEGA (STANDARD CHARACTER)**. ALGAE TO OMEGA HOLDINGS, INC, MULTIPLE CLASS, (INT. CLS. 29, 31 AND 44), (U.S. CLS. 1, 46, 100 AND 101). SN 85-166,908. PUB. 8-9-2011. FILED 11-2-2010.
- 4,044,109. **BLACK DIRT BRAND (STANDARD CHARACTER)**. ROGOWSKI, MARK, MULTIPLE CLASS, (INT. CLS. 29, 30 AND 31), (U.S. CLS. 1 AND 46). SN 85-168,741. PUB. 8-9-2011. FILED 11-4-2010.
- 4,044,149. **CANNON FISH SEATTLE AND DESIGN**. CANNON FISH COMPANY, MULTIPLE CLASS, (INT. CLS. 29 AND 35), (U.S. CLS. 46, 100, 101 AND 102). SN 85-189,410. PUB. 8-9-2011. FILED 12-2-2010.
- 4,044,229. **MISCELLANEOUS DESIGN**. LIN, QISHU, (U.S. CL. 46). SN 85-224,992. PUB. 8-9-2011. FILED 1-24-2011.
- 4,044,333. **VESPA AND DESIGN**. PIAGGIO & C. S.P.A., MULTIPLE CLASS, (INT. CLS. 29, 30, 32, 33, 35 AND 43), (U.S. CLS. 45, 46, 47, 48, 49, 100, 101 AND 102). SN 85-250,236. PUB. 7-19-2011. FILED 2-24-2011.
- 4,044,388. **BIG BOB'S BELLY BUSTER AND DESIGN**. ICE-LANDIC (USA), INC., (U.S. CL. 46). SN 85-258,127. PUB. 8-9-2011. FILED 3-4-2011.
- 4,044,413. **ROB'S RIB SHOTS AND DESIGN**. CRIST, ROBIN, (U.S. CL. 46). SN 85-259,714. PUB. 8-9-2011. FILED 3-7-2011.
- 4,044,459. **SCALA'S ORIGINAL (STANDARD CHARACTER)**. SCALA'S ORIGINAL BEEF & SAUSAGE COMPANY LLC, (U.S. CL. 46). SN 85-261,769. PUB. 8-9-2011. FILED 3-9-2011.
- 4,044,465. **TIGER KING (STANDARD CHARACTER)**. EX-PACK SEAFOOD, INC., (U.S. CL. 46). SN 85-261,944. PUB. 8-9-2011. FILED 3-9-2011.
- 4,044,578. **THE SWEETHEART OF THE YAM (STANDARD CHARACTER)**. BRUCE FOODS CORPORATION, (U.S. CL. 46). SN 85-266,487. PUB. 8-9-2011. FILED 3-14-2011.
- 4,044,699. **DEEP RIVER (STANDARD CHARACTER)**. OLD LYME GOURMET COMPANY, DBA DEEP RIVER SNACKS, MULTIPLE CLASS, (INT. CLS. 29 AND 30), (U.S. CL. 46). SN 85-274,502. PUB. 8-9-2011. FILED 3-23-2011.
- 4,044,922. **CÔT HU TIÊU AND DESIGN**. QUOC VIET FOODS, INC., (U.S. CL. 46). SN 85-277,727. PUB. 8-9-2011. FILED 3-26-2011.
- 4,044,923. **CÔT SÚP GÀ AND DESIGN**. QUOC VIET FOODS, INC., (U.S. CL. 46). SN 85-277,728. PUB. 8-9-2011. FILED 3-26-2011.
- 4,044,924. **CÔT BÚN RIÊU AND DESIGN**. QUOC VIET FOODS, INC., (U.S. CL. 46). SN 85-277,730. PUB. 8-9-2011. FILED 3-26-2011.
- 4,044,925. **CÔT LÂU THÁI LAN AND DESIGN**. QUOC VIET FOODS, INC., (U.S. CL. 46). SN 85-277,732. PUB. 8-9-2011. FILED 3-26-2011.
- 4,044,941. **CÔT CANH CHUA (STYLIZED)**. QUOC VIET FOODS, INC., (U.S. CL. 46). SN 85-277,989. PUB. 8-9-2011. FILED 3-26-2011.
- 4,044,942. **CÔT SÚP CHAY (STYLIZED)**. QUOC VIET FOODS, INC., (U.S. CL. 46). SN 85-277,990. PUB. 8-9-2011. FILED 3-26-2011.
- 4,044,996. **TANGO'S VILLE (STANDARD CHARACTER)**. SPECIAL AMERICA'S BBQ INC, (U.S. CL. 46). SN 85-278,661. PUB. 8-9-2011. FILED 3-28-2011.
- 4,045,075. **HERB'S (STANDARD CHARACTER)**. HERB'S SNACK FOODS LLC, (U.S. CL. 46). SN 85-279,719. PUB. 8-9-2011. FILED 3-29-2011.
- 4,045,081. **HERB'S AND DESIGN**. HERB'S SNACK FOODS LLC, (U.S. CL. 46). SN 85-279,833. PUB. 8-9-2011. FILED 3-29-2011.
- 4,045,091. **MISCELLANEOUS DESIGN**. PARK POULTRY, INC., (U.S. CL. 46). SN 85-279,915. PUB. 8-9-2011. FILED 3-29-2011.
- 4,045,203. **THE SILVER LINE (STANDARD CHARACTER)**. NITTANY CORPORATION, (U.S. CL. 46). SN 85-281,411. PUB. 8-9-2011. FILED 3-30-2011.
- 4,045,204. **THE GOLD LINE (STANDARD CHARACTER)**. NITTANY CORPORATION, (U.S. CL. 46). SN 85-281,413. PUB. 8-9-2011. FILED 3-30-2011.
- 4,045,231. **LUCKY AND DESIGN**. NEBRASKA STAR BEEF, LLC, (U.S. CL. 46). SN 85-281,834. PUB. 8-9-2011. FILED 3-30-2011.
- 4,045,426. **KORI KORI (STANDARD CHARACTER)**. FARMERS SUPPLY CO. OF DINUBA, INC., (U.S. CL. 46). SN 85-284,122. PUB. 8-9-2011. FILED 4-1-2011.
- 4,045,495. **SUGARGROVE (STANDARD CHARACTER)**. SUGARGROVE HAM, LLC, (U.S. CL. 46). SN 85-286,655. PUB. 8-9-2011. FILED 4-5-2011.
- 4,045,508 ( *See Class 5 for this trademark*).
- 4,045,537. **THE CALIFORNIAN (STANDARD CHARACTER)**. ZACKY FARMS, LLC, (U.S. CL. 46). SN 85-297,758. PUB. 8-9-2011. FILED 4-18-2011.
- 4,045,575. **KLUCK BOWL (STANDARD CHARACTER)**. CC INVESTMENTS LLC, (U.S. CL. 46). SN 85-346,162. PUB. 8-9-2011. FILED 6-14-2011.

---

### CLASS 30—STAPLE FOODS

- 4,043,613 ( *See Class 5 for this trademark*).
- 4,043,624. **RUDOLPHS BAR-B-QUE (STANDARD CHARACTER)**. SECOND BITE FOODS, INC., (U.S. CL. 46). SN 76-706,597. PUB. 8-9-2011. FILED 2-28-2011.
- 4,043,723. **CHOCONUT (STANDARD CHARACTER)**. YZ ENTERPRISES, INC., (U.S. CL. 46). SN 77-949,482. PUB. 8-9-2011. FILED 3-3-2010.
- 4,043,746 ( *See Class 3 for this trademark*).
- 4,043,759. **FRUIT LIFE (STYLIZED)**. INOSTRANNOE TCHASTNOE OUNITARNOE PROIZVODSTVENNO-TORGOVOE PREDPRIATIE "KARAVAN" KORPORATSII "KAMBERLI MARKETING KORP.", (U.S. CL. 46). SN 79-085,063. PUB. 8-9-2011. FILED 6-28-2010.
- 4,043,778 ( *See Class 29 for this trademark*).
- 4,043,789. **HALUNKEN TRÜFFELPRALINEN (STANDARD CHARACTER)**. WIEBOLD-CONFISERIE GMBH & CO. KG, (U.S. CL. 46). SN 79-088,937. PUB. 8-9-2011. FILED 9-2-2010.
- 4,043,816. **LA FEE FARINE (STANDARD CHARACTER)**. MINOTERIE PAULIC, (U.S. CL. 46). SN 79-090,453. PUB. 8-9-2011. FILED 8-3-2010.
- 4,043,883. **MISCELLANEOUS DESIGN**. COLOMBINA S.A., (U.S. CL. 46). SN 85-020,042. PUB. 8-9-2011. FILED 4-21-2010.
- 4,043,909. **JAMES SKINNER BAKING COMPANY (STANDARD CHARACTER)**. THE JAMES SKINNER CO., (U.S. CL. 46). SN 85-058,409. PUB. 8-9-2011. FILED 6-9-2010.
- 4,043,919. **MISCELLANEOUS DESIGN**. MARWAN SALAH AL DEEN KABATILO SONS CO., (U.S. CL. 46). SN 85-072,274. PUB. 8-9-2011. FILED 6-25-2010.
- 4,043,922. **HOLIDAY MINT CAPPUCINO AND DESIGN**. FARMER BROS. CO., (U.S. CL. 46). SN 85-075,242. PUB. 8-9-2011. FILED 6-30-2010.
- 4,043,929 ( *See Class 29 for this trademark*).
- 4,043,930 ( *See Class 29 for this trademark*).
- 4,043,937 ( *See Class 18 for this trademark*).
- 4,043,969 ( *See Class 3 for this trademark*).
- 4,043,990. **PURE NRG (STANDARD CHARACTER)**. PURE NRG, LLC, (U.S. CL. 46). SN 85-116,973. PUB. 8-9-2011. FILED 8-26-2010.
- 4,044,041. **SPIKES (STANDARD CHARACTER)**. LIDESTRI FOODS, INC., (U.S. CL. 46). SN 85-135,408. PUB. 8-9-2011. FILED 9-22-2010.
- 4,044,061 ( *See Class 29 for this trademark*).
- 4,044,085. **SNOWFLAKE SALT (STANDARD CHARACTER)**. SALTWORKS, INC., (U.S. CL. 46). SN 85-155,091. PUB. 8-9-2011. FILED 10-18-2010.
- 4,044,086 ( *See Class 2 for this trademark*).
- 4,044,109 ( *See Class 29 for this trademark*).
- 4,044,141. **THE GREAT AMERICAN CHEESECAKE AND DESIGN**. PARYSZ, LISA A, DBA THE GREAT AMERICAN CHEESECAKE, (U.S. CL. 46). SN 85-185,415. PUB. 8-9-



2011. FILED 11-26-2010.  
 4,044,154. **SAMBALATTE TORREFAZIONE AND DESIGN.** SAMBALATTE TORREFAZIONE LLC, MULTIPLE CLASS, (INT. CLS. 30 AND 43), (U.S. CLS. 46, 100 AND 101). SN 85-191,362. PUB. 8-9-2011. FILED 12-6-2010.  
 4,044,194. **BABA CHARLES (STANDARD CHARACTER).** HAMADE, CHARLES, (U.S. CL. 46). SN 85-209,532. PUB. 5-3-2011. FILED 1-3-2011.  
 4,044,279. **WIKI WIKI BALLS (STANDARD CHARACTER).** ALOHA HAWAIIAN STORES, INC., (U.S. CL. 46). SN 85-235,083. PUB. 8-9-2011. FILED 2-5-2011.  
 4,044,314. **THE GUILT EDGED COOKIE (STANDARD CHARACTER).** YZ ENTERPRISES, INC., (U.S. CL. 46). SN 85-246,405. PUB. 8-9-2011. FILED 2-18-2011.  
 4,044,333 ( *See Class 29 for this trademark*).  
 4,044,461. **SCALA'S ORIGINAL (STANDARD CHARACTER).** SCALA'S ORIGINAL BEEF & SAUSAGE COMPANY LLC, (U.S. CL. 46). SN 85-261,814. PUB. 8-9-2011. FILED 3-9-2011.  
 4,044,479. **GREEN COFFEE 800 (STANDARD CHARACTER).** ESPA BEAUTY, LLC, (U.S. CL. 46). SN 85-262,626. PUB. 8-9-2011. FILED 3-9-2011.  
 4,044,504. **DELICIAS DE MICHOACAN (STANDARD CHARACTER).** DELICIAS DE MICHOACAN, INC., (U.S. CL. 46). SN 85-263,280. PUB. 8-9-2011. FILED 3-10-2011.  
 4,044,529. **LULU'S CHOCOLATE (STANDARD CHARACTER).** LULU'S CHOCOLATE, LLC, DBA LULU'S CHOCOLATE, LLC, (U.S. CL. 46). SN 85-264,022. PUB. 8-9-2011. FILED S.R. 3-10-2011; AM. P.R. 6-14-2011.  
 4,044,556. **THE CHEESECAKE GALLERY AND DESIGN.** HUTH, JEFFREY, (U.S. CL. 46). SN 85-265,169. PUB. 8-9-2011. FILED 3-11-2011.  
 4,044,568. **HONEY AND DESIGN.** ELIAS HONEY LTD., (U.S. CL. 46). SN 85-265,622. PUB. 8-9-2011. FILED 3-13-2011.  
 4,044,574. **ANNE'S KOMBUCHA (STANDARD CHARACTER).** RESONATE ELIXIR LLC, (U.S. CL. 46). SN 85-266,308. PUB. 8-9-2011. FILED 3-14-2011.  
 4,044,600. **KATIEPIES AND DESIGN.** COWELL, KAREN, AND COWELL, KAITLYN, (U.S. CL. 46). SN 85-269,079. PUB. 8-9-2011. FILED 3-16-2011.  
 4,044,642. **POPARELLA'S (STANDARD CHARACTER).** PL POPCORN, LLC, (U.S. CL. 46). SN 85-273,640. PUB. 8-9-2011. FILED 3-22-2011.  
 4,044,686. **GOURMET GRANITE (STANDARD CHARACTER).** WINSOME FORGE, LLC, (U.S. CL. 46). SN 85-274,257. PUB. 8-9-2011. FILED 3-23-2011.  
 4,044,699 ( *See Class 29 for this trademark*).  
 4,044,725. **BUTERA'S (STANDARD CHARACTER).** BUTERA'S RESTAURANT OF WOODBURY, (U.S. CL. 46). SN 85-274,917. PUB. 8-9-2011. FILED 3-23-2011.  
 4,044,730. **AMERICAN AS APPLE PIE (STANDARD CHARACTER).** LAZY 8 RANCH SPECIALTY FOOD CO., LLC, (U.S. CL. 46). SN 85-274,978. PUB. 8-9-2011. FILED 3-23-2011.  
 4,044,731. **RANCH HAND (STANDARD CHARACTER).** LAZY 8 RANCH SPECIALTY FOOD CO., LLC, (U.S. CL. 46). SN 85-274,983. PUB. 8-9-2011. FILED 3-23-2011.  
 4,044,779. **GILAK (STANDARD CHARACTER).** JAVAHERIAN, KEYVAN, AND RAMSEY, ROD, (U.S. CL. 46). SN 85-275,743. PUB. 8-9-2011. FILED 3-24-2011.  
 4,044,817. **O'BRIENS OWN GOURMET GRANOLA MADE IN IOWA AND DESIGN.** O'BRIEN & O'BRIEN ENTERPRISES, LLC, DBA O'BRIENS OWN, (U.S. CL. 46). SN 85-276,239. PUB. 8-9-2011. FILED 3-24-2011.  
 4,044,873. **CHOCOLATEN (STANDARD CHARACTER).** TALSIAKIAN PETER E., (U.S. CL. 46). SN 85-277,040. PUB. 8-9-2011. FILED 3-25-2011.  
 4,044,877. **BIG ISLAND BEES (STANDARD CHARACTER).** THE BIG ISLAND BEE COMPANY, LLC, (U.S. CL. 46). SN 85-277,075. PUB. 8-9-2011. FILED 3-25-2011.  
 4,044,881. **THE ADAM BOMB (STANDARD CHARACTER).** ADAMO'S ADAM BOMB LLC, (U.S. CL. 46). SN 85-277,191. PUB. 8-9-2011. FILED 3-25-2011.  
 4,044,955. **RENATA (STANDARD CHARACTER).** PASTIFICIO SELMI S/A, (U.S. CL. 46). SN 85-278,162. PUB. 8-9-2011. FILED 3-28-2011.  
 4,044,958. **SCOTTCAKES (STANDARD CHARACTER).** SCOTT CUNNINGHAM, DBA SCOTTCAKES, (U.S. CL. 46). SN 85-278,207. PUB. 8-9-2011. FILED 3-28-2011.  
 4,044,966. **RAZZIN WATERMELON (STANDARD CHARAC-**

**TER).** WM. WRIGLEY JR. COMPANY, (U.S. CL. 46). SN 85-278,275. PUB. 8-9-2011. FILED 3-28-2011.  
 4,044,975. **MISCELLANEOUS DESIGN.** J & L PEABERRY, (U.S. CL. 46). SN 85-278,446. PUB. 8-9-2011. FILED 3-28-2011.  
 4,044,999. **FEBRUCHERRY AND DESIGN.** KEWPEE, INC., MULTIPLE CLASS, (INT. CLS. 30 AND 43), (U.S. CLS. 46, 100 AND 101). SN 85-278,734. PUB. 8-9-2011. FILED 3-28-2011.  
 4,045,059. **MONSTER SUB (STANDARD CHARACTER).** ELLIOTT'S OFF BROADWAY DELI, INC., (U.S. CL. 46). SN 85-279,460. PUB. 8-9-2011. FILED 3-29-2011.  
 4,045,271. **HOWLING WOLF (STANDARD CHARACTER).** KENNETH WOLFE, (U.S. CL. 46). SN 85-282,211. PUB. 8-9-2011. FILED 3-31-2011.  
 4,045,279. **CAFE COPAN (STANDARD CHARACTER).** COPAN TRADE, (U.S. CL. 46). SN 85-282,321. PUB. 8-9-2011. FILED 3-31-2011.  
 4,045,362. **EAT FRESH BUY OFTEN (STANDARD CHARACTER).** THE EXPRESS CAFE AND BAKERY, LLC, DBA GOOSE FEATHERS, (U.S. CL. 46). SN 85-283,381. PUB. 8-9-2011. FILED 4-1-2011.  
 4,045,402. **FANTASMA (STANDARD CHARACTER).** LMC VENTURES, INC., (U.S. CL. 46). SN 85-283,873. PUB. 8-9-2011. FILED 4-1-2011.  
 4,045,469. **GANOVI (STYLIZED).** BIONOBLE RESEARCH, LLC, (U.S. CL. 46). SN 85-285,086. PUB. 8-9-2011. FILED 4-4-2011.  
 4,045,536. **DIAMOND ELEPHANT (STANDARD CHARACTER).** TRANS FAMILY, INC., (U.S. CL. 46). SN 85-297,517. PUB. 8-9-2011. FILED 4-18-2011.  
 4,045,561. **DALE'S STEAK SEASONING AND DESIGN.** DALE'S SAUCES, INC., (U.S. CL. 46). SN 85-313,526. PUB. 8-9-2011. FILED 5-5-2011.

---

#### CLASS 31—NATURAL AGRICULTURAL PRODUCTS

4,043,746 ( *See Class 3 for this trademark*).  
 4,043,770 ( *See Class 29 for this trademark*).  
 4,043,795 ( *See Class 5 for this trademark*).  
 4,043,803. **SALADBAR GREEN IS BETTER (STYLIZED).** LIONEL GROLEAU, MULTIPLE CLASS, (INT. CLS. 31, 35 AND 43), (U.S. CLS. 1, 46, 100, 101 AND 102). SN 79-089,679. PUB. 8-9-2011. FILED 10-26-2010.  
 4,043,930 ( *See Class 29 for this trademark*).  
 4,043,959. **ULTRA PEARLS (STANDARD CHARACTER).** ULTRA PET COMPANY, INC., (U.S. CLS. 1 AND 46). SN 85-106,026. PUB. 8-9-2011. FILED 8-12-2010.  
 4,044,105 ( *See Class 29 for this trademark*).  
 4,044,109 ( *See Class 29 for this trademark*).  
 4,044,250. **ORGANIC ROCKY MOUNTAIN SWEET (STANDARD CHARACTER).** ANDREW GRANT, DBA GRANT FAMILY FARMS, (U.S. CLS. 1 AND 46). SN 85-230,201. PUB. 8-9-2011. FILED 1-31-2011.  
 4,044,367. **SURVIVOR GARDEN (STANDARD CHARACTER).** HOPE IS GROWING LLC, (U.S. CLS. 1 AND 46). SN 85-254,863. PUB. 8-9-2011. FILED 3-1-2011.  
 4,044,535. **FIESTA ROSES (STANDARD CHARACTER).** WIENCKOSKI, THOMAS, AND ROSSI, TERRY, (U.S. CLS. 1 AND 46). SN 85-264,240. PUB. 8-9-2011. FILED 3-11-2011.  
 4,044,812. **DOGSWELL (STANDARD CHARACTER).** ARTHUR DOGSWELL, L.L.C., AKA DOGSWELL, (U.S. CLS. 1 AND 46). SN 85-276,194. PUB. 8-9-2011. FILED 3-24-2011.  
 4,044,819. **THE RICH TASTE OF HEALTHY LIVING (STANDARD CHARACTER).** BENJAMIN HOLTZ, (U.S. CLS. 1 AND 46). SN 85-276,266. PUB. 8-9-2011. FILED 3-24-2011.  
 4,045,069. **CRUSHED VELVET (STANDARD CHARACTER).** J. FRANK SCHMIDT & SON CO., (U.S. CLS. 1 AND 46). SN 85-279,631. PUB. 8-9-2011. FILED 3-29-2011.  
 4,045,071. **SKINNY GENES (STANDARD CHARACTER).** J. FRANK SCHMIDT & SON CO., (U.S. CLS. 1 AND 46). SN 85-279,650. PUB. 8-9-2011. FILED 3-29-2011.  
 4,045,072. **STREETSPIRE (STANDARD CHARACTER).** J. FRANK SCHMIDT & SON CO., (U.S. CLS. 1 AND 46). SN

- 85-279,662. PUB. 8-9-2011. FILED 3-29-2011.
- 4,045,101. **DOOD "DO(G-FO)OD" AND DESIGN**. NIROOMAND, ALIREZA, (U.S. CLS. 1 AND 46). SN 85-280,075. PUB. 8-9-2011. FILED 3-29-2011.
- 4,045,140. **MISCELLANEOUS DESIGN**. WAL-MART STORES, INC., (U.S. CLS. 1 AND 46). SN 85-280,518. PUB. 8-9-2011. FILED 3-29-2011.
- 4,045,191. **TASTEFUL SELECTIONS AND DESIGN**. TASTEFUL SELECTIONS, LLC, (U.S. CLS. 1 AND 46). SN 85-281,186. PUB. 8-9-2011. FILED 3-30-2011.
- 4,045,235. **ENDURING PRAIRIE (STANDARD CHARACTER)**. THE TRUSTEE OF THE MICHAEL H. COON REVOCABLE TRUST FORMED UNDER AGREEMENT DATED MARCH 4, 2011, AN IOWA TRUST, THE TRUSTEE COMPRISING MICHAEL H. COON, A UNITED STATES CITIZEN, (U.S. CLS. 1 AND 46). SN 85-281,889. PUB. 8-9-2011. FILED 3-30-2011.
- 4,045,475. **POWWOW (STANDARD CHARACTER)**. BALL HORTICULTURAL COMPANY, (U.S. CLS. 1 AND 46). SN 85-285,479. PUB. 8-9-2011. FILED 4-4-2011.
- 4,045,497. **SOMBRERO (STANDARD CHARACTER)**. BALL HORTICULTURAL COMPANY, (U.S. CLS. 1 AND 46). SN 85-286,779. PUB. 8-9-2011. FILED 4-5-2011.
- 4,045,515. **PILL POCKETS (STANDARD CHARACTER)**. THE NUTRO COMPANY, (U.S. CLS. 1 AND 46). SN 85-288,973. PUB. 8-9-2011. FILED 4-7-2011.
- 4,045,550 ( *See Class 5 for this trademark*).

---

### CLASS 32—LIGHT BEVERAGES

- 4,043,623. **DAFRUTA (STYLIZED)**. LIBERTY IMPORTS USA, INC., (U.S. CLS. 45, 46 AND 48). SN 76-706,423. PUB. 8-9-2011. FILED 2-15-2011.
- 4,043,663. **NORTHLAND THE POWER OF DARK FRUIT (STANDARD CHARACTER)**. APPLE & EVE, LLC, (U.S. CLS. 45, 46 AND 48). SN 77-664,947. PUB. 1-19-2010. FILED 2-6-2009.
- 4,043,682. **SHARKBITE (STANDARD CHARACTER)**. GRAIN TO GREEN, (U.S. CLS. 45, 46 AND 48). SN 77-790,092. PUB. 8-9-2011. FILED 7-27-2009.
- 4,043,689 ( *See Class 3 for this trademark*).
- 4,043,764. **SKYSU (STYLIZED)**. ÇOBANPINAR İÇME SUYU VE İNSAAT SANAYİ TİCARET LİMİTED SİRKETİ, (U.S. CLS. 45, 46 AND 48). SN 79-087,248. PUB. 8-9-2011. FILED 4-12-2010.
- 4,043,785 ( *See Class 3 for this trademark*).
- 4,043,929 ( *See Class 29 for this trademark*).
- 4,043,930 ( *See Class 29 for this trademark*).
- 4,043,969 ( *See Class 3 for this trademark*).
- 4,043,970 ( *See Class 5 for this trademark*).
- 4,044,026. **RINCE COCHON (STANDARD CHARACTER)**. DIFCOM LA CAVE DES PERES SOCIÉTÉ ANONYME À CONSEIL D'ADMINISTRATION, (U.S. CLS. 45, 46 AND 48). SN 85-127,134. PUB. 7-5-2011. FILED 9-10-2010.
- 4,044,333 ( *See Class 29 for this trademark*).
- 4,044,432. **ALASKAN SUMMER ALE AND DESIGN**. ALASKAN BREWING CO., (U.S. CLS. 45, 46 AND 48). SN 85-260,660. PUB. 8-9-2011. FILED 3-8-2011.
- 4,044,494. **AMERICAN MUSIC WATER (STANDARD CHARACTER)**. MUSIC WATER OF THE WORLD, INC., (U.S. CLS. 45, 46 AND 48). SN 85-263,199. PUB. 8-9-2011. FILED 3-10-2011.
- 4,044,495. **TEXAS MUSIC WATER (STANDARD CHARACTER)**. MUSIC WATER OF THE WORLD, INC., (U.S. CLS. 45, 46 AND 48). SN 85-263,205. PUB. 8-9-2011. FILED 3-10-2011.
- 4,044,758. **MY BL (STANDARD CHARACTER)**. ANHEUSER-BUSCH INCORPORATED, (U.S. CLS. 45, 46 AND 48). SN 85-275,487. PUB. 8-9-2011. FILED 3-24-2011.
- 4,045,030. **TENDO (STANDARD CHARACTER)**. PURE TROPIC, (U.S. CLS. 45, 46 AND 48). SN 85-279,084. PUB. 8-9-2011. FILED 3-28-2011.
- 4,045,161. **PENSACOLA BAY BREWERY AND DESIGN**. PENSACOLA BAY BREWERY, LLC, MULTIPLE CLASS, (INT. CLS. 32 AND 40), (U.S. CLS. 45, 46, 48, 100, 103 AND 106). SN 85-280,853. PUB. 8-9-2011. FILED 3-30-2011.

- 4,045,352. **PERLA DORADA (STANDARD CHARACTER)**. CERVEZAS ALHAMBRA, S.L., (U.S. CLS. 45, 46 AND 48). SN 85-283,284. PUB. 8-9-2011. FILED 3-31-2011.
- 4,045,530 ( *See Class 20 for this trademark*).

---

### CLASS 33—WINES AND SPIRITS

- 4,043,691. **TRIUMPH (STANDARD CHARACTER)**. THE GLENLIVET DISTILLERS LTD, (U.S. CLS. 47 AND 49). SN 77-854,105. PUB. 8-9-2011. FILED 10-21-2009.
- 4,043,715. **OATH (STANDARD CHARACTER)**. STRANGER & STRANGER LIMITED, (U.S. CLS. 47 AND 49). SN 77-926,208. PUB. 1-18-2011. FILED 2-2-2010.
- 4,043,716. **ONE HORSE (STANDARD CHARACTER)**. STRANGER & STRANGER LIMITED, (U.S. CLS. 47 AND 49). SN 77-926,223. PUB. 1-18-2011. FILED 2-2-2010.
- 4,043,730. **MISCELLANEOUS DESIGN**. GLOBEFILL INCORPORATED, (U.S. CLS. 47 AND 49). SN 77-967,530. PUB. 8-9-2011. FILED 3-24-2010.
- 4,043,745. **APSINTHION DE LUXE AND DESIGN**. DISTILLERIES GROUP TOORANK B.V., (U.S. CLS. 47 AND 49). SN 79-074,443. PUB. 8-9-2011. FILED 10-9-2009.
- 4,043,755. **EXTRA ORDINARY CLARET AND DESIGN**. BERRY BROS. & RUDD LIMITED, (U.S. CLS. 47 AND 49). SN 79-084,096. PUB. 8-9-2011. FILED 5-18-2010.
- 4,043,811. **MISCELLANEOUS DESIGN**. OENOFOROS AB, (U.S. CLS. 47 AND 49). SN 79-090,074. PUB. 8-9-2011. FILED 11-11-2010.
- 4,043,827. **DÎNER EN ROUGE (STANDARD CHARACTER)**. SOCIÉTÉ DES PRODUITS MARNIER LAPOSTOLLE, (U.S. CLS. 47 AND 49). SN 79-091,120. PUB. 8-9-2011. FILED 10-6-2010.
- 4,043,833. **LA BELLA ESTATE AND DESIGN**. TERRE DA VINO S.P.A., (U.S. CLS. 47 AND 49). SN 79-092,351. PUB. 8-9-2011. FILED 11-23-2010.
- 4,043,839. **VOD-K AND DESIGN**. FRYD FOOD & DRINK, (U.S. CLS. 47 AND 49). SN 79-093,376. PUB. 8-9-2011. FILED 12-24-2010.
- 4,043,874. **ALOHA (STANDARD CHARACTER)**. JL BEVERAGE COMPANY LLC, (U.S. CLS. 47 AND 49). SN 85-005,895. PUB. 8-9-2011. FILED 4-5-2010.
- 4,043,930 ( *See Class 29 for this trademark*).
- 4,043,968. **JOTO SAKÉ AND DESIGN**. JOTO SAKE LLC, (U.S. CLS. 47 AND 49). SN 85-112,110. PUB. 3-15-2011. FILED 8-20-2010.
- 4,044,020. **SAVOR THE FLAVOR OF ST. FRANCIS (STANDARD CHARACTER)**. ST. FRANCIS WINERY AND VINEYARDS, L.P., (U.S. CLS. 47 AND 49). SN 85-125,932. PUB. 8-9-2011. FILED 9-9-2010.
- 4,044,046. **BIG POUR (STANDARD CHARACTER)**. PICKETT ROAD WINE COMPANY, LLC, (U.S. CLS. 47 AND 49). SN 85-137,849. PUB. 3-8-2011. FILED 9-24-2010.
- 4,044,099. **ABSOLUT COUNTRY OF SWEDEN ORIENT APPLE (STYLIZED)**. V&S VIN & SPRIT AKTIEBOLAG, (U.S. CLS. 47 AND 49). SN 85-164,507. PUB. 8-9-2011. FILED 10-29-2010.
- 4,044,113. **ALTO REAL (STANDARD CHARACTER)**. COOPERATIVA AGROVINICOLA NUESTRA SENORA DEL ROSARIO, (U.S. CLS. 47 AND 49). SN 85-170,772. PUB. 8-9-2011. FILED 11-5-2010.
- 4,044,182. **MISCELLANEOUS DESIGN**. JL BEVERAGE COMPANY LLC, (U.S. CLS. 47 AND 49). SN 85-207,648. PUB. 5-3-2011. FILED 12-29-2010.
- 4,044,211. **MISCELLANEOUS DESIGN**. JOTO SAKE LLC, (U.S. CLS. 47 AND 49). SN 85-216,709. PUB. 8-9-2011. FILED 1-13-2011.
- 4,044,324. **EDIBATIONS (STANDARD CHARACTER)**. 5STONES HOLDINGS, LLC, (U.S. CLS. 47 AND 49). SN 85-248,159. PUB. 8-9-2011. FILED 2-22-2011.
- 4,044,333 ( *See Class 29 for this trademark*).
- 4,044,456. **BLONDE DE NOIRS (STANDARD CHARACTER)**. NOVA WINES, INC., (U.S. CLS. 47 AND 49). SN 85-261,556. PUB. 8-9-2011. FILED 3-8-2011.
- 4,044,538. **LOVEJOY HAZELNUT (STANDARD CHARACTER)**. REYNOLDS, DOUGLAS, (U.S. CLS. 47 AND 49). SN 85-264,334. PUB. 8-9-2011. FILED 3-11-2011.

4,044,663. **FLASQ (STANDARD CHARACTER)**. GLOBAL WINE CONCEPTS, INC., DBA JT WINES, (U.S. CLS. 47 AND 49). SN 85-273,942. PUB. 8-9-2011. FILED 3-22-2011.

4,044,775. **THINK INSIDE THE BOX (STANDARD CHARACTER)**. CONSTELLATION WINES U.S. INC., (U.S. CLS. 47 AND 49). SN 85-275,704. PUB. 8-9-2011. FILED 3-24-2011.

4,044,834. **CRANBERRY BOG (STANDARD CHARACTER)**. MARTIN'S HONEY FARM AND MEADERY, LLC, DBA MONTEZUMA WINERY, (U.S. CLS. 47 AND 49). SN 85-276,537. PUB. 8-9-2011. FILED 3-25-2011.

4,044,857. **SULEI CELLARS (STANDARD CHARACTER)**. SILVER OWL, LLC, DBA SULEI CELLARS, (U.S. CLS. 47 AND 49). SN 85-276,819. PUB. 8-9-2011. FILED 3-25-2011.

4,044,859. **ROLLER GIRL (STANDARD CHARACTER)**. SILVER OWL, LLC, DBA SULEI CELLARS, (U.S. CLS. 47 AND 49). SN 85-276,832. PUB. 8-9-2011. FILED 3-25-2011.

4,045,170. **TABOR HILL (STANDARD CHARACTER)**. CHI COMPANY, DBA TABOR HILL, MULTIPLE CLASS, (INT. CLS. 33, 40 AND 43), (U.S. CLS. 47, 49, 100, 101, 103 AND 106). SN 85-280,946. PUB. 8-9-2011. FILED 3-30-2011.

4,045,297. **GLENWOOD CELLARS (STANDARD CHARACTER)**. TIEDEMANN WINES, LLC, (U.S. CLS. 47 AND 49). SN 85-282,531. PUB. 8-9-2011. FILED 3-31-2011.

4,045,313. **DOM PIERRE PÉRIGNON DOM PÉRIGNON AND DESIGN**. MOET HENNESSY USA, INC., (U.S. CLS. 47 AND 49). SN 85-282,780. PUB. 8-9-2011. FILED 3-31-2011.

4,045,319. **SOLINDO (STANDARD CHARACTER)**. ZUKMOYA, MELANIE I., (U.S. CLS. 47 AND 49). SN 85-282,862. PUB. 8-9-2011. FILED 3-31-2011.

4,045,435. **WANDERING AENGUS (STANDARD CHARACTER)**. THE TRADITIONAL COMPANY, LLC, (U.S. CLS. 47 AND 49). SN 85-284,229. PUB. 8-9-2011. FILED 4-1-2011.

4,045,456. **EIGHT ARMS (STANDARD CHARACTER)**. BOLTIN, IAIN A., DBA EIGHT ARMS CELLARS, (U.S. CLS. 47 AND 49). SN 85-284,509. PUB. 8-9-2011. FILED 4-2-2011.

4,045,459. **BIPARTISAN (STYLIZED)**. BRUMFIELD CELLARS SELECT WINES, LLC, (U.S. CLS. 47 AND 49). SN 85-284,558. PUB. 8-9-2011. FILED 4-2-2011.

4,045,474. **HIGH & DRY (STANDARD CHARACTER)**. DIAGEO BRANDS B.V., (U.S. CLS. 47 AND 49). SN 85-285,416. PUB. 8-9-2011. FILED 4-4-2011.

4,045,498. **HOPPING RED (STANDARD CHARACTER)**. JEAN-CLAUDE BOISSET WINES, USA, INC., (U.S. CLS. 47 AND 49). SN 85-286,791. PUB. 8-9-2011. FILED 4-5-2011.

4,045,500. **HOPPING WHITE (STANDARD CHARACTER)**. JEAN-CLAUDE BOISSET WINES, USA, INC., (U.S. CLS. 47 AND 49). SN 85-287,060. PUB. 8-9-2011. FILED 4-5-2011.

4,045,501. **CLIQUE (STANDARD CHARACTER)**. PREMIER INNOVATIONS GROUP INC, (U.S. CLS. 47 AND 49). SN 85-287,061. PUB. 8-9-2011. FILED 4-5-2011.

4,045,551. **NEW AMSTERDAM (STANDARD CHARACTER)**. E. & J. GALLO WINERY, (U.S. CLS. 47 AND 49). SN 85-306,605. PUB. 8-9-2011. FILED 4-27-2011.

#### CLASS 34—SMOKERS' ARTICLES

4,043,785 ( *See Class 3 for this trademark* ).

4,043,900. **PETIT 100% TOBACCO SUMATRA AND DESIGN**. SCANDINAVIAN TOBACCO GROUP NYKØBING APS, (U.S. CLS. 2, 8, 9 AND 17). SN 85-054,161. PUB. 8-9-2011. FILED 6-3-2010.

4,044,163. **V VICEROY FLEX (STYLIZED)**. REYNOLDS INNOVATIONS INC., (U.S. CLS. 2, 8, 9 AND 17). SN 85-194,374. PUB. 8-9-2011. FILED 12-9-2010.

4,044,223. **SWM (STANDARD CHARACTER)**. SCHWEITZERMAUDUIT INTERNATIONAL, INC., (U.S. CLS. 2, 8, 9 AND 17). SN 85-223,449. PUB. 8-9-2011. FILED 1-21-2011.

4,044,265. **HOUSE OF MARLEY MARETT TSEHAI DAM AND DESIGN**. FIFTY-SIX HOPE ROAD MUSIC LIMITED, (U.S. CLS. 2, 8, 9 AND 17). SN 85-230,803. PUB. 8-9-2011. FILED 2-1-2011.

4,044,392 ( *See Class 9 for this trademark* ).

4,044,489 ( *See Class 9 for this trademark* ).

4,044,807. **LARGO (STANDARD CHARACTER)**. TOP TOBACCO L.P., (U.S. CLS. 2, 8, 9 AND 17). SN 85-276,098. PUB. 8-9-2011. FILED 3-24-2011.

4,045,005. **A.O.A. (STANDARD CHARACTER)**. THOMPSON & CO. OF TAMPA, INC., (U.S. CLS. 2, 8, 9 AND 17). SN 85-278,797. PUB. 8-9-2011. FILED 3-28-2011.

4,045,465. **TANKTRONICS (STANDARD CHARACTER)**. ELECTRONIC CIGARETTES INC., (U.S. CLS. 2, 8, 9 AND 17). SN 85-284,782. PUB. 8-9-2011. FILED 4-3-2011.

4,045,563. **STORM (STANDARD CHARACTER)**. ELECTRONIC CIGARETTES INC., (U.S. CLS. 2, 8, 9 AND 17). SN 85-313,908. PUB. 8-9-2011. FILED 5-6-2011.

#### SERVICE MARKS

#### CLASS 35—ADVERTISING AND BUSINESS

4,043,612. **HEART + AND DESIGN**. SAUER, DEBBIE DOUGLASS, (U.S. CLS. 100, 101 AND 102). SN 76-701,904. PUB. 8-9-2011. FILED 3-5-2010.

4,043,633. **MILKROUND (STANDARD CHARACTER)**. MILKROUND ONLINE LTD, (U.S. CLS. 100, 101 AND 102). SN 77-002,181. PUB. 8-9-2011. FILED 9-19-2006.

4,043,634. **SWORD (STANDARD CHARACTER)**. SWORDGROUP SA, MULTIPLE CLASS, (INT. CLS. 35 AND 42), (U.S. CLS. 100, 101 AND 102). SN 77-010,358. PUB. 8-9-2011. FILED 9-29-2006.

4,043,635. **PALLADIUM PD (STYLIZED)**. PALLADIUM ALLIANCE INTERNATIONAL, (U.S. CLS. 100, 101 AND 102). SN 77-191,196. PUB. 5-13-2008. FILED 5-26-2007.

4,043,641 ( *See Class 9 for this trademark* ).

4,043,644 ( *See Class 10 for this trademark* ).

4,043,646. **ENLIGHTENED SOCCER UNLEASH YOUR SOCCER GENIUS! AND DESIGN**. ENLIGHTENED SOCCER INC., MULTIPLE CLASS, (INT. CLS. 35 AND 41), (U.S. CLS. 100, 101, 102 AND 107). SN 77-558,678. PUB. 8-9-2011. FILED 8-29-2008.

4,043,652. **ORIGINAL CREATIVE APPAREL (STANDARD CHARACTER)**. GRAINGER ALLAN, MULTIPLE CLASS, (INT. CLS. 35 AND 41), (U.S. CLS. 100, 101, 102 AND 107). SN 77-599,327. PUB. 8-9-2011. FILED 10-23-2008.

4,043,655. **RED BRICK GUIDES AND DESIGN**. RED BRICK GUIDES, LLC, (U.S. CLS. 100, 101 AND 102). SN 77-620,451. PUB. 8-9-2011. FILED 11-24-2008.

4,043,657 ( *See Class 3 for this trademark* ).

4,043,664. **AMALGAMATED ORDER OF REAL BEARDED SANTAS AND DESIGN**. AMALGAMATED ORDER OF REAL BEARDED SANTAS INC., (U.S. CLS. 100, 101 AND 102). SN 77-675,056. PUB. 12-29-2009. FILED 2-20-2009.

4,043,668. **PEDRO TORRES PRESENTA MUJERES ASESINAS AND DESIGN**. THE MATES CONTENTS, S. A. DE C. V., MULTIPLE CLASS, (INT. CLS. 35 AND 41), (U.S. CLS. 100, 101, 102 AND 107). SN 77-720,190. PUB. 8-9-2011. FILED 4-22-2009.

4,043,677. **AMERICAS MEETING POINT (STANDARD CHARACTER)**. B.M.P. BARCELONA MEETING POINT, S.A., (U.S. CLS. 100, 101 AND 102). SN 77-774,822. PUB. 1-18-2011. FILED 7-6-2009.

4,043,678. **ECOLOGIC DEVELOPMENT FUND (STANDARD CHARACTER)**. ECO-LOGIC DEVELOPMENT FUND, MULTIPLE CLASS, (INT. CLS. 35, 36 AND 42), (U.S. CLS. 100, 101 AND 102). SN 77-780,501. PUB. 8-9-2011. FILED 7-14-2009.

4,043,684 ( *See Class 9 for this trademark* ).

4,043,689 ( *See Class 3 for this trademark* ).

4,043,693. **INTEGRATION POINT (STANDARD CHARACTER)**. BARNES, THOMAS D., MULTIPLE CLASS, (INT. CLS. 35 AND 42), (U.S. CLS. 100, 101 AND 102). SN 77-860,721. PUB. 8-9-2011. FILED 10-29-2009.

4,043,695 ( *See Class 9 for this trademark* ).

4,043,696. **STRANDS HANDMADE JEWELRY DESIGNS (STYLIZED)**. STRANDS, LLC, (U.S. CLS. 100, 101 AND 102). SN 77-870,466. PUB. 8-9-2011. FILED 11-11-2009.

4,043,697 ( *See Class 9 for this trademark* ).

4,043,699. **US VERIFY AND DESIGN**. U.S. VERIFY, INC., MULTIPLE CLASS, (INT. CLS. 35 AND 42), (U.S. CLS. 100, 101 AND 102). SN 77-880,555. PUB. 8-9-2011. FILED 11-25-

- 2009.
- 4,043,703. **KIMAYA (STANDARD CHARACTER)**. KIMAYA FASHIONS PRIVATE LIMITED, (U.S. CLS. 100, 101 AND 102). SN 77-886,142. PUB. 8-9-2011. FILED 12-4-2009.
- 4,043,708. **TSCA TEXAS SCHOOL COUNSELOR ASSOCIATION (STANDARD CHARACTER)**. TEXAS COUNSELING ASSOCIATION, (U.S. CLS. 100, 101 AND 102). SN 77-903,730. PUB. 8-9-2011. FILED 12-31-2009.
- 4,043,709. **SWIRL BY DAILYCANDY (STYLIZED)**. DAILY-CANDY, LLC, (U.S. CLS. 100, 101 AND 102). SN 77-906,636. PUB. 8-9-2011. FILED 1-7-2010.
- 4,043,724. **NATIONAL ACADEMY OF INVENTORS (STANDARD CHARACTER)**. THE NATIONAL ACADEMY OF INVENTORS, INC., (U.S. CLS. 100, 101 AND 102). SN 77-951,980. PUB. 8-9-2011. FILED 3-5-2010.
- 4,043,743. **GG GREENGRAFFITI AND DESIGN**. GREENGRAFFITI HOLDING BESLOTEN VENNOOTSCHAP, MULTIPLE CLASS, (INT. CLS. 35 AND 40), (U.S. CLS. 100, 101, 102, 103 AND 106). SN 79-072,629. PUB. 8-9-2011. FILED 7-27-2009.
- 4,043,751 ( *See Class 16 for this trademark*).
- 4,043,763 ( *See Class 9 for this trademark*).
- 4,043,767 ( *See Class 9 for this trademark*).
- 4,043,769 ( *See Class 9 for this trademark*).
- 4,043,771 ( *See Class 14 for this trademark*).
- 4,043,773 ( *See Class 9 for this trademark*).
- 4,043,783 ( *See Class 16 for this trademark*).
- 4,043,784 ( *See Class 7 for this trademark*).
- 4,043,785 ( *See Class 3 for this trademark*).
- 4,043,786. **HAYS (STANDARD CHARACTER)**. HAYS PLC, (U.S. CLS. 100, 101 AND 102). SN 79-088,880. PUB. 8-9-2011. FILED 6-3-2010.
- 4,043,788 ( *See Class 9 for this trademark*).
- 4,043,799 ( *See Class 9 for this trademark*).
- 4,043,800 ( *See Class 7 for this trademark*).
- 4,043,801. **CLAI (STYLIZED)**. CLAI, MULTIPLE CLASS, (INT. CLS. 35, 36, 41 AND 45), (U.S. CLS. 100, 101, 102 AND 107). SN 79-089,573. PUB. 8-9-2011. FILED 6-18-2010.
- 4,043,803 ( *See Class 31 for this trademark*).
- 4,043,807. **GLOBALLY YOURS (STYLIZED)**. TURK HAVA YOLLARI ANONIM ORTAKLIGI, MULTIPLE CLASS, (INT. CLS. 35, 38 AND 39), (U.S. CLS. 100, 101, 102, 104 AND 105). SN 79-089,871. PUB. 8-9-2011. FILED 7-6-2010.
- 4,043,838 ( *See Class 12 for this trademark*).
- 4,043,842. **UHS - UNITED HELICOPTER SERVICES (STANDARD CHARACTER)**. HELIPORTUGAL - TRABALHOS E TRANSPORTE AÉREO, REPRESENTAÇÕES, IMPORTAÇÃO E EXPORTAÇÃO, S.A., (U.S. CLS. 100, 101 AND 102). SN 79-093,759. PUB. 8-9-2011. FILED 10-22-2010.
- 4,043,843 ( *See Class 14 for this trademark*).
- 4,043,851. **4FP FOR FULL POTENTIAL AND DESIGN**. 4 FP CONSULTING AB, MULTIPLE CLASS, (INT. CLS. 35 AND 41), (U.S. CLS. 100, 101, 102 AND 107). SN 79-095,274. PUB. 8-9-2011. FILED 2-28-2011.
- 4,043,856 ( *See Class 9 for this trademark*).
- 4,043,859. **LINGOO (STANDARD CHARACTER)**. ANGLO FRENCH MEDIA SARL, (U.S. CLS. 100, 101 AND 102). SN 79-096,542. PUB. 8-9-2011. FILED 3-31-2011.
- 4,043,860 ( *See Class 3 for this trademark*).
- 4,043,884 ( *See Class 16 for this trademark*).
- 4,043,894. **DAVISON (STANDARD CHARACTER)**. DAVISON DESIGN & DEVELOPMENT, INC., MULTIPLE CLASS, (INT. CLS. 35, 42 AND 45), (U.S. CLS. 100, 101 AND 102). SN 85-043,779. PUB. 8-9-2011. FILED 5-20-2010.
- 4,043,910. **PCC PHARMACEUTICAL CREDIT CORPORATION (STANDARD CHARACTER)**. PHARMACEUTICAL CREDIT CORPORATION, (U.S. CLS. 100, 101 AND 102). SN 85-058,570. PUB. 8-9-2011. FILED 6-9-2010.
- 4,043,913. **ROTOR STUDIOS (STANDARD CHARACTER)**. SCOTT BRADLEY, AND ANTONIO ORENA-BARLIN, MULTIPLE CLASS, (INT. CLS. 35 AND 41), (U.S. CLS. 100, 101, 102 AND 107). SN 85-061,276. PUB. 8-9-2011. FILED 6-11-2010.
- 4,043,917 ( *See Class 9 for this trademark*).
- 4,043,918 ( *See Class 12 for this trademark*).
- 4,043,924. **KARMA COTTAGE (STANDARD CHARACTER)**. KARMA COTTAGE, (U.S. CLS. 100, 101 AND 102). SN 85-075,966. PUB. 11-30-2010. FILED 7-1-2010.
- 4,043,925. **ENVIRONMENTAL RESOURCES TRUST (STANDARD CHARACTER)**. WINROCK INTERNATIONAL INSTITUTE FOR AGRICULTURAL DEVELOPMENT, MULTIPLE CLASS, (INT. CLS. 35, 36, 41, 42 AND 45), (U.S. CLS. 100, 101, 102 AND 107). SN 85-076,129. PUB. 8-9-2011. FILED 7-1-2010.
- 4,043,931. **MAGIC OF TECHNOLOGY (STANDARD CHARACTER)**. MICROBLEND TECHNOLOGIES, INC., (U.S. CLS. 100, 101 AND 102). SN 85-089,952. PUB. 8-9-2011. FILED 7-21-2010.
- 4,043,933. **A AND DESIGN**. ATLAS PIPELINE HOLDINGS, L.P., MULTIPLE CLASS, (INT. CLS. 35, 37, 40 AND 42), (U.S. CLS. 100, 101, 102, 103 AND 106). SN 85-090,916. PUB. 8-9-2011. FILED 7-22-2010.
- 4,043,936. **TEXAS LONGHORNS ENERGY (STANDARD CHARACTER)**. BOARD OF REGENTS, THE UNIVERSITY OF TEXAS SYSTEM, (U.S. CLS. 100, 101 AND 102). SN 85-092,717. PUB. 8-9-2011. FILED 7-26-2010.
- 4,043,940. **FRAUNHOFER TECHBRIDGE (STANDARD CHARACTER)**. FRAUNHOFER USA, INC., MULTIPLE CLASS, (INT. CLS. 35 AND 42), (U.S. CLS. 100, 101 AND 102). SN 85-098,709. PUB. 8-9-2011. FILED 8-3-2010.
- 4,043,954. **TEXAS LONGHORNS ENERGY 100% RENEWABLE ENERGY AND DESIGN**. BOARD OF REGENTS, THE UNIVERSITY OF TEXAS SYSTEM, (U.S. CLS. 100, 101 AND 102). SN 85-103,788. PUB. 8-9-2011. FILED 8-10-2010.
- 4,043,967. **UNHOTEL (STANDARD CHARACTER)**. LIFEALIKE LIMITED, MULTIPLE CLASS, (INT. CLS. 35 AND 43), (U.S. CLS. 100, 101 AND 102). SN 85-111,174. PUB. 2-8-2011. FILED 8-19-2010.
- 4,043,969 ( *See Class 3 for this trademark*).
- 4,043,971. **ATWOODS RANCH HOME AND DESIGN**. ATWOOD DISTRIBUTING, L.P., (U.S. CLS. 100, 101 AND 102). SN 85-112,511. PUB. 8-9-2011. FILED 8-20-2010.
- 4,043,974. **TALL OUTSTANDING WOMEN (STANDARD CHARACTER)**. SPADONI, STEFANO, (U.S. CLS. 100, 101 AND 102). SN 85-113,090. PUB. 8-9-2011. FILED 8-22-2010.
- 4,043,976. **CATERBID AND DESIGN**. CATERBID, LLC, (U.S. CLS. 100, 101 AND 102). SN 85-113,196. PUB. 8-9-2011. FILED 8-23-2010.
- 4,043,979. **GUSTERMAN (STANDARD CHARACTER)**. GUSTERMAN INCORPORATED, DBA GUSTERMANS, (U.S. CLS. 100, 101 AND 102). SN 85-113,958. PUB. 8-9-2011. FILED 8-23-2010.
- 4,043,985. **FSS STAFFING SOLUTIONS AND DESIGN**. FORREST SOLUTIONS GROUP, DBA FSG, (U.S. CLS. 100, 101 AND 102). SN 85-115,183. PUB. 8-9-2011. FILED 8-25-2010.
- 4,043,989. **NATIONAL ASSOCIATION FOR BLACK VETERANS (STANDARD CHARACTER)**. NATIONAL ASSOCIATION FOR BLACK VETERANS, INC., AKA NABVETS, (U.S. CLS. 100, 101 AND 102). SN 85-116,874. PUB. 8-9-2011. FILED 8-26-2010.
- 4,043,991. **CVI (STANDARD CHARACTER)**. CVI, AKA CENTER FOR VETERANS ISSUES, LTD., (U.S. CLS. 100, 101 AND 102). SN 85-117,026. PUB. 8-9-2011. FILED 8-26-2010.
- 4,044,001. **1-800-NEXT-WINDOW (STANDARD CHARACTER)**. RETAIL ADVERTISING TRENDS, LC, (U.S. CLS. 100, 101 AND 102). SN 85-119,511. PUB. 8-9-2011. FILED 8-31-2010.
- 4,044,009. **CHINOO DESIGNS (STANDARD CHARACTER)**. CHINOO DESIGNS LLC, (U.S. CLS. 100, 101 AND 102). SN 85-121,340. PUB. 8-9-2011. FILED 9-1-2010.
- 4,044,017. **CLEVELAND AUTO SHOW (STANDARD CHARACTER)**. GREATER CLEVELAND AUTOMOBILE DEALERS' ASSOCIATION, (U.S. CLS. 100, 101 AND 102). SN 85-124,956. PUB. 8-9-2011. FILED 9-8-2010.
- 4,044,021 ( *See Class 9 for this trademark*).
- 4,044,022. **CLEVELAND AUTO SHOW CLEVELANDAUTOSHOW.COM AND DESIGN**. GREATER CLEVELAND AUTOMOBILE DEALERS' ASSOCIATION, (U.S. CLS. 100, 101 AND 102). SN 85-126,205. PUB. 8-9-2011. FILED 9-9-2010.
- 4,044,027 ( *See Class 3 for this trademark*).
- 4,044,028 ( *See Class 16 for this trademark*).
- 4,044,032. **SMARTKLEAN AND DESIGN**. SMARTKLEAN CORPORATION, DBA SMARTKLEAN, (U.S. CLS. 100, 101 AND 102). SN 85-128,312. PUB. 8-9-2011. FILED 9-13-2010.
- 4,044,051. **UNIFORM SQUARE (STANDARD CHARACTER)**. UNIFORM SQUARE OF AMERICA LLC, DBA UNIFORM

- SQUARE, (U.S. CLS. 100, 101 AND 102). SN 85-139,839. PUB. 3-8-2011. FILED 9-28-2010.
- 4,044,053. **HEALTHCARE IT CONNECT CONNECTIVITY ACROSS THE CARE CONTINUUM AND DESIGN.** HEALTHCARE IT CONNECT CORP., MULTIPLE CLASS, (INT. CLS. 35 AND 41), (U.S. CLS. 100, 101, 102 AND 107). SN 85-141,200. PUB. 8-9-2011. FILED 9-29-2010.
- 4,044,100. **EASYNET (STANDARD CHARACTER).** EASYNET LIMITED, MULTIPLE CLASS, (INT. CLS. 35, 38 AND 42), (U.S. CLS. 100, 101, 102 AND 104). SN 85-164,614. PUB. 8-9-2011. FILED 10-29-2010.
- 4,044,101. **AHF ASSOCIATION FOR HEALTHCARE FOOD-SERVICE AND DESIGN.** ASSOCIATION FOR HEALTHCARE FOODSERVICE, INC., MULTIPLE CLASS, (INT. CLS. 35 AND 41), (U.S. CLS. 100, 101, 102 AND 107). SN 85-165,123. PUB. 8-9-2011. FILED 10-29-2010.
- 4,044,102. **AFROCYCLE GEAR (STANDARD CHARACTER).** SKILLERN, MAURICE, (U.S. CLS. 100, 101 AND 102). SN 85-165,475. PUB. 8-9-2011. FILED 10-30-2010.
- 4,044,103. **CORRUPTION HUNTER (STANDARD CHARACTER).** MICHAEL G. KESSLER & ASSOCIATES, LTD., DBA KESSLER INTERNATIONAL, MULTIPLE CLASS, (INT. CLS. 35 AND 45), (U.S. CLS. 100, 101 AND 102). SN 85-165,482. PUB. 8-9-2011. FILED 10-30-2010.
- 4,044,110. **DIABETIC DEPOT (STANDARD CHARACTER).** 980009 ALBERTA LTD., (U.S. CLS. 100, 101 AND 102). SN 85-169,291. PUB. 8-9-2011. FILED 11-4-2010.
- 4,044,111. **DIABETIC DEPOT AND DESIGN.** 980009 ALBERTA LTD., (U.S. CLS. 100, 101 AND 102). SN 85-169,305. PUB. 8-9-2011. FILED 11-4-2010.
- 4,044,116. **MODE DESIGN GROUP (STANDARD CHARACTER).** MODE DESIGN GROUP, INC., MULTIPLE CLASS, (INT. CLS. 35 AND 42), (U.S. CLS. 100, 101 AND 102). SN 85-174,088. PUB. 5-3-2011. FILED 11-10-2010.
- 4,044,117. **BOB'S STORES ALWAYS REWARDING. AND DESIGN.** BOB'S STORES CORP., (U.S. CLS. 100, 101 AND 102). SN 85-174,384. PUB. 3-29-2011. FILED 11-11-2010.
- 4,044,120. **BREW TEES AND DESIGN.** BLUE SKY INC., (U.S. CLS. 100, 101 AND 102). SN 85-175,312. PUB. 8-9-2011. FILED 11-12-2010.
- 4,044,124. **SIGNATURE TRAVEL NETWORK (STANDARD CHARACTER).** SIGNATURE TRAVEL NETWORK COOPERATIVE INC., MULTIPLE CLASS, (INT. CLS. 35 AND 39 AND U.S. CL. 200), (U.S. CLS. 100, 101, 102 AND 105). SN 85-175,898. PUB. 5-3-2011. FILED 11-12-2010.
- 4,044,125. **SENTRIX HEALTH COMMUNICATIONS (STANDARD CHARACTER).** WPP PROPERTIES, (U.S. CLS. 100, 101 AND 102). SN 85-176,943. PUB. 8-9-2011. FILED 11-15-2010.
- 4,044,127 ( *See Class 3 for this trademark*).
- 4,044,129. **LA SOCIETE STELLA ARTOIS (STANDARD CHARACTER).** ANHEUSER-BUSCH INBEV S.A., (U.S. CLS. 100, 101 AND 102). SN 85-180,046. PUB. 8-9-2011. FILED 11-18-2010.
- 4,044,146. **DIEGO ROCHA (STANDARD CHARACTER).** DIEGO ROCHA CUSTOM DESIGNS, LLC, (U.S. CLS. 100, 101 AND 102). SN 85-188,047. PUB. 8-9-2011. FILED 12-1-2010.
- 4,044,149 ( *See Class 29 for this trademark*).
- 4,044,150. **PINKY THE PARA (STANDARD CHARACTER).** MICHAEL LEVENTHAL, MULTIPLE CLASS, (INT. CLS. 35 AND 41), (U.S. CLS. 100, 101, 102 AND 107). SN 85-189,505. PUB. 8-9-2011. FILED 12-2-2010.
- 4,044,153. **PICTURE MARKETING (STANDARD CHARACTER).** PICTURE MARKETING, INC., (U.S. CLS. 100, 101 AND 102). SN 85-191,235. PUB. 8-9-2011. FILED 12-6-2010.
- 4,044,157. **ENTERTAINMENT FUNDRAISING (STANDARD CHARACTER).** ENTERTAINMENT PUBLICATIONS LLC, MULTIPLE CLASS, (INT. CLS. 35 AND 36), (U.S. CLS. 100, 101 AND 102). SN 85-193,212. PUB. 8-9-2011. FILED 12-8-2010.
- 4,044,159. **H2GAMING (STANDARD CHARACTER).** HOWARD & HOWARD ATTORNEYS PLLC, (U.S. CLS. 100, 101 AND 102). SN 85-193,579. PUB. 8-9-2011. FILED 12-8-2010.
- 4,044,169. **INDIGO SOLUTIONS (STANDARD CHARACTER).** MOMENTUM SOFTWARE, INC. DBA INDIGO SOLUTIONS, (U.S. CLS. 100, 101 AND 102). SN 85-199,882. PUB. 8-9-2011. FILED 12-16-2010.
- 4,044,174. **SPIRAL (STYLIZED).** SPIRAL INCORPORATED, AKA SPIRAL, (U.S. CLS. 100, 101 AND 102). SN 85-204,979. PUB. 8-9-2011. FILED 12-23-2010.
- 4,044,181. **CHURCHMOUSE YARNS & TEAS (STANDARD CHARACTER).** CHURCHMOUSE YARNS & TEAS, INC., (U.S. CLS. 100, 101 AND 102). SN 85-206,750. PUB. 8-9-2011. FILED 12-28-2010.
- 4,044,186. **GROWTHWORKOUT (STANDARD CHARACTER).** NUCRAFT COMPANY, LLC, (U.S. CLS. 100, 101 AND 102). SN 85-208,650. PUB. 8-9-2011. FILED 12-31-2010.
- 4,044,192. **INFINITEE (STYLIZED).** INFINITEE COMMUNICATIONS, INC., (U.S. CLS. 100, 101 AND 102). SN 85-209,473. PUB. 8-9-2011. FILED 1-3-2011.
- 4,044,193. **INFINITEE (STANDARD CHARACTER).** INFINITEE COMMUNICATIONS, INC., (U.S. CLS. 100, 101 AND 102). SN 85-209,477. PUB. 8-9-2011. FILED 1-3-2011.
- 4,044,199. **NERDWESTERN (STANDARD CHARACTER).** PRESTIGE WORLDWIDE, (U.S. CLS. 100, 101 AND 102). SN 85-210,694. PUB. 5-3-2011. FILED 1-5-2011.
- 4,044,200. **COLLABORATIVE INTERVENTION (STANDARD CHARACTER).** FUTURE STATE CONSULTING, INC, (U.S. CLS. 100, 101 AND 102). SN 85-210,864. PUB. 8-9-2011. FILED 1-5-2011.
- 4,044,214 ( *See Class 18 for this trademark*).
- 4,044,218. **SDS SECURE DIGITAL SOLUTIONS AND DESIGN.** SECURE DIGITAL SOLUTIONS, (U.S. CLS. 100, 101 AND 102). SN 85-220,930. PUB. 8-9-2011. FILED 1-19-2011.
- 4,044,222. **EMERGENT AND DESIGN.** DISC INTELLECTUAL PROPERTIES, LLC, MULTIPLE CLASS, (INT. CLS. 35 AND 36), (U.S. CLS. 100, 101 AND 102). SN 85-222,591. PUB. 8-9-2011. FILED 1-20-2011.
- 4,044,224. **SKI NATION (STANDARD CHARACTER).** JOHN R. TURNER, (U.S. CLS. 100, 101 AND 102). SN 85-224,310. PUB. 8-9-2011. FILED 1-24-2011.
- 4,044,225. **SNOWBOARD NATION (STANDARD CHARACTER).** JOHN R. TURNER, (U.S. CLS. 100, 101 AND 102). SN 85-224,423. PUB. 8-9-2011. FILED 1-24-2011.
- 4,044,239. **KIÈRE MEDIA (STANDARD CHARACTER).** WAHLER, ELIZABETH, (U.S. CLS. 100, 101 AND 102). SN 85-227,299. PUB. 8-9-2011. FILED 1-27-2011.
- 4,044,244. **WHEN YOUR TRUCK LOOKS GOOD YOU LOOK GOOD (STANDARD CHARACTER).** SILVER STAR INDUSTRIES, INC., MULTIPLE CLASS, (INT. CLS. 35 AND 37), (U.S. CLS. 100, 101, 102, 103 AND 106). SN 85-227,972. PUB. 8-9-2011. FILED 1-27-2011.
- 4,044,245. **MERITURN (STANDARD CHARACTER).** MERITURN PARTNERS, LLC, MULTIPLE CLASS, (INT. CLS. 35 AND 36), (U.S. CLS. 100, 101 AND 102). SN 85-228,109. PUB. 8-9-2011. FILED 1-27-2011.
- 4,044,251. **THOUGHTS & FEELINGS AND DESIGN.** FORTH-THOUGHT PTY LTD, (U.S. CLS. 100, 101 AND 102). SN 85-230,491. PUB. 8-9-2011. FILED 1-31-2011.
- 4,044,271. **SILVER GOLD BULL AND DESIGN.** SILVER GOLD BULL, INC., (U.S. CLS. 100, 101 AND 102). SN 85-232,693. PUB. 8-9-2011. FILED 2-2-2011.
- 4,044,282. **FIRST GENERATION MONTE CARLO CLUB (STANDARD CHARACTER).** FIRST GENERATION MONTE CARLO CLUB, AKA FGMCC, (U.S. CLS. 100, 101 AND 102). SN 85-237,115. PUB. 8-9-2011. FILED 2-8-2011.
- 4,044,289. **AUTOMOTIVE AFTERMARKET INDUSTRY ASSOCIATION (STANDARD CHARACTER).** AUTOMOTIVE AFTERMARKET INDUSTRY ASSOCIATION, MULTIPLE CLASS, (INT. CLS. 35 AND 41), (U.S. CLS. 100, 101, 102 AND 107). SN 85-238,889. PUB. 8-9-2011. FILED 2-10-2011.
- 4,044,290. **LEADERSHIP. CONNECTION. EMPOWERMENT. (STANDARD CHARACTER).** AUTOMOTIVE AFTERMARKET INDUSTRY ASSOCIATION, MULTIPLE CLASS, (INT. CLS. 35 AND 41), (U.S. CLS. 100, 101, 102 AND 107). SN 85-238,899. PUB. 8-9-2011. FILED 2-10-2011.
- 4,044,293. **COCKYBOYS AND DESIGN.** VINYARD ENTERTAINMENT, LLC, (U.S. CLS. 100, 101 AND 102). SN 85-239,121. PUB. 8-9-2011. FILED 2-10-2011.
- 4,044,303. **CRESCENT AND DESIGN.** CRESCENT PREFERRED PROVIDER ORGANIZATION, INC., DBA CRESCENT HEALTH SOLUTIONS, MULTIPLE CLASS, (INT. CLS. 35, 36, 41, 42 AND 44), (U.S. CLS. 100, 101, 102 AND 107). SN 85-242,542. PUB. 8-9-2011. FILED 2-15-2011.
- 4,044,304. **"OUR BRAND IS BIGGER THAN MINE" (STAN-**

- DARD CHARACTER**). PLAN B, INC., (U.S. CLS. 100, 101 AND 102). SN 85-242,622. PUB. 8-9-2011. FILED 2-15-2011.
- 4,044,316. **JOYFUL VEGAN (STANDARD CHARACTER)**. PATRICK-GOUDREAU, COLLEEN A., DBA COMPASSIONATE COOKS, LLC, (U.S. CLS. 100, 101 AND 102). SN 85-246,839. PUB. 8-9-2011. FILED 2-18-2011.
- 4,044,317. **MISCELLANEOUS DESIGN**. ARTRIP, PAUL D, DBA THE RUM DADDY SPIRITED ADVENTURES, LLC, (U.S. CLS. 100, 101 AND 102). SN 85-247,077. PUB. 8-9-2011. FILED S.R. 2-20-2011; AM. P.R. 5-22-2011.
- 4,044,322. **TAGGLETOOTH AND DESIGN**. TAGGLETOOTH LLC, (U.S. CLS. 100, 101 AND 102). SN 85-247,700. PUB. 8-9-2011. FILED 2-21-2011.
- 4,044,333 ( *See Class 29 for this trademark*).
- 4,044,341. **EVERYTHING BUT WATER (STANDARD CHARACTER)**. ORLANDO BATHING SUIT LLC, (U.S. CLS. 100, 101 AND 102). SN 85-251,635. PUB. 8-9-2011. FILED 2-25-2011.
- 4,044,345. **SNOBBISH GOODS (STANDARD CHARACTER)**. MCLEOD INTERNATIONAL CONSULTINGS, L.L.C., (U.S. CLS. 100, 101 AND 102). SN 85-252,181. PUB. 8-9-2011. FILED 2-25-2011.
- 4,044,346. **EVERYTHING BUT WATER (STYLIZED)**. ORLANDO BATHING SUIT LLC, (U.S. CLS. 100, 101 AND 102). SN 85-252,208. PUB. 8-9-2011. FILED 2-25-2011.
- 4,044,351. **TA (STANDARD CHARACTER)**. TWO NEWTON PLACE, MULTIPLE CLASS, (INT. CLS. 35 AND 38), (U.S. CLS. 100, 101, 102 AND 104). SN 85-253,017. PUB. 8-9-2011. FILED 2-28-2011.
- 4,044,356. **COLLEGE CENTRAL NETWORK (STANDARD CHARACTER)**. COLLEGE CENTRAL NETWORK, INC., (U.S. CLS. 100, 101 AND 102). SN 85-253,348. PUB. 8-9-2011. FILED 2-28-2011.
- 4,044,357. **SIMPSON'S GREENS & FLORAL DISTRIBUTORS, INC. AND DESIGN**. SIMPSON'S GREENS & FLORAL DIST., INC., (U.S. CLS. 100, 101 AND 102). SN 85-253,371. PUB. 8-9-2011. FILED 2-28-2011.
- 4,044,361. **MY UNIVERSITY MOBILE (STANDARD CHARACTER)**. MARLMAR INTERACTIVE LLC, (U.S. CLS. 100, 101 AND 102). SN 85-254,246. PUB. 8-9-2011. FILED 3-1-2011.
- 4,044,363. **AFFORDABLE RX (STANDARD CHARACTER)**. ALSIP, STEPHEN D., (U.S. CLS. 100, 101 AND 102). SN 85-254,506. PUB. 8-9-2011. FILED 3-1-2011.
- 4,044,365. **BLACK FOREST DECOR AND DESIGN**. BLACK FOREST DECOR, LLC, (U.S. CLS. 100, 101 AND 102). SN 85-254,847. PUB. 8-9-2011. FILED 3-1-2011.
- 4,044,370. **SHAWANO FLEA MARKET (STANDARD CHARACTER)**. ZURKO ENTERPRISES, INC., (U.S. CLS. 100, 101 AND 102). SN 85-255,296. PUB. 8-9-2011. FILED 3-2-2011.
- 4,044,371. **THE ACI GROUP (STANDARD CHARACTER)**. THE ACI GROUP, INC., (U.S. CLS. 100, 101 AND 102). SN 85-255,431. PUB. 8-9-2011. FILED 3-2-2011.
- 4,044,377. **ANDERSON GOING THE EXTRA MILE TO MAKE YOU SMILE! (STANDARD CHARACTER)**. ANDERSON MOTORS, LLC, (U.S. CLS. 100, 101 AND 102). SN 85-256,888. PUB. 8-9-2011. FILED 3-3-2011.
- 4,044,384. **MISCELLANEOUS DESIGN**. EARLY LEARNING RESOURCES, LLC, (U.S. CLS. 100, 101 AND 102). SN 85-257,474. PUB. 8-9-2011. FILED 3-3-2011.
- 4,044,386. **MEDIA WHERE & WHEN IT MATTERS (STANDARD CHARACTER)**. PRN CORPORATION, (U.S. CLS. 100, 101 AND 102). SN 85-258,018. PUB. 8-9-2011. FILED 3-4-2011.
- 4,044,387. **FF (STYLIZED)**. THE FADER FINANCIAL GROUP, LTD, TA FADER FINANCIAL, (U.S. CLS. 100, 101 AND 102). SN 85-258,107. PUB. 8-9-2011. FILED 3-4-2011.
- 4,044,389. **CALLING ALL ANGELS GIVING CHILDREN HOPE AND DESIGN**. CALLING ALL ANGELS, INC., (U.S. CLS. 100, 101 AND 102). SN 85-258,143. PUB. 8-9-2011. FILED 3-4-2011.
- 4,044,394. **CLOTH & CROWN (STANDARD CHARACTER)**. CLOTH & CROWN, LLC, (U.S. CLS. 100, 101 AND 102). SN 85-258,627. PUB. 8-9-2011. FILED 3-4-2011.
- 4,044,420. **CFO CONNECT (STANDARD CHARACTER)**. CFO CONNECT, (U.S. CLS. 100, 101 AND 102). SN 85-259,963. PUB. 8-9-2011. FILED 3-7-2011.
- 4,044,429. **WORKERSCOMP ANALYTICS AND DESIGN**. PAUGH, JAMES J., MULTIPLE CLASS, (INT. CLS. 35 AND 36), (U.S. CLS. 100, 101 AND 102). SN 85-260,531. PUB. 8-9-2011. FILED 3-8-2011.
- 4,044,430. **CHALKTALK (STANDARD CHARACTER)**. CHALKTALK SPORTS, INC., (U.S. CLS. 100, 101 AND 102). SN 85-260,546. PUB. 8-9-2011. FILED 3-8-2011.
- 4,044,431. **GONE FOR A RUN (STANDARD CHARACTER)**. CHALKTALK SPORTS, INC., (U.S. CLS. 100, 101 AND 102). SN 85-260,548. PUB. 8-9-2011. FILED 3-8-2011.
- 4,044,436. **WORKERS COMP CLAIM DNA AND DESIGN**. PAUGH, JAMES J., (U.S. CLS. 100, 101 AND 102). SN 85-260,802. PUB. 8-9-2011. FILED 3-8-2011.
- 4,044,437. **SIMPLIFY, UNIFY, OPTIMIZE (STANDARD CHARACTER)**. US DATA MANAGEMENT LLC, (U.S. CLS. 100, 101 AND 102). SN 85-260,822. PUB. 8-9-2011. FILED 3-8-2011.
- 4,044,440. **DISTRICT LINES (STANDARD CHARACTER)**. DISTRICT LINES, INC., MULTIPLE CLASS, (INT. CLS. 35, 40 AND 42), (U.S. CLS. 100, 101, 102, 103 AND 106). SN 85-260,989. PUB. 8-9-2011. FILED 3-8-2011.
- 4,044,445. **TEE & SEA (STANDARD CHARACTER)**. COMMERCE CONSULTING CORPORATION, DBA WORLD TELECOM GROUP, MULTIPLE CLASS, (INT. CLS. 35 AND 41), (U.S. CLS. 100, 101, 102 AND 107). SN 85-261,256. PUB. 8-9-2011. FILED 3-8-2011.
- 4,044,477. **CURRENT SHIFT (STANDARD CHARACTER)**. CURRENT SHIFT LLC, MULTIPLE CLASS, (INT. CLS. 35 AND 42), (U.S. CLS. 100, 101 AND 102). SN 85-262,606. PUB. 8-9-2011. FILED 3-9-2011.
- 4,044,481. **HOOVER'S WE MAKE IT EASIER (STANDARD CHARACTER)**. HOOVER'S, INC., (U.S. CLS. 100, 101 AND 102). SN 85-262,638. PUB. 8-9-2011. FILED 3-9-2011.
- 4,044,482. **PROFILES SIGNATURE SERIES (STANDARD CHARACTER)**. CAVALIER, WES, (U.S. CLS. 100, 101 AND 102). SN 85-262,696. PUB. 8-9-2011. FILED 3-9-2011.
- 4,044,485. **CHI ZETA THETA SORORITY, INC. (STANDARD CHARACTER)**. CHI ZETA THETA SORORITY, INC. (U.S. CLS. 100, 101 AND 102). SN 85-262,746. PUB. 8-9-2011. FILED 3-9-2011.
- 4,044,487. **SUNRAYSE (STANDARD CHARACTER)**. SUNRAYSE, LLC, (U.S. CLS. 100, 101 AND 102). SN 85-262,797. PUB. 8-9-2011. FILED 3-9-2011.
- 4,044,501. **SEAL AFTERMARKET PRODUCTS AND DESIGN**. SEAL AFTERMARKET PRODUCTS, LLC, (U.S. CLS. 100, 101 AND 102). SN 85-263,258. PUB. 8-9-2011. FILED 3-10-2011.
- 4,044,507. **SEAL AFTERMARKET PRODUCTS (STANDARD CHARACTER)**. SEAL AFTERMARKET PRODUCTS, LLC, (U.S. CLS. 100, 101 AND 102). SN 85-263,340. PUB. 8-9-2011. FILED 3-10-2011.
- 4,044,536. **SCHOOLAMOOLA (STANDARD CHARACTER)**. PROVEN DIRECT, INC., (U.S. CLS. 100, 101 AND 102). SN 85-264,296. PUB. 8-9-2011. FILED 3-11-2011.
- 4,044,544. **AIPRO ASSOCIATION OF INDEPENDENT PASSENGER RAIL OPERATORS AND DESIGN**. ASSOCIATION OF INDEPENDENT PASSENGER RAIL OPERATORS, (U.S. CLS. 100, 101 AND 102). SN 85-264,613. PUB. 8-9-2011. FILED 3-11-2011.
- 4,044,547. **SRA SANFORD ROSE ASSOCIATES EXECUTIVE SEARCH AND DESIGN**. SRA INTERNATIONAL, INC., (U.S. CLS. 100, 101 AND 102). SN 85-264,742. PUB. 8-9-2011. FILED 3-11-2011.
- 4,044,551. **PRICE KING (STANDARD CHARACTER)**. PRICE KING, INC., (U.S. CLS. 100, 101 AND 102). SN 85-265,090. PUB. 8-9-2011. FILED 3-11-2011.
- 4,044,563. **PERCEPTION, COMPASSION, LEADERSHIP (STANDARD CHARACTER)**. CHILTERN, DANIEL, G, DBA 9/11 PATRIOT FLAG - KEYSTONE FOUNDATION, (U.S. CLS. 100, 101 AND 102). SN 85-265,465. PUB. 8-9-2011. FILED 3-12-2011.
- 4,044,564. **HELP OUR SCHOOL .COM AND DESIGN**. DREW PARAS, (U.S. CLS. 100, 101 AND 102). SN 85-265,602. PUB. 8-9-2011. FILED 3-13-2011.
- 4,044,567. **TREADMILL WORLD (STANDARD CHARACTER)**. TREE QUEST LLC, DBA TREADMILL WORLD, (U.S. CLS. 100, 101 AND 102). SN 85-265,619. PUB. 8-9-2011. FILED 3-13-2011.
- 4,044,579. **THERMASOURCE (STANDARD CHARACTER)**. THERMASOURCE, LLC, MULTIPLE CLASS, (INT. CLS.

- 35, 37 AND 42), (U.S. CLS. 100, 101, 102, 103 AND 106). SN 85-266,520. PUB. 8-9-2011. FILED 3-14-2011.
- 4,044,588. **BCX EXPERIENTIAL MARKETING POWERED BY TECHNOLOGY AND DESIGN**. BRAND CONNECTIONS, LLC, (U.S. CLS. 100, 101 AND 102). SN 85-267,269. PUB. 8-9-2011. FILED 3-15-2011.
- 4,044,589. **PEOPLEDESIGN (STYLIZED)**. PEOPLE DESIGN, INC., MULTIPLE CLASS, (INT. CLS. 35 AND 42), (U.S. CLS. 100, 101 AND 102). SN 85-267,362. PUB. 8-9-2011. FILED 3-15-2011.
- 4,044,596. **MACS WORLDWIDE (STANDARD CHARACTER)**. MACS WORLDWIDE LLC, (U.S. CLS. 100, 101 AND 102). SN 85-268,728. PUB. 8-9-2011. FILED 3-16-2011.
- 4,044,601. **WTP INTEREST & PENALTY ADVISORS (STANDARD CHARACTER)**. WORLDWIDE TRADE PARTNERS (NEW YORK) LLC, DBA WTP ADVISORS, (U.S. CLS. 100, 101 AND 102). SN 85-269,276. PUB. 8-9-2011. FILED 3-17-2011.
- 4,044,602. **WTP CAPITAL MARKETS (STANDARD CHARACTER)**. WORLDWIDE TRADE PARTNERS (NEW YORK) LLC, DBA WTP ADVISORS, (U.S. CLS. 100, 101 AND 102). SN 85-269,400. PUB. 8-9-2011. FILED 3-17-2011.
- 4,044,604. **WTP GLOBAL BUSINESS INCENTIVES (STANDARD CHARACTER)**. WORLDWIDE TRADE PARTNERS (NEW YORK) LLC, DBA WTP ADVISORS, (U.S. CLS. 100, 101 AND 102). SN 85-269,675. PUB. 8-9-2011. FILED 3-17-2011.
- 4,044,612. **PROPERTIES THE EVERYTHING REAL ESTATE PUBLICATION WWW.PROPERTIESNJ.NET HOMES. ES-TATES . ADULT COMMUNITIES . CONDOMINIUMS/TOWNHOMES RENTALS . COMMERCIAL . WATER-FRONT PROPERTIES . FINANCIAL INSTITUTIONS/SERVICES AND DESIGN**. MENDOZA, NANCY, DBA PROPERTIES, (U.S. CLS. 100, 101 AND 102). SN 85-271,733. PUB. 8-9-2011. FILED 3-20-2011.
- 4,044,614. **A LOUVERTURE CLEARY EDUCATION CAN CHANGE A LIFE, AND THROUGH THAT LIFE, A THOUSAND MORE (STANDARD CHARACTER)**. THE HAITIAN PROJECT, INC., MULTIPLE CLASS, (INT. CLS. 35, 36 AND 41), (U.S. CLS. 100, 101, 102 AND 107). SN 85-271,926. PUB. 8-9-2011. FILED 3-21-2011.
- 4,044,615. . . . **TEACH PEOPLE TO FISH AND SHARE THEIR CATCH, AND YOU WILL FEED THE WORLD (STANDARD CHARACTER)**. THE HAITIAN PROJECT, INC., MULTIPLE CLASS, (INT. CLS. 35, 36 AND 41), (U.S. CLS. 100, 101, 102 AND 107). SN 85-271,941. PUB. 8-9-2011. FILED 3-21-2011.
- 4,044,616. **FAMILY TREE (STANDARD CHARACTER)**. DUN & BRADSTREET, INC., (U.S. CLS. 100, 101 AND 102). SN 85-272,039. PUB. 8-9-2011. FILED 3-21-2011.
- 4,044,619. **AMERICAN ROAMER (STANDARD CHARACTER)**. AMERICAN ROAMER, LLC, MULTIPLE CLASS, (INT. CLS. 35 AND 42), (U.S. CLS. 100, 101 AND 102). SN 85-272,510. PUB. 8-9-2011. FILED 3-21-2011.
- 4,044,621. **ANNOUNCING THE END OF ER WAITING (STANDARD CHARACTER)**. SSM HEALTH CARE OF OKLAHOMA, INC., (U.S. CLS. 100, 101 AND 102). SN 85-273,352. PUB. 8-9-2011. FILED 3-22-2011.
- 4,044,622. **FROM THE FIRST THOUGHT TO THE LAST DETAIL (STANDARD CHARACTER)**. PERALTA-JONES, LAURA, (U.S. CLS. 100, 101 AND 102). SN 85-273,354. PUB. 8-9-2011. FILED 3-22-2011.
- 4,044,628. **SPIKE'S (STANDARD CHARACTER)**. ISADORO SEED INC., (U.S. CLS. 100, 101 AND 102). SN 85-273,394. PUB. 8-9-2011. FILED 3-22-2011.
- 4,044,634. **GRETEL AND DESIGN**. GRETEL INC., MULTIPLE CLASS, (INT. CLS. 35, 41 AND 42), (U.S. CLS. 100, 101, 102 AND 107). SN 85-273,471. PUB. 8-9-2011. FILED 3-22-2011.
- 4,044,643. **MUG AND PIA (STANDARD CHARACTER)**. MUG AND PIA, LLC, (U.S. CLS. 100, 101 AND 102). SN 85-273,669. PUB. 8-9-2011. FILED 3-22-2011.
- 4,044,644. **ANDERSON GOING THE EXTRA MILE TO MAKE YOU SMILE! AND DESIGN**. ANDERSON MOTORS, LLC, (U.S. CLS. 100, 101 AND 102). SN 85-273,686. PUB. 8-9-2011. FILED 3-22-2011.
- 4,044,650. **MAXIMUM TAX SERVICE (STANDARD CHARACTER)**. MAXIMUM TAX LLC, (U.S. CLS. 100, 101 AND 102). SN 85-273,764. PUB. 8-9-2011. FILED 3-22-2011.
- 4,044,652. **FROM YOUR HOUSE TO OUR HOUSE (STANDARD CHARACTER)**. C.R. MARTIN AUCTIONEERS, INC., (U.S. CLS. 100, 101 AND 102). SN 85-273,816. PUB. 8-9-2011. FILED 3-22-2011.
- 4,044,654. **MUNCHAROO AND DESIGN**. MUNCHAROO, LLC, (U.S. CLS. 100, 101 AND 102). SN 85-273,827. PUB. 8-9-2011. FILED 3-22-2011.
- 4,044,660. **BRANDAWAKE (STANDARD CHARACTER)**. PRO-KARMA, INC., (U.S. CLS. 100, 101 AND 102). SN 85-273,891. PUB. 8-9-2011. FILED 3-22-2011.
- 4,044,676. **FORTUNA'S (STANDARD CHARACTER)**. FORTUNA'S SAUSAGE CO. LLC, (U.S. CLS. 100, 101 AND 102). SN 85-274,131. PUB. 8-9-2011. FILED 3-23-2011.
- 4,044,689. **TRE (STANDARD CHARACTER)**. NEW ORLEANS EXCHANGE, INC., (U.S. CLS. 100, 101 AND 102). SN 85-274,359. PUB. 8-9-2011. FILED 3-23-2011.
- 4,044,690. **CLEANVERTISEMENT (STANDARD CHARACTER)**. GREEN CLEAN, LLC, (U.S. CLS. 100, 101 AND 102). SN 85-274,365. PUB. 8-9-2011. FILED 3-23-2011.
- 4,044,692. **YOUR BUSINESS. DELIVERED. (STANDARD CHARACTER)**. AES LOGISTICS, INC., (U.S. CLS. 100, 101 AND 102). SN 85-274,379. PUB. 8-9-2011. FILED 3-23-2011.
- 4,044,696. **H AND DESIGN**. HOOZON LLC, MULTIPLE CLASS, (INT. CLS. 35 AND 41), (U.S. CLS. 100, 101, 102 AND 107). SN 85-274,419. PUB. 8-9-2011. FILED 3-23-2011.
- 4,044,708. **SOMEDIA (STANDARD CHARACTER)**. SOMEDIA SOLUTIONS INC., (U.S. CLS. 100, 101 AND 102). SN 85-274,640. PUB. 8-9-2011. FILED 3-23-2011.
- 4,044,733. **I LIKE WHAT YOU'RE WEARING (STANDARD CHARACTER)**. OLIVIA GOSSETT, AND RICHARD GOSSETT, MULTIPLE CLASS, (INT. CLS. 35 AND 45), (U.S. CLS. 100, 101 AND 102). SN 85-275,061. PUB. 8-9-2011. FILED 3-23-2011.
- 4,044,738 ( *See Class 25 for this trademark*).
- 4,044,762. **E3 EXTREME ENTERPRISE EFFICIENCY (STANDARD CHARACTER)**. DAVID JOHN PATRISHKOFF, DBA INNOVATIVE SOLUTIONS GROUP, (U.S. CLS. 100, 101 AND 102). SN 85-275,558. PUB. 8-9-2011. FILED 3-24-2011.
- 4,044,768. **AOPL (STANDARD CHARACTER)**. ASSOCIATION OF OIL PIPE LINES, AKA AOPL, (U.S. CLS. 100, 101 AND 102). SN 85-275,640. PUB. 8-9-2011. FILED 3-24-2011.
- 4,044,773. **RED IDEA (STANDARD CHARACTER)**. RED IDEA, LLC, (U.S. CLS. 100, 101 AND 102). SN 85-275,663. PUB. 8-9-2011. FILED 3-24-2011.
- 4,044,778. **USFRA (STANDARD CHARACTER)**. U.S. FARMERS & RANCHERS ALLIANCE, INC., (U.S. CLS. 100, 101 AND 102). SN 85-275,736. PUB. 8-9-2011. FILED 3-24-2011.
- 4,044,788. **ZAMRAY (STANDARD CHARACTER)**. ZAMRAY, LLC, (U.S. CLS. 100, 101 AND 102). SN 85-275,838. PUB. 8-9-2011. FILED 3-24-2011.
- 4,044,792. **CREDITGRADE (STANDARD CHARACTER)**. CENTRRO INC., (U.S. CLS. 100, 101 AND 102). SN 85-275,882. PUB. 8-9-2011. FILED 3-24-2011.
- 4,044,798. **CONNECTING EXCEPTIONAL PEOPLE (STANDARD CHARACTER)**. FRIES GROUP LLC, DBA HIREGY, (U.S. CLS. 100, 101 AND 102). SN 85-275,940. PUB. 8-9-2011. FILED 3-24-2011.
- 4,044,802. **GLOBALBOOST (STANDARD CHARACTER)**. PORTER, BRUCE R JR, (U.S. CLS. 100, 101 AND 102). SN 85-275,974. PUB. 8-9-2011. FILED 3-24-2011.
- 4,044,809. **NCONN (STANDARD CHARACTER)**. NATIONAL COALITION OF ONCOLOGY NURSE NAVIGATORS, INC., (U.S. CLS. 100, 101 AND 102). SN 85-276,116. PUB. 8-9-2011. FILED 3-24-2011.
- 4,044,820. **THESITY (STANDARD CHARACTER)**. CHAN, JOHN H., (U.S. CLS. 100, 101 AND 102). SN 85-276,325. PUB. 8-9-2011. FILED 3-24-2011.
- 4,044,827. **DOGSPLURGE SIT.STAY.SHOP. AND DESIGN**. DOGSPLURGE, LLC, (U.S. CLS. 100, 101 AND 102). SN 85-276,434. PUB. 8-9-2011. FILED 3-24-2011.
- 4,044,830. **DIGI-CAPITAL (STANDARD CHARACTER)**. DIGI-CAPITAL LIMITED, MULTIPLE CLASS, (INT. CLS. 35 AND 36), (U.S. CLS. 100, 101 AND 102). SN 85-276,514. PUB. 8-9-2011. FILED 3-25-2011.
- 4,044,832. **BBG AND DESIGN**. THE BARE BOARD GROUP, INC., (U.S. CLS. 100, 101 AND 102). SN 85-276,525. PUB. 8-9-2011. FILED 3-25-2011.
- 4,044,837. **SHOPPER REVIEWS (STANDARD CHARACTER)**.

- DIMO LLC, (U.S. CLS. 100, 101 AND 102), SN 85-276,553. PUB. 8-9-2011. FILED 3-25-2011.
- 4,044,844. **WLT MEDICARD (STANDARD CHARACTER)**. WLT SOFTWARE ENTERPRISES, INC., (U.S. CLS. 100, 101 AND 102), SN 85-276,592. PUB. 8-9-2011. FILED 3-25-2011.
- 4,044,846. **DREAM SPONSORS (STANDARD CHARACTER)**. DREAM SPONSORS, INC., (U.S. CLS. 100, 101 AND 102), SN 85-276,657. PUB. 8-9-2011. FILED 3-25-2011.
- 4,044,852 ( *See Class 9 for this trademark*).
- 4,044,853. **KAN-HAUL (STANDARD CHARACTER)**. PATE CAPITAL GROUP, INC., (U.S. CLS. 100, 101 AND 102), SN 85-276,750. PUB. 8-9-2011. FILED 3-25-2011.
- 4,044,855 ( *See Class 9 for this trademark*).
- 4,044,858. **AXPONA (STANDARD CHARACTER)**. AUDIO EXPO NORTH AMERICA, (U.S. CLS. 100, 101 AND 102), SN 85-276,829. PUB. 8-9-2011. FILED 3-25-2011.
- 4,044,863. **SEEDWELL (STYLIZED)**. SEEDWELL LLC, DBA SEEDWELL VIDEO PRODUCTION, MULTIPLE CLASS, (INT. CLS. 35 AND 41), (U.S. CLS. 100, 101, 102 AND 107), SN 85-276,904. PUB. 8-9-2011. FILED 3-25-2011.
- 4,044,875. **LIVE FOR LESS (STANDARD CHARACTER)**. DD APARTMENTS, LLC, (U.S. CLS. 100, 101 AND 102), SN 85-277,063. PUB. 8-9-2011. FILED 3-25-2011.
- 4,044,897. **GET WELL SOONER (STANDARD CHARACTER)**. ZOCDOC, INC., (U.S. CLS. 100, 101 AND 102), SN 85-277,350. PUB. 8-9-2011. FILED 3-25-2011.
- 4,044,905. **FRO-YOTOPIA AND DESIGN**. DOWNTOWN GARDENS FROZEN YOGURT LLC, (U.S. CLS. 100, 101 AND 102), SN 85-277,421. PUB. 8-9-2011. FILED 3-25-2011.
- 4,044,909 ( *See Class 25 for this trademark*).
- 4,044,912. **QUANTITATIVE DESCRIPTIVE ANALYSIS (QDA) (STANDARD CHARACTER)**. TRAGON CORPORATION, (U.S. CLS. 100, 101 AND 102), SN 85-277,481. PUB. 8-9-2011. FILED 3-25-2011.
- 4,044,914. **STREAMLINE BY DESIGN (STANDARD CHARACTER)**. STREAMLINE BY DESIGN, LLC, MULTIPLE CLASS, (INT. CLS. 35 AND 45), (U.S. CLS. 100, 101 AND 102), SN 85-277,514. PUB. 8-9-2011. FILED 3-25-2011.
- 4,044,935. **WANT2SCRAP (STANDARD CHARACTER)**. MICHELE PARRISH, (U.S. CLS. 100, 101 AND 102), SN 85-277,824. PUB. 8-9-2011. FILED 3-26-2011.
- 4,044,936 ( *See Class 25 for this trademark*).
- 4,044,939. **THE ETHER (STANDARD CHARACTER)**. THE ETHER, MULTIPLE CLASS, (INT. CLS. 35, 41 AND 42), (U.S. CLS. 100, 101, 102 AND 107), SN 85-277,977. PUB. 8-9-2011. FILED 3-26-2011.
- 4,044,940. **ARPA TAX (STANDARD CHARACTER)**. BRILLIANT TAX & ACCOUNTING SERVICES, INC., DBA ARPA TAX, (U.S. CLS. 100, 101 AND 102), SN 85-277,982. PUB. 8-9-2011. FILED 3-26-2011.
- 4,044,943. **REASHORING (STANDARD CHARACTER)**. ESENSE INCORPORATED, MULTIPLE CLASS, (INT. CLS. 35 AND 42), (U.S. CLS. 100, 101 AND 102), SN 85-278,014. PUB. 8-9-2011. FILED 3-27-2011.
- 4,044,950. **FEAST! (STANDARD CHARACTER)**. FEAST LLC, (U.S. CLS. 100, 101 AND 102), SN 85-278,109. PUB. 8-9-2011. FILED 3-27-2011.
- 4,044,971. **ROYAL NEIGHBORS OF AMERICA (STANDARD CHARACTER)**. ROYAL NEIGHBORS OF AMERICA, MULTIPLE CLASS, (INT. CLS. 35 AND 36), (U.S. CLS. 100, 101 AND 102), SN 85-278,361. PUB. 8-9-2011. FILED 3-28-2011.
- 4,044,986. **TELARUS (STANDARD CHARACTER)**. TELARUS, INC., (U.S. CLS. 100, 101 AND 102), SN 85-278,510. PUB. 8-9-2011. FILED 3-28-2011.
- 4,044,993. **FASHIONWARE (STANDARD CHARACTER)**. LIVING IN DIGITAL TIMES, LLC, (U.S. CLS. 100, 101 AND 102), SN 85-278,606. PUB. 8-9-2011. FILED 3-28-2011.
- 4,044,994. **KIDS@PLAY (STANDARD CHARACTER)**. LIVING IN DIGITAL TIMES, LLC, (U.S. CLS. 100, 101 AND 102), SN 85-278,621. PUB. 8-9-2011. FILED 3-28-2011.
- 4,044,995. **COUPONBUY.COM (STANDARD CHARACTER)**. COUPONBUY.COM, LLC, (U.S. CLS. 100, 101 AND 102), SN 85-278,646. PUB. 8-9-2011. FILED 3-28-2011.
- 4,044,998. **SOCIALDEALER (STANDARD CHARACTER)**. AUTOMOTIVE SOURCING TECHNOLOGIES, LLC, (U.S. CLS. 100, 101 AND 102), SN 85-278,727. PUB. 8-9-2011. FILED 3-28-2011.
- 4,045,001. **CITYHINT (STANDARD CHARACTER)**. CITY-HINT, LLC, (U.S. CLS. 100, 101 AND 102), SN 85-278,746. PUB. 8-9-2011. FILED 3-28-2011.
- 4,045,002. **CONNECT TO CARE (STANDARD CHARACTER)**. UNITED JEWISH APPEAL-FEDERATION OF JEWISH PHILANTHROPIES OF NEW YORK, INC., MULTIPLE CLASS, (INT. CLS. 35, 36 AND 45), (U.S. CLS. 100, 101 AND 102), SN 85-278,761. PUB. 8-9-2011. FILED 3-28-2011.
- 4,045,014. **ECENTA (STANDARD CHARACTER)**. ECENTA AMERICA INC., MULTIPLE CLASS, (INT. CLS. 35 AND 42), (U.S. CLS. 100, 101 AND 102), SN 85-278,942. PUB. 8-9-2011. FILED 3-28-2011.
- 4,045,018. **BETTER BY HABIT (STANDARD CHARACTER)**. PROVING GROUND LLC, DBA PROVING GROUND, (U.S. CLS. 100, 101 AND 102), SN 85-278,960. PUB. 8-9-2011. FILED 3-28-2011.
- 4,045,026. **BRANDTRUTH (STANDARD CHARACTER)**. BRANDTRUTH LLC, (U.S. CLS. 100, 101 AND 102), SN 85-279,055. PUB. 8-9-2011. FILED 3-28-2011.
- 4,045,035. **ZURV (STANDARD CHARACTER)**. ZURV LLC., MULTIPLE CLASS, (INT. CLS. 35 AND 42), (U.S. CLS. 100, 101 AND 102), SN 85-279,141. PUB. 8-9-2011. FILED 3-28-2011.
- 4,045,036. **SUGAR . YUMMY . MAMA AND DESIGN**. CHURROS PLUS LLC, (U.S. CLS. 100, 101 AND 102), SN 85-279,147. PUB. 8-9-2011. FILED 3-28-2011.
- 4,045,040. **FANATICS 101 (STANDARD CHARACTER)**. BOWEN, KEDDRAIN, (U.S. CLS. 100, 101 AND 102), SN 85-279,207. PUB. 8-9-2011. FILED 3-28-2011.
- 4,045,046. **DOBANGO (STANDARD CHARACTER)**. DOBANGO INC, (U.S. CLS. 100, 101 AND 102), SN 85-279,235. PUB. 8-9-2011. FILED 3-28-2011.
- 4,045,061. **ACU (STANDARD CHARACTER)**. AMERICAN CONSERVATIVE UNION, (U.S. CLS. 100, 101 AND 102), SN 85-279,504. PUB. 8-9-2011. FILED 3-29-2011.
- 4,045,062. **CPAC (STANDARD CHARACTER)**. AMERICAN CONSERVATIVE UNION, (U.S. CLS. 100, 101 AND 102), SN 85-279,532. PUB. 8-9-2011. FILED 3-29-2011.
- 4,045,066 ( *See Class 28 for this trademark*).
- 4,045,070. **PLAN BRIEF EXECUTE DEBRIEF WIN! AND DESIGN**. AFTERBURNER, INC., MULTIPLE CLASS, (INT. CLS. 35 AND 41), (U.S. CLS. 100, 101, 102 AND 107), SN 85-279,648. PUB. 8-9-2011. FILED 3-29-2011.
- 4,045,073. **WE WORK HARD SO YOU CAN PLAY (STANDARD CHARACTER)**. BOLLINGER, INC., MULTIPLE CLASS, (INT. CLS. 35 AND 36), (U.S. CLS. 100, 101 AND 102), SN 85-279,676. PUB. 8-9-2011. FILED 3-29-2011.
- 4,045,087. **EAT. LIVE. BE HAPPY (STANDARD CHARACTER)**. SMALL POTATOES URBAN DELIVERY INC., (U.S. CLS. 100, 101 AND 102), SN 85-279,875. PUB. 8-9-2011. FILED 3-29-2011.
- 4,045,088. **SIRIUSXM (STANDARD CHARACTER)**. SIRIUS XM RADIO INC., MULTIPLE CLASS, (INT. CLS. 35, 38 AND 41), (U.S. CLS. 100, 101, 102, 104 AND 107), SN 85-279,884. PUB. 8-9-2011. FILED 3-29-2011.
- 4,045,093. **CHALLENGE & FUN (STANDARD CHARACTER)**. CHALLENGE & FUN INC., (U.S. CLS. 100, 101 AND 102), SN 85-279,946. PUB. 8-9-2011. FILED 3-29-2011.
- 4,045,094. **SHOPME.COM (STANDARD CHARACTER)**. SHOPME, INC., (U.S. CLS. 100, 101 AND 102), SN 85-279,976. PUB. 8-9-2011. FILED 3-29-2011.
- 4,045,106. **SAFESTIMATE (STANDARD CHARACTER)**. SAFESTIMATE, (U.S. CLS. 100, 101 AND 102), SN 85-280,176. PUB. 8-9-2011. FILED 3-29-2011.
- 4,045,114. **SPARK GROUP AND DESIGN**. THE SPARK GROUP LLC, (U.S. CLS. 100, 101 AND 102), SN 85-280,263. PUB. 8-9-2011. FILED 3-29-2011.
- 4,045,119. **BELIEVERS IN BUSINESS (STANDARD CHARACTER)**. RIGGS, STEPHANIE, (U.S. CLS. 100, 101 AND 102), SN 85-280,305. PUB. 8-9-2011. FILED 3-29-2011.
- 4,045,144. **DINEDOO (STANDARD CHARACTER)**. BRENNAN, BRADFORD, (U.S. CLS. 100, 101 AND 102), SN 85-280,575. PUB. 8-9-2011. FILED 3-29-2011.
- 4,045,146. **FIVECREATIVE (STYLIZED)**. FIVE CREATIVE INC, AKA FIVE CREATIVE, (U.S. CLS. 100, 101 AND 102), SN 85-280,591. PUB. 8-9-2011. FILED 3-29-2011.
- 4,045,153. **VENTURE48 (STANDARD CHARACTER)**. EAST-



- BIZ CORPORATION, (U.S. CLS. 100, 101 AND 102). SN 85-280,721. PUB. 8-9-2011. FILED 3-30-2011.
- 4,045,154. **THE SPOKESPEOPLE (STANDARD CHARACTER)**. THE SPOKESPEOPLE, (U.S. CLS. 100, 101 AND 102). SN 85-280,761. PUB. 8-9-2011. FILED 3-30-2011.
- 4,045,158. **BREAKPOINT (STANDARD CHARACTER)**. PRISON FELLOWSHIP MINISTRIES, (U.S. CLS. 100, 101 AND 102). SN 85-280,826. PUB. 8-9-2011. FILED 3-30-2011.
- 4,045,165. **MISCELLANEOUS DESIGN**. PRISON FELLOWSHIP MINISTRIES, (U.S. CLS. 100, 101 AND 102). SN 85-280,903. PUB. 8-9-2011. FILED 3-30-2011.
- 4,045,169. **HOW TO SHOP FOR FREE (STANDARD CHARACTER)**. SPENCER, KATHLEEN, (U.S. CLS. 100, 101 AND 102). SN 85-280,944. PUB. 8-9-2011. FILED 3-30-2011.
- 4,045,172. **LOUISIANA SEAFOOD AND DESIGN**. LOUISIANA SEAFOOD PROMOTION AND MARKETING BOARD OF THE DEPARTMENT OF WILDLIFE & FISHERIES, (U.S. CLS. 100, 101 AND 102). SN 85-280,968. PUB. 8-9-2011. FILED 3-30-2011.
- 4,045,176. **CAFFELLI (STYLIZED)**. CAFFELLI LLC, (U.S. CLS. 100, 101 AND 102). SN 85-280,994. PUB. 8-9-2011. FILED 3-30-2011.
- 4,045,208. **GOLDENOFFERTUNITY.COM (STANDARD CHARACTER)**. BRIGHT STAR PRODUCTIONS LLC, (U.S. CLS. 100, 101 AND 102). SN 85-281,502. PUB. 8-9-2011. FILED 3-30-2011.
- 4,045,226. **MAKING POLICY WORK FOR PEOPLE. (STANDARD CHARACTER)**. GLOBAL POLICY SOLUTIONS, LLC, (U.S. CLS. 100, 101 AND 102). SN 85-281,794. PUB. 8-9-2011. FILED 3-30-2011.
- 4,045,233. **WONTON (STANDARD CHARACTER)**. WONTON MEDIA INC., (U.S. CLS. 100, 101 AND 102). SN 85-281,840. PUB. 8-9-2011. FILED 3-30-2011.
- 4,045,240. **WHERE IMAGINATIONS COME TRUE (STANDARD CHARACTER)**. ADAM'S JEWELRY NETWORK PA INC., (U.S. CLS. 100, 101 AND 102). SN 85-281,968. PUB. 8-9-2011. FILED 3-31-2011.
- 4,045,247. **NICKY CIGS (STANDARD CHARACTER)**. MORRIS, RICHARD L. JR. (U.S. CLS. 100, 101 AND 102). SN 85-282,009. PUB. 8-9-2011. FILED 3-31-2011.
- 4,045,253. **NO ONE SHINES BRIGHTER (STANDARD CHARACTER)**. SUN JEWELRY CORPORATION, (U.S. CLS. 100, 101 AND 102). SN 85-282,036. PUB. 8-9-2011. FILED 3-31-2011.
- 4,045,256. **BREAK POINT AND DESIGN**. PRISON FELLOWSHIP MINISTRIES, (U.S. CLS. 100, 101 AND 102). SN 85-282,046. PUB. 8-9-2011. FILED 3-31-2011.
- 4,045,258. **AU AND DESIGN**. SUN JEWELRY CORPORATION, (U.S. CLS. 100, 101 AND 102). SN 85-282,062. PUB. 8-9-2011. FILED 3-31-2011.
- 4,045,276. **G THEGINGRICHTEAM AND DESIGN**. THE GINGRICH TEAM, LLC, (U.S. CLS. 100, 101 AND 102). SN 85-282,283. PUB. 8-9-2011. FILED 3-31-2011.
- 4,045,291. **TESSCO MAKING WIRELESS WORK (STYLIZED)**. TESSCO COMMUNICATIONS INCORPORATED, (U.S. CLS. 100, 101 AND 102). SN 85-282,483. PUB. 8-9-2011. FILED 3-31-2011.
- 4,045,294. **LOGIBIO (STANDARD CHARACTER)**. LOGIBIO, LLC, (U.S. CLS. 100, 101 AND 102). SN 85-282,517. PUB. 8-9-2011. FILED 3-31-2011.
- 4,045,306. **EMERALD (STANDARD CHARACTER)**. DEUTSCHE BANK AKTIENGESELLSCHAFT, LONDON, (U.S. CLS. 100, 101 AND 102). SN 85-282,665. PUB. 8-9-2011. FILED 3-31-2011.
- 4,045,308. **INFORMZ THE WAY TO KNOW EMAIL MARKETING AND DESIGN**. INFORMZ, INC., MULTIPLE CLASS, (INT. CLS. 35 AND 38), (U.S. CLS. 100, 101, 102 AND 104). SN 85-282,704. PUB. 8-9-2011. FILED 3-31-2011.
- 4,045,315. **PAYROLL4CONSTRUCTION.COM (STANDARD CHARACTER)**. FOUNDATION CONSTRUCTION PAYROLL SERVICE, DBA PAYROLL4CONSTRUCTION.COM, (U.S. CLS. 100, 101 AND 102). SN 85-282,806. PUB. 8-9-2011. FILED 3-31-2011.
- 4,045,318. **BREWER (STANDARD CHARACTER)**. BREWER QUILTING AND SEWING SUPPLIES, LLC, (U.S. CLS. 100, 101 AND 102). SN 85-282,853. PUB. 8-9-2011. FILED 3-31-2011.
- 4,045,324. **GIVEPALS (STANDARD CHARACTER)**. ERIC IMASOGIE, DBA GIVEPALS, (U.S. CLS. 100, 101 AND 102). SN 85-282,958. PUB. 8-9-2011. FILED 3-31-2011.
- 4,045,326. **EVERSTORE (STANDARD CHARACTER)**. EVERLOOP, INC., (U.S. CLS. 100, 101 AND 102). SN 85-282,960. PUB. 8-9-2011. FILED 3-31-2011.
- 4,045,332. **SEEING IS BELIEVING (STANDARD CHARACTER)**. EXCELVISION, LLC, (U.S. CLS. 100, 101 AND 102). SN 85-282,993. PUB. 8-9-2011. FILED 3-31-2011.
- 4,045,348. **EXCLUSIVELY KNOWN (STANDARD CHARACTER)**. BRACAMONTE, GIBRAN, (U.S. CLS. 100, 101 AND 102). SN 85-283,249. PUB. 8-9-2011. FILED 3-31-2011.
- 4,045,350. **COME HANG WITH US! (STANDARD CHARACTER)**. BBD CORPORATION, (U.S. CLS. 100, 101 AND 102). SN 85-283,273. PUB. 8-9-2011. FILED 3-31-2011.
- 4,045,365. **TIMECRAFTERS (STANDARD CHARACTER)**. EDITIONS TEMPS INTERNATIONAL LTD, MULTIPLE CLASS, (INT. CLS. 35 AND 41), (U.S. CLS. 100, 101, 102 AND 107). SN 85-283,393. PUB. 8-9-2011. FILED 4-1-2011.
- 4,045,369. **FREE-FLITE (STANDARD CHARACTER)**. FREE FLITE, INC., DBA FREE-FLITE BICYCLES, (U.S. CLS. 100, 101 AND 102). SN 85-283,457. PUB. 8-9-2011. FILED 4-1-2011.
- 4,045,393. **SPIRE LISTEN. RESPOND. GROW. AND DESIGN**. SPIRE, LLC, (U.S. CLS. 100, 101 AND 102). SN 85-283,717. PUB. 8-9-2011. FILED 4-1-2011.
- 4,045,400 ( See Class 16 for this trademark).
- 4,045,409. **MAKING MARKETING WORK (STANDARD CHARACTER)**. BAESMAN GROUP, INC., MULTIPLE CLASS, (INT. CLS. 35 AND 40), (U.S. CLS. 100, 101, 102, 103 AND 106). SN 85-283,910. PUB. 8-9-2011. FILED 4-1-2011.
- 4,045,413. **WAYLOO (STANDARD CHARACTER)**. WAYLOO, INC, (U.S. CLS. 100, 101 AND 102). SN 85-283,965. PUB. 8-9-2011. FILED 4-1-2011.
- 4,045,421. **CLEAR & SIMPLE (STYLIZED)**. THE DORSCHEL GROUP, AKA DORSCHEL AUTOMOTIVE GROUP, (U.S. CLS. 100, 101 AND 102). SN 85-284,048. PUB. 8-9-2011. FILED 4-1-2011.
- 4,045,423. **CLEAR & SIMPLE (STANDARD CHARACTER)**. THE DORSCHEL GROUP, AKA DORSCHEL AUTOMOTIVE GROUP, (U.S. CLS. 100, 101 AND 102). SN 85-284,058. PUB. 8-9-2011. FILED 4-1-2011.
- 4,045,427. **!E DELIVERY AND DESIGN**. 953 ASSOCIATES, LLC, DBA EATERY NYC, (U.S. CLS. 100, 101 AND 102). SN 85-284,131. PUB. 8-9-2011. FILED 4-1-2011.
- 4,045,428. **FAST SLATE (STANDARD CHARACTER)**. THE WOODMANSEE GROUP, LLC, (U.S. CLS. 100, 101 AND 102). SN 85-284,139. PUB. 8-9-2011. FILED 4-1-2011.
- 4,045,430. **STEWART/STAND (STANDARD CHARACTER)**. COCKROACH DESIGN, LLC, DBA STEWART/STAND, (U.S. CLS. 100, 101 AND 102). SN 85-284,162. PUB. 8-9-2011. FILED 4-1-2011.
- 4,045,432. **INSIDE JOBS (STANDARD CHARACTER)**. INSIDE JOBS, LLC, MULTIPLE CLASS, (INT. CLS. 35 AND 41), (U.S. CLS. 100, 101, 102 AND 107). SN 85-284,195. PUB. 8-9-2011. FILED 4-1-2011.
- 4,045,445. **HELPUDOIYOURSELF (STANDARD CHARACTER)**. HOPWOOD, MICHAEL, (U.S. CLS. 100, 101 AND 102). SN 85-284,339. PUB. 8-9-2011. FILED 4-1-2011.
- 4,045,455. **RUFF DRAFT (STANDARD CHARACTER)**. LAWRENCE, LILY ELIZABETH, AND LAWRENCE, DAVID B., (U.S. CLS. 100, 101 AND 102). SN 85-284,481. PUB. 8-9-2011. FILED 4-2-2011.
- 4,045,458. **BRICKSWORTH (STANDARD CHARACTER)**. BRICKSWORTH & CO, LLC, (U.S. CLS. 100, 101 AND 102). SN 85-284,516. PUB. 8-9-2011. FILED 4-2-2011.
- 4,045,467. **LENZMART (STANDARD CHARACTER)**. MORUSPALLI RAGHAVENDRA RAO, DBA LENZMART, (U.S. CLS. 100, 101 AND 102). SN 85-284,821. PUB. 8-9-2011. FILED 4-4-2011.
- 4,045,471. **WICKED SKATEWEAR AND DESIGN**. WICKED SKATEWEAR, (U.S. CLS. 100, 101 AND 102). SN 85-285,124. PUB. 8-9-2011. FILED 4-4-2011.
- 4,045,478. **THE PERSONNEL STORE (STANDARD CHARACTER)**. THE PERSONNEL STORE, INC., (U.S. CLS. 100, 101 AND 102). SN 85-285,636. PUB. 8-9-2011. FILED 4-4-2011.
- 4,045,480. **OFFICE HELP! AND DESIGN**. THE PERSONNEL STORE, INC., (U.S. CLS. 100, 101 AND 102). SN 85-285,663. PUB. 8-9-2011. FILED 4-4-2011.
- 4,045,504. **TD AND DESIGN**. SILLS, JERRY, (U.S. CLS. 100,

- 101 AND 102). SN 85-287,239. PUB. 8-9-2011. FILED 4-5-2011.
- 4,045,507. **GOOD BYTES RECYCLED COMPUTER STORE AND DESIGN**. GOODWILL INDUSTRIES, INC., (U.S. CLS. 100, 101 AND 102). SN 85-287,628. PUB. 8-9-2011. FILED 4-6-2011.
- 4,045,524. **MISCELLANEOUS DESIGN**. ECOHEALTH ALLIANCE INC., (U.S. CLS. 100, 101 AND 102). SN 85-291,382. PUB. 8-9-2011. FILED 4-11-2011.
- 4,045,531. **EA+ (STANDARD CHARACTER)**. WORLDWIDE RESCUE AND SECURITY, INC., MULTIPLE CLASS, (INT. CLS. 35, 39 AND 45), (U.S. CLS. 100, 101, 102 AND 105). SN 85-295,299. PUB. 8-9-2011. FILED 4-14-2011.
- 4,045,533. **TACO LIFE AND DESIGN**. CHRONIC TACOS ENTERPRISES, INC., MULTIPLE CLASS, (INT. CLS. 35 AND 43), (U.S. CLS. 100, 101 AND 102). SN 85-296,801. PUB. 8-9-2011. FILED 4-15-2011.
- 4,045,543. **COLLEGE CENTRAL (STANDARD CHARACTER)**. COLLEGE CENTRAL NETWORK, INC., MULTIPLE CLASS, (INT. CLS. 35 AND 42), (U.S. CLS. 100, 101 AND 102). SN 85-300,809. PUB. 8-9-2011. FILED 4-21-2011.
- 4,045,552. **EXCLUSIVELY.IN (STANDARD CHARACTER)**. EXCLUSIVELY.IN INC., (U.S. CLS. 100, 101 AND 102). SN 85-306,942. PUB. 8-9-2011. FILED 4-28-2011.

### CLASS 36—INSURANCE AND FINANCIAL

- 4,043,632. **ALUMNIMORTGAGE (STYLIZED)**. AMERICAN INSURANCE ADMINISTRATORS, INC., (U.S. CLS. 100, 101 AND 102). SN 76-707,136. PUB. 8-9-2011. FILED 4-6-2011.
- 4,043,678 ( *See Class 35 for this trademark*).
- 4,043,683. **KOZY SHACK PUDDIN' KIDS 1ST VINCENT GRUPPUSO FOUNDATION AND DESIGN**. KOZY SHACK ENTERPRISES, INC., (U.S. CLS. 100, 101 AND 102). SN 77-792,977. PUB. 8-9-2011. FILED 7-30-2009.
- 4,043,684 ( *See Class 9 for this trademark*).
- 4,043,697 ( *See Class 9 for this trademark*).
- 4,043,785 ( *See Class 3 for this trademark*).
- 4,043,801 ( *See Class 35 for this trademark*).
- 4,043,847. **QUANTUM FX (STANDARD CHARACTER)**. ALPARI (UK) LIMITED, (U.S. CLS. 100, 101 AND 102). SN 79-094,365. PUB. 8-9-2011. FILED 2-8-2011.
- 4,043,925 ( *See Class 35 for this trademark*).
- 4,043,962. **MY DENTAL PLAN (STANDARD CHARACTER)**. AMERITAS HOLDING COMPANY, (U.S. CLS. 100, 101 AND 102). SN 85-109,138. PUB. 8-9-2011. FILED 8-17-2010.
- 4,043,998. **YOSEMITE CONSERVANCY AND DESIGN**. YOSEMITE FOUNDATION, (U.S. CLS. 100, 101 AND 102). SN 85-118,010. PUB. 8-9-2011. FILED 8-27-2010.
- 4,044,002. **GOOD HEALTH REWARD CARD (STANDARD CHARACTER)**. CREATIVE MARKETING ASSOCIATES, INC., (U.S. CLS. 100, 101 AND 102). SN 85-119,966. PUB. 8-9-2011. FILED 8-31-2010.
- 4,044,021 ( *See Class 9 for this trademark*).
- 4,044,034. **RUN FOR THE DREAM AND DESIGN**. AN ACHIEVABLE DREAM INC., MULTIPLE CLASS, (INT. CLS. 36 AND 41), (U.S. CLS. 100, 101, 102 AND 107). SN 85-131,165. PUB. 8-9-2011. FILED 9-16-2010.
- 4,044,037. **COMMAND ACCOUNT (STANDARD CHARACTER)**. THE PRUDENTIAL INSURANCE COMPANY OF AMERICA, (U.S. CLS. 100, 101 AND 102). SN 85-132,330. PUB. 8-9-2011. FILED 9-17-2010.
- 4,044,043. **PAYSITE (STANDARD CHARACTER)**. U.S. PAYMENTS, LLC, (U.S. CLS. 100, 101 AND 102). SN 85-136,483. PUB. 8-9-2011. FILED 9-23-2010.
- 4,044,098. **BLUEBLANKET (STANDARD CHARACTER)**. PIERCE AGENCY OF PORTSMOUTH, INC., (U.S. CLS. 100, 101 AND 102). SN 85-164,472. PUB. 5-3-2011. FILED 10-29-2010.
- 4,044,126. **AMERICA AND DESIGN**. AMERICA INSURANCE AGENCY, INC., (U.S. CLS. 100, 101 AND 102). SN 85-177,679. PUB. 5-3-2011. FILED 11-16-2010.
- 4,044,157 ( *See Class 35 for this trademark*).
- 4,044,162. **THE STRENGTH TO REBUILD. (STANDARD CHARACTER)**. CALIFORNIA EARTHQUAKE AUTHORITY, MULTIPLE CLASS, (INT. CLS. 36 AND 41), (U.S. CLS. 100, 101, 102 AND 107). SN 85-194,266. PUB. 8-9-2011. FILED 12-9-2010.
- 4,044,168. **THE BIG BANK ALTERNATIVE (STANDARD CHARACTER)**. MAVERICK FUNDING CORP., (U.S. CLS. 100, 101 AND 102). SN 85-199,441. PUB. 8-9-2011. FILED 12-16-2010.
- 4,044,173. **WEDSURE (STANDARD CHARACTER)**. R. V. NUCCIO & ASSOCIATES INSURANCE BROKERS, INC., (U.S. CLS. 100, 101 AND 102). SN 85-202,669. PUB. 5-3-2011. FILED 12-21-2010.
- 4,044,180. **MONUMATIC (STANDARD CHARACTER)**. MONUMENTAL LIFE INSURANCE COMPANY, (U.S. CLS. 100, 101 AND 102). SN 85-206,443. PUB. 8-9-2011. FILED 12-28-2010.
- 4,044,198. **BOULDERSHARES (STANDARD CHARACTER)**. SOSNOWSKI, LESLIE LISHON, (U.S. CLS. 100, 101 AND 102). SN 85-210,186. PUB. 6-28-2011. FILED 1-4-2011.
- 4,044,219. **ADVANTAGE FAST . FRIENDLY . FLEXIBLE AND DESIGN**. TRISTAR INDEMNITY LLC, (U.S. CLS. 100, 101 AND 102). SN 85-221,237. PUB. 8-9-2011. FILED 1-19-2011.
- 4,044,222 ( *See Class 35 for this trademark*).
- 4,044,233. **ARCHPOINT PARTNERS INVESTMENT BANKING (STANDARD CHARACTER)**. ARCHPOINT CORPORATION, (U.S. CLS. 100, 101 AND 102). SN 85-225,746. PUB. 8-9-2011. FILED 1-25-2011.
- 4,044,234. **A ARCHPOINT PARTNERS INVESTMENT BANKING AND DESIGN**. ARCHPOINT CORPORATION, (U.S. CLS. 100, 101 AND 102). SN 85-225,852. PUB. 8-9-2011. FILED 1-25-2011.
- 4,044,236. **GLOBAL LOSS CONSULTANTS AND DESIGN**. GLOBAL LOSS CONSULTANTS, INC., (U.S. CLS. 100, 101 AND 102). SN 85-226,717. PUB. 8-9-2011. FILED 1-26-2011.
- 4,044,245 ( *See Class 35 for this trademark*).
- 4,044,269. **THE PLACENCIA THE BEAUTY OF BELIZE AND DESIGN**. THE PLACENCIA GROUP, LTD., MULTIPLE CLASS, (INT. CLS. 36 AND 37), (U.S. CLS. 100, 101, 102, 103 AND 106). SN 85-232,610. PUB. 8-9-2011. FILED 2-2-2011.
- 4,044,283. **ICC FRAUDNET COMMERCIAL CRIME SERVICES AND DESIGN**. ICC COMMERCIAL CRIME SERVICES, LTD., MULTIPLE CLASS, (INT. CLS. 36 AND 45), (U.S. CLS. 100, 101 AND 102). SN 85-237,447. PUB. 8-9-2011. FILED 2-9-2011.
- 4,044,297. **NORTHRIM BANK AND DESIGN**. NORTHRIM BANCORP, INC., (U.S. CLS. 100, 101 AND 102). SN 85-239,443. PUB. 8-9-2011. FILED 2-10-2011.
- 4,044,303 ( *See Class 35 for this trademark*).
- 4,044,325. **HERITAGE APPRAISERS (STANDARD CHARACTER)**. HERITAGE APPRAISERS INC., (U.S. CLS. 100, 101 AND 102). SN 85-249,165. PUB. 8-9-2011. FILED 2-23-2011.
- 4,044,329. **STYLIZED LETTER G FOLLOWED BY THE LETTERS P & F THEN A GREEN BAR AND DESIGN**. GRANT PROFESSIONALS FOUNDATION, AKA GPF, (U.S. CLS. 100, 101 AND 102). SN 85-249,631. PUB. 8-9-2011. FILED 2-23-2011.
- 4,044,360. **CODE > ADVISORS AND DESIGN**. CODE ADVISORS, (U.S. CLS. 100, 101 AND 102). SN 85-253,979. PUB. 8-9-2011. FILED 2-28-2011.
- 4,044,385. **DERBY BRUNCH HATWALK AND DESIGN**. HILL, CORLISS N., (U.S. CLS. 100, 101 AND 102). SN 85-257,900. PUB. 8-9-2011. FILED 3-4-2011.
- 4,044,408. **JOE EQCOME GROWTHINCOME RESEARCH & MANAGEMENT, LLC (STANDARD CHARACTER)**. GROWTHINCOME RESEARCH & MANAGEMENT LLC, (U.S. CLS. 100, 101 AND 102). SN 85-259,372. PUB. 8-9-2011. FILED 3-7-2011.
- 4,044,417. **SNPPATAGONIASUR (STANDARD CHARACTER)**. PATAGONIA SUR, LLC, (U.S. CLS. 100, 101 AND 102). SN 85-259,875. PUB. 8-9-2011. FILED 3-7-2011.
- 4,044,419. **SNPPATAGONIASUR (STANDARD CHARACTER)**. PATAGONIA SUR, LLC, (U.S. CLS. 100, 101 AND 102). SN 85-259,934. PUB. 8-9-2011. FILED 3-7-2011.
- 4,044,429 ( *See Class 35 for this trademark*).
- 4,044,460. **YOUANDICANHELP AND DESIGN**. YOUANDICANHELP, (U.S. CLS. 100, 101 AND 102). SN 85-261,773. PUB. 8-9-2011. FILED 3-9-2011.
- 4,044,462. **VALUE FAIR MARKET AND DESIGN**. VALUE FAIR MARKET ST. PETE LLC, (U.S. CLS. 100, 101 AND 102). SN 85-261,911. PUB. 8-9-2011. FILED 3-9-2011.
- 4,044,492. **BOB BELVOIR ONLINE BANKING AND DESIGN**.

- BELVOIR FEDERAL CREDIT UNION, (U.S. CLS. 100, 101 AND 102). SN 85-263,094. PUB. 8-9-2011. FILED 3-10-2011.
- 4,044,510. **MCDP (STANDARD CHARACTER)**. THE SURETY & FIDELITY ASSOCIATION OF AMERICA, (U.S. CLS. 100, 101 AND 102). SN 85-263,442. PUB. 8-9-2011. FILED 3-10-2011.
- 4,044,525. **GOT APPRAISALS AND DESIGN**. AMR APPRAISALS, INC., (U.S. CLS. 100, 101 AND 102). SN 85-263,912. PUB. 8-9-2011. FILED 3-10-2011.
- 4,044,534. **KRELLER GROUP AND DESIGN**. KRELLER BUSINESS INFORMATION GROUP, INC., DBA KRELLER GROUP, MULTIPLE CLASS, (INT. CLS. 36 AND 45), (U.S. CLS. 100, 101 AND 102). SN 85-264,228. PUB. 8-9-2011. FILED 3-11-2011.
- 4,044,614 ( *See Class 35 for this trademark*).
- 4,044,615 ( *See Class 35 for this trademark*).
- 4,044,626. **BEYOND PROCESSING (STANDARD CHARACTER)**. VERACITY PAYMENT SOLUTIONS, (U.S. CLS. 100, 101 AND 102). SN 85-273,382. PUB. 8-9-2011. FILED 3-22-2011.
- 4,044,638. **MOTION PROMOTION (STANDARD CHARACTER)**. BARKSDALE FEDERAL CREDIT UNION, (U.S. CLS. 100, 101 AND 102). SN 85-273,596. PUB. 8-9-2011. FILED 3-22-2011.
- 4,044,694. **SHARE IT (STANDARD CHARACTER)**. PEN AIR FEDERAL CREDIT UNION, (U.S. CLS. 100, 101 AND 102). SN 85-274,402. PUB. 8-9-2011. FILED 3-23-2011.
- 4,044,791. **AFCO (STANDARD CHARACTER)**. BB&T CORPORATION, (U.S. CLS. 100, 101 AND 102). SN 85-275,858. PUB. 8-9-2011. FILED 3-24-2011.
- 4,044,804. **SHOP FIRST... PAY LATER! (STANDARD CHARACTER)**. GENESIS LENDING SERVICES, INC., (U.S. CLS. 100, 101 AND 102). SN 85-275,983. PUB. 8-9-2011. FILED 3-24-2011.
- 4,044,830 ( *See Class 35 for this trademark*).
- 4,044,835. **GIVE LIFE. TWICE (STANDARD CHARACTER)**. THE BRADY KOHN FOUNDATION, (U.S. CLS. 100, 101 AND 102). SN 85-276,546. PUB. 8-9-2011. FILED 3-25-2011.
- 4,044,882. **GRANDE SHORES (STANDARD CHARACTER)**. GRANDE SHORES RENTALS, LLC, MULTIPLE CLASS, (INT. CLS. 36 AND 43), (U.S. CLS. 100, 101 AND 102). SN 85-277,201. PUB. 8-9-2011. FILED 3-25-2011.
- 4,044,903. **EQUITY RISE REAL ESTATE GROUP AND DESIGN**. EQUITY RISE REAL ESTATE GROUP, LLC, (U.S. CLS. 100, 101 AND 102). SN 85-277,390. PUB. 8-9-2011. FILED 3-25-2011.
- 4,044,907. **MISCELLANEOUS DESIGN**. SUSSEX BANCORP, (U.S. CLS. 100, 101 AND 102). SN 85-277,429. PUB. 8-9-2011. FILED 3-25-2011.
- 4,044,934. **PROTECTING YOUR ASSETS. (STANDARD CHARACTER)**. HCF INSURANCE AGENCY, (U.S. CLS. 100, 101 AND 102). SN 85-277,821. PUB. 8-9-2011. FILED 3-26-2011.
- 4,044,944. **MISCELLANEOUS DESIGN**. UNITED STATES OF AMERICA NATIONAL KARATE-DO FEDERATION, (U.S. CLS. 100, 101 AND 102). SN 85-278,018. PUB. 8-9-2011. FILED 3-27-2011.
- 4,044,971 ( *See Class 35 for this trademark*).
- 4,044,987. **WILL TO LIVE (STANDARD CHARACTER)**. THE WILL-TO-LIVE FOUNDATION, INC., (U.S. CLS. 100, 101 AND 102). SN 85-278,512. PUB. 8-9-2011. FILED 3-28-2011.
- 4,044,990. **MISCELLANEOUS DESIGN**. AVP MANAGEMENT SERVICES, INC., (U.S. CLS. 100, 101 AND 102). SN 85-278,583. PUB. 8-9-2011. FILED 3-28-2011.
- 4,045,002 ( *See Class 35 for this trademark*).
- 4,045,023. **THE YES! YES! LENDER (STANDARD CHARACTER)**. WESTLAKE SERVICES, INC., (U.S. CLS. 100, 101 AND 102). SN 85-279,014. PUB. 8-9-2011. FILED 3-28-2011.
- 4,045,034. **BIZURANCE (STANDARD CHARACTER)**. CUMMINGS, TROY L., (U.S. CLS. 100, 101 AND 102). SN 85-279,138. PUB. 8-9-2011. FILED 3-28-2011.
- 4,045,042. **LEMONS TO AID (STANDARD CHARACTER)**. LTA (LEMONS TO AID) FOUNDATION, (U.S. CLS. 100, 101 AND 102). SN 85-279,212. PUB. 8-9-2011. FILED 3-29-2011.
- 4,045,073 ( *See Class 35 for this trademark*).
- 4,045,089. **PUT ON YOUR PINK BRA (STANDARD CHARACTER)**. AMERICAN CANCER SOCIETY, FLORIDA DIVISION, INC., (U.S. CLS. 100, 101 AND 102). SN 85-279,887. PUB. 8-9-2011. FILED 3-29-2011.
- 4,045,098. **TINY SPARROW FOUNDATION AND DESIGN**. TINY SPARROW FOUNDATION, (U.S. CLS. 100, 101 AND 102). SN 85-280,043. PUB. 8-9-2011. FILED 3-29-2011.
- 4,045,136. **Z AND DESIGN**. ZEPPONI & COMPANY, (U.S. CLS. 100, 101 AND 102). SN 85-280,493. PUB. 8-9-2011. FILED 3-29-2011.
- 4,045,142. **ADVANTAGE (STANDARD CHARACTER)**. VIR-TUS BENEFITS, INC., (U.S. CLS. 100, 101 AND 102). SN 85-280,565. PUB. 8-9-2011. FILED 3-29-2011.
- 4,045,166. **MISCELLANEOUS DESIGN**. AMERICAN BANK OF TEXAS, (U.S. CLS. 100, 101 AND 102). SN 85-280,910. PUB. 8-9-2011. FILED 3-30-2011.
- 4,045,178. **IT'S YOUR WORLD. TRADE IT. (STANDARD CHARACTER)**. GAIN CAPITAL GROUP, LLC, DBA FOREX.COM, (U.S. CLS. 100, 101 AND 102). SN 85-281,011. PUB. 8-9-2011. FILED 3-30-2011.
- 4,045,186. **BANK SMARTER (STANDARD CHARACTER)**. BELLCO CREDIT UNION, (U.S. CLS. 100, 101 AND 102). SN 85-281,105. PUB. 8-9-2011. FILED 3-30-2011.
- 4,045,187. **RISK MANAGEMENT FOR THE DECADE AHEAD (STANDARD CHARACTER)**. FRANKLIN RESOURCES, INC., DBA FRANKLIN TEMPLETON INVESTMENTS, (U.S. CLS. 100, 101 AND 102). SN 85-281,128. PUB. 8-9-2011. FILED 3-30-2011.
- 4,045,214. **LOTUS OUTREACH INTERNATIONAL AND DESIGN**. LOTUS OUTREACH, (U.S. CLS. 100, 101 AND 102). SN 85-281,633. PUB. 8-9-2011. FILED 3-30-2011.
- 4,045,228. **PAGETRADER (STANDARD CHARACTER)**. PAGE-TRADER, LTD. (U.S. CLS. 100, 101 AND 102). SN 85-281,812. PUB. 8-9-2011. FILED 3-30-2011.
- 4,045,261. **MCPLUS (STANDARD CHARACTER)**. MACK-CALI REALTY, L.P., (U.S. CLS. 100, 101 AND 102). SN 85-282,101. PUB. 8-9-2011. FILED 3-31-2011.
- 4,045,264. **MC365 (STANDARD CHARACTER)**. MACK-CALI REALTY, L.P., MULTIPLE CLASS, (INT. CLS. 36 AND 37), (U.S. CLS. 100, 101, 102, 103 AND 106). SN 85-282,113. PUB. 8-9-2011. FILED 3-31-2011.
- 4,045,285. **SHAKE THE PIG (STANDARD CHARACTER)**. THE PNC FINANCIAL SERVICES GROUP, INC., (U.S. CLS. 100, 101 AND 102). SN 85-282,417. PUB. 8-9-2011. FILED 3-31-2011.
- 4,045,301. **EAGLE AGRIPROTECT (STANDARD CHARACTER)**. AKITA, INC., (U.S. CLS. 100, 101 AND 102). SN 85-282,576. PUB. 8-9-2011. FILED 3-31-2011.
- 4,045,307. **YOU NEED INSURANCE, WE MAKE IT EASY! (STANDARD CHARACTER)**. LANG INSURANCE SERVICE, INC., (U.S. CLS. 100, 101 AND 102). SN 85-282,692. PUB. 8-9-2011. FILED 3-31-2011.
- 4,045,321. **HEWITT ENNISKNUPP (STYLIZED)**. HEWITT ASSOCIATES LLC, (U.S. CLS. 100, 101 AND 102). SN 85-282,915. PUB. 8-9-2011. FILED 3-31-2011.
- 4,045,377. **FOSTER CARE TO SUCCESS (STANDARD CHARACTER)**. ORPHAN FOUNDATION OF AMERICA, DBA ORPHAN FOUNDATION OF AMERICA, MULTIPLE CLASS, (INT. CLS. 36 AND 41), (U.S. CLS. 100, 101, 102 AND 107). SN 85-283,540. PUB. 8-9-2011. FILED 4-1-2011.
- 4,045,401. **GAPP II (STANDARD CHARACTER)**. GEORGE W. EVANS & ASSOCIATES, INC., (U.S. CLS. 100, 101 AND 102). SN 85-283,867. PUB. 8-9-2011. FILED 4-1-2011.
- 4,045,420. **ESTATEWISE (STANDARD CHARACTER)**. VAN-TIS LIFE INSURANCE COMPANY, (U.S. CLS. 100, 101 AND 102). SN 85-284,025. PUB. 8-9-2011. FILED 4-1-2011.
- 4,045,481. **PURSES FOR POOCHES & PALS (STANDARD CHARACTER)**. HUMANE SOCIETY OF MISSOURI, (U.S. CLS. 100, 101 AND 102). SN 85-285,697. PUB. 8-9-2011. FILED S.R. 4-4-2011; AM. P.R. 6-30-2011.
- 4,045,486. **WORTH THE HURT (STANDARD CHARACTER)**. WORTH THE HURT, INC., (U.S. CLS. 100, 101 AND 102). SN 85-285,887. PUB. 8-9-2011. FILED 4-4-2011.
- 4,045,509. **BORROW FROM A FRIEND. (STANDARD CHARACTER)**. CASHCO FINANCIAL SERVICES, INC., (U.S. CLS. 100, 101 AND 102). SN 85-288,001. PUB. 8-9-2011. FILED 4-6-2011.
- 4,045,511. **PÍDELE PRESTADO A UN AMIGO. (STANDARD CHARACTER)**. CASHCO FINANCIAL SERVICES, INC., (U.S. CLS. 100, 101 AND 102). SN 85-288,087. PUB. 8-9-2011.

- FILED 4-6-2011.  
 4,045,527. **ECS AND DESIGN**. FEDERAL RESERVE BANK OF ST. LOUIS, (U.S. CLS. 100, 101 AND 102). SN 85-292,723. PUB. 8-9-2011. FILED 4-12-2011.  
 4,045,554. **LINCOLN RETIREMENT POWER (STANDARD CHARACTER)**. THE LINCOLN NATIONAL LIFE INSURANCE COMPANY, (U.S. CLS. 100, 101 AND 102). SN 85-308,492. PUB. 8-9-2011. FILED 4-29-2011.  
 4,045,559. **EVERY CORK COUNTS (STANDARD CHARACTER)**. E. & J. GALLO WINERY, (U.S. CLS. 100, 101 AND 102). SN 85-312,404. PUB. 8-9-2011. FILED 5-4-2011.

### CLASS 37—CONSTRUCTION AND REPAIR

- 4,043,609. **INNOVATIVE SOLUTIONS FOR GREENER BUILDINGS (STANDARD CHARACTER)**. DISTECH CONTROLS INC., (U.S. CLS. 100, 103 AND 106). SN 76-698,285. PUB. 8-9-2011. FILED 7-7-2009.  
 4,043,649 ( *See Class 1 for this trademark*).  
 4,043,692. **7TICKS (STANDARD CHARACTER)**. INTERACTIVE DATA CORPORATION, MULTIPLE CLASS, (INT. CLS. 37, 38 AND 42), (U.S. CLS. 100, 101, 103, 104 AND 106). SN 77-859,967. PUB. 8-9-2011. FILED 10-28-2009.  
 4,043,704. **UNITTURNS (STANDARD CHARACTER)**. UNITTURNS, LLC, (U.S. CLS. 100, 103 AND 106). SN 77-893,874. PUB. 8-9-2011. FILED 12-15-2009.  
 4,043,705 ( *See Class 16 for this trademark*).  
 4,043,747 ( *See Class 9 for this trademark*).  
 4,043,784 ( *See Class 7 for this trademark*).  
 4,043,799 ( *See Class 9 for this trademark*).  
 4,043,800 ( *See Class 7 for this trademark*).  
 4,043,805. **BIOTEC AND DESIGN**. BIOTEC UMWELTSERVICES GMBH, MULTIPLE CLASS, (INT. CLS. 37 AND 39), (U.S. CLS. 100, 103, 105 AND 106). SN 79-089,783. PUB. 8-9-2011. FILED 9-8-2010.  
 4,043,835 ( *See Class 7 for this trademark*).  
 4,043,838 ( *See Class 12 for this trademark*).  
 4,043,840. **ECR MINERALS (STANDARD CHARACTER)**. ECR MINERALS PLC, MULTIPLE CLASS, (INT. CLS. 37 AND 42), (U.S. CLS. 100, 101, 103 AND 106). SN 79-093,473. PUB. 8-9-2011. FILED 12-7-2010.  
 4,043,854 ( *See Class 12 for this trademark*).  
 4,043,928. **THAT'S MY NETWORK (STANDARD CHARACTER)**. LT LLC, MULTIPLE CLASS, (INT. CLS. 37, 38 AND 42), (U.S. CLS. 100, 101, 103, 104 AND 106). SN 85-082,698. PUB. 8-9-2011. FILED 7-12-2010.  
 4,043,933 ( *See Class 35 for this trademark*).  
 4,043,945. **THE RICHMAN GROUP (STANDARD CHARACTER)**. THE RICHMAN GROUP, INC., (U.S. CLS. 100, 103 AND 106). SN 85-101,180. PUB. 8-9-2011. FILED 8-5-2010.  
 4,043,946. **THE RICHMAN GROUP OF COMPANIES (STANDARD CHARACTER)**. THE RICHMAN GROUP, INC., (U.S. CLS. 100, 103 AND 106). SN 85-101,196. PUB. 8-9-2011. FILED 8-5-2010.  
 4,043,996 ( *See Class 9 for this trademark*).  
 4,044,091. **SO CAL AND DESIGN**. SO CAL SANITATION LLC, MULTIPLE CLASS, (INT. CLS. 37 AND 44), (U.S. CLS. 100, 101, 103 AND 106). SN 85-159,508. PUB. 8-9-2011. FILED 10-22-2010.  
 4,044,244 ( *See Class 35 for this trademark*).  
 4,044,269 ( *See Class 36 for this trademark*).  
 4,044,273. **SUPERIOR AUTO WORKS AND DESIGN**. SUPERIOR AUTO WORKS, LLC, (U.S. CLS. 100, 103 AND 106). SN 85-233,490. PUB. 8-9-2011. FILED 2-3-2011.  
 4,044,395. **HEATHTECNA (STANDARD CHARACTER)**. HEATH TECNA INC., (U.S. CLS. 100, 103 AND 106). SN 85-258,668. PUB. 8-9-2011. FILED 3-4-2011.  
 4,044,405. **ANTHONY PLUMBING SINCE 1976 AND DESIGN**. ANTHONY PLUMBING, INC., (U.S. CLS. 100, 103 AND 106). SN 85-259,308. PUB. 8-9-2011. FILED 3-7-2011.  
 4,044,409. **STAY GREEN INC. (STANDARD CHARACTER)**. STAY-GREEN, INC., MULTIPLE CLASS, (INT. CLS. 37 AND 44), (U.S. CLS. 100, 101, 103 AND 106). SN 85-259,562. PUB. 8-9-2011. FILED 3-7-2011.  
 4,044,410. **THE NATURAL CHOICE FOR PROFESSIONAL LANDSCAPE SERVICES (STANDARD CHARACTER)**. STAY-GREEN, INC., MULTIPLE CLASS, (INT. CLS. 37 AND 44), (U.S. CLS. 100, 101, 103 AND 106). SN 85-259,591. PUB. 8-9-2011. FILED 3-7-2011.  
 4,044,424. **TECH YEAH (STANDARD CHARACTER)**. BUSINESS CANOE, LLC, (U.S. CLS. 100, 103 AND 106). SN 85-260,075. PUB. 8-9-2011. FILED 3-7-2011.  
 4,044,438 ( *See Class 19 for this trademark*).  
 4,044,439. **DUMPSTER DIVA (STANDARD CHARACTER)**. PINKOWSKI, ALLISON S., DBA DUMPSTER DIVA, (U.S. CLS. 100, 103 AND 106). SN 85-260,959. PUB. 8-9-2011. FILED 3-8-2011.  
 4,044,454. **RESCUE GREEN AND DESIGN**. BLANCO, JOSEPH, (U.S. CLS. 100, 103 AND 106). SN 85-261,491. PUB. 8-9-2011. FILED 3-8-2011.  
 4,044,464. **MORRISSEY (STYLIZED)**. MORRISSEY CONSTRUCTION COMPANY, (U.S. CLS. 100, 103 AND 106). SN 85-261,943. PUB. 8-9-2011. FILED 3-9-2011.  
 4,044,503. **ONECLICK CLEANERS (STANDARD CHARACTER)**. ONECLICK CLEANERS INC, (U.S. CLS. 100, 103 AND 106). SN 85-263,276. PUB. 8-9-2011. FILED 3-10-2011.  
 4,044,513. **GRASS TAGGERS AND DESIGN**. GNAGY, ALAN, (U.S. CLS. 100, 103 AND 106). SN 85-263,482. PUB. 8-9-2011. FILED 3-10-2011.  
 4,044,539. **POWER CITY ELECTRIC (STANDARD CHARACTER)**. POWER CITY ELECTRIC, INC., (U.S. CLS. 100, 103 AND 106). SN 85-264,336. PUB. 8-9-2011. FILED 3-11-2011.  
 4,044,579 ( *See Class 35 for this trademark*).  
 4,044,655. **SOFTLOAD (STANDARD CHARACTER)**. CATALYST SERVICES, INC., (U.S. CLS. 100, 103 AND 106). SN 85-273,828. PUB. 8-9-2011. FILED 3-22-2011.  
 4,044,718. **MISCELLANEOUS DESIGN**. TERRAZAS, GUADALUPE, (U.S. CLS. 100, 103 AND 106). SN 85-274,791. PUB. 8-9-2011. FILED 3-23-2011.  
 4,044,728. **KEEPING YOUR LIFE RUNNING (STANDARD CHARACTER)**. JOHNSON'S AUTOMOTIVE SERVICE, INC., (U.S. CLS. 100, 103 AND 106). SN 85-274,945. PUB. 8-9-2011. FILED 3-23-2011.  
 4,044,749. **FRYER-TO-FUEL (STANDARD CHARACTER)**. GREENLIGHT BIOFUELS HOLDINGS, LLC, DBA GREENLIGHT BIOFUELS, MULTIPLE CLASS, (INT. CLS. 37 AND 40), (U.S. CLS. 100, 103 AND 106). SN 85-275,379. PUB. 8-9-2011. FILED 3-24-2011.  
 4,044,750. **LABWORKS EQUIPMENT SERVICE, INC. (STANDARD CHARACTER)**. LABWORKS EQUIPMENT SERVICE, INC., (U.S. CLS. 100, 103 AND 106). SN 85-275,398. PUB. 8-9-2011. FILED 3-24-2011.  
 4,044,751. **R360 (STANDARD CHARACTER)**. R360 ENVIRONMENTAL SOLUTIONS, INC., MULTIPLE CLASS, (INT. CLS. 37, 39 AND 40), (U.S. CLS. 100, 103, 105 AND 106). SN 85-275,403. PUB. 8-9-2011. FILED 3-24-2011.  
 4,044,782. **PRORIG (STANDARD CHARACTER)**. PRODUCTION AND RIGGING RESOURCES, INC., (U.S. CLS. 100, 103 AND 106). SN 85-275,753. PUB. 8-9-2011. FILED 3-24-2011.  
 4,045,110. **MISCELLANEOUS DESIGN**. MISSOURI BASIN MUNICIPAL POWER AGENCY, DBA MISSOURI RIVER ENERGY SERVICES, (U.S. CLS. 100, 103 AND 106). SN 85-280,236. PUB. 8-9-2011. FILED 3-29-2011.  
 4,045,224. **GOT DIRT? (STANDARD CHARACTER)**. MORGAN, MORRIS, (U.S. CLS. 100, 103 AND 106). SN 85-281,768. PUB. 8-9-2011. FILED 3-30-2011.  
 4,045,264 ( *See Class 36 for this trademark*).  
 4,045,275 ( *See Class 25 for this trademark*).  
 4,045,333. **TIECRAFTERS (STYLIZED)**. TIECRAFTERS, INC., (U.S. CLS. 100, 103 AND 106). SN 85-283,025. PUB. 8-9-2011. FILED 3-31-2011.  
 4,045,336. **BUILDER FOR LIFE (STANDARD CHARACTER)**. DESERT STAR CONSTRUCTION, INC., (U.S. CLS. 100, 103 AND 106). SN 85-283,049. PUB. 8-9-2011. FILED 3-31-2011.  
 4,045,341. **TEAM DSC (STANDARD CHARACTER)**. DESERT STAR CONSTRUCTION, INC., (U.S. CLS. 100, 103 AND 106). SN 85-283,094. PUB. 8-9-2011. FILED 3-31-2011.  
 4,045,378. **REVO STEP AND DESIGN**. REVO INTERNATIONAL, LLC, (U.S. CLS. 100, 103 AND 106). SN 85-283,546. PUB. 8-9-2011. FILED 4-1-2011.  
 4,045,381. **CCC AND DESIGN**. CARPEL CLEANING CORP., (U.S. CLS. 100, 103 AND 106). SN 85-283,604. PUB. 8-9-2011. FILED 4-1-2011.

4,045,399. **SWIM-SAFE (STANDARD CHARACTER)**. JOHNSON, DAN, (U.S. CLS. 100, 103 AND 106). SN 85-283,827. PUB. 8-9-2011. FILED 4-1-2011.

4,045,424. **QT AND DESIGN**. QUALITY TESTING, LLC, MULTIPLE CLASS, (INT. CLS. 37 AND 42), (U.S. CLS. 100, 101, 103 AND 106). SN 85-284,067. PUB. 8-9-2011. FILED 4-1-2011.

4,045,449. **CLEAR LOOK AND DESIGN**. CLEAR LOOK SERVICES, LLC, (U.S. CLS. 100, 103 AND 106). SN 85-284,399. PUB. 8-9-2011. FILED 4-1-2011.

---

### CLASS 38—COMMUNICATION

4,043,642 ( *See Class 9 for this trademark* ).

4,043,671. **GLOBAL DEVELOPMENT LEARNING NETWORK (STANDARD CHARACTER)**. INTERNATIONAL BANK FOR RECONSTRUCTION AND DEVELOPMENT, AKA WORLD BANK, MULTIPLE CLASS, (INT. CLS. 38 AND 41), (U.S. CLS. 100, 101, 104 AND 107). SN 77-728,177. PUB. 8-9-2011. FILED 5-4-2009.

4,043,679. **PROJECT SORA (STANDARD CHARACTER)**. NINTENDO OF AMERICA INC., (U.S. CLS. 100, 101 AND 104). SN 77-789,101. PUB. 7-20-2010. FILED 7-24-2009.

4,043,689 ( *See Class 3 for this trademark* ).

4,043,692 ( *See Class 37 for this trademark* ).

4,043,695 ( *See Class 9 for this trademark* ).

4,043,697 ( *See Class 9 for this trademark* ).

4,043,729. **VOICEPLUS (STANDARD CHARACTER)**. VOICE PLUS, INC., DBA VOICEPLUS, (U.S. CLS. 100, 101 AND 104). SN 77-967,517. PUB. 8-9-2011. FILED 3-24-2010.

4,043,747 ( *See Class 9 for this trademark* ).

4,043,758. **E SURFING AND DESIGN**. CHINA TELECOM CORPORATION LIMITED, (U.S. CLS. 100, 101 AND 104). SN 79-084,558. PUB. 8-9-2011. FILED 4-27-2010.

4,043,773 ( *See Class 9 for this trademark* ).

4,043,785 ( *See Class 3 for this trademark* ).

4,043,788 ( *See Class 9 for this trademark* ).

4,043,807 ( *See Class 35 for this trademark* ).

4,043,908. **SOPHIE@103.7 (STANDARD CHARACTER)**. CBS RADIO STATIONS INC., (U.S. CLS. 100, 101 AND 104). SN 85-057,663. PUB. 8-9-2011. FILED 6-8-2010.

4,043,917 ( *See Class 9 for this trademark* ).

4,043,928 ( *See Class 37 for this trademark* ).

4,044,021 ( *See Class 9 for this trademark* ).

4,044,059. **RUSSELL PETERS (STANDARD CHARACTER)**. JUST THE TIP, INC., (U.S. CLS. 100, 101 AND 104). SN 85-141,500. PUB. 8-9-2011. FILED 9-29-2010.

4,044,081 ( *See Class 9 for this trademark* ).

4,044,082 ( *See Class 9 for this trademark* ).

4,044,100 ( *See Class 35 for this trademark* ).

4,044,112. **GLOBE IFUSION (STANDARD CHARACTER)**. GLOBE WIRELESS, LLC, (U.S. CLS. 100, 101 AND 104). SN 85-169,438. PUB. 8-9-2011. FILED 11-4-2010.

4,044,343. **101 THE ROSE WROZ-FM AND DESIGN**. HALL COMMUNICATIONS, INC., (U.S. CLS. 100, 101 AND 104). SN 85-251,819. PUB. 8-9-2011. FILED 2-25-2011.

4,044,351 ( *See Class 35 for this trademark* ).

4,044,471. **WIRELESS FOR HOPE AND DESIGN**. TELECOM SERVICE BUREAU, INC., (U.S. CLS. 100, 101 AND 104). SN 85-262,250. PUB. 8-9-2011. FILED 3-9-2011.

4,044,679 ( *See Class 9 for this trademark* ).

4,044,842. **WLT MEDICARD (STANDARD CHARACTER)**. WLT SOFTWARE ENTERPRISES, INC., (U.S. CLS. 100, 101 AND 104). SN 85-276,580. PUB. 8-9-2011. FILED 3-25-2011.

4,044,893. **LOVE TRANSFUSION (STANDARD CHARACTER)**. LOVE TRANSFUSION, INC., (U.S. CLS. 100, 101 AND 104). SN 85-277,287. PUB. 8-9-2011. FILED 3-25-2011.

4,044,894. **MISCELLANEOUS DESIGN**. LOVE TRANSFUSION, INC., (U.S. CLS. 100, 101 AND 104). SN 85-277,304. PUB. 8-9-2011. FILED 3-25-2011.

4,044,953 ( *See Class 9 for this trademark* ).

4,044,961. **CLOUDSPOKES (STANDARD CHARACTER)**. APPIRIO INC., MULTIPLE CLASS, (INT. CLS. 38 AND 41), (U.S. CLS. 100, 101, 104 AND 107). SN 85-278,233. PUB. 8-9-2011. FILED 3-28-2011.

4,044,962. **MISCELLANEOUS DESIGN**. APPIRIO INC., MULTIPLE CLASS, (INT. CLS. 38 AND 41), (U.S. CLS. 100, 101, 104 AND 107). SN 85-278,238. PUB. 8-9-2011. FILED 3-28-2011.

4,045,076. **YOUR DAILY DOSE OF INTERESTING. (STANDARD CHARACTER)**. AMERICAN UNIVERSITY, MULTIPLE CLASS, (INT. CLS. 38 AND 41), (U.S. CLS. 100, 101, 104 AND 107). SN 85-279,785. PUB. 8-9-2011. FILED 3-29-2011.

4,045,080. **WELL VERSED. WELL READ. WELL TRAVELED. WELL INFORMED. WELL SPOKEN. WELL LISTENED. (STANDARD CHARACTER)**. AMERICAN UNIVERSITY, MULTIPLE CLASS, (INT. CLS. 38 AND 41), (U.S. CLS. 100, 101, 104 AND 107). SN 85-279,831. PUB. 8-9-2011. FILED 3-29-2011.

4,045,083. **RADIO WITHOUT ALL THE NOISE. (STANDARD CHARACTER)**. AMERICAN UNIVERSITY, MULTIPLE CLASS, (INT. CLS. 38 AND 41), (U.S. CLS. 100, 101, 104 AND 107). SN 85-279,850. PUB. 8-9-2011. FILED 3-29-2011.

4,045,088 ( *See Class 35 for this trademark* ).

4,045,152. **BROKERROSTER (STANDARD CHARACTER)**. SYAGE, INC., (U.S. CLS. 100, 101 AND 104). SN 85-280,703. PUB. 8-9-2011. FILED 3-30-2011.

4,045,201. **P AND DESIGN**. SCREEN MEDIA VENTURES, LLC, (U.S. CLS. 100, 101 AND 104). SN 85-281,375. PUB. 8-9-2011. FILED 3-30-2011.

4,045,299 ( *See Class 9 for this trademark* ).

4,045,308 ( *See Class 35 for this trademark* ).

4,045,327. **HEALTH-ISP (STANDARD CHARACTER)**. GARDEN STATE HEALTH SYSTEMS INC, (U.S. CLS. 100, 101 AND 104). SN 85-282,963. PUB. 8-9-2011. FILED 3-31-2011.

4,045,464. **DEJAMVU (STANDARD CHARACTER)**. FRAUM, COLLIN A., DBA DEJAMVU, INC., (U.S. CLS. 100, 101 AND 104). SN 85-284,773. PUB. 8-9-2011. FILED 4-3-2011.

4,045,513. **ON DEMAND AND DESIGN**. UNIVISION COMMUNICATIONS INC., MULTIPLE CLASS, (INT. CLS. 38 AND 41), (U.S. CLS. 100, 101, 104 AND 107). SN 85-288,192. PUB. 8-9-2011. FILED 4-6-2011.

---

### CLASS 39—TRANSPORTATION AND STORAGE

4,043,649 ( *See Class 1 for this trademark* ).

4,043,689 ( *See Class 3 for this trademark* ).

4,043,705 ( *See Class 16 for this trademark* ).

4,043,740. **WE DELIVER! WWW.CN.CA (STYLIZED)**. CANADIAN NATIONAL RAILWAY COMPANY, (U.S. CLS. 100 AND 105). SN 78-885,934. PUB. 2-16-2010. FILED 5-17-2006.

4,043,754. **CTS AND DESIGN**. CHINA NATIONAL TRAVEL SERVICE; (H.K.) GROUP CORPORATION, MULTIPLE CLASS, (INT. CLS. 39, 41 AND 43), (U.S. CLS. 100, 101, 105 AND 107). SN 79-083,727. PUB. 3-8-2011. FILED 4-13-2010.

4,043,805 ( *See Class 37 for this trademark* ).

4,043,807 ( *See Class 35 for this trademark* ).

4,043,912. **TIKKI BEACH (STANDARD CHARACTER)**. DAWSON, DEBRA K, MULTIPLE CLASS, (INT. CLS. 39 AND 43), (U.S. CLS. 100, 101 AND 105). SN 85-060,091. PUB. 7-5-2011. FILED 6-10-2010.

4,043,993. **SALTY DOG SPORTFISHING KONA HAWAII AND DESIGN**. LATTOF, MITCHELL G. (III), DBA SALTY DOG SPORTFISHING, (U.S. CLS. 100 AND 105). SN 85-117,506. PUB. 8-9-2011. FILED 8-27-2010.

4,044,005. **DINE IN 2NITE (STANDARD CHARACTER)**. FRANVEST INTERNATIONAL, INC., (U.S. CLS. 100 AND 105). SN 85-120,416. PUB. 8-9-2011. FILED 9-1-2010.

4,044,093. **LIDESTRI (STANDARD CHARACTER)**. LIDESTRI FOODS, INC., MULTIPLE CLASS, (INT. CLS. 39, 40 AND 42), (U.S. CLS. 100, 101, 103, 105 AND 106). SN 85-162,103. PUB. 8-9-2011. FILED 10-27-2010.

4,044,124 ( *See Class 35 for this trademark* ).

4,044,133. **TEAM RV AND DESIGN**. MIKE STEWART, DBA TEAM RV, (U.S. CLS. 100 AND 105). SN 85-182,383. PUB. 8-9-2011. FILED S.R. 11-22-2010; AM. P.R. 5-25-2011.

4,044,152. **WATKINS MOTOR LINES, INC. AND DESIGN**. WATKINS ASSOCIATED INDUSTRIES, INC., (U.S. CLS. 100 AND 105). SN 85-191,169. PUB. 8-9-2011. FILED 12-6-2010.

4,044,362. **PLANETHOP! (STANDARD CHARACTER)**. BROAD SKYS LLC, (U.S. CLS. 100 AND 105). SN 85-254,321. PUB. 8-9-2011. FILED 3-1-2011.

4,044,426. **CRUISELINK AND DESIGN**. GLOBAL MARINE TRAVEL LLC, (U.S. CLS. 100 AND 105). SN 85-260,190. PUB. 8-9-2011. FILED 3-7-2011.

4,044,493. **AVID (STANDARD CHARACTER)**. AVID AIRLINE PRODUCTS OF RHODE ISLAND, INC., (U.S. CLS. 100 AND 105). SN 85-263,187. PUB. 8-9-2011. FILED 3-10-2011.

4,044,506. **O.A.R.S. (STANDARD CHARACTER)**. O.A.R.S. COMPANIES, INC., MULTIPLE CLASS, (INT. CLS. 39 AND 43), (U.S. CLS. 100, 101 AND 105). SN 85-263,322. PUB. 8-9-2011. FILED 3-10-2011.

4,044,515. **KEYS4CABS AND DESIGN**. KEYS4CABS, INC., MULTIPLE CLASS, (INT. CLS. 39 AND 41), (U.S. CLS. 100, 101, 105 AND 107). SN 85-263,595. PUB. 8-9-2011. FILED 3-10-2011.

4,044,584. **INNERMIX (STANDARD CHARACTER)**. INNERMIX H2O BEVERAGES, L.L.C., (U.S. CLS. 100 AND 105). SN 85-266,820. PUB. 8-9-2011. FILED 3-14-2011.

4,044,647. **USADDRESS (STYLIZED)**. USADDRESS.COM INC., (U.S. CLS. 100 AND 105). SN 85-273,704. PUB. 8-9-2011. FILED 3-22-2011.

4,044,742. **THE BEST LITTLE AIRPORT IN THE COUNTRY (STANDARD CHARACTER)**. CITY OF NAPLES AIRPORT AUTHORITY, (U.S. CLS. 100 AND 105). SN 85-275,263. PUB. 8-9-2011. FILED 3-24-2011.

4,044,751 ( *See Class 37 for this trademark*).

4,044,829. **IFREIGHT (STANDARD CHARACTER)**. SLABY, CEASAR, (U.S. CLS. 100 AND 105). SN 85-276,461. PUB. 8-9-2011. FILED 3-25-2011.

4,044,851. **REDI-BOX (STANDARD CHARACTER)**. REDI-BOX, (U.S. CLS. 100 AND 105). SN 85-276,740. PUB. 8-9-2011. FILED 3-25-2011.

4,044,871. **R AND DESIGN**. REINAUER TRANSPORTATION COMPANIES, LLC, (U.S. CLS. 100 AND 105). SN 85-277,029. PUB. 8-9-2011. FILED 3-25-2011.

4,044,872. **R AND DESIGN**. REINAUER TRANSPORTATION COMPANIES, LLC, (U.S. CLS. 100 AND 105). SN 85-277,035. PUB. 8-9-2011. FILED 3-25-2011.

4,044,970. **JUNK REMEDY (STANDARD CHARACTER)**. NC JUNK REMOVAL, INC., DBA JUNK REMEDY, (U.S. CLS. 100 AND 105). SN 85-278,354. PUB. 8-9-2011. FILED 3-28-2011.

4,045,009. **BEDRIVEN (STANDARD CHARACTER)**. DRIVEN ENTERPRISES, LLC, (U.S. CLS. 100 AND 105). SN 85-278,873. PUB. 8-9-2011. FILED 3-28-2011.

4,045,025. **YB (STANDARD CHARACTER)**. YOUNG BROTHERS, LIMITED, (U.S. CLS. 100 AND 105). SN 85-279,029. PUB. 8-9-2011. FILED 3-28-2011.

4,045,067. **MISCELLANEOUS DESIGN**. MISSOURI BASIN MUNICIPAL POWER AGENCY, DBA MISSOURI RIVER ENERGY SERVICES, (U.S. CLS. 100 AND 105). SN 85-279,596. PUB. 8-9-2011. FILED 3-29-2011.

4,045,202. **NTC AND DESIGN**. NEBRASKA TRANSPORT CO. INC., (U.S. CLS. 100 AND 105). SN 85-281,402. PUB. 8-9-2011. FILED 3-30-2011.

4,045,209. **MISCELLANEOUS DESIGN**. ALL RESORT COACH, INC., DBA LEWIS STAGES, (U.S. CLS. 100 AND 105). SN 85-281,508. PUB. 8-9-2011. FILED 3-30-2011.

4,045,280. **JOIN THE STAMPEDE (STANDARD CHARACTER)**. BOB LITTER'S FUEL AND HEATING CO., INC., (U.S. CLS. 100 AND 105). SN 85-282,374. PUB. 8-9-2011. FILED 3-31-2011.

4,045,360. **WE LIVE HERE WE DELIVER HERE (STANDARD CHARACTER)**. LONE STAR HOLDINGS, LLC, (U.S. CLS. 100 AND 105). SN 85-283,347. PUB. 8-9-2011. FILED 4-1-2011.

4,045,380. **AREA WIDE PROTECTIVE (STANDARD CHARACTER)**. AWP, INC., MULTIPLE CLASS, (INT. CLS. 39 AND 42), (U.S. CLS. 100, 101 AND 105). SN 85-283,564. PUB. 8-9-2011. FILED 4-1-2011.

4,045,492. **QUINLAN (STANDARD CHARACTER)**. THE QUINLAN COMPANIES, INC., (U.S. CLS. 100 AND 105). SN 85-286,208. PUB. 8-9-2011. FILED 4-5-2011.

4,045,531 ( *See Class 35 for this trademark*).

4,045,573. **ANYWHERE YOU WANT TO GO (STANDARD CHARACTER)**. DRIVEN ENTERPRISES, LLC, (U.S. CLS. 100 AND 105). SN 85-344,329. PUB. 8-9-2011. FILED 6-13-

2011.

**CLASS 40—MATERIAL TREATMENT**

4,043,651 ( *See Class 11 for this trademark*).

4,043,658 ( *See Class 1 for this trademark*).

4,043,743 ( *See Class 35 for this trademark*).

4,043,812 ( *See Class 4 for this trademark*).

4,043,933 ( *See Class 35 for this trademark*).

4,043,992. **MAKE IT SPRAY TODAY (STANDARD CHARACTER)**. HASKELL, DWAYNE, MULTIPLE CLASS, (INT. CLS. 40 AND 42), (U.S. CLS. 100, 101, 103 AND 106). SN 85-117,478. PUB. 8-9-2011. FILED 8-27-2010.

4,044,036. **MAGGIE AUSTIN CAKE (STANDARD CHARACTER)**. LABAUGH, MAGGIE A., (U.S. CLS. 100, 103 AND 106). SN 85-132,267. PUB. 8-9-2011. FILED S.R. 9-17-2010; AM. P.R. 6-13-2011.

4,044,093 ( *See Class 39 for this trademark*).

4,044,121. **GA GEAR CUSTOM SCREEN PRINTING, EMBROIDERY & WEB DESIGN AND DESIGN**. BLUE SKY INC., (U.S. CLS. 100, 103 AND 106). SN 85-175,351. PUB. 8-9-2011. FILED 11-12-2010.

4,044,137. **D AND DESIGN**. DINSMORE & ASSOCIATES, INC., (U.S. CLS. 100, 103 AND 106). SN 85-184,054. PUB. 8-9-2011. FILED 11-23-2010.

4,044,147. **SCRAP APP AND DESIGN**. ROCKAWAY RECYCLING, INC., (U.S. CLS. 100, 103 AND 106). SN 85-188,190. PUB. 5-3-2011. FILED 12-1-2010.

4,044,231. **ALL FIRED UP (STANDARD CHARACTER)**. ALL FIRED UP, LLC, MULTIPLE CLASS, (INT. CLS. 40 AND 41), (U.S. CLS. 100, 101, 103, 106 AND 107). SN 85-225,639. PUB. 8-9-2011. FILED 1-25-2011.

4,044,232. **ALL FIRED UP AND DESIGN**. ALL FIRED UP, LLC, MULTIPLE CLASS, (INT. CLS. 40 AND 41), (U.S. CLS. 100, 101, 103, 106 AND 107). SN 85-225,712. PUB. 8-9-2011. FILED 1-25-2011.

4,044,238 ( *See Class 11 for this trademark*).

4,044,247 ( *See Class 11 for this trademark*).

4,044,336. **SUBLIME-D-ZIGN (STANDARD CHARACTER)**. ERIN GLOCKNER, DBA SUBLIME-D-ZIGN, (U.S. CLS. 100, 103 AND 106). SN 85-250,526. PUB. 8-9-2011. FILED 2-24-2011.

4,044,373. **THE REAL RECYCLER (STANDARD CHARACTER)**. ONSITE ELECTRONICS RECYCLING, LLC, (U.S. CLS. 100, 103 AND 106). SN 85-256,325. PUB. 8-9-2011. FILED 3-2-2011.

4,044,440 ( *See Class 35 for this trademark*).

4,044,488. **BOBBY T GOODSON GOODSON'S ALL TERRAIN LOGGING INC. AND DESIGN**. GOODSON'S ALL TERRAIN LOGGING, INC., (U.S. CLS. 100, 103 AND 106). SN 85-262,804. PUB. 8-9-2011. FILED 3-9-2011.

4,044,576 ( *See Class 25 for this trademark*).

4,044,749 ( *See Class 37 for this trademark*).

4,044,751 ( *See Class 37 for this trademark*).

4,044,836. **MOLDZILLA (STANDARD CHARACTER)**. BLUE STAR ENTERPRISES, LLC, MULTIPLE CLASS, (INT. CLS. 40 AND 42), (U.S. CLS. 100, 101, 103 AND 106). SN 85-276,550. PUB. 8-9-2011. FILED 3-25-2011.

4,045,010. **BCAKENY (STANDARD CHARACTER)**. BCAKENY, LLC, (U.S. CLS. 100, 103 AND 106). SN 85-278,881. PUB. 8-9-2011. FILED 3-28-2011.

4,045,045. **DIGGYPOD (STYLIZED)**. DIGGYPOD, INC., DBA DIGGYPOD, (U.S. CLS. 100, 103 AND 106). SN 85-279,232. PUB. 8-9-2011. FILED 3-28-2011.

4,045,065. **MEDALLION INSTRUMENTATION SYSTEMS AND DESIGN**. MEDALLION INSTRUMENTATION SYSTEMS, LLC, (U.S. CLS. 100, 103 AND 106). SN 85-279,552. PUB. 8-9-2011. FILED 3-29-2011.

4,045,161 ( *See Class 32 for this trademark*).

4,045,170 ( *See Class 33 for this trademark*).

4,045,409 ( *See Class 35 for this trademark*).

4,045,442. **WEATHER WORKS\* (STANDARD CHARACTER)**. MILL WORKS FURNITURE LLC, (U.S. CLS. 100, 103 AND 106). SN 85-284,317. PUB. 8-9-2011. FILED 4-1-2011.

**CLASS 41—EDUCATION AND ENTERTAINMENT**

- 4,043,631. **E AND DESIGN**. ECAMPUSTUTORS, INC., (U.S. CLS. 100, 101 AND 107). SN 76-707,063. PUB. 8-9-2011. FILED 4-1-2011.
- 4,043,644 ( *See Class 10 for this trademark.*).
- 4,043,646 ( *See Class 35 for this trademark.*).
- 4,043,650. **GLOBAL ONENESS COMMUNITY (STANDARD CHARACTER)**. FOR WORLD PEACE PTE LTD, (U.S. CLS. 100, 101 AND 107). SN 77-591,986. PUB. 8-9-2011. FILED 10-14-2008.
- 4,043,652 ( *See Class 35 for this trademark.*).
- 4,043,668 ( *See Class 35 for this trademark.*).
- 4,043,671 ( *See Class 38 for this trademark.*).
- 4,043,674 ( *See Class 9 for this trademark.*).
- 4,043,680. **PROJECT SORA (STANDARD CHARACTER)**. NINTENDO OF AMERICA INC., (U.S. CLS. 100, 101 AND 107). SN 77-789,120. PUB. 7-20-2010. FILED 7-24-2009.
- 4,043,685. **INTERNATIONAL BOXING COUNCIL (STANDARD CHARACTER)**. HAIMOVICI, ALEK, (U.S. CLS. 100, 101 AND 107). SN 77-813,133. PUB. 8-9-2011. FILED 8-26-2009.
- 4,043,690. **LADY LOVES PINSTRIPES (STANDARD CHARACTER)**. CONROY, KATE C, (U.S. CLS. 100, 101 AND 107). SN 77-838,483. PUB. 8-9-2011. FILED 9-30-2009.
- 4,043,695 ( *See Class 9 for this trademark.*).
- 4,043,700 ( *See Class 9 for this trademark.*).
- 4,043,710. **HEAL AFRICA AND DESIGN**. HEAL AFRICA, MULTIPLE CLASS, (INT. CLS. 41 AND 45), (U.S. CLS. 100, 101 AND 107). SN 77-908,750. PUB. 8-9-2011. FILED 1-11-2010.
- 4,043,717. **INTERNATIONAL COLLEGE FOR EXCELLENCE IN PEDIATRIC THERAPEUTICS (STANDARD CHARACTER)**. BOCK, KENNETH, MULTIPLE CLASS, (INT. CLS. 41, 42 AND 44), (U.S. CLS. 100, 101 AND 107). SN 77-928,507. PUB. 8-9-2011. FILED 2-4-2010.
- 4,043,718. **INCEPT (STANDARD CHARACTER)**. BOCK, KENNETH, MULTIPLE CLASS, (INT. CLS. 41, 42 AND 44), (U.S. CLS. 100, 101 AND 107). SN 77-928,523. PUB. 8-9-2011. FILED 2-4-2010.
- 4,043,719 ( *See Class 9 for this trademark.*).
- 4,043,720. **JACKIE ROBINSON PARK OF FAME INC. AND DESIGN**. JACKIE ROBINSON PARK OF FAME, INC., (U.S. CLS. 100, 101 AND 107). SN 77-941,915. PUB. 8-9-2011. FILED 2-22-2010.
- 4,043,728. **THE CHRISTMAS AUNTIE AND DESIGN**. ROBERT ROWEN WESTERMAN, DBA GOLD BOY MUSIC & PUBLICATION, (U.S. CLS. 100, 101 AND 107). SN 77-964,368. PUB. 8-9-2011. FILED 3-22-2010.
- 4,043,732. **A PLUS (STANDARD CHARACTER)**. AUDI AG, (U.S. CLS. 100, 101 AND 107). SN 77-980,801. PUB. 8-9-2011. FILED 11-10-2009.
- 4,043,734. **FIDO'S FENCES (STANDARD CHARACTER)**. WILLIAM CODEN, FORMERLY WILLIAM COHEN, (U.S. CLS. 100, 101 AND 107). SN 77-981,669. PUB. 8-9-2011. FILED 12-22-2009.
- 4,043,739. **BAD HABITS AND DESIGN**. TUFTS, MARTIN, AND WONG, GLORIA, (U.S. CLS. 100, 101 AND 107). SN 78-794,784. PUB. 8-9-2011. FILED 1-19-2006.
- 4,043,750 ( *See Class 5 for this trademark.*).
- 4,043,751 ( *See Class 16 for this trademark.*).
- 4,043,754 ( *See Class 39 for this trademark.*).
- 4,043,763 ( *See Class 9 for this trademark.*).
- 4,043,773 ( *See Class 9 for this trademark.*).
- 4,043,779 ( *See Class 9 for this trademark.*).
- 4,043,780 ( *See Class 9 for this trademark.*).
- 4,043,781 ( *See Class 9 for this trademark.*).
- 4,043,783 ( *See Class 16 for this trademark.*).
- 4,043,785 ( *See Class 3 for this trademark.*).
- 4,043,788 ( *See Class 9 for this trademark.*).
- 4,043,796 ( *See Class 9 for this trademark.*).
- 4,043,797 ( *See Class 9 for this trademark.*).
- 4,043,801 ( *See Class 35 for this trademark.*).
- 4,043,815 ( *See Class 9 for this trademark.*).
- 4,043,824. **CPD THE CPD CERTIFICATION SERVICE AND DESIGN**. THE CPD CERTIFICATION SERVICE LIMITED, (U.S. CLS. 100, 101 AND 107). SN 79-090,962. PUB. 8-9-2011. FILED 7-28-2010.
- 4,043,829 ( *See Class 19 for this trademark.*).
- 4,043,830 ( *See Class 9 for this trademark.*).
- 4,043,841 ( *See Class 9 for this trademark.*).
- 4,043,849. **COURSIO (STANDARD CHARACTER)**. VISIONITE GROUP AB, MULTIPLE CLASS, (INT. CLS. 41 AND 42), (U.S. CLS. 100, 101 AND 107). SN 79-094,985. PUB. 8-9-2011. FILED 1-13-2011.
- 4,043,850. **CYBING (STANDARD CHARACTER)**. ELI FITNESS S.R.O., (U.S. CLS. 100, 101 AND 107). SN 79-095,052. PUB. 8-9-2011. FILED 12-16-2010.
- 4,043,851 ( *See Class 35 for this trademark.*).
- 4,043,882 ( *See Class 9 for this trademark.*).
- 4,043,884 ( *See Class 16 for this trademark.*).
- 4,043,913 ( *See Class 35 for this trademark.*).
- 4,043,917 ( *See Class 9 for this trademark.*).
- 4,043,918 ( *See Class 12 for this trademark.*).
- 4,043,923. **CLICK2HOUSTON (STANDARD CHARACTER)**. POST-NEWSWEEK STATIONS, HOUSTON, INC., (U.S. CLS. 100, 101 AND 107). SN 85-075,910. PUB. 8-9-2011. FILED 7-1-2010.
- 4,043,925 ( *See Class 35 for this trademark.*).
- 4,043,934 ( *See Class 9 for this trademark.*).
- 4,043,961 ( *See Class 25 for this trademark.*).
- 4,043,975. **TALL OUTSTANDING WOMEN (STANDARD CHARACTER)**. SPADONI, STEFANO, (U.S. CLS. 100, 101 AND 107). SN 85-113,095. PUB. 8-9-2011. FILED 8-22-2010.
- 4,043,977. **VENDOR SHOOTOUT (STANDARD CHARACTER)**. BRIJ IMAGE AND INFORMATION, (U.S. CLS. 100, 101 AND 107). SN 85-113,404. PUB. 8-9-2011. FILED 8-23-2010.
- 4,043,980. **SPY ON (STANDARD CHARACTER)**. WENDOH MEDIA, (U.S. CLS. 100, 101 AND 107). SN 85-114,004. PUB. 8-9-2011. FILED 8-23-2010.
- 4,043,987. **IP SJ INSTITUTE OF INTELLECTUAL PROPERTY AND SOCIAL JUSTICE, INC. AND DESIGN**. INSTITUTE OF INTELLECTUAL PROPERTY AND SOCIAL JUSTICE, INC., AKA IIPSI, INC., (U.S. CLS. 100, 101 AND 107). SN 85-116,094. PUB. 8-9-2011. FILED 8-26-2010.
- 4,044,028 ( *See Class 16 for this trademark.*).
- 4,044,033. **WOMEN'S GOLF ASSOCIATION OF NORTHERN CALIFORNIA EST. 1907 AND DESIGN**. WOMEN'S GOLF ASSOCIATION OF NORTHERN CALIFORNIA, (U.S. CLS. 100, 101 AND 107). SN 85-130,656. PUB. 8-9-2011. FILED 9-15-2010.
- 4,044,034 ( *See Class 36 for this trademark.*).
- 4,044,035. **GD GODIGITAL MEDIA GROUP AND DESIGN**. GODIGITAL RECORDS, LLC, DBA GODIGITAL MEDIA GROUP, (U.S. CLS. 100, 101 AND 107). SN 85-131,189. PUB. 8-9-2011. FILED 9-16-2010.
- 4,044,047. **WEBCITYGIRLS (STANDARD CHARACTER)**. PONDER, LYNN, (U.S. CLS. 100, 101 AND 107). SN 85-138,422. PUB. 8-9-2011. FILED 9-26-2010.
- 4,044,048. **THE SOCIALISTS (STANDARD CHARACTER)**. FERNANDO RABIELA, (U.S. CLS. 100, 101 AND 107). SN 85-138,631. PUB. 8-9-2011. FILED 9-27-2010.
- 4,044,053 ( *See Class 35 for this trademark.*).
- 4,044,069. **MONKEY QUEST (STANDARD CHARACTER)**. NEOPETS, INC., (U.S. CLS. 100, 101 AND 107). SN 85-145,157. PUB. 8-9-2011. FILED 10-5-2010.
- 4,044,082 ( *See Class 9 for this trademark.*).
- 4,044,084. **REGAL ROUNDTABLE (STANDARD CHARACTER)**. REGAL MEDIA GROUP, LLC, (U.S. CLS. 100, 101 AND 107). SN 85-154,523. PUB. 8-9-2011. FILED 10-17-2010.
- 4,044,088. **WEBWOC (STANDARD CHARACTER)**. BRYANT ROLSTAD CONSULTANTS, LLC, DBA WEBWOC NURSING EDUCATION PROGRAM, (U.S. CLS. 100, 101 AND 107). SN 85-157,166. PUB. 8-9-2011. FILED 10-20-2010.
- 4,044,089. **WEBWOCNURSE.COM WOUND OSTOMY CONTINENCE AND DESIGN**. BRYANT ROLSTAD CONSULTANTS, LLC, DBA WEBWOC NURSING EDUCATION PROGRAM, (U.S. CLS. 100, 101 AND 107). SN 85-157,267. PUB. 8-9-2011. FILED 10-20-2010.
- 4,044,101 ( *See Class 35 for this trademark.*).
- 4,044,104. **TEXAS STATE TECHNICAL COLLEGE (STANDARD CHARACTER)**. TEXAS STATE TECHNICAL COLLEGE, (U.S. CLS. 100, 101 AND 107). SN 85-165,822. PUB. 8-9-2011. FILED 11-1-2010.
- 4,044,107. **MYST SAGA (STANDARD CHARACTER)**. HILL,

- KORAKOT, (U.S. CLS. 100, 101 AND 107). SN 85-167,556. PUB. 8-9-2011. FILED 11-2-2010.
- 4,044,108. **CERTIFIED SOFTWARE DEVELOPMENT ASSOCIATE (CSDA) (STANDARD CHARACTER)**. THE INSTITUTE OF ELECTRICAL AND ELECTRONICS ENGINEERS, INC., (U.S. CLS. 100, 101 AND 107). SN 85-167,829. PUB. 8-9-2011. FILED 11-3-2010.
- 4,044,115. **ELITE CONTINUING EDUCATION (STANDARD CHARACTER)**. ELITE C.M.E., INC., (U.S. CLS. 100, 101 AND 107). SN 85-172,785. PUB. 8-9-2011. FILED 11-9-2010.
- 4,044,135. **RED BOOK UNIVERSITY SINCE 1925 RBCS AND DESIGN**. VANCE PUBLISHING CORPORATION, (U.S. CLS. 100, 101 AND 107). SN 85-183,773. PUB. 8-9-2011. FILED 11-23-2010.
- 4,044,150 ( *See Class 35 for this trademark*).
- 4,044,155. **IVYSAGE (STANDARD CHARACTER)**. IVYSAGE EDUCATION, LLC, (U.S. CLS. 100, 101 AND 107). SN 85-191,693. PUB. 5-3-2011. FILED 12-6-2010.
- 4,044,162 ( *See Class 36 for this trademark*).
- 4,044,172 ( *See Class 25 for this trademark*).
- 4,044,185. **HHH HIP-HOP DETOXX TRUTH WITHOUT BOUNDARIES AND DESIGN**. MUHAMMAD, ENOCH, DBA HIP-HOP DETOXX, (U.S. CLS. 100, 101 AND 107). SN 85-208,180. PUB. 8-9-2011. FILED 12-30-2010.
- 4,044,187. **GROWTHTHINKING (STANDARD CHARACTER)**. NUCRAFT COMPANY, LLC, (U.S. CLS. 100, 101 AND 107). SN 85-208,659. PUB. 8-9-2011. FILED 12-31-2010.
- 4,044,195 ( *See Class 9 for this trademark*).
- 4,044,202. **ZOOGMA (STANDARD CHARACTER)**. ZOOGMA MUSIC, LLC, DBA ZOOGMA, (U.S. CLS. 100, 101 AND 107). SN 85-211,466. PUB. 8-9-2011. FILED 1-5-2011.
- 4,044,206 ( *See Class 16 for this trademark*).
- 4,044,213. **STUDY SPARKZ (STANDARD CHARACTER)**. CANTIUS INC., (U.S. CLS. 100, 101 AND 107). SN 85-217,741. PUB. 8-9-2011. FILED 1-14-2011.
- 4,044,220. **EARTHEN HAND (STANDARD CHARACTER)**. HOWARD, SCOTT G., TA EARTHEN HAND, (U.S. CLS. 100, 101 AND 107). SN 85-221,568. PUB. 8-9-2011. FILED 1-19-2011.
- 4,044,230. **CIVILITY IS ELEMENTARY (STANDARD CHARACTER)**. JORDON, LESLIE M., (U.S. CLS. 100, 101 AND 107). SN 85-225,044. PUB. 8-9-2011. FILED 1-24-2011.
- 4,044,231 ( *See Class 40 for this trademark*).
- 4,044,232 ( *See Class 40 for this trademark*).
- 4,044,241. **LIVING IN SYNERGY (STANDARD CHARACTER)**. WISCHOW, RENE' E, DBA LIVING IN SYNERGY, MULTIPLE CLASS, (INT. CLS. 41 AND 45), (U.S. CLS. 100, 101 AND 107). SN 85-227,471. PUB. 8-9-2011. FILED 1-27-2011.
- 4,044,252. **JERSEY FILMS (STANDARD CHARACTER)**. DEVITO, DANIEL MICHAEL, (U.S. CLS. 100, 101 AND 107). SN 85-230,550. PUB. 8-9-2011. FILED 1-31-2011.
- 4,044,253. **PE@PF PHYS. ED PLANET FITNESS AND DESIGN**. PFIIP, LLC, (U.S. CLS. 100, 101 AND 107). SN 85-230,656. PUB. 8-9-2011. FILED 1-31-2011.
- 4,044,266. **RESOLUTION REBOOT (STANDARD CHARACTER)**. BALLY TOTAL FITNESS HOLDING CORPORATION, (U.S. CLS. 100, 101 AND 107). SN 85-231,244. PUB. 8-9-2011. FILED 2-1-2011.
- 4,044,268. **NEW YORK NOISE (STANDARD CHARACTER)**. BRAHA, SHIRLEY, (U.S. CLS. 100, 101 AND 107). SN 85-232,258. PUB. 8-9-2011. FILED 2-2-2011.
- 4,044,275. **COLDBOX AND DESIGN**. ORTUS SOLUTIONS, CORP, MULTIPLE CLASS, (INT. CLS. 41 AND 42), (U.S. CLS. 100, 101 AND 107). SN 85-233,801. PUB. 8-9-2011. FILED 2-3-2011.
- 4,044,281. **FUN PHOTO PARTY AND DESIGN**. POLCHEIRA, ELIAS A. B., (U.S. CLS. 100, 101 AND 107). SN 85-236,596. PUB. 8-9-2011. FILED 2-8-2011.
- 4,044,286. **SISTER GIRLS (STANDARD CHARACTER)**. LEGACY PATHWAYS LLC, (U.S. CLS. 100, 101 AND 107). SN 85-238,250. PUB. 8-9-2011. FILED 2-9-2011.
- 4,044,288. **MUSICAL PLAYDATE (STANDARD CHARACTER)**. GREENBERG, YAEL, (U.S. CLS. 100, 101 AND 107). SN 85-238,548. PUB. 8-9-2011. FILED 2-10-2011.
- 4,044,289 ( *See Class 35 for this trademark*).
- 4,044,290 ( *See Class 35 for this trademark*).
- 4,044,291. **SEND IS FOREVER (STANDARD CHARACTER)**. FAHEY COMMUNICATIONS, (U.S. CLS. 100, 101 AND 107). SN 85-239,053. PUB. 8-9-2011. FILED S.R. 2-10-2011; AM. P.R. 6-15-2011.
- 4,044,303 ( *See Class 35 for this trademark*).
- 4,044,306. **SCUBABOARD NEWS AND DESIGN**. MUR, INC, (U.S. CLS. 100, 101 AND 107). SN 85-243,582. PUB. 8-9-2011. FILED 2-16-2011.
- 4,044,320. **LUNA NEGRA DANCE THEATER (STANDARD CHARACTER)**. LUNA NEGRA DANCE THEATER, (U.S. CLS. 100, 101 AND 107). SN 85-247,649. PUB. 8-9-2011. FILED 2-21-2011.
- 4,044,321. **DAILY DOWNPOUR (STANDARD CHARACTER)**. THE WEATHER UNDERGROUND, INC., MULTIPLE CLASS, (INT. CLS. 41 AND 42), (U.S. CLS. 100, 101 AND 107). SN 85-247,692. PUB. 8-9-2011. FILED 2-21-2011.
- 4,044,328. **BODINES (STANDARD CHARACTER)**. SILVER BULLET OF NEVADA, LLC, MULTIPLE CLASS, (INT. CLS. 41 AND 43), (U.S. CLS. 100, 101 AND 107). SN 85-249,321. PUB. 8-9-2011. FILED 2-23-2011.
- 4,044,334. **LEGALLY HUNGRY (STANDARD CHARACTER)**. LEGALLY HUNGRY LLC, MULTIPLE CLASS, (INT. CLS. 41 AND 43), (U.S. CLS. 100, 101 AND 107). SN 85-250,303. PUB. 7-5-2011. FILED 2-24-2011.
- 4,044,342. **DR. QUANTUM (STANDARD CHARACTER)**. WOLF, FRED ALAN, (U.S. CLS. 100, 101 AND 107). SN 85-251,799. PUB. 8-9-2011. FILED 2-25-2011.
- 4,044,347. **ILIKETHAT MEDIA AND DESIGN**. GENER, MATTHEW, (U.S. CLS. 100, 101 AND 107). SN 85-252,428. PUB. 8-9-2011. FILED 2-25-2011.
- 4,044,348. **THE BEAR WHISPERER WITH BLAINE ANTHONY (STANDARD CHARACTER)**. HARVEY NEIL ANTHONY, AKA BLAINE ANTHONY, (U.S. CLS. 100, 101 AND 107). SN 85-252,510. PUB. 8-9-2011. FILED 2-26-2011.
- 4,044,349. **RESPECT LAYER ONE (STANDARD CHARACTER)**. CABLEXPRESS CORPORATION, DBA CXTEC, (U.S. CLS. 100, 101 AND 107). SN 85-252,519. PUB. 8-9-2011. FILED 2-26-2011.
- 4,044,350. **RESPECT LAYER ONE AND DESIGN**. CABLEXPRESS CORPORATION, DBA CXTEC, (U.S. CLS. 100, 101 AND 107). SN 85-252,525. PUB. 8-9-2011. FILED 2-26-2011.
- 4,044,355. **VRBO FROM HOMEAWAY AND DESIGN**. HOMEAWAY.COM, INC., (U.S. CLS. 100, 101 AND 107). SN 85-253,340. PUB. 8-9-2011. FILED 2-28-2011.
- 4,044,374. **PEARSONIFIED (STANDARD CHARACTER)**. PEARSON, CHRIS, MULTIPLE CLASS, (INT. CLS. 41 AND 42), (U.S. CLS. 100, 101 AND 107). SN 85-256,541. PUB. 8-9-2011. FILED 3-3-2011.
- 4,044,390. **THE LUNCH BOX HEALTHY TOOLS TO HELP ALL SCHOOLS AND DESIGN**. FOOD FAMILY FARMING FOUNDATION, (U.S. CLS. 100, 101 AND 107). SN 85-258,323. PUB. 8-9-2011. FILED 3-4-2011.
- 4,044,398. **COME TO THE CROSS MINISTRIES AND DESIGN**. COME TO THE CROSS MINISTRIES, (U.S. CLS. 100, 101 AND 107). SN 85-259,032. PUB. 8-9-2011. FILED 3-5-2011.
- 4,044,399. **LINCOLN ACADEMY (STANDARD CHARACTER)**. LINCOLN ACADEMY, LLC, (U.S. CLS. 100, 101 AND 107). SN 85-259,094. PUB. 8-9-2011. FILED 3-6-2011.
- 4,044,406. **SHORT SALE SUPERSTARS (STANDARD CHARACTER)**. REGROW, LLC, (U.S. CLS. 100, 101 AND 107). SN 85-259,319. PUB. 8-9-2011. FILED 3-7-2011.
- 4,044,407 ( *See Class 9 for this trademark*).
- 4,044,415. **THE RAILROAD REVIVAL TOUR (STANDARD CHARACTER)**. RAILROAD REVIVAL TOURING COMPANY, LLC, (U.S. CLS. 100, 101 AND 107). SN 85-259,749. PUB. 8-9-2011. FILED 3-7-2011.
- 4,044,421. **PREMIER PHYSIQUES (STANDARD CHARACTER)**. MIER, JOHN DAVID, (U.S. CLS. 100, 101 AND 107). SN 85-260,005. PUB. 8-9-2011. FILED 3-7-2011.
- 4,044,441. **RELATIONSHIP CAFE (STANDARD CHARACTER)**. VAN PUTTEN, ZANETTA, MULTIPLE CLASS, (INT. CLS. 41 AND 44), (U.S. CLS. 100, 101 AND 107). SN 85-260,994. PUB. 8-9-2011. FILED 3-8-2011.
- 4,044,443. **AERIAL SAFARI (STANDARD CHARACTER)**. EXPERIENCE BASED LEARNING, INC., (U.S. CLS. 100, 101 AND 107). SN 85-261,110. PUB. 8-9-2011. FILED 3-8-2011.
- 4,044,445 ( *See Class 35 for this trademark*).
- 4,044,468. **SENSATIONAL BABY FROM INFANT MESSAGE USA AND DESIGN**. INFANT MESSAGE USA, (U.S. CLS. 100, 101 AND 107). SN 85-262,159. PUB. 8-9-2011. FILED 3-9-



- 2011.
- 4,044,472. **AUTISM EXPLORES AND DESIGN**. ALBERT EINSTEIN HEALTHCARE NETWORK, (U.S. CLS. 100, 101 AND 107). SN 85-262,286. PUB. 8-9-2011. FILED 3-9-2011.
- 4,044,473. **AUTISM EXPLORES (STANDARD CHARACTER)**. ALBERT EINSTEIN HEALTHCARE NETWORK, (U.S. CLS. 100, 101 AND 107). SN 85-262,330. PUB. 8-9-2011. FILED 3-9-2011.
- 4,044,474. **FIGHT LAWYER AND DESIGN**. JUSTIN E. KLEIN, MULTIPLE CLASS, (INT. CLS. 41 AND 45), (U.S. CLS. 100, 101 AND 107). SN 85-262,399. PUB. 8-9-2011. FILED 3-9-2011.
- 4,044,475. **SINGLE BOUND PRODUCTIONS (STANDARD CHARACTER)**. SINGLE BOUND PRODUCTIONS, INC., (U.S. CLS. 100, 101 AND 107). SN 85-262,567. PUB. 8-9-2011. FILED 3-9-2011.
- 4,044,476. **BIG BLUE SWIM SCHOOL (STANDARD CHARACTER)**. NORTHSHORE SWIM SCIENCE, LLC, (U.S. CLS. 100, 101 AND 107). SN 85-262,589. PUB. 8-9-2011. FILED 3-9-2011.
- 4,044,480. **NIGHT TERRORS (STANDARD CHARACTER)**. THE COLLECTIVE MANAGEMENT GROUP LLC, (U.S. CLS. 100, 101 AND 107). SN 85-262,633. PUB. 8-9-2011. FILED 3-9-2011.
- 4,044,515 ( *See Class 39 for this trademark*).
- 4,044,517. **3NE RECORDS AND DESIGN**. THIRD NATION ENTERTAINMENT, (U.S. CLS. 100, 101 AND 107). SN 85-263,623. PUB. 8-9-2011. FILED 3-10-2011.
- 4,044,522. **THE DARBY BAND (STANDARD CHARACTER)**. COLUMBIA CONSULTANTS, LLC, AND DANUCHT ENTERTAINMENT, LLC, (U.S. CLS. 100, 101 AND 107). SN 85-263,817. PUB. 8-9-2011. FILED 3-10-2011.
- 4,044,530. **ORDO STELLA MATUTINA (STANDARD CHARACTER)**. GRIGGS, MARK, (U.S. CLS. 100, 101 AND 107). SN 85-264,079. PUB. 8-9-2011. FILED 3-11-2011.
- 4,044,540. **MAMBO ROOM LATIN DANCE STUDIO AND DESIGN**. MAMBO ROOM, INC. (U.S. CLS. 100, 101 AND 107). SN 85-264,337. PUB. 8-9-2011. FILED 3-11-2011.
- 4,044,548. **SFO CERTIFIED ADMINISTRATOR OF SCHOOL FINANCE AND OPERATIONS ASBO AND DESIGN**. ASSOCIATION OF SCHOOL BUSINESS OFFICIALS INTERNATIONAL, MULTIPLE CLASS, (INT. CLS. 41 AND 42), (U.S. CLS. 100, 101 AND 107). SN 85-264,758. PUB. 8-9-2011. FILED 3-11-2011.
- 4,044,550. **WEATHER UNDERGROUND (STANDARD CHARACTER)**. THE WEATHER UNDERGROUND, INC., (U.S. CLS. 100, 101 AND 107). SN 85-265,069. PUB. 8-9-2011. FILED 3-11-2011.
- 4,044,552. **WUNDERGROUND (STANDARD CHARACTER)**. THE WEATHER UNDERGROUND, INC., (U.S. CLS. 100, 101 AND 107). SN 85-265,101. PUB. 8-9-2011. FILED 3-11-2011.
- 4,044,553. **THE CAPITAL CONFIDANT APPROACH (STANDARD CHARACTER)**. THE GLOWACKI GROUP, LLC, (U.S. CLS. 100, 101 AND 107). SN 85-265,118. PUB. 8-9-2011. FILED 3-11-2011.
- 4,044,554. **PAYING ATTENTION (STANDARD CHARACTER)**. GEORGIA CREDIT UNION AFFILIATES, INC., (U.S. CLS. 100, 101 AND 107). SN 85-265,120. PUB. 8-9-2011. FILED 3-11-2011.
- 4,044,559. **THE LITTLE REDD SCHOOLHOUSE (STANDARD CHARACTER)**. BANANA PUDDING ENTERPRISES, (U.S. CLS. 100, 101 AND 107). SN 85-265,325. PUB. 8-9-2011. FILED 3-12-2011.
- 4,044,569. **MISTER TONY (STANDARD CHARACTER)**. MISTER TONY ENTERTAINMENT LLC, AKA MISTER TONY, (U.S. CLS. 100, 101 AND 107). SN 85-265,675. PUB. 8-9-2011. FILED 3-13-2011.
- 4,044,575. **'BURIED EVIDENCE INC... AND DESIGN**. BURIED EVIDENCE RECORDS INC., (U.S. CLS. 100, 101 AND 107). SN 85-266,333. PUB. 8-9-2011. FILED 3-14-2011.
- 4,044,595. **HOOKED ON DANGER (STANDARD CHARACTER)**. CURRENT MEDIA, LLC, (U.S. CLS. 100, 101 AND 107). SN 85-268,575. PUB. 8-9-2011. FILED 3-16-2011.
- 4,044,606. **MINDFUL PARTNERSHIP ~ MINDFUL DIVORCE (STANDARD CHARACTER)**. BERGER, ILLANA, (U.S. CLS. 100, 101 AND 107). SN 85-270,140. PUB. 8-9-2011. FILED 3-17-2011.
- 4,044,614 ( *See Class 35 for this trademark*).
- 4,044,615 ( *See Class 35 for this trademark*).
- 4,044,631. **WANNA NEW BIRTHDAY SUIT? (STANDARD CHARACTER)**. TIAMIYU, ADETOLA, (U.S. CLS. 100, 101 AND 107). SN 85-273,434. PUB. 8-9-2011. FILED 3-22-2011.
- 4,044,634 ( *See Class 35 for this trademark*).
- 4,044,651. **RECEPTOR-ORIENTED (STANDARD CHARACTER)**. PERFORMANCE MANAGEMENT GROUP, INC., (U.S. CLS. 100, 101 AND 107). SN 85-273,785. PUB. 8-9-2011. FILED 3-22-2011.
- 4,044,673 ( *See Class 9 for this trademark*).
- 4,044,677. **XPLODE (STANDARD CHARACTER)**. HELIVES, LLC, (U.S. CLS. 100, 101 AND 107). SN 85-274,140. PUB. 8-9-2011. FILED 3-23-2011.
- 4,044,683. **IDEAL I DO'S (STANDARD CHARACTER)**. IDEAL I DO'S INC., MULTIPLE CLASS, (INT. CLS. 41 AND 45), (U.S. CLS. 100, 101 AND 107). SN 85-274,237. PUB. 8-9-2011. FILED 3-23-2011.
- 4,044,696 ( *See Class 35 for this trademark*).
- 4,044,697. **WHERE THE BIBLE COMES TO LIFE! (STANDARD CHARACTER)**. SIGHT AND SOUND MINISTRIES, INC., (U.S. CLS. 100, 101 AND 107). SN 85-274,442. PUB. 8-9-2011. FILED 3-23-2011.
- 4,044,698. **INTENSELY CURIOUS, FOCUSED ON FACTS (STANDARD CHARACTER)**. CASEY RESEARCH, LLC, (U.S. CLS. 100, 101 AND 107). SN 85-274,455. PUB. 8-9-2011. FILED 3-23-2011.
- 4,044,700. **NUUESTRA NAVIDAD (STANDARD CHARACTER)**. UNIVISION COMMUNICATIONS INC., (U.S. CLS. 100, 101 AND 107). SN 85-274,513. PUB. 8-9-2011. FILED 3-23-2011.
- 4,044,702 ( *See Class 25 for this trademark*).
- 4,044,724. **THE MUTUAL FUND SHOW (STANDARD CHARACTER)**. TMFS HOLDINGS, LLC, (U.S. CLS. 100, 101 AND 107). SN 85-274,879. PUB. 8-9-2011. FILED 3-23-2011.
- 4,044,735. **ERGO CARE (STANDARD CHARACTER)**. ERGO-CARE, INC., (U.S. CLS. 100, 101 AND 107). SN 85-275,140. PUB. 8-9-2011. FILED 3-23-2011.
- 4,044,736. **LOVE SHUTTER (STANDARD CHARACTER)**. LOVE SHUTTER, LLC, (U.S. CLS. 100, 101 AND 107). SN 85-275,145. PUB. 8-9-2011. FILED 3-23-2011.
- 4,044,737. **LOVE SHUTTER AND DESIGN**. LOVE SHUTTER, LLC, (U.S. CLS. 100, 101 AND 107). SN 85-275,165. PUB. 8-9-2011. FILED 3-23-2011.
- 4,044,746. **VENOUS SURGERY CENTER OF EXCELLENCE (STANDARD CHARACTER)**. ACCREDITATION COUNCIL FOR SURGICAL QUALITY, (U.S. CLS. 100, 101 AND 107). SN 85-275,363. PUB. 8-9-2011. FILED 3-24-2011.
- 4,044,747. **CARDIAC SURGERY CENTER OF EXCELLENCE (STANDARD CHARACTER)**. ACCREDITATION COUNCIL FOR SURGICAL QUALITY, (U.S. CLS. 100, 101 AND 107). SN 85-275,372. PUB. 8-9-2011. FILED 3-24-2011.
- 4,044,763. **URBAN IMPACT CHANGING LIVES ONE PERSON, ONE FAMILY, ONE BLOCK AT A TIME (STANDARD CHARACTER)**. URBAN IMPACT FOUNDATION, (U.S. CLS. 100, 101 AND 107). SN 85-275,580. PUB. 8-9-2011. FILED 3-24-2011.
- 4,044,764. **MOPHO (STANDARD CHARACTER)**. MOGO MEDIA, LLC, (U.S. CLS. 100, 101 AND 107). SN 85-275,587. PUB. 8-9-2011. FILED 3-24-2011.
- 4,044,766. **VUMBRELLA (STANDARD CHARACTER)**. VIRTUAL UMBRELLA, LLC, MULTIPLE CLASS, (INT. CLS. 41 AND 42), (U.S. CLS. 100, 101 AND 107). SN 85-275,636. PUB. 8-9-2011. FILED 3-24-2011.
- 4,044,769. **TOKYO HIVE (STANDARD CHARACTER)**. 6THEORY MEDIA, LLC., (U.S. CLS. 100, 101 AND 107). SN 85-275,641. PUB. 8-9-2011. FILED 3-24-2011.
- 4,044,774. **LIL DADA (STANDARD CHARACTER)**. HAMP-TON, DASHAE D., (U.S. CLS. 100, 101 AND 107). SN 85-275,670. PUB. 8-9-2011. FILED 3-24-2011.
- 4,044,781. **TSP: TWIN SENSORY PERCEPTION (STANDARD CHARACTER)**. SAINTMYSTERIES PRODUCTIONS, (U.S. CLS. 100, 101 AND 107). SN 85-275,748. PUB. 8-9-2011. FILED 3-24-2011.
- 4,044,786. **HELP MORE PEOPLE (STANDARD CHARACTER)**. EVANS, SUZANNE, (U.S. CLS. 100, 101 AND 107). SN 85-275,822. PUB. 8-9-2011. FILED 3-24-2011.
- 4,044,787. **TO LEARN. TO LOVE. TO SERVE (STANDARD CHARACTER)**. ALVERNIA UNIVERSITY, (U.S. CLS. 100, 101 AND 107). SN 85-275,837. PUB. 8-9-2011. FILED 3-24-

- 2011.
- 4,044,800. **SKILLS FOR THE WORKPLACE, VALUES FOR LIFE (STANDARD CHARACTER)**. ALVERNIA UNIVERSITY, (U.S. CLS. 100, 101 AND 107). SN 85-275,949. PUB. 8-9-2011. FILED 3-24-2011.
- 4,044,823. **EVEN THE ODDS (STANDARD CHARACTER)**. TROPICANA LAS VEGAS, INC., (U.S. CLS. 100, 101 AND 107). SN 85-276,353. PUB. 8-9-2011. FILED 3-24-2011.
- 4,044,828. **THE RHYTHM YARD (STANDARD CHARACTER)**. GERRING, BETHANN, (U.S. CLS. 100, 101 AND 107). SN 85-276,440. PUB. 8-9-2011. FILED 3-25-2011.
- 4,044,838. **MISCELLANEOUS DESIGN**. TARA MARIE, INC., (U.S. CLS. 100, 101 AND 107). SN 85-276,558. PUB. 8-9-2011. FILED 3-25-2011.
- 4,044,843. **KATE YOGA (STANDARD CHARACTER)**. GARLAND KATHLEEN G, DBA KATE | YOGA, (U.S. CLS. 100, 101 AND 107). SN 85-276,588. PUB. 8-9-2011. FILED 3-25-2011.
- 4,044,845. **USFRA (STANDARD CHARACTER)**. U.S. FARMERS & RANCHERS ALLIANCE, INC., (U.S. CLS. 100, 101 AND 107). SN 85-276,618. PUB. 8-9-2011. FILED 3-25-2011.
- 4,044,848. **R.O.P.A. (STANDARD CHARACTER)**. PUNCH INC., (U.S. CLS. 100, 101 AND 107). SN 85-276,668. PUB. 8-9-2011. FILED 3-25-2011.
- 4,044,854. **WATEREDGE (STANDARD CHARACTER)**. FRITZ, CALEB J, AND FRITZ, JOSHUA C, (U.S. CLS. 100, 101 AND 107). SN 85-276,762. PUB. 8-9-2011. FILED 3-25-2011.
- 4,044,862 ( *See Class 16 for this trademark*).
- 4,044,863 ( *See Class 35 for this trademark*).
- 4,044,874. **DESERT SHOWDOWN (STANDARD CHARACTER)**. ROMERO, IRENE, (U.S. CLS. 100, 101 AND 107). SN 85-277,045. PUB. 8-9-2011. FILED 3-25-2011.
- 4,044,878. **ENDWORLD (STANDARD CHARACTER)**. STAMETS, JONATHAN P., (U.S. CLS. 100, 101 AND 107). SN 85-277,109. PUB. 8-9-2011. FILED 3-25-2011.
- 4,044,883. **LITTLE PARADISE (STANDARD CHARACTER)**. RUIZ, WALKIRIA, (U.S. CLS. 100, 101 AND 107). SN 85-277,202. PUB. 8-9-2011. FILED 3-25-2011.
- 4,044,887. **LET THE MEMORIES BEGIN (STANDARD CHARACTER)**. LET THE GAMES BEGIN AMUSEMENTS, LLC, (U.S. CLS. 100, 101 AND 107). SN 85-277,219. PUB. 8-9-2011. FILED 3-25-2011.
- 4,044,899. **MISCELLANEOUS DESIGN**. COLLIN COUNTY COMMUNITY COLLEGE DISTRICT, (U.S. CLS. 100, 101 AND 107). SN 85-277,357. PUB. 8-9-2011. FILED 3-25-2011.
- 4,044,902. **WHERE BROADWAY MEETS WEST BROADWAY (STANDARD CHARACTER)**. LUNDSTRUM CENTER FOR THE PERFORMING ARTS, (U.S. CLS. 100, 101 AND 107). SN 85-277,365. PUB. 8-9-2011. FILED 3-25-2011.
- 4,044,916. **SNOWBIRD JAMMERS AND DESIGN**. SNOWBIRD JAMMERS NON-PROFIT ASSOCIATION, (U.S. CLS. 100, 101 AND 107). SN 85-277,527. PUB. 8-9-2011. FILED 3-25-2011.
- 4,044,927. **YOUR WORLD IS OUR STUDIO (STANDARD CHARACTER)**. DAUGHERTY, SEAN, (U.S. CLS. 100, 101 AND 107). SN 85-277,737. PUB. 8-9-2011. FILED 3-26-2011.
- 4,044,928. **MY FOODMAPS (STANDARD CHARACTER)**. LIFE ODYSSEY COACHING AND CONSULTING LLC, (U.S. CLS. 100, 101 AND 107). SN 85-277,751. PUB. 8-9-2011. FILED 3-26-2011.
- 4,044,939 ( *See Class 35 for this trademark*).
- 4,044,945. **MISCELLANEOUS DESIGN**. UNITED STATES OF AMERICA NATIONAL KARATE-DO FEDERATION, (U.S. CLS. 100, 101 AND 107). SN 85-278,025. PUB. 8-9-2011. FILED 3-27-2011.
- 4,044,946. **AJE (STANDARD CHARACTER)**. AMERICAN JOURNAL EXPERTS, L.L.C., (U.S. CLS. 100, 101 AND 107). SN 85-278,063. PUB. 8-9-2011. FILED 3-27-2011.
- 4,044,947. **AJE AND DESIGN**. AMERICAN JOURNAL EXPERTS, L.L.C., (U.S. CLS. 100, 101 AND 107). SN 85-278,064. PUB. 8-9-2011. FILED 3-27-2011.
- 4,044,956. **BE R.O.P.A. (STANDARD CHARACTER)**. PUNCH INC., (U.S. CLS. 100, 101 AND 107). SN 85-278,181. PUB. 8-9-2011. FILED 3-28-2011.
- 4,044,960. **THE RUNNING COURSE (STANDARD CHARACTER)**. NORTH AMERICAN SEMINARS INC, (U.S. CLS. 100, 101 AND 107). SN 85-278,231. PUB. 8-9-2011. FILED 3-28-2011.
- 4,044,961 ( *See Class 38 for this trademark*).
- 4,044,962 ( *See Class 38 for this trademark*).
- 4,044,965. **SMARTERME (STANDARD CHARACTER)**. NEXT GENERATION FOCUS, INC., (U.S. CLS. 100, 101 AND 107). SN 85-278,259. PUB. 8-9-2011. FILED 3-28-2011.
- 4,044,969. **CHANNELNOMICS (STANDARD CHARACTER)**. THE 2112 STRATEGY GROUP LLC, (U.S. CLS. 100, 101 AND 107). SN 85-278,295. PUB. 8-9-2011. FILED 3-28-2011.
- 4,044,984. **SLIM & STRONG (STANDARD CHARACTER)**. ARIANE HUNDT FITNESS, LLC, (U.S. CLS. 100, 101 AND 107). SN 85-278,500. PUB. 8-9-2011. FILED 3-28-2011.
- 4,044,985. **GET OFF THE WHEEL NOW! (STANDARD CHARACTER)**. CHANDLER BOERNER, KATHERINE ANN, (U.S. CLS. 100, 101 AND 107). SN 85-278,503. PUB. 8-9-2011. FILED 3-28-2011.
- 4,044,991. **TOP RECRUIT (STANDARD CHARACTER)**. SMITH, TRAVIS A., (U.S. CLS. 100, 101 AND 107). SN 85-278,587. PUB. 8-9-2011. FILED 3-28-2011.
- 4,045,021. **D-FRC (STANDARD CHARACTER)**. CHENG CONCRETE LLC, (U.S. CLS. 100, 101 AND 107). SN 85-278,976. PUB. 8-9-2011. FILED 3-28-2011.
- 4,045,029. **CHILD AT HEART (STANDARD CHARACTER)**. CIMBURA, TIM, (U.S. CLS. 100, 101 AND 107). SN 85-279,080. PUB. 8-9-2011. FILED 3-28-2011.
- 4,045,039. **TWELVE SACRED DOORS (STANDARD CHARACTER)**. JENNIFER C. BOOTH, AKA JAIS BOOTH, (U.S. CLS. 100, 101 AND 107). SN 85-279,176. PUB. 8-9-2011. FILED 3-28-2011.
- 4,045,041. **ROCKIN' REBEL (STANDARD CHARACTER)**. WILLIAMS, CHUCK, (U.S. CLS. 100, 101 AND 107). SN 85-279,209. PUB. 8-9-2011. FILED 3-28-2011.
- 4,045,053. **ERASE CAUTI (STANDARD CHARACTER)**. MEDLINE INDUSTRIES, INC., (U.S. CLS. 100, 101 AND 107). SN 85-279,373. PUB. 8-9-2011. FILED 3-29-2011.
- 4,045,054. **GARDENING KNOW HOW (STANDARD CHARACTER)**. GARDENING KNOW HOW LLC, (U.S. CLS. 100, 101 AND 107). SN 85-279,413. PUB. 8-9-2011. FILED 3-29-2011.
- 4,045,070 ( *See Class 35 for this trademark*).
- 4,045,076 ( *See Class 38 for this trademark*).
- 4,045,080 ( *See Class 38 for this trademark*).
- 4,045,083 ( *See Class 38 for this trademark*).
- 4,045,088 ( *See Class 35 for this trademark*).
- 4,045,095. **LAUGH BOWL (STANDARD CHARACTER)**. LAUGH FACTORY INC., (U.S. CLS. 100, 101 AND 107). SN 85-279,984. PUB. 8-9-2011. FILED 3-29-2011.
- 4,045,103. **H AND DESIGN**. 6THEORY MEDIA, LLC., (U.S. CLS. 100, 101 AND 107). SN 85-280,090. PUB. 8-9-2011. FILED 3-29-2011.
- 4,045,105. **TINY SPARROW FOUNDATION AND DESIGN**. TINY SPARROW FOUNDATION, (U.S. CLS. 100, 101 AND 107). SN 85-280,125. PUB. 8-9-2011. FILED 3-29-2011.
- 4,045,108. **SPUD'S (STANDARD CHARACTER)**. EQUINE ASSISTED GROWTH AND LEARNING ASSOCIATION, (U.S. CLS. 100, 101 AND 107). SN 85-280,221. PUB. 8-9-2011. FILED 3-29-2011.
- 4,045,111. **MISCELLANEOUS DESIGN**. JAMESTOWN-YORKTOWN FOUNDATION, (U.S. CLS. 100, 101 AND 107). SN 85-280,244. PUB. 8-9-2011. FILED 3-29-2011.
- 4,045,115. **#BLOGATHONATX (STANDARD CHARACTER)**. HADMARK, INC., (U.S. CLS. 100, 101 AND 107). SN 85-280,273. PUB. 8-9-2011. FILED 3-29-2011.
- 4,045,117. **JESSICA BURKE PHOTOGRAPHY (STANDARD CHARACTER)**. JESSICA BURKE, DBA JESSICA BURKE PHOTOGRAPHY, (U.S. CLS. 100, 101 AND 107). SN 85-280,292. PUB. 8-9-2011. FILED 3-29-2011.
- 4,045,123. **USS CONSTITUTION (STANDARD CHARACTER)**. THE DEPARTMENT OF THE NAVY, (U.S. CLS. 100, 101 AND 107). SN 85-280,377. PUB. 8-9-2011. FILED 3-29-2011.
- 4,045,143. **THE TOOLS YOU NEED TO BUILD THE BODY YOU WANT (STANDARD CHARACTER)**. FIT VENTURES, (U.S. CLS. 100, 101 AND 107). SN 85-280,569. PUB. 8-9-2011. FILED 3-29-2011.
- 4,045,145. **MISCELLANEOUS DESIGN**. CORE FOCUS INC, (U.S. CLS. 100, 101 AND 107). SN 85-280,588. PUB. 8-9-2011. FILED 3-29-2011.
- 4,045,149. **B.A.N.I. (STANDARD CHARACTER)**. VAN-ZEL-

- LER, TERESA, (U.S. CLS. 100, 101 AND 107). SN 85-280,646. PUB. 8-9-2011. FILED 3-29-2011.
- 4,045,150. **TEAM TFS (STANDARD CHARACTER)**. BASTIAN, MICHAEL R., (U.S. CLS. 100, 101 AND 107). SN 85-280,697. PUB. 8-9-2011. FILED 3-29-2011.
- 4,045,156. **COOKTIVITY (STANDARD CHARACTER)**. COOKTIVITY LLC, (U.S. CLS. 100, 101 AND 107). SN 85-280,805. PUB. 8-9-2011. FILED 3-30-2011.
- 4,045,157. **A PINCH OF COOKING AND A DASH OF CREATIVITY (STANDARD CHARACTER)**. COOKTIVITY LLC, (U.S. CLS. 100, 101 AND 107). SN 85-280,808. PUB. 8-9-2011. FILED 3-30-2011.
- 4,045,194. **PAUSE, PRACTICE, & PLAY! (STANDARD CHARACTER)**. BURGESS, SEAN M., (U.S. CLS. 100, 101 AND 107). SN 85-281,228. PUB. 8-9-2011. FILED 3-30-2011.
- 4,045,199. **OLD IRONSIDES (STANDARD CHARACTER)**. THE DEPARTMENT OF THE NAVY, (U.S. CLS. 100, 101 AND 107). SN 85-281,358. PUB. 8-9-2011. FILED 3-30-2011.
- 4,045,205 ( *See Class 9 for this trademark*).
- 4,045,207. **AMERICA'S SHIP OF STATE (STANDARD CHARACTER)**. THE DEPARTMENT OF THE NAVY, (U.S. CLS. 100, 101 AND 107). SN 85-281,478. PUB. 8-9-2011. FILED 3-30-2011.
- 4,045,215. **THE NATION'S TRUSTED SOURCE FOR STUDENT DEGREE AND ENROLLMENT VERIFICATION (STANDARD CHARACTER)**. NATIONAL STUDENT CLEARINGHOUSE, (U.S. CLS. 100, 101 AND 107). SN 85-281,642. PUB. 8-9-2011. FILED 3-30-2011.
- 4,045,230. **MOVEMEND (STANDARD CHARACTER)**. ORTHODYNAMICS INTERNATIONAL LLC, DBA MY-GOODHABIT, MULTIPLE CLASS, (INT. CLS. 41 AND 44), (U.S. CLS. 100, 101 AND 107). SN 85-281,820. PUB. 8-9-2011. FILED 3-30-2011.
- 4,045,237. **FEEVHA (STANDARD CHARACTER)**. ORTIZ, JUAN S., (U.S. CLS. 100, 101 AND 107). SN 85-281,904. PUB. 8-9-2011. FILED 3-31-2011.
- 4,045,238. **TEAM TFS (STYLIZED)**. BASTIAN, MICHAEL R., (U.S. CLS. 100, 101 AND 107). SN 85-281,906. PUB. 8-9-2011. FILED 3-31-2011.
- 4,045,243. **PUT IT ALL ON THE LINE. (STANDARD CHARACTER)**. SOUTHEAST LINEMAN TRAINING CENTER, LLC, (U.S. CLS. 100, 101 AND 107). SN 85-281,985. PUB. 8-9-2011. FILED 3-31-2011.
- 4,045,244 ( *See Class 9 for this trademark*).
- 4,045,266. **THE PRESIDENT'S OWN (STANDARD CHARACTER)**. U.S. MARINE CORPS, A COMPONENT OF THE U.S. DEPARTMENT OF THE NAVY, (U.S. CLS. 100, 101 AND 107). SN 85-282,117. PUB. 8-9-2011. FILED 3-31-2011.
- 4,045,273. **HANDY MOM 101 (STANDARD CHARACTER)**. MOSS CONSTRUCTION COMPANY, INC., (U.S. CLS. 100, 101 AND 107). SN 85-282,236. PUB. 8-9-2011. FILED 3-31-2011.
- 4,045,275 ( *See Class 25 for this trademark*).
- 4,045,278. **CAPTURESQUE (STANDARD CHARACTER)**. CAPTURESQUE PHOTOGRAPHY LLC, (U.S. CLS. 100, 101 AND 107). SN 85-282,313. PUB. 8-9-2011. FILED 3-31-2011.
- 4,045,287. **SPATIAL HARMONICS (STANDARD CHARACTER)**. SPATIAL HARMONICS GROUP, (U.S. CLS. 100, 101 AND 107). SN 85-282,428. PUB. 8-9-2011. FILED 3-31-2011.
- 4,045,290. **GOLFOLOGIST (STANDARD CHARACTER)**. GREGORY P ORTMAN, DBA GREG ORTMAN GOLF SCHOOLS, (U.S. CLS. 100, 101 AND 107). SN 85-282,461. PUB. 8-9-2011. FILED 3-31-2011.
- 4,045,295. **BLACK HONDO (STANDARD CHARACTER)**. GONZALEZ, LUCINA, AND GONZALEZ, JOSE VALENTINO, (U.S. CLS. 100, 101 AND 107). SN 85-282,519. PUB. 8-9-2011. FILED 3-31-2011.
- 4,045,298. **THE GYPSY TRAVELERS (STANDARD CHARACTER)**. HARRIS, DIANE M., AND HARRIS, JIMMY WAYNE, (U.S. CLS. 100, 101 AND 107). SN 85-282,541. PUB. 8-9-2011. FILED 3-31-2011.
- 4,045,302. **TRAIN DON'T COMPLAIN (STANDARD CHARACTER)**. SOSLER, JAMES J., (U.S. CLS. 100, 101 AND 107). SN 85-282,583. PUB. 8-9-2011. FILED 3-31-2011.
- 4,045,314. **THIS BOOK IS ALIVE (STANDARD CHARACTER)**. ETHNOGRAPHIC MEDIA, INC., (U.S. CLS. 100, 101 AND 107). SN 85-282,788. PUB. 8-9-2011. FILED 3-31-2011.
- 4,045,322. **SFLMEDIA (STANDARD CHARACTER)**. THE SOURCE FOR LEARNING, INC., (U.S. CLS. 100, 101 AND 107). SN 85-282,930. PUB. 8-9-2011. FILED 3-31-2011.
- 4,045,328. **OK2ASK (STANDARD CHARACTER)**. THE SOURCE FOR LEARNING, INC., (U.S. CLS. 100, 101 AND 107). SN 85-282,971. PUB. 8-9-2011. FILED 3-31-2011.
- 4,045,331. **OK2ASK (STYLIZED)**. THE SOURCE FOR LEARNING, INC., (U.S. CLS. 100, 101 AND 107). SN 85-282,988. PUB. 8-9-2011. FILED 3-31-2011.
- 4,045,335. **SLICK CHIX (STANDARD CHARACTER)**. DUCKETT, ISSAC, (U.S. CLS. 100, 101 AND 107). SN 85-283,035. PUB. 8-9-2011. FILED 3-31-2011.
- 4,045,339. **LENOX UNDERGROUND (STANDARD CHARACTER)**. GERON, PHILIP, (U.S. CLS. 100, 101 AND 107). SN 85-283,078. PUB. 8-9-2011. FILED 3-31-2011.
- 4,045,346. **MIX AND DESIGN**. WILLIAMS, LESA G., (U.S. CLS. 100, 101 AND 107). SN 85-283,169. PUB. 8-9-2011. FILED 3-31-2011.
- 4,045,351 ( *See Class 9 for this trademark*).
- 4,045,365 ( *See Class 35 for this trademark*).
- 4,045,370. **EARLY RAY (STANDARD CHARACTER)**. BELCHER, RAYEN, (U.S. CLS. 100, 101 AND 107). SN 85-283,468. PUB. 8-9-2011. FILED 4-1-2011.
- 4,045,371. **ALWAYS CONNECTED (STANDARD CHARACTER)**. THOMAS M RICH LLC, (U.S. CLS. 100, 101 AND 107). SN 85-283,477. PUB. 8-9-2011. FILED 4-1-2011.
- 4,045,377 ( *See Class 36 for this trademark*).
- 4,045,382. **CHEAP THRILLS (STANDARD CHARACTER)**. NEW FRONTIER MEDIA, INC., (U.S. CLS. 100, 101 AND 107). SN 85-283,615. PUB. 8-9-2011. FILED 4-1-2011.
- 4,045,388. **WHAT WILL YOU DO TO END VIOLENCE? (STANDARD CHARACTER)**. BUCHOLTZ, JEFFREY, (U.S. CLS. 100, 101 AND 107). SN 85-283,696. PUB. 8-9-2011. FILED 4-1-2011.
- 4,045,398. **VITAMIN G (STANDARD CHARACTER)**. ADVANCE MAGAZINE PUBLISHERS INC., (U.S. CLS. 100, 101 AND 107). SN 85-283,806. PUB. 8-9-2011. FILED 4-1-2011.
- 4,045,400 ( *See Class 16 for this trademark*).
- 4,045,407 ( *See Class 9 for this trademark*).
- 4,045,411. **BOULDER STATION (STANDARD CHARACTER)**. NP IP HOLDINGS LLC, (U.S. CLS. 100, 101 AND 107). SN 85-283,931. PUB. 8-9-2011. FILED 4-1-2011.
- 4,045,415. **MISCELLANEOUS DESIGN**. STATE UNIVERSITY OF NEW YORK AT NEW PALTZ, (U.S. CLS. 100, 101 AND 107). SN 85-283,970. PUB. 8-9-2011. FILED 4-1-2011.
- 4,045,422. **MCW (STANDARD CHARACTER)**. MICRO CHAMPIONSHIP WRESTLING, INC., (U.S. CLS. 100, 101 AND 107). SN 85-284,055. PUB. 8-9-2011. FILED 4-1-2011.
- 4,045,432 ( *See Class 35 for this trademark*).
- 4,045,434. **FANCY ME YET (STANDARD CHARACTER)**. DUENAS, NATASHA JEANETTE, AND GAYNOR, ALEXANDER DARREN, (U.S. CLS. 100, 101 AND 107). SN 85-284,220. PUB. 8-9-2011. FILED 4-1-2011.
- 4,045,439. **COETOGRAPHY (STANDARD CHARACTER)**. AMBER M COE, DBA COETOGRAPHY, (U.S. CLS. 100, 101 AND 107). SN 85-284,293. PUB. 8-9-2011. FILED 4-1-2011.
- 4,045,443. **FEDTELLIGENCE (STANDARD CHARACTER)**. LTC PRO LLC, (U.S. CLS. 100, 101 AND 107). SN 85-284,324. PUB. 8-9-2011. FILED 4-1-2011.
- 4,045,444. **BIG BANG FOR YOUR BITE! (STANDARD CHARACTER)**. FORD, JENNIFER A., (U.S. CLS. 100, 101 AND 107). SN 85-284,328. PUB. 8-9-2011. FILED 4-1-2011.
- 4,045,461. **TG (STANDARD CHARACTER)**. PATRICK POULIN, (U.S. CLS. 100, 101 AND 107). SN 85-284,591. PUB. 8-9-2011. FILED 4-2-2011.
- 4,045,482. **COUPLES ON THE BRINK (STANDARD CHARACTER)**. THINK BIG NOW, INC., DBA COUPLES ON THE BRINK, (U.S. CLS. 100, 101 AND 107). SN 85-285,722. PUB. 8-9-2011. FILED 4-4-2011.
- 4,045,499. **MISCELLANEOUS DESIGN**. QUALITY MUSIC, LLC, (U.S. CLS. 100, 101 AND 107). SN 85-286,937. PUB. 8-9-2011. FILED 4-5-2011.
- 4,045,505. **FLOW CONTROL (STANDARD CHARACTER)**. EBSCO INDUSTRIES, INC., (U.S. CLS. 100, 101 AND 107). SN 85-287,494. PUB. 8-9-2011. FILED 4-6-2011.
- 4,045,510. **WILDCARD (STANDARD CHARACTER)**. QUALITY MUSIC, LLC, (U.S. CLS. 100, 101 AND 107). SN 85-288,035. PUB. 8-9-2011. FILED 4-6-2011.
- 4,045,513 ( *See Class 38 for this trademark*).

- 4,045,514. **FIDELITY PERSPECTIVES (STANDARD CHARACTER)**, FMR LLC, (U.S. CLS. 100, 101 AND 107). SN 85-288,608. PUB. 8-9-2011. FILED 4-7-2011.
- 4,045,521. **MORE WINNERS... ALL THE TIME! (STANDARD CHARACTER)**, THE UPPER SKAGIT INDIAN TRIBE, DBA SKAGIT VALLEY CASINO RESORT, MULTIPLE CLASS, (INT. CLS. 41 AND 43), (U.S. CLS. 100, 101 AND 107). SN 85-290,609. PUB. 8-9-2011. FILED 4-8-2011.
- 4,045,522. **MORE WINNERS! MORE REWARDS! ALL THE TIME! (STANDARD CHARACTER)**, THE UPPER SKAGIT INDIAN TRIBE, DBA SKAGIT VALLEY CASINO RESORT, MULTIPLE CLASS, (INT. CLS. 41 AND 43), (U.S. CLS. 100, 101 AND 107). SN 85-290,617. PUB. 8-9-2011. FILED 4-8-2011.
- 4,045,523. **HEART TANGO AND DESIGN**, HEART TANGO INC., (U.S. CLS. 100, 101 AND 107). SN 85-290,964. PUB. 8-9-2011. FILED 4-9-2011.
- 4,045,544 ( *See Class 9 for this trademark*).
- 4,045,571. **FUN BITES (STANDARD CHARACTER)**, BARONA GROUP OF THE CAPITAN GRANDE BAND OF MISSION INDIANS, DBA BARONA VALLEY RANCH RESORT AND CASINO, MULTIPLE CLASS, (INT. CLS. 41 AND 43), (U.S. CLS. 100, 101 AND 107). SN 85-342,362. PUB. 8-9-2011. FILED 6-9-2011.
- 4,045,572. **C.A.T.C.H. (STANDARD CHARACTER)**, ERIN FILNER, (U.S. CLS. 100, 101 AND 107). SN 85-342,760. PUB. 8-9-2011. FILED 6-9-2011.
- 
- CLASS 42—SCIENTIFIC AND COMPUTER SERVICES**
- 4,043,634 ( *See Class 35 for this trademark*).
- 4,043,636. **4 K (STYLIZED)**, 4DK TECHNOLOGIES, INC., (U.S. CLS. 100 AND 101). SN 77-207,353. PUB. 4-1-2008. FILED 6-15-2007.
- 4,043,637. **4DK (STANDARD CHARACTER)**, 4DK TECHNOLOGIES, INC., (U.S. CLS. 100 AND 101). SN 77-207,375. PUB. 4-1-2008. FILED 6-15-2007.
- 4,043,638. **4DK TECHNOLOGIES INC. (STANDARD CHARACTER)**, 4DK TECHNOLOGIES, INC., (U.S. CLS. 100 AND 101). SN 77-207,400. PUB. 4-1-2008. FILED 6-15-2007.
- 4,043,641 ( *See Class 9 for this trademark*).
- 4,043,649 ( *See Class 1 for this trademark*).
- 4,043,658 ( *See Class 1 for this trademark*).
- 4,043,674 ( *See Class 9 for this trademark*).
- 4,043,678 ( *See Class 35 for this trademark*).
- 4,043,681. **PROJECT SORA (STANDARD CHARACTER)**, NINTENDO OF AMERICA INC., (U.S. CLS. 100 AND 101). SN 77-789,126. PUB. 7-20-2010. FILED 7-24-2009.
- 4,043,684 ( *See Class 9 for this trademark*).
- 4,043,692 ( *See Class 37 for this trademark*).
- 4,043,693 ( *See Class 35 for this trademark*).
- 4,043,695 ( *See Class 9 for this trademark*).
- 4,043,699 ( *See Class 35 for this trademark*).
- 4,043,717 ( *See Class 41 for this trademark*).
- 4,043,718 ( *See Class 41 for this trademark*).
- 4,043,722 ( *See Class 1 for this trademark*).
- 4,043,747 ( *See Class 9 for this trademark*).
- 4,043,767 ( *See Class 9 for this trademark*).
- 4,043,768 ( *See Class 9 for this trademark*).
- 4,043,769 ( *See Class 9 for this trademark*).
- 4,043,772 ( *See Class 12 for this trademark*).
- 4,043,773 ( *See Class 9 for this trademark*).
- 4,043,784 ( *See Class 7 for this trademark*).
- 4,043,791 ( *See Class 9 for this trademark*).
- 4,043,796 ( *See Class 9 for this trademark*).
- 4,043,799 ( *See Class 9 for this trademark*).
- 4,043,812 ( *See Class 4 for this trademark*).
- 4,043,815 ( *See Class 9 for this trademark*).
- 4,043,825 ( *See Class 9 for this trademark*).
- 4,043,829 ( *See Class 19 for this trademark*).
- 4,043,830 ( *See Class 9 for this trademark*).
- 4,043,840 ( *See Class 37 for this trademark*).
- 4,043,841 ( *See Class 9 for this trademark*).
- 4,043,849 ( *See Class 41 for this trademark*).
- 4,043,882 ( *See Class 9 for this trademark*).
- 4,043,892. **DIGITALPULSE (STANDARD CHARACTER)**, ADOBE SYSTEMS INCORPORATED, (U.S. CLS. 100 AND 101). SN 85-040,782. PUB. 8-9-2011. FILED 5-17-2010.
- 4,043,893 ( *See Class 9 for this trademark*).
- 4,043,894 ( *See Class 35 for this trademark*).
- 4,043,897 ( *See Class 9 for this trademark*).
- 4,043,898 ( *See Class 9 for this trademark*).
- 4,043,925 ( *See Class 35 for this trademark*).
- 4,043,926. **ACTION ECONOMY REAL DATA NOW AND DESIGN**, CRAWFORD, TIFFANI A, DBA ACTIONECONOMY, (U.S. CLS. 100 AND 101). SN 85-082,096. PUB. 8-9-2011. FILED 7-11-2010.
- 4,043,928 ( *See Class 37 for this trademark*).
- 4,043,933 ( *See Class 35 for this trademark*).
- 4,043,938. **EVENTSCRIBE (STYLIZED)**, CADMIUM CD LLC, (U.S. CLS. 100 AND 101). SN 85-097,365. PUB. 8-9-2011. FILED 7-30-2010.
- 4,043,940 ( *See Class 35 for this trademark*).
- 4,043,957. **REVO DASHBOARD (STANDARD CHARACTER)**, REVO AMERICA CORPORATION, (U.S. CLS. 100 AND 101). SN 85-104,301. PUB. 8-9-2011. FILED 8-10-2010.
- 4,043,992 ( *See Class 40 for this trademark*).
- 4,044,021 ( *See Class 9 for this trademark*).
- 4,044,040. **VIAJEZ (STANDARD CHARACTER)**, WWW VIAJEZ COM, S.A. DE C.V., (U.S. CLS. 100 AND 101). SN 85-135,219. PUB. 7-12-2011. FILED 9-22-2010.
- 4,044,060. **EDCENTRIX AND DESIGN**, EDCENTRIX, INC., (U.S. CLS. 100 AND 101). SN 85-141,613. PUB. 8-9-2011. FILED 9-30-2010.
- 4,044,065. **OMNISCIENT (STANDARD CHARACTER)**, 4ISOFT LLC, FORMERLY KOMPISOFT ENTERPRISE APPLICATIONS, (U.S. CLS. 100 AND 101). SN 85-144,379. PUB. 8-9-2011. FILED 10-4-2010.
- 4,044,070. **X AND DESIGN**, 10TH MAGNITUDE, INC., (U.S. CLS. 100 AND 101). SN 85-146,082. PUB. 8-9-2011. FILED 10-6-2010.
- 4,044,080. **MISCELLANEOUS DESIGN**, GOVDELIVERY, INC., (U.S. CLS. 100 AND 101). SN 85-151,594. PUB. 8-9-2011. FILED 10-13-2010.
- 4,044,093 ( *See Class 39 for this trademark*).
- 4,044,097. **LEMONFREE.COM (STANDARD CHARACTER)**, LEMONFREE.COM INC., (U.S. CLS. 100 AND 101). SN 85-164,463. PUB. 8-9-2011. FILED 10-29-2010.
- 4,044,100 ( *See Class 35 for this trademark*).
- 4,044,116 ( *See Class 35 for this trademark*).
- 4,044,123. **TICKLE.ME (STANDARD CHARACTER)**, LUSIER, KYLE E, (U.S. CLS. 100 AND 101). SN 85-175,789. PUB. 8-9-2011. FILED 11-12-2010.
- 4,044,134. **DARMA (STANDARD CHARACTER)**, IDM USA LLC, DBA DATAFORMAT.COM, (U.S. CLS. 100 AND 101). SN 85-182,621. PUB. 5-3-2011. FILED 11-22-2010.
- 4,044,140. **OPTISURFACE (STANDARD CHARACTER)**, COX, GRAEME, (U.S. CLS. 100 AND 101). SN 85-185,366. PUB. 8-9-2011. FILED 11-26-2010.
- 4,044,190. **SEMANTICSPACE (STANDARD CHARACTER)**, SEMANTIC SPACE TECHNOLOGIES LIMITED, (U.S. CLS. 100 AND 101). SN 85-209,246. PUB. 5-3-2011. FILED 1-3-2011.
- 4,044,208. **MISCELLANEOUS DESIGN**, ESOZO LLC, (U.S. CLS. 100 AND 101). SN 85-214,596. PUB. 8-9-2011. FILED 1-11-2011.
- 4,044,248. **FOLLOWS/ (STANDARD CHARACTER)**, LEVYTAM, SHALOM, (U.S. CLS. 100 AND 101). SN 85-229,704. PUB. 8-9-2011. FILED 1-31-2011.
- 4,044,275 ( *See Class 41 for this trademark*).
- 4,044,287. **DYNAFILE (STANDARD CHARACTER)**, BLUE RIBBON TECHNOLOGIES, LLC, (U.S. CLS. 100 AND 101). SN 85-238,396. PUB. 8-9-2011. FILED 2-9-2011.
- 4,044,303 ( *See Class 35 for this trademark*).
- 4,044,311. **PRECIPICE (STANDARD CHARACTER)**, PRECIPICE DESIGN LIMITED, (U.S. CLS. 100 AND 101). SN 85-245,753. PUB. 8-9-2011. FILED 2-18-2011.
- 4,044,321 ( *See Class 41 for this trademark*).
- 4,044,339. **DECODE SOLUTIONS AND DESIGN**, DECODE SOLUTIONS LLC, (U.S. CLS. 100 AND 101). SN 85-251,021. PUB. 8-9-2011. FILED 2-24-2011.
- 4,044,368. **LONGWOOD SOFTWARE (STANDARD CHARACTER)**, LONGWOOD SOFTWARE, INC., (U.S. CLS. 100

- AND 101). SN 85-255,026. PUB. 8-9-2011. FILED 3-1-2011.  
4,044,374 ( *See Class 41 for this trademark*).
- 4,044,382. **P PHOTOBIZ PASSIONATE SUPPORT (STYLIZED)**. PHOTOBIZ, LLC, (U.S. CLS. 100 AND 101). SN 85-257,382. PUB. 8-9-2011. FILED 3-3-2011.
- 4,044,414. **JMG SOFTWARE (STANDARD CHARACTER)**. JMG SOFTWARE, LLC, (U.S. CLS. 100 AND 101). SN 85-259,718. PUB. 8-9-2011. FILED 3-7-2011.
- 4,044,425. **HDWORLDMEDIA GLOBAL MEDIA SOLUTIONS (STANDARD CHARACTER)**. HDWORLDMEDIA COMPANIES, LLC, (U.S. CLS. 100 AND 101). SN 85-260,078. PUB. 8-9-2011. FILED 3-7-2011.
- 4,044,435. **CLOUDITNOW AND DESIGN**. SLEEMS CONSULTING, (U.S. CLS. 100 AND 101). SN 85-260,790. PUB. 8-9-2011. FILED S.R. 3-8-2011; AM. P.R. 6-15-2011.
- 4,044,440 ( *See Class 35 for this trademark*).
- 4,044,450. **HOUSE RESEARCH INSTITUTE AND DESIGN**. HOUSE RESEARCH INSTITUTE, (U.S. CLS. 100 AND 101). SN 85-261,378. PUB. 8-9-2011. FILED 3-8-2011.
- 4,044,466. **MYSTIC RIVER COMMUNICATIONS (STANDARD CHARACTER)**. HOWARD C. KATZ LLC, DBA MYSTIC RIVER COMMUNICATIONS, (U.S. CLS. 100 AND 101). SN 85-262,074. PUB. 8-9-2011. FILED 3-9-2011.
- 4,044,477 ( *See Class 35 for this trademark*).
- 4,044,537. **HARVESTER GEAR (STANDARD CHARACTER)**. TS MANAGEMENT, (U.S. CLS. 100 AND 101). SN 85-264,305. PUB. 8-9-2011. FILED 3-11-2011.
- 4,044,541. **ONCOPREDICTOR AND DESIGN**. COMPENDIA BIOSCIENCE, INC., (U.S. CLS. 100 AND 101). SN 85-264,440. PUB. 8-9-2011. FILED 3-11-2011.
- 4,044,542. **O ONCOMINE C O N C E P T S AND DESIGN**. COMPENDIA BIOSCIENCE, INC., (U.S. CLS. 100 AND 101). SN 85-264,469. PUB. 8-9-2011. FILED 3-11-2011.
- 4,044,545. **O ONCOMINE (STYLIZED)**. COMPENDIA BIOSCIENCE, INC., (U.S. CLS. 100 AND 101). SN 85-264,616. PUB. 8-9-2011. FILED 3-11-2011.
- 4,044,548 ( *See Class 41 for this trademark*).
- 4,044,562. **MYSTEELCLOUD (STANDARD CHARACTER)**. MIDWESTERN-USA DATA, (U.S. CLS. 100 AND 101). SN 85-265,416. PUB. 8-9-2011. FILED 3-12-2011.
- 4,044,577. **WHYOUHIRE (STANDARD CHARACTER)**. WHYOUHIRE, LLC, (U.S. CLS. 100 AND 101). SN 85-266,467. PUB. 8-9-2011. FILED 3-14-2011.
- 4,044,579 ( *See Class 35 for this trademark*).
- 4,044,581. **TAKE CONTROL OF YOUR WEBSITE (STANDARD CHARACTER)**. BKMEDIA GROUP, (U.S. CLS. 100 AND 101). SN 85-266,677. PUB. 8-9-2011. FILED 3-14-2011.
- 4,044,582. **INSPIRE YOUR AUDIENCE WITH FRESH DESIGN (STANDARD CHARACTER)**. BKMEDIA GROUP, (U.S. CLS. 100 AND 101). SN 85-266,678. PUB. 8-9-2011. FILED 3-14-2011.
- 4,044,589 ( *See Class 35 for this trademark*).
- 4,044,599. **KID TOYOLOGY (STANDARD CHARACTER)**. WACHTEL, PETER, ANDREW, AKA KID TOYOLOGY, (U.S. CLS. 100 AND 101). SN 85-269,070. PUB. 8-9-2011. FILED S.R. 3-16-2011; AM. P.R. 6-15-2011.
- 4,044,619 ( *See Class 35 for this trademark*).
- 4,044,630. **LIVE AND PLAY (STANDARD CHARACTER)**. THREE ROCKS GAMES LLC, (U.S. CLS. 100 AND 101). SN 85-273,403. PUB. 8-9-2011. FILED 3-22-2011.
- 4,044,634 ( *See Class 35 for this trademark*).
- 4,044,637 ( *See Class 9 for this trademark*).
- 4,044,679 ( *See Class 9 for this trademark*).
- 4,044,684. **HBEPOINT (STANDARD CHARACTER)**. COCO DEVELOPMENT, L.L.C., (U.S. CLS. 100 AND 101). SN 85-274,247. PUB. 8-9-2011. FILED 3-23-2011.
- 4,044,691. **ASSISTLY (STANDARD CHARACTER)**. SALESFORCE.COM, INC., (U.S. CLS. 100 AND 101). SN 85-274,378. PUB. 8-9-2011. FILED 3-23-2011.
- 4,044,701. **ASSISTLY AND DESIGN**. ASSISTLY, INC., (U.S. CLS. 100 AND 101). SN 85-274,548. PUB. 8-9-2011. FILED 3-23-2011.
- 4,044,705. **AUDIOASSESSOR (STANDARD CHARACTER)**. THE EI GROUP, INC., (U.S. CLS. 100 AND 101). SN 85-274,592. PUB. 8-9-2011. FILED 3-23-2011.
- 4,044,706. **RESPIRATORASSESSOR (STANDARD CHARACTER)**. THE EI GROUP, INC., (U.S. CLS. 100 AND 101). SN 85-274,604. PUB. 8-9-2011. FILED 3-23-2011.
- 4,044,729. **IBUILDER (STANDARD CHARACTER)**. PLAY-POWER LT FARMINGTON, INC., (U.S. CLS. 100 AND 101). SN 85-274,951. PUB. 8-9-2011. FILED 3-23-2011.
- 4,044,740. **CODENYC AND DESIGN**. COCHRAN, NINA Y, (U.S. CLS. 100 AND 101). SN 85-275,219. PUB. 8-9-2011. FILED 3-24-2011.
- 4,044,745. **VIDEOBUILDER (STANDARD CHARACTER)**. VIDEO DIRECT LIMITED, TA VIDEOBUILDER.TV, (U.S. CLS. 100 AND 101). SN 85-275,351. PUB. 8-9-2011. FILED 3-24-2011.
- 4,044,753. **AIDI (STANDARD CHARACTER)**. ANALYSIS, INTEGRATION AND DESIGN, INC., (U.S. CLS. 100 AND 101). SN 85-275,438. PUB. 8-9-2011. FILED 3-24-2011.
- 4,044,754. **MZ REACH (STANDARD CHARACTER)**. MILLER ZELL, INC., (U.S. CLS. 100 AND 101). SN 85-275,441. PUB. 8-9-2011. FILED 3-24-2011.
- 4,044,755. **ZENOK (STANDARD CHARACTER)**. ZENOK NV, (U.S. CLS. 100 AND 101). SN 85-275,449. PUB. 8-9-2011. FILED 3-24-2011.
- 4,044,756. **PACKAGEPREP (STANDARD CHARACTER)**. GATEWAY LOAN REVIEW, LLC, (U.S. CLS. 100 AND 101). SN 85-275,462. PUB. 8-9-2011. FILED 3-24-2011.
- 4,044,766 ( *See Class 41 for this trademark*).
- 4,044,783. **XXXXX AND DESIGN**. SHINN, ROBERT, AND ROBERT, DANA, (U.S. CLS. 100 AND 101). SN 85-275,759. PUB. 8-9-2011. FILED 3-24-2011.
- 4,044,836 ( *See Class 40 for this trademark*).
- 4,044,849. **ADT SELECT (STANDARD CHARACTER)**. ADT SERVICES AG, MULTIPLE CLASS, (INT. CLS. 42 AND 45), (U.S. CLS. 100 AND 101). SN 85-276,726. PUB. 8-9-2011. FILED 3-25-2011.
- 4,044,861. **BOXWIRE (STANDARD CHARACTER)**. ONKEW TECHNOLOGY, (U.S. CLS. 100 AND 101). SN 85-276,871. PUB. 8-9-2011. FILED 3-25-2011.
- 4,044,865. **AXIAWARE AND DESIGN**. JX2, LLC, DBA AXIAWARE, (U.S. CLS. 100 AND 101). SN 85-276,927. PUB. 8-9-2011. FILED 3-25-2011.
- 4,044,867. **WOOHWAH AND DESIGN**. CURY, WILLIAM, (U.S. CLS. 100 AND 101). SN 85-276,943. PUB. 8-9-2011. FILED 3-25-2011.
- 4,044,939 ( *See Class 35 for this trademark*).
- 4,044,943 ( *See Class 35 for this trademark*).
- 4,044,957 ( *See Class 9 for this trademark*).
- 4,044,963. **NLOGIC (STANDARD CHARACTER)**. NLOGIC, LLC, (U.S. CLS. 100 AND 101). SN 85-278,245. PUB. 8-9-2011. FILED 3-28-2011.
- 4,044,967 ( *See Class 9 for this trademark*).
- 4,044,988. **HCI.COM (STANDARD CHARACTER)**. BOSTECH CORPORATION, (U.S. CLS. 100 AND 101). SN 85-278,536. PUB. 8-9-2011. FILED 3-28-2011.
- 4,044,997. **PILEUS (STANDARD CHARACTER)**. PILEUS, INC., (U.S. CLS. 100 AND 101). SN 85-278,690. PUB. 8-9-2011. FILED 3-28-2011.
- 4,045,014 ( *See Class 35 for this trademark*).
- 4,045,028. **WEBTRIALZ (STANDARD CHARACTER)**. APT INC, (U.S. CLS. 100 AND 101). SN 85-279,071. PUB. 8-9-2011. FILED 3-28-2011.
- 4,045,035 ( *See Class 35 for this trademark*).
- 4,045,048. **PROGENACELL (STANDARD CHARACTER)**. PROGENACELL, INC, (U.S. CLS. 100 AND 101). SN 85-279,278. PUB. 8-9-2011. FILED 3-28-2011.
- 4,045,049. **HYPLER (STANDARD CHARACTER)**. GANN, JONATHAN R, (U.S. CLS. 100 AND 101). SN 85-279,285. PUB. 8-9-2011. FILED 3-29-2011.
- 4,045,057. **SHARXBYTE (STANDARD CHARACTER)**. SHARXBYTE, INC., (U.S. CLS. 100 AND 101). SN 85-279,442. PUB. 8-9-2011. FILED 3-29-2011.
- 4,045,074. **BE IN THE GAME, GET ON THE GRID (STANDARD CHARACTER)**. PLAYERGRID INC., (U.S. CLS. 100 AND 101). SN 85-279,700. PUB. 8-9-2011. FILED 3-29-2011.
- 4,045,085. **GULFSTUDY (STANDARD CHARACTER)**. U.S. DEPARTMENT OF HEALTH AND HUMAN SERVICES, (U.S. CLS. 100 AND 101). SN 85-279,867. PUB. 8-9-2011. FILED 3-29-2011.
- 4,045,102. **BULLHORN REACH (STANDARD CHARACTER)**. BULLHORN, INC., (U.S. CLS. 100 AND 101). SN 85-280,082. PUB. 8-9-2011. FILED 3-29-2011.
- 4,045,107. **RINGS (STANDARD CHARACTER)**. 2020B LLC,

(U.S. CLS. 100 AND 101), SN 85-280,204. PUB. 8-9-2011. FILED 3-29-2011.

4,045,112. **PULMOAGE (STANDARD CHARACTER)**, PHYSIO-AGE SYSTEMS LLC, (U.S. CLS. 100 AND 101), SN 85-280,248. PUB. 8-9-2011. FILED 3-29-2011.

4,045,118. **FIGHTING FOR A PAIN FREE WEB (STANDARD CHARACTER)**, IZOOX LLC, (U.S. CLS. 100 AND 101), SN 85-280,297. PUB. 8-9-2011. FILED 3-29-2011.

4,045,121. **HELPING THOSE HELPING FAMILIES (STANDARD CHARACTER)**, DATATUDE, INC., (U.S. CLS. 100 AND 101), SN 85-280,347. PUB. 8-9-2011. FILED 3-29-2011.

4,045,133. **EPIZYME (STANDARD CHARACTER)**, EPIZYME, INC., (U.S. CLS. 100 AND 101), SN 85-280,475. PUB. 8-9-2011. FILED 3-29-2011.

4,045,162. **INGENUITY INTENSITY INTEGRITY (STANDARD CHARACTER)**, ASPEN ADVISORS, LLC, (U.S. CLS. 100 AND 101), SN 85-280,889. PUB. 8-9-2011. FILED 3-30-2011.

4,045,164. **PUT YOUR NETWORK TO WORK (STANDARD CHARACTER)**, BULLHORN, INC., (U.S. CLS. 100 AND 101), SN 85-280,902. PUB. 8-9-2011. FILED 3-30-2011.

4,045,185. **NETWORKING THE WORLD OF GOOD INTENTIONS (STANDARD CHARACTER)**, DR. ERIC HERMAN, (U.S. CLS. 100 AND 101), SN 85-281,101. PUB. 8-9-2011. FILED 3-30-2011.

4,045,196. **SPOTJOT (STANDARD CHARACTER)**, WRITE-POLE LLC, (U.S. CLS. 100 AND 101), SN 85-281,286. PUB. 8-9-2011. FILED 3-30-2011.

4,045,244 ( *See Class 9 for this trademark.* )

4,045,275 ( *See Class 25 for this trademark.* )

4,045,300. **CUBIST (STANDARD CHARACTER)**, CUBIST PHARMACEUTICALS, INC., (U.S. CLS. 100 AND 101), SN 85-282,561. PUB. 8-9-2011. FILED 3-31-2011.

4,045,353. **RELAYT (STANDARD CHARACTER)**, PEIRES, GUY, DBA RELAYT, (U.S. CLS. 100 AND 101), SN 85-283,290. PUB. 8-9-2011. FILED 4-1-2011.

4,045,355. **SINGLE PROPERTY SITES (STANDARD CHARACTER)**, SINGLE PROPERTY SITES INC, (U.S. CLS. 100 AND 101), SN 85-283,295. PUB. 8-9-2011. FILED 4-1-2011.

4,045,372. **NURTURE (STANDARD CHARACTER)**, UCB PHARMA, S.A., (U.S. CLS. 100 AND 101), SN 85-283,483. PUB. 8-9-2011. FILED 4-1-2011.

4,045,373. **KNEW GENERATION (STANDARD CHARACTER)**, KNEW GENERATION LLC, (U.S. CLS. 100 AND 101), SN 85-283,510. PUB. 8-9-2011. FILED 4-1-2011.

4,045,380 ( *See Class 39 for this trademark.* )

4,045,386. **SHREDDISK AND DESIGN**, SHREDDISK, INC., (U.S. CLS. 100 AND 101), SN 85-283,685. PUB. 8-9-2011. FILED 4-1-2011.

4,045,389. **ENTERPRISESPIGIT (STANDARD CHARACTER)**, SPIGIT, INC., (U.S. CLS. 100 AND 101), SN 85-283,701. PUB. 8-9-2011. FILED 4-1-2011.

4,045,390. **SPIGIT (STANDARD CHARACTER)**, SPIGIT, INC., (U.S. CLS. 100 AND 101), SN 85-283,710. PUB. 8-9-2011. FILED 4-1-2011.

4,045,391. **SPIGITFUSION (STANDARD CHARACTER)**, SPIGIT, INC., (U.S. CLS. 100 AND 101), SN 85-283,714. PUB. 8-9-2011. FILED 4-1-2011.

4,045,414. **EDITFLOW (STANDARD CHARACTER)**, MATHEMATICAL SCIENCES PUBLISHERS, AKA MSP, (U.S. CLS. 100 AND 101), SN 85-283,969. PUB. 8-9-2011. FILED 4-1-2011.

4,045,424 ( *See Class 37 for this trademark.* )

4,045,425. **SPARKTRUST (STANDARD CHARACTER)**, PARETOLOGIC INC., (U.S. CLS. 100 AND 101), SN 85-284,086. PUB. 8-9-2011. FILED 4-1-2011.

4,045,431. **MYPAREA (STANDARD CHARACTER)**, NATIONAL HELLENIC SOCIETY, INC., (U.S. CLS. 100 AND 101), SN 85-284,171. PUB. 8-9-2011. FILED 4-1-2011.

4,045,457. **SPROUTSHOUT (STANDARD CHARACTER)**, SPROUTSHOUT MEDIA CORPORATION, (U.S. CLS. 100 AND 101), SN 85-284,511. PUB. 8-9-2011. FILED 4-2-2011.

4,045,473. **JUSTHEFAXX (STANDARD CHARACTER)**, JUSTHEFAXX, LLC, (U.S. CLS. 100 AND 101), SN 85-285,292. PUB. 8-9-2011. FILED 4-4-2011.

4,045,485. **PIXELPIPE (STANDARD CHARACTER)**, PIXELPIPE, INC., (U.S. CLS. 100 AND 101), SN 85-285,807. PUB. 8-9-2011. FILED 4-4-2011.

4,045,543 ( *See Class 35 for this trademark.* )

### CLASS 43—HOTEL AND RESTAURANT SERVICES

4,043,607. **PAPOU'S (STANDARD CHARACTER)**, DKL ENTERPRISES, LLC, (U.S. CLS. 100 AND 101), SN 76-651,532. PUB. 8-9-2011. FILED 12-7-2005.

4,043,653. **AVALON (STANDARD CHARACTER)**, AVALON HOTELS, L.L.C., (U.S. CLS. 100 AND 101), SN 77-603,359. PUB. 3-17-2009. FILED 10-29-2008.

4,043,673. **BROTHER GERARD FOUNDATION (STANDARD CHARACTER)**, SOVEREIGN MILITARY HOSPITALLER ORDER OF ST. JOHN OF JERUSALEM OF RHODES AND OF MALTA, MULTIPLE CLASS, (INT. CLS. 43, 44 AND 45), (U.S. CLS. 100 AND 101), SN 77-747,943. PUB. 8-9-2011. FILED 5-29-2009.

4,043,711. **LUIGI'S FAMOUS PIZZA AND DESIGN**, BYRD, DONALD, (U.S. CLS. 100 AND 101), SN 77-915,185. PUB. 8-9-2011. FILED 1-19-2010.

4,043,754 ( *See Class 39 for this trademark.* )

4,043,785 ( *See Class 3 for this trademark.* )

4,043,803 ( *See Class 31 for this trademark.* )

4,043,836. **ESPRESSO ROSSO (STANDARD CHARACTER)**, FERRARI S.P.A., (U.S. CLS. 100 AND 101), SN 79-092,938. PUB. 8-9-2011. FILED 8-25-2010.

4,043,885. **PATACON PISAO ASI SABE COLOMBIA AND DESIGN**, PATINO, SANDRA P., (U.S. CLS. 100 AND 101), SN 85-028,585. PUB. 8-9-2011. FILED 5-3-2010.

4,043,912 ( *See Class 39 for this trademark.* )

4,043,918 ( *See Class 12 for this trademark.* )

4,043,939. **HOT SPUD AND DESIGN**, CEMIL ERZINCANLI, (U.S. CLS. 100 AND 101), SN 85-097,618. PUB. 1-18-2011. FILED 8-1-2010.

4,043,952. **BIG BEN CAFE AND DESIGN**, BIG BEN CAFE, LLC, (U.S. CLS. 100 AND 101), SN 85-102,921. PUB. 8-9-2011. FILED 8-9-2010.

4,043,963. **FRIENDS DON'T LET FRIENDS EAT FROM A SI MENU (STANDARD CHARACTER)**, LARSON, JULIE, (U.S. CLS. 100 AND 101), SN 85-109,953. PUB. 8-9-2011. FILED 8-18-2010.

4,043,966. **EARTHFRUITS YOGURT (STANDARD CHARACTER)**, YOASIS FRANCHISING SYSTEMS, LLC, (U.S. CLS. 100 AND 101), SN 85-110,947. PUB. 8-9-2011. FILED 8-19-2010.

4,043,967 ( *See Class 35 for this trademark.* )

4,043,969 ( *See Class 3 for this trademark.* )

4,044,012. **ROSA MEXICANO RESTAURANTS AND DESIGN**, ROSA MEXICANO BRANDS, INC., (U.S. CLS. 100 AND 101), SN 85-122,019. PUB. 8-9-2011. FILED 9-2-2010.

4,044,144. **PUTTANESCA (STYLIZED)**, MALTA, ROBERT, (U.S. CLS. 100 AND 101), SN 85-186,380. PUB. 5-3-2011. FILED 11-29-2010.

4,044,154 ( *See Class 30 for this trademark.* )

4,044,160. **SIR WINSTON'S (STANDARD CHARACTER)**, CITY OF LONG BEACH, (U.S. CLS. 100 AND 101), SN 85-193,591. PUB. 8-9-2011. FILED 12-8-2010.

4,044,161. **SIR WINSTON'S AND DESIGN**, CITY OF LONG BEACH, (U.S. CLS. 100 AND 101), SN 85-193,599. PUB. 8-9-2011. FILED 12-8-2010.

4,044,183. **CORNELIA STREET CAFE (STANDARD CHARACTER)**, CORNELIA STREET CAFE INC., (U.S. CLS. 100 AND 101), SN 85-207,826. PUB. 8-9-2011. FILED 12-30-2010.

4,044,312. **TAQUERIA LOS OCAMPO ANTOJITOS MEXICANOS AND DESIGN**, TAQUERIA LOS OCAMPO, INC., (U.S. CLS. 100 AND 101), SN 85-246,081. PUB. 8-9-2011. FILED 2-18-2011.

4,044,328 ( *See Class 41 for this trademark.* )

4,044,333 ( *See Class 29 for this trademark.* )

4,044,334 ( *See Class 41 for this trademark.* )

4,044,344. **SPOON THE ONE YOU LOVE... (STANDARD CHARACTER)**, BNF, LLC, DBA SPOONERS FROZEN YOGURT, (U.S. CLS. 100 AND 101), SN 85-251,968. PUB. 8-9-2011. FILED 2-25-2011.

4,044,354. **VRBO FROM HOMEAWAY AND DESIGN**, HOMEAWAY.COM, INC., (U.S. CLS. 100 AND 101), SN 85-253,334. PUB. 8-9-2011. FILED 2-28-2011.

4,044,364. **JIMMY JOHN'S GOURMET SANDWICHES (STANDARD CHARACTER)**, JIMMY JOHN'S ENTERPRISES, LLC, (U.S. CLS. 100 AND 101), SN 85-254,749. PUB. 8-9-2011. FILED 3-1-2011.

- 4,044,418. **SNPPATAGONIASUR (STANDARD CHARACTER)**. PATAGONIA SUR, LLC, MULTIPLE CLASS, (INT. CLS. 43 AND 45), (U.S. CLS. 100 AND 101). SN 85-259,900. PUB. 8-9-2011. FILED 3-7-2011.
- 4,044,427. **EDISON LUNCH BOX AND DESIGN**. TROPICAL SHORES INC., DBA EDISON LUNCH BOX, (U.S. CLS. 100 AND 101). SN 85-260,226. PUB. 8-9-2011. FILED 3-7-2011.
- 4,044,463. **LUCKY OYSTER SEAFOOD GRILL AND DESIGN**. ITALIAN KITCHEN INC., (U.S. CLS. 100 AND 101). SN 85-261,921. PUB. 8-9-2011. FILED 3-9-2011.
- 4,044,506 ( *See Class 39 for this trademark*).
- 4,044,561. **SNO ON THE GO (STYLIZED)**. WRIGHT, MARK, AND WRIGHT, LAURA, (U.S. CLS. 100 AND 101). SN 85-265,415. PUB. 8-9-2011. FILED 3-12-2011.
- 4,044,580. **WHOLE HOG CAFE WORLD CHAMPION BARBECUE AND DESIGN**. WHOLE HOG CAFE, INC., (U.S. CLS. 100 AND 101). SN 85-266,532. PUB. 8-9-2011. FILED 3-14-2011.
- 4,044,726. **FLAUNT YOUR FLAVOR (STANDARD CHARACTER)**. YO FRESH LLC, (U.S. CLS. 100 AND 101). SN 85-274,924. PUB. 8-9-2011. FILED 3-23-2011.
- 4,044,734. **MO-CHICA (STANDARD CHARACTER)**. LA MONA, LLC, DBA MO-CHICA, (U.S. CLS. 100 AND 101). SN 85-275,101. PUB. 8-9-2011. FILED 3-23-2011.
- 4,044,741. **ACTIVE SENIOR LIVING AT ITS FINEST (STANDARD CHARACTER)**. E-QUEST MANAGEMENT, LLC, (U.S. CLS. 100 AND 101). SN 85-275,235. PUB. 8-9-2011. FILED 3-24-2011.
- 4,044,760. **COOKED FRESH TASTES BETTER (STANDARD CHARACTER)**. YOSHINOYA AMERICA, INC., (U.S. CLS. 100 AND 101). SN 85-275,527. PUB. 8-9-2011. FILED 3-24-2011.
- 4,044,761. **TASTES BETTER BECAUSE IT'S COOKED FRESH (STANDARD CHARACTER)**. YOSHINOYA AMERICA, INC., (U.S. CLS. 100 AND 101). SN 85-275,533. PUB. 8-9-2011. FILED 3-24-2011.
- 4,044,869. **GREENSQUARE TAVERN (STANDARD CHARACTER)**. FARM HOUSE PRODUCTIONS LLC, (U.S. CLS. 100 AND 101). SN 85-276,965. PUB. 8-9-2011. FILED 3-25-2011.
- 4,044,880. **FRITOS PIE REMIX (STANDARD CHARACTER)**. FRITO-LAY NORTH AMERICA, INC., (U.S. CLS. 100 AND 101). SN 85-277,156. PUB. 8-9-2011. FILED 3-25-2011.
- 4,044,882 ( *See Class 36 for this trademark*).
- 4,044,954. **WHITTIER (STANDARD CHARACTER)**. WHITTIER PLACE CAFE, LLC, AKA WHITTIER PLACE CAFE AND CATERING, LLC, (U.S. CLS. 100 AND 101). SN 85-278,139. PUB. 8-9-2011. FILED 3-27-2011.
- 4,044,974 ( *See Class 25 for this trademark*).
- 4,044,977. **AQUAVIDA AND DESIGN**. AQUA VIDA INTERNATIONAL, (U.S. CLS. 100 AND 101). SN 85-278,452. PUB. 8-9-2011. FILED 3-28-2011.
- 4,044,999 ( *See Class 30 for this trademark*).
- 4,045,007. **LOVE IT AT HOME (STANDARD CHARACTER)**. ALFONSO TOMITA, (U.S. CLS. 100 AND 101). SN 85-278,845. PUB. 8-9-2011. FILED 3-28-2011.
- 4,045,060. **MISCELLANEOUS DESIGN**. JASON PETERS, (U.S. CLS. 100 AND 101). SN 85-279,469. PUB. 8-9-2011. FILED 3-29-2011.
- 4,045,159. **BOSS MAN (STANDARD CHARACTER)**. JASON PETERS, (U.S. CLS. 100 AND 101). SN 85-280,834. PUB. 8-9-2011. FILED 3-30-2011.
- 4,045,170 ( *See Class 33 for this trademark*).
- 4,045,175. **BLACK & BREW COFFEE HOUSE & BISTRO AND DESIGN**. BLACK & BREW COFFEE HOUSE & BISTRO, INC., (U.S. CLS. 100 AND 101). SN 85-280,988. PUB. 8-9-2011. FILED 3-30-2011.
- 4,045,212. **THE BROS MAKE IT SPECIAL AND DESIGN**. BB FRANCHISING, INC., (U.S. CLS. 100 AND 101). SN 85-281,618. PUB. 8-9-2011. FILED 3-30-2011.
- 4,045,227. **COAL BURGER (STANDARD CHARACTER)**. JOSEPH CIOLLI, (U.S. CLS. 100 AND 101). SN 85-281,805. PUB. 8-9-2011. FILED 3-30-2011.
- 4,045,396. **AXE (STANDARD CHARACTER)**. AXE, LLC, (U.S. CLS. 100 AND 101). SN 85-283,749. PUB. 8-9-2011. FILED 4-1-2011.
- 4,045,416. **BOULDER STATION (STANDARD CHARACTER)**. NP IP HOLDINGS LLC, (U.S. CLS. 100 AND 101). SN 85-283,998. PUB. 8-9-2011. FILED 4-1-2011.
- 4,045,477. **CHAMPY'S FAMOUS FRIED CHICKEN (STANDARD CHARACTER)**. FLATLANDS, LLC, (U.S. CLS. 100 AND 101). SN 85-285,591. PUB. 8-9-2011. FILED 4-4-2011.
- 4,045,521 ( *See Class 41 for this trademark*).
- 4,045,522 ( *See Class 41 for this trademark*).
- 4,045,533 ( *See Class 35 for this trademark*).
- 4,045,548. **FOOD WITH ATTITUDE (STANDARD CHARACTER)**. AFC ENTERPRISES, INC., (U.S. CLS. 100 AND 101). SN 85-304,933. PUB. 8-9-2011. FILED 4-26-2011.
- 4,045,549. **LOUISIANA FAST (STANDARD CHARACTER)**. AFC ENTERPRISES, INC., (U.S. CLS. 100 AND 101). SN 85-304,936. PUB. 8-9-2011. FILED 4-26-2011.
- 4,045,571 ( *See Class 41 for this trademark*).

---

#### CLASS 44—MEDICAL, BEAUTY AND AGRICULTURAL SERVICES

- 4,043,614. **MISCELLANEOUS DESIGN**. HOW, DANA, (U.S. CLS. 100 AND 101). SN 76-704,254. PUB. 8-9-2011. FILED 8-23-2010.
- 4,043,644 ( *See Class 10 for this trademark*).
- 4,043,649 ( *See Class 1 for this trademark*).
- 4,043,673 ( *See Class 43 for this trademark*).
- 4,043,706 ( *See Class 9 for this trademark*).
- 4,043,717 ( *See Class 41 for this trademark*).
- 4,043,718 ( *See Class 41 for this trademark*).
- 4,043,735. **DRYBAR (STANDARD CHARACTER)**. DRYBAR HOLDINGS LLC, (U.S. CLS. 100 AND 101). SN 77-982,583. PUB. 11-23-2010. FILED 2-24-2010.
- 4,043,737 ( *See Class 18 for this trademark*).
- 4,043,750 ( *See Class 5 for this trademark*).
- 4,043,817 ( *See Class 7 for this trademark*).
- 4,043,944. **CALIFORNIA IMPLANT DENTIST (STANDARD CHARACTER)**. THEIN, ROBERT K, (U.S. CLS. 100 AND 101). SN 85-100,581. PUB. 8-9-2011. FILED 8-5-2010.
- 4,043,978. **CIRCLE OF WELLNESS (STANDARD CHARACTER)**. LAVANGA, DANIEL, MULTIPLE CLASS, (INT. CLS. 44 AND 45), (U.S. CLS. 100 AND 101). SN 85-113,597. PUB. 8-9-2011. FILED 8-23-2010.
- 4,044,013. **COUNTRY LANDSCAPES, INC. (STANDARD CHARACTER)**. COUNTRY LANDSCAPES, INC., (U.S. CLS. 100 AND 101). SN 85-122,583. PUB. 8-9-2011. FILED 9-3-2010.
- 4,044,014. **COUNTRY LANDSCAPES, INC. DISTINCTIVE LANDSCAPES SINCE 1981 AND DESIGN**. COUNTRY LANDSCAPES, INC., (U.S. CLS. 100 AND 101). SN 85-122,592. PUB. 8-9-2011. FILED 9-3-2010.
- 4,044,076. **WOW WOMEN ONTO WELLNESS AND DESIGN**. AARONSON, NAOMI, AND TURO, ANN MARIE, (U.S. CLS. 100 AND 101). SN 85-151,021. PUB. 8-9-2011. FILED 10-12-2010.
- 4,044,083. **WARRIOR WOUND CARE (STANDARD CHARACTER)**. RUBBER HITS THE ROAD L.L.C., (U.S. CLS. 100 AND 101). SN 85-154,225. PUB. 8-9-2011. FILED 10-15-2010.
- 4,044,087. **BIG BOY'S BARBER SHOP AND DESIGN**. BIG BOY'S BARBER SHOP, (U.S. CLS. 100 AND 101). SN 85-156,829. PUB. 4-12-2011. FILED 10-20-2010.
- 4,044,091 ( *See Class 37 for this trademark*).
- 4,044,105 ( *See Class 29 for this trademark*).
- 4,044,122 ( *See Class 10 for this trademark*).
- 4,044,201 ( *See Class 9 for this trademark*).
- 4,044,209. **HEALTH 4 KIDZ PEDIATRICS AND DESIGN**. ANNU G SHARMA MD INC, DBA HEALTH 4 KIDZ PEDIATRICS, (U.S. CLS. 100 AND 101). SN 85-215,519. PUB. 8-9-2011. FILED 1-12-2011.
- 4,044,216. **VELOCITY STALLION MANAGEMENT (STANDARD CHARACTER)**. VELOCITY STANDARDBREDS, LLC, (U.S. CLS. 100 AND 101). SN 85-219,596. PUB. 8-9-2011. FILED 1-18-2011.
- 4,044,254. **PEDIATRIC VISION DEVELOPMENT CENTER BOOK AND DESIGN**. PEDIATRIC VISION DEVELOPMENT CENTER OF GWINNETT, LLC, (U.S. CLS. 100 AND 101). SN 85-230,756. PUB. 8-9-2011. FILED 1-31-2011.
- 4,044,255. **OUR FOCUS IS YOUR CHILD'S VISION (STANDARD CHARACTER)**. PEDIATRIC VISION DEVELOPMENT CENTER OF GWINNETT, LLC, (U.S. CLS. 100

- AND 101). SN 85-230,757. PUB. 8-9-2011. FILED 1-31-2011.
- 4,044,270. **MOMMY DOCS AND DESIGN**. MPH ENTERTAINMENT, INC., (U.S. CLS. 100 AND 101). SN 85-232,677. PUB. 8-9-2011. FILED 2-2-2011.
- 4,044,303 ( *See Class 35 for this trademark*).
- 4,044,309. **AUTUMN TREE CARE EXPERTS (STANDARD CHARACTER)**. NATURE'S TREES, INC., (U.S. CLS. 100 AND 101). SN 85-244,630. PUB. 8-9-2011. FILED 2-17-2011.
- 4,044,358. **CANINE PARTNERS FOR LIFE (STANDARD CHARACTER)**. CANINE PARTNERS FOR LIFE, (U.S. CLS. 100 AND 101). SN 85-253,714. PUB. 8-9-2011. FILED 2-28-2011.
- 4,044,403. **KCA WELLNESS (STANDARD CHARACTER)**. KCA WELLNESS, (U.S. CLS. 100 AND 101). SN 85-259,284. PUB. 8-9-2011. FILED 3-7-2011.
- 4,044,409 ( *See Class 37 for this trademark*).
- 4,044,410 ( *See Class 37 for this trademark*).
- 4,044,411. **THE NATURAL CHOICE FOR PROFESSIONAL TREE CARE SERVICES (STANDARD CHARACTER)**. STAY-GREEN, INC., (U.S. CLS. 100 AND 101). SN 85-259,632. PUB. 8-9-2011. FILED 3-7-2011.
- 4,044,412. **THE NATURAL CHOICE FOR EXPERT PLANT HEALTH CARE SERVICES (STANDARD CHARACTER)**. STAY-GREEN, INC., (U.S. CLS. 100 AND 101). SN 85-259,638. PUB. 8-9-2011. FILED 3-7-2011.
- 4,044,433. **SUPERWELL CANCER CARE (STANDARD CHARACTER)**. MEDICAL MUTUAL OF OHIO, (U.S. CLS. 100 AND 101). SN 85-260,694. PUB. 8-9-2011. FILED 3-8-2011.
- 4,044,441 ( *See Class 41 for this trademark*).
- 4,044,442. **MISCELLANEOUS DESIGN**. LOCAL INITIATIVE HEALTH AUTHORITY FOR LOS ANGELES COUNTY, (U.S. CLS. 100 AND 101). SN 85-261,070. PUB. 8-9-2011. FILED 3-8-2011.
- 4,044,448. **GENEDX (STANDARD CHARACTER)**. BIO-REFERENCE LABORATORIES, INC., (U.S. CLS. 100 AND 101). SN 85-261,290. PUB. 8-9-2011. FILED 3-8-2011.
- 4,044,451. **THE ART OF WAXING (STANDARD CHARACTER)**. C+W DIVERSIFIED INTERESTS LLC, (U.S. CLS. 100 AND 101). SN 85-261,408. PUB. 8-9-2011. FILED 3-8-2011.
- 4,044,497. **IBEACH TAN (STANDARD CHARACTER)**. IBEACH LLC, (U.S. CLS. 100 AND 101). SN 85-263,218. PUB. 8-9-2011. FILED 3-10-2011.
- 4,044,571. **NUTRITION IN THE SCHOOLS AND DESIGN**. FLORIN, JILL S., (U.S. CLS. 100 AND 101). SN 85-265,785. PUB. 8-9-2011. FILED 3-14-2011.
- 4,044,572. **INNOVATIVE ALTERNATIVE ACUPUNCTURE (STANDARD CHARACTER)**. INNOVATIVE ALTERNATIVE ACUPUNCTURE, LLC, (U.S. CLS. 100 AND 101). SN 85-265,832. PUB. 8-9-2011. FILED 3-14-2011.
- 4,044,610. **TICK TACKLER LLC AND DESIGN**. TICK TACKLER, LLC, (U.S. CLS. 100 AND 101). SN 85-270,681. PUB. 8-9-2011. FILED 3-18-2011.
- 4,044,632. **KEEP PLAYING (STANDARD CHARACTER)**. THE SILVERTON HOSPITAL, (U.S. CLS. 100 AND 101). SN 85-273,459. PUB. 8-9-2011. FILED 3-22-2011.
- 4,044,664. **BEAUTY BY DOLLY (STANDARD CHARACTER)**. BEAUTY BY DOLLY INC., (U.S. CLS. 100 AND 101). SN 85-273,963. PUB. 8-9-2011. FILED 3-22-2011.
- 4,044,765. **MDCLICK (STANDARD CHARACTER)**. BELLA-VIA, THOMAS, AND CHAFFIN, JASPER, (U.S. CLS. 100 AND 101). SN 85-275,593. PUB. 8-9-2011. FILED 3-24-2011.
- 4,044,780. **EMBRACE YOUR INVESTMENT (STANDARD CHARACTER)**. ALPACA PASTURES OF VIRGINIA, INC., (U.S. CLS. 100 AND 101). SN 85-275,744. PUB. 8-9-2011. FILED 3-24-2011.
- 4,044,841. **LEMON TREE (STANDARD CHARACTER)**. LEMON TREE DEVELOPMENT, LLC, (U.S. CLS. 100 AND 101). SN 85-276,578. PUB. 8-9-2011. FILED 3-25-2011.
- 4,044,850. **YA'STUVUO (STANDARD CHARACTER)**. HOMEBOY INDUSTRIES, (U.S. CLS. 100 AND 101). SN 85-276,733. PUB. 8-9-2011. FILED 3-25-2011.
- 4,044,866. **SMASHBOX (STANDARD CHARACTER)**. DJF ENTERPRISES, (U.S. CLS. 100 AND 101). SN 85-276,941. PUB. 8-9-2011. FILED 3-25-2011.
- 4,044,913. **WOUNDS360° (STANDARD CHARACTER)**. HMP COMMUNICATIONS, LLC, (U.S. CLS. 100 AND 101). SN 85-277,495. PUB. 8-9-2011. FILED 3-25-2011.
- 4,044,933 ( *See Class 3 for this trademark*).
- 4,044,937. **ROCKING THE RED (STANDARD CHARACTER)**. ROCK THE RED INC., DBA ROCKING THE RED, (U.S. CLS. 100 AND 101). SN 85-277,870. PUB. 8-9-2011. FILED 3-26-2011.
- 4,044,938. **MMDR (STANDARD CHARACTER)**. MOBILE MEDICAL DISASTER RELIEF, INC., (U.S. CLS. 100 AND 101). SN 85-277,973. PUB. 8-9-2011. FILED 3-26-2011.
- 4,044,949. **MDCLICK (STANDARD CHARACTER)**. BELLA-VIA, THOMAS, AND CHAFFIN, JASPER, (U.S. CLS. 100 AND 101). SN 85-278,080. PUB. 8-9-2011. FILED 3-27-2011.
- 4,044,989. **{B} AND DESIGN**. KLEINDIENST, KARA, (U.S. CLS. 100 AND 101). SN 85-278,578. PUB. 8-9-2011. FILED 3-28-2011.
- 4,045,047. **BROZILIAN (STANDARD CHARACTER)**. STRIPT WAX BAR, LLC, (U.S. CLS. 100 AND 101). SN 85-279,243. PUB. 8-9-2011. FILED 3-28-2011.
- 4,045,141. **OPERATION TRANSFORMATION (STANDARD CHARACTER)**. GREAT RIVER MEDICAL CENTER, (U.S. CLS. 100 AND 101). SN 85-280,521. PUB. 8-9-2011. FILED 3-29-2011.
- 4,045,184. **MEDILEAN (STANDARD CHARACTER)**. MACER, CYNTHIA, (U.S. CLS. 100 AND 101). SN 85-281,096. PUB. 8-9-2011. FILED 3-30-2011.
- 4,045,230 ( *See Class 41 for this trademark*).
- 4,045,277. **PSYCHEMEDICS (STANDARD CHARACTER)**. PSYCHEMEDICS CORPORATION, (U.S. CLS. 100 AND 101). SN 85-282,305. PUB. 8-9-2011. FILED 3-31-2011.
- 4,045,329. **MISCELLANEOUS DESIGN**. JARRAHNEJAD, PAYAM, (U.S. CLS. 100 AND 101). SN 85-282,975. PUB. 8-9-2011. FILED 3-31-2011.
- 4,045,376. **DAY 3 (STANDARD CHARACTER)**. NUTRITIONAL EXCELLENCE LLC, (U.S. CLS. 100 AND 101). SN 85-283,535. PUB. 8-9-2011. FILED 4-1-2011.
- 4,045,384. **DELIVERING ELEGANT RADIOLOGY (STANDARD CHARACTER)**. FOUNDATION RADIOLOGY, INC., FORMERLY TELERADIOLOGY HOLDINGS, INC., (U.S. CLS. 100 AND 101). SN 85-283,676. PUB. 8-9-2011. FILED 4-1-2011.
- 4,045,407 ( *See Class 9 for this trademark*).
- 4,045,453. **KIDS LOVE US. PARENTS TRUST US. (STANDARD CHARACTER)**. ANGLE ORTHODONTICS, (U.S. CLS. 100 AND 101). SN 85-284,474. PUB. 8-9-2011. FILED 4-2-2011.
- 4,045,526. **65+ CELEBRATING THE SENIOR EPOCH (STYLIZED)**. THE MARKETING COLLABORATIVE, LLC, (U.S. CLS. 100 AND 101). SN 85-292,348. PUB. 8-9-2011. FILED 4-11-2011.

---

#### CLASS 45—PERSONAL AND LEGAL SERVICES

- 4,043,640. **CANMARK (STANDARD CHARACTER)**. BUSINESS NAMES UNLIMITED LTD., (U.S. CLS. 100 AND 101). SN 77-300,797. PUB. 4-26-2011. FILED 10-10-2007.
- 4,043,673 ( *See Class 43 for this trademark*).
- 4,043,710 ( *See Class 41 for this trademark*).
- 4,043,785 ( *See Class 3 for this trademark*).
- 4,043,801 ( *See Class 35 for this trademark*).
- 4,043,806 ( *See Class 9 for this trademark*).
- 4,043,894 ( *See Class 35 for this trademark*).
- 4,043,897 ( *See Class 9 for this trademark*).
- 4,043,898 ( *See Class 9 for this trademark*).
- 4,043,925 ( *See Class 35 for this trademark*).
- 4,043,978 ( *See Class 44 for this trademark*).
- 4,043,997. **YOSEMITE CONSERVANCY AND DESIGN**. YOSEMITE FOUNDATION, (U.S. CLS. 100 AND 101). SN 85-118,005. PUB. 8-9-2011. FILED 8-27-2010.
- 4,044,021 ( *See Class 9 for this trademark*).
- 4,044,103 ( *See Class 35 for this trademark*).
- 4,044,170. **MOMS IN MOTION (STANDARD CHARACTER)**. MOMS IN MOTION, LLC, (U.S. CLS. 100 AND 101). SN 85-200,221. PUB. 8-9-2011. FILED 12-17-2010.
- 4,044,215 ( *See Class 9 for this trademark*).
- 4,044,241 ( *See Class 41 for this trademark*).
- 4,044,283 ( *See Class 36 for this trademark*).
- 4,044,330. **W AND DESIGN**. WALGREEN CO., (U.S. CLS. 100



- AND 101). SN 85-249,691. PUB. 8-9-2011. FILED 2-23-2011.
- 4,044,335. **SUCCESS FOR STEPS (STANDARD CHARACTER)**. ROACH, CHRISTINA M., (U.S. CLS. 100 AND 101). SN 85-250,311. PUB. 8-9-2011. FILED S.R. 2-24-2011; AM. P.R. 6-8-2011.
- 4,044,418 ( *See Class 43 for this trademark*).
- 4,044,474 ( *See Class 41 for this trademark*).
- 4,044,483. **GRACE STYLING (STYLIZED)**. GRACE STYLING INCORPORATED, (U.S. CLS. 100 AND 101). SN 85-262,723. PUB. 8-9-2011. FILED 3-9-2011.
- 4,044,484. **THE ADVOCATE, FIGHTING FOR YOUR SOCIAL SECURITY DISABILITY BENEFITS (STANDARD CHARACTER)**. THE ADVOCATE, LLC, (U.S. CLS. 100 AND 101). SN 85-262,724. PUB. 8-9-2011. FILED 3-9-2011.
- 4,044,534 ( *See Class 36 for this trademark*).
- 4,044,543. **CELEBRATING LIVES LIVED (STANDARD CHARACTER)**. THATCHER'S FUNERAL HOME, INC., (U.S. CLS. 100 AND 101). SN 85-264,542. PUB. 8-9-2011. FILED 3-11-2011.
- 4,044,557. **PINK DRAGON LADIES (STANDARD CHARACTER)**. TEAM SURVIVOR TAMPA BAY, INC., AKA PINK DRAGON LADIES, (U.S. CLS. 100 AND 101). SN 85-265,268. PUB. 8-9-2011. FILED 3-11-2011.
- 4,044,605. **MINDFUL PARTNERSHIP ~ MINDFUL DIVORCE (STANDARD CHARACTER)**. BERGER, ILLANA, (U.S. CLS. 100 AND 101). SN 85-270,128. PUB. 8-9-2011. FILED 3-17-2011.
- 4,044,620. **SINGLETON MOMS SUPPORTING SINGLE PARENTS WITH CANCER AND DESIGN**. SINGLETON MOMS, (U.S. CLS. 100 AND 101). SN 85-273,345. PUB. 8-9-2011. FILED 3-22-2011.
- 4,044,662. **BIGSHO (STANDARD CHARACTER)**. BIGSHO INC., (U.S. CLS. 100 AND 101). SN 85-273,934. PUB. 8-9-2011. FILED 3-22-2011.
- 4,044,683 ( *See Class 41 for this trademark*).
- 4,044,733 ( *See Class 35 for this trademark*).
- 4,044,748. **HOME INSTEAD AND DESIGN**. HOME INSTEAD, INC., (U.S. CLS. 100 AND 101). SN 85-275,373. PUB. 8-9-2011. FILED 3-24-2011.
- 4,044,752. **TURN THE MOUNTAINS ON (STANDARD CHARACTER)**. SLOPE PAL, LLC, (U.S. CLS. 100 AND 101). SN 85-275,417. PUB. 8-9-2011. FILED 3-24-2011.
- 4,044,799. **YOU'RE NOT ALONE. (STANDARD CHARACTER)**. THE HENDLER LAW FIRM, P.C., DBA HENDLERLAW, P.C., (U.S. CLS. 100 AND 101). SN 85-275,942. PUB. 8-9-2011. FILED 3-24-2011.
- 4,044,801. **HENDLERLAW (STANDARD CHARACTER)**. THE HENDLER LAW FIRM, P.C., DBA HENDLERLAW, P.C., (U.S. CLS. 100 AND 101). SN 85-275,951. PUB. 8-9-2011. FILED 3-24-2011.
- 4,044,808. **INNOVATIVE STRATEGIES FOR A WORLD OF SUCCESS (STANDARD CHARACTER)**. THE GLOBAL LAW GROUP, PLC, (U.S. CLS. 100 AND 101). SN 85-276,110. PUB. 8-9-2011. FILED 3-24-2011.
- 4,044,813. **ERGO CARE (STANDARD CHARACTER)**. ERGO CARE, INC., (U.S. CLS. 100 AND 101). SN 85-276,213. PUB. 8-9-2011. FILED 3-24-2011.
- 4,044,816. **HENDLERLAW (STYLIZED)**. THE HENDLER LAW FIRM, P.C., DBA HENDLERLAW, P.C., (U.S. CLS. 100 AND 101). SN 85-276,237. PUB. 8-9-2011. FILED 3-24-2011.
- 4,044,849 ( *See Class 42 for this trademark*).
- 4,044,884. **MISCELLANEOUS DESIGN**. CARING FOR PEOPLE SERVICES, INC., (U.S. CLS. 100 AND 101). SN 85-277,203. PUB. 8-9-2011. FILED 3-25-2011.
- 4,044,914 ( *See Class 35 for this trademark*).
- 4,044,930. **DONE DEALS. DONE RIGHT. (STANDARD CHARACTER)**. VERTSMAN, KONSTANTIN G, (U.S. CLS. 100 AND 101). SN 85-277,793. PUB. 8-9-2011. FILED 3-26-2011.
- 4,044,931. **TYROS (STANDARD CHARACTER)**. THE TYROS, INC., (U.S. CLS. 100 AND 101). SN 85-277,796. PUB. 8-9-2011. FILED 3-26-2011.
- 4,044,932. **T (STYLIZED)**. THE TYROS, INC., (U.S. CLS. 100 AND 101). SN 85-277,805. PUB. 8-9-2011. FILED 3-26-2011.
- 4,045,002 ( *See Class 35 for this trademark*).
- 4,045,006. **WHORUDATING.COM (STANDARD CHARACTER)**. PRECISE PROTECTIVE RESEACH INC., DBA WHORUDATING.COM, (U.S. CLS. 100 AND 101). SN 85-278,826. PUB. 8-9-2011. FILED 3-28-2011.
- 4,045,027. **KO'EV-E-LOO'SHEN AND DESIGN**. KOEVE-LOOSHEN, (U.S. CLS. 100 AND 101). SN 85-279,068. PUB. 8-9-2011. FILED 3-28-2011.
- 4,045,096. **THE ESSENTIALS OF FABULOUS (STANDARD CHARACTER)**. LUBIN-SHERMAN, ELLEN, (U.S. CLS. 100 AND 101). SN 85-279,998. PUB. 8-9-2011. FILED 3-29-2011.
- 4,045,148. **MISCELLANEOUS DESIGN**. ADOPTIONS WITH LOVE, INC., (U.S. CLS. 100 AND 101). SN 85-280,624. PUB. 8-9-2011. FILED 3-29-2011.
- 4,045,217. **BRINGING THE WORLD TOGETHER (STANDARD CHARACTER)**. LIMITED LIABILITY COMPANY "WEB SERVICE", (U.S. CLS. 100 AND 101). SN 85-281,664. PUB. 8-9-2011. FILED 3-30-2011.
- 4,045,325. **MILE OF MEN (STANDARD CHARACTER)**. MTX LLC, (U.S. CLS. 100 AND 101). SN 85-282,959. PUB. 8-9-2011. FILED 3-31-2011.
- 4,045,354. **HABERDASHER (STANDARD CHARACTER)**. CORDOVA & SCHWARTZ, INC., DBA HABERDASHER, (U.S. CLS. 100 AND 101). SN 85-283,294. PUB. 8-9-2011. FILED 4-1-2011.
- 4,045,356. **PANORAK (STANDARD CHARACTER)**. PANORAK ADVENTURE NETWORK, LLC, (U.S. CLS. 100 AND 101). SN 85-283,299. PUB. 8-9-2011. FILED 4-1-2011.
- 4,045,361. **BR AND DESIGN**. BLACK ROYALTY, LLC, (U.S. CLS. 100 AND 101). SN 85-283,380. PUB. 8-9-2011. FILED 4-1-2011.
- 4,045,363. **BLACK ROYALTY (STANDARD CHARACTER)**. BLACK ROYALTY, LLC, (U.S. CLS. 100 AND 101). SN 85-283,384. PUB. 8-9-2011. FILED 4-1-2011.
- 4,045,374. **SECUREMYSTUFF (STANDARD CHARACTER)**. KENTON BROTHERS LOCKSMITHS, INC., (U.S. CLS. 100 AND 101). SN 85-283,529. PUB. 8-9-2011. FILED 4-1-2011.
- 4,045,440. **VOCLY (STANDARD CHARACTER)**. LACKIE, MISTY, (U.S. CLS. 100 AND 101). SN 85-284,304. PUB. 8-9-2011. FILED 4-1-2011.
- 4,045,472. **ARBOR HOME CARE (STANDARD CHARACTER)**. ALL YOUR NEEDS LLC, DBA ARBOR HOME CARE, (U.S. CLS. 100 AND 101). SN 85-285,149. PUB. 8-9-2011. FILED 4-4-2011.
- 4,045,488. **WORTH THE HURT (STANDARD CHARACTER)**. WORTH THE HURT, INC., (U.S. CLS. 100 AND 101). SN 85-285,938. PUB. 8-9-2011. FILED 4-4-2011.
- 4,045,491. **CREDIBLE (STANDARD CHARACTER)**. CREEDIBLE, LLC, (U.S. CLS. 100 AND 101). SN 85-285,950. PUB. 8-9-2011. FILED 4-4-2011.
- 4,045,516 ( *See Class 9 for this trademark*).
- 4,045,531 ( *See Class 35 for this trademark*).

\* \* \* \* \*

SECTION 2.—PRIOR UNITED STATES CLASSIFICATION

COLLECTIVE MEMBERSHIP MARKS

**CLASS 200—COLLECTIVE MEMBERSHIP**

4,043,648. **SHADZ OF ESSENCE MOTORCYCLE CLUB COVERED BY THE GRACE ROCK HILL, SC AND DESIGN.** SHADZ OF ESSENCE MOTORCYCLE CLUB, AKA SHADZ, SN 77-580,599. PUB. 12-15-2009. FILED 9-28-2008.

4,044,124 (*See Class 35 for this trademark*).

4,044,240. **BROTHERHOOD OF BIKERS (STANDARD CHARACTER), BROTHERHOOD OF BIKERS CORPORATION,** SN 85-227,312. PUB. 8-9-2011. FILED 1-27-2011.

4,045,387. **MISCELLANEOUS DESIGN. PHI UPSILON OMI-**

CRON, INC., SN 85-283,686. PUB. 8-9-2011. FILED 4-1-2011.

4,045,392. **MISCELLANEOUS DESIGN. PHI UPSILON OMI-** CRON, INC., SN 85-283,716. PUB. 8-9-2011. FILED 4-1-2011.

---

CERTIFICATION MARKS

CLASS B—SERVICES

4,044,302. **REALSING (STANDARD CHARACTER), MY-MUSE LLC,** SN 85-242,166. PUB. 8-9-2011. FILED 2-15-2011.

4,044,952. **CBIP (STANDARD CHARACTER), NAHIP, LLC,** SN 85-278,129. PUB. 8-9-2011. FILED 3-27-2011.

\* \* \* \* \*

# TRADEMARK REGISTRATIONS ISSUED UNDER SECTION 1(d)

The following marks have registered on the Principal Register pursuant to the intent-to-use provisions of Section 1(d) of the Trademark Act of 1946, as amended.

## SECTION 1.— INTERNATIONAL CLASSIFICATION

The short titles associated below with the international class numbers are terms designed merely for quick identification and are not an official part of the international classification. The full names of international classes are given in section 6.1 of the trademark rules of practice.

The designation "U.S. Cl." appearing in this section refers to the U.S. class in effect prior to Sep. 1, 1973 rather than the international class which applies to applications filed on or after that date. For adoption of international classification see notice in the OFFICIAL GAZETTE of Jun. 26, 1973 (911 O.G. TM 210).

### Application in more than one class

4,045,585. FOUND ANIMALS FOUNDATION, INC., LOS ANGELES, CA. SN 76-699,896. PUB. 8-17-2010, FILED 10-16-2009.

## FoundAnimals

THE MARK CONSISTS OF STANDARD CHARACTERS WITHOUT CLAIM TO ANY PARTICULAR FONT, STYLE, SIZE, OR COLOR.

#### CLASS 35—ADVERTISING AND BUSINESS

FOR PROMOTING PUBLIC AWARENESS OF ANIMAL WELFARE AND CONTROL, AND SCIENTIFIC RESEARCH (U.S. CLS. 100, 101 AND 102).  
FIRST USE 8-0-2008; IN COMMERCE 8-0-2008.

#### CLASS 36—INSURANCE AND FINANCIAL

FOR CHARITABLE FOUNDATION SERVICES, NAMELY, PROVIDING FUND RAISING ACTIVITIES, SUPPLEMENTAL FUNDING, AND FINANCIAL ASSISTANCE FOR PROGRAMS AND SERVICES OF OTHERS; CHARITABLE SERVICES RELATING TO ANIMALS, NAMELY, CHARITABLE FUND RAISING; CHARITABLE FUND RAISING SERVICES FOR ANIMAL WELFARE ORGANIZATIONS; CHARITABLE SERVICES, NAMELY, PROVIDING FINANCIAL ASSISTANCE TO ANIMAL WELFARE ORGANIZATIONS; AND PROVIDING FINANCIAL GRANTS TO SCIENTISTS FOR RESEARCH, INNOVATION, AND DEVELOPMENT IN THE FIELD OF VETERINARY SCIENCE (U.S. CLS. 100, 101 AND 102).  
FIRST USE 8-0-2008; IN COMMERCE 8-0-2008.

#### CLASS 41—EDUCATION AND ENTERTAINMENT

FOR ARRANGING AND CONDUCTING AN AWARD COMPETITION TO AWARD AND RECOGNIZE ACHIEVEMENT IN THE FIELD OF VETERINARY SCIENCE; AND PROVIDING INCENTIVES BY THE WAY OF MONETARY AWARDS FOR SCIENTISTS FOR DEMONSTRATING EXCELLENCE IN THE FIELD OF VETERINARY SCIENCE (U.S. CLS. 100, 101 AND 107).  
FIRST USE 10-0-2008; IN COMMERCE 10-0-2008.

#### CLASS 44—MEDICAL, BEAUTY AND AGRICULTURAL SERVICES

FOR CHARITABLE SERVICES, NAMELY, PROVIDING MATERIAL ASSISTANCE TO ANIMAL WELFARE ORGANIZATIONS IN THE FORM OF VETERINARY EQUIPMENT; AND INSERTION OF SUBCUTANEOUS MICROCHIPS INTO PETS FOR PURPOSES OF TRACKING AND IDENTIFICATION (U.S. CLS. 100 AND 101).  
FIRST USE 8-0-2008; IN COMMERCE 8-0-2008.

#### CLASS 45—PERSONAL AND LEGAL SERVICES

FOR MAKING PET IDENTIFICATION TAGS AVAILABLE TO OTHERS FOR SECURITY OR LOCATION PURPOSES (U.S. CLS. 100 AND 101).  
FIRST USE 8-0-2008; IN COMMERCE 8-0-2008.

4,045,586. JBL TRADING, L.L.C., NEW YORK, NY. SN 76-699,992. PUB. 11-30-2010, FILED 10-22-2009.

## CREST MILLS

THE MARK CONSISTS OF STANDARD CHARACTERS WITHOUT CLAIM TO ANY PARTICULAR FONT, STYLE, SIZE, OR COLOR.

NO CLAIM IS MADE TO THE EXCLUSIVE RIGHT TO USE "MILLS", APART FROM THE MARK AS SHOWN.

#### CLASS 20—FURNITURE AND ARTICLES NOT OTHERWISE CLASSIFIED

FOR PILLOWS, SOLD PRIMARILY TO MASS MERCHANTISERS (U.S. CLS. 2, 13, 22, 25, 32 AND 50).  
FIRST USE 5-0-2011; IN COMMERCE 5-0-2011.

#### CLASS 24—FABRICS

FOR TOWELS AND THROWS, SOLD PRIMARILY TO MASS MERCHANTISERS (U.S. CLS. 42 AND 50).  
FIRST USE 1-0-2010; IN COMMERCE 1-0-2010.

**CLASS 27—FLOOR COVERINGS**

FOR RUGS, SOLD PRIMARILY TO MASS MERCHANTS (U.S. CLS. 19, 20, 37, 42 AND 50).  
FIRST USE 4-0-2011; IN COMMERCE 4-0-2011.

4,045,589. MARUKOME KABUSHIKI KAISHA, NAGANO CITY NAGANO PREFECTURE, JAPAN. SN 76-702,136. PUB. 1-4-2011, FILED 3-18-2010.



OWNER OF U.S. REG. NOS. 3,104,309 AND 3,607,614.  
THE MARK CONSISTS OF THE DESIGN OF A BOY HOLDING A BOWL WITH HIS RIGHT HAND, WITH HIS LEFT ARM RAISED, HAND CLOSED, WITH ONE FINGER EXTENDED.

**CLASS 29—MEATS AND PROCESSED FOODS**

FOR RESERVED SOYBEANS, NAMELY, DRIED SOYBEANS, FERMENTED SOYBEANS; INSTANT SOUP; INSTANT OR PRE-COOKED MISO SOUP; PROCESSED BEANS, MISO, NAMELY, FERMENTED MISO IN THE NATURE OF FERMENTED BEAN CURD; FERMENTED MISO FOR SOUP, NAMELY, FERMENTED BEAN CURD; PROCESSED BEANS, NAMELY, MISO BEANS FOR SOUP; PROCESSED BEANS, NAMELY, MISO BEANS; PROCESSED BEANS; PRESERVED SOYBEANS, NAMELY, PROCESSED SOYBEANS FOR PRESERVED PURPOSES (U.S. CL. 46).  
FIRST USE 0-0-1971; IN COMMERCE 0-0-1985.

**CLASS 30—STAPLE FOODS**

FOR JAPANESE MISO-BEAN PASTE; SEASONINGS; MISO, NAMELY, FERMENTED MISO BEAN PASTE (U.S. CL. 46).  
FIRST USE 0-0-1971; IN COMMERCE 0-0-1985.

4,045,592. KELLY, DEE, MONROE, NY. SN 76-702,603. PUB. 12-28-2010, FILED 4-23-2010.

**THE HOUSE IS YOU**

THE MARK CONSISTS OF STANDARD CHARACTERS WITHOUT CLAIM TO ANY PARTICULAR FONT, STYLE, SIZE, OR COLOR.

**CLASS 9—ELECTRICAL AND SCIENTIFIC APPARATUS**

FOR MAGNETIC COMPASSES; MUSIC CDS; PRE-RECORDED CDS FEATURING MUSIC; PRERECORDED DVDS FEATURING MUSIC (U.S. CLS. 21, 23, 26, 36 AND 38).

FIRST USE 8-16-2011; IN COMMERCE 8-16-2011.

**CLASS 24—FABRICS**

FOR BED SHEETS, PILLOW CASES, PILLOW SHAMS, COMFORTER COVERS (U.S. CLS. 42 AND 50).  
FIRST USE 8-16-2011; IN COMMERCE 8-16-2011.

**CLASS 41—EDUCATION AND ENTERTAINMENT**

FOR ENTERTAINMENT SERVICES, NAMELY, PROVIDING A WEBSITE FEATURING ON-GOING VIDEOS, FEATURING COMMENTARY IN THE FIELD OF FENG SHUI; TELEVISION SHOWS IN THE FIELD OF FENG SHUI (U.S. CLS. 100, 101 AND 107).

FIRST USE 7-27-2010; IN COMMERCE 7-27-2010.

**CLASS 42—SCIENTIFIC AND COMPUTER SERVICES**

FOR CONSULTING SERVICES IN THE FIELD OF FENG SHUI (U.S. CLS. 100 AND 101).  
FIRST USE 7-15-2011; IN COMMERCE 7-15-2011.

4,045,599. DIAMOND CHAIN COMPANY, INC., INDIANAPOLIS, IN. SN 76-703,738. PUB. 12-21-2010, FILED 7-12-2010.

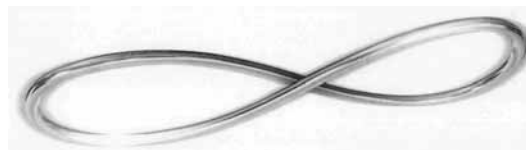

THE MARK CONSISTS OF AN INFINITY SYMBOL.

**CLASS 7—MACHINERY**

FOR POWER TRANSMISSION CHAIN, IN PARTICULAR, ROLLER CHAINS FOR POWER TRANSMISSION IN MACHINERY OTHER THAN LAND VEHICLES (U.S. CLS. 13, 19, 21, 23, 31, 34 AND 35).

FIRST USE 6-15-2011; IN COMMERCE 6-15-2011.

**CLASS 12—VEHICLES**

FOR POWER TRANSMISSION CHAIN, IN PARTICULAR, ROLLER CHAINS FOR POWER TRANSMISSION IN LAND VEHICLES (U.S. CLS. 19, 21, 23, 31, 35 AND 44).  
FIRST USE 6-15-2011; IN COMMERCE 6-15-2011.

4,045,603. OLDE GRANDDAD INDUSTRIES, INC., KEARNY, NJ. SN 76-704,527. PUB. 2-22-2011, FILED 9-14-2010.

**GORILLA SCENTS**

THE MARK CONSISTS OF STANDARD CHARACTERS WITHOUT CLAIM TO ANY PARTICULAR FONT, STYLE,

SIZE, OR COLOR.

NO CLAIM IS MADE TO THE EXCLUSIVE RIGHT TO USE "SCENTS", APART FROM THE MARK AS SHOWN.

### CLASS 3—COSMETICS AND CLEANING PREPARATIONS

FOR FRAGRANCE PRODUCTS FOR LAND VEHICLES, AIRCRAFT, MARINE CRAFT, PERSONAL, COMMERCIAL, INDUSTRIAL AND HOME USE, NAMELY, FRAGRANCES, COLOGNES AND PERFUMES (U.S. CLS. 1, 4, 6, 50, 51 AND 52).

FIRST USE 8-19-2011; IN COMMERCE 8-19-2011.

### CLASS 5—PHARMACEUTICALS

FOR AIR FRESHENING PRODUCTS FOR LAND VEHICLES, AIRCRAFT, MARINE CRAFT, PERSONAL, COMMERCIAL, INDUSTRIAL AND HOME USE, NAMELY, AIR FRESHENERS (U.S. CLS. 6, 18, 44, 46, 51 AND 52).

FIRST USE 8-22-2011; IN COMMERCE 8-22-2011.

---

4,045,605. ERICK ISAAH "IKE" THOMPSON, HENDERSONVILLE, NC. SN 76-705,011. PUB. 5-31-2011, FILED 10-21-2010.

## Classick Recordings

THE MARK CONSISTS OF STANDARD CHARACTERS WITHOUT CLAIM TO ANY PARTICULAR FONT, STYLE, SIZE, OR COLOR.

NO CLAIM IS MADE TO THE EXCLUSIVE RIGHT TO USE "RECORDINGS", APART FROM THE MARK AS SHOWN.

### CLASS 9—ELECTRICAL AND SCIENTIFIC APPARATUS

FOR DOWNLOADABLE MUSICAL SOUND RECORDINGS; MUSICAL SOUND RECORDINGS; MUSICAL VIDEO RECORDINGS (U.S. CLS. 21, 23, 26, 36 AND 38).

FIRST USE 0-0-2008; IN COMMERCE 1-1-2011.

### CLASS 35—ADVERTISING AND BUSINESS

FOR ENTERTAINMENT MARKETING SERVICES, NAMELY, MARKETING, PROMOTION, AND ADVERTISING FOR INDEPENDENT RECORDING ARTISTS; SERVICES COMPRISING THE RECORDING, TRANSCRIPTION, COMPOSITION, COMPILATION, AND SYSTEMATIZATION OF WRITTEN COMMUNICATIONS AND RECORDINGS, AS WELL AS THE COMPILATION OF MATHEMATICAL OR STATISTICAL DATA (U.S. CLS. 100, 101 AND 102).

FIRST USE 0-0-2008; IN COMMERCE 1-1-2011.

### CLASS 41—EDUCATION AND ENTERTAINMENT

FOR PRODUCTION OF SOUND AND MUSIC VIDEO RECORDINGS; PRODUCTION OF SOUND AND IMAGE RECORDINGS ON SOUND AND IMAGE CARRIERS; PRODUCTION OF SOUND RECORDINGS; RECORDING STUDIO SERVICES; RECORDING STUDIOS; SOUND RECORDING STUDIOS (U.S. CLS. 100, 101 AND 107).

FIRST USE 0-0-2008; IN COMMERCE 1-1-2011.

4,045,625. ALIMERA SCIENCES, INC., ALPHARETTA, GA. SN 77-162,736. PUB. 12-4-2007, FILED 4-23-2007.

## ILUVIEN

THE MARK CONSISTS OF STANDARD CHARACTERS WITHOUT CLAIM TO ANY PARTICULAR FONT, STYLE, SIZE, OR COLOR.

"ILUVIEN" APPEARING IN THE MARK HAS NO SIGNIFICANCE IN THE RELEVANT TRADE OR INDUSTRY OR AS APPLIED TO THE GOODS/SERVICES LISTED IN THE APPLICATION, NO GEOGRAPHICAL SIGNIFICANCE, NOR ANY MEANING IN A FOREIGN LANGUAGE.

### CLASS 5—PHARMACEUTICALS

FOR DRUG DELIVERY AGENTS CONSISTING OF POLYMER COMPOUNDS THAT FACILITATE THE DELIVERY OF PHARMACEUTICALS FOR THE TREATMENT OF MACULAR EDEMA, MACULAR DISEASE, RETINAL DISEASE, GLAUCOMA, AND OCCULAR ALLERGY (U.S. CLS. 6, 18, 44, 46, 51 AND 52).

FIRST USE 8-0-2008; IN COMMERCE 9-0-2008.

### CLASS 10—MEDICAL APPARATUS

FOR SUSTAINED DRUG DELIVERY SYSTEMS FOR OCULAR DRUGS (U.S. CLS. 26, 39 AND 44).

FIRST USE 9-0-2008; IN COMMERCE 10-0-2008.

---

4,045,627. PATRICIA B. LOVE, GREENVILLE, SC. SN 77-181,072. PUB. 12-18-2007, FILED 5-15-2007.

## COVER YOUR ANATOMY

THE MARK CONSISTS OF STANDARD CHARACTERS WITHOUT CLAIM TO ANY PARTICULAR FONT, STYLE, SIZE, OR COLOR.

### CLASS 10—MEDICAL APPARATUS

FOR MEDICAL GOWNS, PATIENT EXAMINATION GOWNS, SURGICAL GOWNS, AND SURGICAL SCRUB SUITS (U.S. CLS. 26, 39 AND 44).

FIRST USE 2-16-2011; IN COMMERCE 2-16-2011.

### CLASS 25—CLOTHING

FOR BATHROBES; BED JACKETS; NIGHT GOWNS; NIGHT SHIRTS; NIGHT WEAR; NURSING APPAREL, NAMELY, NURSING GOWNS, NURSING SHIRTS, NURSING NIGHT WEAR, AND NURSING BRAS; SHOULDER WRAPS; YOGA PANTS; AND YOGA SHIRTS (U.S. CLS. 22 AND 39).

FIRST USE 2-16-2011; IN COMMERCE 2-16-2011.

4,045,628. ZINK IMAGING, INC., BEDFORD, MA. SN 77-183,600. PUB. 11-13-2007, FILED 5-17-2007.



THE COLOR(S) BLACK, GRAY, MAGENTA, PURPLE, BLUE, GREEN AND YELLOW IS/ARE CLAIMED AS A FEATURE OF THE MARK.

THE MARK CONSISTS OF THE WORD "ZINK" APPEARING IN THE COLOR BLACK AND THE WORDING "ZERO INK" APPEARING IN THE COLOR GRAY, AND A DESIGN ELEMENT COMPRISING A PROGRESSIVE DEVELOPMENT OF A PRISM WITH COLORS APPEARING AT THE TOP MAGENTA AND PURPLE, IN THE MIDDLE BLUE, ON THE OUTER PORTIONS GRAY AND ON THE BOTTOM, YELLOW AND GREEN.

#### CLASS 9—ELECTRICAL AND SCIENTIFIC APPARATUS

FOR PRINTERS; COMPUTER PERIPHERALS; COLOR PRINTERS; ID CARD PRINTERS; LABEL PRINTERS; WIRELESS COMPUTER PERIPHERALS; CAMERAS; DIGITAL CAMERAS (U.S. CLS. 21, 23, 26, 36 AND 38).  
FIRST USE 2-0-2007; IN COMMERCE 2-0-2007.

#### CLASS 16—PAPER GOODS AND PRINTED MATTER

FOR PRINTING PAPER; PRINTING MEDIA, NAMELY, DIGITAL PRINTING PAPER, LABEL PAPER, AND PLASTIC SHEETS FOR PRINTING (U.S. CLS. 2, 5, 22, 23, 29, 37, 38 AND 50).  
FIRST USE 2-0-2007; IN COMMERCE 2-0-2007.

4,045,630. ISSUU, INC., MENLO PARK, CA. SN 77-200,247. PUB. 5-27-2008, FILED 6-7-2007.

# ISSUU

THE MARK CONSISTS OF STANDARD CHARACTERS WITHOUT CLAIM TO ANY PARTICULAR FONT, STYLE, SIZE, OR COLOR.

#### CLASS 35—ADVERTISING AND BUSINESS

FOR COMPUTER SERVICES, NAMELY, PROVIDING ONLINE INFORMATION TO USERS VIA THE INTERNET AND MOBILE DEVICES REGARDING SHOPPING (U.S. CLS. 100, 101 AND 102).  
FIRST USE 0-0-2009; IN COMMERCE 0-0-2009.

#### CLASS 41—EDUCATION AND ENTERTAINMENT

FOR COMPUTER SERVICES, NAMELY, PROVIDING ONLINE INFORMATION TO USERS VIA THE INTERNET AND MOBILE DEVICES REGARDING ENTERTAINMENT ACTIVITIES (U.S. CLS. 100, 101 AND 107).  
FIRST USE 0-0-2009; IN COMMERCE 0-0-2009.

#### CLASS 42—SCIENTIFIC AND COMPUTER SERVICES

FOR COMPUTER SERVICES, NAMELY, HOSTING AND MAINTAINING AN ONLINE WEBSITE FOR OTHERS TO CREATE, COLLECT, EDIT, ORGANIZE, SEARCH, MODIFY, BOOKMARK, TRANSMIT, STORE, UPLOAD, POST, SHARE, TAG, DOWNLOAD, AND COMMENT ON DOCUMENTS, DATA, AND INFORMATION; APPLICATION SERVICE PROVIDER SERVICES, NAMELY, PROVIDING NONDOWNLOADABLE SOFTWARE FOR USE IN CREATING, COLLECTING, EDITING, ORGANIZING, SEARCHING, MODIFYING, BOOKMARKING, TRANSMITTING, STORING, UPLOADING, POSTING, SHARING, TAGGING, DOWNLOADING, AND COMMENTING ON DOCUMENTS, DATA, AND INFORMATION ON THE INTERNET AND ON MOBILE DEVICES; HOSTING OF DIGITAL CONTENT ON THE INTERNET; WEB SITE HOSTING SERVICES (U.S. CLS. 100 AND 101).  
FIRST USE 12-13-2007; IN COMMERCE 12-13-2007.

#### CLASS 43—HOTEL AND RESTAURANT SERVICES

FOR COMPUTER SERVICES, NAMELY, PROVIDING ONLINE INFORMATION TO USERS VIA THE INTERNET AND MOBILE DEVICES REGARDING RESTAURANTS (U.S. CLS. 100 AND 101).  
FIRST USE 0-0-2009; IN COMMERCE 0-0-2009.

#### CLASS 45—PERSONAL AND LEGAL SERVICES

FOR ONLINE SOCIAL NETWORKING SERVICES (U.S. CLS. 100 AND 101).  
FIRST USE 3-0-2008; IN COMMERCE 3-0-2008.

4,045,637. SPX CORPORATION, CHARLOTTE, NC. SN 77-217,814. PUB. 12-21-2010, FILED 6-28-2007.

# SPX

THE MARK CONSISTS OF STANDARD CHARACTERS WITHOUT CLAIM TO ANY PARTICULAR FONT, STYLE, SIZE, OR COLOR.

OWNER OF U.S. REG. NOS. 2,351,520, 2,528,505, AND 2,647,669.

**CLASS 6—METAL GOODS**

FOR METAL REFRIGERATION HOSE FITTINGS; MANUALLY OPERATED METAL VALVES; MANUALLY OPERATED METAL VALVE ASSEMBLIES COMPRISED OF CONTROL VALVES, BALL VALVES, GLOBE VALVES, BUTTERFLY VALVES, PLUG VALVES, CHECK VALVES, ECCENTRIC VALVES, KNIFE GATE VALVES, GATE VALVES, ISOLATION VALVES, DIVERter VALVES, SLEEVE VALVES, CONSISTENCY TRANSMITTERS, PNEUMATIC AND ELECTRO-PNEUMATIC POSITIONERS, ACTUATORS, SOLENOIDS, REGULATORS, GOVERNORS, PNEUMATIC MOTION TRANSMITTERS, ELECTRIC PNEUMATIC TRANSDUCERS, DESUPERHEATERS, VAPOR AND STEAM CONDITIONING VALVES, STRAINERS, AIR GAP DRAINS, AND/OR SETTERS (U.S. CLS. 2, 12, 13, 14, 23, 25 AND 50).

FIRST USE 12-30-2003; IN COMMERCE 12-30-2003.

**CLASS 7—MACHINERY**

FOR INDUSTRIAL MIXING MACHINE FOR MIXING ALL TYPES OF FLUIDS AND SOLIDS; TRANSMISSION OIL COOLER FLUSH AND FLOW TEST MACHINE; AIR FILTERS FOR INDUSTRIAL INSTALLATIONS; GEAR PUMPS AND CENTRIFUGAL PUMPS FOR INDUSTRIAL PURPOSES; VACUUM PUMPS; ELECTRIC, CENTRIFUGAL AND HYDRAULIC PUMPS FOR INDUSTRIAL PURPOSES; AIR COOLED CONDENSERS; HEAT EXCHANGERS BEING PARTS OF MACHINES (U.S. CLS. 13, 19, 21, 23, 31, 34 AND 35).

FIRST USE 12-30-2003; IN COMMERCE 12-30-2003.

**CLASS 9—ELECTRICAL AND SCIENTIFIC APPARATUS**

FOR WEIGHING SCALES; ENVIRONMENTAL AND ALTITUDE CHAMBERS; AUTOMATIC VALVES, NAMELY, CONTROL VALVES, BALL VALVES, GLOBE VALVES, BUTTERFLY VALVES, PLUG VALVES, CHECK VALVES, ECCENTRIC VALVES, KNIFE GATE VALVES, GATE VALVES, ISOLATION VALVES, DIVERter VALVES AND SLEEVE VALVES; CONTROL VALVES FOR REGULATING THE FLOW OF GASES AND LIQUIDS; AUTOMATIC VALVE ASSEMBLIES AND AUTOMATIC VALVE OPERATING ASSEMBLIES COMPRISED OF CONTROL VALVES, BALL VALVES, GLOBE VALVES, BUTTERFLY VALVES, PLUG VALVES, CHECK VALVES, ECCENTRIC VALVES, KNIFE GATE VALVES, GATE VALVES, ISOLATION VALVES, DIVERter VALVES, SLEEVE VALVES, CONSISTENCY TRANSMITTERS, PNEUMATIC AND ELECTRO-PNEUMATIC POSITIONERS, ACTUATORS, SOLENOIDS, REGULATORS, GOVERNORS, PNEUMATIC MOTION TRANSMITTERS, ELECTRIC TRANSFORMERS; ELECTRIC PNEUMATIC TRANSDUCERS, DESUPERHEATERS, VAPOR AND STEAM CONDITIONING VALVES, STRAINERS, AIR GAP DRAINS, AND/OR SETTERS; BOILER WATER REGULATORS; BOILER PRESSURE GOVERNORS; ELECTRONIC BLADE CONSISTENCY TRANSMITTERS FOR MEASURING LIQUID MIXTURES IN INDUSTRY; COMPUTER SOFTWARE FOR ASSISTING IN VALVE SYSTEMS AND IN SPECIFYING VALVE PRODUCTS; ELECTRONIC DIGITAL CONTROLLER FOR POSITIONING VALVES IN INDUSTRIAL EQUIPMENT; COMPUTER MONITOR AND SIGNAL CONDITIONERS FOR DIAGNOSING CONTROL VALVE PERFORMANCE; ELECTRONIC VALVE ACTUATORS; COAXIAL CABLE; HAND HELD COMPUTER FOR USE IN DETECTING LEAKS IN PRESSURIZED CABLES; ELECTRONIC VALIDATING AND REGISTERING BUS FARE BOXES; TICKET AND TOKEN VENDING MACHINES; REVENUE COLLECTION AND SECURITY EQUIPMENT, NAMELY, CARD READERS; RAILROAD AND TRANSIT ELECTRIC HYDRAULIC CONTROL SWITCHES; UNDERWATER SAFETY LIGHTS TO DIRECT THE MOVEMENT OF FISH; ELECTRONIC RECONNAISSANCE SYSTEMS COMPRISED OF ANTENNAS, COMPUTERS, MACHINE READABLE COMPUTER-PROGRAMS, DIRECTION FINDING RECEIVERS, RADIO FREQUENCY DISTRIBUTION AND SWITCHING APPARATUS; SIGNAL ACQUISITION AND CLASSIFICATION APPARATUS; RADIO JAMMING APPARATUS; BROADCAST EQUIPMENT FOR WIRELESS TRANSMISSIONS, RADIO, AND TELEVISION, NAMELY, ANTENNAS AND STRUCTUR-

AL AND ELECTRICAL COMPONENTS, PARTS AND ACCESSORIES THEREFOR, NAMELY, SWITCHING APPARATUS, DIPLEXERS, TOWERS, TRANSMISSION LINES AND CABLES, MATCHING UNITS AND CONTROL APPARATUS; ELECTRICAL FIBER-OPTIC COMMUNICATION TRANSMISSION LINES FOR AUDIO AND VIDEO SIGNAL TRANSMISSION; OPTICAL WAVEGUIDES; METALLIC WAVEGUIDE AND COAXIAL CABLE AND END-CONNECTORS; AIR FLOW SENSORS; THERMOSTATS; EMERGENCY WARNING LIGHTS, NAMELY, AVIATION OBSTRUCTION LIGHTING; AIRPORT WARNING AND SAFETY LIGHTING SYSTEMS, NAMELY, LIGHT SOCKETS AND BULBS FOR USE WITH AIRPLANE GUIDANCE ON AIRPORT LANDING STRIPS AND OBSTRUCTIONS ON AIRPORT APPROACH; BEACON AND OBSTRUCTION WARNING LIGHTS; HAND HELD COMPUTER FOR DETECTING LEAKS IN PRESSURIZED CABLES; WIRELESS DATA CARRIERS AND RECEIVERS FOR USE WITH VEHICLE DIAGNOSING AND MONITORING; COMPUTER HARDWARE AND SOFTWARE USED FOR RADIO SIGNAL INTERCEPT AND DIRECTION FINDING; RECEIVERS AND PROCESSORS FOR USE WITH SUCH SIGNAL PROCESSING SYSTEMS; AND HEATING, COOLING AND HUMIDIFIED ENVIRONMENTAL CHAMBERS FOR RESEARCH, TESTING AND PRODUCTION (U.S. CLS. 21, 23, 26, 36 AND 38).

FIRST USE 12-30-2003; IN COMMERCE 12-30-2003.

**CLASS 11—ENVIRONMENTAL CONTROL APPARATUS**

FOR WATER COOLING TOWERS; INDUSTRIAL AIR CLEANERS; CABLE PRESSURIZATION UNITS, COMPRISED PRIMARILY OF AIR DRYERS, COMPRESSORS, CENTRAL OFFICE MANIFOLDS, DISTRIBUTION MANIFOLDS, METERS AND PIPE FEED ACCESS PANELS, AND AIR PIPE CONNECTORS SOLD AS A UNIT FOR USE IN FORCING DRY AIR INTO CABLES IN ORDER TO PROTECT THE CABLES FROM WATER DAMAGE; ELECTRIC DEHYDRATORS FOR CONTINUOUS DRYING AND REMOVAL OF MOISTURE FROM COMPRESSED AIR; AIR DRYER MONITORING AND CONTROL SYSTEMS COMPRISED PRIMARILY OF MOISTURE SEPARATORS, VALVES, STRAINERS, HEAT EXCHANGERS AND MOISTURE INDICATORS; HEAT EXCHANGERS NOT BEING PARTS OF MACHINES; COOLING TOWERS; VENTILATING FANS FOR DOMESTIC AND INDUSTRIAL USE; PORTABLE ELECTRIC HEATERS; ELECTRIC WALL HEATERS FOR DOMESTIC AND COMMERCIAL USE; REFRIGERATED AIR DRYERS FOR REMOVING CONTAMINANTS FROM COMPRESSED AIR AND GASES; SWITCHING VALVES FOR DESICCANT AIR DRYERS; AIR FILTERS FOR INDUSTRIAL INSTALLATIONS (U.S. CLS. 13, 21, 23, 31 AND 34).

FIRST USE 12-30-2003; IN COMMERCE 12-30-2003.

**CLASS 36—INSURANCE AND FINANCIAL**

FOR BUSINESS AND INDUSTRIAL FINANCIAL SERVICES, NAMELY, PRIVATE LABEL VENDOR FINANCING, EQUIPMENT FINANCING, BUSINESS CREDIT SALES FINANCING AND CAPITAL FINANCIAL AND EQUITY INVESTMENTS (U.S. CLS. 100, 101 AND 102).

FIRST USE 3-1-2008; IN COMMERCE 3-1-2008.

**CLASS 37—CONSTRUCTION AND REPAIR**

FOR INSTALLATION AND MAINTENANCE OF STEEL AND METAL ANTENNA SUPPORT STRUCTURES, ANTENNA TOWERS, AND LIGHTING EQUIPMENT (U.S. CLS. 100, 103 AND 106).

FIRST USE 11-1-1998; IN COMMERCE 11-1-1998.

**CLASS 40—MATERIAL TREATMENT**

FOR MANUFACTURE OF AEROSPACE COMPONENT PARTS TO THE ORDER AND SPECIFICATION OF OTHERS; RENTAL OF AIR TREATMENT EQUIPMENT; FABRICATION OF STEEL AND METAL ANTENNA SUPPORT STRUCTURES, ANTENNA TOWERS, AND LIGHTING EQUIPMENT (U.S. CLS. 100, 103 AND 106).

FIRST USE 12-30-2003; IN COMMERCE 12-30-2003.

4,045,650. SCHNUCK MARKETS, INC., ST. LOUIS, MO. SN 77-279,432. PUB. 6-10-2008, FILED 9-14-2007.



THE MARK CONSISTS OF "SCHNUCKS" ABOVE "COOKS" IN SCRIPT WITH A PEAR HANGING FROM THE END OF THE LETTER "K".

#### CLASS 35—ADVERTISING AND BUSINESS

FOR RETAIL GROCERY STORE SERVICES (U.S. CLS. 100, 101 AND 102).  
FIRST USE 11-30-2007; IN COMMERCE 11-30-2007.

#### CLASS 41—EDUCATION AND ENTERTAINMENT

FOR COOKING CLASSES; EDUCATIONAL DEMONSTRATION OF PRODUCTS (U.S. CLS. 100, 101 AND 107).  
FIRST USE 11-30-2007; IN COMMERCE 11-30-2007.

#### CLASS 43—HOTEL AND RESTAURANT SERVICES

FOR MEAL PLANNING SERVICES, NAMELY, PROVIDING MEAL, RECIPE AND MENU PLANNING ADVICE (U.S. CLS. 100 AND 101).  
FIRST USE 11-30-2007; IN COMMERCE 11-30-2007.

4,045,651. JANET VALENZA LTD., NEW YORK, NY. SN 77-287,541. PUB. 6-17-2008, FILED 9-24-2007.

### CLOSET REVOLUTION

THE MARK CONSISTS OF STANDARD CHARACTERS WITHOUT CLAIM TO ANY PARTICULAR FONT, STYLE, SIZE, OR COLOR.

NO CLAIM IS MADE TO THE EXCLUSIVE RIGHT TO USE "CLOSET", APART FROM THE MARK AS SHOWN.

#### CLASS 37—CONSTRUCTION AND REPAIR

FOR INSTALLATION OF CLOSETS AND STORAGE SPACES (U.S. CLS. 100, 103 AND 106).  
FIRST USE 0-0-2007; IN COMMERCE 5-0-2011.

#### CLASS 42—SCIENTIFIC AND COMPUTER SERVICES

FOR DESIGN OF CLOSETS AND STORAGE SPACES (U.S. CLS. 100 AND 101).  
FIRST USE 0-0-2007; IN COMMERCE 5-0-2011.

4,045,652. CATERPILLAR INC., PEORIA, IL. SN 77-289,081. PUB. 1-11-2011, FILED 9-26-2007.



OWNER OF U.S. REG. NOS. 564,272 AND 2,140,606.

THE MARK CONSISTS OF A RECTANGULAR SHAPE WITH A DIAGONAL EDGE, CONTAINING THE WORD "CAT" WITH A TRIANGLE BELOW THE LETTER "A".

#### CLASS 1—CHEMICALS

FOR CHEMICALS FOR USE IN INDUSTRY, AGRICULTURE, HORTICULTURE, AND FORESTRY EXCEPT FUNGICIDES, HERBICIDES, INSECTICIDES AND PARATICIDES; UNPROCESSED ARTIFICIAL RESINS, UNPROCESSED PLASTICS; ADHESIVES USED IN INDUSTRY; CEMENT FOR REPAIRS, NAMELY, ADHESIVE CEMENT FOR BONDING, SEALING AND PATCHING CORK, LEATHER, RUBBER, AND METAL; ANTI-FREEZE; COOLANTS; CHEMICAL PREPARATIONS IN THE NATURE OF CONDITIONERS FOR ENHANCING THE PERFORMANCE OF ENGINE COOLING SYSTEMS; CHEMICAL PREPARATIONS IN THE NATURE OF CLEANERS FOR ENHANCING THE PERFORMANCE OF ENGINE COOLING SYSTEMS; CHEMICAL PREPARATIONS FOR LOCKING SCREW THREADS; BATTERY FLUID, NAMELY, ACIDULATED WATER FOR RECHARGING BATTERIES; COLOR BRIGHTENING CHEMICALS FOR INDUSTRIAL USE; CHEMICAL PREPARATIONS IN THE NATURE OF FILTERING MATERIALS FOR INDUSTRIAL USE; HYDRAULIC FLUIDS; FUEL ADDITIVES, NAMELY, CHEMICAL ADDITIVES FOR FUEL TREATMENT; COMPOSITIONS FOR REPAIRING VEHICLE TIRES, NAMELY, RUBBER CEMENT FOR REPAIRING PNEUMATIC TIRES; ARTIFICIAL AND SYNTHETIC RESINS (U.S. CLS. 1, 5, 6, 10, 26 AND 46).

FIRST USE 12-31-2008; IN COMMERCE 12-31-2008.

#### CLASS 2—PAINTS

FOR PAINTS, VARNISHES, LACQUERS; PRESERVATIVES AGAINST RUST IN THE NATURE OF A COATING AND AGAINST DETERIORATION OF WOOD; COLORANTS; MORDANTS USED IN THE MANUFACTURING OF COATINGS; RAW NATURAL RESINS; PRIMERS, AND PAINT THINNERS; METAL PRESERVATIVES IN THE NATURE OF A COATING; COATINGS IN THE FORM OF PAINTS FOR USE IN THE MANUFACTURE OF VEHICLES AND ON PARTS OF VEHICLES; FIREPROOF CEMENT COATINGS (U.S. CLS. 6, 11 AND 16).

FIRST USE 12-31-2008; IN COMMERCE 12-31-2008.

#### CLASS 4—LUBRICANTS AND FUELS

FOR INDUSTRIAL OILS AND GREASES; ALL-PURPOSE LUBRICANTS; DUST ABSORBING COMPOSITION FOR USE ON UNPAVED ROADS, DUST WETTING AND DUST BINDING COMPOSITIONS; FUELS INCLUDING MOTOR SPIRIT AND ILLUMINANTS, NAMELY, LIGHTING FUELS; DIESEL OIL; MOTOR FUEL; NON-CHEMICAL FUEL ADDITIVES; ANTI-SEIZURE LUBRICATING COMPOUNDS FOR USE ON ENGINES; WAXING COMPOSITIONS, NAMELY, PARAFFIN WAX; LUBRICANT DESIGNED FOR USE IN BALL AND ROLLER BEARINGS AND BUSHINGS (U.S. CLS. 1, 6 AND 15).

FIRST USE 12-31-2008; IN COMMERCE 12-31-2008.

#### CLASS 6—METAL GOODS



FOR NON-ELECTRIC CABLES AND WIRES OF COMMON METALS; PIPES AND TUBES OF METAL; METAL PLUGS, METAL STRAPS FOR HANDLING LOADS, METAL PIPE CLIPS, METAL NUTS, METAL BOLTS, METAL SCREWS, METAL SEALING RINGS; METAL BALL LOCK PINS, METAL WASHERS, METAL SEALS, METAL TIE DOWNS, METAL PIPE NIPPLES, BINDING STRIPS OF METAL USED ON PACKAGING, METAL BUNGS, METAL CAPS FOR TUBING ENDS, METAL CLOSURES FOR CONTAINERS, METAL PIPE COLLARS, METAL CLAMPS, METAL COUPLINGS FOR USE WITH HOSES, METAL HOOKS, METAL NAILS, METAL PEGS, METAL RIVETS, METAL STORAGE TANKS, METAL DRAIN PLUGS, METAL COTTER PINS, METAL DRAWBAR PINS, METAL CLEVIS PINS, METAL LOCKING PINS, METAL EYE BOLTS, METAL SNAP RINGS; METAL SCREW THREAD INSERTS; METALLIC DRAIN TRAPS AND DRAIN CAPS; METAL PIPE EXTENSIONS; METAL DEBRIS DEFLECTORS; STEEL REINFORCING GRIDS FOR USE IN PAVING PROCESSES; CLAD STEEL PLATES; METAL TRACK HARDWARE, NAMELY, TRACK LINKS, TRACK SHOES AND TRACK PINS; METAL WELDING RODS; METAL CHAINS, METAL SLINGS FOR LOADING AND PULL-UPS; METAL BELLS; METAL LOCKS AND PADLOCKS; METAL NUMBER PLATES; KNOBS OF METAL; NON-LUMINOUS AND NON-MECHANICAL METAL SIGNS; NON-LUMINOUS AND NON-MECHANICAL METAL SIGNALLING PANELS; REINFORCING MATERIALS OF METAL FOR BUILDING PURPOSES; PARTS AND FITTINGS FOR ALL THE AFORESAID GOODS SOLD AS A UNIT WITH THE GOODS; PARTS FOR LAND VEHICLES, AGRICULTURAL MACHINERY, AND EARTH MOVING MACHINERY, NAMELY, METAL GASKETS FOR MACHINERY AND LAND VEHICLES, METAL PIPE CONNECTORS, METAL PIPE FITTINGS, METAL CYLINDERS FOR COMPRESSED GAS OR LIQUIDS SOLD EMPTY, METAL THREADED FASTENERS, METAL HOSE CLAMPS, AND METAL HOSE FITTINGS (U.S. CLS. 2, 12, 13, 14, 23, 25 AND 50).  
FIRST USE 12-31-2008; IN COMMERCE 12-31-2008.

### CLASS 7—MACHINERY

FOR MOTORS AND ENGINES NOT FOR LAND VEHICLES; MACHINE COUPLINGS AND TRANSMISSION COMPONENTS EXCEPT FOR LAND VEHICLES; VALVES BEING PARTS OF MACHINES; SPARK PLUGS; AIR FILTERS AS PARTS OF MACHINES OR ENGINES FOR MECHANICAL PURPOSES; WATER REGULATORS BEING PARTS OF MACHINES; OIL FILTERS; COUPLINGS FOR MACHINES; ASSEMBLY PRESSES, NAMELY, INDUSTRIAL MACHINE PRESSES; STARTERS FOR MOTORS AND ENGINES; ELECTRIC PUMPS; EXCAVATORS; BULLDOZERS; EARTH MOVING MACHINES, NAMELY, LOADERS; FELLER BUNCHERS; EARTH MOVING MACHINES, NAMELY, SCRAPERS; ASPHALT PAVING MACHINES; CUTTING MACHINES; VIBRATORY SOIL COMPACTORS, SOIL COMPACTORS, VIBRATORY ASPHALT COMPACTORS, AND PNEUMATIC COMPACTORS; FORESTRY MACHINES, NAMELY, SKIDDERS; OIL, AIR, AND GAS FILTERS FOR MOTORS AND ENGINES; BELTS FOR MACHINES; BLADES AS MACHINES PARTS; STEAM ROLLERS, BEING PARTS OF MACHINES; POWER-OPERATED LIFTING AND MOVING EQUIPMENT, NAMELY, PIPE LAYING MACHINES; ATTACHMENTS FOR VEHICLES, NAMELY, GRAPPLE BUCKETS FOR MOVING EARTH AND LOOSE OBJECTS; HYDRAULIC JACKS; ELECTRIC WELDING MACHINES; PAVEMENT PROFILERS; EARTH MOVING MACHINES, NAMELY, SCARIFIERS, MOTOR GRADERS; COMBUSTION ENGINE FUEL NOZZLES; WATER SEPARATORS FOR USE IN ENGINES; FUEL HEATERS FOR ENGINES; POWER-OPERATED CULTIVATORS AND HARVESTERS; AGRICULTURAL MACHINES, NAMELY, THRESHERS; ROAD HEADING MACHINES, TUNNEL HEADING MACHINES, COLD HEADING MACHINES; AGRICULTURAL MACHINES, NAMELY, REAPERS; HAY BINDING MACHINES; AGRICULTURAL MACHINES, NAMELY, MOWING MACHINES, AND TRACTOR-TOWED HARROWS; PLOUGHS AND TRACTOR-TOWED HAY RAKES; AGITATORS FOR CIRCULATING LIQUID MEDIA; AIR CONDENSERS; ALTERNATORS FOR LAND VEHICLES; ANTI-FRICTION BEARINGS FOR MACHINES; ANTI-FRICTION PADS FOR MACHINES; ANTI-POLLUTION DEVICES FOR MOTORS AND ENGINES; AXLES FOR MACHINES; BALL RINGS

FOR BEARINGS FOR MACHINES; BEARING BRACKETS FOR MACHINES; ENGINE BEARINGS; BELT CONVEYORS; ENGINES AND MOTORS FOR BOATS; BRAKE LININGS FOR MACHINES OTHER THAN FOR VEHICLES; BRAKE SEGMENTS FOR MACHINES OTHER THAN FOR VEHICLES; BRAKE SHOES FOR MACHINES OTHER THAN FOR VEHICLES; BRUSHES BEING PARTS OF MACHINES; CARBURETORS; COMPRESSED AIR MACHINES; COMPRESSED AIR PUMPS; COMPRESSORS FOR MACHINES; CONDENSING INSTALLATIONS, NAMELY, AIR CONDENSERS AND AXIAL FAN CONDENSERS; CONNECTING RODS FOR MACHINES, MOTORS, AND ENGINES; CONTROL CABLES BEING PARTS OF MACHINES, ENGINES, OR MOTORS; CURRENT GENERATORS; MILLING CUTTERS; CUTTING MACHINES, CYLINDER HEADS FOR ENGINES; CYLINDERS FOR MACHINES; CYLINDERS FOR MOTORS AND ENGINES; DRILLING BITS BEING PARTS OF MACHINES; DRILLING HEADS BEING PARTS OF MACHINES; DRILLING MACHINES, POWER DRILLS; DYNAMO BELTS; DYNAMO BRUSHES; DYNAMOS; ENGINES, OTHER THAN FOR LAND VEHICLES; FAN BELTS FOR MOTORS AND ENGINES; FANS FOR MOTORS AND ENGINES; FUEL CONVERSION APPARATUS FOR INTERNAL COMBUSTION ENGINES; FUEL ECONOMIZERS FOR MOTORS AND ENGINES; GEAR BOXES OTHER THAN FOR LAND VEHICLES; TRANSMISSION GEARS FOR MACHINES, OTHER THAN FOR LAND VEHICLES; GEAR GRINDING MACHINES; PRECISION GRINDING MACHINES; GUARDS BEING PARTS OF MACHINES; HAMMERS BEING PARTS OF MACHINES; PNEUMATIC HAMMERS; HANDLING APPARATUS, NAMELY, LOADING AND UNLOADING MACHINES; HOISTS; HOPPERS FOR MECHANICAL DISCHARGING; POWER JACKS; LAWNMOWERS; LIFT BELTS; LIFTING INSTALLATION FOR THE TRANSPORT OF GOODS; POWERED LOADING RAMPS IN THE FORM OF CONVEYORS; LUBRICATING PUMPS; LUBRICATORS BEING PARTS OF MACHINES; MACHINE FLY WHEELS; MACHINE WHEELS; METAL WORKING MACHINES; SPRAY GUNS FOR PAINTS; PAINTING MACHINES; PISTONS FOR MOTORS; PNEUMATIC TRANSPORTERS; PULL-UPS BEING PARTS OF MACHINES; ELECTRIC PUMPS; RAMMERS; REDUCTION GEARS OTHER THAN FOR LAND VEHICLES; MECHANICAL POWER SHOVELS; SHAFT COUPLINGS FOR MACHINES; BEARINGS FOR TRANSMISSION SHAFTS BEING PARTS OF MACHINES; SPRAYING MACHINES; SUPERCHARGERS FOR MOTORS AND ENGINES; THREADING MACHINES; THRESHING MACHINES; TRANSMISSION CHAINS AND SHAFTS, OTHER THAN FOR LAND VEHICLES; TRANSMISSIONS FOR MACHINES; TURBINES OTHER THAN FOR LAND VEHICLES; TURBO-COMPRESSORS; VEHICLE WASHING INSTALLATIONS; VULCANIZATION MACHINES; WASTE DISPOSERS BEING PARTS OF MACHINES; WATERING MACHINES FOR AGRICULTURAL PURPOSES; PARTS AND FITTINGS FOR ALL THE AFORESAID GOODS SOLD AS A UNIT WITH THE GOODS; MECHANICAL ENGINE PARTS FOR LAND VEHICLES, AGRICULTURAL MACHINERY, AND EARTH MOVING MACHINERY, NAMELY, STARTING MOTORS, ALTERNATORS, PISTONS, CYLINDER HEADS, COOLING SYSTEMS PARTS, TURBOCHARGERS, LUBRICATING SYSTEMS PARTS, AIR COMPRESSORS, AND BLOCKS; CRANK SHAFTS FOR ENGINES, ENGINE CAMSHAFTS, ENGINE BEARINGS; MUFFLERS FOR ENGINES AND MOTORS; ENGINE EXHAUST CAPS; EXHAUST SILENCERS FOR ENGINES; RADIATORS AND RADIATOR CAPS FOR VEHICLES; EXHAUSTS FOR ENGINES; HAND-HELD GAS WELDING APPARATUS, NAMELY, HEAT WELDING GUNS; ELECTRIC CUTTING TORCHES (U.S. CLS. 13, 19, 21, 23, 31, 34 AND 35).  
FIRST USE 12-31-2008; IN COMMERCE 12-31-2008.

### CLASS 8—HAND TOOLS

FOR HAND TOOLS, NAMELY, TAPS AND DIES; HAND JACKS; CABLE CUTTERS; WIRE CUTTERS; HAND TOOLS, NAMELY, WRENCHES; KNIVES; GLASS INSTALLATION TOOLS, NAMELY, GLASS CUTTERS; HAND-OPERATED CRIMPING TOOLS AND HAND-OPERATED CRIMPING IRONS; HAND HELD CUTTING TOOLS; HAND HELD HOSE CUTTERS; HAND DRILLS AND DRILL BITS FOR HAND DRILLS; MANUALLY OPERATED GREASE GUNS; HAND TOOLS, NAMELY, SOCKET WRENCHES, AND SOCKET SETS; TORQUE WRENCHES; PARTS AND FITTINGS FOR ALL THE AFORESAID GOODS SOLD AS A UNIT WITH THE GOODS; VICES (U.S. CLS. 23, 28 AND 44).

FIRST USE 12-31-2008; IN COMMERCE 12-31-2008.

### **CLASS 9—ELECTRICAL AND SCIENTIFIC APPARATUS**

FOR APPARATUS FOR RECORDING, TRANSMISSION OR REPRODUCTION OF SOUND OR IMAGES; BLANK MAGNETIC DATA CARRIERS; BLANK RECORDING DISCS; DATA PROCESSING EQUIPMENT AND COMPUTERS; COMPUTER HARDWARE AND SOFTWARE FOR SENSING AND RECORDING OPERATIONAL DATA TO MONITOR THE PERFORMANCE AND MAINTENANCE NEEDS OF VEHICLES, EQUIPMENT, AND MACHINERY USED FOR EARTH MOVING, EARTH CONDITIONING, MATERIAL HANDLING, CONSTRUCTION, MINING, PAVING, AGRICULTURE, AND FORESTRY; TELEVISION SETS; ELECTRIC CABLE AND WIRE; ELECTRICITY CONDUITS, ELECTRIC SWITCHES, PRESSURE SWITCHES; ELECTRICAL CONNECTORS, CABLE JUMP LEADS, ELECTRICAL FUSES, CIRCUIT TESTERS, VOLTAGE TESTERS; ELECTRIC FUSE HOLDERS, TRANSFORMERS, BATTERY TESTING APPARATUS FOR SALE IN KIT FORM; THERMOSTATS, PRESSURE GAUGES, AND LEVELING RODS; TAPE MEASURES AND RULES; MICROSCOPES, TACHOMETERS; THERMOMETERS; ANTI-INTRUSION ALARMS, ELECTRONIC WARNING HORNS, FLASHING SAFETY LIGHTS, OPTICAL REFLECTORS, REFLECTIVE MIRRORS TO PREVENT ACCIDENTS, AERIALS, AND BATTERY CHARGERS; ELECTRIC COUPLINGS; METERED PETROL PUMPS; SURVEYOR'S LEVELS; ELECTRONIC LOCKS; RADIOS; BATTERIES; SPEED CHECKING APPARATUS FOR VEHICLES, NAMELY, SENSORS; BATTERY CABLES; ELECTRIC CONNECTORS FOR SALE IN KIT FORM; ELECTRICAL TERMINALS; PROBES FOR TESTING INTEGRATED CIRCUITS; AMMETERS; BATTERY TESTERS, GAS DETECTORS; FLOW METERS; OHMMETERS; WELDING TORCHES; BATTERY GROUND STRAPS; BATTERY TIE DOWNS; EMERGENCY JUMP START APPARATUS, NAMELY, JUMPER CABLES; VOLTAGE CONVERTERS; WELDING APPARATUS, NAMELY, WELDING RESPIRATORS, WELDING HELMETS, WELDING GOGGLES, WELDING JACKETS, WELDING GLOVES, WELDING COATS, AND WELDING BLANKETS; PARTS AND FITTINGS FOR ALL THE AFORESAID GOODS SOLD AS A UNIT WITH THE GOODS; PARTS AND FITTINGS FOR LAND VEHICLES, AGRICULTURAL MACHINERY, AND EARTH MOVING MACHINERY, NAMELY, AMPLIFIERS FOR WIRELESS COMMUNICATIONS, ANTENNAS, ANTENNAS FOR WIRELESS COMMUNICATIONS APPARATUS; AUDIO EQUIPMENT FOR VEHICLES, NAMELY, STEREOs, SPEAKERS, AMPLIFIERS, EQUALIZERS, CROSSOVERS, AND SPEAKER HOUSINGS, BATTERIES FOR VEHICLES, DEVICES FOR WIRELESS RADIO TRANSMISSION, ELECTRIC CONTROL PANELS, ELECTRIC LUMINESCENT DISPLAY PANELS, ELECTRIC RELAYS; ELECTRONIC AND OPTICAL COMMUNICATIONS INSTRUMENTS AND COMPONENTS, NAMELY, OPTICAL TRANSMITTERS; ELECTRONIC AND OPTICAL COMMUNICATIONS INSTRUMENTS AND COMPONENTS, NAMELY, OPTICAL RECEIVERS; ELECTRONIC AND OPTICAL COMMUNICATIONS INSTRUMENTS AND COMPONENTS,

NAMELY, DIGITAL TRANSMITTERS, ELECTRONIC CONTROL SYSTEMS FOR MACHINES, GLOBAL POSITIONING SYSTEMS, LASER OBJECT DETECTORS FOR USE ON VEHICLES, NAVIGATION APPARATUS FOR VEHICLES IN THE NATURE OF ON-BOARD COMPUTERS, RADIOS FOR VEHICLES, VOLTAGE REGULATORS, VOLTAGE STABILIZERS, AND VOLTMETERS; MACHINE PARTS, NAMELY, CONTROL MECHANISMS FOR MACHINES, ENGINES, OR MOTORS; FUEL/AIR RATIO CONTROLS FOR ENGINES; SPEED GOVERNORS FOR MACHINES, ENGINES, AND MOTORS (U.S. CLS. 21, 23, 26, 36 AND 38).

FIRST USE 12-31-2008; IN COMMERCE 12-31-2008.

### **CLASS 11—ENVIRONMENTAL CONTROL APPARATUS**

FOR LIGHT BULBS, HEAD LIGHT BULBS, TAIL LIGHT BULBS, VEHICLE TURN SIGNAL LIGHT BULBS, DASHBOARD LIGHT BULBS; ELECTRIC TORCHES FOR LIGHTING; LIGHTS FOR VEHICLES, LAMPS; REFLECTORS FOR VEHICLES; AIR CONDITIONING APPARATUS; AIR CONDITIONING FILTERS; DEFROSTING APPARATUS FOR VEHICLES; PARTS AND FITTINGS FOR ALL THE AFORESAID GOODS SOLD AS A UNIT WITH THE GOODS; PARTS AND FITTINGS FOR LAND VEHICLES, AGRICULTURAL MACHINERY, AND EARTH MOVING MACHINERY, NAMELY, BACKUP LIGHTS FOR LAND VEHICLES, COOLANT RECOVERY SYSTEMS COMPRISING RESERVOIRS, PUMPS, FILTERS, AND CLEANERS; ELECTRIC LIGHT BULBS, LED LIGHT BULBS, REAR LIGHTS FOR VEHICLES, AND VALVES AS PART OF RADIATORS (U.S. CLS. 13, 21, 23, 31 AND 34).

FIRST USE 12-31-2008; IN COMMERCE 12-31-2008.

### **CLASS 12—VEHICLES**

FOR LAND VEHICLES; TRACTORS AND TRACTOR ENGINES; HAULAGE TRUCKS AND TRAILER WAGONS; VEHICLE CHASSIS; TIRES FOR VEHICLE WHEELS; VEHICLE WHEELS; VEHICLE PARTS, NAMELY, TRACKS; TRUCKS; DUMP TRUCKS; LAND VEHICLES INCORPORATING LOADING, COMPACTING, PIPE LAYING, AND GRADING APPARATUS; TIRE VALVES FOR VEHICLE TIRES; HYDRAULIC CIRCUITS AND HYDRAULIC ADAPTERS FOR CONNECTING COMPONENTS OF HYDRAULIC SYSTEMS IN VEHICLES; TRAILER COUPLINGS FOR VEHICLES; AIR PUMPS FOR VEHICLES; HORNS FOR VEHICLES; REARVIEW MIRRORS, SIDE VIEW MIRRORS; MUD GUARDS FOR VEHICLES, MUD FLAPS FOR VEHICLES, MUD SPRAY GUARDS FOR VEHICLES, MUD SPRAY FLAPS FOR VEHICLES; SEATS AND SEAT BELTS FOR VEHICLES; WINDSCREEN WIPERS AND WINDSCREEN WIPER BLADES; ANTI-SKID CHAINS FOR VEHICLES; BRAKES FOR VEHICLES; BRAKE LININGS FOR VEHICLES; HYDRAULIC APPARATUS FOR USE IN MOVING WORK TOOLS ATTACHED TO VEHICLES AND NOT FOR ENGINES OR MOTORS, NAMELY, HYDRAULIC DRIVES, HYDRAULIC GEARS, HYDRAULIC PUMPS, AND HYDRAULIC SHOCK ABSORBERS; SEMI-FITTED VEHICLE COVERS; PARTS AND FITTINGS FOR ALL THE AFORESAID GOODS SOLD AS A UNIT WITH THE GOODS; PARTS AND FITTINGS FOR LAND VEHICLES, NAMELY, ENGINES, CONNECTING RODS FOR VEHICLES OTHER THAN PARTS OF MOTORS AND ENGINES, TRANSMISSIONS FOR LAND VEHICLES, AND STRUCTURAL, REPAIR, AND REPLACEMENT PARTS THEREFOR (U.S. CLS. 19, 21, 23, 31, 35 AND 44).

FIRST USE 12-31-2008; IN COMMERCE 12-31-2008.

### **CLASS 17—RUBBER GOODS**

FOR NON-METAL SEALS FOR USE ON PIPE JOINTS AND FLANGES; INSULATION TAPES; PLASTIC TAPES USED AS INSULATING, STOPPING AND PACKING MATERIALS; ADHESIVE TAPES FOR INDUSTRIAL AND COMMERCIAL USE; SEMI-PROCESSED BRAKE LINING MATERIAL; CLUTCH LININGS; CYLINDER JOINTING OF RUBBER; CYLINDER JOINTING OF GUM; CYLINDER JOINTING OF PLASTICS; NON-METAL GASKETS FOR COMMERCIAL AND INDUSTRIAL APPLICATIONS; INSULATING GLOVES; COUPLING AND JOINTS NOT OF METAL; RINGS OF RUBBER OR OF PLASTIC FOR USE AS PIPE CONNECTION SEALS; SEALING PLUGS MADE PRIMARILY OF RUBBER; PARTS AND FITTINGS FOR ALL THE AFORESAID GOODS SOLD AS A UNIT WITH THE GOODS; PARTS AND FITTINGS FOR LAND VEHICLES, AGRICULTURAL MACHINES, AND EARTH MOVING MACHINES, NAMELY, CONNECTING HOSES FOR VEHICLE RADIATORS, ELECTRICAL INSULATING TAPE, FLEXIBLE PLASTIC HOSES FOR USE IN VENTILATION, HOSES FOR AIR CONDITIONERS MADE OF RUBBER, HYDRAULIC HOSES MADE OF RUBBER, AND NON-METAL OIL HOSES; ELECTRICAL TAPE; MOISTURE WICKING SEALANT FOR FASTENERS, SILICONE-BASED SEALANT, ADHESIVE SEALANT FOR INDUSTRIAL USE, PIPE SEALANT FOR USE IN SEALING PIPE JOINTS AND FITTINGS (U.S. CLS. 1, 5, 12, 13, 35 AND 50).

FIRST USE 12-31-2008; IN COMMERCE 12-31-2008.

#### **CLASS 20—FURNITURE AND ARTICLES NOT OTHERWISE CLASSIFIED**

FOR BINS, NOT OF METAL; CABLE OR PIPE CLIPS OF PLASTIC; PLASTIC KEY CARDS; DISPLAY CASES OF WOOD OR PLASTIC; CLOSURES NOT OF METAL FOR CONTAINERS; CONTAINERS NOT OF METAL FOR COMMERCIAL USE; LADDERS OF WOOD OR PLASTIC; PULLEYS OF PLASTIC; TOOL HANDLES OF WOOD OR PLASTIC; TRANSPORT PALLETS, NOT OF METAL; VALVES OF PLASTIC, OTHER THAN MACHINE PARTS (U.S. CLS. 2, 13, 22, 25, 32 AND 50).

FIRST USE 12-31-2008; IN COMMERCE 12-31-2008.

4,045,661. SILVER SUNBEAM LIMITED, ROAD TOWN, TORTOLA, BR.VIRGIN ISLANDS. SN 77-338,472. PUB. 12-23-2008, FILED 11-28-2007.

solar.

THE MARK CONSISTS OF THE STYLIZED WORDING "SOLAR" IN LOWERCASE LETTERS WITH THE LETTER "R" COMPRISED OF THE RAISED ARM FROM A FANCIFUL REPRESENTATION OF A SWIMMER, WITH ONLY THE SWIMMER'S HEAD AND ONE ARM VISIBLE.

#### **CLASS 25—CLOTHING**

FOR ARTICLES OF CLOTHING, NAMELY, SWIMWEAR, BEACHWEAR; LEISUREWEAR, NAMELY, T-SHIRTS, SHIRTS, SWEATSHIRTS, VESTS, TANK-TOPS, JACKETS, PAREOS, COVER-UPS, SARONGS, PONCHOS, DRESS SHIRTS, SUNDRESSES, SLIP DRESSES, SKIRT SETS, SHORT SETS, SHORTS, BIKE SHORTS, BOARD SHORTS, HEADWRAPS, VISORS, NONE OF THE FOREGOING MADE OF SILK OR FLEECE (U.S. CLS. 22 AND 39).

FIRST USE 11-0-2002; IN COMMERCE 11-0-2002.

#### **CLASS 35—ADVERTISING AND BUSINESS**

FOR CATALOG ORDERING SERVICE FEATURING CLOTHING; ONLINE RETAIL STORES FEATURING CLOTHING; WHOLESALE AND RETAIL CLOTHING STORES, ALL OF THE FOREGOING EXCLUDING CLOTHING MADE OF SILK OR FLEECE (U.S. CLS. 100, 101 AND 102).

FIRST USE 0-0-2007; IN COMMERCE 0-0-2007.

4,045,659. ALINTER, S.A., SAN JOSÉ, COSTA RICA. SN 77-320,713. PUB. 4-22-2008, FILED 11-3-2007.

AGÚ

THE MARK CONSISTS OF STANDARD CHARACTERS WITHOUT CLAIM TO ANY PARTICULAR FONT, STYLE, SIZE, OR COLOR.

#### **CLASS 5—PHARMACEUTICALS**

FOR BABY FOOD (U.S. CLS. 6, 18, 44, 46, 51 AND 52).  
FIRST USE 1-10-2008; IN COMMERCE 11-27-2009.

#### **CLASS 29—MEATS AND PROCESSED FOODS**

FOR COMPOTES (U.S. CL. 46).  
FIRST USE 10-1-2008; IN COMMERCE 12-27-2009.

4,045,665. UROUTDOORS, INC., ROCKY MOUNT, NC. SN 77-342,758. PUB. 5-6-2008, FILED 12-3-2007.

UROUTDOORS

THE MARK CONSISTS OF STANDARD CHARACTERS WITHOUT CLAIM TO ANY PARTICULAR FONT, STYLE, SIZE, OR COLOR.

#### **CLASS 35—ADVERTISING AND BUSINESS**

FOR PROMOTING THE GOODS AND SERVICES OF OTHERS BY PROVIDING HYPERTEXT LINKS TO THE WEBSITES OF OTHERS (U.S. CLS. 100, 101 AND 102).  
FIRST USE 6-24-2011; IN COMMERCE 6-24-2011.

#### **CLASS 42—SCIENTIFIC AND COMPUTER SERVICES**

FOR COMPUTER SERVICES, NAMELY, PROVIDING SEARCH ENGINES FOR OBTAINING DATA ON A GLOBAL COMPUTER NETWORK (U.S. CLS. 100 AND 101).  
FIRST USE 6-24-2011; IN COMMERCE 6-24-2011.

4,045,674. THE VILLAGE AT BRECKENRIDGE HOME-OWNERS ASSOCIATION, BRECKENRIDGE, CO. SN 77-367,897. PUB. 8-19-2008, FILED 1-9-2008.



NO CLAIM IS MADE TO THE EXCLUSIVE RIGHT TO USE "BRECKENRIDGE", APART FROM THE MARK AS SHOWN.

THE MARK CONSISTS OF THE WORDS "VILLAGE AT BRECKENRIDGE" WITH STYLIZED MOUNTAINS.

#### CLASS 35—ADVERTISING AND BUSINESS

FOR REAL ESTATE SALES MANAGEMENT FOR HOUSING; ASSOCIATION SERVICES, NAMELY, PROMOTING THE INTERESTS OF A HOMEOWNER'S ASSOCIATION (U.S. CLS. 100, 101 AND 102).  
FIRST USE 2-28-2008; IN COMMERCE 2-28-2008.

#### CLASS 36—INSURANCE AND FINANCIAL

FOR REAL ESTATE MANAGEMENT FOR HOUSING; REAL ESTATE RENTAL MANAGEMENT (U.S. CLS. 100, 101 AND 102).  
FIRST USE 9-14-2011; IN COMMERCE 9-14-2011.

4,045,684. POP-IN-KINS, LTD., ALLIANCE, OH. SN 77-378,647. PUB. 7-1-2008, FILED 1-23-2008.

#### CHRISTOPHER POP-IN-KINS

THE MARK CONSISTS OF STANDARD CHARACTERS WITHOUT CLAIM TO ANY PARTICULAR FONT, STYLE, SIZE, OR COLOR.

OWNER OF U.S. REG. NO. 2,761,516.

"CHRISTOPHER POPINKINS" DOES NOT IDENTIFY A LIVING INDIVIDUAL.

#### CLASS 16—PAPER GOODS AND PRINTED MATTER

FOR PRINTED MATERIALS, NAMELY, STORIES IN ILLUSTRATED FORM, CHILDREN'S STORY BOOKS, BOOKLETS IN THE FIELD OF CHILDREN'S STORIES; CALENDARS, POSTERS, GIFT-WRAPPING PAPER AND GREETING CARDS (U.S. CLS. 2, 5, 22, 23, 29, 37, 38 AND 50).  
FIRST USE 8-27-2008; IN COMMERCE 8-27-2008.

#### CLASS 25—CLOTHING

FOR CLOTHING, NAMELY, T-SHIRTS, SWEAT SHIRTS, CAPS, HATS, GLOVES, MITTENS, SCARVES, JOGGING OUTFITS, TIES, SLIPPERS, SHOES, SOCKS AND UNDERWEAR (U.S. CLS. 22 AND 39).  
FIRST USE 11-20-2010; IN COMMERCE 11-20-2010.

#### CLASS 28—TOYS AND SPORTING GOODS

FOR PLAYTHINGS, NAMELY, STUFFED DOLLS AND SOFT SCULPTURE DOLLS; CHRISTMAS TREE ORNAMENTS AND DECORATIONS (U.S. CLS. 22, 23, 38 AND 50).

FIRST USE 8-27-2008; IN COMMERCE 8-27-2008.

4,045,695. ORLANDO DINNER ENTERTAINMENT, INC., ORLANDO, FL. SN 77-392,502. PUB. 6-24-2008, FILED 2-8-2008.

#### PIRATE'S ADVENTURE

THE MARK CONSISTS OF STANDARD CHARACTERS WITHOUT CLAIM TO ANY PARTICULAR FONT, STYLE, SIZE, OR COLOR.

OWNER OF U.S. REG. NO. 2,535,935.

#### CLASS 41—EDUCATION AND ENTERTAINMENT

FOR DINNER THEATERS (U.S. CLS. 100, 101 AND 107).  
FIRST USE 9-14-2011; IN COMMERCE 9-14-2011.

#### CLASS 43—HOTEL AND RESTAURANT SERVICES

FOR RESTAURANT AND BAR SERVICES (U.S. CLS. 100 AND 101).  
FIRST USE 9-14-2011; IN COMMERCE 9-14-2011.

4,045,697. COOPER, LINDA, NEWBURYPORT, MA. SN 77-393,439. PUB. 3-15-2011, FILED 2-11-2008.



THE MARK CONSISTS OF A STYLIZED IMAGE OF THE HEAD AND UPPER TORSO OF A FIGURE. THE WORDS "ONE RACE" APPEAR ABOVE THE FIGURE. THE WORD "HUMAN" APPEARS BELOW THE FACE OF THE FIGURE.

#### CLASS 21—HOUSEWARES AND GLASS

FOR DECORATIVE CERAMIC TILES NOT FOR USE AS BUILDING MATERIALS; MUGS; BEER STEINS; COASTERS NOT OF PAPER AND NOT BEING TABLE LINEN (U.S. CLS. 2, 13, 23, 29, 30, 33, 40 AND 50).  
FIRST USE 8-10-2007; IN COMMERCE 8-10-2007.

**CLASS 25—CLOTHING**

FOR CLOTHING, NAMELY, SHIRTS, T-SHIRTS, SWEATSHIRTS, GOLF SHIRTS, HOODED SWEATSHIRTS, TANK TOPS, CHILDREN'S SHIRTS, CHILDREN'S T-SHIRTS, CHILDREN'S SWEATSHIRTS, CHILDREN'S HOODED SWEATSHIRTS, BOXER SHORTS, HATS, CAPS, INFANT BODY SUITS, INFANT'S CLOTH BIBS (U.S. CLS. 22 AND 39).

FIRST USE 8-10-2007; IN COMMERCE 8-10-2007.

---

4,045,703. SIMPLYSHE, INC., SAN FRANCISCO, CA. SN 77-404,426. PUB. 5-20-2008, FILED 2-22-2008.

SimplyDog

THE MARK CONSISTS OF STANDARD CHARACTERS WITHOUT CLAIM TO ANY PARTICULAR FONT, STYLE, SIZE, OR COLOR.

**CLASS 14—JEWELRY**

FOR PET JEWELRY (U.S. CLS. 2, 27, 28 AND 50).  
FIRST USE 12-31-2006; IN COMMERCE 12-31-2006.

**CLASS 24—FABRICS**

FOR PET BLANKETS (U.S. CLS. 42 AND 50).  
FIRST USE 9-30-2010; IN COMMERCE 9-30-2010.

---

4,045,705. ATLANTIC HEALTH SYSTEM, INC., MORRISTOWN, NJ. SN 77-407,712. PUB. 12-2-2008, FILED 2-27-2008.

ATLANTIC SPORTS HEALTH

THE MARK CONSISTS OF STANDARD CHARACTERS WITHOUT CLAIM TO ANY PARTICULAR FONT, STYLE, SIZE, OR COLOR.

OWNER OF U.S. REG. NOS. 2,793,357, 3,017,051, AND 3,366,538.

NO CLAIM IS MADE TO THE EXCLUSIVE RIGHT TO USE "SPORTS HEALTH", APART FROM THE MARK AS SHOWN.

**CLASS 42—SCIENTIFIC AND COMPUTER SERVICES**

FOR MEDICAL LABORATORY SERVICES (U.S. CLS. 100 AND 101).  
FIRST USE 5-1-2011; IN COMMERCE 5-1-2011.

**CLASS 44—MEDICAL, BEAUTY AND AGRICULTURAL SERVICES**

FOR HEALTH CARE SERVICES IN THE NATURE OF HOSPITAL, MEDICAL, SURGICAL, NURSING, PHYSICAL THERAPY, PSYCHOLOGICAL TREATMENT, PHYSICAL REHABILITATION, INJURY EVALUATION, FUNCTIONAL CAPACITY EVALUATION, PRE-PLACEMENT AND RETURN-TO-WORK PHYSICALS, FITTING OF ORTHOTICS FOR THE FOOT, HAND, ARM AND LEG, DRUG TESTING AND SUBSTANCE ABUSE; SPORTS EVENT HEALTH CARE SERVICES IN THE NATURE OF INJURY EVALUATION AND TREATMENT; PROVIDING A WEB SITE AND ON-LINE COMPUTER DATABASE FEATURING INFORMATION IN THE FIELD OF NUTRITION (U.S. CLS. 100 AND 101).

FIRST USE 5-1-2011; IN COMMERCE 5-1-2011.

---

4,045,721. BACKBONE ENTERTAINMENT, IRVINE, CA. SN 77-450,306. PUB. 4-12-2011, FILED 4-16-2008.

Double Helix

THE MARK CONSISTS OF STANDARD CHARACTERS WITHOUT CLAIM TO ANY PARTICULAR FONT, STYLE, SIZE, OR COLOR.

**CLASS 9—ELECTRICAL AND SCIENTIFIC APPARATUS**

FOR COMPUTER GAME CARTRIDGES AND DISCS; COMPUTER GAME SOFTWARE; ELECTRONIC GAME SOFTWARE FOR HANDHELD ELECTRONIC DEVICES; ELECTRONIC GAME SOFTWARE FOR WIRELESS DEVICES; VIDEO GAME CARTRIDGES AND DISCS; DOWNLOADABLE COMPUTER GAMES VIA THE INTERNET AND WIRELESS DEVICES (U.S. CLS. 21, 23, 26, 36 AND 38).

FIRST USE 3-27-2008; IN COMMERCE 3-27-2008.

**CLASS 42—SCIENTIFIC AND COMPUTER SERVICES**

FOR DESIGNING AND DEVELOPING COMPUTER GAME SOFTWARE AND VIDEO GAME SOFTWARE FOR USE WITH COMPUTERS, VIDEO GAME PROGRAM SYSTEMS AND COMPUTER NETWORKS (U.S. CLS. 100 AND 101).

FIRST USE 3-27-2008; IN COMMERCE 3-27-2008.

4,045,722. BACKBONE ENTERTAINMENT, IRVINE, CA. SN 77-450,307. PUB. 4-5-2011, FILED 4-16-2008.



NO CLAIM IS MADE TO THE EXCLUSIVE RIGHT TO USE "GAMES", APART FROM THE MARK AS SHOWN.

THE MARK CONSISTS OF A SERIES OF HORIZONTAL LINES PRESENTED IN AN HOURGLASS SHAPE ABOVE THE WORDS "DOUBLE HELIX GAMES".

#### CLASS 9—ELECTRICAL AND SCIENTIFIC APPARATUS

FOR COMPUTER GAME CARTRIDGES AND DISCS; COMPUTER GAME SOFTWARE; ELECTRONIC GAME SOFTWARE FOR HANDHELD ELECTRONIC DEVICES; ELECTRONIC GAME SOFTWARE FOR WIRELESS DEVICES; VIDEO GAME CARTRIDGES AND DISCS; DOWNLOADABLE COMPUTER GAMES VIA THE INTERNET AND WIRELESS DEVICES (U.S. CLS. 21, 23, 26, 36 AND 38).

FIRST USE 3-27-2008; IN COMMERCE 3-27-2008.

#### CLASS 42—SCIENTIFIC AND COMPUTER SERVICES

FOR DESIGNING AND DEVELOPING COMPUTER GAME SOFTWARE AND VIDEO GAME SOFTWARE FOR USE WITH COMPUTERS, VIDEO GAME PROGRAM SYSTEMS AND COMPUTER NETWORKS (U.S. CLS. 100 AND 101).

FIRST USE 3-27-2008; IN COMMERCE 3-27-2008.

4,045,726. BIG FISH GAMES, INC., SEATTLE, WA. SN 77-455,995. PUB. 12-23-2008, FILED 4-23-2008.



THE MARK CONSISTS OF A DESIGN OF A FISH.

#### CLASS 38—COMMUNICATION

FOR PROVIDING AN ONLINE FORUM FOR TRANSMISSION OF MESSAGES AMONG COMPUTER USERS CONCERNING GAMES, INTERACTIVE GAME CONTENT, ELECTRONIC GAME CONTENT, COMPUTER GAME CONTENT OR VIDEO GAME CONTENT, WHERE USERS CAN POST RATINGS, REVIEWS, FAVORITES AND RECOMMENDATIONS IN THE FOREGOING FIELDS (U.S. CLS. 100, 101 AND 104).

FIRST USE 8-12-2009; IN COMMERCE 8-12-2009.

#### CLASS 41—EDUCATION AND ENTERTAINMENT

FOR ENTERTAINMENT SERVICES, NAMELY, PROVIDING NON-DOWNLOADABLE ONLINE, INTERACTIVE, COMPUTER, VIDEO AND ELECTRONIC GAMES; NON-DOWNLOADABLE COMPUTER GAMES PROVIDED VIA A GLOBAL COMPUTER NETWORK, MOBILE ACCESS COMPUTERS, HANDHELD GAME PLAYERS AND MOBILE TELEPHONES; PROVIDING A NON-DOWNLOADABLE COMPUTER GAME THAT MAY BE ACCESSED NETWORK-WIDE BY NETWORK USERS; PROVIDING ON-LINE INFORMATION AND CONTENT IN THE FIELD OF GAMES, INTERACTIVE GAME CONTENT, ELECTRONIC GAME CONTENT, COMPUTER GAME CONTENT OR VIDEO GAME CONTENT; PROVIDING TEMPORARY USE OF NON-DOWNLOADABLE INTERACTIVE GAMES, ELECTRONIC GAMES, COMPUTER GAMES OR VIDEO GAMES; PROVIDING NON-DOWNLOADABLE ELECTRONIC NEWSLETTERS IN THE FIELDS OF GAMES, ONLINE COMPUTER GAMES, COMPUTER SOFTWARE GAMES, VIDEO GAMES AND ELECTRONIC GAME SOFTWARE VIA THE INTERNET; PROVIDING A NON-DOWNLOADABLE ON-LINE MULTI-PLAYER ELECTRONIC COMPUTER GAME, NAMELY, A MASSIVELY MULTI-PLAYER ONLINE (MMO) GAME (U.S. CLS. 100, 101 AND 107).

FIRST USE 8-12-2009; IN COMMERCE 8-12-2009.

4,045,746. MATARINE, WASHINGTON, DC. SN 77-516,330. PUB. 12-2-2008, FILED 7-7-2008.



THE MARK CONSISTS OF THE TEXT "MATARINE" TYPED IN THE ORBIT FONT WITH A TROPICAL FLOWER GROWING OUT OF THE "I".

#### CLASS 16—PAPER GOODS AND PRINTED MATTER

FOR BLANK JOURNALS; COASTERS OF PAPER; GREETING CARDS; ILLUSTRATIONS; INVITATION CARDS; NOTEPADS; PRINTS; STATIONERY (U.S. CLS. 2, 5, 22, 23, 29, 37, 38 AND 50).

FIRST USE 2-1-2008; IN COMMERCE 11-1-2010.

#### CLASS 35—ADVERTISING AND BUSINESS

FOR ON-LINE RETAIL STORE SERVICES FEATURING PRINTED GOODS, CARDS, PRINTS, ILLUSTRATIONS, CLOTHING, HOUSE WARES AND ACCESSORIES; WHOLESALE DISTRIBUTORSHIPS FEATURING PRINTED GOODS, CARDS, PRINTS, ILLUSTRATIONS, CLOTHING, HOUSE WARES AND ACCESSORIES (U.S. CLS. 100, 101 AND 102).

FIRST USE 2-1-2008; IN COMMERCE 11-1-2010.

4,045,747. IVERSON GENETIC DIAGNOSTICS, INC., BOTHELL, WA. SN 77-519,261. PUB. 6-16-2009, FILED 7-10-2008.



THE COLOR(S) ORANGE, YELLOW, GREEN, BLUE, PURPLE, RED, BLACK AND WHITE IS/ARE CLAIMED AS A FEATURE OF THE MARK.

THE MARK CONSISTS OF A TRIANGULAR SHAPE CONSISTING OF OBLONG SHAPES IN THE COLORS ORANGE, YELLOW, GREEN, BLUE, PURPLE AND RED WITH WHITE BANDS FOLLOWED BY THE WORD "IVERSON" IN BLACK.

#### CLASS 10—MEDICAL APPARATUS

FOR SPECIMEN COLLECTION KITS COMPRISING BLOOD DRAW VIALS (U.S. CLS. 26, 39 AND 44).  
FIRST USE 5-17-2011; IN COMMERCE 5-17-2011.

#### CLASS 42—SCIENTIFIC AND COMPUTER SERVICES

FOR MEDICAL LABORATORY SERVICES (U.S. CLS. 100 AND 101).  
FIRST USE 11-11-2009; IN COMMERCE 11-11-2009.

#### CLASS 44—MEDICAL, BEAUTY AND AGRICULTURAL SERVICES

FOR MEDICAL CONSULTING SERVICES IN THE FIELD OF GENETICS (U.S. CLS. 100 AND 101).  
FIRST USE 11-11-2009; IN COMMERCE 11-11-2009.

4,045,748. BROWN, JANICE, SAN DIEGO, CA. SN 77-520,598. PUB. 12-2-2008, FILED 7-11-2008.

**CLOUDBURST**

THE MARK CONSISTS OF STANDARD CHARACTERS WITHOUT CLAIM TO ANY PARTICULAR FONT, STYLE, SIZE, OR COLOR.

#### CLASS 35—ADVERTISING AND BUSINESS

FOR BUSINESS CONSULTATION; BUSINESS CONSULTATION SERVICES; BUSINESS MANAGEMENT CONSULTATION IN THE FIELD OF EXECUTIVE AND LEADERSHIP DEVELOPMENT; PROFESSIONAL BUSINESS CONSULTATION; BUSINESS CONSULTING AND BUSINESS INFORMATION FOR ENTERPRISES; BUSINESS MARKETING CONSULTING SERVICES; MARKETING CONSULTING; BUSINESS LEADERSHIP DEVELOPMENT; AND CONSULTATION SERVICES IN THE FIELD OF BUSINESS NETWORKING (U.S. CLS. 100, 101 AND 102).  
FIRST USE 2-17-2011; IN COMMERCE 5-21-2011.

#### CLASS 41—EDUCATION AND ENTERTAINMENT

FOR EDUCATIONAL SERVICES, NAMELY, CONDUCTING SEMINARS AND CONFERENCES IN THE FIELDS OF LEADERSHIP, BUSINESS DEVELOPMENT, RAINMAKING, NETWORKING, AND MARKETING (AND DISTRIBUTION OF COURSE MATERIALS IN CONNECTION THEREWITH); EDUCATIONAL AND ENTERTAINMENT SERVICES, NAMELY, PROVIDING MOTIVATIONAL AND EDUCATIONAL SPEAKERS; AND PROFESSIONAL COACHING SERVICES IN THE FIELDS OF LEADERSHIP, BUSINESS DEVELOPMENT, RAINMAKING, NETWORKING, AND MARKETING (U.S. CLS. 100, 101 AND 107).

FIRST USE 2-17-2011; IN COMMERCE 5-21-2011.

4,045,756. PHILADELPHIA MEDIA NETWORK (DIGITAL) LLC, PHILADELPHIA, PA. SN 77-548,443. PUB. 1-11-2011, FILED 8-15-2008.

**PHREQUENCY.COM**

THE MARK CONSISTS OF STANDARD CHARACTERS WITHOUT CLAIM TO ANY PARTICULAR FONT, STYLE, SIZE, OR COLOR.

#### CLASS 41—EDUCATION AND ENTERTAINMENT

FOR PROVIDING MUSIC AND ENTERTAINMENT INFORMATION VIA THE INTERNET; PROVIDING A WEBSITE FEATURING MUSIC AND ENTERTAINMENT INFORMATION; PROVIDING GENERAL AND CUSTOMIZED MUSIC AND ENTERTAINMENT INFORMATION; ENTERTAINMENT SERVICES, NAMELY, PROVIDING INFORMATION IN THE FIELD OF MUSIC, AND COMMENTARY AND ARTICLES ABOUT MUSIC, ALL ON-LINE VIA A GLOBAL COMPUTER NETWORK; ENTERTAINMENT SERVICES, NAMELY, PROVIDING ONLINE NON-DOWNLOADABLE MUSIC FOR LISTENING (U.S. CLS. 100, 101 AND 107).

FIRST USE 11-11-2008; IN COMMERCE 11-11-2008.

#### CLASS 42—SCIENTIFIC AND COMPUTER SERVICES

FOR ONLINE COMPUTER SERVICES, NAMELY, CREATING INDEXES OF INFORMATION, SITES AND OTHER RESOURCES ON THE INTERNET; SEARCHING AND RETRIEVING INFORMATION, SITES AND OTHER RESOURCES AVAILABLE ON THE INTERNET (U.S. CLS. 100 AND 101).

FIRST USE 11-11-2008; IN COMMERCE 11-11-2008.

#### CLASS 45—PERSONAL AND LEGAL SERVICES

FOR ON-LINE SOCIAL NETWORKING SERVICES (U.S. CLS. 100 AND 101).

FIRST USE 11-11-2008; IN COMMERCE 11-11-2008.

4,045,768. SPEED TO MARKET LIMITED, HONG KONG, HONG KONG. SN 77-603,018. PUB. 6-16-2009, FILED 10-29-2008.

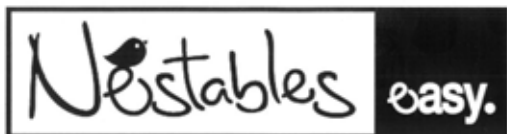

THE MARK CONSISTS OF A WHITE, HORIZONTALLY-ORIENTED RECTANGLE OUTLINED IN BLACK ON THE LEFT, NEXT TO A BLACK SQUARE ON THE RIGHT, WITH THE WORD "NESTABLES" LOCATED IN THE WHITE RECTANGLE IN THE COLOR BLACK, AND THE WORD "EASY" IN THE BLACK SQUARE, IN THE COLOR WHITE. THE DESIGN OF A STYLIZED BIRD IS LOCATED ABOVE THE FIRST LETTER "E" IN "NESTABLES" IN THE COLOR BLACK.

#### CLASS 21—HOUSEWARES AND GLASS

FOR HAND-OPERATED UTENSILS AND APPARATUS FOR HOUSEHOLD AND KITCHEN USE, NAMELY, GRATERS, SIEVES, SPATULAS, STRAINERS, WHISKS, ROLLING PINS AND SERVING FORKS; TOILET UTENSILS, NAMELY, TOILET BRUSHES, TOOTHBRUSH HOLDERS, SOAP DISPENSERS AND DUST BINS; GLASSWARE AND ARTICLES IN PORCELAIN FOR CLEANING PURPOSES, NAMELY, SOAP DISPENSERS AND SOAP DISHES; INSTRUMENTS FOR CLEANING PURPOSES, NAMELY, BRUSHES, CLOTHS AND SPONGES FOR CLEANING TOILETS, SINKS AND FLOORING; SMALL DOMESTIC UTENSILS AND CONTAINERS, NOT OF PRECIOUS METALS OR COATED THEREWITH, FOR HOUSEHOLD AND KITCHEN USE, NAMELY, GLASS BEVERAGEWARE, GLASS DINNERWARE, PORCELAIN BEVERAGEWARE, PORCELAIN DINNERWARE, PORCELAIN MUGS, EARTHEN BEVERAGEWARE, EARTHEN DINNERWARE, EARTHENWARE MUGS AND EARTHENWARE POTS; POTTERY, NAMELY, VASES AND FLOWER POTS; TRASH CANS, BUCKETS, BOXES OF GLASS, DRINKING GLASSES, BASKETS OF WICKER, STRAW, CLOTH AND WOOD FOR DOMESTIC USE, AND CUPS OF PAPER OR PLASTIC (U.S. CLS. 2, 13, 23, 29, 30, 33, 40 AND 50).

FIRST USE 1-31-2010; IN COMMERCE 1-31-2010.

#### CLASS 24—FABRICS

FOR TEXTILES AND TEXTILE COVERS FOR HOUSEHOLD USE, NAMELY, WOVEN FABRICS, BED AND TABLE COVERS, CLOTHS, SHEETS, PILLOW CASES AND WINDOW CURTAINS (U.S. CLS. 42 AND 50).

FIRST USE 1-31-2010; IN COMMERCE 1-31-2010.

4,045,769. TEGRA MEDICAL HOLDINGS, LLC, FRANKLIN, MA. SN 77-603,979. PUB. 1-4-2011, FILED 10-30-2008.

### GENESIS TECH CENTER

THE MARK CONSISTS OF STANDARD CHARACTERS WITHOUT CLAIM TO ANY PARTICULAR FONT, STYLE, SIZE, OR COLOR.

NO CLAIM IS MADE TO THE EXCLUSIVE RIGHT TO USE "TECH CENTER", APART FROM THE MARK AS SHOWN.

#### CLASS 40—MATERIAL TREATMENT

FOR CONTRACT MANUFACTURE FOR OTHERS OF MEDICAL DEVICE PROTOTYPES (U.S. CLS. 100, 103 AND 106).

FIRST USE 3-0-2009; IN COMMERCE 3-0-2009.

#### CLASS 42—SCIENTIFIC AND COMPUTER SERVICES

FOR DESIGN SERVICES FOR MEDICAL DEVICE OEMS (ORIGINAL EQUIPMENT MANUFACTURERS), NAMELY, ENGINEERING DESIGN, DEVELOPMENT AND DESIGN OF MANUFACTURING PROCESSES; DESIGN OF MEDICAL DEVICE PROTOTYPES (U.S. CLS. 100 AND 101).

FIRST USE 3-0-2009; IN COMMERCE 3-0-2009.

4,045,774. AMYK INTERNATIONAL, INC., ENCINITAS, CA. SN 77-609,283. PUB. 3-31-2009, FILED 11-6-2008.

## Ignite Brilliance

THE MARK CONSISTS OF STANDARD CHARACTERS WITHOUT CLAIM TO ANY PARTICULAR FONT, STYLE, SIZE, OR COLOR.

#### CLASS 35—ADVERTISING AND BUSINESS

FOR PREPARATION OF CUSTOM OR NON-CUSTOM ADVERTISING FOR BUSINESSES FOR DISSEMINATION VIA THE WEB, CD OR DVD FOR OPTIONAL UPLOAD OR DOWNLOAD TO A COMPUTER; CUSTOM WRITING SERVICES COMPRISING PUBLIC RELATIONS AND MARKETING MATERIALS FOR THE AUDIO, VIDEO AND TECHNOLOGY INDUSTRIES; PROJECT MANAGEMENT SERVICES FOR OTHERS IN THE FIELDS OF LANGUAGE TRANSLATION, CUSTOM WRITING, TEXT ADAPTATION, INTERPRETING AND PROOFREADING; WRITING OF GRANT PROPOSALS FOR NON-PROFIT ORGANIZATIONS, EDUCATIONAL INSTITUTIONS AND OTHER COMMUNITY ORGANIZATIONS; WRITING OF PUBLICITY TEXTS; ADVERTISING AND PROMOTION SERVICES AND RELATED CONSULTING; BRAND IMAGERY CONSULTING SERVICES; BUSINESS CONSULTING SERVICES RELATING TO PRODUCT DISTRIBUTION, OPERATIONS MANAGEMENT SERVICES, LOGISTICS, REVERSE LOGISTICS, SUPPLY CHAIN, AND PRODUCTION SYSTEMS AND DISTRIBUTION SOLUTIONS; BUSINESS CONSULTING AND BUSINESS INFORMATION FOR ENTERPRISES; BUSINESS CONSULTING AND INFORMATION SERVICES; BUSINESS CONSULTING SERVICES IN THE FIELD OF BUSINESS KNOWLEDGE TRANSFER THROUGH AUDIO TOOLS, NAMELY, RECORDING INTERVIEWS WITH SUBJECT MATTER EXPERTS FOR AN ORGANIZATION'S CAPTURE AND FUTURE USE; BUSINESS CONSULTING SERVICE IN THE FIELD OF MEDICAL IMAGING CENTERS; BUSINESS CONSULTING SERVICES, NAMELY, ASSISTING LEGAL PROFESSIONALS IN ORGANIZING AND SETTING UP THEIR PRACTICES FOR OFFERING DIVORCE PLANNING AND FACILITATION AND LEGAL DOCUMENT SERVICES TO THEIR CLIENTS; BUSINESS CONSULTING SERVICES IN THE FIELD OF ORGANIZATIONAL CHANGE MANAGEMENT; BUSINESS CONSULTING SERVICES, NAMELY, PROVIDING ASSISTANCE IN DEVELOPMENT OF BUSINESS STRATEGIES AND CREATIVE IDEATION; BUSINESS CONSULTING SERVICES RELATED TO MONITORING, CONTROLLING, AND MANAGING TELEPRESENCE ENVIRONMENTS OF OTHERS; BUSINESS CONSULTING SERVICES IN THE FIELD OF INFORMATION ASSURANCE; BUSINESS CONSULTING SERVICES FOR THE ELECTRIC ENERGY INDUSTRY; BUSINESS



CONSULTING, INQUIRIES OR INFORMATION; BUSINESS CONSULTING, MANAGEMENT, PLANNING AND SUPERVISION; BUSINESS MANAGEMENT CONSULTING WITH RELATION TO STRATEGY, MARKETING, PRODUCTION, PERSONNEL AND RETAIL SALE MATTERS; BUSINESS MANAGEMENT CONSULTING AND ADVISORY SERVICES; BUSINESS MANAGEMENT CONSULTING WITH RELATION TO STRATEGY, FINANCING, MARKETING, PRODUCTION, PERSONNEL AND SALE MATTERS FOR COMPANIES INVOLVED WITH THIN FILM AND NANO TECHNOLOGIES AND PLASMA PROCESSES; BUSINESS MANAGEMENT AND CONSULTING SERVICES FOR THE HEALTH CARE INDUSTRY, NAMELY, CUSTOMER SERVICE, ACCOUNTING SERVICES, AND WEB-BASED ADVERTISING AND MARKETING SERVICES; BUSINESS MANAGEMENT CONSULTING IN THE FIELD OF TEAM DEVELOPMENT; BUSINESS MANAGEMENT CONSULTING WITH RELATION TO STRATEGY, MARKETING, SALES, OPERATION, PRODUCT DESIGN PARTICULARLY SPECIALIZING IN THE USE OF ANALYTIC AND STATISTIC MODELS FOR THE UNDERSTANDING AND PREDICTING OF CONSUMERS, BUSINESSES, AND MARKET TRENDS AND ACTIONS; BUSINESS MARKETING AND DIRECT MAIL CONSULTING SERVICES; BUSINESS MARKETING CONSULTING SERVICES; BUSINESS MARKETING CONSULTING SERVICES TO CHILDCARE ORGANIZATIONS; BUSINESS ORGANIZATION AND MANAGEMENT CONSULTING; BUSINESS RELOCATION CONSULTING; BUSINESS SERVICES, NAMELY, CONSULTING IN THE FIELD OF SUPPLY CHAIN VERIFICATION FOR THE PRESENCE OF GENETICALLY MODIFIED ORGANISMS; BUSINESS VENTURE DEVELOPMENT AND FORMATION CONSULTING SERVICES FOR THE RENEWABLE ENERGY INDUSTRY; CONSULTING SERVICES IN THE FIELD OF MANAGING INTELLECTUAL PROPERTIES; CONSULTING SERVICES IN BUSINESS ORGANIZATION AND MANAGEMENT; CONSULTING SERVICES RELATING TO PUBLICITY; CONSULTING SERVICES RELATED TO THE ADMINISTRATIVE COORDINATION OF ORGANIZATIONS PROVIDING HUMANITARIAN ACTIVITIES; CONSULTING SERVICES IN THE FIELD OF DENTAL PRACTICE MANAGEMENT; CONSULTING SERVICES IN THE FIELD OF HUMAN RESOURCES DEVELOPMENT, NAMELY, FOR THE PROMOTION OF EMPLOYEE RETENTION, CAREER GROWTH, AND INCREASED PRODUCTIVITY FOR EMPLOYEES AND EMPLOYERS; CONSULTING SERVICES IN THE AREA OF SUSTAINABLE BUSINESS SOLUTIONS; CONSULTING SERVICES IN THE FIELD OF HIGHER EDUCATION ADMINISTRATION; CONSULTING SERVICES IN THE COST AND PAYMENT MANAGEMENT OF HEALTH CARE; CONSULTING SERVICES IN THE FIELD OF HUMAN RESOURCES DEVELOPMENT, NAMELY, UTILIZING TECHNOLOGY FOR THE PROMOTION OF EMPLOYEE RETENTION, CAREER GROWTH AND INCREASED PRODUCTIVITY FOR EMPLOYEES AND EMPLOYERS; CONSULTING SERVICES IN BUSINESS LEADERSHIP DEVELOPMENT AND BUSINESS MANAGEMENT; CONSULTING SERVICES, NAMELY, PROVIDING EXPECTANT PARENTS WITH CONSUMER INFORMATION ON ALL TYPES OF BABY PRODUCTS AND SERVICES; CONSULTING SERVICES, NAMELY, EXPERT ANALYSIS AND MANAGEMENT CONSULTING IN ECONOMICS AND ACCOUNTING ; CONSULTING SERVICES, NAMELY, TO EMPLOYERS, COMMUNITY ORGANIZATIONS, BROKERS AND BENEFICIARIES, RELATED TO CONSUMER INFORMATION REGARDING HEALTH CARE PLAN OPTIONS, PRODUCTS AND PROGRAMS IN THE FIELD OF MANAGED CARE AND STATE AND FEDERAL MEDICAL CARE PROGRAMS; CORPORATE IMAGE CONSULTING SERVICES; DIRECT MARKETING CONSULTING SERVICES; DISASTER RECOVERY SERVICES, NAMELY, BUSINESS PLANNING AND BUSINESS CONTINUITY CONSULTING; ECONOMIC CONSULTING AND INFORMATION FOR THE INDUSTRIAL AND COMMERCIAL SECTORS FOR PLANNING, ORGANIZING, MONITORING AND CARRYING OUT UNIQUE AND COMPLEX PROJECTS IN DIFFERENT SECTORS OF ONE OR SEVERAL COMPANIES; MANAGEMENT AND BUSINESS CONSULTING SERVICES IN THE FIELD OF TRAINING AND RECRUITMENT; MARKETING CONSULTING; NEW BUSINESS VENTURE DEVELOPMENT AND FORMATION CONSULTING SERVICES; PROFESSIONAL BUSINESS CONSULTING; PROMOTION AND MARKETING SER-

VICES AND RELATED CONSULTING; PROVIDING BUSINESS MANAGEMENT INFORMATION IN CONNECTION WITH CONSULTING AND ADVISORY SERVICES IN THE FIELD OF STRATEGIC PLANNING; PROVIDING CONSULTING SERVICES IN THE FIELD OF FACILITATING THE PLANNING, BUYING, AND SELLING OF MEDIA; PROVIDING ORGANIZATIONAL DEVELOPMENT CONSULTING SERVICES; DISSEMINATION OF ADVERTISING, SCHEDULING AND MANAGING OF TRAINING COURSES AND PROGRAMS FOR OTHERS VIA A GLOBAL COMPUTER NETWORK (U.S. CLS. 100, 101 AND 102).

FIRST USE 2-1-2009; IN COMMERCE 2-1-2009.

#### **CLASS 41—EDUCATION AND ENTERTAINMENT**

FOR CONSULTING SERVICES IN THE FIELD OF PUBLICATION OF NEWSLETTERS; FILM AND VIDEO PRODUCTION CONSULTING SERVICES; CUSTOM WRITING SERVICES; POEM AND LYRIC WRITING; SCRIPT WRITING SERVICES; EDUCATIONAL AND ENTERTAINMENT SERVICES, NAMELY, PROVIDING MOTIVATIONAL SPEAKING SERVICES IN THE FIELD OF BUSINESS LEADERSHIP; ARRANGING PROFESSIONAL WORKSHOP AND TRAINING COURSES; BUSINESS TRAINING; DEVELOPING TRAINING SYSTEMS AND LEARNING METHODOLOGIES FOR OTHERS; EDUCATIONAL SERVICES, NAMELY, A LEARNING AND INNOVATION CENTER FEATURING FULLY CUSTOMIZED LEADERSHIP, MOTIVATIONAL, EDUCATIONAL, AND BRAINSTORMING TRAINING; EDUCATIONAL SERVICES, NAMELY, DEVELOPING AND CONDUCTING WORKOUTS, WORKSHOPS, PRESENTATIONS, RETREATS, AND PERSONAL TRAINING IN RIGHT-BRAIN FITNESS; EDUCATIONAL SERVICES, NAMELY, CONDUCTING CLASSES, SEMINARS, CONFERENCES, WORKSHOPS IN THE FIELD OF LEADERSHIP, SALES, BUSINESS, PERSONAL DEVELOPMENT AND DISTRIBUTION OF TRAINING MATERIAL IN CONNECTION THEREWITH; EDUCATIONAL SERVICES, NAMELY, DEVELOPING AND CONDUCTING TRAINING COURSES AND DISTRIBUTION OF TRAINING MATERIALS IN CONNECTION THEREWITH FOR SUBJECT MATTERS AS REQUESTED BY CUSTOMERS; PROVIDING ON-LINE TRAINING COURSES, SEMINARS, WORKSHOPS IN THE FIELD OF LEADERSHIP, SALES, BUSINESS, PERSONAL DEVELOPMENT; TEACHING AND TRAINING IN BUSINESS, INDUSTRY AND INFORMATION TECHNOLOGY; TRAINING COURSES IN STRATEGIC PLANNING RELATING TO ADVERTISING, PROMOTION, MARKETING AND BUSINESS; WRITING OF ARTICLES FOR JOURNALS OTHER THAN FOR ADVERTISING OR PUBLICITY; WRITING OF ARTICLES FOR PROFESSIONAL JOURNALS OTHER THAN FOR ADVERTISING OR PUBLICITY; WRITING OF ARTICLES FOR PERIODICALS OTHER THAN FOR ADVERTISING OR PUBLICITY; WRITING OF TEXTS OTHER THAN PUBLICITY TEXTS; WRITING OF TEXTS OTHER THAN PUBLICITY TEXT; LIFE COACHING SERVICES IN THE FIELD OF PERSONAL GROWTH AND DEVELOPMENT; PERSONAL COACHING SERVICES IN THE FIELD OF PERSONAL GROWTH AND DEVELOPMENT; PROFESSIONAL COACHING SERVICES IN THE FIELD OF EXECUTIVE AND LEADERSHIP DEVELOPMENT AND BUSINESS GROWTH; PROVIDING GROUP COACHING AND LEARNING FORUMS IN THE FIELD OF LEADERSHIP DEVELOPMENT (U.S. CLS. 100, 101 AND 107).

FIRST USE 2-1-2009; IN COMMERCE 2-1-2009.

4,045,775. PLANETHOPE, LLC, WEST PALM BEACH, FL. SN 77-614,710. PUB. 6-9-2009, FILED 11-14-2008.

# PlanetHope

THE MARK CONSISTS OF STANDARD CHARACTERS WITHOUT CLAIM TO ANY PARTICULAR FONT, STYLE, SIZE, OR COLOR.

## CLASS 35—ADVERTISING AND BUSINESS

FOR ONLINE RETAIL STORE SERVICES FEATURING DVDS, CDS, BOOKS, NATURAL HEALING PRODUCTS, NAMELY, HOMEOPATHIC REMEDIES, YOGA CLOTHES AND ACCESSORIES, NAMELY, YOGA MATS AND YOGA SEATS, ENVIRONMENTALLY SENSITIVE PRODUCTS, NAMELY, LIGHT BULBS, CLEANING SUPPLIES, RECYCLED TOTE BAGS (U.S. CLS. 100, 101 AND 102).

FIRST USE 11-14-2008; IN COMMERCE 8-29-2011.

## CLASS 41—EDUCATION AND ENTERTAINMENT

FOR PRODUCTION AND DISTRIBUTION OF TELEVISION AND RADIO PROGRAMS VIA THE INTERNET, RADIO, BROADCAST TELEVISION, AND SATELLITE, MOBILE MEDIA, CABLE TELEVISION; ENTERTAINMENT SERVICES, NAMELY, PROVIDING A WEBSITE FEATURING VIDEO PRESENTATIONS IN THE FIELDS OF LIFESTYLE, HEALTH, STRESS RELIEF, PROBLEM-SOLVING, YOGA, MEDITATION, INSPIRATION, ORGANIC FOODS, COMMUNITY BASED PROGRAMS, PROFILES OF INSPIRATIONAL PERSONS; ENTERTAINMENT SERVICES, NAMELY, PROVIDING A WEBSITE FEATURING NEWS IN THE FIELDS OF YOGA AND MEDITATION (U.S. CLS. 100, 101 AND 107).

FIRST USE 11-14-2008; IN COMMERCE 8-29-2011.

4,045,787. GREENE, RHAMELLE M., ENGLEWOOD, NJ. SN 77-639,905. PUB. 3-9-2010, FILED 12-24-2008.

# MOVE THE CROWD

THE MARK CONSISTS OF STANDARD CHARACTERS WITHOUT CLAIM TO ANY PARTICULAR FONT, STYLE, SIZE, OR COLOR.

## CLASS 9—ELECTRICAL AND SCIENTIFIC APPARATUS

FOR DIGITAL MEDIA, NAMELY, CDS, DVDS AND DOWNLOADABLE PODCASTS, ALL FEATURING SPEECHES AND PRESENTATIONS IN THE FIELD OF SOCIAL ENTREPRENEURSHIP (U.S. CLS. 21, 23, 26, 36 AND 38).

FIRST USE 5-23-2011; IN COMMERCE 5-23-2011.

## CLASS 25—CLOTHING

FOR T-SHIRTS (U.S. CLS. 22 AND 39).

FIRST USE 9-3-2011; IN COMMERCE 9-3-2011.

## CLASS 41—EDUCATION AND ENTERTAINMENT

FOR EDUCATIONAL SERVICES, NAMELY, CONDUCTING LIVE AND ONLINE EDUCATIONAL SEMINARS, CONFERENCES, WORKSHOPS, AND FORUMS, ALL IN THE FIELD OF SOCIAL ENTREPRENEURSHIP AND DISTRIBUTING COURSE MATERIALS IN CONNECTION THEREWITH (U.S. CLS. 100, 101 AND 107).

FIRST USE 12-1-2009; IN COMMERCE 12-1-2009.

4,045,804. LUND, INC., BUFORD, GA. SN 77-664,157. PUB. 6-9-2009, FILED 2-5-2009.



THE MARK CONSISTS OF THE WORD "NIFTY" WITH AN ARC THAT STARTS FROM THE BOTTOM OF THE "N" AND EXTENDS AROUND AND OVER THE TOP OF THE WORD "NIFTY".

## CLASS 12—VEHICLES

FOR PROTECTIVE LINERS FOR THE CARGO AREA OF VEHICLES (U.S. CLS. 19, 21, 23, 31, 35 AND 44).

FIRST USE 9-0-2009; IN COMMERCE 9-0-2009.

## CLASS 27—FLOOR COVERINGS

FOR MOLDED CARPETS (U.S. CLS. 19, 20, 37, 42 AND 50).

FIRST USE 9-0-2009; IN COMMERCE 9-0-2009.

4,045,776. THE DOLLYWOOD COMPANY, PIGEON FORGE, TN. SN 77-623,702. PUB. 11-24-2009, FILED 12-1-2008.



## CLASS 14—JEWELRY

FOR ORNAMENTAL PINS (U.S. CLS. 2, 27, 28 AND 50).

FIRST USE 3-27-2010; IN COMMERCE 3-27-2010.

## CLASS 41—EDUCATION AND ENTERTAINMENT

FOR THEME PARK SERVICES, NAMELY, AN AREA OF A THEME PARK FEATURING RECREATIONAL RIDES (U.S. CLS. 100, 101 AND 107).

FIRST USE 3-27-2010; IN COMMERCE 3-27-2010.

4,045,808. LOYAL3 HOLDINGS INC., SAN FRANCISCO, CA.  
SN 77-672,860. PUB. 8-17-2010, FILED 2-18-2009.

4,045,818. HONOR SOCIETY EXCEL CLASS LLC, REGO  
PARK, NY. SN 77-680,956. PUB. 6-1-2010, FILED S.R. 3-1-  
2009; AM. P.R. 3-26-2010.

# LOYAL3

THE MARK CONSISTS OF STANDARD CHARACTERS WITHOUT CLAIM TO ANY PARTICULAR FONT, STYLE, SIZE, OR COLOR.

## CLASS 35—ADVERTISING AND BUSINESS

FOR PROVIDING AN ON-LINE COMPUTER WEB SITE THAT PROVIDES COMMERCIAL FINANCIAL TRANSACTION DATA, NAMELY, PROVIDING ONLINE TRANSACTION AND NOTIFICATION SERVICES WHICH ALLOW PUBLICLY TRADED COMPANIES TO INTERACT DIRECTLY WITH THEIR SHAREHOLDERS (U.S. CLS. 100, 101 AND 102).

FIRST USE 4-1-2009; IN COMMERCE 4-1-2009.

## CLASS 36—INSURANCE AND FINANCIAL

FOR FINANCIAL SERVICES IN THE NATURE OF AN INVESTMENT SECURITY, NAMELY, FACILITATING THE PURCHASE AND SALE OF COMPANY SHARES OR STOCK (U.S. CLS. 100, 101 AND 102).

FIRST USE 4-1-2009; IN COMMERCE 4-1-2009.

## CLASS 45—PERSONAL AND LEGAL SERVICES

FOR IDENTIFICATION VERIFICATION SERVICES, NAMELY, PROVIDING SHAREHOLDER STATUS VERIFICATION SERVICES (U.S. CLS. 100 AND 101).

FIRST USE 4-1-2009; IN COMMERCE 4-1-2009.

---

4,045,811. NOBOLEIS VINEYARDS, L.L.C., CHESTER-FIELD, MO. SN 77-673,485. PUB. 7-6-2010, FILED 2-19-2009.

# NOBOLEIS

THE MARK CONSISTS OF STANDARD CHARACTERS WITHOUT CLAIM TO ANY PARTICULAR FONT, STYLE, SIZE, OR COLOR.

## CLASS 33—WINES AND SPIRITS

FOR WINE (U.S. CLS. 47 AND 49).

FIRST USE 8-15-2009; IN COMMERCE 8-15-2009.

## CLASS 40—MATERIAL TREATMENT

FOR WINERY SERVICES (U.S. CLS. 100, 103 AND 106).  
FIRST USE 7-15-2009; IN COMMERCE 7-15-2009.

# Excel Class

THE MARK CONSISTS OF STANDARD CHARACTERS WITHOUT CLAIM TO ANY PARTICULAR FONT, STYLE, SIZE, OR COLOR.

NO CLAIM IS MADE TO THE EXCLUSIVE RIGHT TO USE "CLASS", APART FROM THE MARK AS SHOWN.

## CLASS 9—ELECTRICAL AND SCIENTIFIC APPARATUS

FOR PRE-RECORDED AUDIO AND VIDEO MEDIA FOR STUDENTS FEATURING DIAGNOSTIC AND PRESCRIPTIVE INSTRUCTION TECHNIQUES OFFERING INDIVIDUALIZED SUPPLEMENTAL EDUCATION AND SMALL GROUP INSTRUCTION TO CHILDREN PRE-K THROUGH GRADE 12 IN THE AREAS OF DOMESTIC AND FOREIGN LANGUAGES, READING, MATHEMATICS, WRITING, STUDY SKILLS AND TEST PREPARATION; AND COMPUTER PROGRAMS, ALL FOR EDUCATIONAL TRAINING OF STUDENTS, TESTING, ASSESSMENT AND REMEDIATION PURPOSES, EXCLUDING COMPUTER PROGRAMS INTENDED FOR USE IN THE DEVELOPMENT OF EDUCATIONAL MANUALS FOR TEACHERS, EDUCATORS AND EDUCATIONAL ADMINISTRATORS, OR PROFESSIONAL DEVELOPMENT OF TEACHERS, EDUCATORS AND EDUCATIONAL ADMINISTRATORS (U.S. CLS. 21, 23, 26, 36 AND 38).

FIRST USE 2-1-2010; IN COMMERCE 2-1-2010.

## CLASS 41—EDUCATION AND ENTERTAINMENT

FOR EDUCATIONAL SERVICES FOR STUDENTS, NAMELY, PROVIDING CLASSES AND WEB-BASED PROGRAMS, AND EDUCATIONAL TESTING SERVICES TO STUDENTS, NAMELY, ADMINISTRATION AND EVALUATION SERVICES, ALL IN THE FIELD OF DIAGNOSTIC AND PRESCRIPTIVE INSTRUCTION TECHNIQUES OFFERING INDIVIDUALIZED AND PERSONALIZED INSTRUCTION AND SMALL GROUP INSTRUCTION TO STUDENTS IN THE AREAS OF DOMESTIC AND FOREIGN LANGUAGES, READING, WRITING, MATHEMATICS, STUDY SKILLS AND TEST PREPARATION, EXCLUDING DEVELOPING EDUCATIONAL MANUALS FOR TEACHERS, EDUCATORS AND EDUCATIONAL ADMINISTRATORS, EDUCATIONAL RESEARCH, PROFESSIONAL DEVELOPMENT CLASSES, SEMINARS, AND WORKSHOPS FOR EDUCATORS, AND DEVELOPING CURRICULUM FOR TEACHERS, EDUCATORS AND EDUCATIONAL ADMINISTRATORS; AND TEST PREPARATION FOR STUDENTS FOR CHILDREN PRE-K THROUGH GRADE 12 (U.S. CLS. 100, 101 AND 107).

FIRST USE 2-1-2010; IN COMMERCE 2-1-2010.

4,045,820. ELFENWORKS PRODUCTIONS LLC, BURLINGAME, CA. SN 77-683,707. PUB. 7-7-2009, FILED 3-4-2009.



THE NAME SHOWN IN THE MARK DOES NOT IDENTIFY A PARTICULAR LIVING INDIVIDUAL.

THE MARK CONSISTS OF THE WORDS "COMMODORE CALLAHAN" IN CALLIGRAPHY FORM WITH DECORATIVE FLOURISHES. THE LEADING LETTER "C" OF EACH WORD IS CAPITALIZED AND THE REMAINING LETTERS IN LOWER CASE. THE WORD "COMMODORE" IS POSITIONED ABOVE AND TO THE LEFT OF THE WORD "CALLAHAN" SUCH THAT THE SECOND LETTER "M" IS CENTERED OVER THE LETTER "C" IN THE WORD "CALLAHAN" AND THE BOTTOM END OF THE LETTER "C" IN COMMODORE TOUCHES THE LEFT SHOULDER OF THE LETTER "C" OF THE WORD "CALLAHAN".

#### CLASS 9—ELECTRICAL AND SCIENTIFIC APPARATUS

FOR MUSICAL SOUND RECORDINGS; DOWNLOADABLE MUSICAL SOUND RECORDINGS; MUSICAL VIDEO RECORDINGS; DOWNLOADABLE MUSICAL VIDEO RECORDINGS (U.S. CLS. 21, 23, 26, 36 AND 38). FIRST USE 4-13-2009; IN COMMERCE 4-13-2009.

#### CLASS 35—ADVERTISING AND BUSINESS

FOR PROMOTING PUBLIC AWARENESS IN THE FIELD OF SOCIAL WELFARE (U.S. CLS. 100, 101 AND 102). FIRST USE 8-9-2011; IN COMMERCE 8-9-2011.

#### CLASS 36—INSURANCE AND FINANCIAL

FOR CHARITABLE FUND RAISING SERVICES (U.S. CLS. 100, 101 AND 102). FIRST USE 8-9-2011; IN COMMERCE 8-9-2011.

#### CLASS 41—EDUCATION AND ENTERTAINMENT

FOR ENTERTAINMENT, NAMELY, LIVE PERFORMANCES BY A MUSICAL BAND (U.S. CLS. 100, 101 AND 107). FIRST USE 12-5-2007; IN COMMERCE 6-4-2009.

4,045,831. WOW MEDIA INC., MIAMI BEACH, FL. SN 77-702,237. PUB. 12-15-2009, FILED 3-30-2009.

## BRAVERY BEADS

THE MARK CONSISTS OF STANDARD CHARACTERS WITHOUT CLAIM TO ANY PARTICULAR FONT, STYLE, SIZE, OR COLOR.

NO CLAIM IS MADE TO THE EXCLUSIVE RIGHT TO USE "BEADS", APART FROM THE MARK AS SHOWN.

#### CLASS 14—JEWELRY

FOR NECKLACES; BEADS FOR MAKING JEWELRY (U.S. CLS. 2, 27, 28 AND 50). FIRST USE 4-26-2010; IN COMMERCE 4-26-2010.

#### CLASS 36—INSURANCE AND FINANCIAL

FOR PEDIATRIC HOSPITAL FUNDRAISING SERVICES (U.S. CLS. 100, 101 AND 102). FIRST USE 4-26-2010; IN COMMERCE 4-26-2010.

4,045,833. KINKARACO - GREEN BURIAL PRODUCTS, SAN FRANCISCO, CA. SN 77-704,902. PUB. 5-25-2010, FILED 4-1-2009.

## KINKARACO

THE MARK CONSISTS OF STANDARD CHARACTERS WITHOUT CLAIM TO ANY PARTICULAR FONT, STYLE, SIZE, OR COLOR.

THE WORDING "KINKARACO" HAS NO MEANING IN A FOREIGN LANGUAGE.

#### CLASS 3—COSMETICS AND CLEANING PREPARATIONS

FOR CLEANSERS, NAMELY, FUNERAL, BURIAL, AND CREMATION BODY CLEANSERS; BODY WASHES (U.S. CLS. 1, 4, 6, 50, 51 AND 52). FIRST USE 4-29-2008; IN COMMERCE 4-29-2008.

#### CLASS 24—FABRICS

FOR SHROUDS; TEXTILES, NAMELY, FUNERAL, BURIAL, AND CREMATION SHROUDS (U.S. CLS. 2 AND 50). FIRST USE 4-29-2008; IN COMMERCE 4-29-2008.

4,045,837. OVIDIAN GROUP, LLC, BERKELEY, CA. SN 77-711,229. PUB. 3-2-2010, FILED 4-10-2009.

## OVIDIAN

THE MARK CONSISTS OF STANDARD CHARACTERS WITHOUT CLAIM TO ANY PARTICULAR FONT, STYLE, SIZE, OR COLOR.

**CLASS 35—ADVERTISING AND BUSINESS**

FOR BUSINESS CONSULTING SERVICES IN THE FIELDS OF ACQUIRING, CREATING, DEVELOPING, MANAGING, PROMOTING, EXPLOITING, BUYING, SELLING, DIVESTING AND PROTECTING INTELLECTUAL PROPERTY AND OTHER INTANGIBLE BUSINESS ASSETS, NAMELY, GOODWILL, REPUTATION, BUSINESS RELATIONSHIPS, KNOW-HOW, INFORMATION REGARDING INSTITUTIONAL CAPABILITIES AND KNOWLEDGE, AND HUMAN CAPITAL; BUSINESS CONSULTING SERVICES, NAMELY, PROVIDING ASSISTANCE IN DEVELOPMENT OF BUSINESS STRATEGIES AND CREATIVE IDEATION; BUSINESS ADVISORY SERVICES; NEW BUSINESS VENTURE DEVELOPMENT AND FORMATION CONSULTING SERVICES; STRUCTURING, OPTIMIZING AND CHANGE MANAGEMENT CONSULTING RELATED TO CORPORATE IN-HOUSE INTELLECTUAL PROPERTY DEPARTMENTS AND INTELLECTUAL PROPERTY ASSET MANAGEMENT PROGRAMS; RECRUITING SERVICES FOR FILLING CORPORATE IN-HOUSE INTELLECTUAL PROPERTY POSITIONS; CONSULTING REGARDING INTELLECTUAL PROPERTY RISK MITIGATION PROCESSES; HUMAN RESOURCE ANALYSIS AND CONSULTATION, NAMELY, EVALUATION OF THE CAPABILITIES, QUALITIES, EFFECTIVENESS AND EFFICIENCY OF THIRD-PARTY INTELLECTUAL PROPERTY ADVISORS AND BROKERS FOR PURPOSES OF PERSONNEL RECRUITMENT; PROVIDING CONSUMER INFORMATION, NAMELY, EVALUATION OF THE CAPABILITIES, QUALITIES, EFFECTIVENESS AND EFFICIENCY OF THIRD-PARTY INTELLECTUAL PROPERTY ADVISORS AND BROKERS FOR PURPOSES OF EVALUATING INDEPENDENT SERVICE PROVIDERS FOR OTHERS; ASSISTING THE OWNERS OF INTELLECTUAL PROPERTY AND INTANGIBLE ASSETS IN FINDING INVESTORS; EXCLUDING ALL AFOREMENTIONED SERVICES RELATING TO THE MANUFACTURE, DISTRIBUTION, PROMOTION, MARKETING OR SALE OF MEDICAL OR HEALTHCARE PRODUCTS OR MEDICAL OR HEALTHCARE SERVICES (U.S. CLS. 100, 101 AND 102).

FIRST USE 7-1-2009; IN COMMERCE 7-1-2009.

**CLASS 36—INSURANCE AND FINANCIAL**

FOR FINANCIAL CONSULTING SERVICES, NAMELY, ADVISING OTHERS REGARDING INTELLECTUAL PROPERTY INVESTMENTS; INTELLECTUAL PROPERTY VENTURE FUND MANAGEMENT SERVICES; INTELLECTUAL PROPERTY VENTURE FUND DEVELOPMENT AND FORMATION SERVICES FOR OTHERS; FUND INVESTMENT CONSULTATION SERVICES FOR OTHERS; ADVISING OTHERS CONCERNING INVESTMENTS IN INTELLECTUAL PROPERTY ASSETS AND INTANGIBLE BUSINESS ASSETS, BOTH DIRECTLY AND INDIRECTLY THROUGH OTHER ENTITIES; INTELLECTUAL PROPERTY VALUATION SERVICES; CONSULTING ON THE SUBJECT OF INTELLECTUAL PROPERTY VALUATION; EXCLUDING ALL AFOREMENTIONED SERVICES RELATING TO THE MANUFACTURE, DISTRIBUTION, PROMOTION, MARKETING OR SALE OF MEDICAL OR HEALTHCARE PRODUCTS OR MEDICAL OR HEALTHCARE SERVICES (U.S. CLS. 100, 101 AND 102).

FIRST USE 7-1-2009; IN COMMERCE 7-1-2009.

**CLASS 45—PERSONAL AND LEGAL SERVICES**

FOR INTELLECTUAL PROPERTY CONSULTING SERVICES IN THE FIELD OF INVENTION, IDENTIFICATION, STRATEGY, ANALYTICS, AND INVENTION DISCLOSURE; LICENSING OF INTELLECTUAL PROPERTY INFRASTRUCTURE TECHNOLOGIES, NAMELY, SOFTWARE FOR MANAGEMENT OF INTELLECTUAL PROPERTY RIGHTS; CONSULTING IN THE FIELD OF INTELLECTUAL PROPERTY LICENSING; EXCLUDING ALL AFOREMENTIONED SERVICES RELATING TO THE MANUFACTURE, DISTRIBUTION, PROMOTION, MARKETING OR SALE OF MEDICAL OR HEALTHCARE PRODUCTS OR MEDICAL OR HEALTHCARE SERVICES (U.S. CLS. 100 AND 101).

FIRST USE 7-1-2009; IN COMMERCE 7-1-2009.

4,045,843. MIURA KOGYO KABUSHIKI KAISHA (MIURA CO., LTD.), EHIME 799-2696, JAPAN. SN 77-721,888. PUB. 5-11-2010, FILED 4-24-2009.

**MIURA ON-LINE MAINTENANCE**

OWNER OF U.S. REG. NO. 1,557,830.

NO CLAIM IS MADE TO THE EXCLUSIVE RIGHT TO USE "ON-LINE MAINTENANCE", APART FROM THE MARK AS SHOWN.

THE MARK CONSISTS OF THE WORDS "MIURA ON-LINE MAINTENANCE".

**CLASS 37—CONSTRUCTION AND REPAIR**

FOR REPAIR OR MAINTENANCE OF AIR-CONDITIONING APPARATUSES; REPAIR OR MAINTENANCE OF BOILERS; REPAIR OR MAINTENANCE OF ELECTRIC PUMPS; REPAIR OR MAINTENANCE OF MEASURING AND TESTING MACHINES AND INSTRUMENTS; REPAIR OR MAINTENANCE OF WATER PURIFYING APPARATUSES; REPAIR OR MAINTENANCE OF COOLING TOWERS; REPAIR OR MAINTENANCE OF GARBAGE INCINERATORS FOR INDUSTRIAL PURPOSES; REPAIR OR MAINTENANCE OF WATER-SOFTENING APPARATUSES; REPAIR OR MAINTENANCE OF WATER PURIFYING FILTERS; REPAIR OR MAINTENANCE OF WATER PURIFYING STERILIZERS; REPAIR OR MAINTENANCE OF PURE WATER PRODUCTION SYSTEMS USING REVERSE OSMOSIS MEMBRANES; REPAIR OR MAINTENANCE OF DISSOLVED OXYGEN REMOVING APPARATUSES FOR WATER PURIFICATION; REPAIR OR MAINTENANCE OF PIPING RUST PREVENTING APPARATUSES FOR WATER PURIFICATION; REPAIR OR MAINTENANCE OF TAP-WATER DEOXIDIZING APPARATUSES FOR WATER PURIFICATION; REPAIR OR MAINTENANCE OF HEAT EXCHANGERS; REPAIR OR MAINTENANCE OF WASTE WATER TREATMENT EQUIPMENT; REPAIR OR MAINTENANCE OF BACTERIA CONTROL EQUIPMENT FOR COOLING TOWERS (U.S. CLS. 100, 103 AND 106).

FIRST USE 5-23-2011; IN COMMERCE 5-23-2011.

**CLASS 42—SCIENTIFIC AND COMPUTER SERVICES**

FOR EVALUATION OF WATER QUALITY; TECHNICAL GUIDANCE ON WATER QUALITY IMPROVEMENT; PROVIDING WATER QUALITY INFORMATION; MEASUREMENT AND ANALYSIS OF WATER QUALITY OF WATER FOR BOILERS AND OF BOILER WATER; EVALUATION OF WATER QUALITY OF WATER FOR BOILERS AND OF BOILER WATER; TECHNICAL GUIDANCE ON WATER QUALITY IMPROVEMENT OF WATER FOR BOILERS AND OF BOILER WATER; PROVIDING WATER QUALITY INFORMATION ABOUT WATER FOR BOILERS AND ABOUT BOILER WATER; CHEMICAL ANALYSIS OF WATER QUALITY OF WATER FOR BOILERS AND OF BOILER WATER; TESTING ON WATER QUALITY OF WATER FOR BOILERS AND ON WATER QUALITY OF BOILER WATER (U.S. CLS. 100 AND 101).

FIRST USE 5-23-2011; IN COMMERCE 5-23-2011.

4,045,850. BONNIER ACTIVE MEDIA, INC., FORMERLY TIME4 MEDIA, INC., WINTER PARK, FL. SN 77-740,995. PUB. 5-18-2010, FILED 5-20-2009.

**Transworld Snowboarding  
Team Shoot Out**

THE MARK CONSISTS OF STANDARD CHARACTERS

WITHOUT CLAIM TO ANY PARTICULAR FONT, STYLE, SIZE, OR COLOR.

OWNER OF U.S. REG. NOS. 1,544,399, 3,505,191, AND OTHERS.

NO CLAIM IS MADE TO THE EXCLUSIVE RIGHT TO USE "SNOWBOARDING TEAM", APART FROM THE MARK AS SHOWN.

#### **CLASS 9—ELECTRICAL AND SCIENTIFIC APPARATUS**

FOR DVDS FEATURING PROGRAMS IN THE FIELD OF SNOW SPORTS RELATED COMPETITIONS (U.S. CLS. 21, 23, 26, 36 AND 38).

FIRST USE 7-10-2011; IN COMMERCE 7-10-2011.

#### **CLASS 16—PAPER GOODS AND PRINTED MATTER**

FOR MAGAZINE SECTIONS IN THE FIELD OF COMPETITIONS, NAMELY, SNOW SPORTS RELATED COMPETITIONS (U.S. CLS. 2, 5, 22, 23, 29, 37, 38 AND 50).

FIRST USE 7-10-2011; IN COMMERCE 7-10-2011.

#### **CLASS 41—EDUCATION AND ENTERTAINMENT**

FOR PROVIDING AN INTERNET WEBSITE PORTAL IN THE FIELD OF ENTERTAINMENT AND SPORTING EVENTS FEATURING PROGRAMS IN THE FIELD OF SNOW SPORTS COMPETITIONS; EDUCATION AND ENTERTAINMENT SERVICES, NAMELY, PRODUCTION AND DISTRIBUTION OF TELEVISION PROGRAMS IN THE FIELD OF SNOW SPORTS RELATED COMPETITIONS; ENTERTAINMENT SERVICES, NAMELY, PROVIDING A TELEVISION PROGRAM IN THE FIELD OF SNOW SPORTS COMPETITIONS VIA A GLOBAL COMPUTER NETWORK (U.S. CLS. 100, 101 AND 107).

FIRST USE 7-10-2011; IN COMMERCE 7-10-2011.

---

4,045,851. AVAIRPROS MANAGEMENT, INC., NAPLES, FL. SN 77-741,256. PUB. 6-7-2011, FILED 5-20-2009.

**AvAirPros Services**

THE MARK CONSISTS OF STANDARD CHARACTERS WITHOUT CLAIM TO ANY PARTICULAR FONT, STYLE, SIZE, OR COLOR.

NO CLAIM IS MADE TO THE EXCLUSIVE RIGHT TO USE "SERVICES", APART FROM THE MARK AS SHOWN.

#### **CLASS 35—ADVERTISING AND BUSINESS**

FOR BUSINESS SERVICES, NAMELY, OPERATION OF AIRLINE, AIRPORT, OR AIRPORT RENTAL CAR EQUIPMENT AND FACILITIES FOR OTHERS; AIRLINE CONSORTIUM ADMINISTRATIVE SERVICES, NAMELY, PROVIDING ADMINISTRATIVE SERVICES WHICH CONSIST OF BUSINESS ADMINISTRATION AND OFFICE WORK TO A CONSORTIUM OF AIRLINES AND/OR AIRPORTS; AVIATION MANAGEMENT SERVICES FOR OTHERS, NAMELY, BUSINESS CONSULTING SERVICES REGARDING THE SPECIFICATION, PROCUREMENT, INSTALLATION, TESTING AND START UP OF AIRLINE AND AIRPORT FACILITY EQUIPMENT AND SYSTEMS; BUSINESS MANAGEMENT SERVICES FOR OTHERS IN THE FIELD OF AVIATION, NAMELY, COORDINATING AIRLINE BUSINESS OPERATIONS AND AIRPORT CONSTRUCTION SCHEDULES AMONG AIRLINES FOR BUSINESS PURPOSES; MANAGEMENT SERVICES FOR OTHERS IN THE FIELD OF OPERATING AIRPORT TERMINALS, NAMELY, LEASE NEGOTIATION, PROCURING OF CONTRACTS FOR THE PURCHASE OF GOODS AND LABOR CONTRACTING SERVICES OF OTHERS, OPERATING CONCESSION STANDS FOR OTHERS; BUSINESS MANAGEMENT, PLANNING, AND SUPERVISION IN THE FIELD OF CAPITAL FACILITY DEVELOPMENT OF AIRPORTS; MANAGEMENT OF AIRPORT FACILITIES FOR OTHERS, NAMELY, THE OPERATION OF AIRPORT AND AIRLINE SYSTEMS, EQUIPMENT AND BUILDINGS FOR OTHERS; BUSINESS MANAGEMENT OF AIRPORT COMMON-USE ENVIRONMENTS FOR OTHERS, NAMELY, CHECK-IN COUNTER AND GATE ALLOCATION SCHEDULING AND ADMINISTRATION, AIRPORT FACILITIES MANAGEMENT OF TECHNICAL OPERATIONS, EQUIPMENT AND FACILITY RESOURCE ASSIGNMENT AND COORDINATION IN THE NATURE OF THE BUSINESS MANAGEMENT OF BAGGAGE SYSTEMS, BAGGAGE CLAIMS, PASSENGER LOADING BRIDGES, AIRCRAFT FUELING, GROUND EQUIPMENT FUELING AND DE-ICING EQUIPMENT; MANAGEMENT SERVICES FOR OTHERS, NAMELY, THE OPERATION OF AIRLINE, AIRPORT AND AIRPORT RENTAL CAR FACILITIES AND EQUIPMENT FOR OTHERS; PROVIDING AIRLINE, AIRPORT AND AVIATION INFORMATION, NAMELY, PROVIDING INFORMATION AND DATA COMPILING RELATING TO BUSINESS MANAGEMENT, MAINTENANCE SCHEDULING AND BUSINESS INFORMATION SERVICES; GATHERING AND REPORTING OF BUSINESS INFORMATION; AND PROVIDING INFORMATION CONCERNING THE AIRLINE, AIRPORT AND AVIATION INDUSTRY; AND AVIATION MANAGEMENT FOR OTHERS, NAMELY, GATE HANDLING AND AIRLINE PASSENGER CHECK IN SERVICES (U.S. CLS. 100, 101 AND 102).

FIRST USE 3-1-1997; IN COMMERCE 3-1-1997.

#### **CLASS 36—INSURANCE AND FINANCIAL**

FOR FINANCIAL MANAGEMENT SERVICES FOR THE AVIATION, AIRPORT AND AIRLINE INDUSTRY (U.S. CLS. 100, 101 AND 102).

FIRST USE 3-1-1997; IN COMMERCE 3-1-1997.

#### **CLASS 39—TRANSPORTATION AND STORAGE**

FOR AIRPORT SERVICES (U.S. CLS. 100 AND 105).

FIRST USE 3-1-1997; IN COMMERCE 3-1-1997.

4,045,852. AVAIRPROS MANAGEMENT, INC., NAPLES, FL.  
SN 77-741,417. PUB. 6-7-2011, FILED 5-20-2009.



NO CLAIM IS MADE TO THE EXCLUSIVE RIGHT TO USE "SERVICES", APART FROM THE MARK AS SHOWN.

THE MARK CONSISTS OF THE TERMS "AVAIRPROS" AND "SERVICES", A LINE IN BETWEEN THE TERMS, AND A FOUR-SIDED GEOMETRIC SHAPE.

#### CLASS 35—ADVERTISING AND BUSINESS

FOR BUSINESS SERVICES, NAMELY, OPERATION OF AIRLINE, AIRPORT, OR AIRPORT RENTAL CAR EQUIPMENT AND FACILITIES FOR OTHERS; AIRLINE CONSORTIUM ADMINISTRATIVE SERVICES, NAMELY, PROVIDING ADMINISTRATIVE SERVICES WHICH CONSIST OF BUSINESS ADMINISTRATION AND OFFICE WORK TO A CONSORTIUM OF AIRLINES AND/OR AIRPORTS; AVIATION MANAGEMENT SERVICES FOR OTHERS, NAMELY, BUSINESS CONSULTING SERVICES REGARDING THE SPECIFICATION, PROCUREMENT, INSTALLATION, TESTING AND START UP OF AIRLINE AND AIRPORT FACILITY EQUIPMENT AND SYSTEMS; BUSINESS MANAGEMENT SERVICES FOR OTHERS IN THE FIELD OF AVIATION, NAMELY, COORDINATING AIRLINE BUSINESS OPERATIONS AND AIRPORT CONSTRUCTION SCHEDULES AMONG AIRLINES FOR BUSINESS PURPOSES; MANAGEMENT SERVICES FOR OTHERS IN THE FIELD OF OPERATING AIRPORT TERMINALS, NAMELY, LEASE NEGOTIATION, PROCURING OF CONTRACTS FOR THE PURCHASE OF GOODS AND LABOR CONTRACTING SERVICES OF OTHERS, OPERATING CONCESSION STANDS FOR OTHERS; BUSINESS MANAGEMENT, PLANNING, AND SUPERVISION IN THE FIELD OF CAPITAL FACILITY DEVELOPMENT OF AIRPORTS; MANAGEMENT OF AIRPORT FACILITIES FOR OTHERS, NAMELY, THE OPERATION OF AIRPORT AND AIRLINE SYSTEMS, EQUIPMENT AND BUILDINGS FOR OTHERS; BUSINESS MANAGEMENT OF AIRPORT COMMON-USE ENVIRONMENTS FOR OTHERS, NAMELY, CHECK-IN COUNTER AND GATE ALLOCATION SCHEDULING AND ADMINISTRATION, AIRPORT FACILITIES MANAGEMENT OF TECHNICAL OPERATIONS, EQUIPMENT AND FACILITY RESOURCE ASSIGNMENT AND COORDINATION IN THE NATURE OF THE BUSINESS MANAGEMENT OF BAGGAGE SYSTEMS, BAGGAGE CLAIMS, PASSENGER LOADING BRIDGES, AIRCRAFT FUELING, GROUND EQUIPMENT FUELING AND DE-ICING EQUIPMENT; MANAGEMENT SERVICES FOR OTHERS, NAMELY, THE OPERATION OF AIRLINE, AIRPORT AND AIRPORT RENTAL CAR FACILITIES AND EQUIPMENT FOR OTHERS; PROVIDING AIRLINE, AIRPORT AND AVIATION INFORMATION, NAMELY, PROVIDING INFORMATION AND DATA COMPILING RELATING TO BUSINESS MANAGEMENT, MAINTENANCE SCHEDULING AND BUSINESS INFORMATION SERVICES; GATHERING AND REPORTING OF BUSINESS INFORMATION; AND PROVIDING INFORMATION CONCERNING THE AIRLINE, AIRPORT AND AVIATION INDUSTRY; AND AVIATION MANAGEMENT FOR OTHERS, NAMELY, GATE HANDLING AND AIRLINE PASSENGER CHECK IN SERVICES (U.S. CLS. 100, 101 AND 102).

FIRST USE 5-1-2007; IN COMMERCE 5-1-2007.

#### CLASS 36—INSURANCE AND FINANCIAL

FOR FINANCIAL MANAGEMENT SERVICES FOR THE AVIATION, AIRPORT AND AIRLINE INDUSTRY (U.S. CLS. 100, 101 AND 102).

FIRST USE 5-1-2007; IN COMMERCE 5-1-2007.

#### CLASS 39—TRANSPORTATION AND STORAGE

FOR AIRPORT SERVICES (U.S. CLS. 100 AND 105).  
FIRST USE 5-1-2007; IN COMMERCE 5-1-2007.

4,045,859. RESEARCH!AMERICA, ALEXANDRIA, VA. SN  
77-756,416. PUB. 4-20-2010, FILED 6-10-2009.



OWNER OF U.S. REG. NOS. 2,359,064, 2,479,856, AND 2,638,234.

THE MARK CONSISTS OF AN EXCLAMATION POINT DESIGN.

#### CLASS 35—ADVERTISING AND BUSINESS

FOR PROMOTING PUBLIC AWARENESS OF THE NEED FOR MEDICAL AND SCIENTIFIC RESEARCH; PUBLIC ADVOCACY TO PROMOTE AWARENESS OF THE NEED FOR MEDICAL AND SCIENTIFIC RESEARCH (U.S. CLS. 100, 101 AND 102).

FIRST USE 3-24-2009; IN COMMERCE 3-24-2009.

#### CLASS 42—SCIENTIFIC AND COMPUTER SERVICES

FOR INFORMATION DISSEMINATION, NAMELY, PROVIDING INFORMATION IN THE FIELD OF MEDICAL RESEARCH AND SCIENCE (U.S. CLS. 100 AND 101).

FIRST USE 3-24-2001; IN COMMERCE 3-24-2009.

4,045,860. RESEARCH!AMERICA, ALEXANDRIA, VA. SN  
77-756,524. PUB. 4-20-2010, FILED 6-10-2009.



OWNER OF U.S. REG. NOS. 2,359,064, 2,479,856, AND 2,638,234.

NO CLAIM IS MADE TO THE EXCLUSIVE RIGHT TO USE "RESEARCH", APART FROM THE MARK AS SHOWN.

THE MARK CONSISTS OF THE WORD "RESEARCH" ABOVE THE WORD "AMERICA" ABOVE A DOT (THE DOT BEING PART OF THE EXCLAMATION IN THE WORD "AMERICA").

**CLASS 35—ADVERTISING AND BUSINESS**

FOR PROMOTING PUBLIC AWARENESS OF THE NEED FOR MEDICAL AND SCIENTIFIC RESEARCH; PUBLIC ADVOCACY TO PROMOTE AWARENESS OF THE NEED FOR MEDICAL AND SCIENTIFIC RESEARCH (U.S. CLS. 100, 101 AND 102).

FIRST USE 3-24-2009; IN COMMERCE 3-24-2009.

**CLASS 42—SCIENTIFIC AND COMPUTER SERVICES**

FOR INFORMATION DISSEMINATION, NAMELY, PROVIDING INFORMATION IN THE FIELD OF MEDICAL RESEARCH AND SCIENCE (U.S. CLS. 100 AND 101).

FIRST USE 3-24-2009; IN COMMERCE 3-24-2009.

4,045,871. STENGEL, ADAM M, NEW YORK, NY. SN 77-771,496. PUB. 11-24-2009, FILED 6-30-2009.

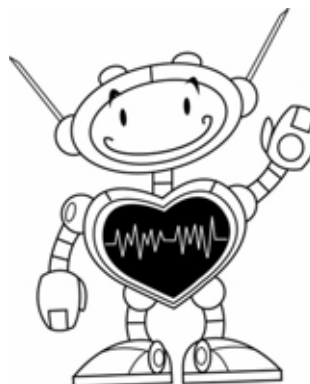

THE MARK CONSISTS OF A SMILING ROBOT/ALIEN IN A METALLIC-LOOKING SPACESUIT AND A HEART MONITOR EMBEDDED IN THE BODY OF THE SUIT.

4,045,865. LEGACY PAVILION LLC, ATLANTA, GA. SN 77-763,845. PUB. 7-12-2011, FILED 6-19-2009.

VENTANAS

THE MARK CONSISTS OF STANDARD CHARACTERS WITHOUT CLAIM TO ANY PARTICULAR FONT, STYLE, SIZE, OR COLOR.

THE ENGLISH TRANSLATION OF "VENTANAS" IN THE MARK IS "WINDOWS".

**CLASS 35—ADVERTISING AND BUSINESS**

FOR PROVIDING FACILITIES FOR BUSINESS MEETINGS (U.S. CLS. 100, 101 AND 102).

FIRST USE 11-2-2010; IN COMMERCE 11-2-2010.

**CLASS 41—EDUCATION AND ENTERTAINMENT**

FOR SPECIAL EVENT PLANNING, COORDINATION AND CONSULTATION SERVICES (U.S. CLS. 100, 101 AND 107).

FIRST USE 10-11-2010; IN COMMERCE 10-11-2010.

**CLASS 43—HOTEL AND RESTAURANT SERVICES**

FOR PROVIDING FACILITIES FOR SPECIAL EVENTS AND PARTIES, NAMELY, PROVIDING BANQUET AND SOCIAL FUNCTION FACILITIES FOR SPECIAL OCCASIONS (U.S. CLS. 100 AND 101).

FIRST USE 10-30-2010; IN COMMERCE 10-30-2010.

**CLASS 16—PAPER GOODS AND PRINTED MATTER**

FOR GIFT BAGS; GIFT BOXES; GIFT CARDS; GIFT WRAP PAPER; GREETINGS CARDS AND POSTCARDS (U.S. CLS. 2, 5, 22, 23, 29, 37, 38 AND 50).

FIRST USE 1-2-2009; IN COMMERCE 6-1-2010.

**CLASS 25—CLOTHING**

FOR ATHLETIC APPAREL, NAMELY, SHIRTS, PANTS, JACKETS, FOOTWEAR, HATS AND CAPS, ATHLETIC UNIFORMS; BALLOON PANTS; CAMP SHIRTS; CLOTHING FOR ATHLETIC USE, NAMELY, PADDED SHIRTS; GOLF PANTS, SHIRTS AND SKIRTS; GOLF SHIRTS; GYM PANTS; HOODED SWEAT SHIRTS; JOGGING PANTS; KNIT SHIRTS; LONG-SLEEVED SHIRTS; PANTS; SHORT-SLEEVED OR LONG-SLEEVED T-SHIRTS; T-SHIRTS (U.S. CLS. 22 AND 39).

FIRST USE 1-2-2009; IN COMMERCE 6-1-2010.

4,045,874. SHOWCASE TECHNOLOGY, INC., TORRANCE, CA. SN 77-777,204. PUB. 6-29-2010, FILED 7-9-2009.

SHOWCASE TECHNOLOGY

THE MARK CONSISTS OF STANDARD CHARACTERS WITHOUT CLAIM TO ANY PARTICULAR FONT, STYLE, SIZE, OR COLOR.

NO CLAIM IS MADE TO THE EXCLUSIVE RIGHT TO USE "TECHNOLOGY", APART FROM THE MARK AS SHOWN.

**CLASS 35—ADVERTISING AND BUSINESS**

FOR RENTAL OF PHOTOCOPY MACHINES FOR BUSINESS TRAVELER USE (U.S. CLS. 100, 101 AND 102).

FIRST USE 6-1-2008; IN COMMERCE 6-1-2008.



**CLASS 38—COMMUNICATION**

FOR RENTAL OF FACSIMILE MACHINES FOR BUSINESS TRAVELER USE (U.S. CLS. 100, 101 AND 104).  
FIRST USE 6-1-2008; IN COMMERCE 6-1-2008.

**CLASS 42—SCIENTIFIC AND COMPUTER SERVICES**

FOR RENTAL OF AUTOMATED COMPUTER SYSTEMS FOR BUSINESS TRAVELER USE (U.S. CLS. 100 AND 101).  
FIRST USE 6-1-2008; IN COMMERCE 6-1-2008.

---

4,045,875. SHOWCASE TECHNOLOGY, INC., TORRANCE, CA. SN 77-777,205. PUB. 6-29-2010, FILED 7-9-2009.

**SHOWCASE BUSINESS CENTERS**

THE MARK CONSISTS OF STANDARD CHARACTERS WITHOUT CLAIM TO ANY PARTICULAR FONT, STYLE, SIZE, OR COLOR.

NO CLAIM IS MADE TO THE EXCLUSIVE RIGHT TO USE "BUSINESS CENTERS", APART FROM THE MARK AS SHOWN.

**CLASS 35—ADVERTISING AND BUSINESS**

FOR RENTAL OF PHOTOCOPY MACHINES FOR BUSINESS TRAVELER USE (U.S. CLS. 100, 101 AND 102).  
FIRST USE 6-1-2008; IN COMMERCE 6-1-2008.

**CLASS 38—COMMUNICATION**

FOR RENTAL OF FACSIMILE MACHINES FOR BUSINESS TRAVELER USE (U.S. CLS. 100, 101 AND 104).  
FIRST USE 6-1-2008; IN COMMERCE 6-1-2008.

**CLASS 42—SCIENTIFIC AND COMPUTER SERVICES**

FOR RENTAL OF AUTOMATED COMPUTER SYSTEMS FOR BUSINESS TRAVELER USE (U.S. CLS. 100 AND 101).  
FIRST USE 6-1-2008; IN COMMERCE 6-1-2008.

---

4,045,881. UNITED STATES DEPARTMENT OF HOMELAND SECURITY, WASHINGTON, DC. SN 77-781,361. PUB. 12-15-2009, FILED 7-15-2009.

**CyberCorps**

THE MARK CONSISTS OF STANDARD CHARACTERS WITHOUT CLAIM TO ANY PARTICULAR FONT, STYLE, SIZE, OR COLOR.

**CLASS 36—INSURANCE AND FINANCIAL**

FOR PROVIDING EDUCATIONAL SCHOLARSHIPS TO STUDENTS PURSUING CAREERS AS CYBER SECURITY PROFESSIONALS (U.S. CLS. 100, 101 AND 102).  
FIRST USE 3-24-2003; IN COMMERCE 3-24-2003.

**CLASS 41—EDUCATION AND ENTERTAINMENT**

FOR EDUCATIONAL SERVICES, NAMELY, PROVIDING EDUCATIONAL PROGRAMS AND TRAINING PROGRAMS FOR CYBER SECURITY STUDENTS IN THE FIELDS OF EDUCATIONAL RESEARCH RELATING TO CYBER SECURITY AND DEALING WITH THREATS TO THE U.S. INFORMATION TECHNOLOGY INFRASTRUCTURE (U.S. CLS. 100, 101 AND 107).  
FIRST USE 3-24-2003; IN COMMERCE 3-24-2003.

---

4,045,891. ENCORE WIRE CORPORATION, MCKINNEY, TX. SN 77-790,370. PUB. 12-21-2010, FILED 7-27-2009.

**ENCORE PERFORMANCE**

THE MARK CONSISTS OF STANDARD CHARACTERS WITHOUT CLAIM TO ANY PARTICULAR FONT, STYLE, SIZE, OR COLOR.

**CLASS 35—ADVERTISING AND BUSINESS**

FOR CUSTOMER SERVICE IN THE FIELD OF ELECTRICAL WIRE AND CABLE; CUSTOMER SERVICE IN THE FIELD OF PROVIDING TIME EFFICIENT HANDLING, SHIPPING, AND DISTRIBUTION OF ELECTRICAL WIRE AND CABLE; PROVISION OF TECHNICAL INFORMATION, NAMELY, PROVIDING TECHNICAL SUPPORT, PROMPT ISSUE RESOLUTION INFORMATION AND ADVICE TO CONSUMERS REGARDING THE SELECTION OF ELECTRICAL WIRE AND CABLE PRODUCTS TO BE PURCHASED; PROVIDING TECHNICAL INFORMATION AND ADVICE PERTAINING TO PROCUREMENT, BUYING AND SELLING RELATING TO ELECTRICAL WIRE AND CABLE AND RELATED SERVICES VIA COMPUTER, TELEPHONE, THE INTERNET OR ELECTRONIC MAIL (U.S. CLS. 100, 101 AND 102).  
FIRST USE 7-5-2011; IN COMMERCE 7-5-2011.

**CLASS 37—CONSTRUCTION AND REPAIR**

FOR PROVIDING TECHNICAL INFORMATION AND ADVICE PERTAINING TO INSTALLATION RELATING TO ELECTRICAL WIRE AND CABLE AND RELATED SERVICES VIA COMPUTER, TELEPHONE, THE INTERNET OR ELECTRONIC MAIL; PROVISION OF A WEB SITE FEATURING INFORMATION REGARDING CONSTRUCTION AND APPLICATION, NAMELY, SPECIFIC USES, OF ELECTRICAL WIRE AND CABLE (U.S. CLS. 100, 103 AND 106).  
FIRST USE 7-5-2011; IN COMMERCE 7-5-2011.

**CLASS 42—SCIENTIFIC AND COMPUTER SERVICES**

FOR PROVIDING QUALITY ASSURANCE SERVICES IN THE FIELD OF ELECTRICAL WIRE AND CABLE (U.S. CLS. 100 AND 101).  
FIRST USE 7-5-2011; IN COMMERCE 7-5-2011.

4,045,892. DUANE READE INTERNATIONAL, LLC, NEW YORK, NY. SN 77-792,468. PUB. 6-1-2010, FILED 7-29-2009.

Prevail

THE MARK CONSISTS OF THE WORD "PREVAIL" IN STYLIZED LETTERING.

### CLASS 3—COSMETICS AND CLEANING PREPARATIONS

FOR COSMETIC APPLICATORS, NAMELY, COSMETIC PADS; MASSAGE OILS; FACIAL CLEANSERS; SKIN CLARIFIERS; SKIN SOAPS; HAIR DRESSINGS FOR MEN; HAIR SHAMPOO; HAIR GELS; BODY CREAM SOAP; BODY OILS; MAKE-UP REMOVERS; AFTER SUN LOTIONS; NON-MEDICATED SUN CARE PREPARATIONS; SUN CARE LOTIONS; SUN CREAMS; MANICURE AND PEDICURE NAIL IMPLEMENTS, NAMELY, EMERY BOARDS AND FOOT SMOOTHING STONES FOR HEELS AND CALLUSES (U.S. CLS. 1, 4, 6, 50, 51 AND 52).

FIRST USE 4-30-2010; IN COMMERCE 4-30-2010.

### CLASS 8—HAND TOOLS

FOR TWEEZERS; MANICURE AND PEDICURE NAIL IMPLEMENTS, NAMELY, NAIL FILES, NAIL CLIPPERS, CUTICLE PUSHERS, NAIL AND CUTICLE SCISSORS, CUTICLE STICKS; COSMETIC IMPLEMENTS, NAMELY, EYELASH CURLERS (U.S. CLS. 23, 28 AND 44).

FIRST USE 6-30-2010; IN COMMERCE 6-30-2010.

### CLASS 14—JEWELRY

FOR JEWELRY (U.S. CLS. 2, 27, 28 AND 50).  
FIRST USE 6-30-2010; IN COMMERCE 6-30-2010.

### CLASS 16—PAPER GOODS AND PRINTED MATTER

FOR COSMETIC IMPLEMENTS, NAMELY, COSMETIC PENCIL SHARPENERS (U.S. CLS. 2, 5, 22, 23, 29, 37, 38 AND 50).

FIRST USE 11-30-2010; IN COMMERCE 11-30-2010.

### CLASS 18—LEATHER GOODS

FOR COSMETIC BAGS SOLD EMPTY (U.S. CLS. 1, 2, 3, 22 AND 41).

FIRST USE 7-31-2010; IN COMMERCE 7-31-2010.

### CLASS 20—FURNITURE AND ARTICLES NOT OTHERWISE CLASSIFIED

FOR MIRRORS (U.S. CLS. 2, 13, 22, 25, 32 AND 50).  
FIRST USE 7-31-2010; IN COMMERCE 7-31-2010.

### CLASS 21—HOUSEWARES AND GLASS

FOR COSMETIC BRUSHES; COSMETIC IMPLEMENTS, NAMELY, FOAM APPLICATOR STICKS FOR APPLYING COSMETICS, SPONGES FOR APPLYING COSMETICS, COSMETIC APPLICATORS, NAMELY, COSMETIC SPATULAS FOR APPLYING COSMETICS, FOAM APPLICATOR STICKS FOR APPLYING COSMETICS, BRUSHES FOR APPLYING COSMETICS, MAKE-UP APPLICATORS, NAMELY, FOAM SPONGES, BRUSHES, SPONGE WEDGES, AND SPATULAS; COSMETIC APPLICATORS, NAMELY, WEDGE-SHAPED FACIAL SPONGES FOR APPLYING MAKE-UP; MANICURE AND PEDICURE NAIL IMPLEMENTS, NAMELY, NAIL BRUSHES; COMBS (U.S. CLS. 2, 13, 23, 29, 30, 33, 40 AND 50).

FIRST USE 7-31-2010; IN COMMERCE 7-31-2010.

4,045,899. IQ POWER FRANCHISING, LLC/, SANFORD, FL. SN 77-801,347. PUB. 5-31-2011, FILED 8-10-2009.

iQ Power

THE MARK CONSISTS OF STANDARD CHARACTERS WITHOUT CLAIM TO ANY PARTICULAR FONT, STYLE, SIZE, OR COLOR.

NO CLAIM IS MADE TO THE EXCLUSIVE RIGHT TO USE "POWER", APART FROM THE MARK AS SHOWN.

### CLASS 11—ENVIRONMENTAL CONTROL APPARATUS

FOR SOLAR COLLECTORS; SOLAR HEAT COLLECTION PANELS; SOLAR THERMAL INSTALLATIONS, NAMELY, SOLAR THERMAL MODULES; SOLAR WATER HEATERS HEATING SYSTEMS FOR RESIDENTIAL AND COMMERCIAL BUILDINGS COMPRISED OF BOILERS, VALVES, PIPES, MANIFOLDS, SOLAR PANELS, CONTROL PANEL, SWITCHES AND ELECTRICAL WIRE, ALL SOLD AS A UNIT; SOLAR ENERGY BASED COOLING APPARATUS; SOLAR LIGHT FIXTURES, NAMELY, INDOOR AND OUTDOOR SOLAR POWERED LIGHTING UNITS AND FIXTURES; SOLAR THERMAL AIR SYSTEMS FOR HEATING PURPOSES; SOLAR THERMAL-BASED POWER PLANTS; SOLAR-POWERED ALL-WEATHER LIGHTS; SOLAR-POWERED COOLING UNITS (U.S. CLS. 13, 21, 23, 31 AND 34).

FIRST USE 7-30-2009; IN COMMERCE 7-30-2009.

### CLASS 37—CONSTRUCTION AND REPAIR

FOR INSTALLATION AND MAINTENANCE OF PHOTOVOLTAIC/SOLAR THERMAL HYBRID INSTALLATIONS; INSTALLATION AND MAINTENANCE OF SOLAR ENERGY BASED POWER PLANTS; INSTALLATION AND MAINTENANCE OF SOLAR THERMAL INSTALLATIONS; REPAIR AND INSTALLATION SERVICES, NAMELY, THE INSTALLATION OF HEATING, COOLING AND ENVIRONMENTAL CONTROL SYSTEMS PRIMARILY USING SOLAR ENERGY, RENEWABLE ENERGY RESOURCES AND RAINWATER (U.S. CLS. 100, 103 AND 106).

FIRST USE 7-30-2009; IN COMMERCE 7-30-2009.

4,045,911. SARDELLA, LLC, ANNAPOLIS, MD. SN 77-814,032. PUB. 7-20-2010, FILED 8-27-2009.

## HELL POINT SEAFOOD

THE MARK CONSISTS OF STANDARD CHARACTERS WITHOUT CLAIM TO ANY PARTICULAR FONT, STYLE, SIZE, OR COLOR.

NO CLAIM IS MADE TO THE EXCLUSIVE RIGHT TO USE "SEAFOOD", APART FROM THE MARK AS SHOWN.

### CLASS 21—HOUSEWARES AND GLASS

FOR HOUSEWARES, NAMELY, MUGS (U.S. CLS. 2, 13, 23, 29, 30, 33, 40 AND 50).  
FIRST USE 7-1-2009; IN COMMERCE 7-1-2009.

### CLASS 25—CLOTHING

FOR SHIRTS, SWEATSHIRTS, HATS, APRONS AND PANTS (U.S. CLS. 22 AND 39).  
FIRST USE 7-1-2009; IN COMMERCE 7-1-2009.

4,045,912. HALLELUJAH ACRES, INC., SHELBY, NC. SN 77-814,785. PUB. 7-6-2010, FILED 8-28-2009.

## WE JUICE UP YOUR LIFE

THE MARK CONSISTS OF STANDARD CHARACTERS WITHOUT CLAIM TO ANY PARTICULAR FONT, STYLE, SIZE, OR COLOR.

### CLASS 5—PHARMACEUTICALS

FOR FOOD CONCENTRATE SUPPLEMENTS AND DIETARY AND NUTRITIONAL FOOD SUPPLEMENTS (U.S. CLS. 6, 18, 44, 46, 51 AND 52).  
FIRST USE 6-4-2010; IN COMMERCE 6-4-2010.

### CLASS 9—ELECTRICAL AND SCIENTIFIC APPARATUS

FOR PRE-RECORDED DVDS AND CDS DEALING WITH HEALTH, NUTRITION AND BIBLICAL INFORMATION (U.S. CLS. 21, 23, 26, 36 AND 38).  
FIRST USE 7-8-2010; IN COMMERCE 7-16-2010.

### CLASS 16—PAPER GOODS AND PRINTED MATTER

FOR BOOKS AND MAGAZINES DEALING WITH HEALTH, NUTRITION AND BIBLICAL INFORMATION (U.S. CLS. 2, 5, 22, 23, 29, 37, 38 AND 50).  
FIRST USE 6-4-2010; IN COMMERCE 6-4-2010.

### CLASS 32—LIGHT BEVERAGES

FOR POWDERS AND CONCENTRATES FOR USE IN THE PREPARATION OF VEGETABLE JUICE (U.S. CLS. 45, 46 AND 48).  
FIRST USE 6-4-2010; IN COMMERCE 6-4-2010.

### CLASS 35—ADVERTISING AND BUSINESS

FOR WHOLESALE DISTRIBUTORSHIP AND RETAIL STORE SERVICES FEATURING DVDS, CDS AND BOOKS, FOOD SUPPLEMENTS, JUICERS, WATER DISTILLERS AND FOOD DEHYDRATORS; HEALTH AND BEAUTY PRODUCTS, PERSONAL CARE PRODUCTS, PREPACKAGED FOODS, NAMELY, SNACKS, WHOLE FOODS, FRUIT AND NUT BARS; RETAIL STORE SERVICES FEATURING PRE-RECORDED AUDIO AND VIDEO TAPES, DVDS, CDS AND BOOKS, FOOD SUPPLEMENTS, JUICERS, WATER DISTILLERS AND FOOD DEHYDRATORS; RETAIL STORE SERVICES OF HEALTH AND BEAUTY PRODUCTS, PERSONAL CARE PRODUCTS, PREPACKAGED FOODS, NAMELY, SNACKS, WHOLE FOODS, FRUIT AND NUT BARS; RETAIL STORE SERVICES FEATURING FRESHLY EXTRACTED FRUIT JUICES, VEGETABLE JUICES AND SMOOTHIES (U.S. CLS. 100, 101 AND 102).  
FIRST USE 12-0-2009; IN COMMERCE 12-0-2009.

### CLASS 41—EDUCATION AND ENTERTAINMENT

FOR EDUCATIONAL SERVICES, NAMELY, PROVIDING COURSES OF INSTRUCTION IN THE FIELD OF DIET, HEALTH AND NUTRITION AND DISTRIBUTION OF COURSE MATERIALS IN CONNECTION THEREWITH; ENTERTAINMENT IN THE NATURE OF CONTINUING PROGRAMMING BROADCAST PERIODICALLY OVER RADIO AND INTERNET ABOUT FOLLOWING REGIMENS OF DIET, HEALTH AND NUTRITION; ON-LINE ELECTRONIC NEWSLETTER SERVICES PROVIDED BY E-MAIL CONTAINING INFORMATION ABOUT HEALTH, DIET AND NUTRITION (U.S. CLS. 100, 101 AND 107).  
FIRST USE 7-7-2010; IN COMMERCE 7-7-2010.

### CLASS 43—HOTEL AND RESTAURANT SERVICES

FOR RESTAURANT SERVICES FEATURING VEGAN FARE AND PREPARED FOOD ITEMS TO GO (U.S. CLS. 100 AND 101).  
FIRST USE 3-11-2011; IN COMMERCE 8-0-2010.

4,045,915. HALLELUJAH ACRES, INC., SHELBY, NC. SN 77-818,700. PUB. 7-6-2010, FILED 9-2-2009.



THE MARK CONSISTS OF A SUN RISING FROM A BANNER.

### CLASS 5—PHARMACEUTICALS

FOR FOOD CONCENTRATE SUPPLEMENTS AND DIETARY AND NUTRITIONAL FOOD SUPPLEMENTS (U.S. CLS. 6, 18, 44, 46, 51 AND 52).  
FIRST USE 6-4-2010; IN COMMERCE 6-4-2010.

### CLASS 9—ELECTRICAL AND SCIENTIFIC APPARATUS

FOR PRE-RECORDED DVDS AND CDS DEALING WITH HEALTH, NUTRITION AND BIBLICAL INFORMATION (U.S. CLS. 21, 23, 26, 36 AND 38).  
FIRST USE 7-8-2010; IN COMMERCE 7-16-2010.

**CLASS 16—PAPER GOODS AND PRINTED MATTER**

FOR BOOKS, MAGAZINES AND NEWSLETTERS DEALING WITH HEALTH, NUTRITION AND BIBLICAL INFORMATION (U.S. CLS. 2, 5, 22, 23, 29, 37, 38 AND 50).  
FIRST USE 6-4-2010; IN COMMERCE 6-4-2010.

**CLASS 32—LIGHT BEVERAGES**

FOR POWDERS AND CONCENTRATES FOR USE IN THE PREPARATION OF VEGETABLE JUICE (U.S. CLS. 45, 46 AND 48).  
FIRST USE 6-4-2010; IN COMMERCE 6-4-2010.

**CLASS 35—ADVERTISING AND BUSINESS**

FOR WHOLESALE DISTRIBUTORSHIP AND RETAIL STORE SERVICES FEATURING PRE-RECORDED DVDS, CDS AND BOOKS, FOOD SUPPLEMENTS, JUICERS, WATER DISTILLERS AND FOOD DEHYDRATORS, HEALTH AND BEAUTY PRODUCTS, PERSONAL CARE PRODUCTS, PREPACKAGED FOODS, NAMELY, SNACKS, WHOLE FOODS, FRUIT AND NUT BARS; RETAIL STORE SERVICES FEATURING PRE-RECORDED AUDIO AND VIDEO TAPES, DVDS, CDS AND BOOKS, FOOD SUPPLEMENTS, JUICERS, WATER DISTILLERS AND FOOD DEHYDRATORS; RETAIL STORE SERVICES OF HEALTH AND BEAUTY PRODUCTS, PERSONAL CARE PRODUCTS, PREPACKAGED FOODS, NAMELY, SNACKS, WHOLE FOODS, FRUIT AND NUT BARS; RETAIL STORE SERVICES FEATURING FRESHLY EXTRACTED FRUIT JUICES, VEGETABLE JUICES AND SMOOTHIES (U.S. CLS. 100, 101 AND 102).  
FIRST USE 12-0-2009; IN COMMERCE 12-0-2009.

**CLASS 41—EDUCATION AND ENTERTAINMENT**

FOR EDUCATIONAL SERVICES, NAMELY, PROVIDING COURSES OF INSTRUCTION IN THE FIELD OF DIET, HEALTH AND NUTRITION AND DISTRIBUTION OF COURSE MATERIALS IN CONNECTION THEREWITH; ENTERTAINMENT IN THE NATURE OF CONTINUING PROGRAMMING BROADCAST PERIODICALLY OVER INTERNET ABOUT FOLLOWING REGIMENS OF DIET, HEALTH AND NUTRITION; ON-LINE ELECTRONIC NEWSLETTER SERVICES PROVIDED BY E-MAIL CONTAINING INFORMATION ABOUT HEALTH, DIET AND NUTRITION (U.S. CLS. 100, 101 AND 107).  
FIRST USE 7-7-2010; IN COMMERCE 7-7-2010.

**CLASS 43—HOTEL AND RESTAURANT SERVICES**

FOR RESTAURANT SERVICES FEATURING VEGAN FARE AND PREPARED FOOD ITEMS TO GO (U.S. CLS. 100 AND 101).  
FIRST USE 3-11-2010; IN COMMERCE 8-0-2010.

**CLASS 5—PHARMACEUTICALS**

FOR FOOD CONCENTRATE SUPPLEMENTS AND DIETARY AND NUTRITIONAL FOOD SUPPLEMENTS (U.S. CLS. 6, 18, 44, 46, 51 AND 52).  
FIRST USE 6-4-2010; IN COMMERCE 6-4-2010.

**CLASS 9—ELECTRICAL AND SCIENTIFIC APPARATUS**

FOR PRE-RECORDED DVDS AND CDS DEALING WITH HEALTH, NUTRITION AND BIBLICAL INFORMATION (U.S. CLS. 21, 23, 26, 36 AND 38).  
FIRST USE 7-8-2010; IN COMMERCE 7-16-2010.

**CLASS 16—PAPER GOODS AND PRINTED MATTER**

FOR BOOKS, MAGAZINES AND NEWSLETTERS DEALING WITH HEALTH, NUTRITION AND BIBLICAL INFORMATION (U.S. CLS. 2, 5, 22, 23, 29, 37, 38 AND 50).  
FIRST USE 6-4-2010; IN COMMERCE 6-4-2010.

**CLASS 32—LIGHT BEVERAGES**

FOR POWDERS AND CONCENTRATES FOR USE IN THE PREPARATION OF VEGETABLE JUICE (U.S. CLS. 45, 46 AND 48).  
FIRST USE 6-4-2010; IN COMMERCE 6-4-2010.

**CLASS 35—ADVERTISING AND BUSINESS**

FOR WHOLESALE DISTRIBUTORSHIP AND RETAIL STORE SERVICES FEATURING PRE-RECORDED DVDS, CDS AND BOOKS, FOOD SUPPLEMENTS, JUICERS, WATER DISTILLERS AND FOOD DEHYDRATORS, HEALTH AND BEAUTY PRODUCTS, PERSONAL CARE PRODUCTS, PREPACKAGED FOODS, NAMELY, SNACKS, WHOLE FOODS, FRUIT AND NUT BARS; RETAIL STORE SERVICES FEATURING PRE-RECORDED AUDIO AND VIDEO TAPES, DVDS, CDS AND BOOKS, FOOD SUPPLEMENTS, JUICERS, WATER DISTILLERS AND FOOD DEHYDRATORS; RETAIL STORE SERVICES OF HEALTH AND BEAUTY PRODUCTS, PERSONAL CARE PRODUCTS, PREPACKAGED FOODS, NAMELY, SNACKS, WHOLE FOODS, FRUIT AND NUT BARS; RETAIL STORE SERVICES FEATURING FRESHLY EXTRACTED FRUIT JUICES, VEGETABLE JUICES AND SMOOTHIES (U.S. CLS. 100, 101 AND 102).  
FIRST USE 12-0-2009; IN COMMERCE 12-0-2009.

**CLASS 41—EDUCATION AND ENTERTAINMENT**

FOR EDUCATIONAL SERVICES, NAMELY, PROVIDING COURSES OF INSTRUCTION IN THE FIELD OF DIET, HEALTH AND NUTRITION AND DISTRIBUTION OF COURSE MATERIALS IN CONNECTION THEREWITH; ENTERTAINMENT IN THE NATURE OF CONTINUING PROGRAMMING BROADCAST PERIODICALLY OVER INTERNET ABOUT FOLLOWING REGIMENS OF DIET, HEALTH AND NUTRITION; ON-LINE ELECTRONIC NEWSLETTER SERVICES PROVIDED BY E-MAIL CONTAINING INFORMATION ABOUT HEALTH, DIET AND NUTRITION (U.S. CLS. 100, 101 AND 107).  
FIRST USE 7-7-2010; IN COMMERCE 7-7-2010.

**CLASS 43—HOTEL AND RESTAURANT SERVICES**

FOR RESTAURANT SERVICES FEATURING VEGAN FARE AND PREPARED FOOD ITEMS TO GO (U.S. CLS. 100 AND 101).  
FIRST USE 3-11-2010; IN COMMERCE 8-0-2010.

4,045,917. HALLELUJAH ACRES, INC., SHELBY, NC. SN 77-820,641. PUB. 7-6-2010, FILED 9-4-2009.



OWNER OF U.S. REG. NOS. 2,077,460, 3,077,237, AND OTHERS.

THE MARK CONSISTS OF A SUN RISING FROM A BANNER ABOVE THE WORDS "HALLELUJAH ACRES".

4,045,923. PELCO ADVISORS LLC, WILTON, CT. SN 77-825,627. PUB. 7-13-2010, FILED 9-14-2009.

## RORI INSTITUTE

THE MARK CONSISTS OF STANDARD CHARACTERS WITHOUT CLAIM TO ANY PARTICULAR FONT, STYLE, SIZE, OR COLOR.

NO CLAIM IS MADE TO THE EXCLUSIVE RIGHT TO USE "INSTITUTE", APART FROM THE MARK AS SHOWN.

### CLASS 35—ADVERTISING AND BUSINESS

FOR MARKETING AND ADVERTISING SERVICES; BUSINESS CONSULTING IN THE FIELD OF RETAIL INVESTMENT DIRECTED TO MANUFACTURERS OF CONSUMER PACKAGED GOODS AND RETAILERS IN ALL INDUSTRIES FOR THE PURPOSE OF GENERATING CONSUMER INTEREST; ADVERTISING CONSULTING SERVICES; CONDUCTING TRADESHOWS AND BUSINESS CONFERENCES IN THE FIELD OF RETAIL INVESTMENT SERVICES, ALL DIRECTED TO MANUFACTURERS OF CONSUMER PACKAGED GOODS AND RETAILERS IN ALL INDUSTRIES FOR THE PURPOSE OF GENERATING CONSUMER INTEREST; MARKET RESEARCH (U.S. CLS. 100, 101 AND 102). FIRST USE 10-19-2010; IN COMMERCE 10-19-2010.

### CLASS 41—EDUCATION AND ENTERTAINMENT

FOR EDUCATION AND EDUCATIONAL INFORMATION SERVICES DIRECTED TO MANUFACTURERS OF CONSUMER PACKAGED GOODS AND RETAILERS IN ALL INDUSTRIES, NAMELY, PROVIDING EDUCATIONAL PROGRAMS, LIVE EDUCATIONAL PRESENTATIONS, AND EDUCATIONAL CONFERENCES IN THE FIELD OF RETAIL INVESTMENT AND SPECIFICALLY FEATURING INFORMATION ON GENERATING CONSUMER INTEREST; CONDUCTING EDUCATIONAL PROGRAMS AND EDUCATIONAL SEMINAR PRESENTATIONS REGARDING RETAIL INVESTMENT STRATEGIES, ALL DIRECTED TO MANUFACTURERS OF CONSUMER PACKAGED GOODS AND RETAILERS IN ALL INDUSTRIES FOR THE PURPOSE OF GENERATING CONSUMER INTEREST (U.S. CLS. 100, 101 AND 107).

FIRST USE 10-19-2010; IN COMMERCE 10-19-2010.

4,045,924. HRHH IP, LLC, NEW YORK, NY. SN 77-831,478. PUB. 8-17-2010, FILED 9-21-2009.

## VANITY

THE MARK CONSISTS OF STANDARD CHARACTERS WITHOUT CLAIM TO ANY PARTICULAR FONT, STYLE, SIZE, OR COLOR.

### CLASS 41—EDUCATION AND ENTERTAINMENT

FOR NIGHT CLUBS (U.S. CLS. 100, 101 AND 107). FIRST USE 12-31-2009; IN COMMERCE 12-31-2009.

### CLASS 43—HOTEL AND RESTAURANT SERVICES

FOR BAR AND RESTAURANT SERVICES (U.S. CLS. 100 AND 101). FIRST USE 12-31-2009; IN COMMERCE 12-31-2009.

4,045,928. AFFINION BENEFITS GROUP, LLC, FRANKLIN, TN. SN 77-837,221. PUB. 2-15-2011, FILED 9-29-2009.

### IN SYNC WITH YOUR LIFESTYLE

THE MARK CONSISTS OF STANDARD CHARACTERS WITHOUT CLAIM TO ANY PARTICULAR FONT, STYLE, SIZE, OR COLOR.

### CLASS 35—ADVERTISING AND BUSINESS

FOR CONSUMER MEMBERSHIP SERVICES, NAMELY, PROVIDING INFORMATION AND ARRANGING FOR DISCOUNTS, SAVINGS AND REBATES ON DINING, HOTEL ACCOMMODATIONS, TRAVEL AND OTHER LEISURE ACTIVITIES, AND CONSUMER MERCHANDISE; PROMOTING THE GOODS AND SERVICES OF OTHERS THROUGH THE DISTRIBUTION OF COUPON BOOKS, CARDS AND DIRECTORIES WHICH ENTITLE THE HOLDER TO RECEIVE DISCOUNTS ON DINING, HOTEL ACCOMMODATIONS, TRAVEL AND OTHER LEISURE ACTIVITIES, AND CONSUMER MERCHANDISE; PROVIDING A COMPUTERIZED ON-LINE MEMBERSHIP PROGRAM ENTITLING THE PARTICIPANTS TO RECEIVE DISCOUNTS ON DINING, HOTEL ACCOMMODATIONS, TRAVEL AND OTHER LEISURE ACTIVITIES, AND CONSUMER MERCHANDISE; PROVIDING AN ON-LINE DIRECTORY OF INFORMATION ABOUT A COMPUTERIZED ON-LINE MEMBERSHIP PROGRAM ENTITLING THE PARTICIPANTS TO RECEIVE DISCOUNTS ON DINING, HOTEL ACCOMMODATIONS, TRAVEL AND OTHER LEISURE ACTIVITIES, AND CONSUMER MERCHANDISE AND A LIST OF PARTICIPATING BUSINESSES; PROVIDING CREDIT CARD REGISTRATION SERVICES IN THE NATURE OF CREDIT CARD CANCELLATION SERVICES FOR LOST OR STOLEN CARDS AND NOTIFICATION SERVICES TO CREDIT CARD ISSUERS; AND MONITORING CONSUMER CREDIT REPORTS AND PROVIDING AN ALERT TO ANY CHANGES THEREIN (U.S. CLS. 100, 101 AND 102).

FIRST USE 12-0-2010; IN COMMERCE 12-0-2010.

### CLASS 45—PERSONAL AND LEGAL SERVICES

FOR MONITORING POTENTIAL THEFT AND MISUSE OF CREDIT CARD AND OTHER PERSONAL INFORMATION; CONSULTATION IN THE FIELD OF DETECTING AND PREVENTING IDENTITY THEFT (U.S. CLS. 100 AND 101).

FIRST USE 12-0-2010; IN COMMERCE 12-0-2010.

4,045,929. ANTHONY L. BIRCH, BETHESDA, MD. SN 77-837,497. PUB. 4-5-2011, FILED 9-29-2009.

## GREEN FLOW

THE MARK CONSISTS OF STANDARD CHARACTERS WITHOUT CLAIM TO ANY PARTICULAR FONT, STYLE, SIZE, OR COLOR.

NO CLAIM IS MADE TO THE EXCLUSIVE RIGHT TO USE "GREEN", APART FROM THE MARK AS SHOWN.

### CLASS 35—ADVERTISING AND BUSINESS

FOR RETAIL STORE SERVICES FEATURING CONVENIENCE STORE ITEMS (U.S. CLS. 100, 101 AND 102). FIRST USE 4-11-2011; IN COMMERCE 4-11-2011.

### CLASS 37—CONSTRUCTION AND REPAIR

FOR VEHICLE SERVICE STATIONS FEATURING ALTERNATIVE FUELS, NAMELY, NATURAL GAS (U.S. CLS. 100, 103 AND 106). FIRST USE 4-11-2011; IN COMMERCE 4-11-2011.

### CLASS 39—TRANSPORTATION AND STORAGE

FOR DISTRIBUTION OF ELECTRICAL ENERGY (U.S. CLS. 100 AND 105). FIRST USE 4-11-2011; IN COMMERCE 4-11-2011.

4,045,930. KATZ LAW OFFICE, LTD., FORMERLY MATTHEW A. KATZ, ATTORNEY AT LAW, CHICAGO, IL. SN 77-838,486. PUB. 7-27-2010, FILED 9-30-2009.



THE COLOR(S) BLACK, WHITE, AND YELLOW IS/ARE CLAIMED AS A FEATURE OF THE MARK.

THE MARK CONSISTS OF A YELLOW SUN WITH BLACK LEGAL SCALES IN THE CENTER OF IT. A BLACK CIRCLE SURROUNDING THE SUN AND THE BLACK LETTERS "EL DERECHO DEL PUEBLO AD CAUSA EX PLEBEIUS" ABOVE THE ENTIRE CIRCLE AND ANOTHER BLACK CIRCLE SURROUNDING THE LETTERS. TWO YELLOW DIAMONDS APPEAR AT OPPOSITE ENDS OF THE MIDPOINT OF THE CIRCLE BETWEEN THE TWO LINES OF BLACK TEXT.

THE ENGLISH TRANSLATION OF "EL DERECHO DEL PUEBLO AD CAUSA EX PLEBEIUS" IN THE MARK IS "THE PEOPLE'S RIGHT THE CAUSE OF THE PEOPLE".

### CLASS 16—PAPER GOODS AND PRINTED MATTER

FOR PRINTED LECTURES (U.S. CLS. 2, 5, 22, 23, 29, 37, 38 AND 50). FIRST USE 8-1-2003; IN COMMERCE 8-1-2004.

### CLASS 38—COMMUNICATION

FOR TELEVISION AND RADIO BROADCASTING SERVICES (U.S. CLS. 100, 101 AND 104). FIRST USE 1-1-2008; IN COMMERCE 1-1-2008.

### CLASS 41—EDUCATION AND ENTERTAINMENT

FOR CONTINUING EDUCATION SERVICES, NAMELY, PROVIDING LIVE AND ON-LINE CONTINUING PROFESSIONAL EDUCATION SEMINARS IN THE LEGAL, MEDICAL, ACCOUNTING, AND REAL ESTATE FIELDS (U.S. CLS. 100, 101 AND 107). FIRST USE 8-1-2003; IN COMMERCE 8-1-2004.

### CLASS 45—PERSONAL AND LEGAL SERVICES

FOR ATTORNEY SERVICES (U.S. CLS. 100 AND 101). FIRST USE 8-1-2004; IN COMMERCE 8-1-2004.

4,045,932. SHANGHAI SOWIN INVESTMENT GROUP CO., LTD., SHANGHAI, CHINA. SN 77-839,142. PUB. 8-31-2010, FILED 10-1-2009.



THE MARK CONSISTS OF THE WORDING "TOSAN" APPEARING IN STYLIZED FONT AND ALL CAPITAL LETTERS, AND TO THE UPPER LEFT OF THE "TOSAN" WORDING APPEARS A SILHOUETTE OF A HORSE HEAD SURROUNDED BY A RECTANGULAR BORDER WHICH IS TOUCHING THE "T" IN "TOSAN".

THE WORDING "TOSAN" HAS NO MEANING IN A FOREIGN LANGUAGE.

### CLASS 7—MACHINERY

FOR AGRICULTURAL MACHINES, NAMELY, HARVESTERS, LAWN MOWERS, SEEDERS, CULTIVATORS, DISK HARROWS; WOODWORKING SAW-TOOTH SETTING MACHINES; CUTTING MACHINES; HAND-HELD TOOLS, NAMELY, POWER-OPERATED HAND-HELD CRIMPERS, ELECTRIC HAND-HELD DRILLS, HAND-HELD POWER-DRIVEN GRINDERS; ELECTRIC ROUTERS; MILLING MACHINES FOR METALWORKING; ELECTRIC HAMMERS; POWER-OPERATED RESIN GRINDING WHEELS; KITCHEN MACHINES, NAMELY, ELECTRIC STANDING MIXERS, ELECTRIC FOOD BLENDERS, ELECTRIC EGG BEATERS; MACHINES AND APPARATUS FOR CLEANING, NAMELY, CARPET CLEANING MACHINES, DRY-CLEANING MACHINES; COMPRESSORS FOR MACHINES; STONE CUTTERS (U.S. CLS. 13, 19, 21, 23, 31, 34 AND 35).

FIRST USE 2-19-2004; IN COMMERCE 3-11-2010.

**CLASS 8—HAND TOOLS**

FOR MANUALLY-OPERATED EMERY GRINDING WHEELS; BUSHHAMMERS; GARDEN TOOLS, HAND-OPERATED, NAMELY, GARDENING SHEARS; HAND DRILLS; HAND-OPERATED SAWS; HAND TOOLS, HAND-OPERATED, NAMELY, LOPPERS, DRILLS, RIVETERS; HAND-OPERATED CUTTING TOOLS; HAND OPERATED LIFTING JACKS; ENGRAVING NEEDLES; TROWELS; SCISSORS (U.S. CLS. 23, 28 AND 44).

FIRST USE 2-19-2004; IN COMMERCE 3-11-2010.

4,045,934. GENMARK DIAGNOSTICS, INC., CARLSBAD, CA. SN 77-841,387. PUB. 5-25-2010, FILED 10-5-2009.

# GenMark

THE MARK CONSISTS OF STANDARD CHARACTERS WITHOUT CLAIM TO ANY PARTICULAR FONT, STYLE, SIZE, OR COLOR.

**CLASS 1—CHEMICALS**

FOR DIAGNOSTIC PREPARATIONS FOR CLINICAL OR MEDICAL LABORATORY USE (U.S. CLS. 1, 5, 6, 10, 26 AND 46).

FIRST USE 11-23-2010; IN COMMERCE 11-23-2010.

**CLASS 5—PHARMACEUTICALS**

FOR DIAGNOSTIC PREPARATIONS FOR MEDICAL PURPOSES (U.S. CLS. 6, 18, 44, 46, 51 AND 52).

FIRST USE 1-13-2011; IN COMMERCE 1-13-2011.

**CLASS 10—MEDICAL APPARATUS**

FOR MEDICAL DEVICES, NAMELY, DEVICES FOR DETECTING GENETIC SEQUENCES (U.S. CLS. 26, 39 AND 44).

FIRST USE 12-17-2010; IN COMMERCE 12-17-2010.

4,045,940. COLORWORKS, INC., CULVER CITY, CA. SN 77-844,389. PUB. 8-31-2010, FILED 10-8-2009.



THE MARK CONSISTS OF THE WORD "COLORWORKS" PRECEDED BY A PINWHEEL DESIGN OF FILM STRIPS.

**CLASS 40—MATERIAL TREATMENT**

FOR TECHNICAL PROCESSING SERVICES FOR THE CREATION, PREPARATION AND DISTRIBUTION OF FILMED AND DIGITAL ENTERTAINMENT CONTENT, NAMELY, COLOR ENHANCEMENT OF BLACK AND WHITE VIDEO FILM, CLOSED CAPTIONING OF FILMS AND VIDEOS, PROCESSING OF CINEMATOGRAPHIC FILMS, PHOTOGRAPHIC FILM DEVELOPING (U.S. CLS. 100, 103 AND 106).

FIRST USE 11-16-2009; IN COMMERCE 11-16-2009.

**CLASS 41—EDUCATION AND ENTERTAINMENT**

FOR TECHNICAL PROCESSING SERVICES FOR THE CREATION, PREPARATION AND DISTRIBUTION OF FILMED AND DIGITAL ENTERTAINMENT CONTENT, NAMELY, FILM MASTERING SERVICES, FILM EDITING, SPECIAL EFFECTS ANIMATION SERVICES FOR FILM AND VIDEO, MOBILE MEDIA AND ENTERTAINMENT SERVICES IN THE NATURE OF CONTENT PREPARATION, PRODUCTION AND POST-PRODUCTION, ENTERTAINMENT SERVICES IN THE NATURE OF DEVELOPMENT, CREATION, PRODUCTION AND POST-PRODUCTION SERVICES OF MULTIMEDIA ENTERTAINMENT CONTENT (U.S. CLS. 100, 101 AND 107).

FIRST USE 11-16-2009; IN COMMERCE 11-16-2009.

4,045,941. LOGOS TECHNOLOGIES, INC., ARLINGTON, VA. SN 77-845,430. PUB. 7-20-2010, FILED 10-9-2009.

# BIOJET

THE MARK CONSISTS OF STANDARD CHARACTERS WITHOUT CLAIM TO ANY PARTICULAR FONT, STYLE, SIZE, OR COLOR.

**CLASS 4—LUBRICANTS AND FUELS**

FOR AVIATION FUEL; FUEL FOR AIRCRAFT/SHIPS; LIQUID FUELS; RENEWABLE FUELS (U.S. CLS. 1, 6 AND 15).

FIRST USE 11-12-2009; IN COMMERCE 11-12-2009.

**CLASS 40—MATERIAL TREATMENT**

FOR PRODUCTION, TREATMENT AND REFINEMENT OF FUEL, DIESEL FUEL, BIOFUEL AND BIODIESEL FUEL FOR OTHERS (U.S. CLS. 100, 103 AND 106).

FIRST USE 2-25-2008; IN COMMERCE 2-25-2008.

**CLASS 42—SCIENTIFIC AND COMPUTER SERVICES**

FOR SCIENTIFIC AND RESEARCH CONSULTATION IN THE FIELD OF FUELS, DIESEL FUEL, BIOFUEL AND BIODIESEL FUEL (U.S. CLS. 100 AND 101).

FIRST USE 2-25-2008; IN COMMERCE 2-25-2008.

4,045,953. TRUST ELEMENT, INC., NEW YORK, NY. SN 77-854,284. PUB. 10-5-2010, FILED 10-21-2009.

# TRUST ELEMENT

THE MARK CONSISTS OF STANDARD CHARACTERS WITHOUT CLAIM TO ANY PARTICULAR FONT, STYLE, SIZE, OR COLOR.

**CLASS 35—ADVERTISING AND BUSINESS**

FOR BUSINESS CONSULTATION SERVICES RELATING TO ENERGY MANAGEMENT, CARBON EFFICIENCY, CLIMATE CHANGE, AND REDUCING THE ENVIRONMENTAL IMPACT CAUSED BY BUSINESSES (U.S. CLS. 100, 101 AND 102).

FIRST USE 11-0-2009; IN COMMERCE 11-0-2009.

**CLASS 42—SCIENTIFIC AND COMPUTER SERVICES**

FOR PROVIDING SCIENTIFIC CONSULTATION SERVICES IN THE FIELDS OF ENERGY MANAGEMENT, CARBON EFFICIENCY, CLIMATE CHANGE, AND REDUCING THE ENVIRONMENTAL IMPACT CAUSED BY BUSINESSES (U.S. CLS. 100 AND 101).

FIRST USE 11-0-2009; IN COMMERCE 11-0-2009.

4,045,961. CONTINENTAL RESOURCES, INC., BEDFORD, MA. SN 77-868,515. PUB. 12-7-2010, FILED 11-9-2009.



OWNER OF U.S. REG. NO. 1,468,654.

THE MARK CONSISTS OF THE WORD "CONRES" IN STYLIZED FORM.

THE WORDING "CONRES" HAS NO MEANING IN A FOREIGN LANGUAGE.

4,045,959. DAWN FOODS, INC., JACKSON, MI. SN 77-865,205. PUB. 12-21-2010, FILED 11-4-2009.

**MI PANADERIA**

THE MARK CONSISTS OF STANDARD CHARACTERS WITHOUT CLAIM TO ANY PARTICULAR FONT, STYLE, SIZE, OR COLOR.

NO CLAIM IS MADE TO THE EXCLUSIVE RIGHT TO USE "PANADERIA", APART FROM THE MARK AS SHOWN.

THE ENGLISH TRANSLATION OF "MI PANADERIA" IN THE MARK IS "MY BAKERY".

**CLASS 1—CHEMICALS**

FOR CHEMICAL ADDITIVES FOR USE IN THE MANUFACTURE OF FOOD; CHEMICAL PRODUCTS FOR THE FRESH-KEEPING AND PRESERVING OF FOOD (U.S. CLS. 1, 5, 6, 10, 26 AND 46).

FIRST USE 8-1-2011; IN COMMERCE 8-1-2011.

**CLASS 29—MEATS AND PROCESSED FOODS**

FOR NON-DAIRY BASED MIXES FOR MAKING WHIPPED ICINGS AND FILLINGS; FOOD GLAZING PREPARATIONS COMPRISED PRIMARILY OF FRUIT AND/OR FRUIT PECTIN FOR USE IN COOKING AND BAKING; SHORTENING; HARDENED OILS; COOKING OIL; NUTMEATS; DAIRY-BASED BEVERAGES AND FOOD PRODUCTS, NAMELY, DAIRY-BASED SNACK FOODS EXCLUDING ICE CREAM, ICE MILK, AND FROZEN YOGURT (U.S. CL. 46).

FIRST USE 8-1-2011; IN COMMERCE 8-1-2011.

**CLASS 30—STAPLE FOODS**

FOR BAKERY MIXES, CONCENTRATED MIXES, AND BASE MIXES FOR DONUTS, CAKE DONUTS, CAKE DONUT STICKS, FRENCH DONUTS, YEAST-RAISED DONUTS, CAKES, SWEET ROLLS, DINNER ROLLS, PIZZA, MUFFINS AND PANCAKES; BAKERY GOODS, FROZEN OR FRESH, NAMELY, PASTRIES; CROISSANTS; DONUTS; BROWNIES; DOUGH CAKES; BREADS; PUDDING CAKES; CRÈME CAKES; MUFFINS; SWEET DOUGH; COOKIES; PIZZA DOUGH; BISCUITS; BAGELS; ROLLS; PRETZELS; PIE CRUST; CRACKERS; DONUT SUGAR; ICING; NON-DAIRY BASED BAKING INGREDIENTS, NAMELY, FLOUR, FOOD FLAVORING; BAKING SPICES; COOKING SALTS; BAKING POWDER; YEAST; AND LIQUID FLAVORING; FLAVORED AND SWEETENED GELATIN, CHOCOLATE AND CHOCOLATES (U.S. CL. 46).

FIRST USE 8-1-2011; IN COMMERCE 8-1-2011.

**CLASS 9—ELECTRICAL AND SCIENTIFIC APPARATUS**

FOR ELECTRONIC TEST AND MEASURING EQUIPMENT, NAMELY, AMPLIFIERS, LOGIC ANALYZERS, AUDIO SIGNAL ANALYZERS, ELECTRONIC SIGNAL ANALYZER, SPECTRUM ANALYZERS, ATTENUATORS, BRIDGES IN THE NATURE OF COMPUTER NETWORK BRIDGES, ACOUSTIC COUPLERS, ELECTRONIC ULTRASOUND FLAW DETECTORS, DIGITAL MULTIMETERS, PERSONAL COMPUTERS, THERMAL IMAGING EQUIPMENT NOT FOR MEDICAL USE AND NOT FOR USE WITH PHARMACEUTICAL PRODUCTS AND MEDICAL DEVICES; UNIVERSAL COUNTERS IN THE NATURE OF EVENT RECORDERS, MICROWAVE COUNTERS IN THE NATURE OF TIMER FOR COUNTING MICROWAVES, POWER METERS, CAPACITANCE METERS IN THE NATURE OF ELECTRICAL CAPACITY METERS, OSCILLOSCOPES, PULSE GENERATORS IN THE NATURE OF ELECTRONIC MAGNETOSTRICTIVE EQUIPMENT IN THE NATURE OF A WAVE GENERATOR, SIGNAL GENERATORS IN THE NATURE OF ELECTRONIC SIGNAL TRANSMITTERS, POWER SUPPLIES, PROBES FOR TESTING INTEGRATED CIRCUITS, ELECTRIC SENSORS FOR TESTING INTEGRATED CIRCUITS; ELECTRONIC TEST AND MEASURING EQUIPMENT, NAMELY, CALIBRATION KITS COMPRISED PRIMARILY OF INDUSTRIAL CALIBRATION SENSORS; ELECTRONIC TEST AND MEASURING EQUIPMENT, NAMELY, COMPUTER HARDWARE (U.S. CLS. 21, 23, 26, 36 AND 38).

FIRST USE 5-0-2010; IN COMMERCE 5-0-2010.

**CLASS 38—COMMUNICATION**

FOR VOICE, VIDEO AND DATA UNIFIED COMMUNICATIONS SOLUTIONS, NAMELY, TELECOMMUNICATIONS CONSULTATION REGARDING UNIFIED VOICE, VIDEO AND DATA COMMUNICATIONS; VIRTUALIZATION AND WIRELESS SOLUTIONS, NAMELY, WIRELESS BROADBAND COMMUNICATION SERVICES (U.S. CLS. 100, 101 AND 104).

FIRST USE 2-0-2010; IN COMMERCE 2-0-2010.

**CLASS 42—SCIENTIFIC AND COMPUTER SERVICES**

FOR INFORMATION TECHNOLOGY SERVICES, NAMELY, INFORMATION TECHNOLOGY CONSULTATION SERVICES IN THE FIELDS OF DATA CENTER MANAGEMENT SERVICES, DESKTOP MANAGEMENT SOLUTIONS, MESSAGING SOLUTIONS, NETWORK INTEGRATION SOLUTIONS, NETWORK SECURITY SOLUTIONS; VIRTUALIZATION AND WIRELESS SOLUTIONS, NAMELY, COMPUTER DESIGN AND SOFTWARE DESIGN FOR THE AFOREMENTIONED SERVICES (U.S. CLS. 100 AND 101).

FIRST USE 2-0-2010; IN COMMERCE 2-0-2010.



4,045,985. WIDE BRIDGE, NEW YORK, NY. SN 77-889,392.  
PUB. 3-1-2011, FILED 12-9-2009.

## WIDE BRIDGE

THE MARK CONSISTS OF STANDARD CHARACTERS WITHOUT CLAIM TO ANY PARTICULAR FONT, STYLE, SIZE, OR COLOR.

### CLASS 35—ADVERTISING AND BUSINESS

FOR BUSINESS APPRAISAL CONSULTATION; BUSINESS MERGER CONSULTATION (U.S. CLS. 100, 101 AND 102).  
FIRST USE 3-1-2009; IN COMMERCE 3-1-2009.

### CLASS 36—INSURANCE AND FINANCIAL

FOR AGENCIES OR BROKERAGE FOR TRADING OF SECURITIES, SECURITIES INDEX FUTURES, SECURITIES OPTIONS, AND OVERSEAS MARKET SECURITIES FUTURES; BROKERAGE SERVICES FOR CAPITAL INVESTMENTS; EQUITY CAPITAL INVESTMENT; FINANCIAL RESEARCH AND EQUITY RESEARCH BROKERAGE SERVICES; FINANCIAL SERVICES, NAMELY, ASSISTING OTHERS WITH THE COMPLETION OF FINANCIAL TRANSACTIONS FOR STOCKS, BONDS, SECURITIES AND EQUITIES; FINANCIAL SERVICES, NAMELY, RAISING DEBT AND EQUITY CAPITAL FOR OTHERS; MANAGEMENT OF PRIVATE EQUITY FUNDS; PRIVATE PLACEMENTS OF HEDGE FUNDS, PRIVATE EQUITY FUNDS, SECURITIES AND DERIVATIVES FOR OTHERS; PUBLIC EQUITY INVESTMENT MANAGEMENT (U.S. CLS. 100, 101 AND 102).  
FIRST USE 3-1-2009; IN COMMERCE 3-1-2009.

4,045,986. THE MUSICIAN NETWORK, LLC, AKA THE MUSICIAN NETWORK, OVERLAND PARK, KS. SN 77-892,905. PUB. 12-21-2010, FILED 12-14-2009.

## TRADE FOR SHOWS

THE MARK CONSISTS OF STANDARD CHARACTERS WITHOUT CLAIM TO ANY PARTICULAR FONT, STYLE, SIZE, OR COLOR.

NO CLAIM IS MADE TO THE EXCLUSIVE RIGHT TO USE "SHOWS", APART FROM THE MARK AS SHOWN.

### CLASS 38—COMMUNICATION

FOR VIDEO BROADCASTING SERVICES OVER THE INTERNET OR OTHER COMMUNICATIONS NETWORK, NAMELY, SHOWING, DISPLAYING, AND ELECTRONICALLY TRANSMITTING VIDEO CLIPS (U.S. CLS. 100, 101 AND 104).  
FIRST USE 7-25-2011; IN COMMERCE 7-25-2011.

### CLASS 41—EDUCATION AND ENTERTAINMENT

FOR ENTERTAINMENT SERVICES, NAMELY, PROVIDING A WEB SITE FEATURING NON-DOWNLOADABLE MUSICAL PERFORMANCES, MUSICAL VIDEOS, RELATED FILM CLIPS, PHOTOGRAPHS, AND OTHER MULTIMEDIA MATERIALS FEATURING MUSICIANS AND BANDS (U.S. CLS. 100, 101 AND 107).  
FIRST USE 7-25-2011; IN COMMERCE 7-25-2011.

### CLASS 45—PERSONAL AND LEGAL SERVICES

FOR ON-LINE SOCIAL NETWORKING SERVICES (U.S. CLS. 100 AND 101).  
FIRST USE 7-25-2011; IN COMMERCE 7-25-2011.

4,045,988. SURRY COUNTY ECONOMIC DEVELOPMENT FOUNDATION, DOBSON, NC. SN 77-894,832. PUB. 5-18-2010, FILED 12-16-2009.



NO CLAIM IS MADE TO THE EXCLUSIVE RIGHT TO USE "PILOT MOUNTAIN" AND "LOCAL FOOD", APART FROM THE MARK AS SHOWN.

THE COLOR(S) LIGHT GREEN AND DARK GREEN IS/ARE CLAIMED AS A FEATURE OF THE MARK.

THE MARK CONSISTS OF A STYLIZED MARK CONTAINING THE LETTERS "P", "M" AND "P", WRAPPED WITH A VINE IMAGE CONTAINING A LEAF ALL IN ONE DESIGN IN DARK GREEN, WITH THE PHRASE "PILOT MOUNTAIN PRIDE" WITH "PILOT" AND "PRIDE" IN DARK GREEN AND "MOUNTAIN" IN LIGHT GREEN. BELOW IS THE WORDING "A LOCAL FOOD MOVEMENT" IN DARK GREEN.

### CLASS 35—ADVERTISING AND BUSINESS

FOR WHOLESALE FOOD DISTRIBUTORSHIP SERVICES (U.S. CLS. 100, 101 AND 102).  
FIRST USE 7-1-2009; IN COMMERCE 7-1-2009.

### CLASS 39—TRANSPORTATION AND STORAGE

FOR FOOD DELIVERY (U.S. CLS. 100 AND 105).  
FIRST USE 7-1-2009; IN COMMERCE 7-1-2009.

### CLASS 40—MATERIAL TREATMENT

FOR FOOD PROCESSING (U.S. CLS. 100, 103 AND 106).  
FIRST USE 7-1-2009; IN COMMERCE 7-1-2009.

4,046,008. MAJI SPORTS, LLC, LOS ANGELES, CA. SN 77-911,341. PUB. 2-15-2011, FILED 1-13-2010.

# Maji Sports

THE MARK CONSISTS OF STANDARD CHARACTERS WITHOUT CLAIM TO ANY PARTICULAR FONT, STYLE, SIZE, OR COLOR.

NO CLAIM IS MADE TO THE EXCLUSIVE RIGHT TO USE "SPORTS", APART FROM THE MARK AS SHOWN.

THE ENGLISH TRANSLATION OF "MAJI" IN THE MARK IS "WATER".

## CLASS 25—CLOTHING

FOR YOGA CLOTHING THAT IS NOT FOR WATER SPORTS, NAMELY, MOISTURE-WICKING SPORTS BRAS, MOISTURE-WICKING SPORTS PANTS, MOISTURE-WICKING SPORTS SHIRTS, SPORT COATS, SPORT SHIRTS, SPORT STOCKINGS, SPORTS BRAS, SPORTS JACKETS, SPORTS JERSEYS, SPORTS JERSEYS AND BREECHES FOR SPORTS, SPORTS OVERUNIFORMS, SPORTS PANTS, SPORTS SHIRTS, AND SPORTS SHIRTS WITH SHORT SLEEVES (U.S. CLS. 22 AND 39).

FIRST USE 6-20-2011; IN COMMERCE 6-20-2011.

## CLASS 28—TOYS AND SPORTING GOODS

FOR SPORTING GOODS NOT FOR WATER SPORTS, NAMELY, A SPORTS TRAINING DEVICE TO IMPROVE STRENGTH, TONING, CONDITIONING, BALANCE, AND PROPRIOCEPTION (U.S. CLS. 22, 23, 38 AND 50).

FIRST USE 6-21-2010; IN COMMERCE 6-21-2010.

## CLASS 16—PAPER GOODS AND PRINTED MATTER

FOR PAPER AND CARDBOARD ARTICLES, NAMELY, APPLIQUES IN THE FORM OF DECALS, BOOKMARKS, CALENDARS, DECALS, GIFT CARDS, GIFT WRAPPING PAPER, PAPER PARTY FAVORS, PAPER TABLE CLOTHS, PRINTED INVITATIONS, GAMES AND ACTIVITIES FOR CHILDREN; PICTURE BOOKS, ARTS AND CRAFT PAINT KITS, FELT PENS, PEN OR PENCIL HOLDERS, PENCILS, PENS AND RUBBER STAMPS (U.S. CLS. 2, 5, 22, 23, 29, 37, 38 AND 50).

FIRST USE 10-15-2009; IN COMMERCE 10-15-2009.

## CLASS 18—LEATHER GOODS

FOR ARTICLES MADE FROM LEATHER AND IMITATIONS OF LEATHER, NAMELY, PURSES, KNAPSACKS, BABY BACKPACKS AND UMBRELLAS (U.S. CLS. 1, 2, 3, 22 AND 41).

FIRST USE 5-1-2010; IN COMMERCE 5-1-2010.

## CLASS 21—HOUSEWARES AND GLASS

FOR HOUSEWARES, KITCHENWARE, DINNERWARE AND BEVERAGE WARE OF PAPER, PLASTIC, CERAMIC, GLASS OR EARTHENWARE, NAMELY, DISHES, PLATES, INSULATED AND NON-INSULATED LUNCH BOXES, NON-METAL SAVINGS PIGGY BANKS AND TOOTHBRUSHES (U.S. CLS. 2, 13, 23, 29, 30, 33, 40 AND 50).

FIRST USE 5-1-2010; IN COMMERCE 5-1-2010.

## CLASS 24—FABRICS

FOR BED BLANKETS, BED SHEETS, COMFORTERS, PILLOW CASES AND TOWELS (U.S. CLS. 42 AND 50).

FIRST USE 5-15-2010; IN COMMERCE 5-15-2010.

## CLASS 25—CLOTHING

FOR CLOTHING AND APPAREL, NAMELY, T-SHIRTS, SLEEPWEAR, SWEAT SHIRTS, GLOVES, MITTENS, PONCHOS, RAINWEAR, FOOTWEAR, HEAD WEAR, SLIPPERS, SOCKS, TIGHTS, BATHING SUITS AND FLIP FLOPS (U.S. CLS. 22 AND 39).

FIRST USE 4-1-2010; IN COMMERCE 4-1-2010.

4,046,016. CEPIA, LLC, ST. LOUIS, MO. SN 77-912,904. PUB. 7-20-2010, FILED 1-15-2010.

# ZHUZHU

THE MARK CONSISTS OF STANDARD CHARACTERS WITHOUT CLAIM TO ANY PARTICULAR FONT, STYLE, SIZE, OR COLOR.

## CLASS 9—ELECTRICAL AND SCIENTIFIC APPARATUS

FOR VIDEO GAME DISCS AND CARTRIDGES FEATURING MUSIC, STORIES, GAMES, AND ACTIVITIES FOR CHILDREN (U.S. CLS. 21, 23, 26, 36 AND 38).

FIRST USE 3-21-2010; IN COMMERCE 3-21-2010.

4,046,024. CELEXION, LLC, CAMBRIDGE, MA. SN 77-915,883. PUB. 1-11-2011, FILED 1-20-2010.

# SECANT

THE MARK CONSISTS OF STANDARD CHARACTERS WITHOUT CLAIM TO ANY PARTICULAR FONT, STYLE, SIZE, OR COLOR.

## CLASS 40—MATERIAL TREATMENT

FOR POLYPEPTIDE PRODUCTION SERVICES TO THE ORDER AND SPECIFICATION OF OTHERS (U.S. CLS. 100, 103 AND 106).

FIRST USE 12-17-2009; IN COMMERCE 12-17-2009.

**CLASS 42—SCIENTIFIC AND COMPUTER SERVICES**

FOR BIOLOGICAL AND PHARMACEUTICAL RESEARCH AND DEVELOPMENT SERVICES; CONSULTING SERVICES IN THE FIELDS OF BIOTECHNOLOGY, PHARMACEUTICAL RESEARCH AND DEVELOPMENT, LABORATORY TESTING, AND INDUSTRIAL APPLICATIONS OF BIOTECHNOLOGY; DRUG DISCOVERY SERVICES; MEDICAL RESEARCH SERVICES, NAMELY, GENERATING AND DISPLAYING RECOMBINANT POLYPEPTIDES FOR PHARMACEUTICAL USE; LABORATORY RESEARCH IN THE FIELD OF GENERATION AND SCREENING OF POLYPEPTIDES FOR ENZYMES, ANTIBODIES, BINDING PROTEINS, AND FUNCTIONAL PROTEINS; PROVIDING LABORATORY RESEARCH SERVICES IN THE BIOLOGICAL AND PHARMACEUTICAL FIELDS FEATURING CELL-SURFACE DISPLAY SERVICES; CHEMICAL RESEARCH AND DEVELOPMENT SERVICES (U.S. CLS. 100 AND 101).

FIRST USE 12-17-2009; IN COMMERCE 12-17-2009.

**CLASS 44—MEDICAL, BEAUTY AND AGRICULTURAL SERVICES**

FOR SCREENING OF RECOMBINANT POLYPEPTIDES FOR MEDICAL DIAGNOSTIC AND THERAPEUTIC PURPOSES; SCREENING LIBRARIES OF CHEMICALS AND DERIVATIVES THEREOF FOR MEDICAL DIAGNOSTIC PURPOSES (U.S. CLS. 100 AND 101).

FIRST USE 12-17-2009; IN COMMERCE 12-17-2009.

**CLASS 42—SCIENTIFIC AND COMPUTER SERVICES**

FOR DESIGN FOR OTHERS OF COMPUTER AND TELECOMMUNICATIONS SYSTEMS AND NETWORKS; INTEGRATION, CONFIGURATION, REMOTE MONITORING, SYSTEMS MANAGEMENT, ADMINISTERING, ASSESSING, ANALYZING AND REPORTING THE PERFORMANCE OF COMPUTER AND TELECOMMUNICATIONS SYSTEMS AND NETWORKS; TROUBLESHOOTING OF COMPUTER AND TELECOMMUNICATIONS SYSTEMS AND NETWORKS VIA TELEPHONE, EMAIL, REMOTE INTERNET ACCESS, AND IN-PERSON; ON-LINE PORTAL SERVICES, NAMELY, PROVIDING A WEB SITE FOR COMPUTER AND TELECOMMUNICATIONS SYSTEMS NETWORK MANAGEMENT AND REPORTING SERVICES (U.S. CLS. 100 AND 101).

FIRST USE 5-31-2010; IN COMMERCE 5-31-2011.

4,046,031. GREER LABORATORIES, INC., LENOIR, NC. SN 77-921,199. PUB. 1-25-2011, FILED 1-27-2010.



4,046,026. TELSOURCE CORPORATION, FAIRFIELD, NJ. SN 77-917,570. PUB. 8-3-2010, FILED 1-22-2010.

ACUATIVE BE READY!

THE MARK CONSISTS OF STANDARD CHARACTERS WITHOUT CLAIM TO ANY PARTICULAR FONT, STYLE, SIZE, OR COLOR.

OWNER OF U.S. REG. NOS. 3,329,805 AND 3,352,777.

**CLASS 37—CONSTRUCTION AND REPAIR**

FOR INSTALLATION AND MAINTENANCE OF COMPUTER AND TELECOMMUNICATIONS SYSTEMS AND NETWORKS (U.S. CLS. 100, 103 AND 106).

FIRST USE 5-31-2011; IN COMMERCE 5-31-2011.

**CLASS 38—COMMUNICATION**

FOR TELECOMMUNICATIONS CONSULTATION (U.S. CLS. 100, 101 AND 104).

FIRST USE 5-31-2011; IN COMMERCE 5-31-2011.

OWNER OF U.S. REG. NOS. 3,075,137, 3,147,131, AND OTHERS.

NO CLAIM IS MADE TO THE EXCLUSIVE RIGHT TO USE "THE ANIMAL ALLERGY SYSTEM", APART FROM THE MARK AS SHOWN.

THE MARK CONSISTS OF THE WORD "GREER" FOLLOWED BY THE WORD "ALLERGCMPLETE" BELOW. THE "G" IN "ALLERGCMPLETE" APPEARS IN A SHADED CIRCLE WITH A LOWER CASE "G" APPEARING IN THE CENTER. THE SHADED CIRCLE ENCLOSING THE "G" IS FURTHER ENCLOSED BY 2 LARGER CIRCLES. THE WORDS "THE ANIMAL ALLERGY SYSTEM" APPEAR BELOW THE WORD "ALLERGCMPLETE".

**CLASS 5—PHARMACEUTICALS**

FOR CHEMICAL REAGENTS FOR VETERINARY PURPOSES, NAMELY, CHEMICAL REAGENTS FOR CLINICAL VETERINARY USE; CLINICAL VETERINARY REAGENTS; DIAGNOSTIC PREPARATIONS FOR VETERINARY USE (U.S. CLS. 6, 18, 44, 46, 51 AND 52).

FIRST USE 4-1-2010; IN COMMERCE 4-1-2010.

**CLASS 10—MEDICAL APPARATUS**

FOR VETERINARY DEVICES, NAMELY, SYRINGES, VIALS AND APPLICATORS TO DELIVER VARIOUS SUBSTANCES, ALL USED IN THE DIAGNOSIS AND TREATMENT OF IMMUNOLOGIC REACTIONS (U.S. CLS. 26, 39 AND 44).

FIRST USE 4-1-2010; IN COMMERCE 4-1-2010.

**CLASS 44—MEDICAL, BEAUTY AND AGRICULTURAL SERVICES**

FOR VETERINARY SPECIALTY SERVICES, NAMELY, PROVIDING ADVANCED DIAGNOSTIC SERVICES FOR ANIMALS (U.S. CLS. 100 AND 101).

FIRST USE 4-1-2010; IN COMMERCE 4-1-2010.

4,046,040. THE FINANCIAL INFORMATION GROUP INC., EATONTOWN, NJ. SN 77-928,639. PUB. 9-14-2010, FILED 2-4-2010.

## DISCOVERY COMPANY

THE MARK CONSISTS OF STANDARD CHARACTERS WITHOUT CLAIM TO ANY PARTICULAR FONT, STYLE, SIZE, OR COLOR.

NO CLAIM IS MADE TO THE EXCLUSIVE RIGHT TO USE "COMPANY", APART FROM THE MARK AS SHOWN.

### CLASS 9—ELECTRICAL AND SCIENTIFIC APPARATUS

FOR ELECTRONIC DATABASES FEATURING INFORMATION IN THE FIELD OF FINANCIAL SERVICES PROFESSIONALS AND FIRMS RECORDED ON COMPUTER MEDIA (U.S. CLS. 21, 23, 26, 36 AND 38).

FIRST USE 5-0-2010; IN COMMERCE 5-0-2010.

### CLASS 35—ADVERTISING AND BUSINESS

FOR ADVERTISING, MARKETING AND CONSULTING SERVICES, NAMELY, PROVIDING BUSINESS DATA AND INTELLIGENCE, MARKETING AND RELATED CONSULTING SERVICES IN THE FIELD OF FINANCIAL SERVICES PROFESSIONALS AND FIRMS (U.S. CLS. 100, 101 AND 102).

FIRST USE 5-0-2010; IN COMMERCE 5-0-2010.

4,046,062. ADVANCED LITHIUM ELECTROCHEMISTRY CO., LTD., TAOYUAN COUNTY, TAIWAN. SN 77-934,337. PUB. 1-18-2011, FILED 2-12-2010.

# Edenway

THE MARK CONSISTS OF STANDARD CHARACTERS WITHOUT CLAIM TO ANY PARTICULAR FONT, STYLE, SIZE, OR COLOR.

### CLASS 9—ELECTRICAL AND SCIENTIFIC APPARATUS

FOR ACCUMULATOR BOXES; ACCUMULATOR JARS; ACCUMULATORS; BATTERIES FOR VEHICLES; BATTERY CASES; BATTERY CHARGE DEVICES; BATTERY CHARGERS; BATTERY PACKS; ELECTRIC ACCUMULATORS; ELECTRIC ACCUMULATORS FOR VEHICLES; ELECTRIC STORAGE SYSTEMS FOR CHARGING BATTERIES IN ELECTRICAL LAND VEHICLES, COMPRISED PRIMARILY OF INTERCONNECTED STORAGE BATTERIES, CAPACITORS, WIRES, CONNECTORS; ELECTRICAL STORAGE BATTERIES; ELECTRODES; POWER STORAGE CELL PACKS; GRID ENERGY STORAGE SYSTEM COMPRISED PRIMARILY OF POWER INVERTERS, AC BATTERY CHARGERS, BATTERIES, CELLS, BATTERY PACKS, ACCUMULATORS (U.S. CLS. 21, 23, 26, 36 AND 38).

FIRST USE 1-12-2010; IN COMMERCE 1-12-2011.

### CLASS 39—TRANSPORTATION AND STORAGE

FOR CAR TRANSPORT, BUS TRANSPORT, ARRANGING OF TOURS, CAR RENTAL, CARTING IN THE NATURE OF TRANSPORT OF GOODS, DELIVERY OF GOODS, FREIGHT TRANSPORTATION BY SHIP, TRAIN, TRUCK, VAN AND LAND VEHICLES, PASSENGER TRANSPORT, PASSENGER AND FREIGHT TRAIN TRANSPORT, COURIER SERVICES (U.S. CLS. 100 AND 105).

FIRST USE 1-12-2010; IN COMMERCE 1-12-2011.

4,046,068. SURVEYMONKEY.COM, LLC, PALO ALTO, CA. SN 77-934,950. PUB. 9-28-2010, FILED 2-12-2010.

## THE BEST DECISIONS START HERE

THE MARK CONSISTS OF STANDARD CHARACTERS WITHOUT CLAIM TO ANY PARTICULAR FONT, STYLE, SIZE, OR COLOR.

### CLASS 35—ADVERTISING AND BUSINESS

FOR DATA PROCESSING SERVICES, NAMELY, DATA INPUT IN CONNECTION WITH THE CREATION, MODIFICATION, UPDATING, COLLECTION, MAINTENANCE, ANALYSIS, REPORTING AND TRANSFER OF ON-LINE SINGLE- AND MULTI-PAGE SURVEYS, QUESTIONNAIRES AND OTHER DATA COLLECTION FORMATS UTILIZING A WEBSITE AND PROPRIETARY NON-DOWNLOADABLE ON-LINE SOFTWARE; RECRUITING SERVICES IN THE NATURE OF PROCUREMENT OF SURVEY PARTICIPANTS (U.S. CLS. 100, 101 AND 102).

FIRST USE 5-24-2010; IN COMMERCE 5-24-2010.

### CLASS 42—SCIENTIFIC AND COMPUTER SERVICES

FOR PROVIDING TEMPORARY USE OF ON-LINE PROPRIETARY, NON-DOWNLOADABLE SOFTWARE FOR CUSTOMER CREATION, MODIFICATION, UPDATING, COLLECTION, MAINTENANCE, ANALYSIS AND REPORTING OF ON-LINE SINGLE- OR MULTI-PAGE SURVEYS, QUESTIONNAIRES AND OTHER DATA COLLECTION FORMATS, AND PUBLISHING, EXPORTING, EMAILING, PRINTING AND TRANSFERRING SURVEYS AND SURVEY RESULTS, REPORTS AND ANALYSIS; PROVIDING SURVEY DESIGN AND RESEARCH SERVICES AND TECHNICAL SUPPORT SERVICES IN THE NATURE OF TROUBLESHOOTING OF COMPUTER SOFTWARE PROBLEMS AND WEBSITE USAGE PROBLEMS TO USERS IN CONNECTION WITH THE CREATION, MODIFICATION, UPDATING, COLLECTION, MAINTENANCE, ANALYSIS, REPORTING AND TRANSFER OF ON-LINE SINGLE- AND MULTI-PAGE SURVEYS, QUESTIONNAIRES AND OTHER DATA COLLECTION FORMATS UTILIZING A WEBSITE AND PROPRIETARY NON-DOWNLOADABLE ON-LINE SOFTWARE (U.S. CLS. 100 AND 101).

FIRST USE 5-24-2010; IN COMMERCE 5-24-2010.

4,046,070. GREER LABORATORIES, INC., LENOIR, NC. SN 77-935,942. PUB. 12-14-2010, FILED 2-15-2010.

### GREER ALLER-G-COMPLETE

THE MARK CONSISTS OF STANDARD CHARACTERS WITHOUT CLAIM TO ANY PARTICULAR FONT, STYLE, SIZE, OR COLOR.

OWNER OF U.S. REG. NOS. 917,452, 3,127,550, AND 3,147,131.

### CLASS 5—PHARMACEUTICALS

FOR CHEMICAL REAGENTS FOR VETERINARY PURPOSES, NAMELY, CHEMICAL REAGENTS FOR CLINICAL VETERINARY USE; CLINICAL VETERINARY REAGENTS; DIAGNOSTIC PREPARATIONS FOR VETERINARY USE (U.S. CLS. 6, 18, 44, 46, 51 AND 52).  
FIRST USE 4-1-2010; IN COMMERCE 4-1-2010.

### CLASS 10—MEDICAL APPARATUS

FOR VETERINARY DEVICES, NAMELY, SYRINGES, VIALS AND APPLICATORS TO DELIVER VARIOUS SUBSTANCES, ALL USED IN THE DIAGNOSIS AND TREATMENT OF IMMUNOLOGIC REACTIONS (U.S. CLS. 26, 39 AND 44).  
FIRST USE 4-1-2010; IN COMMERCE 4-1-2010.

### CLASS 44—MEDICAL, BEAUTY AND AGRICULTURAL SERVICES

FOR VETERINARY SPECIALTY SERVICES, NAMELY, PROVIDING ADVANCED DIAGNOSTIC SERVICES FOR ANIMALS (U.S. CLS. 100 AND 101).  
FIRST USE 4-1-2010; IN COMMERCE 4-1-2010.

4,046,082. BECTON, DICKINSON AND COMPANY, FRANKLIN LAKES, NJ. SN 77-939,843. PUB. 9-28-2010, FILED 2-19-2010.

### BD Assurity Linc

THE MARK CONSISTS OF STANDARD CHARACTERS WITHOUT CLAIM TO ANY PARTICULAR FONT, STYLE, SIZE, OR COLOR.

OWNER OF U.S. REG. NOS. 442,281, 2,510,232, AND OTHERS.

### CLASS 9—ELECTRICAL AND SCIENTIFIC APPARATUS

FOR COMPUTER HARDWARE AND SOFTWARE USED FOR REMOTE DIAGNOSTICS AND TROUBLESHOOTING OF LABORATORY INSTRUMENTS (U.S. CLS. 21, 23, 26, 36 AND 38).  
FIRST USE 8-15-2011; IN COMMERCE 8-15-2011.

### CLASS 42—SCIENTIFIC AND COMPUTER SERVICES

FOR CUSTOMER SUPPORT SERVICES, NAMELY, REMOTE DIAGNOSTICS AND TROUBLESHOOTING OF LABORATORY INSTRUMENTS (U.S. CLS. 100 AND 101).

FIRST USE 8-15-2011; IN COMMERCE 8-15-2011.

4,046,087. VERDE REALTY OPERATING PARTNERSHIP L.P., EL PASO, TX. SN 77-941,569. PUB. 7-20-2010, FILED 2-22-2010.



OWNER OF U.S. REG. NO. 3,309,903.

NO CLAIM IS MADE TO THE EXCLUSIVE RIGHT TO USE "SANTA TERESA", APART FROM THE MARK AS SHOWN.

### CLASS 36—INSURANCE AND FINANCIAL

FOR REAL ESTATE MANAGEMENT SERVICES; REAL ESTATE INVESTMENT OF COMMERCIAL PROPERTIES; MORTGAGE BANKING AND MORTGAGE PROCUREMENT FOR OTHERS; CONSTRUCTION FINANCING FOR HOMEBUILDERS; INSURANCE UNDERWRITING FOR HOMEBUYERS IN THE FIELDS OF HOME AND AUTO INSURANCE; TITLE INSURANCE UNDERWRITING IN THE FIELD OF REAL ESTATE; FINANCIAL SERVICES, NAMELY, PROVIDING CONSTRUCTION LOAN FINANCING FOR HOMEBUILDERS (U.S. CLS. 100, 101 AND 102).  
FIRST USE 8-0-2011; IN COMMERCE 8-0-2011.

### CLASS 37—CONSTRUCTION AND REPAIR

FOR LAND DEVELOPMENT SERVICES, NAMELY, PLANNING AND LAYING OUT OF RESIDENTIAL AND/OR COMMERCIAL COMMUNITIES, RETAIL, INDUSTRIAL AND DISTRIBUTION SPACE, AND APARTMENTS; COMMERCIAL REAL ESTATE PROPERTY DEVELOPMENT (U.S. CLS. 100, 103 AND 106).  
FIRST USE 8-0-2011; IN COMMERCE 8-0-2011.

4,046,100. AAJ COMPUTER SERVICES, INC., DBA AAJ TECHNOLOGIES, FORT LAUDERDALE, FL. SN 77-945,769. PUB. 1-11-2011, FILED 2-26-2010.



THE MARK CONSISTS OF "JET" UPPERCASE, BOLD LETTERS. THE HORIZONTAL LINE OF THE "T" IS EXTENDED TO THE RIGHT SIDE AND FADES AS IT EXTENDS TO THE RIGHT.

**CLASS 35—ADVERTISING AND BUSINESS**

FOR ELECTRONIC DATA COLLECTION AND DATA SUBMISSION SERVICES FOR BUSINESS PURPOSES IN THE FIELDS OF MEDICINE AND HEALTHCARE; HEALTHCARE MANAGEMENT SERVICE ORGANIZATION (MSO) SERVICES, NAMELY, PROVIDING PRACTICE ORGANIZATION, MANAGEMENT AND ADMINISTRATIVE SUPPORT SERVICES TO INDIVIDUAL PHYSICIANS OR SMALL GROUP PRACTICES; MANAGING THE OPERATIONS OF INSURANCE AGENCIES AND BROKERS ON AN OUTSOURCING BASIS (U.S. CLS. 100, 101 AND 102).

FIRST USE 1-1-2010; IN COMMERCE 1-1-2010.

**CLASS 36—INSURANCE AND FINANCIAL**

FOR CONSULTING AND INFORMATION CONCERNING INSURANCE; DENTAL HEALTH INSURANCE ADMINISTRATION; DENTAL HEALTH INSURANCE UNDERWRITING AND ADMINISTRATION; ELECTRONIC PROCESSING OF INSURANCE CLAIMS AND PAYMENT DATA; HEALTH INSURANCE UNDERWRITING; INSURANCE UNDERWRITING CONSULTATION; INSURANCE UNDERWRITING SERVICES FOR ALL TYPES OF INSURANCE (U.S. CLS. 100, 101 AND 102).

FIRST USE 1-1-2010; IN COMMERCE 1-1-2010.

**CLASS 42—SCIENTIFIC AND COMPUTER SERVICES**

FOR APPLICATION SERVICE PROVIDER (ASP) FEATURING SOFTWARE FOR USE IN BUSINESS PROCESS AUTOMATION BY COMMERCIAL BUSINESSES; APPLICATION SERVICE PROVIDER FEATURING APPLICATION PROGRAMMING INTERFACE (API) SOFTWARE FOR ALLOWING DATA RETRIEVAL, UPLOAD, ACCESS AND MANAGEMENT; APPLICATION SERVICE PROVIDER FEATURING APPLICATION PROGRAMMING INTERFACE (API) SOFTWARE FOR USE IN BUILDING SOFTWARE APPLICATIONS; APPLICATION SERVICE PROVIDER, NAMELY, PROVIDING, HOSTING, MANAGING, DEVELOPING, AND MAINTAINING APPLICATIONS, SOFTWARE, WEB SITES, AND DATABASES IN THE FIELDS OF PERSONAL PRODUCTIVITY, WIRELESS COMMUNICATION, MOBILE INFORMATION ACCESS, AND REMOTE DATA MANAGEMENT FOR WIRELESS DELIVERY OF CONTENT TO HANDHELD COMPUTERS, LAPTOPS AND MOBILE ELECTRONIC DEVICES; APPLICATION SERVICE PROVIDER, NAMELY, PROVIDING, HOSTING, MANAGING, DEVELOPING, RESEARCHING, ANALYZING, REPORTING, AND MAINTAINING APPLICATIONS, SOFTWARE, WEB SITES, AND DATABASES OF OTHERS IN THE FIELDS OF HEALTHCARE, BENEFITS PROGRAMS, EMPLOYEE PRODUCTIVITY, RISK MANAGEMENT; APPLICATION SERVICE PROVIDER, NAMELY, PROVIDING, HOSTING, MANAGING, DEVELOPING, RESEARCHING, TRACKING, ANALYZING, REPORTING, AND MAINTAINING APPLICATIONS, SOFTWARE, WEB SITES, AND DATABASES OF OTHERS IN THE FIELDS OF ADVERTISING AND MARKETING; BUSINESS TECHNOLOGY SOFTWARE CONSULTATION SERVICES; CLOUD COMPUTING FEATURING SOFTWARE FOR USE IN BUSINESS PROCESS AUTOMATION BY COMMERCIAL BUSINESSES; COMPUTER HARDWARE AND SOFTWARE CONSULTING SERVICES; COMPUTER HARDWARE AND SOFTWARE DESIGN; COMPUTER PROGRAMMING AND SOFTWARE DESIGN; COMPUTER SOFTWARE CONSULTANCY; COMPUTER SOFTWARE CONSULTATION; COMPUTER SOFTWARE CONSULTING; COMPUTER SOFTWARE DEVELOPMENT; COMPUTER SOFTWARE DEVELOPMENT AND COMPUTER PROGRAMMING DEVELOPMENT FOR OTHERS; COMPUTER SOFTWARE DEVELOPMENT IN THE FIELD OF MOBILE APPLICATIONS; CONSULTANCY IN THE FIELD OF SOFTWARE DESIGN; CONSULTATION SERVICES IN THE FIELDS OF SELECTION, IMPLEMENTATION AND USE OF COMPUTER HARDWARE AND SOFTWARE SYSTEMS FOR OTHERS; CONSULTING IN THE FIELD OF CONFIGURATION MANAGEMENT FOR COMPUTER HARDWARE AND SOFTWARE; CONSULTING IN THE FIELD OF SOFTWARE AND PRODUCT DEVELOPMENT IN THE FIELD OF BUSINESS PROCESS AUTOMATION FOR USE IN HEALTHCARE GOVERNMENT, EDUCATION AND OTHER COMMERCIAL BUSI-

NESSES. CONSULTING IN THE FIELD OF SOFTWARE DEVELOPMENT AND PRODUCT DEVELOPMENT IN THE FIELD OF BUSINESS PROCESS AUTOMATION FOR USE IN HEALTHCARE GOVERNMENT, EDUCATION AND OTHER COMMERCIAL BUSINESSES. CONSULTING IN THE FIELD OF SOFTWARE DEVELOPMENT IN THE FIELD OF BUSINESS PROCESS AUTOMATION FOR USE IN HEALTHCARE GOVERNMENT, EDUCATION AND OTHER COMMERCIAL BUSINESSES. CONSULTING SERVICES IN THE FIELD OF DESIGN, SELECTION, IMPLEMENTATION AND USE OF COMPUTER HARDWARE AND SOFTWARE SYSTEMS FOR OTHERS; CONSULTING SERVICES IN THE FIELD OF HOSTING COMPUTER SOFTWARE APPLICATIONS; CONSULTING SERVICES IN THE FIELD OF SOFTWARE AS A SERVICE (SAAS); CREATION, DESIGN, DEVELOPMENT AND MAINTENANCE OF WEB SITES FOR THIRD PARTIES; CUSTOMIZED SOFTWARE DEVELOPMENT SERVICES; DATA AUTOMATION AND COLLECTION SERVICE USING PROPRIETARY SOFTWARE TO EVALUATE, ANALYZE AND COLLECT SERVICE DATA; DEBUGGING COMPUTER SOFTWARE FOR OTHERS; DESIGN AND DEVELOPMENT OF COMPUTER SOFTWARE; DESIGN AND DEVELOPMENT OF COMPUTER SOFTWARE FOR THE IMPROVEMENTS OF PURCHASING FUNCTIONS OF BUSINESS; DESIGN AND DEVELOPMENT OF COMPUTERS AND PROGRAMS FOR COMPUTERS; DESIGN AND DEVELOPMENT OF MULTIMEDIA PRODUCTS; DESIGN AND DEVELOPMENT OF NETWORKS; DESIGN AND DEVELOPMENT OF ON-LINE COMPUTER SOFTWARE SYSTEMS; DESIGN AND IMPLEMENTATION OF SOFTWARE AND TECHNOLOGY SOLUTIONS FOR THE PURPOSE OF PRODUCT AND DOCUMENT AUTHENTICATION AND TRACKING, AND BRAND MONITORING AND PROTECTION, TO PROTECT AGAINST COUNTERFEITING, TAMPERING, AND DIVERSION, AND TO ENSURE THE INTEGRITY OF GENUINE PRODUCTS AND DOCUMENTS; DESIGN AND TESTING FOR NEW PRODUCT DEVELOPMENT; DESIGN OF HOME PAGES, COMPUTER SOFTWARE AND WEB SITES; DESIGN, DEVELOPMENT AND CONSULTING SERVICES IN THE FIELD OF SOFTWARE FOR CONTENT MANAGEMENT; DESIGN, DEVELOPMENT AND IMPLEMENTATION OF SOFTWARE; DESIGN, INSTALLATION, UPDATING AND MAINTENANCE OF COMPUTER SOFTWARE; DESIGN, MAINTENANCE, DEVELOPMENT AND UPDATING OF COMPUTER SOFTWARE; DESIGNING AND DEVELOPING WEBPAGES ON THE INTERNET; DEVELOPING AND UPDATING COMPUTER SOFTWARE; DEVELOPING COMPUTER SOFTWARE; DEVELOPMENT OF DATA PROCESSING PROGRAMS BY ORDER OF THIRD PARTIES; DEVELOPMENT, DESIGN AND UPDATING OF HOME PAGES; INSTALLATION OF COMPUTER SOFTWARE; MAINTENANCE AND UPDATING OF COMPUTER SOFTWARE; MAINTENANCE AND UPGRADING OF COMPUTER SOFTWARE; MAINTENANCE OF COMPUTER SOFTWARE; PRODUCT DEVELOPMENT; PRODUCT DEVELOPMENT CONSULTATION; PRODUCT DEVELOPMENT FOR OTHERS; PROGRAMMING OF COMPUTER SOFTWARE FOR OTHERS; PROVIDING A WEBSITE THAT GIVES COMPUTER USERS THE ABILITY TO SUBSCRIBE TO ONLINE PUBLICATIONS PERMITTING SEARCHES OF BUILDING CODES AND STANDARDS; SOFTWARE AS A SERVICE (SAAS) SERVICES FEATURING SOFTWARE IN THE FIELD OF BUSINESS PROCESS AUTOMATION FOR USE IN HEALTHCARE GOVERNMENT, EDUCATION AND OTHER COMMERCIAL BUSINESSES; SOFTWARE DESIGN AND DEVELOPMENT; SOFTWARE DEVELOPMENT AND PRODUCT DEVELOPMENT IN THE FIELD OF BUSINESS PROCESS AUTOMATION FOR USE IN HEALTHCARE GOVERNMENT, EDUCATION AND OTHER COMMERCIAL BUSINESSES. SOFTWARE DEVELOPMENT FOR OTHERS IN THE FIELD OF SOFTWARE CONFIGURATION MANAGEMENT; SOFTWARE DEVELOPMENT IN THE FIELD OF BUSINESS PROCESS AUTOMATION FOR USE IN HEALTHCARE GOVERNMENT, EDUCATION AND OTHER COMMERCIAL BUSINESSES; UP-DATING OF COMPUTER SOFTWARE; UPDATING AND DESIGN OF COMPUTER SOFTWARE; WRITING AND UPDATING COMPUTER SOFTWARE (U.S. CLS. 100 AND 101).

FIRST USE 1-1-2010; IN COMMERCE 1-1-2010.

**CLASS 44—MEDICAL, BEAUTY AND AGRICULTURAL SERVICES**

FOR HEALTHCARE (U.S. CLS. 100 AND 101).  
FIRST USE 1-1-2010; IN COMMERCE 1-1-2010.

4,046,116. UNIVERSAL PRODUCTS, INC., ROCK HILL, SC.  
SN 77-950,401. PUB. 7-27-2010, FILED 3-4-2010.

#### **CLASS 45—PERSONAL AND LEGAL SERVICES**

FOR CONSULTING SERVICES IN THE FIELD OF LISTING AND TRACKING OF FOREIGN AND DOMESTIC GOVERNMENT REGULATORY REQUIREMENTS, FOR OBTAINING PERMITS AND REGULATORY COMPLIANCE; PERMITTING, NAMELY, OBTAINING ENVIRONMENTAL, DESIGN, ZONING AND OTHER GOVERNMENTAL PERMITS FOR DEVELOPMENT PROJECTS (U.S. CLS. 100 AND 101).

FIRST USE 1-1-2010; IN COMMERCE 1-1-2010.



THE MARK CONSISTS OF THE STYLIZED TEXT "DURALINK" WITH TWO CABLES LINKED TOGETHER AND TWISTED.

4,046,109. ACADEMY OF MANAGED CARE PHARMACY,  
ALEXANDRIA, VA. SN 77-948,359. PUB. 3-22-2011,  
FILED 3-2-2010.

#### **CLASS 6—METAL GOODS**

FOR METAL CHAINLINK FENCING (U.S. CLS. 2, 12,  
13, 14, 23, 25 AND 50).

FIRST USE 3-1-2010; IN COMMERCE 3-1-2010.

#### **AMCP/APhA MTM Connections**

THE MARK CONSISTS OF STANDARD CHARACTERS WITHOUT CLAIM TO ANY PARTICULAR FONT, STYLE, SIZE, OR COLOR.

OWNER OF U.S. REG. NOS. 1,936,371, 2,314,200, AND OTHERS.

#### **CLASS 20—FURNITURE AND ARTICLES NOT OTHERWISE CLASSIFIED**

FOR DOG KENNELS (U.S. CLS. 2, 13, 22, 25, 32 AND 50).

FIRST USE 3-1-2010; IN COMMERCE 3-1-2010.

#### **CLASS 9—ELECTRICAL AND SCIENTIFIC APPARATUS**

FOR DOWNLOADABLE ELECTRONIC PUBLICATIONS IN THE NATURE OF ARTICLES, STUDIES, PAPERS, BRIEFS, DIGESTS, NEWS RELEASES AND OTHER DOCUMENTS RELATING TO MEDICATION THERAPY MANAGEMENT SERVICES AND PHARMACISTS ROLE IN PATIENT CARE (U.S. CLS. 21, 23, 26, 36 AND 38).

FIRST USE 5-14-2010; IN COMMERCE 5-14-2010.

4,046,119. KONAMI DIGITAL ENTERTAINMENT CO.,  
LTD., TOKYO, JAPAN. SN 77-951,975. PUB. 12-21-2010,  
FILED 3-5-2010.

#### **BOBBLEHEAD PROS**

#### **CLASS 35—ADVERTISING AND BUSINESS**

FOR PROVIDING ON-LINE SEARCHABLE DATABASE FEATURING INFORMATION ABOUT HEALTH PLANS AND HEALTH PRACTITIONERS, NAMELY, MEDICAL REFERRALS INFORMATION FOR HEALTH PLANS AND HEALTH PRACTITIONERS WHO PROVIDE MEDICATION THERAPY MANAGEMENT SERVICES; PROVIDING ON-LINE SEARCHABLE DATABASE FEATURING BUSINESS INFORMATION AND BUSINESS CONTACTS, NAMELY, BUSINESS CONTACT INFORMATION FOR HEALTH PLANS AND HEALTH PRACTITIONERS THAT PROVIDE MEDICATION THERAPY MANAGEMENT SERVICES (U.S. CLS. 100, 101 AND 102).

FIRST USE 5-14-2010; IN COMMERCE 5-14-2010.

THE MARK CONSISTS OF STANDARD CHARACTERS WITHOUT CLAIM TO ANY PARTICULAR FONT, STYLE, SIZE, OR COLOR.

NO CLAIM IS MADE TO THE EXCLUSIVE RIGHT TO USE "BOBBLEHEAD", APART FROM THE MARK AS SHOWN.

#### **CLASS 9—ELECTRICAL AND SCIENTIFIC APPARATUS**

FOR VIDEO GAME SOFTWARE; VIDEO GAME PROGRAMS; COMPUTER GAME SOFTWARE; COMPUTER GAME PROGRAMS; ELECTRONIC GAME PROGRAMS (U.S. CLS. 21, 23, 26, 36 AND 38).

FIRST USE 7-6-2011; IN COMMERCE 7-6-2011.

#### **CLASS 44—MEDICAL, BEAUTY AND AGRICULTURAL SERVICES**

FOR PROVIDING AN ON-LINE SEARCHABLE DATABASE FEATURING INFORMATION IN THE FIELD OF HEALTH AND WELLNESS, NAMELY, ARTICLES, STUDIES, PAPERS, BRIEFS, DIGESTS, NEWS RELEASES AND OTHER DOCUMENTS RELATING TO MEDICATION THERAPY MANAGEMENT SERVICES AND PHARMACISTS ROLE IN PATIENT CARE (U.S. CLS. 100 AND 101).

FIRST USE 5-14-2010; IN COMMERCE 5-14-2010.

#### **CLASS 41—EDUCATION AND ENTERTAINMENT**

FOR ENTERTAINMENT SERVICES, NAMELY, PROVIDING ONLINE COMPUTER GAMES ACCESSIBLE VIA VIDEO GAME MACHINES AND COMPUTERS; PROVIDING ONLINE COMPUTER GAMES VIA NETWORK BETWEEN COMMUNICATIONS NETWORKS AND COMPUTERS (U.S. CLS. 100, 101 AND 107).

FIRST USE 7-6-2011; IN COMMERCE 7-6-2011.

4,046,120. INTERMEDIA SURVEY INSTITUTE, AKA INTERMEDIA, WASHINGTON, DC. SN 77-952,763. PUB. 3-1-2011, FILED 3-8-2010.

## AudienceScapes

THE MARK CONSISTS OF STANDARD CHARACTERS WITHOUT CLAIM TO ANY PARTICULAR FONT, STYLE, SIZE, OR COLOR.

### CLASS 9—ELECTRICAL AND SCIENTIFIC APPARATUS

FOR DOWNLOADABLE ELECTRONIC PUBLICATIONS, NAMELY, REPORTS AND DATA SETS FOR LICENSING, FEATURING CONSUMER OPINIONS REGARDING A CONSUMER'S USE OF VARIOUS MEDIA, NAMELY, RADIO, TELEVISION, INTERNET, MOBILE PHONES AND PRINTED MEDIA, SPECIFICALLY NEWSPAPERS, MAGAZINES, BROCHURES, PAMPHLETS, AND LEAFLETS, ALL VIA A WEBSITE (U.S. CLS. 21, 23, 26, 36 AND 38).

FIRST USE 10-20-2009; IN COMMERCE 1-1-2010.

### CLASS 35—ADVERTISING AND BUSINESS

FOR PROVIDING A WEBSITE THAT OFFERS CONSUMER, MARKET, AND PUBLIC OPINION SURVEYS TO NONPROFIT ORGANIZATIONS, GOVERNMENT AGENCIES, BUSINESSES AND ACADEMIC INSTITUTIONS, AND CONSULTING SERVICES REGARDING CONSUMER RESEARCH ABOUT A CONSUMER'S USE OF VARIOUS MEDIA, NAMELY, RADIO, TELEVISION, INTERNET, MOBILE PHONES AND PRINTED MEDIA, SPECIFICALLY NEWSPAPERS, MAGAZINES, BROCHURES, PAMPHLETS, AND LEAFLETS; PROVISION OF CONSUMER MARKETING RESEARCH VIA A WEBSITE (U.S. CLS. 100, 101 AND 102).

FIRST USE 10-20-2009; IN COMMERCE 1-1-2010.

### CLASS 42—SCIENTIFIC AND COMPUTER SERVICES

FOR PROVIDING AN INTERACTIVE WEBSITE THAT ENABLES USERS TO ENTER, ACCESS, TRACK, MANAGE, MONITOR, AND GENERATE INFORMATION AND REPORTS REGARDING THE RESULTS OF RESEARCH-DRIVEN SURVEYS (U.S. CLS. 100 AND 101).

FIRST USE 10-20-2009; IN COMMERCE 1-1-2010.

---

4,046,128. UNITED COMMUNICATIONS CORPORATION, KENOSHA, WI. SN 77-954,175. PUB. 3-29-2011, FILED 3-9-2010.

## A SOURCE OF TRUST

THE MARK CONSISTS OF STANDARD CHARACTERS WITHOUT CLAIM TO ANY PARTICULAR FONT, STYLE, SIZE, OR COLOR.

### CLASS 9—ELECTRICAL AND SCIENTIFIC APPARATUS

FOR DOWNLOADABLE ELECTRONIC PUBLICATIONS IN THE NATURE OF NEWSPAPERS FEATURING GENERAL AND LOCAL NEWS, AND INFORMATION OF INTEREST TO SPECIFIC GEOGRAPHICAL AREAS; DOWNLOADABLE ELECTRONIC PUBLICATIONS IN THE NATURE OF NEWSPAPERS IN THE FIELD OF LOCAL SPORTS NEWS AND INFORMATION; DOWNLOADABLE ELECTRONIC PUBLICATIONS IN THE NATURE OF MAGAZINES IN THE FIELD OF SPECIALIZED WOMAN'S MAGAZINE; DOWNLOADABLE ELECTRONIC PUBLICATIONS IN THE NATURE OF MAGAZINES IN THE FIELD OF SPECIALIZED MATURE ADULT'S MAGAZINE; DOWNLOADABLE ELECTRONIC PUBLICATIONS IN THE NATURE OF BOOKLETS IN THE FIELD OF RESTAURANT MENUS IN A SPECIFIC GEOGRAPHICAL AREA; DOWNLOADABLE ELECTRONIC PUBLICATIONS IN THE NATURE OF CLASSIFIED ADVERTISEMENTS IN THE FIELD OF JOBS AVAILABLE IN A SPECIFIC GEOGRAPHICAL AREA; DOWNLOADABLE ELECTRONIC PUBLICATIONS IN THE NATURE OF CLASSIFIED ADVERTISEMENTS IN THE FIELD OF AUTOMOBILES IN LOCAL INVENTORY, AUTOMOBILE RESEARCH, AND AUTOMOBILE FEATURES; DOWNLOADABLE ELECTRONIC PUBLICATIONS IN THE NATURE OF CLASSIFIED ADVERTISEMENTS IN THE FIELD OF PROPERTY FOR SALE IN A SPECIFIC GEOGRAPHICAL AREA, INCLUDING PROPERTY MAP LOCATIONS; DOWNLOADABLE ELECTRONIC INTERACTIVE CALCULATORS FOR USE IN THE DETERMINATION OF MORTGAGE PAYMENTS (U.S. CLS. 21, 23, 26, 36 AND 38).

FIRST USE 8-12-2010; IN COMMERCE 8-12-2010.

### CLASS 16—PAPER GOODS AND PRINTED MATTER

FOR PRINTED PUBLICATIONS, NAMELY, NEWSPAPERS FOR GENERAL CIRCULATION; MAGAZINES FEATURING INFORMATION OF INTEREST TO WOMEN; MAGAZINES FEATURING INFORMATION OF INTEREST TO MATURE ADULTS, BOOKLETS FEATURING DOZENS OF RESTAURANT MENUS; PHOTOGRAPHS (U.S. CLS. 2, 5, 22, 23, 29, 37, 38 AND 50).

FIRST USE 8-12-2010; IN COMMERCE 8-12-2010.

### CLASS 36—INSURANCE AND FINANCIAL

FOR PROVIDING REAL ESTATE LISTINGS AND REAL ESTATE INFORMATION VIA THE INTERNET (U.S. CLS. 100, 101 AND 102).

FIRST USE 2-21-2009; IN COMMERCE 2-21-2009.



**CLASS 41—EDUCATION AND ENTERTAINMENT**

FOR PROVIDING NON-DOWNLOADABLE ELECTRONIC PUBLICATIONS IN THE NATURE OF NEWSPAPERS FEATURING GENERAL AND LOCAL NEWS, AND INFORMATION OF INTEREST TO SPECIFIC GEOGRAPHICAL AREAS; PROVIDING NON-DOWNLOADABLE ELECTRONIC PUBLICATIONS IN THE NATURE OF NEWSPAPERS IN THE FIELD OF LOCAL SPORTS NEWS AND INFORMATION; PROVIDING NON-DOWNLOADABLE ELECTRONIC PUBLICATIONS IN THE NATURE OF MAGAZINES IN THE FIELD OF SPECIALIZED WOMAN'S MAGAZINE; PROVIDING NON-DOWNLOADABLE ELECTRONIC PUBLICATIONS IN THE NATURE OF MAGAZINES IN THE FIELD OF SPECIALIZED MATURE ADULT'S MAGAZINE; PROVIDING NON-DOWNLOADABLE ELECTRONIC PUBLICATIONS IN THE NATURE OF BOOKLETS IN THE FIELD OF RESTAURANT MENUS IN A SPECIFIC GEOGRAPHICAL AREA; PROVIDING NON-DOWNLOADABLE ELECTRONIC PUBLICATIONS IN THE NATURE OF CLASSIFIED ADVERTISEMENTS IN THE FIELD OF JOBS AVAILABLE IN A SPECIFIC GEOGRAPHICAL AREA; PROVIDING NON-DOWNLOADABLE ELECTRONIC PUBLICATIONS IN THE NATURE OF CLASSIFIED ADVERTISEMENTS FEATURING AUTOMOBILES IN LOCAL INVENTORY, AUTOMOBILE RESEARCH, AND AUTOMOBILE FEATURES; PROVIDING NON-DOWNLOADABLE ELECTRONIC PUBLICATIONS IN THE NATURE OF CLASSIFIED ADVERTISEMENTS FEATURING PROPERTY FOR SALE IN A SPECIFIC GEOGRAPHICAL AREA, INCLUDING PROPERTY MAP LOCATIONS (U.S. CLS. 100, 101 AND 107).  
FIRST USE 2-21-2009; IN COMMERCE 2-21-2009.

4,046,135. BLOSSOM BUCKET, INC., NORTH LAWRENCE, OH. SN 77-958,122. PUB. 7-13-2010, FILED 3-12-2010.

**GIFTS THAT CELEBRATE THE JOURNEY**

THE MARK CONSISTS OF STANDARD CHARACTERS WITHOUT CLAIM TO ANY PARTICULAR FONT, STYLE, SIZE, OR COLOR.

**CLASS 20—FURNITURE AND ARTICLES NOT OTHERWISE CLASSIFIED**

FOR HOME DECORATING AND HOME DECOR PRODUCTS, NAMELY, STATUETTES AND FIGURINES OF WOOD, PLASTIC RESINS AND FABRIC (U.S. CLS. 2, 13, 22, 25, 32 AND 50).  
FIRST USE 2-28-2011; IN COMMERCE 2-28-2011.

**CLASS 27—FLOOR COVERINGS**

FOR HOME DECORATING AND HOME DECOR PRODUCTS, NAMELY, PLASTIC RESIN AND WOOD WALL HANGINGS (U.S. CLS. 19, 20, 37, 42 AND 50).  
FIRST USE 2-28-2011; IN COMMERCE 2-28-2011.

4,046,136. 2TINGA INC., KITCHENER, ONATRIO, CANADA. SN 77-958,668. PUB. 12-28-2010, FILED 3-15-2010.

**2TINGA**

THE MARK CONSISTS OF STANDARD CHARACTERS WITHOUT CLAIM TO ANY PARTICULAR FONT, STYLE, SIZE, OR COLOR.

PRIORITY CLAIMED UNDER SEC. 44(D) ON CANADA APPLICATION NO. 1471692, FILED 3-3-2010.

**CLASS 12—VEHICLES**

FOR BOATS (U.S. CLS. 19, 21, 23, 31, 35 AND 44).  
FIRST USE 3-0-2011; IN COMMERCE 4-0-2011.

**CLASS 35—ADVERTISING AND BUSINESS**

FOR WHOLESALE AND RETAIL STORE SERVICES FEATURING BOATS (U.S. CLS. 100, 101 AND 102).  
FIRST USE 3-0-2011; IN COMMERCE 3-0-2011.

4,046,148. NONNEL'S SERVICES, LLC, CHICAGO, IL. SN 77-961,332. PUB. 2-1-2011, FILED 3-17-2010.

**(|)talkLoss**

THE MARK CONSISTS OF THREE VARYING SIZED PARENTHESES SYMBOLIZING COMMUNICATION OR TALKING FOLLOWED BY THE WORD "TALKLOSS".

**CLASS 42—SCIENTIFIC AND COMPUTER SERVICES**

FOR COMPUTER SERVICES, NAMELY, CREATING AN ON-LINE COMMUNITY FOR REGISTERED USERS TO PARTICIPATE IN DISCUSSIONS, GET FEEDBACK FROM THEIR PEERS, FORM VIRTUAL COMMUNITIES, AND ENGAGE IN SOCIAL NETWORKING FEATURING AFTERCARE AND SUPPORT FOR THOSE GRIEVING THE DEATH OF FAMILY MEMBERS OR OTHERS; APPLICATION SERVICE PROVIDER (ASP) FEATURING SOFTWARE FOR USE IN UPLOADING, POSTING, SHOWING, DISPLAYING, AND TAGGING PHOTOGRAPHS, AND CREATING AND MAINTAINING BLOGS; AND PROVIDING TEMPORARY USE OF NON-DOWNLOADABLE SOFTWARE APPLICATIONS FOR USE IN POSTING AND SEARCHING CLASSIFIED ADS, CREATING AN ON-LINE VIRTUAL COMMUNITY, ENGAGING IN SOCIAL NETWORKING, PHOTO SHARING, VIDEO SHARING, AND TRANSMISSION OF PHOTOGRAPHIC IMAGES (U.S. CLS. 100 AND 101).  
FIRST USE 1-1-2011; IN COMMERCE 1-1-2011.

**CLASS 45—PERSONAL AND LEGAL SERVICES**

FOR ON-LINE SOCIAL NETWORKING SERVICES (U.S. CLS. 100 AND 101).  
FIRST USE 1-1-2011; IN COMMERCE 1-1-2011.

4,046,149. NONNEL'S SERVICES, LLC, CHICAGO, IL. SN 77-961,435. PUB. 2-1-2011, FILED 3-17-2010.



THE MARK CONSISTS OF THREE VARYING SIZED PARENTHESES SYMBOLIZING COMMUNICATION OR TALKING FOLLOWED BY THE LETTER "T".

**CLASS 42—SCIENTIFIC AND COMPUTER SERVICES**

FOR COMPUTER SERVICES, NAMELY, CREATING AN ON-LINE COMMUNITY FOR REGISTERED USERS TO PARTICIPATE IN DISCUSSIONS, GET FEEDBACK FROM THEIR PEERS, FORM VIRTUAL COMMUNITIES, AND ENGAGE IN SOCIAL NETWORKING FEATURING AFTERCARE AND SUPPORT FOR THOSE GRIEVING THE DEATH OF FAMILY MEMBERS OR OTHERS; APPLICATION SERVICE PROVIDER (ASP) FEATURING SOFTWARE FOR USE IN UPLOADING, POSTING, SHOWING, DISPLAYING, AND TAGGING PHOTOGRAPHS, AND CREATING AND MAINTAINING BLOGS; AND PROVIDING TEMPORARY USE OF NON-DOWNLOADABLE SOFTWARE APPLICATIONS FOR USE IN POSTING AND SEARCHING CLASSIFIED ADS, CREATING AN ON-LINE VIRTUAL COMMUNITY, ENGAGING IN SOCIAL NETWORKING, PHOTO SHARING, VIDEO SHARING, AND TRANSMISSION OF PHOTOGRAPHIC IMAGES (U.S. CLS. 100 AND 101).  
FIRST USE 1-1-2011; IN COMMERCE 1-1-2011.

**CLASS 45—PERSONAL AND LEGAL SERVICES**

FOR ON-LINE SOCIAL NETWORKING SERVICES (U.S. CLS. 100 AND 101).  
FIRST USE 1-1-2011; IN COMMERCE 1-1-2011.

---

4,046,150. HONEYWELL INTERNATIONAL INC., MORRISTOWN, NJ. SN 77-961,709. PUB. 12-14-2010, FILED 3-17-2010.



THE MARK CONSISTS OF STANDARD CHARACTERS WITHOUT CLAIM TO ANY PARTICULAR FONT, STYLE, SIZE, OR COLOR.

NO CLAIM IS MADE TO THE EXCLUSIVE RIGHT TO USE "EARTH", APART FROM THE MARK AS SHOWN.

**CLASS 35—ADVERTISING AND BUSINESS**

FOR PROMOTING PUBLIC AWARENESS OF ENVIRONMENTAL AND ENERGY CONSERVATION FOR SCHOOLS, EDUCATIONAL INSTITUTIONS, MUNICIPALITIES, HOSPITALS, BUSINESSES, AND PUBLIC HOUSING (U.S. CLS. 100, 101 AND 102).  
FIRST USE 12-31-2010; IN COMMERCE 12-31-2010.

**CLASS 41—EDUCATION AND ENTERTAINMENT**

FOR EDUCATIONAL SERVICES, NAMELY, CONDUCTING CLASSES, SEMINARS, AND WORKSHOPS, LIVE AND ONLINE, IN THE FIELD OF ENVIRONMENTAL AND ENERGY CONSERVATION (U.S. CLS. 100, 101 AND 107).  
FIRST USE 10-31-2010; IN COMMERCE 10-31-2010.

**CLASS 42—SCIENTIFIC AND COMPUTER SERVICES**

FOR PROVIDING A WEBSITE FEATURING SCIENTIFIC INFORMATION ABOUT ENVIRONMENTAL AND ENERGY CONSERVATION (U.S. CLS. 100 AND 101).  
FIRST USE 4-30-2010; IN COMMERCE 4-30-2010.

---

4,046,151. HONEYWELL INTERNATIONAL INC., MORRISTOWN, NJ. SN 77-961,715. PUB. 12-21-2010, FILED 3-17-2010.



NO CLAIM IS MADE TO THE EXCLUSIVE RIGHT TO USE "EARTH", APART FROM THE MARK AS SHOWN.  
THE MARK CONSISTS OF THE WORDS "ACT" AND "EARTH" WITH THE IMAGE OF A LEAF.

**CLASS 35—ADVERTISING AND BUSINESS**

FOR PROMOTING PUBLIC AWARENESS OF ENVIRONMENTAL AND ENERGY CONSERVATION FOR SCHOOLS, EDUCATIONAL INSTITUTIONS, MUNICIPALITIES, HOSPITALS, BUSINESSES, AND PUBLIC HOUSING (U.S. CLS. 100, 101 AND 102).  
FIRST USE 12-31-2010; IN COMMERCE 12-31-2010.

**CLASS 41—EDUCATION AND ENTERTAINMENT**

FOR EDUCATIONAL SERVICES, NAMELY, CONDUCTING CLASSES, SEMINARS, AND WORKSHOPS, LIVE AND ONLINE, IN THE FIELD OF ENVIRONMENTAL AND ENERGY CONSERVATION (U.S. CLS. 100, 101 AND 107).  
FIRST USE 10-31-2010; IN COMMERCE 10-31-2010.

**CLASS 42—SCIENTIFIC AND COMPUTER SERVICES**

FOR PROVIDING A WEBSITE FEATURING SCIENTIFIC INFORMATION ABOUT ENVIRONMENTAL AND ENERGY CONSERVATION (U.S. CLS. 100 AND 101).  
FIRST USE 4-30-2010; IN COMMERCE 4-30-2010.

4,046,153. BARSUM FASHION GROUP, INC., BEVERLY HILLS, CA. SN 77-963,685. PUB. 8-10-2010, FILED 3-19-2010.

## FARBOD BARSUM

THE MARK CONSISTS OF STANDARD CHARACTERS WITHOUT CLAIM TO ANY PARTICULAR FONT, STYLE, SIZE, OR COLOR.

THE NAME "FARBOD BARSUM" IDENTIFIES A LIVING INDIVIDUAL WHOSE CONSENT IS OF RECORD.

### CLASS 18—LEATHER GOODS

FOR DUFFEL BAGS; HANDBAGS; WALLETS (U.S. CLS. 1, 2, 3, 22 AND 41).

FIRST USE 6-30-2011; IN COMMERCE 8-29-2011.

### CLASS 25—CLOTHING

FOR BELTS; DRESSES; JACKETS; JEANS; PANTS; SHOES; SHORTS; SKIRTS; SWEAT SHIRTS; T-SHIRTS; TANK TOPS (U.S. CLS. 22 AND 39).

FIRST USE 6-30-2011; IN COMMERCE 8-29-2011.

### CLASS 28—TOYS AND SPORTING GOODS

FOR EXERCISE EQUIPMENT FOR FITNESS PURPOSES, NAMELY, EXERCISE APPARATUSES COMPRISING VARIOUS DEVICES SPECIALLY ADAPTED TO ATTACH TO SPECIFIC PARTS OF THE USER'S BODY WITH A LASER AFFIXED FOR USE IN TRACKING MOVEMENT AND POSITION OF THE USER, FOR PURPOSES OF CONDITIONING AND TONING THE BODY (U.S. CLS. 22, 23, 38 AND 50).

FIRST USE 2-23-2011; IN COMMERCE 2-23-2011.

4,046,165. CANTOR FITZGERALD SECURITIES, NEW YORK, NY. SN 77-981,149. PUB. 4-13-2010, FILED 9-5-2007.

## CANTORCO2E

4,046,160. LASER MOTION SYSTEMS, LLC, SANTA BARBARA, CA. SN 77-968,200. PUB. 1-25-2011, FILED 3-25-2010.



THE MARK CONSISTS OF A MAN IN AN ATHLETIC STANCE WITH ARMS EXTENDED HOLDING A RIBBON THAT CIRCUMSCIBES HIS BODY FORMING A FIGURE EIGHT.

### CLASS 10—MEDICAL APPARATUS

FOR EXERCISE EQUIPMENT FOR PHYSICAL REHABILITATION AND THERAPY, NAMELY, PHYSICAL EXERCISE APPARATUS, FOR MEDICAL PURPOSES (U.S. CLS. 26, 39 AND 44).

FIRST USE 2-23-2011; IN COMMERCE 2-23-2011.

THE MARK CONSISTS OF STANDARD CHARACTERS WITHOUT CLAIM TO ANY PARTICULAR FONT, STYLE, SIZE, OR COLOR.

PRIORITY CLAIMED UNDER SEC. 44(D) ON ERPN CMNTY TM OFC APPLICATION NO. 005762695, FILED 3-6-2007.

OWNER OF U.S. REG. NOS. 1,878,866, 2,895,713, AND OTHERS.

### CLASS 36—INSURANCE AND FINANCIAL

FOR FINANCIAL SERVICES, NAMELY, CONSULTANCY, ADVISORY, AND INFORMATIONAL SERVICES; FINANCIAL TRANSACTIONAL SERVICES IN THE NATURE OF EQUITY AND CARBON FINANCING; BROKERAGE SERVICES FOR TRANSACTING AND TRADING OF FINANCIAL INSTRUMENTS; PROVIDING ENVIRONMENTAL BROKERAGE SERVICES IN THE FIELDS OF ENERGY, ENVIRONMENTAL EMISSION ALLOWANCES, SUSTAINABLE GREENHOUSE GAS OFFSETS AND RELATED SECURITIES AND COMMODITIES; BROKERAGE SERVICES IN THE FIELD OF ENVIRONMENTAL EMISSIONS ALLOWANCES AND RELATED SECURITIES AND COMMODITIES; PROVIDING A MARKETPLACE IN THE NATURE OF A FINANCIAL EXCHANGE THROUGH A GLOBAL ONLINE COMPUTER NETWORK; PROVIDING FINANCIAL INFORMATION IN THE FIELDS OF ENVIRONMENTAL REGULATION AND ENVIRONMENTAL EMISSIONS ALLOWANCES AND RELATED SECURITIES AND COMMODITIES; AND PROVISION OF THESE SERVICES THROUGH AN ONLINE GLOBAL COMPUTER NETWORK (U.S. CLS. 100, 101 AND 102).

FIRST USE 3-12-2007; IN COMMERCE 3-12-2007.

**CLASS 42—SCIENTIFIC AND COMPUTER SERVICES**

FOR SCIENTIFIC AND TECHNOLOGICAL CONSULTANCY SERVICES IN THE FIELDS OF ENERGY, ENVIRONMENTAL EMISSION ALLOWANCES, SUSTAINABLE GREENHOUSE GAS OFFSETS, NAMELY, CONSULTANCY IN THE FIELD OF ENVIRONMENTAL COMPLIANCE, ASSESSMENT, AND PLANNING; SCIENTIFIC RESEARCH AND DESIGN CONSULTING SERVICES IN THE FIELDS OF ENERGY, ENVIRONMENTAL EMISSION ALLOWANCES, SUSTAINABLE GREENHOUSE GAS OFFSETS, ENVIRONMENTAL COMPLIANCE, ASSESSMENT, AND PLANNING; INDUSTRIAL RESEARCH SERVICES IN THE FIELDS OF ENERGY, ENVIRONMENTAL EMISSION ALLOWANCES, SUSTAINABLE GREENHOUSE GAS OFFSETS, ENVIRONMENTAL COMPLIANCE, ASSESSMENT, AND PLANNING; PROVIDING SCIENTIFIC AND TECHNOLOGY INFORMATION IN THE FIELDS OF ENVIRONMENTAL EMISSIONS ALLOWANCES AND SUSTAINABLE GREENHOUSE GAS OFFSETS; AND PROVISION OF THESE SERVICES THROUGH AN ONLINE GLOBAL COMPUTER NETWORK (U.S. CLS. 100 AND 101).

FIRST USE 3-12-2007; IN COMMERCE 3-12-2007.

**CLASS 45—PERSONAL AND LEGAL SERVICES**

FOR PROVIDING ENVIRONMENTAL REGULATORY INFORMATION IN THE FIELDS OF ENVIRONMENTAL REGULATION AND REGULATIONS FOR RELATED SECURITIES AND COMMODITIES; AND PROVISION OF THESE SERVICES THROUGH AN ONLINE GLOBAL COMPUTER NETWORK (U.S. CLS. 100 AND 101).

FIRST USE 3-12-2007; IN COMMERCE 3-12-2007.

4,046,166. ARNETT FACIAL RECONSTRUCTION COURSES, INC., SANTA BARBARA, CA. SN 77-981,470. PUB. 6-8-2010, FILED 1-26-2010.

**FAB**

THE MARK CONSISTS OF STANDARD CHARACTERS WITHOUT CLAIM TO ANY PARTICULAR FONT, STYLE, SIZE, OR COLOR.

OWNER OF U.S. REG. NOS. 3,706,120 AND 3,706,121.

**CLASS 10—MEDICAL APPARATUS**

FOR MEDICAL AND SURGICAL APPARATUS AND INSTRUMENTS, NAMELY, ORTHOPEDIC FIXATION DEVICES USED IN ORAL AND MAXILLOFACIAL SURGERY (U.S. CLS. 26, 39 AND 44).

FIRST USE 7-31-2009; IN COMMERCE 7-31-2009.

**CLASS 41—EDUCATION AND ENTERTAINMENT**

FOR EDUCATIONAL SERVICES, NAMELY, CONDUCTING CLASSES, SEMINARS, CONFERENCES, AND WORKSHOPS IN THE FIELD OF ORAL AND MAXILLOFACIAL SURGERY, AND DISTRIBUTION OF COURSE MATERIAL IN CONNECTION THEREWITH (U.S. CLS. 100, 101 AND 107).

FIRST USE 10-20-2008; IN COMMERCE 10-20-2008.

4,046,171. OPTIMIZE INTERNATIONAL LLC, HOLLIS, NH. SN 77-982,438. PUB. 8-17-2010, FILED 4-23-2008.

**OPTIMIZE INTERNATIONAL**

THE MARK CONSISTS OF STANDARD CHARACTERS WITHOUT CLAIM TO ANY PARTICULAR FONT, STYLE, SIZE, OR COLOR.

NO CLAIM IS MADE TO THE EXCLUSIVE RIGHT TO USE "INTERNATIONAL", APART FROM THE MARK AS SHOWN.

**CLASS 9—ELECTRICAL AND SCIENTIFIC APPARATUS**

FOR PRE-RECORDED ELECTRONIC MEDIA, NAMELY, AUDIO/VIDEO DISCS AND TAPES, DIGITAL RECORDING DISCS AND TAPES, SERIES OF PRE-RECORDED COMPACT SOUND RECORDING DISCS, VIDEO DISCS AND VIDEOTAPES FEATURING INSTRUCTION, SPEECHES AND SOUND EFFECTS IN THE FIELD OF BUSINESS LEADERSHIP DEVELOPMENT THAT INCLUDE INFORMATION REGARDING COMMUNICATION, CONFLICT RESOLUTION, CULTURE, DIVERSITY, LIFESTYLE, MANAGEMENT, MOTIVATION, PERFORMANCE, PERSONAL EMPOWERMENT, PRODUCTIVITY, STRATEGIC RELATIONSHIP BUILDING AND TEAM BUILDING, STRESS AND TIME MANAGEMENT (U.S. CLS. 21, 23, 26, 36 AND 38).

FIRST USE 3-13-2008; IN COMMERCE 9-21-2008.

**CLASS 16—PAPER GOODS AND PRINTED MATTER**

FOR PRINTED MATTER, NAMELY, A SERIES OF WRITTEN ARTICLES FOR PUBLICATION IN BOOKLETS, BROCHURES, CATALOGS, DIRECTORIES, MAGAZINES, MANUALS, NEWSLETTERS, NEWSPAPERS, PAMPHLETS AND PERIODICALS IN THE FIELD OF BUSINESS LEADERSHIP DEVELOPMENT THAT INCLUDE INFORMATION REGARDING COMMUNICATION, CONFLICT RESOLUTION, CULTURE, DIVERSITY, LIFESTYLE, MANAGEMENT, MOTIVATION, PERFORMANCE, PERSONAL EMPOWERMENT, PRODUCTIVITY, STRATEGIC RELATIONSHIP BUILDING AND TEAM BUILDING, STRESS AND TIME MANAGEMENT; AGENDAS, EVENT ALBUMS, BUSINESS CARDS, BOOKMARKS, CALENDARS, DESK DIARIES, PHOTOGRAPHS; PRINTED GREETING CARDS WITH ELECTRONIC INFORMATION STORED THEREIN; PRINTED EDUCATIONAL, INSTRUCTIONAL AND TEACHING MATERIALS IN THE FIELD OF BUSINESS LEADERSHIP DEVELOPMENT THAT INCLUDES INFORMATION REGARDING COMMUNICATION, CONFLICT RESOLUTION, CULTURE, DIVERSITY, LEADERSHIP, LIFESTYLE, MANAGEMENT, MOTIVATION, PERFORMANCE, PERSONAL EMPOWERMENT, PRODUCTIVITY, STRATEGIC RELATIONSHIP BUILDING AND TEAM BUILDING, STRESS AND TIME MANAGEMENT; POSTCARDS AND POSTERS, SERIES OF BOOKS IN THE FIELD OF BUSINESS LEADERSHIP DEVELOPMENT THAT INCLUDE INFORMATION REGARDING COMMUNICATION, CONFLICT RESOLUTION, CULTURE, DIVERSITY, LIFESTYLE, MANAGEMENT, MOTIVATION, PERFORMANCE, PERSONAL EMPOWERMENT, PRODUCTIVITY, STRATEGIC RELATIONSHIP BUILDING AND TEAM BUILDING, STRESS AND TIME MANAGEMENT; WORKBOOKS IN THE FIELD OF BUSINESS LEADERSHIP DEVELOPMENT THAT INCLUDES INFORMATION REGARDING COMMUNICATION, CONFLICT RESOLUTION, CULTURE, DIVERSITY, LEADERSHIP, LIFESTYLE, MANAGEMENT, MOTIVATION, PERFORMANCE, PERSONAL EMPOWERMENT, PRODUCTIVITY, STRATEGIC RELATIONSHIP BUILDING AND TEAM BUILDING, STRESS AND TIME MANAGEMENT; STATIONERY, NAMELY, LETTERHEAD PAPER AND

ENVELOPES, WRITING PADS, STATIONERY COVERS, FOLDERS AND STICKERS; PENS AND PENCILS (U.S. CLS. 2, 5, 22, 23, 29, 37, 38 AND 50).

FIRST USE 9-16-2008; IN COMMERCE 9-16-2008.

#### **CLASS 35—ADVERTISING AND BUSINESS**

FOR CONSULTING SERVICES IN BUSINESS LEADERSHIP DEVELOPMENT, FOR BUSINESSES AND EMPLOYEES, EXECUTIVES AND BUSINESS MANAGERS THAT PROMOTE COMMUNICATION, CONFLICT RESOLUTION, CULTURE, DIVERSITY, LEADERSHIP, LIFESTYLE, MANAGEMENT, MOTIVATION, PERFORMANCE, PERSONAL EMPOWERMENT, PRODUCTIVITY, STRATEGIC RELATIONSHIP BUILDING AND TEAM BUILDING, STRESS AND TIME MANAGEMENT IN THE WORK PLACE; ARRANGING AND CONDUCTING BUSINESS LEADERSHIP DEVELOPMENT CONFERENCES THAT PROMOTE COMMUNICATION, CONFLICT, CULTURE, DIVERSITY, LEADERSHIP, LIFESTYLE, MANAGEMENT, MOTIVATION, PERFORMANCE, PERSONAL EMPOWERMENT, PRODUCTIVITY, STRATEGIC RELATIONSHIP BUILDING AND TEAM BUILDING, STRESS AND TIME MANAGEMENT IN THE WORK PLACE AMONG BUSINESS GROUPS AND LEADERS; BUSINESS LEADERSHIP DEVELOPMENT CONSULTATION AND ADVISORY SERVICES FOR BUSINESSES AND EMPLOYEES, EXECUTIVES AND BUSINESS MANAGERS THAT PROMOTE COMMUNICATION, CONFLICT, CULTURE, DIVERSITY, LEADERSHIP, LIFESTYLE, MANAGEMENT, MOTIVATION, PERFORMANCE, PERSONAL EMPOWERMENT, PRODUCTIVITY, STRATEGIC RELATIONSHIP BUILDING AND TEAM BUILDING, STRESS AND TIME MANAGEMENT (U.S. CLS. 100, 101 AND 102).

FIRST USE 11-20-2008; IN COMMERCE 11-20-2008.

#### **CLASS 41—EDUCATION AND ENTERTAINMENT**

FOR EDUCATIONAL AND INSTRUCTIONAL SERVICES, NAMELY, ARRANGING AND CONDUCTING EDUCATIONAL CONFERENCES, RETREATS, SEMINARS, PERSONAL COACHING AND WORKSHOPS IN THE FIELD OF BUSINESS, COMMUNICATION, CONFLICT, CULTURE, DIVERSITY, LEADERSHIP, LIFESTYLE, MANAGEMENT, MOTIVATION, PERFORMANCE, PERSONAL EMPOWERMENT, PRODUCTIVITY, STRATEGIC RELATIONSHIP BUILDING AND TEAM BUILDING, STRESS AND TIME MANAGEMENT; ENTERTAINMENT SERVICES, NAMELY, LIVE SPEAKING PERFORMANCES AND SPEAKING ENGAGEMENTS IN THE FIELD OF BUSINESS, COMMUNICATION, CONFLICT, CULTURE, DIVERSITY, LEADERSHIP, LIFESTYLE, MANAGEMENT, MOTIVATION, PERFORMANCE, PERSONAL EMPOWERMENT, PRODUCTIVITY, STRATEGIC RELATIONSHIP BUILDING AND TEAM BUILDING, STRESS AND TIME MANAGEMENT; PRODUCTION OF RADIO AND TELEVISION AND FILM PROGRAMS FOR TRANSMISSION VIA BROADCAST, CABLE, DIGITAL AND GLOBAL COMPUTER NETWORK AND PUBLICATION OF ACCOMPANYING MATERIALS IN THE FORM OF BOOKS, MAGAZINES AND NEWSLETTERS (U.S. CLS. 100, 101 AND 107).

FIRST USE 2-28-2008; IN COMMERCE 2-28-2008.

4,046,172. CRYSTAL SPRINGS RANCH, INC., WILSON, WY. SN 77-982,439. PUB. 5-26-2009, FILED 12-7-2007.

**SHOOTING STAR**

THE MARK CONSISTS OF STANDARD CHARACTERS WITHOUT CLAIM TO ANY PARTICULAR FONT, STYLE,

SIZE, OR COLOR.

#### **CLASS 25—CLOTHING**

FOR TEE-SHIRTS, HATS, SWEATSHIRTS, UNDERWEAR, COATS, JACKETS AND BELTS (U.S. CLS. 22 AND 39).

FIRST USE 7-9-2009; IN COMMERCE 7-9-2009.

#### **CLASS 41—EDUCATION AND ENTERTAINMENT**

FOR NORDIC SKIING FACILITIES, SKIJORING, SWIMMING FACILITIES (U.S. CLS. 100, 101 AND 107).

FIRST USE 11-27-2010; IN COMMERCE 11-27-2010.

4,046,175. APPLIED BIOSYSTEMS, LLC, FORMERLY APPLIED BIOSYSTEMS CORPORATION, FOSTER CITY, CA. SN 77-982,450. PUB. 10-5-2010, FILED 10-15-2009.

**AB**

THE MARK CONSISTS OF STANDARD CHARACTERS WITHOUT CLAIM TO ANY PARTICULAR FONT, STYLE, SIZE, OR COLOR.

OWNER OF U.S. REG. NOS. 2,369,619, 3,127,465, AND OTHERS.

#### **CLASS 1—CHEMICALS**

FOR REAGENTS FOR SCIENTIFIC OR RESEARCH USE; CHEMICAL REAGENTS FOR NON-MEDICAL PURPOSES, NAMELY, REAGENTS FOR FORENSICS AND HUMAN IDENTIFICATION (U.S. CLS. 1, 5, 6, 10, 26 AND 46).

FIRST USE 3-30-1982; IN COMMERCE 3-30-1982.

#### **CLASS 9—ELECTRICAL AND SCIENTIFIC APPARATUS**

FOR COMPUTER SOFTWARE USED FOR COLLECTION, ORGANIZATION, ANALYSIS, INTEGRATION AND COMMUNICATION OF SCIENTIFIC DATA; COMPUTER HARDWARE; PRE-RECORDED CD-ROM, DISKETTES, AUDIO AND VIDEO TAPES AND CASSETTES FEATURING SCIENTIFIC INFORMATION; COMPUTER SOFTWARE USED TO OPERATE LABORATORY INSTRUMENT, NAMELY, AUTOMATED MICROSCOPE SOFTWARE FOR USE IN LABORATORY OPERATIONS; LABORATORY INSTRUMENTS, NAMELY, NUCLEIC ACID SEQUENCERS AND SYNTHESIZERS, ELECTROPHORESIS MACHINES FOR NON-MEDICAL USE, LINKAGE ANALYZERS, GENETIC MAPPERS THERMAL CYCLER, CYTOMETER, PROTEINS AND PEPTIDE SYNTHESIZERS, MASS SPECTROMETER AND CHROMATOGRAPH, HIGH-THROUGHPUT INSTRUMENT FOR PREPARATION OF NUCLEIC ACID SAMPLES, LABORATORY ROBOTS, AND ACCESSORIES TO AND PARTS OF THE ABOVE INSTRUMENTS; LABORATORY SUPPLIES, NAMELY, PLASTIC CONSUMABLES, NAMELY, PIPETTE TIPS, RACKS FOR LABORATORY APPARATUS, VIALS, CAPS FOR LABORATORY BOTTLES, SEPTA, NEEDLES, BOTTLES, FLASKS, FILTERS, TUBES, AND SEALS FOR LABORATORY BOTTLES, PLASTIC TRAY COVER, MICRO PLATES, REAGENT RESERVOIRS, OPTICAL HEAT FIELD COVERS, PLASTIC CARDS, AND PLASTIC CAPILLARY ARRAYS; ALL AFORESAID GOODS ARE FOR SCIENTIFIC AND RESEARCH USE (U.S. CLS. 21, 23, 26, 36 AND 38).

FIRST USE 3-30-1982; IN COMMERCE 3-30-1982.

**CLASS 37—CONSTRUCTION AND REPAIR**

FOR INSTALLATION, MAINTENANCE AND REPAIR OF LABORATORY INSTRUMENTS FOR SCIENTIFIC, RESEARCH, MEDICAL, AND DIAGNOSTICS USE; INSTALLATION, MAINTENANCE AND REPAIR OF COMPUTER HARDWARE INSTRUMENTS FOR SCIENTIFIC, RESEARCH, MEDICAL, AND DIAGNOSTICS USE (U.S. CLS. 100, 103 AND 106).

FIRST USE 3-30-1982; IN COMMERCE 3-30-1982.

4,046,178. ASSET MARKETING SYSTEMS INSURANCE SERVICES, LLC, SAN DIEGO, CA. SN 77-982,457. PUB. 12-14-2010, FILED 9-15-2009.



**Asset Marketing Systems**  
THE BUSINESS BUILDERS

OWNER OF U.S. REG. NOS. 2,637,975 AND 2,994,674.  
NO CLAIM IS MADE TO THE EXCLUSIVE RIGHT TO USE "MARKETING SYSTEMS", APART FROM THE MARK AS SHOWN.

THE MARK CONSISTS OF A STYLIZED TRIANGLE, WITH THE PHRASE "ASSET MARKETING SYSTEMS" TO THE RIGHT OF IT AND ABOVE A LINE, AND THE PHRASE "THE BUSINESS BUILDERS" TO THE RIGHT OF IT AND BELOW THE LINE.

**CLASS 35—ADVERTISING AND BUSINESS**

FOR DIRECT MAIL ADVERTISING SERVICES; PRODUCTION AND PLACEMENT OF PRINT ADVERTISING FOR OTHERS IN THE FIELDS OF FINANCIAL PLANNING AND FINANCIAL PRODUCTS (U.S. CLS. 100, 101 AND 102).

FIRST USE 10-0-2009; IN COMMERCE 10-0-2009.

**CLASS 36—INSURANCE AND FINANCIAL**

FOR PROVIDING FINANCIAL INFORMATION, ANALYSIS AND CONSULTATION (U.S. CLS. 100, 101 AND 102).

FIRST USE 10-0-2009; IN COMMERCE 10-0-2009.

**CLASS 41—EDUCATION AND ENTERTAINMENT**

FOR EDUCATIONAL SERVICES, NAMELY, CONDUCTING CLASSES AND SEMINARS IN THE FIELDS OF FINANCIAL PLANNING AND FINANCIAL PRODUCTS AND PRINTABLE MATERIALS AND MANUALS DISTRIBUTED THEREWITH (U.S. CLS. 100, 101 AND 107).

FIRST USE 10-0-2009; IN COMMERCE 10-0-2009.

4,046,181. DENNIS BERNARD, INC, FREEHOLD, NJ. SN 77-982,473. PUB. 6-14-2011, FILED 4-18-2009.

**POWERTOOLS**

THE MARK CONSISTS OF STANDARD CHARACTERS WITHOUT CLAIM TO ANY PARTICULAR FONT, STYLE,

SIZE, OR COLOR.

OWNER OF U.S. REG. NOS. 2,897,307 AND 3,246,575.

**CLASS 1—CHEMICALS**

FOR ADDITIVES TO LIQUID HAIR CARE PRODUCTS (U.S. CLS. 1, 5, 6, 10, 26 AND 46).

FIRST USE 12-31-2001; IN COMMERCE 12-31-2001.

**CLASS 3—COSMETICS AND CLEANING PREPARATIONS**

FOR HAIR CARE PRODUCTS, NAMELY, SHAMPOOS, CONDITIONERS, RINSES, GELS, MOUSES, NON-AEROSOL HAIR FINISHING SPRAYS, STAIN REMOVERS, EXCLUDING COLORED BROW GEL (U.S. CLS. 1, 4, 6, 50, 51 AND 52).

FIRST USE 12-31-1986; IN COMMERCE 12-31-1986.

**CLASS 8—HAND TOOLS**

FOR HAND-OPERATED HAND TOOLS AND IMPLEMENTS FOR HAIR CARE PROFESSIONALS AND FOR HAIR CARE, NAMELY, HAND-OPERATED SHEARS (U.S. CLS. 23, 28 AND 44).

FIRST USE 12-31-2003; IN COMMERCE 12-31-2003.

4,046,184. TARGET BRANDS, INC., MINNEAPOLIS, MN. SN 77-982,522. PUB. 6-15-2010, FILED 10-16-2007.

**CIRCO**

OWNER OF U.S. REG. NOS. 2,693,011, 2,717,303, AND OTHERS.

THE MARK CONSISTS OF THE WORD "CIRCO" IN STYLIZED LETTERING.

THE FOREIGN WORDING IN THE MARK TRANSLATES INTO ENGLISH AS "CIRCUS".

**CLASS 20—FURNITURE AND ARTICLES NOT OTHERWISE CLASSIFIED**

FOR FURNITURE; NON-METAL FABRIC HANGING ORGANIZERS; STORAGE BINS NOT OF METAL; SLEEPING BAGS; FITTED FABRIC FURNITURE COVERS, NAMELY, CHANGING TABLE COVERS; DIAPER CHANGING MATS (U.S. CLS. 2, 13, 22, 25, 32 AND 50).

FIRST USE 10-0-2009; IN COMMERCE 10-0-2009.

**CLASS 21—HOUSEWARES AND GLASS**

FOR BASKETS COMPRISED OF WICKER, STRAW, WOOD OR CLOTH (U.S. CLS. 2, 13, 23, 29, 30, 33, 40 AND 50).

FIRST USE 3-0-2010; IN COMMERCE 3-0-2010.

**CLASS 24—FABRICS**

FOR CRIB BUMPER PADS; BEDSPREADS, COMFORTERS AND BED COVERS; QUILTS AND DUVETS; QUILT AND DUVET COVERS; UNFITTED FABRIC FURNITURE COVERS, NAMELY, CHANGING TABLE COVERS; DIAPER CHANGING PADS NOT OF PAPER; FABRIC WINDOW COVERINGS, NAMELY, CURTAINS, DRAPERIES, SHEERS AND VALANCES (U.S. CLS. 42 AND 50).

FIRST USE 8-0-2008; IN COMMERCE 8-0-2008.

**CLASS 25—CLOTHING**

FOR CLOTHING AND ACCESSORIES, NAMELY, CHILDREN'S BELTS, BIBS NOT OF PAPER, BODY SUITS, BOTTOMS, COATS, COSTUMES FOR USE IN CHILDREN'S DRESS UP PLAY, DRESSES, EAR MUFFS, GLOVES, HALLOWEEN COSTUMES AND MASKS SOLD IN CONNECTION THEREWITH, HEADWEAR, JACKETS, MITTENS, OVERALLS, SLEEPWEAR, SOCKS, SUITS, SWIMWEAR, TIES, TIGHTS, TOPS, UNDERGARMENTS, UNDERWEAR, VESTS; INFANTWEAR; FOOTWEAR (U.S. CLS. 22 AND 39).

FIRST USE 8-0-2008; IN COMMERCE 8-0-2008.

**CLASS 26—FANCY GOODS**

FOR HAIR ACCESSORIES, NAMELY, BANDS, BARRETTES, BOWS, CLAMPS, CLIPS, ORNAMENTS, PINS, PONYTAIL HOLDERS, RIBBONS, SCRUNCHIES, SLIDES, TWISTERS (U.S. CLS. 37, 39, 40, 42 AND 50).

FIRST USE 8-0-2008; IN COMMERCE 8-0-2008.

**CLASS 28—TOYS AND SPORTING GOODS**

FOR TOYS, NAMELY, ACTION FIGURES AND ACCESSORIES THEREFOR, BABY RATTLES, BABY SWINGS, BALLOONS, BATH TOYS, BATTERY OPERATED ACTION TOYS, BEACH BALLS, BEAN BAGS, BENDABLE TOYS, CHILDREN'S MULTIPLE ACTIVITY TABLES, CHILDREN'S PLAY COSMETICS, CHILDREN'S WIRE CONSTRUCTION AND ART ACTIVITY TOYS, CONSTRUCTION TOYS, DOLLS AND ACCESSORIES THEREFOR, ELECTRONIC ACTION TOYS, ELECTRONICALLY OPERATED TOY MOTOR VEHICLES, TOY FLASHLIGHTS, SAND TOYS, INFANT TOYS, INFLATABLE TOYS, TOY LANTERNS, MECHANICAL ACTION TOYS, CHILDREN'S MULTIPLE ACTIVITY TOYS, MUSICAL TOYS, NON-RIDING TRANSPORTATION TOYS, PLAY TENTS, PLAYGROUND BALLS, PLUSH TOYS, PULL TOYS, PUSH TOYS, PUZZLES, SOAP BUBBLES, NAMELY, BUBBLE MAKING SOLUTION; SOFT SCULPTURE TOYS, SQUEEZE TOYS, STACKING TOYS, STUFFED AND PLUSH TOYS, TALKING TOYS, TOY BAKEWARE, COOKWARE, DISHES AND COOKING AND EATING UTENSILS, TOY BANKS AND CASH REGISTERS, TOY BOWLING SETS, TOY BOXES, TOY BUILDING BLOCKS, TOY FIGURES AND ACCESSORIES THEREFOR, TOY FOOD, TOY FURNITURE, TOY MODEL VEHICLES AND TRAIN SETS, TOY MICROWAVE OVEN, PLAY MONEY, TOY ROBOTS, RIDE ON TOYS, TOY SHOPPING CARTS, TOY STROLLERS, TOY STEERING WHEELS, TOY VACUUM CLEANERS, TOY VEHICLES AND VESSELS, TOY WAGONS, BALLS FOR GAMES, GAME TABLES, HAND-HELD GAMES WITH LIQUID CRYSTAL DISPLAYS, RADIO CONTROLLED TOY VEHICLES, WIND-UP TOYS (U.S. CLS. 22, 23, 38 AND 50).

FIRST USE 8-0-2008; IN COMMERCE 8-0-2008.

4,046,187. KARMA'S WORLD, LLC, EAST POINT, GA. SN 77-982,557. PUB. 9-7-2010, FILED 10-20-2009.

**KARMA'S WORLD**

THE MARK CONSISTS OF STANDARD CHARACTERS WITHOUT CLAIM TO ANY PARTICULAR FONT, STYLE, SIZE, OR COLOR.

**CLASS 38—COMMUNICATION**

FOR STREAMING OF AUDIO, VISUAL, AND AUDIO-VISUAL MATERIAL PROVIDED BY MEANS OF THE INTERNET RELATING TO A WIDE RANGE OF INFORMATION ON TOPICS OF INTEREST TO CHILDREN AND THEIR PARENTS AND CAREGIVERS (U.S. CLS. 100, 101 AND 104).

FIRST USE 1-1-2011; IN COMMERCE 1-1-2011.

**CLASS 41—EDUCATION AND ENTERTAINMENT**

FOR ENTERTAINMENT AND EDUCATION SERVICES PROVIDED BY MEANS OF THE INTERNET, NAMELY, PROVIDING AN ONLINE EDUCATIONAL AND ENTERTAINMENT WEBSITE FEATURING ENTERTAINMENT AND EDUCATIONAL INFORMATION ON TOPICS OF INTEREST TO CHILDREN AND THEIR PARENTS AND CAREGIVERS, NAMELY, INTERACTIVE ACTIVITIES FOR CHILDREN, ART PROJECTS, EDUCATIONAL GAMES, MUSIC PROGRAMS, AND EDUCATIONAL AND ENTERTAINMENT PROGRAMS FEATURING STORIES FOR CHILDREN (U.S. CLS. 100, 101 AND 107).

FIRST USE 1-1-2011; IN COMMERCE 1-1-2011.

4,046,188. INTERNATIONAL DATA GROUP, INC., FRAMINGHAM, MA. SN 77-982,566. PUB. 4-8-2008, FILED 5-3-2007.

**CFO WORLD**

THE MARK CONSISTS OF STANDARD CHARACTERS WITHOUT CLAIM TO ANY PARTICULAR FONT, STYLE, SIZE, OR COLOR.

NO CLAIM IS MADE TO THE EXCLUSIVE RIGHT TO USE "CFO", APART FROM THE MARK AS SHOWN.

**CLASS 41—EDUCATION AND ENTERTAINMENT**

FOR PROVIDING AN ONLINE NON-DOWNLOADABLE MAGAZINE, FEATURING INFORMATION IN THE FIELDS OF COMPUTERS, COMPUTER SOFTWARE, ONLINE SERVICES, HIGH TECHNOLOGY, INFORMATION TECHNOLOGY AND INFORMATION SERVICES, ORGANIZING AND CONDUCTING EDUCATIONAL CONFERENCES, SEMINARS AND EXPOSITIONS IN THE FIELDS OF COMPUTERS, COMPUTER SOFTWARE, ONLINE SERVICES, HIGH TECHNOLOGY, INFORMATION TECHNOLOGY AND INFORMATION SERVICES (U.S. CLS. 100, 101 AND 107).

FIRST USE 2-1-2011; IN COMMERCE 2-1-2011.

**CLASS 42—SCIENTIFIC AND COMPUTER SERVICES**

FOR PROVIDING INFORMATION VIA A WEBSITE ON GLOBAL COMPUTER NETWORKS IN THE FIELDS OF COMPUTERS, COMPUTER SOFTWARE, ONLINE SERVICES IN THE FIELD OF COMPUTERS, HIGH TECHNOLOGY IN THE FIELD OF COMPUTERS, COMPUTER INFORMATION TECHNOLOGY AND INFORMATION SERVICES IN THE FIELD OF COMPUTERS (U.S. CLS. 100 AND 101).

FIRST USE 2-1-2011; IN COMMERCE 2-1-2011.

4,046,191. PECOWARE COMPANY, CHINO, CA. SN 78-207,642. PUB. 12-9-2003, FILED 1-27-2003.



NO CLAIM IS MADE TO THE EXCLUSIVE RIGHT TO USE "PINK EYELASH" AS TO CLASS 3, APART FROM THE MARK AS SHOWN.

4,046,189. COMPLETE GENOMICS, INC., MOUNTAIN VIEW, CA. SN 77-982,569. PUB. 7-13-2010, FILED 2-19-2010.



THE MARK CONSISTS OF THREE HUMAN BODIES, SLIGHTLY OVERLAPPING, WITH GRADIENT SHADING AND HORIZONTAL LINES.

**CLASS 42—SCIENTIFIC AND COMPUTER SERVICES**

FOR BIOTECHNOLOGY RESEARCH AND DEVELOPMENT SERVICES FOR OTHERS, NAMELY, GENOME SEQUENCING, GENOME MAPPING, GENOME AND NUCLEIC ACID ANALYSIS, GENOME AMPLIFICATION, GENOME SCANNING, AND HIGH PERFORMANCE COMPUTING SERVICES FOR GENOME SEQUENCING (U.S. CLS. 100 AND 101).

FIRST USE 2-19-2010; IN COMMERCE 2-19-2010.

**CLASS 45—PERSONAL AND LEGAL SERVICES**

FOR LICENSING OF COMPUTER SOFTWARE IN THE FIELD OF GENOME RESEARCH AND DEVELOPMENT (U.S. CLS. 100 AND 101).

FIRST USE 2-19-2010; IN COMMERCE 2-19-2010.

**CLASS 3—COSMETICS AND CLEANING PREPARATIONS**

FOR ALL COSMETICS, NAMELY— AFTER SUN LOTIONS, ADHESIVES FOR ATTACHING ARTIFICIAL FINGERNAILS AND/OR EYELASHES, ANTIBACTERIAL SKIN SOAPS, BABY SHAMPOO, BLUSH, BODY GLITTER, BODY OIL, BODY POWDER, BREATH FRESHENER, COMPACTS CONTAINING MAKEUP, COSMETIC BALLS, COSMETIC PADS, COSMETIC PENCILS, COSMETICS, EYE MAKEUP, EYE MAKEUP REMOVER, EYE PENCIL, EYEBROW PENCILS, EYE SHADOW, BODY LOTION, LIPSTICK, SKIN CREAMS AND FOUNDATIONS, FACE POWDER, FACIAL MAKEUP, FALSE NAILS, FINGERNAIL SCULPTING OVERLAYS, FOUNDATION MAKEUP, FRAGRANCES FOR PERSONAL USE, LIP CREAM, LIP GLOSS PALETTE, LIP LINER, LIPSTICK, SKIN TONER CLEANSER, MASCARA, EYELINER, FALSE EYELASHES, LIP GLOSS; NAIL CREAM, NAIL ENAMEL, NAIL GLITTER, NAIL POLISH, NAIL POLISH REMOVER, NAIL POLISH TOP COAT, NAIL TIPS, NON-MEDICATED LIP CARE PREPARATIONS, ROUGE, STYLING GELS, STYLING LOTIONS, TOPICAL SKIN SPRAYS FOR COSMETIC PURPOSES; ALL CLEANSING PREPARATIONS USED IN PERSONAL BODY CLEANSING AND ENHANCEMENTS, NAMELY, BABY WIPES, BATH BEADS, BATH CRYSTALS, BATH FOAM, BATH GEL, BATH LOTION, BATH OIL, BATH PEARLS, BUBBLE BATH, SHAMPOO, COLD CREAM, COLOGNE, CONDITIONER, DEODORANT SOAP, DEODORANT AND ANTIPERSPIRANTS, FACE WASH, FACIAL CLEANSERS, FACIAL CREAMS, HAIR CARE PREPARATIONS, HAIR CONDITIONERS, HAIR FROST, HAIR GEL, HAIR LIGHTENERS, HAIR LOTIONS, HAIR MOUSSE, HAIR SPRAY, HAND CREAM, HAND LOTIONS, MASSAGE OIL, PERFUME, PERFUME OILS, PERFUMERY, PERSONAL DEODORANTS, PRE-MOISTENED COSMETIC TISSUES, PRE-MOISTENED COSMETIC TOWELETTS, PRE-MOISTENED COSMETIC WIPES, SHAMPOO-CONDITIONERS, SOAP, SKIN CLARIFIERS, SKIN CLEANSERS, SKIN CLEANSING CREAM, SKIN CONDITIONER, SKIN CREAM, SKIN LOTION, SKIN MOISTURIZER, SKIN MOISTURIZER MASK, SKIN TONERS, SKIN SOAP, SUN BLOCK, SUN BLOCK PREPARATIONS, SUN CARE LOTIONS, SUN SCREEN PREPARATIONS, SUN TAN GEL, AND SUN TAN LOTION (U.S. CLS. 1, 4, 6, 50, 51 AND 52).

FIRST USE 1-15-2001; IN COMMERCE 1-15-2001.

**CLASS 14—JEWELRY**

FOR JEWELRY (U.S. CLS. 2, 27, 28 AND 50).

FIRST USE 1-15-2001; IN COMMERCE 1-15-2001.

**CLASS 16—PAPER GOODS AND PRINTED MATTER**



FOR ALL PAPER GOODS AND PRINTED MATTER, NAMELY— AGENDAS, ADDRESS BOOKS, ANNIVERSARY BOOKS, ANNOUNCEMENT CARDS, APPOINTMENT BOOKS, ART PAPER, ART PADS, BLANK WRITING JOURNALS, BUSINESS CARDS, BRAG BOOKS, DIARIES, ADDRESS BOOKS, BOOK COVERS, BOOKMARKS, CALENDAR DESK PADS, CALENDARS, CARDBOARD, CARDBOARD CARTONS, CARDBOARD CONTAINERS, CARDS BEARING UNIVERSAL GREETINGS, CARRYING CASES MADE OF PAPER, CARTOON STRIPS, CARTOON PRINTS, CHILDREN'S ACTIVITY BOOKS, CHILDREN'S STORYBOOK, CHRISTMAS CARDS, COLORING BOOKS, COMPOSITION BOOKS, CONSTRUCTION PAPER, CHILDREN'S BOOKS, CRAFT PAPER, CREPE PAPER, DATE BOOKS, DIARIES, DRAWING PADS, DESK CALENDARS, DESK PADS, DESK TOP PLANNERS, ENVELOPES, FILE CARDS, FILE FOLDERS, GIFT CARDS, GREETING CARDS, GIFT WRAPPING PAPER, JOURNALS FOR STATIONERY USE, MEMO PADS, MEMORANDUM BOOKS, MEMORY BOOKS, NOTE BOOKS, NOTE CARDS, NOTE PADS, NOTE PAPER, NOTEBOOK DIVIDER, NOTEBOOK PAPER, OCCASION CARDS, ORGANIZERS FOR STATIONERY USE, PHOTO ALBUMS, PAPER PARTY DECORATIONS, PAPER PARTY FAVORS, PAPER PARTY HATS, PAPER REPORT COVERS, PAPER RIBBONS, PHOTOGRAPH ALBUMS, PICTURE POSTCARDS, POSTCARDS, PLACEMATS OF PAPER, SIGNATURE AND AUTOGRAPH BOOKS, STICKERS, SCRAPBOOK ALBUMS, SCRAPBOOK PAGES, SCRAPBOOKS, STATIONERY, STATIONERY BOXES, STATIONERY FOLDERS, STATIONERY WRITING PAPER AND ENVELOPES, STATIONERY-TYPE PORTFOLIOS, WEDDING ALBUMS (U.S. CLS. 2, 5, 22, 23, 29, 37, 38 AND 50).

FIRST USE 1-15-2001; IN COMMERCE 1-15-2001.

#### CLASS 25—CLOTHING

FOR ALL CLOTHING, NAMELY, ANKLETS, APRONS, ATHLETIC SHOES, ATHLETIC UNIFORMS, BALLOON PANTS, BATHING CAPS, BATH SLIPPERS, BATHING SUITS, BATHROBES, BATHING SUITS, BRAS, BEACH SHOES, BEACHWEAR, BEANIES, BELTS, BERETS, BERMUDA SHORTS, BIB OVERALLS, BICYCLE GLOVES, BIKINIS, BLAZERS, BLOUSES, BOAS, BONNETS, BOOTIES, BOOTS, BOW TIES, BRIEFS, CAMP SHIRTS, CAPES, CARDIGANS, COATS, CHEERLEADER UNIFORMS, DANCE OUTFITS, DENIM JACKETS, DUNGAREES, EAR MUFFS, FLEECE PULLOVERS, FOOTWEAR, GLOVES, GOWNS, GYM SHORTS, GYM SUITS, HALTER TOPS, HAT BANDS, HATS, HEAD BANDS, HEADGEAR, NAMELY, HATS, HEADWEAR, SHIRTS, PANTS SOCKS, HATS, HOODS, HOSIERY, INFANT WEAR, JACKETS, JEANS, JERSEYS, JOGGING SUITS, LEATHER COATS, LEATHER JACKETS, LOUNGEWEAR, MINI SKIRTS, MITTENS, MOCCASINS, MOCK TURTLE-NECK SWEATER, MUFLERS, NECKLACES, NECKTIES, NECKWEAR, NIGHT GOWNS, NIGHT SHIRT, T-SHIRTS, SHOES, SKIRTS, DRESSES, SWEATERS, PANTIES, PAJAMAS, PANTALOONS, PANTIES, PANTSUITS, PANTYHOSE, PARKAS, POLO SHIRTS, PONCHOS, PULLOVERS, RAIN BOOTS, RAIN COATS, RAIN JACKETS, RAIN SUITS, RAINWEAR, ROBES, SHORTS, SCARVES, SHIRTS, SHOES, SHORTS, SKIRTS, SKORTS, SLACKS, SLEEPWEAR, SLIPPERS, SLIPS, SNEAKERS, SOCKS, SPORT SHIRTS, SUN VISORS, SURF WEAR, SWEAT PANTS, SWEAT SKIRTS, SWEAT SHORTS, SWEATERS, SWEAT SOCKS, SWIM TRUNKS, SWIMSUITS, TANK TOPS, TEDDIES, TENNIS WEAR, THONGS, TIES, TIGHTS, TOPS, TROUSERS, T-SHIRTS, UNDERCLOTHES, UNDERSHIRTS, UNDERWEAR, VESTS, WRAPS, AND WRIST BANDS (U.S. CLS. 22 AND 39).

FIRST USE 1-15-2001; IN COMMERCE 1-15-2001.

4,046,195. BIOFRESH LIMITED, NEWCASTLE-UPON-TYNE, UNITED KINGDOM. SN 78-735,870. PUB. 6-10-2008, FILED 10-19-2005.

## BIOFRESH

THE MARK CONSISTS OF STANDARD CHARACTERS WITHOUT CLAIM TO ANY PARTICULAR FONT, STYLE, SIZE, OR COLOR.

PRIORITY CLAIMED UNDER SEC. 44(D) ON ERPN CMNTY TM OFC APPLICATION NO. 004455523, FILED 6-21-2005, REG. NO. 004455523, DATED 7-12-2006, EXPIRES 6-21-2015.

#### CLASS 11—ENVIRONMENTAL CONTROL APPARATUS

FOR (BASED ON USE IN COMMERCE) ETHYLENE GAS GENERATORS; (BASED ON USE IN COMMERCE AND SECTION 44(E)) APPARATUS FOR PRODUCING AND CONTROLLING OZONE AT TARGETED LEVELS, NAMELY, OZONE GENERATORS THAT KILL MICROBES (U.S. CLS. 13, 21, 23, 31 AND 34).

FIRST USE 8-23-2011; IN COMMERCE 8-23-2011.

#### CLASS 37—CONSTRUCTION AND REPAIR

FOR (BASED ON USE IN COMMERCE) INSTALLATION AND REPAIR OF ETHYLENE GENERATORS, ADVISORY SERVICES RELATING TO THE INSTALLATION AND REPAIR OF ETHYLENE GENERATOR EQUIPMENT; (BASED ON USE IN COMMERCE AND SECTION 44(E)) INSTALLATION AND REPAIR OF GAS CONTROL EQUIPMENT, ETHYLENE GAS CONTROL EQUIPMENT, AND OZONE GAS CONTROL EQUIPMENT; INSTALLATION AND REPAIR OF OZONE GENERATORS; ADVISORY SERVICES RELATING TO THE INSTALLATION AND REPAIR OF GAS SENSOR EQUIPMENT, ETHYLENE GAS SENSOR EQUIPMENT, AND OZONE GAS SENSOR EQUIPMENT; ADVISORY SERVICES RELATING TO THE INSTALLATION AND REPAIR OF OZONE GENERATOR EQUIPMENT (U.S. CLS. 100, 103 AND 106).

FIRST USE 8-23-2011; IN COMMERCE 8-23-2011.

4,046,201. LIFTED RESEARCH GROUP INC, IRVINE, CA. SN 78-930,347. PUB. 6-3-2008, FILED 7-15-2006.

## LUXIRIE

THE MARK CONSISTS OF STANDARD CHARACTERS WITHOUT CLAIM TO ANY PARTICULAR FONT, STYLE, SIZE, OR COLOR.

#### CLASS 18—LEATHER GOODS

FOR BAGS, NAMELY, TRAVEL AND OVERNIGHT BAGS, GARMENT BAGS, ALL PURPOSE SPORT BAGS, KNAPSACKS, TOTE BAGS, WRIST MOUNTED CARRY ALL BAGS, SHOULDER BAGS, PURSES, MESSENGER BAGS (U.S. CLS. 1, 2, 3, 22 AND 41).

FIRST USE 9-11-2009; IN COMMERCE 9-11-2009.

**CLASS 25—CLOTHING**

FOR CLOTHING, FOOTWEAR, AND HEADWEAR, NAMELY, T-SHIRTS, WOVEN SHIRTS, CASUAL TOPS WITH LONG AND SHORT SLEEVES, SWEATSHIRTS, SWEATERS, VESTS, BLAZERS, SUITS, JACKETS, COATS, ANORAKS, PARKAS, JEANS, PANTS, SLACKS, DRESSES, SKIRTS, SHORTS, OVERALLS, BELTS, SKI WEAR, SNOWBOARD WEAR, HATS, BEANIES (U.S. CLS. 22 AND 39).

FIRST USE 11-1-2005; IN COMMERCE 11-1-2005.

**CLASS 18—LEATHER GOODS**

FOR ANIMAL SKINS, HIDES; TRUNKS AND TRAVELING BAGS; UMBRELLAS; SADDLERY; LUGGAGE, SPORTS BAGS, DUFFEL BAGS, GARMENT BAGS, BACKPACKS, BRIEF CASES, FANNY PACKS, HANDBAGS, LUGGAGE TAGS; KNAPSACKS; TOTE BAGS; PURSES; WALLETS; CREDIT CARD CASES; GYM BAGS; ALL-PURPOSE SPORTS GEAR CARRYING BAGS; DOG LEASHES; SHOE BAGS FOR TRAVEL; SCHOOL BAGS; PET COLLARS (U.S. CLS. 1, 2, 3, 22 AND 41).

FIRST USE 12-31-2010; IN COMMERCE 12-31-2010.

**CLASS 20—FURNITURE AND ARTICLES NOT OTHERWISE CLASSIFIED**

FOR NON-METAL KEY RINGS AND CHAINS; HAND-HELD MIRRORS; PLAQUES OF BONE, IVORY, PLASTIC, WAX, AND WOOD; SOFT SCULPTURE WALL DECORATIONS; DECORATIVE MOBILES; PLASTIC AND METAL STANDS FOR DISPLAYING OR HOLDING VARIOUS TYPES OF TOYS AND SPORTING EQUIPMENT; PLASTIC FIGURINES; PLASTIC WATER-FILLED SNOW GLOBES; TOY BOXES; PLASTIC AND WOOD FIGURINES; PLASTIC IDENTIFICATION TAGS; FURNITURE, CHAIRS AND STOOLS, TABLES, FOLDING SPORTS SEATS AND STOOLS, FOOTSTOOLS, INFLATABLE PILLOWS (U.S. CLS. 2, 13, 22, 25, 32 AND 50).

FIRST USE 12-31-2010; IN COMMERCE 12-31-2010.

**CLASS 21—HOUSEWARES AND GLASS**

FOR COMBS, BATH SPONGES, KITCHEN SPONGES; BEVERAGE GLASSWARE; DRINKING CUPS AND GLASSES; JUGS; DECORATIVE AND COMMEMORATIVE PLATES; DINNERWARE; FIGURINES MADE OF CHINA, CRYSTAL, EARTHENWARE, GLASS, PORCELAIN AND TERRA COTTA; MUGS MADE OF EARTHENWARE, GLASS AND PORCELAIN; LUNCH BOXES; TANKARDS NOT OF PRECIOUS METAL; MEAL TRAYS, WASTEPAPER BASKETS; CANDLESTICKS OF GLASS (U.S. CLS. 2, 13, 23, 29, 30, 33, 40 AND 50).

FIRST USE 12-31-2010; IN COMMERCE 12-31-2010.

**CLASS 24—FABRICS**

FOR TABLE LINEN, TABLE CLOTHS NOT OF PAPER, TOWELS; BEACH TOWELS; BED LINENS; TABLE LINENS; CLOTH BANNERS; CLOTH PENNANTS; WOOLEN BLANKETS, SILK BLANKETS, BED BLANKETS; COVERLETS; CLOTH NAPKINS; LAP ROBES (U.S. CLS. 42 AND 50).

FIRST USE 12-31-2010; IN COMMERCE 12-31-2010.

**CLASS 25—CLOTHING**

FOR MEN'S, WOMEN'S AND CHILDREN'S CLOTHING, NAMELY, BATHING SUITS, BELTS, NECKTIES, SUSPENDERS, BANDANAS, INFANT AND TODDLER SLEEPWEAR, BATHROBES, NIGHT SHIRTS, PAJAMAS AND LOUNGEWEAR, BEACH COVER-UP DRESSES, CLOTH DIAPER SETS, KNIT DRESSES WITH PANTS SETS, SHORTS AND TOP SETS, SKIRT/PANTY COMBINATIONS, SOCKS, PLAY SUITS, COVERALLS, UNION SUITS, COLLARLESS SHIRTS, SHORTS, PANTS AND SLACKS, SHIRTS; JACKETS, NAMELY, WIND-RESISTANT JACKETS AND NYLON SHELLS; SPORTS UNIFORMS; SWEATERS; PARKAS; TURTLENECKS; MITTENS; GLOVES; UNDERWEAR; ROMPERS; JERSEYS; HEADWEAR AND SCARVES; EAR MUFFS, EAR BANDS AND HEADBANDS; HOSIERY; RAIN PONCHOS AND JACKETS; BATH THONGS; VISORS; APRONS; SKI AND CLOTH BIBS; T-SHIRTS; SWEATSHIRTS; SWEATPANTS; COATS; PULLOVERS; SKI SUITS; GOLF SHIRTS AND HATS; BLAZERS; LEGWARMERS; EVENING TOPS; JEANS; LEOTARDS; WORKOUT AND SPORTS APPAREL, NAMELY, TANK TOPS, SPORTS BRAS; SKI MASKS; FOOTWEAR, NAMELY, SHOES, BOOTS, SLIPPERS, AND BEACH SANDALS; HEADGEAR, NAMELY, HATS, CAPS, BASEBALL CAPS (U.S. CLS. 22 AND 39).

FIRST USE 12-31-2010; IN COMMERCE 12-31-2010.

4,046,202. WHAM-O, INC., EMERYVILLE, CA. SN 78-931,341.  
PUB. 10-9-2007, FILED 7-17-2006.

# FRISBEE

THE MARK CONSISTS OF STANDARD CHARACTERS WITHOUT CLAIM TO ANY PARTICULAR FONT, STYLE, SIZE, OR COLOR.

OWNER OF U.S. REG. NOS. 679,186, 1,151,090, AND OTHERS.

**CLASS 6—METAL GOODS**

FOR METAL KEY CHAINS; METAL KEY RINGS; FIGURES OF COMMON METAL; FIGURINES OF COMMON METAL; METAL BICYCLE LOCKS; METAL KEY HOLDERS; BRONZE RECOGNITION PLAQUES (U.S. CLS. 2, 12, 13, 14, 23, 25 AND 50).

FIRST USE 12-31-2010; IN COMMERCE 12-31-2010.

**CLASS 9—ELECTRICAL AND SCIENTIFIC APPARATUS**

FOR COMPUTER GAMES AND COMPUTER GAME PROGRAMS, NAMELY, VIDEO GAMES AND INTERACTIVE VIDEO GAMES FOR USE WITH GAMING CONSOLES, CELL PHONES, PERSONAL COMPUTERS, AND HAND-HELD VIDEO GAME DEVICES, DOWNLOADABLE SOFTWARE, NAMELY, VIDEO GAMES AND INTERACTIVE VIDEO GAMES; SUNGLASSES; DECORATIVE MAGNETS; EYEGLASS CASES; TELEPHONES; FASHION EYEGLASSES; SWIMMING GOGGLES; SNOW GOGGLES; DIVING GOGGLES; GOGGLES FOR SPORTS; INFLATABLE FLOATATION DEVICES (U.S. CLS. 21, 23, 26, 36 AND 38).

FIRST USE 12-31-2010; IN COMMERCE 12-31-2010.

**CLASS 14—JEWELRY**

FOR PRECIOUS METALS AND THEIR ALLOYS; HOROLOGICAL AND CHRONOMETRIC INSTRUMENTS; JEWELRY, COSTUME JEWELRY; EARRINGS; RINGS; MEDALLIONS; NON-MONETARY COINS OF PRECIOUS METAL; CLOCKS, WATCHES; STOP WATCHES; ANKLE BRACELETS; BODY PIERCING RINGS AND STUDS; AND IDENTIFICATION BRACELETS (U.S. CLS. 2, 27, 28 AND 50).

FIRST USE 12-31-2010; IN COMMERCE 12-31-2010.

**CLASS 28—TOYS AND SPORTING GOODS**

FOR BOARD GAMES, TARGET GAMES; DECORATIONS FOR CHRISTMAS TREES; TOY FLYING DISKS; SLEDS; TOBOGGANS; BODY BOARDS; BAGS ESPECIALLY DESIGNED FOR SURFBOARDS; LEASHES USED IN CONJUNCTION WITH SURFING; SKIM BOARDS; SURF BOARDS; SWIM FINS; DOLLS AND STUFFED TOY ANIMALS; TOY SCALE MODEL VEHICLES; JIGSAW PUZZLES; CHRISTMAS TREE ORNAMENTS; COMMEMORATIVE SPORTS BALLS; ACTION PUPPETS; INFLATABLE TOYS; TEDDY BEARS; DARTBOARD CABINETS AND DARTS; CHRISTMAS STOCKINGS; BASKETBALL BACKBOARDS; YO-YOS; ACTION FIGURES AND ACCESSORIES THEREFORE; MARBLES; SPORTS BALLS; VOLLEYBALL NETS, TENNIS NETS, NETS FOR BALL GAMES; PLASTIC TOY HOOPS; TOY FOOT BEAN BAGS; GYMNASIUM EQUIPMENT, NAMELY, EQUIPMENT FOR PRACTICING BODY SURFING OUT OF THE WATER; BALLOONS; GOLF GLOVES; RADIO-OPERATED TOY VEHICLES; TOYS FOR PETS; PINBALL MACHINES; DISCUSSES; EXERCISE EQUIPMENT, NAMELY, EQUIPMENT FOR PRACTICING BODY SURFING OUT OF THE WATER; HANDHELD UNITS FOR PLAYING VIDEO GAMES; INFLATABLE FLOAT MATTRESSES OR PADS FOR RECREATIONAL USE; INFLATABLE INNER TUBES FOR AQUATIC RECREATIONAL USE; WATER TOYS; SAND TOYS (U.S. CLS. 22, 23, 38 AND 50).

FIRST USE 12-31-2010; IN COMMERCE 12-31-2010.

**CLASS 38—COMMUNICATION**

FOR TELECOMMUNICATION SERVICES, NAMELY, PROVIDING ACCESS TO PICTURES, VIDEO, ALARM STATUS, BUILDING PLANS AND OTHER BUILDING AND SECURITY INFORMATION AT A REMOTE STATION; TELECOMMUNICATION SERVICES, NAMELY, ELECTRONIC TRANSMISSION OF VOICE, MESSAGES AND DATA; TELECOMMUNICATION SERVICES, NAMELY, INFORMATION TRANSMISSION VIA ELECTRONIC COMMUNICATIONS NETWORKS; TELEPHONE COMMUNICATION SERVICES PROVIDED OVER TELECOMMUNICATION AND COMPUTER NETWORKS; TRANSMISSION OF SOUND, VIDEO AND INFORMATION OVER COMPUTER NETWORKS; TRANSMISSION OF SOUND, PICTURE AND DATA SIGNALS IN THE FORM OF ENTERTAINMENT INFORMATION AND ENTERTAINMENT CONTENT; BROADCASTING SERVICES AND PROVISION OF TELECOMMUNICATION ACCESS TO FILMS AND TV PROGRAMS PROVIDED VIA A VIDEO-ON-DEMAND SERVICE; TRANSMISSION OF SOUND, VIDEO AND INFORMATION IN THE FIELDS OF MULTIMEDIA CONTENT, ALARM FUNCTIONS, VOIP, BILLING AND ADVERTISING INFORMATION, FILE BACKUP, INSTANT MESSAGING, EMAIL MESSAGING, AND PHOTO STORAGE AND SHARING; AND ELECTRONIC TRANSMISSION OF VOICE, DATA AND IMAGES BY TELEVISION AND VIDEO BROADCASTING (U.S. CLS. 100, 101 AND 104).

FIRST USE 10-18-2010; IN COMMERCE 10-18-2010.

**CLASS 39—TRANSPORTATION AND STORAGE**

FOR ELECTRONIC STORAGE OF FILES AND DOCUMENTS; MEDIA SERVICES IN THE NATURE OF STORAGE OF ENTERTAINMENT MEDIA CONTENT, DIGITAL PHOTOGRAPHS AND MESSAGES; STORAGE OF ELECTRONIC MEDIA, NAMELY, IMAGES, TEXT AND AUDIO DATA; STORAGE SERVICES FOR ARCHIVING DATABASES, IMAGES AND OTHER ELECTRONIC DATA (U.S. CLS. 100 AND 105).

FIRST USE 10-18-2010; IN COMMERCE 10-18-2010.

**CLASS 41—EDUCATION AND ENTERTAINMENT**

FOR ENTERTAINMENT INFORMATION; PROVIDING ENTERTAINMENT CONTENT VIA ELECTRONIC PROGRAM GUIDES, NAMELY, DIGITALLY-DISPLAYED MENUS OF RADIO, MUSIC, MOVIE, AND GAME PROGRAM SCHEDULING INFORMATION, INTERACTIVE MEDIA SERVICES, NAMELY, PROVIDING RADIO PROGRAMS FEATURING MUSIC AND INFORMATION REGARDING NEWS, SPORTS, AND WEATHER, NON-DOWNLOADABLE MUSIC, AND NON-DOWNLOADABLE FILMS AND MOVIES, ALL VIA A VIDEO-ON-DEMAND SERVICE LOCALLY AND REMOTELY ACCESSED FROM WIDE AREA AND INTERNET NETWORKS AND DISTRIBUTED THROUGHOUT THE CUSTOMER PREMISE USING HOME NETWORKING; AND PROVIDING ONLINE INTERACTIVE COMPUTER, VIDEO AND ELECTRONIC GAMES USING HOME TO HOME NETWORKING AND ACCESSED VIA TELEVISION (U.S. CLS. 100, 101 AND 107).

FIRST USE 10-18-2010; IN COMMERCE 10-18-2010.

**CLASS 45—PERSONAL AND LEGAL SERVICES**

FOR MONITORING SECURITY SYSTEMS; HOME SECURITY MONITORING USING WIRELESS AND WIRED SENSORS, ALARMS, AND MOTION DETECTORS AND PROVIDING INSTANT NOTIFICATION OF DETECTIONS AND CAPABILITY FOR VIEWING VIDEO CAMERA IMAGES; ALARM RESPONSE AND VERIFICATION SERVICES; COMPUTERIZED HOME-MONITORING SERVICES PROVIDED VIA A GLOBAL COMMUNICATIONS NETWORK, NAMELY, ONLINE MONITORING IN THE NATURE OF VIDEO MONITORING OF HOMES VIEWABLE THROUGH A GLOBAL COMPUTER NETWORK (U.S. CLS. 100 AND 101).

FIRST USE 10-18-2010; IN COMMERCE 10-18-2010.

4,046,203. PRODEA SYSTEMS, INC., PLANO, TX. SN 78-955,039. PUB. 12-28-2010, FILED 8-18-2006.

ROS

THE MARK CONSISTS OF STANDARD CHARACTERS WITHOUT CLAIM TO ANY PARTICULAR FONT, STYLE, SIZE, OR COLOR.

**CLASS 35—ADVERTISING AND BUSINESS**

FOR BUSINESS MANAGEMENT SERVICES; BUSINESS MANAGEMENT SERVICES IN THE FIELDS OF BILLING, PROVISIONING AND ACCOUNTING INTEGRATION; ADMINISTRATION, BILLING AND RECONCILIATION OF ACCOUNTS ON BEHALF OF OTHERS; ADVERTISING AND MARKETING SERVICES; BUSINESS ANALYSIS CONSULTATION SERVICES, NAMELY, COLLECTION, COLLATION AND ANALYSIS OF END-USER HABITS AND PATTERNS FOR THE CONSUMPTION OF ELECTRONIC MEDIA AND ADVERTISING (U.S. CLS. 100, 101 AND 102).

FIRST USE 10-18-2010; IN COMMERCE 10-18-2010.

4,046,223. KONAMI DIGITAL ENTERTAINMENT CO., LTD., TOKYO, JAPAN. SN 85-013,986. PUB. 12-21-2010, FILED 4-14-2010.

4,046,233. FULTON MANAGEMENT SERVICES, INC., PULASKI, NY. SN 85-018,579. PUB. 6-7-2011, FILED 4-20-2010.

## Harmony of Despair

THE MARK CONSISTS OF STANDARD CHARACTERS WITHOUT CLAIM TO ANY PARTICULAR FONT, STYLE, SIZE, OR COLOR.

### CLASS 9—ELECTRICAL AND SCIENTIFIC APPARATUS

FOR VIDEO GAME SOFTWARE; VIDEO GAME PROGRAMS; COMPUTER GAME SOFTWARE; COMPUTER GAME PROGRAMS; ELECTRONIC GAME PROGRAMS (U.S. CLS. 21, 23, 26, 36 AND 38).

FIRST USE 8-4-2010; IN COMMERCE 8-4-2010.

### CLASS 41—EDUCATION AND ENTERTAINMENT

FOR ENTERTAINMENT SERVICES, NAMELY, PROVIDING ONLINE COMPUTER GAMES ACCESSIBLE VIA VIDEO GAME MACHINES, MOBILE PHONES AND COMPUTERS; PROVIDING ONLINE COMPUTER GAMES VIA NETWORK BETWEEN COMMUNICATIONS NETWORKS AND COMPUTERS; PROVIDING INFORMATION TO GAME PLAYERS ABOUT THE RANKING OF THEIR SCORES OF GAMES THROUGH THE WEB SITES; PROVIDING INFORMATION, IMAGES, MUSIC AND/OR SOUND REGARDING GAMES; ENTERTAINMENT SERVICES, NAMELY, ARRANGING, ORGANIZING AND CONDUCTING COMPUTER GAME TOURNAMENTS (U.S. CLS. 100, 101 AND 107).

FIRST USE 8-4-2010; IN COMMERCE 8-4-2010.

---

4,046,228. TAPCO, INC., CHATTANOOGA, TN. SN 85-014,654. PUB. 9-28-2010, FILED 4-15-2010.

## STEEL HORSE

THE MARK CONSISTS OF STANDARD CHARACTERS WITHOUT CLAIM TO ANY PARTICULAR FONT, STYLE, SIZE, OR COLOR.

### CLASS 6—METAL GOODS

FOR SPURS (U.S. CLS. 2, 12, 13, 14, 23, 25 AND 50).  
FIRST USE 6-0-2011; IN COMMERCE 6-0-2011.

### CLASS 18—LEATHER GOODS

FOR HORSE TACK, NAMELY, BITS (U.S. CLS. 1, 2, 3, 22 AND 41).  
FIRST USE 6-0-2011; IN COMMERCE 6-0-2011.



OWNER OF U.S. REG. NO. 690,240.

THE MARK CONSISTS OF STACKED HORIZONTAL LINES AND THE WORD "FULTON".

### CLASS 11—ENVIRONMENTAL CONTROL APPARATUS

FOR BOILERS, NAMELY, STEAM BOILERS AND HOT WATER BOILERS; HEAT EXCHANGERS NOT BEING PARTS OF MACHINES; THERMAL FLUID HEATERS; COMPONENTS, NAMELY, FUEL PRE-HEATERS, TANKS, COMBUSTION BURNERS, BLOWDOWN UNITS, NAMELY, STEAM BLOWDOWN UNITS, AND WATER TREATMENT UNITS, FOR BOILERS AND THERMAL FLUID HEATERS; CONTROL SYSTEMS, NAMELY, CONTROL PANELS, DATA PROCESSORS, AND CONTROL SOFTWARE, FOR BOILERS AND THERMAL FLUID HEATERS; WATER HEATERS; HEAT PUMPS; PULSE COMBUSTORS AND PULSE COMBUSTION DEVICES, NAMELY, PULSE COMBUSTION BOILERS AND PULSE COMBUSTION WATER HEATERS; GAS ABSORPTION UNITS FOR HEATING AND COOLING WATER AND OTHER WORKING FLUIDS, NAMELY, OILS; SELF-CONTAINED BOILER SYSTEMS, NAMELY, PORTABLE BOILERS, NAMELY, STEAM BOILERS AND HOT WATER BOILERS, ON PLATFORM SKIDS OR WITHIN PORTABLE BOILER ROOMS, NAMELY, CONTAINERS AND TRAILERS (U.S. CLS. 13, 21, 23, 31 AND 34).

FIRST USE 4-20-2010; IN COMMERCE 4-20-2010.

### CLASS 37—CONSTRUCTION AND REPAIR

FOR INSTALLATION, MAINTENANCE, AND REFURBISHMENT OF BOILERS, HEATERS AND OTHER HEAT EXCHANGE DEVICES, COMPONENTS AND CONTROL SYSTEMS FOR BOILERS, HEATERS AND OTHER HEAT EXCHANGE DEVICES, AND SELF-CONTAINED BOILER SYSTEMS, NAMELY, PORTABLE BOILER SYSTEMS ON PLATFORM SKIDS OR WITHIN PORTABLE BOILER ROOMS (U.S. CLS. 100, 103 AND 106).

FIRST USE 4-20-2010; IN COMMERCE 4-20-2010.

---

4,046,239. ROBERT MCDAID, OLD BRIDGE, NJ. SN 85-021,477. PUB. 10-5-2010, FILED 4-23-2010.



THE MARK CONSISTS OF STANDARD CHARACTERS WITHOUT CLAIM TO ANY PARTICULAR FONT, STYLE, SIZE, OR COLOR.

**CLASS 41—EDUCATION AND ENTERTAINMENT**

FOR ENTERTAINMENT AND AMUSEMENT CENTERS IN THE NATURE OF AN INDOOR AMUSEMENT PARK HAVING VARIOUS ATTRACTIONS APPEALING TO DIFFERENT AGE GROUPS (U.S. CLS. 100, 101 AND 107).

FIRST USE 7-25-2011; IN COMMERCE 7-25-2011.

**CLASS 43—HOTEL AND RESTAURANT SERVICES**

FOR PROVIDING FACILITIES FOR BANQUETS AND SOCIAL FUNCTIONS (U.S. CLS. 100 AND 101).

FIRST USE 7-25-2011; IN COMMERCE 7-25-2011.

**CLASS 37—CONSTRUCTION AND REPAIR**

FOR MAINTENANCE AND REPAIR OF BULK MATERIAL HANDLING APPARATUS, NAMELY, PUMPS, PUMP LINERS, HYDROCYCLONES, HYDROCYCLONE LINERS, CRUSHER LINERS, ELBOWS, PIPES, HOSES, FINES HANDLING, SCREEN MEDIA, CHUTE AND HOPPER LININGS, SAND TANK VALVES, SAND SCREW SHOES, WATER MANAGEMENT EQUIPMENT, LOG WASHER PADDLES, TROMMELS, SCRUBBER LINERS, URETHANE COMPONENTS, RUBBER COMPONENTS AND CERAMIC COMPONENTS FOR THE AFORESAID GOODS (U.S. CLS. 100, 103 AND 106).

FIRST USE 0-0-2001; IN COMMERCE 0-0-2001.

4,046,243. BARDIN PALOMO LTD., NEW YORK, NY. SN 85-025,296. PUB. 3-15-2011, FILED 4-28-2010.

4,046,240. MCLANAHAN CORPORATION, HOLLIDAYSBURG, PA. SN 85-021,620. PUB. 1-11-2011, FILED 4-23-2010.

**MCLANAHAN**

THE MARK CONSISTS OF STANDARD CHARACTERS WITHOUT CLAIM TO ANY PARTICULAR FONT, STYLE, SIZE, OR COLOR.

OWNER OF U.S. REG. NO. 2,883,767.  
SEC. 2(F).

**CLASS 7—MACHINERY**

FOR BULK MATERIAL HANDLING APPARATUS USED IN THE MINERAL PROCESSING, AGGREGATE PROCESSING, FARMING AND MINING INDUSTRIES AND PARTS THEREFOR, NAMELY, ROTARY PUMPS AND REPLACEABLE WEAR LINERS FOR ROTARY PUMPS, HYDROCYCLONE SEPARATORS AND REPLACEABLE WEAR LINERS FOR HYDROCYCLONE SEPARATORS, REPLACEABLE PROTECTIVE LINERS FOR CRUSHERS, REPLACEABLE WEAR MEDIA, NAMELY, SCREEN MEDIA, SCREEN SIDE LINERS, SCREEN FEED LINERS, SCREEN DISCHARGE LINERS, SPRAY DEFLECTOR NOZZLES, CHUTE AND HOPPER LININGS, SPRAY PIPE SEALS, LOG WASHER PADDLES, AND TANK AND HOPPER LINERS, REPLACEABLE WEAR MEDIA FOR CONVEYOR TRANSFER POINTS, NAMELY, IMPACT LINERS, SKIRT BOARD LINERS, BELT CLEANER INSERTS, BUCKETS, AND FUGITIVE MATERIAL SEALS, WEAR PARTS FOR FINE MATERIAL RECOVERY SYSTEMS, NAMELY, PIPES, HOSES, SAND TANK VALVES, SAND SCREW SHOES, DOWNSPOUTS, DISCHARGE ELBOWS, FLUME LINING, PINCH VALVE INSERTS, MIXER LINERS, AND FLOTATION CELL AGITATORS AND BAFFLES, AND TROMMEL AND SCRUBBER WEAR PARTS, NAMELY, SCREEN PANELS, LIFTER BARS, KICKER PADDLES, SPIRAL FLIGHTS, BAFFLE PLATES, AND FEED, DISCHARGE, AND SHELL LINERS (U.S. CLS. 13, 19, 21, 23, 31, 34 AND 35).

FIRST USE 3-20-1957; IN COMMERCE 3-20-1957.



THE COLOR(S) GREEN IS/ARE CLAIMED AS A FEATURE OF THE MARK.

THE MARK CONSISTS OF A GREEN HERBACEOUS PLANT WITH EXPOSED ROOTS, WITH THE GREEN WORDS "BARDIN PALOMO" AT THE BOTTOM OF THE PLANT, WHITE AS IT APPEARS IN THE MARK REPRESENTS TRANSPARENT AREAS ONLY AND IS NOT PART OF THE MARK.

THE WORDING "BARDIN" AND "PALOMO" HAS NO MEANING IN A FOREIGN LANGUAGE.

**CLASS 41—EDUCATION AND ENTERTAINMENT**

FOR ARRANGING AND CONDUCTING SPECIAL EVENTS; ARRANGING, ORGANIZING, CONDUCTING, AND HOSTING SOCIAL ENTERTAINMENT EVENTS; PARTY PLANNING; SPECIAL EVENT PLANNING; WEDDING PLANNING AND COORDINATION SERVICES (U.S. CLS. 100, 101 AND 107).

FIRST USE 5-2-1992; IN COMMERCE 5-2-1992.

**CLASS 42—SCIENTIFIC AND COMPUTER SERVICES**

FOR DESIGN FOR OTHERS IN THE FIELD OF LIFESTYLE DESIGN, NAMELY, PACKAGING AND WRAPPING MATERIALS, CONTAINERS, DINNERWARE AND TABLE UTENSILS; DESIGN OF INTERIOR DECOR; INTERIOR DECORATION CONSULTATION; INTERIOR DESIGN SERVICES; INTERIOR STYLING SERVICES; PACKAGING DESIGN; PACKAGING DESIGN FOR OTHERS; SHOP INTERIOR DESIGN (U.S. CLS. 100 AND 101).

FIRST USE 5-2-1992; IN COMMERCE 5-2-1992.

4,046,246. EMCO SYSTEMS SOLUTIONS, INC., FOSTER CITY, CA. SN 85-026,894. PUB. 12-28-2010, FILED 4-29-2010.



NO CLAIM IS MADE TO THE EXCLUSIVE RIGHT TO USE "SYSTEMS SOLUTIONS, INC.", APART FROM THE MARK AS SHOWN.

THE MARK CONSISTS OF THE WORDING "EMCO SYSTEMS SOLUTIONS, INC." AND A DESIGN OF A LIGHTNING BOLT PASSING THROUGH AND FORMING A PART OF THE LETTER "M".

#### CLASS 35—ADVERTISING AND BUSINESS

FOR CONSULTATION IN THE FIELDS OF ENERGY CONSUMPTION, ENERGY EFFICIENCY, ENERGY CONSERVATION, AND ENERGY USAGE MANAGEMENT; PROVISION OF ONLINE INFORMATION IN THE FIELDS OF ENERGY CONSUMPTION, ENERGY EFFICIENCY, ENERGY CONSERVATION, AND ENERGY USAGE MANAGEMENT; ENERGY AUDITING; CONSULTATION IN THE FIELD OF MANAGEMENT OF WASTE WATER COLLECTION SYSTEMS FOR OTHERS; PROVISION OF ONLINE INFORMATION IN THE FIELD OF MANAGEMENT OF WASTE WATER COLLECTION SYSTEMS FOR OTHERS; ENVIRONMENTAL SERVICES, NAMELY, PROMOTING PUBLIC AWARENESS OF ENVIRONMENTAL MATTERS (U.S. CLS. 100, 101 AND 102).

FIRST USE 2-28-2010; IN COMMERCE 2-28-2010.

#### CLASS 40—MATERIAL TREATMENT

FOR CONSULTATION IN THE FIELD OF GENERATION OF ENERGY; PROVISION OF ONLINE INFORMATION IN THE FIELD OF GENERATION OF ENERGY; CONSULTATION IN THE FIELD OF WATER TREATMENT SERVICES; PROVISION OF ONLINE INFORMATION IN THE FIELD OF WATER TREATMENT SERVICES; ENVIRONMENTAL SERVICES, NAMELY, WASTE AND WATER TREATMENT SERVICES (U.S. CLS. 100, 103 AND 106).

FIRST USE 2-28-2010; IN COMMERCE 2-28-2010.

4,046,247. EMCO SYSTEMS SOLUTIONS, INC., FOSTER CITY, CA. SN 85-026,897. PUB. 1-4-2011, FILED 4-29-2010.

ARE YOU READY TO GREEN UP?

THE MARK CONSISTS OF STANDARD CHARACTERS WITHOUT CLAIM TO ANY PARTICULAR FONT, STYLE, SIZE, OR COLOR.

#### CLASS 35—ADVERTISING AND BUSINESS

FOR CONSULTATION IN THE FIELDS OF ENERGY CONSUMPTION, ENERGY EFFICIENCY, ENERGY CONSERVATION, AND ENERGY USAGE MANAGEMENT; PROVISION OF ONLINE INFORMATION IN THE FIELDS OF ENERGY CONSUMPTION, ENERGY EFFICIENCY, ENERGY CONSERVATION, AND ENERGY USAGE MANAGEMENT; ENERGY AUDITING; CONSULTATION IN THE FIELD OF MANAGEMENT OF WASTE WATER COLLECTION SYSTEMS FOR OTHERS; PROVISION OF ONLINE INFORMATION IN THE FIELD OF MANAGEMENT OF WASTE WATER COLLECTION SYSTEMS FOR OTHERS; ENVIRONMENTAL SERVICES, NAMELY, PROMOTING PUBLIC AWARENESS OF ENVIRONMENTAL MATTERS (U.S. CLS. 100, 101 AND 102).

FIRST USE 2-28-2010; IN COMMERCE 2-28-2010.

#### CLASS 40—MATERIAL TREATMENT

FOR CONSULTATION IN THE FIELD OF GENERATION OF ENERGY; PROVISION OF ONLINE INFORMATION IN THE FIELD OF GENERATION OF ENERGY; CONSULTATION IN THE FIELD OF WATER TREATMENT SERVICES; PROVISION OF ONLINE INFORMATION IN THE FIELD OF WATER TREATMENT SERVICES; ENVIRONMENTAL SERVICES, NAMELY, WASTE AND WATER TREATMENT SERVICES (U.S. CLS. 100, 103 AND 106).

FIRST USE 2-28-2010; IN COMMERCE 2-28-2010.

4,046,263. NEGOTIATION TECHNOLOGIES, LLC, CORAL SPRINGS, FL. SN 85-031,995. PUB. 5-24-2011, FILED 5-6-2010.

PITBULLTAX

THE MARK CONSISTS OF STANDARD CHARACTERS WITHOUT CLAIM TO ANY PARTICULAR FONT, STYLE, SIZE, OR COLOR.

#### CLASS 35—ADVERTISING AND BUSINESS

FOR PROVIDING A DATABASE FEATURING INFORMATION AND FORMS FOR INTERNAL REVENUE SERVICE TAX RESOLUTION; PROVIDING A WEB-BASED SYSTEM AND ONLINE PORTALS IN THE FIELD OF INTERNAL REVENUE SERVICE TAX RESOLUTION PLANNING; TAX PREPARATION OF INTERNAL REVENUE SERVICE RESOLUTION FORMS (U.S. CLS. 100, 101 AND 102).

FIRST USE 5-9-2010; IN COMMERCE 5-9-2010.

#### CLASS 42—SCIENTIFIC AND COMPUTER SERVICES

FOR COMPUTER SERVICES, NAMELY, PROVIDING A WEB-BASED SYSTEM AND ONLINE PORTAL FEATURING ON-LINE NON-DOWNLOADABLE SOFTWARE IN THE FIELD OF INTERNAL REVENUE SERVICE CONTROVERSY RESOLUTION THAT ENABLES USERS TO ACCESS ANALYSIS TOOLS AND DATA FOR TAX PROFESSIONALS IN THE REPRESENTATION OF CLIENTS IN TAX RESOLUTION MATTERS BEFORE TAX AUTHORITIES (U.S. CLS. 100 AND 101).

FIRST USE 5-9-2010; IN COMMERCE 5-9-2010.

4,046,264. BALL HORTICULTURAL COMPANY, WEST CHICAGO, IL. SN 85-032,146. PUB. 9-21-2010, FILED 5-6-2010.

# TerraShell

THE MARK CONSISTS OF STANDARD CHARACTERS WITHOUT CLAIM TO ANY PARTICULAR FONT, STYLE, SIZE, OR COLOR.

## CLASS 1—CHEMICALS

FOR POLYESTER RESINS (U.S. CLS. 1, 5, 6, 10, 26 AND 46).

FIRST USE 2-1-2011; IN COMMERCE 8-17-2011.

## CLASS 21—HOUSEWARES AND GLASS

FOR POTS (U.S. CLS. 2, 13, 23, 29, 30, 33, 40 AND 50).

FIRST USE 2-1-2011; IN COMMERCE 8-17-2011.

4,046,275. FAIR HEALTH, INC., NEW YORK, NY. SN 85-037,750. PUB. 1-4-2011, FILED 5-13-2010.

# FH

THE MARK CONSISTS OF STANDARD CHARACTERS WITHOUT CLAIM TO ANY PARTICULAR FONT, STYLE, SIZE, OR COLOR.

## CLASS 35—ADVERTISING AND BUSINESS

FOR PROVIDING AN EDUCATIONAL WEBSITE FEATURING INFORMATION ON ADMINISTRATION OF PATIENT REIMBURSEMENT PROGRAMS; PROVIDING A DATABASE AND A WEBSITE FEATURING INFORMATION IN THE FIELDS OF ECONOMIC ANALYSIS OF HEALTH CARE COSTS AND HEALTH CARE COST REVIEW (U.S. CLS. 100, 101 AND 102).

FIRST USE 1-31-2011; IN COMMERCE 1-31-2011.

## CLASS 36—INSURANCE AND FINANCIAL

FOR FINANCIAL INFORMATION SERVICES, NAMELY, PROVIDING A DATABASE AND BENCHMARKING TABLES FEATURING FINANCIAL BENCHMARKING INFORMATION IN THE FIELD OF HEALTH CARE; PROVIDING A WEBSITE FEATURING FINANCIAL INFORMATION IN THE FIELD OF HEALTH CARE (U.S. CLS. 100, 101 AND 102).

FIRST USE 4-1-2011; IN COMMERCE 4-1-2011.

## CLASS 41—EDUCATION AND ENTERTAINMENT

FOR EDUCATIONAL SERVICES, NAMELY, PROVIDING AN EDUCATIONAL WEBSITE FEATURING INFORMATION ON EDUCATION IN THE FIELD OF PATIENT REIMBURSEMENT AND MEDICAL SERVICES COSTS (U.S. CLS. 100, 101 AND 107).

FIRST USE 1-31-2011; IN COMMERCE 1-31-2011.

4,046,281. HIDOODLE LLC, SOMERVILLE, MA. SN 85-041,062. PUB. 10-19-2010, FILED 5-18-2010.

# HiDoodle

THE MARK CONSISTS OF STANDARD CHARACTERS WITHOUT CLAIM TO ANY PARTICULAR FONT, STYLE, SIZE, OR COLOR.

## CLASS 9—ELECTRICAL AND SCIENTIFIC APPARATUS

FOR COMPUTER APPLICATION SOFTWARE FOR MOBILE PHONES, NAMELY, SOFTWARE FOR CREATING NOTES, COLLABORATING WITH THESE NOTES, AND USING THESE NOTES AT A PHYSICAL STORE; COMPUTER SOFTWARE FOR THE COLLECTION, EDITING, ORGANIZING, MODIFYING, BOOK MARKING, TRANSMISSION, STORAGE AND SHARING OF DATA AND INFORMATION (U.S. CLS. 21, 23, 26, 36 AND 38).

FIRST USE 4-10-2011; IN COMMERCE 4-10-2011.

## CLASS 42—SCIENTIFIC AND COMPUTER SERVICES

FOR PROVIDING ON-LINE NON-DOWNLOADABLE SOFTWARE FOR CREATING NOTES, COLLABORATING WITH THESE NOTES, AND USING THESE NOTES AT A PHYSICAL STORE (U.S. CLS. 100 AND 101).

FIRST USE 4-1-2007; IN COMMERCE 4-1-2007.

4,046,294. LEVY PREMIUM FOODSERVICE LIMITED PARTNERSHIP, CHICAGO, IL. SN 85-046,008. PUB. 1-11-2011, FILED 5-24-2010.

# GOOGIE BURGER

THE MARK CONSISTS OF STANDARD CHARACTERS WITHOUT CLAIM TO ANY PARTICULAR FONT, STYLE, SIZE, OR COLOR.

NO CLAIM IS MADE TO THE EXCLUSIVE RIGHT TO USE "BURGER", APART FROM THE MARK AS SHOWN.

## CLASS 35—ADVERTISING AND BUSINESS

FOR CONCESSION STANDS FEATURING FOOD AND BEVERAGES (U.S. CLS. 100, 101 AND 102).

FIRST USE 7-13-2010; IN COMMERCE 7-13-2010.

**CLASS 43—HOTEL AND RESTAURANT SERVICES**

FOR CATERING; CONTRACT FOOD SERVICES; RESTAURANT SERVICES; SERVING FOOD AND DRINKS (U.S. CLS. 100 AND 101).

FIRST USE 7-13-2010; IN COMMERCE 7-13-2010.

**CLASS 28—TOYS AND SPORTING GOODS**

FOR CHILDREN'S MULTIPLE ACTIVITY TOYS; PLUSH TOYS; STUFFED AND PLUSH TOYS (U.S. CLS. 22, 23, 38 AND 50).

FIRST USE 8-4-2010; IN COMMERCE 8-4-2011.

4,046,295. OUTREACH, INC., VISTA, CA. SN 85-046,582. PUB. 5-31-2011, FILED 5-24-2010.

# OUTREACH

THE MARK CONSISTS OF STANDARD CHARACTERS WITHOUT CLAIM TO ANY PARTICULAR FONT, STYLE, SIZE, OR COLOR.

OWNER OF U.S. REG. NOS. 2,995,141, 3,053,559, AND 3,185,587.

SEC. 2(F).

THE 2(F) CLAIM IS RESTRICTED TO CLASS(ES) 16

**CLASS 16—PAPER GOODS AND PRINTED MATTER**

FOR BOOKS IN THE FIELD OF RELIGION; NOVELS (U.S. CLS. 2, 5, 22, 23, 29, 37, 38 AND 50).

FIRST USE 12-22-2003; IN COMMERCE 2-13-2004.

**CLASS 41—EDUCATION AND ENTERTAINMENT**

FOR BOOK PUBLISHING (U.S. CLS. 100, 101 AND 107).

FIRST USE 12-22-2003; IN COMMERCE 12-22-2003.

4,046,303. CAMPBELL, SUSAN M, DBA FICKLE FACE, BETHESDA, MD. SN 85-050,098. PUB. 10-26-2010, FILED 5-28-2010.

THE COLOR(S) RED, BLUE AND WHITE IS/ARE CLAIMED AS A FEATURE OF THE MARK.

THE MARK CONSISTS OF RED ROUNDED LETTERS WITH "FICKLE" STACKED ON TOP OF "FACE". ALL CAPS. THE "A" IN "FACE" HAS TWO ROUND WHITE EYES WITH BLUE PUPILS.

**CLASS 25—CLOTHING**

FOR SHIRTS; SHIRTS FOR INFANTS, BABIES, TODDLERS AND CHILDREN; T-SHIRTS (U.S. CLS. 22 AND 39).

FIRST USE 8-4-2010; IN COMMERCE 8-4-2011.

4,046,311. STANDARD CHARTERED PLC, LONDON, EC2V 7SB, UNITED KINGDOM. SN 85-051,899. PUB. 12-28-2010, FILED 6-1-2010.

# SAADIQ

THE MARK CONSISTS OF STANDARD CHARACTERS WITHOUT CLAIM TO ANY PARTICULAR FONT, STYLE, SIZE, OR COLOR.

THE ENGLISH TRANSLATION OF "SAADIQ" IN THE MARK IS "TRUTHFUL".

**CLASS 16—PAPER GOODS AND PRINTED MATTER**

FOR BOOKS, BOOKLETS, CATALOGUES, MAGAZINES, PERIODICAL PUBLICATIONS, NAMELY, NEWSLETTERS, BROCHURES, PAMPHLETS, POSTERS, CHECKBOOKS, NOTEPADS, NOTEPAPER, PAPER, BLANK BANK DEPOSIT AND WITHDRAWAL SLIPS, PAPER FOR USE IN PRINT ADS FOR MAGAZINES AND NEWSPAPERS, BLANK INVOICE FORMS, BLANK BANK STATEMENT FORMS, PAPER NAME TAGS, TENT CARDS, STICKERS, ENVELOPES, PAPER FOLDERS, PAPER FILE JACKETS, BILLBOARDS, NAMELY, ADVERTISING SIGNS OF PAPER OR CARDBOARD, TABLE CALENDARS, CALENDAR CARDS, DIARIES, PAPER NAME CARDS, PRINTED ANNUAL REPORTS, GREETING CARDS AND MANUALS MADE FROM PAPER, ALL RELATING TO BANKING, CORPORATE AND PERSONAL FINANCE, CREDIT PRODUCTS AND PROVISION, REAL ESTATE, PERSONAL FINANCIAL AND TAX PLANNING, INVESTMENTS, CORPORATE FINANCE, CURRENCY AND ALL TYPES OF INSURANCE; TRAVELLERS' CHECKS, POSTAL MONEY ORDERS, MONEY DRAFTS AND BANK CHECKS; CARDBOARD AND PLASTIC BUSINESS OR ADVERTISING CARDS; BOOK BINDINGS, BOOKBINDING CLOTH AND TAPE; STATIONERY; PENS AND PENCILS; DOCUMENT FILES AND FOLDERS; CHECKBOOK AND PASSBOOK WALLETS; TYPEWRITERS, OFFICE STATIONERY, DESK PADS, PAPER, NAMELY, COPIER PAPER, PRINTER PAPER, LETTER PAPER, WRITING PAPER, NOTEPADS, NOTEPAPER, NOTE PAPER WITH ADHESIVE STRIP, PRINTED CALENDARS, DRAWING RULERS; PRINTED INSTRUCTIONAL AND TEACHING MATERIAL IN THE FIELD OF BANKING, CORPORATE AND PERSONAL FINANCE, CREDIT PRODUCTS AND PROVISION, REAL ESTATE, PERSONAL FINANCIAL AND TAX PLANNING, INVESTMENTS, CORPORATE FINANCE, CURRENCY AND ALL TYPES OF INSURANCE; GENERAL PURPOSE PLASTIC BAGS, ENVELOPES AND PLASTIC BUBBLE PACKS FOR MERCHANDISE PACKAGING (U.S. CLS. 2, 5, 22, 23, 29, 37, 38 AND 50).

FIRST USE 11-6-2006; IN COMMERCE 9-27-2010.

**CLASS 36—INSURANCE AND FINANCIAL**



FOR BANKING SERVICES; ON-LINE BANKING SERVICES; BANKING SERVICES PROVIDED FOR PAYING BILLS BY TELEPHONE; SERVICES IN DEALING WITH CURRENCY, NAMELY, CURRENCY EXCHANGE AND ADVICE; BUREAU DE CHANGE SERVICES IN THE NATURE OF FOREIGN CURRENCY EXCHANGE; FOREIGN CURRENCY EXCHANGE SERVICES; CURRENCY TRADING; INVESTMENT BANKING SERVICES, NAMELY, FORWARD BUYING OF CURRENCY; CREDIT CARD SERVICES; FINANCIAL AND INVESTMENT SAFEKEEPING AND CUSTODIAL SERVICES IN THE NATURE OF FINANCIAL TRUST OPERATIONS; CUSTODIAL BANKING SERVICES; FINANCIAL TRUSTEESHIP SERVICES; FINANCIAL MANAGEMENT SERVICES; PROVIDING INFORMATION, TRADING, TRADING FOR OTHERS, BROKERAGE, PROVIDING ADVICE AND RECOMMENDATIONS, VALUATION AND HANDLING SERVICES IN THE NATURE OF BROKERAGE, FINANCIAL MANAGEMENT, PROVIDING MANAGEMENT SERVICES, ALL IN RELATION TO BONDS, STOCKS, SECURITIES, FINANCIAL INSTRUMENTS, DERIVATIVES, FUTURES AND COMMODITIES, AS WELL AS PORTFOLIOS OF ANY OF THE FOREGOING; SHARE UNDERWRITING SERVICES; SECURITIES LENDING SERVICES; DIVIDEND COLLECTION SERVICES; PAYMENT COLLECTION SERVICES; INVESTMENT RESEARCH AND INFORMATION SERVICES; MARKET MAKING SERVICES IN THE SECURITIES FIELD; UNIT TRUST MANAGEMENT AND INVESTMENT SERVICES; INVESTMENT TRUST MANAGEMENT SERVICES; CORPORATE FINANCE CONSULTANCY SERVICES AND FINANCIAL CONSULTANCY; ELECTRONIC STOCK TRANSFER SERVICES, PERSONAL FINANCE SERVICES, NAMELY, FINANCIAL SERVICES IN THE NATURE OF AN INVESTMENT SECURITY, FINANCIAL SERVICES IN THE FIELD OF MONEY LENDING, FINANCIAL SERVICES, NAMELY, PROVIDING ON-LINE STORED VALUE ACCOUNTS IN AN ELECTRONIC ENVIRONMENT, FINANCIAL SERVICES, NAMELY, INVESTMENT FUND TRANSFER AND TRANSACTION SERVICES, FINANCIAL SERVICES, NAMELY, ASSISTING OTHERS WITH THE COMPLETION OF FINANCIAL TRANSACTIONS FOR STOCKS, BONDS, SECURITIES AND EQUITIES, FINANCIAL SERVICES, NAMELY, ISSUANCE AND MANAGEMENT OF CERTIFICATES BACKED BY LOAN PORTFOLIOS WHICH ARE SUBSEQUENTLY MANAGED TO INSURE THE INTEGRITY OF THE CERTIFICATES, FINANCIAL SERVICES, NAMELY, A TOTAL PORTFOLIO OFFERING FOR HIGH NET WORTH CLIENTS CONSISTING OF BOTH SEPARATE ACCOUNTS AND MUTUAL FUNDS FOR EQUITY AND FIXED INCOME INVESTMENTS, FINANCIAL SERVICES, NAMELY, SAVINGS PROGRAMS FOR YOUTHS, FINANCIAL SERVICES, NAMELY, THE PURCHASE OF RESIDENTIAL MORTGAGES ON BEHALF OF OTHERS AND ISSUANCE OF MORTGAGED-BACKED SECURITIES, FINANCIAL TRUST OPERATIONS AND FINANCIAL VALUATION OF PERSONAL PROPERTY AND REAL ESTATE; ACTUARIAL SERVICES; REAL ESTATE ADVICE, CONSULTING, VALUATION, BROKERAGE AND FINANCING; VALUATIONS AND FINANCIAL APPRAISALS OF MOVABLE PROPERTY AND REAL ESTATE; REAL ESTATE ACQUISITION AND MANAGEMENT; RENTAL, LETTING AND LEASING OF REAL PROPERTY; FINANCIAL ADMINISTRATION, NAMELY, ADMINISTRATION OF SAVINGS ACCOUNTS, ADMINISTRATION OF MUTUAL FUND INVESTMENTS, HEDGE FUND INVESTMENTS; CHARITABLE FUND RAISING SERVICES; ADMINISTRATION OF MUTUAL FUNDS; MUTUAL FUNDS SERVICES, NAMELY, MUTUAL FUND BROKERAGE, MUTUAL FUND INVESTMENT, MUTUAL FUND DISTRIBUTION; CASH MANAGEMENT SERVICES; FACTORING SERVICES; INVOICE DISCOUNTING SERVICES; AUTOMATED TELLER MACHINE SERVICES; LOAN FINANCING AND MORTGAGE LENDING SERVICES; MORTGAGE LENDING AND MORTGAGE BROKERAGE; PROVISION OF SECURITY FOR LOANS, NAMELY, GUARANTEEING LOANS; BAIL BONDING SERVICES; LEASE PURCHASE FINANCING, HIRE PURCHASE FINANCING; ISSUING CHARGE CARDS, CASH CARDS, CHECK GUARANTEED CARDS, DEBIT CARDS, AND STORED VALUE CARDS IN THE NATURE OF PAYMENT CARDS, FINANCIAL CARDS AND PURCHASE CARDS; STORED VALUE, DEBIT CARD AND CASH REPLACEMENT SERVICES RENDERED BY CREDIT CARD; PROVIDING DATABASES IN THE FIELD OF PAYMENT CARD AND

CREDIT CARD DATA; ELECTRONIC PAYMENT SERVICES, NAMELY, ELECTRONIC PROCESSING AND TRANSMISSION OF BILL PAYMENT DATA; MERCHANT BANKING AND INVESTMENT BANKING AND TREASURY SERVICES IN THE NATURE OF FOREIGN EXCHANGE INFORMATION SERVICES, CASH MANAGEMENT; INVESTMENT SERVICES, NAMELY, PROVIDING CERTIFICATES OF DEPOSIT AND MONEY MARKET ACCOUNTS; INVESTMENT MANAGEMENT; INVESTMENT AND FINANCIAL MANAGEMENT SERVICES; CONSULTATION AND ADVISING IN THE FIELDS OF PERSONAL EQUITY AND ESTATE PLANNING; INVESTMENT ADVISORY SERVICES; PENSION FUND BROKERAGE, MANAGEMENT AND ADVISORY SERVICES (U.S. CLS. 100, 101 AND 102).

FIRST USE 11-6-2006; IN COMMERCE 9-27-2010.

---

4,046,312. A&E TELEVISION NETWORKS, LLC, NEW YORK, NY. SN 85-052,511. PUB. 12-7-2010, FILED 6-2-2010.

## GROWING UP TWISTED

THE MARK CONSISTS OF STANDARD CHARACTERS WITHOUT CLAIM TO ANY PARTICULAR FONT, STYLE, SIZE, OR COLOR.

### CLASS 9—ELECTRICAL AND SCIENTIFIC APPARATUS

FOR MULTIMEDIA GOODS, NAMELY, PRERECORDED DIGITAL VIDEO DISCS AND DVDS ABOUT FAMILY LIFE WITH A CELEBRITY FAMILY MEMBER; DIGITAL MEDIA, NAMELY, DOWNLOADABLE AUDIO AND VIDEO FILES ABOUT FAMILY LIFE WITH A CELEBRITY FAMILY MEMBER; DOWNLOADABLE WEBCASTS ABOUT FAMILY LIFE WITH A CELEBRITY FAMILY MEMBER; DOWNLOADABLE RING TONES AND GRAPHICS FOR MOBILE DEVICES, AND DOWNLOADABLE ON-LINE DISCUSSION BOARDS ABOUT FAMILY LIFE WITH A CELEBRITY FAMILY MEMBER (U.S. CLS. 21, 23, 26, 36 AND 38).

FIRST USE 7-28-2010; IN COMMERCE 7-28-2010.

### CLASS 41—EDUCATION AND ENTERTAINMENT

FOR ENTERTAINMENT SERVICES, NAMELY, AN ON-GOING REALITY-BASED SERIES ABOUT FAMILY LIFE WITH A CELEBRITY FAMILY MEMBER DISTRIBUTED VIA VARIOUS PLATFORMS ACROSS MULTIPLE FORMS OF TRANSMISSION MEDIA; PROVIDING ENTERTAINMENT INFORMATION VIA THE INTERNET ABOUT A TELEVISION PROGRAM SERIES DEPICTING FAMILY LIFE WITH A CELEBRITY FAMILY MEMBER (U.S. CLS. 100, 101 AND 107).

FIRST USE 7-27-2010; IN COMMERCE 7-27-2010.

4,046,317. IAN PERCY CORPORATION, THE, SCOTTS-DALE, AZ. SN 85-055,555. PUB. 12-21-2010, FILED 6-5-2010.



THE MARK CONSISTS OF INTERTWINED INFINITY SYMBOLS.

**CLASS 14—JEWELRY**

FOR JEWELRY (U.S. CLS. 2, 27, 28 AND 50).  
FIRST USE 7-31-2009; IN COMMERCE 7-31-2009.

**CLASS 25—CLOTHING**

FOR T-SHIRTS, TANK TOPS; CLOTHING FOR WOMEN, NAMELY, SHIRTS (U.S. CLS. 22 AND 39).  
FIRST USE 7-31-2008; IN COMMERCE 7-31-2008.

**CLASS 35—ADVERTISING AND BUSINESS**

FOR ONLINE RETAIL STORE SERVICES FEATURING JEWELRY AND CLOTHING; CONSULTING SERVICES IN THE FIELD OF ORGANIZATIONAL DEVELOPMENT (U.S. CLS. 100, 101 AND 102).  
FIRST USE 7-31-2008; IN COMMERCE 7-31-2008.

4,046,320. JOB4SIGHT, LLC, AUGUSTA, WV. SN 85-057,104. PUB. 3-22-2011, FILED 6-8-2010.

**HILO**

THE MARK CONSISTS OF STANDARD CHARACTERS WITHOUT CLAIM TO ANY PARTICULAR FONT, STYLE, SIZE, OR COLOR.

**CLASS 35—ADVERTISING AND BUSINESS**

FOR PROVIDING ONLINE INTERACTIVE EMPLOYMENT COUNSELING AND RECRUITMENT SERVICES; PROVIDING ONLINE EMPLOYMENT PLACEMENT SERVICES, NAMELY, ONLINE RESUME MATCHING SERVICES; COUNSELING CONCERNING CAREERS AND SKILLS FOR USE IN EMPLOYMENT SETTINGS; EMPLOYMENT COUNSELING CONCERNING PERSONALITY TESTING TO MATCH PROSPECTIVE EMPLOYEES TO AVAILABLE JOB OPENINGS FOR USE IN EMPLOYMENT SETTINGS (U.S. CLS. 100, 101 AND 102).  
FIRST USE 7-25-2011; IN COMMERCE 7-25-2011.

**CLASS 44—MEDICAL, BEAUTY AND AGRICULTURAL SERVICES**

FOR PROVIDING ONLINE INFORMATION REGARDING PSYCHOLOGICAL TESTING AND SCORING; AND PROVIDING ONLINE PSYCHOLOGICAL TESTING SERVICES (U.S. CLS. 100 AND 101).  
FIRST USE 7-25-2011; IN COMMERCE 7-25-2011.

4,046,323. ELLEN ALLEN, INC., MILLERSVILLE, MD. SN 85-058,228. PUB. 11-2-2010, FILED 6-9-2010.

**Ellen Allen**

THE MARK CONSISTS OF STANDARD CHARACTERS WITHOUT CLAIM TO ANY PARTICULAR FONT, STYLE, SIZE, OR COLOR.

OWNER OF U.S. REG. NO. 3,716,043.

THE NAME "ELLEN ALLEN" IDENTIFIES A LIVING INDIVIDUAL WHOSE CONSENT IS OF RECORD.

**CLASS 16—PAPER GOODS AND PRINTED MATTER**

FOR STATIONERY (U.S. CLS. 2, 5, 22, 23, 29, 37, 38 AND 50).  
FIRST USE 8-1-2007; IN COMMERCE 7-15-2009.

**CLASS 18—LEATHER GOODS**

FOR CLUTCH BAGS; CLUTCH PURSES; CLUTCHES; FASHION HANDBAGS; HANDBAGS FOR LADIES; HANDBAGS, PURSES AND WALLETS; PURSES AND WALLETS; TOILETRY CASES SOLD EMPTY; TOTE BAGS; WALLETS (U.S. CLS. 1, 2, 3, 22 AND 41).  
FIRST USE 8-1-2007; IN COMMERCE 7-15-2009.

**CLASS 25—CLOTHING**

FOR SILK SCARVES; BOW TIES; TIES (U.S. CLS. 22 AND 39).  
FIRST USE 8-1-2007; IN COMMERCE 7-15-2009.

4,046,342. COLMUS-MCGEE, PAMELA, PRINCESS ANNE, MD. SN 85-062,773. PUB. 11-16-2010, FILED 6-15-2010.



NO CLAIM IS MADE TO THE EXCLUSIVE RIGHT TO USE "BALLS", APART FROM THE MARK AS SHOWN.

THE COLOR(S) RED AND BLACK IS/ARE CLAIMED AS A FEATURE OF THE MARK.

THE MARK CONSISTS OF THE WORDS "BUSTER'S BALLS" WHICH ARE IN BRIGHT RED WITH A MEDIUM BLACK OUTLINE. THE WORDS APPEAR IN A SLIGHT ARCH ABOVE A BRIGHT RED CRAB OUTLINED IN BLACK. THERE ARE TWO BLACK EYES THAT EXTEND ABOVE THE BODY AND ARE ATTACHED TO TWO RED ELONGATED OVALS OUTLINED IN BLACK. THE COLOR WHITE IN THE EYES REPRESENTS A TRANSPARENT AREA AND IS NOT A FEATURE OF THE MARK. THE EYES ARE SHAPED TO RESEMBLE CIRCLES WITH A SMALL BLACK CIRCLE WITH A BLACK INTERIOR IN EACH EYE. THE BODY OF THE CRAB IS ATTACHED TO TWO LARGE PINCHERS, ONE ON EACH SIDE AND THREE SMALLER LEGS BELOW ON EACH SIDE. THE TWO LARGE PINCHERS EACH HAVE THREE BLACK MARKS WHICH INDICATE MOTION. THERE IS ONE MARK ON THE SIDE OF EACH PINCHER FACING THE BODY AND TWO ACTION MARKS ON THE SIDE OF EACH PINCHER FACING AWAY FROM THE BODY. THE CRAB HAS A MEDIUM BLACK LINE DRAWN TO FORM A SMILE IN THE MIDDLE OF THE BODY.

#### CLASS 25—CLOTHING

FOR CLOTHING, NAMELY, HEADWEAR FOR CONSUMERS (U.S. CLS. 22 AND 39).

FIRST USE 8-12-2010; IN COMMERCE 8-12-2010.

#### CLASS 29—MEATS AND PROCESSED FOODS

FOR MEATS AND PROCESSED FOOD PRODUCTS, NAMELY, CRAB AND CHEESE BALL FOR CONSUMERS OF ALL AGES (U.S. CL. 46).

FIRST USE 8-12-2010; IN COMMERCE 8-12-2010.

---

4,046,353. HUDSON FURNITURE INC., NEW YORK, NY. SN 85-067,405. PUB. 11-16-2010, FILED 6-21-2010.

## HUDSON FURNITURE

THE MARK CONSISTS OF STANDARD CHARACTERS WITHOUT CLAIM TO ANY PARTICULAR FONT, STYLE, SIZE, OR COLOR.

NO CLAIM IS MADE TO THE EXCLUSIVE RIGHT TO USE "FURNITURE", APART FROM THE MARK AS SHOWN.

#### CLASS 20—FURNITURE AND ARTICLES NOT OTHERWISE CLASSIFIED

FOR FURNITURE (U.S. CLS. 2, 13, 22, 25, 32 AND 50). FIRST USE 6-29-2011; IN COMMERCE 6-29-2011.

#### CLASS 35—ADVERTISING AND BUSINESS

FOR RETAIL STORE SERVICES FEATURING FURNITURE (U.S. CLS. 100, 101 AND 102).

FIRST USE 5-0-2004; IN COMMERCE 5-0-2004.

4,046,365. MFP-NS HOCKEY VENTURES, LLC, NEW YORK, NY. SN 85-071,927. PUB. 11-23-2010, FILED 6-25-2010.



NO CLAIM IS MADE TO THE EXCLUSIVE RIGHT TO USE "GREENVILLE", APART FROM THE MARK AS SHOWN.

THE MARK CONSISTS OF THE STYLIZED WORD "GREENVILLE" IN A BANNER OVER THE WORD STYLIZED "ROAD" OVER THE STYLIZED WORD "WARRIORS" OVER A DEPICTION OF A BEARDED MAN WEARING A HELMET WITH TRIANGLE DESIGNS IN THE BACKGROUND.

#### CLASS 25—CLOTHING

FOR CLOTHING GOODS, NAMELY, SHIRTS, T-SHIRTS, HATS, CAPS, SWEATSHIRTS, AND JERSEYS (U.S. CLS. 22 AND 39).

FIRST USE 6-26-2010; IN COMMERCE 6-26-2010.

#### CLASS 41—EDUCATION AND ENTERTAINMENT

FOR ENTERTAINMENT SERVICES, NAMELY, PROVIDING PROFESSIONAL HOCKEY EXHIBITIONS (U.S. CLS. 100, 101 AND 107).

FIRST USE 6-26-2010; IN COMMERCE 6-26-2010.

---

4,046,367. SMITH MICRO SOFTWARE, INC., ALISO VIEJO, CA. SN 85-072,084. PUB. 4-26-2011, FILED 6-25-2010.

## SENDSTUFF

THE MARK CONSISTS OF STANDARD CHARACTERS WITHOUT CLAIM TO ANY PARTICULAR FONT, STYLE, SIZE, OR COLOR.

#### CLASS 38—COMMUNICATION

FOR SECURE TRANSFER OF DATA FILES AND MEDIA BY TELECOMMUNICATIONS; PROVIDING PERMISSION-BASED ACCESS TO DATABASES, DATA FILES AND MEDIA (U.S. CLS. 100, 101 AND 104).

FIRST USE 7-15-2010; IN COMMERCE 7-15-2010.

**CLASS 39—TRANSPORTATION AND STORAGE**

FOR ELECTRONIC STORAGE OF FILES, MEDIA AND DATA (U.S. CLS. 100 AND 105).  
FIRST USE 7-15-2010; IN COMMERCE 7-15-2010.

**CLASS 42—SCIENTIFIC AND COMPUTER SERVICES**

FOR ENCRYPTION AND DIGITAL COMPRESSION OF DATA FILES AND MEDIA (U.S. CLS. 100 AND 101).  
FIRST USE 7-15-2010; IN COMMERCE 7-15-2010.

4,046,368. CARAVAN CANOPY INTERNATIONAL, INC., LA MIRADA, CA. SN 85-072,203. PUB. 1-4-2011, FILED 6-25-2010.

**TRUNKSHADE**

THE MARK CONSISTS OF STANDARD CHARACTERS WITHOUT CLAIM TO ANY PARTICULAR FONT, STYLE, SIZE, OR COLOR.

**CLASS 6—METAL GOODS**

FOR PREFABRICATED TEMPORARY METALLIC FRAME STRUCTURES, NAMELY, SHEDS, GARAGES, GAZEBOS, CARPORTS, AND SHADE COVERS HAVING FABRIC, CANVAS OR TEXTILE FRAME COVERINGS (U.S. CLS. 2, 12, 13, 14, 23, 25 AND 50).  
FIRST USE 9-0-2010; IN COMMERCE 9-0-2010.

**CLASS 22—CORDAGE AND FIBERS**

FOR CANVAS CANOPIES, TENTS AND FOLDABLE CANOPIES WITH CANVAS COVERINGS FOR OUTDOOR USE (U.S. CLS. 1, 2, 7, 19, 22, 42 AND 50).  
FIRST USE 9-0-2010; IN COMMERCE 9-0-2010.

4,046,369. LAUREN MOSHI LLC, COMMERCE, CA. SN 85-072,258. PUB. 3-22-2011, FILED 6-25-2010.

**LAUREN MOSHI**

THE MARK CONSISTS OF STANDARD CHARACTERS WITHOUT CLAIM TO ANY PARTICULAR FONT, STYLE, SIZE, OR COLOR.

OWNER OF U.S. REG. NO. 3,526,753.  
THE NAME(S), PORTRAIT(S), AND/OR SIGNATURE(S) SHOWN IN THE MARK IDENTIFIES A LIVING INDIVIDUAL, WHOSE CONSENT(S) TO REGISTER IS MADE OF RECORD.

**CLASS 14—JEWELRY**

FOR JEWELRY (U.S. CLS. 2, 27, 28 AND 50).  
FIRST USE 8-1-2011; IN COMMERCE 8-1-2011.

**CLASS 18—LEATHER GOODS**

FOR HANDBAGS, BAGS, NAMELY, ALL-PURPOSE CARRYING BAGS; PURSES, WALLETS, SUITCASES, BRIEFCASES, DOCUMENT BRIEFCASES, TRUNKS AND TRAVELLING BAGS (U.S. CLS. 1, 2, 3, 22 AND 41).  
FIRST USE 8-1-2011; IN COMMERCE 8-1-2011.

4,046,376. RAVEN SECURITIES CORP., NEW YORK, NY. SN 85-073,716. PUB. 11-30-2010, FILED 6-29-2010.

**Raven Securities**

THE MARK CONSISTS OF STANDARD CHARACTERS WITHOUT CLAIM TO ANY PARTICULAR FONT, STYLE, SIZE, OR COLOR.

NO CLAIM IS MADE TO THE EXCLUSIVE RIGHT TO USE "SECURITIES", APART FROM THE MARK AS SHOWN.

**CLASS 35—ADVERTISING AND BUSINESS**

FOR CONNECTING BUYERS AND SELLERS OF FINANCIAL ASSETS; ANALYZING AND COMPILING DATA FOR MEASURING THE PERFORMANCE OF FINANCIAL MARKETS; COMPILING FINANCIAL, SECURITIES, STOCK EXCHANGE, TRADE AND QUOTE, INDEX VALUE AND OTHER FINANCIAL MARKET INFORMATION FOR BUSINESS PURPOSES; PREPARING FINANCIAL REPORTS FOR OTHERS; PROVIDING AN ON-LINE COMPUTER WEB SITE THAT PROVIDES COMMERCIAL FINANCIAL TRANSACTION DATA, ACCOUNT MANAGEMENT, FINANCIAL REPORTING, ACCOUNTING FEATURES AND RELATED REFERENCE INFORMATION (U.S. CLS. 100, 101 AND 102).  
FIRST USE 6-7-2010; IN COMMERCE 6-7-2010.

**CLASS 36—INSURANCE AND FINANCIAL**

FOR FINANCIAL ADMINISTRATION OF STOCK EXCHANGE TRADING OF SHARES AND OTHER FINANCIAL SECURITIES IN FINANCIAL MARKETS; FINANCIAL INVESTMENT BROKERAGE; FINANCIAL PORTFOLIO MANAGEMENT; FINANCIAL SERVICES IN THE NATURE OF AN INVESTMENT SECURITY; ELECTRONIC FINANCIAL TRADING SERVICES; FINANCIAL ADVICE; FINANCIAL ADVICE AND CONSULTANCY SERVICES; FINANCIAL ADVISORY AND CONSULTANCY SERVICES; FINANCIAL ANALYSES; FINANCIAL ANALYSIS AND CONSULTATION; FINANCIAL ANALYSIS AND RESEARCH SERVICES; FINANCIAL AND INVESTMENT SERVICES, NAMELY, MANAGEMENT AND BROKERAGE IN THE FIELDS OF STOCKS, BONDS, OPTIONS, COMMODITIES, FUTURES AND OTHER SECURITIES, AND THE INVESTMENT OF FUNDS OF OTHERS; FINANCIAL ASSET MANAGEMENT; FINANCIAL CONSULTANCY; FINANCIAL CONSULTATION; FINANCIAL CONSULTING; FINANCIAL CONSULTING SERVICES, NAMELY, EXPERT ANALYSIS IN FINANCE; FINANCIAL EXCHANGE; FINANCIAL INFORMATION; FINANCIAL INFORMATION AND ADVISORY SERVICES; FINANCIAL INFORMATION AND EVALUATIONS; FINANCIAL INFORMATION PROVIDED BY ELECTRONIC MEANS; FINANCIAL INVESTMENT ANALYSIS AND STOCK RESEARCH; FINANCIAL MANAGEMENT; FINANCIAL MANAGEMENT VIA THE INTERNET; FINANCIAL PLANNING; FINANCIAL PLANNING AND INVESTMENT ADVISORY SERVICES; FINANCIAL PLANNING CONSULTATION; FINANCIAL PORTFOLIO ANALYSIS SERVICES; FINANCIAL RESEARCH; FINANCIAL RESEARCH AND EQUITY RESEARCH BROKERAGE SERVICES; FINANCIAL RESEARCH AND INFORMATION SERVICES; FINANCIAL RISK MANAGEMENT; FINANCIAL RISK MANAGEMENT

CONSULTATION; FINANCIAL SECURITIES EXCHANGE SERVICES; FINANCIAL SERVICES, NAMELY, ASSISTING OTHERS WITH THE COMPLETION OF FINANCIAL TRANSACTIONS FOR STOCKS, BONDS, SECURITIES AND EQUITIES; FINANCIAL SERVICES, NAMELY, COORDINATION, WITHIN A SINGLE ACCOUNT, OF AN INVESTMENT PORTFOLIO'S MAINTENANCE, TRADING, REBALANCING, AND TAX MANAGEMENT NEEDS; FINANCIAL SERVICES, NAMELY, PROVIDING FOR THE EXCHANGE OF FOREIGN CURRENCY, COMMODITIES, FINANCIAL DERIVATIVES, INTEREST RATE PRODUCTS, AND EQUITIES VIA THE INTERNET AND INTRANET SYSTEMS; FINANCIAL SERVICES, NAMELY, RAISING MONEY FOR THE HEDGE FUNDS OF OTHERS; FINANCIAL SERVICES, NAMELY, THE TRADING OF FINANCIAL INSTRUMENTS, SECURITIES, SHARES, OPTIONS AND OTHER DERIVATIVE PRODUCTS; FINANCIAL SERVICES, NAMELY, WEALTH MANAGEMENT SERVICES; FINANCIAL VALUATIONS; ON-LINE TRADING OF FINANCIAL INSTRUMENTS, SHARES, OPTIONS AND OTHER DERIVATIVE PRODUCTS; PROVIDING A WEBSITE FEATURING NON-DOWNLOADABLE VIDEOS IN THE FIELD OF FINANCIAL PLANNING; PROVIDING FINANCIAL INFORMATION; PROVIDING INFORMATION AND RESEARCH IN THE FIELD OF FINANCE AND FINANCIAL INVESTMENTS; PROVISION OF FINANCIAL INFORMATION; STRATEGIC FINANCIAL ADVISORY SERVICES (U.S. CLS. 100, 101 AND 102).

FIRST USE 6-7-2010; IN COMMERCE 6-7-2010.

---

4,046,385. THOMPSON, PETER D., HARRISBURG, PA. SN 85-076,501. PUB. 11-30-2010, FILED 7-1-2010.

## ARIEL STREAM

THE MARK CONSISTS OF STANDARD CHARACTERS WITHOUT CLAIM TO ANY PARTICULAR FONT, STYLE, SIZE, OR COLOR.

NO CLAIM IS MADE TO THE EXCLUSIVE RIGHT TO USE "STREAM", APART FROM THE MARK AS SHOWN.

### CLASS 38—COMMUNICATION

FOR BROADCASTING SERVICES, NAMELY, DIGITAL AUDIO BROADCASTING SERVICES PROVIDED VIA A GLOBAL COMMUNICATIONS NETWORK (U.S. CLS. 100, 101 AND 104).

FIRST USE 7-6-2010; IN COMMERCE 6-23-2011.

### CLASS 41—EDUCATION AND ENTERTAINMENT

FOR ENTERTAINMENT SERVICES, NAMELY, PROVIDING NONDOWNLOADABLE PRERECORDED MUSIC VIA A GLOBAL COMMUNICATIONS NETWORK, AND MUSIC PROGRAMS FOR TRADITIONAL, TERRESTRIAL BROADCAST RADIO, NAMELY, RADIO PROGRAM SYNDICATION (U.S. CLS. 100, 101 AND 107).

FIRST USE 7-6-2010; IN COMMERCE 7-7-2011.

4,046,386. 24 HOUR FITNESS USA, INC., SAN RAMON, CA. SN 85-076,585. PUB. 5-24-2011, FILED 7-1-2010.

## APEX

THE MARK CONSISTS OF STANDARD CHARACTERS WITHOUT CLAIM TO ANY PARTICULAR FONT, STYLE, SIZE, OR COLOR.

### CLASS 42—SCIENTIFIC AND COMPUTER SERVICES

FOR TEMPORARY USE OF ON-LINE NON-DOWNLOADABLE SOFTWARE FOR TRACKING DIET, EXERCISE, FITNESS, ATHLETIC PERFORMANCE AND WEIGHT MANAGEMENT (U.S. CLS. 100 AND 101).

FIRST USE 10-0-2000; IN COMMERCE 10-0-2000.

### CLASS 44—MEDICAL, BEAUTY AND AGRICULTURAL SERVICES

FOR COMPUTER ONLINE SERVICES, NAMELY, PROVIDING A WEBSITE FEATURING INFORMATION, ONLINE LINKS AND ELECTRONIC RESOURCES RELATED TO HUMAN PHYSIOLOGY AND HEALTH (U.S. CLS. 100 AND 101).

FIRST USE 10-0-2000; IN COMMERCE 10-0-2000.

---

4,046,401. ISLE OF CAPRI CASINOS, INC., ST. LOUIS, MO. SN 85-081,003. PUB. 11-2-2010, FILED 7-9-2010.

## GET WINNING

THE MARK CONSISTS OF STANDARD CHARACTERS WITHOUT CLAIM TO ANY PARTICULAR FONT, STYLE, SIZE, OR COLOR.

### CLASS 41—EDUCATION AND ENTERTAINMENT

FOR CASINOS (U.S. CLS. 100, 101 AND 107).

FIRST USE 7-0-2011; IN COMMERCE 7-0-2011.

### CLASS 43—HOTEL AND RESTAURANT SERVICES

FOR HOTEL SERVICES (U.S. CLS. 100 AND 101).

FIRST USE 7-25-2011; IN COMMERCE 7-25-2011.

4,046,407. UNIVERSITY OF MOUNT UNION, ALLIANCE, OH. SN 85-082,573. PUB. 4-19-2011, FILED 7-12-2010.

### UNIVERSITY OF MOUNT UNION

THE MARK CONSISTS OF STANDARD CHARACTERS WITHOUT CLAIM TO ANY PARTICULAR FONT, STYLE, SIZE, OR COLOR.

NO CLAIM IS MADE TO THE EXCLUSIVE RIGHT TO USE "UNIVERSITY", APART FROM THE MARK AS SHOWN.

### CLASS 25—CLOTHING

FOR CLOTHING, NAMELY, CAPS, HATS, T-SHIRTS, SWEATSHIRTS, SLACKS, PANTS, SOCKS, UNDERGARMENTS, COATS, JACKETS AND WIND RESISTANT JACKETS (U.S. CLS. 22 AND 39).

FIRST USE 8-1-2010; IN COMMERCE 8-1-2010.

### CLASS 41—EDUCATION AND ENTERTAINMENT

FOR ARRANGING AND CONDUCTING ATHLETIC COMPETITIONS; EDUCATIONAL SERVICES, NAMELY, PROVIDING COLLEGE LEVEL UNDERGRADUATE AND GRADUATE INSTRUCTION, DISTRIBUTING COURSE MATERIALS IN CONNECTION THEREWITH; EDUCATIONAL SERVICES, NAMELY, CONDUCTING CLASSES, SEMINARS, LECTURES, AND WORKSHOPS IN THE FIELD OF ART, BIOLOGY, CHEMISTRY, COMMUNICATIONS, COMPUTER SCIENCE AND INFORMATION SYSTEMS, ECONOMICS, ACCOUNTING, BUSINESS ADMINISTRATION, EDUCATION, ENGLISH, FOREIGN LANGUAGES, GEOLOGY, HISTORY, HUMAN PERFORMANCE, SPORTS MANAGEMENT, MATHEMATICS, MUSIC, PHILOSOPHY, RELIGIOUS STUDIES, PHYSICS, ASTRONOMY, POLITICAL SCIENCE, PSYCHOLOGY, SOCIOLOGY AND THEATER; ENTERTAINMENT SERVICES IN THE NATURE OF SPORTING EVENTS (U.S. CLS. 100, 101 AND 107).

FIRST USE 8-1-2010; IN COMMERCE 8-1-2010.

4,046,408. UNIVERSITY OF MOUNT UNION, ALLIANCE, OH. SN 85-082,598. PUB. 12-14-2010, FILED 7-12-2010.

### WHERE EXCEPTIONAL BEGINS

THE MARK CONSISTS OF STANDARD CHARACTERS WITHOUT CLAIM TO ANY PARTICULAR FONT, STYLE, SIZE, OR COLOR.

### CLASS 25—CLOTHING

FOR CLOTHING, NAMELY, CAPS, HATS, T-SHIRTS, SWEATSHIRTS, SLACKS, PANTS, SOCKS, UNDERGARMENTS, COATS, JACKETS AND WIND RESISTANT JACKETS (U.S. CLS. 22 AND 39).

FIRST USE 8-1-2010; IN COMMERCE 8-1-2010.

### CLASS 41—EDUCATION AND ENTERTAINMENT

FOR ARRANGING AND CONDUCTING ATHLETIC COMPETITIONS; EDUCATIONAL SERVICES, NAMELY, PROVIDING COLLEGE LEVEL UNDERGRADUATE AND GRADUATE INSTRUCTION, DISTRIBUTING COURSE MATERIALS IN CONNECTION THEREWITH; EDUCATIONAL SERVICES, NAMELY, CONDUCTING CLASSES, SEMINARS, LECTURES, AND WORKSHOPS IN THE FIELD OF ART, BIOLOGY, CHEMISTRY, COMMUNICATIONS, COMPUTER SCIENCE AND INFORMATION SYSTEMS, ECONOMICS, ACCOUNTING, BUSINESS ADMINISTRATION, EDUCATION, ENGLISH, FOREIGN LANGUAGES, GEOLOGY, HISTORY, HUMAN PERFORMANCE, SPORTS MANAGEMENT, MATHEMATICS, MUSIC, PHILOSOPHY, RELIGIOUS STUDIES, PHYSICS, ASTRONOMY, POLITICAL SCIENCE, PSYCHOLOGY, SOCIOLOGY AND THEATER; ENTERTAINMENT SERVICES IN THE NATURE OF SPORTING EVENTS (U.S. CLS. 100, 101 AND 107).

FIRST USE 8-1-2010; IN COMMERCE 8-1-2010.

4,046,417. PET APPEAL, INC., CLACKAMAS, OR. SN 85-084,741. PUB. 12-21-2010, FILED 7-14-2010.



OWNER OF U.S. REG. NOS. 2,678,524, 3,663,354, AND OTHERS.

NO CLAIM IS MADE TO THE EXCLUSIVE RIGHT TO USE "SINCE 1999" AND "NATURAL", APART FROM THE MARK AS SHOWN.

THE MARK CONSISTS OF THE WORDS "CASTOR & POLLUX NATURAL PETWORKS" SURROUNDING A CENTRAL DIAMOND SHAPE IN WHICH THE WORDS "SINCE" AND "1999" BRACKET IMAGES OF A DOG AND A CAT. THE ENTIRE MARK FORMS A LARGER DIAMOND SHAPE, THE TOP EDGE OF WHICH IS OUTLINED ABOVE THE WORDS "CASTOR & POLLUX."

### CLASS 3—COSMETICS AND CLEANING PREPARATIONS

FOR NATURAL PET SHAMPOO; NATURAL PET STAIN AND ODOR REMOVER FOR CARPET AND UPHOLSTERY (U.S. CLS. 1, 4, 6, 50, 51 AND 52).

FIRST USE 7-0-2010; IN COMMERCE 7-0-2010.

### CLASS 18—LEATHER GOODS

FOR RAWHIDE CHEWS FOR ANIMALS (U.S. CLS. 1, 2, 3, 22 AND 41).

FIRST USE 7-0-2010; IN COMMERCE 7-0-2010.

### CLASS 28—TOYS AND SPORTING GOODS

FOR PET TOYS MADE WITH NONTOXIC MATERIALS (U.S. CLS. 22, 23, 38 AND 50).

FIRST USE 7-0-2010; IN COMMERCE 7-0-2010.

### CLASS 31—NATURAL AGRICULTURAL PRODUCTS

FOR NATURAL PET FOOD; NATURAL PET TREATS (U.S. CLS. 1 AND 46).

FIRST USE 7-0-2010; IN COMMERCE 7-0-2010.

4,046,428. GEISINGER SYSTEM SERVICES, DANVILLE, PA.  
SN 85-086,318. PUB. 1-18-2011, FILED 7-16-2010.

4,046,443. CLIC LIFESTYLE LIMITED, TSUEN WAN, HONG  
KONG. SN 85-089,154. PUB. 4-12-2011, FILED 7-21-2010.

# CLIC

## KEYSTONE BEACON COMMUNITY

THE MARK CONSISTS OF STANDARD CHARACTERS WITHOUT CLAIM TO ANY PARTICULAR FONT, STYLE, SIZE, OR COLOR.

OWNER OF U.S. REG. NO. 3,662,462.

NO CLAIM IS MADE TO THE EXCLUSIVE RIGHT TO USE "BEACON COMMUNITY", APART FROM THE MARK AS SHOWN.

## CLASS 35—ADVERTISING AND BUSINESS

FOR ANALYTICAL SERVICES IN THE FIELD OF HEALTHCARE, NAMELY, COLLECTION, AGGREGATION, ANALYSIS AND REPORTING OF COMPREHENSIVE, PATIENT-CENTERED HEALTH AND HEALTH CARE DATA FOR USE IN ASSESSING PRACTICE MANAGEMENT, CLINICAL PERFORMANCE, PRODUCT PERFORMANCE, HEALTH OUTCOMES, ECONOMICS AND QUALITY OF CARE, ALL FOR HEALTHCARE OPERATIONS AND PAYMENT PURPOSES (U.S. CLS. 100, 101 AND 102).

FIRST USE 1-14-2011; IN COMMERCE 1-14-2011.

## CLASS 38—COMMUNICATION

FOR PROVIDING SECURE ELECTRONIC ACCESS TO A DATABASE FEATURING THE HEALTH CARE INFORMATION OF PARTICIPATING PATIENTS FOR ACCESS BY SUCH PARTICIPATING PATIENTS AND THEIR HEALTHCARE PROVIDERS FOR THE PURPOSE OF MEDICAL TREATMENT (U.S. CLS. 100, 101 AND 104).

FIRST USE 1-14-2011; IN COMMERCE 1-14-2011.

## CLASS 44—MEDICAL, BEAUTY AND AGRICULTURAL SERVICES

FOR PROVIDING HEALTH CARE COORDINATION SERVICES SUPPORTED BY HEALTH INFORMATION TECHNOLOGY, NAMELY, HEALTH CARE MANAGEMENT AND DISEASE MANAGEMENT PROGRAMS; ANALYTICAL SERVICES IN THE FIELD OF HEALTHCARE, NAMELY, COLLECTION, AGGREGATION, ANALYSIS AND REPORTING OF COMPREHENSIVE, PATIENT-CENTERED HEALTH AND HEALTH CARE DATA FOR USE IN ASSESSING PRACTICE MANAGEMENT, CLINICAL PERFORMANCE, PRODUCT PERFORMANCE, HEALTH OUTCOMES, ECONOMICS AND QUALITY OF CARE, ALL FOR TREATMENT AND DIAGNOSTIC PURPOSES (U.S. CLS. 100 AND 101).

FIRST USE 1-14-2011; IN COMMERCE 1-14-2011.

## CLASS 45—PERSONAL AND LEGAL SERVICES

FOR PROVIDING HEALTH CARE COORDINATION SERVICES SUPPORTED BY HEALTH INFORMATION TECHNOLOGY, NAMELY, CASE MANAGEMENT SERVICES IN THE NATURE OF COORDINATING NECESSARY MEDICAL SERVICES FOR PATIENTS AND COORDINATING THE PROCUREMENT AND ADMINISTRATION OF PATIENT MEDICATION (U.S. CLS. 100 AND 101).

FIRST USE 1-14-2011; IN COMMERCE 1-14-2011.

THE MARK CONSISTS OF STANDARD CHARACTERS WITHOUT CLAIM TO ANY PARTICULAR FONT, STYLE, SIZE, OR COLOR.

## CLASS 14—JEWELRY

FOR JEWELRY (U.S. CLS. 2, 27, 28 AND 50).  
FIRST USE 8-31-2011; IN COMMERCE 8-31-2011.

## CLASS 18—LEATHER GOODS

FOR BAGS, NAMELY, TRAVEL BAGS AND LUGGAGE (U.S. CLS. 1, 2, 3, 22 AND 41).  
FIRST USE 8-31-2011; IN COMMERCE 8-31-2011.

## CLASS 25—CLOTHING

FOR WOMEN'S AND CHILDREN'S CLOTHING, NAMELY, T-SHIRTS, TANK TOPS, JACKETS, JERSEYS, SHORTS, PANTS, SWEATSHIRTS, SWEAT PANTS, JACKETS, JEANS, HEAD WEAR, DRESSES, LEOTARDS, BELTS, SCARVES, UNDERGARMENTS, NIGHTWEAR; FOOTWEAR; WOMEN'S AND CHILDREN'S FOOTWEAR (U.S. CLS. 22 AND 39).

FIRST USE 8-31-2011; IN COMMERCE 8-31-2011.

4,046,445. BERTHEL FISHER & COMPANY FINANCIAL SERVICES, INC., MARION, IA. SN 85-089,351. PUB. 12-21-2010, FILED 7-21-2010.



THE MARK CONSISTS OF AN ANIMATED TWO DIMENSIONAL REPRESENTATION OF A THREE DIMENSIONAL CONFIGURATION OF TWO CONCENTRIC RINGS IN MOTION DISPOSED ABOUT A CENTRAL BALL WHERE THE RINGS ROTATE INDEPENDENTLY AROUND THE STATIONARY BALL.

## CLASS 36—INSURANCE AND FINANCIAL

FOR FINANCIAL AND INVESTMENT SERVICES, NAMELY, MANAGEMENT AND BROKERAGE IN THE FIELDS OF STOCKS, BONDS, OPTIONS, COMMODITIES, FUTURES AND OTHER SECURITIES, AND THE INVESTMENT OF FUNDS FOR OTHERS (U.S. CLS. 100, 101 AND 102).

FIRST USE 8-11-2011; IN COMMERCE 8-11-2011.

**CLASS 42—SCIENTIFIC AND COMPUTER SERVICES**

FOR COMPUTER SERVICES, NAMELY, PROVIDING A WEB-BASED SYSTEM AND ONLINE PORTAL FOR CUSTOMERS TO REMOTELY MANAGE, ADMINISTER, MODIFY AND CONTROL THEIR END USER COMPUTER DEVICES, DATA AND SOFTWARE APPLICATIONS (U.S. CLS. 100 AND 101).

FIRST USE 8-11-2011; IN COMMERCE 8-11-2011.

4,046,454. WILSON COMAS, TAMARAC, FL. SN 85-090,695. PUB. 1-4-2011, FILED 7-22-2010.

# LATINXPLOT

THE MARK CONSISTS OF STANDARD CHARACTERS WITHOUT CLAIM TO ANY PARTICULAR FONT, STYLE, SIZE, OR COLOR.

THE WORDING "LATINXPLOT" HAS NO MEANING IN A FOREIGN LANGUAGE.

**CLASS 9—ELECTRICAL AND SCIENTIFIC APPARATUS**

FOR DOWNLOADABLE MP3 FILES AND MP3 RECORDINGS FEATURING MUSIC FOR EXERCISE CLASSES; DOWNLOADABLE VIDEO RECORDINGS FEATURING DANCE AND EXERCISE INSTRUCTION; PRERECORDED DIGITAL VIDEO DISKS FEATURING DANCE AND EXERCISE INSTRUCTION; VIDEO RECORDINGS FEATURING DANCE AND EXERCISE INSTRUCTION (U.S. CLS. 21, 23, 26, 36 AND 38).

FIRST USE 8-1-2010; IN COMMERCE 8-1-2010.

**CLASS 25—CLOTHING**

FOR SHIRTS; SHORTS; SWEAT PANTS; SWEAT SHIRTS (U.S. CLS. 22 AND 39).

FIRST USE 8-1-2010; IN COMMERCE 8-1-2010.

**CLASS 41—EDUCATION AND ENTERTAINMENT**

FOR EDUCATION SERVICES, NAMELY, PROVIDING CLASSES AND INSTRUCTION IN THE FIELDS OF DANCE AND EXERCISE (U.S. CLS. 100, 101 AND 107).

FIRST USE 5-29-2010; IN COMMERCE 5-29-2010.

4,046,462. ALL AMERICAN APPETITE, LLC, DBA FIT CRISPS, NEWPORT BEACH, CA. SN 85-091,222. PUB. 1-4-2011, FILED 7-23-2010.



NO CLAIM IS MADE TO THE EXCLUSIVE RIGHT TO USE "CRISPS", APART FROM THE MARK AS SHOWN.

THE MARK CONSISTS OF THE WORDS "FIT CRISPS"

WHEREIN THE "I" IN "FIT" IS IN STYLIZED LOWER CASE FORMAT AND CONSISTS OF A COMPLETELY SHADED CIRCLE APPEARING AS THE DOT IN THE LETTER "I," AND WHEREIN THE SAME "I" AS WELL AS THE UPPER RIGHT PORTION OF THE "F," AND THE UPPER LEFT PORTION OF THE "T," ARE CURVED TO BORDER THE DOT OF THE LETTER "I" IN "FIT".

**CLASS 29—MEATS AND PROCESSED FOODS**

FOR NUT-BASED SNACK FOODS, NAMELY, NUT CRISPS; POTATO-BASED SNACK FOODS; VEGETABLE-BASED SNACK FOODS (U.S. CL. 46).

FIRST USE 8-15-2010; IN COMMERCE 1-5-2011.

**CLASS 30—STAPLE FOODS**

FOR BREAKFAST CEREALS; CEREAL-BASED SNACK FOODS; GRAIN-BASED SNACK FOODS; MULTIGRAIN-BASED SNACK FOODS; READY-TO-EAT CEREALS; RICE-BASED SNACK FOODS (U.S. CL. 46).

FIRST USE 8-15-2010; IN COMMERCE 1-5-2011.

4,046,469. ERIEZ MANUFACTURING CO., ERIE, PA. SN 85-092,442. PUB. 1-11-2011, FILED 7-26-2010.

# GO GREEN WITH ORANGE

THE MARK CONSISTS OF STANDARD CHARACTERS WITHOUT CLAIM TO ANY PARTICULAR FONT, STYLE, SIZE, OR COLOR.

**CLASS 7—MACHINERY**

FOR ELECTROMAGNETIC SEPARATING MACHINES, NAMELY, VIBRATING SCREEN SEPARATORS HAVING HORIZONTAL, VERTICAL AND GYRATORY MOTION COMPONENTS FOR USE IN GRADING, SEPARATING AND SCREENING WET AND DRY MATERIALS OR OBJECTS, SUPERCONDUCTIVE MAGNETIC SEPARATORS, MAGNETIC SEPARATORS FOR INDUSTRIAL USE FOR SEPARATING MAGNETIC PARTICLES FROM NON-MAGNETIC SOLIDS AND LIQUIDS, AND MAGNETIC SEPARATORS USING RARE EARTH MATERIALS; MAGNETIC CONVEYORS; PULLEYS BEING PARTS OF MACHINES, NAMELY, MAGNETIC HEAD PULLEYS FOR HOLDING, CONTROLLING AND MOVING FERROUS MATERIALS IN MAGNETIC CONVEYORS; MAGNETIC VIBRATORY SCREEN SEPARATORS; ELECTROMAGNETIC AND MECHANICAL MACHINES FOR FEEDING, CONVEYING, OR CONTROLLING FERROUS PARTS (U.S. CLS. 13, 19, 21, 23, 31, 34 AND 35).

FIRST USE 8-16-2011; IN COMMERCE 8-16-2011.

**CLASS 9—ELECTRICAL AND SCIENTIFIC APPARATUS**

FOR MAGNETS, NAMELY, LIFTING MAGNETS, PERMANENT NON-ELECTRIC MAGNETS, ELONGATED SINGLE DOMAIN MAGNETS, CERAMIC MAGNETS, RUBBER MAGNETS, PLASTIC MAGNETS; METAL DETECTORS; VIBRATING MAGNETS; MAGNETS IN THE FORM OF PERMANENT MAGNETIC POWER CASTINGS, PRESSINGS, EXTRUSIONS, AND MOULDINGS WHICH INCLUDE VARIOUS TYPES OF PERMANENT MAGNET MATERIAL (U.S. CLS. 21, 23, 26, 36 AND 38).

FIRST USE 8-16-2011; IN COMMERCE 8-16-2011.



4,046,475. DIAMOND HOLDINGS SA, 2800-DELEMONT, SWITZERLAND. SN 85-093,480. PUB. 1-11-2011, FILED 7-27-2010.

**BAILEY BANKS & BIDDLE**

OWNER OF U.S. REG. NOS. 1,123,513 AND 1,436,870. THE MARK CONSISTS OF THE STYLIZED WORDS "BAILEY BANKS & BIDDLE".

**CLASS 14—JEWELRY**

FOR JEWELRY; PRECIOUS STONES (U.S. CLS. 2, 27, 28 AND 50).  
FIRST USE 10-15-2010; IN COMMERCE 10-15-2010.

**CLASS 35—ADVERTISING AND BUSINESS**

FOR RETAIL JEWELRY STORES (U.S. CLS. 100, 101 AND 102).  
FIRST USE 10-15-2010; IN COMMERCE 10-15-2010.

4,046,485. GEOPHYSICAL RESEARCH, LLC, HOUSTON, TX. SN 85-094,679. PUB. 1-25-2011, FILED 7-28-2010.

 **GEOPHYSICAL  
INSIGHTS**

NO CLAIM IS MADE TO THE EXCLUSIVE RIGHT TO USE "GEOPHYSICAL", APART FROM THE MARK AS SHOWN.

THE MARK CONSISTS OF A WAVING FLAG DESIGN, COMPOSED OF THREE BANDS, ON THE LEFT OF THE WORDING "GEOPHYSICAL INSIGHTS".

**CLASS 41—EDUCATION AND ENTERTAINMENT**

FOR TRAINING SERVICES IN THE OIL AND GAS EXPLORATION AND PRODUCTION INDUSTRY (U.S. CLS. 100, 101 AND 107).  
FIRST USE 7-21-2010; IN COMMERCE 7-21-2010.

**CLASS 42—SCIENTIFIC AND COMPUTER SERVICES**

FOR COMPUTER SOFTWARE DEVELOPMENT SERVICES; RESEARCH SERVICES IN THE FIELD OF GEOLOGY AND GEOPHYSICS; CONSULTING SERVICES IN THE FIELD OF OIL AND GAS EXPLORATION (U.S. CLS. 100 AND 101).  
FIRST USE 7-21-2010; IN COMMERCE 7-21-2010.

4,046,497. RHYTHM PHARMACEUTICALS, INC., BOSTON, MA. SN 85-096,215. PUB. 1-11-2011, FILED 7-29-2010.

 **rhythm**

THE MARK CONSISTS OF THE WORD "RHYTHM" IN LOWER-CASE LETTERS, WITH A DEPICTION OF A HUMMINGBIRD HOVERING ABOVE THE LETTER "Y".

**CLASS 5—PHARMACEUTICALS**

FOR PHARMACEUTICALS AND MEDICINES FOR THE TREATMENT OF METABOLIC DISEASES AND DISORDERS, INCLUDING OBESITY, DIABETES, METABOLIC SYNDROME AND CACHEXIA, AND GASTROINTESTINAL DISEASES AND DISORDERS, INCLUDING GASTROPARESIS, POST-OPERATIVE ILEUS, CHRONIC CONSTIPATION, AND INFLAMMATORY BOWEL DISEASE (U.S. CLS. 6, 18, 44, 46, 51 AND 52).  
FIRST USE 11-9-2010; IN COMMERCE 11-9-2010.

**CLASS 42—SCIENTIFIC AND COMPUTER SERVICES**

FOR RESEARCH AND PRODUCT DEVELOPMENT SERVICES IN THE FIELDS OF METABOLIC DISEASES AND DISORDERS, INCLUDING OBESITY, DIABETES, METABOLIC SYNDROME AND CACHEXIA, AND GASTROINTESTINAL DISEASES AND DISORDERS, INCLUDING GASTROPARESIS, POST-OPERATIVE ILEUS, CHRONIC CONSTIPATION, AND INFLAMMATORY BOWEL DISEASE (U.S. CLS. 100 AND 101).  
FIRST USE 9-7-2010; IN COMMERCE 9-7-2010.

4,046,499. PLRR, LLC, CHAPIN, SC. SN 85-096,848. PUB. 1-18-2011, FILED 7-30-2010.

**PEACE LOVE & ROCKY ROAST**

THE MARK CONSISTS OF STANDARD CHARACTERS WITHOUT CLAIM TO ANY PARTICULAR FONT, STYLE, SIZE, OR COLOR.

NO CLAIM IS MADE TO THE EXCLUSIVE RIGHT TO USE "ROAST", APART FROM THE MARK AS SHOWN.

**CLASS 30—STAPLE FOODS**

FOR COFFEE; COFFEE BASED BEVERAGES; COFFEE BEANS; GROUND COFFEE BEANS; ROASTED COFFEE BEANS (U.S. CL. 46).  
FIRST USE 8-15-2011; IN COMMERCE 8-15-2011.

**CLASS 43—HOTEL AND RESTAURANT SERVICES**

FOR CAFE AND RESTAURANT SERVICES; COFFEE-HOUSE AND SNACK-BAR SERVICES; ICE CREAM SHOP SERVICES IN THE NATURE OF A RESTAURANT; RESTAURANT SERVICES FEATURING COFFEE BASED BEVERAGES, ICE CREAM, AND LIGHT MEALS (U.S. CLS. 100 AND 101).

FIRST USE 8-15-2011; IN COMMERCE 8-15-2011.

4,046,506. PLRR, LLC, CHAPIN, SC. SN 85-098,014. PUB. 1-11-2011, FILED 8-2-2010.

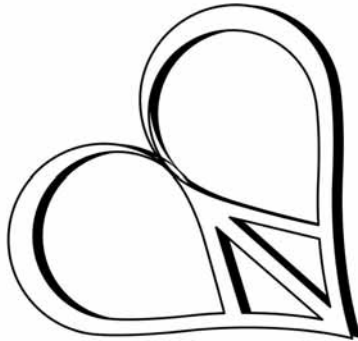

THE MARK CONSISTS OF A PEACE SYMBOL WITHIN A HEART.

**CLASS 30—STAPLE FOODS**

FOR COFFEE; COFFEE BASED BEVERAGES; COFFEE BEANS; GROUND COFFEE BEANS; ROASTED COFFEE BEANS (U.S. CL. 46).

FIRST USE 8-15-2011; IN COMMERCE 8-15-2011.

**CLASS 43—HOTEL AND RESTAURANT SERVICES**

FOR CAFE AND RESTAURANT SERVICES; COFFEE-HOUSE AND SNACK-BAR SERVICES; ICE CREAM SHOP SERVICES IN THE NATURE OF A RESTAURANT; RESTAURANT SERVICES FEATURING COFFEE BASED BEVERAGES, ICE CREAM, AND LIGHT MEALS (U.S. CLS. 100 AND 101).

FIRST USE 8-15-2011; IN COMMERCE 8-15-2011.

4,046,513. KAMAGON FITNESS, LLC, TULSA, OK. SN 85-098,317. PUB. 1-11-2011, FILED 8-2-2010.

# KAMAGON

THE MARK CONSISTS OF STANDARD CHARACTERS WITHOUT CLAIM TO ANY PARTICULAR FONT, STYLE, SIZE, OR COLOR.

THE WORDING "KAMAGON" HAS NO MEANING IN A FOREIGN LANGUAGE.

**CLASS 25—CLOTHING**

FOR APPAREL, NAMELY, SHIRTS, T-SHIRTS, SWEATERS, PANTS, SHORTS, HATS, JACKETS AND HOODED SWEATSHIRTS (U.S. CLS. 22 AND 39).

FIRST USE 8-31-2010; IN COMMERCE 8-31-2010.

**CLASS 28—TOYS AND SPORTING GOODS**

FOR MANUALLY-OPERATED EXERCISE EQUIPMENT FOR PHYSICAL FITNESS PURPOSES (U.S. CLS. 22, 23, 38 AND 50).

FIRST USE 7-16-2010; IN COMMERCE 7-16-2010.

**CLASS 41—EDUCATION AND ENTERTAINMENT**

FOR PROVIDING FITNESS AND EXERCISE FACILITIES; PERSONAL FITNESS TRAINING SERVICES; AND EDUCATIONAL SERVICES RELATING TO NUTRITION, HEALTH AND/OR WELLNESS, NAMELY, PHYSICAL FITNESS INSTRUCTION, EXERCISE CLASSES, AND PHYSICAL FITNESS STUDIO SERVICES IN THE NATURE OF PROVIDING EXERCISE CLASSES, BODY SCULPTING CLASSES AND GROUP FITNESS CLASSES (U.S. CLS. 100, 101 AND 107).

FIRST USE 8-27-2010; IN COMMERCE 8-27-2010.

4,046,520. DOLLAMUR, LP, NASHVILLE, TN. SN 85-099,120. PUB. 11-23-2010, FILED 8-3-2010.

TRAIN ON THE SAME MAT YOU  
COMPETE ON

THE MARK CONSISTS OF STANDARD CHARACTERS WITHOUT CLAIM TO ANY PARTICULAR FONT, STYLE, SIZE, OR COLOR.

**CLASS 27—FLOOR COVERINGS**

FOR SPORTING MATS, NAMELY, MARTIAL ARTS MATS, GRAPPLING MATS, WRESTLING MATS, GYMNASIUM MATS, CHEERLEADING MATS, AND GYMNASIUM TUMBLING MATS (U.S. CLS. 19, 20, 37, 42 AND 50).

FIRST USE 2-0-2009; IN COMMERCE 2-0-2009.

**CLASS 28—TOYS AND SPORTING GOODS**

FOR PERSONAL EXERCISE MATS (U.S. CLS. 22, 23, 38 AND 50).

FIRST USE 2-0-2009; IN COMMERCE 2-0-2009.

4,046,521. THE DUN & BRADSTREET CORPORATION, SHORT HILLS, NJ. SN 85-099,133. PUB. 1-18-2011, FILED 8-3-2010.

# D&B360

THE MARK CONSISTS OF STANDARD CHARACTERS WITHOUT CLAIM TO ANY PARTICULAR FONT, STYLE, SIZE, OR COLOR.

OWNER OF U.S. REG. NOS. 852,926, 3,794,999, AND OTHERS.

4,046,523. DRIVE LIKE YOUR KIDS LIVE HERE, LLC, WETHERSFIELD, CT. SN 85-099,301. PUB. 1-18-2011, FILED 8-3-2010.

#### **CLASS 35—ADVERTISING AND BUSINESS**

FOR PROVIDING GENERAL BUSINESS INFORMATION CONCERNING SALES, SIZE AND POSITION; CONDUCTING MARKETING STUDIES, PROVIDING BUSINESS INFORMATION SERVICES PERTAINING TO MARKETING, DEMOGRAPHICS AND STATISTICAL FIELDS; COMPUTERIZED MARKETING CONSULTING SERVICES RENDERED TO BUSINESSES, NAMELY, PROVIDING INFORMATION THAT IDENTIFY CORPORATE LINES OF BUSINESS; PROVIDING DEMOGRAPHIC INFORMATION ON DIFFERENT BUSINESSES IN SPECIFIC GEOGRAPHIC AREAS, PREPARATION OF LISTS OF COMPANIES FOR OTHERS; EVALUATION OF SUPPLIERS OF GOODS AND SERVICES WITH REGARD TO OVERALL FINANCIAL, OPERATIONAL AND RISK LEVEL (U.S. CLS. 100, 101 AND 102).

FIRST USE 8-0-2011; IN COMMERCE 8-0-2011.

#### **CLASS 36—INSURANCE AND FINANCIAL**

FOR PROVIDING INFORMATION ON CREDIT AND COLLECTIONS OF BUSINESSES; FURNISHING CREDIT RATING REPORTS; PROVIDING CREDIT RATING AND FINANCIAL REPORTING AND ANALYSIS; PROVIDING INFORMATION SERVICES AND INVESTMENT RATING SERVICES, NAMELY, CREDIT INFORMATION SERVICES RENDERED BY COMPUTER SOFTWARE; CREDIT RISK ANALYSIS (U.S. CLS. 100, 101 AND 102).

FIRST USE 8-0-2011; IN COMMERCE 8-0-2011.

4,046,522. BADGER METER, INC., MILWAUKEE, WI. SN 85-099,163. PUB. 1-18-2011, FILED 8-3-2010.

### **COX FLOW MEASUREMENT**

THE MARK CONSISTS OF STANDARD CHARACTERS WITHOUT CLAIM TO ANY PARTICULAR FONT, STYLE, SIZE, OR COLOR.

NO CLAIM IS MADE TO THE EXCLUSIVE RIGHT TO USE "FLOW MEASUREMENT", APART FROM THE MARK AS SHOWN.

#### **CLASS 9—ELECTRICAL AND SCIENTIFIC APPARATUS**

FOR FLOW METERS (U.S. CLS. 21, 23, 26, 36 AND 38). FIRST USE 2-0-2011; IN COMMERCE 2-0-2011.

#### **CLASS 42—SCIENTIFIC AND COMPUTER SERVICES**

FOR CALIBRATION (U.S. CLS. 100 AND 101). FIRST USE 2-0-2011; IN COMMERCE 2-0-2011.

### **DRIVE LIKE YOUR KIDS LIVE HERE**

THE MARK CONSISTS OF STANDARD CHARACTERS WITHOUT CLAIM TO ANY PARTICULAR FONT, STYLE, SIZE, OR COLOR.

#### **CLASS 6—METAL GOODS**

FOR NON-LUMINOUS AND NON-MECHANICAL METAL SIGNS (U.S. CLS. 2, 12, 13, 14, 23, 25 AND 50). FIRST USE 2-1-2011; IN COMMERCE 2-1-2011.

#### **CLASS 16—PAPER GOODS AND PRINTED MATTER**

FOR BUMPER STICKERS; STICKERS (U.S. CLS. 2, 5, 22, 23, 29, 37, 38 AND 50). FIRST USE 7-30-2009; IN COMMERCE 9-9-2009.

#### **CLASS 20—FURNITURE AND ARTICLES NOT OTHERWISE CLASSIFIED**

FOR PLASTIC KEY CHAINS; PLASTIC SIGNBOARDS; (FIRST USE: 09/03/2011; USE IN COMMERCE: 09/03/2011) PLASTIC FLAGS (U.S. CLS. 2, 13, 22, 25, 32 AND 50). FIRST USE 7-30-2009; IN COMMERCE 9-9-2009.

#### **CLASS 25—CLOTHING**

FOR HATS; (FIRST USE: 09/03/2011; USE IN COMMERCE: 09/03/2011) TEE SHIRTS; WEARABLE GARMENTS AND CLOTHING, NAMELY, SHIRTS (U.S. CLS. 22 AND 39). FIRST USE 7-30-2009; IN COMMERCE 9-9-2009.

4,046,532. BLUEBIRD BIO, INC., CAMBRIDGE, MA. SN 85-100,061. PUB. 1-18-2011, FILED 8-4-2010.

### **BLUEBIRD BIO**

THE MARK CONSISTS OF STANDARD CHARACTERS WITHOUT CLAIM TO ANY PARTICULAR FONT, STYLE, SIZE, OR COLOR.

NO CLAIM IS MADE TO THE EXCLUSIVE RIGHT TO USE "BIO", APART FROM THE MARK AS SHOWN.

#### **CLASS 5—PHARMACEUTICALS**

FOR BIO-ENGINEERED COMPONENT FOR A THERAPEUTIC MATERIAL, NAMELY, VIRAL VECTORS AND CELL LINES USED FOR GENE THERAPY; PHARMACEUTICAL PREPARATIONS FOR THE TREATMENT OF GENETIC DISEASES (U.S. CLS. 6, 18, 44, 46, 51 AND 52).

FIRST USE 6-24-2011; IN COMMERCE 6-24-2011.

**CLASS 42—SCIENTIFIC AND COMPUTER SERVICES**

FOR PHARMACEUTICAL RESEARCH AND DEVELOPMENT (U.S. CLS. 100 AND 101).  
FIRST USE 9-9-2010; IN COMMERCE 9-9-2010.

4,046,539. METALTEK INTERNATIONAL, INC., WAUKESHA, WI. SN 85-101,309. PUB. 1-11-2011, FILED 8-5-2010.

**COMPLIANT TO THE CORE**

THE MARK CONSISTS OF STANDARD CHARACTERS WITHOUT CLAIM TO ANY PARTICULAR FONT, STYLE, SIZE, OR COLOR.

**CLASS 6—METAL GOODS**

FOR METAL CASTINGS AND ENGINEERED METAL FORGINGS; ENGINEERED METAL ROLLINGS, NAMELY, RING SHAPED FITTINGS OF METAL (U.S. CLS. 2, 12, 13, 14, 23, 25 AND 50).  
FIRST USE 7-8-2011; IN COMMERCE 7-8-2011.

**CLASS 39—TRANSPORTATION AND STORAGE**

FOR DISTRIBUTION SERVICES, NAMELY, DELIVERY OF METAL PARTS (U.S. CLS. 100 AND 105).  
FIRST USE 7-8-2011; IN COMMERCE 7-8-2011.

**CLASS 40—MATERIAL TREATMENT**

FOR MANUFACTURING METAL PARTS TO THE SPECIFICATION OF OTHERS (U.S. CLS. 100, 103 AND 106).  
FIRST USE 7-8-2011; IN COMMERCE 7-8-2011.

4,046,544. AKTIEBOLAGET ELECTROLUX, STOCKHOLM, SWEDEN. SN 85-101,684. PUB. 1-25-2011, FILED 8-6-2010.

**LAGOON**

THE MARK CONSISTS OF STANDARD CHARACTERS WITHOUT CLAIM TO ANY PARTICULAR FONT, STYLE, SIZE, OR COLOR.

**CLASS 7—MACHINERY**

FOR LAUNDRY MACHINES, NAMELY, WASHING MACHINES AND ELECTRIC CLOTHING PRESSING MACHINES, NAMELY, FORM FINISHERS, FINISHING TABLES, TROUSER CONDITIONERS AND MULTIFINISHERS (U.S. CLS. 13, 19, 21, 23, 31, 34 AND 35).  
FIRST USE 6-21-2011; IN COMMERCE 6-21-2011.

**CLASS 11—ENVIRONMENTAL CONTROL APPARATUS**

FOR CLOTHES DRYERS, NAMELY, SPIN DRYERS AND TUMBLE DRYERS (U.S. CLS. 13, 21, 23, 31 AND 34).  
FIRST USE 6-21-2011; IN COMMERCE 6-21-2011.

4,046,552. OGDEN DIRECTORIES OF PA, INC., ALTOONA, PA. SN 85-102,953. PUB. 1-25-2011, FILED 8-9-2010.

**EZToUse.com**

THE MARK CONSISTS OF STANDARD CHARACTERS WITHOUT CLAIM TO ANY PARTICULAR FONT, STYLE, SIZE, OR COLOR.

OWNER OF U.S. REG. NO. 3,179,738.  
SEC. 2(F) AS TO EZ TO USE.

**CLASS 16—PAPER GOODS AND PRINTED MATTER**

FOR TELEPHONE DIRECTORIES (U.S. CLS. 2, 5, 22, 23, 29, 37, 38 AND 50).  
FIRST USE 4-1-2011; IN COMMERCE 4-1-2011.

**CLASS 35—ADVERTISING AND BUSINESS**

FOR TELEPHONE DIRECTORY INFORMATION (U.S. CLS. 100, 101 AND 102).  
FIRST USE 7-1-2010; IN COMMERCE 7-1-2010.

4,046,553. OGDEN DIRECTORIES OF PA, INC., ALTOONA, PA. SN 85-102,983. PUB. 1-25-2011, FILED 8-9-2010.



THE COLOR(S) WHITE, YELLOW, AND BLACK IS/ARE CLAIMED AS A FEATURE OF THE MARK.

THE MARK CONSISTS OF BLACK FINGERS ON A WHITE, YELLOW, AND BLACK COMPUTER MOUSE.

**CLASS 16—PAPER GOODS AND PRINTED MATTER**

FOR TELEPHONE DIRECTORIES (U.S. CLS. 2, 5, 22, 23, 29, 37, 38 AND 50).  
FIRST USE 4-1-2011; IN COMMERCE 4-1-2011.

**CLASS 35—ADVERTISING AND BUSINESS**

FOR TELEPHONE DIRECTORY INFORMATION (U.S. CLS. 100, 101 AND 102).  
FIRST USE 7-1-2010; IN COMMERCE 7-1-2010.

4,046,563. METAMORPHITNESS, LLC, WASHINGTON, DC.  
SN 85-105,790. PUB. 2-1-2011, FILED 8-12-2010.

## MPH Athletics

THE MARK CONSISTS OF STANDARD CHARACTERS WITHOUT CLAIM TO ANY PARTICULAR FONT, STYLE, SIZE, OR COLOR.

NO CLAIM IS MADE TO THE EXCLUSIVE RIGHT TO USE "ATHLETICS", APART FROM THE MARK AS SHOWN.

**CLASS 41—EDUCATION AND ENTERTAINMENT**

FOR CONSULTING SERVICES IN THE FIELDS OF FITNESS AND EXERCISE; COUNSELING SERVICES IN THE FIELD OF PHYSICAL FITNESS; PERSONAL FITNESS TRAINING SERVICES AND CONSULTANCY; PHYSICAL FITNESS CONDITIONING CLASSES; PHYSICAL FITNESS CONSULTATION; PHYSICAL FITNESS INSTRUCTION; PHYSICAL FITNESS STUDIO SERVICES, NAMELY, PROVIDING GROUP EXERCISE INSTRUCTION, EQUIPMENT, AND FACILITIES; PHYSICAL FITNESS TRAINING SERVICES; PROVIDING A WEBSITE FEATURING INFORMATION ON EXERCISE AND FITNESS; PROVIDING ASSISTANCE, PERSONAL TRAINING AND PHYSICAL FITNESS CONSULTATION TO INDIVIDUALS TO HELP THEM MAKE PHYSICAL FITNESS, STRENGTH, CONDITIONING, AND EXERCISE IMPROVEMENT IN THEIR DAILY LIVING; PROVIDING FITNESS AND EXERCISE FACILITIES (U.S. CLS. 100, 101 AND 107).

FIRST USE 8-31-2010; IN COMMERCE 8-31-2010.

**CLASS 44—MEDICAL, BEAUTY AND AGRICULTURAL SERVICES**

FOR PROVIDING ASSISTANCE, FITNESS EVALUATION AND CONSULTATION TO INDIVIDUALS TO HELP THEM MAKE HEALTH, WELLNESS AND NUTRITIONAL CHANGES IN THEIR DAILY LIVING TO IMPROVE HEALTH (U.S. CLS. 100 AND 101).

FIRST USE 8-31-2010; IN COMMERCE 8-31-2010.

4,046,602. KEPLER, BRITTANY L., HAYMARKET, VA. SN 85-114,870. PUB. 2-8-2011, FILED 8-24-2010.

## FIGHT LIKE A MOM!

THE MARK CONSISTS OF STANDARD CHARACTERS WITHOUT CLAIM TO ANY PARTICULAR FONT, STYLE, SIZE, OR COLOR.

**CLASS 9—ELECTRICAL AND SCIENTIFIC APPARATUS**

FOR DECORATIVE MAGNETS; MAGNETS (U.S. CLS. 21, 23, 26, 36 AND 38).  
FIRST USE 6-1-2011; IN COMMERCE 8-1-2011.

**CLASS 25—CLOTHING**

FOR HATS; SHIRTS; SWEATSHIRTS; T-SHIRTS (U.S. CLS. 22 AND 39).  
FIRST USE 6-1-2011; IN COMMERCE 8-2-2011.

4,046,634. WYNDHAM TM CORP., PARSIPPANY, NJ. SN 85-120,710. PUB. 2-15-2011, FILED 9-1-2010.



OWNER OF U.S. REG. NOS. 3,485,726, 3,690,444, AND OTHERS.

NO CLAIM IS MADE TO THE EXCLUSIVE RIGHT TO USE "REWARDS", APART FROM THE MARK AS SHOWN.

THE COLOR(S) BLUE AND GREY IS/ARE CLAIMED AS A FEATURE OF THE MARK.

THE MARK CONSISTS OF A SWOOSH IN THE COLOR GREY APPEARS ABOVE AND TO THE LEFT OF THE WORD "WYNDHAM" WHICH IS IN THE COLOR BLUE. THE WORD "REWARDS" APPEARS BELOW IN THE COLOR GREY.

**CLASS 35—ADVERTISING AND BUSINESS**

FOR PROMOTING THE GOODS AND SERVICES OF OTHERS BY AWARDING PURCHASE POINTS FOR MEMBERSHIP CARD AND MEMBERSHIP NUMBER USE; DEVELOPING AND ADMINISTERING A MEMBERSHIP REWARDS PROGRAM FOR LODGING GUESTS TO OBTAIN DISCOUNTS ON GOODS AND SERVICES (U.S. CLS. 100, 101 AND 102).

FIRST USE 9-0-2010; IN COMMERCE 9-0-2010.

**CLASS 43—HOTEL AND RESTAURANT SERVICES**

FOR HOTEL SERVICES FEATURING FREQUENT GUEST REWARD PROGRAM SERVICES WITH ADDED FEATURES WHICH ALLOW PARTICIPANTS TO EARN FREE LODGING AND OTHER TRAVEL-RELATED BENEFITS, AND ACQUIRE POINTS REDEEMABLE FOR CONSUMER PRODUCTS AND SERVICES (U.S. CLS. 100 AND 101).

FIRST USE 9-0-2010; IN COMMERCE 9-0-2010.

4,046,635. ALLEGHENY COUNTY BAR ASSOCIATION, PITTSBURGH, PA. SN 85-120,868. PUB. 5-10-2011, FILED 9-1-2010.

## PROLIANCE

THE MARK CONSISTS OF STANDARD CHARACTERS WITHOUT CLAIM TO ANY PARTICULAR FONT, STYLE,

SIZE, OR COLOR.

**CLASS 9—ELECTRICAL AND SCIENTIFIC APPARATUS**

FOR SOFTWARE FOR LAWYER REFERRAL SERVICES, HUMAN RESOURCES, AND PROVIDING ELECTRONIC COMMUNICATIONS (U.S. CLS. 21, 23, 26, 36 AND 38).

FIRST USE 3-23-2011; IN COMMERCE 8-5-2011.

**CLASS 38—COMMUNICATION**

FOR LEGAL, LITIGATION, AND BUSINESS SUPPORT SERVICES, NAMELY, PROVIDING FACILITIES AND EQUIPMENT FOR VIDEO CONFERENCING AND VIDEOGRAPHY (U.S. CLS. 100, 101 AND 104).

FIRST USE 3-23-2011; IN COMMERCE 4-5-2011.

**CLASS 41—EDUCATION AND ENTERTAINMENT**

FOR LEGAL, LITIGATION, AND BUSINESS SUPPORT SERVICES, NAMELY, PRODUCTION OF VIDEO DISCS, VIDEO CASSETTES FOR DEPOSITIONS, TRIALS, AND OTHER LEGAL PROCEEDINGS (U.S. CLS. 100, 101 AND 107).

FIRST USE 3-23-2011; IN COMMERCE 4-5-2011.

**CLASS 45—PERSONAL AND LEGAL SERVICES**

FOR LEGAL SERVICES, NAMELY, COURT REPORTING AND ALTERNATIVE DISPUTE RESOLUTION (U.S. CLS. 100 AND 101).

FIRST USE 3-23-2011; IN COMMERCE 4-5-2011.

---

4,046,643. FISCHER, BRETT, PHOENIX, AZ. SN 85-121,809. PUB. 5-10-2011, FILED 9-2-2010.



NO CLAIM IS MADE TO THE EXCLUSIVE RIGHT TO USE "AB", APART FROM THE MARK AS SHOWN.

THE MARK CONSISTS OF THE WORDS "AB DOLLY" WITH THREE DOTTED WAVY LINES ABOVE "DOLLY".

**CLASS 9—ELECTRICAL AND SCIENTIFIC APPARATUS**

FOR PRE-RECORDED DVDS FEATURING FITNESS EXERCISES (U.S. CLS. 21, 23, 26, 36 AND 38).

FIRST USE 11-0-2010; IN COMMERCE 11-0-2010.

**CLASS 28—TOYS AND SPORTING GOODS**

FOR EXERCISE EQUIPMENT, NAMELY, A RIGID DISK MOUNTED ON CASTERS WITH HANDGRIPS ATTACHED TO THE RIM USED FOR EXERCISING (U.S. CLS. 22, 23, 38 AND 50).

FIRST USE 11-0-2010; IN COMMERCE 11-0-2010.

---

4,046,664. PALO ALTO RESEARCH CENTER, INC., PALO ALTO, CA. SN 85-127,140. PUB. 1-25-2011, FILED 9-10-2010.

## The Business of Breakthroughs

THE MARK CONSISTS OF STANDARD CHARACTERS WITHOUT CLAIM TO ANY PARTICULAR FONT, STYLE, SIZE, OR COLOR.

**CLASS 35—ADVERTISING AND BUSINESS**

FOR BUSINESS CONSULTATION IN INTERNET COMMERCE (U.S. CLS. 100, 101 AND 102).

FIRST USE 8-12-2010; IN COMMERCE 8-31-2010.

**CLASS 42—SCIENTIFIC AND COMPUTER SERVICES**

FOR RESEARCH, DEVELOPMENT AND CONSULTING IN THE FIELDS OF PRINTING TECHNOLOGY, SEMICONDUCTORS, LASERS, SENSING AND DIAGNOSTIC ELECTRONICS, DISTRIBUTED CONTROL ELECTRONIC DEVICES, ELECTRONIC DISPLAYS, ROBOTICS, CRYPTOGRAPHY AND SECURITY ELECTRONICS, COMPUTERIZED IMAGE RECOGNITION, DATA COMPRESSION, COMPUTER IMAGING AND COMPUTER VIDEO ANALYSIS, ELECTRONIC DOCUMENT CONTENT ANALYSIS; COMPUTER SOFTWARE APPLICATIONS DEVELOPMENT; COMPUTER SOFTWARE SYSTEMS DESIGN; COMPUTER NETWORK DESIGN (U.S. CLS. 100 AND 101).

FIRST USE 8-12-2010; IN COMMERCE 8-31-2010.

---

4,046,692. UNVEILED, LLC, DBA WEDDINGS UNVEILED MAGAZINE, MOORESVILLE, NC. SN 85-131,519. PUB. 6-21-2011, FILED 9-16-2010.

## UNVEILED

THE MARK CONSISTS OF STANDARD CHARACTERS WITHOUT CLAIM TO ANY PARTICULAR FONT, STYLE, SIZE, OR COLOR.

OWNER OF U.S. REG. NOS. 3,817,015 AND 3,863,586.

**CLASS 16—PAPER GOODS AND PRINTED MATTER**

FOR PUBLICATIONS, NAMELY, MAGAZINES IN THE FIELDS OF WEDDING AND BRIDAL STYLE AND FASHION (U.S. CLS. 2, 5, 22, 23, 29, 37, 38 AND 50).

FIRST USE 11-22-2004; IN COMMERCE 6-1-2005.

**CLASS 35—ADVERTISING AND BUSINESS**

FOR PROVIDING BUSINESS INFORMATION AND ONLINE BUSINESS INFORMATION IN THE FIELD OF THE BRIDAL AND WEDDING INDUSTRY (U.S. CLS. 100, 101 AND 102).

FIRST USE 11-22-2004; IN COMMERCE 6-1-2005.

**CLASS 41—EDUCATION AND ENTERTAINMENT**

FOR PROVIDING ON-LINE MAGAZINES IN THE FIELD OF WEDDING AND BRIDAL STYLE AND FASHION (U.S. CLS. 100, 101 AND 107).

FIRST USE 11-22-2004; IN COMMERCE 6-1-2005.

4,046,693. LEBANON SEABOARD CORP., LEBANON, PA. SN 85-131,808. PUB. 6-7-2011, FILED 9-17-2010.



NO CLAIM IS MADE TO THE EXCLUSIVE RIGHT TO USE "ENHANCED EFFICIENCY FERTILIZER" AND "FOR A GREEN LAWN", APART FROM THE MARK AS SHOWN. THE COLOR(S) DARK GREEN, LIGHT GREEN, YELLOW-GREEN, YELLOW, BLACK, AND WHITE IS/ARE CLAIMED AS A FEATURE OF THE MARK.

THE MARK CONSISTS OF THE STYLIZED WORDING "GREENSMART" IN THE COLOR DARK GREEN, THE STYLIZED WORDING "ENHANCED EFFICIENCY FERTILIZER" IN THE COLOR BLACK ABOVE THE WORDING "GREENSMART", AND THE STYLIZED WORDING "FOR A GREEN LAWN" IN THE COLOR YELLOW-GREEN BELOW THE WORDING "GREENSMART". THE MARK ALSO CONSISTS OF A GENERALLY CIRCULAR DESIGN FORMED BY FOUR LEAF SHAPES, IN WHICH THE LEAF ON THE LEFT HAND SIDE OF THE CIRCLE IS IN THE COLOR DARK GREEN, THE LEAF ON THE TOP IS A LIGHT GREEN COLOR, THE LEAF ON THE RIGHT SIDE IS YELLOW-GREEN, AND THE LEAF ON THE BOTTOM OF THE CIRCLE IS YELLOW. THE YELLOW-GREEN AND YELLOW LEAVES OVERLAP. A YELLOW-GREEN OUTLINE OF A BULLET SHAPED CARRIER WITH A WHITE FILL CONTAINS ALL ELEMENTS OF THE MARK.

**CLASS 1—CHEMICALS**

FOR FERTILIZERS (U.S. CLS. 1, 5, 6, 10, 26 AND 46). FIRST USE 1-27-2011; IN COMMERCE 1-27-2011.

**CLASS 5—PHARMACEUTICALS**

FOR COMBINATION HERBICIDE AND FERTILIZER PREPARATION (U.S. CLS. 6, 18, 44, 46, 51 AND 52). FIRST USE 1-27-2011; IN COMMERCE 1-27-2011.

4,046,694. CINTAS HOLDINGS, LLC, MASON, OH. SN 85-132,103. PUB. 3-22-2011, FILED 9-17-2010.

# SIGNET

THE MARK CONSISTS OF STANDARD CHARACTERS WITHOUT CLAIM TO ANY PARTICULAR FONT, STYLE, SIZE, OR COLOR.

**CLASS 3—COSMETICS AND CLEANING PREPARATIONS**

FOR CLEANING PREPARATIONS FOR INDUSTRIAL AND COMMERCIAL USES (U.S. CLS. 1, 4, 6, 50, 51 AND 52).

FIRST USE 5-31-2011; IN COMMERCE 5-31-2011.

**CLASS 5—PHARMACEUTICALS**

FOR SANITIZING PREPARATIONS FOR USE IN INSTITUTIONAL AND INDUSTRIAL AREAS (U.S. CLS. 6, 18, 44, 46, 51 AND 52).

FIRST USE 5-31-2011; IN COMMERCE 5-31-2011.

4,046,696. 1-800-FLOWERS.COM, INC., CARLE PLACE, NY. SN 85-132,475. PUB. 3-29-2011, FILED 9-17-2010.

OWNER OF U.S. REG. NOS. 1,337,014 AND 2,665,226.

THE MARK CONSISTS OF A SPATULA WITH FROSTING ON THE END BENEATH THE STYLIZED WORD "CHERYL'S".

**CLASS 30—STAPLE FOODS**

FOR FOOD, NAMELY, CHOCOLATES, CANDIES, POPCORN AND BAKED CONFECTIONARIES, NAMELY, COOKIES, BROWNIES, CAKES, AND PASTRIES (U.S. CL. 46).

FIRST USE 7-7-2010; IN COMMERCE 7-7-2010.

**CLASS 35—ADVERTISING AND BUSINESS**

FOR RETAIL STORE SERVICES FEATURING CHOCOLATES, CANDIES, POPCORN AND BAKED CONFECTIONARIES, NAMELY, COOKIES, BROWNIES, CAKES, AND PASTRIES; TELEPHONE AND ONLINE-ACCESSED RETAIL STORE SERVICES FEATURING CHOCOLATES, CANDIES AND BAKED CONFECTIONARIES, NAMELY, COOKIES, BROWNIES, AND CAKES; MAIL ORDER AND CATALOG SERVICES FEATURING CHOCOLATES, CANDIES, POPCORN AND BAKED CONFECTIONARIES, NAMELY, COOKIES, BROWNIES AND CAKES; TELEPHONE AND ONLINE-ACCESSED RETAIL STORE SERVICES FEATURING POPCORN (U.S. CLS. 100, 101 AND 102).

FIRST USE 7-7-2010; IN COMMERCE 7-7-2010.

**CLASS 45—PERSONAL AND LEGAL SERVICES**

FOR PREPARATION OF CUSTOMIZED FOOD GIFT BASKETS REGARDING A PARTICULAR OCCASION OR THEME (U.S. CLS. 100 AND 101).

FIRST USE 7-22-2010; IN COMMERCE 7-22-2010.

4,046,697. 1-800-FLOWERS.COM, INC., CARLE PLACE, NY. SN 85-132,517. PUB. 3-29-2011, FILED 9-17-2010.

# CHERYL'S

THE MARK CONSISTS OF STANDARD CHARACTERS WITHOUT CLAIM TO ANY PARTICULAR FONT, STYLE, SIZE, OR COLOR.

OWNER OF U.S. REG. NOS. 1,337,014 AND 2,665,226.

**CLASS 30—STAPLE FOODS**

FOR FOOD, NAMELY, CHOCOLATES, CANDIES, POPCORN AND BAKED CONFECTIONARIES, NAMELY, COOKIES, BROWNIES, CAKES, AND PASTRIES (U.S. CL. 46).

FIRST USE 7-7-2010; IN COMMERCE 7-7-2010.

**CLASS 35—ADVERTISING AND BUSINESS**

FOR RETAIL STORE SERVICES FEATURING CHOCOLATES, CANDIES, POPCORN AND BAKED CONFECTIONARIES, NAMELY, COOKIES, BROWNIES, CAKES, AND PASTRIES; TELEPHONE AND ONLINE-ACCESSED RETAIL STORE SERVICES FEATURING CHOCOLATES, CANDIES AND BAKED CONFECTIONARIES, NAMELY, COOKIES, BROWNIES, AND CAKES; MAIL ORDER AND CATALOG SERVICES FEATURING CHOCOLATES, CANDIES, POPCORN AND BAKED CONFECTIONARIES, NAMELY, COOKIES, BROWNIES AND CAKES; TELEPHONE AND ONLINE-ACCESSED RETAIL STORE SERVICES FEATURING POPCORN (U.S. CLS. 100, 101 AND 102).

FIRST USE 7-7-2010; IN COMMERCE 7-7-2010.

**CLASS 45—PERSONAL AND LEGAL SERVICES**

FOR PREPARATION OF CUSTOMIZED FOOD GIFT BASKETS REGARDING A PARTICULAR OCCASION OR THEME (U.S. CLS. 100 AND 101).

FIRST USE 7-22-2010; IN COMMERCE 7-22-2010.

4,046,727. CLEVER SENSE, INC., MOUNTAIN VIEW, CA. SN 85-140,633. PUB. 3-29-2011, FILED 9-29-2010.

# SEYMOUR

THE MARK CONSISTS OF STANDARD CHARACTERS WITHOUT CLAIM TO ANY PARTICULAR FONT, STYLE, SIZE, OR COLOR.

**CLASS 9—ELECTRICAL AND SCIENTIFIC APPARATUS**

FOR COMPUTER PROGRAMS FOR PROVIDING CONTEXTUALLY AWARE PERSONALIZED RECOMMENDATIONS; COMPUTER PROGRAMS FOR PROVIDING PERSONAL ASSISTANCE SERVICES, NAMELY, PROVIDING SUGGESTIONS, PERSONALIZED RECOMMENDATIONS, BOOKING AND PLANNING SERVICES FOR INDIVIDUALS AND GROUPS; COMPUTER PROGRAMS FOR USE IN TARGETING USERS AND SUGGESTING PLACES AND ITEMS OF INTEREST; COMPUTER PROGRAMS FOR PROVIDING PERSONALIZED RECOMMENDATIONS BASED ON USER'S INTERESTS; COMPUTER PROGRAMS FOR PROVIDING PERSONALIZED RECOMMENDATIONS, SUGGESTIONS, REVIEWS, BOOKING AND PLANNING SERVICES ON PLACES, ATTRACTIONS, EVENTS, RETAIL PRODUCTS, RESTAURANTS, BARS AND COFFEE SHOPS FOR INDIVIDUALS OR GROUPS; COMPUTER PROGRAMS FOR PROVIDING PERSONALIZED RECOMMENDATIONS VIA MOBILE DEVICES, TABLET COMPUTERS, NOTEBOOK COMPUTERS AND PERSONAL COMPUTERS BASED ON CONTEXT INCLUDING GEO-LOCATION, SOCIAL GRAPH, USER HISTORY, OR USER'S FRIEND'S HISTORY (U.S. CLS. 21, 23, 26, 36 AND 38).

FIRST USE 11-7-2010; IN COMMERCE 11-7-2010.

**CLASS 42—SCIENTIFIC AND COMPUTER SERVICES**

FOR APPLICATION SERVICE PROVIDER SERVICES FEATURING COMPUTER PROGRAMS FOR PROVIDING CONTEXTUALLY AWARE PERSONALIZED RECOMMENDATIONS, COMPUTER PROGRAMS FOR PROVIDING PERSONAL ASSISTANCE SERVICES, NAMELY, PROVIDING SUGGESTIONS, PERSONALIZED RECOMMENDATIONS, BOOKING AND PLANNING SERVICES FOR INDIVIDUALS AND GROUPS, COMPUTER PROGRAMS FOR USE IN TARGETING USERS AND SUGGESTING PLACES AND ITEMS OF INTEREST, COMPUTER PROGRAMS FOR PROVIDING PERSONALIZED RECOMMENDATIONS BASED ON USER'S INTERESTS, COMPUTER PROGRAMS FOR PROVIDING PERSONALIZED RECOMMENDATIONS, SUGGESTIONS, REVIEWS, BOOKING AND PLANNING SERVICES ON PLACES, ATTRACTIONS, EVENTS, RETAIL PRODUCTS, RESTAURANTS, BARS AND COFFEE SHOPS FOR INDIVIDUALS OR GROUPS, AND COMPUTER PROGRAMS FOR PROVIDING PERSONALIZED RECOMMENDATIONS VIA MOBILE DEVICES, TABLET COMPUTERS, NOTEBOOK COMPUTERS AND PERSONAL COMPUTERS BASED ON CONTEXT INCLUDING GEO-LOCATION, SOCIAL GRAPH, USER HISTORY, OR USER'S FRIEND'S HISTORY (U.S. CLS. 100 AND 101).

FIRST USE 11-7-2010; IN COMMERCE 11-7-2010.

4,046,738. BRITA, LP, NEUCHATEL, SWITZERLAND. SN 85-142,542. PUB. 3-22-2011, FILED 9-30-2010.

# Brita Bottle

THE MARK CONSISTS OF STANDARD CHARACTERS WITHOUT CLAIM TO ANY PARTICULAR FONT, STYLE, SIZE, OR COLOR.

OWNER OF U.S. REG. NOS. 1,418,810, 2,916,481, AND OTHERS.

NO CLAIM IS MADE TO THE EXCLUSIVE RIGHT TO USE "BOTTLE", APART FROM THE MARK AS SHOWN.



**CLASS 11—ENVIRONMENTAL CONTROL APPARATUS**

FOR WATER FILTERS (U.S. CLS. 13, 21, 23, 31 AND 34).  
FIRST USE 2-14-2011; IN COMMERCE 2-14-2011.

**CLASS 21—HOUSEWARES AND GLASS**

FOR PLASTIC WATER BOTTLES SOLD EMPTY (U.S. CLS. 2, 13, 23, 29, 30, 33, 40 AND 50).  
FIRST USE 2-14-2011; IN COMMERCE 2-14-2011.

4,046,739. PDB SPORTS, LTD., ENGLEWOOD, CO. SN 85-142,973. PUB. 1-18-2011, FILED 10-1-2010.



OWNER OF U.S. REG. NOS. 2,177,555, 3,239,474, AND OTHERS.

NO CLAIM IS MADE TO THE EXCLUSIVE RIGHT TO USE "RIDE" FOR INTERNATIONAL CLASS 41, APART FROM THE MARK AS SHOWN.

THE MARK CONSISTS OF THE WORDS "ORANGE RIDE" WITH A BICYCLE WHERE THE FRONT TIRE OF THE BICYCLE IS THE "O" IN "ORANGE" AND A HORSE HEAD IS THE DOT ON TOP OF THE "I" IN "RIDE".

**CLASS 25—CLOTHING**

FOR MEN'S, WOMEN'S AND CHILDREN'S CLOTHING, NAMELY, FLEECE TOPS AND BOTTOMS, CAPS, HEADWEAR, T-SHIRTS, SWEATSHIRTS, SHORTS, TANK TOPS, SWEATERS, PANTS, JACKETS, TURTLE-NECKS, JUMPSUITS, GOLF SHIRTS, JERSEYS, WRISTBANDS, WARM UP SUITS, SWIMWEAR, WIND RESISTANT JACKETS, RAINCOATS, PARKAS, PONCHOS, TIES, SUSPENDERS, CLOTH BIBS, SLEEPWEAR, NAMELY, ROBES, NIGHT SHIRTS AND PAJAMAS, GLOVES MITTENS, KNIT HATS, SCARVES, APRONS, HEADBANDS, EAR MUFFS AND UNDERWEAR (U.S. CLS. 22 AND 39).  
FIRST USE 10-1-2010; IN COMMERCE 10-17-2010.

**CLASS 41—EDUCATION AND ENTERTAINMENT**

FOR ENTERTAINMENT IN THE NATURE OF ORGANIZING AND CONDUCTING A BICYCLE RIDE TO PROMOTE A PROFESSIONAL FOOTBALL GAME (U.S. CLS. 100, 101 AND 107).  
FIRST USE 10-1-2010; IN COMMERCE 10-17-2010.

4,046,741. THOMAS JEFFERSON FOUNDATION, INC., CHARLOTTESVILLE, VA. SN 85-143,274. PUB. 3-15-2011, FILED 10-1-2010.

**MONTALTO**

THE MARK CONSISTS OF STANDARD CHARACTERS WITHOUT CLAIM TO ANY PARTICULAR FONT, STYLE, SIZE, OR COLOR.

**CLASS 16—PAPER GOODS AND PRINTED MATTER**

FOR BALLPOINT PENS; NOTE PADS; PAPER NAPKINS; PENCILS (U.S. CLS. 2, 5, 22, 23, 29, 37, 38 AND 50).  
FIRST USE 7-19-2011; IN COMMERCE 7-19-2011.

**CLASS 21—HOUSEWARES AND GLASS**

FOR CUPS AND MUGS (U.S. CLS. 2, 13, 23, 29, 30, 33, 40 AND 50).  
FIRST USE 7-19-2011; IN COMMERCE 7-19-2011.

**CLASS 35—ADVERTISING AND BUSINESS**

FOR ARRANGING AND CONDUCTING BUSINESS CONFERENCES; PROVIDING FACILITIES FOR BUSINESS MEETINGS (U.S. CLS. 100, 101 AND 102).  
FIRST USE 5-20-2011; IN COMMERCE 5-20-2011.

**CLASS 41—EDUCATION AND ENTERTAINMENT**

FOR ARRANGING AND CONDUCTING EDUCATIONAL CONFERENCES; GUIDED TOURS OF AN HISTORICAL SITE; PARTY AND WEDDING PLANNING AND COORDINATION SERVICES; PROVIDING FACILITIES FOR MOVIES, SHOWS, PLAYS, MUSIC OR EDUCATIONAL TRAINING; SPECIAL EVENT PLANNING FOR SOCIAL ENTERTAINMENT PURPOSES (U.S. CLS. 100, 101 AND 107).  
FIRST USE 5-20-2011; IN COMMERCE 5-20-2011.

**CLASS 43—HOTEL AND RESTAURANT SERVICES**

FOR PROVIDING SOCIAL MEETING, BANQUET AND SOCIAL FUNCTION FACILITIES; PROVISION OF CONFERENCE, EXHIBITION AND MEETING FACILITIES (U.S. CLS. 100 AND 101).  
FIRST USE 5-20-2011; IN COMMERCE 5-20-2011.

4,046,745. GUANLAN NETWORKS (HANG ZHOU) CO., LTD, HANGZHOU, CHINA. SN 85-144,464. PUB. 3-15-2011, FILED 10-4-2010.

THE MARK CONSISTS OF THE WORD "BIOMART" IN A STYLIZED FORMAT WITH AN ARCH DESIGN OVER THE LETTERS "ART".

**CLASS 35—ADVERTISING AND BUSINESS**

FOR IMPORT AND EXPORT AGENCIES; SALES PROMOTION FOR THIRD PARTIES; PROCUREMENT, NAMELY, PURCHASING OFFICE FURNITURE FOR OTHERS; COMPILATION AND SYSTEMIZATION OF INFORMATION INTO COMPUTER DATABASES; COMMERCIAL INFORMATION AND ADVICE FOR CONSUMERS; BUSINESS ADVICE AND INFORMATION; PROFESSIONAL BUSINESS CONSULTANCY; COMMERCIAL INFORMATION AGENCIES; ORGANIZATION OF FAIRS FOR COMMERCIAL AND ADVERTISING PURPOSES (U.S. CLS. 100, 101 AND 102).

FIRST USE 10-9-2010; IN COMMERCE 3-10-2011.

**CLASS 42—SCIENTIFIC AND COMPUTER SERVICES**

FOR COMPUTER PROGRAMMING; COMPUTER SOFTWARE DESIGN; SERVICES FOR UPDATING COMPUTER SOFTWARE; UPDATING OF COMPUTER SOFTWARE FOR OTHERS; MAINTENANCE OF COMPUTER SOFTWARE; COMPUTER SYSTEMS ANALYSIS; COMPUTER SYSTEM DESIGN SERVICES; CONVERSION OF DATA OR DOCUMENTS FROM PHYSICAL TO ELECTRONIC MEDIA; DATA CONVERSION OF COMPUTER PROGRAMS AND DATA, NOT PHYSICAL CONVERSION; CREATING AND MAINTAINING WEB SITES FOR OTHERS (U.S. CLS. 100 AND 101).

FIRST USE 10-9-2010; IN COMMERCE 3-10-2011.

WITHOUT CLAIM TO ANY PARTICULAR FONT, STYLE, SIZE, OR COLOR.

NO CLAIM IS MADE TO THE EXCLUSIVE RIGHT TO USE "ENERGY PRODUCTS", APART FROM THE MARK AS SHOWN.

**CLASS 6—METAL GOODS**

FOR METAL CASTINGS AND ENGINEERED METAL FORGINGS; ENGINEERED METAL ROLLINGS, NAMELY, RING SHAPED FITTINGS OF METAL (U.S. CLS. 2, 12, 13, 14, 23, 25 AND 50).

FIRST USE 7-8-2011; IN COMMERCE 7-8-2011.

**CLASS 39—TRANSPORTATION AND STORAGE**

FOR DISTRIBUTION SERVICES, NAMELY, DELIVERY OF METAL PARTS (U.S. CLS. 100 AND 105).

FIRST USE 7-8-2011; IN COMMERCE 7-8-2011.

**CLASS 40—MATERIAL TREATMENT**

FOR MANUFACTURING METAL PARTS TO THE SPECIFICATION OF OTHERS (U.S. CLS. 100, 103 AND 106).

FIRST USE 7-8-2011; IN COMMERCE 7-8-2011.

4,046,749. NUVASIVE, INC., SAN DIEGO, CA. SN 85-145,288. PUB. 5-24-2011, FILED 10-5-2010.

4,046,762. NEW HOME SALES COACH, LLC, SAVAGE, MN. SN 85-151,274. PUB. 5-24-2011, FILED 10-13-2010.

**SPEED OF INNOVATION**

THE MARK CONSISTS OF STANDARD CHARACTERS WITHOUT CLAIM TO ANY PARTICULAR FONT, STYLE, SIZE, OR COLOR.

**CLASS 35—ADVERTISING AND BUSINESS**

FOR ASSOCIATION SERVICES, NAMELY, PROMOTING THE STUDY AND ADVANCEMENT OF SPINAL SURGERY (U.S. CLS. 100, 101 AND 102).

FIRST USE 1-30-2011; IN COMMERCE 1-30-2011.

**CLASS 41—EDUCATION AND ENTERTAINMENT**

FOR EDUCATIONAL SERVICES, NAMELY, CONDUCTING TRAINING, SEMINARS, AND WORKSHOPS ON THE USE OF MEDICAL DEVICES FOR TREATMENT OF THE SPINE (U.S. CLS. 100, 101 AND 107).

FIRST USE 1-30-2011; IN COMMERCE 1-30-2011.

4,046,760. METALTEK INTERNATIONAL, INC., WAUKESHA, WI. SN 85-148,765. PUB. 1-11-2011, FILED 10-8-2010.

**METALTEK ENERGY PRODUCTS**

THE MARK CONSISTS OF STANDARD CHARACTERS

**LIFE STAGE**

THE MARK CONSISTS OF STANDARD CHARACTERS WITHOUT CLAIM TO ANY PARTICULAR FONT, STYLE, SIZE, OR COLOR.

**CLASS 37—CONSTRUCTION AND REPAIR**

FOR HOME REMODELING CONSULTATION (U.S. CLS. 100, 103 AND 106).

FIRST USE 9-23-2010; IN COMMERCE 9-23-2010.

**CLASS 42—SCIENTIFIC AND COMPUTER SERVICES**

FOR ARCHITECTURAL PLANNING AND DESIGN OF NEW HOMES (U.S. CLS. 100 AND 101).

FIRST USE 9-23-2010; IN COMMERCE 9-23-2010.

4,046,775. SCULLY, JAMES L, ZIMMERMAN, MN. SN 85-154,827. PUB. 4-12-2011, FILED 10-18-2010.

**BREAST COLLECTORS**

THE MARK CONSISTS OF STANDARD CHARACTERS WITHOUT CLAIM TO ANY PARTICULAR FONT, STYLE, SIZE, OR COLOR.

**CLASS 16—PAPER GOODS AND PRINTED MATTER**

FOR STICKERS AND DECALOMANIAS (U.S. CLS. 2, 5, 22, 23, 29, 37, 38 AND 50).  
FIRST USE 6-15-2011; IN COMMERCE 7-8-2011.

**CLASS 25—CLOTHING**

FOR HUNTING APPAREL, NAMELY, SHIRTS, JACKETS, BIBS, VESTS, COATS, PANTS, HATS AND GLOVES (U.S. CLS. 22 AND 39).  
FIRST USE 6-15-2011; IN COMMERCE 7-8-2011.

**CLASS 28—TOYS AND SPORTING GOODS**

FOR HUNTING EQUIPMENT, NAMELY, HUNTING GAME CALLS, HUNTING DECOYS, AND LEASHES, NAMELY, GAME STRAPS USED IN BIRD HUNTING (U.S. CLS. 22, 23, 38 AND 50).  
FIRST USE 6-15-2011; IN COMMERCE 7-8-2011.

---

4,046,777. S. C. JOHNSON & SON, INC., RACINE, WI. SN 85-154,951. PUB. 3-1-2011, FILED 10-18-2010.

**AVENTURA TROPICAL**

THE MARK CONSISTS OF STANDARD CHARACTERS WITHOUT CLAIM TO ANY PARTICULAR FONT, STYLE, SIZE, OR COLOR.

THE ENGLISH TRANSLATION OF THE WORDS "AVENTURA TROPICAL" IN THE MARK IS TROPICAL ADVENTURE.

**CLASS 4—LUBRICANTS AND FUELS**

FOR CANDLES (U.S. CLS. 1, 6 AND 15).  
FIRST USE 8-12-2011; IN COMMERCE 8-12-2011.

**CLASS 5—PHARMACEUTICALS**

FOR AIR FRESHENERS (U.S. CLS. 6, 18, 44, 46, 51 AND 52).  
FIRST USE 8-19-2011; IN COMMERCE 8-19-2011.

---

4,046,813. FRITO-LAY NORTH AMERICA, INC., PLANO, TX. SN 85-164,032. PUB. 4-12-2011, FILED 10-28-2010.

**NATURALLY DELICIOUS MIX**

THE MARK CONSISTS OF STANDARD CHARACTERS WITHOUT CLAIM TO ANY PARTICULAR FONT, STYLE, SIZE, OR COLOR.

NO CLAIM IS MADE TO THE EXCLUSIVE RIGHT TO USE "DELICIOUS MIX", APART FROM THE MARK AS SHOWN.

**CLASS 29—MEATS AND PROCESSED FOODS**

FOR POTATO-BASED SNACK FOODS (U.S. CL. 46).  
FIRST USE 6-0-2011; IN COMMERCE 6-0-2011.

**CLASS 30—STAPLE FOODS**

FOR CORN-BASED SNACK FOODS; PRETZELS (U.S. CL. 46).  
FIRST USE 6-0-2011; IN COMMERCE 6-0-2011.

---

4,046,814. LONG MOTOR CORPORATION, LENEXA, KS. SN 85-164,794. PUB. 4-19-2011, FILED 10-29-2010.

**LMC AUTO CARPET**

THE MARK CONSISTS OF STANDARD CHARACTERS WITHOUT CLAIM TO ANY PARTICULAR FONT, STYLE, SIZE, OR COLOR.

OWNER OF U.S. REG. NOS. 2,969,332, 3,788,769, AND OTHERS.

NO CLAIM IS MADE TO THE EXCLUSIVE RIGHT TO USE "AUTO CARPET", APART FROM THE MARK AS SHOWN.

**CLASS 27—FLOOR COVERINGS**

FOR CARPET, CARPET PADDING, AND FLOOR AND TRUNK MATS FOR AUTOMOBILES AND TRUCKS (U.S. CLS. 19, 20, 37, 42 AND 50).

FIRST USE 7-29-2011; IN COMMERCE 8-10-2011.

**CLASS 35—ADVERTISING AND BUSINESS**

FOR ON-LINE ORDERING SERVICES FEATURING CARPET, CARPET PADDING, AND MATS FOR AUTOMOBILES AND TRUCKS (U.S. CLS. 100, 101 AND 102).  
FIRST USE 7-29-2011; IN COMMERCE 7-29-2011.

---

4,046,816. PURPLE BOX JEWELRY, INC., CHANHASSEN, MN. SN 85-164,898. PUB. 4-19-2011, FILED 10-29-2010.

**PURPLE BOX JEWELRY**

THE MARK CONSISTS OF STANDARD CHARACTERS WITHOUT CLAIM TO ANY PARTICULAR FONT, STYLE, SIZE, OR COLOR.

NO CLAIM IS MADE TO THE EXCLUSIVE RIGHT TO USE "JEWELRY", APART FROM THE MARK AS SHOWN.

**CLASS 14—JEWELRY**

FOR JEWELRY (U.S. CLS. 2, 27, 28 AND 50).  
FIRST USE 4-29-2011; IN COMMERCE 4-29-2011.

**CLASS 35—ADVERTISING AND BUSINESS**

FOR ON-LINE RETAIL STORE SERVICES FEATURING JEWELRY (U.S. CLS. 100, 101 AND 102).  
FIRST USE 4-29-2011; IN COMMERCE 4-29-2011.

4,046,821. FALL, CHERYL, WASHOUGAL, WA. SN 85-166,509. PUB. 4-12-2011, FILED 11-1-2010.

## NeedleKnowledge

THE MARK CONSISTS OF STANDARD CHARACTERS WITHOUT CLAIM TO ANY PARTICULAR FONT, STYLE, SIZE, OR COLOR.

**CLASS 16—PAPER GOODS AND PRINTED MATTER**

FOR PRINTED EDUCATIONAL MATERIALS IN THE FIELD OF NEEDLEWORK (U.S. CLS. 2, 5, 22, 23, 29, 37, 38 AND 50).  
FIRST USE 10-30-2010; IN COMMERCE 10-30-2010.

**CLASS 40—MATERIAL TREATMENT**

FOR PROVIDING A WEBSITE FEATURING INFORMATION ON NEEDLEWORKING (U.S. CLS. 100, 103 AND 106).  
FIRST USE 10-30-2010; IN COMMERCE 10-30-2010.

4,046,826. ARGENTO SC, NEW YORK, NY. SN 85-167,730. PUB. 4-26-2011, FILED 11-3-2010.



NO CLAIM IS MADE TO THE EXCLUSIVE RIGHT TO USE "COUTURE", APART FROM THE MARK AS SHOWN. THE MARK CONSISTS OF THE LITERAL ELEMENTS "FURRY COUTURE" WHERE THERE IS AN IMAGE OF A DOG BESIDE THE WORD "FURRY" FACING TOWARDS RIGHT AND THE WORD "COUTURE" IS BELOW THE WORD "FURRY" AS SHOWN IN THE MARK.

**CLASS 3—COSMETICS AND CLEANING PREPARATIONS**

FOR COSMETICS, NAMELY, SHAMPOOS (U.S. CLS. 1, 4, 6, 50, 51 AND 52).  
FIRST USE 2-1-2011; IN COMMERCE 2-1-2011.

**CLASS 14—JEWELRY**

FOR JEWELRY PRODUCTS, NAMELY, COATED PRECIOUS METALS AND ALLOYS AND DOG NECKLACES (U.S. CLS. 2, 27, 28 AND 50).  
FIRST USE 2-1-2011; IN COMMERCE 2-1-2011.

**CLASS 18—LEATHER GOODS**

FOR LEATHER PRODUCTS, NAMELY, DOG COLLARS AND LEASHES (U.S. CLS. 1, 2, 3, 22 AND 41).  
FIRST USE 2-1-2011; IN COMMERCE 2-1-2011.

**CLASS 20—FURNITURE AND ARTICLES NOT OTHERWISE CLASSIFIED**

FOR FURNITURE, NAMELY, BEDS FOR PETS (U.S. CLS. 2, 13, 22, 25, 32 AND 50).  
FIRST USE 2-1-2011; IN COMMERCE 2-1-2011.

4,046,829. OWENS, ROBIN, ROEBUCK, SC. SN 85-168,845. PUB. 3-29-2011, FILED 11-4-2010.



THE MARK CONSISTS OF A STYLIZED HAND.

**CLASS 16—PAPER GOODS AND PRINTED MATTER**

FOR BUMPER STICKERS, STICKERS AND TRANSFERS, DECALS, DECORATIVE DECALS FOR VEHICLE WINDOWS, 3D DECALS FOR USE ON ANY SURFACE (U.S. CLS. 2, 5, 22, 23, 29, 37, 38 AND 50).  
FIRST USE 12-0-2010; IN COMMERCE 12-0-2010.

**CLASS 25—CLOTHING**

FOR SHIRTS, HATS, COATS, PANTS, JACKETS, HEADWEAR, TEE SHIRTS, PAJAMAS, SLEEPWEAR, SWEATERS, SWEATSHIRTS, FOOTWEAR, SHORTS (U.S. CLS. 22 AND 39).  
FIRST USE 12-0-2010; IN COMMERCE 12-0-2010.

4,046,837. ECONNECTIX CORPORATION, CHICAGO, IL. SN 85-173,585. PUB. 5-10-2011, FILED 11-10-2010.

## KOVE

THE MARK CONSISTS OF STANDARD CHARACTERS WITHOUT CLAIM TO ANY PARTICULAR FONT, STYLE, SIZE, OR COLOR.

**CLASS 9—ELECTRICAL AND SCIENTIFIC APPARATUS**

FOR HIGH PERFORMANCE COMPUTER STORAGE SYSTEMS, NAMELY, COMPUTER BACKUP AND STORAGE SYSTEMS WITH DRAM SERVER MEMORY MODULES, AND HIGH PERFORMANCE COMPUTER STORAGE DEVICES, NAMELY, HIGH-SPEED STORAGE SUBSYSTEMS FOR STORAGE AND BACKUP OF ELECTRONIC DATA EITHER LOCALLY OR VIA A TELECOMMUNICATIONS NETWORK, ALL FOR USE WITH A RANGE OF SMALL TO DEMANDING ENTERPRISE APPLICATIONS (U.S. CLS. 21, 23, 26, 36 AND 38).

FIRST USE 11-15-2010; IN COMMERCE 11-15-2010.

**CLASS 42—SCIENTIFIC AND COMPUTER SERVICES**

FOR PROVIDING INFORMATION MANAGEMENT SYSTEM SERVICES, NAMELY, REMOTE AND ON-SITE MANAGEMENT OF THE INFORMATION TECHNOLOGY SYSTEMS OF OTHERS AND CONSULTING IN THE FIELD OF CONFIGURATION MANAGEMENT FOR COMPUTER HARDWARE AND SOFTWARE FOR HIGH PERFORMANCE COMPUTER STORAGE MANAGEMENT AND DATA MANAGEMENT (U.S. CLS. 100 AND 101).

FIRST USE 11-15-2010; IN COMMERCE 11-15-2010.

4,046,888. WALGREEN CO., DEERFIELD, IL. SN 85-190,482. PUB. 3-1-2011, FILED 12-3-2010.

**WALGREENS WAY TO WELL COMMITMENT**

THE MARK CONSISTS OF STANDARD CHARACTERS WITHOUT CLAIM TO ANY PARTICULAR FONT, STYLE, SIZE, OR COLOR.

OWNER OF U.S. REG. NOS. 2,292,545, 3,303,249, AND OTHERS.

**CLASS 35—ADVERTISING AND BUSINESS**

FOR RETAIL DRUG STORE SERVICES; PROMOTING THE CHARITABLE SERVICES OF OTHERS, NAMELY, PROVIDING INDIVIDUALS WITH INFORMATION FOR THE PURPOSE OF MAKING DONATIONS TO CHARITIES (U.S. CLS. 100, 101 AND 102).

FIRST USE 1-11-2011; IN COMMERCE 1-11-2011.

**CLASS 36—INSURANCE AND FINANCIAL**

FOR CHARITABLE FUNDRAISING SERVICES (U.S. CLS. 100, 101 AND 102).

FIRST USE 1-11-2011; IN COMMERCE 1-11-2011.

4,046,889. HUFFMAN, DREW, LORAIN, OH. SN 85-191,577. PUB. 4-19-2011, FILED 12-6-2010.

**BariMetabolic**

THE MARK CONSISTS OF STANDARD CHARACTERS WITHOUT CLAIM TO ANY PARTICULAR FONT, STYLE,

SIZE, OR COLOR.

**CLASS 5—PHARMACEUTICALS**

FOR NUTRITIONAL SUPPLEMENT IN THE NATURE OF A NUTRIENT-DENSE, PROTEIN-BASED DRINK MIX; PROTEIN REDUCED AND GLUTEN FREE FOOD FOR MEDICAL PURPOSES; PROTEIN SUPPLEMENTS; SOY PROTEIN FOR USE AS A NUTRITIONAL SUPPLEMENT IN VARIOUS POWDERED AND READY-TO-DRINK BEVERAGES; WHEY PROTEIN SUPPLEMENTS (U.S. CLS. 6, 18, 44, 46, 51 AND 52).

FIRST USE 1-1-2011; IN COMMERCE 1-1-2011.

**CLASS 29—MEATS AND PROCESSED FOODS**

FOR PROTEIN BASED, NUTRIENT-DENSE SNACK BARS; PROTEIN FOR USE AS A FOOD ADDITIVE; PROTEIN FOR USE AS A FOOD FILLER; PROTEIN POWDERS FOR HUMAN CONSUMPTION FOR USE AS A FOOD ADDITIVE; PROTEINS BEING FOODSTUFFS FOR HUMAN CONSUMPTION; SOY PROTEIN FOR USE AS A FOOD ADDITIVE (U.S. CL. 46).

FIRST USE 1-1-2011; IN COMMERCE 1-1-2011.

4,046,896. MJ IMAGO, LLC, RICHMOND, VA. SN 85-192,313. PUB. 4-19-2011, FILED 12-7-2010.

**When Good Curls Go Bad**

THE MARK CONSISTS OF STANDARD CHARACTERS WITHOUT CLAIM TO ANY PARTICULAR FONT, STYLE, SIZE, OR COLOR.

**CLASS 25—CLOTHING**

FOR T-SHIRTS (U.S. CLS. 22 AND 39). FIRST USE 6-24-2011; IN COMMERCE 6-24-2011.

**CLASS 44—MEDICAL, BEAUTY AND AGRICULTURAL SERVICES**

FOR HAIR SALON SERVICES (U.S. CLS. 100 AND 101). FIRST USE 12-7-2010; IN COMMERCE 12-7-2010.

4,046,898. MENON & ASSOCIATES, INC., SAN DIEGO, CA. SN 85-192,714. PUB. 4-19-2011, FILED 12-7-2010.

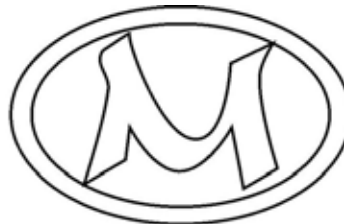

**MENON**

THE MARK CONSISTS OF A STYLIZED "M" IN A HORIZONTAL OVAL WITH THE WORD "MENON" CEN-

TERED DIRECTLY UNDERNEATH THE OVAL.

4,046,944. OKTA, INC., SAN FRANCISCO, CA. SN 85-208,058. PUB. 7-5-2011, FILED 12-30-2010.

#### CLASS 4—LUBRICANTS AND FUELS

FOR BIOFUEL (U.S. CLS. 1, 6 AND 15).  
FIRST USE 8-9-2011; IN COMMERCE 8-9-2011.

OKTA YOUR CLOUD, COVERED

#### CLASS 9—ELECTRICAL AND SCIENTIFIC APPARATUS

FOR ELECTRONIC BIOTHRREAT DETECTORS (U.S. CLS. 21, 23, 26, 36 AND 38).  
FIRST USE 5-4-2011; IN COMMERCE 5-4-2011.

THE MARK CONSISTS OF STANDARD CHARACTERS WITHOUT CLAIM TO ANY PARTICULAR FONT, STYLE, SIZE, OR COLOR.

#### CLASS 31—NATURAL AGRICULTURAL PRODUCTS

FOR ANIMAL FEED (U.S. CLS. 1 AND 46).  
FIRST USE 8-9-2011; IN COMMERCE 8-9-2011.

#### CLASS 42—SCIENTIFIC AND COMPUTER SERVICES

FOR COMPUTER SERVICES, NAMELY, PROVIDING UNIFICATION, MANAGEMENT, OPTIMIZATION AND INTEGRATION OF COMPUTER SYSTEMS AND NETWORKS, ENTERPRISE SOFTWARE APPLICATIONS, USERS, AND INTERNET RESOURCES; COMPUTER SERVICES, NAMELY, MONITORING, ANALYZING, AND REPORTING ON THE PERFORMANCE OF COMPUTER SYSTEMS, NETWORKS, AND ENTERPRISE SOFTWARE APPLICATIONS (U.S. CLS. 100 AND 101).  
FIRST USE 1-27-2011; IN COMMERCE 1-27-2011.

4,046,929. ADVANCED-CONNECTEK INC., TAIPEI, TAIWAN. SN 85-202,146. PUB. 6-7-2011, FILED 12-20-2010.



OWNER OF U.S. REG. NO. 3,778,767.  
THE MARK CONSISTS OF THE DESIGN OF A SHADED CIRCLE ON THE RIGHT SIDE OF WHICH IS LOCATED A LIGHTER, SIDEWAYS U SHAPE; TO THE RIGHT OF THE DESIGN IS THE WORD "JUSTLED" IN STYLIZED, WIDELY-SPACED CAPITAL LETTERS.

#### CLASS 45—PERSONAL AND LEGAL SERVICES

FOR IDENTIFICATION VERIFICATION SERVICES, NAMELY, PROVIDING AUTHENTICATION OF PERSONAL IDENTIFICATION INFORMATION; PROVIDING USER AUTHENTICATION SERVICES IN E-COMMERCE TRANSACTIONS FOR PROVIDING NETWORK ACCESS CONTROL, DIGITAL IDENTITY AUTHENTICATION, SECURITY MANAGEMENT AND SECURITY APPLICATION AUDITING (U.S. CLS. 100 AND 101).  
FIRST USE 1-27-2011; IN COMMERCE 1-27-2011.

#### CLASS 9—ELECTRICAL AND SCIENTIFIC APPARATUS

FOR LIGHT EMITTING DIODE (LED); LIGHT EMITTING DIODE (LED) INDICATOR LIGHT; EMERGENCY LIGHTING, NAMELY, EMERGENCY WARNING LIGHTS (U.S. CLS. 21, 23, 26, 36 AND 38).  
FIRST USE 12-20-2010; IN COMMERCE 8-2-2011.

4,046,948. MATTRESS FIRM, INC., HOUSTON, TX. SN 85-208,529. PUB. 6-21-2011, FILED 12-31-2010.

#### CLASS 11—ENVIRONMENTAL CONTROL APPARATUS

FOR LIGHT BULBS; DROPLIGHT, NAMELY, CEILING LAMPS; TABLE LAMPS; STREETLIGHTS; STREET LAMPS; EMBEDDED LAMPS; FLOOR LAMPS; PROJECTION LAMPS; STANDARD LAMPS; UNDERWATER LAMPS; SOLAR LAMPS NOT FOR MEDICAL PURPOSES; AUTOMOTIVE INTERIOR LIGHTING, NAMELY, INTERIOR VEHICLE LIGHTS; ILLUMINATION APPLIANCE, NAMELY, BICYCLE LIGHTS, ELECTRIC NIGHT LIGHTS, LAMP WHOSE LIGHTS CAN BE TURNED IN ALL DIRECTIONS, LIGHT POST LUMINARIES, LIGHTS FOR ILLUMINATING STAIRS, DOORS AND OTHER PORTIONS OF BUILDINGS, LIGHTS FOR USE IN ILLUMINATING SIGNS AND DISPLAYS, LIGHTS FOR VEHICLES, RUNNING LIGHTS FOR LAND VEHICLES, WALL LIGHTS, LAMPS, LED LIGHTING FIXTURES, LED LAMPS NOT FOR MEDICAL PURPOSES, DESK LAMPS, READING LAMPS, HANGING LAMPS, ROAD LAMPS, STREET LAMPS, LIGHT BARS FOR EMERGENCY VEHICLES, LED LIGHT BULBS, AUTOMOTIVE LAMPS, AUTOMOTIVE HEADLIGHTS; ILLUMINATION EQUIPMENT FOR TRANSPORTATION, NAMELY, AUTOMOTIVE LAMPS, FOG LAMPS, BRAKE LIGHTS, REVERSING LIGHTS, AUTOMOTIVE HEADLIGHTS, AUTOMOTIVE TAILLIGHTS, AUTOMOTIVE SIDELIGHTS (U.S. CLS. 13, 21, 23, 31 AND 34).

FIRST USE 12-20-2010; IN COMMERCE 8-2-2011.



THE MARK CONSISTS OF THE OUTLINE OF TWO MEN STANDING SIDE-BY-SIDE.

#### CLASS 35—ADVERTISING AND BUSINESS

FOR RETAIL STORES SERVICES FEATURING, FURNITURE, BEDS, MATTRESSES, MATTRESSES THAT HEAT AND COOL, MATTRESS FRAMES, MATTRESS FOUNDATIONS, BOX SPRINGS, MATTRESS COVERS, MATTRESS PADS, MATTRESS TOPPERS, PILLOWS, PILLOW COVERS AND SLEEP-RELATED PRODUCTS (U.S. CLS. 100, 101 AND 102).  
FIRST USE 5-1-2010; IN COMMERCE 5-1-2010.

**CLASS 39—TRANSPORTATION AND STORAGE**

FOR DELIVERY OF HOUSEHOLD GOODS BY TRUCK (U.S. CLS. 100 AND 105).  
FIRST USE 5-1-2010; IN COMMERCE 5-1-2010.

4,046,958. HARVARD MAINTENANCE, INC., NEW YORK, NY. SN 85-210,108. PUB. 5-17-2011, FILED 1-4-2011.



The logo for HARVARD WORKS features the word "HARVARD" in a dark blue, serif font, with a stylized "V" that extends above the other letters. To the right of "HARVARD" is the word "WORKS" in a green, sans-serif font.

OWNER OF U.S. REG. NOS. 2,825,189 AND 2,825,190.  
THE COLOR(S) DARK BLUE AND GREEN IS/ARE CLAIMED AS A FEATURE OF THE MARK.

THE MARK CONSISTS OF THE TERM "HARVARD" IN DARK BLUE, WITH THE RIGHT SIDE OF THE "V" EXTENDING ABOVE THE OTHER LETTERS, FOLLOWED BY THE TERM "WORKS" IN GREEN.

**CLASS 37—CONSTRUCTION AND REPAIR**

FOR CLEANING OF BUILDINGS AND FACILITIES; MAINTENANCE AND RENOVATION OF BUILDINGS AND FACILITIES; JANITORIAL SERVICES; CARPET AND RUG CLEANING AND SHAMPOOING; WINDOW CLEANING; TRASH COLLECTION; WASTE DISPOSAL FOR OTHERS; CLEANING, BUFFING AND POLISHING OF METAL AND STONE; DOOR MAINTENANCE AND REPAIR SERVICES; FURNITURE RESTORATION, REPAIR AND MAINTENANCE; FLOOR SANDING; PEST CONTROL AND EXTERMINATION OTHER THAN FOR AGRICULTURE (U.S. CLS. 100, 103 AND 106).  
FIRST USE 4-0-2011; IN COMMERCE 4-0-2011.

**CLASS 45—PERSONAL AND LEGAL SERVICES**

FOR SECURITY GUARD SERVICES; MONITORING SECURITY SYSTEMS (U.S. CLS. 100 AND 101).  
FIRST USE 4-0-2011; IN COMMERCE 4-0-2011.

4,046,959. HARVARD MAINTENANCE, INC., NEW YORK, NY. SN 85-210,165. PUB. 5-17-2011, FILED 1-4-2011.



The logo for HARVARD MAINTENANCE features the word "HARVARD" in a dark blue, serif font, with a stylized "V" that extends above the other letters. To the right of "HARVARD" is the word "MAINTENANCE" in a gray, sans-serif font.

OWNER OF U.S. REG. NOS. 2,825,189 AND 2,825,190.  
NO CLAIM IS MADE TO THE EXCLUSIVE RIGHT TO USE "MAINTENANCE", APART FROM THE MARK AS SHOWN.

THE COLOR(S) DARK BLUE AND GRAY IS/ARE CLAIMED AS A FEATURE OF THE MARK.

THE MARK CONSISTS OF THE TERM "HARVARD" IN DARK BLUE, WITH THE RIGHT SIDE OF THE "V" EXTENDING ABOVE THE OTHER LETTERS, FOLLOWED BY THE TERM "MAINTENANCE" IN GRAY.

**CLASS 35—ADVERTISING AND BUSINESS**

FOR MAIL ROOM AND MESSAGE CENTER SERVICES FOR OTHERS, NAMELY, STAFFING AND RUNNING A MAIL ROOM OR MESSAGE CENTER IN A CORPORATE OFFICE, BUILDING OR FACILITY ENVIRONMENT (U.S. CLS. 100, 101 AND 102).  
FIRST USE 4-0-2011; IN COMMERCE 4-0-2011.

**CLASS 37—CONSTRUCTION AND REPAIR**

FOR CLEANING OF BUILDINGS AND FACILITIES; MAINTENANCE AND RENOVATION OF BUILDINGS AND FACILITIES; JANITORIAL SERVICES; CARPET AND RUG CLEANING AND SHAMPOOING; WINDOW CLEANING; TRASH COLLECTION; WASTE DISPOSAL FOR OTHERS; CLEANING, BUFFING AND POLISHING OF METAL AND STONE; DOOR MAINTENANCE AND REPAIR SERVICES; FURNITURE RESTORATION, REPAIR AND MAINTENANCE; FLOOR SANDING; PEST CONTROL AND EXTERMINATION OTHER THAN FOR AGRICULTURE (U.S. CLS. 100, 103 AND 106).  
FIRST USE 4-0-2011; IN COMMERCE 4-0-2011.

**CLASS 45—PERSONAL AND LEGAL SERVICES**

FOR SECURITY GUARD SERVICES; MONITORING SECURITY SYSTEMS (U.S. CLS. 100 AND 101).  
FIRST USE 4-0-2011; IN COMMERCE 4-0-2011.

4,046,970. BEHR PROCESS CORPORATION, SANTA ANA, CA. SN 85-211,959. PUB. 4-12-2011, FILED 1-6-2011.



The logo for BEHRPRO consists of the word "BEHRPRO" in a bold, black, serif font.

THE MARK CONSISTS OF STANDARD CHARACTERS WITHOUT CLAIM TO ANY PARTICULAR FONT, STYLE, SIZE, OR COLOR.

OWNER OF U.S. REG. NOS. 942,246, 3,695,067, AND OTHERS.

**CLASS 37—CONSTRUCTION AND REPAIR**

FOR PAINTING CONTRACTOR SERVICES (U.S. CLS. 100, 103 AND 106).  
FIRST USE 1-31-2011; IN COMMERCE 1-31-2011.

**CLASS 39—TRANSPORTATION AND STORAGE**

FOR DISTRIBUTION SERVICES, NAMELY, DELIVERY OF PAINT (U.S. CLS. 100 AND 105).  
FIRST USE 1-31-2011; IN COMMERCE 1-31-2011.

4,046,971. STACY RAY C/O LADON SWANN, MOBILE, AL. SN 85-212,656. PUB. 6-14-2011, FILED 1-7-2011.



The logo for Smart Yard, Healthy Gulf consists of the words "Smart Yard, Healthy Gulf" in a serif font, with "Smart Yard" on the top line and "Healthy Gulf" on the bottom line.

THE MARK CONSISTS OF STANDARD CHARACTERS WITHOUT CLAIM TO ANY PARTICULAR FONT, STYLE, SIZE, OR COLOR.

**CLASS 35—ADVERTISING AND BUSINESS**

FOR CONDUCTING A PUBLIC AWARENESS CAMPAIGN IN THE FIELD OF WATER QUALITY AND NUTRIENT RUNOFF AND DISTRIBUTION OF PRINTED MATERIALS IN CONNECTION THEREWITH IN HARD COPY OR ELECTRONIC FORMAT ON THE SAME TOPICS (U.S. CLS. 100, 101 AND 102).  
FIRST USE 12-16-2010; IN COMMERCE 4-1-2011.

**CLASS 41—EDUCATION AND ENTERTAINMENT**

FOR EDUCATIONAL SERVICES, NAMELY, CONDUCTING CLASSES AND SEMINARS IN THE FIELD OF WATER QUALITY AND NUTRIENT RUNOFF AND DISTRIBUTION OF PRINTED MATERIALS IN CONNECTION THEREWITH IN HARD COPY OR ELECTRONIC FORMAT ON THE SAME TOPICS (U.S. CLS. 100, 101 AND 107).  
FIRST USE 12-16-2010; IN COMMERCE 4-1-2011.

4,046,989. BBY SOLUTIONS, INC., RICHFIELD, MN. SN 85-216,600. PUB. 5-17-2011, FILED 1-13-2011.



THE MARK CONSISTS OF A CIRCLE CONTAINING THE NUMBER "24" AND A CURVED LINE REPRESENTING A MOUTH.

4,046,988. BBY SOLUTIONS, INC., RICHFIELD, MN. SN 85-216,577. PUB. 5-17-2011, FILED 1-13-2011.

HAPPY 24

THE MARK CONSISTS OF STANDARD CHARACTERS WITHOUT CLAIM TO ANY PARTICULAR FONT, STYLE, SIZE, OR COLOR.

**CLASS 35—ADVERTISING AND BUSINESS**

FOR PROVIDING CONSUMER PRODUCT INFORMATION AND ADVICE RELATING TO MOBILE PHONES AND MOBILE PHONE PLANS; PROVIDING INFORMATION REGARDING DISCOUNTS, SPECIAL OFFERS, AND PRODUCT UPGRADES FOR MOBILE PHONES AND MOBILE PHONE PLANS; ADMINISTRATION OF CUSTOMER LOYALTY AND REWARD PROGRAMS OFFERED AND ACCESSED VIA MOBILE PHONES; RETAIL STORE SERVICES IN THE FIELDS OF TELECOMMUNICATION PRODUCTS AND RETAIL STORE SERVICES FEATURING TELECOMMUNICATIONS SERVICE PLANS (U.S. CLS. 100, 101 AND 102).  
FIRST USE 5-5-2010; IN COMMERCE 5-5-2010.

**CLASS 38—COMMUNICATION**

FOR TRANSMISSION OF NOTIFICATIONS OF PROMOTIONS, SALES, DISCOUNTS, SPECIAL OFFERS, AND PRODUCT UPGRADES, PROGRAM LOYALTY INFORMATION, NEW PRODUCT INFORMATION VIA TELECOMMUNICATIONS NETWORKS; PROVIDING NOTIFICATIONS REGARDING MOBILE PHONES, MOBILE PHONE PLANS, MOBILE PHONE USER TIPS, PRODUCT INFORMATION, AND PROMOTIONAL OFFERS VIA ELECTRONIC MAIL, TEXT MESSAGE, AND MOBILE PHONES (U.S. CLS. 100, 101 AND 104).  
FIRST USE 5-5-2010; IN COMMERCE 5-5-2010.

**CLASS 35—ADVERTISING AND BUSINESS**

FOR PROVIDING CONSUMER PRODUCT INFORMATION AND ADVICE RELATING TO MOBILE PHONES AND MOBILE PHONE PLANS; PROVIDING INFORMATION REGARDING DISCOUNTS, SPECIAL OFFERS, AND PRODUCT UPGRADES FOR MOBILE PHONES AND MOBILE PHONE PANS; ADMINISTRATION OF CUSTOMER LOYALTY AND REWARD PROGRAMS OFFERED AND ACCESSED VIA MOBILE PHONES; RETAIL STORE SERVICES IN THE FIELDS OF TELECOMMUNICATION PRODUCTS AND RETAIL STORE SERVICES FEATURING TELECOMMUNICATIONS SERVICE PLANS (U.S. CLS. 100, 101 AND 102).  
FIRST USE 5-5-2010; IN COMMERCE 5-5-2010.

**CLASS 38—COMMUNICATION**

FOR TRANSMISSION OF NOTIFICATIONS OF PROMOTIONS, SALES, DISCOUNTS, SPECIAL OFFERS, AND PRODUCT UPGRADES, PROGRAM LOYALTY INFORMATION, NEW PRODUCT INFORMATION VIA TELECOMMUNICATIONS NETWORKS; PROVIDING NOTIFICATIONS REGARDING MOBILE PHONES, MOBILE PHONE PLANS, MOBILE PHONE USER TIPS, PRODUCT INFORMATION, AND PROMOTIONAL OFFERS VIA ELECTRONIC MAIL, TEXT MESSAGE, AND MOBILE PHONES (U.S. CLS. 100, 101 AND 104).  
FIRST USE 5-5-2010; IN COMMERCE 5-5-2010.

4,046,998. ORTIZ, DEREK, YONKERS, NY. AND HYLAND, COURTNEY, NEW ROCHELLE, NY. AND ARGONDIZA, MICHAEL, MASSAPEQUA, NY. AND BILANCIA, NICHOLAS, YONKERS, NY. AND MAURIELLO, ANTHONY, BAYVILLE, NJ. AND GRIFFIN, SCOTT, SALISBURY, MD. SN 85-218,938. PUB. 5-31-2011, FILED 1-17-2011.

Go For Launch

THE MARK CONSISTS OF STANDARD CHARACTERS WITHOUT CLAIM TO ANY PARTICULAR FONT, STYLE, SIZE, OR COLOR.



**CLASS 9—ELECTRICAL AND SCIENTIFIC APPARATUS**

FOR DIGITAL MEDIA, NAMELY, CDS, DVDS, DOWNLOADABLE AUDIO FILES, VINYL RECORDS, CASSETTES FEATURING MUSIC (U.S. CLS. 21, 23, 26, 36 AND 38).

FIRST USE 9-26-2009; IN COMMERCE 9-26-2009.

**CLASS 41—EDUCATION AND ENTERTAINMENT**

FOR ENTERTAINMENT SERVICES IN THE NATURE OF LIVE MUSICAL PERFORMANCES; ENTERTAINMENT, NAMELY, LIVE PERFORMANCES BY A MUSICAL BAND; PRESENTATION OF MUSICAL PERFORMANCE (U.S. CLS. 100, 101 AND 107).

FIRST USE 9-26-2009; IN COMMERCE 9-26-2009.

4,047,036. RICH RIGHT LTD. INC, ORLANDO, FL. SN 85-232,734. PUB. 7-5-2011, FILED 2-2-2011.

**PROtecDRAPE**

THE MARK CONSISTS OF STANDARD CHARACTERS WITHOUT CLAIM TO ANY PARTICULAR FONT, STYLE, SIZE, OR COLOR.

**CLASS 10—MEDICAL APPARATUS**

FOR PRIVACY DRAPES USED IN HOSPITALS, CLINICS, AND CARE UNITS FOR SURGICAL AND SURGICAL EXAMINATION PURPOSES (U.S. CLS. 26, 39 AND 44).

FIRST USE 8-31-2011; IN COMMERCE 8-31-2011.

**CLASS 24—FABRICS**

FOR PRIVACY DRAPES USED IN HOSPITALS, CLINICS, AND CARE UNITS AND NOT FOR SURGICAL OR SURGICAL EXAMINATION PURPOSES (U.S. CLS. 42 AND 50).

FIRST USE 8-31-2011; IN COMMERCE 8-31-2011.

4,047,037. PATHFINDER SERVICES, INC., HUNTINGTON, IN. SN 85-232,900. PUB. 6-14-2011, FILED 2-3-2011.

**ControlAbility**

THE MARK CONSISTS OF STANDARD CHARACTERS WITHOUT CLAIM TO ANY PARTICULAR FONT, STYLE, SIZE, OR COLOR.

**CLASS 3—COSMETICS AND CLEANING PREPARATIONS**

FOR HAIR CONDITIONERS; HAIR SHAMPOO; HAIR SHAMPOOS AND CONDITIONERS; SHAMPOO-CONDITIONERS; SHAMPOOS (U.S. CLS. 1, 4, 6, 50, 51 AND 52).

FIRST USE 5-2-2011; IN COMMERCE 5-24-2011.

**CLASS 5—PHARMACEUTICALS**

FOR HAND-SANITIZING PREPARATIONS; SPRAY SANITIZER FOR PERSONAL USE (U.S. CLS. 6, 18, 44, 46, 51 AND 52).

FIRST USE 5-2-2011; IN COMMERCE 5-24-2011.

4,047,038. KELLY'S KIDS & CRITTERS, LLC, WEST CHESTER, PA. SN 85-233,193. PUB. 6-21-2011, FILED 2-3-2011.

**READ2DREAM**

THE MARK CONSISTS OF STANDARD CHARACTERS WITHOUT CLAIM TO ANY PARTICULAR FONT, STYLE, SIZE, OR COLOR.

**CLASS 16—PAPER GOODS AND PRINTED MATTER**

FOR CHILDREN'S BOOKS (U.S. CLS. 2, 5, 22, 23, 29, 37, 38 AND 50).

FIRST USE 6-0-2010; IN COMMERCE 4-0-2011.

**CLASS 24—FABRICS**

FOR BLANKET THROWS (U.S. CLS. 42 AND 50).

FIRST USE 6-0-2010; IN COMMERCE 4-0-2011.

**CLASS 25—CLOTHING**

FOR CLOTHING, NAMELY, SHIRTS, SWEATERS AND SWEATSHIRTS (U.S. CLS. 22 AND 39).

FIRST USE 6-0-2010; IN COMMERCE 4-0-2011.

4,047,061. GENESIS ADVISERS LLC, NEWTON, MA. SN 85-242,471. PUB. 7-12-2011, FILED 2-15-2011.

**Breakthrough Negotiation**

THE MARK CONSISTS OF STANDARD CHARACTERS WITHOUT CLAIM TO ANY PARTICULAR FONT, STYLE, SIZE, OR COLOR.

NO CLAIM IS MADE TO THE EXCLUSIVE RIGHT TO USE "NEGOTIATION", APART FROM THE MARK AS SHOWN.

**CLASS 16—PAPER GOODS AND PRINTED MATTER**

FOR PRINTED INSTRUCTIONAL, EDUCATIONAL, AND TEACHING MATERIALS IN THE FIELD OF NEGOTIATION (U.S. CLS. 2, 5, 22, 23, 29, 37, 38 AND 50).

FIRST USE 11-1-2010; IN COMMERCE 11-1-2010.

**CLASS 41—EDUCATION AND ENTERTAINMENT**

FOR EDUCATION SERVICES, NAMELY, PROVIDING LIVE AND ON-LINE PROGRAMS, SEMINARS, WORKSHOPS IN THE FIELD OF NEGOTIATION (U.S. CLS. 100, 101 AND 107).

FIRST USE 1-12-2011; IN COMMERCE 1-12-2011.

4,047,063. DAI ENTERPRISES LLC, BEVERLY HILLS, CA. SN 85-243,007. PUB. 4-12-2011, FILED 2-15-2011.



THE MARK CONSISTS OF A SMILING FACE DESIGN ON A SQUARE BACKGROUND WITH ROUNDED CORNERS AND A BEVELED EDGE.

**CLASS 3—COSMETICS AND CLEANING PREPARATIONS**

FOR BREATH FRESHENING CONFECTIONARY, NAMELY, DISSOLVABLE BREATH STRIPS, BREATH MINTS, CANDY AND GUM; BREATH MINTS FOR USE AS A BREATH FRESHENER (U.S. CLS. 1, 4, 6, 50, 51 AND 52).

FIRST USE 4-29-2011; IN COMMERCE 4-29-2011.

**CLASS 5—PHARMACEUTICALS**

FOR VITAMIN AND MINERAL PREPARATIONS FOR USE AS INGREDIENTS IN THE FOOD AND PHARMACEUTICAL INDUSTRY; VITAMIN AND MINERAL SUPPLEMENTS (U.S. CLS. 6, 18, 44, 46, 51 AND 52).

FIRST USE 4-29-2011; IN COMMERCE 4-29-2011.

4,047,079. LETTUCE ENTERTAIN YOU ENTERPRISES, INC., CHICAGO, IL. SN 85-272,118. PUB. 6-21-2011, FILED 3-21-2011.

**LETTUCE WINE CELLARS**

THE MARK CONSISTS OF STANDARD CHARACTERS WITHOUT CLAIM TO ANY PARTICULAR FONT, STYLE, SIZE, OR COLOR.

NO CLAIM IS MADE TO THE EXCLUSIVE RIGHT TO USE "WINE CELLARS", APART FROM THE MARK AS SHOWN.

**CLASS 35—ADVERTISING AND BUSINESS**

FOR RETAIL WINE STORE SERVICES (U.S. CLS. 100, 101 AND 102).

FIRST USE 6-20-2011; IN COMMERCE 6-20-2011.

**CLASS 39—TRANSPORTATION AND STORAGE**

FOR WINE CLUB SERVICES FEATURING PERIODIC SHIPMENTS OF WINE TO MEMBERS (U.S. CLS. 100 AND 105).

FIRST USE 6-20-2011; IN COMMERCE 6-20-2011.

4,047,082. LETTUCE ENTERTAIN YOU ENTERPRISES, INC., CHICAGO, IL. SN 85-276,113. PUB. 6-21-2011, FILED 3-24-2011.



NO CLAIM IS MADE TO THE EXCLUSIVE RIGHT TO USE "WINE CELLARS", APART FROM THE MARK AS SHOWN.

THE MARK CONSISTS OF THE WORDING "LETTUCE" AND "WINE" STACKED ON TOP OF EACH OTHER WITHIN A SHADED RECTANGLE WITH THE LETTER "U" IN "LETTUCE" AND THE LETTER "I" IN "WINE" CREATED BY A WINE CLASS. UNDER THE WORD "WINE" IS A LINE AND THE WORD "CELLARS" IN A SECOND SHADED RECTANGLE.

**CLASS 35—ADVERTISING AND BUSINESS**

FOR RETAIL WINE STORE SERVICES (U.S. CLS. 100, 101 AND 102).

FIRST USE 6-20-2011; IN COMMERCE 6-20-2011.

**CLASS 39—TRANSPORTATION AND STORAGE**

FOR WINE CLUB SERVICES FEATURING PERIODIC SHIPMENTS OF WINE TO MEMBERS (U.S. CLS. 100 AND 105).

FIRST USE 6-20-2011; IN COMMERCE 6-20-2011.

4,047,091. PEIER, ELISABETH RACHAL, DBA PETITES FRITES, WOODLAND HILLS, CA. AND PEIER, CURZON JEAN-CLAUDE, DBA PETITES FRITES, WOODLAND HILLS, CA. SN 85-975,560. PUB. 6-7-2011, FILED 1-29-2011.

**Petites Frites**

THE MARK CONSISTS OF STANDARD CHARACTERS WITHOUT CLAIM TO ANY PARTICULAR FONT, STYLE,

SIZE, OR COLOR.

THE ENGLISH TRANSLATION OF "PETITES FRITES" IN THE MARK IS "SMALL FRIES".

#### CLASS 24—FABRICS

FOR BABY BLANKETS; BURP CLOTHS (U.S. CLS. 42 AND 50).

FIRST USE 11-10-2010; IN COMMERCE 7-31-2011.

#### CLASS 25—CLOTHING

FOR BABY BIBS NOT OF PAPER; CHILDREN'S AND INFANTS' CLOTH BIBS (U.S. CLS. 22 AND 39).

FIRST USE 11-10-2010; IN COMMERCE 7-31-2011.

4,047,092. THE FLOWWALKING COMPANY LLC, MUNSTER, IN. SN 85-975,564. PUB. 12-28-2010, FILED 7-19-2010.

### STEP OUT OF PAIN, FEEL THE GAIN

THE MARK CONSISTS OF STANDARD CHARACTERS WITHOUT CLAIM TO ANY PARTICULAR FONT, STYLE, SIZE, OR COLOR.

#### CLASS 16—PAPER GOODS AND PRINTED MATTER

FOR PRINTED MATTER, NAMELY, BOOKS FEATURING INFORMATION ABOUT EXERCISE, FITNESS AND HEALTH PROGRAMS (U.S. CLS. 2, 5, 22, 23, 29, 37, 38 AND 50).

FIRST USE 6-23-2011; IN COMMERCE 6-23-2011.

#### CLASS 41—EDUCATION AND ENTERTAINMENT

FOR EDUCATIONAL SERVICES, NAMELY, CONDUCTING SEMINARS, WORKSHOPS AND RETREATS IN THE FIELD OF EXERCISE AND FITNESS PROGRAMS (U.S. CLS. 100, 101 AND 107).

FIRST USE 7-5-2010; IN COMMERCE 7-5-2010.

4,047,097. MONOSOL LLC, MERRILLVILLE, IN. SN 85-975,619. PUB. 5-24-2011, FILED 12-29-2010.



OWNER OF U.S. REG. NOS. 695,462, 3,554,767, AND

OTHERS.

THE MARK CONSISTS OF A CIRCULAR ELEMENT WITHIN WHICH THE LITERAL ELEMENT "MONOSOL" APPEARS ON A BAND POSITIONED IN FRONT OF A WATER DROP ELEMENT THAT INCLUDES A SUPERIMPOSED SPHERE WITH GRID LINES.

THE WORDING "MONOSOL" HAS NO MEANING IN A FOREIGN LANGUAGE.

#### CLASS 10—MEDICAL APPARATUS

FOR MEDICAL BAGS MADE OF WATER SOLUBLE FILM SPECIALLY ADAPTED FOR HOLDING ITEMS CONTAMINATED WITH MEDICAL WASTE, SOLD EMPTY (U.S. CLS. 26, 39 AND 44).

FIRST USE 7-14-2011; IN COMMERCE 7-14-2011.

#### CLASS 17—RUBBER GOODS

FOR WATER SOLUBLE FILMS, NAMELY, WATER SOLUBLE PLASTIC FILMS FOR USE IN MANUFACTURING OF WATER SOLUBLE BAGS FOR HOUSEHOLD AND AGRICULTURAL USE, NAMELY, FOR USE IN PACKAGING FOR DETERGENTS AND AGRICHEMICALS, AND FOR GENERAL INDUSTRIAL USE; PLASTIC MATERIAL IN THE FORM OF FILM FOR USE IN MANUFACTURING; AND PLASTIC MATERIAL IN EXTRUDED FORM FOR USE IN PRODUCTION; POLYVINYL ALCOHOL WATER SOLUBLE FILM FOR USE AS A BACKING OR TOPPING TO SUPPORT EMBROIDERY ON TEXTILES AND APPAREL; WATER SOLUBLE FILMS, NAMELY, WATER SOLUBLE PLASTIC FILMS FOR USE AS A SUPPORT FOR EMBROIDERY OR SEWING ON TEXTILES AND APPAREL, AND AS A BACKING FOR EMBROIDERY OR SEWING ON TEXTILES AND APPAREL (U.S. CLS. 1, 5, 12, 13, 35 AND 50).

FIRST USE 9-1-2010; IN COMMERCE 9-1-2010.

#### CLASS 20—FURNITURE AND ARTICLES NOT OTHERWISE CLASSIFIED

FOR CONTAINERS MADE FROM WATER SOLUBLE PLASTIC FILM, NAMELY, WATER SOLUBLE PACKAGING FOR DETERGENTS, WATER SOLUBLE PACKAGING FOR AGRICHEMICALS, WATER SOLUBLE PACKAGING FOR INDUSTRIAL AND COMMERCIAL USE (U.S. CLS. 2, 13, 22, 25, 32 AND 50).

FIRST USE 9-8-2010; IN COMMERCE 9-8-2010.

#### CLASS 40—MATERIAL TREATMENT

FOR MANUFACTURE OF WATER SOLUBLE FILMS MADE OF PLASTIC OR POLYVINYL ALCOHOL, TO ORDER AND/OR SPECIFICATION OF OTHERS (U.S. CLS. 100, 103 AND 106).

FIRST USE 12-8-2010; IN COMMERCE 12-8-2010.

#### CLASS 42—SCIENTIFIC AND COMPUTER SERVICES

FOR PROVIDING TESTING AND ANALYSIS SERVICES FOR OTHERS OF WATER SOLUBLE FILMS MADE OF PLASTIC OR POLYVINYL ALCOHOL (U.S. CLS. 100 AND 101).

FIRST USE 6-30-2010; IN COMMERCE 6-30-2010.



NETWORK INFRASTRUCTURE; SOFTWARE AS A SERVICE (SAAS) SERVICES, NAMELY, SOFTWARE TEST SERVICES FOR OTHERS AND QUALITY CONTROL FOR OTHERS IN THE FIELD OF SOFTWARE; PLATFORM AS A SERVICE (PAAS) FEATURING COMPUTER SOFTWARE PLATFORMS FOR THE EXECUTION OF SOFTWARE WEB APPLICATIONS THAT CAN BE ACCESSED ONLINE BY END-USERS; INFRASTRUCTURE AS A SERVICE (IAAS) SERVICES, NAMELY, COMPUTER HARDWARE MONITORING SERVICES TO ENABLE THE ISSUANCE OF ALERTS TO USERS OF COMPUTER SOFTWARE PERTAINING TO SOFTWARE UPGRADES, UPDATES, REPAIRS, MALFUNCTIONS AND THE BACKUP AND RESTORATION OF COMPUTER DATA; PROVIDING TEMPORARY USE OF NON-DOWNLOADABLE SOFTWARE THAT ENABLES USERS TO DEVELOP, PROVIDE AND USE ONLINE MARKETS AND ELECTRONIC AND ONLINE COMMERCE APPLICATIONS (U.S. CLS. 100 AND 101).  
 FIRST USE 2-10-2011; IN COMMERCE 2-10-2011.

4,047,105. OMNI INDUSTRIES, INC., GREENWELL SPRINGS, LA. SN 85-975,685. PUB. 12-28-2010, FILED 7-22-2010.

# XTRA REV

THE MARK CONSISTS OF STANDARD CHARACTERS WITHOUT CLAIM TO ANY PARTICULAR FONT, STYLE, SIZE, OR COLOR.

OWNER OF U.S. REG. NO. 3,781,772.

## CLASS 1—CHEMICALS

FOR TRANSMISSION FLUID; POWER STEERING FLUID (U.S. CLS. 1, 5, 6, 10, 26 AND 46).  
 FIRST USE 9-0-2010; IN COMMERCE 9-0-2010.

## CLASS 4—LUBRICANTS AND FUELS

FOR AUTOMOTIVE LUBRICANTS, INDUSTRIAL LUBRICANTS, MOTOR OIL (U.S. CLS. 1, 6 AND 15).  
 FIRST USE 9-0-2010; IN COMMERCE 9-0-2010.

\* \* \* \* \*

## SECTION 2.— INTERNATIONAL CLASSIFICATION

The short titles associated below with the international class numbers are terms designed merely for quick identification and are not an official part of the international classification. The full names of international classes are given in section 6.1 of the trademark rules of practice.

The designation "U.S. Cl." appearing in this section refers to the U.S. class in effect prior to Sep. 1, 1973 rather than the international class which applies to applications filed on or after that date. For adoption of international classification see notice in the OFFICIAL GAZETTE of Jun. 26, 1973 (911 O.G. TM 210).

### Application in one class

#### CLASS 1—CHEMICALS

4,045,677. PRO FORM PRODUCTS LTD., MILTON, ONTARIO, CANADA. SN 77-373,178. PUB. 12-9-2008, FILED 1-16-2008.

# TOTALPRO

THE MARK CONSISTS OF STANDARD CHARACTERS WITHOUT CLAIM TO ANY PARTICULAR FONT, STYLE, SIZE, OR COLOR.

FOR ARTIFICIAL AND SYNTHETIC RESIN COMPOUND FOR USE IN AUTOMOBILE OR VEHICLE BODY REPAIR (U.S. CLS. 1, 5, 6, 10, 26 AND 46).

FIRST USE 3-4-2011; IN COMMERCE 3-4-2011.

4,045,698. GLOBAL ENERGY RESEARCH & DEVELOPMENT, INC., DBA TRAVIS H EGGERICHS, OSTEEN, FL. SN 77-394,584. PUB. 6-21-2011, FILED 2-12-2008.



NO CLAIM IS MADE TO THE EXCLUSIVE RIGHT TO USE "FUEL ADDITIVE", APART FROM THE MARK AS SHOWN.

THE COLOR(S) BLACK, RED, GOLD IS/ARE CLAIMED AS A FEATURE OF THE MARK.

THE MARK CONSISTS OF "CLEAN FIRE" IS SET IN GOLD LETTERS WITH RED TRIM, "THE NEXT GENERATION FUEL ADDITIVE" IS SET IN RED, ALL ON BLACK BACK GROUND.

FOR CHEMICAL ADDITIVES FOR ENHANCING THE PERFORMANCE OF LUBRICATING OILS, GREASES AND INTERNAL COMBUSTION ENGINE FUELS; CHEMICAL ADDITIVES FOR FUEL TREATMENT; CHEMICAL ADDITIVES FOR USE WITH INTERNAL COMBUSTION ENGINE FUELS; CHEMICAL ENGINE TREATMENTS AND ADDITIVES FOR ENGINE OILS, GASOLINE AND DIESEL FUELS, TRANSMISSION FLUIDS AND COOLING SYSTEMS (U.S. CLS. 1, 5, 6, 10, 26 AND 46).

FIRST USE 1-31-2007; IN COMMERCE 1-31-2007.

#### CLASS 1—(Continued).

4,045,742. EMD CROP BIOSCIENCE INC., BROOKFIELD, WI. SN 77-512,542. PUB. 12-23-2008, FILED 7-1-2008.

# RATCHET

THE MARK CONSISTS OF STANDARD CHARACTERS WITHOUT CLAIM TO ANY PARTICULAR FONT, STYLE, SIZE, OR COLOR.

FOR NATURAL MOLECULE OR BACTERIA FOR PLANT GROWTH ENHANCEMENT IN AGRICULTURAL CROPS (U.S. CLS. 1, 5, 6, 10, 26 AND 46).

FIRST USE 3-0-2011; IN COMMERCE 3-0-2011.

4,045,754. IDEMITSU KOSAN CO., LTD., CHIYODA-KU, TOKYO, JAPAN. SN 77-538,155. PUB. 12-30-2008, FILED 8-4-2008.

# L-MODU

THE MARK CONSISTS OF STANDARD CHARACTERS WITHOUT CLAIM TO ANY PARTICULAR FONT, STYLE, SIZE, OR COLOR.

FOR CHEMICALS FOR USE IN INDUSTRY AND SCIENCE; UNPROCESSED PLASTICS; SYNTHETIC RESINS (U.S. CLS. 1, 5, 6, 10, 26 AND 46).

FIRST USE 4-0-2011; IN COMMERCE 8-19-2011.

**CLASS 1—(Continued).**

4,045,935. NUTRIENTS PLUS, L.L.C., VIRGINIA BEACH, VA.  
SN 77-841,634. PUB. 8-31-2010, FILED 10-5-2009.

# CLARUS

THE MARK CONSISTS OF STANDARD CHARACTERS WITHOUT CLAIM TO ANY PARTICULAR FONT, STYLE, SIZE, OR COLOR.

THE ENGLISH TRANSLATION OF "CLARUS" IN THE MARK IS CLEAR.

FOR FERTILIZERS (U.S. CLS. 1, 5, 6, 10, 26 AND 46).  
FIRST USE 8-15-2009; IN COMMERCE 2-1-2010.

**CLASS 1—(Continued).**

4,046,028. ADJUVANTS UNLIMITED, INC., TULSA, OK. SN  
77-919,299. PUB. 6-22-2010, FILED 1-25-2010.

# PROZORB

THE MARK CONSISTS OF STANDARD CHARACTERS WITHOUT CLAIM TO ANY PARTICULAR FONT, STYLE, SIZE, OR COLOR.

FOR SURFACTANTS AND CHEMICAL ADDITIVES USED WITH PESTICIDES AND PLANT NUTRITION PRODUCTS (U.S. CLS. 1, 5, 6, 10, 26 AND 46).

FIRST USE 6-1-2011; IN COMMERCE 6-1-2011.

4,046,000. TALON HOLDINGS, LLC, LEO, IN. SN 77-904,478.  
PUB. 5-25-2010, FILED 1-4-2010.

# TALON

THE MARK CONSISTS OF STANDARD CHARACTERS WITHOUT CLAIM TO ANY PARTICULAR FONT, STYLE, SIZE, OR COLOR.

FOR POTTING SOIL, GARDEN SOIL, PLANTING SOIL, POTTING COMPOST, HORTICULTURAL POTTING MIXTURES, PEAT AND POTTING COMPOST (U.S. CLS. 1, 5, 6, 10, 26 AND 46).

FIRST USE 10-0-2010; IN COMMERCE 10-0-2010.

4,046,061. NORTH AMERICAN SALT COMPANY, OVERLAND PARK, KS. SN 77-933,471. PUB. 9-21-2010, FILED 2-11-2010.

# X20

THE MARK CONSISTS OF STANDARD CHARACTERS WITHOUT CLAIM TO ANY PARTICULAR FONT, STYLE, SIZE, OR COLOR.

FOR WATER TREATMENT CHEMICALS FOR USE IN SWIMMING POOLS AND SPAS (U.S. CLS. 1, 5, 6, 10, 26 AND 46).

FIRST USE 7-31-2011; IN COMMERCE 7-31-2011.

4,046,001. TALON HOLDINGS, LLC, LEO, IN. SN 77-904,488.  
PUB. 5-25-2010, FILED 1-4-2010.

# TALON TERRA

THE MARK CONSISTS OF STANDARD CHARACTERS WITHOUT CLAIM TO ANY PARTICULAR FONT, STYLE, SIZE, OR COLOR.

FOR POTTING SOIL, GARDEN SOIL, PLANTING SOIL, POTTING COMPOST, HORTICULTURAL POTTING MIXTURES, PEAT AND POTTING COMPOST (U.S. CLS. 1, 5, 6, 10, 26 AND 46).

FIRST USE 10-0-2010; IN COMMERCE 10-0-2010.

4,046,144. SABINSA CORPORATION, EAST WINDSOR, NJ. SN 77-960,237. PUB. 8-3-2010, FILED 3-16-2010.

# OLEPENT

THE MARK CONSISTS OF STANDARD CHARACTERS WITHOUT CLAIM TO ANY PARTICULAR FONT, STYLE, SIZE, OR COLOR.

FOR CHEMICALS AND ACTIVE INGREDIENTS FOR THE MANUFACTURE OF COSMETIC COMPOSITIONS, NAMELY, OLEANOYL PENTAPEPTIDE (U.S. CLS. 1, 5, 6, 10, 26 AND 46).

FIRST USE 4-1-2011; IN COMMERCE 4-1-2011.

**CLASS 1—(Continued).**

4,046,152. AMERICAN DECORATIVE CONCRETE SUPPLY CO., LOWELL, AR. SN 77-963,562. PUB. 2-22-2011, FILED 3-19-2010.

## DENSI-COLOR

THE MARK CONSISTS OF STANDARD CHARACTERS WITHOUT CLAIM TO ANY PARTICULAR FONT, STYLE, SIZE, OR COLOR.

FOR CHEMICAL APPLICATIONS FOR CONCRETE, NAMELY, CONCRETE ADDITIVES, CONCRETE ADMIXTURES (U.S. CLS. 1, 5, 6, 10, 26 AND 46).  
FIRST USE 1-1-2010; IN COMMERCE 1-1-2010.

---

4,046,414. SURMODICS, INC., EDEN PRAIRIE, MN. SN 85-084,102. PUB. 6-21-2011, FILED 7-14-2010.

## STABILBLOT

THE MARK CONSISTS OF STANDARD CHARACTERS WITHOUT CLAIM TO ANY PARTICULAR FONT, STYLE, SIZE, OR COLOR.

OWNER OF U.S. REG. NOS. 1,651,251, 2,158,020, AND OTHERS.

FOR CHEMICAL PREPARATIONS FOR SCIENTIFIC PURPOSES USED FOR BLOCKING AND ANTIBODY DILUTION IN BLOTTING APPLICATIONS; CHEMICAL PREPARATIONS FOR SCIENTIFIC PURPOSES FOR USE WITH ANALYTICAL PROCEDURES IN RESEARCH AND DIAGNOSTIC APPLICATIONS (U.S. CLS. 1, 5, 6, 10, 26 AND 46).

FIRST USE 8-25-2010; IN COMMERCE 8-25-2010.

**CLASS 1—(Continued).**

4,046,478. LATOUR, LUIS M., DORAL, FL. SN 85-094,087. PUB. 4-5-2011, FILED 7-27-2010.

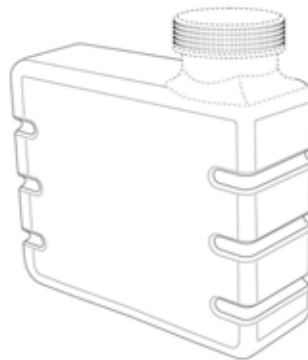

THE MARK CONSISTS OF THE THREE-DIMENSIONAL CONFIGURATION OF A RADIATOR SHAPED CONTAINER, USED AS PACKAGING FOR THE GOODS. THE MATTER SHOWN IN BROKEN LINES; I.E., THE CAP AND NECK OF THE CONTAINER, IS NOT PART OF THE MARK AND SHOWS ONLY POSITION OF THOSE ELEMENTS IN THE MARK.

FOR CHEMICAL RADIATOR TREATMENT ADDITIVE FOR AUTOMOBILE ENGINES (U.S. CLS. 1, 5, 6, 10, 26 AND 46).

FIRST USE 8-26-2010; IN COMMERCE 12-13-2010.

---

4,046,846. SCENTCO, LLC, THOMASVILLE, GA. SN 85-177,572. PUB. 4-26-2011, FILED 11-16-2010.

## Decorate With Fragrance!

THE MARK CONSISTS OF STANDARD CHARACTERS WITHOUT CLAIM TO ANY PARTICULAR FONT, STYLE, SIZE, OR COLOR.

NO CLAIM IS MADE TO THE EXCLUSIVE RIGHT TO USE "FRAGRANCE", APART FROM THE MARK AS SHOWN.

FOR SCENTED ADDITIVE FOR HOUSE PAINTS, VARNISHES AND INDUSTRIAL COATINGS (U.S. CLS. 1, 5, 6, 10, 26 AND 46).

FIRST USE 8-22-2011; IN COMMERCE 8-22-2011.

**CLASS 2—PAINTS**



**CLASS 2—(Continued).**

4,046,434. DUNCAN ENTERPRISES, FRESNO, CA. SN 85-087,107. PUB. 1-11-2011, FILED 7-17-2010.

**TULIP LIQUID DYE**

THE MARK CONSISTS OF STANDARD CHARACTERS WITHOUT CLAIM TO ANY PARTICULAR FONT, STYLE, SIZE, OR COLOR.

OWNER OF U.S. REG. NOS. 2,436,880, 2,475,771, AND OTHERS.

NO CLAIM IS MADE TO THE EXCLUSIVE RIGHT TO USE "LIQUID DYE", APART FROM THE MARK AS SHOWN.

FOR DYE FOR FABRICS (U.S. CLS. 6, 11 AND 16).  
FIRST USE 3-22-2011; IN COMMERCE 3-22-2011.

4,046,761. CARDINAL INDUSTRIAL FINISHES, SOUTH EL MONTE, CA. SN 85-150,081. PUB. 4-5-2011, FILED 10-11-2010.

**Luthierthane**

THE MARK CONSISTS OF STANDARD CHARACTERS WITHOUT CLAIM TO ANY PARTICULAR FONT, STYLE, SIZE, OR COLOR.

FOR CLEAR AND PIGMENTED COATINGS USED IN THE NATURE OF PAINT; COATING COMPOSITIONS IN THE NATURE OF PAINT FOR INDUSTRIAL APPLICATIONS; COATING PREPARATIONS HAVING WATER REPELLENT PROPERTIES; COATINGS FOR WOOD AS PAINTS; COATINGS IN THE NATURE OF INDUSTRIAL SEALANTS FOR WATERPROOFING AND SURFACE HARDENING; COATINGS IN THE NATURE OF PAINTS AND CLEAR COATINGS FOR USE IN ADDING COLORS AND PROTECTING VARIOUS SURFACES FOR GUITARS AND OTHER MUSICAL INSTRUMENTS, AND HOUSEHOLD AND INDUSTRIAL GOODS; COATINGS USED FOR FURNITURE FINISHING; COATINGS, NAMELY, STAINS AND CLEAR FINISHES FOR EXTERIOR AND INTERIOR USE ON A VARIETY OF SUBSTRATES; COLOR PIGMENTS; COLORANTS; COLORANTS FOR USE IN THE MANUFACTURE OF PAINT; COLORANTS FOR USE IN THE MANUFACTURE OF GUITARS AND OTHER MUSICAL INSTRUMENTS, AND HOUSEHOLD AND INDUSTRIAL GOODS; COLORANTS, PAINTS AND DYES FOR GENERAL INDUSTRIAL USE; COLOURANTS; DECORATIVE SPRAY COATING; DIRECT DYES; DYES FOR WOOD; ENAMEL PAINTS; FLUORESCENT PAINTS; GLAZES; LACQUERS; LACQUERS IN THE NATURE OF A COATING; MIXED PAINTS; PAINT FOR USE IN THE MANUFACTURE OF GUITARS AND OTHER MUSICAL INSTRUMENTS, AND HOUSEHOLD AND INDUSTRIAL GOODS; PAINTS; PAINTS AND LACQUERS; PAINTS, LACQUERS, VARNISHES; PIGMENTS; PRIMER; PRIMERS; PRIMERS FOR PREPARING SURFACES TO BE PAINTED; UNDERCOATING FOR SURFACES TO BE PAINTED; VARNISH; VARNISHES; WOOD STAINS (U.S. CLS. 6, 11 AND 16).

FIRST USE 8-1-2011; IN COMMERCE 8-1-2011.

**CLASS 3—COSMETICS AND CLEANING PREPARATIONS**

4,045,604. OSHRY, SCOTT, NEW YORK, NY. SN 76-704,674. PUB. 3-15-2011, FILED 9-27-2010.

**NEWBERRY FIELDS**

THE MARK CONSISTS OF STANDARD CHARACTERS WITHOUT CLAIM TO ANY PARTICULAR FONT, STYLE, SIZE, OR COLOR.

FOR SKIN CARE PRODUCTS, NAMELY, CREAMS, LOTIONS AND SOAPS; AND COSMETICS (U.S. CLS. 1, 4, 6, 50, 51 AND 52).

FIRST USE 7-1-2011; IN COMMERCE 7-1-2011.

4,045,626. COLGATE-PALMOLIVE COMPANY, NEW YORK, NY. SN 77-176,147. PUB. 6-10-2008, FILED 5-9-2007.



NO CLAIM IS MADE TO THE EXCLUSIVE RIGHT TO USE THE FEATURES OF THE CONTAINER COMPRISING THE OUTER SIDES AND THE OUTER CONFIGURATION OF THE CAP, APART FROM THE MARK AS SHOWN.

THE COLOR(S) LIGHT BLUE, BLUE AND DARK BLUE IS/ARE CLAIMED AS A FEATURE OF THE MARK.

THE MARK CONSISTS OF AN OPAQUE BOTTLE WITH BOTTLE CAP FEATURING GRADATIONS OF THE COLOR BLUE, DARKEST AT THE BOTTOM OF THE BOTTLE AND GETTING PROGRESSIVELY LIGHTER TOWARDS THE NECK OF THE BOTTLE. THE CAP IS THE LIGHTEST SHADE OF BLUE. A SWIRL-SHAPED DEPRESSION RUNS ALONG THE ENTIRE VERTICAL LENGTH OF THE BOTTLE. THE CAP FEATURES AN UNEVEN, PETAL-LIKE COLLAR WHOSE LOWER-MOST POINT IS ALIGNED WITH THE TOP END OF THE SWIRL-SHAPED DEPRESSION. THE DOTTED LINES REPRESENT THE FEATURES OF THE CONTAINER COMPRISING THE OUTER SIDES AND THE OUTER CONFIGURATION OF THE CAP TO WHICH NO CLAIM IS MADE.

FOR FABRIC SOFTENERS, FABRIC CONDITIONERS AND FINE FABRIC DETERGENTS (U.S. CLS. 1, 4, 6, 50, 51 AND 52).

FIRST USE 8-24-2011; IN COMMERCE 8-24-2011.

**CLASS 3—(Continued).**

4,045,632. NOVALASH, INC., HOUSTON, TX. SN 77-201,929. PUB. 6-3-2008, FILED 6-8-2007.

# LASHCANDY

THE MARK CONSISTS OF STANDARD CHARACTERS WITHOUT CLAIM TO ANY PARTICULAR FONT, STYLE, SIZE, OR COLOR.

FOR COSMETICS, NAMELY, ARTIFICIAL EYELASHES, EYELASH EXTENSIONS AND ARTIFICIAL EYELASH APPLIQUES (U.S. CLS. 1, 4, 6, 50, 51 AND 52). FIRST USE 7-25-2011; IN COMMERCE 7-25-2011.

4,045,649. APPOLOS, INC., ANAHEIM, CA 92806, CA. SN 77-265,407. PUB. 5-19-2009, FILED 8-27-2007.

# BIOGEM

THE MARK CONSISTS OF STANDARD CHARACTERS WITHOUT CLAIM TO ANY PARTICULAR FONT, STYLE, SIZE, OR COLOR.

FOR COSMETIC PRODUCTS, NAMELY, SHAMPOOS AND HAIR CONDITIONERS (U.S. CLS. 1, 4, 6, 50, 51 AND 52).

FIRST USE 8-1-2006; IN COMMERCE 9-26-2006.

4,045,663. ARIZONA SUNWASH, LLC, PHOENIX, AZ. SN 77-341,061. PUB. 8-3-2010, FILED 11-30-2007.

# SOLISE

THE MARK CONSISTS OF STANDARD CHARACTERS WITHOUT CLAIM TO ANY PARTICULAR FONT, STYLE, SIZE, OR COLOR.

FOR BODY WASH WITH SUNSCREEN, HAND WASH WITH SUNSCREEN (U.S. CLS. 1, 4, 6, 50, 51 AND 52). FIRST USE 1-31-2009; IN COMMERCE 1-31-2009.

**CLASS 3—(Continued).**

4,045,744. MOSKOW, ELIZABETH, BOULDER, CO. SN 77-515,220. PUB. 1-6-2009, FILED 7-5-2008.

# Balm Chicky Balm Balm

THE MARK CONSISTS OF STANDARD CHARACTERS WITHOUT CLAIM TO ANY PARTICULAR FONT, STYLE, SIZE, OR COLOR.

FOR NON-MEDICATED FLAVORED LIP BALM; NON-MEDICATED SKIN CARE PREPARATION IN THE NATURE OF BODY BALMS; MOISTURIZING CREAMS; SKIN MOISTURIZERS IN THE FORMS OF CREAMS; COSMETICS (U.S. CLS. 1, 4, 6, 50, 51 AND 52). FIRST USE 7-7-2007; IN COMMERCE 5-1-2011.

4,045,753. LINDBERG BEAUTY CORPORATION, TORRANCE, CA. SN 77-537,386. PUB. 6-16-2009, FILED 8-1-2008.

# LINDBERG

THE MARK CONSISTS OF STANDARD CHARACTERS WITHOUT CLAIM TO ANY PARTICULAR FONT, STYLE, SIZE, OR COLOR.

OWNER OF U.S. REG. NO. 2,558,493. SEC. 2(F).

FOR SERUMS (U.S. CLS. 1, 4, 6, 50, 51 AND 52). FIRST USE 9-28-2010; IN COMMERCE 9-28-2010.

4,045,790. VICTORIA'S SECRET STORES BRAND MANAGEMENT, INC., REYNOLDSBURG, OH. SN 77-642,524. PUB. 3-24-2009, FILED 1-2-2009.

# SECRET CHARM

THE MARK CONSISTS OF STANDARD CHARACTERS WITHOUT CLAIM TO ANY PARTICULAR FONT, STYLE, SIZE, OR COLOR.

FOR BODY SCRUB (U.S. CLS. 1, 4, 6, 50, 51 AND 52). FIRST USE 6-14-2011; IN COMMERCE 6-14-2011.

**CLASS 3—(Continued).**

4,045,819. LAMU COSMETICS INC, FULLERTON, CA. SN 77-682,703. PUB. 6-30-2009, FILED 3-3-2009.

# LAMU

THE MARK CONSISTS OF STANDARD CHARACTERS WITHOUT CLAIM TO ANY PARTICULAR FONT, STYLE, SIZE, OR COLOR.

FOR ANTI-AGING CREAM; ANTI-WRINKLE CREAM; SKIN REJUVENATION CREAM; EYE CREAM; FACE AND BODY BEAUTY CREAMS; FACE CREAMS FOR COSMETIC USE; FACIAL CREAM; HAIR CARE CREAMS; HAIR PRODUCTS, NAMELY, THICKENING CONTROL CREAMS; MOISTURIZING CREAMS; NIGHT CREAM; SKIN WHITENING CREAMS; SUNSCREEN CREAM (U.S. CLS. 1, 4, 6, 50, 51 AND 52).  
FIRST USE 6-30-2010; IN COMMERCE 6-30-2010.

4,045,855. ZZY INC, MIAMI, FL. SN 77-752,168. PUB. 11-16-2010, FILED 6-4-2009.

# VENOM

THE MARK CONSISTS OF STANDARD CHARACTERS WITHOUT CLAIM TO ANY PARTICULAR FONT, STYLE, SIZE, OR COLOR.

FOR EAU DE TOILETTE AND EAU DE COLOGNE; PERFUMES AND AFTERSHAVES (U.S. CLS. 1, 4, 6, 50, 51 AND 52).  
FIRST USE 6-8-2011; IN COMMERCE 6-8-2011.

4,045,869. UNILEVER SUPPLY CHAIN, INC., CLINTON, CT. SN 77-770,496. PUB. 5-18-2010, FILED 6-29-2009.

# SUMMER CARE

THE MARK CONSISTS OF STANDARD CHARACTERS WITHOUT CLAIM TO ANY PARTICULAR FONT, STYLE, SIZE, OR COLOR.

FOR BEAUTY BARS FOR CLEANSING AND NOURISHING THE SKIN (U.S. CLS. 1, 4, 6, 50, 51 AND 52).  
FIRST USE 2-0-2010; IN COMMERCE 2-0-2010.

**CLASS 3—(Continued).**

4,045,913. BGK TRADEMARK HOLDINGS, LLC, NEW YORK, NY. SN 77-817,094. PUB. 3-15-2011, FILED 9-1-2009.

# BEYONCÉ HEAT RUSH

THE MARK CONSISTS OF STANDARD CHARACTERS WITHOUT CLAIM TO ANY PARTICULAR FONT, STYLE, SIZE, OR COLOR.

THE NAME SHOWN IN THE MARK IDENTIFIES "BEYONCE G. KNOWLES" WHOSE CONSENT IS MADE OF RECORD.

FOR PERFUMERY, ESSENTIAL OILS FOR FACE AND BODY, SOAPS FOR FACE AND BODY, COSMETICS, AND HAIR LOTIONS (U.S. CLS. 1, 4, 6, 50, 51 AND 52).  
FIRST USE 1-31-2011; IN COMMERCE 1-31-2011.

4,045,916. NATERRA INTERNATIONAL, INC., FLOWER MOUND, TX. SN 77-820,232. PUB. 2-1-2011, FILED 9-4-2009.

# DIAPER RX

THE MARK CONSISTS OF STANDARD CHARACTERS WITHOUT CLAIM TO ANY PARTICULAR FONT, STYLE, SIZE, OR COLOR.

NO CLAIM IS MADE TO THE EXCLUSIVE RIGHT TO USE "DIAPER", APART FROM THE MARK AS SHOWN.

FOR NON-MEDICATED DIAPER RASH OINTMENTS AND LOTIONS; NON-MEDICATED SKIN CREAMS (U.S. CLS. 1, 4, 6, 50, 51 AND 52).  
FIRST USE 4-30-2010; IN COMMERCE 4-30-2010.

4,045,922. GILL, TAMARA D., DBA LOVII, UPPER MARLBORO, MD. SN 77-823,219. PUB. 2-2-2010, FILED 9-9-2009.



THE COLOR(S) LOVII - DARK BROWN ABOVE DOTTED I'S IS A FUSHIA LOTUS FLOWER IS/ARE CLAIMED AS A FEATURE OF THE MARK.

THE MARK CONSISTS OF THE WORD "LOVII" IS ACTUALLY THE COLOR DARK BROWN AND ABOVE THE LETTERS "I" IS A FUCHSIA LOTUS FLOWER.

FOR AROMATHERAPY BODY CARE PRODUCTS, NAMELY, BODY LOTION, SHOWER GEL, CUTICLE CREAM, SHAMPOO, CONDITIONER, NON-MEDICATED LIP BALM, SOAP, BODY POLISH, BODY AND FOOT SCRUB AND NON-MEDICATED FOOT CREAM; AROMATHERAPY LOTIONS; BEAUTY LOTIONS; BODY AND BEAUTY CARE COSMETICS; BODY BUTTER; BODY CREAM; BODY CREAMS (U.S. CLS. 1, 4, 6, 50, 51 AND 52).

FIRST USE 5-1-2009; IN COMMERCE 5-1-2009.

**CLASS 3—(Continued).**

4,045,963. MERLE NORMAN COSMETICS, INC., LOS ANGELES, CA. SN 77-870,715. PUB. 4-20-2010, FILED 11-11-2009.



OWNER OF U.S. REG. NOS. 1,427,083 AND 3,257,101. THE MARK CONSISTS OF THE LETTERS "MN" DISPLAYED IN A CIRCLE.

FOR COSMETICS, NAMELY, A HOUSE MARK FOR A FULL LINE OF PERSONAL SKIN CARE AND COLOR PREPARATIONS; COSMETICS, NAMELY, A FULL LINE OF SKIN CARE AND COLOR PRODUCTS; COSMETICS, NAMELY, FACIAL TONER, FACIAL CLARIFIER, FACIAL CLEANSER, FACIAL SCRUB, FACIAL MOISTURIZER, FACIAL EXFOLIANT, MOISTURIZING CREAM, EYE CREAM, EYE GEL, FACIAL MASK, NECK CREAM, FACIAL POWDER FOUNDATION, COMPACT CONTAINING FACIAL POWDER FOUNDATION, FOUNDATION MAKEUP, MASCARA, BODY MOISTURIZER, BODY SCRUB, BODY EXFOLIANT, AND BODY TONER (U.S. CLS. 1, 4, 6, 50, 51 AND 52).  
FIRST USE 5-16-2011; IN COMMERCE 5-16-2011.

4,045,964. MERLE NORMAN COSMETICS, INC., LOS ANGELES, CA. SN 77-870,716. PUB. 4-20-2010, FILED 11-11-2009.

**MERLE NORMAN**

OWNER OF U.S. REG. NOS. 1,391,300, 2,077,608, AND OTHERS. THE NAME(S), PORTRAIT(S), AND/OR SIGNATURE(S) SHOWN IN THE MARK DOES NOT IDENTIFY A PARTICULAR LIVING INDIVIDUAL.

**CLASS 3—(Continued).**

THE MARK CONSISTS OF THE WORDS "MERLE NORMAN" IN STYLIZED FORM.

FOR COSMETICS, NAMELY, A HOUSE MARK FOR A FULL LINE OF PERSONAL SKIN CARE AND COLOR PREPARATIONS; COSMETICS, NAMELY, A FULL LINE OF SKIN CARE AND COLOR PRODUCTS; COSMETICS, NAMELY, FACIAL TONER, FACIAL CLARIFIER, FACIAL CLEANSER, FACIAL SCRUB, FACIAL MOISTURIZER, FACIAL EXFOLIANT, MOISTURIZING CREAM, EYE CREAM, EYE GEL, FACIAL MASK, NECK CREAM, FACIAL POWDER FOUNDATION, COMPACT CONTAINING FACIAL POWDER FOUNDATION, FOUNDATION MAKEUP, MASCARA, BODY MOISTURIZER, BODY SCRUB, BODY EXFOLIANT, AND BODY TONER (U.S. CLS. 1, 4, 6, 50, 51 AND 52).

FIRST USE 5-16-2011; IN COMMERCE 5-16-2011.

4,045,976. O'CONNOR, NOELLE, CO. KILDARE, IRELAND. SN 77-881,171. PUB. 1-11-2011, FILED 11-25-2009.



NO CLAIM IS MADE TO THE EXCLUSIVE RIGHT TO USE "SUNLESS TAN", APART FROM THE MARK AS SHOWN.

THE MARK CONSISTS OF THE TEXT "TANORGANIC SUNLESS TAN THE NATURAL WAY" WITH A STYLIZED "O".

FOR BODY CREAMS, EXFOLIANTS FOR SKIN, SELF-TANNING PREPARATIONS, AND SUNTAN CREAMS ALL MADE WITH ORGANIC COMPONENTS (U.S. CLS. 1, 4, 6, 50, 51 AND 52).

FIRST USE 6-17-2010; IN COMMERCE 2-21-2011.

4,045,992. JOHNSON & JOHNSON, NEW BRUNSWICK, NJ. SN 77-897,797. PUB. 11-30-2010, FILED 12-21-2009.

**ALLERFREE**

THE MARK CONSISTS OF STANDARD CHARACTERS WITHOUT CLAIM TO ANY PARTICULAR FONT, STYLE, SIZE, OR COLOR.

FOR COMBINATION OF INGREDIENTS FOR USE AS A COMPONENT PART OF SKIN AND HAIR CARE PREPARATIONS FOR BABIES AND CHILDREN (U.S. CLS. 1, 4, 6, 50, 51 AND 52).

FIRST USE 7-2-2010; IN COMMERCE 7-2-2010.

**CLASS 3—(Continued).**

4,046,086. COLGATE-PALMOLIVE COMPANY, NEW YORK, NY. SN 77-941,229. PUB. 7-13-2010, FILED 2-22-2010.

**POLAR RUSH**

THE MARK CONSISTS OF STANDARD CHARACTERS WITHOUT CLAIM TO ANY PARTICULAR FONT, STYLE, SIZE, OR COLOR.

FOR TOOTHPASTE (U.S. CLS. 1, 4, 6, 50, 51 AND 52).  
FIRST USE 7-1-2011; IN COMMERCE 7-1-2011.

---

4,046,097. EBEL INTERNATIONAL LTD., HAMILTON, BERMUDA. SN 77-945,000. PUB. 7-20-2010, FILED 2-25-2010.

**1200°C**

THE MARK CONSISTS OF STANDARD CHARACTERS WITHOUT CLAIM TO ANY PARTICULAR FONT, STYLE, SIZE, OR COLOR.

FOR FRAGRANCES, COLOGNE, PARFUMS AND AFTER-SHAVE LOTION (U.S. CLS. 1, 4, 6, 50, 51 AND 52).

FIRST USE 4-0-2011; IN COMMERCE 4-0-2011.

---

4,046,098. SUNFLOWER DERMATOLOGY AND DAY SPA, LLC, RIVERSIDE, MO. SN 77-945,006. PUB. 3-15-2011, FILED 2-25-2010.

**AVOID THE BURN**

THE MARK CONSISTS OF STANDARD CHARACTERS WITHOUT CLAIM TO ANY PARTICULAR FONT, STYLE, SIZE, OR COLOR.

FOR NON-MEDICATED SKIN CARE PRODUCTS, NAMELY, SUNSCREEN, LOTION, MOISTURIZERS, CLEANSERS, TONERS, FACE CREAM, EYE CREAM, BODY CREAM, BATH GEL, SHAVING GEL, AFTER-SUN GEL, SUNBURN TREATMENT OINTMENT, COSMETICS, AND ACNE TREATMENT PREPARATIONS (U.S. CLS. 1, 4, 6, 50, 51 AND 52).

FIRST USE 4-0-2010; IN COMMERCE 4-0-2010.

**CLASS 3—(Continued).**

4,046,099. SUNFLOWER DERMATOLOGY AND DAY SPA, LLC, RIVERSIDE, MO. SN 77-945,012. PUB. 3-15-2011, FILED 2-25-2010.

**ECO-SPORT**

THE MARK CONSISTS OF STANDARD CHARACTERS WITHOUT CLAIM TO ANY PARTICULAR FONT, STYLE, SIZE, OR COLOR.

FOR NON-MEDICATED SKIN CARE PRODUCTS, NAMELY, SUNSCREEN, LOTION, MOISTURIZERS, CLEANSERS, TONERS, FACE CREAM, EYE CREAM, BODY CREAM, BATH GEL, SHAVING GEL, AFTER-SUN GEL, SUNBURN TREATMENT OINTMENT, COSMETICS, AND ACNE TREATMENT PREPARATIONS (U.S. CLS. 1, 4, 6, 50, 51 AND 52).

FIRST USE 4-0-2010; IN COMMERCE 4-0-2010.

---

4,046,147. POSH FACE LLC., MANSFIELD, OH. SN 77-960,705. PUB. 5-10-2011, FILED 3-17-2010.

**SMART BOMB COSMETICS**

THE MARK CONSISTS OF STANDARD CHARACTERS WITHOUT CLAIM TO ANY PARTICULAR FONT, STYLE, SIZE, OR COLOR.

NO CLAIM IS MADE TO THE EXCLUSIVE RIGHT TO USE "COSMETICS", APART FROM THE MARK AS SHOWN.

FOR COSMETICS AND CLEANING PRODUCTS, NAMELY, CLEANSING OF SKIN, NAMELY, LIQUID SOAPS FOR HANDS, FACE, AND BODY, FACIAL AND SKIN CLEANSERS, SOAPS, PERFUMERY, ESSENTIAL OILS, HAIR LOTIONS, DENTIFRICES, SKINCARE PRODUCTS, NAMELY, COSMETIC PREPARATIONS FOR SKIN CARE, NON-MEDICATED SKIN CARE PREPARATIONS, FOUNDATION, BLUSH, MASCARA, CONCEALERS FOR SKIN, FACE, AND BODY, EYE SHADOW, EYELINER, AND HAIR PRODUCTS, NAMELY, HAIR CARE PREPARATIONS, HAIR SHAMPOOS AND CONDITIONERS FOR CONSUMERS OF ALL AGES (U.S. CLS. 1, 4, 6, 50, 51 AND 52).

FIRST USE 2-1-2010; IN COMMERCE 3-1-2010.

**CLASS 3—(Continued).**

4,046,215. ZOTOS INTERNATONAL, INC., DARIEN, CT. SN 85-008,032. PUB. 9-7-2010, FILED 4-7-2010.



THE MARK CONSISTS OF THE STYLIZED WORDING "QUANTUM 5" WITH THE LETTER "Q" EXTENDING INTO A CURVED LINE UNDERNEATH THE ENTIRE WORD "QUANTUM", AND THE NUMBER "5" APPEARING TO THE RIGHT IN A LARGER FONT.

FOR PERMANENT WAVING LOTIONS (U.S. CLS. 1, 4, 6, 50, 51 AND 52).

FIRST USE 6-1-2010; IN COMMERCE 6-1-2010.

4,046,252. UNILEVER SUPPLY CHAIN, INC., CLINTON, CT. SN 85-028,750. PUB. 2-15-2011, FILED 5-3-2010.

**WHITE CHARM**

THE MARK CONSISTS OF STANDARD CHARACTERS WITHOUT CLAIM TO ANY PARTICULAR FONT, STYLE, SIZE, OR COLOR.

FOR SOAP AND BODY CLEANING WASHES (U.S. CLS. 1, 4, 6, 50, 51 AND 52).

FIRST USE 10-0-2010; IN COMMERCE 10-0-2010.

4,046,266. PURE & NATURAL COMPANY, SCOTTSDALE, AZ. SN 85-034,618. PUB. 1-25-2011, FILED 5-10-2010.

**GREEK ISLES**

THE MARK CONSISTS OF STANDARD CHARACTERS WITHOUT CLAIM TO ANY PARTICULAR FONT, STYLE, SIZE, OR COLOR.

FOR HAND SOAPS; LIQUID SOAPS (U.S. CLS. 1, 4, 6, 50, 51 AND 52).

FIRST USE 12-23-2010; IN COMMERCE 12-23-2010.

**CLASS 3—(Continued).**

4,046,270. UNILEVER SUPPLY CHAIN, INC., CLINTON, CT. SN 85-035,451. PUB. 4-5-2011, FILED 5-11-2010.

**UNDERSTATED LOOK**

THE MARK CONSISTS OF STANDARD CHARACTERS WITHOUT CLAIM TO ANY PARTICULAR FONT, STYLE, SIZE, OR COLOR.

FOR HAIR LOTIONS; HAIR CARE PREPARATIONS; HAIR COLORANTS, HAIR DYES, HAIR LOTIONS, HAIR WAVING PREPARATIONS, HAIR SHAMPOOS, HAIR CONDITIONERS, HAIR SPRAYS, HAIR LACQUERS, HAIR MOUSSES, HAIR GLAZES, HAIR GELS, HAIR MOISTURIZERS IN THE NATURE OF HAIR MOISTURIZING CONDITIONER, HAIR PRESERVATION TREATMENTS IN THE NATURE OF HAIR CONDITIONERS, HAIR OILS, HAIR TONIC, HAIR CREAMS (U.S. CLS. 1, 4, 6, 50, 51 AND 52).

FIRST USE 9-0-2010; IN COMMERCE 9-0-2010.

4,046,305. PALACIOS, JUDITH, VICTORVILLE, CA. SN 85-051,301. PUB. 11-9-2010, FILED 5-31-2010.

**KALIVE 2 STYLE**

THE MARK CONSISTS OF STANDARD CHARACTERS WITHOUT CLAIM TO ANY PARTICULAR FONT, STYLE, SIZE, OR COLOR.

FOR 3-IN-1 HAIR CONDITIONERS; 3-IN-1 HAIR SHAMPOOS; BABY HAIR CONDITIONER; COSMETIC PREPARATIONS FOR THE HAIR AND SCALP; EXFOLIANTS FOR HAIR; GEL FOR HAIR; HAIR BALSAM; HAIR BLEACH; HAIR BLEACHES; HAIR BLEACHING PREPARATIONS; HAIR CARE CREAMS; HAIR CARE KITS COMPRISING NON-MEDICATED HAIR CARE PREPARATIONS, NAMELY, SHAMPOO, CONDITIONER, GLAZED, GEL, POLISH, RECONSTRUCTOR, POMADE; HAIR CARE LOTIONS; HAIR CARE PREPARATIONS; HAIR CARE PREPARATIONS CONSISTING OF ORGANIC COCONUT VIRGIN OIL AND COCONUT VIRGIN OIL; HAIR CLEANING PREPARATIONS; HAIR COLOR; HAIR COLOR REMOVERS; HAIR COLORANTS; HAIR COLORING PREPARATIONS; HAIR COLOURANTS; HAIR COLOURING; HAIR COLOURING AND DYES; HAIR COLOURING PREPARATIONS; HAIR CONDITIONER; HAIR CONDITIONERS; HAIR CONDITIONERS FOR BABIES; HAIR CREAMS; HAIR CURLING PREPARATIONS; HAIR DECOLORANTS; HAIR DRESSINGS FOR MEN; HAIR DRESSINGS FOR WOMEN; HAIR DYE; HAIR DYES; HAIR EMOLLIENTS; HAIR FIXERS; HAIR FROSTS; HAIR GEL; HAIR GEL AND HAIR MOUSSE; HAIR GELS; HAIR GLAZE; HAIR LACQUERS; HAIR LIGHTENERS; HAIR LOTION; HAIR LOTIONS; HAIR MASCARA; HAIR MASKS; HAIR MOUSSE; HAIR MOUSSES; HAIR NOURISHERS; HAIR OILS; HAIR PIECE BONDING GLUE; HAIR POMADES; HAIR PRODUCTS, NAMELY, THICKENING CONTROL CREAMS; HAIR RELAXERS; HAIR RELAXING PREPARATIONS; HAIR REMOVING CREAM; HAIR RINSES; HAIR RINSES; HAIR SHAMPOO; HAIR SHAMPOOS AND CONDITIONERS; HAIR SHEEN SPRAY; HAIR SPRAY; HAIR SPRAYS; HAIR SPRAYS AND HAIR GELS; HAIR STRAIGHTENING PREPARATIONS; HAIR STYLING FIXATIVE IN THE

**CLASS 3—(Continued).**

NATURE OF HAIR WAX; HAIR STYLING GEL; HAIR STYLING PREPARATIONS; HAIR STYLING SPRAY; HAIR TONIC; HAIR TONICS; HAIR WAVING LOTION; HAIR WAVING PREPARATIONS; HAIR WAX; HAIR-WASHING POWDER; JAPANESE HAIR FIXING OIL (BINTSUKU-ABURA); LOTIONS FOR HAIR; MOUSSE FOR HAIR; NON-MEDICATED BALMS FOR USE ON HAIR; NON-MEDICATED HAIR RESTORATION LOTIONS; NON-MEDICATED HAIR SERUMS; NON-MEDICATED HAIR TREATMENT PREPARATIONS FOR COSMETIC PURPOSES; NON-MEDICATED PREPARATIONS ALL FOR THE CARE OF SKIN, HAIR AND SCALP; NON-MEDICATED SERUMS FOR USE ON HAIR; OIL BATHS FOR HAIR CARE; OILS FOR HAIR CONDITIONING; POMADES FOR HAIR; PREPARATIONS FOR PERMANENT HAIR WAVES; PREPARATIONS FOR SETTING HAIR; STYLING CLAY FOR HAIR; STYLING FOAM FOR HAIR; STYLING PASTE FOR HAIR; WAX FOR REMOVING BODY HAIR; WAX STRIPS FOR REMOVING BODY HAIR (U.S. CLS. 1, 4, 6, 50, 51 AND 52).  
FIRST USE 7-20-2010; IN COMMERCE 7-20-2010.

4,046,308. TETRA PHARM 1997 LTD., TEL AVIV, ISRAEL. SN 85-051,653. PUB. 1-11-2011, FILED 6-1-2010.

**SeboCalm**

OWNER OF ISRAEL REG. NO. 82359, DATED 3-5-1995, EXPIRES 3-5-2015.  
FOR COSMETICS PREPARATIONS FOR THE TREATMENT OF SEBORRHEA; SOAPS; PERFUMERY; COSMETICS; ESSENTIAL OILS; COSMETIC PREPARATIONS CONTAINING HERBAL, VITAMIN, MINERAL, BEVERAGE AND/OR FOOD SUPPLEMENTS; COSMETIC PREPARATIONS FOR THE TREATMENT OF SEBORRHEA; HAIR AND BODY LOTIONS; BATH FOAMS; SHAMPOOS; HAIR CONDITIONERS; SKIN CARE CREAMS, GELS, MOISTURIZERS; BATH SALTS; TALCUM POWDERS; NON-MEDICAL TOILETRIES; AFTERSHAVES; MAKE-UP PREPARATIONS; DEODORANTS FOR PERSONAL USE; COSMETIC PREPARATIONS FOR THE TREATMENT AND CARE OF THE FACE AND THE BODY; DENTRIFICES; NON-MEDICAL DENTAL PREPARATIONS; BLEACHING PREPARATIONS AND OTHER SUBSTANCES FOR LAUNDRY USE; CLEANING, POLISHING, SCOURING AND ABRASIVE PREPARATIONS (U.S. CLS. 1, 4, 6, 50, 51 AND 52).  
FIRST USE 1-0-2011; IN COMMERCE 1-0-2011.

4,046,344. UNILEVER SUPPLY CHAIN, INC., CLINTON, CT. SN 85-063,003. PUB. 4-5-2011, FILED 6-15-2010.

**IGNITING CITRUS**

THE MARK CONSISTS OF STANDARD CHARACTERS WITHOUT CLAIM TO ANY PARTICULAR FONT, STYLE, SIZE, OR COLOR.

**CLASS 3—(Continued).**

NO CLAIM IS MADE TO THE EXCLUSIVE RIGHT TO USE "CITRUS", APART FROM THE MARK AS SHOWN.  
FOR NON-MEDICATED HAIR CARE PREPARATIONS, NAMELY, HAIR SHAMPOOS, HAIR CONDITIONERS (U.S. CLS. 1, 4, 6, 50, 51 AND 52).  
FIRST USE 9-0-2009; IN COMMERCE 9-0-2009.

4,046,355. ORLY INTERNATIONAL, INC., VAN NUYS, CA. SN 85-067,591. PUB. 5-24-2011, FILED 6-21-2010.

**CUTI-GROOM**

THE MARK CONSISTS OF STANDARD CHARACTERS WITHOUT CLAIM TO ANY PARTICULAR FONT, STYLE, SIZE, OR COLOR.  
OWNER OF U.S. REG. NOS. 2,992,503, 2,992,504, AND 3,072,070.  
FOR NAIL CARE PREPARATIONS (U.S. CLS. 1, 4, 6, 50, 51 AND 52).  
FIRST USE 12-22-2010; IN COMMERCE 12-22-2010.

4,046,356. ORLY INTERNATIONAL, INC., VAN NUYS, CA. SN 85-067,607. PUB. 5-24-2011, FILED 6-21-2010.

**CUTI-CARE**

THE MARK CONSISTS OF STANDARD CHARACTERS WITHOUT CLAIM TO ANY PARTICULAR FONT, STYLE, SIZE, OR COLOR.  
OWNER OF U.S. REG. NOS. 2,992,503, 2,992,504, AND 3,072,070.  
FOR NAIL CARE PREPARATIONS (U.S. CLS. 1, 4, 6, 50, 51 AND 52).  
FIRST USE 12-22-2010; IN COMMERCE 12-22-2010.

4,046,457. PHYSICIANS FORMULA, INC., AZUSA, CA. SN 85-091,022. PUB. 6-14-2011, FILED 7-22-2010.

**GLOW-BOOSTING SUN STONES**

THE MARK CONSISTS OF STANDARD CHARACTERS WITHOUT CLAIM TO ANY PARTICULAR FONT, STYLE, SIZE, OR COLOR.

**CLASS 3—(Continued).**

NO CLAIM IS MADE TO THE EXCLUSIVE RIGHT TO USE "STONES", APART FROM THE MARK AS SHOWN.  
FOR COSMETICS (U.S. CLS. 1, 4, 6, 50, 51 AND 52).  
FIRST USE 12-8-2010; IN COMMERCE 12-8-2010.

4,046,476. CHRISTOPHER J. DANNAKER, MONTEREY, CA.  
SN 85-093,646. PUB. 1-11-2011, FILED 7-27-2010.

## AZACLEAR

THE MARK CONSISTS OF STANDARD CHARACTERS WITHOUT CLAIM TO ANY PARTICULAR FONT, STYLE, SIZE, OR COLOR.

FOR LOTIONS FOR FACE AND SKIN; NON-MEDICATED SKIN CARE CREAMS AND LOTIONS; SKIN LOTIONS (U.S. CLS. 1, 4, 6, 50, 51 AND 52).  
FIRST USE 2-1-2011; IN COMMERCE 2-1-2011.

4,046,529. ATD SUPPLY COMPANY LLC, FENTON, MO. SN  
85-099,671. PUB. 1-18-2011, FILED 8-4-2010.

## DURTY DAWG

THE MARK CONSISTS OF STANDARD CHARACTERS WITHOUT CLAIM TO ANY PARTICULAR FONT, STYLE, SIZE, OR COLOR.

FOR ALL PURPOSE CLEANER FOR HARD SURFACES; ALL PURPOSE CLEANER FOR VINYL, PLASTIC, LEATHER, CARPET, UPHOLSTERY, FABRIC, AND RUBBER (U.S. CLS. 1, 4, 6, 50, 51 AND 52).  
FIRST USE 10-0-2009; IN COMMERCE 7-0-2010.

4,046,576. ALCHABAOUN, MOHAMMED, FONTANA, CA.  
SN 85-109,755. PUB. 5-17-2011, FILED 8-17-2010.



NO CLAIM IS MADE TO THE EXCLUSIVE RIGHT TO USE "SHOE CLEANER", APART FROM THE MARK AS SHOWN.

**CLASS 3—(Continued).**

THE MARK CONSISTS OF THE STYLIZED TEXT "REFRESHED SHOE CLEANER" WITH SIX SHOES.  
FOR CLEANER FOR USE ON SHOES (U.S. CLS. 1, 4, 6, 50, 51 AND 52).  
FIRST USE 6-1-2010; IN COMMERCE 6-1-2010.

4,046,595. WYATT, STEVEN, RAPID CITY, SD. SN 85-114,040.  
PUB. 1-25-2011, FILED 8-23-2010.

## Hamster Bubbles

THE MARK CONSISTS OF STANDARD CHARACTERS WITHOUT CLAIM TO ANY PARTICULAR FONT, STYLE, SIZE, OR COLOR.

NO CLAIM IS MADE TO THE EXCLUSIVE RIGHT TO USE "HAMSTER", APART FROM THE MARK AS SHOWN.  
FOR PET SHAMPOO AND BUBBLE BATH (U.S. CLS. 1, 4, 6, 50, 51 AND 52).  
FIRST USE 10-31-2010; IN COMMERCE 10-31-2010.

4,046,604. SPARTAN BRANDS, INC., NEW YORK, NY. SN  
85-115,047. PUB. 12-21-2010, FILED 8-24-2010.

## NEUTRLAXER

THE MARK CONSISTS OF STANDARD CHARACTERS WITHOUT CLAIM TO ANY PARTICULAR FONT, STYLE, SIZE, OR COLOR.

FOR HAIR RELAXER AND HAIR CONDITIONER (U.S. CLS. 1, 4, 6, 50, 51 AND 52).  
FIRST USE 2-18-2011; IN COMMERCE 2-18-2011.

4,046,611. ALOXXI INTERNATIONAL CORPORATION,  
SHERMAN OAKS, CA. SN 85-115,789. PUB. 2-15-2011,  
FILED 8-25-2010.

## ARRIVIDERCI ROOTS!

THE MARK CONSISTS OF STANDARD CHARACTERS WITHOUT CLAIM TO ANY PARTICULAR FONT, STYLE, SIZE, OR COLOR.



**CLASS 3—(Continued).**

THE ENGLISH TRANSLATION OF THE WORD "ARRIVDERCI" IN THE MARK IS TILL WE MEET AGAIN.

FOR HAIR BLEACHING PREPARATIONS, NON-MEDICATED HAIR CARE PREPARATIONS, HAIR CLEANING PREPARATIONS, HAIR COLOR REMOVERS, HAIR COLORING PREPARATIONS, HAIR LIGHTENERS, HAIR COLORING RINSE, HAIR LIGHTENING BLEACH, HAIR RINSES, HAIR COLOR PREPARATIONS, ALL IN THE FORM OF LIQUID, GEL AND CREAM (U.S. CLS. 1, 4, 6, 50, 51 AND 52).

FIRST USE 1-15-2011; IN COMMERCE 1-15-2011.

4,046,619. ALOXXI INTERNATIONAL CORPORATION, SHERMAN OAKS, CA. SN 85-117,563. PUB. 2-15-2011, FILED 8-27-2010.

## MEZZALUNA

THE MARK CONSISTS OF STANDARD CHARACTERS WITHOUT CLAIM TO ANY PARTICULAR FONT, STYLE, SIZE, OR COLOR.

FOR HAIR BLEACHING PREPARATIONS, NON-MEDICATED HAIR CARE PREPARATIONS, HAIR CLEANING PREPARATIONS, HAIR COLOR REMOVERS, HAIR COLORING PREPARATIONS, HAIR LIGHTENERS, HAIR COLORING RINSE, HAIR LIGHTENING BLEACH, HAIR RINSES, HAIR COLORANTS, ALL IN THE FORM OF LIQUID, GEL AND CREAM (U.S. CLS. 1, 4, 6, 50, 51 AND 52).

FIRST USE 1-15-2011; IN COMMERCE 1-15-2011.

4,046,624. ISOMERS LABORATORIES INC., TORONTO, CANADA. SN 85-118,988. PUB. 5-31-2011, FILED 8-30-2010.

## AGE DIFFUSER

THE MARK CONSISTS OF STANDARD CHARACTERS WITHOUT CLAIM TO ANY PARTICULAR FONT, STYLE, SIZE, OR COLOR.

NO CLAIM IS MADE TO THE EXCLUSIVE RIGHT TO USE "AGE", APART FROM THE MARK AS SHOWN.

FOR BLUSHER; BODY AND BEAUTY CARE COSMETICS; COSMETIC CREAMS; COSMETIC CREAMS FOR SKIN CARE; COSMETIC OILS; COSMETIC PREPARATIONS; COSMETIC PREPARATIONS AGAINST SUNBURN; COSMETIC PREPARATIONS FOR BODY CARE; COSMETIC PREPARATIONS FOR PROTECTING THE SKIN FROM THE SUN'S RAYS; COSMETIC PREPARATIONS FOR SKIN RENEWAL; COSMETIC PREPARATIONS FOR THE HAIR AND SCALP; COSMETIC ROUGES; COSMETIC SOAPS; COSMETIC SUN-PROTECTING PREPARATIONS; COSMETIC SUN-TANNING PREPARATIONS; COSMETIC SUNTAN LOTIONS; COSMETIC SUNTAN PREPARATIONS; COSMETICS AND MAKE-UP; DEODORANTS FOR BODY CARE; EYE LINER; EYE PENCILS; EYE SHADOW; FACE POWDER; FOUNDATION; HAIR COLOR; HAIR COLORING PREPARATIONS; HAIR REMOVING CREAM; LIP GLOSS; LIPSTICK; LIQUID SOAPS; LIQUID SOAPS FOR HANDS, FACE AND BODY; LOTIONS FOR FACE AND

**CLASS 3—(Continued).**

BODY CARE; MAKE UP FOUNDATIONS; MAKE-UP PENCILS; MASCARA; MOISTURIZING PREPARATIONS FOR THE SKIN; MOISTURIZING SOLUTIONS FOR THE SKIN; NON-MEDICATED LIP CARE PREPARATIONS; NON-MEDICATED PREPARATIONS ALL FOR THE CARE OF SKIN, HAIR AND SCALP; NON-MEDICATED SKIN CARE CREAMS AND LOTIONS; NON-MEDICATED SKIN CARE PREPARATION, NAMELY, BODY MIST; NON-MEDICATED SKIN CARE PREPARATIONS; NON-MEDICATED SKIN CARE PREPARATIONS, NAMELY, CREAMS, LOTIONS, GELS, TONERS, CLEANSERS AND PEELS; NON-MEDICATED SKIN CREAMS; NON-MEDICATED SUN CARE PREPARATIONS; ROUGE; SKIN AND BODY TOPICAL LOTIONS, CREAMS AND OILS FOR COSMETIC USE; SKIN CLEANSERS; SKIN CLEANSING CREAM; SKIN CLEANSING LOTION; SKIN CONDITIONERS; SKIN CONDITIONING CREAMS FOR COSMETIC PURPOSES; SKIN CREAM; SKIN CREAMS; SKIN CREAMS IN LIQUID AND IN SOLID FORM; SKIN CREAMS IN LIQUID AND SOLID; SKIN GELS FOR ACCELERATING, ENHANCING OR EXTENDING TANS; SKIN LIGHTENERS; SKIN LIGHTENING CREAMS; SKIN LOTION; SKIN MOISTURIZER; SKIN MOISTURIZING GEL; SKIN SOAP; SUN CARE LOTIONS (U.S. CLS. 1, 4, 6, 50, 51 AND 52).

FIRST USE 10-1-2010; IN COMMERCE 10-1-2010.

4,046,645. BISSELL HOMECARE, INC., GRAND RAPIDS, MI. SN 85-122,018. PUB. 2-15-2011, FILED 9-2-2010.

## CRUD SUDS

THE MARK CONSISTS OF STANDARD CHARACTERS WITHOUT CLAIM TO ANY PARTICULAR FONT, STYLE, SIZE, OR COLOR.

NO CLAIM IS MADE TO THE EXCLUSIVE RIGHT TO USE "SUDS", APART FROM THE MARK AS SHOWN.

FOR PET STAIN AND ODOR REMOVERS (U.S. CLS. 1, 4, 6, 50, 51 AND 52).

FIRST USE 4-4-2011; IN COMMERCE 4-4-2011.

4,046,652. ALOXXI INTERNATIONAL CORPORATION, SHERMAN OAKS, CA. SN 85-123,937. PUB. 2-15-2011, FILED 9-7-2010.

## APERITIV-O FOR 2

THE MARK CONSISTS OF STANDARD CHARACTERS WITHOUT CLAIM TO ANY PARTICULAR FONT, STYLE, SIZE, OR COLOR.

FOR HAIR BLEACHING PREPARATIONS, NON-MEDICATED HAIR CARE PREPARATIONS, HAIR CLEANING PREPARATIONS, HAIR COLOR REMOVERS, HAIR COLORING PREPARATIONS, HAIR LIGHTENERS, HAIR COLORING RINSE, HAIR LIGHTENING BLEACH, HAIR RINSES, HAIR COLORANTS, ALL IN THE FORM OF LIQUID, GEL AND CREAM (U.S. CLS. 1, 4, 6, 50, 51 AND 52).

FIRST USE 1-15-2011; IN COMMERCE 1-15-2011.

**CLASS 3—(Continued).**

4,046,653. ALOXXI INTERNATIONAL CORPORATION, SHERMAN OAKS, CA. SN 85-123,987. PUB. 2-15-2011, FILED 9-7-2010.

**GEORGIO'S FOLLY**

THE MARK CONSISTS OF STANDARD CHARACTERS WITHOUT CLAIM TO ANY PARTICULAR FONT, STYLE, SIZE, OR COLOR.

THE NAME "GEORGIO" DOES NOT IDENTIFY A LIVING INDIVIDUAL.

FOR HAIR BLEACHING PREPARATIONS, NON-MEDICATED HAIR CARE PREPARATIONS, HAIR CLEANING PREPARATIONS, HAIR COLOR REMOVERS, HAIR COLORING PREPARATIONS, HAIR LIGHTENERS, HAIR COLORING RINSE, HAIR LIGHTENING BLEACH, HAIR RINSES, HAIR COLORANTS, ALL IN THE FORM OF LIQUID, GEL AND CREAM (U.S. CLS. 1, 4, 6, 50, 51 AND 52).

FIRST USE 1-15-2011; IN COMMERCE 1-15-2011.

4,046,654. ALOXXI INTERNATIONAL CORPORATION, SHERMAN OAKS, CA. SN 85-124,309. PUB. 2-22-2011, FILED 9-7-2010.

**SAN REMO VINO**

THE MARK CONSISTS OF STANDARD CHARACTERS WITHOUT CLAIM TO ANY PARTICULAR FONT, STYLE, SIZE, OR COLOR.

FOR HAIR BLEACHING PREPARATIONS, NON-MEDICATED HAIR CARE PREPARATIONS, HAIR CLEANING PREPARATIONS, HAIR COLOR REMOVERS, HAIR COLORING PREPARATIONS, HAIR LIGHTENERS, HAIR COLORING RINSE, HAIR LIGHTENING BLEACH, HAIR RINSES, HAIR COLORANTS, ALL IN THE FORM OF LIQUID, GEL AND CREAM (U.S. CLS. 1, 4, 6, 50, 51 AND 52).

FIRST USE 1-15-2011; IN COMMERCE 1-15-2011.

**CLASS 3—(Continued).**

4,046,655. ALOXXI INTERNATIONAL CORPORATION, SHERMAN OAKS, CA. SN 85-124,334. PUB. 2-15-2011, FILED 9-7-2010.

**SUNLIGHT IN PALERMO**

THE MARK CONSISTS OF STANDARD CHARACTERS WITHOUT CLAIM TO ANY PARTICULAR FONT, STYLE, SIZE, OR COLOR.

FOR HAIR BLEACHING PREPARATIONS, NON-MEDICATED HAIR CARE PREPARATIONS, HAIR CLEANING PREPARATIONS, HAIR COLOR REMOVERS, HAIR COLORING PREPARATIONS, HAIR LIGHTENERS, HAIR COLORING RINSE, HAIR LIGHTENING BLEACH, HAIR RINSES, HAIR COLORANTS, ALL IN THE FORM OF LIQUID, GEL AND CREAM (U.S. CLS. 1, 4, 6, 50, 51 AND 52).

FIRST USE 1-15-2011; IN COMMERCE 1-15-2011.

4,046,656. ALOXXI INTERNATIONAL CORPORATION, SHERMAN OAKS, CA. SN 85-124,752. PUB. 2-22-2011, FILED 9-8-2010.

**WOMEN ARE FROM VENICE**

THE MARK CONSISTS OF STANDARD CHARACTERS WITHOUT CLAIM TO ANY PARTICULAR FONT, STYLE, SIZE, OR COLOR.

FOR HAIR BLEACHING PREPARATIONS, NON-MEDICATED HAIR CARE PREPARATIONS, HAIR CLEANING PREPARATIONS, HAIR COLOR REMOVERS, HAIR COLORING PREPARATIONS, HAIR LIGHTENERS, HAIR COLORING RINSE, HAIR LIGHTENING BLEACH, HAIR RINSES, HAIR COLORANTS, ALL IN THE FORM OF LIQUID, GEL AND CREAM (U.S. CLS. 1, 4, 6, 50, 51 AND 52).

FIRST USE 1-15-2011; IN COMMERCE 1-15-2011.

4,046,669. PURE & NATURAL COMPANY, SCOTTSDALE, AZ. SN 85-128,439. PUB. 3-1-2011, FILED 9-13-2010.

**DIAL**

THE MARK CONSISTS OF STANDARD CHARACTERS WITHOUT CLAIM TO ANY PARTICULAR FONT, STYLE, SIZE, OR COLOR.

**CLASS 3—(Continued).**

OWNER OF U.S. REG. NOS. 834,877, 3,488,550, AND OTHERS.

FOR BODY LOTIONS; FACIAL LOTION; HAND LOTIONS; SKIN LOTIONS (U.S. CLS. 1, 4, 6, 50, 51 AND 52).  
FIRST USE 12-14-2010; IN COMMERCE 12-14-2010.

---

4,046,673. ALOXXI INTERNATIONAL CORPORATION, SHERMAN OAKS, CA. SN 85-129,132. PUB. 2-15-2011, FILED 9-14-2010.

ONCE IN A BLUE LUNA

THE MARK CONSISTS OF STANDARD CHARACTERS WITHOUT CLAIM TO ANY PARTICULAR FONT, STYLE, SIZE, OR COLOR.

FOR HAIR BLEACHING PREPARATIONS, NON-MEDICATED HAIR CARE PREPARATIONS, HAIR CLEANING PREPARATIONS, HAIR COLOR REMOVERS, HAIR COLORING PREPARATIONS, HAIR LIGHTENERS, HAIR COLORING RINSE, HAIR LIGHTENING BLEACH, HAIR RINSES, HAIR COLORANTS, ALL IN THE FORM OF LIQUID, GEL AND CREAM (U.S. CLS. 1, 4, 6, 50, 51 AND 52).  
FIRST USE 1-15-2011; IN COMMERCE 1-15-2011.

---

4,046,674. L'OREAL USA CREATIVE, INC., NEW YORK, NY. SN 85-129,253. PUB. 3-1-2011, FILED 9-14-2010.

IRON IN

THE MARK CONSISTS OF STANDARD CHARACTERS WITHOUT CLAIM TO ANY PARTICULAR FONT, STYLE, SIZE, OR COLOR.

OWNER OF U.S. REG. NO. 3,295,615.  
FOR HAIR STYLING PREPARATION (U.S. CLS. 1, 4, 6, 50, 51 AND 52).  
FIRST USE 6-0-2011; IN COMMERCE 6-0-2011.

**CLASS 3—(Continued).**

4,046,686. WRIGHT TOOTHPASTE, INC., ST. LOUIS, MO. SN 85-131,009. PUB. 3-1-2011, FILED 9-16-2010.

VORTEX

THE MARK CONSISTS OF STANDARD CHARACTERS WITHOUT CLAIM TO ANY PARTICULAR FONT, STYLE, SIZE, OR COLOR.

FOR TOOTHPASTE (U.S. CLS. 1, 4, 6, 50, 51 AND 52).  
FIRST USE 7-26-2011; IN COMMERCE 7-26-2011.

---

4,046,714. MAINTENANCE SUPPLY & CHEMICAL CO. LLC, DENVER, NC. SN 85-136,820. PUB. 6-7-2011, FILED 9-23-2010.



NO CLAIM IS MADE TO THE EXCLUSIVE RIGHT TO USE "BOWLING BALL CLEANER", APART FROM THE MARK AS SHOWN.

THE COLOR(S) BLUE, WHITE, AND BLACK IS/ARE CLAIMED AS A FEATURE OF THE MARK.

THE MARK CONSISTS OF THE WORD "TAC" WRITTEN HORIZONTALLY WITH THE WORD "UP" APPEARING VERTICALLY. BELOW ARE THE WORDS "BOWLING BALL CLEANER" WHICH APPEAR IN BLACK. THE WORD "TAC" AND "UP" APPEAR IN BLUE, WHITE AND BLACK.

FOR BOWLING ACCESSORIES NOT USED AS ALL-PURPOSE CLEANERS OR COSMETIC CLEANERS, NAMELY, BOWLING BALL CLEANERS, BOWLING BALL POLISHES, AND PERFORMANCE ENHANCING BUFFING COMPOUNDS FOR USE WITH BOWLING BALLS (U.S. CLS. 1, 4, 6, 50, 51 AND 52).  
FIRST USE 7-30-2010; IN COMMERCE 9-1-2010.

---

4,046,736. SIGNAL INVESTMENT & MANAGEMENT CO., WILMINGTON, DE. SN 85-142,065. PUB. 3-15-2011, FILED 9-30-2010.

SILKSOFTNESS

THE MARK CONSISTS OF STANDARD CHARACTERS WITHOUT CLAIM TO ANY PARTICULAR FONT, STYLE, SIZE, OR COLOR.

FOR BODY LOTIONS; HAND LOTIONS (U.S. CLS. 1, 4, 6, 50, 51 AND 52).  
FIRST USE 6-1-2011; IN COMMERCE 6-1-2011.

**CLASS 3—(Continued).**

4,046,737. SIGNAL INVESTMENT & MANAGEMENT CO., WILMINGTON, DE. SN 85-142,072. PUB. 3-15-2011, FILED 9-30-2010.

**PEARLRADIANCE**

THE MARK CONSISTS OF STANDARD CHARACTERS WITHOUT CLAIM TO ANY PARTICULAR FONT, STYLE, SIZE, OR COLOR.

FOR BODY LOTIONS; HAND LOTIONS (U.S. CLS. 1, 4, 6, 50, 51 AND 52).  
FIRST USE 6-1-2011; IN COMMERCE 6-1-2011.

---

4,046,753. 360 DEGREES INC., STAMFORD, CT. SN 85-147,254. PUB. 3-15-2011, FILED 10-7-2010.

**ICED WHITE**

THE MARK CONSISTS OF STANDARD CHARACTERS WITHOUT CLAIM TO ANY PARTICULAR FONT, STYLE, SIZE, OR COLOR.

FOR FRAGRANCES FOR PERSONAL USE (U.S. CLS. 1, 4, 6, 50, 51 AND 52).  
FIRST USE 10-3-2010; IN COMMERCE 6-15-2011.

---

4,046,759. JOSE MARTIN CUEVAS COBOS, MEXICO, D.F., MEXICO. SN 85-148,564. PUB. 6-14-2011, FILED 10-8-2010.

**PF BLUE PEDRO FERNANDEZ**

THE MARK CONSISTS OF STANDARD CHARACTERS WITHOUT CLAIM TO ANY PARTICULAR FONT, STYLE, SIZE, OR COLOR.

NO CLAIM IS MADE TO THE EXCLUSIVE RIGHT TO USE "BLUE", APART FROM THE MARK AS SHOWN.

THE NAME "PEDRO FERNANDEZ" IDENTIFIES A LIVING INDIVIDUAL WHOSE CONSENT IS OF RECORD. FOR PERFUMERY (U.S. CLS. 1, 4, 6, 50, 51 AND 52).  
FIRST USE 5-5-2011; IN COMMERCE 5-5-2011.

**CLASS 3—(Continued).**

4,046,774. MATLON INC., CONWAY, AR. SN 85-154,803. PUB. 3-15-2011, FILED 10-18-2010.

**SKIN CARE FOR THE SERIOUS  
OUTDOORSMAN**

THE MARK CONSISTS OF STANDARD CHARACTERS WITHOUT CLAIM TO ANY PARTICULAR FONT, STYLE, SIZE, OR COLOR.

NO CLAIM IS MADE TO THE EXCLUSIVE RIGHT TO USE "SKIN CARE", APART FROM THE MARK AS SHOWN. FOR SKIN CREAMS; SKIN LOTIONS (U.S. CLS. 1, 4, 6, 50, 51 AND 52).

FIRST USE 10-20-2009; IN COMMERCE 10-20-2009.

---

4,046,865. BISSELL HOMECARE, INC., GRAND RAPIDS, MI. SN 85-184,841. PUB. 4-12-2011, FILED 11-24-2010.

**AHHH**

THE MARK CONSISTS OF STANDARD CHARACTERS WITHOUT CLAIM TO ANY PARTICULAR FONT, STYLE, SIZE, OR COLOR.

FOR CLEANING PREPARATIONS; CLEANERS FOR CARPETS, RUGS, UPHOLSTERY (U.S. CLS. 1, 4, 6, 50, 51 AND 52).

FIRST USE 2-3-2011; IN COMMERCE 2-3-2011.

---

4,046,919. KIM, JESSE, JACKSON HEIGHTS, NY. SN 85-198,677. PUB. 4-26-2011, FILED 12-15-2010.

**EVOS**

THE MARK CONSISTS OF THE STYLIZED WORDING "EVOS" IN LOWER CAPS.

FOR 3-IN-1 HAIR CONDITIONERS; 3-IN-1 HAIR SHAMPOOS; HAIR CARE CREAMS; HAIR CARE LOTIONS; HAIR CARE PREPARATIONS; HAIR CARE PRODUCTS, NAMELY, HEAT PROTECTION SPRAYS; HAIR COLOR; HAIR CONDITIONERS; HAIR GEL AND HAIR MOUSSE; HAIR MASKS; HAIR OILS; HAIR POMADES; HAIR PRODUCTS, NAMELY, THICKENING CONTROL CREAMS; HAIR RELAXERS; HAIR RELAXING PREPARATIONS; HAIR SPRAYS AND HAIR GELS; HAIR STRAIGHTENING PREPARATIONS; PET CARE KITS COMPRISING SHAMPOO, CONDITIONER, BODY SPRAY; PET ODOR REMOVERS; PET SHAMPOO AND CONDITIONER (U.S. CLS. 1, 4, 6, 50, 51 AND 52).

FIRST USE 5-16-2011; IN COMMERCE 5-30-2011.

**CLASS 3—(Continued).**

4,047,002. WENDY S. BERGER, NEW YORK, NY. SN 85-219,766. PUB. 6-7-2011, FILED 1-18-2011.

**CHARITY FOR THE WORLD**

THE MARK CONSISTS OF STANDARD CHARACTERS WITHOUT CLAIM TO ANY PARTICULAR FONT, STYLE, SIZE, OR COLOR.

NO CLAIM IS MADE TO THE EXCLUSIVE RIGHT TO USE "CHARITY", APART FROM THE MARK AS SHOWN. FOR COLOGNES, PERFUMES AND COSMETICS (U.S. CLS. 1, 4, 6, 50, 51 AND 52).

FIRST USE 8-8-2011; IN COMMERCE 8-8-2011.

4,047,042. KIEHNAU, BRENDA A., CEDARBURG, WI. SN 85-235,756. PUB. 6-14-2011, FILED 2-7-2011.

**ORGANIC SELF**

THE MARK CONSISTS OF STANDARD CHARACTERS WITHOUT CLAIM TO ANY PARTICULAR FONT, STYLE, SIZE, OR COLOR.

NO CLAIM IS MADE TO THE EXCLUSIVE RIGHT TO USE "ORGANIC", APART FROM THE MARK AS SHOWN. FOR BODY CARE PRODUCTS, NAMELY, SOAP, SHOWER GEL, BODY OIL, BATH SALTS, HAIR SHAMPOO, HAIR CONDITIONER, BODY BUTTER, BODY LOTION, ESSENTIAL OILS, ESSENTIAL OIL LOTION, AND ESSENTIAL OIL BODY BUTTER, ALL MADE OF ORGANIC INGREDIENTS (U.S. CLS. 1, 4, 6, 50, 51 AND 52).

FIRST USE 1-31-2011; IN COMMERCE 3-31-2011.

4,047,058. ELHAM JAFARIMOJARRAD M.D., INC., NEWPORT COAST, CA. SN 85-241,425. PUB. 6-21-2011, FILED 2-14-2011.

**amoderm**

THE MARK CONSISTS OF STANDARD CHARACTERS WITHOUT CLAIM TO ANY PARTICULAR FONT, STYLE, SIZE, OR COLOR.

FOR COSMETIC PREPARATIONS FOR SKIN CARE (U.S. CLS. 1, 4, 6, 50, 51 AND 52). FIRST USE 3-1-2011; IN COMMERCE 8-1-2011.

**CLASS 3—(Continued).**

4,047,075. N.V. PERRICONE LLC, MERIDEN, CT. SN 85-258,122. PUB. 6-14-2011, FILED 3-4-2011.

**THE CREASE CURE**

THE MARK CONSISTS OF STANDARD CHARACTERS WITHOUT CLAIM TO ANY PARTICULAR FONT, STYLE, SIZE, OR COLOR.

OWNER OF U.S. REG. NOS. 2,640,234, 3,898,161, AND OTHERS.

NO CLAIM IS MADE TO THE EXCLUSIVE RIGHT TO USE "CREASE", APART FROM THE MARK AS SHOWN. FOR SKIN CREAM; SKIN LOTION; SKIN MOISTURIZER; SKIN TONERS (U.S. CLS. 1, 4, 6, 50, 51 AND 52). FIRST USE 4-1-2011; IN COMMERCE 4-1-2011.

4,047,076. N.V. PERRICONE LLC, MERIDEN, CT. SN 85-258,168. PUB. 6-14-2011, FILED 3-4-2011.

**STOP YOUR WRINKLES FROM BECOMING CREASES**

THE MARK CONSISTS OF STANDARD CHARACTERS WITHOUT CLAIM TO ANY PARTICULAR FONT, STYLE, SIZE, OR COLOR.

OWNER OF U.S. REG. NOS. 2,640,234, 3,898,161, AND OTHERS.

FOR SKIN CREAM; SKIN LOTION; SKIN MOISTURIZER; SKIN TONERS (U.S. CLS. 1, 4, 6, 50, 51 AND 52). FIRST USE 4-1-2011; IN COMMERCE 4-1-2011.

4,047,078. PURE & NATURAL COMPANY, SCOTTSDALE, AZ. SN 85-263,759. PUB. 6-7-2011, FILED 3-10-2011.

**TURN IT UP**

THE MARK CONSISTS OF STANDARD CHARACTERS WITHOUT CLAIM TO ANY PARTICULAR FONT, STYLE, SIZE, OR COLOR.

FOR BAR SOAP; BATH SOAPS; BODY WASH; HAND SOAPS; LIQUID SOAPS (U.S. CLS. 1, 4, 6, 50, 51 AND 52). FIRST USE 4-21-2011; IN COMMERCE 4-21-2011.

**CLASS 4—LUBRICANTS AND FUELS**

**CLASS 4—(Continued).**

4,045,784. INSTA-FIRE INC., RIVERDALE, UT. SN 77-638,405. PUB. 6-8-2010, FILED 12-22-2008.

# INSTA-FIRE

THE MARK CONSISTS OF STANDARD CHARACTERS WITHOUT CLAIM TO ANY PARTICULAR FONT, STYLE, SIZE, OR COLOR.

FOR SOLID FIRE STARTERS, NAMELY, PORTABLE FLAMMABLE MATERIAL THAT CAN BE USED AS AN ACCELERANT, AND EXCLUDING DIRECT SPARK IGNITERS (U.S. CLS. 1, 6 AND 15).

FIRST USE 6-15-2008; IN COMMERCE 6-15-2008.

**CLASS 4—(Continued).**

4,046,390. MVP GROUP INTERNATIONAL, INC., CHARLESTON, SC. SN 85-078,536. PUB. 1-18-2011, FILED 7-6-2010.

# wick

NO CLAIM IS MADE TO THE EXCLUSIVE RIGHT TO USE "WICK", APART FROM THE MARK AS SHOWN.

THE MARK CONSISTS OF THE WORD "WICK" WITH A LEAF-SHAPED FLAME AS A DOT ON THE "I".

FOR CANDLES; SCENTED CANDLES (U.S. CLS. 1, 6 AND 15).

FIRST USE 1-31-2011; IN COMMERCE 1-31-2011.

4,045,867. FOREST CONCEPTS, LLC, AUBURN, WA. SN 77-766,276. PUB. 11-10-2009, FILED 6-23-2009.

# CRUMBLES

THE MARK CONSISTS OF STANDARD CHARACTERS WITHOUT CLAIM TO ANY PARTICULAR FONT, STYLE, SIZE, OR COLOR.

FOR BIOFUELS (U.S. CLS. 1, 6 AND 15).

FIRST USE 7-7-2011; IN COMMERCE 6-23-2009.

4,046,763. LAFCO ENTERPRISES INC., NEW YORK, NY. SN 85-151,348. PUB. 1-11-2011, FILED 10-13-2010.

LAFCO  
NEW YORK  
LUXURY ARTICLES & FRAGRANCE COMPANY

NO CLAIM IS MADE TO THE EXCLUSIVE RIGHT TO USE "NEW YORK LUXURY ARTICLES & FRAGRANCE COMPANY", APART FROM THE MARK AS SHOWN.

THE MARK CONSISTS OF THE LITERAL ELEMENTS "LAFCO NEW YORK LUXURY ARTICLES & FRAGRANCE COMPANY" IN A RECTANGULAR CARRIER.

FOR CANDLES (U.S. CLS. 1, 6 AND 15).

FIRST USE 2-0-2008; IN COMMERCE 2-0-2008.

4,045,904. FOREST CONCEPTS, LLC, AUBURN, WA. SN 77-809,549. PUB. 5-11-2010, FILED 8-20-2009.

# PRECISION FEEDSTOCKS

THE MARK CONSISTS OF STANDARD CHARACTERS WITHOUT CLAIM TO ANY PARTICULAR FONT, STYLE, SIZE, OR COLOR.

NO CLAIM IS MADE TO THE EXCLUSIVE RIGHT TO USE "FEEDSTOCKS", APART FROM THE MARK AS SHOWN.

FOR BIOFUELS (U.S. CLS. 1, 6 AND 15).

FIRST USE 8-20-2009; IN COMMERCE 7-7-2011.

4,046,834. AMSOIL INC., SUPERIOR, WI. SN 85-172,500. PUB. 3-8-2011, FILED 11-9-2010.

# Z-ROD

THE MARK CONSISTS OF STANDARD CHARACTERS WITHOUT CLAIM TO ANY PARTICULAR FONT, STYLE, SIZE, OR COLOR.

FOR MOTOR OIL AND LUBRICANTS (U.S. CLS. 1, 6 AND 15).

FIRST USE 5-1-2011; IN COMMERCE 5-1-2011.

**CLASS 4—(Continued).**

4,047,089. MVP GROUP INTERNATIONAL, INC., CHARLESTON, SC. SN 85-306,376. PUB. 7-19-2011, FILED 4-27-2011.

## COZY COTTAGE

THE MARK CONSISTS OF STANDARD CHARACTERS WITHOUT CLAIM TO ANY PARTICULAR FONT, STYLE, SIZE, OR COLOR.

FOR CANDLES; SCENTED CANDLES (U.S. CLS. 1, 6 AND 15).

FIRST USE 8-5-2011; IN COMMERCE 8-5-2011.

**CLASS 5—PHARMACEUTICALS**

4,045,619. ZOGENIX, INC., SAN DIEGO, CA. SN 77-098,291. PUB. 12-9-2008, FILED 2-2-2007.



FOR SINGLE-USE, NEEDLE-FREE SUBCUTANEOUS INJECTORS SOLD FILLED WITH PHARMACEUTICAL PREPARATIONS FOR THE TREATMENT OF CENTRAL NERVOUS SYSTEM DISEASES AND DISORDERS, PAIN, PSYCHIATRIC DISEASES AND DISORDERS (U.S. CLS. 6, 18, 44, 46, 51 AND 52).

FIRST USE 1-4-2010; IN COMMERCE 1-4-2010.

4,045,644. ANGIOBLAST SYSTEMS INCORPORATED, NEW YORK, NY. SN 77-242,134. PUB. 6-10-2008, FILED 7-30-2007.

## REVASCOR

THE MARK CONSISTS OF STANDARD CHARACTERS WITHOUT CLAIM TO ANY PARTICULAR FONT, STYLE, SIZE, OR COLOR.

**CLASS 5—(Continued).**

THE WORD "REVASCOR" HAS NO MEANING IN A FOREIGN LANGUAGE.

FOR PHARMACEUTICAL PREPARATIONS FOR THE PREVENTION, MANAGEMENT, AND TREATMENT OF CONNECTIVE TISSUE AND MUSCO-SKELETAL DISORDERS AND INDICATIONS; BIOTECHNOLOGY PREPARATIONS FOR THE PREVENTION, MANAGEMENT, DIAGNOSIS AND TREATMENT OF CONNECTIVE TISSUE AND MUSCO-SKELETAL DISORDERS AND INDICATIONS; MEDICAL PREPARATIONS FOR THE PREVENTION, MANAGEMENT, AND TREATMENT OF CONNECTIVE TISSUE AND MUSCO-SKELETAL DISORDERS AND INDICATIONS; HUMAN ALLOGRAFT TISSUE; HUMAN TISSUE FOR TRANSPLANTATION OR IMPLANTATION, MEDICAL AND SURGICAL PURPOSES; HUMAN CELLS INCLUDING STEM CELLS, PHARMACEUTICAL PREPARATIONS FOR THE TREATMENT, RECONSTRUCTION AND REPAIR OF TISSUE (U.S. CLS. 6, 18, 44, 46, 51 AND 52).

FIRST USE 8-30-2011; IN COMMERCE 8-30-2011.

4,045,668. ROTAM LTD., CHAI WAN, HONG KONG. SN 77-344,956. PUB. 7-8-2008, FILED 12-5-2007.

## DAKOTA

THE MARK CONSISTS OF STANDARD CHARACTERS WITHOUT CLAIM TO ANY PARTICULAR FONT, STYLE, SIZE, OR COLOR.

FOR AGRICULTURAL HERBICIDES (U.S. CLS. 6, 18, 44, 46, 51 AND 52).

FIRST USE 3-0-2011; IN COMMERCE 3-0-2011.

4,045,678. EVERFRESH BEVERAGES, INC., DBA SUNDANCE BEVERAGE COMPANY, WARREN, MI. SN 77-375,050. PUB. 6-3-2008, FILED 1-18-2008.

## BODYWORX

THE MARK CONSISTS OF STANDARD CHARACTERS WITHOUT CLAIM TO ANY PARTICULAR FONT, STYLE, SIZE, OR COLOR.

FOR NUTRITIONALLY FORTIFIED BEVERAGES; VITAMIN FORTIFIED BEVERAGES (U.S. CLS. 6, 18, 44, 46, 51 AND 52).

FIRST USE 1-31-2008; IN COMMERCE 1-31-2008.

**CLASS 5—(Continued).**

4,045,718. ROTAM LTD., CHAI WAN, HONG KONG. SN 77-435,369. PUB. 7-8-2008, FILED 3-31-2008.

## ROWRUNNER

THE MARK CONSISTS OF STANDARD CHARACTERS WITHOUT CLAIM TO ANY PARTICULAR FONT, STYLE, SIZE, OR COLOR.

FOR AGRICULTURAL HERBICIDES (U.S. CLS. 6, 18, 44, 46, 51 AND 52).

FIRST USE 10-0-2009; IN COMMERCE 10-0-2009.

---

4,045,731. HARTMANN USA, INC., ROCK HILL, SC. SN 77-479,254. PUB. 12-16-2008, FILED 5-20-2008.



THE MARK CONSISTS OF WORDS "HYDROCURA ADVANTAGE" WITH SWIRL DESIGN TO THE LEFT OF THE WORDS.

FOR INCONTINENCE PADS AND DIAPERS AND UNDERPANTS (U.S. CLS. 6, 18, 44, 46, 51 AND 52).

FIRST USE 6-30-2011; IN COMMERCE 6-30-2011.

---

4,045,732. HARTMANN USA, INC., ROCK HILL, SC. SN 77-479,267. PUB. 12-2-2008, FILED 5-20-2008.

## HYDROCURA ADVANTAGE

THE MARK CONSISTS OF STANDARD CHARACTERS WITHOUT CLAIM TO ANY PARTICULAR FONT, STYLE, SIZE, OR COLOR.

FOR INCONTINENCE PADS AND DIAPERS AND UNDERPANTS (U.S. CLS. 6, 18, 44, 46, 51 AND 52).

FIRST USE 6-30-2011; IN COMMERCE 6-30-2011.

**CLASS 5—(Continued).**

4,045,749. TAIWAN LIPOSOME CO., LTD., TAIPEI, TAIWAN. SN 77-520,894. PUB. 12-9-2008, FILED 7-13-2008.

## AmBiL

THE MARK CONSISTS OF STANDARD CHARACTERS WITHOUT CLAIM TO ANY PARTICULAR FONT, STYLE, SIZE, OR COLOR.

FOR ALL PURPOSE DISINFECTANTS; ANTIBIOTIC CREAMS; ANTIBIOTIC OINTMENTS; ANTIBIOTICS; ANTIFUNGAL CREAMS FOR MEDICAL USE; ANTI-SEPTICS; ANTI-INFECTIVES; FUNGAL MEDICATIONS; FUNGICIDES; FUNGICIDES FOR MEDICAL USE; PHARMACEUTICAL PREPARATIONS FOR THE TREATMENT OF INFECTIOUS DISEASES; PHARMACEUTICAL PREPARATIONS FOR THE PREVENTION AND TREATMENT OF OCULAR DISORDERS OR DISEASES, FOR THE TREATMENT OF BACTERIA-BASED DISEASES, FOR THE TREATMENT OF DIABETES, AND ANTI-INFECTIVE PREPARATIONS, ANTIVIRAL PREPARATIONS, ANTIBIOTICS, ANTIFUNGAL PREPARATIONS AND VACCINES; ALL AFOREMENTIONED GOODS AVAILABLE BY PRESCRIPTION ONLY (U.S. CLS. 6, 18, 44, 46, 51 AND 52).

FIRST USE 7-24-2008; IN COMMERCE 11-17-2008.

---

4,045,757. TEOCALLI, LLC, INCLINE VILLAGE, NV. SN 77-549,918. PUB. 12-16-2008, FILED 8-18-2008.

## BONEXID

THE MARK CONSISTS OF STANDARD CHARACTERS WITHOUT CLAIM TO ANY PARTICULAR FONT, STYLE, SIZE, OR COLOR.

FOR FOOD SUPPLEMENTS (U.S. CLS. 6, 18, 44, 46, 51 AND 52).

FIRST USE 8-14-2010; IN COMMERCE 8-14-2010.

---

4,045,758. MEDA PHARMACEUTICALS INC., SOMERSET, NJ. SN 77-557,224. PUB. 5-5-2009, FILED 8-27-2008.

## EDLUAR

THE MARK CONSISTS OF STANDARD CHARACTERS WITHOUT CLAIM TO ANY PARTICULAR FONT, STYLE, SIZE, OR COLOR.



**CLASS 5—(Continued).**

THE WORDING "EDLUAR" HAS NO MEANING IN A FOREIGN LANGUAGE.

FOR PHARMACEUTICAL PREPARATIONS FOR THE TREATMENT OF SLEEP DISORDERS (U.S. CLS. 6, 18, 44, 46, 51 AND 52).

FIRST USE 8-17-2009; IN COMMERCE 8-17-2009.

---

4,045,765. PIONEER SURGICAL TECHNOLOGY, INC., MARQUETTE, MI. SN 77-575,692. PUB. 12-9-2008, FILED 9-22-2008.

**TRIOMATRIX**

THE MARK CONSISTS OF STANDARD CHARACTERS WITHOUT CLAIM TO ANY PARTICULAR FONT, STYLE, SIZE, OR COLOR.

FOR IMPLANTABLE ORTHOPEDIC DEVICES, NAMELY, SURGICAL IMPLANTS AND BONE IMPLANTS COMPOSED OF LIVING OR NATURAL MATERIALS; SPINAL FIXATION AND STABILIZATION MATERIALS COMPOSED OF LIVING OR NATURAL MATERIALS; BONE FILLERS CONSISTING OF LIVING OR NATURAL MATERIALS; BONE CEMENT FOR MEDICAL PURPOSES (U.S. CLS. 6, 18, 44, 46, 51 AND 52).

FIRST USE 6-0-2010; IN COMMERCE 6-0-2010.

---

4,045,799. QUINN SPECIALTY PRODUCTS, INC., DUNN, NC. SN 77-654,640. PUB. 5-12-2009, FILED 1-22-2009.

**HYDRONATOR**

THE MARK CONSISTS OF STANDARD CHARACTERS WITHOUT CLAIM TO ANY PARTICULAR FONT, STYLE, SIZE, OR COLOR.

FOR NUTRITIONALLY FORTIFIED BEVERAGES (U.S. CLS. 6, 18, 44, 46, 51 AND 52).

FIRST USE 3-1-2009; IN COMMERCE 3-1-2009.

---

4,045,817. ESTABLECIMIENTOS ANCALMO, S.A. DE C.V., ANTIGUO CUSCATLÁN, EL SALVADOR. SN 77-678,593. PUB. 12-1-2009, FILED 2-25-2009.

**SUERO EN POLVO ANCALMO**

THE MARK CONSISTS OF STANDARD CHARACTERS WITHOUT CLAIM TO ANY PARTICULAR FONT, STYLE, SIZE, OR COLOR.

**CLASS 5—(Continued).**

OWNER OF U.S. REG. NO. 3,053,657.

NO CLAIM IS MADE TO THE EXCLUSIVE RIGHT TO USE "SUERO EN POLVO", APART FROM THE MARK AS SHOWN.

THE ENGLISH TRANSLATION OF "SUERO EN POLVO" IN THE MARK IS "POWDER SERUM". THE WORDING "ANCALMO" HAS NO MEANING IN A FOREIGN LANGUAGE.

FOR NUTRITIONAL SUPPLEMENTS (U.S. CLS. 6, 18, 44, 46, 51 AND 52).

FIRST USE 12-8-1999; IN COMMERCE 7-31-2011.

---

4,045,825. GRUPO OMNILIFE, S.A. DE C.V., GUADALAJARA, JALISCO, MEXICO. SN 77-696,783. PUB. 9-21-2010, FILED 3-23-2009.

**MIMIS**

THE MARK CONSISTS OF STANDARD CHARACTERS WITHOUT CLAIM TO ANY PARTICULAR FONT, STYLE, SIZE, OR COLOR.

FOR MINERAL FOOD SUPPLEMENTS; VITAMIN PREPARATIONS; DIETARY SUPPLEMENTS (U.S. CLS. 6, 18, 44, 46, 51 AND 52).

FIRST USE 2-7-2009; IN COMMERCE 7-6-2009.

---

4,045,836. MERIAL LIMITED, HARLOW, ESSEX CM19 5QA, UNITED KINGDOM. SN 77-707,333. PUB. 10-20-2009, FILED 4-6-2009.

**CERTIFECT**

THE MARK CONSISTS OF STANDARD CHARACTERS WITHOUT CLAIM TO ANY PARTICULAR FONT, STYLE, SIZE, OR COLOR.

PRIORITY CLAIMED UNDER SEC. 44(D) ON UNITED KINGDOM APPLICATION NO. 2512567, FILED 4-2-2009, REG. NO. 2512567, DATED 4-2-2009, EXPIRES 4-2-2019.

FOR VETERINARY PREPARATIONS, NAMELY, INSECTICIDES AND ANTIPARASITIC PRODUCTS FOR VETERINARY USE (U.S. CLS. 6, 18, 44, 46, 51 AND 52).

FIRST USE 7-16-2011; IN COMMERCE 7-16-2011.

**CLASS 5—(Continued).**

4,045,863. WESTERN HOLDINGS, LLC, CARSON CITY, NV.  
SN 77-760,630. PUB. 5-25-2010, FILED 6-16-2009.



NO CLAIM IS MADE TO THE EXCLUSIVE RIGHT TO USE "INTERNATIONAL", APART FROM THE MARK AS SHOWN.

THE COLOR(S) BLACK AND PINK IS/ARE CLAIMED AS A FEATURE OF THE MARK.

THE MARK CONSISTS OF THE WORDS "THIN CARE INTERNATIONAL" IN BLACK WITH TWO CURVING PINK LINES RESEMBLING A SILHOUETTE OF A HUMAN BODY BETWEEN THE WORDS "THIN" AND "CARE".

FOR DIETARY SUPPLEMENTS (U.S. CLS. 6, 18, 44, 46, 51 AND 52).

FIRST USE 7-21-2009; IN COMMERCE 7-21-2009.

4,045,902. INSMED, INC., RICHMOND, VA. SN 77-807,144.  
PUB. 7-13-2010, FILED 8-18-2009.

iPlex

THE MARK CONSISTS OF STANDARD CHARACTERS WITHOUT CLAIM TO ANY PARTICULAR FONT, STYLE, SIZE, OR COLOR.

FOR PRESCRIPTION PHARMACEUTICAL PREPARATIONS FOR THE TREATMENT OF ENDOCRINE AND METABOLIC DISEASES (U.S. CLS. 6, 18, 44, 46, 51 AND 52).

FIRST USE 5-0-2006; IN COMMERCE 5-0-2006.

4,045,931. GRAIN FREE PLANET, LLC, CENTENNIAL, CO.  
SN 77-838,573. PUB. 6-15-2010, FILED 9-30-2009.



NO CLAIM IS MADE TO THE EXCLUSIVE RIGHT TO USE "GRAIN FREE" AND "GLUTEN-FREE BAKED GOODS", APART FROM THE MARK AS SHOWN.

**CLASS 5—(Continued).**

THE MARK CONSISTS OF THE WORDING "GRAIN FREE" IN LARGE FONT SEPARATED BY A DOT WITH A DEPICTION OF A GLOBE WITHIN BRACES BELOW AND TO THE RIGHT OF THE GLOBE DESIGN IS THE WORD "PLANET" IN LARGE FONT WITH THE WORDS "GLUTEN-FREE BAKED GOODS" IN SMALL FONT BELOW "PLANET."

FOR GLUTEN-FREE FOOD TO ACCOMMODATE SPECIAL MEDICAL AND HEALTH CONDITIONS (U.S. CLS. 6, 18, 44, 46, 51 AND 52).

FIRST USE 1-1-2011; IN COMMERCE 1-1-2011.

4,045,933. MEDLINE INDUSTRIES, INC., MUNDELEIN, IL.  
SN 77-839,435. PUB. 12-29-2009, FILED 10-1-2009.

CAPRI PLUS

THE MARK CONSISTS OF STANDARD CHARACTERS WITHOUT CLAIM TO ANY PARTICULAR FONT, STYLE, SIZE, OR COLOR.

FOR BLADDER CONTROL PADS (U.S. CLS. 6, 18, 44, 46, 51 AND 52).

FIRST USE 3-8-2011; IN COMMERCE 3-8-2011.

4,045,973. ENZYMEDICA, PORT CHARLOTTE, FL. SN 77-880,104. PUB. 3-9-2010, FILED 11-24-2009.

Identify

THE MARK CONSISTS OF STANDARD CHARACTERS WITHOUT CLAIM TO ANY PARTICULAR FONT, STYLE, SIZE, OR COLOR.

FOR DIETARY AND NUTRITIONAL SUPPLEMENTS (U.S. CLS. 6, 18, 44, 46, 51 AND 52).

FIRST USE 7-11-2011; IN COMMERCE 7-11-2011.

**CLASS 5—(Continued).**

4,046,009. CYANOTECH CORPORATION, KAILUA-KONA, HI. SN 77-911,380. PUB. 6-22-2010, FILED 1-13-2010.

**KING OF THE CAROTENOIDS**

THE MARK CONSISTS OF STANDARD CHARACTERS WITHOUT CLAIM TO ANY PARTICULAR FONT, STYLE, SIZE, OR COLOR.

FOR NUTRITIONAL SUPPLEMENTS FOR HUMAN CONSUMPTION; NUTRACEUTICALS FOR THE TREATMENT OF OXIDATIVE STRESS, DECREASED IMMUNITY, AND INFLAMMATORY CONDITIONS; NUTRACEUTICALS FOR USE AS A DIETARY SUPPLEMENT; DIETARY SUPPLEMENTS; NUTRITIONAL SUPPLEMENTS; NUTRITIONAL ADDITIVES FOR MEDICAL PURPOSES FOR USE IN FOODS AND DIETARY SUPPLEMENTS FOR HUMAN CONSUMPTION; NUTRITIONAL ADDITIVES FOR USE IN FEED FOR ANIMALS FOR MEDICAL PURPOSES; DIETARY SUPPLEMENTS FOR ANIMAL CONSUMPTION; FOOD SUPPLEMENTS; FOOD SUPPLEMENTS, NAMELY, ANTI-OXIDANTS; HOMEOPATHIC SUPPLEMENTS, NAMELY, DILUTED DOSES FROM THE PLANT, MINERAL AND ANIMAL KINGDOMS FOR HUMAN CONSUMPTION; DRINK MIXES, NAMELY, DIETARY DRINK MIX FOR USE AS A MEAL REPLACEMENT, POWDERED FRUIT-FLAVORED DIETARY SUPPLEMENT DRINK MIX, NUTRITIONAL SUPPLEMENT IN THE NATURE OF A NUTRIENT-DENSE, PROTEIN-BASED DRINK MIX; ALL OF THE FOREGOING CONTAINING CAROTENOIDS (U.S. CLS. 6, 18, 44, 46, 51 AND 52).

FIRST USE 8-12-2011; IN COMMERCE 8-12-2011.

**CLASS 5—(Continued).**

4,046,058. STANDARD HOMEOPATHIC COMPANY, LOS ANGELES, CA. SN 77-932,598. PUB. 1-11-2011, FILED 2-10-2010.

**HYLAND'S COMPLETE ALLERGY  
4 KIDS**

THE MARK CONSISTS OF STANDARD CHARACTERS WITHOUT CLAIM TO ANY PARTICULAR FONT, STYLE, SIZE, OR COLOR.

NO CLAIM IS MADE TO THE EXCLUSIVE RIGHT TO USE "COMPLETE ALLERGY 4 KIDS", APART FROM THE MARK AS SHOWN.

FOR HOMEOPATHIC PHARMACEUTICALS AND HOMEOPATHIC MEDICATION FOR THE TREATMENT AND SYMPTOMATIC RELIEF OF ALLERGIES (U.S. CLS. 6, 18, 44, 46, 51 AND 52).

FIRST USE 12-18-2009; IN COMMERCE 7-1-2010.

4,046,071. INTEGRA LIFESCIENCES CORPORATION, PLAINSBORO, NJ. SN 77-936,230. PUB. 7-13-2010, FILED 2-16-2010.

**LIMIT UNCERTAINTY**

4,046,027. HEALTH TO HAPPINES INC., LARGO, FL. SN 77-917,763. PUB. 5-17-2011, FILED 1-22-2010.

*The Swedish Diet*

NO CLAIM IS MADE TO THE EXCLUSIVE RIGHT TO USE "DIET", APART FROM THE MARK AS SHOWN.

THE MARK CONSISTS OF THE STYLIZED TEXT "THE SWEDISH DIET".

FOR LIQUID DIETARY VITAMIN SUPPLEMENT (U.S. CLS. 6, 18, 44, 46, 51 AND 52).

FIRST USE 6-0-2010; IN COMMERCE 6-0-2010.

THE MARK CONSISTS OF STANDARD CHARACTERS WITHOUT CLAIM TO ANY PARTICULAR FONT, STYLE, SIZE, OR COLOR.

FOR SURGICAL IMPLANTS COMPRISING MATERIAL DERIVED FROM LIVING TISSUE; TISSUE REGENERATION MATRICES COMPRISING MATERIAL DERIVED FROM LIVING TISSUE; HUMAN ALLOGRAFT TISSUE; HUMAN ALLOGRAFT BONE IMPLANTS; MEDICAL AND SURGICAL DRESSINGS; WOUND DRESSINGS; WOUND DRESSING FOR SURGICAL AND DENTAL APPLICATIONS; IMPLANTABLE OR GRAFTABLE MEDICAL DEVICES COMPRISING MATERIAL DERIVED FROM LIVING TISSUE FOR USE IN THE TREATMENT OF THE NERVE, DURA MATER, SKIN, BONE OR TENDON; BONE GRAFT SUBSTITUTE COMPRISING MATERIAL DERIVED FROM LIVING TISSUE; PHARMACEUTICAL PREPARATION COMPRISING COLLAGEN USED FOR NEUROSURGERY, ORTHOPEDIC SURGERY, SPINE SURGERY, RECONSTRUCTIVE SURGERY, AND PLASTIC SURGERY; MEDICAL IMPLANTS COMPRISING MATERIAL DERIVED FROM LIVING TISSUE FOR ORTHOPEDIC OR SPINAL APPLICATIONS (U.S. CLS. 6, 18, 44, 46, 51 AND 52).

FIRST USE 10-5-2010; IN COMMERCE 10-5-2010.

**CLASS 5—(Continued).**

4,046,113. THE PROCTER & GAMBLE COMPANY, CINCINNATI, OH. SN 77-949,471. PUB. 11-30-2010, FILED 3-3-2010.

**BREEZY BERRY BUBBLEGUM**

THE MARK CONSISTS OF STANDARD CHARACTERS WITHOUT CLAIM TO ANY PARTICULAR FONT, STYLE, SIZE, OR COLOR.

NO CLAIM IS MADE TO THE EXCLUSIVE RIGHT TO USE "BERRY BUBBLEGUM", APART FROM THE MARK AS SHOWN.

FOR ANTICAVITY MOUTH RINSE AND DENTAL RINSE (U.S. CLS. 6, 18, 44, 46, 51 AND 52).

FIRST USE 7-25-2011; IN COMMERCE 7-25-2011.

4,046,142. POTTS, KATHI, CARLSBAD, CA. SN 77-960,209. PUB. 9-7-2010, FILED 3-16-2010.

**IBFIT BITES**

THE MARK CONSISTS OF STANDARD CHARACTERS WITHOUT CLAIM TO ANY PARTICULAR FONT, STYLE, SIZE, OR COLOR.

NO CLAIM IS MADE TO THE EXCLUSIVE RIGHT TO USE "BITES", APART FROM THE MARK AS SHOWN.

FOR ENERGY BOOSTING BARS FOR USE AS A MEAL REPLACEMENT, MEAL REPLACEMENT BARS AND SNACK BITES, NUTRITIONAL ENERGY BARS FOR USE AS A MEAL REPLACEMENT, NUTRITIONAL FOOD BARS FOR USE AS A MEAL REPLACEMENT, MEAL REPLACEMENT SNACK ENERGY BITES, ENERGY BOOSTING BARS FOR ENDURANCE FOR USE AS A MEAL REPLACEMENT, MEAL REPLACEMENT SNACK BITES FOR ENDURANCE, PROTEIN ENRICHED MEAL REPLACEMENT BARS AND SNACK BITES; ALL NATURAL ORGANIC AND NON-ORGANIC MEAL REPLACEMENT SNACK BITES, MEAL REPLACEMENT BARS, MEAL REPLACEMENT SHAKES, POWDERS, DRINKS, AND SNACKS, AND MEAL REPLACEMENT ENERGY BARS (U.S. CLS. 6, 18, 44, 46, 51 AND 52).

FIRST USE 3-17-2010; IN COMMERCE 3-17-2010.

**CLASS 5—(Continued).**

4,046,143. MEDI IP, LLC, TAMPA, FL. SN 77-960,217. PUB. 8-3-2010, FILED 3-16-2010.

**POWERPLAY**

THE MARK CONSISTS OF STANDARD CHARACTERS WITHOUT CLAIM TO ANY PARTICULAR FONT, STYLE, SIZE, OR COLOR.

FOR NUTRITIONAL SUPPLEMENTS (U.S. CLS. 6, 18, 44, 46, 51 AND 52).

FIRST USE 7-1-2011; IN COMMERCE 7-1-2011.

4,046,167. EILANDT, SVENJA, 38667 BAD HARZBURG, FED REP GERMANY. AND EILANDT, ARNE, 38667 BAD HARZBURG, FED REP GERMANY. SN 77-982,377. PUB. 11-3-2009, FILED 7-17-2008.

**ERO SEXIN**

THE MARK CONSISTS OF STANDARD CHARACTERS WITHOUT CLAIM TO ANY PARTICULAR FONT, STYLE, SIZE, OR COLOR.

THE WORDING "ERO SEXIN" HAS NO MEANING IN A FOREIGN LANGUAGE.

FOR SANITARY PREPARATIONS FOR MEDICAL USE; PHARMACEUTICAL PREPARATIONS FOR HUMAN USE OF SEXUAL STIMULATION COMPRISED OF VITAMINS, PLANT EXTRACTS, AMINO ACIDS AND MINERAL PREPARATIONS, ALL FOR MEDICAL USE; STIMULANTS, NAMELY, DIETARY AND NUTRITIONAL PREPARATIONS, NAMELY, VITAMINS, PLANT EXTRACTS, AMINO ACIDS, AND MINERAL PREPARATIONS, ALL FOR MEDICAL USE AND FOR STIMULATING SEXUAL ENCOUNTERS; VITAMINS AND VITAMIN PREPARATIONS; ENERGY PREPARATIONS AND ENERGY PRODUCTS, NAMELY, MEDICINAL PLANTS, HERBS AND BOTANICAL EXTRACTS; DIETETIC FOODS ADAPTED FOR MEDICAL USE; DIETETIC SUGAR FOR MEDICAL USE; DIETARY SUPPLEMENTS; DIETARY AND NUTRITIONAL SUPPLEMENTS COMPRISED OF VITAMINS, PLANTS, AMINO ACIDS AND MINERALS; DIETARY AND NUTRITIONALLY FORTIFIED FOOD PRODUCTS ADAPTED FOR MEDICAL USE; DIETARY FOOD SUPPLEMENTS; ALL-PURPOSE DISINFECTANTS; BATH OILS AND BATH PREPARATIONS FOR MEDICAL AND THERAPEUTIC PURPOSES; MINERAL FOOD SUPPLEMENTS AND MINERAL WATER FOR MEDICAL PURPOSES (U.S. CLS. 6, 18, 44, 46, 51 AND 52).

FIRST USE 2-9-2009; IN COMMERCE 2-9-2009.

**CLASS 5—(Continued).**

4,046,205. ABBOTT LABORATORIES, ABBOTT PARK, IL. SN 85-002,179. PUB. 1-4-2011, FILED 3-30-2010.

**VITAL AF 1.2 CAL**

THE MARK CONSISTS OF STANDARD CHARACTERS WITHOUT CLAIM TO ANY PARTICULAR FONT, STYLE, SIZE, OR COLOR.

OWNER OF U.S. REG. NOS. 1,116,291 AND 3,416,048.

NO CLAIM IS MADE TO THE EXCLUSIVE RIGHT TO USE "AF 1.2 CAL", APART FROM THE MARK AS SHOWN.

FOR DIETETIC FOODS ADAPTED FOR MEDICAL USE; COMPLETE ELEMENTAL MEDICAL FOOD; FOOD FOR ENTERAL FEEDING FOR MEDICAL PURPOSES; ENTERAL FEEDING FOODS FOR MEDICAL DIETARY PURPOSES (U.S. CLS. 6, 18, 44, 46, 51 AND 52).

FIRST USE 9-8-2010; IN COMMERCE 9-8-2010.

4,046,206. VITAL HEALTH PHARMACEUTICALS, INC., LAS VEGAS, NV. SN 85-002,893. PUB. 9-7-2010, FILED 3-31-2010.

**VITAL HEALTH**

THE MARK CONSISTS OF STANDARD CHARACTERS WITHOUT CLAIM TO ANY PARTICULAR FONT, STYLE, SIZE, OR COLOR.

NO CLAIM IS MADE TO THE EXCLUSIVE RIGHT TO USE "HEALTH", APART FROM THE MARK AS SHOWN.

FOR VITAMIN AND DIETARY SUPPLEMENTS (U.S. CLS. 6, 18, 44, 46, 51 AND 52).

FIRST USE 1-18-2011; IN COMMERCE 1-18-2011.

4,046,207. VITAL HEALTH PHARMACEUTICALS, INC., LAS VEGAS, NV. SN 85-002,973. PUB. 9-28-2010, FILED 3-31-2010.

**C TAMIN**

THE MARK CONSISTS OF STANDARD CHARACTERS WITHOUT CLAIM TO ANY PARTICULAR FONT, STYLE, SIZE, OR COLOR.

NO CLAIM IS MADE TO THE EXCLUSIVE RIGHT TO USE "C", APART FROM THE MARK AS SHOWN.

FOR VITAMIN AND DIETARY SUPPLEMENTS CONTAINING VITAMIN C (U.S. CLS. 6, 18, 44, 46, 51 AND 52).

FIRST USE 1-18-2011; IN COMMERCE 1-18-2011.

**CLASS 5—(Continued).**

4,046,272. TEVA PHARMACEUTICALS USA, INC., NORTH WALES, PA. SN 85-036,659. PUB. 10-26-2010, FILED 5-12-2010.

**CAMRESE**

THE MARK CONSISTS OF STANDARD CHARACTERS WITHOUT CLAIM TO ANY PARTICULAR FONT, STYLE, SIZE, OR COLOR.

FOR PHARMACEUTICALS, NAMELY, ORAL CONTRACEPTIVES, HORMONE REPLACEMENT THERAPY PREPARATIONS AND PHARMACEUTICAL PREPARATIONS, NAMELY, HORMONAL AGENTS FOR TREATING HORMONE DISORDERS AND CONDITIONS RELATED TO WOMEN'S HEALTH (U.S. CLS. 6, 18, 44, 46, 51 AND 52).

FIRST USE 7-28-2011; IN COMMERCE 7-28-2011.

4,046,274. HAMMAN, CHARLES J, CHICAGO, IL. SN 85-037,205. PUB. 12-28-2010, FILED 5-13-2010.



THE MARK CONSISTS OF THE IMAGE OF DOUBLE OUTLINED CIRCLE CONTAINING SHEEP'S HEAD WEARING A SLEEPING MASK WHICH DISPLAYS STARS AND MOONS, AND A SERIES OF "Z" S EMANATING FROM THE CIRCLE, USED TO INDICATE SLEEP.

FOR DIETARY SUPPLEMENT BEVERAGE FOR AIDING IN SLEEP AND RELAXATION; DIETARY SUPPLEMENTAL DRINKS; DIETARY SUPPLEMENTS; HERBAL DRINKS USED TO AID IN SLEEP AND RELAXATION (U.S. CLS. 6, 18, 44, 46, 51 AND 52).

FIRST USE 7-0-2010; IN COMMERCE 7-0-2010.

**CLASS 5—(Continued).**

4,046,310. AKER BIOMARINE ASA, OSLO, NORWAY. SN 85-051,878. PUB. 1-4-2011, FILED 6-1-2010.

# SOS KRILL

THE MARK CONSISTS OF STANDARD CHARACTERS WITHOUT CLAIM TO ANY PARTICULAR FONT, STYLE, SIZE, OR COLOR.

NO CLAIM IS MADE TO THE EXCLUSIVE RIGHT TO USE "KRILL", APART FROM THE MARK AS SHOWN.

FOR DIETARY SUPPLEMENTS FOR HUMAN CONSUMPTION CONTAINING KRILL OIL OR OTHER KRILL DERIVATIVES (U.S. CLS. 6, 18, 44, 46, 51 AND 52).

FIRST USE 6-24-2011; IN COMMERCE 6-24-2011.

---

4,046,375. ASURAGEN, INC., AUSTIN, TX. SN 85-073,037. PUB. 2-1-2011, FILED 6-28-2010.

# Amplidex

THE MARK CONSISTS OF STANDARD CHARACTERS WITHOUT CLAIM TO ANY PARTICULAR FONT, STYLE, SIZE, OR COLOR.

FOR DIAGNOSTIC KITS CONSISTING PRIMARILY OF DIAGNOSTIC REAGENTS AND INSTRUCTIONS SOLD AS A UNIT FOR MEDICAL DIAGNOSTIC USES (U.S. CLS. 6, 18, 44, 46, 51 AND 52).

FIRST USE 8-16-2010; IN COMMERCE 8-16-2010.

---

4,046,383. YOUR VITAMINS, INC., DBA PROCAPS LABORATORIES, HENDERSON, NV. SN 85-075,812. PUB. 11-30-2010, FILED 7-1-2010.

# nuonce

THE MARK CONSISTS OF THE WORDS "NU" AND "ONCE" IN BLOCK LETTERS.

FOR DIETARY AND NUTRITIONAL SUPPLEMENTS (U.S. CLS. 6, 18, 44, 46, 51 AND 52).

FIRST USE 7-25-2011; IN COMMERCE 7-25-2011.

**CLASS 5—(Continued).**

4,046,423. U-S. S. MEDICAL CORP., GARDENVILLE, PUERTO RICO. SN 85-085,415. PUB. 2-1-2011, FILED 7-15-2010.



THE COLOR(S) ORANGE IS/ARE CLAIMED AS A FEATURE OF THE MARK.

THE MARK CONSISTS OF AN ORANGE STYLIZED LOWER CASE LETTER "U" ENCLOSED IN A SEMI-CIRCLE.

FOR DIETARY AND NUTRITIONAL SUPPLEMENTS; MULTI-VITAMIN PREPARATIONS (U.S. CLS. 6, 18, 44, 46, 51 AND 52).

FIRST USE 1-19-2011; IN COMMERCE 1-19-2011.

---

4,046,464. AP&G CO., INC., BROOKLYN, NY. SN 85-091,258. PUB. 1-4-2011, FILED 7-23-2010.

# BBEDS

THE MARK CONSISTS OF STANDARD CHARACTERS WITHOUT CLAIM TO ANY PARTICULAR FONT, STYLE, SIZE, OR COLOR.

FOR INSECTICIDE SPRAY FOR KILLING BEDBUGS (U.S. CLS. 6, 18, 44, 46, 51 AND 52).

FIRST USE 10-15-2010; IN COMMERCE 10-15-2010.

---

4,046,498. MONAVIE LLC, SOUTH JORDAN, UT. SN 85-096,336. PUB. 2-22-2011, FILED 7-29-2010.

# M O N A • V I E

the premier açai blend

OWNER OF U.S. REG. NOS. 3,106,147, 3,691,548, AND OTHERS.

NO CLAIM IS MADE TO THE EXCLUSIVE RIGHT TO USE "AÇAI BLEND", APART FROM THE MARK AS SHOWN.

**CLASS 5—(Continued).**

THE MARK CONSISTS OF THE STYLIZED WORD "MONA" WITH AN UPSIDE DOWN "V" REPRESENTING THE LETTER "A" FOLLOWED BY THE WORD "VIE", A DOT BETWEEN THE WORDS "MONA" AND "VIE", THE PHRASE "THE PREMIER ACAI BLEND" BELOW THE WORDS "MONA" AND "VIE", THE LETTER "C" IN "ACAI" HAVING A CEDILLA.

THE WORDING "MONA VIE" HAS NO MEANING IN A FOREIGN LANGUAGE.

FOR DIETARY AND NUTRITIONAL SUPPLEMENTS CONTAINING AÇAI BERRY (U.S. CLS. 6, 18, 44, 46, 51 AND 52).

FIRST USE 2-0-2007; IN COMMERCE 2-0-2007.

---

4,046,514. RIGHT TRACK GLOBAL, LLC, IRVINE, CA. SN 85-098,470. PUB. 1-11-2011, FILED 8-2-2010.

## COOL FUEL

THE MARK CONSISTS OF STANDARD CHARACTERS WITHOUT CLAIM TO ANY PARTICULAR FONT, STYLE, SIZE, OR COLOR.

FOR PEDIATRIC NUTRITIVE PREPARATIONS; DIETARY NUTRITIONAL SUPPLEMENT DRINKS FOR CHILDREN (U.S. CLS. 6, 18, 44, 46, 51 AND 52).

FIRST USE 9-1-2010; IN COMMERCE 9-1-2010.

---

4,046,519. THORNE BIOSCIENCE LLC, LOUISVILLE, KY. SN 85-099,092. PUB. 1-18-2011, FILED 8-3-2010.

## SUCROMATE

THE MARK CONSISTS OF STANDARD CHARACTERS WITHOUT CLAIM TO ANY PARTICULAR FONT, STYLE, SIZE, OR COLOR.

FOR VETERINARY PREPARATIONS FOR DOMESTIC ANIMALS TO STIMULATE OVULATION AND ESTRUS WITHIN A CONTROLLED TIME PERIOD (U.S. CLS. 6, 18, 44, 46, 51 AND 52).

FIRST USE 2-28-2011; IN COMMERCE 2-28-2011.

**CLASS 5—(Continued).**

4,046,545. OCULUS INNOVATIVE SCIENCES, INC., PETA-LUMA, CA. SN 85-101,711. PUB. 1-25-2011, FILED 8-6-2010.

## XuSorb

THE MARK CONSISTS OF STANDARD CHARACTERS WITHOUT CLAIM TO ANY PARTICULAR FONT, STYLE, SIZE, OR COLOR.

FOR WOUND DRESSINGS (U.S. CLS. 6, 18, 44, 46, 51 AND 52).

FIRST USE 11-1-2010; IN COMMERCE 11-1-2010.

---

4,046,560. AGRI LABORATORIES, LTD., ST. JOSEPH, MO. SN 85-105,233. PUB. 1-25-2011, FILED 8-11-2010.

## Achieve

THE MARK CONSISTS OF STANDARD CHARACTERS WITHOUT CLAIM TO ANY PARTICULAR FONT, STYLE, SIZE, OR COLOR.

FOR FEED SUPPLEMENTS FOR LIVESTOCK (U.S. CLS. 6, 18, 44, 46, 51 AND 52).

FIRST USE 1-7-2011; IN COMMERCE 1-7-2011.

---

4,046,571. BRAIN PHARMA, LLC, HOLLYWOOD, FL. SN 85-108,467. PUB. 1-11-2011, FILED 8-16-2010.

## RoxyLean ECA

THE MARK CONSISTS OF STANDARD CHARACTERS WITHOUT CLAIM TO ANY PARTICULAR FONT, STYLE, SIZE, OR COLOR.

NO CLAIM IS MADE TO THE EXCLUSIVE RIGHT TO USE "ECA", APART FROM THE MARK AS SHOWN.

FOR DIETARY AND NUTRITIONAL SUPPLEMENTS; DIETARY AND NUTRITIONAL SUPPLEMENTS FOR HUMAN CONSUMPTION, NAMELY, PROTEIN SUPPLEMENTS FOR MUSCLE GROWTH AND RECOVERY; DIETARY AND NUTRITIONAL SUPPLEMENTS FOR INCREASING METABOLISM AND SUPPRESSING APETITE; DIETARY SUPPLEMENTS FOR HUMAN CONSUMPTION SOLD VIA INTERNET COMMERCE AND SPORTS NUTRITIONAL STORES (U.S. CLS. 6, 18, 44, 46, 51 AND 52).

FIRST USE 9-15-2010; IN COMMERCE 9-15-2010.

**CLASS 5—(Continued).**

4,046,588. WATSON PHARMACEUTICALS, INC., CORONA, CA. SN 85-111,408. PUB. 1-25-2011, FILED 8-19-2010.

# JEVANTIQUE

THE MARK CONSISTS OF STANDARD CHARACTERS WITHOUT CLAIM TO ANY PARTICULAR FONT, STYLE, SIZE, OR COLOR.

FOR HORMONE REPLACEMENT THERAPY PREPARATIONS; ORAL CONTRACEPTIVES (U.S. CLS. 6, 18, 44, 46, 51 AND 52).

FIRST USE 7-15-2011; IN COMMERCE 7-15-2011.

---

4,046,589. LOVELAND PRODUCTS, INC., LOVELAND, CO. SN 85-111,636. PUB. 11-23-2010, FILED 8-19-2010.

# MATADOR

THE MARK CONSISTS OF STANDARD CHARACTERS WITHOUT CLAIM TO ANY PARTICULAR FONT, STYLE, SIZE, OR COLOR.

FOR PESTICIDES (U.S. CLS. 6, 18, 44, 46, 51 AND 52).

FIRST USE 2-23-2011; IN COMMERCE 2-23-2011.

---

4,046,622. KB MEDIA GROUP, LLC, SAN FRANCISCO, CA. SN 85-118,609. PUB. 1-11-2011, FILED 8-30-2010.

# SIR ROCK

THE MARK CONSISTS OF STANDARD CHARACTERS WITHOUT CLAIM TO ANY PARTICULAR FONT, STYLE, SIZE, OR COLOR.

FOR NUTRACEUTICALS FOR USE AS A DIETARY SUPPLEMENT; NUTRITIONAL SUPPLEMENTS (U.S. CLS. 6, 18, 44, 46, 51 AND 52).

FIRST USE 8-26-2011; IN COMMERCE 8-26-2011.

**CLASS 5—(Continued).**

4,046,667. UPSHER-SMITH LABORATORIES, MAPLE GROVE, MN. SN 85-128,361. PUB. 6-28-2011, FILED 9-13-2010.

# TRIANEX

THE MARK CONSISTS OF STANDARD CHARACTERS WITHOUT CLAIM TO ANY PARTICULAR FONT, STYLE, SIZE, OR COLOR.

FOR PHARMACEUTICAL PRODUCTS, NAMELY, TOPICAL CORTICOSTEROIDS (U.S. CLS. 6, 18, 44, 46, 51 AND 52).

FIRST USE 7-11-2011; IN COMMERCE 7-11-2011.

---

4,046,743. NEOGENIS LABORATORIES, INC, AUSTIN, TX. SN 85-144,038. PUB. 3-1-2011, FILED 10-4-2010.



NO CLAIM IS MADE TO THE EXCLUSIVE RIGHT TO USE "LABS", APART FROM THE MARK AS SHOWN.

THE COLOR(S) RED, BLUE, WHITE, AND DARK BLUE IS/ARE CLAIMED AS A FEATURE OF THE MARK.

THE MARK CONSISTS OF WHITE TEXT "NEOGENIS LABS" ON A BACKGROUND OF OVERLAPPING RED AND BLUE CIRCLES, WITH DARK BLUE IN THE AREA OF OVERLAP.

FOR HEALTH AND WELLNESS PRODUCTS, NAMELY, NUTRACEUTICALS FOR USE AS DIETARY SUPPLEMENTS, DIETETIC FOODS AND BEVERAGES ADAPTED FOR MEDICAL PURPOSES, DIETARY AND NUTRITIONAL SUPPLEMENTS, HERBAL SUPPLEMENTS, VITAMIN AND MINERAL SUPPLEMENTS, DIETARY SUPPLEMENTS FOR WEIGHT-LOSS OR ENERGY BOOSTING IN THE NATURE OF POWDERS, TABLETS, CAPSULES, LOZENGES, AND MEAL-REPLACEMENT BARS, AND IMMUNITY BOOSTING NUTRITIONAL SUPPLEMENTS (U.S. CLS. 6, 18, 44, 46, 51 AND 52).

FIRST USE 8-18-2010; IN COMMERCE 8-18-2010.



**CLASS 5—(Continued).**

4,046,778. KHETARPAL LIVING TRUST, VALENCIA, CA. SN 85-155,290. PUB. 3-15-2011, FILED 10-18-2010.

# CANDEE CAINE

THE MARK CONSISTS OF STANDARD CHARACTERS WITHOUT CLAIM TO ANY PARTICULAR FONT, STYLE, SIZE, OR COLOR.

FOR TOPICAL ANESTHETICS (U.S. CLS. 6, 18, 44, 46, 51 AND 52).

FIRST USE 1-20-2011; IN COMMERCE 1-20-2011.

4,046,780. GOLDEN BIOTECHNOLOGY CORPORATION, TAIPEI COUNTY, TAIWAN. SN 85-155,744. PUB. 3-22-2011, FILED 10-19-2010.

# ZSAINO

THE MARK CONSISTS OF STANDARD CHARACTERS WITHOUT CLAIM TO ANY PARTICULAR FONT, STYLE, SIZE, OR COLOR.

THE WORDING "ZSAINO" HAS NO MEANING IN A FOREIGN LANGUAGE.

FOR ANTIALLERGIC MEDICINES; PHARMACEUTICAL PREPARATIONS THAT MODULATE THE IMMUNE SYSTEM, NAMELY, PHARMACEUTICAL PREPARATIONS FOR THE PREVENTION AND TREATMENT OF DISORDERS OF THE IMMUNE SYSTEM; ANTI-CANCER PREPARATIONS; ANTI-PARKINSON'S PREPARATIONS; ANTI-BREAST CANCER PREPARATIONS; PHARMACEUTICAL PREPARATIONS FOR THE TREATMENT OF LIVER AILMENTS; ANTIVIRAL PREPARATIONS; FOOD SUPPLEMENTS, NAMELY, ANTI-OXIDANTS; DIETARY SUPPLEMENTS FOR HUMAN CONSUMPTION; NUTRITIONAL ADDITIVES FOR MEDICAL PURPOSES FOR USE IN FOODS AND DIETARY SUPPLEMENTS FOR HUMAN CONSUMPTION; NUTRITIONAL SUPPLEMENT IN THE NATURE OF A HERB-EXTRACT; PHARMACEUTICAL PREPARATIONS FOR THE PREVENTION AND TREATMENT OF OCULAR DISORDERS OR DISEASES, FOR THE TREATMENT OF BACTERIA-BASED DISEASES, AND FOR THE TREATMENT OF DIABETES, AND ANTI-INFECTIVE PREPARATIONS, ANTIVIRAL PREPARATIONS, ANTIBIOTICS, ANTIFUNGAL PREPARATIONS; DIETARY BEVERAGE SUPPLEMENTS FOR HUMAN CONSUMPTION IN LIQUID AND DRY MIX FORM FOR THERAPEUTIC PURPOSES; MEDICINAL HERBS; ANIMAL FEED SUPPLEMENTS; NON-MEDICATED ADDITIVES FOR ANIMAL FEED FOR USE AS NUTRITIONAL SUPPLEMENTS (U.S. CLS. 6, 18, 44, 46, 51 AND 52).

FIRST USE 10-7-2010; IN COMMERCE 5-17-2010.

**CLASS 5—(Continued).**

4,046,878. DRUGTECH CORPORATION, WILMINGTON, DE. SN 85-187,580. PUB. 4-19-2011, FILED 11-30-2010.

# MAKENA

THE MARK CONSISTS OF STANDARD CHARACTERS WITHOUT CLAIM TO ANY PARTICULAR FONT, STYLE, SIZE, OR COLOR.

FOR PHARMACEUTICAL PREPARATIONS FOR OBSTETRICS AND GYNECOLOGY, NAMELY, FOR THE TREATMENT OF MISCARRIAGE, PRETERM LABOR, PRETERM BIRTH, ABNORMALITIES AND COMPLICATIONS OF PREGNANCY AND ABNORMALITIES AND COMPLICATIONS OF LABOR AND DELIVERY (U.S. CLS. 6, 18, 44, 46, 51 AND 52).

FIRST USE 3-31-2011; IN COMMERCE 3-31-2011.

4,046,893. PROSTATE CANCER INSTITUTE LLC, NEWPORT BEACH, CA. SN 85-192,104. PUB. 4-26-2011, FILED 12-7-2010.

# Prost-P10X

THE MARK CONSISTS OF STANDARD CHARACTERS WITHOUT CLAIM TO ANY PARTICULAR FONT, STYLE, SIZE, OR COLOR.

FOR DIETARY SUPPLEMENTS (U.S. CLS. 6, 18, 44, 46, 51 AND 52).

FIRST USE 2-15-2011; IN COMMERCE 2-15-2011.

4,046,960. MYBODY, L.L.C., PHOENIX, AZ. SN 85-210,785. PUB. 5-3-2011, FILED 1-5-2011.



THE COLOR(S) WHITE, RED AND GRAY IS/ARE CLAIMED AS A FEATURE OF THE MARK.

**CLASS 5—(Continued).**

THE MARK CONSISTS OF A WHITE DESIGN HEART WITHIN A RED DESIGN HEART WITH THE WORD "MY-BODY" IN GRAY.

FOR MEDICATED SKIN CARE PREPARATIONS; MEDICATED SKIN CARE PREPARATIONS, NAMELY, CREAMS, LOTIONS, GELS, TONERS, CLEANERS AND PEELS; MEDICINAL CREAMS FOR SKIN CARE; NON-MEDICATED, THERAPEUTIC SKIN CREAMS FOR THE TREATMENT OF ACNE; NUTRITIONAL SUPPLEMENTS FOR PROMOTING HEALTHY SKIN; NUTRITIONAL SUPPLEMENTS IN LOTION FORM SOLD AS A COMPONENT OF NUTRITIONAL SKIN CARE PRODUCTS; VAGINAL MOISTURIZERS; VAGINAL PREPARATIONS, NAMELY, ANTIFUNGALS; VAGINAL WASHES (U.S. CLS. 6, 18, 44, 46, 51 AND 52).

FIRST USE 1-28-2011; IN COMMERCE 1-28-2011.

---

4,047,071. INDUSTRIALIZADORA INTEGRAL DEL AGAVE S.A. DE C.V., TLAQUEPAQUE, JALISCO, MEXICO. SN 85-251,193. PUB. 6-21-2011, FILED 2-24-2011.



NO CLAIM IS MADE TO THE EXCLUSIVE RIGHT TO USE "FOOD", APART FROM THE MARK AS SHOWN.

THE MARK CONSISTS OF THE WORD "INUFIB" IN A STYLIZED DESIGN, THE WORD "FOOD" INSIDE A HEXAGON AND THE FIGURE OF A STYLIZED PLANT.

THE WORDING "INUFIB" HAS NO MEANING IN A FOREIGN LANGUAGE.

FOR FOOD SUPPLEMENTS FOR HUMAN USE (U.S. CLS. 6, 18, 44, 46, 51 AND 52).

FIRST USE 6-15-2011; IN COMMERCE 6-15-2011.

---

4,047,104. NOCAP, LLC, SALT LAKE CITY, UT. SN 85-975,681. PUB. 1-11-2011, FILED 7-29-2010.

# BOIJOY

THE MARK CONSISTS OF STANDARD CHARACTERS WITHOUT CLAIM TO ANY PARTICULAR FONT, STYLE, SIZE, OR COLOR.

FOR HERBAL SUPPLEMENTS (U.S. CLS. 6, 18, 44, 46, 51 AND 52).

FIRST USE 9-27-2010; IN COMMERCE 9-27-2010.

**CLASS 6—METAL GOODS****CLASS 6—(Continued).**

4,045,591. A&P TOOL, INC., HICKSVILLE, OH. SN 76-702,601. PUB. 3-22-2011, FILED 4-23-2010.

# SWIVEL LINK

THE MARK CONSISTS OF STANDARD CHARACTERS WITHOUT CLAIM TO ANY PARTICULAR FONT, STYLE, SIZE, OR COLOR.

NO CLAIM IS MADE TO THE EXCLUSIVE RIGHT TO USE "SWIVEL", APART FROM THE MARK AS SHOWN.

FOR BALL AND SOCKET MOUNT WITH INFINITE MOUNTING CAPABILITY FOR INDUSTRIAL AND HOBBY APPLICATIONS, NAMELY, A METALLIC MOUNT FOR MOUNTING START BUTTONS, SWITCHES, CAMERAS, JOYSTICKS, CRAFTS AND ARTWORK (U.S. CLS. 2, 12, 13, 14, 23, 25 AND 50).

FIRST USE 4-0-2010; IN COMMERCE 4-0-2010.

---

4,045,711. TRUE VALUE COMPANY, CHICAGO, IL. SN 77-424,074. PUB. 12-2-2008, FILED 3-17-2008.



OWNER OF U.S. REG. NOS. 1,249,555 AND 1,561,687. FOR METAL CLAMPS (U.S. CLS. 2, 12, 13, 14, 23, 25 AND 50).

FIRST USE 1-0-2007; IN COMMERCE 1-0-2007.

---

4,045,729. CSPS METAL CO., LTD., DOU-LIOU, TAIWAN. SN 77-467,644. PUB. 11-18-2008, FILED 5-7-2008.

# HighAway

THE MARK CONSISTS OF STANDARD CHARACTERS WITHOUT CLAIM TO ANY PARTICULAR FONT, STYLE, SIZE, OR COLOR.

FOR GENERAL PURPOSE METAL CEILING STORAGE UNITS (U.S. CLS. 2, 12, 13, 14, 23, 25 AND 50).

FIRST USE 8-8-2008; IN COMMERCE 8-8-2008.

**CLASS 6—(Continued).**

4,045,886. WAL-MART STORES, INC., BENTONVILLE, AR.  
SN 77-788,448. PUB. 11-24-2009, FILED 7-23-2009.



OWNER OF U.S. REG. NO. 3,373,555.  
THE MARK CONSISTS OF A DESIGN OF SIX RAYS  
SYMMETRICALLY CENTERED AROUND A CIRCLE.  
FOR METAL KEY CHAINS (U.S. CLS. 2, 12, 13, 14, 23,  
25 AND 50).  
FIRST USE 6-30-2009; IN COMMERCE 6-30-2009.

4,045,966. MBA BUILDING SUPPLIES, LIBERTYVILLE, IL.  
SN 77-873,238. PUB. 3-1-2011, FILED 11-16-2009.

**MBA Metal Framing**

THE MARK CONSISTS OF STANDARD CHARACTERS  
WITHOUT CLAIM TO ANY PARTICULAR FONT, STYLE,  
SIZE, OR COLOR.  
NO CLAIM IS MADE TO THE EXCLUSIVE RIGHT TO  
USE "METAL FRAMING", APART FROM THE MARK AS  
SHOWN.  
FOR BUILDING WALL FRAMING MADE PRIMAR-  
ILY OF METAL; IRONS AND STEELS; ROLLED STEELS;  
STEEL FRAMES FOR BUILDING; ZINC-COATED STEEL  
SHEETS (U.S. CLS. 2, 12, 13, 14, 23, 25 AND 50).  
FIRST USE 2-9-2009; IN COMMERCE 6-9-2009.

**CLASS 6—(Continued).**

4,045,994. HOFFMAN, DONALD G., OCEANSIDE, CA. SN 77-  
899,168. PUB. 6-15-2010, FILED 12-22-2009.

**MAN FLOWERS**

THE MARK CONSISTS OF STANDARD CHARACTERS  
WITHOUT CLAIM TO ANY PARTICULAR FONT, STYLE,  
SIZE, OR COLOR.  
FOR REUSABLE APPARATUS, NAMELY, A METAL  
CLIP USED TO CLASP GIFTS TO EACH OTHER (U.S.  
CLS. 2, 12, 13, 14, 23, 25 AND 50).  
FIRST USE 8-9-2011; IN COMMERCE 8-9-2011.

4,046,017. ZAPP AG, RATINGEN, FED REP GERMANY. SN  
77-913,339. PUB. 5-18-2010, FILED 1-15-2010.

**Z-A11 PM**

THE MARK CONSISTS OF STANDARD CHARACTERS  
WITHOUT CLAIM TO ANY PARTICULAR FONT, STYLE,  
SIZE, OR COLOR.  
NO CLAIM IS MADE TO THE EXCLUSIVE RIGHT TO  
USE "PM", APART FROM THE MARK AS SHOWN.  
FOR IRON-BASED HOT ISOSTATIC PRESSED (HIP)  
POWDER METALS FOR USE AS TOOL STEELS FOR  
THE MANUFACTURE OF MACHINE TOOLS AND  
MACHINERY COMPONENTS (U.S. CLS. 2, 12, 13, 14,  
23, 25 AND 50).  
FIRST USE 1-31-2010; IN COMMERCE 1-31-2010.

4,046,018. ZAPP AG, RATINGEN, FED REP GERMANY. SN  
77-913,376. PUB. 5-18-2010, FILED 1-15-2010.

**Z-A11LV PM**

THE MARK CONSISTS OF STANDARD CHARACTERS  
WITHOUT CLAIM TO ANY PARTICULAR FONT, STYLE,  
SIZE, OR COLOR.  
NO CLAIM IS MADE TO THE EXCLUSIVE RIGHT TO  
USE "PM", APART FROM THE MARK AS SHOWN.  
FOR IRON-BASED HOT ISOSTATIC PRESSED (HIP)  
POWDER METALS FOR USE AS TOOL STEELS FOR  
THE MANUFACTURE OF MACHINE TOOLS AND  
MACHINERY COMPONENTS (U.S. CLS. 2, 12, 13, 14,  
23, 25 AND 50).  
FIRST USE 1-31-2010; IN COMMERCE 1-31-2010.

**CLASS 6—(Continued).**

4,046,019. ZAPP AG, RATINGEN, FED REP GERMANY. SN 77-913,387. PUB. 5-18-2010, FILED 1-15-2010.

**Z-Wear PM**

THE MARK CONSISTS OF STANDARD CHARACTERS WITHOUT CLAIM TO ANY PARTICULAR FONT, STYLE, SIZE, OR COLOR.

NO CLAIM IS MADE TO THE EXCLUSIVE RIGHT TO USE "PM", APART FROM THE MARK AS SHOWN.

FOR IRON-BASED HOT ISOSTATIC PRESSED (HIP) POWDER METALS FOR USE AS TOOL STEELS FOR THE MANUFACTURE OF MACHINE TOOLS AND MACHINERY COMPONENTS (U.S. CLS. 2, 12, 13, 14, 23, 25 AND 50).

FIRST USE 1-31-2010; IN COMMERCE 1-31-2010.

---

4,046,020. ZAPP AG, RATINGEN, FED REP GERMANY. SN 77-913,394. PUB. 5-18-2010, FILED 1-15-2010.

**Z-M4 PM**

THE MARK CONSISTS OF STANDARD CHARACTERS WITHOUT CLAIM TO ANY PARTICULAR FONT, STYLE, SIZE, OR COLOR.

NO CLAIM IS MADE TO THE EXCLUSIVE RIGHT TO USE "PM", APART FROM THE MARK AS SHOWN.

FOR IRON-BASED HOT ISOSTATIC PRESSED (HIP) POWDER METALS FOR USE AS TOOL STEELS FOR THE MANUFACTURE OF MACHINE TOOLS AND MACHINERY COMPONENTS (U.S. CLS. 2, 12, 13, 14, 23, 25 AND 50).

FIRST USE 1-31-2010; IN COMMERCE 1-31-2010.

---

4,046,021. ZAPP AG, RATINGEN, FED REP GERMANY. SN 77-913,399. PUB. 5-18-2010, FILED 1-15-2010.

**Z-T15 PM**

THE MARK CONSISTS OF STANDARD CHARACTERS WITHOUT CLAIM TO ANY PARTICULAR FONT, STYLE, SIZE, OR COLOR.

NO CLAIM IS MADE TO THE EXCLUSIVE RIGHT TO USE "PM", APART FROM THE MARK AS SHOWN.

FOR IRON-BASED HOT ISOSTATIC PRESSED (HIP) POWDER METALS FOR USE AS TOOL STEELS FOR THE MANUFACTURE OF MACHINE TOOLS AND MACHINERY COMPONENTS (U.S. CLS. 2, 12, 13, 14, 23, 25 AND 50).

FIRST USE 1-31-2010; IN COMMERCE 1-31-2010.

**CLASS 6—(Continued).**

4,046,121. ROTOR CLIP COMPANY, INC., SOMERSET, NJ. SN 77-953,073. PUB. 8-3-2010, FILED 3-8-2010.

**TRUWAVE**

THE MARK CONSISTS OF STANDARD CHARACTERS WITHOUT CLAIM TO ANY PARTICULAR FONT, STYLE, SIZE, OR COLOR.

FOR METAL WAVE SPRINGS USED IN ASSEMBLY TOOLS AND EQUIPMENT FOR AUTOMOTIVE MANUFACTURING AND IN PARTS OF AUTOMOBILES, NAMELY, IN CLUTCHES, ROLLING DOORS, CAR MIRRORS, AIRBAGS, AND AIRBAG INFLATORS (U.S. CLS. 2, 12, 13, 14, 23, 25 AND 50).

FIRST USE 8-23-2011; IN COMMERCE 8-23-2011.

---

4,046,169. PRIMESOURCE BUILDING PRODUCTS, INC., IRVING, TX. SN 77-982,421. PUB. 5-19-2009, FILED 3-6-2009.



OWNER OF U.S. REG. NOS. 2,953,644, 3,298,813, AND OTHERS.

THE MARK CONSISTS OF THE WORDS "GRIP RITE" INSIDE A QUADRILATERAL.

FOR METAL LATH (U.S. CLS. 2, 12, 13, 14, 23, 25 AND 50).

FIRST USE 7-1-2011; IN COMMERCE 7-1-2011.

**CLASS 6—(Continued).**

4,046,208. EASYLINK INDUSTRIAL CO., LTD., KAOHSIUNG, TAIWAN. SN 85-003,964. PUB. 4-5-2011, FILED 4-1-2010.

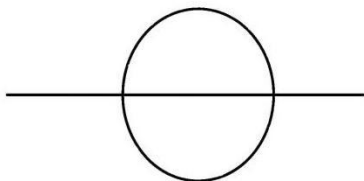

THE MARK CONSISTS OF A DESIGN IN THE FORM OF A CIRCLE DIVIDED INTO HALVES BY A HORIZONTAL LINE.

FOR METAL FASTENERS, NAMELY, SCREWS, BOLTS, NUTS, NAILS; METAL HARDWARE, NAMELY, WASHERS; METAL SCREWS; SCREWS OF METAL (U.S. CLS. 2, 12, 13, 14, 23, 25 AND 50).  
FIRST USE 2-25-2011; IN COMMERCE 2-25-2011.

4,046,432. PETERSEN ALUMINUM CORPORATION, ELK GROVE VILLAGE, IL. SN 85-086,723. PUB. 1-4-2011, FILED 7-16-2010.

# PAC-TITE

THE MARK CONSISTS OF STANDARD CHARACTERS WITHOUT CLAIM TO ANY PARTICULAR FONT, STYLE, SIZE, OR COLOR.

FOR METAL BUILDING AND CONSTRUCTION MATERIALS, NAMELY, ROOF EDGE FASCIA (U.S. CLS. 2, 12, 13, 14, 23, 25 AND 50).

FIRST USE 1-31-2011; IN COMMERCE 1-31-2011.

4,046,798. THE DELANEY CO., CUMMING, GA. SN 85-159,957. PUB. 3-22-2011, FILED 10-25-2010.

# BRIONA

THE MARK CONSISTS OF STANDARD CHARACTERS WITHOUT CLAIM TO ANY PARTICULAR FONT, STYLE, SIZE, OR COLOR.

FOR METAL HARDWARE, NAMELY, DOOR HANDLE SETS (U.S. CLS. 2, 12, 13, 14, 23, 25 AND 50).  
FIRST USE 8-8-2011; IN COMMERCE 8-8-2011.

**CLASS 6—(Continued).**

4,046,799. THE DELANEY CO., CUMMING, GA. SN 85-159,964. PUB. 3-22-2011, FILED 10-25-2010.

# SANTO

THE MARK CONSISTS OF STANDARD CHARACTERS WITHOUT CLAIM TO ANY PARTICULAR FONT, STYLE, SIZE, OR COLOR.

FOR METAL HARDWARE, NAMELY, DOOR KNOBS (U.S. CLS. 2, 12, 13, 14, 23, 25 AND 50).

FIRST USE 8-8-2011; IN COMMERCE 8-8-2011.

4,047,053. EXTECH EXTERIOR TECHNOLOGIES, INC., PITTSBURGH, PA. SN 85-238,705. PUB. 6-28-2011, FILED 2-10-2011.

# LONGFELLOW

THE MARK CONSISTS OF STANDARD CHARACTERS WITHOUT CLAIM TO ANY PARTICULAR FONT, STYLE, SIZE, OR COLOR.

FOR METAL SKYLIGHTS GLAZED WITH THERMOPLASTIC PANELS (U.S. CLS. 2, 12, 13, 14, 23, 25 AND 50).

FIRST USE 6-0-2010; IN COMMERCE 6-0-2010.

**CLASS 7—MACHINERY**

4,045,583. MEAT PROCESSING EQUIPMENT LLC., DBA MP EQUIPMENT CO., BUFORD, GA. SN 76-687,956. PUB. 6-3-2008, FILED 3-21-2008.

# MPADVANTAGE VCS BATTER MIXER

THE MARK CONSISTS OF STANDARD CHARACTERS WITHOUT CLAIM TO ANY PARTICULAR FONT, STYLE, SIZE, OR COLOR.

NO CLAIM IS MADE TO THE EXCLUSIVE RIGHT TO USE "BATTER MIXER", APART FROM THE MARK AS SHOWN.

FOR COMMERCIAL AND INDUSTRIAL FOOD PROCESSING MACHINES FOR APPLYING BREADING, BATTERS, SEASONING AND FLOUR TO FOOD PRODUCTS (U.S. CLS. 13, 19, 21, 23, 31, 34 AND 35).

FIRST USE 1-0-2011; IN COMMERCE 1-0-2011.

**CLASS 7—(Continued).**

4,045,683. GALA INDUSTRIES, INC., EAGLE ROCK, VA. SN 77-378,526. PUB. 6-3-2008, FILED 1-23-2008.

# i-Heat

THE MARK CONSISTS OF STANDARD CHARACTERS WITHOUT CLAIM TO ANY PARTICULAR FONT, STYLE, SIZE, OR COLOR.

FOR MACHINERY FOR PROCESSING EXTRUDABLE POLYMERIC MATERIAL COMPOSITES, CONTAINING BOTH POLYMERS AND BIOPOLYMERS, TO FORM PELLETS, INCLUDING UNDERWATER PELLETIZER AND DRYER, WITH AIR INJECTION BETWEEN PELLETIZER AND DRYER (U.S. CLS. 13, 19, 21, 23, 31, 34 AND 35).

FIRST USE 5-0-2011; IN COMMERCE 5-0-2011.

**CLASS 7—(Continued).**

4,046,133. MENARD, INC., DBA MENARDS, EAU CLAIRE, WI. SN 77-957,030. PUB. 1-11-2011, FILED 3-11-2010.

# SHOCKWAVE

THE MARK CONSISTS OF STANDARD CHARACTERS WITHOUT CLAIM TO ANY PARTICULAR FONT, STYLE, SIZE, OR COLOR.

FOR POWER TOOLS, NAMELY, OSCILLATING MULTI-PURPOSE POWER TOOL USED FOR SANDING, GRINDING, POLISHING, SHARPENING, RASPING, SAWING, AND SCRAPING, EXCLUDING TOOLS IN THE OIL WELL DRILLING INDUSTRY; ACCESSORIES FOR POWER TOOLS, NAMELY, PROFILE SANDERS, SHARPENERS, SANDING PADS, SANDING SHEETS, CARBIDE RASPS, SAW BLADES, POLISHING PADS, EXCLUDING ACCESSORIES IN THE OIL WELL DRILLING INDUSTRY (U.S. CLS. 13, 19, 21, 23, 31, 34 AND 35).

FIRST USE 10-1-2010; IN COMMERCE 10-1-2010.

4,045,712. TRUE VALUE COMPANY, CHICAGO, IL. SN 77-424,086. PUB. 12-2-2008, FILED 3-17-2008.



OWNER OF U.S. REG. NOS. 1,249,555 AND 1,561,687. FOR POWER TOOLS AND ACCESSORIES, NAMELY, ROTARY DRILLS (U.S. CLS. 13, 19, 21, 23, 31, 34 AND 35).

FIRST USE 6-0-2005; IN COMMERCE 6-0-2005.

4,046,209. UNIVERSAL ACOUSTIC & EMISSION TECHNOLOGIES, INC., STOUGHTON, WI. SN 85-004,963. PUB. 8-24-2010, FILED 4-2-2010.

# QUIETSHIELD

THE MARK CONSISTS OF STANDARD CHARACTERS WITHOUT CLAIM TO ANY PARTICULAR FONT, STYLE, SIZE, OR COLOR.

FOR MUFFLERS FOR ENGINES, AIR COMPRESSORS, AND INDUSTRIAL BLOWERS; EXHAUST SILENCERS FOR ENGINES, AIR COMPRESSORS, AND INDUSTRIAL BLOWERS (U.S. CLS. 13, 19, 21, 23, 31, 34 AND 35).

FIRST USE 10-5-2010; IN COMMERCE 10-5-2010.

**CLASS 7—(Continued).**

4,046,242. KABUSHIKI KAISHA JQR, KANAGAWA-KEN, JAPAN. SN 85-025,063. PUB. 9-28-2010, FILED 4-28-2010.

THE MARK CONSISTS OF THE STYLIZED LETTERS "JQR".

FOR ENGINE MUFFLERS FOR AUTOMOBILES; EXHAUST SILENCERS FOR AUTOMOBILES; CATALYTIC CONVERTERS FOR AUTOMOBILES (U.S. CLS. 13, 19, 21, 23, 31, 34 AND 35).

FIRST USE 4-1-2010; IN COMMERCE 4-26-2011.

**CLASS 7—(Continued).**

4,046,448. ARDISAM, INC., CUMBERLAND, WI. SN 85-089,955. PUB. 12-28-2010, FILED 7-21-2010.

THE MARK CONSISTS OF STANDARD CHARACTERS WITHOUT CLAIM TO ANY PARTICULAR FONT, STYLE, SIZE, OR COLOR.

FOR POWER OPERATED ICE DRILLS, POWER ICE AUGERS, POWER AUGER BLADES, POWER AUGER EXTENSION BARS AND POWER AUGER BLADE PROTECTORS (U.S. CLS. 13, 19, 21, 23, 31, 34 AND 35).

FIRST USE 12-31-1967; IN COMMERCE 12-31-1967.

4,046,282. GRACO MINNESOTA INC., MINNEAPOLIS, MN. SN 85-041,283. PUB. 2-1-2011, FILED 5-18-2010.

THE MARK CONSISTS OF STANDARD CHARACTERS WITHOUT CLAIM TO ANY PARTICULAR FONT, STYLE, SIZE, OR COLOR.

FOR POSITIVE DISPLACEMENT PUMPS; BIN UNLOADERS, NAMELY, MACHINERY FOR UNLOADING BULK CONTAINERS OF VISCOUS FOOD MATERIALS SUCH AS TOMATO PASTE AND PEANUT BUTTER TO USE IN THE MIXING, ASSEMBLY AND MANUFACTURE OF FOOD PRODUCTS SUCH AS PREPARED PIZZA (U.S. CLS. 13, 19, 21, 23, 31, 34 AND 35).

FIRST USE 12-17-2010; IN COMMERCE 12-17-2010.

4,046,557. MEADWESTVACO CORPORATION, RICHMOND, VA. SN 85-104,034. PUB. 1-25-2011, FILED 8-10-2010.

THE MARK CONSISTS OF STANDARD CHARACTERS WITHOUT CLAIM TO ANY PARTICULAR FONT, STYLE, SIZE, OR COLOR.

OWNER OF U.S. REG. NO. 3,864,716. FOR PACKAGING MACHINES (U.S. CLS. 13, 19, 21, 23, 31, 34 AND 35).

FIRST USE 5-13-2011; IN COMMERCE 5-13-2011.

4,046,313. DOUGLAS MACHINE INC, ALEXANDRIA, MN. SN 85-053,469. PUB. 11-2-2010, FILED 6-3-2010.

THE MARK CONSISTS OF STANDARD CHARACTERS WITHOUT CLAIM TO ANY PARTICULAR FONT, STYLE, SIZE, OR COLOR.

FOR PACKAGING MACHINES (U.S. CLS. 13, 19, 21, 23, 31, 34 AND 35).

FIRST USE 10-1-2010; IN COMMERCE 10-1-2010.

4,046,566. FNA IP HOLDINGS, INC., ELK GROVE VILLAGE, IL. SN 85-106,160. PUB. 2-1-2011, FILED 8-12-2010.

NO CLAIM IS MADE TO THE EXCLUSIVE RIGHT TO USE "POWERWASHER", APART FROM THE MARK AS SHOWN.

THE MARK CONSISTS OF AN OVAL-SHAPED DESIGN WITH SWIRLED EDGES AND THE STYLIZED WORD "POWERWASHER".

FOR PRESSURE WASHERS, PARTS AND ACCESSORIES THERETO (U.S. CLS. 13, 19, 21, 23, 31, 34 AND 35).

FIRST USE 9-1-2009; IN COMMERCE 9-1-2009.

**CLASS 7—(Continued).**

4,046,614. SHOP VAC CORPORATION, WILLIAMSPORT, PA.  
SN 85-116,610. PUB. 12-7-2010, FILED 8-26-2010.

**HAWKEYE**

THE MARK CONSISTS OF STANDARD CHARACTERS WITHOUT CLAIM TO ANY PARTICULAR FONT, STYLE, SIZE, OR COLOR.

FOR FLOOR CLEANING MACHINES; VACUUM CLEANERS (U.S. CLS. 13, 19, 21, 23, 31, 34 AND 35).  
FIRST USE 5-15-2006; IN COMMERCE 5-15-2006.

**CLASS 7—(Continued).**

4,046,728. MURAI LTED. CORP., HUMACAO, PUERTO RICO. SN 85-140,922. PUB. 3-8-2011, FILED 9-29-2010.

**OXITRON LGG**

THE MARK CONSISTS OF STANDARD CHARACTERS WITHOUT CLAIM TO ANY PARTICULAR FONT, STYLE, SIZE, OR COLOR.

FOR AUTOMOTIVE COMPONENTS, NAMELY, OZONE GENERATORS FOR MOTOR VEHICLE ENGINES (U.S. CLS. 13, 19, 21, 23, 31, 34 AND 35).  
FIRST USE 8-15-2011; IN COMMERCE 8-15-2011.

4,046,685. TECHTRONIC FLOOR CARE TECHNOLOGY LIMITED, ROAD TOWN, TORTOLA, BR.VIRGIN ISLANDS. SN 85-130,186. PUB. 1-18-2011, FILED 9-15-2010.

**GROUND COMMAND**

THE MARK CONSISTS OF STANDARD CHARACTERS WITHOUT CLAIM TO ANY PARTICULAR FONT, STYLE, SIZE, OR COLOR.

FOR VACUUM CLEANERS; CARPET CLEANING MACHINES, NAMELY, CARPET EXTRACTORS; AIR MOVERS; POWER OPERATED FLOOR BURNISHERS; AND FLOOR POLISHERS (U.S. CLS. 13, 19, 21, 23, 31, 34 AND 35).

FIRST USE 12-0-2010; IN COMMERCE 12-0-2010.

4,046,781. CONN-WELD INDUSTRIES, INC., PRINCETON, WV. SN 85-155,799. PUB. 3-22-2011, FILED 10-19-2010.

**PANELOK II**

THE MARK CONSISTS OF STANDARD CHARACTERS WITHOUT CLAIM TO ANY PARTICULAR FONT, STYLE, SIZE, OR COLOR.

OWNER OF U.S. REG. NO. 1,721,414.  
FOR SCREEN PANELS FOR VIBRATING MACHINES (U.S. CLS. 13, 19, 21, 23, 31, 34 AND 35).

FIRST USE 3-9-2011; IN COMMERCE 3-9-2011.

4,046,718. PFAFF INDUSTRIAL OF AMERICA, INC., NORCROSS, GA. SN 85-138,731. PUB. 3-8-2011, FILED 9-27-2010.

**METRO SPEZIAL**

THE MARK CONSISTS OF STANDARD CHARACTERS WITHOUT CLAIM TO ANY PARTICULAR FONT, STYLE, SIZE, OR COLOR.

FOR SEWING MACHINES (U.S. CLS. 13, 19, 21, 23, 31, 34 AND 35).  
FIRST USE 6-3-2010; IN COMMERCE 7-22-2011.

4,046,851. HALE PRODUCTS, INC., CONSHOHOCKEN, PA. SN 85-179,260. PUB. 4-12-2011, FILED 11-17-2010.

**SWIFT HANDLE**

THE MARK CONSISTS OF STANDARD CHARACTERS WITHOUT CLAIM TO ANY PARTICULAR FONT, STYLE, SIZE, OR COLOR.

NO CLAIM IS MADE TO THE EXCLUSIVE RIGHT TO USE "HANDLE", APART FROM THE MARK AS SHOWN.  
FOR GEAR LEVER KNOBS FOR MACHINES (U.S. CLS. 13, 19, 21, 23, 31, 34 AND 35).

FIRST USE 12-1-2009; IN COMMERCE 12-1-2009.



**CLASS 7—(Continued).**

4,046,884. KSIN LUXEMBOURG III. S.AR.L., LUXEMBOURG. SN 85-189,972. PUB. 5-24-2011, FILED 12-3-2010.



OWNER OF U.S. REG. NOS. 49,601 AND 49,602.  
NO CLAIM IS MADE TO THE EXCLUSIVE RIGHT TO USE "SEWING", APART FROM THE MARK AS SHOWN.  
THE MARK CONSISTS OF A STYLIZED LETTER "S" WITHIN AN OVAL FOLLOWED BY THE WORDS "SINGER | SEWING MADE EASY".  
FOR EMBROIDERY MACHINES; SERGERS; SEWING MACHINES (U.S. CLS. 13, 19, 21, 23, 31, 34 AND 35).  
FIRST USE 5-1-2011; IN COMMERCE 5-1-2011.

4,046,885. KSIN LUXEMBOURG III. S.AR.L., LUXEMBOURG. SN 85-189,977. PUB. 5-24-2011, FILED 12-3-2010.

**SEWING MADE EASY**

THE MARK CONSISTS OF STANDARD CHARACTERS WITHOUT CLAIM TO ANY PARTICULAR FONT, STYLE, SIZE, OR COLOR.  
NO CLAIM IS MADE TO THE EXCLUSIVE RIGHT TO USE "SEWING", APART FROM THE MARK AS SHOWN.  
FOR EMBROIDERY MACHINES; SERGERS; SEWING MACHINES (U.S. CLS. 13, 19, 21, 23, 31, 34 AND 35).  
FIRST USE 5-1-2011; IN COMMERCE 5-1-2011.

4,046,886. KSIN LUXEMBOURG III. S.AR.L., LUXEMBOURG. SN 85-189,990. PUB. 5-24-2011, FILED 12-3-2010.

**SINGER IS SEWING MADE EASY**

THE MARK CONSISTS OF STANDARD CHARACTERS WITHOUT CLAIM TO ANY PARTICULAR FONT, STYLE, SIZE, OR COLOR.  
OWNER OF U.S. REG. NOS. 49,601 AND 49,602.  
NO CLAIM IS MADE TO THE EXCLUSIVE RIGHT TO USE "SEWING", APART FROM THE MARK AS SHOWN.  
FOR EMBROIDERY MACHINES; SERGERS; SEWING MACHINES (U.S. CLS. 13, 19, 21, 23, 31, 34 AND 35).  
FIRST USE 5-1-2011; IN COMMERCE 5-1-2011.

**CLASS 7—(Continued).**

4,046,887. SKY CLIMBER, LLC, DELAWARE, OH. SN 85-190,275. PUB. 4-19-2011, FILED 12-3-2010.



THE MARK CONSISTS OF A BLACK AND WHITE LINE DRAWING OF A BIRD IN FLIGHT.  
FOR HOISTS (U.S. CLS. 13, 19, 21, 23, 31, 34 AND 35).  
FIRST USE 5-27-2011; IN COMMERCE 5-27-2011.

4,046,909. CHAIN-HEADWAY MACHINE TOOLS CO., LTD., TAICHUNG HSIEN, TAIWAN. SN 85-195,842. PUB. 4-26-2011, FILED 12-11-2010.



THE MARK CONSISTS OF THE HIGHLY STYLIZED LETTERS "WN" ADJACENT THE STYLIZED WORDS "WE" AND "NEED" WITH THE WORD "WE" ABOVE THE WORD "NEED".

FOR CHUCKS FOR POWER DRILLS; DIAMOND-POINTED METAL-CUTTING TOOLS; MACHINE PARTS, NAMELY, BEARING INSERTS; MACHINE PARTS, NAMELY, BLADES; MACHINE TOOL HOLDERS; MACHINES AND MACHINE TOOLS FOR THE CUTTING AND FORMING OF MATERIALS; MACHINE TOOL, NAMELY, GEAR CUTTERS; METAL WORKING MACHINES, NAMELY, SAWS AND CUTTERS; POWER DRILL ACCESSORIES, NAMELY, NON-ELECTRICAL ADAPTERS FOR USE IN JOINING EXTENSIONS AND POWER DRILL BITS; POWER DRILL BITS; POWER DRILLS; POWER TOOLS, NAMELY, END MILLS, REAMERS, THREAD MILLS; TOOL BITS FOR MACHINES; MACHINE TOOL, NAMELY, MILLING CUTTERS, THREAD MILLING CUTTERS (U.S. CLS. 13, 19, 21, 23, 31, 34 AND 35).  
FIRST USE 7-6-2011; IN COMMERCE 7-6-2011.

**CLASS 7—(Continued).**

4,046,913. HELBY IMPORT CO., CARTERET, NJ. SN 85-197,041. PUB. 4-19-2011, FILED 12-14-2010.

# BOB-EEZ

THE MARK CONSISTS OF STANDARD CHARACTERS WITHOUT CLAIM TO ANY PARTICULAR FONT, STYLE, SIZE, OR COLOR.

FOR BOBBINS FOR WEAVING LOOMS (U.S. CLS. 13, 19, 21, 23, 31, 34 AND 35).  
FIRST USE 1-1-2006; IN COMMERCE 1-1-2006.

4,047,020. TENNECO AUTOMOTIVE OPERATING COMPANY INC., LAKE FOREST, IL. SN 85-227,485. PUB. 6-21-2011, FILED 1-27-2011.

# SOUNDFIT

THE MARK CONSISTS OF STANDARD CHARACTERS WITHOUT CLAIM TO ANY PARTICULAR FONT, STYLE, SIZE, OR COLOR.

FOR LAND VEHICLE PARTS, NAMELY, MUFFLERS, CATALYTIC CONVERTERS AND EXHAUST PIPES (U.S. CLS. 13, 19, 21, 23, 31, 34 AND 35).  
FIRST USE 5-0-2011; IN COMMERCE 5-0-2011.

4,047,065. ROTARY COMPOSTERS, LLC, DENVER, PA. SN 85-243,397. PUB. 6-28-2011, FILED 2-16-2011.



THE COLOR(S) ORANGE AND GREEN IS/ARE CLAIMED AS A FEATURE OF THE MARK.

**CLASS 7—(Continued).**

THE MARK CONSISTS OF A TAPERED ORANGE LOOP WITH AN ARROWHEAD IN ORANGE AT ITS LARGE END AND WITH THREE GREEN LEAVES AT ITS SMALL END. FOR MACHINES, NAMELY, COMPOSTERS (U.S. CLS. 13, 19, 21, 23, 31, 34 AND 35).

FIRST USE 3-8-2011; IN COMMERCE 3-8-2011.

4,047,066. ROTARY COMPOSTERS, LLC, DENVER, PA. SN 85-243,401. PUB. 6-28-2011, FILED 2-16-2011.

# ROTOPOSTER

THE MARK CONSISTS OF STANDARD CHARACTERS WITHOUT CLAIM TO ANY PARTICULAR FONT, STYLE, SIZE, OR COLOR.

FOR MACHINES, NAMELY, COMPOSTERS (U.S. CLS. 13, 19, 21, 23, 31, 34 AND 35).  
FIRST USE 3-8-2011; IN COMMERCE 3-8-2011.

**CLASS 8—HAND TOOLS**

4,045,587. ANCRA INTERNATIONAL, LLC, HAWTHORNE, CA. SN 76-700,334. PUB. 3-8-2011, FILED 11-12-2009.

**A NEW ANGLE ON THE WINCH BAR**

THE MARK CONSISTS OF STANDARD CHARACTERS WITHOUT CLAIM TO ANY PARTICULAR FONT, STYLE, SIZE, OR COLOR.

NO CLAIM IS MADE TO THE EXCLUSIVE RIGHT TO USE "WINCH BAR", APART FROM THE MARK AS SHOWN.

FOR HAND TOOLS, NAMELY, A WINCH BAR USED TO TURN A WINCH SPOOL TO APPLY TENSION TO TIE-DOWN STRAPS (U.S. CLS. 23, 28 AND 44).

FIRST USE 9-14-2011; IN COMMERCE 9-14-2011.

4,046,449. ARDISAM, INC., CUMBERLAND, WI. SN 85-089,957. PUB. 12-28-2010, FILED 7-21-2010.

# ESKIMO

THE MARK CONSISTS OF STANDARD CHARACTERS WITHOUT CLAIM TO ANY PARTICULAR FONT, STYLE, SIZE, OR COLOR.

FOR HAND TOOLS, NAMELY, HAND-POWERED ICE AUGERS AND CHISELS (U.S. CLS. 23, 28 AND 44).  
FIRST USE 12-31-1997; IN COMMERCE 12-31-1997.

**CLASS 8—(Continued).**

4,046,755. TRAN, NGHE, BOTHELL, WA. SN 85-148,089. PUB. 6-7-2011, FILED 10-8-2010.



NO CLAIM IS MADE TO THE EXCLUSIVE RIGHT TO USE "NIPPERS", APART FROM THE MARK AS SHOWN.

THE MARK CONSISTS OF AN INVERTED TWEEZER LIKE IMAGE WITH THE WORDS "NIPPERS" WRITTEN ON ITS BOTTOM LEFT SIDE WITH TWO ARCS FORMING AN UNCLOSED HEART SHAPED LIKE IMAGE, AS SHOWN IN THE MARK.

FOR HAND TOOLS, NAMELY, CUTICLE SCISSORS; MANICURE IMPLEMENTS, NAMELY, NAIL FILES, NAIL CLIPPERS, CUTICLE PUSHERS, TWEEZERS; PEDICURE IMPLEMENTS, NAMELY, NAIL AND CUTICLE NIPPERS (U.S. CLS. 23, 28 AND 44).

FIRST USE 2-23-2011; IN COMMERCE 2-23-2011.

4,046,828. MENTOR GROUP, L.L.C., OREGON CITY, OR. SN 85-168,624. PUB. 3-29-2011, FILED 11-3-2010.

**MOUNTAINSIDE**

THE MARK CONSISTS OF STANDARD CHARACTERS WITHOUT CLAIM TO ANY PARTICULAR FONT, STYLE, SIZE, OR COLOR.

FOR FIXED BLADE KNIVES (U.S. CLS. 23, 28 AND 44).

FIRST USE 2-15-2011; IN COMMERCE 2-15-2011.

**CLASS 9—ELECTRICAL AND SCIENTIFIC APPARATUS**

4,045,581. L-3 COMMUNICATIONS CORPORATION, NEW YORK, NY. SN 76-678,865. PUB. 7-29-2008, FILED 6-28-2007.

**SIMUSPHERE HD**

THE MARK CONSISTS OF STANDARD CHARACTERS WITHOUT CLAIM TO ANY PARTICULAR FONT, STYLE, SIZE, OR COLOR.

**CLASS 9—(Continued).**

OWNER OF U.S. REG. NOS. 2,707,390 AND 3,109,712.

NO CLAIM IS MADE TO THE EXCLUSIVE RIGHT TO USE "HD", APART FROM THE MARK AS SHOWN.

FOR A SIMULATION VISUAL SYSTEM COMPRISED OF A MULTI-FACETED ENGLOBING STRUCTURE CONTAINING HIGH DEFINITION, WIDE FIELD OF VIEW, REAR PROJECTION SCREENS (U.S. CLS. 21, 23, 26, 36 AND 38).

FIRST USE 12-0-2008; IN COMMERCE 12-0-2008.

4,045,588. KAZAK-MARS, INC., VAN NUYS, CA. SN 76-701,342. PUB. 1-18-2011, FILED 1-25-2010.

**UNDERGRAM**

THE MARK CONSISTS OF STANDARD CHARACTERS WITHOUT CLAIM TO ANY PARTICULAR FONT, STYLE, SIZE, OR COLOR.

FOR EYEGLASSES AND EYEGLASS FRAMES (U.S. CLS. 21, 23, 26, 36 AND 38).

FIRST USE 2-2-2010; IN COMMERCE 2-2-2010.

4,045,596. MIAMICA OF NEW YORK, INC., A DIVISION OF SHALOM INTERNATIONAL, CORP., PERTH AMBOY, NJ. SN 76-703,590. PUB. 12-7-2010, FILED 6-30-2010.

**TRENDY TECHIE**

THE MARK CONSISTS OF STANDARD CHARACTERS WITHOUT CLAIM TO ANY PARTICULAR FONT, STYLE, SIZE, OR COLOR.

NO CLAIM IS MADE TO THE EXCLUSIVE RIGHT TO USE "TECHIE", APART FROM THE MARK AS SHOWN.

FOR LAPTOP COMPUTER CASES AND CASES FOR PDA'S AND CELL PHONES (U.S. CLS. 21, 23, 26, 36 AND 38).

FIRST USE 7-0-2008; IN COMMERCE 7-0-2008.

4,045,607. JERMAINE JENKINS & TABARI LOFTON, DBA SLUM DOGG ENTERTAINMENT, FT. LAUDERDALE, FL. SN 76-705,114. PUB. 3-22-2011, FILED 10-28-2010.

**SLUM DOGG ENTERTAINMENT**

THE MARK CONSISTS OF STANDARD CHARACTERS WITHOUT CLAIM TO ANY PARTICULAR FONT, STYLE, SIZE, OR COLOR.

**CLASS 9—(Continued).**

NO CLAIM IS MADE TO THE EXCLUSIVE RIGHT TO USE "ENTERTAINMENT", APART FROM THE MARK AS SHOWN.

FOR AUDIO RECORDINGS FEATURING MUSIC; DIGITAL MATERIALS, NAMELY, CDS FEATURING MUSIC; DIGITAL MATERIALS, NAMELY, DVDS FEATURING MUSIC; DOWNLOADABLE ELECTRONIC PUBLICATIONS IN THE NATURE OF PAMPHLETS IN THE FIELD OF ENTERTAINMENT; DOWNLOADABLE MULTIMEDIA FILES CONTAINING ARTWORK, TEXT, AUDIO, VIDEO, GAMES AND INTERNET WEB LINKS RELATING TO MUSICAL ARTISTS; DOWNLOADABLE RINGTONES, GRAPHICS AND MUSIC VIA A GLOBAL COMPUTER NETWORK AND WIRELESS DEVICES; DOWNLOADABLE VIDEO RECORDINGS FEATURING MUSICAL ARTISTS; MUSICAL SOUND RECORDINGS, MUSICAL VIDEO RECORDINGS; SOUND RECORDINGS FEATURING MUSIC (U.S. CLS. 21, 23, 26, 36 AND 38).

FIRST USE 9-1-2009; IN COMMERCE 9-1-2009.

4,045,615. DISNEY ENTERPRISES, INC., BURBANK, CA. SN 77-050,047. PUB. 1-18-2011, FILED 11-22-2006.

# GREEK

THE MARK CONSISTS OF STANDARD CHARACTERS WITHOUT CLAIM TO ANY PARTICULAR FONT, STYLE, SIZE, OR COLOR.

FOR PRE-RECORDED DVDS, DIGITAL VERSATILE DISCS AND DIGITAL VIDEO DISCS FEATURING TELEVISION SHOWS FEATURING LIFE AT A FICTITIOUS COLLEGE (U.S. CLS. 21, 23, 26, 36 AND 38).

FIRST USE 8-8-2009; IN COMMERCE 8-8-2009.

4,045,617. SEARS BRANDS, LLC, HOFFMAN ESTATES, IL. SN 77-076,327. PUB. 1-25-2011, FILED 1-4-2007.

# EVOLUTION TECHNOLOGY

THE MARK CONSISTS OF STANDARD CHARACTERS WITHOUT CLAIM TO ANY PARTICULAR FONT, STYLE, SIZE, OR COLOR.

NO CLAIM IS MADE TO THE EXCLUSIVE RIGHT TO USE "TECHNOLOGY", APART FROM THE MARK AS SHOWN.

FOR BATTERIES (U.S. CLS. 21, 23, 26, 36 AND 38).  
FIRST USE 3-0-2007; IN COMMERCE 3-0-2007.

**CLASS 9—(Continued).**

4,045,620. REEL FX, INC., DALLAS, TX. SN 77-106,283. PUB. 6-3-2008, FILED 2-13-2007.



THE MARK CONSISTS OF A PEAK DESIGN WITHIN A CIRCLE.

FOR ELECTRONIC PUBLICATIONS, NAMELY, NEWSLETTERS FEATURING CONTENT FOR CHILDREN RECORDED ON COMPUTER MEDIA; CHILDREN'S ENTERTAINMENT SOFTWARE FOR GAMES AND INTERACTIVE MULTIMEDIA; ELECTRONIC GAME SOFTWARE AND OTHER ELECTRONIC GAME PROGRAMS FOR ENTERTAINMENT AND EDUCATION (U.S. CLS. 21, 23, 26, 36 AND 38).

FIRST USE 4-6-2009; IN COMMERCE 4-6-2009.

4,045,621. REEL FX, INC., DALLAS, TX. SN 77-106,292. PUB. 5-20-2008, FILED 2-13-2007.

# THE VERY FIRST NOEL

THE MARK CONSISTS OF STANDARD CHARACTERS WITHOUT CLAIM TO ANY PARTICULAR FONT, STYLE, SIZE, OR COLOR.

FOR PRE-RECORDED AUDIO, VIDEO AND AUDIO-VISUAL DISCS, AND DVDS IN THE FIELDS OF MOVIES, SHOWS, MUSIC, GAMES, BOOKS, AND INTERACTIVE MULTIMEDIA ENTERTAINMENT AND CHILDREN'S, PARENTING, AND RELIGIOUS EDUCATION; ELECTRONIC PUBLICATIONS, NAMELY, BROCHURES, NEWSLETTERS, MAGAZINES AND BOOKS FEATURING CHILDREN'S ENTERTAINMENT AND CHILDREN'S, PARENTING AND RELIGIOUS EDUCATION RECORDED ON COMPUTER MEDIA; SOFTWARE FOR USE IN CHILDREN'S, PARENTING AND RELIGIOUS EDUCATIONAL PROGRAMS AND ENTERTAINMENT PROGRAMS IN THE FIELDS OF MOVIES, SHOWS, MUSIC, GAMES, BOOKS, AND INTERACTIVE MULTIMEDIA; ELECTRONIC GAME SOFTWARE; DIGITAL MEDIA, NAMELY, DOWNLOADABLE AUDIO, VIDEO AND AUDIO-VISUAL CONTENT IN THE FIELDS OF MOVIES, SHOWS, MUSIC, GAMES, BOOKS, AND INTERACTIVE MULTIMEDIA ENTERTAINMENT AND CHILDREN'S, PARENTING, AND RELIGIOUS EDUCATION; AND SUNGLASSES (U.S. CLS. 21, 23, 26, 36 AND 38).

FIRST USE 10-6-2007; IN COMMERCE 10-6-2007.

**CLASS 9—(Continued).**

4,045,623. DENOVO, ANDREW, CHICAGO, IL. AND LOEB, CHARLES, CHICAGO, IL. SN 77-134,647. PUB. 5-20-2008, FILED 3-19-2007.

## CLAD SECURITY AND COMPLIANCE

THE MARK CONSISTS OF STANDARD CHARACTERS WITHOUT CLAIM TO ANY PARTICULAR FONT, STYLE, SIZE, OR COLOR.

NO CLAIM IS MADE TO THE EXCLUSIVE RIGHT TO USE "SECURITY AND COMPLIANCE", APART FROM THE MARK AS SHOWN.

FOR SOFTWARE FOR USE IN DATABASE MANAGEMENT AND GENERATING REPORTS IN THE FIELD OF SECURITY AND RISK ASSESSMENT FOR INFORMATION TECHNOLOGY AND REGULATORY COMPLIANCE (U.S. CLS. 21, 23, 26, 36 AND 38).

FIRST USE 8-12-2011; IN COMMERCE 8-12-2011.

4,045,624. SEVEN WOODS AUDIO, INC., BELMONT, MA. SN 77-138,764. PUB. 10-2-2007, FILED 3-23-2007.

## iSPACE

THE MARK CONSISTS OF STANDARD CHARACTERS WITHOUT CLAIM TO ANY PARTICULAR FONT, STYLE, SIZE, OR COLOR.

FOR AUDIO AMPLIFIERS; AUDIO ELECTRONIC COMPONENTS, NAMELY, SURROUND SOUND SYSTEMS; COMPUTER SOFTWARE FOR MANIPULATING DIGITAL AUDIO INFORMATION FOR USE IN AUDIO MEDIA APPLICATIONS; COMPUTER SOFTWARE TO CONTROL AND IMPROVE COMPUTER AND AUDIO EQUIPMENT SOUND QUALITY; COMPUTER SOFTWARE TO ENHANCE THE AUDIO-VISUAL CAPABILITIES OF MULTIMEDIA APPLICATIONS, NAMELY, FOR THE INTEGRATION OF TEXT, AUDIO, GRAPHICS, STILL IMAGES AND MOVING PICTURES; ELECTRONIC PRODUCTS FOR THE MANIPULATION OF THE FREQUENCY, TIME, AND AMPLITUDE CHARACTERISTICS OF AUDIO SIGNALS, NAMELY, AUDIO PROCESSORS; SOFTWARE TO CONTROL AND IMPROVE AUDIO EQUIPMENT SOUND QUALITY (U.S. CLS. 21, 23, 26, 36 AND 38).

FIRST USE 12-1-2010; IN COMMERCE 3-30-2011.

**CLASS 9—(Continued).**

4,045,646. EPIQ SYSTEMS, INC., KANSAS CITY, KS. SN 77-246,802. PUB. 5-13-2008, FILED 8-3-2007.

## CREDITORMATRIX

THE MARK CONSISTS OF STANDARD CHARACTERS WITHOUT CLAIM TO ANY PARTICULAR FONT, STYLE, SIZE, OR COLOR.

FOR COMPUTER SOFTWARE THAT MANAGES TEXT, DOCUMENTS AND IMAGES IN THE FIELDS OF BANKRUPTCY, AND LITIGATION ADMINISTRATION (U.S. CLS. 21, 23, 26, 36 AND 38).

FIRST USE 1-0-2006; IN COMMERCE 1-0-2006.

4,045,655. LANDACORP, INC., LOUISVILLE, KY. SN 77-301,952. PUB. 6-24-2008, FILED 10-11-2007.

## CareFind

THE MARK CONSISTS OF STANDARD CHARACTERS WITHOUT CLAIM TO ANY PARTICULAR FONT, STYLE, SIZE, OR COLOR.

FOR COMPUTER SOFTWARE FOR USE IN THE ADMINISTRATION AND MANAGEMENT OF HEALTH CARE PLANS AND PAYMENTS IN THE HEALTHCARE INDUSTRY; WEB-BASED DOWNLOADABLE MEDICAL MANAGEMENT SOFTWARE THAT PERFORMS ADMINISTRATIVE AND CARE-PLANNING FUNCTIONS FOR MANAGED CARE ORGANIZATIONS AND OTHER ENTITIES THAT ADMINISTER HEALTHCARE PLANS AND PAYMENTS TO MEMBER POPULATIONS IN THE MEDICAL FIELD; WEB-BASED DOWNLOADABLE COMPUTER SOFTWARE APPLICATION THAT ALLOWS MANAGED CARE STAFF, PROVIDERS AND MEMBERS TO SUBMIT AND EXCHANGE MEDICAL REQUESTS, INQUIRIES, AND MESSAGES OVER THE INTERNET IN THE MEDICAL FIELD; WEB-BASED DOWNLOADABLE COMPUTER SOFTWARE APPLICATION THAT ALLOWS FOR THE CALCULATING OF CLINICAL INDICATORS FOR DEFINED POPULATIONS IN THE MEDICAL FIELD (U.S. CLS. 21, 23, 26, 36 AND 38).

FIRST USE 4-21-2010; IN COMMERCE 4-21-2010.

**CLASS 9—(Continued).**

4,045,656. BRADLEY, HEATHER M., CULVER CITY, CA. SN 77-304,780. PUB. 5-6-2008, FILED 10-16-2007.

**FITFACE**

THE MARK CONSISTS OF STANDARD CHARACTERS WITHOUT CLAIM TO ANY PARTICULAR FONT, STYLE, SIZE, OR COLOR.

FOR DVDS AND DOWNLOADABLE MULTI-MEDIA SOFTWARE FEATURING INFORMATION ABOUT EXERCISE, HEALTH AND WELLNESS (U.S. CLS. 21, 23, 26, 36 AND 38).

FIRST USE 10-30-2007; IN COMMERCE 7-26-2011.

4,045,667. SANDISK CORPORATION, MILPITAS, CA. SN 77-344,881. PUB. 1-19-2010, FILED 12-5-2007.

**SANSA FUZE**

THE MARK CONSISTS OF STANDARD CHARACTERS WITHOUT CLAIM TO ANY PARTICULAR FONT, STYLE, SIZE, OR COLOR.

OWNER OF U.S. REG. NO. 3,178,105. FOR DIGITAL AUDIO AND VIDEO PLAYERS (U.S. CLS. 21, 23, 26, 36 AND 38).

FIRST USE 3-0-2008; IN COMMERCE 3-0-2008.

4,045,689. TAFFY PRODUCTIONS, LLC, WOODLAND HILLS, CA. SN 77-381,787. PUB. 6-10-2008, FILED 1-28-2008.

**HERO:  
108**

THE MARK CONSISTS OF A STYLIZATION OF "HERO: 108".

FOR PRE-RECORDED VIDEO, DIGITAL VIDEO DISCS ALL FEATURING ANIMATED CARTOONS AND MOTION PICTURE FILMS FOR ENTERTAINMENT OF CHILDREN; VIDEO RECORDINGS FEATURING A SERIES OF CHILDREN'S PROGRAMS; VIDEO AND COMPUTER GAME PROGRAMS AND SOFTWARE; VIDEO GAME CARTRIDGES, VIDEO GAME MACHINES WITH CONSOLES FOR USE WITH TELEVISIONS AND COMPUTERS (U.S. CLS. 21, 23, 26, 36 AND 38).

FIRST USE 6-14-2011; IN COMMERCE 6-14-2011.

**CLASS 9—(Continued).**

4,045,720. LG ELECTRONICS INC., SEOUL, REPUBLIC OF KOREA. SN 77-444,561. PUB. 7-29-2008, FILED 4-10-2008.

**ATTUNE**

THE MARK CONSISTS OF STANDARD CHARACTERS WITHOUT CLAIM TO ANY PARTICULAR FONT, STYLE, SIZE, OR COLOR.

FOR MOBILE PHONES (U.S. CLS. 21, 23, 26, 36 AND 38).

FIRST USE 6-28-2011; IN COMMERCE 6-28-2011.

4,045,733. ORACLE INTERNATIONAL CORPORATION, REDWOOD CITY, CA. SN 77-484,946. PUB. 4-14-2009, FILED 5-28-2008.

**ORACLE EXADATA**

THE MARK CONSISTS OF STANDARD CHARACTERS WITHOUT CLAIM TO ANY PARTICULAR FONT, STYLE, SIZE, OR COLOR.

OWNER OF U.S. REG. NOS. 2,159,140, 3,116,749, AND OTHERS.

FOR COMPUTER HARDWARE AND SOFTWARE FOR USE IN STORAGE, MANAGEMENT, ANALYSIS AND OPTIMIZATION OF DATA WAREHOUSES AND VERY LARGE DATABASES (U.S. CLS. 21, 23, 26, 36 AND 38).

FIRST USE 8-0-2009; IN COMMERCE 8-0-2009.

4,045,735. VISICS CORPORATION, WELLESLEY, MA. SN 77-495,229. PUB. 5-19-2009, FILED 6-10-2008.

**SCORE**

THE MARK CONSISTS OF STANDARD CHARACTERS WITHOUT CLAIM TO ANY PARTICULAR FONT, STYLE, SIZE, OR COLOR.

FOR AUTOMATED PROCESS CONTROL SOFTWARE FOR USE IN PROGRAMMING PROGRAMMABLE HARDWARE DEVICES, NAMELY, PROGRAMMABLE LOGIC CONTROLLERS, TO SPECIFY AN ORDER OF OPERATION FOR INDUSTRIAL MACHINERY, NAMELY, SEMICONDUCTOR MANUFACTURING MACHINES, PACKAGING MACHINES, METAL WORKING MACHINES, INJECTION MOLDING MACHINES, ELECTRIC FOOD PREPARATION MACHINES FOR COMMERCIAL AND INDUSTRIAL USE, AND ELECTRONIC CIRCUIT BOARD MANUFACTURING MACHINES (U.S. CLS. 21, 23, 26, 36 AND 38).

FIRST USE 1-19-2011; IN COMMERCE 1-19-2011.

**CLASS 9—(Continued).**

4,045,739. COUPONBAIT, INC., MISSION VIEJO, CA. SN 77-509,576. PUB. 11-18-2008, FILED 6-27-2008.

# COUPONBAIT

THE MARK CONSISTS OF STANDARD CHARACTERS WITHOUT CLAIM TO ANY PARTICULAR FONT, STYLE, SIZE, OR COLOR.

FOR CONSUMER COUPONS DOWNLOADED FROM A GLOBAL COMPUTER NETWORK (U.S. CLS. 21, 23, 26, 36 AND 38).

FIRST USE 6-1-2011; IN COMMERCE 6-1-2011.



4,045,743. COMPOUND LEARNING LLC, FALMOUTH, ME. SN 77-514,298. PUB. 5-26-2009, FILED 7-3-2008.

# Compound Learning

THE MARK CONSISTS OF STANDARD CHARACTERS WITHOUT CLAIM TO ANY PARTICULAR FONT, STYLE, SIZE, OR COLOR.

FOR COMPUTER SOFTWARE FOR THE COLLECTION, EDITING, ORGANIZING, MODIFYING, BOOK MARKING, TRANSMISSION, STORAGE AND SHARING OF DATA AND INFORMATION (U.S. CLS. 21, 23, 26, 36 AND 38).

FIRST USE 6-6-2011; IN COMMERCE 6-17-2011.



4,045,755. TASER INTERNATIONAL, INC., SCOTTSDALE, AZ. SN 77-542,349. PUB. 6-16-2009, FILED 8-8-2008.

# AXON

THE MARK CONSISTS OF STANDARD CHARACTERS WITHOUT CLAIM TO ANY PARTICULAR FONT, STYLE, SIZE, OR COLOR.

FOR VIDEO CAMERAS (U.S. CLS. 21, 23, 26, 36 AND 38).

FIRST USE 5-25-2010; IN COMMERCE 5-25-2010.

**CLASS 9—(Continued).**

4,045,764. T-MOBILE USA, INC., BELLEVUE, WA. SN 77-573,201. PUB. 8-18-2009, FILED 9-18-2008.

# WEB2GO

THE MARK CONSISTS OF STANDARD CHARACTERS WITHOUT CLAIM TO ANY PARTICULAR FONT, STYLE, SIZE, OR COLOR.

FOR COMPUTER SOFTWARE FOR OPTIMIZING INTERNET CONTENT FOR PRESENTATION ON MOBILE DEVICES; COMPUTER SOFTWARE FOR SEARCHING AND RETRIEVING INFORMATION, MUSIC, VIDEO AND DATA CONTENT, WEBSITES, AND OTHER RESOURCES ON COMPUTER NETWORKS AND THE INTERNET; COMPUTER SOFTWARE FOR PROVIDING MULTIPLE-USER ACCESS TO COMPUTER NETWORKS AND THE INTERNET; COMPUTER GAMING SOFTWARE (U.S. CLS. 21, 23, 26, 36 AND 38).

FIRST USE 11-16-2008; IN COMMERCE 11-16-2008.



4,045,779. COOL ENERGY, INC., BOULDER, CO. SN 77-631,126. PUB. 4-21-2009, FILED 12-11-2008.

# SolarHeart

THE MARK CONSISTS OF STANDARD CHARACTERS WITHOUT CLAIM TO ANY PARTICULAR FONT, STYLE, SIZE, OR COLOR.

FOR STIRLING ENGINE SOLD AS AN INTEGRAL COMPONENT OF APPARATUS FOR CONVERTING THERMAL ENERGY TO ELECTRICAL ENERGY (U.S. CLS. 21, 23, 26, 36 AND 38).

FIRST USE 1-10-2007; IN COMMERCE 12-10-2010.



4,045,796. IGT, RENO, NV. SN 77-649,588. PUB. 4-28-2009, FILED 1-14-2009.

# BELLS OF IRELAND

THE MARK CONSISTS OF STANDARD CHARACTERS WITHOUT CLAIM TO ANY PARTICULAR FONT, STYLE, SIZE, OR COLOR.

FOR GAMING MACHINES, NAMELY, DEVICES WHICH ACCEPT A WAGER (U.S. CLS. 21, 23, 26, 36 AND 38).

FIRST USE 7-25-2011; IN COMMERCE 7-25-2011.

**CLASS 9—(Continued).**

4,045,797. REVLON CONSUMER PRODUCTS CORPORATION, NEW YORK, NY. SN 77-650,889. PUB. 11-10-2009, FILED 1-16-2009.

**REVLON RADIANCE**

THE MARK CONSISTS OF STANDARD CHARACTERS WITHOUT CLAIM TO ANY PARTICULAR FONT, STYLE, SIZE, OR COLOR.

FOR HOT AIR BRUSHES (U.S. CLS. 21, 23, 26, 36 AND 38).

FIRST USE 5-31-2009; IN COMMERCE 5-31-2009.

4,045,798. BLUESAIL SOLUTIONS INC., QUEBEC, CANADA. SN 77-652,105. PUB. 7-13-2010, FILED 1-19-2009.

**xBPM**

THE MARK CONSISTS OF STANDARD CHARACTERS WITHOUT CLAIM TO ANY PARTICULAR FONT, STYLE, SIZE, OR COLOR.

FOR COMPUTER SOFTWARE FOR FINANCIAL PROCESS MODELING (U.S. CLS. 21, 23, 26, 36 AND 38).

FIRST USE 11-0-2010; IN COMMERCE 11-0-2010.

4,045,809. EMULEX DESIGN & MANUFACTURING CORPORATION, COSTA MESA, CA. SN 77-672,861. PUB. 12-22-2009, FILED 2-18-2009.

**ONECONNECT**

THE MARK CONSISTS OF STANDARD CHARACTERS WITHOUT CLAIM TO ANY PARTICULAR FONT, STYLE, SIZE, OR COLOR.

FOR COMPUTER HARDWARE, NAMELY, COMPUTER NETWORK ADAPTER HARDWARE FOR USE IN MANAGEMENT OF NETWORKED STORAGE DEVICES AND ETHERNET DEVICES; COMPUTER SOFTWARE FOR USE IN MANAGEMENT OF NETWORKED STORAGE DEVICES AND ETHERNET DEVICES WITH ADAPTER HARDWARE SUPPORTING STORAGE DEVICES AND ETHERNET DEVICES (U.S. CLS. 21, 23, 26, 36 AND 38).

FIRST USE 10-26-2009; IN COMMERCE 10-26-2009.

**CLASS 9—(Continued).**

4,045,810. EMULEX DESIGN & MANUFACTURING CORPORATION, COSTA MESA, CA. SN 77-672,875. PUB. 12-22-2009, FILED 2-18-2009.

**ONECOMMAND**

THE MARK CONSISTS OF STANDARD CHARACTERS WITHOUT CLAIM TO ANY PARTICULAR FONT, STYLE, SIZE, OR COLOR.

FOR COMPUTER SOFTWARE FOR USE IN NETWORK MANAGEMENT, NAMELY, DRIVER AND UTILITY SOFTWARE THAT PROVIDES COMPUTER COMMANDS OVER A COMPUTER NETWORK TO REMOTELY LOCATE, CONFIGURE AND MANAGE ONE OR MORE HARDWARE OR SOFTWARE ADAPTERS, FOR USE BY STORAGE AND COMMUNICATIONS DEVICES (U.S. CLS. 21, 23, 26, 36 AND 38).

FIRST USE 10-27-2009; IN COMMERCE 10-27-2009.

4,045,821. SINGER, ERIC, NEW YORK, NY. SN 77-684,817. PUB. 8-24-2010, FILED 3-5-2009.

**Congressional Wealth  
Destruction Monitor**

THE MARK CONSISTS OF STANDARD CHARACTERS WITHOUT CLAIM TO ANY PARTICULAR FONT, STYLE, SIZE, OR COLOR.

NO CLAIM IS MADE TO THE EXCLUSIVE RIGHT TO USE "CONGRESSIONAL WEALTH DESTRUCTION", APART FROM THE MARK AS SHOWN.

FOR DOWNLOADABLE ELECTRONIC NEWSLETTERS IN THE FIELD OF REPORTING ON THE DELETERIOUS EFFECTS AND UNINTENDED CONSEQUENCES OF CONGRESSIONAL ACTION AND DELIBERATION ON INVESTMENT PERFORMANCE (U.S. CLS. 21, 23, 26, 36 AND 38).

FIRST USE 7-1-2008; IN COMMERCE 7-28-2008.

4,045,823. ZHEJIANG YIZHOU ELECTRONIC TECHNOLOGY CO., LTD., ZHEJIANG PROVINCE, CHINA. SN 77-694,414. PUB. 7-21-2009, FILED 3-19-2009.

**DuacARRIER**

THE MARK CONSISTS OF STANDARD CHARACTERS WITHOUT CLAIM TO ANY PARTICULAR FONT, STYLE, SIZE, OR COLOR.



**CLASS 9—(Continued).**

THE WORDING "DUACARRIER" HAS NO MEANING IN A FOREIGN LANGUAGE.

FOR COAXIAL CABLES; COMMUNICATIONS SERVERS; COMMUNICATIONS SOFTWARE FOR CONNECTING COMPUTER NETWORK USERS; GLOBAL COMPUTER NETWORKS; CONNECTIONS FOR ELECTRIC LINES; ELECTRIC CONNECTIONS; ELECTRIC CONTACTS; ELECTRIC PLUGS; ELECTRIC SOCKETS; ELECTRIC WIRE AND CABLE; FIBER OPTIC CABLES; PORTABLE TELEPHONES; TELEPHONE WIRES (U.S. CLS. 21, 23, 26, 36 AND 38).

FIRST USE 6-30-2011; IN COMMERCE 7-30-2011.

---

4,045,826. BLUEARC CORPORATION, SAN JOSE, CA. SN 77-697,759. PUB. 7-28-2009, FILED 3-24-2009.

**BLUEARC MERCURY**

THE MARK CONSISTS OF STANDARD CHARACTERS WITHOUT CLAIM TO ANY PARTICULAR FONT, STYLE, SIZE, OR COLOR.

OWNER OF U.S. REG. NOS. 2,764,965 AND 2,767,302. FOR NETWORK ATTACHED STORAGE SERVER APPLIANCE NOT FOR USE BY RETAIL FLORISTS AND GIFT SHOPS FOR THE PURPOSE OF PROCESSING RETAIL FLOWER ORDERS (U.S. CLS. 21, 23, 26, 36 AND 38).

FIRST USE 7-31-2009; IN COMMERCE 7-31-2009.

---

4,045,829. AARP, WASHINGTON, DC. SN 77-702,183. PUB. 6-9-2009, FILED 3-30-2009.



OWNER OF U.S. REG. NOS. 3,135,601, 3,229,121, AND OTHERS.

THE MARK CONSISTS OF "AARP" WITH A STYLIZED BANNER-LIKE DESIGN PROJECTING FROM THE HORIZONTAL ELEMENT OF THE FIRST "A".

FOR PRE-RECORDED VIDEO AND AUDIO TAPES AND DISCS FEATURING INFORMATION IN THE FIELDS OF MATURE INDIVIDUALS, MATURE POPULATIONS, NON-PROFIT AND ADVOCACY ASSOCIATIONS, MEDICAL SERVICES, ELDERCARE, EMPLOYMENT, LEGAL ASSISTANCE, BUSINESS, INSURANCE, REAL ESTATE, TRAVEL, ELDER ASSISTANCE, RETIREMENT, MATURE OR RETIRED LIFESTYLES, FINANCE, HEALTH, AGING, CONSUMER ISSUES, ECONOMIC SECURITY, AND FITNESS; DOWNLOADABLE ELECTRONIC PUBLICATIONS IN THE NATURE OF BOOKS, NEWSLETTERS, BULLETINS, BROCHURES, PAMPHLETS, AND MAGAZINES IN THE FIELDS OF MATURE INDIVIDUALS, MATURE POPULATIONS, NON-PROFIT AND ADVOCACY ASSOCIATIONS, MEDICAL SERVICES, ELDERCARE, EMPLOYMENT, LEGAL ASSISTANCE, BUSINESS, INSURANCE, REAL ESTATE, TRAVEL, ELDER ASSISTANCE, RETIREMENT, MATURE OR RETIRED LIFE-

**CLASS 9—(Continued).**

STYLES, FINANCE, HEALTH, AGING, CONSUMER ISSUES, ECONOMIC SECURITY, AND FITNESS; ELECTRONIC PUBLICATIONS RECORDED ON COMPUTER MEDIA IN THE NATURE OF BOOKS, NEWSLETTERS, BULLETINS, BROCHURES, PAMPHLETS, AND MAGAZINES IN THE FIELDS OF MATURE INDIVIDUALS, MATURE POPULATIONS, NON-PROFIT AND ADVOCACY ASSOCIATIONS, MEDICAL SERVICES, ELDERCARE, EMPLOYMENT, LEGAL ASSISTANCE, BUSINESS, INSURANCE, REAL ESTATE, TRAVEL, ELDER ASSISTANCE, RETIREMENT, MATURE OR RETIRED LIFESTYLES, FINANCE, HEALTH, AGING, CONSUMER ISSUES, ECONOMIC SECURITY, AND FITNESS; COMPUTER SOFTWARE USE TO ACCESS, MANAGE AND DISPLAY INFORMATION IN THE FIELDS OF MATURE INDIVIDUALS, MATURE POPULATIONS, NON-PROFIT AND ADVOCACY ASSOCIATIONS, MEDICAL SERVICES, ELDERCARE, EMPLOYMENT, LEGAL ASSISTANCE, BUSINESS, INSURANCE, REAL ESTATE, TRAVEL, ELDER ASSISTANCE, RETIREMENT, MATURE OR RETIRED LIFESTYLES, FINANCE, HEALTH, AGING, CONSUMER ISSUES, ECONOMIC SECURITY, AND FITNESS; AND DATABASE MANAGEMENT SOFTWARE IN THE FIELDS OF MATURE INDIVIDUALS, MATURE POPULATIONS, NON-PROFIT AND ADVOCACY ASSOCIATIONS, MEDICAL SERVICES, ELDERCARE, EMPLOYMENT, LEGAL ASSISTANCE, BUSINESS, INSURANCE, REAL ESTATE, TRAVEL, ELDER ASSISTANCE, RETIREMENT, MATURE OR RETIRED LIFESTYLES, FINANCE, HEALTH, AGING, CONSUMER ISSUES, ECONOMIC SECURITY, AND FITNESS; AND DATABASE MANAGEMENT SOFTWARE IN THE FIELDS OF MATURE INDIVIDUALS, MATURE POPULATIONS, NON-PROFIT AND ADVOCACY ASSOCIATIONS, MEDICAL SERVICES, ELDERCARE, EMPLOYMENT, LEGAL ASSISTANCE, BUSINESS, INSURANCE, REAL ESTATE, TRAVEL, ELDER ASSISTANCE, RETIREMENT, MATURE OR RETIRED LIFESTYLES, FINANCE, HEALTH, AGING, CONSUMER ISSUES, ECONOMIC SECURITY, AND FITNESS (U.S. CLS. 21, 23, 26, 36 AND 38).

FIRST USE 1-0-2008; IN COMMERCE 1-0-2008.

---

4,045,830. AARP, WASHINGTON, DC. SN 77-702,195. PUB. 6-9-2009, FILED 3-30-2009.



THE MARK CONSISTS OF STANDARD CHARACTERS WITHOUT CLAIM TO ANY PARTICULAR FONT, STYLE, SIZE, OR COLOR.

OWNER OF U.S. REG. NOS. 3,135,601, 3,229,121, AND OTHERS.

FOR PRE-RECORDED VIDEO AND AUDIO TAPES AND DISCS FEATURING INFORMATION IN THE FIELDS OF MATURE INDIVIDUALS, MATURE POPULATIONS, NON-PROFIT AND ADVOCACY ASSOCIATIONS, MEDICAL SERVICES, ELDERCARE, EMPLOYMENT, LEGAL ASSISTANCE, BUSINESS, INSURANCE, REAL ESTATE, TRAVEL, ELDER ASSISTANCE, RETIREMENT, MATURE OR RETIRED LIFESTYLES, FINANCE, HEALTH, AGING, CONSUMER ISSUES, ECONOMIC SECURITY, AND FITNESS; DOWNLOADABLE ELECTRONIC PUBLICATIONS IN THE NATURE OF BOOKS, NEWSLETTERS, BULLETINS, BROCHURES, PAMPHLETS, AND MAGAZINES IN THE FIELDS OF MATURE INDIVIDUALS, MATURE POPULATIONS, NON-PROFIT AND ADVOCACY ASSOCIATIONS, MEDICAL SERVICES, ELDERCARE, EMPLOYMENT, LEGAL ASSISTANCE, BUSINESS, INSURANCE, REAL ESTATE, TRAVEL, ELDER ASSISTANCE, RETIREMENT, MATURE OR RETIRED LIFESTYLES, FINANCE, HEALTH, AGING, CONSUMER ISSUES, ECONOMIC SECURITY, AND FITNESS; ELECTRONIC PUBLICATIONS RECORDED ON COMPUTER MEDIA IN THE NATURE OF BOOKS, NEWSLETTERS, BULLETINS, BROCHURES, PAMPHLETS, AND MAGAZINES IN THE FIELDS OF MATURE INDIVIDUALS, MATURE POPULATIONS, NON-PROFIT AND ADVOCACY ASSOCIATIONS, MEDICAL SERVICES, ELDERCARE, EMPLOYMENT, LEGAL ASSISTANCE,

**CLASS 9—(Continued).**

BUSINESS, INSURANCE, REAL ESTATE, TRAVEL, ELDER ASSISTANCE, RETIREMENT, MATURE OR RETIRED LIFESTYLES, FINANCE, HEALTH, AGING, CONSUMER ISSUES, ECONOMIC SECURITY, AND FITNESS; COMPUTER SOFTWARE USE TO ACCESS, MANAGE AND DISPLAY INFORMATION IN THE FIELDS OF MATURE INDIVIDUALS, MATURE POPULATIONS, NON-PROFIT AND ADVOCACY ASSOCIATIONS, MEDICAL SERVICES, ELDERCARE, EMPLOYMENT, LEGAL ASSISTANCE, BUSINESS, INSURANCE, REAL ESTATE, TRAVEL, ELDER ASSISTANCE, RETIREMENT, MATURE OR RETIRED LIFESTYLES, FINANCE, HEALTH, AGING, CONSUMER ISSUES, ECONOMIC SECURITY, AND FITNESS; AND DATABASE MANAGEMENT SOFTWARE IN THE FIELDS OF MATURE INDIVIDUALS, MATURE POPULATIONS, NON-PROFIT AND ADVOCACY ASSOCIATIONS, MEDICAL SERVICES, ELDERCARE, EMPLOYMENT, LEGAL ASSISTANCE, BUSINESS, INSURANCE, REAL ESTATE, TRAVEL, ELDER ASSISTANCE, RETIREMENT, MATURE OR RETIRED LIFESTYLES, FINANCE, HEALTH, AGING, CONSUMER ISSUES, ECONOMIC SECURITY, AND FITNESS (U.S. CLS. 21, 23, 26, 36 AND 38).

FIRST USE 1-0-2008; IN COMMERCE 1-0-2008.

---

4,045,835. THE CODEMASTERS SOFTWARE COMPANY LIMITED, WARWICKSHIRE, UNITED KINGDOM. SN 77-706,054. PUB. 8-4-2009, FILED 4-3-2009.

## BodyCount

THE MARK CONSISTS OF STANDARD CHARACTERS WITHOUT CLAIM TO ANY PARTICULAR FONT, STYLE, SIZE, OR COLOR.

FOR ELECTRONIC GAME SOFTWARE; ELECTRONIC GAME SOFTWARE FOR HANDHELD ELECTRONIC DEVICES; VIDEO GAME SOFTWARE; DIGITAL MATERIALS, NAMELY, CD'S AND DATA CARRIERS FEATURING COMPUTER GAMES AND ENTERTAINMENT; COMPUTER GAME SOFTWARE (U.S. CLS. 21, 23, 26, 36 AND 38).

FIRST USE 9-2-2011; IN COMMERCE 9-2-2011.

---

4,045,849. ARISTOCRAT TECHNOLOGIES AUSTRALIA PTY LTD, NORTH RYDE BC NSW, AUSTRALIA. SN 77-740,590. PUB. 7-7-2009, FILED 5-19-2009.

## PEEKING DUCK

THE MARK CONSISTS OF STANDARD CHARACTERS WITHOUT CLAIM TO ANY PARTICULAR FONT, STYLE, SIZE, OR COLOR.

FOR GAMING MACHINES, NAMELY, DEVICES WHICH ACCEPT A WAGER (U.S. CLS. 21, 23, 26, 36 AND 38).

FIRST USE 6-1-2011; IN COMMERCE 6-1-2011.

**CLASS 9—(Continued).**

4,045,853. TECMO KOEI AMERICA CORPORATION, BURLINGAME, CA. SN 77-745,957. PUB. 4-19-2011, FILED 5-27-2009.

## Family Fun Football

THE MARK CONSISTS OF STANDARD CHARACTERS WITHOUT CLAIM TO ANY PARTICULAR FONT, STYLE, SIZE, OR COLOR.

NO CLAIM IS MADE TO THE EXCLUSIVE RIGHT TO USE "FOOTBALL", APART FROM THE MARK AS SHOWN.

FOR COMPUTER GAME DISCS; COMPUTER GAME SOFTWARE; COMPUTER GAME SOFTWARE FOR PERSONAL COMPUTERS AND HOME VIDEO GAME CONSOLES; ELECTRONIC GAME PROGRAMS; ELECTRONIC GAME SOFTWARE; INTERACTIVE VIDEO GAME PROGRAMS; VIDEO AND COMPUTER GAME PROGRAMS; VIDEO GAME DISCS; VIDEO GAME SOFTWARE (U.S. CLS. 21, 23, 26, 36 AND 38).

FIRST USE 9-29-2009; IN COMMERCE 9-29-2009.

---

4,045,887. BRANDOFINO COMMUNICATIONS INC., SYOSSET, NY. SN 77-788,713. PUB. 2-15-2011, FILED 7-24-2009.

## PracticeRx

THE MARK CONSISTS OF STANDARD CHARACTERS WITHOUT CLAIM TO ANY PARTICULAR FONT, STYLE, SIZE, OR COLOR.

FOR COMPUTER APPLICATION SOFTWARE FOR MOBILE PHONES, HAND HELD COMPUTERS, AND ELECTRONIC BOOK READERS FOR HEALTHCARE PRACTITIONERS AND CONSUMERS TO ENTER AND OBTAIN INFORMATION ON MEDICATION SAFETY, ERROR REPORTING, MEDICATION ERROR ALERTS, PRACTICE MANAGEMENT TOPICS AND TIPS (U.S. CLS. 21, 23, 26, 36 AND 38).

FIRST USE 1-3-2011; IN COMMERCE 1-3-2011.

---

4,045,888. PARADIGM ELECTRONICS INC., MISSISSAUGA, ONTARIO, CANADA. SN 77-789,381. PUB. 1-25-2011, FILED 7-24-2009.

## ANTHEM

THE MARK CONSISTS OF STANDARD CHARACTERS WITHOUT CLAIM TO ANY PARTICULAR FONT, STYLE, SIZE, OR COLOR.

**CLASS 9—(Continued).**

OWNER OF CANADA REG. NO. TMA659960, DATED 3-1-2006, EXPIRES 3-1-2021.

FOR PREAMPLIFIERS; INTEGRATED AMPLIFIERS; POWER AMPLIFIERS; ELECTRICAL POWER SUPPLIES; CD PLAYERS; AND REMOTE CONTROLS FOR CD PLAYERS, SURROUND SOUND PROCESSORS, TUNERS, OPTICAL DISC DRIVES, VIDEO PROJECTORS AND RECEIVERS; SURROUND-SOUND PROCESSORS; RADIO SIGNAL TUNERS; HIGH DEFINITION OPTICAL DISC PLAYERS; VIDEO PROJECTORS; AUDIO RECEIVERS; DIGITAL MEDIA RECEIVERS; VIDEO RECEIVERS; AND MP3 PLAYERS; PREAMPLIFIERS; INTEGRATED AMPLIFIERS; POWER AMPLIFIERS; ELECTRICAL POWER SUPPLIES; CD PLAYERS; AND REMOTE CONTROLS FOR CD PLAYERS, SURROUND SOUND PROCESSORS, TUNERS, OPTICAL DISC DRIVES, VIDEO PROJECTORS AND RECEIVERS; SURROUND-SOUND PROCESSORS; RADIO SIGNAL TUNERS (U.S. CLS. 21, 23, 26, 36 AND 38).

FIRST USE 10-29-2010; IN COMMERCE 10-29-2010.

---

4,045,889. AINSWORTH GAME TECHNOLOGY LIMITED, NEWINGTON, AUSTRALIA. SN 77-789,805. PUB. 12-8-2009, FILED 7-27-2009.

**Emperor's Garden**

THE MARK CONSISTS OF STANDARD CHARACTERS WITHOUT CLAIM TO ANY PARTICULAR FONT, STYLE, SIZE, OR COLOR.

FOR COMPUTER SOFTWARE AND FIRMWARE FOR GAMES OF CHANCE ON ANY COMPUTERIZED PLATFORM, INCLUDING DEDICATED GAMING CONSOLES, VIDEO BASED SLOT MACHINES, REEL BASED SLOT MACHINES, AND VIDEO LOTTERY TERMINALS (U.S. CLS. 21, 23, 26, 36 AND 38).

FIRST USE 8-25-2011; IN COMMERCE 8-25-2011.

---

4,045,942. DISNEY ENTERPRISES, INC., BURBANK, CA. SN 77-845,700. PUB. 1-25-2011, FILED 10-9-2009.

**MAD HATTER**

THE MARK CONSISTS OF STANDARD CHARACTERS WITHOUT CLAIM TO ANY PARTICULAR FONT, STYLE, SIZE, OR COLOR.

FOR CELLULAR TELEPHONE CASES; FACE PLATES FOR CELLULAR TELEPHONES; MOUSE PADS; MUSICAL RECORDINGS; VIDEO GAME CARTRIDGES; VIDEO GAME DISCS; VIDEO RECORDINGS FEATURING LIVE ACTION AND ANIMATED ENTERTAINMENT FOR CHILDREN, MUSIC, STORIES, GAMES FOR CHILDREN (U.S. CLS. 21, 23, 26, 36 AND 38).

FIRST USE 10-31-2010; IN COMMERCE 10-31-2010.

**CLASS 9—(Continued).**

4,045,946. STI, INC., MEMPHIS, TN. SN 77-848,298. PUB. 10-5-2010, FILED 10-14-2009.



OWNER OF U.S. REG. NO. 3,307,867.

THE MARK CONSISTS OF THE WORD "SKYCOPI" IN FRONT OF A SHAPE OF A SHIELD ABOVE THE WORD "CADET".

FOR ELECTRONIC SURVEILLANCE DEVICES THAT ARE MOBILE, NAMELY, ELECTRONIC VIDEO SURVEILLANCE INSTALLATIONS, ELECTRONIC AUDIO SURVEILLANCE INSTALLATIONS, RADAR DETECTORS, AND LICENSE PLATE RECOGNITION SYSTEMS COMPRISING CAMERAS AND SOFTWARE THEREFORE (U.S. CLS. 21, 23, 26, 36 AND 38).

FIRST USE 11-0-2009; IN COMMERCE 11-0-2009.

---

4,045,949. KNO, INC., SANTA CLARA, CA. SN 77-852,804. PUB. 5-25-2010, FILED 10-20-2009.

**KNO**

THE MARK CONSISTS OF STANDARD CHARACTERS WITHOUT CLAIM TO ANY PARTICULAR FONT, STYLE, SIZE, OR COLOR.

FOR SOFTWARE AND HARDWARE FOR DELIVERY, DISPLAY, STORAGE AND MANIPULATION OF DATA, TEXT, IMAGES, AUDIO, AND VIDEO (U.S. CLS. 21, 23, 26, 36 AND 38).

FIRST USE 10-0-2010; IN COMMERCE 6-2-2011.

**CLASS 9—(Continued).**

4,045,982. LIGHTHOUSE STRATEGIC PROJECTS GROUP, INC., LANGHORNE, PA. SN 77-888,385. PUB. 5-25-2010, FILED 12-8-2009.



NO CLAIM IS MADE TO THE EXCLUSIVE RIGHT TO USE "ACCELERATED MARKETING FOR AGENCIES, NETWORKS, DISTRIBUTORS, AND ASSOCIATES.", APART FROM THE MARK AS SHOWN.

THE COLOR(S) BLACK, BLUE, GREEN, AND CYAN IS/ ARE CLAIMED AS A FEATURE OF THE MARK.

THE MARK CONSISTS OF THE WORD "AMANDA" IN BLUE, GREEN, AND CYAN THAT SITS ABOVE THE WORDS "ACCELERATED MARKETING FOR AGENCIES, NETWORKS, DISTRIBUTORS, AND ASSOCIATES." IN BLACK ABOVE A CYAN LINE.

FOR INTERACTIVE MULTIMEDIA COMPUTER PROGRAM FOR EDUCATIONAL PURPOSES (U.S. CLS. 21, 23, 26, 36 AND 38).

FIRST USE 5-1-2010; IN COMMERCE 5-1-2010.

4,045,984. AASTRA TECHNOLOGIES LIMITED, CONCORD, ONTARIO, CANADA. SN 77-888,767. PUB. 9-28-2010, FILED 12-8-2009.



THE MARK CONSISTS OF TWO ARROWS IN VARIOUS SHADES TO THE RIGHT OF THE WORD "OPEASY".

FOR SOFTWARE APPLICATIONS TO STREAMLINE VOICE OVER IP PROVISIONING, MAINTENANCE, MONITORING AND USER PRODUCTIVITY, NAMELY, SOFTWARE USED TO QUICKLY PROVISION SIP TERMINALS, MANAGE SIP TERMINAL TEMPLATES, MONITOR THE HEALTH OF THE VOICE OVER IP PLATFORMS, AND PROVIDE USER FEATURES TO THE SIP TERMINALS (U.S. CLS. 21, 23, 26, 36 AND 38).

FIRST USE 11-15-2009; IN COMMERCE 1-12-2010.

**CLASS 9—(Continued).**

4,045,993. APPRION, LLC, BOULDER, CO. SN 77-898,348. PUB. 7-20-2010, FILED 12-21-2009.

**CORE SKILLS MASTERY**

THE MARK CONSISTS OF STANDARD CHARACTERS WITHOUT CLAIM TO ANY PARTICULAR FONT, STYLE, SIZE, OR COLOR.

FOR DIGITAL MATERIALS, NAMELY, SOFTWARE, AUDIO FILES, VISUAL FILES AND TEXT FILES FEATURING ASSESSMENT AND TRAINING IN THE FIELD OF ACADEMIC SKILLS (U.S. CLS. 21, 23, 26, 36 AND 38). FIRST USE 4-5-2010; IN COMMERCE 4-5-2010.

4,045,995. SRS LABS, INC., SANTA ANA, CA. SN 77-901,749. PUB. 12-7-2010, FILED 12-28-2009.

**SRS HD AUDIO LAB**

THE MARK CONSISTS OF STANDARD CHARACTERS WITHOUT CLAIM TO ANY PARTICULAR FONT, STYLE, SIZE, OR COLOR.

NO CLAIM IS MADE TO THE EXCLUSIVE RIGHT TO USE "HD AUDIO", APART FROM THE MARK AS SHOWN.

FOR COMPUTER SOFTWARE WHICH USES AUDIO SIGNAL PROCESSING METHODS USED TO CREATE AN ENHANCED AUDIO IMAGE AND IMPROVED CLARITY, TO CREATE A SURROUND SOUND AUDIO IMAGE, AND TO CREATE AN EXPANDED AUDIO IMAGE DURING THE PLAYBACK OF MUSIC AND VIDEO SIGNALS THROUGH AUDIO SPEAKERS, HEADPHONES, NOTEBOOK PCS, DESKTOP COMPUTERS, NETBOOK COMPUTERS, AND COMPUTER VIDEO MONITORS (U.S. CLS. 21, 23, 26, 36 AND 38).

FIRST USE 6-0-2010; IN COMMERCE 6-0-2010.

4,045,996. PRIME SENSE LTD., TEL AVIV, ISRAEL. SN 77-902,599. PUB. 5-17-2011, FILED 12-30-2009.

**NATURAL INTERACTION**

THE MARK CONSISTS OF STANDARD CHARACTERS WITHOUT CLAIM TO ANY PARTICULAR FONT, STYLE, SIZE, OR COLOR.

OWNER OF U.S. REG. NO. 3,247,681.

**CLASS 9—(Continued).**

NO CLAIM IS MADE TO THE EXCLUSIVE RIGHT TO USE "INTERACTION", APART FROM THE MARK AS SHOWN.

FOR ELECTRONIC IMAGING DEVICES AND COMPUTER SOFTWARE FOR THREE-DIMENSIONAL SENSING AND MAPPING; COMPUTER HARDWARE AND SOFTWARE FOR SENSING USER GESTURES OR OTHER THREE-DIMENSIONAL MOTION OF THE USER (U.S. CLS. 21, 23, 26, 36 AND 38).

FIRST USE 10-31-2010; IN COMMERCE 10-31-2010.

---

4,045,997. BAGDASARIAN PRODUCTIONS, LLC, MONTECITO, CA. SN 77-902,885. PUB. 5-18-2010, FILED 12-30-2009.

# ALVINNN!!!

THE MARK CONSISTS OF STANDARD CHARACTERS WITHOUT CLAIM TO ANY PARTICULAR FONT, STYLE, SIZE, OR COLOR.

FOR MOTION PICTURE FILMS FEATURING ALL OF OR A COMBINATION OF THE FOLLOWING, COMEDY, DRAMA, ACTION, ADVENTURE OR ANIMATION; MOTION PICTURE FILMS FOR BROADCAST ON TELEVISION FEATURING ALL OF OR A COMBINATION OF THE FOLLOWING, COMEDY, DRAMA, ACTION, ADVENTURE OR ANIMATION; AUDIO VIDEO DISCS, COMPACT DISCS, AND DIGITAL VERSATILE DISCS FEATURING ALL OF OR A COMBINATION OF THE FOLLOWING MUSIC, COMEDY, DRAMA, ACTION, ADVENTURE, AND ANIMATION; INTERACTIVE VIDEO GAME PROGRAMS AND COMPUTER GAME PROGRAMS; VIDEO GAME CARTRIDGES AND CASSETTES, VIDEO AND COMPUTER GAME SOFTWARE (U.S. CLS. 21, 23, 26, 36 AND 38).

FIRST USE 9-16-2008; IN COMMERCE 9-16-2008.

---

4,046,002. IGT, RENO, NV. SN 77-904,631. PUB. 5-11-2010, FILED 1-4-2010.

# CACTUS FLOWER

THE MARK CONSISTS OF STANDARD CHARACTERS WITHOUT CLAIM TO ANY PARTICULAR FONT, STYLE, SIZE, OR COLOR.

FOR GAMING MACHINES, NAMELY, DEVICES WHICH ACCEPT A WAGER (U.S. CLS. 21, 23, 26, 36 AND 38).

FIRST USE 7-18-2011; IN COMMERCE 7-19-2011.

**CLASS 9—(Continued).**

4,046,010. AUTOMATED DOCUMENT SERVICES, INC., RANCHO SANTA MARGARITA, CA. SN 77-911,482. PUB. 1-11-2011, FILED 1-13-2010.

# INTELLIJACKS

THE MARK CONSISTS OF STANDARD CHARACTERS WITHOUT CLAIM TO ANY PARTICULAR FONT, STYLE, SIZE, OR COLOR.

FOR ELECTRONIC SENSOR AND DETECTOR UNITS FOR USE IN CONTROLLING THE ACTUATION AND OPERATION OF LEVELING AND HITCH POSITIONING OF RECREATIONAL VEHICLES; RECREATIONAL VEHICLE LEVELING CONTROL SYSTEMS, NAMELY, ELECTRONIC CONTROLS AND INDICATOR LIGHTS FOR MANUALLY OR AUTOMATICALLY LEVELING THE VEHICLE (U.S. CLS. 21, 23, 26, 36 AND 38).

FIRST USE 6-1-2010; IN COMMERCE 6-1-2010.

---

4,046,025. PLUM ENTERPRISES, INC., VALLEY FORGE, PA. SN 77-916,201. PUB. 1-4-2011, FILED 1-20-2010.

# Fires Cape

THE MARK CONSISTS OF STANDARD CHARACTERS WITHOUT CLAIM TO ANY PARTICULAR FONT, STYLE, SIZE, OR COLOR.

NO CLAIM IS MADE TO THE EXCLUSIVE RIGHT TO USE "CAPE", APART FROM THE MARK AS SHOWN.

FOR PROTECTIVE CLOTHING, NAMELY, FLAME RETARDANT APRONS, SMOCKS AND CAPES WITH OR WITHOUT SLEEVES, FOR PROTECTION AGAINST CIGARETTE ASHES WHILE SMOKING AND FOR PROTECTION AGAINST BURNS WHILE COOKING (U.S. CLS. 21, 23, 26, 36 AND 38).

FIRST USE 3-1-2011; IN COMMERCE 4-29-2011.

**CLASS 9—(Continued).**

4,046,029. TANDBERG DATA HOLDINGS S.À.R.L., LUXEMBOURG, LUXEMBOURG. SN 77-919,385. PUB. 1-11-2011, FILED 1-25-2010.

# DPS2000

OWNER OF U.S. REG. NOS. 3,855,452, 3,855,453, AND 3,858,844.  
 FOR DATA PROTECTION DISK APPLIANCE, NAMELY, A COMPUTER BACKUP AND STORAGE SYSTEM WHICH INCLUDES DATA PROTECTION SOFTWARE AND PROVIDES FOR FILE SHARING, BACKUP, STORAGE, MANAGEMENT, PROTECTION AND RECOVERY OF DATA (U.S. CLS. 21, 23, 26, 36 AND 38).  
 FIRST USE 3-0-2010; IN COMMERCE 3-0-2010.

4,046,032. RHINOBOOTS, S.A. DE C.V., PUREPERO, MI-CHOACAN, MEXICO. SN 77-922,373. PUB. 1-18-2011, FILED 1-28-2010.



NO CLAIM IS MADE TO THE EXCLUSIVE RIGHT TO USE "COMFORT & SAFETY FOOTWEAR", APART FROM THE MARK AS SHOWN.  
 THE COLOR(S) SILVER, YELLOW, ORANGE, BLACK AND DARK BLUE IS/ARE CLAIMED AS A FEATURE OF THE MARK.  
 THE MARK CONSISTS OF THE WORD "GUEPARDO" IN SILVER; WORDS "COMFORT & SAFETY FOOTWEAR" IN YELLOW, BELOW A YELLOW LINE; AN IMAGE OF A RUNNING CHEETAH IN THE UPPER RIGHT CORNER, IN ORANGE WITH BLACK DOTS; ALL WITH A DARK BLUE BACKGROUND.  
 THE ENGLISH TRANSLATION OF "GUEPARDO" IN THE MARK IS CHEETAH.  
 FOR PROTECTIVE INDUSTRIAL SHOES; SHOES FOR PROTECTION AGAINST ACCIDENTS AND FIRE (U.S. CLS. 21, 23, 26, 36 AND 38).  
 FIRST USE 2-4-2010; IN COMMERCE 2-4-2010.

**CLASS 9—(Continued).**

4,046,095. BALLY GAMING, INC., DBA BALLY TECHNOLOGIES, LAS VEGAS, NV. SN 77-944,229. PUB. 7-20-2010, FILED 2-24-2010.

# GOLDEN PHARAOH

THE MARK CONSISTS OF STANDARD CHARACTERS WITHOUT CLAIM TO ANY PARTICULAR FONT, STYLE, SIZE, OR COLOR.  
 FOR GAMING DEVICES, NAMELY, SLOT MACHINES WITH OR WITHOUT VIDEO OUTPUT (U.S. CLS. 21, 23, 26, 36 AND 38).  
 FIRST USE 7-11-2011; IN COMMERCE 7-11-2011.

4,046,129. ANALOGUE HOLDINGS LTD., NORTH POINT, HONG KONG. SN 77-954,360. PUB. 8-24-2010, FILED 3-9-2010.



NO CLAIM IS MADE TO THE EXCLUSIVE RIGHT TO USE "CONTROL REDUNDANCY", "EXPANSION OF CONTROL STEPS", "CONTROL VALUE AVERAGING", "SEQUENTIAL LOAD ACTIVATION", "DATA SYNCHRONIZATION" AND "DUTY SHARING", APART FROM THE MARK AS SHOWN.  
 THE MARK CONSISTS OF THE WORD "CO-WORK" INSIDE A PARTIALLY SHADED HEXAGON, SURROUNDED ON ALL SIDES BY SIX OTHER PARTIALLY SHADED HEXAGONS, EACH OF WHICH CONTAINS ONE OF THE FOLLOWING RESPECTIVE PHRASES, STARTING AT THE TOP HEXAGON AND PROCEEDING CLOCKWISE, "CONTROL REDUNDANCY", "EXPANSION OF CONTROL STEPS", "CONTROL VALUE AVERAGING", "SEQUENTIAL LOAD ACTIVATION", "DATA SYNCHRONIZATION" AND "DUTY SHARING".  
 FOR INTER-NETWORK ELECTRICAL CONTROLLER SYSTEM COMPRISING A CONTROL BOARD WITH EMBEDDED SOFTWARE LOGIC FOR AIR-CONDITIONING UNITS; INTER-NETWORK ELECTRICAL CONTROLLER SYSTEM COMPRISING A CONTROL BOARD WITH EMBEDDED SOFTWARE LOGIC TO ENABLE A SERIES OF STAND-ALONE AIR-CONDITIONING UNITS TO BE CONTROLLED AND OPERATED AS A SINGLE SYSTEM (U.S. CLS. 21, 23, 26, 36 AND 38).  
 FIRST USE 0-0-1997; IN COMMERCE 0-0-1997.

**CLASS 9—(Continued).**

4,046,130. ANALOGUE HOLDINGS LTD., NORTH POINT, HONG KONG. SN 77-954,362. PUB. 8-3-2010, FILED 3-9-2010.

**CO-WORK**

THE MARK CONSISTS OF STANDARD CHARACTERS WITHOUT CLAIM TO ANY PARTICULAR FONT, STYLE, SIZE, OR COLOR.

FOR INTER-NETWORK ELECTRICAL CONTROLLER SYSTEM COMPRISING A CONTROL BOARD WITH EMBEDDED SOFTWARE LOGIC FOR AIR-CONDITIONING UNITS; INTER-NETWORK ELECTRICAL CONTROLLER SYSTEM COMPRISING A CONTROL BOARD WITH EMBEDDED SOFTWARE LOGIC TO ENABLE A SERIES OF STAND-ALONE AIR-CONDITIONING UNITS TO BE CONTROLLED AND OPERATED AS A SINGLE SYSTEM (U.S. CLS. 21, 23, 26, 36 AND 38).

FIRST USE 0-0-1997; IN COMMERCE 0-0-1997.

---

4,046,146. SONY ERICSSON MOBILE COMMUNICATIONS AB, LUND, SWEDEN. SN 77-960,415. PUB. 7-20-2010, FILED 3-16-2010.

**LIFE.EPISODE**

THE MARK CONSISTS OF STANDARD CHARACTERS WITHOUT CLAIM TO ANY PARTICULAR FONT, STYLE, SIZE, OR COLOR.

FOR COMPUTER SOFTWARE FOR STORING, USING, PLAYING, VIEWING, AND TRANSFERRING DIGITAL AND MEDIA CONTENT ON OR BETWEEN MOBILE PHONES, MOBILE DEVICES, PERSONAL COMPUTERS, AND ELECTRONIC GAME DEVICES (U.S. CLS. 21, 23, 26, 36 AND 38).

FIRST USE 7-0-2010; IN COMMERCE 7-0-2010.

---

4,046,213. BALTIC LATVIAN UNIVERSAL ELECTRONICS, LLC, WESTLAKE VILLAGE, CA. SN 85-007,721. PUB. 8-31-2010, FILED 4-6-2010.

**REACTOR**

THE MARK CONSISTS OF STANDARD CHARACTERS WITHOUT CLAIM TO ANY PARTICULAR FONT, STYLE, SIZE, OR COLOR.

FOR MICROPHONES (U.S. CLS. 21, 23, 26, 36 AND 38). FIRST USE 1-13-2011; IN COMMERCE 5-26-2011.

**CLASS 9—(Continued).**

4,046,219. SIMULATED SURGICAL SYSTEMS, LLC, WILLIAMSVILLE, NY. SN 85-011,670. PUB. 9-14-2010, FILED 4-12-2010.

**RoSS**

THE MARK CONSISTS OF STANDARD CHARACTERS WITHOUT CLAIM TO ANY PARTICULAR FONT, STYLE, SIZE, OR COLOR.

FOR SURGICAL TRAINING DEVICES, NAMELY, A ROBOTIC SURGERY TRAINING CONSOLE THAT USES VIRTUAL REALITY SOFTWARE TO TEACH ROBOTIC SURGICAL TECHNIQUES AND REALISTICALLY INTRODUCE THE USER TO THE OPERATION AND FEEL OF A ROBOTIC SURGICAL CONSOLE (U.S. CLS. 21, 23, 26, 36 AND 38).

FIRST USE 8-4-2010; IN COMMERCE 8-4-2010.

---

4,046,232. OKTA, INC., SAN FRANCISCO, CA. SN 85-018,338. PUB. 2-8-2011, FILED 4-20-2010.

**OKTA**

THE MARK CONSISTS OF STANDARD CHARACTERS WITHOUT CLAIM TO ANY PARTICULAR FONT, STYLE, SIZE, OR COLOR.

FOR COMPUTER SOFTWARE FOR THE UNIFICATION, MANAGEMENT, OPTIMIZATION AND INTEGRATION OF COMPUTER SYSTEMS AND NETWORKS, ENTERPRISE SOFTWARE APPLICATIONS, USERS, AND INTERNET RESOURCES; COMPUTER SOFTWARE FOR COMPUTER SYSTEMS AND NETWORK ACCESS CONTROL FEATURING DIGITAL IDENTITY AUTHENTICATION, SECURITY MANAGEMENT AND SECURITY APPLICATION AUDITING; COMPUTER SOFTWARE FOR THE MONITORING, ANALYZING, AND REPORTING ON THE PERFORMANCE OF COMPUTER SYSTEMS, NETWORKS, AND ENTERPRISE SOFTWARE APPLICATIONS (U.S. CLS. 21, 23, 26, 36 AND 38).

FIRST USE 7-1-2010; IN COMMERCE 7-1-2010.

**CLASS 9—(Continued).**

4,046,235. CINRAM INTERNATIONAL INC., SCARBOROUGH, ONTARIO, CANADA. SN 85-019,318. PUB. 11-2-2010, FILED 4-21-2010.



NO CLAIM IS MADE TO THE EXCLUSIVE RIGHT TO USE "FLICKS", APART FROM THE MARK AS SHOWN.

THE MARK CONSISTS OF THE WORDS "GRIP FLIX" ABOVE A HAND HOLDING A PERSONAL DIGITAL ASSISTANT DEVICE.

FOR DATA STORAGE MEDIA, NAMELY, PRERECORDED INTEGRATED CIRCUIT MEMORY CARDS FEATURING MOVIES, TELEVISION PROGRAMS, DOCUMENTARIES, MUSIC, VIDEO GAMES, COMPUTER SOFTWARE AND APPLICATIONS FOR VIDEO AND COMPUTER GAMES, EDUCATIONAL FILMS AND VIDEOS FOR CHILDREN AND ADULTS, AND AUDIO BOOKS (U.S. CLS. 21, 23, 26, 36 AND 38).

FIRST USE 6-2-2010; IN COMMERCE 6-2-2010.

4,046,237. ZENITH INFOTECH INC., WARRENDALE, PA. SN 85-020,857. PUB. 11-2-2010, FILED 4-22-2010.

## MirrorCloud

THE MARK CONSISTS OF STANDARD CHARACTERS WITHOUT CLAIM TO ANY PARTICULAR FONT, STYLE, SIZE, OR COLOR.

FOR COMPUTER HARDWARE AND SOFTWARE USED IN DATA REPLICATION, DATA BACKUP AND DATA RECOVERY FOR TRANSMITTING DATA; COMPUTER HARDWARE FOR USE IN DISASTER RECOVERY SERVICES FOR COMPUTER NETWORKS, COMPUTER WORKSTATIONS, DESKTOP COMPUTERS, MOBILE COMPUTERS, COMPUTER HARD DRIVES, AND COMPUTER SERVERS; COMPUTER SOFTWARE FOR USE IN DISASTER RECOVERY SERVICES FOR COMPUTER NETWORKS, COMPUTER WORKSTATIONS, DESKTOP COMPUTERS, MOBILE COMPUTERS, COMPUTER HARD DRIVES, AND COMPUTER SERVERS FOR TRANSMITTING DATA; COMPUTER HARDWARE AND COMPUTER SOFTWARE FOR TRANSMITTING DATA DESIGNED TO WORK TOGETHER FOR USE IN DATA BACKUP, DATA REPLICATION, AND DATA RECOVERY SITUATIONS (U.S. CLS. 21, 23, 26, 36 AND 38).

FIRST USE 4-1-2010; IN COMMERCE 3-10-2011.

**CLASS 9—(Continued).**

4,046,249. SU, WEN CHIEH, TAIPEI COUNTY 235, TAIWAN. SN 85-028,179. PUB. 2-15-2011, FILED 5-2-2010.

THE MARK CONSISTS OF THE INCLINED STYLIZED LETTERS "SATE" WITH THE "A" HAVING A DIAMOND LIKE CONTOUR OVER THE "A" WITH NO CROSS-BAR WITHIN THE "A".

FOR AMUSEMENT APPARATUS ADAPTED FOR USE WITH AN EXTERNAL DISPLAY SCREEN OR MONITOR; BAR CODE READERS; BATTERIES; BATTERY CHARGERS; CALCULATING MACHINES; COMPACT DISK PLAYERS; COMPUTER CAMERAS; COMPUTER HARDWARE AND COMPUTER PERIPHERAL DEVICES; COMPUTER KEYBOARDS; COMPUTER MOUSE; COMPUTER PERIPHERAL DEVICES; COMPUTERS; DVD PLAYERS; ELECTRIC CONNECTIONS; ELECTRICAL PLUGS AND SOCKETS; ELECTRONIC DOWNLOADABLE PUBLICATIONS IN THE NATURE OF MAGAZINES AND BOOKS IN THE FIELD OF SCIENCE AND MEDICINE; ELECTRIC FLAT IRONS; HANDS FREE KITS FOR PHONES; HEADPHONES; INTERFACES FOR COMPUTERS; LAPTOP COMPUTERS; LOUD SPEAKERS; MOBILE PHONES; COMPUTER MOUSE PADS; NAVIGATION APPARATUS FOR VEHICLES IN THE NATURE OF ON-BOARD COMPUTERS; PERSONAL STEREOs; POCKET CALCULATORS; PORTABLE TELEPHONES; RADIOS; RECEIVERS FOR TELEPHONE, AUDIO, VIDEO; REMOTE CONTROL TELEMETERING MACHINES AND APPARATUS; SLIDE OR PHOTOGRAPH PROJECTION APPARATUS; SOLAR BATTERIES; SOUND REPRODUCTION APPARATUS; TRANSFORMERS; TV MONITORS; VIDEO TELEPHONES (U.S. CLS. 21, 23, 26, 36 AND 38).

FIRST USE 8-14-2010; IN COMMERCE 11-20-2010.

4,046,251. TOPCON POSITIONING SYSTEMS, INC., LIVERMORE, CA. SN 85-028,525. PUB. 1-4-2011, FILED 5-3-2010.

## IP-S2

THE MARK CONSISTS OF STANDARD CHARACTERS WITHOUT CLAIM TO ANY PARTICULAR FONT, STYLE, SIZE, OR COLOR.

FOR THREE DIMENSIONAL MOBILE MAPPING SYSTEM COMPRISED OF A GLOBAL POSITIONING SYSTEM (GPS) DEVICE, LASER SCANNER, CAMERA AND COMPUTER SOFTWARE FOR GATHERING IMAGES AND DATA (U.S. CLS. 21, 23, 26, 36 AND 38).

FIRST USE 9-30-2009; IN COMMERCE 9-30-2009.



**CLASS 9—(Continued).**

4,046,255. KOTTER INTERNATIONAL, INC., CAMBRIDGE, MA. SN 85-029,592. PUB. 4-19-2011, FILED 5-4-2010.

**KOTTER INTERNATIONAL**

THE MARK CONSISTS OF STANDARD CHARACTERS WITHOUT CLAIM TO ANY PARTICULAR FONT, STYLE, SIZE, OR COLOR.

NO CLAIM IS MADE TO THE EXCLUSIVE RIGHT TO USE "INTERNATIONAL", APART FROM THE MARK AS SHOWN.

FOR DIGITAL MATERIALS, NAMELY, DVDS FEATURING EDUCATIONAL TOPICS IN THE FIELDS OF ORGANIZATIONAL CHANGE MANAGEMENT, BUSINESS MANAGEMENT, AND EXECUTIVE AND LEADERSHIP DEVELOPMENT (U.S. CLS. 21, 23, 26, 36 AND 38).

FIRST USE 2-0-2010; IN COMMERCE 2-0-2010.

4,046,259. KOTTER INTERNATIONAL, INC., CAMBRIDGE, MA. SN 85-029,754. PUB. 4-26-2011, FILED 5-4-2010.

**Kotter**  
INTERNATIONAL

NO CLAIM IS MADE TO THE EXCLUSIVE RIGHT TO USE "INTERNATIONAL", APART FROM THE MARK AS SHOWN.

THE MARK CONSISTS OF THE LITERAL ELEMENTS "KOTTER INTERNATIONAL" AND AN IMAGE OF A PENGUIN BETWEEN THE TWO "T'S IN "KOTTER".

FOR DIGITAL MATERIALS, NAMELY, DVDS FEATURING EDUCATIONAL TOPICS IN THE FIELDS OF ORGANIZATIONAL CHANGE MANAGEMENT, BUSINESS MANAGEMENT, AND EXECUTIVE AND LEADERSHIP DEVELOPMENT (U.S. CLS. 21, 23, 26, 36 AND 38).

FIRST USE 2-0-2010; IN COMMERCE 2-0-2010.

4,046,261. RAWLINGS SPORTING GOODS COMPANY, INC., ST. LOUIS, MO. SN 85-030,668. PUB. 1-11-2011, FILED 5-5-2010.

**RAWLINGS NRG**

THE MARK CONSISTS OF STANDARD CHARACTERS WITHOUT CLAIM TO ANY PARTICULAR FONT, STYLE, SIZE, OR COLOR.

**CLASS 9—(Continued).**

OWNER OF U.S. REG. NOS. 412,343 AND 1,149,932. FOR FOOTBALL HELMETS (U.S. CLS. 21, 23, 26, 36 AND 38). FIRST USE 7-0-2010; IN COMMERCE 7-0-2010.

4,046,290. WORLD WRESTLING ENTERTAINMENT, INC., STAMFORD, CT. SN 85-044,158. PUB. 9-21-2010, FILED 5-20-2010.

**WWE ALL STARS**

THE MARK CONSISTS OF STANDARD CHARACTERS WITHOUT CLAIM TO ANY PARTICULAR FONT, STYLE, SIZE, OR COLOR.

OWNER OF U.S. REG. NOS. 3,056,074, 3,621,017, AND OTHERS.

NO CLAIM IS MADE TO THE EXCLUSIVE RIGHT TO USE "ALL STARS", APART FROM THE MARK AS SHOWN.

FOR VIDEO AND COMPUTER GAME TAPES, VIDEO AND COMPUTER GAME DISCS, VIDEO AND COMPUTER GAME CASSETTES, VIDEO AND COMPUTER GAME CARTRIDGES, VIDEO AND COMPUTER GAME CD-ROMS, VIDEO OUTPUT GAME MACHINES FOR USE WITH TELEVISIONS; VIDEO AND COMPUTER GAME SOFTWARE; COIN-FED AMUSEMENT GAMING MACHINES; INTERACTIVE VIDEO GAME PROGRAMS AND COMPUTER GAME CARTRIDGES; INTERACTIVE MULTIMEDIA COMPUTER GAMES ON ALL PLATFORMS COMPRISED OF COMPUTER HARDWARE AND COMPUTER GAME SOFTWARE; ELECTRONIC GAMES THAT INVOLVES INTERACTION WITH A USER INTERFACE TO GENERATE VISUAL FEEDBACK ON A VIDEO DEVICE (U.S. CLS. 21, 23, 26, 36 AND 38).

FIRST USE 3-29-2011; IN COMMERCE 3-29-2011.

4,046,301. ENTERPRISE PRODUCTIVITY SYSTEMS, INC., GREAT FALLS, VA. SN 85-049,041. PUB. 12-28-2010, FILED 5-27-2010.



**Enterprise Productivity Systems, Inc.**  
"Mission Driven Systems Integration"

NO CLAIM IS MADE TO THE EXCLUSIVE RIGHT TO USE "ENTERPRISE PRODUCTIVITY SYSTEMS INC." AND "SYSTEMS INTEGRATION", APART FROM THE MARK AS SHOWN.

THE COLOR(S) BLACK, BLUE, AND RED IS/ARE CLAIMED AS A FEATURE OF THE MARK.

**CLASS 9—(Continued).**

THE MARK CONSISTS OF THE STYLIZED WORDING "ENTERPRISE PRODUCTIVITY SYSTEMS, INC." IN THE COLOR BLACK AND ABOVE THE STYLIZED WORDING "MISSION DRIVEN SYSTEMS INTEGRATION" IN THE COLOR BLUE. TO THE LEFT OF THE WORDING IS A COMPASS FORMED FROM A BLACK CIRCLE WITH RED PRIMARY DIRECTIONAL ARROWS AND BLUE SECONDARY DIRECTIONAL ARROWS. AROUND THE OUTSIDE OF THE BLACK CIRCLE ARE THE LETTERS "N" "E" "W" AND "S" IN THE COLOR BLACK.

FOR COMPUTER SOFTWARE FOR INCREASING ENTERPRISE PRODUCTIVITY BY CONSOLIDATING DATA, STORING, REPORTING, ANALYZING, AND CREATING VISUAL IMAGES OF COLLECTED DATA (U.S. CLS. 21, 23, 26, 36 AND 38).

FIRST USE 4-29-2011; IN COMMERCE 4-29-2011.

**CLASS 9—(Continued).**

4,046,328. AMYLIN PHARMACEUTICALS, INC., SAN DIEGO, CA. SN 85-059,570. PUB. 5-17-2011, FILED 6-10-2010.

4,046,307. MITAC INTERNATIONAL CORP., HSINCHU HSIEN, TAIWAN. SN 85-051,536. PUB. 4-19-2011, FILED 6-1-2010.



## Magellan ToughCase

THE MARK CONSISTS OF STANDARD CHARACTERS WITHOUT CLAIM TO ANY PARTICULAR FONT, STYLE, SIZE, OR COLOR.

OWNER OF U.S. REG. NO. 2,791,841.

FOR PROTECTIVE CASES AND COVERS FOR ELECTRONIC BOOK; PROTECTIVE CASES AND COVERS FOR E-BOOK; CASES AND COVERS FOR TELEPHONES; CASES AND COVERS FOR MOBILE PHONES; CARRYING CASES AND PROTECTIVE COVERS FOR MOBILE COMPUTER USE; CARRYING CASES AND PROTECTIVE COVERS FOR COMPUTING DEVICES, NAMELY, BIKE MOBILE COMPUTERS, TABLET COMPUTERS, AND NOTEBOOK COMPUTERS; CARRYING CASES AND PROTECTIVE COVERS FOR GPS DEVICES; WATERPROOF AND RUGGEDIZED PROTECTIVE CARRYING CASES AND PROTECTIVE COVERS FOR ELECTRONIC DEVICES IN THE NATURE OF E-BOOK, MOBILE COMPUTERS, TABLET COMPUTERS, NOTEBOOK COMPUTERS, GPS DEVICES, MOBILE PHONES, AND PORTABLE MEDIA PLAYERS; PROTECTIVE CARRYING CASES AND PROTECTIVE COVERS THAT PROTECT ELECTRONIC DEVICES IN THE NATURE OF E-BOOK, MOBILE COMPUTERS, TABLET COMPUTERS, NOTEBOOK COMPUTERS, GPS DEVICES, MOBILE PHONES, AND PORTABLE MEDIA PLAYERS WHILE ENABLING THE USER TO ACCESS THE FULL FUNCTIONALITY OF THE ELECTRONIC DEVICE ENCLOSED WITHIN (U.S. CLS. 21, 23, 26, 36 AND 38).

FIRST USE 6-16-2010; IN COMMERCE 6-16-2010.

NO CLAIM IS MADE TO THE EXCLUSIVE RIGHT TO USE "DIABETES", APART FROM THE MARK AS SHOWN.

THE COLOR(S) WHITE, BLUE, GREEN, DARK YELLOW, RED, AND ORANGE IS/ARE CLAIMED AS A FEATURE OF THE MARK.

THE MARK CONSISTS OF A COLORED BACKGROUND THAT FADES FROM THE COLOR BLUE ON THE TOP TO THE COLOR GREEN ON THE BOTTOM IN THE SHAPE OF A SQUARE. IN THE CENTER OF THE SQUARE IS AN IMAGE OF A HEART IN THE COLOR RED WITH SHADING IN THE COLOR ORANGE IN THE UPPER RIGHT SIDE OF THE HEART. THE HEART IS OUTLINED IN THE COLOR WHITE. AN IMAGE OF A SPHERE-LIKE RING IN THE COLOR BLUE WITH A WHITE OUTLINE ENCIRCLES THE IMAGE OF THE HEART FROM THE BACKSIDE OF THE HEART TO THE FRONT. BEHIND THE IMAGES OF THE HEART AND THE RING IS A CURVED MUSICAL STAFF IN THE COLOR DARK YELLOW THAT CROSSES FROM LEFT TO RIGHT. THE WORDS "DIABETES LIFE" APPEAR IN THE COLOR WHITE ABOVE THE IMAGES OF THE HEART, RING, AND MUSICAL STAFF. THE WORD "HARMONIZED" APPEARS IN THE COLOR WHITE BELOW THE IMAGES OF THE HEART, RING, AND MUSICAL STAFF.

FOR COMPUTER SOFTWARE THAT PROVIDES WEB-BASED ACCESS TO EDUCATIONAL AND INFORMATION SERVICES IN THE FIELDS OF DIABETES, OBESITY, AND CARDIOVASCULAR DISEASE THROUGH A WEB OPERATING SYSTEM PORTAL (U.S. CLS. 21, 23, 26, 36 AND 38).

FIRST USE 9-20-2010; IN COMMERCE 9-20-2010.

**CLASS 9—(Continued).**

4,046,366. SMITH MICRO SOFTWARE, INC., ALISO VIEJO, CA. SN 85-072,075. PUB. 4-26-2011, FILED 6-25-2010.

# SENDSTUFF

THE MARK CONSISTS OF STANDARD CHARACTERS WITHOUT CLAIM TO ANY PARTICULAR FONT, STYLE, SIZE, OR COLOR.

FOR COMPUTER SOFTWARE FOR FILE, MEDIA AND DATA TRANSFERS INCLUDING DELIVERY AND RECEIPT OVER THE INTERNET, OR WITHIN AN ENTERPRISE, AND ACROSS DIFFERENT PLATFORMS AND COMMUNICATION NETWORKS AND DEVICES, INCLUDING THE MONITORING AND TRACKING THEREOF; COMPUTER SOFTWARE FOR USERS AND ENTITIES TO ENCRYPT, COMPRESS, SEND, RECEIVE, STORE, MONITOR, ACCESS AND TRACK FILES, MEDIA AND DATA TRANSFERS OVER THE INTERNET, OR WITHIN AN ENTERPRISE, AND ACROSS DIFFERENT PLATFORMS AND COMMUNICATION NETWORKS AND DEVICES (U.S. CLS. 21, 23, 26, 36 AND 38).

FIRST USE 7-15-2010; IN COMMERCE 7-15-2010.

**CLASS 9—(Continued).**

4,046,371. BSD DISTRIBUTORS, INC., BROOKLYN, NY. SN 85-072,510. PUB. 11-23-2010, FILED 6-27-2010.



THE COLOR(S) DARK BLUE, LIGHT BLUE, GRAY, WHITE IS/ARE CLAIMED AS A FEATURE OF THE MARK.

THE MARK CONSISTS OF THE TERM "IRONTECH" WRITTEN IN GRAY AND WHITE IN FRONT OF A BLUE AND WHITE OVAL WITH A GRAY AND WHITE BORDER.

FOR AUDIO SPEAKERS; BATTERY CHARGERS; CABLES, ELECTRIC; CARRYING CASES FOR CELL PHONES; CELL PHONE BATTERY CHARGERS FOR USE IN VEHICLES; CELL PHONE CASES; COMPUTER CARRYING CASES; COMPUTER KEYBOARDS; COMPUTER MOUSE; COMPUTER PERIPHERALS; COMPUTER SCREEN FILTERS; MOUSEPADS; WIRELESS CELLULAR PHONE HEADSETS (U.S. CLS. 21, 23, 26, 36 AND 38).

FIRST USE 7-20-2011; IN COMMERCE 7-20-2011.

4,046,377. GIGASTONE CORPORATION, TAIPEI CITY, TAIWAN. SN 85-073,749. PUB. 4-26-2011, FILED 6-29-2010.

# GIGASTONE

PRIORITY CLAIMED UNDER SEC. 44(D) ON TAIWAN APPLICATION NO. 099009707, FILED 3-5-2010, REG. NO. 01436701, DATED 9-16-2010, EXPIRES 9-15-2020.

THE COLOR(S) RED IS/ARE CLAIMED AS A FEATURE OF THE MARK.

THE MARK CONSISTS OF THE WORD "GIGASTONE" IN RED WITH THE LETTER "A" FORMED BY AN INVERTED "V" AND A TRIANGLE.

FOR RANDOM ACCESS MEMORY CARDS, LIQUID CRYSTAL DISPLAYS, COMPUTER DISPLAY SCREENS, COMPUTERS, PERSONAL COMPUTERS, LAPTOP COMPUTERS, POCKET PERSONAL COMPUTERS, PORTABLE COMPUTERS, RANDOMIZED ACCESS MEMORY MODULES, RANDOMIZED ACCESS MEMORY CARDS, FLASH MEMORY HARD DISK DRIVES, CHIP CARD READERS, DIGITAL IMAGE STORAGE DEVICES, NAMELY, DIGITAL IMAGE PHOTO CONVERTERS, PORTABLE FLASH MEMORY CARDS, CELL PHONES, LIGHT EMITTING DIODES, LED DISPLAYS, TOUCH PANELS AND ELECTRONIC FLAT PANEL IMAGE DISPLAY SCREENS (U.S. CLS. 21, 23, 26, 36 AND 38).

FIRST USE 3-0-2010; IN COMMERCE 7-0-2010.

4,046,370. BSD DISTRIBUTORS, INC., BROOKLYN, NY. SN 85-072,509. PUB. 11-23-2010, FILED 6-27-2010.

# IronTech

THE MARK CONSISTS OF STANDARD CHARACTERS WITHOUT CLAIM TO ANY PARTICULAR FONT, STYLE, SIZE, OR COLOR.

FOR AUDIO SPEAKERS; BATTERY CHARGERS; CABLES, ELECTRIC; CARRYING CASES FOR CELL PHONES; CELL PHONE BATTERY CHARGERS FOR USE IN VEHICLES; CELL PHONE CASES; COMPUTER CARRYING CASES; COMPUTER KEYBOARDS; COMPUTER MOUSE; COMPUTER PERIPHERALS; COMPUTER SCREEN FILTERS; MOUSEPADS; WIRELESS CELLULAR PHONE HEADSETS (U.S. CLS. 21, 23, 26, 36 AND 38).

FIRST USE 7-20-2011; IN COMMERCE 7-20-2011.

**CLASS 9—(Continued).**

4,046,378. MODERN OPTICAL INTERNATIONAL, LTD., ROSELLE, IL. SN 85-073,988. PUB. 2-22-2011, FILED 6-29-2010.



OWNER OF U.S. REG. NO. 3,397,792.  
THE MARK CONSISTS OF THE WORD "MODERN" PRINTED IN A STYLIZED FORM WITH SHADOWING BEHIND EACH OF THE LETTERS AND A THICK UNDERSCORE BENEATH THE LETTER "O". THE WORD "ART" APPEARS TO THE RIGHT OF THE WORD "MODERN" IN A STYLIZED FORM WITH A PORTION OF THE INITIAL LETTER "A" APPEARING BEHIND THE LETTER "N" IN "MODERN". THERE IS A DESIGN CONSISTING OF TWO SQUARE-LIKE SHAPES APPEARING BEHIND THE STYLIZED LETTER "M" WITH THE BOTTOM LINE EXTENDING TO THE RIGHT UNDERSCORING THE WORD "MODERN" AND A PORTION OF THE WORD "ART".

FOR EYEWEAR, NAMELY, SUNGLASSES, EYEGLASSES AND OPHTHALMIC FRAMES AND CASES THEREFOR (U.S. CLS. 21, 23, 26, 36 AND 38).

FIRST USE 1-0-2011; IN COMMERCE 1-0-2011.

**CLASS 9—(Continued).**

4,046,405. SKYUNION PTE. LTD., 159308, SINGAPORE. SN 85-082,034. PUB. 10-26-2010, FILED 7-11-2010.

## Age of Titan

THE MARK CONSISTS OF STANDARD CHARACTERS WITHOUT CLAIM TO ANY PARTICULAR FONT, STYLE, SIZE, OR COLOR.

FOR COMPUTER GAME PROGRAMS; COMPUTER GAME SOFTWARE; COMPUTER OPERATING PROGRAMS, RECORDED; COMPUTER PERIPHERAL DEVICES; COMPUTER PROGRAMS FOR PRE-RECORDED GAMES; COMPUTER PROGRAMS RECORDED ON DATA MEDIA (SOFTWARE) DESIGNED FOR USE IN CONSTRUCTION AND AUTOMATED MANUFACTURING (CAD/CAM); COMPUTERS; DOWNLOADABLE COMPUTER PROGRAMS FEATURING POSITIONABLE GAME PIECE FIGURES FOR USE IN THE FIELD OF COMPUTER GAMES; DOWNLOADABLE ELECTRONIC PUBLICATIONS IN THE NATURE OF MAGAZINES IN THE FIELD OF COMPUTER GAMES; ELECTRONIC POCKET TRANSLATORS; ELECTRONIC TEST AND MEASUREMENT DEVICES FOR USE IN THE FIELDS OF NETWORKS AND TELECOMMUNICATIONS, NAMELY, INSTRUMENTATION USED TO TEST AND CERTIFY NEW AND EXISTING DATA AND VOICE COMMUNICATION CABLE AND COAXIAL CABLE (U.S. CLS. 21, 23, 26, 36 AND 38).

FIRST USE 9-30-2010; IN COMMERCE 9-30-2010.

4,046,397. TETRIS ONLINE, INC., HONOLULU, HI. SN 85-079,145. PUB. 12-14-2010, FILED 7-7-2010.

## MONSTER FUSION

THE MARK CONSISTS OF STANDARD CHARACTERS WITHOUT CLAIM TO ANY PARTICULAR FONT, STYLE, SIZE, OR COLOR.

FOR DOWNLOADABLE GAME SOFTWARE AND ELECTRONIC GAME SOFTWARE FOR WIRELESS DEVICES AND COMPUTERS (U.S. CLS. 21, 23, 26, 36 AND 38).

FIRST USE 5-25-2011; IN COMMERCE 5-25-2011.

4,046,416. BEACH CHAIR FITNESS, NORTH WILDWOOD, NJ. SN 85-084,521. PUB. 12-14-2010, FILED 7-14-2010.

## BEACH CHAIR WORKOUT

THE MARK CONSISTS OF STANDARD CHARACTERS WITHOUT CLAIM TO ANY PARTICULAR FONT, STYLE, SIZE, OR COLOR.

NO CLAIM IS MADE TO THE EXCLUSIVE RIGHT TO USE "WORKOUT", APART FROM THE MARK AS SHOWN.

FOR PRE-RECORDED DVDS FEATURING EXERCISING AND HEALTH AND WELLNESS INSTRUCTION AND INFORMATION (U.S. CLS. 21, 23, 26, 36 AND 38).

FIRST USE 5-19-2011; IN COMMERCE 5-19-2011.

**CLASS 9—(Continued).**

4,046,418. JAMISON ERNEST, NEW YORK, NY. SN 85-084,762. PUB. 12-21-2010, FILED 7-14-2010.

**BURLAP TO CASHMERE**

THE MARK CONSISTS OF STANDARD CHARACTERS WITHOUT CLAIM TO ANY PARTICULAR FONT, STYLE, SIZE, OR COLOR.

FOR SOUND RECORDINGS FEATURING MUSIC (U.S. CLS. 21, 23, 26, 36 AND 38).

FIRST USE 6-1-1997; IN COMMERCE 6-1-1997.

---

4,046,420. U.S.A ABC TECHNOLOGY INC, SALT LAKE CITY, UT. SN 85-085,026. PUB. 1-25-2011, FILED 7-15-2010.



THE MARK CONSISTS OF THE LETTER "B" IN STYLIZED FONT, WITH HORIZONTAL BARS IN THE BODY OF THE LETTER "B" AND WITH THE BOTTOM OF THE BODY OF THE LETTER CURVING AROUND THE LEFT SIDE OF THE LETTER TO END ABOVE THE LETTER.

FOR BUILDING SECURITY SYSTEMS COMPRISING SOFTWARE AND HARDWARE FOR PROVIDING PICTURE, VIDEO, ALARM STATUS, BUILDING PLANS, AND OTHER INFORMATION TO A REMOTE STATION; CAMCORDERS; CLOSED CIRCUIT TV SYSTEMS FOR SECURITY AND SURVEILLANCE, NAMELY, CAMERAS, SWITCHERS, MONITORS, MICROPHONES, AND RECORDERS; COMPUTER HARDWARE FOR IP VIDEO SURVEILLANCE; COMPUTER MONITOR FRAMES; COMPUTER MONITORS; ELECTRIC AND ELECTRONIC VIDEO SURVEILLANCE INSTALLATIONS; ELECTRICAL AND ELECTRONIC BURGLAR ALARMS; ELECTRONIC NOTICE BOARDS; ELECTRONIC VIDEO SURVEILLANCE PRODUCTS, NAMELY, ELECTRONIC COMPONENTS OF SECURITY SYSTEMS; PARTS FOR ANTI-THEFT AUTOMOTIVE ALARMS, NAMELY, ELECTRONIC SENSORS, REMOTE CONTROL TRANSMITTERS AND RECEIVERS FOR REMOTELY OPERATING LAND VEHICLES; THEFT ALARMS; VIDEO RECORDERS (U.S. CLS. 21, 23, 26, 36 AND 38).

FIRST USE 3-28-2009; IN COMMERCE 9-20-2010.

**CLASS 9—(Continued).**

4,046,425. SARCIO GROUP, LLC, KERRVILLE, TX. SN 85-085,998. PUB. 2-15-2011, FILED 7-15-2010.

**IMPROVING THE HUMAN EXPERIENCE**

THE MARK CONSISTS OF STANDARD CHARACTERS WITHOUT CLAIM TO ANY PARTICULAR FONT, STYLE, SIZE, OR COLOR.

FOR ANTI-ANXIETY KIT AND REFILLS THEREFOR FOR USE IN MEDICAL AND DENTAL PROCEDURES, COMPRISED PRIMARILY OF AN MP3 PLAYER PRELOADED WITH BRAINWAVE-ENHANCING RECORDINGS FOR RELAXATION, NOISE-CANCELLING HEADSET, CRANIAL ELECTRONIC STIMULATOR, ANTI-ANXIETY TABLETS, BLACK-OUT EYEGLASSES, EXPLANATORY MATERIALS AND INSTRUCTIONS SOLD AS A UNIT FOR REDUCTION OF PATIENT ANXIETY IN A CLINICAL SETTING (U.S. CLS. 21, 23, 26, 36 AND 38).

FIRST USE 12-0-2009; IN COMMERCE 12-0-2009.

---

4,046,441. SANOMEDICS DEVELOPMENT CORPORATION, MIAMI, FL. SN 85-088,891. PUB. 12-21-2010, FILED 7-20-2010.

**TEMP4SURE**

THE MARK CONSISTS OF STANDARD CHARACTERS WITHOUT CLAIM TO ANY PARTICULAR FONT, STYLE, SIZE, OR COLOR.

FOR INFRA-RED THERMOMETERS (U.S. CLS. 21, 23, 26, 36 AND 38).

FIRST USE 8-9-2011; IN COMMERCE 8-9-2011.

**CLASS 9—(Continued).**

4,046,444. DEPARTMENT OF THE ARMY, WASHINGTON, DC. SN 85-089,334. PUB. 1-4-2011, FILED 7-21-2010.



THE COLOR(S) WHITE, GREY, BLUE AND BROWN IS/ARE CLAIMED AS A FEATURE OF THE MARK.

THE MARK CONSISTS OF AN EQUILATERAL TRIANGLE INSCRIBED IN A REGULAR HEXAGON. THE INTERIOR OF THE TRIANGLE IS DIVIDED INTO THREE EQUAL SECTIONS, ONE WHITE, ONE SHADED LIGHT GREY, AND ONE SHADED DARKER GREY. THE REMAINING INTERIOR SPACES OF THE HEXAGON ARE THREE OBTUSE ISOSCELES TRIANGLES, ONE WITH A PHOTO OF THE SURFACE OF WATER WITH SHADES OF BLUE, ONE WITH A PHOTO OF WHITE CLOUDS IN A BLUE SKY, AND ONE WITH A PHOTO OF SANDY BROWN EARTH.

FOR COMPUTER SOFTWARE FOR ASSESSING ENVIRONMENTAL HEALTH RISKS (U.S. CLS. 21, 23, 26, 36 AND 38).

FIRST USE 8-0-2009; IN COMMERCE 8-0-2009.

---

4,046,446. LEUPOLD & STEVENS, INC., BEAVERTON, OR. SN 85-089,861. PUB. 1-4-2011, FILED 7-21-2010.

# DNA

THE MARK CONSISTS OF STANDARD CHARACTERS WITHOUT CLAIM TO ANY PARTICULAR FONT, STYLE, SIZE, OR COLOR.

FOR LASER RANGEFINDERS; COMPONENTS OF LASER RANGEFINDERS WHICH ENHANCE THEIR ACCURACY, NAMELY, LASER RANGEFINDER ENGINES, COMPRISED PRINCIPALLY OF LASER DIODES, ELECTRIC DIODES, DIGITAL SIGNAL PROCESSORS, SEMICONDUCTORS, AND COMPUTER FIRMWARE FOR CONTROLLING AND PROCESSING LASER RANGEFINDER FUNCTIONS (U.S. CLS. 21, 23, 26, 36 AND 38).

FIRST USE 12-23-2010; IN COMMERCE 12-23-2010.

**CLASS 9—(Continued).**

4,046,461. PERLA, ANTHONY L., DBA EAGLE ZAP TECHNOLOGIES, PORT SAINT LUCIE, FL. AND WONG, HINKMOND B., DBA EAGLE ZAP TECHNOLOGIES, PORT SAINT LUCIE, FL. SN 85-091,186. PUB. 3-22-2011, FILED 7-23-2010.

# EAGLE ZAP

THE MARK CONSISTS OF STANDARD CHARACTERS WITHOUT CLAIM TO ANY PARTICULAR FONT, STYLE, SIZE, OR COLOR.

FOR COMPUTER GAME SOFTWARE; COMPUTER GAME SOFTWARE DOWNLOADABLE FROM A GLOBAL COMPUTER NETWORK; COMPUTER GAME SOFTWARE FOR PERSONAL COMPUTERS AND HOME VIDEO GAME CONSOLES; COMPUTER GAME SOFTWARE FOR USE WITH PERSONAL COMPUTERS, HOME VIDEO GAME CONSOLES USED WITH TELEVISIONS, AND FOR ARCADE-BASED VIDEO GAME CONSOLES; COMPUTER GRAPHICS SOFTWARE; ELECTRONIC GAME PROGRAMS; ELECTRONIC GAME SOFTWARE; ELECTRONIC GAME SOFTWARE FOR CELLULAR TELEPHONES; ELECTRONIC GAME SOFTWARE FOR HANDHELD ELECTRONIC DEVICES; ELECTRONIC GAME SOFTWARE FOR WIRELESS DEVICES; INTERACTIVE GAME SOFTWARE; INTERACTIVE VIDEO GAME PROGRAMS; INTERACTIVE VIDEO GAMES OF VIRTUAL REALITY COMPRISED OF COMPUTER HARDWARE FOR USE WITH AN EXTERNAL MONITOR AND SOFTWARE; VIRTUAL REALITY GAME SOFTWARE (U.S. CLS. 21, 23, 26, 36 AND 38).

FIRST USE 7-24-2010; IN COMMERCE 7-24-2010.

---

4,046,484. CALDWELL, HAMLIN, HUNTSVILLE, AL. SN 85-094,548. PUB. 1-11-2011, FILED 7-28-2010.

# FLY TIES

THE MARK CONSISTS OF STANDARD CHARACTERS WITHOUT CLAIM TO ANY PARTICULAR FONT, STYLE, SIZE, OR COLOR.

FOR EYEGLASS CORDS (U.S. CLS. 21, 23, 26, 36 AND 38).

FIRST USE 5-6-2011; IN COMMERCE 8-4-2011.

**CLASS 9—(Continued).**

4,046,512. INNOCORP, LTD., VERONA, WI. SN 85-098,231. PUB. 1-11-2011, FILED 8-2-2010.

**PHONE CONDOM**

THE MARK CONSISTS OF STANDARD CHARACTERS WITHOUT CLAIM TO ANY PARTICULAR FONT, STYLE, SIZE, OR COLOR.

NO CLAIM IS MADE TO THE EXCLUSIVE RIGHT TO USE "PHONE", APART FROM THE MARK AS SHOWN.

FOR CARRYING CASES FOR CELL PHONES AND PORTABLE MEDIA PLAYERS (U.S. CLS. 21, 23, 26, 36 AND 38).

FIRST USE 9-1-2010; IN COMMERCE 9-1-2010.

4,046,526. AINSWORTH GAME TECHNOLOGY LIMITED, NEWINGTON, AUSTRALIA. SN 85-099,565. PUB. 1-18-2011, FILED 8-4-2010.

**Panda King**

THE MARK CONSISTS OF STANDARD CHARACTERS WITHOUT CLAIM TO ANY PARTICULAR FONT, STYLE, SIZE, OR COLOR.

FOR COMPUTER SOFTWARE AND FIRMWARE FOR GAMES OF CHANCE ON ANY COMPUTERIZED PLATFORM, INCLUDING DEDICATED GAMING CONSOLES, VIDEO BASED SLOT MACHINES, REEL BASED SLOT MACHINES, AND VIDEO LOTTERY TERMINALS (U.S. CLS. 21, 23, 26, 36 AND 38).

FIRST USE 8-15-2011; IN COMMERCE 8-15-2011.

4,046,530. MIDWEST INSTRUMENT CO., INC., HARTLAND, WI. SN 85-099,705. PUB. 1-18-2011, FILED 8-4-2010.



OWNER OF U.S. REG. NOS. 1,742,933, 2,594,222, AND OTHERS.

NO CLAIM IS MADE TO THE EXCLUSIVE RIGHT TO USE "GROUP" AND "WIRELESS HARDWARE SYSTEM", APART FROM THE MARK AS SHOWN.

**CLASS 9—(Continued).**

THE MARK CONSISTS OF STYLIZED LETTER M OVERLAID WITH A REPRESENTATION OF AN ATOMIC MODEL TO THE RIGHT OF WHICH "MINCO" AND "GROUP" ARE VERTICALLY STACKED. WITH THE LETTER I IN "MINCO" REPRESENTED BY AN ANTENNA SIGNAL AND "GROUP" CONTAINED WITHIN A PARTIALLY SHADED RECTANGLE. CENTERED BELOW APPEAR "WIRELESS HARDWARE" ON THE FIRST LINE AND "SYSTEM" ON THE SECOND.

FOR MOLTEN METAL PROCESSING EQUIPMENT FOR USE IN METALLURGICAL APPLICATIONS, PARTICULARLY STEELMAKING, NAMELY, COMPUTER HARDWARE AND SOFTWARE INCORPORATING WIRELESS COMMUNICATION DEVICES FOR TRANSMITTING DATA, IMMERSIBLE LANCES, PROBES AND SAMPLING PROBES IN THE NATURE OF ELECTRIC SENSORS, THERMOCOUPLES, TRANSMITTERS OF ELECTRIC SIGNALS AND READOUT DISPLAY MONITORS FOR THE OBTAINED MEASUREMENTS, ALL FOR MEASURING CONTENT WITHIN THE MOLTEN METAL OF ITS COMPOSITION AND/OR IMPURITIES, INCLUDING CARBON OR GASEOUS COMPONENTS SUCH AS HYDROGEN, OXYGEN, NITROGEN, AND FOR STATUS OF THE MOLTEN METAL AND MEASURING THE RATE OF MOVEMENT OF MATERIALS THROUGH THE PROCESSING EQUIPMENT (U.S. CLS. 21, 23, 26, 36 AND 38).

FIRST USE 4-7-2011; IN COMMERCE 4-7-2011.

4,046,534. MEDISERVE INFORMATION SYSTEMS, INC., CHANDLER, AZ. SN 85-100,405. PUB. 1-25-2011, FILED 8-4-2010.

**MEDISERVE ACHIEVE**

THE MARK CONSISTS OF STANDARD CHARACTERS WITHOUT CLAIM TO ANY PARTICULAR FONT, STYLE, SIZE, OR COLOR.

OWNER OF U.S. REG. NOS. 3,223,872 AND 3,508,523.

FOR CLINICAL AND MANAGERIAL SOFTWARE FOR USE BY HEALTHCARE ORGANIZATIONS TO CAPTURE AND MANAGE PATIENT AND HOSPITAL DATA, PERFORM OUTCOME ANALYSIS AND PROVIDE DECISION SUPPORT (U.S. CLS. 21, 23, 26, 36 AND 38).

FIRST USE 8-22-2011; IN COMMERCE 8-22-2011.

4,046,536. CHEVRON INTELLECTUAL PROPERTY LLC, SAN RAMON, CA. SN 85-100,728. PUB. 4-26-2011, FILED 8-5-2010.

**NEXT\***

THE MARK CONSISTS OF STANDARD CHARACTERS WITHOUT CLAIM TO ANY PARTICULAR FONT, STYLE, SIZE, OR COLOR.

**CLASS 9—(Continued).**

OWNER OF U.S. REG. NO. 3,801,225.

FOR ELECTRONIC PUBLICATIONS, NAMELY, DOWNLOADABLE E-ZINES AND ELECTRONIC MAGAZINES IN THE FIELD OF ENERGY, ENERGY COMPANIES AND ENERGY TECHNOLOGY (U.S. CLS. 21, 23, 26, 36 AND 38).

FIRST USE 9-30-2008; IN COMMERCE 9-30-2008.

---

4,046,547. BRIDGESTOR, LLC, POWAY, CA. SN 85-101,866. PUB. 1-18-2011, FILED 8-6-2010.

# Bridgestor

THE MARK CONSISTS OF STANDARD CHARACTERS WITHOUT CLAIM TO ANY PARTICULAR FONT, STYLE, SIZE, OR COLOR.

FOR COMPUTER FIRMWARE FOR OPERATING SYSTEM PROGRAMS, NAMELY, FOR SYSTEM VIRTUAL MACHINES PROVIDING PLATFORMS WHICH SUPPORT THE EXECUTION OF A COMPLETE OPERATING SYSTEM; COMPUTER HARDWARE AND COMPUTER PERIPHERAL DEVICES; COMPUTER HARDWARE FOR UPLOAD, STORAGE, RETRIEVAL, DOWNLOAD, TRANSMISSION AND DELIVERY OF DIGITAL CONTENT; COMPUTER MEMORY HARDWARE; COMPUTER PROGRAMS FOR CONNECTING REMOTELY TO COMPUTERS OR COMPUTER NETWORKS; COMPUTER SOFTWARE FOR ENCRYPTION, DECRYPTION, COMPRESSION AND ELIMINATION OF DUPLICATE AND REDUNDANT DATA, FOR COMPRESSION OF DIGITAL FILES, INCLUDING AUDIO, VIDEO, TEXT, BINARY, STILL IMAGES, GRAPHICS, AND MULTIMEDIA FILES, AND FOR OPERATING SYSTEM PROGRAMS, NAMELY, FOR SYSTEM VIRTUAL MACHINES PROVIDING PLATFORMS WHICH SUPPORT THE EXECUTION OF A COMPLETE OPERATING SYSTEM (U.S. CLS. 21, 23, 26, 36 AND 38).

FIRST USE 11-30-2010; IN COMMERCE 11-30-2010.

---

4,046,556. NUVOTON TECHNOLOGY CORPORATION, HSINCHU SCIENCE PARK, TAIWAN. SN 85-103,728. PUB. 1-25-2011, FILED 8-10-2010.

# NuMicro M058

THE MARK CONSISTS OF THE WORDS "NUMICRO M058".

**CLASS 9—(Continued).**

THE WORDING "NUMICRO" HAS NO MEANING IN A FOREIGN LANGUAGE.

FOR CENTRAL PROCESSING UNITS (CPU); COMPUTER CHIPS; COMPUTER MEMORIES; DATA PROCESSORS; ELECTRONIC CHIPS FOR THE MANUFACTURE OF INTEGRATED CIRCUITS; ELECTRONIC INTEGRATED CIRCUITS; INTEGRATED CIRCUIT MODULES; INTEGRATED CIRCUITS; INTEGRATED CIRCUITS, INTEGRATED CIRCUIT CHIPS, AND INTEGRATED CIRCUIT MODULES FOR DIGITAL VIDEO COMPRESSION AND DECOMPRESSION; INTEGRATED CIRCUITS, INTEGRATED CIRCUIT CHIPS, AND INTEGRATED CIRCUIT MODULES FOR ENCODING AND DECODING DIGITAL VIDEO; INTERFACE CARDS FOR DATA PROCESSING EQUIPMENT IN THE FORM OF PRINTED CIRCUITS; MEMORY CARDS; MICRO-PROCESSORS; MICROCHIPS; MICROCOMPUTERS; MICRO-PROCESSORS; PRINTED CIRCUITS; SEMICONDUCTORS; SEMICONDUCTOR CHIPS; SEMICONDUCTOR DEVICES; SEMICONDUCTORS; SENSOR CHIPS FOR SCIENTIFIC USE; SILICON CHIPS; SILICON WAFERS; TIME RECORDING APPARATUS (U.S. CLS. 21, 23, 26, 36 AND 38).

FIRST USE 9-1-2010; IN COMMERCE 1-1-2011.

---

4,046,572. GRAND VISION GAMING, LLC, BILLINGS, MT. SN 85-109,008. PUB. 2-1-2011, FILED 8-17-2010.

# JUNGLE TREASURE

THE MARK CONSISTS OF STANDARD CHARACTERS WITHOUT CLAIM TO ANY PARTICULAR FONT, STYLE, SIZE, OR COLOR.

FOR GAMING MACHINES (U.S. CLS. 21, 23, 26, 36 AND 38).

FIRST USE 11-2-2010; IN COMMERCE 11-2-2010.

---

4,046,590. NOVA GAMING, LLC, GREENVILLE, SC. SN 85-111,940. PUB. 1-11-2011, FILED 8-20-2010.

# FROG ON IT!

THE MARK CONSISTS OF STANDARD CHARACTERS WITHOUT CLAIM TO ANY PARTICULAR FONT, STYLE, SIZE, OR COLOR.

FOR GAMING MACHINES, NAMELY, DEVICES WHICH ACCEPT A WAGER (U.S. CLS. 21, 23, 26, 36 AND 38).

FIRST USE 12-11-2010; IN COMMERCE 12-11-2010.



**CLASS 9—(Continued).**

4,046,601. MATRIX NETWORK, INC., COPPELL, TX. SN 85-114,567. PUB. 2-8-2011, FILED 8-24-2010.

**ATVISION PRO**

THE MARK CONSISTS OF STANDARD CHARACTERS WITHOUT CLAIM TO ANY PARTICULAR FONT, STYLE, SIZE, OR COLOR.

OWNER OF U.S. REG. NOS. 2,222,578 AND 3,615,664.

NO CLAIM IS MADE TO THE EXCLUSIVE RIGHT TO USE "PRO", APART FROM THE MARK AS SHOWN.

FOR DIGITAL VIDEO RECORDING SOFTWARE AND EQUIPMENT, NAMELY, APPARATUS FOR RECORDING, TRANSMISSION, PROCESSING AND REPRODUCTION OF SOUND, IMAGES OR DATA (U.S. CLS. 21, 23, 26, 36 AND 38).

FIRST USE 11-5-2010; IN COMMERCE 11-5-2010.

**CLASS 9—(Continued).**

4,046,647. A10 NETWORKS, INC., SAN JOSE, CA. SN 85-122,764. PUB. 12-7-2010, FILED 9-3-2010.

**aFlow**

THE MARK CONSISTS OF STANDARD CHARACTERS WITHOUT CLAIM TO ANY PARTICULAR FONT, STYLE, SIZE, OR COLOR.

FOR COMPUTER HARDWARE; COMPUTER SOFTWARE FOR USE IN INFORMATION FLOW-CONTROLLING, SECURING, ACCELERATING, MONITORING, AND MANAGING COMPUTER NETWORK TRAFFIC AND APPLICATIONS COMMUNICATING ACROSS NETWORKS (U.S. CLS. 21, 23, 26, 36 AND 38).

FIRST USE 7-22-2011; IN COMMERCE 7-22-2011.

4,046,627. DARK FIELD TECHNOLOGIES, INC., ORANGE, CT. SN 85-119,710. PUB. 3-29-2011, FILED 8-31-2010.

**NXTGEN**

THE MARK CONSISTS OF STANDARD CHARACTERS WITHOUT CLAIM TO ANY PARTICULAR FONT, STYLE, SIZE, OR COLOR.

FOR INSPECTION SYSTEM FOR DETECTION OF VISUAL DEFECTS IN WEB AND SHEET PROCESSES COMPRISED OF LASERS NOT FOR MEDICAL PURPOSES, LINE SCAN CAMERAS, BROADBAND ILLUMINATORS, COMPUTER HARDWARE AND SOFTWARE (U.S. CLS. 21, 23, 26, 36 AND 38).

FIRST USE 2-13-2009; IN COMMERCE 2-13-2009.

4,046,660. VERIMATRIX, INC., SAN DIEGO, CA. SN 85-125,409. PUB. 2-15-2011, FILED 9-8-2010.

**StreamMark**

THE MARK CONSISTS OF STANDARD CHARACTERS WITHOUT CLAIM TO ANY PARTICULAR FONT, STYLE, SIZE, OR COLOR.

FOR SOFTWARE FOR AUTOMATING A PROCESS FOR AUTHENTICATION AND IDENTIFICATION OF DIGITAL AUDIO AND VIDEO MEDIA FOR SECURITY PURPOSES (U.S. CLS. 21, 23, 26, 36 AND 38).

FIRST USE 1-12-2011; IN COMMERCE 1-12-2011.

4,046,628. NEW MILLENNIUM BUILDING SYSTEMS, LLC, FORT WAYNE, IN. SN 85-119,857. PUB. 2-15-2011, FILED 8-31-2010.

**DYNAMIC JOIST**

THE MARK CONSISTS OF STANDARD CHARACTERS WITHOUT CLAIM TO ANY PARTICULAR FONT, STYLE, SIZE, OR COLOR.

NO CLAIM IS MADE TO THE EXCLUSIVE RIGHT TO USE "JOIST", APART FROM THE MARK AS SHOWN.

FOR COMPUTER SOFTWARE FOR DESIGNING, DRAWING AND 3-D GRAPHIC MODELING OF JOISTS IN BUILDING CONSTRUCTION PLANS (U.S. CLS. 21, 23, 26, 36 AND 38).

FIRST USE 9-14-2010; IN COMMERCE 9-14-2010.

4,046,662. BIONIC TRADER SYSTEMS, LLC, CHICAGO, IL. SN 85-127,012. PUB. 4-26-2011, FILED 9-10-2010.

**KEYBOARD TRADER**

THE MARK CONSISTS OF STANDARD CHARACTERS WITHOUT CLAIM TO ANY PARTICULAR FONT, STYLE, SIZE, OR COLOR.

NO CLAIM IS MADE TO THE EXCLUSIVE RIGHT TO USE "KEYBOARD", APART FROM THE MARK AS SHOWN.

FOR KEYBOARDS (U.S. CLS. 21, 23, 26, 36 AND 38).

FIRST USE 10-15-2010; IN COMMERCE 8-11-2011.

**CLASS 9—(Continued).**

4,046,665. GRAND VISION GAMING, LLC, BILLINGS, MT.  
SN 85-127,716. PUB. 2-1-2011, FILED 9-12-2010.

**CLASS 9—(Continued).**

4,046,689. ARISTOCRAT TECHNOLOGIES AUSTRALIA PTY  
LTD., NORTH RYDE, NSW, AUSTRALIA. SN 85-131,263.  
PUB. 2-15-2011, FILED 9-16-2010.

**SITTING DUCKS**

THE MARK CONSISTS OF STANDARD CHARACTERS  
WITHOUT CLAIM TO ANY PARTICULAR FONT, STYLE,  
SIZE, OR COLOR.

FOR GAMING MACHINES (U.S. CLS. 21, 23, 26, 36  
AND 38).

FIRST USE 11-2-2010; IN COMMERCE 11-2-2010.

**CAPTAIN CUTTHROAT**

THE MARK CONSISTS OF STANDARD CHARACTERS  
WITHOUT CLAIM TO ANY PARTICULAR FONT, STYLE,  
SIZE, OR COLOR.

THE NAME(S), PORTRAIT(S), AND/OR SIGNATURE(S)  
SHOWN IN THE MARK DOES NOT IDENTIFY A PARTI-  
CULAR LIVING INDIVIDUAL.

FOR ELECTRONIC GAMING MACHINES, NAMELY,  
DEVICES WHICH ACCEPT A WAGER (U.S. CLS. 21, 23,  
26, 36 AND 38).

FIRST USE 7-1-2011; IN COMMERCE 7-1-2011.

4,046,671. DISNEY ENTERPRISES, INC., BURBANK, CA. SN  
85-128,582. PUB. 1-11-2011, FILED 9-13-2010.

**TOYHOPPER**

THE MARK CONSISTS OF STANDARD CHARACTERS  
WITHOUT CLAIM TO ANY PARTICULAR FONT, STYLE,  
SIZE, OR COLOR.

FOR COMPUTER APPLICATION SOFTWARE FOR  
MOBILE PHONES AND HANDHELD COMPUTERS,  
NAMELY, SOFTWARE FOR SUGGESTING TO USERS  
TOYS TO BE CONSIDERED AS OPTIONS TO GIVE AS  
GIFTS (U.S. CLS. 21, 23, 26, 36 AND 38).

FIRST USE 10-31-2010; IN COMMERCE 10-31-2010.

4,046,690. ARISTOCRAT TECHNOLOGIES AUSTRALIA PTY  
LTD., NORTH RYDE, NSW, AUSTRALIA. SN 85-131,299.  
PUB. 2-15-2011, FILED 9-16-2010.

4,046,675. ECO LIGHTING LLC, MIAMI, FL. SN 85-129,357.  
PUB. 3-15-2011, FILED 9-14-2010.

**LUXADD**

THE MARK CONSISTS OF STANDARD CHARACTERS  
WITHOUT CLAIM TO ANY PARTICULAR FONT, STYLE,  
SIZE, OR COLOR.

THE WORDING "LUXADD" HAS NO MEANING IN A  
FOREIGN LANGUAGE.

FOR FLUORESCENT LAMP ADAPTERS AND BAL-  
LASTS, NAMELY, ADAPTERS CONVERTING MAG-  
NETIC LAMP BALLASTS TO ELECTRONIC LAMP  
BALLASTS INCLUDING T12 AND T8 LIGHTING FIX-  
TURES INTO T5 LIGHTING FIXTURES (U.S. CLS. 21, 23,  
26, 36 AND 38).

FIRST USE 2-3-2011; IN COMMERCE 3-11-2011.

**WIN YOUR WAY**

THE MARK CONSISTS OF STANDARD CHARACTERS  
WITHOUT CLAIM TO ANY PARTICULAR FONT, STYLE,  
SIZE, OR COLOR.

FOR ELECTRONIC GAMING MACHINES, NAMELY,  
DEVICES WHICH ACCEPT A WAGER (U.S. CLS. 21, 23,  
26, 36 AND 38).

FIRST USE 7-1-2011; IN COMMERCE 7-1-2011.

**CLASS 9—(Continued).**

4,046,698. LI SI YANG, HONOLULU, HI. SN 85-133,473. PUB. 1-11-2011, FILED 9-20-2010.



THE MARK CONSISTS OF AN UNEVEN, SINGLE LINE SQUARE BORDER. THE SQUARE BECOMES INTERMITTENT ON THE RIGHT SIDE NEARING THE LOWER RIGHT HAND CORNER. IN THE SQUARE IS A PARTIALLY OBSTRUCTED SUN WITH DETACHED RAYS OF ALTERNATING LENGTHS. THE SUN IS PARTIALLY OBSTRUCTED AT AN ANGLE BY STYLIZED LINES INDICATING WATER.

FOR DVDS FEATURING PHYSICAL FITNESS INSTRUCTIONS, EXERCISE HOW-TO (U.S. CLS. 21, 23, 26, 36 AND 38).

FIRST USE 2-10-2011; IN COMMERCE 2-10-2011.

4,046,730. BROCADE COMMUNICATIONS SYSTEMS, INC., SAN JOSE, CA. SN 85-141,454. PUB. 5-17-2011, FILED 9-29-2010.

# VDX

THE MARK CONSISTS OF STANDARD CHARACTERS WITHOUT CLAIM TO ANY PARTICULAR FONT, STYLE, SIZE, OR COLOR.

FOR COMPUTER SOFTWARE USED TO OPTIMIZE NETWORK CLOUDS AND VIRTUALIZED DATA CENTERS; COMPUTER HARDWARE FOR USE IN COMPUTER NETWORKS, NAMELY, ROUTERS, BACKBONES, SWITCHES, ACCESS POINTS AND CONTROLLERS (U.S. CLS. 21, 23, 26, 36 AND 38).

FIRST USE 11-1-2010; IN COMMERCE 11-1-2010.

**CLASS 9—(Continued).**

4,046,746. MASTERGUARD, LP, COPPELL, TX. SN 85-144,669. PUB. 3-15-2011, FILED 10-4-2010.

# PYROTEX

THE MARK CONSISTS OF STANDARD CHARACTERS WITHOUT CLAIM TO ANY PARTICULAR FONT, STYLE, SIZE, OR COLOR.

FOR FIRE EXTINGUISHERS (U.S. CLS. 21, 23, 26, 36 AND 38).

FIRST USE 8-0-2011; IN COMMERCE 8-0-2011.

4,046,751. INTERNATIONAL DATA GROUP, INC., FRAMINGHAM, MA. SN 85-147,115. PUB. 5-17-2011, FILED 10-7-2010.

# MACWORLD DAILY READER

THE MARK CONSISTS OF STANDARD CHARACTERS WITHOUT CLAIM TO ANY PARTICULAR FONT, STYLE, SIZE, OR COLOR.

OWNER OF U.S. REG. NOS. 1,427,411, 1,873,845, AND OTHERS.

NO CLAIM IS MADE TO THE EXCLUSIVE RIGHT TO USE "DAILY READER", APART FROM THE MARK AS SHOWN.

FOR DOWNLOADABLE SOFTWARE THAT ALLOWS USERS TO ACCESS NON-DOWNLOADABLE AND DOWNLOADABLE MAGAZINE ARTICLES AND CONTENT IN THE FIELDS OF COMPUTERS, COMPUTER SOFTWARE, HIGH TECHNOLOGY, INFORMATION TECHNOLOGY, ONLINE SERVICES OF OTHERS, TELECOMMUNICATIONS, COMMUNICATIONS, INFORMATION SERVICES OF OTHERS AND INTERACTIVE ENTERTAINMENT (U.S. CLS. 21, 23, 26, 36 AND 38).

FIRST USE 1-25-2011; IN COMMERCE 1-25-2011.

4,046,773. CROWDSTAR INTERNATIONAL LIMITED, BLACKROCK, CO. DUBLIN, IRELAND. SN 85-154,689. PUB. 5-3-2011, FILED 10-18-2010.

# CROWDSTAR'S IT GIRL

THE MARK CONSISTS OF STANDARD CHARACTERS WITHOUT CLAIM TO ANY PARTICULAR FONT, STYLE, SIZE, OR COLOR.

**CLASS 9—(Continued).**

OWNER OF U.S. REG. NOS. 3,800,884 AND 3,885,298.

FOR DOWNLOADABLE COMPUTER GAME SOFTWARE FOR USE ON WIRELESS DEVICES AND COMPUTERS; COMPUTER-GAME SOFTWARE, VIDEO GAME SOFTWARE, AND COMPUTER GAME APPLICATION SOFTWARE; INTERACTIVE-VIDEO-GAME PROGRAMS; ELECTRONIC GAME SOFTWARE AND ELECTRONIC GAME APPLICATION SOFTWARE THAT MAY BE ACCESSED VIA THE INTERNET, COMPUTERS AND WIRELESS DEVICES (U.S. CLS. 21, 23, 26, 36 AND 38).

FIRST USE 3-8-2011; IN COMMERCE 3-8-2011.

4,046,794. SHUFFLE MASTER AUSTRALASIA PTY LIMITED, MILPERRA NSW, AUSTRALIA. SN 85-158,518. PUB. 4-5-2011, FILED 10-21-2010.



THE MARK CONSISTS OF A JESTER'S HAT.

FOR HARDWARE AND SOFTWARE FOR INCORPORATING A BONUS FEATURE IN A GAMING MACHINE WITH OR WITHOUT VIDEO OUTPUT, HARDWARE AND SOFTWARE FOR PROVIDING A BONUSING SYSTEM FOR LINKED GAMING MACHINES (U.S. CLS. 21, 23, 26, 36 AND 38).

FIRST USE 9-24-2008; IN COMMERCE 11-19-2009.

4,046,800. VISUALCUE TECHNOLOGIES, LLC, MELBOURNE, FL. SN 85-160,327. PUB. 6-7-2011, FILED 10-25-2010.

**THE ART OF BUSINESS INTELLIGENCE**

THE MARK CONSISTS OF STANDARD CHARACTERS WITHOUT CLAIM TO ANY PARTICULAR FONT, STYLE, SIZE, OR COLOR.

NO CLAIM IS MADE TO THE EXCLUSIVE RIGHT TO USE "BUSINESS INTELLIGENCE", APART FROM THE MARK AS SHOWN.

FOR DATA VISUALIZATION BUSINESS COMPUTER SOFTWARE FOR THE REPRESENTATION OF DATA VIA GRAPHICAL IMAGES, ICONS, AND OTHER SYMBOL BASED METHODS, NAMELY, SOFTWARE FOR DATA ANALYSIS IN THE FIELD OF BUSINESS MANAGEMENT (U.S. CLS. 21, 23, 26, 36 AND 38).

FIRST USE 10-27-2010; IN COMMERCE 10-27-2010.

**CLASS 9—(Continued).**

4,046,809. KABUSHIKI KAISHA SQUARE ENIX, TA SQUARE ENIX CO., LTD., TOKYO, JAPAN. SN 85-163,294. PUB. 3-15-2011, FILED 10-28-2010.

**DUODECIM PROLOGUS**

THE MARK CONSISTS OF STANDARD CHARACTERS WITHOUT CLAIM TO ANY PARTICULAR FONT, STYLE, SIZE, OR COLOR.

FOR COMPUTER GAME SOFTWARE; VIDEO GAME SOFTWARE (U.S. CLS. 21, 23, 26, 36 AND 38).

FIRST USE 1-18-2011; IN COMMERCE 3-15-2011.

4,046,817. BALLY GAMING, INC., DBA BALLY TECHNOLOGIES, LAS VEGAS, NV. SN 85-164,929. PUB. 3-15-2011, FILED 10-29-2010.

**TIGER TREASURES**

THE MARK CONSISTS OF STANDARD CHARACTERS WITHOUT CLAIM TO ANY PARTICULAR FONT, STYLE, SIZE, OR COLOR.

FOR COMPUTER GAMING SOFTWARE; GAMING SOFTWARE THAT GENERATES OR DISPLAYS WAGER OUTCOMES OF GAMING MACHINES; DOWNLOADABLE COMPUTER GAME SOFTWARE FOR GAMING; GAMING MACHINES, NAMELY, DEVICES THAT ACCEPT A WAGER; SLOT MACHINES (U.S. CLS. 21, 23, 26, 36 AND 38).

FIRST USE 8-1-2011; IN COMMERCE 8-1-2011.

4,046,824. ALPHAVISTA SERVICES, INC., SUNNYVALE, CA. SN 85-166,708. PUB. 5-3-2011, FILED 11-2-2010.

**CEEK12**

THE MARK CONSISTS OF STANDARD CHARACTERS WITHOUT CLAIM TO ANY PARTICULAR FONT, STYLE, SIZE, OR COLOR.

FOR EDUCATIONAL SOFTWARE FOR CHILDREN (U.S. CLS. 21, 23, 26, 36 AND 38).

FIRST USE 8-1-2011; IN COMMERCE 8-1-2011.

**CLASS 9—(Continued).**

4,046,852. GOINS, JERAY, NEWPORT BEACH, CA. SN 85-180,416. PUB. 4-12-2011, FILED 11-18-2010.



THE MARK CONSISTS OF THE STYLIZED TEXT "VI".  
FOR DVDS FEATURING EXERCISE (U.S. CLS. 21, 23,  
26, 36 AND 38).  
FIRST USE 10-10-2010; IN COMMERCE 6-7-2011.

4,046,853. RAMSEY, DAVID, SAN FRANCISCO, CA. SN 85-180,434. PUB. 4-5-2011, FILED 11-18-2010.

**APPOINTBOOK**

THE MARK CONSISTS OF STANDARD CHARACTERS  
WITHOUT CLAIM TO ANY PARTICULAR FONT, STYLE,  
SIZE, OR COLOR.

FOR COMPUTER APPLICATION SOFTWARE FOR  
MOBILE PHONES, NAMELY, SOFTWARE FOR USERS  
TO SEARCH AND MANAGE PERSONAL AND PROFESSIONAL  
SCHEDULING, MARKETING, PROMOTIONS,  
AND CLIENTS ONLINE FROM THEIR MOBILE  
PHONES; COMPUTER APPLICATION SOFTWARE FOR  
COMPUTERS, NAMELY, SOFTWARE FOR USERS TO  
SEARCH AND MANAGE PERSONAL AND PROFESSIONAL  
SCHEDULING, MARKETING, PROMOTIONS,  
AND CLIENTS ONLINE FROM THEIR COMPUTERS  
(U.S. CLS. 21, 23, 26, 36 AND 38).

FIRST USE 1-15-2011; IN COMMERCE 1-15-2011.

4,046,892. DONOHOO, RUSTY S, BURLINGTON, KY. SN 85-191,975. PUB. 5-17-2011, FILED 12-7-2010.

**CodeKase**

THE MARK CONSISTS OF STANDARD CHARACTERS  
WITHOUT CLAIM TO ANY PARTICULAR FONT, STYLE,  
SIZE, OR COLOR.

FOR ELECTRONIC LCD ADVERTISEMENT DISPLAY  
UNIT USED FOR PROMOTIONS TO AUTO DEALERSHIPS  
AND CASINOS (U.S. CLS. 21, 23, 26, 36 AND 38).  
FIRST USE 6-1-2011; IN COMMERCE 6-1-2011.

**CLASS 9—(Continued).**

4,046,930. SCHOLASTIC INC., NEW YORK, NY. SN 85-202,535. PUB. 5-3-2011, FILED 12-21-2010.

**TOUCH & TILT**

THE MARK CONSISTS OF STANDARD CHARACTERS  
WITHOUT CLAIM TO ANY PARTICULAR FONT, STYLE,  
SIZE, OR COLOR.

FOR ELECTRONIC PUBLICATIONS, NAMELY,  
BOOKS FOR CHILDREN IN THE FIELD OF READING  
IMPROVEMENT RECORDED ON COMPUTER MEDIA  
(U.S. CLS. 21, 23, 26, 36 AND 38).

FIRST USE 1-3-2011; IN COMMERCE 1-3-2011.

4,046,931. SCHOLASTIC INC., NEW YORK, NY. SN 85-202,543. PUB. 5-3-2011, FILED 12-21-2010.



THE MARK CONSISTS OF THE WORD "TOUCH" IN  
STYLIZED LETTERING, UNDERNEATH WHICH IS A  
STYLIZED "&" WITHIN A CIRCLE, BOTH OF WHICH  
ARE WITHIN A ROUNDED SHAPE, AND BELOW WHICH  
IS THE WORD "TILT" IN STYLIZED LETTERING,  
LOCATED WITHIN A DESIGN OF A SIGN.

FOR ELECTRONIC PUBLICATIONS, NAMELY,  
BOOKS FOR CHILDREN IN THE FIELD OF READING  
IMPROVEMENT RECORDED ON COMPUTER MEDIA  
(U.S. CLS. 21, 23, 26, 36 AND 38).

FIRST USE 7-27-2011; IN COMMERCE 7-27-2011.

**CLASS 9—(Continued).**

4,046,939. ECOMASTER TECHNOLOGY CORPORATION, TAOYUAN, TAIWAN. SN 85-205,603. PUB. 5-24-2011, FILED 12-24-2010.

# LEPA

THE MARK CONSISTS OF STANDARD CHARACTERS WITHOUT CLAIM TO ANY PARTICULAR FONT, STYLE, SIZE, OR COLOR.

FOR COMPUTER PERIPHERAL DEVICES; INTERNAL COOLING FANS FOR COMPUTERS; INTERNAL COOLING FANS FOR ELECTRONIC COMPONENTS; INTERNAL COOLING FANS FOR POWER SUPPLIES; CENTRAL PROCESSING UNIT (CPU) FANS; UNINTERRUPTIBLE ELECTRICAL POWER SUPPLIES; ELECTRICAL POWER SUPPLIES (U.S. CLS. 21, 23, 26, 36 AND 38).  
FIRST USE 11-29-2010; IN COMMERCE 11-29-2010.

---

4,046,946. AKER WADE POWER TECHNOLOGIES, LLC, CHARLOTTESVILLE, VA. SN 85-208,149. PUB. 5-17-2011, FILED 12-30-2010.

# EMAX HF

THE MARK CONSISTS OF STANDARD CHARACTERS WITHOUT CLAIM TO ANY PARTICULAR FONT, STYLE, SIZE, OR COLOR.

NO CLAIM IS MADE TO THE EXCLUSIVE RIGHT TO USE "HF", APART FROM THE MARK AS SHOWN.  
FOR BATTERY CHARGERS; CHARGERS FOR ELECTRIC VEHICLE BATTERIES (U.S. CLS. 21, 23, 26, 36 AND 38).

FIRST USE 9-1-2011; IN COMMERCE 9-1-2011.

---

4,046,950. JUNE TAILOR, INC., RICHFIELD, WI. SN 85-208,980. PUB. 5-24-2011, FILED 1-3-2011.

# PINTASTIC

THE MARK CONSISTS OF STANDARD CHARACTERS WITHOUT CLAIM TO ANY PARTICULAR FONT, STYLE, SIZE, OR COLOR.

FOR BATTERY-OPERATED SEWING PIN DISPENSERS (U.S. CLS. 21, 23, 26, 36 AND 38).

FIRST USE 4-30-2011; IN COMMERCE 4-30-2011.

**CLASS 9—(Continued).**

4,046,953. JACK SHOCKLEE, SPRING HILL, TN. SN 85-209,792. PUB. 5-24-2011, FILED 1-4-2011.

# SHAE SHOC

THE MARK CONSISTS OF STANDARD CHARACTERS WITHOUT CLAIM TO ANY PARTICULAR FONT, STYLE, SIZE, OR COLOR.

FOR AUDIO AND VIDEO RECORDINGS FEATURING MUSIC AND ARTISTIC PERFORMANCES; AUDIO TAPES FEATURING MUSIC; COMPACT DISCS FEATURING MUSIC; DIGITAL MUSIC DOWNLOADABLE FROM THE INTERNET; DOWNLOADABLE MUSICAL SOUND RECORDINGS; DOWNLOADABLE RING TONES, GRAPHICS AND MUSIC VIA A GLOBAL COMPUTER NETWORK AND WIRELESS DEVICES; DOWNLOADABLE VIDEO RECORDINGS FEATURING MUSIC; MUSICAL VIDEO RECORDINGS; PHONOGRAPH RECORDS FEATURING MUSIC; PRERECORDED AUDIO TAPES FEATURING MUSIC; PRERECORDED VIDEO CASSETTES FEATURING MUSIC; PRERECORDED VIDEO TAPES FEATURING MUSIC (U.S. CLS. 21, 23, 26, 36 AND 38).

FIRST USE 7-4-2008; IN COMMERCE 7-4-2008.

---

4,046,991. OLYMPUS CORPORATION, TOKYO, JAPAN. SN 85-216,780. PUB. 4-19-2011, FILED 1-13-2011.

# ILD

THE MARK CONSISTS OF STANDARD CHARACTERS WITHOUT CLAIM TO ANY PARTICULAR FONT, STYLE, SIZE, OR COLOR.

FOR LED LIGHT SOURCES FOR INDUSTRIAL ENDOSCOPES AND FOR MICROSCOPES (U.S. CLS. 21, 23, 26, 36 AND 38).

FIRST USE 11-10-2010; IN COMMERCE 11-10-2010.

**CLASS 9—(Continued).**

4,046,996. TECMO KOEI GAMES CO., LTD., YOKOHAMA, KANAGAWA, JAPAN. SN 85-217,963. PUB. 5-3-2011, FILED 1-14-2011.

WARRIORS; LEGENDS OF TROY

THE MARK CONSISTS OF STANDARD CHARACTERS WITHOUT CLAIM TO ANY PARTICULAR FONT, STYLE, SIZE, OR COLOR.

FOR COMPUTER GAME DISCS; COMPUTER GAME PROGRAMS; COMPUTER GAME SOFTWARE; VIDEO GAME DISCS; VIDEO GAME PROGRAMS; VIDEO GAME SOFTWARE; DOWNLOADABLE COMPUTER GAME SOFTWARE; DOWNLOADABLE VIDEO GAME SOFTWARE (U.S. CLS. 21, 23, 26, 36 AND 38).  
FIRST USE 3-8-2011; IN COMMERCE 3-8-2011.

4,047,026. LIGHTSPEED TECHNOLOGIES, INC., TUALATIN, OR. SN 85-229,100. PUB. 6-14-2011, FILED 1-28-2011.

TOPCAT

THE MARK CONSISTS OF STANDARD CHARACTERS WITHOUT CLAIM TO ANY PARTICULAR FONT, STYLE, SIZE, OR COLOR.

FOR AUDIO AMPLIFICATION SYSTEMS COMPRISED OF A WIRELESS RECEIVER, AMPLIFIER AND A SPEAKER (U.S. CLS. 21, 23, 26, 36 AND 38).  
FIRST USE 6-26-2011; IN COMMERCE 8-18-2011.

4,047,031. NOVATROX AB, STOCKHOLM, SWEDEN. SN 85-230,953. PUB. 6-7-2011, FILED 2-1-2011.

IntelliSlide

THE MARK CONSISTS OF STANDARD CHARACTERS WITHOUT CLAIM TO ANY PARTICULAR FONT, STYLE, SIZE, OR COLOR.

FOR COMPUTER PROGRAMS FOR SEARCHING REMOTELY FOR CONTENT ON COMPUTERS AND COMPUTER NETWORKS (U.S. CLS. 21, 23, 26, 36 AND 38).  
FIRST USE 2-15-2011; IN COMMERCE 2-15-2011.

**CLASS 9—(Continued).**

4,047,048. AMERICA TECHCODE SEMICONDUCTOR, INC., CUPERTINO, CA. SN 85-237,362. PUB. 6-14-2011, FILED 2-8-2011.

Techcode

THE MARK CONSISTS OF STANDARD CHARACTERS WITHOUT CLAIM TO ANY PARTICULAR FONT, STYLE, SIZE, OR COLOR.

FOR INTEGRATED CIRCUIT CHIPS FOR USE IN SEMICONDUCTORS (U.S. CLS. 21, 23, 26, 36 AND 38).  
FIRST USE 1-4-2011; IN COMMERCE 1-4-2011.

4,047,051. SHARAGA, LLOYD, WOODLAND HILLS, CA. SN 85-238,438. PUB. 6-14-2011, FILED 2-9-2011.



THE COLOR(S) GOLD IS/ARE CLAIMED AS A FEATURE OF THE MARK.

THE MARK CONSISTS OF A 3-DIMENSIONAL GOLD SWIRL-POLISHED BACKGROUND HEART, WITH A HIGHLY-POLISHED 3-DIMENSIONAL GOLD EIGHT-NOTE POSITIONED VERTICALLY DOWN THE MIDDLE OF THE HEART, SEEMINGLY FLOATING ABOVE THE HEART.

FOR AUDIO RECORDINGS FEATURING MUSIC (U.S. CLS. 21, 23, 26, 36 AND 38).  
FIRST USE 5-15-2011; IN COMMERCE 5-15-2011.

**CLASS 9—(Continued).**

4,047,055. 4SIGHT SUNGLASSES, LLC, SAN FRANCISCO, CA. SN 85-239,614. PUB. 6-21-2011, FILED 2-11-2011.

# 4SIGHT

THE MARK CONSISTS OF STANDARD CHARACTERS WITHOUT CLAIM TO ANY PARTICULAR FONT, STYLE, SIZE, OR COLOR.

FOR SUNGLASSES (U.S. CLS. 21, 23, 26, 36 AND 38).  
FIRST USE 10-1-2010; IN COMMERCE 4-28-2011.

4,047,070. 745 LLC, BOSTON, MA. SN 85-250,692. PUB. 7-19-2011, FILED 2-24-2011.

# BEAT POP

THE MARK CONSISTS OF STANDARD CHARACTERS WITHOUT CLAIM TO ANY PARTICULAR FONT, STYLE, SIZE, OR COLOR.

FOR COMPUTER GAME SOFTWARE; COMPUTER GAME SOFTWARE FOR MOBILE DEVICES; COMPUTER GAME SOFTWARE DOWNLOADABLE TO WIRELESS DEVICES; COMPUTER GAME SOFTWARE DOWNLOADABLE VIA A GLOBAL COMPUTER NETWORK (U.S. CLS. 21, 23, 26, 36 AND 38).

FIRST USE 4-30-2011; IN COMMERCE 4-30-2011.

4,047,083. BEAR-ECO TECHNOLOGIES, LLC, BRISTOW, VA. SN 85-280,794. PUB. 7-19-2011, FILED 3-30-2011.

# Pirate Ph.D.

THE MARK CONSISTS OF STANDARD CHARACTERS WITHOUT CLAIM TO ANY PARTICULAR FONT, STYLE, SIZE, OR COLOR.

NO CLAIM IS MADE TO THE EXCLUSIVE RIGHT TO USE "PIRATE", APART FROM THE MARK AS SHOWN.

FOR CHILDREN'S EDUCATIONAL SOFTWARE (U.S. CLS. 21, 23, 26, 36 AND 38).

FIRST USE 9-12-2011; IN COMMERCE 9-12-2011.

**CLASS 9—(Continued).**

4,047,098. STRECK, INC., OMAHA, NE. SN 85-975,620. PUB. 9-28-2010, FILED 5-27-2010.

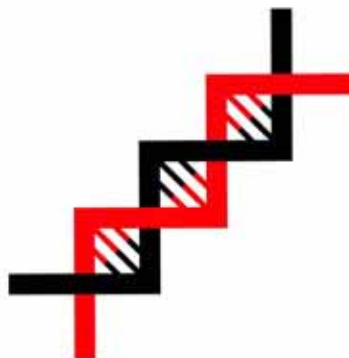

THE COLOR(S) BLACK AND RED IS/ARE CLAIMED AS A FEATURE OF THE MARK.

THE MARK CONSISTS OF A STYLIZED BLACK AND RED DNA HELIX DESIGN COMPRISED OF A BLACK DIAGONAL ZIGZAG LINE INTERTWINED WITH A RED DIAGONAL ZIGZAG LINE FORMING THREE DIAMOND SHAPES WITH VERTICAL RED AND BLACK LINES LOCATED IN THE DIAMOND SHAPES. THE COLOR WHITE APPEARS AS BACKGROUND IN THE MARK AND IS NOT CLAIMED AS A FEATURE OF THE MARK.

FOR LABORATORY INSTRUMENTS AND TUBES FOR THE PURPOSE OF PERFORMING POLYMERASE CHAIN REACTION TESTS FOR MEDICAL AND VETERINARY USE; COMPUTER SOFTWARE AND HARDWARE FOR USE WITH LABORATORY INSTRUMENTS, NAMELY, FOR USE IN POLYMERASE CHAIN REACTION ANALYSIS (U.S. CLS. 21, 23, 26, 36 AND 38).

FIRST USE 6-1-2011; IN COMMERCE 6-1-2011.

4,047,099. STRECK, INC., OMAHA, NE. SN 85-975,621. PUB. 9-7-2010, FILED 5-27-2010.

# philisa

THE COLOR(S) BLACK AND RED IS/ARE CLAIMED AS A FEATURE OF THE MARK.

THE MARK CONSISTS OF THE STYLIZED WORDING "PHILISA" IN BLACK LOWERCASE LETTERING WITH A RED HORIZONTAL STRIPE RUNNING THROUGH THE CENTER OF EACH LETTER.

THE ENGLISH TRANSLATION OF "PHILISA" IS "BE HEALTHY".

FOR LABORATORY INSTRUMENTS AND TUBES FOR THE PURPOSE OF PERFORMING POLYMERASE CHAIN REACTION TESTS FOR MEDICAL AND VETERINARY USE; COMPUTER SOFTWARE AND HARDWARE FOR USE IN LABORATORY INSTRUMENTS, NAMELY, FOR USE IN POLYMERASE CHAIN REACTION ANALYSIS (U.S. CLS. 21, 23, 26, 36 AND 38).

FIRST USE 6-1-2011; IN COMMERCE 6-1-2011.



**CLASS 10—MEDICAL APPARATUS**

4,045,672. MEDISIZE B.V., AB HILLEGOM, NETHERLANDS.  
SN 77-363,063. PUB. 5-27-2008, FILED 1-3-2008.

# MEDISIZE

THE MARK CONSISTS OF STANDARD CHARACTERS WITHOUT CLAIM TO ANY PARTICULAR FONT, STYLE, SIZE, OR COLOR.

OWNER OF U.S. REG. NOS. 2,502,433 AND 3,324,785.  
FOR MEDICAL DISPOSABLE ARTICLES, NAMELY, MEDICAL TUBES ON A ROLL, HEAT AND MOISTURE EXCHANGER FILTERS, ANESTHESIA MASKS, BREATHING CIRCUITS, NAMELY, RESPIRATORY HOSES AND CATHETER MOUNTS (U.S. CLS. 26, 39 AND 44).

FIRST USE 12-31-1998; IN COMMERCE 12-31-1998.

4,045,686. ABBOTT MEDICAL OPTICS INC., SANTA ANA, CA. SN 77-379,009. PUB. 3-17-2009, FILED 1-23-2008.

# iFS

THE MARK CONSISTS OF STANDARD CHARACTERS WITHOUT CLAIM TO ANY PARTICULAR FONT, STYLE, SIZE, OR COLOR.

FOR SURGICAL APPARATUS FOR USE IN OPHTHALMIC SURGERY, NAMELY, OPHTHALMOLOGICAL SURGERY SYSTEMS COMPRISED OF A MEDICAL LASER, OPTICAL DEVICES FOR DELIVERING LASER ENERGY TO THE EYE, AND COMPUTER SOFTWARE FOR OPERATING THE SURGERY SYSTEM, AND INSTRUCTION MANUALS AND PARTS FOR THE ABOVE SYSTEMS, ALL SOLD AS A UNIT (U.S. CLS. 26, 39 AND 44).

FIRST USE 6-1-2008; IN COMMERCE 9-1-2009.

**CLASS 10—(Continued).**

4,045,730. NEUROTECH USA, INC., LINCOLN, RI. SN 77-473,520. PUB. 10-21-2008, FILED 5-13-2008.

# RENEXUS

THE MARK CONSISTS OF STANDARD CHARACTERS WITHOUT CLAIM TO ANY PARTICULAR FONT, STYLE, SIZE, OR COLOR.

FOR INTRAOCULAR IMPLANT FOR THE TREATMENT OF RETINAL DEGENERATIVE DISEASES (U.S. CLS. 26, 39 AND 44).

FIRST USE 8-8-2011; IN COMMERCE 8-8-2011.

4,045,761. MCCLANAHAN, RAY, PORTLAND, OR. SN 77-564,808. PUB. 3-17-2009, FILED 9-8-2008.

# Correct Toes

THE MARK CONSISTS OF STANDARD CHARACTERS WITHOUT CLAIM TO ANY PARTICULAR FONT, STYLE, SIZE, OR COLOR.

NO CLAIM IS MADE TO THE EXCLUSIVE RIGHT TO USE "TOES", APART FROM THE MARK AS SHOWN.

FOR MEDICAL GRADE SILICONE DEVICE DESIGNED TO REPOSITION ALL THE TOES IN NATURAL ANATOMY (U.S. CLS. 26, 39 AND 44).

FIRST USE 1-1-2006; IN COMMERCE 1-1-2006.

4,045,782. MYRIAD GENETICS, INC., SALT LAKE CITY, UT. SN 77-636,847. PUB. 11-17-2009, FILED 12-19-2008.

# PREZEON

THE MARK CONSISTS OF STANDARD CHARACTERS WITHOUT CLAIM TO ANY PARTICULAR FONT, STYLE, SIZE, OR COLOR.

**CLASS 10—(Continued).**

THE WORDING "PREZEON" HAS NO MEANING IN A FOREIGN LANGUAGE.

FOR MEDICAL DIAGNOSTIC AND PROGNOSTIC TEST KITS COMPRISING SPECIMEN COLLECTION TUBES AND CONTAINERS FOR COLLECTING PATIENT SPECIMENS, TEST FORMS, MAILING MATERIALS, AND USER INFORMATION INSERTS, USED IN CONNECTION WITH PROVIDING GUIDANCE FOR DRUG SELECTION, PREDICTION OF DISEASE PROGNOSIS, DETECTION OF DISEASE, CHARACTERIZATION OF DISEASE, AND MONITORING THE PROGRESSION, RESPONSE OR RECURRENCE OF DISEASE OR THERAPEUTIC RESPONSE TO CANCER (U.S. CLS. 26, 39 AND 44).

FIRST USE 12-22-2009; IN COMMERCE 12-22-2009.

---

4,045,795. CONFIRM MONITORING SYSTEMS, INC., CEN-  
TENNIAL, CO. SN 77-648,388. PUB. 5-26-2009, FILED 1-13-  
2009.

# SOFTX

THE MARK CONSISTS OF STANDARD CHARACTERS WITHOUT CLAIM TO ANY PARTICULAR FONT, STYLE, SIZE, OR COLOR.

FOR DENTAL PRODUCTS, NAMELY, BITE WING LOOPS (U.S. CLS. 26, 39 AND 44).

FIRST USE 6-9-2009; IN COMMERCE 6-9-2009.

---

4,045,822. ACCLARENT, INC., MENLO PARK, CA. SN 77-  
684,907. PUB. 12-8-2009, FILED 3-6-2009.

## ACCLARENT CYCLOPS

THE MARK CONSISTS OF STANDARD CHARACTERS WITHOUT CLAIM TO ANY PARTICULAR FONT, STYLE, SIZE, OR COLOR.

OWNER OF U.S. REG. NO. 3,235,916.

FOR ENDOSCOPIC EQUIPMENT; MEDICAL DEVICES, NAMELY, ENDOSCOPES FOR USE IN TREATING OF DISEASES AND CONDITIONS OF, OR INVOLVING, THE EARS, NOSE, PARANASAL SINUSES AND THROAT (U.S. CLS. 26, 39 AND 44).

FIRST USE 6-2-2011; IN COMMERCE 6-2-2011.

**CLASS 10—(Continued).**

4,045,828. OHIO MEDICAL CORPORATION, GURNEE, IL.  
SN 77-702,156. PUB. 2-15-2011, FILED 3-30-2009.

# TRUSEAL

THE MARK CONSISTS OF STANDARD CHARACTERS WITHOUT CLAIM TO ANY PARTICULAR FONT, STYLE, SIZE, OR COLOR.

FOR KITS FOR CARE OF A WOUND NOT INCLUDING A TRACHEOSTOMA OR A WOUND RESULTING FROM A LARYNGOSCOPY, THE KIT COMPRISED OF A PROTECTIVE BARRIER WIPE, GAUZE, NON-ADHERENT DRESSING, AND FILM DRESSING, ALL SOLD AS A UNIT (U.S. CLS. 26, 39 AND 44).

FIRST USE 5-27-2009; IN COMMERCE 5-27-2009.

---

4,045,864. JACQUELINE JONES, BELLAIRE, TX. SN 77-  
762,285. PUB. 4-20-2010, FILED 6-17-2009.

## DOC COUTURE

THE MARK CONSISTS OF STANDARD CHARACTERS WITHOUT CLAIM TO ANY PARTICULAR FONT, STYLE, SIZE, OR COLOR.

NO CLAIM IS MADE TO THE EXCLUSIVE RIGHT TO USE "DOC", APART FROM THE MARK AS SHOWN.

FOR MEDICAL APPAREL, NAMELY, SCRUB TOPS AND SCRUB PANTS (U.S. CLS. 26, 39 AND 44).

FIRST USE 11-8-2010; IN COMMERCE 12-6-2010.

---

4,045,955. WARSAW ORTHOPEDIC, INC., WARSAW, IN. SN  
77-858,149. PUB. 1-19-2010, FILED 10-27-2009.

## MARROWMAX

THE MARK CONSISTS OF STANDARD CHARACTERS WITHOUT CLAIM TO ANY PARTICULAR FONT, STYLE, SIZE, OR COLOR.

FOR MEDICAL APPARATUS, NAMELY, ASPIRATION NEEDLES (U.S. CLS. 26, 39 AND 44).

FIRST USE 1-29-2011; IN COMMERCE 1-29-2011.

**CLASS 10—(Continued).**

4,046,079. ANSELL LIMITED, RICHMOND, AUSTRALIA. SN 77-938,562. PUB. 2-1-2011, FILED 2-18-2010.

**LIFESTYLES THRYLL**

THE MARK CONSISTS OF STANDARD CHARACTERS WITHOUT CLAIM TO ANY PARTICULAR FONT, STYLE, SIZE, OR COLOR.

OWNER OF U.S. REG. NOS. 1,185,626, 3,534,659, AND OTHERS.

FOR CONDOMS (U.S. CLS. 26, 39 AND 44).  
FIRST USE 4-8-2011; IN COMMERCE 4-8-2011.

4,046,080. ANSELL LIMITED, RICHMOND, AUSTRALIA. SN 77-938,580. PUB. 2-1-2011, FILED 2-18-2010.

**THRYLL**

THE MARK CONSISTS OF STANDARD CHARACTERS WITHOUT CLAIM TO ANY PARTICULAR FONT, STYLE, SIZE, OR COLOR.

FOR CONDOMS (U.S. CLS. 26, 39 AND 44).  
FIRST USE 4-8-2011; IN COMMERCE 4-8-2011.

4,046,106. NUVASIVE, INC., SAN DIEGO, CA. SN 77-947,870. PUB. 6-1-2010, FILED 3-1-2010.

**X-CORE**

THE MARK CONSISTS OF STANDARD CHARACTERS WITHOUT CLAIM TO ANY PARTICULAR FONT, STYLE, SIZE, OR COLOR.

FOR SURGICAL IMPLANTS COMPRISING ARTIFICIAL MATERIAL AND ASSOCIATED SURGICAL INSTRUMENT SETS (U.S. CLS. 26, 39 AND 44).  
FIRST USE 3-30-2010; IN COMMERCE 3-30-2010.

**CLASS 10—(Continued).**

4,046,107. NUVASIVE, INC., SAN DIEGO, CA. SN 77-947,872. PUB. 6-1-2010, FILED 3-1-2010.

**BRIGADE**

THE MARK CONSISTS OF STANDARD CHARACTERS WITHOUT CLAIM TO ANY PARTICULAR FONT, STYLE, SIZE, OR COLOR.

FOR SURGICAL IMPLANTS COMPRISING ARTIFICIAL MATERIAL AND ASSOCIATED SURGICAL INSTRUMENT SETS (U.S. CLS. 26, 39 AND 44).

FIRST USE 7-26-2010; IN COMMERCE 7-26-2010.

4,046,110. DEL PALMA ORTHOPEDICS, COLUMBIA CITY, IN. SN 77-948,572. PUB. 2-22-2011, FILED 3-2-2010.



THE MARK CONSISTS OF THE LETTERS "AMT" TO THE LEFT OF A SQUARE SHAPE HAVING A TRIANGLE SHAPE INSIDE THE SQUARE WITH A PART OF THE INSIDE OF THE SQUARE FOLDED BACK TO REVEAL THE TRIANGLE SHAPE.

FOR PLATFORM APPARATUS IN THE NATURE OF DEVICES USED IN SURGICAL PROCEDURES TO POSITION SURGICAL INSTRUMENTS TO CUT HUMAN AND ANIMAL TISSUE (U.S. CLS. 26, 39 AND 44).

FIRST USE 9-9-2011; IN COMMERCE 9-9-2011.

4,046,112. GREER LABORATORIES, INC., LENOIR, NC. SN 77-949,068. PUB. 12-14-2010, FILED 3-3-2010.

**GREER PICK**

THE MARK CONSISTS OF STANDARD CHARACTERS WITHOUT CLAIM TO ANY PARTICULAR FONT, STYLE, SIZE, OR COLOR.

OWNER OF U.S. REG. NOS. 917,452, 3,147,131, AND OTHERS.

NO CLAIM IS MADE TO THE EXCLUSIVE RIGHT TO USE "PICK", APART FROM THE MARK AS SHOWN. SEC. 2(F).

FOR MEDICAL DIAGNOSTIC DEVICES, NAMELY, APPLICATORS TO DELIVER VARIOUS SUBSTANCES USED TO TEST FOR POSSIBLE ALLERGIC REACTIONS (U.S. CLS. 26, 39 AND 44).

FIRST USE 12-31-1955; IN COMMERCE 12-31-1955.

**CLASS 10—(Continued).**

4,046,126. EDWARDS LIFESCIENCES CORPORATION, IRVINE, CA. SN 77-953,983. PUB. 7-13-2010, FILED 3-9-2010.

**VASCUSHUNT**

THE MARK CONSISTS OF STANDARD CHARACTERS WITHOUT CLAIM TO ANY PARTICULAR FONT, STYLE, SIZE, OR COLOR.

FOR MEDICAL DEVICES THAT FACILITATE FLUID FLOW WITHIN THE HEART; MEDICAL DEVICES, NAMELY, CAROTID SHUNTS; MEDICAL DEVICES, NAMELY, BALLOON SHUNTS (U.S. CLS. 26, 39 AND 44). FIRST USE 1-1-1996; IN COMMERCE 1-1-1996.

4,046,132. ADVANCED NEUROMODULATION SYSTEMS, INC., PLANO, TX. SN 77-956,644. PUB. 8-3-2010, FILED 3-11-2010.

**EPIDUCER**

THE MARK CONSISTS OF STANDARD CHARACTERS WITHOUT CLAIM TO ANY PARTICULAR FONT, STYLE, SIZE, OR COLOR.

FOR INTRODUCERS, NAMELY, MEDICAL APPARATUS FOR INTRODUCING MEDICAL LEADS, CATHETERS OR PHARMACEUTICAL PREPARATIONS INTO THE HUMAN BODY (U.S. CLS. 26, 39 AND 44). FIRST USE 5-18-2011; IN COMMERCE 7-12-2011.

4,046,358. ICAD, INC., NASHUA, NH. SN 85-068,550. PUB. 12-14-2010, FILED 6-22-2010.

**VERSAVUE**

THE MARK CONSISTS OF STANDARD CHARACTERS WITHOUT CLAIM TO ANY PARTICULAR FONT, STYLE, SIZE, OR COLOR.

FOR MEDICAL WORKSTATION FOR DETECTING AND DIAGNOSING CANCER BY USING COMPUTER SOFTWARE AND HARDWARE TO GATHER, PROCESS, DISPLAY AND TRANSMIT MAGNETIC RESONANCE IMAGES (U.S. CLS. 26, 39 AND 44). FIRST USE 8-12-2010; IN COMMERCE 8-12-2010.

**CLASS 10—(Continued).**

4,046,381. C. R. BARD, INC., MURRAY HILL, NJ. SN 85-075,173. PUB. 10-26-2010, FILED 6-30-2010.

**DENALI**

THE MARK CONSISTS OF STANDARD CHARACTERS WITHOUT CLAIM TO ANY PARTICULAR FONT, STYLE, SIZE, OR COLOR.

FOR MEDICAL DEVICES AND APPARATUS, NAMELY, VENA CAVA FILTERS AND PARTS AND FITTINGS THEREFOR (U.S. CLS. 26, 39 AND 44). FIRST USE 6-22-2011; IN COMMERCE 6-22-2011.

4,046,465. MAPA GMBH, ZEVEN 27404, FED REP GERMANY. SN 85-091,311. PUB. 1-11-2011, FILED 7-23-2010.

**THE EXCITINGLY DIFFERENT  
CONDOM**

THE MARK CONSISTS OF STANDARD CHARACTERS WITHOUT CLAIM TO ANY PARTICULAR FONT, STYLE, SIZE, OR COLOR.

NO CLAIM IS MADE TO THE EXCLUSIVE RIGHT TO USE "CONDOM", APART FROM THE MARK AS SHOWN. FOR CONDOMS (U.S. CLS. 26, 39 AND 44). FIRST USE 7-2-2011; IN COMMERCE 7-2-2011.

4,046,495. FREEDOM INNOVATIONS, LLC, IRVINE, CA. SN 85-096,104. PUB. 1-18-2011, FILED 7-29-2010.

**THRIVE**

THE MARK CONSISTS OF STANDARD CHARACTERS WITHOUT CLAIM TO ANY PARTICULAR FONT, STYLE, SIZE, OR COLOR.

FOR MEDICAL DEVICES, NAMELY, PROSTHETIC FEET (U.S. CLS. 26, 39 AND 44). FIRST USE 8-2-2010; IN COMMERCE 9-13-2010.

**CLASS 10—(Continued).**

4,046,504. ORTHORELIEF, LLC, HASTINGS, NE. SN 85-097,855. PUB. 5-10-2011, FILED 8-2-2010.

**CLASS 10—(Continued).**

4,046,550. GP INVESTIMENTI S.R.L., FLORENCE, ITALY. SN 85-102,398. PUB. 1-18-2011, FILED 8-6-2010.



THE MARK CONSISTS OF THE LETTER "M", THE LETTER "C" ADJACENT TO THE LETTER "M" AND THE NUMBER "1" ADJACENT TO THE LETTER "C", WITH A CIRCULAR DESIGN POSITIONED AROUND A LOWER PORTION OF THE NUMBER "1" AND MULTIPLE SOLID CIRCULAR SHAPES POSITIONED BENEATH THE NUMBER "1".

FOR ELECTROMEDICAL INSTRUMENTS, NAMELY, ELECTRIC MASSAGE APPARATUS FOR MEDICAL PURPOSE; THERAPEUTIC MEDICAL DEVICES EMPLOYING COMPUTERIZED NON-INVASIVE VACUUM-DRIVEN MEMBRANE MASSAGE, MECHANICAL MASSAGE AND ULTRASONIC INDUCED MECHANICAL MASSAGE TO RELIEVE MUSCLE ACHES AND PAINS, RELIEVE MUSCLE SPASMS, IMPROVE LOCAL BLOOD CIRCULATION AND REDUCE THE APPEARANCE OF CELLULITE AND FOR ULTRASONIC PHYSIOTHERAPY TO RELIEVE PAIN, MUSCLE SPASMS AND JOINT CONTRACTURES; CONVENTIONAL AND ULTRASOUND APPARATUS FOR MASSAGE THERAPIES, NAMELY, ULTRASOUND PROBE FOR MEDICAL USE, MEDICAL ULTRASOUND APPARATUS; ELECTRONIC STIMULATORS FOR SKIN, MUSCLE, NERVE; STRUCTURAL AND REPLACEMENT PARTS FOR ALL THE AFORESAID PRODUCTS (U.S. CLS. 26, 39 AND 44).

FIRST USE 5-28-2010; IN COMMERCE 5-28-2010.

4,046,605. PULSE VETERINARY TECHNOLOGIES, LLC, ALPHARETTA, GA. SN 85-115,380. PUB. 2-15-2011, FILED 8-25-2010.

NO CLAIM IS MADE TO THE EXCLUSIVE RIGHT TO USE "ORTHO", APART FROM THE MARK AS SHOWN.

THE MARK CONSISTS OF THE DRAWING OF A STYLIZED TOOTH WITH STYLIZED BRACES CONSISTING OF A CURVED LINE, A SHADED SQUARE AND TWO SMALL CRESCENTS WITHIN THE SQUARE. THE WORDING "ORTHO RELIEF" APPEARS IN A STACKED PRESENTATION NEXT TO THE TOOTH.

FOR MEDICAL APPARATUS, NAMELY, MOUTHPIECES FOR USE PRIOR TO, DURING, AND/OR AFTER DENTAL OR ORTHODONTIC PROCEDURES FOR PATIENT COMFORT, CRYOANESTHETIC DENTAL MOUTHPIECES, ANESTHETIC DENTAL DEVICES, AND CRYOANESTHETIC DENTAL DEVICES (U.S. CLS. 26, 39 AND 44).

FIRST USE 4-15-2010; IN COMMERCE 4-15-2010.

# PROTEC

THE MARK CONSISTS OF STANDARD CHARACTERS WITHOUT CLAIM TO ANY PARTICULAR FONT, STYLE, SIZE, OR COLOR.

FOR PLATELET RICH PLASMA SYSTEM KITS FOR MEDICAL VETERINARY USE FEATURING NEEDLES, SYRINGES, TUBES AND COMPONENTS TO DRAW AND REINJECT BLOOD (U.S. CLS. 26, 39 AND 44).

FIRST USE 10-14-2010; IN COMMERCE 10-14-2010.

**CLASS 10—(Continued).**

4,046,744. NICHOLSON, EGERTON, BLAINE, WA. SN 85-144,400. PUB. 3-15-2011, FILED 10-4-2010.

**FROSTY MAMAS**

THE MARK CONSISTS OF STANDARD CHARACTERS WITHOUT CLAIM TO ANY PARTICULAR FONT, STYLE, SIZE, OR COLOR.

FOR CHEMICALLY ACTIVATED COLD GEL PACKS FOR MEDICAL PURPOSES ; THERAPEUTIC COLD THERAPY PACKS (U.S. CLS. 26, 39 AND 44).

FIRST USE 4-1-2010; IN COMMERCE 4-1-2010.

---

4,046,769. SENSUS HEALTHCARE LLC, BOCA RATON, FL. SN 85-152,438. PUB. 4-5-2011, FILED 10-14-2010.

**SENSUS HEALTHCARE**

THE MARK CONSISTS OF STANDARD CHARACTERS WITHOUT CLAIM TO ANY PARTICULAR FONT, STYLE, SIZE, OR COLOR.

NO CLAIM IS MADE TO THE EXCLUSIVE RIGHT TO USE "HEALTHCARE", APART FROM THE MARK AS SHOWN.

FOR MEDICAL DEVICES USED IN THE TREATMENT OF SKIN CANCER AND OTHER CANCERS (U.S. CLS. 26, 39 AND 44).

FIRST USE 7-4-2010; IN COMMERCE 7-4-2010.

---

4,046,776. SANOMEDICS DEVELOPMENT CORPORATION, MIAMI, FL. SN 85-154,931. PUB. 3-22-2011, FILED 10-18-2010.

**CAREGIVER**

THE MARK CONSISTS OF STANDARD CHARACTERS WITHOUT CLAIM TO ANY PARTICULAR FONT, STYLE, SIZE, OR COLOR.

FOR THERMOMETERS FOR MEDICAL PURPOSES (U.S. CLS. 26, 39 AND 44).

FIRST USE 6-20-2011; IN COMMERCE 6-20-2011.

**CLASS 10—(Continued).**

4,046,830. SPINEFRONTIER, INC., BEVERLY, MA. SN 85-168,993. PUB. 3-1-2011, FILED 11-4-2010.

**INSPAN**

THE MARK CONSISTS OF STANDARD CHARACTERS WITHOUT CLAIM TO ANY PARTICULAR FONT, STYLE, SIZE, OR COLOR.

FOR ORTHOPEDIC IMPLANTS CONSISTING OF ARTIFICIAL MATERIALS AND MEDICAL INSTRUMENTS FOR USE IN ORTHOPEDIC SURGERY (U.S. CLS. 26, 39 AND 44).

FIRST USE 11-30-2010; IN COMMERCE 11-30-2010.

---

4,046,845. POS-T-VAC, DODGE CITY, KS. SN 85-177,269. PUB. 4-26-2011, FILED 11-15-2010.



NO CLAIM IS MADE TO THE EXCLUSIVE RIGHT TO USE "MEDICAL SYSTEMS", APART FROM THE MARK AS SHOWN.

THE MARK CONSISTS OF TWO STYLIZED RHINO HORNS, WITH ONE HORN WAIVING OVER THE TOP LEFT CORNER AS WELL AS ONE HORN WAIVING THE BOTTOM RIGHT CORNER AND THE WORDING "URO-MATRIX MEDICAL SYSTEMS".

FOR URINARY CONDOM CATHETERS FOR URINARY CONTROL PURPOSES; UROLOGICAL THERAPEUTIC APPARATUS AND INSTRUMENTS, NAMELY, PENILE TENSION DEVICES OR BANDS FOR USE IN MAINTAINING PENILE RIGIDITY IN MEN WITH ERECTILE DYSFUNCTION OR PREMATURE EJACULATION, VACUUM THERAPY SYSTEMS IN THE NATURE OF PENILE PUMPS FOR USE IN CREATING AN ERECTION AND THEN MAINTAINING PENILE RIGIDITY SUFFICIENT FOR INTERCOURSE IN MEN WITH ERECTILE DYSFUNCTION. AUTO INJECTION DEVICES FOR PHARMACEUTICALS USED FOR DIABETICS AS WELL AS FOR PENILE INJECTIONS FOR MEN WITH ERECTILE DYSFUNCTION (U.S. CLS. 26, 39 AND 44).

FIRST USE 10-0-2010; IN COMMERCE 10-0-2010.

**CLASS 10—(Continued).**

4,046,879. NORDSON CORPORATION, WESTLAKE, OH. SN 85-187,918. PUB. 5-3-2011, FILED 12-1-2010.

# ARTISTE

THE MARK CONSISTS OF STANDARD CHARACTERS WITHOUT CLAIM TO ANY PARTICULAR FONT, STYLE, SIZE, OR COLOR.

FOR MEDICAL DEVICE FOR USE IN THE ADMINISTRATION OF STERILE MATERIALS INTO PATIENT SKIN UNDER ASEPTIC CONDITIONS (U.S. CLS. 26, 39 AND 44).

FIRST USE 4-8-2011; IN COMMERCE 4-8-2011.

---

4,046,976. HS TM, LLC, NEWARK, DE. SN 85-213,745. PUB. 5-24-2011, FILED 1-10-2011.

# ZIRLUX

THE MARK CONSISTS OF STANDARD CHARACTERS WITHOUT CLAIM TO ANY PARTICULAR FONT, STYLE, SIZE, OR COLOR.

FOR MATERIALS MADE IN WHOLE OR SUBSTANTIAL PART OF ZIRCONIUM DIOXIDE USED TO PRODUCE DENTAL FIXTURE, CROWN AND BRIDGE SUBSTRUCTURES, NAMELY, COPING AND FRAMEWORK USED TO MAKE DENTAL CROWNS AND BRIDGES (U.S. CLS. 26, 39 AND 44).

FIRST USE 8-8-2011; IN COMMERCE 8-8-2011.

---

4,046,999. IN.GENU DESIGN GROUP INC., DBA MENDME-SHOP, COLLINGWOOD, ONTARIO, CANADA. SN 85-219,134. PUB. 6-7-2011, FILED 1-17-2011.



OWNER OF U.S. REG. NOS. 3,727,278 AND 3,727,280.

NO CLAIM IS MADE TO THE EXCLUSIVE RIGHT TO USE "WRAP", APART FROM THE MARK AS SHOWN.

THE MARK CONSISTS OF THE LITERAL ELEMENT "INFERNO WRAP" WITH A DESIGN ELEMENT ON TOP OF THE WORDS "INFERNO WRAP". THE DESIGN ELEMENT CONSISTS OF FLAMES RISING IN A NON-UNIFORM PATTERN ABOVE THE WORDS.

FOR INFRARED RADIATOR UNITS FOR THERAPEUTIC PURPOSES (U.S. CLS. 26, 39 AND 44).

FIRST USE 8-9-2011; IN COMMERCE 8-9-2011.

**CLASS 10—(Continued).**

4,047,062. REDPOINT INTERNATIONAL, INC., VANCOUVER, WA. SN 85-242,958. PUB. 7-12-2011, FILED 2-15-2011.

# STEDLINE

THE MARK CONSISTS OF STANDARD CHARACTERS WITHOUT CLAIM TO ANY PARTICULAR FONT, STYLE, SIZE, OR COLOR.

FOR NON-INVASIVE, DISPOSABLE MEDICAL TUBING STABILIZATION DEVICE (U.S. CLS. 26, 39 AND 44).

FIRST USE 2-0-2011; IN COMMERCE 5-12-2011.

**CLASS 11—ENVIRONMENTAL CONTROL APPARATUS**

---

4,045,608. MASTER SPAS, INC. FORT WAYNE, IN. SN 76-705,223. PUB. 3-22-2011, FILED 11-5-2010.

# MP FORCE

THE MARK CONSISTS OF STANDARD CHARACTERS WITHOUT CLAIM TO ANY PARTICULAR FONT, STYLE, SIZE, OR COLOR.

FOR SPAS IN THE NATURE OF HEATED POOLS (U.S. CLS. 13, 21, 23, 31 AND 34).

FIRST USE 2-24-2011; IN COMMERCE 2-24-2011.

---

4,045,613. ENNIS PAINT, INC., DALLAS, TX. SN 76-979,182. PUB. 12-7-2010, FILED 4-2-2010.

**ENNIS TRAFFIC SAFETY SOLUTIONS**

THE MARK CONSISTS OF STANDARD CHARACTERS WITHOUT CLAIM TO ANY PARTICULAR FONT, STYLE, SIZE, OR COLOR.

OWNER OF U.S. REG. NO. 3,730,331.

NO CLAIM IS MADE TO THE EXCLUSIVE RIGHT TO USE "TRAFFIC SAFETY SOLUTIONS", APART FROM THE MARK AS SHOWN.

FOR PLASTIC LIGHT REFLECTORS (U.S. CLS. 13, 21, 23, 31 AND 34).

FIRST USE 3-0-2010; IN COMMERCE 3-0-2010.

**CLASS 11—(Continued).**

4,045,654. GEO. A. MORLAN PLUMBING & APPLIANCE CO., PORTLAND, OR. SN 77-295,079. PUB. 3-25-2008, FILED 10-3-2007.

**DKDC**

THE MARK CONSISTS OF STANDARD CHARACTERS WITHOUT CLAIM TO ANY PARTICULAR FONT, STYLE, SIZE, OR COLOR.

FOR KITCHEN SINKS; SINK PEDESTALS; SINKS; TOILET BOWLS; TOILET SEATS; TOILET TANKS; TOILETS; BATH TUBS; WHIRLPOOL BATHS; SHOWER ENCLOSURES; SHOWER PANELS; SHOWER TUBS (U.S. CLS. 13, 21, 23, 31 AND 34).

FIRST USE 5-26-2010; IN COMMERCE 5-26-2010.

4,045,673. PENTAIR FILTRATION, INC., SHEBOYAGN, WI. SN 77-365,658. PUB. 6-23-2009, FILED 1-7-2008.

**VERSAFLEX**

THE MARK CONSISTS OF STANDARD CHARACTERS WITHOUT CLAIM TO ANY PARTICULAR FONT, STYLE, SIZE, OR COLOR.

FOR REPLACEABLE FILTER CARTRIDGES MADE OF POLYPROPYLENE FIBERS FOR THE REMOVAL OF DISSOLVED AND SOLID CONTAMINANTS AND OTHER IMPURITIES FROM LIQUIDS AND GASES (U.S. CLS. 13, 21, 23, 31 AND 34).

FIRST USE 4-1-2008; IN COMMERCE 5-1-2011.

4,045,675. INNOVATION SERVICES, INC., KNOXVILLE, TN. SN 77-370,583. PUB. 6-17-2008, FILED 1-14-2008.

**INTERCEPTOR WASTE TREATMENT SYSTEM**

THE MARK CONSISTS OF STANDARD CHARACTERS WITHOUT CLAIM TO ANY PARTICULAR FONT, STYLE, SIZE, OR COLOR.

NO CLAIM IS MADE TO THE EXCLUSIVE RIGHT TO USE "WASTE TREATMENT SYSTEM", APART FROM THE MARK AS SHOWN.

FOR FLUID WASTE TREATMENT EQUIPMENT, NAMELY, WASTE COLLECTION UNITS, METAL ION INFUSION UNITS, WET OXIDATION UNITS AND CHELATION UNITS, FOR COLLECTING, DISINFECTING, DENATURING AND DISCHARGING FLUID MEDICAL WASTE STREAMS (U.S. CLS. 13, 21, 23, 31 AND 34).

FIRST USE 9-7-2011; IN COMMERCE 9-7-2011.

**CLASS 11—(Continued).**

4,045,706. MCCABE, DERALD, KATY, TX. SN 77-407,999. PUB. 7-22-2008, FILED 2-27-2008.

**SRS**

THE MARK CONSISTS OF STANDARD CHARACTERS WITHOUT CLAIM TO ANY PARTICULAR FONT, STYLE, SIZE, OR COLOR.

FOR VACUUM ASSISTED VIBRATORY SEPARATOR FOR USE IN THE SEPARATION OF SOLIDS FROM SOLIDS-CONTAINING LIQUIDS (U.S. CLS. 13, 21, 23, 31 AND 34).

FIRST USE 8-12-2011; IN COMMERCE 8-12-2011.

4,045,707. INNOVATION SERVICES, INC., KNOXVILLE, TN. SN 77-415,828. PUB. 6-17-2008, FILED 3-7-2008.

**MED-SAN**

THE MARK CONSISTS OF STANDARD CHARACTERS WITHOUT CLAIM TO ANY PARTICULAR FONT, STYLE, SIZE, OR COLOR.

FOR FLUID WASTE TREATMENT EQUIPMENT, NAMELY, WASTE COLLECTION UNITS, METAL ION INFUSION UNITS, WET OXIDATION UNITS AND CHELATION UNITS, FOR COLLECTING, DISINFECTING, DENATURING AND DISCHARGING FLUID MEDICAL WASTE STREAMS (U.S. CLS. 13, 21, 23, 31 AND 34).

FIRST USE 9-7-2011; IN COMMERCE 9-7-2011.

4,045,839. BRASS-CRAFT MANUFACTURING COMPANY, NOVI, MI. SN 77-714,400. PUB. 9-21-2010, FILED 4-15-2009.

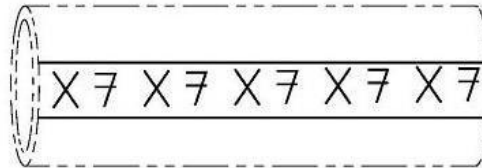

THE MARK CONSISTS OF A REPEATING SEQUENCE OF THE LETTER "X" AND NUMERAL "7" BETWEEN TWO SOLID LINES EXTENDING ACROSS SUBSTANTIALLY THE LENGTH OF THE GOODS. THE MATTER SHOWN IN BROKEN LINES IS NOT PART OF THE MARK AND SERVES ONLY TO SHOW THE RELATIVE PLACEMENT OF THE MARK.

FOR PLUMBING FITTINGS, NAMELY, VALVES AND COUPLERS (U.S. CLS. 13, 21, 23, 31 AND 34).

FIRST USE 1-0-2010; IN COMMERCE 1-0-2010.



**CLASS 11—(Continued).**

4,045,840. BRASS-CRAFT MANUFACTURING COMPANY, NOVI, MI. SN 77-714,460. PUB. 9-21-2010, FILED 4-15-2009.



THE MARK CONSISTS OF A REPEATING SEQUENCE OF "O" AND STYLIZED "NL" BETWEEN TWO SOLID LINES EXTENDING ACROSS SUBSTANTIALLY THE LENGTH OF THE GOODS. THE MATTER SHOWN IN BROKEN LINES IS NOT PART OF THE MARK AND SERVES ONLY TO SHOW THE RELATIVE PLACEMENT OF THE MARK.  
FOR PLUMBING FITTINGS, NAMELY, VALVES AND COUPLERS (U.S. CLS. 13, 21, 23, 31 AND 34).  
FIRST USE 6-0-2010; IN COMMERCE 6-0-2010.

4,045,841. BRASS-CRAFT MANUFACTURING COMPANY, NOVI, MI. SN 77-714,501. PUB. 9-21-2010, FILED 4-15-2009.

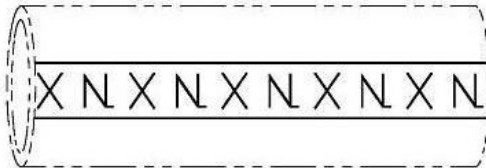

THE MARK CONSISTS OF A REPEATING SEQUENCE OF "X" AND STYLIZED "NL" BETWEEN TWO SOLID LINES EXTENDING ACROSS SUBSTANTIALLY THE LENGTH OF THE GOODS. THE MATTER SHOWN IN BROKEN LINES IS NOT PART OF THE MARK AND SERVES ONLY TO SHOW THE RELATIVE PLACEMENT OF THE MARK.  
FOR PLUMBING FITTINGS, NAMELY, VALVES AND COUPLERS (U.S. CLS. 13, 21, 23, 31 AND 34).  
FIRST USE 6-0-2010; IN COMMERCE 6-0-2010.

4,045,890. MJSI, INC., SHOREWOOD, IL. SN 77-789,960. PUB. 7-13-2010, FILED 7-27-2009.

**HYDROFLUSH**

THE MARK CONSISTS OF STANDARD CHARACTERS WITHOUT CLAIM TO ANY PARTICULAR FONT, STYLE, SIZE, OR COLOR.  
FOR DUAL FLUSH TOILET FLUSH VALVES (U.S. CLS. 13, 21, 23, 31 AND 34).  
FIRST USE 2-7-2011; IN COMMERCE 2-7-2011.

**CLASS 11—(Continued).**

4,045,903. SUSPENDED SOLUTIONS LLC, LEEDS, NY. SN 77-808,723. PUB. 1-26-2010, FILED 8-20-2009.



THE COLOR(S) BLUE AND LIGHT BLUE IS/ARE CLAIMED AS A FEATURE OF THE MARK.  
THE MARK CONSISTS OF THE WORDING "HALO SS1" IN BLUE AND TO THE LEFT OF THE WORDING IS A DESIGN OF A SLANTED CHEVRON IN LIGHT BLUE CONTAINED INSIDE BLUE CONCENTRIC OVALS.  
FOR HOLDER FOR HAIR DRYERS (U.S. CLS. 13, 21, 23, 31 AND 34).  
FIRST USE 2-23-2011; IN COMMERCE 2-23-2011.

4,045,936. COMPONENT HARDWARE GROUP, INC., LAKEWOOD, NJ. SN 77-842,548. PUB. 5-4-2010, FILED 10-6-2009.



OWNER OF U.S. REG. NO. 3,539,930.  
THE COLOR(S) RED IS CLAIMED AS A FEATURE OF THE MARK. IS/ARE CLAIMED AS A FEATURE OF THE MARK.  
THE MARK CONSISTS OF THE WORDS "FLAME GARD" WITH THE RED FLAME DESIGN SURROUNDING THE LETTER "F". THE LETTER "F" IS IN WHITE AND THE REMAINING LETTERS ARE IN BLACK. THE COLORS WHITE AND BLACK IN THE WORDS "FLAME GARD" ARE INTENDED AS BACKGROUND, OUTLINING, SHADING AND/OR TRANSPARENT AREAS AND ARE NOT PART OF THE MARK.  
FOR AIR FILTERING INSTALLATIONS COMPRISED OF MESH AIR FILTERS, MOULDINGS AND DIVIDERS, GREASE CUPS AND DRAINS; CANOPY HOOD LIGHTING FIXTURES AND REPLACEMENT PARTS, NAMELY, DAMPERS IN THE NATURE OF CONTROL DEVICES USED IN AIR DUCTS TO REGULATE THE FLOW OF AIR, HEAT REGISTERS, LIGHT DIFFUSERS, AND SUPPLY GRILLS (U.S. CLS. 13, 21, 23, 31 AND 34).  
FIRST USE 6-15-2011; IN COMMERCE 6-15-2011.

**CLASS 11—(Continued).**

4,045,947. SIEMENS INDUSTRY, INC., ALPHARETTA, GA. SN 77-850,644. PUB. 7-20-2010, FILED 10-16-2009.

**MONOSEP**

THE MARK CONSISTS OF STANDARD CHARACTERS WITHOUT CLAIM TO ANY PARTICULAR FONT, STYLE, SIZE, OR COLOR.

FOR APPARATUS FOR SEPARATING OIL FROM WATER, NAMELY, A COALESCING MEDIA FILTER (U.S. CLS. 13, 21, 23, 31 AND 34).

FIRST USE 4-20-2010; IN COMMERCE 4-20-2010.

**CLASS 11—(Continued).**

4,046,289. SPARK INNOVATIONS, INC., KING CITY, CANADA. SN 85-043,394. PUB. 10-19-2010, FILED 5-20-2010.

**SNUFF LIGHTER**

THE MARK CONSISTS OF STANDARD CHARACTERS WITHOUT CLAIM TO ANY PARTICULAR FONT, STYLE, SIZE, OR COLOR.

NO CLAIM IS MADE TO THE EXCLUSIVE RIGHT TO USE "LIGHTER", APART FROM THE MARK AS SHOWN.

FOR LIGHTER PRIMARILY FOR LIGHTING CANDLES (U.S. CLS. 13, 21, 23, 31 AND 34).

FIRST USE 3-2-2011; IN COMMERCE 3-2-2011.

4,045,983. RAB LIGHTING INC., NORTHVALE, NJ. SN 77-888,531. PUB. 5-4-2010, FILED 12-8-2009.

**BLED**

THE MARK CONSISTS OF STANDARD CHARACTERS WITHOUT CLAIM TO ANY PARTICULAR FONT, STYLE, SIZE, OR COLOR.

FOR ELECTRIC LIGHTING FIXTURES; LED (LIGHT EMITTING DIODE) LIGHTING FIXTURES; LED AND HID LIGHT FIXTURES; LIGHTING FIXTURES (U.S. CLS. 13, 21, 23, 31 AND 34).

FIRST USE 1-3-2011; IN COMMERCE 1-3-2011.

4,046,346. 2GO PRODUCTS, LLC, SAN DIEGO, CA. SN 85-063,849. PUB. 11-16-2010, FILED 6-15-2010.

**Joy Bidet**

THE MARK CONSISTS OF STANDARD CHARACTERS WITHOUT CLAIM TO ANY PARTICULAR FONT, STYLE, SIZE, OR COLOR.

NO CLAIM IS MADE TO THE EXCLUSIVE RIGHT TO USE "BIDET", APART FROM THE MARK AS SHOWN.

FOR BIDETS; SPOUTS FOR AFFIXING ON WALLS FOR BATHS, BASINS, BIDETS (U.S. CLS. 13, 21, 23, 31 AND 34).

FIRST USE 7-7-2010; IN COMMERCE 7-31-2010.

4,046,055. 89 NORTH, INC., BURLINGTON, VT. SN 77-931,519. PUB. 6-29-2010, FILED 2-9-2010.

**HELIOPHOR**

THE MARK CONSISTS OF STANDARD CHARACTERS WITHOUT CLAIM TO ANY PARTICULAR FONT, STYLE, SIZE, OR COLOR.

FOR FLUORESCENCE ILLUMINATORS FOR INSTRUMENTS AND APPARATUS USED IN THE FIELDS OF MEDICAL AND SCIENTIFIC RESEARCH; LIGHTING DEVICES IN THE NATURE OF FLUORESCENCE ILLUMINATORS COMPRISING A LIGHT SOURCE AND LED LIGHT ENGINE FOR IMAGING SYSTEMS AND IMAGING INSTRUMENTS USED IN BIOMEDICAL, IN VIVO, AND LIFE SCIENCES APPLICATIONS (U.S. CLS. 13, 21, 23, 31 AND 34).

FIRST USE 4-28-2011; IN COMMERCE 4-28-2011.

4,046,389. REFLECTIONS BY CLAUDIA, INC., EAST LONGMEADOW, MA. SN 85-078,109. PUB. 12-7-2010, FILED 7-6-2010.

**REFLECTIONS BY CLAUDIA**

THE MARK CONSISTS OF STANDARD CHARACTERS WITHOUT CLAIM TO ANY PARTICULAR FONT, STYLE, SIZE, OR COLOR.

FOR LAMPS (U.S. CLS. 13, 21, 23, 31 AND 34).

FIRST USE 9-6-2011; IN COMMERCE 9-6-2011.

**CLASS 11—(Continued).**

4,046,426. GREENTECH ENVIRONMENTAL, GRAY, TN. SN 85-086,257. PUB. 12-21-2010, FILED 7-16-2010.

# PureWash

THE MARK CONSISTS OF STANDARD CHARACTERS WITHOUT CLAIM TO ANY PARTICULAR FONT, STYLE, SIZE, OR COLOR.

FOR WASHING MACHINE WATER TREATMENT DEVICE CONNECTED TO THE COLD WATER INLET TO ELIMINATE NEED FOR DETERGENT (U.S. CLS. 13, 21, 23, 31 AND 34).

FIRST USE 7-4-2010; IN COMMERCE 3-9-2011.

---

4,046,528. PROFILE PRODUCTS, LLC, BUFFALO GROVE, IL. SN 85-099,655. PUB. 1-18-2011, FILED 8-4-2010.

# PROCLEANSE

THE MARK CONSISTS OF STANDARD CHARACTERS WITHOUT CLAIM TO ANY PARTICULAR FONT, STYLE, SIZE, OR COLOR.

FOR WATER PURIFYING AND FILTERING UNITS FOR POTABLE WATER FOR DOMESTIC USE (U.S. CLS. 13, 21, 23, 31 AND 34).

FIRST USE 11-23-2010; IN COMMERCE 11-23-2010.

---

4,046,562. THE HONG KONG WINALITE GROUP LIMITED, MONGKOK, KOWLOON, HONG KONG. SN 85-105,688. PUB. 1-25-2011, FILED 8-12-2010.

# Achelous

THE WORDING "ACHELOUS" HAS NO MEANING IN A FOREIGN LANGUAGE.

FOR MULTI-PURPOSE, ELECTRIC COUNTERTOP FOOD PREPARATION APPARATUS FOR COOKING, BAKING, BROILING, ROASTING, TOASTING, SEARING, BROWNING, BARBECUING AND GRILLING FOOD; ELECTRIC PRESSURE COOKERS; ELECTRIC KETTLES; BAKING OVENS; REFRIGERATORS; HEATING BOILERS; HYDRANTS; SHOWERS; WATER PURIFICATION INSTALLATIONS; ELECTRIC RADIATORS (U.S. CLS. 13, 21, 23, 31 AND 34).

FIRST USE 10-2-2010; IN COMMERCE 10-2-2010.

**CLASS 11—(Continued).**

4,046,663. CONAIR CORPORATION, STAMFORD, CT. SN 85-127,113. PUB. 1-4-2011, FILED 9-10-2010.

# Thermaluxe

THE MARK CONSISTS OF STANDARD CHARACTERS WITHOUT CLAIM TO ANY PARTICULAR FONT, STYLE, SIZE, OR COLOR.

FOR ELECTRIC TOWEL WARMERS (U.S. CLS. 13, 21, 23, 31 AND 34).

FIRST USE 7-0-2011; IN COMMERCE 7-0-2011.

---

4,046,668. DISCOVERY COMMUNICATIONS, LLC, SILVER SPRING, MD. SN 85-128,363. PUB. 1-18-2011, FILED 9-13-2010.



THE MARK CONSISTS OF THE LETTER "D" AND A GLOBE.

FOR LANTERNS, FLASH LIGHTS (U.S. CLS. 13, 21, 23, 31 AND 34).

FIRST USE 12-0-2010; IN COMMERCE 12-0-2010.

---

4,046,765. KLEIN ELECTRONICS, INC., ESCONDIDO, CA. SN 85-151,704. PUB. 1-25-2011, FILED 10-13-2010.

# LUMENCAM

THE MARK CONSISTS OF STANDARD CHARACTERS WITHOUT CLAIM TO ANY PARTICULAR FONT, STYLE, SIZE, OR COLOR.

FOR HAND HELD TACTICAL FLASHLIGHTS WITH BUILT IN DIGITAL VIDEO RECORDERS (U.S. CLS. 13, 21, 23, 31 AND 34).

FIRST USE 12-30-2010; IN COMMERCE 12-30-2010.

**CLASS 11—(Continued).**

4,046,787. KLEIN ELECTRONICS, INC., ESCONDIDO, CA. SN 85-157,229. PUB. 1-25-2011, FILED 10-20-2010.

**ILLUMINATING THE EVIDENCE**

THE MARK CONSISTS OF STANDARD CHARACTERS WITHOUT CLAIM TO ANY PARTICULAR FONT, STYLE, SIZE, OR COLOR.

FOR HAND HELD TACTICAL FLASHLIGHTS WITH BUILT IN DIGITAL VIDEO RECORDERS (U.S. CLS. 13, 21, 23, 31 AND 34).

FIRST USE 12-30-2010; IN COMMERCE 12-30-2010.

4,046,811. KOHLER CO., KOHLER, WI. SN 85-163,787. PUB. 6-21-2011, FILED 10-28-2010.

**NUMI**

THE MARK CONSISTS OF STANDARD CHARACTERS WITHOUT CLAIM TO ANY PARTICULAR FONT, STYLE, SIZE, OR COLOR.

THE WORDING "NUMI" HAS NO MEANING IN A FOREIGN LANGUAGE.

FOR TOILETS (U.S. CLS. 13, 21, 23, 31 AND 34).  
FIRST USE 4-30-2011; IN COMMERCE 4-30-2011.

4,047,008. BROAN-NUTONE, LLC, HARTFORD, WI. SN 85-222,172. PUB. 5-10-2011, FILED 1-20-2011.

**LUNAURA**

THE MARK CONSISTS OF STANDARD CHARACTERS WITHOUT CLAIM TO ANY PARTICULAR FONT, STYLE, SIZE, OR COLOR.

FOR LIGHTING SYSTEM CONSISTING ESSENTIALLY OF LIGHTS AND SWITCHES FOR VENTILATION EXHAUST FANS; LIGHTING SYSTEM CONSISTING ESSENTIALLY OF LIGHTS AND SWITCHES FOR RANGE HOODS; VENTILATION EXHAUST FANS; RANGE HOODS (U.S. CLS. 13, 21, 23, 31 AND 34).

FIRST USE 5-0-2011; IN COMMERCE 5-0-2011.

**CLASS 11—(Continued).**

4,047,032. IP HOLDINGS, LLC, VANCOUVER, WA. SN 85-231,606. PUB. 6-7-2011, FILED 2-1-2011.

**Tek-Wave**

THE MARK CONSISTS OF STANDARD CHARACTERS WITHOUT CLAIM TO ANY PARTICULAR FONT, STYLE, SIZE, OR COLOR.

FOR LIGHTING FIXTURES (U.S. CLS. 13, 21, 23, 31 AND 34).

FIRST USE 6-30-2011; IN COMMERCE 6-30-2011.

4,047,039. HARPER INTERNATIONAL CORPORATION, LANCASTER, NY. SN 85-234,083. PUB. 7-12-2011, FILED 2-4-2011.



OWNER OF U.S. REG. NO. 1,198,594.

NO CLAIM IS MADE TO THE EXCLUSIVE RIGHT TO USE "INTERNATIONAL", APART FROM THE MARK AS SHOWN.

THE MARK CONSISTS OF TWO SIDED SPARK IMAGE WITH THE STYLIZED TEXT "HARPER INTERNATIONAL".

FOR THERMAL PROCESSING EQUIPMENT, NAMELY, INDUSTRIAL COOKING FURNACES, INDUSTRIAL OVENS, KILNS (U.S. CLS. 13, 21, 23, 31 AND 34).

FIRST USE 4-1-2011; IN COMMERCE 4-1-2011.

4,047,088. IP HOLDINGS LLC, VANCOUVER, WA. SN 85-295,601. PUB. 7-5-2011, FILED 4-14-2011.

**Blazer**

THE MARK CONSISTS OF STANDARD CHARACTERS WITHOUT CLAIM TO ANY PARTICULAR FONT, STYLE, SIZE, OR COLOR.

FOR LIGHT REFLECTORS; REFLECTORS FOR HORTICULTURE AND INDOOR GARDENING (U.S. CLS. 13, 21, 23, 31 AND 34).

FIRST USE 8-30-2011; IN COMMERCE 8-30-2011.

**CLASS 12—VEHICLES**

**CLASS 12—(Continued).**

4,045,577. MAHINDRA & MAHINDRA LIMITED, WORLI MUMBAI, INDIA. SN 75-897,658. PUB. 11-12-2002, FILED 1-18-2000.



OWNER OF U.S. REG. NOS. 1,679,947, 2,017,063, AND 2,255,311.  
FOR TRACTORS (U.S. CLS. 19, 21, 23, 31, 35 AND 44).  
FIRST USE 2-0-2010; IN COMMERCE 2-0-2010.

4,045,578. MAHINDRA & MAHINDRA LIMITED, WORLI MUMBAI, INDIA. SN 76-066,214. PUB. 11-12-2002, FILED 6-8-2000.



**Mahindra**

FOR TRACTORS (U.S. CLS. 19, 21, 23, 31, 35 AND 44).  
FIRST USE 2-0-2010; IN COMMERCE 2-0-2010.

4,045,582. QUANTUM FUEL SYSTEMS TECHNOLOGIES WORLDWIDE, INC., IRVINE, CA. SN 76-684,518. PUB. 11-11-2008, FILED 11-30-2007.

**Q DRIVE**

THE MARK CONSISTS OF STANDARD CHARACTERS WITHOUT CLAIM TO ANY PARTICULAR FONT, STYLE, SIZE, OR COLOR.

NO CLAIM IS MADE TO THE EXCLUSIVE RIGHT TO USE "DRIVE", APART FROM THE MARK AS SHOWN.

FOR ELECTRIC AND ELECTRIC HYBRID LAND VEHICLES AND STRUCTURAL PARTS THEREFOR (U.S. CLS. 19, 21, 23, 31, 35 AND 44).

FIRST USE 7-26-2011; IN COMMERCE 7-26-2011.

**CLASS 12—(Continued).**

4,045,745. RAWLINGS SPORTING GOODS COMPANY, INC., ST. LOUIS, MO. SN 77-515,696. PUB. 6-2-2009, FILED 7-7-2008.

**APPLIED PRODUCTS**

THE MARK CONSISTS OF STANDARD CHARACTERS WITHOUT CLAIM TO ANY PARTICULAR FONT, STYLE, SIZE, OR COLOR.

NO CLAIM IS MADE TO THE EXCLUSIVE RIGHT TO USE "PRODUCTS", APART FROM THE MARK AS SHOWN.

FOR BICYCLE AND BICYCLE COMPONENTS AND PARTS, NAMELY, FRAME TUBES, FRAMES, HANDLEBARS, SEAT POSTS, STEEL TUBES, PEDALS, SHOCK ABSORBER TUBES, BRAKES AND WHEELS (U.S. CLS. 19, 21, 23, 31, 35 AND 44).

FIRST USE 0-0-1999; IN COMMERCE 0-0-1999.

4,045,794. BRIMSTONE CYCLES LLC, TOLEDO, OH. SN 77-646,355. PUB. 5-26-2009, FILED 1-9-2009.



NO CLAIM IS MADE TO THE EXCLUSIVE RIGHT TO USE "CYCLES", APART FROM THE MARK AS SHOWN.

THE MARK CONSISTS OF A MOTORCYCLE GRILLE HAVING BARS AND SCROLLS AND THE WORDING "BRIMSTONE CYCLES" APPEARING ACROSS THE GRILLE.

FOR LAND VEHICLE PARTS, NAMELY, FENDERS; MOTORCYCLE ACCESSORIES, NAMELY, GAS TANK AND RADIATOR SHROUDS; MOTORCYCLES AND STRUCTURAL PARTS THEREFOR (U.S. CLS. 19, 21, 23, 31, 35 AND 44).

FIRST USE 7-14-2011; IN COMMERCE 7-14-2011.

**CLASS 12—(Continued).**

4,046,145. TRADE UNION INTERNATIONAL, INC., DBA TOPLINE PRODUCTS, MONTCLAIR, CA. SN 77-960,348. PUB. 9-14-2010, FILED 3-16-2010.

# TOPLINE

THE MARK CONSISTS OF STANDARD CHARACTERS WITHOUT CLAIM TO ANY PARTICULAR FONT, STYLE, SIZE, OR COLOR.

OWNER OF U.S. REG. NO. 2,056,686.  
FOR LUG NUTS FOR VEHICLE WHEELS; TIRES; VEHICLE WHEEL RIMS AND STRUCTURAL PARTS THEREFOR; VEHICLE WHEELS; WHEEL COVERS (U.S. CLS. 19, 21, 23, 31, 35 AND 44).

FIRST USE 11-1-2010; IN COMMERCE 11-1-2010.

4,046,196. EMBRAER - EMBRAER EMPRESA BRASILEIRA DE AERONÁUTICA S.A., SAN JOSE DOS CAMPOS, BRAZIL. SN 78-744,133. PUB. 1-11-2011, FILED 11-1-2005.

# PHENOM

THE MARK CONSISTS OF STANDARD CHARACTERS WITHOUT CLAIM TO ANY PARTICULAR FONT, STYLE, SIZE, OR COLOR.

PRIORITY CLAIMED UNDER SEC. 44(D) ON BRAZIL APPLICATION NO. 8277707622, FILED 9-15-2005, REG. NO. 827707622, DATED 10-6-2009, EXPIRES 10-6-2019.

FOR COMMUTER AIRCRAFT AND TURBO-JET AIRPLANES FOR PASSENGERS IN THE EXECUTIVE AND CORPORATE AVIATION MARKET (U.S. CLS. 19, 21, 23, 31, 35 AND 44).

FIRST USE 12-24-2008; IN COMMERCE 12-24-2008.

4,046,503. PERFORMANCE, INC., CHAPEL HILL, NC. SN 85-097,837. PUB. 1-11-2011, FILED 8-2-2010.

# Forté

THE MARK CONSISTS OF STANDARD CHARACTERS WITHOUT CLAIM TO ANY PARTICULAR FONT, STYLE, SIZE, OR COLOR.

FOR BICYCLE PARTS, NAMELY, BICYCLE PEDAL CLEATS, BICYCLE BRAKE PADS, BICYCLE TUBE PATCH KITS, AND, BICYCLE PEDAL ACCESSORIES, NAMELY, BICYCLE PEDAL CAGES, BICYCLE PEDAL CAGE STRAPS, AND CLEAT COVERS; BICYCLE WATER BOTTLE CAGES (U.S. CLS. 19, 21, 23, 31, 35 AND 44).

FIRST USE 9-7-2011; IN COMMERCE 9-7-2011.

**CLASS 12—(Continued).**

4,046,511. DAHON TECHNOLOGIES LTD., BAOAN, SHENZHEN 518125, CHINA. SN 85-098,224. PUB. 1-11-2011, FILED 8-2-2010.

# Sit Ground

THE MARK CONSISTS OF STANDARD CHARACTERS WITHOUT CLAIM TO ANY PARTICULAR FONT, STYLE, SIZE, OR COLOR.

FOR BICYCLES; MOTORIZED BICYCLES; ELECTRICAL BICYCLES; CYCLE CARS; MOTORIZED SCOOTERS; NON-MOTORIZED SCOOTERS; MOTORCYCLES; SADDLES FOR BICYCLES, CYCLES; MOTOR ASSISTED BICYCLES, NAMELY, MOPEDS; FRAMES FOR BICYCLES, CYCLES (U.S. CLS. 19, 21, 23, 31, 35 AND 44).

FIRST USE 4-30-2010; IN COMMERCE 4-30-2010.

4,046,555. GRUV INC., YORBA LINDA, CA. SN 85-103,676. PUB. 1-25-2011, FILED 8-9-2010.



FOR MOBILE STORAGE AND TRANSPORTATION CARTS, NAMELY, UTILITY CARTS THAT MAY BE CONVERTED INTO MULTIPLE CONFIGURATIONS TO HOLD AND TRANSPORT CARGO (U.S. CLS. 19, 21, 23, 31, 35 AND 44).

FIRST USE 1-0-2007; IN COMMERCE 1-0-2007.

4,046,716. GENERAL MOTORS LLC, DETROIT, MI. SN 85-137,581. PUB. 2-15-2011, FILED 9-24-2010.

## IT'S MORE CAR THAN ELECTRIC

THE MARK CONSISTS OF STANDARD CHARACTERS WITHOUT CLAIM TO ANY PARTICULAR FONT, STYLE, SIZE, OR COLOR.

FOR EXTENDED RANGE ELECTRIC AUTOMOBILES (U.S. CLS. 19, 21, 23, 31, 35 AND 44).

FIRST USE 2-24-2011; IN COMMERCE 2-24-2011.

**CLASS 12—(Continued).**

4,046,791. ARMORED SOLUTIONS, INC., PITTSFIELD, MA.  
SN 85-157,733. PUB. 3-22-2011, FILED 10-21-2010.

# TK-4

THE MARK CONSISTS OF STANDARD CHARACTERS  
WITHOUT CLAIM TO ANY PARTICULAR FONT, STYLE,  
SIZE, OR COLOR.

FOR ARMORED VEHICLES (U.S. CLS. 19, 21, 23, 31, 35  
AND 44).

FIRST USE 7-1-2011; IN COMMERCE 7-1-2011.

**CLASS 13—(Continued).**

4,046,578. B.J. ALAN COMPANY, YOUNGSTOWN, OH. SN  
85-110,020. PUB. 2-1-2011, FILED 8-18-2010.

# SNAKES IN THE GRASS

THE MARK CONSISTS OF STANDARD CHARACTERS  
WITHOUT CLAIM TO ANY PARTICULAR FONT, STYLE,  
SIZE, OR COLOR.

FOR FIREWORKS (U.S. CLS. 2 AND 9).

FIRST USE 1-3-2011; IN COMMERCE 1-3-2011.

4,046,949. NO CHOKE, LLC, LELAND, NC. SN 85-208,934.  
PUB. 5-17-2011, FILED 1-3-2011.

# No-Choke

THE MARK CONSISTS OF STANDARD CHARACTERS  
WITHOUT CLAIM TO ANY PARTICULAR FONT, STYLE,  
SIZE, OR COLOR.

FOR FITTED FABRIC COVERS FOR VEHICLE SEAT  
BELTS FOR USE IN RELOCATING THE SEAT BELT  
AWAY FROM THE PASSENGER'S NECK AND THROAT  
AREA (U.S. CLS. 19, 21, 23, 31, 35 AND 44).

FIRST USE 8-6-2001; IN COMMERCE 2-15-2011.

4,046,579. B.J. ALAN COMPANY, YOUNGSTOWN, OH. SN  
85-110,035. PUB. 2-1-2011, FILED 8-18-2010.

# HATCHING SNAKES

THE MARK CONSISTS OF STANDARD CHARACTERS  
WITHOUT CLAIM TO ANY PARTICULAR FONT, STYLE,  
SIZE, OR COLOR.

FOR FIREWORKS (U.S. CLS. 2 AND 9).

FIRST USE 1-3-2011; IN COMMERCE 1-3-2011.

**CLASS 13—FIREARMS**

4,045,971. SUSAN C. LARSON, MONTCLAIR, CA. SN 77-  
878,845. PUB. 4-20-2010, FILED 11-23-2009.

# THE RELIC

THE MARK CONSISTS OF STANDARD CHARACTERS  
WITHOUT CLAIM TO ANY PARTICULAR FONT, STYLE,  
SIZE, OR COLOR.

FOR FIREARMS (U.S. CLS. 2 AND 9).

FIRST USE 1-1-2011; IN COMMERCE 1-1-2011.

4,046,710. LEUPOLD & STEVENS, INC., BEAVERTON, OR.  
SN 85-135,935. PUB. 1-11-2011, FILED 9-22-2010.

# MARK 1

THE MARK CONSISTS OF STANDARD CHARACTERS  
WITHOUT CLAIM TO ANY PARTICULAR FONT, STYLE,  
SIZE, OR COLOR.

OWNER OF U.S. REG. NOS. 1,646,687 AND 3,372,786.

FOR FIREARM ATTACHMENTS, NAMELY, MOUNTS  
FOR ATTACHING TELESCOPIC SIGHTS TO A FIRE-  
ARM (U.S. CLS. 2 AND 9).

FIRST USE 12-22-2010; IN COMMERCE 12-22-2010.

**CLASS 13—(Continued).**

4,046,711. LEUPOLD & STEVENS, INC., BEAVERTON, OR. SN 85-135,969. PUB. 1-11-2011, FILED 9-22-2010.

**CLASS 14—(Continued).**

4,045,898. WALKER-SPRY, JENNIFER E., DOUGLASSVILLE, PA. SN 77-800,497. PUB. 2-1-2011, FILED 8-10-2009.

**MARK 2**

THE MARK CONSISTS OF STANDARD CHARACTERS WITHOUT CLAIM TO ANY PARTICULAR FONT, STYLE, SIZE, OR COLOR.

OWNER OF U.S. REG. NOS. 1,646,687 AND 3,372,786. FOR FIREARM ATTACHMENTS, NAMELY, MOUNTS FOR ATTACHING TELESCOPIC SIGHTS TO A FIREARM (U.S. CLS. 2 AND 9).

FIRST USE 12-22-2010; IN COMMERCE 12-22-2010.

**EARRING PEARS**

THE MARK CONSISTS OF STANDARD CHARACTERS WITHOUT CLAIM TO ANY PARTICULAR FONT, STYLE, SIZE, OR COLOR.

NO CLAIM IS MADE TO THE EXCLUSIVE RIGHT TO USE "EARRING", APART FROM THE MARK AS SHOWN. FOR EARRING HOLDERS (U.S. CLS. 2, 27, 28 AND 50). FIRST USE 7-4-2011; IN COMMERCE 7-4-2011.

**CLASS 14—JEWELRY**

4,045,609. GOOD BEAD, INC., THE MINNETONKA, MN. SN 76-705,749. PUB. 4-26-2011, FILED 12-20-2010.

4,046,035. AXELLE.NET LLC, MIAMI BEACH, FL. SN 77-924,413. PUB. 7-6-2010, FILED 1-31-2010.

**LUTINI**

THE MARK CONSISTS OF STANDARD CHARACTERS WITHOUT CLAIM TO ANY PARTICULAR FONT, STYLE, SIZE, OR COLOR.

FOR JEWELRY (U.S. CLS. 2, 27, 28 AND 50). FIRST USE 1-3-2011; IN COMMERCE 1-15-2011.

**VONDERBITCH**

THE MARK CONSISTS OF THE WORDING "VONDERBITCH" REPRESENTED IN STYLIZED FONT BELOW A DESIGN OF A HEAD OF A DOG SEEN IN PROFILE LOOKING RIGHT AND WEARING A COLLAR.

FOR BRACELETS; CHARMS FOR COLLAR JEWELRY AND BRACELET; DIAMOND JEWELRY; NECKLACES; PET JEWELRY; WATCHES, CLOCKS, JEWELRY AND IMITATION JEWELRY (U.S. CLS. 2, 27, 28 AND 50).

FIRST USE 5-1-2010; IN COMMERCE 8-1-2010.

4,045,827. TAMPA BAY RAYS BASEBALL LTD., ST. PETERSBURG, FL. SN 77-697,969. PUB. 6-9-2009, FILED 3-24-2009.



4,046,047. SCOTT KAY, INC., TEANECK, NJ. SN 77-930,427. PUB. 6-15-2010, FILED 2-8-2010.

**NUCLEUS**

THE MARK CONSISTS OF THE STYLIZED REPRESENTATION OF A SUNBURST DESIGN.

FOR JEWELRY (U.S. CLS. 2, 27, 28 AND 50). FIRST USE 4-1-2011; IN COMMERCE 4-1-2011.

THE MARK CONSISTS OF STANDARD CHARACTERS WITHOUT CLAIM TO ANY PARTICULAR FONT, STYLE, SIZE, OR COLOR.

FOR JEWELRY (U.S. CLS. 2, 27, 28 AND 50). FIRST USE 4-0-2010; IN COMMERCE 4-0-2010.



**CLASS 14—(Continued).**

4,046,048. SCOTT KAY, INC., TEANECK, NJ. SN 77-930,464.  
PUB. 6-15-2010, FILED 2-8-2010.

# DEVOUT

THE MARK CONSISTS OF STANDARD CHARACTERS WITHOUT CLAIM TO ANY PARTICULAR FONT, STYLE, SIZE, OR COLOR.  
FOR JEWELRY (U.S. CLS. 2, 27, 28 AND 50).  
FIRST USE 5-0-2009; IN COMMERCE 5-0-2009.

4,046,049. SCOTT KAY, INC., TEANECK, NJ. SN 77-930,517.  
PUB. 6-15-2010, FILED 2-8-2010.

# ARDOR

THE MARK CONSISTS OF STANDARD CHARACTERS WITHOUT CLAIM TO ANY PARTICULAR FONT, STYLE, SIZE, OR COLOR.  
FOR JEWELRY (U.S. CLS. 2, 27, 28 AND 50).  
FIRST USE 4-0-2010; IN COMMERCE 4-0-2010.

4,046,081. DC COMICS, NEW YORK, NY. SN 77-938,821. PUB.  
7-13-2010, FILED 2-18-2010.

# GREEN LANTERN

THE MARK CONSISTS OF STANDARD CHARACTERS WITHOUT CLAIM TO ANY PARTICULAR FONT, STYLE, SIZE, OR COLOR.

OWNER OF U.S. REG. NO. 1,078,899.  
FOR JEWELRY, NAMELY, BRACELETS, CHAINS, CUFF-LINKS, NECKLACES, PENDANTS AND RINGS (U.S. CLS. 2, 27, 28 AND 50).  
FIRST USE 11-25-2009; IN COMMERCE 11-25-2009.

**CLASS 14—(Continued).**

4,046,117. GUJAR, SUBHASH, PUNE, MAHARASHTRA, INDIA. SN 77-950,466. PUB. 2-22-2011, FILED 3-4-2010.

# OPAL

THE MARK CONSISTS OF STANDARD CHARACTERS WITHOUT CLAIM TO ANY PARTICULAR FONT, STYLE, SIZE, OR COLOR.

FOR CLOCKS AND WATCHES NOT INCLUDING OPALS (U.S. CLS. 2, 27, 28 AND 50).  
FIRST USE 10-1-2010; IN COMMERCE 10-1-2010.

4,046,161. SMITH, JAMES TODD, NEW YORK, NY. SN 77-968,831. PUB. 12-7-2010, FILED 3-25-2010.

# SIMONE I. SMITH

THE MARK CONSISTS OF STANDARD CHARACTERS WITHOUT CLAIM TO ANY PARTICULAR FONT, STYLE, SIZE, OR COLOR.

THE NAME "SIMONE I. SMITH" IDENTIFIES A LIVING INDIVIDUAL WHOSE CONSENT IS OF RECORD.

FOR JEWELRY; SILVER WRIST CUFF BRACELETS (U.S. CLS. 2, 27, 28 AND 50).  
FIRST USE 2-14-2011; IN COMMERCE 2-14-2011.

4,046,176. CASHFLOW TECHNOLOGIES, INC., SCOTTS-DALE, AZ. SN 77-982,455. PUB. 12-7-2010, FILED 6-19-2009.

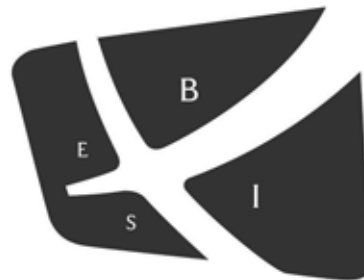

OWNER OF U.S. REG. NOS. 2,517,284, 2,798,544, AND OTHERS.

THE MARK CONSISTS OF THE LETTERS "E", "B", "S" AND "I", WHEREIN EACH LETTER IS ABSTRACTLY POSITIONED INTO ONE OF FOUR QUADRANTS SECTIONED BY CURVED BANDS.

FOR COINS, NAMELY, COLLECTIBLE COINS, COMMEMORATIVE COINS, NON-MONETARY COINS, AND/OR SOUVENIR PRESSED COINS (U.S. CLS. 2, 27, 28 AND 50).

FIRST USE 5-1-2009; IN COMMERCE 5-1-2009.

**CLASS 14—(Continued).**

4,046,200. CHRISTINE ALEXANDER, INC., FEDERAL WAY, WA. SN 78-926,098. PUB. 2-20-2007, FILED 7-10-2006.



FOR COSTUME JEWELRY NOT RELATING TO SPORTS OR TO A SPORTS TEAM (U.S. CLS. 2, 27, 28 AND 50).

FIRST USE 11-21-2003; IN COMMERCE 11-21-2003.

4,046,265. WHITMORE, STACEY, BEVERLEY HILLS, CA. SN 85-034,157. PUB. 10-19-2010, FILED 5-10-2010.

**THE PRINCESS COLLECTION**

THE MARK CONSISTS OF STANDARD CHARACTERS WITHOUT CLAIM TO ANY PARTICULAR FONT, STYLE, SIZE, OR COLOR.

NO CLAIM IS MADE TO THE EXCLUSIVE RIGHT TO USE "COLLECTION", APART FROM THE MARK AS SHOWN.

FOR JEWELRY (U.S. CLS. 2, 27, 28 AND 50).  
FIRST USE 9-2-2011; IN COMMERCE 9-2-2011.

4,046,315. OLD WORLD IMPORTS, INC., PALM BEACH, FL. SN 85-055,065. PUB. 1-11-2011, FILED 6-4-2010.

**IRIS APFEL**

THE MARK CONSISTS OF STANDARD CHARACTERS WITHOUT CLAIM TO ANY PARTICULAR FONT, STYLE, SIZE, OR COLOR.

THE NAME(S), PORTRAIT(S), AND/OR SIGNATURE(S) SHOWN IN THE MARK IDENTIFIES "IRIS APFEL", WHOSE CONSENT(S) TO REGISTER IS MADE OF RECORD.

FOR JEWELRY (U.S. CLS. 2, 27, 28 AND 50).  
FIRST USE 1-31-2011; IN COMMERCE 1-31-2011.

**CLASS 14—(Continued).**

4,046,427. BUY4STORE.COM, LOS ANGELES, CA. SN 85-086,300. PUB. 1-4-2011, FILED 7-16-2010.



THE COLOR(S) RED, GREEN, AND PURPLE IS/ARE CLAIMED AS A FEATURE OF THE MARK.

THE MARK CONSISTS OF THE WORDING "BUY4STORE.COM" WHERE THE WORDING "BUY" AND "STORE.COM" ARE IN RED CAPS, THE NUMBER "4" IS IN PURPLE AND A GREEN CIRCLE AROUND THE NUMBER "4".

FOR GIFT ITEMS, TOYS, JEWELRY AND CLOTHING ACCESSORIES (U.S. CLS. 2, 27, 28 AND 50).

FIRST USE 7-16-2010; IN COMMERCE 7-16-2010.

4,046,603. BENEFICENCE, INC., LIVERMORE, CO. SN 85-114,915. PUB. 2-1-2011, FILED 8-24-2010.



THE MARK CONSISTS OF A STYLIZED LETTER "B" IN THE SHAPE OF A HEART.

FOR BRACELETS; CHARMS; CHARMS FOR COLLAR JEWELRY AND BRACELET; COSTUME JEWELRY; IDENTIFICATION BRACELETS; JEWELRY; JEWELRY AND IMITATION JEWELRY; JEWELRY FOR ATTACHMENT TO CLOTHING; JEWELRY THAT INCORPORATES TECHNOLOGY FOR REBALANCING THE HUMAN ENERGY FIELD; JEWELRY, NAMELY, DOG TAGS FOR WEAR BY HUMANS FOR DECORATIVE PURPOSES; KEY CHAINS AS JEWELLERY; LAPEL PINS; NECKLACES; PET JEWELRY; PINS BEING JEWELRY (U.S. CLS. 2, 27, 28 AND 50).

FIRST USE 1-5-2011; IN COMMERCE 6-9-2011.

**CLASS 14—(Continued).**

4,046,606. WILSHIRE FASHIONS, INC., NEW YORK, NY. SN 85-115,385. PUB. 2-8-2011, FILED 8-25-2010.

**CLASS 14—(Continued).**

4,046,748. MEIJER, INC., GRAND RAPIDS, MI. SN 85-145,006. PUB. 3-15-2011, FILED 10-5-2010.

# MIA & BAILEY

# Enduring Heart When Love is Eternal

THE MARK CONSISTS OF STANDARD CHARACTERS WITHOUT CLAIM TO ANY PARTICULAR FONT, STYLE, SIZE, OR COLOR.  
FOR JEWELRY, NAMELY, BRACELETS, PENDANTS (U.S. CLS. 2, 27, 28 AND 50).  
FIRST USE 12-1-2010; IN COMMERCE 12-1-2010.

THE MARK CONSISTS OF STANDARD CHARACTERS WITHOUT CLAIM TO ANY PARTICULAR FONT, STYLE, SIZE, OR COLOR.  
FOR JEWELRY (U.S. CLS. 2, 27, 28 AND 50).  
FIRST USE 9-24-2010; IN COMMERCE 9-24-2010.

4,046,670. KIMAYA USA, INC. SECAUCUS, NJ. SN 85-128,517. PUB. 1-11-2011, FILED 9-13-2010.

4,046,856. VICTORIA PRINCIPAL PRODUCTIONS, INC., NASHVILLE, TN. SN 85-181,014. PUB. 3-29-2011, FILED 11-19-2010.

# FANCY FACE

# KEYS & HEARTS

THE MARK CONSISTS OF STANDARD CHARACTERS WITHOUT CLAIM TO ANY PARTICULAR FONT, STYLE, SIZE, OR COLOR.  
FOR WATCHES (U.S. CLS. 2, 27, 28 AND 50).  
FIRST USE 12-15-2010; IN COMMERCE 12-15-2010.

THE MARK CONSISTS OF STANDARD CHARACTERS WITHOUT CLAIM TO ANY PARTICULAR FONT, STYLE, SIZE, OR COLOR.  
FOR JEWELRY (U.S. CLS. 2, 27, 28 AND 50).  
FIRST USE 11-1-2010; IN COMMERCE 1-21-2011.

4,046,742. PASCAL MOUAWAD, INC., LOS ANGELES, CA. SN 85-143,839. PUB. 3-15-2011, FILED 10-3-2010.

4,046,993. MAR2MAR, INCORPORATED, DBA MAR2MAR, INC., HIGHLAND PARK, IL. SN 85-217,037. PUB. 3-15-2011, FILED 1-13-2011.

# Glam House

# txTag!

THE MARK CONSISTS OF STANDARD CHARACTERS WITHOUT CLAIM TO ANY PARTICULAR FONT, STYLE, SIZE, OR COLOR.  
FOR BRACELETS, FASHION JEWELRY, STERLING SILVER JEWELRY, AND FASHION WATCHES (U.S. CLS. 2, 27, 28 AND 50).  
FIRST USE 8-1-2010; IN COMMERCE 8-1-2011.

THE MARK CONSISTS OF STANDARD CHARACTERS WITHOUT CLAIM TO ANY PARTICULAR FONT, STYLE, SIZE, OR COLOR.  
FOR NECKLACES (U.S. CLS. 2, 27, 28 AND 50).  
FIRST USE 8-4-2011; IN COMMERCE 8-4-2011.

**CLASS 14—(Continued).**

4,047,057. OSTBYE & ANDERSON, INC., PLYMOUTH, MN. SN 85-240,099. PUB. 6-14-2011, FILED 2-11-2011.

**OSTBYEBLUE**

THE MARK CONSISTS OF STANDARD CHARACTERS WITHOUT CLAIM TO ANY PARTICULAR FONT, STYLE, SIZE, OR COLOR.

OWNER OF U.S. REG. NO. 1,871,890.  
FOR JEWELRY (U.S. CLS. 2, 27, 28 AND 50).  
FIRST USE 3-31-2011; IN COMMERCE 3-31-2011.

4,047,087. LOS ANGELES GEM & JEWELRY DESIGN, INC., LOS ANGELES, CA. SN 85-294,001. PUB. 6-28-2011, FILED 4-13-2011.

**UNWRITTEN**

THE MARK CONSISTS OF STANDARD CHARACTERS WITHOUT CLAIM TO ANY PARTICULAR FONT, STYLE, SIZE, OR COLOR.

FOR BANGLES; BRACELETS; CHARMS; EARRINGS; JEWELRY; JEWELRY CHAINS; LOCKETS; NECKLACES; PENDANTS; RINGS; SILVER; WOMEN'S JEWELRY (U.S. CLS. 2, 27, 28 AND 50).  
FIRST USE 1-12-2011; IN COMMERCE 7-15-2011.

**CLASS 15—MUSICAL INSTRUMENTS**

4,045,700. ESMEL, GREGORY M., PLYMOUTH, MA. SN 77-401,574. PUB. 2-15-2011, FILED 2-20-2008.

**BLACK WAVE**

THE MARK CONSISTS OF STANDARD CHARACTERS WITHOUT CLAIM TO ANY PARTICULAR FONT, STYLE, SIZE, OR COLOR.

NO CLAIM IS MADE TO THE EXCLUSIVE RIGHT TO USE "BLACK", APART FROM THE MARK AS SHOWN.

FOR ELECTRONIC EFFECTS PEDALS FOR USE WITH MUSICAL INSTRUMENTS; MUSICAL INSTRUMENT ACCESSORIES, NAMELY, STANDS, CASES, CARRYING BAGS AND STORAGE BAGS; MUSICAL INSTRUMENTS; SOUND EFFECT PEDALS FOR MUSICAL INSTRUMENTS (U.S. CLS. 2, 21 AND 36).  
FIRST USE 5-6-2011; IN COMMERCE 5-6-2011.

**CLASS 15—(Continued).**

4,046,091. MOHAJERIN SOHRAB, PLEASANTON, CA. SN 77-944,150. PUB. 1-4-2011, FILED 2-24-2010.



THE MARK CONSISTS OF AN ELLIPSE ON TOP CENTER WITH THE LETTER "Z" OF "ZODIAC GC" INSIDE THE ELLIPSE AND THE REST OF THE LETTERS OUTSIDE IN HORIZONTAL, AND THREE STROKES DEPICTING THE LETTER "Z" GRAPHICALLY UNDERNEATH THE ELLIPSE.

FOR ACOUSTIC GUITARS; BASS GUITARS; ELECTRIC BASS GUITARS; ELECTRIC GUITARS; GUITAR PEDALS; GUITAR PICKS; GUITAR PLAYING ASSISTANCE DEVICES, NAMELY, A SLIDING CLAMP-LIKE STRUCTURE POSITIONED ONTO THE GUITAR NECK TO FORM AND SOUND GUITAR CHORDS AND NOTES; GUITAR SKINS FOR ELECTRIC GUITARS; GUITAR STRAPS; GUITAR STRINGS; GUITARS; MUSICAL INSTRUMENTS, NAMELY, BASS GUITARS; MUSICAL INSTRUMENTS, NAMELY, PEDAL STEEL GUITARS; THREE-STRINGED JAPANESE GUITARS (SHAMISEN) (U.S. CLS. 2, 21 AND 36).

FIRST USE 8-25-2011; IN COMMERCE 8-25-2011.

4,046,699. BEIJING CENTURY HAORYUN LINGYIN MUSIC INSTRUMENT CORPORATION, BEIJING, CHINA. SN 85-133,805. PUB. 3-8-2011, FILED 9-20-2010.

**STUPOROUS**

THE MARK CONSISTS OF STANDARD CHARACTERS WITHOUT CLAIM TO ANY PARTICULAR FONT, STYLE, SIZE, OR COLOR.

FOR CYMBALS; GUITARS; MUSICAL INSTRUMENTS, NAMELY, DRUMS; TAMBOURINES; KETTLE-DRUMS; PERCUSSION INSTRUMENTS; DRUMSTICKS; STRINGS FOR MUSICAL INSTRUMENTS; CASES FOR MUSICAL INSTRUMENTS; PLECTRUMS; DRUM-HEADS; SHEET MUSIC STANDS; STANDS FOR MUSICAL INSTRUMENTS (U.S. CLS. 2, 21 AND 36).

FIRST USE 11-1-2010; IN COMMERCE 3-1-2011.

**CLASS 15—(Continued).**

4,046,700. BEIJING CENTURY HAOYUN LINGYIN MUSIC INSTRUMENT CORPORATION, BEIJING, CHINA. SN 85-133,888. PUB. 5-24-2011, FILED 9-20-2010.



THE MARK CONSISTS OF THE WORDS "BLACK EIGHT" IN STYLIZED LETTERING ABOVE THE DESIGN OF AN 8 BALL BILLIARD BALL.

FOR CYMBALS; GUITARS; MUSICAL INSTRUMENTS, NAMELY, DRUMS; TAMBOURINES; KETTLE DRUMS; PERCUSSION INSTRUMENTS; DRUMSTICKS; STRINGS FOR MUSICAL INSTRUMENTS; CASES FOR MUSICAL INSTRUMENTS; PLECTRUMS; DRUMHEADS; SHEET MUSIC STANDS; STANDS FOR MUSICAL INSTRUMENTS (U.S. CLS. 2, 21 AND 36).  
FIRST USE 3-1-2011; IN COMMERCE 5-1-2011.

4,046,883. COTTAGE GARDEN, INC., BAINBRIDGE, IN. SN 85-189,262. PUB. 4-12-2011, FILED 12-2-2010.

**MUSIC BOX BY YOU**

THE MARK CONSISTS OF STANDARD CHARACTERS WITHOUT CLAIM TO ANY PARTICULAR FONT, STYLE, SIZE, OR COLOR.

NO CLAIM IS MADE TO THE EXCLUSIVE RIGHT TO USE "MUSIC BOX", APART FROM THE MARK AS SHOWN.  
FOR MUSIC BOXES; MUSICAL BOXES (U.S. CLS. 2, 21 AND 36).

FIRST USE 1-1-2011; IN COMMERCE 1-1-2011.

**CLASS 16—PAPER GOODS AND PRINTED MATTER**

**CLASS 16—(Continued).**

4,045,600. WHITE, KARIANNE, BORDENTOWN, NJ. AND WHITE, MATTHEW, BORDENTOWN, NJ. SN 76-703,824. PUB. 1-4-2011, FILED 7-19-2010.

**ELLA DELLA**

THE MARK CONSISTS OF STANDARD CHARACTERS WITHOUT CLAIM TO ANY PARTICULAR FONT, STYLE, SIZE, OR COLOR.

THE NAME "ELLA DELLA" DOES NOT IDENTIFY A LIVING INDIVIDUAL.

FOR HEIRLOOM ENVELOPES (U.S. CLS. 2, 5, 22, 23, 29, 37, 38 AND 50).

FIRST USE 8-23-2011; IN COMMERCE 8-23-2011.

4,045,614. NINTENDO OF AMERICA INC., REDMOND, WA. SN 77-045,955. PUB. 12-21-2010, FILED 11-16-2006.

**WII POINTS**

THE MARK CONSISTS OF STANDARD CHARACTERS WITHOUT CLAIM TO ANY PARTICULAR FONT, STYLE, SIZE, OR COLOR.

NO CLAIM IS MADE TO THE EXCLUSIVE RIGHT TO USE "POINTS", APART FROM THE MARK AS SHOWN.

FOR GIFT CARDS; NON-MAGNETICALLY ENCODED PREPAID VALUE CARDS FOR ALLOWING USERS TO TRANSFER FINANCIAL VALUE ON-LINE VIA RETAIL COMPUTER NETWORKS; NON-MAGNETICALLY ENCODED PREPAID VALUE CARDS FOR THE ONLINE PURCHASE OF AND/OR ACCESS TO DOWNLOADABLE GAMES AND ENTERTAINMENT CONTENT VIA THE INTERNET; SCRATCH CARDS TO PROVIDE AN ACCESS CODE FOR PURCHASE OF AND ACCESS TO DOWNLOADABLE GAMES AND ENTERTAINMENT CONTENT (U.S. CLS. 2, 5, 22, 23, 29, 37, 38 AND 50).

FIRST USE 11-19-2006; IN COMMERCE 11-19-2006.

4,045,648. GREEN DAY, INC., SAN RAFAEL, CA. SN 77-263,059. PUB. 5-20-2008, FILED 8-23-2007.

**POP DISASTER TOUR**

THE MARK CONSISTS OF STANDARD CHARACTERS WITHOUT CLAIM TO ANY PARTICULAR FONT, STYLE, SIZE, OR COLOR.

**CLASS 16—(Continued).**

NO CLAIM IS MADE TO THE EXCLUSIVE RIGHT TO USE "TOUR", APART FROM THE MARK AS SHOWN.

FOR SOUVENIR PROGRAMS AND TOUR BOOKS IN THE FIELD OF MUSIC, MUSICAL GROUPS, MUSICAL CONCERTS AND ENTERTAINMENT; STICKERS, DECALS, POSTERS, PHOTOGRAPHS (U.S. CLS. 2, 5, 22, 23, 29, 37, 38 AND 50).

FIRST USE 8-12-2011; IN COMMERCE 8-12-2011.

---

4,045,653. COVALENCE SPECIALTY COATINGS LLC, FRANKLIN, MA. SN 77-294,572. PUB. 5-13-2008, FILED 10-2-2007.

**DUST-TAINER**

THE MARK CONSISTS OF STANDARD CHARACTERS WITHOUT CLAIM TO ANY PARTICULAR FONT, STYLE, SIZE, OR COLOR.

FOR BULK CONTAINER, NAMELY, PLASTIC BAGS FOR THE DISPOSAL OF DUST WASTE (U.S. CLS. 2, 5, 22, 23, 29, 37, 38 AND 50).

FIRST USE 4-4-2011; IN COMMERCE 4-4-2011.

---

4,045,734. STILES, CHARLES RICHARD, COPPERHILL, TN. SN 77-492,783. PUB. 11-4-2008, FILED 6-6-2008.

**THE RETALIATORS**

THE MARK CONSISTS OF STANDARD CHARACTERS WITHOUT CLAIM TO ANY PARTICULAR FONT, STYLE, SIZE, OR COLOR.

FOR COMIC BOOKS (U.S. CLS. 2, 5, 22, 23, 29, 37, 38 AND 50).

FIRST USE 2-17-2009; IN COMMERCE 1-9-2011.

---

4,045,781. POSITIVE COACHING ALLIANCE, MOUNTAIN VIEW, CA. SN 77-633,601. PUB. 4-21-2009, FILED 12-15-2008.

**TRIPLE-IMPACT COMPETITOR**

THE MARK CONSISTS OF STANDARD CHARACTERS WITHOUT CLAIM TO ANY PARTICULAR FONT, STYLE, SIZE, OR COLOR.

**CLASS 16—(Continued).**

NO CLAIM IS MADE TO THE EXCLUSIVE RIGHT TO USE "COMPETITOR", APART FROM THE MARK AS SHOWN.

FOR PRINTED INSTRUCTIONAL, EDUCATIONAL, AND TEACHING MATERIALS IN THE FIELDS OF ATHLETICS AND COACHING (U.S. CLS. 2, 5, 22, 23, 29, 37, 38 AND 50).

FIRST USE 9-30-2006; IN COMMERCE 9-30-2006.

---

4,045,801. ACTION WOBBLE, INC., IRVINE, CA. SN 77-660,265. PUB. 6-15-2010, FILED 1-30-2009.

**BRANDICIA**

THE MARK CONSISTS OF STANDARD CHARACTERS WITHOUT CLAIM TO ANY PARTICULAR FONT, STYLE, SIZE, OR COLOR.

FOR CUSTOMIZABLE POSTAL INDICIA, NAMELY, POSTAL ADDRESS LABELS AND STAMPS (U.S. CLS. 2, 5, 22, 23, 29, 37, 38 AND 50).

FIRST USE 1-0-2011; IN COMMERCE 1-0-2011.

---

4,045,802. ACTION WOBBLE, INC., IRVINE, CA. SN 77-660,302. PUB. 11-24-2009, FILED 1-30-2009.

**BRANDCENTIVES**

THE MARK CONSISTS OF STANDARD CHARACTERS WITHOUT CLAIM TO ANY PARTICULAR FONT, STYLE, SIZE, OR COLOR.

FOR PRINTED VISUALS IN THE NATURE OF PROMOTIONAL MATERIALS, COUPONS, PRINTED VOUCHERS, PRINTED PAPER LABELS AND PRINTED CERTIFICATES (U.S. CLS. 2, 5, 22, 23, 29, 37, 38 AND 50).

FIRST USE 8-0-2010; IN COMMERCE 8-0-2010.

---

4,045,805. CREATION BY DESIGN LLC, TEANECK, NJ. SN 77-665,097. PUB. 6-2-2009, FILED 2-6-2009.

**MY BIBLE CARDS**

THE MARK CONSISTS OF STANDARD CHARACTERS WITHOUT CLAIM TO ANY PARTICULAR FONT, STYLE, SIZE, OR COLOR.

**CLASS 16—(Continued).**

NO CLAIM IS MADE TO THE EXCLUSIVE RIGHT TO USE "BIBLE CARDS", APART FROM THE MARK AS SHOWN.

FOR EDUCATIONAL LEARNING CARDS FEATURING BIBLICAL THEMES AND EXPLANATORY TEXT (U.S. CLS. 2, 5, 22, 23, 29, 37, 38 AND 50).

FIRST USE 4-0-2011; IN COMMERCE 4-0-2011.

4,045,870. CANSON, ANNONAY, FRANCE. SN 77-771,197.  
PUB. 12-7-2010, FILED 6-30-2009.



OWNER OF FRANCE REG. NO. 3420188, DATED 3-31-2006, EXPIRES 3-31-2016.

THE MARK CONSISTS OF THE LETTERS "XL" WITHIN MULTIPLE QUADRILATERALS.

FOR PAPER FOR ALL ARTISTIC TECHNIQUES, NAMELY, PAPER FOR FINE ART, GRAPHIC ARTS, DRAWING, PAINTING (U.S. CLS. 2, 5, 22, 23, 29, 37, 38 AND 50).

FIRST USE 1-1-1995; IN COMMERCE 4-0-2009.

4,045,894. BLUE AGAVE LLC, DBA BLUE AGAVE, MESA, AZ. SN 77-796,317. PUB. 1-11-2011, FILED 8-4-2009.

## Tequila Paper

THE MARK CONSISTS OF STANDARD CHARACTERS WITHOUT CLAIM TO ANY PARTICULAR FONT, STYLE, SIZE, OR COLOR.

NO CLAIM IS MADE TO THE EXCLUSIVE RIGHT TO USE "PAPER", APART FROM THE MARK AS SHOWN.

FOR PAPER AND PAPER PRODUCTS, NAMELY, BLANK ART PAPER, COPY PAPER, STATIONERY, BOND PAPER, WRITING PAPER, COMPUTER PAPER, FIBER PAPER, GUMMED PAPER, LOOSE LEAF PAPER, NOTE PADS, NOTEBOOKS, PAPER GIFT BOXES, CARDBOARD PACKING BOXES, ENVELOPES, SHIPPING ENVELOPES, FIBER PAPER, BLANK JOURNALS, GIFT CARDS, PRODUCT PAPER LABELS, PAPER HOLIDAY CARDS, POSTERS, GREETING CARDS, PRINTED VISUALS IN THE NATURE OF PROMOTIONAL MATERIALS, GIFT WRAPPING PAPER, PAPER TO BE SOLD IN BULK AND REAMS (U.S. CLS. 2, 5, 22, 23, 29, 37, 38 AND 50).

FIRST USE 1-10-2010; IN COMMERCE 5-14-2010.

**CLASS 16—(Continued).**

4,045,943. MARKET STUDIES, LLC, SCOTTSDALE, AZ. SN 77-846,957. PUB. 3-15-2011, FILED 10-12-2009.

## RANGE EXPANSION INDEX

THE MARK CONSISTS OF STANDARD CHARACTERS WITHOUT CLAIM TO ANY PARTICULAR FONT, STYLE, SIZE, OR COLOR.

OWNER OF U.S. REG. NOS. 3,866,588, 3,869,345, AND 3,869,346.

NO CLAIM IS MADE TO THE EXCLUSIVE RIGHT TO USE "INDEX", APART FROM THE MARK AS SHOWN.

SEC. 2(F).

FOR PUBLICATIONS, NAMELY, BOOKS, MAGAZINES, NEWSLETTERS, PRINTED TEACHING AND LECTURE MATERIALS AND PRINTED LECTURES ALL IN THE FIELD OF FINANCIAL MARKETS AND EXCHANGE TRADED COMMODITIES (U.S. CLS. 2, 5, 22, 23, 29, 37, 38 AND 50).

FIRST USE 12-31-2008; IN COMMERCE 12-31-2008.

4,045,979. BEROL CORPORATION, ATLANTA, GA. SN 77-886,120. PUB. 1-18-2011, FILED 12-4-2009.

OWNER OF U.S. REG. NOS. 565,961, 3,104,593, AND OTHERS.

THE MARK CONSISTS OF THE WORDING "PAPER" FOLLOWED BY A DESIGN OF TWO HEARTS APPEARING VERTICALLY FOLLOWED BY THE WORDING "MATE".

FOR WRITING AND DRAWING INSTRUMENTS, LIQUID CORRECTION PRODUCTS FOR DOCUMENTS, NAMELY, CORRECTION FLUIDS FOR DOCUMENTS, TAPE CORRECTION PRODUCTS FOR DOCUMENTS, NAMELY, CORRECTING TAPE FOR DOCUMENTS, PENCIL SHARPENERS, WRITING GRIPS, GLUE FOR STATIONERY OR HOUSEHOLD USE, PENCIL CASES (U.S. CLS. 2, 5, 22, 23, 29, 37, 38 AND 50).

FIRST USE 6-1-2010; IN COMMERCE 6-1-2010.

4,045,998. POLY-AMERICA, L.P., GRAND PRAIRIE, TX. SN 77-902,910. PUB. 5-18-2010, FILED 12-30-2009.

## FLEX 'N STAY

THE MARK CONSISTS OF STANDARD CHARACTERS WITHOUT CLAIM TO ANY PARTICULAR FONT, STYLE, SIZE, OR COLOR.

FOR PLASTIC TRASH BAGS (U.S. CLS. 2, 5, 22, 23, 29, 37, 38 AND 50).

FIRST USE 2-1-2011; IN COMMERCE 2-1-2011.

**CLASS 16—(Continued).**

4,046,005. JOHANN FROESCHEIS LYRA-BLEISTIFT-FABRIK GMBH & CO. KG, NÜRNBERG, FED REP GERMANY. SN 77-908,722. PUB. 2-15-2011, FILED 1-11-2010.



PRIORITY CLAIMED UNDER SEC. 44(D) ON ERPN CMNTY TM OFC APPLICATION NO. 008756991, FILED 11-23-2009, REG. NO. 008756991, DATED 6-11-2010, EXPIRES 11-23-2019.

OWNER OF U.S. REG. NOS. 639,377 AND 1,768,589.

NO CLAIM IS MADE TO THE EXCLUSIVE RIGHT TO USE "GERMANY", APART FROM THE MARK AS SHOWN.

THE MARK CONSISTS OF THE WORDING "GERMANY" UNDERNEATH THE WORDING "LYRA". A DESIGN OF A STRINGED INSTRUMENT APPEARS TO THE LEFT OF THE WORD "LYRA".

FOR WRITING, DRAWING AND PAINTING GOODS, NAMELY, PENS, CRAYONS, PENCILS, WRITING IMPLEMENTS, COLORED PENCILS, ERASERS, CHALKS; PAINT BOXES FOR USE IN SCHOOL; PENCIL SHARPENERS; ARTISTS' MATERIALS, NAMELY, PAINT BRUSHES (U.S. CLS. 2, 5, 22, 23, 29, 37, 38 AND 50).

FIRST USE 2-24-2010; IN COMMERCE 2-24-2010.

4,046,036. BECKER&MAYER!, BELLEVUE, WA. SN 77-925,087. PUB. 1-4-2011, FILED 2-1-2010.

# Epic Ink

THE MARK CONSISTS OF STANDARD CHARACTERS WITHOUT CLAIM TO ANY PARTICULAR FONT, STYLE, SIZE, OR COLOR.

FOR BOOK PUBLISHING (U.S. CLS. 2, 5, 22, 23, 29, 37, 38 AND 50).

FIRST USE 6-1-2011; IN COMMERCE 6-1-2011.

4,046,244. CHRISTIAN BRANDS, INC., PHOENIX, AZ. SN 85-025,815. PUB. 9-28-2010, FILED 4-28-2010.

# AMBROSIANA

THE MARK CONSISTS OF STANDARD CHARACTERS WITHOUT CLAIM TO ANY PARTICULAR FONT, STYLE, SIZE, OR COLOR.

FOR PRINTED MATERIALS, NAMELY, PRAYER CARDS, GREETING CARDS, INVITATIONS, AND INSPIRATIONAL PAMPHLETS, BROCHURES, JOURNALS, BULLETINS, AND CATALOGS IN THE FIELD OF RELIGION (U.S. CLS. 2, 5, 22, 23, 29, 37, 38 AND 50).

FIRST USE 7-1-2002; IN COMMERCE 7-1-2002.

**CLASS 16—(Continued).**

4,046,254. KOTTER INTERNATIONAL, INC., CAMBRIDGE, MA. SN 85-029,583. PUB. 4-19-2011, FILED 5-4-2010.

## KOTTER INTERNATIONAL

THE MARK CONSISTS OF STANDARD CHARACTERS WITHOUT CLAIM TO ANY PARTICULAR FONT, STYLE, SIZE, OR COLOR.

NO CLAIM IS MADE TO THE EXCLUSIVE RIGHT TO USE "INTERNATIONAL", APART FROM THE MARK AS SHOWN.

FOR PRINTED BOOKS, EDUCATIONAL AND INSTRUCTIONAL MATERIALS IN THE FIELDS OF ORGANIZATIONAL CHANGE MANAGEMENT, BUSINESS MANAGEMENT, AND EXECUTIVE AND LEADERSHIP DEVELOPMENT (U.S. CLS. 2, 5, 22, 23, 29, 37, 38 AND 50).

FIRST USE 2-0-2010; IN COMMERCE 2-0-2010.

4,046,258. KOTTER INTERNATIONAL, INC., CAMBRIDGE, MA. SN 85-029,749. PUB. 4-12-2011, FILED 5-4-2010.

# Kotter

INTERNATIONAL

NO CLAIM IS MADE TO THE EXCLUSIVE RIGHT TO USE "INTERNATIONAL", APART FROM THE MARK AS SHOWN.

THE MARK CONSISTS OF THE LITERAL ELEMENTS "KOTTER INTERNATIONAL" AND AN IMAGE OF A PENGUIN BETWEEN THE TWO "T'S" IN "KOTTER".

FOR PRINTED BOOKS, EDUCATIONAL AND INSTRUCTIONAL MATERIALS IN THE FIELDS OF ORGANIZATIONAL CHANGE MANAGEMENT, BUSINESS MANAGEMENT, AND EXECUTIVE AND LEADERSHIP DEVELOPMENT (U.S. CLS. 2, 5, 22, 23, 29, 37, 38 AND 50).

FIRST USE 2-0-2010; IN COMMERCE 2-0-2010.



**CLASS 16—(Continued).**

4,046,325. LAROSE INDUSTRIES, LLC, RANDOLPH, NJ. SN 85-058,649. PUB. 1-11-2011, FILED 6-9-2010.

**CAROUSEL OF COLORS**

THE MARK CONSISTS OF STANDARD CHARACTERS WITHOUT CLAIM TO ANY PARTICULAR FONT, STYLE, SIZE, OR COLOR.

FOR ARTS AND CRAFT SET FOR CHILDREN COMPRISING MARKERS SOLD AS A UNIT; ARTS AND CRAFT SET FOR CHILDREN PRIMARILY COMPRISED OF CRAYONS AND PENCIL SHARPENER, ALL SOLD AS A UNIT (U.S. CLS. 2, 5, 22, 23, 29, 37, 38 AND 50).  
FIRST USE 8-9-2011; IN COMMERCE 8-9-2011.

---

4,046,359. K & COMPANY LLC, KANSAS CITY, MO. SN 85-068,606. PUB. 11-2-2010, FILED 6-22-2010.

**SWEET NECTAR**

THE MARK CONSISTS OF STANDARD CHARACTERS WITHOUT CLAIM TO ANY PARTICULAR FONT, STYLE, SIZE, OR COLOR.

FOR ART PAPER; MEMORY BOOKS; PAPER; SCRAPBOOK ALBUMS; SCRAPBOOKS; STICKERS (U.S. CLS. 2, 5, 22, 23, 29, 37, 38 AND 50).  
FIRST USE 1-1-2011; IN COMMERCE 1-1-2011.

---

4,046,363. KDM ENTERPRISES L.L.C., CARPENTERSVILLE, IL. SN 85-071,591. PUB. 1-11-2011, FILED 6-25-2010.

**TREELIABLE**

THE MARK CONSISTS OF STANDARD CHARACTERS WITHOUT CLAIM TO ANY PARTICULAR FONT, STYLE, SIZE, OR COLOR.

FOR COMPUTER PAPER, CUSTOM PRINTED BUSINESS FORMS, GLUED PRINTED FORMS; PAPER IN THE FORM OF CUSTOM LASER CUT SHEETS; PRINTED FORMS, NAMELY, SNAP SETS, CUSTOM PRINTED SCRATCH PADS, CUSTOM PRINTED ENVELOPES, PAPER IN THE FORM OF STOCK AND CUSTOM PRINTED JUMBO LASER ROLLS, COPY PAPER, PAPER IN THE FORM OF ROLLS FOR RETAIL AND POINT OF SALE USE, PAPER IN THE FORM OF WIDE FORMAT MEDIA ENGINEERING ROLLS AND PAPER IN THE FORM OF INKJET MEDIA ROLLS (U.S. CLS. 2, 5, 22, 23, 29, 37, 38 AND 50).  
FIRST USE 10-0-2010; IN COMMERCE 10-0-2010.

**CLASS 16—(Continued).**

4,046,364. KDM ENTERPRISES L.L.C., CARPENTERSVILLE, IL. SN 85-071,596. PUB. 1-11-2011, FILED 6-25-2010.



THE MARK CONSISTS OF THE WORD "TREELIABLE" OVER TOP OF LEAVES ON A TREE.

FOR COMPUTER PAPER, CUSTOM PRINTED BUSINESS FORMS, GLUED PRINTED FORMS; PAPER IN THE FORM OF CUSTOM LASER CUT SHEETS; PRINTED FORMS, NAMELY, SNAP SETS, CUSTOM PRINTED SCRATCH PADS, CUSTOM PRINTED ENVELOPES, PAPER IN THE FORM OF STOCK AND CUSTOM PRINTED JUMBO LASER ROLLS, COPY PAPER, PAPER IN THE FORM OF ROLLS FOR RETAIL AND POINT OF SALE USE, PAPER IN THE FORM OF WIDE FORMAT MEDIA ENGINEERING ROLLS AND PAPER IN THE FORM OF INKJET MEDIA ROLLS (U.S. CLS. 2, 5, 22, 23, 29, 37, 38 AND 50).  
FIRST USE 10-0-2010; IN COMMERCE 10-0-2010.

---

4,046,433. BUNNIE WISE, LLC, FORMERLY BUNNIE LOVE, LLC, PORT ST. LUCIE, FL. SN 85-086,878. PUB. 12-21-2010, FILED 7-16-2010.



THE COLOR(S) BEIGE, PINK, OLIVE, RED, BLACK AND WHITE IS/ARE CLAIMED AS A FEATURE OF THE MARK.

THE MARK CONSISTS OF A BEIGE RABBIT OUTLINED IN BLACK WITH LONG FRONT LEGS, A PINK NOSE AND BLACK EYES, WEARING ROUND, BLACK WIRE-RIMMED SPECTACLES AND DRESSED IN AN OLIVE VEST WITH RED AND OLIVE SPOTS AND A WHITE SHIRT SITTING IN FRONT OF A LARGE OUTLINE OF A HEART.

FOR CHILDREN'S BOOKS; STORY BOOKS (U.S. CLS. 2, 5, 22, 23, 29, 37, 38 AND 50).  
FIRST USE 8-1-2010; IN COMMERCE 8-1-2010.

**CLASS 16—(Continued).**

4,046,491. ASSOCIATION OF INTERSTATE TRUCKING LAWYERS OF AMERICA, LLC, SPRINGFIELD, MO. SN 85-095,556. PUB. 1-4-2011, FILED 7-29-2010.

**THE LAWYER'S LOGBOOK**

THE MARK CONSISTS OF STANDARD CHARACTERS WITHOUT CLAIM TO ANY PARTICULAR FONT, STYLE, SIZE, OR COLOR.

NO CLAIM IS MADE TO THE EXCLUSIVE RIGHT TO USE "LAWYER'S", APART FROM THE MARK AS SHOWN. FOR MAGAZINES IN THE FIELD OF INTERSTATE TRUCKING LAW AND LITIGATION (U.S. CLS. 2, 5, 22, 23, 29, 37, 38 AND 50).

FIRST USE 4-12-2011; IN COMMERCE 4-12-2011.

4,046,494. WELSON, CATHY, BLOOMFIELD, CT. SN 85-096,033. PUB. 1-11-2011, FILED 7-29-2010.

**Bundles & Ink**

THE MARK CONSISTS OF STANDARD CHARACTERS WITHOUT CLAIM TO ANY PARTICULAR FONT, STYLE, SIZE, OR COLOR.

NO CLAIM IS MADE TO THE EXCLUSIVE RIGHT TO USE "INK", APART FROM THE MARK AS SHOWN.

FOR COLLAGES; PAINTINGS (U.S. CLS. 2, 5, 22, 23, 29, 37, 38 AND 50).

FIRST USE 7-31-2010; IN COMMERCE 7-31-2010.

4,046,610. K & COMPANY LLC, KANSAS CITY, MO. SN 85-115,555. PUB. 11-2-2010, FILED 8-25-2010.

**ABRIANNA**

THE MARK CONSISTS OF STANDARD CHARACTERS WITHOUT CLAIM TO ANY PARTICULAR FONT, STYLE, SIZE, OR COLOR.

FOR ART PADS; BRAG BOOKS; MEMORY BOOKS; SCRAP BOOKS; STICKERS (U.S. CLS. 2, 5, 22, 23, 29, 37, 38 AND 50).

FIRST USE 4-29-2011; IN COMMERCE 4-29-2011.

**CLASS 16—(Continued).**

4,046,626. SOCIETE BIC, CLICHY, FRANCE. SN 85-119,364. PUB. 2-15-2011, FILED 8-31-2010.

**BIC IMPRESSIONS**

THE MARK CONSISTS OF STANDARD CHARACTERS WITHOUT CLAIM TO ANY PARTICULAR FONT, STYLE, SIZE, OR COLOR.

FOR WRITING INSTRUMENTS, NAMELY, PENCILS AND MECHANICAL PENCILS (U.S. CLS. 2, 5, 22, 23, 29, 37, 38 AND 50).

FIRST USE 2-25-2011; IN COMMERCE 2-25-2011.

4,046,733. THE GENERAL HOSPITAL CORPORATION, BOSTON, MA. SN 85-141,886. PUB. 2-15-2011, FILED 9-30-2010.

**PEDIWISE**

THE MARK CONSISTS OF STANDARD CHARACTERS WITHOUT CLAIM TO ANY PARTICULAR FONT, STYLE, SIZE, OR COLOR.

FOR PRINTED GUIDES FOR USE BY PARENTS AND CAREGIVERS TO OBTAIN INFORMATION IN THE FIELD OF PEDIATRIC HEALTH AND MEDICAL CARE, AND TO PREPARE FOR VISITS TO HEALTHCARE PROFESSIONALS (U.S. CLS. 2, 5, 22, 23, 29, 37, 38 AND 50).

FIRST USE 9-6-2011; IN COMMERCE 9-6-2011.

4,046,802. PACTIV CORPORATION, LAKE FOREST, IL. SN 85-161,311. PUB. 3-22-2011, FILED 10-26-2010.

**BLACKOUT**

THE MARK CONSISTS OF STANDARD CHARACTERS WITHOUT CLAIM TO ANY PARTICULAR FONT, STYLE, SIZE, OR COLOR.

FOR PLASTIC TRASH BAGS; TRASH BAGS (U.S. CLS. 2, 5, 22, 23, 29, 37, 38 AND 50).

FIRST USE 12-31-2010; IN COMMERCE 12-31-2010.

**CLASS 16—(Continued).**

4,046,803. PACTIV CORPORATION, LAKE FOREST, IL. SN 85-161,324. PUB. 3-22-2011, FILED 10-26-2010.

KEEP YOUR GARBAGE IN THE  
DARK

THE MARK CONSISTS OF STANDARD CHARACTERS WITHOUT CLAIM TO ANY PARTICULAR FONT, STYLE, SIZE, OR COLOR.

FOR PLASTIC TRASH BAGS; TRASH BAGS (U.S. CLS. 2, 5, 22, 23, 29, 37, 38 AND 50).

FIRST USE 12-31-2010; IN COMMERCE 12-31-2010.

4,046,819. ORBITAL WRAP SYSTEMS PTY LTD, EDWARDS-TOWN, AUSTRALIA. SN 85-166,223. PUB. 4-12-2011, FILED 11-1-2010.

AIR RAP

THE MARK CONSISTS OF STANDARD CHARACTERS WITHOUT CLAIM TO ANY PARTICULAR FONT, STYLE, SIZE, OR COLOR.

NO CLAIM IS MADE TO THE EXCLUSIVE RIGHT TO USE "WRAP", APART FROM THE MARK AS SHOWN.

FOR PLASTIC WRAP AND PLASTIC BAGS FOR PACKAGING FOR FOOD (U.S. CLS. 2, 5, 22, 23, 29, 37, 38 AND 50).

FIRST USE 12-17-2010; IN COMMERCE 12-17-2010.

4,046,822. WILKINS, CYNTHIA MARIE, ONTARIO, CA. SN 85-166,582. PUB. 3-29-2011, FILED 11-1-2010.



THE COLOR(S) LIGHT BROWN, BLACK, WHITE, GOLD AND VIOLET IS/ARE CLAIMED AS A FEATURE OF THE MARK.

**CLASS 16—(Continued).**

THE MARK CONSISTS OF A LIGHT BROWN HAND WITH A WHITE SLEEVE HOLDING A BLACK PEN WITH A GOLD COLOR TRIM AND TIP, WITH A VIOLET SHADOW BEHIND THE HAND AND PEN.

FOR STATIONERY; STATIONERY WRITING PAPER AND ENVELOPES (U.S. CLS. 2, 5, 22, 23, 29, 37, 38 AND 50).

FIRST USE 7-31-2011; IN COMMERCE 7-31-2011.

4,046,843. BALANCED VIEW, MILL VALLEY, CA. SN 85-175,549. PUB. 1-18-2011, FILED 11-12-2010.

Balanced View Media

THE MARK CONSISTS OF STANDARD CHARACTERS WITHOUT CLAIM TO ANY PARTICULAR FONT, STYLE, SIZE, OR COLOR.

NO CLAIM IS MADE TO THE EXCLUSIVE RIGHT TO USE "MEDIA", APART FROM THE MARK AS SHOWN.

FOR PAMPHLETS ABOUT LIVING IN EQUILIBRIUM AND HARMONY (U.S. CLS. 2, 5, 22, 23, 29, 37, 38 AND 50).

FIRST USE 9-1-2011; IN COMMERCE 9-1-2011.

4,046,858. M & Q IP LEASING, INC., WILMINGTON, DE. SN 85-182,205. PUB. 4-12-2011, FILED 11-22-2010.

PANSAVER ECO

THE MARK CONSISTS OF STANDARD CHARACTERS WITHOUT CLAIM TO ANY PARTICULAR FONT, STYLE, SIZE, OR COLOR.

OWNER OF U.S. REG. NO. 2,303,546.

FOR PLASTIC FILM SOLD IN BAG FORM FOR USE IN COOKING FOODS (U.S. CLS. 2, 5, 22, 23, 29, 37, 38 AND 50).

FIRST USE 4-29-2011; IN COMMERCE 4-29-2011.

**CLASS 16—(Continued).**

4,046,870. WILKINS, BILLY, WILMINGTON, NC. SN 85-186,027. PUB. 4-19-2011, FILED 11-29-2010.

**LECOMPART**

THE MARK CONSISTS OF STANDARD CHARACTERS WITHOUT CLAIM TO ANY PARTICULAR FONT, STYLE, SIZE, OR COLOR.

FOR PHOTOGRAPHS THAT HAVE BEEN COMPUTER MANIPULATED AND ENHANCED TO LOOK LIKE PAINTINGS (U.S. CLS. 2, 5, 22, 23, 29, 37, 38 AND 50).  
FIRST USE 3-1-2009; IN COMMERCE 3-1-2009.

---

4,046,905. SAMSILL CORPORATION, FORT WORTH, TX. SN 85-194,154. PUB. 4-19-2011, FILED 12-9-2010.

**SPEEDY SPINE**

THE MARK CONSISTS OF STANDARD CHARACTERS WITHOUT CLAIM TO ANY PARTICULAR FONT, STYLE, SIZE, OR COLOR.

FOR BINDERS (U.S. CLS. 2, 5, 22, 23, 29, 37, 38 AND 50).

FIRST USE 11-1-2010; IN COMMERCE 11-1-2010.

---

4,046,915. WEVEEL LLC, HASLET, TX. SN 85-197,942. PUB. 5-24-2011, FILED 12-14-2010.



THE MARK CONSISTS OF THE STYLIZED WORD "SCENTOS" IN UPPER CASE CAPITAL LETTERS.

FOR FELT TIP MARKERS; FIBER-TIP MARKERS; MARKERS (U.S. CLS. 2, 5, 22, 23, 29, 37, 38 AND 50).  
FIRST USE 1-10-2011; IN COMMERCE 1-10-2011.

**CLASS 16—(Continued).**

4,046,984. CHAPMAN, SUNNI, GRASS VALLEY, CA. AND CHAPMAN, MARY, GRASS VALLEY, CA. SN 85-215,906. PUB. 5-24-2011, FILED 1-12-2011.

**Mimi & Boo**

THE MARK CONSISTS OF STANDARD CHARACTERS WITHOUT CLAIM TO ANY PARTICULAR FONT, STYLE, SIZE, OR COLOR.

FOR ART PRINTS; GREETING CARDS; STATIONERY (U.S. CLS. 2, 5, 22, 23, 29, 37, 38 AND 50).  
FIRST USE 12-1-2010; IN COMMERCE 3-1-2011.

---

4,047,094. THE FLOWWALKING COMPANY LLC, MUNSTER, IN. SN 85-975,572. PUB. 12-21-2010, FILED 7-16-2010.

**FloWalking**

THE MARK CONSISTS OF STANDARD CHARACTERS WITHOUT CLAIM TO ANY PARTICULAR FONT, STYLE, SIZE, OR COLOR.

FOR PRINTED MATTER, NAMELY, BOOKS FEATURING INFORMATION ABOUT EXERCISE, FITNESS AND HEALTH PROGRAMS (U.S. CLS. 2, 5, 22, 23, 29, 37, 38 AND 50).

FIRST USE 6-23-2011; IN COMMERCE 6-23-2011.

**CLASS 17—RUBBER GOODS**

4,045,647. PRIMEX PLASTICS CORP., RICHMOND, IN. SN 77-257,208. PUB. 3-4-2008, FILED 8-16-2007.

**PRINT-X**

THE MARK CONSISTS OF STANDARD CHARACTERS WITHOUT CLAIM TO ANY PARTICULAR FONT, STYLE, SIZE, OR COLOR.

FOR PLASTIC IN SMOOTH PRINT-GRADE PLASTIC SHEETS AND ROLLS FOR GENERAL INDUSTRIAL USE; PLASTIC FLEXIBLE PACKAGING SHEET SOLD IN BULK TO INDUSTRIAL AND COMMERCIAL MANUFACTURERS (U.S. CLS. 1, 5, 12, 13, 35 AND 50).  
FIRST USE 12-31-2008; IN COMMERCE 12-31-2008.

**CLASS 17—(Continued).**

4,046,044. POLYGLASS USA, INC., FERNLEY, NV. SN 77-929,294. PUB. 12-28-2010, FILED 2-5-2010.

**MODIGLASS**

THE MARK CONSISTS OF STANDARD CHARACTERS WITHOUT CLAIM TO ANY PARTICULAR FONT, STYLE, SIZE, OR COLOR.

FOR INSULATING WATERPROOF MEMBRANES FOR ABOVE AND BELOW GRADE USE; ROOFING MEMBRANES FOR INSULATING AND WATERPROOFING PURPOSES; WATERPROOFING MEMBRANES FOR USE ON ROOFS (U.S. CLS. 1, 5, 12, 13, 35 AND 50).  
FIRST USE 1-2-1996; IN COMMERCE 1-2-1996.

4,046,045. POLYGLASS USA, INC., FERNLEY, NV. SN 77-929,298. PUB. 12-28-2010, FILED 2-5-2010.

**MODIBOND**

THE MARK CONSISTS OF STANDARD CHARACTERS WITHOUT CLAIM TO ANY PARTICULAR FONT, STYLE, SIZE, OR COLOR.

FOR INSULATING WATERPROOF MEMBRANES FOR ABOVE AND BELOW GRADE USE; ROOFING MEMBRANES FOR INSULATING AND WATERPROOFING PURPOSES; WATERPROOFING MEMBRANES FOR USE ON ROOFS (U.S. CLS. 1, 5, 12, 13, 35 AND 50).  
FIRST USE 1-2-1998; IN COMMERCE 1-2-1998.

4,046,056. EDGETECH I.G., INC., CAMBRIDGE, OH. SN 77-931,958. PUB. 7-6-2010, FILED 2-9-2010.



OWNER OF U.S. REG. NOS. 2,174,901 AND 2,174,910.  
THE MARK CONSISTS OF THE STYLIZED LETTER "E" AND THE WORD "EDGETECH" DISPOSED ABOVE THE WORDS "BETWEEN YOU AND THE ELEMENTS".

FOR INSULATING GLASS UNIT COMPONENTS, NAMELY, SPACERS FABRICATED PRIMARILY FROM FOAM FOR INSULATING GLASS APPLICATIONS (U.S. CLS. 1, 5, 12, 13, 35 AND 50).  
FIRST USE 8-30-2011; IN COMMERCE 8-30-2011.

**CLASS 17—(Continued).**

4,046,509. EATON CORPORATION, CLEVELAND, OH. SN 85-098,192. PUB. 6-7-2011, FILED 8-2-2010.

**STEAM SLAYER**

THE MARK CONSISTS OF STANDARD CHARACTERS WITHOUT CLAIM TO ANY PARTICULAR FONT, STYLE, SIZE, OR COLOR.

NO CLAIM IS MADE TO THE EXCLUSIVE RIGHT TO USE "STEAM", APART FROM THE MARK AS SHOWN.  
FOR STEAM HOSES MADE OF RUBBER FOR STEAM TRANSFER APPLICATIONS LIKE CLEANING, HEATING, OR MELTING (U.S. CLS. 1, 5, 12, 13, 35 AND 50).  
FIRST USE 11-23-2010; IN COMMERCE 11-23-2010.

4,046,515. FLINT TRADING, INC., THOMASVILLE, NC. SN 85-098,684. PUB. 1-18-2011, FILED 8-3-2010.

**FLAMETAPE**

THE MARK CONSISTS OF STANDARD CHARACTERS WITHOUT CLAIM TO ANY PARTICULAR FONT, STYLE, SIZE, OR COLOR.

FOR PREFORMED THERMOPLASTIC SHEETS FOR USE AS PAVEMENT MARKINGS (U.S. CLS. 1, 5, 12, 13, 35 AND 50).  
FIRST USE 6-21-2010; IN COMMERCE 6-21-2010.

4,046,516. FLINT TRADING, INC., THOMASVILLE, NC. SN 85-098,755. PUB. 1-18-2011, FILED 8-3-2010.

**THERMALINE**

THE MARK CONSISTS OF STANDARD CHARACTERS WITHOUT CLAIM TO ANY PARTICULAR FONT, STYLE, SIZE, OR COLOR.

FOR PREFORMED THERMOPLASTIC SHEETS FOR USE AS PAVEMENT MARKINGS (U.S. CLS. 1, 5, 12, 13, 35 AND 50).  
FIRST USE 3-24-2011; IN COMMERCE 3-24-2011.

**CLASS 17—(Continued).**

4,046,582. COLLECT TECHNOLOGIES, LLC, WEST HYANNISPORT, MA. SN 85-110,572. PUB. 11-30-2010, FILED 8-18-2010.

**OPFLEX PAD**

THE MARK CONSISTS OF STANDARD CHARACTERS WITHOUT CLAIM TO ANY PARTICULAR FONT, STYLE, SIZE, OR COLOR.

OWNER OF U.S. REG. NO. 3,583,235.

NO CLAIM IS MADE TO THE EXCLUSIVE RIGHT TO USE "PAD", APART FROM THE MARK AS SHOWN.

FOR HYDROCARBON- AND OIL-ABSORBENT FLEXIBLE FOAMED PLASTIC FOR USE IN HYDROCARBON, OIL, AND OIL-BASED CHEMICAL SPILL CLEAN-UP, CONTAINMENT AND CLEAN-UP OF HYDROCARBON, OIL, AND OIL-BASED CHEMICALS, AND REMOVAL OF HYDROCARBON, OIL, AND OIL-BASED CHEMICALS FROM GROUNDWATER, STORM WATER RUN-OFF, SNOW MELT RUN-OFF, RIVERS, LAKES, AND OCEANS (U.S. CLS. 1, 5, 12, 13, 35 AND 50).  
FIRST USE 8-4-2010; IN COMMERCE 8-4-2010.

4,046,583. COLLECT TECHNOLOGIES, LLC, WEST HYANNISPORT, MA. SN 85-110,580. PUB. 11-30-2010, FILED 8-18-2010.

**OPFLEX BOOM**

THE MARK CONSISTS OF STANDARD CHARACTERS WITHOUT CLAIM TO ANY PARTICULAR FONT, STYLE, SIZE, OR COLOR.

OWNER OF U.S. REG. NO. 3,583,235.

NO CLAIM IS MADE TO THE EXCLUSIVE RIGHT TO USE "BOOM", APART FROM THE MARK AS SHOWN.

FOR HYDROCARBON- AND OIL-ABSORBENT FLEXIBLE FOAMED PLASTIC FOR USE IN HYDROCARBON, OIL, AND OIL-BASED CHEMICAL SPILL CLEAN-UP, CONTAINMENT AND CLEAN-UP OF HYDROCARBON, OIL, AND OIL-BASED CHEMICALS, AND REMOVAL OF HYDROCARBON, OIL, AND OIL-BASED CHEMICALS FROM GROUNDWATER, STORM WATER RUN-OFF, SNOW MELT RUN-OFF, RIVERS, LAKES, AND OCEANS (U.S. CLS. 1, 5, 12, 13, 35 AND 50).  
FIRST USE 8-4-2010; IN COMMERCE 8-4-2010.

**CLASS 17—(Continued).**

4,046,584. COLLECT TECHNOLOGIES, LLC, WEST HYANNISPORT, MA. SN 85-110,623. PUB. 11-30-2010, FILED 8-18-2010.

**OPFLEX MITT**

THE MARK CONSISTS OF STANDARD CHARACTERS WITHOUT CLAIM TO ANY PARTICULAR FONT, STYLE, SIZE, OR COLOR.

OWNER OF U.S. REG. NO. 3,583,235.

NO CLAIM IS MADE TO THE EXCLUSIVE RIGHT TO USE "MITT", APART FROM THE MARK AS SHOWN.

FOR HYDROCARBON- AND OIL-ABSORBENT FLEXIBLE FOAMED PLASTIC FOR USE IN HYDROCARBON, OIL, AND OIL-BASED CHEMICAL SPILL CLEAN-UP, CONTAINMENT AND CLEAN-UP OF HYDROCARBON, OIL, AND OIL-BASED CHEMICALS, AND REMOVAL OF HYDROCARBON, OIL, AND OIL-BASED CHEMICALS FROM GROUNDWATER, STORM WATER RUN-OFF, SNOW MELT RUN-OFF, RIVERS, LAKES, AND OCEANS (U.S. CLS. 1, 5, 12, 13, 35 AND 50).  
FIRST USE 8-4-2010; IN COMMERCE 8-4-2010.

4,046,862. HUNTER PANELS LLC, PORTLAND, ME. SN 85-183,392. PUB. 2-22-2011, FILED 11-23-2010.

**XCI HUNTER**

THE MARK CONSISTS OF STANDARD CHARACTERS WITHOUT CLAIM TO ANY PARTICULAR FONT, STYLE, SIZE, OR COLOR.

FOR FOAM INSULATION FOR USE IN BUILDING AND CONSTRUCTION (U.S. CLS. 1, 5, 12, 13, 35 AND 50).

FIRST USE 2-24-2011; IN COMMERCE 2-24-2011.

4,047,046. INDUSTRIAL PACKAGING SUPPLIES OF GREENVILLE, INC., FOUNTAIN INN, SC. SN 85-236,448. PUB. 6-14-2011, FILED 2-8-2011.

**CORNERSTONE**

THE MARK CONSISTS OF STANDARD CHARACTERS WITHOUT CLAIM TO ANY PARTICULAR FONT, STYLE, SIZE, OR COLOR.

OWNER OF U.S. REG. NO. 3,524,916.

FOR AIR-FILLED DUNNAGE BAGS (U.S. CLS. 1, 5, 12, 13, 35 AND 50).

FIRST USE 6-15-2011; IN COMMERCE 6-15-2011.

**CLASS 17—(Continued).**

4,047,060. ILLINOIS TOOL WORKS INC., GLENVIEW, IL. SN 85-241,827. PUB. 5-17-2011, FILED 2-14-2011.

# G-FORCE

THE MARK CONSISTS OF STANDARD CHARACTERS WITHOUT CLAIM TO ANY PARTICULAR FONT, STYLE, SIZE, OR COLOR.

FOR A SYSTEM COMPRISED PRIMARILY OF FOAM PADS AND STRAPS USED TO SECURE, STABILIZE, RESTRAIN AND PROTECT SHIPMENTS DURING TRANSPORT (U.S. CLS. 1, 5, 12, 13, 35 AND 50).

FIRST USE 7-5-2011; IN COMMERCE 7-5-2011.

**CLASS 18—(Continued).**

4,045,908. TASER INTERNATIONAL, INC., SCOTTSDALE, AZ. SN 77-813,113. PUB. 7-13-2010, FILED 8-26-2009.



THE MARK CONSISTS OF AN IMAGE OF A STYLIZED LIGHTNING BOLT WITHIN A CIRCLE.

FOR POLICE DUTY BAGS, NAMELY, GENERAL PURPOSE BAGS FOR CARRYING LAW ENFORCEMENT EQUIPMENT (U.S. CLS. 1, 2, 3, 22 AND 41).

FIRST USE 11-6-2009; IN COMMERCE 12-2-2009.

**CLASS 18—LEATHER GOODS**

4,045,846. MARESCA, FRANCIS G., NORTH BERGEN, NJ. SN 77-734,371. PUB. 12-1-2009, FILED 5-11-2009.

# BINKI & BOO

THE MARK CONSISTS OF STANDARD CHARACTERS WITHOUT CLAIM TO ANY PARTICULAR FONT, STYLE, SIZE, OR COLOR.

FOR PET PRODUCTS, NAMELY, DOG APPAREL, COATS, SWEATERS, HATS, BOOTS, HALLOWEEN COSTUMES, PET CARRIERS, TOTE BAGS FOR USE AS ANIMAL CARRIERS, PET LEASHES, PET COLLARS, PET HARNESSSES; PET CLOTHING, NAMELY, COATS, T-SHIRTS, SWEATERS, DRESSES, JACKETS; SMALL LEATHER GOODS, NAMELY, WALLETS, KEY CHAINS, KEY CASES; ANIMAL LEASHES, COLLARS FOR PETS, ANIMAL COLLARS, HARNESSSES, ANIMAL CARRIERS, TOTE BAGS (U.S. CLS. 1, 2, 3, 22 AND 41).

FIRST USE 7-0-2011; IN COMMERCE 7-0-2011.

4,045,972. MONAVIE LLC, SOUTH JORDAN, UT. SN 77-879,073. PUB. 4-19-2011, FILED 11-23-2009.

# MONA·VIE

THE MARK CONSISTS OF STANDARD CHARACTERS WITHOUT CLAIM TO ANY PARTICULAR FONT, STYLE, SIZE, OR COLOR.

OWNER OF U.S. REG. NOS. 3,106,146, 3,111,333, AND OTHERS.

FOR TRAVEL BAGS AND TOTE BAGS; BUSINESS CARD CASES; AND LUGGAGE (U.S. CLS. 1, 2, 3, 22 AND 41).

FIRST USE 6-1-2007; IN COMMERCE 6-1-2007.

**CLASS 18—(Continued).**

4,046,007. POLEWKA, TAMMY L., SACRAMENTO, CA. SN 77-910,204. PUB. 7-20-2010, FILED 1-12-2010.



NO CLAIM IS MADE TO THE EXCLUSIVE RIGHT TO USE "BAGS WITH BLING", APART FROM THE MARK AS SHOWN.

THE MARK CONSISTS OF LARGE STYLIZED LETTERS "L" AND "B" WITH A SMALL DIAMOND BELOW CONTAINED IN A BOX. NEXT TO THE BOX IS THE STYLIZED LETTERING "BA-LING (BAGS WITH BLING)".

FOR HANDBAGS WITH CUSTOMIZABLE, REMOVABLE, AND INTERCHANGEABLE SHOULDER STRAPS AND BAG ORNAMENTATION THAT CAN ALSO BE WORN AS BELTS, NECKLACES, BRACELETS, AND OTHER PIECES OF JEWELRY (U.S. CLS. 1, 2, 3, 22 AND 41).

FIRST USE 3-2-2011; IN COMMERCE 3-2-2011.

4,046,030. CHAN CONLYN, NEW YORK, NY. SN 77-920,923. PUB. 1-18-2011, FILED 1-27-2010.

**LAWLESS**

THE MARK CONSISTS OF STANDARD CHARACTERS WITHOUT CLAIM TO ANY PARTICULAR FONT, STYLE, SIZE, OR COLOR.

FOR CLUTCH BAGS AND SHOULDER BAGS IN EXOTIC SKIN (U.S. CLS. 1, 2, 3, 22 AND 41).

FIRST USE 4-1-2009; IN COMMERCE 7-1-2010.

4,046,218. TYSON FRESH MEATS, INC., SPRINGDALE, AR. SN 85-011,274. PUB. 9-7-2010, FILED 4-11-2010.



OWNER OF U.S. REG. NOS. 1,020,013, 1,112,830, AND 1,209,465.

NO CLAIM IS MADE TO THE EXCLUSIVE RIGHT TO USE "EXCELLENCE", APART FROM THE MARK AS SHOWN.

**CLASS 18—(Continued).**

THE MARK CONSISTS OF THE WORD "TRUSTED" APPEARS BELOW THE LETTERS "IB" AND THE WORD "EXCELLENCE" APPEARS BELOW THE LETTER "P".

FOR ANIMAL SKINS AND HIDES (U.S. CLS. 1, 2, 3, 22 AND 41).

FIRST USE 1-14-2011; IN COMMERCE 1-14-2011.

4,046,248. NORDSTROM, INC., SEATTLE, WA. SN 85-027,486. PUB. 11-9-2010, FILED 4-30-2010.

**HINGE**

THE MARK CONSISTS OF STANDARD CHARACTERS WITHOUT CLAIM TO ANY PARTICULAR FONT, STYLE, SIZE, OR COLOR.

OWNER OF U.S. REG. NO. 3,814,881. FOR HANDBAGS AND PURSES (U.S. CLS. 1, 2, 3, 22 AND 41).

FIRST USE 7-5-2010; IN COMMERCE 7-5-2010.

4,046,391. INDENYA UEHARA YUSHICHI CO., LTD., YAMANASHI, JAPAN. SN 85-078,561. PUB. 5-10-2011, FILED 7-6-2010.

**INDEN-YA**

THE MARK CONSISTS OF STANDARD CHARACTERS WITHOUT CLAIM TO ANY PARTICULAR FONT, STYLE, SIZE, OR COLOR.

THE WORDING "INDEN-YA" HAS NO MEANING IN A FOREIGN LANGUAGE.

FOR BAGS, NAMELY, LEATHER AND IMITATION LEATHER BAGS, DUFFEL BAGS, CARRY-ALL BAGS; POUCHES, NAMELY, LEATHER POUCHES, JAPANESE UTILITY POUCHES; RAWHIDES; UNFITTED VANITY CASES (U.S. CLS. 1, 2, 3, 22 AND 41).

FIRST USE 4-1-1998; IN COMMERCE 4-1-1998.



**CLASS 18—(Continued).**

4,046,607. WILSHIRE FASHIONS, INC., NEW YORK, NY. SN 85-115,389. PUB. 2-8-2011, FILED 8-25-2010.

**MIA & BAILEY**

THE MARK CONSISTS OF STANDARD CHARACTERS WITHOUT CLAIM TO ANY PARTICULAR FONT, STYLE, SIZE, OR COLOR.  
FOR HANDBAGS (U.S. CLS. 1, 2, 3, 22 AND 41).  
FIRST USE 12-1-2010; IN COMMERCE 12-1-2010.

4,046,715. PANAMA JACK INTERNATIONAL, INC., ORLANDO, FL. SN 85-137,345. PUB. 1-4-2011, FILED 9-24-2010.

**PANAMA JACK ESCAPE**

THE MARK CONSISTS OF STANDARD CHARACTERS WITHOUT CLAIM TO ANY PARTICULAR FONT, STYLE, SIZE, OR COLOR.

OWNER OF U.S. REG. NOS. 1,673,955, 3,265,789, AND OTHERS.

FOR BACKPACKS, DUFFEL BAGS, ALL PURPOSE GEAR BAGS, FANNY PACKS, TRAVEL BAGS, TOTE BAGS, BEACH BAGS, WALLETS, HANDBAGS, LUGGAGE TAGS, TRUNKS, LEATHER KEY CHAINS, UMBRELLAS, ROLL BAGS, ALL-PURPOSE SPORT BAGS, COSMETIC BAGS SOLD EMPTY, LUGGAGE, ATHLETIC BAGS, CLUTCH BAGS, BOOK BAGS, OVERNIGHT BAGS; PURSES; SCHOOL BAGS (U.S. CLS. 1, 2, 3, 22 AND 41).

FIRST USE 1-0-2011; IN COMMERCE 1-0-2011.

**CLASS 19—NON-METALLIC BUILDING MATERIALS**

4,045,699. GREENWOOD, INC., DBA GREENWOOD PLASTICS CO., DANVILLE, IL. SN 77-401,424. PUB. 2-24-2009, FILED 2-20-2008.

**ELITE**

THE MARK CONSISTS OF STANDARD CHARACTERS WITHOUT CLAIM TO ANY PARTICULAR FONT, STYLE, SIZE, OR COLOR.

OWNER OF U.S. REG. NO. 2,442,361.

FOR BURIAL VAULTS NOT OF METAL HAVING OPTIONAL EXTERIOR METAL FINISHING (U.S. CLS. 1, 12, 33 AND 50).

FIRST USE 1-1-2008; IN COMMERCE 1-1-2008.

**CLASS 19—(Continued).**

4,045,816. MASCO CABINETRY LLC, ANN ARBOR, MI. SN 77-678,061. PUB. 1-19-2010, FILED 2-25-2009.

**DENOVA BEGINNINGS**

THE MARK CONSISTS OF STANDARD CHARACTERS WITHOUT CLAIM TO ANY PARTICULAR FONT, STYLE, SIZE, OR COLOR.

FOR BUILDING MATERIALS, NAMELY, NON-METAL COUNTERTOPS FOR FURTHER INSTALLATION IN KITCHENS AND BATHROOMS (U.S. CLS. 1, 12, 33 AND 50).

FIRST USE 9-8-2009; IN COMMERCE 9-8-2009.

4,045,848. POROUS TECHNOLOGIES, LLC, NORTH YARMOUTH, ME. SN 77-740,173. PUB. 9-22-2009, FILED 5-19-2009.

**WHEN IT RAINS ... IT'S POROUS**

THE MARK CONSISTS OF STANDARD CHARACTERS WITHOUT CLAIM TO ANY PARTICULAR FONT, STYLE, SIZE, OR COLOR.

FOR CONCRETE; CONCRETE BLOCKS; CONCRETE ROAD PAVEMENT BOARDS; PAVERS (U.S. CLS. 1, 12, 33 AND 50).

FIRST USE 11-16-2010; IN COMMERCE 7-18-2011.

4,046,074. CALPORTLAND COMPANY, GLENDORA, CA. SN 77-937,161. PUB. 7-6-2010, FILED 2-16-2010.



OWNER OF U.S. REG. NOS. 1,754,373, 3,693,593, AND OTHERS.

THE MARK CONSISTS OF A LARGE LETTER "C" NEXT TO A LARGE LETTER "P", THE "P" BEING OVER THE WORD "ADVANTAGE".

FOR AGGREGATE MATERIAL COMPOSED OF ROCK, SAND AND GRAVEL; ASPHALT; CEMENT MIXES; CONCRETE (U.S. CLS. 1, 12, 33 AND 50).

FIRST USE 2-25-2010; IN COMMERCE 2-25-2010.

**CLASS 19—(Continued).**

4,046,253. LOXCREEN CANADA LTD., MISSISSAUGA, ONTARIO, CANADA. SN 85-029,374. PUB. 1-4-2011, FILED 5-4-2010.

**PROVA-SHOWER**

THE MARK CONSISTS OF STANDARD CHARACTERS WITHOUT CLAIM TO ANY PARTICULAR FONT, STYLE, SIZE, OR COLOR.

PRIORITY CLAIMED UNDER SEC. 44(D) ON CANADA APPLICATION NO. 1,465,076, FILED 1-8-2010, REG. NO. TMA781854, DATED 11-8-2010, EXPIRES 11-8-2025.

FOR TILE SHOWER INSTALLATION KITS COMPRISING SLOPED FLOOR PAN AND WATERPROOFING MEMBRANE IN THE FORM OF TILE UNDERLAYMENT (U.S. CLS. 1, 12, 33 AND 50).

FIRST USE 12-11-2009; IN COMMERCE 12-11-2009.

---

4,046,411. FIBER COMPOSITES, LLC, NEW LONDON, NC. SN 85-083,460. PUB. 12-14-2010, FILED 7-13-2010.

**FIBERON PRO-TECT**

THE MARK CONSISTS OF STANDARD CHARACTERS WITHOUT CLAIM TO ANY PARTICULAR FONT, STYLE, SIZE, OR COLOR.

OWNER OF U.S. REG. NOS. 2,358,135 AND 3,143,512. FOR COMPOSITE NON-METAL DECKING BOARDS (U.S. CLS. 1, 12, 33 AND 50).

FIRST USE 4-15-2011; IN COMMERCE 4-15-2011.

---

4,046,450. ARDISAM, INC., CUMBERLAND, WI. SN 85-089,959. PUB. 12-28-2010, FILED 7-21-2010.

**ESKIMO**

THE MARK CONSISTS OF STANDARD CHARACTERS WITHOUT CLAIM TO ANY PARTICULAR FONT, STYLE, SIZE, OR COLOR.

FOR NON-METAL PORTABLE ICE FISHING SHELTERS (U.S. CLS. 1, 12, 33 AND 50).

FIRST USE 12-31-2000; IN COMMERCE 12-31-2000.

**CLASS 19—(Continued).**

4,046,458. OVERHEAD DOOR CORPORATION, LEWISVILLE, TX. SN 85-091,025. PUB. 12-7-2010, FILED 7-22-2010.

**IMPRESSION COLLECTION**

THE MARK CONSISTS OF STANDARD CHARACTERS WITHOUT CLAIM TO ANY PARTICULAR FONT, STYLE, SIZE, OR COLOR.

NO CLAIM IS MADE TO THE EXCLUSIVE RIGHT TO USE "COLLECTION", APART FROM THE MARK AS SHOWN.

FOR NON-METAL UPWARD ACTING GARAGE DOOR (U.S. CLS. 1, 12, 33 AND 50).

FIRST USE 1-1-2011; IN COMMERCE 1-1-2011.

---

4,046,538. THERMA-TRU CORP., MAUMEE, OH. SN 85-101,169. PUB. 1-11-2011, FILED 8-5-2010.

**MAPLE PARK**

THE MARK CONSISTS OF STANDARD CHARACTERS WITHOUT CLAIM TO ANY PARTICULAR FONT, STYLE, SIZE, OR COLOR.

FOR DECORATIVE GLASS PANELS FOR DOORS (U.S. CLS. 1, 12, 33 AND 50).

FIRST USE 1-0-2011; IN COMMERCE 1-0-2011.

---

4,046,928. EAGLE MATERIALS IP LLC, DALLAS, TX. SN 85-202,116. PUB. 4-26-2011, FILED 12-20-2010.

**LIGHTROC**

THE MARK CONSISTS OF STANDARD CHARACTERS WITHOUT CLAIM TO ANY PARTICULAR FONT, STYLE, SIZE, OR COLOR.

FOR WALL BOARDS (U.S. CLS. 1, 12, 33 AND 50).

FIRST USE 3-0-2011; IN COMMERCE 3-0-2011.

**CLASS 19—(Continued).**

4,047,102. TREE ISLAND WIRE (USA), INC., WALNUT, CA. SN 85-975,666. PUB. 1-11-2011, FILED 7-28-2010.

**TRUE SPEC**

THE MARK CONSISTS OF STANDARD CHARACTERS WITHOUT CLAIM TO ANY PARTICULAR FONT, STYLE, SIZE, OR COLOR.

OWNER OF U.S. REG. NOS. 3,438,054 AND 3,438,055. FOR ASPHALT SHEATHING PAPER (U.S. CLS. 1, 12, 33 AND 50). FIRST USE 3-2-2011; IN COMMERCE 3-2-2011.

**CLASS 20—FURNITURE AND ARTICLES NOT OTHERWISE CLASSIFIED**

4,045,786. RAPID RACK INDUSTRIES, INC., CITY OF INDUSTRY, CA. SN 77-639,480. PUB. 6-8-2010, FILED 12-23-2008.

**FLEXI**

THE MARK CONSISTS OF STANDARD CHARACTERS WITHOUT CLAIM TO ANY PARTICULAR FONT, STYLE, SIZE, OR COLOR.

FOR METAL AND NON-METAL SHELVING, STORAGE RACKS, WORK BENCHES, WORK TABLES; ASSEMBLY KITS FOR MAKING METAL AND NON-METAL STORAGE RACKS, WORK TABLES AND WORK BENCHES (U.S. CLS. 2, 13, 22, 25, 32 AND 50). FIRST USE 5-20-2008; IN COMMERCE 5-20-2008.

4,045,861. ALLFLEX USA, INC., DFW AIRPORT, TX. SN 77-757,493. PUB. 11-3-2009, FILED 6-11-2009.

**A-Tag**

THE MARK CONSISTS OF STANDARD CHARACTERS WITHOUT CLAIM TO ANY PARTICULAR FONT, STYLE, SIZE, OR COLOR.

FOR PLASTIC EAR TAGS FOR LIVESTOCK (U.S. CLS. 2, 13, 22, 25, 32 AND 50). FIRST USE 8-0-2010; IN COMMERCE 11-0-2010.

**CLASS 20—(Continued).**

4,045,862. JUDI COSTELLO, DBA UNIQUE UPHOLSTERY & INTERIOR DESIGN, LLC, COVINA, CA. SN 77-759,979. PUB. 5-4-2010, FILED 6-15-2009.

**BABYBUNNS.COM**

THE MARK CONSISTS OF STANDARD CHARACTERS WITHOUT CLAIM TO ANY PARTICULAR FONT, STYLE, SIZE, OR COLOR.

FOR CHAIR CUSHIONS, BOOSTER CUSHIONS FOR BABIES AND CHILDREN (U.S. CLS. 2, 13, 22, 25, 32 AND 50). FIRST USE 3-15-2010; IN COMMERCE 3-15-2010.

4,046,050. GRIMCO, INC., FENTON, MO. SN 77-930,649. PUB. 5-25-2010, FILED 2-8-2010.

**PINNACLE BANNER**

THE MARK CONSISTS OF STANDARD CHARACTERS WITHOUT CLAIM TO ANY PARTICULAR FONT, STYLE, SIZE, OR COLOR.

NO CLAIM IS MADE TO THE EXCLUSIVE RIGHT TO USE "BANNER", APART FROM THE MARK AS SHOWN. FOR BANNER MATERIAL MADE OF PVC VINYL AND POLYESTER (U.S. CLS. 2, 13, 22, 25, 32 AND 50). FIRST USE 4-1-2010; IN COMMERCE 4-1-2010.

4,046,085. WEILERT PAMELA, HAYS, KS. SN 77-940,764. PUB. 7-20-2010, FILED 2-21-2010.

**Boobilicious Pillow**

THE MARK CONSISTS OF STANDARD CHARACTERS WITHOUT CLAIM TO ANY PARTICULAR FONT, STYLE, SIZE, OR COLOR.

NO CLAIM IS MADE TO THE EXCLUSIVE RIGHT TO USE "PILLOW", APART FROM THE MARK AS SHOWN. FOR BED PILLOWS; HEAD SUPPORTING PILLOWS; MATERNITY PILLOWS; PILLOWS (U.S. CLS. 2, 13, 22, 25, 32 AND 50). FIRST USE 9-14-2011; IN COMMERCE 9-14-2011.

**CLASS 20—(Continued).**

4,046,127. SWEDECOLLECTION, LLC, COLLIERVILLE, TN.  
SN 77-954,062. PUB. 8-3-2010, FILED 3-9-2010.



THE MARK CONSISTS OF A CROWN WITH THE  
STYLIZED TEXT "SWEDE".  
FOR FURNITURE (U.S. CLS. 2, 13, 22, 25, 32 AND 50).  
FIRST USE 2-0-2010; IN COMMERCE 2-0-2010.

4,046,260. KINGSDOWN, INC., MEBANE, NC. SN 85-030,016.  
PUB. 9-28-2010, FILED 5-4-2010.



OWNER OF U.S. REG. NOS. 520,839, 1,404,987, AND  
2,581,811.  
THE MARK CONSISTS OF THE STYLIZED WORD  
"KINGSDOWN" UNDERNEATH A BLACK OVAL WITH A  
CROWN INSIDE OF IT.  
FOR MATTRESSES AND BOX SPRINGS (U.S. CLS. 2,  
13, 22, 25, 32 AND 50).  
FIRST USE 7-6-2010; IN COMMERCE 8-1-2010.

4,046,352. GRADY, MICHAEL, MANHATTAN BEACH, CA.  
SN 85-067,359. PUB. 11-16-2010, FILED 6-21-2010.

**BETTER BUDDIES**

THE MARK CONSISTS OF STANDARD CHARACTERS  
WITHOUT CLAIM TO ANY PARTICULAR FONT, STYLE,  
SIZE, OR COLOR.  
FOR BEDS FOR HOUSEHOLD PETS; INFLATABLE  
PET BEDS; PET CUSHIONS; PET FURNITURE; PORTA-  
BLE BEDS FOR PETS (U.S. CLS. 2, 13, 22, 25, 32 AND 50).  
FIRST USE 4-1-2011; IN COMMERCE 6-15-2011.

**CLASS 20—(Continued).**

4,046,402. ZINUS INC., DBA VIVON LIFE, HAYWARD, CA.  
SN 85-081,399. PUB. 10-26-2010, FILED 7-9-2010.

**VIVON RISER**

THE MARK CONSISTS OF STANDARD CHARACTERS  
WITHOUT CLAIM TO ANY PARTICULAR FONT, STYLE,  
SIZE, OR COLOR.

NO CLAIM IS MADE TO THE EXCLUSIVE RIGHT TO  
USE "RISER", APART FROM THE MARK AS SHOWN.

FOR BEDS; FURNITURE; MATTRESS FOUNDA-  
TIONS; MATTRESS TOPPERS; MATTRESSES; MAT-  
TRESSES AND PILLOWS (U.S. CLS. 2, 13, 22, 25, 32  
AND 50).

FIRST USE 5-1-2010; IN COMMERCE 7-1-2010.

4,046,480. WING ENTERPRISES, INC., SPRINGVILLE, UT.  
SN 85-094,237. PUB. 12-28-2010, FILED 7-27-2010.

**LUNAR**

THE MARK CONSISTS OF STANDARD CHARACTERS  
WITHOUT CLAIM TO ANY PARTICULAR FONT, STYLE,  
SIZE, OR COLOR.

FOR LADDERS, NAMELY, LADDERS MADE SUB-  
STANTIALLY OF NON-METAL COMPONENTS (U.S.  
CLS. 2, 13, 22, 25, 32 AND 50).

FIRST USE 3-25-2011; IN COMMERCE 3-25-2011.

4,046,482. NATURALIA BY POLIGON S.L., UGENA - TOLE-  
DO, SPAIN. SN 85-094,399. PUB. 6-7-2011, FILED 7-28-2010.



THE COLOR(S) GREEN AND WHITE IS/ARE CLAIMED  
AS A FEATURE OF THE MARK.

THE MARK CONSISTS OF THE STYLIZED WORD  
"NATURALIA" IN LOWER-CASE WITH THE LETTERS.  
THE LETTERS "IA" APPEAR OVER A LEAF.

**CLASS 20—(Continued).**

THE WORDING "NATURALIA" HAS NO MEANING IN A FOREIGN LANGUAGE.

FOR BEDS; BEDS, MATTRESSES, PILLOWS AND BOLSTERS; CHAIR MATS IN THE NATURE OF A PILLOW OR SEAT LINER; CUSHIONS; FEATHER BEDS; FUTON MATTRESSES; HEAD SUPPORTING PILLOWS; INFLATABLE PILLOWS; MATERNITY PILLOWS; MATTRESS COMPONENT, NAMELY, ELASTIC GEL MATERIAL LOCATED IN THE TOP UPHOLSTERY LAYER OF MATTRESSES SOLD AS AN INTEGRAL COMPONENT OF THE MATTRESSES; MATTRESS CUSHIONS; MATTRESS FOUNDATIONS; MATTRESS TOPPERS; MATTRESSES; MATTRESSES AND PILLOWS; NECK-SUPPORTING PILLOWS; PILLOWS; SLEEP PRODUCTS, NAMELY, MATTRESSES, SPRING MATTRESSES, BOX SPRINGS AND MATTRESS FOUNDATIONS; SPRING MATTRESSES (U.S. CLS. 2, 13, 22, 25, 32 AND 50).

FIRST USE 2-20-2007; IN COMMERCE 10-20-2010.

---

4,046,559. WU, YAO-CHUAN, CHIAYI HSIEN, 621, TAIWAN.  
SN 85-104,843. PUB. 4-5-2011, FILED 8-11-2010.

优 Ioo

THE MARK CONSISTS OF A CHINESE CHARACTER FOLLOWED BY THE LETTER "I" IN UPPERCASE AND THE LETTERS "OO" IN LOWERCASE.

THE NON-LATIN CHARACTERS IN THE MARK TRANSLITERATE TO "IOO" AND THIS MEANS GOOD IN ENGLISH.

FOR BEDS; CABINETS; CHAIR CUSHIONS; CHAIR PADS; CHAIRS; FURNITURE PARTS, NAMELY, ARM RESTS, CHAIR LEGS; HIGH CHAIRS FOR BABIES; OFFICE CHAIRS; OFFICE SEATS; PORTABLE BACK SUPPORT FOR USE WITH CHAIRS; RECLINING CHAIRS; RESIDENTIAL AND COMMERCIAL WROUGHT IRON FURNITURE; SOFAS; TABLES (U.S. CLS. 2, 13, 22, 25, 32 AND 50).

FIRST USE 6-28-2011; IN COMMERCE 6-28-2011.

---

4,046,570. OFF THE WALL VENTURES, LLC, RICHMOND, IN. SN 85-108,428. PUB. 1-25-2011, FILED 8-16-2010.

PARTYGATE

THE MARK CONSISTS OF STANDARD CHARACTERS WITHOUT CLAIM TO ANY PARTICULAR FONT, STYLE, SIZE, OR COLOR.

FOR BUFFETS (U.S. CLS. 2, 13, 22, 25, 32 AND 50).  
FIRST USE 7-30-2011; IN COMMERCE 7-30-2011.

**CLASS 20—(Continued).**

4,046,573. METAL DESIGN STORE, DALY CITY, CA. SN 85-109,275. PUB. 3-22-2011, FILED 8-17-2010.

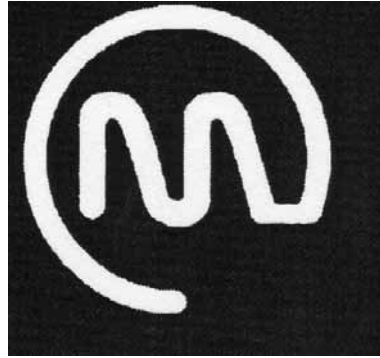

THE MARK CONSISTS OF A THICK SOLID LINE SPECIFICALLY CURVED TO FORM THE SHAPE OF THE LETTER "M" INSIDE A THREE-QUARTER CIRCLE, ALL DRAWN WITH ONE CONTINUOUS LINE, AS THOUGH TO RESEMBLE A PIECE OF METAL THAT WAS BENT INTO A SHAPE TO USE AS A BRANDING IRON, THE "M" DESIGN IS INSIDE A SQUARE.

FOR BOTTLE RACKS; CABINET DRAWERS FOR FURNITURE CABINETS; CABINETS; CABINETS FOR DISPLAY PURPOSES; DISPLAY RACKS; DISPLAY STANDS; FILING CABINETS; FURNITURE; FURNITURE OF METAL; METAL CABINETS; METAL STORAGE CABINETS; PILLOWS; PLATE RACKS; SHELVES; SHELVES FOR STORAGE; SHELVING AND COMPONENT PARTS THEREOF, NAMELY, SHELVES AND BRACKETS SOLD AS A UNIT; SLANTED SHELVES; STORAGE AND ORGANIZATION SYSTEMS COMPRISING SHELVES, DRAWERS, CUPBOARDS, BASKETS AND CLOTHES RODS, SOLD AS A UNIT; WINE RACKS (U.S. CLS. 2, 13, 22, 25, 32 AND 50).

FIRST USE 6-21-2011; IN COMMERCE 6-21-2011.

---

4,046,844. KOHLER CO., KOHLER, WI. SN 85-177,157. PUB. 6-21-2011, FILED 11-15-2010.

CATALAN

THE MARK CONSISTS OF STANDARD CHARACTERS WITHOUT CLAIM TO ANY PARTICULAR FONT, STYLE, SIZE, OR COLOR.

FOR CABINETS (U.S. CLS. 2, 13, 22, 25, 32 AND 50).  
FIRST USE 4-30-2011; IN COMMERCE 4-30-2011.

**CLASS 20—(Continued).**

4,046,916. CONROY FOODS, INC., PITTSBURGH, PA. SN 85-198,073. PUB. 4-26-2011, FILED 12-15-2010.

**FLIP TIP**

THE MARK CONSISTS OF STANDARD CHARACTERS WITHOUT CLAIM TO ANY PARTICULAR FONT, STYLE, SIZE, OR COLOR.

FOR PLASTIC CONTAINER CLOSURES (U.S. CLS. 2, 13, 22, 25, 32 AND 50).

FIRST USE 11-22-2010; IN COMMERCE 7-27-2011.

4,046,941. FOOT LEVELERS, INC., ROANOKE, VA. SN 85-207,148. PUB. 4-5-2011, FILED 12-29-2010.

**SUREREST**

THE MARK CONSISTS OF STANDARD CHARACTERS WITHOUT CLAIM TO ANY PARTICULAR FONT, STYLE, SIZE, OR COLOR.

FOR PILLOWS (U.S. CLS. 2, 13, 22, 25, 32 AND 50).

FIRST USE 1-31-2011; IN COMMERCE 1-31-2011.

4,046,961. CLAYTON-MARCUS COMPANY, INC., MCLEAN, VA. SN 85-210,839. PUB. 5-3-2011, FILED 1-5-2011.

**KENSINGTON BY CLAYTON  
MARCUS**

THE MARK CONSISTS OF STANDARD CHARACTERS WITHOUT CLAIM TO ANY PARTICULAR FONT, STYLE, SIZE, OR COLOR.

OWNER OF U.S. REG. NOS. 1,150,447 AND 1,627,170.

THE NAME(S), PORTRAIT(S), AND/OR SIGNATURE(S) SHOWN IN THE MARK DOES NOT IDENTIFY A PARTICULAR LIVING INDIVIDUAL.

FOR UPHOLSTERED FURNITURE (U.S. CLS. 2, 13, 22, 25, 32 AND 50).

FIRST USE 4-0-2011; IN COMMERCE 4-0-2011.

**CLASS 20—(Continued).**

4,046,985. COMFORT REVOLUTION, LLC, EATONTOWN, NJ. SN 85-216,234. PUB. 4-26-2011, FILED 1-12-2011.



THE COLOR(S) GREEN IS/ARE CLAIMED AS A FEATURE OF THE MARK.

THE MARK CONSISTS OF THE FOLLOWING: A ROUNDEL DESIGN APPEARING IN THE COLOR GREEN.

FOR PILLOWS, MATTRESSES, AND MATTRESS TOPPERS (U.S. CLS. 2, 13, 22, 25, 32 AND 50).

FIRST USE 1-15-2011; IN COMMERCE 1-15-2011.

4,046,986. COMFORT REVOLUTION, LLC, EATONTOWN, NJ. SN 85-216,254. PUB. 4-26-2011, FILED 1-12-2011.



OWNER OF U.S. REG. NO. 3,887,015.

THE COLOR(S) GREEN AND GRAY IS/ARE CLAIMED AS A FEATURE OF THE MARK.

THE MARK CONSISTS OF THE FOLLOWING: A ROUNDEL DESIGN APPEARING IN THE COLOR GREEN, TO THE RIGHT OF WHICH IS THE TEXT "COMFORT REVOLUTION" APPEARING IN THE COLOR GRAY.

FOR PILLOWS, MATTRESSES, AND MATTRESS TOPPERS (U.S. CLS. 2, 13, 22, 25, 32 AND 50).

FIRST USE 1-15-2011; IN COMMERCE 1-15-2011.

**CLASS 20—(Continued).**

4,047,016. PACIFIC CASCADE PARKING EQUIPMENT CORPORATION, VANCOUVER, WA. SN 85-223,630. PUB. 6-7-2011, FILED 1-21-2011.

# GREENDROP

THE MARK CONSISTS OF STANDARD CHARACTERS WITHOUT CLAIM TO ANY PARTICULAR FONT, STYLE, SIZE, OR COLOR.

FOR RECYCLING CENTERS FOR COMMERCIAL USE, NAMELY, NON-METAL CONTAINERS FOR COLLECTION AND DISPOSAL OF WASTE, COMPRISING MULTIPLE COMPARTMENTS FOR SEPARATING COMPOSTABLE AND RECYCLABLE MATERIALS FROM TRASH (U.S. CLS. 2, 13, 22, 25, 32 AND 50).

FIRST USE 3-16-2011; IN COMMERCE 3-16-2011.

4,047,050. PACIFIC CASCADE PARKING EQUIPMENT CORPORATION, VANCOUVER, WA. SN 85-238,183. PUB. 6-7-2011, FILED 2-9-2011.



THE MARK CONSISTS OF THE LETTERS "GREEN-DROP", BORDERED AND SLANTED TO THE LEFT, WITH THE LETTER "O" REPRESENTED AS THREE ARROWS MOVING COUNTERCLOCKWISE.

FOR RECYCLING CENTERS FOR COMMERCIAL USE, NAMELY, NON-METAL CONTAINERS FOR COLLECTION AND DISPOSAL OF WASTE, COMPRISING MULTIPLE COMPARTMENTS FOR SEPARATING COMPOSTABLE AND RECYCLABLE MATERIALS FROM TRASH (U.S. CLS. 2, 13, 22, 25, 32 AND 50).

FIRST USE 3-16-2011; IN COMMERCE 3-16-2011.

**CLASS 20—(Continued).**

4,047,077. PACIFIC CASCADE PARKING EQUIPMENT CORPORATION, VANCOUVER, WA. SN 85-262,682. PUB. 6-7-2011, FILED 3-9-2011.

# FANS OF THE PLANET

THE MARK CONSISTS OF STANDARD CHARACTERS WITHOUT CLAIM TO ANY PARTICULAR FONT, STYLE, SIZE, OR COLOR.

FOR RECYCLING CENTERS FOR COMMERCIAL USE, NAMELY, NON-METAL CONTAINERS FOR COLLECTION AND DISPOSAL OF WASTE, COMPRISING MULTIPLE COMPARTMENTS FOR SEPARATING COMPOSTABLE AND RECYCLABLE MATERIALS FROM TRASH (U.S. CLS. 2, 13, 22, 25, 32 AND 50).

FIRST USE 3-16-2011; IN COMMERCE 3-16-2011.

**CLASS 21—HOUSEWARES AND GLASS**

4,045,645. STERNICK, SCOTT M., WEST NEW YORK, NJ. SN 77-243,916. PUB. 5-6-2008, FILED 8-1-2007.

# LEMONCADDY

THE MARK CONSISTS OF STANDARD CHARACTERS WITHOUT CLAIM TO ANY PARTICULAR FONT, STYLE, SIZE, OR COLOR.

FOR FOOD AND BEVERAGE SERVING APPARATUS, NAMELY, A HOLDER FOR SELECTIVELY ATTACHING A UTENSIL AND/OR EDIBLE CONDIMENT TO THE RIM OF A GLASS, CUP OR BOWL IN A SANITARY MANNER (U.S. CLS. 2, 13, 23, 29, 30, 33, 40 AND 50).

FIRST USE 7-1-2011; IN COMMERCE 7-1-2011.

4,045,812. RAY MARKS CO. LLC, NEW YORK, NY. SN 77-673,532. PUB. 12-1-2009, FILED 2-19-2009.

# SOUP IT UP

THE MARK CONSISTS OF STANDARD CHARACTERS WITHOUT CLAIM TO ANY PARTICULAR FONT, STYLE, SIZE, OR COLOR.

FOR COOKING SET, COMPRISED OF A POT, SERVING LADLE AND SPATULA (U.S. CLS. 2, 13, 23, 29, 30, 33, 40 AND 50).

FIRST USE 2-2-2011; IN COMMERCE 2-2-2011.

**CLASS 21—(Continued).**

4,045,814. PERLAGE SYSTEMS, INC., SEATTLE, WA. SN 77-675,958. PUB. 1-11-2011, FILED 2-23-2009.

**THE PERLAGE SYSTEM**

THE MARK CONSISTS OF STANDARD CHARACTERS WITHOUT CLAIM TO ANY PARTICULAR FONT, STYLE, SIZE, OR COLOR.

NO CLAIM IS MADE TO THE EXCLUSIVE RIGHT TO USE "SYSTEM", APART FROM THE MARK AS SHOWN.

FOR A BAR ACCESSORY KIT USED TO MAINTAIN CARBONATION IN CHAMPAGNE, SPARKLING WINES AND OTHER CARBONATED BEVERAGES, CONSISTING OF AN EXTERIOR PLASTIC SAFETY CONTAINER FOR COMMERCIAL OR DOMESTIC USE AND A PRESURIZING UNIT DESIGNED TO PURGE AIR FROM, AND MAINTAIN THE CARBONATION OF, CARBONATED BEVERAGES, ALL SOLD AS A UNIT (U.S. CLS. 2, 13, 23, 29, 30, 33, 40 AND 50).

FIRST USE 8-24-2008; IN COMMERCE 8-24-2008.

4,045,872. JOHNSON & JOHNSON, NEW BRUNSWICK, NJ. SN 77-772,454. PUB. 11-24-2009, FILED 7-1-2009.

**HARD TO REACH PLACES**

THE MARK CONSISTS OF STANDARD CHARACTERS WITHOUT CLAIM TO ANY PARTICULAR FONT, STYLE, SIZE, OR COLOR.

OWNER OF U.S. REG. NOS. 1,031,482, 3,593,027, AND OTHERS.

FOR HAND HELD DENTAL FLOSSERS; DENTAL FLOSS REFILLS FOR HAND HELD DENTAL FLOSSERS (U.S. CLS. 2, 13, 23, 29, 30, 33, 40 AND 50).

FIRST USE 1-31-2010; IN COMMERCE 1-31-2010.

**CLASS 21—(Continued).**

4,045,967. THE LIBMAN COMPANY, ARCOLA, IL. SN 77-873,938. PUB. 11-16-2010, FILED 11-17-2009.

**GREENSTEPS**

THE MARK CONSISTS OF STANDARD CHARACTERS WITHOUT CLAIM TO ANY PARTICULAR FONT, STYLE, SIZE, OR COLOR.

FOR MOPS, DUST MOPS, FLOOR MOPS, MICROFIBER MOPS, ROLLER MOPS, SPONGE MOPS, SPONGE MOPS FEATURING SCRUB BRUSHES, SPRAY MOPS, STRIP MOPS, TWIST MOPS, WET MOPS, AND REFILLS FOR MOPS; BROOMS, CORN BROOMS, HARD BROOMS, PLASTIC BROOMS, PUSH BROOMS, WHISK BROOMS; CLEANING CLOTHS, MICROFIBER CLEANING CLOTHS; SCOURING SPONGES (U.S. CLS. 2, 13, 23, 29, 30, 33, 40 AND 50).

FIRST USE 12-31-2009; IN COMMERCE 12-31-2009.

4,045,968. THE LIBMAN COMPANY, ARCOLA, IL. SN 77-873,940. PUB. 6-22-2010, FILED 11-17-2009.



THE MARK CONSISTS OF A STYLIZED LEAF.

FOR MOPS, DUST MOPS, FLOOR MOPS, MICROFIBER MOPS, ROLLER MOPS, SPONGE MOPS, SPONGE MOPS FEATURING SCRUB BRUSHES, SPRAY MOPS, STRIP MOPS, TWIST MOPS, WET MOPS, AND REFILLS FOR MOPS; BROOMS, CORN BROOMS, HARD BROOMS, PLASTIC BROOMS, PUSH BROOMS, WHISK BROOMS; CLEANING CLOTHS, MICROFIBER CLEANING CLOTHS; SCOURING SPONGES (U.S. CLS. 2, 13, 23, 29, 30, 33, 40 AND 50).

FIRST USE 12-31-2009; IN COMMERCE 12-31-2009.



**CLASS 21—(Continued).**

4,046,039. ROBERT T. BOCK CONSULTANCY LLC, BREWSTER, NY. SN 77-928,279. PUB. 6-29-2010, FILED 2-4-2010.

# SMILEX

THE MARK CONSISTS OF STANDARD CHARACTERS WITHOUT CLAIM TO ANY PARTICULAR FONT, STYLE, SIZE, OR COLOR.

FOR ELECTRIC TOOTHBRUSHES; ELECTRICAL TOOTHBRUSHES; HOME DENTAL CARE PRODUCTS FOR DOGS AND CATS, NAMELY, TOOTHBRUSH; MANUAL TOOTHBRUSHES; TOOTHBRUSH CASES; TOOTHBRUSH HOLDERS; TOOTHBRUSHES (U.S. CLS. 2, 13, 23, 29, 30, 33, 40 AND 50).

FIRST USE 3-26-2011; IN COMMERCE 4-26-2011.

**CLASS 21—(Continued).**

4,046,564. MCCOMBS, KAREN, NEW CITY, NY. SN 85-105,812. PUB. 1-25-2011, FILED 8-12-2010.

# Switch-A-Dish

THE MARK CONSISTS OF STANDARD CHARACTERS WITHOUT CLAIM TO ANY PARTICULAR FONT, STYLE, SIZE, OR COLOR.

NO CLAIM IS MADE TO THE EXCLUSIVE RIGHT TO USE "DISH", APART FROM THE MARK AS SHOWN.

FOR DINNERWARE (U.S. CLS. 2, 13, 23, 29, 30, 33, 40 AND 50).

FIRST USE 12-27-2010; IN COMMERCE 12-27-2010.

4,046,138. HOLMON, HERBERT, WOODLAND HILLS, CA. AND HOLMON, PAULETTE, WOODLAND HILLS, CA. SN 77-959,239. PUB. 1-25-2011, FILED 3-15-2010.

# JUST SLEEVE IT

THE MARK CONSISTS OF STANDARD CHARACTERS WITHOUT CLAIM TO ANY PARTICULAR FONT, STYLE, SIZE, OR COLOR.

FOR DECORATIVE COVERS ADAPTED TO FIT AROUND BEVERAGE CONTAINERS SUCH AS BOTTLES, CANS, AND OTHER CYLINDRICAL-SHAPED BEVERAGE CONTAINERS (U.S. CLS. 2, 13, 23, 29, 30, 33, 40 AND 50).

FIRST USE 11-20-2009; IN COMMERCE 5-12-2011.

4,046,586. UNITEX INTERNATIONAL, INC., DULUTH, GA. SN 85-110,974. PUB. 2-8-2011, FILED 8-19-2010.

# KEEPER SWEEPER

THE MARK CONSISTS OF STANDARD CHARACTERS WITHOUT CLAIM TO ANY PARTICULAR FONT, STYLE, SIZE, OR COLOR.

NO CLAIM IS MADE TO THE EXCLUSIVE RIGHT TO USE "SWEEPER", APART FROM THE MARK AS SHOWN.

FOR REUSABLE CLEANING CLOTHS (U.S. CLS. 2, 13, 23, 29, 30, 33, 40 AND 50).

FIRST USE 6-15-2011; IN COMMERCE 7-20-2011.

4,046,234. PINTA INTERNATIONAL, INC., HAYWARD, CA. SN 85-018,734. PUB. 3-29-2011, FILED 4-20-2010.



The logo for "NewAgeGarden" features the word "New" in green, "Age" in blue, and "Garden" in green. The letters are in a sans-serif font, with "Age" and "Garden" appearing slightly larger and more prominent than "New".

OWNER OF U.S. REG. NO. 3,536,115.  
NO CLAIM IS MADE TO THE EXCLUSIVE RIGHT TO USE "GARDEN", APART FROM THE MARK AS SHOWN.  
THE COLOR(S) GREEN AND BLUE IS/ARE CLAIMED AS A FEATURE OF THE MARK.

THE MARK CONSISTS OF THE WORDS "NEW" AND "AGE" IN GREEN AND THE LETTERS "G", "A", "D", "E" AND "N" OF "GARDEN" IN BLUE, WITH THE "R" IN "GARDEN" AS A GREEN BLADE OF GRASS.

FOR PLANTERS FOR FLOWERS AND PLANTS (U.S. CLS. 2, 13, 23, 29, 30, 33, 40 AND 50).

FIRST USE 7-15-2010; IN COMMERCE 7-15-2010.

4,046,682. WORLD CHOICE INVESTMENTS, LLC, PIGEON FORGE, TN. SN 85-129,895. PUB. 3-1-2011, FILED 9-15-2010.

# PIRATES VOYAGE

THE MARK CONSISTS OF STANDARD CHARACTERS WITHOUT CLAIM TO ANY PARTICULAR FONT, STYLE, SIZE, OR COLOR.

FOR BEVERAGeware MADE OF GLASS AND PLASTIC (U.S. CLS. 2, 13, 23, 29, 30, 33, 40 AND 50).

FIRST USE 6-3-2011; IN COMMERCE 6-3-2011.

**CLASS 21—(Continued).**

4,046,707. THE SPORN COMPANY, NEW YORK, NY. SN 85-134,780. PUB. 1-11-2011, FILED 9-21-2010.

**AQUA THEMES**

THE MARK CONSISTS OF STANDARD CHARACTERS WITHOUT CLAIM TO ANY PARTICULAR FONT, STYLE, SIZE, OR COLOR.

NO CLAIM IS MADE TO THE EXCLUSIVE RIGHT TO USE "THEMES", APART FROM THE MARK AS SHOWN.

FOR AQUARIUM ORNAMENTS (U.S. CLS. 2, 13, 23, 29, 30, 33, 40 AND 50).

FIRST USE 9-17-2010; IN COMMERCE 3-8-2011.

---

4,046,935. ROYAL PET INCORPORATED, INVER GROVE HEIGHTS, MN. SN 85-203,081. PUB. 5-24-2011, FILED 12-21-2010.

**MAX FLEX**

THE MARK CONSISTS OF STANDARD CHARACTERS WITHOUT CLAIM TO ANY PARTICULAR FONT, STYLE, SIZE, OR COLOR.

NO CLAIM IS MADE TO THE EXCLUSIVE RIGHT TO USE "FLEX", APART FROM THE MARK AS SHOWN.

FOR ANIMAL LITTER PAN LINERS (U.S. CLS. 2, 13, 23, 29, 30, 33, 40 AND 50).

FIRST USE 2-28-2011; IN COMMERCE 2-28-2011.

---

4,046,937. G2 DISTRIBUTORS, INC., CANTON, GA. SN 85-204,132. PUB. 4-26-2011, FILED 12-22-2010.

**BUTTLEOPENER**

THE MARK CONSISTS OF STANDARD CHARACTERS WITHOUT CLAIM TO ANY PARTICULAR FONT, STYLE, SIZE, OR COLOR.

FOR BOTTLE OPENERS (U.S. CLS. 2, 13, 23, 29, 30, 33, 40 AND 50).

FIRST USE 7-6-2011; IN COMMERCE 7-6-2011.

**CLASS 21—(Continued).**

4,047,035. HANNON GROUP LTD., BURLINGTON, WI. SN 85-232,725. PUB. 5-3-2011, FILED 2-2-2011.

**KORA**

THE MARK CONSISTS OF STANDARD CHARACTERS WITHOUT CLAIM TO ANY PARTICULAR FONT, STYLE, SIZE, OR COLOR.

FOR INSULATED BAGS FOR FOOD OR BEVERAGE FOR DOMESTIC USE; INSULATED CONTAINERS FOR BEVERAGE CANS FOR DOMESTIC USE; INSULATED CONTAINERS FOR FOOD OR BEVERAGE FOR DOMESTIC USE; THERMAL INSULATED BAGS FOR FOOD OR BEVERAGES; THERMAL INSULATED CONTAINERS FOR FOOD OR BEVERAGES (U.S. CLS. 2, 13, 23, 29, 30, 33, 40 AND 50).

FIRST USE 1-31-2011; IN COMMERCE 4-19-2011.

**CLASS 24—FABRICS**

4,045,629. COOLIBAR, INC., ST. LOUIS PARK, MN. SN 77-184,022. PUB. 5-13-2008, FILED 5-17-2007.

**SUNTECT**

THE MARK CONSISTS OF STANDARD CHARACTERS WITHOUT CLAIM TO ANY PARTICULAR FONT, STYLE, SIZE, OR COLOR.

FOR BLANKET THROWS; BLANKETS FOR OUTDOOR USE; CHILDREN'S BLANKETS; THROWS; THROWS DESIGNED TO ALSO BE WRAPPED AROUND A PERSON; FABRICS FOR THE MANUFACTURE OF CLOTHING; SUN PROTECTIVE FABRICS FOR THE MANUFACTURE OF CLOTHING (U.S. CLS. 42 AND 50).

FIRST USE 4-15-2008; IN COMMERCE 4-15-2008.

**CLASS 24—(Continued).**

4,045,642. LE GALA INTERNATIONAL LTD., PEI-TOU, TAIPEI, TAIWAN. SN 77-237,555. PUB. 2-26-2008, FILED 7-24-2007.

*Empire  
sateen*  
御璽緞品

NO CLAIM IS MADE TO THE EXCLUSIVE RIGHT TO USE "SATEEN", APART FROM THE MARK AS SHOWN.

THE MARK CONSISTS OF THE WORDS "EMPIRE SATEEN" IN STYLIZED FONT ABOVE THE CHINESE CHARACTERS YU, XI, DUAN, AND PIN.

THE NON-LATIN CHARACTERS IN THE MARK TRANSLITERATE TO YU, XI, DUAN, AND PIN. THE ENGLISH TRANSLATION OF YU IS "IMPERIAL OR ROYAL; TO DRIVE; TO RESIST", THE ENGLISH TRANSLATION OF XI IS "AN IMPERIAL OR ROYAL SEAL", THE ENGLISH TRANSLATION OF DUAN IS "SATIN" AND THE ENGLISH TRANSLATION OF PIN IS "ARTICLES, GRADE, QUALITY, TO ASCERTAIN THE TASTE OR QUALITY OF".

FOR BED BLANKETS; BED COVERS; BED SHEETS; TABLE LINEN; TEXTILE TABLECLOTHS; PILLOW COVERS; PILLOWCASES; TOWELS; HANDKERCHIEFS; TEXTILE FABRICS FOR THE MANUFACTURE OF CLOTHING (U.S. CLS. 42 AND 50).

FIRST USE 3-2-2011; IN COMMERCE 3-2-2011.

4,045,662. TRUE TEXTILES, INC., GRAND RAPIDS, MI. SN 77-338,949. PUB. 5-6-2008, FILED 11-28-2007.

TRUE

THE MARK CONSISTS OF STANDARD CHARACTERS WITHOUT CLAIM TO ANY PARTICULAR FONT, STYLE, SIZE, OR COLOR.

FOR FABRIC FOR USE IN THE MANUFACTURE OF VEHICLES AND OFFICE FURNITURE (U.S. CLS. 42 AND 50).

FIRST USE 6-9-2008; IN COMMERCE 7-27-2011.

**CLASS 24—(Continued).**

4,045,750. BRITANNICA HOME FASHIONS, INC., NEW YORK, NY. SN 77-521,261. PUB. 6-30-2009, FILED 7-14-2008.

FEATHERLOFT

THE MARK CONSISTS OF STANDARD CHARACTERS WITHOUT CLAIM TO ANY PARTICULAR FONT, STYLE, SIZE, OR COLOR.

FOR THROWS (U.S. CLS. 42 AND 50).

FIRST USE 8-31-2007; IN COMMERCE 8-31-2007.

4,045,834. KINKARACO - GREEN BURIAL PRODUCTS, SAN FRANCISCO, CA. SN 77-705,716. PUB. 5-25-2010, FILED 4-2-2009.

MORT COUTURE

THE MARK CONSISTS OF STANDARD CHARACTERS WITHOUT CLAIM TO ANY PARTICULAR FONT, STYLE, SIZE, OR COLOR.

NO CLAIM IS MADE TO THE EXCLUSIVE RIGHT TO USE "COUTURE", APART FROM THE MARK AS SHOWN.

FOR SHROUDS; TEXTILES, NAMELY, FUNERAL, BURIAL, AND CREMATION SHROUDS (U.S. CLS. 42 AND 50).

FIRST USE 9-15-2009; IN COMMERCE 9-15-2009.

4,045,991. HANOVER COMPANY STORE, LLC, WEEHAWKEN, NJ. SN 77-895,466. PUB. 12-14-2010, FILED 12-17-2009.

LOFTHOME BY THE COMPANY  
STORE

THE MARK CONSISTS OF STANDARD CHARACTERS WITHOUT CLAIM TO ANY PARTICULAR FONT, STYLE, SIZE, OR COLOR.

OWNER OF U.S. REG. NOS. 1,263,272, 1,284,377, AND 2,573,439.

SEC. 2(F) AS TO "THE COMPANY STORE".

FOR BED SHEETS, PILLOWCASES, COMFORTER COVERS, SHAMS AND COVERS, NAMELY, BED COVERS, PILLOW COVERS, QUILT COVERS, DUVET COVERS (U.S. CLS. 42 AND 50).

FIRST USE 3-15-2010; IN COMMERCE 3-15-2010.

**CLASS 25—CLOTHING**

**CLASS 25—(Continued).**

4,045,579. MELHMAN PRODUCTION GROUP, LLC, UPLAND, CA. SN 76-674,598. PUB. 10-2-2007, FILED 3-26-2007.

# Skatin Satan

THE MARK CONSISTS OF STANDARD CHARACTERS WITHOUT CLAIM TO ANY PARTICULAR FONT, STYLE, SIZE, OR COLOR.

FOR CLOTHING, NAMELY, SHIRTS, JACKETS AND CAPS (U.S. CLS. 22 AND 39).

FIRST USE 12-24-2010; IN COMMERCE 12-24-2010.

4,045,597. AFRO-SAPIEN, LLC., NORTH MIAMI GARDENS, FL. SN 76-703,650. PUB. 1-11-2011, FILED 7-2-2010.

# AFRO-SAPIEN

THE MARK CONSISTS OF STANDARD CHARACTERS WITHOUT CLAIM TO ANY PARTICULAR FONT, STYLE, SIZE, OR COLOR.

FOR T-SHIRTS AND HALTER TOPS (U.S. CLS. 22 AND 39).

FIRST USE 9-1-2010; IN COMMERCE 2-6-2011.

4,045,598. AFRO-SAPIEN, LLC., NORTH MIAMI GARDENS, FL. SN 76-703,652. PUB. 1-11-2011, FILED 7-2-2010.



THE MARK CONSISTS OF A STYLIZED REPRESENTATION OF THE LETTER "A".

FOR T-SHIRTS AND HALTER TOPS (U.S. CLS. 22 AND 39).

FIRST USE 9-1-2010; IN COMMERCE 2-6-2011.

**CLASS 25—(Continued).**

4,045,633. THE BODYGYM CORPORATION, HILLSBOROUGH, NJ. SN 77-205,680. PUB. 4-8-2008, FILED 6-14-2007.

# The Future of Fitness

THE MARK CONSISTS OF STANDARD CHARACTERS WITHOUT CLAIM TO ANY PARTICULAR FONT, STYLE, SIZE, OR COLOR.

NO CLAIM IS MADE TO THE EXCLUSIVE RIGHT TO USE "FITNESS", APART FROM THE MARK AS SHOWN.

FOR EXERCISE AND FITNESS APPAREL, NAMELY, SWEAT SUITS, PANTS, TOPS, SHIRTS AND JACKETS (U.S. CLS. 22 AND 39).

FIRST USE 5-12-2008; IN COMMERCE 6-6-2011.

4,045,643. CHET ATKINS PROFESSIONAL PROPERTY TRUST, NASHVILLE, TN. SN 77-238,003. PUB. 6-3-2008, FILED 7-25-2007.

# MISTER GUITAR

THE MARK CONSISTS OF STANDARD CHARACTERS WITHOUT CLAIM TO ANY PARTICULAR FONT, STYLE, SIZE, OR COLOR.

OWNER OF U.S. REG. NO. 2,732,427.

NO CLAIM IS MADE TO THE EXCLUSIVE RIGHT TO USE "GUITAR", APART FROM THE MARK AS SHOWN.

FOR CLOTHING, NAMELY, SHIRTS, T-SHIRTS (U.S. CLS. 22 AND 39).

FIRST USE 0-0-2000; IN COMMERCE 0-0-2000.

4,045,669. HOLT HOSIERY MILLS, INCORPORATED, BURLINGTON, NC. SN 77-350,919. PUB. 12-21-2010, FILED 12-13-2007.

# SHAPE ME SMOOTH ME

THE MARK CONSISTS OF STANDARD CHARACTERS WITHOUT CLAIM TO ANY PARTICULAR FONT, STYLE, SIZE, OR COLOR.

FOR PANTIES; LADIES' UNDERWEAR; WOMEN'S UNDERWEAR (U.S. CLS. 22 AND 39).

FIRST USE 7-1-2009; IN COMMERCE 7-1-2009.

**CLASS 25—(Continued).**

4,045,670. CATCH SURFBOARD CO., LLC, SAN CLEMENTE, CA. SN 77-356,708. PUB. 6-3-2008, FILED 12-20-2007.

**CATCH SURF**

THE MARK CONSISTS OF STANDARD CHARACTERS WITHOUT CLAIM TO ANY PARTICULAR FONT, STYLE, SIZE, OR COLOR.

OWNER OF U.S. REG. NOS. 3,648,775 AND 3,648,776. NO CLAIM IS MADE TO THE EXCLUSIVE RIGHT TO USE "SURF", APART FROM THE MARK AS SHOWN. FOR T-SHIRTS (U.S. CLS. 22 AND 39). FIRST USE 3-0-2011; IN COMMERCE 3-0-2011.

---

4,045,676. ATRY CONSULTING SERVICES, LLC, MERIDIAN, MS. SN 77-371,914. PUB. 6-3-2008, FILED 1-15-2008.

**NOBODY'S PERFECT**

THE MARK CONSISTS OF STANDARD CHARACTERS WITHOUT CLAIM TO ANY PARTICULAR FONT, STYLE, SIZE, OR COLOR.

FOR CAPS; JERSEYS; POLO SHIRTS; T-SHIRTS; TROUSERS (U.S. CLS. 22 AND 39). FIRST USE 8-1-2011; IN COMMERCE 8-1-2011.

---

4,045,679. TRUE GRIT ENTERTAINMENT, INC., CULVER CITY, CA. SN 77-377,238. PUB. 12-21-2010, FILED 1-22-2008.

**L.A. LIGHTNING**

THE MARK CONSISTS OF STANDARD CHARACTERS WITHOUT CLAIM TO ANY PARTICULAR FONT, STYLE, SIZE, OR COLOR.

NO CLAIM IS MADE TO THE EXCLUSIVE RIGHT TO USE "L.A.", APART FROM THE MARK AS SHOWN.

FOR SHIRTS, T-SHIRTS, PANTS, SHORTS, UNIFORMS, JERSEYS, SWEAT SHIRTS, SWEATERS, CAPS, HATS, BANDANAS, HEADBANDS, WRIST BANDS, SOCKS, SHOES, JACKETS, COATS, BELTS AND PAJAMAS (U.S. CLS. 22 AND 39). FIRST USE 8-2-2011; IN COMMERCE 8-2-2011.

**CLASS 25—(Continued).**

4,045,687. RAISING THE BLUES, LTD., MELROSE, MA. SN 77-380,385. PUB. 12-23-2008, FILED 1-25-2008.

**RAISING THE BLUES**

THE MARK CONSISTS OF STANDARD CHARACTERS WITHOUT CLAIM TO ANY PARTICULAR FONT, STYLE, SIZE, OR COLOR.

NO CLAIM IS MADE TO THE EXCLUSIVE RIGHT TO USE "BLUES", APART FROM THE MARK AS SHOWN.

FOR CLOTHING, NAMELY, T-SHIRTS, JACKETS, BABY BIBS NOT OF PAPER, INFANT WEAR, TIES, FLIP FLOPS, SWEATSHIRTS (U.S. CLS. 22 AND 39). FIRST USE 9-6-2011; IN COMMERCE 9-6-2011.

---

4,045,690. TAFFY PRODUCTIONS, LLC, WOODLAND HILLS, CA. SN 77-381,838. PUB. 6-10-2008, FILED 1-28-2008.

**HERO:  
108**

THE MARK CONSISTS OF A STYLIZATION OF "HERO: 108".

FOR CLOTHING, NAMELY, BANDANAS, BATHING SUITS, BATHROBES, BEACHWEAR, GYM SHORTS, MASQUERADE AND HALLOWEEN COSTUMES AND MASKS SOLD IN CONNECTION THEREWITH, HEADBANDS, JACKETS, PAJAMAS, PANTS, POLO SHIRTS, ROBES, SHIRTS, SHORTS, SLACKS, SLEEPWEAR, SWEATERS, SWEATPANTS, SWEATSHIRTS, T-SHIRTS, TURTLENECKS, UNDERCLOTHES, UNDERWEAR, VESTS, WARM UP SUITS; FOOTWEAR, NAMELY, SANDALS, SNEAKERS, SLIPPERS; HEADWEAR, NAMELY, HATS, SUN VISORS, CAPS (U.S. CLS. 22 AND 39).

FIRST USE 3-15-2011; IN COMMERCE 3-15-2011.

**CLASS 25—(Continued).**

4,045,696. NEELEY, DIAMOND J, NAPLES, FL. SN 77-393,246. PUB. 6-24-2008, FILED 2-10-2008.

# TimeOnWater

THE MARK CONSISTS OF STANDARD CHARACTERS WITHOUT CLAIM TO ANY PARTICULAR FONT, STYLE, SIZE, OR COLOR.

FOR SHIRTS (U.S. CLS. 22 AND 39).  
FIRST USE 9-12-2011; IN COMMERCE 9-12-2011.

4,045,704. NORDSTROM, INC., SEATTLE, WA. SN 77-405,173. PUB. 6-10-2008, FILED 2-25-2008.

# FREE PRESS

THE MARK CONSISTS OF STANDARD CHARACTERS WITHOUT CLAIM TO ANY PARTICULAR FONT, STYLE, SIZE, OR COLOR.

FOR SWEATPANTS, JACKETS, SHIRTS, TANK TOPS, SHORTS, BLAZERS, SWEATERS, CARDIGANS, FOOTWEAR, JEANS, COATS, SWEATSHIRTS (U.S. CLS. 22 AND 39).

FIRST USE 9-0-2008; IN COMMERCE 9-0-2008.

4,045,740. ANNA SUI CORP., NEW YORK, NY. SN 77-509,578. PUB. 12-2-2008, FILED 6-27-2008.

**ANNA SUI**  
**mini**

OWNER OF U.S. REG. NOS. 2,267,280, 2,759,304, AND OTHERS.

NO CLAIM IS MADE TO THE EXCLUSIVE RIGHT TO USE "MINI", APART FROM THE MARK AS SHOWN.

THE NAME "ANNA SUI" IDENTIFIES A LIVING INDIVIDUAL WHOSE CONSENT IS OF RECORD.

**CLASS 25—(Continued).**

THE MARK CONSISTS OF THE WORDS "ANNA SUI MINI" IN STYLIZED LETTERS WITH THE "M" OVER A FIVE PETAL FLOWER.

FOR CLOTHING FOR GIRLS, BOYS AND INFANTS, NAMELY, POLO SHIRTS, VESTS, COATS, OVERCOATS, RAINCOATS, JACKETS, SWEATERS, CARDIGANS, SUITS, PANTS, JEANS, HALTER TOPS, BEACHWEAR, NAMELY, SWIMMING SUITS, SWIMMING CAPS, COVER PANTS, HOSIERY, TIGHTS, STOCKINGS, TIES, BELTS, HATS, CAPS, SUN VISORS, HEADBANDS, MUFFLERS, SHAWLS FOR GIRLS; SLEEPWEAR, TANK TOPS, UNDERSHIRTS, BATHROBES, UNDERWEAR, BODY SUITS, BIBS, BOOTEES, OVERALLS; FOOTWEAR, NAMELY, BOOTS, SLIPPERS, SANDALS, RAIN SHOES, SNEAKERS, SHOES, FIRST SHOES AND ATHLETIC SHOES (U.S. CLS. 22 AND 39).

FIRST USE 8-1-2010; IN COMMERCE 8-1-2010.

4,045,741. PUSHPA DISCOUNT STORE, INC., ROCK HILL, SC. SN 77-510,251. PUB. 11-18-2008, FILED 6-27-2008.

# ROMAN ROYALTY

THE MARK CONSISTS OF STANDARD CHARACTERS WITHOUT CLAIM TO ANY PARTICULAR FONT, STYLE, SIZE, OR COLOR.

FOR CLOTHING, NAMELY, SHIRTS, T-SHIRTS, TOPS, BOTTOMS AND JEANS (U.S. CLS. 22 AND 39).

FIRST USE 7-25-2011; IN COMMERCE 7-25-2011.

4,045,760. WORLD WRESTLING ENTERTAINMENT, INC., STAMFORD, CT. SN 77-561,301. PUB. 8-4-2009, FILED 9-3-2008.

# WWE AUTHENTIC WEAR

THE MARK CONSISTS OF STANDARD CHARACTERS WITHOUT CLAIM TO ANY PARTICULAR FONT, STYLE, SIZE, OR COLOR.

NO CLAIM IS MADE TO THE EXCLUSIVE RIGHT TO USE "AUTHENTIC WEAR", APART FROM THE MARK AS SHOWN.

FOR CLOTHING, NAMELY, TANK TOPS, T-SHIRTS, SHIRTS, SPORT SHIRTS, POLO SHIRTS, UNDERSHIRTS, SWEATSHIRTS, SWEATERS, PULLOVERS, BLOUSES, JACKETS, RAINCOATS, PANTS, JEAN PANTS, JOGGING SUITS, EXERCISE PANTS, EXERCISE SUITS, SWEATPANTS, SHORTS, UNDERWEAR, BOXER SHORTS, SOCKS, CLOTHING TIES, PAJAMAS, BELTS, GLOVES, WRIST BANDS, BANDANNAS; FOOTWEAR, NAMELY, SHOES, SNEAKERS, SLIPPERS; HEADWEAR, NAMELY, HATS, CAPS (U.S. CLS. 22 AND 39).

FIRST USE 8-31-2008; IN COMMERCE 8-31-2008.

**CLASS 25—(Continued).**

4,045,780. KAMAZU FASHION INC., CONCORD, ONTARIO, CANADA. SN 77-631,954. PUB. 4-27-2010, FILED 12-12-2008.

# FLEXXICE

THE MARK CONSISTS OF STANDARD CHARACTERS WITHOUT CLAIM TO ANY PARTICULAR FONT, STYLE, SIZE, OR COLOR.

OWNER OF CANADA REG. NO. TMA758649, DATED 2-2-2010, EXPIRES 2-2-2025.

FOR SPORTS JERSEYS, NAMELY, HOCKEY JERSEYS AND SWEATERS; HOCKEY SOCKS; T-SHIRTS; SWEAT-PANTS; SWEATSHIRTS; HEADWEAR, NAMELY, CAPS, HATS (U.S. CLS. 22 AND 39).

FIRST USE 9-0-2009; IN COMMERCE 9-0-2009.

4,045,793. JONES, JEFF, FRANKLIN, TN. SN 77-646,101. PUB. 5-12-2009, FILED 1-8-2009.

# The Black Boot

THE MARK CONSISTS OF STANDARD CHARACTERS WITHOUT CLAIM TO ANY PARTICULAR FONT, STYLE, SIZE, OR COLOR.

FOR CLOTHING, NAMELY, T-SHIRTS, JEANS; HATS (U.S. CLS. 22 AND 39).

FIRST USE 7-30-2011; IN COMMERCE 7-30-2011.

4,045,807. COASTAL CULTURE, LLC, BIRMINGHAM, AL. SN 77-671,564. PUB. 6-9-2009, FILED 2-16-2009.

# COASTAL CULTURE

THE MARK CONSISTS OF STANDARD CHARACTERS WITHOUT CLAIM TO ANY PARTICULAR FONT, STYLE, SIZE, OR COLOR.

FOR HEADWEAR; NECKWEAR; POLO SHIRTS; T-SHIRTS (U.S. CLS. 22 AND 39).

FIRST USE 5-10-2011; IN COMMERCE 5-10-2011.

**CLASS 25—(Continued).**

4,045,842. OLD BLUE, LLC, LAKE GENEVA, WI. SN 77-715,128. PUB. 7-6-2010, FILED 4-16-2009.

# XANADU

THE MARK CONSISTS OF STANDARD CHARACTERS WITHOUT CLAIM TO ANY PARTICULAR FONT, STYLE, SIZE, OR COLOR.

FOR DRESSES; HEADWEAR; JACKETS; LOUNGEWEAR; PANTS; SCARVES; SHIRTS; SHORTS; SKIRTS; SLEEPWEAR; SWEATERS; TOPS (U.S. CLS. 22 AND 39).  
FIRST USE 8-31-2007; IN COMMERCE 8-31-2007.

4,045,844. GO GIRL SPORT, LLC, PHOENIX, AZ. SN 77-730,741. PUB. 5-25-2010, FILED 5-6-2009.



THE MARK CONSISTS OF THE WORD "GO" ENCOMPASSED BY A STYLIZED FLOWER.

FOR ANKLE SOCKS; ATHLETIC APPAREL, NAMELY, SHIRTS, PANTS, JACKETS, FOOTWEAR, HATS AND CAPS, ATHLETIC UNIFORMS; ATHLETIC FOOTWEAR; BATHING SUITS; BATHING TRUNKS; BIKINIS; BOTTOMS; CAPRI PANTS; CAPRIS; CAPS; CAPS WITH VISORS; CLOTHING, NAMELY, ARM WARMERS; COATS; COATS FOR MEN AND WOMEN; CYCLISTS' JERSEYS; GLOVES; GYM SHORTS; GYM SUITS; HATS; HEADBANDS; HEADBANDS AGAINST SWEATING; JACKETS; JOGGING OUTFITS; JOGGING PANTS; JOGGING SUITS; MOISTURE-WICKING SPORTS BRAS; MOISTURE-WICKING SPORTS PANTS; MOISTURE-WICKING SPORTS SHIRTS; SHIRTS; SHORTS; SHORT-SLEEVED OR LONG-SLEEVED T-SHIRTS; SHORT-SLEEVED SHIRTS; SINGLET; SKIRTS; SKORTS; SPORT SHIRTS; SPORTS BRA; SPORTS BRAS; SPORTS JACKETS; SWEAT PANTS; SWEAT SHIRTS; SWEAT SHORTS; SWEAT SUITS; SWIM TRUNKS; SWIM WEAR; TANK-TOPS; TIGHTS; TOPS; TRACK JACKETS; TRACK PANTS; TRACKSUITS; TRIATHLON CLOTHING, NAMELY, TRIATHLON TIGHTS, TRIATHLON SHORTS, TRIATHLON SINGLET, TRIATHLON SHIRTS, TRIATHLON SUITS; T-SHIRTS; UNDERSHIRTS; UNDERWEAR; UNDERWEAR, NAMELY, BOY SHORTS; VISORS; WARM UP SUITS; WATERPROOF JACKETS AND PANTS; WRISTBANDS; WRISTBANDS CONTAINING A COOLING SUBSTANCE TO COOL THE WEARER; YOGA PANTS; YOGA SHIRTS (U.S. CLS. 22 AND 39).

FIRST USE 6-6-2010; IN COMMERCE 6-6-2010.

**CLASS 25—(Continued).**

4,045,857. LINDSTRÖM, MARIA ANNA JOHANNA, ÖRNSKÖLDSVIK, SWEDEN. SN 77-756,072. PUB. 3-23-2010, FILED 6-10-2009.



NO CLAIM IS MADE TO THE EXCLUSIVE RIGHT TO USE "SWEDEN", APART FROM THE MARK AS SHOWN. FOR BELTS; HEAD WEAR; PANTS; SHIRTS; SHOES; SOCKS; UNDER GARMENTS (U.S. CLS. 22 AND 39). FIRST USE 7-15-2010; IN COMMERCE 6-30-2011.

**CLASS 25—(Continued).**

4,045,877. LEEJAMES INC., DALLAS, TX. SN 77-777,574. PUB. 12-15-2009, FILED 7-9-2009.

**THE SLOT SHIRT**

THE MARK CONSISTS OF STANDARD CHARACTERS WITHOUT CLAIM TO ANY PARTICULAR FONT, STYLE, SIZE, OR COLOR.

NO CLAIM IS MADE TO THE EXCLUSIVE RIGHT TO USE "SHIRT", APART FROM THE MARK AS SHOWN. FOR CLOTHING, NAMELY, SHIRTS (U.S. CLS. 22 AND 39).

FIRST USE 7-11-2011; IN COMMERCE 7-11-2011.

4,045,878. TULONG, LLC, LOVELAND, OH. SN 77-779,019. PUB. 12-1-2009, FILED 7-11-2009.

**SLOUNGWEAR**

THE MARK CONSISTS OF STANDARD CHARACTERS WITHOUT CLAIM TO ANY PARTICULAR FONT, STYLE, SIZE, OR COLOR.

FOR CASUAL CLOTHING, NAMELY, T-SHIRTS, SWEATSHIRTS, HOODED SWEATSHIRTS, SWEAT-PANTS, SPORT JERSEYS, TRADITIONAL SHIRTS, ACTIVE WEAR, NAMELY, SHIRTS, SHORTS AND PANTS (U.S. CLS. 22 AND 39).

FIRST USE 8-17-2011; IN COMMERCE 8-17-2011.

4,045,873. ALAN G LLC, NEW YORK, NY. SN 77-772,763. PUB. 11-3-2009, FILED 7-1-2009.

**Isn't She Lovely by Sweetest Addiction**

THE MARK CONSISTS OF STANDARD CHARACTERS WITHOUT CLAIM TO ANY PARTICULAR FONT, STYLE, SIZE, OR COLOR.

FOR BRAS; CAMISOLES; CHEMISES; CORSETS; FITTED SWIMMING COSTUMES WITH BRA CUPS; FLEECE SHORTS; GARTER BELTS; GARTERS; GYM SHORTS; LINGERIE; LINGERIE ACCESSORIES, NAMELY, REMOVABLE SILICONE BREAST ENHANCER PADS USED IN A BRA; LOUNGWEAR; MATERNITY SLEEPWEAR; MOISTURE-WICKING SPORTS BRAS; PAJAMA BOTTOMS; PAJAMAS; PANTIES; PANTIES, SHORTS AND BRIEFS; SHAPEWEAR, NAMELY, BRAS, CORSETS, WAIST CINCHERS; SHIRTS AND SHORT-SLEEVED SHIRTS; SHORT PETTICOATS; SHORT SETS; SHORT TROUSERS; SLEEPWEAR; SPORTS BRA; SPORTS BRAS; STRAPLESS BRAS; STRAPS FOR BRAS (U.S. CLS. 22 AND 39).

FIRST USE 1-25-2011; IN COMMERCE 1-25-2011.

4,045,879. ARONSON, TAYLOR, SALINAS, CA. SN 77-779,943. PUB. 12-1-2009, FILED 7-13-2009.

**ALTER NATION**

THE MARK CONSISTS OF STANDARD CHARACTERS WITHOUT CLAIM TO ANY PARTICULAR FONT, STYLE, SIZE, OR COLOR.

FOR JACKETS; SHIRTS; SWEAT SHIRTS (U.S. CLS. 22 AND 39).

FIRST USE 5-11-2009; IN COMMERCE 1-15-2010.



**CLASS 25—(Continued).**

4,045,882. FELDMUS MATTEO, ROBIN, HOPELAWN, NJ. SN 77-783,907. PUB. 11-30-2010, FILED 7-17-2009.

# PEACE • OLOGY

THE MARK CONSISTS OF THE TERMS "PEACE" AND "OLOGY" SEPARATED BY A DOT.

FOR CLOTHING, NAMELY, SWEATSHIRTS; HOODED SHIRTS; THERMALS, NAMELY, THERMAL SHIRTS; T-SHIRTS; TANKTOPS; SWEATERS; YOGA APPAREL, NAMELY, YOGA PANTS, YOGA SHIRTS, YOGA TANK TOPS; APPAREL FOR CHILDREN, NAMELY, T-SHIRTS; ONE-PIECE INFANT CLOTHING (U.S. CLS. 22 AND 39).

FIRST USE 10-10-2010; IN COMMERCE 10-10-2010.

---

4,045,907. ADTN INTERNATIONAL LTD., NEW YORK, NY. SN 77-812,340. PUB. 1-19-2010, FILED 8-25-2009.

# SEVEN OAKS

THE MARK CONSISTS OF STANDARD CHARACTERS WITHOUT CLAIM TO ANY PARTICULAR FONT, STYLE, SIZE, OR COLOR.

FOR BOTTOMS, SHORTS (U.S. CLS. 22 AND 39).  
FIRST USE 7-19-2010; IN COMMERCE 6-11-2011.

---

4,045,921. NIKE, INC., BEAVERTON, OR. SN 77-823,059. PUB. 12-15-2009, FILED 9-9-2009.

THE MARK CONSISTS OF A STYLIZED "M" AND "S" POSITIONED SIDE BY SIDE WITH LONG, SLEEK LINES. THE "M" IS ON THE LEFT SIDE OF THE "S", CONNECTED AT THE TOP AND OVERLAPPING AT THE BOTTOM.

FOR ATHLETIC FOOTWEAR; ATHLETIC APPAREL, NAMELY, SHIRTS, JACKETS, SKIRTS, DRESSES, HATS, CAPS AND VISORS (U.S. CLS. 22 AND 39).

FIRST USE 1-1-2011; IN COMMERCE 1-1-2011.

**CLASS 25—(Continued).**

4,045,944. LIANIDES LLC, REDWOOD CITY, CA. SN 77-847,142. PUB. 7-13-2010, FILED 10-12-2009.

THE MARK CONSISTS OF STYLIZED "ML".  
FOR WOMEN'S CLOTHING, NAMELY, SWIMSUITS, DRESSES, TUNICS, COATS, SHIRTS, PANTS, TEE-SHIRTS, LONG SLEEVED SHIRTS, KNIT TOPS, BIKINIS, TANKINIS, ONE PIECE BIKINI-STYLE SWIMWEAR, BLOUSES, LINGERIE, PANTIES, AND BRAS (U.S. CLS. 22 AND 39).

FIRST USE 7-12-2010; IN COMMERCE 7-12-2010.

---

4,045,956. MAXFIELD, CLAYTON W, CHICAGO, IL. SN 77-859,937. PUB. 9-28-2010, FILED 10-28-2009.

# Sangre Nueva

THE MARK CONSISTS OF STANDARD CHARACTERS WITHOUT CLAIM TO ANY PARTICULAR FONT, STYLE, SIZE, OR COLOR.

THE ENGLISH TRANSLATION OF "SANGRE NUEVA" IN THE MARK IS NEW BLOOD.

FOR CLOTHING, NAMELY, SHIRTS, PANTS, SHORTS, UNDERWEAR, SOCKS, SCARVES, HEADWEAR, FOOTWEAR, DRESSES, TANK TOPS, SKIRTS, BLOUSES, SWEATSHIRTS, T-SHIRTS, SLEEPWEAR, SWIMWEAR, BELTS FOR CLOTHING, BOXER SHORTS, GLOVES, SWEAT BANDS; OUTERWEAR, NAMELY, JACKETS, CAPES, CLOAKS, COATS AND PULLOVERS (U.S. CLS. 22 AND 39).

FIRST USE 10-15-2009; IN COMMERCE 10-15-2009.

**CLASS 25—(Continued).**

4,045,980. FIORENTINO, SUSAN WHITMAN, ROME, ITALY. SN 77-887,106. PUB. 7-6-2010, FILED 12-6-2009.

# Quiltcho

THE MARK CONSISTS OF STANDARD CHARACTERS WITHOUT CLAIM TO ANY PARTICULAR FONT, STYLE, SIZE, OR COLOR.

FOR CLOTHING, NAMELY, PONCHOS CONSTRUCTED WITH PATCHWORK TECHNIQUES SUCH AS APPLIQUE, TRADITIONAL PIECING, PAPER/FOUNDATION PIECING AND OTHER SEWN TECHNIQUES, WHICH MAY INCLUDE THE ADDITION OF EMBELLISHMENTS, ALL HELD TOGETHER WITH THE STITCHED ART OF QUILTING (U.S. CLS. 22 AND 39).  
FIRST USE 5-31-2010; IN COMMERCE 5-31-2010.

4,045,981. HEADSHOT, ONTARIO, NY. SN 77-887,341. PUB. 5-4-2010, FILED 12-7-2009.



THE COLOR(S) RED AND BLACK IS/ARE CLAIMED AS A FEATURE OF THE MARK.

THE MARK CONSISTS OF A CIRCLE WITH CROSS HAIRS AND LINES EXTENDING HORIZONTALLY FROM THE LEFT AND RIGHT OF THE CIRCLE. THE LETTER "H" CROSSES AT THE TOP OF THE CIRCLE, THE LETTER "S" IS IN THE CENTER OF THE CROSSHAIRS, AND THE LETTER "I" CROSSES AT THE BOTTOM OF THE CIRCLE; ALL OF THE FOREGOING ELEMENTS IN RED OVER A BLACK BACKGROUND.

FOR HATS; HEADGEAR, NAMELY, HATS, CAPS, AND BASEBALL CAPS; HOODED SWEAT SHIRTS; HUNTING SHIRTS; SHIRTS; SWEAT SHIRTS; T-SHIRTS; WEARABLE GARMENTS AND CLOTHING, NAMELY, SHIRTS (U.S. CLS. 22 AND 39).  
FIRST USE 12-4-2009; IN COMMERCE 12-1-2010.

**CLASS 25—(Continued).**

4,046,015. SKECHERS U.S.A., INC. II, MANHATTAN BEACH, CA. SN 77-912,416. PUB. 6-15-2010, FILED 1-14-2010.

# SRT

THE MARK CONSISTS OF STANDARD CHARACTERS WITHOUT CLAIM TO ANY PARTICULAR FONT, STYLE, SIZE, OR COLOR.

FOR FOOTWEAR (U.S. CLS. 22 AND 39).  
FIRST USE 5-10-2010; IN COMMERCE 5-10-2010.

4,046,072. UNITED STATES DOG AGILITY ASSOCIATION, INC., RICHARDSON, TX. SN 77-936,723. PUB. 7-6-2010, FILED 2-16-2010.



THE COLOR(S) RED AND ORANGE IS/ARE CLAIMED AS A FEATURE OF THE MARK.

THE MARK CONSISTS OF THREE DOGS ABOVE A CURVED HORIZON LINE, WITH LEFT TO RIGHT, RED TO ORANGE, COLOR GRADIENT.

FOR CLOTHING, NAMELY, CAPS, JACKETS, POLO-SHIRTS, AND T-SHIRTS (U.S. CLS. 22 AND 39).  
FIRST USE 9-0-2010; IN COMMERCE 9-0-2010.

4,046,111. FORTUNE FIVE CLOTHING, LLC, MIAMI, FL. SN 77-948,976. PUB. 1-18-2011, FILED 3-3-2010.

# FORTUNE FIVE

THE MARK CONSISTS OF STANDARD CHARACTERS WITHOUT CLAIM TO ANY PARTICULAR FONT, STYLE, SIZE, OR COLOR.

FOR CLOTHING PRODUCTS, NAMELY, TOPS, BOTTOMS, SKIRTS, PANTS, UNDERWEAR, FOOTWEAR, HEADWEAR, DRESSES, JACKETS, COATS, BELTS, NECKWEAR, BEACHWEAR, AND SLEEPWEAR (U.S. CLS. 22 AND 39).  
FIRST USE 2-1-2009; IN COMMERCE 2-1-2009.

**CLASS 25—(Continued).**

4,046,170. DILLARD'S, INC., LITTLE ROCK, AR. SN 77-982,437. PUB. 6-29-2010, FILED 2-24-2010.



THE MARK CONSISTS OF 3 ANGLES.  
FOR KNIT SHIRTS, WOVEN SHIRTS, SHORTS,  
BELTS, OUTERWEAR, NAMELY, JACKETS, COATS;  
SWEATERS, PANTS (U.S. CLS. 22 AND 39).  
FIRST USE 9-25-2010; IN COMMERCE 9-25-2010.

4,046,179. ESPRIT IP LIMITED, ROAD TOWN, TORTOLA,  
BR.VIRGIN ISLANDS. SN 77-982,458. PUB. 8-18-2009,  
FILED 10-3-2008.



THE MARK CONSISTS OF THE LETTER "E" MADE  
WITH THREE HORIZONTAL LINES.  
FOR CLOTHING AND CLOTHING ACCESSORIES,  
NAMELY, SHIRTS, T-SHIRTS, SHORTS, SWEATERS,  
BLOUSES, TOPS, BOTTOMS, KNIT TOPS, HALTER  
TOPS, SMOCK TOPS, JACKETS, COATS, PANTS, VESTS,  
WIND RESISTANT JACKETS, DRESSES, SWEATSHIRTS,  
SCARVES, GLOVES, BELTS (U.S. CLS. 22 AND 39).  
FIRST USE 0-0-2003; IN COMMERCE 0-0-2003.

**CLASS 25—(Continued).**

4,046,183. NATIONAL HOT ROD ASSOCIATION, AKA  
NHRA, GLENDORA, CA. SN 77-982,521. PUB. 6-15-2010,  
FILED 9-3-2009.

**NHRA ORIGINALS**

THE MARK CONSISTS OF STANDARD CHARACTERS  
WITHOUT CLAIM TO ANY PARTICULAR FONT, STYLE,  
SIZE, OR COLOR.

NO CLAIM IS MADE TO THE EXCLUSIVE RIGHT TO  
USE "ORIGINALS", APART FROM THE MARK AS SHOWN.  
FOR SHIRTS; T-SHIRTS (U.S. CLS. 22 AND 39).  
FIRST USE 4-11-2011; IN COMMERCE 4-11-2011.

4,046,190. ADRIENNE VITTADINI, LLC, COLUMBUS, OH.  
SN 77-982,584. PUB. 3-24-2009, FILED 10-27-2008.

**ADRIENNE VITTADINI STUDIO**

THE MARK CONSISTS OF STANDARD CHARACTERS  
WITHOUT CLAIM TO ANY PARTICULAR FONT, STYLE,  
SIZE, OR COLOR.

OWNER OF U.S. REG. NOS. 1,241,274, 2,848,383, AND  
OTHERS.

NO CLAIM IS MADE TO THE EXCLUSIVE RIGHT TO  
USE "STUDIO", APART FROM THE MARK AS SHOWN.

THE NAME "ADRIENNE VITTADINI" IDENTIFIES A  
LIVING INDIVIDUAL WHOSE CONSENT IS OF RECORD.

FOR CLOTHING, NAMELY, JACKETS, DRESSES,  
COATS, BELTS, SCARVES, AND SOCKS; FOOTWEAR  
(U.S. CLS. 22 AND 39).

FIRST USE 2-0-2011; IN COMMERCE 2-0-2011.

4,046,193. PREMIUM DENIM, LLC, CULVER CITY, CA. SN  
78-447,486. PUB. 6-14-2005, FILED 7-8-2004.

**PAIGE**

THE MARK CONSISTS OF STANDARD CHARACTERS  
WITHOUT CLAIM TO ANY PARTICULAR FONT, STYLE,  
SIZE, OR COLOR.

FOR CLOTHING, NAMELY, JEANS, PANTS, LEG-  
GINGS, SKIRTS, DRESSES, SHIRTS, T-SHIRTS, TANK  
TOPS, JACKETS (U.S. CLS. 22 AND 39).

FIRST USE 1-17-2005; IN COMMERCE 1-17-2005.

**CLASS 25—(Continued).**

4,046,194. TOMMY BAHAMA GROUP, INC., NEW YORK, NY. SN 78-470,543. PUB. 6-16-2009, FILED 8-19-2004.

# Hibiscus

THE MARK CONSISTS OF STANDARD CHARACTERS WITHOUT CLAIM TO ANY PARTICULAR FONT, STYLE, SIZE, OR COLOR.

FOR WOMEN'S CLOTHING, NAMELY, KNIT AND WOVEN SHIRTS (U.S. CLS. 22 AND 39),  
FIRST USE 2-1-2011; IN COMMERCE 2-1-2011.

4,046,210. DAVID A. BURNS, WATER VALLEY, MS. AND CLAUDE STEVEN THOMPSON, WATER VALLEY, MS. SN 85-005,708. PUB. 3-8-2011, FILED 4-3-2010.



**OXFORD, MISSISSIPPI**

NO CLAIM IS MADE TO THE EXCLUSIVE RIGHT TO USE "OXFORD, MISSISSIPPI", APART FROM THE MARK AS SHOWN.

THE MARK CONSISTS OF THE STYLIZED WORDING "THE GIN", SUPPORTED BY FLORAL ELEMENTS, ABOVE THE STENCIL STYLED WORDING, "OXFORD, MISSISSIPPI".

FOR BASEBALL CAPS AND HATS; HATS; SHORT-SLEEVED OR LONG-SLEEVED T-SHIRTS; T-SHIRTS; TEE SHIRTS (U.S. CLS. 22 AND 39).

FIRST USE 6-23-2011; IN COMMERCE 7-5-2011.

**CLASS 25—(Continued).**

4,046,226. AMERICAN GIRL, LLC, EL SEGUNDO, CA. SN 85-014,644. PUB. 6-29-2010, FILED 4-15-2010.



THE MARK CONSISTS OF THE WORDING "INNERSTARU.COM", WITH THE "I" BEING DOTTED WITH A STAR, ON THE UPPER PORTION OF A SHIELD SHAPE. BELOW THE WORDING IS A RIBBON DESIGN WITH THE LETTER "U" IN THE CENTER AND A TILTED STAR SHAPE TO THE LEFT OF IT.

FOR CLOTHING AND FOOTWEAR FOR GIRLS, NAMELY, PAJAMAS, NIGHTGOWNS, ROBES, SLIPPERS, T-SHIRTS, SHIRTS, DRESSES, SKIRTS, JACKETS, COATS, BERETS, HATS, PANTS, TIGHTS, SWIMSUITS, SWEATERS, SWEATSHIRTS, TANK TOPS, SHORTS, AND VESTS (U.S. CLS. 22 AND 39).

FIRST USE 7-13-2010; IN COMMERCE 7-13-2010.

4,046,236. NINE WEST DEVELOPMENT CORPORATION, WILMINGTON, DE. SN 85-020,352. PUB. 8-3-2010, FILED 4-22-2010.

**NINE WEST RUNWAY RELIEF**

THE MARK CONSISTS OF STANDARD CHARACTERS WITHOUT CLAIM TO ANY PARTICULAR FONT, STYLE, SIZE, OR COLOR.

OWNER OF U.S. REG. NOS. 1,775,652, 2,518,612, AND OTHERS.

FOR FOOTWEAR (U.S. CLS. 22 AND 39).

FIRST USE 8-31-2010; IN COMMERCE 8-31-2010.

4,046,262. NEZGODA, TERESA A., DBA UNEEK COWGIRL DESIGNS, LAS VEGAS, NV. SN 85-031,306. PUB. 11-23-2010, FILED 5-5-2010.



THE COLOR(S) BLACK, BEIGE, WHITE IS/ARE CLAIMED AS A FEATURE OF THE MARK.

THE MARK CONSISTS OF THE STYLIZED TERM "UN-

**CLASS 25—(Continued).**

EEK COWGIRL" APPEARING IN THE COLOR BEIGE AND OUTLINED IN BLACK. WITH A HORSESHOE SYMBOLIZING THE "U" THE CREASE AND NAILS OF THE HORSESHOE APPEAR IN BLACK. A BLACK SPUR SITS ON THE END OF THE "K", WITH A WHITE CIRCLE IN THE CENTER THAT SYMBOLIZES THE HOLE OF THE SPUR. THE "C" IS IN THE FORM OF A BEIGE ROPE, OUTLINED IN BLACK, AND CIRCLES UNDER THE "OWGIR" AND CURLS AROUND TO MAKE THE "L". A BEIGE HAT, OUTLINED IN BLACK, SITS ATOP THE "L". THE HAT-BAND IS BLACK, AS IS THE HAT CREASES.

FOR BODY SHIRTS (U.S. CLS. 22 AND 39).  
FIRST USE 12-1-1998; IN COMMERCE 7-1-2001.

**CLASS 25—(Continued).**

4,046,304. DEF-STAR CLOTHING, WESTMINSTER, CO. SN 85-051,019. PUB. 2-15-2011, FILED 5-30-2010.

## Def-Star Clothing

4,046,273. MARK E. CHRIST, FORT WALTON BEACH, FL. SN 85-036,968. PUB. 4-12-2011, FILED 5-12-2010.

## Damn-It-Man

THE MARK CONSISTS OF STANDARD CHARACTERS WITHOUT CLAIM TO ANY PARTICULAR FONT, STYLE, SIZE, OR COLOR.

FOR CLOTHING, NAMELY, T-SHIRTS (U.S. CLS. 22 AND 39).  
FIRST USE 7-1-2011; IN COMMERCE 7-1-2011.

THE MARK CONSISTS OF STANDARD CHARACTERS WITHOUT CLAIM TO ANY PARTICULAR FONT, STYLE, SIZE, OR COLOR.

NO CLAIM IS MADE TO THE EXCLUSIVE RIGHT TO USE "CLOTHING", APART FROM THE MARK AS SHOWN. FOR SHORT-SLEEVED OR LONG-SLEEVED T-SHIRTS (U.S. CLS. 22 AND 39).

FIRST USE 9-15-2009; IN COMMERCE 10-1-2009.

4,046,296. VICTORIA F. LEONARD, SAN FRANCISCO, CA. SN 85-046,714. PUB. 10-26-2010, FILED 5-24-2010.

## BluKicks

THE MARK CONSISTS OF STANDARD CHARACTERS WITHOUT CLAIM TO ANY PARTICULAR FONT, STYLE, SIZE, OR COLOR.

FOR BEACH FOOTWEAR; BEACH SHOES; CANVAS SHOES; FOOTWEAR FOR MEN AND WOMEN; INFANT AND TODDLER ONE PIECE CLOTHING; INFANTS' SHOES AND BOOTS; SANDALS; SHIRTS; SHOES; SWEAT SHIRTS; T-SHIRTS (U.S. CLS. 22 AND 39).

FIRST USE 6-24-2011; IN COMMERCE 6-24-2011.

4,046,326. PANDA UNIVERSITY LLC, DBA PANDA UNIVERSITY LLC, MAPLEWOOD, NJ. SN 85-058,748. PUB. 5-24-2011, FILED 6-9-2010.

## PANDA UNIVERSITY

THE STIPLING IS A FEATURE OF THE MARK AND DOES NOT INDICATE COLOR.

THE MARK CONSISTS OF THE STYLIZED WORDING "PANDA UNIVERSITY".

FOR CLOTHING, NAMELY, SHIRTS; TEE-SHIRTS; JEANS; SHORTS; PANTS; SKIRTS; DRESSES; HOODED SWEATSHIRTS; CARDIGANS; JACKETS; BLAZERS; PUFFER VESTS; SCARVES AND BELTS; HEADWEAR; CHILDREN'S WEAR, NAMELY, SHIRTS, PANTS; SWEAT PANTS; SWEAT SHIRTS; SUITS; OVERALLS; TROUSERS; OUTER CLOTHING, NAMELY, COATS, JACKETS; OVERCOATS; PULLOVERS; SWEATERS; WAISTCOATS; SPORT SHIRTS; POLO SHIRTS; RUGBY SHIRTS; NIGHTWEAR; PAJAMAS; BATH ROBES; UNDERWEAR, NAMELY, TANK TOPS; BOXER SHORTS AND BRIEFS AND UNDERPANTS (U.S. CLS. 22 AND 39).

FIRST USE 3-1-2011; IN COMMERCE 3-1-2011.

**CLASS 25—(Continued).**

4,046,334. UNITED FOOTBALL LEAGUE, LLC, NEW YORK, NY. SN 85-061,419. PUB. 11-9-2010, FILED 6-12-2010.



THE MARK CONSISTS OF THE DESIGN OF A STYLIZED AIRCRAFT FLYING AT AN ANGLE FROM LEFT TO RIGHT AND FROM BEHIND AND THROUGH A DESIGNED CIRCLE.

FOR MEN'S, WOMEN'S AND CHILDREN'S CLOTHING AND FOOTWEAR, NAMELY, COACHES CAPS, WOOL HATS, BASEBALL CAPS, VISORS, EAR MUFFS, BELTS, WRISTBANDS, T-SHIRTS, TANK TOPS, PAJAMAS, GOLF SHIRTS, SWEATERS, SWEATSHIRTS, JACKETS, NECKTIES, CLOTH BIBS, JERSEYS, NIGHT SHIRTS, COATS, ROBES, RAINCOATS, PARKAS, SCARVES, MITTENS, APRONS, LEATHER JACKETS, SHORTS, SWEAT PANTS, PANTS, SOCKS, FLEECE PULLOVERS, TURTLENECKS, GLOVES, KNIT CAPS, PONCHOS ALL USED TO PROMOTE A PROFESSIONAL FOOTBALL TEAM (U.S. CLS. 22 AND 39).

FIRST USE 9-24-2010; IN COMMERCE 9-24-2010.

4,046,335. UNITED FOOTBALL LEAGUE, LLC, NEW YORK, NY. SN 85-061,424. PUB. 11-9-2010, FILED 6-12-2010.



THE MARK CONSISTS OF THE DESIGN OF A STYLIZED "S" ANGLED TO THE RIGHT WITH RIGHT-FACING PROFILE OF THE HEAD OF MOUNTAIN LION AT THE TOP OF THE LETTER "S".

FOR MEN'S, WOMEN'S AND CHILDREN'S CLOTHING AND FOOTWEAR, NAMELY, COACHES CAPS, WOOL HATS, BASEBALL CAPS, VISORS, EAR MUFFS, BELTS, WRISTBANDS, T-SHIRTS, TANK TOPS, PAJAMAS, GOLF SHIRTS, SWEATERS, SWEATSHIRTS, JACKETS, NECKTIES, CLOTH BIBS, JERSEYS, NIGHT SHIRTS, COATS, ROBES, RAINCOATS, PARKAS, SCARVES, MITTENS, APRONS, LEATHER JACKETS, SHORTS, SWEAT PANTS, PANTS, SOCKS, FLEECE PULLOVERS, TURTLENECKS, GLOVES, KNIT CAPS, PONCHOS ALL USED TO PROMOTE A PROFESSIONAL FOOTBALL TEAM (U.S. CLS. 22 AND 39).

FIRST USE 9-18-2010; IN COMMERCE 9-18-2010.

**CLASS 25—(Continued).**

4,046,345. UNITED FOOTBALL LEAGUE, LLC, NEW YORK, NY. SN 85-063,754. PUB. 11-9-2010, FILED 6-15-2010.



THE MARK CONSISTS OF A DESIGN OF AN EAGLE WITH ITS WINGS FORMING A HIGHLY STYLIZED DESIGN OF THE LETTER "H" AND HOLDING A FOOTBALL, SUPERIMPOSED OVER A DESIGN OF A STYLIZED LETTER "C", WITH OBLONG GEOMETRIC SHAPES OF DIFFERENT SIZES RADIATING FROM BEHIND THE "C" TO THE RIGHT AND LEFT SIDES OF THE "C" AND THE RADIATING OBLONG GEOMETRIC SHAPES ARE MIRROR IMAGES ON EITHER SIDE OF THE "C". THE STYLIZED LETTER "C" INCORPORATES THIRTEEN STARS.

FOR MEN'S, WOMEN'S AND CHILDREN'S CLOTHING AND FOOTWEAR, NAMELY, COACHES CAPS, WOOL HATS, BASEBALL CAPS, VISORS, EAR MUFFS, BELTS, WRISTBANDS, T-SHIRTS, TANK TOPS, PAJAMAS, GOLF SHIRTS, SWEATERS, SWEATSHIRTS, JACKETS, NECKTIES, CLOTH BIBS, JERSEYS, NIGHT SHIRTS, COATS, ROBES, RAINCOATS, PARKAS, SCARVES, MITTENS, APRONS, LEATHER JACKETS, SHORTS, SWEAT PANTS, PANTS, SOCKS, FLEECE PULLOVERS, TURTLENECKS, GLOVES, KNIT CAPS, PONCHOS ALL USED TO PROMOTE A PROFESSIONAL FOOTBALL TEAM (U.S. CLS. 22 AND 39).

FIRST USE 9-18-2010; IN COMMERCE 9-18-2010.

4,046,372. REPAREL LLC, CINCINNATI, OH. SN 85-072,578. PUB. 12-28-2010, FILED 6-28-2010.

**REPAIR THE WORLD**

THE MARK CONSISTS OF STANDARD CHARACTERS WITHOUT CLAIM TO ANY PARTICULAR FONT, STYLE, SIZE, OR COLOR.

FOR DRESSES; HOODED SWEAT SHIRTS; PANTS; SHIRTS; SHORTS; T-SHIRTS; TOPS (U.S. CLS. 22 AND 39).

FIRST USE 10-29-2010; IN COMMERCE 10-29-2010.

**CLASS 25—(Continued).**

4,046,379. DEANZERIS III, MICHAEL F., SARATOGA SPRINGS, NY. SN 85-074,563. PUB. 11-30-2010, FILED 6-30-2010.

THE PASSION OF HORSE RACING

THE MARK CONSISTS OF STANDARD CHARACTERS WITHOUT CLAIM TO ANY PARTICULAR FONT, STYLE, SIZE, OR COLOR.

FOR CLOTHING, NAMELY, SWEATERS, SUITS, COATS, JACKETS, VESTS, SLACKS, SHORTS, BLOUSES, SKIRTS, DRESSES, SHIRTS, HOSIERY, SWEATSHIRTS, SOCKS, GLOVES, T-SHIRTS, SCARVES, SWIMWEAR, UNDERWEAR, SLEEPWEAR, NECKWEAR, HEADWEAR AND FOOTWEAR (U.S. CLS. 22 AND 39).

FIRST USE 4-26-2010; IN COMMERCE 4-26-2010.

4,046,382. BOOT ROYALTY COMPANY, L.P., FORT WORTH, TX. SN 85-075,326. PUB. 11-30-2010, FILED 6-30-2010.



OWNER OF U.S. REG. NOS. 1,101,091, 3,764,941, AND OTHERS.

NO CLAIM IS MADE TO THE EXCLUSIVE RIGHT TO USE "BOOTS", APART FROM THE MARK AS SHOWN.

THE MARK CONSISTS OF THE LETTERS "B" AND "R" AND THE "JUSTIN BOOTS" LOGO. THE LETTER "B" IS STACKED ON TOP OF THE LETTER "R". THE "B" IS SLIGHTLY OFF-CENTER AND TO THE LEFT OF THE "R". PART OF THE TOP OF THE LOOP IN THE "R" OVERLAPS WITH THE BASE OF THE "B". THE TAIL OF THE "R" IS EXTENDED LIKE THE ROCKER ON A ROCKING CHAIR AND FORMS AN UPWARD ARC UNDER THE "B" AND "R". THE "JUSTIN BOOTS" LOGO APPEARS TO THE LEFT OF THE LETTER "R". THE "JUSTIN BOOTS" LOGO CONSISTS OF TWO CONCENTRIC OVALS AND THE WORDS "JUSTIN" AND "BOOTS". "JUSTIN" IS CENTERED ACROSS THE CONCENTRIC OVALS, AND THE "J" IS LARGER THAN THE REMAINDER OF THE LETTERS IN "JUSTIN". THE WORD "BOOTS" APPEARS BENEATH THE WORD "JUSTIN".

FOR FOOTWEAR (U.S. CLS. 22 AND 39).  
FIRST USE 1-0-2009; IN COMMERCE 1-0-2009.

**CLASS 25—(Continued).**

4,046,387. TODD GOHMERT, PINEVILLE, LA. SN 85-077,044. PUB. 6-7-2011, FILED 7-2-2010.



NO CLAIM IS MADE TO THE EXCLUSIVE RIGHT TO USE "CHRISTIAN APPAREL TEES", APART FROM THE MARK AS SHOWN.

THE MARK CONSISTS OF THE WORD "CAT" IN STYLIZED FONT THAT DEPICTS THE SHAPE OF A CAT. THE FACE OF THE CAT IS WITHIN THE LETTER "C" AND THE TAIL IS THE LETTER "T". DIRECTLY BELOW THE WORD "CAT" IS THE PHRASE "CHRISTIAN APPAREL TEES" IN STYLIZED FONT.

FOR T-SHIRTS (U.S. CLS. 22 AND 39).  
FIRST USE 6-1-2010; IN COMMERCE 8-6-2011.

4,046,409. SOCIAL FABRIC, LLC, BIRMINGHAM, AL. SN 85-082,677. PUB. 12-21-2010, FILED 7-12-2010.

SOMETHIN'S GONNA DIE

THE MARK CONSISTS OF STANDARD CHARACTERS WITHOUT CLAIM TO ANY PARTICULAR FONT, STYLE, SIZE, OR COLOR.

FOR FOOTWEAR; HEADWEAR; PANTS; SHIRTS (U.S. CLS. 22 AND 39).

FIRST USE 7-24-2010; IN COMMERCE 7-24-2010.

4,046,451. IN OUR GENES, LLC, PHOENIX, AZ. SN 85-090,454. PUB. 1-11-2011, FILED 7-22-2010.

I OG IN OUR GENES

THE MARK CONSISTS OF STANDARD CHARACTERS WITHOUT CLAIM TO ANY PARTICULAR FONT, STYLE, SIZE, OR COLOR.

FOR WEARING APPAREL, NAMELY, T-SHIRTS (U.S. CLS. 22 AND 39).

FIRST USE 10-7-2010; IN COMMERCE 10-7-2010.



**CLASS 25—(Continued).**

4,046,452. IN OUR GENES, LLC, PHOENIX, AZ. SN 85-090,489. PUB. 1-4-2011, FILED 7-22-2010.

**KNOW FIGHT THRIVE**

THE MARK CONSISTS OF STANDARD CHARACTERS WITHOUT CLAIM TO ANY PARTICULAR FONT, STYLE, SIZE, OR COLOR.

FOR WEARING APPAREL, NAMELY, T-SHIRTS (U.S. CLS. 22 AND 39).

FIRST USE 10-7-2010; IN COMMERCE 10-7-2010.

4,046,468. SOCIAL FABRIC, LLC, BIRMINGHAM, AL. SN 85-091,849. PUB. 12-21-2010, FILED 7-23-2010.



THE MARK CONSISTS OF A DEER HEAD. FOR FOOTWEAR; HEADWEAR; PANTS; SHIRTS (U.S. CLS. 22 AND 39).

FIRST USE 7-24-2010; IN COMMERCE 7-24-2010.

4,046,472. PACIFIC TRADING VENTURES LLC, BROOKLYN, NY. SN 85-092,765. PUB. 4-5-2011, FILED 7-26-2010.

**SWISS CROSS**

THE MARK CONSISTS OF STANDARD CHARACTERS WITHOUT CLAIM TO ANY PARTICULAR FONT, STYLE, SIZE, OR COLOR.

FOR MEN'S, WOMEN'S, CHILDREN'S AND INFANTS' CLOTHING, NAMELY, SHIRTS, BLOUSES, PANTS, SHORTS, HOSIERY, JACKETS, UNDERWEAR, SWEATERS, HATS, BATHING SUITS AND SLEEPWEAR (U.S. CLS. 22 AND 39).

FIRST USE 12-0-2006; IN COMMERCE 7-0-2007.

**CLASS 25—(Continued).**

4,046,474. ONANTZIN CLOTHING LLC, LOS ANGELES, CA. SN 85-093,332. PUB. 1-11-2011, FILED 7-26-2010.

**ONANTZIN**

THE MARK CONSISTS OF STANDARD CHARACTERS WITHOUT CLAIM TO ANY PARTICULAR FONT, STYLE, SIZE, OR COLOR.

FOR SHORT-SLEEVED OR LONG-SLEEVED T-SHIRTS; T-SHIRTS; TANK TOPS (U.S. CLS. 22 AND 39).

FIRST USE 9-1-2010; IN COMMERCE 11-1-2010.

4,046,481. CARRERO, RAFAEL, PEMBROKE PINES, FL. AND BIAGGINI, LISANDRO, PEMBROKE PINES, FL. SN 85-094,374. PUB. 1-11-2011, FILED 7-28-2010.



THE MARK CONSISTS OF A CROSS LOCATED WITHIN A BROKEN CIRCULAR FIGURE, WITH THE WORDING "SHAREPOSITIVE" LOCATED BELOW THE FOREGOING.

FOR SHIRTS; T-SHIRTS; TOPS; WRISTBANDS (U.S. CLS. 22 AND 39).

FIRST USE 8-0-2011; IN COMMERCE 8-0-2011.

4,046,501. BIFLEX INTIMATES GROUP, LTD., NEW YORK, NY. SN 85-097,199. PUB. 4-19-2011, FILED 7-30-2010.



THE MARK CONSISTS OF THE WORD "MISS" FOLLOWED BY CAPITAL "B" FOLLOWED BY AN APOSTROPHE AND CAPITAL "H" FOLLOWED BY "AVIN" FOLLOWED BY A PICTURE OF LIPS.

FOR LINGERIE, NAMELY, BRAS AND PANTIES (U.S. CLS. 22 AND 39).

FIRST USE 2-1-2011; IN COMMERCE 2-1-2011.



**CLASS 25—(Continued).**

4,046,508. CAMERON, WILLIAM L., MATTHEWS, NC. SN 85-098,160. PUB. 1-18-2011, FILED 8-2-2010.

**YOUR ADVANTAGE**

THE MARK CONSISTS OF STANDARD CHARACTERS WITHOUT CLAIM TO ANY PARTICULAR FONT, STYLE, SIZE, OR COLOR.

FOR CLOTHING, NAMELY, KNIT SHIRTS, T-SHIRTS, JACKETS, HATS, SHORTS (U.S. CLS. 22 AND 39).  
FIRST USE 2-15-2011; IN COMMERCE 2-15-2011.

4,046,524. LO, CHIH-HSIANG, ZHONGLI CITY, TAOYUAN, TAIWAN. SN 85-099,558. PUB. 1-18-2011, FILED 8-4-2010.



THE MARK CONSISTS OF A DESIGNED LETTER "S" INSIDE TWO CIRCLES.

FOR BOOTS; CAPES; COATS; NECKTIES; PANTS; SCARFS; SHIRTS; SHOES; SKIRTS; SOCKS; SWEATERS; TEE SHIRTS; UNDERWEAR (U.S. CLS. 22 AND 39).  
FIRST USE 5-5-2008; IN COMMERCE 3-1-2011.

4,046,535. FORTUNATO, LAWRENCE J., ENCINO, CA. SN 85-100,520. PUB. 1-18-2011, FILED 8-4-2010.

**Buzzsaw Industries**

THE MARK CONSISTS OF STANDARD CHARACTERS WITHOUT CLAIM TO ANY PARTICULAR FONT, STYLE, SIZE, OR COLOR.

NO CLAIM IS MADE TO THE EXCLUSIVE RIGHT TO USE "INDUSTRIES", APART FROM THE MARK AS SHOWN.

FOR CLOTHING, NAMELY, T-SHIRTS (U.S. CLS. 22 AND 39).  
FIRST USE 8-31-2011; IN COMMERCE 8-31-2011.

**CLASS 25—(Continued).**

4,046,540. LITEFOOT ENTERPRISES, LLC, SEATTLE, WA. SN 85-101,503. PUB. 1-18-2011, FILED 8-5-2010.



THE MARK CONSISTS OF A DESIGN OF A NATIVE AMERICAN INDIAN HEADDRESS WITH TERM "LITE-FOOT" ON THE HEADBAND RESTING ON TOP OF A MICROPHONE.

FOR SHOES AND FOOTWEAR; MEN'S, WOMEN'S AND CHILDREN'S CLOTHING, NAMELY, SHIRTS, T-SHIRTS, SWEATSHIRTS, GOLF SHIRTS, TANK TOPS (U.S. CLS. 22 AND 39).

FIRST USE 7-0-2011; IN COMMERCE 7-0-2011.

4,046,551. BOWE KATINA M, ORLANDO, FL. SN 85-102,756. PUB. 1-25-2011, FILED 8-9-2010.

**INITIALS INK**

THE MARK CONSISTS OF STANDARD CHARACTERS WITHOUT CLAIM TO ANY PARTICULAR FONT, STYLE, SIZE, OR COLOR.

FOR T-SHIRTS (U.S. CLS. 22 AND 39).

FIRST USE 3-30-2011; IN COMMERCE 3-30-2011.

4,046,591. BUTES, LLC, WILLIAMSVILLE, NY. SN 85-112,253. PUB. 11-30-2010, FILED 8-20-2010.

**MOTIVATOR**

THE MARK CONSISTS OF STANDARD CHARACTERS WITHOUT CLAIM TO ANY PARTICULAR FONT, STYLE, SIZE, OR COLOR.

FOR CLOTHING, NAMELY, MEN'S AND WOMEN'S SHAPEWEAR, NAMELY, BODY SHAPERS AND LEG SHAPERS (U.S. CLS. 22 AND 39).

FIRST USE 11-26-2010; IN COMMERCE 11-26-2010.

**CLASS 25—(Continued).**

4,046,596. PRESS1, LLC, MIAMI, FL. SN 85-114,071. PUB. 2-1-2011, FILED 8-23-2010.



THE COLOR(S) BLACK AND WHITE IS/ARE CLAIMED AS A FEATURE OF THE MARK.

THE MARK CONSISTS OF HUMAN FIGURE WITH "X'S" AS EYES IN A COAT JACKET AND PANTS. WEARING A HAT THAT CONTAINS THE NUMBER "1" IN THE FRONT.

FOR A-SHIRTS; APPAREL FOR DANCERS, NAMELY, TEE SHIRTS, SWEATSHIRTS, PANTS, LEGGINGS, SHORTS AND JACKETS; ATHLETIC APPAREL, NAMELY, SHIRTS, PANTS, JACKETS, FOOTWEAR, HATS AND CAPS, ATHLETIC UNIFORMS; BASEBALL CAPS AND HATS; BODY SHIRTS; BUTTON DOWN SHIRTS; BUTTON-FRONT ALOHA SHIRTS; CAMOUFLAGE SHIRTS; CAMP SHIRTS; CHEF'S HATS; CLOTHING FOR ATHLETIC USE, NAMELY, PADDED SHIRTS; CLOTHING SHIELDS, NAMELY, PADS APPLIED TO THE UNDERARMS OF SHIRTS, BLOUSES AND SWEATERS; COLLARED SHIRTS; CREW NECK SWEATERS; DRESS SHIRTS; FISHING SHIRTS; FUR HATS; GOLF PANTS, SHIRTS AND SKIRTS; GOLF SHIRTS; HAT BANDS; HATS; HATS FOR INFANTS, BABIES, TODDLERS AND CHILDREN; HEADGEAR, NAMELY, HATS, CAPS; HOODED SWEAT SHIRTS; HUNTING SHIRTS; KNIT SHIRTS; LEATHER HATS; LEATHER SHIRTS; LONG-SLEEVED SHIRTS; MOCK TURTLE-NECK SWEATERS; MOISTURE-WICKING SPORTS SHIRTS; NIGHT SHIRTS; OPEN-NECKED SHIRTS; OVER SHIRTS; PAPER HATS FOR USE AS CLOTHING ITEMS; PARTY HATS; PERSPIRATION ABSORBENT STRAP TO BE USED IN THE BILL OF A HAT; PIQUE SHIRTS; POLO SHIRTS; RAIN HATS; RUGBY SHIRTS; SCIENTIFIC AND TECHNOLOGICAL APPAREL, NAMELY, SHIRTS, PANTS, JACKETS, FOOTWEAR, HATS AND CAPS, UNIFORMS; SEDGE HATS (SUGEGASA); SHIRT FRONTS; SHIRT YOKES; SHIRTS; SHIRTS AND SHORT-SLEEVED SHIRTS; SHIRTS AND SLIPS; SHIRTS FOR INFANTS, BABIES, TODDLERS AND CHILDREN; SHIRTS FOR SUITS; SHORT-SLEEVED OR LONG-SLEEVED T-SHIRTS; SHORT-SLEEVED SHIRTS; SLEEP SHIRTS; SMALL HATS; SPORT SHIRTS; SPORTS CAPS AND HATS; SPORTS SHIRTS; SPORTS SHIRTS WITH SHORT SLEEVES; SWEAT SHIRTS; SWEATERS; T-SHIRTS; TEE SHIRTS; TOBOGGAN HATS, PANTS AND CAPS; TRIATHLON CLOTHING, NAMELY, TRIATHLON TIGHTS, TRIATHLON SHORTS, TRIATHLON SINGLET, TRIATHLON SHIRTS, TRIATHLON SUITS; TURTLE NECK SHIRTS; TURTLENECK SWEATERS; V-NECK SWEATERS; WEARABLE GARMENTS AND CLOTHING, NAMELY, SHIRTS; WIND SHIRTS; WOMEN'S HATS AND HOODS; WOOLLY HATS; YOGA SHIRTS (U.S. CLS. 22 AND 39). FIRST USE 6-24-2010; IN COMMERCE 6-30-2010.

**CLASS 25—(Continued).**

4,046,598. ANGELA T. PEWITT, DBA ALEKTRA RUNNING SHORTS, MOUNTAIN BROOK, AL. SN 85-114,259. PUB. 2-8-2011, FILED 8-24-2010.

# ALEKTRA

THE MARK CONSISTS OF STANDARD CHARACTERS WITHOUT CLAIM TO ANY PARTICULAR FONT, STYLE, SIZE, OR COLOR.

FOR CLOTHING, NAMELY, RUNNING SHORTS (U.S. CLS. 22 AND 39).

FIRST USE 2-11-2011; IN COMMERCE 2-11-2011.

4,046,600. ANGELA T. PEWITT, DBA ALEKTRA RUNNING SHORTS, MOUNTAIN BROOK, AL. SN 85-114,334. PUB. 2-8-2011, FILED 8-24-2010.



THE MARK CONSISTS OF A FEMALE STICK FIGURE SHOWN IN RUNNING STRIDE WITH FLOWING HAIR.

FOR CLOTHING, NAMELY, RUNNING SHORTS (U.S. CLS. 22 AND 39).

FIRST USE 2-11-2011; IN COMMERCE 2-11-2011.

4,046,608. WILSHIRE FASHIONS, INC., NEW YORK, NY. SN 85-115,403. PUB. 6-21-2011, FILED 8-25-2010.

# MIA & BAILEY

THE MARK CONSISTS OF STANDARD CHARACTERS WITHOUT CLAIM TO ANY PARTICULAR FONT, STYLE, SIZE, OR COLOR.

FOR CLOTHING FOR WOMEN, NAMELY, SHIRTS, BLOUSES, T-SHIRTS, SWEATERS, VESTS, DRESSES, JEANS, TROUSERS, PANTS, JACKETS, COATS, OVERCOATS, SCARVES, BELTS, SOCKS AND SHOES (U.S. CLS. 22 AND 39).

FIRST USE 12-1-2010; IN COMMERCE 12-1-2010.

**CLASS 25—(Continued).**

4,046,637. JOAQUIN SORIA, MIAMI, FL. SN 85-121,164. PUB. 1-11-2011, FILED 9-1-2010.



THE MARK CONSISTS OF A CIRCLE. INSIDE THE CIRCLE THERE IS A SIDE PROFILE OF AN ELEPHANT'S HEAD WEARING HEADPHONES WITH THE WORDING "OUT OF HAND" WRITTEN BELOW THE TOP OF THE ELEPHANT'S TRUNK.

FOR A-SHIRTS; ATHLETIC APPAREL, NAMELY, SHIRTS, PANTS, JACKETS, FOOTWEAR, HATS AND CAPS, ATHLETIC UNIFORMS; BUTTON DOWN SHIRTS; COLLARED SHIRTS; DRESS SHIRTS; SHIRTS AND SHORT-SLEEVED SHIRTS (U.S. CLS. 22 AND 39).  
FIRST USE 4-15-2004; IN COMMERCE 8-9-2005.

4,046,638. FERACO INDUSTRIES INC., HUNTINGTON STATION, NY. SN 85-121,454. PUB. 2-15-2011, FILED 9-2-2010.

## New York Dirt Shirts

THE MARK CONSISTS OF STANDARD CHARACTERS WITHOUT CLAIM TO ANY PARTICULAR FONT, STYLE, SIZE, OR COLOR.

NO CLAIM IS MADE TO THE EXCLUSIVE RIGHT TO USE "NEW YORK" AND "SHIRTS", APART FROM THE MARK AS SHOWN.

FOR JERSEYS; SHORT-SLEEVED OR LONG-SLEEVED T-SHIRTS; SLEEVELESS JERSEYS; SPORTS JERSEYS; SPORTS JERSEYS AND BREECHES FOR SPORTS; T-SHIRTS (U.S. CLS. 22 AND 39).  
FIRST USE 10-1-2010; IN COMMERCE 12-1-2010.

**CLASS 25—(Continued).**

4,046,648. SISTER SAM, LLC, LOS ANGELES, CA. SN 85-122,835. PUB. 2-15-2011, FILED 9-3-2010.

## B44 CORE

THE MARK CONSISTS OF STANDARD CHARACTERS WITHOUT CLAIM TO ANY PARTICULAR FONT, STYLE, SIZE, OR COLOR.

FOR WOMEN'S AND GIRL'S CLOTHING, NAMELY, TOPS, BOTTOMS, SHIRTS, BLOUSES, DRESSES, SKIRTS, JACKETS, PANTS AND SHORTS (U.S. CLS. 22 AND 39).

FIRST USE 9-1-2010; IN COMMERCE 2-15-2011.

4,046,649. SISTER SAM, LLC, LOS ANGELES, CA. SN 85-122,840. PUB. 2-15-2011, FILED 9-3-2010.

## B44 DRESSED

THE MARK CONSISTS OF STANDARD CHARACTERS WITHOUT CLAIM TO ANY PARTICULAR FONT, STYLE, SIZE, OR COLOR.

FOR WOMEN'S AND GIRL'S CLOTHING, NAMELY, DRESSES (U.S. CLS. 22 AND 39).

FIRST USE 9-1-2010; IN COMMERCE 2-15-2011.

4,046,666. PRIME GARMENTS, INC., NEW YORK, NY. SN 85-128,064. PUB. 3-1-2011, FILED 9-13-2010.

## I.B.Diffusion

THE MARK CONSISTS OF STANDARD CHARACTERS WITHOUT CLAIM TO ANY PARTICULAR FONT, STYLE, SIZE, OR COLOR.

FOR BOTTOMS; SWEATERS; TOPS (U.S. CLS. 22 AND 39).

FIRST USE 5-1-2011; IN COMMERCE 5-1-2011.

**CLASS 25—(Continued).**

4,046,681. WORLD CHOICE INVESTMENTS, LLC, PIGEON FORGE, TN. SN 85-129,877. PUB. 3-1-2011, FILED 9-15-2010.

**PIRATES VOYAGE**

THE MARK CONSISTS OF STANDARD CHARACTERS WITHOUT CLAIM TO ANY PARTICULAR FONT, STYLE, SIZE, OR COLOR.

FOR CLOTHING, NAMELY, HEADWEAR, TOPS AND BOTTOMS, SHOES AND BOOTS (U.S. CLS. 22 AND 39). FIRST USE 6-3-2011; IN COMMERCE 6-3-2011.

4,046,719. MENDEZ, MARIA VERONICA, NEW YORK, NY. SN 85-138,897. PUB. 3-22-2011, FILED 9-27-2010.

**Verra Carrera**

THE MARK CONSISTS OF STANDARD CHARACTERS WITHOUT CLAIM TO ANY PARTICULAR FONT, STYLE, SIZE, OR COLOR.

"VERRA CARRERA" IS NOT THE NAME OF A LIVING INDIVIDUAL, BUT IS FANCIFUL.

THE ENGLISH TRANSLATION OF "VERRA CARRERA" IN THE MARK IS "TRUTH WILL SOON BE KNOWN RACE".

FOR CLOTHING AND EXERCISE CLOTHING, NAMELY, SHIRTS, T-SHIRTS, SWEATERS, EXERCISE JACKETS, JACKETS, THERMAL RUNNING SHIRTS, THERMAL RUNNING PANTS, THERMAL PANTS AND SHIRTS, THERMAL UNDERWEAR, POLO SHIRTS, HATS, VISORS, BEANIES, FLEECE PULLOVERS, WIND SHIRTS, WIND JACKETS, FOOTWEAR, PARKAS, COATS, SWEATERS, VESTS, SOCKS, CLOTH BELTS, LEATHER BELTS, SANDALS, SHOES, RUNNING SHOES, HIKING SHOES, CYCLING SHOES, CYCLING SHORTS, CYCLING SHIRTS, CYCLING LEGGINGS, BODYSUITS, SHORTS, PANTS, YOGA OUTFITS, YOGA PANTS, YOGA SHIRTS, SWEAT PANTS, SWEAT SHIRTS, SWIM SUITS, SWIM CAPS, LEATHER JACKETS, JEANS, DRESSES, UNDERWEAR, TROUSERS, OVERALLS, TRUNKS, BANDANAS, NIGHT GOWNS, PAJAMAS, PONCHOS, BATHROBES, JERSEYS, CAPRI PANTS, SNAP CROTCH SHIRTS, ROMPERS, PANTIES, DRESSES, SKIRTS, BLOUSES, SCARVES, BOXER SHORTS, BRIEFS, BIBS, SPORTS BRAS, TANK TOPS, JEANS (U.S. CLS. 22 AND 39).

FIRST USE 8-30-2011; IN COMMERCE 8-30-2011.

**CLASS 25—(Continued).**

4,046,721. PONZI, VINCENT, MADISON, TN. SN 85-139,453. PUB. 3-8-2011, FILED 9-28-2010.

**NUKIEGIRL**

THE MARK CONSISTS OF STANDARD CHARACTERS WITHOUT CLAIM TO ANY PARTICULAR FONT, STYLE, SIZE, OR COLOR.

FOR CLOTHING, NAMELY, SHIRTS, T-SHIRTS, SHORTS, HATS, JACKETS, PANTS, SWEATSHIRTS, PAJAMAS, UNDERWEAR, SOCKS (U.S. CLS. 22 AND 39).

FIRST USE 8-20-2010; IN COMMERCE 8-20-2010.

4,046,722. HBI BRANDED APPAREL ENTERPRISES, LLC, WINSTON-SALEM, NC. SN 85-139,551. PUB. 1-11-2011, FILED 9-28-2010.

**FUTURE FRIENDLY**

THE MARK CONSISTS OF STANDARD CHARACTERS WITHOUT CLAIM TO ANY PARTICULAR FONT, STYLE, SIZE, OR COLOR.

FOR JACKETS; PANTS; SHIRTS; SHORTS; SWEAT PANTS; SWEAT SHIRTS; T-SHIRTS (U.S. CLS. 22 AND 39).

FIRST USE 6-24-2011; IN COMMERCE 6-24-2011.

4,046,731. STURDY GIRL SPORTS, LLC, LOUISVILLE, CO. SN 85-141,668. PUB. 3-22-2011, FILED 9-30-2010.



NO CLAIM IS MADE TO THE EXCLUSIVE RIGHT TO USE "SPORTS", APART FROM THE MARK AS SHOWN.

**CLASS 25—(Continued).**

THE MARK CONSISTS OF A STANDING PONYTAILED WOMAN WITH AN ARCHED BACK AND UPTURNED HEAD LOOKING AT A SPHERE SHE IS HOLDING ABOVE HER HEAD; TO THE LEFT, OR IN FRONT OF THE WOMAN, IS THE WORD "STURDY" IN A LARGE FONT; TO THE RIGHT, OR BEHIND THE WOMAN, IS THE WORD "GIRL" IN A LARGE FONT, WITH THE WORD "SPORTS" APPEARING IN A SMALLER FONT BELOW THE WORD "GIRL".

FOR BRAS, WOMEN'S TOPS WITH BUILT-IN BRAS, SHIRTS, SWEAT SHIRTS, HOODED SWEAT SHIRTS, JACKETS, SHORTS, PANTS, LEGGINGS, SKIRTS, DRESSES (U.S. CLS. 22 AND 39).

FIRST USE 9-30-2010; IN COMMERCE 8-7-2011.

---

4,046,764. CHARLTON, JASON, PORT HURON, MI. SN 85-151,490. PUB. 4-5-2011, FILED 10-13-2010.



NO CLAIM IS MADE TO THE EXCLUSIVE RIGHT TO USE "LIGHT WEIGHT", APART FROM THE MARK AS SHOWN.

THE MARK CONSISTS OF A SHIELD WITH THE STYLIZED LETTERS "LW" APPEARING INSIDE THE SHIELD. COMING OUT OF THE SHIELD ARE FEATHERS OF VARIOUS SIZES AND SHAPES. THE STYLIZED WORDS "LIGHT WEIGHT" APPEAR BELOW THE SHIELD.

FOR CLOTHING, NAMELY, T-SHIRTS, LONG SLEEVE SHIRTS, SWEAT-SHIRTS, A-SHIRTS, SLEEVELESS T-SHIRTS, JACKETS, HOODED SWEAT SHIRTS, FLANNEL SHIRTS, SPORTS BRAS, FLEECE BOTTOMS, FLEECE PULLOVERS, FLEECE TOPS, SWEAT PANTS, PANTS, SHORTS, SPANDEX SHORTS, SPANDEX RUNNING PANTS, AND CAPRI PANTS (U.S. CLS. 22 AND 39).

FIRST USE 8-0-2011; IN COMMERCE 8-0-2011.

---

4,046,772. LEADING EDGE FOOTWEAR GROUP, INC., SECAUCUS, NJ. SN 85-153,957. PUB. 3-22-2011, FILED 10-15-2010.

**STRADA VITA**

THE MARK CONSISTS OF STANDARD CHARACTERS WITHOUT CLAIM TO ANY PARTICULAR FONT, STYLE, SIZE, OR COLOR.

THE ENGLISH TRANSLATION OF "STRADA VITA" IN THE MARK IS "ROAD LIFE".

FOR HEADGEAR, NAMELY, HATS AND CAPS; BOOTS; FLIP FLOPS; JACKETS; JEANS; PANTS; SANDALS; SHIRTS; SHOES; SNEAKERS; SWEAT SHIRTS; SWIMWEAR; T-SHIRTS; UNDERWEAR (U.S. CLS. 22 AND 39).

FIRST USE 5-25-2011; IN COMMERCE 5-25-2011.

**CLASS 25—(Continued).**

4,046,785. ZOO CITY APPAREL INCORPORATED, MISSOULA, MT. SN 85-156,264. PUB. 4-12-2011, FILED 10-19-2010.

**406**

---

THE MARK CONSISTS OF STANDARD CHARACTERS WITHOUT CLAIM TO ANY PARTICULAR FONT, STYLE, SIZE, OR COLOR.

FOR T-SHIRTS; SWEATSHIRTS (U.S. CLS. 22 AND 39). FIRST USE 11-15-2010; IN COMMERCE 11-15-2010.

---

4,046,786. ZOO CITY APPAREL INCORPORATED, MISSOULA, MT. SN 85-156,275. PUB. 4-12-2011, FILED 10-19-2010.

**[406]**

THE MARK CONSISTS OF THE NUMBERS "406" INSIDE OF BRACKETS.

FOR T-SHIRTS; SWEATSHIRTS (U.S. CLS. 22 AND 39). FIRST USE 11-15-2010; IN COMMERCE 11-15-2010.

---

4,046,804. LANE BRYANT PURCHASING CORP, COLUMBUS, OH. SN 85-162,741. PUB. 5-17-2011, FILED 10-27-2010.

**SMOOTH AFFAIR**

THE MARK CONSISTS OF STANDARD CHARACTERS WITHOUT CLAIM TO ANY PARTICULAR FONT, STYLE, SIZE, OR COLOR.

FOR WOMEN'S WEARING APPAREL, NAMELY, BODY BRIEFS, BODY SHAPERS, BODY STOCKINGS, BODY SUITS, BODY WRAPS, BRAS, BRASSIERES, BUSTIERS, CAMISOLES, CHEMISES, CHEMISETTES, CONTROL UNDERGARMENTS, CORSETS, FOUNDATION GARMENTS, HOSIERY, LEGGINGS, LINGERIE, PANTIES, PANTYHOSE, LEG SHAPERS, SHAPING SHORTS, STOCKINGS, TEDDIES, THIGH SHAPERS, UNDERPANTS, UNDERWEAR (U.S. CLS. 22 AND 39).

FIRST USE 4-1-2011; IN COMMERCE 4-1-2011.

**CLASS 25—(Continued).**

4,046,806. LANE BRYANT PURCHASING CORP, COLUMBUS, OH. SN 85-162,822. PUB. 5-17-2011, FILED 10-27-2010.

**SERIOUSLY SEAMLESS**

THE MARK CONSISTS OF STANDARD CHARACTERS WITHOUT CLAIM TO ANY PARTICULAR FONT, STYLE, SIZE, OR COLOR.

FOR WOMEN'S WEARING APPAREL, NAMELY, BODY BRIEFS, BODY SHAPERS, BODY STOCKINGS, BODY SUITS, BODY WRAPS, BRAS, BRASSIERES, BUSTIERS, CAMISOLES, CHEMISES, CHEMISETTES, CONTROL UNDERGARMENTS, CORSETS, FOUNDATION GARMENTS, HOSIERY, LEGGINGS, LINGERIE, PANTIES, PANTYHOSE, LEG SHAPERS, SHAPING SHORTS, STOCKINGS, TEDDIES, THIGH SHAPERS, UNDERPANTS, UNDERWEAR (U.S. CLS. 22 AND 39).

FIRST USE 4-1-2011; IN COMMERCE 4-1-2011.

---

4,046,808. MONIQUE LAURA FRIEDMAN, CHICAGO, IL. SN 85-163,289. PUB. 3-29-2011, FILED 10-28-2010.

**FLIPINISTA**

THE MARK CONSISTS OF STANDARD CHARACTERS WITHOUT CLAIM TO ANY PARTICULAR FONT, STYLE, SIZE, OR COLOR.

FOR FLIP FLOPS (U.S. CLS. 22 AND 39).

FIRST USE 1-1-2011; IN COMMERCE 1-1-2011.

---

4,046,810. ALFRED DUNNER, INC., NEW YORK, NY. SN 85-163,401. PUB. 4-12-2011, FILED 10-28-2010.

**SAMANTHA GREY**

THE MARK CONSISTS OF STANDARD CHARACTERS WITHOUT CLAIM TO ANY PARTICULAR FONT, STYLE, SIZE, OR COLOR.

THE NAME "SAMANTHA GREY" DOES NOT IDENTIFY A LIVING INDIVIDUAL.

FOR WOMEN'S CLOTHING, NAMELY, SKIRTS, DRESSES, BLOUSES, T-SHIRTS, SWEATERS, JACKETS, BLAZERS, PANTS, SHORTS, VESTS AND COATS (U.S. CLS. 22 AND 39).

FIRST USE 8-26-2011; IN COMMERCE 8-26-2011.

**CLASS 25—(Continued).**

4,046,823. GOGO SPORTS, INC., HAYWARD, CA. SN 85-166,594. PUB. 4-12-2011, FILED 11-1-2010.



NO CLAIM IS MADE TO THE EXCLUSIVE RIGHT TO USE "SD", APART FROM THE MARK AS SHOWN.

THE COLOR(S) BLACK AND RED IS/ARE CLAIMED AS A FEATURE OF THE MARK.

THE MARK CONSISTS OF THE LETTER "I" IN BLACK, FOLLOWED BY THE IMAGE OF A STYLIZED RED HEART, FOLLOWED BY THE LETTERS "SD" IN BLACK UNDERNEATH THE FOREGOING.

FOR CAPS; HATS; HEADWEAR; JACKETS; SHIRTS; SWEAT SHIRTS; TOPS (U.S. CLS. 22 AND 39).

FIRST USE 1-1-2009; IN COMMERCE 1-1-2009.

---

4,046,825. RICE, SANCHEZ, HESPERIA, CA. SN 85-167,602. PUB. 3-29-2011, FILED 11-2-2010.



*Forbidden Kitten*

THE MARK CONSISTS OF A KITTEN WITH SCRUFFY HAIR AND THE STYLIZED TEXT "FORBIDDEN KITTEN".

FOR JACKETS; PAJAMAS; PANTS; SOCKS; T-SHIRTS; UNDERWEAR (U.S. CLS. 22 AND 39).

FIRST USE 7-1-2011; IN COMMERCE 7-1-2011.

**CLASS 25—(Continued).**

4,046,860. MARTEN, KIRT, DEERBROOK, WI. SN 85-182,579.  
PUB. 4-12-2011, FILED 11-22-2010.

**CHIN DOWN**

THE MARK CONSISTS OF STANDARD CHARACTERS WITHOUT CLAIM TO ANY PARTICULAR FONT, STYLE, SIZE, OR COLOR.

FOR CLOTHING, NAMELY, SHIRTS AND PANTS; HEADGEAR, NAMELY, HATS; ATHLETIC APPAREL, NAMELY, SHIRTS AND ATHLETIC UNIFORMS; ATHLETIC ROBES, CAPS, EXERCISE GYM SUITS, JACKETS, GYM TRUNKS, HATS, HOODED SWEATSHIRTS, JOGGING SUITS, MUSCLE SHIRTS, PULLOVERS, SHORTS, SKULL CAPS, SWEATSHIRTS, TANK TOPS, TOPS, T-SHIRTS, WARMUP JACKETS, WARMUP PANTS, WIND SUITS, WRESTLING TRUNKS, AND BOXING AND MARTIAL ARTS TRUNKS (U.S. CLS. 22 AND 39).

FIRST USE 11-30-2010; IN COMMERCE 11-30-2010.

4,046,874. SCOODEEZ, LLC, LA PALMA, CA. SN 85-187,154.  
PUB. 4-26-2011, FILED 11-30-2010.



NO CLAIM IS MADE TO THE EXCLUSIVE RIGHT TO USE "SCOODIE", APART FROM THE MARK AS SHOWN.

THE MARK CONSISTS OF THE STYLIZED WORDING "SCOODIE" WITH THE LETTER "O'S BEING FORMED BY TWO BUTTONS. THERE IS A DIACRITICAL BREVE MARK OVER THE TWO BUTTONS.

FOR HEAD SCARVES; SHAWLS AND HEAD-SCARVES; SHOULDER SCARVES (U.S. CLS. 22 AND 39).  
FIRST USE 9-20-2010; IN COMMERCE 9-20-2010.

4,046,875. GARDNER LANDRY COMMUNICATIONS LP,  
HOUSTON, TX. SN 85-187,481. PUB. 2-22-2011, FILED 11-30-2010.

**OCEAN FLOWER**

THE MARK CONSISTS OF STANDARD CHARACTERS WITHOUT CLAIM TO ANY PARTICULAR FONT, STYLE, SIZE, OR COLOR.

FOR CLOTHING, NAMELY, SHIRTS (U.S. CLS. 22 AND 39).  
FIRST USE 7-0-2011; IN COMMERCE 7-0-2011.

**CLASS 25—(Continued).**

4,046,876. GARDNER LANDRY COMMUNICATIONS LP,  
HOUSTON, TX. SN 85-187,486. PUB. 2-22-2011, FILED 11-30-2010.

**SEA FAN**

THE MARK CONSISTS OF STANDARD CHARACTERS WITHOUT CLAIM TO ANY PARTICULAR FONT, STYLE, SIZE, OR COLOR.

FOR CLOTHING, NAMELY, SHIRTS (U.S. CLS. 22 AND 39).

FIRST USE 7-0-2011; IN COMMERCE 7-0-2011.

4,046,877. GARDNER LANDRY COMMUNICATIONS LP,  
HOUSTON, TX. SN 85-187,492. PUB. 2-22-2011, FILED 11-30-2010.

**OCEAN SUNBURST**

THE MARK CONSISTS OF STANDARD CHARACTERS WITHOUT CLAIM TO ANY PARTICULAR FONT, STYLE, SIZE, OR COLOR.

FOR CLOTHING, NAMELY, SHIRTS (U.S. CLS. 22 AND 39).

FIRST USE 7-0-2011; IN COMMERCE 7-0-2011.

4,046,890. KITTRELL, DAN, FORT PIERCE, FL. AND WILLIAMS, ROBERT, FORT PIERCE, FL. SN 85-191,730.  
PUB. 5-3-2011, FILED 12-6-2010.



THE MARK CONSISTS THE WORDS "BOOTY QUEST" ON EITHER SIDE OF A PIRATE SKULL WITH AN EYE PATCH, AN EYE, A DIVE FLAG BANDANA ON THE HEAD, AND SPEAR POLES RATHER THAN CROSS BONES.  
FOR HATS; SHIRTS (U.S. CLS. 22 AND 39).  
FIRST USE 8-1-2008; IN COMMERCE 8-1-2010.

**CLASS 25—(Continued).**

4,046,925. ACI INTERNATIONAL, LOS ANGELES, CA. SN 85-199,371. PUB. 4-19-2011, FILED 12-16-2010.

**HONEYCOMB CUSHIONING**

THE MARK CONSISTS OF STANDARD CHARACTERS WITHOUT CLAIM TO ANY PARTICULAR FONT, STYLE, SIZE, OR COLOR.

NO CLAIM IS MADE TO THE EXCLUSIVE RIGHT TO USE "CUSHIONING", APART FROM THE MARK AS SHOWN.

FOR FOOTWEAR (U.S. CLS. 22 AND 39).  
FIRST USE 8-3-2011; IN COMMERCE 8-3-2011.

---

4,046,983. BERRY, JESSICA, RENO, NV. SN 85-215,870. PUB. 5-24-2011, FILED 1-12-2011.



NO CLAIM IS MADE TO THE EXCLUSIVE RIGHT TO USE "CLOTHING", APART FROM THE MARK AS SHOWN. THE COLOR(S) BLACK, GRAY, AND WHITE IS/ARE CLAIMED AS A FEATURE OF THE MARK.

THE MARK CONSISTS OF STYLIZED SHOUTING ROOSTER HEAD WITH A BLACK EYE HAVING WHITE PLUMAGE AND BEAK, A GREY COMB AND WATTLE, AND A BLACK-COLORED BACKGROUND BALLOON EMANATING FROM THE ROOSTER'S MOUTH FURTHER DISPLAYING WHITE LETTERS FOR THE WORDS "BUTCH CLOTHING", THE LETTER "U" HAVING AN UMLAUT OR A DIAERESIS.

FOR ARTICLES OF CLOTHING, NAMELY, DRESS SHIRTS, GOLF SHIRTS, HOODED SWEAT SHIRTS, KNIT SHIRTS, LONG-SLEEVED SHIRTS, SHORT SLEEVED SHIRTS, MOISTURE-WICKING SPORTS SHIRTS, OPEN-NECKED SHIRTS, PIQUE SHIRTS, POLO SHIRTS, RUGBY SHIRTS, YOGA SHIRTS, SHORT-SLEEVED T-SHIRTS, LONG-SLEEVED T-SHIRTS; WIND SHIRTS, SWEAT PULLOVERS, PANTS, TROUSERS, SWEAT PANTS, JEANS, SHORTS, GYM SHORTS, CARGO SHORTS, JACKETS, WIND RESISTANT JACKETS, COATS, DRESSES, SKIRTS, BLOUSES, SWEATERS, HEAD WEAR, PAPER HATS FOR USE AS CLOTHING ITEMS, CAPS, HATS, HEADBANDS, WOOLLY CAPS, FOOTWEAR, SHOES, BOOTS, SANDALS, PULL-ON SHOES, SLIP-ON SHOES, FLIP-FLOPS, SLIPPERS, CANVAS SNEAKERS, GYM SHOES, DECK SHOES, DRESS SHOES, OPEN TOE SHOES, HIGH HEEL SHOES, WEDGE SHOES, CLOGS, LOAFERS (U.S. CLS. 22 AND 39).

FIRST USE 4-1-2011; IN COMMERCE 4-11-2011.

**CLASS 25—(Continued).**

4,047,000. S.W.B. APPAREL, INC., EAST RUTHERFORD, NJ. SN 85-219,326. PUB. 5-17-2011, FILED 1-17-2011.

**STATUS QUO**

THE MARK CONSISTS OF STANDARD CHARACTERS WITHOUT CLAIM TO ANY PARTICULAR FONT, STYLE, SIZE, OR COLOR.

FOR CLOTHING, NAMELY, T-SHIRTS, SHIRTS, SWEATSHIRTS, SWEATERS, JACKETS, RAINCOATS, JEANS, SHORTS, PANTS, TRACK SUITS, JOGGING SUITS, SWEATPANTS, FLEECE SHIRTS, FLEECE JACKETS, FLEECE PULLOVERS, SLEEPWEAR, UNDERWEAR, CAPRI PANTS, VESTS, POLO SHIRTS, DRESS SHIRTS, MESH SHIRTS, MESH SHORTS, JERSEYS, TANK TOPS, DOWN JACKETS, TRACK JACKETS, LEATHER JACKETS, SUEDE JACKETS, DENIM JACKETS, LEATHER PANTS, BELTS, GLOVES, SUSPENDERS, CAPS, HATS, VISORS, BASEBALL CAPS, SHOES AND SNEAKERS (U.S. CLS. 22 AND 39).

FIRST USE 8-1-2011; IN COMMERCE 8-1-2011.

---

4,047,004. ARMEND, COREY, COVINA, CA. SN 85-220,504. PUB. 4-26-2011, FILED 1-18-2011.

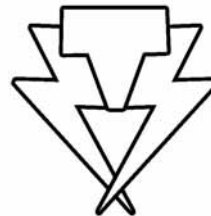

THE MARK CONSISTS OF THE LETTER "T" WITH LIGHTNING BOLTS ON EACH SIDE.

FOR BANDANAS; HATS; JACKETS; PANTS; SHIRTS; SHOES; SHORTS; SOCKS; SWEATSHIRTS; TANK TOPS; UNDERWEAR (U.S. CLS. 22 AND 39).

FIRST USE 2-1-2011; IN COMMERCE 2-1-2011.



**CLASS 25—(Continued).**

4,047,006. GARSH, DDS, DONALD R., PALM SPRINGS, CA. SN 85-221,792. PUB. 5-31-2011, FILED 1-20-2011.

**CLASS 25—(Continued).**

4,047,019. INSPIRED BY POSITIVE PATTY LLC, NAPLES, FL. SN 85-226,750. PUB. 6-28-2011, FILED 1-26-2011.

**Inspired by Positive Patty**

**BLUFFEM**

THE MARK CONSISTS OF STANDARD CHARACTERS WITHOUT CLAIM TO ANY PARTICULAR FONT, STYLE, SIZE, OR COLOR.

FOR HATS; HOODED SWEATSHIRTS; JACKETS; SHIRTS; SWEATERS; T-SHIRTS (U.S. CLS. 22 AND 39). FIRST USE 8-30-2011; IN COMMERCE 8-30-2011.

THE MARK CONSISTS OF STANDARD CHARACTERS WITHOUT CLAIM TO ANY PARTICULAR FONT, STYLE, SIZE, OR COLOR.

FOR CLOTHING, NAMELY, JACKETS, COATS, FABRIC BELTS, LEATHER BELTS, CLOTH BELTS, T-SHIRTS, POLO SHIRTS, TANK TOPS, SWEATSHIRTS, WIND SHIRTS, DRESS SHIRTS, BLOUSES, SWEAT SUITS, SWIMSUITS, SWEATERS, BLAZERS, VESTS, PARKAS, PULLOVERS, PONCHOS, WIND RESISTANT JACKETS, DRESSES, SKIRTS, HATS, CAPS, VISORS, BEANIES, CARDIGANS, PANTS, TROUSERS, SWEAT PANTS, CAPRI'S, SHORTS, BOXING SHORTS, FIGHTING SHORTS, SWIM TRUNKS, BOARD SHORTS, WIND SHORTS, SNAP CROTCH SHORTS, SNAP CROTCH SHIRTS, BANDANAS, GLOVES, SCARVES, MITTENS, FOOTWEAR, SHOES, SANDALS, BOOTS, FLIP FLOPS, UNDERGARMENTS, PANTIES, UNDERWEAR, BOXERS, BRIEFS, SOCKS, NIGHT GOWNS, PAJAMAS, BATHROBES, BODYSUITS, ROMPERS, YOGA PANTS, SHORTS AND TOPS; BIKING PANTS, SHORTS AND TOPS; HIKING PANTS, SHORTS AND TOPS; LEOTARDS, TIGHTS (U.S. CLS. 22 AND 39). FIRST USE 7-31-2011; IN COMMERCE 7-31-2011.

4,047,010. DEER STAGS CONCEPTS INC., NEW YORK, NY. SN 85-222,655. PUB. 5-31-2011, FILED 1-20-2011.

4,047,085. PARIS ACCESSORIES, INC., NEW YORK, NY. SN 85-285,226. PUB. 6-21-2011, FILED 4-4-2011.

**GIVE YOUR FEET A HOLIDAY**

**DETOUR**

THE MARK CONSISTS OF STANDARD CHARACTERS WITHOUT CLAIM TO ANY PARTICULAR FONT, STYLE, SIZE, OR COLOR.

FOR FOOTWEAR, NAMELY, SLIPPERS (U.S. CLS. 22 AND 39). FIRST USE 7-7-2011; IN COMMERCE 8-10-2011.

THE MARK CONSISTS OF STANDARD CHARACTERS WITHOUT CLAIM TO ANY PARTICULAR FONT, STYLE, SIZE, OR COLOR.

FOR FOOTWEAR (U.S. CLS. 22 AND 39). FIRST USE 5-24-2011; IN COMMERCE 5-24-2011.

**CLASS 26—FANCY GOODS**

**CLASS 26—(Continued).**

4,046,180. MATTEL, INC., EL SEGUNDO, CA. SN 77-982,463.  
PUB. 12-7-2010, FILED 2-23-2010.

**MONSTER HIGH**

THE MARK CONSISTS OF STANDARD CHARACTERS WITHOUT CLAIM TO ANY PARTICULAR FONT, STYLE, SIZE, OR COLOR.

FOR BOBBI PINS, HAIR EXTENSIONS AND HAIR STREAKS IN THE NATURE OF STREAKED HAIR PIECES (U.S. CLS. 37, 39, 40, 42 AND 50).

FIRST USE 10-31-2010; IN COMMERCE 10-31-2010.

4,046,459. CINDERELLAHAIR, INC., SANTA FE SPRINGS, CA. SN 85-091,054. PUB. 1-11-2011, FILED 7-22-2010.

**OUR HAIR YOUR WAY**

THE MARK CONSISTS OF STANDARD CHARACTERS WITHOUT CLAIM TO ANY PARTICULAR FONT, STYLE, SIZE, OR COLOR.

NO CLAIM IS MADE TO THE EXCLUSIVE RIGHT TO USE "HAIR", APART FROM THE MARK AS SHOWN.

FOR HAIR EXTENSIONS (U.S. CLS. 37, 39, 40, 42 AND 50).

FIRST USE 2-9-2011; IN COMMERCE 2-9-2011.

4,046,488. THE SPORN COMPANY, NEW YORK, NY. SN 85-095,140. PUB. 1-11-2011, FILED 7-28-2010.

**SWIM ASSIST**

THE MARK CONSISTS OF STANDARD CHARACTERS WITHOUT CLAIM TO ANY PARTICULAR FONT, STYLE, SIZE, OR COLOR.

NO CLAIM IS MADE TO THE EXCLUSIVE RIGHT TO USE "SWIM", APART FROM THE MARK AS SHOWN.

FOR HARNESES FOR GUIDING CHILDREN (U.S. CLS. 37, 39, 40, 42 AND 50).

FIRST USE 8-8-2011; IN COMMERCE 8-8-2011.

**CLASS 26—(Continued).**

4,046,500. NATIONAL MOLDING LLC., MIAMI LAKES, FL. SN 85-097,152. PUB. 1-18-2011, FILED 7-30-2010.

**TECHNO GRAB**

THE MARK CONSISTS OF STANDARD CHARACTERS WITHOUT CLAIM TO ANY PARTICULAR FONT, STYLE, SIZE, OR COLOR.

FOR PLASTIC BUCKLES FOR USE IN CONNECTION WITH LUGGAGE, SPORTING GOODS, CAMERA BAGS, FOUL WEATHER GEAR, APPAREL, AND SIMILAR ARTICLES (U.S. CLS. 37, 39, 40, 42 AND 50).

FIRST USE 5-0-2011; IN COMMERCE 5-0-2011.

4,046,609. WILSHIRE FASHIONS, INC., NEW YORK, NY. SN 85-115,409. PUB. 2-8-2011, FILED 8-25-2010.

**MIA & BAILEY**

THE MARK CONSISTS OF STANDARD CHARACTERS WITHOUT CLAIM TO ANY PARTICULAR FONT, STYLE, SIZE, OR COLOR.

FOR CLOTHING ACCESSORIES, NAMELY, CLOTHING BROOCHES (U.S. CLS. 37, 39, 40, 42 AND 50).

FIRST USE 12-1-2010; IN COMMERCE 12-1-2010.

**CLASS 27—FLOOR COVERINGS**

4,045,905. G9 TURF, INC., HAUPPAUGE, NY. SN 77-810,351. PUB. 1-19-2010, FILED 8-21-2009.

**THE PLAYER'S CHOICE**

THE MARK CONSISTS OF STANDARD CHARACTERS WITHOUT CLAIM TO ANY PARTICULAR FONT, STYLE, SIZE, OR COLOR.

FOR ARTIFICIAL TURF (U.S. CLS. 19, 20, 37, 42 AND 50).

FIRST USE 8-0-2010; IN COMMERCE 8-0-2010.

**CLASS 27—(Continued).**

4,046,615. PHM - PHILIPPE MORISSE SAS, OLORON-SAINTE-MARIE, FRANCE. SN 85-116,643. PUB. 1-25-2011, FILED 8-26-2010.



THE MARK CONSISTS OF THE TERM "PLIFIX" IN STYLIZED FONT DIRECTLY BELOW AN ABSTRACT DRAWING OF A TUFT OF GRASS HAVING A SCREW SHAPED DESIGN THAT MAKES UP THE ROOTS. WITHIN THE ROOT DESIGN ARE TWO DOTS AND A CURVED LINE THAT CREATE A SMILING FACE.

FOR SYNTHETIC GRASS IMPLANTS FOR GROUND MARKING; ARTIFICIAL GRASS AND TURFS OF GRASS; COLORED FIBER TURFS OF SYNTHETIC MATERIALS; APPLICATORS FOR IMPLANTING SYNTHETIC FIBER TURF (U.S. CLS. 19, 20, 37, 42 AND 50). FIRST USE 9-2-2011; IN COMMERCE 9-2-2011.

**CLASS 28—TOYS AND SPORTING GOODS**

4,045,616. WILDLIFE RESEARCH CENTER, INC., RAMSEY, MN. SN 77-064,553. PUB. 2-1-2011, FILED 12-14-2006.

99

THE MARK CONSISTS OF STANDARD CHARACTERS WITHOUT CLAIM TO ANY PARTICULAR FONT, STYLE, SIZE, OR COLOR.

FOR PRODUCTS ALL SPECIFICALLY DESIGNED FOR USE IN HUNTING BIG GAME, NAMELY, HUNTERS' SCENT LURE FOR USE AS A BIG GAME ATTRACTANT AND DISPENSERS THEREOF, AND HUNTERS' SCENT PRODUCTS FOR MASKING HUMAN SCENT OR ELIMINATING HUMAN SCENT, NAMELY, BODY SOAPS, LAUNDRY DETERGENTS, AND APPAREL LIQUID SPRAYS USED FOR BIG GAME HUNTING (U.S. CLS. 22, 23, 38 AND 50).

FIRST USE 1-1-2008; IN COMMERCE 1-1-2008.

**CLASS 28—(Continued).**

4,045,618. AMERICAN GATEWAY MARKETING GROUP, INC., SAN JOSE, CA. SN 77-094,874. PUB. 1-11-2011, FILED 1-30-2007.



THE COLOR(S) RED, MAROON AND BLACK IS/ARE CLAIMED AS A FEATURE OF THE MARK.

THE MARK CONSISTS OF THE STYLIZED WORD "ZENERGY", THE "Z" AND "E" BEING THE COLOR RED, THE "N" BEING THE COLOR MAROON, THE REMAINING LETTERS BEING THE COLOR BLACK APPEARING ABOVE THE STYLIZED WORDS "ENERGIZE THE SPIRIT" ALL BEING THE COLOR BLACK.

FOR PERSONAL EXERCISE MATS; YOGA MATS (U.S. CLS. 22, 23, 38 AND 50).

FIRST USE 0-0-2002; IN COMMERCE 0-0-2002.

4,045,691. TAFFY PRODUCTIONS, LLC, WOODLAND HILLS, CA. SN 77-381,847. PUB. 6-24-2008, FILED 1-28-2008.



THE MARK CONSISTS OF A STYLIZATION OF "HERO: 108".

FOR TOYS, GAMES AND PLAYTHINGS, NAMELY, CARD GAMES; DOLLS; PLUSH AND STUFFED DOLLS AND TOYS; TOY WATCHES; BUBBLE MAKING WAND AND SOLUTION SETS; HAND PUPPETS; MOLDED PLASTIC TOY FIGURINES; ACTION FIGURES AND ACCESSORIES THEREOF; BATTERY-OPERATED ACTION TOYS; RIDE-ON TOYS; TOY VEHICLES; BOARD GAMES; ROLE PLAYING GAMES; JIGSAW PUZZLES; PLAYING CARDS; FLYING DISCS; YO-YOS; BALLOONS; SPORTING ARTICLES, NAMELY, BALLS, BASEBALLS, FOOTBALLS, BASEBALL BATS, PLAYGROUND BALLS, RUBBER AND FOAM ACTION BALLS; HAND HELD UNIT FOR PLAYING VIDEO GAMES (U.S. CLS. 22, 23, 38 AND 50).

FIRST USE 8-13-2010; IN COMMERCE 8-13-2010.

**CLASS 28—(Continued).**

4,045,701. LAS VEGAS SANDS CORP., LAS VEGAS, NV. SN 77-401,857. PUB. 5-27-2008, FILED 2-20-2008.

**SANDS**

THE MARK CONSISTS OF STANDARD CHARACTERS WITHOUT CLAIM TO ANY PARTICULAR FONT, STYLE, SIZE, OR COLOR.

OWNER OF U.S. REG. NO. 1,209,102.

FOR TOYS IN THE NATURE OF ELECTRONIC LEARNING AND ACTION TOYS; BATTERY OPERATED ACTION TOYS; MECHANICAL TOYS; PLUSH TOYS; PLUSH ANIMALS; STUFFED TOYS; STUFFED ANIMALS; TOY SLOT MACHINES; TOY ROULETTE MACHINES; TOY POKER MACHINES; HAND HELD UNIT FOR PLAYING ELECTRONIC GAMES; GAMING CHIPS; DICE; PLAYING CARDS; GOLF BALLS; GOLF BALL MARKERS; GOLF TEES; CHRISTMAS TREE ORNAMENTS; DOMINOES (U.S. CLS. 22, 23, 38 AND 50).

FIRST USE 7-1-2007; IN COMMERCE 7-1-2007.

4,045,727. OUTSET MEDIA CORPORATION, VICTORIA, BC, CANADA. SN 77-456,460. PUB. 5-5-2009, FILED 4-23-2008.

**GENDER RULES**

THE MARK CONSISTS OF STANDARD CHARACTERS WITHOUT CLAIM TO ANY PARTICULAR FONT, STYLE, SIZE, OR COLOR.

FOR BOARD GAMES; CARD GAMES; PARLOR GAMES; PARTY GAMES (U.S. CLS. 22, 23, 38 AND 50).

FIRST USE 7-27-2011; IN COMMERCE 7-27-2011.

4,045,806. EVERLAST WORLD'S BOXING HEADQUARTERS CORPORATION, NEW YORK, NY. SN 77-667,232. PUB. 6-9-2009, FILED 2-10-2009.

**EVERCOOL**

THE MARK CONSISTS OF STANDARD CHARACTERS WITHOUT CLAIM TO ANY PARTICULAR FONT, STYLE, SIZE, OR COLOR.

FOR ATHLETIC EQUIPMENT, NAMELY, EAR AND EYEBROW PROTECTORS FOR BOXERS, BOXING MASKS, HAND WRAPS, BOXING AND WEIGHT-LIFTING GLOVES, SPORTS GLOVES, NAMELY, WEIGHT LIFTING GLOVES, BOXING GLOVES AND WORK-OUT GLOVES, FIGHTING GLOVES; BOXING EQUIPMENT, NAMELY, HEADGUARDS (U.S. CLS. 22, 23, 38 AND 50).

FIRST USE 9-1-2010; IN COMMERCE 9-1-2010.

**CLASS 28—(Continued).**

4,045,813. COMPOUND FUN LLC, BELLEVUE, WA. SN 77-673,918. PUB. 6-23-2009, FILED 2-19-2009.

**ARCANE LEGIONS**

THE MARK CONSISTS OF STANDARD CHARACTERS WITHOUT CLAIM TO ANY PARTICULAR FONT, STYLE, SIZE, OR COLOR.

FOR BOARD GAMES AND MINIATURE FIGURE TABLETOP GAMES (U.S. CLS. 22, 23, 38 AND 50).

FIRST USE 8-10-2009; IN COMMERCE 8-10-2009.

4,045,815. HUTCHISON, MICHAEL C., TRAVERSE CITY, MI. SN 77-676,546. PUB. 7-7-2009, FILED 2-23-2009.

**POWERPLUS MOUTHGUARD**

THE MARK CONSISTS OF STANDARD CHARACTERS WITHOUT CLAIM TO ANY PARTICULAR FONT, STYLE, SIZE, OR COLOR.

NO CLAIM IS MADE TO THE EXCLUSIVE RIGHT TO USE "MOUTHGUARD", APART FROM THE MARK AS SHOWN.

FOR A MANDIBULAR ATHLETIC MOUTH GUARD (U.S. CLS. 22, 23, 38 AND 50).

FIRST USE 6-1-2011; IN COMMERCE 6-1-2011.

4,045,838. MATTEL, INC., EL SEGUNDO, CA. SN 77-713,898. PUB. 12-29-2009, FILED 4-14-2009.

**FRIGHT BIKE**

THE MARK CONSISTS OF STANDARD CHARACTERS WITHOUT CLAIM TO ANY PARTICULAR FONT, STYLE, SIZE, OR COLOR.

NO CLAIM IS MADE TO THE EXCLUSIVE RIGHT TO USE "BIKE", APART FROM THE MARK AS SHOWN.

FOR TOYS, GAMES AND PLAYTHINGS, NAMELY, TOY VEHICLES AND ACCESSORIES THEREFOR (U.S. CLS. 22, 23, 38 AND 50).

FIRST USE 5-18-2011; IN COMMERCE 5-18-2011.

**CLASS 28—(Continued).**

4,045,858. D & G SPORTS VENTURES LLC, BELLFLOWER, CA. SN 77-756,356. PUB. 5-11-2010, FILED 6-10-2009.



THE MARK CONSISTS OF THE LETTER "G" IN A CIRCLE WITH THICKENED LINE AT BOTTOM OF CIRCLE AND SMALL LINES SUGGESTING SPEED ON EACH SIDE OF CIRCLE.

FOR PAINTBALLS; PAINTBALL GUNS; PAINTBALL GUNS CONTAINING PAINT; ALL BEING ARTICLES FOR PLAYING PAINTBALL (U.S. CLS. 22, 23, 38 AND 50).

FIRST USE 1-1-2011; IN COMMERCE 1-1-2011.

4,045,918. OUTLAW HOBBY PRODUCTS, LLC, PENNSBORO, WV. SN 77-821,271. PUB. 8-24-2010, FILED 9-7-2009.

## Outlaw Hobby Products

THE MARK CONSISTS OF STANDARD CHARACTERS WITHOUT CLAIM TO ANY PARTICULAR FONT, STYLE, SIZE, OR COLOR.

NO CLAIM IS MADE TO THE EXCLUSIVE RIGHT TO USE "HOBBY PRODUCTS", APART FROM THE MARK AS SHOWN.

FOR REMOTE CONTROL TOY VEHICLES AND ACCESSORIES NOT BEING ALL-TERRAIN VEHICLES OR ALL-TERRAIN VEHICLE RIDE-ON TOYS (U.S. CLS. 22, 23, 38 AND 50).

FIRST USE 8-11-2009; IN COMMERCE 10-1-2009.

4,045,925. STEIN TENNIS PRODUCTS LLC, LONG GROVE, IL. SN 77-833,425. PUB. 2-9-2010, FILED 9-23-2009.

## BALL BITER

THE MARK CONSISTS OF STANDARD CHARACTERS WITHOUT CLAIM TO ANY PARTICULAR FONT, STYLE, SIZE, OR COLOR.

**CLASS 28—(Continued).**

NO CLAIM IS MADE TO THE EXCLUSIVE RIGHT TO USE "BALL", APART FROM THE MARK AS SHOWN.

FOR A HOOK AND LOOP ENHANCED MOLDING WHICH ATTACHES TO THE BOTTOM OF TENNIS NETS, TENNIS DIVIDER NETTING, TENNIS COURT WINDSCREENS, AND TENNIS COURT FENCING USED TO EXTEND THE PRODUCT LIFE OF THE FOREGOING AND INCREASE PLAYER SAFETY BY ALLOWING TENNIS BALLS TO ADHERE TO THE HOOK AND LOOP MOLDINGS THEREBY PREVENTING TENNIS BALLS FROM ROLLING INTO THE PLAYING AREA DURING PLAY (U.S. CLS. 22, 23, 38 AND 50).

FIRST USE 12-24-2010; IN COMMERCE 12-24-2010.

4,045,969. KLOKOW, JONATHAN M., FORT LAUDERDALE, FL. SN 77-875,524. PUB. 12-21-2010, FILED 11-18-2009.

## BEVELBOARD

THE MARK CONSISTS OF STANDARD CHARACTERS WITHOUT CLAIM TO ANY PARTICULAR FONT, STYLE, SIZE, OR COLOR.

FOR SURF BOARDS AND BOARDS FOR WAVE-RIDING, NAMELY, SURFBOARDS (U.S. CLS. 22, 23, 38 AND 50).

FIRST USE 1-26-2010; IN COMMERCE 1-26-2010.

4,046,006. CHEEZBURGER, INC., SEATTLE, WA. SN 77-909,518. PUB. 5-3-2011, FILED 1-11-2010.

## LOLMART

THE MARK CONSISTS OF STANDARD CHARACTERS WITHOUT CLAIM TO ANY PARTICULAR FONT, STYLE, SIZE, OR COLOR.

FOR PLUSH TOYS (U.S. CLS. 22, 23, 38 AND 50).

FIRST USE 8-23-2011; IN COMMERCE 8-23-2011.

**CLASS 28—(Continued).**

4,046,063. MATTEL, INC., EL SEGUNDO, CA. SN 77-934,359.  
PUB. 6-29-2010, FILED 2-12-2010.

**QUEEN MARLENA**

THE MARK CONSISTS OF STANDARD CHARACTERS WITHOUT CLAIM TO ANY PARTICULAR FONT, STYLE, SIZE, OR COLOR.

FOR TOYS, GAMES AND PLAYTHINGS, NAMELY, TOY ACTION FIGURES AND ACCESSORIES THEREFOR (U.S. CLS. 22, 23, 38 AND 50).

FIRST USE 7-11-2011; IN COMMERCE 7-11-2011.

---

4,046,064. MY BEAST FRIENDS, LLC, CORAL GABLES, FL.  
SN 77-934,375. PUB. 6-29-2010, FILED 2-12-2010.



THE MARK CONSISTS OF THE STYLIZED, COMPACTED WORDS "MY BEAST FRIENDS" WHEREIN THE "A" IN "BEAST" LOOKS LIKE A ONE-EYED, SMILING MONSTER WITH THREE TEETH AND POINTED LEGS.

FOR DOLLS; STUFFED TOYS (U.S. CLS. 22, 23, 38 AND 50).

FIRST USE 8-24-2011; IN COMMERCE 8-24-2011.

---

4,046,065. DISNEY ENTERPRISES, INC., BURBANK, CA. SN 77-934,548. PUB. 1-4-2011, FILED 2-12-2010.

**TANGLED**

THE MARK CONSISTS OF STANDARD CHARACTERS WITHOUT CLAIM TO ANY PARTICULAR FONT, STYLE, SIZE, OR COLOR.

FOR BALLOONS; CHILDREN'S PLAY COSMETICS; DOLLS; DOLL CLOTHING; DOLL ACCESSORIES; DOLL PLAYSETS; JIGSAW PUZZLES; PARLOR GAMES; PARTY GAMES; PLUSH TOYS; STUFFED TOYS; TOY VEHICLES; TOY FIGURES (U.S. CLS. 22, 23, 38 AND 50).

FIRST USE 10-31-2010; IN COMMERCE 10-31-2010.

**CLASS 28—(Continued).**

4,046,066. DISNEY ENTERPRISES, INC., BURBANK, CA. SN 77-934,553. PUB. 1-4-2011, FILED 2-12-2010.

**DISNEY TANGLED**

THE MARK CONSISTS OF STANDARD CHARACTERS WITHOUT CLAIM TO ANY PARTICULAR FONT, STYLE, SIZE, OR COLOR.

OWNER OF U.S. REG. NOS. 3,521,197, 3,767,867, AND OTHERS.

FOR BALLOONS; TOY BANKS (U.S. CLS. 22, 23, 38 AND 50).

FIRST USE 6-30-2010; IN COMMERCE 6-30-2010.

---

4,046,108. RAMJOHN, PATRICIA, MIAMI, FL. SN 77-948,197.  
PUB. 7-27-2010, FILED 3-2-2010.



NO CLAIM IS MADE TO THE EXCLUSIVE RIGHT TO USE "TREE", APART FROM THE MARK AS SHOWN.

THE MARK CONSISTS OF A STYLIZED SPARKLING STAR ON TOP OF A TREE CONSISTING OF 6 STYLIZED OVALS IN A DESCENDING PATTERN WITH THE TOP OVAL BEING THE SMALLEST AND THE BOTTOM OVAL BEING THE LARGEST, AND THE BOTTOM OVAL ALSO PART OF THE LETTER "P" AND "T" IN THE WORDS "PROMISE TREE" APPEARING HORIZONTALLY UNDER THE BOTTOM OVAL.

FOR CHRISTMAS TREE ORNAMENTS AND DECORATIONS (U.S. CLS. 22, 23, 38 AND 50).

FIRST USE 7-10-2011; IN COMMERCE 7-10-2011.

**CLASS 28—(Continued).**

4,046,168. DISNEY ENTERPRISES, INC., BURBANK, CA. SN 77-982,412. PUB. 11-30-2010, FILED 1-22-2010.

**PRINCESS & ME**

THE MARK CONSISTS OF STANDARD CHARACTERS WITHOUT CLAIM TO ANY PARTICULAR FONT, STYLE, SIZE, OR COLOR.

FOR DOLLS; DOLL CLOTHING; DOLL ACCESSORIES; DOLL PAYSETS (U.S. CLS. 22, 23, 38 AND 50).  
FIRST USE 7-31-2010; IN COMMERCE 7-31-2010.

---

4,046,204. BIRDZONE LLC, SAN ANTONIO, TX. SN 85-000,248. PUB. 8-17-2010, FILED 3-28-2010.

**Tour4**

THE MARK CONSISTS OF STANDARD CHARACTERS WITHOUT CLAIM TO ANY PARTICULAR FONT, STYLE, SIZE, OR COLOR.

FOR GOLF-PUTTING AIDS, NAMELY, GOLF-PUTTING GAME SYSTEMS GENERALLY COMPRISING GOLF-PUTTING TARGETS FOR AFFIXING TO A GOLF CUP AND GOLF-PUTTING GREENS, AND SPECIFICALLY COMPRISING GOLF-PUTTING TARGETS AND GOLF-PUTTING GREENS THAT UTILIZE AN ASYMMETRICAL TARGET ZONE FOR REINFORCING GOOD PUTTING HABITS BY EMPHASIZING DIRECTING PUTTS TOWARD THE HIGH-PERCENTAGE SIDE OF THE GOLF CUP (U.S. CLS. 22, 23, 38 AND 50).

FIRST USE 9-1-2009; IN COMMERCE 9-1-2009.

---

4,046,216. MATTEL, INC., EL SEGUNDO, CA. SN 85-009,200. PUB. 2-15-2011, FILED 4-8-2010.

**SPLASH 'N SPRAY WATER PARK**

THE MARK CONSISTS OF STANDARD CHARACTERS WITHOUT CLAIM TO ANY PARTICULAR FONT, STYLE, SIZE, OR COLOR.

NO CLAIM IS MADE TO THE EXCLUSIVE RIGHT TO USE "WATER PARK", APART FROM THE MARK AS SHOWN.

FOR DOLL PLAYSETS AND ACCESSORIES THEREFOR; BATH TOYS (U.S. CLS. 22, 23, 38 AND 50).  
FIRST USE 11-30-2010; IN COMMERCE 11-30-2010.

**CLASS 28—(Continued).**

4,046,227. MATTEL, INC., EL SEGUNDO, CA. SN 85-014,651. PUB. 2-15-2011, FILED 4-15-2010.

**COLOSSAL STUNT WORLD**

THE MARK CONSISTS OF STANDARD CHARACTERS WITHOUT CLAIM TO ANY PARTICULAR FONT, STYLE, SIZE, OR COLOR.

OWNER OF U.S. REG. NOS. 3,251,154 AND 3,616,767.  
FOR TOY VEHICLE TRACK SETS AND ACCESSORIES THEREFOR (U.S. CLS. 22, 23, 38 AND 50).

FIRST USE 8-17-2010; IN COMMERCE 8-17-2010.

---

4,046,229. MATTEL, INC., EL SEGUNDO, CA. SN 85-014,663. PUB. 2-15-2011, FILED 4-15-2010.

**SLAM BLAST BATTLE**

THE MARK CONSISTS OF STANDARD CHARACTERS WITHOUT CLAIM TO ANY PARTICULAR FONT, STYLE, SIZE, OR COLOR.

OWNER OF U.S. REG. NO. 3,813,000.  
FOR TOY VEHICLES AND ACCESSORIES THEREFOR; TOY VEHICLE LAUNCHERS (U.S. CLS. 22, 23, 38 AND 50).

FIRST USE 12-14-2010; IN COMMERCE 12-14-2010.

**CLASS 28—(Continued).**

4,046,245. YOSEM (SIXTY NINE) INTERNATIONAL CO., LTD., TAIPEI COUNTY, TAIWAN. SN 85-025,852. PUB. 12-14-2010, FILED 4-28-2010.



THE MARK CONSISTS OF THE WORD "SOAK" SHOWN IN STYLIZED LETTERS AND A WATER SPLASH DESIGN. FOR AMUSEMENT PRODUCTS, NAMELY, INFLATABLE BALLS; BALLS FOR GAMES; BASEBALL BATS; BOARDS USED IN THE PRACTICE OF WATER SPORTS; BODY-BUILDING APPARATUS; BODY-TRAINING APPARATUS; FLYING DISCS; GAME APPARATUS, NAMELY, BASES, BATS, AND BALLS FOR PLAYING INDOOR AND OUTDOOR GAMES; INFLATABLE TOYS; MANUALLY-OPERATED EXERCISE EQUIPMENT; SNOWBOARDS; SOFTBALL BATS; SPORT BALLS; SPORTBALLS; SPORTING GOODS, NAMELY, A SPORTS TRAINING DEVICE TO IMPROVE STRENGTH, TONING, CONDITIONING, BALANCE, AND PROPRIOCEPTION; SURF BOARDS; SURFBOARDS; SWIMMING BOARDS; TOY BALLOONS; TOY SWORDS; WATER PISTOLS; WATER SKIS; WATER SQUIRTING TOYS; WATER TOYS; WATERSKIS (U.S. CLS. 22, 23, 38 AND 50).

FIRST USE 3-1-2009; IN COMMERCE 10-1-2010.

4,046,271. FUN AND FUNCTION LLC, MERION STATION, PA. SN 85-036,182. PUB. 4-19-2011, FILED 5-12-2010.

**GUESS HOW I FEEL?**

THE MARK CONSISTS OF STANDARD CHARACTERS WITHOUT CLAIM TO ANY PARTICULAR FONT, STYLE, SIZE, OR COLOR.

FOR EDUCATIONAL PARLOR GAME (U.S. CLS. 22, 23, 38 AND 50).

FIRST USE 1-1-2011; IN COMMERCE 1-1-2011.

**CLASS 28—(Continued).**

4,046,286. BAY, LARRY R., RENTON, WA. SN 85-043,222. PUB. 4-19-2011, FILED 5-19-2010.

**CLEAN-SHOT**

THE MARK CONSISTS OF STANDARD CHARACTERS WITHOUT CLAIM TO ANY PARTICULAR FONT, STYLE, SIZE, OR COLOR.

FOR ARCHERY EQUIPMENT, NAMELY, BROAD-HEADS, ARROW HEADS AND ARROW TIPS (U.S. CLS. 22, 23, 38 AND 50).

FIRST USE 1-6-2011; IN COMMERCE 1-6-2011.

4,046,287. BAY, LARRY R., RENTON, WA. SN 85-043,228. PUB. 4-19-2011, FILED 5-19-2010.

**SPOT-ON**

THE MARK CONSISTS OF STANDARD CHARACTERS WITHOUT CLAIM TO ANY PARTICULAR FONT, STYLE, SIZE, OR COLOR.

FOR ARCHERY EQUIPMENT, NAMELY, BROAD-HEADS, ARROW HEADS AND ARROW TIPS (U.S. CLS. 22, 23, 38 AND 50).

FIRST USE 1-6-2011; IN COMMERCE 1-6-2011.

4,046,292. CYRUS, GERALDINE WILSON, WEST PALM BEACH, FL. SN 85-045,269. PUB. 1-25-2011, FILED 5-21-2010.



NO CLAIM IS MADE TO THE EXCLUSIVE RIGHT TO USE "BATON", APART FROM THE MARK AS SHOWN.

THE COLOR(S) BLACK AND RED IS/ARE CLAIMED AS A FEATURE OF THE MARK.

THE MARK CONSISTS OF THE WORD "BATON" IS WRITTEN IN RED WITH THE LETTER "B" CAPITALIZED AND THE "T" IS BLACK AND CONVEYED AS A STICK FIGURE SHAPE WITH LEGS IN THE SHAPE OF AN UPSIDE DOWN V AND THE FIGURE IS HOLDING A BATON OVER IT'S HEAD. THE WORD "BUDDY" IS WRITTEN ABOVE THE WORD "BATON", IN BLACK, AND IN CURSIVE WITH THE EXCEPTION OF THE "B", WHICH IS THE SAME "B" USED TO FORM THE WORD "BATON" (PRINTED IN RED, CAPITALIZED).

FOR EXERCISE EQUIPMENT, NAMELY, WEIGHTED EXERCISE BAR (U.S. CLS. 22, 23, 38 AND 50).

FIRST USE 10-16-2009; IN COMMERCE 10-16-2009.



**CLASS 28—(Continued).**

4,046,316. ADRENALIN GAMING, LLC, LADERA RANCH, CA. SN 85-055,504. PUB. 9-28-2010, FILED 6-5-2010.

ROCK THE NET

THE MARK CONSISTS OF STANDARD CHARACTERS WITHOUT CLAIM TO ANY PARTICULAR FONT, STYLE, SIZE, OR COLOR.

FOR EQUIPMENT SOLD AS A UNIT FOR PLAYING A BOARD GAME (U.S. CLS. 22, 23, 38 AND 50). FIRST USE 8-17-2010; IN COMMERCE 8-17-2010.

**CLASS 28—(Continued).**

4,046,362. AQUA-LEISURE INDUSTRIES, INC., AVON, MA. SN 85-070,781. PUB. 9-21-2010, FILED 6-24-2010.



THE MARK CONSISTS OF THE WORDS "EVERY" AND "WON" WITH THE NUMBER "1" INSIDE A STAR IN THE MIDDLE OF THE MARK.

FOR RECREATIONAL PRODUCTS, NAMELY, SOFT FABRIC COVERED BALLS (U.S. CLS. 22, 23, 38 AND 50). FIRST USE 1-1-2011; IN COMMERCE 1-1-2011.

4,046,413. KITMAKER INC., MIAMI BEACH, FL. SN 85-083,565. PUB. 12-21-2010, FILED 7-13-2010.

kitmaker

THE MARK CONSISTS OF STANDARD CHARACTERS WITHOUT CLAIM TO ANY PARTICULAR FONT, STYLE, SIZE, OR COLOR.

FOR ELECTRONIC GAMES OTHER THAN THOSE ADAPTED FOR USE WITH TELEVISION RECEIVERS ONLY (U.S. CLS. 22, 23, 38 AND 50). FIRST USE 1-1-2011; IN COMMERCE 1-1-2011.

4,046,422. SIMON GOLF COMPANY, LLC, INDIANAPOLIS, IN. SN 85-085,383. PUB. 5-17-2011, FILED 7-15-2010.

WEAPON

THE MARK CONSISTS OF STANDARD CHARACTERS WITHOUT CLAIM TO ANY PARTICULAR FONT, STYLE, SIZE, OR COLOR.

FOR GOLF CLUBS (U.S. CLS. 22, 23, 38 AND 50). FIRST USE 1-0-2011; IN COMMERCE 1-0-2011.

4,046,318. THE OUTDOOR RECREATION GROUP, LOS ANGELES, CA. SN 85-057,019. PUB. 11-2-2010, FILED 6-8-2010.



THE COLOR(S) BLACK, GRAY, BLUE AND WHITE IS/ ARE CLAIMED AS A FEATURE OF THE MARK.

THE MARK CONSISTS OF A DARK GREY FISH OUTLINED IN BLACK WITH BLUE EYES OVER THE WORDING "CHATAHOOCHEE CHOMPER" IN WHITE AGAINST A BLACK BACKGROUND.

FOR FISHING TACKLE BAGS AND FISHING GEAR, NAMELY, FISHING TACKLE BOXES AND FISHING ROD CASES (U.S. CLS. 22, 23, 38 AND 50). FIRST USE 11-0-2009; IN COMMERCE 11-0-2009.

**CLASS 28—(Continued).**

4,046,463. TAHOE BOARD WORKS, LLC, RENO, NV. SN 85-091,246. PUB. 1-11-2011, FILED 7-23-2010.

**KOREGUARD**

THE MARK CONSISTS OF STANDARD CHARACTERS WITHOUT CLAIM TO ANY PARTICULAR FONT, STYLE, SIZE, OR COLOR.

FOR PADDLE BOARDS (U.S. CLS. 22, 23, 38 AND 50).  
FIRST USE 8-0-2010; IN COMMERCE 1-26-2011.

---

4,046,470. MATTEL, INC., EL SEGUNDO, CA. SN 85-092,492.  
PUB. 1-4-2011, FILED 7-26-2010.

**SPEED TRAP**

THE MARK CONSISTS OF STANDARD CHARACTERS WITHOUT CLAIM TO ANY PARTICULAR FONT, STYLE, SIZE, OR COLOR.

FOR TOY VEHICLES AND ACCESSORIES THEREFOR (U.S. CLS. 22, 23, 38 AND 50).  
FIRST USE 5-18-2011; IN COMMERCE 5-18-2011.

---

4,046,471. MATTEL, INC., EL SEGUNDO, CA. SN 85-092,498.  
PUB. 1-4-2011, FILED 7-26-2010.

**RETRO-ACTIVE**

THE MARK CONSISTS OF STANDARD CHARACTERS WITHOUT CLAIM TO ANY PARTICULAR FONT, STYLE, SIZE, OR COLOR.

FOR TOY VEHICLES AND ACCESSORIES THEREFOR (U.S. CLS. 22, 23, 38 AND 50).  
FIRST USE 7-25-2011; IN COMMERCE 7-25-2011.

**CLASS 28—(Continued).**

4,046,483. INTERNATIONAL PLAYTHINGS LLC, PARSIPPANY, NJ. SN 85-094,428. PUB. 4-12-2011, FILED 7-28-2010.

**KIDOOZIE**

THE MARK CONSISTS OF STANDARD CHARACTERS WITHOUT CLAIM TO ANY PARTICULAR FONT, STYLE, SIZE, OR COLOR.

FOR TOYS, NAMELY, INFANT SHAPE SORTING TOYS, PULL TOYS, TOY VEHICLES, DOLLS, PLUSH TOYS ANIMALS, MUSICAL TOYS, ROLE PLAYING TOYS IN THE NATURE OF PLAY SETS FOR CHILDREN TO IMITATE REAL LIFE OCCUPATIONS, TOY SHOPPING CARTS, TOY DOCTOR/NURSE KITS COMPRISED OF MEDICAL BAGS, TOY REFLEX HAMMER, TOY THERMOMETER, TOY SQUEAKING SYRINGE, TOY AURISCOPE, TOY LARYNGOSCOPE AND PRETEND BANDAGE, PLAY BEAUTY KITS COMPRISED OF SOFT TRAVEL BAG, TOY MOTORIZED HAIR DRYER, TOY HAND HELD MIRROR, TOY CURLERS, TOY HAIR BRUSH AND TOY CURLING IRON, SAND TOYS, BUBBLE MAKING WAND AND SOLUTION SETS, ALL FOR TODDLER AND PRESCHOOL CHILDREN AND NOT RELATED TO SPORTS; PLAYTHINGS, NAMELY, TOY FOAM BATS, PLASTIC TOY GOLF SETS WITH FOAM BALLS, TOY BOWLING AND LACROSSE SETS WITH FOAM BALLS, ALL FOR TODDLER AND PRESCHOOL CHILDREN AND NOT INTENDED FOR USE IN SPORTING ACTIVITIES (U.S. CLS. 22, 23, 38 AND 50).  
FIRST USE 1-3-2011; IN COMMERCE 1-3-2011.

---

4,046,531. WIZARDS OF THE COAST LLC, PAWTUCKET, RI. SN 85-099,919. PUB. 7-12-2011, FILED 8-4-2010.

**MIRRODIN BESIEGED**

THE MARK CONSISTS OF STANDARD CHARACTERS WITHOUT CLAIM TO ANY PARTICULAR FONT, STYLE, SIZE, OR COLOR.

OWNER OF U.S. REG. NOS. 2,867,611 AND 2,872,415.  
FOR CARD GAMES, TRADING CARD GAMES, PLAYING CARDS (U.S. CLS. 22, 23, 38 AND 50).  
FIRST USE 2-4-2011; IN COMMERCE 2-4-2011.

**CLASS 28—(Continued).**

4,046,537. EIDOLON BRANDS, LLC, VICTORIA, TX. SN 85-100,735. PUB. 1-18-2011, FILED 8-5-2010.

# GENIUS

THE MARK CONSISTS OF STANDARD CHARACTERS WITHOUT CLAIM TO ANY PARTICULAR FONT, STYLE, SIZE, OR COLOR.

FOR GOLF CLUB SHAFTS AND GOLF CLUBS (U.S. CLS. 22, 23, 38 AND 50).

FIRST USE 12-1-2010; IN COMMERCE 12-1-2010.

**CLASS 28—(Continued).**

4,046,543. MUROKI NAOTO, TOKYO, JAPAN. SN 85-101,644. PUB. 1-18-2011, FILED 8-6-2010.



NO CLAIM IS MADE TO THE EXCLUSIVE RIGHT TO USE "SURFBOARDS", APART FROM THE MARK AS SHOWN.

THE MARK CONSISTS OF THE WORDS "FRESH SURFBOARDS" WITH STYLIZED DESIGN.

FOR SURFBOARDS (U.S. CLS. 22, 23, 38 AND 50).

FIRST USE 1-20-2009; IN COMMERCE 6-10-2009.

4,046,650. SAFARI PROGRAMS, INC., MIAMI GARDENS, FL. SN 85-123,077. PUB. 2-15-2011, FILED 9-3-2010.

# DAYS OF OLD

THE MARK CONSISTS OF STANDARD CHARACTERS WITHOUT CLAIM TO ANY PARTICULAR FONT, STYLE, SIZE, OR COLOR.

FOR TOYS, NAMELY, PLASTIC TOY FIGURINES OF CHARACTERS AND CREATURES (U.S. CLS. 22, 23, 38 AND 50).

FIRST USE 1-31-2011; IN COMMERCE 1-31-2011.

4,046,680. WORLD CHOICE INVESTMENTS, LLC, PIGEON FORGE, TN. SN 85-129,863. PUB. 3-1-2011, FILED 9-15-2010.



THE MARK CONSISTS OF THE WORD "MODEX" AND THREE CIRCLES PARTIALLY OVERLAPPING WITH EACH OTHER ABOVE THE WORD.

THE WORDING "MODEX" HAS NO MEANING IN A FOREIGN LANGUAGE.

FOR SURFBOARDS (U.S. CLS. 22, 23, 38 AND 50).

FIRST USE 1-20-2009; IN COMMERCE 6-10-2009.

# PIRATES VOYAGE

THE MARK CONSISTS OF STANDARD CHARACTERS WITHOUT CLAIM TO ANY PARTICULAR FONT, STYLE, SIZE, OR COLOR.

NO CLAIM IS MADE TO THE EXCLUSIVE RIGHT TO USE "PIRATES", APART FROM THE MARK AS SHOWN.

FOR TOYS, NAMELY, TOY GUNS, TOY KNIVES, TOY SHIPS AND BOATS, TOY FIGURES, TOY PIRATES AND TOY MERMAIDS (U.S. CLS. 22, 23, 38 AND 50).

FIRST USE 6-3-2011; IN COMMERCE 6-3-2011.

**CLASS 28—(Continued).**

4,046,683. KARSTEN MANUFACTURING CORPORATION, PHOENIX, AZ. SN 85-130,008. PUB. 3-8-2011, FILED 9-15-2010.

# MESQUITE

THE MARK CONSISTS OF STANDARD CHARACTERS WITHOUT CLAIM TO ANY PARTICULAR FONT, STYLE, SIZE, OR COLOR.

FOR GOLF CLUBS (U.S. CLS. 22, 23, 38 AND 50).  
FIRST USE 7-26-2011; IN COMMERCE 7-26-2011.

---

4,046,684. KARSTEN MANUFACTURING CORPORATION, PHOENIX, AZ. SN 85-130,053. PUB. 3-8-2011, FILED 9-15-2010.

# SHEA

THE MARK CONSISTS OF STANDARD CHARACTERS WITHOUT CLAIM TO ANY PARTICULAR FONT, STYLE, SIZE, OR COLOR.

FOR GOLF CLUBS (U.S. CLS. 22, 23, 38 AND 50).  
FIRST USE 7-26-2011; IN COMMERCE 7-26-2011.

---

4,046,706. KARSTEN MANUFACTURING CORPORATION, PHOENIX, AZ. SN 85-134,731. PUB. 3-8-2011, FILED 9-21-2010.

# SENITA

THE MARK CONSISTS OF STANDARD CHARACTERS WITHOUT CLAIM TO ANY PARTICULAR FONT, STYLE, SIZE, OR COLOR.

FOR GOLF CLUBS (U.S. CLS. 22, 23, 38 AND 50).  
FIRST USE 7-26-2011; IN COMMERCE 7-26-2011.

**CLASS 28—(Continued).**

4,046,740. PARADISE KIDS, LLC, GREENWICK, CT. SN 85-143,176. PUB. 3-15-2011, FILED 10-1-2010.

THE MARK CONSISTS OF THE LITERAL ELEMENT "BE MY GIRL" DISPLAYED IN A STAIR STEP FORMATION WITH A STYLIZED FONT, WITH AN ORNATE LINE APPEARING TO THE RIGHT OF THE WORD "BE" AND BELOW THE WORDS "MY" AND "GIRL".

FOR DOLL ACCESSORIES; DOLL CASES; DOLL CLOTHING; DOLL FURNITURE; DOLLS; DOLLS AND ACCESSORIES THEREFOR; DOLLS AND DOLLS' CLOTHING; DOLLS AND PLAYSETS THEREFOR; DOLLS' CLOTHES; DOLLS' FEEDING BOTTLES; PLUSH DOLLS; RAG DOLLS; STUFFED DOLLS AND ANIMALS (U.S. CLS. 22, 23, 38 AND 50).

FIRST USE 2-15-2011; IN COMMERCE 8-15-2011.

---

4,046,779. MATTEL, INC., EL SEGUNDO, CA. SN 85-155,373. PUB. 1-4-2011, FILED 10-18-2010.

# RING BLAST

THE MARK CONSISTS OF STANDARD CHARACTERS WITHOUT CLAIM TO ANY PARTICULAR FONT, STYLE, SIZE, OR COLOR.

FOR TOY VEHICLES AND ACCESSORIES THEREFOR (U.S. CLS. 22, 23, 38 AND 50).

FIRST USE 7-25-2011; IN COMMERCE 7-25-2011.

---

4,046,835. BATTAT INCORPORATED, PLATTSBURGH, NY. SN 85-172,604. PUB. 3-15-2011, FILED 11-9-2010.

# JULIET

THE MARK CONSISTS OF STANDARD CHARACTERS WITHOUT CLAIM TO ANY PARTICULAR FONT, STYLE, SIZE, OR COLOR.

FOR DOLLS AND ACCESSORIES THEREFOR (U.S. CLS. 22, 23, 38 AND 50).

FIRST USE 10-31-2010; IN COMMERCE 10-31-2010.

**CLASS 28—(Continued).**

4,046,868. TRALY (U.S.A.) INC., BOCA RATON, FL. SN 85-185,775. PUB. 6-28-2011, FILED 11-28-2010.

**FROMBIES**

THE MARK CONSISTS OF STANDARD CHARACTERS WITHOUT CLAIM TO ANY PARTICULAR FONT, STYLE, SIZE, OR COLOR.

FOR COLLECTIBLE TOYS, NAMELY, PLUSH TOYS, COLLECTIBLE TOY FIGURES; ART TOYS, NAMELY, UNASSEMBLED MODEL TOYS FOR ASSEMBLY AND PAINTING (U.S. CLS. 22, 23, 38 AND 50).

FIRST USE 8-22-2011; IN COMMERCE 8-22-2011.

**CLASS 28—(Continued).**

4,046,922. SMITH, DAVID M, HUNTINGTON BEACH, CA. SN 85-198,985. PUB. 5-10-2011, FILED 12-15-2010.

**Inshore Explorer**

THE MARK CONSISTS OF STANDARD CHARACTERS WITHOUT CLAIM TO ANY PARTICULAR FONT, STYLE, SIZE, OR COLOR.

NO CLAIM IS MADE TO THE EXCLUSIVE RIGHT TO USE "INSHORE", APART FROM THE MARK AS SHOWN.

FOR FISHING RODS; FISHING TACKLE (U.S. CLS. 22, 23, 38 AND 50).

FIRST USE 11-0-2010; IN COMMERCE 11-0-2010.

4,046,920. SMITH, DAVID M, HUNTINGTON BEACH, CA. SN 85-198,878. PUB. 5-10-2011, FILED 12-15-2010.

**SURF EXPLORER**

THE MARK CONSISTS OF STANDARD CHARACTERS WITHOUT CLAIM TO ANY PARTICULAR FONT, STYLE, SIZE, OR COLOR.

NO CLAIM IS MADE TO THE EXCLUSIVE RIGHT TO USE "SURF", APART FROM THE MARK AS SHOWN.

FOR FISHING RODS; FISHING TACKLE (U.S. CLS. 22, 23, 38 AND 50).

FIRST USE 11-0-2010; IN COMMERCE 11-0-2010.

4,046,980. STOUT STUFF, LLC, BENTONVILLE, AR. SN 85-214,126. PUB. 5-3-2011, FILED 1-10-2011.

**STRATEGY**

THE MARK CONSISTS OF STANDARD CHARACTERS WITHOUT CLAIM TO ANY PARTICULAR FONT, STYLE, SIZE, OR COLOR.

FOR HUNTING BLINDS (U.S. CLS. 22, 23, 38 AND 50).

FIRST USE 8-1-2011; IN COMMERCE 8-1-2011.

4,046,921. SMITH, DAVID M, HUNTINGTON BEACH, CA. SN 85-198,982. PUB. 5-10-2011, FILED 12-15-2010.

**Offshore Explorer**

THE MARK CONSISTS OF STANDARD CHARACTERS WITHOUT CLAIM TO ANY PARTICULAR FONT, STYLE, SIZE, OR COLOR.

NO CLAIM IS MADE TO THE EXCLUSIVE RIGHT TO USE "OFFSHORE", APART FROM THE MARK AS SHOWN.

FOR FISHING RODS; FISHING TACKLE (U.S. CLS. 22, 23, 38 AND 50).

FIRST USE 11-0-2010; IN COMMERCE 11-0-2010.

4,046,997. KIM D. BOWDEN, NEWCASTLE, WA. SN 85-218,698. PUB. 5-31-2011, FILED 1-15-2011.

**BEERBASKETBALL**

THE MARK CONSISTS OF STANDARD CHARACTERS WITHOUT CLAIM TO ANY PARTICULAR FONT, STYLE, SIZE, OR COLOR.

FOR BASKETBALL TABLE TOP GAMES (U.S. CLS. 22, 23, 38 AND 50).

FIRST USE 4-11-2011; IN COMMERCE 4-11-2011.

**CLASS 28—(Continued).**

4,047,021. BON HIVER, INC., CHESTER, NY. SN 85-227,681.  
 PUB. 3-29-2011, FILED 1-27-2011.

**BON HIVER**

THE MARK CONSISTS OF STANDARD CHARACTERS WITHOUT CLAIM TO ANY PARTICULAR FONT, STYLE, SIZE, OR COLOR.

THE ENGLISH TRANSLATION OF "BON HIVER" IN THE MARK IS "GOOD WINTER".

FOR BINDINGS FOR SNOWBOARDS (U.S. CLS. 22, 23, 38 AND 50).

FIRST USE 8-21-2011; IN COMMERCE 8-21-2011.

4,047,022. BON HIVER, INC., CHESTER, NY. SN 85-227,719.  
 PUB. 3-29-2011, FILED 1-27-2011.



THE MARK CONSISTS OF A STYLIZED "B" WITH AN EMBEDDED "H" IN CONTRASTING COLOR POSITIONED ACROSS THE UPRIGHT PORTION OF THE "B" AND WITH A SNOWFLAKE DESIGN OF CONTRASTING COLOR POSITIONED BETWEEN THE TWO HEMISPHERES OF THE STYLIZED "B", ALL OF WHICH IS ENCIRCLED BY TWO SEMI-CIRCULAR BORDERS.

FOR BINDINGS FOR SNOWBOARDS (U.S. CLS. 22, 23, 38 AND 50).

FIRST USE 8-21-2011; IN COMMERCE 8-21-2011.

**CLASS 28—(Continued).**

4,047,027. SHIMANO AMERICAN CORPORATION, IRVINE, CA. SN 85-229,459. PUB. 6-14-2011, FILED 1-29-2011.

**Super 8 Slick**

THE MARK CONSISTS OF THE STYLIZED NUMBER "8" DISPOSED BETWEEN THE WORDS "SUPER" AND "SLICK".

FOR FISHING LINES; LINES FOR FISHING (U.S. CLS. 22, 23, 38 AND 50).

FIRST USE 6-14-2011; IN COMMERCE 7-13-2011.

4,047,028. SHUFFLE MASTER, INC., LAS VEGAS, NV. SN 85-229,469. PUB. 6-28-2011, FILED 1-29-2011.



OWNER OF U.S. REG. NO. 3,011,454.  
 THE MARK CONSISTS OF THE "2" OF CLUBS ABOVE AN OVAL WITH "MD2CR" STARTING IN THE OVAL AND THE "R" EXTENDING BEYOND THE OVAL.

FOR CASINO TABLE GAME EQUIPMENT, NAMELY, PLAYING CARD SHUFFLING DEVICES AND PARTS THEREFORE (U.S. CLS. 22, 23, 38 AND 50).

FIRST USE 4-23-2011; IN COMMERCE 4-23-2011.

4,047,033. OKUMA FISHING TACKLE, ONTARIO, CA. SN 85-231,937. PUB. 6-14-2011, FILED 2-2-2011.

**DEAD EYE**

THE MARK CONSISTS OF STANDARD CHARACTERS WITHOUT CLAIM TO ANY PARTICULAR FONT, STYLE, SIZE, OR COLOR.

FOR FISHING RODS; FISHING TACKLE; FISHING REELS (U.S. CLS. 22, 23, 38 AND 50).

FIRST USE 6-1-2011; IN COMMERCE 7-15-2011.

**CLASS 28—(Continued).**

4,047,072. SETALIP LLC, PASADENA, CA. SN 85-253,891.  
PUB. 7-12-2011, FILED 2-28-2011.

**WE MAKE EXERCISE EASY**

THE MARK CONSISTS OF STANDARD CHARACTERS WITHOUT CLAIM TO ANY PARTICULAR FONT, STYLE, SIZE, OR COLOR.

FOR MANUALLY-OPERATED EXERCISE EQUIPMENT (U.S. CLS. 22, 23, 38 AND 50).  
FIRST USE 5-25-2011; IN COMMERCE 5-25-2011.

4,047,073. SIMPLYFUN, LLC, BELLEVUE, WA. SN 85-257,529.  
PUB. 6-7-2011, FILED 3-3-2011.

**PAIRAMID**

THE MARK CONSISTS OF STANDARD CHARACTERS WITHOUT CLAIM TO ANY PARTICULAR FONT, STYLE, SIZE, OR COLOR.

FOR BOARD GAMES; GAME EQUIPMENT SOLD AS A UNIT FOR PLAYING PARLOR GAMES AND BOARD GAMES (U.S. CLS. 22, 23, 38 AND 50).  
FIRST USE 7-28-2011; IN COMMERCE 7-28-2011.

4,047,074. SIMPLYFUN, LLC, BELLEVUE, WA. SN 85-257,535.  
PUB. 6-7-2011, FILED 3-3-2011.

**SHARE A BERRY**

THE MARK CONSISTS OF STANDARD CHARACTERS WITHOUT CLAIM TO ANY PARTICULAR FONT, STYLE, SIZE, OR COLOR.

FOR GAME EQUIPMENT SOLD AS A UNIT FOR PLAYING PARLOR GAMES AND EDUCATIONAL GAMES; GAMES, NAMELY, PARLOR GAMES AND EDUCATIONAL GAMES USING WOODEN BEADS, LACES, AND CARDS (U.S. CLS. 22, 23, 38 AND 50).  
FIRST USE 4-29-2011; IN COMMERCE 4-29-2011.

**CLASS 28—(Continued).**

4,047,080. FLEET WHOLESALE SUPPLY CO., INC., APPLETON, WI. SN 85-273,536. PUB. 6-28-2011, FILED 3-22-2011.

**HUNTER HANK**

THE MARK CONSISTS OF STANDARD CHARACTERS WITHOUT CLAIM TO ANY PARTICULAR FONT, STYLE, SIZE, OR COLOR.

OWNER OF U.S. REG. NOS. 3,895,379 AND 3,943,496.  
NO CLAIM IS MADE TO THE EXCLUSIVE RIGHT TO USE "HUNTER", APART FROM THE MARK AS SHOWN.  
FOR ARCHERY TARGETS; ARCHERY ARROWS; ARCHERY BOWS; ARCHERY BOW STRINGS; ARCHERY BOW CASES/BAGS; NON-TELESCOPIC ARCHERY BOW SIGHTS; ARCHERY QUIVERS; ARCHERY SETS (U.S. CLS. 22, 23, 38 AND 50).  
FIRST USE 7-16-2011; IN COMMERCE 7-16-2011.

4,047,081. FLEET WHOLESALE SUPPLY CO., INC., APPLETON, WI. SN 85-273,539. PUB. 6-28-2011, FILED 3-22-2011.



OWNER OF U.S. REG. NOS. 3,895,379 AND 3,943,496.  
NO CLAIM IS MADE TO THE EXCLUSIVE RIGHT TO USE "HUNTER", APART FROM THE MARK AS SHOWN.

THE MARK CONSISTS OF THE SILHOUETTE OF A HUNTER HOLDING A BOW AND ARROW, AN ARCHERY TARGET, AND THE WORDING "HUNTER HANK" IN A STYLIZED FORMAT.

FOR ARCHERY TARGETS; ARCHERY ARROWS; ARCHERY BOWS; ARCHERY BOW STRINGS; ARCHERY BOW CASES/BAGS; NON-TELESCOPIC ARCHERY BOW SIGHTS; ARCHERY QUIVERS; ARCHERY SETS (U.S. CLS. 22, 23, 38 AND 50).  
FIRST USE 7-16-2011; IN COMMERCE 7-16-2011.

4,047,095. ADVANTAGE BAIT COMPANY, ELK GROVE VILLAGE, IL. SN 85-975,587. PUB. 12-28-2010, FILED 7-16-2010.

**ADVANTAGE BAIT COMPANY**

THE MARK CONSISTS OF STANDARD CHARACTERS WITHOUT CLAIM TO ANY PARTICULAR FONT, STYLE, SIZE, OR COLOR.

**CLASS 28—(Continued).**

NO CLAIM IS MADE TO THE EXCLUSIVE RIGHT TO USE "BAIT COMPANY", APART FROM THE MARK AS SHOWN.  
FOR FISHING LURES; FISHING LURE PARTS; ARTIFICIAL FISHING LURES; FISHING LURES, NAMELY, SPOONS, BLADES, SPINNERS, AND ATTRACTORS (U.S. CLS. 22, 23, 38 AND 50).

FIRST USE 1-26-2011; IN COMMERCE 1-26-2011.

4,047,096. ADVANTAGE BAIT COMPANY, ELK GROVE VILLAGE, IL. SN 85-975,588. PUB. 12-28-2010, FILED 7-16-2010.



THE COLOR(S) GREEN, RED, WHITE, YELLOW, GOLD, SILVER AND BLUE IS/ARE CLAIMED AS A FEATURE OF THE MARK.

THE MARK CONSISTS OF A CARTOON OF A MUSCULAR, GRIMACING FISH WITH VARYING SHADES OF GREEN WITH RED CHEEKS AND WHITE TORSO AND MOUTH, HOLDING THE ENDS OF A BROKEN YELLOW AND GREEN FISHING ROD AND REEL IN EACH HAND WITH A GOLD AND SILVER LURE IN HIS MOUTH AND BLUE DROPS OF WATER COMING OFF HIS BODY.

FOR FISHING LURES; FISHING LURE PARTS; ARTIFICIAL FISHING LURES; FISHING LURES, NAMELY, SPOONS, BLADES, SPINNERS, AND ATTRACTORS (U.S. CLS. 22, 23, 38 AND 50).

FIRST USE 1-26-2011; IN COMMERCE 1-26-2011.

**CLASS 29—MEATS AND PROCESSED FOODS**

4,045,590. BURGERS' OZARK COUNTRY CURED HAMS, INC., CALIFORNIA, MO. SN 76-702,288. PUB. 6-7-2011, FILED 3-29-2010.



NO CLAIM IS MADE TO THE EXCLUSIVE RIGHT TO USE "BACON STEAK CUTS ORIGINAL", APART FROM THE MARK AS SHOWN.

**CLASS 29—(Continued).**

THE MARK CONSISTS OF THE WORDING "BACON STEAK CUTS" IN STYLIZED FONT, ON A RECTANGULAR BACKGROUND DESIGN WITH A CURVED TOP. THE WORD "ORIGINAL" APPEARS ON A RIBBON BENEATH "BACON STEAK CUTS", AND ALL THE FOREGOING APPEAR IN FRONT OF A RECTANGULAR CHECKERBOARD DESIGN.

FOR MEAT, NAMELY, STEAKS (U.S. CL. 46).  
FIRST USE 9-0-2009; IN COMMERCE 11-0-2009.

4,045,631. GLOBAL ANIMAL PARTNERSHIP, WASHINGTON, DC. SN 77-201,394. PUB. 4-22-2008, FILED 6-8-2007.

## 5-STEP

THE MARK CONSISTS OF STANDARD CHARACTERS WITHOUT CLAIM TO ANY PARTICULAR FONT, STYLE, SIZE, OR COLOR.

FOR MEATS, GAME, PORK, BEEF, POULTRY, BISON, CHICKEN, DUCK, GOAT, RABBIT, LAMB, TURKEY, VEAL, SAUSAGE, QUAIL, PHEASANT, HENS, AND GEESSE (U.S. CL. 46).

FIRST USE 8-4-2009; IN COMMERCE 8-4-2009.

4,045,688. BISON CAPITAL LLC, VENICE, FL. SN 77-381,301. PUB. 6-10-2008, FILED 1-25-2008.

## Chickles

THE MARK CONSISTS OF STANDARD CHARACTERS WITHOUT CLAIM TO ANY PARTICULAR FONT, STYLE, SIZE, OR COLOR.

FOR CHERRY PICKLES (U.S. CL. 46).

FIRST USE 4-18-2011; IN COMMERCE 4-18-2011.

4,045,693. BERTHELSEN, GEIR, KRISTIANSAND, NORWAY. SN 77-390,803. PUB. 6-24-2008, FILED 2-7-2008.

## SlowCheese

THE MARK CONSISTS OF STANDARD CHARACTERS WITHOUT CLAIM TO ANY PARTICULAR FONT, STYLE, SIZE, OR COLOR.

FOR CHEESE (U.S. CL. 46).

FIRST USE 8-15-2011; IN COMMERCE 8-15-2011.



**CLASS 29—(Continued).**

4,045,694. STRAUSS BRANDS INCORPORATED, HALES CORNERS, WI. SN 77-391,628. PUB. 7-1-2008, FILED 2-7-2008.

NATURE GIVES. WE ACCEPT.

THE MARK CONSISTS OF STANDARD CHARACTERS WITHOUT CLAIM TO ANY PARTICULAR FONT, STYLE, SIZE, OR COLOR.

FOR MEAT (U.S. CL. 46).  
FIRST USE 8-15-2008; IN COMMERCE 8-15-2008.

4,045,717. ORION SEAFOOD INTERNATIONAL, INC., PORTSMOUTH, NH. SN 77-435,201. PUB. 2-22-2011, FILED 3-30-2008.



THE COLOR(S) RED, WHITE, BLUE AND YELLOW IS/ ARE CLAIMED AS A FEATURE OF THE MARK.

THE MARK CONSISTS OF THE WORD "ORION" IN RED, ON A WHITE BACKGROUND BETWEEN BLUE BARS, THE BOTTOM BAR BEING WAVY WITH A WAVY WHITE LINE AND THE TOP BAR BEING STRAIGHT WITH THREE YELLOW STARS.

FOR SEAFOOD, BOTH FRESH AND FROZEN (U.S. CL. 46).  
FIRST USE 5-1-1994; IN COMMERCE 5-1-1994.

**CLASS 29—(Continued).**

4,045,752. ALDI INC., BATAVIA, IL. SN 77-535,873. PUB. 6-30-2009, FILED 7-31-2008.

**CATTLEMEN'S RANCH**

THE MARK CONSISTS OF STANDARD CHARACTERS WITHOUT CLAIM TO ANY PARTICULAR FONT, STYLE, SIZE, OR COLOR.

FOR MEAT, STEAKS, NAMELY, MEAT STEAKS, BEEF STEAKS FOR SALE ONLY THROUGH ALDI OWNED AND OPERATED STORES (U.S. CL. 46).  
FIRST USE 3-31-2011; IN COMMERCE 3-31-2011.

4,046,033. SIROB IMPORTS, INC., LINDENHURST, NY. SN 77-923,447. PUB. 1-11-2011, FILED 1-29-2010.

**FIORINO**

THE MARK CONSISTS OF STANDARD CHARACTERS WITHOUT CLAIM TO ANY PARTICULAR FONT, STYLE, SIZE, OR COLOR.

THE ENGLISH TRANSLATION OF THE WORD "FIORINO" IN THE MARK IS "FLORIN".  
FOR COOKING OILS, OLIVE OIL AND BLENDS THEREOF (U.S. CL. 46).

FIRST USE 12-31-1999; IN COMMERCE 12-31-1999.

4,046,360. GENERAL MILLS, INC., MINNEAPOLIS, MN. SN 85-069,457. PUB. 3-22-2011, FILED 6-23-2010.

**MOOD MORPHERS**

THE MARK CONSISTS OF STANDARD CHARACTERS WITHOUT CLAIM TO ANY PARTICULAR FONT, STYLE, SIZE, OR COLOR.

OWNER OF U.S. REG. NO. 3,073,311.  
FOR FRUIT-BASED SNACK FOOD (U.S. CL. 46).  
FIRST USE 1-3-2011; IN COMMERCE 1-3-2011.

**CLASS 29—(Continued).**

4,046,396. NINGBO BLUE STAR SEAFOOD CO., LTD., ZHEJIANG, CHINA. SN 85-079,012. PUB. 2-22-2011, FILED 7-6-2010.

**Corsario Premium Seafoods**

THE MARK CONSISTS OF STANDARD CHARACTERS WITHOUT CLAIM TO ANY PARTICULAR FONT, STYLE, SIZE, OR COLOR.

NO CLAIM IS MADE TO THE EXCLUSIVE RIGHT TO USE "PREMIUM SEAFOODS", APART FROM THE MARK AS SHOWN.

THE ENGLISH TRANSLATION OF "CORSAIR" IN THE MARK IS CORSAIR OR PIRATE.

FOR CRUSTACEANS; FISH; FISH FILLETS; LOBSTERS; PRESERVED FISH; SEAFOOD; SHELLFISH, NOT LIVE; SHRIMPS, NOT LIVE; TINNED SEAFOOD (U.S. CL. 46).

FIRST USE 1-20-2011; IN COMMERCE 3-11-2011.

4,046,507. VALUE QUEST FOODS, ATLANTA, GA. SN 85-098,091. PUB. 7-12-2011, FILED 8-2-2010.

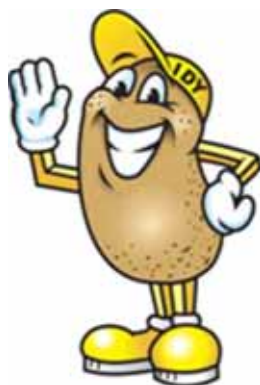

THE COLOR(S) BROWN, YELLOW, BLACK, WHITE IS/ARE CLAIMED AS A FEATURE OF THE MARK.

THE MARK CONSISTS OF THE FOLLOWING: A POTATO AS THE BODY IN BROWN, THE EYES, GLOVES, AND MOUTH ARE WHITE AND BLACK, POTATO STICKS AS THE ARMS AND LEGS IN YELLOW. THE FEET HAVE SHOES IN YELLOW, BLACK, AND WHITE. THE CHARACTER IS WEARING A YELLOW BASEBALL HAT AND WITHIN THE BASEBALL CAP IS THE LETTERS "IDY" IN BLACK. THE ENTIRE POTATO IS OUTLINED IN BLACK.

FOR FRENCH FRIED POTATOES; FRIED POTATOES; POTATO CHIPS; POTATO CRISPS; POTATO CRISPS AND CHIPS; POTATO STICKS; POTATO-BASED SNACK FOODS (U.S. CL. 46).

FIRST USE 11-16-2010; IN COMMERCE 11-16-2010.

**CLASS 29—(Continued).**

4,046,725. AHARONI & STEELE, INC., SANTA CLARA, CA. SN 85-140,303. PUB. 3-8-2011, FILED 9-28-2010.

**SANTE**

THE MARK CONSISTS OF STANDARD CHARACTERS WITHOUT CLAIM TO ANY PARTICULAR FONT, STYLE, SIZE, OR COLOR.

THE ENGLISH TRANSLATION OF "SANTE" IN THE MARK IS "HEALTH".

FOR SEASONED NUTS (U.S. CL. 46).

FIRST USE 7-6-2011; IN COMMERCE 7-6-2011.

4,046,726. AHARONI & STEELE, INC., SANTA CLARA, CA. SN 85-140,307. PUB. 3-8-2011, FILED 9-28-2010.

**SANTÉ**

THE MARK CONSISTS OF STANDARD CHARACTERS WITHOUT CLAIM TO ANY PARTICULAR FONT, STYLE, SIZE, OR COLOR.

THE ENGLISH TRANSLATION OF "SANTÉ" IN THE MARK IS "HEALTH".

FOR SEASONED NUTS (U.S. CL. 46).

FIRST USE 7-6-2011; IN COMMERCE 7-6-2011.

4,046,873. WHITEWAVE SERVICES, INC., DALLAS, TX. SN 85-186,915. PUB. 2-22-2011, FILED 11-30-2010.

**SHARE YOUR DELIGHT**

THE MARK CONSISTS OF STANDARD CHARACTERS WITHOUT CLAIM TO ANY PARTICULAR FONT, STYLE, SIZE, OR COLOR.

FOR CREAMERS FOR BEVERAGES; NON-DAIRY CREAMER (U.S. CL. 46).

FIRST USE 8-15-2011; IN COMMERCE 8-15-2011.

**CLASS 29—(Continued).**

4,046,977. ALDI INC., BATAVIA, IL. SN 85-213,838. PUB. 5-3-2011, FILED 1-10-2011.

**LUNCH BUDDIES**

THE MARK CONSISTS OF STANDARD CHARACTERS WITHOUT CLAIM TO ANY PARTICULAR FONT, STYLE, SIZE, OR COLOR.

OWNER OF U.S. REG. NOS. 3,782,300 AND 3,842,889.

NO CLAIM IS MADE TO THE EXCLUSIVE RIGHT TO USE "LUNCH", APART FROM THE MARK AS SHOWN.

FOR CANDIED FRUIT SNACKS; FRUIT-BASED SNACK FOOD (U.S. CL. 46).

FIRST USE 5-4-2010; IN COMMERCE 5-4-2010.

---

4,047,043. METZGER SPECIALTY BRANDS, INC., NEW YORK, NY. SN 85-235,900. PUB. 7-12-2011, FILED 2-7-2011.

**BADA BING CHERRIES**

THE MARK CONSISTS OF STANDARD CHARACTERS WITHOUT CLAIM TO ANY PARTICULAR FONT, STYLE, SIZE, OR COLOR.

NO CLAIM IS MADE TO THE EXCLUSIVE RIGHT TO USE "CHERRIES", APART FROM THE MARK AS SHOWN.

FOR MARASCHINO CHERRIES, NAMELY, NATURALLY PRESERVED BING CHERRIES (U.S. CL. 46).

FIRST USE 6-28-2011; IN COMMERCE 6-28-2011.

---

4,047,101. WESTBRAE NATURAL, INC., MELVILLE, NY. SN 85-975,663. PUB. 1-4-2011, FILED 6-9-2010.

**COCONUT DREAM**

THE MARK CONSISTS OF STANDARD CHARACTERS WITHOUT CLAIM TO ANY PARTICULAR FONT, STYLE, SIZE, OR COLOR.

NO CLAIM IS MADE TO THE EXCLUSIVE RIGHT TO USE "COCONUT", APART FROM THE MARK AS SHOWN.

FOR NON-DAIRY COCONUT BASED BEVERAGES USED AS A MILK SUBSTITUTE (U.S. CL. 46).

FIRST USE 12-13-2010; IN COMMERCE 12-13-2010.

**CLASS 30—STAPLE FOODS****CLASS 30—(Continued).**

4,045,710. HIGHTECH MANUFACTURING, INC., WYOMING, MI. SN 77-422,278. PUB. 8-5-2008, FILED 3-14-2008.

**My Sweet Lord Candy & Confections**

THE MARK CONSISTS OF STANDARD CHARACTERS WITHOUT CLAIM TO ANY PARTICULAR FONT, STYLE, SIZE, OR COLOR.

NO CLAIM IS MADE TO THE EXCLUSIVE RIGHT TO USE "CANDY & CONFECTIONS", APART FROM THE MARK AS SHOWN.

FOR CANDIES; FROZEN CONFECTIONS (U.S. CL. 46). FIRST USE 3-15-2008; IN COMMERCE 6-5-2011.

---

4,045,926. SISTER CHRIS'S FRUIT FLAVORED PRODUCTS, LLC, MINNEAPOLIS, MN. SN 77-836,923. PUB. 2-23-2010, FILED 9-29-2009.

**SISTER CHRIS'S FRUIT FLAVORED BBQ SAUCE**

THE MARK CONSISTS OF STANDARD CHARACTERS WITHOUT CLAIM TO ANY PARTICULAR FONT, STYLE, SIZE, OR COLOR.

NO CLAIM IS MADE TO THE EXCLUSIVE RIGHT TO USE "FRUIT FLAVORED BBQ SAUCE", APART FROM THE MARK AS SHOWN.

FOR SAUCES (U.S. CL. 46).

FIRST USE 7-31-2008; IN COMMERCE 7-31-2008.

---

4,046,041. THIS, LLC, MADISON, CT. SN 77-928,857. PUB. 7-13-2010, FILED 2-5-2010.

**SMORBAR**

THE MARK CONSISTS OF STANDARD CHARACTERS WITHOUT CLAIM TO ANY PARTICULAR FONT, STYLE, SIZE, OR COLOR.

OWNER OF U.S. REG. NOS. 2,453,828 AND 2,698,364.

FOR CANDY BARS (U.S. CL. 46).

FIRST USE 6-2-2011; IN COMMERCE 6-2-2011.

**CLASS 30—(Continued).**

4,046,134. CHIPITA AMERICA, INC., WESTCHESTER, IL. SN 77-957,611. PUB. 12-7-2010, FILED 3-12-2010.



OWNER OF U.S. REG. NOS. 3,165,358 AND 3,518,536.  
NO CLAIM IS MADE TO THE EXCLUSIVE RIGHT TO USE "BRAND", "BAKERY" AND "RISOTTO CHIPS", APART FROM THE MARK AS SHOWN.

THE COLOR(S) BROWN, WHITE, BEIGE, GREEN, GOLD, AND YELLOW IS/ARE CLAIMED AS A FEATURE OF THE MARK.

THE MARK CONSISTS OF THE "NEW YORK STYLE BRAND" LOGO, WHICH IS A DEPICTION OF A SKYLINE WITH THE SUN IN YELLOW AND GOLD SETTING BEHIND THE BUILDINGS, WHICH ARE DISPLAYED IN BROWN AND BEIGE WITH THE WINDOWS IN YELLOW. A BANNER IN GREEN IS SITUATED DIRECTLY BELOW THE BUILDINGS WITH THE WORDS "NEW YORK STYLE BRAND" IN WHITE CONTAINED THEREIN. THE WORDING "BAKERY" SHOWN ON THE BUILDING ON THE RIGHT IS DISPLAYED IN WHITE AND OUTLINED IN GREEN. THE DOOR OF THE BUILDING IS GREEN, AND THE AWNING IS STRIPED IN GREEN AND WHITE. THE WHITE LINING IS A FEATURE OF THE MARK. THE STYLIZED WORD "RISOTTO" IN BROWN IS SHOWN BELOW THE LOGO; THE TERM "CHIPS" IS BROWN AND IS DEPICTED BELOW "RISOTTO". A WHITE CIRCLE IS DISPLAYED IN THE BACKGROUND OF THE WORD "RISOTTO" EMITTING WHITE RAYS. THE REMAINDER OF THE BACKGROUND IS BEIGE.

SEC. 2(F) AS TO "NEW YORK STYLE".  
FOR RICE-BASED SNACK FOODS (U.S. CL. 46).  
FIRST USE 10-1-2009; IN COMMERCE 10-1-2009.

4,046,250. SCHWAN'S IP, LLC, MARSHALL, MN. SN 85-028,335. PUB. 9-14-2010, FILED 5-3-2010.

**SIMPLY ... INSPIRED**

THE MARK CONSISTS OF STANDARD CHARACTERS WITHOUT CLAIM TO ANY PARTICULAR FONT, STYLE, SIZE, OR COLOR.

FOR PIZZA (U.S. CL. 46).  
FIRST USE 2-14-2011; IN COMMERCE 2-14-2011.

**CLASS 30—(Continued).**

4,046,291. EMAX'S, LLC, BOULDER, CO. SN 85-045,234. PUB. 10-19-2010, FILED 5-21-2010.

**Max's Caramel Bar**

THE MARK CONSISTS OF STANDARD CHARACTERS WITHOUT CLAIM TO ANY PARTICULAR FONT, STYLE, SIZE, OR COLOR.

OWNER OF U.S. REG. NO. 2,351,874.

NO CLAIM IS MADE TO THE EXCLUSIVE RIGHT TO USE "CARAMEL BAR", APART FROM THE MARK AS SHOWN.

FOR BAKERY PRODUCTS (U.S. CL. 46).  
FIRST USE 6-1-1996; IN COMMERCE 6-1-1996.

4,046,332. CONFETTI LLC, VIRGINIA BEACH, VA. SN 85-060,270. PUB. 5-3-2011, FILED 6-11-2010.

**CONFETTI GELATO**

THE MARK CONSISTS OF STANDARD CHARACTERS WITHOUT CLAIM TO ANY PARTICULAR FONT, STYLE, SIZE, OR COLOR.

NO CLAIM IS MADE TO THE EXCLUSIVE RIGHT TO USE "GELATO", APART FROM THE MARK AS SHOWN.

FOR GELATO (U.S. CL. 46).  
FIRST USE 5-6-2011; IN COMMERCE 5-6-2011.

4,046,436. OAT SOLUTIONS, LLC, PALM BEACH GARDENS, FL. SN 85-087,474. PUB. 12-21-2010, FILED 7-19-2010.

**DRINK OUTSIDE THE BOX**

THE MARK CONSISTS OF STANDARD CHARACTERS WITHOUT CLAIM TO ANY PARTICULAR FONT, STYLE, SIZE, OR COLOR.

FOR NON-ALCOHOLIC GRAIN BASED BEVERAGES; NON-ALCOHOLIC GRAIN BASED BEVERAGES CONTAINING FRUIT (U.S. CL. 46).

FIRST USE 2-1-2011; IN COMMERCE 2-1-2011.

**CLASS 30—(Continued).**

4,046,437. OAT SOLUTIONS, LLC, PALM BEACH GARDENS, FL. SN 85-087,483. PUB. 12-21-2010, FILED 7-19-2010.

**OAT-SMART HUNGER**

THE MARK CONSISTS OF STANDARD CHARACTERS WITHOUT CLAIM TO ANY PARTICULAR FONT, STYLE, SIZE, OR COLOR.

FOR NON-ALCOHOLIC GRAIN BASED BEVERAGES; NON-ALCOHOLIC GRAIN BASED BEVERAGES CONTAINING FRUIT (U.S. CL. 46).

FIRST USE 11-30-2010; IN COMMERCE 11-30-2010.

---

4,046,438. ABBEY OF GETHSEMANI, TRAPPIST, KY. SN 85-087,617. PUB. 1-4-2011, FILED 7-19-2010.

**CHOCOLATE MINT JULEP**

THE MARK CONSISTS OF STANDARD CHARACTERS WITHOUT CLAIM TO ANY PARTICULAR FONT, STYLE, SIZE, OR COLOR.

NO CLAIM IS MADE TO THE EXCLUSIVE RIGHT TO USE "CHOCOLATE" AND "MINT", APART FROM THE MARK AS SHOWN.

FOR FUDGE (U.S. CL. 46).

FIRST USE 3-3-2011; IN COMMERCE 3-21-2011.

---

4,046,561. RICH PRODUCTS CORPORATION, BUFFALO, NY. SN 85-105,476. PUB. 1-25-2011, FILED 8-11-2010.

**INSTANT IMPRESSIONS**

THE MARK CONSISTS OF STANDARD CHARACTERS WITHOUT CLAIM TO ANY PARTICULAR FONT, STYLE, SIZE, OR COLOR.

FOR ICING, NAMELY, FROZEN ICING IN FLAT SHEETS (U.S. CL. 46).

FIRST USE 7-1-2010; IN COMMERCE 7-1-2010.

**CLASS 30—(Continued).**

4,046,613. PEPSICO, INC., PURCHASE, NY. SN 85-116,116. PUB. 2-8-2011, FILED 8-26-2010.

**WANNA ROCK**

THE MARK CONSISTS OF STANDARD CHARACTERS WITHOUT CLAIM TO ANY PARTICULAR FONT, STYLE, SIZE, OR COLOR.

FOR LOLLIPOPS, CANDY COVERED GUM AND CONFECTIONERY (U.S. CL. 46).

FIRST USE 6-0-2011; IN COMMERCE 6-1-2011.

---

4,046,623. MOUNTANOS BROTHERS COFFEE CO., SOUTH SAN FRANCISCO, CA. SN 85-118,838. PUB. 3-1-2011, FILED 8-30-2010.

**ATHINAI BLEND**

THE MARK CONSISTS OF STANDARD CHARACTERS WITHOUT CLAIM TO ANY PARTICULAR FONT, STYLE, SIZE, OR COLOR.

NO CLAIM IS MADE TO THE EXCLUSIVE RIGHT TO USE "BLEND", APART FROM THE MARK AS SHOWN.

THE ENGLISH TRANSLATION OF "ATHINAI" IS THE CITY OF ATHENS.

FOR COFFEE (U.S. CL. 46).

FIRST USE 4-29-2010; IN COMMERCE 4-29-2010.

---

4,046,702. THE PILLSBURY COMPANY, LLC, MINNEAPOLIS, MN. SN 85-134,271. PUB. 4-5-2011, FILED 9-21-2010.

**TRIPLE BERRY BLAST**

THE MARK CONSISTS OF STANDARD CHARACTERS WITHOUT CLAIM TO ANY PARTICULAR FONT, STYLE, SIZE, OR COLOR.

NO CLAIM IS MADE TO THE EXCLUSIVE RIGHT TO USE "TRIPLE BERRY", APART FROM THE MARK AS SHOWN.

FOR FRENCH TOAST (U.S. CL. 46).

FIRST USE 7-18-2011; IN COMMERCE 7-18-2011.

**CLASS 30—(Continued).**

4,046,703. THE PILLSBURY COMPANY, LLC, MINNEAPOLIS, MN. SN 85-134,275. PUB. 4-5-2011, FILED 9-21-2010.

**CINNAMON RUSH**

THE MARK CONSISTS OF STANDARD CHARACTERS WITHOUT CLAIM TO ANY PARTICULAR FONT, STYLE, SIZE, OR COLOR.

NO CLAIM IS MADE TO THE EXCLUSIVE RIGHT TO USE "CINNAMON", APART FROM THE MARK AS SHOWN.

FOR FRENCH TOAST (U.S. CL. 46).  
FIRST USE 7-18-2011; IN COMMERCE 7-18-2011.

4,046,782. ICE'RS ENTERPRISES, MISSION VIEJO, CA. SN 85-155,845. PUB. 3-22-2011, FILED 10-19-2010.

**ICE'RS**

THE MARK CONSISTS OF STANDARD CHARACTERS WITHOUT CLAIM TO ANY PARTICULAR FONT, STYLE, SIZE, OR COLOR.

FOR FROZEN BITE SIZE CHEWABLE ICE THAT HYDRATES (U.S. CL. 46).  
FIRST USE 9-4-2011; IN COMMERCE 9-4-2011.

4,046,801. H & S BAKERY, INC., BALTIMORE, MD. SN 85-160,858. PUB. 1-25-2011, FILED 10-25-2010.

**SLIM BAGELS**

THE MARK CONSISTS OF STANDARD CHARACTERS WITHOUT CLAIM TO ANY PARTICULAR FONT, STYLE, SIZE, OR COLOR.

NO CLAIM IS MADE TO THE EXCLUSIVE RIGHT TO USE "BAGELS", APART FROM THE MARK AS SHOWN.  
FOR BAGELS (U.S. CL. 46).  
FIRST USE 9-1-2011; IN COMMERCE 9-1-2011.

**CLASS 30—(Continued).**

4,046,917. SPANGLER CANDY COMPANY, BRYAN, OH. SN 85-198,134. PUB. 4-26-2011, FILED 12-15-2010.

**MYSTERY MANIA**

THE MARK CONSISTS OF STANDARD CHARACTERS WITHOUT CLAIM TO ANY PARTICULAR FONT, STYLE, SIZE, OR COLOR.

FOR CANDY (U.S. CL. 46).  
FIRST USE 4-1-2011; IN COMMERCE 4-1-2011.

4,047,030. EBY-BROWN LLC, NAPERVILLE, IL. SN 85-230,322. PUB. 6-21-2011, FILED 1-31-2011.

**AROMA BAY CAFÉ**

THE MARK CONSISTS OF STANDARD CHARACTERS WITHOUT CLAIM TO ANY PARTICULAR FONT, STYLE, SIZE, OR COLOR.

NO CLAIM IS MADE TO THE EXCLUSIVE RIGHT TO USE "CAFÉ", APART FROM THE MARK AS SHOWN.  
FOR BEVERAGES, NAMELY, COFFEE AND TEA (U.S. CL. 46).  
FIRST USE 4-1-2011; IN COMMERCE 4-1-2011.

4,047,054. DIPPIN' DOTS, INC., PADUCAH, KY. SN 85-238,877. PUB. 7-12-2011, FILED 2-10-2011.

**DIPPIN' CANDY**

THE MARK CONSISTS OF STANDARD CHARACTERS WITHOUT CLAIM TO ANY PARTICULAR FONT, STYLE, SIZE, OR COLOR.

OWNER OF U.S. REG. NOS. 1,551,183, 3,043,871, AND OTHERS.  
NO CLAIM IS MADE TO THE EXCLUSIVE RIGHT TO USE "CANDY", APART FROM THE MARK AS SHOWN.  
FOR CANDY (U.S. CL. 46).  
FIRST USE 6-30-2011; IN COMMERCE 6-30-2011.

**CLASS 30—(Continued).**

4,047,068. GOLDEN FLOWER TRADING, LLC, LONE TREE, CO. SN 85-246,941. PUB. 6-14-2011, FILED 2-19-2011.

**HEALTH NATURALLY**

THE MARK CONSISTS OF STANDARD CHARACTERS WITHOUT CLAIM TO ANY PARTICULAR FONT, STYLE, SIZE, OR COLOR.

NO CLAIM IS MADE TO THE EXCLUSIVE RIGHT TO USE "HEALTH", APART FROM THE MARK AS SHOWN. FOR TEA (U.S. CL. 46). FIRST USE 3-0-2011; IN COMMERCE 3-0-2011.

**CLASS 31—NATURAL AGRICULTURAL PRODUCTS**

4,045,883. TROPICANA PRODUCTS, INC., BRADENTON, FL. SN 77-784,502. PUB. 10-27-2009, FILED 7-20-2009.

**TROPICANA TROPICALS**

THE MARK CONSISTS OF STANDARD CHARACTERS WITHOUT CLAIM TO ANY PARTICULAR FONT, STYLE, SIZE, OR COLOR.

OWNER OF U.S. REG. NOS. 630,572, 1,303,002, AND OTHERS. NO CLAIM IS MADE TO THE EXCLUSIVE RIGHT TO USE "TROPICALS", APART FROM THE MARK AS SHOWN. FOR FRESH FRUIT (U.S. CLS. 1 AND 46). FIRST USE 10-31-2009; IN COMMERCE 10-31-2009.

4,045,919. D & D COMMODITIES LIMITED, STEPHEN, MN. SN 77-821,389. PUB. 7-27-2010, FILED 9-8-2009.

**BUFFET**

THE MARK CONSISTS OF STANDARD CHARACTERS WITHOUT CLAIM TO ANY PARTICULAR FONT, STYLE, SIZE, OR COLOR.

FOR BIRD FOOD (U.S. CLS. 1 AND 46). FIRST USE 10-0-1990; IN COMMERCE 10-0-1990.

**CLASS 31—(Continued).**

4,046,269. WINFIELD SOLUTIONS, LLC, SHOREVIEW, MN. SN 85-035,407. PUB. 10-12-2010, FILED 5-11-2010.

**SUN QUEST**

THE MARK CONSISTS OF STANDARD CHARACTERS WITHOUT CLAIM TO ANY PARTICULAR FONT, STYLE, SIZE, OR COLOR.

FOR AGRICULTURAL SEEDS (U.S. CLS. 1 AND 46). FIRST USE 8-26-2010; IN COMMERCE 8-26-2010.

4,046,455. TENNESSEE FARMERS COOPERATIVE, LAVERGNE, TN. SN 85-090,774. PUB. 12-28-2010, FILED 7-22-2010.

**PROTRITION**

THE MARK CONSISTS OF STANDARD CHARACTERS WITHOUT CLAIM TO ANY PARTICULAR FONT, STYLE, SIZE, OR COLOR.

FOR ANIMAL FEED (U.S. CLS. 1 AND 46). FIRST USE 4-6-2011; IN COMMERCE 4-6-2011.

4,046,577. BLUE ARCHIPELAGO BERHAD (655173-D), PETALING JAYA, SELANGO, MALAYSIA. SN 85-109,989. PUB. 2-22-2011, FILED 8-18-2010.

**PELAGOS**

THE MARK CONSISTS OF STANDARD CHARACTERS WITHOUT CLAIM TO ANY PARTICULAR FONT, STYLE, SIZE, OR COLOR.

THE ENGLISH TRANSLATION OF "PELAGOS" IN THE MARK IS "SEA".

FOR SHRIMP; ANIMAL FOODSTUFFS; CUT FLOWERS; FLOWER BULBS; FLOWERS; LIVE FLOWERS; LIVE PLANTS; FLOWER SEEDS; SEEDS FOR FLOWERS; AGRICULTURAL, HORTICULTURAL AND FORESTRY PRODUCTS AND GRAINS NOT INCLUDED IN OTHER CLASSES, NAMELY, AGRICULTURAL SEEDS; LIVE ANIMALS, FRESH FRUITS AND VEGETABLES (U.S. CLS. 1 AND 46).

FIRST USE 8-0-2010; IN COMMERCE 0-0-2010.

**CLASS 31—(Continued).**

4,046,658. COMPANION BRANDS, LLC, NASHVILLE, TN.  
SN 85-124,819. PUB. 2-22-2011, FILED 9-8-2010.

# EVOLVE

THE MARK CONSISTS OF STANDARD CHARACTERS  
WITHOUT CLAIM TO ANY PARTICULAR FONT, STYLE,  
SIZE, OR COLOR.

FOR DOG FOOD AND CAT FOOD (U.S. CLS. 1 AND  
46).

FIRST USE 11-15-1998; IN COMMERCE 11-15-1998.

**CLASS 31—(Continued).**

4,046,793. GEMINI FINE FOODS LTD, LONDON, UNITED  
KINGDOM. SN 85-158,128. PUB. 3-15-2011, FILED 10-21-  
2010.

# THRILL

THE MARK CONSISTS OF STANDARD CHARACTERS  
WITHOUT CLAIM TO ANY PARTICULAR FONT, STYLE,  
SIZE, OR COLOR.

FOR CAT FOOD; CAT TREATS; DOG FOOD; DOG  
TREATS (U.S. CLS. 1 AND 46).

FIRST USE 3-28-2011; IN COMMERCE 3-28-2011.

4,046,732. PROVEN WINNERS NORTH AMERICA LLC,  
CAMPBELL, CA. SN 85-141,764. PUB. 5-24-2011, FILED 9-  
30-2010.

# GOLDDUST

THE MARK CONSISTS OF STANDARD CHARACTERS  
WITHOUT CLAIM TO ANY PARTICULAR FONT, STYLE,  
SIZE, OR COLOR.

FOR NON-WOODY, HERBACEOUS LIVING PLANTS,  
NAMESLY, MECARDONIA (U.S. CLS. 1 AND 46).

FIRST USE 4-30-2011; IN COMMERCE 4-30-2011.

**CLASS 32—LIGHT BEVERAGES**

4,045,638. MAURO, MARIA, NIAGARA FALLS, NY. AND  
CARROLL, ELIZABETH, NIAGARA FALLS, NY. SN 77-  
221,740. PUB. 6-22-2010, FILED 7-3-2007.

# Tropicanimals

THE MARK CONSISTS OF STANDARD CHARACTERS  
WITHOUT CLAIM TO ANY PARTICULAR FONT, STYLE,  
SIZE, OR COLOR.

FOR HEALTHFUL DRINKS, NAMESLY, SPRING  
WATER AND FRUIT JUICES (U.S. CLS. 45, 46 AND 48).

FIRST USE 5-31-2011; IN COMMERCE 7-6-2011.

4,046,752. KAYTEE PRODUCTS INCORPORATED, CHIL-  
TON, WI. SN 85-147,193. PUB. 5-10-2011, FILED 10-7-2010.

# ULTRA WILD FINCH BLEND

THE MARK CONSISTS OF STANDARD CHARACTERS  
WITHOUT CLAIM TO ANY PARTICULAR FONT, STYLE,  
SIZE, OR COLOR.

NO CLAIM IS MADE TO THE EXCLUSIVE RIGHT TO  
USE "WILD FINCH BLEND", APART FROM THE MARK AS  
SHOWN.

FOR WILD BIRD FOOD (U.S. CLS. 1 AND 46).  
FIRST USE 2-1-2011; IN COMMERCE 2-1-2011.

4,045,702. BERTHELSEN, GEIR, KRISTIANSAND, NOR-  
WAY. SN 77-402,456. PUB. 6-24-2008, FILED 2-21-2008.

# SlowJuice

THE MARK CONSISTS OF STANDARD CHARACTERS  
WITHOUT CLAIM TO ANY PARTICULAR FONT, STYLE,  
SIZE, OR COLOR.

FOR FRUIT DRINKS AND FRUIT JUICES (U.S. CLS.  
45, 46 AND 48).

FIRST USE 8-15-2011; IN COMMERCE 8-15-2011.



**CLASS 32—(Continued).**

4,045,716. LOPERA, FRANK, BEVERLY HILLS, CA. SN 77-432,214. PUB. 8-5-2008, FILED 3-26-2008.

# SPEEDY

THE MARK CONSISTS OF STANDARD CHARACTERS WITHOUT CLAIM TO ANY PARTICULAR FONT, STYLE, SIZE, OR COLOR.

FOR ENERGY DRINKS (U.S. CLS. 45, 46 AND 48).  
FIRST USE 6-8-2011; IN COMMERCE 6-8-2011.

**CLASS 32—(Continued).**

4,045,856. MJK DISTRIBUTORS, LLC., NEW YORK, NY. SN 77-753,514. PUB. 10-20-2009, FILED 6-5-2009.



THE MARK CONSISTS OF A MONKEY FACE.  
FOR COCONUT WATER (U.S. CLS. 45, 46 AND 48).  
FIRST USE 7-28-2010; IN COMMERCE 7-28-2010.

4,045,785. HANSEN BEVERAGE COMPANY, CORONA, CA. SN 77-639,325. PUB. 10-27-2009, FILED 12-23-2008.

# LIQUIDFRUIT

THE MARK CONSISTS OF STANDARD CHARACTERS WITHOUT CLAIM TO ANY PARTICULAR FONT, STYLE, SIZE, OR COLOR.

FOR FRUIT JUICES, FRUIT DRINKS, FRUIT FLAVORED SOFT DRINKS (U.S. CLS. 45, 46 AND 48).  
FIRST USE 6-0-1999; IN COMMERCE 6-0-1999.

4,045,868. ALDI INC., BATAVIA, IL. SN 77-769,879. PUB. 2-1-2011, FILED 6-29-2009.

# NATURE'S NECTAR

THE MARK CONSISTS OF STANDARD CHARACTERS WITHOUT CLAIM TO ANY PARTICULAR FONT, STYLE, SIZE, OR COLOR.

OWNER OF U.S. REG. NOS. 1,070,733, 2,187,708, AND 2,686,367.

NO CLAIM IS MADE TO THE EXCLUSIVE RIGHT TO USE "NECTAR", APART FROM THE MARK AS SHOWN.  
FOR FRUIT FLAVORED DRINKS; AND FRUIT PUNCH, NAMELY, CITRUS PUNCH (U.S. CLS. 45, 46 AND 48).

FIRST USE 6-30-2011; IN COMMERCE 6-30-2011.

4,045,847. THE COCA-COLA COMPANY, ATLANTA, GA. SN 77-736,373. PUB. 8-3-2010, FILED 5-13-2009.

# PLANTBOTTLE

THE MARK CONSISTS OF STANDARD CHARACTERS WITHOUT CLAIM TO ANY PARTICULAR FONT, STYLE, SIZE, OR COLOR.

FOR NON-ALCOHOLIC BEVERAGES, NAMELY, FRUIT DRINKS AND JUICES (U.S. CLS. 45, 46 AND 48).  
FIRST USE 4-1-2011; IN COMMERCE 4-1-2011.

4,045,945. SUPER BAKERY, INCORPORATED, PITTSBURGH, PA. SN 77-848,179. PUB. 9-14-2010, FILED 10-14-2009.

# OKLAHOMAADE

THE MARK CONSISTS OF STANDARD CHARACTERS WITHOUT CLAIM TO ANY PARTICULAR FONT, STYLE, SIZE, OR COLOR.

FOR SPORTS DRINKS AND PERFORMANCE DRINKS IN THE NATURE OF FRUIT DRINKS (U.S. CLS. 45, 46 AND 48).

FIRST USE 12-3-2010; IN COMMERCE 12-3-2010.

**CLASS 32—(Continued).**

4,046,046. LEWIS, SHARON CARPENTER, EASTON, MD. SN 77-930,168. PUB. 6-22-2010, FILED 2-8-2010.

## Chick Beer

THE MARK CONSISTS OF STANDARD CHARACTERS WITHOUT CLAIM TO ANY PARTICULAR FONT, STYLE, SIZE, OR COLOR.

NO CLAIM IS MADE TO THE EXCLUSIVE RIGHT TO USE "BEER", APART FROM THE MARK AS SHOWN. FOR BEER (U.S. CLS. 45, 46 AND 48). FIRST USE 4-1-2011; IN COMMERCE 7-26-2011.

**CLASS 32—(Continued).**

4,046,164. ALACER CORPORATION, FOOTHILL RANCH, CA. SN 77-980,773. PUB. 5-4-2010, FILED 10-23-2009.

## FEEL THE GOOD

THE MARK CONSISTS OF STANDARD CHARACTERS WITHOUT CLAIM TO ANY PARTICULAR FONT, STYLE, SIZE, OR COLOR.

OWNER OF U.S. REG. NOS. 3,483,518, 3,513,030, AND 3,521,887.

FOR FOUNTAIN BEVERAGES, NAMELY, SOFT DRINKS TO BE DISPENSED AT RETAIL VENUES (U.S. CLS. 45, 46 AND 48). FIRST USE 2-9-2009; IN COMMERCE 2-9-2009.

4,046,084. APOLLINARIS BRANDS GMBH, BERLIN 10117, FED REP GERMANY. SN 77-940,140. PUB. 7-20-2010, FILED 2-19-2010.

## APOLLINARIS

THE MARK CONSISTS OF STANDARD CHARACTERS WITHOUT CLAIM TO ANY PARTICULAR FONT, STYLE, SIZE, OR COLOR.

OWNER OF U.S. REG. NOS. 640,430 AND 2,786,339. FOR MINERAL AND AERATED WATERS (U.S. CLS. 45, 46 AND 48). FIRST USE 12-31-1872; IN COMMERCE 12-31-1872.

4,046,337. BARKER, RONALD, FAR ROCKAWAY, NY. SN 85-061,630. PUB. 2-22-2011, FILED 6-14-2010.

## SHARP V.T.M.D

THE MARK CONSISTS OF STANDARD CHARACTERS WITHOUT CLAIM TO ANY PARTICULAR FONT, STYLE, SIZE, OR COLOR.

FOR LIGHT BEVERAGES, NAMELY, NONALCOHOLIC DRINKS, NAMELY, AERATED WATER AND FRUIT JUICES WITH VITAMINS (U.S. CLS. 45, 46 AND 48).

FIRST USE 5-23-2011; IN COMMERCE 5-23-2011.

4,046,096. DELORES A. HALL, MIAMI, FL. SN 77-944,491. PUB. 7-20-2010, FILED 2-25-2010.

## GLEENDALE

THE MARK CONSISTS OF STANDARD CHARACTERS WITHOUT CLAIM TO ANY PARTICULAR FONT, STYLE, SIZE, OR COLOR.

FOR BOTTLED WATER (U.S. CLS. 45, 46 AND 48). FIRST USE 2-2-2011; IN COMMERCE 2-20-2011.

4,046,415. VAN VELZEN, JORIS, BERLIN, FED REP GERMANY. SN 85-084,161. PUB. 12-28-2010, FILED 7-14-2010.

## WOSTOK

THE MARK CONSISTS OF STANDARD CHARACTERS WITHOUT CLAIM TO ANY PARTICULAR FONT, STYLE, SIZE, OR COLOR.

FOR NON-ALCOHOLIC BEVERAGES, IN PARTICULAR NON-ALCOHOLIC AERATED BEVERAGES, NON-ALCOHOLIC BEVERAGES MADE WITH PLANT OR HERBAL EXTRACTS, NON-ALCOHOLIC SOFT DRINKS, LEMONADE (U.S. CLS. 45, 46 AND 48).

FIRST USE 5-2-2009; IN COMMERCE 10-6-2010.

**CLASS 32—(Continued).**

4,046,466. OLD OAK BEER CO. LLC, SAN FRANCISCO, CA. SN 85-091,598. PUB. 1-4-2011, FILED 7-23-2010.

**Farm To Barrel**

THE MARK CONSISTS OF STANDARD CHARACTERS WITHOUT CLAIM TO ANY PARTICULAR FONT, STYLE, SIZE, OR COLOR.

FOR BEER (U.S. CLS. 45, 46 AND 48).  
FIRST USE 6-1-2010; IN COMMERCE 6-30-2011.

4,046,701. WHITE-BERARDI, TERI, SAN DIEGO, CA. SN 85-133,908. PUB. 3-8-2011, FILED 9-20-2010.

**FIRST CLASS MIXER**

THE MARK CONSISTS OF STANDARD CHARACTERS WITHOUT CLAIM TO ANY PARTICULAR FONT, STYLE, SIZE, OR COLOR.

NO CLAIM IS MADE TO THE EXCLUSIVE RIGHT TO USE "MIXER", APART FROM THE MARK AS SHOWN.

FOR NON-ALCOHOLIC COCKTAIL BASES; NON-ALCOHOLIC COCKTAIL MIXES (U.S. CLS. 45, 46 AND 48).  
FIRST USE 9-20-2010; IN COMMERCE 10-10-2010.

4,046,705. LUXEMBOURG CAPITAL LLC, NEW YORK, NY. SN 85-134,687. PUB. 3-8-2011, FILED 9-21-2010.

**212 BEER**

THE MARK CONSISTS OF STANDARD CHARACTERS WITHOUT CLAIM TO ANY PARTICULAR FONT, STYLE, SIZE, OR COLOR.

NO CLAIM IS MADE TO THE EXCLUSIVE RIGHT TO USE "BEER", APART FROM THE MARK AS SHOWN.

FOR BEER (U.S. CLS. 45, 46 AND 48).  
FIRST USE 8-3-2011; IN COMMERCE 8-3-2011.

**CLASS 32—(Continued).**

4,046,812. HERO/WHITEWAVE, LLC, BROOMFIELD, CO. SN 85-163,973. PUB. 3-29-2011, FILED 10-28-2010.

**SUMMER LOVIN'**

THE MARK CONSISTS OF STANDARD CHARACTERS WITHOUT CLAIM TO ANY PARTICULAR FONT, STYLE, SIZE, OR COLOR.

FOR FRUIT JUICES; FRUIT NECTARS; NON-ALCOHOLIC FRUIT JUICE BEVERAGES (U.S. CLS. 45, 46 AND 48).

FIRST USE 2-6-2011; IN COMMERCE 4-16-2011.

4,046,849. LOWELL INTERNATIONAL COMPANY, FRANKLIN PARK, IL. SN 85-178,344. PUB. 4-5-2011, FILED 11-16-2010.



THE COLOR(S) BLACK, WHITE, BLUE, ORANGE, GREEN, AND RED IS/ARE CLAIMED AS A FEATURE OF THE MARK.

THE MARK CONSISTS OF THE WORD "BUENA" WITH A CAPITAL "B" ON TOP OF THE WORD "CARROTENA" WITH A CAPITAL "C". THE WORD "CARROTENA" APPEARS AS A SEMI-CIRCLE THAT CURVES UP AROUND THE SIDES OF THE WORD "BUENA". THE WORD "BUENA" AND THE WORD "CARROTENA" APPEAR IN A BLUE COLOR. THE LETTERS ARE STYLIZED. THE LETTER "T" IN "CARROTENA" IS ORANGE AND LOOKS LIKE A SMILING CARROT WITH EARS. THE BOTTOM OF THE CARROT CURVES TO THE RIGHT. THE BODY AND EARS OF THE CARROT ARE ORANGE. THE TOP OF THE CARROT HAS GREEN LEAVES. THE CARROT HAS WHITE OVAL EYES WITH BLACK PUPILS. IT HAS BLACK EYEBROWS. THE SMILE ON THE CARROT SHOWS A BLACK MOUTH WITH A THIN BLACK MUSTACHE. THE MOUTH HAS A RED TONGUE AND TWO SMALL WHITE TEETH.

THE ENGLISH TRANSLATION OF "BUENA" IN THE MARK IS "GOOD". THE WORDING "CARROTENA" HAS NO MEANING IN A FOREIGN LANGUAGE.

FOR VEGETABLE DRINKS; VEGETABLE JUICE; VEGETABLE-FRUIT JUICES (U.S. CLS. 45, 46 AND 48).  
FIRST USE 6-20-2011; IN COMMERCE 6-20-2011.

**CLASS 32—(Continued).**

4,046,863. HERO AG, LENZBURG, SWITZERLAND. SN 85-183,839. PUB. 5-24-2011, FILED 11-23-2010.



NO CLAIM IS MADE TO THE EXCLUSIVE RIGHT TO USE "FRUIT", APART FROM THE MARK AS SHOWN. THE COLOR(S) RED, ORANGE, YELLOW AND WHITE IS/ARE CLAIMED AS A FEATURE OF THE MARK.

THE MARK CONSISTS OF A RED RECTANGLE CONTAINING THE TERM "FRUIT2DAY" IN RED LETTERS IN A YELLOW SUNRISE DESIGN ABOVE THE TERM "MORNING" IN WHITE LETTERS AGAINST AN ORANGE BACKGROUND.

FOR FRUIT JUICE BEVERAGES, FRUIT JUICES, FRUIT NECTARS; ALL SUCH BEVERAGES CONTAINING PROTEIN AND FIBER (U.S. CLS. 45, 46 AND 48).

FIRST USE 4-15-2011; IN COMMERCE 4-15-2011.

4,046,864. HERO AG, LENZBURG, SWITZERLAND. SN 85-184,806. PUB. 5-24-2011, FILED 11-24-2010.



NO CLAIM IS MADE TO THE EXCLUSIVE RIGHT TO USE "FRUIT", APART FROM THE MARK AS SHOWN.

THE MARK CONSISTS OF THE TERM "FRUIT2DAY" IN A SUNRISE DESIGN OVER THE TERM "MORNING" AGAINST A DARK BACKGROUND.

FOR FRUIT JUICE BEVERAGES, FRUIT JUICES, FRUIT NECTARS (U.S. CLS. 45, 46 AND 48).

FIRST USE 4-15-2011; IN COMMERCE 4-15-2011.

4,046,866. HANGAR 24 CRAFT BREWERY, LLC, REDLANDS, CA. SN 85-184,974. PUB. 3-8-2011, FILED 11-24-2010.

# IMMELMANN

THE MARK CONSISTS OF STANDARD CHARACTERS WITHOUT CLAIM TO ANY PARTICULAR FONT, STYLE, SIZE, OR COLOR.

FOR BEER (U.S. CLS. 45, 46 AND 48).

FIRST USE 12-18-2010; IN COMMERCE 12-18-2010.

**CLASS 32—(Continued).**

4,046,918. AVANA INTERNATIONAL CORPORATION, PARK RIDGE, IL. SN 85-198,144. PUB. 4-26-2011, FILED 12-15-2010.

## BECAUSE I LIVE.

THE MARK CONSISTS OF STANDARD CHARACTERS WITHOUT CLAIM TO ANY PARTICULAR FONT, STYLE, SIZE, OR COLOR.

FOR ENERGY DRINKS; FRUIT-FLAVORED BEVERAGES; POWDERS USED IN THE PREPARATION OF ISOTONIC SPORTS DRINKS AND SPORTS BEVERAGES; CONCENTRATES, POWDERS USED IN THE PREPARATION OF SPORTS AND ENERGY DRINKS (U.S. CLS. 45, 46 AND 48).

FIRST USE 7-14-2011; IN COMMERCE 7-14-2011.

4,046,992. HEALTHYMOUTH, LLC, MALIBU, CA. SN 85-216,812. PUB. 5-31-2011, FILED 1-13-2011.

## HEALTHYMOUTH WATER

THE MARK CONSISTS OF STANDARD CHARACTERS WITHOUT CLAIM TO ANY PARTICULAR FONT, STYLE, SIZE, OR COLOR.

FOR WATER BEVERAGES; CONCENTRATE USED IN THE PREPARATION OF WATER BEVERAGES (U.S. CLS. 45, 46 AND 48).

FIRST USE 8-8-2011; IN COMMERCE 8-8-2011.

4,047,009. PEPSICO, INC., PURCHASE, NY. SN 85-222,610. PUB. 5-31-2011, FILED 1-20-2011.

## PEPSI NEXT

THE MARK CONSISTS OF STANDARD CHARACTERS WITHOUT CLAIM TO ANY PARTICULAR FONT, STYLE, SIZE, OR COLOR.

OWNER OF U.S. REG. NOS. 824,150, 824,152, AND OTHERS.

FOR CONCENTRATES, SYRUPS OR POWDERS USED IN THE PREPARATION OF SOFT DRINKS; SOFT DRINKS (U.S. CLS. 45, 46 AND 48).

FIRST USE 7-15-2011; IN COMMERCE 7-15-2011.

**CLASS 33—WINES AND SPIRITS**

**CLASS 33—(Continued).**

4,045,639. BISON CAPITAL LLC, VENICE, FL. SN 77-233,181.  
PUB. 6-10-2008, FILED 7-18-2007.

## Texas 1836

THE MARK CONSISTS OF STANDARD CHARACTERS WITHOUT CLAIM TO ANY PARTICULAR FONT, STYLE, SIZE, OR COLOR.

NO CLAIM IS MADE TO THE EXCLUSIVE RIGHT TO USE "TEXAS", APART FROM THE MARK AS SHOWN.  
FOR DISTILLED SPIRITS (U.S. CLS. 47 AND 49).  
FIRST USE 8-26-2011; IN COMMERCE 8-26-2011.

4,045,640. BISON CAPITAL LLC, VENICE, FL. SN 77-233,185.  
PUB. 6-10-2008, FILED 7-18-2007.

## Pedernales

THE MARK CONSISTS OF STANDARD CHARACTERS WITHOUT CLAIM TO ANY PARTICULAR FONT, STYLE, SIZE, OR COLOR.

THE FOREIGN WORDING IN THE MARK TRANSLATES INTO ENGLISH AS "FLINTS" OR "FLINTSTONES".

FOR DISTILLED SPIRITS AND ALCOHOLIC MALT BEVERAGES, NAMELY, FLAVORED MALT BEVERAGES AND PREPARED COCKTAILS (U.S. CLS. 47 AND 49).

FIRST USE 4-25-2011; IN COMMERCE 4-25-2011.

4,045,657. WELL BLACK LLC, NEW YORK, NY. SN 77-310,242. PUB. 4-8-2008, FILED 10-22-2007.

## BLACK GOLD

THE MARK CONSISTS OF STANDARD CHARACTERS WITHOUT CLAIM TO ANY PARTICULAR FONT, STYLE, SIZE, OR COLOR.

FOR RUM (U.S. CLS. 47 AND 49).  
FIRST USE 7-5-2011; IN COMMERCE 7-5-2011.

**CLASS 33—(Continued).**

4,045,692. BISON CAPITAL LLC, VENICE, FL. SN 77-389,523.  
PUB. 6-17-2008, FILED 2-5-2008.

## Lavender

THE MARK CONSISTS OF STANDARD CHARACTERS WITHOUT CLAIM TO ANY PARTICULAR FONT, STYLE, SIZE, OR COLOR.

FOR DISTILLED SPIRITS (U.S. CLS. 47 AND 49).  
FIRST USE 4-25-2011; IN COMMERCE 4-25-2011.

4,045,725. FINE ESTATES FROM SPAIN, DEDHAM, MA. SN 77-455,896. PUB. 4-19-2011, FILED 4-23-2008.

## LA CANA

THE MARK CONSISTS OF STANDARD CHARACTERS WITHOUT CLAIM TO ANY PARTICULAR FONT, STYLE, SIZE, OR COLOR.

THE FOREIGN WORDING IN THE MARK TRANSLATES INTO ENGLISH AS "THE CANE".

FOR WINE (U.S. CLS. 47 AND 49).

FIRST USE 5-18-2009; IN COMMERCE 5-18-2009.

4,045,770. TORRES SALCEDO, JOSÉ HIRAM, ZAPOPAN, MEXICO. AND MARTÍNEZ DOMÍNGUEZ, CARLOS GERARDO, ZAPOPAN, MEXICO. AND OCHOA, CAMBEROS ALEJANDRO, ZAPOPAN, MEXICO. AND GONZÁLEZ, PÉREZ RICARDO, GUADALAJARA, MEXICO. SN 77-604,328. PUB. 1-11-2011, FILED 10-30-2008.



THE MARK CONSISTS OF A PIGGY BANK PAINTED WITH MEXICAN FLOWERS AND SYMBOLS SHOWN ON AN ISOMETRIC VIEW AND IT HAS THE SAME FLOWER AND LEAVE DESIGN ON THE BACKGROUND AS A PATTERN, THE WORDING "CHULA VISTA" APPEARS UNDERNEATH THE PIGGY BANK AND IN FRONT OF THE PATTERN.

**CLASS 33—(Continued).**

THE ENGLISH TRANSLATION OF "CHULA VISTA" IN THE MARK IS "NICE VIEW".  
FOR TEQUILA (U.S. CLS. 47 AND 49).  
FIRST USE 11-4-2010; IN COMMERCE 11-4-2010.

---

4,045,800. DANCIN VINEYARDS, LLC, JACKSONVILLE, OR. SN 77-657,703. PUB. 12-8-2009, FILED 1-27-2009.

**DANCIN VINEYARDS**

THE MARK CONSISTS OF STANDARD CHARACTERS WITHOUT CLAIM TO ANY PARTICULAR FONT, STYLE, SIZE, OR COLOR.  
NO CLAIM IS MADE TO THE EXCLUSIVE RIGHT TO USE "VINEYARDS", APART FROM THE MARK AS SHOWN.  
FOR WINES (U.S. CLS. 47 AND 49).  
FIRST USE 7-21-2011; IN COMMERCE 7-21-2011.

---

4,045,880. HAGEN, STEPHEN M, DBA OLD SCHOOL VINEYARDS, JUNCTION CITY, OR. SN 77-780,184. PUB. 6-22-2010, FILED 7-14-2009.

**Old School Vineyards**

THE MARK CONSISTS OF STANDARD CHARACTERS WITHOUT CLAIM TO ANY PARTICULAR FONT, STYLE, SIZE, OR COLOR.  
NO CLAIM IS MADE TO THE EXCLUSIVE RIGHT TO USE "VINEYARDS", APART FROM THE MARK AS SHOWN.  
FOR GRAPE WINE (U.S. CLS. 47 AND 49).  
FIRST USE 7-8-2011; IN COMMERCE 7-12-2011.

---

4,045,906. VILLAFANE Y GUZMAN, SRL, MAIPU, MENDOZA, ARGENTINA. SN 77-811,159. PUB. 1-25-2011, FILED 8-24-2009.

**DON MANUEL VILLAFANE**

THE MARK CONSISTS OF STANDARD CHARACTERS WITHOUT CLAIM TO ANY PARTICULAR FONT, STYLE, SIZE, OR COLOR.

**CLASS 33—(Continued).**

THE NAME(S), PORTRAIT(S), AND/OR SIGNATURE(S) SHOWN IN THE MARK DOES NOT IDENTIFY A PARTICULAR LIVING INDIVIDUAL.  
FOR WINES (U.S. CLS. 47 AND 49).  
FIRST USE 8-29-2008; IN COMMERCE 8-29-2008.

---

4,046,003. FELICIANO VIVANCO Y ASOCIADOS SA DE CV, ARANDAS JALISCO, MEXICO. SN 77-906,264. PUB. 12-21-2010, FILED 1-6-2010.



THE MARK CONSISTS OF A STYLISTIC LETTER "A" WITH THE WORD "AMISTAD" IN SMALLER LETTERS WRITTEN ACROSS THE LETTER "A".  
THE ENGLISH TRANSLATION OF "AMISTAD" IN THE MARK IS FRIENDSHIP.  
FOR ALCOHOLIC BEVERAGES, INCLUDING WINE (EXCEPT BEERS), TEQUILA (U.S. CLS. 47 AND 49).  
FIRST USE 7-14-2010; IN COMMERCE 7-14-2010.

---

4,046,004. WORD VINEYARDS LLC, COSTA MESA, CA. SN 77-908,331. PUB. 5-25-2010, FILED 1-8-2010.

**OLELO**

THE MARK CONSISTS OF STANDARD CHARACTERS WITHOUT CLAIM TO ANY PARTICULAR FONT, STYLE, SIZE, OR COLOR.  
FOR ALCOHOLIC BEVERAGES EXCEPT BEERS (U.S. CLS. 47 AND 49).  
FIRST USE 8-0-2011; IN COMMERCE 8-0-2011.

**CLASS 33—(Continued).**

4,046,023. WHITE ROCK DISTILLERIES, INC., LEWISTON, ME. SN 77-915,858. PUB. 5-25-2010, FILED 1-20-2010.

**THE NOT SO PROPER TEA**

THE MARK CONSISTS OF STANDARD CHARACTERS WITHOUT CLAIM TO ANY PARTICULAR FONT, STYLE, SIZE, OR COLOR.

FOR VODKA; DISTILLED SPIRITS (U.S. CLS. 47 AND 49).

FIRST USE 9-30-2008; IN COMMERCE 9-30-2008.

4,046,083. TIERRAS DEL ANDE S.A., MENDOZA, ARGENTINA. SN 77-940,083. PUB. 1-25-2011, FILED 2-19-2010.



THE MARK CONSISTS OF THE STYLIZED WORD "CAFETIN" AND A STYLIZED DESIGN OF A MAN AND WOMAN DANCING TOGETHER BELOW AND TO THE RIGHT OF THE WORD "CAFETIN".

FOR WINES (U.S. CLS. 47 AND 49).

FIRST USE 7-2-2010; IN COMMERCE 7-2-2010.

4,046,090. DIOTA HOLDINGS, LLC, MENLO PARK, CA. SN 77-943,465. PUB. 7-20-2010, FILED 2-24-2010.

**BAILIWICK**

THE MARK CONSISTS OF STANDARD CHARACTERS WITHOUT CLAIM TO ANY PARTICULAR FONT, STYLE, SIZE, OR COLOR.

FOR WINES (U.S. CLS. 47 AND 49).

FIRST USE 8-30-2011; IN COMMERCE 8-30-2011.

**CLASS 33—(Continued).**

4,046,137. SOLVI BRAND, LLC, ROSWELL, GA. SN 77-959,145. PUB. 8-3-2010, FILED 3-15-2010.



NO CLAIM IS MADE TO THE EXCLUSIVE RIGHT TO USE "JUICE", APART FROM THE MARK AS SHOWN.

THE COLOR(S) GREY, WHITE AND BLACK IS/ARE CLAIMED AS A FEATURE OF THE MARK.

THE MARK CONSISTS OF THE STYLIZED ABBREVIATION "CJ" WITH DIAMOND-SHAPED DASHES ON EITHER SIDE APPEARING IN GRAY FONT ABOVE THE STYLIZED WORDS "CRUNK JUCE" APPEARING IN WHITE FONT, ALL ON A BLACK BACKGROUND.

FOR FLAVORED BREWED MALT BEVERAGE (U.S. CLS. 47 AND 49).

FIRST USE 6-22-2010; IN COMMERCE 6-22-2010.

4,046,197. CUCA FRESCA EXPORTS, LLC, PLEASANTVILLE, NY. SN 78-825,139. PUB. 12-25-2007, FILED 2-28-2006.



THE MARK CONSISTS OF STYLIZED LETTERING OF THE WORD MARK "CUCA FRESCA".

THE ENGLISH TRANSLATION OF "CUCA FRESCA" IS "COOL HEAD".

FOR RUM (U.S. CLS. 47 AND 49).

FIRST USE 1-31-2007; IN COMMERCE 1-31-2007.

**CLASS 33—(Continued).**

4,046,214. SOUTHERN COMFORT PROPERTIES, INC., SAN RAFAEL, CA. SN 85-007,790. PUB. 1-18-2011, FILED 4-6-2010.



OWNER OF U.S. REG. NOS. 1,522,030, 2,797,121, AND OTHERS.

NO CLAIM IS MADE TO THE EXCLUSIVE RIGHT TO USE "NEW ORLEANS ORIGINAL EST 1874" AND "CRESCENT CITY", APART FROM THE MARK AS SHOWN.

THE NAME(S), PORTRAIT(S), AND/OR SIGNATURE(S) SHOWN IN THE MARK DOES NOT IDENTIFY A PARTICULAR LIVING INDIVIDUAL.

THE MARK CONSISTS OF A SHIELD DESIGN CONTAINING A FLEUR-DE-LIS WITH FOUR DARKENED CIRCLES ON EACH SIDE ABOVE THE WORDS "NEW ORLEANS ORIGINAL" ARCHED ABOVE THE WORD "SOUTHERN" ABOVE A SCROLLED DESIGN ABOVE THE WORD "COMFORT" ABOVE AN OVAL SHAPE WITH A COLLAGE OF THE FOLLOWING IMAGES INSIDE: BUILDINGS, CRESCENT MOON AND STARS, LAMP POST, MAN ON HORSE, TROLLEY CAR, BRIDGE, RIVER BOAT AND WATER, PICKET FENCE. TO THE LEFT OF THE OVAL IS THE TERM "EST" AND TO THE RIGHT OF THE OVAL IS THE NUMBER "1874". ON EITHER SIDE OF THE OVAL IS A DARKENED TRIANGULAR SHAPE WITH FOUR DARKENED CIRCLES BORDERING EACH UPPER SIDE OF THE OVAL. BENEATH THE SHIELD DESIGN IS THE WORDING "M.W. HERON" IN A SCRIPT FONT. BENEATH THIS WORDING, AT THE BOTTOM OF THE BOTTLE IS A RECTANGULAR BORDER WITH A CURVE IN THE TOP CONTAINING THE WORDING "NONE GENUINE" ON THE LEFT AND "BUT MINE" ON THE RIGHT. BENEATH THIS WORDING ARE TWO ROWS OF DARKENED CIRCLES. IN THE CENTER OF THE RECTANGLE IS A DARKENED CIRCLE CONTAINING THE DESIGN OF A CRESCENT MOON, A DECORATIVE SCROLL AND THE LETTERS "SC". TO THE LEFT OF THE CIRCLE IS THE NUMBER "18" AND TO THE RIGHT OF THE CIRCLE IS THE NUMBER "74". BENEATH THE CIRCLE ARE TWO SMALL TRIANGULAR SHAPES. TO THE LEFT OF CIRCLE, BENEATH THE SMALL DARKENED CIRCLES IS THE WORDING "INSPIRED BY THE CRESCENT CITY". TO THE RIGHT OF THE CIRCLE, BENEATH THE SMALL DARKENED CIRCLES IS THE WORDING "PERFECTED BY M.W. HERON". THE CONFIGURATION OF RAISED VERTICAL RIBS APPEARS AROUND THE SHOULDER OF THE BOTTLE, AND THE BOTTLE NECK AND CAP CONTAINS THE FOLLOWING: WOMEN'S FACE, CRESCENT MOON, ALLIGATOR, HAND, STREET CAR, THE LETTERS "RESTAU," MAN'S FACE, AND BELOW THAT THE WORDS "SOUTHERN COMFORT". THE SHAPE OF THE BOTTLE IS NOT CLAIMED AS PART OF THE MARK AND APPEARS IN DOTTED LINES.

SEC. 2(F) RAISED VERTICAL RIBS AROUND THE SHOULDER OF THE BOTTLE HAS BECOME DISTINCTIVE OF THE GOODS/SERVICES AS EVIDENCED BY THE OWNERSHIP ON THE PRINCIPAL REGISTER FOR THE SAME MARK FOR RELATED GOODS OR SERVICES OF U.S. REGISTRATION NO(S). 2617158 AND 2797121. .

FOR DISTILLED SPIRITS (U.S. CLS. 47 AND 49).  
FIRST USE 5-1-2010; IN COMMERCE 5-1-2010.

**CLASS 33—(Continued).**

4,046,306. GOLDEN DISTILLERY, BOW, WA. SN 85-051,497. PUB. 11-9-2010, FILED 6-1-2010.

**GOLDEN DISTILLERY**

THE MARK CONSISTS OF STANDARD CHARACTERS WITHOUT CLAIM TO ANY PARTICULAR FONT, STYLE, SIZE, OR COLOR.

NO CLAIM IS MADE TO THE EXCLUSIVE RIGHT TO USE "DISTILLERY", APART FROM THE MARK AS SHOWN.

FOR BRANDY; CORDIALS; GIN; VODKA; WHISKEY (U.S. CLS. 47 AND 49).

FIRST USE 8-30-2011; IN COMMERCE 8-30-2011.

4,046,322. INTERCONTINENTAL PACKAGING CO., ST. PAUL, MN. SN 85-058,136. PUB. 8-3-2010, FILED 6-9-2010.

**IN THE PINK**

THE MARK CONSISTS OF STANDARD CHARACTERS WITHOUT CLAIM TO ANY PARTICULAR FONT, STYLE, SIZE, OR COLOR.

FOR WINES (U.S. CLS. 47 AND 49).

FIRST USE 3-1-2011; IN COMMERCE 7-1-2011.



**CLASS 33—(Continued).**

4,046,403. ARCO DEL CABO DISTRIBUTING, INC., CAROLTON, TX. SN 85-081,549. PUB. 12-21-2010, FILED 7-9-2010.



THE MARK CONSISTS OF THE STYLIZED WORDS "EL ARCO", WITH STYLIZED UNDERLINING, APPEARING ABOVE THE IMAGE OF THE ARCH OF CABO, WITH A STARBURST DESIGN APPEARING ON THE RIGHT SIDE OF THE ARCH. THE MATTER SHOWN BY THE BROKEN LINES IN THE DRAWING IS NOT A PART OF THE MARK; IT SERVES ONLY TO SHOW THE POSITION OF THE MARK ON THE BOTTLES IN WHICH APPLICANT'S GOODS ARE SOLD.

THE ENGLISH TRANSLATION OF "EL ARCO" IN THE MARK IS "THE ARCH".

FOR TEQUILA (U.S. CLS. 47 AND 49).  
FIRST USE 5-6-2011; IN COMMERCE 5-6-2011.

**CLASS 33—(Continued).**

4,046,517. LEPRECHAUN CIDER COMPANY, LLC, HOUSTON, TX. SN 85-098,776. PUB. 1-18-2011, FILED 8-3-2010.



NO CLAIM IS MADE TO THE EXCLUSIVE RIGHT TO USE "CIDER", APART FROM THE MARK AS SHOWN.

THE MARK CONSISTS OF WORDING "LEPRECHAUN GOLDEN CIDER" WITH A STYLIZED "C" THAT RESEMBLES THE SHAPE OF A FRUIT; DIAMOND-SHAPED DESIGN IN THE CENTER WITH TWO DOGS FACING ONE ANOTHER; DESIGN OF BRANCHES AND LEAVES IN THE SURROUNDING BACKGROUND; AND A SNAKE WRAPPED AROUND A BRANCH.

FOR HARD CIDER (U.S. CLS. 47 AND 49).  
FIRST USE 2-0-2011; IN COMMERCE 2-0-2011.

4,046,518. VINNICO EXPORT S.L., JAVEA (ALICANTE), SPAIN. SN 85-098,869. PUB. 1-11-2011, FILED 8-3-2010.



**X VALLEY BLACK**

THE MARK CONSISTS OF STANDARD CHARACTERS WITHOUT CLAIM TO ANY PARTICULAR FONT, STYLE, SIZE, OR COLOR.

NO CLAIM IS MADE TO THE EXCLUSIVE RIGHT TO USE "BLACK", APART FROM THE MARK AS SHOWN.

FOR WINES (U.S. CLS. 47 AND 49).  
FIRST USE 4-0-2009; IN COMMERCE 6-0-2011.

THE MARK CONSISTS OF THE TEXT "EL VIEJO CASTILLO DE MONLERO" PRESENTED IN STYLIZED SCRIPT AT AN ANGLE, ABOVE THE TEXT IS A CREST WITH TWO LIONS FACING A SHIELD WITH A CROWN AND STANDING ON A BANNER WITH THE TEXT "BRAVE LOYAL UNITE".

THE ENGLISH TRANSLATION OF "EL VIEJO CASTILLO DE MONLERO" IN THE MARK IS "THE OLD MONLERO CASTLE".

FOR WINE (U.S. CLS. 47 AND 49).  
FIRST USE 1-22-2002; IN COMMERCE 8-3-2011.

**CLASS 33—(Continued).**

4,046,567. WHITELATCH-HOCH, LLC, KENNEWICK, WA.  
SN 85-107,325. PUB. 1-25-2011, FILED 8-13-2010.

**Nicola's Redmark**

THE MARK CONSISTS OF STANDARD CHARACTERS  
WITHOUT CLAIM TO ANY PARTICULAR FONT, STYLE,  
SIZE, OR COLOR.  
FOR WINES (U.S. CLS. 47 AND 49).  
FIRST USE 8-3-2010; IN COMMERCE 11-1-2010.

4,046,568. WHITELATCH-HOCH, LLC, KENNEWICK, WA.  
SN 85-107,389. PUB. 1-25-2011, FILED 8-13-2010.



THE COLOR(S) RED, BLACK AND WHITE IS/ARE  
CLAIMED AS A FEATURE OF THE MARK.  
THE MARK CONSISTS OF A SWATH OF RED ABOVE A  
BLOCK OF BLACK WHICH CONTAINS THE LITERAL  
ELEMENT OF THE MARK, THE WORD "RED" IS "RED" IN  
COLOR AND THE WORDS "NICOLA'S" AND "MARK" ARE  
WHITE IN COLOR.  
FOR WINES (U.S. CLS. 47 AND 49).  
FIRST USE 8-3-2010; IN COMMERCE 11-1-2010.

4,046,594. VINEBURG LLC, VINEBURG, CA. SN 85-113,757.  
PUB. 2-1-2011, FILED 8-23-2010.

**SWAMI**

THE MARK CONSISTS OF STANDARD CHARACTERS  
WITHOUT CLAIM TO ANY PARTICULAR FONT, STYLE,  
SIZE, OR COLOR.  
FOR ALCOHOLIC BEVERAGES EXCEPT BEERS (U.S.  
CLS. 47 AND 49).  
FIRST USE 7-26-2011; IN COMMERCE 7-26-2011.

**CLASS 33—(Continued).**

4,046,709. MAISON DES FUTAILLES S.E.C., DBA KRUGER  
WINES & SPIRITS, CHICAGO, IL. SN 85-135,515. PUB. 3-8-  
2011, FILED 9-22-2010.

**SPICEBOX**

THE MARK CONSISTS OF STANDARD CHARACTERS  
WITHOUT CLAIM TO ANY PARTICULAR FONT, STYLE,  
SIZE, OR COLOR.  
FOR ALCOHOLIC BEVERAGES, NAMELY, FLAVOR-  
INFUSED WHISKEY; WHISKEY (U.S. CLS. 47 AND 49).  
FIRST USE 5-25-2011; IN COMMERCE 5-25-2011.

4,046,768. RIVERAERIE CELLARS LLC, DBA BUNNELL  
FAMILY CELLAR, RIVERAERIE, PROSSER, WA. SN 85-  
152,198. PUB. 4-19-2011, FILED 10-13-2010.

**wine o'clock**

THE MARK CONSISTS OF STANDARD CHARACTERS  
WITHOUT CLAIM TO ANY PARTICULAR FONT, STYLE,  
SIZE, OR COLOR.  
OWNER OF U.S. REG. NO. 3,732,281.  
NO CLAIM IS MADE TO THE EXCLUSIVE RIGHT TO  
USE "WINE", APART FROM THE MARK AS SHOWN.  
FOR GRAPE WINE (U.S. CLS. 47 AND 49).  
FIRST USE 7-21-2011; IN COMMERCE 7-21-2011.

4,046,770. FINCA FLICHMAN S.A., BUENOS AIRES 1066,  
ARGENTINA. SN 85-152,994. PUB. 4-19-2011, FILED 10-14-  
2010.

**TIERRA DE ANTES**

THE MARK CONSISTS OF STANDARD CHARACTERS  
WITHOUT CLAIM TO ANY PARTICULAR FONT, STYLE,  
SIZE, OR COLOR.  
THE ENGLISH TRANSLATION OF "TIERRA DE ANTES"  
IS "PAST LAND".  
FOR WINES (U.S. CLS. 47 AND 49).  
FIRST USE 2-0-2011; IN COMMERCE 2-0-2011.

**CLASS 33—(Continued).**

4,046,805. PATERNO IMPORTS, LTD., DBA TERLATO WINES INTERNATIONAL, LAKE BLUFF, IL. SN 85-162,759. PUB. 3-22-2011, FILED 10-27-2010.

**DUELING PISTOLS**

THE MARK CONSISTS OF STANDARD CHARACTERS WITHOUT CLAIM TO ANY PARTICULAR FONT, STYLE, SIZE, OR COLOR.

FOR WINE (U.S. CLS. 47 AND 49).  
FIRST USE 7-21-2011; IN COMMERCE 7-21-2011.

**CLASS 33—(Continued).**

4,046,848. E. & J. GALLO WINERY, MODESTO, CA. SN 85-177,750. PUB. 5-10-2011, FILED 11-16-2010.

**FOUNDER'S OAK**

THE MARK CONSISTS OF STANDARD CHARACTERS WITHOUT CLAIM TO ANY PARTICULAR FONT, STYLE, SIZE, OR COLOR.

NO CLAIM IS MADE TO THE EXCLUSIVE RIGHT TO USE "OAK", APART FROM THE MARK AS SHOWN.  
FOR WINES (U.S. CLS. 47 AND 49).  
FIRST USE 4-30-2011; IN COMMERCE 4-30-2011.

4,046,833. MICHAEL-DAVID, LLC, LODI, CA. SN 85-171,889.  
PUB. 3-29-2011, FILED 11-8-2010.



THE MARK CONSISTS OF A PAIR OF INTERSECTING CORKSCREWS WITH THE LETTERS "M", "D" AND "W" IN THE BACKGROUND.

FOR WINE (U.S. CLS. 47 AND 49).  
FIRST USE 7-0-2011; IN COMMERCE 7-0-2011.

4,046,880. 3D DEVELOPMENT & HOLDINGS LLC, PHOENIX, AZ. SN 85-189,161. PUB. 4-19-2011, FILED 12-2-2010.

**Camp Jack**

THE MARK CONSISTS OF STANDARD CHARACTERS WITHOUT CLAIM TO ANY PARTICULAR FONT, STYLE, SIZE, OR COLOR.

FOR WINE (U.S. CLS. 47 AND 49).  
FIRST USE 8-23-2011; IN COMMERCE 8-23-2011.

4,046,838. A TO Z WINeworks, LLC, NEWBERG, OR. SN 85-173,907. PUB. 3-29-2011, FILED 11-10-2010.

**SILVER  BLACK**

THE MARK CONSISTS OF THE WORDS "SILVER" AND "BLACK" WITH THE DESIGN OF A SPUR IN BETWEEN THE TWO WORDS.

FOR WINE (U.S. CLS. 47 AND 49).  
FIRST USE 2-16-2011; IN COMMERCE 2-16-2011.

4,046,881. 3D DEVELOPMENT & HOLDINGS LLC, PHOENIX, AZ. SN 85-189,179. PUB. 4-19-2011, FILED 12-2-2010.

**The Wine that Grows on  
Trees**

THE MARK CONSISTS OF STANDARD CHARACTERS WITHOUT CLAIM TO ANY PARTICULAR FONT, STYLE, SIZE, OR COLOR.

FOR FRUIT WINE (U.S. CLS. 47 AND 49).  
FIRST USE 8-23-2011; IN COMMERCE 8-23-2011.

**CLASS 33—(Continued).**

4,046,901. TALL GUY WINES, LLC, ST. HELENA, CA. SN 85-193,573. PUB. 5-3-2011, FILED 12-8-2010.

## Tall Guy Wines

THE MARK CONSISTS OF STANDARD CHARACTERS WITHOUT CLAIM TO ANY PARTICULAR FONT, STYLE, SIZE, OR COLOR.

NO CLAIM IS MADE TO THE EXCLUSIVE RIGHT TO USE "WINES", APART FROM THE MARK AS SHOWN. FOR WINE (U.S. CLS. 47 AND 49). FIRST USE 5-9-2011; IN COMMERCE 5-9-2011.

**CLASS 33—(Continued).**

4,047,084. CARINA WINES, LLC, RENO, NV. SN 85-283,537. PUB. 6-28-2011, FILED 4-1-2011.

## Z53

THE MARK CONSISTS OF STANDARD CHARACTERS WITHOUT CLAIM TO ANY PARTICULAR FONT, STYLE, SIZE, OR COLOR.

FOR WINE (U.S. CLS. 47 AND 49). FIRST USE 7-10-2011; IN COMMERCE 7-10-2011.

4,046,994. FINE ESTATES FROM SPAIN, INC., DEDHAM, MA. SN 85-217,057. PUB. 6-7-2011, FILED 1-13-2011.

## TARIMA HILL

THE MARK CONSISTS OF STANDARD CHARACTERS WITHOUT CLAIM TO ANY PARTICULAR FONT, STYLE, SIZE, OR COLOR.

OWNER OF U.S. REG. NOS. 3,884,185 AND 3,887,825. THE NAME(S), PORTRAIT(S), AND/OR SIGNATURE(S) SHOWN IN THE MARK DOES NOT IDENTIFY A PARTICULAR LIVING INDIVIDUAL.

THE ENGLISH TRANSLATION OF "TARIMA" IN THE MARK IS "PLATFORM".

FOR WINES (U.S. CLS. 47 AND 49). FIRST USE 6-29-2011; IN COMMERCE 6-29-2011.

4,047,086. DYSON, CHRISTOPHER, WEST HOLLYWOOD, CA. SN 85-293,418. PUB. 6-28-2011, FILED 4-12-2011.

## DRINK?...NATURALLY

THE MARK CONSISTS OF STANDARD CHARACTERS WITHOUT CLAIM TO ANY PARTICULAR FONT, STYLE, SIZE, OR COLOR.

FOR AN ALCOHOLIC BEVERAGE MADE PRIMARILY WITH VODKA AND COCONUT JUICE (U.S. CLS. 47 AND 49).

FIRST USE 7-1-2011; IN COMMERCE 7-1-2011.

4,047,018. SALT COMMUNICATIONS LLC, CHICAGO, IL. SN 85-224,737. PUB. 5-31-2011, FILED 1-24-2011.

## BRELLA

THE MARK CONSISTS OF STANDARD CHARACTERS WITHOUT CLAIM TO ANY PARTICULAR FONT, STYLE, SIZE, OR COLOR.

FOR WINE (U.S. CLS. 47 AND 49). FIRST USE 1-31-2011; IN COMMERCE 1-31-2011.

**CLASS 34—SMOKERS' ARTICLES**

4,045,724. FUENTE MARKETING LTD., PROVIDENCIALES, TURKS/CAICOS IS. SN 77-453,176. PUB. 9-16-2008, FILED 4-21-2008.

## NEVER ENDING STORY

THE MARK CONSISTS OF STANDARD CHARACTERS WITHOUT CLAIM TO ANY PARTICULAR FONT, STYLE, SIZE, OR COLOR.

FOR CIGARS (U.S. CLS. 2, 8, 9 AND 17). FIRST USE 7-9-2010; IN COMMERCE 7-9-2010.

**CLASS 34—(Continued).**

4,046,156. DAVIDOFF & CIE SA, 1200 GENEVA, SWITZERLAND. SN 77-967,328. PUB. 8-3-2010, FILED 3-24-2010.



*Zino*

**ZINO PLATINUM**  
SCEPTER SERIES

OWNER OF U.S. REG. NOS. 2,819,729, 3,029,488, AND OTHERS.

NO CLAIM IS MADE TO THE EXCLUSIVE RIGHT TO USE "SERIES", APART FROM THE MARK AS SHOWN.

THE NAME(S), PORTRAIT(S), AND/OR SIGNATURE(S) SHOWN IN THE MARK DOES NOT IDENTIFY A PARTICULAR LIVING INDIVIDUAL.

THE MARK CONSISTS OF A STYLIZED CREST, CENTERED WITHIN WHICH IS A STYLIZED LETTER "Z" OVERLAYING A STYLIZED SCEPTER. CENTERED BENEATH THE CREST DESIGN ARE THE TERMS "ZINO" IN A STYLIZED FONT, BENEATH WITH IS CENTERED "ZINO PLATINUM", BENEATH WHICH IS CENTERED "SCEPTER SERIES".

FOR CIGARS (U.S. CLS. 2, 8, 9 AND 17).  
FIRST USE 6-0-2003; IN COMMERCE 6-0-2003.

4,046,435. JESMER, SUSAN M., DBA NATIVE TRADING ASSOCIATES, HOGANSBURG, NY. SN 85-087,111. PUB. 11-16-2010, FILED 7-17-2010.

**MOHAWK**

THE MARK CONSISTS OF STANDARD CHARACTERS WITHOUT CLAIM TO ANY PARTICULAR FONT, STYLE, SIZE, OR COLOR.

FOR CIGARETTES; SMOKING TOBACCO (U.S. CLS. 2, 8, 9 AND 17).  
FIRST USE 8-16-2011; IN COMMERCE 8-16-2011.

**CLASS 34—(Continued).**

4,046,541. TATUAJE CIGARS, INC., LOS ANGELES, CA. SN 85-101,573. PUB. 1-18-2011, FILED 8-5-2010.

**SAINTS & SINNERS**

THE MARK CONSISTS OF STANDARD CHARACTERS WITHOUT CLAIM TO ANY PARTICULAR FONT, STYLE, SIZE, OR COLOR.

FOR CIGARS (U.S. CLS. 2, 8, 9 AND 17).  
FIRST USE 6-16-2011; IN COMMERCE 6-16-2011.

4,046,625. TATUAJE CIGARS, INC., LOS ANGELES, CA. SN 85-119,112. PUB. 1-18-2011, FILED 8-30-2010.

**AVION**

THE MARK CONSISTS OF STANDARD CHARACTERS WITHOUT CLAIM TO ANY PARTICULAR FONT, STYLE, SIZE, OR COLOR.

THE ENGLISH TRANSLATION OF "AVION" IN THE MARK IS AIRPLANE.

FOR CIGARS (U.S. CLS. 2, 8, 9 AND 17).  
FIRST USE 7-15-2011; IN COMMERCE 7-15-2011.

4,046,757. NICARAGUA AMERICAN CIGAR, S.A., ESTELI NICARAGUA, NICARAGUA. SN 85-148,316. PUB. 3-15-2011, FILED 10-8-2010.

**Red Dot**

THE MARK CONSISTS OF STANDARD CHARACTERS WITHOUT CLAIM TO ANY PARTICULAR FONT, STYLE, SIZE, OR COLOR.

OWNER OF U.S. REG. NO. 270,997.  
FOR CIGARS (U.S. CLS. 2, 8, 9 AND 17).  
FIRST USE 1-1-1908; IN COMMERCE 1-1-1908.

**SERVICE MARKS**

**CLASS 35—ADVERTISING AND BUSINESS**

**CLASS 35—(Continued).**

4,045,580. COSWAY COMPANY, INC., CARSON, CA. SN 76-675,086. PUB. 1-15-2008, FILED 4-5-2007.

## HEAD ORGANICS

THE MARK CONSISTS OF STANDARD CHARACTERS WITHOUT CLAIM TO ANY PARTICULAR FONT, STYLE, SIZE, OR COLOR.

OWNER OF U.S. REG. NO. 3,147,755.

NO CLAIM IS MADE TO THE EXCLUSIVE RIGHT TO USE "ORGANICS", APART FROM THE MARK AS SHOWN. SEC. 2(F) AS TO "HEAD".

FOR ONLINE RETAIL STORE AND MAIL ORDER CATALOG SERVICES IN THE FIELD OF PERSONAL CARE PRODUCTS, COSMETICS, TOILETRIES, FRAGRANCES, SKIN CARE PRODUCTS AND HAIR CARE PRODUCTS, CANDLES, FRAGRANCE ROOM SPRAYS, ESSENTIAL OILS, INCENSE, BOOKS, JEWELRY (U.S. CLS. 100, 101 AND 102).

FIRST USE 4-1-2007; IN COMMERCE 4-1-2007.

**CLASS 35—(Continued).**

4,045,602. SOIGNE K, LLC, NEW YORK, NY. SN 76-704,165. PUB. 7-12-2011, FILED 8-19-2010.

## SOIGNE K

THE MARK CONSISTS OF STANDARD CHARACTERS WITHOUT CLAIM TO ANY PARTICULAR FONT, STYLE, SIZE, OR COLOR.

"SOIGNE K" IDENTIFIES THE UNDERSIGNED, A LIVING INDIVIDUAL, "SOIGNE KOTHARI", WHOSE CONSENT AND AUTHORIZATION IS SET FORTH HERE IN ABOVE.

FOR RETAIL STORE SERVICES IN THE FIELD OF WOMEN'S ACCESSORIES FEATURING HANDBAGS, SCARVES, SHOES, PERFUMES, JEWELRY AND CLOTHING (U.S. CLS. 100, 101 AND 102).

FIRST USE 9-14-2010; IN COMMERCE 9-14-2010.

4,045,593. MAX PAY GOLD, LLC, FORT WORTH, TX. SN 76-703,243. PUB. 11-23-2010, FILED 6-4-2010.

## MAX PAY GOLD

THE MARK CONSISTS OF STANDARD CHARACTERS WITHOUT CLAIM TO ANY PARTICULAR FONT, STYLE, SIZE, OR COLOR.

NO CLAIM IS MADE TO THE EXCLUSIVE RIGHT TO USE "PAY GOLD", APART FROM THE MARK AS SHOWN.

FOR RETAIL STORE SERVICES, ONLINE RETAIL STORE SERVICES, MAIL ORDER SERVICES AND RETAIL SHOP-AT-HOME PARTY SERVICES ALL FEATURING GOLD, OTHER PRECIOUS METALS AND PRECIOUS STONES (U.S. CLS. 100, 101 AND 102).

FIRST USE 2-24-2010; IN COMMERCE 3-15-2010.

4,045,634. FOUNDATION HEALTHCARE AFFILIATES, LLC, OKLAHOMA CITY, OK. SN 77-207,253. PUB. 5-20-2008, FILED 6-15-2007.

## FOUNDATION HEALTHCARE AFFILIATES

THE MARK CONSISTS OF STANDARD CHARACTERS WITHOUT CLAIM TO ANY PARTICULAR FONT, STYLE, SIZE, OR COLOR.

OWNER OF U.S. REG. NO. 2,668,387.

NO CLAIM IS MADE TO THE EXCLUSIVE RIGHT TO USE "HEALTHCARE AFFILIATES", APART FROM THE MARK AS SHOWN.

FOR BUSINESS DEVELOPMENT SERVICES, NAMELY, DEVELOPING, STARTING UP AND OPENING AMBULATORY SURGERY CENTERS AND SURGICAL HOSPITALS, AND MANAGEMENT SERVICES FOR EXISTING AMBULATORY SURGERY CENTERS AND SURGICAL HOSPITALS (U.S. CLS. 100, 101 AND 102).

FIRST USE 8-12-2011; IN COMMERCE 8-12-2011.

**CLASS 35—(Continued).**

4,045,636. JAMES K. LACY, MISSION, KS. SN 77-209,388.  
PUB. 5-27-2008, FILED 6-19-2007.

# QUIKFLIP

THE MARK CONSISTS OF STANDARD CHARACTERS WITHOUT CLAIM TO ANY PARTICULAR FONT, STYLE, SIZE, OR COLOR.

FOR WHOLESALE STORES FEATURING TOYS, GAMES AND NOVELTY ITEMS; ON-LINE RETAIL STORE SERVICES FEATURING TOYS, GAMES AND NOVELTY ITEMS; RETAIL STORE SERVICES FEATURING TOYS, GAMES AND NOVELTY ITEMS (U.S. CLS. 100, 101 AND 102).

FIRST USE 8-18-2011; IN COMMERCE 8-18-2011.

---

4,045,641. BLUMBERG, J. SETH, HERNDON, VA. SN 77-235,101. PUB. 6-3-2008, FILED 7-20-2007.

# FANS RULE

THE MARK CONSISTS OF STANDARD CHARACTERS WITHOUT CLAIM TO ANY PARTICULAR FONT, STYLE, SIZE, OR COLOR.

FOR CONDUCTING PUBLIC OPINION POLLS; PROVIDING ONLINE OPINION POLLING SERVICES; PROVIDING ONLINE USER-DIRECTED OPINION POLLING SERVICES; PROVIDING USER-DESIGNATED ONLINE OPINION POLLS; PROMOTING THE GOODS AND SERVICES OF OTHERS VIA A GLOBAL COMPUTER NETWORK (U.S. CLS. 100, 101 AND 102).

FIRST USE 7-27-2011; IN COMMERCE 8-22-2011.

---

4,045,664. WELLS, KEVIN VINCENT GUSTAVUS, NEW YORK, NY. SN 77-342,105. PUB. 5-20-2008, FILED 12-3-2007.

# ADDVENDOR

THE MARK CONSISTS OF STANDARD CHARACTERS WITHOUT CLAIM TO ANY PARTICULAR FONT, STYLE, SIZE, OR COLOR.

FOR PROVIDING AN ONLINE SECURED DATABASE FEATURING TRADE INFORMATION, NAMELY, AN IDENTIFICATION OF CUSTOMERS AND MATCHING OF SUPPLIER INFORMATION RELATING TO DOMESTIC AND INTERNATIONAL TRADE (U.S. CLS. 100, 101 AND 102).

FIRST USE 7-27-2011; IN COMMERCE 7-27-2011.

**CLASS 35—(Continued).**

4,045,681. PEACELABS MUSIC, INC., SAN FRANCISCO, CA. SN 77-377,670. PUB. 6-3-2008, FILED 1-22-2008.

# MISSION DRIVEN LIVING

THE MARK CONSISTS OF STANDARD CHARACTERS WITHOUT CLAIM TO ANY PARTICULAR FONT, STYLE, SIZE, OR COLOR.

FOR CHARITABLE SERVICES, NAMELY, ORGANIZING AND CONDUCTING VOLUNTEER PROGRAMS AND COMMUNITY SERVICE PROJECTS; ORGANIZING, PLANNING, ARRANGING AND CONDUCTING BUSINESS OPERATIONS RELATING TO VOLUNTEER PROGRAMS AND COMMUNITY SERVICE PROJECTS (U.S. CLS. 100, 101 AND 102).

FIRST USE 7-5-2008; IN COMMERCE 8-17-2011.

---

4,045,709. BISON CAPITAL LLC, VENICE, FL. SN 77-420,940.  
PUB. 6-17-2008, FILED 3-13-2008.

# GREEN NEIGHBOR

THE MARK CONSISTS OF STANDARD CHARACTERS WITHOUT CLAIM TO ANY PARTICULAR FONT, STYLE, SIZE, OR COLOR.

NO CLAIM IS MADE TO THE EXCLUSIVE RIGHT TO USE "GREEN", APART FROM THE MARK AS SHOWN.

FOR CATALOG ORDERING, MAIL ORDER, AND DISTRIBUTORSHIP SERVICES FEATURING ENVIRONMENTALLY FRIENDLY PRODUCTS (U.S. CLS. 100, 101 AND 102).

FIRST USE 3-14-2011; IN COMMERCE 3-14-2011.

**CLASS 35—(Continued).**

4,045,719. DREXEL UNIVERSITY, PHILADELPHIA, PA. SN 77-437,099. PUB. 6-16-2009, FILED 4-1-2008.

## ENGAGING U

THE MARK CONSISTS OF STANDARD CHARACTERS WITHOUT CLAIM TO ANY PARTICULAR FONT, STYLE, SIZE, OR COLOR.

FOR HUMAN RESOURCES SERVICES AND SOLUTIONS, NAMELY, PROVIDING INFORMATION TO POTENTIAL JOB APPLICANTS REGARDING EMPLOYMENT, CAREERS, RECRUITMENT, JOB RESOURCES, AND BENEFITS THAT ENABLE INCREASED FACULTY, STAFF AND STUDENT ENGAGEMENT THROUGH A HUMAN CAPITAL APPROACH DESIGNED TO ATTRACT, REWARD, DEVELOP AND RETAIN DIVERSE QUALITY TALENT (U.S. CLS. 100, 101 AND 102).

FIRST USE 2-1-2010; IN COMMERCE 2-1-2010.

4,045,738. STEVE RINKENBERGER, PHOENIX, AZ. SN 77-504,572. PUB. 11-11-2008, FILED 6-20-2008.

## CLEARPROFIT

THE MARK CONSISTS OF STANDARD CHARACTERS WITHOUT CLAIM TO ANY PARTICULAR FONT, STYLE, SIZE, OR COLOR.

FOR BUSINESS CONSULTATION SERVICES (U.S. CLS. 100, 101 AND 102).

FIRST USE 5-6-2009; IN COMMERCE 1-25-2010.

4,045,763. CITYLIFE REAL ESTATE GROUP, INC., HOBOKEN, NJ. SN 77-569,381. PUB. 3-3-2009, FILED 9-13-2008.

## CITYLIFE GREEN

THE MARK CONSISTS OF STANDARD CHARACTERS WITHOUT CLAIM TO ANY PARTICULAR FONT, STYLE, SIZE, OR COLOR.

**CLASS 35—(Continued).**

NO CLAIM IS MADE TO THE EXCLUSIVE RIGHT TO USE "GREEN", APART FROM THE MARK AS SHOWN.

FOR MATCHING CONSUMERS WITH REAL ESTATE PROFESSIONALS IN THE FIELD OF REAL ESTATE SERVICES VIA COMPUTER NETWORK; PROMOTING THE GOODS AND SERVICES OF OTHERS BY PROVIDING HYPERTEXT LINKS TO THE WEB SITES OF OTHERS IN THE FIELD OF REAL ESTATE; PROMOTING, ADVERTISING AND MARKETING OF THE ONLINE WEB SITES OF OTHERS IN THE FIELD OF REAL ESTATE; PROVIDING LISTINGS OF BUSINESSES FOR SALE; PROVIDING REAL ESTATE LEADS FOR PROSPECTIVE PURCHASERS; REAL ESTATE ADVERTISING SERVICES; REAL ESTATE AUCTIONS; REAL ESTATE MARKETING SERVICES IN THE FIELD OF RESIDENTIAL AND COMMERCIAL REAL ESTATE; REAL ESTATE MARKETING SERVICES, NAMELY, ON-LINE SERVICES FEATURING THE PROMOTION OF RESIDENTIAL NEW CONSTRUCTION, WHICH ALSO CONTAINS BACK OFFICE SOLUTIONS FOR BUILDERS; REAL ESTATE MARKETING SERVICES, NAMELY, ON-LINE SERVICES FEATURING TOURS OF RESIDENTIAL AND COMMERCIAL REAL ESTATE; REAL ESTATE SALES MANAGEMENT (U.S. CLS. 100, 101 AND 102).

FIRST USE 4-14-2010; IN COMMERCE 4-14-2010.

4,045,772. INTERSECT PTP, INC., SEATTLE, WA. SN 77-606,698. PUB. 6-7-2011, FILED 11-4-2008.

## INTERSECT

THE MARK CONSISTS OF STANDARD CHARACTERS WITHOUT CLAIM TO ANY PARTICULAR FONT, STYLE, SIZE, OR COLOR.

FOR ADVERTISING AND PROMOTIONAL SERVICES AND RELATED CONSULTING, IN THE FIELD OF ONLINE ADVERTISING SERVICES; PROVIDING ONLINE ADVERTISING SERVICES FEATURING ADVERTISING IN THE FIELDS OF CLASSIFIED ADVERTISEMENTS, VIRTUAL COMMUNITIES, SOCIAL NETWORKING, SOCIAL INTRODUCTIONS; PROVIDING ON-LINE COMPUTER DATABASES AND ON-LINE SEARCHABLE DATABASES IN THE FIELD OF CLASSIFIED ADVERTISEMENTS (U.S. CLS. 100, 101 AND 102).

FIRST USE 9-8-2010; IN COMMERCE 9-8-2010.



**CLASS 35—(Continued).**

4,045,789. PERSEPHONE 11 INC., WEST ISLIP, NY. SN 77-642,037. PUB. 11-24-2009, FILED 12-31-2008.



THE STIPPLING IS FOR SHADING PURPOSES ONLY. THE MARK CONSISTS OF THE STYLIZED TEXT "GS" BOXED IN.

FOR ON-LINE RETAIL STORE SERVICES FEATURING CLOTHING, JEWELRY AND ACCESSORIES (U.S. CLS. 100, 101 AND 102).

FIRST USE 5-21-2011; IN COMMERCE 5-21-2011.

**CLASS 35—(Continued).**

4,045,803. ACCESS COMMUNITY HEALTH NETWORK, CHICAGO, IL. SN 77-661,584. PUB. 5-26-2009, FILED 2-2-2009.



THE MARK CONSISTS OF A STYLIZED FIGURE OF A LEGLESS WOMAN WITH ARMS OUTSTRETCHED. THE HEAD IS FORMED BY A LOOP OF RIBBON AND THE WOMAN IS WEARING A SLEEVELESS DRESS.

FOR CONDUCTING EVENTS FOR PROMOTING BREAST CANCER AWARENESS AND SCREENINGS, AND FOR PUBLICIZING DIAGNOSTIC AND TREATMENT OPPORTUNITIES FOR WHICH WOMEN MAY BE ELIGIBLE (U.S. CLS. 100, 101 AND 102).

FIRST USE 3-31-2009; IN COMMERCE 3-31-2009.

4,045,791. PERSEPHONE 11 INC., WEST ISLIP, NY. SN 77-643,660. PUB. 11-24-2009, FILED 1-5-2009.



THE STIPPLING IS FOR SHADING PURPOSES ONLY. THE MARK CONSISTS OF THE STYLIZED TEXT "G" INSIDE A CIRCLE.

FOR ON-LINE RETAIL STORE SERVICES FEATURING CLOTHING, JEWELRY AND ACCESSORIES (U.S. CLS. 100, 101 AND 102).

FIRST USE 5-22-2011; IN COMMERCE 5-22-2011.

4,045,824. HARRIS, KENNETH, MONTREAL, CANADA. SN 77-696,687. PUB. 9-29-2009, FILED 3-23-2009.

**PLUSGRADE**

THE MARK CONSISTS OF STANDARD CHARACTERS WITHOUT CLAIM TO ANY PARTICULAR FONT, STYLE, SIZE, OR COLOR.

FOR ONLINE TICKET UPGRADE SERVICES, NAMELY, PROVIDING THIRD-PARTY OFFERS TO CONSUMERS WITH EXISTING TICKET RESERVATIONS FOR TRAVEL, ENTERTAINMENT, LODGING, OR OTHER TICKETED ACTIVITIES FOR THE PURPOSES OF UPGRADING THEIR TICKETS WITH TICKET PROVIDERS (U.S. CLS. 100, 101 AND 102).

FIRST USE 7-1-2009; IN COMMERCE 1-15-2010.

**CLASS 35—(Continued).**

4,045,939. HENRI BENDEL, INC., NEW YORK, NY. SN 77-844,169. PUB. 8-31-2010, FILED 10-8-2009.

**THE NEW & THE NEXT**

THE MARK CONSISTS OF STANDARD CHARACTERS WITHOUT CLAIM TO ANY PARTICULAR FONT, STYLE, SIZE, OR COLOR.

FOR RETAIL STORE SERVICES, MAIL ORDER CATALOG SERVICES AND ON-LINE RETAIL STORE SERVICES FEATURING CLOTHING, HANDBAGS, FRAGRANCES, JEWELRY AND CANDLES (U.S. CLS. 100, 101 AND 102).

FIRST USE 11-30-2006; IN COMMERCE 11-30-2006.

4,045,948. RYDER, TRACEY ANN, SANTA BARBARA, CA. AND TOPALIAN, CAROLE JANE, SANTA BARBARA, CA. SN 77-851,547. PUB. 4-6-2010, FILED 10-19-2009.

**EDIBLE MEDIA**

THE MARK CONSISTS OF STANDARD CHARACTERS WITHOUT CLAIM TO ANY PARTICULAR FONT, STYLE, SIZE, OR COLOR.

OWNER OF U.S. REG. NOS. 3,391,715, 3,474,533, AND OTHERS.

NO CLAIM IS MADE TO THE EXCLUSIVE RIGHT TO USE "MEDIA", APART FROM THE MARK AS SHOWN.

FOR ADVERTISING, MARKETING AND PROMOTION SERVICES; BUSINESS CONSULTING AND MANAGEMENT REGARDING MARKETING ACTIVITIES AND LAUNCHING OF NEW PRODUCTS; BUSINESS MARKETING CONSULTING SERVICES; BUSINESS MARKETING SERVICES; COOPERATIVE ADVERTISING AND MARKETING (U.S. CLS. 100, 101 AND 102).

FIRST USE 4-1-2010; IN COMMERCE 4-1-2010.

**CLASS 35—(Continued).**

4,045,965. ENERGY EDUCATION, INC., DALLAS, TX. SN 77-870,892. PUB. 4-13-2010, FILED 11-12-2009.

**NICKELS AND DIMES,  
MILLIONS OF TIMES**

THE MARK CONSISTS OF STANDARD CHARACTERS WITHOUT CLAIM TO ANY PARTICULAR FONT, STYLE, SIZE, OR COLOR.

FOR CONSULTATION IN THE FIELD OF ENERGY EFFICIENCY; ENERGY AUDITING; ENERGY USAGE MANAGEMENT; ENERGY USAGE MANAGEMENT INFORMATION SERVICES; INFORMATION IN THE FIELD OF ENERGY EFFICIENCY (U.S. CLS. 100, 101 AND 102).

FIRST USE 3-1-2010; IN COMMERCE 3-1-2010.

4,045,978. LY, THON SIEU, DBA HEART BANK, LONG BEACH, CA. SN 77-884,746. PUB. 7-20-2010, FILED 12-2-2009.

**Heart Bank**

THE MARK CONSISTS OF STANDARD CHARACTERS WITHOUT CLAIM TO ANY PARTICULAR FONT, STYLE, SIZE, OR COLOR.

FOR ACCOUNTING SERVICES (U.S. CLS. 100, 101 AND 102).

FIRST USE 5-1-2007; IN COMMERCE 2-6-2011.

4,045,987. NUCLEUS WORLDWIDE, LLC, HERMOSA BEACH, CA. SN 77-893,593. PUB. 12-21-2010, FILED 12-15-2009.



NO CLAIM IS MADE TO THE EXCLUSIVE RIGHT TO USE "WORLDWIDE", APART FROM THE MARK AS SHOWN.

THE COLOR(S) LIGHT BLUE, NAVY BLUE, PURPLE AND BLACK. IS/ARE CLAIMED AS A FEATURE OF THE MARK.

**CLASS 35—(Continued).**

THE MARK CONSISTS OF AN AMOeba DESIGN IN NAVY BLUE, LIGHT BLUE, AND PURPLE TO THE LEFT OF THE WORDING "NUCLEUS WORLDWIDE" IN BLACK, THE COLOR WHITE APPEARING IN THE INNER PORTION OF THE DESIGN ELEMENT REPRESENTS BACKGROUND AND IS NOT A PART OF THE MARK.

FOR ADVERTISING AND MARKETING SERVICES, NAMELY, PROMOTING THE GOODS AND SERVICES OF OTHERS, EXCEPT IN THE AREA OF LIFE SCIENCES AND HEALTHCARE TECHNOLOGY (U.S. CLS. 100, 101 AND 102).

FIRST USE 2-1-2010; IN COMMERCE 2-1-2010.

---

4,045,990. HANOVER COMPANY STORE, LLC, WEEHAWKEN, NJ. SN 77-895,447. PUB. 12-14-2010, FILED 12-17-2009.

THE COMPANY STORE  
WE'RE ALL ABOUT COMFORT

THE MARK CONSISTS OF STANDARD CHARACTERS WITHOUT CLAIM TO ANY PARTICULAR FONT, STYLE, SIZE, OR COLOR.

OWNER OF U.S. REG. NOS. 1,263,272, 1,284,377, AND 2,573,439.

SEC. 2(F) AS TO "THE COMPANY STORE".

FOR MAIL ORDER CATALOG SERVICES FEATURING BEDDING PRODUCTS, TOWELS, PILLOWS, PILLOW PROTECTORS, FEATHERBED PROTECTORS, CLOTHING, BATHROBES, SLIPPERS, MATTRESS PADS, FEATHERBEDS, AND TRAVEL PILLOWS; ON-LINE RETAIL STORE SERVICES FEATURING BEDDING PRODUCTS, TOWELS, PILLOWS, PILLOW PROTECTORS, FEATHERBED PROTECTORS, CLOTHING, BATHROBES, SLIPPERS, MATTRESS PADS, FEATHERBEDS, AND TRAVEL PILLOWS (U.S. CLS. 100, 101 AND 102).

FIRST USE 12-8-2009; IN COMMERCE 12-8-2009.

---

4,046,037. PARTNERSHIP FOR A DRUG-FREE NEW JERSEY, THE, MILLBURN, NJ. SN 77-925,719. PUB. 5-3-2011, FILED 2-2-2010.



NO CLAIM IS MADE TO THE EXCLUSIVE RIGHT TO USE "THE AMERICAN MEDICINE" AND "CHALLENGE", APART FROM THE MARK AS SHOWN.

THE MARK CONSISTS OF A STAR WITH STARS AND STRIPES INSIDE THE STAR AND A PRESCRIPTION BOTTLE.

FOR ARRANGING AND CONDUCTING SPECIAL EVENTS FOR DISPOSAL OF EXPIRED AND UNUSED MEDICATIONS FOR BUSINESS PURPOSES, NAMELY, FOR PUBLIC SERVICE PURPOSES (U.S. CLS. 100, 101 AND 102).

FIRST USE 7-0-2010; IN COMMERCE 7-0-2010.

**CLASS 35—(Continued).**

4,046,069. ADDIS INTELLECTUAL CAPITAL, LLC, KING OF PRUSSIA, PA. SN 77-935,711. PUB. 1-11-2011, FILED 2-15-2010.

## RISK RUNNER 360

THE MARK CONSISTS OF STANDARD CHARACTERS WITHOUT CLAIM TO ANY PARTICULAR FONT, STYLE, SIZE, OR COLOR.

NO CLAIM IS MADE TO THE EXCLUSIVE RIGHT TO USE "RISK", APART FROM THE MARK AS SHOWN.

FOR INFORMATION, ADVISORY AND CONSULTANCY SERVICES IN THE FIELD OF BUSINESS RISK MANAGEMENT; PROVIDING A WEBSITE FEATURING INFORMATION, ADVISORY AND CONSULTANCY SERVICES IN THE FIELD OF BUSINESS RISK MANAGEMENT (U.S. CLS. 100, 101 AND 102).

FIRST USE 12-31-2010; IN COMMERCE 12-31-2010.

---

4,046,077. THE BRAINY BABY COMPANY, LLC, SUWANEE, GA. SN 77-937,785. PUB. 7-13-2010, FILED 2-17-2010.

## BRAINYLAND

THE MARK CONSISTS OF STANDARD CHARACTERS WITHOUT CLAIM TO ANY PARTICULAR FONT, STYLE, SIZE, OR COLOR.

OWNER OF U.S. REG. NOS. 3,353,556, 3,482,000, AND OTHERS.

FOR WHOLESALE AND RETAIL STORE SERVICES AND ON-LINE RETAIL AND WHOLESALE STORE SERVICES FEATURING GENERAL CONSUMER MERCHANDISE FOR INFANTS AND CHILDREN (U.S. CLS. 100, 101 AND 102).

FIRST USE 8-1-2011; IN COMMERCE 8-1-2011.

**CLASS 35—(Continued).**

4,046,092. ADVANTAGE RESOURCING AMERICA, INC., NORWOOD, MA. SN 77-944,170. PUB. 1-4-2011, FILED 2-24-2010.



The logo for Advantage xPO features the word "Advantage" in a large, serif font. To its right, "xPO" is written in a smaller, sans-serif font, with the "x" and "P" overlapping. The "O" is a large, stylized letter that partially overlaps the end of "Advantage".

OWNER OF U.S. REG. NOS. 2,415,344, 3,549,496, AND OTHERS.

FOR EMPLOYMENT AGENCY SERVICES; EMPLOYMENT COUNSELING AND RECRUITING; EMPLOYMENT HIRING, PLACEMENT, STAFFING AND CAREER NETWORKING SERVICES; EMPLOYMENT OUTPLACEMENT SERVICES; TEMPORARY EMPLOYMENT AGENCY SERVICES; MANAGEMENT AND CONSULTATION IN THE FIELD OF HUMAN RESOURCES FOR BUSINESS; MANAGEMENT PERSONNEL STAFFING, PLACEMENT AND RECRUITMENT SERVICES; EMPLOYEE LEASING, RELOCATION AND INFORMATION SERVICES; EMPLOYEE ADMINISTRATIVE SERVICES; ON-SITE EMPLOYEE AND STAFFING MANAGEMENT SERVICES; VENDOR MANAGEMENT SERVICES FOR BUSINESS OFFICES; PERSONNEL OUTSOURCING SERVICES (U.S. CLS. 100, 101 AND 102).

FIRST USE 10-1-2009; IN COMMERCE 10-1-2009.

4,046,093. ADVANTAGE RESOURCING AMERICA, INC., NORWOOD, MA. SN 77-944,173. PUB. 12-21-2010, FILED 2-24-2010.

## HIRE THINKING

THE MARK CONSISTS OF STANDARD CHARACTERS WITHOUT CLAIM TO ANY PARTICULAR FONT, STYLE, SIZE, OR COLOR.

OWNER OF U.S. REG. NO. 3,236,569.

FOR EMPLOYMENT AGENCY SERVICES; EMPLOYMENT COUNSELING AND RECRUITING; EMPLOYMENT HIRING, PLACEMENT, STAFFING AND CAREER NETWORKING SERVICES; EMPLOYMENT OUTPLACEMENT SERVICES; TEMPORARY EMPLOYMENT AGENCY SERVICES; MANAGEMENT AND CONSULTATION IN THE FIELD OF HUMAN RESOURCES FOR BUSINESS; MANAGEMENT PERSONNEL STAFFING, PLACEMENT AND RECRUITMENT SERVICES; EMPLOYEE LEASING, RELOCATION AND INFORMATION SERVICES; EMPLOYEE ADMINISTRATIVE SERVICES; ON-SITE EMPLOYEE AND STAFFING MANAGEMENT SERVICES; VENDOR MANAGEMENT SERVICES FOR BUSINESS OFFICES; PERSONNEL OUTSOURCING SERVICES (U.S. CLS. 100, 101 AND 102).

FIRST USE 7-11-2004; IN COMMERCE 7-11-2004.

**CLASS 35—(Continued).**

4,046,094. ADVANTAGE RESOURCING AMERICA, INC., NORWOOD, MA. SN 77-944,176. PUB. 12-21-2010, FILED 2-24-2010.

## HIRETHINKING.COM

THE MARK CONSISTS OF STANDARD CHARACTERS WITHOUT CLAIM TO ANY PARTICULAR FONT, STYLE, SIZE, OR COLOR.

OWNER OF U.S. REG. NO. 3,236,569.

NO CLAIM IS MADE TO THE EXCLUSIVE RIGHT TO USE ".COM", APART FROM THE MARK AS SHOWN.

FOR EMPLOYMENT AGENCY SERVICES; EMPLOYMENT COUNSELING AND RECRUITING; EMPLOYMENT HIRING, PLACEMENT, STAFFING AND CAREER NETWORKING SERVICES; EMPLOYMENT OUTPLACEMENT SERVICES; TEMPORARY EMPLOYMENT AGENCY SERVICES; MANAGEMENT AND CONSULTATION IN THE FIELD OF HUMAN RESOURCES FOR BUSINESS; MANAGEMENT PERSONNEL STAFFING, PLACEMENT AND RECRUITMENT SERVICES; EMPLOYEE LEASING, RELOCATION AND INFORMATION SERVICES; EMPLOYEE ADMINISTRATIVE SERVICES; ON-SITE EMPLOYEE AND STAFFING MANAGEMENT SERVICES; VENDOR MANAGEMENT SERVICES FOR BUSINESS OFFICES; PERSONNEL OUTSOURCING SERVICES (U.S. CLS. 100, 101 AND 102).

FIRST USE 7-11-2004; IN COMMERCE 7-11-2004.

4,046,104. PRIMUS ASSURANCE GROUP, SALT LAKE CITY, UT. SN 77-947,528. PUB. 2-15-2011, FILED 3-1-2010.

## PROFESSIONAL GUARD

THE MARK CONSISTS OF STANDARD CHARACTERS WITHOUT CLAIM TO ANY PARTICULAR FONT, STYLE, SIZE, OR COLOR.

NO CLAIM IS MADE TO THE EXCLUSIVE RIGHT TO USE "PROFESSIONAL", APART FROM THE MARK AS SHOWN.

FOR PROVIDING A PRICING PROGRAM IN THE FIELDS OF ERRORS AND OMISSIONS INSURANCE, CYBER LIABILITY INSURANCE, BUSINESS OWNER POLICY INSURANCE, AND BUSINESS INTERRUPTION INSURANCE THROUGH WHICH MEMBERS OF QUALIFIED COMPANIES, ORGANIZATIONS, OR INDIVIDUALS MAY BE OFFERED OR GRANTED DOWNWARD ADJUSTMENTS IN THE PREMIUMS FOR SUCH INSURANCES (U.S. CLS. 100, 101 AND 102).

FIRST USE 10-20-2010; IN COMMERCE 10-20-2010.

**CLASS 35—(Continued).**

4,046,122. APPBACKR INC., PALO ALTO, CA. SN 77-953,149.  
PUB. 7-27-2010, FILED 3-8-2010.

# APPBACKR

THE MARK CONSISTS OF STANDARD CHARACTERS WITHOUT CLAIM TO ANY PARTICULAR FONT, STYLE, SIZE, OR COLOR.

FOR PROVIDING A WEB SITE FOR CONNECTING WEB APPLICATION DEVELOPERS WITH BUYERS AND DISTRIBUTORS (U.S. CLS. 100, 101 AND 102).

FIRST USE 3-21-2010; IN COMMERCE 6-3-2011.

---

4,046,158. AFFINION BENEFITS GROUP, LLC, FRANKLIN, TN. SN 77-968,170. PUB. 12-14-2010, FILED 3-25-2010.



NO CLAIM IS MADE TO THE EXCLUSIVE RIGHT TO USE "CASH SAVINGS", APART FROM THE MARK AS SHOWN.

THE MARK CONSISTS OF A DESIGN OF A CREDIT CARD ENCIRCLED BY A TILTED ORBIT OR RING WITH THREE SURROUNDING STARS AND THE STYLIZED WORDING "EVERYWHERE CASH SAVINGS", UNDERLINED BY A DOTTED LINE, APPEARING TO THE RIGHT OF THE CREDIT CARD.

FOR CONSUMER MEMBERSHIP SERVICES, NAMELY, ADMINISTRATION OF A DISCOUNT PROGRAM ENABLING PARTICIPANTS TO OBTAIN DISCOUNTS AND SAVINGS ON GOODS AND SERVICES, IN THE FIELDS OF, HEALTH AND BEAUTY, DINING, AUTOMOTIVE, LEISURE AND RECREATION, AND OTHER MERCHANDISE AND SERVICES, AND PROVIDING IN CONNECTION THEREWITH AN ON-LINE DIRECTORY OF INFORMATION ABOUT THE PROGRAM AND PARTICIPATING BUSINESSES; PROVIDING DISCOUNT COUPONS FOR PURCHASE OF THE FOREGOING; PROVIDING ALL OF THE FOREGOING SERVICES ELECTRONICALLY BY MEANS OF THE INTERNET; PROVIDING ON-LINE INCENTIVE CASH BACK REWARDS PROGRAM TO DEBIT AND CREDIT CARDHOLDERS TO PROMOTE THE PURCHASE OF RETAIL PRODUCTS BY MEANS OF CREDIT OR DEBIT CARDS (U.S. CLS. 100, 101 AND 102).

FIRST USE 5-1-2010; IN COMMERCE 5-1-2010.

**CLASS 35—(Continued).**

4,046,159. AFFINION BENEFITS GROUP, LLC, FRANKLIN, TN. SN 77-968,179. PUB. 12-14-2010, FILED 3-25-2010.

# EVERYWHERE CASH SAVINGS

THE MARK CONSISTS OF STANDARD CHARACTERS WITHOUT CLAIM TO ANY PARTICULAR FONT, STYLE, SIZE, OR COLOR.

NO CLAIM IS MADE TO THE EXCLUSIVE RIGHT TO USE "CASH SAVINGS", APART FROM THE MARK AS SHOWN.

FOR CONSUMER MEMBERSHIP SERVICES, NAMELY, ADMINISTRATION OF A DISCOUNT PROGRAM ENABLING PARTICIPANTS TO OBTAIN DISCOUNTS AND SAVINGS ON GOODS AND SERVICES, IN THE FIELDS OF, HEALTH AND BEAUTY, DINING, AUTOMOTIVE, LEISURE AND RECREATION, AND OTHER MERCHANDISE AND SERVICES, AND PROVIDING IN CONNECTION THEREWITH AN ON-LINE DIRECTORY OF INFORMATION ABOUT THE PROGRAM AND PARTICIPATING BUSINESSES; PROVIDING DISCOUNT COUPONS FOR PURCHASE OF THE FOREGOING; PROVIDING ALL OF THE FOREGOING SERVICES ELECTRONICALLY BY MEANS OF THE INTERNET; PROVIDING ON-LINE INCENTIVE CASH BACK REWARDS PROGRAM TO DEBIT AND CREDIT CARDHOLDERS TO PROMOTE THE PURCHASE OF RETAIL PRODUCTS BY MEANS OF CREDIT OR DEBIT CARDS (U.S. CLS. 100, 101 AND 102).

FIRST USE 5-1-2010; IN COMMERCE 5-1-2010.

---

4,046,185. LIFE FOR MOTHERS, NEW YORK, NY. SN 77-982,536. PUB. 1-4-2011, FILED 2-9-2010.



NO CLAIM IS MADE TO THE EXCLUSIVE RIGHT TO USE "MOTHERS", APART FROM THE MARK AS SHOWN.

**CLASS 35—(Continued).**

THE MARK CONSISTS OF THE TERM "LIFE FOR MOTHERS" WRAPS HORIZONTALLY ACROSS THE UPPER-LEFT PORTION OF THE MARK. A DESIGN IN THE SHAPE OF A "C" APPEARS TO THE RIGHT OF THE TEXT.

FOR CHARITABLE SERVICES, NAMELY, DEVELOPING, IMPLEMENTING, AND MANAGING INTEGRATED PACKAGES OF HEALTH CARE CONSULTING SERVICES RELATED TO MATERNAL, NEWBORN AND CHILD HEALTH, NAMELY, ORGANIZING VOLUNTEER PROGRAMS AND COMMUNITY SERVICE PROJECTS TO ADVANCE MATERNAL, NEWBORN AND CHILD HEALTH, AND ORGANIZING AND DEVELOPING PROJECTS THAT AIM TO IMPROVE THE LIVES OF UNDERPRIVILEGED AND IMPOVERISHED PEOPLE; PUBLIC ADVOCACY TO PROMOTE AWARENESS OF MATERNAL, NEWBORN, AND CHILD HEALTH ISSUES; COLLECTION AND COMPILATION OF INFORMATION INTO COMPUTER DATABASES IN THE FIELD OF MATERNAL, NEWBORN AND CHILD HEALTH; LOBBYING SERVICES, NAMELY, PROMOTING THE INTERESTS OF WOMEN AND CHILDREN IN THE FIELDS OF HEALTHCARE AND SOCIAL PROTECTION; AND PROMOTING THE GOODS AND SERVICES OF OTHERS BY ARRANGING FOR SPONSORS TO AFFILIATE THEIR GOODS AND SERVICES WITH OUTREACH, EDUCATION AND TRAINING PROGRAMS AND COUNSELING SERVICES (U.S. CLS. 100, 101 AND 102).

FIRST USE 7-31-2010; IN COMMERCE 7-31-2010.

4,046,186. T T E TRANSCRIPTS WORLDWIDE, LTD., HUNTLEY, IL. SN 77-982,551. PUB. 7-13-2010, FILED 1-18-2010.

**SLEUTHSCRIBE**

THE MARK CONSISTS OF STANDARD CHARACTERS WITHOUT CLAIM TO ANY PARTICULAR FONT, STYLE, SIZE, OR COLOR.

OWNER OF U.S. REG. NO. 2,990,992.  
FOR PROVIDING VOICE TRANSCRIPTION SERVICES VIA TELEPHONE COMMUNICATIONS AND THE INTERNET (U.S. CLS. 100, 101 AND 102).

FIRST USE 7-1-2011; IN COMMERCE 7-1-2011.

4,046,220. WHOSAY, INC., GERMANTOWN, NY. SN 85-011,806. PUB. 2-8-2011, FILED 4-12-2010.



THE COLOR(S) BLUE AND WHITE IS/ARE CLAIMED AS A FEATURE OF THE MARK.

**CLASS 35—(Continued).**

THE MARK CONSISTS OF TWO BLUE OVERLAPPING CONVERSATION BUBBLES, ONE CONTAINING THE WORD "WHO" IN WHITE AND ONE CONTAINING THE WORD "SAY" IN WHITE, LOCATED IN THE MIDDLE OF THE WHITE FIELD.

FOR ADVERTISING AND PROMOTION SERVICES, NAMELY, OPERATION OF AN ONLINE DATA MANAGEMENT SERVICE FOR USE IN PROVIDING ADVERTISING AND PUBLICITY INFORMATION DISSEMINATED THROUGH MEDIA OUTLETS IN THE NATURE OF THE INTERNET, MOBILE DEVICES, TELEVISION AND PRINT PUBLICATIONS (U.S. CLS. 100, 101 AND 102).

FIRST USE 5-1-2010; IN COMMERCE 5-1-2010.

4,046,256. PUBLIC RADIO PARTNERS, INC., PHOENIX, AZ. SN 85-029,607. PUB. 9-21-2010, FILED 5-4-2010.

**ENGINUITY OUTSOURCING**

THE MARK CONSISTS OF STANDARD CHARACTERS WITHOUT CLAIM TO ANY PARTICULAR FONT, STYLE, SIZE, OR COLOR.

NO CLAIM IS MADE TO THE EXCLUSIVE RIGHT TO USE "OUTSOURCING", APART FROM THE MARK AS SHOWN.

FOR OUTSOURCING SERVICES IN THE FIELD OF PUBLIC MEDIA, NAMELY, BUSINESS DEVELOPMENT AND THE DEVELOPMENT AND MANAGEMENT OF ADVERTISING INITIATIVES, MARKETING INITIATIVES, AND GIFT DRIVES (U.S. CLS. 100, 101 AND 102).

FIRST USE 5-6-2010; IN COMMERCE 5-6-2010.

4,046,276. GREENARAMA, CINCINNATI, OH. SN 85-038,468. PUB. 4-19-2011, FILED 5-14-2010.

**GREENARAMA**

THE MARK CONSISTS OF STANDARD CHARACTERS WITHOUT CLAIM TO ANY PARTICULAR FONT, STYLE, SIZE, OR COLOR.

FOR PROMOTIONAL SERVICES, NAMELY, PROMOTING CONSTRUCTION AND CONTRACTOR EVENTS, HOME SHOWS, TOURS, EVENTS, CONVENTIONS, AND MEETINGS WHICH FOCUS ON THE SUSTAINABILITY OF THE ENVIRONMENT, CONSERVATION, LEED INITIATIVES, TAX ABATEMENTS, OR INCENTIVES THROUGH DISTRIBUTION OF PRINTED MATERIALS, SIGNAGE, BILLBOARDS, AND ONLINE ADVERTISING (U.S. CLS. 100, 101 AND 102).

FIRST USE 11-2-2010; IN COMMERCE 11-2-2010.

**CLASS 35—(Continued).**

4,046,314. NINGBO LOCTEK IMP&EXP CO.,LTD, NINGBO, CHINA. SN 85-054,516. PUB. 12-21-2010, FILED 6-4-2010.

**ICHIPRICE**

THE MARK CONSISTS OF THE STYLIZED WORDING "ICHIPRICE".

THE WORDING "ICHIPRICE" HAS NO MEANING IN A FOREIGN LANGUAGE.

FOR ADVERTISING AGENCIES; ASSISTANCE IN MANAGEMENT OF BUSINESS ACTIVITIES; COMPILATION AND SYSTEMIZATION OF INFORMATION INTO COMPUTER DATABASES; DIRECT MAIL ADVERTISING SERVICES; GOODS IMPORT-EXPORT AGENCIES; IMPORT AND EXPORT AGENCIES; IMPORT-EXPORT AGENCIES IN THE FIELD OF ENERGY; INFORMATION IN BUSINESS MATTERS; ORGANIZATION OF FAIRS FOR COMMERCIAL AND ADVERTISING PURPOSES; PRESENTATION OF GOODS ON COMMUNICATION MEDIA FOR RETAIL PURPOSES; PURCHASING AND PROCUREMENT SERVICES, NAMELY, PROCURING OF CONTRACTS FOR OTHERS FOR THE PURCHASE OF GOODS AND LABOR CONTRACTING SERVICES; SALES PROMOTION FOR THIRD PARTIES (U.S. CLS. 100, 101 AND 102).

FIRST USE 7-1-2010; IN COMMERCE 7-1-2010.

4,046,327. HASH, SONYA, WEST CHESTER, PA. SN 85-058,912. PUB. 3-22-2011, FILED 6-9-2010.



NO CLAIM IS MADE TO THE EXCLUSIVE RIGHT TO USE "DIGITAL SCRAPBOOKING", APART FROM THE MARK AS SHOWN.

THE MARK CONSISTS OF A LAPTOP COMPUTER WITH THE STYLIZED TEXT "DIGITAL SCRAPBOOKING DELIGHTS" ON THE MONITOR. TO THE LEFT THERE IS A CUP OF COFFEE. TO THE RIGHT THERE IS A MOUSE. THERE ARE SWIRLS, HEARTS, STARS, AND SPARKLES COMING OUT OF THE MOUSE TOWARD THE COMPUTER.

FOR ON-LINE RETAIL STORE SERVICES FEATURING DIGITAL GRAPHIC ARTS FILES USED DIGITALLY OR PRINTED OUT AND USED IN A PHOTO ALBUM PRIMARILY FOR USE IN SCRAPBOOKING (U.S. CLS. 100, 101 AND 102).

FIRST USE 4-1-2010; IN COMMERCE 4-1-2010.

**CLASS 35—(Continued).**

4,046,333. GENERAL FINANCIAL SUPPLY, INC., MID-LOTHIAN, TX. SN 85-060,571. PUB. 11-9-2010, FILED 6-11-2010.

**micrlink** 

THE MARK CONSISTS OF THE LETTERS "MICRLINK" FOLLOWED BY SQUARES, THAT ARE SLIGHTLY CURVED AND SLIGHTLY OVERLAPPING ONE ANOTHER, SOME HIGHER THAN OTHERS.

FOR ON-LINE ORDERING AND INVENTORY MONITORING SERVICES IN THE FIELD OF FINANCIAL AND BUSINESS FORMS AND DOCUMENTS (U.S. CLS. 100, 101 AND 102).

FIRST USE 2-28-2011; IN COMMERCE 2-28-2011.

4,046,343. THE CISCO COMPANIES, INDIANAPOLIS, IN. SN 85-062,992. PUB. 6-7-2011, FILED 6-15-2010.

**CoverCrops USA** 

NO CLAIM IS MADE TO THE EXCLUSIVE RIGHT TO USE "COVERCROPS" AND "USA", APART FROM THE MARK AS SHOWN.

THE MARK CONSISTS OF THE WORDS "COVERCROPS" AND "USA" WITH A STAR SHAPE SEPARATING "COVERCROPS" AND "USA".

FOR RETAIL SERVICES BY DIRECT SOLICITATION BY DIRECT MAILINGS, TRADE SHOWS, AND WEBSITE PROMOTION TO END USERS IN THE FIELD OF CROP SEEDS (U.S. CLS. 100, 101 AND 102).

FIRST USE 7-27-2011; IN COMMERCE 7-27-2011.

4,046,347. INNOTRAC CORPORATION, JOHNS CREEK, GA. SN 85-064,061. PUB. 1-25-2011, FILED 6-16-2010.

**SMARTHUB**

THE MARK CONSISTS OF STANDARD CHARACTERS WITHOUT CLAIM TO ANY PARTICULAR FONT, STYLE, SIZE, OR COLOR.

FOR BUSINESS CONSULTING SERVICES RELATING TO PRODUCT DISTRIBUTION, OPERATIONS MANAGEMENT SERVICES, LOGISTICS, REVERSE LOGISTICS, SUPPLY CHAIN AND DISTRIBUTION SOLUTIONS FOR OTHERS (U.S. CLS. 100, 101 AND 102).

FIRST USE 3-0-2011; IN COMMERCE 3-0-2011.

**CLASS 35—(Continued).**

4,046,350. HOLBERG, JORDAN R., NEW YORK, NY. SN 85-065,133. PUB. 12-21-2010, FILED 6-17-2010.

## SHOPULARITY

THE MARK CONSISTS OF STANDARD CHARACTERS WITHOUT CLAIM TO ANY PARTICULAR FONT, STYLE, SIZE, OR COLOR.

FOR ON-LINE CONTESTS AWARDING MERCHANDISE OF OTHERS BASED UPON THE VOTING PREFERENCES OF USERS, TO PROMOTE THE SALE OF PRODUCTS AND SERVICES OF OTHERS (U.S. CLS. 100, 101 AND 102).

FIRST USE 6-11-2011; IN COMMERCE 6-11-2011.

4,046,354. WALKER, MORRIS, CORVALLIS, OR. SN 85-067,420. PUB. 11-16-2010, FILED 6-21-2010.

*You Deserve*  
**HAWAII**

NO CLAIM IS MADE TO THE EXCLUSIVE RIGHT TO USE "HAWAII", APART FROM THE MARK AS SHOWN.

THE MARK CONSISTS OF "YOU DESERVE" IN CURSIVE STYLIZED FONT WITH "HAWAII" BELOW IN CAPITALIZED STYLIZED FONT.

FOR CONVENTION AND VISITORS BUREAU SERVICES, NAMELY, PROMOTING BUSINESS AND TOURISM IN THE HAWAII AREA; PROMOTING RECREATION AND TOURISM IN HAWAII; PROMOTING TOURISM IN HAWAII AREA (U.S. CLS. 100, 101 AND 102).

FIRST USE 8-0-2010; IN COMMERCE 8-0-2010.

4,046,357. MOBILEATION, INC., ANTHEM, AZ. SN 85-068,137. PUB. 1-25-2011, FILED 6-21-2010.



OWNER OF U.S. REG. NO. 3,243,280.

THE COLOR(S) SILVER, WHITE, BLACK, RED, YELLOW, GREEN, PINK, BLUE, PURPLE, AND BROWN IS/ARE CLAIMED AS A FEATURE OF THE MARK.

THE MARK CONSISTS OF A TRAIN WITH A RED ENGINE HAVING BROWN EYES IN THE WHITE SHADED FRONT WINDOWS, WITH A BLACK AND WHITE NOSE, EXHAUST AND PLOW IN FRONT, SILVER WHISTLE AND BELL AND THE TERM "EXPRESS" WRITTEN WITHIN AN OUTLINE DESIGN ALL IN YELLOW ON THE SIDE AND RED, WHITE AND YELLOW WHEELS; A RED CABOOSE WITH A YELLOW ROUNDED SQUARE CONTAINING THE YELLOW LETTERS ".COM" IN YELLOW ON THE SIDE

**CLASS 35—(Continued).**

AND BLACK SHADED WINDOWS OUTLINED IN SILVER; 11 SQUARE TRAIN CARS BETWEEN THE ENGINE AND CABOOSE, EACH CONTAINING A SINGLE LETTER AND TOGETHER SPELLING THE WORD "MOBILEATION", WITH COLORS OF EACH TRAIN CAR FROM LEFT TO RIGHT BEING RED, YELLOW, GREEN, PINK, BLUE, PURPLE, RED, YELLOW, GREEN, PINK, BLUE, AND THE LETTERS APPEARING IN BLACK OUTLINE WITH WHITE SHADING ALL APPEARING ON BLACK SHADED WHEELS OUTLINED IN SILVER.

FOR COMPUTERIZED ONLINE RETAIL, MAIL ORDER RETAIL, AND RETAIL STORE SERVICES FEATURING TOYS AND CHILDRENS' FURNITURE (U.S. CLS. 100, 101 AND 102).

FIRST USE 6-1-2010; IN COMMERCE 6-1-2010.

4,046,380. MINOT AREA DEVELOPMENT CORPORATION, MINOT, ND. SN 85-074,710. PUB. 11-30-2010, FILED 6-30-2010.

## Gateway to the Bakken

THE MARK CONSISTS OF STANDARD CHARACTERS WITHOUT CLAIM TO ANY PARTICULAR FONT, STYLE, SIZE, OR COLOR.

NO CLAIM IS MADE TO THE EXCLUSIVE RIGHT TO USE "BAKKEN", APART FROM THE MARK AS SHOWN.

FOR PROMOTING THE ECONOMIC DEVELOPMENT IN THE CITY OF MINOT, NORTH DAKOTA (U.S. CLS. 100, 101 AND 102).

FIRST USE 6-30-2010; IN COMMERCE 6-30-2010.

4,046,392. STAR STRATEGIES, LLC, ST. LOUIS, MO. SN 85-078,640. PUB. 2-1-2011, FILED 7-6-2010.

## STAR STRATEGIES

THE MARK CONSISTS OF STANDARD CHARACTERS WITHOUT CLAIM TO ANY PARTICULAR FONT, STYLE, SIZE, OR COLOR.

NO CLAIM IS MADE TO THE EXCLUSIVE RIGHT TO USE "STRATEGIES", APART FROM THE MARK AS SHOWN.

FOR BUSINESS CONSULTING, STRATEGIC PLANNING, CONSUMER RESEARCH, NAMELY, ATTITUDINAL RESEARCH, MARKETING CONSULTANCY, DEVELOPMENT OF MARKETING STRATEGIES AND CONCEPTS IN THE FIELDS OF EDUCATION, HEALTH CARE AND SCIENCE (U.S. CLS. 100, 101 AND 102).

FIRST USE 1-14-2011; IN COMMERCE 1-14-2011.



**CLASS 35—(Continued).**

4,046,393. MATTEL, INC., EL SEGUNDO, CA. SN 85-078,664.  
PUB. 12-7-2010, FILED 7-6-2010.

THE MOST POWERFUL CLUB IN  
THE UNIVERSE!

THE MARK CONSISTS OF STANDARD CHARACTERS WITHOUT CLAIM TO ANY PARTICULAR FONT, STYLE, SIZE, OR COLOR.

NO CLAIM IS MADE TO THE EXCLUSIVE RIGHT TO USE "CLUB", APART FROM THE MARK AS SHOWN.

FOR CUSTOMER LOYALTY SERVICES AND CUSTOMER CLUB SERVICES FOR COMMERCIAL, PROMOTIONAL AND/OR ADVERTISING PURPOSES (U.S. CLS. 100, 101 AND 102).

FIRST USE 8-16-2011; IN COMMERCE 8-16-2011.

4,046,394. STAR STRATEGIES, LLC, ST. LOUIS, MO. SN 85-078,841. PUB. 2-1-2011, FILED 7-6-2010.

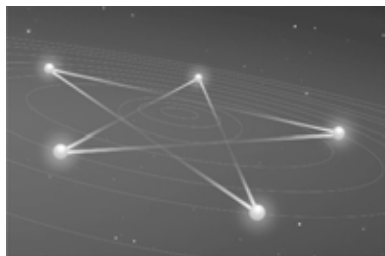

THE MARK CONSISTS OF A FIVE POINTED STAR. THE TIP OF EACH POINT CONTAINS A SPHERE, WHICH ARE ARRANGED ON CONCENTRIC CIRCLES. ADDITIONAL CONCENTRIC CIRCLES ARE ALSO PRESENT. THERE ARE A SERIES OF DOTS APPEARING THROUGHOUT THE DESIGN WHICH RESEMBLE A STAR FIELD.

FOR BUSINESS CONSULTING, STRATEGIC PLANNING, CONSUMER RESEARCH, NAMELY, ATTITUDINAL RESEARCH, MARKETING CONSULTANCY, DEVELOPMENT OF MARKETING STRATEGIES AND CONCEPTS IN THE FIELDS OF EDUCATION, HEALTH CARE AND SCIENCE (U.S. CLS. 100, 101 AND 102).

FIRST USE 1-14-2011; IN COMMERCE 1-14-2011.

**CLASS 35—(Continued).**

4,046,399. ELLIE'S ECO HOME STORE, INC., BOULDER, CO. SN 85-080,299. PUB. 4-5-2011, FILED 7-8-2010.

N.E.W.

THE MARK CONSISTS OF STANDARD CHARACTERS WITHOUT CLAIM TO ANY PARTICULAR FONT, STYLE, SIZE, OR COLOR.

FOR WHOLESALE DISTRIBUTORSHIP SERVICES, FEATURING NATURAL SPONGES, FOOD CONTAINERS, REUSABLE STORAGE BAGS, FOOD CLEANERS, BABY BOTTLES AND PACIFIERS, LUNCH BOXES, GROCERY AND SHOPPING BAGS, SANDWICH AND SNACK BAGS, PET FOOD, FERTILIZERS, GARDEN WEEDERS AND CULTIVATORS, LAUNDRY DETERGENT, ALUMINUM FOIL, BAKING SHEETS, COFFEE FILTERS, KITCHEN GLOVES, DINNER PLATES, DRINKING CUPS, GARBAGE BAGS, HOUSEHOLD CLEANERS, DRAIN CLEANERS, ALL-PURPOSE CLEANERS, GLASS CLEANERS, BATHROOM CLEANERS, DISHWASHING LIQUID, HOUSEHOLD CLEANERS AND DEGREASERS, AIR FRESHENERS, PROVIDED TO RETAILERS, GOVERNMENT AGENCIES AND OTHER BUSINESSES (U.S. CLS. 100, 101 AND 102).

FIRST USE 3-2-2010; IN COMMERCE 3-2-2010.

4,046,400. DEIPI.COM LLC, DBA CITYPON, LA JOLLA, CA. SN 85-080,925. PUB. 12-7-2010, FILED 7-9-2010.



THE MARK CONSISTS OF THE WORD "CITYPON" WITH A CITY LANDSCAPE ABOVE THE WORD.

FOR PROMOTING THE GOODS AND SERVICES OF OTHERS BY PROVIDING A WEB SITE FEATURING COUPONS, REBATES, PRICE-COMPARISON INFORMATION, PRODUCT REVIEWS, LINKS TO THE RETAIL WEB SITES OF OTHERS, AND DISCOUNT INFORMATION (U.S. CLS. 100, 101 AND 102).

FIRST USE 8-15-2011; IN COMMERCE 9-1-2011.

**CLASS 35—(Continued).**

4,046,424. KEVIN A. PRICE, OAK PARK, IL. SN 85-085,629.  
PUB. 12-21-2010, FILED 7-15-2010.

**NEED A PART? WE CAN HELP!**

THE MARK CONSISTS OF STANDARD CHARACTERS WITHOUT CLAIM TO ANY PARTICULAR FONT, STYLE, SIZE, OR COLOR.

FOR ON-LINE, TELEPHONE AND RETAIL ORDERING SERVICES FEATURING PARTS AND ACCESSORIES FOR HOUSEHOLD APPLIANCES, EQUIPMENT, FIXTURES AND DURABLE GOODS; ADVERTISING AND PROMOTIONAL SERVICES; PROVIDING BUSINESS MARKETING INFORMATION AND BUSINESS MARKETING DATA TO OTHERS (U.S. CLS. 100, 101 AND 102).

FIRST USE 7-0-2010; IN COMMERCE 7-0-2010.

4,046,442. GLAMROCK.COM LLC, MIAMI, FL. SN 85-088,941. PUB. 12-21-2010, FILED 7-20-2010.

**RADIO SPACE**

THE MARK CONSISTS OF STANDARD CHARACTERS WITHOUT CLAIM TO ANY PARTICULAR FONT, STYLE, SIZE, OR COLOR.

FOR RETAIL CLOTHING STORES; RETAIL STORE AND ON-LINE RETAIL STORE SERVICES FEATURING CLOTHING AND RELATED ACCESSORIES (U.S. CLS. 100, 101 AND 102).

FIRST USE 4-0-2011; IN COMMERCE 4-0-2011.

4,046,453. TOM JOYNER ONLINE EDUCATION, LLC, DALLAS, TX. SN 85-090,598. PUB. 4-5-2011, FILED 7-22-2010.

**STUDENT SUPPORT PLUS**

THE MARK CONSISTS OF STANDARD CHARACTERS WITHOUT CLAIM TO ANY PARTICULAR FONT, STYLE, SIZE, OR COLOR.

**CLASS 35—(Continued).**

NO CLAIM IS MADE TO THE EXCLUSIVE RIGHT TO USE "STUDENT SUPPORT", APART FROM THE MARK AS SHOWN.

FOR EDUCATIONAL COUNSELING SERVICES FOR ASSISTING STUDENTS WITH PLANNING AND PREPARING FOR FURTHER EDUCATION, NAMELY, ASSISTING AND ADVISING STUDENTS IN THE FIELD OF DEGREE OR CERTIFICATE COURSE COMPLETION AND RE-ENROLLMENT; PROVIDING EDUCATION INFORMATION, ASSISTANCE, TECHNIQUES AND SUPPORT FOR ONLINE STUDENTS IN THE FIELD OF TIME MANAGEMENT, COURSE ACTION PLANS AND STRATEGIES (U.S. CLS. 100, 101 AND 102).

FIRST USE 9-0-2010; IN COMMERCE 9-0-2010.

4,046,456. WHITMIRE, ALISON, NEWCASTLE, WA. SN 85-091,013. PUB. 1-11-2011, FILED 7-22-2010.

**C-LEVER**

THE MARK CONSISTS OF STANDARD CHARACTERS WITHOUT CLAIM TO ANY PARTICULAR FONT, STYLE, SIZE, OR COLOR.

FOR BUSINESS MANAGEMENT CONSULTATION IN THE FIELD OF EXECUTIVE AND LEADERSHIP DEVELOPMENT (U.S. CLS. 100, 101 AND 102).

FIRST USE 2-1-2011; IN COMMERCE 6-1-2011.

4,046,487. PILOT TRAVEL CENTERS LLC, KNOXVILLE, TN. SN 85-094,969. PUB. 5-10-2011, FILED 7-28-2010.



OWNER OF U.S. REG. NOS. 2,232,992, 3,424,157, AND OTHERS.

THE MARK CONSISTS OF THE WORD "PILOT" WITH A LINE UNDER THE LETTERS "I" THROUGH "T" AND BENEATH THE LINE ARE THE WORDS "FLYING J" BESIDE AN AIRPLANE RESEMBLING THE LETTER "J" FLYING UPWARD IN A CIRCLE, THE SHADED RECTANGLE BEHIND THE MARK REPRESENTS BACKGROUND ONLY AND IS NOT PART OF THE MARK.

FOR RETAIL STORE SERVICES IN THE FIELD OF FOOD PRODUCTS, GASOLINE AND MOTOR OIL (U.S. CLS. 100, 101 AND 102).

FIRST USE 8-31-2010; IN COMMERCE 8-31-2010.

**CLASS 35—(Continued).**

4,046,496. BROOKSHIRE BROTHERS, LTD., LUFKIN, TX. SN 85-096,140. PUB. 1-11-2011, FILED 7-29-2010.

**BBROSCONNECTS**

THE MARK CONSISTS OF STANDARD CHARACTERS WITHOUT CLAIM TO ANY PARTICULAR FONT, STYLE, SIZE, OR COLOR.

FOR PROVIDING A CUSTOMER LOYALTY INCENTIVE AND BONUS PROGRAM FEATURING COUPONS, REBATES, PRICE-COMPARISON INFORMATION, PRODUCT REVIEWS, CONTESTS, RECIPES, ADVERTISEMENTS, NEWSLETTERS, AND DISCOUNT INFORMATION (U.S. CLS. 100, 101 AND 102).

FIRST USE 10-25-2010; IN COMMERCE 10-25-2010.

4,046,533. MILLENIUM PREVIEW, LLC, DBA EVERGREEN MARKETING, STAUNTON, VA. SN 85-100,076. PUB. 1-18-2011, FILED 8-4-2010.



THE MARK CONSISTS OF A DRAWING OF A CELLULAR PHONE WITH A FACE AND ARMS AND THREE CURVED LINES REPRESENTING RADIO WAVES EMANATING FROM THE ANTENNA. THE WORD "MOBILEMAN" IS NEXT TO THE BOTTOM RIGHT CORNER OF THE PHONE.

FOR PROMOTING THE GOODS OF OTHERS, NAMELY, PROVIDING COUPONS FOR LOCAL BUSINESSES THAT CAN BE ACCESSED, DISPLAYED AND REDEEMED USING A MOBILE TELEPHONE (U.S. CLS. 100, 101 AND 102).

FIRST USE 5-1-2011; IN COMMERCE 5-1-2011.

**CLASS 35—(Continued).**

4,046,575. FIFTH THIRD BANCORP, CINCINNATI, OH. SN 85-109,573. PUB. 6-14-2011, FILED 8-17-2010.



OWNER OF U.S. REG. NOS. 3,170,394 AND 3,248,998. NO CLAIM IS MADE TO THE EXCLUSIVE RIGHT TO USE "REWARDS", APART FROM THE MARK AS SHOWN.

THE MARK CONSISTS OF "5/3" IN A STYLIZED BOX WITH AN ARCHED LINE ON EACH SIDE APPEARING ABOVE THE WORDS "REAL LIFE REWARDS" IN STYLIZED LETTERS.

FOR PROVIDING INCENTIVE AWARD PROGRAMS FOR CUSTOMERS FOR THE PURPOSE OF PROMOTING AND REWARDING LOYALTY THROUGH THE ISSUANCE AND PROCESSING OF LOYALTY POINTS FOR PURCHASE OF PRODUCTS (U.S. CLS. 100, 101 AND 102).

FIRST USE 7-18-2011; IN COMMERCE 7-18-2011.

4,046,597. AGATHON INVESTMENT S.R.L., DBA ITALY BE LIVE, MORLUPO, ITALY. SN 85-114,176. PUB. 2-8-2011, FILED 8-25-2010.



THE COLOR(S) BLACK, GREEN, WHITE AND RED IS/ ARE CLAIMED AS A FEATURE OF THE MARK.

THE MARK CONSISTS OF BLACK BACKGROUND THE WORD "ITALY BE LIVE" 3D CHARACTER IS WRITTEN AS FOLLOWS "ITALY" PART USES THE COLOR GREEN, WHILE THE WORD IS USED "BE" WHITE, "LIVE" IS WRITTEN IN RED.

FOR ONLINE RETAIL SERVICES THROUGH DIRECT SOLICITATION BY DISTRIBUTORS DIRECTED TO END-USERS FEATURING OF CLOTHING; ONLINE RETAIL SERVICES THROUGH DIRECT SOLICITATION BY SALESPERSONS DIRECTED TO END-USERS OF CLOTHING; WHOLESALE AND RETAIL STORE SERVICES AND ON-LINE RETAIL AND WHOLESALE STORE SERVICES FEATURING OF CLOTHING; WHOLESALE AND RETAIL STORE SERVICES FEATURING OF CLOTHING; WHOLESALE STORES FEATURING OF CLOTHING (U.S. CLS. 100, 101 AND 102).

FIRST USE 4-4-2011; IN COMMERCE 5-5-2011.

**CLASS 35—(Continued).**

4,046,636. AMERICAN COLLEGE OF RADIOLOGY, RESTON, VA. SN 85-121,093. PUB. 1-18-2011, FILED 9-1-2010.



THE COLOR(S) RED AND BLACK IS/ARE CLAIMED AS A FEATURE OF THE MARK.

THE MARK CONSISTS OF THE WORDING "LAMAMOGRAFIASALVAVIDAS UNA DE ELLAS PUEDE SER LA SUYA" WITH A RIBBON DESIGN. THE RIBBON IS RED, AS ARE THE CAPITAL LETTERS "M", "S", AND "V". THE REMAINDER OF THE WORDING IS BLACK.

THE ENGLISH TRANSLATION OF "LAMAMOGRAFIA-SALVAVIDAS UNA DE ELLAS PUEDE SER LA SUYA" IN THE MARK IS "MAMMOGRAPHY SAVES LIVES ONE OF THEM CAN BE YOURS".

FOR PROMOTING PUBLIC AWARENESS OF THE VALUE OF MAMMOGRAPHY AND ITS PUBLIC HEALTH BENEFITS (U.S. CLS. 100, 101 AND 102).

FIRST USE 9-0-2010; IN COMMERCE 9-0-2010.

4,046,642. TRACFONE WIRELESS, INC., MIAMI, FL. SN 85-121,708. PUB. 2-1-2011, FILED 9-2-2010.

**STRAIGHT TALK RESERVE**

THE MARK CONSISTS OF STANDARD CHARACTERS WITHOUT CLAIM TO ANY PARTICULAR FONT, STYLE, SIZE, OR COLOR.

OWNER OF U.S. REG. NOS. 3,794,491, 3,815,424, AND OTHERS.

FOR ONLINE RETAIL STORE SERVICES FEATURING CELLULAR TELEPHONES, PREPAID WIRELESS AIR TIME CARDS, CELLULAR TELEPHONE ACCESSORIES AND WIRELESS SERVICES; DISTRIBUTORSHIP SERVICES FEATURING CELLULAR TELEPHONES, PREPAID AIR TIME CELLULAR TELEPHONE AND PREPAID AIR TIME DEBIT CARDS (U.S. CLS. 100, 101 AND 102).

FIRST USE 11-30-2010; IN COMMERCE 11-30-2010.

4,046,644. READER COUPONS, LLC, SAN DIEGO, CA. SN 85-121,995. PUB. 2-22-2011, FILED 9-2-2010.

**GET ONE FREE**

THE MARK CONSISTS OF STANDARD CHARACTERS WITHOUT CLAIM TO ANY PARTICULAR FONT, STYLE, SIZE, OR COLOR.

**CLASS 35—(Continued).**

OWNER OF U.S. REG. NO. 2,874,414.

FOR PROMOTING THE GOODS AND SERVICES OF OTHERS BY PROVIDING A WEB SITE FEATURING COUPONS, REBATES, PRICE-COMPARISON INFORMATION, PRODUCT REVIEWS, LINKS TO THE RETAIL WEB SITES OF OTHERS, AND DISCOUNT INFORMATION; PROMOTING THE SALE OF GOODS OF AND SERVICES OTHERS, NAMELY, PROVIDING COUPONS, REBATES AND VOUCHERS FOR THE GOODS OF OTHERS; EVENT PLANNING AND MANAGEMENT FOR MARKETING, BRANDING, PROMOTING OR ADVERTISING THE GOODS AND SERVICES OF OTHERS (U.S. CLS. 100, 101 AND 102).

FIRST USE 1-24-2003; IN COMMERCE 1-24-2003.

4,046,646. COVERDELL & COMPANY, INC., CHICAGO, IL. SN 85-122,552. PUB. 4-26-2011, FILED 9-3-2010.



THE MARK CONSISTS OF THE WORDS "HEALTHSTAR" IN A STYLIZED FONT AND A SUN LOGO WITH SUN-RAYS.

FOR MEMBERSHIP CLUB SERVICES, NAMELY, ADMINISTRATION OF A PROGRAM FOR ENABLING PARTICIPANTS TO OBTAIN DISCOUNTS ON PRODUCTS AND SERVICES OF OTHERS (U.S. CLS. 100, 101 AND 102).

FIRST USE 6-16-2011; IN COMMERCE 6-16-2011.

4,046,657. HARDING, DAVID, EDINA, MN. SN 85-124,812. PUB. 2-22-2011, FILED 9-8-2010.

**QUOTESAVVY**

THE MARK CONSISTS OF STANDARD CHARACTERS WITHOUT CLAIM TO ANY PARTICULAR FONT, STYLE, SIZE, OR COLOR.

FOR PROVIDING A WEB SITE WHEREBY BUYERS OF GOODS OR SERVICES LOCATE AND RECEIVE BIDS FROM MULTIPLE COMPETITIVE SOURCES AND SELLERS OF GOODS OR SERVICES IDENTIFY AND BID ON MULTIPLE NEW SALES OPPORTUNITIES (U.S. CLS. 100, 101 AND 102).

FIRST USE 1-1-2011; IN COMMERCE 1-1-2011.

**CLASS 35—(Continued).**

4,046,679. WORLD CHOICE INVESTMENTS, LLC, PIGEON FORGE, TN. SN 85-129,845. PUB. 3-1-2011, FILED 9-15-2010.

**PIRATES VOYAGE**

THE MARK CONSISTS OF STANDARD CHARACTERS WITHOUT CLAIM TO ANY PARTICULAR FONT, STYLE, SIZE, OR COLOR.

FOR RETAIL STORE SERVICES IN THE FIELD OF SOUVENIR HARD GOODS, NAMELY, T-SHIRTS, HATS, SHOES, GLASSWARE, WOOD CARVINGS, FLAGS, BANDANAS, PANTS, SKIRTS AND TOYS (U.S. CLS. 100, 101 AND 102).

FIRST USE 6-3-2011; IN COMMERCE 6-3-2011.

---

4,046,688. TRA GLOBAL, INC., DBA TRA, INC., NEW YORK, NY. SN 85-131,175. PUB. 12-28-2010, FILED 9-16-2010.

**PLAN BUY ROI**

THE MARK CONSISTS OF STANDARD CHARACTERS WITHOUT CLAIM TO ANY PARTICULAR FONT, STYLE, SIZE, OR COLOR.

FOR MARKET RESEARCH SERVICES; ADVERTISING RESEARCH SERVICES; CONSUMER PURCHASE AND BEHAVIOR RESEARCH SERVICES; MEDIA RESEARCH SERVICES, NAMELY, PROVIDING AN INTERNET-BASED DATABASE IN THE FIELD OF CONSUMER AUDIENCE VIEWERSHIP, ADVERTISING SALES EFFECTIVENESS, AND SELECTION OF MEDIA TO OPTIMIZE SALES RESULTS (U.S. CLS. 100, 101 AND 102).

FIRST USE 11-0-2009; IN COMMERCE 11-0-2009.

---

4,046,717. TREFFILETTI, CORY, SAN FRANCISCO, CA. SN 85-138,508. PUB. 3-8-2011, FILED 9-27-2010.

**ARKITEKTIVE**

THE MARK CONSISTS OF STANDARD CHARACTERS WITHOUT CLAIM TO ANY PARTICULAR FONT, STYLE, SIZE, OR COLOR.

FOR ADVERTISING AND MARKETING SERVICES; SPECIFICALLY THE DEVELOPMENT, MANAGEMENT AND EXECUTION OF STRATEGIC MARKETING SERVICES IN AND RELATED TO CLIENT SERVICES (U.S. CLS. 100, 101 AND 102).

FIRST USE 12-1-2010; IN COMMERCE 12-1-2010.

**CLASS 35—(Continued).**

4,046,756. OPENSESAME INC., PORTLAND, OR. SN 85-148,238. PUB. 3-15-2011, FILED 10-8-2010.

**OPENSESAME**

THE MARK CONSISTS OF STANDARD CHARACTERS WITHOUT CLAIM TO ANY PARTICULAR FONT, STYLE, SIZE, OR COLOR.

FOR PROVIDING AN ONLINE MARKETPLACE WHERE USERS CAN REVIEW, BUY, AND SELL E-LEARNING COURSES (U.S. CLS. 100, 101 AND 102).

FIRST USE 6-1-2010; IN COMMERCE 6-1-2010.

---

4,046,796. N.V. PERRICONE LLC, MERIDEN, CT. SN 85-159,089. PUB. 2-1-2011, FILED 10-22-2010.



THE COLOR(S) RED AND WHITE IS/ARE CLAIMED AS A FEATURE OF THE MARK.

THE MARK CONSISTS OF A RED RECTANGLE WITH ROUNDED CORNERS CONTAINING TWO HORIZONTAL WHITE ARROWS WITH POINTED ENDS; THE TOP ARROW TIP FACES LEFT AND THE BOTTOM ARROW TIP FACES RIGHT.

FOR ON-LINE RETAIL STORE SERVICES FEATURING SKIN CARE PRODUCTS, NUTRITIONAL SUPPLEMENTS AND VITAMIN SUPPLEMENTS, AND FOOD BARS (U.S. CLS. 100, 101 AND 102).

FIRST USE 4-1-2011; IN COMMERCE 4-1-2011.

**CLASS 35—(Continued).**

4,046,820. NOAR FOUNDATION FOR GLOBAL COMMUNITY DEVELOPMENT, TOWSON, MD. SN 85-166,495. PUB. 5-3-2011, FILED 11-1-2010.

## Think Globally - Act Locally

THE MARK CONSISTS OF STANDARD CHARACTERS WITHOUT CLAIM TO ANY PARTICULAR FONT, STYLE, SIZE, OR COLOR.

FOR CHARITABLE SERVICES, NAMELY, ORGANIZING AND DEVELOPING PROJECTS THAT AIM TO IMPROVE THE LIVES OF UNDERPRIVILEGED AND IMPOVERISHED PEOPLE (U.S. CLS. 100, 101 AND 102). FIRST USE 6-1-2007; IN COMMERCE 1-20-2008.

4,046,827. ATTERRO, INC., FORMERLY DOBBS TEMPORARY SERVICES, INC., MINNEAPOLIS, MN. SN 85-168,262. PUB. 4-19-2011, FILED 11-3-2010.

## ATTERRO

THE MARK CONSISTS OF STANDARD CHARACTERS WITHOUT CLAIM TO ANY PARTICULAR FONT, STYLE, SIZE, OR COLOR.

THE ENGLISH TRANSLATION OF "ATTERRO" IS "I LAND".

FOR CAREER PLACEMENT SERVICES OF TEMPORARY AND PERMANENT PERSONNEL (U.S. CLS. 100, 101 AND 102).

FIRST USE 11-1-2010; IN COMMERCE 11-1-2010.

4,046,840. HEDAHL, INC., BISMARCK, ND. SN 85-174,496. PUB. 4-26-2011, FILED 11-11-2010.

## AUTO PARTS AND STUFF

THE MARK CONSISTS OF STANDARD CHARACTERS WITHOUT CLAIM TO ANY PARTICULAR FONT, STYLE, SIZE, OR COLOR.

NO CLAIM IS MADE TO THE EXCLUSIVE RIGHT TO USE "AUTO PARTS", APART FROM THE MARK AS SHOWN.

FOR COMPUTERIZED ON-LINE RETAIL STORE SERVICES IN THE FIELD OF AUTOMOTIVE PARTS AND AUTOMOTIVE ACCESSORIES (U.S. CLS. 100, 101 AND 102).

FIRST USE 7-28-2011; IN COMMERCE 7-28-2011.

**CLASS 35—(Continued).**

4,046,841. ALVAREZ & MARSAL HOLDINGS, LLC, NEW YORK, NY. SN 85-174,696. PUB. 4-19-2011, FILED 11-11-2010.

## A&M RAPID RESULTS PROGRAM

THE MARK CONSISTS OF STANDARD CHARACTERS WITHOUT CLAIM TO ANY PARTICULAR FONT, STYLE, SIZE, OR COLOR.

OWNER OF U.S. REG. NO. 2,810,398.

NO CLAIM IS MADE TO THE EXCLUSIVE RIGHT TO USE "PROGRAM", APART FROM THE MARK AS SHOWN. FOR BUSINESS CONSULTING SERVICES (U.S. CLS. 100, 101 AND 102).

FIRST USE 8-11-2011; IN COMMERCE 8-11-2011.

4,046,857. SUSAN STERN PUBLIC RELATIONS, INC., DBA STERN + ASSOCIATES, CRANFORD, NJ. SN 85-181,394. PUB. 6-21-2011, FILED 11-19-2010.

## CONNECTED COMMUNICATIONS

THE MARK CONSISTS OF STANDARD CHARACTERS WITHOUT CLAIM TO ANY PARTICULAR FONT, STYLE, SIZE, OR COLOR.

NO CLAIM IS MADE TO THE EXCLUSIVE RIGHT TO USE "COMMUNICATIONS", APART FROM THE MARK AS SHOWN.

FOR PUBLIC RELATIONS AND MARKETING SERVICES, NAMELY, PROMOTING AND MARKETING THE GOODS AND SERVICES OF OTHERS THROUGH ALL PUBLIC COMMUNICATIONS MEANS (U.S. CLS. 100, 101 AND 102).

FIRST USE 11-8-2010; IN COMMERCE 3-1-2011.

4,046,867. JAN GANDHI, DBA THE PEACOCK PARADE INC., TORONTO, ONTARIO, CANADA. SN 85-185,681. PUB. 6-28-2011, FILED 11-27-2010.

## THE PEACOCK PARADE

THE MARK CONSISTS OF THE WORDS "PEACOCK PARADE".

FOR ON-LINE RETAIL STORE SERVICES FEATURING APPAREL, FOOTWEAR, CLOTHING ACCESSORIES, AND RELATED GOODS (U.S. CLS. 100, 101 AND 102).

FIRST USE 2-5-2011; IN COMMERCE 7-20-2011.

**CLASS 35—(Continued).**

4,046,871. K2 ELECTRONICS, NEW YORK, NY. SN 85-186,058. PUB. 5-3-2011, FILED 11-29-2010.



THE COLOR(S) BLUE, RED, WHITE IS/ARE CLAIMED AS A FEATURE OF THE MARK.

THE MARK CONSISTS OF A "V" WITH IN THE COLOR BLUE WITH WHITE TRIM. THE "V" APPEARS AS A POINTED ARROW WITH WINGS ON THE SIDE. THE LETTER "T" IN THE COLOR RED WITH WHITE TRIM APPEARS INSIDE THE "V". THE TERM, "TECVOZ", IN BLUE WITH WHITE TRIM APPEARS TO THE RIGHT OF THE "TV". THE "T" AND "V" IN "TECVOZ" APPEAR IN A SLIGHTLY BIGGER FONT THAN THE REST OF THE TERMS. THE ENTIRE MARK APPEARS ON A WHITE BACKGROUND.

FOR RETAIL ELECTRONIC SECURITY SYSTEMS STORES (U.S. CLS. 100, 101 AND 102).

FIRST USE 2-1-2011; IN COMMERCE 2-1-2011.

4,046,891. EDGE GEO LLC, FRISCO, TX. SN 85-191,734. PUB. 5-10-2011, FILED 12-6-2010.

## The Earth Friendly EDGE.

THE MARK CONSISTS OF STANDARD CHARACTERS WITHOUT CLAIM TO ANY PARTICULAR FONT, STYLE, SIZE, OR COLOR.

NO CLAIM IS MADE TO THE EXCLUSIVE RIGHT TO USE "EARTH FRIENDLY", APART FROM THE MARK AS SHOWN.

FOR WHOLESALE DISTRIBUTORSHIPS FEATURING GEOTHERMAL HEAT PUMPS AND ACCESSORIES (U.S. CLS. 100, 101 AND 102).

FIRST USE 12-8-2010; IN COMMERCE 2-8-2011.

4,046,900. ELMHURST MEMORIAL HOSPITAL, ELMHURST, IL. SN 85-193,527. PUB. 5-3-2011, FILED 12-8-2010.

## WILD ROSE

THE MARK CONSISTS OF STANDARD CHARACTERS WITHOUT CLAIM TO ANY PARTICULAR FONT, STYLE, SIZE, OR COLOR.

NO CLAIM IS MADE TO THE EXCLUSIVE RIGHT TO USE "ROSE", APART FROM THE MARK AS SHOWN.

FOR RETAIL GIFT SHOPS; RETAIL FLORIST SHOPS (U.S. CLS. 100, 101 AND 102).

FIRST USE 6-25-2011; IN COMMERCE 6-25-2011.

**CLASS 35—(Continued).**

4,046,902. VIRGO PUBLISHING, LLC, PHOENIX, AZ. SN 85-193,707. PUB. 6-14-2011, FILED 12-8-2010.

## MOBILE HEALTHCARE TODAY

THE MARK CONSISTS OF STANDARD CHARACTERS WITHOUT CLAIM TO ANY PARTICULAR FONT, STYLE, SIZE, OR COLOR.

NO CLAIM IS MADE TO THE EXCLUSIVE RIGHT TO USE "MOBILE HEALTHCARE", APART FROM THE MARK AS SHOWN.

FOR PROVIDING ONLINE INFORMATION ABOUT THE PRODUCTS OF OTHERS IN THE FIELD OF MOBILE COMMUNICATIONS TECHNOLOGY FOR HEALTHCARE PROVIDERS TO HELP IN MAKING THEIR PURCHASING DECISIONS (U.S. CLS. 100, 101 AND 102).

FIRST USE 1-15-2011; IN COMMERCE 1-15-2011.

4,046,906. LOOTOK, LTD, NEW YORK, NY. SN 85-194,228. PUB. 5-10-2011, FILED 12-9-2010.

## RISK SHRINK

THE MARK CONSISTS OF STANDARD CHARACTERS WITHOUT CLAIM TO ANY PARTICULAR FONT, STYLE, SIZE, OR COLOR.

NO CLAIM IS MADE TO THE EXCLUSIVE RIGHT TO USE "RISK", APART FROM THE MARK AS SHOWN.

FOR BUSINESS CONSULTATION IN THE FIELD OF DISASTER RECOVERY AND BUSINESS CONTINUITY MANAGEMENT (U.S. CLS. 100, 101 AND 102).

FIRST USE 7-2-2011; IN COMMERCE 7-2-2011.

4,046,932. SITTERCITY, INC., CHICAGO, IL. SN 85-202,835. PUB. 4-26-2011, FILED 12-21-2010.

## SITTERCITY PLEDGE

THE MARK CONSISTS OF STANDARD CHARACTERS WITHOUT CLAIM TO ANY PARTICULAR FONT, STYLE, SIZE, OR COLOR.

OWNER OF U.S. REG. NOS. 3,029,158, 3,029,159, AND 3,050,204.

FOR REFERRALS IN THE FIELDS OF HEALTH CARE, CHILD CARE, NEWBORN CARE, ELDER CARE, PET CARE, AND HOUSE MONITORING AND CARE (U.S. CLS. 100, 101 AND 102).

FIRST USE 12-14-2010; IN COMMERCE 12-14-2010.

**CLASS 35—(Continued).**

4,046,933. SITTERCITY, INC., CHICAGO, IL. SN 85-202,845.  
PUB. 4-26-2011, FILED 12-21-2010.

**CLASS 35—(Continued).**

4,046,942. VINTAGE MARKETING, INC., SANTA MONICA,  
CA. SN 85-207,167. PUB. 5-3-2011, FILED 12-29-2010.

## SITTERCITY SHORT NOTICE

THE MARK CONSISTS OF STANDARD CHARACTERS WITHOUT CLAIM TO ANY PARTICULAR FONT, STYLE, SIZE, OR COLOR.

OWNER OF U.S. REG. NOS. 3,029,158, 3,029,159, AND 3,050,204.

FOR REFERRALS IN THE FIELDS OF HEALTH CARE, CHILD CARE, NEWBORN CARE, ELDER CARE, PET CARE, AND HOUSE MONITORING AND CARE (U.S. CLS. 100, 101 AND 102).

FIRST USE 3-3-2011; IN COMMERCE 3-3-2011.



THE MARK CONSISTS OF THE LETTERS "IH", THE DOT OVER THE "I" HAVING A CIRCLE AROUND IT.

FOR PROVIDING BUSINESS MARKETING INFORMATION (U.S. CLS. 100, 101 AND 102).

FIRST USE 8-21-2011; IN COMMERCE 8-21-2011.

4,046,934. MORGAN, ROSALIE, SPARKS, NV. SN 85-202,857.  
PUB. 6-14-2011, FILED 12-21-2010.

4,046,945. PENNSYLVANIA ASSOCIATION OF REALTORS,  
LEMOYNE, PA. SN 85-208,117. PUB. 6-7-2011, FILED 12-30-2010.

# Hand-Up

# KEYSTONE ANALYTICS

THE MARK CONSISTS OF STANDARD CHARACTERS WITHOUT CLAIM TO ANY PARTICULAR FONT, STYLE, SIZE, OR COLOR.

FOR BUSINESS DEVELOPMENT SERVICES, NAMELY, PROVIDING START-UP SUPPORT FOR BUSINESSES OF OTHERS (U.S. CLS. 100, 101 AND 102).

FIRST USE 9-12-2011; IN COMMERCE 9-12-2011.

THE MARK CONSISTS OF STANDARD CHARACTERS WITHOUT CLAIM TO ANY PARTICULAR FONT, STYLE, SIZE, OR COLOR.

NO CLAIM IS MADE TO THE EXCLUSIVE RIGHT TO USE "ANALYTICS", APART FROM THE MARK AS SHOWN.

FOR POLITICAL AND PUBLIC POLICY OPINION POLLING SERVICES (U.S. CLS. 100, 101 AND 102).

FIRST USE 8-24-2011; IN COMMERCE 8-24-2011.



**CLASS 35—(Continued).**

4,046,947. PALAS SOFTWARE SYSTEMS, INC., CHARLESTON, SC. SN 85-208,154. PUB. 5-3-2011, FILED 12-30-2010.

**INTELLIDEAL**

THE MARK CONSISTS OF STANDARD CHARACTERS WITHOUT CLAIM TO ANY PARTICULAR FONT, STYLE, SIZE, OR COLOR.

FOR PROMOTING THE GOODS AND SERVICES OF OTHERS BY PROVIDING A WEBSITE FEATURING COUPONS, DISCOUNTED OFFERS, VOUCHERS, GIFT CERTIFICATES AND LINKS TO THE RETAIL WEBSITES OF OTHERS (U.S. CLS. 100, 101 AND 102).

FIRST USE 5-19-2011; IN COMMERCE 5-19-2011.

---

4,046,957. SELECT INTELLECTUAL, LLC, PITTSBURGH, PA. SN 85-209,944. PUB. 5-3-2011, FILED 1-4-2011.

**NURSEFIT**

THE MARK CONSISTS OF STANDARD CHARACTERS WITHOUT CLAIM TO ANY PARTICULAR FONT, STYLE, SIZE, OR COLOR.

FOR BUSINESS SERVICES, NAMELY, PROVIDING PERSONNEL SELECTION AND ASSESSMENT SERVICES BY IDENTIFYING, AND SCREENING OF EMPLOYMENT SKILLS OF EMPLOYEE CANDIDATES (U.S. CLS. 100, 101 AND 102).

FIRST USE 7-21-2011; IN COMMERCE 7-21-2011.

---

4,046,967. SKY RIDGE CONSULTING, INC., LOS GATOS, CA. SN 85-211,652. PUB. 5-24-2011, FILED 1-6-2011.

**LifeEncore**

THE MARK CONSISTS OF STANDARD CHARACTERS WITHOUT CLAIM TO ANY PARTICULAR FONT, STYLE, SIZE, OR COLOR.

FOR CONSULTING IN THE FIELD OF NON-FINANCIAL RETIREMENT TRANSITION PLANNING RELATING TO CAREER INFORMATION, VOLUNTEERISM, AND PERSONAL RELOCATION (U.S. CLS. 100, 101 AND 102).

FIRST USE 12-9-2010; IN COMMERCE 12-9-2010.

**CLASS 35—(Continued).**

4,046,969. TRIAD DIGITAL MEDIA, LLC, SOUTHFIELD, MI. SN 85-211,920. PUB. 5-24-2011, FILED 1-6-2011.

**TRIAD RETAIL MEDIA**

THE MARK CONSISTS OF STANDARD CHARACTERS WITHOUT CLAIM TO ANY PARTICULAR FONT, STYLE, SIZE, OR COLOR.

OWNER OF U.S. REG. NO. 3,707,829.

NO CLAIM IS MADE TO THE EXCLUSIVE RIGHT TO USE "RETAIL MEDIA", APART FROM THE MARK AS SHOWN.

FOR WEBSITE ADVERTISING AND MARKETING SERVICES, NAMELY, PROVIDING ADVERTISING AND MARKETING CONSULTING IN RELATION TO WEBSITES; WEBSITE MONETIZATION IN THE NATURE OF EVALUATING THE ONLINE ADVERTISING AND MARKETING PERFORMANCE OF WEBSITES OF OTHERS AND PROVIDING ADVERTISING AND MARKETING CONSULTING TO INCREASE WEBSITE PERFORMANCE; PROVIDING ADVERTISING AND MARKETING CONSULTING IN RELATION TO SEARCH ENGINES; AND EVALUATING THE ONLINE MARKETING PERFORMANCE OF THE WEBSITES OF OTHERS (U.S. CLS. 100, 101 AND 102).

FIRST USE 11-0-2010; IN COMMERCE 11-0-2010.

---

4,046,974. JEFFREY BARTLETT, LLC, CINCINNATI, OH. SN 85-212,852. PUB. 5-24-2011, FILED 1-7-2011.



NO CLAIM IS MADE TO THE EXCLUSIVE RIGHT TO USE "CLOTHING DIRECT", APART FROM THE MARK AS SHOWN.

THE MARK CONSISTS OF AN IMAGE OF A NEEDLE AND THREAD INTERSECTING A SPOOL OF THREAD APPEARING INSIDE OF A PARTIAL CIRCLE AND ABOVE A PARTIAL HORIZONTAL LINE, ALL OF WHICH IS DISPLAYED OVER THE WORDING "CLOTHING DIRECT".

FOR ON-LINE WHOLESALE AND RETAIL STORE SERVICES FEATURING CLOTHING (U.S. CLS. 100, 101 AND 102).

FIRST USE 1-1-2011; IN COMMERCE 1-1-2011.

**CLASS 35—(Continued).**

4,046,979. 1 LIFE LEGACY, EDEN, NC. SN 85-213,893. PUB. 5-31-2011, FILED 1-10-2011.



THE MARK CONSISTS OF THE STYLIZED NUMBERS, LETTERS, AND WORDS "1 L L 1 LIFE LEGACY" WITH AN IMAGE OF A SHIELD WITH WINGS AND A SMALL CROWN ON TOP.

FOR RETAIL STORE SERVICES FEATURING CLOTHING AND ACCESSORIES (U.S. CLS. 100, 101 AND 102).  
FIRST USE 5-1-2011; IN COMMERCE 7-1-2011.

**CLASS 35—(Continued).**

(WIROC), LLC" DISPLAYED IN A SCRIPT FONT ENCIRCLING THE DESIGN OF THE WINGS AROUND THE GLOBE. ON BOTH ENDS OF AND UNDERNEATH THE DESIGN, THE PHRASE ""LET US HELP YOU DEVELOP YOUR WINGS OF RESILIENCE"", THE PHRASE ""A RESILIENT PEOPLE, ORGANIZATION, AND FUTURE"", THE PHRASE "RISE ABOVE CHALLENGES, TRAUMA, CRISIS, OR DISASTER WITH INNOVATIVE & RESILIENT SOLUTIONS", THE PHRASE "WIROCS IF YOU ROCK!" AND THE PHRASE "WIROCS THE WORLD!".

FOR BUSINESS AND MANAGEMENT CONSULTING FOR HEALTHCARE PROVIDERS AND RELATED BUSINESSES; BUSINESS MANAGEMENT CONSULTING; BUSINESS MANAGEMENT CONSULTING IN THE FIELD OF TEAM DEVELOPMENT; BUSINESS ORGANIZATION CONSULTING; BUSINESS RISK MANAGEMENT CONSULTATION; CONSULTING SERVICES IN THE FIELD OF HUMAN RESOURCES DEVELOPMENT, NAMELY, FOR THE PROMOTION OF EMPLOYEE RETENTION, CAREER GROWTH, AND INCREASED PRODUCTIVITY FOR EMPLOYEES AND EMPLOYERS (U.S. CLS. 100, 101 AND 102).

FIRST USE 8-1-2011; IN COMMERCE 8-1-2011.

4,047,001. TROTTA, GAIL, SANDPOINT, ID. SN 85-219,491. PUB. 5-31-2011, FILED 1-18-2011.

**THE SAND STALLION**

THE MARK CONSISTS OF STANDARD CHARACTERS WITHOUT CLAIM TO ANY PARTICULAR FONT, STYLE, SIZE, OR COLOR.

FOR RETAIL VARIETY STORES (U.S. CLS. 100, 101 AND 102).  
FIRST USE 5-6-2011; IN COMMERCE 5-6-2011.

4,046,981. WALACH, CHRISTOPHER E., LAS VEGAS, NV. SN 85-214,820. PUB. 6-28-2011, FILED 1-11-2011.



NO CLAIM IS MADE TO THE EXCLUSIVE RIGHT TO USE "MEDICAL RISK MITIGATION" AND "CONSULTING" AND "LLC", APART FROM THE MARK AS SHOWN.

THE COLOR(S) BLUE, LIGHT BLUE, GRAY, SILVER, GOLD, BLACK, AND WHITE IS/ARE CLAIMED AS A FEATURE OF THE MARK.

THE MARK CONSISTS OF WORDS PLUS A DESIGN OF BLUE (TOP), SILVER (CENTER), GRAY (CENTER AND BOTTOM), AND GOLD OUTLINED WINGS WITH BLACK MARKINGS AND EARTH (GLOBE). THE GLOBE IS BLUE, LIGHT BLUE AND WHITE. THE WINGS ARE ATTACHED TO BOTH SIDES OF THE EARTH (GLOBE) WITH THE STYLIZED WORDS: "LIFE" (LEFT SIDE), "RESILIENCE" (CENTER), AND "MEDICAL RISK MITIGATION" (RIGHT SIDE) TRANPOSED IN THE SILVER WING AREA AND THE WORDS "WI ROC" TRANPOSED ON THE BLUE WING UPPER AREA. THE STYLED COMPANY NAME "WINGS OF INNOVATION & RESILIENCE CONSULTING

4,047,005. AUTO WASH MAINTENANCE CORP., MALDEN, MA. SN 85-221,786. PUB. 5-3-2011, FILED 1-20-2011.

**AutowashOnline**

NO CLAIM IS MADE TO THE EXCLUSIVE RIGHT TO USE "AUTO WASH ONLINE", APART FROM THE MARK AS SHOWN.

THE MARK CONSISTS OF THE WORDS "AUTOWASHONLINE" WITH A WAVE EXTENDING THROUGH THE WORD "ONLINE" AND AN ABSTRACT DESIGN WITHIN THE "O" IN "AUTOWASH".

FOR DISTRIBUTORSHIP SERVICES IN THE FIELD OF VEHICLE WASHING EQUIPMENT, PARTS, AND SUPPLIES; ONLINE DISTRIBUTORSHIP SERVICES IN THE FIELD OF VEHICLE WASHING EQUIPMENT, PARTS, AND SUPPLIES (U.S. CLS. 100, 101 AND 102).

FIRST USE 6-0-2011; IN COMMERCE 6-0-2011.

**CLASS 35—(Continued).**

4,047,007. MCOMBER, MICHAEL, SALT LAKE CITY, UT. SN 85-222,010. PUB. 6-14-2011, FILED 1-20-2011.



THE MARK CONSISTS OF THE WORDS "MYTOPOFF.COM" IN STYLIZED FONT WITH THE LETTER "O" IN THE WORD "OFF" SHOWN AS A DESIGN OF A BOTTLE CAP.

FOR ONLINE RETAIL STORE SERVICES FEATURING BOTTLE OPENERS, BEVERAGE COOLERS, BEVERAGE HOLDERS, AND OTHER RELATED ACCESSORIES (U.S. CLS. 100, 101 AND 102).

FIRST USE 6-6-2011; IN COMMERCE 6-6-2011.

4,047,024. G4 HOLDINGS, INC., LEWISTON, ME. SN 85-228,288. PUB. 5-31-2011, FILED 1-27-2011.

## Brandspiration

THE MARK CONSISTS OF STANDARD CHARACTERS WITHOUT CLAIM TO ANY PARTICULAR FONT, STYLE, SIZE, OR COLOR.

FOR ADVERTISING, MARKETING AND PROMOTION SERVICES; SPECIALTY MERCHANDISING SERVICES, NAMELY, PROMOTING THE GOODS AND SERVICES OF OTHERS THROUGH THE DISTRIBUTION OF CUSTOMIZED ADVERTISING MATERIALS, NAMELY, CLOTHING, PENS, COFFEE MUGS, CALENDARS, PORTFOLIOS, AND WORKSPACE DECORATIONS (U.S. CLS. 100, 101 AND 102).

FIRST USE 1-3-2011; IN COMMERCE 1-3-2011.

4,047,049. GRAHAM & BUFFETT, LTD., PLANO, TX. SN 85-237,529. PUB. 6-28-2011, FILED 2-9-2011.

## Doctor's Wellness Solutions

THE MARK CONSISTS OF STANDARD CHARACTERS WITHOUT CLAIM TO ANY PARTICULAR FONT, STYLE, SIZE, OR COLOR.

**CLASS 35—(Continued).**

NO CLAIM IS MADE TO THE EXCLUSIVE RIGHT TO USE "WELLNESS SOLUTIONS", APART FROM THE MARK AS SHOWN.

FOR DISTRIBUTORSHIP SERVICES IN THE FIELD OF DIETARY AND NUTRITIONAL SUPPLEMENTS, DIETARY SUPPLEMENT DRINKS, NUTRITIONALLY FORTIFIED BEVERAGES, FRUIT JUICES AND FRUIT DRINKS, AND NON-ALCOHOLIC FRUIT JUICE BEVERAGES; MULTI-LEVEL MARKETING BUSINESS SERVICES; ONLINE RETAIL SERVICES THROUGH DIRECT SOLICITATION BY DISTRIBUTORS DIRECTED TO END-USERS FEATURING DIETARY AND NUTRITIONAL SUPPLEMENTS, DIETARY SUPPLEMENT DRINKS, NUTRITIONALLY FORTIFIED BEVERAGES, FRUIT JUICES AND FRUIT DRINKS, AND NON-ALCOHOLIC FRUIT JUICE BEVERAGES; PLANNING, DESIGN, DEVELOPMENT, MAINTENANCE, TRACKING AND REPORTING OF ONLINE MARKETING ACTIVITIES FOR THIRD PARTIES (U.S. CLS. 100, 101 AND 102).

FIRST USE 3-1-2011; IN COMMERCE 3-1-2011.

4,047,056. THE PLAN9 GROUP, LLC, SANTA MONICA, CA. SN 85-240,028. PUB. 5-17-2011, FILED 2-11-2011.

## Plango!

THE MARK CONSISTS OF STANDARD CHARACTERS WITHOUT CLAIM TO ANY PARTICULAR FONT, STYLE, SIZE, OR COLOR.

FOR COMPUTERIZED ON-LINE ORDERING SERVICES IN THE FIELD OF TEACHING MATERIALS FOR FOREIGN LANGUAGE LEARNING (U.S. CLS. 100, 101 AND 102).

FIRST USE 7-4-2011; IN COMMERCE 7-4-2011.

4,047,059. C&S WHOLESALE GROCERS, INC., KEENE, NH. SN 85-241,468. PUB. 4-26-2011, FILED 2-14-2011.

## SELECT THE BEST

THE MARK CONSISTS OF STANDARD CHARACTERS WITHOUT CLAIM TO ANY PARTICULAR FONT, STYLE, SIZE, OR COLOR.

FOR DISTRIBUTORSHIP IN THE FIELD OF CONSUMER GOODS AND GROCERIES; WHOLESALE DISTRIBUTORSHIP OF CONSUMER GOODS AND GROCERIES (U.S. CLS. 100, 101 AND 102).

FIRST USE 4-1-2011; IN COMMERCE 4-1-2011.

**CLASS 35—(Continued).**

4,047,090. BATZ ENTERPRISES LLC, BLOOMINGTON, MN. SN 85-975,452. PUB. 11-30-2010, FILED 7-1-2010.

**CLASS 36—(Continued).**

4,045,622. CLOUDCOVER IP, LLC, ST. PAUL, MN. SN 77-123,544. PUB. 6-10-2008, FILED 3-6-2007.

WHAT REALLY WORKS

CloudCover

THE MARK CONSISTS OF STANDARD CHARACTERS WITHOUT CLAIM TO ANY PARTICULAR FONT, STYLE, SIZE, OR COLOR.

FOR BUSINESS CONSULTATION IN THE FIELD OF BUSINESS LEADERSHIP DEVELOPMENT; BUSINESS MANAGEMENT CONSULTATION IN THE FIELD OF EXECUTIVE AND LEADERSHIP DEVELOPMENT (U.S. CLS. 100, 101 AND 102).

FIRST USE 1-19-2010; IN COMMERCE 9-20-2010.

THE MARK CONSISTS OF STANDARD CHARACTERS WITHOUT CLAIM TO ANY PARTICULAR FONT, STYLE, SIZE, OR COLOR.

FOR INSURANCE SERVICES, NAMELY, UNDERWRITING DIGITAL RISK INSURANCE TO MONITOR VALUE OF INTERNET TRANSMITTED DATA (U.S. CLS. 100, 101 AND 102).

FIRST USE 8-4-2011; IN COMMERCE 8-4-2011.

4,045,660. MERCANTIL SERVICIOS FINANCIEROS, C.A., CARACAS, VENEZUELA. SN 77-333,196. PUB. 1-13-2009, FILED 11-19-2007.

**CLASS 36—INSURANCE AND FINANCIAL**

4,045,606. NORTH AMERICAN EQUIPMENT DEALERS ASSN, FENTON, MO. SN 76-705,062. PUB. 4-26-2011, FILED 10-25-2010.

**Wcps**  
Warranty Claim Processing System

**Mercantil**  
Commercebank  
Trust Company

NO CLAIM IS MADE TO THE EXCLUSIVE RIGHT TO USE "WARRANTY CLAIM PROCESSING SYSTEM", APART FROM THE MARK AS SHOWN.

THE MARK CONSISTS OF THE LETTERS "WCPS" WITH CUTOUT ARROWS IN OPPOSITE DIRECTIONS AS PART OF THE LETTERS "C" AND "P" AND THE ARROW ON THE END OF THE "P" AND THE WORDS "WARRANTY CLAIM PROCESSING SYSTEM" UNDERNEATH "WCPS".

FOR PROVIDING ADVICE RELATING TO THE PROCESSING OF WARRANTY CLAIMS MADE AGAINST EQUIPMENT DEALERS AS MEMBERS OF AN ASSOCIATION (U.S. CLS. 100, 101 AND 102).

FIRST USE 11-18-2008; IN COMMERCE 11-18-2008.

NO CLAIM IS MADE TO THE EXCLUSIVE RIGHT TO USE "MERCANTIL COMMERCE BANK TRUST COMPANY", APART FROM THE MARK AS SHOWN.

THE COLOR(S) BLUE, ORANGE AND GRAY IS/ARE CLAIMED AS A FEATURE OF THE MARK.

THE MARK CONSISTS OF THE COLOR BLUE FOR THE WORDING "MERCANTIL COMMERCEBANK", THE COLOR GRAY FOR THE WORDING "TRUST COMPANY", BLUE ON THE INTERIOR OF THE CURVED DESIGN AND DARK ORANGE ON THE OUTSIDE WITH LIGHT ORANGE SHADING AROUND THE EDGES OF THE OUTSIDE OF THE CURVED DESIGN.

**CLASS 36—(Continued).**

THE ENGLISH TRANSLATION OF THE WORD "MERCANTIL" IN THE MARK IS "MERCANTILE".

FOR BANKING; CAPITAL INVESTMENT SERVICES; CHARITABLE FUND RAISING; CHECK VERIFICATION; FINANCIAL CLEARING HOUSES; FINANCIAL CONSULTANCY; INSURANCE CONSULTANCY; CREDIT BUREAU; CREDIT CARD SERVICES; ISSUANCE OF CREDIT CARDS; DEBIT CARD SERVICES; SAFE DEPOSIT BOX SERVICES FOR THE DEPOSIT OF VALUABLES; EXCHANGING MONEY; FINANCIAL EVALUATION FOR BANKING, REAL ESTATE, AND INSURANCE PURPOSES; PROVIDING FINANCIAL INFORMATION; FINANCIAL MANAGEMENT; FINANCIAL SPONSORSHIP OF ATHLETIC EVENTS; FINANCING SERVICES, NAMELY, MONEY LENDING, INVESTMENT FUND TRANSFER AND TRANSACTION SERVICES, MORTGAGE PLANNING; FUNDS INVESTMENT; ELECTRONIC FUNDS TRANSFER; FINANCIAL GUARANTEE AND SURETY; HEALTH INSURANCE UNDERWRITING; INSURANCE INFORMATION; INSTALLMENT LOANS; INSURANCE BROKERAGE; INSURANCE CONSULTANCY; INSURANCE INFORMATION; INSURANCE UNDERWRITING; ISSUE OF TOKENS OF VALUE; ISSUING OF TRAVELLERS' CHECKS; LEASE-PURCHASE FINANCING; LIFE INSURANCE UNDERWRITING; LOAN FINANCING; FINANCIAL MANAGEMENT; MORTGAGE BANKING; MUTUAL FUND BROKERAGE; SAFE DEPOSIT BOX SERVICES; SAVINGS BANKS; SECURITIES BROKERAGE; SURETY SERVICES; TRUSTEESHIP REPRESENTATIVES; LAND AND REAL ESTATE VALUATIONS (U.S. CLS. 100, 101 AND 102).

FIRST USE 11-0-2007; IN COMMERCE 11-0-2007.

4,045,680. PEACELABS MUSIC, INC., SAN FRANCISCO, CA. SN 77-377,644. PUB. 6-3-2008, FILED 1-22-2008.

**MISSION DRIVEN LIVING**

THE MARK CONSISTS OF STANDARD CHARACTERS WITHOUT CLAIM TO ANY PARTICULAR FONT, STYLE, SIZE, OR COLOR.

FOR CHARITABLE FUNDRAISING SERVICES, NAMELY, RAISING MONEY TO SUPPORT VOLUNTEER PROGRAMS AND COMMUNITY SERVICE PROJECTS AND GRANTING FUNDS TO VOLUNTEER ORGANIZATIONS AND INDIVIDUALS (U.S. CLS. 100, 101 AND 102).

FIRST USE 7-5-2008; IN COMMERCE 8-17-2011.

4,045,714. THE PNC FINANCIAL SERVICES GROUP, INC., PITTSBURGH, PA. SN 77-426,981. PUB. 12-23-2008, FILED 3-20-2008.

 **Virtual Wallet**  
by PNC BANK

OWNER OF U.S. REG. NOS. 1,416,898, 2,980,693, AND OTHERS.

**CLASS 36—(Continued).**

NO CLAIM IS MADE TO THE EXCLUSIVE RIGHT TO USE "VIRTUAL" AND "BANK", APART FROM THE MARK AS SHOWN.

THE MARK CONSISTS OF A DESIGN ELEMENT LOCATED TO THE LEFT OF THE WORDS "VIRTUAL WALLET". THE WORDS "BY PNC BANK" ARE LOCATED BELOW THE WORD "WALLET".

FOR BANKING SERVICES; ON-LINE BANKING SERVICES; BILL PAYMENT SERVICES PROVIDED THROUGH A WEBSITE (U.S. CLS. 100, 101 AND 102).

FIRST USE 7-21-2008; IN COMMERCE 7-21-2008.

4,045,715. UNITED SERVICES AUTOMOBILE ASSOCIATION, SAN ANTONIO, TX. SN 77-431,011. PUB. 6-24-2008, FILED 3-25-2008.

**THE USAA ADVANTAGE**

THE MARK CONSISTS OF STANDARD CHARACTERS WITHOUT CLAIM TO ANY PARTICULAR FONT, STYLE, SIZE, OR COLOR.

FOR FINANCIAL AND INVESTMENT SERVICES, NAMELY, MANAGEMENT AND BROKERAGE IN THE FIELDS OF STOCKS, BONDS, OPTIONS, COMMODITIES, MUTUAL FUNDS, REAL ESTATE, FUTURES AND OTHER SECURITIES, AND THE INVESTMENT OF FUNDS OF OTHERS; FINANCIAL AND INVESTMENT INFORMATION, ADVICE, ANALYSIS, CONSULTATION, RESEARCH, PLANNING AND MANAGEMENT SERVICES (U.S. CLS. 100, 101 AND 102).

FIRST USE 9-1-2008; IN COMMERCE 9-1-2008.

4,045,737. TAWA CHARITABLE FOUNDATION, BUENA PARK, CA. SN 77-501,777. PUB. 4-7-2009, FILED 6-18-2008.



NO CLAIM IS MADE TO THE EXCLUSIVE RIGHT TO USE "CHARITABLE FOUNDATION" AND THE NON-LATIN CHARACTERS THAT MEAN "CHARITY FOUNDATION", APART FROM THE MARK AS SHOWN.

**CLASS 36—(Continued).**

THE NON-LATIN CHARACTERS IN THE MARK TRANSLITERATE TO "DA HUA CISHAN JIJINHUI," AND THIS MEANS "GREAT CHINA CHARITY FOUNDATION" IN ENGLISH.

FOR ACCEPTING AND ADMINISTERING MONETARY CHARITABLE CONTRIBUTIONS AND CHARITABLE FUNDRAISING SERVICES (U.S. CLS. 100, 101 AND 102).

FIRST USE 4-3-2009; IN COMMERCE 6-30-2010.

---

4,045,885. MOLINA HEALTHCARE, INC., LONG BEACH, CA. SN 77-787,382. PUB. 12-8-2009, FILED 7-22-2009.

## HEALTHY ADVANTAGE BY MOLINA MEDICARE

THE MARK CONSISTS OF STANDARD CHARACTERS WITHOUT CLAIM TO ANY PARTICULAR FONT, STYLE, SIZE, OR COLOR.

OWNER OF U.S. REG. NOS. 2,549,167, 2,619,592, AND 2,619,593.

NO CLAIM IS MADE TO THE EXCLUSIVE RIGHT TO USE "HEALTHY" AND "ADVANTAGE", APART FROM THE MARK AS SHOWN.

FOR ORGANIZATION AND ADMINISTRATION OF MEDICARE HEALTHCARE INSURANCE PLANS (U.S. CLS. 100, 101 AND 102).

FIRST USE 10-1-2009; IN COMMERCE 10-1-2009.

---

4,045,920. RESTAT, LLC, MILWAUKEE, WI. SN 77-823,013. PUB. 2-15-2011, FILED 9-9-2009.

## ALIGN

THE MARK CONSISTS OF STANDARD CHARACTERS WITHOUT CLAIM TO ANY PARTICULAR FONT, STYLE, SIZE, OR COLOR.

FOR PHARMACEUTICAL BENEFITS MANAGEMENT SERVICES (U.S. CLS. 100, 101 AND 102).

FIRST USE 10-0-2009; IN COMMERCE 10-0-2009.

**CLASS 36—(Continued).**

4,045,962. RENTSHARE INC, NEW YORK, NY. SN 77-868,578. PUB. 10-19-2010, FILED 11-9-2009.

## RentShare

THE MARK CONSISTS OF STANDARD CHARACTERS WITHOUT CLAIM TO ANY PARTICULAR FONT, STYLE, SIZE, OR COLOR.

FOR BILL PAYMENT SERVICES PROVIDED THROUGH A WEBSITE (U.S. CLS. 100, 101 AND 102).

FIRST USE 12-1-2009; IN COMMERCE 7-1-2010.

---

4,045,970. ADP, INC., ROSELAND, NJ. SN 77-875,826. PUB. 12-28-2010, FILED 11-18-2009.

## ADP HEALTH & BENEFITS ADVANTAGE

THE MARK CONSISTS OF STANDARD CHARACTERS WITHOUT CLAIM TO ANY PARTICULAR FONT, STYLE, SIZE, OR COLOR.

OWNER OF U.S. REG. NOS. 2,367,685, 3,481,221, AND OTHERS.

NO CLAIM IS MADE TO THE EXCLUSIVE RIGHT TO USE "HEALTH AND BENEFITS", APART FROM THE MARK AS SHOWN.

FOR PROVIDING HEALTH INSURANCE AND EMPLOYEE BENEFIT SERVICES, NAMELY, ADMINISTERING, MANAGING, AND PROVIDING INFORMATION, FORMS, AND REPORTS; PROVIDING ASSISTANCE AND ADMINISTRATION IN THE FIELD OF HEALTH BENEFIT SERVICES; PROVIDING HEALTH INSURANCE BENEFIT ADMINISTRATION SERVICES FEATURING INTEGRATION OF SERVICES BETWEEN PAYROLL ADMINISTRATION AND HEALTH INSURANCE BENEFIT SERVICES TO FACILITATE PREMIUM PAYMENTS TO CARRIERS (U.S. CLS. 100, 101 AND 102).

FIRST USE 10-0-2009; IN COMMERCE 10-0-2009.

---

4,045,974. EAR SERVICE CORPORATION, INC, AKA ESCO, PLYMOUTH, MN. SN 77-880,521. PUB. 5-11-2010, FILED 11-25-2009.

## The Happy Plan :)

NO CLAIM IS MADE TO THE EXCLUSIVE RIGHT TO USE "PLAN", APART FROM THE MARK AS SHOWN.

**CLASS 36—(Continued).**

THE MARK CONSISTS OF THE WORDING "THE HAPPY PLAN" ADJACENT TO A SMILING EMOTICON.

FOR INSURANCE SERVICES, NAMELY, UNDERWRITING EXTENDED WARRANTY CONTRACTS IN THE FIELD OF HEARING AIDS; PROVIDING WARRANTIES ON GOODS MANUFACTURED BY OTHERS, NAMELY, HEARING AIDS (U.S. CLS. 100, 101 AND 102).  
FIRST USE 2-2-2010; IN COMMERCE 2-2-2010.

---

4,045,989. PROMILA DHANUKA, MD, INC, DBA P.A.C.E CANCER CENTER, REDDING, CA. SN 77-895,273. PUB. 5-11-2010, FILED 12-16-2009.

## Lung Affair

THE MARK CONSISTS OF STANDARD CHARACTERS WITHOUT CLAIM TO ANY PARTICULAR FONT, STYLE, SIZE, OR COLOR.

NO CLAIM IS MADE TO THE EXCLUSIVE RIGHT TO USE "LUNG", APART FROM THE MARK AS SHOWN.

FOR CHARITABLE SERVICES, NAMELY, PROVIDING FINANCIAL SUPPORT TO DISADVANTAGED PATIENTS FOR THE PURPOSE OF FACILITATING GOOD HEALTH (U.S. CLS. 100, 101 AND 102).

FIRST USE 11-14-2009; IN COMMERCE 11-14-2009.

---

4,046,078. GENERAL BOARD OF PENSION AND HEALTH BENEFITS OF THE UNITED METHODIST CHURCH, INCORPORATED IN ILLINOIS, EVANSTON, IL. SN 77-938,122. PUB. 7-13-2010, FILED 2-17-2010.

## WESPATH

THE MARK CONSISTS OF STANDARD CHARACTERS WITHOUT CLAIM TO ANY PARTICULAR FONT, STYLE, SIZE, OR COLOR.

FOR FINANCIAL SERVICES, NAMELY, MANAGEMENT AND ADMINISTRATION OF EMPLOYEE HEALTH AND WELFARE BENEFIT PLANS, EMPLOYEE PENSION PLANS AND RETIREMENT PLANS; FINANCIAL AND INVESTMENT SERVICES, NAMELY, ASSET ACQUISITION, CONSULTATION, DEVELOPMENT AND MANAGEMENT SERVICES; FINANCIAL PLANNING AND INVESTMENT ADVISORY SERVICES; FINANCIAL SERVICES, NAMELY, INVESTMENT ADVICE, INVESTMENT MANAGEMENT, INVESTMENT CONSULTATION AND INVESTMENT OF FUNDS FOR OTHERS; CHARITABLE FUNDRAISING SERVICES (U.S. CLS. 100, 101 AND 102).

FIRST USE 3-15-2011; IN COMMERCE 3-15-2011.

**CLASS 36—(Continued).**

4,046,089. OWENS ONLINE, INC., TAMPA, FL. SN 77-942,922. PUB. 7-13-2010, FILED 2-23-2010.

## COUNTRYSKAN

THE MARK CONSISTS OF STANDARD CHARACTERS WITHOUT CLAIM TO ANY PARTICULAR FONT, STYLE, SIZE, OR COLOR.

FOR CREDIT REPORTING SERVICES; FINANCIAL DUE DILIGENCE (U.S. CLS. 100, 101 AND 102).  
FIRST USE 9-6-2011; IN COMMERCE 9-6-2011.

---

4,046,105. MELINDA MURRAY, EAST ELMHURST, NY. SN 77-947,579. PUB. 7-27-2010, FILED 3-1-2010.

## "This Is My Season"

THE MARK CONSISTS OF STANDARD CHARACTERS WITHOUT CLAIM TO ANY PARTICULAR FONT, STYLE, SIZE, OR COLOR.

FOR CHARITABLE FUNDRAISING SERVICES BY MEANS OF SELLING T-SHIRTS, WRISTBANDS, LANYARDS, AND BASEBALL CAPS TO RAISE FUNDS FOR SCHOLARSHIPS, SPORTS, HEALTH, EDUCATION AND SAFETY, AND PREVENTION OF CARDIAC FAILURE (U.S. CLS. 100, 101 AND 102).

FIRST USE 8-14-2010; IN COMMERCE 8-14-2010.

---

4,046,123. WEST BEND MUTUAL INSURANCE COMPANY, WEST BEND, WI. SN 77-953,464. PUB. 1-11-2011, FILED 3-8-2010.

## ARGENT

THE MARK CONSISTS OF STANDARD CHARACTERS WITHOUT CLAIM TO ANY PARTICULAR FONT, STYLE, SIZE, OR COLOR.

FOR INSURANCE SERVICES, NAMELY, WRITING WORKERS COMPENSATION INSURANCE (U.S. CLS. 100, 101 AND 102).

FIRST USE 3-11-2010; IN COMMERCE 3-11-2010.

**CLASS 36—(Continued).**

4,046,140. THE PRUDENTIAL INSURANCE COMPANY OF AMERICA, NEWARK, NJ. SN 77-959,987. PUB. 1-11-2011, FILED 3-16-2010.

**PRUDENTIAL PROTECTION**

THE MARK CONSISTS OF STANDARD CHARACTERS WITHOUT CLAIM TO ANY PARTICULAR FONT, STYLE, SIZE, OR COLOR.

NO CLAIM IS MADE TO THE EXCLUSIVE RIGHT TO USE "PROTECTION", APART FROM THE MARK AS SHOWN.

FOR ASSET PROTECTION SERVICES, NAMELY, FINANCIAL ASSET MANAGEMENT FOR THE PROTECTION OF RETIREMENT ACCOUNTS; FINANCIAL ADMINISTRATION OF RETIREMENT SAVINGS PLANS FEATURING U.S. GOVERNMENT/AGENCY SECURITIES, INVESTMENT-GRADE CORPORATE BONDS, ASSET-BACKED SECURITIES, COMMERCIAL MORTGAGE-BACKED SECURITIES, CASH, CDS, MONEY MARKETS, AND AGENCY AND NON-AGENCY RESIDENTIAL MORTGAGE-BACKED SECURITIES (U.S. CLS. 100, 101 AND 102).

FIRST USE 4-1-2010; IN COMMERCE 4-1-2010.

---

4,046,141. THE PRUDENTIAL INSURANCE COMPANY OF AMERICA, NEWARK, NJ. SN 77-960,031. PUB. 1-11-2011, FILED 3-16-2010.

**PRUDENTIAL PROTECTION  
ACCOUNT PLUS**

THE MARK CONSISTS OF STANDARD CHARACTERS WITHOUT CLAIM TO ANY PARTICULAR FONT, STYLE, SIZE, OR COLOR.

NO CLAIM IS MADE TO THE EXCLUSIVE RIGHT TO USE "PROTECTION ACCOUNT", APART FROM THE MARK AS SHOWN.

FOR ASSET PROTECTION SERVICES, NAMELY, FINANCIAL ASSET MANAGEMENT FOR THE PROTECTION OF RETIREMENT ACCOUNTS; FINANCIAL ADMINISTRATION OF RETIREMENT SAVINGS PLANS FEATURING U.S. GOVERNMENT/AGENCY SECURITIES, INVESTMENT-GRADE CORPORATE BONDS, ASSET-BACKED SECURITIES, COMMERCIAL MORTGAGE-BACKED SECURITIES, CASH, CDS, MONEY MARKETS, AND AGENCY AND NON-AGENCY RESIDENTIAL MORTGAGE-BACKED SECURITIES (U.S. CLS. 100, 101 AND 102).

FIRST USE 4-1-2010; IN COMMERCE 4-1-2010.

**CLASS 36—(Continued).**

4,046,173. FONDATION A.R.C.A.D AIDE ET RECHERCHE EN CANCÉROLOGIE DIGESTIVE, PARIS, FRANCE. SN 77-982,442. PUB. 6-15-2010, FILED 1-26-2010.



NO CLAIM IS MADE TO THE EXCLUSIVE RIGHT TO USE "FONDATION" AND "AIDE ET RECHERCHE EN CANCÉROLOGIE DIGESTIVE", APART FROM THE MARK AS SHOWN.

THE COLOR(S) BLUE AND RED IS/ARE CLAIMED AS A FEATURE OF THE MARK.

THE MARK CONSISTS OF THE WORD "FONDATION" IN BLUE, ABOVE "A.R.C.A.D." IN RED, WHICH IN TURN IS ABOVE THE PHRASE "AIDE ET RECHERCHE EN CANCÉROLOGIE DIGESTIVE" IN BLUE (EXCEPT FOR THE CAPITALIZED LETTERS OF EACH WORD, WHICH ARE IN RED), ALL OVERLAYING A DIAGONAL BLUE RIBBON WITH A RED DOT BELOW THE TOP END OF THE BLUE RIBBON AND ANOTHER RED DOT ABOVE THE BOTTOM END OF THE BLUE RIBBON.

THE ENGLISH TRANSLATION OF "FONDATION" IN THE MARK IS "FOUNDATION". THE ENGLISH TRANSLATION OF "AIDE ET RECHERCHE EN CANCÉROLOGIE DIGESTIVE" IN THE MARK IS "ANALYSIS AND RESEARCH IN CANCERS OF THE DIGESTIVE SYSTEM".

FOR FINANCING MEDICAL AND SCIENTIFIC RESEARCH OF OTHERS; CHARITABLE FUNDRAISING (U.S. CLS. 100, 101 AND 102).

FIRST USE 12-0-2009; IN COMMERCE 12-0-2009.

---

4,046,177. FONDATION A.R.C.A.D AIDE ET RECHERCHE EN CANCÉROLOGIE DIGESTIVE, PARIS, FRANCE. SN 77-982,456. PUB. 6-15-2010, FILED 1-26-2010.

**A.R.C.A.D**

THE MARK CONSISTS OF STANDARD CHARACTERS WITHOUT CLAIM TO ANY PARTICULAR FONT, STYLE, SIZE, OR COLOR.

FOR FINANCING MEDICAL AND SCIENTIFIC RESEARCH OF OTHERS; CHARITABLE FUNDRAISING (U.S. CLS. 100, 101 AND 102).

FIRST USE 12-0-2009; IN COMMERCE 12-0-2009.



**CLASS 36—(Continued).**

4,046,231. OK MOZART INC., BARTLESVILLE, OK. SN 85-018,059. PUB. 9-28-2010, FILED 4-20-2010.

**No Child Clef Behind**

THE MARK CONSISTS OF STANDARD CHARACTERS WITHOUT CLAIM TO ANY PARTICULAR FONT, STYLE, SIZE, OR COLOR.

FOR CHARITABLE FUNDRAISING; FUNDRAISING SERVICES, NAMELY, ORGANIZING FUNDRAISERS FOR SCHOOLS AND OTHER GROUPS (U.S. CLS. 100, 101 AND 102).

FIRST USE 12-10-2010; IN COMMERCE 12-10-2010.

---

4,046,268. SUNCOAST SCHOOLS FEDERAL CREDIT UNION, TAMPA, FL. SN 85-035,238. PUB. 1-25-2011, FILED 5-11-2010.

**RIGHT TIME**

THE MARK CONSISTS OF STANDARD CHARACTERS WITHOUT CLAIM TO ANY PARTICULAR FONT, STYLE, SIZE, OR COLOR.

FOR FINANCIAL SERVICES, NAMELY, MORTGAGE LENDING, MORTGAGE FINANCING, MORTGAGE REFINANCING, HOME EQUITY LOAN FINANCING, AND REAL ESTATE MORTGAGE ESCROW SERVICES (U.S. CLS. 100, 101 AND 102).

FIRST USE 8-23-2011; IN COMMERCE 8-23-2011.

---

4,046,298. BLOOMBERG L.P., NEW YORK, NY. SN 85-047,359. PUB. 12-14-2010, FILED 5-25-2010.

**IWUD**

THE MARK CONSISTS OF STANDARD CHARACTERS WITHOUT CLAIM TO ANY PARTICULAR FONT, STYLE, SIZE, OR COLOR.

FOR FINANCIAL SERVICES IN THE NATURE OF A SECURITIES TRADING SYSTEM, NAMELY, PROVIDING A SERVICE THAT ALERTS CLIENTS OF AN OPPORTUNITY TO TRADE AGAINST ANOTHER CLIENT BASED ON WATCHLISTS THAT THEY CREATE AND CONTROL, AND EFFECTS THE EXECUTION SHOULD THEY BOTH ELECT TO TRADE (U.S. CLS. 100, 101 AND 102).

FIRST USE 7-5-2011; IN COMMERCE 7-5-2011.

**CLASS 36—(Continued).**

4,046,302. TAYBANDZ, INC., SCARSDALE, NY. SN 85-049,480. PUB. 5-24-2011, FILED 5-27-2010.



THE COLOR(S) WHITE, YELLOW, RED, BLUE, BLACK, AND BEIGE IS/ARE CLAIMED AS A FEATURE OF THE MARK.

THE MARK CONSISTS OF A BLUE, YELLOW, WHITE, AND RED RAINBOW CONNECTING TWO WHITE CLOUDS WITH YELLOW OUTLINES, A LADYBUG ON THE RIGHT CLOUD IN THE COLORS RED, BLACK, AND BEIGE, A YELLOW SUN POSITIONED BEHIND THE RAINBOW, THE WORD "TAY-BANDZ" IN BLUE BELOW THE SUN AND RAINBOW AND ABOVE THE WORDS "KIDS CURING CANCER" IN RED.

FOR CHARITABLE FUNDRAISING SERVICES (U.S. CLS. 100, 101 AND 102).

FIRST USE 12-0-2010; IN COMMERCE 12-0-2010.

---

4,046,331. SEQUOIA FINANCIAL ADVISORS, INC., PHOENIX, AZ. SN 85-060,230. PUB. 1-18-2011, FILED 6-11-2010.

**401K MADE SIMPLE**

THE MARK CONSISTS OF STANDARD CHARACTERS WITHOUT CLAIM TO ANY PARTICULAR FONT, STYLE, SIZE, OR COLOR.

NO CLAIM IS MADE TO THE EXCLUSIVE RIGHT TO USE "401K", APART FROM THE MARK AS SHOWN.

FOR FINANCIAL SERVICES, NAMELY, INVESTMENT ADVISORY SERVICES FOR QUALIFIED RETIREMENT PLANS; PENSION PLANNING; QUALIFIED RETIREMENT PLANNING; RETIREMENT PLAN CONSULTING; INVESTMENT ADVISORY SERVICES FOR CONSUMERS, CORPORATIONS, BUSINESS OWNERS, QUALIFIED PLAN TRUSTEES, SPONSORS AND PARTICIPANTS (U.S. CLS. 100, 101 AND 102).

FIRST USE 6-1-2011; IN COMMERCE 7-10-2011.

**CLASS 36—(Continued).**

4,046,339. SUMMER STREET CAPITAL PARTNERS, LLC, BUFFALO, NY. SN 85-062,298. PUB. 11-16-2010, FILED 6-14-2010.

# Focus Chart

THE MARK CONSISTS OF STANDARD CHARACTERS WITHOUT CLAIM TO ANY PARTICULAR FONT, STYLE, SIZE, OR COLOR.

FOR MANAGEMENT OF PRIVATE EQUITY FUNDS; PRIVATE EQUITY FUND INVESTMENT SERVICES (U.S. CLS. 100, 101 AND 102).

FIRST USE 5-31-2010; IN COMMERCE 5-31-2010.

4,046,351. AMERICAN PENSION SERVICES, INC., RIVERTON, UT. SN 85-065,595. PUB. 3-29-2011, FILED 6-17-2010.

# Genuine Self-Direction

THE MARK CONSISTS OF STANDARD CHARACTERS WITHOUT CLAIM TO ANY PARTICULAR FONT, STYLE, SIZE, OR COLOR.

NO CLAIM IS MADE TO THE EXCLUSIVE RIGHT TO USE "SELF-DIRECTION", APART FROM THE MARK AS SHOWN.

FOR CONSULTING SERVICES IN THE FIELD OF RETIREMENT PLAN ADMINISTRATION AND FIDUCIARY COMPLIANCE (U.S. CLS. 100, 101 AND 102).

FIRST USE 6-23-2011; IN COMMERCE 6-23-2011.

4,046,479. EZCORP, INC., AUSTIN, TX. SN 85-094,094. PUB. 1-11-2011, FILED 7-27-2010.



NO CLAIM IS MADE TO THE EXCLUSIVE RIGHT TO USE "CASH", APART FROM THE MARK AS SHOWN.

**CLASS 36—(Continued).**

THE MARK CONSISTS OF THREE OVERLAPPING TRIANGLES, INCREASING IN SIZE FROM LEFT TO RIGHT WITH THE WORD "CHANGE" TO THE RIGHT. THE WORDS "CASH, CONVENIENCE, CONTROL," ARE LOCATED UNDER THE WORD "CHANGE" IN A SMALLER FONT.

FOR FINANCIAL SERVICES, NAMELY, CREDIT AND DEBIT CARD SERVICES, SAVINGS ACCOUNT SERVICES, PRE-PAID CARD SERVICES, NAMELY, PROCESSING ELECTRONIC PAYMENTS THROUGH PREPAID CARDS, AND STORED VALUE CARD SERVICES; PREPAID STORED VALUE CARD RELOAD SERVICES; BILL PAYMENT SERVICES; FUNDS REMITTANCE SERVICES; MOBILE FINANCIAL SERVICES, NAMELY, MOBILE BANKING, PAYMENTS AND ELECTRONIC FUNDS TRANSFERS; ON-LINE FINANCIAL SERVICES, NAMELY, ONLINE BANKING AND PROVIDING FINANCIAL ACCOUNT INFORMATION (U.S. CLS. 100, 101 AND 102).

FIRST USE 10-26-2010; IN COMMERCE 10-26-2010.

4,046,505. HYATT CORPORATION, CHICAGO, IL. SN 85-097,921. PUB. 1-11-2011, FILED 8-2-2010.

# HYATT

THE MARK CONSISTS OF STANDARD CHARACTERS WITHOUT CLAIM TO ANY PARTICULAR FONT, STYLE, SIZE, OR COLOR.

OWNER OF U.S. REG. NOS. 945,384, 3,368,516, AND OTHERS.

FOR CREDIT CARD SERVICES (U.S. CLS. 100, 101 AND 102).

FIRST USE 9-2-2010; IN COMMERCE 9-2-2010.

4,046,565. WHEELS FINANCIAL GROUP, INC., ENCINO, CA. SN 85-105,938. PUB. 1-25-2011, FILED 8-12-2010.

# 800LOANDADDY

THE MARK CONSISTS OF STANDARD CHARACTERS WITHOUT CLAIM TO ANY PARTICULAR FONT, STYLE, SIZE, OR COLOR.

FOR LOAN ORIGINATING SERVICES (U.S. CLS. 100, 101 AND 102).

FIRST USE 12-1-2010; IN COMMERCE 8-12-2011.

**CLASS 36—(Continued).**

4,046,569. ANSCO, INC., NEW YORK, NY. SN 85-108,339.  
PUB. 1-18-2011, FILED 8-16-2010.

**LOFT LOVE REWARDS**

THE MARK CONSISTS OF STANDARD CHARACTERS WITHOUT CLAIM TO ANY PARTICULAR FONT, STYLE, SIZE, OR COLOR.

OWNER OF U.S. REG. NOS. 3,697,910, 3,782,059, AND OTHERS.

NO CLAIM IS MADE TO THE EXCLUSIVE RIGHT TO USE "REWARDS", APART FROM THE MARK AS SHOWN. FOR PROVIDING CASH AND OTHER REBATES FOR CREDIT CARD USE AS PART OF A CUSTOMER LOYALTY PROGRAM (U.S. CLS. 100, 101 AND 102).

FIRST USE 11-1-2010; IN COMMERCE 11-1-2010.

4,046,587. EFG CAPITAL INTERNATIONAL CORP., MIAMI, FL. SN 85-111,372. PUB. 3-1-2011, FILED 8-19-2010.

**KEYSTAR GROUP**

THE MARK CONSISTS OF STANDARD CHARACTERS WITHOUT CLAIM TO ANY PARTICULAR FONT, STYLE, SIZE, OR COLOR.

NO CLAIM IS MADE TO THE EXCLUSIVE RIGHT TO USE "GROUP", APART FROM THE MARK AS SHOWN.

FOR FINANCIAL SERVICES, NAMELY, WEALTH MANAGEMENT AND FINANCIAL ADVISORY SERVICES TO HIGH NET WORTH INDIVIDUALS (U.S. CLS. 100, 101 AND 102).

FIRST USE 3-30-2011; IN COMMERCE 3-30-2011.

4,046,612. HUTCHISON, PERRY & ASSOCIATES, INC., TUCSON, AZ. SN 85-116,068. PUB. 2-8-2011, FILED 8-26-2010.

**RECOVERING REVENUE...  
REBUILDING RELATIONSHIPS**

THE MARK CONSISTS OF STANDARD CHARACTERS WITHOUT CLAIM TO ANY PARTICULAR FONT, STYLE, SIZE, OR COLOR.

FOR FINANCIAL SERVICES, NAMELY, COMMERCIAL DEBT COLLECTION SERVICES (U.S. CLS. 100, 101 AND 102).

FIRST USE 1-1-2011; IN COMMERCE 1-1-2011.

**CLASS 36—(Continued).**

4,046,616. BRIDGELIGHT CAPITAL, LLC, SCOTTSDALE, AZ. SN 85-116,863. PUB. 2-15-2011, FILED 8-26-2010.

**BRIDGELIGHT**

THE MARK CONSISTS OF STANDARD CHARACTERS WITHOUT CLAIM TO ANY PARTICULAR FONT, STYLE, SIZE, OR COLOR.

FOR WEALTH ADVISORY SERVICES, NAMELY, FINANCIAL PLANNING, WEALTH PRESERVATION AND WEALTH MANAGEMENT SERVICES; FINANCIAL SERVICES, NAMELY, ADVICE RELATED TO INVESTMENTS, FINANCIAL ASSET MANAGEMENT, CASH MANAGEMENT; FINANCIAL ANALYSIS AND CONSULTATION, FINANCIAL PLANNING CONSULTATION, FINANCIAL PORTFOLIO MANAGEMENT, FINANCIAL RESEARCH AND FINANCIAL RISK MANAGEMENT; PROVIDING STOCK MARKET AND SECURITIES MARKET INFORMATION; BROKERAGE IN THE FIELD OF STOCKS, MUTUAL FUNDS AND OTHER SECURITIES; MUTUAL FUND INVESTMENT AND MUTUAL FUND DISTRIBUTION; FINANCIAL SERVICES, NAMELY, ASSISTING OTHERS WITH THE COMPLETION OF FINANCIAL TRANSACTIONS FOR STOCKS, BONDS, SECURITIES AND EQUITIES; INVESTMENT SERVICES, NAMELY, ASSET ACQUISITION, CONSULTATION, DEVELOPMENT AND MANAGEMENT SERVICES (U.S. CLS. 100, 101 AND 102).

FIRST USE 4-14-2011; IN COMMERCE 4-14-2011.

4,046,620. MITSUBISHI UFJ ASSET MANAGEMENT KABUSHIKI KAISHA A/T/A MITSUBISHI UFJ ASSET MANAGEMENT CO., LTD., CHIYODA-KU, TOKYO, JAPAN. SN 85-117,784. PUB. 2-15-2011, FILED 8-27-2010.

**MAXIS**

THE MARK CONSISTS OF STANDARD CHARACTERS WITHOUT CLAIM TO ANY PARTICULAR FONT, STYLE, SIZE, OR COLOR.

FOR MUTUAL FUNDS INVESTMENT (U.S. CLS. 100, 101 AND 102).

FIRST USE 9-22-2008; IN COMMERCE 7-13-2011.

4,046,621. PHILIPPE AUDI, DUBAI, UNITED ARAB EMIR.. SN 85-118,370. PUB. 3-8-2011, FILED 8-30-2010.

**LEVANT CAPITAL**

NO CLAIM IS MADE TO THE EXCLUSIVE RIGHT TO USE "LEVANT CAPITAL", APART FROM THE MARK AS SHOWN.

**CLASS 36—(Continued).**

THE MARK CONSISTS OF A SERIES OF FOUR DIAGONAL LINES OF VARYING LENGTH AND WIDTH PRECEDING THE WORDS "LEVANT CAPITAL".

FOR FINANCIAL AND INVESTMENT SERVICES, NAMELY, MUTUAL FUND INVESTMENT SERVICES, STOCK BROKERAGE SERVICES, AND PRIVATE EQUITY FUND INVESTMENT SERVICES (U.S. CLS. 100, 101 AND 102).

FIRST USE 8-16-2011; IN COMMERCE 8-16-2011.

---

4,046,630. IRON HOLDINGS, LLC, NORTHBROOK, IL. SN 85-119,891. PUB. 1-18-2011, FILED 8-31-2010.

**IRONINVESTMENTS**

THE MARK CONSISTS OF STANDARD CHARACTERS WITHOUT CLAIM TO ANY PARTICULAR FONT, STYLE, SIZE, OR COLOR.

OWNER OF U.S. REG. NOS. 3,827,464, 3,827,465, AND 3,827,467.

FOR FINANCIAL PORTFOLIO MANAGEMENT; INVESTMENT SERVICES, NAMELY, FUNDS INVESTMENT, FUND INVESTMENT CONSULTATION, INVESTMENT MANAGEMENT OF AND DISTRIBUTION OF VARIABLE ANNUITIES, MUTUAL FUND INVESTMENT; INVESTMENT ACCOUNT SERVICES, NAMELY, MAINTAINING ESCROW ACCOUNTS FOR INVESTMENTS; CASH MANAGEMENT ACCOUNT SERVICES; RETIREMENT FUND INVESTMENT SERVICES, NAMELY, INVESTMENT OF FUNDS FOR OTHERS; FINANCIAL INFORMATION AND CONSULTATION IN THE NATURE OF RETIREMENT PLANNING, RETIREMENT PLAN DESIGN AND SUPPORT AND RETIREMENT PLAN ADMINISTRATION SERVICES; FUNDS INVESTMENT AND CONSULTATION SERVICES IN ALL ASSET CLASSES; HIGH-YIELD FUNDS INVESTMENT AND CONSULTATION SERVICES; MUTUAL FUNDS AND CAPITAL INVESTMENT; RETIREMENT FUND ADMINISTRATION SERVICES, NAMELY, PLAN DESIGN, ADMINISTRATION, AND RECORD KEEPING; FIXED INCOME, EQUITIES, ALTERNATIVE INVESTMENTS, AND DERIVATIVES FUND MANAGEMENT AND CONSULTATION SERVICES (U.S. CLS. 100, 101 AND 102).

FIRST USE 5-0-2010; IN COMMERCE 5-0-2010.

---

4,046,631. IRON HOLDINGS, LLC, NORTHBROOK, IL. SN 85-119,911. PUB. 1-18-2011, FILED 8-31-2010.

**IRON INVESTMENT MANAGEMENT**

THE MARK CONSISTS OF STANDARD CHARACTERS WITHOUT CLAIM TO ANY PARTICULAR FONT, STYLE, SIZE, OR COLOR.

OWNER OF U.S. REG. NOS. 3,827,464, 3,827,465, AND 3,827,467.

**CLASS 36—(Continued).**

NO CLAIM IS MADE TO THE EXCLUSIVE RIGHT TO USE "INVESTMENT MANAGEMENT", APART FROM THE MARK AS SHOWN.

FOR FINANCIAL PORTFOLIO MANAGEMENT; INVESTMENT SERVICES, NAMELY, FUNDS INVESTMENT, FUND INVESTMENT CONSULTATION, INVESTMENT MANAGEMENT OF AND DISTRIBUTION OF VARIABLE ANNUITIES, MUTUAL FUND INVESTMENT; INVESTMENT ACCOUNT SERVICES, NAMELY, MAINTAINING ESCROW ACCOUNTS FOR INVESTMENTS; CASH MANAGEMENT ACCOUNT SERVICES; RETIREMENT FUND INVESTMENT SERVICES, NAMELY, INVESTMENT OF FUNDS FOR OTHERS; FINANCIAL INFORMATION AND CONSULTATION IN THE NATURE OF RETIREMENT PLANNING, RETIREMENT PLAN DESIGN AND SUPPORT AND RETIREMENT PLAN ADMINISTRATION SERVICES; FUNDS INVESTMENT AND CONSULTATION SERVICES IN ALL ASSET CLASSES; HIGH-YIELD FUNDS INVESTMENT AND CONSULTATION SERVICES; MUTUAL FUNDS AND CAPITAL INVESTMENT; RETIREMENT FUND ADMINISTRATION SERVICES, NAMELY, PLAN DESIGN, ADMINISTRATION, AND RECORD KEEPING; FIXED INCOME, EQUITIES, ALTERNATIVE INVESTMENTS, AND DERIVATIVES FUND MANAGEMENT AND CONSULTATION SERVICES (U.S. CLS. 100, 101 AND 102).

FIRST USE 5-0-2010; IN COMMERCE 5-0-2010.

---

4,046,632. IRON HOLDINGS, LLC, NORTHBROOK, ID. SN 85-119,971. PUB. 1-18-2011, FILED 8-31-2010.

**IRON RETIREMENT**

THE MARK CONSISTS OF STANDARD CHARACTERS WITHOUT CLAIM TO ANY PARTICULAR FONT, STYLE, SIZE, OR COLOR.

OWNER OF U.S. REG. NOS. 3,827,464, 3,827,465, AND 3,827,467.

NO CLAIM IS MADE TO THE EXCLUSIVE RIGHT TO USE "RETIREMENT", APART FROM THE MARK AS SHOWN.

FOR RETIREMENT FUND INVESTMENT SERVICES, NAMELY, INVESTMENT OF FUNDS FOR OTHERS; FINANCIAL INFORMATION AND CONSULTATION IN THE NATURE OF RETIREMENT PLANNING, RETIREMENT PLAN DESIGN AND SUPPORT AND RETIREMENT PLAN ADMINISTRATION SERVICES; FIXED INCOME FINANCIAL MANAGEMENT AND CONSULTATION SERVICES; FINANCIAL PORTFOLIO MANAGEMENT; RETIREMENT FUND ADMINISTRATION SERVICES, NAMELY, PLAN DESIGN, ADMINISTRATION, AND RECORDKEEPING (U.S. CLS. 100, 101 AND 102).

FIRST USE 1-0-2009; IN COMMERCE 1-0-2009.

**CLASS 36—(Continued).**

4,046,639. WORLD WEAR PROJECT, LLC, DALLAS, TX. SN 85-121,602. PUB. 3-1-2011, FILED 9-2-2010.

world wear project

THE MARK CONSISTS OF STANDARD CHARACTERS WITHOUT CLAIM TO ANY PARTICULAR FONT, STYLE, SIZE, OR COLOR.

NO CLAIM IS MADE TO THE EXCLUSIVE RIGHT TO USE "WEAR PROJECT", APART FROM THE MARK AS SHOWN.

FOR FUNDRAISING SERVICES, NAMELY, PARTNERING WITH NON-PROFIT ORGANIZATIONS TO COLLECT CLOTHING AND FOOTWEAR, AND PAYING THE ORGANIZATIONS FOR THE COLLECTED CLOTHING AND FOOTWEAR (U.S. CLS. 100, 101 AND 102).

FIRST USE 9-0-2010; IN COMMERCE 9-0-2010.

4,046,640. WORLD WEAR PROJECT, LLC, DALLAS, TX. SN 85-121,613. PUB. 3-1-2011, FILED 9-2-2010.



NO CLAIM IS MADE TO THE EXCLUSIVE RIGHT TO USE "WEAR PROJECT", APART FROM THE MARK AS SHOWN.

THE MARK CONSISTS OF A GLOBE SURROUNDED BY A REPEATING PATTERN OF GEOMETRICAL SHAPES REPRESENTING ARTICLES OF CLOTHING, NAMELY, SEMI-CIRCLES REPRESENTING SHOES, THREE INTERSECTING QUADRILATERALS WITH ROUNDED SIDES REPRESENTING PANTS, AND THREE INTERSECTING QUADRILATERALS WITH ROUNDED SIDES REPRESENTING A SHIRT. THE PATTERN OF GEOMETRICAL SHAPES REPEATS THREE TIMES AROUND THE CIRCUMFERENCE OF THE GLOBE. THE WORDS "WORLD WEAR PROJECT" ARE POSITIONED TO THE RIGHT OF THE DESIGN ELEMENT, WITH THE WORD "WORLD" PLACED ABOVE THE WORD "WEAR" AND THE WORD "WEAR" PLACED ABOVE THE WORD "PROJECT".

FOR FUNDRAISING SERVICES, NAMELY, PARTNERING WITH NON-PROFIT ORGANIZATIONS TO COLLECT CLOTHING AND FOOTWEAR, AND PAYING THE ORGANIZATIONS FOR THE COLLECTED CLOTHING AND FOOTWEAR (U.S. CLS. 100, 101 AND 102).

FIRST USE 9-0-2010; IN COMMERCE 9-0-2010.

**CLASS 36—(Continued).**

4,046,651. EXTRACO CORPORATION, WACO, TX. SN 85-123,929. PUB. 2-15-2011, FILED 9-7-2010.



OWNER OF U.S. REG. NOS. 2,396,460, 2,858,834, AND OTHERS.

NO CLAIM IS MADE TO THE EXCLUSIVE RIGHT TO USE "BANKS", APART FROM THE MARK AS SHOWN.

THE MARK CONSISTS OF A STYLIZED BIRD SYMBOL TO THE LEFT OF THE WORDS "EXTRACO BANKS".

FOR BANKING SERVICES; CHECKING ACCOUNT SERVICES; CREDIT AND LOAN SERVICES; CREDIT CARD AND DEBIT CARD SERVICES; FINANCIAL ANALYSIS AND CONSULTATION; FINANCIAL ASSET MANAGEMENT; FINANCIAL EXCHANGE; FINANCING AND LOAN SERVICES; SAFE DEPOSIT BOX SERVICES; SAVINGS ACCOUNT SERVICES (U.S. CLS. 100, 101 AND 102).

FIRST USE 5-6-2011; IN COMMERCE 5-16-2011.

4,046,676. SUMMIT CAPITAL ADVISORS, INC., YAKIMA, WA. SN 85-129,650. PUB. 2-8-2011, FILED 9-14-2010.

"Managing Your Wealth For  
Life"

THE MARK CONSISTS OF STANDARD CHARACTERS WITHOUT CLAIM TO ANY PARTICULAR FONT, STYLE, SIZE, OR COLOR.

FOR FINANCIAL ADVICE AND CONSULTANCY SERVICES; FINANCIAL ADVISORY AND CONSULTANCY SERVICES, NAMELY, THE CREATION OF PERSONALIZED STRATEGIES TO ACHIEVE FINANCIAL INDEPENDENCE; FINANCIAL AND INVESTMENT SERVICES, NAMELY, MANAGEMENT AND BROKERAGE IN THE FIELDS OF STOCKS, BONDS, OPTIONS, COMMODITIES, FUTURES AND OTHER SECURITIES, AND THE INVESTMENT OF FUNDS OF OTHERS; FINANCIAL ASSET MANAGEMENT (U.S. CLS. 100, 101 AND 102).

FIRST USE 4-5-2011; IN COMMERCE 4-5-2011.

**CLASS 36—(Continued).**

4,046,712. DELMARVA RENTAL, CALLAWAY, MD. SN 85-136,058. PUB. 3-15-2011, FILED 9-22-2010.



NO CLAIM IS MADE TO THE EXCLUSIVE RIGHT TO USE "RENT MY VACATION HOME.COM", APART FROM THE MARK AS SHOWN.

THE MARK CONSISTS OF "RENT MY" AT THE TOP, "VACATION" IN LARGER LETTERS IN THE MIDDLE, WITH A PALM TREE FOR THE FIRST "A", A SAIL BOAT FOR THE SECOND "A", AND A SUN FOR THE LETTER "O", AND "HOME.COM" AT THE BOTTOM.

FOR REAL ESTATE SERVICES, NAMELY, RENTAL OF VACATION HOMES (U.S. CLS. 100, 101 AND 102). FIRST USE 1-1-2010; IN COMMERCE 1-1-2010.

4,046,758. KEYCORP, CLEVELAND, OH. SN 85-148,455. PUB. 5-3-2011, FILED 10-8-2010.



NO CLAIM IS MADE TO THE EXCLUSIVE RIGHT TO USE "FINANCE", APART FROM THE MARK AS SHOWN. THE COLOR(S) RED IS/ARE CLAIMED AS A FEATURE OF THE MARK.

THE MARK CONSISTS OF 4 INTERLOCKING SOLID DISKS DESIGNED TO FORM A CLOVER SHAPE, WITH A GEOMETRIC SHAPE IN THE CENTER. THE WORDS "YOUR KEY" ARE IN THE CENTER. THE PHRASES "SAFEGUARD SAFEGUARD YOUR BUSINESS.", "FINANCE FINANCE YOUR FUTURE.", "PLAN PLAN PERSONAL AND EMPLOYEE FINANCES," AND "MANAGE MANAGE YOUR CASH." ARE PLACED SO THAT ONE OF THE PHRASES APPEARS IN EACH OF THE INTERLOCKING DISKS.

FOR BANKING AND FINANCING SERVICES (U.S. CLS. 100, 101 AND 102). FIRST USE 12-31-2010; IN COMMERCE 12-31-2010.

**CLASS 36—(Continued).**

4,046,766. THE INSURANCE EXCHANGE TRUST, INCORPORATED, WASHINGTON, DC. SN 85-151,963. PUB. 7-12-2011, FILED 10-13-2010.



THE COLOR(S) BLUE AND GREEN IS/ARE CLAIMED AS A FEATURE OF THE MARK.

THE MARK CONSISTS OF A GREEN CURVED LINE IN THE SHAPE OF AN ARCH WITH POINTED ENDS INDICATING ARROWS APPEARING ABOVE A BLUE SEMI CIRCLE.

FOR FINANCIAL TRUST OPERATIONS; MEMBERSHIP ORGANIZATION SERVICES, NAMELY, PROVIDING INFORMATION ON INSURANCE MARKETPLACE PRODUCTS AND SERVICES, FOR FINANCIAL PURPOSES (U.S. CLS. 100, 101 AND 102). FIRST USE 11-22-2010; IN COMMERCE 11-22-2010.

4,046,767. THE INSURANCE EXCHANGE TRUST, INCORPORATED, WASHINGTON, DC. SN 85-151,979. PUB. 7-12-2011, FILED 10-13-2010.



NO CLAIM IS MADE TO THE EXCLUSIVE RIGHT TO USE "INSURANCE EXCHANGE TRUST", APART FROM THE MARK AS SHOWN.

THE COLOR(S) BLUE, GREEN AND BLACK IS/ARE CLAIMED AS A FEATURE OF THE MARK.

THE MARK CONSISTS OF A GREEN CURVED LINE IN THE SHAPE OF AN ARCH WITH POINTED ENDS INDICATING ARROWS APPEARING ABOVE A BLUE SEMI CIRCLE TO RIGHT OF WHICH APPEARS THE WORDS "INSURANCE EXCHANGE TRUST" IN BLACK LETTERS.

FOR FINANCIAL TRUST OPERATIONS; MEMBERSHIP ORGANIZATION SERVICES, NAMELY, PROVIDING INFORMATION ON INSURANCE MARKETPLACE PRODUCTS AND SERVICES, FOR FINANCIAL PURPOSES (U.S. CLS. 100, 101 AND 102). FIRST USE 11-22-2010; IN COMMERCE 11-22-2010.

**CLASS 36—(Continued).**

4,046,784. BURGER KING CORPORATION, MIAMI, FL. SN 85-156,013. PUB. 3-22-2011, FILED 10-19-2010.

# WHOPPER

THE MARK CONSISTS OF STANDARD CHARACTERS WITHOUT CLAIM TO ANY PARTICULAR FONT, STYLE, SIZE, OR COLOR.

OWNER OF U.S. REG. NOS. 899,775, 3,736,954, AND 3,736,973.

FOR PROVIDING COLLEGE AND EDUCATIONAL SCHOLARSHIPS (U.S. CLS. 100, 101 AND 102).

FIRST USE 7-31-2011; IN COMMERCE 7-31-2011.

---

4,046,869. DUPAGE CREDIT UNION, NAPERVILLE, IL. SN 85-185,877. PUB. 5-3-2011, FILED 11-29-2010.



The logo for DuPage mortgage features the word "DuPage" in a bold, sans-serif font, with a stylized house roof icon above the letter "a". The word "mortgage" is in a smaller, lowercase, sans-serif font to the right of "DuPage".

NO CLAIM IS MADE TO THE EXCLUSIVE RIGHT TO USE "DUPAGE MORTGAGE", APART FROM THE MARK AS SHOWN.

THE MARK CONSISTS OF THE WORDS "DUPAGE MORTGAGE" BELOW A STYLIZED HOUSE ROOF WITH WINDOW AND CHIMNEY.

FOR FINANCIAL SERVICES, NAMELY, MORTGAGE REFINANCING; MORTGAGE LENDING (U.S. CLS. 100, 101 AND 102).

FIRST USE 1-10-2011; IN COMMERCE 1-10-2011.

---

4,046,899. FIELDSTONE INSURANCE GROUP, LLC, LITTLE FALLS, NJ. SN 85-193,463. PUB. 4-26-2011, FILED 12-8-2010.

FIELDSTONE INSURANCE GROUP

THE MARK CONSISTS OF STANDARD CHARACTERS WITHOUT CLAIM TO ANY PARTICULAR FONT, STYLE, SIZE, OR COLOR.

NO CLAIM IS MADE TO THE EXCLUSIVE RIGHT TO USE "INSURANCE GROUP", APART FROM THE MARK AS SHOWN.

FOR INSURANCE AGENCY AND BROKERAGE; PROCESSING, ADMINISTERING, SALES AND MANAGEMENT OF EMPLOYEE BENEFIT PLANS CONCERNING INSURANCE AND FINANCE (U.S. CLS. 100, 101 AND 102).

FIRST USE 3-28-2011; IN COMMERCE 3-28-2011.

**CLASS 36—(Continued).**

4,046,910. MIDWESTERN SECURITIES TRADING COMPANY, LLC, EAST PEORIA, IL. SN 85-195,920. PUB. 4-26-2011, FILED 12-11-2010.

Grow & Protect with MSTC

THE MARK CONSISTS OF STANDARD CHARACTERS WITHOUT CLAIM TO ANY PARTICULAR FONT, STYLE, SIZE, OR COLOR.

FOR BROKERAGE SERVICES IN THE FIELD OF SECURITIES AND COMMODITIES INVESTING; FINANCIAL SERVICES, NAMELY, BROKER/DEALER SERVICES ON SECURITIES EXCHANGES AND OVER-THE-COUNTER MARKETS (U.S. CLS. 100, 101 AND 102).

FIRST USE 10-1-2010; IN COMMERCE 10-1-2010.

---

4,046,912. KAPLAN, JED P., BOCA RATON, FL. SN 85-196,662. PUB. 5-31-2011, FILED 12-13-2010.

SHEARSON FINANCIAL SERVICES

THE MARK CONSISTS OF STANDARD CHARACTERS WITHOUT CLAIM TO ANY PARTICULAR FONT, STYLE, SIZE, OR COLOR.

OWNER OF U.S. REG. NO. 3,610,292.

NO CLAIM IS MADE TO THE EXCLUSIVE RIGHT TO USE "FINANCIAL SERVICES", APART FROM THE MARK AS SHOWN.

FOR SECURITIES BROKERAGE, INVESTMENT BROKERAGE, FINANCIAL AND INVESTMENT CONSULTING, AND INVESTMENT BANKING SERVICES; INVESTMENT OF FUNDS FOR OTHERS; INVESTMENT MANAGEMENT; FINANCIAL PORTFOLIO MANAGEMENT; FINANCIAL ASSET MANAGEMENT; FINANCIAL PLANNING FOR RETIREMENT; FINANCIAL ADMINISTRATION OF RETIREMENT PLANS; AND FINANCIAL SERVICES, NAMELY, ESTATE ASSET ACQUISITION AND ESTATE SETTLEMENT SERVICES (U.S. CLS. 100, 101 AND 102).

FIRST USE 4-11-2011; IN COMMERCE 4-11-2011.

---

4,046,927. MERIT PROPERTY MANAGEMENT, INC., ALISO VIEJO, CA. SN 85-201,973. PUB. 5-17-2011, FILED 12-20-2010.

# MAS

THE MARK CONSISTS OF STANDARD CHARACTERS WITHOUT CLAIM TO ANY PARTICULAR FONT, STYLE, SIZE, OR COLOR.

**CLASS 36—(Continued).**

OWNER OF U.S. REG. NOS. 2,705,078 AND 3,807,987.  
 FOR REAL PROPERTY MANAGEMENT AND CONSULTATION RELATED THERETO, DIRECTED TOWARD COMMUNITY HOMEOWNERS ASSOCIATIONS (U.S. CLS. 100, 101 AND 102).  
 FIRST USE 10-15-1985; IN COMMERCE 10-15-1985.

4,046,951. FAMILIES EXPLORING DOWN SYNDROME OF BREVARD INC., COCOA BEACH, FL. SN 85-209,412. PUB. 6-21-2011, FILED 1-3-2011.



NO CLAIM IS MADE TO THE EXCLUSIVE RIGHT TO USE "DOWN SYNDROME" AND "BREVARD", APART FROM THE MARK AS SHOWN.

THE MARK CONSISTS OF A CIRCLE WITH THE WORDING "STEP UP FOR DOWN SYNDROME BREVARD" IN THE CENTER OF THE CIRCLE WHERE THE WORD "STEP" APPEARS CENTERED AT THE TOP OF THE CIRCLE, THE WORDING "UP" APPEARS CENTERED UNDERNEATH THE LETTER "S" IN THE WORD "STEP" AND THE WORD "FOR" APPEARS BELOW THE LETTER "E" IN THE WORD "STEP" WITH THE WORD "DOWN" CENTERED BELOW THE WORD "FOR". THE WORD "SYNDROME" IS CENTERED BELOW THE WORDING "UP" AND "DOWN" AND THE WORD "BREVARD" IS CENTERED BELOW THE WORD "SYNDROME". THERE ARE TWO FOOTPRINTS WITH THE TOES POINTING UPWARD TO THE RIGHT OF THE WORDING "FOR" AND TWENTY (20) PAIRS OF FOOTPRINTS WITH THE TOES POINTING OUTWARD SURROUNDING THE BORDER OF THE CIRCLE.

FOR CHARITABLE FUNDRAISING SERVICES (U.S. CLS. 100, 101 AND 102).  
 FIRST USE 1-1-2010; IN COMMERCE 1-1-2010.

4,047,013. CHRONIC DISEASE FUND, PLANO, TX. SN 85-223,436. PUB. 5-24-2011, FILED 1-21-2011.

# RE:SOLVE

THE MARK CONSISTS OF STANDARD CHARACTERS WITHOUT CLAIM TO ANY PARTICULAR FONT, STYLE, SIZE, OR COLOR.

FOR CHARITABLE FUNDRAISING SERVICES (U.S. CLS. 100, 101 AND 102).  
 FIRST USE 2-1-2011; IN COMMERCE 3-31-2011.

**CLASS 36—(Continued).**

4,047,014. CHRONIC DISEASE FUND, PLANO, TX. SN 85-223,469. PUB. 5-24-2011, FILED 1-21-2011.

# CDF

THE MARK CONSISTS OF STANDARD CHARACTERS WITHOUT CLAIM TO ANY PARTICULAR FONT, STYLE, SIZE, OR COLOR.

FOR CHARITABLE SERVICES, NAMELY, PROVIDING FINANCIAL ASSISTANCE TO QUALIFYING PATIENTS FOR SATISFACTION OF HEALTH INSURANCE COPAYMENT CHARGES (U.S. CLS. 100, 101 AND 102).  
 FIRST USE 9-1-2010; IN COMMERCE 1-3-2011.

4,047,044. HAWAII LIFE REAL ESTATE SERVICES, LLC, AKA HAWAII LIFE, HANALEI, HI. SN 85-236,192. PUB. 6-14-2011, FILED 2-7-2011.

# Global Reach. Local Style

THE MARK CONSISTS OF STANDARD CHARACTERS WITHOUT CLAIM TO ANY PARTICULAR FONT, STYLE, SIZE, OR COLOR.

FOR COMMERCIAL AND RESIDENTIAL REAL ESTATE AGENCY SERVICES; PROVIDING A DATABASE OF INFORMATION ABOUT RESIDENTIAL REAL ESTATE LISTINGS IN DIFFERENT NEIGHBORHOODS AND COMMUNITIES; PROVIDING A DATABASE OF RESIDENTIAL REAL ESTATE LISTINGS WITHIN NEIGHBORHOODS AND COMMUNITIES SPECIFICALLY IDENTIFIED BY USERS; PROVIDING INFORMATION IN THE FIELD OF REAL ESTATE BY MEANS OF LINKING THE WEB SITE TO OTHER WEB SITES FEATURING REAL ESTATE INFORMATION; PROVIDING INFORMATION IN THE FIELD OF REAL ESTATE VIA THE INTERNET; PROVIDING REAL ESTATE LISTINGS AND REAL ESTATE INFORMATION VIA THE INTERNET; PROVIDING REAL ESTATE LISTINGS VIA THE INTERNET; REAL ESTATE BROKERAGE; REAL ESTATE MANAGEMENT OF VACATION HOMES (U.S. CLS. 100, 101 AND 102).

FIRST USE 2-1-2011; IN COMMERCE 3-10-2011.



**CLASS 36—(Continued).**

4,047,045. NAU HOLDING COMPANY, LLC, RAMSEY, MN. SN 85-236,443. PUB. 6-14-2011, FILED 2-8-2011.

**NAU COUNTRY**

THE MARK CONSISTS OF STANDARD CHARACTERS WITHOUT CLAIM TO ANY PARTICULAR FONT, STYLE, SIZE, OR COLOR.

OWNER OF U.S. REG. NO. 3,622,725.  
FOR INSURANCE SERVICES, NAMELY, UNDERWRITING, INSURANCE ADMINISTRATION, CLAIMS ADMINISTRATION AND AGENCY SERVICES IN THE FIELD OF AGRICULTURE (U.S. CLS. 100, 101 AND 102).  
FIRST USE 9-10-2003; IN COMMERCE 9-10-2003.

4,047,069. NOT ALONE, BEND, OR. SN 85-247,879. PUB. 6-28-2011, FILED 2-22-2011.

**TEAM NOT ALONE**

THE MARK CONSISTS OF STANDARD CHARACTERS WITHOUT CLAIM TO ANY PARTICULAR FONT, STYLE, SIZE, OR COLOR.

FOR CHARITABLE FUNDRAISING SERVICES (U.S. CLS. 100, 101 AND 102).  
FIRST USE 4-13-2011; IN COMMERCE 4-13-2011.

4,047,100. TAYBANDZ, INC., SCARSDALE, NY. SN 85-975,656. PUB. 4-12-2011, FILED 6-1-2010.

**Kids Curing Cancer**

THE MARK CONSISTS OF STANDARD CHARACTERS WITHOUT CLAIM TO ANY PARTICULAR FONT, STYLE, SIZE, OR COLOR.

SEC. 2(F).  
FOR CHARITABLE FUND RAISING SERVICES (U.S. CLS. 100, 101 AND 102).  
FIRST USE 11-1-2009; IN COMMERCE 11-1-2009.

**CLASS 37—CONSTRUCTION AND REPAIR****CLASS 37—(Continued).**

4,045,767. BLUESCOPE STEEL LIMITED, MELBOURNE, VIC 3000, AUSTRALIA. SN 77-576,290. PUB. 6-23-2009, FILED 9-23-2008.



NO CLAIM IS MADE TO THE EXCLUSIVE RIGHT TO USE "CONSTRUCTION", APART FROM THE MARK AS SHOWN.

THE COLOR(S) BLUE IS/ARE CLAIMED AS A FEATURE OF THE MARK.

THE MARK CONSISTS OF THE WORDS "BLUESCOPE CONSTRUCTION" IN BLUE STYLIZED LETTERING BELOW FIVE WAVY LINES ALSO IN BLUE.

FOR BUILDING CONSTRUCTION AND REPAIR SERVICES; BUILDING PROJECT MANAGEMENT, NAMELY, BUILDING CONSTRUCTION SUPERVISION; APPLICATION OF PROTECTIVE METAL COATINGS (U.S. CLS. 100, 103 AND 106).

FIRST USE 1-5-2009; IN COMMERCE 1-5-2009.

4,045,884. T3 PARTNERS, DBA TECHSTOP, DENVER, CO. SN 77-785,007. PUB. 12-15-2009, FILED 7-20-2009.

THE MARK CONSISTS OF THE WORD "TECHSTOP" IN A STYLIZED FONT IN LOWER CASE LETTERS WITH A DESIGN OF A VERTICAL LINE THROUGH THE TOP OF THE "O".

FOR CONSUMER TECHNOLOGY SUPPORT SERVICES IN THE NATURE OF TECHNICAL SUPPORT SERVICES, NAMELY, TROUBLESHOOTING IN THE NATURE OF MAINTENANCE AND REPAIR OF COMPUTER HARDWARE AND SOFTWARE (U.S. CLS. 100, 103 AND 106).

FIRST USE 1-14-2010; IN COMMERCE 1-14-2010.

**CLASS 37—(Continued).**

4,046,057. HUNTER COMMUNITIES, INC., HUNTSVILLE, AL. SN 77-932,400. PUB. 1-4-2011, FILED 2-10-2010.

## WHY RENT?

THE MARK CONSISTS OF STANDARD CHARACTERS WITHOUT CLAIM TO ANY PARTICULAR FONT, STYLE, SIZE, OR COLOR.

FOR RESIDENTIAL HOME BUILDING CONSTRUCTION SERVICES (U.S. CLS. 100, 103 AND 106).  
FIRST USE 12-15-2006; IN COMMERCE 12-15-2006.

4,046,075. CALPORTLAND COMPANY, GLENDORA, CA. SN 77-937,167. PUB. 7-6-2010, FILED 2-16-2010.



OWNER OF U.S. REG. NOS. 1,754,373, 3,693,593, AND OTHERS.

THE MARK CONSISTS OF A LARGE LETTER "C" NEXT TO A LARGE LETTER "P", THE "P" BEING OVER THE WORD "ADVANTAGE".

FOR CONSTRUCTION SERVICES, NAMELY, SITE PREPARATION, GRADING AND FINISHING OF CONCRETE, ASPHALT AND AGGREGATE; PUMPING, POURING AND PLACING OF CONCRETE AND ASPHALT; PLACING OF AGGREGATE; PAVING CONTRACTOR SERVICES; AND FOUNDATION CONTRACTOR SERVICES (U.S. CLS. 100, 103 AND 106).  
FIRST USE 2-25-2010; IN COMMERCE 2-25-2010.

4,046,324. ECO GREEN INVESTMENTS LLC, SAN ANTONIO, TX. SN 85-058,392. PUB. 5-31-2011, FILED 6-9-2010.



NO CLAIM IS MADE TO THE EXCLUSIVE RIGHT TO USE "GREEN" AND "DRY CLEANERS", APART FROM THE MARK AS SHOWN.

**CLASS 37—(Continued).**

THE MARK CONSISTS OF AN ABSTRACT SQUARE DESIGN CONTAINING TWO SERIES OF CURVED BANDS TO THE LEFT OF THE STYLIZED WORD "TRUE" OVER THE STYLIZED WORD "GREEN", HAVING A DOUBLE HORIZONTAL LINE SEPARATING "TRUE" AND "GREEN", BELOW IS A HORIZONTAL LINE AND UNDERNEATH THE STYLIZED WORDING "DRY CLEANERS".

FOR ENVIRONMENTALLY AND ECOLOGICALLY FRIENDLY DRY CLEANING SERVICES (U.S. CLS. 100, 103 AND 106).

FIRST USE 4-0-2010; IN COMMERCE 3-0-2011.

4,046,439. CCA GLOBAL PARTNERS, INC., EARTH CITY, MO. SN 85-088,255. PUB. 11-23-2010, FILED 7-20-2010.

## HEALTHIER LIVING

THE MARK CONSISTS OF STANDARD CHARACTERS WITHOUT CLAIM TO ANY PARTICULAR FONT, STYLE, SIZE, OR COLOR.

FOR FLOORING INSTALLATION SERVICES (U.S. CLS. 100, 103 AND 106).  
FIRST USE 10-31-2010; IN COMMERCE 10-31-2010.

4,046,750. PATEL, MIKE, NEWPORT BEACH, CA. SN 85-146,725. PUB. 3-22-2011, FILED 10-6-2010.

## T2 DEVELOPMENT

THE MARK CONSISTS OF STANDARD CHARACTERS WITHOUT CLAIM TO ANY PARTICULAR FONT, STYLE, SIZE, OR COLOR.

NO CLAIM IS MADE TO THE EXCLUSIVE RIGHT TO USE "DEVELOPMENT", APART FROM THE MARK AS SHOWN.

FOR REAL ESTATE DEVELOPMENT AND BUILDING CONSTRUCTION SERVICES (U.S. CLS. 100, 103 AND 106).

FIRST USE 2-1-2011; IN COMMERCE 3-21-2011.

**CLASS 37—(Continued).**

4,046,839. ONE STEP, CARLSBAD, CA. SN 85-173,993. PUB. 3-29-2011, FILED 11-10-2010.

**ALLERGY-CLEAN**

THE MARK CONSISTS OF STANDARD CHARACTERS WITHOUT CLAIM TO ANY PARTICULAR FONT, STYLE, SIZE, OR COLOR.

FOR MAID SERVICES (U.S. CLS. 100, 103 AND 106).  
FIRST USE 1-3-2009; IN COMMERCE 1-3-2009.

4,046,855. HUNTER RESIDENTIAL SERVICES, LLC, BRADENTON, FL. SN 85-180,930. PUB. 4-12-2011, FILED 11-19-2010.

**THE SURFIN' PLUMBERS**

THE MARK CONSISTS OF STANDARD CHARACTERS WITHOUT CLAIM TO ANY PARTICULAR FONT, STYLE, SIZE, OR COLOR.

NO CLAIM IS MADE TO THE EXCLUSIVE RIGHT TO USE "PLUMBERS", APART FROM THE MARK AS SHOWN.  
FOR PLUMBING SERVICES (U.S. CLS. 100, 103 AND 106).  
FIRST USE 2-0-2011; IN COMMERCE 2-0-2011.

4,046,952. HARVARD MAINTENANCE, INC., NEW YORK, NY. SN 85-209,789. PUB. 5-17-2011, FILED 1-4-2011.

**HARVARD CARE**

OWNER OF U.S. REG. NOS. 2,825,189 AND 2,825,190.  
NO CLAIM IS MADE TO THE EXCLUSIVE RIGHT TO USE "CARE", APART FROM THE MARK AS SHOWN.  
THE COLOR(S) DARK BLUE AND GREEN IS/ARE CLAIMED AS A FEATURE OF THE MARK.

THE MARK CONSISTS OF THE TERM "HARVARD" IN DARK BLUE, WITH THE RIGHT SIDE OF THE "V" EXTENDING ABOVE THE OTHER LETTERS, FOLLOWED BY THE TERM "CARE" IN GREEN.

FOR CLEANING OF BUILDINGS AND FACILITIES; MAINTENANCE AND RENOVATION OF BUILDINGS AND FACILITIES; JANITORIAL SERVICES; CARPET AND RUG CLEANING AND SHAMPOOING; WINDOW CLEANING; TRASH COLLECTION; WASTE DISPOSAL FOR OTHERS; CLEANING, BUFFING AND POLISHING OF METAL AND STONE; DOOR MAINTENANCE AND REPAIR SERVICES; FURNITURE RESTORATION, REPAIR AND MAINTENANCE; FLOOR SANDING; PEST CONTROL AND EXTERMINATION OTHER THAN FOR AGRICULTURE (U.S. CLS. 100, 103 AND 106).  
FIRST USE 4-0-2011; IN COMMERCE 4-0-2011.

**CLASS 37—(Continued).**

4,046,954. HARVARD MAINTENANCE, INC., NEW YORK, NY. SN 85-209,812. PUB. 5-17-2011, FILED 1-4-2011.

**HARVARD CLEAN**

OWNER OF U.S. REG. NOS. 2,825,189 AND 2,825,190.  
NO CLAIM IS MADE TO THE EXCLUSIVE RIGHT TO USE "CLEAN", APART FROM THE MARK AS SHOWN.  
THE COLOR(S) DARK BLUE AND GREEN IS/ARE CLAIMED AS A FEATURE OF THE MARK.

THE MARK CONSISTS OF THE TERM "HARVARD" IN DARK BLUE, WITH THE RIGHT SIDE OF THE "V" EXTENDING ABOVE THE OTHER LETTERS, FOLLOWED BY THE TERM "CLEAN" IN GREEN.

FOR CLEANING OF BUILDINGS AND FACILITIES; MAINTENANCE AND RENOVATION OF BUILDINGS AND FACILITIES; JANITORIAL SERVICES; CARPET AND RUG CLEANING AND SHAMPOOING; WINDOW CLEANING; TRASH COLLECTION; WASTE DISPOSAL FOR OTHERS; CLEANING, BUFFING AND POLISHING OF METAL AND STONE; DOOR MAINTENANCE AND REPAIR SERVICES; FURNITURE RESTORATION, REPAIR AND MAINTENANCE; FLOOR SANDING; PEST CONTROL AND EXTERMINATION OTHER THAN FOR AGRICULTURE (U.S. CLS. 100, 103 AND 106).  
FIRST USE 4-0-2011; IN COMMERCE 4-0-2011.

4,046,955. HARVARD MAINTENANCE, INC., NEW YORK, NY. SN 85-209,830. PUB. 5-17-2011, FILED 1-4-2011.

**HARVARD DOORS**

OWNER OF U.S. REG. NOS. 2,825,189 AND 2,825,190.  
NO CLAIM IS MADE TO THE EXCLUSIVE RIGHT TO USE "DOORS", APART FROM THE MARK AS SHOWN.  
THE COLOR(S) DARK BLUE AND GREEN IS/ARE CLAIMED AS A FEATURE OF THE MARK.

THE MARK CONSISTS OF THE TERM "HARVARD" IN DARK BLUE, WITH THE RIGHT SIDE OF THE "V" EXTENDING ABOVE THE OTHER LETTERS, FOLLOWED BY THE TERM "DOORS" IN GREEN.

FOR CLEANING OF BUILDINGS AND FACILITIES; MAINTENANCE AND RENOVATION OF BUILDINGS AND FACILITIES; CLEANING, BUFFING AND POLISHING OF METAL AND STONE; DOOR MAINTENANCE AND REPAIR SERVICES (U.S. CLS. 100, 103 AND 106).  
FIRST USE 4-0-2011; IN COMMERCE 4-0-2011.

**CLASS 38—COMMUNICATION**

**CLASS 38—(Continued).**

4,045,773. INTERSECT PTP, INC., SEATTLE, WA. SN 77-606,706. PUB. 5-31-2011, FILED 11-4-2008.

# INTERSECT

THE MARK CONSISTS OF STANDARD CHARACTERS WITHOUT CLAIM TO ANY PARTICULAR FONT, STYLE, SIZE, OR COLOR.

OWNER OF U.S. REG. NO. 3,875,059.

FOR PROVIDING ON-LINE CHAT ROOMS AND ELECTRONIC BULLETIN BOARDS FOR TRANSMISSION OF MESSAGES AMONG USERS IN THE FIELD OF GENERAL INTEREST, CLASSIFIED ADVERTISEMENTS, EVENT CALENDARS, VIRTUAL COMMUNITIES AND SOCIAL NETWORKING; WIRELESS BROADBAND COMMUNICATION SERVICES; TELECOMMUNICATION SERVICES, NAMELY, TRANSMISSION OF VOICE, DATA, GRAPHICS, IMAGES, AUDIO AND VIDEO BY MEANS OF TELECOMMUNICATIONS NETWORKS, WIRELESS COMMUNICATION NETWORKS, AND THE INTERNET (U.S. CLS. 100, 101 AND 104).

FIRST USE 9-8-2010; IN COMMERCE 9-8-2010.

4,045,832. COOKIE JAR ENTERTAINMENT, INC., TORONTO, ONTARIO, CANADA. SN 77-703,538. PUB. 1-12-2010, FILED 3-31-2009.

# JAROO

THE MARK CONSISTS OF STANDARD CHARACTERS WITHOUT CLAIM TO ANY PARTICULAR FONT, STYLE, SIZE, OR COLOR.

FOR BROADBAND INTERNET BROADCASTING SERVICES (U.S. CLS. 100, 101 AND 104).

FIRST USE 11-3-2009; IN COMMERCE 11-3-2009.

4,045,897. ELECTRIC POWER BOARD AN INDEPENDENT BOARD OF THE CITY OF CHATTANOOGA, CHATTANOOGA, TN. SN 77-799,427. PUB. 6-28-2011, FILED 8-7-2009.

# FI TV

THE MARK CONSISTS OF STANDARD CHARACTERS WITHOUT CLAIM TO ANY PARTICULAR FONT, STYLE, SIZE, OR COLOR.

**CLASS 38—(Continued).**

NO CLAIM IS MADE TO THE EXCLUSIVE RIGHT TO USE "TV", APART FROM THE MARK AS SHOWN.

FOR TELECOMMUNICATIONS SERVICES, NAMELY, PROVIDING TRANSMISSION OF TELEVISION SIGNALS VIA A BROADBAND OPTICAL NETWORK (U.S. CLS. 100, 101 AND 104).

FIRST USE 9-1-2009; IN COMMERCE 9-1-2009.

4,045,950. KNO, INC., SANTA CLARA, CA. SN 77-852,876. PUB. 5-25-2010, FILED 10-20-2009.

# KNO

THE MARK CONSISTS OF STANDARD CHARACTERS WITHOUT CLAIM TO ANY PARTICULAR FONT, STYLE, SIZE, OR COLOR.

FOR ELECTRONIC TRANSMISSION OF DATA, TEXT, IMAGES, AUDIO, AND VIDEO TO COMPUTERS AND WIRELESS DEVICES (U.S. CLS. 100, 101 AND 104).

FIRST USE 10-0-2010; IN COMMERCE 6-2-2011.

4,045,977. PROCONGPS, INC., KNOXVILLE, TN. SN 77-882,187. PUB. 3-9-2010, FILED 11-30-2009.

# REPO TRACE

THE MARK CONSISTS OF STANDARD CHARACTERS WITHOUT CLAIM TO ANY PARTICULAR FONT, STYLE, SIZE, OR COLOR.

NO CLAIM IS MADE TO THE EXCLUSIVE RIGHT TO USE "REPO", APART FROM THE MARK AS SHOWN.

FOR SUBSCRIPTION BASED SERVICES, NAMELY, ELECTRONIC TRANSMISSION OF DATA AND INFORMATION VIA A GLOBAL COMPUTER NETWORK FOR TRACKING THE LOCATION OF A WIRELESS DEVICE AND FOR CONTROLLING FUNCTIONS OF A VEHICLE IN WHICH THE WIRELESS DEVICE IS INSTALLED, AND TELECOMMUNICATION CONSULTATION, NAMELY, PROVIDING ASSISTANCE TO A USER OF THE WIRELESS DEVICE BASED ON REQUESTS COMMUNICATED BY THE USER TO THE SERVICE PROVIDER (U.S. CLS. 100, 101 AND 104).

FIRST USE 3-16-2010; IN COMMERCE 3-16-2010.

**CLASS 38—(Continued).**

4,046,154. THE CARTOON NETWORK, INC., ATLANTA, GA. SN 77-964,726. PUB. 3-15-2011, FILED 3-22-2010.



OWNER OF U.S. REG. NOS. 3,124,575, 3,582,803, AND OTHERS.

NO CLAIM IS MADE TO THE EXCLUSIVE RIGHT TO USE "NETWORK", APART FROM THE MARK AS SHOWN.

THE MARK CONSISTS OF WHITE LETTER "C" IN A SQUARE NEXT TO A BLACK LETTER "N" WITH THE WORDS "CARTOON NETWORK" UNDERNEATH. SEC. 2(F) AS TO "CARTOON".

FOR CABLE TELEVISION AND SATELLITE TELEVISION BROADCASTING SERVICES, STREAMING OF AUDIO, VIDEO AND AUDIO/VIDEO MATERIALS OVER THE INTERNET (U.S. CLS. 100, 101 AND 104).

FIRST USE 5-29-2010; IN COMMERCE 5-29-2010.

4,046,198. HEALTHINATION, INC., NEW YORK, NY. SN 78-920,723. PUB. 6-17-2008, FILED 6-30-2006.

**HEALTHINATION**

THE MARK CONSISTS OF STANDARD CHARACTERS WITHOUT CLAIM TO ANY PARTICULAR FONT, STYLE, SIZE, OR COLOR.

FOR BROADCASTING PROGRAMS VIA THE INTERNET, CABLE TELEVISION, AND HANDHELD DEVICES INCLUDING MOBILE PHONES; STREAMING OF AUDIO AND VIDEO MATERIAL ON THE INTERNET; LISTSERVICES FOR TRANSMISSION OF MESSAGES IN THE FIELDS OF HEALTH AND HEALTH CARE; AND TRANSMISSION OF INFORMATION, NEWS, AND MESSAGES IN THE FIELDS OF HEALTH AND HEALTH CARE OVER ELECTRONIC MEDIA (U.S. CLS. 100, 101 AND 104).

FIRST USE 6-0-2006; IN COMMERCE 6-0-2006.

**CLASS 38—(Continued).**

4,046,410. MOTOLIFE INC., PORTLAND, OR. SN 85-083,335. PUB. 1-4-2011, FILED 7-13-2010.

**MOTOLIFETV**

THE MARK CONSISTS OF STANDARD CHARACTERS WITHOUT CLAIM TO ANY PARTICULAR FONT, STYLE, SIZE, OR COLOR.

FOR BROADCAST OF CABLE TELEVISION PROGRAMMES; STREAMING OF AUDIO, VISUAL AND AUDIOVISUAL MATERIAL VIA A GLOBAL COMPUTER NETWORK; STREAMING OF VIDEO MATERIAL ON THE INTERNET; STREAMING OF AUDIOVISUAL MATERIAL ON THE INTERNET; TELEVISION BROADCASTING (U.S. CLS. 100, 101 AND 104).

FIRST USE 1-0-2004; IN COMMERCE 1-0-2004.

4,046,548. MEDIAFRIENDS, INC., WOBURN, MA. SN 85-101,991. PUB. 7-12-2011, FILED 8-6-2010.

**HEYWIRE**

THE MARK CONSISTS OF STANDARD CHARACTERS WITHOUT CLAIM TO ANY PARTICULAR FONT, STYLE, SIZE, OR COLOR.

FOR PROVIDING MOBILE COMMUNICATIONS SERVICES IN THE NATURE OF WIRELESS INFORMATION TRANSMISSION SERVICES VIA ELECTRONIC COMMUNICATIONS NETWORKS, NAMELY, TEXT MESSAGING, SHORT MESSAGE SERVICES (SMS), MULTIMEDIA MESSAGE SERVICES (MMS) AND INSTANT MESSAGING, INCLUDING MULTI-PERSON, ONE-TO-ONE AND ONE-TO-MANY FEATURES AND LOCATION-BASED FEATURES, DELIVERED BY WAY OF IP-ENABLED DEVICES (U.S. CLS. 100, 101 AND 104).

FIRST USE 9-21-2010; IN COMMERCE 9-21-2010.

4,046,641. TRACFONE WIRELESS, INC., MIAMI, FL. SN 85-121,707. PUB. 2-1-2011, FILED 9-2-2010.

**STRAIGHT TALK RESERVE**

THE MARK CONSISTS OF STANDARD CHARACTERS WITHOUT CLAIM TO ANY PARTICULAR FONT, STYLE, SIZE, OR COLOR.

**CLASS 38—(Continued).**

OWNER OF U.S. REG. NOS. 3,794,491, 3,815,424, AND OTHERS.

FOR CELLULAR TELEPHONE COMMUNICATIONS SERVICES; CELLULAR TELEPHONE TELECOMMUNICATIONS SERVICES PROVIDED VIA PREPAID AIR TIME CELLULAR TELEPHONES AND PREPAID AIR TIME CELLULAR TELEPHONE CALLING CARD SERVICES (U.S. CLS. 100, 101 AND 104).

FIRST USE 11-30-2010; IN COMMERCE 11-30-2010.

---

4,046,691. GRIDIRON VENTURES, LLC, CHAPEL HILL, NC. SN 85-131,346. PUB. 3-8-2011, FILED 9-16-2010.

# GRUNTS

THE MARK CONSISTS OF STANDARD CHARACTERS WITHOUT CLAIM TO ANY PARTICULAR FONT, STYLE, SIZE, OR COLOR.

FOR ELECTRONIC TRANSMISSION OF SPORTS AND ENTERTAINMENT MEDIA CONTENT (U.S. CLS. 100, 101 AND 104).

FIRST USE 4-28-2011; IN COMMERCE 4-28-2011.

---

4,046,904. ALLIED WIRELESS COMMUNICATIONS CORPORATION, LITTLE ROCK, AR. SN 85-194,152. PUB. 4-19-2011, FILED 12-9-2010.

# SIMPLE FREEDOM

THE MARK CONSISTS OF STANDARD CHARACTERS WITHOUT CLAIM TO ANY PARTICULAR FONT, STYLE, SIZE, OR COLOR.

FOR WIRELESS TELEPHONE TELECOMMUNICATIONS SERVICES, NAMELY, WIRELESS MOBILE TELEPHONE CALLING PLANS (U.S. CLS. 100, 101 AND 104).

FIRST USE 8-20-2011; IN COMMERCE 8-20-2011.

---

4,046,907. TWENTIETH CENTURY FOX FILM CORPORATION, LOS ANGELES, CA. SN 85-194,646. PUB. 5-10-2011, FILED 12-9-2010.

# FOX SOCCER

THE MARK CONSISTS OF STANDARD CHARACTERS WITHOUT CLAIM TO ANY PARTICULAR FONT, STYLE, SIZE, OR COLOR.

**CLASS 38—(Continued).**

OWNER OF U.S. REG. NOS. 3,058,283, 3,784,518, AND OTHERS.

NO CLAIM IS MADE TO THE EXCLUSIVE RIGHT TO USE "SOCCER", APART FROM THE MARK AS SHOWN, FOR TELEVISION TRANSMISSION AND BROADCASTING SERVICES (U.S. CLS. 100, 101 AND 104).

FIRST USE 5-5-2011; IN COMMERCE 5-5-2011.

---

4,047,025. KIPSU, LLC, PLYMOUTH, MN. SN 85-228,446. PUB. 6-7-2011, FILED 1-28-2011.

# KIPSU

THE MARK CONSISTS OF STANDARD CHARACTERS WITHOUT CLAIM TO ANY PARTICULAR FONT, STYLE, SIZE, OR COLOR.

FOR BROADCAST COMMUNICATION SERVICES, NAMELY, TRANSMITTING E-MAILS AND TEXT MESSAGES TO DESIGNATED RECIPIENTS FOR OTHERS (U.S. CLS. 100, 101 AND 104).

FIRST USE 1-20-2011; IN COMMERCE 1-20-2011.

**CLASS 39—TRANSPORTATION AND STORAGE**

4,045,783. LAND SPAN, INC., ATLANTA, GA. SN 77-638,021. PUB. 11-17-2009, FILED 12-22-2008.

## LAND SPAN ON-DEMAND GUARANTEED EXPEDITED SERVICE!

THE MARK CONSISTS OF STANDARD CHARACTERS WITHOUT CLAIM TO ANY PARTICULAR FONT, STYLE, SIZE, OR COLOR.

OWNER OF U.S. REG. NOS. 1,474,526, 2,604,244, AND 3,439,914.

NO CLAIM IS MADE TO THE EXCLUSIVE RIGHT TO USE "ON-DEMAND GUARANTEED EXPEDITED SERVICE", APART FROM THE MARK AS SHOWN.

FOR TRUCK FREIGHT TRANSPORTATION SERVICES (U.S. CLS. 100 AND 105).

FIRST USE 12-0-2008; IN COMMERCE 12-0-2008.

**CLASS 39—(Continued).**

4,046,088. CARLSBAD-PALOMAR AIRLINES, INC., DBA CALIFORNIA PACIFIC AIRLINES, CARLSBAD, CA. SN 77-942,019. PUB. 4-26-2011, FILED 2-23-2010.

## California Pacific Airlines

THE MARK CONSISTS OF STANDARD CHARACTERS WITHOUT CLAIM TO ANY PARTICULAR FONT, STYLE, SIZE, OR COLOR.

NO CLAIM IS MADE TO THE EXCLUSIVE RIGHT TO USE "CALIFORNIA" AND "AIRLINES", APART FROM THE MARK AS SHOWN.

FOR AIRLINE TRANSPORTATION SERVICES (U.S. CLS. 100 AND 105).

FIRST USE 3-31-2010; IN COMMERCE 5-31-2011.

---

4,046,283. 3TRACE, IRVINE, CA. SN 85-042,102. PUB. 12-7-2010, FILED 5-18-2010.

## WHAT IS YOUR X

THE MARK CONSISTS OF STANDARD CHARACTERS WITHOUT CLAIM TO ANY PARTICULAR FONT, STYLE, SIZE, OR COLOR.

FOR CONSULTING IN THE FIELD OF STORAGE SERVICES FOR MANAGING, NAMELY, ARCHIVING ELECTRONIC DATA (U.S. CLS. 100 AND 105).

FIRST USE 4-1-2010; IN COMMERCE 4-1-2010.

---

4,046,288. 3TRACE, DBA TRACE 3, IRVINE, CA. SN 85-043,280. PUB. 12-7-2010, FILED 5-20-2010.

## TRACE YOUR WAY BACK TO THE BUSINESS

THE MARK CONSISTS OF STANDARD CHARACTERS WITHOUT CLAIM TO ANY PARTICULAR FONT, STYLE, SIZE, OR COLOR.

FOR CONSULTING IN THE FIELD OF STORAGE SERVICES FOR MANAGING, NAMELY, ARCHIVING ELECTRONIC DATA (U.S. CLS. 100 AND 105).

FIRST USE 11-18-2010; IN COMMERCE 11-18-2010.

**CLASS 39—(Continued).**

4,046,404. DE TEZANOS PINTO, CESAR CARLOS, BUENOS AIRES, ARGENTINA. AND HUIDOBRO, FELIPE BARTOLOME, BUENOS AIRES, ARGENTINA. SN 85-081,994. PUB. 1-11-2011, FILED 7-10-2010.

## SOULMAX

THE MARK CONSISTS OF STANDARD CHARACTERS WITHOUT CLAIM TO ANY PARTICULAR FONT, STYLE, SIZE, OR COLOR.

FOR TRAVEL AGENCY SERVICES, NAMELY, MAKING RESERVATIONS AND BOOKINGS FOR AIRLINE FLIGHTS; TRAVEL AGENCY SERVICES, NAMELY, RESERVATION AND BOOKING FOR TRANSPORTATION; RESERVATION AND BOOKING OF SEATS FOR TRAVEL; RENTAL CAR RESERVATION; TRAVEL AGENCY SERVICES, NAMELY, TRAVEL BOOKING AGENCIES AND TRAVEL, EXCURSION AND CRUISE ARRANGEMENT; ORGANIZATION OF TRAVEL; TRAVEL INFORMATION SERVICES (U.S. CLS. 100 AND 105).

FIRST USE 2-0-1990; IN COMMERCE 7-5-2011.

---

4,046,818. LAS VEGAS LOUNGE, LAS VEGAS, NV. SN 85-165,392. PUB. 3-22-2011, FILED 10-29-2010.

NO CLAIM IS MADE TO THE EXCLUSIVE RIGHT TO USE "LAS VEGAS", APART FROM THE MARK AS SHOWN.

THE MARK CONSISTS OF THE STYLIZED WORDING "LAS VEGAS" ABOVE AND SLIGHTLY TO THE LEFT OF THE STYLIZED AND UNDERLINED WORDING "LOUNGE" WITH A LITTLE STAR NEXT TO IT.

FOR PROVIDING A WEBSITE FEATURING INFORMATION ON TRAVEL; TRAVEL GUIDE AND TRAVEL INFORMATION SERVICES; TRAVEL GUIDE SERVICES (U.S. CLS. 100 AND 105).

FIRST USE 7-18-2010; IN COMMERCE 12-8-2010.

**CLASS 39—(Continued).**

4,046,982. AMERICAN EXPRESS MARKETING & DEVELOPMENT CORP., NEW YORK, NY. SN 85-214,885. PUB. 6-14-2011, FILED 1-11-2011.

**DISCO TREKKER**

THE MARK CONSISTS OF STANDARD CHARACTERS WITHOUT CLAIM TO ANY PARTICULAR FONT, STYLE, SIZE, OR COLOR.

FOR ARRANGING TRAVEL TOURS, NAMELY, CUSTOMIZED MYSTERY TRIP BASED ON RESPONSES TO A QUIZ; CUSTOMIZED MYSTERY TRIP BASED ON RESPONSES TO A QUIZ, NAMELY, MAKING RESERVATIONS AND BOOKINGS FOR TRANSPORTATION (U.S. CLS. 100 AND 105).

FIRST USE 4-4-2011; IN COMMERCE 4-4-2011.

**CLASS 40—(Continued).**

4,045,766. WUXI SUNTECH POWER CO., LTD., WUXI, CHINA. SN 77-575,903. PUB. 3-31-2009, FILED 9-22-2008.



THE MARK CONSISTS OF A HUMAN FIGURE HOLDING A PHOTOVOLTAIC SOLAR MODULE.

FOR PROVIDING ONLINE INFORMATION ABOUT PHOTOVOLTAIC SOLAR MODULES (U.S. CLS. 100, 103 AND 106).

FIRST USE 4-1-2008; IN COMMERCE 4-1-2008.

4,046,043. CONSUMERS ENERGY COMPANY, JACKSON, MI. SN 77-929,145. PUB. 1-11-2011, FILED 2-5-2010.

**CROSS WINDS**

THE MARK CONSISTS OF STANDARD CHARACTERS WITHOUT CLAIM TO ANY PARTICULAR FONT, STYLE, SIZE, OR COLOR.

FOR PRODUCTION OF ENERGY (U.S. CLS. 100, 103 AND 106).

FIRST USE 7-1-2010; IN COMMERCE 7-1-2010.

4,046,076. CALPORTLAND COMPANY, GLENDORA, CA. SN 77-937,169. PUB. 7-6-2010, FILED 2-16-2010.



OWNER OF U.S. REG. NOS. 1,754,373, 3,693,593, AND OTHERS.

4,047,029. NEXEO SOLUTIONS, LLC, DUBLIN, OH. SN 85-229,995. PUB. 6-28-2011, FILED 1-31-2011.

**Nexeo Solutions**

THE MARK CONSISTS OF STANDARD CHARACTERS WITHOUT CLAIM TO ANY PARTICULAR FONT, STYLE, SIZE, OR COLOR.

NO CLAIM IS MADE TO THE EXCLUSIVE RIGHT TO USE "SOLUTIONS", APART FROM THE MARK AS SHOWN.

FOR DISTRIBUTION SERVICES FOR INDUSTRIAL PRODUCTS IN THE NATURE OF CHEMICALS AND RESINS (U.S. CLS. 100 AND 105).

FIRST USE 4-1-2011; IN COMMERCE 4-1-2011.

**CLASS 40—MATERIAL TREATMENT**



**CLASS 40—(Continued).**

THE MARK CONSISTS OF A LARGE LETTER "C" NEXT TO A LARGE LETTER "P", THE "P" BEING OVER THE WORD "ADVANTAGE".

FOR CUSTOM MANUFACTURE OF CEMENT, CONCRETE, ASPHALT AND AGGREGATE; MANUFACTURING SERVICES FOR OTHERS IN THE FIELD OF CEMENT, CONCRETE, ASPHALT AND AGGREGATE (U.S. CLS. 100, 103 AND 106).

FIRST USE 2-25-2010; IN COMMERCE 2-25-2010.

4,046,125. AMERICAN BLUE RIBBON HOLDINGS, LLC, DENVER, CO. SN 77-953,658. PUB. 2-8-2011, FILED 3-8-2010.



NO CLAIM IS MADE TO THE EXCLUSIVE RIGHT TO USE "BAKING" AND "SINCE 1969", APART FROM THE MARK AS SHOWN.

THE MARK CONSISTS OF THE WORDING "LEGENDARY BAKING SINCE 1969" FEATURING A PIE WITH STEAM IN THE MIDDLE OF A CIRCLE WITH SCALLOPED EDGES ABOVE THE WORD "LEGENDARY" IN SCRIPT, WHICH IS ABOVE A BANNER INSIDE OF WHICH IS THE WORD "BAKING" AND BELOW WHICH ARE THE WORDS "SINCE 1969".

FOR PROVISION OF BAKERY PRODUCTS FOR RESTAURANTS AND GROCERY STORES, NAMELY, THE MANUFACTURE OF BAKERY PRODUCTS TO THE ORDER AND SPECIFICATION OF RESTAURANTS AND GROCERY STORES; BAKERY SERVICES, NAMELY, THE MANUFACTURE OF BAKERY PRODUCTS TO ORDER AND/OR SPECIFICATION OF OTHERS; PRIVATE LABEL BAKING SERVICES (U.S. CLS. 100, 103 AND 106).

FIRST USE 6-6-2010; IN COMMERCE 6-6-2010.

4,046,490. STEUTE MEDITECH, INC., RIDGEFIELD, CT. SN 85-095,512. PUB. 1-11-2011, FILED 7-29-2010.

**OFF-THE-SHELF-CUSTOM**

THE MARK CONSISTS OF STANDARD CHARACTERS WITHOUT CLAIM TO ANY PARTICULAR FONT, STYLE, SIZE, OR COLOR.

FOR CUSTOM MANUFACTURE OF SWITCHES AND CONTROLS IN THE FIELD OF MEDICAL EQUIPMENT AND APPARATUS; TECHNICAL SUPPORT SERVICES, NAMELY, PROVIDING TECHNICAL ADVICE RELATED TO THE MANUFACTURE OF MEDICAL EQUIPMENT AND APPARATUS (U.S. CLS. 100, 103 AND 106).

FIRST USE 12-1-2010; IN COMMERCE 12-1-2010.

**CLASS 40—(Continued).**

4,046,747. FOGLIZZO DI PAOLO FOGLIZZO & C. S.A.S., TORINO, ITALY. SN 85-144,941. PUB. 6-21-2011, FILED 10-5-2010.

**FOGLIZZO**

THE MARK CONSISTS OF STANDARD CHARACTERS WITHOUT CLAIM TO ANY PARTICULAR FONT, STYLE, SIZE, OR COLOR.

FOR CUSTOM FABRICATION OF LEATHER; CUTTING OF TEXTILE, NAMELY, DYEING OF LEATHER; EDGING OF LEATHER; LEATHER TREATMENT, NAMELY, EMBOSSING WORDS, DESIGNS OR IMAGES, TANNING, CUTTING; LEATHER STAINING; PERMANENT PRESS TREATMENT OF LEATHER; PRE-SHRINKING OF LEATHER; SEWING SERVICES, NAMELY, TAILORING LEATHER CONSTRUCTION (U.S. CLS. 100, 103 AND 106).

FIRST USE 1-7-2011; IN COMMERCE 1-7-2011.

4,046,940. SWEET CHEEKS, INC., HOLLY SPRINGS, NC. SN 85-207,068. PUB. 5-17-2011, FILED 12-29-2010.

**HEAVENLY BAKED GOODS**

THE MARK CONSISTS OF STANDARD CHARACTERS WITHOUT CLAIM TO ANY PARTICULAR FONT, STYLE, SIZE, OR COLOR.

NO CLAIM IS MADE TO THE EXCLUSIVE RIGHT TO USE "BAKED GOODS", APART FROM THE MARK AS SHOWN.

FOR BAKERY SERVICES, NAMELY, THE MANUFACTURE OF BAKERY PRODUCTS TO ORDER AND/OR SPECIFICATION OF OTHERS (U.S. CLS. 100, 103 AND 106).

FIRST USE 6-1-2009; IN COMMERCE 6-1-2009.

4,046,962. EXELON CORPORATION, PHILADELPHIA, PA. SN 85-210,954. PUB. 6-7-2011, FILED 1-5-2011.

**EXELON NUCLEAR**

THE MARK CONSISTS OF STANDARD CHARACTERS WITHOUT CLAIM TO ANY PARTICULAR FONT, STYLE, SIZE, OR COLOR.

OWNER OF U.S. REG. NOS. 2,602,151, 3,546,844, AND OTHERS.

**CLASS 40—(Continued).**

NO CLAIM IS MADE TO THE EXCLUSIVE RIGHT TO USE "NUCLEAR", APART FROM THE MARK AS SHOWN.

FOR GENERATION OF ELECTRICAL ENERGY FROM NUCLEAR SOURCES (U.S. CLS. 100, 103 AND 106).

FIRST USE 10-0-2000; IN COMMERCE 10-0-2000.

---

4,046,963. EXELON CORPORATION, PHILADELPHIA, PA. SN 85-210,958. PUB. 6-7-2011, FILED 1-5-2011.

## EXELON WIND

THE MARK CONSISTS OF STANDARD CHARACTERS WITHOUT CLAIM TO ANY PARTICULAR FONT, STYLE, SIZE, OR COLOR.

OWNER OF U.S. REG. NOS. 2,602,151, 3,546,844, AND OTHERS.

NO CLAIM IS MADE TO THE EXCLUSIVE RIGHT TO USE "WIND", APART FROM THE MARK AS SHOWN.

FOR GENERATION OF ELECTRICAL ENERGY FROM WIND SOURCES (U.S. CLS. 100, 103 AND 106).

FIRST USE 12-2-2010; IN COMMERCE 12-2-2010.

---

4,046,964. EXELON CORPORATION, PHILADELPHIA, PA. SN 85-210,960. PUB. 6-7-2011, FILED 1-5-2011.

## EXELON HYDRO

THE MARK CONSISTS OF STANDARD CHARACTERS WITHOUT CLAIM TO ANY PARTICULAR FONT, STYLE, SIZE, OR COLOR.

OWNER OF U.S. REG. NOS. 2,602,151, 3,546,844, AND OTHERS.

NO CLAIM IS MADE TO THE EXCLUSIVE RIGHT TO USE "HYDRO", APART FROM THE MARK AS SHOWN.

FOR GENERATION OF ELECTRICAL ENERGY WATER SOURCES (U.S. CLS. 100, 103 AND 106).

FIRST USE 1-0-2011; IN COMMERCE 1-0-2011.

---

4,046,965. EXELON CORPORATION, PHILADELPHIA, PA. SN 85-210,963. PUB. 6-7-2011, FILED 1-5-2011.

## EXELON SOLAR

THE MARK CONSISTS OF STANDARD CHARACTERS WITHOUT CLAIM TO ANY PARTICULAR FONT, STYLE, SIZE, OR COLOR.

**CLASS 40—(Continued).**

OWNER OF U.S. REG. NOS. 2,602,151, 3,546,844, AND OTHERS.

NO CLAIM IS MADE TO THE EXCLUSIVE RIGHT TO USE "SOLAR", APART FROM THE MARK AS SHOWN.

FOR GENERATION OF ELECTRICAL ENERGY FROM SOLAR SOURCES (U.S. CLS. 100, 103 AND 106).

FIRST USE 1-0-2011; IN COMMERCE 1-0-2011.

**CLASS 41—EDUCATION AND ENTERTAINMENT**

---

4,045,594. O'NEIL, EDWARD G., HOLLYWOOD, CA. SN 76-703,373. PUB. 11-9-2010, FILED 6-14-2010.

## DESTINATION HOLLYWOOD

THE MARK CONSISTS OF STANDARD CHARACTERS WITHOUT CLAIM TO ANY PARTICULAR FONT, STYLE, SIZE, OR COLOR.

NO CLAIM IS MADE TO THE EXCLUSIVE RIGHT TO USE "HOLLYWOOD", APART FROM THE MARK AS SHOWN.

FOR ENTERTAINMENT SERVICES, NAMELY, ARRANGING, ORGANIZING, PRODUCING AND CONDUCTING MUSICAL VOCAL CONTESTS; ENTERTAINMENT IN THE NATURE OF COMPETITIONS IN THE FIELD OF VOCAL MUSIC; ON-GOING TELEVISION SHOWS FEATURING VOCAL MUSIC COMPETITIONS (U.S. CLS. 100, 101 AND 107).

FIRST USE 7-15-2011; IN COMMERCE 7-15-2011.

---

4,045,601. PSYCHOLOGICAL ASSOCIATES, INC., ST. LOUIS, MO. SN 76-704,113. PUB. 2-8-2011, FILED 8-13-2010.

## WYN

THE MARK CONSISTS OF STANDARD CHARACTERS WITHOUT CLAIM TO ANY PARTICULAR FONT, STYLE, SIZE, OR COLOR.

FOR EDUCATIONAL SERVICES, NAMELY, CONDUCTING SEMINARS IN THE FIELD OF BUSINESS MANAGEMENT AND EMPLOYEE PERFORMANCE, AND DEVELOPING AND CONDUCTING MOTIVATIONAL SEMINARS AND WORKSHOPS IN THE APPLICATION OF PSYCHOLOGICAL PRINCIPALS TO THE PROBLEMS OF BUSINESS ORGANIZATION (U.S. CLS. 100, 101 AND 107).

FIRST USE 3-5-2009; IN COMMERCE 8-25-2009.

**CLASS 41—(Continued).**

4,045,610. MARANDO, SHAWN, SHARON, MA. SN 76-706,049. PUB. 6-7-2011, FILED 1-19-2011.

# COPKIDO

THE MARK CONSISTS OF STANDARD CHARACTERS WITHOUT CLAIM TO ANY PARTICULAR FONT, STYLE, SIZE, OR COLOR.

FOR MARTIAL ART INSTRUCTION IN A NON-VIOLENT MARTIAL ART DEVELOPED SPECIFICALLY FOR LAW ENFORCEMENT AND PUBLIC EMPLOYEES, TO AVOID CLAIMS OF POLICE BRUTALITY AND EXCESSIVE FORCE (U.S. CLS. 100, 101 AND 107).

FIRST USE 1-1-2000; IN COMMERCE 10-1-2010.

---

4,045,611. MARANDO, SHAWN, SHARON, MA. SN 76-706,050. PUB. 6-7-2011, FILED 1-19-2011.

## PROGRESSIVE DEFENSE SYSTEMS

THE MARK CONSISTS OF STANDARD CHARACTERS WITHOUT CLAIM TO ANY PARTICULAR FONT, STYLE, SIZE, OR COLOR.

NO CLAIM IS MADE TO THE EXCLUSIVE RIGHT TO USE "DEFENSE SYSTEMS", APART FROM THE MARK AS SHOWN.

FOR MARTIAL ARTS INSTRUCTION DEVELOPED SPECIFICALLY FOR PUBLIC AND PRIVATE SERVICE PERSONNEL (U.S. CLS. 100, 101 AND 107).

FIRST USE 11-29-2002; IN COMMERCE 11-29-2002.

---

4,045,612. MARANDO, SHAWN, SHARON, MA. SN 76-706,051. PUB. 6-7-2011, FILED 1-19-2011.

## COPKIDO, THE SOLUTION TO EXCESSIVE FORCE.

THE MARK CONSISTS OF STANDARD CHARACTERS WITHOUT CLAIM TO ANY PARTICULAR FONT, STYLE, SIZE, OR COLOR.

FOR MARTIAL ART INSTRUCTION IN A NON-VIOLENT MARTIAL ART DEVELOPED SPECIFICALLY FOR LAW ENFORCEMENT AND PUBLIC EMPLOYEES, TO AVOID CLAIMS OF POLICE BRUTALITY AND EXCESSIVE FORCE (U.S. CLS. 100, 101 AND 107).

FIRST USE 1-22-2011; IN COMMERCE 1-22-2011.

**CLASS 41—(Continued).**

4,045,635. SHAPING CHAMPIONS LLC, NORWICH, VT. SN 77-208,803. PUB. 11-18-2008, FILED 6-18-2007.



NO CLAIM IS MADE TO THE EXCLUSIVE RIGHT TO USE "EST. 2008", APART FROM THE MARK AS SHOWN.

FOR PHYSICAL EDUCATION FOR CHILDREN, NAMELY, PROVIDING SPECIALIZED WORKOUT PROGRAMS AND SKILLS CLASSES (U.S. CLS. 100, 101 AND 107).

FIRST USE 1-0-2008; IN COMMERCE 1-0-2008.

---

4,045,666. JACKSON, LYNN ANTHONY, HAYMARKET, VA. SN 77-343,897. PUB. 5-6-2008, FILED 12-4-2007.

## livinsoul

THE MARK CONSISTS OF STANDARD CHARACTERS WITHOUT CLAIM TO ANY PARTICULAR FONT, STYLE, SIZE, OR COLOR.

FOR ENTERTAINMENT SERVICES, NAMELY, PROVIDING A WEBSITE FEATURING PHOTOGRAPHIC, AUDIO, VIDEO AND PROSE PRESENTATIONS FEATURING CHRISTIAN LIVING; ON-LINE JOURNALS, NAMELY, BLOGS FEATURING CHRISTIAN LIVING; ENTERTAINMENT SERVICES, NAMELY, PROVIDING PODCASTS IN THE FIELD OF CHRISTIAN LIVING (U.S. CLS. 100, 101 AND 107).

FIRST USE 1-1-1997; IN COMMERCE 6-22-2010.

**CLASS 41—(Continued).**

4,045,682. PEACELABS MUSIC, INC., SAN FRANCISCO, CA. SN 77-377,677. PUB. 6-3-2008, FILED 1-22-2008.

**MISSION DRIVEN LIVING**

THE MARK CONSISTS OF STANDARD CHARACTERS WITHOUT CLAIM TO ANY PARTICULAR FONT, STYLE, SIZE, OR COLOR.

FOR EDUCATION SERVICES, NAMELY, CLASSES, COURSES, SEMINARS, CLINICS, WORKSHOPS, LECTURES, TUTORING, AND MENTORING IN THE FIELDS OF VOLUNTEER PROGRAMS AND COMMUNITY SERVICE PROJECTS; ORGANIZING, PLANNING, ARRANGING AND CONDUCTING SPECIAL EVENTS RELATING TO VOLUNTEER PROGRAMS AND COMMUNITY SERVICE PROJECTS (U.S. CLS. 100, 101 AND 107).

FIRST USE 7-5-2008; IN COMMERCE 8-26-2011.

4,045,728. CHRISTOPHER M. KEEME-SAYRE, MESA, AZ. SN 77-463,632. PUB. 12-29-2009, FILED 5-1-2008.

**RULE**

THE MARK CONSISTS OF STANDARD CHARACTERS WITHOUT CLAIM TO ANY PARTICULAR FONT, STYLE, SIZE, OR COLOR.

FOR PRODUCTION OF VIDEO GAME AND COMPUTER GAME SOFTWARE, NAMELY, ON-LINE COMPUTER GAMES, ON-LINE ROLE-PLAYING GAMES, MASSIVE MULTIPLAYER ONLINE ROLE-PLAYING GAMES; ENTERTAINMENT SERVICES, NAMELY, PROVIDING ON-LINE COMPUTER GAMES THAT MAY BE ACCESSED NETWORK-WIDE BY NETWORK MEMBERS (U.S. CLS. 100, 101 AND 107).

FIRST USE 7-1-2008; IN COMMERCE 8-9-2008.

4,045,751. TECOMATE WILDLIFE SYSTEMS, LLC, SAN ANTONIO, TX. SN 77-525,342. PUB. 12-16-2008, FILED 7-17-2008.

**WHITETAIL NATION**

THE MARK CONSISTS OF STANDARD CHARACTERS WITHOUT CLAIM TO ANY PARTICULAR FONT, STYLE, SIZE, OR COLOR.

**CLASS 41—(Continued).**

NO CLAIM IS MADE TO THE EXCLUSIVE RIGHT TO USE "WHITETAIL", APART FROM THE MARK AS SHOWN.

FOR ENTERTAINMENT SERVICES IN THE NATURE OF TELEVISION PROGRAMMING; PRODUCTION OF TELEVISION PROGRAMS AND DISTRIBUTION OF TELEVISION PROGRAMMING; PROVIDING INFORMATION RELATING TO TELEVISION PROGRAMMING VIA A GLOBAL COMPUTER NETWORK (U.S. CLS. 100, 101 AND 107).

FIRST USE 12-27-2010; IN COMMERCE 12-27-2010.

4,045,762. CSS STUDIOS, LLC, LOS ANGELES, CA. SN 77-566,037. PUB. 4-5-2011, FILED 9-9-2008.



NO CLAIM IS MADE TO THE EXCLUSIVE RIGHT TO USE "STUDIOS", APART FROM THE MARK AS SHOWN.

THE MARK CONSISTS OF A STYLIZED DESIGN OF FIVE VERTICAL, ELONGATED OVALS OF DIFFERENT LENGTHS OVER THE STYLIZED WORDING "CSS STUDIOS".

FOR RECORDING STUDIO SERVICES (U.S. CLS. 100, 101 AND 107).

FIRST USE 12-31-2008; IN COMMERCE 12-31-2008.

4,045,771. LUTTERY, TEISHA L., CHICAGO, IL. SN 77-606,665. PUB. 6-2-2009, FILED 11-4-2008.



THE COLOR(S) TAN, RED, YELLOW, GREEN, WHITE AND PINK IS/ARE CLAIMED AS A FEATURE OF THE MARK.

THE MARK CONSISTS OF A FEMALE CAT WITH HUMAN ATTRIBUTES IN TAN, WEARING A RED SHIRT AND YELLOW NECKLACE AND BRACELET; THE TONGUE, NOSE AND INNER PORTIONS OF THE CAT'S EARS APPEAR IN PINK AND THE CAT'S EYE APPEAR IN GREEN AND WHITE.

FOR ENTERTAINMENT IN THE NATURE OF LIVE MUSICAL PERFORMANCES (U.S. CLS. 100, 101 AND 107).

FIRST USE 3-13-2010; IN COMMERCE 3-13-2010.

**CLASS 41—(Continued).**

4,045,845. WHAMSPOT, LLC, SAN FRANCISCO, CA. SN 77-733,058. PUB. 6-1-2010, FILED 5-8-2009.



NO CLAIM IS MADE TO THE EXCLUSIVE RIGHT TO USE "GAME", APART FROM THE MARK AS SHOWN. THE COLOR(S) WHITE, RED AND BLACK IS/ARE CLAIMED AS A FEATURE OF THE MARK. THE MARK CONSISTS OF BLACK CIRCLE SURROUNDING A RED CIRCLE, WITH A BLACK HEART IN THE MIDDLE. THE WORD "GAME" IN BLACK, AND THE WORD "CRUSH" IN RED IN AN ITALICIZED FONT. BOTH WORDS ARE IN ALL CAPS, AND THE BACKGROUND IS WHITE. FOR PROVIDING ONLINE COMPUTER GAMES AND VIDEO GAMES (U.S. CLS. 100, 101 AND 107). FIRST USE 11-15-2009; IN COMMERCE 3-23-2010.

4,045,876. BOSTON COMMON PRESS LIMITED PARTNERSHIP, BROOKLINE VILLAGE, MA. SN 77-777,504. PUB. 12-1-2009, FILED 7-9-2009.

**AMERICA'S TEST KITCHEN COOKING SCHOOL**

THE MARK CONSISTS OF STANDARD CHARACTERS WITHOUT CLAIM TO ANY PARTICULAR FONT, STYLE, SIZE, OR COLOR. OWNER OF U.S. REG. NOS. 2,582,964, 2,649,901, AND OTHERS. NO CLAIM IS MADE TO THE EXCLUSIVE RIGHT TO USE "COOKING SCHOOL", APART FROM THE MARK AS SHOWN. FOR EDUCATIONAL SERVICES, NAMELY, PROVIDING ON-LINE CLASSES IN THE FIELD OF FOOD AND COOKING AND DISTRIBUTING COURSE MATERIAL IN CONNECTION THEREWITH (U.S. CLS. 100, 101 AND 107). FIRST USE 7-15-2011; IN COMMERCE 7-15-2011.

**CLASS 41—(Continued).**

4,045,893. HENDRICKS INVESTMENT HOLDINGS, LLC, SILVER SPRING, MD. SN 77-793,219. PUB. 12-15-2009, FILED 7-30-2009.

**CURIOSITY**

THE MARK CONSISTS OF STANDARD CHARACTERS WITHOUT CLAIM TO ANY PARTICULAR FONT, STYLE, SIZE, OR COLOR. FOR ENTERTAINMENT SERVICES IN THE NATURE OF A NON-FICTION TELEVISION SERIES GEARED TOWARDS ADULTS THAT EXPLORES SCIENCE, CIVILIZATION, AND SELF-IMPROVEMENT (U.S. CLS. 100, 101 AND 107). FIRST USE 8-7-2011; IN COMMERCE 8-7-2011.

4,045,901. QUILL PROFESSIONAL DEVELOPMENT LLC, EAST LANSING, MI. AND WILLOW TREE WAY, LLC, EAST LANSING, MI. SN 77-804,000. PUB. 7-6-2010, FILED 8-13-2009.

**QUILLTREE COMMUNITY**

THE MARK CONSISTS OF STANDARD CHARACTERS WITHOUT CLAIM TO ANY PARTICULAR FONT, STYLE, SIZE, OR COLOR. NO CLAIM IS MADE TO THE EXCLUSIVE RIGHT TO USE "COMMUNITY", APART FROM THE MARK AS SHOWN. FOR PROVIDING AN INTERACTIVE WEB SITE FEATURING EDUCATIONAL CURRICULUM AND UNIT/LESSON PLAN DEVELOPMENT, INFORMATION; EDUCATIONAL SERVICES, NAMELY, PROVIDING CONTINUING PROFESSIONAL EDUCATION COURSES FOR PRIMARY, SECONDARY AND COLLEGE TEACHING PERSONNEL AND INSTRUCTIONAL LEADERS VIA AN INTERACTIVE WEB SITE; EDUCATIONAL COURSE MONITORING, NAMELY, TRACKING STUDENT PERFORMANCE (U.S. CLS. 100, 101 AND 107). FIRST USE 4-4-2009; IN COMMERCE 4-4-2009.

**CLASS 41—(Continued).**

4,045,909. TASER INTERNATIONAL, INC., SCOTTSDALE, AZ. SN 77-813,141. PUB. 7-13-2010, FILED 8-26-2009.



THE MARK CONSISTS OF AN IMAGE OF A STYLIZED LIGHTNING BOLT WITHIN A CIRCLE.

FOR EDUCATIONAL SERVICES, NAMELY, CONDUCTING CLASSES, WORKSHOPS, SEMINARS, AND PRACTICE SESSIONS IN THE FIELDS OF ELECTRONIC WEAPONS, USE OF ELECTRONIC WEAPONS, MAINTENANCE OF ELECTRONIC WEAPONS, EVIDENCE COLLECTION, EVIDENCE MANAGEMENT, EVIDENCE ANALYSIS, CERTIFICATION FOR ELECTRONIC WEAPON USE, MEDICAL AND PSYCHOLOGICAL ISSUES RELATED TO ELECTRONIC WEAPON USE, PERSONAL SAFETY, SELF DEFENSE, DECISION MAKING IN THE DEPLOYMENT OF FORCE, ELECTRONIC WEAPON USE IN A CORRECTIONAL ENVIRONMENT, RISK MANAGEMENT, AND LEGAL ISSUES RELATED TO ELECTRONIC WEAPONS, AND INSTRUCTOR PREPARATION (U.S. CLS. 100, 101 AND 107).

FIRST USE 8-24-2009; IN COMMERCE 8-24-2009.

4,045,910. THE LEARNING ANNEX, L.P., NEW YORK, NY. SN 77-813,182. PUB. 2-9-2010, FILED 8-26-2009.

**MAKING YOU SMARTER**

THE MARK CONSISTS OF STANDARD CHARACTERS WITHOUT CLAIM TO ANY PARTICULAR FONT, STYLE, SIZE, OR COLOR.

FOR EDUCATION SERVICES, NAMELY, PROVIDING SEMINARS IN THE FIELD OF GENERAL EDUCATION AT THE COLLEGE LEVEL FOR INDIVIDUALS OF ALL AGES AND EDUCATIONAL BACKGROUNDS (U.S. CLS. 100, 101 AND 107).

FIRST USE 4-19-2011; IN COMMERCE 4-19-2011.

**CLASS 41—(Continued).**

4,045,938. CENTER FOR RESTORATIVE BREAST SURGERY, LLC, NEW ORLEANS, LA. SN 77-843,007. PUB. 2-8-2011, FILED 10-6-2009.

**ENCOURAGE**

THE MARK CONSISTS OF STANDARD CHARACTERS WITHOUT CLAIM TO ANY PARTICULAR FONT, STYLE, SIZE, OR COLOR.

FOR EDUCATIONAL SERVICES, NAMELY, CONDUCTING WORKSHOPS IN THE FIELD OF BREAST CANCER (U.S. CLS. 100, 101 AND 107).

FIRST USE 8-1-2007; IN COMMERCE 8-1-2007.

4,045,952. WIENER, ALITZAH, HACIENDA HEIGHTS, CA. SN 77-853,362. PUB. 9-28-2010, FILED 10-20-2009.



THE MARK CONSISTS OF THE WORDING "TWINKLE TIME" IS IN STYLIZED FONT; THE DOTTED "I'S" ARE IN THE SHAPE OF HEARTS.

FOR ENTERTAINMENT IN THE NATURE OF AN ONGOING SPECIAL VARIETY, NEWS, MUSIC OR COMEDY SHOW FEATURING EDUCATIONAL ENTERTAINMENT FOR CHILDREN BROADCAST OVER TELEVISION, SATELLITE, AUDIO, AND VIDEO MEDIA (U.S. CLS. 100, 101 AND 107).

FIRST USE 12-15-2007; IN COMMERCE 11-17-2009.

4,045,957. SOCIAL REPUBLIC, LLC, VALLEY VILLAGE, CA. SN 77-862,110. PUB. 9-28-2010, FILED 10-31-2009.

**DIRTY BUBBLE**

THE MARK CONSISTS OF STANDARD CHARACTERS WITHOUT CLAIM TO ANY PARTICULAR FONT, STYLE, SIZE, OR COLOR.

FOR PROVIDING A WEB SITE WHERE USERS CAN POST RATINGS, REVIEWS AND RECOMMENDATIONS ON PERSONS IN THE FIELD OF ENTERTAINMENT (U.S. CLS. 100, 101 AND 107).

FIRST USE 9-15-2011; IN COMMERCE 9-15-2011.

**CLASS 41—(Continued).**

4,045,960. LEGORRETA, LEONARDO, SACRAMENTO, CA. SN 77-867,441. PUB. 4-13-2010, FILED 11-6-2009.

**Black Lab Press**

THE MARK CONSISTS OF STANDARD CHARACTERS WITHOUT CLAIM TO ANY PARTICULAR FONT, STYLE, SIZE, OR COLOR.

NO CLAIM IS MADE TO THE EXCLUSIVE RIGHT TO USE "PRESS", APART FROM THE MARK AS SHOWN.

FOR BOOK PUBLISHING; DESKTOP PUBLISHING FOR OTHERS; DIGITAL VIDEO, AUDIO, AND MULTIMEDIA PUBLISHING SERVICES; ELECTRONIC PUBLISHING SERVICES, NAMELY, PUBLICATION OF TEXT AND GRAPHIC WORKS OF OTHERS ONLINE FEATURING A VARIETY OF TOPICS; MULTIMEDIA PUBLISHING OF BOOKS, MAGAZINES, JOURNALS, SOFTWARE, GAMES, MUSIC, AND ELECTRONIC PUBLICATIONS; ONLINE ELECTRONIC PUBLISHING OF BOOKS AND PERIODICALS; PUBLISHING OF BOOKS AND REVIEWS; PUBLISHING OF BOOKS, E-BOOKS, AUDIO BOOKS, MUSIC AND ILLUSTRATIONS; PUBLISHING OF BOOKS, MAGAZINES; PUBLISHING OF ELECTRONIC PUBLICATIONS (U.S. CLS. 100, 101 AND 107).

FIRST USE 12-1-2010; IN COMMERCE 12-1-2010.

---

4,045,975. RESTORATIVE ACTION, LLC, EDINA, MN. SN 77-881,044. PUB. 7-27-2010, FILED 11-25-2009.

**RESTORATIVE CULTURE**

THE MARK CONSISTS OF STANDARD CHARACTERS WITHOUT CLAIM TO ANY PARTICULAR FONT, STYLE, SIZE, OR COLOR.

FOR EDUCATIONAL SERVICES, NAMELY, PROVIDING WORKSHOPS AND CURRICULUM IN THE FIELDS OF HUMAN DEVELOPMENT AND COMMUNICATION FOR DEVELOPING LEARNING METHODOLOGIES AND INSTRUCTIONAL STRATEGIES TO HELP EDUCATORS CREATE A SAFE LEARNING ENVIRONMENT AND HELP STUDENT ACHIEVEMENT (U.S. CLS. 100, 101 AND 107).

FIRST USE 11-18-2010; IN COMMERCE 11-18-2010.

**CLASS 41—(Continued).**

4,046,022. CARPENTER, MAURICE, CHESTER, VA. SN 77-915,341. PUB. 6-15-2010, FILED 1-19-2010.

**THE INKREDIBLES**

THE MARK CONSISTS OF STANDARD CHARACTERS WITHOUT CLAIM TO ANY PARTICULAR FONT, STYLE, SIZE, OR COLOR.

FOR MULTIMEDIA ENTERTAINMENT SERVICES IN THE NATURE OF RECORDING, PRODUCTION AND POST-PRODUCTION SERVICES IN THE FIELDS OF MUSIC, VIDEO, AND FILMS (U.S. CLS. 100, 101 AND 107).

FIRST USE 6-1-2008; IN COMMERCE 6-1-2008.

---

4,046,060. IRON CITY LIVE, INC., BIRMINGHAM, AL. SN 77-933,395. PUB. 7-27-2010, FILED 2-11-2010.

**"WHO DO YOU FIGHT FOR"**

THE MARK CONSISTS OF STANDARD CHARACTERS WITHOUT CLAIM TO ANY PARTICULAR FONT, STYLE, SIZE, OR COLOR.

FOR CONDUCTING AND PROVIDING FACILITIES FOR LIVE SHOW PERFORMANCE IN CONNECTION WITH VARIOUS FUND RAISING EVENTS; SPECIAL EVENT AND PARTY PLANNING SERVICES FOR FUNDRAISING EVENTS (U.S. CLS. 100, 101 AND 107).

FIRST USE 2-1-2010; IN COMMERCE 3-31-2010.

---

4,046,073. UNITED STATES DOG AGILITY ASSOCIATION, INC., RICHARDSON, TX. SN 77-936,730. PUB. 7-6-2010, FILED 2-16-2010.



THE COLOR(S) RED AND ORANGE IS/ARE CLAIMED AS A FEATURE OF THE MARK.

**CLASS 41—(Continued).**

THE MARK CONSISTS OF THREE DOGS ABOVE A CURVED HORIZON LINE, WITH LEFT TO RIGHT, RED TO ORANGE, COLOR GRADIENT.

FOR ENTERTAINMENT SERVICES, NAMELY, ORGANIZING PET AGILITY CONTESTS AND ESTABLISHING AND PROMULGATING INTERNATIONAL RULES FOR SUCH CONTESTS (U.S. CLS. 100, 101 AND 107).

FIRST USE 9-1-2010; IN COMMERCE 9-1-2010.

---

4,046,101. HISTORIC MOTORSPORTS PRODUCTIONS, INC., ZIONSVILLE, IN. SN 77-946,418. PUB. 3-15-2011, FILED 2-26-2010.



NO CLAIM IS MADE TO THE EXCLUSIVE RIGHT TO USE "MOTORSPORTS", APART FROM THE MARK AS SHOWN.

THE MARK CONSISTS OF A BOX FORMED BY BROAD AND NARROW LINES CONTAINING THE WORD "LEGENDS" ABOVE A SPREAD WINGED DESIGN CONTAINING THE WORD "OF", ABOVE A SMALLER BLACK BOX, OVERLAYING THE BOTTOM LINES OF THE LARGER BOX AND CONTAINING THE WORD "MOTORSPORTS".

FOR CONDUCTING ENTERTAINMENT EXHIBITIONS IN THE NATURE OF HISTORIC AUTOMOBILE RACES AND EXHIBITIONS, PARADES OF RACE CARS, AND CONDUCTING SPECIAL EVENTS FOR SOCIAL ENTERTAINMENT PURPOSES (U.S. CLS. 100, 101 AND 107).

FIRST USE 3-31-2010; IN COMMERCE 3-31-2010.

---

4,046,102. HISTORIC MOTORSPORTS PRODUCTIONS, INC., ZIONSVILLE, IN. SN 77-946,423. PUB. 3-15-2011, FILED 2-26-2010.

**LEGENDS OF MOTORSPORTS**

THE MARK CONSISTS OF STANDARD CHARACTERS WITHOUT CLAIM TO ANY PARTICULAR FONT, STYLE, SIZE, OR COLOR.

NO CLAIM IS MADE TO THE EXCLUSIVE RIGHT TO USE "MOTORSPORTS", APART FROM THE MARK AS SHOWN.

FOR CONDUCTING ENTERTAINMENT EXHIBITIONS IN THE NATURE OF HISTORIC AUTOMOBILE RACES AND EXHIBITIONS, PARADES OF RACE CARS, AND CONDUCTING SPECIAL EVENTS FOR SOCIAL ENTERTAINMENT PURPOSES (U.S. CLS. 100, 101 AND 107).

FIRST USE 3-31-2010; IN COMMERCE 3-31-2010.

**CLASS 41—(Continued).**

4,046,103. HISTORIC MOTORSPORTS PRODUCTIONS, INC., ZIONSVILLE, IN. SN 77-946,426. PUB. 7-27-2010, FILED 2-26-2010.

# HMP

THE MARK CONSISTS OF STANDARD CHARACTERS WITHOUT CLAIM TO ANY PARTICULAR FONT, STYLE, SIZE, OR COLOR.

FOR CONDUCTING ENTERTAINMENT EXHIBITIONS IN THE NATURE OF HISTORIC AUTOMOBILE RACES AND EXHIBITIONS, PARADES OF RACE CARS; AND CONDUCTING SPECIAL EVENTS FOR SOCIAL ENTERTAINMENT PURPOSES (U.S. CLS. 100, 101 AND 107).

FIRST USE 8-31-2009; IN COMMERCE 8-31-2009.

---

4,046,124. TWENTIETH CENTURY FOX FILM CORPORATION, LOS ANGELES, CA. SN 77-953,652. PUB. 8-3-2010, FILED 3-8-2010.

**FRIENDS WITH BENEFITS**

THE MARK CONSISTS OF STANDARD CHARACTERS WITHOUT CLAIM TO ANY PARTICULAR FONT, STYLE, SIZE, OR COLOR.

FOR ENTERTAINMENT SERVICES IN THE NATURE OF A TELEVISION SERIES FEATURING COMEDY; PROVIDING ON-LINE INFORMATION IN THE FIELD OF TELEVISION AND VIDEO ENTERTAINMENT FEATURING COMEDY VIA THE INTERNET; ENTERTAINMENT SERVICES IN THE NATURE OF NON-DOWNLOADABLE VIDEOS AND IMAGES FEATURING TELEVISION SHOWS AND ENTERTAINMENT TRANSMITTED VIA THE INTERNET AND WIRELESS COMMUNICATION NETWORKS (U.S. CLS. 100, 101 AND 107).

FIRST USE 8-5-2011; IN COMMERCE 8-5-2011.

---

4,046,139. AMERICAN GIRL, LLC, EL SEGUNDO, CA. SN 77-959,362. PUB. 1-11-2011, FILED 3-15-2010.

**INNERSTAR UNIVERSITY**

THE MARK CONSISTS OF STANDARD CHARACTERS WITHOUT CLAIM TO ANY PARTICULAR FONT, STYLE, SIZE, OR COLOR.



**CLASS 41—(Continued).**

OWNER OF U.S. REG. NOS. 3,188,726, 3,276,604, AND 3,482,098.  
FOR ENTERTAINMENT SERVICES, NAMELY, PROVIDING ON-LINE GAMES (U.S. CLS. 100, 101 AND 107).  
FIRST USE 8-30-2011; IN COMMERCE 8-30-2011.

4,046,155. FANTA-Z HOLDINGS, LLC, LAS VEGAS, CA. SN 77-966,700. PUB. 10-12-2010, FILED 3-23-2010.

**WHERE SKILL PAYS**

THE MARK CONSISTS OF STANDARD CHARACTERS WITHOUT CLAIM TO ANY PARTICULAR FONT, STYLE, SIZE, OR COLOR.

FOR ENTERTAINMENT SERVICES, NAMELY, PROVIDING ONLINE COMPUTER GAMES; ENTERTAINMENT SERVICES, NAMELY, PROVIDING ELECTRONIC GAMES THAT ARE PLAYED VIA TELEPHONES (U.S. CLS. 100, 101 AND 107).  
FIRST USE 2-20-2011; IN COMMERCE 2-20-2011.

4,046,162. REPUBLIC OF BEANS, INC., NEW YORK, NY. SN 77-969,221. PUB. 12-7-2010, FILED 3-26-2010.

**True Italian**

THE MARK CONSISTS OF STANDARD CHARACTERS WITHOUT CLAIM TO ANY PARTICULAR FONT, STYLE, SIZE, OR COLOR.

NO CLAIM IS MADE TO THE EXCLUSIVE RIGHT TO USE "ITALIAN", APART FROM THE MARK AS SHOWN.

FOR EDUCATIONAL SERVICES, NAMELY, CONDUCTING CLASSES IN THE FIELD OF ITALIAN FOOD AND WINE; TRAINING SERVICES IN THE FIELD OF ITALIAN FOOD AND WINE (U.S. CLS. 100, 101 AND 107).

FIRST USE 1-1-2005; IN COMMERCE 3-31-2010.

**CLASS 41—(Continued).**

4,046,163. SCIENCEFRIDAY, INC., STAMFORD, CT. SN 77-969,320. PUB. 1-18-2011, FILED 3-26-2010.

**MAKING SCIENCE RADIOACTIVE**

THE MARK CONSISTS OF STANDARD CHARACTERS WITHOUT CLAIM TO ANY PARTICULAR FONT, STYLE, SIZE, OR COLOR.

FOR EDUCATIONAL AND ENTERTAINMENT SERVICES, NAMELY, PROVIDING CONTINUING PRERECORDED AUDIO PROGRAMS IN THE FIELD OF SCIENCE ACCESSIBLE OVER THE INTERNET; EDUCATIONAL AND ENTERTAINMENT SERVICES, NAMELY, PROVIDING AUDIO PROGRAMS IN THE FIELD OF SCIENCE VIA A GLOBAL COMPUTER NETWORK FOR PLAYBACK ON PORTABLE AND DESKTOP DIGITAL PLAYBACK DEVICES (U.S. CLS. 100, 101 AND 107).

FIRST USE 12-31-2005; IN COMMERCE 12-31-2005.

4,046,182. YOUR BABY CAN, LLC, CARLSBAD, CA. SN 77-982,485. PUB. 12-8-2009, FILED 6-11-2009.

**YOUR BABY CAN**

THE MARK CONSISTS OF STANDARD CHARACTERS WITHOUT CLAIM TO ANY PARTICULAR FONT, STYLE, SIZE, OR COLOR.

OWNER OF U.S. REG. NOS. 2,282,427 AND 3,447,584.

FOR PROVIDING A WEBSITE FEATURING INFORMATION IN THE FIELD OF EDUCATION, NAMELY, MATH, READING, SCIENCE AND SOCIAL STUDIES FOR INFANTS AND TODDLERS, AND CHILDREN IN A PRE-KINDERGARTEN AND KINDERGARTEN EDUCATIONAL CURRICULUM FEATURING LEARNING AND EDUCATIONAL GAMES AND ACTIVITIES FOR INFANTS AND TODDLERS, FEATURING INFORMATION IN THE FIELD OF TEACHING SKILLS IN THE FIELD OF EDUCATION FOR PARENTS, AND NEWS IN THE FIELD OF EDUCATION AND TEACHING METHODOLOGY (U.S. CLS. 100, 101 AND 107).

FIRST USE 4-0-2008; IN COMMERCE 4-0-2008.

**CLASS 41—(Continued).**

4,046,192. DEBORAH STOLLER, BROOKLYN, NY. SN 78-417,593. PUB. 6-23-2009, FILED 5-12-2004.

STITCH 'N BITCH

THE MARK CONSISTS OF STANDARD CHARACTERS WITHOUT CLAIM TO ANY PARTICULAR FONT, STYLE, SIZE, OR COLOR.

FOR ENTERTAINMENT SERVICES, NAMELY, A TELEVISION SHOW IN THE FIELD OF KNITTING (U.S. CLS. 100, 101 AND 107).

FIRST USE 12-1-1999; IN COMMERCE 9-5-2011.

---

4,046,217. ADULT PROFICIENCY AND EQUIVALENCY EXAMINATIONS, INC., LAS VEGAS, NV. SN 85-010,600. PUB. 9-7-2010, FILED 4-9-2010.

APEX

THE MARK CONSISTS OF STANDARD CHARACTERS WITHOUT CLAIM TO ANY PARTICULAR FONT, STYLE, SIZE, OR COLOR.

FOR ANALYZING OF EDUCATIONAL TEST SCORES AND DATA FOR OTHERS; EDUCATIONAL TESTING (U.S. CLS. 100, 101 AND 107).

FIRST USE 1-10-2011; IN COMMERCE 1-10-2011.

**CLASS 41—(Continued).**

4,046,221. CREATIVE OKLAHOMA, INC., OKLAHOMA CITY, OK. SN 85-012,569. PUB. 4-12-2011, FILED 4-13-2010.



NO CLAIM IS MADE TO THE EXCLUSIVE RIGHT TO USE "CREATIVITY" AND "OKLAHOMA", APART FROM THE MARK AS SHOWN.

THE MARK CONSISTS OF THE WORDS "OKLAHOMA CREATIVITY" AND "CREATIVE OKLAHOMA" WITH A RECTANGULAR DESIGN.

FOR ORGANIZATION OF EXHIBITIONS FOR CULTURAL OR EDUCATION PURPOSES; ARRANGING AND CONDUCTING EDUCATIONAL CONFERENCES; ARRANGING OF SEMINARS (U.S. CLS. 100, 101 AND 107).

FIRST USE 8-2-2011; IN COMMERCE 8-2-2011.

---

4,046,230. AIRMARC, LLC, ORLANDO, FL. SN 85-015,688. PUB. 9-21-2010, FILED 4-16-2010.

RIP SLIDE

THE MARK CONSISTS OF STANDARD CHARACTERS WITHOUT CLAIM TO ANY PARTICULAR FONT, STYLE, SIZE, OR COLOR.

NO CLAIM IS MADE TO THE EXCLUSIVE RIGHT TO USE "SLIDE", APART FROM THE MARK AS SHOWN.

FOR ENTERTAINMENT SERVICES IN THE NATURE OF ON-SITE OPERATION OF INFLATABLE WATER-SLIDES (U.S. CLS. 100, 101 AND 107).

FIRST USE 11-16-2009; IN COMMERCE 1-4-2010.

**CLASS 41—(Continued).**

4,046,238. KOLVET, KERRY J, RENO, NV. SN 85-021,329. PUB. 7-12-2011, FILED 4-22-2010.

# STILETTO

THE MARK CONSISTS OF STANDARD CHARACTERS WITHOUT CLAIM TO ANY PARTICULAR FONT, STYLE, SIZE, OR COLOR.

FOR ENTERTAINMENT IN THE NATURE OF CONDUCTING BOUDOIR PHOTOGRAPHY PARTIES; PHOTOGRAPHY SERVICES (U.S. CLS. 100, 101 AND 107).

FIRST USE 5-15-2010; IN COMMERCE 5-15-2010.

---

4,046,257. GRADUA NETWORKS INFORMÁTICA LTDA, BRASÍLIA, BRAZIL. SN 85-029,718. PUB. 1-18-2011, FILED 5-4-2010.

# WriteWork

THE MARK CONSISTS OF STANDARD CHARACTERS WITHOUT CLAIM TO ANY PARTICULAR FONT, STYLE, SIZE, OR COLOR.

FOR PROVIDING AN ON-LINE DIGITAL LIBRARY FEATURING ESSAYS, TERM PAPERS, BOOK REPORTS, THESES, AND RESEARCH PAPERS (U.S. CLS. 100, 101 AND 107).

FIRST USE 3-31-2010; IN COMMERCE 3-31-2010.

---

4,046,267. HARRIS TRAINING SYSTEMS LLC, LIBERTYVILLE, IL. SN 85-034,638. PUB. 10-19-2010, FILED 5-10-2010.



NO CLAIM IS MADE TO THE EXCLUSIVE RIGHT TO USE "TRAINING SYSTEMS LLC", APART FROM THE MARK AS SHOWN.

THE MARK CONSISTS OF A RUNNING MAN WITH "HARRIS TRAINING SYSTEMS LLC" UNDER THE RUNNING MAN.

FOR PHYSICAL FITNESS TRAINING AND COACHING SERVICES (U.S. CLS. 100, 101 AND 107).

FIRST USE 9-1-2010; IN COMMERCE 9-1-2010.

**CLASS 41—(Continued).**

4,046,278. TENCENT HOLDINGS LIMITED, GEORGE TOWN, CAYMAN ISLANDS. SN 85-039,758. PUB. 10-19-2010, FILED 5-17-2010.



THE COLOR(S) WHITE, PINK, GREEN, RED, ORANGE, BROWN AND LIGHT BROWN IS/ARE CLAIMED AS A FEATURE OF THE MARK.

THE MARK CONSISTS OF THE WORD "CAFE" IN STYLIZED FONT IN WHITE ON THE LEFT, THE WORD "LIFE" IN STYLIZED FONT IN PINK WITH A WHITE BORDER ON THE RIGHT, AND AN ORANGE CAKE WITH A RED STRAWBERRY WITH A GREEN STEM AND WHITE FROSTING ON TOP WRAPPED IN A BROWN WRAPPER, IN FRONT OF A FILLED CIRCLE IN LIGHT BROWN THAT IS INSIDE ANOTHER LIGHT BROWN CIRCLE BETWEEN THE WORDS; THE COLOR BLACK, AS IT APPEARS IN THE MARK, REPRESENTS BACKGROUND, OUTLINING, SHADING AND/OR TRANSPARENT AREAS AND IS NOT PART OF THE MARK.

FOR ENTERTAINMENT SERVICES, NAMELY, PROVIDING AN ON-LINE COMPUTER GAME; ENTERTAINMENT AND EDUCATION SERVICES, NAMELY, PROVIDING ONLINE GAMES IN THE NATURE OF COMPUTER CONTESTS; ENTERTAINMENT SERVICES, NAMELY, CONDUCTING ALTERNATE REALITY GAMES VIA THE INTERNET (U.S. CLS. 100, 101 AND 107).

FIRST USE 5-31-2010; IN COMMERCE 5-31-2010.

---

4,046,279. CHOW KIDS LLC, MINNEAPOLIS, MN. SN 85-040,101. PUB. 12-28-2010, FILED 5-17-2010.

# CHOW KIDS

THE MARK CONSISTS OF STANDARD CHARACTERS WITHOUT CLAIM TO ANY PARTICULAR FONT, STYLE, SIZE, OR COLOR.

NO CLAIM IS MADE TO THE EXCLUSIVE RIGHT TO USE "KIDS", APART FROM THE MARK AS SHOWN.

FOR EDUCATION SERVICES, NAMELY, PROVIDING TEACHING AND INSTRUCTIONAL SERVICES IN THE FIELDS OF COOKING AND NUTRITION; EDUCATIONAL SERVICES, NAMELY, CONDUCTING SEMINARS, WORKSHOPS, TUTORIALS, AND PROGRAMS OF INSTRUCTION IN THE FIELD OF COOKING AND NUTRITION; EDUCATIONAL SERVICES, NAMELY, PROVIDING ON-LINE WRITTEN AND AUDIO-VISUAL RESOURCES IN THE FIELD OF COOKING AND NUTRITION (U.S. CLS. 100, 101 AND 107).

FIRST USE 7-10-2011; IN COMMERCE 7-10-2011.

**CLASS 41—(Continued).**

4,046,297. SPORTSPIE, LLC, TUCSON, AZ. SN 85-047,178.  
PUB. 10-19-2010, FILED 5-25-2010.



THE COLOR(S) YELLOW, WHITE, BROWN, RED, AND BLACK IS/ARE CLAIMED AS A FEATURE OF THE MARK.

THE MARK CONSISTS OF YELLOW BACKGROUND; WHITE, BLACK AND BROWN PIE; RED FLAGS ON TOP OF PIE; BLACK, RED AND YELLOW STADIUM BELOW PIE; WHITE LINES RADIATING FROM THE BOTTOM AND SIDES OF STADIUM; THE TERM "SPORTSPIE.COM" IN BLACK STYLIZED LETTERS WITH WHITE HIGHLIGHTS; THE TERM "SPORTSPIE.COM" IS LOCATED ON THE RIGHT SIDE OF THE PIE AND STADIUM DESIGN.

FOR SPORTS NEWS AND INFORMATION WEBSITE (U.S. CLS. 100, 101 AND 107).

FIRST USE 12-14-2010; IN COMMERCE 1-24-2011.

**CLASS 41—(Continued).**

4,046,309. TREGOED INC., PRINCETON, NJ. SN 85-051,845.  
PUB. 5-3-2011, FILED 6-1-2010.

TREGOED WE'RE CRITICAL TO  
THINKING!

THE MARK CONSISTS OF STANDARD CHARACTERS WITHOUT CLAIM TO ANY PARTICULAR FONT, STYLE, SIZE, OR COLOR.

FOR EDUCATIONAL SERVICES, NAMELY, PROVIDING WORKSHOPS TO EDUCATORS AND STUDENTS FOR PROBLEM SOLVING AND DECISION MAKING IN K-12 SCHOOLS AND DISTRICTS; PROVIDING ONLINE INTERACTIVE WEBSITES WHERE ELEMENTARY, MIDDLE AND HIGH SCHOOL TEACHERS CAN CONDUCT LESSONS IN THE FIELD OF PROBLEM SOLVING AND DECISION MAKING (U.S. CLS. 100, 101 AND 107).  
FIRST USE 3-30-2010; IN COMMERCE 3-30-2010.

4,046,300. TREGOED INC., PRINCETON, NJ. SN 85-048,047.  
PUB. 5-3-2011, FILED 5-26-2010.

4,046,321. LEPORT EDUCATIONAL INSTITUTE, INC., DBA LEPORT SCHOOLS, HUNTINGTON BEACH, CA. SN 85-057,338. PUB. 5-10-2011, FILED 6-8-2010.

tregoED

KNOWLEDGE FOR LIFE

THE MARK CONSISTS OF STANDARD CHARACTERS WITHOUT CLAIM TO ANY PARTICULAR FONT, STYLE, SIZE, OR COLOR.

FOR EDUCATIONAL SERVICES, NAMELY, PROVIDING WORKSHOPS TO EDUCATORS AND STUDENTS FOR PROBLEM SOLVING AND DECISION MAKING IN K-12 SCHOOLS AND DISTRICTS; PROVIDING ONLINE INTERACTIVE WEBSITES WHERE ELEMENTARY, MIDDLE AND HIGH SCHOOL TEACHERS CAN CONDUCT LESSONS IN THE FIELD OF PROBLEM SOLVING AND DECISION MAKING (U.S. CLS. 100, 101 AND 107).

FIRST USE 3-30-2010; IN COMMERCE 3-30-2010.

THE MARK CONSISTS OF STANDARD CHARACTERS WITHOUT CLAIM TO ANY PARTICULAR FONT, STYLE, SIZE, OR COLOR.

FOR EDUCATIONAL SERVICES, NAMELY, PROVIDING CLASSES, LECTURES, COURSES, INSTRUCTION, SEMINARS, WORKSHOPS, TUTORING AND MENTORING IN THE FIELDS OF ACADEMIC SUBJECTS FOR STUDENTS IN PRE-KINDERGARTEN THROUGH HIGH-SCHOOL (U.S. CLS. 100, 101 AND 107).

FIRST USE 9-1-2010; IN COMMERCE 9-1-2010.

**CLASS 41—(Continued).**

4,046,329. INTEREALITY MEDIA LLC, SAN DIEGO, CA. SN 85-060,065. PUB. 7-12-2011, FILED 6-10-2010.



## HEALTHCARE HEROES

NO CLAIM IS MADE TO THE EXCLUSIVE RIGHT TO USE "HEALTHCARE", APART FROM THE MARK AS SHOWN.

THE STIPPLING IS FOR SHADING PURPOSES ONLY.

THE MARK CONSISTS OF A CIRCLE BACKGROUND UPON WHICH APPEAR TWO LETTERS "H", WITH ONE "H" ARRANGED VERTICALLY OVER THE OTHER TO FORM A PLUS SIGN IN BETWEEN; A HORIZONTAL ZIG-ZAG LINE BISECTS THE CIRCLE BACKGROUND AND THE PLUS SIGN BETWEEN THE LETTERS "H"; BELOW THE AFOREMENTIONED WORDING AND DESIGNS APPEARS THE STYLIZED WORDING "HEALTHCARE HEROES". THE STIPPLING IS FOR SHADING PURPOSES ONLY.

FOR EDUCATIONAL AND ENTERTAINMENT SERVICES, NAMELY, PROGRAMS ABOUT HEALTHCARE, HOSPITALS AND MEDICINE, ACCESSIBLE BY TELEVISION, SATELLITE, VIDEO AND COMPUTER NETWORK (U.S. CLS. 100, 101 AND 107).

FIRST USE 9-0-2009; IN COMMERCE 9-0-2009.

4,046,340. LIFELONG EDUCATION INSTITUTE, MILL VALLEY, CA. SN 85-062,306. PUB. 5-17-2011, FILED 6-14-2010.



NO CLAIM IS MADE TO THE EXCLUSIVE RIGHT TO USE "INTEGRATED SCIENCE PROGRAM", APART FROM THE MARK AS SHOWN.

THE COLOR(S) YELLOW, BLUE, BLACK AND WHITE IS/ARE CLAIMED AS A FEATURE OF THE MARK.

THE MARK CONSISTS OF THE LETTERS "I", "S" AND "P" IN BLACK, EACH CONTAINED WITHIN A SEPARATE WHITE-OUTLINED HEXAGON. THESE ELEMENTS APPEAR ON A BLUE BACKGROUND. TO THE RIGHT IS THE WORDING "INTEGRATED SCIENCE PROGRAM" IN BLACK STACKED VERTICALLY OVER THE WORDING "LEARN SCIENCE IN MONTHS NOT YEARS" IN BLACK. THESE ELEMENTS APPEAR ON A YELLOW BACKGROUND.

FOR EDUCATIONAL SERVICES, NAMELY, CONDUCTING CLASSES, SEMINARS, TRAINING AND WORKSHOPS IN THE FIELD OF SCIENCE AND DISTRIBUTING EDUCATIONAL MATERIALS AND CURRICULUM IN CONNECTION THEREWITH (U.S. CLS. 100, 101 AND 107).

FIRST USE 9-2-2008; IN COMMERCE 9-2-2008.

**CLASS 41—(Continued).**

4,046,395. ASCENDI GROUP, INC., MIAMI, FL. SN 85-078,940. PUB. 12-14-2010, FILED 7-6-2010.

## DO WHAT MATTERS

THE MARK CONSISTS OF STANDARD CHARACTERS WITHOUT CLAIM TO ANY PARTICULAR FONT, STYLE, SIZE, OR COLOR.

FOR EDUCATION SERVICES, NAMELY, PROVIDING SEMINARS, WORKSHOPS IN THE FIELDS OF COMMUNICATION SKILLS, INTERPERSONAL SKILLS, LEADERSHIP SKILLS, CUSTOMER RELATIONS, STRESS MANAGEMENT, TEAMWORK, TIME MANAGEMENT AND ORGANIZATIONAL AND WORKPLACE PERFORMANCE; PERSONAL, PROFESSIONAL, LIFE AND GROUP PERFORMANCE COACHING IN THE FIELD OF COMMUNICATION SKILLS, INTERPERSONAL SKILLS, LEADERSHIP SKILLS, CUSTOMER RELATIONS, STRESS MANAGEMENT, TEAMWORK, TIME MANAGEMENT AND ORGANIZATIONAL AND WORKPLACE PERFORMANCE (U.S. CLS. 100, 101 AND 107).

FIRST USE 7-1-2010; IN COMMERCE 3-21-2011.

4,046,406. SKYUNION PTE. LTD., 159308, SINGAPORE. SN 85-082,037. PUB. 10-26-2010, FILED 7-11-2010.

## Age of Titan

THE MARK CONSISTS OF STANDARD CHARACTERS WITHOUT CLAIM TO ANY PARTICULAR FONT, STYLE, SIZE, OR COLOR.

FOR COMPUTER EDUCATION TRAINING; EDUCATIONAL EXAMINATION; ELECTRONIC PUBLISHING SERVICES, NAMELY, PUBLICATION OF TEXT AND GRAPHIC WORKS OF OTHERS ON CD, DVD AND ONLINE FEATURING COMPUTER GAMES; ENTERTAINMENT INFORMATION; ENTERTAINMENT SERVICES, NAMELY, PROVIDING AN ON-LINE COMPUTER GAME; ORGANISATION OF SPORTS COMPETITIONS; ORGANIZATION OF EXHIBITIONS FOR CULTURAL OR EDUCATIONAL PURPOSES; PUBLICATION OF BOOKS; PUBLICATION OF ELECTRONIC MAGAZINES; PUBLICATION OF TEXTS, BOOKS, MAGAZINES AND OTHER PRINTED MATTER; PUBLISHING OF ELECTRONIC PUBLICATIONS; SOCIAL CLUB SERVICES, NAMELY, ARRANGING, ORGANIZING, AND HOSTING SOCIAL EVENTS, GET-TOGETHERS, AND PARTIES FOR CLUB MEMBERS (U.S. CLS. 100, 101 AND 107).

FIRST USE 9-30-2010; IN COMMERCE 9-30-2010.

**CLASS 41—(Continued).**

4,046,419. TRILABRYS INTERACTIVE, INC., AUSTIN, TX. SN 85-084,769. PUB. 12-21-2010, FILED 7-14-2010.

**FOREVER 17**

THE MARK CONSISTS OF STANDARD CHARACTERS WITHOUT CLAIM TO ANY PARTICULAR FONT, STYLE, SIZE, OR COLOR.

FOR ENTERTAINMENT SERVICES, NAMELY, PROVIDING ON-LINE COMPUTER GAMES (U.S. CLS. 100, 101 AND 107).

FIRST USE 5-29-2010; IN COMMERCE 10-25-2010.

4,046,421. TAMPA BAY RAYS BASEBALL LTD., ST. PETERSBURG, FL. SN 85-085,146. PUB. 12-21-2010, FILED 7-15-2010.

**ORLANDO RAYS**

THE MARK CONSISTS OF STANDARD CHARACTERS WITHOUT CLAIM TO ANY PARTICULAR FONT, STYLE, SIZE, OR COLOR.

OWNER OF U.S. REG. NOS. 2,247,891, 3,747,816, AND OTHERS.

NO CLAIM IS MADE TO THE EXCLUSIVE RIGHT TO USE "ORLANDO", APART FROM THE MARK AS SHOWN.

FOR ENTERTAINMENT SERVICES, NAMELY, PROVIDING NEWS, INFORMATION, ALL OF THE FOREGOING IN THE FIELD OF SPORTS (U.S. CLS. 100, 101 AND 107).

FIRST USE 4-8-1997; IN COMMERCE 4-8-1997.

4,046,431. MOORE, SHAYNE, WHEATON, IL. SN 85-086,671. PUB. 12-21-2010, FILED 7-16-2010.

**Global Soccer Mom**

THE MARK CONSISTS OF STANDARD CHARACTERS WITHOUT CLAIM TO ANY PARTICULAR FONT, STYLE, SIZE, OR COLOR.

FOR ON-LINE JOURNALS, NAMELY, BLOGS FEATURING COMMENTARY ON CURRENT EVENTS, SOCIAL JUSTICE, AND RELIGION (U.S. CLS. 100, 101 AND 107).

FIRST USE 1-0-2011; IN COMMERCE 1-0-2011.

**CLASS 41—(Continued).**

4,046,440. SHIRLEY, DEVIN, DBA KRAV FIT, SHERWOOD, AR. SN 85-088,278. PUB. 5-10-2011, FILED 7-20-2010.



NO CLAIM IS MADE TO THE EXCLUSIVE RIGHT TO USE "KRAV" AND "FIT", APART FROM THE MARK AS SHOWN.

THE MARK CONSIST OF THE TERM "KRAV" ABOVE A STYLIZED DESIGN OF THE HEBREW CHARACTERS "QOF" AND "KAF" WITH THE TERM "FIT" BENEATH.

THE ENGLISH TRANSLATION OF "KRAV" IN THE MARK IS "COMBAT".

FOR PROVIDING GENERAL FITNESS AND MIXED MARTIAL ARTS FACILITIES THAT REQUIRE MEMBERSHIPS AND ARE FOCUSED IN THE FIELDS OF GENERAL FITNESS, EXERCISE, AND MIXED MARTIAL ARTS (U.S. CLS. 100, 101 AND 107).

FIRST USE 6-3-2010; IN COMMERCE 6-3-2010.

4,046,473. AMERICAN BOARD OF FAMILY MEDICINE, INC., LEXINGTON, KY. SN 85-092,910. PUB. 1-11-2011, FILED 7-26-2010.

**ABFM MC-FP**

THE MARK CONSISTS OF STANDARD CHARACTERS WITHOUT CLAIM TO ANY PARTICULAR FONT, STYLE, SIZE, OR COLOR.

OWNER OF U.S. REG. NO. 3,745,934.

FOR EDUCATION AND TRAINING SERVICES, NAMELY, DEVELOPING, PROVIDING, MAINTAINING, AND ADMINISTERING EXAMINATIONS, PERFORMANCE ASSESSMENTS, AND SELF ASSESSMENTS TO DETERMINE, EVALUATE, AND MAINTAIN QUALIFICATIONS OF PRACTITIONERS IN THE MEDICAL SPECIALTY OF FAMILY MEDICINE AND RESIDENTS IN RESIDENCY TRAINING PROGRAMS IN THE MEDICAL SPECIALTY OF FAMILY MEDICINE (U.S. CLS. 100, 101 AND 107).

FIRST USE 1-1-2011; IN COMMERCE 1-1-2011.

**CLASS 41—(Continued).**

4,046,489. EARTH DAY NETWORK, INC., WASHINGTON, DC. SN 85-095,246. PUB. 11-23-2010, FILED 7-28-2010.

**ROAD TO RIO**

THE MARK CONSISTS OF STANDARD CHARACTERS WITHOUT CLAIM TO ANY PARTICULAR FONT, STYLE, SIZE, OR COLOR.

NO CLAIM IS MADE TO THE EXCLUSIVE RIGHT TO USE "RIO", APART FROM THE MARK AS SHOWN.

FOR ORGANIZING, PLANNING, ARRANGING AND CONDUCTING EVENTS IN THE NATURE OF CONTESTS, CONCERTS, COURSES AND SEMINARS RELATING TO THE ENVIRONMENT; EDUCATION SERVICES, NAMELY, ARRANGING CLASSES, COURSES, SEMINARS, CLINICS, WORKSHOPS, LECTURES, TUTORING AND MENTORING ON ENVIRONMENTAL ISSUES (U.S. CLS. 100, 101 AND 107).

FIRST USE 3-7-2011; IN COMMERCE 3-7-2011.

---

4,046,554. TELEVISION FOOD NETWORK, G.P., NEW YORK, NY. SN 85-103,335. PUB. 1-18-2011, FILED 8-9-2010.

**FOODOGRAPHY**

THE MARK CONSISTS OF STANDARD CHARACTERS WITHOUT CLAIM TO ANY PARTICULAR FONT, STYLE, SIZE, OR COLOR.

FOR EDUCATIONAL AND ENTERTAINMENT SERVICES, NAMELY, A CONTINUING PROGRAM ABOUT COOKING, ACCESSIBLE BY RADIO, TELEVISION, CABLE, FIBER OPTIC NETWORKS, WIRELESS NETWORKS, SATELLITE, AUDIO VIDEO, AND COMPUTER NETWORKS (U.S. CLS. 100, 101 AND 107).

FIRST USE 7-4-2010; IN COMMERCE 7-4-2010.

---

4,046,592. LL GLOBAL, INC., WINDSOR, CT. SN 85-113,246. PUB. 7-12-2011, FILED 8-23-2010.

**TRUSTWORTHY SELLING**

THE MARK CONSISTS OF STANDARD CHARACTERS WITHOUT CLAIM TO ANY PARTICULAR FONT, STYLE, SIZE, OR COLOR.

NO CLAIM IS MADE TO THE EXCLUSIVE RIGHT TO USE "SELLING", APART FROM THE MARK AS SHOWN.

FOR EDUCATION SERVICES, NAMELY, PROVIDING COURSES AND CONFERENCES IN THE FIELDS OF SALES TRAINING (U.S. CLS. 100, 101 AND 107).

FIRST USE 2-23-2011; IN COMMERCE 8-1-2011.

**CLASS 41—(Continued).**

4,046,593. HARLENE ELLIN, RIVER FOREST, IL. SN 85-113,756. PUB. 2-15-2011, FILED 8-23-2010.



NO CLAIM IS MADE TO THE EXCLUSIVE RIGHT TO USE "DESIGN DINE & WINE", APART FROM THE MARK AS SHOWN.

THE MARK CONSISTS OF THE LETTER "F" SURROUNDED BY A CIRCLE, THE LETTER "I" SURROUNDED BY A CIRCLE, THE LETTER "N" SURROUNDED BY A CIRCLE, THE LETTER "E" SURROUNDED BY A CIRCLE, AND THE WORDS "DESIGN DINE & WINE".

FOR ON-LINE JOURNAL FEATURING RESTAURANT DINING, RESTAURANT INTERIOR DESIGN AND WINE (U.S. CLS. 100, 101 AND 107).

FIRST USE 1-9-2011; IN COMMERCE 1-9-2011.

---

4,046,618. LIFETIME ENTERTAINMENT SERVICES, LLC, NEW YORK, NY. SN 85-117,405. PUB. 1-18-2011, FILED 8-27-2010.

**FAIRY JOBMOTHER**

THE MARK CONSISTS OF STANDARD CHARACTERS WITHOUT CLAIM TO ANY PARTICULAR FONT, STYLE, SIZE, OR COLOR.

FOR ENTERTAINMENT SERVICES, NAMELY, AN ON-GOING TELEVISION SERIES ABOUT FAMILY DYNAMICS, FAMILY MEMBERS, AND SEEKING NEW EMPLOYMENT POSITIONS; ENTERTAINMENT SERVICES, NAMELY, A MULTIMEDIA PROGRAM SERIES ABOUT FAMILY DYNAMICS, FAMILY MEMBERS, AND SEEKING NEW EMPLOYMENT POSITIONS DISTRIBUTED VIA VARIOUS PLATFORMS ACROSS MULTIPLE FORMS OF TRANSMISSION MEDIA (U.S. CLS. 100, 101 AND 107).

FIRST USE 10-28-2010; IN COMMERCE 10-28-2010.

**CLASS 41—(Continued).**

4,046,629. SONY PICTURES TELEVISION INC., CULVER CITY, CA. AND HARPO PRODUCTIONS, INC., CHICAGO, IL. SN 85-119,876. PUB. 3-22-2011, FILED 8-31-2010.

**INSTANT DESIGN STUDIO**

THE MARK CONSISTS OF STANDARD CHARACTERS WITHOUT CLAIM TO ANY PARTICULAR FONT, STYLE, SIZE, OR COLOR.

NO CLAIM IS MADE TO THE EXCLUSIVE RIGHT TO USE "DESIGN STUDIO", APART FROM THE MARK AS SHOWN.

FOR ENTERTAINMENT SERVICES IN THE NATURE OF A SEGMENT WITHIN A TELEVISION SERIES FEATURING HOME DESIGN PLANNING (U.S. CLS. 100, 101 AND 107).

FIRST USE 9-13-2010; IN COMMERCE 9-13-2010.

4,046,633. MIAMI LIGHTHOUSE FOR THE BLIND & VISUALLY IMPAIRED, INC., MIAMI, FL. SN 85-120,610. PUB. 3-8-2011, FILED 9-1-2010.

**BETTER CHANCE MUSIC PRODUCTION PROGRAM**

THE MARK CONSISTS OF STANDARD CHARACTERS WITHOUT CLAIM TO ANY PARTICULAR FONT, STYLE, SIZE, OR COLOR.

NO CLAIM IS MADE TO THE EXCLUSIVE RIGHT TO USE "MUSIC PRODUCTION PROGRAM", APART FROM THE MARK AS SHOWN.

FOR EDUCATION SERVICES IN THE NATURE OF CLASSES AND WORKSHOPS IN THE FIELD OF MUSIC DIRECTED TO THE VISUALLY IMPAIRED (U.S. CLS. 100, 101 AND 107).

FIRST USE 4-0-2011; IN COMMERCE 4-0-2011.

4,046,677. WORLD CHOICE INVESTMENTS, LLC, PIGEON FORGE, TN. SN 85-129,818. PUB. 3-1-2011, FILED 9-15-2010.

**PIRATES VOYAGE**

THE MARK CONSISTS OF STANDARD CHARACTERS WITHOUT CLAIM TO ANY PARTICULAR FONT, STYLE, SIZE, OR COLOR.

**CLASS 41—(Continued).**

NO CLAIM IS MADE TO THE EXCLUSIVE RIGHT TO USE "PIRATES", APART FROM THE MARK AS SHOWN.

FOR PIRATE THEMED DINNER THEATER SERVICES AND ENTERTAINMENT SERVICES IN THE NATURE OF PLAYS, LIVE SHOWS AND PAGEANTS FEATURING PIRATE CHARACTERS (U.S. CLS. 100, 101 AND 107).

FIRST USE 6-3-2011; IN COMMERCE 6-3-2011.

4,046,708. BRINKLEY, HEIDI, SOUTHFIELD, MI. SN 85-134,938. PUB. 3-8-2011, FILED 9-21-2010.

**AGREE 2 DISAGREE**

THE MARK CONSISTS OF STANDARD CHARACTERS WITHOUT CLAIM TO ANY PARTICULAR FONT, STYLE, SIZE, OR COLOR.

FOR ENTERTAINMENT, NAMELY, A CONTINUING TALK, CURRENT EVENTS, AND LIFESTYLE SHOW BROADCAST OVER RADIO AND TELEVISION (U.S. CLS. 100, 101 AND 107).

FIRST USE 4-0-2011; IN COMMERCE 4-0-2011.

4,046,720. PHILLIPS, JOHN, MARIETTA, GA. SN 85-139,249. PUB. 3-8-2011, FILED 9-27-2010.

**BOOTS TO LOAFERS**

THE MARK CONSISTS OF STANDARD CHARACTERS WITHOUT CLAIM TO ANY PARTICULAR FONT, STYLE, SIZE, OR COLOR.

FOR EDUCATION SERVICES, NAMELY, PROVIDING SEMINARS AND TRAINING TO MILITARY FOR TRANSITIONING OUT OF THE MILITARY AND INTO THE PRIVATE SECTOR (U.S. CLS. 100, 101 AND 107).

FIRST USE 5-11-2011; IN COMMERCE 5-11-2011.



**CLASS 41—(Continued).**

4,046,729. THE PENN MUTUAL LIFE INSURANCE COMPANY, HORSHAM, PA. SN 85-141,174. PUB. 1-11-2011, FILED 9-29-2010.

SUCCESS OVER SURVIVAL:  
PLANNING STRATEGIES YOUR  
BUSINESS CAN'T LIVE WITHOUT

THE MARK CONSISTS OF STANDARD CHARACTERS WITHOUT CLAIM TO ANY PARTICULAR FONT, STYLE, SIZE, OR COLOR.

FOR EDUCATIONAL SERVICES, NAMELY, CONDUCTING SEMINARS IN THE FIELD OF BUSINESS SUCCESSION PLANNING, RETIREMENT PLANNING, ESTATE PLANNING, AND KEY EMPLOYEE BENEFITS AND DISTRIBUTION OF PRINTED MATERIALS IN CONNECTION THEREWITH IN HARD COPY OR ELECTRONIC FORMAT ON THE SAME TOPICS (U.S. CLS. 100, 101 AND 107).

FIRST USE 1-27-2011; IN COMMERCE 1-27-2011.

4,046,754. THE PLAYROOM ACADEMY OF MUSIC, LLC, CHARLOTTE, NC. SN 85-147,952. PUB. 3-22-2011, FILED 10-7-2010.

GUITARS ON THE GO

THE MARK CONSISTS OF STANDARD CHARACTERS WITHOUT CLAIM TO ANY PARTICULAR FONT, STYLE, SIZE, OR COLOR.

NO CLAIM IS MADE TO THE EXCLUSIVE RIGHT TO USE "GUITARS", APART FROM THE MARK AS SHOWN.

FOR EDUCATION SERVICES, NAMELY, PROVIDING PROGRAMS IN THE FIELD OF MUSIC; EDUCATIONAL SERVICES, NAMELY, CONDUCTING PROGRAMS IN THE FIELD OF MUSIC (U.S. CLS. 100, 101 AND 107).

FIRST USE 8-22-2011; IN COMMERCE 8-22-2011.

**CLASS 41—(Continued).**

4,046,795. GOH, SUA HUAT, PUCHONG, SELANGOR, MALAYSIA. SN 85-159,063. PUB. 3-22-2011, FILED 10-22-2010.

GLOBBIEART

THE MARK CONSISTS OF STANDARD CHARACTERS WITHOUT CLAIM TO ANY PARTICULAR FONT, STYLE, SIZE, OR COLOR.

FOR EDUCATION SERVICES, NAMELY, PROVIDING WORKSHOPS AND SEMINARS IN THE FIELD OF ART AND DISTRIBUTION OF COURSE MATERIAL IN CONNECTION THEREWITH; PUBLICATION OF BOOKS; PUBLICATION OF JOURNALS; PUBLICATION OF TEXT BOOKS (U.S. CLS. 100, 101 AND 107).

FIRST USE 10-0-2010; IN COMMERCE 10-0-2010.

4,046,807. LIVE NATION WORLDWIDE, INC., BEVERLY HILLS, CA. SN 85-163,013. PUB. 2-1-2011, FILED 10-27-2010.

RED SKY

THE MARK CONSISTS OF STANDARD CHARACTERS WITHOUT CLAIM TO ANY PARTICULAR FONT, STYLE, SIZE, OR COLOR.

FOR ENTERTAINMENT SERVICES IN THE NATURE OF A LIVE MUSIC FESTIVAL (U.S. CLS. 100, 101 AND 107).

FIRST USE 12-15-2010; IN COMMERCE 12-15-2010.

4,046,831. BENITO, THEODORE I., LOS ANGELES, CA. SN 85-171,003. PUB. 3-29-2011, FILED 11-7-2010.

JAZZMOPOLITAN

THE MARK CONSISTS OF STANDARD CHARACTERS WITHOUT CLAIM TO ANY PARTICULAR FONT, STYLE, SIZE, OR COLOR.

FOR ENTERTAINMENT IN THE NATURE OF LIVE STAGE PERFORMANCES IN THE NATURE OF MUSIC CONCERTS OR LECTURE FOR HIRE IN THE FIELD OF MUSIC BY AN INDIVIDUAL; ENTERTAINMENT, NAMELY, LIVE MUSIC CONCERTS (U.S. CLS. 100, 101 AND 107).

FIRST USE 11-1-2010; IN COMMERCE 11-1-2010.

**CLASS 41—(Continued).**

4,046,836. DANIEL D'ARCO, POTTSVILLE, PA. SN 85-172,864. PUB. 3-29-2011, FILED 11-9-2010.

**ROCK CHEMISTRY**

THE MARK CONSISTS OF STANDARD CHARACTERS WITHOUT CLAIM TO ANY PARTICULAR FONT, STYLE, SIZE, OR COLOR.

FOR ENTERTAINMENT SERVICES IN THE NATURE OF A CONTINUING TELEVISION REALITY SHOW (U.S. CLS. 100, 101 AND 107).

FIRST USE 7-12-2011; IN COMMERCE 7-12-2011.

---

4,046,842. VINTAGE PAINTBALL PARK, LLC, RIVER FALLS, WI. SN 85-175,139. PUB. 4-19-2011, FILED 11-12-2010.

**VINTAGE PAINTBALL PARK**

THE MARK CONSISTS OF STANDARD CHARACTERS WITHOUT CLAIM TO ANY PARTICULAR FONT, STYLE, SIZE, OR COLOR.

NO CLAIM IS MADE TO THE EXCLUSIVE RIGHT TO USE "PAINTBALL PARK", APART FROM THE MARK AS SHOWN.

FOR PROVIDING FACILITIES FOR PLAYING PAINTBALL GAMES (U.S. CLS. 100, 101 AND 107).

FIRST USE 6-1-2010; IN COMMERCE 6-1-2010.

---

4,046,847. ASCENDING TO ONENESS LLC, DBA INNER SOURCE TOOLS, TAMPA, FL. SN 85-177,736. PUB. 5-10-2011, FILED 11-16-2010.

**IST**

THE MARK CONSISTS OF STANDARD CHARACTERS WITHOUT CLAIM TO ANY PARTICULAR FONT, STYLE, SIZE, OR COLOR.

FOR MEDITATION TRAINING, NAMELY, INSTRUCTION ON MEDITATING TECHNIQUES TO REDUCE STRESS IN THE WORKPLACE (U.S. CLS. 100, 101 AND 107).

FIRST USE 1-24-2011; IN COMMERCE 1-24-2011.

**CLASS 41—(Continued).**

4,046,854. BEHR PROCESS CORPORATION, SANTA ANA, CA. SN 85-180,916. PUB. 4-12-2011, FILED 11-19-2010.

**COLORFULLY, BEHR**

THE MARK CONSISTS OF STANDARD CHARACTERS WITHOUT CLAIM TO ANY PARTICULAR FONT, STYLE, SIZE, OR COLOR.

OWNER OF U.S. REG. NOS. 942,246, 1,551,547, AND OTHERS.

FOR ONLINE JOURNALS, NAMELY, BLOGS FEATURING PAINTING AND DECORATING ADVICE AND COMMENTARY (U.S. CLS. 100, 101 AND 107).

FIRST USE 8-31-2011; IN COMMERCE 8-31-2011.

---

4,046,861. DISCOVERY COMMUNICATIONS, LLC, WASHINGTON, DC. SN 85-182,786. PUB. 4-19-2011, FILED 11-22-2010.

**QUINTS BY SURPRISE**

THE MARK CONSISTS OF STANDARD CHARACTERS WITHOUT CLAIM TO ANY PARTICULAR FONT, STYLE, SIZE, OR COLOR.

NO CLAIM IS MADE TO THE EXCLUSIVE RIGHT TO USE "QUINTS", APART FROM THE MARK AS SHOWN.

FOR ENTERTAINMENT AND EDUCATIONAL SERVICES IN THE NATURE OF TELEVISION AND MULTIMEDIA PROGRAM SERIES FEATURING SUBJECTS OF GENERAL HUMAN INTEREST DISTRIBUTED VIA VARIOUS PLATFORMS ACROSS MULTIPLE FORMS OF TRANSMISSION MEDIA; PROVIDING ENTERTAINMENT INFORMATION TO OTHERS VIA A GLOBAL COMPUTER NETWORK (U.S. CLS. 100, 101 AND 107).

FIRST USE 8-20-2010; IN COMMERCE 8-30-2010.

**CLASS 41—(Continued).**

4,046,882. MILLER, SHAUNA R., LOS ANGELES, CA. SN 85-189,256. PUB. 4-19-2011, FILED 12-2-2010.

## PENNY CHIC

THE MARK CONSISTS OF STANDARD CHARACTERS WITHOUT CLAIM TO ANY PARTICULAR FONT, STYLE, SIZE, OR COLOR.

FOR PROVIDING ONLINE JOURNALS, NAMELY, BLOGS CONTAINING PHOTOS AND COMMENTARY ON CLOTHING AND ACCESSORIES SOLD AT DISCOUNT RETAIL STORES USED TO CREATE AND STYLE OUTFITS WITH A SPECIFIED CHIC AND TRENDY LOOK AND IDENTITY (U.S. CLS. 100, 101 AND 107).

FIRST USE 11-7-2010; IN COMMERCE 5-31-2011.

4,046,903. FIRST ROUND EXCHANGE LLC, BRENTWOOD, TN. SN 85-193,878. PUB. 5-10-2011, FILED 12-9-2010.

## Play the Draft

THE MARK CONSISTS OF STANDARD CHARACTERS WITHOUT CLAIM TO ANY PARTICULAR FONT, STYLE, SIZE, OR COLOR.

FOR ENTERTAINMENT SERVICES, NAMELY, PROVIDING ON-LINE COMPUTER GAMES (U.S. CLS. 100, 101 AND 107).

FIRST USE 3-28-2011; IN COMMERCE 3-28-2011.

4,046,908. TWENTIETH CENTURY FOX FILM CORPORATION, LOS ANGELES, CA. SN 85-194,653. PUB. 5-10-2011, FILED 12-9-2010.

## FOX SOCCER

THE MARK CONSISTS OF STANDARD CHARACTERS WITHOUT CLAIM TO ANY PARTICULAR FONT, STYLE, SIZE, OR COLOR.

OWNER OF U.S. REG. NOS. 3,058,283, 3,784,518, AND OTHERS.

**CLASS 41—(Continued).**

NO CLAIM IS MADE TO THE EXCLUSIVE RIGHT TO USE "SOCCER", APART FROM THE MARK AS SHOWN.

FOR PRODUCTION AND DISTRIBUTION OF TELEVISION PROGRAMS FEATURING SPORTS, NEWS AND ENTERTAINMENT; ENTERTAINMENT SERVICES IN THE NATURE OF ONGOING TELEVISION PROGRAMS FEATURING SPORTS, NEWS AND ENTERTAINMENT; PROVIDING ON-LINE INFORMATION IN THE FIELD OF TELEVISION AND VIDEO ENTERTAINMENT FEATURING SPORTS, CURRENT EVENT NEWS AND ENTERTAINMENT VIA THE INTERNET; ENTERTAINMENT SERVICES IN THE NATURE OF NON-DOWNLOADABLE VIDEOS AND IMAGES FEATURING TELEVISION SHOWS, SPORTS, NEWS AND ENTERTAINMENT TRANSMITTED VIA THE INTERNET AND WIRELESS COMMUNICATION NETWORKS (U.S. CLS. 100, 101 AND 107).

FIRST USE 5-5-2011; IN COMMERCE 5-5-2011.

4,046,926. ECPI COLLEGES, INC., VIRGINIA BEACH, VA. SN 85-200,685. PUB. 6-7-2011, FILED 12-17-2010.

## ECPI UNIVERSITY

THE MARK CONSISTS OF STANDARD CHARACTERS WITHOUT CLAIM TO ANY PARTICULAR FONT, STYLE, SIZE, OR COLOR.

OWNER OF U.S. REG. NOS. 2,546,694 AND 2,549,600.

NO CLAIM IS MADE TO THE EXCLUSIVE RIGHT TO USE "UNIVERSITY", APART FROM THE MARK AS SHOWN.

FOR EDUCATIONAL SERVICES, NAMELY, PROVIDING COURSES OF INSTRUCTION AT THE UNIVERSITY LEVEL (U.S. CLS. 100, 101 AND 107).

FIRST USE 6-3-2011; IN COMMERCE 6-3-2011.

4,046,938. REVOLUTIONARY VELO-WATTS, BURNT HILLS, NY. SN 85-205,331. PUB. 6-7-2011, FILED 12-23-2010.



THE MARK CONSISTS OF A BICYCLE CRANK WITH COGS AND UPRIGHT CRANK ARM WITH A MONSTER HEAD WHERE THE PEDAL WOULD BE, AN UPRIGHT ARROW IN FRONT OF THE MONSTER HEAD, AND THE WORDING "REVOLUTIONARY VELO-WATTS".

THE ENGLISH TRANSLATION OF "VELO" IN THE MARK IS "BICYCLE".

FOR PERSONAL COACHING SERVICES IN THE FIELD OF CYCLING (U.S. CLS. 100, 101 AND 107).

FIRST USE 11-1-2010; IN COMMERCE 1-1-2011.

**CLASS 41—(Continued).**

4,046,968. YOUNG, KAREN, NEW YORK, NY. SN 85-211,764. PUB. 5-24-2011, FILED 1-6-2011.

## Sweet Readers

THE MARK CONSISTS OF STANDARD CHARACTERS WITHOUT CLAIM TO ANY PARTICULAR FONT, STYLE, SIZE, OR COLOR.

NO CLAIM IS MADE TO THE EXCLUSIVE RIGHT TO USE "READERS", APART FROM THE MARK AS SHOWN.

FOR EDUCATIONAL SERVICES, NAMELY, CONDUCTING EDUCATIONAL WORKSHOPS, CLASSES AND/OR DEMONSTRATIONS IN THE FIELD OF INTERGENERATIONAL COMMUNICATIONS, PUBLIC SPEAKING, READING, LITERACY AND/OR CONNECTING WITH PEOPLE SUFFERING FROM ALZHEIMER'S DISEASE AND DISTRIBUTION OF PRINTED MATERIALS IN CONNECTION THEREWITH IN HARD COPY OR ELECTRONIC FORMAT ON THE SAME TOPICS (U.S. CLS. 100, 101 AND 107).

FIRST USE 4-1-2011; IN COMMERCE 4-30-2011.

---

4,046,973. KIDGINEER, LLC, LAUREL, MD. SN 85-212,836. PUB. 5-3-2011, FILED 1-7-2011.

## I am a KidGINEER. When I grow up, I'll be an Engineer!

THE MARK CONSISTS OF STANDARD CHARACTERS WITHOUT CLAIM TO ANY PARTICULAR FONT, STYLE, SIZE, OR COLOR.

OWNER OF U.S. REG. NO. 3,826,399.

FOR EDUCATION SERVICES, NAMELY, MENTORING IN THE FIELD OF MATH, SCIENCE, ENGINEERING AND TECHNOLOGY; EDUCATION SERVICES, NAMELY, ONE-ON-ONE MENTORING IN THE FIELDS OF MATH, SCIENCE, ENGINEERING AND TECHNOLOGY; EDUCATION SERVICES, NAMELY, PROVIDING MENTORING, TUTORING, CLASSES, SEMINARS AND WORKSHOPS IN THE FIELD OF MATH, SCIENCE, ENGINEERING AND TECHNOLOGY; EDUCATION SERVICES, NAMELY, PROVIDING TUTORIAL SESSIONS IN THE FIELDS OF MATH, SCIENCE, ENGINEERING AND TECHNOLOGY; EDUCATIONAL AND ENTERTAINMENT SERVICES, NAMELY, PROVIDING MOTIVATIONAL AND EDUCATIONAL SPEAKERS; PROVIDING SCIENCE EDUCATIONAL MENTORING SERVICES AND PROGRAMS (U.S. CLS. 100, 101 AND 107).

FIRST USE 11-19-2009; IN COMMERCE 11-19-2009.

**CLASS 41—(Continued).**

4,046,975. LINKESH A DIWAN, DBA WISE EARTH PUBLISHERS, NORWICH, CT. SN 85-213,418. PUB. 5-24-2011, FILED 1-8-2011.



WISE EARTH PUBLISHERS

NO CLAIM IS MADE TO THE EXCLUSIVE RIGHT TO USE "PUBLISHERS", APART FROM THE MARK AS SHOWN.

THE MARK CONSISTS OF AN ELEPHANT PULLING A FOUR-WHEELED CART BY MEANS OF A HALTER AND CHAIN, IN WHICH SITS AN IMAGE OF THE GLOBE WITH OCEANS, CLOUDS, AND CONTINENTS, WITH THE WORDS "WISE EARTH PUBLISHERS" BELOW OR NEARBY THE IMAGE.

FOR ELECTRONIC DESKTOP PUBLISHING; MUSIC VIDEO PRODUCTION; PRODUCTION OF MUSICAL VIDEOS; PRODUCTION OF SOUND AND MUSIC VIDEO RECORDINGS; PROVIDING A WEBSITE FEATURING BLOGS AND NON-DOWNLOADABLE PUBLICATIONS IN THE NATURE OF ARTICLES, BROCHURES, ARTWORK, AND AUDIO/VIDEO MULTIMEDIA IN THE FIELD(S) OF ETHICS, ECONOMICS, ECOLOGY, PHILOSOPHY, SPIRITUALITY, RELIGION, MARRIAGE AND FAMILY, AND LAW; PUBLISHING OF BOOKS, E-BOOKS, AUDIO BOOKS, MUSIC AND ILLUSTRATIONS FILM AND VIDEO PRODUCTION (U.S. CLS. 100, 101 AND 107).

FIRST USE 5-16-2008; IN COMMERCE 5-21-2010.

---

4,046,978. AMERICAN EXPRESS MARKETING & DEVELOPMENT CORP., NEW YORK, NY. SN 85-213,841. PUB. 4-19-2011, FILED 1-10-2011.

## UNSTAGED AN ORIGINAL SERIES FROM AMERICAN EXPRESS

THE MARK CONSISTS OF STANDARD CHARACTERS WITHOUT CLAIM TO ANY PARTICULAR FONT, STYLE, SIZE, OR COLOR.

NO CLAIM IS MADE TO THE EXCLUSIVE RIGHT TO USE "AN ORIGINAL SERIES", APART FROM THE MARK AS SHOWN.

FOR ENTERTAINMENT IN THE NATURE OF LIVE PERFORMANCES BY MUSICAL ARTISTS TO LIVE-STREAM CONCERTS OVER THE INTERNET (U.S. CLS. 100, 101 AND 107).

FIRST USE 8-5-2010; IN COMMERCE 8-5-2010.

**CLASS 41—(Continued).**

4,046,990. GONZALEZ, WILLIAM, DBA DASHING PHOTOGRAPHY, FRAMINGHAM, MA. SN 85-216,673. PUB. 5-31-2011, FILED 1-13-2011.

**Dashing Photography**

THE MARK CONSISTS OF STANDARD CHARACTERS WITHOUT CLAIM TO ANY PARTICULAR FONT, STYLE, SIZE, OR COLOR.

NO CLAIM IS MADE TO THE EXCLUSIVE RIGHT TO USE "PHOTOGRAPHY", APART FROM THE MARK AS SHOWN.

FOR PHOTOGRAPHY SERVICES (U.S. CLS. 100, 101 AND 107).

FIRST USE 11-11-2009; IN COMMERCE 11-11-2009.

4,046,995. VARSHNEY, ANURAG, ISELIN, NJ. SN 85-217,478. PUB. 5-24-2011, FILED 1-13-2011.

**TUTORMINDS**

THE MARK CONSISTS OF STANDARD CHARACTERS WITHOUT CLAIM TO ANY PARTICULAR FONT, STYLE, SIZE, OR COLOR.

FOR EDUCATION SERVICES, NAMELY, PROVIDING TUTORING IN THE FIELD OF ACADEMICS, COMPUTER, AND LANGUAGES (U.S. CLS. 100, 101 AND 107).

FIRST USE 2-1-2011; IN COMMERCE 4-1-2011.

4,047,003. HOLLANDER, SUZANNE, MIAMI BEACH, FL. SN 85-219,968. PUB. 5-31-2011, FILED 1-18-2011.

**PROFESSOR REAL ESTATE**

THE MARK CONSISTS OF STANDARD CHARACTERS WITHOUT CLAIM TO ANY PARTICULAR FONT, STYLE, SIZE, OR COLOR.

NO CLAIM IS MADE TO THE EXCLUSIVE RIGHT TO USE "REAL ESTATE", APART FROM THE MARK AS SHOWN.

FOR EDUCATIONAL SERVICES, NAMELY, CONDUCTING WORKSHOPS, RETREATS, LECTURES AND SEMINARS IN THE FIELDS OF REAL ESTATE AND DISTRIBUTION OF TRAINING MATERIALS IN CONNECTION THEREWITH; ENTERTAINMENT, NAMELY, PRODUCTION OF AN ON-GOING TELEVISION PROGRAM IN THE FIELD OF REAL ESTATE; PROVIDING ON-LINE NEWSLETTERS IN THE FIELD OF REAL ESTATE; ENTERTAINMENT SERVICES, NAMELY, LIVE AND TELEVISED APPEARANCES BY A PROFESSIONAL IN THE FIELD OF REAL ESTATE; PUBLICATION OF BOOKS (U.S. CLS. 100, 101 AND 107).

FIRST USE 0-0-2010; IN COMMERCE 1-0-2011.

**CLASS 41—(Continued).**

4,047,011. SEA WORLD LLC, ORLANDO, FL. SN 85-222,765. PUB. 5-31-2011, FILED 1-21-2011.

**ONE OCEAN**

THE MARK CONSISTS OF STANDARD CHARACTERS WITHOUT CLAIM TO ANY PARTICULAR FONT, STYLE, SIZE, OR COLOR.

FOR ENTERTAINMENT SERVICES IN THE NATURE OF AN AMUSEMENT PARK SHOW (U.S. CLS. 100, 101 AND 107).

FIRST USE 4-0-2011; IN COMMERCE 4-0-2011.

4,047,023. PERSPECTIVE PARTNERING, LLC, MILTON, GA. SN 85-228,174. PUB. 5-31-2011, FILED 1-27-2011.

**Learning to Lead by  
choosing to follow**

THE MARK CONSISTS OF STANDARD CHARACTERS WITHOUT CLAIM TO ANY PARTICULAR FONT, STYLE, SIZE, OR COLOR.

FOR EDUCATIONAL SERVICES, NAMELY, CONDUCTING CLASSES, SEMINARS, CONFERENCES, WORKSHOPS IN THE FIELD OF RELIGIOUS STUDIES AND DISTRIBUTION OF PRINTED MATERIALS IN CONNECTION THEREWITH IN HARD COPY OR ELECTRONIC FORMAT ON THE SAME TOPICS (U.S. CLS. 100, 101 AND 107).

FIRST USE 1-1-2011; IN COMMERCE 1-1-2011.

4,047,041. FAZIO, KAREN M, KEYPORT, NJ. SN 85-235,378. PUB. 6-28-2011, FILED 2-7-2011.



NO CLAIM IS MADE TO THE EXCLUSIVE RIGHT TO USE "THE DOG SUPER NANNY", APART FROM THE MARK AS SHOWN.

THE COLOR(S) BLACK, RED, AND GREY IS/ARE CLAIMED AS A FEATURE OF THE MARK.

THE MARK CONSISTS OF THE WORDS "THE DOG SUPER NANNY", WITH A PAW PRINT IN BETWEEN THE WORDS "SUPER" AND "NANNY". PAW PRINT IS RED WITH A GREY OUTLINE. WORDS ARE IN BLACK. THE BEGINNING WORD "THE" IS ITALICIZED.

FOR DOG TRAINING (U.S. CLS. 100, 101 AND 107).

FIRST USE 3-1-2011; IN COMMERCE 3-1-2011.

**CLASS 41—(Continued).**

4,047,047. JOYRIDE CYCLE STUDIO, LLC, WESTPORT, CT. SN 85-236,453. PUB. 6-14-2011, FILED 2-8-2011.

Life's a Trip. Enjoy the Ride!

THE MARK CONSISTS OF STANDARD CHARACTERS WITHOUT CLAIM TO ANY PARTICULAR FONT, STYLE, SIZE, OR COLOR.

FOR PROVIDING FITNESS AND EXERCISE STUDIO SERVICES, NAMELY, PROVIDING INDOOR CYCLING FITNESS CLASSES (U.S. CLS. 100, 101 AND 107). FIRST USE 1-1-2011; IN COMMERCE 5-25-2011.

---

4,047,052. SHUFFLE MASTER, INC., LAS VEGAS, NV. SN 85-238,493. PUB. 6-14-2011, FILED 2-9-2011.

STRAIGHT JACK

THE MARK CONSISTS OF STANDARD CHARACTERS WITHOUT CLAIM TO ANY PARTICULAR FONT, STYLE, SIZE, OR COLOR.

FOR ENTERTAINMENT SERVICES, NAMELY, PROVIDING A LIVE CASINO GAME OF CHANCE ON A GAMING TABLE (U.S. CLS. 100, 101 AND 107). FIRST USE 4-23-2011; IN COMMERCE 4-23-2011.

---

4,047,064. KABAM, INC., REDWOOD CITY, CA. SN 85-243,141. PUB. 6-21-2011, FILED 2-15-2011.

EDGEWORLD

THE MARK CONSISTS OF STANDARD CHARACTERS WITHOUT CLAIM TO ANY PARTICULAR FONT, STYLE, SIZE, OR COLOR.

FOR ENTERTAINMENT SERVICES, NAMELY, PROVIDING ON-LINE COMPUTER GAMES (U.S. CLS. 100, 101 AND 107). FIRST USE 5-17-2011; IN COMMERCE 5-17-2011.

**CLASS 41—(Continued).**

4,047,093. CHERYL A. THOMAS, TOMS RIVER, NJ. AND KELLY J. SPARKS, MAYS LANDING, NJ. SN 85-975,569. PUB. 12-21-2010, FILED 4-9-2010.



THE MARK CONSISTS OF THE LETTERS "ISC" IN THE CENTER OF A CIRCLE FORMED BY TWO SWIRLED ARROWS.

FOR PROVIDING ASSISTANCE, PERSONAL TRAINING AND PHYSICAL FITNESS CONSULTATION TO INDIVIDUALS TO HELP THEM MAKE PHYSICAL FITNESS, STRENGTH, CONDITIONING, AND EXERCISE IMPROVEMENT IN THEIR DAILY LIVING; FITNESS SERVICES, NAMELY, PROVIDING FITNESS CONSULTATION, INSTRUCTION, CONDITIONING CLASSES AND EXERCISE INSTRUCTION TO INDIVIDUALS; PROVIDING RECREATIONAL AREAS IN THE NATURE OF PLAY AREAS FOR CHILDREN WITH COMPUTERS; PHYSICAL FITNESS CONDITIONING CLASSES; PROVIDING FITNESS AND EXERCISE FACILITIES; PERSONAL TRAINING SERVICES, NAMELY, STRENGTH AND CONDITIONING TRAINING; HEALTH CLUB SERVICES, NAMELY, PROVIDING INSTRUCTION IN THE FIELD OF PHYSICAL EXERCISE; FITNESS CENTER SERVICES, NAMELY, PROVIDING PHYSICAL FITNESS INSTRUCTION AND TRAINING SERVICES; PROVIDING A WEBSITE FEATURING INFORMATION IN THE FIELD OF FITNESS; EDUCATIONAL SERVICES, NAMELY, CONDUCTING COURSES IN THE FIELD OF HEALTH AND WELLNESS; EDUCATIONAL SERVICES, NAMELY, PROVIDING INSTRUCTION FOR USE OF EQUIPMENT IN THE FIELD OF PHYSICAL EXERCISE (U.S. CLS. 100, 101 AND 107).

FIRST USE 6-1-2011; IN COMMERCE 6-1-2011.

**CLASS 42—SCIENTIFIC AND COMPUTER SERVICES**

---

4,045,658. GROUP KAITU, LLC, RICHMOND, VA. SN 77-311,807. PUB. 5-26-2009, FILED 10-24-2007.

EROS GUIDE

THE MARK CONSISTS OF STANDARD CHARACTERS WITHOUT CLAIM TO ANY PARTICULAR FONT, STYLE, SIZE, OR COLOR.

OWNER OF U.S. REG. NOS. 2,549,369, 3,134,894, AND OTHERS.

**CLASS 42—(Continued).**

NO CLAIM IS MADE TO THE EXCLUSIVE RIGHT TO USE "GUIDE", APART FROM THE MARK AS SHOWN.

FOR PROVIDING A WEB SITE THAT GIVES COMPUTER USERS THE ABILITY TO CUSTOMIZE WEB PAGES IN THE FIELD OF ADULT-THEMED PRODUCTS, SERVICES AND ENTERTAINMENT VIA A GLOBAL COMPUTER NETWORK (U.S. CLS. 100 AND 101).

FIRST USE 7-16-2010; IN COMMERCE 7-16-2010.

**CLASS 42—(Continued).**

4,045,759. HALLIBURTON ENERGY SERVICES, INC., CARROLLTON, TX. SN 77-561,259. PUB. 12-30-2008, FILED 9-3-2008.

**LEAN WELLSITE**

4,045,723. CARDOMAIN NETWORK, INC., SEATTLE, WA. SN 77-451,349. PUB. 10-13-2009, FILED 4-17-2008.

THE MARK CONSISTS OF STANDARD CHARACTERS WITHOUT CLAIM TO ANY PARTICULAR FONT, STYLE, SIZE, OR COLOR.

FOR CONSULTATION FOR THE OIL AND GAS INDUSTRY RELATED TO PROJECT AND DESIGN MANAGEMENT SERVICES CONCERNING OPTIMIZING WELL SURFACE OPERATIONS, DESIGN OF SPECIALTY SURFACE MATERIAL AND SUPPLY TOOLS, PLACEMENT AND SCHEDULING OF SURFACE EQUIPMENT AND SUPPLIES, PROJECT COORDINATION FOR SUB-SUPPLIERS AND VENDORS, ALL DESIGNED TO REDUCE NON-PRODUCTIVE TIME FOR THE CUSTOMER (U.S. CLS. 100 AND 101).

FIRST USE 8-15-2011; IN COMMERCE 8-15-2011.



4,045,777. INVENTIV COMMUNICATIONS, INC., WESTERVILLE, OH. SN 77-628,491. PUB. 12-28-2010, FILED 12-8-2008.

**AXCELO**

OWNER OF U.S. REG. NO. 3,077,864.  
THE MARK CONSISTS OF A STYLIZED AUTOMOTIVE GAUGE CONTAINED WITHIN A RIGHT SLANTING OVAL.

FOR COMPUTER SERVICES, NAMELY, PROVIDING CUSTOMIZED ONLINE WEB PAGES FEATURING USER-DEFINED CONTENT AND INFORMATION OF INTEREST TO AUTOMOBILE ENTHUSIASTS; PROVIDING A WEB SITE FEATURING TEMPORARY USE OF NONDOWNLOADABLE SOFTWARE ALLOWING WEB SITE USERS TO UPLOAD ONLINE VIDEOS AND PHOTOGRAPHS FOR SHARING WITH OTHERS; PROVIDING TEMPORARY USE OF NONDOWNLOADABLE SOFTWARE APPLICATIONS FOR USE IN CONNECTION WITH THIRD PARTY SOCIAL NETWORKING SITES (U.S. CLS. 100 AND 101).

FIRST USE 6-9-2008; IN COMMERCE 6-9-2008.

THE MARK CONSISTS OF STANDARD CHARACTERS WITHOUT CLAIM TO ANY PARTICULAR FONT, STYLE, SIZE, OR COLOR.

FOR MEDICAL CONSULTING, NAMELY, MEDICAL SCIENCE LIAISON SERVICES, NAMELY, CONSULTING WITH MEDICAL AND HEALTH CARE CENTERS TO ACCELERATE PHARMACEUTICAL PRODUCT DEVELOPMENT (U.S. CLS. 100 AND 101).

FIRST USE 2-1-2009; IN COMMERCE 2-1-2009.

**CLASS 42—(Continued).**

4,045,778. FISION, LLC, MINNEAPOLIS, MN. SN 77-630,971.  
PUB. 4-28-2009, FILED 12-11-2008.

# Fision

THE MARK CONSISTS OF STANDARD CHARACTERS WITHOUT CLAIM TO ANY PARTICULAR FONT, STYLE, SIZE, OR COLOR.

FOR PROVIDING TEMPORARY USE OF NON-DOWNLOADABLE COMPUTER SOFTWARE FOR MANAGING DIGITAL ASSETS; APPLICATION SERVICE PROVIDER (ASP) FEATURING SOFTWARE FOR USE MANAGING DIGITAL ASSETS (U.S. CLS. 100 AND 101).

FIRST USE 1-31-2009; IN COMMERCE 1-31-2009.

4,045,896. CHRISTOPHER O. BILLS, PROVO, UT. SN 77-798,861. PUB. 6-15-2010, FILED 8-6-2009.

# TWIG & WIRE

THE MARK CONSISTS OF STANDARD CHARACTERS WITHOUT CLAIM TO ANY PARTICULAR FONT, STYLE, SIZE, OR COLOR.

FOR ENVIRONMENTAL SERVICES, NAMELY, ENGINEERING SERVICES, TECHNICAL CONSULTATION IN THE FIELD OF ENVIRONMENTAL SCIENCES, NAMELY, ENVIRONMENTALLY FRIENDLY PRODUCTS, DESIGN FOR OTHERS IN THE FIELD OF ENVIRONMENTAL ENGINEERING, NAMELY, ENVIRONMENTALLY FRIENDLY PRODUCTS, AND DESIGNING AND TESTING OF NEW ENVIRONMENTAL PRODUCTS FOR OTHERS (U.S. CLS. 100 AND 101).

FIRST USE 4-14-2011; IN COMMERCE 8-9-2011.

4,045,900. CLOUDPATH NETWORKS, INC., WESTMINSTER, CO. SN 77-803,433. PUB. 7-20-2010, FILED 8-12-2009.

# CLOUDPATH

THE MARK CONSISTS OF STANDARD CHARACTERS WITHOUT CLAIM TO ANY PARTICULAR FONT, STYLE, SIZE, OR COLOR.

FOR PROVIDING ACCESS TO ONLINE SOFTWARE FOR USE IN AUTOMATED TROUBLE SHOOTING OF COMPUTER SOFTWARE PROBLEMS WITH ACCESS RESTRICTED TO AUTHORIZED USERS (U.S. CLS. 100 AND 101).

FIRST USE 10-1-2008; IN COMMERCE 10-1-2008.

**CLASS 42—(Continued).**

4,045,914. CELGENE CORPORATION, SUMMIT, NJ. SN 77-818,474. PUB. 1-26-2010, FILED 9-2-2009.



THE MARK CONSISTS OF WORDS "MAINSAIL" WITH A BOAT SAIL NEXT TO IT.

FOR CONDUCTING CLINICAL TRIALS ON THE SAFETY AND EFFECTIVENESS OF LENALIDOMIDE (U.S. CLS. 100 AND 101).

FIRST USE 3-1-2011; IN COMMERCE 3-1-2011.

4,045,951. KNO, INC., SANTA CLARA, CA. SN 77-852,890.  
PUB. 5-25-2010, FILED 10-20-2009.

# KNO

THE MARK CONSISTS OF STANDARD CHARACTERS WITHOUT CLAIM TO ANY PARTICULAR FONT, STYLE, SIZE, OR COLOR.

FOR PROVIDING TEMPORARY USE OF ON-LINE NON-DOWNLOADABLE SOFTWARE FOR DELIVERY, DISPLAY, STORAGE AND MANIPULATION OF DATA, TEXT, IMAGES, AUDIO, AND VIDEO; APPLICATION SERVICE PROVIDER (ASP) FEATURING SOFTWARE FOR DELIVERY, DISPLAY, STORAGE AND MANIPULATION OF DATA, TEXT, IMAGES, AUDIO, AND VIDEO (U.S. CLS. 100 AND 101).

FIRST USE 10-0-2010; IN COMMERCE 6-2-2011.

4,045,954. THE RUBICON PROJECT, INC., LOS ANGELES, CA. SN 77-857,782. PUB. 1-18-2011, FILED 10-26-2009.

# REVV

THE MARK CONSISTS OF STANDARD CHARACTERS WITHOUT CLAIM TO ANY PARTICULAR FONT, STYLE, SIZE, OR COLOR.

FOR PROVIDING AN INFORMATION TECHNOLOGY PLATFORM, NAMELY, PROVIDING TEMPORARY USE OF ON-LINE NON-DOWNLOADABLE SOFTWARE FOR DIGITAL ADVERTISING AND DATA OPTIMIZATION, INVENTORY MANAGEMENT, REPRESENTATION, DISTRIBUTION, SERVING, TARGETING, TRACKING, REPORTING AND QUALITY CERTIFICATION VIA THE INTERNET, MOBILE, VIDEO AND OTHER DIGITAL FORMATS (U.S. CLS. 100 AND 101).

FIRST USE 10-7-2009; IN COMMERCE 10-7-2009.



**CLASS 42—(Continued).**

4,046,011. SERVICEMESH, INC., SANTA MONICA, CA. SN 77-912,317. PUB. 1-18-2011, FILED 1-14-2010.

**AGILITY PLANNER**

THE MARK CONSISTS OF STANDARD CHARACTERS WITHOUT CLAIM TO ANY PARTICULAR FONT, STYLE, SIZE, OR COLOR.

NO CLAIM IS MADE TO THE EXCLUSIVE RIGHT TO USE "PLANNER", APART FROM THE MARK AS SHOWN.

FOR SOFTWARE AS A SERVICE (SAAS) SERVICES FEATURING SOFTWARE ALLOWING USERS TO RETRIEVE, UPLOAD, MANAGE, AND INTEGRATE THIRD-PARTY INFORMATION TECHNOLOGY (IT) SYSTEMS SOFTWARE AND DATA IN THE FIELD OF INTERNET CLOUD COMPUTING (U.S. CLS. 100 AND 101).

FIRST USE 12-20-2009; IN COMMERCE 12-20-2009.

4,046,012. SERVICEMESH, INC., SANTA MONICA, CA. SN 77-912,342. PUB. 1-18-2011, FILED 1-14-2010.

**AGILITY FACTORY**

THE MARK CONSISTS OF STANDARD CHARACTERS WITHOUT CLAIM TO ANY PARTICULAR FONT, STYLE, SIZE, OR COLOR.

FOR SOFTWARE AS A SERVICE (SAAS) SERVICES FEATURING SOFTWARE ALLOWING USERS TO RETRIEVE, UPLOAD, MANAGE, AND INTEGRATE THIRD-PARTY INFORMATION TECHNOLOGY (IT) SYSTEMS SOFTWARE AND DATA IN THE FIELD OF INTERNET CLOUD COMPUTING (U.S. CLS. 100 AND 101).

FIRST USE 12-20-2009; IN COMMERCE 12-20-2009.

4,046,013. SERVICEMESH, INC., SANTA MONICA, CA. SN 77-912,354. PUB. 1-18-2011, FILED 1-14-2010.

**AGILITY MANAGER**

THE MARK CONSISTS OF STANDARD CHARACTERS WITHOUT CLAIM TO ANY PARTICULAR FONT, STYLE, SIZE, OR COLOR.

**CLASS 42—(Continued).**

NO CLAIM IS MADE TO THE EXCLUSIVE RIGHT TO USE "MANAGER", APART FROM THE MARK AS SHOWN.

FOR SOFTWARE AS A SERVICE (SAAS) SERVICES FEATURING SOFTWARE ALLOWING USERS TO RETRIEVE, UPLOAD, MANAGE, AND INTEGRATE THIRD-PARTY INFORMATION TECHNOLOGY (IT) SYSTEMS SOFTWARE AND DATA IN THE FIELD OF INTERNET CLOUD COMPUTING (U.S. CLS. 100 AND 101).

FIRST USE 12-20-2009; IN COMMERCE 12-20-2009.

4,046,014. SERVICEMESH, INC., SANTA MONICA, CA. SN 77-912,368. PUB. 1-18-2011, FILED 1-14-2010.

**AGILITY CENTERPOINT**

THE MARK CONSISTS OF STANDARD CHARACTERS WITHOUT CLAIM TO ANY PARTICULAR FONT, STYLE, SIZE, OR COLOR.

FOR SOFTWARE AS A SERVICE (SAAS) SERVICES FEATURING SOFTWARE ALLOWING USERS TO RETRIEVE, UPLOAD, MANAGE, AND INTEGRATE THIRD-PARTY INFORMATION TECHNOLOGY (IT) SYSTEMS SOFTWARE AND DATA IN THE FIELD OF INTERNET CLOUD COMPUTING (U.S. CLS. 100 AND 101).

FIRST USE 12-20-2009; IN COMMERCE 12-20-2009.

4,046,038. EVOLVED MEDIA LLC, NEW YORK, NY. SN 77-927,744. PUB. 1-4-2011, FILED 2-4-2010.

**CITO RESEARCH**

THE MARK CONSISTS OF STANDARD CHARACTERS WITHOUT CLAIM TO ANY PARTICULAR FONT, STYLE, SIZE, OR COLOR.

NO CLAIM IS MADE TO THE EXCLUSIVE RIGHT TO USE "RESEARCH", APART FROM THE MARK AS SHOWN.

FOR CONSULTING AND RESEARCH IN THE FIELD OF INFORMATION TECHNOLOGY; PROVIDING A WEBSITE FEATURING INFORMATION ON RESEARCH AND NEWS IN THE FIELD OF INFORMATION TECHNOLOGY (U.S. CLS. 100 AND 101).

FIRST USE 5-0-2010; IN COMMERCE 5-0-2010.

**CLASS 42—(Continued).**

4,046,042. PUBSHIFT, LLC, ANAHEIM, CA. SN 77-929,141.  
PUB. 6-22-2010, FILED 2-5-2010.

# Pubshift

THE MARK CONSISTS OF STANDARD CHARACTERS WITHOUT CLAIM TO ANY PARTICULAR FONT, STYLE, SIZE, OR COLOR.

FOR PROVIDING AN INTERACTIVE WEBSITE FEATURING TECHNOLOGY THAT ALLOWS USERS TO UPLOAD, DOWNLOAD, SHARE AND SELL CUSTOM AND BRANDED DIGITAL PUBLICATIONS (U.S. CLS. 100 AND 101).

FIRST USE 6-10-2011; IN COMMERCE 7-15-2011.

4,046,118. MIRA DX, INC., NEW HAVEN, CT. SN 77-951,482.  
PUB. 8-10-2010, FILED 3-5-2010.

# MIRA DX

THE MARK CONSISTS OF STANDARD CHARACTERS WITHOUT CLAIM TO ANY PARTICULAR FONT, STYLE, SIZE, OR COLOR.

NO CLAIM IS MADE TO THE EXCLUSIVE RIGHT TO USE "DX", APART FROM THE MARK AS SHOWN.

FOR RESEARCH AND DEVELOPMENT SERVICES IN THE PHARMACEUTICAL AND BIOTECHNOLOGY FIELDS, NAMELY, RESEARCH FOR AND DEVELOPMENT OF GENE-BASED LABORATORY TESTS BASED ON GENOMIC RESEARCH CONDUCTED ON MICRO RNAS (U.S. CLS. 100 AND 101).

FIRST USE 7-0-2010; IN COMMERCE 7-0-2010.

4,046,131. QUALYS, INC., REDWOOD SHORES, CA. SN 77-954,885. PUB. 2-22-2011, FILED 3-9-2010.



NO CLAIM IS MADE TO THE EXCLUSIVE RIGHT TO USE "SECURE", APART FROM THE MARK AS SHOWN.

**CLASS 42—(Continued).**

THE MARK CONSISTS OF THE LETTER "Q" WITHIN A SHIELD DESIGN; FOLLOWED BY THE WORD "QUALYS" ABOVE THE WORD "SECURE"; ALL ENCLOSED WITHIN A RECTANGLE WITH ROUNDED CORNERS.

FOR COMPUTER NETWORK AND WEBSITE SECURITY SERVICES, NAMELY, HOSTING SOFTWARE FOR TESTING THE NETWORKS AND WEBSITES OF OTHERS FOR MALWARE AND NETWORK AND WEB APPLICATION VULNERABILITIES, AND FOR VALIDATING THE WEBSITES' SECURE SOCKETS LAYER ("SSL") CERTIFICATES (U.S. CLS. 100 AND 101).

FIRST USE 3-1-2010; IN COMMERCE 3-1-2010.

4,046,174. BRIGHTSOURCE ENERGY, INC., OAKLAND, CA.  
SN 77-982,448. PUB. 12-1-2009, FILED 12-19-2007.

# BRIGHTSOURCE

THE MARK CONSISTS OF STANDARD CHARACTERS WITHOUT CLAIM TO ANY PARTICULAR FONT, STYLE, SIZE, OR COLOR.

FOR PROVIDING ENGINEERING AND DEVELOPMENT SERVICES IN THE FIELD OF SOLAR POWER (U.S. CLS. 100 AND 101).

FIRST USE 0-0-2009; IN COMMERCE 0-0-2009.

4,046,199. NFC FORUM, INC., WAKEFIELD, MA. SN 78-920,804. PUB. 3-25-2008, FILED 6-30-2006.



THE MARK CONSISTS OF A STYLIZED LETTER "N". FOR TECHNICAL CONSULTATION IN THE FIELD OF DATA COMMUNICATIONS; CONSULTANCY, RESEARCH AND ADVISORY SERVICES ALL RELATING TO COMPUTERS, COMPUTER NETWORKS AND COMPUTER SOFTWARE (U.S. CLS. 100 AND 101).

FIRST USE 6-30-2006; IN COMMERCE 6-2-2009.

**CLASS 42—(Continued).**

4,046,284. THE SMEAD MANUFACTURING COMPANY, HASTINGS, MN. SN 85-042,794. PUB. 4-12-2011, FILED 5-19-2010.

**COLORBAR EXPRESS**

THE MARK CONSISTS OF STANDARD CHARACTERS WITHOUT CLAIM TO ANY PARTICULAR FONT, STYLE, SIZE, OR COLOR.

OWNER OF U.S. REG. NO. 2,016,335.  
FOR ONLINE FILE LABELING SYSTEM FEATURING A WEB-BASED NON-DOWNLOADABLE SOFTWARE FOR USERS TO DESIGN AND PRINT LABELS FOR FILE FOLDERS (U.S. CLS. 100 AND 101).  
FIRST USE 1-3-2007; IN COMMERCE 1-3-2007.

---

4,046,285. LANDAUER, INC., GLENWOOD, IL. SN 85-043,146. PUB. 5-17-2011, FILED 5-19-2010.

**VERIFII**

THE MARK CONSISTS OF STANDARD CHARACTERS WITHOUT CLAIM TO ANY PARTICULAR FONT, STYLE, SIZE, OR COLOR.

FOR QUALITY ASSURANCE SERVICES IN THE FIELD OF DOSIMETRY; TESTING AND EVALUATION OF DOSIMETRY EQUIPMENT, NAMELY, LINEAR ACCELERATORS, CT SIMULATORS AND PET/CT SIMULATORS, FOR THE PURPOSES OF QUALITY ASSURANCE AND SETTING MEASUREMENTS (U.S. CLS. 100 AND 101).

FIRST USE 7-28-2010; IN COMMERCE 7-28-2010.

---

4,046,293. HUTH, RUSSELL BARRY, ROGGE BAY, SOUTH AFRICA. SN 85-045,982. PUB. 1-4-2011, FILED 5-24-2010.

**ikomee**

THE MARK CONSISTS OF STANDARD CHARACTERS WITHOUT CLAIM TO ANY PARTICULAR FONT, STYLE, SIZE, OR COLOR.

THE WORDING "IKOME" HAS NO MEANING IN A FOREIGN LANGUAGE.

FOR PROVIDING A WEB SITE FEATURING TEMPORARY USE OF NON-DOWNLOADABLE SOFTWARE FOR WEBSITE BUILDING (U.S. CLS. 100 AND 101).

FIRST USE 1-1-2011; IN COMMERCE 6-1-2011.

**CLASS 42—(Continued).**

4,046,299. MPI RESEARCH, INC., MATTAWAN, MI. SN 85-047,977. PUB. 10-26-2010, FILED 5-26-2010.



---

OWNER OF U.S. REG. NO. 2,136,645.  
NO CLAIM IS MADE TO THE EXCLUSIVE RIGHT TO USE "RESEARCH" AND "CUSTOMIZED" AND "ON-TIME", APART FROM THE MARK AS SHOWN.

THE MARK CONSISTS OF THE LETTERS "MPI" ABOVE THE WORD "RESEARCH" WHICH ARE INTERSECTED BY A LINE. THE WORDS "CUSTOMIZED, RESPONSIVE, ON-TIME," ARE UNDERNEATH THE WORDS "MPI RESEARCH".

FOR ARRANGING AND CONDUCTING PRE-CLINICAL RESEARCH AND PRE-CLINICAL TRIALS FOR PHARMACEUTICAL, INDUSTRIAL, CHEMICAL, AGROCHEMICAL, BIOTECHNOLOGY, VETERINARY, FOOD, HEALTH CARE, AND CONSUMER COMPANIES TO ASSURE COMPLIANCE WITH FEDERAL REGULATIONS (U.S. CLS. 100 AND 101).

FIRST USE 3-29-2010; IN COMMERCE 5-3-2010.

---

4,046,336. CHINOY, MITREN L, HOUSTON, TX. SN 85-061,495. PUB. 3-8-2011, FILED 6-13-2010.

**NERTIM**

THE MARK CONSISTS OF STANDARD CHARACTERS WITHOUT CLAIM TO ANY PARTICULAR FONT, STYLE, SIZE, OR COLOR.

FOR CONSULTATION IN THE FIELD OF SOFTWARE DESIGN AND DEVELOPMENT (U.S. CLS. 100 AND 101).

FIRST USE 5-1-2011; IN COMMERCE 5-5-2011.

**CLASS 42—(Continued).**

4,046,361. GANSCHOW, TIMOTHY C, CHICAGO, IL. SN 85-070,159. PUB. 11-16-2010, FILED 6-23-2010.

**CROWDSURFING**

THE MARK CONSISTS OF STANDARD CHARACTERS WITHOUT CLAIM TO ANY PARTICULAR FONT, STYLE, SIZE, OR COLOR.

FOR PROVIDING TEMPORARY USE OF ON-LINE NON-DOWNLOADABLE COMPUTER SOFTWARE FOR LINKING METADATA TAGS WITH PHOTOGRAPHIC FILES AND USER PROFILES TO ENABLE SEARCH ENGINE RETRIEVAL, AGGREGATION AND ONLINE SHARING, AND TO ENABLE ONLINE ACCESS TO USER PROFILES VIA ASSOCIATED PHOTOGRAPHIC FILES AND ONLINE ACCESS TO PHOTOGRAPHIC FILES VIA ASSOCIATED USER PROFILES (U.S. CLS. 100 AND 101).

FIRST USE 5-15-2010; IN COMMERCE 4-7-2011.

4,046,398. DISCOVERYBIOMED, LLC, BIRMINGHAM, AL. SN 85-079,926. PUB. 12-28-2010, FILED 7-7-2010.



OWNER OF U.S. REG. NO. 3,547,677.

THE MARK CONSISTS OF A STYLIZED REPRESENTATION OF A TISSUE CULTURE PLATE AND THE WORDING "DISCOVERY BIOMED".

FOR SCIENTIFIC RESEARCH AND DEVELOPMENT SERVICES, NAMELY, HIGH THROUGHPUT SCREENING SERVICES TO SUPPORT THERAPEUTIC AND DIAGNOSTIC DRUG DEVELOPMENT; SCIENTIFIC RESEARCH AND DEVELOPMENT SERVICES, NAMELY, THE DEVELOPMENT OF ASSAYS AND CELL MODELS FOR USE IN HIGH THROUGHPUT SCREENING FOR CLINICAL AND LABORATORY USE; CONSULTING SERVICES IN THE AREA OF HIGH THROUGHPUT SCREENING AND ASSAY DESIGN (U.S. CLS. 100 AND 101).

FIRST USE 2-22-2011; IN COMMERCE 2-22-2011.

**CLASS 42—(Continued).**

4,046,429. BERTHEL FISHER & COMPANY FINANCIAL SERVICES, INC., MARION, IA. SN 85-086,347. PUB. 12-21-2010, FILED 7-16-2010.



THE MARK CONSISTS OF THE WORDS "BERTHEL ONE" WHERE THE "O" IS TWO CONCENTRIC RINGS DISPOSED ABOUT A CENTRAL BALL WHERE THE RINGS APPEAR INDEPENDENTLY AROUND THE STATIONARY BALL.

FOR COMPUTER SERVICES, NAMELY, PROVIDING A WEB-BASED SYSTEM AND ONLINE PORTAL FOR CUSTOMERS TO REMOTELY MANAGE, ADMINISTER, MODIFY AND CONTROL THEIR END USER COMPUTER DEVICES, DATA AND SOFTWARE APPLICATIONS (U.S. CLS. 100 AND 101).

FIRST USE 8-11-2011; IN COMMERCE 8-11-2011.

4,046,460. TAIYI PRECISION TECH CORP., TAIPEI HSIEN, TAIWAN. SN 85-091,061. PUB. 12-28-2010, FILED 7-22-2010.



OWNER OF U.S. REG. NOS. 3,299,579, 3,320,676, AND 3,320,677.

NO CLAIM IS MADE TO THE EXCLUSIVE RIGHT TO USE "PRECISION", APART FROM THE MARK AS SHOWN. THE MARK CONSISTS OF AN OVAL WITH THE WORDS "TAIYI PRECISION" WITHIN. STYLIZED CHINESE CHARACTERS APPEAR IN THE BACKGROUND.

THE WORDING "TAIYI" HAS NO MEANING IN A FOREIGN LANGUAGE.

**CLASS 42—(Continued).**

THE NON-LATIN CHARACTERS IN THE MARK TRANSLITERATE TO "TAIYI" AND THIS HAS NO MEANING IN A FOREIGN LANGUAGE.

FOR COMPUTER AIDED DESIGN FOR OTHERS; COMPUTER PROGRAMMING AND SOFTWARE DESIGN; DATA CONVERSION OF COMPUTER PROGRAMS AND DATA, NOT PHYSICAL CONVERSION; DESIGN OF MOBILE TELEPHONES; DESIGNING OF PACKAGING AND WRAPPING MATERIALS; INDUSTRIAL AND GRAPHIC ART DESIGN; INDUSTRIAL DESIGN; INDUSTRIAL DESIGN SERVICES; PRODUCT DEVELOPMENT AND ENGINEERING SERVICES FOR OTHERS; PRODUCT RESEARCH AND DEVELOPMENT (U.S. CLS. 100 AND 101).

FIRST USE 7-18-2011; IN COMMERCE 7-18-2011.

---

4,046,467. INTELLIJECT, INC., RICHMOND, VA. SN 85-091,715. PUB. 4-12-2011, FILED 7-23-2010.



NO CLAIM IS MADE TO THE EXCLUSIVE RIGHT TO USE "DRUG DATA DEVICE", APART FROM THE MARK AS SHOWN.

THE MARK CONSISTS OF A TRIANGLE HAVING THE WORD "DRUG" AT ITS TOP POINT AND THE WORDS "DATA" AND "DEVICE" AT ITS LEFT AND RIGHT POINTS.

FOR MEDICAL RESEARCH; DESIGN AND DEVELOPMENT OF MEDICAL PRODUCTS (U.S. CLS. 100 AND 101).

FIRST USE 9-2-2011; IN COMMERCE 9-2-2011.

---

4,046,493. LEGAL XTRANET INC., SAN ANTONIO, TX. SN 85-095,949. PUB. 1-11-2011, FILED 7-29-2010.

# elumicor

THE MARK CONSISTS OF STANDARD CHARACTERS WITHOUT CLAIM TO ANY PARTICULAR FONT, STYLE, SIZE, OR COLOR.

FOR COMPUTER SERVICE, NAMELY, ACTING AS AN APPLICATION SERVICE PROVIDER IN THE FIELD OF LEGAL SERVICES AND LITIGATION MANAGEMENT TO HOST COMPUTER APPLICATION SOFTWARE FOR USE IN PROCESSING OPTICAL CHARACTER RECOGNITION, NATIVE FILE AND TIFF IMAGES, AND FOR CONCEPT CLUSTERING FOR THE ORGANIZATION OF DATA AND DOCUMENTS (U.S. CLS. 100 AND 101).

FIRST USE 11-23-2010; IN COMMERCE 11-23-2010.

**CLASS 42—(Continued).**

4,046,527. LITTLE WING WORLD, LLC, MIAMI BEACH, FL. SN 85-099,619. PUB. 1-18-2011, FILED 8-4-2010.

## WHISTLERS WORLD

THE MARK CONSISTS OF STANDARD CHARACTERS WITHOUT CLAIM TO ANY PARTICULAR FONT, STYLE, SIZE, OR COLOR.

FOR COMPUTER SERVICES, NAMELY, CREATING AN ON-LINE COMMUNITY FOR REGISTERED USERS TO ENGAGE IN SOCIAL NETWORKING, PARTICIPATE IN INTERACTIVE DISCUSSIONS, SHOWCASE PROGRAMS IN EDUCATION, SHOWCASE PROGRAMS IN WORKING WITH SPECIAL NEEDS PERSONS, SHOWCASE APPLICATIONS OF MUSIC AND LANGUAGE GAMES TO EDUCATION AND SPECIAL NEEDS PROGRAMS, GET FEEDBACK FROM THEIR PEERS, AND FOR FACILITATING AND CONDUCTING ONLINE CONNECTIONS AND COLLABORATIONS; DEVELOPING COMPUTER SOFTWARE (U.S. CLS. 100 AND 101).

FIRST USE 4-10-2010; IN COMMERCE 4-10-2010.

---

4,046,546. BRIDGESTOR, LLC, POWAY, CA. SN 85-101,840. PUB. 1-18-2011, FILED 8-6-2010.

# Bridgestor

THE MARK CONSISTS OF STANDARD CHARACTERS WITHOUT CLAIM TO ANY PARTICULAR FONT, STYLE, SIZE, OR COLOR.

FOR BACK-UP SERVICES FOR COMPUTER HARD DRIVE DATA; CLOUD COMPUTING FEATURING SOFTWARE FOR USE IN ACCESSING AND RETRIEVAL OF REMOTELY STORED DATA AND INFORMATION AND FOR USE IN DATA STORAGE AND MANAGEMENT; COMPUTER HARDWARE AND SOFTWARE DESIGN; COMPUTER SERVICES, NAMELY, ENCRYPTED DATA RECOVERY SERVICES; COMPUTER SOFTWARE DEVELOPMENT; COMPUTER SOFTWARE DEVELOPMENT IN THE FIELD OF DATA MANAGEMENT AND STORAGE SERVICES, PRODUCTS AND SOLUTIONS; DATA ENCRYPTION SERVICES; DATA WAREHOUSING; DESIGN AND DEVELOPMENT OF SOFTWARE AND HARDWARE FOR COMPRESSION AND DECOMPRESSION OF MULTIMEDIA CONTENTS; DESIGN AND DEVELOPMENT OF SOFTWARE AND HARDWARE FOR ELIMINATION OF DUPLICATE AND REDUNDANT DATA; DIGITAL COMPRESSION OF COMPUTER DATA; PLANNING, DESIGN AND IMPLEMENTATION OF VIRTUALIZATION TECHNOLOGIES FOR ENTERPRISES AND BUSINESSES; RECORDING DATA FOR OTHERS ON OPTICAL, DIGITAL AND MAGNETIC MEDIA FOR ELECTRONIC STORAGE; REMOTE COMPUTER BACK-UP SERVICES; REMOTE ONLINE BACKUP OF COMPUTER DATA (U.S. CLS. 100 AND 101).

FIRST USE 11-30-2010; IN COMMERCE 11-30-2010.

**CLASS 42—(Continued).**

4,046,549. BRIDGESTOR, LLC, POWAY, CA. SN 85-102,243. PUB. 1-18-2011, FILED 8-6-2010.

# BridgeSTOR

THE MARK CONSISTS OF THE STYLIZED LETTERS "BRIDGESTOR".

FOR BACK-UP SERVICES FOR COMPUTER HARD DRIVE DATA; CLOUD COMPUTING FEATURING SOFTWARE FOR USE IN ACCESSING AND RETRIEVAL OF REMOTELY STORED DATA AND INFORMATION AND FOR USE IN DATA STORAGE AND MANAGEMENT; COMPUTER HARDWARE AND SOFTWARE DESIGN; COMPUTER SERVICES, NAMELY, ENCRYPTED DATA RECOVERY SERVICES; COMPUTER SOFTWARE DEVELOPMENT; COMPUTER SOFTWARE DEVELOPMENT IN THE FIELD OF DATA MANAGEMENT AND STORAGE SERVICES, PRODUCTS AND SOLUTIONS; DATA ENCRYPTION SERVICES; DATA WAREHOUSING; DESIGN AND DEVELOPMENT OF SOFTWARE AND HARDWARE FOR COMPRESSION AND DECOMPRESSION OF MULTIMEDIA CONTENTS; DESIGN AND DEVELOPMENT OF SOFTWARE AND HARDWARE FOR ELIMINATION OF DUPLICATE AND REDUNDANT DATA; DIGITAL COMPRESSION OF COMPUTER DATA; PLANNING, DESIGN AND IMPLEMENTATION OF VIRTUALIZATION TECHNOLOGIES FOR ENTERPRISES AND BUSINESSES; RECORDING DATA FOR OTHERS ON OPTICAL, DIGITAL AND MAGNETIC MEDIA FOR ELECTRONIC STORAGE; REMOTE COMPUTER BACK-UP SERVICES; REMOTE ONLINE BACKUP OF COMPUTER DATA (U.S. CLS. 100 AND 101).

FIRST USE 11-30-2010; IN COMMERCE 11-30-2010.

4,046,558. GRAPHIC SOLUTIONS INC. LLC, HIXSON, TN. SN 85-104,500. PUB. 1-25-2011, FILED 8-10-2010.

# vinrite

THE MARK CONSISTS OF THE STYLIZED TEXT "VINRITE".

FOR PROVIDING TEMPORARY USE OF A WEB-BASED SOFTWARE APPLICATION FOR CALCULATING VEHICLE IDENTIFICATION NUMBERS, NAMELY, ALLOWING MANUFACTURERS OF VEHICLES AND TRAILERS TO IDENTIFY AND CREATE PROPER STATE AND FEDERALLY MANDATED VEHICLE DOCUMENTATION EASILY AND EFFICIENTLY, WHILE FILLING OUT THE MANDATED LABELS, SUCH AS FEDERAL CERTIFICATION LABELS, TIRE PLACARDS, AND CERTIFICATES OF ORIGIN, AS WELL AS STORING VEHICLE, CUSTOMER, AND SALES DATA (U.S. CLS. 100 AND 101).

FIRST USE 6-1-2011; IN COMMERCE 7-1-2011.

**CLASS 42—(Continued).**

4,046,687. DANE, ARABELLA S., CENTER HARBOR, NH. SN 85-131,036. PUB. 4-19-2011, FILED 9-16-2010.

# PLANTIPEDIA

THE MARK CONSISTS OF STANDARD CHARACTERS WITHOUT CLAIM TO ANY PARTICULAR FONT, STYLE, SIZE, OR COLOR.

FOR PROVIDING A NON-DOWNLOADABLE INTERACTIVE DATABASE FOR THE IDENTIFICATION OF FLOWERS AND OTHER PLANTS (U.S. CLS. 100 AND 101).

FIRST USE 11-22-2010; IN COMMERCE 11-22-2010.

4,046,704. HEALTHSTREAM, INC., NASHVILLE, TN. SN 85-134,468. PUB. 3-8-2011, FILED 9-21-2010.



THE MARK CONSISTS OF A SOLID SPHERE SURROUNDED BY FOUR CIRCULAR RINGS.

FOR SOFTWARE AS A SERVICE (SAAS) SERVICES IN THE FIELD OF HEALTHCARE THAT ENABLES USERS TO MANAGE, OPERATE AND RUN HEALTHCARE AND MEDICAL SIMULATION MANAGEMENT AND TRAINING PROGRAMS ONLINE (U.S. CLS. 100 AND 101).

FIRST USE 10-1-2010; IN COMMERCE 10-1-2010.

**CLASS 42—(Continued).**

4,046,713. SPAFINDER, INC., NEW YORK, NY. SN 85-136,600. PUB. 1-11-2011, FILED 9-23-2010.

## GramercyOne

THE MARK CONSISTS OF STANDARD CHARACTERS WITHOUT CLAIM TO ANY PARTICULAR FONT, STYLE, SIZE, OR COLOR.

FOR PROVIDING ONLINE NON-DOWNLOADABLE SOFTWARE FOR USE IN SCHEDULING AND MANAGEMENT OF RESERVATIONS FOR CUSTOMERS, POINT-OF-SALE SOLUTIONS FOR FLOOR AND MANAGEMENT STAFF, MANAGEMENT OF EMPLOYEES SCHEDULES, CREATING REPORTS, AND CREATING AND PROVIDING GIFT CERTIFICATES, COUPONS AND PROMOTIONAL SPECIALS (U.S. CLS. 100 AND 101).

FIRST USE 10-31-2010; IN COMMERCE 10-31-2010.

---

4,046,723. P&C GROUP, INC., NEW YORK, NY. SN 85-140,112. PUB. 3-8-2011, FILED 9-28-2010.

## POSVISION

THE MARK CONSISTS OF STANDARD CHARACTERS WITHOUT CLAIM TO ANY PARTICULAR FONT, STYLE, SIZE, OR COLOR.

FOR PROVIDING TEMPORARY USE OF NON-DOWNLOADABLE COMPUTER SOFTWARE FOR INSURANCE COMPANIES, THIRD PARTY ADMINISTRATORS, SELF-INSURED ENTITIES, MANAGING GENERAL AGENTS AND GOVERNMENTAL ENTITIES FOR MANAGING INSURANCE CLAIMS (U.S. CLS. 100 AND 101).

FIRST USE 8-1-2011; IN COMMERCE 8-1-2011.

**CLASS 42—(Continued).**

4,046,724. INTELLISTRY INFORMATION SYSTEMS, INC., IRVINE, CA. SN 85-140,155. PUB. 3-8-2011, FILED 9-28-2010.

## GEO.TO

THE MARK CONSISTS OF STANDARD CHARACTERS WITHOUT CLAIM TO ANY PARTICULAR FONT, STYLE, SIZE, OR COLOR.

FOR CARTOGRAPHY AND MAPPING; PROVIDING CUSTOMER-DEFINED GENERATED CONTENT AND CONTENT OF OTHERS AUTOMATICALLY SELECTED AND CUSTOMIZED BASED ON THE KNOWN OR ESTIMATED GEOGRAPHICAL LOCATION OF AN INTERNET, MOBILE TELEPHONE OR OTHER WIRED OR WIRELESS DIGITAL NETWORK BASED CUSTOMER (U.S. CLS. 100 AND 101).

FIRST USE 6-30-2011; IN COMMERCE 6-30-2011.

---

4,046,771. HNTB HOLDINGS LTD, KANSAS CITY, MO. SN 85-153,667. PUB. 5-3-2011, FILED 10-15-2010.

## RAILADVISE

THE MARK CONSISTS OF STANDARD CHARACTERS WITHOUT CLAIM TO ANY PARTICULAR FONT, STYLE, SIZE, OR COLOR.

FOR PROVIDING ONLINE NONDOWNLOADABLE SOFTWARE AND SOFTWARE TOOLS FOR PROVIDING RAILROAD RAIL SYSTEM CONDITION DATA AND MONITORING AND CONTROLLING RAILROAD TRANSPORTATION ASSETS (U.S. CLS. 100 AND 101).

FIRST USE 1-13-2011; IN COMMERCE 1-13-2011.

---

4,046,788. BLOCKCHALK, INC., SAN FRANCISCO, CA. SN 85-157,470. PUB. 3-22-2011, FILED 10-20-2010.

## BLOCKBOARD

THE MARK CONSISTS OF STANDARD CHARACTERS WITHOUT CLAIM TO ANY PARTICULAR FONT, STYLE, SIZE, OR COLOR.

FOR SOFTWARE AS A SERVICE (SAAS) SERVICES FEATURING SOFTWARE FOR USERS TO POST AND SHARE A WIDE VARIETY OF INFORMATION IN THE FORM OF TEXT, VIDEO, PHOTOS, AND OTHER ELECTRONIC MEDIA (U.S. CLS. 100 AND 101).

FIRST USE 2-11-2011; IN COMMERCE 2-11-2011.

**CLASS 42—(Continued).**

4,046,797. BELL, ANDREA, DBA ONE WEEKEND WEBSITE, ESTERO, FL. SN 85-159,554. PUB. 4-12-2011, FILED 10-22-2010.

## One Weekend Website

THE MARK CONSISTS OF STANDARD CHARACTERS WITHOUT CLAIM TO ANY PARTICULAR FONT, STYLE, SIZE, OR COLOR.

NO CLAIM IS MADE TO THE EXCLUSIVE RIGHT TO USE "WEBSITE", APART FROM THE MARK AS SHOWN. FOR DESIGN OF HOMEPAGES AND WEBSITES (U.S. CLS. 100 AND 101).

FIRST USE 10-22-2010; IN COMMERCE 12-26-2010.

**CLASS 42—(Continued).**

4,046,936. HNTB HOLDINGS LTD, KANSAS CITY, MO. SN 85-203,676. PUB. 5-17-2011, FILED 12-22-2010.



THE MARK CONSISTS OF THE WORD "RAILADVISED" NEXT TO THE STYLIZED DESIGN OF A RAILROAD TRACK.

FOR PROVIDING ONLINE NONDOWNLOADABLE SOFTWARE AND SOFTWARE TOOLS FOR PROVIDING RAILROAD RAIL SYSTEM CONDITION DATA AND MONITORING AND CONTROLLING RAILROAD TRANSPORTATION ASSETS (U.S. CLS. 100 AND 101).

FIRST USE 1-31-2011; IN COMMERCE 1-31-2011.

4,046,815. SPC RESOURCES, INC., HARTSVILLE, SC. SN 85-164,826. PUB. 3-8-2011, FILED 10-29-2010.

## ONE COMPANY INFINITE PACKAGING SOLUTIONS

THE MARK CONSISTS OF STANDARD CHARACTERS WITHOUT CLAIM TO ANY PARTICULAR FONT, STYLE, SIZE, OR COLOR.

NO CLAIM IS MADE TO THE EXCLUSIVE RIGHT TO USE "PACKAGING SOLUTIONS", APART FROM THE MARK AS SHOWN.

FOR CUSTOMIZED PACKAGING DESIGN FOR OTHERS (U.S. CLS. 100 AND 101).

FIRST USE 8-1-2011; IN COMMERCE 8-1-2011.

4,047,012. GODADDY.COM, INC., SCOTTSDALE, AZ. SN 85-223,036. PUB. 6-7-2011, FILED 1-21-2011.

## GoDaddy.co

THE MARK CONSISTS OF STANDARD CHARACTERS WITHOUT CLAIM TO ANY PARTICULAR FONT, STYLE, SIZE, OR COLOR.

OWNER OF U.S. REG. NOS. 2,904,954, 3,672,975, AND OTHERS.

FOR REGISTRATION, TRANSFER AND ACCOUNT MANAGEMENT SERVICES OF DOMAIN NAMES FOR IDENTIFICATION OF USERS ON A GLOBAL COMPUTER NETWORK (U.S. CLS. 100 AND 101).

FIRST USE 2-6-2011; IN COMMERCE 2-6-2011.

4,046,872. SMAPPS INC., WAYNESBORO, VA. SN 85-186,480. PUB. 4-19-2011, FILED 11-29-2010.

## SMApps

THE MARK CONSISTS OF STANDARD CHARACTERS WITHOUT CLAIM TO ANY PARTICULAR FONT, STYLE, SIZE, OR COLOR.

FOR WEB SITE DESIGN; DESIGN OF SMARTPHONE APPLICATIONS FOR OTHER PEOPLE (U.S. CLS. 100 AND 101).

FIRST USE 10-25-2010; IN COMMERCE 2-28-2011.

4,047,106. ECHIDNA, INC., MINNEAPOLIS, MN. SN 85-975,686. PUB. 6-7-2011, FILED 6-11-2010.

## PROLIPHIQ

THE MARK CONSISTS OF STANDARD CHARACTERS WITHOUT CLAIM TO ANY PARTICULAR FONT, STYLE, SIZE, OR COLOR.

FOR PROVIDING A WEBSITE FEATURING INFORMATION ABOUT SOCIAL MEDIA CONTENT, NAMELY, USER-GENERATED CONTENT, PROFILES OF SOCIAL MEDIA USERS, AND THE SORTING, RANKING AND ORGANIZATION THEREOF (U.S. CLS. 100 AND 101).

FIRST USE 7-30-2011; IN COMMERCE 7-30-2011.



**CLASS 43—HOTEL AND RESTAURANT SERVICES**

4,045,584. BASTION RESTAURANTS, INC., FORT WORTH, TX. SN 76-692,114. PUB. 1-6-2009, FILED 8-18-2008.

# BASTION

FOR RESTAURANT SERVICES (U.S. CLS. 100 AND 101).  
FIRST USE 7-15-2011; IN COMMERCE 7-15-2011.

4,045,685. SOUL HOLLYWOOD, L.L.C., COMMERCE, CA. SN 77-378,748. PUB. 6-10-2008, FILED 1-23-2008.

## SOUL HOLLYWOOD

THE MARK CONSISTS OF STANDARD CHARACTERS WITHOUT CLAIM TO ANY PARTICULAR FONT, STYLE, SIZE, OR COLOR.

NO CLAIM IS MADE TO THE EXCLUSIVE RIGHT TO USE "HOLLYWOOD", APART FROM THE MARK AS SHOWN.

FOR BAR AND RESTAURANT SERVICES; CAFE AND RESTAURANT SERVICES; CAFE-RESTAURANTS; RESTAURANT; RESTAURANT AND BAR SERVICES; RESTAURANT SERVICES; RESTAURANTS (U.S. CLS. 100 AND 101).

FIRST USE 2-19-2009; IN COMMERCE 2-19-2009.

4,045,708. HUANG, ZHI HAO, TORRANCE, CA. SN 77-416,463. PUB. 7-29-2008, FILED 3-7-2008.



NO CLAIM IS MADE TO THE EXCLUSIVE RIGHT TO USE "FISH GRILL", APART FROM THE MARK AS SHOWN. THE COLOR(S) GREEN, YELLOW, BLACK, RED, PINK, WHITE AND BLUE IS/ARE CLAIMED AS A FEATURE OF THE MARK.

**CLASS 43—(Continued).**

THE MARK CONSISTS OF A PICTURE OF A FISH APPEARING IN BLUE WITH YELLOW LINES AND YELLOW SCALES. THE FISH'S MOUTH CONTAINS PINK EYES AND A PINK MOUTH. THE FISH IS SITUATED AGAINST WHITE AND BLUE WATER THAT IS SURROUNDED BY A YELLOW, RED AND BLACK OVAL. THE WORD "FISH'S WILD" APPEARS IN GREEN WITH A YELLOW AND BLACK OUTLINE. THE WORDS "FISH GRILL & MORE!" APPEAR IN RED, YELLOW AND BLACK.

FOR RESTAURANT SERVICES (U.S. CLS. 100 AND 101).

FIRST USE 2-1-2011; IN COMMERCE 2-1-2011.

4,045,713. ICON BURGER DEVELOPMENT COMPANY, LLC, DENVER, CO. SN 77-426,393. PUB. 7-29-2008, FILED 3-19-2008.

## HOME OF THE SMASHBURGER

THE MARK CONSISTS OF STANDARD CHARACTERS WITHOUT CLAIM TO ANY PARTICULAR FONT, STYLE, SIZE, OR COLOR.

FOR CARRY-OUT RESTAURANTS; RESTAURANT SERVICES; SELF-SERVICE RESTAURANTS (U.S. CLS. 100 AND 101).

FIRST USE 5-0-1992; IN COMMERCE 5-0-1992.

4,045,792. HEALEO LLC, SEATTLE, WA. SN 77-643,945. PUB. 4-28-2009, FILED 1-6-2009.

## HEALEO

THE MARK CONSISTS OF STANDARD CHARACTERS WITHOUT CLAIM TO ANY PARTICULAR FONT, STYLE, SIZE, OR COLOR.

FOR CAFÉ SERVICES; DELI SERVICES (U.S. CLS. 100 AND 101).

FIRST USE 5-31-2011; IN COMMERCE 5-31-2011.

4,046,034. ALVAREZ, GEORGE, CORAL GABLES, FL. SN 77-923,598. PUB. 1-11-2011, FILED 1-29-2010.

## OceanCoralTurquesa.com

THE MARK CONSISTS OF STANDARD CHARACTERS WITHOUT CLAIM TO ANY PARTICULAR FONT, STYLE, SIZE, OR COLOR.

**CLASS 43—(Continued).**

THE ENGLISH TRANSLATION OF "TURQUESA" IN THE MARK IS "TURQUOISE".

FOR TRAVEL SERVICES, NAMELY, MAKING RESERVATIONS AND BOOKINGS FOR TEMPORARY LODGING; MAKING HOTEL AND LODGING RESERVATIONS FOR INDIVIDUALS AND GROUPS VIA A GLOBAL COMPUTER NETWORK (U.S. CLS. 100 AND 101).

FIRST USE 10-21-2010; IN COMMERCE 10-21-2010.

4,046,059. GOOD EATS, LLC, MILL VALEY, CA. SN 77-932,988. PUB. 1-11-2011, FILED 2-10-2010.

**SALT HOUSE**

THE MARK CONSISTS OF STANDARD CHARACTERS WITHOUT CLAIM TO ANY PARTICULAR FONT, STYLE, SIZE, OR COLOR.

FOR BAR SERVICES; RESTAURANT SERVICES; RESTAURANTS (U.S. CLS. 100 AND 101).

FIRST USE 10-26-2006; IN COMMERCE 10-26-2006.

4,046,067. INGLES MARKETS, INC., ASHEVILLE, NC. SN 77-934,683. PUB. 1-11-2011, FILED 2-12-2010.

**CHEF'S KITCHEN**

THE MARK CONSISTS OF STANDARD CHARACTERS WITHOUT CLAIM TO ANY PARTICULAR FONT, STYLE, SIZE, OR COLOR.

NO CLAIM IS MADE TO THE EXCLUSIVE RIGHT TO USE "KITCHEN", APART FROM THE MARK AS SHOWN.

FOR CATERING SERVICES (U.S. CLS. 100 AND 101).

FIRST USE 3-3-2011; IN COMMERCE 3-3-2011.

4,046,211. BAYROCK/SAPIR ORGANIZATION LLC, NEW YORK, NY. SN 85-006,284. PUB. 4-12-2011, FILED 4-5-2010.

**KASTEL**

THE MARK CONSISTS OF STANDARD CHARACTERS WITHOUT CLAIM TO ANY PARTICULAR FONT, STYLE, SIZE, OR COLOR.

**CLASS 43—(Continued).**

THE WORDING "KASTEL" HAS NO MEANING IN A FOREIGN LANGUAGE.

FOR RESTAURANT AND BAR SERVICES (U.S. CLS. 100 AND 101).

FIRST USE 4-9-2010; IN COMMERCE 4-9-2010.

4,046,222. PREMIER STAR ENTERPRISES LLC, SANTA ANA, CA. SN 85-013,206. PUB. 9-28-2010, FILED 4-13-2010.



NO CLAIM IS MADE TO THE EXCLUSIVE RIGHT TO USE "SOHO TACO" AND "GOURMET TACO CATERING", APART FROM THE MARK AS SHOWN.

THE MARK CONSISTS OF THREE INTERSECTING CIRCLES CONTAINING A FORK, KNIFE AND SPOON APPEARING ABOVE THE WORDING "SOHO TACO" AND "GOURMET TACO CATERING".

FOR CATERING; MOBILE CAFE SERVICES FOR PROVIDING FOOD AND DRINK (U.S. CLS. 100 AND 101).

FIRST USE 8-1-2010; IN COMMERCE 8-1-2010.

4,046,319. CJF CONNECTION, CORP., DBA VINZEE'S MAGIC FOUNTAIN, BROOKLYN, NY. SN 85-057,081. PUB. 1-11-2011, FILED 6-8-2010.



THE NAME "VINZEE'S" DOES NOT IDENTIFY A LIVING INDIVIDUAL.

THE COLOR(S) BLACK, WHITE, RED, YELLOW, BLUE, GREEN, PINK, BROWN, BEIGE, GRAY, PURPLE AND GOLD IS/ARE CLAIMED AS A FEATURE OF THE MARK.

THE MARK CONSISTS OF A DESIGN OF A BLACK HAT WITH BLUE, GOLD, PURPLE, GREEN AND PINK SPARKLES COMING OUT OF IT CARRYING A BEIGE HAMBURGER BUN, WITH YELLOW CHEESE, BROWN BURGER, RED TOMATO AND GREEN LETTUCE, A BEIGE HOT DOG BUN CONTAINING A BROWN HOT DOG WITH YELLOW MUSTARD, A BEIGE ICE CREAM CONE CONTAINING PINK AND WHITE ICE CREAM, A WHITE MILKSHAKE WITH A RED CHERRY AND RED AND WHITE RIBBON CONTAINED IN A PINK GLASS WITH RED UPPER AND LOWER CIRCLES ON A PINK SAUCER, YELLOW FRIES IN A RED CONTAINER, WITH BLUE, GOLD AND PINK STARS SURROUNDING ALL OF THEM; AND THE WORD "VINZEE'S" TO THE RIGHT OF THOSE

**CLASS 43—(Continued).**

DESIGNS WITH THE LETTERS "VNZEE'S" APPEARING IN RED WITH A BLACK OUTLINING AND THE LETTER "I" IN THAT WORD APPEARING AS A DESIGN OF A MAGIC WAND WITH AN UPPER AND LOWER GRAY TIP, BLACK MIDDLE SECTION AND THE DOT REPRESENTED AS GOLD STARS COMING OUT OF THE TIP OF THE LETTER "I" WITH A GREEN CURVE LINE AROUND THAT LETTER; UNDERNEATH THE WORDING "VINZEE'S" APPEARS THE WORDING "MAGIC FOUNTAIN" APPEARING IN BLACK LETTERS.

FOR CAFE-RESTAURANTS; FAST-FOOD RESTAURANTS; FAST-FOOD RESTAURANTS AND SNACK-BARS; FROZEN YOGURT SHOP SERVICES IN THE NATURE OF A RESTAURANT; ICE CREAM SHOP SERVICES IN THE NATURE OF A RESTAURANT; RESTAURANT; RESTAURANT SERVICES, INCLUDING SIT-DOWN SERVICE OF FOOD AND TAKE-OUT RESTAURANT SERVICES; RESTAURANTS; RESTAURANTS FEATURING HOME DELIVERY (U.S. CLS. 100 AND 101).

FIRST USE 6-1-2011; IN COMMERCE 6-1-2011.

4,046,341. VAN EERDE, ROBERT, DBA SHORT-TERM EXECUTIVE MANAGEMENT, MIAMI, FL. SN 85-062,439. PUB. 11-9-2010, FILED 6-14-2010.

# STEM

THE MARK CONSISTS OF STANDARD CHARACTERS WITHOUT CLAIM TO ANY PARTICULAR FONT, STYLE, SIZE, OR COLOR.

FOR CONSULTING SERVICES IN THE FIELD OF HOSPITALITY; HOTEL SERVICES FOR PREFERRED CUSTOMERS (U.S. CLS. 100 AND 101).

FIRST USE 1-1-2011; IN COMMERCE 1-1-2011.

4,046,349. SCHNABEL RESTAURANTS, LLC, NAVARRE, OH. SN 85-065,030. PUB. 11-30-2010, FILED 6-17-2010.



NO CLAIM IS MADE TO THE EXCLUSIVE RIGHT TO USE "BURGERS", APART FROM THE MARK AS SHOWN.

**CLASS 43—(Continued).**

THE MARK CONSISTS OF AN ARROW POINTING TO THE RIGHT WITH THE WORDS "SCHNAB'S BURGERS HERE" CONTAINED INSIDE THE ARROW.

FOR RESTAURANT SERVICES (U.S. CLS. 100 AND 101).

FIRST USE 2-16-2011; IN COMMERCE 2-16-2011.

4,046,384. BR IP HOLDER LLC, CANTON, MA. SN 85-076,001. PUB. 12-21-2010, FILED 7-1-2010.

## MORE FLAVORS, MORE FUN

THE MARK CONSISTS OF STANDARD CHARACTERS WITHOUT CLAIM TO ANY PARTICULAR FONT, STYLE, SIZE, OR COLOR.

FOR RESTAURANT SERVICES; CAFE SERVICES; SNACK BAR SERVICES; CARRY-OUT FOOD SERVICES (U.S. CLS. 100 AND 101).

FIRST USE 6-1-2010; IN COMMERCE 7-26-2011.

4,046,412. JS IP LLC, AVENTURA, FL. SN 85-083,473. PUB. 11-30-2010, FILED 7-13-2010.

# ARKADIA

THE MARK CONSISTS OF STANDARD CHARACTERS WITHOUT CLAIM TO ANY PARTICULAR FONT, STYLE, SIZE, OR COLOR.

FOR COCKTAIL LOUNGE SERVICES; RESTAURANT SERVICES (U.S. CLS. 100 AND 101).

FIRST USE 10-23-2010; IN COMMERCE 10-23-2010.

4,046,477. KIDSCOOK PRODUCTIONS, LLC, CAMBRIDGE, MA. SN 85-093,904. PUB. 7-5-2011, FILED 7-27-2010.

## KICKIN KITCHEN

THE MARK CONSISTS OF STANDARD CHARACTERS WITHOUT CLAIM TO ANY PARTICULAR FONT, STYLE, SIZE, OR COLOR.

**CLASS 43—(Continued).**

NO CLAIM IS MADE TO THE EXCLUSIVE RIGHT TO USE "KITCHEN", APART FROM THE MARK AS SHOWN.

FOR PROVIDING A WEB SITE FEATURING CONTENT IN THE FIELD OF HEALTHY EATING, NAMELY, INFORMATION ABOUT HEALTHY RECIPES, INGREDIENTS AND COOKING INFORMATION (U.S. CLS. 100 AND 101).

FIRST USE 8-25-2011; IN COMMERCE 8-25-2011.

**CLASS 43—(Continued).**

4,046,574. NEW YORK - NEW YORK HOTEL & CASINO, LLC, LAS VEGAS, NV. SN 85-109,510. PUB. 2-1-2011, FILED 8-17-2010.

4,046,492. SHIN, DONG GEUN, LITTLE NECK, NY. SN 85-095,848. PUB. 7-12-2011, FILED 7-29-2010.



NO CLAIM IS MADE TO THE EXCLUSIVE RIGHT TO USE "COFFEE", APART FROM THE MARK AS SHOWN.

THE COLOR(S) ARE BROWN AND BLUE IS/ARE CLAIMED AS A FEATURE OF THE MARK.

THE MARK CONSISTS OF SHAPES OF COFFEE BEANS IN BROWN AND BLUE ABOVE THE WORDS "ROASTOWN" IN BROWN AND "COFFEE" IN BLUE SURROUNDED BY A BROWN SQUARE OUTLINE. THE COLOR WHITE, AND GRAY REPRESENT BACKGROUND, OUTLINING, SHADING AND/OR TRANSPARENT AREAS AND ARE NOT PART OF THE MARK.

FOR COFFEE SHOPS (U.S. CLS. 100 AND 101).

FIRST USE 4-1-2011; IN COMMERCE 4-1-2011.

**SPORTING HOUSE**

THE MARK CONSISTS OF STANDARD CHARACTERS WITHOUT CLAIM TO ANY PARTICULAR FONT, STYLE, SIZE, OR COLOR.

FOR RESTAURANT AND BAR SERVICES (U.S. CLS. 100 AND 101).

FIRST USE 10-10-2010; IN COMMERCE 10-10-2010.

4,046,585. JIMMY JOHN'S ENTERPRISES, LLC, CHAMPAIGN, IL. SN 85-110,829. PUB. 1-18-2011, FILED 8-18-2010.

4,046,525. 103 GW12 LLC, NEW YORK, NY. SN 85-099,564. PUB. 1-18-2011, FILED 8-4-2010.

**DAMN GOOD DAMN FAST****MONUMENT LANE**

THE MARK CONSISTS OF STANDARD CHARACTERS WITHOUT CLAIM TO ANY PARTICULAR FONT, STYLE, SIZE, OR COLOR.

FOR RESTAURANT SERVICES (U.S. CLS. 100 AND 101).

FIRST USE 5-0-2011; IN COMMERCE 5-0-2011.

THE MARK CONSISTS OF STANDARD CHARACTERS WITHOUT CLAIM TO ANY PARTICULAR FONT, STYLE, SIZE, OR COLOR.

OWNER OF U.S. REG. NOS. 3,824,686 AND 3,868,093. FOR CARRY-OUT RESTAURANTS; RESTAURANT SERVICES (U.S. CLS. 100 AND 101).

FIRST USE 7-0-2011; IN COMMERCE 7-0-2011.

**CLASS 43—(Continued).**

4,046,599. GENERAL MILLS, INC., MINNEAPOLIS, MN. SN 85-114,280. PUB. 12-28-2010, FILED 8-24-2010.



THE MARK CONSISTS OF AN OUTER CIRCLE ENCLOSING BACKGROUND IMAGES OF SPOONS POSITIONED SYMMETRICALLY WITHIN THE CIRCLE AND OVERLAPPING SUPERIMPOSED IMAGES OF A KNIFE, A FORK AND A SPOON.

FOR PROVIDING RECIPES VIA AN INTERNET WEBSITE (U.S. CLS. 100 AND 101).

FIRST USE 4-22-2010; IN COMMERCE 4-22-2010.

4,046,678. WORLD CHOICE INVESTMENTS, LLC, PIGEON FORGE, TN. SN 85-129,828. PUB. 3-1-2011, FILED 9-15-2010.

**PIRATES VOYAGE**

THE MARK CONSISTS OF STANDARD CHARACTERS WITHOUT CLAIM TO ANY PARTICULAR FONT, STYLE, SIZE, OR COLOR.

FOR RESTAURANT SERVICES (U.S. CLS. 100 AND 101).

FIRST USE 6-3-2011; IN COMMERCE 6-3-2011.

4,046,792. BAYSIDE WEDDINGS, LLC, SANTA ROSA BEACH, FL. SN 85-157,757. PUB. 4-5-2011, FILED 10-21-2010.



THE COLOR(S) GREEN, RED AND BLUE IS/ARE CLAIMED AS A FEATURE OF THE MARK.

**CLASS 43—(Continued).**

THE MARK CONSISTS OF A GREEN PALM LEAF APPEARING ABOVE THE STYLIZED, RED WORDING "CABANA" WHICH APPEARS LOCATED ABOVE THE STYLIZED, BLUE WORDING "BLUE".

FOR PROVIDING BANQUET AND SOCIAL FUNCTION FACILITIES FOR SPECIAL OCCASIONS; PROVIDING BANQUET AND SOCIAL FUNCTION FACILITIES FOR SPECIAL OCCASIONS, NAMELY, WEDDINGS (U.S. CLS. 100 AND 101).

FIRST USE 8-0-2011; IN COMMERCE 8-0-2011.

4,046,832. SPRINGDELL ASSOCIATES, LLC, COATESVILLE, PA. SN 85-171,095. PUB. 4-19-2011, FILED 11-8-2010.

**THE WHIP TAVERN**

THE MARK CONSISTS OF STANDARD CHARACTERS WITHOUT CLAIM TO ANY PARTICULAR FONT, STYLE, SIZE, OR COLOR.

NO CLAIM IS MADE TO THE EXCLUSIVE RIGHT TO USE "TAVERN", APART FROM THE MARK AS SHOWN.

FOR RESTAURANTS (U.S. CLS. 100 AND 101).

FIRST USE 5-1-2005; IN COMMERCE 5-1-2005.

4,046,850. THE HEALTH AND HOSPITAL CORPORATION OF MARION COUNTY, DBA WISHARD HEALTH SERVICES, INDIANAPOLIS, IN. SN 85-179,162. PUB. 4-26-2011, FILED 11-17-2010.

**CAFE SOLEIL AT WISHARD**

THE MARK CONSISTS OF STANDARD CHARACTERS WITHOUT CLAIM TO ANY PARTICULAR FONT, STYLE, SIZE, OR COLOR.

OWNER OF U.S. REG. NOS. 3,217,429, 3,813,427, AND OTHERS.

NO CLAIM IS MADE TO THE EXCLUSIVE RIGHT TO USE "CAFE", APART FROM THE MARK AS SHOWN.

THE ENGLISH TRANSLATION OF THE WORD "SOLEIL" IN THE MARK IS SUN.

FOR IN-HOUSE CAFE AND RESTAURANT SERVICES FOR EMPLOYEES, PATIENTS AND VISITORS (U.S. CLS. 100 AND 101).

FIRST USE 4-1-2010; IN COMMERCE 7-29-2011.

**CLASS 43—(Continued).**

4,046,943. WREATH EQUITY, LLC, CARLSBAD, CA. SN 85-208,056. PUB. 5-24-2011, FILED 12-30-2010.



OWNER OF U.S. REG. NOS. 3,382,024, 3,455,878, AND OTHERS.

NO CLAIM IS MADE TO THE EXCLUSIVE RIGHT TO USE "CALIFORNIA GREEK", APART FROM THE MARK AS SHOWN.

THE MARK CONSISTS OF A CIRCLE WITH A SERIES OF OLIVE WREATH LEAVES INSIDE; BENEATH THE CIRCLE ARE THE WORDS "DAPHNE'S" AND "CALIFORNIA GREEK"; THE CIRCLE IS CENTERED OVER THE "A" AND "P" IN "DAPHNE'S"; THE WORDS "CALIFORNIA GREEK" ARE 1/2 THE SIZE OF, AND ARE LOCATED BENEATH AND OFF-CENTERED TO THE RIGHT OF THE WORD "DAPHNE'S".

FOR CAFE-RESTAURANTS; CARRY-OUT RESTAURANTS; FAST-FOOD RESTAURANTS; RESTAURANT SERVICES; RESTAURANTS; RESTAURANTS FEATURING HOME DELIVERY (U.S. CLS. 100 AND 101).

FIRST USE 2-25-2011; IN COMMERCE 2-25-2011.

4,046,966. U.S.A. HARVEST, INC., LOUISVILLE, KY. SN 85-211,130. PUB. 5-3-2011, FILED 1-5-2011.

**THE POWER OF 80**

THE MARK CONSISTS OF STANDARD CHARACTERS WITHOUT CLAIM TO ANY PARTICULAR FONT, STYLE, SIZE, OR COLOR.

NO CLAIM IS MADE TO THE EXCLUSIVE RIGHT TO USE "80", APART FROM THE MARK AS SHOWN.

FOR CHARITABLE SERVICES, NAMELY, PROVIDING FOOD TO NEEDY PERSONS (U.S. CLS. 100 AND 101).

FIRST USE 2-4-2011; IN COMMERCE 2-4-2011.

**CLASS 43—(Continued).**

4,046,987. RESTAURANT DEVELOPMENT GROUP, LLC, NORTH PALM BEACH, FL. SN 85-216,323. PUB. 4-5-2011, FILED 1-12-2011.

**THE BURGERFICATION OF THE NATION**

THE MARK CONSISTS OF STANDARD CHARACTERS WITHOUT CLAIM TO ANY PARTICULAR FONT, STYLE, SIZE, OR COLOR.

FOR FAST-FOOD RESTAURANTS AND SNACKBARS; RESTAURANTS (U.S. CLS. 100 AND 101).

FIRST USE 2-7-2011; IN COMMERCE 2-7-2011.

4,047,040. TREASURE ISLAND, LLC, LAS VEGAS, NV. SN 85-234,628. PUB. 6-14-2011, FILED 2-4-2011.



NO CLAIM IS MADE TO THE EXCLUSIVE RIGHT TO USE "MARGARITA BAR", APART FROM THE MARK AS SHOWN.

THE MARK CONSISTS OF A DRAWING OF A PIECE OF STEM WARE WITH A WEDGE OF CITRUS ON ITS RIM TO THE RIGHT OF WHICH ARE THE STYLIZED WORDS "MARGARITA BAR" WHICH ARE OVER THE STYLIZED WORDS "AT TI".

FOR BAR SERVICES; COCKTAIL LOUNGE SERVICES (U.S. CLS. 100 AND 101).

FIRST USE 8-25-2011; IN COMMERCE 8-25-2011.

**CLASS 44—MEDICAL, BEAUTY AND AGRICULTURAL SERVICES**

4,045,671. LAS VEGAS SANDS CORP., LAS VEGAS, NV. SN 77-360,921. PUB. 2-1-2011, FILED 12-28-2007.

**PALAZZO**

THE MARK CONSISTS OF STANDARD CHARACTERS WITHOUT CLAIM TO ANY PARTICULAR FONT, STYLE, SIZE, OR COLOR.

OWNER OF U.S. REG. NOS. 2,683,895 AND 2,729,637.

**CLASS 44—(Continued).**

THE ENGLISH TRANSLATION OF THE WORD "PALAZZO" IN THE MARK IS PALACE.

FOR FLORAL DECORATION SERVICES AND FLORAL DESIGN SERVICES FOR WEDDINGS AND SPECIAL EVENTS (U.S. CLS. 100 AND 101).

FIRST USE 12-28-2007; IN COMMERCE 12-28-2007.

4,045,788. SHEN, MD, JOSEPH T., PORT WASHINGTON, NY.  
SN 77-640,528. PUB. 7-13-2010, FILED 12-29-2008.

## PREMIER HEART'S MULTIFUNCTION CARDIOGRAM

THE MARK CONSISTS OF STANDARD CHARACTERS WITHOUT CLAIM TO ANY PARTICULAR FONT, STYLE, SIZE, OR COLOR.

NO CLAIM IS MADE TO THE EXCLUSIVE RIGHT TO USE "HEART'S MULTIFUNCTION CARDIOGRAM", APART FROM THE MARK AS SHOWN.

FOR MEDICAL TESTING, NAMELY, ELECTROPHYSIOLOGICAL MEASUREMENT AND ELECTROCARDIOGRAM EXAMINATION BY PHYSICIANS TO DIAGNOSE HEART DISEASES (U.S. CLS. 100 AND 101).

FIRST USE 3-3-2011; IN COMMERCE 3-3-2011.

4,045,999. GENETICS & IVF INSTITUTE, FAIRFAX, VA. SN 77-903,684. PUB. 7-20-2010, FILED 12-31-2009.

## WHERE VALUE MEETS QUALITY

THE MARK CONSISTS OF STANDARD CHARACTERS WITHOUT CLAIM TO ANY PARTICULAR FONT, STYLE, SIZE, OR COLOR.

FOR REPRODUCTIVE TISSUE BANKING; SPERM BANK SERVICES; SPERM SORTING SERVICES; LABORATORY SERVICES, NAMELY, GENETIC TESTING AND DNA ANALYSIS AND PROFILING FOR MEDICAL PURPOSES; CLINICAL SERVICES, NAMELY, GENETIC COUNSELING, DONOR SPERM SCREENING SERVICES IN THE NATURE OF MEDICAL TESTING OF SPERM FOR MEDICAL PURPOSES, DONOR SPERM SELECTION SERVICES IN THE NATURE OF GENETIC TESTING OF SPERM FOR MEDICAL PURPOSES, AND MALE AND FEMALE INFERTILITY AND ASSISTED REPRODUCTIVE SERVICES; MEDICAL TESTING; AND COLLECTION AND PRESERVATION OF SPERM AND REPRODUCTIVE TISSUES (U.S. CLS. 100 AND 101).

FIRST USE 1-0-2011; IN COMMERCE 1-0-2011.

**CLASS 44—(Continued).**

4,046,115. EMERUS HOLDINGS, INC., THE WOODLANDS, TX. SN 77-949,914. PUB. 1-11-2011, FILED 3-3-2010.

## EMERUS

THE MARK CONSISTS OF STANDARD CHARACTERS WITHOUT CLAIM TO ANY PARTICULAR FONT, STYLE, SIZE, OR COLOR.

FOR MEDICAL EMERGENCY HOSPITAL SERVICES; MEDICAL EMERGENCY ROOM SERVICES; EMERGENCY MEDICAL ASSISTANCE; EMERGENCY MEDICAL RESPONSE SERVICES; MEDICAL ASSISTANCE SERVICES; MEDICAL CLINICS; MEDICAL CONSULTATIONS; MEDICAL IMAGING SERVICES; MEDICAL RADIOLOGY SERVICES (U.S. CLS. 100 AND 101).

FIRST USE 6-16-2010; IN COMMERCE 6-16-2010.

4,046,212. MONOGRAM BIOSCIENCES, INC., SOUTH SAN FRANCISCO, CA. SN 85-006,467. PUB. 8-31-2010, FILED 4-5-2010.

## VERATAG

THE MARK CONSISTS OF STANDARD CHARACTERS WITHOUT CLAIM TO ANY PARTICULAR FONT, STYLE, SIZE, OR COLOR.

FOR MEDICAL TESTING SERVICES FOR DIAGNOSTIC OR TREATMENT PURPOSES (U.S. CLS. 100 AND 101).

FIRST USE 8-0-2011; IN COMMERCE 8-0-2011.

4,046,224. EMERUS HOLDINGS, INC., THE WOODLANDS, TX. SN 85-014,020. PUB. 1-11-2011, FILED 4-14-2010.

## EMERUS THE EMERGENCY SPECIALISTS

THE MARK CONSISTS OF STANDARD CHARACTERS WITHOUT CLAIM TO ANY PARTICULAR FONT, STYLE, SIZE, OR COLOR.

NO CLAIM IS MADE TO THE EXCLUSIVE RIGHT TO USE "EMERGENCY SPECIALISTS", APART FROM THE MARK AS SHOWN.

FOR MEDICAL EMERGENCY HOSPITAL SERVICES; MEDICAL EMERGENCY ROOM SERVICES; EMERGENCY MEDICAL ASSISTANCE; EMERGENCY MEDICAL RESPONSE SERVICES; MEDICAL ASSISTANCE SERVICES; MEDICAL CLINICS; MEDICAL CONSULTATIONS; MEDICAL IMAGING SERVICES; MEDICAL RADIOLOGY SERVICES (U.S. CLS. 100 AND 101).

FIRST USE 6-16-2010; IN COMMERCE 6-16-2010.

**CLASS 44—(Continued).**

4,046,225. EMERUS HOLDINGS, INC., THE WOODLANDS, TX. SN 85-014,022. PUB. 1-11-2011, FILED 4-14-2010.

EMERUS ADVANCED EMERGENCY  
CARE

THE MARK CONSISTS OF STANDARD CHARACTERS WITHOUT CLAIM TO ANY PARTICULAR FONT, STYLE, SIZE, OR COLOR.

NO CLAIM IS MADE TO THE EXCLUSIVE RIGHT TO USE "ADVANCED EMERGENCY CARE", APART FROM THE MARK AS SHOWN.

FOR MEDICAL EMERGENCY HOSPITAL SERVICES; MEDICAL EMERGENCY ROOM SERVICES; EMERGENCY MEDICAL ASSISTANCE; EMERGENCY MEDICAL RESPONSE SERVICES; MEDICAL ASSISTANCE SERVICES; MEDICAL CLINICS; MEDICAL CONSULTATIONS; MEDICAL IMAGING SERVICES; MEDICAL RADIOLOGY SERVICES (U.S. CLS. 100 AND 101).

FIRST USE 6-16-2010; IN COMMERCE 6-16-2010.

4,046,241. PALM BEACH GARDENS COMMUNITY HOSPITAL, INC., DALLAS, TX. SN 85-023,339. PUB. 3-22-2011, FILED 4-26-2010.



NO CLAIM IS MADE TO THE EXCLUSIVE RIGHT TO USE "HEART INSTITUTE", APART FROM THE MARK AS SHOWN.

THE COLOR(S) BLUE AND RED IS/ARE CLAIMED AS A FEATURE OF THE MARK.

THE MARK CONSISTS OF FOUR INDIVIDUAL HEARTS OUTLINED IN RED MAKING UP A CIRCLE TO THE LEFT OF THE WORDS "PALM BEACH GARDENS" IN BLUE AND "HEART INSTITUTE" IN RED.

SEC. 2(F) "PALM BEACH GARDENS".

FOR HEALTH CARE (U.S. CLS. 100 AND 101).

FIRST USE 6-0-2010; IN COMMERCE 6-0-2010.

4,046,280. DOROTHY SIMINOVITCH, BEACHWOOD, OH. SN 85-040,124. PUB. 1-4-2011, FILED 5-17-2010.

Gestalt Coaching Works

THE MARK CONSISTS OF STANDARD CHARACTERS WITHOUT CLAIM TO ANY PARTICULAR FONT, STYLE, SIZE, OR COLOR.

NO CLAIM IS MADE TO THE EXCLUSIVE RIGHT TO USE "GESTALT COACHING", APART FROM THE MARK AS SHOWN.

FOR PSYCHOLOGICAL COUNSELING TO ASSIST INDIVIDUALS AND GROUPS IN WORK AND LIFE ENHANCEMENT (U.S. CLS. 100 AND 101).

FIRST USE 9-1-2008; IN COMMERCE 9-1-2008.

**CLASS 44—(Continued).**

4,046,338. ALZCARE, INC., HAMILTON, NJ. SN 85-061,793. PUB. 5-17-2011, FILED 6-14-2010.

ALZCARE

THE MARK CONSISTS OF STANDARD CHARACTERS WITHOUT CLAIM TO ANY PARTICULAR FONT, STYLE, SIZE, OR COLOR.

FOR HOME HEALTH CARE SERVICES (U.S. CLS. 100 AND 101).

FIRST USE 3-28-2011; IN COMMERCE 3-28-2011.

4,046,373. LYT UP NEW YORK INC., NEW YORK, NY. SN 85-072,871. PUB. 1-11-2011, FILED 6-28-2010.

COLONICS ROCK

THE MARK CONSISTS OF STANDARD CHARACTERS WITHOUT CLAIM TO ANY PARTICULAR FONT, STYLE, SIZE, OR COLOR.

NO CLAIM IS MADE TO THE EXCLUSIVE RIGHT TO USE "COLONICS", APART FROM THE MARK AS SHOWN.

FOR COLONIC TREATMENTS, NAMELY, IRRIGATION OF THE COLON FOR CLEANSING PURPOSES BY INJECTING LARGE AMOUNTS OF FLUID HIGH INTO THE COLON (U.S. CLS. 100 AND 101).

FIRST USE 9-5-2011; IN COMMERCE 9-5-2011.

4,046,374. LYT UP NEW YORK INC., NEW YORK, NY. SN 85-072,931. PUB. 1-11-2011, FILED 6-28-2010.

DETOX ROCKS

THE MARK CONSISTS OF STANDARD CHARACTERS WITHOUT CLAIM TO ANY PARTICULAR FONT, STYLE, SIZE, OR COLOR.



**CLASS 44—(Continued).**

NO CLAIM IS MADE TO THE EXCLUSIVE RIGHT TO USE "DETOX", APART FROM THE MARK AS SHOWN.

FOR ACUPUNCTURE; ADDICTION TREATMENT SERVICES; ALTERNATIVE MEDICINE SERVICES, NAMELY, DETOXIFICATION SERVICES; ANTI-SMOKING THERAPY; COLONIC TREATMENTS; CONSULTING SERVICES IN THE FIELDS OF HEALTH AND NUTRITION; COUNSELING SERVICES IN THE FIELDS OF HEALTH, HERBALISM, AND LIFESTYLE WELLNESS; HEALTH CARE SERVICES, NAMELY, VIBRATION THERAPY; HEALTH SPA SERVICES FOR HEALTH AND WELLNESS OF THE BODY AND SPIRIT; MASSAGE THERAPY SERVICES; PROVIDING IN-PERSON ENERGY HEALING SERVICES; PROVIDING IN-PERSON HOLISTIC HEALTH CARE SERVICES; PROVIDING SMOKING CESSATION TREATMENT SERVICES; PROVIDING WELLNESS SERVICES, NAMELY, PERSONAL ASSESSMENTS, PERSONALIZED ROUTINES, MAINTENANCE SCHEDULES, AND COUNSELING; REFLEXOLOGY SERVICES; WEIGHT MANAGEMENT SERVICES, NAMELY, PROVIDING WEIGHT LOSS AND/OR WEIGHT MAINTENANCE PROGRAMS (U.S. CLS. 100 AND 101).

FIRST USE 9-5-2011; IN COMMERCE 9-5-2011.

4,046,388. BOCHNER CHIROPRACTIC CARE, P.C., NEW YORK, NY. SN 85-077,051. PUB. 12-7-2010, FILED 7-2-2010.

**PREPARE TO COMPETE**

THE MARK CONSISTS OF STANDARD CHARACTERS WITHOUT CLAIM TO ANY PARTICULAR FONT, STYLE, SIZE, OR COLOR.

FOR CHIROPRACTIC EVALUATION, IDENTIFICATION, AND MANAGEMENT OF MOVEMENT DYSFUNCTION TO RESTORE, MAINTAIN, AND PROMOTE OPTIMAL PHYSICAL FUNCTION PREVENTING THE ONSET, SYMPTOMS AND PROGRESSION OF IMPAIRMENTS, FUNCTIONAL LIMITATIONS, AND DISABILITIES RESULTING FROM DISEASE, DISORDERS, CONDITIONS, OR INJURIES (U.S. CLS. 100 AND 101).

FIRST USE 3-1-2010; IN COMMERCE 3-1-2010.

**CLASS 44—(Continued).**

4,046,581. BOCHNER CHIROPRACTIC CARE, P.C., NEW YORK, NY. SN 85-110,464. PUB. 12-7-2010, FILED 8-18-2010.

**PTC**

THE MARK CONSISTS OF STANDARD CHARACTERS WITHOUT CLAIM TO ANY PARTICULAR FONT, STYLE, SIZE, OR COLOR.

FOR CHIROPRACTIC EVALUATION, IDENTIFICATION, AND MANAGEMENT OF INVOLVEMENT DYSFUNCTION TO RESTORE, MAINTAIN, AND PROMOTE OPTIMAL PHYSICAL FUNCTION PREVENTING THE ONSET, SYMPTOMS AND PROGRESSION OF IMPAIRMENTS, FUNCTIONAL LIMITATIONS, AND DISABILITIES RESULTING FROM DISEASE, DISORDERS, CONDITIONS OR INJURIES (U.S. CLS. 100 AND 101).

FIRST USE 3-1-2010; IN COMMERCE 3-1-2010.

4,046,617. DNA HEALTH SERVICES, DBA DNA HOME HEALTH SERVICES, DALLAS, TX. SN 85-117,080. PUB. 5-17-2011, FILED 8-26-2010.

**DnA Health Services**

THE MARK CONSISTS OF STANDARD CHARACTERS WITHOUT CLAIM TO ANY PARTICULAR FONT, STYLE, SIZE, OR COLOR.

NO CLAIM IS MADE TO THE EXCLUSIVE RIGHT TO USE "HEALTH SERVICES", APART FROM THE MARK AS SHOWN.

THE WORDING "DNA" HAS NO MEANING IN A FOREIGN LANGUAGE.

FOR HOME HEALTH CARE SERVICES, NAMELY, SKILL NURSING SERVICES, NAMELY, MEDICATION ADMINISTRATION, WOUND CARE; THERAPEUTIC SERVICES, NAMELY, PHYSICAL THERAPY, SPEECH-LANGUAGE PATHOLOGY SERVICES, OCCUPATIONAL THERAPY, MEDICAL SERVICES, AND HOME HEALTH CARE SERVICES; REHABILITATION SERVICES IN THE NATURE OF HELPING PATIENTS REGAIN RANGE OF MOTION AND AMBULATION (U.S. CLS. 100 AND 101).

FIRST USE 1-27-2010; IN COMMERCE 3-30-2011.

**CLASS 44—(Continued).**

4,046,659. PENINSULA REGIONAL MEDICAL CENTER, SALISBURY, MD. SN 85-124,832. PUB. 1-25-2011, FILED 9-8-2010.

**CLASS 44—(Continued).**

4,046,695. JJS INVESTMENTS, LLC, MESA, AZ. SN 85-132,344. PUB. 6-7-2011, FILED 9-17-2010.

# MEMD

EXCEPTIONAL HEALTHCARE.  
EXCEPTIONAL PEOPLE.

THE MARK CONSISTS OF STANDARD CHARACTERS WITHOUT CLAIM TO ANY PARTICULAR FONT, STYLE, SIZE, OR COLOR.

FOR MEDICAL SERVICES; HOSPITALS (U.S. CLS. 100 AND 101).

FIRST USE 10-0-2010; IN COMMERCE 10-0-2010.

THE MARK CONSISTS OF STANDARD CHARACTERS WITHOUT CLAIM TO ANY PARTICULAR FONT, STYLE, SIZE, OR COLOR.

FOR COORDINATING HEALTHCARE AT HOME FOR PATIENTS VIA A SECURE WEB VIDEO CONFERENCE CONNECTION, NAMELY, PROVIDING A SECURE VIDEO-ENABLED WEBSITE FOR A PATIENT AT HOME TO INPUT PERSONAL MEDICAL HISTORY FOR REVIEW BY A THIRD PARTY MEDICAL PROVIDER, RECEIVE MEDICAL SCREENING BASED ON THE INPUT MEDICAL HISTORY, RECEIVE WEB-BASED VIDEO PHYSICAL EXAMINATION FOR MEDICAL DIAGNOSTIC PURPOSES FROM A THIRD PARTY MEDICAL PROVIDER, AND RECEIVE MEDICAL CONSULTATIONS PROVIDED VIA ONLINE VIDEOCONFERENCING FROM A THIRD PARTY MEDICAL PROVIDER (U.S. CLS. 100 AND 101).

FIRST USE 5-2-2011; IN COMMERCE 5-2-2011.

4,046,661. DOCVIA, LLC, TULSA, OK. SN 85-126,640. PUB. 2-22-2011, FILED 9-10-2010.

4,046,783. GLAMWORKS, LLC, HEMPSTEAD, NY. SN 85-155,977. PUB. 4-12-2011, FILED 10-19-2010.

# ICE.

THE MARK CONSISTS OF STANDARD CHARACTERS WITHOUT CLAIM TO ANY PARTICULAR FONT, STYLE, SIZE, OR COLOR.

FOR PROVIDING AN INTERACTIVE COMPUTER DATABASE ACCESSIBLE VIA A GLOBAL COMPUTER NETWORK IN THE FIELD OF PERSONAL HEALTH INFORMATION AUTHORIZED BY PATIENTS IN A HIPAA-COMPLIANT, SECURE, STRUCTURED MANNER (U.S. CLS. 100 AND 101).

FIRST USE 9-11-2010; IN COMMERCE 9-11-2010.

GLAMWORKS  
Beauty is embodied Glamour is achieved.

OWNER OF U.S. REG. NO. 3,255,502.

THE COLOR(S) BLACK, PINK AND WHITE IS/ARE CLAIMED AS A FEATURE OF THE MARK.

THE MARK CONSISTS OF THE WORD "GLAMWORKS" IN BLACK WITH PINK PUCKERING LIPS IN PLACE OF THE LETTER "O" IN "GLAMWORKS" BELOW WHICH IS THE PHRASE "BEAUTY IS EMBODIED GLAMOUR IS ACHIEVED" IN PINK LETTERING ALL SET AGAINST A WHITE BACKGROUND.

FOR HAIR STYLING SERVICES, FASHION STYLING, BEAUTY SALONS AND COSMETICIAN SERVICES FOR CELEBRITY CLIENTELE AND THE GENERAL PUBLIC (U.S. CLS. 100 AND 101).

FIRST USE 9-24-2010; IN COMMERCE 10-1-2010.

**CLASS 44—(Continued).**

4,046,859. BEABER FAMILY ORTHODONTICS, P.C., HIGHLANDS RANCH, CO. SN 85-182,524. PUB. 4-12-2011, FILED 11-22-2010.



THE COLOR(S) BLACK, WHITE AND YELLOW IS/ARE CLAIMED AS A FEATURE OF THE MARK.

THE MARK CONSISTS OF YELLOW HAPPY FACE WITH BLACK EYES AND GLEAMING WHITE TEETH.

FOR DENTAL AND ORTHODONTIC SERVICES, NAMELY, DENTISTRY, ORTHODONTICS, ORAL SURGERY AND DENTAL IMPLANT SERVICES (U.S. CLS. 100 AND 101).

FIRST USE 11-10-2010; IN COMMERCE 5-19-2011.

4,046,897. PASSPORT HEALTH COMMUNICATIONS, INC., FRANKLIN, TN. SN 85-192,448. PUB. 5-3-2011, FILED 12-7-2010.

**PAYMENT CERTAINTY FOR EVERY PATIENT**

THE MARK CONSISTS OF STANDARD CHARACTERS WITHOUT CLAIM TO ANY PARTICULAR FONT, STYLE, SIZE, OR COLOR.

FOR PROVISION OF HEALTHCARE INFORMATION BY ELECTRONIC MEANS (U.S. CLS. 100 AND 101).

FIRST USE 2-21-2011; IN COMMERCE 2-21-2011.

**CLASS 44—(Continued).**

4,046,972. BLORE, MICHAEL, ROSEVILLE, CA. AND BLORE, ASHLEIGH, ROSEVILLE, CA. SN 85-212,740. PUB. 5-24-2011, FILED 1-7-2011.

**See it, Live it, Love it**

THE MARK CONSISTS OF STANDARD CHARACTERS WITHOUT CLAIM TO ANY PARTICULAR FONT, STYLE, SIZE, OR COLOR.

FOR TANNING SALONS (U.S. CLS. 100 AND 101). FIRST USE 10-25-2007; IN COMMERCE 11-5-2007.

4,047,015. CHRONIC DISEASE FUND, DALLAS, TX. SN 85-223,501. PUB. 5-24-2011, FILED 1-21-2011.

**CDFRX**

THE MARK CONSISTS OF STANDARD CHARACTERS WITHOUT CLAIM TO ANY PARTICULAR FONT, STYLE, SIZE, OR COLOR.

FOR DISPENSING OF PHARMACEUTICALS (U.S. CLS. 100 AND 101). FIRST USE 11-8-2010; IN COMMERCE 1-3-2011.

4,047,034. RPC ACQUISITION CORP., MINNEAPOLIS, MN. SN 85-232,158. PUB. 6-14-2011, FILED 2-2-2011.

**pro★cuts**

OWNER OF U.S. REG. NOS. 1,144,560, 2,000,483, AND OTHERS.

THE MARK CONSISTS OF THE STYLIZED TERMS "PRO CUTS" WITH A STAR BETWEEN "PRO" AND "CUTS".

FOR HAIR CUTTING SERVICES; HAIR SALON SERVICES; HAIR STYLING (U.S. CLS. 100 AND 101).

FIRST USE 2-0-2011; IN COMMERCE 2-0-2011.

**CLASS 44—(Continued).**

4,047,067. TRIAL CONSULTANTS, INC., GAINESVILLE, FL. SN 85-244,190. PUB. 7-12-2011, FILED 2-16-2011.

**DISCOVERY REACTION**

THE MARK CONSISTS OF STANDARD CHARACTERS WITHOUT CLAIM TO ANY PARTICULAR FONT, STYLE, SIZE, OR COLOR.

NO CLAIM IS MADE TO THE EXCLUSIVE RIGHT TO USE "DISCOVERY", APART FROM THE MARK AS SHOWN.

FOR LEGAL SUPPORT SERVICES, NAMELY, CONSULTING, RESEARCH AND ANALYSIS SERVICES FOR TRIAL PREPARATION, CASE EVALUATION, AND SETTLEMENT NEGOTIATIONS; JURY CONSULTANCY; CONDUCTING MOCK-JURY TRIALS AND MOCK-JURY FOCUS GROUPS PRIOR TO TRIAL FOR ATTORNEYS AND THEIR CLIENTS TO IDENTIFY EFFECTIVE LITIGATION STRATEGIES, UNDERSTAND THE ISSUES, EVALUATE POTENTIAL LIABILITY AND ESTIMATE DAMAGES, AND TO OBSERVE THE JURY DECISION PROCESS (U.S. CLS. 100 AND 101).  
FIRST USE 8-0-2011; IN COMMERCE 8-0-2011.

**CLASS 45—PERSONAL AND LEGAL SERVICES**

4,045,595. HEART AND HOBBY LLC, HENDERSON, NV. SN 76-703,522. PUB. 11-30-2010, FILED 6-25-2010.



THE COLOR(S) RED AND BLACK IS/ARE CLAIMED AS A FEATURE OF THE MARK.

THE MARK CONSISTS OF THE WORD "HEART" IN A SCRIPT RED FONT, DIRECTLY OVER THE WORD "HOBBY" IN A BLACK BOLD FONT. TO THE LEFT OF THE WORDING ARE TWO RED HEARTS APPEAR IN 3D, LAYING SIDE BY SIDE, AND TOUCHING.

FOR INTERNET BASED SOCIAL NETWORKING AND DATING SERVICES GEARED TO MATCH PEOPLE BY COMMON INTERESTS (U.S. CLS. 100 AND 101).  
FIRST USE 3-1-2010; IN COMMERCE 6-1-2010.

**CLASS 45—(Continued).**

4,045,736. LONDON IP, INC., ALEXANDRIA, VA. SN 77-495,437. PUB. 10-21-2008, FILED 6-10-2008.

**PATENT WORKBENCH**

THE MARK CONSISTS OF STANDARD CHARACTERS WITHOUT CLAIM TO ANY PARTICULAR FONT, STYLE, SIZE, OR COLOR.

NO CLAIM IS MADE TO THE EXCLUSIVE RIGHT TO USE "PATENT", APART FROM THE MARK AS SHOWN.

FOR PROVIDING AN ELECTRONIC PATENT FILE DATABASE (U.S. CLS. 100 AND 101).

FIRST USE 7-12-2011; IN COMMERCE 7-29-2011.

4,045,854. PROLEXIC TECHNOLOGIES, INC., HOLLYWOOD, FL. SN 77-751,162. PUB. 1-19-2010, FILED 6-3-2009.

**Touchless Baselining**

THE MARK CONSISTS OF STANDARD CHARACTERS WITHOUT CLAIM TO ANY PARTICULAR FONT, STYLE, SIZE, OR COLOR.

NO CLAIM IS MADE TO THE EXCLUSIVE RIGHT TO USE "BASELINING", APART FROM THE MARK AS SHOWN.

FOR PROVIDING A FEATURE OF COMPUTER NETWORK SECURITY SERVICES, NAMELY, A DATA TRAFFIC ROUTING FEATURE IN THE MONITORING OF PUBLIC-FACING NETWORK TRAFFIC FOR SECURITY PURPOSES, ALL FOR PURPOSES OF MITIGATING DISTRIBUTED DENIAL OF SERVICE (DDOS) ATTACKS ON COMPUTER SERVERS CONNECTED TO THE INTERNET (U.S. CLS. 100 AND 101).  
FIRST USE 11-30-2010; IN COMMERCE 11-30-2010.

4,045,866. NEW DIRECTIONS INTERNATIONAL, BURLINGTON, NC. SN 77-765,966. PUB. 7-13-2010, FILED 6-23-2009.

**Feed The Hunger**

THE MARK CONSISTS OF STANDARD CHARACTERS WITHOUT CLAIM TO ANY PARTICULAR FONT, STYLE, SIZE, OR COLOR.

FOR MINISTERIAL SERVICES (U.S. CLS. 100 AND 101).

FIRST USE 4-15-2009; IN COMMERCE 4-19-2009.

**CLASS 45—(Continued).**

4,045,895. SHAH, SHASHEEN, CARY, NC. SN 77-796,737.  
PUB. 11-30-2010, FILED 8-4-2009.



THE MARK CONSISTS OF A CIRCULAR FIELD OF BLACK HAVING THREE WHITE CURVATE ELEMENTS ON SUCH FIELD, WHEREIN THE CURVATE ELEMENTS TOGETHER DEPICT A STYLIZED FANCIFUL FRONTAL PROFILE OF AN ELEPHANT'S HEAD AND TRUNK. THE COLORS BLACK AND WHITE BACKGROUND, OUTLINING, SHADING AND/OR TRANSPARENT AREAS AND ARE NOT PART OF THE MARK.

FOR PROVIDING A SOCIAL NETWORKING WEBSITE FOR A COMMUNITY OF USERS COMMITTED TO RESOLUTION OF COMMUNICATION ISSUES AMONG PARTIES SUCH AS SPOUSES, FAMILIES, PARENTS, CHILDREN, FRIENDS, CO-WORKERS, STUDENTS AND TEACHERS, FEATURING COMMUNICATIONS IN AN ONLINE COMMUNITY INVOLVING SHARING PERSONAL STORIES REGARDING COMMUNICATION INTERACTIONS, PROVIDING INFORMATION AND FACILITATING DISCUSSIONS REGARDING CONTEXT OF COMMUNICATION, TYPES OF COMMUNICATION, SELF-EXPRESSION, ACTIVE LISTENING, PERSPECTIVES IN COMMUNICATION, EMOTIONAL SUPPORT, SHARED EXPERIENCES, AND EDUCATION REGARDING IMPROVEMENT OF COMMUNICATION (U.S. CLS. 100 AND 101).

FIRST USE 12-17-2009; IN COMMERCE 12-17-2009.

4,045,927. SECURERETURN, INC., DEL MAR, CA. SN 77-837,167. PUB. 8-24-2010, FILED 9-29-2009.

## SECURERETURN

THE MARK CONSISTS OF STANDARD CHARACTERS WITHOUT CLAIM TO ANY PARTICULAR FONT, STYLE, SIZE, OR COLOR.

FOR SECURITY SERVICES, NAMELY, CONDUCTING RECOVERY OPERATIONS FOR RECOVERY OF PROPERTY (U.S. CLS. 100 AND 101).

FIRST USE 10-23-2009; IN COMMERCE 10-23-2009.

**CLASS 45—(Continued).**

4,045,937. CENTER FOR RESTORATIVE BREAST SURGERY, LLC, NEW ORLEANS, LA. SN 77-843,004. PUB. 2-8-2011, FILED 10-6-2009.

## ENCOURAGE

THE MARK CONSISTS OF STANDARD CHARACTERS WITHOUT CLAIM TO ANY PARTICULAR FONT, STYLE, SIZE, OR COLOR.

FOR ORGANIZING AND CONDUCTING SUPPORT GROUPS IN THE FIELD OF BREAST CANCER (U.S. CLS. 100 AND 101).

FIRST USE 8-1-2007; IN COMMERCE 8-1-2007.

4,046,114. OUTSPARK, INC., SAN FRANCISCO, CA. SN 77-949,905. PUB. 7-20-2010, FILED 3-3-2010.

## DIVINE SOULS

THE MARK CONSISTS OF STANDARD CHARACTERS WITHOUT CLAIM TO ANY PARTICULAR FONT, STYLE, SIZE, OR COLOR.

FOR ON-LINE SOCIAL NETWORKING SERVICES (U.S. CLS. 100 AND 101).

FIRST USE 12-14-2010; IN COMMERCE 12-14-2010.

4,046,277. FARSEDAKIS HOLDINGS, LLC, BOCA RATON, FL. SN 85-038,584. PUB. 5-17-2011, FILED 5-14-2010.

NO CLAIM IS MADE TO THE EXCLUSIVE RIGHT TO USE "ID RATING", APART FROM THE MARK AS SHOWN. THE MARK CONSISTS OF A STYLIZED TAG TO THE LEFT OF THE WORDS "ID RATING".

FOR ONLINE IDENTITY RELIABILITY SERVICES TO CONFIRM A PERSON'S OR A COMPANY'S IDENTITY ON THE INTERNET (U.S. CLS. 100 AND 101).

FIRST USE 7-0-2010; IN COMMERCE 7-0-2010.

**CLASS 45—(Continued).**

4,046,430. STINSON MORRISON HECKER LLP, KANSAS CITY, MO. SN 85-086,461. PUB. 12-21-2010, FILED 7-16-2010.

# eSpark

THE MARK CONSISTS OF STANDARD CHARACTERS WITHOUT CLAIM TO ANY PARTICULAR FONT, STYLE, SIZE, OR COLOR.  
FOR LEGAL SERVICES (U.S. CLS. 100 AND 101).  
FIRST USE 8-13-2010; IN COMMERCE 8-13-2010.

4,046,447. JINU T THOMAS, BRIDGEWATER, NJ. SN 85-089,929. PUB. 12-28-2010, FILED 7-21-2010.

# COLLYDE

THE MARK CONSISTS OF STANDARD CHARACTERS WITHOUT CLAIM TO ANY PARTICULAR FONT, STYLE, SIZE, OR COLOR.  
OWNER OF U.S. REG. NO. 3,794,757.  
FOR INTERNET-BASED SOCIAL NETWORKING SERVICES (U.S. CLS. 100 AND 101).  
FIRST USE 8-23-2010; IN COMMERCE 8-23-2010.

4,046,486. BUTLER UNIVERSITY, INDIANAPOLIS, IN. SN 85-094,853. PUB. 1-11-2011, FILED 7-28-2010.

# BULLDOG NATION

THE MARK CONSISTS OF STANDARD CHARACTERS WITHOUT CLAIM TO ANY PARTICULAR FONT, STYLE, SIZE, OR COLOR.  
FOR ONLINE SOCIAL NETWORKING SERVICES FOR USE BY UNIVERSITY STUDENTS, FACULTY, STAFF, AND ALUMNI TO EXCHANGE INFORMATION CONCERNING ACADEMIC COLLABORATIONS, BUSINESS OPPORTUNITIES, AND GENERAL INTEREST INFORMATION (U.S. CLS. 100 AND 101).  
FIRST USE 8-0-2010; IN COMMERCE 8-0-2010.

**CLASS 45—(Continued).**

4,046,580. BROWN, ROBERT E, MR., ROCHESTER, NY. SN 85-110,345. PUB. 2-1-2011, FILED 8-18-2010.

# ESOP Plus

THE MARK CONSISTS OF STANDARD CHARACTERS WITHOUT CLAIM TO ANY PARTICULAR FONT, STYLE, SIZE, OR COLOR.

NO CLAIM IS MADE TO THE EXCLUSIVE RIGHT TO USE "ESOP", APART FROM THE MARK AS SHOWN.  
FOR LEGAL SERVICES, NAMELY, PROVIDING CUSTOMIZED INFORMATION, COUNSELING, ADVICE AND LITIGATION SERVICES IN ALL AREAS OF EMPLOYMENT AND LABOR LAW FOR BOTH EMPLOYEES AND EMPLOYERS (U.S. CLS. 100 AND 101).  
FIRST USE 8-10-2010; IN COMMERCE 8-1-2011.

4,046,734. ONLINE BUDDIES, INC., CAMBRIDGE, MA. SN 85-142,010. PUB. 3-15-2011, FILED 9-30-2010.

# BIG BEAR DEN

THE MARK CONSISTS OF STANDARD CHARACTERS WITHOUT CLAIM TO ANY PARTICULAR FONT, STYLE, SIZE, OR COLOR.  
FOR ONLINE DATING SERVICES (U.S. CLS. 100 AND 101).  
FIRST USE 3-1-2011; IN COMMERCE 3-1-2011.

4,046,735. ONLINE BUDDIES, INC., CAMBRIDGE, MA. SN 85-142,063. PUB. 3-15-2011, FILED 9-30-2010.



THE MARK CONSISTS OF "BIG BEAR" STACKED ABOVE "DEN" AND A VERTICALLY ORIENTED PAW DRAWING. THE PAW HAS A PAD, FIVE SPACED TOES, AND FIVE SPACED CLAWS. ALL OF THE ELEMENTS ARE SURROUNDED BY A GENERALLY RECTANGULAR BORDER.  
FOR ONLINE DATING SERVICES (U.S. CLS. 100 AND 101).  
FIRST USE 3-1-2011; IN COMMERCE 3-1-2011.

**CLASS 45—(Continued).**

4,046,789. NATIONAL ASSOCIATION FOR STOCK CAR AUTO RACING, INC., DAYTONA BEACH, FL. SN 85-157,700. PUB. 2-1-2011, FILED 10-21-2010.

**NASCAR TEAM PROPERTIES**

THE MARK CONSISTS OF STANDARD CHARACTERS WITHOUT CLAIM TO ANY PARTICULAR FONT, STYLE, SIZE, OR COLOR.

OWNER OF U.S. REG. NOS. 990,987, 1,054,100, AND 1,850,527.

NO CLAIM IS MADE TO THE EXCLUSIVE RIGHT TO USE "TEAM PROPERTIES", APART FROM THE MARK AS SHOWN.

FOR LICENSING OF INTELLECTUAL PROPERTY, NAMELY, LICENSING THE GOODS AND SERVICES OF OTHERS FOR THE RIGHT TO USE THE NAMES, LOGOS, SIGNATURES, LIKENESSES, VOICES, PHOTOGRAPHS AND IMAGES IN THE FIELD OF AUTOMOBILE RACING (U.S. CLS. 100 AND 101).

FIRST USE 2-20-2011; IN COMMERCE 2-20-2011.

4,046,790. NATIONAL ASSOCIATION FOR STOCK CAR AUTO RACING, INC., DAYTONA BEACH, FL. SN 85-157,703. PUB. 2-1-2011, FILED 10-21-2010.



OWNER OF U.S. REG. NOS. 990,987, 1,054,100, AND 1,850,527.

NO CLAIM IS MADE TO THE EXCLUSIVE RIGHT TO USE "TEAM PROPERTIES", APART FROM THE MARK AS SHOWN.

THE MARK CONSISTS OF SLANTED "NASCAR" BAR LOGO WITH THE WORDS "TEAM PROPERTIES" INSIDE A RECTANGLE BOX AND A SMALL BOX WITH A PICTURE OF FOUR RACE CARS.

FOR LICENSING OF INTELLECTUAL PROPERTY, NAMELY, LICENSING THE GOODS AND SERVICES OF OTHERS FOR THE RIGHT TO USE THE NAMES, LOGOS, SIGNATURES, LIKENESSES, VOICES, PHOTOGRAPHS AND IMAGES IN THE FIELD OF AUTOMOBILE RACING (U.S. CLS. 100 AND 101).

FIRST USE 2-20-2011; IN COMMERCE 2-20-2011.

**CLASS 45—(Continued).**

4,046,894. FILE RIGHT LLC, MIDDLETOWN, DE. SN 85-192,211. PUB. 5-10-2011, FILED 12-7-2010.

# File Right

THE MARK CONSISTS OF STANDARD CHARACTERS WITHOUT CLAIM TO ANY PARTICULAR FONT, STYLE, SIZE, OR COLOR.

NO CLAIM IS MADE TO THE EXCLUSIVE RIGHT TO USE "FILE", APART FROM THE MARK AS SHOWN.

FOR PROVIDING A WEBSITE FEATURING GENERAL IMMIGRATION-RELATED LEGAL INFORMATION VIA A WEBSITE ON GLOBAL COMPUTER NETWORKS (U.S. CLS. 100 AND 101).

FIRST USE 3-21-2011; IN COMMERCE 3-21-2011.

4,046,895. FILE RIGHT LLC, MIDDLETOWN, DE. SN 85-192,230. PUB. 5-10-2011, FILED 12-7-2010.

# File Right

THE MARK CONSISTS OF STANDARD CHARACTERS WITHOUT CLAIM TO ANY PARTICULAR FONT, STYLE, SIZE, OR COLOR.

NO CLAIM IS MADE TO THE EXCLUSIVE RIGHT TO USE "FILE", APART FROM THE MARK AS SHOWN.

FOR LEGAL DOCUMENT PREPARATION SERVICES AND PROVIDING GENERAL IMMIGRATION-RELATED LEGAL INFORMATION VIA A WEBSITE ON GLOBAL COMPUTER NETWORKS (U.S. CLS. 100 AND 101).

FIRST USE 3-21-2011; IN COMMERCE 3-21-2011.

4,046,911. ZENKAS, LTD., BRAINTREE, MA. SN 85-196,642. PUB. 5-3-2011, FILED 12-13-2010.



NO CLAIM IS MADE TO THE EXCLUSIVE RIGHT TO USE "GIFTS", APART FROM THE MARK AS SHOWN.

THE MARK CONSISTS OF THE LETTER "Z" INSIDE A CIRCLE, WITH A GIFT BOW ON THE TOP OF THE CIRCLE AND THE WORDS "ZENKAS GIFTS OF DISTINCTION" TO THE RIGHT OF THE LETTER "Z".

FOR PREPARATION OF CUSTOMIZED GIFT BASKETS (U.S. CLS. 100 AND 101).

FIRST USE 10-1-2010; IN COMMERCE 10-1-2010.

**CLASS 45—(Continued).**

4,046,914. BEELER, BRENNEN LARS, HUNTINGTON BEACH, CA. SN 85-197,891. PUB. 6-7-2011, FILED 12-14-2010.

# REGENERATE

THE MARK CONSISTS OF STANDARD CHARACTERS WITHOUT CLAIM TO ANY PARTICULAR FONT, STYLE, SIZE, OR COLOR.

FOR CHRISTIAN MINISTRY SERVICES; CONDUCTING RELIGIOUS PRAYER SERVICES; MINISTERIAL SERVICES, NAMELY, HOLDING SPIRITUAL RETREATS TO ASSIST RELIGIOUS LEADERS, BOTH CLERGY AND LAY, TO DEVELOP AND ENHANCE THEIR SPIRITUAL LIVES; RELIGIOUS AND SPIRITUAL SERVICES, NAMELY, PROVIDING GATHERINGS AND RETREATS TO DEVELOP AND ENHANCE THE SPIRITUAL LIVES OF INDIVIDUALS; RELIGIOUS AND SPIRITUAL SERVICES, NAMELY, CONDUCTING RELIGIOUS WORSHIP, MARRIAGE CEREMONIES, BAPTISMAL CEREMONIES, BABY DEDICATIONS, BE-REAVEMENT CEREMONIES AND RELIGIOUS COUNSELING; RELIGIOUS SERVICES, NAMELY, PRAYER MEETINGS, PROVIDING A WEBSITE FEATURING INFORMATION ABOUT BIBLICAL STUDIES AND RELIGIOUS SERVICES, NAMELY, PROVIDING WORSHIP GATHERINGS TO DEVELOP AND ENHANCE THE SPIRITUAL LIVES OF INDIVIDUALS (U.S. CLS. 100 AND 101).

FIRST USE 1-6-2011; IN COMMERCE 1-6-2011.

4,046,923. THOUGHTFUL, INC., SEATTLE, WA. SN 85-199,033. PUB. 5-10-2011, FILED 12-15-2010.

# Thoughtful.co

THE MARK CONSISTS OF STANDARD CHARACTERS WITHOUT CLAIM TO ANY PARTICULAR FONT, STYLE, SIZE, OR COLOR.

FOR PROVIDING ADVICE AND INFORMATION ON APPROPRIATE GIFTS FOR SIGNIFICANT OTHERS (U.S. CLS. 100 AND 101).

FIRST USE 2-1-2011; IN COMMERCE 2-1-2011.

**CLASS 45—(Continued).**

4,046,924. THOUGHTFUL, INC., SEATTLE, WA. SN 85-199,044. PUB. 5-10-2011, FILED 12-15-2010.

# Thoughtful

THE MARK CONSISTS OF STANDARD CHARACTERS WITHOUT CLAIM TO ANY PARTICULAR FONT, STYLE, SIZE, OR COLOR.

FOR PERSONAL GIFT SELECTION FOR OTHERS (U.S. CLS. 100 AND 101).

FIRST USE 2-1-2011; IN COMMERCE 2-1-2011.

4,046,956. HARVARD MAINTENANCE, INC., NEW YORK, NY. SN 85-209,882. PUB. 5-17-2011, FILED 1-4-2011.



OWNER OF U.S. REG. NOS. 2,825,189 AND 2,825,190. NO CLAIM IS MADE TO THE EXCLUSIVE RIGHT TO USE "PROTECT", APART FROM THE MARK AS SHOWN. THE COLOR(S) DARK BLUE AND RED IS/ARE CLAIMED AS A FEATURE OF THE MARK.

THE MARK CONSISTS OF THE TERM "HARVARD" IN DARK BLUE, WITH THE RIGHT SIDE OF THE "V" EXTENDING ABOVE THE OTHER LETTERS, FOLLOWED BY THE TERM "PROTECT" IN RED.

FOR SECURITY GUARD SERVICES; MONITORING SECURITY SYSTEMS (U.S. CLS. 100 AND 101).

FIRST USE 4-0-2011; IN COMMERCE 4-0-2011.

4,047,017. TAYLOR ENGLISH DUMA LLP, ATLANTA, GA. SN 85-223,807. PUB. 5-31-2011, FILED 1-22-2011.

## THE PURPOSE-BUILT LAW FIRM

THE MARK CONSISTS OF STANDARD CHARACTERS WITHOUT CLAIM TO ANY PARTICULAR FONT, STYLE, SIZE, OR COLOR.

FOR LEGAL SERVICES (U.S. CLS. 100 AND 101).

FIRST USE 4-15-2011; IN COMMERCE 4-15-2011.



PRIOR UNITED STATES CLASSIFICATION

APPLICATION IN ONE CLASS

COLLECTIVE MEMBERSHIP MARKS

**CLASS 200—COLLECTIVE MEMBERSHIP**

4,045,958. HANANEEL, INDIANAPOLIS, IN. SN 77-863,850. PUB. 1-11-2011, FILED 11-3-2009.

Hananeel

THE MARK CONSISTS OF STANDARD CHARACTERS WITHOUT CLAIM TO ANY PARTICULAR FONT, STYLE, SIZE, OR COLOR.

FOR INDICATING MEMBERSHIP IN AN ORGANIZATION OF MUSICIANS THAT CREATES, PERFORMS, WRITES AND PRODUCES JAZZ, FUSION AND FUNK MUSIC (U.S. CL. 200).

FIRST USE 6-13-2009; IN COMMERCE 6-13-2009.

---

CERTIFICATION MARKS

**CLASS A—GOODS**

4,046,348. NATIONAL ELECTRICAL MANUFACTURERS ASSOCIATION, ROSSLYN, VA. SN 85-064,138. PUB. 1-4-2011, FILED 6-16-2010.



NO CLAIM IS MADE TO THE EXCLUSIVE RIGHT TO USE "ENERGY", APART FROM THE MARK AS SHOWN.

THE MARK CONSISTS OF THE STACKED TERMS "ENERGY AWARE" WITH A CHECK MARK INSIDE A SQUARE BOX ABOVE THE TERM "ENERGY", ALL WHICH ARE INSIDE A SQUARE SHAPED BOX.

THE CERTIFICATION MARK, AS INTENDED TO BE USED BY AUTHORIZED PERSONS, IS INTENDED TO CERTIFY THAT THE GOODS HAVE MET THE ENERGY EFFICIENCY STANDARDS SET BY THE CERTIFIER.

FOR PROGRAMMABLE THERMOSTATS (U.S. CL. A). FIRST USE 4-0-2011; IN COMMERCE 4-0-2011.

CERTIFICATION MARKS

**CLASS B—SERVICES**

4,046,051. IT SERVICE MANAGEMENT FORUM-USA, GLEN-DORA, CA. SN 77-931,105. PUB. 1-18-2011, FILED 2-9-2010.

ASM

THE MARK CONSISTS OF STANDARD CHARACTERS WITHOUT CLAIM TO ANY PARTICULAR FONT, STYLE, SIZE, OR COLOR.

THE CERTIFICATION MARK, AS INTENDED TO BE USED BY AUTHORIZED PERSONS, IS INTENDED TO CERTIFY THAT THE PERSON'S SERVICES HAVE DEMONSTRATED A PARTICULAR LEVEL OF COMPETENCY IN THE FIELD OF INFORMATION TECHNOLOGY SERVICE MANAGEMENT SERVICES BY HAVING MET CERTAIN EDUCATIONAL AND EXPERIENTIAL STANDARDS FOR INFORMATION TECHNOLOGY SERVICE MANAGEMENT SERVICES SET BY THE CERTIFIER.

FOR INFORMATION TECHNOLOGY SERVICE MANAGEMENT SERVICES (U.S. CL. B).

FIRST USE 4-0-2011; IN COMMERCE 4-0-2011.

---

4,046,052. IT SERVICE MANAGEMENT FORUM-USA, GLEN-DORA, CA. SN 77-931,106. PUB. 2-15-2011, FILED 2-9-2010.

PSM

THE MARK CONSISTS OF STANDARD CHARACTERS WITHOUT CLAIM TO ANY PARTICULAR FONT, STYLE, SIZE, OR COLOR.

THE CERTIFICATION MARK, AS INTENDED TO BE USED BY AUTHORIZED PERSONS, IS INTENDED TO CERTIFY THAT THE PERSON'S SERVICES HAVE DEMONSTRATED A PARTICULAR LEVEL OF COMPETENCY IN THE FIELD OF INFORMATION TECHNOLOGY SERVICE MANAGEMENT SERVICES BY HAVING MET CERTAIN EDUCATIONAL AND EXPERIENTIAL STANDARDS FOR INFORMATION TECHNOLOGY SERVICE MANAGEMENT SERVICES SET BY THE CERTIFIER.

FOR INFORMATION TECHNOLOGY SERVICE MANAGEMENT SERVICES (U.S. CL. B).

FIRST USE 4-0-2011; IN COMMERCE 4-0-2011.

---

4,046,053. IT SERVICE MANAGEMENT FORUM-USA, GLEN-

DORA, CA. SN 77-931,108. PUB. 2-8-2011, FILED 2-9-2010.

4,046,157. CERTIFICATION COUNCIL FOR PROFESSIONAL DOG TRAINERS, NEW YORK, NY. SN 77-967,331. PUB. 8-10-2010, FILED 3-24-2010.

SSM

THE MARK CONSISTS OF STANDARD CHARACTERS WITHOUT CLAIM TO ANY PARTICULAR FONT, STYLE, SIZE, OR COLOR.

THE CERTIFICATION MARK, AS INTENDED TO BE USED BY AUTHORIZED PERSONS, IS INTENDED TO CERTIFY THAT THE PERSON'S SERVICES HAVE DEMONSTRATED A PARTICULAR LEVEL OF COMPETENCY IN THE FIELD OF INFORMATION TECHNOLOGY SERVICE MANAGEMENT SERVICES BY HAVING MET CERTAIN EDUCATIONAL AND EXPERIENTIAL STANDARDS FOR INFORMATION TECHNOLOGY SERVICE MANAGEMENT SERVICES SET BY THE CERTIFIER.

FOR INFORMATION TECHNOLOGY SERVICE MANAGEMENT SERVICES (U.S. CL. B).

FIRST USE 4-0-2011; IN COMMERCE 4-0-2011.



NO CLAIM IS MADE TO THE EXCLUSIVE RIGHT TO USE "CERTIFIED PROFESSIONAL DOG TRAINER" AND "KNOWLEDGE & SKILLS ASSESSED", APART FROM THE MARK AS SHOWN.

THE COLOR(S) BLUE, PURPLE AND WHITE IS/ARE CLAIMED AS A FEATURE OF THE MARK.

THE MARK CONSISTS OF A PURPLE BANNER WITH A THIN BLUE TRIM ALONG THE TOP AND BOTTOM OF THE BANNER AND THE WHITE LETTERS "CPDT-KSA" INSIDE THE BANNER, WITH A PURPLE RIBBON CONNECTED ALONG THE LEFT HAND SIDE OF THE BANNER, AND THE BLUE WORDS "CERTIFIED PROFESSIONAL DOG TRAINER KNOWLEDGE & SKILLS ASSESSED" BELOW THE BANNER.

THE CERTIFICATION MARK, AS INTENDED TO BE USED BY AUTHORIZED PERSONS, IS INTENDED TO CERTIFY THAT THE DOG TRAINER HAS DEMONSTRATED A RECOGNIZED STANDARD OF COMPETENCE IN DOG TRAINING KNOWLEDGE AND SKILLS WHICH PROMOTES HUMANE PRACTICES AS SUPPORTED BY CURRENT SCIENTIFIC RESEARCH.

FOR DOG TRAINING (U.S. CL. B).

FIRST USE 3-0-2010; IN COMMERCE 6-21-2011.

4,046,054. AMERICAN BOARD OF OPTOMETRY, ST. LOUIS, MO. SN 77-931,437. PUB. 1-4-2011, FILED 2-9-2010.



NO CLAIM IS MADE TO THE EXCLUSIVE RIGHT TO USE "AMERICAN BOARD OF OPTOMETRY", APART FROM THE MARK AS SHOWN.

THE MARK CONSISTS OF THE WORD ELEMENTS "ABO AMERICAN BOARD OF OPTOMETRY" AND AN ABSTRACT OPTICAL DESIGN ELEMENT.

THE CERTIFICATION MARK, AS INTENDED TO BE USED BY AUTHORIZED PERSONS, IS INTENDED TO CERTIFY THAT AUTHORIZED PERSONS HAVE MET THE REQUIREMENTS ESTABLISHED BY THE CERTIFIER THAT DEMONSTRATE CLINICAL COMPETENCE IN THE FIELD OF OPTOMETRY.

FOR OPTOMETRY SERVICES (U.S. CL. B).

FIRST USE 2-11-2010; IN COMMERCE 2-11-2010.

4,046,330. LOCKHEED MARTIN CORPORATION, BETHESDA, MD. SN 85-060,185. PUB. 12-7-2010, FILED 6-10-2010.



OWNER OF U.S. REG. NOS. 2,022,037, 3,079,714, AND OTHERS.

NO CLAIM IS MADE TO THE EXCLUSIVE RIGHT TO USE "PRODUCTS" AND "APPROVED REPAIR CENTER", APART FROM THE MARK AS SHOWN.

THE MARK CONSISTS OF A CIRCLE CONTAINING THE WORDS "C-130 B-H APPROVED REPAIR CENTER" SURROUNDING TWO OVERLAPPING ARROW SHAPES LOCATED ABOVE THE WORDS "HOLOGRAM PRODUCTS LOCKHEED MARTIN".

THE CERTIFICATION MARK, AS INTENDED TO BE USED BY AUTHORIZED PERSONS, IS INTENDED TO CERTIFY THAT THE SERVICES HAVE BEEN PROVIDED PURSUANT TO QUALITY CONTROL STANDARDS FOR SAFETY AND RELIABILITY IN CONNECTION WITH PARTS FOR AIRCRAFT INITIALLY MANUFACTURED BY THE CERTIFIER, AS DETERMINED AND SPECIFIED BY THE CERTIFIER, AND WHICH SUPPLEMENT THE STANDARDS ESTABLISHED BY FEDERAL REGULATIONS.

FOR MAINTENANCE, REPAIR, SERVICE AND RECONDITIONING OF STRUCTURAL PARTS FOR AIRCRAFT, NON-STRUCTURAL PARTS AND FITTINGS FOR AIRCRAFT, AERONAUTICAL AND NAVIGATIONAL EQUIPMENT FOR AIRCRAFT, ELECTRICAL AND ELECTRONIC PARTS FOR AIRCRAFT, RADAR SYSTEM PARTS FOR AIRCRAFT, COMMUNICATIONS PARTS FOR AIRCRAFT, PARTS FOR WEAPON CONTROL SYSTEMS FOR AIRCRAFT (U.S. CL. B).

FIRST USE 10-31-2010; IN COMMERCE 10-31-2010.

THE CERTIFICATION MARK, AS INTENDED TO BE USED BY AUTHORIZED PERSONS, IS INTENDED TO CERTIFY THAT THE SERVICES ASSOCIATED WITH THE MARK MEET THE STANDARDS AND SPECIFICATIONS DEVELOPED BY THE CERTIFIER WITH RESPECT TO EXPERIENCE, EDUCATION AND PROFESSIONALISM.

FOR PERSONS PRACTICING REAL ESTATE BROKERAGE BY REPRESENTING BUYERS AND SELLERS OF RESIDENTIAL INVESTMENT REAL ESTATE (U.S. CL. B).

FIRST USE 4-22-2011; IN COMMERCE 4-22-2011.

4,046,672. COMMITTEE FOR DIGITAL ADVERTISING AND MARKETING ACCOUNTABILITY, WASHINGTON, DC. SN 85-129,122. PUB. 2-15-2011, FILED 9-14-2010.

4,046,502. KOAL, JAN, PULLMAN, WA. SN 85-097,740. PUB. 1-18-2011, FILED 8-2-2010.

ARIC

THE MARK CONSISTS OF STANDARD CHARACTERS WITHOUT CLAIM TO ANY PARTICULAR FONT, STYLE, SIZE, OR COLOR.

### Why did I get this ad?

THE MARK CONSISTS OF STANDARD CHARACTERS WITHOUT CLAIM TO ANY PARTICULAR FONT, STYLE, SIZE, OR COLOR.

NO CLAIM IS MADE TO THE EXCLUSIVE RIGHT TO USE "AD", APART FROM THE MARK AS SHOWN.

THE CERTIFICATION MARK, AS INTENDED TO BE USED BY AUTHORIZED PERSONS, IS INTENDED TO CERTIFY THAT THE SERVICES COMPLY WITH THE SELF-REGULATORY PRINCIPLES FOR ONLINE BEHAVIORAL ADVERTISING AND OTHERWISE MEET THE CERTIFIER'S STANDARDS OF ACCOUNTABILITY.

FOR ADVERTISING, ADVERTISEMENT AND MARKETING; INTERNET ADVERTISING, ADVERTISEMENT AND MARKETING (U.S. CL. B).

FIRST USE 8-29-2011; IN COMMERCE 8-29-2011.

\* \* \* \* \*

# SUPPLEMENTAL REGISTER

These registrations are not subject to opposition.

## SECTION 1.— INTERNATIONAL CLASSIFICATION

The short titles associated below with the international class numbers are terms designed merely for quick identification and are not an official part of the international classification. The full names of international classes are given in section 6.1 of the trademark rules of practice.

The designation "U.S. Cl." appearing in this section refers to the U.S. class in effect prior to Sep. 1, 1973 rather than the international class which applies to applications filed on or after that date. For adoption of international classification see notice in the OFFICIAL GAZETTE of Jun. 26, 1973 (911 O.G. TM 210).

### Application in more than one class

4,047,114. BARKING FISH ENTERTAINMENT, LLC, COVINGTON, KY. SN 77-924,056. FILED P.R. 1-29-2010; AM. S.R. 9-20-2011.

4,047,116. GRAYDAZE CONTRACTING, INC., ALPHARETTA, GA. SN 77-949,142. FILED P.R. 3-3-2010; AM. S.R. 8-31-2011.



THE NAME(S), PORTRAIT(S), AND/OR SIGNATURE(S) SHOWN IN THE MARK IDENTIFIES PETE ROSE, WHOSE CONSENT(S) TO REGISTER IS MADE OF RECORD.

THE MARK CONSISTS OF THE NUMBER "4192" WITH THE SILHOUETTE IMAGE OF A MAN RAISING HIS LEFT ARM, POINTING HIS LEFT INDEX FINGER, INDICATING "NUMBER ONE", HOLDING A BASEBALL CAP IN HIS RIGHT HAND AND THE NUMBER "14" ON HIS CHEST, STANDS IN THE POSITION OF THE "1" IN "4192". BELOW "4192" THE WORDS IN ALL CAPS ARE "THE CROWNING OF THE HIT KING" IN BIG NOODLE TITLING FONT. THE NUMBERS "4192" ARE ALSO IN BIG NOODLE TITLING FONT.

#### CLASS 25—CLOTHING

FOR ATHLETIC APPAREL, NAMELY, SHIRTS, PANTS, JACKETS, FOOTWEAR, HATS AND CAPS, ATHLETIC UNIFORMS (U.S. CLS. 22 AND 39).  
FIRST USE 4-6-2010; IN COMMERCE 4-6-2010.

#### CLASS 28—TOYS AND SPORTING GOODS

FOR BASEBALL BATS; BASEBALLS; GAME APPARATUS, NAMELY, BATS, AND BALLS FOR PLAYING BASEBALL-LIKE INDOOR AND OUTDOOR GAMES (U.S. CLS. 22, 23, 38 AND 50).  
FIRST USE 6-10-2010; IN COMMERCE 7-14-2010.

### COATINGMANAGER

THE MARK CONSISTS OF STANDARD CHARACTERS WITHOUT CLAIM TO ANY PARTICULAR FONT, STYLE, SIZE, OR COLOR.

#### CLASS 9—ELECTRICAL AND SCIENTIFIC APPARATUS

FOR COMPUTER SOFTWARE FOR USE IN CREATING AND MANAGING BUDGETS; COMPUTER SOFTWARE FOR USE IN GATHERING AND MANAGING INFORMATION; DATABASE MANAGEMENT SOFTWARE; SOFTWARE USED IN THE BUDGETING AND PLANNING OF CAPITAL EXPENDITURES FOR PROPERTIES; COMPUTER SOFTWARE FOR MANAGING REQUESTS AND RESPONSES BETWEEN BUYERS AND SELLERS; COMPUTER SOFTWARE FOR MANAGING WARRANTY INFORMATION (U.S. CLS. 21, 23, 26, 36 AND 38).

FIRST USE 6-1-2007; IN COMMERCE 6-1-2007.

#### CLASS 42—SCIENTIFIC AND COMPUTER SERVICES

FOR PROVIDING AN INTERACTIVE WEB SITE THAT ENABLES USERS TO ENTER, ACCESS, TRACK, SEARCH, MONITOR, SCHEDULE AND GENERATE REPORTS REGARDING COATINGS AND SEALANTS FOR INDUSTRIAL PROPERTIES; PROVIDING TEMPORARY USE OF NON-DOWNLOADABLE COMPUTER SOFTWARE FOR ENTERING, ACCESSING, TRACKING, SEARCHING, MONITORING, COST ESTIMATING, PLANNING, SCHEDULING AND GENERATING REPORTS REGARDING COATINGS AND SEALANTS FOR INDUSTRIAL PROPERTIES (U.S. CLS. 100 AND 101).

FIRST USE 6-1-2007; IN COMMERCE 6-1-2007.

4,047,121. 21 ENTERTAINMENT GROUP INC., TORONTO, ONTARIO, CANADA. SN 85-003,206. FILED P.R. 3-31-2010; AM. S.R. 1-17-2011.

4,047,140. CHICOPEE, INC., CHARLOTTE, NC. SN 85-112,269. FILED P.R. 8-20-2010; AM. S.R. 9-12-2011.

## TOP 10 WORKOUTS



THE MARK CONSISTS OF STANDARD CHARACTERS WITHOUT CLAIM TO ANY PARTICULAR FONT, STYLE, SIZE, OR COLOR.

### CLASS 9—ELECTRICAL AND SCIENTIFIC APPARATUS

FOR DOWNLOADABLE PRE-RECORDED AUDIO, VIDEO, TEXT, GRAPHICS, AND RING TONES AND TUNES FROM THE INTERNET TO ALL OUTPUT MEDIA DEVICES INCLUDING AND NOT LIMITED TO ALL MOBILE DEVICES AND COMPUTERS; PRE-RECORDED CDS, DVDS FEATURING INSTRUCTION IN THE FIELD OF EXERCISE AND PHYSICAL FITNESS (U.S. CLS. 21, 23, 26, 36 AND 38).

FIRST USE 1-1-2010; IN COMMERCE 1-1-2010.

### CLASS 35—ADVERTISING AND BUSINESS

FOR PROVIDING AN ONLINE BUSINESS DIRECTORY FEATURING INFORMATION ABOUT FITNESS TRAINERS AND THEIR WORKOUT PROGRAMS; PROVIDING ONLINE CONSUMER TIPS AND GUIDES TO BETTER LIVING; PROMOTING THE GOODS AND SERVICES OF OTHERS; MARKETING SERVICES, NAMELY, DEVELOPING INTEGRATED MARKETING CAMPAIGNS FOR OTHERS; ADVERTISING SERVICES, NAMELY, PLACING AND PREPARING ADVERTISING FOR OTHERS, DISSEMINATION OF ADVERTISING MATERIAL AND IMPLEMENTING DIRECT MAIL CAMPAIGNS (U.S. CLS. 100, 101 AND 102).

FIRST USE 1-1-2010; IN COMMERCE 1-1-2010.

### CLASS 38—COMMUNICATION

FOR PROVIDING ONLINE TELECOMMUNICATION SERVICES, NAMELY, WIRELESS TRANSMISSION VIA COMPUTER NETWORKS FEATURING REAL-TIME INTERACTION AMONG USERS OF COMPUTERS, MOBILE AND HAND-HELD COMPUTERS, WIRED AND WIRELESS COMMUNICATION DEVICES; TRANSMISSION OF MESSAGES VIA EMAIL, INSTANT MESSAGING OR WEBSITE VIA THE INTERNET (U.S. CLS. 100, 101 AND 104).

FIRST USE 1-1-2010; IN COMMERCE 1-1-2010.

### CLASS 41—EDUCATION AND ENTERTAINMENT

FOR PROVIDING ONLINE EXERCISE AND FITNESS PROGRAMS FOR INSTRUCTION RELATING TO PARTICULAR BODY PARTS (U.S. CLS. 100, 101 AND 107).

FIRST USE 1-1-2010; IN COMMERCE 1-1-2010.

THE MARK CONSISTS OF A DESIGN MADE OF A PATTERN OF DIAMONDS CONTINUOUSLY EXTENDING ACROSS THE ENTIRE SURFACE OF THE GOODS, THE LINES BEING READILY DISCERNIBLE AGAINST THE BACKGROUND UPON WHICH THE TRADEMARK APPEARS. THE DESIGN IN ITS ENTIRETY IS THE ESSENTIAL FEATURE OF THE MARK, NO PARTICULAR COLOR OR COMBINATION OF COLORS BEING SIGNIFICANT. THE DOTTED LINES ARE NOT A FEATURE OF THE MARK BUT MERELY INDICATE THAT THE MARK EXTENDS ACROSS THE ENTIRE SURFACE OF THE GOODS.

### CLASS 21—HOUSEWARES AND GLASS

FOR NON-WOVEN DISPOSABLE TEXTILE WIPES NOT IMPREGNATED WITH CHEMICALS OR COMPOUNDS (U.S. CLS. 2, 13, 23, 29, 30, 33, 40 AND 50).

FIRST USE 3-15-1995; IN COMMERCE 3-15-1995.

### CLASS 24—FABRICS

FOR NON-WOVEN TEXTILE FABRICS (U.S. CLS. 42 AND 50).

FIRST USE 3-15-1995; IN COMMERCE 3-15-1995.

4,047,145. THE ANNAPOLIS GROUP, LTD., ANNAPOLIS, MD. SN 85-132,031. FILED P.R. 9-17-2010; AM. S.R. 6-28-2011.

## INSTITUTE FOR ART RISK MANAGEMENT

THE MARK CONSISTS OF STANDARD CHARACTERS WITHOUT CLAIM TO ANY PARTICULAR FONT, STYLE, SIZE, OR COLOR.

**CLASS 35—ADVERTISING AND BUSINESS**

FOR PURCHASING AGENT REPRESENTATION FOR BUYERS IN THE FIELD OF ART; EXCHANGE SERVICES, NAMELY, BARTERING AND EXCHANGING OF ART FOR OTHERS; RETAIL CONSIGNMENT SERVICES IN THE FIELD OF ART; COMMISSIONING THE CREATION OF ART FOR OTHERS; BUSINESS EVALUATION AND COST PRICE ANALYSIS FOR THE ART INDUSTRY; AUCTION SERVICES IN THE FIELD OF ART; CONSULTING SERVICES IN THE FIELD OF COMMERCIAL ADMINISTRATION OF THE LICENSING OF ART OF OTHERS; ART ADVERTISING SERVICES, NAMELY, PREPARING ADVERTISEMENTS FOR OTHERS IN THE FIELD OF ART AND PLACING ADVERTISEMENTS FOR OTHERS IN THE FIELD OF ART; PROVIDING ON-LINE RETAIL STORE SERVICES FEATURING ART AND ART-RELATED MERCHANDISE VIA A GLOBAL COMPUTER NETWORK; PROVIDING ON-LINE MARKETING OF ART AND ART-RELATED MERCHANDISE FOR OTHERS VIA A GLOBAL COMPUTER NETWORK; COMPUTERIZED ON-LINE ART GALLERY SERVICES; COMPUTERIZED ON-LINE ORDERING, BUSINESS CONSULTING AND BUSINESS ADVISORY SERVICES IN THE FIELD OF ART AND ART-RELATED MATERIAL; WHOLESALE DISTRIBUTORSHIP AND DISTRIBUTORSHIP SERVICES FEATURING ART AND ART REPRODUCTIONS; IMPORTING AND EXPORTING OF ART; BUYING AND SELLING OF ART FOR OTHERS; PROMOTION AND SALE OF ART FOR OTHERS BY OPERATING AN ON-LINE MARKETPLACE FOR SELLERS AND PURCHASERS OF ART (U.S. CLS. 100, 101 AND 102).

FIRST USE 4-28-2011; IN COMMERCE 4-28-2011.

**CLASS 36—INSURANCE AND FINANCIAL**

FOR FINANCIAL RISK MANAGEMENT SERVICES FOR THE ART INDUSTRY, ART MUSEUMS, ART FOUNDATIONS, CULTURAL INSTITUTIONS, PRIVATE COLLECTORS, ARTISTS AND ART DEALERS, NAMELY, PROVIDING ADVICE IN THE FIELD OF PROPERTY AND CASUALTY INSURANCE, ART TITLE INSURANCE, AND ART PROVENANCE INSURANCE FOR FINE ART, CULTURAL ARTIFACTS, AND ANTIQUITIES FOR ART; FINANCIAL VALUATION OF PERSONAL PROPERTY FOR OTHERS, NAMELY, ARTWORK; ON-LINE COMPUTER DATABASE VALUATION SERVICES TO ASSIST IN THE SALE PRICE CALCULATION, APPRAISAL, AND VALUATION OF WORKS OF ART; INSURANCE UNDERWRITING IN THE FIELD OF ART; INSURANCE BROKERAGE; INSURANCE CONSULTATION; PROVIDING INSURANCE INFORMATION IN THE FIELD OF ART; FINANCING OF ART FOR OTHERS; ASSET-BASED FINANCING OF ART FOR OTHERS; FINANCIAL CLEARING HOUSE FOR THE FINANCING OF ART; LEASE-PURCHASE LOANS IN THE FIELD OF ART LEASE-PURCHASE FINANCING IN THE FIELD OF ART; CONSULTING IN THE FIELD OF BROKERAGE OF ART; FINANCIAL CONSULTING IN THE FIELD OF ART APPRAISAL FOR THE PURPOSE OF SELLING ART; CONSULTING IN THE FIELD OF VALUATION OF ART; CONSULTING IN THE FIELD OF INSURING ART; CONSULTING IN THE FIELD OF ART APPRAISALS; CONSULTING IN THE FIELD OF FINANCING OF ART; FINANCIAL DUE DILIGENCE IN THE FIELD OF WORKS OF ART; ART APPRAISAL CONSULTING FOR ART COLLECTORS (U.S. CLS. 100, 101 AND 102).

FIRST USE 4-28-2011; IN COMMERCE 4-28-2011.

**CLASS 37—CONSTRUCTION AND REPAIR**

FOR CONSULTATION SERVICES IN THE FIELD OF ART RESTORATION (U.S. CLS. 100, 103 AND 106).

FIRST USE 4-28-2011; IN COMMERCE 4-28-2011.

**CLASS 41—EDUCATION AND ENTERTAINMENT**

FOR EDUCATIONAL SERVICES, NAMELY, TRAINING SEMINARS, CONFERENCES, CLASSES AND WORKSHOPS IN THE FIELD OF ART RISK MANAGEMENT, ART THEFT, AUTHENTICATION OF WORKS OF ART, DUE DILIGENCE RELATING TO WORKS OF ART, THEFT RECOVERY AND ART FRAUD, ART THEFT RISK ASSESSMENT, THREAT SIMULATION VULNERABILITY ANALYSIS AND MITIGATION AND EMERGENCY AND CRISIS RESPONSE, AND PROTECTION AGAINST COPYING, COUNTERFEITING, TAMPERING, DIVERSION, AND THEFT (U.S. CLS. 100, 101 AND 107).

FIRST USE 4-28-2011; IN COMMERCE 4-28-2011.

**CLASS 42—SCIENTIFIC AND COMPUTER SERVICES**

FOR AUTHENTICATION IN THE FIELD OF FINE ART, NAMELY, PROVIDING DUE DILIGENCE PROVENANCE SERVICES FOR FINE ART IN DETERMINING OWNERSHIP ISSUES; SCIENTIFIC RESEARCH CONSULTING SERVICES FOR OTHERS IN THE FIELD OF THE AGE, PROVENANCE, AND HISTORY OF WORKS OF ART; CONSULTATION SERVICES IN THE FIELD OF AUTHENTICATION OF WORKS OF ART; COMPUTER SERVICES, NAMELY, PROVIDING SEARCH ENGINES FOR OBTAINING DATA ON A GLOBAL COMPUTER NETWORK IN THE FIELD OF ART, NAMELY, ARTIST BIOGRAPHIES, ART EXHIBITIONS, ART GALLERIES, WORK TITLES, ART FOR SALE, ART VALUATION, ART FINANCING, AND ART INSURANCE; CONSULTING IN THE FIELD OF AUTHENTICATION OF ART (U.S. CLS. 100 AND 101).

FIRST USE 4-28-2011; IN COMMERCE 4-28-2011.

**CLASS 45—PERSONAL AND LEGAL SERVICES**

FOR COMPILING INVENTORIES OF PERSONAL ART ITEMS FOR OTHERS FOR INSURANCE, PRESERVATION OR SECURITY PURPOSES; CONSULTATION IN THE FIELD OF ART THEFT; PROVIDING INFORMATION TO LOCAL, STATE, FEDERAL AND INTERNATIONAL LAW ENFORCEMENT AGENCIES RELATING TO ART THEFT, RECOVERY AND ART FRAUD; SECURITY SERVICES, NAMELY, THREAT SIMULATION VULNERABILITY ANALYSIS AND MITIGATION AND EMERGENCY AND CRISIS RESPONSE; ASSIGNING IDENTIFYING INFORMATION TO AFFIX TO ARTWORK, COLLECTIBLES, VALUABLES AND OTHER PROPERTY TO FACILITATE ITS RECOVERY FOLLOWING LOSS; SECURITY SERVICES, NAMELY, CONDUCTING RECOVERY OPERATIONS FOR THE RECOVERY OF STOLEN PROPERTY; SECURITY SERVICES, NAMELY, PROVIDING SECURITY ASSESSMENTS OF PHYSICAL LOCATIONS, INFORMATION SYSTEMS, AND WORKING ENVIRONMENTS; SECURITY SERVICES, NAMELY, PROVIDING A LIST AND PHOTOGRAPHS OF WORKS OF ART, COLLECTIBLES, VALUABLES AND OTHER BELONGINGS IN A RESIDENCE AND BUSINESS, AS A RECORD TO THE OWNER OF THE CONTENTS IN THE EVENT OF THEFT, DISASTER OR OTHER CRISIS; AND TITLE SEARCHING; COMPILING ART INVENTORIES OF ART FOR OTHERS FOR INSURANCE AND SECURITY PURPOSES (U.S. CLS. 100 AND 101).

FIRST USE 4-28-2011; IN COMMERCE 4-28-2011.

4,047,162. FOUNDATION FOR INNOVATION AND INTERNET FREEDOM, WASHINGTON, DC. SN 85-172,237. FILED P.R. 11-9-2010; AM. S.R. 8-26-2011.

## Foundation for Innovation and Internet Freedom

THE MARK CONSISTS OF STANDARD CHARACTERS WITHOUT CLAIM TO ANY PARTICULAR FONT, STYLE, SIZE, OR COLOR.

NO CLAIM IS MADE TO THE EXCLUSIVE RIGHT TO USE "FOUNDATION", APART FROM THE MARK AS SHOWN.

### CLASS 35—ADVERTISING AND BUSINESS

FOR PROVIDING INFORMATION ONLINE ABOUT POLITICAL ISSUES IN THE FIELD OF ONLINE FREEDOM OF SPEECH AND ONLINE FREEDOM OF EXPRESSION TO PROMOTE ONLINE INNOVATION AND FREEDOM (U.S. CLS. 100, 101 AND 102).

FIRST USE 8-23-2011; IN COMMERCE 8-23-2011.

### CLASS 41—EDUCATION AND ENTERTAINMENT

FOR EDUCATION SERVICES, NAMELY, PROVIDING LECTURES, WORKSHOPS AND SEMINARS IN THE FIELDS OF ONLINE FREEDOM OF SPEECH AND ONLINE FREEDOM OF EXPRESSION TO PROMOTE ONLINE INNOVATION AND FREEDOM FOR OTHERS (U.S. CLS. 100, 101 AND 107).

FIRST USE 8-23-2011; IN COMMERCE 8-23-2011.

---

4,047,171. NRRM, LLC, ST. PETERS, MO. SN 85-181,500. FILED P.R. 11-19-2010; AM. S.R. 8-29-2011.

## AUTOGOLDCARD

THE MARK CONSISTS OF STANDARD CHARACTERS WITHOUT CLAIM TO ANY PARTICULAR FONT, STYLE, SIZE, OR COLOR.

### CLASS 35—ADVERTISING AND BUSINESS

FOR ADMINISTRATION OF A PROGRAM FOR ENABLING PARTICIPANTS TO OBTAIN DISCOUNTS ON AUTOMOTIVE REPAIR SERVICES (U.S. CLS. 100, 101 AND 102).

FIRST USE 11-9-2009; IN COMMERCE 11-9-2009.

### CLASS 37—CONSTRUCTION AND REPAIR

FOR EMERGENCY ROADSIDE ASSISTANCE SERVICES, NAMELY, RESPONDING TO CALLS FOR ROADSIDE ASSISTANCE, FLAT TIRE CHANGING, EMERGENCY FUEL SUPPLYING, AND BATTERY JUMP STARTING (U.S. CLS. 100, 103 AND 106).

FIRST USE 11-9-2009; IN COMMERCE 11-9-2009.

4,047,192. BOTTOM LINE FOOD PROCESSORS, INC., DBA MICHAEL ANGELO'S GOURMET FOODS, INC., AUSTIN, TX. SN 85-199,006. FILED P.R. 12-15-2010; AM. S.R. 8-22-2011.

## ITALIAN NATURAL CUISINE

THE MARK CONSISTS OF STANDARD CHARACTERS WITHOUT CLAIM TO ANY PARTICULAR FONT, STYLE, SIZE, OR COLOR.

NO CLAIM IS MADE TO THE EXCLUSIVE RIGHT TO USE "CUISINE", APART FROM THE MARK AS SHOWN.

### CLASS 29—MEATS AND PROCESSED FOODS

FOR PREPARED FROZEN ENTREES CONSISTING PRIMARILY OF POULTRY, MEATS OR COOKED VEGETABLES WITH ONE OR MORE OF PASTAS, LASAGNAS, SPAGHETTIS, NOODLES, RICE, TOMATO SAUCE, PIZZA SAUCE OR SPAGHETTI SAUCE (U.S. CL. 46).

FIRST USE 3-0-2011; IN COMMERCE 3-0-2011.

### CLASS 30—STAPLE FOODS

FOR PREPARED FROZEN ENTREES CONSISTING PRIMARILY OF PASTAS, LASAGNAS, SPAGHETTIS, NOODLES, AND RICES WITH ONE OR MORE OF TOMATO SAUCE, PIZZA SAUCE, SPAGHETTI SAUCE, POULTRY, MEATS OR COOKED VEGETABLES (U.S. CL. 46).

FIRST USE 3-0-2011; IN COMMERCE 3-0-2011.

---

4,047,201. T&B ENTERPRISES INC., GARDNER, KS. SN 85-231,407. FILED P.R. 2-1-2011; AM. S.R. 4-30-2011.

## Specialized Logistics

THE MARK CONSISTS OF STANDARD CHARACTERS WITHOUT CLAIM TO ANY PARTICULAR FONT, STYLE, SIZE, OR COLOR.

NO CLAIM IS MADE TO THE EXCLUSIVE RIGHT TO USE "LOGISTICS", APART FROM THE MARK AS SHOWN.

### CLASS 35—ADVERTISING AND BUSINESS

FOR AD SERVING, NAMELY, PLACING ADVERTISEMENTS ON WEBSITES FOR OTHERS USING SPECIALIZED COMPUTER SOFTWARE; ADVERTISING AGENCY SPECIALIZING IN THE DESIGN AND EXECUTION OF WORD OF MOUTH, VIRAL, BUZZ AND EXPERIENTIAL MARKETING PROGRAMS; ADVERTISING SERVICES, NAMELY, PRODUCTION OF SPECIAL EFFECTS INCLUDING MODEL-MAKING SERVICES, COMPUTER-GENERATED IMAGERY AND COMPUTER-GENERATED GRAPHICS FOR THE PRODUCTION OF COMMERCIALS; AN INTERACTIVE WEB SITE FOR USERS TO REVIEW AND RATE INTERNET CONTENT, PEOPLE, COMPANIES, PRODUCTS AND/OR SERVICES UTILIZING A SOFTWARE APPLICATION TO AWARD POINTS WHEREBY WEB SITE USERS ARE ELIGIBLE TO EXCHANGE POINTS EARNED FOR PROMOTIONAL

ITEMS CONSISTING OF COUPONS, REBATES, DISCOUNTS OR SPECIAL OFFERINGS ON GOODS AND/OR SERVICE PROVIDED BY WEB SITE SPONSORS; ARRANGING AND CONDUCTING SPECIAL EVENTS FOR BUSINESS PURPOSES; ARRANGING AND CONDUCTING SPECIAL EVENTS FOR COMMERCIAL, PROMOTIONAL OR ADVERTISING PURPOSES; BUSINESS CONSULTING SERVICES RELATING TO PRODUCT DISTRIBUTION, OPERATIONS MANAGEMENT SERVICES, LOGISTICS, REVERSE LOGISTICS, SUPPLY CHAIN, AND PRODUCTION SYSTEMS AND DISTRIBUTION SOLUTIONS; BUSINESS MANAGEMENT CONSULTANCY IN THE FIELD OF INSOURCING, NAMELY, ASSISTING BUSINESSES IN THE DEVELOPMENT OF PROCESSES FOR THE ANALYSIS AND THE IMPLEMENTATION OF THE DELEGATION OF OPERATIONS OR JOBS FROM PRODUCTION WITHIN A BUSINESS TO AN INTERNAL ENTITY THAT SPECIALIZES IN THAT OPERATION; BUSINESS MANAGEMENT CONSULTING WITH RELATION TO STRATEGY, MARKETING, SALES, OPERATION, PRODUCT DESIGN PARTICULARLY SPECIALIZING IN THE USE OF ANALYTIC AND STATISTIC MODELS FOR THE UNDERSTANDING AND PREDICTING OF CONSUMERS, BUSINESSES, AND MARKET TRENDS AND ACTIONS; BUSINESS MANAGEMENT SERVICES, NAMELY, MANAGING LOGISTICS, REVERSE LOGISTICS, SUPPLY CHAIN SERVICES, SUPPLY CHAIN VISIBILITY AND SYNCHRONIZATION, SUPPLY AND DEMAND FORECASTING AND PRODUCT DISTRIBUTION PROCESSES FOR OTHERS; BUSINESS MANAGEMENT SERVICES, NAMELY, SUPPLY CHAIN LOGISTICS, REVERSE LOGISTICS AND LIQUIDATION OF GOODS OF OTHERS; BUSINESS MONITORING AND CONSULTING SERVICES, NAMELY, TRACKING WEB SITES AND APPLICATIONS OF OTHERS TO PROVIDE STRATEGY, INSIGHT, MARKETING, SALES, OPERATION, PRODUCT DESIGN, PARTICULARLY SPECIALIZING IN THE USE OF ANALYTIC AND STATISTIC MODELS FOR THE UNDERSTANDING AND PREDICTING OF CONSUMERS, BUSINESSES, AND MARKET TRENDS AND ACTIONS; COMMERCIAL MAIL RECEIVING AGENCY, NAMELY, PROVIDING SPECIALIZED MAIL MANAGEMENT SERVICES; CONSUMER STRATEGY BUSINESS CONSULTING IN THE FIELDS OF MARKETING, SALES, OPERATION, AND PRODUCT DESIGN PARTICULARLY SPECIALIZING IN THE USE OF ANALYTIC MODELS FOR THE UNDERSTANDING AND PREDICTING OF CONSUMER, BUSINESS, AND RETAIL MARKET TRENDS AND ACTIONS; FREIGHT LOGISTICS MANAGEMENT; LOGISTICS MANAGEMENT IN THE FIELD OF CONSUMER, INDUSTRIAL, AND COMMERCIAL PRODUCTS; MARKETING AND CONSULTING SERVICES IN THE FIELD OF PROMOTING AND TRACKING THE GOODS, SERVICES, AND BRANDS OF OTHERS THROUGH ALL PUBLIC COMMUNICATION MEANS, PARTICULARLY SPECIALIZING IN THE USE OF MOBILE, SOCIAL, AND PRINT MEDIA TO DRIVE CONSUMER INTEREST, ENGAGEMENT AND ACTION; PROMOTING THE GOODS OF OTHERS, NAMELY, PROVIDING INFORMATION REGARDING DISCOUNTS, COUPONS, REBATES, VOUCHERS AND SPECIAL OFFERS FOR THE GOODS OF OTHERS; PROVIDING MARKETING AND PROMOTION OF SPECIAL EVENTS; SPECIAL EVENT PLANNING FOR BUSINESS PURPOSES; SPECIAL EVENT PLANNING FOR COMMERCIAL, PROMOTIONAL OR ADVERTISING PURPOSES; THE BRINGING TOGETHER, FOR THE BENEFIT OF OTHERS, OF A VARIETY OF GOODS AND SERVICES, ENABLING CUSTOMERS TO CONVENIENTLY VIEW AND PURCHASE THOSE GOODS AND SERVICES FROM AN INTERNET WEB SITE PARTICULARLY SPECIALIZING IN THE MARKETING OF THE SALE OF GOODS AND SERVICES OF OTHERS; TRANSPORTATION LOGISTICS SERVICES, NAMELY, ARRANGING THE TRANSPORTATION OF GOODS FOR OTHERS; TRANSPORTATION LOGISTICS SERVICES, NAMELY, PLANNING AND SCHEDULING SHIPMENTS FOR USERS OF TRANSPORTATION SERVICES (U.S. CLS. 100, 101 AND 102).

FIRST USE 7-1-1993; IN COMMERCE 7-1-1993.

### CLASS 39—TRANSPORTATION AND STORAGE

FOR SUPPLY CHAIN LOGISTICS AND REVERSE LOGISTICS SERVICES, NAMELY, STORAGE, TRANSPORTATION AND DELIVERY OF DOCUMENTS, PACKAGES, RAW MATERIALS, AND OTHER FREIGHT FOR OTHERS BY AIR, RAIL, SHIP OR TRUCK; SUPPLY CHAIN LOGISTICS AND REVERSE LOGISTICS SERVICES, NAMELY, STORAGE, TRANSPORTATION AND DELIVERY OF GOODS FOR OTHERS BY AIR, RAIL, SHIP OR TRUCK (U.S. CLS. 100 AND 105).

FIRST USE 7-1-1993; IN COMMERCE 7-1-1993.

4,047,202. HURLEY, BRYAN, MT. DORA, FL. SN 85-239,236. FILED P.R. 2-10-2011; AM. S.R. 9-12-2011.

### THE GREAT AMERICAN COOKWARE COMPANY

THE MARK CONSISTS OF STANDARD CHARACTERS WITHOUT CLAIM TO ANY PARTICULAR FONT, STYLE, SIZE, OR COLOR.

NO CLAIM IS MADE TO THE EXCLUSIVE RIGHT TO USE "AMERICAN COOKWARE COMPANY", APART FROM THE MARK AS SHOWN.

### CLASS 11—ENVIRONMENTAL CONTROL APPARATUS

FOR ELECTRIC GRIDDLES; ELECTRIC SLOW COOKERS (U.S. CLS. 13, 21, 23, 31 AND 34).

FIRST USE 3-1-2011; IN COMMERCE 3-1-2011.

### CLASS 21—HOUSEWARES AND GLASS

FOR BAKEWARE; CHOPPING BOARDS FOR KITCHEN USE; COOKIE CUTTERS; COOKIE SHEETS; COOKWARE, NAMELY, SAUCEPANS, POTS, PANS, SKILLETS, RICERS, STEAMERS, STRAINERS, PASTA BASKETS, DUTCH OVENS, NON-ELECTRIC GRIDDLES, ROASTING PANS, AND NON-ELECTRIC SLOW COOKERS; HOUSEHOLD UTENSILS, NAMELY, LADLES, SPATULAS, TONGS, SERVING FORKS, PASTA FORKS AND SERVING SPOONS; NON-ELECTRIC JUICERS (U.S. CLS. 2, 13, 23, 29, 30, 33, 40 AND 50).

FIRST USE 3-1-2011; IN COMMERCE 3-1-2011.

4,047,207. TWELVE DOORS, LLC, ALBANY, NY. SN 85-249,162. FILED P.R. 2-23-2011; AM. S.R. 8-31-2011.

### WORLD'S FINEST CONVERTIBLE FURNITURE

THE MARK CONSISTS OF STANDARD CHARACTERS WITHOUT CLAIM TO ANY PARTICULAR FONT, STYLE, SIZE, OR COLOR.

NO CLAIM IS MADE TO THE EXCLUSIVE RIGHT TO USE "CONVERTIBLE FURNITURE", APART FROM THE MARK AS SHOWN.



**CLASS 20—FURNITURE AND ARTICLES NOT OTHERWISE CLASSIFIED**

FOR FURNITURE (U.S. CLS. 2, 13, 22, 25, 32 AND 50).  
FIRST USE 6-0-2010; IN COMMERCE 6-0-2010.

**CLASS 35—ADVERTISING AND BUSINESS**

FOR DISTRIBUTORSHIP SERVICES IN THE FIELD OF FURNITURE (U.S. CLS. 100, 101 AND 102).  
FIRST USE 6-0-2010; IN COMMERCE 6-0-2010.

**CLASS 40—MATERIAL TREATMENT**

FOR MANUFACTURING SERVICES FOR OTHERS IN THE FIELD OF FURNITURE (U.S. CLS. 100, 103 AND 106).  
FIRST USE 6-0-2010; IN COMMERCE 6-0-2010.

**CLASS 35—ADVERTISING AND BUSINESS**

FOR PROVIDING A WEBSITE FEATURING COMMENTARY AND ANALYSIS IN THE FIELD OF GOVERNMENT AFFAIRS CONCERNING TAX AND FISCAL POLICIES AND LEGISLATION (U.S. CLS. 100, 101 AND 102).  
FIRST USE 8-5-2009; IN COMMERCE 8-5-2009.

**CLASS 41—EDUCATION AND ENTERTAINMENT**

FOR EDUCATIONAL SERVICES, NAMELY, PROVIDING SPEECHES AND ORAL PRESENTATIONS TO OTHERS IN THE FIELD OF LEGISLATION, PUBLIC POLICY, SOCIAL PROGRAMS AND INVESTMENT STRATEGIES (U.S. CLS. 100, 101 AND 107).  
FIRST USE 8-5-2009; IN COMMERCE 8-5-2009.

---

4,047,217. PONCE DECK, LLC, ALPHARETTA, GA. SN 85-267,751. FILED P.R. 3-15-2011; AM. S.R. 8-29-2011.

---

4,047,232. HEINRICH HAHNE GMBH & CO. KG, 45711 DATTELN, FED REP GERMANY. SN 85-293,397. FILED P.R. 4-12-2011; AM. S.R. 9-7-2011.

# DECKARD'S

THE MARK CONSISTS OF STANDARD CHARACTERS WITHOUT CLAIM TO ANY PARTICULAR FONT, STYLE, SIZE, OR COLOR.

**CLASS 25—CLOTHING**

FOR T-SHIRTS (U.S. CLS. 22 AND 39).  
FIRST USE 9-1-2010; IN COMMERCE 9-1-2010.

**CLASS 43—HOTEL AND RESTAURANT SERVICES**

FOR RESTAURANT AND BAR SERVICES (U.S. CLS. 100 AND 101).  
FIRST USE 9-1-2010; IN COMMERCE 9-1-2010.

---

4,047,221. THE WASHINGTON UPDATE, LLC, MCLEAN, VA. SN 85-278,639. FILED P.R. 3-28-2011; AM. S.R. 7-13-2011.

# THE WASHINGTON UPDATE

THE MARK CONSISTS OF STANDARD CHARACTERS WITHOUT CLAIM TO ANY PARTICULAR FONT, STYLE, SIZE, OR COLOR.

# hahne

THE MARK CONSISTS OF STANDARD CHARACTERS WITHOUT CLAIM TO ANY PARTICULAR FONT, STYLE, SIZE, OR COLOR.

OWNER OF FED REP GERMANY REG. NO. 39850517, DATED 10-27-1998, EXPIRES 9-30-2018.

**CLASS 1—CHEMICALS**

FOR ARTIFICIAL RESINS FOR BUILDING, IMPREGNATING PREPARATIONS FOR BUILDING, NAMELY, WATERPROOFING CHEMICAL COMPOSITIONS FOR ARTICLES OF MASONRY, WOOD AND OTHER BUILDING AND/OR CONSTRUCTION SURFACES; ADHESIVES USED IN INDUSTRY, NAMELY, CONSTRUCTION AND STRUCTURAL ADHESIVES; CHEMICAL ADDITIVES FOR USE IN THE MANUFACTURE OF CEMENT, MORTAR AND CONCRETE AND RELEASE AGENTS, NAMELY, MOLD RELEASE COMPOUNDS FOR USE IN CONCRETE FABRICATION (U.S. CLS. 1, 5, 6, 10, 26 AND 46).

**CLASS 2—PAINTS**

FOR BITUMEN, PAINTS, LACQUERS, AND IMPREGNATING PREPARATIONS FOR PAINTING PURPOSES, NAMELY, WEATHERPROOFING COATINGS, WATER-PROOF PAINTS, COATING PREPARATIONS HAVING WATER REPELLENT PROPERTIES, FLOOR COATINGS, CONCRETE SEALERS IN THE FORM OF COATINGS, CONCRETE MOISTURE BARRIER COATING, STONE SEALER COATINGS (U.S. CLS. 6, 11 AND 16).

**CLASS 17—RUBBER GOODS**

FOR PACKING, STOPPING AND INSULATING MATERIALS, NAMELY, FOAM INSULATION, WITH A PLASTIC BASE, FOR USE IN BUILDING AND CONSTRUCTION, BUILDING INSULATION, INSULATING MATERIALS, INSULATING PLASTER, INSULATING PAINT, ELASTIC JOINT SEALANTS FOR BUILDINGS, GAP-FILLING COMPOSITIONS, NAMELY, EXPANSION JOINT FILLERS AND SEALANTS FOR BUILDINGS, MINERAL-SEALING MATERIAL, NAMELY, MINERAL SEALANTS FOR BUILDINGS AND PORE-SEALANT FOR NATURAL STONES (U.S. CLS. 1, 5, 12, 13, 35 AND 50).

**CLASS 19—NON-METALLIC BUILDING MATERIALS**

FOR NON-METALLIC BUILDING MATERIALS, NAMELY, CEMENT, READY-MIXED MORTAR, READY-MIXED CONCRETE, READY-MIXED SCREED AND PLASTER, NATURAL STONES, QUARTZ, ALL IN PARTICULAR BEING DRY BUILDING MATERIALS; ADDITIVES FOR CEMENT, NAMELY, CEMENT AGGREGATES; BITUMEN, BITUMINOUS PRODUCTS FOR BUILDING, NAMELY, BITUMEN STRIPS, BITUMEN-BASED ROOFING SEALANTS, BITUMINOUS ROOF COATINGS, ROOFING FELTS (U.S. CLS. 1, 12, 33 AND 50).

4,047,243. CASCO MEDIA, CORP., BILLERICA, MA. SN 85-312,090. FILED P.R. 5-4-2011; AM. S.R. 9-7-2011.

**CARD NOT PRESENT**

THE MARK CONSISTS OF STANDARD CHARACTERS WITHOUT CLAIM TO ANY PARTICULAR FONT, STYLE, SIZE, OR COLOR.

**CLASS 35—ADVERTISING AND BUSINESS**

FOR ADVERTISING SERVICES, NAMELY, PROMOTING THE GOODS AND SERVICES OF OTHERS BY DISTRIBUTING ADVERTISEMENTS ON A WEBSITE (U.S. CLS. 100, 101 AND 102).  
FIRST USE 5-8-2010; IN COMMERCE 5-8-2010.

**CLASS 38—COMMUNICATION**

FOR STREAMING OF AUDIO MATERIAL ON THE INTERNET (U.S. CLS. 100, 101 AND 104).  
FIRST USE 5-8-2010; IN COMMERCE 5-8-2010.

**CLASS 41—EDUCATION AND ENTERTAINMENT**

FOR ONLINE PUBLICATION OF NEWS ARTICLES IN THE FIELD OF CONSUMER AND BUSINESS CARD NOT PRESENT TRANSACTIONS (U.S. CLS. 100, 101 AND 107).  
FIRST USE 5-8-2010; IN COMMERCE 5-8-2010.

4,047,247. THE MRS. NETWORK LLC, SHOREWOOD, MN. SN 85-315,712. FILED P.R. 5-9-2011; AM. S.R. 9-2-2011.

**DIY Weddings**

THE MARK CONSISTS OF STANDARD CHARACTERS WITHOUT CLAIM TO ANY PARTICULAR FONT, STYLE, SIZE, OR COLOR.

**CLASS 9—ELECTRICAL AND SCIENTIFIC APPARATUS**

FOR DIGITAL MATERIALS, NAMELY, DOWNLOADABLE ELECTRONIC MAGAZINES FEATURING THE SUBJECT OF WEDDINGS (U.S. CLS. 21, 23, 26, 36 AND 38).  
FIRST USE 1-1-2010; IN COMMERCE 9-1-2010.

**CLASS 16—PAPER GOODS AND PRINTED MATTER**

FOR MAGAZINES FEATURING THE SUBJECT OF WEDDINGS (U.S. CLS. 2, 5, 22, 23, 29, 37, 38 AND 50).  
FIRST USE 1-1-2010; IN COMMERCE 9-1-2010.

\* \* \* \* \*

## SECTION 2.— INTERNATIONAL CLASSIFICATION

The short titles associated below with the international class numbers are terms designed merely for quick identification and are not an official part of the international classification. The full names of international classes are given in section 6.1 of the trademark rules of practice.

The designation "U.S. Cl." appearing in this section refers to the U.S. class in effect prior to Sep. 1, 1973 rather than the international class which applies to applications filed on or after that date. For adoption of international classification see notice in the OFFICIAL GAZETTE of Jun. 26, 1973 (911 O.G. TM 210).

### Application in one class

#### CLASS 1—CHEMICALS

4,047,109. SHAMMAS, MILO, WINTERS, CA. SN 76-706,449. FILED P.R. 2-17-2011; AM. S.R. 8-24-2011.

#### CLASS 1—(Continued).

4,047,225. SEACHEM LABORATORIES, INC., MADISON, GA. SN 85-285,053. FILED P.R. 4-4-2011; AM. S.R. 9-6-2011.

### **ADVANCED ORGANICS**

THE MARK CONSISTS OF STANDARD CHARACTERS WITHOUT CLAIM TO ANY PARTICULAR FONT, STYLE, SIZE, OR COLOR.

FOR ORGANIC AMMONIUM CHLORIDE FERTILIZER; ORGANIC AMMONIUM NITRATE FERTILIZER; ORGANIC AMMONIUM SULPHATE FERTILIZER; ORGANIC BLOOD POWDER; ORGANIC BONE MEAL; ORGANIC BREWERS' GRAIN; ORGANIC CALCINED POTASSIUM FERTILIZER; ORGANIC CALCIUM SILICATE FERTILIZER; ORGANIC CALCIUM SUPERPHOSPHATE FERTILIZER; ORGANIC CHEMICAL FERTILIZERS; ORGANIC CHEMICALLY CONVERTED COMPOUND FERTILIZERS; ORGANIC COMPLEX FERTILIZER; ORGANIC COMPLEX FERTILIZERS; ORGANIC COMPOST; ORGANIC DOUBLE OR TRIPLE SUPERPHOSPHATE FERTILIZER; ORGANIC FERTILIZERS; ORGANIC FERTILIZERS AND MANURES; ORGANIC FERTILIZERS FOR AGRICULTURAL USE; ORGANIC FERTILIZERS FOR DOMESTIC USE; ORGANIC FERTILIZING PREPARATIONS; ORGANIC GYPSUM FOR USE AS A FERTILIZER; ORGANIC LEAF MOLD; ORGANIC MANGANESE FERTILIZER; ORGANIC MARINE FERTILIZER; ORGANIC MIXED FERTILIZERS; ORGANIC NATURAL FERTILIZERS; ORGANIC NON-CHEMICAL LIE-FERTILIZERS; ORGANIC NUTRITIVE ADDITIVE TO ENHANCE THE BIOLOGICAL ACTIVITY OF WATER, SOIL, SEEDS AND PLANTS FOR PURPOSES OF FERTILIZATION AND BIO REMEDIATION OF POLLUTANTS; ORGANIC PEAT; ORGANIC POTASSIUM CHLORIDE FERTILIZER; ORGANIC POTASSIUM SULPHATE FERTILIZER; ORGANIC RICE BRAN; ORGANIC SODIUM NITRATE FERTILIZER; ORGANIC THOMAS PHOSPHATIC FERTILIZER; ORGANIC UREA FERTILIZER (U.S. CLS. 1, 5, 6, 10, 26 AND 46).

FIRST USE 12-17-2007; IN COMMERCE 12-17-2007.

# salinity

THE MARK CONSISTS OF STANDARD CHARACTERS WITHOUT CLAIM TO ANY PARTICULAR FONT, STYLE, SIZE, OR COLOR.

FOR WATER CONDITIONER FOR USE IN AQUARIUMS (U.S. CLS. 1, 5, 6, 10, 26 AND 46).

FIRST USE 12-10-2009; IN COMMERCE 12-10-2009.

---

#### CLASS 3—COSMETICS AND CLEANING PREPARATIONS

4,047,112. AROMA VENTURES, LLC, DALLAS, TX. SN 77-820,442. FILED P.R. 9-4-2009; AM. S.R. 8-22-2011.

# Black Magic Smoke

THE MARK CONSISTS OF STANDARD CHARACTERS WITHOUT CLAIM TO ANY PARTICULAR FONT, STYLE, SIZE, OR COLOR.

FOR INCENSE (U.S. CLS. 1, 4, 6, 50, 51 AND 52).

FIRST USE 4-7-2010; IN COMMERCE 4-7-2010.

**CLASS 3—(Continued).**

4,047,123. COMMANDER INTERNATIONAL, INC., LOS ANGELES, CA. SN 85-014,693. FILED P.R. 4-15-2010; AM. S.R. 8-16-2011.

**4-IN-1**

THE MARK CONSISTS OF STANDARD CHARACTERS WITHOUT CLAIM TO ANY PARTICULAR FONT, STYLE, SIZE, OR COLOR.

FOR AUTOMOBILE AND CAR WAX PREPARATIONS; AUTOMOBILE CLEANERS; AUTOMOBILE POLISH; AUTOMOTIVE CLEANING PREPARATIONS (U.S. CLS. 1, 4, 6, 50, 51 AND 52).

FIRST USE 7-31-2011; IN COMMERCE 7-31-2011.

**CLASS 5—PHARMACEUTICALS**

4,047,118. CYTOSPORT, INC., BENICIA, CA. SN 77-960,437. FILED P.R. 3-16-2010; AM. S.R. 7-7-2011.

**MUSCLE N.O.**

THE MARK CONSISTS OF STANDARD CHARACTERS WITHOUT CLAIM TO ANY PARTICULAR FONT, STYLE, SIZE, OR COLOR.

NO CLAIM IS MADE TO THE EXCLUSIVE RIGHT TO USE "NO", APART FROM THE MARK AS SHOWN.

FOR DIETARY AND NUTRITIONAL SUPPLEMENTS; DIETARY AND NUTRITIONAL SUPPLEMENTS CONTAINING NITRIC OXIDE; POWDERED NUTRITIONAL SUPPLEMENT DRINK MIX (U.S. CLS. 6, 18, 44, 46, 51 AND 52).

FIRST USE 5-10-2010; IN COMMERCE 5-10-2010.

4,047,163. GOUGHNOUR, SHEILA A, DBA FARGO IMPORTS, FARGO, ND. SN 85-172,354. FILED P.R. 11-9-2010; AM. S.R. 8-20-2011.

**Smelly Shoe Spray**

THE MARK CONSISTS OF STANDARD CHARACTERS WITHOUT CLAIM TO ANY PARTICULAR FONT, STYLE, SIZE, OR COLOR.

NO CLAIM IS MADE TO THE EXCLUSIVE RIGHT TO USE "SHOE SPRAY", APART FROM THE MARK AS SHOWN.

FOR SHOE DEODORIZERS (U.S. CLS. 6, 18, 44, 46, 51 AND 52).

FIRST USE 7-15-2010; IN COMMERCE 8-4-2010.

**CLASS 5—(Continued).**

4,047,180. NUTRASOURCE LLC, MIAMI, FL. SN 85-189,037. FILED P.R. 12-2-2010; AM. S.R. 9-13-2011.

**CARDIOCORE**

THE MARK CONSISTS OF STANDARD CHARACTERS WITHOUT CLAIM TO ANY PARTICULAR FONT, STYLE, SIZE, OR COLOR.

FOR DIETARY SUPPLEMENTS CONSISTING OF VITAMINS, MINERALS, HERBS, FIBER, NUTRACEUTICALS, OR PROTEIN IN TABLET, POWDER, CAPSULE OR LIQUID FORM, NUTRITIONAL DRINK MIXES (U.S. CLS. 6, 18, 44, 46, 51 AND 52).

FIRST USE 4-21-2011; IN COMMERCE 4-21-2011.

4,047,181. NUTRASOURCE LLC, MIAMI, FL. SN 85-189,039. FILED P.R. 12-2-2010; AM. S.R. 9-9-2011.

**HEALTHY CORE**

THE MARK CONSISTS OF STANDARD CHARACTERS WITHOUT CLAIM TO ANY PARTICULAR FONT, STYLE, SIZE, OR COLOR.

FOR DIETARY SUPPLEMENTS CONSISTING OF VITAMINS, MINERALS, HERBS, FIBER, NUTRACEUTICALS, OR PROTEIN IN TABLET, POWDER, CAPSULE OR LIQUID FORM, NUTRITIONAL DRINK MIXES (U.S. CLS. 6, 18, 44, 46, 51 AND 52).

FIRST USE 4-21-2011; IN COMMERCE 4-21-2011.

4,047,183. PRIMARY INVESTMENTS GROUP LIMITED, ROAD TOWN, TORTOLA, BR.VIRGIN ISLANDS. SN 85-190,626. FILED P.R. 12-3-2010; AM. S.R. 8-17-2011.

**FOLLICLE & SCALP FORMULA  
HAIR FOR MEN**

THE MARK CONSISTS OF STANDARD CHARACTERS WITHOUT CLAIM TO ANY PARTICULAR FONT, STYLE, SIZE, OR COLOR.

FOR DIETARY SUPPLEMENTS; FOOD SUPPLEMENTS; HERBAL SUPPLEMENTS; NUTRITIONAL SUPPLEMENTS; VITAMIN SUPPLEMENTS; MINERAL SUPPLEMENTS; MULTI-VITAMIN AND MINERAL SUPPLEMENTS (U.S. CLS. 6, 18, 44, 46, 51 AND 52).

FIRST USE 4-7-2011; IN COMMERCE 4-27-2011.

**CLASS 5—(Continued).**

4,047,203. SCHEL, CHARLES L., MCCORMICK, SC. SN 85-239,855. FILED P.R. 2-11-2011; AM. S.R. 7-1-2011.

# D'SOLVE

THE MARK CONSISTS OF STANDARD CHARACTERS WITHOUT CLAIM TO ANY PARTICULAR FONT, STYLE, SIZE, OR COLOR.

FOR DIETARY AND NUTRITIONAL SUPPLEMENTS (U.S. CLS. 6, 18, 44, 46, 51 AND 52).

FIRST USE 2-11-2011; IN COMMERCE 6-14-2011.

**CLASS 6—METAL GOODS**

4,047,158. THE DELANEY CO., CUMMING, GA. SN 85-159,963. FILED P.R. 10-25-2010; AM. S.R. 8-10-2011.

# CANOVA

THE MARK CONSISTS OF STANDARD CHARACTERS WITHOUT CLAIM TO ANY PARTICULAR FONT, STYLE, SIZE, OR COLOR.

FOR METAL HARDWARE, NAMELY, DOOR KNOBS (U.S. CLS. 2, 12, 13, 14, 23, 25 AND 50).

FIRST USE 8-8-2011; IN COMMERCE 8-8-2011.

4,047,245. WALLINGFORD'S, INC., OAKLAND, ME. SN 85-313,293. FILED 5-5-2011.

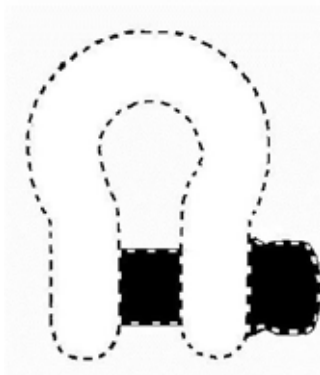

THE COLOR(S) BLACK IS/ARE CLAIMED AS A FEATURE OF THE MARK.

**CLASS 6—(Continued).**

THE MARK CONSISTS OF THE COLOR BLACK AS APPLIED TO THE ENTIRETY OF THE GOODS. THE DRAWING DEPICTS A SHACKLE PIN INSERTED INTO A SHACKLE. THE DOTTED OUTLINE OF THE DRAWING IS INTENDED TO SHOW THE POSITION OF THE MARK ON THE GOODS AND IS NOT PART OF THE MARK.

FOR METAL SHACKLE PINS, NAMELY, METAL PINS FOR INDUSTRIAL CHAIN AND CABLE SHACKLES, INDUSTRIAL CHAIN AND CABLE HOOKS AND INDUSTRIAL CHAIN AND CABLE CLEVISES; METAL BOLTS FOR CHOKER CHAIN ASSEMBLIES; METAL PIN HOOKS FOR CHOKER CHAIN ASSEMBLIES (U.S. CLS. 2, 12, 13, 14, 23, 25 AND 50).

FIRST USE 2-1-2011; IN COMMERCE 2-3-2011.

**CLASS 7—MACHINERY**

4,047,136. ADVANCED MANUFACTURING TECHNOLOGY FOR BOTTLES INC, LOVELAND, CO. SN 85-084,753. FILED P.R. 7-14-2010; AM. S.R. 8-8-2011.

# Anysize

THE MARK CONSISTS OF STANDARD CHARACTERS WITHOUT CLAIM TO ANY PARTICULAR FONT, STYLE, SIZE, OR COLOR.

FOR CONVEYER BELTS; CONVEYERS (U.S. CLS. 13, 19, 21, 23, 31, 34 AND 35).

FIRST USE 4-10-2008; IN COMMERCE 4-10-2008.

4,047,262. JOSEPH WARRENDER, HIGHLAND PARK, IL. SN 85-333,824. FILED 5-31-2011.

# M Pumps

THE MARK CONSISTS OF STANDARD CHARACTERS WITHOUT CLAIM TO ANY PARTICULAR FONT, STYLE, SIZE, OR COLOR.

FOR AC VARIABLE FREQUENCY DRIVES THAT ARE USED TO CONTROL SMALL AND MEDIUM-SIZED MOTORS IN APPLICATIONS SUCH AS MANUFACTURING PROCESSES, HVAC AND PUMPS; AQUARIUM PUMPS; BIODIESEL-GENERATION MACHINES, NAMELY, MIXING EQUIPMENT, PUMPS AND HEATERS; CENTRIFUGAL PUMPS; HIGH-PRESSURE PUMPS FOR WASHING APPLIANCES AND INSTALLATIONS; MOTORS AND PUMPS FOR REFRIGERATORS AND FREEZERS; POSITIVE DISPLACEMENT PUMPS; PUMPS FOR THE BEVERAGE INDUSTRY; PUMPS FOR MACHINES; REFRIGERANT RECOVERY PUMPS; REVERSE OSMOSIS PUMPS; ROTARY PUMPS; SUCTION PUMPS; SUMP PUMPS (U.S. CLS. 13, 19, 21, 23, 31, 34 AND 35).

FIRST USE 1-1-1988; IN COMMERCE 2-15-1988.

**CLASS 8—HAND TOOLS**

**CLASS 8—(Continued).**

4,047,185. WUU JAU CO. INC., EDMOND, OK. SN 85-192,397.  
FILED P.R. 12-7-2010; AM. S.R. 8-29-2011.

**MILSPEC U.S.A.**

THE MARK CONSISTS OF STANDARD CHARACTERS WITHOUT CLAIM TO ANY PARTICULAR FONT, STYLE, SIZE, OR COLOR.

FOR POCKET KNIVES (U.S. CLS. 23, 28 AND 44).  
FIRST USE 0-0-2010; IN COMMERCE 0-0-2010.

**CLASS 9—ELECTRICAL AND SCIENTIFIC APPARATUS**

4,047,122. IRIS ID, INC., SEOUL, REPUBLIC OF KOREA. SN 85-008,193. FILED P.R. 4-7-2010; AM. S.R. 8-15-2011.

**IRIS ID**

THE MARK CONSISTS OF STANDARD CHARACTERS WITHOUT CLAIM TO ANY PARTICULAR FONT, STYLE, SIZE, OR COLOR.

NO CLAIM IS MADE TO THE EXCLUSIVE RIGHT TO USE "IRIS", APART FROM THE MARK AS SHOWN.

FOR IRIS RECOGNITION PRODUCTS, NAMELY, CAMERAS, MICRO-PROCESSORS, DISPLAY DEVICES, NAMELY, LIQUID CRYSTAL DISPLAYS, LED DISPLAYS, PLASMA DISPLAY PANELS, AND VIDEO MONITORS; COMPUTER SOFTWARE FOR SECURITY APPLICATIONS, NAMELY, SOFTWARE FOR AUTHENTICATING THE IDENTITY OF HUMAN BEINGS (U.S. CLS. 21, 23, 26, 36 AND 38).  
FIRST USE 6-1-2010; IN COMMERCE 6-1-2010.

4,047,155. MITRATECH HOLDINGS, INC., LOS ANGELES, CA. SN 85-153,858. FILED P.R. 10-15-2010; AM. S.R. 8-1-2011.

**COLLABORATIVE  
ACCOUNTABILITY**

THE MARK CONSISTS OF STANDARD CHARACTERS WITHOUT CLAIM TO ANY PARTICULAR FONT, STYLE, SIZE, OR COLOR.

**CLASS 9—(Continued).**

NO CLAIM IS MADE TO THE EXCLUSIVE RIGHT TO USE "COLLABORATIVE", APART FROM THE MARK AS SHOWN.

FOR COMPUTER APPLICATION SOFTWARE FOR PERSONAL COMPUTERS, NAMELY, SOFTWARE FOR ALLOWING A TEAM OF MULTIPLE PERSONS, INCLUDING, PARTNERS, VENDORS AND/OR SERVICE PROVIDERS TO COMMUNICATE AND MANAGE INFORMATION RELATING TO FINANCES, BILLING, JOB PERFORMANCE AND RELATED INFORMATION WITHIN THE CORPORATE COMPLIANCE, INSURANCE AND GOVERNMENT SECTORS (U.S. CLS. 21, 23, 26, 36 AND 38).

FIRST USE 3-0-2009; IN COMMERCE 3-0-2009.

4,047,197. PFB DESIGNS, FAIRFAX, CA. SN 85-217,167.  
FILED P.R. 1-13-2011; AM. S.R. 9-1-2011.

**nitespecs**

THE MARK CONSISTS OF STANDARD CHARACTERS WITHOUT CLAIM TO ANY PARTICULAR FONT, STYLE, SIZE, OR COLOR.

FOR EYEGLASSES (U.S. CLS. 21, 23, 26, 36 AND 38).  
FIRST USE 12-1-2010; IN COMMERCE 12-30-2010.

4,047,210. YAKE SOLAR POWER CORP., MIAMI, FL. SN 85-261,917. FILED P.R. 3-9-2011; AM. S.R. 9-16-2011.

**YAKE SOLAR**

THE MARK CONSISTS OF STANDARD CHARACTERS WITHOUT CLAIM TO ANY PARTICULAR FONT, STYLE, SIZE, OR COLOR.

NO CLAIM IS MADE TO THE EXCLUSIVE RIGHT TO USE "SOLAR", APART FROM THE MARK AS SHOWN.

FOR ELECTRICAL MACHINERY, EQUIPMENT, AND ACCESSORIES FOR USE WITH SOLAR PHOTOVOLTAIC TECHNOLOGY, NAMELY, PHOTOVOLTAIC SOLAR MODULES AND PANELS FOR PRODUCTION OF ELECTRICITY, SOLAR CELLS AND SOLAR BATTERIES (U.S. CLS. 21, 23, 26, 36 AND 38).

FIRST USE 8-1-2011; IN COMMERCE 8-1-2011.

**CLASS 9—(Continued).**

4,047,238. SYMONS, DOMINIC, PASADENA, CA. SN 85-306,267. FILED P.R. 4-27-2011; AM. S.R. 9-1-2011.

# MINIDOCK

THE MARK CONSISTS OF STANDARD CHARACTERS WITHOUT CLAIM TO ANY PARTICULAR FONT, STYLE, SIZE, OR COLOR.

FOR ADAPTER PLUGS; ADAPTERS; BATTERY CHARGERS; CELL PHONE BATTERY CHARGERS; CHARGERS FOR ELECTRIC BATTERIES; ELECTRIC POWER CONVERTERS; ELECTRICAL PLUG DEVICE ENABLING CONNECTION AND DISCONNECTION OF POWER AND/OR CONTROL CABLES; ELECTRICAL POWER CONNECTORS; POWER ADAPTERS; POWER CONNECTORS; POWER INVERTERS; POWER SUPPLY CONNECTORS AND ADAPTORS FOR USE WITH PORTABLE ELECTRONIC DEVICES; USB (UNIVERSAL SERIAL BUS) HARDWARE (U.S. CLS. 21, 23, 26, 36 AND 38).

FIRST USE 4-6-2011; IN COMMERCE 8-8-2011.

4,047,244. MNB TECHNOLOGIES, INC., BLOOMINGTON, IN. SN 85-312,675. FILED P.R. 5-4-2011; AM. S.R. 9-8-2011.

# hprcREPOSITORY

THE MARK CONSISTS OF STANDARD CHARACTERS WITHOUT CLAIM TO ANY PARTICULAR FONT, STYLE, SIZE, OR COLOR.

FOR COMPUTER SOFTWARE FOR ARCHIVING AND DISTRIBUTING COMPUTER SOFTWARE THAT MAY BE DOWNLOADED FROM A GLOBAL COMPUTER NETWORK (U.S. CLS. 21, 23, 26, 36 AND 38).

FIRST USE 9-11-2009; IN COMMERCE 9-11-2009.

**CLASS 10—MEDICAL APPARATUS**

4,047,127. VASCULAR DESIGNS INC., SAN JOSE, CA. SN 85-029,178. FILED P.R. 5-3-2010; AM. S.R. 9-2-2011.

# VASCULARDESIGNS

THE MARK CONSISTS OF STANDARD CHARACTERS WITHOUT CLAIM TO ANY PARTICULAR FONT, STYLE, SIZE, OR COLOR.

**CLASS 10—(Continued).**

OWNER OF U.S. REG. NO. 3,550,803.  
FOR CATHETERS AND PARTS AND FITTINGS THEREFOR (U.S. CLS. 26, 39 AND 44).  
FIRST USE 6-14-2002; IN COMMERCE 4-22-2008.

4,047,142. IX MEDICAL, DBA RADICAL SOLUTIONS, LONG BEACH, CA. SN 85-126,388. FILED P.R. 9-9-2010; AM. S.R. 8-26-2011.

**WEST COAST CUSTOM APRONS**

THE MARK CONSISTS OF STANDARD CHARACTERS WITHOUT CLAIM TO ANY PARTICULAR FONT, STYLE, SIZE, OR COLOR.

NO CLAIM IS MADE TO THE EXCLUSIVE RIGHT TO USE "APRONS", APART FROM THE MARK AS SHOWN, FOR RADIOLOGICAL APPARATUS FOR MEDICAL PURPOSES (U.S. CLS. 26, 39 AND 44).

FIRST USE 6-29-2009; IN COMMERCE 6-29-2009.

4,047,198. ORCAWEST HOLDINGS, LLC, GLENDALE, CO. SN 85-221,439. FILED P.R. 1-19-2011; AM. S.R. 8-12-2011.



THE COLOR(S) ORANGE IS/ARE CLAIMED AS A FEATURE OF THE MARK.

THE MARK CONSISTS OF THE COLOR ORANGE AS APPLIED TO THE EXTERIOR SURFACE OF A PORTABLE ULTRASOUND DEVICE. THE MATTER SHOWN IN DOTTED OR BROKEN LINES SHOWS THE POSITION OR PLACEMENT OF THE MARK ON THE GOODS. THE CONFIGURATION OF THE ULTRASOUND DEVICE IS NOT CLAIMED AS PART OF THE MARK.

FOR ULTRASOUND DIAGNOSTIC APPARATUS (U.S. CLS. 26, 39 AND 44).

FIRST USE 3-0-2009; IN COMMERCE 3-0-2009.

**CLASS 11—ENVIRONMENTAL CONTROL APPARATUS**

**CLASS 11—(Continued).**

4,047,138. PLASTIC INDUSTRIES, ATHENS, TN. SN 85-092,610. FILED P.R. 7-26-2010; AM. S.R. 9-7-2011.



THE MARK CONSISTS OF THE STYLIZED TEXT "SOFT" WITH A SWOOSH AT THE BOTTOM.

FOR COLD AND HEAT PACKS FOR COOLING AND HEATING THE BODY AND NOT FOR MEDICAL PURPOSES (U.S. CLS. 13, 21, 23, 31 AND 34).

FIRST USE 12-13-2010; IN COMMERCE 12-13-2010.

4,047,144. VODE LIGHTING LLC, SONOMA, CA. SN 85-131,354. FILED P.R. 9-16-2010; AM. S.R. 4-28-2011.

# Arm Anchor

THE MARK CONSISTS OF STANDARD CHARACTERS WITHOUT CLAIM TO ANY PARTICULAR FONT, STYLE, SIZE, OR COLOR.

FOR LIGHTING FIXTURES (U.S. CLS. 13, 21, 23, 31 AND 34).

FIRST USE 8-1-2009; IN COMMERCE 10-1-2009.

**CLASS 11—(Continued).**

4,047,169. MOSHIRNOROOZI MASOUD, DBA SERIALIGHT, SAN DIEGO, CA. SN 85-180,249. FILED P.R. 11-18-2010; AM. S.R. 8-16-2011.

# Serialight

THE MARK CONSISTS OF STANDARD CHARACTERS WITHOUT CLAIM TO ANY PARTICULAR FONT, STYLE, SIZE, OR COLOR.

FOR LED (LIGHT EMITTING DIODE) LIGHTING FIXTURES; LED (LIGHT EMITTING DIODES) LIGHTING FIXTURES FOR USE IN DISPLAY, COMMERCIAL, INDUSTRIAL, RESIDENTIAL, AND ARCHITECTURAL ACCENT LIGHTING APPLICATIONS; LED LIGHT ASSEMBLIES FOR STREET LIGHTS, SIGNS, COMMERCIAL LIGHTING, AUTOMOBILES, BUILDINGS, AND OTHER ARCHITECTURAL USES; LED LIGHTING FIXTURES FOR INDOOR AND OUTDOOR LIGHTING APPLICATIONS; LED LIGHTING SYSTEMS, NAMELY, LED MODULES, POWER SUPPLIES, AND WIRING; LED LIGHTS FOR STRINGS, FLOWERS, BRANCHES AND OTHER ORNAMENTAL DECORATIONS; LED UNDERWATER LIGHTS; LIGHTED PARTY-THEMED DECORATIONS, ELECTRIC LIGHT DECORATIVE STRINGS; LIGHTING APPARATUS FOR THEATRES, CLUBS AND DISCOTHEQUES; LIGHTING DEVICES FOR SHOWCASES; LIGHTING FIXTURES FOR USE IN PARKING DECKS AND GARAGES; LIGHTING FIXTURES FOR USE IN PARKING LOTS AND WALKWAYS; OUTDOOR LIGHTED CHRISTMAS ORNAMENTS; PORTABLE BATTERY-OPERATED LIGHTS THAT CAN BE PLACED ON SURFACES WHERE OTHER LIGHT SOURCES ARE UNAVAILABLE (U.S. CLS. 13, 21, 23, 31 AND 34).

FIRST USE 8-2-2008; IN COMMERCE 11-18-2010.

**CLASS 12—VEHICLES**

4,047,124. TNMJ CALIBER, LLC, PRESCOTT, AZ. SN 85-018,563. FILED P.R. 4-20-2010; AM. S.R. 9-14-2011.

# DYAD DRIVE SYSTEM

THE MARK CONSISTS OF STANDARD CHARACTERS WITHOUT CLAIM TO ANY PARTICULAR FONT, STYLE, SIZE, OR COLOR.

NO CLAIM IS MADE TO THE EXCLUSIVE RIGHT TO USE "DRIVE SYSTEM", APART FROM THE MARK AS SHOWN.

FOR MULTI-DISC CLUTCH SYSTEM FOR LAND VEHICLES COMPRISING CLUTCHES AND CLUTCH MECHANISMS (U.S. CLS. 19, 21, 23, 31, 35 AND 44).

FIRST USE 7-0-2010; IN COMMERCE 7-0-2010.



**CLASS 12—(Continued).**

4,047,125. TNMJ CALIBER, LLC, PRESCOTT, AZ. SN 85-018,571. FILED P.R. 4-20-2010; AM. S.R. 9-14-2011.

# DYAD DS

THE MARK CONSISTS OF STANDARD CHARACTERS WITHOUT CLAIM TO ANY PARTICULAR FONT, STYLE, SIZE, OR COLOR.

NO CLAIM IS MADE TO THE EXCLUSIVE RIGHT TO USE "DS", APART FROM THE MARK AS SHOWN.

FOR MULTI-DISC CLUTCH SYSTEM FOR LAND VEHICLES COMPRISING CLUTCHES AND CLUTCH MECHANISMS (U.S. CLS. 19, 21, 23, 31, 35 AND 44).

FIRST USE 7-0-2010; IN COMMERCE 7-0-2010.

4,047,184. GROS, EUGENE, W., WHITE CITY, OR. SN 85-190,886. FILED P.R. 12-5-2010; AM. S.R. 9-6-2011.

# LockUp Box

THE MARK CONSISTS OF STANDARD CHARACTERS WITHOUT CLAIM TO ANY PARTICULAR FONT, STYLE, SIZE, OR COLOR.

FOR METAL BOXES WITH LOCKABLE SLIDE-OUT COMPARTMENTS ESPECIALLY ADAPTED TO FIT IN SUVs AND OTHER VEHICLES (U.S. CLS. 19, 21, 23, 31, 35 AND 44).

FIRST USE 1-1-2001; IN COMMERCE 1-1-2001.

**CLASS 14—JEWELRY**

**CLASS 14—(Continued).**

4,047,139. CWEB, INC, HENDERSON, NV. SN 85-110,517. FILED P.R. 8-18-2010; AM. S.R. 8-18-2010.

# Paris

THE MARK CONSISTS OF STANDARD CHARACTERS WITHOUT CLAIM TO ANY PARTICULAR FONT, STYLE, SIZE, OR COLOR.

FOR BEADS FOR USE IN THE MANUFACTURE OF JEWELRY; BODY JEWELRY; BRACELETS; BROACHES; BRONZE JEWELRY; BROOCHES; CHARMS; CHARMS FOR COLLAR JEWELRY AND BRACELET; COSTUME JEWELRY; DIAMOND JEWELRY; GEMSTONE JEWELRY; GOLD THREAD JEWELRY; IDENTIFICATION BRACELETS; INEXPENSIVE NON-JEWELRY WATCHES; JEWELRY; JEWELRY AND IMITATION JEWELRY; JEWELRY BOXES; JEWELRY BOXES NOT OF METAL; JEWELRY BROOCHES; JEWELRY CASES; JEWELRY CASES NOT OF PRECIOUS METAL; JEWELRY CASES OF PRECIOUS METAL; JEWELRY CHAINS; JEWELRY PINS FOR USE ON HATS; JEWELRY RING HOLDERS; JEWELRY, NAMELY, AMULETS; JEWELRY, NAMELY, ANKLETS; JEWELRY, NAMELY, CROSSES; LAPEL PINS; PET JEWELRY; PINS BEING JEWELRY; PRECIOUS AND SEMI-PRECIOUS CRYSTAL STONES AND BEADS FOR USE IN JEWELRY; RINGS; RINGS BEING JEWELRY; WATCHES AND JEWELRY; WATCHES, CLOCKS, JEWELRY AND IMITATION JEWELRY; WOMEN'S JEWELRY (U.S. CLS. 2, 27, 28 AND 50).

FIRST USE 12-26-2009; IN COMMERCE 12-26-2009.

4,047,252. JAY-AIMEE DESIGNS, INC., LONG ISLAND CITY, NY. AND MATALON, SHLOMO, WOODBURY, NY. SN 85-321,084. FILED 5-14-2011.

# Tattoo Bandz

THE MARK CONSISTS OF STANDARD CHARACTERS WITHOUT CLAIM TO ANY PARTICULAR FONT, STYLE, SIZE, OR COLOR.

NO CLAIM IS MADE TO THE EXCLUSIVE RIGHT TO USE "BANDS", APART FROM THE MARK AS SHOWN.

FOR ANKLE BRACELETS; BANGLE BRACELETS; BRACELETS; BRACELETS MADE OF SILICONE; CHARMS FOR COLLAR JEWELRY AND BRACELET; JEWELRY, NAMELY, BRACELETS, WRISTBANDS AND NECKLACES THAT ALSO PROVIDES NOTIFICATION TO THE WEARER OF A PENDING MEDICAL RELATED TASK; NECKLACES MADE OF SILICONE; PLASTIC BRACELETS IN THE NATURE OF JEWELRY; RUBBER OR SILICON WRISTBANDS IN THE NATURE OF A BRACELET (U.S. CLS. 2, 27, 28 AND 50).

FIRST USE 3-9-2011; IN COMMERCE 3-9-2011.

**CLASS 16—PAPER GOODS AND PRINTED MATTER**

**CLASS 16—(Continued).**

4,047,113. RINCON, JUAN CARLOS, NEWTON, MA. SN 77-862,116. FILED P.R. 10-31-2009; AM. S.R. 7-5-2011.

**GREEN FOOD PACKAGING**

THE MARK CONSISTS OF STANDARD CHARACTERS WITHOUT CLAIM TO ANY PARTICULAR FONT, STYLE, SIZE, OR COLOR.

NO CLAIM IS MADE TO THE EXCLUSIVE RIGHT TO USE "FOOD PACKAGING", APART FROM THE MARK AS SHOWN.

FOR PAPER PACKAGING AND CONTAINERS FOR FOOD AND BEVERAGES COMPRISED OF MATERIALS DESIGNED TO LESSEN ADVERSE EFFECTS ON THE ENVIRONMENT; PLASTIC OR PAPER BAGS FOR MERCHANDISE PACKAGING (U.S. CLS. 2, 5, 22, 23, 29, 37, 38 AND 50).

FIRST USE 5-1-2006; IN COMMERCE 7-1-2008.

4,047,117. INTERNET MEDIA SERVICES, INC., SANTA MONICA, CA. SN 77-951,152. FILED P.R. 3-4-2010; AM. S.R. 8-19-2011.

**LegalStore**

THE MARK CONSISTS OF STANDARD CHARACTERS WITHOUT CLAIM TO ANY PARTICULAR FONT, STYLE, SIZE, OR COLOR.

FOR BINDERS (OFFICE SUPPLIES); LEGAL PADS (U.S. CLS. 2, 5, 22, 23, 29, 37, 38 AND 50).

FIRST USE 1-23-1999; IN COMMERCE 1-23-1999.

**CLASS 16—(Continued).**

4,047,137. ALERT PAWS, INC., MIAMI, FL. SN 85-085,107. FILED P.R. 7-15-2010; AM. S.R. 9-16-2011.



THE MARK CONSISTS OF THE WORD "ALERT" IN VERTICAL FORMAT WITH A DEPICTION OF A PAW IN THE BACKGROUND.

FOR REMOVABLE TATTOOS; STICKERS AND DECALCOMANIAS; TEMPORARY TATTOOS (U.S. CLS. 2, 5, 22, 23, 29, 37, 38 AND 50).

FIRST USE 8-25-2010; IN COMMERCE 8-25-2010.

4,047,146. AVERY DENNISON CORPORATION, PASADENA, CA. SN 85-134,019. FILED P.R. 9-20-2010; AM. S.R. 8-31-2011.

**11436**

THE MARK CONSISTS OF STANDARD CHARACTERS WITHOUT CLAIM TO ANY PARTICULAR FONT, STYLE, SIZE, OR COLOR.

FOR NOTEBOOK DIVIDERS; INDEX DIVIDERS; SHEET PROTECTOR INDEX DIVIDERS; TABBED NOTEBOOK DIVIDERS; AND BINDER DIVIDERS (U.S. CLS. 2, 5, 22, 23, 29, 37, 38 AND 50).

FIRST USE 1-1-1994; IN COMMERCE 1-1-1994.

4,047,147. AVERY DENNISON CORPORATION, PASADENA, CA. SN 85-134,022. FILED P.R. 9-20-2010; AM. S.R. 8-31-2011.

**11437**

THE MARK CONSISTS OF STANDARD CHARACTERS WITHOUT CLAIM TO ANY PARTICULAR FONT, STYLE, SIZE, OR COLOR.

FOR NOTEBOOK DIVIDERS; INDEX DIVIDERS; SHEET PROTECTOR INDEX DIVIDERS; TABBED NOTEBOOK DIVIDERS; AND BINDER DIVIDERS (U.S. CLS. 2, 5, 22, 23, 29, 37, 38 AND 50).

FIRST USE 1-1-1994; IN COMMERCE 1-1-1994.

**CLASS 16—(Continued).**

4,047,151. AVERY DENNISON CORPORATION, PASADENA, CA. SN 85-147,690. FILED P.R. 10-7-2010; AM. S.R. 8-31-2011.

# 5164

THE MARK CONSISTS OF STANDARD CHARACTERS WITHOUT CLAIM TO ANY PARTICULAR FONT, STYLE, SIZE, OR COLOR.

OWNER OF U.S. REG. NOS. 2,076,725 AND 2,076,726.

FOR ADDRESS LABELS; BLANK PAPER LABELS; ADHESIVE LABELS; STICKERS; BLANK PAPER IDENTIFICATION LABELS; PAPER LABELS; LABELS AND STICKERS FOR INFORMATION AND DECORATION PURPOSES MADE FROM PAPER; PAPER LABELS AND STICKERS SUPPLIED IN SHEET FORM; RETURN ADDRESS LABELS; SELF-ADHESIVE LABELS; SELF-ADHESIVE PAPER FOR USE IN LASER PRINTERS; SELF-ADHESIVE PAPER FOR MAKING LABELS; UNPRINTED SELF-ADHESIVE LABELS; UNPRINTED PAPER LABELS AND BLANK PAPER LABEL STOCK; PAPER LABELS; SHIPPING LABELS; AND PRESSURE-SENSITIVE PRINTING PAPERS FOR LABELS (U.S. CLS. 2, 5, 22, 23, 29, 37, 38 AND 50).

FIRST USE 1-3-2006; IN COMMERCE 1-3-2006.

---

4,047,152. AVERY DENNISON CORPORATION, PASADENA, CA. SN 85-147,710. FILED P.R. 10-7-2010; AM. S.R. 8-31-2011.

# 5366

THE MARK CONSISTS OF STANDARD CHARACTERS WITHOUT CLAIM TO ANY PARTICULAR FONT, STYLE, SIZE, OR COLOR.

OWNER OF U.S. REG. NOS. 2,076,725 AND 2,076,726.

FOR ADDRESS LABELS; BLANK PAPER LABELS; ADHESIVE LABELS; STICKERS; BLANK PAPER IDENTIFICATION LABELS; PAPER LABELS; LABELS AND STICKERS FOR INFORMATION AND DECORATION PURPOSES MADE FROM PAPER; PAPER LABELS AND STICKERS SUPPLIED IN SHEET FORM; RETURN ADDRESS LABELS; SELF-ADHESIVE LABELS; SELF-ADHESIVE PAPER FOR USE IN LASER PRINTERS; SELF-ADHESIVE PAPER FOR MAKING LABELS; UNPRINTED SELF-ADHESIVE LABELS; UNPRINTED PAPER LABELS AND BLANK PAPER LABEL STOCK; PAPER LABELS; SHIPPING LABELS; AND PRESSURE-SENSITIVE PRINTING PAPERS FOR LABELS (U.S. CLS. 2, 5, 22, 23, 29, 37, 38 AND 50).

FIRST USE 1-3-2006; IN COMMERCE 1-3-2006.

**CLASS 16—(Continued).**

4,047,153. AVERY DENNISON CORPORATION, PASADENA, CA. SN 85-147,731. FILED P.R. 10-7-2010; AM. S.R. 8-31-2011.

# 5960

THE MARK CONSISTS OF STANDARD CHARACTERS WITHOUT CLAIM TO ANY PARTICULAR FONT, STYLE, SIZE, OR COLOR.

OWNER OF U.S. REG. NOS. 2,076,725 AND 2,076,726.

FOR ADDRESS LABELS; BLANK PAPER LABELS; ADHESIVE LABELS; STICKERS; BLANK PAPER IDENTIFICATION LABELS; PAPER LABELS; LABELS AND STICKERS FOR INFORMATION AND DECORATION PURPOSES MADE FROM PAPER; PAPER LABELS AND STICKERS SUPPLIED IN SHEET FORM; RETURN ADDRESS LABELS; SELF-ADHESIVE LABELS; SELF-ADHESIVE PAPER FOR USE IN LASER PRINTERS; SELF-ADHESIVE PAPER FOR MAKING LABELS; UNPRINTED SELF-ADHESIVE LABELS; UNPRINTED PAPER LABELS AND BLANK PAPER LABEL STOCK; PAPER LABELS; SHIPPING LABELS; AND PRESSURE-SENSITIVE PRINTING PAPERS FOR LABELS (U.S. CLS. 2, 5, 22, 23, 29, 37, 38 AND 50).

FIRST USE 1-3-2006; IN COMMERCE 1-3-2006.

---

4,047,160. ME & MY BIG IDEAS, INC., LAKE FOREST, CA. SN 85-170,716. FILED P.R. 11-5-2010; AM. S.R. 8-16-2011.

# DRINK BLING

THE MARK CONSISTS OF STANDARD CHARACTERS WITHOUT CLAIM TO ANY PARTICULAR FONT, STYLE, SIZE, OR COLOR.

FOR DECALS; STICKERS (U.S. CLS. 2, 5, 22, 23, 29, 37, 38 AND 50).

FIRST USE 8-17-2010; IN COMMERCE 8-17-2010.

**CLASS 16—(Continued).**

4,047,215. DAVID HOWELL PRODUCT DESIGN INC., DBA DAVID HOWELL & COMPANY, BEDFORD HILLS, NY. SN 85-266,977. FILED P.R. 3-15-2011; AM. S.R. 8-29-2011.



NO CLAIM IS MADE TO THE EXCLUSIVE RIGHT TO USE "BOOKMARK", APART FROM THE MARK AS SHOWN.

THE MARK CONSISTS OF THE DESIGN OF BACKGROUND OF PRODUCT PACKAGING. THE DESIGN CONSISTS OF A RECTANGULAR CARD WITH A LOWER DARK RECTANGLE HAVING AN INTERIOR RECTANGLE IN WHICH A REFERENCE IMAGE MAY BE POSITIONED; AN UPPER LIGHT RECTANGLE TRANS-SECTED BY A DARK HORIZONTAL STRIPE CONTAINING THE TERM "BOOKMARK" AND WHICH DIVIDES THE UPPER LIGHT RECTANGLE INTO A TOP SPACE FOR CONTAINING AN ARTIST NAME AND A MIDDLE SPACE ON WHICH THE BOOKMARK IS MOUNTED.

FOR BOOKMARKS (U.S. CLS. 2, 5, 22, 23, 29, 37, 38 AND 50).

FIRST USE 1-30-2011; IN COMMERCE 1-30-2011.

4,047,234. PARKSBYNATURE NETWORK, LLC, NEW YORK, NY. SN 85-298,085. FILED P.R. 4-18-2011; AM. S.R. 8-22-2011.

## The Official Mobile Tour Package

THE MARK CONSISTS OF STANDARD CHARACTERS WITHOUT CLAIM TO ANY PARTICULAR FONT, STYLE, SIZE, OR COLOR.

FOR PRINTED INFORMATIONAL BOOKLETS THAT CONTAIN INFORMATION PERTAINING TO TOUR GUIDES FOR OUTDOOR PARKS AND RECREATION, TOURIST FACILITIES, SMART PHONE TECHNOLOGY SERVICES, ONLINE SOCIAL NETWORKING SERVICES, AND TOURIST ATTRACTIONS (U.S. CLS. 2, 5, 22, 23, 29, 37, 38 AND 50).

FIRST USE 11-19-2009; IN COMMERCE 9-2-2010.

**CLASS 16—(Continued).**

4,047,241. BRIGGS MEDICAL SERVICE COMPANY, WEST DES MOINES, IA. SN 85-309,436. FILED P.R. 5-2-2011; AM. S.R. 9-12-2011.

## EZtoC

THE MARK CONSISTS OF STANDARD CHARACTERS WITHOUT CLAIM TO ANY PARTICULAR FONT, STYLE, SIZE, OR COLOR.

FOR PRINTED MEDICAL FORMS (U.S. CLS. 2, 5, 22, 23, 29, 37, 38 AND 50).

FIRST USE 8-5-2011; IN COMMERCE 8-5-2011.

4,047,253. BRAGG, STEVEN M., CENTENNIAL, CO. SN 85-321,276. FILED P.R. 5-15-2011; AM. S.R. 8-31-2011.

## AccountingTools

THE MARK CONSISTS OF STANDARD CHARACTERS WITHOUT CLAIM TO ANY PARTICULAR FONT, STYLE, SIZE, OR COLOR.

FOR A SERIES OF BOOKS AND WRITTEN ARTICLES IN THE FIELD OF ACCOUNTING AND FINANCE (U.S. CLS. 2, 5, 22, 23, 29, 37, 38 AND 50).

FIRST USE 3-31-2011; IN COMMERCE 3-31-2011.

4,047,259. HEARST COMMUNICATIONS, INC., NEW YORK, NY. SN 85-327,026. FILED 5-23-2011.

## SHOE ADDICT

THE MARK CONSISTS OF STANDARD CHARACTERS WITHOUT CLAIM TO ANY PARTICULAR FONT, STYLE, SIZE, OR COLOR.

FOR MAGAZINE COLUMN AND MAGAZINE SECTIONS RELATING TO WOMEN'S FASHIONS, PUBLISHED MONTHLY AND/OR AT OTHER PERIODIC INTERVALS (U.S. CLS. 2, 5, 22, 23, 29, 37, 38 AND 50).

FIRST USE 2-4-2011; IN COMMERCE 2-4-2011.

**CLASS 17—RUBBER GOODS**

**CLASS 17—(Continued).**

4,047,191. PROGRESSIVE ENERGY SOLUTIONS, BELMONT, NC. SN 85-197,378. FILED P.R. 12-14-2010; AM. S.R. 8-31-2011.

# Seal A Vent

THE MARK CONSISTS OF STANDARD CHARACTERS WITHOUT CLAIM TO ANY PARTICULAR FONT, STYLE, SIZE, OR COLOR.  
FOR SEALING AND INSULATING MATERIALS (U.S. CLS. 1, 5, 12, 13, 35 AND 50).  
FIRST USE 11-7-2007; IN COMMERCE 4-11-2008.

**CLASS 19—(Continued).**

4,047,189. SOUTHERN CROSS TECHNOLOGIES, INC., BOYNTON BEACH, FL. SN 85-196,053. FILED P.R. 12-12-2010; AM. S.R. 6-4-2011.

# GREENE-BOARD

THE MARK CONSISTS OF STANDARD CHARACTERS WITHOUT CLAIM TO ANY PARTICULAR FONT, STYLE, SIZE, OR COLOR.  
FOR SHEATHING BOARD; WALL BOARDS; WALL PANELS NOT OF METAL; BUILDING MATERIALS, NAMELY, MAGNESIUM OXIDE BOARDS; CEMENT BONDED PARTICLE BOARD; FLOORING UNDERLAYMENTS; ROOFING UNDERLAYMENT; CONSTRUCTION MATERIAL, NAMELY, NONMETAL EXTERIOR BOARDS; FIREPROOF TILES; NON-METAL FLOOR TILES; NON-METAL ROOFING TILES; TILES OF CLAY, GLASS, GYPSUM, CERAMIC OR EARTHENWARE (U.S. CLS. 1, 12, 33 AND 50).  
FIRST USE 1-0-2007; IN COMMERCE 1-0-2007.

**CLASS 19—NON-METALLIC BUILDING MATERIALS**

4,047,166. KERBER INDUSTRIES, INC, MONTCLAIR, CA. SN 85-178,083. FILED P.R. 11-16-2010; AM. S.R. 8-31-2011.



NO CLAIM IS MADE TO THE EXCLUSIVE RIGHT TO USE "BLEND", APART FROM THE MARK AS SHOWN.  
FOR BLENDED CEMENT MIXES (U.S. CLS. 1, 12, 33 AND 50).  
FIRST USE 1-30-2009; IN COMMERCE 1-30-2009.

**CLASS 21—HOUSEWARES AND GLASS**

4,047,119. MYSTIC WORLDWIDE, INC., PANAMA, PANAMA. SN 77-982,143. FILED P.R. 8-12-2008; AM. S.R. 2-24-2011.

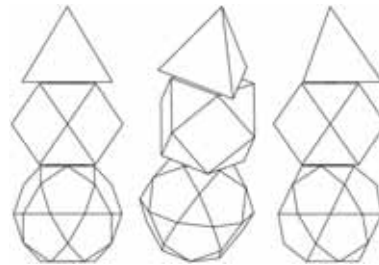

OWNER OF COLOMBIA REG. NO. 412446, DATED 10-29-2010, EXPIRES 10-29-2020.  
THE MARK CONSISTS OF A THREE-DIMENSIONAL DESIGN OF A BOTTLE COMPRISED OF TWO STACKED AND ROUNDED GEOMETRIC SHAPES WITH A BOTTLE CAP IN THE SHAPE OF A PYRAMID.  
FOR PLASTIC BOTTLES SOLD EMPTY AND CONTAINERS NOT OF PRECIOUS METAL OR COATED THEREWITH FOR HOUSEHOLD OR KITCHEN USE; GLASS, PORCELAIN, AND EARTHENWARE BOTTLES SOLD EMPTY; GLASS FLASKS, GLASS JARS (U.S. CLS. 2, 13, 23, 29, 30, 33, 40 AND 50).

**CLASS 21—(Continued).**

4,047,182. ERIC SILVERS, DBA SIMPLE SOLUTIONS, N. MIDDLESEX, VT. SN 85-189,901. FILED P.R. 12-3-2010; AM. S.R. 9-7-2011.

**THE GRUNGE BRUSH**

THE MARK CONSISTS OF STANDARD CHARACTERS WITHOUT CLAIM TO ANY PARTICULAR FONT, STYLE, SIZE, OR COLOR.

NO CLAIM IS MADE TO THE EXCLUSIVE RIGHT TO USE "BRUSH", APART FROM THE MARK AS SHOWN.

FOR CLEANING BRUSHES, NAMELY, BRUSHES FOR CLEANING MOTORCYCLE AND BICYCLE DRIVE CHAINS AND COMPONENTS, ASSEMBLY LINE CHAINS, STEEL WIRE CABLES BEING PARTS OF MACHINES, AND SMALL KITCHEN APPLIANCE PARTS (U.S. CLS. 2, 13, 23, 29, 30, 33, 40 AND 50).

FIRST USE 12-1-1994; IN COMMERCE 6-1-1995.

---

4,047,188. BURCKHARDT, BRIAN C, BOERNE, TX. SN 85-195,032. FILED P.R. 12-10-2010; AM. S.R. 8-26-2011.

**HILL COUNTRY POTTERY**

THE MARK CONSISTS OF STANDARD CHARACTERS WITHOUT CLAIM TO ANY PARTICULAR FONT, STYLE, SIZE, OR COLOR.

NO CLAIM IS MADE TO THE EXCLUSIVE RIGHT TO USE "POTTERY", APART FROM THE MARK AS SHOWN.

FOR CERAMIC VESSELS (U.S. CLS. 2, 13, 23, 29, 30, 33, 40 AND 50).

FIRST USE 10-1-2009; IN COMMERCE 1-1-2010.

---

4,047,224. MAZUR, ROBERT G, CANTON, MI. SN 85-284,823. FILED 4-4-2011.

**Easy Load PillBox**

THE MARK CONSISTS OF STANDARD CHARACTERS WITHOUT CLAIM TO ANY PARTICULAR FONT, STYLE, SIZE, OR COLOR.

NO CLAIM IS MADE TO THE EXCLUSIVE RIGHT TO USE "PILLBOX", APART FROM THE MARK AS SHOWN.

FOR CONTAINERS FOR HOUSEHOLD OR KITCHEN USE (U.S. CLS. 2, 13, 23, 29, 30, 33, 40 AND 50).

FIRST USE 10-15-2006; IN COMMERCE 4-4-2011.

**CLASS 21—(Continued).**

4,047,263. ORA LIVING, LLC, EVANSTON, IL. SN 85-337,368. FILED P.R. 6-3-2011; AM. S.R. 8-30-2011.



THE MARK CONSISTS OF AN OUTLINE OF A HEAD OF BROCCOLI WITH THE WORDING "EAT AS MANY VEGGIES AS YOU'D LIKE!!", AN OUTLINE OF A FISH WITH THE WORDING "FOR HEALTHY EATING, FIT YOUR PROTEIN INSIDE HERE", AN OUTLINE OF A SLICE OF BREAD WITH THE WORDING "TO BE HEALTHY, FIT YOUR WHOLE GRAIN IN HERE", AND A SMALL CIRCLE WITH THE WORD "FATS" ALL APPEARING WITHIN A CIRCULAR PLATE. THE MATTER SHOWN IN BROKEN LINES IS FOR PLACEMENT PURPOSES AND IS NOT CLAIMED AS A FEATURE OF THE MARK AND ONLY IS TO SHOW THE RELATIVE PLACEMENT OF THE MARK RELATIVE TO THE GOODS.

FOR DINNERWARE, NAMELY, PLATES, CUPS, BOWLS AND SILVERWARE (U.S. CLS. 2, 13, 23, 29, 30, 33, 40 AND 50).

FIRST USE 6-20-2006; IN COMMERCE 9-15-2010.

**CLASS 25—CLOTHING**

---

4,047,154. S-GO INTERNATIONAL, INC., LOS ANGELES, CA. SN 85-148,072. FILED P.R. 10-8-2010; AM. S.R. 7-7-2011.

**ETHICAL COTTON**

THE MARK CONSISTS OF STANDARD CHARACTERS WITHOUT CLAIM TO ANY PARTICULAR FONT, STYLE, SIZE, OR COLOR.

NO CLAIM IS MADE TO THE EXCLUSIVE RIGHT TO USE "COTTON", APART FROM THE MARK AS SHOWN.

FOR CLOTHING MADE OF ETHICAL COTTON, NAMELY, SHORT SLEEVED T-SHIRTS, LONG SLEEVED SHIRTS (U.S. CLS. 22 AND 39).

FIRST USE 7-1-2011; IN COMMERCE 7-1-2011.

**CLASS 25—(Continued).**

4,047,170. SMUGGLER'S EVENT MANAGEMENT, LLC,  
PUNTA GORDA, FL. SN 85-181,489. FILED 11-19-2010.



NO CLAIM IS MADE TO THE EXCLUSIVE RIGHT TO USE "SERIES", APART FROM THE MARK AS SHOWN.

THE MARK CONSISTS OF THE STYLIZED WORDING "FLATSMASTERS SERIES" AND A STYLIZED FISH.

FOR CLOTHING, NAMELY, TEE SHIRTS, POLO SHIRTS, BUTTON DOWN SHIRTS, SHORTS, AND HEADGEAR, NAMELY, HATS, VISORS, CAPS, BANDANAS (U.S. CLS. 22 AND 39).

FIRST USE 3-1-2001; IN COMMERCE 3-1-2001.

4,047,179. POGLIANI, WALTER, ISLAND PARK, NY. SN 85-188,867. FILED P.R. 12-2-2010; AM. S.R. 9-3-2011.

POGLIANI

THE MARK CONSISTS OF STANDARD CHARACTERS WITHOUT CLAIM TO ANY PARTICULAR FONT, STYLE, SIZE, OR COLOR.

FOR CLOTHING, NAMELY, SHIRTS, SWEATERS, AND JACKETS (U.S. CLS. 22 AND 39).

FIRST USE 11-28-2010; IN COMMERCE 12-1-2010.

4,047,190. SCHRIFEN LLC, NEW YORK, NY. SN 85-196,819. FILED P.R. 12-13-2010; AM. S.R. 9-16-2011.

Schriffen

THE MARK CONSISTS OF STANDARD CHARACTERS WITHOUT CLAIM TO ANY PARTICULAR FONT, STYLE, SIZE, OR COLOR.

FOR SPORTSWEAR FOR MEN AND WOMEN, NAMELY, CAMIS, TOPS, T-SHIRTS, LONG-SLEEVE TOPS, WARM UP JACKETS, SHORTS, PANTS, ATHLETIC HEADBANDS, YOGA SHIRTS, MOISTURE-WICKING SPORTS SHIRTS, MOISTURE-WICKING TANK TOPS AND MOISTURE WICKING PANTS, SWEAT SHIRTS, LEGGINGS (U.S. CLS. 22 AND 39).

FIRST USE 11-5-2009; IN COMMERCE 11-5-2009.

**CLASS 25—(Continued).**

4,047,204. HEISER, ROBERT, AUSTIN, TX. SN 85-242,592. FILED P.R. 2-15-2011; AM. S.R. 9-3-2011.

AUSTIN MOTOR CLUB

THE MARK CONSISTS OF STANDARD CHARACTERS WITHOUT CLAIM TO ANY PARTICULAR FONT, STYLE, SIZE, OR COLOR.

FOR CLOTHING, NAMELY, TOPS, BOTTOMS, T-SHIRTS (U.S. CLS. 22 AND 39).

FIRST USE 8-15-2011; IN COMMERCE 8-15-2011.

4,047,222. JADED & HATED CLOTHING CO., LLC, MARICOPA, AZ. SN 85-281,260. FILED P.R. 3-30-2011; AM. S.R. 8-17-2011.

JADED & HATED

THE MARK CONSISTS OF THE STYLIZED WORDING "JADED & HATED" WITH THE LETTERS "D" AND "T" AND THE SYMBOL "&" HAVING A DOWNWARD DRIP EFFECT.

FOR CLOTHING, NAMELY, T-SHIRTS, HOODED SWEATSHIRTS AND TANK TOPS (U.S. CLS. 22 AND 39).

FIRST USE 4-5-2010; IN COMMERCE 10-29-2010.

4,047,223. SANDLEX CORPORATION, WILKES-BARRE, PA. SN 85-281,490. FILED P.R. 3-30-2011; AM. S.R. 8-15-2011.

TheBestWarmer

THE MARK CONSISTS OF STANDARD CHARACTERS WITHOUT CLAIM TO ANY PARTICULAR FONT, STYLE, SIZE, OR COLOR.

FOR CLOTHING FOR OUTDOOR USE IN THE NATURE OF WRAP-AROUNDS (U.S. CLS. 22 AND 39).

FIRST USE 3-18-2011; IN COMMERCE 3-18-2011.

**CLASS 25—(Continued).**

4,047,236. CROSSFIT, INC., WASHINGTON, DC. SN 85-303,240. FILED P.R. 4-25-2011; AM. S.R. 8-8-2011.

# 3...2...1...GO!

THE MARK CONSISTS OF STANDARD CHARACTERS WITHOUT CLAIM TO ANY PARTICULAR FONT, STYLE, SIZE, OR COLOR.

FOR SHIRTS (U.S. CLS. 22 AND 39).  
FIRST USE 8-0-1998; IN COMMERCE 8-0-1998.

4,047,240. AUSTIN, GRANT, OAKWOOD, GA. SN 85-308,369. FILED P.R. 4-29-2011; AM. S.R. 9-3-2011.

## ULTIMATE DANCE BOOTS

THE MARK CONSISTS OF STANDARD CHARACTERS WITHOUT CLAIM TO ANY PARTICULAR FONT, STYLE, SIZE, OR COLOR.

OWNER OF U.S. REG. NO. 3,963,813.  
NO CLAIM IS MADE TO THE EXCLUSIVE RIGHT TO USE "DANCE BOOTS", APART FROM THE MARK AS SHOWN.  
FOR FOOTWEAR; BOOTS; DANCE BOOTS (U.S. CLS. 22 AND 39).  
FIRST USE 10-1-2010; IN COMMERCE 10-1-2010.

4,047,246. SHERRY LYNN CARTER, DBA EMERSON EAGLES INC., NORTH LAS VEGAS, NV. SN 85-315,123. FILED P.R. 5-7-2011; AM. S.R. 8-31-2011.

# EMERSON EAGLES

THE MARK CONSISTS OF STANDARD CHARACTERS WITHOUT CLAIM TO ANY PARTICULAR FONT, STYLE, SIZE, OR COLOR.

FOR SHORT-SLEEVED OR LONG-SLEEVED T-SHIRTS (U.S. CLS. 22 AND 39).  
FIRST USE 5-1-2011; IN COMMERCE 5-6-2011.

**CLASS 28—TOYS AND SPORTING GOODS**

**CLASS 28—(Continued).**

4,047,111. SCS INTERACTIVE, INC., DENVER, CO. SN 77-737,468. FILED P.R. 5-14-2009; AM. S.R. 4-8-2011.

# HYDROSTRUCTURE

THE MARK CONSISTS OF STANDARD CHARACTERS WITHOUT CLAIM TO ANY PARTICULAR FONT, STYLE, SIZE, OR COLOR.

FOR PLAY YARDS IN THE NATURE OF OUTDOOR PLAY STRUCTURES; PLAY YARDS IN THE NATURE OF WATER PARK PLAY STRUCTURES (U.S. CLS. 22, 23, 38 AND 50).  
FIRST USE 2-17-2010; IN COMMERCE 2-17-2010.

4,047,177. JUGS SPORTS, INC., TUALATIN, OR. SN 85-188,071. FILED P.R. 12-1-2010; AM. S.R. 12-1-2010.



OWNER OF U.S. REG. NO. 2,417,586.  
THE COLOR(S) BLUE IS/ARE CLAIMED AS A FEATURE OF THE MARK.

THE MARK CONSISTS OF THE COLOR BLUE ON ALL OF THE COMPONENTS OF THE PORTABLE PROTECTIVE SCREEN BACKSTOP COMPRISED OF A ROUNDED FRAME WITH FOUR SUPPORT BARS EMANATING FROM THE FRAME AND A FLAT BOTTOM WITH TWO OPEN PANELS. THE TARGET PORTION OF THE SCREEN IS NOT A PART OF THE MARK AND IS DEPICTED IN DOTTED LINES. THE DOTTED OUTLINE OF THE GOODS IS INTENDED TO SHOW THE POSITION OF THE MARK ON THE GOODS AND IS NOT PART OF THE MARK. THE CONFIGURATION OF THE GOODS IS ALSO NOT A PART OF THE MARK.

FOR PORTABLE PROTECTIVE SCREEN BACKSTOP FOR BASEBALL, SOFTBALL, FOOTBALL, SOCCER, GOLF AND TENNIS PRACTICE DRILLS (U.S. CLS. 22, 23, 38 AND 50).  
FIRST USE 0-0-1998; IN COMMERCE 0-0-1998.

**CLASS 29—MEATS AND PROCESSED FOODS**



**CLASS 29—(Continued).**

4,047,157. CALIFORNIA OILS CORPORATION, RICHMOND, CA. SN 85-159,295. FILED P.R. 10-22-2010; AM. S.R. 7-26-2011.

# QUBE

THE MARK CONSISTS OF STANDARD CHARACTERS WITHOUT CLAIM TO ANY PARTICULAR FONT, STYLE, SIZE, OR COLOR.  
FOR VEGETABLE OILS AND SHORTENING (U.S. CL. 46).  
FIRST USE 4-0-2011; IN COMMERCE 4-0-2011.

4,047,214. ANDERSON INTERNATIONAL FOODS, MINEOLA, NY. SN 85-265,840. FILED P.R. 3-14-2011; AM. S.R. 9-7-2011.



NO CLAIM IS MADE TO THE EXCLUSIVE RIGHT TO USE "KOSHER", APART FROM THE MARK AS SHOWN.  
THE MARK CONSISTS OF THE WORDS "PURE AND KOSHER" INSIDE A RECTANGULAR BOX. THE WORDS "PURE AND KOSHER" ARE DISPLAYED IN LOWERCASE LETTERS DIRECTLY ON TOP OF ONE ANOTHER. THE WORD "AND" IS DISPLAYED VERTICALLY IN LOWERCASE LETTERS AND IS POSITIONED ADJACENT TO THE WORD "PURE AND" ABOVE THE "R" IN "KOSHER".  
FOR KOSHER CHEESES (U.S. CL. 46).  
FIRST USE 11-30-2010; IN COMMERCE 11-30-2010.

**CLASS 30—STAPLE FOODS**

4,047,149. CRO-BAR, L.L.C., KINGSPORT, TN. SN 85-143,231. FILED P.R. 10-1-2010; AM. S.R. 8-30-2011.

# SAUCEBURGER

THE MARK CONSISTS OF STANDARD CHARACTERS WITHOUT CLAIM TO ANY PARTICULAR FONT, STYLE, SIZE, OR COLOR.  
FOR HAMBURGER SANDWICHES (U.S. CL. 46).  
FIRST USE 0-0-1992; IN COMMERCE 0-0-1992.

**CLASS 30—(Continued).**

4,047,159. RONNOCO COFFEE COMPANY, ST. LOUIS, MO. SN 85-167,878. FILED P.R. 11-3-2010; AM. S.R. 8-11-2011.

# MICROCLIMATE

THE MARK CONSISTS OF STANDARD CHARACTERS WITHOUT CLAIM TO ANY PARTICULAR FONT, STYLE, SIZE, OR COLOR.  
FOR COFFEE (U.S. CL. 46).  
FIRST USE 8-1-2011; IN COMMERCE 8-1-2011.

4,047,233. SAIFAN BOSMAT LTD., TEL AVIV, ISRAEL. SN 85-294,791. FILED P.R. 4-14-2011; AM. S.R. 8-30-2011.

# THE LEAVES COLLECTION

THE MARK CONSISTS OF STANDARD CHARACTERS WITHOUT CLAIM TO ANY PARTICULAR FONT, STYLE, SIZE, OR COLOR.  
FOR TEA (U.S. CL. 46).  
FIRST USE 10-15-2009; IN COMMERCE 10-15-2010.

4,047,254. OCHO RIOS HOLDING CORP., MIAMI, FL. SN 85-321,482. FILED P.R. 5-16-2011; AM. S.R. 9-1-2011.

# SAZÓN COMBO

THE MARK CONSISTS OF STANDARD CHARACTERS WITHOUT CLAIM TO ANY PARTICULAR FONT, STYLE, SIZE, OR COLOR.  
OWNER OF U.S. REG. NO. 3,912,515.  
THE ENGLISH TRANSLATION OF "SAZÓN COMBO" IN THE MARK IS "COMBO SEASONING".  
FOR SEASONINGS (U.S. CL. 46).  
FIRST USE 11-5-2010; IN COMMERCE 11-5-2010.

**CLASS 30—(Continued).**

4,047,256. ARIZONA SPICE COMPANY LLC, MESA, AZ. AND DEBRAH ROBERTI, MESA, AZ. SN 85-324,503. FILED P.R. 5-19-2011; AM. S.R. 9-8-2011.

**Green Ghost Seasoning Mix**

THE MARK CONSISTS OF STANDARD CHARACTERS WITHOUT CLAIM TO ANY PARTICULAR FONT, STYLE, SIZE, OR COLOR.

NO CLAIM IS MADE TO THE EXCLUSIVE RIGHT TO USE "SEASONING MIX", APART FROM THE MARK AS SHOWN.

FOR HOT PEPPER POWDER; PEPPER POWDER; SEASONING MIXES; SPICE BLENDS; SPICE RUBS (U.S. CL. 46).

FIRST USE 4-1-2011; IN COMMERCE 4-1-2011.

**CLASS 32—(Continued).**

4,047,242. FLYING DOG BREWERY, LLLP, DENVER, CO. SN 85-309,586. FILED P.R. 5-2-2011; AM. S.R. 8-15-2011.

**WOODY CREEK WHITE**

THE MARK CONSISTS OF STANDARD CHARACTERS WITHOUT CLAIM TO ANY PARTICULAR FONT, STYLE, SIZE, OR COLOR.

NO CLAIM IS MADE TO THE EXCLUSIVE RIGHT TO USE "WHITE", APART FROM THE MARK AS SHOWN.

FOR BREWED MALT-BASED ALCOHOLIC BEVERAGE IN THE NATURE OF A BEER (U.S. CLS. 45, 46 AND 48).

FIRST USE 4-0-2007; IN COMMERCE 5-0-2007.

**CLASS 32—LIGHT BEVERAGES**

4,047,186. CALDERA BREWING COMPANY, ASHLAND, OR. SN 85-192,571. FILED P.R. 12-7-2010; AM. S.R. 8-18-2011.



THE MARK CONSISTS OF THE TRADE DRESS FOR THE PLACEMENT AND COMBINATION OF A PURPLE STRIPE AS PLACED ON THE TOP OF A CAN. THE SHAPE OF THE CAN IS NOT A FEATURE OF THE MARK AND THE DOTTED OUTLINE IS USED ONLY TO ILLUSTRATE PLACEMENT OF THE MARK.

FOR ALE; BEER (U.S. CLS. 45, 46 AND 48).  
FIRST USE 8-0-2007; IN COMMERCE 8-0-2007.

**CLASS 33—WINES AND SPIRITS**

4,047,115. HARRIS ESCHER VINEYARDS LLC, RUTHERFORD, CA. SN 77-924,130. FILED P.R. 1-29-2010; AM. S.R. 8-8-2011.

**cultivar**

THE MARK CONSISTS OF STANDARD CHARACTERS WITHOUT CLAIM TO ANY PARTICULAR FONT, STYLE, SIZE, OR COLOR.

FOR ALCOHOLIC BEVERAGES, NAMELY, WINE (U.S. CLS. 47 AND 49).

FIRST USE 4-21-2010; IN COMMERCE 4-21-2010.

**CLASS 33—(Continued).**

4,047,134. GERARDO GUSTAVO HERNANDEZ VEGA., TEPATITLAN, JALISCO., MEXICO. SN 85-074,345. FILED P.R. 6-29-2010; AM. S.R. 4-29-2011.



OWNER OF MEXICO REG. NO. 780894, DATED 2-27-2003, EXPIRES 7-19-2012.

THE MARK CONSISTS OF A THREE-DIMENSIONAL FIGURE WITH RECTANGULAR SHAPE CONSISTING OF A PLASTIC PACKAGING OR BAG TO CONTAIN ALCOHOLIC BEVERAGES, WHICH IS TO BE STORED IN THE POCKET.

FOR ALCOHOLIC BEVERAGES, NAMELY TEQUILA (U.S. CLS. 47 AND 49).

4,047,167. PUERTA DORADA, LLC, RUTHERFORD, CA. SN 85-179,728. FILED P.R. 11-18-2010; AM. S.R. 8-30-2011.

**CHATEAU NAPA**

THE MARK CONSISTS OF STANDARD CHARACTERS WITHOUT CLAIM TO ANY PARTICULAR FONT, STYLE, SIZE, OR COLOR.

NO CLAIM IS MADE TO THE EXCLUSIVE RIGHT TO USE "NAPA", APART FROM THE MARK AS SHOWN.

FOR WINES DERIVED FROM GRAPES GROWN IN NAPA COUNTY, CALIFORNIA, LABELED AND ADVERTISED IN COMPLIANCE WITH UNITED STATES LAWS FOR THE NAPA COUNTY APPELLATION OF ORIGIN OR THE NAPA VALLEY AMERICAN VITICULTURAL AREA APPELLATION OF ORIGIN (U.S. CLS. 47 AND 49).

FIRST USE 8-19-2011; IN COMMERCE 8-19-2011.

**SERVICE MARKS**

**CLASS 35—ADVERTISING AND BUSINESS**

**CLASS 35—(Continued).**

4,047,107. CASEY & TRIXIE'S PET SUPPLY COMPANY, HILLSBOROUGH, NJ. SN 76-691,962. FILED P.R. 8-12-2008; AM. S.R. 7-13-2011.

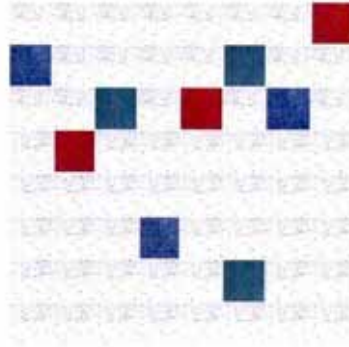

THE COLOR(S) RED, WHITE, BLUE, GREEN AND YELLOW IS/ARE CLAIMED AS A FEATURE OF THE MARK.

THE MARK CONSISTS OF TRADE DRESS COMPRISED OF A REPEATING PATTERN OF TILES COVERING THE FLOOR OF A RETAIL STORE IN THE FIELD OF PET AND ANIMAL SUPPLIES. THE PATTERN CONSISTS PRIMARILY OF WHITE TILES WITH RED, BLUE AND YELLOW SPECKLES THEREON, WITH A GREEN TILE, RED TILE, THEN BLUE TILE FORMING A HORIZONTAL LINE WITH THE WHITE SPECKLED TILES IN BETWEEN, ANOTHER RED TILE BELOW AND TO THE LEFT OF THE GREEN TILE IN THE HORIZONTAL LINE, ANOTHER BLUE TILE ABOVE AND TWO TILES TO THE LEFT OF THE GREEN TILE IN THE HORIZONTAL LINE, ANOTHER BLUE TILE ABOVE AND TWO TILES TO THE LEFT OF THE GREEN TILE IN THE HORIZONTAL LINE, ANOTHER BLUE TILE IN BETWEEN AND THREE TILES BELOW THE GREEN AND RED TILES IN THE HORIZONTAL LINE, ANOTHER GREEN TILE ABOVE AND IN BETWEEN THE RED AND BLUE TILES IN THE HORIZONTAL LINE, ANOTHER GREEN TILE FOUR TILES BELOW AND IN BETWEEN THE RED AND BLUE TILES IN THE HORIZONTAL LINE, AND ANOTHER RED TILE TO THE RIGHT AND TWO TILES ABOVE THE BLUE TILE IN THE HORIZONTAL LINE.

FOR RETAIL STORE SERVICES IN THE FIELD OF PET AND ANIMAL SUPPLIES, NAMELY, PET FOOD, PET DIETARY SUPPLEMENTS, OVER-THE-COUNTER MEDICINES, PET SNACKS, PET HOUSING, PET TOYS, PET TRAINING PRODUCTS, PET WASTE MANAGEMENT PRODUCTS, PET GROOMING PRODUCTS, PET COLLARS AND LEASHES, AND PET ACCESSORIES (U.S. CLS. 100, 101 AND 102).

FIRST USE 8-1-1994; IN COMMERCE 8-1-1994.

4,047,120. GETTY HEIGHTS, LLC, ARMONK, NY. SN 85-002,102. FILED P.R. 3-30-2010; AM. S.R. 8-1-2011.

**NATIONAL SPORTS BAR LEAGUE**

THE MARK CONSISTS OF STANDARD CHARACTERS WITHOUT CLAIM TO ANY PARTICULAR FONT, STYLE, SIZE, OR COLOR.

**CLASS 35—(Continued).**

NO CLAIM IS MADE TO THE EXCLUSIVE RIGHT TO USE "SPORTS BAR LEAGUE", APART FROM THE MARK AS SHOWN.

FOR ASSOCIATION SERVICES IN THE NATURE OF A COMPETITIVE LEAGUE DESIGNED TO PROMOTE THE GOODS AND SERVICES OF BAR AND RESTAURANT OWNERS, NAMELY, ORGANIZING CONTESTS AMONG AND BETWEEN BARS AND RESTAURANTS; ORGANIZING AND CONDUCTING CONTESTS TO PROMOTE THE SERVICES OF BAR AND RESTAURANT OWNERS; PROMOTIONAL MARKETING SERVICES FOR OTHERS IN THE ESTABLISHMENT AND OPERATION OF CONTESTS AMONG BAR AND RESTAURANT OWNERS; ASSOCIATION SERVICES, NAMELY, PROMOTING THE INTERESTS OF BAR AND RESTAURANT OWNERS (U.S. CLS. 100, 101 AND 102).

FIRST USE 5-0-2010; IN COMMERCE 5-0-2010.

---

4,047,126. RESEARCH PANEL ASIA INC., SHIBUYA, TOKYO, JAPAN. SN 85-019,180. FILED P.R. 4-21-2010; AM. S.R. 9-13-2011.



The logo for Research Panel ASIA features the words "Research Panel" in a bold, sans-serif font, followed by "ASIA" in a larger, bold, sans-serif font. A stylized, curved line passes through the letters "A", "S", and "I" of "ASIA".

THE MARK CONSISTS OF THE WORDS "RESEARCH PANEL" IN UPPER AND LOWERCASE LETTERS AND THE WORD "ASIA" IN ALL UPPERCASE LETTERS WITH A DOWNWARDLY-CURVED, PROGRESSIVELY-SHADED LINE DESIGN ELEMENT RUNNING THROUGH THE WORD "ASIA".

FOR ADVERTISING AND PUBLICITY SERVICES; DISTRIBUTION OF SAMPLES OF PRODUCTS; ISSUING AND MANAGING COUPONS FOR PROMOTING PRODUCTS AND SERVICES OF OTHERS; PLANNING PROMOTIONS FOR PRODUCTS AND SERVICES, AND IMPLEMENTING SUCH PROMOTIONS ON BEHALF OF OTHER PARTIES; PROMOTING THE GOODS OF OTHERS, NAMELY, ISSUING AND PROCESSING TRADING STAMPS, COUPONS, POINT CARDS, AND DISCOUNT CARDS FOR THE GOODS OF OTHERS; CONDUCTING MARKET RESEARCH; PUBLIC-OPINION POLLING; CONDUCTING TEST-USER MARKET SURVEYS; CONDUCTING QUESTIONNAIRE MARKET SURVEYS; COMPILING AND ANALYZING RESULTS OF MARKETING RESEARCH, PUBLIC-OPINION POLLING, TEST-USER MARKET SURVEYS, AND QUESTIONNAIRE MARKET SURVEYS, AND PROVIDING INFORMATION RELATED THERETO; ANALYZING BUSINESS-MANAGEMENT POLICIES AND PRACTICES, AND PROVIDING CONSULTANCY SERVICES REGARDING SAME; MEDIATION OF PRODUCT-SALES CONTRACTS; PROVIDING INFORMATION ABOUT COMMERCIAL SALES; SYSTEMIZING, COMPILING, AND ENTERING INFORMATION INTO COMPUTER DATABASES, AND CONSULTING AND ADVISORY SERVICES RELATED THERETO; PROVIDING AND RENTAL OF ADVERTISING SPACE ON THE INTERNET; PROVIDING OFFICE FUNCTIONS, NAMELY, FILING DOCUMENTS AND MAGNETIC TAPE; PROVIDING EMPLOYMENT AGENCY SERVICES; PROVIDING EMPLOYMENT INFORMATION SERVICES (U.S. CLS. 100, 101 AND 102).

FIRST USE 10-1-2009; IN COMMERCE 10-7-2010.

**CLASS 35—(Continued).**

4,047,129. GEISSELE AUTOMATICS LLC, NORRISTOWN, PA. SN 85-048,013. FILED P.R. 5-26-2010; AM. S.R. 9-8-2011.

## WEAPONMAKERS

THE MARK CONSISTS OF STANDARD CHARACTERS WITHOUT CLAIM TO ANY PARTICULAR FONT, STYLE, SIZE, OR COLOR.

FOR WHOLESALE AND ON-LINE WHOLESALE DISTRIBUTORSHIPS, AND WHOLESALE STORE SERVICES, FEATURING FIREARMS AND FIREARM COMPONENTS (U.S. CLS. 100, 101 AND 102).

FIRST USE 4-2-2009; IN COMMERCE 4-2-2009.

---

4,047,133. PRIZE CAPITAL, LLC, SAN DIEGO, CA. SN 85-072,232. FILED P.R. 6-25-2010; AM. S.R. 9-10-2011.

## CARBON CAPTURE AND RECYCLING PRIZE

THE MARK CONSISTS OF STANDARD CHARACTERS WITHOUT CLAIM TO ANY PARTICULAR FONT, STYLE, SIZE, OR COLOR.

NO CLAIM IS MADE TO THE EXCLUSIVE RIGHT TO USE "PRIZE", APART FROM THE MARK AS SHOWN.

FOR PROMOTING AWARENESS OF THE NEED FOR THE DEVELOPMENT AND CREATION OF TECHNOLOGICAL INNOVATIONS AND INVENTIONS AND RESEARCH AND DEVELOPMENT THROUGH A COMPETITION AND THE OFFERING OF PRIZES AND INCENTIVES; PROMOTING TECHNOLOGICAL INNOVATION AND INVENTION THROUGH COMPETITIONS AND THE OFFERING OF A PRIZE AND INCENTIVES; CONTESTS AND INCENTIVE PROGRAMS TO PROMOTE TECHNOLOGICAL INNOVATION AND DEVELOPMENT (U.S. CLS. 100, 101 AND 102).

FIRST USE 7-1-2010; IN COMMERCE 7-1-2010.

**CLASS 35—(Continued).**

4,047,135. HARRIS TEETER, INC., MATTHEWS, NC. SN 85-081,038. FILED P.R. 7-9-2010; AM. S.R. 8-30-2011.



THE MARK CONSISTS OF THE WORDS "THE CELLARS" IN AN OVAL.

FOR RETAIL STORE SERVICES FEATURING BEER, WINE, ALCOHOLIC BEVERAGES, MIXERS AND RELATED PRODUCTS AND ACCESSORIES (U.S. CLS. 100, 101 AND 102).

FIRST USE 7-12-2011; IN COMMERCE 7-12-2011.

4,047,164. NATIONAL DEFAULT SERVICING, LLC, GLASTONBURY, CT. SN 85-176,745. FILED P.R. 11-15-2010; AM. S.R. 8-26-2011.

**NATIONAL DEFAULT SERVICING**

THE MARK CONSISTS OF STANDARD CHARACTERS WITHOUT CLAIM TO ANY PARTICULAR FONT, STYLE, SIZE, OR COLOR.

FOR OUTSOURCING IN THE FIELD OF REO (REAL ESTATE OWNED) PROPERTIES (U.S. CLS. 100, 101 AND 102).

FIRST USE 6-30-2004; IN COMMERCE 6-30-2004.

4,047,172. NATALIA NUNEZ, FORT LEE, NJ. SN 85-183,015. FILED P.R. 11-22-2010; AM. S.R. 8-23-2011.

**National Criminal Defense Bar Association**

THE MARK CONSISTS OF STANDARD CHARACTERS WITHOUT CLAIM TO ANY PARTICULAR FONT, STYLE, SIZE, OR COLOR.

NO CLAIM IS MADE TO THE EXCLUSIVE RIGHT TO USE "BAR ASSOCIATION", APART FROM THE MARK AS SHOWN.

FOR ASSOCIATION SERVICES, NAMELY, PROMOTING THE INTERESTS OF CRIMINAL DEFENSE LAWYERS (U.S. CLS. 100, 101 AND 102).

FIRST USE 8-14-2002; IN COMMERCE 8-14-2002.

**CLASS 35—(Continued).**

4,047,173. HR LEVERAGE LLC, ALEXANDRIA, VA. SN 85-183,069. FILED P.R. 11-23-2010; AM. S.R. 8-27-2011.

**STRATEGIES FROM HIRING TO RETIRING**

THE MARK CONSISTS OF STANDARD CHARACTERS WITHOUT CLAIM TO ANY PARTICULAR FONT, STYLE, SIZE, OR COLOR.

FOR CONSULTING SERVICES IN THE FIELD OF HUMAN RESOURCES DEVELOPMENT, NAMELY, FOR THE PROMOTION OF EMPLOYEE RETENTION, CAREER GROWTH, BRIEFINGS AND REPORTS, AND INCREASED PRODUCTIVITY FOR EMPLOYEES AND EMPLOYERS (U.S. CLS. 100, 101 AND 102).

FIRST USE 8-9-2010; IN COMMERCE 11-19-2010.

4,047,174. ALLIED BUSINESS INTELLIGENCE, INC., OYSTER BAY, NY. SN 85-184,225. FILED P.R. 11-23-2010; AM. S.R. 9-2-2011.

**TECHNOLOGY BAROMETER**

THE MARK CONSISTS OF STANDARD CHARACTERS WITHOUT CLAIM TO ANY PARTICULAR FONT, STYLE, SIZE, OR COLOR.

FOR PROVIDING ON-GOING CONSUMER SURVEY-BASED INFORMATION THAT TRACKS TRENDS IN CONSUMER PURCHASE INTENTIONS, USAGE, OWNERSHIP AND ADOPTION OF MULTIPLE DIFFERENT TECHNOLOGIES, EQUIPMENT TYPES AND TECHNOLOGY SERVICES (U.S. CLS. 100, 101 AND 102).

FIRST USE 2-24-2011; IN COMMERCE 2-24-2011.

4,047,187. RIVER NORTH GROUP, LLC, CHICAGO, IL. SN 85-194,257. FILED P.R. 12-9-2010; AM. S.R. 9-7-2011.

**RIVER NORTH GROUP**

THE MARK CONSISTS OF STANDARD CHARACTERS WITHOUT CLAIM TO ANY PARTICULAR FONT, STYLE, SIZE, OR COLOR.

FOR ADVERTISING AND MARKETING SERVICES, NAMELY, PROMOTING THE GOODS AND SERVICES OF OTHERS (U.S. CLS. 100, 101 AND 102).

FIRST USE 8-3-2007; IN COMMERCE 8-3-2007.

**CLASS 35—(Continued).**

4,047,193. SIDESHOW ENTERTAINMENT, INC., ALAMEDA, CA. SN 85-201,151. FILED P.R. 12-17-2010; AM. S.R. 8-6-2011.

# Half Off!

THE MARK CONSISTS OF STANDARD CHARACTERS WITHOUT CLAIM TO ANY PARTICULAR FONT, STYLE, SIZE, OR COLOR.

FOR PROMOTING THE GOODS AND SERVICES OF OTHERS BY PROVIDING A WEBSITE FEATURING COUPONS, REBATES, PRICE-COMPARISON INFORMATION, PRODUCT REVIEWS, LINKS TO THE RETAIL WEBSITES OF OTHERS, AND DISCOUNT INFORMATION (U.S. CLS. 100, 101 AND 102).

FIRST USE 4-4-2009; IN COMMERCE 4-4-2009.

4,047,195. PARADISE EMPIRE JEWELRY INC., NEW YORK, NY. SN 85-206,248. FILED P.R. 12-27-2010; AM. S.R. 8-9-2011.

## BIGGEST DIAMOND .COM

THE MARK CONSISTS OF STANDARD CHARACTERS WITHOUT CLAIM TO ANY PARTICULAR FONT, STYLE, SIZE, OR COLOR.

NO CLAIM IS MADE TO THE EXCLUSIVE RIGHT TO USE ".COM", APART FROM THE MARK AS SHOWN.

FOR ON-LINE RETAIL STORE SERVICES FEATURING JEWELRY (U.S. CLS. 100, 101 AND 102).

FIRST USE 1-0-2011; IN COMMERCE 1-0-2011.

4,047,200. DIXON HUGHES GOODMAN LLP, CHARLOTTE, NC. SN 85-231,001. FILED P.R. 2-1-2011; AM. S.R. 9-6-2011.

# eXception

THE MARK CONSISTS OF STANDARD CHARACTERS WITHOUT CLAIM TO ANY PARTICULAR FONT, STYLE, SIZE, OR COLOR.

FOR BUSINESS CONSULTING SERVICES, NAMELY, ASSISTING TRANSPORTATION INDUSTRY RETAILERS WITH THE IDENTIFICATION OF POTENTIAL ACCOUNTING ERRORS AND IRREGULARITIES IN BUSINESS OPERATIONS (U.S. CLS. 100, 101 AND 102).

FIRST USE 1-10-2011; IN COMMERCE 7-1-2011.

**CLASS 35—(Continued).**

4,047,205. ILASH INC., HEBER CITY, UT. SN 85-243,355. FILED P.R. 2-16-2011; AM. S.R. 9-7-2011.

# ILASHSTORE

THE MARK CONSISTS OF STANDARD CHARACTERS WITHOUT CLAIM TO ANY PARTICULAR FONT, STYLE, SIZE, OR COLOR.

FOR ON-LINE RETAIL STORE SERVICES FEATURING SEMI-PERMANENT EYELASH EXTENSION PRODUCTS (U.S. CLS. 100, 101 AND 102).

FIRST USE 5-1-2010; IN COMMERCE 5-1-2010.

4,047,209. MADE IN MICHIGAN TALENT NETWORK, LLC, STERLING HEIGHTS, MI. SN 85-255,259. FILED P.R. 3-2-2011; AM. S.R. 8-22-2011.

## MADE IN MICHIGAN TALENT NETWORK

THE MARK CONSISTS OF STANDARD CHARACTERS WITHOUT CLAIM TO ANY PARTICULAR FONT, STYLE, SIZE, OR COLOR.

FOR PROVIDING AN ONLINE BUSINESS DIRECTORY; PROVIDING AN ONLINE SERVICE FOR CONNECTING SOCIAL MEDIA USERS, NAMELY, ON-LINE PROFESSIONAL NETWORKING SERVICES (U.S. CLS. 100, 101 AND 102).

FIRST USE 10-1-2010; IN COMMERCE 2-7-2011.

4,047,212. OPFER, SCOTT, SPRINGFIELD, MO. SN 85-264,342. FILED P.R. 3-11-2011; AM. S.R. 9-16-2011.

## AMAZING INVENTIONS

THE MARK CONSISTS OF STANDARD CHARACTERS WITHOUT CLAIM TO ANY PARTICULAR FONT, STYLE, SIZE, OR COLOR.

FOR ADVERTISING AND MARKETING SERVICES, NAMELY, PROMOTING THE GOODS AND SERVICES OF OTHERS (U.S. CLS. 100, 101 AND 102).

FIRST USE 3-21-2011; IN COMMERCE 3-21-2011.

**CLASS 35—(Continued).**

4,047,216. RAWLINGS SPORTING GOODS COMPANY, INC., ST. LOUIS, MO. SN 85-267,230. FILED P.R. 3-15-2011; AM. S.R. 8-30-2011.

NATIONAL PLAY CATCH WITH  
YOUR KIDS MONTH

THE MARK CONSISTS OF STANDARD CHARACTERS WITHOUT CLAIM TO ANY PARTICULAR FONT, STYLE, SIZE, OR COLOR.

NO CLAIM IS MADE TO THE EXCLUSIVE RIGHT TO USE "MONTH", APART FROM THE MARK AS SHOWN.

FOR PROMOTING ANTI-OBESITY INITIATIVES; PROMOTING PUBLIC AWARENESS OF THE DANGERS OF CHILDHOOD OBESITY; PROMOTING PUBLIC AWARENESS OF HEALTHY CHILDHOOD PRACTICES (U.S. CLS. 100, 101 AND 102).

FIRST USE 3-30-2011; IN COMMERCE 3-30-2011.

4,047,239. NATIONAL SHOOTING SPORTS FOUNDATION, INC., NEWTOWN, CT. SN 85-307,266. FILED P.R. 4-28-2011; AM. S.R. 9-7-2011.

ORIGINAL GREEN MOVEMENT

THE MARK CONSISTS OF STANDARD CHARACTERS WITHOUT CLAIM TO ANY PARTICULAR FONT, STYLE, SIZE, OR COLOR.

FOR PROMOTING PUBLIC AWARENESS OF SHOOTING SPORTS, OUTDOOR SPORTS, HUNTING, FISHING, AND ARCHERY, AND ENVIRONMENTAL AND WILDLIFE CONSERVATION (U.S. CLS. 100, 101 AND 102).

FIRST USE 4-3-2011; IN COMMERCE 4-3-2011.

4,047,249. VEGETARIANVITAMINS.COM LLC, STERRETT, AL. SN 85-316,395. FILED P.R. 5-9-2011; AM. S.R. 9-2-2011.

VEGETARIANVITAMINS.COM

THE MARK CONSISTS OF STANDARD CHARACTERS WITHOUT CLAIM TO ANY PARTICULAR FONT, STYLE, SIZE, OR COLOR.

**CLASS 35—(Continued).**

NO CLAIM IS MADE TO THE EXCLUSIVE RIGHT TO USE ".COM", APART FROM THE MARK AS SHOWN.

FOR ON-LINE RETAIL STORE SERVICES FEATURING DIETARY AND NUTRITIONAL SUPPLEMENTS, DIETARY SUPPLEMENTS, HEALTH FOOD SUPPLEMENTS, HERBAL SUPPLEMENTS, MINERAL SUPPLEMENTS, NUTRITIONAL SUPPLEMENTS, VITAMIN AND MINERAL SUPPLEMENTS, VITAMIN SUPPLEMENTS, VITAMINS (U.S. CLS. 100, 101 AND 102).

FIRST USE 5-24-2006; IN COMMERCE 5-24-2006.

4,047,260. HATCH, INC., WINSTON-SALEM, NC. SN 85-329,678. FILED P.R. 5-25-2011; AM. S.R. 8-11-2011.

*The Early Learning Experts*

THE MARK CONSISTS OF THE WORDS "THE EARLY LEARNING EXPERTS" IN GRAY UPPERCASE AND LOWERCASE LETTERS.

FOR DIRECT MARKETING TO SCHOOLS; MAIL ORDER CATALOG SERVICES AND ON-LINE RETAIL STORE SERVICES IN THE FIELD OF COMPUTER HARDWARE AND SOFTWARE, CLASSROOM EQUIPMENT, CLASSROOM FURNITURE, AND TEACHING AIDS, GAMES, BOOKS AND EDUCATIONAL KITS; CONDUCTING TRADE SHOW EXHIBITIONS IN THE FIELD OF COMPUTER HARDWARE AND SOFTWARE, CLASSROOM EQUIPMENT, CLASSROOM FURNITURE, AND TEACHING AIDS, GAMES, BOOKS AND EDUCATIONAL KITS (U.S. CLS. 100, 101 AND 102).

FIRST USE 5-9-2011; IN COMMERCE 5-9-2011.

4,047,261. AARDVARK PROMOTIONS, INC., CHICAGO, IL. SN 85-331,493. FILED P.R. 5-26-2011; AM. S.R. 9-13-2011.

THE VINTAGE BAZAAR

THE MARK CONSISTS OF STANDARD CHARACTERS WITHOUT CLAIM TO ANY PARTICULAR FONT, STYLE, SIZE, OR COLOR.

NO CLAIM IS MADE TO THE EXCLUSIVE RIGHT TO USE "BAZAAR", APART FROM THE MARK AS SHOWN.

FOR PROVIDING A WEBSITE FOR CONNECTING BUYERS WITH SELLERS VIA A MOBILE FLEA MARKET THAT ALSO PROVIDES INFORMATION ABOUT THE TIME AND PLACE THE FLEA MARKET WILL TAKE PLACE AS WELL AS CONSUMER PRODUCT INFORMATION ABOUT THE VENDORS AND TYPES OF ITEMS TO BE SOLD; FLEA MARKET SERVICES (U.S. CLS. 100, 101 AND 102).

FIRST USE 9-2-2009; IN COMMERCE 9-2-2009.

**CLASS 35—(Continued).**

4,047,265. MIRIAM CARRIAZO, LOWELL, MA. SN 85-975,638. FILED P.R. 3-7-2011; AM. S.R. 8-10-2011.

**CARRIAZO TALENT**

THE MARK CONSISTS OF STANDARD CHARACTERS WITHOUT CLAIM TO ANY PARTICULAR FONT, STYLE, SIZE, OR COLOR.

NO CLAIM IS MADE TO THE EXCLUSIVE RIGHT TO USE "TALENT", APART FROM THE MARK AS SHOWN.

FOR TALENT AGENCY SERVICES (U.S. CLS. 100, 101 AND 102).

FIRST USE 2-1-2011; IN COMMERCE 2-1-2011.

**CLASS 36—INSURANCE AND FINANCIAL**

4,047,128. SOUTHWESTRE, ADDISON, TX. SN 85-042,933. FILED P.R. 5-19-2010; AM. S.R. 9-6-2011.

**COMPLETE AUTO PROTECTION**

THE MARK CONSISTS OF STANDARD CHARACTERS WITHOUT CLAIM TO ANY PARTICULAR FONT, STYLE, SIZE, OR COLOR.

NO CLAIM IS MADE TO THE EXCLUSIVE RIGHT TO USE "AUTO PROTECTION", APART FROM THE MARK AS SHOWN.

FOR PROVIDING WARRANTIES ON GOODS MANUFACTURED BY OTHERS, NAMELY, VEHICLES (U.S. CLS. 100, 101 AND 102).

FIRST USE 4-4-2010; IN COMMERCE 4-4-2010.

4,047,130. SOMETRICS, INC., EL SEGUNDO, CA. SN 85-049,648. FILED P.R. 5-27-2010; AM. S.R. 9-1-2011.

**GAME COINS**

THE MARK CONSISTS OF STANDARD CHARACTERS WITHOUT CLAIM TO ANY PARTICULAR FONT, STYLE, SIZE, OR COLOR.

FOR FINANCIAL SERVICES, NAMELY, PROVIDING A VIRTUAL CURRENCY FOR USE BY MEMBERS OF AN ON-LINE COMMUNITY VIA A GLOBAL COMPUTER NETWORK (U.S. CLS. 100, 101 AND 102).

FIRST USE 12-15-2009; IN COMMERCE 12-15-2009.

**CLASS 36—(Continued).**

4,047,148. SARVARY, MARK, CARLSBAD, CA. SN 85-136,052. FILED 9-22-2010.

**One Fee Club**

THE MARK CONSISTS OF STANDARD CHARACTERS WITHOUT CLAIM TO ANY PARTICULAR FONT, STYLE, SIZE, OR COLOR.

FOR REAL ESTATE LISTING (U.S. CLS. 100, 101 AND 102).

FIRST USE 10-12-2010; IN COMMERCE 10-12-2010.

4,047,165. HIRTLE, CALLAGHAN & CO., LLC, WEST CONSHOCKEN, PA. SN 85-177,914. FILED P.R. 11-16-2010; AM. S.R. 8-4-2011.

**AMERICA'S FIRST OUTSOURCED  
CHIEF INVESTMENT OFFICERS**

THE MARK CONSISTS OF STANDARD CHARACTERS WITHOUT CLAIM TO ANY PARTICULAR FONT, STYLE, SIZE, OR COLOR.

OWNER OF U.S. REG. NO. 2,063,364.

FOR INVESTMENT SERVICES, NAMELY, INVESTMENT OF FUNDS FOR OTHERS, INVESTMENT ADVISORY SERVICES, FINANCIAL RISK MANAGEMENT, FINANCIAL PORTFOLIO MANAGEMENT, PRIVATE EQUITY FUND INVESTMENT, FAMILY FINANCIAL ASSET MANAGEMENT, INSTITUTIONAL FINANCIAL ASSET MANAGEMENT FOR ENDOWMENTS, FOUNDATIONS AND HEALTHCARE INSTITUTIONS (U.S. CLS. 100, 101 AND 102).

FIRST USE 6-0-2009; IN COMMERCE 6-0-2009.

4,047,178. LESSONS FOR CHARITY, LLC, BOSTON, MA. SN 85-188,094. FILED P.R. 12-1-2010; AM. S.R. 9-6-2011.

**Lessons for Charity**

THE MARK CONSISTS OF STANDARD CHARACTERS WITHOUT CLAIM TO ANY PARTICULAR FONT, STYLE, SIZE, OR COLOR.

NO CLAIM IS MADE TO THE EXCLUSIVE RIGHT TO USE "CHARITY", APART FROM THE MARK AS SHOWN.

FOR CHARITABLE FUNDRAISING (U.S. CLS. 100, 101 AND 102).

FIRST USE 12-5-2010; IN COMMERCE 1-5-2011.



**CLASS 36—(Continued).**

4,047,219. NORTHWEST BANK AND TRUST COMPANY, DAVENPORT, IA. SN 85-274,310. FILED P.R. 3-23-2011; AM. S.R. 8-30-2011.

**BANK MANAGER SOLUTIONS**

THE MARK CONSISTS OF STANDARD CHARACTERS WITHOUT CLAIM TO ANY PARTICULAR FONT, STYLE, SIZE, OR COLOR.

FOR FINANCIAL SERVICES TO ASSIST FINANCIAL INSTITUTIONS, NAMELY, FINANCIAL MANAGEMENT AND FINANCIAL ADMINISTRATION OF IN-HOUSE SWEEP ACCOUNTS, COLLATERALIZED DEPOSITS, LOAN PRICING, LOAN ADMINISTRATION, AND BANK OPERATIONS IN THE NATURE OF TURN-KEY PACKAGES (U.S. CLS. 100, 101 AND 102).

FIRST USE 2-20-2011; IN COMMERCE 2-20-2011.

4,047,258. BRIGHTER FUTURE EVENTS, INC., DBA STREAK FOR CANCER, AUBURN, ME. SN 85-326,025. FILED P.R. 5-20-2011; AM. S.R. 9-7-2011.

**STREAK FOR CANCER**

THE MARK CONSISTS OF STANDARD CHARACTERS WITHOUT CLAIM TO ANY PARTICULAR FONT, STYLE, SIZE, OR COLOR.

FOR CHARITABLE SERVICES, NAMELY, ORGANIZING FUNDRAISING SERVICES AND EVENTS TO RAISE FUNDS IN THE FIELD OF MEDICAL RESEARCH, SUPPORT FOR MEDICAL PATIENTS, AND SUPPORT FOR THE FAMILIES OF MEDICAL PATIENTS (U.S. CLS. 100, 101 AND 102).

FIRST USE 4-0-2011; IN COMMERCE 5-20-2011.

**CLASS 37—CONSTRUCTION AND REPAIR****CLASS 37—(Continued).**

4,047,206. GRILL GROOMERS, LLC, SCOTTSDALE, AZ. SN 85-244,478. FILED P.R. 2-17-2011; AM. S.R. 9-16-2011.

**Grill Groomers**

THE MARK CONSISTS OF STANDARD CHARACTERS WITHOUT CLAIM TO ANY PARTICULAR FONT, STYLE, SIZE, OR COLOR.

FOR CLEANING OF BARBEQUE GRILLS AND FIRE PITS USING SOLVENTS, VAPORS AND HIGH TEMPERATURE CARBONIZATION (U.S. CLS. 100, 103 AND 106).

FIRST USE 2-13-2011; IN COMMERCE 7-1-2011.

4,047,226. WHEELKRAFT NW, VANCOUVER, WA. SN 85-285,082. FILED P.R. 4-4-2011; AM. S.R. 8-12-2011.

**"WE FIX WHEELS"**

THE MARK CONSISTS OF STANDARD CHARACTERS WITHOUT CLAIM TO ANY PARTICULAR FONT, STYLE, SIZE, OR COLOR.

FOR INSTALLATION, MAINTENANCE AND REPAIR OF AUTOMOBILE WHEELS; MAINTENANCE AND/OR REPAIR OF AUTOMOBILE WHEELS (U.S. CLS. 100, 103 AND 106).

FIRST USE 5-18-2010; IN COMMERCE 5-18-2010.

4,047,228. BATZNER BED BUG SERVICES, INC., NEW BERLIN, WI. SN 85-288,016. FILED P.R. 4-6-2011; AM. S.R. 9-2-2011.



THE COLOR(S) RED, BLUE, YELLOW, BROWN, AND GRAY IS/ARE CLAIMED AS A FEATURE OF THE MARK.

**CLASS 37—(Continued).**

THE MARK CONSISTS OF THE STYLIZED WORDING "NO BED BUG ZONE". WITH THE WORD "NO" IN RED, "BED BUG" IN BLUE, AND "ZONE" IN YELLOW WITH GRAY SHADOWING. THE LETTER "O" IN "NO" IS MADE UP OF THE UNIVERSAL PROHIBITION SYMBOL IN RED ON TOP OF A REPRESENTATION OF A BED BUG IN BROWN.

FOR PEST CONTROL (U.S. CLS. 100, 103 AND 106).  
FIRST USE 11-17-2010; IN COMMERCE 11-17-2010.

4,047,235. BATZNER BED BUG SERVICES, INC., NEW BERLIN, WI. SN 85-301,449. FILED P.R. 4-21-2011; AM. S.R. 9-2-2011.

### Wisconsin's Most Experienced Bed Bug Company

THE MARK CONSISTS OF STANDARD CHARACTERS WITHOUT CLAIM TO ANY PARTICULAR FONT, STYLE, SIZE, OR COLOR.

NO CLAIM IS MADE TO THE EXCLUSIVE RIGHT TO USE "COMPANY", APART FROM THE MARK AS SHOWN.  
FOR PEST CONTROL (U.S. CLS. 100, 103 AND 106).  
FIRST USE 4-20-2011; IN COMMERCE 4-21-2011.

**CLASS 38—COMMUNICATION**

4,047,132. NOREK, JOSH, LAFAYETTE, CA. SN 85-065,973. FILED P.R. 6-17-2010; AM. S.R. 7-28-2011.



NO CLAIM IS MADE TO THE EXCLUSIVE RIGHT TO USE "THE LATIN ALTERNATIVE", APART FROM THE MARK AS SHOWN.

THE COLOR(S) RED AND WHITE IS/ARE CLAIMED AS A FEATURE OF THE MARK.

THE MARK CONSISTS OF WHITE TEXT STATING "THE LATIN ALTERNATIVE" WITHIN A RED SQUARE BACKGROUND.

FOR BROADCASTING SERVICES SPECIALIZED IN LATIN ALTERNATIVE ROCK, HIP-HOP AND ELECTRONIC MUSIC RENDERED THROUGH SYNDICATED RADIO BROADCASTS, WEBCASTING AND TRANSMISSIONS TO WIRELESS COMMUNICATIONS DEVICES, HANDHELD COMPUTERS, PERSONAL DIGITAL ASSISTANTS, AND CELL PHONES (U.S. CLS. 100, 101 AND 104).

FIRST USE 7-1-2009; IN COMMERCE 7-1-2009.

**CLASS 38—(Continued).**

4,047,196. TODD R SAUNDERS, GOBLES, MI. SN 85-213,501. FILED 1-8-2011.

### WebCastYourSelf

THE MARK CONSISTS OF STANDARD CHARACTERS WITHOUT CLAIM TO ANY PARTICULAR FONT, STYLE, SIZE, OR COLOR.

FOR AUDIO AND VIDEO BROADCASTING SERVICES OVER THE INTERNET; BROADCAST COMMUNICATION SERVICES, NAMELY, TRANSMITTING E-MAILS, FAXES, TEXT MESSAGES AND TELEPHONE VOICE MESSAGES TO DESIGNATED RECIPIENTS FOR OTHERS; BROADCASTING OF VIDEO AND AUDIO PROGRAMMING OVER THE INTERNET; BROADCASTING PROGRAMS VIA A GLOBAL COMPUTER NETWORK; BROADCASTING SERVICES AND PROVISION OF TELECOMMUNICATION ACCESS TO VIDEO AND AUDIO CONTENT PROVIDED VIA A VIDEO-ON-DEMAND SERVICE VIA THE INTERNET; CHAT ROOM SERVICES FOR SOCIAL NETWORKING; COMMUNICATION SERVICES, NAMELY, TRANSMISSION OF VOICE, AUDIO, VISUAL IMAGES AND DATA BY TELECOMMUNICATIONS NETWORKS, WIRELESS COMMUNICATION NETWORKS, THE INTERNET, INFORMATION SERVICES NETWORKS AND DATA NETWORKS; COMMUNICATIONS SERVICES, NAMELY, TRANSMITTING STREAMED SOUND AND AUDIOVISUAL RECORDINGS VIA THE INTERNET; COMPUTER SERVICES, NAMELY, PROVIDING ON-LINE FACILITIES FOR REAL-TIME INTERACTION WITH OTHER COMPUTER USERS CONCERNING TOPICS OF EDUCATION; COMPUTER SERVICES, NAMELY, PROVIDING ON-LINE FACILITIES FOR REAL-TIME INTERACTION WITH OTHER COMPUTER USERS CONCERNING TOPICS OF GENERAL INTEREST; EDUCATIONAL TEXT MESSAGING SERVICES FOR TRANSMISSION OF EDUCATIONAL CONTENT VIA SMS; ELECTRONIC TRANSMISSION FOR OTHERS OF SECURITIES AND FINANCIAL INFORMATION VIA COMPUTER LINKING SERVICES, NAMELY, COMMUNICATING AND ROUTING TRADE INFORMATION INVOLVING ORDERS, ENTRY AND EXECUTION SERVICES, TO OTHERS VIA A GLOBAL COMPUTER NETWORK; INTERNET BASED PAGING AND ALERTING SERVICES, NAMELY, PROVIDING A WEB SITE AT WHICH USERS CAN SEND MESSAGES TO ELECTRONIC PAGING DEVICES; INTERNET BROADCASTING SERVICES; INTERNET RADIO BROADCASTING SERVICES; INTERNET RADIO SERVICES, NAMELY, TRANSMISSION OF AUDIO MATERIAL VIA THE INTERNET; MESSAGE SENDING AND RECEIVING SERVICES; NETWORK CONFERENCING SERVICES; PEER-TO-PEER NETWORK COMPUTER SERVICES, NAMELY, ELECTRONIC TRANSMISSION OF AUDIO, VIDEO AND OTHER DATA AND DOCUMENTS AMONG COMPUTERS; PEER-TO-PEER PHOTO SHARING SERVICES, NAMELY, ELECTRONIC TRANSMISSION OF DIGITAL PHOTO FILES AMONG INTERNET USERS; PODCASTING SERVICES; SIMULCASTING BROADCAST TELEVISION OVER GLOBAL COMMUNICATION NETWORKS, THE INTERNET AND WIRELESS NETWORKS; TELECOMMUNICATION SERVICES, NAMELY, TRANSMISSION OF VOICE, DATA, GRAPHICS, IMAGES, AUDIO AND VIDEO BY MEANS OF TELECOMMUNICATIONS NETWORKS, WIRELESS COMMUNICATION NET-

**CLASS 38—(Continued).**

WORKS, AND THE INTERNET; TELECONFERENCING AND VIDEO CONFERENCING SERVICES; TRANSMISSION SERVICES VIA THE INTERNET, FEATURING MP3 FILES AND MUSIC VIDEOS; VIDEO BROADCASTING; VIDEO BROADCASTING AND TRANSMISSION SERVICES VIA THE INTERNET, FEATURING FILMS AND MOVIES; VIDEO BROADCASTING SERVICES OVER THE INTERNET OR OTHER COMMUNICATIONS NETWORK FEATURING THE UPLOADED, POSTED AND TAGGED VIDEOS OF OTHERS; VIDEO BROADCASTING SERVICES OVER THE INTERNET OR OTHER COMMUNICATIONS NETWORK, NAMELY, ELECTRONICALLY TRANSMITTING VIDEO CLIPS; VIDEO BROADCASTING SERVICES VIA THE INTERNET; VIDEO CONFERENCING SERVICES; VIDEO STREAMING SERVICES VIA THE INTERNET, FEATURING INDEPENDENT FILMS AND MOVIES; VIDEO-ON-DEMAND TRANSMISSION SERVICES; VIDEO-ON-DEMAND TRANSMISSION SERVICES VIA THE INTERNET; WEB CASTING SERVICES; WEB CONFERENCING SERVICES; WEBCASTING SERVICES (U.S. CLS. 100, 101 AND 104).  
FIRST USE 1-12-2006; IN COMMERCE 1-12-2006.

---

4,047,266. SCENE, LLC, KALISPELL, MT. SN 85-975,704. FILED P.R. 6-16-2010; AM. S.R. 2-3-2011.

**SPEEDTEST**

THE MARK CONSISTS OF STANDARD CHARACTERS WITHOUT CLAIM TO ANY PARTICULAR FONT, STYLE, SIZE, OR COLOR.

FOR PROVIDING INFORMATION IN THE FIELD OF INTERNET CONNECTIONS; PROVIDING INFORMATION IN THE FIELD OF INTERNET CONNECTIONS VIA THE INTERNET (U.S. CLS. 100, 101 AND 104).  
FIRST USE 9-30-2006; IN COMMERCE 9-30-2006.

**CLASS 39—TRANSPORTATION AND STORAGE**

---

4,047,248. A METAL SOURCE, LLC, CLEVELAND, OH. SN 85-316,388. FILED P.R. 5-9-2011; AM. S.R. 8-31-2011.

**A Metal Source, LLC**

THE MARK CONSISTS OF STANDARD CHARACTERS WITHOUT CLAIM TO ANY PARTICULAR FONT, STYLE, SIZE, OR COLOR.

NO CLAIM IS MADE TO THE EXCLUSIVE RIGHT TO USE "LLC", APART FROM THE MARK AS SHOWN.

FOR DISTRIBUTION SERVICES, NAMELY, DELIVERY OF STANDARD AND CUSTOM-MADE PRODUCTS MADE FROM METALS, ALLOYS AND/OR RARE EARTH METALS (U.S. CLS. 100 AND 105).  
FIRST USE 10-8-2010; IN COMMERCE 10-8-2010.

**CLASS 40—MATERIAL TREATMENT**

4,047,108. BARGAIN BASEMENT PRINTING, LLC, BOSTON, MA. SN 76-705,042. FILED P.R. 10-25-2010; AM. S.R. 8-1-2011.

**BARGAIN BASEMENT PRINTING**

NO CLAIM IS MADE TO THE EXCLUSIVE RIGHT TO USE "PRINTING", APART FROM THE MARK AS SHOWN. FOR PRINTING SERVICES (U.S. CLS. 100, 103 AND 106).

FIRST USE 2-28-2011; IN COMMERCE 2-28-2011.

---

4,047,150. TENSHON, LLC, MESA, AZ. SN 85-144,759. FILED P.R. 10-4-2010; AM. S.R. 9-3-2011.

**Tenshon**

THE MARK CONSISTS OF STANDARD CHARACTERS WITHOUT CLAIM TO ANY PARTICULAR FONT, STYLE, SIZE, OR COLOR.

FOR MANUFACTURING SERVICES FOR OTHERS IN THE FIELD OF SHADE SAILS AND SHADING PRODUCTS (U.S. CLS. 100, 103 AND 106).

FIRST USE 8-1-2008; IN COMMERCE 8-1-2008.

---

4,047,208. MOBILE RECYCLING USA, INC, DBA MOBILE RECYCLING, CENTENNIAL, CO. SN 85-251,979. FILED P.R. 2-25-2011; AM. S.R. 9-6-2011.

**Mobile Recycling**

THE MARK CONSISTS OF STANDARD CHARACTERS WITHOUT CLAIM TO ANY PARTICULAR FONT, STYLE, SIZE, OR COLOR.

NO CLAIM IS MADE TO THE EXCLUSIVE RIGHT TO USE "RECYCLING", APART FROM THE MARK AS SHOWN.

FOR RECYCLING (U.S. CLS. 100, 103 AND 106).

FIRST USE 5-26-2010; IN COMMERCE 6-11-2010.

**CLASS 41—EDUCATION AND ENTERTAINMENT**

**CLASS 41—(Continued).**

4,047,110. NATIONAL HURRICANE MUSEUM AND SCIENCE CENTER, INC., LAKE CHARLES, LA. SN 77-735,296. FILED P.R. 5-12-2009; AM. S.R. 12-30-2010.

**NATIONAL HURRICANE MUSEUM  
& SCIENCE CENTER**

THE MARK CONSISTS OF STANDARD CHARACTERS WITHOUT CLAIM TO ANY PARTICULAR FONT, STYLE, SIZE, OR COLOR.

NO CLAIM IS MADE TO THE EXCLUSIVE RIGHT TO USE "MUSEUM & SCIENCE CENTER", APART FROM THE MARK AS SHOWN.

FOR MUSEUMS; ART EXHIBITIONS (U.S. CLS. 100, 101 AND 107).

FIRST USE 12-17-2010; IN COMMERCE 12-17-2010.

4,047,131. LOVEJULIET LLC, CLOSTER, NJ. SN 85-053,534. FILED P.R. 6-3-2010; AM. S.R. 8-18-2011.

**Bergen Mama**

THE MARK CONSISTS OF STANDARD CHARACTERS WITHOUT CLAIM TO ANY PARTICULAR FONT, STYLE, SIZE, OR COLOR.

FOR ONLINE ENTERTAINMENT SERVICES FOCUSED ON SUBURBAN MOMS IN BERGEN COUNTY, NEW JERSEY, NAMELY, PROVIDING ON-LINE NEWSLETTERS IN THE FIELD OF MERCHANDISE SALES, EVENTS, AND SERVICES AVAILABLE TO THE PUBLIC (U.S. CLS. 100, 101 AND 107).

FIRST USE 7-1-2009; IN COMMERCE 12-1-2009.

4,047,143. DETAILS EVENT MANAGEMENT, LLC, GILBERT, AZ. SN 85-129,763. FILED P.R. 9-15-2010; AM. S.R. 6-28-2011.

**THE ANNUAL MOM  
ENTREPRENEUR CELEBRATION**

THE MARK CONSISTS OF STANDARD CHARACTERS WITHOUT CLAIM TO ANY PARTICULAR FONT, STYLE, SIZE, OR COLOR.

**CLASS 41—(Continued).**

NO CLAIM IS MADE TO THE EXCLUSIVE RIGHT TO USE "CELEBRATION", APART FROM THE MARK AS SHOWN.

FOR EDUCATIONAL SERVICES, NAMELY, PROVIDING INCENTIVES TO INDIVIDUALS TO DEMONSTRATE EXCELLENCE IN THE FIELD OF ENTREPRENEURSHIP; EDUCATIONAL SERVICES, NAMELY, PROVIDING INCENTIVES TO INDIVIDUALS TO DEMONSTRATE EXCELLENCE IN THE FIELD OF ENTREPRENEURSHIP THROUGH THE ISSUANCE OF AWARDS; ENTERTAINMENT IN THE NATURE OF CONDUCTING AN AWARDS PROGRAM AND CEREMONY IN THE FIELD OF ENTREPRENEURSHIP; ENTERTAINMENT SERVICES, NAMELY, CONDUCTING PARTIES; PROVIDING RECOGNITION AND INCENTIVES BY THE WAY OF AWARDS AND CONTESTS TO DEMONSTRATE EXCELLENCE IN THE FIELD OF ENTREPRENEURSHIP (U.S. CLS. 100, 101 AND 107).

FIRST USE 5-0-2011; IN COMMERCE 5-0-2011.

4,047,168. EDUCATIONAL TECHNOLOGY AND LIFE CORPORATION, IRVINE, CA. SN 85-179,936. FILED P.R. 11-18-2010; AM. S.R. 9-1-2011.

**EdTechTeam**

THE MARK CONSISTS OF STANDARD CHARACTERS WITHOUT CLAIM TO ANY PARTICULAR FONT, STYLE, SIZE, OR COLOR.

FOR EDUCATIONAL SERVICES, NAMELY, PROVIDING MOTIVATIONAL AND EDUCATIONAL SPEAKERS; EDUCATION SERVICES, NAMELY, PROVIDING LIVE AND ON-LINE SEMINARS IN THE FIELD OF EDUCATION TECHNOLOGY (U.S. CLS. 100, 101 AND 107).

FIRST USE 7-1-2010; IN COMMERCE 7-1-2010.

4,047,176. SANDY MARCUCCI INTERNATIONAL CAMPS, INC., WILLIAMSTOWN, NJ. SN 85-187,076. FILED P.R. 11-30-2010; AM. S.R. 9-1-2011.

**Philadelphia International  
Music Festival**

THE MARK CONSISTS OF STANDARD CHARACTERS WITHOUT CLAIM TO ANY PARTICULAR FONT, STYLE, SIZE, OR COLOR.

NO CLAIM IS MADE TO THE EXCLUSIVE RIGHT TO USE "MUSIC", APART FROM THE MARK AS SHOWN.

FOR PROVIDING AN EDUCATIONAL PROGRAM FOR STUDENT MUSICIANS TO STUDY WITH PROFESSIONAL ORCHESTRA MUSICIANS AND OTHER PROFESSIONAL MUSICIANS; EDUCATIONAL SERVICES, NAMELY, PROVIDING PRIVATE LESSONS, DAILY ORCHESTRA AND CHAMBER MUSIC REHEARSALS, MASTER CLASSES, SOLO PERFORMANCE OPPORTUNITIES TO PERFORM, CONCERTO COMPETITIONS, PRIVATE PRACTICE SEMINARS, MANDATORY PRIVATE PRACTICE HOURS, AND CHOIR AND EAR-TRAINING COURSES FOR ASPIRING MUSICIANS (U.S. CLS. 100, 101 AND 107).

FIRST USE 10-19-2010; IN COMMERCE 10-19-2010.

**CLASS 41—(Continued).**

4,047,199. LEGALBIZDEV, BOSTON, MA. SN 85-225,123.  
FILED P.R. 1-25-2011; AM. S.R. 8-9-2011.

## Certified Legal Project Manager

THE MARK CONSISTS OF STANDARD CHARACTERS WITHOUT CLAIM TO ANY PARTICULAR FONT, STYLE, SIZE, OR COLOR.

FOR EDUCATION SERVICES, NAMELY, PROVIDING CUSTOM TRAINING VIA THE INTERNET AND TRADITIONAL CLASSROOMS IN THE FIELD OF PROJECT MANAGEMENT FOR LAWYERS (U.S. CLS. 100, 101 AND 107).

FIRST USE 11-1-2010; IN COMMERCE 11-1-2010.

---

4,047,211. WORLD AWARD, LLC, TIBURON, CA. SN 85-262,827. FILED P.R. 3-9-2011; AM. S.R. 9-4-2011.

## WORLD AWARD

THE MARK CONSISTS OF STANDARD CHARACTERS WITHOUT CLAIM TO ANY PARTICULAR FONT, STYLE, SIZE, OR COLOR.

NO CLAIM IS MADE TO THE EXCLUSIVE RIGHT TO USE "AWARD", APART FROM THE MARK AS SHOWN.

FOR ARRANGING OF CONTESTS; RESEARCH IN THE FIELDS OF ARTS, HUMANITIES, AND SPORTS (U.S. CLS. 100, 101 AND 107).

FIRST USE 0-0-2003; IN COMMERCE 0-0-2003.

---

4,047,213. PERFECT TUTORS, LLC, OVERLAND PARK, KS. SN 85-264,897. FILED P.R. 3-11-2011; AM. S.R. 8-10-2011.

## Math Enrichment Center

THE MARK CONSISTS OF STANDARD CHARACTERS WITHOUT CLAIM TO ANY PARTICULAR FONT, STYLE, SIZE, OR COLOR.

FOR EDUCATION SERVICES, NAMELY, PROVIDING TUTORING IN THE FIELDS OF ELEMENTARY SCHOOL THROUGH HIGH SCHOOL SUBJECTS (U.S. CLS. 100, 101 AND 107).

FIRST USE 1-7-2011; IN COMMERCE 1-7-2011.

**CLASS 41—(Continued).**

4,047,218. CERWINSKE, LAURA, MIAMI, FL. SN 85-269,237.  
FILED P.R. 3-17-2011; AM. S.R. 8-31-2011.

## Radical Writing

THE MARK CONSISTS OF STANDARD CHARACTERS WITHOUT CLAIM TO ANY PARTICULAR FONT, STYLE, SIZE, OR COLOR.

NO CLAIM IS MADE TO THE EXCLUSIVE RIGHT TO USE "WRITING", APART FROM THE MARK AS SHOWN.

FOR ON LINE AND IN PERSON CLASSES COMBINING PRINCIPLES OF SPIRITUALITY AND CREATIVITY WITH WRITING EXERCISES FOR UNINHIBITED SELF-EXPLORATION AND SELF-EXPRESSION RESULTING IN PHYSICAL AND EMOTIONAL HEALING AND ARTISTIC LIBERATION (U.S. CLS. 100, 101 AND 107).

FIRST USE 6-1-2007; IN COMMERCE 6-1-2007.

---

4,047,229. WORLD AWARD, LLC, TIBURON, CA. SN 85-289,655. FILED P.R. 4-7-2011; AM. S.R. 9-4-2011.

## WORLD PRODUCT AWARD

THE MARK CONSISTS OF STANDARD CHARACTERS WITHOUT CLAIM TO ANY PARTICULAR FONT, STYLE, SIZE, OR COLOR.

NO CLAIM IS MADE TO THE EXCLUSIVE RIGHT TO USE "PRODUCT AWARD", APART FROM THE MARK AS SHOWN.

FOR ARRANGING OF CONTESTS (U.S. CLS. 100, 101 AND 107).

FIRST USE 0-0-2010; IN COMMERCE 0-0-2010.

---

4,047,237. NORTH COUNTY JUMPERS, ESCONDIDO, CA. SN 85-304,208. FILED P.R. 4-25-2011; AM. S.R. 8-3-2011.

## North County Jumpers

THE MARK CONSISTS OF STANDARD CHARACTERS WITHOUT CLAIM TO ANY PARTICULAR FONT, STYLE, SIZE, OR COLOR.

OWNER OF U.S. REG. NO. 8,530,420.

NO CLAIM IS MADE TO THE EXCLUSIVE RIGHT TO USE "JUMPERS", APART FROM THE MARK AS SHOWN.

THE ENGLISH TRANSLATION OF "JUMPERS" IN THE MARK IS "JUMPERS". THE WORDING "JUMPERS" HAS NO MEANING IN A FOREIGN LANGUAGE.

FOR RENTAL OF INFLATABLE BOUNCE HOUSES FOR PARTIES (U.S. CLS. 100, 101 AND 107).

FIRST USE 1-0-2008; IN COMMERCE 1-0-2008.

**CLASS 41—(Continued).**

4,047,250. CAMBRIDGE MANHATTAN GROUP, LLC, SCOTTS VALLEY, CA. SN 85-319,506. FILED P.R. 5-12-2011; AM. S.R. 9-6-2011.

### SILICON VALLEY BUSINESS SCHOOL

THE MARK CONSISTS OF STANDARD CHARACTERS WITHOUT CLAIM TO ANY PARTICULAR FONT, STYLE, SIZE, OR COLOR.

NO CLAIM IS MADE TO THE EXCLUSIVE RIGHT TO USE "BUSINESS SCHOOL", APART FROM THE MARK AS SHOWN.

FOR BUSINESS EDUCATION AND TRAINING SERVICES, NAMELY, DEVELOPING AND FACILITATING CUSTOMIZED LEADERSHIP AND EXECUTIVE DEVELOPMENT PROGRAMS, PROVIDING EXECUTIVE COACHING SERVICES, AND PROVIDING BUSINESS EDUCATION PROGRAMS TO EMPLOYEES AND EXECUTIVES; CONTINUING EDUCATION SERVICES, NAMELY, PROVIDING LIVE AND ON-LINE CONTINUING PROFESSIONAL EDUCATION SEMINARS IN THE LEGAL, MEDICAL, ACCOUNTING, AND REAL ESTATE FIELDS; EDUCATING AT UNIVERSITY OR COLLEGES; EDUCATION SERVICES IN THE NATURE OF COURSES AT THE UNIVERSITY LEVEL; EDUCATIONAL SERVICES IN THE NATURE OF CORRESPONDENCE SCHOOLS; EDUCATIONAL SERVICES, NAMELY, CONDUCTING DISTANCE LEARNING INSTRUCTION AT THE SECONDARY, COLLEGE AND GRADUATE LEVELS; EDUCATIONAL SERVICES, NAMELY, CONDUCTING DISTANCE LEARNING INSTRUCTION AT THE UNIVERSITY LEVEL; PROVIDING CONTINUING BUSINESS EDUCATION COURSES; PROVIDING CONTINUING LEGAL EDUCATION COURSES (U.S. CLS. 100, 101 AND 107).

FIRST USE 9-12-2010; IN COMMERCE 9-14-2010.

4,047,251. OC AIR SHOW, LLC, COCOA BEACH, FL. SN 85-319,768. FILED P.R. 5-12-2011; AM. S.R. 9-1-2011.

### Ocean City Air Show

THE MARK CONSISTS OF STANDARD CHARACTERS WITHOUT CLAIM TO ANY PARTICULAR FONT, STYLE, SIZE, OR COLOR.

NO CLAIM IS MADE TO THE EXCLUSIVE RIGHT TO USE "AIR SHOW", APART FROM THE MARK AS SHOWN.

FOR ENTERTAINMENT IN THE NATURE OF AIR SHOWS (U.S. CLS. 100, 101 AND 107).

FIRST USE 9-25-2007; IN COMMERCE 2-1-2008.

**CLASS 41—(Continued).**

4,047,255. JOYCE, JOHN, DRACUT, MA. SN 85-324,383. FILED P.R. 5-18-2011; AM. S.R. 9-8-2011.

### Boston's Best Comedians

THE MARK CONSISTS OF STANDARD CHARACTERS WITHOUT CLAIM TO ANY PARTICULAR FONT, STYLE, SIZE, OR COLOR.

NO CLAIM IS MADE TO THE EXCLUSIVE RIGHT TO USE "COMEDIANS", APART FROM THE MARK AS SHOWN.

FOR ENTERTAINMENT SERVICES IN THE NATURE OF COMEDY SHOWS (U.S. CLS. 100, 101 AND 107).

FIRST USE 2-1-2008; IN COMMERCE 2-1-2008.

4,047,264. WORLD PUBLICATIONS, LLC, WINTER PARK, FL. SN 85-393,981. FILED 8-10-2011.

### SPORT FISHING TELEVISION

THE MARK CONSISTS OF STANDARD CHARACTERS WITHOUT CLAIM TO ANY PARTICULAR FONT, STYLE, SIZE, OR COLOR.

OWNER OF U.S. REG. NOS. 1,854,625, 3,467,465, AND OTHERS.

NO CLAIM IS MADE TO THE EXCLUSIVE RIGHT TO USE "TELEVISION", APART FROM THE MARK AS SHOWN.

FOR ENTERTAINMENT IN THE NATURE OF ONGOING PROGRAMS IN THE FIELD OF FISHING, BROADCAST OVER TELEVISION, SATELLITE, CABLE, GLOBAL COMPUTER NETWORK, AUDIO, AND VIDEO MEDIA (U.S. CLS. 100, 101 AND 107).

FIRST USE 1-3-2009; IN COMMERCE 1-3-2009.

**CLASS 42—SCIENTIFIC AND COMPUTER SERVICES**

4,047,141. UNITED SAFETY, LTD., AIRDRIE, ALBERTA, CANADA. SN 85-122,513. FILED P.R. 9-3-2010; AM. S.R. 6-17-2011.

### PLUMETRACKER

THE MARK CONSISTS OF STANDARD CHARACTERS WITHOUT CLAIM TO ANY PARTICULAR FONT, STYLE, SIZE, OR COLOR.

**CLASS 42—(Continued).**

PRIORITY CLAIMED UNDER SEC. 44(D) ON CANADA APPLICATION NO. 1490677, FILED 7-30-2010, REG. NO. TMA800004, DATED 6-15-2011, EXPIRES 6-15-2026.

FOR RENTAL OF ELECTRONIC EQUIPMENT, NAMELY, A PORTABLE, BATTERY-POWERED, SENSING DEVICE FOR USE IN MONITORING AND RECORDING DATA REGARDING GAS CONCENTRATIONS IN THE OIL AND GAS, PETROCHEMICAL, REFINING, MINING, POWER GENERATION AND INDUSTRIAL SECTORS IN THE AREAS OF SAFETY, HEALTH AND ENVIRONMENTAL NEEDS (U.S. CLS. 100 AND 101).

---

4,047,156. SPACENAV, LLC, BOULDER, CO. SN 85-159,086. FILED P.R. 10-22-2010; AM. S.R. 7-19-2011.

## SPACENAV

THE MARK CONSISTS OF STANDARD CHARACTERS WITHOUT CLAIM TO ANY PARTICULAR FONT, STYLE, SIZE, OR COLOR.

FOR AEROSPACE ENGINEERING SERVICES, NAMELY, SOFTWARE DEVELOPMENT FOR SPACE SITUATIONAL AWARENESS THAT ENABLES SPACECRAFT OPERATORS TO ANALYZE THE PROBABILITY OF, QUANTIFY AND MITIGATE COLLISION RISKS BETWEEN SPACE OBJECTS (U.S. CLS. 100 AND 101).

FIRST USE 12-31-2009; IN COMMERCE 12-31-2009.

---

4,047,161. GIS CLOUD LTD, LONDON, UNITED KINGDOM. SN 85-171,116. FILED P.R. 11-8-2010; AM. S.R. 8-18-2011.

## GIS CLOUD

THE MARK CONSISTS OF STANDARD CHARACTERS WITHOUT CLAIM TO ANY PARTICULAR FONT, STYLE, SIZE, OR COLOR.

FOR PROVIDING TEMPORARY USE OF ONLINE NON-DOWNLOADABLE COMPUTER SOFTWARE, NAMELY, A WEB BASED GEOGRAPHIC INFORMATION SYSTEM AS A SERVICE OVER THE INTERNET IN A GEOSPATIAL ENVIRONMENT FOR USE IN CREATING MAPS (U.S. CLS. 100 AND 101).

FIRST USE 10-21-2008; IN COMMERCE 2-7-2010.

**CLASS 42—(Continued).**

4,047,175. COMPUTING SERVICES SUPPORT SOLUTIONS, INC., LOS ANGELES, CA. SN 85-185,013. FILED P.R. 11-24-2010; AM. S.R. 9-8-2011.

## COMBO SEARCH

THE MARK CONSISTS OF STANDARD CHARACTERS WITHOUT CLAIM TO ANY PARTICULAR FONT, STYLE, SIZE, OR COLOR.

FOR COMPUTER SERVICES, NAMELY, PROVIDING A WEB-BASED SYSTEM AND ONLINE PORTAL FEATURING ON-LINE NON-DOWNLOADABLE SOFTWARE THAT ENABLES USERS TO SEARCH USING CRITERIA THAT CAN SPAN MANY DATA SOURCES, STORED AT DIFFERENT LOCATIONS AND IN DIFFERENT DATA FORMATS, AND RENDER THE SEARCH RESULTS INTO A SINGLE, CORRELATED TABLE (U.S. CLS. 100 AND 101).

FIRST USE 2-2-2008; IN COMMERCE 5-15-2008.

---

4,047,257. THE NURSE COMPANY, INC., NASHVILLE, TN. SN 85-325,113. FILED P.R. 5-19-2011; AM. S.R. 9-15-2011.

## Nurse Wall

THE MARK CONSISTS OF STANDARD CHARACTERS WITHOUT CLAIM TO ANY PARTICULAR FONT, STYLE, SIZE, OR COLOR.

FOR COMPUTER SERVICES, NAMELY, CREATING AN ON-LINE COMMUNITY FOR REGISTERED USERS TO PARTICIPATE IN DISCUSSIONS, GET FEEDBACK FROM THEIR PEERS, FORM VIRTUAL COMMUNITIES, AND ENGAGE IN SOCIAL NETWORKING SERVICES IN THE FIELD OF NURSING (U.S. CLS. 100 AND 101).

FIRST USE 4-4-2011; IN COMMERCE 4-4-2011.

**CLASS 43—HOTEL AND RESTAURANT SERVICES**

4,047,220. BENEFIT INN, LLC, BONITA SPRINGS, FL. SN 85-276,710. FILED P.R. 3-25-2011; AM. S.R. 8-25-2011.

## Benefit Inn

THE MARK CONSISTS OF STANDARD CHARACTERS WITHOUT CLAIM TO ANY PARTICULAR FONT, STYLE, SIZE, OR COLOR.

**CLASS 45—(Continued).**

NO CLAIM IS MADE TO THE EXCLUSIVE RIGHT TO USE "INN", APART FROM THE MARK AS SHOWN.  
FOR HOTEL ACCOMMODATION SERVICES (U.S. CLS. 100 AND 101).  
FIRST USE 1-6-2011; IN COMMERCE 6-1-2011.



**CLASS 44—MEDICAL, BEAUTY AND AGRICULTURAL SERVICES**

4,047,194. PROGRESSIVE MRI, LLC, DBA PROGRESSIVE RADIOLOGY, FALLS CHURCH, VA. SN 85-203,390. FILED P.R. 12-21-2010; AM. S.R. 8-30-2011.

**EXCEPTIONAL SERVICE EVERY TIME**

THE MARK CONSISTS OF STANDARD CHARACTERS WITHOUT CLAIM TO ANY PARTICULAR FONT, STYLE, SIZE, OR COLOR.  
FOR MEDICAL DIAGNOSTIC IMAGING AND RADIOLOGY SERVICES (U.S. CLS. 100 AND 101).  
FIRST USE 9-30-2010; IN COMMERCE 9-30-2010.



4,047,227. AJM QUEST LLC, DBA HEALING PATH CONCEPTS, MIRAMAR BEACH, FL. SN 85-287,915. FILED P.R. 4-6-2011; AM. S.R. 9-1-2011.

**Cellular Level Healing**

THE MARK CONSISTS OF STANDARD CHARACTERS WITHOUT CLAIM TO ANY PARTICULAR FONT, STYLE, SIZE, OR COLOR.

**CLASS 44—(Continued).**

NO CLAIM IS MADE TO THE EXCLUSIVE RIGHT TO USE "HEALING", APART FROM THE MARK AS SHOWN.  
FOR ENERGY HEALING TRANSFORMATIONAL SERVICES AT THE CELLULAR LEVEL AND DISTRIBUTION OF ASSOCIATED CDS IN CONNECTION THEREWITH; PROVIDING IN-PERSON ENERGY HEALING SERVICES BOTH INDIVIDUAL OR IN A GROUP; PROVIDING LONG-DISTANCE ENERGY HEALING SERVICES; PROVIDING A WEBSITE FEATURING INFORMATION CONCERNING ALTERNATIVE HEALTH AND HEALING (U.S. CLS. 100 AND 101).  
FIRST USE 1-10-2011; IN COMMERCE 1-10-2011.



**CLASS 45—PERSONAL AND LEGAL SERVICES**

4,047,230. JOHN W. WALKER, PA, MOSCOW, ID. SN 85-293,243. FILED P.R. 4-12-2011; AM. S.R. 9-6-2011.

**IDAHO AUTO INJURY LAWYERS**

THE MARK CONSISTS OF STANDARD CHARACTERS WITHOUT CLAIM TO ANY PARTICULAR FONT, STYLE, SIZE, OR COLOR.  
NO CLAIM IS MADE TO THE EXCLUSIVE RIGHT TO USE "AUTO INJURY LAWYERS", APART FROM THE MARK AS SHOWN.  
FOR LEGAL SERVICES (U.S. CLS. 100 AND 101).  
FIRST USE 5-24-2011; IN COMMERCE 5-24-2011.



4,047,231. JOHN W. WALKER, PA, MOSCOW, ID. SN 85-293,269. FILED P.R. 4-12-2011; AM. S.R. 9-6-2011.

**WASHINGTON AUTO INJURY LAWYERS**

THE MARK CONSISTS OF STANDARD CHARACTERS WITHOUT CLAIM TO ANY PARTICULAR FONT, STYLE, SIZE, OR COLOR.  
NO CLAIM IS MADE TO THE EXCLUSIVE RIGHT TO USE "AUTO INJURY LAWYERS", APART FROM THE MARK AS SHOWN.  
FOR LEGAL SERVICES (U.S. CLS. 100 AND 101).  
FIRST USE 5-24-2011; IN COMMERCE 5-24-2011.



# TRADEMARK REGISTRATIONS RENEWED

The designation "U.S. Cl." appearing in this section refers to the U.S. class in effect prior to Sep. 1, 1973 rather than the international class which applies to applications filed on or after that date. For adoption of international classification see notice in the OFFICIAL GAZETTE of Jun. 26, 1973 (911 O.G. TM 210).

84,050.	HYDROCIDE (STYLIZED). U.S. CL. 16. (INT. CLS. 2 AND 19). REG. 10-31-1911.	721,442.	MISCELLANEOUS DESIGN. U.S. CL. 105. (INT. CL. 39). REG. 9-12-1961.
144,210.	PULVULES. U.S. CL. 6. (INT. CLS. 1, 2, 3, 4 AND 5). REG. 6-28-1921.	721,683.	NECCO (STYLIZED). U.S. CL. 46. (INT. CL. 30). REG. 9-19-1961.
152,719.	JUNKET. U.S. CL. 46. (INT. CL. 29). REG. 3-7-1922.	721,903.	TRI-WING. U.S. CL. 26. (INT. CL. 9). REG. 9-26-1961.
156,769.	U AND DESIGN. U.S. CL. 28. (INT. CL. 14). REG. 7-11-1922.	722,885.	GOLD LABEL (STYLIZED). U.S. CL. 46. (INT. CLS. 29 AND 31). REG. 10-17-1961.
285,004.	TRIMENE BASE. INT. CL. 1. (U.S. CL. 1). REG. 7-14-1931.	723,173.	WECOBEE (STYLIZED). U.S. CL. 46. (INT. CL. 29). REG. 10-24-1961.
286,436.	NO. 7 (STYLIZED). U.S. CL. 44. (INT. CL. 5). REG. 8-25-1931.	723,672.	KIRIN BEER AND DESIGN. U.S. CL. 48. (INT. CL. 32). REG. 11-7-1961.
287,869.	SENTINEL (STYLIZED). U.S. CL. 13. (INT. CL. 6). REG. 10-13-1931.	726,335.	PIKESVILLE MARYLAND STRAIGHT RYE WHISKEY AND DESIGN. U.S. CL. 49. (INT. CL. 33). REG. 1-9-1962.
288,068.	ACIPCO (STYLIZED). U.S. CL. 13. (INT. CL. 6). REG. 10-20-1931.	726,468.	INGERSOLL. U.S. CL. 23. (INT. CL. 7). REG. 1-16-1962.
388,629.	CLIPPER. U.S. CL. 12. (INT. CL. 19). REG. 7-1-1941.	735,560.	SWISHER SWEETS AND DESIGN. U.S. CL. 17. (INT. CL. 34). REG. 8-7-1962.
396,981.	SANTA FE (STYLIZED). U.S. CL. 17. (INT. CL. 34). REG. 8-11-1942.	736,538.	WIPE AWAY (STYLIZED). U.S. CL. 52. (INT. CL. 3). REG. 8-21-1962.
397,101.	WONDER GRO. U.S. CL. 10. (INT. CL. 31). REG. 8-18-1942.	907,393.	LOXIOL. U.S. CL. 6. (INT. CL. 1). REG. 2-9-1971.
536,242.	MAGNAVOX (STYLIZED). U.S. CL. 21. (INT. CL. 9). REG. 1-9-1951.	909,948.	X-PRESS. U.S. CL. 13. (INT. CL. 6). REG. 3-16-1971.
543,056.	Q AND Q (STYLIZED). U.S. CL. 46. (INT. CL. 30). REG. 5-29-1951.	910,474.	INNOXA ONE & ALL. U.S. CL. 51. (INT. CL. 3). REG. 3-23-1971.
547,548.	KEDEM (STYLIZED). U.S. CL. 47. (INT. CL. 33). REG. 9-4-1951.	914,892.	WORLD OF MARBLE AND DESIGN. U.S. CL. 12. (INT. CL. 19). REG. 6-15-1971.
547,894.	BLUE BONNET (STYLIZED). U.S. CL. 46. (INT. CLS. 1, 5, 29, 30, 31 AND 32). REG. 9-11-1951.	916,674.	HYDRASIEVE. U.S. CL. 23. (INT. CLS. 6, 7, 8, 9, 11, 12, 16, 21 AND 28). REG. 7-20-1971.
548,468.	MEEHANITE. U.S. CL. 101. (INT. CL. 35). REG. 9-18-1951.	916,989.	NEO-PYNAMIN. U.S. CL. 6. (INT. CL. 5). REG. 7-27-1971.
554,429.	HYDRO-FLO (STYLIZED). U.S. CL. 13. (INT. CL. 6). REG. 2-5-1952.	917,041.	HERITAGE. U.S. CL. 13. (INT. CL. 11). REG. 7-27-1971.
563,636.	WEDAC. U.S. CL. 52. (INT. CL. 3). REG. 9-2-1952.	917,233.	HEATH. U.S. CL. 38. (INT. CL. 16). REG. 7-27-1971.
710,703.	MYCO AND DESIGN. U.S. CL. 52. (INT. CL. 3). REG. 1-31-1961.	917,675.	4024. U.S. CL. 37. (INT. CL. 16). REG. 8-3-1971.
711,622.	CHIQUITA. U.S. CL. 46. (INT. CL. 31). REG. 2-21-1961.	917,801.	CALORIE LINE. U.S. CL. 46. (INT. CL. 29). REG. 8-3-1971.
712,941.	DE ZAAAN. U.S. CL. 46. (INT. CL. 30). REG. 3-21-1961.	917,934.	PTI AND DESIGN. U.S. CL. 2. (INT. CL. 20). REG. 8-10-1971.
715,860.	DUNKIN' DONUTS AND DESIGN. U.S. CL. 46. (INT. CL. 30). REG. 5-23-1961.	918,217.	M&T. U.S. CLS. 100, 101 AND 102. (INT. CLS. 35, 36, 37, 38, 39, 40, 41 AND 42). REG. 8-10-1971.
716,670.	SACHA. U.S. CL. 3. (INT. CL. 18). REG. 6-13-1961.	918,431.	RIPLEY'S BELIEVE IT OR NOT! (STYLIZED). U.S. CLS. 22, 38, 39, 101 AND 107 ONLY. (INT. CLS. 9, 16, 18, 20, 22, 25, 28, 35, 36, 38, 41 AND 42). REG. 8-17-1971.
719,141.	EASYARC. U.S. CL. 14. (INT. CL. 6). REG. 8-1-1961.	918,500.	INSULONE. U.S. CL. 35. (INT. CL. 17). REG. 8-17-1971.
719,540.	DEX-O-TEX. U.S. CL. 16. (INT. CL. 2). REG. 8-8-1961.	919,237.	MISCELLANEOUS DESIGN. U.S. CLS. 13 AND 23. (INT. CLS. 6 AND 7). REG. 8-31-1971.
719,883.	ROYAL SCOT. U.S. CL. 15. (INT. CL. 1). REG. 8-15-1961.	919,506.	CLAUSSEN. U.S. CL. 46. (INT. CLS. 29 AND 30). REG. 8-31-1971.
719,885.	RING-FREE. U.S. CL. 15. (INT. CL. 1). REG. 8-15-1961.	919,634.	HIGHLAND. U.S. CL. 5. (INT. CL. 17). REG. 9-7-1971.
720,117.	RED & WHITE. U.S. CL. 52. (INT. CL. 3). REG. 8-15-1961.	919,655.	ZYBAN. U.S. CL. 6. (INT. CL. 5). REG. 9-7-1971.
720,161.	LUSTRAN. INT. CL. 1. (U.S. CL. 1). REG. 8-22-1961.	920,477.	SUPRAPUR. U.S. CL. 6. (INT. CL. 1). REG. 9-21-1971.
720,270.	MYLANTA (STYLIZED). U.S. CL. 18. (INT. CL. 5). REG. 8-22-1961.	920,684.	G AND DESIGN. U.S. CL. 34. (INT. CL. 11). REG. 9-21-1971.
720,283.	MISS UNIVERSE. U.S. CL. 22. (INT. CL. 28). REG. 8-22-1961.	920,688.	BOWMABRAZE. U.S. CL. 34. (INT. CL. 6). REG. 9-21-1971.
720,287.	SPINFISHER. U.S. CL. 22. (INT. CL. 28). REG. 8-22-1961.	921,002.	ASHLAND. U.S. CL. 16. (INT. CL. 2). REG. 9-28-1971.
720,802.	BIO-RAD. INT. CL. 1. (U.S. CL. 1). REG. 9-5-1961.	921,124.	G AND DESIGN. U.S. CL. 31. (INT. CL. 11). REG. 9-28-1971.
720,947.	ECONOREEL. U.S. CL. 23. (INT. CL. 7). REG. 9-5-1961.	921,332.	PECO. U.S. CL. 103. (INT. CL. 37). REG. 9-28-1971.
721,100.	BUTTERNUT. U.S. CL. 46. (INT. CL. 30). REG. 9-5-1961.	921,393.	RED DEVIL. U.S. CL. 12. (INT. CL. 17). REG. 10-5-1971.
721,208.	TRI-ETHANE (STYLIZED). U.S. CL. 6. (INT. CL. 1). REG. 9-12-1961.	921,456.	MISCELLANEOUS DESIGN. U.S. CL. 19. (INT. CL. 12). REG. 10-5-1971.

- 921,679. E & E (STYLIZED). U.S. CL. 100. (INT. CL. 42). REG. 10-5-1971.
- 921,826. MOTORCRAFT. U.S. CL. 15. (INT. CL. 4). REG. 10-12-1971.
- 921,922. DAMPP-CHASER. U.S. CLS. 26 AND 34. (INT. CLS. 9 AND 11). REG. 10-12-1971.
- 922,271. MITSUMI. U.S. CL. 21. (INT. CLS. 7 AND 9). REG. 10-19-1971.
- 922,713. MISCELLANEOUS DESIGN. U.S. CL. 21. (INT. CLS. 7 AND 9). REG. 10-26-1971.
- 923,560. HARVARD. U.S. CL. 46. (INT. CLS. 1, 5, 29, 30, 31 AND 32). REG. 11-9-1971.
- 925,778. SPOT-SPITTER. U.S. CL. 13. (INT. CL. 11). REG. 12-21-1971.
- 925,978. MOX. U.S. CL. 52. (INT. CL. 3). REG. 12-21-1971.
- 931,878. MRS. ADLER'S. U.S. CL. 46. (INT. CLS. 1, 5, 29, 30, 31 AND 32). REG. 4-4-1972.
- 932,155. HONDA (STYLIZED). U.S. CL. 23. (INT. CL. 7). REG. 4-11-1972.
- 932,996. CAMP AMERICA. U.S. CL. 101. (INT. CL. 35). REG. 4-25-1972.
- 934,231. FIJI. U.S. CL. 200. REG. 5-16-1972.
- 935,953. XXX AND DESIGN. U.S. CL. 19. (INT. CLS. 7, 12, 22 AND 27). REG. 6-20-1972.
- 937,386. TOWNSEND (STYLIZED). U.S. CL. 12. (INT. CL. 19). REG. 7-11-1972.
- 940,356. KIRBY (STYLIZED). U.S. CL. 21. (INT. CL. 9). REG. 8-8-1972.
- 940,486. BROWN JORDAN. U.S. CL. 32. (INT. CL. 20). REG. 8-8-1972.
- 941,919. ACCO AND DESIGN. U.S. CL. 23. (INT. CL. 7). REG. 8-29-1972.
- 1,146,477. SWENSEN'S AND DESIGN. INT. CLS. 35 AND 42. (U.S. CLS. 100 AND 101). REG. 1-27-1981.
- 1,147,784. BIG HUG. INT. CL. 31. (U.S. CL. 1). REG. 2-24-1981.
- 1,149,089. SONNY AND DESIGN. INT. CL. 30. (U.S. CL. 46). REG. 3-24-1981.
- 1,149,157. ONE STOP AND DESIGN. INT. CL. 37. (U.S. CL. 103). REG. 3-24-1981.
- 1,150,556. FIREDOG. INT. CL. 29. (U.S. CL. 46). REG. 4-7-1981.
- 1,152,146. SUPER-CUSHION. INT. CLS. 7 AND 12. (U.S. CLS. 13, 19 AND 23). REG. 4-28-1981.
- 1,152,717. HARPO'S. INT. CL. 42. (U.S. CL. 100). REG. 4-28-1981.
- 1,153,302. SEA LEGS (STYLIZED). INT. CL. 29. (U.S. CL. 46). REG. 5-5-1981.
- 1,155,427. DISCOVER THE DIFFERENCE. INT. CL. 41 ONLY. (U.S. CL. 107). REG. 5-26-1981.
- 1,157,911. SPEC 55. INT. CL. 9. (U.S. CL. 21). REG. 6-23-1981.
- 1,158,093. AMARA (STYLIZED). INT. CLS. 18, 24 AND 25. (U.S. CLS. 1, 39 AND 42). REG. 6-23-1981.
- 1,158,808. LEVELFLEX SCALEMASTER. INT. CL. 7. (U.S. CL. 23). REG. 6-30-1981.
- 1,158,822. THE GENERAL AND DESIGN. INT. CL. 7. (U.S. CLS. 13, 19, 21, 23, 31, 34 AND 35). REG. 6-30-1981.
- 1,159,031. INSTANT-FLOW. INT. CL. 11. (U.S. CL. 34). REG. 6-30-1981.
- 1,159,032. C AND DESIGN. INT. CL. 11. (U.S. CL. 34). REG. 6-30-1981.
- 1,159,071. CHECKMATE AND DESIGN. INT. CL. 12. (U.S. CL. 19). REG. 6-30-1981.
- 1,159,428. TUNE-UP CLINIC. INT. CL. 37. (U.S. CL. 103). REG. 6-30-1981.
- 1,159,571. PAPYRUS. INT. CL. 42. (U.S. CL. 101). REG. 6-30-1981.
- 1,159,700. SOUNDOLIER. INT. CLS. 6 AND 9. (U.S. CLS. 2, 12, 13, 14, 21, 23, 25, 26 AND 50). REG. 7-7-1981.
- 1,159,762. HECTOR HEATHCOTE. INT. CL. 9 ONLY. (U.S. CL. 38). REG. 7-7-1981.
- 1,160,178. BIG BEEF CHEVY. INT. CL. 29. (U.S. CL. 46). REG. 7-7-1981.
- 1,160,809. HELIODENT. INT. CL. 10. (U.S. CL. 44). REG. 7-14-1981.
- 1,160,958. NORBORD. INT. CL. 19. (U.S. CL. 12). REG. 7-14-1981.
- 1,161,328. POLYGON. INT. CL. 37. (U.S. CL. 103). REG. 7-14-1981.
- 1,161,356. XTRA. INT. CL. 39. (U.S. CLS. 100 AND 105). REG. 7-14-1981.
- 1,161,394. WH AND DESIGN. INT. CL. 41. (U.S. CL. 107). REG. 7-14-1981.
- 1,162,170. MISCELLANEOUS DESIGN. INT. CLS. 36 AND 39. (U.S. CLS. 102 AND 105). REG. 7-21-1981.
- 1,162,493. MORRIS. INT. CL. 7. (U.S. CL. 23). REG. 7-28-1981.
- 1,162,728. EL CENTINELA. INT. CL. 16. (U.S. CL. 38). REG. 7-28-1981.
- 1,162,830. KASPER. INT. CL. 25. (U.S. CLS. 22 AND 39). REG. 7-28-1981.
- 1,162,959. TIPSYPY. INT. CL. 30. (U.S. CL. 46). REG. 7-28-1981.
- 1,163,281. ALFA LAVAL. INT. CL. 6 ONLY. (U.S. CLS. 2, 12, 13, 14, 23, 25 AND 50). REG. 8-4-1981.
- 1,163,330. PDI. INT. CL. 5. (U.S. CLS. 18, 44 AND 52). REG. 8-4-1981.
- 1,163,412. ALFA LAVAL. INT. CLS. 7 AND 11. (U.S. CLS. 13, 19, 21, 23, 31, 34 AND 35). REG. 8-4-1981.
- 1,163,640. MISCELLANEOUS DESIGN. INT. CL. 12. (U.S. CL. 19). REG. 8-4-1981.
- 1,163,938. THE SILVER PALATE. INT. CLS. 29 AND 30. (U.S. CL. 46). REG. 8-4-1981.
- 1,164,397. THE REVOLVER. INT. CL. 7. (U.S. CL. 23). REG. 8-11-1981.
- 1,164,466. MORLEY. INT. CL. 9. (U.S. CLS. 21 AND 36). REG. 8-11-1981.
- 1,164,614. ABA BANKING JOURNAL. INT. CL. 16. (U.S. CL. 38). REG. 8-11-1981.
- 1,164,639. TETRAGLAS-T (STYLIZED). INT. CL. 17. (U.S. CL. 35). REG. 8-11-1981.
- 1,164,713. THE FINAL FOUR. INT. CL. 25. (U.S. CL. 39). REG. 8-11-1981.
- 1,164,860. DEE SIGN FOR SALE SOLD AND DESIGN. INT. CL. 35. (U.S. CL. 101). REG. 8-11-1981.
- 1,164,906. THE BAY (STYLIZED). INT. CL. 36. (U.S. CL. 102). REG. 8-11-1981.
- 1,164,925. HOUSE DETECTIVE AND DESIGN. INT. CL. 37. (U.S. CL. 103). REG. 8-11-1981.
- 1,164,983. SULLIVAN AWARD. INT. CL. 41. (U.S. CL. 107). REG. 8-11-1981.
- 1,165,018. AMERICAN OPTOMETRIC ASSOCIATION AND DESIGN. INT. CL. 42. (U.S. CL. 100). REG. 8-11-1981.
- 1,165,168. IODOSORB. INT. CL. 5. (U.S. CLS. 6, 18, 44, 46, 51 AND 52). REG. 8-18-1981.
- 1,165,202. SHEARTRANZ. INT. CL. 6. (U.S. CL. 12). REG. 8-18-1981.
- 1,165,250. S (STYLIZED). INT. CL. 7. (U.S. CL. 23). REG. 8-18-1981.
- 1,165,271. NOCO. INT. CL. 8. (U.S. CL. 23). REG. 8-18-1981.
- 1,165,312. IKEGAMI. INT. CL. 9. (U.S. CLS. 21, 23, 26, 36 AND 38). REG. 8-18-1981.
- 1,165,421. MIRA FOUNT. INT. CL. 11. (U.S. CL. 13). REG. 8-18-1981.
- 1,165,525. N-K SCRATCH-PADS, INC. AND DESIGN. INT. CL. 16. (U.S. CL. 37). REG. 8-18-1981.
- 1,165,697. PINNACLE. INT. CL. 28. (U.S. CL. 22). REG. 8-18-1981.
- 1,165,717. BUTTERMAID AND DESIGN. INT. CL. 30. (U.S. CL. 46). REG. 8-18-1981.
- 1,165,923. AMERICAN OPTOMETRIC ASSOCIATION AND DESIGN. INT. CL. 42. (U.S. CL. 100). REG. 8-18-1981.
- 1,165,924. AMERICAN OPTOMETRIC ASSOCIATION AND DESIGN. INT. CL. 42. (U.S. CL. 100). REG. 8-18-1981.
- 1,165,992. ACCUSAND. INT. CL. 1. (U.S. CL. 1). REG. 8-25-1981.
- 1,166,056. DURAPHAT. INT. CL. 5. (U.S. CL. 44). REG. 8-25-1981.
- 1,166,113. MOGA. INT. CLS. 14, 18 AND 25 ONLY. (U.S. CLS. 1, 2, 3, 22, 27, 28, 39, 41 AND 50). REG. 8-25-1981.
- 1,166,133. MEYER (STYLIZED). INT. CL. 7. (U.S. CL. 23). REG. 8-25-1981.
- 1,166,157. STURDY AND DESIGN. INT. CL. 7. (U.S. CL. 23). REG. 8-25-1981.
- 1,166,158. STURDY. INT. CL. 7. (U.S. CL. 23). REG. 8-25-1981.
- 1,166,266. HARMAN/KARDON. INT. CL. 9. (U.S. CLS. 21, 23, 26, 36 AND 38). REG. 8-25-1981.
- 1,166,303. R AND DESIGN. INT. CL. 9. (U.S. CL. 23). REG. 8-25-1981.
- 1,166,355. THERMO CORK. INT. CL. 10. (U.S. CL. 44). REG. 8-25-1981.
- 1,166,373. SILENT-FLEX AND DESIGN. INT. CL. 11. (U.S. CL. 34). REG. 8-25-1981.
- 1,166,509. RITE-PAK. INT. CL. 17. (U.S. CL. 35). REG. 8-25-1981.
- 1,166,732. APB. INT. CL. 35. (U.S. CL. 101). REG. 8-25-1981.

- 1,166,823. DREAM MACHINE. INT. CL. 41. (U.S. CL. 107). REG. 8-25-1981.
- 1,166,870. EAA. U.S. CL. 200. REG. 8-25-1981.
- 1,167,022. OMNIFIT. INT. CL. 9. (U.S. CL. 26). REG. 9-1-1981.
- 1,167,202. BYRDLAND. INT. CL. 15. (U.S. CL. 36). REG. 9-1-1981.
- 1,167,254. BEEMAK. INT. CL. 16. (U.S. CLS. 2, 32 AND 37). REG. 9-1-1981.
- 1,167,262. LISTEN. INT. CL. 16. (U.S. CL. 38). REG. 9-1-1981.
- 1,167,323. LOTHERM. INT. CL. 19. (U.S. CL. 12). REG. 9-1-1981.
- 1,167,519. YU.QUI.TAS. INT. CL. 29. (U.S. CL. 46). REG. 9-1-1981.
- 1,167,666. SNECMA. INT. CLS. 37 AND 42. (U.S. CLS. 100 AND 103). REG. 9-1-1981.
- 1,168,025. CALDWELL (STYLIZED). INT. CLS. 6 AND 11. (U.S. CLS. 12, 26 AND 34). REG. 9-8-1981.
- 1,168,048. ZEPHYR AND DESIGN. INT. CLS. 7 AND 8. (U.S. CL. 23). REG. 9-8-1981.
- 1,168,070. CAMBRI-LINK. INT. CL. 7. (U.S. CL. 23). REG. 9-8-1981.
- 1,168,194. AMPHIB. INT. CL. 9. (U.S. CL. 21). REG. 9-8-1981.
- 1,168,306. KRYPTO. INT. CL. 16. (U.S. CL. 38). REG. 9-8-1981.
- 1,168,341. TORK. INT. CLS. 16 AND 21. (U.S. CLS. 2 AND 37). REG. 9-8-1981.
- 1,168,432. MACOR. INT. CL. 21. (U.S. CL. 1). REG. 9-8-1981.
- 1,168,636. MISCELLANEOUS DESIGN. INT. CL. 35. (U.S. CL. 101). REG. 9-8-1981.
- 1,168,641. ICM. INT. CLS. 35 AND 36. (U.S. CLS. 101 AND 102). REG. 9-8-1981.
- 1,168,754. MISCELLANEOUS DESIGN. INT. CL. 42. (U.S. CL. 100). REG. 9-8-1981.
- 1,169,107. AKG (STYLIZED). INT. CL. 9. (U.S. CLS. 21, 26 AND 36). REG. 9-15-1981.
- 1,169,195. APEX. INT. CL. 13. (U.S. CL. 9). REG. 9-15-1981.
- 1,169,770. KERRY NOR. INT. CL. 1. (U.S. CL. 46). REG. 9-22-1981.
- 1,169,809. MEADOW BLEND. INT. CL. 3. (U.S. CLS. 1, 4, 6, 50, 51 AND 52). REG. 9-22-1981.
- 1,169,923. FRANCIS FIRST. INT. CL. 8. (U.S. CLS. 23 AND 28). REG. 9-22-1981.
- 1,169,938. HUMICAP. INT. CL. 9. (U.S. CL. 26). REG. 9-22-1981.
- 1,170,042. SUB-Q-SET. INT. CL. 10. (U.S. CL. 44). REG. 9-22-1981.
- 1,170,102. FRANCIS FIRST. INT. CL. 14. (U.S. CLS. 2, 27, 28 AND 50). REG. 9-22-1981.
- 1,170,119. PLATT'S OILGRAM NEWS. INT. CL. 16. (U.S. CL. 38). REG. 9-22-1981.
- 1,170,120. PLATT'S OILGRAM PRICE REPORT. INT. CL. 16. (U.S. CL. 38). REG. 9-22-1981.
- 1,170,231. INNERBOND. INT. CL. 19. (U.S. CL. 12). REG. 9-22-1981.
- 1,170,296. VISA (STYLIZED). INT. CL. 24. (U.S. CL. 42). REG. 9-22-1981.
- 1,170,312. 9 WEST. INT. CL. 25. (U.S. CL. 39). REG. 9-22-1981.
- 1,170,615. MORNINGLAND. INT. CLS. 41 AND 42. (U.S. CLS. 100 AND 107). REG. 9-22-1981.
- 1,170,656. MICRO AGE (STYLIZED). INT. CL. 42. (U.S. CL. 101). REG. 9-22-1981.
- 1,170,698. MRS. WINNER'S (STYLIZED). INT. CL. 42. (U.S. CL. 100). REG. 9-22-1981.
- 1,171,597. COVER X. INT. CL. 36. (U.S. CL. 102). REG. 9-29-1981.
- 1,171,662. PSYCHOLOGICAL ASSOCIATES. INT. CL. 41. (U.S. CL. 107). REG. 9-29-1981.
- 1,171,695. THE SHARPER IMAGE. INT. CL. 42. (U.S. CL. 101). REG. 9-29-1981.
- 1,171,972. BESELER. INT. CL. 7. (U.S. CL. 23). REG. 10-6-1981.
- 1,172,056. NIPPON CHEMI-CON AND DESIGN. INT. CL. 9. (U.S. CL. 21). REG. 10-6-1981.
- 1,172,219. HOME TEXTILES TODAY. INT. CL. 16. (U.S. CL. 38). REG. 10-6-1981.
- 1,172,308. "THE MOST COMFORTABLE SEAT IN THE HOUSE." INT. CL. 20. (U.S. CL. 32). REG. 10-6-1981.
- 1,172,448. GOLD CREST. INT. CL. 29. (U.S. CL. 46). REG. 10-6-1981.
- 1,172,552. MORTGAGE MASTER. INT. CL. 36. (U.S. CLS. 100, 101 AND 102). REG. 10-6-1981.
- 1,172,616. AYER, HOY Y SIEMPRE. INT. CL. 41. (U.S. CL. 107). REG. 10-6-1981.
- 1,172,768. ST. IVES. INT. CL. 3. (U.S. CL. 51). REG. 10-13-1981.
- 1,172,881. X-SAM. INT. CL. 7. (U.S. CL. 23). REG. 10-13-1981.
- 1,173,420. FRENCH-TECH. INT. CL. 25. (U.S. CL. 39). REG. 10-13-1981.
- 1,173,947. RAPISTAN. INT. CL. 7. (U.S. CL. 23). REG. 10-20-1981.
- 1,174,047. PATIENT PAL. INT. CL. 10. (U.S. CL. 44). REG. 10-20-1981.
- 1,174,073. HQI. INT. CL. 11. (U.S. CL. 21). REG. 10-20-1981.
- 1,174,630. MRS. WINNER'S. INT. CL. 42. (U.S. CL. 100). REG. 10-20-1981.
- 1,175,139. EPERAN. INT. CL. 17. (U.S. CLS. 1 AND 35). REG. 10-27-1981.
- 1,175,256. KANEKALON EXCELLE (STYLIZED). INT. CLS. 22 AND 26. (U.S. CLS. 7 AND 40). REG. 10-27-1981.
- 1,176,052. TOYO AND DESIGN. INT. CL. 12. (U.S. CL. 19). REG. 11-3-1981.
- 1,176,210. STURD-I-FLOOR. INT. CL. 19. (U.S. CL. 12). REG. 11-3-1981.
- 1,176,223. FIBERCRIB. INT. CL. 19. (U.S. CL. 12). REG. 11-3-1981.
- 1,176,273. SEOPRENE. INT. CL. 22. (U.S. CL. 7). REG. 11-3-1981.
- 1,176,736. ORGANIC GARDENER (STYLIZED). INT. CL. 1. (U.S. CL. 10). REG. 11-10-1981.
- 1,176,766. BZN. INT. CLS. 3 AND 7. (U.S. CLS. 4 AND 23). REG. 11-10-1981.
- 1,176,895. THRIFT EDGE. INT. CL. 7. (U.S. CL. 23). REG. 11-10-1981.
- 1,177,064. IOBAN. INT. CL. 10. (U.S. CL. 44). REG. 11-10-1981.
- 1,177,625. OFF THE RECORD. INT. CL. 41. (U.S. CL. 107). REG. 11-10-1981.
- 1,178,095. AG WORLD. INT. CL. 16. (U.S. CL. 38). REG. 11-17-1981.
- 1,178,947. OPTIMA. INT. CL. 9. (U.S. CLS. 23 AND 26). REG. 11-24-1981.
- 1,179,593. FOOD 4 LESS. INT. CL. 42. (U.S. CL. 101). REG. 11-24-1981.
- 1,179,804. WICHARD. INT. CL. 6. (U.S. CL. 14). REG. 12-1-1981.
- 1,180,131. A.L.I. AND DESIGN. INT. CL. 16. (U.S. CL. 38). REG. 12-1-1981.
- 1,180,162. PREOX. INT. CL. 17. (U.S. CLS. 12 AND 42). REG. 12-1-1981.
- 1,180,922. VEGA. INT. CL. 9. (U.S. CLS. 13 AND 21). REG. 12-8-1981.
- 1,180,983. PROSPLINTS. INT. CL. 10. (U.S. CL. 44). REG. 12-8-1981.
- 1,181,744. TOUGH COAT. INT. CL. 2. (U.S. CLS. 6, 11 AND 16). REG. 12-15-1981.
- 1,181,981. 3M (STYLIZED). INT. CL. 10. (U.S. CL. 44). REG. 12-15-1981.
- 1,182,242. FOGAL (STYLIZED). INT. CL. 25. (U.S. CL. 39). REG. 12-15-1981.
- 1,182,588. OMNISOLV. INT. CL. 1. (U.S. CL. 6). REG. 12-22-1981.
- 1,183,365. MAYCO AND DESIGN. INT. CL. 1. (U.S. CL. 6). REG. 12-29-1981.
- 1,183,780. PYRAN. INT. CL. 19. (U.S. CL. 12). REG. 12-29-1981.
- 1,184,289. T.L.S. INT. CL. 1. (U.S. CLS. 6 AND 52). REG. 1-5-1982.
- 1,185,852. PULLMAN CLOTH. INT. CL. 24. (U.S. CL. 42). REG. 1-12-1982.
- 1,186,698. A JOVE BOOK. INT. CL. 16. (U.S. CL. 38). REG. 1-19-1982.
- 1,189,402. PATAGONIA. INT. CL. 25. (U.S. CL. 39). REG. 2-9-1982.
- 1,189,758. VSCS. INT. CL. 7. (U.S. CL. 23). REG. 2-16-1982.
- 1,190,563. EJECT-A-DIP. INT. CL. 9. (U.S. CL. 21). REG. 2-23-1982.
- 1,191,900. WALL-NUT. INT. CL. 1. (U.S. CL. 6). REG. 3-9-1982.
- 1,192,572. NITI-1. INT. CL. 28. (U.S. CL. 22). REG. 3-23-1982.
- 1,194,410. MINIT CHEF AND DESIGN. INT. CL. 29. (U.S. CL. 46). REG. 4-27-1982.
- 1,194,816. MISCELLANEOUS DESIGN. INT. CL. 30. (U.S. CL. 46). REG. 5-4-1982.
- 1,196,293. MISCELLANEOUS DESIGN. INT. CL. 25. (U.S. CL. 39). REG. 5-25-1982.

- 1,196,401. VENTANA VINEYARDS. INT. CL. 33. (U.S. CL. 47). REG. 5-25-1982.
- 1,196,687. FURUNO. INT. CL. 9. (U.S. CLS. 21 AND 26). REG. 6-1-1982.
- 1,196,816. VAPORSTOP. INT. CL. 19. (U.S. CL. 12). REG. 6-1-1982.
- 1,197,304. ORAL-B (STYLIZED). INT. CL. 21. (U.S. CL. 29). REG. 6-8-1982.
- 1,197,543. CYASORB. INT. CL. 1. (U.S. CL. 6). REG. 6-15-1982.
- 1,198,259. G AND DESIGN. INT. CL. 37. (U.S. CL. 103). REG. 6-15-1982.
- 1,198,605. HATTERAS. INT. CL. 12. (U.S. CL. 19). REG. 6-22-1982.
- 1,198,717. GROWTH. INT. CL. 16. (U.S. CL. 38). REG. 6-22-1982.
- 1,199,560. TRI-PLI. INT. CL. 19. (U.S. CL. 12). REG. 6-29-1982.
- 1,204,052. NEED IT? RENT IT!. INT. CL. 42. (U.S. CL. 100). REG. 8-3-1982.
- 1,204,108. AMERICAN RESCUE WORKERS. INT. CL. (U.S. CLS. ). U.S. CL. 200. REG. 8-3-1982.
- 1,204,903. ATLANTA TRACK CLUB AND DESIGN. INT. CL. 41. (U.S. CL. 107). REG. 8-10-1982.
- 1,205,440. TERRIFIC TRIMMERS. INT. CL. 16. (U.S. CL. 37). REG. 8-17-1982.
- 1,628,390. EXANDRA. INT. CL. 25. (U.S. CLS. 22 AND 39). REG. 12-18-1990.
- 1,630,366. MR. MUNCH. INT. CL. 41. (U.S. CL. 107). REG. 1-1-1991.
- 1,630,539. CETOL DEK. INT. CL. 2. (U.S. CL. 16). REG. 1-8-1991.
- 1,633,655. SAND. INT. CL. 3. (U.S. CL. 51). REG. 2-5-1991.
- 1,635,369. VIDA. INT. CL. 9. (U.S. CL. 38). REG. 2-19-1991.
- 1,635,545. LE CORDON BLEU PARIS 1895 AND DESIGN. INT. CL. 25. (U.S. CLS. 22 AND 39). REG. 2-19-1991.
- 1,636,209. MISCELLANEOUS DESIGN. INT. CL. 25. (U.S. CLS. 22 AND 39). REG. 2-26-1991.
- 1,636,392. LONG & FOSTER INSTITUTE OF REAL ESTATE AND DESIGN. INT. CL. 41. (U.S. CL. 107). REG. 2-26-1991.
- 1,637,080. MB AND DESIGN. INT. CL. 35. (U.S. CL. 101). REG. 3-5-1991.
- 1,637,151. WORLD ART PROJECT. INT. CL. 41. (U.S. CL. 107). REG. 3-5-1991.
- 1,639,742. MUSIC NUT. INT. CL. 16. (U.S. CLS. 37 AND 50). REG. 4-2-1991.
- 1,639,743. BASEBALL NUT. INT. CL. 16. (U.S. CLS. 37 AND 50). REG. 4-2-1991.
- 1,639,745. BOWLING NUT. INT. CL. 16. (U.S. CLS. 37 AND 50). REG. 4-2-1991.
- 1,641,260. FOOTBALL NUT. INT. CL. 16. (U.S. CLS. 37 AND 50). REG. 4-16-1991.
- 1,641,899. ROTO ZIP. INT. CL. 7. (U.S. CL. 23). REG. 4-23-1991.
- 1,642,075. FISHING NUT. INT. CL. 16. (U.S. CLS. 37 AND 50). REG. 4-23-1991.
- 1,643,295. MISCELLANEOUS DESIGN. INT. CL. 3. (U.S. CLS. 1, 4, 6, 50, 51 AND 52). REG. 5-7-1991.
- 1,643,515. MICRO FLAPPER. INT. CL. 11. (U.S. CLS. 13 AND 34). REG. 5-7-1991.
- 1,644,099. IMPRESSIONS. INT. CL. 30. (U.S. CL. 46). REG. 5-7-1991.
- 1,645,573. WOMEN'S LIFE (STYLIZED). INT. CL. 41. (U.S. CL. 107). REG. 5-21-1991.
- 1,646,256. RENTALHUNTERS AND DESIGN. INT. CL. 36. (U.S. CLS. 100, 101 AND 102). REG. 5-28-1991.
- 1,646,934. PRINCE OF PERSIA. INT. CL. 28. (U.S. CLS. 22 AND 38). REG. 6-4-1991.
- 1,647,205. CITO. INT. CL. 7. (U.S. CL. 23). REG. 6-11-1991.
- 1,648,371. HOLLAND AMERICA WESTOURS. INT. CL. 39. (U.S. CL. 105). REG. 6-18-1991.
- 1,648,651. UFP. INT. CL. 6. (U.S. CLS. 1 AND 14). REG. 6-25-1991.
- 1,649,142. TRIBUNE BUSINESS WEEKLY AND DESIGN. INT. CL. 16. (U.S. CL. 38). REG. 6-25-1991.
- 1,649,362. UNIMAX. INT. CL. 9. (U.S. CL. 21). REG. 7-2-1991.
- 1,649,696. AVIS LUBE (STYLIZED). INT. CL. 37. (U.S. CL. 103). REG. 7-2-1991.
- 1,649,778. RTI. INT. CL. 42. (U.S. CL. 100). REG. 7-2-1991.
- 1,649,819. AIR-STORM. INT. CL. 9. (U.S. CLS. 21 AND 23). REG. 7-2-1991.
- 1,649,837. ENGINEERING FOR OPTIMUM PERFORMANCE. INT. CLS. 37 AND 42. (U.S. CLS. 100, 101 AND 103). REG. 7-2-1991.
- 1,649,936. SEI AND DESIGN. INT. CL. 7. (U.S. CL. 23). REG. 7-9-1991.
- 1,649,974. AIM-1. INT. CL. 9. (U.S. CL. 21). REG. 7-9-1991.
- 1,650,147. PACKAGING DIGEST. INT. CL. 16. (U.S. CL. 38). REG. 7-9-1991.
- 1,650,300. JORDAN AND DESIGN. INT. CL. 33. (U.S. CL. 47). REG. 7-9-1991.
- 1,650,501. CARQUEST AND DESIGN. INT. CLS. 1, 4 AND 12 ONLY. (U.S. CLS. 6, 15, 19 AND 31). REG. 7-16-1991.
- 1,650,534. ZAM. INT. CL. 3. (U.S. CLS. 4 AND 52). REG. 7-16-1991.
- 1,650,629. PIC (STYLIZED). INT. CL. 9. (U.S. CL. 26). REG. 7-16-1991.
- 1,650,974. SAMUEL T. CROCKETT. INT. CL. 33. (U.S. CL. 49). REG. 7-16-1991.
- 1,650,977. CRAFTSMAN'S BENCH. INT. CL. 34. (U.S. CL. 17). REG. 7-16-1991.
- 1,651,083. CRUISIN' NOT BOOZIN'. INT. CL. 41. (U.S. CL. 107). REG. 7-16-1991.
- 1,651,253. ENVIROPLUG. INT. CL. 1. (U.S. CLS. 1 AND 6). REG. 7-23-1991.
- 1,651,515. NURRE CAXTON. INT. CL. 20. (U.S. CL. 32). REG. 7-23-1991.
- 1,652,335. MAKTAB TARIGHAT OVEYSSI SHAHMAGH-SOUDI (SCHOOL OF ISLAMIC SUFISM). INT. CL. 16. (U.S. CLS. 2, 5, 22, 23, 29, 37, 38 AND 50). REG. 7-30-1991.
- 1,652,352. FAITHDOME. INT. CLS. 16 AND 42. (U.S. CLS. 38 AND 100). REG. 7-30-1991.
- 1,652,358. MISCELLANEOUS DESIGN. INT. CL. 16. (U.S. CL. 38). REG. 7-30-1991.
- 1,652,439. RIDGID AND DESIGN. INT. CL. 20. (U.S. CLS. 2, 13, 22, 25, 32 AND 50). REG. 7-30-1991.
- 1,652,457. WOLLASTIC. INT. CL. 22. (U.S. CL. 7). REG. 7-30-1991.
- 1,652,602. MISCELLANEOUS DESIGN. INT. CL. 36. (U.S. CLS. 100, 101 AND 102). REG. 7-30-1991.
- 1,652,628. ARTCO. INT. CL. 39. (U.S. CL. 105). REG. 7-30-1991.
- 1,653,076. SIMPLY SAID. INT. CL. 16. (U.S. CLS. 37 AND 38). REG. 8-6-1991.
- 1,653,083. PAVER GUARD. INT. CL. 17. (U.S. CL. 35). REG. 8-6-1991.
- 1,653,107. REFLECTIONS. INT. CL. 20. (U.S. CL. 32). REG. 8-6-1991.
- 1,653,233. HOOTERS. INT. CL. 38. (U.S. CL. 104). REG. 8-6-1991.
- 1,653,334. LIL' BUBBLER. INT. CL. 28. (U.S. CL. 22). REG. 8-6-1991.
- 1,653,376. INTERLOCK. INT. CL. 1. (U.S. CLS. 6 AND 16). REG. 8-13-1991.
- 1,653,441. NATURE'S PATH TO HEALTH. INT. CL. 5. (U.S. CL. 18). REG. 8-13-1991.
- 1,653,465. PHI. INT. CLS. 7, 9 AND 37 ONLY. (U.S. CLS. 13, 19, 21, 23, 26, 31, 34, 35, 100, 103 AND 106). REG. 8-13-1991.
- 1,653,578. CAROMED. INT. CL. 10. (U.S. CL. 44). REG. 8-13-1991.
- 1,653,587. MAXI CARE. INT. CL. 10. (U.S. CL. 44). REG. 8-13-1991.
- 1,653,628. NJ AND DESIGN. INT. CLS. 16, 18, 20, 24, 25, 28 AND 41. (U.S. CLS. 3, 22, 38, 39, 42, 50 AND 107). REG. 8-13-1991.
- 1,653,822. AMADEUS. INT. CL. 30. (U.S. CL. 46). REG. 8-13-1991.
- 1,653,898. CALLIDUS TECHNOLOGIES. INT. CLS. 37 AND 42. (U.S. CLS. 100, 103 AND 106). REG. 8-13-1991.
- 1,654,053. TUNA TANGO. INT. CL. 28. (U.S. CL. 22). REG. 8-13-1991.
- 1,654,136. ENSAR. INT. CLS. 8, 11 AND 16 ONLY. (U.S. CLS. 13, 23 AND 29). REG. 8-20-1991.
- 1,654,195. INKEL (STYLIZED). INT. CL. 9. (U.S. CLS. 21 AND 26). REG. 8-20-1991.
- 1,654,199. ANTEL. INT. CL. 9. (U.S. CL. 21). REG. 8-20-1991.
- 1,654,259. HEMAVET. INT. CL. 10. (U.S. CL. 44). REG. 8-20-1991.
- 1,654,288. MISCELLANEOUS DESIGN. INT. CL. 14. (U.S. CL. 28). REG. 8-20-1991.
- 1,654,320. FORMICA AND DESIGN. INT. CL. 17. (U.S. CLS. 5 AND 12). REG. 8-20-1991.

- 1,654,345. BAKER'S BEST. INT. CL. 21. (U.S. CL. 2). REG. 8-20-1991.
- 1,654,350. CC AND DESIGN. INT. CL. 21. (U.S. CL. 29). REG. 8-20-1991.
- 1,654,355. HITECH. INT. CL. 24. (U.S. CL. 42). REG. 8-20-1991.
- 1,654,669. SEMICONDUCTOR INSIGHTS INC.. INT. CL. 42. (U.S. CL. 100). REG. 8-20-1991.
- 1,654,671. MISCELLANEOUS DESIGN. INT. CL. 42. (U.S. CL. 100). REG. 8-20-1991.
- 1,654,735. IJ AND DESIGN. INT. CL. 7. (U.S. CL. 23). REG. 8-27-1991.
- 1,654,742. THERMOLIFT. INT. CL. 7. (U.S. CL. 23). REG. 8-27-1991.
- 1,654,747. EUROPEERLESS AND DESIGN. INT. CL. 7. (U.S. CL. 23). REG. 8-27-1991.
- 1,654,752. POWERLINE. INT. CL. 7. (U.S. CL. 23). REG. 8-27-1991.
- 1,654,874. TECHNAORO. INT. CL. 14. (U.S. CL. 28). REG. 8-27-1991.
- 1,655,078. SHACK. INT. CL. 42. (U.S. CLS. 100 AND 101). REG. 8-27-1991.
- 1,655,284. CAL SPAS (STYLIZED). INT. CL. 9. (U.S. CLS. 21, 23, 26 AND 31). REG. 9-3-1991.
- 1,655,409. EDISIM. INT. CL. 9. (U.S. CLS. 21, 23, 26, 36 AND 38). REG. 9-3-1991.
- 1,655,549. LBAII. INT. CL. 16. (U.S. CL. 36). REG. 9-3-1991.
- 1,655,747. SUNFLOWER. INT. CL. 35. (U.S. CL. 101). REG. 9-3-1991.
- 1,656,025. PEER. INT. CL. 9. (U.S. CL. 38). REG. 9-10-1991.
- 1,656,070. INSCRIBER. INT. CL. 9. (U.S. CL. 26). REG. 9-10-1991.
- 1,656,080. ROLLTRACK. INT. CL. 9. (U.S. CLS. 26 AND 38). REG. 9-10-1991.
- 1,656,143. MP2. INT. CL. 9. (U.S. CL. 38). REG. 9-10-1991.
- 1,656,178. GLASDEK. INT. CL. 11. (U.S. CL. 34). REG. 9-10-1991.
- 1,656,185. TCI. INT. CL. 12. (U.S. CLS. 19 AND 23). REG. 9-10-1991.
- 1,656,326. ALDEN AND DESIGN. INT. CL. 25. (U.S. CL. 39). REG. 9-10-1991.
- 1,656,369. FANTASTIC FOODS. INT. CLS. 29 AND 30. (U.S. CL. 46). REG. 9-10-1991.
- 1,656,509. MISCELLANEOUS DESIGN. INT. CL. 42. (U.S. CL. 100). REG. 9-10-1991.
- 1,656,595. MONOTIER. INT. CL. 7. (U.S. CL. 23). REG. 9-10-1991.
- 1,656,602. LIBERATOR. INT. CL. 7. (U.S. CLS. 23 AND 35). REG. 9-10-1991.
- 1,656,947. STAGG PRIVATE RESERVE. INT. CL. 29. (U.S. CL. 46). REG. 9-10-1991.
- 1,657,177. HART. INT. CL. 8. (U.S. CL. 23). REG. 9-17-1991.
- 1,657,211. SILHOUETTE. INT. CL. 9. (U.S. CLS. 26 AND 32). REG. 9-17-1991.
- 1,657,323. KOYO. INT. CL. 12. (U.S. CL. 19). REG. 9-17-1991.
- 1,657,335. BLISTERING SKY. INT. CL. 13. (U.S. CL. 9). REG. 9-17-1991.
- 1,657,341. MISCELLANEOUS DESIGN. INT. CLS. 14, 16, 18, 20, 21, 25, 27 AND 28. (U.S. CLS. 2, 3, 13, 19, 22, 25, 28, 32, 33, 37, 39 AND 50). REG. 9-17-1991.
- 1,657,514. FOXTAIL. INT. CL. 28. (U.S. CL. 22). REG. 9-17-1991.
- 1,657,623. TROXEL. INT. CLS. 37 AND 40. (U.S. CLS. 103 AND 106). REG. 9-17-1991.
- 1,657,766. FURON. INT. CLS. 7 AND 9. (U.S. CLS. 13, 19, 21, 23, 26, 31, 34, 35, 36 AND 38). REG. 9-17-1991.
- 1,657,773. PARADE GLOSS. INT. CL. 3. (U.S. CL. 4). REG. 9-17-1991.
- 1,657,900. ASAHIPAK (STYLIZED). INT. CL. 1. (U.S. CLS. 1, 5, 6, 10, 26 AND 46). REG. 9-24-1991.
- 1,658,115. MEGANAC. INT. CL. 9. (U.S. CL. 26). REG. 9-24-1991.
- 1,658,154. DISTRACTION DEVICE. INT. CL. 13. (U.S. CLS. 2 AND 9). REG. 9-24-1991.
- 1,658,235. DIAMOND-LOK. INT. CL. 20. (U.S. CL. 50). REG. 9-24-1991.
- 1,658,243. ALLURE. INT. CL. 21. (U.S. CL. 50). REG. 9-24-1991.
- 1,658,244. SHOWCAKE. INT. CL. 21. (U.S. CL. 2). REG. 9-24-1991.
- 1,658,435. HIGH COUNTRY AND DESIGN. INT. CL. 31. (U.S. CL. 46). REG. 9-24-1991.
- 1,658,463. THE DALMORE AND DESIGN. INT. CL. 33. (U.S. CL. 49). REG. 9-24-1991.
- 1,658,639. THERMOSCAN. INT. CL. 9. (U.S. CLS. 26 AND 44). REG. 9-24-1991.
- 1,658,681. OASIS. INT. CL. 20. (U.S. CLS. 2, 26 AND 32). REG. 9-24-1991.
- 1,658,707. DEMITASSE. INT. CL. 30. (U.S. CL. 46). REG. 9-24-1991.
- 1,658,877. NETBLAZER. INT. CL. 9. (U.S. CLS. 21 AND 26). REG. 10-1-1991.
- 1,658,977. GRAND OPENING. INT. CL. 18. (U.S. CL. 3). REG. 10-1-1991.
- 1,659,395. VERTIGOHEEL. INT. CL. 5. (U.S. CL. 18). REG. 10-8-1991.
- 1,659,684. MAG. INT. CL. 14. (U.S. CL. 28). REG. 10-8-1991.
- 1,659,756. FIELDLINE. INT. CLS. 18 AND 25. (U.S. CLS. 3, 22 AND 39). REG. 10-8-1991.
- 1,659,757. FIELDLINE AND DESIGN. INT. CLS. 18 AND 25. (U.S. CLS. 3, 22 AND 39). REG. 10-8-1991.
- 1,660,076. CAPS. INT. CL. 36. (U.S. CLS. 101 AND 102). REG. 10-8-1991.
- 1,660,124. MISS TEEN USA. INT. CL. 41. (U.S. CL. 107). REG. 10-8-1991.
- 1,660,212. CAPS. INT. CL. 42. (U.S. CL. 100). REG. 10-8-1991.
- 1,660,524. CUTTERS EDGE AND DESIGN. INT. CL. 7. (U.S. CL. 23). REG. 10-15-1991.
- 1,660,691. PICOCHIP. INT. CL. 9. (U.S. CL. 26). REG. 10-15-1991.
- 1,660,748. POWERMITE. INT. CL. 13. (U.S. CLS. 2 AND 9). REG. 10-15-1991.
- 1,661,013. SOUTH MILL. INT. CL. 31. (U.S. CL. 46). REG. 10-15-1991.
- 1,661,096. H AND DESIGN. INT. CLS. 37 AND 42. (U.S. CLS. 100, 101 AND 103). REG. 10-15-1991.
- 1,661,228. THE REAL NEW YORK PIZZA AND DESIGN. INT. CL. 42. (U.S. CL. 100). REG. 10-15-1991.
- 1,661,631. PAUL SMITH. INT. CLS. 14 AND 18. (U.S. CLS. 3 AND 27). REG. 10-22-1991.
- 1,661,670. MICROSOFT PRESS. INT. CL. 16. (U.S. CL. 38). REG. 10-22-1991.
- 1,661,760. HAMMARY. INT. CL. 20. (U.S. CL. 32). REG. 10-22-1991.
- 1,662,000. THE NEW YORK WINE EXPERIENCE. INT. CL. 41. (U.S. CL. 107). REG. 10-22-1991.
- 1,662,564. DEVILS. INT. CL. 25. (U.S. CL. 39). REG. 10-29-1991.
- 1,662,635. MISCELLANEOUS DESIGN. INT. CL. 30. (U.S. CL. 46). REG. 10-29-1991.
- 1,662,644. S SPECIALTY BAKERS AND DESIGN. INT. CL. 30. (U.S. CL. 46). REG. 10-29-1991.
- 1,663,158. ZEEL. INT. CL. 5. (U.S. CL. 18). REG. 11-5-1991.
- 1,663,424. DIVERSI-PLAST. INT. CL. 17. (U.S. CLS. 1, 35 AND 50). REG. 11-5-1991.
- 1,663,619. SURFACES. INT. CL. 35. (U.S. CL. 101). REG. 11-5-1991.
- 1,664,049. SUNGATE. INT. CL. 12. (U.S. CL. 19). REG. 11-12-1991.
- 1,664,096. FOLD KRAFT. INT. CL. 16. (U.S. CL. 37). REG. 11-12-1991.
- 1,664,307. TRUE CRYSTALS. INT. CL. 32. (U.S. CL. 45). REG. 11-12-1991.
- 1,664,965. THE ASTUTE INVESTOR. INT. CL. 16. (U.S. CL. 38). REG. 11-19-1991.
- 1,665,032. ULTRADUR. INT. CL. 17. (U.S. CLS. 1 AND 50). REG. 11-19-1991.
- 1,665,118. THE ULTIMATE LIVE BAIT CATCHER. INT. CL. 28. (U.S. CL. 22). REG. 11-19-1991.
- 1,665,379. IOTEK. INT. CL. 1. (U.S. CL. 1). REG. 11-19-1991.
- 1,665,572. SUPER VALUE. INT. CL. 34. (U.S. CL. 17). REG. 11-19-1991.
- 1,666,420. ENHANCE. INT. CLS. 5 AND 10. (U.S. CLS. 18 AND 44). REG. 12-3-1991.
- 1,666,452. FANGGS. INT. CL. 7. (U.S. CL. 23). REG. 12-3-1991.
- 1,666,558. CYBEROPTICS. INT. CL. 9. (U.S. CL. 26). REG. 12-3-1991.
- 1,666,562. SPORTVIEW. INT. CL. 9. (U.S. CLS. 21, 23, 26, 36 AND 38). REG. 12-3-1991.
- 1,667,345. VINTAGE SQUARE (STYLIZED). INT. CL. 6. (U.S. CL. 12). REG. 12-10-1991.
- 1,667,417. TEW (STYLIZED). INT. CL. 9. (U.S. CLS. 21 AND 26). REG. 12-10-1991.
- 1,667,482. STURTEVANT RICHMONT. INT. CL. 9. (U.S. CL. 26). REG. 12-10-1991.
- 1,667,569. THE CHARTIST. INT. CL. 16. (U.S. CL. 38). REG. 12-10-1991.

- 1,668,529. INSULSPAN. INT. CL. 19. (U.S. CL. 12). REG. 12-17-1991.
- 1,668,679. HEART BREAKERS (STYLIZED). INT. CL. 30. (U.S. CL. 46). REG. 12-17-1991.
- 1,669,015. ESTATE SHIELD. INT. CL. 36. (U.S. CL. 102). REG. 12-17-1991.
- 1,669,292. SANISPRAY. INT. CL. 11. (U.S. CL. 13). REG. 12-24-1991.
- 1,669,447. BLH2OCK (STYLIZED). INT. CL. 17. (U.S. CLS. 1, 6 AND 12). REG. 12-24-1991.
- 1,670,431. DAYOUB. INT. CL. 31. (U.S. CL. 46). REG. 12-31-1991.
- 1,670,922. VIGEVANO. INT. CL. 25. (U.S. CL. 39). REG. 12-31-1991.
- 1,671,049. VETTEST. INT. CL. 10. (U.S. CL. 44). REG. 1-7-1992.
- 1,671,364. E-Z EXPORT. INT. CL. 39. (U.S. CL. 105). REG. 1-7-1992.
- 1,671,584. CHAINAWAY. INT. CL. 6. (U.S. CL. 13). REG. 1-14-1992.
- 1,672,059. QUEST. INT. CL. 36. (U.S. CLS. 101 AND 102). REG. 1-14-1992.
- 1,672,213. HARDWARE HANK AND DESIGN. INT. CL. 42. (U.S. CL. 101). REG. 1-14-1992.
- 1,672,521. PLASTALUME. INT. CL. 10. (U.S. CL. 44). REG. 1-21-1992.
- 1,672,979. GAS SHIELD. INT. CL. 11. (U.S. CL. 31). REG. 1-21-1992.
- 1,673,167. FUR-SO-FRESH. INT. CL. 3. (U.S. CLS. 51 AND 52). REG. 1-28-1992.
- 1,673,357. THE NAKED GUN. INT. CL. 9. (U.S. CLS. 21 AND 38). REG. 1-28-1992.
- 1,673,535. HONDA. INT. CL. 28. (U.S. CL. 22). REG. 1-28-1992.
- 1,673,830. MISCELLANEOUS DESIGN. INT. CL. 9. (U.S. CL. 26). REG. 1-28-1992.
- 1,674,813. EXCALIBUR. INT. CL. 8. (U.S. CL. 23). REG. 2-11-1992.
- 1,674,993. CS (STYLIZED). INT. CL. 14. (U.S. CL. 28). REG. 2-11-1992.
- 1,675,385. TEJANO CONJUNTO FESTIVAL. INT. CL. 41. (U.S. CL. 107). REG. 2-11-1992.
- 1,675,711. PRISM. INT. CL. 9. (U.S. CL. 38). REG. 2-18-1992.
- 1,677,287. AUSSIE. INT. CL. 3. (U.S. CLS. 1, 4, 6, 50, 51 AND 52). REG. 3-3-1992.
- 1,679,044. LOG CABIN LITE. INT. CL. 30. (U.S. CL. 46). REG. 3-10-1992.
- 1,681,170. SPORTS SPECTRUM. INT. CLS. 16 AND 41. (U.S. CLS. 38 AND 107). REG. 3-31-1992.
- 1,684,297. CASHIN. INT. CLS. 7 AND 9. (U.S. CLS. 21 AND 26). REG. 4-28-1992.
- 1,684,586. JOLLY RANCHER. INT. CL. 30. (U.S. CL. 46). REG. 4-28-1992.
- 1,684,878. A AND DESIGN. INT. CL. 36. (U.S. CLS. 101, 102 AND 105). REG. 4-28-1992.
- 1,685,468. FIBRIMEX. INT. CL. 29. (U.S. CL. 46). REG. 5-5-1992.
- 1,685,759. CITRIX. INT. CL. 9. (U.S. CL. 38). REG. 5-5-1992.
- 1,685,963. CLINICARE. INT. CL. 5. (U.S. CL. 18). REG. 5-12-1992.
- 1,686,163. VHT AMPLIFICATION AND DESIGN. INT. CL. 9. (U.S. CL. 21). REG. 5-12-1992.
- 1,687,936. SAGE (STYLIZED). INT. CLS. 25 AND 28. (U.S. CLS. 22, 23, 38, 39 AND 50). REG. 5-19-1992.
- 1,688,042. GLORIA FERRER AND DESIGN. INT. CL. 33. (U.S. CL. 47). REG. 5-19-1992.
- 1,688,374. DEAREST. INT. CL. 14. (U.S. CL. 28). REG. 5-19-1992.
- 1,688,994. THE UNITED METHODIST HYMNAL AND DESIGN. INT. CL. 16. (U.S. CL. 38). REG. 5-26-1992.
- 1,690,894. STUD-PLANK (STYLIZED). INT. CL. 37. (U.S. CLS. 100, 103 AND 106). REG. 6-2-1992.
- 1,690,902. MHEI. INT. CL. 41. (U.S. CL. 107). REG. 6-2-1992.
- 1,691,160. MISCELLANEOUS DESIGN. INT. CL. 6. (U.S. CL. 12). REG. 6-9-1992.
- 1,691,230. PHOTOFLEX PROFESSIONAL PHOTOGEAR AND DESIGN. INT. CL. 9. (U.S. CLS. 21 AND 26). REG. 6-9-1992.
- 1,691,426. KICKS (STYLIZED). INT. CL. 16. (U.S. CL. 38). REG. 6-9-1992.
- 1,691,707. FIDDLESTX. INT. CL. 28. (U.S. CL. 22). REG. 6-9-1992.
- 1,692,137. SMITH'S FOOD & DRUG CENTERS AND DESIGN. INT. CL. 42. (U.S. CL. 101). REG. 6-9-1992.
- 1,692,276. BMC (STYLIZED). INT. CL. 2. (U.S. CL. 16). REG. 6-9-1992.
- 1,693,014. BLAZEGUARD. INT. CL. 19. (U.S. CL. 12). REG. 6-9-1992.
- 1,694,194. MERCURY MEDICAL. INT. CL. 10. (U.S. CL. 44). REG. 6-16-1992.
- 1,695,009. RINGER HUT AND DESIGN. INT. CL. 42. (U.S. CL. 100). REG. 6-16-1992.
- 1,695,907. EQUI-TAPE. INT. CL. 9. (U.S. CL. 21). REG. 6-23-1992.
- 1,696,023. THERMLFILM. INT. CL. 16. (U.S. CL. 37). REG. 6-23-1992.
- 1,696,132. MUTT MITT. INT. CL. 21. (U.S. CL. 39). REG. 6-23-1992.
- 1,696,186. THE RAINSWETTER. INT. CL. 25. (U.S. CL. 39). REG. 6-23-1992.
- 1,698,051. MCCLOUD AND DESIGN. INT. CLS. 37 AND 42. (U.S. CLS. 100, 101, 103 AND 106). REG. 6-30-1992.
- 1,698,167. CLASSIC GARDEN ORNAMENTS, LTD.. INT. CL. 42. (U.S. CL. 101). REG. 6-30-1992.
- 1,700,056. NEWPELCA. INT. CL. 1. (U.S. CLS. 1 AND 6). REG. 7-14-1992.
- 1,700,270. PHOTOFLEX. INT. CL. 9. (U.S. CL. 26). REG. 7-14-1992.
- 1,701,722. FILE 'N SAVE SYSTEM. INT. CL. 16. (U.S. CLS. 2 AND 38). REG. 7-21-1992.
- 1,702,032. SOL. INT. CL. 32. (U.S. CL. 48). REG. 7-21-1992.
- 1,702,524. LYRICA. INT. CL. 21. (U.S. CL. 2). REG. 7-21-1992.
- 1,703,395. GLOWOSAURS. INT. CL. 25. (U.S. CLS. 22 AND 39). REG. 7-28-1992.
- 1,703,503. STREET BEAST. INT. CL. 28. (U.S. CL. 22). REG. 7-28-1992.
- 1,704,016. POLYCARBALLOY. INT. CL. 1. (U.S. CL. 6). REG. 7-28-1992.
- 1,705,263. FOWL THING. INT. CL. 30. (U.S. CL. 46). REG. 8-4-1992.
- 1,707,295. THE GODFATHER AND DESIGN. INT. CL. 41. (U.S. CL. 107). REG. 8-11-1992.
- 1,707,466. MILAM. INT. CL. 42. (U.S. CL. 100). REG. 8-11-1992.
- 1,708,212. BENTOMAT. INT. CL. 19. (U.S. CL. 12). REG. 8-18-1992.
- 1,708,679. C AND DESIGN. INT. CL. 37. (U.S. CLS. 100, 103 AND 106). REG. 8-18-1992.
- 1,708,811. WORKING WOMEN'S WEDNESDAY. INT. CL. 41. (U.S. CL. 107). REG. 8-18-1992.
- 1,709,526. PI PHI EXPRESS. INT. CL. 42. (U.S. CLS. 100 AND 101). REG. 8-18-1992.
- 1,711,598. PERSONAL STRENGTHS PUBLISHING. INT. CL. 16. (U.S. CLS. 37 AND 38). REG. 9-1-1992.
- 1,713,004. AMSCO WINDOWS AND DESIGN. INT. CL. 19 ONLY. (U.S. CLS. 12 AND 33). REG. 9-8-1992.
- 1,713,215. NORTHERN COMPUTERS, INC. AND DESIGN. INT. CL. 9. (U.S. CLS. 26 AND 38). REG. 9-8-1992.
- 1,713,548. AMERICAN HUNTER. INT. CL. 16. (U.S. CL. 38). REG. 9-8-1992.
- 1,714,596. BATCHMASTER. INT. CL. 7. (U.S. CLS. 13, 19, 21, 23, 31, 34 AND 35). REG. 9-8-1992.
- 1,715,017. UNITED ROTARY BRUSH CORPORATION AND DESIGN. INT. CL. 7. (U.S. CLS. 13, 19, 21, 23, 31, 34 AND 35). REG. 9-15-1992.
- 1,716,792. LASERDROP. INT. CL. 42. (U.S. CL. 101). REG. 9-15-1992.
- 1,716,808. SIERRA MODEL. INT. CL. 42. (U.S. CL. 100). REG. 9-15-1992.
- 2,405,152. ENDO UNIVERSAL. INT. CL. 10. (U.S. CLS. 26, 39 AND 44). REG. 11-21-2000.
- 2,415,196. GARDOFLOC. INT. CL. 1 ONLY. (U.S. CLS. 1, 5, 6, 10, 26 AND 46). REG. 12-26-2000.
- 2,416,939. GARDOCOOL. INT. CL. 4 ONLY. (U.S. CLS. 1, 6 AND 15). REG. 1-2-2001.
- 2,416,940. GARDOSTRIP. INT. CL. 3 ONLY. (U.S. CLS. 1, 4, 6, 50, 51 AND 52). REG. 1-2-2001.
- 2,421,728. PAC SYSTEM. INT. CL. 11. (U.S. CLS. 13, 21, 23, 31 AND 34). REG. 1-16-2001.
- 2,423,840. ROOFLIDER. INT. CL. 7. (U.S. CLS. 13, 19, 21, 23, 31, 34 AND 35). REG. 1-23-2001.
- 2,423,915. L.WOODS PINE LODGE. INT. CL. 42. (U.S. CLS. 100 AND 101). REG. 1-23-2001.
- 2,427,028. ?). INT. CL. 35. (U.S. CLS. 100, 101 AND 102). REG. 2-6-2001.
- 2,427,217. EASY JET. INT. CL. 25. (U.S. CLS. 22 AND 39). REG. 2-6-2001.

- 2,428,132. FREEDOM PAY. INT. CL. 36. (U.S. CLS. 100, 101 AND 102). REG. 2-13-2001.
- 2,428,532. CHOCOLIC BUFFET. INT. CL. 39. (U.S. CLS. 100 AND 105). REG. 2-13-2001.
- 2,429,576. FUNDSKAN. INT. CL. 36. (U.S. CLS. 100, 101 AND 102). REG. 2-20-2001.
- 2,430,628. TRF (STYLIZED). INT. CL. 18 ONLY. (U.S. CLS. 1, 2, 3, 22 AND 41). REG. 2-27-2001.
- 2,430,826. FRIED, FRANK, HARRIS, SHRIVER & JACOBSON. INT. CLS. 16 AND 42. (U.S. CLS. 2, 5, 22, 23, 29, 37, 38, 50, 100 AND 101). REG. 2-27-2001.
- 2,431,330. PHYLLIS BERGMAN AND DESIGN. INT. CL. 14. (U.S. CLS. 2, 27, 28 AND 50). REG. 2-27-2001.
- 2,431,925. SRS. INT. CL. 9. (U.S. CLS. 21, 23, 26, 36 AND 38). REG. 2-27-2001.
- 2,432,700. MISCELLANEOUS DESIGN. INT. CLS. 35, 37, 39, 40 AND 42 ONLY. (U.S. CLS. 100, 101, 102, 103, 105 AND 106). REG. 3-6-2001.
- 2,432,809. CHALLENGE BY CHOICE. INT. CL. 41. (U.S. CLS. 100, 101 AND 107). REG. 3-6-2001.
- 2,432,810. THE MOTHER OF ALL WORKOUTS. INT. CL. 41. (U.S. CLS. 100, 101 AND 107). REG. 3-6-2001.
- 2,434,374. MISCELLANEOUS DESIGN. INT. CL. 3. (U.S. CLS. 1, 4, 6, 50, 51 AND 52). REG. 3-6-2001.
- 2,434,800. MAGNUM. INT. CL. 7. (U.S. CLS. 13, 19, 21, 23, 31, 34 AND 35). REG. 3-13-2001.
- 2,435,360. GYRO. INT. CL. 35. (U.S. CLS. 100, 101 AND 102). REG. 3-13-2001.
- 2,435,452. CUISINE DE FRANCE AND DESIGN. INT. CL. 30. (U.S. CL. 46). REG. 3-13-2001.
- 2,436,438. BLOOMSERVICE AND DESIGN. INT. CL. 35. (U.S. CLS. 100, 101 AND 102). REG. 3-20-2001.
- 2,436,461. FIBERCAT. INT. CL. 9. (U.S. CLS. 21, 23, 26, 36 AND 38). REG. 3-20-2001.
- 2,436,695. MAJAMAS. INT. CL. 25. (U.S. CLS. 22 AND 39). REG. 3-20-2001.
- 2,436,798. CLAPPY THE CRAB. INT. CL. 42. (U.S. CLS. 100 AND 101). REG. 3-20-2001.
- 2,436,953. GREAT GRIPS. INT. CL. 20. (U.S. CLS. 2, 13, 22, 25, 32 AND 50). REG. 3-20-2001.
- 2,437,537. AT AND DESIGN. INT. CLS. 6 AND 26. (U.S. CLS. 2, 12, 13, 14, 23, 25, 37, 39, 40, 42 AND 50). REG. 3-20-2001.
- 2,437,936. QUIK-FIRE. INT. CL. 7. (U.S. CLS. 13, 19, 21, 23, 31, 34 AND 35). REG. 3-27-2001.
- 2,438,501. MWIVET.COM. INT. CL. 35. (U.S. CLS. 100, 101 AND 102). REG. 3-27-2001.
- 2,438,533. P L AND DESIGN. INT. CL. 14. (U.S. CLS. 2, 27, 28 AND 50). REG. 3-27-2001.
- 2,439,441. LATIN DOLL. INT. CL. 25. (U.S. CLS. 22 AND 39). REG. 3-27-2001.
- 2,439,465. LATIN DOLL. INT. CL. 41. (U.S. CLS. 100, 101 AND 107). REG. 3-27-2001.
- 2,440,090. DATATRAC. INT. CL. 9. (U.S. CLS. 21, 23, 26, 36 AND 38). REG. 4-3-2001.
- 2,441,495. CLEAR APPROACH. INT. CL. 5. (U.S. CLS. 6, 18, 44, 46, 51 AND 52). REG. 4-3-2001.
- 2,441,799. AMERICAN DIVERSATECH MANUFACTURING AND DESIGN. INT. CL. 6. (U.S. CLS. 2, 12, 13, 14, 23, 25 AND 50). REG. 4-10-2001.
- 2,442,412. FX SERVICE CENTER. INT. CL. 9. (U.S. CLS. 21, 23, 26, 36 AND 38). REG. 4-10-2001.
- 2,442,479. THE INDEPENDENT. INT. CL. 16. (U.S. CLS. 2, 5, 22, 23, 29, 37, 38 AND 50). REG. 4-10-2001.
- 2,446,022. VILLA DE VARDIA. INT. CL. 33. (U.S. CLS. 47 AND 49). REG. 4-24-2001.
- 2,446,889. ULTRA-REALISTIC. INT. CL. 10. (U.S. CLS. 26, 39 AND 44). REG. 4-24-2001.
- 2,448,252. GR8TRADE. INT. CL. 36. (U.S. CLS. 100, 101 AND 102). REG. 5-1-2001.
- 2,448,303. DIRECTQUALITY. INT. CL. 9. (U.S. CLS. 21, 23, 26, 36 AND 38). REG. 5-1-2001.
- 2,448,380. BEAM GARRETSON. INT. CLS. 7 AND 9. (U.S. CLS. 13, 19, 21, 23, 26, 31, 34, 35, 36 AND 38). REG. 5-1-2001.
- 2,450,227. MID-AIR MAYHEM. INT. CL. 13. (U.S. CLS. 2 AND 9). REG. 5-8-2001.
- 2,450,323. BLOOD ALCOHOL EDUCATOR. INT. CLS. 16 AND 42 ONLY. (U.S. CLS. 2, 5, 22, 23, 29, 37, 38, 50, 100 AND 101). REG. 5-8-2001.
- 2,450,820. MISCELLANEOUS DESIGN. INT. CLS. 8, 18, 25 AND 28. (U.S. CLS. 1, 2, 3, 22, 23, 28, 38, 39, 41, 44 AND 50). REG. 5-15-2001.
- 2,451,048. DRITEC. INT. CL. 11. (U.S. CLS. 13, 21, 23, 31 AND 34). REG. 5-15-2001.
- 2,451,703. COMPLETION-PAC. INT. CL. 20. (U.S. CLS. 2, 13, 22, 25, 32 AND 50). REG. 5-15-2001.
- 2,454,754. SUPERIOR TATTOO EQUIPMENT. INT. CL. 7. (U.S. CLS. 13, 19, 21, 23, 31, 34 AND 35). REG. 5-29-2001.
- 2,455,477. INETIME.COM. INT. CL. 35. (U.S. CLS. 100, 101 AND 102). REG. 5-29-2001.
- 2,455,818. G GYROS AND DESIGN. INT. CLS. 7 AND 8 ONLY. (U.S. CLS. 13, 19, 21, 23, 28, 31, 34, 35 AND 44). REG. 5-29-2001.
- 2,455,823. TAPETA. INT. CLS. 41 AND 42. (U.S. CLS. 100, 101 AND 107). REG. 5-29-2001.
- 2,456,571. SUMMER LAND AND DESIGN. INT. CL. 31. (U.S. CLS. 1 AND 46). REG. 6-5-2001.
- 2,456,786. MEDIAVOICE. INT. CL. 41. (U.S. CLS. 100, 101 AND 107). REG. 6-5-2001.
- 2,457,320. ARRIVE. INT. CL. 16. (U.S. CLS. 2, 5, 22, 23, 29, 37, 38 AND 50). REG. 6-5-2001.
- 2,458,324. RUBBERCRETE. INT. CL. 19. (U.S. CLS. 1, 12, 33 AND 50). REG. 6-5-2001.
- 2,459,567. BLOCK&BIND. INT. CL. 5. (U.S. CLS. 6, 18, 44, 46, 51 AND 52). REG. 6-12-2001.
- 2,461,261. LIGHT THE NIGHT FOR SIGHT. INT. CL. 36. (U.S. CLS. 100, 101 AND 102). REG. 6-19-2001.
- 2,461,597. MP&S. INT. CL. 42. (U.S. CLS. 100 AND 101). REG. 6-19-2001.
- 2,461,752. MISCELLANEOUS DESIGN. INT. CL. 35. (U.S. CLS. 100, 101 AND 102). REG. 6-19-2001.
- 2,462,947. INTERNATIONAL FUNCTIONAL ELECTRICAL STIMULATION SOCIETY. INT. CL. 41. (U.S. CLS. 100, 101 AND 107). REG. 6-19-2001.
- 2,463,031. MISCELLANEOUS DESIGN. INT. CL. 6. (U.S. CLS. 2, 12, 13, 14, 23, 25 AND 50). REG. 6-26-2001.
- 2,463,032. MISCELLANEOUS DESIGN. INT. CL. 6. (U.S. CLS. 2, 12, 13, 14, 23, 25 AND 50). REG. 6-26-2001.
- 2,464,668. TANKOR. INT. CL. 28. (U.S. CLS. 22, 23, 38 AND 50). REG. 6-26-2001.
- 2,465,341. INFORCER. INT. CL. 9. (U.S. CLS. 21, 23, 26, 36 AND 38). REG. 7-3-2001.
- 2,465,886. NATIONAL ENDOWMENT FOR FINANCIAL EDUCATION. INT. CL. 9. (U.S. CLS. 21, 23, 26, 36 AND 38). REG. 7-3-2001.
- 2,466,676. BUZZSAW. INT. CL. 28. (U.S. CLS. 22, 23, 38 AND 50). REG. 7-3-2001.
- 2,466,699. SEAN JOHN. INT. CL. 25. (U.S. CLS. 22 AND 39). REG. 7-3-2001.
- 2,466,863. GRIP-IT STRIPS. INT. CL. 16. (U.S. CLS. 2, 5, 22, 23, 29, 37, 38 AND 50). REG. 7-10-2001.
- 2,467,101. TEXAS CHILDREN'S HEALTH CENTERS. INT. CLS. 41 AND 42. (U.S. CLS. 100, 101 AND 107). REG. 7-10-2001.
- 2,467,357. RUBBER PAVEMENTS ASSOCIATION. INT. CLS. 16, 41 AND 42. (U.S. CLS. 2, 5, 22, 23, 29, 37, 38, 50, 100, 101 AND 107). REG. 7-10-2001.
- 2,467,764. FRAZZLED. INT. CL. 16. (U.S. CLS. 2, 5, 22, 23, 29, 37, 38 AND 50). REG. 7-10-2001.
- 2,468,006. SKIES OF BLUE. INT. CL. 16. (U.S. CLS. 2, 5, 22, 23, 29, 37, 38 AND 50). REG. 7-10-2001.
- 2,468,028. SST. INT. CL. 13. (U.S. CLS. 2 AND 9). REG. 7-10-2001.
- 2,468,397. HCAM. INT. CL. 35. (U.S. CLS. 100, 101 AND 102). REG. 7-10-2001.
- 2,468,673. TAKE HOME DEFENSIVE DRIVING. INT. CL. 41. (U.S. CLS. 100, 101 AND 107). REG. 7-17-2001.
- 2,468,704. CP AND DESIGN. INT. CL. 42. (U.S. CLS. 100 AND 101). REG. 7-17-2001.
- 2,468,946. PROQUEST. INT. CL. 42. (U.S. CLS. 100 AND 101). REG. 7-17-2001.
- 2,468,990. TEXAS CHILDREN'S HEART CENTER. INT. CLS. 41 AND 42. (U.S. CLS. 100, 101 AND 107). REG. 7-17-2001.
- 2,469,037. INTERLOCH. INT. CL. 20. (U.S. CLS. 2, 13, 22, 25, 32 AND 50). REG. 7-17-2001.
- 2,469,244. ENFAMIL. INT. CL. 5. (U.S. CLS. 6, 18, 44, 46, 51 AND 52). REG. 7-17-2001.
- 2,469,580. MORGAN LEWIS. INT. CL. 42. (U.S. CLS. 100 AND 101). REG. 7-17-2001.
- 2,469,997. LUCKY ME. INT. CL. 25. (U.S. CLS. 22 AND 39). REG. 7-17-2001.
- 2,470,016. B.E.S.T.. INT. CL. 27. (U.S. CLS. 19, 20, 37, 42 AND 50). REG. 7-17-2001.
- 2,470,069. OSTEOCEL. INT. CL. 5. (U.S. CLS. 6, 18, 44, 46, 51 AND 52). REG. 7-17-2001.
- 2,470,618. GEOEX. INT. CL. 16. (U.S. CLS. 2, 5, 22, 23, 29, 37, 38 AND 50). REG. 7-17-2001.

- 2,471,595. MISCELLANEOUS DESIGN. INT. CL. 42. (U.S. CLS. 100 AND 101). REG. 7-24-2001.
- 2,471,635. MISCELLANEOUS DESIGN. INT. CL. 25. (U.S. CLS. 22 AND 39). REG. 7-24-2001.
- 2,472,329. SCRIPTLOGIC. INT. CL. 9. (U.S. CLS. 21, 23, 26, 36 AND 38). REG. 7-24-2001.
- 2,472,363. DIVOTOOL. INT. CL. 28. (U.S. CLS. 22, 23, 38 AND 50). REG. 7-24-2001.
- 2,472,617. SKYLINK. INT. CL. 9. (U.S. CLS. 21, 23, 26, 36 AND 38). REG. 7-31-2001.
- 2,472,979. MISCELLANEOUS DESIGN. INT. CL. 36 ONLY. (U.S. CLS. 100, 101 AND 102). REG. 7-31-2001.
- 2,473,470. HOLLYWOOD'S BODY & PAINT. INT. CL. 37. (U.S. CLS. 100, 103 AND 106). REG. 7-31-2001.
- 2,473,484. SURFLINER. INT. CL. 39. (U.S. CLS. 100 AND 105). REG. 7-31-2001.
- 2,473,738. JOURNAL OF CLINICAL RHEUMATOLOGY. INT. CL. 16. (U.S. CLS. 2, 5, 22, 23, 29, 37, 38 AND 50). REG. 7-31-2001.
- 2,473,837. CAMO-CLAD. INT. CL. 17. (U.S. CLS. 1, 5, 12, 13, 35 AND 50). REG. 7-31-2001.
- 2,473,983. MISCELLANEOUS DESIGN. INT. CL. 25. (U.S. CLS. 22 AND 39). REG. 7-31-2001.
- 2,474,348. JUICE PLUS+ COMPLETE. INT. CL. 5. (U.S. CLS. 6, 18, 44, 46, 51 AND 52). REG. 7-31-2001.
- 2,474,423. PRAISESONG. INT. CL. 16. (U.S. CLS. 2, 5, 22, 23, 29, 37, 38 AND 50). REG. 7-31-2001.
- 2,474,800. LEATHER MAN AND DESIGN. INT. CL. 25. (U.S. CLS. 22 AND 39). REG. 8-7-2001.
- 2,474,898. FAST OEM PARTS AND DESIGN. INT. CLS. 7, 9 AND 11. (U.S. CLS. 13, 19, 21, 23, 26, 31, 34, 35, 36 AND 38). REG. 8-7-2001.
- 2,475,013. GDFOK AND DESIGN. INT. CLS. 29, 30 AND 33 ONLY. (U.S. CLS. 46, 47 AND 49). REG. 8-7-2001.
- 2,475,039. HYDROCEL. INT. CL. 7. (U.S. CLS. 13, 19, 21, 23, 31, 34 AND 35). REG. 8-7-2001.
- 2,475,225. EZ LINE PUTTERS AND DESIGN. INT. CL. 28. (U.S. CLS. 22, 23, 38 AND 50). REG. 8-7-2001.
- 2,475,333. PACIFIC SURFLINER. INT. CL. 39. (U.S. CLS. 100 AND 105). REG. 8-7-2001.
- 2,475,467. LANDQART AND DESIGN. INT. CL. 16. (U.S. CLS. 2, 5, 22, 23, 29, 37, 38 AND 50). REG. 8-7-2001.
- 2,475,495. FIRST STEP. INT. CL. 5. (U.S. CLS. 6, 18, 44, 46, 51 AND 52). REG. 8-7-2001.
- 2,475,576. DHC. INT. CL. 9. (U.S. CLS. 21, 23, 26, 36 AND 38). REG. 8-7-2001.
- 2,475,732. LAGUNA VINEYARD. INT. CL. 33. (U.S. CLS. 47 AND 49). REG. 8-7-2001.
- 2,475,775. ACCESS DEVELOPMENT. INT. CL. 35. (U.S. CLS. 100, 101 AND 102). REG. 8-7-2001.
- 2,475,825. MANIFEST TECHNOLOGY. INT. CL. 42. (U.S. CLS. 100 AND 101). REG. 8-7-2001.
- 2,476,153. NOXIT. INT. CL. 2. (U.S. CLS. 6, 11 AND 16). REG. 8-7-2001.
- 2,476,291. INVENTION ON DEMAND. INT. CLS. 41 AND 42. (U.S. CLS. 100, 101 AND 107). REG. 8-7-2001.
- 2,476,756. SECRETS OF THE DEAD. INT. CL. 41. (U.S. CLS. 100, 101 AND 107). REG. 8-7-2001.
- 2,476,773. JOINT MAINTENANCE. INT. CL. 5. (U.S. CLS. 6, 18, 44, 46, 51 AND 52). REG. 8-7-2001.
- 2,476,976. PROFLOWERS. INT. CL. 35. (U.S. CLS. 100, 101 AND 102). REG. 8-14-2001.
- 2,477,235. MISCELLANEOUS DESIGN. INT. CL. 25. (U.S. CLS. 22 AND 39). REG. 8-14-2001.
- 2,477,252. S2S. INT. CLS. 16 AND 41. (U.S. CLS. 2, 5, 22, 23, 29, 37, 38, 50, 100, 101 AND 107). REG. 8-14-2001.
- 2,477,372. SPECTRUM. INT. CL. 36. (U.S. CLS. 100, 101 AND 102). REG. 8-14-2001.
- 2,477,551. K-KIDS K KIWANIS AND DESIGN. INT. CLS. 36 AND 42. (U.S. CLS. 100, 101 AND 102). REG. 8-14-2001.
- 2,477,628. BCTGM BAKERY, CONFECTIONERY, TOBACCO WORKERS & GRAIN MILLERS INTERNATIONAL UNION, AFL-CIO CLC. U.S. CL. 200. REG. 8-14-2001.
- 2,477,696. GRUNDER LANDSCAPING CO. WHERE SERVICE IS ALWAYS IN SEASON! AND DESIGN. INT. CL. 42. (U.S. CLS. 100 AND 101). REG. 8-14-2001.
- 2,477,749. W AND DESIGN. INT. CLS. 9, 16 AND 35. (U.S. CLS. 2, 5, 21, 22, 23, 26, 29, 36, 37, 38, 50, 100, 101 AND 102). REG. 8-14-2001.
- 2,478,021. FIERCELY PROTECTIVE GEAR. INT. CL. 28. (U.S. CLS. 22, 23, 38 AND 50). REG. 8-14-2001.
- 2,478,084. THERMATWO. INT. CL. 11. (U.S. CLS. 13, 21, 23, 31 AND 34). REG. 8-14-2001.
- 2,478,235. 3BALLS. INT. CL. 35. (U.S. CLS. 100, 101 AND 102). REG. 8-14-2001.
- 2,478,496. YANKEE FLIPPER. INT. CL. 21. (U.S. CLS. 2, 13, 23, 29, 30, 33, 40 AND 50). REG. 8-14-2001.
- 2,478,638. POWERPREP PLUS. INT. CL. 7. (U.S. CLS. 13, 19, 21, 23, 31, 34 AND 35). REG. 8-14-2001.
- 2,478,659. AHEADERIZER. INT. CL. 7. (U.S. CLS. 13, 19, 21, 23, 31, 34 AND 35). REG. 8-14-2001.
- 2,478,851. HYDROBRITE. INT. CL. 4. (U.S. CLS. 1, 6 AND 15). REG. 8-21-2001.
- 2,478,966. TREND MAGAZINE AND DESIGN. INT. CL. 42. (U.S. CLS. 100 AND 101). REG. 8-21-2001.
- 2,479,029. ECO BRASS. INT. CL. 6. (U.S. CLS. 2, 12, 13, 14, 23, 25 AND 50). REG. 8-21-2001.
- 2,479,093. CLEAR POINT CONSULTANTS, INC.. INT. CL. 35. (U.S. CLS. 100, 101 AND 102). REG. 8-21-2001.
- 2,479,134. PROSTAVAN. INT. CL. 5. (U.S. CLS. 6, 18, 44, 46, 51 AND 52). REG. 8-21-2001.
- 2,479,241. WHAT TO DO ABOUT YOUR BRAIN-INJURED CHILD. INT. CLS. 16 AND 41. (U.S. CLS. 2, 5, 22, 23, 29, 37, 38, 50, 100, 101 AND 107). REG. 8-21-2001.
- 2,479,266. DMU. INT. CLS. 25 AND 41. (U.S. CLS. 22, 39, 100, 101 AND 107). REG. 8-21-2001.
- 2,479,302. PHILTRE D'AMOUR. INT. CL. 3. (U.S. CLS. 1, 4, 6, 50, 51 AND 52). REG. 8-21-2001.
- 2,479,321. ACINDAR AND DESIGN. INT. CL. 6. (U.S. CLS. 2, 12, 13, 14, 23, 25 AND 50). REG. 8-21-2001.
- 2,479,335. PASTOSA AND DESIGN. INT. CL. 30. (U.S. CL. 46). REG. 8-21-2001.
- 2,479,494. WHOLEY AND DESIGN. INT. CL. 29. (U.S. CL. 46). REG. 8-21-2001.
- 2,479,516. MOVEX. INT. CL. 11. (U.S. CLS. 13, 21, 23, 31 AND 34). REG. 8-21-2001.
- 2,479,540. ECON-O-HEX. INT. CL. 6. (U.S. CLS. 2, 12, 13, 14, 23, 25 AND 50). REG. 8-21-2001.
- 2,479,574. COLLISION EXPRESS. INT. CL. 37. (U.S. CLS. 100, 103 AND 106). REG. 8-21-2001.
- 2,479,633. THE KEY TO WINNING. INT. CL. 41. (U.S. CLS. 100, 101 AND 107). REG. 8-21-2001.
- 2,479,652. MOUNTAIN SUN. INT. CL. 32. (U.S. CLS. 45, 46 AND 48). REG. 8-21-2001.
- 2,479,762. GLA FORTE. INT. CL. 5. (U.S. CLS. 6, 18, 44, 46, 51 AND 52). REG. 8-21-2001.
- 2,479,796. GOLDEN-DRAIN. INT. CL. 10. (U.S. CLS. 26, 39 AND 44). REG. 8-21-2001.
- 2,479,896. HAV-A-DANNA. INT. CL. 25. (U.S. CLS. 22 AND 39). REG. 8-21-2001.
- 2,479,980. H2ORGANIC. INT. CL. 1. (U.S. CLS. 1, 5, 6, 10, 26 AND 46). REG. 8-21-2001.
- 2,479,995. SMARTACCESS. INT. CL. 36. (U.S. CLS. 100, 101 AND 102). REG. 8-21-2001.
- 2,480,019. SURFLEX. INT. CL. 9. (U.S. CLS. 21, 23, 26, 36 AND 38). REG. 8-21-2001.
- 2,480,036. RAINEY AND DESIGN. INT. CL. 10. (U.S. CLS. 26, 39 AND 44). REG. 8-21-2001.
- 2,480,050. EDITHEAD. INT. CL. 41. (U.S. CLS. 100, 101 AND 107). REG. 8-21-2001.
- 2,480,262. ASSISTGUIDE. INT. CLS. 35, 36, 39, 41 AND 42. (U.S. CLS. 100, 101, 102, 105 AND 107). REG. 8-21-2001.
- 2,480,366. THE PHANTOM MENACE. INT. CL. 16. (U.S. CLS. 2, 5, 22, 23, 29, 37, 38 AND 50). REG. 8-21-2001.
- 2,480,467. ZYDECO. INT. CL. 20. (U.S. CLS. 2, 13, 22, 25, 32 AND 50). REG. 8-21-2001.
- 2,480,480. AUTONATION. INT. CL. 36. (U.S. CLS. 100, 101 AND 102). REG. 8-21-2001.
- 2,480,577. SHOTSKI. INT. CL. 21. (U.S. CLS. 2, 13, 23, 29, 30, 33, 40 AND 50). REG. 8-21-2001.
- 2,480,848. ECHONET (STYLIZED). INT. CLS. 36 AND 42. (U.S. CLS. 100, 101 AND 102). REG. 8-21-2001.
- 2,480,901. SPECIALISTS IN THE ART OF TRAVEL. INT. CLS. 35, 38 AND 42. (U.S. CLS. 100, 101, 102 AND 104). REG. 8-21-2001.
- 2,481,017. LENOX HILL HEART AND VASCULAR INSTITUTE OF NEW YORK. INT. CLS. 41 AND 42. (U.S. CLS. 100, 101 AND 107). REG. 8-21-2001.
- 2,481,083. EPC. INT. CL. 9. (U.S. CLS. 21, 23, 26, 36 AND 38). REG. 8-28-2001.
- 2,481,129. PROFIVE. INT. CL. 9. (U.S. CLS. 21, 23, 26, 36 AND 38). REG. 8-28-2001.



- 2,481,240. LAMBERTI'S CUCINA AND DESIGN. INT. CL. 42. (U.S. CLS. 100 AND 101). REG. 8-28-2001.
- 2,481,304. DAYTONA CLUB AND DESIGN. INT. CL. 41. (U.S. CLS. 100, 101 AND 107). REG. 8-28-2001.
- 2,481,318. COLTON'S STEAK HOUSE & GRILL AND DESIGN. INT. CL. 42. (U.S. CLS. 100 AND 101). REG. 8-28-2001.
- 2,481,355. REPLAY AND DESIGN. INT. CL. 9. (U.S. CLS. 21, 23, 26, 36 AND 38). REG. 8-28-2001.
- 2,481,443. PENN FABRICATION. INT. CL. 6. (U.S. CLS. 2, 12, 13, 14, 23, 25 AND 50). REG. 8-28-2001.
- 2,481,519. TRANSCANADA TURBINES. INT. CLS. 37 AND 42. (U.S. CLS. 100, 101, 103 AND 106). REG. 8-28-2001.
- 2,481,531. C-MORE SYSTEMS. INT. CLS. 9 AND 25. (U.S. CLS. 21, 22, 23, 26, 36, 38 AND 39). REG. 8-28-2001.
- 2,481,532. C-MORE SYSTEMS AND DESIGN. INT. CLS. 9 AND 25. (U.S. CLS. 21, 22, 23, 26, 36, 38 AND 39). REG. 8-28-2001.
- 2,481,566. SILCHEM. INT. CL. 1. (U.S. CLS. 1, 5, 6, 10, 26 AND 46). REG. 8-28-2001.
- 2,481,586. KNOWLEDGE IN A NUTSHELL. INT. CL. 16. (U.S. CLS. 2, 5, 22, 23, 29, 37, 38 AND 50). REG. 8-28-2001.
- 2,481,746. CLARITY. INT. CL. 5. (U.S. CLS. 6, 18, 44, 46, 51 AND 52). REG. 8-28-2001.
- 2,481,882. MISCELLANEOUS DESIGN. INT. CL. 36. (U.S. CLS. 100, 101 AND 102). REG. 8-28-2001.
- 2,481,938. EXECUTIVE DISCOVERY. INT. CL. 35. (U.S. CLS. 100, 101 AND 102). REG. 8-28-2001.
- 2,482,006. MIZUNO WAVE. INT. CL. 25. (U.S. CLS. 22 AND 39). REG. 8-28-2001.
- 2,482,103. L-BOW. INT. CL. 25. (U.S. CLS. 22 AND 39). REG. 8-28-2001.
- 2,482,131. DRUG STORE NEWS. INT. CL. 16. (U.S. CLS. 2, 5, 22, 23, 29, 37, 38 AND 50). REG. 8-28-2001.
- 2,482,193. MIJAO. INT. CL. 30. (U.S. CL. 46). REG. 8-28-2001.
- 2,482,195. APAMATE. INT. CL. 30. (U.S. CL. 46). REG. 8-28-2001.
- 2,482,196. SIZERITE. INT. CL. 9. (U.S. CLS. 21, 23, 26, 36 AND 38). REG. 8-28-2001.
- 2,482,252. CAR TATTOOS. INT. CL. 16. (U.S. CLS. 2, 5, 22, 23, 29, 37, 38 AND 50). REG. 8-28-2001.
- 2,482,262. THE BINGO STORE ON WHEELS. INT. CL. 28. (U.S. CLS. 22, 23, 38 AND 50). REG. 8-28-2001.
- 2,482,323. CHRISTIAN FAMILY JEWELERS. INT. CL. 14. (U.S. CLS. 2, 27, 28 AND 50). REG. 8-28-2001.
- 2,482,337. BLINDS TO GO. INT. CL. 24. (U.S. CLS. 42 AND 50). REG. 8-28-2001.
- 2,482,360. TEXTURE CRAFT. INT. CL. 27. (U.S. CLS. 19, 20, 37, 42 AND 50). REG. 8-28-2001.
- 2,482,410. TERRAMAX. INT. CL. 14. (U.S. CLS. 2, 27, 28 AND 50). REG. 8-28-2001.
- 2,482,421. YELLOW STRIPE (STYLIZED). INT. CL. 16. (U.S. CLS. 2, 5, 22, 23, 29, 37, 38 AND 50). REG. 8-28-2001.
- 2,482,553. CLC. INT. CL. 35. (U.S. CLS. 100, 101 AND 102). REG. 8-28-2001.
- 2,482,600. CERUS. INT. CL. 5. (U.S. CLS. 6, 18, 44, 46, 51 AND 52). REG. 8-28-2001.
- 2,482,688. GECKO. INT. CL. 34. (U.S. CLS. 2, 8, 9 AND 17). REG. 8-28-2001.
- 2,482,694. PECO. INT. CL. 39. (U.S. CLS. 100 AND 105). REG. 8-28-2001.
- 2,482,746. WILLIE ESCO. INT. CL. 25. (U.S. CLS. 22 AND 39). REG. 8-28-2001.
- 2,482,907. YAHOO!. INT. CL. 16 ONLY. (U.S. CLS. 2, 5, 22, 23, 29, 37, 38 AND 50). REG. 8-28-2001.
- 2,482,918. M/BED BLOCK SYSTEM AND DESIGN. INT. CLS. 6 AND 19. (U.S. CLS. 1, 2, 12, 13, 14, 23, 25, 33 AND 50). REG. 8-28-2001.
- 2,482,924. ALLSECTOR TECHNOLOGY GROUP. INT. CL. 42. (U.S. CLS. 100 AND 101). REG. 8-28-2001.
- 2,482,983. MVTA. INT. CL. 9. (U.S. CLS. 21, 23, 26, 36 AND 38). REG. 8-28-2001.
- 2,483,181. RUDER FINN INTERACTIVE. INT. CLS. 35 AND 42. (U.S. CLS. 100, 101 AND 102). REG. 8-28-2001.
- 2,483,855. TURNING HOW INTO WOW!. INT. CL. 35. (U.S. CLS. 100, 101 AND 102). REG. 8-28-2001.
- 2,483,890. VARIABLE LOAD. INT. CL. 7. (U.S. CLS. 13, 19, 21, 23, 31, 34 AND 35). REG. 8-28-2001.
- 2,483,958. OPCION ESPECIAL. INT. CL. 41 ONLY. (U.S. CLS. 100, 101 AND 107). REG. 8-28-2001.
- 2,483,985. LAW ACTORS. INT. CL. 35. (U.S. CLS. 100, 101 AND 102). REG. 8-28-2001.
- 2,483,995. COPYRIGHTBUREAU.COM. INT. CL. 42. (U.S. CLS. 100 AND 101). REG. 8-28-2001.
- 2,484,020. CORPORATEBUREAU.COM. INT. CL. 42. (U.S. CLS. 100 AND 101). REG. 8-28-2001.
- 2,484,064. DIGITAL DENTAL OFFICE. INT. CL. 9. (U.S. CLS. 21, 23, 26, 36 AND 38). REG. 8-28-2001.
- 2,484,196. LIFELINK. INT. CLS. 41 AND 42. (U.S. CLS. 100, 101 AND 107). REG. 9-4-2001.
- 2,484,293. SORRENTO. INT. CL. 12. (U.S. CLS. 19, 21, 23, 31, 35 AND 44). REG. 9-4-2001.
- 2,484,296. MINIMETRO. INT. CLS. 12, 37 AND 42 ONLY. (U.S. CLS. 19, 21, 23, 31, 35, 44, 100, 101, 103 AND 106). REG. 9-4-2001.
- 2,484,314. CAREERENGINE. INT. CL. 35 ONLY. (U.S. CLS. 100, 101 AND 102). REG. 9-4-2001.
- 2,484,336. MANE STAY (STYLIZED). INT. CL. 3. (U.S. CLS. 1, 4, 6, 50, 51 AND 52). REG. 9-4-2001.
- 2,484,341. TIMECONTROL. INT. CL. 9. (U.S. CLS. 21, 23, 26, 36 AND 38). REG. 9-4-2001.
- 2,484,381. CONTROL MASTERS, INCORPORATED. INT. CLS. 9 AND 42. (U.S. CLS. 21, 23, 26, 36, 38, 100 AND 101). REG. 9-4-2001.
- 2,484,458. E SPEED (STYLIZED). INT. CL. 38. (U.S. CLS. 100, 101 AND 104). REG. 9-4-2001.
- 2,484,563. MISCELLANEOUS DESIGN. INT. CLS. 14, 16 AND 25. (U.S. CLS. 2, 5, 22, 23, 27, 28, 29, 37, 38, 39 AND 50). REG. 9-4-2001.
- 2,484,631. BENDEEZ. INT. CL. 20. (U.S. CLS. 2, 13, 22, 25, 32 AND 50). REG. 9-4-2001.
- 2,484,697. CORPORATE IMAGE. INT. CL. 40. (U.S. CLS. 100, 103 AND 106). REG. 9-4-2001.
- 2,484,799. THINNER (STYLIZED). INT. CL. 9. (U.S. CLS. 21, 23, 26, 36 AND 38). REG. 9-4-2001.
- 2,484,902. WE DELIVER PREFERRED SOLUTIONS. INT. CLS. 37 AND 40. (U.S. CLS. 100, 103 AND 106). REG. 9-4-2001.
- 2,485,004. STUDY WHIZ. INT. CL. 16. (U.S. CLS. 2, 5, 22, 23, 29, 37, 38 AND 50). REG. 9-4-2001.
- 2,485,215. APPLIED. INT. CL. 35. (U.S. CLS. 100, 101 AND 102). REG. 9-4-2001.
- 2,485,230. CULINAR AND DESIGN. INT. CL. 41. (U.S. CLS. 100, 101 AND 107). REG. 9-4-2001.
- 2,485,303. MATCHMAKER. INT. CL. 9. (U.S. CLS. 21, 23, 26, 36 AND 38). REG. 9-4-2001.
- 2,485,320. BTS. INT. CL. 7. (U.S. CLS. 13, 19, 21, 23, 31, 34 AND 35). REG. 9-4-2001.
- 2,485,367. KIDSFOOTLOCKER.COM. INT. CLS. 35 AND 42. (U.S. CLS. 100, 101 AND 102). REG. 9-4-2001.
- 2,485,554. AMICUS. INT. CL. 20. (U.S. CLS. 2, 13, 22, 25, 32 AND 50). REG. 9-4-2001.
- 2,485,876. WINTRIM. INT. CL. 19. (U.S. CLS. 1, 12, 33 AND 50). REG. 9-4-2001.
- 2,485,888. RG AND E (STYLIZED). INT. CL. 40. (U.S. CLS. 100, 103 AND 106). REG. 9-4-2001.
- 2,485,933. STICKSHOOTER. INT. CL. 7. (U.S. CLS. 13, 19, 21, 23, 31, 34 AND 35). REG. 9-4-2001.
- 2,486,016. ACER. INT. CL. 1. (U.S. CLS. 1, 5, 6, 10, 26 AND 46). REG. 9-4-2001.
- 2,486,084. OUR CLIENTS MEET WITH SUCCESS. INT. CL. 35. (U.S. CLS. 100, 101 AND 102). REG. 9-4-2001.
- 2,486,279. FREEDOM CARD. INT. CL. 9. (U.S. CLS. 21, 23, 26, 36 AND 38). REG. 9-4-2001.
- 2,486,562. HUMAN RIGHTS CAMPAIGN AND DESIGN. INT. CL. 42. (U.S. CLS. 100 AND 101). REG. 9-11-2001.
- 2,486,657. NEW SURFACE. INT. CL. 40. (U.S. CLS. 100, 103 AND 106). REG. 9-11-2001.
- 2,486,685. ITT AND DESIGN. INT. CLS. 9, 40 AND 42. (U.S. CLS. 21, 23, 26, 36, 38, 100, 101, 103 AND 106). REG. 9-11-2001.
- 2,486,734. BUSHI (STYLIZED). INT. CL. 25. (U.S. CLS. 22 AND 39). REG. 9-11-2001.
- 2,486,781. EPCOR. INT. CL. 37. (U.S. CLS. 100, 103 AND 106). REG. 9-11-2001.
- 2,486,790. THERE'S SCIENCE BEHIND IT. INT. CL. 3. (U.S. CLS. 1, 4, 6, 50, 51 AND 52). REG. 9-11-2001.
- 2,486,875. OWL. INT. CL. 9. (U.S. CLS. 21, 23, 26, 36 AND 38). REG. 9-11-2001.
- 2,486,888. CH ENERGY GROUP, INC. AND DESIGN. INT. CLS. 39, 40 AND 42. (U.S. CLS. 100, 101, 103, 105 AND 106). REG. 9-11-2001.
- 2,486,956. PARTS TODAY. INT. CL. 35. (U.S. CLS. 100, 101 AND 102). REG. 9-11-2001.

- 2,486,961. I INFO AND DESIGN. INT. CL. 9. (U.S. CLS. 21, 23, 26, 36 AND 38). REG. 9-11-2001.
- 2,487,050. FLEXPAY. INT. CL. 36. (U.S. CLS. 100, 101 AND 102). REG. 9-11-2001.
- 2,487,176. AIRBORNE A A AND DESIGN. U.S. CL. 200. REG. 9-11-2001.
- 2,487,260. OSCAR AND DESIGN. INT. CL. 9. (U.S. CLS. 21, 23, 26, 36 AND 38). REG. 9-11-2001.
- 2,487,403. PROAC. INT. CL. 9. (U.S. CLS. 21, 23, 26, 36 AND 38). REG. 9-11-2001.
- 2,487,445. MIPHARM AND DESIGN. INT. CL. 42 ONLY. (U.S. CLS. 100 AND 101). REG. 9-11-2001.
- 2,487,509. ACCU-TUFF. INT. CL. 7. (U.S. CLS. 13, 19, 21, 23, 31, 34 AND 35). REG. 9-11-2001.
- 2,487,552. PYRO DECK. INT. CL. 11. (U.S. CLS. 13, 21, 23, 31 AND 34). REG. 9-11-2001.
- 2,487,598. CRAZY COIN KEEPER. INT. CL. 9. (U.S. CLS. 21, 23, 26, 36 AND 38). REG. 9-11-2001.
- 2,487,599. BIG SPENDER. INT. CL. 21. (U.S. CLS. 2, 13, 23, 29, 30, 33, 40 AND 50). REG. 9-11-2001.
- 2,487,769. SACHA. INT. CL. 29. (U.S. CL. 46). REG. 9-11-2001.
- 2,487,832. AVAUNT. INT. CL. 5. (U.S. CLS. 6, 18, 44, 46, 51 AND 52). REG. 9-11-2001.
- 2,487,858. GADFLY PRODUCTIONS. INT. CLS. 9, 16 AND 41. (U.S. CLS. 2, 5, 21, 22, 23, 26, 29, 36, 37, 38, 50, 100, 101 AND 107). REG. 9-11-2001.
- 2,488,042. FORCE COMMANDER. INT. CL. 9. (U.S. CLS. 21, 23, 26, 36 AND 38). REG. 9-11-2001.
- 2,488,050. DEUCE. INT. CL. 9. (U.S. CLS. 21, 23, 26, 36 AND 38). REG. 9-11-2001.
- 2,488,060. EARTHBORN AND DESIGN. INT. CL. 35. (U.S. CLS. 100, 101 AND 102). REG. 9-11-2001.
- 2,488,114. HOME CAPITAL NETWORK. INT. CL. 36. (U.S. CLS. 100, 101 AND 102). REG. 9-11-2001.
- 2,488,126. MISCELLANEOUS DESIGN. INT. CL. 32. (U.S. CLS. 45, 46 AND 48). REG. 9-11-2001.
- 2,488,128. DIGI-TYRE. INT. CL. 12. (U.S. CLS. 19, 21, 23, 31, 35 AND 44). REG. 9-11-2001.
- 2,488,134. PRECISION SAFETY. INT. CL. 9. (U.S. CLS. 21, 23, 26, 36 AND 38). REG. 9-11-2001.
- 2,488,420. ECLECTIC REMEDIES. INT. CL. 3. (U.S. CLS. 1, 4, 6, 50, 51 AND 52). REG. 9-11-2001.
- 2,488,611. BALLESTER AND DESIGN. INT. CL. 29. (U.S. CL. 46). REG. 9-11-2001.
- 2,488,637. PULSE WAVE. INT. CL. 10. (U.S. CLS. 26, 39 AND 44). REG. 9-11-2001.
- 2,488,746. BUILDING LEADERSHIP BRANDS. INT. CLS. 35 AND 42. (U.S. CLS. 100, 101 AND 102). REG. 9-11-2001.
- 2,488,922. JAR JAR'S JOURNEY. INT. CL. 9. (U.S. CLS. 21, 23, 26, 36 AND 38). REG. 9-11-2001.
- 2,488,929. MISCELLANEOUS DESIGN. INT. CL. 30. (U.S. CL. 46). REG. 9-11-2001.
- 2,488,979. OUR WORLD REVOLVES AROUND YOU. INT. CL. 35. (U.S. CLS. 100, 101 AND 102). REG. 9-11-2001.
- 2,488,989. ESSENTIAL DEFENSE. INT. CL. 5. (U.S. CLS. 6, 18, 44, 46, 51 AND 52). REG. 9-11-2001.
- 2,488,995. SIENNA. INT. CL. 16. (U.S. CLS. 2, 5, 22, 23, 29, 37, 38 AND 50). REG. 9-11-2001.
- 2,489,202. NWSOURCE.COM. INT. CLS. 35 AND 42. (U.S. CLS. 100, 101 AND 102). REG. 9-11-2001.
- 2,489,278. TOTAL ERASE. INT. CL. 16. (U.S. CLS. 2, 5, 22, 23, 29, 37, 38 AND 50). REG. 9-11-2001.
- 2,489,365. BAPTISTA'S. INT. CL. 30 ONLY. (U.S. CL. 46). REG. 9-11-2001.
- 2,489,422. PETAL TOPS. INT. CL. 10. (U.S. CLS. 26, 39 AND 44). REG. 9-11-2001.
- 2,489,426. MEDALLION. INT. CL. 6. (U.S. CLS. 2, 12, 13, 14, 23, 25 AND 50). REG. 9-11-2001.
- 2,489,727. G FORCE AND DESIGN. INT. CLS. 9 AND 25. (U.S. CLS. 21, 22, 23, 26, 36, 38 AND 39). REG. 9-18-2001.
- 2,489,831. WORX (STYLIZED). INT. CL. 9. (U.S. CLS. 21, 23, 26, 36 AND 38). REG. 9-18-2001.
- 2,489,832. STARE. INT. CL. 16. (U.S. CLS. 2, 5, 22, 23, 29, 37, 38 AND 50). REG. 9-18-2001.
- 2,489,918. WILD SCIENCE AND DESIGN. INT. CL. 28. (U.S. CLS. 22, 23, 38 AND 50). REG. 9-18-2001.
- 2,489,920. FUZZI. INT. CLS. 18 AND 25 ONLY. (U.S. CLS. 1, 2, 3, 22, 39 AND 41). REG. 9-18-2001.
- 2,489,938. CASA GUADALAJARA. INT. CL. 42. (U.S. CLS. 100 AND 101). REG. 9-18-2001.
- 2,489,947. OPENINVOICE. INT. CL. 35. (U.S. CLS. 100, 101 AND 102). REG. 9-18-2001.
- 2,489,967. LMT. INT. CLS. 9 AND 42. (U.S. CLS. 21, 23, 26, 36, 38, 100 AND 101). REG. 9-18-2001.
- 2,489,973. CENTER FOR CHEMICAL PROCESS SAFETY. INT. CL. 42. (U.S. CLS. 100 AND 101). REG. 9-18-2001.
- 2,490,031. MAS. INT. CLS. 1 AND 5. (U.S. CLS. 1, 5, 6, 10, 18, 26, 44, 46, 51 AND 52). REG. 9-18-2001.
- 2,490,110. ZAHORIK. INT. CL. 36. (U.S. CLS. 100, 101 AND 102). REG. 9-18-2001.
- 2,490,187. BLIZZARD. INT. CL. 9. (U.S. CLS. 21, 23, 26, 36 AND 38). REG. 9-18-2001.
- 2,490,201. CONTI AIR. INT. CLS. 16 AND 24. (U.S. CLS. 2, 5, 22, 23, 29, 37, 38, 42 AND 50). REG. 9-18-2001.
- 2,490,334. BEAR. INT. CL. 12. (U.S. CLS. 19, 21, 23, 31, 35 AND 44). REG. 9-18-2001.
- 2,490,341. PROJECTS PLUS. INT. CL. 35. (U.S. CLS. 100, 101 AND 102). REG. 9-18-2001.
- 2,490,368. LISAP AND DESIGN. INT. CL. 3. (U.S. CLS. 1, 4, 6, 50, 51 AND 52). REG. 9-18-2001.
- 2,490,375. VISIOTHERM. INT. CLS. 9 AND 21. (U.S. CLS. 2, 13, 21, 23, 26, 29, 30, 33, 36, 38, 40 AND 50). REG. 9-18-2001.
- 2,490,384. FLCOS. INT. CL. 9. (U.S. CLS. 21, 23, 26, 36 AND 38). REG. 9-18-2001.
- 2,490,387. ACURA AND DESIGN. INT. CLS. 35, 38 AND 41. (U.S. CLS. 100, 101, 102, 104 AND 107). REG. 9-18-2001.
- 2,490,392. AROMAS SPECIALTY COFFEES & GOURMET BAKERY. INT. CL. 42. (U.S. CLS. 100 AND 101). REG. 9-18-2001.
- 2,490,406. AUTOXRAY. INT. CL. 9. (U.S. CLS. 21, 23, 26, 36 AND 38). REG. 9-18-2001.
- 2,490,568. ESSAY EDGE. INT. CL. 42. (U.S. CLS. 100 AND 101). REG. 9-18-2001.
- 2,490,606. MISCELLANEOUS DESIGN. INT. CL. 9. (U.S. CLS. 21, 23, 26, 36 AND 38). REG. 9-18-2001.
- 2,490,634. ARMSTRONG AND DESIGN. INT. CLS. 6, 7, 8, 9 AND 20. (U.S. CLS. 2, 12, 13, 14, 19, 21, 22, 23, 25, 26, 28, 31, 32, 34, 35, 36, 38, 44 AND 50). REG. 9-18-2001.
- 2,490,659. FDC. INT. CL. 17. (U.S. CLS. 1, 5, 12, 13, 35 AND 50). REG. 9-18-2001.
- 2,490,662. PLANET DOG. INT. CLS. 25, 28 AND 31. (U.S. CLS. 1, 22, 23, 38, 39, 46 AND 50). REG. 9-18-2001.
- 2,490,681. E AND DESIGN. INT. CL. 9. (U.S. CLS. 21, 23, 26, 36 AND 38). REG. 9-18-2001.
- 2,490,692. PLANETARY PLUS. INT. CL. 28. (U.S. CLS. 22, 23, 38 AND 50). REG. 9-18-2001.
- 2,490,718. CAMPUS RECORDS. INT. CL. 35 ONLY. (U.S. CLS. 100, 101 AND 102). REG. 9-18-2001.
- 2,490,782. KELLER (STYLIZED). INT. CLS. 6 AND 20. (U.S. CLS. 2, 12, 13, 14, 22, 23, 25, 32 AND 50). REG. 9-18-2001.
- 2,490,834. VECTOR. INT. CL. 7. (U.S. CLS. 13, 19, 21, 23, 31, 34 AND 35). REG. 9-18-2001.
- 2,490,890. MCCARTY. INT. CL. 15. (U.S. CLS. 2, 21 AND 36). REG. 9-18-2001.
- 2,490,908. WITS. INT. CL. 36. (U.S. CLS. 100, 101 AND 102). REG. 9-18-2001.
- 2,490,916. SYM-MAT. INT. CL. 27. (U.S. CLS. 19, 20, 37, 42 AND 50). REG. 9-18-2001.
- 2,490,978. CREDIT UNION VALUES. . . DEALERSHIP CONVENIENCE. INT. CL. 36. (U.S. CLS. 100, 101 AND 102). REG. 9-18-2001.
- 2,491,011. IN HIS GRIP. INT. CLS. 16 AND 28. (U.S. CLS. 2, 5, 22, 23, 29, 37, 38 AND 50). REG. 9-18-2001.
- 2,491,077. KOHONES. INT. CL. 25. (U.S. CLS. 22 AND 39). REG. 9-18-2001.
- 2,491,080. C.O.D. SECURE. INT. CL. 36. (U.S. CLS. 100, 101 AND 102). REG. 9-18-2001.
- 2,491,085. PIZZA INN AND DESIGN. INT. CL. 42 ONLY. (U.S. CLS. 100 AND 101). REG. 9-18-2001.
- 2,491,098. KENTUCKY SPEEDWAY. INT. CLS. 6, 14, 16, 18, 21, 24, 25, 28 AND 41. (U.S. CLS. 1, 2, 3, 5, 12, 13, 14, 22, 23, 25, 27, 28, 29, 30, 33, 37, 38, 39, 40, 41, 42, 50, 100, 101 AND 107). REG. 9-18-2001.
- 2,491,104. CSG WORKFORCE MANAGEMENT. INT. CL. 9. (U.S. CLS. 21, 23, 26, 36 AND 38). REG. 9-18-2001.
- 2,491,118. LIFT DEFENSE. INT. CL. 3. (U.S. CLS. 1, 4, 6, 50, 51 AND 52). REG. 9-18-2001.
- 2,491,124. UPS. INT. CL. 39. (U.S. CLS. 100 AND 105). REG. 9-18-2001.
- 2,491,145. RAVE STUDIO. INT. CL. 42. (U.S. CLS. 100 AND 101). REG. 9-18-2001.

- 2,491,165. INTERBOX. INT. CL. 39. (U.S. CLS. 100 AND 105). REG. 9-18-2001.
- 2,491,202. BAUDIS. INT. CLS. 9 AND 42. (U.S. CLS. 21, 23, 26, 36, 38, 100 AND 101). REG. 9-18-2001.
- 2,491,206. ACRILEX. INT. CL. 2 ONLY. (U.S. CLS. 6, 11 AND 16). REG. 9-18-2001.
- 2,491,207. CARDIOFOCUS. INT. CLS. 9 AND 10. (U.S. CLS. 21, 23, 26, 36, 38, 39 AND 44). REG. 9-18-2001.
- 2,491,232. FULL MOON. INT. CL. 11. (U.S. CLS. 13, 21, 23, 31 AND 34). REG. 9-18-2001.
- 2,491,236. VMWARE. INT. CL. 16. (U.S. CLS. 2, 5, 22, 23, 29, 37, 38 AND 50). REG. 9-18-2001.
- 2,491,270. URBAN. INT. CL. 42. (U.S. CLS. 100 AND 101). REG. 9-18-2001.
- 2,491,298. MAC-IN-MINUTES (STYLIZED). INT. CL. 30. (U.S. CL. 46). REG. 9-18-2001.
- 2,491,303. 56. INT. CLS. 14, 16, 20, 21, 25, 28 AND 35 ONLY. (U.S. CLS. 2, 5, 13, 22, 23, 25, 27, 28, 29, 30, 32, 33, 37, 38, 39, 40, 50, 100, 101 AND 102). REG. 9-18-2001.
- 2,491,320. AMERICAN LEGACY FOUNDATION. INT. CL. 42. (U.S. CLS. 100 AND 101). REG. 9-18-2001.
- 2,491,339. COMEDY CURES. INT. CL. 41. (U.S. CLS. 100, 101 AND 107). REG. 9-18-2001.
- 2,491,340. CASH CROP. INT. CL. 9. (U.S. CLS. 21, 23, 26, 36 AND 38). REG. 9-18-2001.
- 2,491,366. 4EMPOWERMENT.COM AND DESIGN. INT. CL. 41. (U.S. CLS. 100, 101 AND 107). REG. 9-18-2001.
- 2,491,463. KIANA. INT. CL. 25. (U.S. CLS. 22 AND 39). REG. 9-18-2001.
- 2,491,464. PURRFECTLY FRESH. INT. CL. 1. (U.S. CLS. 1, 5, 6, 10, 26 AND 46). REG. 9-18-2001.
- 2,491,496. FLY RIGHT. INT. CL. 25. (U.S. CLS. 22 AND 39). REG. 9-18-2001.
- 2,491,498. YAHOO!. INT. CL. 18 ONLY. (U.S. CLS. 1, 2, 3, 22 AND 41). REG. 9-18-2001.
- 2,491,566. INTERNATIONAL CURRICULUM. INT. CLS. 9 AND 16. (U.S. CLS. 2, 5, 21, 22, 23, 26, 29, 36, 37, 38 AND 50). REG. 9-18-2001.
- 2,491,744. NEW BREED. INT. CLS. 35, 37, 39 AND 42. (U.S. CLS. 100, 101, 102, 103, 105 AND 106). REG. 9-25-2001.
- 2,491,767. SCHNEIDER ELECTRIC S (STYLIZED). INT. CLS. 9, 11 AND 42 ONLY. (U.S. CLS. 13, 21, 23, 26, 31, 34, 36, 38, 100 AND 101). REG. 9-25-2001.
- 2,491,899. GEPCO GENERAL ECONOPAK, INC. DISPOSABLEPRODUCTS AND DESIGN. INT. CL. 10. (U.S. CLS. 26, 39 AND 44). REG. 9-25-2001.
- 2,491,938. DIGITALGORILLA. INT. CL. 38. (U.S. CLS. 100, 101 AND 104). REG. 9-25-2001.
- 2,492,042. ASSISTENT. INT. CL. 7. (U.S. CLS. 13, 19, 21, 23, 31, 34 AND 35). REG. 9-25-2001.
- 2,492,052. NORTHWESTERN MUTUAL AND DESIGN. INT. CL. 36. (U.S. CLS. 100, 101 AND 102). REG. 9-25-2001.
- 2,492,123. MOAB. INT. CL. 9. (U.S. CLS. 21, 23, 26, 36 AND 38). REG. 9-25-2001.
- 2,492,141. ELECTREX AND DESIGN. INT. CL. 37. (U.S. CLS. 100, 103 AND 106). REG. 9-25-2001.
- 2,492,186. NEW BREED. INT. CL. 42. (U.S. CLS. 100 AND 101). REG. 9-25-2001.
- 2,492,235. RAINIER. INT. CL. 12. (U.S. CLS. 19, 21, 23, 31, 35 AND 44). REG. 9-25-2001.
- 2,492,280. ULTRAANSWER. INT. CL. 9. (U.S. CLS. 21, 23, 26, 36 AND 38). REG. 9-25-2001.
- 2,492,291. AMPHIBIVILLE. INT. CL. 41. (U.S. CLS. 100, 101 AND 107). REG. 9-25-2001.
- 2,492,315. MERCY - USA FOR AID AND DEVELOPMENT. INT. CLS. 36 AND 42. (U.S. CLS. 100, 101 AND 102). REG. 9-25-2001.
- 2,492,337. SIAA. INT. CL. 36. (U.S. CLS. 100, 101 AND 102). REG. 9-25-2001.
- 2,492,338. SIAA AND DESIGN. INT. CL. 36. (U.S. CLS. 100, 101 AND 102). REG. 9-25-2001.
- 2,492,342. CROPPER HOPPER AND DESIGN. INT. CL. 20. (U.S. CLS. 2, 13, 22, 25, 32 AND 50). REG. 9-25-2001.
- 2,492,367. GEOTOOL. INT. CL. 9. (U.S. CLS. 21, 23, 26, 36 AND 38). REG. 9-25-2001.
- 2,492,434. MISCELLANEOUS DESIGN. INT. CL. 40. (U.S. CLS. 100, 103 AND 106). REG. 9-25-2001.
- 2,492,521. IT'S A GREAT DAY FOR ICE CREAM. INT. CL. 42. (U.S. CLS. 100 AND 101). REG. 9-25-2001.
- 2,492,650. DINO-SAW. INT. CL. 7. (U.S. CLS. 13, 19, 21, 23, 31, 34 AND 35). REG. 9-25-2001.
- 2,492,681. ASHROSS. INT. CL. 7. (U.S. CLS. 13, 19, 21, 23, 31, 34 AND 35). REG. 9-25-2001.
- 2,492,858. WEATHERPROOF SINCE 1948 GARMENT COMPANY AND DESIGN. INT. CL. 25. (U.S. CLS. 22 AND 39). REG. 9-25-2001.
- 2,492,875. INTER-STOP. INT. CL. 12. (U.S. CLS. 19, 21, 23, 31, 35 AND 44). REG. 9-25-2001.
- 2,492,931. PLASMA SWORD. INT. CL. 9. (U.S. CLS. 21, 23, 26, 36 AND 38). REG. 9-25-2001.
- 2,493,042. API100. INT. CL. 9. (U.S. CLS. 21, 23, 26, 36 AND 38). REG. 9-25-2001.
- 2,493,054. KING BIO NATURAL MEDICINE. INT. CL. 5. (U.S. CLS. 6, 18, 44, 46, 51 AND 52). REG. 9-25-2001.
- 2,493,089. BASSO AND DESIGN. INT. CL. 7. (U.S. CLS. 13, 19, 21, 23, 31, 34 AND 35). REG. 9-25-2001.
- 2,493,111. LEARNING PATHWAYS. INT. CL. 42. (U.S. CLS. 100 AND 101). REG. 9-25-2001.
- 2,493,141. GUITAR RESEARCH. INT. CL. 15 ONLY. (U.S. CLS. 2, 21 AND 36). REG. 9-25-2001.
- 2,493,215. ENVIRONMENTAL DEFENSE. INT. CL. 16 ONLY. (U.S. CLS. 2, 5, 22, 23, 29, 37, 38 AND 50). REG. 9-25-2001.
- 2,493,283. PUTTING THE BEST AT YOUR FINGERTIPS. INT. CL. 4. (U.S. CLS. 1, 6 AND 15). REG. 9-25-2001.
- 2,493,347. CALCISNAX. INT. CL. 30. (U.S. CL. 46). REG. 9-25-2001.
- 2,493,386. COMPORIUM. INT. CLS. 16, 35, 37, 38, 41 AND 42. (U.S. CLS. 2, 5, 22, 23, 29, 37, 38, 50, 100, 101, 102, 103, 104, 106 AND 107). REG. 9-25-2001.
- 2,493,475. CHARLES & COLVARD. INT. CL. 35. (U.S. CLS. 100, 101 AND 102). REG. 9-25-2001.
- 2,493,494. CELL SCIENCE. INT. CL. 3. (U.S. CLS. 1, 4, 6, 50, 51 AND 52). REG. 9-25-2001.
- 2,493,507. WELCHOL. INT. CL. 5. (U.S. CLS. 6, 18, 44, 46, 51 AND 52). REG. 9-25-2001.
- 2,493,509. PRISMA AND DESIGN. INT. CL. 31. (U.S. CLS. 1 AND 46). REG. 9-25-2001.
- 2,493,532. TRI-LOK. INT. CL. 25. (U.S. CLS. 22 AND 39). REG. 9-25-2001.
- 2,493,537. SNAP-BISCUIT. INT. CL. 31. (U.S. CLS. 1 AND 46). REG. 9-25-2001.
- 2,493,615. NEWPORT AQUARIUM. INT. CL. 41. (U.S. CLS. 100, 101 AND 107). REG. 9-25-2001.
- 2,493,642. ASSOCIATES OF VIETNAM VETERANS OF AMERICA. U.S. CL. 200. REG. 9-25-2001.
- 2,493,653. DOUBLE WALL. INT. CL. 28. (U.S. CLS. 22, 23, 38 AND 50). REG. 9-25-2001.
- 2,493,693. THE JOURNAL OF WEALTH MANAGEMENT. INT. CL. 16. (U.S. CLS. 2, 5, 22, 23, 29, 37, 38 AND 50). REG. 9-25-2001.
- 2,493,765. CENTER FOR EMPLOYMENT TRAINING. INT. CL. 41. (U.S. CLS. 100, 101 AND 107). REG. 10-2-2001.
- 2,493,942. GREENWALL. INT. CL. 19. (U.S. CLS. 1, 12, 33 AND 50). REG. 10-2-2001.
- 2,493,975. MAGIC RIVER MEDIA AND DESIGN. INT. CL. 42. (U.S. CLS. 100 AND 101). REG. 10-2-2001.
- 2,494,006. EDVISORS. INT. CLS. 41 AND 42. (U.S. CLS. 100, 101 AND 107). REG. 10-2-2001.
- 2,494,273. BORSHEIMS STANDARD CHARACTER MARK. INT. CL. 14. (U.S. CLS. 2, 27, 28 AND 50). REG. 10-2-2001.
- 2,494,400. PRI. INT. CLS. 17 AND 19. (U.S. CLS. 1, 5, 12, 13, 33, 35 AND 50). REG. 10-2-2001.
- 2,494,585. INQWIRE AND DESIGN. INT. CL. 10. (U.S. CLS. 26, 39 AND 44). REG. 10-2-2001.
- 2,494,586. INQWIRE. INT. CL. 10. (U.S. CLS. 26, 39 AND 44). REG. 10-2-2001.
- 2,494,674. PHOENIX INTERNATIONAL RACEWAY AND DESIGN. INT. CLS. 9, 21, 25, 28 AND 41. (U.S. CLS. 2, 13, 21, 22, 23, 26, 29, 30, 33, 36, 38, 39, 40, 50, 100, 101 AND 107). REG. 10-2-2001.
- 2,494,716. QUICK FIT T&G AND DESIGN. INT. CL. 19. (U.S. CLS. 1, 12, 33 AND 50). REG. 10-2-2001.
- 2,494,794. CLOTHESKEEPING. INT. CL. 37. (U.S. CLS. 100, 103 AND 106). REG. 10-2-2001.
- 2,494,871. HEYTESBURY. INT. CL. 33. (U.S. CLS. 47 AND 49). REG. 10-2-2001.
- 2,494,872. MISCELLANEOUS DESIGN. INT. CL. 33. (U.S. CLS. 47 AND 49). REG. 10-2-2001.
- 2,494,908. HW AND DESIGN. INT. CL. 7. (U.S. CLS. 13, 19, 21, 23, 31, 34 AND 35). REG. 10-2-2001.

- 2,494,934. TENSYLON. INT. CL. 22. (U.S. CLS. 1, 2, 7, 19, 22, 42 AND 50). REG. 10-2-2001.
- 2,495,015. HOGWARTS. INT. CL. 25. (U.S. CLS. 22 AND 39). REG. 10-2-2001.
- 2,495,131. SPROUTED FOR LIFE. INT. CL. 30. (U.S. CL. 46). REG. 10-2-2001.
- 2,495,168. CONSUMER FEDERATION OF AMERICA (STYLIZED). INT. CL. 42. (U.S. CLS. 100 AND 101). REG. 10-2-2001.
- 2,495,204. VIGO. INT. CLS. 29 AND 30. (U.S. CL. 46). REG. 10-9-2001.
- 2,495,222. ULTRAJET. INT. CL. 2. (U.S. CLS. 6, 11 AND 16). REG. 10-9-2001.
- 2,495,226. COLDSTREAM HILLS. INT. CL. 33. (U.S. CLS. 47 AND 49). REG. 10-9-2001.
- 2,495,319. XYTEX. INT. CL. 24. (U.S. CLS. 42 AND 50). REG. 10-9-2001.
- 2,495,536. FIRSTFLIGHT. INT. CLS. 35 AND 41. (U.S. CLS. 100, 101, 102 AND 107). REG. 10-9-2001.
- 2,495,629. FRYE AND DESIGN. INT. CL. 9. (U.S. CLS. 21, 23, 26, 36 AND 38). REG. 10-9-2001.
- 2,495,676. BARNES AEROSPACE. INT. CL. 37. (U.S. CLS. 100, 103 AND 106). REG. 10-9-2001.
- 2,495,827. OFFBEAT TRAINING AND DESIGN. INT. CL. 41. (U.S. CLS. 100, 101 AND 107). REG. 10-9-2001.
- 2,495,844. BABY'S COFFEE. INT. CLS. 30 AND 35. (U.S. CLS. 46, 100, 101 AND 102). REG. 10-9-2001.
- 2,495,994. STAAB. INT. CL. 42. (U.S. CLS. 100 AND 101). REG. 10-9-2001.
- 2,496,047. EQUUS. INT. CL. 33. (U.S. CLS. 47 AND 49). REG. 10-9-2001.
- 2,496,107. GROOVY TOOBEY. INT. CL. 30. (U.S. CL. 46). REG. 10-9-2001.
- 2,496,222. K KITCHEN EXPO AND DESIGN. INT. CL. 35. (U.S. CLS. 100, 101 AND 102). REG. 10-9-2001.
- 2,496,240. PFLAG. INT. CL. 42. (U.S. CLS. 100 AND 101). REG. 10-9-2001.
- 2,496,341. BUSINESS CONSULTING FOR TODAY'S WORLD. INT. CL. 35. (U.S. CLS. 100, 101 AND 102). REG. 10-9-2001.
- 2,496,451. LOGIC. INT. CL. 19. (U.S. CLS. 1, 12, 33 AND 50). REG. 10-9-2001.
- 2,496,476. SUSTIVA. INT. CL. 5. (U.S. CLS. 6, 18, 44, 46, 51 AND 52). REG. 10-9-2001.
- 2,496,577. SUPARTZ. INT. CLS. 5 AND 10. (U.S. CLS. 6, 18, 26, 39, 44, 46, 51 AND 52). REG. 10-9-2001.
- 2,496,726. TEXAS CHILDREN'S CENTER FOR TELEHEALTH. INT. CLS. 41 AND 42. (U.S. CLS. 100, 101 AND 107). REG. 10-9-2001.
- 2,496,878. ISABELLE AND DESIGN. INT. CL. 30. (U.S. CL. 46). REG. 10-9-2001.
- 2,497,580. MISCELLANEOUS DESIGN. INT. CL. 41. (U.S. CLS. 100, 101 AND 107). REG. 10-16-2001.
- 2,498,087. THE ULTIMATE DRIVING EXPERIENCE. INT. CL. 41. (U.S. CLS. 100, 101 AND 107). REG. 10-16-2001.
- 2,498,097. SILHOUETTES. INT. CL. 35. (U.S. CLS. 100, 101 AND 102). REG. 10-16-2001.
- 2,498,579. CINEMA BY PANOS ZINAS. INT. CL. 25. (U.S. CLS. 22 AND 39). REG. 10-16-2001.
- 2,498,600. DOWA. INT. CLS. 9, 11 AND 40 ONLY. (U.S. CLS. 13, 21, 23, 26, 31, 34, 36, 38, 100, 103 AND 106). REG. 10-16-2001.
- 2,498,605. MARTI AUTENTICO (STYLIZED). INT. CL. 33. (U.S. CLS. 47 AND 49). REG. 10-16-2001.
- 2,498,636. THE SILVER COMET TRAIL. INT. CLS. 25 AND 41. (U.S. CLS. 22, 39, 100, 101 AND 107). REG. 10-16-2001.
- 2,498,691. GRADE MAKER. INT. CL. 29. (U.S. CL. 46). REG. 10-16-2001.
- 2,498,700. CENTER FOR SIMPLIFIED STRATEGIC PLANNING. INT. CLS. 16 AND 41. (U.S. CLS. 2, 5, 22, 23, 29, 37, 38, 50, 100, 101 AND 107). REG. 10-16-2001.
- 2,499,129. C-SPOT. INT. CL. 3. (U.S. CLS. 1, 4, 6, 50, 51 AND 52). REG. 10-16-2001.
- 2,499,247. ROBOTOYS. INT. CL. 35. (U.S. CLS. 100, 101 AND 102). REG. 10-16-2001.
- 2,499,259. RED MOUNTAIN. INT. CL. 33. (U.S. CLS. 47 AND 49). REG. 10-23-2001.
- 2,499,521. BUSHI. INT. CL. 25. (U.S. CLS. 22 AND 39). REG. 10-23-2001.
- 2,499,589. CAFE DES AMIS (STYLIZED). INT. CL. 42. (U.S. CLS. 100 AND 101). REG. 10-23-2001.
- 2,499,974. MISCELLANEOUS DESIGN. INT. CL. 10. (U.S. CLS. 26, 39 AND 44). REG. 10-23-2001.
- 2,500,009. DIXIE OUTFITTERS. INT. CL. 25. (U.S. CLS. 22 AND 39). REG. 10-23-2001.
- 2,500,100. HEP C CONNECTION. INT. CL. 42. (U.S. CLS. 100 AND 101). REG. 10-23-2001.
- 2,500,247. DELTA FORCE. INT. CL. 10. (U.S. CLS. 26, 39 AND 44). REG. 10-23-2001.
- 2,500,296. BELL & GOSSETT. INT. CL. 9. (U.S. CLS. 21, 23, 26, 36 AND 38). REG. 10-23-2001.
- 2,500,310. SYNCRON. INT. CL. 35. (U.S. CLS. 100, 101 AND 102). REG. 10-23-2001.
- 2,500,336. TEMPCARD. INT. CL. 16. (U.S. CLS. 2, 5, 22, 23, 29, 37, 38 AND 50). REG. 10-23-2001.
- 2,500,410. THE GLEN. INT. CL. 41. (U.S. CLS. 100, 101 AND 107). REG. 10-23-2001.
- 2,500,713. HUSH. INT. CL. 9. (U.S. CLS. 21, 23, 26, 36 AND 38). REG. 10-23-2001.
- 2,500,726. ART FX AND DESIGN. INT. CL. 25. (U.S. CLS. 22 AND 39). REG. 10-23-2001.
- 2,500,833. COZEEZ. INT. CL. 25. (U.S. CLS. 22 AND 39). REG. 10-23-2001.
- 2,500,845. PRECISELY AS INTENDED. INT. CL. 37. (U.S. CLS. 100, 103 AND 106). REG. 10-23-2001.
- 2,500,957. MAGIC HOLDER. INT. CL. 20. (U.S. CLS. 2, 13, 22, 25, 32 AND 50). REG. 10-23-2001.
- 2,501,447. QUICK LAWN. INT. CL. 31. (U.S. CLS. 1 AND 46). REG. 10-30-2001.
- 2,501,620. GPR. INT. CL. 9. (U.S. CLS. 21, 23, 26, 36 AND 38). REG. 10-30-2001.
- 2,501,825. FINLANDIA AND DESIGN. INT. CL. 29. (U.S. CL. 46). REG. 10-30-2001.
- 2,501,854. MISCELLANEOUS DESIGN. INT. CL. 36. (U.S. CLS. 100, 101 AND 102). REG. 10-30-2001.
- 2,502,047. SCHMITT MUSIC AND DESIGN. INT. CL. 35. (U.S. CLS. 100, 101 AND 102). REG. 10-30-2001.
- 2,502,142. NEO-TEC. INT. CL. 5. (U.S. CLS. 6, 18, 44, 46, 51 AND 52). REG. 10-30-2001.
- 2,502,259. PARROTHEAD RADIO. INT. CLS. 38 AND 41. (U.S. CLS. 100, 101, 104 AND 107). REG. 10-30-2001.
- 2,502,541. QUICK LOAD. INT. CL. 10. (U.S. CLS. 26, 39 AND 44). REG. 10-30-2001.
- 2,502,767. DOCKWEILER. INT. CL. 6. (U.S. CLS. 2, 12, 13, 14, 23, 25 AND 50). REG. 10-30-2001.
- 2,502,847. MISCELLANEOUS DESIGN. INT. CL. 6. (U.S. CLS. 2, 12, 13, 14, 23, 25 AND 50). REG. 10-30-2001.
- 2,502,895. HANDY BAND. INT. CL. 17. (U.S. CLS. 1, 5, 12, 13, 35 AND 50). REG. 10-30-2001.
- 2,502,929. UNIPREMIUM. INT. CL. 31. (U.S. CLS. 1 AND 46). REG. 10-30-2001.
- 2,502,930. UNIBEST. INT. CL. 31. (U.S. CLS. 1 AND 46). REG. 10-30-2001.
- 2,503,072. WOLF FAMILY VINEYARDS. INT. CL. 33. (U.S. CLS. 47 AND 49). REG. 10-30-2001.
- 2,503,111. FINAL FANTASY. INT. CL. 28. (U.S. CLS. 22, 23, 38 AND 50). REG. 10-30-2001.
- 2,503,211. ON INVESTING. INT. CL. 36. (U.S. CLS. 100, 101 AND 102). REG. 10-30-2001.
- 2,503,234. FRONIUS. INT. CLS. 8, 9 AND 42 ONLY. (U.S. CLS. 21, 23, 26, 28, 36, 38, 44, 100 AND 101 ONLY). REG. 10-30-2001.
- 2,503,244. EWORKPLACE. INT. CL. 35. (U.S. CLS. 100, 101 AND 102). REG. 10-30-2001.
- 2,503,264. QUICK HEAT. INT. CL. 11. (U.S. CLS. 13, 21, 23, 31 AND 34). REG. 10-30-2001.
- 2,503,340. RANDALLS FOOD & PHARMACY. INT. CL. 42. (U.S. CL. 101). REG. 11-6-2001.
- 2,503,806. NATION'S RESTAURANT NEWS. INT. CL. 16. (U.S. CLS. 2, 5, 22, 23, 29, 37, 38 AND 50). REG. 11-6-2001.
- 2,503,959. K M T. INT. CL. 39. (U.S. CLS. 100 AND 105). REG. 11-6-2001.
- 2,504,069. SAVE OUR KIDS OUTREACH A CHILD SHALL LEAD THEM. ISAIAH 11:6 AND DESIGN. INT. CL. 42. (U.S. CLS. 100 AND 101). REG. 11-6-2001.
- 2,504,373. THE CELATOR. INT. CL. 16. (U.S. CLS. 2, 5, 22, 23, 29, 37, 38 AND 50). REG. 11-6-2001.
- 2,504,400. EQUI-SENTIAL. INT. CL. 31. (U.S. CLS. 1 AND 46). REG. 11-6-2001.
- 2,504,441. SUNOCO AND DESIGN. INT. CL. 37. (U.S. CLS. 100, 103 AND 106). REG. 11-6-2001.

- 2,504,542. READ, PLAY AND LEARN!. INT. CL. 16. (U.S. CLS. 2, 5, 22, 23, 29, 37, 38 AND 50). REG. 11-6-2001.
- 2,504,718. MECHA. INT. CL. 6. (U.S. CLS. 2, 12, 13, 14, 23, 25 AND 50). REG. 11-6-2001.
- 2,504,864. CREEKSTONE FARMS. INT. CL. 29. (U.S. CL. 46). REG. 11-6-2001.
- 2,505,065. INCOUNSEL. INT. CLS. 35 AND 45. (U.S. CLS. 100, 101 AND 102). REG. 11-6-2001.
- 2,505,173. BN PROSPEC. INT. CL. 10. (U.S. CLS. 26, 39 AND 44). REG. 11-6-2001.
- 2,505,186. 2C. INT. CL. 9. (U.S. CLS. 21, 23, 26, 36 AND 38). REG. 11-6-2001.
- 2,505,269. CALCIBITES. INT. CL. 30. (U.S. CL. 46). REG. 11-6-2001.
- 2,505,418. RAIN FOREST. INT. CL. 3. (U.S. CLS. 1, 4, 6, 50, 51 AND 52). REG. 11-6-2001.
- 2,505,713. SRI CONSULTING AND DESIGN. INT. CLS. 35, 36 AND 42. (U.S. CLS. 100, 101 AND 102). REG. 11-13-2001.
- 2,505,783. CHLOROPAC. INT. CL. 9. (U.S. CLS. 21, 23, 26, 36 AND 38). REG. 11-13-2001.
- 2,505,920. SHOESTORE.COM AND DESIGN. INT. CL. 35. (U.S. CLS. 100, 101 AND 102). REG. 11-13-2001.
- 2,506,036. WOMEN IN HOLLYWOOD. INT. CL. 16. (U.S. CLS. 2, 5, 22, 23, 29, 37, 38 AND 50). REG. 11-13-2001.
- 2,506,049. IPRINT.COM AND DESIGN. INT. CL. 42. (U.S. CLS. 100 AND 101). REG. 11-13-2001.
- 2,506,094. STAAB FUNERAL HOME. INT. CL. 42. (U.S. CLS. 100 AND 101). REG. 11-13-2001.
- 2,506,213. SEA QUEEN. INT. CL. 29. (U.S. CL. 46). REG. 11-13-2001.
- 2,506,390. SPRING MILL BREAD CO. AND DESIGN. INT. CL. 30. (U.S. CL. 46). REG. 11-13-2001.
- 2,506,504. ANGELS OF THE POOR. INT. CL. 42. (U.S. CLS. 100 AND 101). REG. 11-13-2001.
- 2,506,735. SWEETEST SUITES. INT. CL. 42. (U.S. CLS. 100 AND 101). REG. 11-13-2001.
- 2,507,323. SYNTHASIL. INT. CL. 5. (U.S. CLS. 6, 18, 44, 46, 51 AND 52). REG. 11-13-2001.
- 2,507,770. POPULAR STREET. INT. CLS. 16 AND 36. (U.S. CLS. 2, 5, 22, 23, 29, 37, 38, 50, 100, 101 AND 102). REG. 11-13-2001.
- 2,507,884. CALCITREATS. INT. CL. 30. (U.S. CL. 46). REG. 11-13-2001.
- 2,508,086. FOOKIES. INT. CL. 30. (U.S. CL. 46). REG. 11-13-2001.
- 2,508,133. THE MONTECITO PICTURE COMPANY. INT. CLS. 9 AND 41. (U.S. CLS. 21, 23, 26, 36, 38, 100, 101 AND 107). REG. 11-13-2001.
- 2,508,671. BELARC. INT. CLS. 9 AND 42. (U.S. CLS. 21, 23, 26, 36, 38, 100 AND 101). REG. 11-20-2001.
- 2,508,843. PNC AND DESIGN. INT. CL. 36. (U.S. CLS. 100, 101 AND 102). REG. 11-20-2001.
- 2,509,083. LABWORLDSOFT. INT. CL. 9. (U.S. CLS. 21, 23, 26, 36 AND 38). REG. 11-20-2001.
- 2,509,181. FLOTRON AND DESIGN. INT. CLS. 8 AND 42. (U.S. CLS. 23, 28, 44, 100 AND 101). REG. 11-20-2001.
- 2,509,216. KALFLO. INT. CL. 19. (U.S. CLS. 1, 12, 33 AND 50). REG. 11-20-2001.
- 2,509,344. IDEALLIANCE. INT. CLS. 35 AND 42. (U.S. CLS. 100, 101 AND 102). REG. 11-20-2001.
- 2,509,637. CONTACT EAST. INT. CL. 35. (U.S. CLS. 100, 101 AND 102). REG. 11-20-2001.
- 2,509,675. SBUDDIES. INT. CL. 30. (U.S. CL. 46). REG. 11-20-2001.
- 2,509,791. FISHING HAS NO BOUNDARIES AND DESIGN. INT. CL. 41. (U.S. CLS. 100, 101 AND 107). REG. 11-20-2001.
- 2,510,088. SILOLINER. INT. CL. 10. (U.S. CLS. 26, 39 AND 44). REG. 11-20-2001.
- 2,510,471. NO ONE REGRETS BUYING THE BEST. INT. CL. 6. (U.S. CLS. 2, 12, 13, 14, 23, 25 AND 50). REG. 11-20-2001.
- 2,510,566. SENIX. INT. CL. 9. (U.S. CLS. 21, 23, 26, 36 AND 38). REG. 11-20-2001.
- 2,510,767. DR. GELDA'S. INT. CL. 5. (U.S. CLS. 6, 18, 44, 46, 51 AND 52). REG. 11-20-2001.
- 2,510,833. SUPERSHIELD. INT. CL. 2. (U.S. CLS. 6, 11 AND 16). REG. 11-20-2001.
- 2,510,942. MISCELLANEOUS DESIGN. INT. CL. 35. (U.S. CLS. 100, 101 AND 102). REG. 11-20-2001.
- 2,511,287. MARKETPLACEDETROIT.COM. INT. CL. 35. (U.S. CLS. 100, 101 AND 102). REG. 11-20-2001.
- 2,511,455. LAWFINANCE GROUP. INT. CL. 36. (U.S. CLS. 100, 101 AND 102). REG. 11-27-2001.
- 2,511,470. STUDYABROAD.COM. INT. CL. 35. (U.S. CLS. 100, 101 AND 102). REG. 11-27-2001.
- 2,511,488. LIT. INT. CL. 25. (U.S. CLS. 22 AND 39). REG. 11-27-2001.
- 2,511,544. MISCELLANEOUS DESIGN. INT. CL. 35. (U.S. CLS. 100, 101 AND 102). REG. 11-27-2001.
- 2,511,552. G AND DESIGN. INT. CL. 36. (U.S. CLS. 100, 101 AND 102). REG. 11-27-2001.
- 2,511,553. GEMGROUP. INT. CL. 36. (U.S. CLS. 100, 101 AND 102). REG. 11-27-2001.
- 2,511,981. CHRISTOPHER FARR. INT. CL. 27. (U.S. CLS. 19, 20, 37, 42 AND 50). REG. 11-27-2001.
- 2,512,122. VILLAGE VENTURES. INT. CLS. 35 AND 36. (U.S. CLS. 100, 101 AND 102). REG. 11-27-2001.
- 2,512,370. TURBOTAX. INT. CL. 35. (U.S. CLS. 100, 101 AND 102). REG. 11-27-2001.
- 2,512,980. PRETZEL DIPS. INT. CL. 30. (U.S. CL. 46). REG. 11-27-2001.
- 2,513,056. MOTTAHEDDEH. INT. CL. 42. (U.S. CLS. 100 AND 101). REG. 11-27-2001.
- 2,513,068. HUSHMAIL. INT. CL. 9. (U.S. CLS. 21, 23, 26, 36 AND 38). REG. 11-27-2001.
- 2,513,699. FARMER'S HICKORY BRAND. INT. CL. 29. (U.S. CL. 46). REG. 12-4-2001.
- 2,513,838. CIVILDESIGN (STYLIZED). INT. CL. 9. (U.S. CLS. 21, 23, 26, 36 AND 38). REG. 12-4-2001.
- 2,513,839. CIVILCADD (STYLIZED). INT. CL. 9. (U.S. CLS. 21, 23, 26, 36 AND 38). REG. 12-4-2001.
- 2,513,844. THERMO BAR. INT. CL. 7. (U.S. CLS. 13, 19, 21, 23, 31, 34 AND 35). REG. 12-4-2001.
- 2,513,928. RENTHAL. INT. CLS. 12, 16 AND 25. (U.S. CLS. 2, 5, 19, 21, 22, 23, 29, 31, 35, 37, 38, 39, 44 AND 50). REG. 12-4-2001.
- 2,513,929. R (STYLIZED). INT. CLS. 12, 16 AND 25. (U.S. CLS. 2, 5, 19, 21, 22, 23, 29, 31, 35, 37, 38, 39, 44 AND 50). REG. 12-4-2001.
- 2,514,131. HZPC. INT. CL. 31. (U.S. CLS. 1 AND 46). REG. 12-4-2001.
- 2,514,177. HOLCOTE. INT. CL. 2. (U.S. CLS. 6, 11 AND 16). REG. 12-4-2001.
- 2,514,806. RAYS OF HOPE. INT. CL. 42. (U.S. CLS. 100 AND 101). REG. 12-4-2001.
- 2,515,007. FOTO FACIAL. INT. CL. 3. (U.S. CLS. 1, 4, 6, 50, 51 AND 52). REG. 12-4-2001.
- 2,515,382. MISCELLANEOUS DESIGN. INT. CL. 9. (U.S. CLS. 21, 23, 26, 36 AND 38). REG. 12-4-2001.
- 2,515,520. HAIRCEUTICALS. INT. CL. 3. (U.S. CLS. 1, 4, 6, 50, 51 AND 52). REG. 12-4-2001.
- 2,515,554. BOSTON SOUND 1968. INT. CL. 9. (U.S. CLS. 21, 23, 26, 36 AND 38). REG. 12-4-2001.
- 2,515,663. SIKAREINFORCER. INT. CL. 17. (U.S. CLS. 1, 5, 12, 13, 35 AND 50). REG. 12-4-2001.
- 2,515,757. MISCELLANEOUS DESIGN. INT. CL. 7. (U.S. CLS. 13, 19, 21, 23, 31, 34 AND 35). REG. 12-4-2001.
- 2,515,869. NOFLAME. INT. CL. 9. (U.S. CLS. 21, 23, 26, 36 AND 38). REG. 12-4-2001.
- 2,516,047. SATURDAY NIGHT FEVER. INT. CL. 9 ONLY. (U.S. CLS. 21, 23, 26, 36 AND 38). REG. 12-11-2001.
- 2,516,176. MISCELLANEOUS DESIGN. INT. CL. 7. (U.S. CLS. 13, 19, 21, 23, 31, 34 AND 35). REG. 12-11-2001.
- 2,516,468. MISCELLANEOUS DESIGN. INT. CL. 42 ONLY. (U.S. CLS. 100 AND 101). REG. 12-11-2001.
- 2,516,475. DON AND DESIGN. INT. CL. 35. (U.S. CLS. 100, 101 AND 102). REG. 12-11-2001.
- 2,516,904. NULOMOLINE AND DESIGN. INT. CL. 30. (U.S. CL. 46). REG. 12-11-2001.
- 2,517,795. LASERQC. INT. CL. 9. (U.S. CLS. 21, 23, 26, 36 AND 38). REG. 12-11-2001.
- 2,517,917. SINGLE STAGE. INT. CL. 37. (U.S. CLS. 100, 103 AND 106). REG. 12-11-2001.
- 2,518,100. TFOCA-II. INT. CL. 9. (U.S. CLS. 21, 23, 26, 36 AND 38). REG. 12-11-2001.
- 2,518,368. DLT SUPER TAPE AND DESIGN. INT. CL. 9. (U.S. CLS. 21, 23, 26, 36 AND 38). REG. 12-11-2001.
- 2,518,649. DOUBLEBEE'S. INT. CL. 35. (U.S. CLS. 100, 101 AND 102). REG. 12-11-2001.

- 2,518,931. THE ROTHBURY ESTATE. INT. CL. 33. (U.S. CLS. 47 AND 49). REG. 12-18-2001.
- 2,518,980. THE CHALLENGE PRINTING COMPANY AND DESIGN. INT. CLS. 35, 40 AND 42 ONLY. (U.S. CLS. 100, 101, 102, 103 AND 106). REG. 12-18-2001.
- 2,519,223. WE PLAY AND DESIGN. INT. CL. 28. (U.S. CLS. 22, 23, 38 AND 50). REG. 12-18-2001.
- 2,519,989. OPTIFLUX. INT. CL. 10. (U.S. CLS. 26, 39 AND 44). REG. 12-18-2001.
- 2,520,063. BETCOBEST. INT. CL. 3. (U.S. CLS. 1, 4, 6, 50, 51 AND 52). REG. 12-18-2001.
- 2,520,171. FI-TECH, INC.. INT. CL. 35. (U.S. CLS. 100, 101 AND 102). REG. 12-18-2001.
- 2,520,803. CLASSICAL MAGIC. INT. CLS. 9 AND 16. (U.S. CLS. 2, 5, 21, 22, 23, 26, 29, 36, 37, 38 AND 50). REG. 12-18-2001.
- 2,520,804. TRESPASS. INT. CL. 14. (U.S. CLS. 2, 27, 28 AND 50). REG. 12-18-2001.
- 2,520,951. A LA NUIT (STYLIZED). INT. CL. 3. (U.S. CLS. 1, 4, 6, 50, 51 AND 52). REG. 12-18-2001.
- 2,521,146. NOT JUST FASTER. BETTER.. INT. CL. 37. (U.S. CLS. 100, 103 AND 106). REG. 12-18-2001.
- 2,521,186. RAINFOREST CAFE AND DESIGN. INT. CLS. 9, 18, 20 AND 26. (U.S. CLS. 1, 2, 3, 13, 21, 22, 23, 25, 26, 32, 36, 37, 38, 39, 40, 41, 42 AND 50). REG. 12-18-2001.
- 2,521,382. WEALTH MANAGEMENT INDEX. INT. CL. 36. (U.S. CLS. 100, 101 AND 102). REG. 12-18-2001.
- 2,521,734. MISCELLANEOUS DESIGN. INT. CLS. 6 AND 40 ONLY. (U.S. CLS. 2, 12, 13, 14, 23, 25, 50, 100, 103 AND 106). REG. 12-25-2001.
- 2,521,801. TROUTHALL. INT. CL. 32. (U.S. CLS. 45, 46 AND 48). REG. 12-25-2001.
- 2,522,001. EQUIP. INT. CL. 37. (U.S. CLS. 100, 103 AND 106). REG. 12-25-2001.
- 2,522,005. WHITNESS. INT. CL. 3. (U.S. CLS. 1, 4, 6, 50, 51 AND 52). REG. 12-25-2001.
- 2,522,006. MASTER EYE ASSOCIATES. INT. CL. 42. (U.S. CLS. 100 AND 101). REG. 12-25-2001.
- 2,522,159. KITTY HILL RESORT FOR CATS. INT. CL. 42. (U.S. CLS. 100 AND 101). REG. 12-25-2001.
- 2,522,244. DUCKIN.COM AND DESIGN. INT. CL. 36. (U.S. CLS. 100, 101 AND 102). REG. 12-25-2001.
- 2,522,343. DUCTSOX (STYLIZED). INT. CL. 11. (U.S. CLS. 13, 21, 23, 31 AND 34). REG. 12-25-2001.
- 2,522,431. GCG (STYLIZED). INT. CL. 36. (U.S. CLS. 100, 101 AND 102). REG. 12-25-2001.
- 2,522,489. CREATING A CULTURE OF ACCOUNTABILITY. INT. CLS. 35 AND 41. (U.S. CLS. 100, 101, 102 AND 107). REG. 12-25-2001.
- 2,523,071. PIZZA HUT AND DESIGN. INT. CL. 16. (U.S. CLS. 2, 5, 22, 23, 29, 37, 38 AND 50). REG. 12-25-2001.
- 2,523,318. PANORAMA AND DESIGN. INT. CL. 42 ONLY. (U.S. CLS. 100 AND 101). REG. 12-25-2001.
- 2,524,284. NYTRILE AND DESIGN. INT. CL. 10. (U.S. CLS. 26, 39 AND 44). REG. 1-1-2002.
- 2,524,452. HEAVEN'S DELIGHT. INT. CL. 30. (U.S. CL. 46). REG. 1-1-2002.
- 2,524,513. TAHOE. INT. CL. 12. (U.S. CLS. 19, 21, 23, 31, 35 AND 44). REG. 1-1-2002.
- 2,524,968. PRO-CAST. INT. CL. 7. (U.S. CLS. 13, 19, 21, 23, 31, 34 AND 35). REG. 1-1-2002.
- 2,525,141. STANGARD. INT. CL. 1. (U.S. CLS. 1, 5, 6, 10, 26 AND 46). REG. 1-1-2002.
- 2,525,142. STANWHITE. INT. CL. 1. (U.S. CLS. 1, 5, 6, 10, 26 AND 46). REG. 1-1-2002.
- 2,525,143. STANDARD ONE. INT. CL. 1. (U.S. CLS. 1, 5, 6, 10, 26 AND 46). REG. 1-1-2002.
- 2,525,286. GRAND MAX (STYLIZED). INT. CL. 28. (U.S. CLS. 22, 23, 38 AND 50). REG. 1-1-2002.
- 2,525,500. HLINK. INT. CL. 38. (U.S. CLS. 100, 101 AND 104). REG. 1-1-2002.
- 2,525,514. AUTHENTIDATE. INT. CL. 9. (U.S. CLS. 21, 23, 26, 36 AND 38). REG. 1-1-2002.
- 2,525,657. LITE BUILDER. INT. CL. 9. (U.S. CLS. 21, 23, 26, 36 AND 38). REG. 1-1-2002.
- 2,526,076. WAFERETTE. INT. CL. 29. (U.S. CL. 46). REG. 1-1-2002.
- 2,526,101. FIRST LADY SUITS. INT. CL. 25. (U.S. CLS. 22 AND 39). REG. 1-1-2002.
- 2,526,128. FREEDOM READER. INT. CL. 9. (U.S. CLS. 21, 23, 26, 36 AND 38). REG. 1-1-2002.
- 2,526,457. UNITED PROPANE GAS. INT. CLS. 4, 35 AND 39. (U.S. CLS. 1, 6, 15, 100, 101, 102 AND 105). REG. 1-8-2002.
- 2,526,520. BLACK SHEEP. INT. CL. 32. (U.S. CLS. 45, 46 AND 48). REG. 1-8-2002.
- 2,526,999. ENERGYZER. INT. CL. 7. (U.S. CLS. 13, 19, 21, 23, 31, 34 AND 35). REG. 1-8-2002.
- 2,527,197. DPM DESIGN PRESERVATION MODELS AND DESIGN. INT. CL. 28. (U.S. CLS. 22, 23, 38 AND 50). REG. 1-8-2002.
- 2,527,271. MISCELLANEOUS DESIGN. INT. CL. 16. (U.S. CLS. 2, 5, 22, 23, 29, 37, 38 AND 50). REG. 1-8-2002.
- 2,527,444. I ILLUMINATA (STYLIZED). INT. CLS. 16 AND 42. (U.S. CLS. 2, 5, 22, 23, 29, 37, 38, 50, 100 AND 101). REG. 1-8-2002.
- 2,527,973. LOVE YOUR PET. INT. CL. 35. (U.S. CLS. 100, 101 AND 102). REG. 1-8-2002.
- 2,528,169. PRONTO PARTS. INT. CL. 1. (U.S. CLS. 1, 5, 6, 10, 26 AND 46). REG. 1-8-2002.
- 2,528,286. FABRAZYME. INT. CL. 5. (U.S. CLS. 6, 18, 44, 46, 51 AND 52). REG. 1-8-2002.
- 2,528,554. GLAMOUR SUITS. INT. CL. 25. (U.S. CLS. 22 AND 39). REG. 1-8-2002.
- 2,528,606. TEXTSLING. INT. CL. 18. (U.S. CLS. 1, 2, 3, 22 AND 41). REG. 1-8-2002.
- 2,529,219. COMFORT GRIP. INT. CL. 8. (U.S. CLS. 23, 28 AND 44). REG. 1-15-2002.
- 2,529,221. THE TOTAL ELECTRONIC PACKAGE SOLUTION. INT. CL. 35. (U.S. CLS. 100, 101 AND 102). REG. 1-15-2002.
- 2,529,223. INFOBRANCH. INT. CL. 42. (U.S. CLS. 100 AND 101). REG. 1-15-2002.
- 2,529,537. PROX. INT. CLS. 7 AND 17. (U.S. CLS. 1, 5, 12, 13, 19, 21, 23, 31, 34, 35 AND 50). REG. 1-15-2002.
- 2,529,594. 435. INT. CL. 7. (U.S. CLS. 13, 19, 21, 23, 31, 34 AND 35). REG. 1-15-2002.
- 2,529,871. SUPER SERIES AND DESIGN. INT. CL. 12. (U.S. CLS. 19, 21, 23, 31, 35 AND 44). REG. 1-15-2002.
- 2,530,357. SUPPORT.COM. INT. CLS. 9 AND 42. (U.S. CLS. 21, 23, 26, 36, 38, 100 AND 101). REG. 1-15-2002.
- 2,530,436. NORTHWESTERN MUTUAL FINANCIAL NETWORK. INT. CL. 36. (U.S. CLS. 100, 101 AND 102). REG. 1-15-2002.
- 2,530,569. BUENA VENTURA AND DESIGN. INT. CL. 29. (U.S. CL. 46). REG. 1-15-2002.
- 2,530,716. DRAUGHT HORSE. INT. CL. 42. (U.S. CLS. 100 AND 101). REG. 1-15-2002.
- 2,531,139. METALTITE. INT. CL. 5. (U.S. CLS. 6, 18, 44, 46, 51 AND 52). REG. 1-22-2002.
- 2,531,459. WIST. INT. CL. 42. (U.S. CLS. 100 AND 101). REG. 1-22-2002.
- 2,531,517. GOOD BUSINESS DAY. INT. CL. 42. (U.S. CLS. 100 AND 101). REG. 1-22-2002.
- 2,531,697. EC AND DESIGN. INT. CL. 19. (U.S. CLS. 1, 12, 33 AND 50). REG. 1-22-2002.
- 2,531,749. SHAPE A DREAM... BUILD A FUTURE. INT. CL. 42. (U.S. CLS. 100 AND 101). REG. 1-22-2002.
- 2,532,650. VESPERA. INT. CL. 3. (U.S. CLS. 1, 4, 6, 50, 51 AND 52). REG. 1-22-2002.
- 2,532,743. FAST BREW. INT. CL. 11. (U.S. CLS. 13, 21, 23, 31 AND 34). REG. 1-22-2002.
- 2,532,781. PUREZE. INT. CL. 3. (U.S. CLS. 1, 4, 6, 50, 51 AND 52). REG. 1-22-2002.
- 2,532,824. EZKEY (STYLIZED). INT. CL. 9. (U.S. CLS. 21, 23, 26, 36 AND 38). REG. 1-22-2002.
- 2,532,828. BALANCE BALL. INT. CL. 28. (U.S. CLS. 22, 23, 38 AND 50). REG. 1-22-2002.
- 2,533,071. POWERSLOPE. INT. CL. 6. (U.S. CLS. 2, 12, 13, 14, 23, 25 AND 50). REG. 1-22-2002.
- 2,533,263. UPG UNITED PROPANE GAS (STYLIZED). INT. CLS. 4, 35 AND 39. (U.S. CLS. 1, 6, 15, 100, 101, 102 AND 105). REG. 1-29-2002.
- 2,533,539. PACTOR. INT. CL. 7. (U.S. CLS. 13, 19, 21, 23, 31, 34 AND 35). REG. 1-29-2002.
- 2,533,589. PAULIST PRESS. INT. CL. 16. (U.S. CLS. 2, 5, 22, 23, 29, 37, 38 AND 50). REG. 1-29-2002.
- 2,533,730. MISCELLANEOUS DESIGN. INT. CL. 30. (U.S. CL. 46). REG. 1-29-2002.
- 2,533,731. MISCELLANEOUS DESIGN. INT. CL. 35. (U.S. CLS. 100, 101 AND 102). REG. 1-29-2002.
- 2,533,758. CET CENTER FOR EMPLOYMENT TRAINING SKILL TRAINING\*HUMAN DEVELOPMENT AND DESIGN. INT. CL. 41. (U.S. CLS. 100, 101 AND 107). REG. 1-29-2002.

- 2,534,135. POOLTITE. INT. CL. 19. (U.S. CLS. 1, 12, 33 AND 50). REG. 1-29-2002.
- 2,534,150. ABSINTHE REFINED. INT. CL. 33. (U.S. CLS. 47 AND 49). REG. 1-29-2002.
- 2,534,171. DREAM DANCE DANCE TO THE RHYTHM OF YOUR SOUL AND DESIGN. INT. CL. 25. (U.S. CLS. 22 AND 39). REG. 1-29-2002.
- 2,534,562. BLASTS. INT. CL. 9. (U.S. CLS. 21, 23, 26, 36 AND 38). REG. 1-29-2002.
- 2,534,928. NUEMD. INT. CL. 9. (U.S. CLS. 21, 23, 26, 36 AND 38). REG. 1-29-2002.
- 2,535,179. TWIN CAM 88. INT. CL. 12 ONLY. (U.S. CLS. 19, 21, 23, 31, 35 AND 44). REG. 2-5-2002.
- 2,535,822. MISCELLANEOUS DESIGN. INT. CL. 41. (U.S. CLS. 100, 101 AND 107). REG. 2-5-2002.
- 2,535,933. TMW. INT. CL. 40. (U.S. CLS. 100, 103 AND 106). REG. 2-5-2002.
- 2,536,372. FLOORNET. INT. CL. 36. (U.S. CLS. 100, 101 AND 102). REG. 2-5-2002.
- 2,536,588. BE HAPPY INSIDE. INT. CL. 42. (U.S. CLS. 100 AND 101). REG. 2-5-2002.
- 2,536,837. POWER CRUNCH. INT. CL. 5. (U.S. CLS. 6, 18, 44, 46, 51 AND 52). REG. 2-5-2002.
- 2,537,018. E-A-RSOFT (STYLIZED). INT. CL. 9. (U.S. CLS. 21, 23, 26, 36 AND 38). REG. 2-5-2002.
- 2,537,371. NUEMD. INT. CL. 38. (U.S. CLS. 100, 101 AND 104). REG. 2-5-2002.
- 2,537,465. AUTOMEDIA.COM. INT. CL. 35. (U.S. CLS. 100, 101 AND 102). REG. 2-5-2002.
- 2,537,662. EMOTIONAL SMARTS. INT. CLS. 16, 41 AND 42. (U.S. CLS. 2, 5, 22, 23, 29, 37, 38, 50, 100, 101 AND 107). REG. 2-12-2002.
- 2,537,741. YOSHINOYA RESTAURANTS AND DESIGN. INT. CLS. 29, 30 AND 42. (U.S. CLS. 46, 100 AND 101). REG. 2-12-2002.
- 2,538,117. NAPA VALLEY THE MAIDEN AND DESIGN. INT. CL. 33. (U.S. CLS. 47 AND 49). REG. 2-12-2002.
- 2,538,373. NO BROKEN PROMISES. INT. CLS. 37 AND 40. (U.S. CLS. 100, 103 AND 106). REG. 2-12-2002.
- 2,538,443. L-VIS. INT. CL. 40 ONLY. (U.S. CLS. 100, 103 AND 106). REG. 2-12-2002.
- 2,538,746. ASHTON GREEN. INT. CLS. 8, 11 AND 35. (U.S. CLS. 13, 21, 23, 28, 31, 34, 44, 100, 101 AND 102). REG. 2-19-2002.
- 2,539,060. CENTRACARE. INT. CLS. 36 AND 42. (U.S. CLS. 100, 101 AND 102). REG. 2-19-2002.
- 2,539,440. THE HORSEMAN'S CARD AND DESIGN. INT. CL. 35. (U.S. CLS. 100, 101 AND 102). REG. 2-19-2002.
- 2,539,820. CHRISTINI'S. INT. CL. 42. (U.S. CLS. 100 AND 101). REG. 2-19-2002.
- 2,539,995. COMMONANGELS. INT. CL. 36. (U.S. CLS. 100, 101 AND 102). REG. 2-19-2002.
- 2,540,056. RICE UNIVERSITY. INT. CL. 16. (U.S. CLS. 2, 5, 22, 23, 29, 37, 38 AND 50). REG. 2-19-2002.
- 2,540,067. RICE UNIVERSITY. INT. CL. 24. (U.S. CLS. 42 AND 50). REG. 2-19-2002.
- 2,540,151. RICE OWLS. INT. CL. 16. (U.S. CLS. 2, 5, 22, 23, 29, 37, 38 AND 50). REG. 2-19-2002.
- 2,541,236. TIM. INT. CL. 20. (U.S. CLS. 2, 13, 22, 25, 32 AND 50). REG. 2-19-2002.
- 2,541,237. TABLES IN MOTION. INT. CL. 20. (U.S. CLS. 2, 13, 22, 25, 32 AND 50). REG. 2-19-2002.
- 2,541,438. HOSTCENTRIC. INT. CLS. 38 AND 42. (U.S. CLS. 100, 101 AND 104). REG. 2-19-2002.
- 2,542,629. GRETSCH AND DESIGN. INT. CL. 15. (U.S. CLS. 2, 21 AND 36). REG. 2-26-2002.
- 2,543,026. CASINO PRODUCTIONS. INT. CL. 41. (U.S. CLS. 100, 101 AND 107). REG. 2-26-2002.
- 2,543,618. BRUSH ON BLU. INT. CL. 1. (U.S. CLS. 1, 5, 6, 10, 26 AND 46). REG. 2-26-2002.
- 2,543,809. NATIONWIDE RECOVERY SERVICE. INT. CL. 36. (U.S. CLS. 100, 101 AND 102). REG. 3-5-2002.
- 2,543,892. 88 TEES. INT. CL. 25. (U.S. CLS. 22 AND 39). REG. 3-5-2002.
- 2,544,947. KENDAL FLORAL SUPPLY INC. AND DESIGN. INT. CL. 31. (U.S. CLS. 1 AND 46). REG. 3-5-2002.
- 2,544,980. OPTIMARKET. INT. CL. 35. (U.S. CLS. 100, 101 AND 102). REG. 3-5-2002.
- 2,545,149. MIBB. INT. CL. 10. (U.S. CLS. 26, 39 AND 44). REG. 3-5-2002.
- 2,545,815. BETASTAR (STYLIZED). INT. CLS. 9, 10 AND 37. (U.S. CLS. 21, 23, 26, 36, 38, 39, 44, 100, 103 AND 106). REG. 3-12-2002.
- 2,546,208. INFOBLOX. INT. CL. 9. (U.S. CLS. 21, 23, 26, 36 AND 38). REG. 3-12-2002.
- 2,547,083. ECM. INT. CL. 36. (U.S. CLS. 100, 101 AND 102). REG. 3-12-2002.
- 2,547,466. TOMMY BAHAMA. INT. CL. 16. (U.S. CLS. 2, 5, 22, 23, 29, 37, 38 AND 50). REG. 3-12-2002.
- 2,547,539. ROYAL DANSK AND DESIGN. INT. CL. 30. (U.S. CL. 46). REG. 3-12-2002.
- 2,548,362. TEXTSLING. INT. CL. 20. (U.S. CLS. 2, 13, 22, 25, 32 AND 50). REG. 3-12-2002.
- 2,548,454. ALIGNSTAR. INT. CL. 9. (U.S. CLS. 21, 23, 26, 36 AND 38). REG. 3-12-2002.
- 2,548,658. RMS. INT. CL. 9. (U.S. CLS. 21, 23, 26, 36 AND 38). REG. 3-19-2002.
- 2,548,684. STARSKY & HUTCH. INT. CL. 41. (U.S. CLS. 100, 101 AND 107). REG. 3-19-2002.
- 2,548,761. NUTRI JECT AND DESIGN. INT. CL. 40. (U.S. CLS. 100, 103 AND 106). REG. 3-19-2002.
- 2,549,228. LIQUID ICE. INT. CL. 32. (U.S. CLS. 45, 46 AND 48). REG. 3-19-2002.
- 2,550,270. FILAMAT. INT. CLS. 20 AND 40 ONLY. (U.S. CLS. 2, 13, 22, 25, 32, 50, 100, 103 AND 106). REG. 3-19-2002.
- 2,550,384. XTENSA. INT. CL. 9. (U.S. CLS. 21, 23, 26, 36 AND 38). REG. 3-19-2002.
- 2,550,782. STAN ZINC. INT. CL. 1. (U.S. CLS. 1, 5, 6, 10, 26 AND 46). REG. 3-19-2002.
- 2,551,210. TOMMY BAHAMA. INT. CL. 14. (U.S. CLS. 2, 27, 28 AND 50). REG. 3-19-2002.
- 2,551,594. BOURBON COUNTRY. INT. CL. 30. (U.S. CL. 46). REG. 3-26-2002.
- 2,551,974. ANTHONY ROBBINS GET THE EDGE. INT. CL. 9. (U.S. CLS. 21, 23, 26, 36 AND 38). REG. 3-26-2002.
- 2,552,113. APA. INT. CL. 19. (U.S. CLS. 1, 12, 33 AND 50). REG. 3-26-2002.
- 2,552,227. ADVENTURE BAY EARLY LEARNING CENTERS AND DESIGN. INT. CLS. 41 AND 42. (U.S. CLS. 100, 101 AND 107). REG. 3-26-2002.
- 2,553,310. MILLENNIUM FORCE. INT. CLS. 16, 21, 25, 28 AND 41 ONLY. (U.S. CLS. 2, 5, 13, 22, 23, 29, 30, 33, 37, 38, 39, 40, 50, 100, 101 AND 107). REG. 3-26-2002.
- 2,553,672. CHARLIE'S ANGELS. INT. CL. 16. (U.S. CLS. 2, 5, 22, 23, 29, 37, 38 AND 50). REG. 3-26-2002.
- 2,554,390. THE ORIGINAL CAKE CANDLE COMPANY. INT. CL. 35. (U.S. CLS. 100, 101 AND 102). REG. 3-26-2002.
- 2,554,496. MINILINK. INT. CL. 7. (U.S. CLS. 13, 19, 21, 23, 31, 34 AND 35). REG. 4-2-2002.
- 2,555,209. FREGULLIVER. INT. CL. 36. (U.S. CLS. 100, 101 AND 102). REG. 4-2-2002.
- 2,555,314. LET'S DO ... ORGANIC. INT. CL. 30. (U.S. CL. 46). REG. 4-2-2002.
- 2,555,518. LUCKY MONEY. INT. CL. 36. (U.S. CLS. 100, 101 AND 102). REG. 4-2-2002.
- 2,556,202. R/O FREE. INT. CL. 3. (U.S. CLS. 1, 4, 6, 50, 51 AND 52). REG. 4-2-2002.
- 2,556,802. BEL GAS. INT. CLS. 9 AND 35. (U.S. CLS. 21, 23, 26, 36, 38, 100, 101 AND 102). REG. 4-2-2002.
- 2,556,875. EMAX. INT. CL. 19. (U.S. CLS. 1, 12, 33 AND 50). REG. 4-2-2002.
- 2,556,962. EGG MIT. INT. CL. 30. (U.S. CL. 46). REG. 4-2-2002.
- 2,557,111. T AND DESIGN. INT. CLS. 18, 25 AND 28. (U.S. CLS. 1, 2, 3, 22, 23, 38, 39, 41 AND 50). REG. 4-2-2002.
- 2,557,731. WE GO TO THEM. INT. CL. 42. (U.S. CLS. 100 AND 101). REG. 4-9-2002.
- 2,559,311. MARIANJOY REHABLINK. INT. CL. 42. (U.S. CLS. 100 AND 101). REG. 4-9-2002.
- 2,559,639. TRUSTMARK. INT. CL. 36. (U.S. CLS. 100, 101 AND 102). REG. 4-9-2002.
- 2,561,025. CHARLOTTE. INT. CL. 9. (U.S. CLS. 21, 23, 26, 36 AND 38). REG. 4-16-2002.
- 2,562,020. DIGISAN. INT. CL. 5. (U.S. CLS. 6, 18, 44, 46, 51 AND 52). REG. 4-16-2002.
- 2,563,655. 1-800-FLOODED. INT. CL. 37. (U.S. CLS. 100, 103 AND 106). REG. 4-23-2002.
- 2,563,863. SAHARA. INT. CL. 1. (U.S. CLS. 1, 5, 6, 10, 26 AND 46). REG. 4-23-2002.

- 2,565,278. NELWELD. INT. CLS. 6, 7 AND 9. (U.S. CLS. 2, 12, 13, 14, 19, 21, 23, 25, 26, 31, 34, 35, 36, 38 AND 50). REG. 4-30-2002.
- 2,565,493. AMSAN. INT. CLS. 37 AND 41. (U.S. CLS. 100, 101, 103, 106 AND 107). REG. 4-30-2002.
- 2,565,832. MISCELLANEOUS DESIGN. INT. CL. 12. (U.S. CLS. 19, 21, 23, 31, 35 AND 44). REG. 4-30-2002.
- 2,565,886. CRANBERRY ESSENTIALS. INT. CL. 5. (U.S. CLS. 6, 18, 44, 46, 51 AND 52). REG. 4-30-2002.
- 2,566,683. EROTIC IMAGE. INT. CL. 41. (U.S. CLS. 100, 101 AND 107). REG. 5-7-2002.
- 2,566,826. SIVOIA. INT. CL. 20. (U.S. CLS. 2, 13, 22, 25, 32 AND 50). REG. 5-7-2002.
- 2,567,667. PINEROCK. INT. CLS. 35 AND 41. (U.S. CLS. 100, 101, 102 AND 107). REG. 5-7-2002.
- 2,569,029. SATWEST. INT. CL. 38. (U.S. CLS. 100, 101 AND 104). REG. 5-14-2002.
- 2,569,383. BEST YEAR EVER!. INT. CLS. 16, 41 AND 42. (U.S. CLS. 2, 5, 22, 23, 29, 37, 38, 50, 100, 101 AND 107). REG. 5-14-2002.
- 2,569,874. VERMEIL. INT. CL. 3. (U.S. CLS. 1, 4, 6, 50, 51 AND 52). REG. 5-14-2002.
- 2,570,098. INVENTIGO. INT. CL. 42. (U.S. CLS. 100 AND 101). REG. 5-14-2002.
- 2,570,500. MISCELLANEOUS DESIGN. INT. CL. 28. (U.S. CLS. 22, 23, 38 AND 50). REG. 5-21-2002.
- 2,573,998. PERFECT10.COM. INT. CL. 41. (U.S. CLS. 100, 101 AND 107). REG. 5-28-2002.
- 2,574,892. PRIMALSCRIPT. INT. CL. 9. (U.S. CLS. 21, 23, 26, 36 AND 38). REG. 6-4-2002.
- 2,575,123. "NEED DIRECTION?" - GOD. INT. CL. 42. (U.S. CLS. 100 AND 101). REG. 6-4-2002.
- 2,575,124. "BIG BANG THEORY, YOU'VE GOT TO BE KIDDING." -GOD. INT. CL. 42. (U.S. CLS. 100 AND 101). REG. 6-4-2002.
- 2,575,178. HOS AND DESIGN. INT. CL. 39. (U.S. CLS. 100 AND 105). REG. 6-4-2002.
- 2,576,167. YOU STAND ON IT. WE STAND BEHIND IT.. INT. CLS. 19 AND 40. (U.S. CLS. 1, 12, 33, 50, 100, 103 AND 106). REG. 6-4-2002.
- 2,576,704. TEAM TBA. INT. CL. 35. (U.S. CLS. 100, 101 AND 102). REG. 6-4-2002.
- 2,577,174. REFUEL. INT. CL. 37. (U.S. CLS. 100, 103 AND 106). REG. 6-11-2002.
- 2,577,188. ROGERS RAW MATERIALS FUND, LP. INT. CL. 36. (U.S. CLS. 100, 101 AND 102). REG. 6-11-2002.
- 2,577,639. DIETS DON'T WORK. INT. CL. 42. (U.S. CLS. 100 AND 101). REG. 6-11-2002.
- 2,578,365. LYMAN. INT. CL. 25. (U.S. CLS. 22 AND 39). REG. 6-11-2002.
- 2,578,571. TEAL LAKE. INT. CL. 33. (U.S. CLS. 47 AND 49). REG. 6-11-2002.
- 2,578,598. GAMBLER (STYLIZED). INT. CL. 34. (U.S. CLS. 2, 8, 9 AND 17). REG. 6-11-2002.
- 2,578,693. TODAY'S SOLUTIONS. TOMORROW'S DREAMS.. INT. CL. 36. (U.S. CLS. 100, 101 AND 102). REG. 6-11-2002.
- 2,579,750. LIFE IN PROVENCE. INT. CLS. 29 AND 30. (U.S. CL. 46). REG. 6-11-2002.
- 2,580,149. REDAN. INT. CL. 16. (U.S. CLS. 2, 5, 22, 23, 29, 37, 38 AND 50). REG. 6-11-2002.
- 2,580,541. TIARA. INT. CLS. 16 AND 20 ONLY. (U.S. CLS. 2, 5, 13, 22, 23, 25, 29, 32, 37, 38 AND 50). REG. 6-18-2002.
- 2,580,907. GRIPSOFT. INT. CLS. 8 AND 21. (U.S. CLS. 2, 13, 23, 28, 29, 30, 33, 40, 44 AND 50). REG. 6-18-2002.
- 2,581,170. BUSINESS CONNECTION AND DESIGN. INT. CL. 35. (U.S. CLS. 100, 101 AND 102). REG. 6-18-2002.
- 2,581,430. GREAT LAKES CROSSING. INT. CL. 35. (U.S. CLS. 100, 101 AND 102). REG. 6-18-2002.
- 2,581,463. INFOWORLD. INT. CL. 42. (U.S. CLS. 100 AND 101). REG. 6-18-2002.
- 2,581,600. X5 (STYLIZED). INT. CL. 11. (U.S. CLS. 13, 21, 23, 31 AND 34). REG. 6-18-2002.
- 2,581,697. FANCIFUL GARDENS. INT. CL. 31. (U.S. CLS. 1 AND 46). REG. 6-18-2002.
- 2,582,022. MISCELLANEOUS DESIGN. INT. CL. 32. (U.S. CLS. 45, 46 AND 48). REG. 6-18-2002.
- 2,583,399. CARECENTRIX. INT. CL. 16. (U.S. CLS. 2, 5, 22, 23, 29, 37, 38 AND 50). REG. 6-18-2002.
- 2,583,714. KINGDOM FIRST. INT. CL. 36. (U.S. CLS. 100, 101 AND 102). REG. 6-18-2002.
- 2,586,384. NUEMD. INT. CLS. 35 AND 42. (U.S. CLS. 100, 101 AND 102). REG. 6-25-2002.
- 2,587,682. AFOP AND DESIGN. INT. CL. 9. (U.S. CLS. 21, 23, 26, 36 AND 38). REG. 7-2-2002.
- 2,587,684. MLINK TECHNOLOGIES. INT. CL. 9. (U.S. CLS. 21, 23, 26, 36 AND 38). REG. 7-2-2002.
- 2,589,792. STARTAK. INT. CL. 1. (U.S. CLS. 1, 5, 6, 10, 26 AND 46). REG. 7-2-2002.
- 2,590,047. COMMERCIAL ELECTRONIC OFFICE. INT. CLS. 35 AND 36. (U.S. CLS. 100, 101 AND 102). REG. 7-2-2002.
- 2,590,226. BUCK CONSULTANTS. INT. CLS. 16, 35, 36, 38 AND 42. (U.S. CLS. 2, 5, 22, 23, 29, 37, 38, 50, 100, 101, 102 AND 104). REG. 7-9-2002.
- 2,590,456. LIFETOUCH YEARBOOKS. INT. CL. 16. (U.S. CLS. 2, 5, 22, 23, 29, 37, 38 AND 50). REG. 7-9-2002.
- 2,590,597. EARTHNET. INT. CLS. 35, 38 AND 42. (U.S. CLS. 100, 101, 102 AND 104). REG. 7-9-2002.
- 2,592,374. SLAM. INT. CLS. 29 AND 30. (U.S. CL. 46). REG. 7-9-2002.
- 2,592,649. ENVIROCLAD UV. INT. CL. 19. (U.S. CLS. 1, 12, 33 AND 50). REG. 7-9-2002.
- 2,592,787. IP AND DESIGN. INT. CL. 9. (U.S. CLS. 21, 23, 26, 36 AND 38). REG. 7-9-2002.
- 2,594,858. SIGNATURE. INT. CL. 15. (U.S. CLS. 2, 21 AND 36). REG. 7-16-2002.
- 2,595,252. WAVEWIN. INT. CL. 9. (U.S. CLS. 21, 23, 26, 36 AND 38). REG. 7-16-2002.
- 2,595,508. BENDA TWIN. INT. CL. 10. (U.S. CLS. 26, 39 AND 44). REG. 7-16-2002.
- 2,596,819. THE LEADING EDGE. INT. CL. 41. (U.S. CLS. 100, 101 AND 107). REG. 7-23-2002.
- 2,596,853. MISCELLANEOUS DESIGN. INT. CL. 42. (U.S. CLS. 100 AND 101). REG. 7-23-2002.
- 2,597,057. CWD. INT. CL. 35. (U.S. CLS. 100, 101 AND 102). REG. 7-23-2002.
- 2,597,147. FOX SECURITY & COMMUNICATIONS, INC. AND DESIGN. INT. CL. 37. (U.S. CLS. 100, 103 AND 106). REG. 7-23-2002.
- 2,597,192. OUCH POUCH JR.. INT. CL. 25. (U.S. CLS. 22 AND 39). REG. 7-23-2002.
- 2,597,196. OUCH POUCH. INT. CL. 25. (U.S. CLS. 22 AND 39). REG. 7-23-2002.
- 2,597,611. SUPPORTAX. INT. CL. 9. (U.S. CLS. 21, 23, 26, 36 AND 38). REG. 7-23-2002.
- 2,598,125. REDMANE TECHNOLOGY AND DESIGN. INT. CL. 42. (U.S. CLS. 100 AND 101). REG. 7-23-2002.
- 2,598,956. EXECUTIVE CAR WASH. INT. CL. 37. (U.S. CLS. 100, 103 AND 106). REG. 7-23-2002.
- 2,598,998. NUEMD. INT. CL. 35. (U.S. CLS. 100, 101 AND 102). REG. 7-23-2002.
- 2,599,631. ANODROL. INT. CL. 5. (U.S. CLS. 6, 18, 44, 46, 51 AND 52). REG. 7-23-2002.
- 2,600,305. WOMEN ON TARGET FROM THE WOMEN OF THE NRA AND DESIGN. INT. CL. 42. (U.S. CLS. 100 AND 101). REG. 7-30-2002.
- 2,600,329. OFFICIAL NATIONAL THOROUGHBRED RACING HALL OF FAME. INT. CL. 41. (U.S. CLS. 100, 101 AND 107). REG. 7-30-2002.
- 2,600,490. TERMATRAC. INT. CL. 9. (U.S. CLS. 21, 23, 26, 36 AND 38). REG. 7-30-2002.
- 2,600,638. THE DINI GROUP. INT. CL. 42. (U.S. CLS. 100 AND 101). REG. 7-30-2002.
- 2,600,750. INFINITE FUNCTIONS. INT. CL. 42. (U.S. CLS. 100 AND 101). REG. 7-30-2002.
- 2,600,763. STURM FOODS AND DESIGN. INT. CL. 40. (U.S. CLS. 100, 103 AND 106). REG. 7-30-2002.
- 2,600,801. CHERRY BERRIES GRAPE TOMATOES A SWEET TREAT, NATURALLY!. INT. CL. 31. (U.S. CLS. 1 AND 46). REG. 7-30-2002.
- 2,600,999. BARBECUE MAGIC. INT. CL. 30. (U.S. CL. 46). REG. 7-30-2002.
- 2,601,000. FAJITA MAGIC. INT. CL. 30. (U.S. CL. 46). REG. 7-30-2002.
- 2,601,008. MYSTIC LAKE. INT. CL. 28. (U.S. CLS. 22, 23, 38 AND 50). REG. 7-30-2002.
- 2,601,062. T-BONE (STYLIZED). INT. CL. 9. (U.S. CLS. 21, 23, 26, 36 AND 38). REG. 7-30-2002.
- 2,601,230. CHUKAR. INT. CLS. 29 AND 30. (U.S. CL. 46). REG. 7-30-2002.
- 2,601,633. EDGAREXPLORER. INT. CL. 36. (U.S. CLS. 100, 101 AND 102). REG. 7-30-2002.
- 2,602,369. CHEENIES. INT. CL. 30. (U.S. CL. 46). REG. 7-30-2002.



- 2,602,764. MT. EVEREST AIR THE CLIMB-IT SPECIALISTS. INT. CL. 37. (U.S. CLS. 100, 103 AND 106). REG. 7-30-2002.
- 2,602,923. CONRAD. INT. CL. 42. (U.S. CLS. 100 AND 101). REG. 7-30-2002.
- 2,602,978. SANOVA. INT. CL. 1. (U.S. CLS. 1, 5, 6, 10, 26 AND 46). REG. 7-30-2002.
- 2,603,233. CERTIFIED FORENSIC PHYSICIAN. INT. CL. 42. (U.S. CLS. 100 AND 101). REG. 7-30-2002.
- 2,603,330. ZIPPER SOURCE. INT. CL. 26. (U.S. CLS. 37, 39, 40, 42 AND 50). REG. 8-6-2002.
- 2,603,630. READ. INT. CL. 16. (U.S. CLS. 2, 5, 22, 23, 29, 37, 38 AND 50). REG. 8-6-2002.
- 2,603,818. MISCELLANEOUS DESIGN. INT. CL. 16. (U.S. CLS. 2, 5, 22, 23, 29, 37, 38 AND 50). REG. 8-6-2002.
- 2,603,946. VYKON. INT. CL. 42. (U.S. CLS. 100 AND 101). REG. 8-6-2002.
- 2,604,290. FINITE MATERIALS. INT. CL. 9. (U.S. CLS. 21, 23, 26, 36 AND 38). REG. 8-6-2002.
- 2,604,303. PERMAFLEX. INT. CL. 19. (U.S. CLS. 1, 12, 33 AND 50). REG. 8-6-2002.
- 2,604,504. MEYER'S. INT. CL. 30. (U.S. CL. 46). REG. 8-6-2002.
- 2,604,543. FIT. INT. CL. 7. (U.S. CLS. 13, 19, 21, 23, 31, 34 AND 35). REG. 8-6-2002.
- 2,604,645. GRAVY & GUMBO MAGIC. INT. CL. 30. (U.S. CL. 46). REG. 8-6-2002.
- 2,604,646. MAGIC SEASONING SALT. INT. CL. 30. (U.S. CL. 46). REG. 8-6-2002.
- 2,604,756. BARREL (STYLIZED). INT. CL. 9. (U.S. CLS. 21, 23, 26, 36 AND 38). REG. 8-6-2002.
- 2,604,768. STYLE GIRLS (STYLIZED). INT. CL. 9. (U.S. CLS. 21, 23, 26, 36 AND 38). REG. 8-6-2002.
- 2,605,674. BORN TO BE WIRELESS. INT. CL. 38. (U.S. CLS. 100, 101 AND 104). REG. 8-6-2002.
- 2,605,675. BORN TO BE WIRELESS. INT. CL. 35. (U.S. CLS. 100, 101 AND 102). REG. 8-6-2002.
- 2,605,744. QUEEN ANNE'S REVENGE STEAK & SEAFOOD. INT. CL. 42. (U.S. CLS. 100 AND 101). REG. 8-6-2002.
- 2,606,142. MISCELLANEOUS DESIGN. INT. CL. 7. (U.S. CLS. 13, 19, 21, 23, 31, 34 AND 35). REG. 8-6-2002.
- 2,606,436. @YOUR.SERVICE AND DESIGN. INT. CL. 36. (U.S. CLS. 100, 101 AND 102). REG. 8-13-2002.
- 2,606,813. MAASDAM POW'R-PULL. INT. CL. 8. (U.S. CLS. 23, 28 AND 44). REG. 8-13-2002.
- 2,606,897. FOREMAN. INT. CL. 7. (U.S. CLS. 13, 19, 21, 23, 31, 34 AND 35). REG. 8-13-2002.
- 2,607,046. UNIPLEX. INT. CLS. 40 AND 42. (U.S. CLS. 100, 101, 103 AND 106). REG. 8-13-2002.
- 2,607,159. M AND DESIGN. INT. CL. 37. (U.S. CLS. 100, 103 AND 106). REG. 8-13-2002.
- 2,607,545. BOARDER GIRLS (STYLIZED). INT. CL. 9. (U.S. CLS. 21, 23, 26, 36 AND 38). REG. 8-13-2002.
- 2,607,997. GELRON 2000. INT. CL. 25. (U.S. CLS. 22 AND 39). REG. 8-13-2002.
- 2,608,745. ECOPOL. INT. CL. 1. (U.S. CLS. 1, 5, 6, 10, 26 AND 46). REG. 8-20-2002.
- 2,608,880. THE WORKPLACE HELPLINE. INT. CLS. 35 AND 39. (U.S. CLS. 100, 101, 102 AND 105). REG. 8-20-2002.
- 2,609,178. PAL. INT. CL. 10. (U.S. CLS. 26, 39 AND 44). REG. 8-20-2002.
- 2,609,271. SPROUSE. INT. CL. 19. (U.S. CLS. 1, 12, 33 AND 50). REG. 8-20-2002.
- 2,609,284. SAINT PAUL SUNDAY. INT. CL. 41. (U.S. CLS. 100, 101 AND 107). REG. 8-20-2002.
- 2,609,445. CLIFFORD THE BIG RED DOG. INT. CL. 25. (U.S. CLS. 22 AND 39). REG. 8-20-2002.
- 2,609,744. VIVID BOARD. INT. CL. 16. (U.S. CLS. 2, 5, 22, 23, 29, 37, 38 AND 50). REG. 8-20-2002.
- 2,610,185. P AND DESIGN. INT. CLS. 3, 10, 14 AND 25 ONLY. (U.S. CLS. 1, 2, 4, 6, 22, 26, 27, 28, 39, 44, 50, 51 AND 52). REG. 8-20-2002.
- 2,610,524. NEW FRONTIER MEDIA. INT. CL. 41. (U.S. CLS. 100, 101 AND 107). REG. 8-20-2002.
- 2,610,706. OXY-BLOCK. INT. CL. 5. (U.S. CLS. 6, 18, 44, 46, 51 AND 52). REG. 8-20-2002.
- 2,610,843. UMBRELLA LICENSE. INT. CL. 42. (U.S. CLS. 100 AND 101). REG. 8-20-2002.
- 2,610,953. WORKPLACE GREETINGS. INT. CL. 16. (U.S. CLS. 2, 5, 22, 23, 29, 37, 38 AND 50). REG. 8-20-2002.
- 2,611,340. "WILL THE ROAD YOU'RE ON GET YOU TO MY PLACE?"- GOD. INT. CL. 42. (U.S. CLS. 100 AND 101). REG. 8-27-2002.
- 2,611,374. RIM ARCHITECTS. INT. CL. 42. (U.S. CLS. 100 AND 101). REG. 8-27-2002.
- 2,611,616. MID-AMERICA DENTAL & HEARING CENTER AND DESIGN. INT. CL. 42. (U.S. CLS. 100 AND 101). REG. 8-27-2002.
- 2,611,659. STORMTECH AND DESIGN. INT. CL. 11. (U.S. CLS. 13, 21, 23, 31 AND 34). REG. 8-27-2002.
- 2,611,721. MISCELLANEOUS DESIGN. INT. CLS. 29 AND 30. (U.S. CL. 46). REG. 8-27-2002.
- 2,612,209. GARTNER. INT. CL. 42. (U.S. CLS. 100 AND 101). REG. 8-27-2002.
- 2,612,423. EVERYDAY LIVING. INT. CLS. 4, 11 AND 24 ONLY. (U.S. CLS. 1, 6, 13, 15, 21, 23, 31, 34, 42 AND 50). REG. 8-27-2002.
- 2,612,442. THE TIGER LILY AND DESIGN. INT. CL. 31. (U.S. CLS. 1 AND 46). REG. 8-27-2002.
- 2,612,530. ECONOWOOD (STYLIZED). INT. CL. 20. (U.S. CLS. 2, 13, 22, 25, 32 AND 50). REG. 8-27-2002.
- 2,612,557. MISCELLANEOUS DESIGN. INT. CLS. 36 AND 37. (U.S. CLS. 100, 101, 102, 103 AND 106). REG. 8-27-2002.
- 2,612,939. GET THE CRUNCH. INT. CLS. 29 AND 30. (U.S. CL. 46). REG. 8-27-2002.
- 2,613,273. WEBSPECS. INT. CL. 9. (U.S. CLS. 21, 23, 26, 36 AND 38). REG. 8-27-2002.
- 2,613,894. CHECKCITE. INT. CL. 9. (U.S. CLS. 21, 23, 26, 36 AND 38). REG. 9-3-2002.
- 2,613,910. EORIGINAL THE ELECTRONIC ORIGINAL COMPANY AND DESIGN. INT. CLS. 9, 38 AND 39. (U.S. CLS. 21, 23, 26, 36, 38, 100, 101, 104 AND 105). REG. 9-3-2002.
- 2,614,356. CLIFFORD THE BIG RED DOG. INT. CL. 9. (U.S. CLS. 21, 23, 26, 36 AND 38). REG. 9-3-2002.
- 2,614,452. ALPINE FAX. INT. CLS. 16 AND 42. (U.S. CLS. 2, 5, 22, 23, 29, 37, 38, 50, 100 AND 101). REG. 9-3-2002.
- 2,614,537. MYODYNAMIC REMODELING. INT. CL. 42. (U.S. CLS. 100 AND 101). REG. 9-3-2002.
- 2,614,632. ROOT AND DESIGN. INT. CL. 4. (U.S. CLS. 1, 6 AND 15). REG. 9-3-2002.
- 2,614,647. CITRIX. INT. CLS. 37 AND 42. (U.S. CLS. 100, 101, 103 AND 106). REG. 9-3-2002.
- 2,614,655. CAMWARMER. INT. CL. 21. (U.S. CLS. 2, 13, 23, 29, 30, 33, 40 AND 50). REG. 9-3-2002.
- 2,615,022. THE OUTER TOONS. INT. CL. 41. (U.S. CLS. 100, 101 AND 107). REG. 9-3-2002.
- 2,615,080. SOLEUS AIR (STYLIZED). INT. CL. 11. (U.S. CLS. 13, 21, 23, 31 AND 34). REG. 9-3-2002.
- 2,615,100. CALTEL LONG DISTANCE. INT. CL. 38. (U.S. CLS. 100, 101 AND 104). REG. 9-3-2002.
- 2,615,193. HOT ENGINEERING ... COOL SOFTWARE. INT. CL. 9. (U.S. CLS. 21, 23, 26, 36 AND 38). REG. 9-3-2002.
- 2,615,541. ONE MEDIA. INT. CL. 9. (U.S. CLS. 21, 23, 26, 36 AND 38). REG. 9-3-2002.
- 2,616,442. SUPER SERIES BASEBALL OF AMERICA. INT. CL. 41. (U.S. CLS. 100, 101 AND 107). REG. 9-10-2002.
- 2,616,978. SKILLSERIES. INT. CL. 16 ONLY. (U.S. CLS. 2, 5, 22, 23, 29, 37, 38 AND 50). REG. 9-10-2002.
- 2,617,314. MT. ATHOS GREEN OLIVES. INT. CL. 29. (U.S. CL. 46). REG. 9-10-2002.
- 2,617,682. VIRTUAL PRE-K! AND DESIGN. INT. CL. 41. (U.S. CLS. 100, 101 AND 107). REG. 9-10-2002.
- 2,617,867. ABESOFMAINE.COM. INT. CL. 35. (U.S. CLS. 100, 101 AND 102). REG. 9-10-2002.
- 2,617,954. LINEN NATURALS. INT. CL. 16. (U.S. CLS. 2, 5, 22, 23, 29, 37, 38 AND 50). REG. 9-10-2002.
- 2,618,071. THE JOURNAL OF CLINICAL INVESTIGATION. INT. CL. 16. (U.S. CLS. 2, 5, 22, 23, 29, 37, 38 AND 50). REG. 9-10-2002.
- 2,618,297. HI TRON AND DESIGN. INT. CLS. 9 AND 42. (U.S. CLS. 21, 23, 26, 36, 38, 100 AND 101). REG. 9-10-2002.
- 2,618,462. DOUGH BOY'S CALIFORNIA PIZZA. INT. CL. 42. (U.S. CLS. 100 AND 101). REG. 9-10-2002.
- 2,618,861. CYCLEMANAGER. INT. CL. 9. (U.S. CLS. 21, 23, 26, 36 AND 38). REG. 9-10-2002.
- 2,618,952. CHOICE CONFECTIONS AND DESIGN. INT. CL. 30. (U.S. CL. 46). REG. 9-10-2002.

TM 1844

OFFICIAL GAZETTE

OCTOBER 25, 2011

2,621,081. CLOROX. INT. CL. 21. (U.S. CLS. 2, 13, 23, 29, 30,  
33, 40 AND 50). REG. 9-17-2002.

\* \* \* \* \*

# TRADEMARK REGISTRATIONS CANCELED

The designation "U.S. Cl." appearing in this section refers to the U.S. class in effect prior to Sep. 1, 1973 rather than the international class which applies to applications filed on or after that date. For adoption of international classification see notice in the OFFICIAL GAZETTE of Jun. 26, 1973 (911 O.G. TM 210).

## SECTION 7(D)

- 2,486,615. SMALLBIZSEARCH.COM. INT. CL. 35. REG. 9-11-2001.
- 3,117,748. S SUSHI FRUITI AND DESIGN. INT. CL. 30. REG. 7-18-2006.
- 3,194,692. ACROBAT STANDARD CHARACTER MARK. INT. CL. 33. REG. 1-2-2007.
- 3,327,733. MISCELLANEOUS DESIGN. INT. CL. 25. REG. 10-30-2007.
- 3,697,241. GLOBAL CHILDRENS VILLAGES FOR ORPHANS STANDARD CHARACTER MARK. INT. CL. 35. REG. 10-13-2009.
- 3,738,417. FOOD SHELTER HEALTH MINISTRY STANDARD CHARACTER MARK. INT. CL. 45. REG. 1-12-2010.
- 3,891,836. HUCKN ROLL STANDARD CHARACTER MARK. INT. CL. 35. REG. 12-21-2010.
- 3,895,082. SAFEHOME BY UNIQUE HOME DESIGNS AND DESIGN. INT. CL. 6. REG. 12-21-2010.
- 3,930,336. COLORADO COLORADO COLORADO COLORADO COLORADO AND DESIGN. INT. CL. 25. REG. 3-8-2011.
- 3,960,135. ACADEMIA STANDARD CHARACTER MARK. INT. CL. 25. REG. 5-10-2011.
- 3,989,684. SUMMER HAIRX (STYLIZED). INT. CL. 3. REG. 7-5-2011.
- 2,288,855. WIGGLES AND DESIGN. INT. CL. 42. REG. 10-26-1999.
- 2,306,164. SUBSTANCE ABUSE SPECIALTIES, INC.. INT. CL. 5. REG. 1-4-2000.
- 2,317,934. C MATE. INT. CL. 6. REG. 2-15-2000.
- 2,325,240. TRACCELL. INT. CL. 9. REG. 3-7-2000.
- 2,328,771. PEARL DEPENDABLE DENTAL. INT. CL. 36. REG. 3-14-2000.
- 2,341,920. NATURE'S VOICE. INT. CL. 42. REG. 4-11-2000.
- 2,345,121. PSYCHIC PATHWAYS. INT. CL. 14. REG. 4-25-2000.
- 2,415,196. GARDOFLOC. INT. CL. 42 ONLY. REG. 12-26-2000.
- 2,415,447. IUCN THE WORLD CONSERVATION UNION (STYLIZED). INT. CLS. 16, 41 AND 42. REG. 12-26-2000.
- 2,416,939. GARDOCOOL. INT. CL. 42 ONLY. REG. 1-2-2001.
- 2,416,940. GARDOSTRIP. INT. CL. 42 ONLY. REG. 1-2-2001.
- 2,427,717. LA PAZ. INT. CL. 42. REG. 2-13-2001.
- 2,427,741. AUTO BANC. INT. CL. 35. REG. 2-13-2001.
- 2,427,754. MONDOR CLASSIQUES AND DESIGN. INT. CLS. 18 AND 25. REG. 2-13-2001.
- 2,427,762. JOIN THE ESTHETIC REVOLUTION. INT. CL. 41. REG. 2-13-2001.
- 2,427,771. AMERICASBANK AND DESIGN. INT. CL. 36. REG. 2-13-2001.
- 2,427,776. COMPASS ROSE MEDIA. INT. CL. 35. REG. 2-13-2001.
- 2,427,798. RAINFOREST WORLD. INT. CL. 42. REG. 2-13-2001.
- 2,427,813. WRANGLERS WICHITA AND DESIGN. INT. CLS. 16, 25, 28 AND 41. REG. 2-13-2001.
- 2,427,837. M MECENE (STYLIZED). INT. CL. 25. REG. 2-13-2001.
- 2,427,843. A SECONDARY MARKET FOR REAL ESTATE NOTES AND ALL OTHER CASH FLOWS. INT. CL. 36. REG. 2-13-2001.
- 2,427,858. STEVE PARK. INT. CL. 25. REG. 2-13-2001.
- 2,427,860. DEVA. INT. CLS. 6 AND 20. REG. 2-13-2001.
- 2,427,868. UNEXT.COM. INT. CL. 41. REG. 2-13-2001.
- 2,427,874. FLASHPATH. INT. CL. 9. REG. 2-13-2001.
- 2,427,875. IPP DELTAFLEX. INT. CL. 6. REG. 2-13-2001.
- 2,427,877. AANETCOM (STYLIZED). INT. CL. 35. REG. 2-13-2001.
- 2,427,891. I N M O T I O N PICTURES AND DESIGN. INT. CL. 9. REG. 2-13-2001.
- 2,427,897. BTI. INT. CLS. 36, 38 AND 42. REG. 2-13-2001.
- 2,427,911. INSIDE & OUT (STYLIZED). INT. CL. 16. REG. 2-13-2001.
- 2,427,916. CLOCKWISE. INT. CL. 42. REG. 2-13-2001.
- 2,427,923. DMNI. INT. CL. 42. REG. 2-13-2001.
- 2,427,932. YES. OR KNOW. NOW.. INT. CL. 35. REG. 2-13-2001.
- 2,427,938. LIAISON AND DESIGN. INT. CL. 42. REG. 2-13-2001.
- 2,427,945. INSTITUTIONAL PORTFOLIO CHANNEL. INT. CL. 36. REG. 2-13-2001.
- 2,427,946. INPC. INT. CL. 36. REG. 2-13-2001.
- 2,427,951. SWX. INT. CLS. 9, 16, 35, 36, 38, 41 AND 42. REG. 2-13-2001.
- 2,427,953. CONMET. INT. CL. 9. REG. 2-13-2001.
- 2,427,957. ACCEL FIRE SYSTEMS. INT. CL. 42. REG. 2-13-2001.

## SECTION 8

- 668,134. WHINK AND DESIGN. U.S. CL. 52. REG. 10-7-1958.
- 833,983. PROFESSIONAL SABATIER (STYLIZED). U.S. CL. 23. REG. 8-22-1967.
- 907,360. HAZEL (STYLIZED). U.S. CLS. 3 AND 37. REG. 2-9-1971.
- 918,431. RIPLEY'S BELIEVE IT OR NOT! (STYLIZED). U.S. CL. 28, ONLY. REG. 8-17-1971.
- 1,155,427. DISCOVER THE DIFFERENCE. INT. CL. 9 ONLY. REG. 5-26-1981.
- 1,159,762. HECTOR HEATHCOTE. INT. CL. 16 ONLY. REG. 7-7-1981.
- 1,570,434. LACE RATINGS. INT. CL. 42. REG. 12-5-1989.
- 1,572,611. LACE FINANCIAL CORPORATION. INT. CL. 42. REG. 12-19-1989.
- 1,601,271. VITA-SUN AND DESIGN. INT. CL. 32. REG. 6-12-1990.
- 1,633,063. SUPERNET. INT. CL. 9. REG. 1-29-1991.
- 1,634,783. COSMOTON. INT. CL. 14. REG. 2-12-1991.
- 1,654,136. ENSAR. INT. CLS. 3 AND 21 ONLY. REG. 8-20-1991.
- 1,713,004. AMSCO WINDOWS AND DESIGN. INT. CL. 6 ONLY. REG. 9-8-1992.
- 2,096,573. R.R.I. RHEUMATOLOGY RESEARCH INTERNATIONAL. INT. CL. 42. REG. 9-16-1997.
- 2,281,091. SNUGGLEWOOD. INT. CL. 4. REG. 9-28-1999.
- 2,281,238. JOKER. INT. CL. 11. REG. 9-28-1999.

- 2,427,962. LACTRON AND DESIGN. INT. CLS. 20, 22, 23 AND 24. REG. 2-13-2001.
- 2,427,968. MISCELLANEOUS DESIGN. INT. CL. 37. REG. 2-13-2001.
- 2,427,976. ULTIMATE FLEX. INT. CL. 19. REG. 2-13-2001.
- 2,427,992. LIFE LIGHTS. INT. CL. 4. REG. 2-13-2001.
- 2,428,005. CUEROFLEX (STYLIZED). INT. CL. 18. REG. 2-13-2001.
- 2,428,021. VALENTINO THE MUSICAL AND DESIGN. INT. CLS. 9 AND 41. REG. 2-13-2001.
- 2,428,026. CHANGING YOUR SHAPE FOR THE FUTURE. INT. CL. 42. REG. 2-13-2001.
- 2,428,027. MISCELLANEOUS DESIGN. INT. CL. 42. REG. 2-13-2001.
- 2,428,028. IVILLAGE.COM. INT. CL. 38. REG. 2-13-2001.
- 2,428,029. ADVANTAGE HUMAN RESOURCING (STYLIZED). INT. CL. 35. REG. 2-13-2001.
- 2,428,038. VAULTRACS. INT. CL. 9. REG. 2-13-2001.
- 2,428,039. DT DATATAKER AND DESIGN. INT. CL. 9. REG. 2-13-2001.
- 2,428,041. JUMP FOR THE CAUSE. INT. CL. 36. REG. 2-13-2001.
- 2,428,062. STEIFF KNOPF IM OHR AND DESIGN. INT. CLS. 6, 20 AND 21. REG. 2-13-2001.
- 2,428,071. MISCELLANEOUS DESIGN. INT. CL. 9. REG. 2-13-2001.
- 2,428,072. MISCELLANEOUS DESIGN. INT. CL. 3. REG. 2-13-2001.
- 2,428,079. ILE' AND DESIGN. INT. CL. 14. REG. 2-13-2001.
- 2,428,085. MISCELLANEOUS DESIGN. INT. CL. 35. REG. 2-13-2001.
- 2,428,089. WWW.BBANDT.COM (STYLIZED). INT. CL. 36. REG. 2-13-2001.
- 2,428,093. AMO ASSET MANAGEMENT OUTSOURCING, INC. (STYLIZED). INT. CLS. 35 AND 36. REG. 2-13-2001.
- 2,428,098. CAPITAL EFFECTIVENESS. INT. CL. 36. REG. 2-13-2001.
- 2,428,105. NGT NEW GLOBAL TELECOM, INC. AND DESIGN. INT. CL. 38. REG. 2-13-2001.
- 2,428,112. MLM INDEX. INT. CL. 36. REG. 2-13-2001.
- 2,428,118. PERFECT VOICE PROFESSIONAL. INT. CL. 9. REG. 2-13-2001.
- 2,428,122. SPA GEAR. INT. CL. 35. REG. 2-13-2001.
- 2,428,124. NUVO. INT. CLS. 9, 14, 21 AND 28. REG. 2-13-2001.
- 2,428,136. CLICK TO VERIFY TRUSTE KIDS PRIVACY STATEMENT AND DESIGN. U.S. CL. B. REG. 2-13-2001.
- 2,428,141. RAT TRAP (STYLIZED). INT. CL. 41. REG. 2-13-2001.
- 2,428,143. TWIGGES. INT. CL. 35. REG. 2-13-2001.
- 2,428,149. CACTUS WILLIES STEAK BUFFET & BAKERY. INT. CL. 42. REG. 2-13-2001.
- 2,428,187. ITDECISIONGURU. INT. CL. 9. REG. 2-13-2001.
- 2,428,189. FLOW-TILTER. INT. CL. 7. REG. 2-13-2001.
- 2,428,195. PROFILE, INC. PROFESSIONAL EMPLOYER ORGANIZATION AND DESIGN. INT. CL. 35. REG. 2-13-2001.
- 2,428,209. THE CLEAR CHOICE FOR VALUE.. INT. CLS. 6 AND 19. REG. 2-13-2001.
- 2,428,214. AMERITRUST. INT. CL. 36. REG. 2-13-2001.
- 2,428,220. W W W COWBOY HEAVEN.COM AND DESIGN. INT. CL. 35. REG. 2-13-2001.
- 2,428,221. WWW.COWBOYHEAVEN.COM. INT. CL. 35. REG. 2-13-2001.
- 2,428,222. CHIQUILIBROS. INT. CL. 16. REG. 2-13-2001.
- 2,428,225. THE GOLDEN TRUFFLE AND DESIGN. INT. CL. 42. REG. 2-13-2001.
- 2,428,236. PLANTSPEC. INT. CL. 9. REG. 2-13-2001.
- 2,428,240. RENTCHEX. INT. CL. 9. REG. 2-13-2001.
- 2,428,242. KEEP-INTOUCH. INT. CL. 9. REG. 2-13-2001.
- 2,428,244. PHOTOS NOW! AND DESIGN. INT. CL. 40. REG. 2-13-2001.
- 2,428,246. AIM & DRIVE. INT. CL. 9. REG. 2-13-2001.
- 2,428,260. HUGGY BUGGY AND DESIGN. INT. CL. 28. REG. 2-13-2001.
- 2,428,264. THE HOME DEPOT. INT. CL. 28. REG. 2-13-2001.
- 2,428,268. PAYMENT PROTECTION SYSTEMS. INT. CL. 9. REG. 2-13-2001.
- 2,428,269. DYNAMIC DJ'S. INT. CL. 41. REG. 2-13-2001.
- 2,428,275. SEBRING. INT. CL. 3. REG. 2-13-2001.
- 2,428,276. LET CARE BE OUR LONG TERM COMMITMENT AND DESIGN. INT. CL. 42. REG. 2-13-2001.
- 2,428,285. CHUPAH. INT. CL. 16. REG. 2-13-2001.
- 2,428,287. DISENGAGE. INT. CL. 41. REG. 2-13-2001.
- 2,428,310. THE LONG LOG ADVANTAGE. INT. CL. 42. REG. 2-13-2001.
- 2,428,316. RITE-OVER. INT. CL. 12. REG. 2-13-2001.
- 2,428,322. WATCH US FLY!. INT. CLS. 35 AND 40. REG. 2-13-2001.
- 2,428,331. THE NATURAL SOURCE FOR ELECTRICITY. INT. CL. 9. REG. 2-13-2001.
- 2,428,333. BRASS BRICK HOMES BUILDING INGENUITY ONE BRICK AT A TIME. AND DESIGN. INT. CL. 37. REG. 2-13-2001.
- 2,428,341. PNY TECHNOLOGIES AND DESIGN. INT. CL. 9. REG. 2-13-2001.
- 2,428,351. IMPULSE. INT. CL. 9. REG. 2-13-2001.
- 2,428,355. MISCELLANEOUS DESIGN. INT. CL. 39. REG. 2-13-2001.
- 2,428,377. MABEL'S KITCHEN. INT. CL. 30. REG. 2-13-2001.
- 2,428,387. WOLFEXPRESS. INT. CL. 35. REG. 2-13-2001.
- 2,428,395. MISCELLANEOUS DESIGN. INT. CL. 3. REG. 2-13-2001.
- 2,428,396. GREASE MONKEY. INT. CL. 3. REG. 2-13-2001.
- 2,428,402. ASTOUND AND DESIGN. INT. CL. 38. REG. 2-13-2001.
- 2,428,412. LOCKMYLOAN.COM. INT. CL. 36. REG. 2-13-2001.
- 2,428,419. THE REGGAE SOURCE. INT. CL. 35. REG. 2-13-2001.
- 2,428,424. WONDERGIRL MUSIC AND DESIGN. INT. CL. 9. REG. 2-13-2001.
- 2,428,428. MARY-KATE & ASHLEY (STYLIZED). INT. CL. 41. REG. 2-13-2001.
- 2,428,438. NU-ERA. INT. CL. 35. REG. 2-13-2001.
- 2,428,439. FISHPRO. INT. CL. 42. REG. 2-13-2001.
- 2,428,441. MISCELLANEOUS DESIGN. INT. CL. 37. REG. 2-13-2001.
- 2,428,495. DORITOS AND DESIGN. INT. CL. 30. REG. 2-13-2001.
- 2,428,529. FOR EVERYTHING YOU DO!. INT. CL. 25. REG. 2-13-2001.
- 2,428,539. ABSOLUTE PAPER PROGRAM. INT. CL. 35. REG. 2-13-2001.
- 2,428,541. MISCELLANEOUS DESIGN. INT. CL. 3. REG. 2-13-2001.
- 2,428,555. BELVEDERE BELGIAN STYLE CHOCOLATES. INT. CL. 30. REG. 2-13-2001.
- 2,428,560. ADSTAR.COM. INT. CL. 35. REG. 2-13-2001.
- 2,428,564. MISCELLANEOUS DESIGN. INT. CL. 9. REG. 2-13-2001.
- 2,428,566. A TO Z IMPORTS AND DESIGN. INT. CL. 35. REG. 2-13-2001.
- 2,428,570. Q.WORLD. INT. CL. 38. REG. 2-13-2001.
- 2,428,581. HOUSE OF MOHAN. INT. CL. 3. REG. 2-13-2001.
- 2,428,583. KFA. INT. CL. 36. REG. 2-13-2001.
- 2,428,600. AIG NETADVANTAGE. INT. CL. 36. REG. 2-13-2001.
- 2,428,606. JUSTIFY YOUR EXISTENCE. INT. CLS. 16 AND 42. REG. 2-13-2001.
- 2,428,609. SARA STEPHEN. INT. CL. 25. REG. 2-13-2001.
- 2,428,610. THE CLEAR EDGE (STYLIZED). INT. CL. 9. REG. 2-13-2001.
- 2,428,612. BE, YOU# (K) (STYLIZED). INT. CL. 25. REG. 2-13-2001.
- 2,428,614. OSPREY AND DESIGN. INT. CL. 22. REG. 2-13-2001.
- 2,428,630. BURGLABAR. INT. CL. 20. REG. 2-13-2001.
- 2,428,631. DLOO. INT. CL. 9. REG. 2-13-2001.
- 2,428,637. STARSHIP TROOPERS. INT. CL. 16. REG. 2-13-2001.
- 2,428,644. VICTORY CIGAR. INT. CL. 34. REG. 2-13-2001.

- 2,428,650. RAPID SENSE AND DESIGN. INT. CL. 5. REG. 2-13-2001.
- 2,428,652. AUXIGRO. INT. CL. 1. REG. 2-13-2001.
- 2,428,654. BENEFICIAL BODYWORK AND DESIGN. INT. CL. 42. REG. 2-13-2001.
- 2,428,681. MUSCLE BEACH LEMONADE ESTABLISHED AT HOT DOG ON A STICK 1946 AND DESIGN. INT. CL. 42. REG. 2-13-2001.
- 2,428,688. MACROLOGIX AND DESIGN. INT. CL. 42. REG. 2-13-2001.
- 2,428,699. APOLLO NUTRITION FACTORY. INT. CL. 5. REG. 2-13-2001.
- 2,428,707. HUIITE AND DESIGN. INT. CL. 25. REG. 2-13-2001.
- 2,428,711. MENICON Z AND DESIGN. INT. CL. 9. REG. 2-13-2001.
- 2,428,722. WADEMAN. INT. CL. 14. REG. 2-13-2001.
- 2,428,728. MEGALINK. INT. CL. 10. REG. 2-13-2001.
- 2,428,738. CLEARSOURCE. INT. CLS. 38 AND 42. REG. 2-13-2001.
- 2,428,742. HEAVEN AND MIRTH. INT. CL. 16. REG. 2-13-2001.
- 2,428,743. EASI SHEETS. INT. CL. 16. REG. 2-13-2001.
- 2,428,746. BIQUTZ. INT. CL. 25. REG. 2-13-2001.
- 2,428,748. FLASH. INT. CL. 9. REG. 2-13-2001.
- 2,428,766. CERTIFIED FUME HOOD SPECIALIST AND DESIGN. U.S. CL. A. REG. 2-13-2001.
- 2,428,773. READING IS THE TICKET. INT. CL. 41. REG. 2-13-2001.
- 2,428,774. SIGNATURE WORLD CLASS CANVAS AND DESIGN. INT. CL. 16. REG. 2-13-2001.
- 2,428,781. PINPOINT. INT. CL. 31. REG. 2-13-2001.
- 2,428,786. SIGNATURE. INT. CL. 16. REG. 2-13-2001.
- 2,428,787. CRAFUND ADVISORS, INC.. INT. CL. 36. REG. 2-13-2001.
- 2,428,789. E-COMM2 AND DESIGN. INT. CL. 36. REG. 2-13-2001.
- 2,428,798. SIZEFREE. INT. CL. 25. REG. 2-13-2001.
- 2,428,807. TERRANOVA. INT. CL. 25. REG. 2-13-2001.
- 2,428,808. POLONAISE (STYLIZED). INT. CL. 28. REG. 2-13-2001.
- 2,428,813. THE FINAL TOUCH. INT. CL. 20. REG. 2-13-2001.
- 2,428,830. POLY-RIB. INT. CL. 24. REG. 2-13-2001.
- 2,428,833. SPOOKY COOKIES FROM THE WITCHES' OVEN. INT. CL. 30. REG. 2-13-2001.
- 2,428,835. HHHFRRRGGH. INT. CL. 42. REG. 2-13-2001.
- 2,428,836. KRONOS. INT. CL. 42. REG. 2-13-2001.
- 2,428,839. THE DESI GEESTMAN FOUNDATION. INT. CL. 42. REG. 2-13-2001.
- 2,428,842. VERCITTI. INT. CL. 42. REG. 2-13-2001.
- 2,428,845. X - TRACT. INT. CL. 3. REG. 2-13-2001.
- 2,428,847. IMAGE GRAMMAR. INT. CL. 9. REG. 2-13-2001.
- 2,428,857. RUGGED SAILS. INT. CL. 32. REG. 2-13-2001.
- 2,428,858. BURGER KING AND DESIGN. INT. CL. 9. REG. 2-13-2001.
- 2,428,880. SAVE A MINUTE...SAVE A LIFE. INT. CL. 9. REG. 2-13-2001.
- 2,428,889. BJ PUCK. INT. CL. 21. REG. 2-13-2001.
- 2,428,898. BLUE STREAK. INT. CL. 13. REG. 2-13-2001.
- 2,428,913. HEAVEN'S GIFT. INT. CL. 14. REG. 2-13-2001.
- 2,428,922. PERIMETER. INT. CL. 24. REG. 2-13-2001.
- 2,428,923. CARIBBEAN COVE. INT. CL. 25. REG. 2-13-2001.
- 2,428,924. BAY BREEZE. INT. CL. 25. REG. 2-13-2001.
- 2,428,929. THE CANDLE PANTRY. INT. CLS. 4 AND 21. REG. 2-13-2001.
- 2,428,949. PARTY PRINTS. INT. CL. 25. REG. 2-13-2001.
- 2,428,954. MULTICEUTICAL COMPOUND. INT. CL. 3. REG. 2-13-2001.
- 2,428,964. 14KTONLINE. INT. CL. 14. REG. 2-13-2001.
- 2,428,965. ATLANTIC AIR. INT. CL. 18. REG. 2-13-2001.
- 2,428,975. PAINTFREE DENT REPAIR. INT. CL. 37. REG. 2-13-2001.
- 2,428,981. RIGID/BUS. INT. CL. 9. REG. 2-13-2001.
- 2,428,984. VIDEOSHARE. INT. CL. 9. REG. 2-13-2001.
- 2,428,986. REGISTERED SAFETY OFFICER. INT. CL. 41. REG. 2-13-2001.
- 2,428,987. ORTHODONTIC PRODUCTS. INT. CLS. 16 AND 35. REG. 2-13-2001.
- 2,428,989. REGISTERED ENVIRONMENTAL OFFICER. INT. CL. 41. REG. 2-13-2001.
- 2,428,992. EXPRESS 10. INT. CL. 36. REG. 2-13-2001.
- 2,428,999. LONG ISLAND FUNERAL TRUST. INT. CL. 36. REG. 2-13-2001.
- 2,429,006. HEPAFELT. INT. CL. 24. REG. 2-13-2001.
- 2,429,007. TEXAS ORTHOPEDIC. INT. CL. 16. REG. 2-13-2001.
- 2,429,013. FAMILY & PERFORMANCE BOATING. INT. CL. 16. REG. 2-13-2001.
- 2,450,323. BLOOD ALCOHOL EDUCATOR. INT. CL. 9 ONLY. REG. 5-8-2001.
- 2,455,818. G GYROS AND DESIGN. INT. CL. 16 ONLY. REG. 5-29-2001.
- 2,470,438. COVERAGE WIZARD. INT. CL. 36. REG. 7-17-2001.
- 2,472,979. MISCELLANEOUS DESIGN. INT. CLS. 35 AND 42 ONLY. REG. 7-31-2001.
- 2,484,296. MINIMETRO. INT. CL. 7 ONLY. REG. 9-4-2001.
- 2,490,718. CAMPUS RECORDS. INT. CL. 41 ONLY. REG. 9-18-2001.
- 2,491,085. PIZZA INN AND DESIGN. INT. CL. 30 ONLY. REG. 9-18-2001.
- 2,491,206. ACRILEX. INT. CL. 16 ONLY. REG. 9-18-2001.
- 2,491,303. 56. INT. CLS. 4, 6, 18 AND 24 ONLY. REG. 9-18-2001.
- 2,491,498. YAHOO!. INT. CLS. 9, 14 AND 16 ONLY. REG. 9-18-2001.
- 2,493,141. GUITAR RESEARCH. INT. CLS. 3, 8 AND 9 ONLY. REG. 9-25-2001.
- 2,493,215. ENVIRONMENTAL DEFENSE. INT. CL. 42 ONLY. REG. 9-25-2001.
- 2,497,999. QVC PRODUCTWORKS. INT. CL. 35. REG. 10-16-2001.
- 2,503,234. FRONIUS. INT. CLS. 1 AND 6 ONLY. REG. 10-30-2001.
- 2,516,047. SATURDAY NIGHT FEVER. INT. CLS. 14, 16, 21, 25, 28 AND 41 ONLY. REG. 12-11-2001.
- 2,523,318. PANORAMA AND DESIGN. INT. CL. 41 ONLY. REG. 12-25-2001.
- 2,535,179. TWIN CAM 88. INT. CL. 25 ONLY. REG. 2-5-2002.
- 2,538,443. L-VIS. INT. CL. 9 ONLY. REG. 2-12-2002.
- 2,616,978. SKILLSERIES. INT. CL. 9 ONLY. REG. 9-10-2002.
- 2,642,475. RA-H AND DESIGN. INT. CL. 5. REG. 10-29-2002.
- 2,665,371. AIRCAPT AND DESIGN. INT. CL. 9. REG. 12-24-2002.
- 2,673,060. POWER BUYING DEALERS USA. INT. CL. 25. REG. 1-7-2003.
- 2,683,453. OFFICEBYDESIGN.COM. INT. CL. 35. REG. 2-4-2003.
- 2,701,276. SANSTAR SANITARY WARE AND DESIGN. INT. CL. 11. REG. 3-25-2003.
- 2,704,867. SETTLE. INT. CL. 41. REG. 4-8-2003.
- 2,730,054. SPORTS EXPRESS. INT. CLS. 35 AND 39. REG. 6-24-2003.
- 2,736,425. MINDFUL MEDICINE. INT. CL. 41. REG. 7-15-2003.
- 2,736,736. TOUCHED BY THE SUN. INT. CLS. 3 AND 35. REG. 7-15-2003.
- 2,794,253. CHO DANG TOFU RESTAURANT. INT. CL. 43. REG. 12-16-2003.
- 2,808,545. DORMEO. INT. CL. 20. REG. 1-27-2004.
- 2,830,403. STEVIADENT (STYLIZED). INT. CL. 5. REG. 4-6-2004.
- 2,890,480. 4 GIRLS. INT. CL. 3. REG. 9-28-2004.
- 2,912,667. TOMAURO. INT. CL. 16. REG. 12-21-2004.
- 2,921,914. Z-MAP. INT. CL. 9 ONLY. REG. 2-1-2005.
- 2,922,439. ABBEY ROSE STANDARD CHARACTER MARK. INT. CL. 3. REG. 2-1-2005.
- 2,924,757. ACCESS TO YOUR MONEY ... ANYWHERE, ANYTIME. INT. CL. 36. REG. 2-8-2005.
- 2,926,119. ENERCON. INT. CLS. 7 AND 11. REG. 2-15-2005.
- 2,926,124. STEVIES BY STEVE MADDEN. INT. CL. 28. REG. 2-15-2005.
- 2,926,127. VENTAVIS. INT. CLS. 5 AND 10. REG. 2-15-2005.
- 2,926,135. MISCELLANEOUS DESIGN. INT. CL. 42. REG. 2-15-2005.
- 2,926,145. LEOPARD. INT. CLS. 7, 9 AND 16. REG. 2-15-2005.

- 2,926,154. HIGHRIDGE. INT. CL. 36. REG. 2-15-2005.
- 2,926,156. J JOHNSON TRUST AND DESIGN. INT. CL. 36. REG. 2-15-2005.
- 2,926,183. ONE SOURCE. INT. CL. 36. REG. 2-15-2005.
- 2,926,204. BJ'S REWARDS MEMBERSHIP. INT. CL. 35. REG. 2-15-2005.
- 2,926,217. FIRTAIDE AND DESIGN. INT. CL. 5. REG. 2-15-2005.
- 2,926,293. ISPSOFT. INT. CLS. 35, 37 AND 42. REG. 2-15-2005.
- 2,926,295. BIRKORTHOPEDIC. INT. CL. 10. REG. 2-15-2005.
- 2,926,300. COLLAGE. INT. CL. 21. REG. 2-15-2005.
- 2,926,301. ANCH ANKH AND DESIGN. INT. CLS. 14, 16, 18 AND 25. REG. 2-15-2005.
- 2,926,302. RICEM. INT. CLS. 17, 19 AND 22. REG. 2-15-2005.
- 2,926,311. FIBRESTAR. INT. CL. 9. REG. 2-15-2005.
- 2,926,331. THE FOUNTAIN FACTORY. INT. CL. 11. REG. 2-15-2005.
- 2,926,367. SOBE DRAGON AND DESIGN. INT. CL. 32. REG. 2-15-2005.
- 2,926,381. WEAR LUCK FOLLOWING FENG SHUI FUNDAMENTALS FOR COLOR, DESIGN AND THEORY STANDARD CHARACTER MARK. INT. CL. 25. REG. 2-15-2005.
- 2,926,456. COLIMACON AND DESIGN. INT. CLS. 24 AND 25. REG. 2-15-2005.
- 2,926,457. PINPOINT. INT. CL. 9. REG. 2-15-2005.
- 2,926,459. GZHELKA VODKA OF RUSSIA AND DESIGN. INT. CL. 33. REG. 2-15-2005.
- 2,926,460. POWER POP. INT. CLS. 28 AND 30. REG. 2-15-2005.
- 2,926,463. TELETRAK. INT. CL. 9. REG. 2-15-2005.
- 2,926,467. THOMSON LEARNING. INT. CL. 35. REG. 2-15-2005.
- 2,926,469. MULTIBASE. INT. CL. 19. REG. 2-15-2005.
- 2,926,470. AQUA MIST STANDARD CHARACTER MARK. INT. CL. 32. REG. 2-15-2005.
- 2,926,474. BIOSIGHT. INT. CL. 9. REG. 2-15-2005.
- 2,926,476. COME ALIVE AND DESIGN. INT. CL. 30. REG. 2-15-2005.
- 2,926,478. PROMOMENU. INT. CL. 35. REG. 2-15-2005.
- 2,926,479. CARTER'S AND DESIGN. INT. CLS. 12, 16, 20, 24, 25 AND 28. REG. 2-15-2005.
- 2,926,484. RESUPPLY. INT. CL. 5. REG. 2-15-2005.
- 2,926,485. SULEND. INT. CL. 5. REG. 2-15-2005.
- 2,926,486. CONVERGE MEDICAL. INT. CL. 10. REG. 2-15-2005.
- 2,926,487. JUNGLE-TRIBE. INT. CL. 31. REG. 2-15-2005.
- 2,926,489. REDEFINING DINING. INT. CLS. 35 AND 42. REG. 2-15-2005.
- 2,926,490. COMPHONIX. INT. CL. 16. REG. 2-15-2005.
- 2,926,491. SPI SMARTSERVER. INT. CL. 36. REG. 2-15-2005.
- 2,926,496. WE LOOK FORWARD TO YOUR RETURN.. INT. CL. 35. REG. 2-15-2005.
- 2,926,497. ONE FIELD, TWO PAYDAYS. INT. CL. 31. REG. 2-15-2005.
- 2,926,499. INDOORGPS. INT. CL. 9. REG. 2-15-2005.
- 2,926,500. DIRTY SANCHEZ. INT. CLS. 9 AND 41. REG. 2-15-2005.
- 2,926,501. FINDIT. INT. CL. 25. REG. 2-15-2005.
- 2,926,502. BIOSTEEL. INT. CL. 1. REG. 2-15-2005.
- 2,926,504. WASHINGTON MUTUAL. INT. CL. 41. REG. 2-15-2005.
- 2,926,505. BATTERY LIFEPRESERVER. INT. CL. 9. REG. 2-15-2005.
- 2,926,506. COLORLAST SDXL NYLON. INT. CL. 23. REG. 2-15-2005.
- 2,926,507. FULLUM & HOLT AND DESIGN. INT. CLS. 16, 18 AND 25. REG. 2-15-2005.
- 2,926,508. C CROSS (STYLIZED). INT. CL. 9. REG. 2-15-2005.
- 2,926,509. LOGOMETRIX. INT. CL. 9. REG. 2-15-2005.
- 2,926,510. M AND DESIGN. INT. CL. 9. REG. 2-15-2005.
- 2,926,518. IMAGION. INT. CL. 30. REG. 2-15-2005.
- 2,926,520. TAICHIFIT. INT. CL. 41. REG. 2-15-2005.
- 2,926,521. PILATESFIT. INT. CL. 41. REG. 2-15-2005.
- 2,926,524. SITEONE ON SITE. ON LINE. ON TIME. AND DESIGN. INT. CL. 37. REG. 2-15-2005.
- 2,926,525. TRELLEBORG WHEEL SYSTEMS. INT. CL. 12. REG. 2-15-2005.
- 2,926,530. AUNT EMMA'S PREMIUM DELI AND DESIGN. INT. CL. 29. REG. 2-15-2005.
- 2,926,532. M.Q.. INT. CL. 41. REG. 2-15-2005.
- 2,926,534. SIFI (STYLIZED). INT. CL. 9. REG. 2-15-2005.
- 2,926,535. MAN-TAN. INT. CL. 3. REG. 2-15-2005.
- 2,926,540. BIGSHOT MOVIES. INT. CL. 9. REG. 2-15-2005.
- 2,926,542. FAT-CHANGE. INT. CL. 5. REG. 2-15-2005.
- 2,926,543. EMPHASYS AND DESIGN. INT. CL. 10. REG. 2-15-2005.
- 2,926,547. TRIVIATOR. INT. CL. 41. REG. 2-15-2005.
- 2,926,548. ROCK U. INT. CL. 41. REG. 2-15-2005.
- 2,926,552. CARD MOUSE. INT. CL. 9. REG. 2-15-2005.
- 2,926,553. MISCELLANEOUS DESIGN. INT. CL. 5. REG. 2-15-2005.
- 2,926,554. SOLVER PAINTS. INT. CL. 2. REG. 2-15-2005.
- 2,926,557. DISPLAY COMMANDER. INT. CL. 9. REG. 2-15-2005.
- 2,926,559. TELEVOICE. INT. CL. 9. REG. 2-15-2005.
- 2,926,560. JOW ORIGINAL WORKBOOTS JUSTIN BOOTS AND DESIGN. INT. CL. 25. REG. 2-15-2005.
- 2,926,561. DESTINATION LAB AND DESIGN. INT. CL. 41. REG. 2-15-2005.
- 2,926,562. WEBCHEMDRILL. INT. CL. 42. REG. 2-15-2005.
- 2,926,563. INNOVATIVE CHEMISTRY SOFTWARE. INT. CL. 42. REG. 2-15-2005.
- 2,926,566. WORLD CULINARY INSTITUTE AND DESIGN. INT. CL. 41. REG. 2-15-2005.
- 2,926,577. TRIPLE PLAY. INT. CL. 36. REG. 2-15-2005.
- 2,926,579. CADET GOLF. INT. CL. 28. REG. 2-15-2005.
- 2,926,581. BACALETTE STANDARD CHARACTER MARK. INT. CL. 28. REG. 2-15-2005.
- 2,926,582. QI QUALITY INTERNATIONAL. INT. CL. 41. REG. 2-15-2005.
- 2,926,584. MY Q (STYLIZED). INT. CL. 9. REG. 2-15-2005.
- 2,926,585. MY Q. INT. CL. 9. REG. 2-15-2005.
- 2,926,586. COMFORT TECH. INT. CL. 44. REG. 2-15-2005.
- 2,926,588. NANO-TEX AND DESIGN. INT. CL. 1. REG. 2-15-2005.
- 2,926,590. HIGH ON LIFE. INT. CL. 28. REG. 2-15-2005.
- 2,926,593. CUSTOMER COMMITTED C 2 AND DESIGN. INT. CL. 36. REG. 2-15-2005.
- 2,926,595. EVENT DRIVEN CCTV AND DESIGN. INT. CL. 9. REG. 2-15-2005.
- 2,926,597. AMERICAN HIGHER ED INC AND DESIGN. INT. CL. 41. REG. 2-15-2005.
- 2,926,598. SMYLOS. INT. CL. 31. REG. 2-15-2005.
- 2,926,603. NO BOUNDARIES. INT. CL. 20. REG. 2-15-2005.
- 2,926,607. CYTOSOURCE. INT. CLS. 5 AND 10. REG. 2-15-2005.
- 2,926,608. GENESEED. INT. CLS. 5 AND 10. REG. 2-15-2005.
- 2,926,609. GENESOURCE. INT. CLS. 5 AND 10. REG. 2-15-2005.
- 2,926,610. CYTOSEED. INT. CLS. 5 AND 10. REG. 2-15-2005.
- 2,926,611. AFF ACTIVE FULLSCREEN FUNCTION AND DESIGN. INT. CL. 9. REG. 2-15-2005.
- 2,926,613. HOT WHEELS HIGHWAY 35 AND DESIGN. INT. CL. 28. REG. 2-15-2005.
- 2,926,618. WE ARE ALL NEW YORKERS. INT. CL. 25. REG. 2-15-2005.
- 2,926,619. SMOOTH STROKE EXPERIENCE THE CONFIDENCE. INT. CL. 3. REG. 2-15-2005.
- 2,926,622. NANOWORKS. INT. CL. 9. REG. 2-15-2005.
- 2,926,623. PROTECT YOUR ART. INT. CL. 3. REG. 2-15-2005.
- 2,926,624. SPUR TECHNOLOGIES. INT. CL. 42. REG. 2-15-2005.
- 2,926,625. ORDER IT TODAY, GET IT TODAY AND DESIGN. INT. CLS. 35 AND 39. REG. 2-15-2005.
- 2,926,626. NFP. INT. CL. 7. REG. 2-15-2005.
- 2,926,627. CAVATINI. INT. CL. 25. REG. 2-15-2005.
- 2,926,632. MANGROVE SYSTEMS. INT. CL. 9. REG. 2-15-2005.
- 2,926,634. 2DS. INT. CL. 19. REG. 2-15-2005.
- 2,926,636. MAMMOTH GRIP SPRINKLER SPACER AND DESIGN. INT. CL. 20. REG. 2-15-2005.

- 2,926,637. ADVISOR'S RESOURCE. INT. CL. 9. REG. 2-15-2005.
- 2,926,638. BOSLEY HEALTHY HAIR. INT. CLS. 3 AND 44. REG. 2-15-2005.
- 2,926,639. TIM. INT. CLS. 9, 37 AND 41. REG. 2-15-2005.
- 2,926,640. JETFRESH. INT. CL. 5. REG. 2-15-2005.
- 2,926,641. THE CHARITABLE PARTNERS PROGRAM. INT. CL. 36. REG. 2-15-2005.
- 2,926,643. MAPICS AND DESIGN. INT. CLS. 9 AND 42. REG. 2-15-2005.
- 2,926,645. BERTOLLI LUCCA AND DESIGN. INT. CL. 30. REG. 2-15-2005.
- 2,926,647. SS3. INT. CL. 9. REG. 2-15-2005.
- 2,926,649. BEE-GUARDED (STYLIZED). INT. CL. 21. REG. 2-15-2005.
- 2,926,650. AI EXPERT. INT. CL. 16. REG. 2-15-2005.
- 2,926,654. PERSONAL PLAY. INT. CL. 28. REG. 2-15-2005.
- 2,926,656. MISCELLANEOUS DESIGN. INT. CL. 9. REG. 2-15-2005.
- 2,926,657. ELMER'S TEACHERS' FINEST. INT. CL. 16. REG. 2-15-2005.
- 2,926,658. SECURFILM. INT. CL. 17. REG. 2-15-2005.
- 2,926,660. JOE COTTON. INT. CL. 25. REG. 2-15-2005.
- 2,926,662. SILKSATIONS. INT. CL. 14. REG. 2-15-2005.
- 2,926,663. FLAVOR ADVENTURES. INT. CLS. 29 AND 30. REG. 2-15-2005.
- 2,926,664. THE FLAVOR PEOPLE. INT. CLS. 29 AND 30. REG. 2-15-2005.
- 2,926,666. GREAT TASTE SMART SNACK AND DESIGN. INT. CLS. 29 AND 30. REG. 2-15-2005.
- 2,926,667. KOOL TOYZ AND DESIGN. INT. CL. 28. REG. 2-15-2005.
- 2,926,668. KOOL TOYZ. INT. CL. 28. REG. 2-15-2005.
- 2,926,670. CENTURY FIBRE. INT. CL. 29. REG. 2-15-2005.
- 2,926,671. CROWN INTERNATIONAL STEEL BUILDING SYSTEMS. INT. CLS. 35 AND 41. REG. 2-15-2005.
- 2,926,674. ICE-A-COOKIE. INT. CL. 21. REG. 2-15-2005.
- 2,926,675. TONI TWIST. INT. CL. 26. REG. 2-15-2005.
- 2,926,676. CHESAPEAKE ORGANICS WE PUT LIFE IN YOUR SOIL! AND DESIGN. INT. CL. 1. REG. 2-15-2005.
- 2,926,677. JACKSON & PERKINS. INT. CLS. 1, 8, 21 AND 31. REG. 2-15-2005.
- 2,926,678. PLUSH TOUCH. INT. CL. 25. REG. 2-15-2005.
- 2,926,680. MOBILE-LINK. INT. CL. 9. REG. 2-15-2005.
- 2,926,681. CAN-Z. INT. CL. 1. REG. 2-15-2005.
- 2,926,682. CAN-Z PAC. INT. CL. 1. REG. 2-15-2005.
- 2,926,685. SKIN ESSENTIALS. INT. CL. 44. REG. 2-15-2005.
- 2,926,688. DIPTOS. INT. CL. 30. REG. 2-15-2005.
- 2,926,689. CRESCENT AND DESIGN. INT. CL. 25. REG. 2-15-2005.
- 2,926,690. TRIPLE PLAY. INT. CL. 5. REG. 2-15-2005.
- 2,926,691. THE \$99 FURNITURE STORE & ACCESSORIES AND DESIGN. INT. CL. 35. REG. 2-15-2005.
- 2,926,693. SUNSET SOFTBOARDS AND DESIGN. INT. CL. 28. REG. 2-15-2005.
- 2,926,696. CRASH FORCE. INT. CL. 28. REG. 2-15-2005.
- 2,926,697. BRIDGES TO EXCELLENCE DIABETES CARE REWARDS REWARDING QUALITY ACROSS THE HEALTHCARE SYSTEM AND DESIGN. INT. CL. 35. REG. 2-15-2005.
- 2,926,698. GARDEN PARTY. INT. CL. 21. REG. 2-15-2005.
- 2,926,699. BLOOMERS. INT. CL. 21. REG. 2-15-2005.
- 2,926,701. SUPERLITE. INT. CL. 16. REG. 2-15-2005.
- 2,926,704. APPERA. INT. CL. 3. REG. 2-15-2005.
- 2,926,707. JUMBO BOLD. INT. CL. 31. REG. 2-15-2005.
- 2,926,708. BABY BOLD. INT. CL. 31. REG. 2-15-2005.
- 2,926,709. VIRTUAL LEARNING INSTITUTE AND DESIGN. INT. CLS. 9 AND 41. REG. 2-15-2005.
- 2,926,713. SURE CLEAN. INT. CL. 7. REG. 2-15-2005.
- 2,926,714. DIGITALOPE. INT. CL. 9. REG. 2-15-2005.
- 2,926,716. UNEARTH THE POSSIBILITIES. INT. CL. 31. REG. 2-15-2005.
- 2,926,720. TUTTI FRUTTI. INT. CL. 28. REG. 2-15-2005.
- 2,926,721. WEBSECRET. INT. CL. 9. REG. 2-15-2005.
- 2,926,723. NUPRESERV 2000. INT. CLS. 1 AND 5. REG. 2-15-2005.
- 2,926,726. STEVEN. INT. CL. 26. REG. 2-15-2005.
- 2,926,731. MY CAR, MY CHOICE. INT. CL. 35. REG. 2-15-2005.
- 2,926,732. GLOBAL BALANCE AND DESIGN. INT. CL. 9. REG. 2-15-2005.
- 2,926,734. CROSS TERRAIN. INT. CL. 18. REG. 2-15-2005.
- 2,926,735. THE LIVING LAB. INT. CL. 35. REG. 2-15-2005.
- 2,926,738. BOW LEGGER. INT. CL. 28. REG. 2-15-2005.
- 2,926,740. COMFORT COMMAND AND DESIGN. INT. CL. 25. REG. 2-15-2005.
- 2,926,741. RB ROOL AND DESIGN. INT. CL. 25. REG. 2-15-2005.
- 2,926,742. CRYSTALEZE. INT. CL. 14. REG. 2-15-2005.
- 2,926,743. ON-TIME ADVANTAGE. INT. CL. 36. REG. 2-15-2005.
- 2,926,744. MISCELLANEOUS DESIGN. INT. CL. 33. REG. 2-15-2005.
- 2,926,749. WELL WEIGHS. INT. CL. 36. REG. 2-15-2005.
- 2,926,753. PROMISE KIDS. INT. CL. 41. REG. 2-15-2005.
- 2,926,755. XYTEX OVATIONS. INT. CL. 44. REG. 2-15-2005.
- 2,926,756. UPLAC. INT. CL. 29. REG. 2-15-2005.
- 2,926,757. INSPIRATION MEDICAL SPA. INT. CL. 44. REG. 2-15-2005.
- 2,926,760. PLAIN-VU. INT. CL. 34. REG. 2-15-2005.
- 2,926,762. CHOICE CAPS. INT. CL. 6. REG. 2-15-2005.
- 2,926,764. SUNDAY'S FINEST. INT. CL. 30. REG. 2-15-2005.
- 2,926,767. POLLCAT. INT. CL. 12. REG. 2-15-2005.
- 2,926,768. ACOUSTIKAL. INT. CL. 25. REG. 2-15-2005.
- 2,926,774. DINNER SOLUTION. INT. CL. 43. REG. 2-15-2005.
- 2,926,775. FAGDOG. INT. CL. 16. REG. 2-15-2005.
- 2,926,777. MYSTAR VIDEO. INT. CL. 41. REG. 2-15-2005.
- 2,926,780. DEEP FORCE. INT. CL. 9. REG. 2-15-2005.
- 2,926,781. IT'S ALL THAT. INT. CL. 3. REG. 2-15-2005.
- 2,926,784. DURAWAY STANDARD CHARACTER MARK. INT. CL. 19. REG. 2-15-2005.
- 2,926,786. LOYALTY YEARS STANDARD CHARACTER MARK. INT. CL. 35. REG. 2-15-2005.
- 2,926,787. ATMOS ENERGY AND DESIGN. INT. CL. 36. REG. 2-15-2005.
- 2,926,789. PHYS. ED. FUNK. INT. CLS. 9, 12 AND 28. REG. 2-15-2005.
- 2,926,791. JAZZ MESSENGER. INT. CL. 41. REG. 2-15-2005.
- 2,926,792. MASTERFOODSUSA AND DESIGN. INT. CL. 30. REG. 2-15-2005.
- 2,926,793. TELEMICS. INT. CLS. 9, 37 AND 42. REG. 2-15-2005.
- 2,926,794. LIFEIMAGER. INT. CLS. 1, 9 AND 10. REG. 2-15-2005.
- 2,926,797. MISCELLANEOUS DESIGN. INT. CLS. 25 AND 41. REG. 2-15-2005.
- 2,926,802. MISCELLANEOUS DESIGN. INT. CL. 5. REG. 2-15-2005.
- 2,926,803. OPEN SKY. INT. CL. 42. REG. 2-15-2005.
- 2,926,804. THE CARD THAT'S AS SMART AS I WANT IT TO BE. INT. CL. 36. REG. 2-15-2005.
- 2,926,805. SIMFINDER. INT. CL. 35. REG. 2-15-2005.
- 2,926,807. INTERLUDE. INT. CL. 5. REG. 2-15-2005.
- 2,926,808. ANDROMEDA 2500. INT. CL. 28. REG. 2-15-2005.
- 2,926,811. LEE PIPES AND DESIGN. INT. CLS. 18 AND 25. REG. 2-15-2005.
- 2,926,812. CALMATRIX. INT. CL. 10. REG. 2-15-2005.
- 2,926,816. OCEAN DRIVE. INT. CLS. 3 AND 16. REG. 2-15-2005.
- 2,926,818. SATALINK. INT. CL. 9. REG. 2-15-2005.
- 2,926,819. EASY TRACK AND DESIGN. INT. CL. 9. REG. 2-15-2005.
- 2,926,820. ENGENUITY. INT. CLS. 36 AND 41. REG. 2-15-2005.
- 2,926,825. PIONEERSERVICECOMPANY.BIZ. INT. CL. 9. REG. 2-15-2005.
- 2,926,827. CARRIERBOND. INT. CL. 1. REG. 2-15-2005.
- 2,926,829. LIVE YOUR FREQUENCY. INT. CL. 25. REG. 2-15-2005.
- 2,926,831. UNITEDNATIONAL MORTGAGE, CORP. AND DESIGN. INT. CL. 36. REG. 2-15-2005.
- 2,926,832. ALERTWORKS. INT. CL. 9. REG. 2-15-2005.
- 2,926,835. FORMLOCK. INT. CL. 7. REG. 2-15-2005.

- 2,926,836. H TO O HOPE TO OTHERS. INT. CL. 16. REG. 2-15-2005.
- 2,926,837. H TO O HOPE TO OTHERS. INT. CL. 36. REG. 2-15-2005.
- 2,926,839. DATASHOT. INT. CL. 9. REG. 2-15-2005.
- 2,926,842. LUCKY STROKE. INT. CLS. 25 AND 28. REG. 2-15-2005.
- 2,926,843. MARTHA STEWART SIGNATURE. INT. CL. 20. REG. 2-15-2005.
- 2,926,845. WORLDTRAVEL MEETINGS & INCENTIVES AND DESIGN. INT. CLS. 39, 42 AND 43. REG. 2-15-2005.
- 2,926,846. TRUDENTAL. INT. CL. 44. REG. 2-15-2005.
- 2,926,847. FASTMETRICS. INT. CLS. 38 AND 42. REG. 2-15-2005.
- 2,926,848. CONOZCA SU SALUD. INT. CLS. 16 AND 44. REG. 2-15-2005.
- 2,926,850. WCCF AND DESIGN. INT. CL. 41. REG. 2-15-2005.
- 2,926,851. AIG PREMIER PPVUL. INT. CL. 36. REG. 2-15-2005.
- 2,926,854. CENTRE FOR AESTHETICS, REJUVENATION & ENHANCEMENT (CARE). INT. CL. 44. REG. 2-15-2005.
- 2,926,856. MERRYVILLE. INT. CL. 21. REG. 2-15-2005.
- 2,926,859. RAS. INT. CL. 42. REG. 2-15-2005.
- 2,926,864. H&W SMOKEHOUSE. INT. CL. 30. REG. 2-15-2005.
- 2,926,867. GENIE U. INT. CL. 41. REG. 2-15-2005.
- 2,926,869. SECRET SISTER. INT. CL. 16. REG. 2-15-2005.
- 2,926,871. EMERGING HEALTH INFORMATION TECHNOLOGY HT AND DESIGN. INT. CL. 35. REG. 2-15-2005.
- 2,926,872. EXPAND IT AND DESIGN. INT. CLS. 7 AND 8. REG. 2-15-2005.
- 2,926,873. TOWN & COUNTRY ELECTRIC. INT. CL. 37. REG. 2-15-2005.
- 2,926,875. FORENSICIQ. INT. CL. 9. REG. 2-15-2005.
- 2,926,880. FITWORKS AND DESIGN. INT. CL. 44. REG. 2-15-2005.
- 2,926,883. SNAKE HUNTER. INT. CL. 28. REG. 2-15-2005.
- 2,926,884. PIZZA SCREENS. INT. CL. 21. REG. 2-15-2005.
- 2,926,885. DYNAMIC PROCESS. INT. CL. 9. REG. 2-15-2005.
- 2,926,888. WORK EASIER. LIVE EASIER.. INT. CL. 16. REG. 2-15-2005.
- 2,926,889. INFINI-AVAILABILITY. INT. CL. 9. REG. 2-15-2005.
- 2,926,890. PURE CREATE AND DESIGN. INT. CL. 9. REG. 2-15-2005.
- 2,926,891. RICOCHET. INT. CL. 20. REG. 2-15-2005.
- 2,926,893. DREXEL HERITAGE HOME ACCENTS. INT. CL. 27. REG. 2-15-2005.
- 2,926,894. KLORIGEN. INT. CL. 11. REG. 2-15-2005.
- 2,926,895. EVERYBODY PLAYS. INT. CL. 28. REG. 2-15-2005.
- 2,926,896. GFLER. INT. CL. 9. REG. 2-15-2005.
- 2,926,897. DIRECTDIALOGUE. INT. CL. 36. REG. 2-15-2005.
- 2,926,898. FASU. INT. CLS. 1 AND 5. REG. 2-15-2005.
- 2,926,902. ROCK U AND DESIGN. INT. CL. 41. REG. 2-15-2005.
- 2,926,909. VENTANA HOMES. INT. CL. 37. REG. 2-15-2005.
- 2,926,913. VACATION ESSENTIALS. INT. CL. 45. REG. 2-15-2005.
- 2,926,914. ESSENTIALS FOR VACATIONERS. INT. CL. 45. REG. 2-15-2005.
- 2,926,915. ACHIEVEMARK. INT. CL. 41. REG. 2-15-2005.
- 2,926,917. YOUR HOME SUPERSTORE. INT. CL. 36. REG. 2-15-2005.
- 2,926,918. ENETRIX TECHNOLOGIES. INT. CL. 42. REG. 2-15-2005.
- 2,926,919. FX@BTM. INT. CL. 36. REG. 2-15-2005.
- 2,926,921. KORET IMPRESSIONS. INT. CL. 25. REG. 2-15-2005.
- 2,926,922. YOUR ULTIMATE PLAN DESIGN. INT. CL. 42. REG. 2-15-2005.
- 2,926,925. FORTRESS AMERICA. INT. CL. 45. REG. 2-15-2005.
- 2,926,926. HOME SPEC. INT. CL. 9. REG. 2-15-2005.
- 2,926,928. MEDI-TIMER. INT. CL. 10. REG. 2-15-2005.
- 2,926,930. EUROTRASH. INT. CL. 14. REG. 2-15-2005.
- 2,926,935. ENVIROAD MAG. INT. CL. 1. REG. 2-15-2005.
- 2,926,936. ENVIROAD GARD. INT. CL. 1. REG. 2-15-2005.
- 2,926,937. ENVIROTHAW ELITE. INT. CL. 1. REG. 2-15-2005.
- 2,926,939. ROYAL HIP R & V AND DESIGN. INT. CL. 14. REG. 2-15-2005.
- 2,926,940. DVMK. INT. CL. 35. REG. 2-15-2005.
- 2,926,942. UNIPAD. INT. CL. 9. REG. 2-15-2005.
- 2,926,943. DROP SHOT. INT. CL. 43. REG. 2-15-2005.
- 2,926,945. GAME ENJOYMENT SYSTEM STANDARD CHARACTER MARK. INT. CL. 28. REG. 2-15-2005.
- 2,926,947. ENRICO VISCONTI. INT. CL. 25. REG. 2-15-2005.
- 2,926,953. BEAUTIFUL WINDOW COVERINGS. INT. CL. 24. REG. 2-15-2005.
- 2,926,954. AROMALIGHT. INT. CL. 11. REG. 2-15-2005.
- 2,926,959. WHATEVER YOUR DREAM, WE HAVE YOU COVERED. INT. CL. 36. REG. 2-15-2005.
- 2,926,960. RIM SKIN. INT. CL. 28. REG. 2-15-2005.
- 2,926,963. WONDERFUL GRAFFITI. INT. CLS. 16 AND 42. REG. 2-15-2005.
- 2,926,964. VINOTES. INT. CL. 16. REG. 2-15-2005.
- 2,926,965. BEYOND GOOD! BRAND (STYLIZED). INT. CL. 29. REG. 2-15-2005.
- 2,926,968. EXPAND YOUR SCOPE. INT. CL. 36. REG. 2-15-2005.
- 2,926,969. C. V. STARR & CO. AND DESIGN. INT. CL. 36. REG. 2-15-2005.
- 2,926,977. COZY GLOW NIGHTLIGHT. INT. CL. 11. REG. 2-15-2005.
- 2,926,979. GOOD OL' HOME COOKIN' IN A CAN. INT. CL. 29. REG. 2-15-2005.
- 2,926,980. FIDELITY RETIREMENT NETWORK. INT. CL. 35. REG. 2-15-2005.
- 2,926,981. WILD DUCK. INT. CL. 24. REG. 2-15-2005.
- 2,926,982. CONVERTX (STYLIZED). INT. CL. 9. REG. 2-15-2005.
- 2,926,983. GIGAREC (STYLIZED). INT. CL. 9. REG. 2-15-2005.
- 2,926,984. SECUREC (STYLIZED). INT. CL. 9. REG. 2-15-2005.
- 2,926,985. Q-CHECK (STYLIZED). INT. CL. 9. REG. 2-15-2005.
- 2,926,987. STRAE HALO. INT. CL. 41. REG. 2-15-2005.
- 2,926,993. WITHIT. INT. CL. 9. REG. 2-15-2005.
- 2,926,996. CARTRIDGE WEB AND DESIGN. INT. CL. 2. REG. 2-15-2005.
- 2,926,997. CANDURA. INT. CL. 19. REG. 2-15-2005.
- 2,926,998. IT'S NOT DISEASE MANAGEMENT. IT'S LIFE IMPROVEMENT.. INT. CL. 44. REG. 2-15-2005.
- 2,926,999. IF PEOPLE ARE HEALTHIER, THE BOTTOM LINE WILL BE, TOO.. INT. CL. 35. REG. 2-15-2005.
- 2,927,000. CHARITYMANIA. INT. CL. 36. REG. 2-15-2005.
- 2,927,001. BUILT TO LAST A LIGHT TIME YUZZI AUTOMOTIVE LAMPS AND DESIGN. INT. CL. 11. REG. 2-15-2005.
- 2,927,002. LINERKEEPER. INT. CL. 24. REG. 2-15-2005.
- 2,927,003. G2G. INT. CL. 30. REG. 2-15-2005.
- 2,927,004. JOEY. INT. CL. 41. REG. 2-15-2005.
- 2,927,007. WARNER'S ALL THE RIGHT MOVES. INT. CL. 25. REG. 2-15-2005.
- 2,927,008. SELECCOTE. INT. CL. 19. REG. 2-15-2005.
- 2,927,009. SELECLINK. INT. CL. 19. REG. 2-15-2005.
- 2,927,010. LOCALCLICKS. INT. CL. 35. REG. 2-15-2005.
- 2,927,011. SELECCORE. INT. CL. 19. REG. 2-15-2005.
- 2,927,012. GARY NULL'S NUTRITIOUS CHOCOLATE. INT. CL. 30. REG. 2-15-2005.
- 2,927,015. ELM CAPITAL. INT. CL. 36. REG. 2-15-2005.
- 2,927,016. ARTIST REVOLUTION. INT. CL. 35. REG. 2-15-2005.
- 2,927,017. PROJECT HELPER. INT. CL. 21. REG. 2-15-2005.
- 2,927,020. UNREAL ESTATES. INT. CL. 37. REG. 2-15-2005.
- 2,927,021. SOUR PATCH. INT. CL. 3. REG. 2-15-2005.
- 2,927,024. SPRING UPSTYLER STANDARD CHARACTER MARK. INT. CL. 3. REG. 2-15-2005.
- 2,927,025. COOLGUARD. INT. CL. 9. REG. 2-15-2005.



- 2,927,026. GET FLIPPED. INT. CL. 40. REG. 2-15-2005.  
 2,927,027. MGIS. INT. CL. 36. REG. 2-15-2005.  
 2,927,029. PAINNOT (STYLIZED). INT. CL. 10. REG. 2-15-2005.  
 2,927,030. ONE BREATH AT A TIME. INT. CL. 41. REG. 2-15-2005.  
 2,927,033. A PRIVATE PERFORMANCE. INT. CL. 3. REG. 2-15-2005.  
 2,927,035. PUBLIQUIK. INT. CL. 9. REG. 2-15-2005.  
 2,927,036. VISCO MAX. INT. CL. 24. REG. 2-15-2005.  
 2,927,040. LEARNING WELL'S WRITING BOOSTERS. INT. CL. 9. REG. 2-15-2005.  
 2,927,042. ZIP PEN. INT. CL. 16. REG. 2-15-2005.  
 2,927,043. IRON BOOT PUB. INT. CL. 43. REG. 2-15-2005.  
 2,927,045. JEWELERS SECURITYPLUS. INT. CL. 36. REG. 2-15-2005.  
 2,927,046. WELL OF INFORMATION. INT. CL. 16. REG. 2-15-2005.  
 2,927,050. ROTO-SWEEP. INT. CL. 7. REG. 2-15-2005.  
 2,927,052. FALCON. INT. CL. 9. REG. 2-15-2005.  
 2,927,053. FALCON LEAK TEST SYSTEM AND DESIGN. INT. CL. 9. REG. 2-15-2005.  
 2,927,058. RUDY BAGGS STANDARD CHARACTER MARK. INT. CL. 30. REG. 2-15-2005.  
 2,927,060. AMES COPPERHEAD STANDARD CHARACTER MARK. INT. CL. 8. REG. 2-15-2005.  
 2,927,062. DOC-O-MATIC STANDARD CHARACTER MARK. INT. CL. 9. REG. 2-15-2005.  
 2,927,063. TITAN GOLD FRUIT AND VEGETABLE JUICER MADE IN U.S.A. AND DESIGN. INT. CL. 7. REG. 2-15-2005.  
 2,927,064. MODERN MASTERS STANDARD CHARACTER MARK. INT. CL. 5. REG. 2-15-2005.  
 2,927,065. REACHIT ADDA-POLE STANDARD CHARACTER MARK. INT. CL. 7. REG. 2-15-2005.  
 2,927,066. STARFIX STANDARD CHARACTER MARK. INT. CL. 10. REG. 2-15-2005.  
 2,927,067. MARKET STAND STANDARD CHARACTER MARK. INT. CL. 29. REG. 2-15-2005.  
 2,927,069. FLOWTRAK STANDARD CHARACTER MARK. INT. CL. 6. REG. 2-15-2005.  
 2,927,070. ALOEVATIONS. INT. CLS. 5 AND 32. REG. 2-15-2005.  
 2,927,071. H-COMMERCE. INT. CLS. 9, 16 AND 35. REG. 2-15-2005.  
 2,927,072. PURPOSE. INT. CL. 36. REG. 2-15-2005.  
 2,927,073. NETWORKS FOR BUSINESS NEW YORK AND DESIGN. INT. CLS. 35 AND 41. REG. 2-15-2005.  
 2,927,075. SAPIAS. INT. CL. 35. REG. 2-15-2005.  
 2,927,076. MARC ECKO. INT. CL. 25. REG. 2-15-2005.  
 2,928,265. HOGSMEADE. INT. CL. 28. REG. 2-22-2005.  
 2,931,803. HARRY POTTER AND THE PRISONER OF AZKABAN. INT. CL. 28. REG. 3-8-2005.  
 2,932,662. MISCELLANEOUS DESIGN. INT. CL. 11 ONLY. REG. 3-15-2005.  
 2,933,497. KINETEK. INT. CL. 12 ONLY. REG. 3-15-2005.  
 2,933,907. WIPRO APPLYING THOUGHT SIX SIGMA AND DESIGN. INT. CL. 16 ONLY. REG. 3-15-2005.  
 2,983,435. FLOWTECH. INT. CL. 8 ONLY. REG. 8-9-2005.  
 2,983,814. TWISTED WHISKERS. INT. CL. 20 ONLY. REG. 8-9-2005.  
 2,984,462. SAVE ON CARTRIDGE PLUS. INT. CLS. 2 AND 35 ONLY. REG. 8-16-2005.  
 2,984,889. FUSION. INT. CLS. 11 AND 24 ONLY. REG. 8-16-2005.  
 2,984,942. WETHEPEOPLE BIKECOMPANY (STYLIZED). INT. CL. 9 ONLY. REG. 8-16-2005.  
 2,984,949. CALIFORNIA REAL PROPERTY JOURNAL AND DESIGN. INT. CL. 41 ONLY. REG. 8-16-2005.  
 2,984,954. MY FAIR LADY AND DESIGN. INT. CL. 25 ONLY. REG. 8-16-2005.  
 2,985,073. ONEOK AND DESIGN. INT. CLS. 37 AND 42 ONLY. REG. 8-16-2005.  
 2,985,274. PRODUCTS AND IDEAS THAT WORK STANDARD CHARACTER MARK. INT. CLS. 35 AND 40 ONLY. REG. 8-16-2005.  
 2,985,681. 12. INT. CL. 35 ONLY. REG. 8-16-2005.  
 2,985,796. G AND DESIGN. INT. CLS. 8 AND 19 ONLY. REG. 8-16-2005.  
 2,987,328. AUDI AND DESIGN. INT. CLS. 18, 20 AND 28 ONLY. REG. 8-23-2005.  
 2,988,897. WE (STYLIZED). INT. CL. 18 ONLY. REG. 8-30-2005.  
 2,989,895. FRODO BAGGINS. INT. CLS. 6, 16 AND 25 ONLY. REG. 8-30-2005.  
 2,989,896. ELROND. INT. CL. 16 ONLY. REG. 8-30-2005.  
 2,992,011. TECHMARKET COMMUNICATIONS AND DESIGN. INT. CL. 41 ONLY. REG. 9-6-2005.  
 2,994,124. EC 225. INT. CL. 38 ONLY. REG. 9-13-2005.  
 2,995,434. FEAR THE TURTLE. INT. CL. 16 ONLY. REG. 9-13-2005.  
 2,999,458. SUBARU RALLY TEAM USA AND DESIGN. INT. CL. 9 ONLY. REG. 9-27-2005.  
 3,000,578. ZINO PLATINUM CHUBBY. INT. CL. 14 ONLY. REG. 9-27-2005.  
 3,005,841. CIGARTAINMENT STANDARD CHARACTER MARK. INT. CL. 35 ONLY. REG. 10-11-2005.  
 3,007,193. DEBBIE MUMM. INT. CLS. 4, 6, 8, 9, 11, 14, 15, 18, 20, 25, 26, 27, 28, 30 AND 32 ONLY. REG. 10-18-2005.  
 3,010,533. OPENING TECHNOLOGIES. INT. CL. 41 ONLY. REG. 11-1-2005.  
 3,023,075. MISCELLANEOUS DESIGN. INT. CL. 5 ONLY. REG. 12-6-2005.  
 3,025,512. CHURCHILL YACHT PARTNERS STANDARD CHARACTER MARK. INT. CLS. 35, 36 AND 37 ONLY. REG. 12-13-2005.  
 3,044,492. XPOSED AND DESIGN. INT. CL. 16 ONLY. REG. 1-17-2006.  
 3,054,380. MIND4SALE STANDARD CHARACTER MARK. INT. CLS. 9, 16 AND 21 ONLY. REG. 1-31-2006.  
 3,085,709. BADLANDERS. INT. CLS. 9, 38 AND 41 ONLY. REG. 4-25-2006.  
 3,118,001. GOH GLENN O. HAWBAKER, INC. HEAVY CONSTRUCTION SERVICES AND PRODUCTS AND DESIGN. INT. CL. 40 ONLY. REG. 7-18-2006.  
 3,121,460. DAYMON WORLDWIDE. INT. CL. 40 ONLY. REG. 7-25-2006.  
 3,140,289. IN HER OWN VOICE STANDARD CHARACTER MARK. INT. CL. 16 ONLY. REG. 9-5-2006.
- 
- SECTION 18**
- 1,201,345. BONKERS!. INT. CL. 30. REG. 7-13-1982.  
 3,080,896. SMARTBOOST STANDARD CHARACTER MARK. INT. CL. 5. REG. 4-11-2006.  
 3,354,029. TEAM SHADOW STANDARD CHARACTER MARK. INT. CLS. 35 AND 42. REG. 12-11-2007.  
 3,385,431. CASH DROP STANDARD CHARACTER MARK. INT. CL. 9. REG. 2-19-2008.  
 3,443,013. TIRED OF BEING TIRED? STANDARD CHARACTER MARK. INT. CL. 5. REG. 6-3-2008.  
 3,629,849. A ARWIN AND DESIGN. INT. CL. 3. REG. 6-2-2009.  
 3,680,234. REDA STANDARD CHARACTER MARK. INT. CLS. 5 AND 30. REG. 9-8-2009.  
 3,866,675. SVYTURYS STANDARD CHARACTER MARK. INT. CL. 32. REG. 10-26-2010.

3,975,512. GIVE 'EM THE BIRD STANDARD CHARACTER MARK. INT. CL. 33. REG. 6-7-2011.

2,992,649. VW STANDARD CHARACTER MARK. INT. CLS. 7 AND 38 ONLY. REG. 9-6-2005.

3,029,430. KORSCH STANDARD CHARACTER MARK. INT. CLS. 7 AND 42 ONLY. REG. 12-13-2005.

3,107,068. ASTOR STANDARD CHARACTER MARK. INT. CL. 9. REG. 6-20-2006.

---

**SECTION 37**

2,504,141. SEE IT! SAY IT!. INT. CL. 16. REG. 11-6-2001.

---

**SECTION 71**

---

**INADVERTENTLY ISSUED REGISTRATION NUMBERS**

2,925,489. PAZO VILADOMAR STANDARD CHARACTER MARK. INT. CL. 33. REG. 2-8-2005.

3,984,333. CORAZON MAYA STANDARD CHARACTER MARK. INT. CL. 33. REG. 6-28-2011. RESTORED TO SN 85-104,632.

2,987,626. POWERCEM STANDARD CHARACTER MARK. INT. CLS. 1 AND 6 ONLY. REG. 8-23-2005.

3,987,875. RESISTAIN (STYLIZED). INT. CL. 23. REG. 7-5-2011. RESTORED TO SN 79-078,260.

\* \* \* \* \*

# TRADEMARK REGISTRATIONS AMENDED, CORRECTED, ETC.

The designation "U.S. Cl." appearing in this section refers to the U.S. class in effect prior to Sep. 1, 1973 rather than the international class which applies to applications filed on or after that date. For adoption of international classification see notice in the OFFICIAL GAZETTE of Jun. 26, 1973 (911 O.G. TM 210).

Any change to the registration will be indicated at the bottom of each entry under ELEMENTS AMENDED, CORRECTED OR RESTRICTED. With the exception of changes to the goods and services, additions to the registration will appear in asterisks and deletions of the registration will appear in brackets. Elements which are only changed will be listed with no punctuation. As to the goods/services statement, amendments to the goods/services will appear in asterisks and deletions will appear in brackets. In addition if any change to the goods/services occurs, the element "Goods/Services" will be listed under ELEMENTS AMENDED, CORRECTED OR RESTRICTED.

845,170. REG. 2-27-1968. FARRELL'S INTERNATIONAL, INC. (CALIFORNIA CORPORATION) 17 NEW CHARDON, LAGUNA NIGUEL, CA. 92677, SN 72-253,965. FILED 9-7-1966. PRINCIPAL REGISTER.



REGISTRATION LIMITED TO THE AREA COMPRISING THE CONTINENTAL UNITED STATES, PUERTO RICO, VIRGIN ISLAND, AND OTHER TERRITORIES OF THE UNITED STATES EXCLUDING THE STATE OF HAWAII PURSUANT TO CONCURRENT USE PROCEEDING NO. 94002401. CONCURRENT USE WITH APPLICATION SERIAL NOS. 77592999, 77597689, 77597754, 77603383, 77617840, AND 77601522.

WITHOUT RELINQUISHING ANY OF ITS COMMON LAW RIGHTS, APPLICANT HEREBY DISCLAIMS THE WORDS "ICE CREAM PARLOUR" APART FROM THE MARK AS SHOWN.

INT. CL. 42/U.S. CL. 100

FOR RESTAURANT AND CARRY-OUT FOOD SERVICES.

FIRST USE 6-1-1963; IN COMMERCE 2-8-1966.

ELEMENTS AMENDED

\*ORDER RESTRICTING THE SCOPE OF REG.\*

845,610. REG. 3-5-1968. FARRELL'S INTERNATIONAL, INC. (CALIFORNIA CORPORATION) 17 NEW CHARDON, LAGUNA NIGUEL, CA. 92677, SN 72-253,966. FILED 9-7-1966. PRINCIPAL REGISTER.



REGISTRATION LIMITED TO THE AREA COMPRISING THE CONTINENTAL UNITED STATES, PUERTO RICO, VIRGIN ISLAND, AND OTHER TERRITORIES OF THE UNITED STATES EXCLUDING THE STATE OF HAWAII PURSUANT TO CONCURRENT USE PROCEEDING NO. 94002401. CONCURRENT USE WITH APPLICATION SERIAL NOS. 77592999, 77597689, 77597754, 77603383, 77617840, AND 77601522.

WITHOUT RELINQUISHING ANY OF ITS COMMON LAW RIGHTS, APPLICANT DISCLAIMS THE WORDS "ICE CREAM PARLOUR" APART FROM THE MARK AS SHOWN.

INT. CL. 42/U.S. CL. 100

FOR RESTAURANT AND CARRY-OUT FOOD SERVICES.

FIRST USE 6-1-1963; IN COMMERCE 2-8-1966.

ELEMENTS AMENDED

\*ASSIGNMENT/NAME CHANGE\*

\*ORDER RESTRICTING THE SCOPE OF REG.\*

1,198,661. REG. 6-22-1982. AMERICAN PSYCHOLOGICAL ASSOCIATION, INC. (D.C. NON-PROFIT CORPORATION) 750 FIRST STREET, NE, WASHINGTON, DC, 200024242, SN 73-276,614. FILED 9-4-1980. PRINCIPAL REGISTER.

## JOURNAL OF EXPERIMENTAL PSYCHOLOGY: GENERAL

SEC. 2(F).

INT. CL. 16/U.S. CL. 38

FOR PRINTED JOURNAL PERIODICALLY PUBLISHED AND DISTRIBUTED TO MEMBERS AND TO OTHER PERSONS IN THE SCIENCE COMMUNITY.

FIRST USE 3-15-1975; IN COMMERCE 3-15-1975.

ELEMENTS CORRECTED

OWNER NAME

ENTITY

1,480,112. REG. 3-8-1988. ACCOR (FRANCE COMPANY) 2 RUE DE LA MARE NEUVE, EVRY, FRANCE, F-91000, SN 73-594,834. FILED 4-23-1986. PRINCIPAL REGISTER.

## PULLMAN

PRIORITY CLAIMED UNDER SEC. 44(D) ON FRANCE APPLICATION NO. 781198, FILED 2-12-1986, REG. NO. 1342422, DATED 2-12-1986.

INT. CL. 42/U.S. CLS. 100 AND 101

FOR [ HOTEL AND ] HOTEL RESERVATION SERVICES; [ RESTAURANT SERVICES ] ; RETIREMENT AND CONVALESCENT HOME SERVICES; HAIRDRESSING SALON SERVICES ].  
FIRST USE ; IN COMMERCE .

ELEMENTS AMENDED  
GOODS/SERVICES

2,256,156. REG. 6-29-1999. STETSON UNIVERSITY, INC. (FLORIDA CORPORATION) 421 NORTH WOODLAND BOULEVARD, SUITE 8357, DELAND, FL. 327203777. SN 74-390,961. FILED 5-17-1993. PRINCIPAL REGISTER.

1,668,752. REG. 12-17-1991. WILLIAMS & SELYEM, LLC (CALIFORNIA LIMITED LIABILITY COMPANY) 6575 WESTSIDE ROAD, HEALDSBURG, CA, 95448, SN 74-136,641. FILED 2-5-1991. PRINCIPAL REGISTER.

## WILLIAMS SELYEM

"WILLIAMS SELYEM" DOES NOT REPRESENT A LIVING INDIVIDUAL.  
INT. CL. 33/U.S. CL. 47  
FOR WINES.  
FIRST USE 4-17-1986; IN COMMERCE 4-17-1986.

ELEMENTS CORRECTED  
\*OWNER NAME\*  
\*OWNER ADDRESS\*  
\*CITIZENSHIP\*  
\*ENTITY\*

1,861,067. REG. 11-1-1994. KOEZE COMPANY (MICHIGAN CORPORATION) 2555 BURLINGAM AVENUE, S.W., GRAND RAPIDS, MI, 49509, SN 74-429,737. FILED 8-30-1993. PRINCIPAL REGISTER.

## KOEZE

THE MARK CONSISTS OF STANDARD CHARACTERS WITHOUT CLAIM TO ANY PARTICULAR FONT, STYLE, SIZE, OR COLOR.  
SEC. 2(F).  
INT. CL. 29/U.S. CL. 46  
FOR PEANUT BUTTER, PROCESSED PEANUTS, AND ROASTED NUTS.  
FIRST USE 0-0-1919; IN COMMERCE 0-0-1919.  
INT. CL. 30/U.S. CL. 46  
FOR CANDY .  
FIRST USE 0-0-1919; IN COMMERCE 0-0-1919.

ELEMENTS AMENDED  
MARK



NO CLAIM IS MADE TO THE EXCLUSIVE RIGHT TO USE "UNIVERSITY", "FLORIDA" AND "1883", APART FROM THE MARK AS SHOWN.  
INT. CL. 16/U.S. CLS. 37 AND 38

FOR BOOKS, PAMPHLETS, BROCHURES AND CATALOGS, ALL ON THE SUBJECT OF STETSON UNIVERSITY, UNIVERSITY STUDENTS AND ALUMNI, AND UNIVERSITY ACTIVITIES.  
FIRST USE 0-0-1988; IN COMMERCE 0-0-1988.

ELEMENTS AMENDED  
MARK  
DISCLAIMER

2,277,594. REG. 9-14-1999. GENERAL PENCIL COMPANY, INC. (NEW JERSEY CORPORATION) 67-73 FLEET STREET, JERSEY CITY, NJ, 07306, SN 75-473,630. FILED 4-24-1998. PRINCIPAL REGISTER.

## THE MASTERS

INT. CL. 3/U.S. CLS. 1, 4, 6, 50, 51 AND 52  
FOR ARTISTS SUPPLIES NAMELY, HANDSOAP AND CLEANING COMPOUND FOR CLEANING PAINT FROM PAINT BRUSHES.  
FIRST USE 1-13-1979; IN COMMERCE 1-24-1979.

ELEMENTS CORRECTED  
OWNER NAME

2,430,770. REG. 2-27-2001. WORLD OF CHILDREN, INC. (OHIO CORPORATION) 6200 STONERIDGE MALL ROAD, 3RD FLOOR, PLEASANTON, CA, 94588, SN 75-664,800. FILED 3-17-1999. PRINCIPAL REGISTER.



THE STIPPLING IN THE DRAWING IS FOR SHADING PURPOSES ONLY AND NOT TO INDICATE COLOR.

THE MARK CONSISTS OF A STYLIZED GLOBE SURROUNDED BY A RING OF STYLIZED CHILDREN TOUCHING HANDS WITH THEIR FEET ON THE OUTSIDE EDGE OF THE GLOBE. ALL OF THE CHILDREN HAVE A STYLIZED HEART ON THEIR CHESTS. SUPERIMPOSED OVER THE GLOBE IS A BOX WITH A STYLIZED CHILD WITH A STYLIZED HEART ON THE CHEST AND A JAGGED LINE RUNNING THROUGH THE HEAD, TORSO AND ON LEG.

INT. CL. 41/U.S. CLS. 100, 101 AND 107

FOR PROMOTING THE RECOGNITION OF OUTSTANDING INDIVIDUAL CONTRIBUTIONS IN THE FIELD OF CHILD ADVOCACY THROUGH THE AWARD OF PRIZES.

FIRST USE 9-0-1997; IN COMMERCE 9-0-1997.

ELEMENTS AMENDED  
MARK

2,437,552. REG. 3-20-2001. NUTRIO.COM, INC. (DELAWARE CORPORATION) SUITE 600, 1000 CORPORATE DRIVE, FT. LAUDERDALE, FL, 33334, SN 75-691,188. FILED 4-26-1999. PRINCIPAL REGISTER.

# NUTRIO

THE MARK CONSISTS OF STANDARD CHARACTERS WITHOUT CLAIM TO ANY PARTICULAR FONT, STYLE, SIZE, OR COLOR.

INT. CL. 38/U.S. CLS. 100, 101 AND 104

FOR [ PROVIDING ON-LINE [ CHAT ROOMS AND ] BULLETIN BOARDS FOR TRANSMISSION OF MESSAGES AMONG COMPUTER USERS CONCERNING INFORMATION RELATED TO DIET, WEIGHT LOSS, HEALTH, EXERCISE, NUTRITION, EATING DISORDERS, VITAMINS AND HERBAL SUPPLEMENTS ].

FIRST USE 3-24-2000; IN COMMERCE 3-24-2000.

INT. CL. 42/U.S. CLS. 100 AND 101

FOR PROVIDING A WEB SITE FEATURING A WIDE VARIETY OF INFORMATION RELATED TO DIET, WEIGHT-LOSS, HEALTH, EXERCISE, NUTRITION [ EATING DISORDERS, VITAMINS AND HERBAL SUPPLEMENTS, AND CHAT ROOMS AND BULLETIN BOARDS RELATED THERETO ].

FIRST USE 3-24-2000; IN COMMERCE 3-24-2000.

ELEMENTS AMENDED  
OWNER ADDRESS

MARK

2,470,618. REG. 7-17-2001. GEOGRAPHIC EXPEDITIONS, INC. (CALIFORNIA CORPORATION) 1008 GENERAL KENNEDY AVE, SAN FRANCISCO, CA, 941290902, SN 75-941,638. FILED 3-10-2000. PRINCIPAL REGISTER.

## GEOEX

OWNER OF U.S. REG. NO. 2,197,200.  
INT. CL. 16/U.S. CLS. 2, 5, 22, 23, 29, 37, 38 AND 50  
FOR TRAVEL NEWSLETTERS, CATALOGUES, AND BROCHURES.  
FIRST USE 1-31-2000; IN COMMERCE 1-31-2000.

ELEMENTS CORRECTED  
GOODS/SERVICES  
OWNER NAME

2,480,036. REG. 8-21-2001. RAINEY APPAREL MANUFACTURING, INC. (GEORGIA CORPORATION) 1599A MEMORIAL DRIVE, SUITE 142, ATLANTA, GA, 30317, SN 76-123,129. FILED 9-5-2000. PRINCIPAL REGISTER.

INT. CL. 10/U.S. CLS. 26, 39 AND 44  
FOR PRE- AND POST-OPERATIVE MEDICAL COVERING GARMENTS.  
FIRST USE 2-0-2000; IN COMMERCE 2-0-2000.

ELEMENTS CORRECTED  
OWNER NAME

2,548,813. REG. 3-19-2002. AMERICAN PSYCHOLOGICAL ASSOCIATION, INC. (D.C. NON-PROFIT CORPORATION) 750 FIRST STREET, N.E., WASHINGTON, DC, 200024242, SN 75-783,579. FILED 8-24-1999. PRINCIPAL REGISTER.

## PUBLICATION MANUAL

OWNER OF U.S. REG. NO. 2,445,780.  
NO CLAIM IS MADE TO THE EXCLUSIVE RIGHT TO USE "MANUAL", APART FROM THE MARK AS SHOWN. SEC. 2(F).

INT. CL. 16/U.S. CLS. 2, 5, 22, 23, 29, 37, 38 AND 50  
FOR PRINTED GUIDE TO ASSIST IN THE WRITING OF SCHOLARLY PAPERS IN THE FIELDS OF PSYCHOLOGY AND THE SOCIAL SCIENCES.

FIRST USE 0-0-1952; IN COMMERCE 0-0-1952.

ELEMENTS CORRECTED  
OWNER NAME  
ENTITY

2,551,043. REG. 3-19-2002. IGENE BIOTECHNOLOGY, INC. (MARYLAND CORPORATION) 9110 RED BRANCH ROAD, COLUMBIA, MD, 21045, SN 76-049,635. FILED 5-8-2000. PRINCIPAL REGISTER.

2,593,241. REG. 7-9-2002. AMERICAN PSYCHOLOGICAL ASSOCIATION, INC. (D.C. NON-PROFIT CORPORATION) 750 FIRST STREET, N.E, WASHINGTON, DC, 200024242, SN 76-210,427. FILED P.R. 2-15-2001; AM. S.R. 12-26-2001. SUPPLEMENTAL REGISTER.

**PHAFFIASE**

INT. CL. 1/U.S. CLS. 1  
FOR CHEMICALS, NAMELY, A MIXTURE OF DIFFERENT ENZYMES USED TO DISRUPT THE CELL WALLS OF YEAST IN THE FOOD AND FEED INDUSTRIES.  
FIRST USE 12-3-1997; IN COMMERCE 12-3-1997.

ELEMENTS CORRECTED  
OWNER NAME



2,565,278. REG. 4-30-2002. NELSON STUD WELDING, INC. (DELAWARE CORPORATION) 7900 WEST RIDGE ROAD, ELYRIA, OH, 44036, SN 76-269,079. FILED 6-8-2001. PRINCIPAL REGISTER.

**NELWELD**

INT. CL. 6/U.S. CLS. 2, 12, 13, 14, 23, 25 AND 50  
FOR METAL FASTENERS, NAMELY, WELD STUDS AND [ THREAD ] \* THREADED \* [ WELDING ] \* WELD \* STUDS.  
FIRST USE 12-26-1945; IN COMMERCE 12-26-1945.  
INT. CL. 7/U.S. CLS. 13, 19, 21, 23, 31, 34 AND 35  
FOR HANDHELD, PORTABLE, AND FIXED WELDING MACHINES FOR INSTALLING WELDING ELEMENTS.  
FIRST USE 12-26-1945; IN COMMERCE 12-26-1945.  
INT. CL. 9/U.S. CLS. 21, 23, 26, 36 AND 38  
FOR ELECTRIC ARC WELDERS.  
FIRST USE 12-26-1945; IN COMMERCE 12-26-1945.

ELEMENTS CORRECTED  
GOODS/SERVICES



2,587,070. REG. 7-2-2002. HOLOFIBER ENTERPRISES, INC. (CALIFORNIA CORPORATION) 1112 MONTANA AVE., STE 13, SANTA MONICA, CA, 90403, SN 75-662,029. FILED 3-17-1999. PRINCIPAL REGISTER.

**HOLOFIBER**

INT. CL. 25/U.S. CLS. 22 AND 39  
FOR CLOTHING NAMELY, HATS, T-SHIRTS, TANK TOPS, JACKETS, PANTS, JEANS, SWEATSHIRTS, SWEATPANTS, BANDANNAS, SHORTS, UNDERWEAR, JERSEYS, AND SHIRTS.  
FIRST USE 11-15-1998; IN COMMERCE 1-1-1999.

ELEMENTS CORRECTED  
OWNER ADDRESS

**PSYCHOLOGY OF MEN & MASCULINITY**

OWNER OF U.S. REG. NO. 2,376,279.  
INT. CL. 9/U.S. CLS. 21, 23, 26, 36 AND 38  
FOR DOWNLOADABLE ELECTRONIC PSYCHOLOGY JOURNALS.  
FIRST USE 3-0-2000; IN COMMERCE 3-0-2000.

ELEMENTS CORRECTED  
OWNER NAME  
ENTITY



2,856,585. REG. 6-22-2004. HOSPITAL FOR SPECIAL SURGERY (NEW YORK NOT FOR PROFIT CORPORATION) 535 EAST 70TH STREET, NEW YORK, NY, 10021, SN 76-485,863. FILED 1-16-2003. PRINCIPAL REGISTER.



NO CLAIM IS MADE TO THE EXCLUSIVE RIGHT TO USE "IMAGING", APART FROM THE MARK AS SHOWN.  
INT. CL. 44/U.S. CLS. 100 AND 101  
FOR RADIOLOGY AND IMAGING SERVICES.  
FIRST USE 1-1-1998; IN COMMERCE 1-1-1998.

ELEMENTS CORRECTED  
OWNER NAME

2,882,861. REG. 9-7-2004. SGL ITALIA S.R.L. (ITALY LIMITED LIABILITY COMPANY) 10156 TORINO, STRADA SAN MAURO 25, TORINO, ITALY, 10156, SN 78-098,652. FILED 12-17-2001. PRINCIPAL REGISTER.

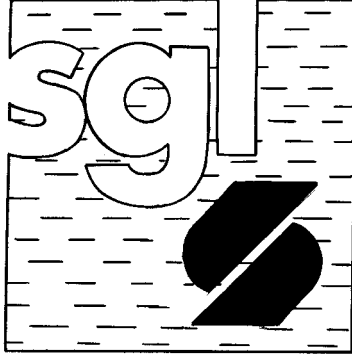

THE LINING IS A FEATURE OF THE MARK AND DOES NOT INDICATE COLOR.

INT. CL. 7/U.S. CLS. 13, 19, 21, 23, 31, 34 AND 35

FOR [ ELECTRIC COFFEE GRINDERS; ELECTRIC FOOD SLICERS ]

FIRST USE 7-0-2002; IN COMMERCE 7-0-2002.

INT. CL. 11/U.S. CLS. 13, 21, 23, 31 AND 34

FOR ELECTRIC COFFEE FILTERS; ELECTRIC COFFEE MACHINES; COUNTER HOT WATER BOILERS; ELECTRIC STEAM BOILERS FOR COFFEE MACHINES, ELECTRIC BOILERS FOR COFFEE MACHINES, AND DISTRIBUTOR BODY IN THE NATURE OF A FLUID DISPENSING NOZZLE TO SELECT COFFEE/VAPOR IN COFFEE MACHINE; FIXED COFFEE POWDER SUPPORT CUP FOR OBTAINING A CONNECTION WITH THE FLUID DISPENSER IN COFFEE MACHINES; [ ELECTRIC KETTLES; AIR CONDITIONERS ]

FIRST USE 7-0-2002; IN COMMERCE 7-0-2002.

ELEMENTS AMENDED  
GOODS/SERVICES

2,935,076. REG. 3-22-2005. PURESTYLE LIVING LLC (CALIFORNIA LIMITED LIABILITY COMPANY) SUITE 202, 5390 KIETZKE LANE, RENO, NV, 89511, SN 78-384,818. FILED 3-16-2004. PRINCIPAL REGISTER.

# PURESTYLE

THE MARK CONSISTS OF STANDARD CHARACTERS WITHOUT CLAIM TO ANY PARTICULAR FONT, STYLE, SIZE, OR COLOR.

INT. CL. 41/U.S. CLS. 100, 101 AND 107

FOR SPECIAL EVENT PLANNING; CONDUCTING EVENTS FEATURING YOGA INSTRUCTION AND EDUCATIONAL COOKING DEMONSTRATIONS.

FIRST USE 12-0-2003; IN COMMERCE 12-0-2003.

ELEMENTS CORRECTED  
OWNER NAME

OWNER ADDRESS

2,943,692. REG. 4-26-2005. A. M. F. FARMS, INC. (WASHINGTON CORPORATION) 424 GREENLEAF AVENUE, BURLINGTON, WA, 98233, SN 78-315,062. FILED 10-17-2003. PRINCIPAL REGISTER.

## FRUIT DECO

NO CLAIM IS MADE TO THE EXCLUSIVE RIGHT TO USE "FRUIT", APART FROM THE MARK AS SHOWN.

INT. CL. 31/U.S. CLS. 1 AND 46

FOR PRODUCE HAVING IMAGES REPRESENTED THEREON, NAMELY, APPLES, BANANAS, COCONUTS, CUCUMBERS, GRAPEFRUIT, LEMONS, LIMES, MANGO, MELONS, NECTARINES, ORANGES, PEARS, [ PINEAPPLES, ] POMEGRANATES, POTATOES, PUMPKINS, SQUASH AND SWEET POTATOES.

FIRST USE 12-0-2002; IN COMMERCE 12-0-2002.

INT. CL. 42/U.S. CLS. 100 AND 101

FOR CUSTOM PRODUCE DECORATING SERVICES FOR OTHERS, NAMELY, PROVIDING IMAGES ON PRODUCE.

FIRST USE 10-17-2003; IN COMMERCE 10-17-2003.

ELEMENTS CORRECTED  
OWNER NAME

2,995,902. REG. 9-13-2005. TERRA INDUSTRIES INC. (DELAWARE CORPORATION) SUITE 400, 4 PARKWAY NORTH, DEERFIELD, IL, 60015, SN 78-318,402. FILED 10-24-2003. PRINCIPAL REGISTER.

## TERRA ENVIRONMENTAL TECHNOLOGIES

THE MARK CONSISTS OF STANDARD CHARACTERS WITHOUT CLAIM TO ANY PARTICULAR FONT, STYLE, SIZE, OR COLOR.

NO CLAIM IS MADE TO THE EXCLUSIVE RIGHT TO USE ENVIRONMENTAL TECHNOLOGIES, APART FROM THE MARK AS SHOWN.

INT. CL. 42/U.S. CLS. 100 AND 101

FOR CONSULTING SERVICES, NAMELY PROVIDING ANALYSIS AND ADVISE ON METHODS AND PROCEDURES TO REDUCE DANGEROUS POWER PLANT EMISSIONS AND ENVIRONMENTAL CLEANING PROCESSES; DESIGN OF POWER PLANT EMISSION CONTROL TECHNOLOGIES FOR OTHERS; DESIGN OF POWER PLANT EMISSION REGULATIONS FOR OTHERS; CONSULTATION, NAMELY EVALUATING THE ACCURACY OF PERFORMANCE OF POWER PLANT EMISSIONS EQUIPMENT FOR OTHERS.

FIRST USE 4-21-2004; IN COMMERCE 4-21-2004.

ELEMENTS CORRECTED  
OWNER ADDRESS  
MARK

3,026,314. REG. 12-13-2005. GENERAL PENCIL COMPANY, INC. (NEW JERSEY CORPORATION) 67-73 FLEET STREET, JERSEY CITY, NJ, 07306, SN 76-626,673. FILED 1-3-2005. PRINCIPAL REGISTER.

# PRIMO

THE MARK CONSISTS OF STANDARD CHARACTERS WITHOUT CLAIM TO ANY PARTICULAR FONT, STYLE, SIZE, OR COLOR.

THE ENGLISH TRANSLATION OF "PRIMO" IS "FIRST".  
INT. CL. 16/U.S. CLS. 2, 5, 22, 23, 29, 37, 38 AND 50  
FOR ARTISTS' PENCILS.

FIRST USE 6-3-2004; IN COMMERCE 6-3-2004.

ELEMENTS CORRECTED  
OWNER NAME

3,038,952. REG. 1-10-2006. 'MERKOS L'INYONEI CHINUCH, INC. (NEW YORK CORPORATION) 770 EASTERN PARKWAY, BROOKLYN, NY, 11213, SN 76-539,934. FILED 8-11-2003. PRINCIPAL REGISTER.



THE MARK IS IN THE FORM OF A RECTANGULAR DESIGN, WHICH MAY BE DESCRIBED AS FOLLOWS—THE LEFT SIDE OF THE DESIGN INCORPORATES THE HEBREW WORDS "MERKOS L'INYONEI CHINUCH", WHICH, IN ENGLISH, MEANS "CENTRAL ORGANIZATION FOR JEWISH EDUCATION". ON THE BOTTOM OF THE DESIGN IS A TRANSLITERATION INTO ENGLISH OF THE HEBREW WORDS "MERKOS L'INYONEI CHINUCH". IN THE CENTER OF THE DESIGN IS A REPRESENTATION OF A PORTION OF THE GLOBE OF THE WORLD AND A REPRESENTATION OF THE TWO SQUARE TABLETS OF THE TEN COMMANDMENTS AND RAYS EMANATING FROM THE ABOVE-MENTIONED WORDS TO THE GLOBE.

THE ENGLISH TRANSLATION OF MERKOS L'INYONEI CHINUCH AND ITS REPETITION IN HEBREW LETTERS IS CENTRAL ORGANIZATION OF JEWISH EDUCATION.

AS TO MERKOS L'INYONEI CHINUCH AND ITS HEBREW EQUIVALENT.

INT. CL. 16/U.S. CLS. 2, 5, 22, 23, 29, 37, 38 AND 50

FOR HEBREW ALPHABET CHARTS AND JEWISH HISTORY CHARTS; JEWISH PRAYER BOOKS, CHILDREN'S BOOKS DEALING WITH JEWISH LIFE AND EDUCATIONAL BOOKS DEALING WITH JEWISH LIFE.

FIRST USE 0-0-1942; IN COMMERCE 0-0-1942.

ELEMENTS CORRECTED  
OWNER NAME  
DESCRIPTION OF MARK

3,046,627. REG. 1-17-2006. DAISHOWA SEIKI KABUSHIKI KAISHA (JAPAN CORPORATION), DBA BIG DAISHOWA SEIKI CO LTD, NISHIHIKIRICHO 3-3-39, HIGASHIOSAKASHI OSAKA, JAPAN, 579-8013, SN 76-544,176. FILED 8-26-2003. PRINCIPAL REGISTER.

INT. CL. 7/U.S. CLS. 13, 19, 21, 23, 31, 34 AND 35

FOR POWER OPERATED TOOLS, NAMELY, BORING TOOLS, FACING TOOLS, MILLING CUTTERS, DRILLING BITS AND DRILL HEADS, CUTTING INSERTS, CEMENTED CARBIDE TOOLS, TOOL ADAPTERS, TOOL HOLDERS, WORKPIECE CHUCKS; TOOL PRESETTERS FOR PRESETTING CUTTING TOOLS; AIR MOTORS; GROOVE COVERS FOR MACHINE TOOLS; ELECTRIC MOTORS FOR MACHINES; AND CLEANING TOOLS FOR CUTTING SWarf AND OIL.

FIRST USE 6-0-1971; IN COMMERCE 7-0-1984.

ELEMENTS CORRECTED  
\*DBA/AKA\*  
OWNER NAME  
MARK

3,048,937. REG. 1-24-2006. R-STYL', LLC (FLORIDA LIMITED LIABILITY COMPANY) 5272 NW 55TH TERRACE, COCONUT CREEK, FL, 33073, SN 78-423,062. FILED 5-21-2004. PRINCIPAL REGISTER.

# R-STYL

THE MARK CONSISTS OF STANDARD CHARACTERS WITHOUT CLAIM TO ANY PARTICULAR FONT, STYLE, SIZE, OR COLOR.

INT. CL. 41/U.S. CLS. 100, 101 AND 107

FOR ENTERTAINMENT IN THE NATURE OF A MUSICAL GROUP.

FIRST USE 7-1-2003; IN COMMERCE 7-1-2003.

ELEMENTS AMENDED  
MARK

3,107,526. REG. 6-20-2006. ANULEX TECHNOLOGIES, INC. (DELAWARE CORPORATION) 5600 ROWLAND ROAD, SUITE 280, MINNETONKA, MN, 55343, SN 78-269,656. FILED 7-2-2003. PRINCIPAL REGISTER.

# INCLOSE

INT. CL. 10/U.S. CLS. 26, 39 AND 44

FOR SURGICAL MESH FOR REPAIR OF INTERVERTEBRAL DISC.

FIRST USE 11-18-2005; IN COMMERCE 11-18-2005.

ELEMENTS CORRECTED  
CITIZENSHIP



3,117,964. REG. 7-18-2006. SUREPAYROLL, INC. (DELAWARE CORPORATION) 2350 RAVINE DRIVE, GLENVIEW, IL, 60025, SN 78-356,079. FILED 1-22-2004. PRINCIPAL REGISTER.

# SURESTART

THE MARK CONSISTS OF STANDARD CHARACTERS WITHOUT CLAIM TO ANY PARTICULAR FONT, STYLE, SIZE, OR COLOR.

OWNER OF U.S. REG. NOS. 2,840,380 AND 2,840,381.  
INT. CL. 35/U.S. CLS. 100, 101 AND 102

FOR ON-LINE WAGE PAYROLL PREPARATION SERVICES PROVIDED VIA A GLOBAL COMPUTER NETWORK [ ; CALCULATION OF WITHHOLDING, INSURANCE, 401K CONTRIBUTIONS, AND OTHER DEDUCTIONS FROM WAGES AND SALARIES; BOOK-KEEPING FOR ELECTRONIC FUNDS TRANSFERS; CREATING AND PROVIDING ELECTRONIC PAYROLL REPORTS THAT CAN BE USED BY BUSINESSES TO PREPARE TAX RETURNS AND GENERATE REQUIRED TAX FORMS ] .

FIRST USE 6-4-2004; IN COMMERCE 6-4-2004.

ELEMENTS AMENDED  
MARK

3,130,160. REG. 8-15-2006. BIOLOGISCHE INSEL LOTHAR MOLL GMBH & CO. KG (FED REP GERMANY GMBH & CO. KG) RHEINTALSTRASSE 35-43, 68723 SCHWETZINGEN, FED REP GERMANY., SN 79-018,470. FILED 8-24-2004. PRINCIPAL REGISTER.

# INTELLO

THE MARK CONSISTS OF STANDARD CHARACTERS WITHOUT CLAIM TO ANY PARTICULAR FONT, STYLE, SIZE, OR COLOR.

PRIORITY DATE OF 3-5-2004 IS CLAIMED.  
OWNER OF INTERNATIONAL REGISTRATION 0870274 DATED 8-24-2004, EXPIRES 8-24-2014.  
INT. CL. 1/U.S. CLS. 1

FOR ADHESIVES FOR CONSTRUCTION MATERIALS MADE OF WOOD, PAPER OR PLASTIC; ADHESIVES FOR AIR SEALING SHEETS, FOR FLOORS AND WALL COVERINGS, FOR FILMS AND ROOF UNDERLAY SHEETING, ESPECIALLY ADHESIVE CORD; SEALING CORD; HOT-MELT ADHESIVE FOR INDUSTRIAL AND STRUCTURAL PURPOSES; AIR SEALING ADHESIVE FOR WOOD, PAPER OR PLASTIC.

INT. CL. 17/U.S. CLS. 1, 5, 12, 13, 35 AND 50

FOR [ REINFORCEMENT INTERLAID SCRIM MADE OF PLASTIC USED AS INSULATION MATERIAL, NAMELY, BUILDING INSULATION; FABRIC MADE OF PLASTIC USED AS INSULATION MATERIAL FOR BUILDING INSULATION; ] AIR SEALING SHEETS MADE OF PAPER FILMS AND PLASTIC FILMS FOR RESIDENTIAL BUILDINGS, NAMELY, POLYPROPYLENE FILM, POLYETHYLENE FILM, POLYURETHANE FILM, IONOMER FILM, POLYAMIDE FILM, POLYESTER FILM; [ INSULATION MATERIALS MADE OF PLANT FIBERS AND ANIMAL HAIR, NAMELY, COTTON, WOOL, FLAX, WOOD FIBERS, HAMP; INSULATION MATERIALS MADE OF FIBERS, ESPECIALLY OF SYNTHETIC AND RENEWABLE RAW MATERIALS ESPECIALLY OF SYNTHETIC MATERIALS, NAMELY, OIL, PETROLEUM; FIBERS MADE OF PLASTIC, OF RENEWABLE RAW MATERIALS, ESPECIALLY OF PLANT FIBERS, OF ANIMAL HAIR, OF PAPER MATERIALS FOR THERMAL INSULATION ELEMENTS, NAMELY, COTTON, WOOL, FLAX, WOOD FIBER, GLASS FIBER, POLYPROPYLENE FIBER, POLYETHYLENE FIBER, POLYURETHANE FIBER, IONOMER FIBER, POLYAMIDE FIBER, POLYESTER FIBER;

FILMS MADE OF PLASTIC OR PAPER FOR LINING ROOFS AND WALLS OF HOME AND FACTORY BUILDINGS; FIBERS FOR FOOTFALL SOUND INSULATION MADE OF PLASTIC, OF RENEWABLE RAW MATERIALS, ESPECIALLY OF PLANT FIBERS, OF ANIMAL HAIR, OF PAPER MATERIALS; FOOTFALL SOUND INSULATION MADE OF SYNTHETIC AND RENEWABLE RAW MATERIALS, ESPECIALLY OF PLANT FIBERS, OF ANIMAL HAIR, OF PAPER RAW MATERIALS AND FOAMED PLASTICS FOR USE IN CONSTRUCTION; THERMAL INSULATION MATERIALS MADE OF PAPER, OF MINERALS OR FOAMED PLASTICS FOR STRUCTURAL PURPOSES, ESPECIALLY WOOL; ] ADHESIVE STRIPS FOR GLUING FILMS, CARDBOARD, [ PANELS, ] PAPER MATERIALS [AND CONSTRUCTION MATERIALS SUCH AS WOOD, STONE, CONCRETE AND GYPSUM, ], NAMELY, TAPE, SEALANT; TWO LAYERED OR MULTI LAYERED ADHESIVE STRIPS, NAMELY, TAPE, SEALANT; SEALING MATERIAL, NAMELY, CAOUTHOUC, LATEX ACRYLICS, SILICON, ARYL-ACID COPOLYMERS; BUTYL RUBBER FOR INDUSTRIAL AND STRUCTURAL PURPOSES.

FIRST USE ; IN COMMERCE .  
INT. CL. 19/U.S. CLS. 1, 12, 33 AND 50

FOR [ REINFORCEMENT INTERLAID SCRIM AND FABRICS NOT MADE OF METAL FOR CONSTRUCTION, NAMELY, SHEETS TO OVERCOAT WALLS, FLOORS AND CEILINGS; CARDBOARD FOR LINING ROOFS AND WALLS; FLOOR COVERINGS MADE OF WOOD, NAMELY, TILES, PANELS; ROOF UNDERLAY SHEETING MADE OF FILM, CARDBOARD AND PAPER; ROOF COVERINGS NOT MADE OF METAL; ] VAPOR BARRIERS AND VAPOR SEALS IN THE FORM OF SHEETS FOR CONSTRUCTION PURPOSES, NAMELY, A FILM OF PLASTIC; FABRICS [ , INTERLAID SCRIM AND NON-WOVENS ] AS INSULATION AND REINFORCEMENT MATERIAL MADE OF PLASTIC, OF RENEWABLE MATERIALS, ESPECIALLY OF PLANT FIBERS, OF ANIMAL HAIR AND OF PAPER MATERIALS FOR INSULATING WALLS AND ROOFS OF BUILDINGS [ ; GEOTEXTILES AS INSULATION AND REINFORCEMENT MATERIAL FOR INSULATING WALLS, AND ROOFS OF BUILDINGS; WOOD MATERIALS IN THE FORM OF PANELS, MATS AND SHEETS, NAMELY, FLOOR AND WALL TILES, FLOOR AND WALL PANELS, NOISE BARRIERS; PANELS MADE OF WOOD AND PLASTIC FOR WALLS AND CEILINGS, NAMELY, WALL TILES, WALL BOARDS ] .

FIRST USE ; IN COMMERCE .

ELEMENTS CORRECTED  
OWNER ADDRESS

3,131,815. REG. 8-22-2006. ERBE ELEKTROMEDIZIN GMBH (FED REP GERMANY CORPORATION) WALDHORNLESTRASSE 17, TUBINGEN, FED REP GERMANY, 72072, SN 78-152,754. FILED 8-9-2002. PRINCIPAL REGISTER.

# PRECISE APC

THE MARK CONSISTS OF STANDARD CHARACTERS WITHOUT CLAIM TO ANY PARTICULAR FONT, STYLE, SIZE, OR COLOR.

OWNER OF ERPN CMNTY TM OFC REG. NO. 002556819, DATED 10-31-2003.  
INT. CL. 10/U.S. CLS. 26, 39 AND 44

FOR HIGH FREQUENCY SYSTEM CONSISTING OF HIGH FREQUENCY DEVICE FOR CUTTING, COAGULATING, VAPORIZING AND DEVITALIZING OF TISSUE FOR MEDICAL AND SURGICAL PURPOSES.

ELEMENTS AMENDED  
MARK

3,223,413. REG. 3-27-2007. COMESTIBLES MASTER CO., LTD. (TAIWAN CORPORATION) IF., NO. 35, GONGYE-CYU 23RD RD., NANTUN DISTRICT, TAICHUNG CITY, TAIWAN, 408, SN 76-643,837. FILED 7-28-2005. PRINCIPAL REGISTER.

85°C

INT. CL. 30/U.S. CL. 46

FOR FARINACEOUS FOOD PASTES FOR HUMAN CONSUMPTION, BISCUITS, COOKIES, SWEETMEATS, CANDY, COCOA, COFFEE, CAKES, EDIBLE DECORATIONS FOR CAKES, CHOCOLATE, POPCORN, ICE CREAM, COCOA BEVERAGES WITH MILK, COFFEE-BASED BEVERAGE CONTAINING MILK, MILK CHOCOLATE, BREAD, HONEY, NOODLES, PIES, MEAT PIES, SANDWICHES, PASTRIES, SPAGHETTI, PASTIES, PIZZA, RUSKS, BUNS, PANCAKES, SUSHI, TORTILLAS, EDIBLE FRUIT ICES, PROCESSED OATS, BEVERAGES MADE OF COFFEE, PREPARED COCOA AND COCOA-BASED BEVERAGES, PREPARED COFFEE AND COFFEE-BASED BEVERAGES, PREPARED CHOCOLATE AND CHOCOLATE FOOD BEVERAGES NOT BEING DAIRY-BASED OR VEGETABLE BASED, CUSTARD, FRUIT JELLIES, ICED TEA, TEA-BASED BEVERAGES WITH FRUIT FLAVORING, BEVERAGES MADE OF TEA, SHERBETS, SORBETS.

FIRST USE 2-28-2006; IN COMMERCE 2-28-2006.

INT. CL. 32/U.S. CLS. 45, 46 AND 48

FOR NON-ALCOHOLIC FRUIT EXTRACTS USED IN THE PREPARATION OF BEVERAGES, BEER, NON-ALCOHOLIC FRUIT JUICE BEVERAGES, WHEY BEVERAGES, FRUIT JUICES, AERATED WATER, DRINKING WATERS, MINERAL WATER, SELTZER WATER, MUST, LEMONADES, VEGETABLE JUICES, GRAPE MUST, SODA WATER, TOMATO JUICE, NON-ALCOHOLIC BEVERAGES CONTAINING FRUIT JUICES, NON-ALCOHOLIC BEVERAGES WITH TEA FLAVOR, FRUIT-BASED SOFT DRINKS FLAVORED WITH TEA, SOFT DRINKS FLAVORED WITH TEA, FRUIT NECTARS, NON-ALCOHOLIC APERITIFS, NON-ALCOHOLIC COCKTAIL MIXES.

FIRST USE 2-28-2006; IN COMMERCE 2-28-2006.

INT. CL. 43/U.S. CLS. 100 AND 101

FOR BAR SERVICES, TEA ROOMS, CAFES, CAFETERIAS, CANTEN SERVICES, HOTELS, RESTAURANTS, SELF-SERVICE RESTAURANTS, COFFEEHOUSE AND SNACKBAR SERVICES, COFFEE SHOPS, CARRY-OUT RESTAURANTS, COCKTAIL LOUNGES, COCKTAIL LOUNGE BUFFETS, OFFICE COFFEE SUPPLY SERVICES, RENTAL OF FOOD SERVICE EQUIPMENT, RESTAURANTS FEATURING HOME DELIVERY, SALAD BARS.

FIRST USE 2-28-2006; IN COMMERCE 2-28-2006.

ELEMENTS CORRECTED

\*ASSIGNMENT/NAME CHANGE\*

3,236,932. REG. 5-1-2007. MAINLAND MART CORP. (CALIFORNIA CORPORATION) 2535 DURFEE AVENUE, EL MONTE, CA, 91732, SN 78-912,218. FILED 6-20-2006. PRINCIPAL REGISTER.

OCEAN MIST

THE MARK CONSISTS OF STANDARD CHARACTERS WITHOUT CLAIM TO ANY PARTICULAR FONT, STYLE, SIZE, OR COLOR.

OWNER OF U.S. REG. NO. 2,947,934.

NO CLAIM IS MADE TO THE EXCLUSIVE RIGHT TO USE "MIST", APART FROM THE MARK AS SHOWN.

INT. CL. 9/U.S. CLS. 21, 23, 26, 36 AND 38

FOR ELECTRIC LIGHT SWITCHES; LIGHT EMITTING DIODE DISPLAYS; LIGHT EMITTING DIODES; LIGHT SWITCHES.

FIRST USE 1-5-2004; IN COMMERCE 1-5-2004.

ELEMENTS CORRECTED

OWNER NAME

3,321,981. REG. 10-23-2007. TEXAS BEST SMOKEHOUSE, INC. (TEXAS CORPORATION) 105 YMCA DRIVE, WAXAHACHIE, TX, 75165, SN 77-159,704. FILED P.R. 4-18-2007; AM. S.R. 8-14-2007. SUPPLEMENTAL REGISTER.

TEXAS BEST SMOKEHOUSE

THE MARK CONSISTS OF STANDARD CHARACTERS WITHOUT CLAIM TO ANY PARTICULAR FONT, STYLE, SIZE, OR COLOR.

INT. CL. 29/U.S. CL. 46

FOR [ PROCESSED NUTS, CANDIED NUTS, ] PRESERVED AND COOKED FRUITS AND VEGETABLES, [ AND ] JAMS AND JELLIES; \* CANDIES \*

FIRST USE 2-28-2007; IN COMMERCE 2-28-2007.

INT. CL. 30/U.S. CL. 46

FOR CANDIES.

FIRST USE 2-28-2007; IN COMMERCE 2-28-2007.

INT. CL. 31/U.S. CLS. 1 AND 46

FOR [ UNPROCESSED NUTS AND FRESH NUTS ].

FIRST USE 2-28-2007; IN COMMERCE 2-28-2007.

ELEMENTS AMENDED

GOODS/SERVICES

3,384,695. REG. 2-19-2008. PELTON, ERIK MICHAEL (UNITED STATES INDIVIDUAL) PO BOX 100637, ARLINGTON, VA, 22210, SN 77-211,400. FILED 6-20-2007. PRINCIPAL REGISTER.

TM4SMALLBIZ

THE MARK CONSISTS OF STANDARD CHARACTERS WITHOUT CLAIM TO ANY PARTICULAR FONT, STYLE, SIZE, OR COLOR.

INT. CL. 45/U.S. CLS. 100 AND 101

FOR LEGAL SERVICES.  
FIRST USE 2-0-2002; IN COMMERCE 6-0-2002.

3,455,835. REG. 6-24-2008. ANULEX TECHNOLOGIES, INC.  
(DELAWARE CORPORATION) 5600 ROWLAND ROAD,  
SUITE 280, MINNETONKA, MN, 55343, SN 78-965,758.  
FILED 9-1-2006. PRINCIPAL REGISTER.

ELEMENTS AMENDED  
MARK



3,385,464. REG. 2-19-2008. ANULEX TECHNOLOGIES, INC.  
(DELAWARE CORPORATION) 5600 ROWLAND ROAD,  
SUITE 280, MINNETONKA, MN, 55343, SN 78-847,732.  
FILED 3-28-2006. PRINCIPAL REGISTER.



THE COLOR(S) LIGHT BLUE AND DARK BLUE IS/ARE  
CLAIMED AS A FEATURE OF THE MARK.

THE COLOR LIGHT BLUE APPEARS IN THE FORE-  
GROUND OF THE LETTER "X". THE COLOR DARK BLUE  
APPEARS IN THE LETTERING "CLOSE" AND IN THE  
BACKGROUND HIGHLIGHTING OF THE LETTER "X".

INT. CL. 5/U.S. CLS. 6, 18, 44, 46, 51 AND 52

FOR FIXATION AND REPAIR LIVE IMPLANTS, AND  
DELIVERY INSTRUMENTS THEREFOR, SOLD AS A  
UNIT, FOR THE REPAIR OF SOFT TISSUE OF THE  
SPINE.

FIRST USE 2-15-2007; IN COMMERCE 2-27-2007.

INT. CL. 10/U.S. CLS. 26, 39 AND 44

FOR FIXATION AND REPAIR ARTIFICIAL AND  
SYNTHETIC TISSUE IMPLANTS, AND DELIVERY IN-  
STRUMENTS THEREFOR SOLD AS A UNIT, FOR THE  
REPAIR OF SOFT TISSUE OF THE SPINE.

FIRST USE 2-15-2007; IN COMMERCE 2-27-2007.

INT. CL. 5/U.S. CLS. 6, 18, 44, 46, 51 AND 52

FOR FIXATION AND REPAIR LIVE IMPLANTS, AND  
DELIVERY INSTRUMENTS THEREFOR, SOLD AS A  
UNIT FOR THE REPAIR OF SOFT TISSUE OF THE  
SPINE.

FIRST USE 11-18-2005; IN COMMERCE 11-18-2005.

INT. CL. 10/U.S. CLS. 26, 39 AND 44

FOR FIXATION AND REPAIR ARTIFICIAL/SYN-  
THETIC TISSUE IMPLANTS, AND DELIVERY INSTRU-  
MENTS THEREFOR, FOR THE REPAIR OF SOFT  
TISSUE OF THE SPINE.

FIRST USE 11-18-2005; IN COMMERCE 11-18-2005.

ELEMENTS CORRECTED  
CITIZENSHIP

ELEMENTS CORRECTED  
CITIZENSHIP

3,466,283. REG. 7-15-2008. THE RENTAL STORE, INC.  
(ARIZONA CORPORATION), AKA TRS, INC., 9977  
NORTH 90TH STREET, #150, SCOTTSDALE, AZ, 85258,  
SN 77-287,981. FILED 9-25-2007. PRINCIPAL REGISTER.

3,455,463. REG. 6-24-2008. ANULEX TECHNOLOGIES, INC.  
(DELAWARE CORPORATION) 5600 ROWLAND ROAD,  
SUITE 280, MINNETONKA, MN, 55343, SN 78-809,651.  
FILED 2-8-2006. PRINCIPAL REGISTER.



THE MARK CONSISTS OF STANDARD CHARACTERS  
WITHOUT CLAIM TO ANY PARTICULAR FONT, STYLE,  
SIZE, OR COLOR.

INT. CL. 5/U.S. CLS. 6, 18, 44, 46, 51 AND 52

FOR FIXATION AND REPAIR LIVE IMPLANTS, AND  
DELIVERY INSTRUMENTS THEREFOR, SOLD AS A  
UNIT FOR THE REPAIR OF SOFT TISSUE OF THE  
SPINE .

FIRST USE 2-15-2007; IN COMMERCE 2-27-2007.

INT. CL. 10/U.S. CLS. 26, 39 AND 44

FOR FIXATION AND REPAIR ARTIFICIAL /SYN-  
THETIC TISSUE IMPLANTS, AND DELIVERY INSTRU-  
MENTS THEREFOR, FOR THE REPAIR OF SOFT  
TISSUE OF THE SPINE.

FIRST USE 2-15-2007; IN COMMERCE 2-27-2007.

NO CLAIM IS MADE TO THE EXCLUSIVE RIGHT TO  
USE "EASY PAY", APART FROM THE MARK AS SHOWN.  
INT. CL. 36/U.S. CLS. 100, 101 AND 102

FOR LEASE PURCHASE SERVICES IN THE NATURE  
OF PROVIDING RENT-TO-OWN LEASE PURCHASE  
AGREEMENTS USED TO OBTAIN HOME FURNISH-  
INGS.

FIRST USE 4-15-2006; IN COMMERCE 8-15-2006.

ELEMENTS CORRECTED  
CITIZENSHIP

ELEMENTS CORRECTED  
\*DBA/AKA\*  
OWNER NAME  
CITIZENSHIP

3,513,002. REG. 10-7-2008. CITY OF LAS VEGAS (NEVADA MUNICIPAL CORPORATION) 400 EAST STEWART AVENUE, LAS VEGAS, NV, 89101, SN 77-005,828. FILED 9-22-2006. PRINCIPAL REGISTER.

3,513,004. REG. 10-7-2008. CITY OF LAS VEGAS (NEVADA MUNICIPAL CORPORATION) 400 EAST STEWART AVENUE, LAS VEGAS, NV, 89101, SN 77-005,852. FILED 9-22-2006. PRINCIPAL REGISTER.

# FREMONT EAST



THE MARK CONSISTS OF STANDARD CHARACTERS WITHOUT CLAIM TO ANY PARTICULAR FONT, STYLE, SIZE, OR COLOR.

INT. CL. 21/U.S. CLS. 2, 13, 23, 29, 30, 33, 40 AND 50  
FOR BEVERAGeware; SPORTS BOTTLES SOLD EMPTY; [ COOKIE JARS; ICE BUCKETS; COOLERS FOR WINE; FLASKS; BOTTLE OPENERS; LUNCH BOXES; SALT MILLS; PEPPER MILLS; SALT SHAKERS; PEPPER SHAKERS; WINE CARAFES;] COASTERS NOT OF PAPER AND NOT BEING TABLE LINEN; [ VASES; WASTEPAPER BASKETS; WOODEN BASKETS; CONTAINERS FOR HOUSEHOLD AND KITCHEN USE NOT OF PRECIOUS METAL; HOUSEHOLD CONTAINERS FOR FOOD; DISHES; ] THERMAL INSULATED WRAPS FOR BEVERAGE AND FOOD CONTAINERS [ ; STATUETTES OF CHINA, CRYSTAL, GLASS, AND EARTHENWARE; AND CANDLESTICKS NOT OF PRECIOUS METAL ] .

FIRST USE 7-17-2008; IN COMMERCE 7-17-2008.

ELEMENTS AMENDED  
GOODS/SERVICES

INT. CL. 21/U.S. CLS. 2, 13, 23, 29, 30, 33, 40 AND 50  
FOR BEVERAGeware; SPORTS BOTTLES SOLD EMPTY; [ COOKIE JARS; ICE BUCKETS; COOLERS FOR WINE; FLASKS; BOTTLE OPENERS; LUNCH BOXES; SALT MILLS; PEPPER MILLS; SALT SHAKERS; PEPPER SHAKERS; WINE CARAFES;] COASTERS NOT OF PAPER AND NOT BEING TABLE LINEN; [ VASES; WASTEPAPER BASKETS; WOODEN BASKETS; CONTAINERS FOR HOUSEHOLD AND KITCHEN USE NOT OF PRECIOUS METAL; HOUSEHOLD CONTAINERS FOR FOOD; DISHES; ] THERMAL INSULATED WRAPS FOR BEVERAGE AND FOOD CONTAINERS [ ; STATUETTES OF CHINA, CRYSTAL, GLASS, AND EARTHENWARE; AND CANDLESTICKS NOT OF PRECIOUS METAL ] .

FIRST USE 7-17-2008; IN COMMERCE 7-17-2008.

ELEMENTS AMENDED  
GOODS/SERVICES

3,513,003. REG. 10-7-2008. CITY OF LAS VEGAS (NEVADA MUNICIPAL CORPORATION) 400 EAST STEWART AVENUE, LAS VEGAS, NV, 89101, SN 77-005,833. FILED 9-22-2006. PRINCIPAL REGISTER.

3,513,005. REG. 10-7-2008. CITY OF LAS VEGAS (NEVADA MUNICIPAL CORPORATION) 400 EAST STEWART AVENUE, LAS VEGAS, NV, 89101, SN 77-005,854. FILED 9-22-2006. PRINCIPAL REGISTER.

# FREMONT EAST



THE MARK CONSISTS OF STANDARD CHARACTERS WITHOUT CLAIM TO ANY PARTICULAR FONT, STYLE, SIZE, OR COLOR.

INT. CL. 25/U.S. CLS. 22 AND 39  
FOR CLOTHING AND CLOTHING ACCESSORIES, NAMELY, [ INFANT WEAR, ] SHIRTS, T-SHIRTS, [ COATS, ] JACKETS, [ VESTS, ] TANK TOPS, HALTER TOPS, [ SLEEPWEAR, SWEATERS, ] SWEAT SHIRTS, HEADWEAR, [ ROBES, JOGGING SUITS, SHORTS, PANTS, JEANS, SKIRTS, DRESSES, ] AND UNDERGARMENTS [ , LINGERIE, SOCKS, SWIM WEAR, BELTS, TIES, OVERALLS, BLOUSES, SCARVES, GLOVES, FOUL WEATHER GEAR, FOOTWEAR ] .

FIRST USE 7-17-2008; IN COMMERCE 7-17-2008.

ELEMENTS AMENDED  
GOODS/SERVICES

INT. CL. 25/U.S. CLS. 22 AND 39  
FOR CLOTHING AND CLOTHING ACCESSORIES, NAMELY, [ INFANTWEAR, ] SHIRTS, T-SHIRTS, [ COATS, ] JACKETS, [ VESTS, ] TANK TOPS, HALTER TOPS, [ SLEEPWEAR, SWEATERS, ] SWEAT SHIRTS, HEADWEAR, [ ROBES, JOGGING SUITS, SHORTS, PANTS, JEANS, SKIRTS, DRESSES, ] AND UNDERGARMENTS [ , LINGERIE, SOCKS, SWIM WEAR, BELTS, TIES, OVERALLS, BLOUSES, SCARVES, GLOVES, FOUL WEATHER GEAR, AND FOOTWEAR ] .

FIRST USE 7-17-2008; IN COMMERCE 7-17-2008.

ELEMENTS AMENDED  
GOODS/SERVICES

3,547,375. REG. 12-16-2008. ELARA NUTRICEUTICALS, INC. (FLORIDA CORPORATION) P.O. BOX 335, FATE, TX, 75132, SN 77-084,223. FILED 1-16-2007. PRINCIPAL REGISTER.

3,556,154. REG. 1-6-2009. CLYDE COMPANIES, INC. (UTAH CORPORATION) 730 NORTH 1500 WEST, OREM, UT, 84057, SN 77-331,718. FILED 11-16-2007. PRINCIPAL REGISTER.

# Paranex

THE MARK CONSISTS OF STANDARD CHARACTERS WITHOUT CLAIM TO ANY PARTICULAR FONT, STYLE, SIZE, OR COLOR.

INT. CL. 5/U.S. CLS. 6, 18, 44, 46, 51 AND 52

FOR ANIMAL FEED ADDITIVES FOR USE AS A NUTRITIONAL SUPPLEMENT FOR MEDICAL PURPOSES; ANIMAL FEED SUPPLEMENTS; DIETARY AND NUTRITIONAL SUPPLEMENTS \* FOR ANIMALS \*; DIETARY FOOD SUPPLEMENTS \* FOR ANIMALS \*; [ DIETARY SUPPLEMENTS; ] DIETARY SUPPLEMENTS FOR ANIMALS; FOOD SUPPLEMENTS \* FOR ANIMALS \*; HERBAL SUPPLEMENTS \* FOR ANIMALS \*; NUTRACEUTICALS FOR USE AS A DIETARY SUPPLEMENT \* FOR ANIMALS \*; NUTRITIONAL SUPPLEMENTS \* FOR ANIMALS \*.

FIRST USE 7-1-2007; IN COMMERCE 7-1-2007.

ELEMENTS AMENDED  
GOODS/SERVICES



NO CLAIM IS MADE TO THE EXCLUSIVE RIGHT TO USE "COMPANY", APART FROM THE MARK AS SHOWN. INT. CL. 39/U.S. CLS. 100 AND 105

FOR DELIVERY OF AGGREGATE GOODS BY TRUCK; \* EXCLUDING DELIVERY OF CONSTRUCTION MATERIALS, NAMELY, CRUSHED STONE, SAND, GRAVEL, BITUMINOUS CONCRETE, ASPHALT, AND READY-MIX CONCRETE \*.

FIRST USE 12-31-1999; IN COMMERCE 12-31-1999.

ELEMENTS AMENDED  
GOODS/SERVICES

3,549,103. REG. 12-23-2008. CLYDE COMPANIES, INC. (UTAH CORPORATION) 730 NORTH 1500 WEST, OREM, UT, 84057, SN 77-321,692. FILED 11-5-2007. PRINCIPAL REGISTER.



NO CLAIM IS MADE TO THE EXCLUSIVE RIGHT TO USE "COMPANY", APART FROM THE MARK AS SHOWN. INT. CL. 37/U.S. CLS. 100, 103 AND 106

FOR CONSTRUCTION AND MAINTENANCE SERVICES FOR NEW COMMERCIAL, INDUSTRIAL, GOVERNMENT AND UTILITY BUILDINGS; INSTALLATION OF GARAGE DOORS, GARAGE DOOR OPENERS, INSULATION, WINDOWS, ROOFING AND DECKING; PAVING CONTRACTOR SERVICES; ROAD PAVING; EXCAVATION SERVICES; EARTHWORKS CONSTRUCTION; MASONRY; \* EXCLUDING ALL SERVICES RELATING TO CRUSHED STONE, SAND, GRAVEL, BITUMINOUS CONCRETE, ASPHALT, AND READY-MIX CONCRETE \* [CONCRETE CONSTRUCTION; LAND DEVELOPMENT AND CONSTRUCTION SERVICES IN THE NATURE OF SITE WORK, NAMELY, GRADING, CLEARING, CUTTING AND PATCHING ASPHALT AND CONCRETE, PLACEMENT AND COMPACTION OF ROCK, SAND, DIRT, ASPHALT, AND CONCRETE].

FIRST USE 12-31-1999; IN COMMERCE 12-31-1999.

ELEMENTS AMENDED  
GOODS/SERVICES

3,599,443. REG. 3-31-2009. BROWN, AMY (UNITED STATES INDIVIDUAL) 7432 E. PALO ALTO, SIERRA VISTA, AZ, 85650, SN 77-294,918. FILED 10-3-2007. PRINCIPAL REGISTER.

# 181 INDUSTRIES

THE MARK CONSISTS OF STANDARD CHARACTERS WITHOUT CLAIM TO ANY PARTICULAR FONT, STYLE, SIZE, OR COLOR.

NO CLAIM IS MADE TO THE EXCLUSIVE RIGHT TO USE "INDUSTRIES", APART FROM THE MARK AS SHOWN.

INT. CL. 25/U.S. CLS. 22 AND 39

FOR BANDANAS; HATS; JACKETS; PANTS \* SPECIFICALLY EXCLUDING JEANS \*; SHIRTS; SHOES; SHORTS; SOCKS; SWEAT SHIRTS; SWIMWEAR; TANK TOPS; UNDERWEAR; \* ALL FOR SALE TO PARTICIPANTS AND FANS OF THE MOTOCROSS INDUSTRY AT MOTOCROSS RACES, AT MOTOCROSS EVENTS, AND AT SPECIALTY MOTOCROSS CLOTHING STORES \*.

FIRST USE 11-20-2007; IN COMMERCE 11-25-2007.

ELEMENTS AMENDED  
GOODS/SERVICES

3,662,238. REG. 7-28-2009. BIERMANN PRODUCTIONS LLC (KANSAS LIMITED LIABILITY COMPANY) 601 N. BROADMOOR, WICHITA, KS, 67206, SN 78-675,164. FILED P.R. 7-21-2005; AM. S.R. 5-16-2009. SUPPLEMENTAL REGISTER.

**Live Entertainment Network Presents**

NO CLAIM IS MADE TO THE EXCLUSIVE RIGHT TO USE "LIVE" AND "ENTERTAINMENT NETWORK", APART FROM THE MARK AS SHOWN.

INT. CL. 41/U.S. CLS. 100, 101 AND 107

FOR ENTERTAINMENT SERVICES, NAMELY, CONTINUING MUSIC AND VARIETY PROGRAMMING BROADCAST OVER TELEVISION, AUDIO AND VIDEO MEDIA.

FIRST USE 11-20-2008; IN COMMERCE 11-20-2008.

ELEMENTS CORRECTED  
OWNER ADDRESS  
MARK

3,690,381. REG. 9-29-2009. HUMAN TRIBE PROJECT, LLC (ARIZONA LIMITED LIABILITY COMPANY) 1437 NORTH 1ST STREET, SUITE 102, PHOENIX, AZ, 85004, SN 77-526,301. FILED 7-18-2008. PRINCIPAL REGISTER.

**TRIBE TAGS**

THE MARK CONSISTS OF STANDARD CHARACTERS WITHOUT CLAIM TO ANY PARTICULAR FONT, STYLE, SIZE, OR COLOR.

NO CLAIM IS MADE TO THE EXCLUSIVE RIGHT TO USE "TAGS", APART FROM THE MARK AS SHOWN.

INT. CL. 36/U.S. CLS. 100, 101 AND 102

FOR CHARITABLE FUND-RAISING SERVICES UTILIZING TOKENS, NECKLACES, OR TAGS ACQUIRED BY DONORS AS GIFTS; \* ALL OF THE FOREGOING NOT RELATING TO SPORTS OR A SPORTS TEAM\*.

FIRST USE 7-14-2009; IN COMMERCE 7-14-2009.

ELEMENTS AMENDED  
GOODS/SERVICES

3,695,129. REG. 10-13-2009. ATE MY HEART INC. (CALIFORNIA CORPORATION) C/O JEFF GILLMAN, GELFAND, RENNERT AND, FELDMAN, L.L.P. 1880 CENTURY PARK EAST, SUITE 1600, LOS ANGELES, CA, 90067, SN 77-648,609. FILED 1-13-2009. PRINCIPAL REGISTER.

**LADY GAGA**

THE MARK CONSISTS OF STANDARD CHARACTERS WITHOUT CLAIM TO ANY PARTICULAR FONT, STYLE, SIZE, OR COLOR.

"LADY GAGA" IDENTIFIES THE STAGE NAME OF STEFANI GERMANOTTA, A LIVING INDIVIDUAL WHOSE CONSENT IS OF RECORD.

INT. CL. 25/U.S. CLS. 22 AND 39

FOR CLOTHING FOR WOMEN, MEN AND CHILDREN, NAMELY, [ SHIRTS, ] T-SHIRTS, SWEATSHIRTS, [ BLOUSES, ] PULLOVERS, TANK TOPS, [ JACKETS, COATS, SWEATERS, ] VESTS, [ PANTS, SWEATPANTS, ] SHORTS [ , BOTTOMS, SKIRTS, ] AND DRESSES; FASHION ACCESSORIES, NAMELY, HATS, [ CAPS, VISORS, ] HEADBANDS, WRISTBANDS, [ HOODS, ] SCARVES [ , ] \*AND\* BANDANAS [ , NECKTIES, MUFFLERS, GLOVES, MITTENS AND BELTS; UNDERWEAR, NAMELY, BOXER SHORTS, UNDERSHORTS, UNDERPANTS, BRAS, SOCKS, AND HOSIERY; FOOTWEAR, NAMELY, SHOES, SNEAKERS AND BOOTS; SWIM WEAR, BEACHWEAR, AND LOUNGEWEAR, NAMELY, PAJAMAS AND ROBES ].

FIRST USE 6-0-2008; IN COMMERCE 6-0-2008.

ELEMENTS AMENDED  
DATE OF FIRST USE  
DATE OF FIRST USE IN COMMERCE

3,703,348. REG. 10-27-2009. MEXCOR, INC. (TEXAS CORPORATION) 8950 RAILWOOD DRIVE, HOUSTON, TX, 77078, SN 77-631,768. FILED 12-12-2008. PRINCIPAL REGISTER.

**GOLMAR**

THE MARK CONSISTS OF STANDARD CHARACTERS WITHOUT CLAIM TO ANY PARTICULAR FONT, STYLE, SIZE, OR COLOR.

INT. CL. 33/U.S. CLS. 47 AND 49

FOR [ MESCAL; RUM; ] SPIRITS AND LIQUEURS; [ TEQUILA; VODKA; WHISKEY; ] AND WINE.

FIRST USE 6-1-2009; IN COMMERCE 6-1-2009.

ELEMENTS AMENDED  
GOODS/SERVICES

3,731,881. REG. 12-29-2009. MAYR, KARIN (UNITED STATES INDIVIDUAL) 510 MIRANDA DRIVE, PITTSBURGH, PA, 15241, SN 77-261,515. FILED 8-22-2007. PRINCIPAL REGISTER.

**SABIKA**

THE MARK CONSISTS OF STANDARD CHARACTERS WITHOUT CLAIM TO ANY PARTICULAR FONT, STYLE, SIZE, OR COLOR.

INT. CL. 14/U.S. CLS. 2, 27, 28 AND 50

FOR [ PRECIOUS METALS AND THEIR ALLOYS; ] JEWELRY; [ PRECIOUS STONES; HOROLOGICAL AND CHRONOMETRIC INSTRUMENTS; AMULETS; ] PINS; BRACELETS; [ WATCH STRAPS; WRIST WATCHES; JEWELRY OF AMBER; BROOCHES; THREADS OF PRECIOUS METAL; UNWROUGHT OR SEMI-WROUGHT PRECIOUS METALS; ALLOYS OF PRECIOUS METAL; UNWROUGHT OR BEATEN GOLD; GOLD THREADS; JEWELRY MADE OF ORMOLU; SEMI-PRECIOUS STONES; ] NECKLACES; [ HAT ORNAMENTS OF PRECIOUS METAL; JEWELRY CHAINS; WATCH CHAINS; CUFF-LINKS; MEDALLIONS; TIE CLIPS; TIE PINS; ORNAMENTAL PINS; ORNAMENTS OF PRECIOUS METALS; ] EARRINGS; [ PEARLS; ] RINGS; [ KEY RINGS OF PRECIOUS METAL; WATCH FOBS; BUCKLES FOR WATCH STRAPS; UNWROUGHT OR CHASED SILVER; SILVER THREADS; SILVER ORNAMENTS; PASTE JEWELRY; JEWELRY TRINKETS ]

FIRST USE 8-0-2000; IN COMMERCE 8-0-2000.

ELEMENTS AMENDED  
GOODS/SERVICES

3,749,596. REG. 2-16-2010. CONAIR CORPORATION (DELAWARE CORPORATION) ONE CUMMINGS POINT ROAD, STAMFORD, CT, 06902, SN 77-778,688. FILED 7-10-2009. PRINCIPAL REGISTER.

# POLLENEX

THE MARK CONSISTS OF STANDARD CHARACTERS WITHOUT CLAIM TO ANY PARTICULAR FONT, STYLE, SIZE, OR COLOR.

OWNER OF U.S. REG. NO. 1,164,528.

INT. CL. 27/U.S. CLS. 19, 20, 37, 42 AND 50  
FOR BATH MATS.

FIRST USE 1-30-2005; IN COMMERCE 1-30-2005.

ELEMENTS CORRECTED  
OWNER NAME

3,839,282. REG. 8-24-2010. FIRST IN, INC. (ARIZONA CORPORATION) 21432 NORTH CENTRAL AVENUE, PHOENIX, AZ, 85024, SN 77-864,842. FILED 11-4-2009. PRINCIPAL REGISTER.



NO CLAIM IS MADE TO THE EXCLUSIVE RIGHT TO USE "INC", APART FROM THE MARK AS SHOWN.

THE STIPPLING IS FOR SHADING PURPOSES ONLY.

THE MARK CONSISTS OF TWO CONCENTRIC OVALS (ONE OUTER AND ONE INNER) WITH THE TEXT "FIRST IN, INC" INSIDE THE INNER OVAL.

INT. CL. 35/U.S. CLS. 100, 101 AND 102

FOR DEALERSHIPS IN THE FIELD OF FIRE TRUCKS AND AMBULANCES; RETAIL STORE AND ON-LINE RETAIL STORE SERVICES FEATURING EMERGENCY [ AND POLICE EQUIPMENT ] \*EQUIPMENT EXCLUDING POLICE EQUIPMENT\*.

FIRST USE 2-9-2010; IN COMMERCE 2-9-2010.

INT. CL. 37/U.S. CLS. 100, 103 AND 106

FOR INSTALLATION, MAINTENANCE AND REPAIR OF FIRE [ POLICE ] AND AMBULANCE VEHICLES AND EQUIPMENT \*EXCLUDING POLICE VEHICLES AND EQUIPMENT\*.

FIRST USE 2-9-2010; IN COMMERCE 2-9-2010.

ELEMENTS AMENDED  
GOODS/SERVICES

3,889,930. REG. 12-14-2010. FINITIV CORPORATION (CALIFORNIA CORPORATION) 1730 S. EL CAMINO REAL, SUITE 480, SAN MATEO, CA, 94402, SN 85-023,569. FILED 4-26-2010. PRINCIPAL REGISTER.

THE COLOR(S) BLUE, GREEN, AND BLACK IS/ARE CLAIMED AS A FEATURE OF THE MARK.

THE MARK CONSISTS OF THE WORD "FINITIV" IN BLACK WITH THE FIRST DOT ABOVE THE SECOND LETTER "I" BLENDING INTO AND BECOMING PART OF THE LETTER "F"; AND THE DOTS ABOVE THE FOURTH AND SIXTH LETTERS "I" IN THE COLORS BLUE AND GREEN, RESPECTIVELY.

THE WORDING "FINITIV" HAS NO MEANING IN A FOREIGN LANGUAGE.

INT. CL. 35/U.S. CLS. 100, 101 AND 102

FOR [ ADVERTISEMENT FOR OTHERS ON THE INTERNET; ADVERTISING AND ADVERTISEMENT SERVICES; ADVERTISING AND BUSINESS MANAGEMENT CONSULTANCY; ADVERTISING AND BUSINESS SERVICES, NAMELY, PROVIDING AN ONLINE WEBSITE WHERE ADVERTISERS, MARKETERS, AND CONTENT PROVIDERS CAN INTERACT WITH USERS FOR ADVERTISING, BRANDING, AND PROMOTING KNOWLEDGE, PRODUCTS, AND SERVICES, AND TRADESHOWS, ON BEHALF OF THEMSELVES AND OTHERS, AND FOR EVALUATING AND RATING THE SAME, ALL THE FOREGOING RELEVANT TO HUMAN ACTIVITIES AFFECTING CLIMATE CHANGE AND RELATED FIELDS; ADVERTISING AND BUSINESS SERVICES, NAMELY, SECURING AIRTIME ON ALL FORMS OF MEDIA COMMUNICATIONS STATIONS, SYSTEMS, NETWORKS, AND SERVICES FOR THE PURPOSE OF PROMOTING THE GOODS AND SERVICES OF OTHERS; ADVERTISING AND COMMERCIAL INFORMATION SERVICES, VIA THE INTERNET; ADVERTISING AND MARKETING; ADVERTISING AND MARKETING CONSULTANCY; ADVERTISING AND MARKETING SERVICES, NAMELY, PROMOTING THE GOODS AND SERVICES OF OTHERS; ADVERTISING AND PROMOTIONAL SERVICES; ADVERTISING AND PUBLICITY SERVICES, NAMELY, PROMOTING THE GOODS, SERVICES, BRAND IDENTITY AND COMMERCIAL INFORMATION AND NEWS OF THIRD PARTIES THROUGH PRINT, AUDIO, VIDEO, DIGITAL AND ON-LINE MEDIUM; ADVERTISING CONSULTATION; ADVERTISING ON THE INTERNET FOR OTHERS; ADVERTISING, MARKETING AND PROMOTION SERVICES; ] ASSISTANCE, ADVISORY SERVICES AND CONSULTANCY WITH REGARD TO BUSINESS PLANNING, BUSINESS ANALYSIS, BUSINESS MANAGEMENT, BUSINESS ORGANIZATION, MARKETING AND CUSTOMER ANALYSIS [ ; BRANDING SERVICES, NAMELY, CONSULTING, DEVELOPMENT, MANAGEMENT AND MARKETING OF BRANDS FOR BUSINESSES; BUSINESS CONSULTATION AND MANAGEMENT REGARDING MARKETING ACTIVITIES AND LAUNCHING OF NEW PRODUCTS; CON-

SULTING SERVICES IN THE FIELD OF INTERNET MARKETING; CREATION OF MARKETING TOOLS DESIGNED TO INCREASE A CLIENT COMPANY'S KNOWLEDGE OF CUSTOMER NEEDS, AND ITS COMPETITORS' PRODUCTS AND SERVICES, PRICING, ADVERTISING STRATEGY AND SALES STRATEGY; CREATIVE MARKETING DESIGN SERVICES; DESIGN OF INTERNET ADVERTISING; DISSEMINATION OF ADVERTISING FOR OTHERS VIA THE INTERNET; MARKETING CONSULTATION IN THE FIELD OF PUBLISHING AND MEDIA; PROVIDING CONSULTING SERVICES IN THE FIELD OF FACILITATING THE PLANNING, BUYING, AND SELLING OF MEDIA; PROVIDING INFORMATION IN THE FIELD OF MARKETING AND ON-LINE MARKETING MEDIA VIA THE INTERNET ]

FIRST USE 5-8-2008; IN COMMERCE 5-8-2008.

ELEMENTS AMENDED  
GOODS/SERVICES  
OWNER ADDRESS

3,935,005. REG. 3-22-2011. MEXCOR, INC. (TEXAS CORPORATION) 8950 RAILWOOD DRIVE, RAILWOOD INDUSTRIAL PARK, HOUSTON, TX, 77078, SN 77-741,440. FILED 5-20-2009. PRINCIPAL REGISTER.

## WILDCATTER

THE MARK CONSISTS OF STANDARD CHARACTERS WITHOUT CLAIM TO ANY PARTICULAR FONT, STYLE, SIZE, OR COLOR.

INT. CL. 33/U.S. CLS. 47 AND 49

FOR [ ALCOHOLIC BEVERAGES, NAMELY,] WHISKEY [ RUM, LIQUEURS, BRANDY, VODKA].

FIRST USE 12-15-2010; IN COMMERCE 12-15-2010.

ELEMENTS AMENDED  
GOODS/SERVICES

3,939,289. REG. 3-29-2011. THE GRIEF RECOVERY INSTITUTE, LLC (CALIFORNIA LIMITED LIABILITY COMPANY) 4716 WOODMAN AVENUE, SHERMAN OAKS, CA, 91423, SN 85-039,400. FILED P.R. 5-14-2010; AM. S.R. 12-29-2010. SUPPLEMENTAL REGISTER.

## Certified Grief Recovery Specialist

THE MARK CONSISTS OF STANDARD CHARACTERS WITHOUT CLAIM TO ANY PARTICULAR FONT, STYLE, SIZE, OR COLOR.

OWNER OF U.S. REG. NOS. 2,019,818 AND 2,478,750.

INT. CL. 41/U.S. CLS. 100, 101 AND 107

FOR LECTURING AND CONDUCTING CLASSES IN THE FIELD OF DEALING WITH BEREAVEMENT.

FIRST USE 12-10-2010; IN COMMERCE 12-10-2010.

ELEMENTS CORRECTED  
OWNER NAME  
ENTITY  
[DBA/AKA]

3,973,706. REG. 6-7-2011. PRICE, JOANNE (UNITED STATES INDIVIDUAL) STE 110, 444 CAMINO DEL RIO S, SAN DIEGO, CA, 92108, AND LIFE SAFETY TECHNOLOGIES (CALIFORNIA CORPORATION) 444 CAMINO DEL RIO S., STE 110, SAN DIEGO, CA, 92108, SN 85-145,096. FILED 10-5-2010. PRINCIPAL REGISTER.



NO CLAIM IS MADE TO THE EXCLUSIVE RIGHT TO USE "SIGNS", APART FROM THE MARK AS SHOWN.

THE MARK CONSISTS OF THE STYLIZED TEXT "RE-MIND SIGNS" WITH A HEART IN THE MIDDLE AND A BOW OVER THE HEART.

INT. CL. 16/U.S. CLS. 2, 5, 22, 23, 29, 37, 38 AND 50 FOR PRINTED PAPER SIGNS.

FIRST USE 7-30-2010; IN COMMERCE 8-15-2010.

ELEMENTS CORRECTED  
OWNER NAME  
OWNER ADDRESS  
CITIZENSHIP  
ENTITY

3,990,774. REG. 7-5-2011. JACK ROGERS HOLDING COMPANY LLC (DELAWARE LIMITED LIABILITY COMPANY) 155 FIFTH AVENUE, 6TH FLOOR, NEW YORK, NY, 10010, SN 77-879,729. FILED 11-24-2009. PRINCIPAL REGISTER.

## HELLO JACK

THE MARK CONSISTS OF STANDARD CHARACTERS WITHOUT CLAIM TO ANY PARTICULAR FONT, STYLE, SIZE, OR COLOR.

INT. CL. 16/U.S. CLS. 2, 5, 22, 23, 29, 37, 38 AND 50

FOR GIFT CARDS, NAMELY, PROVIDING ONLINE GIFT CARDS THAT MAY BE REDEEMED FOR GOODS.

FIRST USE 11-24-2009; IN COMMERCE 11-24-2009.

ELEMENTS CORRECTED  
GOODS/SERVICES  
OWNER ADDRESS



3,991,309. REG. 7-5-2011. NEW JERSEY STATE LEAGUE OF MUNICIPALITIES, INC. (NEW JERSEY A 501(C)(4) NON-PROFIT CORPORATION), DBA MAYORS COMMITTEE FOR A GREEN FUTURE, 222 WEST STATE STREET, TRENTON, NJ, 08608, SN 85-076,047. FILED P.R. 7-1-2010; AM. S.R. 4-18-2011. SUPPLEMENTAL REGISTER.

## SUSTAINABLE JERSEY

THE MARK CONSISTS OF STANDARD CHARACTERS WITHOUT CLAIM TO ANY PARTICULAR FONT, STYLE, SIZE, OR COLOR.

THE CERTIFICATION MARK, AS USED OR INTENDED TO BE USED BY PERSONS AUTHORIZED BY THE CERTIFIER, CERTIFIES OR IS INTENDED TO CERTIFY THAT THE GOODS AND/OR SERVICES PROVIDED HAVE COMPLIED WITH ENVIRONMENTAL STANDARDS AND STANDARDS TO CONTROL COSTS AND MAINTAIN SUSTAINABILITY

INT. CL. B /U.S. CL. B

FOR MUNICIPAL SERVICES, NAMELY, THE PROMOTING, PROVIDING AND MONITORING OF COMMUNITY PARTNERSHIP AND OUTREACH PROGRAMS; DIVERSITY AND EQUITY; ENERGY EFFICIENCY; GREENHOUSE GAS; GREEN DESIGN; HEALTH AND WELLNESS; LAND USE AND TRANSPORTATION; LOCAL ECONOMIC DEVELOPMENT; PRODUCTION AND DISTRIBUTIONS OF FOOD; NATURAL RESOURCES; OPERATIONS AND MAINTENANCE; SUSTAINABILITY PLANNING; WASTE MANAGEMENT; INNOVATION DEMONSTRATION PROJECTS; ANIMALS IN THE COMMUNITY; ARTS; CULTURE AND HISTORIC PRESERVATION.

FIRST USE 1-31-2009; IN COMMERCE 1-31-2009.

ELEMENTS CORRECTED  
INTERNATIONAL CLASS(ES)

FOR CONSTRUCTION SERVICES, NAMELY, CONSTRUCTION OF ELECTRICAL POWER TRANSMISSION LINES DONE BY HELICOPTER; CONSTRUCTION SERVICES, NAMELY, INSTALLATION OF FIBER OPTIC GROUND WIRE CABLE DONE BY HELICOPTER; CONSTRUCTION SERVICES, NAMELY, INSTALLATION ON ELECTRIC POWER TRANSMISSION LINES, OF INSULATORS, VIBRATION DAMPERS, BIRD DISCOURAGERS, CONDUCTOR SPACERS, MARKER BALLS, AERIAL NUMBERS, TRANSMISSION LINE WIRE, ALL DONE BY HELICOPTER; INSULATOR WASHING SERVICES, NAMELY, HIGH PRESSURE WATER WASHING OF INSULATORS ON ENERGIZED OR DE-ENERGIZED ELECTRIC POWER TRANSMISSION LINES DONE BY HELICOPTER; INSPECTION OF ELECTRICAL POWER TRANSMISSION LINES IN THE COURSE OF CONSTRUCTION DONE BY HELICOPTER; MAINTENANCE SERVICES, NAMELY, PERFORMING MAINTENANCE ON ELECTRIC POWER TRANSMISSION LINES DONE BY HELICOPTER.

FIRST USE 0-0-1985; IN COMMERCE 0-0-1985.

INT. CL. 41/U.S. CLS. 100, 101 AND 107

FOR EDUCATIONAL SERVICES, NAMELY, CONDUCTING TRAINING IN THE FIELDS OF INSPECTION, MAINTENANCE AND REPAIR OF ELECTRICAL POWER TRANSMISSION LINES DONE BY HELICOPTER [ ; EDUCATIONAL SERVICES, NAMELY, CONDUCTING TRAINING VIA THE INTERNET IN THE FIELDS OF INSPECTION, MAINTENANCE AND REPAIR OF ELECTRICAL POWER TRANSMISSION LINES DONE BY HELICOPTER ]

FIRST USE 4-0-2007; IN COMMERCE 4-0-2007.

INT. CL. 42/U.S. CLS. 100 AND 101

FOR INSPECTION SERVICES AND COMPREHENSIVE INSPECTION SERVICES, NAMELY, INSPECTING ELECTRIC POWER TRANSMISSION LINES DONE BY HELICOPTER INCLUDING HIGH SPEED VISUAL OBSERVATION OF ELECTRIC POWER TRANSMISSION LINES, CLOSE VISUAL AND PHOTOGRAPHIC INSPECTION, X-RAY INSPECTIONS OF ELECTRICAL POWER TRANSMISSION LINE HARDWARE, INFRARED INSPECTIONS OF ELECTRICAL POWER TRANSMISSION LINES AND LINE COMPONENTS ALL DONE BY HELICOPTER.

FIRST USE 0-0-1983; IN COMMERCE 0-0-1983.

INT. CL. 44/U.S. CLS. 100 AND 101

FOR AERIAL TREE TRIMMING SERVICES, NAMELY, PROVIDING AERIAL TRIMMING OF TREES ALONG ELECTRICAL TRANSMISSION AND DISTRIBUTION LINE CORRIDORS AND PIPELINE CORRIDORS DONE BY HELICOPTERS .

FIRST USE 5-31-2009; IN COMMERCE 5-31-2009.

ELEMENTS AMENDED  
GOODS/SERVICES

4,005,975. REG. 8-2-2011. HAVERFIELD INTERNATIONAL INCORPORATED (DELAWARE CORPORATION), DBA HAVERFIELD AVIATION, INC., 1750 EMMITSBURG ROAD, GETTYSBURG, PA, 17325, SN 85-210,083. FILED 1-4-2011. PRINCIPAL REGISTER.

## HAVERFIELD

THE MARK CONSISTS OF STANDARD CHARACTERS WITHOUT CLAIM TO ANY PARTICULAR FONT, STYLE, SIZE, OR COLOR.

OWNER OF U.S. REG. NOS. 1,645,516, 1,682,224 AND 3,140,874.

SEC. 2(F).

INT. CL. 37/U.S. CLS. 100, 103 AND 106

4,006,387. REG. 8-2-2011. DISNEY ENTERPRISES, INC. (DELAWARE CORPORATION) 500 SOUTH BUENA VISTA STREET, BURBANK, CA, 91521, SN 77-154,442. FILED 4-11-2007. PRINCIPAL REGISTER.



THE MARK CONSISTS OF CASTLE DEVICE.  
INT. CL. 9/U.S. CLS. 21, 23, 26, 36 AND 38

FOR AUDIO AND VISUAL RECORDINGS FEATURING LIVE ACTION AND ANIMATED ENTERTAINMENT FOR CHILDREN; MOTION PICTURE FILMS, TELEVISION SHOWS, MUSIC, AND STORIES IN THE NATURE OF ENTERTAINMENT FOR CHILDREN; VIDEO GAME CARTRIDGES, DISCS AND SOFTWARE FEATURING MUSIC, STORIES, GAMES, AND ACTIVITIES FOR CHILDREN; COMPUTER GAME DISCS AND SOFTWARE FEATURING MUSIC, STORIES, GAMES, AND ACTIVITIES FOR CHILDREN; SUNGLASSES.  
 FIRST USE 10-16-2009; IN COMMERCE 10-16-2009.  
 INT. CL. 41/U.S. CLS. 100, 101 AND 107  
 FOR PRODUCTION AND DISTRIBUTION OF MOTION PICTURE FILMS; PRODUCTION AND DISTRIBUTION OF TELEVISION PROGRAMS.  
 FIRST USE 12-31-2002; IN COMMERCE 12-31-2002.

ELEMENTS CORRECTED  
 DATE OF FIRST USE  
 DATE OF FIRST USE IN COMMERCE

4,006,400. REG. 8-2-2011. DISNEY ENTERPRISES, INC. (DELAWARE CORPORATION) 500 SOUTH BUENA VISTA STREET, BURBANK, CA, 91521, SN 77-225,318. FILED 7-9-2007. PRINCIPAL REGISTER.

# WALT DISNEY

THE MARK CONSISTS OF STANDARD CHARACTERS WITHOUT CLAIM TO ANY PARTICULAR FONT, STYLE, SIZE, OR COLOR.  
 OWNER OF U.S. REG. NOS. 826,419, 1,266,700 AND OTHERS.  
 INT. CL. 41/U.S. CLS. 100, 101 AND 107  
 FOR PRODUCTION AND DISTRIBUTION OF MOTION PICTURE FILMS; PRODUCTION AND DISTRIBUTION OF TELEVISION PROGRAMS.  
 FIRST USE 3-31-1969; IN COMMERCE 3-31-1969.

ELEMENTS CORRECTED  
 DATE OF FIRST USE IN COMMERCE

4,013,189. REG. 8-16-2011. WESTBLOCK SYSTEMS, INC. (OREGON CORPORATION) P.O. BOX 5348, SALEM, OR, 97304, SN 77-921,659. FILED 1-27-2010. PRINCIPAL REGISTER.

# GRAVITYSTONE EDGE

THE MARK CONSISTS OF STANDARD CHARACTERS WITHOUT CLAIM TO ANY PARTICULAR FONT, STYLE, SIZE, OR COLOR.  
 OWNER OF U.S. REG. NO. 1,777,206.  
 INT. CL. 19/U.S. CLS. 1, 12, 33 AND 50  
 FOR CONCRETE BUILDING MATERIALS, NAMELY, CONCRETE BLOCKS FOR USE IN CONSTRUCTING RETAINING WALLS, FENCES AND CRIBBING.  
 FIRST USE 8-31-2010; IN COMMERCE 8-31-2010.

ELEMENTS CORRECTED  
 DATE OF FIRST USE

4,020,995. REG. 9-6-2011. DHX MEDIA LTD. (CANADA CORPORATION) 1478 QUEEN STREET, HALIFAX, NOVA SCOTIA, CANADA, B3J2H7, SN 77-730,977. FILED 5-6-2009. PRINCIPAL REGISTER.

# KID VS KAT

THE MARK CONSISTS OF STANDARD CHARACTERS WITHOUT CLAIM TO ANY PARTICULAR FONT, STYLE, SIZE, OR COLOR.  
 PRIORITY CLAIMED UNDER SEC. 44(D) ON CANADA APPLICATION NO. 1436834, FILED 5-4-2009, REG. NO. TMA766174, DATED 5-7-2010, EXPIRES 5-7-2025.  
 INT. CL. 41/U.S. CLS. 100, 101 AND 107  
 FOR ON-LINE ENTERTAINMENT SERVICES OFFERED OVER A WORLDWIDE COMMUNICATIONS NETWORK, NAMELY, PROVIDING ENTERTAINMENT INFORMATION RELATING TO GAMES, VIDEOS, ARTWORK, A TELEVISION PROGRAM SERIES, AND MOTION PICTURE FILMS.  
 FIRST USE 10-9-2007; IN COMMERCE 3-27-2008.

ELEMENTS CORRECTED  
 GOODS/SERVICES

4,021,951. REG. 9-6-2011. AMERICAN ASSOCIATION OF COLLEGES FOR TEACHER EDUCATION (D.C. NON-PROFIT ORGANIZATION) SUITE 300, 1307 NEW YORK AVENUE, NW, WASHINGTON, DC, 20005, SN 85-193,364. FILED 12-8-2010. PRINCIPAL REGISTER.



THE MARK CONSISTS OF A STYLIZED SCHOOLHOUSE.  
 INT. CL. 35/U.S. CLS. 100, 101 AND 102  
 FOR ASSOCIATION SERVICES, NAMELY, PROMOTING THE INTERESTS OF INSTITUTIONS THAT PROVIDE EDUCATOR PREPARATION TO EDUCATORS AT THE PRE-KINDERGARTEN THROUGH 12TH GRADE LEVELS; AND PROMOTING PUBLIC AWARENESS OF THE NEED TO ENHANCE STUDENT LEARNING AT THE PRE-KINDERGARTEN THROUGH 12TH GRADE LEVELS THROUGH EDUCATOR PREPARATION.  
 FIRST USE 10-0-2008; IN COMMERCE 10-0-2008.

ELEMENTS CORRECTED  
 DATE OF FIRST USE IN COMMERCE

OCTOBER 25, 2011

U.S. PATENT AND TRADEMARK OFFICE

TM 1869

4,025,743. REG. 9-13-2011. JT SALES LLC (NEW JERSEY LIMITED LIABILITY COMPANY) 20 PINE ROAD, ROSELAND, NJ, 07068, SN 85-238,071. FILED 2-9-2011. PRINCIPAL REGISTER.

NO CLAIM IS MADE TO THE EXCLUSIVE RIGHT TO USE "CUSTOM CABINETRY", APART FROM THE MARK AS SHOWN.

## GHI CUSTOM CABINETRY

INT. CL. 20/U.S. CLS. 2, 13, 22, 25, 32 AND 50  
FOR BUILT-IN CABINETS.  
FIRST USE 12-31-2008; IN COMMERCE 12-31-2008.

THE MARK CONSISTS OF STANDARD CHARACTERS WITHOUT CLAIM TO ANY PARTICULAR FONT, STYLE, SIZE, OR COLOR.

ELEMENTS CORRECTED  
OWNER NAME

\* \* \* \* \*

# TRADEMARK REGISTRATIONS—NEW CERTIFICATES

New Certificates issued under section 7(d) of the Trademark Act of 1946 for the unexpired term of the original registrations.

501,154. SACRO-EASE. U.S. CL. 32. MCCARTY, COEUR D'ALENE, ID. REG. 7-27-1948. NEW CERT. SEC. 7(D) TO REGISTRANT.

3,755,620. CHANGEREcipe STANDARD CHARACTER MARK. INT. CL. 45. ICHANGE NETWORK, INC., PASADENA, CA. REG. 3-2-2010. NEW CERT. SEC. 7(D) TO REGISTRANT.

2,019,818. GRIEF RECOVERY AND DESIGN. INT. CL. 41. GRIEF RECOVERY INSTITUTE, THE, SHERMAN OAKS, CA. REG. 11-26-1996. NEW CERT. SEC. 7(D) TO REGISTRANT.

3,832,879. KRATOR STANDARD CHARACTER MARK. INT. CL. 9. KGUARD INFORMATION CO., LTD., TAIPEI HSIEN 235, TAIWAN. REG. 8-10-2010. NEW CERT. SEC. 7(D) TO REGISTRANT.

2,144,079. CNM. U.S. CL. B. ACNM CERTIFICATION COUNCIL, INC. ("ACC"), LANDOVER, MD. REG. 3-17-1998. NEW CERT. SEC. 7(D) TO REGISTRANT.

3,916,783. SOHO TAVERN EST. 2008 AND DESIGN. INT. CL. 43. FRANKLIN STREET MARKET, LLC, RIVERVIEW, FL. REG. 2-8-2011. NEW CERT. SEC. 7(D) TO REGISTRANT.

2,253,969. CM. U.S. CL. B. ACNM CERTIFICATION COUNCIL, INC. ("ACC"), LANDOVER, MD. REG. 6-15-1999. NEW CERT. SEC. 7(D) TO REGISTRANT.

3,935,685. INFOINTSALE STANDARD CHARACTER MARK. INT. CL. 9. INNOVATIVE BUSINESS TECHNOLOGY, INC., PANAMA CITY, PANAMA. REG. 3-22-2011. NEW CERT. SEC. 7(D) TO REGISTRANT.

\* \* \* \* \*

# INDEX OF REGISTRANTS

OCTOBER 25, 2011

(Registered; Renewed; Canceled; Amended, Corrected, etc.; New Certificates; 12c Publications.)

The designation "U.S. Cl." appearing in this section refers to the U.S. class in effect prior to Sep. 1, 1973 rather than the international class which applies to applications filed on or after that date. For adoption of international classification see notice in the OFFICIAL GAZETTE of Jun. 26, 1973 (911 O.G. TM 210).

'MERKOS L'INYONEI CHINUCH, INC., BROOKLYN, NY:  
3,038,952, COR. INT. CL. 16.

"SPARKY GROUP" AD, BG-1220 SOFIA, BULGARIA:  
4,043,809, PUB. 8-9-2011. INT. CL. 7.

ÇOBANPINAR İÇME SUYU VE INSAAT SANAYI TICARET  
LIMITED SİRKETİ, TURKEY:  
4,043,764, PUB. 8-9-2011. INT. CL. 32.

A METAL SOURCE, LLC, CLEVELAND, OH:  
4,047,248, INT. CL. 39.

A TO Z IMPORTS, MT. STERLING, OH:  
2,428,566, CANC. INT. CL. 35.

A TO Z WINeworks, LLC, NEWBERG, OR:  
4,046,838, INT. CL. 33.

A. I. ROOT COMPANY, THE, MEDINA, OH:  
2,614,632. REN. 9-16-11. INT. CL. 4.

A. M. F. FARMS, INC., BURLINGTON, WA:  
2,943,692, COR. MULTIPLE CLASS, INT. CLS. 31 AND  
42.

A.P. GREEN INDUSTRIES, INC., MOON TOWNSHIP, PA, A.  
P. GREEN FIRE BRICK COMPANY, MEXICO, MO:  
388,629. REN. 9-19-11. U.S. CL. 12 (INT. CL. 19).

A.T.X. INTERNATIONAL, INC., LINCOLN, RI:  
2,926,508, CANC. INT. CL. 9.

A.V.W. INC, FT LAUDERDALE, FL, DBA MAX PROFES-  
SIONAL:  
4,045,267, PUB. 8-9-2011. INT. CL. 21.

A&E TELEVISION NETWORKS, LLC, NEW YORK, NY:  
4,046,312, MULTIPLE CLASS, INT. CLS. 9 AND 41.

A&P TOOL, INC., HICKSVILLE, OH:  
4,045,591, INT. CL. 6.

AAF-MCQUAY INC., LOUISVILLE, KY:  
2,475,039. REN. 9-20-11. INT. CL. 7.

AAJ COMPUTER SERVICES, INC., FORT LAUDERDALE,  
FL, DBA AAJ TECHNOLOGIES:  
4,046,100, MULTIPLE CLASS, INT. CLS. 35, 36, 42, 44  
AND 45.

AARDVARK PROMOTIONS, INC., CHICAGO, IL:  
4,047,261, INT. CL. 35.

AARONSON, NAOMI, BAYSIDE, NY AND TURO, ANN  
MARIE, BOSTON, MA:  
4,044,076, PUB. 8-9-2011. INT. CL. 44.

AARP, WASHINGTON, DC:  
4,045,829, INT. CL. 9.  
4,045,830, INT. CL. 9.

AASTRA TECHNOLOGIES LIMITED, CONCORD, ONTAR-  
IO, CANADA:  
4,045,984, INT. CL. 9.

ABBEY OF GETHSEMANI, TRAPPIST, KY:  
4,046,438, INT. CL. 30.

ABBOTT CARDIOVASCULAR SYSTEMS, INC., SANTA  
CLARA, CA:  
2,428,728, CANC. INT. CL. 10.

ABBOTT LABORATORIES, ABBOTT PARK, IL, PET-AG,  
INC., ELGIN, IL:  
1,685,963. REN. 9-21-11. INT. CL. 5.

ABBOTT LABORATORIES, ABBOTT PARK, IL:  
4,045,556, PUB. 8-9-2011. INT. CL. 1.  
4,045,558, PUB. 8-9-2011. INT. CL. 1.  
4,046,205, INT. CL. 5.

ABBOTT MEDICAL OPTICS INC., SANTA ANA, CA:  
4,045,686, INT. CL. 10.

ABE'S ELECTRONIC CENTER, INC., EDISON, NJ:  
2,617,867. REN. 9-21-11. INT. CL. 35.

ABM TECHNOLOGIES, 94140 ALFORTVILLE, FRANCE:  
4,044,021, PUB. 8-9-2011. MULTIPLE CLASS, INT. CLS. 9,  
35, 36, 38, 42 AND 45.

ABRANTE, ALBERTO R., MIAMI, FL, NATIONAL FOOD  
INDUSTRIES INC., MIAMI, FL:  
1,167,519. REN. 9-21-11. INT. CL. 29.

ABSENTE LLC, PALM COAST, FL:  
2,534,150. REN. 9-20-11. INT. CL. 33.

ABSOLUTE LOGISTICS, LLC, ENGLEWOOD, CO:  
2,428,539, CANC. INT. CL. 35.

ACADEMY OF MANAGED CARE PHARMACY, ALEXAN-  
DRIA, VA:  
4,046,109, MULTIPLE CLASS, INT. CLS. 9, 35 AND 44.

ACCEL FIRE SYSTEMS, INC., ANCHORAGE, AK:  
2,427,957, CANC. INT. CL. 42.

ACCELERATED CARE PLUS CORP., RENO, NV:  
4,043,934, PUB. 5-3-2011. MULTIPLE CLASS, INT. CLS. 9,  
10 AND 41.

ACCESS COMMUNITY HEALTH NETWORK, CHICAGO,  
IL:  
4,045,803, INT. CL. 35.

ACCESS VG, L.L.C., SALT LAKE CITY, UT:  
2,475,775. REN. 9-21-11. INT. CL. 35.

ACCLARENT, INC., MENLO PARK, CA:  
4,045,822, INT. CL. 10.

ACCOR, EVRY, FRANCE:  
1,480,112, AM. INT. CL. 42.

ACCREDITATION COUNCIL FOR SURGICAL QUALITY,  
CAMBRIDGE, MA:  
4,044,746, PUB. 8-9-2011. INT. CL. 41.  
4,044,747, PUB. 8-9-2011. INT. CL. 41.

ACCREDITED INVESTORS, INC., EDINA, MN:  
2,521,382. REN. 9-18-11. INT. CL. 36.

ACCTON TECHNOLOGY CORPORATION, HSINCHU, 300,  
TAIWAN:  
2,510,942. REN. 9-16-11. INT. CL. 35.

ACELERANT INCORPORATED, JUPITER, FL, DBA STIN-  
GRAY BRANDS:  
4,044,332, PUB. 8-9-2011. INT. CL. 28.

ACH FOOD COMPANIES, INC., CORDOVA, TN:  
4,044,086, PUB. 8-9-2011. MULTIPLE CLASS, INT. CLS. 2,  
4, 21 AND 30.

ACI INTERNATIONAL, LOS ANGELES, CA:  
4,046,925, INT. CL. 25.

ACINDAR INDUSTRIA ARGENTINA DE ACEROS S.A.,  
PROVINCIA DE BUENOS AIRES, ARGENTINA:  
2,479,321. REN. 9-20-11. INT. CL. 6.

ACIRCA, INC., MELVILLE, NY:  
2,479,652. REN. 9-19-11. INT. CL. 32.

ACRILEX TINTAS ESPECIAIS S/A, 09842-080 SAO BERNAR-  
DO DO CAMPO SP, BRAZIL:  
2,491,206. REN. 9-20-11. INT. CL. 2.  
2,491,206, CANC. INT. CL. 16.

ACTION WOBBLE, INC., IRVINE, CA:  
4,045,801, INT. CL. 16.  
4,045,802, INT. CL. 16.

ACUSHNET COMPANY, FAIRHAVEN, MA:  
1,165,697. REN. 9-19-11. INT. CL. 28.

- ADAM'S JEWELRY NETWORK PA INC., STROUDSBURG, PA:  
4,045,240, PUB. 8-9-2011. INT. CL. 35.
- ADAMO'S ADAM BOMB LLC, BORDENTOWN, NJ:  
4,044,881, PUB. 8-9-2011. INT. CL. 30.
- ADDIS INTELLECTUAL CAPITAL, LLC, KING OF PRUSSIA, PA:  
4,046,069, INT. CL. 35.
- ADEGA VALDES, S.L., SPAIN:  
2,925,489.
- ADJUVANTS UNLIMITED, INC., TULSA, OK:  
4,046,028, INT. CL. 1.
- ADOBE SYSTEMS INCORPORATED, SAN JOSE, CA:  
4,043,892, PUB. 8-9-2011. INT. CL. 42.
- ADOPTIONS WITH LOVE, INC., NEWTON, MA:  
4,045,148, PUB. 8-9-2011. INT. CL. 45.
- ADP P2P CANADA, INC., CALGARY, CANADA, DIGITAL OILFIELD INC., CALGARY, CANADA:  
2,489,947. REN. 9-21-11. INT. CL. 35.
- ADP, INC., ROSELAND, NJ:  
4,045,970, INT. CL. 36.
- ADRENALIN GAMING, LLC, LADERA RANCH, CA:  
4,046,316, INT. CL. 28.
- ADRIENNE VITTADINI, LLC, COLUMBUS, OH:  
4,046,190, INT. CL. 25.
- ADSTAR, INC., MARINA DEL REY, CA:  
2,428,560, CANC. INT. CL. 35.
- ADT SERVICES AG, SCHAFFHAUSEN, SWITZERLAND:  
4,044,849, PUB. 8-9-2011. MULTIPLE CLASS, INT. CLS. 42 AND 45.  
4,045,516, PUB. 8-9-2011. MULTIPLE CLASS, INT. CLS. 9 AND 45.
- ADTN INTERNATIONAL LTD., NEW YORK, NY:  
4,045,907, INT. CL. 25.
- ADULT PROFICIENCY AND EQUIVALENCY EXAMINATIONS, INC., LAS VEGAS, NV:  
4,046,217, INT. CL. 41.
- ADVANCE MAGAZINE PUBLISHERS INC., NEW YORK, NY:  
4,045,398, PUB. 8-9-2011. INT. CL. 41.
- ADVANCED AESTHETICS, INC., SPANISH FORK, UT:  
2,493,494. REN. 9-20-11. INT. CL. 3.
- ADVANCED BUSINESS STRATEGIES, BEAVERTON, OR:  
2,496,341. REN. 9-19-11. INT. CL. 35.
- ADVANCED LITHIUM ELECTROCHEMISTRY CO., LTD., TAOYUAN COUNTY, TAIWAN:  
4,046,062, MULTIPLE CLASS, INT. CLS. 9 AND 39.
- ADVANCED MANUFACTURING TECHNOLOGY FOR BOTTLES INC, LOVELAND, CO:  
4,047,136, INT. CL. 7.
- ADVANCED MICRO DEVICES, INC., SUNNYVALE, CA:  
1,633,063, CANC. INT. CL. 9.
- ADVANCED NEUROMODULATION SYSTEMS, INC., PLANO, TX:  
4,046,132, INT. CL. 10.
- ADVANCED NUTRIENTS LTD., ABBOTSFORD, CANADA:  
4,043,666, PUB. 7-12-2011. INT. CL. 1.  
4,043,667, PUB. 7-19-2011. INT. CL. 1.
- ADVANCED NUTRIENTS LTD., ABBOTSFORD, BC, CANADA:  
4,044,175, PUB. 7-26-2011. INT. CL. 11.  
4,044,176, PUB. 7-26-2011. INT. CL. 11.
- ADVANCED-CONNECTEK INC., TAIPEI, TAIWAN:  
4,046,929, MULTIPLE CLASS, INT. CLS. 9 AND 11.
- ADVANTAGE BAIT COMPANY, ELK GROVE VILLAGE, IL:  
4,047,095, INT. CL. 28.  
4,047,096, INT. CL. 28.
- ADVANTAGE RESOURCING AMERICA, INC., DEDHAM, MA:  
2,428,029, CANC. INT. CL. 35.
- ADVANTAGE RESOURCING AMERICA, INC., NORWOOD, MA:  
4,046,092, INT. CL. 35.  
4,046,093, INT. CL. 35.  
4,046,094, INT. CL. 35.
- ADVANTEST CORPORATION, NERIMA-KU, TOKYO 179, JAPAN:  
2,926,534, CANC. INT. CL. 9.
- ADVENT MARINE TECHNOLOGIES (MALAYSIA) SDN BHD, KUALA LUMPUR, MALAYSIA:  
4,045,063, PUB. 8-9-2011. INT. CL. 12.
- ADVENTURE BAY EARLY LEARNING CENTERS, INC., CORAL SPRINGS, FL:  
2,552,227. REN. 9-20-11. MULTIPLE CLASS, INT. CLS. 41 AND 42.
- ADWIN USA, INC., CARSON, CA, DBA COHBE:  
4,044,062, PUB. 8-9-2011. INT. CL. 3.
- ADZZOO LLC, MCDONOUGH, GA:  
4,044,852, PUB. 8-9-2011. MULTIPLE CLASS, INT. CLS. 9, 16 AND 35.
- AERO INSTRUMENTS, HILO, HI:  
4,043,927, PUB. 8-9-2011. INT. CL. 9.
- AES LOGISTICS, INC., BURIEN, WA:  
4,044,692, PUB. 8-9-2011. INT. CL. 35.
- AETREX WORLDWIDE, INC., TEANECK, NJ:  
1,166,355. REN. 9-19-11. INT. CL. 10.
- AFC ENTERPRISES, INC., ATLANTA, GA:  
4,045,548, PUB. 8-9-2011. INT. CL. 43.  
4,045,549, PUB. 8-9-2011. INT. CL. 43.
- AFFINION BENEFITS GROUP, LLC, FRANKLIN, TN:  
4,045,928, MULTIPLE CLASS, INT. CLS. 35 AND 45.  
4,046,158, INT. CL. 35.  
4,046,159, INT. CL. 35.
- AFIRM XL, LLC, LADERA RANCH, CA:  
4,044,810, PUB. 8-9-2011. INT. CL. 5.
- AFRO-SAPIEN, LLC., NORTH MIAMI GARDENS, FL:  
4,045,597, INT. CL. 25.  
4,045,598, INT. CL. 25.
- AFSHAR, MEHDI, NEW YORK, NY, DBA TECHNARO, AFSHAR, INC., NEW YORK, NY, DBA TECHNARO:  
1,654,874. REN. 9-22-11. INT. CL. 14.
- AFTERBURNER, INC., ATLANTA, GA:  
4,045,070, PUB. 8-9-2011. MULTIPLE CLASS, INT. CLS. 35 AND 41.
- AG HOLDING S.A., LUXEMBOURG, LUXEMBOURG:  
4,044,127, PUB. 8-9-2011. MULTIPLE CLASS, INT. CLS. 3, 14, 18, 25 AND 35.
- AG SPECTRUM COMPANY, DEWITT, IA:  
4,044,911, PUB. 8-9-2011. INT. CL. 1.
- AGATHON INVESTMENT S.R.L, MORLUPO, ITALY, DBA ITALY BE LIVE:  
4,046,597, INT. CL. 35.
- AGC, LLC, CLEVELAND, OH, MARCEL SCHURMAN COMPANY, INC., OAKLAND, CA:  
1,159,571. REN. 9-19-11. INT. CL. 42.
- AGIS NETWORK, INC., ST. LOUIS, MO:  
2,480,262. REN. 9-21-11. MULTIPLE CLASS, INT. CLS. 35, 36, 39, 41 AND 42.
- AGRARIAN MARKETING CORPORATION, MIDDLEBURY, IN:  
4,044,645, PUB. 8-9-2011. INT. CL. 5.
- AGRI LABORATORIES, LTD., ST. JOSEPH, MO:  
4,046,560, INT. CL. 5.
- AGRIUM ADVANCED TECHNOLOGIES (U.S.) INC., SYLACAUGA, AL:  
4,043,672, PUB. 8-9-2011. INT. CL. 1.
- AHARONI & STEELE, INC., SANTA CLARA, CA:  
4,046,725, INT. CL. 29.  
4,046,726, INT. CL. 29.
- AHCOF INDUSTRIAL DEVELOPMENT CO., LTD., CHINA AND AHCOF INTERNATIONAL DEVELOPMENT CO., LTD., CHINA AND ANHUI CEREALS, OILS & FOODSTUFFS IMPORT & EXPORT (GROUP) CORPORATION, CHINA:  
4,043,770, PUB. 8-9-2011. MULTIPLE CLASS, INT. CLS. 29 AND 31.
- AHEAD, INC., NEW BEDFORD, MA:  
2,478,659. REN. 9-20-11. INT. CL. 7.
- AHRENS AGRICULTURAL INDUSTRIES CO., GRINNELL, IA, MIRACLE RECREATION EQUIPMENT COMPANY, GRINNELL, IA:  
1,165,421. REN. 9-21-11. INT. CL. 11.
- AIFS, INC., STAMFORD, CT, NEW ENGLAND TRAVEL CORPORATION, GREENWICH, CT:  
932,996. REN. 9-19-11. U.S. CL. 101 (INT. CL. 35).

AINSWORTH GAME TECHNOLOGY LIMITED, NEWINGTON, AUSTRALIA:  
4,045,889, INT. CL. 9.  
4,046,526, INT. CL. 9.

AIR PRODUCTS AND CHEMICALS, INC., ALLENTOWN, PA:  
920,684, REN. 9-16-11. U.S. CL. 34 (INT. CL. 11).  
921,124, REN. 9-16-11. U.S. CL. 31 (INT. CL. 11).

AIRMARC, LLC, ORLANDO, FL:  
4,046,230, INT. CL. 41.

AIRWAY INDUSTRIES, INC., ELLWOOD CITY, PA:  
2,428,965, CANC. INT. CL. 18.

AISONNE HOLDINGS, LLC, MINDEN, NV:  
4,044,004, PUB. 8-9-2011. INT. CL. 29.

AJM QUEST LLC, MIRAMAR BEACH, FL, DBA HEALING PATH CONCEPTS:  
4,047,227, INT. CL. 44.

AKER BIOMARINE ASA, OSLO, NORWAY:  
4,046,310, INT. CL. 5.

AKER WADE POWER TECHNOLOGIES, LLC, CHARLOTTEVILLE, VA:  
4,046,946, INT. CL. 9.

AKG ACOUSTICS GMBH, WEIN, AUSTRIA, AKG AKUSTISCHE U. KINO-GERATE GESELLSCHAFT M.B.H., VIENNA 15, AUSTRIA:  
1,169,107, REN. 9-18-11. INT. CL. 9.

AKITA, INC, WILMINGTON, DE:  
4,045,301, PUB. 8-9-2011. INT. CL. 36.

AKTIEBOLAGET CARL MUNTERS, KISTA, SWEDEN:  
1,656,178, REN. 9-21-11. INT. CL. 11.

AKTIEBOLAGET ELECTROLUX, SE-105 45 STOCKHOLM, SWEDEN:  
2,492,042, REN. 9-18-11. INT. CL. 7.

AKTIEBOLAGET ELECTROLUX, STOCKHOLM, SWEDEN:  
4,046,544, MULTIPLE CLASS, INT. CLS. 7 AND 11.

AKZO NOBEL COATINGS INTERNATIONAL B.V., 6824 BM, ARNHEM, NETHERLANDS, AKZO COATINGS INTERNATIONAL B.V., HOOFDDORP, NETHERLANDS:  
1,630,539, REN. 9-20-11. INT. CL. 2.

ALABAMA SPACE SCIENCE EXHIBIT COMMISSION, HUNTSVILLE, AL:  
2,926,561, CANC. INT. CL. 41.

ALACER CORPORATION, FOOTHILL RANCH, CA:  
4,046,164, INT. CL. 32.

ALAN G LLC, NEW YORK, NY:  
4,045,873, INT. CL. 25.

ALASKAN BREWING CO., JUNEAU, AK:  
4,044,432, PUB. 8-9-2011. INT. CL. 32.

ALBERT EINSTEIN HEALTHCARE NETWORK, PHILADELPHIA, PA:  
4,044,472, PUB. 8-9-2011. INT. CL. 41.  
4,044,473, PUB. 8-9-2011. INT. CL. 41.

ALCHABAOUN, MOHAMMED, FONTANA, CA:  
4,046,576, INT. CL. 3.

ALCOR SCIENTIFIC, INC., WARWICK, RI:  
4,044,300, PUB. 8-9-2011. INT. CL. 10.

ALDEBARAN ROBOTICS, F-75014 PARIS, FRANCE:  
4,043,751, PUB. 8-9-2011. MULTIPLE CLASS, INT. CLS. 16, 35 AND 41.

ALDEN SHOE COMPANY, MIDDLEBOROUGH, MA:  
1,656,326, REN. 9-21-11. INT. CL. 25.

ALDI INC., BATAVIA, IL:  
2,506,213, REN. 9-20-11. INT. CL. 29.  
4,045,752, INT. CL. 29.  
4,045,868, INT. CL. 32.  
4,046,977, INT. CL. 29.

ALERT PAWS, INC., MIAMI, FL:  
4,047,137, INT. CL. 16.

ALEXANDER LESLIE WILSON, SWITZERLAND:  
4,043,844, PUB. 8-9-2011. INT. CL. 9.

ALFA LAVAL CORPORATE AB, LUND, SWEDEN:  
1,163,281, REN. 9-19-11. INT. CL. 6.  
1,163,412, REN. 9-19-11. MULTIPLE CLASS, INT. CLS. 7 AND 11.

ALFONSO TOMITA, SAN ANTONIO, TX:  
4,045,007, PUB. 8-9-2011. INT. CL. 43.

ALFRED DUNNER, INC., NEW YORK, NY:  
4,046,810, INT. CL. 25.

ALGAE TO OMEGA HOLDINGS, INC, OAKLAND PARK, FL:  
4,044,105, PUB. 8-9-2011. MULTIPLE CLASS, INT. CLS. 29, 31 AND 44.

ALGOOD FOOD COMPANY, LOUISVILLE, KY:  
4,043,981, PUB. 8-9-2011. INT. CL. 29.

ALI INDUSTRIES, INC., FAIRBORN, OH:  
2,529,219, REN. 9-22-11. INT. CL. 8.

ALIBABA GROUP HOLDING LIMITED, GRAND CAYMAN, CAYMAN ISLANDS:  
4,043,695, PUB. 8-9-2011. MULTIPLE CLASS, INT. CLS. 9, 16, 35, 38, 41 AND 42.  
4,043,917, PUB. 8-9-2011. MULTIPLE CLASS, INT. CLS. 9, 16, 35, 38 AND 41.

ALIEN AFTER ALL SOCIÉTÉ PAR ACTIONS SIMPLIFIÉE, F-95200 SARCELLES, FRANCE:  
4,043,763, PUB. 8-9-2011. MULTIPLE CLASS, INT. CLS. 9, 35 AND 41.

ALIMERA SCIENCES, INC., ALPHARETTA, GA:  
4,045,625, MULTIPLE CLASS, INT. CLS. 5 AND 10.

ALINTER, S.A., SAN JOSÉ, COSTA RICA:  
4,045,659, MULTIPLE CLASS, INT. CLS. 5 AND 29.

ALL AMERICAN APPETITE, LLC, NEWPORT BEACH, CA, DBA FIT CRISPS:  
4,046,462, MULTIPLE CLASS, INT. CLS. 29 AND 30.

ALL FIRED UP, LLC, RICHMOND, VA:  
4,044,231, PUB. 8-9-2011. MULTIPLE CLASS, INT. CLS. 40 AND 41.

ALL FIRED UP, LLC, RICHMOND, VA:  
4,044,232, PUB. 8-9-2011. MULTIPLE CLASS, INT. CLS. 40 AND 41.

ALL RESORT COACH, INC., PARK CITY, UT, DBA LEWIS STAGES:  
4,045,209, PUB. 8-9-2011. INT. CL. 39.

ALL YOUR NEEDS LLC, DALLAS, TX, DBA ARBOR HOME CARE:  
4,045,472, PUB. 8-9-2011. INT. CL. 45.

ALL-TEMP SYSTEMS, INC., MILFORD, MA:  
2,428,441, CANC. INT. CL. 37.

ALLEGHANY PHARMACAL, GREAT NECK, NY:  
4,044,558, PUB. 8-9-2011. INT. CL. 3.

ALLEGHANY PHARMACAL CORPORATION, GREAT NECK, NY:  
2,926,781, CANC. INT. CL. 3.

ALLEGHENY COUNTY BAR ASSOCIATION, PITTSBURGH, PA:  
4,046,635, MULTIPLE CLASS, INT. CLS. 9, 38, 41 AND 45.

ALLEGIANCE CORPORATION, MCGAW PARK, IL:  
2,488,637, REN. 9-22-11. INT. CL. 10.

ALLFLEX USA, INC., DFW AIRPORT, TX:  
4,045,861, INT. CL. 20.

ALLIANCE FIBER OPTIC PRODUCTS, INC., SUNNYVALE, CA, AKA AFOP:  
2,587,682, REN. 9-19-11. INT. CL. 9.

ALLIED BUSINESS INTELLIGENCE, INC., OYSTER BAY, NY:  
4,047,174, INT. CL. 35.

ALLIED WIRELESS COMMUNICATIONS CORPORATION, LITTLE ROCK, AR:  
4,046,904, INT. CL. 38.

ALLSECTOR TECHNOLOGY GROUP, INC., NEW YORK, NY:  
2,482,924, REN. 9-21-11. INT. CL. 42.

ALMONT COMPANY, INC., THE, SOUTH BOSTON, MA, DBA BOXERBRAND:  
2,617,954, REN. 9-20-11. INT. CL. 16.

ALOHA HAWAIIAN STORES, INC., KAINALIU, HI:  
4,044,279, PUB. 8-9-2011. INT. CL. 30.

ALLOXXI INTERNATIONAL CORPORATION, SHERMAN OAKS, CA:  
4,046,611, INT. CL. 3.  
4,046,619, INT. CL. 3.  
4,046,652, INT. CL. 3.  
4,046,653, INT. CL. 3.  
4,046,654, INT. CL. 3.  
4,046,655, INT. CL. 3.  
4,046,656, INT. CL. 3.  
4,046,673, INT. CL. 3.

- ALPACA PASTURES OF VIRGINIA, INC., BEAVERDAM, VA:  
4,044,772, PUB. 8-9-2011. INT. CL. 3.  
4,044,780, PUB. 8-9-2011. INT. CL. 44.
- ALPARI (UK) LIMITED, LONDON EC2M 3AB, UNITED KINGDOM:  
4,043,847, PUB. 8-9-2011. INT. CL. 36.
- ALPHAVISTA SERVICES, INC., SUNNYVALE, CA:  
4,046,824, INT. CL. 9.
- ALPINE BANKS OF COLORADO, GLENWOOD SPRINGS, CO:  
2,614,452, REN. 9-21-11. MULTIPLE CLASS, INT. CLS. 16 AND 42.
- ALSIP, STEPHEN D., WINNIPEG MANITOBA, CANADA:  
4,044,363, PUB. 8-9-2011. INT. CL. 35.
- ALTEC, INC., BROUSSARD, LA, DBA ALTEC GAS LIFT, INC.:  
2,483,890, REN. 9-21-11. INT. CL. 7.
- ALTERNA HOLDINGS CORP., CENTURY CITY, CA:  
3,989,684, CANC. INT. CL. 3.
- ALVAREZ & MARSAL HOLDINGS, LLC, NEW YORK, NY:  
4,046,841, INT. CL. 35.
- ALVAREZ AUTOMOTRIZ, S.A. DE C.V., TLANEPANTLA EDO., MEXICO:  
4,045,340, PUB. 8-9-2011. INT. CL. 12.
- ALVAREZ, GEORGE, CORAL GABLES, FL:  
4,046,034, INT. CL. 43.
- ALVERNIA UNIVERSITY, READING, PA:  
4,044,787, PUB. 8-9-2011. INT. CL. 41.  
4,044,800, PUB. 8-9-2011. INT. CL. 41.
- ALZCARE, INC., HAMILTON, NJ:  
4,046,338, INT. CL. 44.
- AMADA COMPANY LIMITED, KANAGAWA-KEN, JAPAN, AMADA COMPANY LIMITED, KANAGAWA-KEN, JAPAN:  
2,493,042, REN. 9-21-11. INT. CL. 9.
- AMALGAMATED ORDER OF REAL BEARDED SANTAS INC., MAYFIELD, KY:  
4,043,664, PUB. 12-29-2009. INT. CL. 35.
- AMANDA HOLT COREY CRAFTS, NEW YORK, NY:  
4,044,353, PUB. 8-9-2011. MULTIPLE CLASS, INT. CLS. 16 AND 20.
- AMANN GIRRBACH AG, KOBLACH, AUSTRIA:  
2,515,869, REN. 9-18-11. INT. CL. 9.
- AMARILLO CHAMBER OF COMMERCE, AMARILLO, TX:  
2,581,170, REN. 9-22-11. INT. CL. 35.
- AMATEUR ATHLETIC UNION OF THE UNITED STATES, INC., LAKE BUENA VISTA, FL:  
1,164,983, REN. 9-19-11. INT. CL. 41.
- AMBER M COE, RALEIGH, NC, DBA COETOGRAPHY:  
4,045,439, PUB. 8-9-2011. INT. CL. 41.
- AMBITIOUS IDEAS, INC., SANTA MONICA, CA:  
2,926,501, CANC. INT. CL. 25.
- AMC INTERNATIONAL ALFA METALCRAFT CORPORATION AG, 6343 ROTKREUZ, SWITZERLAND:  
2,490,375, REN. 9-16-11. MULTIPLE CLASS, INT. CLS. 9 AND 21.
- AMCOL INTERNATIONAL CORPORATION, HOFFMAN ESTATES, IL, AMERICAN COLLOID COMPANY, ARLINGTON HEIGHTS, IL:  
1,708,212, REN. 9-21-11. INT. CL. 19.
- AMEFA FRANCE, F-42440 NOIRÉTABLE, FRANCE:  
4,043,749, PUB. 5-3-2011. MULTIPLE CLASS, INT. CLS. 6, 8 AND 21.
- AMERI-PAC, INC., ST. JOSEPH, MO:  
2,610,706, REN. 9-21-11. INT. CL. 5.
- AMERICA INSURANCE AGENCY, INC., PHILADELPHIA, PA:  
4,044,126, PUB. 5-3-2011. INT. CL. 36.
- AMERICA TECHCODE SEMICONDUCTOR, INC., CUPERTINO, CA:  
4,047,048, INT. CL. 9.
- AMERICAN APPAREL ACCESSORIES, INC., EL MONTE, CA, DBA AAA HANGERS:  
4,045,418, PUB. 8-9-2011. INT. CL. 20.
- AMERICAN ASSOCIATION OF COLLEGES FOR TEACHER EDUCATION, WASHINGTON, DC:  
4,021,951, COR. INT. CL. 35.
- AMERICAN BANK OF TEXAS, SHERMAN, TX:  
4,045,166, PUB. 8-9-2011. INT. CL. 36.
- AMERICAN BANKERS ASSOCIATION, WASHINGTON, DC:  
1,164,614, REN. 9-21-11. INT. CL. 16.
- AMERICAN BLUE RIBBON HOLDINGS, LLC, DENVER, CO:  
4,046,125, INT. CL. 40.
- AMERICAN BOARD OF FAMILY MEDICINE, INC., LEXINGTON, KY:  
4,046,473, INT. CL. 41.
- AMERICAN BOARD OF OPTOMETRY, ST. LOUIS, MO:  
4,046,054, U.S. CL. B.
- AMERICAN CANCER SOCIETY, FLORIDA DIVISION, INC., TAMPA, FL:  
4,045,089, PUB. 8-9-2011. INT. CL. 36.
- AMERICAN CAST IRON PIPE COMPANY, BIRMINGHAM, AL:  
288,068, REN. 9-22-11. U.S. CL. 13 (INT. CL. 6).
- AMERICAN COLLEGE OF RADIOLOGY, RESTON, VA:  
4,046,636, INT. CL. 35.
- AMERICAN CONSERVATIVE UNION, ALEXANDRIA, VA:  
4,045,061, PUB. 8-9-2011. INT. CL. 35.  
4,045,062, PUB. 8-9-2011. INT. CL. 35.
- AMERICAN COWBOY COMPANY, SIOUX FALLS, SD:  
3,085,709, CANC. MULTIPLE CLASS, INT. CLS. 9, 38 AND 41.
- AMERICAN DECORATIVE CONCRETE SUPPLY CO., LOWELL, AR:  
4,046,152, INT. CL. 1.
- AMERICAN DREAM ENTERPRISES CORP., BOCA RATON, FL:  
2,427,798, CANC. INT. CL. 42.
- AMERICAN EDUCATIONAL MUSIC PUBLICATIONS, INC., FAIRFIELD, IA, DBA EARTHBORN PRODUCTS INTERNATIONAL:  
2,488,060, REN. 9-16-11. INT. CL. 35.
- AMERICAN EXPRESS MARKETING & DEVELOPMENT CORP., NEW YORK, NY:  
4,046,978, INT. CL. 41.  
4,046,982, INT. CL. 39.
- AMERICAN GATEWAY MARKETING GROUP, INC., SAN JOSE, CA:  
4,045,618, INT. CL. 28.
- AMERICAN GIRL, LLC, EL SEGUNDO, CA:  
4,046,139, INT. CL. 41.  
4,046,226, INT. CL. 25.
- AMERICAN HIGHER ED, INC., HINGHAM, MA:  
2,926,597, CANC. INT. CL. 41.
- AMERICAN HOME MORTGAGE SERVICING, INC, IRVING, TX:  
2,926,743, CANC. INT. CL. 36.
- AMERICAN INSTITUTE OF CHEMICAL ENGINEERS, NEW YORK, NY:  
2,489,973, REN. 9-22-11. INT. CL. 42.
- AMERICAN INSURANCE ADMINISTRATORS, INC., COLUMBUS, OH:  
4,043,632, PUB. 8-9-2011. INT. CL. 36.
- AMERICAN INTERNATIONAL GROUP, INC., NEW YORK, NY:  
2,428,600, CANC. INT. CL. 36.  
2,926,851, CANC. INT. CL. 36.
- AMERICAN JOURNAL EXPERTS, L.L.C., DURHAM, NC:  
4,044,946, PUB. 8-9-2011. INT. CL. 41.  
4,044,947, PUB. 8-9-2011. INT. CL. 41.
- AMERICAN LAW INSTITUTE, PHILADELPHIA, PA:  
1,180,131, REN. 9-20-11. INT. CL. 16.
- AMERICAN LEGACY FOUNDATION, WASHINGTON, DC:  
2,491,320, REN. 9-21-11. INT. CL. 42.
- AMERICAN LIBRARY ASSOCIATION, CHICAGO, IL:  
2,603,630, REN. 9-18-11. INT. CL. 16.
- AMERICAN MEDICAL ALERT CORPORATION, OCEANSIDE, NY:  
2,525,500, REN. 9-19-11. INT. CL. 38.
- AMERICAN MIDWIFERY CERTIFICATION BOARD, INC., LINTHICUM, MD:  
2,144,079 NEW CERT. 10-25-2011. U.S. CL. B.  
2,253,969 NEW CERT. 10-25-2011. U.S. CL. B.



AMERICAN NUT & CHOCOLATE, INC., NEWTON, MA:  
923,560. REN. 9-21-11. U.S. CL. 46 (INT. CLS. 1, 5, 29, 30, 31 AND 32).

AMERICAN OPTOMETRIC ASSOCIATION, ST. LOUIS, MO:  
1,165,018. REN. 9-21-11. INT. CL. 42.  
1,165,923. REN. 9-16-11. INT. CL. 42.  
1,165,924. REN. 9-16-11. INT. CL. 42.  
1,168,754. REN. 9-19-11. INT. CL. 42.

AMERICAN PENSION SERVICES, INC., RIVERTON, UT:  
4,046,351. INT. CL. 36.

AMERICAN PROMOTIONAL EVENTS, INC., FLORENCE, AL, CHINA PYROTECHNICS, INC., FLORENCE, AL:  
1,657,335. REN. 9-21-11. INT. CL. 13.

AMERICAN PSYCHOLOGICAL ASSOCIATION, WASHINGTON, DC:  
2,548,813. COR. INT. CL. 16.

AMERICAN PSYCHOLOGICAL ASSOCIATION, INC., ARLINGTON, VA:  
1,198,661. COR. INT. CL. 16.

AMERICAN PSYCHOLOGICAL ASSOCIATION, INC., WASHINGTON, DC:  
2,593,241. COR. INT. CL. 9.

AMERICAN RENTAL ASSOCIATION, MOLINE, IL:  
1,204,052. REN. 9-18-11. INT. CL. 42.

AMERICAN RESCUE WORKERS, INC., PHILADELPHIA, PA:  
1,204,108. REN. 9-19-11. MULTIPLE CLASS, U.S. CL. 200 INT. CL. 42.

AMERICAN ROAMER, LLC, MEMPHIS, TN:  
4,044,619. PUB. 8-9-2011. MULTIPLE CLASS, INT. CLS. 35 AND 42.

AMERICAN SOCIETY FOR CLINICAL INVESTIGATION, INC., THE ANN ARBOR, MI:  
2,618,071. REN. 9-19-11. INT. CL. 16.

AMERICAN SPORTS LICENSING, INC., WILMINGTON, DE:  
2,926,579. CANC. INT. CL. 28.

AMERICAN SUGAR REFINING, INC., YONKERS, NY:  
2,516,904. REN. 9-20-11. INT. CL. 30.

AMERICAN TEXTILE, LLC., DULUTH, GA:  
4,045,337. PUB. 8-9-2011. INT. CL. 1.

AMERICAN TRANSPORTATION SYSTEMS, INC., LAWRENCEVILLE, GA:  
1,684,878. REN. 9-20-11. INT. CL. 36.

AMERICAN UNIVERSITY, WASHINGTON, DC:  
4,045,076. PUB. 8-9-2011. MULTIPLE CLASS, INT. CLS. 38 AND 41.  
4,045,080. PUB. 8-9-2011. MULTIPLE CLASS, INT. CLS. 38 AND 41.  
4,045,083. PUB. 8-9-2011. MULTIPLE CLASS, INT. CLS. 38 AND 41.

AMERICASBANK CORP., TOWSON, MD:  
2,427,771. CANC. INT. CL. 36.

AMERITAS HOLDING COMPANY, LINCOLN, NE:  
4,043,962. PUB. 8-9-2011. INT. CL. 36.

AMES TRUE TEMPER PROPERTIES, INC., WILMINGTON, DE:  
2,927,060. CANC. INT. CL. 8.

AMJAD, AYNE, BECKLEY, WV:  
4,045,535. PUB. 8-9-2011. INT. CL. 5.

AMR APPRAISALS, INC., SAN RAMON, CA:  
4,044,525. PUB. 8-9-2011. INT. CL. 36.

AMSCO WINDOWS, SALT LAKE CITY, UT:  
1,713,004. REN. 9-18-11. INT. CL. 19.  
1,713,004. CANC. INT. CL. 6.

AMSOIL INC., SUPERIOR, WI:  
4,046,834. INT. CL. 4.

AMTAI IMPORTS, INC., SUNNYVALE, CA:  
4,044,811. PUB. 8-9-2011. INT. CL. 25.

AMYK INTERNATIONAL, INC., ENCINITAS, CA:  
4,045,774. MULTIPLE CLASS, INT. CLS. 35 AND 41.

AMYLIN PHARMACEUTICALS, INC., SAN DIEGO, CA:  
4,046,328. INT. CL. 9.

AN ACHIEVABLE DREAM INC., NEWPORT NEWS, VA:  
4,044,034. PUB. 8-9-2011. MULTIPLE CLASS, INT. CLS. 36 AND 41.

ANALOGUE HOLDINGS LTD., NORTH POINT, HONG KONG:  
4,046,129. INT. CL. 9.  
4,046,130. INT. CL. 9.

ANALYSIS, INTEGRATION AND DESIGN, INC., MELBOURNE, FL:  
4,044,753. PUB. 8-9-2011. INT. CL. 42.  
4,044,767. PUB. 8-9-2011. INT. CL. 9.

ANCRA INTERNATIONAL, LLC, HAWTHORNE, CA:  
4,045,587. INT. CL. 8.

ANDERSON INTERNATIONAL FOODS, MINEOLA, NY:  
4,047,214. INT. CL. 29.

ANDERSON MOTORS, LLC, COCKEYSVILLE, MD:  
4,044,377. PUB. 8-9-2011. INT. CL. 35.  
4,044,644. PUB. 8-9-2011. INT. CL. 35.

ANDPAK-EMA INC., MORGAN HILL, CA:  
2,476,153. REN. 9-19-11. INT. CL. 2.

ANDREW GRANT, WELINGTON, CO, DBA GRANT FAMILY FARMS:  
4,044,250. PUB. 8-9-2011. INT. CL. 31.

ANDRITZ INC., ALPHARETTA, GA:  
916,674. REN. 9-20-11. U.S. CL. 23 (INT. CLS. 6, 7, 8, 9, 11, 12, 16, 21 AND 28).

ANGELA T. PEWITT, MOUNTAIN BROOK, AL, DBA ALEKTRA RUNNING SHORTS:  
4,046,598. INT. CL. 25.  
4,046,600. INT. CL. 25.

ANGHA, NADER, SAN RAFAEL, CA, DBA MAKTAB TARIGHE OVEYSSI SHAHMAGHSOUDI:  
1,652,335. REN. 9-21-11. INT. CL. 16.

ANGIOBLAST SYSTEMS INCORPORATED, NEW YORK, NY:  
4,045,644. INT. CL. 5.

ANGLE ORTHODONTICS, PORTLAND, OR:  
4,045,453. PUB. 8-9-2011. INT. CL. 44.

ANGLO FRENCH MEDIA SARL, FRANCE:  
4,043,859. PUB. 8-9-2011. INT. CL. 35.

ANHEUSER-BUSCH INBEV S.A., BRUSSELS, BELGIUM:  
4,044,129. PUB. 8-9-2011. INT. CL. 35.

ANHEUSER-BUSCH INCORPORATED, ST. LOUIS, MO:  
4,044,758. PUB. 8-9-2011. INT. CL. 32.

ANHING CORPORATION, LOS ANGELES, CA:  
2,611,721. REN. 9-22-11. MULTIPLE CLASS, INT. CLS. 29 AND 30.

ANKLESARIA, JIMMY, DEL MAR, CA:  
2,428,246. CANC. INT. CL. 9.

ANNA SUI CORP., NEW YORK, NY:  
4,045,740. INT. CL. 25.

ANNCO, INC., NEW YORK, NY:  
4,046,569. INT. CL. 36.

ANNIDIS HEALTH SYSTEMS CORP., OTTAWA, ONTARIO, CANADA:  
4,043,706. PUB. 8-9-2011. MULTIPLE CLASS, INT. CLS. 9, 10 AND 44.

ANNU G SHARMA MD INC, IRVINE, CA, DBA HEALTH 4 KIDZ PEDIATRICS:  
4,044,209. PUB. 8-9-2011. INT. CL. 44.

ANSELL LIMITED, RICHMOND, AUSTRALIA:  
4,046,079. INT. CL. 10.  
4,046,080. INT. CL. 10.

ANTEL INTERNATIONAL, INC., ROCKFORD, IL:  
1,654,199. REN. 9-19-11. INT. CL. 9.

ANTHONY L. BIRCH, BETHESDA, MD:  
4,045,929. MULTIPLE CLASS, INT. CLS. 35, 37 AND 39.

ANTHONY PLUMBING, INC., SEWELL, NJ:  
4,044,405. PUB. 8-9-2011. INT. CL. 37.

ANULEX TECHNOLOGIES, INC., MINNETONKA, MN:  
3,107,526. COR. INT. CL. 10.  
3,385,464. COR. MULTIPLE CLASS, INT. CLS. 5 AND 10.  
3,455,463. COR. MULTIPLE CLASS, INT. CLS. 5 AND 10.  
3,455,835. COR. MULTIPLE CLASS, INT. CLS. 5 AND 10.

AP&G CO., INC., BROOKLYN, NY:  
4,046,464. INT. CL. 5.

APA - THE ENGINEERED WOOD ASSOCIATION, TACOMA, WA:  
2,494,400. REN. 9-19-11. MULTIPLE CLASS, INT. CLS. 17

- AND 19.  
2,494,716. REN. 9-19-11. INT. CL. 19.  
2,552,113. REN. 9-18-11. INT. CL. 19.
- APEX BRANDS, INC., APEX, NC:  
2,490,634. REN. 9-16-11. MULTIPLE CLASS, INT. CLS. 6,  
7, 8, 9 AND 20.
- APEX COMPUTER SYSTEMS, INC., CERRITOS, CA:  
2,596,853. REN. 9-21-11. INT. CL. 42.
- APEX DIGITAL, INC., ONTARIO, CA:  
2,926,611. CANC. INT. CL. 9.
- APOLLINARIS BRANDS GMBH, BERLIN 10117, FED REP  
GERMANY:  
4,046,084. INT. CL. 32.
- APPALACHIA HOLDING COMPANY, ABINGDON, VA:  
2,607,159. REN. 9-21-11. INT. CL. 37.
- APPBACKR INC., PALO ALTO, CA:  
4,046,122. INT. CL. 35.
- APPIRIO INC., SAN MATEO, CA:  
4,044,961. PUB. 8-9-2011. MULTIPLE CLASS, INT. CLS. 38  
AND 41.  
4,044,962. PUB. 8-9-2011. MULTIPLE CLASS, INT. CLS. 38  
AND 41.
- APPLE & EVE, LLC, PORT WASHINGTON, NY:  
4,043,663. PUB. 1-19-2010. INT. CL. 32.
- APPLEYARD, RUSSEL L., PLYMOUTH, MA:  
2,428,377. CANC. INT. CL. 30.
- APPLIED BIOSYSTEMS, LLC, FOSTER CITY, CA, FOR-  
MERLY APPLIED BIOSYSTEMS CORPORATION:  
4,046,175. MULTIPLE CLASS, INT. CLS. 1, 9 AND 37.
- APPLIED INDUSTRIAL TECHNOLOGIES, INC., CLEVEL-  
LAND, OH:  
2,485,215. REN. 9-20-11. INT. CL. 35.
- APPLIED MATERIALS, INC., SANTA CLARA, CA:  
4,044,528. PUB. 8-9-2011. INT. CL. 7.  
4,045,043. PUB. 8-9-2011. INT. CL. 7.
- APPLIED PRECISION, INC., ISSAQUAH, WA:  
2,489,831. REN. 9-20-11. INT. CL. 9.
- APPLIED SCIENTIFIC INTERNATIONAL, LLC, RICH-  
MOND, IN:  
4,045,283. PUB. 8-9-2011. INT. CL. 3.
- APPNOLA, LLC, NEW ORLEANS, LA:  
4,045,274. PUB. 8-9-2011. INT. CL. 9.
- APPOLOS, INC., ANAHEIM, CA 92806, CA:  
4,045,649. INT. CL. 3.
- APPRION, LLC, BOULDER, CO:  
4,045,993. INT. CL. 9.
- APT INC, ALLENTOWN, PA:  
4,045,028. PUB. 8-9-2011. INT. CL. 42.
- APT-THE ENGINEERED WOOD ASSOCIATION, TACOMA,  
WA, AMERICAN PLYWOOD ASSOCIATION, TACOMA,  
WA:  
1,176,210. REN. 9-19-11. INT. CL. 19.
- AQUA VIDA INTERNATIONAL, CHICAGO, IL:  
4,044,977. PUB. 8-9-2011. INT. CL. 43.
- AQUA-LEISURE INDUSTRIES, INC., AVON, MA:  
4,046,362. INT. CL. 28.
- ARAMIS INC., NEW YORK, NY:  
2,927,033. CANC. INT. CL. 3.
- ARBURG GMBH & CO., LOSSBURG D-72290, FED REP  
GERMANY, ARBURG MASCHINENFABRIK HEHL &  
SOEHNE GMBH & CO. KG, LOSSBURG, FED REP  
GERMANY:  
1,654,742. REN. 9-21-11. INT. CL. 7.
- ARC TECHNOLOGY SOLUTIONS, NASHUA, NH:  
4,045,286. PUB. 8-9-2011. INT. CL. 9.
- ARCHER DANIELS MIDLAND COMPANY, DECATUR, IL:  
1,652,628. REN. 9-20-11. INT. CL. 39.  
2,428,781. CANC. INT. CL. 31.
- ARCHER-DANIELS-MIDLAND COMPANY, DECATUR, IL,  
NAAMLOZE VENNOOTSCHAP CACAOFABRIEK "DE  
ZAAN", ZAANDIJK, KOOG AAN DE ZAAAN, NETHER-  
LANDS:  
712,941. REN. 9-21-11. U.S. CL. 46 (INT. CL. 30).
- ARCHPOINT CORPORATION, MAITLAND, FL:  
4,044,233. PUB. 8-9-2011. INT. CL. 36.  
4,044,234. PUB. 8-9-2011. INT. CL. 36.
- ARCO DEL CABO DISTRIBUTING, INC., CARROLTON,  
TX:  
4,046,403. INT. CL. 33.
- ARDISAM, INC., CUMBERLAND, WI:  
4,046,448. INT. CL. 7.  
4,046,449. INT. CL. 8.  
4,046,450. INT. CL. 19.
- ARGENTO SC, NEW YORK, NY:  
4,046,826. MULTIPLE CLASS, INT. CLS. 3, 14, 18 AND 20.
- ARGUS MEDIA LIMITED, LONDON, UNITED KINGDOM:  
4,043,697. PUB. 8-9-2011. MULTIPLE CLASS, INT. CLS. 9,  
35, 36 AND 38.
- ARIANE HUNDT FITNESS, LLC, NEW YORK, NY:  
4,044,984. PUB. 8-9-2011. INT. CL. 41.
- ARIES ELECTRONICS, INC., BRISTOL, PA:  
1,190,563. REN. 9-19-11. INT. CL. 9.
- ARISTOCRAT TECHNOLOGIES AUSTRALIA PTY LTD,  
NORTH RYDE, NSW, AUSTRALIA:  
3,385,431. CANC. INT. CL. 9.
- ARISTOCRAT TECHNOLOGIES AUSTRALIA PTY LTD,  
NORTH RYDE BC NSW, AUSTRALIA:  
4,045,849. INT. CL. 9.
- ARISTOCRAT TECHNOLOGIES AUSTRALIA PTY LTD.,  
NORTH RYDE, NSW, AUSTRALIA:  
4,046,689. INT. CL. 9.  
4,046,690. INT. CL. 9.
- ARIZONA SPICE COMPANY LLC, MESA, AZ AND DEB-  
RAH ROBERTI, MESA, AZ:  
4,047,256. INT. CL. 30.
- ARIZONA SUNWASH, LLC, PHOENIX, AZ:  
4,045,663. INT. CL. 3.
- ARMEND, COREY, COVINA, CA:  
4,047,004. INT. CL. 25.
- ARMORED SOLUTIONS, INC., PITTSFIELD, MA:  
4,046,791. INT. CL. 12.
- ARNETT FACIAL RECONSTRUCTION COURSES, INC.,  
SANTA BARBARA, CA:  
4,046,166. MULTIPLE CLASS, INT. CLS. 10 AND 41.
- ARNSTON, CATHARINE V., BOSTON, MA, DBA THE  
NAUGHTY NUTRITIONIST:  
4,044,000. PUB. 5-3-2011. INT. CL. 5.
- AROMA VENTURES, LLC, DALLAS, TX:  
4,047,112. INT. CL. 3.
- ARONOW, ALAN, HADDAM, CT:  
2,428,240. CANC. INT. CL. 9.
- ARONSON, TAYLOR, SALINAS, CA:  
4,045,879. INT. CL. 25.
- ARROW INTERNATIONAL, INC., CLEVELAND, OH:  
2,926,654. CANC. INT. CL. 28.
- ARROW MANUFACTURING INCORPORATED, QUEBEC,  
H2G 2H7, CANADA:  
2,926,507. CANC. MULTIPLE CLASS, INT. CLS. 16, 18  
AND 25.
- ART BLAKEY ESTATE, COMPRISING TAKASHI BUHAINA  
BLAKEY, A U.S. CITIZEN, WEEHAWKEN, NJ:  
2,926,791. CANC. INT. CL. 41.
- ARTEMIS RUBBER TECHNOLOGY, INC., LONGMONT,  
CO:  
4,043,948. PUB. 8-9-2011. MULTIPLE CLASS, INT. CLS. 11  
AND 28.
- ARTFX, INC., NORFOLK, VA:  
2,500,726. REN. 9-22-11. INT. CL. 25.
- ARTHUR DOGSWELL, L.L.C., LOS ANGELES, CA, AKA  
DOGSWELL:  
4,044,812. PUB. 8-9-2011. INT. CL. 31.
- ARTISAN VEHICLE SYSTEMS, INC., CAMARILLO, CA:  
4,044,727. PUB. 8-9-2011. INT. CL. 12.
- ARTRIP, PAUL D, VIRGINIA BEACH, VA, DBA THE RUM  
DADDY SPIRITED ADVENTURES, LLC:  
4,044,317. PUB. 8-9-2011. INT. CL. 35.
- ARTYARNS, INC., WHITE PLAINS, NY:  
4,044,722. PUB. 8-9-2011. INT. CL. 23.
- ARWIN BIO-TECH. (TAIWAN) CO., LTD., YANG MEI  
TOWN, TAIWAN:  
3,629,849. CANC. INT. CL. 3.
- AS AMERICAN AS DOUGHNUTS, INC., SALT LAKE CITY,  
UT:  
2,509,675. REN. 9-21-11. INT. CL. 30.

ASAR INDUSTRIES, INC., SECAUCUS, NJ:  
4,044,178, PUB. 8-9-2011. INT. CL. 25.

ASCENDI GROUP, INC., MIAMI, FL:  
4,046,395, INT. CL. 41.

ASCENDING TO ONENESS LLC, TAMPA, FL, DBA INNER SOURCE TOOLS:  
4,046,847, INT. CL. 41.

ASHBURY INTERNATIONAL GROUP INC., CHARLOTTEVILLE, VA:  
4,044,407, PUB. 8-9-2011. MULTIPLE CLASS, INT. CLS. 9, 16 AND 41.

ASHLAND LICENSING AND INTELLECTUAL PROPERTY LLC, DUBLIN, OH, ASHLAND OIL, INC., ASHLAND, KY:  
921,002, REN. 9-19-11. U.S. CL. 16 (INT. CL. 2).

ASHROSS, L.L.C., PLEASANT GROVE, UT:  
2,492,681, REN. 9-19-11. INT. CL. 7.

ASHTON GREEN LIMITED, OTTAWA, ONTARIO K1T 3V2, CANADA:  
2,538,746, REN. 9-18-11. MULTIPLE CLASS, INT. CLS. 8, 11 AND 35.

ASIA FASTENING (US), INC., WILMINGTON, DE:  
2,262,705 NEW CERT. 10-25-2011. INT. CL. 6.

ASIRAK LLC, NEW YORK, NY:  
4,044,648, PUB. 8-9-2011. INT. CL. 25.

ASKMAN, SALLY, WOODINVILLE, WA:  
2,427,992, CANC. INT. CL. 4.

ASPEN ADVISORS, LLC, PITTSBURGH, PA:  
4,045,162, PUB. 8-9-2011. INT. CL. 42.

ASPLUNDH INVESTMENTS, INC., WILMINGTON, DE, ASPLUNDH TREE EXPERT CO., WILLOW GROVE, PA:  
1,656,509, REN. 9-21-11. INT. CL. 42.

ASPLUNDH INVESTMENTS, INC., WILMINGTON, DE:  
4,045,312, PUB. 8-9-2011. INT. CL. 9.

ASSET MANAGEMENT OUTSOURCING, INC., NORCROSS, GA:  
2,428,093, CANC. MULTIPLE CLASS, INT. CLS. 35 AND 36.  
2,543,809, REN. 9-21-11. INT. CL. 36.

ASSET MARKETING SYSTEMS INSURANCE SERVICES, LLC, SAN DIEGO, CA:  
4,046,178, MULTIPLE CLASS, INT. CLS. 35, 36 AND 41.

ASSISTLY, INC., SAN FRANCISCO, CA:  
4,044,701, PUB. 8-9-2011. INT. CL. 42.

ASSOCIATES OF VIETNAM VETERANS OF AMERICA, INC., SILVER SPRINGS, MD:  
2,493,642, REN. 9-19-11. U.S. CL. 200.

ASSOCIATION FOR HEALTHCARE FOODSERVICE, INC., LOUISVILLE, KY:  
4,044,101, PUB. 8-9-2011. MULTIPLE CLASS, INT. CLS. 35 AND 41.

ASSOCIATION OF INDEPENDENT PASSENGER RAIL OPERATORS, WASHINGTON, DC:  
4,044,544, PUB. 8-9-2011. INT. CL. 35.

ASSOCIATION OF INTERSTATE TRUCKING LAWYERS OF AMERICA, LLC, SPRINGFIELD, MO:  
4,046,491, INT. CL. 16.

ASSOCIATION OF OIL PIPE LINES, WASHINGTON, DC, AKA AOPL:  
4,044,768, PUB. 8-9-2011. INT. CL. 35.

ASSOCIATION OF SCHOOL BUSINESS OFFICIALS INTERNATIONAL, RESTON, VA:  
4,044,548, PUB. 8-9-2011. MULTIPLE CLASS, INT. CLS. 41 AND 42.

ASSUT EUROPE S.P.A., ITALY:  
4,043,866, PUB. 8-9-2011. INT. CL. 10.

ASTENJOHNSON, INC., CHARLESTON, SC, ASTEN GROUP, INC., CHARLESTON, SC:  
1,656,595, REN. 9-20-11. INT. CL. 7.

ASTON MARTIN LAGONDA LIMITED, WARWICK, UNITED KINGDOM:  
4,043,854, PUB. 8-9-2011. MULTIPLE CLASS, INT. CLS. 12 AND 37.

ASURAGEN, INC., AUSTIN, TX:  
4,046,375, INT. CL. 5.

ASURION PROTECTION SERVICES, LLC, KANSAS CITY, MO:  
2,490,908, REN. 9-21-11. INT. CL. 36.

ATD SUPPLY COMPANY LLC, FENTON, MO:  
4,046,529, INT. CL. 3.

ATE MY HEART INC., LOS ANGELES, CA:  
3,695,129, AM. INT. CL. 25.

ATIV SOLUTIONS LLC, SANTA ROSA, CA, DBA ATIV SOFTWARE:  
4,045,433, PUB. 8-9-2011. INT. CL. 9.

ATLANTA TRACK CLUB, INC., ATLANTA, GA:  
1,204,903, REN. 9-20-11. INT. CL. 41.

ATLANTIC HEALTH SYSTEM, INC., MORRISTOWN, NJ:  
4,045,705, MULTIPLE CLASS, INT. CLS. 42 AND 44.

ATLANTIC STEEL CORPORATION, MINEOLA, NY:  
4,044,948, PUB. 8-9-2011. INT. CL. 6.

ATLAS PIPELINE HOLDINGS, L.P., MOON TOWNSHIP, PA:  
4,043,933, PUB. 8-9-2011. MULTIPLE CLASS, INT. CLS. 35, 37, 40 AND 42.

ATLAS SOUNDOLIER, LP, PHOENIX, AZ, DBA ATLAS SOUND, LP, SOUNDOLIER, INC., ST. LOUIS, MO:  
1,159,700, REN. 9-20-11. MULTIPLE CLASS, INT. CLS. 6 AND 9.

ATMOS ENERGY CORPORATION, DALLAS, TX:  
2,926,787, CANC. INT. CL. 36.

ATSKO, INC., ORANGEBURG, SC:  
4,044,896, PUB. 8-9-2011. INT. CL. 1.

ATTERRO, INC., MINNEAPOLIS, MN, FORMERLY DOBBS TEMPORARY SERVICES, INC.:  
4,046,827, INT. CL. 35.

ATTICUS, INC., MOUNT DORA, FL:  
4,044,028, PUB. 8-9-2011. MULTIPLE CLASS, INT. CLS. 16, 35 AND 41.

ATW AUTOMATION INC., DAYTON, OH:  
2,487,260, REN. 9-18-11. INT. CL. 9.

ATWOOD DISTRIBUTING, L.P., ENID, OK:  
4,043,971, PUB. 8-9-2011. INT. CL. 35.

AU'SOME, INC., MONMOUTH JUNCTION, NJ:  
2,926,460, CANC. MULTIPLE CLASS, INT. CLS. 28 AND 30.

AUBURN UNIVERSITY, AUBURN, AL:  
2,471,635, REN. 9-19-11. INT. CL. 25.

AUDI A.G., INGOLSTADT, FED REP GERMANY:  
2,987,328, CANC. MULTIPLE CLASS, INT. CLS. 18, 20 AND 28.

AUDI AG, INGOLSTADT, FED REP GERMANY:  
2,481,083, REN. 9-21-11. INT. CL. 9.  
4,043,732, PUB. 8-9-2011. INT. CL. 41.

AUDIO EXPO NORTH AMERICA, DAYTONA BEACH, FL:  
4,044,858, PUB. 8-9-2011. INT. CL. 35.

AUGELLO-COOK, ALICIA, LOS ANGELES, CA:  
4,045,288, PUB. 8-9-2011. MULTIPLE CLASS, INT. CLS. 14, 25 AND 26.

AULD, PAMELA A., PROSSER, WA:  
2,601,230, REN. 9-22-11. MULTIPLE CLASS, INT. CLS. 29 AND 30.

AUSTIN, BRETT R., BALTIMORE, MD:  
2,428,149, CANC. INT. CL. 42.

AUSTIN, GRANT, OAKWOOD, GA:  
4,047,240, INT. CL. 25.

AUTHENTIDATE HOLDING CORP., BERKELEY HEIGHTS, NJ:  
2,525,514, REN. 9-16-11. INT. CL. 9.

AUTO BANK OF NORTH OAK, INC., KANSAS CITY, MO:  
2,427,741, CANC. INT. CL. 35.

AUTO WASH MAINTENANCE CORP., MALDEN, MA:  
4,047,005, INT. CL. 35.

AUTOMATED DOCUMENT SERVICES, INC., RANCHO SANTA MARGARITA, CA:  
4,046,010, INT. CL. 9.

AUTOMEDIA SOLUTIONS, INC., TORRANCE, CA:  
2,537,465, REN. 9-22-11. INT. CL. 35.

AUTOMOTIVE AFTERMARKET INDUSTRY ASSOCIATION, BETHESDA, MD:  
4,044,289, PUB. 8-9-2011. MULTIPLE CLASS, INT. CLS. 35 AND 41.  
4,044,290, PUB. 8-9-2011. MULTIPLE CLASS, INT. CLS. 35 AND 41.

AUTOMOTIVE PROFIT BUILDERS, INC., NATICK, MA:  
1,166,732, REN. 9-20-11. INT. CL. 35.

- AUTOMOTIVE SOURCING TECHNOLOGIES, LLC, OAK-BROOK TERRACE, IL:  
4,044,998, PUB. 8-9-2011. INT. CL. 35.
- AUTONATION HOLDING CORP., FORT LAUDERDALE, FL, AUTONATION HOLDING CORP., FORT LAUDERDALE, FL:  
2,480,480. REN. 9-16-11. INT. CL. 36.
- AUTRY CONSULTING SERVICES, LLC, MERIDIAN, MS:  
4,045,676, INT. CL. 25.
- AVAIRPROS MANAGEMENT, INC., NAPLES, FL:  
4,045,851, MULTIPLE CLASS, INT. CLS. 35, 36 AND 39.  
4,045,852, MULTIPLE CLASS, INT. CLS. 35, 36 AND 39.
- AVALON & TAHOE MFG., INC., ALMA, MI:  
2,524,513. REN. 9-19-11. INT. CL. 12.
- AVALON HOTELS, L.L.C., LOS ANGELES, CA:  
4,043,653, PUB. 3-17-2009. INT. CL. 43.
- AVANA INTERNATIONAL CORPORATION, PARK RIDGE, IL:  
4,046,918, INT. CL. 32.
- AVERY DENNISON CORPORATION, PASADENA, CA:  
4,047,146, INT. CL. 16.  
4,047,147, INT. CL. 16.  
4,047,151, INT. CL. 16.  
4,047,152, INT. CL. 16.  
4,047,153, INT. CL. 16.
- AVID AIRLINE PRODUCTS OF RHODE ISLAND, INC., MIDDLETOWN, RI:  
4,044,493, PUB. 8-9-2011. INT. CL. 39.
- AVNET, INC., PHOENIX, AZ:  
2,427,938, CANC. INT. CL. 42.
- AVP MANAGEMENT SERVICES, INC., AUSTIN, TX:  
4,044,990, PUB. 8-9-2011. INT. CL. 36.
- AWARENESS, CORPORATION, CHANDLER, AZ:  
4,043,628, PUB. 8-9-2011. INT. CL. 5.  
4,043,629, PUB. 8-9-2011. INT. CL. 5.
- AWP, INC., KENT, OH:  
4,045,380, PUB. 8-9-2011. MULTIPLE CLASS, INT. CLS. 39 AND 42.
- AXE, LLC, VENICE, CA:  
4,045,396, PUB. 8-9-2011. INT. CL. 43.
- AXELLE.NET LLC, MIAMI BEACH, FL:  
4,046,035, INT. CL. 14.
- AXIOLOGIX EDUCATION CORPORATION, EGG HARBOR TOWNSHIP, NJ:  
4,044,145, PUB. 8-9-2011. INT. CL. 9.
- AXL MUSICAL INSTRUMENTS, CO. LTD., MILLBRAE, CA:  
1,686,163. REN. 9-20-11. INT. CL. 9.
- AXXIOM MANUFACTURING, INC., FRESNO, TX:  
4,044,511, PUB. 8-9-2011. INT. CL. 6.
- A10 NETWORKS, INC., SAN JOSE, CA:  
4,046,647, INT. CL. 9.
- B CORP, BORDEAUX, FRANCE:  
2,428,612, CANC. INT. CL. 25.
- B. E. MEYERS & CO., INC., REDMOND, WA:  
2,486,875. REN. 9-19-11. INT. CL. 9.
- B.J. ALAN COMPANY, YOUNGSTOWN, OH:  
2,428,898, CANC. INT. CL. 13.  
2,450,227. REN. 9-16-11. INT. CL. 13.  
4,046,578, INT. CL. 13.  
4,046,579, INT. CL. 13.
- B.M.P. BARCELONA MEETING POINT, S.A., BARCELONA, SPAIN:  
4,043,677, PUB. 1-18-2011. INT. CL. 35.
- B&I OVERSEAS TRADING INC, VAN NUYS, CA:  
3,866,675, CANC. INT. CL. 32.
- B-H-T INVESTMENT CO., INC., SEARCY, AR:  
2,518,649. REN. 9-20-11. INT. CL. 35.
- BABY ABUELITA PRODUCTIONS, LLC, MIAMI, FL:  
4,044,491, PUB. 8-9-2011. INT. CL. 28.
- BABY'S COFFEE LLC, KEY WEST, FL:  
2,495,844. REN. 9-19-11. MULTIPLE CLASS, INT. CLS. 30 AND 35.
- BACKBONE ENTERTAINMENT, IRVINE, CA:  
4,045,721, MULTIPLE CLASS, INT. CLS. 9 AND 42.  
4,045,722, MULTIPLE CLASS, INT. CLS. 9 AND 42.
- BACKCOUNTRY.COM, INC., PARK CITY, UT:  
3,891,836, CANC. INT. CL. 35.
- BADGER METER, INC., MILWAUKEE, WI:  
4,046,522, MULTIPLE CLASS, INT. CLS. 9 AND 42.
- BAE SYSTEMS TENSYLON HIGH PERFORMANCE MATERIALS INC., MONROE, NC:  
2,494,934. REN. 9-19-11. INT. CL. 22.
- BAESMAN GROUP, INC., HILLIARD, OH:  
4,045,409, PUB. 8-9-2011. MULTIPLE CLASS, INT. CLS. 35 AND 40.
- BAGDASARIAN PRODUCTIONS, LLC, MONTECITO, CA:  
4,045,997, INT. CL. 9.
- BAKATUS, LLC, SAINT PAUL, MN:  
4,044,285, PUB. 8-9-2011. INT. CL. 25.
- BAKER HUGHES INCORPORATED, HOUSTON, TX:  
2,926,835, CANC. INT. CL. 7.
- BAKER MANUFACTURING COMPANY, INC., PINEVILLE, LA:  
2,480,467. REN. 9-17-11. INT. CL. 20.
- BAKERY, CONFECTIONERY, TOBACCO WORKERS AND GRAIN MILLERS INTERNATIONAL UNION, KENSINGTON, MD:  
2,477,628. REN. 9-20-11. U.S. CL. 200.
- BALANCED ELEMENTAL MEDICINE LLC, SEBASTOPOL, CA:  
4,044,066, PUB. 8-9-2011. INT. CL. 25.
- BALANCED VIEW, MILL VALLEY, CA:  
4,046,843, INT. CL. 16.
- BALL HORTICULTURAL COMPANY, WEST CHICAGO, IL:  
4,045,475, PUB. 8-9-2011. INT. CL. 31.  
4,045,497, PUB. 8-9-2011. INT. CL. 31.  
4,046,264, MULTIPLE CLASS, INT. CLS. 1 AND 21.
- BALLET MAKERS, INC., TOTOWA, NJ:  
2,597,192. REN. 9-21-11. INT. CL. 25.  
2,597,196. REN. 9-21-11. INT. CL. 25.
- BALLET THEATRE FOUNDATION, INC., NEW YORK, NY:  
4,045,296, PUB. 8-9-2011. INT. CL. 18.  
4,045,303, PUB. 8-9-2011. INT. CL. 25.
- BALLY GAMING, INC., LAS VEGAS, NV, DBA BALLY TECHNOLOGIES:  
4,045,560, PUB. 8-9-2011. INT. CL. 9.  
4,046,095, INT. CL. 9.  
4,046,817, INT. CL. 9.
- BALLY TOTAL FITNESS HOLDING CORPORATION, CHICAGO, IL:  
4,044,266, PUB. 8-9-2011. INT. CL. 41.
- BALTIC LATVIAN UNIVERSAL ELECTRONICS, LLC, WESTLAKE VILLAGE, CA:  
4,046,213, INT. CL. 9.
- BANANA PUDDING ENTERPRISES, MEMPHIS, TN:  
4,044,559, PUB. 8-9-2011. INT. CL. 41.
- BANE-CLENE CORPORATION, INDIANAPOLIS, IN:  
1,184,289. REN. 9-17-11. INT. CL. 1.
- BANK OF AMERICA CORPORATION, CHARLOTTE, NC:  
2,427,945, CANC. INT. CL. 36.  
2,427,946, CANC. INT. CL. 36.
- BAPTISTA'S BAKERY, INC., FRANKLIN, WI, BAPTISTA'S BAKERY, INC., FRANKLIN, WI:  
2,489,365. REN. 9-21-11. INT. CL. 30.
- BARBER AND COMPANY OF ODUM, INC., ODUM, GA:  
2,500,009. REN. 9-22-11. INT. CL. 25.
- BARDIN PALOMO LTD., NEW YORK, NY:  
4,046,243, MULTIPLE CLASS, INT. CLS. 41 AND 42.
- BARENBRUG USA INC, TANGENT, OR:  
2,501,447. REN. 9-20-11. INT. CL. 31.
- BARGAIN BASEMENT PRINTING, LLC, BOSTON, MA:  
4,047,108, INT. CL. 40.
- BARKER, RONALD, FAR ROCKAWAY, NY:  
4,046,337, INT. CL. 32.
- BARKING FISH ENTERTAINMENT, LLC, COVINGTON, KY:  
4,047,114, MULTIPLE CLASS, INT. CLS. 25 AND 28.
- BARKSDALE FEDERAL CREDIT UNION, BOSSIER CITY, LA:  
4,044,638, PUB. 8-9-2011. INT. CL. 36.
- BARNES, THOMAS D., MATTHEWS, NC:  
4,043,693, PUB. 8-9-2011. MULTIPLE CLASS, INT. CLS. 35 AND 42.
- BARNESANDNOBLE.COM LLC, NEW YORK, NY:  
2,926,625, CANC. MULTIPLE CLASS, INT. CLS. 35 AND

39.  
BARONA GROUP OF THE CAPITAN GRANDE BAND OF MISSION INDIANS, LAKESIDE, CA, DBA BARONA VALLEY RANCH RESORT AND CASINO:  
4,045,571, PUB. 8-9-2011. MULTIPLE CLASS, INT. CLS. 41 AND 43.
- BARSUM FASHION GROUP, INC., BEVERLY HILLS, CA:  
4,046,153, MULTIPLE CLASS, INT. CLS. 18 AND 25.
- BASF CORPORATION, FLORHAM PRK, NJ, L. SONNEBORN SONS, INC., NEW YORK, NY:  
84,050. REN. 9-16-11. U.S. CL. 16 (INT. CLS. 2 AND 19).
- BASF CORPORATION, FLORHAM PARK, NJ, WHITMIRE RESEARCH LABORATORIES, INC., ST. LOUIS, MO:  
1,658,243. REN. 9-16-11. INT. CL. 21.
- BASF CORPORATION, FLORHAM PARK, NJ:  
2,481,746. REN. 9-16-11. INT. CL. 5.
- BASF SE, LUDWIGSHAFEN AM RHEIN, FED REP GERMANY:  
1,665,032. REN. 9-21-11. INT. CL. 17.
- BASSO INDUSTRY CORP., TAICHUNG, TAIWAN:  
2,493,089. REN. 9-20-11. INT. CL. 7.
- BASTIAN, MICHAEL R, RENO, NV:  
4,045,150, PUB. 8-9-2011. INT. CL. 41.  
4,045,238, PUB. 8-9-2011. INT. CL. 41.
- BASTION RESTAURANTS, INC., FORT WORTH, TX:  
4,045,584, INT. CL. 43.
- BATTAT INCORPORATED, PLATTSBURGH, NY:  
4,046,835, INT. CL. 28.
- BATZ ENTERPRISES LLC, BLOOMINGTON, MN:  
4,047,090, INT. CL. 35.
- BATZNER BED BUG SERVICES, INC., NEW BERLIN, WI:  
4,047,228, INT. CL. 37.  
4,047,235, INT. CL. 37.
- BAUMULLER NURNBERG GMBH, D-90482 NURNBERG, FED REP GERMANY:  
2,491,202. REN. 9-16-11. MULTIPLE CLASS, INT. CLS. 9 AND 42.
- BAXTER INTERNATIONAL INC., DEERFIELD, IL, AUTOSYRINGE, INC., HOOKSETT, NH:  
1,170,042. REN. 9-16-11. INT. CL. 10.
- BAY, LARRY R., RENTON, WA:  
4,046,286, INT. CL. 28.  
4,046,287, INT. CL. 28.
- BAYER SCHERING PHARMA AKTIENGESELLSCHAFT, BERLIN, FED REP GERMANY:  
2,926,127, CANC. MULTIPLE CLASS, INT. CLS. 5 AND 10.
- BAYERISCHE MOTOREN WERKE AKTIENGESELLSCHAFT, D-80788 MUENCHEN, FED REP GERMANY:  
2,498,087. REN. 9-21-11. INT. CL. 41.
- BAYROCK/SAPIR ORGANIZATION LLC, NEW YORK, NY:  
4,046,211, INT. CL. 43.
- BAYSIDE WEDDINGS, LLC, SANTA ROSA BEACH, FL:  
4,046,792, INT. CL. 43.
- BB FRANCHISING, INC., DALLAS, TX:  
4,045,212, PUB. 8-9-2011. INT. CL. 43.
- BB&T CORPORATION, WINSTON-SALEM, NC:  
2,428,089, CANC. INT. CL. 36.  
4,044,791, PUB. 8-9-2011. INT. CL. 36.
- BBD CORPORATION, KENNESAW, GA:  
4,045,350, PUB. 8-9-2011. INT. CL. 35.
- BBY SOLUTIONS, INC., RICHFIELD, MN:  
4,046,988, MULTIPLE CLASS, INT. CLS. 35 AND 38.  
4,046,989, MULTIPLE CLASS, INT. CLS. 35 AND 38.
- BCAKENY, LLC, BROOKLYN, NY:  
4,045,010, PUB. 8-9-2011. INT. CL. 40.
- BCD HOLDINGS N.V., WILLEMSTAD - CURACAO, NETHERLANDS:  
2,926,845, CANC. MULTIPLE CLASS, INT. CLS. 39, 42 AND 43.
- BEABER FAMILY ORTHODONTICS, P.C., HIGHLANDS RANCH, CO:  
4,046,859, INT. CL. 44.
- BEACH CHAIR FITNESS, NORTH WILDWOOD, NJ:  
4,046,416, INT. CL. 9.
- BEACH MARKETING, INC., FORT LAUDERDALE, FL, DBA BEACH MARKETING:  
4,044,519, PUB. 8-9-2011. INT. CL. 3.
- BEACHBODY, LLC, SANTA MONICA, CA:  
4,045,113, PUB. 8-9-2011. INT. CL. 5.
- BEAR TRAILER MANUFACTURING, INC., LEBANON, MO:  
2,490,334. REN. 9-18-11. INT. CL. 12.
- BEAR-ECO TECHNOLOGIES, LLC, BRISTOW, VA:  
4,047,083, INT. CL. 9.
- BEATIFUL WINDOW COVERINGS AND INTERIORS, INC., HOPEWELL JUNCTION, NY:  
2,926,953, CANC. INT. CL. 24.
- BEAUTY BY DOLLY INC., SAN DIEGO, CA:  
4,044,664, PUB. 8-9-2011. INT. CL. 44.
- BECKER&MAYER!, BELLEVUE, WA:  
4,046,036, INT. CL. 16.
- BECTON, DICKINSON AND COMPANY, FRANKLIN LAKES, NJ:  
4,046,082, MULTIPLE CLASS, INT. CLS. 9 AND 42.
- BEELAND INTERESTS, INC., MIAMI, FL:  
2,577,188. REN. 9-18-11. INT. CL. 36.
- BEELER, BRENNEN LARS, HUNTINGTON BEACH, CA:  
4,046,914, INT. CL. 45.
- BEEMAK PLASTICS, LLC, RANCHO DOMINGUE, CA, BEEMAK PLASTICS, LOS ANGELES, CA:  
1,167,254. REN. 9-21-11. INT. CL. 16.
- BEHR PROCESS CORPORATION, SANTA ANA, CA:  
4,046,854, INT. CL. 41.  
4,046,970, MULTIPLE CLASS, INT. CLS. 37 AND 39.
- BEIJING CENTURY HAOYUN LINGYIN MUSIC INSTRUMENT CORPORATION, BEIJING, CHINA:  
4,046,699, INT. CL. 15.  
4,046,700, INT. CL. 15.
- BEIJING CITY CHANGPING ZONE NORTHERN AUTOMOTIVE LEAF-SPRING FACTORY, BEIJING, CHINA:  
4,043,982, PUB. 8-9-2011. INT. CL. 12.
- BEIJING NUFRONT MOBILE MULTIMEDIA TECHNOLOGY CO., LTD, CHINA:  
4,043,846, PUB. 5-3-2011. INT. CL. 9.
- BELANGER, INC., NORTHVILLE, MI:  
2,490,834. REN. 9-21-11. INT. CL. 7.
- BELARBI, MOHAMED, SAINT TROPEZ, FRANCE:  
4,043,689, PUB. 5-17-2011. MULTIPLE CLASS, INT. CLS. 3, 16, 24, 28, 32, 35, 38 AND 39.
- BELARC, INC., MAYNARD, MA:  
2,508,671. REN. 9-22-11. MULTIPLE CLASS, INT. CLS. 9 AND 42.
- BELCHER, RAYEN, ROCK HILL, SC:  
4,045,370, PUB. 8-9-2011. INT. CL. 41.
- BELL, ANDREA, ESTERO, FL, DBA ONE WEEKEND WEBSITE:  
4,046,797, INT. CL. 42.
- BELL, MICHAEL, MONROE, NJ:  
4,045,293, PUB. 8-9-2011. INT. CL. 9.
- BELL'S BREWERY, INC., GALESBURG, MI:  
4,045,530, PUB. 8-9-2011. MULTIPLE CLASS, INT. CLS. 20, 25 AND 32.
- BELLA FOREVER LIMITED, INC., PEMBROKE PINES, FL:  
4,045,466, PUB. 8-9-2011. INT. CL. 14.
- BELLAVIA, THOMAS, HASBROUCK HEIGHTS, NJ AND CHAFFIN, JASPER, HASBROUCK HEIGHTS, NJ:  
4,044,765, PUB. 8-9-2011. INT. CL. 44.  
4,044,949, PUB. 8-9-2011. INT. CL. 44.
- BELLCO CREDIT UNION, GREENWOOD VILLAGE, CO:  
4,045,186, PUB. 8-9-2011. INT. CL. 36.
- BELLOFRAM CORPORATION, NEWELL, WV:  
2,556,802. REN. 9-22-11. MULTIPLE CLASS, INT. CLS. 9 AND 35.
- BELMONT, DAVE, ENUMCLAW, WA:  
4,045,210, PUB. 8-9-2011. INT. CL. 3.
- BELVOIR FEDERAL CREDIT UNION, WOODBRIDGE, VA:  
4,044,492, PUB. 8-9-2011. INT. CL. 36.
- BENEFICENCE, INC., LIVERMORE, CO:  
4,046,603, INT. CL. 14.
- BENEFIT INN, LLC, BONITA SPRINGS, FL:  
4,047,220, INT. CL. 43.

- BENITO, THEODORE I., LOS ANGELES, CA:  
4,046,831, INT. CL. 41.
- BENJAMIN HOLTZ, ESCONDIDO, CA:  
4,044,819, PUB. 8-9-2011. INT. CL. 31.
- BENNETT, MICHAEL, ROY, UT:  
4,044,864, PUB. 8-9-2011. INT. CL. 28.
- BERBAY CORPORATION, LOS ANGELES, CA:  
2,427,028. REN. 9-21-11. INT. CL. 35.
- BERBAY CORPORATION, TARZANA, CA:  
2,483,855. REN. 9-21-11. INT. CL. 35.
- BERGER, ILLANA, APTOS, CA:  
4,044,605, PUB. 8-9-2011. INT. CL. 45.  
4,044,606, PUB. 8-9-2011. INT. CL. 41.  
4,044,607, PUB. 8-9-2011. INT. CL. 16.  
4,044,608, PUB. 8-9-2011. INT. CL. 9.
- BERGIO INTERNATIONAL, INC., HILLSDALE, NJ:  
4,044,806, PUB. 8-9-2011. INT. CL. 14.
- BERGMAN, PHYLLIS, NEW YORK, NY:  
2,431,330. REN. 9-16-11. INT. CL. 14.
- BERNADEAU, JACQUELINE, STONEHAM, MA:  
4,043,972, PUB. 8-9-2011. INT. CL. 3.
- BERNSTEIN, HELEN PERELMAN, NEW YORK, NY, TA  
PERELMAN, HELEN:  
4,045,460, PUB. 8-9-2011. INT. CL. 16.
- BEROL CORPORATION, ATLANTA, GA:  
4,045,979, INT. CL. 16.
- BERRY BROS. & RUDD LIMITED, UNITED KINGDOM:  
4,043,755, PUB. 8-9-2011. INT. CL. 33.
- BERRY PLASTICS HOLDING CORPORATION, EVANS-  
VILLE, IN:  
2,502,895. REN. 9-19-11. INT. CL. 17.
- BERRY YARNS,; NAAMLOZE VENNOOTSCHAP, BEL-  
GIUM:  
3,987,875, CANC. IIRN. RESTORED TO S.N. 79-078,260.
- BERRY, JESSICA, RENO, NV:  
4,046,983, INT. CL. 25.
- BERRY, KEITH, THOUSAND OAKS, CA:  
2,491,938. REN. 9-21-11. INT. CL. 38.
- BERTHEL FISHER & COMPANY FINANCIAL SERVICES,  
INC., MARION, IA:  
4,046,429, INT. CL. 42.  
4,046,445, MULTIPLE CLASS, INT. CLS. 36 AND 42.
- BERTHELSEN, GEIR, KRISTIANSAND, NORWAY:  
4,045,693, INT. CL. 29.  
4,045,702, INT. CL. 32.
- BEST INDUSTRIES, INC., SPRINGFIELD, VA:  
2,926,607, CANC. MULTIPLE CLASS, INT. CLS. 5 AND  
10.  
2,926,608, CANC. MULTIPLE CLASS, INT. CLS. 5 AND  
10.  
2,926,609, CANC. MULTIPLE CLASS, INT. CLS. 5 AND  
10.  
2,926,610, CANC. MULTIPLE CLASS, INT. CLS. 5 AND  
10.
- BEST YEAR EVER!, INC., WHEATON, IL:  
2,569,383. REN. 9-16-11. MULTIPLE CLASS, INT. CLS. 16,  
41 AND 42.
- BETCO CORPORATION, TOLEDO, OH:  
2,520,063. REN. 9-22-11. INT. CL. 3.  
2,606,897. REN. 9-19-11. INT. CL. 7.
- BEVERLY HILLS FINANCIAL GROUP, BEVERLY HILLS,  
CA:  
2,428,412, CANC. INT. CL. 36.
- BEVERLY HILLS HAIR RESTORATION, INC., BEVERLY  
HILLS, CA:  
4,045,225, PUB. 8-9-2011. INT. CL. 3.
- BEVRON LABS, INC., KANSAS CITY, MO:  
2,428,699, CANC. INT. CL. 5.
- BGC PARTNERS, INC., NEW YORK, NY, ESPEED, INC.,  
NEW YORK, NY:  
2,484,458. REN. 9-20-11. INT. CL. 38.
- BGK TRADEMARK HOLDINGS, LLC, NEW YORK, NY:  
4,045,913, INT. CL. 3.
- BIERMANN PRODUCTIONS LLC, WICHITA, KS:  
3,662,238, COR. INT. CL. 41.
- BIFLEX INTIMATES GROUP, LTD., NEW YORK, NY:  
4,046,501, INT. CL. 25.
- BIG BEN CAFE, LLC, PROSPECT, KY:  
4,043,952, PUB. 8-9-2011. INT. CL. 43.
- BIG BOY'S BARBER SHOP, EL MONTE, CA:  
4,044,087, PUB. 4-12-2011. INT. CL. 44.
- BIG FISH GAMES, INC., SEATTLE, WA:  
4,045,726, MULTIPLE CLASS, INT. CLS. 38 AND 41.
- BIG IDEA GUYS, INC., SAN JOSE, CA:  
4,044,919, PUB. 8-9-2011. INT. CL. 15.
- BIGGS, W. JOSEPH, PANAMA CITY BEACH, FL:  
4,043,647, PUB. 1-20-2009. INT. CL. 25.
- BIGI CO., LTD., MINATO-KU, TOKYO, JAPAN:  
1,166,113. REN. 9-17-11. MULTIPLE CLASS, INT. CLS. 14,  
18 AND 25.
- BIGSHO INC., WILMINGTON, DE:  
4,044,662, PUB. 8-9-2011. INT. CL. 45.
- BINSI, INC., LONGMONT, CO:  
4,043,627, PUB. 8-9-2011. INT. CL. 25.
- BIO-RAD LABORATORIES, INC., HERCULES, CA:  
720,802. REN. 9-20-11. U.S. CL. 1 (INT. CL. 1).
- BIO-REFERENCE LABORATORIES, INC., ELMWOOD  
PARK, NJ:  
4,044,448, PUB. 8-9-2011. INT. CL. 44.
- BIOALLIANCE PHARMA, PARIS, FRANCE:  
4,044,319, PUB. 5-24-2011. INT. CL. 5.
- BIOFRESH LIMITED, NEWCASTLE-UPON-TYNE, UNITED  
KINGDOM:  
4,046,195, MULTIPLE CLASS, INT. CLS. 11 AND 37.
- BIOLAB (AUST) PTY LTD, SYDNEY NSW 2000, AUSTRA-  
LIA:  
2,428,039, CANC. INT. CL. 9.
- BIOLOGISCHE HEILMITTEL HEEL GMBH, 76532 BADEN-  
BADEN, FED REP GERMANY:  
1,659,395. REN. 9-22-11. INT. CL. 5.  
1,663,158. REN. 9-22-11. INT. CL. 5.
- BIOLOGISCHE INSEL LOTHAR MOLL GMBH & CO. KG,  
FED REP GERMANY:  
3,130,160, COR. MULTIPLE CLASS, INT. CLS. 1, 17 AND  
19.
- BIONIC TRADER SYSTEMS, LLC, CHICAGO, IL:  
4,046,662, INT. CL. 9.
- BIONOBLE RESEARCH, LLC, LAS VEGAS, NV:  
4,045,469, PUB. 8-9-2011. INT. CL. 30.
- BIOSTIME, INC. (GUANGZHOU), GUANGZHOU, GUANG-  
DONG, CHINA:  
4,043,889, PUB. 3-1-2011. INT. CL. 3.
- BIOSTIME, INC. (GUANGZHOU), GUANGZHOU, GUANG-  
DONG, CHINA:  
4,043,890, PUB. 3-1-2011. INT. CL. 5.  
4,043,891, PUB. 3-1-2011. INT. CL. 10.
- BIOTEC UMWELTSERVICES GMBH, FED REP GERMANY:  
4,043,805, PUB. 8-9-2011. MULTIPLE CLASS, INT. CLS. 37  
AND 39.
- BIOTRACE MICROSAFE S.R.L., FONTE NUOVA, ROME,  
ITALY:  
2,665,371, CANC. INT. CL. 9.
- BIQUTZ CORPORATION, MINNEAPOLIS, MN:  
2,428,746, CANC. INT. CL. 25.
- BIRDZONE LLC, SAN ANTONIO, TX:  
4,046,204, INT. CL. 28.
- BIRKO ORTHOPAEDIE GMBH, 53545 LINZ, FED REP  
GERMANY:  
2,926,295, CANC. INT. CL. 10.
- BISCOMERICA CORPORATION, RIALTO, CA:  
2,428,833, CANC. INT. CL. 30.
- BISON CAPITAL LLC, VENICE, FL:  
4,045,639, INT. CL. 33.  
4,045,640, INT. CL. 33.  
4,045,688, INT. CL. 29.  
4,045,692, INT. CL. 33.  
4,045,709, INT. CL. 35.
- BISSELL HOMECARE, INC., GRAND RAPIDS, MI:  
4,046,645, INT. CL. 3.  
4,046,865, INT. CL. 3.
- BITTER, PATRICK H., JR., LOS GATOS, CA:  
2,515,007. REN. 9-20-11. INT. CL. 3.
- BKMEDIA GROUP, LONGMONT, CO:  
4,044,581, PUB. 8-9-2011. INT. CL. 42.  
4,044,582, PUB. 8-9-2011. INT. CL. 42.

BLACK & BREW COFFEE HOUSE & BISTRO, INC., LAKE-  
LAND, FL:  
4,045,175, PUB. 8-9-2011. INT. CL. 43.

BLACK FOREST DECOR, LLC, ENID, OK:  
4,044,365, PUB. 8-9-2011. INT. CL. 35.

BLACK LAB SECURITY SYSTEMS, INC., COLUMBIA, MD:  
3,354,029, CANC. MULTIPLE CLASS, INT. CLS. 35 AND  
42.

BLACK ROYALTY, LLC, LOGANVILLE, GA:  
4,045,361, PUB. 8-9-2011. INT. CL. 45.  
4,045,363, PUB. 8-9-2011. INT. CL. 45.

BLACK SHEEP BREWERY PLC, THE, RIPON HG4 4EN,  
UNITED KINGDOM:  
2,526,520. REN. 9-20-11. INT. CL. 32.

BLACK SWAMP PERCUSSION, ZEELAND, MI:  
4,044,486, PUB. 8-9-2011. INT. CL. 15.

BLACKMAGIC DESIGN PTY LTD, PORT MELBOURNE,  
AUSTRALIA:  
4,044,119, PUB. 3-8-2011. INT. CL. 9.

BLAINE BROOKE PHOTOGRAPHY, INC., LOUISVILLE,  
KY:  
2,926,618, CANC. INT. CL. 25.

BLANCHARD TRAINING AND DEVELOPMENT, INC.,  
ESCONDIDO, CA:  
1,655,549. REN. 9-19-11. INT. CL. 16.

BLANCO, JOSEPH, CORONA, CA:  
4,044,454, PUB. 8-9-2011. INT. CL. 37.

BLINDS TO GO (U.S.) INC., ISELIN, NJ:  
2,482,337. REN. 9-20-11. INT. CL. 24.

BLIVEN, RANDALL P., MARSHFIELD, WI:  
2,926,777, CANC. INT. CL. 41.

BLIZZARD ENTERTAINMENT, INC., IRVINE, CA:  
2,490,187. REN. 9-20-11. INT. CL. 9.

BLOCKCHALK, INC., SAN FRANCISCO, CA:  
4,046,788, INT. CL. 42.

BLOOMBERG L.P., NEW YORK, NY:  
4,046,298, INT. CL. 36.

BLORE, MICHAEL, ROSEVILLE, CA AND BLORE, ASH-  
LEIGH, ROSEVILLE, CA:  
4,046,972, INT. CL. 44.

BLOSSOM BUCKET, INC., NORTH LAWRENCE, OH:  
4,046,135, MULTIPLE CLASS, INT. CLS. 20 AND 27.

BLUE AGAVE LLC, MESA, AZ, DBA BLUE AGAVE:  
4,045,894, INT. CL. 16.

BLUE ARCHIPELAGO BERHAD (655173-D), PETALING  
JAYA, SELANGO, MALAYSIA:  
4,046,577, INT. CL. 31.

BLUE OX HOCKEY, LLC, MUSKEGON, MI, DBA MUSKE-  
GON LUMBERJACKS:  
4,044,172, PUB. 5-3-2011. MULTIPLE CLASS, INT. CLS. 25  
AND 41.

BLUE RIBBON TECHNOLOGIES, LLC, GREENWOOD VIL-  
LAGE, CO:  
4,044,287, PUB. 8-9-2011. INT. CL. 42.

BLUE SKY INC., CUMBERLAND, ME:  
4,044,120, PUB. 8-9-2011. INT. CL. 35.  
4,044,121, PUB. 8-9-2011. INT. CL. 40.

BLUE STAR ENTERPRISES, LLC, SUNRISE, FL:  
4,044,836, PUB. 8-9-2011. MULTIPLE CLASS, INT. CLS. 40  
AND 42.

BLUEAIR AB, STOCKHOLM, SWEDEN:  
4,044,886, PUB. 8-9-2011. INT. CL. 11.  
4,044,900, PUB. 8-9-2011. INT. CL. 11.

BLUEARC CORPORATION, SAN JOSE, CA:  
4,045,826, INT. CL. 9.

BLUEBIRD BIO, INC., CAMBRIDGE, MA:  
4,046,532, MULTIPLE CLASS, INT. CLS. 5 AND 42.

BLUENOTE, INC., SAN FRANCISCO, CA:  
3,080,896, CANC. INT. CL. 5.

BLUESAIL SOLUTIONS INC., QUEBEC, CANADA:  
4,045,798, INT. CL. 9.

BLUESCOPE STEEL LIMITED, MELBOURNE, VIC 3000,  
AUSTRALIA:  
4,045,767, INT. CL. 37.

BLUMBERG, J. SETH, HERNDON, VA:  
4,045,641, INT. CL. 35.

BLUMENTHAL DISTRIBUTING, INC., ONTARIO, CA, DBA  
OFFICE STAR PRODUCTS:  
4,045,032, PUB. 8-9-2011. INT. CL. 20.

BNF, LLC, FORT COLLINS, CO, DBA SPOONERS FROZEN  
YOGURT:  
4,044,344, PUB. 8-9-2011. INT. CL. 43.

BOARD OF EDUCATION OF THE CITY OF CHICAGO,  
CHICAGO, IL:  
2,617,682. REN. 9-19-11. INT. CL. 41.

BOARD OF REGENTS, THE UNIVERSITY OF TEXAS  
SYSTEM, AUSTIN, TX:  
4,043,936, PUB. 8-9-2011. INT. CL. 35.  
4,043,954, PUB. 8-9-2011. INT. CL. 35.

BOB LITTER'S FUEL AND HEATING CO., INC., CHILLI-  
COTHE, OH:  
4,045,280, PUB. 8-9-2011. INT. CL. 39.

BOB'S STORES CORP., MERIDEN, CT:  
4,044,117, PUB. 3-29-2011. INT. CL. 35.

BOCHNER CHIROPRACTIC CARE, P.C., NEW YORK, NY:  
4,046,388, INT. CL. 44.  
4,046,581, INT. CL. 44.

BOCK, KENNETH, BEARSVILLE, NY:  
4,043,717, PUB. 8-9-2011. MULTIPLE CLASS, INT. CLS.  
41, 42 AND 44.  
4,043,718, PUB. 8-9-2011. MULTIPLE CLASS, INT. CLS.  
41, 42 AND 44.

BODYONICS, LTD., FARMINGDALE, NY:  
3,443,013, CANC. INT. CL. 5.

BOEHRINGER INGELHEIM INTERNATIONAL GMBH,  
FED REP GERMANY:  
4,043,853, PUB. 8-9-2011. INT. CL. 5.

BOGARI HOLDINGS, INC., NEW YORK, NY:  
4,045,192, PUB. 8-9-2011. INT. CL. 25.

BOLANOS FAMILY TRUST, QUEEN CREEK, AZ:  
4,045,487, PUB. 8-9-2011. INT. CL. 5.

BOLLINGER, INC., SHORT HILLS, NJ:  
4,045,073, PUB. 8-9-2011. MULTIPLE CLASS, INT. CLS. 35  
AND 36.

BOLTIN, IAIN A., BERKELEY, CA, DBA EIGHT ARMS  
CELLARS:  
4,045,456, PUB. 8-9-2011. INT. CL. 33.

BOMZE, HANNAH, NEW YORK, NY:  
4,044,822, PUB. 8-9-2011. INT. CL. 25.

BON HIVER, INC., CHESTER, NY:  
4,047,021, INT. CL. 28.  
4,047,022, INT. CL. 28.

BONNIE BERK, INC., CARLISLE, PA:  
2,428,564, CANC. INT. CL. 9.

BONNIER ACTIVE MEDIA, INC., WINTER PARK, FL,  
FORMERLY TIME4 MEDIA, INC.:  
4,045,850, MULTIPLE CLASS, INT. CLS. 9, 16 AND 41.

BONSAL AMERICAN, INC., CHARLOTTE, NC:  
2,604,303. REN. 9-20-11. INT. CL. 19.

BOOKS FOR KIDS FOUNDATION, THE, NEW YORK, NY:  
2,531,749. REN. 9-16-11. INT. CL. 42.

BOOT ROYALTY COMPANY, L.P., FORT WORTH, TX:  
2,926,560, CANC. INT. CL. 25.  
4,046,382, INT. CL. 25.

BORA CREATIONS S.L., 51001 CEUTA, SPAIN:  
4,043,870, PUB. 3-1-2011. MULTIPLE CLASS, INT. CLS. 3,  
5 AND 21.

BORDES, GREGORY A, BALTIMORE, MD:  
4,045,229, PUB. 8-9-2011. INT. CL. 25.

BORSHEIM JEWELRY COMPANY, INC., OMAHA, NE:  
2,494,273. REN. 9-22-11. INT. CL. 14.

BOSCHELE, INC., MOORESVILLE, NC:  
2,926,917, CANC. INT. CL. 36.

BOSLEY, INC., BEVERLY HILLS, CA:  
2,926,638, CANC. MULTIPLE CLASS, INT. CLS. 3 AND  
44.

BOSTECH CORPORATION, INDIANAPOLIS, IN:  
4,044,988, PUB. 8-9-2011. INT. CL. 42.

BOSTON CHILDREN'S HEART FOUNDATION, INC., BOS-  
TON, MA:  
4,045,044, PUB. 8-9-2011. INT. CL. 16.

BOSTON COMMON PRESS LIMITED PARTNERSHIP,  
BROOKLINE VILLAGE, MA:  
4,045,876, INT. CL. 41.

- BOTTOM LINE FOOD PROCESSORS, INC., AUSTIN, TX,  
DBA MICHAEL ANGELO'S GOURMET FOODS, INC.:  
4,047,192, MULTIPLE CLASS, INT. CLS. 29 AND 30.
- BOWE KATINA M, ORLANDO, FL:  
4,046,551, INT. CL. 25.
- BOWEN, KEDDRAIN, JOHNSON CITY, TN:  
4,045,040, PUB. 8-9-2011. INT. CL. 35.
- BOYER, LLC, LAWRENCE, KS:  
1,692,276. REN. 9-22-11. INT. CL. 2.
- BP SOLAR INTERNATIONAL INC., HOUSTON, TX:  
2,428,331, CANC. INT. CL. 9.
- BR IP HOLDER LLC, CANTON, MA:  
4,046,384, INT. CL. 43.
- BRACAMONTE, GIBRAN, NEW YORK, NY:  
4,045,348, PUB. 8-9-2011. INT. CL. 35.
- BRADLEY, HEATHER M., CULVER CITY, CA:  
4,045,656, INT. CL. 9.
- BRADY WORLDWIDE, INC., MILWAUKEE, WI:  
2,500,336. REN. 9-19-11. INT. CL. 16.
- BRAGG, STEVEN M., CENTENNIAL, CO:  
4,047,253, INT. CL. 16.
- BRAHA, SHIRLEY, BROOKLYN, NY:  
4,044,268, PUB. 8-9-2011. INT. CL. 41.
- BRAIN PHARMA, LLC, HOLLYWOOD, FL:  
4,046,571, INT. CL. 5.
- BRAND CONNECTIONS, LLC, NEW YORK, NY:  
4,044,588, PUB. 8-9-2011. INT. CL. 35.
- BRANDOFINO COMMUNICATIONS INC., SYOSSET, NY:  
4,045,887, INT. CL. 9.
- BRANDT CONSOLIDATED, INC., SPRINGFIELD, IL:  
2,502,142. REN. 9-20-11. INT. CL. 5.
- BRANDTRUTH LLC, KIRKLAND, WA:  
4,045,026, PUB. 8-9-2011. INT. CL. 35.
- BRASS BRICK HOMES, INC., OKLAHOMA CITY, OK:  
2,428,333, CANC. INT. CL. 37.
- BRASS-CRAFT MANUFACTURING COMPANY, NOVI, MI:  
4,045,839, INT. CL. 11.  
4,045,840, INT. CL. 11.  
4,045,841, INT. CL. 11.
- BRAY, CHRISTOPHER, ATLANTA, GA:  
4,045,292, PUB. 8-9-2011. INT. CL. 25.
- BRAZABRA CORP., LEE, MA:  
2,489,422. REN. 9-18-11. INT. CL. 10.
- BRAZTECH INTERNATIONAL, L.C., MIAMI, FL:  
4,044,885, PUB. 8-9-2011. INT. CL. 13.
- BREEZYPRINT CORPORATION, OAKLAND, CA:  
4,044,709, PUB. 8-9-2011. INT. CL. 9.  
4,044,712, PUB. 8-9-2011. INT. CL. 9.
- BRENNAN, BRADFORD, HENDERSON, NV:  
4,045,144, PUB. 8-9-2011. INT. CL. 35.
- BREWER QUILTING AND SEWING SUPPLIES, LLC, AURORA, IL:  
4,045,318, PUB. 8-9-2011. INT. CL. 35.
- BRICKSWORTH & CO, LLC, CHINO, CA:  
4,045,458, PUB. 8-9-2011. INT. CL. 35.
- BRIDGELIGHT CAPITAL, LLC, SCOTTSDALE, AZ:  
4,046,616, INT. CL. 36.
- BRIDGESTOR, LLC, POWAY, CA:  
4,046,546, INT. CL. 42.  
4,046,547, INT. CL. 9.  
4,046,549, INT. CL. 42.
- BRIDWELL, NORMAN, EDGARTOWN, MA:  
2,609,445. REN. 9-21-11. INT. CL. 25.  
2,614,356. REN. 9-21-11. INT. CL. 9.
- BRIGGS MEDICAL SERVICE COMPANY, WEST DES MOINES, IA:  
4,047,241, INT. CL. 16.
- BRIGHT STAR PRODUCTIONS LLC, PHOENIX, AZ:  
4,045,208, PUB. 8-9-2011. INT. CL. 35.
- BRIGHTER FUTURE EVENTS, INC., AUBURN, ME, DBA STREAK FOR CANCER:  
4,047,258, INT. CL. 36.
- BRIGHTSOURCE ENERGY, INC., OAKLAND, CA:  
4,046,174, INT. CL. 42.
- BRIJ IMAGE AND INFORMATION, GREENSBORO, NC:  
4,043,977, PUB. 8-9-2011. INT. CL. 41.
- BRILLIANT TAX & ACCOUNTING SERVICES, INC., GLENDALE, CA, DBA ARPA TAX:  
4,044,940, PUB. 8-9-2011. INT. CL. 35.
- BRIMSTONE CYCLES LLC, TOLEDO, OH:  
4,045,794, INT. CL. 12.
- BRINKLEY, HEIDI, SOUTHFIELD, MI:  
4,046,708, INT. CL. 41.
- BRISTOL-MYERS SQUIBB PHARMA COMPANY, PRINCETON, NJ, DUPONT PHARMACEUTICALS COMPANY, WILMINGTON, DE:  
2,496,476. REN. 9-20-11. INT. CL. 5.
- BRITA, LP, NEUCHATEL, SWITZERLAND:  
4,046,738, MULTIPLE CLASS, INT. CLS. 11 AND 21.
- BRITANNICA HOME FASHIONS, INC., NEW YORK, NY:  
4,045,750, INT. CL. 24.
- BROAD RUN HOLDINGS, INC., WILMINGTON, DE:  
1,661,013. REN. 9-21-11. INT. CL. 31.
- BROAD SKYS LLC, WOOLWICH TOWNSHIP, NJ:  
4,044,362, PUB. 8-9-2011. INT. CL. 39.
- BROADCAST LLC, BLACKFOOT, ID:  
4,045,037, PUB. 8-9-2011. MULTIPLE CLASS, INT. CLS. 25 AND 28.
- BROADCASTING HOLDINGS PLC, UNITED KINGDOM:  
4,043,835, PUB. 8-9-2011. MULTIPLE CLASS, INT. CLS. 7 AND 37.
- BROAN-NUTONE, LLC, HARTFORD, WI:  
4,047,008, INT. CL. 11.
- BROCADE COMMUNICATIONS SYSTEMS, INC., SAN JOSE, CA:  
4,046,730, INT. CL. 9.
- BRONOX LTD., MONROVIA, LIBERIA, UNITED STATES SHOE CORPORATION, THE, CINCINNATI, OH:  
1,173,420. REN. 9-20-11. INT. CL. 25.
- BROOKER, SAM, NASHVILLE, TN:  
2,927,016, CANC. INT. CL. 35.
- BROOKSHIRE BROTHERS, LTD., LUFKIN, TX:  
4,046,496, INT. CL. 35.
- BROTHERHOOD OF BIKERS CORPORATION, MEXIA, TX:  
4,044,240, PUB. 8-9-2011. U.S. CL. 200.
- BROWE, INC., MADISON HEIGHTS, MI:  
4,043,914, PUB. 8-9-2011. INT. CL. 9.
- BROWN JORDAN INTERNATIONAL, INC., ST. AUGUSTINE, FL, SCOTT PAPER COMPANY, PHILADELPHIA, PA:  
940,486. REN. 9-21-11. U.S. CL. 32 (INT. CL. 20).
- BROWN MEDICAL INDUSTRIES, INC., SPIRIT LAKE, IA:  
1,672,521. REN. 9-16-11. INT. CL. 10.
- BROWN, AMY, SIERRA VISTA, AZ:  
3,599,443, AM. INT. CL. 25.
- BROWN, JANICE, SAN DIEGO, CA:  
4,045,748, MULTIPLE CLASS, INT. CLS. 35 AND 41.
- BROWN, ROBERT E, MR., ROCHESTER, NY:  
4,046,580, INT. CL. 45.
- BRUCE FOODS CORPORATION, NEW IBERIA, LA:  
4,044,578, PUB. 8-9-2011. INT. CL. 29.
- BRUMFIELD CELLARS SELECT WINES, LLC, HEALDSBURG, CA:  
4,045,459, PUB. 8-9-2011. INT. CL. 33.
- BRUNSWICK CORPORATION, LAKE FOREST, IL, AMF INCORPORATED, WHITE PLAINS, NY:  
1,198,605. REN. 9-20-11. INT. CL. 12.
- BRYANT ROLSTAD CONSULTANTS, LLC, MINNEAPOLIS, MN, DBA WEBWOC NURSING EDUCATION PROGRAM:  
4,044,088, PUB. 8-9-2011. INT. CL. 41.  
4,044,089, PUB. 8-9-2011. INT. CL. 41.
- BRYN MAWR REHABILITATION HOSPITAL, MALVERN, PA:  
1,651,083. REN. 9-20-11. INT. CL. 41.
- BSD DISTRIBUTORS, INC., BROOKLYN, NY:  
4,046,370, INT. CL. 9.  
4,046,371, INT. CL. 9.
- BUCHOLTZ, JEFFREY, SAN DIEGO, CA:  
4,045,388, PUB. 8-9-2011. INT. CL. 41.
- BUCK CONSULTANTS, LLC, NEW YORK, NY:  
2,590,226. REN. 9-21-11. MULTIPLE CLASS, INT. CLS. 16, 35, 36, 38 AND 42.
- BUCKAROO COMMUNICATIONS, LLC, DAYTON, TN:  
2,429,013, CANC. INT. CL. 16.



BUILDBLOCK BUILDING SYSTEMS, LLC, OKLAHOMA CITY, OK:  
4,045,195, PUB. 8-9-2011. INT. CL. 17.

BUILDING MATERIALS INVESTMENT CORP., DALLAS, TX:  
4,044,094, PUB. 8-9-2011. INT. CL. 19.  
4,044,151, PUB. 8-9-2011. INT. CL. 19.

BULLHORN, INC., BOSTON, MA:  
4,045,102, PUB. 8-9-2011. INT. CL. 42.  
4,045,164, PUB. 8-9-2011. INT. CL. 42.

BUNNIE WISE, LLC, PORT ST. LUCIE, FL, FORMERLY BUNNIE LOVE, LLC:  
4,046,433, INT. CL. 16.

BUNNY TAILS, MULINO, OR:  
4,043,947, PUB. 1-25-2011. INT. CL. 25.

BUNZL DISTRIBUTION USA, INC., ST. LOUIS, MO:  
2,927,017, CANC. INT. CL. 21.

BURCKHARDT, BRIAN C, BOERNE, TX:  
4,047,188, INT. CL. 21.

BURGER KING CORPORATION, MIAMI, FL:  
2,428,858, CANC. INT. CL. 9.  
4,046,784, INT. CL. 36.

BURGERS' OZARK COUNTRY CURED HAMS, INC., CALIFORNIA, MO:  
4,045,590, INT. CL. 29.

BURGESS, SEAN M., BROKEN ARROW, OK:  
4,045,194, PUB. 8-9-2011. INT. CL. 41.

BURIED EVIDENCE RECORDS INC., DEER PARK, NY:  
4,044,575, PUB. 8-9-2011. INT. CL. 41.

BURRELL MINING PRODUCTS, INC., NEW KENSINGTON, PA, BURRELL CONSTRUCTION & SUPPLY CO., NEW KENSINGTON, PA:  
1,176,223, REN. 9-20-11. INT. CL. 19.

BUSHNELL INC., OVERLAND PARK, KS, BAUSCH & LOMB INCORPORATED, ROCHESTER, NY:  
1,666,562, REN. 9-20-11. INT. CL. 9.  
1,673,830, REN. 9-20-11. INT. CL. 9.

BUSINESS CANOE, LLC, SAVANNAH, GA:  
4,044,424, PUB. 8-9-2011. INT. CL. 37.

BUSINESS NAMES UNLIMITED LTD., OTTAWA, ONTARIO, CANADA:  
4,043,640, PUB. 4-26-2011. INT. CL. 45.

BUSINESS TELECOM, INC., RALEIGH, NC:  
2,427,897, CANC. MULTIPLE CLASS, INT. CLS. 36, 38 AND 42.

BUTERA'S RESTAURANT OF WOODBURY, WOODBURY, NY:  
4,044,725, PUB. 8-9-2011. INT. CL. 30.

BUTES, LLC, WILLIAMSVILLE, NY:  
4,046,591, INT. CL. 25.

BUTLER UNIVERSITY, INDIANAPOLIS, IN:  
4,046,486, INT. CL. 45.

BUTTERBALL, LLC, GARNER, NC, SWIFT & COMPANY, CHICAGO, IL:  
1,172,448, REN. 9-19-11. INT. CL. 29.

BUTTS, HARRIET JANE, BEN LOMOND, CA:  
2,522,159, REN. 9-22-11. INT. CL. 42.

BUY4STORE.COM, LOS ANGELES, CA:  
4,046,427, INT. CL. 14.

BUZZTIME ENTERTAINMENT, INC., CARLSBAD, CA:  
2,926,547, CANC. INT. CL. 41.

BWG BERGWERK- UND WALZWERK-MASCHINENBAU GMBH, D-4100 DUISBERG, FED REP GERMANY:  
1,158,808, REN. 9-19-11. INT. CL. 7.

BYRD, DONALD, OAKHURST, NJ:  
4,043,711, PUB. 8-9-2011. INT. CL. 43.

C & E DISTRIBUTING, SAN CLEMENTE, CA:  
4,044,201, PUB. 8-9-2011. MULTIPLE CLASS, INT. CLS. 9 AND 44.

C & K COMPONENTS, INC., NEWTON, MA, C&K/UNIMAX, INC., WALLINGFORD, CT:  
1,649,362, REN. 9-22-11. INT. CL. 9.

C. A. SCHROEDER, INC., SAN FERNANDO, CA, AKA CASCO:  
1,166,373, REN. 9-20-11. INT. CL. 11.

C. R. BARD, INC., MURRAY HILL, NJ:  
4,046,381, INT. CL. 10.

C.L. INDUSTRIES, INC., ORLANDO, FL:  
2,534,135, REN. 9-20-11. INT. CL. 19.

C.R. MARTIN AUCTIONEERS, INC., OAKLAND, CA:  
4,044,652, PUB. 8-9-2011. INT. CL. 35.

C.V. STARR & CO., SAN FRANCISCO, CA:  
2,926,969, CANC. INT. CL. 36.

C+W DIVERSIFIED INTERESTS LLC, AUSTIN, TX:  
4,044,451, PUB. 8-9-2011. INT. CL. 44.

C&H LURES ULTIMATE TACKLE, INC., JACKSONVILLE, FL:  
1,653,334, REN. 9-21-11. INT. CL. 28.  
1,654,053, REN. 9-20-11. INT. CL. 28.

C&S WHOLESALE GROCERS, INC., KEENE, NH:  
4,047,059, INT. CL. 35.

C-MORE SYSTEMS, MANASSAS, VA:  
2,481,531, REN. 9-21-11. MULTIPLE CLASS, INT. CLS. 9 AND 25.  
2,481,532, REN. 9-21-11. MULTIPLE CLASS, INT. CLS. 9 AND 25.

CABLEXPRESS CORPORATION, SYRACUSE, NY, DBA CXTEC:  
4,044,349, PUB. 8-9-2011. INT. CL. 41.  
4,044,350, PUB. 8-9-2011. INT. CL. 41.

CADBURY TREBOR ALLAN INC., TORONTO, ONTARIO:  
2,927,021, CANC. INT. CL. 3.

CADMIUM CD LLC, FOREST HILL, MD:  
4,043,938, PUB. 8-9-2011. INT. CL. 42.

CAFARELLI, DAVID, GREEN ACRES, FL:  
4,045,198, PUB. 8-9-2011. INT. CL. 5.

CAFE DES AMIS, INC., BREAUX BRIDGE, LA:  
2,499,589, REN. 9-18-11. INT. CL. 42.

CAFFELLI LLC, PORTLAND, OR:  
4,045,176, PUB. 8-9-2011. INT. CL. 35.

CALDERA BREWING COMPANY, ASHLAND, OR:  
4,047,186, INT. CL. 32.

CALDWELL, HAMLIN, HUNTSVILLE, AL:  
4,046,484, INT. CL. 9.

CALGON CARBON CORPORATION, PITTSBURGH, PA:  
2,491,464, REN. 9-18-11. INT. CL. 1.

CALIFORNIA CHARTER SCHOOLS ASSOCIATION, LOS ANGELES, CA:  
4,045,544, PUB. 8-9-2011. MULTIPLE CLASS, INT. CLS. 9 AND 41.

CALIFORNIA CROP IMPROVEMENT ASSOCIATION, DAVIS, CA:  
1,652,358, REN. 9-21-11. INT. CL. 16.

CALIFORNIA EARTHQUAKE AUTHORITY, SACRAMENTO, CA:  
4,044,162, PUB. 8-9-2011. MULTIPLE CLASS, INT. CLS. 36 AND 41.

CALIFORNIA EXOTIC NOVELTIES, LLC, CHINO, CA:  
4,044,063, PUB. 8-9-2011. INT. CL. 10.

CALIFORNIA OILS CORPORATION, RICHMOND, CA:  
4,047,157, INT. CL. 29.

CALIFORNIA SOURCING, INC., LOS ANGELES, CA:  
4,044,661, PUB. 8-9-2011. INT. CL. 25.

CALLAWAY GOLF COMPANY, CARLSBAD, CA:  
2,926,945, CANC. INT. CL. 28.

CALLIDUS TECHNOLOGIES, L.L.C., TULSA, OK, CALLIDUS TECHNOLOGIES, INC., TULSA, OK:  
1,653,898, REN. 9-20-11. MULTIPLE CLASS, INT. CLS. 37 AND 42.

CALLING ALL ANGELS, INC., DETROIT, MI:  
4,044,389, PUB. 8-9-2011. INT. CL. 35.

CALPORTLAND COMPANY, GLENDORA, CA:  
4,046,074, INT. CL. 19.  
4,046,075, INT. CL. 37.  
4,046,076, INT. CL. 40.

CALTEL LONG DISTANCE, COPPEROPOLIS, CA:  
2,615,100, REN. 9-21-11. INT. CL. 38.

CALVIS, MARCELO, PROVINCE OF BUENOS AIRES, ARGENTINA:  
2,926,627, CANC. INT. CL. 25.

CAMBRIDGE INTERNATIONAL, INC., CAMBRIDGE, MD, CAMBRIDGE WIRE CLOTH COMPANY, THE, CAMBRIDGE, MA:  
1,168,070, REN. 9-22-11. INT. CL. 7.

- CAMBRIDGE INTERNATIONAL, INC., CAMBRIDGE, MD:  
2,538,373. REN. 9-20-11. MULTIPLE CLASS, INT. CLS. 37  
AND 40.
- CAMBRIDGE MANHATTAN GROUP, LLC, SCOTTS VAL-  
LEY, CA:  
4,047,250. INT. CL. 41.
- CAMBRO MANUFACTURING COMPANY, HUNTINGTON  
BEACH, CA:  
2,614,655. REN. 9-20-11. INT. CL. 21.
- CAMCO INTERNATIONAL LIMITED, ST. HELIER, JER-  
SEY:  
4,043,684. PUB. 1-18-2011. MULTIPLE CLASS, INT. CLS.  
9, 16, 35, 36 AND 42.
- CAMERON MACKINTOSH LIMITED, LONDON, UNITED  
KINGDOM:  
2,984,954. CANC. INT. CL. 25.
- CAMERON, WILLIAM L., MATTHEWS, NC:  
4,046,508. INT. CL. 25.
- CAMO-CLAD, INC., MOUNDS, IL:  
2,473,837. REN. 9-20-11. INT. CL. 17.
- CAMPBELL, SUSAN M., BETHESDA, MD, DBA FICKLE  
FACE:  
4,046,303. MULTIPLE CLASS, INT. CLS. 25 AND 28.
- CAN 56, INC., EDEN PRAIRIE, MN:  
2,926,856. CANC. INT. CL. 21.
- CANADIAN AUTOMOTIVE INSTRUMENTS LTD., STONY  
PLAIN, AB, CANADA:  
4,045,304. PUB. 8-9-2011. INT. CL. 9.
- CANADIAN FISH EXPORTERS, INC., AUBURNDALE, MA:  
2,530,569. REN. 9-16-11. INT. CL. 29.
- CANADIAN NATIONAL RAILWAY COMPANY, MON-  
TREAL, QUEBEC, CANADA:  
4,043,740. PUB. 2-16-2010. INT. CL. 39.
- CANET, DIEGO, MENDOZA, ARGENTINA AND NAVAR-  
RO, MIGUEL ANGEL, MENDOZA, ARGENTINA:  
4,046,510. INT. CL. 33.
- CANFIELD SCIENTIFIC, INC., FAIRFIELD, NJ:  
4,044,796. PUB. 8-9-2011. INT. CL. 9.
- CANIDAE CORPORATION, SAN LUIS OBISPO, CA:  
2,493,537. REN. 9-19-11. INT. CL. 31.
- CANINE PARTNERS FOR LIFE, COCHRANVILLE, PA:  
4,044,358. PUB. 8-9-2011. INT. CL. 44.
- CANNON FISH COMPANY, SEATTLE, WA:  
4,044,149. PUB. 8-9-2011. MULTIPLE CLASS, INT. CLS. 29  
AND 35.
- CANON COMMUNICATIONS LLC, LOS ANGELES, CT,  
DELTA COMMUNICATIONS, INC., CHICAGO, IL:  
1,650,147. REN. 9-20-11. INT. CL. 16.
- CANON KABUSHIKI KAISHA, TOKYO, JAPAN:  
2,501,620. REN. 9-21-11. INT. CL. 9.
- CANSON, ANNONAY, FRANCE:  
4,045,870. INT. CL. 16.
- CANTIUS INC., VIENNA, VA:  
4,044,213. PUB. 8-9-2011. INT. CL. 41.
- CANTOR FITZGERALD SECURITIES, NEW YORK, NY:  
4,046,165. MULTIPLE CLASS, INT. CLS. 36, 42 AND 45.
- CANYON STREET CROSSING LIMITED LIABILITY COM-  
PANY, BOULDER, CO:  
726,468. REN. 9-19-11. U.S. CL. 23 (INT. CL. 7).
- CAO GROUP, INC., WEST JORDAN, UT:  
4,044,972. PUB. 8-9-2011. INT. CL. 5.  
4,044,973. PUB. 8-9-2011. INT. CL. 5.  
4,044,978. PUB. 8-9-2011. INT. CL. 10.  
4,044,983. PUB. 8-9-2011. INT. CL. 10.  
4,045,012. PUB. 8-9-2011. INT. CL. 10.
- CAPCOM CO., LTD., CHUO-KU OSAKA, JAPAN:  
2,492,931. REN. 9-19-11. INT. CL. 9.
- CAPE FEAR SYSTEMS, LLC, WILMINGTON, NC:  
2,428,880. CANC. INT. CL. 9.
- CAPITAL ONE FINANCIAL CORPORATION, RICHMOND,  
VA:  
2,428,999. CANC. INT. CL. 36.
- CAPTURESQUE PHOTOGRAPHY LLC, FORT COLLINS,  
CO:  
4,045,278. PUB. 8-9-2011. INT. CL. 41.
- CAR TATTOOS DECALS AND SPORTSWEAR LTD., YON-  
KERS, NY:  
2,482,252. REN. 9-20-11. INT. CL. 16.
- CARAVAN CANOPY INTERNATIONAL, INC., LA MIRA-  
DA, CA:  
4,046,368. MULTIPLE CLASS, INT. CLS. 6 AND 22.
- CARDEAN LEARNING GROUP LLC, STAMFORD, CT:  
2,427,868. CANC. INT. CL. 41.
- CARDINAL INDUSTRIAL FINISHES, SOUTH EL MONTE,  
CA:  
4,046,761. INT. CL. 2.
- CARDIOFOCUS, INC., MARLBOROUGH, MA:  
2,491,207. REN. 9-21-11. MULTIPLE CLASS, INT. CLS. 9  
AND 10.
- CARDOMAIN NETWORK, INC., SEATTLE, WA:  
4,045,723. INT. CL. 42.
- CARDWELL, CHARLES E., KINGSTON, TN, DBA THE  
ASTUTE INVESTOR:  
1,664,965. REN. 9-22-11. INT. CL. 16.
- CARE CAM INNOVATIONS, LLC, GREENVILLE, SC:  
4,045,574. PUB. 8-9-2011. INT. CL. 9.
- CARECENTRIX, INC., EAST HARTFORD, CT:  
2,583,399. REN. 9-22-11. INT. CL. 16.
- CAREFUSION 303, INC., SAN DIEGO, CA:  
4,044,030. PUB. 8-9-2011. INT. CL. 9.  
4,044,031. PUB. 8-9-2011. INT. CL. 9.
- CAREMARK INTERNATIONAL INC., NORTHBROOK, IL:  
2,926,998. CANC. INT. CL. 44.  
2,926,999. CANC. INT. CL. 35.
- CARESEE INC., BROOKLYN, NY:  
2,701,276. CANC. INT. CL. 11.
- CARGILL, INCORPORATED, WAYZATA, MN:  
2,926,577. CANC. INT. CL. 36.  
2,926,764. CANC. INT. CL. 30.
- CARINA WINES, LLC, RENO, NV:  
4,047,084. INT. CL. 33.
- CARING FOR PEOPLE SERVICES, INC., OMAHA, NE:  
4,044,884. PUB. 8-9-2011. INT. CL. 45.
- CARLSBAD-PALOMAR AIRLINES, INC., CARLSBAD, CA,  
DBA CALIFORNIA PACIFIC AIRLINES:  
4,046,088. INT. CL. 39.
- CAROLINA HOSIERY MILLS, INC., BURLINGTON, NC:  
4,044,624. PUB. 8-9-2011. INT. CL. 25.  
4,044,682. PUB. 8-9-2011. INT. CL. 25.
- CAROLINA MANUFACTURING COMPANY, GREEN-  
VILLE, SC:  
2,479,896. REN. 9-16-11. INT. CL. 25.
- CAROMED INTERNATIONAL, INC., RALEIGH, NC:  
1,653,578. REN. 9-21-11. INT. CL. 10.
- CARPEL CLEANING CORP., PINE BROOK, NJ:  
4,045,381. PUB. 8-9-2011. INT. CL. 37.
- CARPENTER, MAURICE, CHESTER, VA:  
4,046,022. INT. CL. 41.
- CARQUEST CORPORATION, RALEIGH, NC:  
1,650,501. REN. 9-19-11. MULTIPLE CLASS, INT. CLS. 1,  
4 AND 12.
- CARRERO, RAFAEL, PEMBROKE PINES, FL AND BIAG-  
GINI, LISANDRO, PEMBROKE PINES, FL:  
4,046,481. INT. CL. 25.
- CARROLL HALL SHELBY TRUST, LOS ANGELES, CA:  
4,043,733. PUB. 5-3-2011. INT. CL. 28.
- CARVIN POOL EQUIPMENT INC., ST. HYACINTHE, QUE-  
BEC, CANADA, AKA 9204-1987 QUEBEC INC.:  
2,434,800. REN. 9-18-11. INT. CL. 7.  
2,491,232. REN. 9-19-11. INT. CL. 11.
- CASA GUADALAJARA, LLC, SAN DIEGO, CA:  
2,489,938. REN. 9-17-11. INT. CL. 42.
- CASCO MEDIA, CORP., BILLERICA, MA:  
4,047,243. MULTIPLE CLASS, INT. CLS. 35, 38 AND 41.
- CASEY & TRIXIE'S PET SUPPLY COMPANY, HILLSBOR-  
OUGH, NJ:  
4,047,107. INT. CL. 35.
- CASEY RESEARCH, LLC, ASPEN, CO:  
4,044,672. PUB. 8-9-2011. INT. CL. 9.  
4,044,698. PUB. 8-9-2011. INT. CL. 41.
- CASH, LARRY S., ANCHORAGE, AK, CASH, LARRY S.,  
ANCHORAGE, AK:  
2,611,374. REN. 9-22-11. INT. CL. 42.
- CASHCO FINANCIAL SERVICES, INC., TIGARD, OR:  
4,045,509. PUB. 8-9-2011. INT. CL. 36.  
4,045,511. PUB. 8-9-2011. INT. CL. 36.

CASHFLOW TECHNOLOGIES, INC., SCOTTSDALE, AZ:  
4,046,176, INT. CL. 14.

CASIO KEISANKI KABUSHIKI KAISHA, SHIBUYA-KU,  
TOKYO, JAPAN, DBA CASIO COMPUTER CO., LTD.:  
2,428,722, CANC. INT. CL. 14.

CASS COMMERCIAL BANK, BRIDGETON, MO:  
2,583,714, REN. 9-21-11. INT. CL. 36.

CASS POLYMERS OF MICHIGAN, INC., MADISON  
HEIGHTS, MI:  
2,528,169, REN. 9-22-11. INT. CL. 1.

CASTER, 75008 PARIS, FRANCE:  
4,044,301, PUB. 7-12-2011. INT. CL. 3.

CATALYST SERVICES, INC., DEER PARK, TX:  
4,044,655, PUB. 8-9-2011. INT. CL. 37.

CATCH SURFBOARD CO., LLC, SAN CLEMENTE, CA:  
4,045,670, INT. CL. 25.

CATERBID, LLC, NEW YORK, NY:  
4,043,976, PUB. 8-9-2011. INT. CL. 35.

CATERPILLAR INC., PEORIA, IL:  
4,044,833, PUB. 8-9-2011. INT. CL. 12.  
4,045,652, MULTIPLE CLASS, INT. CLS. 1, 2, 4, 6, 7, 8, 9,  
11, 12, 17 AND 20.

CATSTACTICALLLC, GILROY, CA:  
4,045,019, PUB. 8-9-2011. INT. CL. 13.

CAVALIER, WES, COLORADO SPRINGS, CO:  
4,044,482, PUB. 8-9-2011. INT. CL. 35.

CBS OPERATIONS INC., STUDIO CITY, CA:  
1,159,762, REN. 9-20-11. INT. CL. 9.  
1,159,762, CANC. INT. CL. 16.

CBS RADIO STATIONS INC., NEW YORK, NY:  
4,043,908, PUB. 8-9-2011. INT. CL. 38.

CC INVESTMENTS LLC, GRAND JUNCTION, CO:  
4,045,575, PUB. 8-9-2011. INT. CL. 29.

CCA GLOBAL PARTNERS, INC., EARTH CITY, MO:  
4,046,439, INT. CL. 37.

CCA INDUSTRIES, INC., EAST RUTHERFORD, NJ:  
2,926,535, CANC. INT. CL. 3.

CCM IP, S.A., CH-1005 LAUSANNE, SWITZERLAND, CER-  
VECCERIA MOCTEZUMA, S.A. DE C.V., MONTEREY,  
NEUVO LEON 64442, MEXICO:  
1,702,032, REN. 9-16-11. INT. CL. 32.

CEBON COGNAC COMPANY, INC., SAN FRANCISCO, CA:  
2,926,744, CANC. INT. CL. 33.

CEC ENTERTAINMENT CONCEPTS, L.P., IRVING, TX,  
SHOWBIZ PIZZA TIME, INC., IRVING, TX:  
1,630,366, REN. 9-20-11. INT. CL. 41.

CEDAR FAIR, L.P., SANDUSKY, OH:  
2,553,310, REN. 9-22-11. MULTIPLE CLASS, INT. CLS. 16,  
21, 25, 28 AND 41.

CELAYIX, INC., VANCOUVER, CANADA:  
4,043,674, PUB. 8-9-2011. MULTIPLE CLASS, INT. CLS. 9,  
41 AND 42.

CELEXION, LLC, CAMBRIDGE, MA:  
4,046,024, MULTIPLE CLASS, INT. CLS. 40, 42 AND 44.

CELGENE CORPORATION, SUMMI, NJ:  
4,045,529, PUB. 7-26-2011. INT. CL. 5.

CELGENE CORPORATION, SUMMIT, NJ:  
4,045,914, INT. CL. 42.

CELINE DION, LAVAL (QUEBEC), CANADA:  
4,043,662, PUB. 8-9-2011. MULTIPLE CLASS, INT. CLS. 9,  
14 AND 20.

CELLECT TECHNOLOGIES, LLC, WEST HYANNISPORT,  
MA:  
4,046,582, INT. CL. 17.  
4,046,583, INT. CL. 17.  
4,046,584, INT. CL. 17.

CELLERATION, INC., EDEN PRAIRIE, MN:  
3,023,075, CANC. INT. CL. 5.

CEMIL ERZINCANLI, SAN FRANCISCO, CA:  
4,043,939, PUB. 1-18-2011. INT. CL. 43.

CENTER FOR EMPLOYMENT TRAINING, SAN JOSE, CA:  
2,493,765, REN. 9-21-11. INT. CL. 41.  
2,533,758, REN. 9-22-11. INT. CL. 41.

CENTER FOR RESTORATIVE BREAST SURGERY, LLC,  
NEW ORLEANS, LA:  
4,045,937, INT. CL. 45.  
4,045,938, INT. CL. 41.

CENTER FOR SIMPLIFIED STRATEGIC PLANNING, INC.,  
ANN ARBOR, MI:  
2,498,700, REN. 9-21-11. MULTIPLE CLASS, INT. CLS. 16  
AND 41.

CENTER FOR SUCCESS INCORPORATED, SOUTH BEND,  
IN:  
2,479,633, REN. 9-19-11. INT. CL. 41.

CENTINEL SPINE, INC., NEW YORK, NY:  
4,044,714, PUB. 8-9-2011. INT. CL. 10.

CENTRACARE HEALTH SYSTEM, ST. CLOUD, MN:  
2,539,060, REN. 9-16-11. MULTIPLE CLASS, INT. CLS. 36  
AND 42.

CENTREX PLASTICS, LLC, FINDLAY, OH:  
4,045,403, PUB. 8-9-2011. INT. CL. 21.

CENTRIX, INC., SHELTON, CT:  
2,595,508, REN. 9-22-11. INT. CL. 10.

CENTRRO INC., OAKLAND, CA:  
4,044,792, PUB. 8-9-2011. INT. CL. 35.

CENTURY COUNCIL, THE, ARLINGTON, VA:  
2,450,323, REN. 9-21-11. MULTIPLE CLASS, INT. CLS. 16  
AND 42.  
2,450,323, CANC. INT. CL. 9.

CENTURY PUBLISHING COMPANY, INC., POST FALLS,  
ID:  
2,468,704, REN. 9-19-11. INT. CL. 42.

CEPIA, LLC, ST. LOUIS, MO:  
4,046,016, MULTIPLE CLASS, INT. CLS. 9, 16, 18, 21, 24  
AND 25.

CERTIFICATION COUNCIL FOR PROFESSIONAL DOG  
TRAINERS, NEW YORK, NY:  
4,046,157, U.S. CL. B.

CERTIS U.S.A. L.L.C., COLUMBIA, MD:  
4,044,326, PUB. 8-9-2011. INT. CL. 5.  
4,044,327, PUB. 8-9-2011. INT. CL. 5.

CERULEAN STUDIOS, LLC, BROOKFIELD, CT:  
4,044,953, PUB. 8-9-2011. MULTIPLE CLASS, INT. CLS. 9  
AND 38.

CERUS CORPORATION, CONCORD, CA:  
2,482,600, REN. 9-21-11. INT. CL. 5.

CERVEZAS ALHAMBRA, S.L., GRANADA, SPAIN:  
4,045,352, PUB. 8-9-2011. INT. CL. 32.

CERWINSKE, LAURA, MIAMI, FL:  
4,047,218, INT. CL. 41.

CFO CONNECT, SAN DIEGO, CA:  
4,044,420, PUB. 8-9-2011. INT. CL. 35.

CH ENERGY GROUP, INC, POUQHKEEPSIE, NY:  
2,486,888, REN. 9-21-11. MULTIPLE CLASS, INT. CLS. 39,  
40 AND 42.

CHAI DAVE, BREA, CA:  
4,044,770, PUB. 8-9-2011. INT. CL. 11.

CHAIN AWAY CORPORATION, BILLINGS, MT:  
1,671,584, REN. 9-16-11. INT. CL. 6.

CHAIN-HEADWAY MACHINE TOOLS CO., LTD., TAI-  
CHUNG HSIEN, TAIWAN:  
4,046,909, INT. CL. 7.

CHALKTALK SPORTS, INC., NORWALK, CT:  
4,044,430, PUB. 8-9-2011. INT. CL. 35.  
4,044,431, PUB. 8-9-2011. INT. CL. 35.

CHALLENGE & FUN INC., ASHLAND, MA:  
4,045,093, PUB. 8-9-2011. INT. CL. 35.

CHALLENGE PRINTING COMPANY, THE, CLIFTON, NJ:  
2,518,980, REN. 9-20-11. MULTIPLE CLASS, INT. CLS. 35,  
40 AND 42.

CHAN CONLYN, NEW YORK, NY:  
4,046,030, INT. CL. 18.

CHAN, JOHN H., OAKLAND, CA:  
4,044,820, PUB. 8-9-2011. INT. CL. 35.

CHANDLER BOERNER, KATHERINE ANN, ANGIER, NC:  
4,044,985, PUB. 8-9-2011. INT. CL. 41.

CHANEL, INC., NEW YORK, NY:  
1,654,350, REN. 9-21-11. INT. CL. 21.

CHANG, HUA-TING, WEST DISTRICT, TAICHUNG CITY,  
TAIWAN:  
3,223,413, COR. MULTIPLE CLASS, INT. CLS. 30, 32  
AND 43.

CHAPMAN, SUNNI, GRASS VALLEY, CA AND CHAPMAN,  
MARY, GRASS VALLEY, CA:  
4,046,984, INT. CL. 16.

- CHAPPELL, WALTER, SONORA, CA, DBA CHASE TECHNOLOGIES:  
2,492,280. REN. 9-16-11. INT. CL. 9.
- CHARGER CONNECTION, LLC, CINCINNATI, OH:  
4,044,228. PUB. 8-9-2011. INT. CL. 9.
- CHARITYMANIA LLC, SAN DIEGO, CA:  
2,927,000. CANC. INT. CL. 36.
- CHARLES & COLVARD, LTD., MORRISVILLE, NC, CHARLES & COLVARD, LTD., MORRISVILLE, NC:  
2,493,475. REN. 9-22-11. INT. CL. 35.
- CHARLES BESLER CORP., STROUDSBURG, NJ, CHARLES BESELER COMPANY, FLORHAM PARK, NJ:  
1,171,972. REN. 9-20-11. INT. CL. 7.
- CHARLES SCHWAB & CO., INC., SAN FRANCISCO, CA:  
2,503,211. REN. 9-22-11. INT. CL. 36.
- CHARLES, CHRISTOPHER ADRIAN, ORLANDO, FL:  
2,615,022. REN. 9-18-11. INT. CL. 41.
- CHARLTON, JASON, PORT HURON, MI:  
4,046,764. INT. CL. 25.
- CHARTIST, INC., LONG BEACH, CA:  
1,667,569. REN. 9-21-11. INT. CL. 16.
- CHASE CORPORATION, BRIDGEWATER, MA, DBA CHASE & SONS:  
1,669,447. REN. 9-22-11. INT. CL. 17.
- CHASE PRODUCTS COMPANY, BROADVIEW, IL:  
2,493,283. REN. 9-16-11. INT. CL. 4.
- CHAVEZ, PAUL G., SHERMAN OAKS, CA:  
2,499,247. REN. 9-20-11. INT. CL. 35.
- CHECK IN THE MAIL, INC., NEW BRAUNFELS, TX:  
2,506,049. REN. 9-21-11. INT. CL. 42.
- CHECK MATE TEST LLC, BENSALEM, PA:  
4,043,983. PUB. 2-8-2011. INT. CL. 5.
- CHECKMATE MARINE, INC., BUCYRUS, OH:  
1,159,071. REN. 9-20-11. INT. CL. 12.
- CHEEZBURGER, INC., SEATTLE, WA:  
4,046,006. INT. CL. 28.
- CHEMETALL GMBH, D-60487 FRANKFURT, FED REP GERMANY:  
2,415,196. REN. 9-19-11. INT. CL. 1.  
2,415,196. CANC. INT. CL. 42.
- CHEMETALL GMBH, D-60487 FRANKFURT AM MAIN, FED REP GERMANY:  
2,416,939. REN. 9-19-11. INT. CL. 4.  
2,416,939. CANC. INT. CL. 42.
- CHEMETALL GMBH, D-60487 FRANKFURT, FED REP GERMANY:  
2,416,940. REN. 9-19-11. INT. CL. 3.  
2,416,940. CANC. INT. CL. 42.
- CHEMSTAR PRODUCTS COMPANY, MINNEAPOLIS, MN:  
2,589,792. REN. 9-19-11. INT. CL. 1.
- CHEMTURA CORPORATION, MIDDLEBURY, CT, NAUGATUCK CHEMICAL COMPANY, THE, NEW YORK, NY:  
285,004. REN. 9-20-11. U.S. CL. 1 (INT. CL. 1).
- CHEN YUPING, CHINA:  
4,043,852. PUB. 8-9-2011. INT. CL. 18.
- CHENG CONCRETE LLC, BERKELEY, CA:  
4,045,013. PUB. 8-9-2011. INT. CL. 1.  
4,045,015. PUB. 8-9-2011. INT. CL. 19.  
4,045,017. PUB. 8-9-2011. INT. CL. 1.  
4,045,020. PUB. 8-9-2011. INT. CL. 19.  
4,045,021. PUB. 8-9-2011. INT. CL. 41.
- CHERYL A. THOMAS, TOMS RIVER, NJ AND KELLY J. SPARKS, MAYS LANDING, NJ:  
4,047,093. INT. CL. 41.
- CHET ATKINS PROFESSIONAL PROPERTY TRUST, NASHVILLE, TN:  
4,045,643. INT. CL. 25.
- CHEVRON INTELLECTUAL PROPERTY LLC, SAN RAMON, CA:  
4,046,536. INT. CL. 9.
- CHEYNE, JAMES C., KLAMATH FALLS, OR:  
1,658,435. REN. 9-16-11. INT. CL. 31.
- CHI COMPANY, BUCHANAN, MI, DBA TABOR HILL:  
4,045,170. PUB. 8-9-2011. MULTIPLE CLASS, INT. CLS. 33, 40 AND 43.
- CHI ZETA THETA SORORITY, INC, LOXAHACHEE, FL:  
4,044,485. PUB. 8-9-2011. INT. CL. 35.
- CHIC BIZOU, INC., BOCA RATON, FL:  
4,044,687. PUB. 8-9-2011. INT. CL. 25.
- CHICOPEE, INC., CHARLOTTE, NC:  
4,047,140. MULTIPLE CLASS, INT. CLS. 21 AND 24.
- CHIEF INDUSTRIES, INC., GRAND ISLAND, NE, AKA CALDWELL MANUFACTURING CO.:  
1,168,025. REN. 9-20-11. MULTIPLE CLASS, INT. CLS. 6 AND 11.
- CHILTERN, DANIEL, G, CHICAGO, IL, DBA 9/11 PATRIOT FLAG - KEYSTONE FOUNDATION:  
4,044,563. PUB. 8-9-2011. INT. CL. 35.
- CHINA NATIONAL TRAVEL SERVICE; (H.K.) GROUP CORPORATION, BEIJING, CHINA:  
4,043,754. PUB. 3-8-2011. MULTIPLE CLASS, INT. CLS. 39, 41 AND 43.
- CHINA TELECOM CORPORATION LIMITED, CHINA:  
4,043,758. PUB. 8-9-2011. INT. CL. 38.
- CHINOO DESIGNS LLC, CHICAGO, IL:  
4,044,009. PUB. 8-9-2011. INT. CL. 35.
- CHINOY, MITREN L, HOUSTON, TX:  
4,046,336. INT. CL. 42.
- CHIPITA AMERICA, INC., WESTCHESTER, IL:  
4,046,134. INT. CL. 30.
- CHIQUITA BRANDS L.L.C., CINCINNATI, OH, UNITED FRUIT COMPANY, BOSTON, MA:  
711,622. REN. 9-21-11. U.S. CL. 46 (INT. CL. 31).
- CHOCOLATES EL REY, C.A., LA URBINA, CARACAS, VENEZUELA:  
2,482,193. REN. 9-16-11. INT. CL. 30.  
2,482,195. REN. 9-16-11. INT. CL. 30.
- CHOW KIDS LLC, MINNEAPOLIS, MN:  
4,046,279. INT. CL. 41.
- CHRISTIAN BRANDS, INC., PHOENIX, AZ:  
4,046,244. INT. CL. 16.
- CHRISTIAN CASEY LLC, NEW YORK, NY:  
2,466,699. REN. 9-19-11. INT. CL. 25.
- CHRISTIAN, JOHN G., ORANGE PARK, FL, DBA HAIR LASER HELMETS:  
4,044,921. PUB. 8-9-2011. INT. CL. 10.
- CHRISTINE ALEXANDER, INC., FEDERAL WAY, WA:  
4,046,200. INT. CL. 14.
- CHRISTINI'S, INC., ORLANDO, FL:  
2,539,820. REN. 9-22-11. INT. CL. 42.
- CHRISTOPHER J. DANNAKER, MONTEREY, CA:  
4,046,476. INT. CL. 3.
- CHRISTOPHER M. KEEME-SAYRE, MESA, AZ:  
4,045,728. INT. CL. 41.
- CHRISTOPHER O. BILLS, PROVO, UT:  
4,045,896. INT. CL. 42.
- CHRONIC DISEASE FUND, PLANO, TX:  
4,047,013. INT. CL. 36.  
4,047,014. INT. CL. 36.
- CHRONIC DISEASE FUND, DALLAS, TX:  
4,047,015. INT. CL. 44.
- CHRONIC TACOS ENTERPRISES, INC., SAN CLEMENTE, CA:  
4,045,533. PUB. 8-9-2011. MULTIPLE CLASS, INT. CLS. 35 AND 43.
- CHRONOMITE LABORATORIES, INC., HARBOR CITY, CA:  
1,159,031. REN. 9-19-11. INT. CL. 11.  
1,159,032. REN. 9-19-11. INT. CL. 11.
- CHRYSLER GROUP LLC, AUBURN HILLS, MI:  
4,043,984. PUB. 8-9-2011. MULTIPLE CLASS, INT. CLS. 11 AND 12.
- CHURCHILL YACHT PARTNERS, LLC, MINNEAPOLIS, MN:  
3,025,512. CANC. MULTIPLE CLASS, INT. CLS. 35, 36 AND 37.
- CHURCHMOUSE YARNS & TEAS, INC., BAINBRIDGE ISLAND, WA:  
4,044,181. PUB. 8-9-2011. INT. CL. 35.
- CHURROS PLUS LLC, MIAMI, FL:  
4,045,036. PUB. 8-9-2011. INT. CL. 35.
- CIERI, DENNIS, RUTHERFORD, NJ:  
4,044,143. PUB. 8-9-2011. INT. CL. 5.
- CIGNA INTELLECTUAL PROPERTY, INC., CLAYMONT, DE:  
2,428,836. CANC. INT. CL. 42.

CIMBURA, TIM, BLAINE, MN:  
4,045,029, PUB. 8-9-2011. INT. CL. 41.

CIMINO DEVELOPMENT GROUP, INC., FEASTERVILLE, PA:  
2,479,574. REN. 9-20-11. INT. CL. 37.

CINCINNATI TEST SYSTEMS, INC., CLEVELAND, OH:  
2,927,052, CANC. INT. CL. 9.  
2,927,053, CANC. INT. CL. 9.

CINDERELLAHAIR, INC., SANTA FE SPRINGS, CA:  
4,046,459, INT. CL. 26.

CINETIC LANDIS CORP., HAGERSTOWN, MD:  
2,516,176. REN. 9-19-11. INT. CL. 7.

CINRAM INTERNATIONAL INC., SCARBOROUGH, ONTARIO, CANADA:  
4,046,235, INT. CL. 9.

CINTAS HOLDINGS, LLC, MASON, OH:  
4,046,694, MULTIPLE CLASS, INT. CLS. 3 AND 5.

CIRCUIT COMPONENTS, INC, TEMPE, AZ:  
2,428,981, CANC. INT. CL. 9.

CISNE ENTERPRISES, INC., ODESSA, TX:  
4,045,099, PUB. 8-9-2011. INT. CL. 5.

CITIFINANCIAL CREDIT COMPANY, BALTIMORE, MD:  
2,578,693. REN. 9-19-11. INT. CL. 36.

CITIZENS COMMUNITY FEDERAL, EAU CLAIRE, WI:  
2,926,183, CANC. INT. CL. 36.

CITO-SYSTEM GMBH, NURNBERG, FED REP GERMANY, LUDWIG METHFESSEL CITO-SYSTEM GMBH, D-90571 SCHWAIG BEI, NURNBERG, FED REP GERMANY:  
1,647,205. REN. 9-19-11. INT. CL. 7.

CITRIX SYSTEMS, INC., FT. LAUDERDALE, FL:  
1,685,759. REN. 9-22-11. INT. CL. 9.  
2,614,647. REN. 9-19-11. MULTIPLE CLASS, INT. CLS. 37 AND 42.

CITY OF DETROIT, DETROIT, MI:  
2,492,291. REN. 9-20-11. INT. CL. 41.

CITY OF LAS VEGAS, LAS VEGAS, NV:  
3,513,002, AM. INT. CL. 21.  
3,513,003, AM. INT. CL. 25.  
3,513,004, AM. INT. CL. 21.  
3,513,005, AM. INT. CL. 25.

CITY OF LONG BEACH, LONG BEACH, CA:  
4,044,160, PUB. 8-9-2011. INT. CL. 43.  
4,044,161, PUB. 8-9-2011. INT. CL. 43.

CITY OF NAPLES AIRPORT AUTHORITY, NAPLES, FL:  
4,044,742, PUB. 8-9-2011. INT. CL. 39.

CITYHINT, LLC, NEW YORK, NY:  
4,045,001, PUB. 8-9-2011. INT. CL. 35.

CITYLIFE REAL ESTATE GROUP, INC., HOBOKEN, NJ:  
4,045,763, INT. CL. 35.

CIURO AESCHMANN, CRISTINA, KEY BISCAYNE, FL:  
4,044,532, PUB. 8-9-2011. INT. CL. 3.

CJF CONNECTION, CORP., BROOKLYN, NY, DBA VINZEE'S MAGIC FOUNTAIN:  
4,046,319, INT. CL. 43.

CLAAS KGAA MBH, FED REP GERMANY:  
4,043,784, PUB. 8-9-2011. MULTIPLE CLASS, INT. CLS. 7, 9, 12, 35, 37 AND 42.

CLAI, PARIS, FRANCE:  
4,043,801, PUB. 8-9-2011. MULTIPLE CLASS, INT. CLS. 35, 36, 41 AND 45.

CLARK, STANLEY K., STILLWATER, OK, DBA ESKIMO JOE'S AND DBA ESKIMO JOE'S CLOTHES:  
1,705,263. REN. 9-21-11. INT. CL. 30.

CLARKE, ROBERT SPENCER, JR., BRANDON, FL:  
2,926,731, CANC. INT. CL. 35.

CLASSIC GARDEN ORNAMENTS, LTD., POMONA, IL, CHARLOTTE PETERS GARDENS, INC., EVANSTON, IL, DBA CLASSIC GARDEN ORNAMENTS, LTD.:  
1,698,167. REN. 9-21-11. INT. CL. 42.

CLASSICAL MAGIC, INC., BANNER ELK, NC:  
2,520,803. REN. 9-22-11. MULTIPLE CLASS, INT. CLS. 9 AND 16.

CLASSIFIED SOLUTIONS GROUP, INC., NEW YORK, NY:  
2,484,314. REN. 9-20-11. INT. CL. 35.

CLAYTON-MARCUS COMPANY, INC., MCLEAN, VA:  
4,046,961, INT. CL. 20.

CLEAR EDGE COMPANY, L.L.C., THE, EAST HANOVER, NJ:  
2,428,610, CANC. INT. CL. 9.

CLEAR LOOK SERVICES, LLC, NEW YORK, NY:  
4,045,449, PUB. 8-9-2011. INT. CL. 37.

CLEAR POINT CONSULTANTS, INC., MANCHESTER, MA:  
2,479,093. REN. 9-20-11. INT. CL. 35.

CLEAR SOURCE, INC, AUSTIN, TX TO GRANDE COMMUNICATIONS NETWORKS, INC., SAN MARCOS, TX:  
2,428,738, CANC. MULTIPLE CLASS, INT. CLS. 38 AND 42.

CLEATS LLC, MARLBOROUGH, MA:  
2,493,532. REN. 9-21-11. INT. CL. 25.

CLEVER SENSE, INC., MOUNTAIN VIEW, CA:  
4,046,727, MULTIPLE CLASS, INT. CLS. 9 AND 42.

CLIC LIFESTYLE LIMITED, TSUEN WAN, HONG KONG:  
4,046,443, MULTIPLE CLASS, INT. CLS. 14, 18 AND 25.

CLIFF ELECTRONIC COMPONENTS LIMITED, REDHILL, SURREY, UNITED KINGDOM:  
4,044,096, PUB. 8-9-2011. INT. CL. 9.

CLIFFSTAR LLC, DUNKIRK, NY:  
2,428,857, CANC. INT. CL. 32.

CLOCKWISE TECHNOLOGIES LTD., TEL-AVIV, ISRAEL:  
2,427,916, CANC. INT. CL. 42.

CLOROX COMPANY, THE, OAKLAND, CA:  
2,621,081. REN. 9-21-11. INT. CL. 21.

CLOTH & CROWN, LLC, MISSOULA, MT:  
4,044,394, PUB. 8-9-2011. INT. CL. 35.

CLOUDBEES, INC., DOVER, DE:  
4,047,103, MULTIPLE CLASS, INT. CLS. 9, 41 AND 42.

CLOUDCO, INC., CLEVELAND, OH:  
2,983,814, CANC. INT. CL. 20.

CLOUDCOVER IP, LLC, ST. PAUL, MN:  
4,045,622, INT. CL. 36.

CLOUDPATH NETWORKS, INC., WESTMINSTER, CO:  
4,045,900, INT. CL. 42.

CLOUDS AND STARS, INC., THORNTON, CO:  
4,044,716, PUB. 8-9-2011. INT. CL. 24.

CLYDE COMPANIES, INC., OREM, UT:  
3,549,103, AM. INT. CL. 37.  
3,556,154, AM. INT. CL. 39.

CMF GLOBAL, INC., CHULA VISTA, CA:  
4,045,462, PUB. 8-9-2011. INT. CL. 17.  
4,045,463, PUB. 8-9-2011. INT. CL. 17.

CMI PRODUCTIONS LIMITED, MALAHIDE, CO. DUBLIN, IRELAND:  
4,044,520, PUB. 8-9-2011. INT. CL. 9.

COACHCOMM, LLC, AUBURN, AL:  
4,044,723, PUB. 8-9-2011. INT. CL. 9.

COASTAL CULTURE, LLC, BIRMINGHAM, AL:  
4,045,807, INT. CL. 25.

COBRA INTERNATIONAL CO., LTD., CHONBURI PROVINCE, 20000, THAILAND:  
2,926,693, CANC. INT. CL. 28.

COCHRAN, NINA Y, BRONX, NY:  
4,044,740, PUB. 8-9-2011. INT. CL. 42.

COCKROACH DESIGN, LLC, GOLDENS BRIDGE, NY, DBA STEWART/STAND:  
4,045,405, PUB. 8-9-2011. INT. CL. 14.  
4,045,410, PUB. 8-9-2011. INT. CL. 18.  
4,045,430, PUB. 8-9-2011. INT. CL. 35.

COCO DEVELOPMENT, L.L.C., OMAHA, NE:  
4,044,684, PUB. 8-9-2011. INT. CL. 42.

CODE ADVISORS, SAN FRANCISCO, CA:  
4,044,360, PUB. 8-9-2011. INT. CL. 36.

CODEWEAVERS, INC., ST. PAUL, MN:  
4,045,200, PUB. 8-9-2011. INT. CL. 9.

COFER, MARIE E., BRICK, NJ:  
2,428,269, CANC. INT. CL. 41.

COFFIN CHARLES R, POWELL BUTTE, OR, DBA COD-RIVE:  
4,045,397, PUB. 8-9-2011. MULTIPLE CLASS, INT. CLS. 7 AND 9.

COLD STONE CREAMERY, INC., SCOTTSDALE, AZ:  
2,492,521. REN. 9-18-11. INT. CL. 42.

COLE, DOUGLAS, SACRAMENTO, CA:  
4,045,220, PUB. 8-9-2011. INT. CL. 20.

- COLEMAN CABLE, INC., WAUKEGAN, IL:  
1,176,273. REN. 9-19-11. INT. CL. 22.  
4,043,726. PUB. 7-5-2011. INT. CL. 11.
- COLEMAN, SYDNEY R., NEW YORK, NY:  
2,926,854. CANC. INT. CL. 44.
- COLGATE-PALMOLIVE COMPANY, NEW YORK, NY:  
1,166,056. REN. 9-19-11. INT. CL. 5.
- COLGATE-PALMOLIVE COMPANY, NEW YORK, NY:  
4,045,626. INT. CL. 3.  
4,046,086. INT. CL. 3.
- COLLEGE CENTRAL NETWORK, INC., NEW YORK, NY:  
4,044,356. PUB. 8-9-2011. INT. CL. 35.  
4,045,543. PUB. 8-9-2011. MULTIPLE CLASS, INT. CLS. 35  
AND 42.
- COLLIERS INTERNATIONAL PROPERTY CONSULTANTS,  
INC., WILMINGTON, DE:  
1,652,602. REN. 9-19-11. INT. CL. 36.
- COLLIN COUNTY COMMUNITY COLLEGE DISTRICT,  
MCKINNEY, TX:  
4,044,899. PUB. 8-9-2011. INT. CL. 41.
- COLMUS-MCGEE, PAMELA, PRINCESS ANNE, MD:  
4,046,342. MULTIPLE CLASS, INT. CLS. 25 AND 29.
- COLOMBINA S.A., ZARZAL, VALLE, COLOMBIA:  
4,043,883. PUB. 8-9-2011. INT. CL. 30.
- COLOR JEWELS, INC, NEW YORK, NY:  
4,044,016. PUB. 8-9-2011. INT. CL. 14.
- COLORADO GREAT GRIPS, INC., COLORADO SPRINGS,  
CO:  
2,436,953. REN. 9-16-11. INT. CL. 20.
- COLORWORKS, INC., CULVER CITY, CA:  
4,045,940. MULTIPLE CLASS, INT. CLS. 40 AND 41.
- COLTON'S RESTAURANT GROUP, INC., LITTLE ROCK,  
AR. COLTON'S RESTAURANT GROUP, INC., LITTLE  
ROCK, AR:  
2,481,318. REN. 9-22-11. INT. CL. 42.
- COLUCCI, NICHOLAS, STATEN ISLAND, NY:  
2,475,225. REN. 9-21-11. INT. CL. 28.
- COLUMBIA CONSULTANTS, LLC, NEW YORK, NY AND  
DANUCHT ENTERTAINMENT, LLC, NEW YORK, NY:  
4,044,522. PUB. 8-9-2011. INT. CL. 41.
- COLUMBIA INSURANCE COMPANY, OMAHA, NE:  
2,927,008. CANC. INT. CL. 19.  
2,927,009. CANC. INT. CL. 19.  
2,927,011. CANC. INT. CL. 19.
- COLUMBIA PICTURES INDUSTRIES, INC., CULVER CITY,  
CA:  
2,548,684. REN. 9-21-11. INT. CL. 41.  
2,553,672. REN. 9-19-11. INT. CL. 16.
- COME TO THE CROSS MINISTRIES, LAS VEGAS, NV:  
4,044,398. PUB. 8-9-2011. INT. CL. 41.
- COMFORT REVOLUTION, LLC, EATONTOWN, NJ:  
4,046,985. INT. CL. 20.  
4,046,986. INT. CL. 20.
- COMMANDER INTERNATIONAL, INC., LOS ANGELES,  
CA:  
4,047,123. INT. CL. 3.
- COMMERCE CONSULTING CORPORATION, MALIBU, CA,  
DBA WORLD TELECOM GROUP:  
4,044,445. PUB. 8-9-2011. MULTIPLE CLASS, INT. CLS. 35  
AND 41.
- COMMITTEE FOR DIGITAL ADVERTISING AND MAR-  
KETING ACCOUNTABILITY, WASHINGTON, DC:  
4,046,672. U.S. CL. B.
- COMMONANGELS, INC., WALTHAM, MA:  
2,539,995. REN. 9-22-11. INT. CL. 36.
- COMMUNITY PLUS HOLDINGS, L.P., SAN ANTONIO, TX:  
2,926,909. CANC. INT. CL. 37.
- COMPANION BRANDS, LLC, NASHVILLE, TN:  
4,046,658. INT. CL. 31.
- COMPASS ROSE MEDIA, L.L.C., SANTA CRUZ, CA:  
2,427,776. CANC. INT. CL. 35.
- COMPENDIA BIOSCIENCE, INC., ANN ARBOR, MI:  
4,044,541. PUB. 8-9-2011. INT. CL. 42.  
4,044,542. PUB. 8-9-2011. INT. CL. 42.  
4,044,545. PUB. 8-9-2011. INT. CL. 42.
- COMPLETE GENOMICS, INC., MOUNTAIN VIEW, CA:  
4,046,189. MULTIPLE CLASS, INT. CLS. 42 AND 45.
- COMPONENT HARDWARE GROUP, INC., LAKEWOOD,  
NJ:  
4,045,936. INT. CL. 11.
- COMPOUND FUN LLC, BELLEVUE, WA:  
4,045,813. INT. CL. 28.
- COMPOUND LEARNING LLC, FALMOUTH, ME:  
4,045,743. INT. CL. 9.
- COMPUCREDIT INTELLECTUAL PROPERTY HOLDINGS  
CORP. II, LAS VEGAS, NV:  
2,927,072. CANC. INT. CL. 36.
- COMPUTING SERVICES SUPPORT SOLUTIONS, INC., LOS  
ANGELES, CA:  
4,047,175. INT. CL. 42.
- CONAGRA FOODS RDM, INC., OMAHA, NE:  
547,894. REN. 9-20-11. U.S. CL. 46 (INT. CLS. 1, 5, 29, 30, 31  
AND 32).  
2,926,663. CANC. MULTIPLE CLASS, INT. CLS. 29 AND  
30.
- CONAIR CORPORATION, STAMFORD, CT:  
2,478,638. REN. 9-21-11. INT. CL. 7.  
2,484,799. REN. 9-21-11. INT. CL. 9.  
3,749,596. COR. INT. CL. 27.  
4,045,532. PUB. 8-9-2011. INT. CL. 3.  
4,045,553. PUB. 8-9-2011. INT. CL. 20.  
4,046,663. INT. CL. 11.
- CONCRETE COUNCIL OF ST. LOUIS, CLAYTON, MO:  
1,708,679. REN. 9-16-11. INT. CL. 37.
- CONFETTI LLC, VIRGINIA BEACH, VA:  
4,046,332. INT. CL. 30.
- CONFIRM MONITORING SYSTEMS, INC., CENTENNIAL,  
CO:  
4,045,795. INT. CL. 10.
- CONGRESSIONAL HISPANIC CAUCUS INSTITUTE, INC.,  
WASHINGTON, DC:  
4,043,884. PUB. 8-9-2011. MULTIPLE CLASS, INT. CLS.  
16, 35 AND 41.
- CONKLIN COMPANY, INC., SHAKOPEE, MN:  
925,978. REN. 9-21-11. U.S. CL. 52 (INT. CL. 3).
- CONN-WELD INDUSTRIES, INC., PRINCETON, WV:  
2,487,509. REN. 9-20-11. INT. CL. 7.  
4,046,781. INT. CL. 7.
- CONCOPHILLIPS COMPANY, HOUSTON, TX:  
4,045,320. PUB. 8-9-2011. INT. CL. 4.
- CONROY FOODS, INC., PITTSBURGH, PA:  
4,046,916. INT. CL. 20.
- CONROY, KATE C, NEW YORK, NY:  
4,043,690. PUB. 8-9-2011. INT. CL. 41.
- CONSOLIDATED PROPERTY HOLDINGS, INC., LAS VE-  
GAS, NV:  
4,043,896. PUB. 8-9-2011. MULTIPLE CLASS, INT. CLS. 8  
AND 21.
- CONSTELLATION WINES U.S. INC., CANANDAIGUA, NY:  
4,044,775. PUB. 8-9-2011. INT. CL. 33.
- CONSTRUCTION LABOR GROUP, INC., THE, RICHFIELD,  
OH:  
2,482,553. REN. 9-20-11. INT. CL. 35.
- CONSUMER FEDERATION OF AMERICA, WASHINGTON,  
DC:  
2,495,168. REN. 9-16-11. INT. CL. 42.
- CONSUMERS ENERGY COMPANY, JACKSON, MI:  
4,046,043. INT. CL. 40.
- CONTINENTAL REIFEN DEUTSCHLAND GMBH, HANN-  
OVER, FED REP GERMANY:  
2,490,201. REN. 9-16-11. MULTIPLE CLASS, INT. CLS. 16  
AND 24.
- CONTINENTAL RESOURCES, INC., BEDFORD, MA:  
4,045,961. MULTIPLE CLASS, INT. CLS. 9, 38 AND 42.
- CONTROL MASTERS, INCORPORATED, DOWNERS  
GROVE, IL:  
2,484,381. REN. 9-20-11. MULTIPLE CLASS, INT. CLS. 9  
AND 42.
- CONVERGE MEDICAL, INC., SUNNYVALE, CA:  
2,926,486. CANC. INT. CL. 10.
- COOKIE JAR ENTERTAINMENT, INC., TORONTO, ON-  
TARIO, CANADA:  
4,045,832. INT. CL. 38.

COOKTIVITY LLC, PEARL RIVER, NY:  
4,045,156, PUB. 8-9-2011. INT. CL. 41.  
4,045,157, PUB. 8-9-2011. INT. CL. 41.

COOL ENERGY, INC., BOULDER, CO:  
4,045,779, INT. CL. 9.

COOLIBAR, INC., ST. LOUIS PARK, MN:  
4,045,629, INT. CL. 24.

COOLPEN LLC, DALLAS, TX:  
2,927,042, CANC. INT. CL. 16.

COOPER, CARRIE L., SAN ANTONIO, TX:  
2,926,757, CANC. INT. CL. 44.

COOPER, LINDA, NEWBURYPORT, MA:  
4,045,697, MULTIPLE CLASS, INT. CLS. 21 AND 25.

COOPER, REBECCA, LAKE FOREST, CA:  
2,577,639, REN. 9-21-11. INT. CL. 42.

COOPERATIVA AGROVNICOLA NUESTRA SENORA DEL ROSARIO, BULLAS, MURCIA, SPAIN:  
4,044,113, PUB. 8-9-2011. INT. CL. 33.

COPAN TRADE, MAGNOLIA, TX:  
4,045,279, PUB. 8-9-2011. INT. CL. 30.

COPOMON ENTERPRISES, LLC, BOCA RATON, FL:  
4,045,316, PUB. 8-9-2011. INT. CL. 3.

CORDOVA & SCHWARTZ, INC., HERMOSA BEACH, CA, DBA HABERDASHER:  
4,045,354, PUB. 8-9-2011. INT. CL. 45.

CORE FOCUS INC, FLORAL PARK, NY:  
4,045,145, PUB. 8-9-2011. INT. CL. 41.

CORENSIC, INC., SEATTLE, WA:  
4,043,879, PUB. 7-5-2011. INT. CL. 9.

CORIN LIMITED, GLOUCESTERSHIRE GL7 1YJ, UNITED KINGDOM:  
4,043,790, PUB. 8-9-2011. INT. CL. 10.

CORNELIA STREET CAFE INC., NEW YORK, NY:  
4,044,183, PUB. 8-9-2011. INT. CL. 43.

CORNING INCORPORATED, CORNING, NY, CORNING GLASS WORKS, CORNING, NY:  
1,168,432, REN. 9-22-11. INT. CL. 21.

CORPORATE IMAGE, INC., DES MOINES, IA:  
2,484,697, REN. 9-21-11. INT. CL. 40.

CORPORATE SERVICE BUREAU, INC., ALBANY, NY:  
2,483,995, REN. 9-17-11. INT. CL. 42.  
2,484,020, REN. 9-19-11. INT. CL. 42.

CORROSIVE LABS, INC., LAS VEGAS, NV:  
4,043,950, PUB. 8-9-2011. INT. CL. 28.

COSTRUZIONI ELETTRONICHE INDUSTRIALI AUTOMATISMI S.P.A.C.E.I.A. S.P.A., CIVITELLA IN VAL DI CHIARA (AREZZO), ITALY:  
2,486,279, REN. 9-21-11. INT. CL. 9.  
2,526,128, REN. 9-21-11. INT. CL. 9.

COSWAY COMPANY, INC., CARSON, CA:  
4,045,580, INT. CL. 35.

COT-CLEAN OIL TECHNOLOGY AB, SE-417 55 GÖTEBORG, SWEDEN:  
4,043,812, PUB. 8-9-2011. MULTIPLE CLASS, INT. CLS. 4, 7, 11, 40 AND 42.

COTT BEVERAGES INC., TAMPA, FL:  
2,926,470, CANC. INT. CL. 32.

COTTAGE GARDEN, INC., BAINBRIDGE, IN:  
4,046,883, INT. CL. 15.

COTTON EMPORIUM, INC., GLENDALE, NY:  
2,427,217, REN. 9-20-11. INT. CL. 25.

COTY US LLC, NEW YORK, NY:  
4,043,659, PUB. 8-9-2011. INT. CL. 3.

COUNTRY LANDSCAPES, INC., AMES, IA:  
4,044,013, PUB. 8-9-2011. INT. CL. 44.  
4,044,014, PUB. 8-9-2011. INT. CL. 44.

COUPONBAIT, INC., MISSION VIEJO, CA:  
4,045,739, INT. CL. 9.

COUPONBUY.COM, LLC, TIBURON, CA:  
4,044,995, PUB. 8-9-2011. INT. CL. 35.

COVALENCE SPECIALTY COATINGS LLC, FRANKLIN, MA:  
4,045,653, INT. CL. 16.

COVEME SPA, I-34170 GORIZIA LOCALITÀ SANT'ANDREA, ITALY:  
4,043,845, PUB. 8-9-2011. INT. CL. 17.

COVER X CORPORATION, SOUTHFIELD, MI:  
1,171,597, REN. 9-22-11. INT. CL. 36.

COVERDELL & COMPANY, INC., CHICAGO, IL:  
4,046,646, INT. CL. 35.

COWELL, KAREN, VALENCIA, CA AND COWELL, KAITLYN, VALENCIA, CA:  
4,044,600, PUB. 8-9-2011. INT. CL. 30.

COX, GRAEME, MOLENDINAR, AUSTRALIA:  
4,044,140, PUB. 8-9-2011. INT. CL. 42.

COZOC GROUPS INC., CITY OF INDUSTRY, CA:  
4,044,238, PUB. 8-9-2011. MULTIPLE CLASS, INT. CLS. 11, 12 AND 40.  
4,044,247, PUB. 8-9-2011. MULTIPLE CLASS, INT. CLS. 11, 12 AND 40.

CRAFUND ADVISORS, INC., WESTON, FL:  
2,428,787, CANC. INT. CL. 36.

CRANE ACQUISITION, LLC, RICHLAND CENTER, WI:  
4,044,593, PUB. 8-9-2011. MULTIPLE CLASS, INT. CLS. 7 AND 9.

CRAWFORD, TIFFANI A, MOUNTAIN VIEW, CA, DBA ACTIONECONOMY:  
4,043,926, PUB. 8-9-2011. INT. CL. 42.

CRC MERGER ACQUISITION CORP., SAN JOSE, CA, DBA SIERRA TUCSON, INC., SIERRA TUCSON COMPANIES, INC., TUCSON, AZ:  
1,716,808, REN. 9-19-11. INT. CL. 42.

CREATION BY DESIGN LLC, TEANECK, NJ:  
4,045,805, INT. CL. 16.

CREATIVE MARKETING ASSOCIATES, INC., KANSAS CITY, MO:  
4,044,002, PUB. 8-9-2011. INT. CL. 36.

CREATIVE OKLAHOMA, INC., OKLAHOMA CITY, OK:  
4,046,221, INT. CL. 41.

CREEDIBLE, LLC, SOUTHLINGTON, CT:  
4,045,491, PUB. 8-9-2011. INT. CL. 45.

CREEKSTONE FARMS PREMIUM BEEF LLC, ARKANSAS CITY, KS:  
2,504,864, REN. 9-20-11. INT. CL. 29.

CRENSHAW CHRISTIAN CENTER CHURCH, LOS ANGELES, CA:  
1,652,352, REN. 9-20-11. MULTIPLE CLASS, INT. CLS. 16 AND 42.

CRESCENT PREFERRED PROVIDER ORGANIZATION, INC., ASHEVILLE, NC, DBA CRESCENT HEALTH SOLUTIONS:  
4,044,303, PUB. 8-9-2011. MULTIPLE CLASS, INT. CLS. 35, 36, 41, 42 AND 44.

CRESCENT, INC., NIOTA, TN:  
2,926,689, CANC. INT. CL. 25.

CRETAN HERBALCHEM S.A., IRAKLION, GREECE:  
4,045,412, PUB. 8-9-2011. INT. CL. 3.

CRIST, ROBIN, FLINTON, PA:  
4,044,413, PUB. 8-9-2011. INT. CL. 29.

CRISTOBAL ORDONEZ, LA VERNE, CA AND DIEGO ORDONEZ, LA VERNE, CA:  
4,043,876, PUB. 8-9-2011. MULTIPLE CLASS, INT. CLS. 3 AND 5.

CRO-BAR, L.L.C., KINGSPORT, TN:  
4,047,149, INT. CL. 30.

CROFTGATE USA, LLC, HOLLYWOOD, FL:  
4,044,707, PUB. 8-9-2011. INT. CL. 3.

CROSSFIELD PRODUCTS CORPORATION, RANCHO DOMINGUEZ, CA:  
719,540, REN. 9-22-11. U.S. CL. 16 (INT. CL. 2).

CROSSFIT, INC., WASHINGTON, DC:  
4,047,236, INT. CL. 25.

CROTTS, DANA JEFFREY, SEATTLE, WA AND BARRON, ROZ, SEATTLE, WA:  
2,926,987, CANC. INT. CL. 41.

CROWDSTAR INTERNATIONAL LIMITED, BLACKROCK, CO. DUBLIN, IRELAND:  
4,046,773, INT. CL. 9.

CROWN ENVELOPE, LLC, CINCINNATI, OH:  
2,926,714, CANC. INT. CL. 9.

CROYSDILL, LUCY J, VANCOUVER, BC, CANADA, DBA PIVOT STAR DESIGNS:  
4,044,018, PUB. 2-22-2011. INT. CL. 25.

CRS HOLDINGS, INC., WILMINGTON, DE:  
1,648,651, REN. 9-19-11. INT. CL. 6.

- CRUMP, ARTHUR S, SAN CLEMENTE, CA, DBA ARCADE MFG:  
4,044,404, PUB. 8-9-2011. INT. CL. 28.
- CRYSTAL SPRINGS RANCH, INC., WILSON, WY:  
4,046,172, MULTIPLE CLASS, INT. CLS. 25 AND 41.
- CRYSTAL WINDOW & DOOR SYSTEMS, LTD., FLUSHING, NY:  
2,428,209, CANC. MULTIPLE CLASS, INT. CLS. 6 AND 19.
- CSG SYSTEMS, INC., ENGLEWOOD, CO:  
2,491,104, REN. 9-22-11. INT. CL. 9.
- CSPS METAL CO., LTD., DOU-LIOU, TAIWAN:  
4,045,729, INT. CL. 6.
- CSS STUDIOS, LLC, LOS ANGELES, CA:  
4,045,762, INT. CL. 41.
- CU DIRECT CORPORATION, ONTARIO, CA:  
2,490,978, REN. 9-22-11. INT. CL. 36.
- CUBIST PHARMACEUTICALS, INC., LEXINGTON, MA:  
4,045,300, PUB. 8-9-2011. INT. CL. 42.
- CUCA FRESCA EXPORTS, LLC, PLEASANTVILLE, NY:  
4,046,197, INT. CL. 33.
- CUEROFLEX S.A., PROVINCIA DE BUENOS AIRES, ARGENTINA:  
2,428,005, CANC. INT. CL. 18.
- CULLIMORE AND RING TECHNOLOGIES, INC., BOULDER, CO:  
2,615,193, REN. 9-16-11. INT. CL. 9.
- CUMMINGS, TROY L, LOUISVILLE, KY:  
4,045,034, PUB. 8-9-2011. INT. CL. 36.
- CURANT COMMUNICATIONS, INC., LOS ANGELES, CA:  
2,428,987, CANC. MULTIPLE CLASS, INT. CLS. 16 AND 35.
- CURRENT MEDIA, LLC, SAN FRANCISCO, CA:  
4,044,595, PUB. 8-9-2011. INT. CL. 41.
- CURRENT SHIFT LLC, PORTLAND, OR:  
4,044,477, PUB. 8-9-2011. MULTIPLE CLASS, INT. CLS. 35 AND 42.
- CURY, WILLIAM, HEWITT, NJ:  
4,044,867, PUB. 8-9-2011. INT. CL. 42.
- CUTIE PAWTOOTIE POOCHWARE, LLC, BEAR, DE:  
4,044,825, PUB. 8-9-2011. INT. CL. 18.
- CVI, MILWAUKEE, WI, AKA CENTER FOR VETERANS ISSUES, LTD.:  
4,043,991, PUB. 8-9-2011. INT. CL. 35.
- CWEB, INC, HENDERSON, NV:  
4,047,139, INT. CL. 14.
- CYANOTECH CORPORATION, KAILUA-KONA, HI:  
4,046,009, INT. CL. 5.
- CYBEROPTICS CORPORATION, GOLDEN VALLEY, MN:  
1,666,558, REN. 9-16-11. INT. CL. 9.
- CYRUS, GERALDINE WILSON, WEST PALM BEACH, FL:  
4,046,292, INT. CL. 28.
- CYTEC TECHNOLOGY CORP., WILMINGTON, DE:  
1,197,543, REN. 9-20-11. INT. CL. 1.
- CYTOSPORT, INC., BENICIA, CA:  
4,047,118, INT. CL. 5.
- D & D COMMODITIES LIMITED, STEPHEN, MN:  
4,045,919, INT. CL. 31.
- D & G SPORTS VENTURES LLC, BELLFLOWER, CA:  
4,045,858, INT. CL. 28.
- D. J. LIVINGSTON & COMPANY, INC., WEST LEBANON, NH:  
2,427,932, CANC. INT. CL. 35.
- D.P.I. IMPORTS INC., BAY SHORE, NY, DAVID PEYSER SPORTSWEAR INC., BAY SHORE, NY:  
2,492,858, REN. 9-21-11. INT. CL. 25.
- D.S. SEWING, INC., NEW HAVEN, CT:  
4,044,982, PUB. 8-9-2011. INT. CL. 22.
- DA LIAN YA TU TOU ZI ZI XUN YOU XIAN GONG SI, LIAONING PROVINCE, CHINA:  
4,043,820, PUB. 8-9-2011. INT. CL. 9.  
4,043,821, PUB. 8-9-2011. INT. CL. 9.  
4,043,822, PUB. 8-9-2011. INT. CL. 9.  
4,043,823, PUB. 8-9-2011. INT. CL. 9.
- DAC INCORPORATED, WASHINGTON, MO:  
907,360, CANC. MULTIPLE CLASS, U.S. CLS. 3 AND 37.
- DADA CORPORATION, SEOUL, REPUBLIC OF KOREA:  
2,428,798, CANC. INT. CL. 25.
- DAHON TECHNOLOGIES LTD., BAOAN, SHENZHEN 518125, CHINA:  
4,046,511, INT. CL. 12.
- DAI ENTERPRISES LLC, BEVERLY HILLS, CA:  
4,047,063, MULTIPLE CLASS, INT. CLS. 3 AND 5.
- DAIICHI SANKYO, INC., PARSIPPANY, NJ:  
2,493,507, REN. 9-21-11. INT. CL. 5.
- DAILEY, GARRETT C., OAKLAND, CA:  
2,597,611, REN. 9-21-11. INT. CL. 9.
- DAILYCANDY, LLC, LOS ANGELES, CA:  
4,043,709, PUB. 8-9-2011. INT. CL. 35.
- DAIMLER AG, STUTTGART, FED REP GERMANY:  
4,043,877, PUB. 8-9-2011. INT. CL. 16.  
4,043,918, PUB. 8-9-2011. MULTIPLE CLASS, INT. CLS. 12, 14, 16, 18, 25, 35, 41 AND 43.
- DAISHOWA SEIKI KABUSHIKI KAISHA, HIGASHIOSAKA, OSAKA, JAPAN, DBA BIG DAISHOWA SEIKI CO LTD:  
3,046,627, COR. INT. CL. 7.
- DALE'S SAUCES, INC., BIRMINGHAM, AL:  
4,045,561, PUB. 8-9-2011. INT. CL. 30.
- DALER-ROWNEY USA LIMITED, CRANBURY, NJ:  
2,488,995, REN. 9-19-11. INT. CL. 16.
- DALLAS BASKETBALL LIMITED, DALLAS, TX:  
2,926,510, CANC. INT. CL. 9.
- DAMPP-CHASER ELECTRONICS CORPORATION, HENDERSONVILLE, NC, DAMPP-CHASER ELECTRONICS, INC., HENDERSONVILLE, NC:  
921,922, REN. 9-21-11. MULTIPLE CLASS, U.S. CLS. 26 (INT. CL. 9) AND 34 (INT. CL. 11).
- DANCE, RICHARD, PHOENIX, AZ:  
2,736,425, CANC. INT. CL. 41.
- DANCIN VINEYARDS, LLC, JACKSONVILLE, OR:  
4,045,800, INT. CL. 33.
- DANE, ARABELLA S., CENTER HARBOR, NH:  
4,046,687, INT. CL. 42.
- DANIEL D'ARCO, POTTSVILLE, PA:  
4,046,836, INT. CL. 41.
- DARCO SOUTHERN, INC., INDEPENDENCE, VA:  
1,164,639, REN. 9-20-11. INT. CL. 17.
- DARK FIELD TECHNOLOGIES, INC., ORANGE, CT:  
4,046,627, INT. CL. 9.
- DATATUDE, INC., HOUSTON, TX:  
4,045,121, PUB. 8-9-2011. INT. CL. 42.
- DAUGHERTY, SEAN, PEACE DALE, RI:  
4,044,927, PUB. 8-9-2011. INT. CL. 41.
- DAVID A. BURNS, WATER VALLEY, MS AND CLAUDE STEVEN THOMPSON, WATER VALLEY, MS:  
4,046,210, INT. CL. 25.
- DAVID HOWELL PRODUCT DESIGN INC., BEDFORD HILLS, NY, DBA DAVID HOWELL & COMPANY:  
4,047,215, INT. CL. 16.
- DAVID JOHN PATRISHKOFF, ORLANDO, FL, DBA INNOVATIVE SOLUTIONS GROUP:  
4,044,762, PUB. 8-9-2011. INT. CL. 35.
- DAVIDOFF & CIE SA, 1200 GENEVE, SWITZERLAND:  
3,000,578, CANC. INT. CL. 14.
- DAVIDOFF & CIE SA, 1200 GENEVA, SWITZERLAND:  
4,046,156, INT. CL. 34.
- DAVIS WIRE PUEBLO CORPORATION, IRWINDALE, CA:  
287,869, REN. 9-19-11. U.S. CL. 13 (INT. CL. 6).
- DAVIS, SPENCER L, NEW ORLEANS, LA:  
4,044,434, PUB. 8-9-2011. INT. CL. 25.
- DAVISON DESIGN & DEVELOPMENT, INC., PITTSBURGH, PA:  
4,043,894, PUB. 8-9-2011. MULTIPLE CLASS, INT. CLS. 35, 42 AND 45.
- DAWN FOODS, INC., JACKSON, MI:  
4,045,959, MULTIPLE CLASS, INT. CLS. 1, 29 AND 30.
- DAWSON, DEBRA K, MIAMI, FL:  
4,043,912, PUB. 7-5-2011. MULTIPLE CLASS, INT. CLS. 39 AND 43.
- DAY-TIMERS, INC., EAST TEXAS, PA:  
4,044,633, PUB. 8-9-2011. INT. CL. 9.
- DAYCO PRODUCTS, LLC, TULSA, OK, DAYCO CORPORATION, DAYTON, OH:  
918,500, REN. 9-16-11. U.S. CL. 35 (INT. CL. 17).
- DAYMON WORLDWIDE INC., STAMFORD, CT:  
3,121,460, CANC. INT. CL. 40.



DAYOUB MARKETING INC., DUNKIRK, NY:  
1,670,431. REN. 9-16-11. INT. CL. 31.

DAYTON SUPERIOR CORPORATION, DAYTON, OH:  
4,043,722. PUB. 8-9-2011. MULTIPLE CLASS, INT. CLS. 1,  
2, 3, 6, 7, 8, 9, 17, 19 AND 42.

DC COMICS, NEW YORK, NY, DC COMICS INC., NEW  
YORK, NY:  
1,168,306. REN. 9-19-11. INT. CL. 16.

DC COMICS, NEW YORK, NY:  
4,046,081. INT. CL. 14.

DD APARTMENTS, LLC, BETHESDA, MD:  
4,044,875. PUB. 8-9-2011. INT. CL. 35.

DD IP HOLDER LLC, CANTON, MA, DUNKIN' DONUTS  
OF AMERICA, INC., QUINCY, MA:  
715,860. REN. 9-21-11. U.S. CL. 46 (INT. CL. 30).

DE BEERS CENTENARY AG, 6000 LUZERN 6, SWITZER-  
LAND:  
4,043,725. PUB. 2-1-2011. INT. CL. 9.

DE TEZANOS PINTO, CESAR CARLOS, BUENOS AIRES,  
ARGENTINA AND HUIDOBRO, FELIPE BARTOLOME,  
BUENOS AIRES, ARGENTINA:  
4,046,404. INT. CL. 39.

DEANZERIS III, MICHAEL F., SARATOGA SPRINGS, NY:  
4,046,379. INT. CL. 25.

DEBBIE MUMM, INC., SPOKANE, WA:  
3,007,193. CANC. MULTIPLE CLASS, INT. CLS. 4, 6, 8, 9,  
11, 14, 15, 18, 20, 25, 26, 27, 28, 30 AND 32.

DEBORAH STOLLER, BROOKLYN, NY:  
4,046,192. INT. CL. 41.

DECODE SOLUTIONS LLC, RALEIGH, NC:  
4,044,337. PUB. 8-9-2011. INT. CL. 9.  
4,044,338. PUB. 8-9-2011. INT. CL. 9.  
4,044,339. PUB. 8-9-2011. INT. CL. 42.

DEE SIGN CO., WEST CHESTER, OH:  
1,164,860. REN. 9-20-11. INT. CL. 35.

DEER STAGS CONCEPTS INC., NEW YORK, NY:  
4,047,010. INT. CL. 25.

DEERE & COMPANY, MOLINE, IL:  
1,666,452. REN. 9-21-11. INT. CL. 7.

DEERING MANAGEMENT, INCORPORATED, WACONIA,  
MN:  
2,482,103. REN. 9-19-11. INT. CL. 25.

DEF-STAR CLOTHING, WESTMINSTER, CO:  
4,046,304. INT. CL. 25.

DEFINO, FRANK, JR., CAROL STREAM, IL:  
2,926,656. CANC. INT. CL. 9.

DEIPI.COM LLC, LA JOLLA, CA, DBA CITYPON:  
4,046,400. INT. CL. 35.

DEL MAR DATATRAC, INC., SAN DIEGO, CA, AKA DMD:  
2,440,090. REN. 9-19-11. INT. CL. 9.

DEL PALMA ORTHOPEDICS, COLUMBIA CITY, IN:  
4,046,110. INT. CL. 10.

DELAWARE CAPITAL FORMATION, INC., WILMINGTON,  
DE:  
4,044,603. PUB. 8-9-2011. INT. CL. 9.

DELCORP FOODS, INC., TORONTO, ONTARIO, CANADA:  
2,926,530. CANC. INT. CL. 29.

DELICIAS DE MICHOACAN, INC., ONTARIO, CA:  
4,044,504. PUB. 8-9-2011. INT. CL. 30.

DELMARVA RENTAL, CALLAWAY, MD:  
4,046,712. INT. CL. 36.

DELORES A. HALL, MIAMI, FL:  
4,046,096. INT. CL. 32.

DELP, THOMAS R, COLUMBUS, OH, DBA THE MOODY  
HOUSEWIFE:  
4,045,438. PUB. 8-9-2011. INT. CL. 4.

DELTA PERFUME HOUSE, INC., BROOKLYN, NY, DELTA  
PERFUME HOUSE, INC., BROOKLYN, NY:  
2,569,874. REN. 9-20-11. INT. CL. 3.

DELUXE STITCHER COMPANY INC., CHICAGO, IL:  
2,515,757. REN. 9-22-11. INT. CL. 7.

DEMARTINO, JEFFREY R., PHILLIPSBURG, NJ:  
2,478,021. REN. 9-22-11. INT. CL. 28.

DEMATIC CORP., GRAND RAPIDS, MI:  
1,173,947. REN. 9-16-11. INT. CL. 7.

DENNIS BERNARD, INC, FREEHOLD, NJ:  
4,046,181. MULTIPLE CLASS, INT. CLS. 1, 3 AND 8.

DENNIS GARBERG AND ASSOCIATES, LENEXA, KS, DBA  
THE SUNFLOWER GROUP:  
1,655,747. REN. 9-20-11. INT. CL. 35.

DENOVO, ANDREW, CHICAGO, IL AND LOEB, CHARLES,  
CHICAGO, IL:  
4,045,623. INT. CL. 9.

DENT DOCTOR, INC., LITTLE ROCK, AR:  
2,428,975. CANC. INT. CL. 37.

DENTACO DENTALINDUSTRIE UND - MARKETING  
GMBH, 61352 BAD HOMBURG, FED REP GERMANY:  
4,043,665. PUB. 5-3-2011. MULTIPLE CLASS, INT. CLS. 1  
AND 5.

DENTOVATIONS, INC, BOSTON, MA:  
2,926,704. CANC. INT. CL. 3.

DENTSPLY INTERNATIONAL INC., YORK, PA, DENTS-  
PLY INTERNATIONAL INC., YORK, PA:  
1,666,420. REN. 9-21-11. MULTIPLE CLASS, INT. CLS. 5  
AND 10.

DENTSPLY INTERNATIONAL INC., YORK, PA:  
2,516,475. REN. 9-16-11. INT. CL. 35.

DEPARTMENT OF THE ARMY, WASHINGTON, DC:  
2,487,176. REN. 9-20-11. U.S. CL. 200.  
4,046,444. INT. CL. 9.

DES MOINES UNIVERSITY OSTEOPATHIC MEDICAL  
CENTER, DES MOINES, IA:  
2,479,266. REN. 9-20-11. MULTIPLE CLASS, INT. CLS. 25  
AND 41.

DESERT STAR CONSTRUCTION, INC., SCOTTSDALE, AZ:  
4,045,330. PUB. 8-9-2011. INT. CL. 9.  
4,045,336. PUB. 8-9-2011. INT. CL. 37.  
4,045,341. PUB. 8-9-2011. INT. CL. 37.

DESI GEESTMAN FOUNDATION, INC., THE, LA CRES-  
CENTA, CA:  
2,428,839. CANC. INT. CL. 42.

DESIGN SOURCE - USA, INC., GOLDEN VALLEY, MN:  
2,926,660. CANC. INT. CL. 25.

DESIGNED ALLOY PRODUCTS, INC., AURORA, IL:  
2,521,734. REN. 9-21-11. MULTIPLE CLASS, INT. CLS. 6  
AND 40.

DETAILS EVENT MANAGEMENT, LLC, GILBERT, AZ:  
4,047,143. INT. CL. 41.

DETROIT NEWSPAPER PARTNERSHIP, L.P., MCLEAN,  
VA:  
2,511,287. REN. 9-19-11. INT. CL. 35.

DEUTSCH, CHRISTOPHER N., SCOTTSDALE, AZ:  
2,428,688. CANC. INT. CL. 42.

DEUTSCHE BANK AKTIENGESELLSCHAFT, LONDON,  
LONDON, UNITED KINGDOM:  
4,045,306. PUB. 8-9-2011. INT. CL. 35.

DEVAULT PACKING, CO., INC., DEVAULT, PA:  
2,526,076. REN. 9-22-11. INT. CL. 29.

DEVITO, DANIEL MICHAEL, BEVERLY HILLS, CA:  
4,044,252. PUB. 8-9-2011. INT. CL. 41.

DEXCEL LTD., HADERA, ISRAEL:  
4,043,888. PUB. 8-9-2011. MULTIPLE CLASS, INT. CLS. 3  
AND 5.

DFO, LLC., SPARTANBURG, SC:  
2,592,374. REN. 9-16-11. MULTIPLE CLASS, INT. CLS. 29  
AND 30.

DHC SPECIALTY CORP., TAIPEI CITY, TAIWAN:  
2,475,576. REN. 9-20-11. INT. CL. 9.

DHS SYSTEMS LLC, ORANGEBURG, NY:  
2,495,319. REN. 9-20-11. INT. CL. 24.

DHX MEDIA LTD., HALIFAX, NOVA SCOTIO, CANADA:  
4,020,995. COR. INT. CL. 41.

DIAGEO BRANDS B.V., AMSTERDAM 1014 BG, NETHER-  
LANDS:  
4,045,474. PUB. 8-9-2011. INT. CL. 33.

DIALOGUEDIRECT, LTD., OXFORD, UNITED KINGDOM:  
2,926,897. CANC. INT. CL. 36.

DIAMOND CHAIN COMPANY, INC., INDIANAPOLIS, IN:  
4,045,599. MULTIPLE CLASS, INT. CLS. 7 AND 12.

DIAMOND HOLDINGS SA, 2800-DELEMONT, SWITZER-  
LAND:  
4,046,475. MULTIPLE CLASS, INT. CLS. 14 AND 35.

DIAMOND INNOVATIONS, INC., WORTHINGTON, OH:  
1,176,766. REN. 9-16-11. MULTIPLE CLASS, INT. CLS. 3  
AND 7.

- DIAMONDBACK OUTDOORS, LLC, WEST JORDAN, UT:  
4,044,524, PUB. 8-9-2011. INT. CL. 18.
- DIBA INDUSTRIES LIMITED, CAMBRIDGESHIRE, UNITED KINGDOM, OMNIFIT LIMITED, CAMBRIDGE, ENGLAND:  
1,167,022. REN. 9-20-11. INT. CL. 9.
- DIBBEM LICENSING, LLC, TAMPA, FL:  
4,044,617, PUB. 8-9-2011. INT. CL. 9.
- DICKINSON, MICHAEL W., NORTH EAST, MD:  
2,455,823. REN. 9-19-11. MULTIPLE CLASS, INT. CLS. 41 AND 42.
- DIEGO ROCHA CUSTOM DESIGNS, LLC, CHICAGO, IL:  
4,044,146, PUB. 8-9-2011. INT. CL. 35.
- DIFCO PERFORMANCE FABRICS INC., MONTREAL, QUEBEC, CANADA:  
2,926,981, CANC. INT. CL. 24.
- DIFCOM LA CAVE DES PERES SOCIÉTÉ ANONYME À CONSEIL D'ADMINISTRATION, VILLENEUVE D'ASCQ, FRANCE:  
4,044,026, PUB. 7-5-2011. INT. CL. 32.
- DIGGYPOD, INC., SALINE, MI, DBA DIGGYPOD:  
4,045,045, PUB. 8-9-2011. INT. CL. 40.
- DIGI INTERNATIONAL INC., MINNETONKA, MN, TELEBIT CORPORATION, SUNNYVALE, CA:  
1,658,877. REN. 9-22-11. INT. CL. 9.
- DIGI-CAPITAL LIMITED, LONDON, UNITED KINGDOM:  
4,044,830, PUB. 8-9-2011. MULTIPLE CLASS, INT. CLS. 35 AND 36.
- DIGITAL HOUSE, INC., POWAY, CA:  
2,618,297. REN. 9-19-11. MULTIPLE CLASS, INT. CLS. 9 AND 42.
- DIGITAL MEDIA NETWORK, INC., FT. LAUDERDALE, FL:  
2,427,923, CANC. INT. CL. 42.
- DIGITAL ROUTE AB, STOCKHOLM, SWEDEN:  
4,044,679, PUB. 8-9-2011. MULTIPLE CLASS, INT. CLS. 9, 38 AND 42.
- DILLARD'S, INC., LITTLE ROCK, AR:  
4,046,170, INT. CL. 25.
- DILLON, AUSTIN, WELCOME, NC:  
4,044,702, PUB. 8-9-2011. MULTIPLE CLASS, INT. CLS. 25 AND 41.  
4,044,704, PUB. 8-9-2011. INT. CL. 28.
- DIMARE ENTERPRISES, INC., NEWMAN, CA, RICHARD A. GLASS COMPANY, INC., INDIO, CA:  
722,885. REN. 9-21-11. U.S. CL. 46 (INT. CLS. 29 AND 31).
- DIMO LLC, RANCHO CORDOVA, CA:  
4,044,837, PUB. 8-9-2011. INT. CL. 35.
- DINAIR INDUSTRIES AB, SWEDEN:  
4,043,762, PUB. 8-9-2011. INT. CL. 11.
- DINI GROUP LA JOLLA, INC., THE, LA JOLLA, CA:  
2,600,638. REN. 9-22-11. INT. CL. 42.
- DINSMORE & ASSOCIATES, INC., COSTA MESA, CA:  
4,044,137, PUB. 8-9-2011. INT. CL. 40.
- DIOTA HOLDINGS, LLC, MENLO PARK, CA:  
4,046,090, INT. CL. 33.
- DIPPIN' DOTS, INC., PADUCAH, KY:  
4,047,054, INT. CL. 30.
- DIRECTV, INC., EL SEGUNDO, CA:  
2,483,958. REN. 9-21-11. INT. CL. 41.
- DISC INTELLECTUAL PROPERTIES, LLC, BURBANK, CA:  
4,044,222, PUB. 8-9-2011. MULTIPLE CLASS, INT. CLS. 35 AND 36.
- DISCOVERY COMMUNICATIONS, LLC, SILVER SPRING, MD:  
4,046,668, INT. CL. 11.
- DISCOVERY COMMUNICATIONS, LLC, WASHINGTON, DC:  
4,046,861, INT. CL. 41.
- DISCOVERYBIOMED, LLC, BIRMINGHAM, AL:  
4,046,398, INT. CL. 42.
- DISENGAGE, INC., LAKEWOOD, OH:  
2,428,287, CANC. INT. CL. 41.
- DISNEY ENTERPRISES, INC., BURBANK, CA:  
4,006,387, COR. MULTIPLE CLASS, INT. CLS. 9 AND 41.  
4,006,400, COR. INT. CL. 41.  
4,045,615, INT. CL. 9.  
4,045,942, INT. CL. 9.  
4,046,065, INT. CL. 28.  
4,046,066, INT. CL. 28.  
4,046,168, INT. CL. 28.  
4,046,671, INT. CL. 9.
- DISTECH CONTROLS INC., BROSSARD (QUEBEC) J4Y 2P4, CANADA:  
4,043,609, PUB. 8-9-2011. INT. CL. 37.
- DISTILLERIES GROUP TOORANK B.V., NETHERLANDS:  
4,043,745, PUB. 8-9-2011. INT. CL. 33.
- DISTRICT LINES, INC., WINTER PARK, FL:  
4,044,440, PUB. 8-9-2011. MULTIPLE CLASS, INT. CLS. 35, 40 AND 42.
- DITTO SALES, INC., JASPER, IN, DBA VERSTEEL:  
2,541,236. REN. 9-17-11. INT. CL. 20.  
2,541,237. REN. 9-19-11. INT. CL. 20.
- DIVERSATECH, INC., WEST TRENTON, NJ:  
2,441,799. REN. 9-19-11. INT. CL. 6.
- DIVERSITYPRO CORP., MIAMI, FL:  
2,926,816, CANC. MULTIPLE CLASS, INT. CLS. 3 AND 16.
- DIXON HUGHES GOODMAN LLP, CHARLOTTE, NC:  
4,047,200, INT. CL. 35.
- DIXON, DOUGLAS F., HOPEWELL, NJ:  
2,475,825. REN. 9-20-11. INT. CL. 42.
- DJF ENTERPRISES, NEW YORK, NY:  
4,044,866, PUB. 8-9-2011. INT. CL. 44.
- DKG GROUP CORP., ANAHEIM, CA:  
4,044,641, PUB. 8-9-2011. INT. CL. 25.
- DKL ENTERPRISES, LLC, DENVER, CO:  
4,043,607, PUB. 8-9-2011. INT. CL. 43.
- DLOO, ALAMEDA, CA:  
2,428,631, CANC. INT. CL. 9.
- DNA HEALTH SERVICES, DALLAS, TX, DBA DNA HOME HEALTH SERVICES:  
4,046,617, INT. CL. 44.
- DOBANGO INC, SUNNYVALE, CA:  
4,045,046, PUB. 8-9-2011. INT. CL. 35.
- DOC MILO PRODUCTIONS, INC., MALVERN, PA:  
4,044,635, PUB. 8-9-2011. INT. CL. 16.
- DOCKWEILER AG, 19306 NEUSTADT-GLEWE, GERMAN DEM REP:  
2,502,767. REN. 9-22-11. INT. CL. 6.
- DOCVIA, LLC, TULSA, OK:  
4,046,661, INT. CL. 44.
- DOGS FOR DIABETICS, INC., CONCORD, CA:  
4,045,182, PUB. 8-9-2011. INT. CL. 16.
- DOGSPLURGE, LLC, FORT WORTH, TX:  
4,044,827, PUB. 8-9-2011. INT. CL. 35.
- DOLLAMUR, LP, NASHVILLE, TN:  
4,046,520, MULTIPLE CLASS, INT. CLS. 27 AND 28.
- DON EVANS, INC., DEFOREST, WI:  
2,492,434. REN. 9-21-11. INT. CL. 40.
- DONALDSON & ASSOCIATES, INC., CALGARY, AB, CANADA:  
2,537,662. REN. 9-20-11. MULTIPLE CLASS, INT. CLS. 16, 41 AND 42.
- DONOHOO, RUSTY S, BURLINGTON, KY:  
4,046,892, INT. CL. 9.
- DOROTHY SIMINOVITCH, BEACHWOOD, OH:  
4,046,280, INT. CL. 44.
- DORVAL TRADING CO., LTD., NANUET, NY:  
2,618,952. REN. 9-21-11. INT. CL. 30.
- DOUGLAS MACHINE INC, ALEXANDRIA, MN:  
4,046,313, INT. CL. 7.
- DOWA HOLDINGS CO., LTD., CHIYODA-KU, TOKYO, JAPAN:  
2,498,600. REN. 9-19-11. MULTIPLE CLASS, INT. CLS. 9, 11 AND 40.
- DOWNTOWN GARDENS FROZEN YOGURT LLC, PALM BEACH GARDENS, FL:  
4,044,905, PUB. 8-9-2011. INT. CL. 35.
- DR. ERIC HERMAN, RENTON, WA:  
4,045,185, PUB. 8-9-2011. INT. CL. 42.

DR. JAY S. NITZKIN, DDS, P.C., LIVONIA, MI:  
2,926,586, CANC. INT. CL. 44.

DR. JUERGEN O. KIRCHNER, FED REP GERMANY:  
4,043,776, PUB. 8-9-2011. INT. CL. 3.

DREAM MACHINE ENTERTAINMENT LLC, PRINCETON,  
MA, HOTEL IMPERIAL, INC., BOSTON, MA:  
1,166,823. REN. 9-21-11. INT. CL. 41.

DREAM SPONSORS, INC., WELLINGTON, FL:  
4,044,846, PUB. 8-9-2011. INT. CL. 35.

DREAPER, THOMAS S., LAS VEGAS, NV AND DUNNING,  
ROBERT H., LAS VEGAS, NV:  
2,926,581, CANC. INT. CL. 28.

DRESAN INVESTMENTS B.V., 5261 NG VUGHT, NETHER-  
LANDS:  
4,045,234, PUB. 8-9-2011. INT. CL. 24.

DREW PARAS, DULUTH, GA:  
4,044,564, PUB. 8-9-2011. INT. CL. 35.

DREW SCIENTIFIC HOLDINGS, INC., WILMINGTON, DE,  
CDC TECHNOLOGIES, INC., OXFORD, CT:  
1,654,259. REN. 9-16-11. INT. CL. 10.

DREXEL UNIVERSITY, PHILADELPHIA, PA:  
4,045,719, INT. CL. 35.

DRI-EAZ PRODUCTS, INC., BURLINGTON, WA:  
2,451,048. REN. 9-22-11. INT. CL. 11.

DRIVE LIKE YOUR KIDS LIVE HERE, LLC, WETHERS-  
FIELD, CT:  
4,046,523, MULTIPLE CLASS, INT. CLS. 6, 16, 20 AND 25.

DRIVEN ENTERPRISES, LLC, MARBLEHEAD, MA:  
4,045,009, PUB. 8-9-2011. INT. CL. 39.  
4,045,573, PUB. 8-9-2011. INT. CL. 39.

DROLL YANKEES, INC., FOSTER, RI:  
2,478,496. REN. 9-20-11. INT. CL. 21.

DRUGTECH CORPORATION, WILMINGTON, DE:  
4,046,878, INT. CL. 5.

DRYBAR HOLDINGS LLC, DALLAS, TX:  
4,043,735, PUB. 11-23-2010. INT. CL. 44.

DT VIDEOLABS LLC, PHOENIX, AZ:  
4,045,265, PUB. 8-9-2011. INT. CL. 9.

DUALSTAR ENTERTAINMENT GROUP LLC, LOS AN-  
GELES, CA:  
2,428,428, CANC. INT. CL. 41.

DUANE READE INTERNATIONAL, LLC, NEW YORK, NY:  
4,045,892, MULTIPLE CLASS, INT. CLS. 3, 8, 14, 16, 18, 20  
AND 21.

DUBINSKIY, YURIY, LAKE ZURICH, IL AND GORO-  
KHOVSKY, ALEXANDER, DEERFIELD, IL:  
4,044,906, PUB. 8-9-2011. INT. CL. 12.

DUCKETT, ISSAC, MITCHELL, IL:  
4,045,335, PUB. 8-9-2011. INT. CL. 41.

DUCKIN.COM, INC., SEATTLE, WA:  
2,522,244. REN. 9-21-11. INT. CL. 36.

DUENAS, NATASHA JEANETTE, MIAMI, FL AND GAY-  
NOR, ALEXANDER DARREN, MIAMI, FL:  
4,045,434, PUB. 8-9-2011. INT. CL. 41.

DUN & BRADSTREET, INC., SHORT HILLS, NJ:  
4,044,616, PUB. 8-9-2011. INT. CL. 35.

DUNCAN ENTERPRISES, FRESNO, CA:  
4,046,434, INT. CL. 2.

DUPAGE CREDIT UNION, NAPERVILLE, IL:  
4,046,869, INT. CL. 36.

DVMK ENTERPRISES, INC., HIGHLAND, IL:  
2,926,940, CANC. INT. CL. 35.

DYNAKING CRANE, LLC, HOUSTON, TX:  
4,044,901, PUB. 8-9-2011. INT. CL. 7.

DYNAMAXX INTERNATIONAL LTD, IRVING, TX:  
4,045,494, PUB. 8-9-2011. INT. CL. 5.

DYNAMIC SPORTS NUTRITION, LLC, HOUSTON, TX:  
4,045,084, PUB. 8-9-2011. INT. CL. 5.

DYNO NOBEL INC., SALT LAKE CITY, UT, IRECO  
INCORPORATED, SALT LAKE CITY, UT:  
1,660,748. REN. 9-20-11. INT. CL. 13.

DYSON, CHRISTOPHER, WEST HOLLYWOOD, CA:  
4,047,086, INT. CL. 33.

E. & J. GALLO WINERY, MODESTO, CA:  
2,475,732. REN. 9-21-11. INT. CL. 33.  
2,499,259. REN. 9-18-11. INT. CL. 33.  
4,045,551, PUB. 8-9-2011. INT. CL. 33.  
4,045,559, PUB. 8-9-2011. INT. CL. 36.  
4,046,848, INT. CL. 33.

E. I. DU PONT DE NEMOURS AND COMPANY, WILMING-  
TON, DE:  
2,487,832. REN. 9-16-11. INT. CL. 5.

E.E.P.D. ELECTRONIC EQUIPMENT PRODUKTION & DIS-  
TRIBUTION GMBH, WEICHS, FED REP GERMANY:  
2,481,129. REN. 9-21-11. INT. CL. 9.

E.P. RADIOLOGICAL SERVICES, CANOGA PARK, CA:  
4,045,289, PUB. 8-9-2011. INT. CL. 9.

E-COMM2, LLC, ALBANY, NY:  
2,428,789, CANC. INT. CL. 36.

E-QUEST MANAGEMENT, LLC, FRIENDSWOOD, TX:  
4,044,741, PUB. 8-9-2011. INT. CL. 43.

EAGLE MATERIALS IP LLC, DALLAS, TX:  
4,046,928, INT. CL. 19.

EAR SERVICE CORPORATION, INC, PLYMOUTH, MN,  
AKA ESCO:  
4,045,974, INT. CL. 36.

EARLY LEARNING RESOURCES, LLC, MOUNT LAUREL,  
NJ:  
4,044,384, PUB. 8-9-2011. INT. CL. 35.

EARTH DAY NETWORK, INC., WASHINGTON, DC:  
4,046,489, INT. CL. 41.

EARTHNET, INC., BOULDER, CO:  
2,590,597. REN. 9-20-11. MULTIPLE CLASS, INT. CLS. 35,  
38 AND 42.

EARWICKER, JAMES, J., VENTURA, CA:  
2,926,808, CANC. INT. CL. 28.

EASTBIZ CORPORATION, TORRANCE, CA:  
4,045,153, PUB. 8-9-2011. INT. CL. 35.

EASY ACES, INC., CUMBERLAND, RI, DBA FRED &  
FRIENDS:  
4,045,004, PUB. 8-9-2011. INT. CL. 21.

EASYLINK INDUSTRIAL CO., LTD., KAOHSIUNG, TAI-  
WAN:  
4,046,208, INT. CL. 6.

EASYNET LIMITED, LONDON WIT 2RJ, ENGLAND:  
4,044,100, PUB. 8-9-2011. MULTIPLE CLASS, INT. CLS.  
35, 38 AND 42.

EATON CORPORATION, CLEVELAND, OH:  
4,046,509, INT. CL. 17.

EBEL INTERNATIONAL LTD., HAMILTON, BERMUDA:  
4,046,097, INT. CL. 3.

EBLEN, EDMUND L., SHERMAN OAKS, CA:  
4,044,797, PUB. 8-9-2011. INT. CL. 15.

EBSCO INDUSTRIES, INC., BIRMINGHAM, AL:  
2,570,500. REN. 9-20-11. INT. CL. 28.  
4,045,505, PUB. 8-9-2011. INT. CL. 41.

EBY-BROWN LLC, NAPERVILLE, IL:  
4,047,030, INT. CL. 30.

ECAMPUSTUTORS, INC., AUSTIN, TX:  
4,043,631, PUB. 8-9-2011. INT. CL. 41.

ECCA ENTERPRISES, INC., SAN ANTONIO, TX:  
2,522,006. REN. 9-16-11. INT. CL. 42.

ECENTA AMERICA INC., BELLEVUE, WA:  
4,045,014, PUB. 8-9-2011. MULTIPLE CLASS, INT. CLS. 35  
AND 42.

ECHIDNA, INC., MINNEAPOLIS, MN:  
4,047,106, INT. CL. 42.

ECLIPSE GAMING SYSTEMS, LLC, LAWRENCEVILLE, GA:  
4,044,565, PUB. 8-9-2011. INT. CL. 9.  
4,044,566, PUB. 8-9-2011. INT. CL. 9.

ECO GREEN INVESTMENTS LLC, SAN ANTONIO, TX:  
4,046,324, INT. CL. 37.

ECO LIGHTING LLC, MIAMI, FL:  
4,046,675, INT. CL. 9.

ECO-LOGIC DEVELOPMENT FUND, CAMBRIDGE, MA:  
4,043,678, PUB. 8-9-2011. MULTIPLE CLASS, INT. CLS.  
35, 36 AND 42.

ECOHEALTH ALLIANCE INC., NEW YORK, NY:  
4,045,524, PUB. 8-9-2011. INT. CL. 35.

- ECOLAB INC., ST. PAUL, MN:  
1,658,681. REN. 9-20-11. INT. CL. 20.  
2,556,202. REN. 9-21-11. INT. CL. 3.  
2,562,020. REN. 9-19-11. INT. CL. 5.  
2,602,978. REN. 9-19-11. INT. CL. 1.
- ECOLAB USA INC., SAINT PAUL, MN:  
4,043,937. PUB. 8-9-2011. MULTIPLE CLASS, INT. CLS. 18, 22, 25, 26, 27, 28 AND 30.
- ECOLOGY AND ENVIRONMENT, INCORPORATED, LANCASTER, NY:  
921,679. REN. 9-20-11. U.S. CL. 100 (INT. CL. 42).
- ECOMASTER TECHNOLOGY CORPORATION, TAOYUAN, TAIWAN:  
4,046,939. INT. CL. 9.
- ECONNECTIX CORPORATION, CHICAGO, IL:  
4,046,837. MULTIPLE CLASS, INT. CLS. 9 AND 42.
- ECONOMY MUD PRODUCTS COMPANY, HOUSTON, TX:  
2,608,745. REN. 9-20-11. INT. CL. 1.
- ECOTENSIL, INC., LARKSPUR, CA:  
4,045,127. PUB. 8-9-2011. INT. CL. 8.
- ECPI COLLEGES, INC., VIRGINIA BEACH, VA:  
4,046,926. INT. CL. 41.
- ECR MINERALS PLC, UNITED KINGDOM:  
4,043,840. PUB. 8-9-2011. MULTIPLE CLASS, INT. CLS. 37 AND 42.
- EDCENTRIX, INC., SPRINGFIELD, MO:  
4,044,060. PUB. 8-9-2011. INT. CL. 42.
- EDGAR ONLINE, INC, ROCKVILLE, MD:  
2,601,633. REN. 9-20-11. INT. CL. 36.
- EDGE GEO LLC, FRISCO, TX:  
4,046,891. INT. CL. 35.
- EDGE INDUSTRIES, INC., BAKER CITY, CA:  
1,660,524. REN. 9-21-11. INT. CL. 7.
- EDGE TECH I.G., INC., CAMBRIDGE, OH:  
4,046,056. INT. CL. 17.
- EDIFIER INTERNATIONAL, LTD., 89 QUEENSWAY, HONG KONG:  
4,044,860. PUB. 8-9-2011. INT. CL. 9.
- EDITHEAD, INC., BROOKLYN, NY:  
2,480,050. REN. 9-22-11. INT. CL. 41.
- EDITIONS TEMPS INTERNATIONAL LTD, HONG KONG, HONG KONG:  
4,045,365. PUB. 8-9-2011. MULTIPLE CLASS, INT. CLS. 35 AND 41.
- EDT CORP., VANCOUVER, WA:  
4,045,447. PUB. 8-9-2011. INT. CL. 7.
- EDUCATION CORPORATION OF AMERICA, BIRMINGHAM, AL:  
2,485,230. REN. 9-22-11. INT. CL. 41.
- EDUCATIONAL TECHNOLOGY AND LIFE CORPORATION, IRVINE, CA:  
4,047,168. INT. CL. 41.
- EDUCATIONDYNAMICS, LLC, HOBOKEN, NJ, EDUCATIONAL DIRECTORIES UNLIMITED, INC., CHESTER, PA:  
2,511,470. REN. 9-21-11. INT. CL. 35.
- EDUN APPAREL LIMITED, IRELAND:  
4,043,771. PUB. 8-9-2011. MULTIPLE CLASS, INT. CLS. 14, 18 AND 35.  
4,043,788. PUB. 8-9-2011. MULTIPLE CLASS, INT. CLS. 9, 18, 25, 35, 38 AND 41.
- EDVISORS NETWORK, INC, QUINCY, MA:  
2,494,006. REN. 9-19-11. MULTIPLE CLASS, INT. CLS. 41 AND 42.
- EDWARD & SONS TRADING COMPANY, INC., CARPINTERIA, CA:  
2,555,314. REN. 9-21-11. INT. CL. 30.
- EDWARDS LIFESCIENCES CORPORATION, IRVINE, CA:  
4,046,126. INT. CL. 10.
- EFFIGI INC., LAVAL, QUEBEC H7W 5J8, CANADA:  
2,926,456. CANC. MULTIPLE CLASS, INT. CLS. 24 AND 25.
- EFG CAPITAL INTERNATIONAL CORP., MIAMI, FL:  
4,046,587. INT. CL. 36.
- EGL COMPANY, INC, BERKELEY HEIGHTS, NJ:  
4,044,280. PUB. 8-9-2011. INT. CL. 11.
- EIDOLON BRANDS, LLC, VICTORIA, TX:  
4,046,537. INT. CL. 28.
- EILANDT, SVENJA, 38667 BAD HARZBURG, FED REP GERMANY AND EILANDT, ARNE, 38667 BAD HARZBURG, FED REP GERMANY:  
4,046,167. INT. CL. 5.
- EINSTEIN/NOAH BAGEL PARTNERS, INC., LAKEWOOD, CO, EINSTEIN/NOAH BAGEL PARTNERS, INC., LAKEWOOD, CO:  
2,556,962. REN. 9-21-11. INT. CL. 30.
- ELARA NUTRICEUTICALS, INC., FATE, TX:  
3,547,375. AM. INT. CL. 5.
- ELECTREX COMPANY, INC., HARRISON TOWNSHIP, MI:  
2,492,141. REN. 9-21-11. INT. CL. 37.
- ELECTRIC POWER BOARD AN INDEPENDENT BOARD OF THE CITY OF CHATTANOOGA, CHATTANOOGA, TN:  
4,045,897. INT. CL. 38.
- ELECTROLYTIC TECHNOLOGIES CORPORATION, NORTH MIAMI BEACH, FL:  
2,926,894. CANC. INT. CL. 11.
- ELECTRONIC CIGARETTES INC., BINGHAMTON, NY:  
4,045,465. PUB. 8-9-2011. INT. CL. 34.  
4,045,563. PUB. 8-9-2011. INT. CL. 34.
- ELEMENTS/JILL SCHWARTZ INC., GREAT BARRINGTON, MA:  
1,654,288. REN. 9-17-11. INT. CL. 14.
- ELFENWORKS PRODUCTIONS LLC, BURLINGAME, CA:  
4,045,820. MULTIPLE CLASS, INT. CLS. 9, 35, 36 AND 41.
- ELHAM JAFARIMOJARRAD M.D., INC., NEWPORT COAST, CA:  
4,047,058. INT. CL. 3.
- ELI FITNESS S.R.O., CZECH REPUBLIC:  
4,043,850. PUB. 8-9-2011. INT. CL. 41.
- ELI LILLY AND COMPANY, INDIANAPOLIS, IN:  
144,210. REN. 9-20-11. U.S. CL. 6 (INT. CLS. 1, 2, 3, 4 AND 5).
- ELIAS HONEY LTD., PRINCE GEORGE, B.C., CANADA:  
4,044,568. PUB. 8-9-2011. INT. CL. 30.
- ELITE C.M.E., INC., ORMOND BEACH, FL:  
4,044,115. PUB. 8-9-2011. INT. CL. 41.
- ELLEN ALLEN, INC., MILLERSVILLE, MD:  
4,046,323. MULTIPLE CLASS, INT. CLS. 16, 18 AND 25.
- ELLENBOGEN, ROBERT, SLINGERLANDS, NY:  
2,490,718. REN. 9-19-11. INT. CL. 35.  
2,490,718. CANC. INT. CL. 41.
- ELLIE'S ECO HOME STORE, INC., BOULDER, CO:  
4,046,399. INT. CL. 35.
- ELLIOTT'S OFF BROADWAY DELI, INC., OAK BROOK, IL:  
4,045,059. PUB. 8-9-2011. INT. CL. 30.
- ELLIS COFFEE COMPANY, PHILADELPHIA, PA:  
1,644,099. REN. 9-19-11. INT. CL. 30.
- ELM CAPITAL GROUP, LLC, ATLANTA, GA:  
2,927,015. CANC. INT. CL. 36.
- ELMER'S INVESTMENTS LLC, COLUMBUS, OH:  
2,926,657. CANC. INT. CL. 16.
- ELMHURST MEMORIAL HOSPITAL, ELMHURST, IL:  
4,046,900. INT. CL. 35.
- ELMORE, REX L., NASHVILLE, TN:  
2,926,562. CANC. INT. CL. 42.  
2,926,563. CANC. INT. CL. 42.
- ELVINS, EILEEN MCDARGH, DANA POINT, CA:  
3,140,289. CANC. INT. CL. 16.
- EMAX'S, LLC, BOULDER, CO:  
4,046,291. INT. CL. 30.
- EMBRAER - EMBRAER EMPRESA BRASILEIRA DE AERONÁUTICA S.A., SAN JOSE DOS CAMPOS, BRAZIL:  
4,046,196. INT. CL. 12.
- EMCO SYSTEMS SOLUTIONS, INC., FOSTER CITY, CA:  
4,046,246. MULTIPLE CLASS, INT. CLS. 35 AND 40.  
4,046,247. MULTIPLE CLASS, INT. CLS. 35 AND 40.
- EMD CROP BIOSCIENCE INC., BROOKFIELD, WI:  
4,045,742. INT. CL. 1.
- EMERALD BIO AGRICULTURE, LANSING, MI:  
2,428,652. CANC. INT. CL. 1.
- EMERGING HEALTH INFORMATION TECHNOLOGY LLC, BRONX, NY:  
2,926,871. CANC. INT. CL. 35.

EMERUS HOLDINGS, INC., THE WOODLANDS, TX:  
4,046,115, INT. CL. 44.  
4,046,224, INT. CL. 44.  
4,046,225, INT. CL. 44.

EMERY OLEOCHEMICALS GMBH, DUESSELDORF, FED  
REP GERMANY:  
907,393, REN. 9-21-11. U.S. CL. 6 (INT. CL. 1).

EMISSIVE ENERGY CORPORATION, NORTH KING-  
STOWN, RI:  
2,581,600, REN. 9-21-11. INT. CL. 11.

EMPHASYS MEDICAL, INC., REDWOOD CITY, CA:  
2,926,543, CANC. INT. CL. 10.

EMULEX DESIGN & MANUFACTURING CORPORATION,  
COSTA MESA, CA:  
4,045,809, INT. CL. 9.  
4,045,810, INT. CL. 9.

ENCORE GROUP, INC., LANHAM, MD:  
2,427,911, CANC. INT. CL. 16.

ENCORE WIRE CORPORATION, MCKINNEY, TX:  
4,045,891, MULTIPLE CLASS, INT. CLS. 35, 37 AND 42.

ENDE ENTERPRISES, LLC, ST. PAUL, MN:  
2,926,913, CANC. INT. CL. 45.  
2,926,914, CANC. INT. CL. 45.

ENDEVCO CORPORATION, SAN JUAN CAPISTRANO, CA,  
ALLIED-SIGNAL INC., MORRISTOWN, NJ:  
1,660,691, REN. 9-22-11. INT. CL. 9.

ENDIMENSIONS, LLC, SAN CARLOS, CA, DBA ENDIMEN-  
SIONS:  
4,044,917, PUB. 8-9-2011. INT. CL. 9.

ENERCON GMBH, D-26605 AURICH, FED REP GERMANY:  
2,926,119, CANC. MULTIPLE CLASS, INT. CLS. 7 AND  
11.

ENERGY EDUCATION, INC., DALLAS, TX:  
4,045,965, INT. CL. 35.

ENERGY INTELLIGENCE GROUP, INC., NEW YORK, NY:  
4,044,591, PUB. 8-9-2011. INT. CL. 9.

ENESCO, LLC, ITASCA, IL:  
2,926,720, CANC. INT. CL. 28.

ENETRIX, LLC, MIDDLETON, WI:  
2,926,918, CANC. INT. CL. 42.

ENGENUITY, LLC, SALT LAKE CITY, UT:  
2,926,820, CANC. MULTIPLE CLASS, INT. CLS. 36 AND  
41.

ENGLAND, INC., NEW TAZEWELL, TN:  
2,469,037, REN. 9-20-11. INT. CL. 20.

ENLIGHTENED SOCCER INC., CALGARY, CANADA:  
4,043,646, PUB. 8-9-2011. MULTIPLE CLASS, INT. CLS. 35  
AND 41.

ENNIS PAINT, INC., DALLAS, TX:  
4,045,613, INT. CL. 11.

ENSAR CORPORATION, WHEELING, IL:  
1,654,136, REN. 9-17-11. MULTIPLE CLASS, INT. CLS. 8,  
11 AND 16.  
1,654,136, CANC. MULTIPLE CLASS, INT. CLS. 3 AND  
21.

ENTERPRISE PRODUCTIVITY SYSTEMS, INC., GREAT  
FALLS, VA:  
4,046,301, INT. CL. 9.

ENTERTAINMENT PUBLICATIONS LLC, TROY, MI:  
4,044,157, PUB. 8-9-2011. MULTIPLE CLASS, INT. CLS. 35  
AND 36.

ENTREPRENEUR MEDIA, INC., IRVINE, CA:  
2,486,615, CANC. INT. CL. 35.

ENVIRONMENTAL ACCOUSTICAL RESEARCH, INC.,  
BOULDER, CO, DBA E.A.R., INC.:  
4,044,305, PUB. 8-9-2011. INT. CL. 9.

ENVIRONMENTAL DEFENSE FUND, INCORPORATED,  
NEW YORK, NY:  
2,493,215, REN. 9-16-11. INT. CL. 16.  
2,493,215, CANC. INT. CL. 42.

ENWAVE CORPORATION, VANCOUVER, BC, CANADA:  
4,043,651, PUB. 7-12-2011. MULTIPLE CLASS, INT. CLS.  
11 AND 40.

ENZYMATIC THERAPY, INC., GREEN BAY, WI:  
2,499,129, REN. 9-19-11. INT. CL. 3.

ENZYMEDICA, PORT CHARLOTTE, FL:  
4,045,973, INT. CL. 5.

EORIGINAL, INC., BALTIMORE, MD:  
2,613,910, REN. 9-18-11. MULTIPLE CLASS, INT. CLS. 9,  
38 AND 39.

EPIQ SYSTEMS, INC., KANSAS CITY, KS:  
4,045,646, INT. CL. 9.

EPIZYME, INC., CAMBRIDGE, MA:  
4,045,133, PUB. 8-9-2011. INT. CL. 42.

EQUALIZER INDUSTRIES, INC., ROUND ROCK, TX,  
EQUALIZER INDUSTRIES, INC., ROUND ROCK, TX:  
1,674,813, REN. 9-20-11. INT. CL. 8.

EQUIHOME MORTGAGE, CORP., BERNARDSVILLE, NJ:  
2,926,831, CANC. INT. CL. 36.

EQUINE ASSISTED GROWTH AND LEARNING ASSOCIA-  
TION, SANTAQUIN, UT:  
4,045,108, PUB. 8-9-2011. INT. CL. 41.

EQUIPO IVI, S.L., SPAIN:  
4,043,750, PUB. 3-8-2011. MULTIPLE CLASS, INT. CLS. 5,  
9, 41 AND 44.

EQUITY RISE REAL ESTATE GROUP, LLC, FAIRFAX, VA:  
4,044,903, PUB. 8-9-2011. INT. CL. 36.

ER MARKS, INC., WILMINGTON, DE:  
2,497,999, CANC. INT. CL. 35.

ERBE ELEKTROMEDIZIN GMBH, TUBINGEN, FED REP  
GERMANY:  
3,131,815, AM. INT. CL. 10.

ERGOCARE, INC., RIVERSIDE, CA:  
4,044,735, PUB. 8-9-2011. INT. CL. 41.  
4,044,813, PUB. 8-9-2011. INT. CL. 45.

ERIC IMASOGIE, HOUSTON, TX, DBA GIVEPALS:  
4,045,324, PUB. 8-9-2011. INT. CL. 35.

ERIC SILVERS, N. MIDDLESEX, VT, DBA SIMPLE SOLU-  
TIONS:  
4,047,182, INT. CL. 21.

ERICK ISAIAH "IKE" THOMPSON, HENDERSONVILLE,  
NC:  
4,045,605, MULTIPLE CLASS, INT. CLS. 9, 35 AND 41.

ERICKSEN, ADAM C., BOUNTIFUL, UT, DBA UTAH  
IDAHO LEATHER LLC:  
4,044,318, PUB. 8-9-2011. MULTIPLE CLASS, INT. CLS. 14  
AND 18.

ERIEZ MANUFACTURING CO., ERIE, PA:  
4,046,469, MULTIPLE CLASS, INT. CLS. 7 AND 9.

ERIN FILNER, VALLEY COTTAGE, NY:  
4,045,572, PUB. 8-9-2011. INT. CL. 41.

ERIN GLOCKNER, FLAGSTAFF, AZ, DBA SUBLIME-D-  
ZIGN:  
4,044,336, PUB. 8-9-2011. INT. CL. 40.

EROTIC IMAGE, INC., SOUTHFIELD, MI:  
2,566,683, REN. 9-19-11. INT. CL. 41.

ES EQUIPMENT, GOTHENBURG, SWEDEN:  
4,045,147, PUB. 8-9-2011. INT. CL. 8.

ESCROW ASSOCIATES, LLC, ATLANTA, GA:  
2,491,303, REN. 9-19-11. MULTIPLE CLASS, INT. CLS. 14,  
16, 20, 21, 25, 28 AND 35.  
2,491,303, CANC. MULTIPLE CLASS, INT. CLS. 4, 6, 18  
AND 24.

ESENSE INCORPORATED, FISHERS, IN:  
4,044,943, PUB. 8-9-2011. MULTIPLE CLASS, INT. CLS. 35  
AND 42.

ESMEL, GREGORY M., PLYMOUTH, MA:  
4,045,700, INT. CL. 15.

ESOZO LLC, FLEMINGTON, NJ:  
4,044,208, PUB. 8-9-2011. INT. CL. 42.

ESPA BEAUTY, LLC, DANIA, FL:  
4,044,479, PUB. 8-9-2011. INT. CL. 30.

ESPRIT IP LIMITED, ROAD TOWN, TORTOLA, BR. VIRGIN  
ISLANDS:  
4,046,179, INT. CL. 25.

ESSILOR INTERNATIONAL (COMPAGNIE GENERALE  
D'OPTIQUE), F-94220 CHARENTON LE PONT, FRANCE:  
4,043,817, PUB. 8-9-2011. MULTIPLE CLASS, INT. CLS. 7,  
9 AND 44.

ESTABLECIMIENTOS ANCALMO, S.A. DE C.V., ANTIGUO  
CUSCATLÁN, EL SALVADOR:  
4,045,817, INT. CL. 5.

ESYS CORPORATION, AUBURN HILLS, MI:  
4,044,444, PUB. 8-9-2011. INT. CL. 9.

- ETHNOGRAPHIC MEDIA, INC., OKLAHOMA CITY, OK:  
4,045,314, PUB. 8-9-2011. INT. CL. 41.
- EUGENE OVERLINE, GILBERT, AZ:  
4,044,139, PUB. 8-9-2011. INT. CL. 11.
- EURARK, LLC, BATESVILLE, AR:  
2,927,070, CANC. MULTIPLE CLASS, INT. CLS. 5 AND 32.  
2,927,071, CANC. MULTIPLE CLASS, INT. CLS. 9, 16 AND 35.
- EUROCOPTER, 13725 MARIGNANE CEDEX, FRANCE:  
2,994,124, CANC. INT. CL. 38.
- EUROPEAN PNEUMATIC COMPONENTS OVERHAUL & REPAIR (EPCOR) B.V., SCHIPHOL-RIJK HOLLAND, 1119 NT, NETHERLANDS:  
2,486,781, REN. 9-16-11. INT. CL. 37.
- EUROTRASH, CORP., NEW YORK, NY:  
2,926,930, CANC. INT. CL. 14.
- EVA KENNOCHA LLC, EL PASO, TX:  
4,045,451, PUB. 8-9-2011. INT. CL. 3.
- EVANS, SUZANNE, MURRELLS INLET, SC:  
4,044,786, PUB. 8-9-2011. INT. CL. 41.  
4,044,790, PUB. 8-9-2011. INT. CL. 9.
- EVAPCO, INC., TANEYTOWN, MD:  
4,045,092, PUB. 8-9-2011. INT. CL. 11.
- EVENFLO COMPANY, INC., VANDALIA, OH:  
2,926,734, CANC. INT. CL. 18.
- EVEREADY BATTERY COMPANY, INC., ST. LOUIS, MO:  
2,926,977, CANC. INT. CL. 11.
- EVERETT CASH MUTUAL INSURANCE COMPANY, EVERETT, PA:  
2,547,083, REN. 9-20-11. INT. CL. 36.
- EVERFRESH BEVERAGES, INC., WARREN, MI, DBA SUNDANCE BEVERAGE COMPANY:  
4,045,678, INT. CL. 5.
- EVERGLADES DIRECT, INC., NORTH MANKATO, MN:  
2,610,953, REN. 9-16-11. INT. CL. 16.  
2,616,978, REN. 9-16-11. INT. CL. 16.  
2,616,978, CANC. INT. CL. 9.
- EVERLAST WORLD'S BOXING HEADQUARTERS CORPORATION, NEW YORK, NY:  
4,045,806, INT. CL. 28.
- EVERLOOP, INC., DANVILLE, CA:  
4,045,326, PUB. 8-9-2011. INT. CL. 35.
- EVERPURE, INC., HANOVER PARK, IL:  
2,926,890, CANC. INT. CL. 9.
- EVERRIS INTERNATIONAL B.V., HEERLEN, NETHERLANDS, MALLINCKRODT CHEMICAL WORKS, SAINT LOUIS, MO:  
919,655, REN. 9-20-11. U.S. CL. 6 (INT. CL. 5).
- EVOLVED MEDIA LLC, NEW YORK, NY:  
4,046,038, INT. CL. 42.
- EVONIK STOCKHAUSEN GMBH, KREFELD, FED REP GERMANY:  
4,043,902, PUB. 5-24-2011. INT. CL. 3.  
4,043,903, PUB. 5-10-2011. INT. CL. 5.  
4,043,904, PUB. 5-17-2011. INT. CL. 9.  
4,043,905, PUB. 5-10-2011. INT. CL. 11.  
4,043,906, PUB. 5-17-2011. INT. CL. 16.  
4,043,907, PUB. 5-10-2011. INT. CL. 21.
- EWER, GERALD G, OMAHA, NE AND EWER, BETTY M., OMAHA, NE:  
2,428,889, CANC. INT. CL. 21.
- EWO SRL/GMBH, ITALY:  
4,043,791, PUB. 8-9-2011. MULTIPLE CLASS, INT. CLS. 9, 11 AND 42.
- EXCELVISION, LLC, NEW YORK, NY:  
4,045,332, PUB. 8-9-2011. INT. CL. 35.
- EXCLUSIVE SOURCE INTERNATIONAL, INC., LOS ANGELES, IN:  
4,045,479, PUB. 8-9-2011. INT. CL. 14.
- EXCLUSIVELY.IN INC., NEW YORK, NY:  
4,045,552, PUB. 8-9-2011. INT. CL. 35.
- EXECUTIVE BUSINESS SERVICES, INC., TEMECULA, CA:  
2,428,242, CANC. INT. CL. 9.
- EXECUTIVE DISCOVERY, LLC, PUELBLO WEST, CO:  
2,481,938, REN. 9-19-11. INT. CL. 35.
- EXELON CORPORATION, PHILADELPHIA, PA:  
4,046,962, INT. CL. 40.  
4,046,963, INT. CL. 40.  
4,046,964, INT. CL. 40.  
4,046,965, INT. CL. 40.
- EXIDE TECHNOLOGIES, MILTON, GA:  
2,926,780, CANC. INT. CL. 9.
- EXPACK SEAFOOD, INC., WOODBRIDGE, NJ:  
4,044,465, PUB. 8-9-2011. INT. CL. 29.
- EXPERIENCE BASED LEARNING, INC., ROCKFORD, IL:  
4,044,443, PUB. 8-9-2011. INT. CL. 41.
- EXPERIENT HOLDING COMPANY INC., TWINSBURG, OH:  
2,486,084, REN. 9-16-11. INT. CL. 35.
- EXPERIMENTAL AIRCRAFT ASSOCIATION, INC., OSHKOSH, WI:  
1,166,870, REN. 9-20-11. U.S. CL. 200.
- EXPERT NETWORK SOLUTIONS, INC., JESSUP, MD:  
2,455,477, REN. 9-20-11. INT. CL. 35.
- EXPRESS OIL CHANGE, L.L.C., BIRMINGHAM, AL, TUNE-UP CLINIC, INC., MARIETTA, GA:  
1,159,428, REN. 9-19-11. INT. CL. 37.
- EXTECH EXTERIOR TECHNOLOGIES, INC., PITTSBURGH, PA:  
4,047,053, INT. CL. 6.
- EXTRACO CORPORATION, WACO, TX:  
4,046,651, INT. CL. 36.
- EXXON MOBIL CORPORATION, IRVING, TX, EXXON CORPORATION, IRVING, TX:  
1,665,379, REN. 9-20-11. INT. CL. 1.
- EZCORP, INC., AUSTIN, TX:  
4,046,479, INT. CL. 36.
- EZKEY CORP., TAIPEI HSIEN, TAIWAN:  
2,532,824, REN. 9-22-11. INT. CL. 9.
- F.P. WOLL & COMPANY, PHILADELPHIA, PA:  
1,652,457, REN. 9-20-11. INT. CL. 22.
- FAB APPS, INC, ARLINGTON, VA:  
4,044,521, PUB. 8-9-2011. INT. CL. 9.
- FACC AG, A-4910 RIED IM INNKREIS, AUSTRIA:  
4,043,772, PUB. 8-9-2011. MULTIPLE CLASS, INT. CLS. 12, 17 AND 42.
- FACONNABLE SAS, NICE, FRANCE, GOLDBERG, ALBERT, NICE, FRANCE AND GOLDBERG, MYRIAM, NICE, FRANCE:  
1,636,209, REN. 9-22-11. INT. CL. 25.
- FACTORY CONNECTION, LLC, ALBERTVILLE, AL:  
4,045,375, PUB. 8-9-2011. INT. CL. 14.
- FAHEY COMMUNICATIONS, CRANFORD, NJ:  
4,044,291, PUB. 8-9-2011. INT. CL. 41.
- FAIR HEALTH, INC., NEW YORK, NY:  
4,046,275, MULTIPLE CLASS, INT. CLS. 35, 36 AND 41.
- FAIRFIELD PROCESSING CORPORATION, DANBURY, CT:  
4,044,416, PUB. 8-9-2011. INT. CL. 22.
- FAITH TECHNOLOGIES, INC., APPLETON, WI:  
2,926,873, CANC. INT. CL. 37.
- FALL, CHERYL, WASHOUGAL, WA:  
4,046,821, MULTIPLE CLASS, INT. CLS. 16 AND 40.
- FAMILIES EXPLORING DOWN SYNDROME OF BREVARD INC., COCOA BEACH, FL:  
4,046,951, INT. CL. 36.
- FANTA-Z HOLDINGS, LLC, LAS VEGAS, CA:  
4,046,155, INT. CL. 41.
- FANTASTIC FOODS, INC., PROVIDENCE, RI:  
1,656,369, REN. 9-22-11. MULTIPLE CLASS, INT. CLS. 29 AND 30.
- FANTL, JAN, COLOGNE, FED REP GERMANY:  
2,926,582, CANC. INT. CL. 41.
- FARM HOUSE PRODUCTIONS LLC, NEW YORK, NY:  
4,044,869, PUB. 8-9-2011. INT. CL. 43.
- FARM SHOW PUBLISHING INC., LAKEVILLE, MN:  
1,178,095, REN. 9-21-11. INT. CL. 16.
- FARMER BROS. CO., TORRANCE, CA:  
4,043,922, PUB. 8-9-2011. INT. CL. 30.
- FARMERS SUPPLY CO. OF DINUBA, INC., REEDLEY, CA:  
4,045,426, PUB. 8-9-2011. INT. CL. 29.

FARR PARTNERSHIP, THE, LONDON W1A 2RH, UNITED KINGDOM:  
2,511,981. REN. 9-21-11. INT. CL. 27.

FARRELL'S INTERNATIONAL, INC., LAGUNA NIGUEL, CA:  
845,170, AM. U.S. CL. 100.

FARRELL'S, INC., PORTLAND, OR TO FARRELL'S INTERNATIONAL, INC., LAGUNA NIGUEL, CA:  
845,610, AM. U.S. CL. 100.

FARSEDAKIS HOLDINGS, LLC, BOCA RATON, FL:  
4,046,277, INT. CL. 45.

FASTMETRICS, LLC, SAN FRANCISCO, CA:  
2,926,847, CANC. MULTIPLE CLASS, INT. CLS. 38 AND 42.

FAZIO, KAREN M, KEYPORT, NJ:  
4,047,041, INT. CL. 41.

FC ACQUISITION CORP., WILMINGTON, DE:  
2,442,412. REN. 9-22-11. INT. CL. 9.

FDC GRAPHIC FILMS, INC., SOUTH BEND, IN:  
2,490,659. REN. 9-22-11. INT. CL. 17.

FEAST LLC, CHARLOTTESVILLE, VA:  
4,044,950, PUB. 8-9-2011. INT. CL. 35.

FEDELITY MUSIC, BROKEN ARROW, OK:  
4,045,272, PUB. 8-9-2011. INT. CL. 9.

FEDERAL RESERVE BANK OF ST. LOUIS, ST. LOUIS, MO:  
4,045,527, PUB. 8-9-2011. INT. CL. 36.

FEDERATED LIFE INSURANCE COMPANY, OWATONNA, MN:  
1,669,015. REN. 9-17-11. INT. CL. 36.

FEDERATED MUTUAL INSURANCE COMPANY, OWATONNA, MN:  
2,927,045, CANC. INT. CL. 36.

FEDERSPIEL CORPORATION, EL CERRITO, CA, AKA FEDERSPIEL CONTROLS:  
4,044,926, PUB. 8-9-2011. INT. CL. 9.

FEEL FOXY, LLC, RICHMOND, TX:  
4,045,011, PUB. 8-9-2011. INT. CL. 25.

FELDMUS MATTEO, ROBIN, HOPELAWN, NJ:  
4,045,882, INT. CL. 25.

FELICIANO VIVANCO Y ASOCIADOS SA DE CV, ARANDAS JALISCO, MEXICO:  
4,046,003, INT. CL. 33.

FERACO INDUSTRIES INC., HUNTINGTON STATION, NY:  
4,046,638, INT. CL. 25.

FERNANDO RABIELA, CHICAGO, IL:  
4,044,048, PUB. 8-9-2011. INT. CL. 41.

FERRANIA TECHNOLOGIES S.P.A., CAIRO MONTENOTTE, ITALY:  
2,926,794, CANC. MULTIPLE CLASS, INT. CLS. 1, 9 AND 10.

FERRARI S.P.A., ITALY:  
4,043,836, PUB. 8-9-2011. INT. CL. 43.

FERRO CORPORATION, CLEVELAND, OH:  
2,510,833. REN. 9-20-11. INT. CL. 2.

FI-TECH, INC., RICHMOND, VA:  
2,520,171. REN. 9-22-11. INT. CL. 35.

FIBER COMPOSITES, LLC, NEW LONDON, NC:  
4,046,411, INT. CL. 19.

FIBER SYSTEMS INTERNATIONAL, ALLEN, TX, DBA AMPHENOL FIBER SYSTEMS INTERNATIONAL:  
2,518,100. REN. 9-21-11. INT. CL. 9.

FIELDSTONE INSURANCE GROUP, LLC, LITTLE FALLS, NJ:  
4,046,899, INT. CL. 36.

FIFTH THIRD BANCORP, CINCINNATI, OH:  
2,536,372. REN. 9-19-11. INT. CL. 36.  
4,046,575, INT. CL. 35.

FIFTY-SIX HOPE ROAD MUSIC LIMITED, NASSAU, BAHAMAS:  
4,044,256, PUB. 8-9-2011. INT. CL. 11.  
4,044,257, PUB. 8-9-2011. INT. CL. 14.  
4,044,258, PUB. 8-9-2011. INT. CL. 16.  
4,044,259, PUB. 8-9-2011. INT. CL. 18.  
4,044,260, PUB. 8-9-2011. MULTIPLE CLASS, INT. CLS. 20 AND 21.

4,044,261, PUB. 8-9-2011. INT. CL. 24.  
4,044,262, PUB. 8-9-2011. INT. CL. 25.  
4,044,263, PUB. 8-9-2011. INT. CL. 26.  
4,044,264, PUB. 8-9-2011. INT. CL. 28.  
4,044,265, PUB. 8-9-2011. INT. CL. 34.

FILAMAT COMPOSITES INC., MISSISSAUGA, ONTARIO, CANADA:  
2,550,270. REN. 9-22-11. MULTIPLE CLASS, INT. CLS. 20 AND 40.

FILE RIGHT LLC, MIDDLETOWN, DE:  
4,046,894, INT. CL. 45.  
4,046,895, INT. CL. 45.

FINCA FLICHTMAN S.A., BUENOS AIRES 1066, ARGENTINA:  
4,046,770, INT. CL. 33.

FINE ESTATES FROM SPAIN, DEDHAM, MA:  
4,045,725, INT. CL. 33.

FINE ESTATES FROM SPAIN, INC., DEDHAM, MA:  
4,046,994, INT. CL. 33.

FINITE MATERIALS INC, CRESTON, CA:  
2,604,290. REN. 9-19-11. INT. CL. 9.

FINITIV CORPORATION, SAN MATEO, CA:  
3,889,930, AM. INT. CL. 35.

FIorentino, SUSAN WHITMAN, ROME, ITALY:  
4,045,980, INT. CL. 25.

FIRST GENERATION MONTE CARLO CLUB, AURORA, IL, AKA FGMCC:  
4,044,282, PUB. 8-9-2011. INT. CL. 35.

FIRST IN, INC., PHOENIX, AZ:  
3,839,282, AM. MULTIPLE CLASS, INT. CLS. 35 AND 37.

FIRST ROUND EXCHANGE LLC, BRENTWOOD, TN:  
4,046,903, INT. CL. 41.

FISCHER, BRETT, PHOENIX, AZ:  
4,046,643, MULTIPLE CLASS, INT. CLS. 9 AND 28.

FISHING HAS NO BOUNDARIES, INC., HAYWARD, WI:  
2,509,791. REN. 9-19-11. INT. CL. 41.

FISION, LLC, MINNEAPOLIS, MN:  
4,045,778, INT. CL. 42.

FIT VENTURES, COLUMBIA, SC:  
4,045,143, PUB. 8-9-2011. INT. CL. 41.

FIT-N-FUN OF WESTON, L.L.C., WESTON, FL:  
2,926,880, CANC. INT. CL. 44.

FIVE SEASONS REAL ESTATE S.R.L., ITALY:  
4,043,804, PUB. 8-9-2011. INT. CL. 25.

FJC, INC., MOUNT MOURNE, NC:  
4,043,686, PUB. 8-9-2011. INT. CL. 12.

FKI INDUSTRIES INC., FAIRFIELD, CT:  
941,919. REN. 9-19-11. U.S. CL. 23 (INT. CL. 7).

FLAGEOLI, LIMITED, LAS VEGAS, NV:  
2,428,845, CANC. INT. CL. 3.

FLAGS UNLIMITED CORPORATION, BARRIE, ONTARIO, CANADA:  
2,428,322, CANC. MULTIPLE CLASS, INT. CLS. 35 AND 40.

FLANDIA, INC., LANSING, MI:  
2,927,058, CANC. INT. CL. 30.

FLATLANDS, LLC, CHATTANOOGA, TN:  
4,045,477, PUB. 8-9-2011. INT. CL. 43.

FLEET WHOLESALE SUPPLY CO., INC., APPLETON, WI:  
4,047,080, INT. CL. 28.  
4,047,081, INT. CL. 28.

FLEXCELL INTERNATIONAL CORPORATION, HILLSBOROUGH, NC:  
2,480,019. REN. 9-21-11. INT. CL. 9.

FLEXCON COMPANY, INC., SPENCER, MA:  
1,696,023. REN. 9-20-11. INT. CL. 16.

FLEXIANT LIMITED, LIVINGSTON EH54 6GU, UNITED KINGDOM:  
4,043,897, PUB. 7-19-2011. MULTIPLE CLASS, INT. CLS. 9, 42 AND 45.  
4,043,898, PUB. 8-9-2011. MULTIPLE CLASS, INT. CLS. 9, 42 AND 45.

FLINT TRADING, INC., THOMASVILLE, NC:  
4,046,515, INT. CL. 17.  
4,046,516, INT. CL. 17.

- FLIP MODE LICENSING, LLC, BALDWIN, NY:  
2,486,734. REN. 9-17-11. INT. CL. 25.  
2,499,521. REN. 9-19-11. INT. CL. 25.
- FLIPSID5 INC., RESTON, VA:  
4,043,712, PUB. 6-8-2010. INT. CL. 9.
- FLOORTEX EUROPE LIMITED, GLOUCESTERSHIRE,  
UNITED KINGDOM:  
4,043,621, PUB. 5-3-2011. MULTIPLE CLASS, INT. CLS. 16  
AND 27.
- FLORIAN SEITNER, WIEN, AUSTRIA:  
4,043,825, PUB. 8-9-2011. MULTIPLE CLASS, INT. CLS. 9  
AND 42.
- FLORIN, JILL S., DRESHER, PA:  
4,044,571, PUB. 8-9-2011. INT. CL. 44.
- FLORISTS' TRANSWORLD DELIVERY, INC., DOWNERS  
GROVE, IL:  
1,147,784. REN. 9-19-11. INT. CL. 31.
- FLOTRON, INC., VISTA, CA:  
2,509,181. REN. 9-20-11. MULTIPLE CLASS, INT. CLS. 8  
AND 42.
- FLUID ENERGY CONTROLS, INC., LOS ANGELES, CA:  
4,045,441, PUB. 8-9-2011. INT. CL. 9.
- FLYBIKES, S.L., 36201-VIGO(PONTEVEDRA), SPAIN:  
4,044,197, PUB. 8-9-2011. INT. CL. 12.
- FLYING DOG BREWERY, LLLP, DENVER, CO:  
4,047,242, INT. CL. 32.
- FMR LLC, BOSTON, MA:  
2,503,244. REN. 9-20-11. INT. CL. 35.  
2,926,922, CANC. INT. CL. 42.  
2,926,980, CANC. INT. CL. 35.  
4,045,514, PUB. 8-9-2011. INT. CL. 41.
- FMT EQUIPMENT CORPORATION, HAMDEN, CT:  
1,656,080. REN. 9-17-11. INT. CL. 9.
- FNA IP HOLDINGS, INC., ELK GROVE VILLAGE, IL:  
4,046,566, INT. CL. 7.
- FOGAL AG, ZURICH, SWITZERLAND:  
1,182,242. REN. 9-21-11. INT. CL. 25.
- FOGLIA, OMAR H., CORAL SPRINGS, FL:  
4,045,470, PUB. 8-9-2011. INT. CL. 25.
- FOGLIZZO DI PAOLO FOGLIZZO & C. S.A.S., TORINO,  
ITALY:  
4,046,747, INT. CL. 40.
- FOMA BOHEMIA, SPOL. S R.O., 1604 CZ-501 04 HRADEC  
KRALOVÉ, CZECH REPUBLIC:  
4,043,766, PUB. 8-9-2011. INT. CL. 1.
- FONDATION A.R.C.A.D AIDE ET RECHERCHE EN CAN-  
CEROLOGIE DIGESTIVE, PARIS, FRANCE:  
4,046,173, INT. CL. 36.  
4,046,177, INT. CL. 36.
- FOOD FAMILY FARMING FOUNDATION, BOULDER, CO:  
4,044,390, PUB. 8-9-2011. INT. CL. 41.
- FOOD FOR LIFE BAKING CO., INC., CORONA, CA:  
2,495,131. REN. 9-21-11. INT. CL. 30.
- FOOD FOR THE POOR, INC., COCONUT CREEK, FL:  
2,506,504. REN. 9-19-11. INT. CL. 42.
- FOOD SHELTER HEALTH MINISTRY, DALLAS, TX:  
3,738,417, CANC. INT. CL. 45.
- FOOD SHELTER HEALTH MINISTRY INC., DALLAS, TX,  
DBA GLOBAL CHILDRENS VILLAGES FOR ORPHANS:  
3,697,241, CANC. INT. CL. 35.
- FOODEO.COM, INC., AUSTIN, TX:  
2,926,566, CANC. INT. CL. 41.
- FOOT LEVELERS, INC., ROANOKE, VA:  
4,046,941, INT. CL. 20.
- FOOT LOCKER RETAIL, INC., NEW YORK, NY:  
2,485,367. REN. 9-20-11. MULTIPLE CLASS, INT. CLS. 35  
AND 42.
- FOR WORLD PEACE PTE LTD, SINGAPORE, SINGAPORE:  
4,043,650, PUB. 8-9-2011. INT. CL. 41.
- FORD MOTOR COMPANY, DEARBORN, MI:  
921,826. REN. 9-21-11. U.S. CL. 15 (INT. CL. 4).
- FORD, JENNIFER A., HUNTINGTON BEACH, CA:  
4,045,444, PUB. 8-9-2011. INT. CL. 41.
- FOREST CONCEPTS, LLC, AUBURN, WA:  
4,045,867, INT. CL. 4.  
4,045,904, INT. CL. 4.
- FORETHOUGHT PTY LTD, MELBOURNE VIC, AUSTRALIA:  
4,044,251, PUB. 8-9-2011. INT. CL. 35.
- FORMAX, INC., MOKENA, IL:  
1,684,297. REN. 9-20-11. MULTIPLE CLASS, INT. CLS. 7  
AND 9.
- FORREST SOLUTIONS GROUP, NEW YORK, NY, DBA  
FSG:  
4,043,985, PUB. 8-9-2011. INT. CL. 35.
- FORSYTH OF CANADA, INC., MISSISSAUGA, CANADA:  
4,043,901, PUB. 8-9-2011. INT. CL. 25.
- FORTIFIBER CORPORATION, FERNLEY, NV:  
1,196,816. REN. 9-22-11. INT. CL. 19.  
1,199,560. REN. 9-22-11. INT. CL. 19.
- FORTRESS GLOBAL INVESTIGATIONS CORPORATION,  
GREAT NECK, NY:  
2,926,925, CANC. INT. CL. 45.
- FORTRESS TECHNOLOGY, INC., TORONTO, ON, CANA-  
DA:  
4,044,681, PUB. 8-9-2011. INT. CL. 9.
- FORTUNA'S SAUSAGE CO. LLC, SANDGATE, VT:  
4,044,676, PUB. 8-9-2011. INT. CL. 35.
- FORTUNATO, LAWRENCE J., ENCINO, CA:  
4,046,535, INT. CL. 25.
- FORTUNE FIVE CLOTHING, LLC, MIAMI, FL:  
4,046,111, INT. CL. 25.
- FOSECO INTERNATIONAL LIMITED, DERBYSHIRE S43  
4XA, UNITED KINGDOM:  
2,509,216. REN. 9-22-11. INT. CL. 19.  
2,514,177. REN. 9-22-11. INT. CL. 2.
- FOUND ANIMALS FOUNDATION, INC., LOS ANGELES,  
CA:  
4,045,585, MULTIPLE CLASS, INT. CLS. 35, 36, 41, 44  
AND 45.
- FOUNDATION CONSTRUCTION PAYROLL SERVICE,  
BRUNSWICK, OH, DBA PAYROLL4CONSTRUCTION.-  
COM:  
4,045,315, PUB. 8-9-2011. INT. CL. 35.
- FOUNDATION FOR INNOVATION AND INTERNET FREE-  
DOM, WASHINGTON, DC:  
4,047,162, MULTIPLE CLASS, INT. CLS. 35 AND 41.
- FOUNDATION HEALTHCARE AFFILIATES, LLC, OKLA-  
HOMA CITY, OK:  
4,045,634, INT. CL. 35.
- FOUNDATION RADIOLOGY, INC., PITTSBURGH, PA,  
FORMERLY TELERADIOLOGY HOLDINGS, INC.:  
4,045,384, PUB. 8-9-2011. INT. CL. 44.
- FOUNTAIN FACTORY, INC., DEER PARK, NY:  
2,926,331, CANC. INT. CL. 11.
- FOUNTAIN HILLS - HOLLYWOOD'S BODY AND PAINT,  
L.L.C., FOUNTAIN HILLS, AZ:  
2,473,470. REN. 9-19-11. INT. CL. 37.
- FOX SECURITY & COMMUNICATIONS, INC., ARNOLD,  
CA:  
2,597,147. REN. 9-21-11. INT. CL. 37.
- FRAGRANCE OF THE BAHAMAS LIMITED, FREEPORT,  
GRAND BAHAMA ISLAND, BAHAMAS:  
1,633,655. REN. 9-20-11. INT. CL. 3.
- FRAMED LEGACY, INC., BOISE, ID:  
4,044,467, PUB. 8-9-2011. INT. CL. 16.
- FRANK R. WALKER COMPANY, LISLE, IL:  
2,477,749. REN. 9-22-11. MULTIPLE CLASS, INT. CLS. 9,  
16 AND 35.
- FRANK V. SCIGLIANO, JR., DANVERS, MA:  
4,044,964, PUB. 8-9-2011. INT. CL. 8.
- FRANKLIN RESOURCES, INC., SAN MATEO, CA, DBA  
FRANKLIN TEMPLETON INVESTMENTS:  
4,045,187, PUB. 8-9-2011. INT. CL. 36.
- FRANSEN, CATHY LEE, IRVINE, CA:  
2,428,220, CANC. INT. CL. 35.
- FRANSEN, CATHY LEE, IRVIN, CA:  
2,428,221, CANC. INT. CL. 35.
- FRANVEST INTERNATIONAL, INC., SAN DIEGO, CA:  
4,044,005, PUB. 8-9-2011. INT. CL. 39.
- FRASER, KEITH, ANNAPOLIS, MD:  
4,045,446, PUB. 8-9-2011. INT. CL. 25.



FRATERNITY OF PHI GAMMA DELTA, INC., THE, LEXINGTON, KY, FRATERNITY OF PHI GAMMA DELTA, THE, WASHINGTON, DC:  
934,231. REN. 9-22-11. U.S. CL. 200.

FRAUM, COLLIN A., BOYNTON BEACH, FL, DBA DEJAM-VU, INC.:  
4,045,464. PUB. 8-9-2011. INT. CL. 38.

FRAUNHOFER USA, INC., CAMBRIDGE, MA:  
4,043,940. PUB. 8-9-2011. MULTIPLE CLASS, INT. CLS. 35 AND 42.

FRAUNHOFER-GESELLSCHAFT ZUR FÖRDERUNG DER ANGEWANDTEN FORSCHUNG E.V., 80686 MÜNCHEN, FED REP GERMANY:  
4,043,841. PUB. 8-9-2011. MULTIPLE CLASS, INT. CLS. 9, 41 AND 42.

FRED W. GRETSCH ENTERPRISES, LTD., POOLER, GA:  
2,542,629. REN. 9-18-11. INT. CL. 15.

FRED. OLSEN & CO., OSLO, NORWAY:  
721,442. REN. 9-17-11. U.S. CL. 105 (INT. CL. 39).

FREDERICK ALLAN LEPOW, EL CAJON, CA, DBA CDP CONSULTANTS:  
4,044,369. PUB. 8-9-2011. INT. CL. 9.

FREE FLITE, INC., MARIETTA, GA, DBA FREE-FLITE BICYCLES:  
4,045,369. PUB. 8-9-2011. INT. CL. 35.

FREEDOM INNOVATIONS, LLC, IRVINE, CA:  
4,046,495. INT. CL. 10.

FREEDOM PAY, INC., RADNOR, PA, FREEDOM PAY, INC., RADNOR, PA:  
2,428,132. REN. 9-20-11. INT. CL. 36.

FREI, GREGORY M., SALT LAKE CITY, UT, DBA ZERO GRAVITY:  
1,703,395. REN. 9-21-11. INT. CL. 25.

FREIXENET, S.A., BARCELONA, SPAIN:  
1,688,042. REN. 9-20-11. INT. CL. 33.

FREMONT INTERNATIONAL TRADING, INC., FREMONT, CA:  
2,604,543. REN. 9-16-11. INT. CL. 7.

FREQUENCY DESIGNS, INC., LAKESIDE, MT:  
2,926,829. CANC. INT. CL. 25.

FRESENIUS USA MARKETING, INC., WALTHAM, MA:  
2,519,989. REN. 9-22-11. INT. CL. 10.

FRESH TRADING LIMITED, LONDON, UNITED KINGDOM:  
4,043,929. PUB. 4-12-2011. MULTIPLE CLASS, INT. CLS. 29, 30 AND 32.

FRIED, FRANK, HARRIS, SHRIVER & JACOBSON LLP, NEW YORK, NY:  
2,430,826. REN. 9-21-11. MULTIPLE CLASS, INT. CLS. 16 AND 42.

FRIEDLER, FRANK, III, NEW ORLEANS, LA:  
2,555,209. REN. 9-20-11. INT. CL. 36.

FRIEL, ANTONY, TAMPA, FL:  
3,916,783 NEW CERT. 10-25-2011. INT. CL. 43.

FRIES GROUP LLC, TAMPA, FL, DBA HIREGY:  
4,044,798. PUB. 8-9-2011. INT. CL. 35.

FRITO-LAY NORTH AMERICA, INC., PLANO, TX:  
2,428,495. CANC. INT. CL. 30.  
2,926,666. CANC. MULTIPLE CLASS, INT. CLS. 29 AND 30.  
4,044,880. PUB. 8-9-2011. INT. CL. 43.  
4,046,813. MULTIPLE CLASS, INT. CLS. 29 AND 30.

FRITZ, CALEB J, BLOOMSBURG, PA AND FRITZ, JOSHUA C, BLOOMSBURG, PA:  
4,044,854. PUB. 8-9-2011. INT. CL. 41.

FROG SPRING - TU, INC., CHADDS FORD, PA:  
2,530,716. REN. 9-18-11. INT. CL. 42.

FRONIUS INTERNATIONAL GMBH, PETTENBACH, AUSTRIA, FRONIUS SCHWEISSMASCHINEN PRODUKTION GMBH & CO. KG, PETTENBACH, AUSTRIA:  
2,503,234. REN. 9-20-11. MULTIPLE CLASS, INT. CLS. 8, 9 AND 42.

FRONIUS SCHWEISSMASCHINEN PRODUKTION GMBH & CO. KG, PETTENBACH, AUSTRIA TO FRONIUS INTERNATIONAL GMBH, PETTENBACH, AUSTRIA:  
2,503,234. CANC. MULTIPLE CLASS, INT. CLS. 1 AND 6.

FRYD FOOD & DRINK, FRANCE:  
4,043,839. PUB. 8-9-2011. INT. CL. 33.

FRYE ELECTRONICS, INC., TIGARD, OR:  
2,495,629. REN. 9-16-11. INT. CL. 9.

FUENTE MARKETING LTD., PROVIDENCIALES, TURKS/CAICOS IS.:  
4,045,724. INT. CL. 34.

FUJI JUKOGYO KABUSHIKI KAISHA, SHINJUKU-KU, TOKYO, JAPAN, TA FUJI HEAVY INDUSTRIES LTD.:  
2,999,458. CANC. INT. CL. 9.

FUJITSU NETWORK COMMUNICATIONS, INC., RICHARDSON, TX:  
2,428,748. CANC. INT. CL. 9.

FULLER BRUSH COMPANY, INC., GREAT BEND, KS, MASURY-YOUNG COMPANY, CHARLESTOWN, BOSTON, MA:  
710,703. REN. 9-20-11. U.S. CL. 52 (INT. CL. 3).  
4,046,233. MULTIPLE CLASS, INT. CLS. 11 AND 37.

FUMAGALLI INDUSTRIA ALIMENTARI S.P.A., ITALY:  
4,043,868. PUB. 8-9-2011. INT. CL. 29.

FUMEX AB, SKELLEFTEA, SWEDEN:  
2,479,516. REN. 9-22-11. INT. CL. 11.

FUN AND FUNCTION LLC, MERION STATION, PA:  
4,046,271. INT. CL. 28.

FUNCOM GMBH, SWITZERLAND:  
4,043,797. PUB. 8-9-2011. MULTIPLE CLASS, INT. CLS. 9, 28 AND 41.

FURUNO ELECTRIC CO., LTD., NISHINOMIYA CITY, JAPAN:  
1,196,687. REN. 9-20-11. INT. CL. 9.

FUTURE STATE CONSULTING, INC, ALPHARETTA, GA:  
4,044,200. PUB. 8-9-2011. INT. CL. 35.

FUZZI S.P.A., SAN GIOVANNI IN MARGNANO (RIMINI), ITALY:  
2,489,920. REN. 9-20-11. MULTIPLE CLASS, INT. CLS. 18 AND 25.

G. G. PROPERTIES, LTD., HAMILTON, BERMUDA:  
2,612,209. REN. 9-16-11. INT. CL. 42.

G&G GOURMET, INC., DURHAM, NC:  
2,602,369. REN. 9-16-11. INT. CL. 30.

GABAI, ILAN Y, NEW YORK, NY:  
4,045,239. PUB. 8-9-2011. INT. CL. 25.

GABET, RENEE A., LIGONIER, IN:  
2,488,420. REN. 9-17-11. INT. CL. 3.

GABRIEL SKIN CARE DISTRIBUTORS, INC., WESTLAKE, OH:  
2,441,495. REN. 9-21-11. INT. CL. 5.

GABRIELLE STUDIO, INC., NEW YORK, NY:  
4,044,267. PUB. 8-9-2011. INT. CL. 25.

GAIAM, INC., LOUISVILLE, CO, GAIAM INTERNATIONAL, INC., VENICE, CA:  
2,532,828. REN. 9-20-11. INT. CL. 28.

GAIN CAPITAL GROUP, LLC, BEDMINSTER, NJ, DBA FOREX.COM:  
4,045,178. PUB. 8-9-2011. INT. CL. 36.

GAINES MANUFACTURING, INC., POWAY, CA:  
2,510,471. REN. 9-19-11. INT. CL. 6.

GALA INDUSTRIES, INC., EAGLE ROCK, VA:  
4,045,683. INT. CL. 7.

GANN, JONATHAN R, TULSA, OK:  
4,045,049. PUB. 8-9-2011. INT. CL. 42.

GANSCHOW, TIMOTHY C, CHICAGO, IL:  
4,046,361. INT. CL. 42.

GARDEN STATE HEALTH SYSTEMS INC, NEWARK, NJ:  
4,045,327. PUB. 8-9-2011. INT. CL. 38.

GARDENING KNOW HOW LLC, BEDFORD, OH:  
4,045,054. PUB. 8-9-2011. INT. CL. 41.

GARDNER LANDRY COMMUNICATIONS LP, HOUSTON, TX:  
4,046,875. INT. CL. 25.  
4,046,876. INT. CL. 25.  
4,046,877. INT. CL. 25.

GARLAND COMMERCIAL RANGES LIMITED, MISSISSAUGA, ONTARIO, CANADA:  
2,487,552. REN. 9-16-11. INT. CL. 11.

GARLAND KATHLEEN G, MONROVIA, CA, DBA KATE | YOGA:  
4,044,843. PUB. 8-9-2011. INT. CL. 41.

- GARSH, DDS, DONALD R., PALM SPRINGS, CA:  
4,047,006, INT. CL. 25.
- GARY D. MOLINE, SAN DIMAS, CA:  
2,927,063, CANC. INT. CL. 7.
- GARY NULL & ASSOCIATES, INC., NEW YORK, NY:  
2,927,012, CANC. INT. CL. 30.
- GATEWAY LOAN REVIEW, LLC, BIRMINGHAM, MI:  
4,044,756, PUB. 8-9-2011. INT. CL. 42.
- GATTACA, L.L.C., BEND, OR:  
2,482,410, REN. 9-20-11. INT. CL. 14.
- GE CAPITAL AVIATION TRAINING LIMITED, WEST SUSSEX, UNITED KINGDOM:  
2,926,805, CANC. INT. CL. 35.
- GEA POWER COOLING, INC., LAKEWOOD, CO:  
2,421,728, REN. 9-20-11. INT. CL. 11.
- GECKO TRADING COMPANY, INC., MAKAWAO, HI:  
2,482,688, REN. 9-22-11. INT. CL. 34.
- GEISINGER SYSTEM SERVICES, DANVILLE, PA:  
4,046,428, MULTIPLE CLASS, INT. CLS. 35, 38, 44 AND 45.
- GEISSELE AUTOMATICS LLC, NORRISTOWN, PA:  
4,047,129, INT. CL. 35.
- GELDA SCIENTIFIC AND INDUSTRIAL DEVELOPMENT CORPORATION, MISSISSAUGA, ONTARIO, CANADA:  
2,510,767, REN. 9-21-11. INT. CL. 5.
- GEMGROUP, INC., PITTSBURGH, PA:  
2,511,552, REN. 9-21-11. INT. CL. 36.  
2,511,553, REN. 9-22-11. INT. CL. 36.
- GEMINI FINE FOODS LTD, LONDON, UNITED KINGDOM:  
4,046,793, INT. CL. 31.
- GENER, MATTHEW, FREEHOLD, NJ:  
4,044,347, PUB. 8-9-2011. INT. CL. 41.
- GENERAL BEARING CORPORATION, WEST NYACK, NY:  
1,158,822, REN. 9-20-11. INT. CL. 7.
- GENERAL BINDING CORPORATION, LINCOLNSHIRE, IL:  
2,489,278, REN. 9-20-11. INT. CL. 16.
- GENERAL BINDING CORPORATION, NORTHBROOK, IL:  
2,926,658, CANC. INT. CL. 17.
- GENERAL BOARD OF PENSION AND HEALTH BENEFITS OF THE UNITED METHODIST CHURCH, INCORPORATED IN ILLINOIS, EVANSTON, IL:  
4,046,078, INT. CL. 36.
- GENERAL ECONOPAK, INC., PHILADELPHIA, PA:  
2,491,899, REN. 9-22-11. INT. CL. 10.
- GENERAL FINANCIAL SUPPLY, INC., MIDLOTHIAN, TX:  
4,046,333, INT. CL. 35.
- GENERAL MILLS, INC., MINNEAPOLIS, MN:  
4,046,360, INT. CL. 29.  
4,046,599, INT. CL. 43.
- GENERAL MOTORS LLC, DETROIT, MI:  
4,046,716, INT. CL. 12.
- GENERAL PENCIL COMPANY, JERSEY CITY, NJ:  
2,277,594, COR. INT. CL. 3.  
3,026,314, COR. INT. CL. 16.
- GENERAL PLASTIC INDUSTRIAL CO., LTD., TAICHUNG COUNTY, TAIWAN:  
2,926,996, CANC. INT. CL. 2.
- GENESIS ADVISERS LLC, NEWTON, MA:  
4,047,061, MULTIPLE CLASS, INT. CLS. 16 AND 41.
- GENESIS LENDING SERVICES, INC., BEAVERTON, OR:  
4,044,804, PUB. 8-9-2011. INT. CL. 36.
- GENETICS & IVF INSTITUTE, FAIRFAX, VA:  
4,045,999, INT. CL. 44.
- GENIUS CENTER, THE, MONTEBELLO, VA:  
2,926,867, CANC. INT. CL. 41.
- GENMARK DIAGNOSTICS, INC., CARLSBAD, CA:  
4,045,934, MULTIPLE CLASS, INT. CLS. 1, 5 AND 10.
- GENOMMA LAB INTERNACIONAL, S.A.B. DE C.V., C.P., MEXICO:  
4,043,670, PUB. 8-9-2011. INT. CL. 5.
- GENTEX CORPORATION, CARBONDALE, PA:  
1,180,162, REN. 9-17-11. INT. CL. 17.
- GENUINE FIRST AID, CLEARWATER, FL:  
4,045,349, PUB. 8-9-2011. MULTIPLE CLASS, INT. CLS. 5 AND 10.
- GENZYME THERAPEUTIC PRODUCTS LIMITED PARTNERSHIP, CAMBRIDGE, MA:  
2,528,286, REN. 9-19-11. INT. CL. 5.
- GEO. A. MORLAN PLUMBING & APPLIANCE CO., PORTLAND, OR:  
4,045,654, INT. CL. 11.
- GEO. M. MARTIN COMPANY, EMERYVILLE, CA:  
2,485,320, REN. 9-20-11. INT. CL. 7.
- GEOGRAPHIC EXPEDITIONS, INC., SAN FRANCISCO, CA:  
2,470,618, REN. 9-20-11. INT. CL. 16.  
2,470,618, COR. INT. CL. 16.
- GEOPHYSICAL RESEARCH, LLC, HOUSTON, TX:  
4,046,485, MULTIPLE CLASS, INT. CLS. 41 AND 42.
- GEORGE W. EVANS & ASSOCIATES, INC., HOUSTON, TX:  
4,045,401, PUB. 8-9-2011. INT. CL. 36.
- GEORGIA CREDIT UNION AFFILIATES, INC., DULUTH, GA:  
4,044,554, PUB. 8-9-2011. INT. CL. 41.
- GEORGIA-PACIFIC CHEMICALS LLC, ATLANTA, GA:  
2,926,827, CANC. INT. CL. 1.
- GEORGIA-PACIFIC CONSUMER PRODUCTS LP, ATLANTA, GA:  
4,043,736, PUB. 8-9-2011. INT. CL. 21.
- GEORGIA-PACIFIC LLC, ATLANTA, GA:  
1,198,717, REN. 9-20-11. INT. CL. 16.
- GERARDO GUSTAVO HERNANDEZ VEGA., TEPATITLAN, JALISCO., MEXICO:  
4,047,134, INT. CL. 33.
- GERON, PHILIP, WESTFIELD, NJ:  
4,045,339, PUB. 8-9-2011. INT. CL. 41.
- GERRING, BETHANN, WOODSTOCK, GA:  
4,044,828, PUB. 8-9-2011. INT. CL. 41.
- GERTEIS, PAUL, CH-8645 JONA, SWITZERLAND:  
2,533,539, REN. 9-18-11. INT. CL. 7.
- GESUND, INC., COLUMBUS, OH, DBA NOLAN HOOF HEALTH:  
4,044,242, PUB. 8-9-2011. INT. CL. 10.  
4,044,243, PUB. 8-9-2011. INT. CL. 10.
- GET FLIPPED!, INC., ORANGE, CA:  
2,927,026, CANC. INT. CL. 40.
- GET OUTDOORS HUNTING, LLC, VASSAR, MI:  
2,926,738, CANC. INT. CL. 28.
- GETTY HEIGHTS, LLC, ARMONK, NY:  
4,047,120, INT. CL. 35.
- GFY BEVERAGES COMPANY, NEW YORK, NY:  
2,498,605, REN. 9-18-11. INT. CL. 33.
- GHENT MANUFACTURING, INC., LEBANON, OH:  
2,609,744, REN. 9-21-11. INT. CL. 16.
- GIANT BICYCLE, INC., RANCHO DOMINGUEZ, CA:  
2,492,235, REN. 9-21-11. INT. CL. 12.
- GIBSON GUITAR CORP., NASHVILLE, TN, NORLIN INDUSTRIES, INC., LINCOLNWOOD, IL:  
1,167,202, REN. 9-20-11. INT. CL. 15.
- GIBSON, GREGORY R., COUNCIL BLUFF, IA:  
2,926,775, CANC. INT. CL. 16.
- GIGASTONE CORPORATION, TAIPEI CITY, TAIWAN:  
4,046,377, INT. CL. 9.
- GILBERT CONSULTING GROUP, LLC, KANSAS CITY, MO:  
2,522,431, REN. 9-22-11. INT. CL. 36.
- GILL, TAMARA D., UPPER MARLBORO, MD, DBA LOVII:  
4,045,922, INT. CL. 3.
- GILSTER-MARY LEE CORPORATION, CHESTER, IL:  
2,491,298, REN. 9-21-11. INT. CL. 30.
- GIS CLOUD LTD, LONDON, UNITED KINGDOM:  
4,047,161, INT. CL. 42.
- GLAMROCK.COM LLC, MIAMI, FL:  
4,046,442, INT. CL. 35.
- GLAMWORKS, LLC, HEMPSTEAD, NY:  
4,046,783, INT. CL. 44.
- GLENEAGLES OF EDINBURGH LIMITED, BROXBURN, WEST LOTHIAN, UNITED KINGDOM:  
2,926,300, CANC. INT. CL. 21.
- GLENN O. HAWBAKER, INC., STATE COLLEGE, PA:  
3,118,001, CANC. INT. CL. 40.
- GLOBAL ANIMAL PARTNERSHIP, WASHINGTON, DC:  
4,045,631, INT. CL. 29.

GLOBAL ENERGY RESEARCH & DEVELOPMENT, INC., OSTEEN, FL, DBA TRAVIS H EGGERICHS:  
4,045,698, INT. CL. 1.

GLOBAL EVANGELISM TELEVISION, INC., SAN ANTONIO, TX:  
1,155,427, REN. 9-20-11. INT. CL. 41.  
1,155,427, CANC. INT. CL. 9.

GLOBAL HEALTH AND INFORMATION SERVICES CORPORATION, CARSON, CA:  
4,044,531, PUB. 8-9-2011. INT. CL. 5.

GLOBAL LOCATE, INC., IRVINE, CA:  
2,926,499, CANC. INT. CL. 9.

GLOBAL LOSS CONSULTANTS, INC., BOCA RATON, FL:  
4,044,236, PUB. 8-9-2011. INT. CL. 36.

GLOBAL MARINE TRAVEL LLC, FT. LAUDERDALE, FL:  
4,044,426, PUB. 8-9-2011. INT. CL. 39.

GLOBAL POLICY SOLUTIONS, LLC, WASHINGTON, DC:  
4,045,226, PUB. 8-9-2011. INT. CL. 35.

GLOBAL WINE CONCEPTS, INC., ST. HELENA, CA, DBA JT WINES:  
4,044,663, PUB. 8-9-2011. INT. CL. 33.

GLOBE WIRELESS, LLC, PALM BAY, FL:  
4,044,112, PUB. 8-9-2011. INT. CL. 38.

GLOBEFILL INCORPORATED, KINGSTON, ONTARIO, CANADA:  
4,043,730, PUB. 8-9-2011. INT. CL. 33.

GMA ACCESSORIES, INC., NEW YORK, NY:  
2,561,025, REN. 9-17-11. INT. CL. 9.

GNAGY, ALAN, EDMOND, OK:  
4,044,513, PUB. 8-9-2011. INT. CL. 37.

GO GIRL SPORT, LLC, PHOENIX, AZ:  
4,045,844, INT. CL. 25.

GODADDY.COM, INC., SCOTTSDALE, AZ:  
4,047,012, INT. CL. 42.

GODIGITAL RECORDS, LLC, SANTA MONICA, CA, DBA GODIGITAL MEDIA GROUP:  
4,044,035, PUB. 8-9-2011. INT. CL. 41.

GODSPEAKS, INC., ATLANTA, GA:  
2,575,123, REN. 9-16-11. INT. CL. 42.  
2,575,124, REN. 9-16-11. INT. CL. 42.  
2,611,340, REN. 9-16-11. INT. CL. 42.

GOGO SPORTS, INC., HAYWARD, CA:  
3,930,336, CANC. INT. CL. 25.  
4,046,823, INT. CL. 25.

GOH, SUA HUAT, PUCHONG, SELANGOR, MALAYSIA:  
4,046,795, INT. CL. 41.

GOINS, JERAY, NEWPORT BEACH, CA:  
4,046,852, INT. CL. 9.

GOLDEN BIOTECHNOLOGY CORPORATION, TAIPEI COUNTY, TAIWAN:  
4,044,164, PUB. 8-9-2011. INT. CL. 5.  
4,046,780, INT. CL. 5.

GOLDEN DISTILLERY, BOW, WA:  
4,046,306, INT. CL. 33.

GOLDEN FLOWER TRADING, LLC, LONE TREE, CO:  
4,047,068, INT. CL. 30.

GOLDEN PHEASANT FOODS, LLC, KENT, WA:  
2,508,086, REN. 9-20-11. INT. CL. 30.

GOLDEN STAR CORP, NEW YORK, NY:  
4,045,534, PUB. 8-9-2011. INT. CL. 9.

GOLF ETC. OF AMERICA, INC., GRANBURY, TX:  
4,044,166, PUB. 8-9-2011. INT. CL. 25.

GONZALEZ, LUCINA, SAN DIEGO, CA AND GONZALEZ, JOSE VALENTINO, SAN DIEGO, CA:  
4,045,295, PUB. 8-9-2011. INT. CL. 41.

GONZALEZ, WILLIAM, FRAMINGHAM, MA, DBA DASHING PHOTOGRAPHY:  
4,046,990, INT. CL. 41.

GOOD BEAD, INC., THE, MINNETONKA, MN:  
4,045,609, INT. CL. 14.

GOOD EATS, LLC, MILL VALEY, CA:  
4,046,059, INT. CL. 43.

GOOD SHEPHERD MINISTRIES INTERNATIONAL, SAN BERNARDINO, CA:  
2,491,566, REN. 9-22-11. MULTIPLE CLASS, INT. CLS. 9 AND 16.

GOODBABY CHILD PRODUCTS CO., LTD., CHINA:  
4,043,782, PUB. 8-9-2011. MULTIPLE CLASS, INT. CLS. 12, 20 AND 28.

GOODSON'S ALL TERRAIN LOGGING, INC., JACKSONVILLE, NC:  
4,044,470, PUB. 8-9-2011. INT. CL. 25.  
4,044,488, PUB. 8-9-2011. INT. CL. 40.

GOODWILL INDUSTRIES, INC., OMAHA, NE:  
4,045,507, PUB. 8-9-2011. INT. CL. 35.

GORDON FOOD SERVICE, INC., GRAND RAPIDS, MI:  
2,926,979, CANC. INT. CL. 29.

GOUGHNOUR, SHEILA A, FARGO, ND, DBA FARGO IMPORTS:  
4,047,163, INT. CL. 5.

GOULD, MAX ADAM, BROOKLYN, NY:  
4,044,909, PUB. 8-9-2011. MULTIPLE CLASS, INT. CLS. 25 AND 35.

GOVDELIVERY, INC., ST. PAUL, MN:  
4,044,080, PUB. 8-9-2011. INT. CL. 42.

GOVERNOR AND COMPANY OF ADVENTURERS OF ENGLAND TRADING INTO HUDSON'S BAY, THE, TORONTO, ONTARIO, CANADA, AKA HUDSON'S BAY COMPANY:  
1,164,906, REN. 9-21-11. INT. CL. 36.

GP INVESTIMENTI S.R.L., FLORENCE, ITALY:  
4,046,550, INT. CL. 10.

GRACE STYLING INCORPORATED, SAN DIEGO, CA:  
4,044,483, PUB. 8-9-2011. INT. CL. 45.

GRACO MINNESOTA INC., MINNEAPOLIS, MN:  
4,046,282, INT. CL. 7.

GRADUA NETWORKS INFORMÁTICA LTDA, BRASÍLIA, BRAZIL:  
4,046,257, INT. CL. 41.

GRADY, MICHAEL, MANHATTAN BEACH, CA:  
4,046,352, INT. CL. 20.

GRAHAM & BUFFETT, LTD., PLANO, TX:  
4,047,049, INT. CL. 35.

GRAIN FREE PLANET, LLC, CENTENNIAL, CO:  
4,045,931, INT. CL. 5.

GRAIN TO GREEN, CARLSBAD, CA:  
4,043,682, PUB. 8-9-2011. INT. CL. 32.

GRAINGER ALLAN, RICHMOND, VA:  
4,043,652, PUB. 8-9-2011. MULTIPLE CLASS, INT. CLS. 35 AND 41.

GRAND VISION GAMING, LLC, BILLINGS, MT:  
4,046,572, INT. CL. 9.  
4,046,665, INT. CL. 9.

GRANDE SHORES RENTALS, LLC, NORTH MYRTLE BEACH, SC:  
4,044,882, PUB. 8-9-2011. MULTIPLE CLASS, INT. CLS. 36 AND 43.

GRANT PROFESSIONALS FOUNDATION, KANSAS CITY, KS, AKA GPF:  
4,044,329, PUB. 8-9-2011. INT. CL. 36.

GRAPHIC SOLUTIONS INC. LLC, HIXSON, TN:  
4,046,558, INT. CL. 42.

GRAPHIK DIMENSIONS LIMITED, HIGH POINT, NC:  
2,612,530, REN. 9-22-11. INT. CL. 20.

GRAYDAZE CONTRACTING, INC., ALPHARETTA, GA:  
4,047,116, MULTIPLE CLASS, INT. CLS. 9 AND 42.

GREAT RIVER MEDICAL CENTER, WEST BURLINGTON, IA:  
4,045,141, PUB. 8-9-2011. INT. CL. 44.

GREATER CLEVELAND AUTOMOBILE DEALERS' ASSOCIATION, BRECKSVILLE, OH:  
4,044,017, PUB. 8-9-2011. INT. CL. 35.  
4,044,022, PUB. 8-9-2011. INT. CL. 35.

GREELEY, ALAN R., COSTA MESA, CA:  
2,428,225, CANC. INT. CL. 42.

GREEN CLEAN, LLC, COCOA, FL:  
4,044,690, PUB. 8-9-2011. INT. CL. 35.

GREEN DAY, INC., SAN RAFAEL, CA:  
4,045,648, INT. CL. 16.

GREEN DOT CORPORATION, MONROVIA, CA:  
2,926,721, CANC. INT. CL. 9.

GREEN, TED, COLUMBUS, OH AND REFUEL ENVIRONMENTAL SERVICES, LLC, COLUMBUS, OH:  
2,577,174, REN. 9-20-11. INT. CL. 37.

GREENARAMA, CINCINNATI, OH:  
4,046,276, INT. CL. 35.

- GREENARRAYS, INC., INCLINE VILLAGE, NV:  
4,045,357, PUB. 8-9-2011. INT. CL. 9.
- GREENBERG, YAEL, NEW ROCHELLE, NY:  
4,044,288, PUB. 8-9-2011. INT. CL. 41.
- GREENE, RHAMELLE M., ENGLEWOOD, NJ:  
4,045,787, MULTIPLE CLASS, INT. CLS. 9, 25 AND 41.
- GREENFIELD SOLAR CORP., NORTH RIDGEVILLE, OH:  
4,043,995, PUB. 8-9-2011. INT. CL. 9.  
4,043,996, PUB. 8-9-2011. MULTIPLE CLASS, INT. CLS. 9  
AND 37.
- GREENGRAFFITI HOLDING BESLOTEN VEN-  
NOOTSCHAP, NL-1015 LZ AMSTERDAM, NETHER-  
LANDS:  
4,043,743, PUB. 8-9-2011. MULTIPLE CLASS, INT. CLS. 35  
AND 40.
- GREENLEE TEXTRON INC., ROCKFORD, IL:  
2,436,461. REN. 9-22-11. INT. CL. 9.
- GREENLIGHT BIOFUELS HOLDINGS, LLC, CHARLOT-  
TESVILLE, VA, DBA GREENLIGHT BIOFUELS:  
4,044,749, PUB. 8-9-2011. MULTIPLE CLASS, INT. CLS. 37  
AND 40.
- GREENTECH ENVIRONMENTAL, GRAY, TN:  
4,046,426, INT. CL. 11.
- GREENWOOD, INC., DANVILLE, IL, DBA GREENWOOD  
PLASTICS CO.:  
4,045,699, INT. CL. 19.
- GREER LABORATORIES, INC., LENOIR, NC:  
4,046,031, MULTIPLE CLASS, INT. CLS. 5, 10 AND 44.  
4,046,070, MULTIPLE CLASS, INT. CLS. 5, 10 AND 44.  
4,046,112, INT. CL. 10.
- GREGORY P ORTMAN, CENTRAL CITY, PA, DBA GREG  
ORTMAN GOLF SCHOOLS:  
4,045,290, PUB. 8-9-2011. INT. CL. 41.
- GRETCHEN BELLINGER INC., COHES, NY:  
1,185,852. REN. 9-16-11. INT. CL. 24.
- GRETEL INC., NEW YORK, NY:  
4,044,634, PUB. 8-9-2011. MULTIPLE CLASS, INT. CLS.  
35, 41 AND 42.
- GRIDIRON VENTURES, LLC, CHAPEL HILL, NC:  
4,046,691, INT. CL. 38.
- GRIFFIN, KEVIN E., BERKELEY, CA:  
2,927,030, CANC. INT. CL. 41.
- GRIGGS, MARK, SMITHFIELD, NC:  
4,044,530, PUB. 8-9-2011. INT. CL. 41.
- GRILL GROOMERS, LLC, SCOTTSDALE, AZ:  
4,047,206, INT. CL. 37.
- GRIMCO, INC., FENTON, MO:  
4,046,050, INT. CL. 20.
- GRIZZLY INDUSTRIAL, INC., BELLINGHAM, WA:  
2,606,142. REN. 9-21-11. INT. CL. 7.
- GROBET FILE CO. OF AMERICA, INC., CARLSTADT, NJ:  
1,650,534. REN. 9-19-11. INT. CL. 3.
- GROHE AG, 58675 HEMER, FED REP GERMANY:  
4,043,920, PUB. 2-22-2011. INT. CL. 11.
- GROS, EUGENE, W., WHITE CITY, OR:  
4,047,184, INT. CL. 12.
- GROUP KAITU, LLC, RICHMOND, VA:  
4,045,658, INT. CL. 42.
- GROWSEED AG, VADUZ, LIECHTENSTEIN:  
1,201,345, CANC. INT. CL. 30.
- GROWTHINCOME RESEARCH & MANAGEMENT LLC,  
TOWSON, MD:  
4,044,408, PUB. 8-9-2011. INT. CL. 36.
- GRUPO OMNILIFE, S.A. DE C.V., GUADALAJARA, JALIS-  
CO, MEXICO:  
4,045,825, INT. CL. 5.
- GRUV INC., YORBA LINDA, CA:  
4,046,555, INT. CL. 12.
- GUADALUPE CULTURAL ARTS CENTER, SAN ANTONIO,  
TX:  
1,675,385. REN. 9-20-11. INT. CL. 41.
- GUANGDONG FOODSTUFFS IMPORT & EXPORT  
(GROUP) CORPORATION, GUANGZHOU, CHINA:  
2,475,013. REN. 9-20-11. MULTIPLE CLASS, INT. CLS. 29,  
30 AND 33.
- GUANLAN NETWORKS (HANG ZHOU) CO., LTD, HANG-  
ZHOU, CHINA:  
4,046,745, MULTIPLE CLASS, INT. CLS. 35 AND 42.
- GUERLAIN S.A., 75008 PARIS, FRANCE:  
2,479,302. REN. 9-20-11. INT. CL. 3.
- GUESS?, INC., LOS ANGELES, CA:  
4,044,455, PUB. 8-9-2011. INT. CL. 14.
- GUIDO, RICHARD, LOS ANGELES, CA:  
4,044,478, PUB. 8-9-2011. INT. CL. 25.
- GUJAR, SUBHASH, PUNE, MAHARASHTRA, INDIA:  
4,046,117, INT. CL. 14.
- GUSTERMAN INCORPORATED, SANTA FE, NM, DBA  
GUSTERMANS:  
4,043,979, PUB. 8-9-2011. INT. CL. 35.
- GUY TAKAYAMA, WESTMINSTER, CA, DBA GUY TA-  
KAYAMA:  
4,044,039, PUB. 8-9-2011. MULTIPLE CLASS, INT. CLS. 25  
AND 28.
- GXI OUTDOOR POWER LLC, CLAYTON, NC:  
4,044,670, PUB. 8-9-2011. INT. CL. 7.
- GYROS PRECISION TOOLS, INC., MONSEY, NY:  
2,455,818. REN. 9-16-11. MULTIPLE CLASS, INT. CLS. 7  
AND 8.  
2,455,818, CANC. INT. CL. 16.
- G2 DISTRIBUTORS, INC., CANTON, GA:  
4,046,937, INT. CL. 21.
- G4 HOLDINGS, INC., LEWISTON, ME:  
4,047,024, INT. CL. 35.
- G9 TURF, INC., HAUPPAUGE, NY:  
4,045,905, INT. CL. 27.
- H & S BAKERY, INC., BALTIMORE, MD:  
4,046,801, INT. CL. 30.
- H & W ATTACHMENTS, L.L.C., BOERNE, TX:  
4,044,868, PUB. 8-9-2011. INT. CL. 7.
- H-D MICHIGAN, LLC, ANN ARBOR, MI:  
2,535,179. REN. 9-21-11. INT. CL. 12.  
2,535,179, CANC. INT. CL. 25.
- HADMARK, INC., AUSTIN, TX:  
4,045,115, PUB. 8-9-2011. INT. CL. 41.
- HAGEN, STEPHEN M, JUNCTION CITY, OR, DBA OLD  
SCHOOL VINEYARDS:  
4,045,880, INT. CL. 33.
- HAIMOVICI, ALEK, SANTA BARBARA, CA:  
4,043,685, PUB. 8-9-2011. INT. CL. 41.
- HAIR COLOR RESEARCH GROUP, INC., FLUSHING, NY:  
4,044,423, PUB. 8-9-2011. INT. CL. 3.
- HAIRSTYLISTS MANAGEMENT SYSTEMS, INC., PLY-  
MOUTH, MN:  
2,491,270. REN. 9-21-11. INT. CL. 42.
- HAL LEONARD CORPORATION, MILWAUKEE, WI:  
2,474,423. REN. 9-21-11. INT. CL. 16.
- HALE PRODUCTS, INC., CONSHOHOCKEN, PA:  
4,046,851, INT. CL. 7.
- HALL COMMUNICATIONS, INC., LAKELAND, FL:  
4,044,343, PUB. 8-9-2011. INT. CL. 38.
- HALLELUJAH ACRES, INC., SHELBY, NC:  
4,045,912, MULTIPLE CLASS, INT. CLS. 5, 9, 16, 32, 35, 41  
AND 43.  
4,045,915, MULTIPLE CLASS, INT. CLS. 5, 9, 16, 32, 35, 41  
AND 43.  
4,045,917, MULTIPLE CLASS, INT. CLS. 5, 9, 16, 32, 35, 41  
AND 43.
- HALLIBURTON ENERGY SERVICES, INC., CARROLL-  
TON, TX, N L INDUSTRIES, INC., NEW YORK, NY:  
1,191,900. REN. 9-20-11. INT. CL. 1.
- HALLIBURTON ENERGY SERVICES, INC., CARROLL-  
TON, TX:  
4,045,759, INT. CL. 42.
- HAMADE, CHARLES, ENGLEWOOD, NJ:  
4,044,194, PUB. 5-3-2011. INT. CL. 30.
- HAMILTON, RICHARD A, LOS ANGELES, CA:  
4,043,676, PUB. 8-9-2011. INT. CL. 16.
- HAMMAN, CHARLES J, CHICAGO, IL:  
4,046,274, INT. CL. 5.
- HAMPTON, DASHAE D., ALBUQUERQUE, NM:  
4,044,774, PUB. 8-9-2011. INT. CL. 41.
- HANANEEL, INDIANAPOLIS, IN:  
4,045,958, U.S. CL. 200.
- HANCOR, INC., FINDLAY, OH:  
4,043,727, PUB. 8-9-2011. INT. CL. 17.

HANDI-FOIL CORP., WHEELING, IL:  
2,489,426. REN. 9-22-11. INT. CL. 6.

HANGAR 24 CRAFT BREWERY, LLC, REDLANDS, CA:  
4,046,866. INT. CL. 32.

HANLEY-WOOD, LLC, WASHINGTON, DC, WESTERN  
FLOOR COVERING ASSOCIATION, ANAHEIM, CA:  
1,663,619. REN. 9-21-11. INT. CL. 35.

HANNA INSTRUMENTS, INC., WOONSOCKET, RI:  
2,427,953. CANC. INT. CL. 9.

HANNON GROUP LTD., BURLINGTON, WI:  
4,047,035. INT. CL. 21.

HANOVER COMPANY STORE, LLC, WEEHAWKEN, NJ:  
4,045,990. INT. CL. 35.  
4,045,991. INT. CL. 24.

HANSEN BEVERAGE COMPANY, CORONA, CA:  
4,045,785. INT. CL. 32.

HAOXIANGNI JUJUBE INDUSTRY CO., LTD., HENAN  
PROVINCE, CHINA:  
4,043,988. PUB. 8-9-2011. INT. CL. 29.

HARALD KOFLER, OAKDALE, PA:  
4,045,262. PUB. 8-9-2011. INT. CL. 22.

HARBISON-WALKER REFACTORIES COMPANY, MOON  
TOWNSHIP, PA, DRESSER INDUSTRIES, INC., DALLAS,  
TX:  
1,167,323. REN. 9-20-11. INT. CL. 19.

HARCOURT ACHIEVE INC., AUSTIN, TX:  
2,428,222. CANC. INT. CL. 16.

HARDING, DAVID, EDINA, MN:  
4,046,657. INT. CL. 35.

HARLAN ESTATE WINERY, INC., OAKVILLE, CA:  
2,538,117. REN. 9-18-11. INT. CL. 33.

HARLAND CLARKE CORP., SAN ANTONIO, TX:  
4,044,496. PUB. 8-9-2011. INT. CL. 16.  
4,044,498. PUB. 8-9-2011. INT. CL. 16.

HARLAND FINANCIAL SOLUTIONS, INC., PORTLAND,  
OR:  
2,529,223. REN. 9-21-11. INT. CL. 42.

HARLENE ELLIN, RIVER FOREST, IL:  
4,046,593. INT. CL. 41.

HARMAN INTERNATIONAL INDUSTRIES INCORPORATED,  
NORTHBRIDGE, CA, HARMAN-KARDON, IN-  
CORPORATED, PLAINVIEW, NY:  
1,166,266. REN. 9-22-11. INT. CL. 9.

HARPER INTERNATIONAL CORPORATION, LANCASTER,  
NY:  
4,047,039. INT. CL. 11.

HARRIS CANADA SYSTEMS, INC., TORONTO, CANADA:  
1,656,070. REN. 9-20-11. INT. CL. 9.

HARRIS CORPORATION, MELBOURNE, FL:  
2,428,071. CANC. INT. CL. 9.  
2,428,351. CANC. INT. CL. 9.

HARRIS ESCHER VINEYARDS LLC, RUTHERFORD, CA:  
4,047,115. INT. CL. 33.

HARRIS GROUP INC., SEATTLE, WA:  
1,649,837. REN. 9-22-11. MULTIPLE CLASS, INT. CLS. 37  
AND 42.  
1,661,096. REN. 9-22-11. MULTIPLE CLASS, INT. CLS. 37  
AND 42.

HARRIS SOUP CO., THE, PORTLAND, OR:  
2,524,452. REN. 9-16-11. INT. CL. 30.

HARRIS TEETER, INC., MATTHEWS, NC:  
4,047,135. INT. CL. 35.

HARRIS TRAINING SYSTEMS LLC, LIBERTYVILLE, IL:  
4,046,267. INT. CL. 41.

HARRIS, DIANE M., MOORPARK, CA AND HARRIS,  
JIMMY WAYNE, MOORPARK, CA:  
4,045,298. PUB. 8-9-2011. INT. CL. 41.

HARRIS, IAN, CHICAGO, IL:  
2,483,985. REN. 9-22-11. INT. CL. 35.

HARRIS, KENNETH, MONTREAL, CANADA:  
4,045,824. INT. CL. 35.

HARTFORD FIRE INSURANCE COMPANY, HARTFORD,  
CT:  
2,477,372. REN. 9-21-11. INT. CL. 36.

HARTGER, RICHARD W., GRAND RAPIDS, MI:  
2,618,861. REN. 9-20-11. INT. CL. 9.

HARTMANN USA, INC., ROCK HILL, SC:  
4,045,731. INT. CL. 5.  
4,045,732. INT. CL. 5.

HARVARD MAINTENANCE, INC., NEW YORK, NY:  
4,046,952. INT. CL. 37.  
4,046,954. INT. CL. 37.  
4,046,955. INT. CL. 37.  
4,046,956. INT. CL. 45.  
4,046,958. MULTIPLE CLASS, INT. CLS. 37 AND 45.  
4,046,959. MULTIPLE CLASS, INT. CLS. 35, 37 AND 45.

HARVEY NEIL ANTHONY, BENTON, ME, AKA BLAINE  
ANTHONY:  
4,044,348. PUB. 8-9-2011. INT. CL. 41.

HARWICK STANDARD DISTRIBUTION CORPORATION,  
AKRON, OH:  
2,525,141. REN. 9-19-11. INT. CL. 1.  
2,525,142. REN. 9-19-11. INT. CL. 1.  
2,525,143. REN. 9-19-11. INT. CL. 1.  
2,550,782. REN. 9-19-11. INT. CL. 1.

HASBRO, INC., PAWTUCKET, RI:  
2,464,668. REN. 9-20-11. INT. CL. 28.  
2,466,676. REN. 9-20-11. INT. CL. 28.  
4,044,711. PUB. 8-9-2011. INT. CL. 28.  
4,044,771. PUB. 8-9-2011. INT. CL. 28.  
4,044,777. PUB. 8-9-2011. INT. CL. 28.  
4,044,784. PUB. 8-9-2011. INT. CL. 28.  
4,044,785. PUB. 8-9-2011. INT. CL. 28.

HASH, SONYA, WEST CHESTER, PA:  
4,046,327. INT. CL. 35.

HASKELL, DWAYNE, SHAPLEIGH, ME:  
4,043,992. PUB. 8-9-2011. MULTIPLE CLASS, INT. CLS. 40  
AND 42.

HATCH, INC., WINSTON-SALEM, NC:  
4,047,260. INT. CL. 35.

HAVERFIELD INTERNATIONAL INCORPORATED, GET-  
TYSBURG, PA, DBA HAVERFIELD AVIATION, INC.:  
4,005,975. AM. MULTIPLE CLASS, INT. CLS. 37, 41, 42  
AND 44.

HAWAII LIFE REAL ESTATE SERVICES, LLC, HANAIEI,  
HI, AKA HAWAII LIFE:  
4,047,044. INT. CL. 36.

HAYS PLC, UNITED KINGDOM:  
4,043,786. PUB. 8-9-2011. INT. CL. 35.

HBC CHEMICAL INC., NEW YORK, NY:  
4,044,703. PUB. 8-9-2011. INT. CL. 21.  
4,044,713. PUB. 8-9-2011. INT. CL. 5.

HBI BRANDED APPAREL ENTERPRISES, LLC, WINSTON-  
SALEM, NC:  
4,046,722. INT. CL. 25.

HCF INSURANCE AGENCY, WOODLAND HILLS, CA:  
4,044,934. PUB. 8-9-2011. INT. CL. 36.

HDM FURNITURE INDUSTRIES, INC., HIGH POINT, NC:  
2,926,893. CANC. INT. CL. 27.

HDOS ENTERPRISES, CARLSBAD, CA:  
2,428,681. CANC. INT. CL. 42.

HDR ENGINEERING, INC., OMAHA, NE:  
2,428,439. CANC. INT. CL. 42.

HDWORLDMEDIA COMPANIES, LLC, NEPTUNE BEACH,  
FL:  
4,044,422. PUB. 8-9-2011. INT. CL. 9.  
4,044,425. PUB. 8-9-2011. INT. CL. 42.

HEADSHOT, ONTARIO, NY:  
4,045,981. INT. CL. 25.

HEAL AFRICA, MONROE, WA:  
4,043,710. PUB. 8-9-2011. MULTIPLE CLASS, INT. CLS. 41  
AND 45.

HEALEO LLC, SEATTLE, WA:  
4,045,792. INT. CL. 43.

HEALTH CARE INCENTIVES IMPROVEMENT INSTITUTE,  
INC, NEWTOWN, CT:  
2,926,697. CANC. INT. CL. 35.

HEALTH DEVICES CORPORATION, NORTH HOLLY-  
WOOD, CA:  
2,446,889. REN. 9-16-11. INT. CL. 10.

HEALTH TO HAPPINES INC., LARGO, FL:  
4,046,027. INT. CL. 5.

HEALTHCARE INTERACTIVE, INC., MINNEAPOLIS, MN:  
4,045,407. PUB. 8-9-2011. MULTIPLE CLASS, INT. CLS. 9,

- 41 AND 44.  
HEALTHCARE IT CONNECT CORP., LOS ANGELES, CA:  
4,044,053, PUB. 8-9-2011. MULTIPLE CLASS, INT. CLS. 35  
AND 41.
- HEALTHINATION, INC., NEW YORK, NY:  
4,046,198, INT. CL. 38.
- HEALTHSMART HOLDINGS INC., IRVING, TX:  
2,479,995, REN. 9-20-11. INT. CL. 36.
- HEALTHSTREAM, INC., NASHVILLE, TN:  
4,046,704, INT. CL. 42.
- HEALTHY DIRECTIONS, LLC, POTOMAC, MD:  
2,565,886, REN. 9-20-11. INT. CL. 5.
- HEALTHYMOUTH, LLC, MALIBU, CA:  
4,046,992, INT. CL. 32.
- HEARST COMMUNICATIONS, INC., NEW YORK, NY:  
4,047,259, INT. CL. 16.
- HEARST MAGAZINES, INC., NEW YORK, NY:  
2,506,036, REN. 9-19-11. INT. CL. 16.
- HEART AND HOBBY LLC, HENDERSON, NV:  
4,045,595, INT. CL. 45.
- HEART TANGO INC., MIAMI, FL:  
4,045,523, PUB. 8-9-2011. INT. CL. 41.
- HEATH TECNA INC., BELLINGHAM, WA:  
4,044,395, PUB. 8-9-2011. INT. CL. 37.  
4,044,396, PUB. 8-9-2011. INT. CL. 12.
- HED INTERNATIONAL, INC., RINGOES, NJ:  
2,524,968, REN. 9-21-11. INT. CL. 7.
- HEDAHL, INC., BISMARCK, ND:  
4,046,840, INT. CL. 35.
- HEIKE SPIESS, FED REP GERMANY:  
4,043,802, PUB. 8-9-2011. INT. CL. 9.
- HEINRICH HAHNE GMBH & CO. KG, 45711 DATTELN,  
FED REP GERMANY:  
4,047,232, MULTIPLE CLASS, INT. CLS. 1, 2, 17 AND 19.
- HEIR ATELLIER, LOS ANGELES, CA:  
4,044,272, PUB. 8-9-2011. INT. CL. 3.  
4,044,310, PUB. 8-9-2011. INT. CL. 3.
- HEISER, ROBERT, AUSTIN, TX:  
4,047,204, INT. CL. 25.
- HELBY IMPORT CO., CARTERET, NJ:  
4,046,913, INT. CL. 7.
- HELIPORTUGAL - TRABALHOS E TRANSPORTE AÉREO,  
REPRESENTAÇÕES, IMPORTAÇÃO E EXPORTAÇÃO,  
S.A., PORTUGAL:  
4,043,842, PUB. 8-9-2011. INT. CL. 35.
- HELIVES, LLC, DACULA, GA:  
4,044,677, PUB. 8-9-2011. INT. CL. 41.
- HELMER INC., NOBLESVILLE, IN:  
4,045,000, PUB. 8-9-2011. INT. CL. 9.
- HENDRICKS INVESTMENT HOLDINGS, LLC, SILVER  
SPRING, MD:  
4,045,893, INT. CL. 41.
- HENDRICKS ORTHOTIC PROSTHETIC ENTERPRISES,  
INC., PLANO, TX:  
4,044,378, PUB. 8-9-2011. INT. CL. 10.  
4,044,379, PUB. 8-9-2011. INT. CL. 10.  
4,044,380, PUB. 8-9-2011. INT. CL. 10.
- HENDRIX GENETICS LIMITED, KITCHENER, ONTARIO  
N2K 3S2, CANADA:  
2,498,691, REN. 9-21-11. INT. CL. 29.
- HENRI BENDEL, INC., NEW YORK, NY:  
4,045,939, INT. CL. 35.
- HEP C CONNECTION, THE, DENVER, CO:  
2,500,100, REN. 9-20-11. INT. CL. 42.
- HERAEUS NOBLELIGHT GMBH, D-63450 HANAU, FED  
REP GERMANY:  
4,043,615, PUB. 8-9-2011. MULTIPLE CLASS, INT. CLS. 9  
AND 11.
- HERB'S SNACK FOODS LLC, GIBBSTOWN, NJ:  
4,045,075, PUB. 8-9-2011. INT. CL. 29.  
4,045,081, PUB. 8-9-2011. INT. CL. 29.
- HERBALIFE INTERNATIONAL, INC., LOS ANGELES, CA:  
3,755,620 NEW CERT. 10-25-2011. INT. CL. 45.
- HERITAGE APPRAISERS INC., SHAKER HEIGHTS, OH:  
4,044,325, PUB. 8-9-2011. INT. CL. 36.
- HERMAN, MIRA, SEBASTOPOL, CA, DBA ROSEMIRA  
ORGANICS:  
4,044,315, PUB. 8-9-2011. MULTIPLE CLASS, INT. CLS. 3  
AND 5.
- HERNANDEZ, CARLOS M., NEW CITY, NY:  
2,491,077, REN. 9-16-11. INT. CL. 25.
- HERNANDEZ, NUMAEL D, SAN FRANCISCO, CA:  
2,493,975, REN. 9-20-11. INT. CL. 42.
- HERO AG, LENZBURG, SWITZERLAND:  
4,046,863, INT. CL. 32.  
4,046,864, INT. CL. 32.
- HERO/WHITEWAVE, LLC, BROOMFIELD, CO:  
4,046,812, INT. CL. 32.
- HESTIA CREATIONS, INC., MARBLEHEAD, MA:  
4,045,052, PUB. 8-9-2011. INT. CL. 20.
- HEURISTIC MANAGEMENT SYSTEMS INC., POINTE-  
CLAIRE, QUEBEC, CANADA:  
2,484,341, REN. 9-20-11. INT. CL. 9.
- HEWITT ASSOCIATES LLC, LINCOLNSHIRE, IL:  
4,045,321, PUB. 8-9-2011. INT. CL. 36.
- HEWITT, STEVE, GALVESTON, TX AND HEWITT, TIF-  
FANY, GALVESTON, TX:  
4,045,450, PUB. 8-9-2011. INT. CL. 25.
- HEWLETT-PACKARD DEVELOPMENT COMPANY, L.P.,  
HOUSTON, TX:  
4,044,452, PUB. 8-9-2011. INT. CL. 16.
- HEYTESBURY PTY LTD., WESTERN AUSTRALIA, AUS-  
TRALIA:  
2,494,871, REN. 9-20-11. INT. CL. 33.
- HHFFRRRRGGH, INC., JANESVILLE, WI:  
2,428,835, CANC. INT. CL. 42.
- HI LIMITED PARTNERSHIP, ATLANTA, GA:  
1,653,233, REN. 9-19-11. INT. CL. 38.
- HICKMAN & WEATHERFORD, INC., RANCHO CUCA-  
MONGA, CA:  
2,926,864, CANC. INT. CL. 30.
- HIDOODLE LLC, SOMERVILLE, MA:  
4,046,281, MULTIPLE CLASS, INT. CLS. 9 AND 42.
- HIGHTECH MANUFACTURING, INC., WYOMING, MI:  
4,045,710, INT. CL. 30.
- HIJOS DE EUSTAQUIO ABAD Y CIA., S.R.C., 03660 NO-  
VELDA (ALICANTE), SPAIN:  
1,662,635, REN. 9-20-11. INT. CL. 30.
- HILL, CORLISS N., DULUTH, GA:  
4,044,385, PUB. 8-9-2011. INT. CL. 36.
- HILL, KORAKOT, MOBILE, AL:  
4,044,107, PUB. 8-9-2011. INT. CL. 41.
- HIRTLE, CALLAGHAN & CO., LLC, WEST CONSHOCK-  
EN, PA:  
4,047,165, INT. CL. 36.
- HISTORIC MOTORSPORTS PRODUCTIONS, INC., ZIONS-  
VILLE, IN:  
4,046,101, INT. CL. 41.  
4,046,102, INT. CL. 41.  
4,046,103, INT. CL. 41.
- HLT CONRAD IP LLC, MEMPHIS, TN, CONRAD HOSPI-  
TALITY, LLC, BEVERLY HILLS, CA:  
2,602,923, REN. 9-20-11. INT. CL. 42.
- HMP COMMUNICATIONS, LLC, MALVERN, PA:  
4,044,913, PUB. 8-9-2011. INT. CL. 44.
- HNTB HOLDINGS LTD, KANSAS CITY, MO:  
4,046,771, INT. CL. 42.  
4,046,936, INT. CL. 42.
- HOECHST GMBH, AM MAIN, FED REP GERMANY:  
4,044,611, PUB. 8-9-2011. MULTIPLE CLASS, INT. CLS. 5  
AND 10.
- HOFFMAN, DONALD G., OCEANSIDE, CA:  
4,045,994, INT. CL. 6.
- HOGG, ALAN J., HOMOSASSA, FL:  
2,428,316, CANC. INT. CL. 12.
- HOLBERG, JORDAN R., NEW YORK, NY:  
4,046,350, INT. CL. 35.
- HOLLAND AMERICA LINE - USA INC., SEATTLE, WA:  
1,648,371, REN. 9-20-11. INT. CL. 39.
- HOLLANDER, SUZANNE, MIAMI BEACH, FL:  
4,047,003, INT. CL. 41.
- HOLMON, HERBERT, WOODLAND HILLS, CA AND HOL-  
MON, PAULETTE, WOODLAND HILLS, CA:  
4,046,138, INT. CL. 21.
- HOLOFIBER ENTERPRISES, INC., SANTA MONICA, CA:  
2,587,070, COR. INT. CL. 25.

HOLOGIC, INC., MARLBOROUGH, MA:  
2,325,240, CANC. INT. CL. 9.

HOLT HOSIERY MILLS, INCORPORATED, BURLINGTON, NC:  
4,045,669, INT. CL. 25.

HOME BOX OFFICE, INC., NEW YORK, NY:  
4,045,540, PUB. 8-9-2011. INT. CL. 25.

HOME CAPITAL NETWORK, L.L.C., PENNINGTON, NJ:  
2,488,114, REN. 9-22-11. INT. CL. 36.

HOME INSTEAD, INC., OMAHA, NE:  
4,044,748, PUB. 8-9-2011. INT. CL. 45.

HOME REVIVALS LLC, MOUNT PLEASANT, SC:  
4,044,546, PUB. 8-9-2011. INT. CL. 9.

HOMEAWAY.COM, INC., AUSTIN, TX:  
4,044,354, PUB. 8-9-2011. INT. CL. 43.  
4,044,355, PUB. 8-9-2011. INT. CL. 41.

HOMEBOY INDUSTRIES, LOS ANGELES, CA:  
4,044,850, PUB. 8-9-2011. INT. CL. 44.

HOMEMATE, S.A. DE C.V., DELEGACION BENITO JUAREZ, C.P. 04870, MEXICO:  
2,428,079, CANC. INT. CL. 14.

HOMER LAUGHLIN CHINA COMPANY, THE, NEWELL, WV:  
1,702,524, REN. 9-20-11. INT. CL. 21.

HOMER TLC, INC., CLAYMONT, DE:  
2,428,264, CANC. INT. CL. 28.

HONDA GIKEN KABUSHIKI KAISHA, MINATO-KU, TOKYO 107, JAPAN:  
1,673,535, REN. 9-17-11. INT. CL. 28.

HONDA GIKEN KOGYO KABUSHIKI KAISHA, MINATO-KU, TOKYO 107, JAPAN:  
932,155, REN. 9-17-11. U.S. CL. 23 (INT. CL. 7).  
2,490,387, REN. 9-21-11. MULTIPLE CLASS, INT. CLS. 35, 38 AND 41.

HONEYWELL INTERNATIONAL INC., MORRISTOWN, NJ:  
1,713,215, REN. 9-21-11. INT. CL. 9.  
4,046,150, MULTIPLE CLASS, INT. CLS. 35, 41 AND 42.  
4,046,151, MULTIPLE CLASS, INT. CLS. 35, 41 AND 42.

HONOR SOCIETY EXCEL CLASS LLC, REGO PARK, NY:  
4,045,818, MULTIPLE CLASS, INT. CLS. 9 AND 41.

HOORAY LLC, WHITE PLAINS, NY:  
2,428,260, CANC. INT. CL. 28.

HOOVER'S, INC., AUSTIN, TX:  
4,044,481, PUB. 8-9-2011. INT. CL. 35.

HOOZON LLC, PONTE VEDRA BEACH, FL:  
4,044,696, PUB. 8-9-2011. MULTIPLE CLASS, INT. CLS. 35 AND 41.

HOPE IS GROWING LLC, ELYRIA, OH:  
4,044,367, PUB. 8-9-2011. INT. CL. 31.

HOPE, RONALD W., FRANKLIN, TN:  
2,428,141, CANC. INT. CL. 41.

HOPING SKILLS, LLC, BEVERLY, MA:  
2,912,667, CANC. INT. CL. 16.

HOPWOOD, MICHAEL, LAKEWOOD, CA:  
4,045,445, PUB. 8-9-2011. INT. CL. 35.

HORMEL FOODS LLC, AUSTIN, MN, STAGG FOODS, INC., COMMERCE, CA:  
1,656,947, REN. 9-20-11. INT. CL. 29.

HORNADY MANUFACTURING COMPANY, GRAND ISLAND, NE:  
2,468,028, REN. 9-19-11. INT. CL. 13.

HORNBECK, TODD M., COVINGTON, LA AND HORNBECK, TROY A., COVINGTON, LA:  
2,575,178, REN. 9-22-11. INT. CL. 39.

HORROCKS ENTERPRISES, LLC, COLLEGE STATION, TX:  
4,044,179, PUB. 8-9-2011. INT. CL. 5.

HORSEMAN'S FINANCIAL GROUP, INC., LEXINGTON, KY:  
2,539,440, REN. 9-19-11. INT. CL. 35.

HOSPITAL FOR SPECIAL SURGERY, NEW YORK, NY:  
2,856,585, COR. INT. CL. 44.

HOSPITAL SERVICE ASSOCIATION OF NORTHEASTERN PENNSYLVANIA, WILKES-BARRE, PA, DBA BLUE CROSS OF NORTHEASTERN PENNSYLVANIA:  
2,926,749, CANC. INT. CL. 36.

HOSTESS BRANDS, INC., IRVING, TX, INTERSTATE BAKERIES CORPORATION, KANSAS CITY, MO:  
721,100, REN. 9-19-11. U.S. CL. 46 (INT. CL. 30).

HOSTESS BRANDS, INC., IRVING, TX, WARD FOODS, INC., WILMETTE, IL:  
1,165,717, REN. 9-20-11. INT. CL. 30.

HOUGHTON MIFFLIN HARCOURT PUBLISHING COMPANY, BOSTON, MA, RAYTHEON COMPANY, LEXINGTON, MA:  
917,233, REN. 9-22-11. U.S. CL. 38 (INT. CL. 16).

HOUSE OF MOHAN CORPORATION, ALEXANDRIA, VA:  
2,428,581, CANC. INT. CL. 3.

HOUSE RESEARCH INSTITUTE, LOS ANGELES, CA:  
4,044,450, PUB. 8-9-2011. INT. CL. 42.

HOW, DANA, VIRGINIA BEACH, VA:  
4,043,614, PUB. 8-9-2011. INT. CL. 44.

HOWARD & HOWARD ATTORNEYS PLLC, ROYAL OAK, MI:  
4,044,159, PUB. 8-9-2011. INT. CL. 35.

HOWARD BERGER CO., INC., CRANBURY, NJ:  
2,482,421, REN. 9-21-11. INT. CL. 16.  
2,492,650, REN. 9-21-11. INT. CL. 7.

HOWARD C. KATZ LLC, JAMAICA PLAIN, MA, DBA MYSTIC RIVER COMMUNICATIONS:  
4,044,466, PUB. 8-9-2011. INT. CL. 42.

HOWARD, SCOTT G., PORTLAND, OR, TA EARTHEN HAND:  
4,044,220, PUB. 8-9-2011. INT. CL. 41.

HP HOOD LLC, LYNNFIELD, MA, PENN MAID FOODS, INC., PHILADELPHIA, PA:  
917,801, REN. 9-20-11. U.S. CL. 46 (INT. CL. 29).

HR LEVERAGE LLC, ALEXANDRIA, VA:  
4,047,173, INT. CL. 35.

HRHH IP, LLC, NEW YORK, NY:  
4,045,924, MULTIPLE CLASS, INT. CLS. 41 AND 43.

HRUBY, JEFFREY THOMAS, VISTA, CA:  
4,045,232, PUB. 8-9-2011. INT. CL. 7.

HS TM, LLC, NEWARK, DE:  
2,484,064, REN. 9-21-11. INT. CL. 9.

HS TM, LLC, NEWARK, NJ:  
2,524,284, REN. 9-22-11. INT. CL. 10.

HS TM, LLC, NEWARK, DE:  
4,046,976, INT. CL. 10.

HU, JIAN, RUFAN, CHINA:  
4,043,899, PUB. 5-3-2011. INT. CL. 12.

HUANG, ZHI HAO, TORRANCE, CA:  
4,045,708, INT. CL. 43.

HUBBELL INCORPORATED, SHELTON, CT, GLEASON REEL CORP., MAYVILLE, WI:  
720,947, REN. 9-19-11. U.S. CL. 23 (INT. CL. 7).

HUCU SOLAR ESPANA, S.L., ANTEQUERA, MALAGA, SPAIN:  
4,043,935, PUB. 8-9-2011. MULTIPLE CLASS, INT. CLS. 9 AND 11.

HUDSON FURNITURE INC., NEW YORK, NY:  
4,046,353, MULTIPLE CLASS, INT. CLS. 20 AND 35.

HUFFMAN, DREW, LORAIN, OH:  
4,046,889, MULTIPLE CLASS, INT. CLS. 5 AND 29.

HUGO BOSS TRADE MARK MANAGEMENT GMBH & CO. KG, FED REP GERMANY:  
4,043,860, PUB. 8-9-2011. MULTIPLE CLASS, INT. CLS. 3, 9, 14, 18, 25 AND 35.

HUGO BOSS TRADE MARK MANAGEMENT GMBH & CO. KG, METZINGEN, FED REP GERMANY:  
4,045,496, PUB. 8-9-2011. INT. CL. 18.

HUHTAMAKI FINANCE B.V., 2132 HE HOOFDDORP, NETHERLANDS, LEAF, INC., BANNOCKBURN, IL:  
1,684,586, REN. 9-21-11. INT. CL. 30.

HUITE SHOES CO., LTD., WENZHOU CITY, ZHEJIANG PROVINCE, CHINA:  
2,428,707, CANC. INT. CL. 25.

HULL, HOWARD, THE COLONY, TX:  
2,926,839, CANC. INT. CL. 9.

HUMAN RIGHTS CAMPAIGN, THE, WASHINGTON, DC:  
2,486,562, REN. 9-20-11. INT. CL. 42.

HUMAN TRIBE PROJECT, LLC, PHOENIX, AZ:  
3,690,381, AM. INT. CL. 36.

HUMANE SOCIETY OF MISSOURI, ST. LOUIS, MO:  
4,045,481, PUB. 8-9-2011. INT. CL. 36.

HUNTER COMMUNITIES, INC., HUNTSVILLE, AL:  
4,046,057, INT. CL. 37.

- HUNTER ENGINEERING COMPANY, BRIDGETON, MO:  
2,485,303. REN. 9-21-11. INT. CL. 9.  
2,613,273. REN. 9-21-11. INT. CL. 9.
- HUNTER PANELS LLC, PORTLAND, ME:  
4,046,862. INT. CL. 17.
- HUNTER RESIDENTIAL SERVICES, LLC, BRADENTON, FL:  
4,046,855. INT. CL. 37.
- HURLEY, BRYAN, MT. DORA, FL:  
4,047,202. MULTIPLE CLASS, INT. CLS. 11 AND 21.
- HURRICANES HOCKEY, LP, RALEIGH, NC, NEW ENGLAND WHALERS HOCKEY CLUB, HARTFORD, CT:  
1,161,394. REN. 9-21-11. INT. CL. 41.
- HUSH COMMUNICATIONS USA, INC., AUSTIN, TX, HUSH COMMUNICATIONS USA, INC., AUSTIN, TX:  
2,500,713. REN. 9-20-11. INT. CL. 9.  
2,513,068. REN. 9-20-11. INT. CL. 9.
- HUTCHISON, MICHAEL C., TRAVERSE CITY, MI:  
4,045,815. INT. CL. 28.
- HUTCHISON, PERRY & ASSOCIATES, INC., TUCSON, AZ:  
4,046,612. INT. CL. 36.
- HUTH, JEFFREY, EL CAJON, CA:  
4,044,556. PUB. 8-9-2011. INT. CL. 30.
- HUTH, RUSSELL BARRY, ROGGE BAY, SOUTH AFRICA:  
4,046,293. INT. CL. 42.
- HYATT CORPORATION, CHICAGO, IL:  
4,046,505. INT. CL. 36.
- HYCLONE LABORATORIES, INC., LOGAN, UT:  
4,043,932. PUB. 8-9-2011. INT. CL. 1.
- HYE EUN LEE, CHULA VISTA, CA, DBA DEAR ALICE:  
4,044,904. PUB. 8-9-2011. INT. CL. 25.
- HYPERCOM CORPORATION, SCOTTSDALE, AZ:  
1,658,115. REN. 9-17-11. INT. CL. 9.
- HZPC HOLLAND B.V., JOURE, NETHERLANDS:  
2,514,131. REN. 9-21-11. INT. CL. 31.
- I & J FISNAR INC., FAIR LAWN, NJ:  
1,654,735. REN. 9-22-11. INT. CL. 7.
- I DRIVE SAFELY, LLC, CARLSBAD, CA:  
2,468,673. REN. 9-20-11. INT. CL. 41.
- I-BUS CORPORATION, SAN JOSE, CA:  
2,926,889. CANC. INT. CL. 9.
- IAN PERCY CORPORATION, THE, SCOTTSDALE, AZ:  
4,046,317. MULTIPLE CLASS, INT. CLS. 14, 25 AND 35.
- IAWS TECHNOLOGY & GLOBAL SERVICES, DUBLIN 22, IRELAND:  
2,435,452. REN. 9-20-11. INT. CL. 30.
- IBEAACH LLC, MINNEAPOLIS, MN:  
4,044,497. PUB. 8-9-2011. INT. CL. 44.
- IC TECHNOLOGIES, INC., EAST SYRACUSE, NY:  
4,045,344. PUB. 8-9-2011. INT. CL. 9.
- ICAD, INC., NASHUA, NH:  
4,046,358. INT. CL. 10.
- ICC COMMERCIAL CRIME SERVICES, LTD., LONDON, UNITED KINGDOM:  
4,044,283. PUB. 8-9-2011. MULTIPLE CLASS, INT. CLS. 36 AND 45.
- ICE'RS ENTERPRISES, MISSION VIEJO, CA:  
4,046,782. INT. CL. 30.
- ICELANDIC (USA), INC., NEWPORT NEWS, VA:  
4,044,388. PUB. 8-9-2011. INT. CL. 29.
- ICON BURGER DEVELOPMENT COMPANY, LLC, DENVER, CO:  
4,045,713. INT. CL. 43.
- IDEAL I DO'S INC., DELRAY BEACH, FL:  
4,044,683. PUB. 8-9-2011. MULTIPLE CLASS, INT. CLS. 41 AND 45.
- IDEAL STANDARD INTERNATIONAL BVBA, BRUSSELS, BELGIUM:  
917,041. REN. 9-20-11. U.S. CL. 13 (INT. CL. 11).
- IDEMITSU KOSAN CO., LTD., CHIYODA-KU, TOKYO, JAPAN:  
4,045,754. INT. CL. 1.
- IDEXX LABORATORIES, INC., WESTBROOK, ME:  
1,671,049. REN. 9-16-11. INT. CL. 10.
- IDM USA LLC, BRADENTON, FL, DBA DATAFORMAT-COM:  
4,044,134. PUB. 5-3-2011. INT. CL. 42.
- IGENE BIOTECHNOLOGY, INC., COLUMBIA, MD:  
2,551,043. COR. INT. CL. 1.
- IGNITE USA, LLC, CHICAGO, IL:  
4,044,068. PUB. 8-9-2011. INT. CL. 21.
- IGP ACQUISITION LLC, LAWRENCEBURG, IN:  
2,581,697. REN. 9-21-11. INT. CL. 31.
- IGT, RENO, NV:  
4,045,796. INT. CL. 9.  
4,046,002. INT. CL. 9.
- IKA-WERKE GMBH & CO. KG, STAUFEN, FED REP GERMANY:  
2,509,083. REN. 9-19-11. INT. CL. 9.
- IKEGAMI TSUSHINKI CO., LTD., OHTA-KU, TOKYO, JAPAN:  
1,165,312. REN. 9-19-11. INT. CL. 9.
- ILASH INC., HEBER CITY, UT:  
4,047,205. INT. CL. 35.
- ILLINOIS TOOL WORKS INC., GLENVIEW, IL:  
2,495,222. REN. 9-22-11. INT. CL. 2.  
4,047,060. INT. CL. 17.
- ILLUMINATA, INC., NASHUA, NH:  
2,527,444. REN. 9-21-11. MULTIPLE CLASS, INT. CLS. 16 AND 42.
- ILLUSIVE DREAMS, INC., BURBANK, CA:  
4,043,694. PUB. 8-9-2011. MULTIPLE CLASS, INT. CLS. 16, 21, 25 AND 28.
- ILSA S.P.A., I-37136 VERONA (VR), ITALY:  
4,043,826. PUB. 8-9-2011. INT. CL. 1.
- ILUMEN, INC., ATLANTA, GA:  
4,044,957. PUB. 8-9-2011. MULTIPLE CLASS, INT. CLS. 9 AND 42.
- IMAGINE THAT! CONSUMER PRODUCTS LLC, CHELSEA, MI:  
4,045,483. PUB. 8-9-2011. INT. CL. 18.
- IMI PERFORMANCE PRODUCTS, INC., WHITTIER, CA:  
4,044,237. PUB. 8-9-2011. INT. CL. 7.
- IMMUNITY PRODUCTS, LLC, MIAMI BEACH, FL, DBA IMMUNITY SOLUTIONS:  
4,044,739. PUB. 8-9-2011. INT. CL. 9.
- IMPCO TECHNOLOGIES, INC., SANTA ANA, CA:  
2,448,380. REN. 9-22-11. MULTIPLE CLASS, INT. CLS. 7 AND 9.
- IMPRESS GROUP B.V., 7418 AH DEVENTER, NETHERLANDS:  
4,043,654. PUB. 7-20-2010. MULTIPLE CLASS, INT. CLS. 6, 20 AND 21.
- IMPRINTOR, INC., OGLESBY, IL:  
4,044,759. PUB. 8-9-2011. MULTIPLE CLASS, INT. CLS. 2 AND 7.
- IMPROVED PIPING PRODUCTS, INC., EMERYVILLE, CA:  
2,427,875. CANC. INT. CL. 6.
- IMRAE CORPORATION, LAKE ELSINORE, CA, DBA IMRAE CORPORATION:  
4,044,397. PUB. 8-9-2011. INT. CL. 2.
- IMS- INTERNATIONAL MEDICAL SERVCE S.R.L., ITALY:  
4,043,869. PUB. 8-9-2011. INT. CL. 5.
- IN HIS GRIP RESOURCES, LLC, THOMPSON'S STATION, TN, DBA IN HIS GRIP GOLF:  
2,491,011. REN. 9-19-11. MULTIPLE CLASS, INT. CLS. 16 AND 28.
- IN OUR GENES, LLC, PHOENIX, AZ:  
4,046,451. INT. CL. 25.  
4,046,452. INT. CL. 25.
- IN.GENU DESIGN GROUP INC., COLLINGWOOD, ONTARIO, CANADA, DBA MENDMESHOP:  
4,046,999. INT. CL. 10.
- INAEXPO, QUITO, ECUADOR:  
2,487,769. REN. 9-17-11. INT. CL. 29.
- INCLAN ENTERPRISES, INC., LOUISVILLE, KY, DBA BOURBON COUNTRY, INC.:  
2,533,730. REN. 9-20-11. INT. CL. 30.  
2,533,731. REN. 9-20-11. INT. CL. 35.  
2,551,594. REN. 9-21-11. INT. CL. 30.
- INCOUNSEL LLC, WAYLAND, MA:  
2,505,065. REN. 9-19-11. MULTIPLE CLASS, INT. CLS. 35 AND 45.



- INDENYA UEHARA YUSHICHI CO., LTD., YAMANASHI, JAPAN:  
4,046,391, INT. CL. 18.
- INDUSTRIA DE DISEÑO TEXTIL, S.A., ARTEIXO (A CORUNA), SPAIN, AKA INDITEX, S.A.:  
2,430,628. REN. 9-21-11. INT. CL. 18.
- INDUSTRIAL MEDIUM LLC, MCLEAN, VA:  
4,044,879, PUB. 8-9-2011. INT. CL. 9.
- INDUSTRIAL PACKAGING SUPPLIES OF GREENVILLE, INC., FOUNTAIN INN, SC:  
4,047,046, INT. CL. 17.
- INDUSTRIALIZADORA INTEGRAL DEL AGAVE S.A. DE C.V., TLAQUEPAQUE, JALISCO, MEXICO:  
4,047,071, INT. CL. 5.
- INDUSTRIAS AS, S.A. DE C.V., NAUCALPAN EDO. DE MEXICO 53370, MEXICO:  
2,496,451. REN. 9-22-11. INT. CL. 19.
- INEOS ABS (JERSEY) LIMITED, ST. HELIER, JERSEY, MONSANTO CHEMICAL COMPANY, ST. LOUIS, MO:  
720,161. REN. 9-16-11. U.S. CL. 1 (INT. CL. 1).
- INFANT MASSAGE USA, SPRINGFIELD, VA:  
4,044,468, PUB. 8-9-2011. INT. CL. 41.
- INFINIA CORPORATION, KENNEWICK, WA:  
4,043,880, PUB. 8-9-2011. INT. CL. 7.
- INFINITE FUNCTIONS INC, CRESTON, CA:  
2,600,750. REN. 9-19-11. INT. CL. 42.
- INFINITEE COMMUNICATIONS, INC., ATLANTA, GA:  
4,044,192, PUB. 8-9-2011. INT. CL. 35.  
4,044,193, PUB. 8-9-2011. INT. CL. 35.
- INFO INVESTMENT INTERNATIONAL INC., TORTOLA, BR. VIRGIN ISLANDS:  
2,486,961. REN. 9-21-11. INT. CL. 9.
- INFOBLOX, INC., SANTA CLARA, CA:  
2,546,208. REN. 9-20-11. INT. CL. 9.
- INFOR GLOBAL SOLUTIONS (MICHIGAN), INC., ALPHARETTA, GA:  
1,656,143. REN. 9-17-11. INT. CL. 9.
- INFOR GLOBAL SOLUTIONS (MICHIGAN), INC., BINGHAM FARMS, MI, MARCAM CORPORATION, NEWTON, MA:  
1,675,711. REN. 9-22-11. INT. CL. 9.
- INFOR GLOBAL SOLUTIONS (MICHIGAN), INC., BINGHAM FARMS, MI:  
2,926,643, CANC. MULTIPLE CLASS, INT. CLS. 9 AND 42.
- INFORMZ, INC., SARATOGA SPRINGS, NY:  
4,045,308, PUB. 8-9-2011. MULTIPLE CLASS, INT. CLS. 35 AND 38.
- INFRAIN AG, ZURICH, SWITZERLAND:  
2,926,301, CANC. MULTIPLE CLASS, INT. CLS. 14, 16, 18 AND 25.
- INFUSION DEVELOPMENT, NEW YORK, NY:  
4,044,967, PUB. 8-9-2011. MULTIPLE CLASS, INT. CLS. 9 AND 42.
- INGLES MARKETS, INC., ASHEVILLE, NC:  
4,046,067, INT. CL. 43.
- INKEL CORPORATION, BUPYEONG-GU, INCHEON, REPUBLIC OF KOREA, INKEL CORPORATION LTD., DOBONG-KU, SEOUL, REPUBLIC OF KOREA:  
1,654,195. REN. 9-17-11. INT. CL. 9.
- INNERMIX H2O BEVERAGES, L.L.C., SEDONA, AZ:  
4,044,584, PUB. 8-9-2011. INT. CL. 39.
- INNO-LABS LP, WINFIELD, KS:  
4,045,151, PUB. 8-9-2011. INT. CL. 21.
- INNOCORP, LTD., VERONA, WI:  
4,046,512, INT. CL. 9.
- INNOTRAC CORPORATION, JOHNS CREEK, GA:  
4,046,347, INT. CL. 35.
- INNOVA BIOSCIENCES LIMITED, CAMBRIDGE, UNITED KINGDOM:  
4,044,212, PUB. 8-9-2011. MULTIPLE CLASS, INT. CLS. 1 AND 5.
- INNOVARO, INC., UNITED STATES:  
4,043,767, PUB. 8-9-2011. MULTIPLE CLASS, INT. CLS. 9, 35 AND 42.  
4,043,769, PUB. 8-9-2011. MULTIPLE CLASS, INT. CLS. 9, 35 AND 42.
- INNOVATION SERVICES, INC., KNOXVILLE, TN:  
4,045,675, INT. CL. 11.  
4,045,707, INT. CL. 11.
- INNOVATIVE ALTERNATIVE ACUPUNCTURE, LLC, LAUREL, MD:  
4,044,572, PUB. 8-9-2011. INT. CL. 44.
- INNOVATIVE BEAUTY LABS, LLC, RANCHO SANTA FE, CA, DBA SHIMMER STRANDS:  
4,044,156, PUB. 8-9-2011. INT. CL. 26.
- INNOVATIVE DESIGNS, INC., PITTSBURGH, PA:  
4,044,847, PUB. 8-9-2011. INT. CL. 17.
- INNOVATORS INC, CHICAGO, IL:  
4,043,915, PUB. 8-9-2011. INT. CL. 8.
- INNOXA MARKS PTY LIMITED, VICTORIA, AUSTRALIA, INNOXA, SOCIETE A RESPONSABILITE LIMITEE, PARIS, FRANCE:  
910,474. REN. 9-19-11. U.S. CL. 51 (INT. CL. 3).
- INOSTRANNOE TCHASTNOE OUNITARNOE PROIZVODSTVENNO-TORGOVOE PREDPRIATIE "KARAVAN" KORPORATSII "KAMBERLI MARKETING KORP.", BELARUS:  
4,043,759, PUB. 8-9-2011. INT. CL. 30.
- INSCAPE PUBLISHING, INC., MINNEAPOLIS, MN:  
2,592,787. REN. 9-20-11. INT. CL. 9.
- INSIDE JOBS, LLC, SEATTLE, WA:  
4,045,432, PUB. 8-9-2011. MULTIPLE CLASS, INT. CLS. 35 AND 41.
- INSMED, INC., RICHMOND, VA:  
4,045,902, INT. CL. 5.
- INSPIRATION & MOTIVATION, INC., CHARLOTTE, NC:  
4,044,206, PUB. 5-3-2011. MULTIPLE CLASS, INT. CLS. 16 AND 41.
- INSPIRED BY POSITIVE PATTY LLC, NAPLES, FL:  
4,047,019, INT. CL. 25.
- INSTA-FIRE INC., RIVERDALE, UT:  
4,045,784, INT. CL. 4.
- INSTITUTE FOR SPECIALIZED MEDICINE, INC, DEL MAR, CA:  
4,044,274, PUB. 8-9-2011. INT. CL. 5.
- INSTITUTE OF INTELLECTUAL PROPERTY AND SOCIAL JUSTICE, INC., COLUMBIA, MD, AKA IIPJS, INC.:  
4,043,987, PUB. 8-9-2011. INT. CL. 41.
- INSTITUTES FOR THE ACHIEVEMENT OF HUMAN POTENTIAL, THE, WYNDMOOR, PA:  
2,479,241. REN. 9-19-11. MULTIPLE CLASS, INT. CLS. 16 AND 41.
- INSTITUTIONAL INVESTOR, INC., NEW YORK, NY:  
2,493,693. REN. 9-18-11. INT. CL. 16.
- INSTRUMENTATION LABORATORY COMPANY, BEDFORD, MA, INSTRUMENTATION LABORATORY COMPANY, BEDFORD, MA:  
2,507,323. REN. 9-20-11. INT. CL. 5.
- INSULSPAN, INC., BLISSFIELD, MI, FOAM PRODUCTS CORPORATION, MARYLAND HEIGHTS, MO:  
1,668,529. REN. 9-20-11. INT. CL. 19.
- INTEGRA LIFESCIENCES CORPORATION, PLAINSBORO, NJ:  
4,046,071, INT. CL. 5.
- INTEGROMICS, S.L., ES-18100 ARMILLA, SPAIN:  
4,044,685, PUB. 8-9-2011. INT. CL. 9.
- INTEGRYS ENERGY GROUP, INC., CHICAGO, IL:  
2,432,700. REN. 9-18-11. MULTIPLE CLASS, INT. CLS. 35, 37, 39, 40 AND 42.
- INTELLIGENT PRODUCTS INCORPORATED OF ILLINOIS, BURLINGTON, KY, INTELLIGENT PRODUCTS INCORPORATED, CHICAGO, IL:  
1,696,132. REN. 9-20-11. INT. CL. 21.
- INTELLIGENT SOFTWARE SOLUTIONS, INC., COLORADO SPRINGS, CO:  
4,045,576, PUB. 8-9-2011. INT. CL. 9.
- INTELLIJECT, INC., RICHMOND, VA:  
4,046,467, INT. CL. 42.
- INTELLISTRY INFORMATION SYSTEMS, INC., IRVINE, CA:  
4,046,724, INT. CL. 42.
- INTERACTIVE DATA CORPORATION, BEDFORD, MA:  
4,043,692, PUB. 8-9-2011. MULTIPLE CLASS, INT. CLS. 37, 38 AND 42.

- INTERCONTINENTAL PACKAGING CO., ST. PAUL, MN:  
4,046,322, INT. CL. 33.
- INTEREALITY MEDIA LLC, SAN DIEGO, CA:  
4,046,329, INT. CL. 41.
- INTERLINE BRANDS, INC., JACKSONVILLE, FL:  
2,428,396, CANC. INT. CL. 3.  
2,565,493, REN. 9-21-11. MULTIPLE CLASS, INT. CLS. 37  
AND 41.
- INTERMEDIA SURVEY INSTITUTE, WASHINGTON, DC,  
AKA INTERMEDIA:  
4,046,120, MULTIPLE CLASS, INT. CLS. 9, 35 AND 42.
- INTERNATIONAL ASSET SYSTEMS LIMITED, HAMILTON  
HM 12, BERMUDA:  
2,491,165, REN. 9-21-11. INT. CL. 39.
- INTERNATIONAL BANK FOR RECONSTRUCTION AND  
DEVELOPMENT, WASHINGTON, DC, AKA WORLD  
BANK:  
4,043,671, PUB. 8-9-2011. MULTIPLE CLASS, INT. CLS. 38  
AND 41.
- INTERNATIONAL BARRIER TECHNOLOGY INC, WAT-  
KINS, MN, WEYERHAEUSER COMPANY, TACOMA,  
WA:  
1,693,014, REN. 9-19-11. INT. CL. 19.
- INTERNATIONAL BOARD OF ENVIRONMENTAL,  
HEALTH AND SAFETY, TUCSON, AZ:  
2,428,986, CANC. INT. CL. 41.  
2,428,989, CANC. INT. CL. 41.
- INTERNATIONAL COMFORT PRODUCTS, LLC, LEWIS-  
BURG, TN:  
2,474,898, REN. 9-20-11. MULTIPLE CLASS, INT. CLS. 7,  
9 AND 11.
- INTERNATIONAL CREATIVE MANAGEMENT, INC., LOS  
ANGELES, CA:  
1,168,641, REN. 9-16-11. MULTIPLE CLASS, INT. CLS. 35  
AND 36.
- INTERNATIONAL DATA GROUP, INC., FRAMINGHAM,  
MA:  
2,581,463, REN. 9-22-11. INT. CL. 42.  
4,046,188, MULTIPLE CLASS, INT. CLS. 41 AND 42.  
4,046,751, INT. CL. 9.
- INTERNATIONAL DIGITAL ENTERPRISE ALLIANCE,  
INC., ALEXANDRIA, VA:  
2,509,344, REN. 9-20-11. MULTIPLE CLASS, INT. CLS. 35  
AND 42.
- INTERNATIONAL FUNCTIONAL ELECTRICAL STIMULA-  
TION SOCIETY, INC., GLENDALE, CA:  
2,462,947, REN. 9-20-11. INT. CL. 41.
- INTERNATIONAL LUTHERAN CLAYMEN'S LEAGUE, ST.  
LOUIS, MO:  
1,172,616, REN. 9-16-11. INT. CL. 41.
- INTERNATIONAL ORDER OF THE GOLDEN RULE, AUS-  
TIN, TX:  
2,442,479, REN. 9-20-11. INT. CL. 16.
- INTERNATIONAL PLAYTHINGS LLC, PARSIPPANY, NJ:  
4,046,483, INT. CL. 28.
- INTERNATIONAL PRESS OF BOSTON, INC., CONCORD,  
MA:  
4,043,960, PUB. 8-9-2011. INT. CL. 9.
- INTERNATIONAL SPEEDWAY, INC., DAYTONA BEACH,  
FL, INTERNATIONAL SPEEDWAY, INC., DAYTONA  
BEACH, FL:  
2,481,304, REN. 9-22-11. INT. CL. 41.
- INTERNATIONAL TECHNOLOGIES (LASERS) LTD., 75140  
RISHON LEZION, ISRAEL:  
1,649,974, REN. 9-20-11. INT. CL. 9.
- INTERNATIONAL TOBACCO MACHINERY POLAND SP. Z  
O.O., POLAND:  
4,043,865, PUB. 8-9-2011. INT. CL. 7.
- INTERNATIONAL WOOD SHUTTERS, INC., TAMPA, FL:  
2,428,813, CANC. INT. CL. 20.
- INTERNET MEDIA SERVICES, INC., SANTA MONICA, CA:  
4,047,117, INT. CL. 16.
- INTERSECT PTP, INC., SEATTLE, WA:  
4,045,772, INT. CL. 35.  
4,045,773, INT. CL. 38.
- INTUARY, INC., SAN FRANCISCO, CA:  
4,045,077, PUB. 8-9-2011. INT. CL. 9.  
4,045,078, PUB. 8-9-2011. INT. CL. 9.
- INTUIT INC., MOUNTAIN VIEW, CA:  
2,480,848, REN. 9-20-11. MULTIPLE CLASS, INT. CLS. 36  
AND 42.  
2,512,370, REN. 9-22-11. INT. CL. 35.
- INVENTIGO LLC, WALNUT CREEK, CA:  
2,570,098, REN. 9-22-11. INT. CL. 42.
- INVENTIV COMMUNICATIONS, INC., WESTERVILLE, OH:  
4,045,777, INT. CL. 42.
- INVESCO INSTITUTIONAL (N.A.), INC., ATLANTA, GA:  
2,428,098, CANC. INT. CL. 36.
- IP HOLDINGS LLC, VANCOUVER, WA:  
4,047,088, INT. CL. 11.
- IP HOLDINGS, LLC, VANCOUVER, WA:  
4,047,032, INT. CL. 11.
- IPCAPITAL GROUP, INC., WILLISTON, VT:  
2,476,291, REN. 9-20-11. MULTIPLE CLASS, INT. CLS. 41  
AND 42.
- IPME, LLLP, WESTMINSTER, CO:  
2,427,843, CANC. INT. CL. 36.
- IQ POWER FRANCHISING, LLC/, SANFORD, FL:  
4,045,899, MULTIPLE CLASS, INT. CLS. 11 AND 37.
- IRIS ID, INC., SEOUL, REPUBLIC OF KOREA:  
4,047,122, INT. CL. 9.
- IRIS PROPERTIES, INC., NEW YORK, NY:  
2,515,554, REN. 9-19-11. INT. CL. 9.
- IRON CITY LIVE, INC., BIRMINGHAM, AL:  
4,046,060, INT. CL. 41.
- IRON HOLDINGS, LLC, NORTHBROOK, IL:  
4,046,630, INT. CL. 36.  
4,046,631, INT. CL. 36.
- IRON HOLDINGS, LLC, NORTHBROOK, ID:  
4,046,632, INT. CL. 36.
- ISABELLE (TAIWAN) CO., LTD., TAIPEI, TAIWAN:  
2,496,878, REN. 9-19-11. INT. CL. 30.
- ISADORO SEED INC., ST. PAUL, MN:  
4,044,628, PUB. 8-9-2011. INT. CL. 35.
- ISCIENCE INTERVENTIONAL CORPORATION, MENLO  
PARK, CA:  
4,043,608, PUB. 8-9-2011. INT. CL. 10.
- ISLE OF CAPRI CASINOS, INC., ST. LOUIS, MO:  
4,046,401, MULTIPLE CLASS, INT. CLS. 41 AND 43.
- ISOMERS LABORATORIES INC., TORONTO, CANADA:  
4,046,624, INT. CL. 3.
- ISP INVESTMENTS INC., WILMINGTON, DE:  
4,045,557, PUB. 8-9-2011. INT. CL. 10.  
4,045,562, PUB. 8-9-2011. INT. CL. 9.  
4,045,569, PUB. 8-9-2011. INT. CL. 9.
- ISPSOFT, INC., TINTON FALLS, NJ:  
2,926,293, CANC. MULTIPLE CLASS, INT. CLS. 35, 37  
AND 42.
- ISSUU, INC., MENLO PARK, CA:  
4,045,630, MULTIPLE CLASS, INT. CLS. 35, 41, 42, 43  
AND 45.
- ISTARUSA, INC., CITY OF INDUSTRY, CA:  
4,044,323, PUB. 8-9-2011. INT. CL. 9.
- ISW GROUP, INC., CHESTERFIELD, MO:  
2,926,619, CANC. INT. CL. 3.
- IT SERVICE MANAGEMENT FORUM-USA, GLENDORA,  
CA:  
4,046,051, U.S. CL. B.  
4,046,052, U.S. CL. B.  
4,046,053, U.S. CL. B.
- ITALIAN KITCHEN INC., VIRGINIA BEACH, VA:  
4,044,463, PUB. 8-9-2011. INT. CL. 43.
- ITG SOFTWARE SOLUTIONS, INC., CULVER CITY, CA:  
2,926,491, CANC. INT. CL. 36.
- ITT CORPORATION, WHITE PLAINS, NY, BELL & GOS-  
SETT COMPANY, MORTON GROVE, IL:  
554,429, REN. 9-21-11. U.S. CL. 13 (INT. CL. 6).
- ITT CORPORATION, WHITE PLAINS, NY, INTERNA-  
TIONAL TELEPHONE AND TELEGRAPH CORPORA-  
TION, NEW YORK, NY:  
1,189,758, REN. 9-21-11. INT. CL. 7.
- ITT CORPORATION, WHITE PLAINS, NY:  
2,500,296, REN. 9-21-11. INT. CL. 9.
- ITT MANUFACTURING ENTERPRISES, INC., WILMING-  
TON, DE:  
2,486,685, REN. 9-17-11. MULTIPLE CLASS, INT. CLS. 9,

- 40 AND 42.  
2,511,544, REN. 9-19-11. INT. CL. 35.
- IUCN, INTERNATIONAL UNION FOR CONSERVATION OF NATURE AND NATURAL RESOURCES, GLAND, SWITZERLAND:  
2,415,447, CANC. MULTIPLE CLASS, INT. CLS. 16, 41 AND 42.
- IVERSON GENETIC DIAGNOSTICS, INC., BOTHELL, WA:  
4,045,747, MULTIPLE CLASS, INT. CLS. 10, 42 AND 44.
- IVILLAGE INC., NEW YORK, NY:  
2,428,028, CANC. INT. CL. 38.
- IVOCLAR VIVADENT, INC., AMHERST, NY:  
2,427,762, CANC. INT. CL. 41.
- IVYSAGE EDUCATION, LLC, NEW YORK, NY:  
4,044,155, PUB. 5-3-2011. INT. CL. 41.
- IWASAKI ELECTRIC CO., LTD., JAPAN:  
4,043,774, PUB. 8-9-2011. MULTIPLE CLASS, INT. CLS. 9 AND 11.
- IX MEDICAL, LONG BEACH, CA, DBA RADICAL SOLUTIONS:  
4,047,142, INT. CL. 10.
- IZOOX LLC, MONTROSE, CO:  
4,045,118, PUB. 8-9-2011. INT. CL. 42.
- IZZO, JAMES, SUMMERVILLE, SC:  
4,043,643, PUB. 8-9-2011. INT. CL. 9.
- J & L PEABERRY, EMERYVILLE, CA:  
4,044,975, PUB. 8-9-2011. INT. CL. 30.
- J WILLIAMS, LAGUNA BEACH, CA, DBA JJ NUMBER 8, INC.:  
4,045,394, PUB. 8-9-2011. MULTIPLE CLASS, INT. CLS. 14, 18 AND 25.
- J WORLD SPORTS, INC., HACKENSACK, NJ:  
4,044,428, PUB. 8-9-2011. INT. CL. 18.
- J. & P. COATS, LIMITED, GLASGOW, SCOTLAND:  
4,045,079, PUB. 8-9-2011. INT. CL. 23.  
4,045,082, PUB. 8-9-2011. INT. CL. 23.  
4,045,086, PUB. 8-9-2011. INT. CL. 23.  
4,045,090, PUB. 8-9-2011. INT. CL. 23.  
4,045,255, PUB. 8-9-2011. INT. CL. 23.  
4,045,257, PUB. 8-9-2011. INT. CL. 23.  
4,045,259, PUB. 8-9-2011. INT. CL. 23.  
4,045,263, PUB. 8-9-2011. INT. CL. 23.
- J. FRANK SCHMIDT & SON CO., BORING, OR:  
4,045,069, PUB. 8-9-2011. INT. CL. 31.  
4,045,071, PUB. 8-9-2011. INT. CL. 31.  
4,045,072, PUB. 8-9-2011. INT. CL. 31.
- J.A.O. TOOL, INC., ORANGE, CA:  
4,045,008, PUB. 8-9-2011. INT. CL. 8.
- J.C. NEWMAN CIGAR CO., TAMPA, FL, M & N CIGAR MANUFACTURERS, INC., TAMPA, FL:  
1,650,977, REN. 9-19-11. INT. CL. 34.
- J.I. PESTON PTY. LTD., STAPYLTON QLD, AUSTRALIA:  
2,600,490, REN. 9-21-11. INT. CL. 9.
- JAAS BEAUTY PRODUCTS, DUNDEE, IL:  
4,044,500, PUB. 8-9-2011. INT. CL. 3.
- JACK ROGERS HOLDING COMPANY LLC, NEW YORK, NY:  
3,990,774, COR. INT. CL. 16.
- JACK SHOCKLEE, SPRING HILL, TN:  
4,046,953, INT. CL. 9.
- JACKIE ROBINSON PARK OF FAME, INC., STAMFORD, CT:  
4,043,720, PUB. 8-9-2011. INT. CL. 41.
- JACKPOT CASINO PRODUCTIONS, INC., WEST ROXBURY, MA:  
2,543,026, REN. 9-19-11. INT. CL. 41.
- JACKSON & PERKINS COMPANY, MEDFORD, OR:  
2,926,677, CANC. MULTIPLE CLASS, INT. CLS. 1, 8, 21 AND 31.
- JACKSON, LYNN ANTHONY, HAYMARKET, VA:  
4,045,666, INT. CL. 41.
- JACOBS & TURNER LIMITED, KINNING PARK, GLASGOW, UNITED KINGDOM:  
2,520,804, REN. 9-20-11. INT. CL. 14.
- JACQUELINE JONES, BELLAIRE, TX:  
4,045,864, INT. CL. 10.
- JADED & HATED CLOTHING CO., LLC, MARICOPA, AZ:  
4,047,222, INT. CL. 25.
- JAGEX LIMITED, CAMBRIDGE, UNITED KINGDOM:  
4,043,719, PUB. 8-9-2011. MULTIPLE CLASS, INT. CLS. 9, 16, 25, 28 AND 41.
- JAIN IRRIGATION INC., ONTARIO, CA, WADE MANUFACTURING CO., TUALATIN, OR:  
1,643,515, REN. 9-16-11. INT. CL. 11.
- JAM PAK, INC., DEKALB, IL:  
2,428,419, CANC. INT. CL. 35.
- JAMES AUSTIN COMPANY, MARS, PA:  
736,538, REN. 9-22-11. U.S. CL. 52 (INT. CL. 3).
- JAMES K. LACY, MISSION, KS:  
4,045,636, INT. CL. 35.
- JAMES O. LUCAS, ST. AUGUSTINE, FL:  
4,044,757, PUB. 8-9-2011. INT. CL. 28.
- JAMESTOWN-YORKTOWN FOUNDATION, WILLIAMS-BURG, VA:  
4,045,111, PUB. 8-9-2011. INT. CL. 41.
- JAMISON ERNEST, NEW YORK, NY:  
4,046,418, INT. CL. 9.
- JAN GANDHI, TORONTO, ONTARIO, CANADA, DBA THE PEACOCK PARADE INC.:  
4,046,867, INT. CL. 35.
- JANET VALENZA LTD., NEW YORK, NY:  
4,045,651, MULTIPLE CLASS, INT. CLS. 37 AND 42.
- JAQUITH INDUSTRIES, INC., SYRACUSE, NY:  
1,180,922, REN. 9-20-11. INT. CL. 9.
- JARRAHNEJAD, PAYAM, PACIFIC PALISADES, CA:  
4,045,329, PUB. 8-9-2011. INT. CL. 44.
- JASON PETERS, PORTSMOUTH, RI:  
4,045,060, PUB. 8-9-2011. INT. CL. 43.  
4,045,159, PUB. 8-9-2011. INT. CL. 43.
- JAVAHERIAN, KEYVAN, LOS ANGELES, CA AND RAMSEY, ROD, LOS ANGELES, CA:  
4,044,779, PUB. 8-9-2011. INT. CL. 30.
- JAY-AIMEE DESIGNS, INC., LONG ISLAND CITY, NY AND MATALON, SHLOMO, WOODBURY, NY:  
4,047,252, INT. CL. 14.
- JBL TRADING, L.L.C., NEW YORK, NY:  
4,045,586, MULTIPLE CLASS, INT. CLS. 20, 24 AND 27.
- JC BEAL CONSTRUCTION, INC., ANN ARBOR, MI:  
2,500,845, REN. 9-19-11. INT. CL. 37.
- JCW ENTERPRISES, INC., NEW YORK, NY:  
4,045,125, PUB. 8-9-2011. INT. CL. 25.  
4,045,131, PUB. 8-9-2011. INT. CL. 25.
- JDA SOFTWARE GROUP, INC., SCOTTSDALE, AZ:  
2,985,681, CANC. INT. CL. 35.
- JEAN WATSON, LLC, BOULDER, CO:  
4,045,134, PUB. 8-9-2011. INT. CL. 3.
- JEAN-CLAUDE BOISSET WINES, USA, INC., ST. HELENA, CA:  
4,045,498, PUB. 8-9-2011. INT. CL. 33.  
4,045,500, PUB. 8-9-2011. INT. CL. 33.
- JEFFREY BARTLETT, LLC, CINCINNATI, OH:  
4,046,974, INT. CL. 35.
- JEMINI INTERNATIONAL INC., BONITA SPRINGS, FL:  
2,428,929, CANC. MULTIPLE CLASS, INT. CLS. 4 AND 21.
- JENNIFER C. BOOTH, OAKLAND, CA, AKA JAIS BOOTH:  
4,045,039, PUB. 8-9-2011. INT. CL. 41.
- JERMAINE JENKINS & TABARI LOFTON, FT. LAUDERDALE, FL, DBA SLUM DOGG ENTERTAINMENT:  
4,045,607, INT. CL. 9.
- JESMER, SUSAN M., HOGANSBURG, NY, DBA NATIVE TRADING ASSOCIATES:  
4,046,435, INT. CL. 34.
- JESSICA BURKE, CONCORD, CA, DBA JESSICA BURKE PHOTOGRAPHY:  
4,045,117, PUB. 8-9-2011. INT. CL. 41.
- JESSICA JANSEN, GLEN ELLYN, IL, DBA LITTLE LADY STUDIO:  
4,045,180, PUB. 8-9-2011. INT. CL. 16.
- JGR ENTERPRISES, LLC, FORT WORTH, TX, DBA O. B. MACARONI COMPANY, FORT WORTH MACARONI COMPANY, FORT WORTH, TX:  
543,056, REN. 9-21-11. U.S. CL. 46 (INT. CL. 30).
- JIM BEAM BRANDS CO., DEERFIELD, IL:  
3,975,512, CANC. INT. CL. 33.

- JIMMY JOHN'S ENTERPRISES, LLC, CHAMPAIGN, IL:  
4,044,364, PUB. 8-9-2011. INT. CL. 43.  
4,046,585, INT. CL. 43.
- JINLONG MACHINERY & ELECTRONICS CO., LTD.,  
325603 ZHEJIANG PROVINCE, CHINA:  
4,043,794, PUB. 8-9-2011. INT. CL. 7.
- JINU T THOMAS, BRIDGEWATER, NJ:  
4,046,447, INT. CL. 45.
- JJS INVESTMENTS, LLC, MESA, AZ:  
4,046,695, INT. CL. 44.
- JL BEVERAGE COMPANY LLC, HENDERSON, NV:  
4,043,874, PUB. 8-9-2011. INT. CL. 33.  
4,044,182, PUB. 5-3-2011. INT. CL. 33.
- JMG SOFTWARE, LLC, AKRON, OH:  
4,044,414, PUB. 8-9-2011. INT. CL. 42.
- JNI CORPORATION, SAN DIEGO, CA:  
2,926,311, CANC. INT. CL. 9.
- JOAQUIN SORIA, MIAMI, FL:  
4,046,637, INT. CL. 25.
- JOB4SIGHT, LLC, AUGUSTA, WV:  
4,046,320, MULTIPLE CLASS, INT. CLS. 35 AND 44.
- JOE BUCHER, EAGLE RIVER, WI:  
4,044,656, PUB. 8-9-2011. INT. CL. 28.
- JOHANN FROESCHEIS LYRA-BLEISTIFT-FABRIK GMBH  
& CO. KG, NÜRNBERG, FED REP GERMANY:  
4,046,005, INT. CL. 16.
- JOHN CRANE INC., MORTON GROVE, IL, CRANE PACK-  
ING COMPANY, MORTON GROVE, IL:  
1,166,509. REN. 9-22-11. INT. CL. 17.
- JOHN DEERE WATER, INC., SAN DIEGO, CA:  
925,778. REN. 9-19-11. U.S. CL. 13 (INT. CL. 11).
- JOHN P. PEARL & ASSOCIATES, LTD., PEORIA HEIGHTS,  
IL:  
2,328,771, CANC. INT. CL. 36.
- JOHN R. TURNER, DURANGO, CO:  
4,044,224, PUB. 8-9-2011. INT. CL. 35.  
4,044,225, PUB. 8-9-2011. INT. CL. 35.
- JOHN ROBERT HAAK, OAK RIDGE NORTH, TX:  
4,044,659, PUB. 8-9-2011. INT. CL. 9.
- JOHN W. WALKER, PA, MOSCOW, ID:  
4,047,230, INT. CL. 45.  
4,047,231, INT. CL. 45.
- JOHN WU, TORRANCE, CA:  
4,044,383, PUB. 8-9-2011. INT. CL. 9.
- JOHNNY C CHOI, ARCADIA, CA:  
4,045,033, PUB. 8-9-2011. INT. CL. 25.
- JOHNNY CHUN CHOI, ARCADIA, CA:  
4,045,128, PUB. 8-9-2011. INT. CL. 25.  
4,045,132, PUB. 8-9-2011. INT. CL. 25.  
4,045,135, PUB. 8-9-2011. INT. CL. 25.
- JOHNSON & JOHNSON, NEW BRUNSWICK, NJ:  
4,045,872, INT. CL. 21.  
4,045,992, INT. CL. 3.
- JOHNSON & JOHNSON-MERCK CONSUMER PHARMA-  
CEUTICALS COMPANY, FORT WASHINGTON, PA:  
720,270. REN. 9-19-11. U.S. CL. 18 (INT. CL. 5).
- JOHNSON FINANCIAL GROUP, INC., RACINE, WI:  
2,926,156, CANC. INT. CL. 36.
- JOHNSON, ARRON, SONOMA, CA:  
4,044,576, PUB. 8-9-2011. MULTIPLE CLASS, INT. CLS. 25  
AND 40.
- JOHNSON, DAN, SARASOTA, FL:  
4,045,399, PUB. 8-9-2011. INT. CL. 37.
- JOHNSON, WAYNE R., LAWRENCEVILLE, GA:  
4,044,560, PUB. 8-9-2011. INT. CL. 25.
- JOHNSON'S AUTOMOTIVE SERVICE, INC., CHARLESTON,  
IL:  
4,044,728, PUB. 8-9-2011. INT. CL. 37.
- JONES INVESTMENT CO. INC., WILMINGTON, DE, KAS-  
PER; HERBERT, NEW YORK, NY:  
1,162,830. REN. 9-19-11. INT. CL. 25.
- JONES, JEFF, FRANKLIN, TN:  
4,045,793, INT. CL. 25.
- JONES, MONICA G, SAN ANTONIO, TX, DBA RITZY  
BITZY DESIGNS:  
4,044,609, PUB. 8-9-2011. INT. CL. 10.
- JONMOR INVESTMENTS, INC., WILMINGTON, DE:  
2,513,699. REN. 9-21-11. INT. CL. 29.
- JORDON, LESLIE M., NORWICH, VT:  
4,044,230, PUB. 8-9-2011. INT. CL. 41.
- JOSE MARTIN CUEVAS COBOS, MEXICO, D.F., MEXICO:  
4,046,759, INT. CL. 3.
- JOSEPH CIOLLI, TEMPE, AZ:  
4,045,227, PUB. 8-9-2011. INT. CL. 43.
- JOSEPH E. BONADIMAN & ASSOCIATES, INC., SAN  
BERNARDINO, CA:  
2,513,838. REN. 9-21-11. INT. CL. 9.  
2,513,839. REN. 9-21-11. INT. CL. 9.
- JOSEPH NUDELMAN, INCORPORATED, SUNRISE, FL:  
2,428,964, CANC. INT. CL. 14.
- JOSEPH WARRENDER, HIGHLAND PARK, IL:  
4,047,262, INT. CL. 7.
- JOTO SAKE LLC, NEW YORK, NY:  
4,043,968, PUB. 3-15-2011. INT. CL. 33.  
4,044,211, PUB. 8-9-2011. INT. CL. 33.
- JOYCE, JOHN, DRACUT, MA:  
4,047,255, INT. CL. 41.
- JOYRIDE CYCLE STUDIO, LLC, WESTPORT, CT:  
4,047,047, INT. CL. 41.
- JPA FURNITURE, INC., PHOENIX, AZ:  
2,926,691, CANC. INT. CL. 35.
- JS IP LLC, AVENTURA, FL:  
4,046,412, INT. CL. 43.
- JT SALES LLC, ROSELAND, NJ:  
4,025,743, COR. INT. CL. 20.
- JTEKT CORPORATION, OSAKA, JAPAN:  
1,657,323. REN. 9-16-11. INT. CL. 12.
- JUAN BALLESTER ROSES SUCESTORES, S.A., 43500 TOR-  
TOSA (TARRAGONA), SPAIN:  
2,488,611. REN. 9-21-11. INT. CL. 29.
- JUDD WADDELL LLC, NEW YORK, NY:  
4,043,630, PUB. 8-9-2011. INT. CL. 25.
- JUDI COSTELLO, COVINA, CA, DBA UNIQUE UPHOLS-  
TERY & INTERIOR DESIGN, LLC:  
4,045,862, INT. CL. 20.
- JUDY'S GROUP, INC., NEW YORK, NY:  
2,526,101. REN. 9-18-11. INT. CL. 25.  
2,528,554. REN. 9-18-11. INT. CL. 25.
- JUGGLE ANGELS, SOCIÉTÉ PRIVÉE À RESPONSABILITÉ  
LIMITÉE, B-1050 IXELLES, BELGIUM:  
4,043,843, PUB. 8-9-2011. MULTIPLE CLASS, INT. CLS.  
14, 25 AND 35.
- JUGS SPORTS, INC., TUALATIN, OR:  
4,047,177, INT. CL. 28.
- JUNE TAILOR, INC., RICHFIELD, WI:  
4,046,950, INT. CL. 9.
- JUNO MANUFACTURING, LLC, DES PLAINES, IL:  
4,043,738, PUB. 8-9-2011. INT. CL. 11.
- JUPITERIMAGES CORPORATION, TUCSON, AZ:  
2,926,540, CANC. INT. CL. 9.
- JUST MOBILE LTD., TAICHUNG CITY 406, TAIWAN:  
4,044,549, PUB. 8-9-2011. INT. CL. 9.
- JUST THE TIP, INC., TORONTO, ONTARIO, CANADA:  
4,044,054, PUB. 8-9-2011. INT. CL. 16.  
4,044,055, PUB. 8-9-2011. INT. CL. 16.  
4,044,056, PUB. 8-9-2011. INT. CL. 25.  
4,044,057, PUB. 8-9-2011. INT. CL. 25.  
4,044,059, PUB. 8-9-2011. INT. CL. 38.
- JUSTHEFAXX, LLC, ORLANDO, FL:  
4,045,473, PUB. 8-9-2011. INT. CL. 42.
- JUSTIN E. KLEIN, NEW YORK, NY:  
4,044,474, PUB. 8-9-2011. MULTIPLE CLASS, INT. CLS. 41  
AND 45.
- JVW CORPORATION, HEALDSBURG, CA, JORDAN, THO-  
MAS N., JR., HEALDSBURG, CA, DBA JORDAN VINE-  
YARD & WINERY:  
1,650,300. REN. 9-20-11. INT. CL. 33.
- JW PET COMPANY, INC, TETERBORO, NJ:  
2,580,907. REN. 9-21-11. MULTIPLE CLASS, INT. CLS. 8  
AND 21.
- JX2, LLC, VIENNA, VA, DBA AXIAWARE:  
4,044,865, PUB. 8-9-2011. INT. CL. 42.
- JYP ENTERTAINMENT CO., LTD., SEOUL, DEM REP OF  
KOREA:  
2,428,424, CANC. INT. CL. 9.

K & COMPANY LLC, KANSAS CITY, MO:  
4,046,359, INT. CL. 16.  
4,046,610, INT. CL. 16.

K 5600, INC., NORTH HOLLYWOOD, CA:  
2,281,238, CANC. INT. CL. 11.

K.-W. PFANNENSCHMIDT, 22459 HAMBURG, FED REP GERMANY:  
4,044,895, PUB. 8-9-2011. INT. CL. 5.

KABAM, INC., REDWOOD CITY, CA:  
4,047,064, INT. CL. 41.

KABUSHIKI KAISHA JQR, KANAGAWA-KEN, JAPAN:  
4,046,242, INT. CL. 7.

KABUSHIKI KAISHA NAKASHIMATO SHOTEN, ALSO TRADING AS NAKASHIMATO CO., LTD., SHIBUYA-KU, TOKYO, JAPAN:  
4,044,061, PUB. 8-9-2011. MULTIPLE CLASS, INT. CLS. 29 AND 30.

KABUSHIKI KAISHA SQUARE ENIX, TOKYO, JAPAN, TA SQUARE ENIX CO., LTD.:  
4,046,809, INT. CL. 9.

KABUSHIKI KAISHA SQUARE ENIX HOLDINGS (ALSO TRADING AS SQUARE ENIX HOLDINGS CO., LTD.), TOKYO, JAPAN:  
2,503,111, REN. 9-22-11. INT. CL. 28.

KALAN INDUSTRIES, INC., HENDERSON, NV:  
4,044,586, PUB. 8-9-2011. INT. CL. 21.

KALTMAN CREATIONS LLC, SUWANEE, GA:  
4,045,174, PUB. 8-9-2011. INT. CL. 9.

KAMAGON FITNESS, LLC, TULSA, OK:  
4,046,513, MULTIPLE CLASS, INT. CLS. 25, 28 AND 41.

KAMAZU FASHION INC., CONCORD, ONTARIO, CANADA:  
4,045,780, INT. CL. 25.

KAMDAR, VALARIE, PARK CITY, UT:  
2,527,973, REN. 9-22-11. INT. CL. 35.

KANEBO KABUSHIKI KAISHA, SUMIDA-KU, TOKYO, JAPAN:  
2,427,962, CANC. MULTIPLE CLASS, INT. CLS. 20, 22, 23 AND 24.

KANEKA CORPORATION, OSAKA, JAPAN:  
1,175,139, REN. 9-21-11. INT. CL. 17.

KANEKA CORPORATION, KITA-KU, OSAKA, JAPAN:  
1,175,256, REN. 9-19-11. MULTIPLE CLASS, INT. CLS. 22 AND 26.

KAPLAN, JED P., BOCA RATON, FL:  
4,046,912, INT. CL. 36.

KAPLAN, JEFFREY, FT. LAUDERDALE, FL:  
4,044,298, PUB. 8-9-2011. INT. CL. 25.

KAPRIELIAN ENTERPRISES, INC., NEW YORK, NY:  
1,674,993, REN. 9-17-11. INT. CL. 14.

KARL-GEORG GLEHN, FED REP GERMANY:  
4,043,746, PUB. 10-26-2010. MULTIPLE CLASS, INT. CLS. 3, 29, 30 AND 31.

KARMA COTTAGE, ELIZABETH, CO:  
4,043,924, PUB. 11-30-2010. INT. CL. 35.

KARMA'S WORLD, LLC, EAST POINT, GA:  
4,046,187, MULTIPLE CLASS, INT. CLS. 38 AND 41.

KARMAN HEALTHCARE INC., CITY OF INDUSTRY, CA:  
4,044,138, PUB. 8-9-2011. INT. CL. 12.

KARSTEN MANUFACTURING CORPORATION, PHOENIX, AZ:  
4,046,683, INT. CL. 28.  
4,046,684, INT. CL. 28.  
4,046,706, INT. CL. 28.

KATE SPADE LLC, NEW YORK, NY:  
4,045,538, PUB. 8-9-2011. INT. CL. 25.

KATHY BERNU DESIGNS, INC., MEDINA, MN:  
2,482,323, REN. 9-21-11. INT. CL. 14.

KATRIN MENGEL, 20146 HAMBURG, FED REP GERMANY AND THOMAS WINGERTER, 20146 HAMBURG, FED REP GERMANY:  
4,043,848, PUB. 8-9-2011. MULTIPLE CLASS, INT. CLS. 9, 14, 16, 18 AND 20.

KATZ LAW OFFICE, LTD., CHICAGO, IL, FORMERLY MATTHEW A. KATZ, ATTORNEY AT LAW:  
4,045,930, MULTIPLE CLASS, INT. CLS. 16, 38, 41 AND 45.

KAWNEER COMPANY, INC., NORCROSS, GA:  
2,533,071, REN. 9-21-11. INT. CL. 6.

KAY CHEMICAL COMPANY, GREENSBORO, NC:  
2,563,863, REN. 9-19-11. INT. CL. 1.

KAYTEE PRODUCTS INCORPORATED, CHILTON, WI:  
4,046,752, INT. CL. 31.

KAZ USA, INC., SOUTHBOROUGH, MA:  
1,658,639, REN. 9-21-11. INT. CL. 9.

KAZ, INC., SOUTHBOROUGH, MA, HONEYWELL INTERNATIONAL INC., MORRISTOWN, NJ:  
2,503,264, REN. 9-22-11. INT. CL. 11.

KAZAK-MARS, INC., VAN NUYS, CA:  
4,045,588, INT. CL. 9.

KB MEDIA GROUP, LLC, SAN FRANCISCO, CA:  
4,046,622, INT. CL. 5.

KCA WELLNESS, SAN FRANCISCO, CA:  
4,044,403, PUB. 8-9-2011. INT. CL. 44.

KDM ENTERPRISES L.L.C., CARPENTERSVILLE, IL:  
4,046,363, INT. CL. 16.  
4,046,364, INT. CL. 16.

KELLSTROM AEROSPACE, LLC, MIRAMAR, FL:  
2,461,752, REN. 9-16-11. INT. CL. 35.

KELLWOOD COMPANY, CHESTERFIELD, MO:  
2,926,921, CANC. INT. CL. 25.

KELLY, DEE, MONROE, NY:  
4,045,592, MULTIPLE CLASS, INT. CLS. 9, 24, 41 AND 42.

KELLY'S KIDS & CRITTERS, LLC, WEST CHESTER, PA:  
4,047,038, MULTIPLE CLASS, INT. CLS. 16, 24 AND 25.

KELSEN GROUP A/S, NORRE SNEDE, DENMARK:  
2,547,539, REN. 9-22-11. INT. CL. 30.

KENDAL FLORAL SUPPLY, INC., CARLSBAD, CA:  
2,544,947, REN. 9-20-11. INT. CL. 31.

KENNETH WOLFE, THERESA, WI:  
4,045,271, PUB. 8-9-2011. INT. CL. 30.

KENNEY, GERRARD FRANCIS, STATE COLLEGE, PA:  
4,043,881, PUB. 8-9-2011. INT. CL. 9.

KENTON BROTHERS LOCKSMITHS, INC., KANSAS CITY, MO:  
4,045,374, PUB. 8-9-2011. INT. CL. 45.

KEPLER, BRITTANY L., HAYMARKET, VA:  
4,046,602, MULTIPLE CLASS, INT. CLS. 9 AND 25.

KERBER INDUSTRIES, INC, MONTCLAIR, CA:  
4,047,166, INT. CL. 19.

KERRY I&F CONTRACTING COMPANY, BELOIT, WI, AKA KERRY INGREDIENTS & FLAVOURS:  
1,664,307, REN. 9-22-11. INT. CL. 32.

KERSHAW, THOMAS R, CAPE CORAL, FL:  
2,926,960, CANC. INT. CL. 28.

KERSHNER TECHNOLOGY AND INNOVATION, LLC, AUSTIN, TX:  
2,448,252, REN. 9-21-11. INT. CL. 36.

KESHA STOWE SPENCE, EAST STROUDSBURG, PA:  
4,043,622, PUB. 8-9-2011. INT. CL. 25.

KEVIN A. PRICE, OAK PARK, IL:  
4,046,424, INT. CL. 35.

KEWAUNEE SCIENTIFIC CORPORATION, STATESVILLE, NC:  
1,657,211, REN. 9-21-11. INT. CL. 9.  
2,428,766, CANC. U.S. CL. A.

KEWPREE, INC., LIMA, OH:  
4,044,999, PUB. 8-9-2011. MULTIPLE CLASS, INT. CLS. 30 AND 43.

KEYCORP, CLEVELAND, OH:  
4,046,758, INT. CL. 36.

KEYSHEEN INDUSTRY (SHANGHAI) CO., LTD., QINGPU DISTRICT, SHANGHAI, CHINA:  
2,528,606, REN. 9-21-11. INT. CL. 18.  
2,548,362, REN. 9-21-11. INT. CL. 20.

KEYS4CABS, INC., TULSA, OK:  
4,044,515, PUB. 8-9-2011. MULTIPLE CLASS, INT. CLS. 39 AND 41.

KHETARPAL LIVING TRUST, VALENCIA, CA:  
4,046,778, INT. CL. 5.

KIDDIE'S PARADISE INC., TAIPEI, TAIWAN:  
2,519,223, REN. 9-21-11. INT. CL. 28.

KIDGINEER, LLC, LAUREL, MD:  
4,046,973, INT. CL. 41.

- KIDSCOOK PRODUCTIONS, LLC, CAMBRIDGE, MA:  
4,046,477, INT. CL. 43.
- KIEHNAU, BRENDA A., CEDARBURG, WI:  
4,047,042, INT. CL. 3.
- KIKKERIMOKA SOFTWARE INC, SUNNYVALE, CA:  
4,045,468, PUB. 8-9-2011. INT. CL. 9.
- KILLETTE, ANDREW HOYT, LAGRANGE, NC:  
4,044,680, PUB. 8-9-2011. MULTIPLE CLASS, INT. CLS. 25 AND 28.  
4,045,254, PUB. 8-9-2011. MULTIPLE CLASS, INT. CLS. 25 AND 28.
- KIM AND MIKE WILLIAMS, INC, WOODSTOWN, NJ, DBA K M TRANSPORTATION CO.:  
2,503,959. REN. 9-20-11. INT. CL. 39.
- KIM D. BOWDEN, NEWCASTLE, WA:  
4,046,997, INT. CL. 28.
- KIM, JESSE, JACKSON HEIGHTS, NY:  
4,046,919, INT. CL. 3.
- KIM, KEVIN SAN, SANTA ANA, CA, DBA FRESH IN ALTERNATIVE SENSE, INC.:  
2,642,475, CANC. INT. CL. 5.
- KIMAYA FASHIONS PRIVATE LIMITED, MUMBAI, INDIA:  
4,043,702, PUB. 8-9-2011. INT. CL. 14.  
4,043,703, PUB. 8-9-2011. INT. CL. 35.
- KIMAYA USA, INC, SECAUCUS, NJ:  
4,046,670, INT. CL. 14.
- KIMBALL UNION ACADEMY, MERIDEN, NH:  
4,045,408, PUB. 8-9-2011. INT. CL. 25.
- KINETEK, INC., DEERFIELD, IL:  
2,933,497, CANC. INT. CL. 12.
- KING BIO, INC., ASHEVILLE, NC:  
2,493,054. REN. 9-21-11. INT. CL. 5.
- KING DAVID INTERACTIVE CORP., MCKEES ROCKS, PA:  
2,926,671, CANC. MULTIPLE CLASS, INT. CLS. 35 AND 41.
- KINGSDOWN, INC., MEBANE, NC:  
4,046,260, INT. CL. 20.
- KINKARACO - GREEN BURIAL PRODUCTS, SAN FRANCISCO, CA:  
4,045,833, MULTIPLE CLASS, INT. CLS. 3 AND 24.  
4,045,834, INT. CL. 24.
- KINLEA HOLDINGS PTY LTD, ST LEONARDS, NSW, AUSTRALIA:  
2,489,918. REN. 9-21-11. INT. CL. 28.
- KIPSU, LLC, PLYMOUTH, MN:  
4,047,025, INT. CL. 38.
- KIRIN HOLDINGS KABUSHIKI KAISHA A/T/A KIRIN HOLDINGS CO., LTD., TOKYO, JAPAN:  
723,672. REN. 9-21-11. U.S. CL. 48 (INT. CL. 32).
- KIRK, BRIDGETTE, CENTENNIAL PARK, AUSTRALIA:  
4,043,911, PUB. 5-3-2011. INT. CL. 3.
- KISER ARENA SPECIALISTS, INC., GAINESVILLE, TX:  
4,044,235, PUB. 8-9-2011. INT. CL. 7.
- KITMAKER INC., MIAMI BEACH, FL:  
4,046,413, INT. CL. 28.
- KITTRELL, DAN, FORT PIERCE, FL AND WILLIAMS, ROBERT, FORT PIERCE, FL:  
4,046,890, INT. CL. 25.
- KIWANIS INTERNATIONAL, INC., INDIANAPOLIS, IN:  
2,477,551. REN. 9-19-11. MULTIPLE CLASS, INT. CLS. 36 AND 42.
- KKDC PTY LTD, MILSONS POINT NSW 2061, AUSTRALIA:  
4,043,756, PUB. 8-9-2011. INT. CL. 11.  
4,043,757, PUB. 8-9-2011. INT. CL. 11.
- KLEIN ELECTRONICS, INC., ESCONDIDO, CA:  
4,046,765, INT. CL. 11.  
4,046,787, INT. CL. 11.
- KLEINDIENST, KARA, NEW YORK, NY:  
4,044,989, PUB. 8-9-2011. INT. CL. 44.
- KLOKOW, JONATHAN M., FORT LAUDERDALE, FL:  
4,045,969, INT. CL. 28.
- KNEW GENERATION LLC, JERSEY CITY, NJ:  
4,045,373, PUB. 8-9-2011. INT. CL. 42.
- KNO, INC., SANTA CLARA, CA:  
4,045,949, INT. CL. 9.  
4,045,950, INT. CL. 38.  
4,045,951, INT. CL. 42.
- KNOTT, MARK S., CALLAWAY, MD:  
2,926,590, CANC. INT. CL. 28.
- KNOWLEDGE IN A NUTSHELL, INC., PITTSBURGH, PA:  
2,481,586, REN. 9-21-11. INT. CL. 16.
- KNOWLEDGE UNLIMITED, INC., MADISON, WI:  
2,428,773, CANC. INT. CL. 41.
- KOAL, JAN, PULLMAN, WA:  
4,046,502, U.S. CL. B.
- KOEVELOOSHEN, HENDERSONVILLE, TN:  
4,045,027, PUB. 8-9-2011. INT. CL. 45.
- KOEZE COMPANY, GRAND RAPIDS, MI:  
1,861,067, AM. MULTIPLE CLASS, INT. CLS. 29 AND 30.
- KOGER, INC., PARAMUS, NJ:  
4,044,171, PUB. 5-3-2011. INT. CL. 9.
- KOHBURG, INC., POMONA, CA:  
4,044,221, PUB. 8-9-2011. INT. CL. 20.
- KOHLER CO., KOHLER, WI:  
4,046,811, INT. CL. 11.  
4,046,844, INT. CL. 20.
- KOLVET, KERRY J, RENO, NV:  
4,046,238, INT. CL. 41.
- KONAMI DIGITAL ENTERTAINMENT CO., LTD., TOKYO, JAPAN:  
4,046,119, MULTIPLE CLASS, INT. CLS. 9 AND 41.  
4,046,223, MULTIPLE CLASS, INT. CLS. 9 AND 41.
- KONINKLIJKE PHILIPS ELECTRONICS N.V., NETHERLANDS:  
4,043,793, PUB. 8-9-2011. INT. CL. 9.
- KORNEGAY, JAMES, GATE CITY, VA TO J.M. RIDGEWORTH INC., AVENTURA, FL:  
2,428,644, CANC. INT. CL. 34.
- KORNIT DIGITAL LTD, 48092 ROSH HAAYIN, ISRAEL:  
4,044,184, PUB. 8-9-2011. INT. CL. 9.
- KOROKNAY, TOM, LEXINGTON, OH:  
2,578,365. REN. 9-16-11. INT. CL. 25.
- KORSCH AG, FED REP GERMANY:  
3,029,430.
- KOTTER INTERNATIONAL, INC., CAMBRIDGE, MA:  
4,046,254, INT. CL. 16.  
4,046,255, INT. CL. 9.  
4,046,258, INT. CL. 16.  
4,046,259, INT. CL. 9.
- KOZY SHACK ENTERPRISES, INC., HICKSVILLE, NY:  
4,043,683, PUB. 8-9-2011. INT. CL. 36.
- KRAFT FOODS GLOBAL BRANDS LLC, NORTHFIELD, IL:  
919,506. REN. 9-19-11. U.S. CL. 46 (INT. CLS. 29 AND 30).
- KRAMER ELECTRONICS LTD., JERUSALEM, ISRAEL:  
4,043,698, PUB. 7-12-2011. INT. CL. 9.
- KRELLER BUSINESS INFORMATION GROUP, INC., CINCINNATI, OH, DBA KRELLER GROUP:  
4,044,534, PUB. 8-9-2011. MULTIPLE CLASS, INT. CLS. 36 AND 45.
- KRISHNAMURTI FOUNDATION OF AMERICA, OJAI, CA:  
2,428,583, CANC. INT. CL. 36.
- KRISTEN A. BITTNER, VANCOUVER, WA, DBA STUNT QUEEN AND CHRISTOPHER B. BITTNER, VANCOUVER, WA, DBA STUNT QUEEN:  
4,045,216, PUB. 8-9-2011. INT. CL. 25.
- KROGER CO. OF MICHIGAN, THE, LIVONIA, MI, KROGER CO. OF MICHIGAN, THE, LIVONIA, MI:  
2,612,423. REN. 9-20-11. MULTIPLE CLASS, INT. CLS. 4, 11 AND 24.
- KSIN LUXEMBOURG III. S.A.R.L., LUXEMBOURG:  
4,046,884, INT. CL. 7.  
4,046,885, INT. CL. 7.  
4,046,886, INT. CL. 7.
- KUMKANG SHOE MANUFACTURING CO., LTD., TENAFLY, NJ:  
1,670,922. REN. 9-16-11. INT. CL. 25.
- KURARAY CO., LTD., KURASHIKI CITY OKAYAMA PREFECTURE, JAPAN:  
1,158,093. REN. 9-20-11. MULTIPLE CLASS, INT. CLS. 18, 24 AND 25.
- KUREHA CORPORATION, TOKYO 103-8552,, JAPAN:  
2,525,286. REN. 9-20-11. INT. CL. 28.
- KURT GUTMANN JEWELRY, INC., NEWTOWN, PA:  
2,926,662, CANC. INT. CL. 14.

KURT S. ADLER, INC., NEW YORK, NY:  
2,428,808, CANC. INT. CL. 28.

KWORLD COMPUTER CO., LTD., NEW TAIPEI CITY,  
TAIWAN:  
3,832,879 NEW CERT. 10-25-2011. INT. CL. 9.

K2 ELECTRONICS, NEW YORK, NY:  
4,046,871, INT. CL. 35.

K2 ENERGY SOLUTIONS, INC., HENDERSON, NV:  
4,044,636, PUB. 8-9-2011. INT. CL. 9.

L & V INVESTMENTS, LLC, DESTIN, FL:  
2,598,956. REN. 9-22-11. INT. CL. 37.

L+D PUBLISHING LLC, HOUSTON, TX:  
4,045,311, PUB. 8-9-2011. INT. CL. 16.

L-FASHION GROUP OY, LAHTI, FINLAND:  
4,043,741, PUB. 5-15-2007. INT. CL. 25.

L-3 COMMUNICATIONS CORPORATION, NEW YORK, NY:  
4,045,581, INT. CL. 9.

L'AIR LIQUIDE, SOCIÉTÉ ANONYME POUR L'ETUDE ET  
L'EXPLOITATION DES PROCÉDÉS GEORGES CLAUDE,  
PARIS, FRANCE:  
4,044,025, PUB. 8-9-2011. INT. CL. 1.

L'OREAL, PARIS, FRANCE:  
2,515,520. REN. 9-22-11. INT. CL. 3.

L'OREAL USA CREATIVE, INC., NEW YORK, NY:  
2,927,024, CANC. INT. CL. 3.  
4,046,674, INT. CL. 3.

LA MONA, LLC, LOS ANGELES, CA, DBA MO-CHICA:  
4,044,734, PUB. 8-9-2011. INT. CL. 43.

LA REDOUTE, 59110 ROUBAIX (NORD), FRANCE:  
2,427,837, CANC. INT. CL. 25.

LA-Z-BOY GREENSBORO, INC., MONROE, MI:  
1,661,760. REN. 9-20-11. INT. CL. 20.

LABAUGH, MAGGIE A., TAKOMA PARK, MD:  
4,044,036, PUB. 8-9-2011. INT. CL. 40.

LABORATOIRE CCD, F-75010 PARIS, FRANCE:  
4,043,792, PUB. 8-9-2011. MULTIPLE CLASS, INT. CLS. 3,  
5 AND 10.

LABORATOIRES EXPANSCIENCE, COURBEVOIE,  
FRANCE:  
2,926,898, CANC. MULTIPLE CLASS, INT. CLS. 1 AND 5.

LABORATORIOS HIGIA, S.A., TLALPAN 14420, MEXICO:  
4,044,136, PUB. 8-9-2011. INT. CL. 5.

LABWORKS EQUIPMENT SERVICE, INC., NOVATO, CA:  
4,044,750, PUB. 8-9-2011. INT. CL. 37.

LACE FINANCIAL CORPORATION, FREDERICK, MD:  
1,570,434, CANC. INT. CL. 42.  
1,572,611, CANC. INT. CL. 42.

LACKIE, MISTY, OCEANO, CA:  
4,045,440, PUB. 8-9-2011. INT. CL. 45.

LAFARGE NORTH AMERICA INC., RESTON, VA:  
2,926,784, CANC. INT. CL. 19.

LAFCO ENTERPRISES INC., NEW YORK, NY:  
4,046,763, INT. CL. 4.

LAKESHORE INVESTMENT CORPORATION, INC., SEAT-  
TLE, WA:  
2,481,882. REN. 9-20-11. INT. CL. 36.

LAKESIDE RECOVERY CENTERS, INC., KIRKLAND, WA:  
1,707,466. REN. 9-21-11. INT. CL. 42.

LAMBERTI, ROMUALDO, CHERRY HILL, NJ:  
2,481,240. REN. 9-21-11. INT. CL. 42.

LAMU COSMETICS INC, FULLERTON, CA:  
4,045,819, INT. CL. 3.

LANCASTER BINGO COMPANY, INC., THE, LANCASTER,  
OH:  
2,482,262. REN. 9-20-11. INT. CL. 28.

LANCOME PARFUMS ET BEAUTE & CIE, PARIS, FRANCE:  
4,043,921, PUB. 8-9-2011. INT. CL. 3.

LAND SPAN, INC., ATLANTA, GA:  
4,045,783, INT. CL. 39.

LANDACORP, INC., LOUISVILLE, KY:  
4,045,655, INT. CL. 9.

LANDAUER, INC., GLENWOOD, IL:  
4,046,285, INT. CL. 42.

LANDEC AG, INC., MONTICELLO, IN:  
2,926,497, CANC. INT. CL. 31.

LONDON IP, INC., ALEXANDRIA, VA:  
4,045,736, INT. CL. 45.

LANDQART, LANDQUART-FABRIKEN, SWITZERLAND:  
2,475,467. REN. 9-16-11. INT. CL. 16.

LANE BRYANT PURCHASING CORP, COLUMBUS, OH:  
4,046,804, INT. CL. 25.  
4,046,806, INT. CL. 25.

LANE FURNITURE INDUSTRIES, INC., TUPELO, MS:  
1,172,308. REN. 9-21-11. INT. CL. 20.

LANG INSURANCE SERVICE, INC., ST. CHARLES, MO:  
4,045,307, PUB. 8-9-2011. INT. CL. 36.

LANIAK, MAUREEN L., MATTHEWS, NC:  
4,044,490, PUB. 8-9-2011. INT. CL. 3.

LAP GMBH LASER APPLIKATIONEN, FED REP GER-  
MANY:  
3,107,068.

LAROSE INDUSTRIES, LLC, RANDOLPH, NJ:  
4,046,325, INT. CL. 16.

LARSON, JULIE, LAS VEGAS, NV:  
4,043,963, PUB. 8-9-2011. INT. CL. 43.

LAS VEGAS LOUNGE, LAS VEGAS, NV:  
4,046,818, INT. CL. 39.

LAS VEGAS SANDS CORP., LAS VEGAS, NV:  
4,045,671, INT. CL. 44.  
4,045,701, INT. CL. 28.

LASER MOTION SYSTEMS, LLC, SANTA BARBARA, CA:  
4,046,160, MULTIPLE CLASS, INT. CLS. 10 AND 28.

LATCHMAN, ROBERT, RAHWAY, NJ:  
2,521,801. REN. 9-22-11. INT. CL. 32.

LATIN DOLL VENTURES, INC., BROOKLYN, NY:  
2,439,441. REN. 9-22-11. INT. CL. 25.  
2,439,465. REN. 9-22-11. INT. CL. 41.

LATOUR, LUIS M., DORAL, FL:  
4,046,478, INT. CL. 1.

LATTOF, MITCHELL G. (III), MOBILE, AL, DBA SALTY  
DOG SPORTFISHING:  
4,043,993, PUB. 8-9-2011. INT. CL. 39.

LAUGH FACTORY INC., LOS ANGELES, CA:  
4,045,095, PUB. 8-9-2011. INT. CL. 41.

LAUREN MOSHI LLC, COMMERCE, CA:  
4,046,369, MULTIPLE CLASS, INT. CLS. 14 AND 18.

LAVA LITE, LLC, CHICAGO, IL:  
4,043,605, PUB. 8-9-2011. INT. CL. 11.

LAVANGA, DANIEL, FEASTERVILLE, PA:  
4,043,978, PUB. 8-9-2011. MULTIPLE CLASS, INT. CLS. 44  
AND 45.

LAVENDER, GERRY, R. SAN ANTONIO, TX, DBA NET-  
SOFT ENGINEERING:  
4,045,097, PUB. 8-9-2011. INT. CL. 9.

LAWFINANCE GROUP, INC., SAN FRANCISCO, CA:  
2,511,455. REN. 9-22-11. INT. CL. 36.

LAWRENCE DISTRIBUTION INC, LAKE ZURICH, IL:  
2,281,091, CANC. INT. CL. 4.

LAWRENCE, KEVIN, IRVINE, CA:  
2,536,837. REN. 9-21-11. INT. CL. 5.

LAWRENCE, LILY ELIZABETH, SANTA MONICA, CA AND  
LAWRENCE, DAVID B., SANTA MONICA, CA:  
4,045,455, PUB. 8-9-2011. INT. CL. 35.

LAYCOCK, SUSAN S., COTTAGE GROVE, OR:  
4,043,625, PUB. 8-9-2011. INT. CL. 3.

LAZY 8 RANCH SPECIALTY FOOD CO., LLC, DRIFT-  
WOOD, TX:  
4,044,730, PUB. 8-9-2011. INT. CL. 30.  
4,044,731, PUB. 8-9-2011. INT. CL. 30.

LCN APPAREL, INC., NEW YORK, NY:  
2,482,746. REN. 9-21-11. INT. CL. 25.

LCS INTERNATIONAL B.V., CL ROTTERDAM, NETHER-  
LANDS:  
4,044,214, PUB. 8-9-2011. MULTIPLE CLASS, INT. CLS.  
18, 25 AND 35.

LE CORDON BLEU INTERNATIONAL B.V., AMSTERDAM,  
NETHERLANDS, RENAUD COINTREAU & CIE, PARIS,  
FRANCE:  
1,635,545. REN. 9-16-11. INT. CL. 25.

LE GALA INTERNATIONAL LTD., PEI-TOU, TAIPEI,  
TAIWAN:  
4,045,642, INT. CL. 24.

LEAD CO., LTD., SEOUL, REPUBLIC OF KOREA:  
2,473,983. REN. 9-19-11. INT. CL. 25.

- LEAD VENTURES, LLC, EAST GREENWICH, RI:  
2,428,276, CANC. INT. CL. 42.
- LEADING EDGE FOOTWEAR GROUP, INC., SECAUCUS, NJ:  
4,046,772, INT. CL. 25.
- LEARNING PATHWAYS INC., NEW YORK, NY:  
2,493,111, REN. 9-20-11. INT. CL. 42.
- LEARNING RESOURCES, INC., VERNON HILLS, IL:  
2,492,367, REN. 9-18-11. INT. CL. 9.
- LEATHERMAN TOOL GROUP, INC., PORTLAND, OR:  
2,474,800, REN. 9-20-11. INT. CL. 25.
- LEBANON SEABOARD CORP., LEBANON, PA:  
4,046,693, MULTIPLE CLASS, INT. CLS. 1 AND 5.
- LEBANON SEABOARD CORPORATION, LEBANON, PA,  
TAYLOR MILLING CORPORATION, LOS ANGELES, CA:  
397,101, REN. 9-19-11. U.S. CL. 10 (INT. CL. 31).
- LEBHAR-FRIEDMAN INC., NEW YORK, NY:  
2,482,131, REN. 9-17-11. INT. CL. 16.
- LEE, YOUNG SIK, TORRANCE, CA:  
2,794,253, CANC. INT. CL. 43.
- LEECO INDUSTRIES, INC., HERNANDO, MS:  
2,492,342, REN. 9-20-11. INT. CL. 20.
- LEEJAMES INC., DALLAS, TX:  
4,045,877, INT. CL. 25.
- LEGACY PATHWAYS LLC, WYNNWOOD, PA:  
4,044,286, PUB. 8-9-2011. INT. CL. 41.
- LEGACY PAVILION LLC, ATLANTA, GA:  
4,045,865, MULTIPLE CLASS, INT. CLS. 35, 41 AND 43.
- LEGAL XTRANET INC., SAN ANTONIO, TX:  
4,046,493, INT. CL. 42.
- LEGALBIZDEV, BOSTON, MA:  
4,047,199, INT. CL. 41.
- LEGALLY HUNGRY LLC, CLIFTON, NJ:  
4,044,334, PUB. 7-5-2011. MULTIPLE CLASS, INT. CLS. 41  
AND 43.
- LEGORRETA, LEONARDO, SACRAMENTO, CA:  
4,045,960, INT. CL. 41.
- LEITNER S.P.A., I-39049 VIPITENO (BZ), ITALY:  
2,484,296, REN. 9-19-11. MULTIPLE CLASS, INT. CLS. 12,  
37 AND 42.  
2,484,296, CANC. INT. CL. 7.
- LEMON TREE DEVELOPMENT, LLC, EAST HANOVER, NJ:  
4,044,841, PUB. 8-9-2011. INT. CL. 44.
- LEMONFREE.COM INC., WINNIPEG, MANITOBA, CANA-  
DA:  
4,044,097, PUB. 8-9-2011. INT. CL. 42.
- LEO PAPER BAGS MANUFACTURING (1982) LIMITED,  
KOWLOON BAY, KOWLOON, HONG KONG:  
4,044,067, PUB. 8-9-2011. INT. CL. 16.
- LEONARD DEMTRIOUS JONES, BIRMINGHAM, AL:  
4,043,610, PUB. 8-9-2011. INT. CL. 25.
- LEPORINO, DANIEL E., SPRING HILL, FL, DBA PIZZA  
VILLA RESTAURANT:  
1,661,228, REN. 9-16-11. INT. CL. 42.
- LEPORT EDUCATIONAL INSTITUTE, INC., HUNTING-  
TON BEACH, CA, DBA LEPORT SCHOOLS:  
4,046,321, INT. CL. 41.
- LEPRECHAUN CIDER COMPANY, LLC, HOUSTON, TX:  
4,046,517, INT. CL. 33.
- LES ALIMENTS ROSE HILL FOODS INC., ST-LAURENT,  
QUEBEC H4S 2A2, CANADA:  
2,926,664, CANC. MULTIPLE CLASS, INT. CLS. 29 AND  
30.
- LES PIERRES STONEDGE INC., ST-HUBERT, QUEBEC,  
CANADA:  
4,043,606, PUB. 8-28-2007. INT. CL. 19.
- LESSONS FOR CHARITY, LLC, BOSTON, MA:  
4,047,178, INT. CL. 36.
- LET THE GAMES BEGIN AMUSEMENTS, LLC, CARMI-  
CHAE, CA:  
4,044,887, PUB. 8-9-2011. INT. CL. 41.
- LETTUCE ENTERTAIN YOU ENTERPRISES, INC., CHICA-  
GO, IL:  
2,423,915, REN. 9-19-11. INT. CL. 42.  
4,047,079, MULTIPLE CLASS, INT. CLS. 35 AND 39.  
4,047,082, MULTIPLE CLASS, INT. CLS. 35 AND 39.
- LEUPOLD & STEVENS, INC., BEAVERTON, OR:  
4,046,446, INT. CL. 9.  
4,046,710, INT. CL. 13.  
4,046,711, INT. CL. 13.
- LEVINGER COMPANY, DELRAY BEACH, FL:  
2,468,006, REN. 9-21-11. INT. CL. 16.
- LEVY PREMIUM FOODSERVICE LIMITED PARTNER-  
SHIP, CHICAGO, IL:  
4,046,294, MULTIPLE CLASS, INT. CLS. 35 AND 43.
- LEVYTAM, SHALOM, LONDON, ONTARIO, CANADA:  
4,044,248, PUB. 8-9-2011. INT. CL. 42.
- LEWIS BROTHERS BAKERIES INCORPORATED, EVANS-  
VILLE, IN, DBA LEWIS BAKERIES, INC.:  
2,488,929, REN. 9-20-11. INT. CL. 30.
- LEWIS, SHARON CARPENTER, EASTON, MD:  
4,046,046, INT. CL. 32.
- LEYAT SÄRL, SWITZERLAND:  
4,043,761, PUB. 8-9-2011. INT. CL. 8.
- LF, LLC, MOUNT MOURNE, NC:  
2,985,796, CANC. MULTIPLE CLASS, INT. CLS. 8 AND  
19.
- LG ELECTRONICS INC., SEOUL, REPUBLIC OF KOREA:  
4,044,024, PUB. 8-9-2011. INT. CL. 7.  
4,045,720, INT. CL. 9.
- LI SI YANG, HONOLULU, HI:  
4,046,698, INT. CL. 9.
- LIANIDES LLC, REDWOOD CITY, CA:  
4,045,944, INT. CL. 25.
- LIBBY, PERSZYK, KATHMAN, INC., CINCINNATI, OH:  
2,488,746, REN. 9-19-11. MULTIPLE CLASS, INT. CLS. 35  
AND 42.
- LIBERTY DIVERSIFIED INDUSTRIES, MINNEAPOLIS,  
MN:  
1,663,424, REN. 9-20-11. INT. CL. 17.
- LIBERTY IMPORTS USA, INC., ALLENTOWN, PA:  
4,043,623, PUB. 8-9-2011. INT. CL. 32.
- LIDESTRI FOODS, INC., FAIRPORT, NY:  
4,044,041, PUB. 8-9-2011. INT. CL. 30.  
4,044,093, PUB. 8-9-2011. MULTIPLE CLASS, INT. CLS.  
39, 40 AND 42.
- LIFE FOR MOTHERS, NEW YORK, NY:  
4,046,185, INT. CL. 35.
- LIFE IN PROVENCE, INC., LOS ANGELES, CA:  
2,579,750, REN. 9-19-11. MULTIPLE CLASS, INT. CLS. 29  
AND 30.
- LIFE ODYSSEY COACHING AND CONSULTING LLC,  
NEW CANAAN, CT:  
4,044,928, PUB. 8-9-2011. INT. CL. 41.
- LIFEALIKE LIMITED, LONDON, EC1Y 4UP, UNITED  
KINGDOM:  
4,043,967, PUB. 2-8-2011. MULTIPLE CLASS, INT. CLS. 35  
AND 43.
- LIFELINK FOUNDATION, INC., TAMPA, FL:  
2,484,196, REN. 9-19-11. MULTIPLE CLASS, INT. CLS. 41  
AND 42.
- LIFELONG EDUCATION INSTITUTE, MILL VALLEY, CA:  
4,046,340, INT. CL. 41.
- LIFETIME ENTERTAINMENT SERVICES, LLC, NEW  
YORK, NY:  
4,046,618, INT. CL. 41.
- LIFETOUCH INC., EDEN PRAIRIE, MN:  
2,590,456, REN. 9-21-11. INT. CL. 16.
- LIFTED RESEARCH GROUP INC, IRVINE, CA:  
4,046,201, MULTIPLE CLASS, INT. CLS. 18 AND 25.
- LIGHT IN THE BOX LIMITED, DES VOEUX RD C  
CENTRAL, HONG KONG:  
4,045,358, PUB. 8-9-2011. INT. CL. 9.  
4,045,359, PUB. 8-9-2011. INT. CL. 25.
- LIGHTHOUSE STRATEGIC PROJECTS GROUP, INC., LAN-  
GHORNE, PA:  
4,045,982, INT. CL. 9.
- LIGHTSPEED TECHNOLOGIES, INC., TUALATIN, OR:  
4,047,026, INT. CL. 9.
- LIMBIC SYSTEMS, INC., BELLINGHAM, WA:  
2,926,875, CANC. INT. CL. 9.
- LIMITED LIABILITY COMPANY "WEB SERVICE", MOS-  
COW, RUSSIAN FED.:  
4,045,217, PUB. 8-9-2011. INT. CL. 45.



LIN, JOSEPH JUI-CHI, BUENA PARK, CA:  
2,500,957. REN. 9-21-11. INT. CL. 20.

LIN, QISHU, WESTBURY, NY:  
4,044,229. PUB. 8-9-2011. INT. CL. 29.

LINCOLN ACADEMY, LLC, HOUSTON, TX:  
4,044,399. PUB. 8-9-2011. INT. CL. 41.

LINCOLN GLOBAL, INC., MONTEREY PARK, CA, AIR  
REDUCTION COMPANY, INCORPORATED, NEW  
YORK, NY:  
719,141. REN. 9-20-11. U.S. CL. 14 (INT. CL. 6).

LINCOLN WOOD PRODUCTS, INC., MERRILL, WI:  
2,525,657. REN. 9-16-11. INT. CL. 9.

LINDBERG BEAUTY CORPORATION, TORRANCE, CA:  
4,045,753. INT. CL. 3.

LINDE AG, MÜNCHEN, FED REP GERMANY:  
2,427,968. CANC. INT. CL. 37.

LINDSEY, ELEANOR, NORTH LITTLE ROCK, AR:  
2,428,949. CANC. INT. CL. 25.

LINDSTRÖM, MARIA ANNA JOHANNA, ÖRNSKÖLDS-  
VIK, SWEDEN:  
4,045,857. INT. CL. 25.

LINE ART, INC., HOLLYWOOD, FL:  
2,534,171. REN. 9-16-11. INT. CL. 25.

LINKESH A DIWAN, NORWICH, CT, DBA WISE EARTH  
PUBLISHERS:  
4,046,975. INT. CL. 41.

LIONEL GROLEAU, FRANCE:  
4,043,803. PUB. 8-9-2011. MULTIPLE CLASS, INT. CLS.  
31, 35 AND 43.

LIQUID ICE, INC., MARLBORO, MA:  
2,549,228. REN. 9-20-11. INT. CL. 32.

LISAP LABORATORI COSMETICI S.P.A., 20123 MILAN,  
ITALY:  
2,490,368. REN. 9-21-11. INT. CL. 3.

LISTMARKETER SOFTWARE, INC., CHEYENNE, WY:  
4,043,714. PUB. 1-18-2011. INT. CL. 9.

LIT, BEVERLY HILLS, CA:  
2,511,488. REN. 9-19-11. INT. CL. 25.

LITEFOOT ENTERPRISES, LLC, SEATTLE, WA:  
4,046,540. INT. CL. 25.

LITTLE WING WORLD, LLC, MIAMI BEACH, FL:  
4,046,527. INT. CL. 42.

LIVE NATION WORLDWIDE, INC., BEVERLY HILLS, CA:  
2,926,548. CANC. INT. CL. 41.  
2,926,902. CANC. INT. CL. 41.  
4,046,807. INT. CL. 41.

LIVING IN DIGITAL TIMES, LLC, NEW YORK, NY:  
4,044,993. PUB. 8-9-2011. INT. CL. 35.  
4,044,994. PUB. 8-9-2011. INT. CL. 35.

LIVINGSTON, LAURIE, SANTA MONICA, CA:  
4,044,453. PUB. 8-9-2011. INT. CL. 25.

LL GLOBAL, INC., WINDSOR, CT:  
4,046,592. INT. CL. 41.

LLOYDS IP HOLDINGS, LLC, POMONA, CA:  
1,655,284. REN. 9-21-11. INT. CL. 9.

LMC VENTURES, INC., DEL MAR, CA:  
4,045,402. PUB. 8-9-2011. INT. CL. 30.

LMT LICHTMESSTECHNIK GMBH BERLIN, BERLIN, FED  
REP GERMANY:  
2,489,967. REN. 9-19-11. MULTIPLE CLASS, INT. CLS. 9  
AND 42.

LNL BUILDING PRODUCTS, LLC, SUWANEE, GA:  
4,044,132. PUB. 8-9-2011. INT. CL. 19.

LO, CHIH-HSIANG, ZHONGLI CITY, TAOYUAN, TAIWAN:  
4,046,524. INT. CL. 25.

LOCAL INITIATIVE HEALTH AUTHORITY FOR LOS  
ANGELES COUNTY, LOS ANGELES, CA:  
4,044,442. PUB. 8-9-2011. INT. CL. 44.

LOCKHEED MARTIN CORPORATION, BETHESDA, MD:  
4,046,330. U.S. CL. B.

LOGENA AUTOMOTIVE LLC, ALLENTOWN, PA:  
4,043,893. PUB. 8-9-2011. MULTIPLE CLASS, INT. CLS. 9,  
12 AND 42.

LOGIBIO, LLC, HOUSTON, TX:  
4,045,294. PUB. 8-9-2011. INT. CL. 35.

LOGOMETRIX CORPORATION, GLENDALE, AZ:  
2,926,509. CANC. INT. CL. 9.

LOGOS TECHNOLOGIES, INC., ARLINGTON, VA:  
4,045,941. MULTIPLE CLASS, INT. CLS. 4, 40 AND 42.

LONE STAR HOLDINGS, LLC, AUSTIN, TX:  
4,045,360. PUB. 8-9-2011. INT. CL. 39.

LONE STAR SPECIALTY PRODUCTS, LLC, LONE STAR,  
TX, DBA LONE STAR SPECIALTIES, LLC:  
4,044,391. PUB. 8-9-2011. INT. CL. 19.

LONESTAR ASSOCIATES L.P., EDINBURGH, UNITED  
KINGDOM:  
3,935,685 NEW CERT. 10-25-2011. INT. CL. 9.

LONG & FOSTER COMPANIES, INC., CHANTILLY, VA:  
1,636,392. REN. 9-21-11. INT. CL. 41.

LONG MOTOR CORPORATION, LENEXA, KS:  
4,046,814. MULTIPLE CLASS, INT. CLS. 27 AND 35.

LONGWOOD SOFTWARE, INC., MAYNARD, MA:  
4,044,368. PUB. 8-9-2011. INT. CL. 42.

LOOTOK, LTD, NEW YORK, NY:  
4,046,906. INT. CL. 35.

LOPERA, FRANK, BEVERLY HILLS, CA:  
4,045,716. INT. CL. 32.

LOPEZ, JOHN, SANTA MARIA, CA AND LOPEZ, AYDA,  
SANTA MARIA, CA:  
2,505,920. REN. 9-22-11. INT. CL. 35.

LORMAN BUSINESS CENTER, INC., EAU CLAIRE, WI:  
2,596,819. REN. 9-21-11. INT. CL. 41.

LOS ANGELES GEM & JEWELRY DESIGN, INC., LOS  
ANGELES, CA:  
4,047,087. INT. CL. 14.

LOTHAR COLLINI, AUSTRIA:  
4,043,798. PUB. 8-9-2011. MULTIPLE CLASS, INT. CLS. 6,  
11 AND 20.

LOTTMEN, BILLY, POTTSTOWN, PA:  
4,045,281. PUB. 8-9-2011. INT. CL. 3.

LOTUS OUTREACH, SAN DIEGO, CA:  
4,045,214. PUB. 8-9-2011. INT. CL. 36.

LOUIS BERKMAN COMPANY, THE, STUEBENVILLE, OH:  
1,166,133. REN. 9-22-11. INT. CL. 7.

LOUISIANA SEAFOOD PROMOTION AND MARKETING  
BOARD OF THE DEPARTMENT OF WILDLIFE & FISH-  
ERIES, NEW ORLEANS, LA:  
4,045,172. PUB. 8-9-2011. INT. CL. 35.

LOUISVILLE BEDDING COMPANY, LOUISVILLE, KY:  
2,927,036. CANC. INT. CL. 24.

LOVE SHUTTER, LLC, HUNTERSVILLE, NC:  
4,044,736. PUB. 8-9-2011. INT. CL. 41.  
4,044,737. PUB. 8-9-2011. INT. CL. 41.

LOVE TRANSFUSION, INC., NEWARK, DE:  
4,044,893. PUB. 8-9-2011. INT. CL. 38.  
4,044,894. PUB. 8-9-2011. INT. CL. 38.

LOVEJULIET LLC, CLOSTER, NJ:  
4,047,131. INT. CL. 41.

LOVELAND PRODUCTS, INC., LOVELAND, CO:  
4,046,589. INT. CL. 5.

LOWELL INTERNATIONAL COMPANY, FRANKLIN  
PARK, IL:  
4,046,849. INT. CL. 32.

LOXCREEN CANADA LTD., MISSISSAUGA, ONTARIO,  
CANADA:  
4,046,253. INT. CL. 19.

LOYAL ELITE INC., WEST HILLS, CA:  
4,045,068. PUB. 8-9-2011. INT. CL. 25.

LOYAL3 HOLDINGS INC., SAN FRANCISCO, CA:  
4,045,808. MULTIPLE CLASS, INT. CLS. 35, 36 AND 45.

LSI SOLUTIONS, INC., VICTOR, NY:  
2,502,541. REN. 9-21-11. INT. CL. 10.

LT LLC, BOXBOROUGH, MA:  
4,043,928. PUB. 8-9-2011. MULTIPLE CLASS, INT. CLS.  
37, 38 AND 42.

LTA (LEMONS TO AID) FOUNDATION, DALLAS, TX:  
4,045,042. PUB. 8-9-2011. INT. CL. 36.

LTC PRO LLC, LAKEWOOD, CO:  
4,045,443. PUB. 8-9-2011. INT. CL. 41.

LUBIN-SHERMAN, ELLEN, MILLBURN, NJ:  
4,045,096. PUB. 8-9-2011. INT. CL. 45.

LUCAS, LEE A, VENICE, CA, DBA THE LOOKSY:  
4,045,236. PUB. 8-9-2011. INT. CL. 14.

- LUCASFILM ENTERTAINMENT COMPANY LTD., SAN FRANCISCO, CA:  
2,480,366. REN. 9-19-11. INT. CL. 16.  
2,488,042. REN. 9-17-11. INT. CL. 9.  
2,488,922. REN. 9-17-11. INT. CL. 9.
- LUCIANO SOPRANI S.R.L., I-20135 MILANO, ITALY:  
4,043,787, PUB. 8-9-2011. INT. CL. 25.
- LUCK STONE CORPORATION, RICHMOND, VA:  
4,044,042, PUB. 8-9-2011. INT. CL. 16.
- LUCKY BRAND DUNGAREES, INC., VERNON, CA:  
2,469,997. REN. 9-20-11. INT. CL. 25.
- LUCKY MONEY INC., SAN FRANCISCO, CA:  
2,555,518. REN. 9-19-11. INT. CL. 36.
- LUGGAGE FORWARD, INC., BOSTON, MA:  
2,730,054, CANC. MULTIPLE CLASS, INT. CLS. 35 AND 39.
- LULU'S CHOCOLATE, LLC, SEDONA, AZ, DBA LULU'S CHOCOLATE, LLC:  
4,044,529, PUB. 8-9-2011. INT. CL. 30.
- LUMI-LITE CANDLE COMPANY, INC., NORWICH, OH:  
2,554,390. REN. 9-19-11. INT. CL. 35.
- LUNA NEGRA DANCE THEATER, CHICAGO, IL:  
4,044,320, PUB. 8-9-2011. INT. CL. 41.
- LUNA SOPOR LLC., SAN JOSE, CA, AKA LUNA SOPOR:  
4,044,673, PUB. 8-9-2011. MULTIPLE CLASS, INT. CLS. 9 AND 41.
- LUND, INC., BUFORD, GA:  
4,045,804, MULTIPLE CLASS, INT. CLS. 12 AND 27.
- LUNDSTRUM CENTER FOR THE PERFORMING ARTS, MINNEAPOLIS, MN:  
4,044,902, PUB. 8-9-2011. INT. CL. 41.
- LUSSIER, KYLE E, POWDER SPRINGS, GA:  
4,044,123, PUB. 8-9-2011. INT. CL. 42.
- LUTRON ELECTRONICS CO., INC., COOPERSBURG, PA:  
2,566,826. REN. 9-16-11. INT. CL. 20.
- LUTTERY, TEISHA L., CHICAGO, IL:  
4,045,771, INT. CL. 41.
- LUXEMBOURG CAPITAL LLC, NEW YORK, NY:  
4,046,705, INT. CL. 32.
- LY, THON SIEU, LONG BEACH, CA, DBA HEART BANK:  
4,045,978, INT. CL. 35.
- LYNCH, GEORGE M, VALENCIA, CA AND LYNCH, DANICA J, VALENCIA, CA:  
4,044,527, PUB. 8-9-2011. INT. CL. 15.
- LYT UP NEW YORK INC., NEW YORK, NY:  
4,046,373, INT. CL. 44.  
4,046,374, INT. CL. 44.
- M & Q IP LEASING, INC., WILMINGTON, DE:  
4,046,858, INT. CL. 16.
- M HOLDINGS, LLC, BALTIMORE, MD:  
4,043,970, PUB. 8-9-2011. MULTIPLE CLASS, INT. CLS. 5 AND 32.
- M/BED BLOCK SYSTEMS, LLC, ST. LOUIS, MO:  
2,482,918. REN. 9-20-11. MULTIPLE CLASS, INT. CLS. 6 AND 19.
- MACER, CYNTHIA, ROLLING HILLS ESTATES, CA:  
4,045,184, PUB. 8-9-2011. INT. CL. 44.
- MACK-CALI REALTY, L.P., EDISON, NJ:  
4,045,261, PUB. 8-9-2011. INT. CL. 36.  
4,045,264, PUB. 8-9-2011. MULTIPLE CLASS, INT. CLS. 36 AND 37.
- MACROVITA - A. & E. VASILAKAKI O.E., GREECE:  
4,043,753, PUB. 8-9-2011. INT. CL. 3.
- MACS WORLDWIDE LLC, HILLSBORO, OR:  
4,044,596, PUB. 8-9-2011. INT. CL. 35.
- MADE IN MICHIGAN TALENT NETWORK, LLC, STERLING HEIGHTS, MI:  
4,047,209, INT. CL. 35.
- MAG-NIF INCORPORATED, MENTOR, OH:  
2,487,598. REN. 9-16-11. INT. CL. 9.  
2,487,599. REN. 9-16-11. INT. CL. 21.
- MAGIC SEASONING BLENDS, LLC, HARAHAN, LA:  
2,600,999. REN. 9-17-11. INT. CL. 30.  
2,601,000. REN. 9-17-11. INT. CL. 30.  
2,604,645. REN. 9-17-11. INT. CL. 30.  
2,604,646. REN. 9-17-11. INT. CL. 30.
- MAGID GLOVE AND SAFETY MANUFACTURING CO., L.L.C., CHICAGO, IL:  
2,488,134. REN. 9-18-11. INT. CL. 9.
- MAGNETIC MARKETING & SERVICES, INC., INDIANAPOLIS, IN:  
4,045,155, PUB. 8-9-2011. INT. CL. 9.
- MAGNUM CREATION INC., NEW YORK, NY:  
1,659,684. REN. 9-21-11. INT. CL. 14.
- MAHINDRA & MAHINDRA LIMITED, WORLI MUMBAI, INDIA:  
4,045,577, INT. CL. 12.  
4,045,578, INT. CL. 12.
- MAID-RITE STEAK CO., INC., DUNMORE, PA:  
1,194,410. REN. 9-20-11. INT. CL. 29.
- MAINE ORNAMENTAL WOODWORKERS, INC., ELIOT, ME:  
2,926,762, CANC. INT. CL. 6.
- MAINLAND MART CORP., EL MONTE, CA:  
3,236,932, COR. INT. CL. 9.
- MAINTENANCE SUPPLY & CHEMICAL CO. LLC, DENVER, NC:  
4,046,714, INT. CL. 3.
- MAINWAY HANDLING SYSTEMS INC., BURLINGTON, ONTARIO, CANADA:  
2,428,189, CANC. INT. CL. 7.
- MAISON DES FUTAILLES S.E.C., CHICAGO, IL, DBA KRUGER WINES & SPIRITS:  
4,046,709, INT. CL. 33.
- MAJAK, INC., KILL DEVIL HILLS, NC:  
2,436,798. REN. 9-21-11. INT. CL. 42.
- MAJI SPORTS, LLC, LOS ANGELES, CA:  
4,046,008, MULTIPLE CLASS, INT. CLS. 25 AND 28.
- MAKALU WEAR, LLC, COLUMBUS, OH:  
4,044,929, PUB. 8-9-2011. INT. CL. 25.
- MALTA, ROBERT, NEW YORK, NY:  
4,044,144, PUB. 5-3-2011. INT. CL. 43.
- MALTESE, BRIAN E., CHANDLER, AZ:  
2,926,943, CANC. INT. CL. 43.
- MAMA'S NO YUCK, LYNN, MA:  
4,044,052, PUB. 8-9-2011. INT. CL. 3.
- MAMBO ROOM, INC, NORFOLK, VA:  
4,044,540, PUB. 8-9-2011. INT. CL. 41.
- MANDRACCHIA, CHARLES, NEW YORK CITY, NY AND DEJOSIA, FRANCESCA, NEW YORK CITY, NY:  
2,428,021, CANC. MULTIPLE CLASS, INT. CLS. 9 AND 41.
- MANGROVE SYSTEMS, INC., WALLINGFORD, CT:  
2,926,632, CANC. INT. CL. 9.
- MANUFACTURED HOUSING EDUCATIONAL INSTITUTE, INC., ARLINGTON, VA, AKA MHEI:  
1,690,902. REN. 9-21-11. INT. CL. 41.
- MANUFACTURERS AND TRADERS TRUST COMPANY, BUFFALO, NY:  
918,217. REN. 9-19-11. MULTIPLE CLASS, U.S. CLS. 100 (INT. CLS. 35, 36, 37, 38, 39, 40, 41 AND 42), 101 (INT. CLS. 35, 36, 38, 41 AND 42) AND 102 (INT. CL. 36).
- MAP SUPPLY, INC., LEXINGTON, NC:  
4,044,372, PUB. 8-9-2011. INT. CL. 16.
- MAPA GMBH, ZEVEN 27404, FED REP GERMANY:  
4,046,465, INT. CL. 10.
- MAQUET GMBH & CO. KG, RASTATT, FED REP GERMANY:  
2,545,815. REN. 9-21-11. MULTIPLE CLASS, INT. CLS. 9, 10 AND 37.
- MAR-CONE APPLIANCE PARTS CO., ST. LOUIS, MO, DBA MARCONE APPLIANCE PARTS CENTER:  
2,486,956. REN. 9-20-11. INT. CL. 35.
- MARANDO, SHAWN, SHARON, MA:  
4,045,610, INT. CL. 41.  
4,045,611, INT. CL. 41.  
4,045,612, INT. CL. 41.
- MARATHON PRODUCTS, INC., SAN LEANDRO, CA:  
2,505,186. REN. 9-21-11. INT. CL. 9.
- MARESCA, FRANCIS G., NORTH BERGEN, NJ:  
4,045,846, INT. CL. 18.
- MARGARETE STEIFF GMBH, 89537 GIENGEN, FED REP GERMANY:  
2,428,062, CANC. MULTIPLE CLASS, INT. CLS. 6, 20

- AND 21.  
MARGARITAVILLE ENTERPRISES, LLC, PALM BEACH, FL:  
2,502,259. REN. 9-22-11. MULTIPLE CLASS, INT. CLS. 38 AND 41.
- MARIANJOY REHABLINK, INC., WHEATON, IL:  
2,559,311. REN. 9-21-11. INT. CL. 42.
- MARK E. CHRIST, FORT WALTON BEACH, FL:  
4,046,273. INT. CL. 25.
- MARKET STUDIES, LLC, SCOTTSDALE, AZ:  
4,045,943. INT. CL. 16.
- MARKS, IRA, LAGUNA NIGEUL, CA:  
2,466,863. REN. 9-20-11. INT. CL. 16.
- MARLIMAR INTERACTIVE LLC, LOUISVILLE, KY:  
4,044,361. PUB. 8-9-2011. INT. CL. 35.
- MARS, INCORPORATED, MCLEAN, VA:  
2,926,518. CANC. INT. CL. 30.  
2,926,792. CANC. INT. CL. 30.
- MARSHALL; JOHN M., SOUTH BEND, IN, DBA JOHN M. MARSHALL'S DIAMOND IMPORT COMPANY:  
1,168,636. REN. 9-17-11. INT. CL. 35.
- MARSHFIELD DOORSYSTEMS, INC., MARSHFIELD, WI:  
2,592,649. REN. 9-16-11. INT. CL. 19.
- MARTEN, KIRT, DEERBROOK, WI:  
4,046,860. INT. CL. 25.
- MARTEX NUTRITION, INC., MIAMI, FL:  
4,045,555. PUB. 8-9-2011. INT. CL. 5.
- MARTHA STEWART LIVING OMNIMEDIA LLC, NEW YORK, NY:  
2,494,794. REN. 9-19-11. INT. CL. 37.
- MARTHA STEWART LIVING OMNIMEDIA, INC., NEW YORK, NY:  
2,926,843. CANC. INT. CL. 20.
- MARTIN J. GRUNDER, JR., INC., MIAMISBURG, OH:  
2,477,696. REN. 9-20-11. INT. CL. 42.
- MARTIN, ANN MARIE, ST. MICHAEL, PA, PCOLA; ANDREW P., ST. MICHAEL, PA, DBA PCOLA'S LURES:  
1,192,572. REN. 9-17-11. INT. CL. 28.
- MARTIN, SCOTT, CAMDENTON, MO:  
4,045,245. PUB. 8-9-2011. INT. CL. 2.
- MARTIN'S HONEY FARM AND MEADERY, LLC, SENECA FALLS, NY, DBA MONTEZUMA WINERY:  
4,044,834. PUB. 8-9-2011. INT. CL. 33.
- MARTINEZ ORTEGA, JOSE, ALBACETE, SPAIN:  
4,045,160. PUB. 8-9-2011. INT. CL. 8.
- MARUKOME KABUSHIKI KAISHA, NAGANO CITY NAGANO PREFECTURE, JAPAN:  
4,045,589. MULTIPLE CLASS, INT. CLS. 29 AND 30.
- MARWAN SALAH AL DEEN KABATILO SONS CO., AMMAN, JORDAN:  
4,043,919. PUB. 8-9-2011. INT. CL. 30.
- MAR2MAR, INCORPORATED, HIGHLAND PARK, IL, DBA MAR2MAR, INC.:  
4,046,993. INT. CL. 14.
- MASCO CABINETRY LLC, ANN ARBOR, MI:  
4,045,816. INT. CL. 19.
- MASTER SPAS, INC, FORT WAYNE, IN:  
4,045,608. INT. CL. 11.
- MASTERCARD INTERNATIONAL INCORPORATED, PURCHASE, NY:  
2,926,804. CANC. INT. CL. 36.
- MASTERGUARD, LP, COPPELL, TX:  
4,046,746. INT. CL. 9.
- MASTERSOFT, INC., CHICAGO, IL, DBA VISITVIEW:  
4,045,347. PUB. 8-9-2011. INT. CL. 9.
- MATARINE, WASHINGTON, DC:  
4,045,746. MULTIPLE CLASS, INT. CLS. 16 AND 35.
- MATERIAL WORKS, LTD., THE, RED BUD, IL:  
2,535,933. REN. 9-21-11. INT. CL. 40.
- MATHEMATICAL SCIENCES PUBLISHERS, BERKELEY, CA, AKA MSP:  
4,045,414. PUB. 8-9-2011. INT. CL. 42.
- MATLON INC., CONWAY, AR:  
4,046,774. INT. CL. 3.
- MATRIX NETWORK, INC., COPPELL, TX:  
4,046,601. INT. CL. 9.
- MATTA INT., INC., MIAMI, FL:  
4,045,310. PUB. 8-9-2011. MULTIPLE CLASS, INT. CLS. 3
- AND 5.  
MATTEL, INC., EL SEGUNDO, CA:  
1,703,503. REN. 9-20-11. INT. CL. 28.  
2,926,613. CANC. INT. CL. 28.  
2,926,883. CANC. INT. CL. 28.  
4,045,838. INT. CL. 28.  
4,046,063. INT. CL. 28.  
4,046,180. INT. CL. 26.  
4,046,216. INT. CL. 28.  
4,046,227. INT. CL. 28.  
4,046,229. INT. CL. 28.  
4,046,393. INT. CL. 35.  
4,046,470. INT. CL. 28.  
4,046,471. INT. CL. 28.  
4,046,779. INT. CL. 28.
- MATTRESS FIRM, INC., HOUSTON, TX:  
4,046,948. MULTIPLE CLASS, INT. CLS. 35 AND 39.
- MAURO, MARIA, NIAGARA FALLS, NY AND CARROLL, ELIZABETH, NIAGARA FALLS, NY:  
4,045,638. INT. CL. 32.
- MAVERICK FUNDING CORP., PARSIPPANY, NJ:  
4,044,168. PUB. 8-9-2011. INT. CL. 36.
- MAX PAY GOLD, LLC, FORT WORTH, TX:  
4,045,593. INT. CL. 35.
- MAX ROHR, INC., WILMINGTON, DE:  
1,665,572. REN. 9-21-11. INT. CL. 34.
- MAXFIELD, CLAYTON W, CHICAGO, IL:  
4,045,956. INT. CL. 25.
- MAXI-BLAST, INC., SOUTH BEND, IN:  
1,704,016. REN. 9-19-11. INT. CL. 1.
- MAXIMUM TAX LLC, DEARBORN, MI:  
4,044,650. PUB. 8-9-2011. INT. CL. 35.
- MAXWELL-BRADLEY, INC., MONTICELLO, AR, PO-TLATCH FORESTS, INC., SAN FRANCISCO, CA:  
937,386. REN. 9-22-11. U.S. CL. 12 (INT. CL. 19).
- MAY, LANA, MT. PROSPECT, IL:  
2,428,654. CANC. INT. CL. 42.
- MAYCO WELLCHEM, INC., HOUSTON, TX:  
1,183,365. REN. 9-19-11. INT. CL. 1.
- MAYR, KARIN, PITTSBURGH, PA:  
3,731,881. AM. INT. CL. 14.
- MAYRON'S GOODS, INC., LOS ANGELES, CA:  
4,044,658. PUB. 8-9-2011. INT. CL. 3.
- MAYTUM, ZACK, BOULDER, CO:  
4,045,206. PUB. 8-9-2011. INT. CL. 28.
- MAYWAY CORPORATION, OAKLAND, CA:  
2,927,064. CANC. INT. CL. 5.
- MAZUR, ROBERT G, CANTON, MI:  
4,047,224. INT. CL. 21.
- MBA BUILDING SUPPLIES, LIBERTYVILLE, IL:  
4,045,966. INT. CL. 6.
- MCCABE, DERALD, KATY, TX:  
4,045,706. INT. CL. 11.
- MCCARTHY, BRIAN K., LAKE OSWEGO, OR:  
2,926,915. CANC. INT. CL. 41.
- MCCARTY'S SACRO-EASE, L.L.C., COEUR D'ALENE, ID:  
501,154 NEW CERT. 10-25-2011. U.S. CL. 32.
- MCCLANAHAN, RAY, PORTLAND, OR:  
4,045,761. INT. CL. 10.
- MCCOMBS, KAREN, NEW CITY, NY:  
4,046,564. INT. CL. 21.
- MCDOUGALL-BENBOW, LORNA D, LOS ANGELES, CA, DBA TELMIWARE, INC:  
4,043,941. PUB. 8-9-2011. INT. CL. 9.
- MCGRAW-HILL COMPANIES, INC., THE, NEW YORK, NY:  
1,170,120. REN. 9-16-11. INT. CL. 16.
- MCLANAHAN CORPORATION, HOLLIDAYSBURG, PA:  
4,046,240. MULTIPLE CLASS, INT. CLS. 7 AND 37.
- MCLEAN, DON, NASHVILLE, TN:  
2,497,580. REN. 9-20-11. INT. CL. 41.
- MCLEOD INTERNATIONAL CONSULTINGS, L.L.C., HOUSTON, TX:  
4,044,345. PUB. 8-9-2011. INT. CL. 35.
- MCM INVENTIONS, INC., HOUSTON, TX:  
4,044,613. PUB. 8-9-2011. INT. CL. 20.
- MCOMBER, MICHAEL, SALT LAKE CITY, UT:  
4,047,007. INT. CL. 35.

- ME & MY BIG IDEAS, INC., LAKE FOREST, CA:  
4,047,160, INT. CL. 16.
- MEAD JOHNSON & COMPANY, EVANSVILLE, IN:  
2,469,244, REN. 9-20-11. INT. CL. 5.
- MEADWESTVACO CORPORATION, RICHMOND, VA:  
1,664,096, REN. 9-22-11. INT. CL. 16.  
4,046,557, INT. CL. 7.
- MEAT PROCESSING EQUIPMENT LLC., BUFORD, GA,  
DBA MP EQUIPMENT CO.:  
4,045,583, INT. CL. 7.
- MEDA PHARMACEUTICALS INC., SOMERSET, NJ:  
4,045,758, INT. CL. 5.
- MEDALLION INSTRUMENTATION SYSTEMS, LLC,  
SPRING LAKE, MI:  
4,045,065, PUB. 8-9-2011. INT. CL. 40.
- MEDI GMBH & CO. KG, FED REP GERMANY:  
4,043,765, PUB. 8-9-2011. INT. CL. 10.
- MEDI GMBH & CO. KG, 95448 BAYREUTH, FED REP  
GERMANY:  
4,043,775, PUB. 8-9-2011. INT. CL. 10.
- MEDI IP, LLC, TAMPA, FL:  
4,046,143, INT. CL. 5.
- MEDIAFRIENDS, INC., WOBURN, MA:  
4,046,548, INT. CL. 38.
- MEDIASTORM, LLC, BROOKLYN, NY:  
4,044,082, PUB. 5-3-2011. MULTIPLE CLASS, INT. CLS. 9,  
16, 38 AND 41.
- MEDICAL ANALYSIS SYSTEMS, INC., FREMONT, CA:  
2,490,031, REN. 9-21-11. MULTIPLE CLASS, INT. CLS. 1  
AND 5.
- MEDICAL GROUP INSURANCE SERVICES, INC., SALT  
LAKE CITY, UT:  
2,927,027, CANC. INT. CL. 36.
- MEDICAL MUTUAL OF OHIO, CLEVELAND, OH:  
4,044,433, PUB. 8-9-2011. INT. CL. 44.
- MEDICAL SPECIALTIES INCORPORATED, CHARLOTTE,  
NC:  
1,180,983, REN. 9-17-11. INT. CL. 10.
- MEDISERVE INFORMATION SYSTEMS, INC., CHAND-  
LER, AZ:  
4,046,534, INT. CL. 9.
- MEDISIZE B.V., AB HILLEGOM, NETHERLANDS:  
4,045,672, INT. CL. 10.
- MEDLINE INDUSTRIES, INC., MUNDELEIN, IL:  
2,428,830, CANC. INT. CL. 24.  
4,045,053, PUB. 8-9-2011. INT. CL. 41.  
4,045,933, INT. CL. 5.
- MEDTRONIC, INC., MINNEAPOLIS, MN:  
2,927,066, CANC. INT. CL. 10.
- MEEHANITE WORLDWIDE CORPORATION, SPARTA, NJ,  
MEEHANITE METAL CORPORATION, CHATTANOOGA,  
TN:  
548,468, REN. 9-16-11. U.S. CL. 101 (INT. CL. 35).
- MEEKS, JENNIFER, HOUSTON, TX:  
4,044,457, PUB. 8-9-2011. INT. CL. 9.
- MEGA TECH HOLDING B.V., NETHERLANDS:  
2,987,626.
- MEGGITT TRAINING SYSTEMS, INC., SUWANEE, GA:  
2,431,925, REN. 9-20-11. INT. CL. 9.
- MEIJER, INC., GRAND RAPIDS, MI:  
4,046,748, INT. CL. 14.
- MELALEUCA, INC., IDAHO FALLS, ID:  
2,479,134, REN. 9-20-11. INT. CL. 5.
- MELHMAN PRODUCTION GROUP, LLC, UPLAND, CA:  
4,045,579, INT. CL. 25.
- MELINDA MURRAY, EAST ELMHURST, NY:  
4,046,105, INT. CL. 36.
- MELITTA HAUSHALTSPRODUKTE GMBH AND CO.  
KOMMANDITGESELLSCHAFT, 32427 MINDEN, FED  
REP GERMANY:  
2,532,743, REN. 9-22-11. INT. CL. 11.
- MELTZER, PURTILL & STELLE, SCHAUMBURG, IL:  
2,461,597, REN. 9-21-11. INT. CL. 42.
- MENARD, INC., EAU CLAIRE, WI, DBA MENARDS:  
4,046,133, INT. CL. 7.
- MENDEZ, MARIA VERONICA, NEW YORK, NY:  
4,046,719, INT. CL. 25.
- MENDOZA, NANCY, KEYPORT, NJ, DBA PROPERTIES:  
4,044,612, PUB. 8-9-2011. INT. CL. 35.
- MENICON CO., LTD., AICHI-KEN, JAPAN:  
2,428,711, CANC. INT. CL. 9.
- MENIKS INC., BONITA SPRINGS, FL:  
2,428,923, CANC. INT. CL. 25.  
2,428,924, CANC. INT. CL. 25.
- MENON & ASSOCIATES, INC., SAN DIEGO, CA:  
4,046,898, MULTIPLE CLASS, INT. CLS. 4, 9 AND 31.
- MENTOR GROUP, L.L.C., OREGON CITY, OR:  
4,046,828, INT. CL. 8.
- MERCANTIL SERVICIOS FINANCIEROS, C.A., CARACAS,  
VENEZUELA:  
4,045,660, INT. CL. 36.
- MERCK KGAA, DARMSTADT 64293, FED REP GERMANY:  
920,477, REN. 9-17-11. U.S. CL. 6 (INT. CL. 1).
- MERCK KGAA, DARMSTADT, FED REP GERMANY:  
1,182,588, REN. 9-17-11. INT. CL. 1.
- MERCK SHARP & DOHME CORP., WHITEHOUSE STA-  
TION, NJ:  
2,428,743, CANC. INT. CL. 16.
- MERCURY ENTERPRISES, INC., CLEARWATER, FL:  
1,694,194, REN. 9-20-11. INT. CL. 10.
- MERCY - USA FOR AID AND DEVELOPMENT, INC.,  
PLYMOUTH, MI:  
2,492,315, REN. 9-20-11. MULTIPLE CLASS, INT. CLS. 36  
AND 42.
- MERIAL LIMITED, HARLOW, ESSEX CM19 5QA, UNITED  
KINGDOM:  
4,045,836, INT. CL. 5.
- MERIT MEDICAL SYSTEMS, INC., SOUTH JORDAN, UT:  
2,494,585, REN. 9-22-11. INT. CL. 10.  
2,494,586, REN. 9-22-11. INT. CL. 10.
- MERIT PROPERTY MANAGEMENT, INC., ALISO VIEJO,  
CA:  
4,046,927, INT. CL. 36.
- MERITURN PARTNERS, LLC, RALEIGH, NC:  
4,044,245, PUB. 8-9-2011. MULTIPLE CLASS, INT. CLS. 35  
AND 36.
- MERLE NORMAN COSMETICS, INC., LOS ANGELES, CA:  
4,045,963, INT. CL. 3.  
4,045,964, INT. CL. 3.
- MESON BRO ENTERPRISE, LAKEWOOD, WA:  
4,044,666, PUB. 8-9-2011. INT. CL. 25.
- MESSE DÜSSELDORF GMBH, FED REP GERMANY:  
4,043,783, PUB. 8-9-2011. MULTIPLE CLASS, INT. CLS.  
16, 35 AND 41.
- MESSER CUTTING SYSTEMS, INC., MENOMONEE FALLS,  
WI:  
4,044,585, PUB. 8-9-2011. INT. CL. 7.
- METAGENICS, INC., SAN CLEMENTE, CA:  
2,479,762, REN. 9-20-11. INT. CL. 5.  
2,488,989, REN. 9-16-11. INT. CL. 5.
- METAL DESIGN STORE, DALY CITY, CA:  
4,046,573, INT. CL. 20.
- METALTEK INTERNATIONAL, INC., WAUKESHA, WI:  
4,046,539, MULTIPLE CLASS, INT. CLS. 6, 39 AND 40.  
4,046,760, MULTIPLE CLASS, INT. CLS. 6, 39 AND 40.
- METAMORPHITNESS, LLC, WASHINGTON, DC:  
4,046,563, MULTIPLE CLASS, INT. CLS. 41 AND 44.
- METZGER SPECIALTY BRANDS, INC., NEW YORK, NY:  
4,047,043, INT. CL. 29.
- MEXCOR, INC., HOUSTON, TX:  
3,703,348, AM. INT. CL. 33.  
3,935,005, AM. INT. CL. 33.
- MEXICAN SPECIALTY FOODS, INC., KENNESAW, GA:  
2,427,717, CANC. INT. CL. 42.
- MEYNARD DESIGNS, INC., WALTHAM, MA, MEYNARD  
DESIGNS, INC., WALTHAM, MA:  
2,607,997, REN. 9-21-11. INT. CL. 25.
- MFP-NS HOCKEY VENTURES, LLC, NEW YORK, NY:  
4,046,365, MULTIPLE CLASS, INT. CLS. 25 AND 41.
- MGA ENTERTAINMENT, INC., NORTH HILLS, CA:  
2,926,789, CANC. MULTIPLE CLASS, INT. CLS. 9, 12  
AND 28.
- MIA ELECTRIC GMBH, FED REP GERMANY:  
4,043,838, PUB. 8-9-2011. MULTIPLE CLASS, INT. CLS.  
12, 35 AND 37.

- MIAMI LIGHTHOUSE FOR THE BLIND & VISUALLY IMPAIRED, INC., MIAMI, FL:  
4,046,633, INT. CL. 41.
- MIAMICA OF NEW YORK, INC., A DIVISION OF SHALOM INTERNATIONAL, CORP., PERTH AMBOY, NJ:  
4,045,596, INT. CL. 9.
- MICHAEL EDWARDS COMMUNICATIONS, INC., CHICAGO, IL:  
2,926,786, CANC. INT. CL. 35.
- MICHAEL G. KESSLER & ASSOCIATES, LTD., NEW YORK, NY, DBA KESSLER INTERNATIONAL:  
4,044,103, PUB. 8-9-2011. MULTIPLE CLASS, INT. CLS. 35 AND 45.
- MICHAEL J WATERSTREET, OSHKOSH, WI AND RYAN D WATERSTREET, GRAND CHUTE, WI:  
4,044,671, PUB. 8-9-2011. INT. CL. 25.
- MICHAEL L. TANEL, SR., MILWAUKEE, WI:  
4,044,007, PUB. 8-9-2011. INT. CL. 19.
- MICHAEL LEVENTHAL, DEL RAY BEACH, FL:  
4,044,150, PUB. 8-9-2011. MULTIPLE CLASS, INT. CLS. 35 AND 41.
- MICHAEL T. O'MALLEY, TELFORD, PA:  
2,492,123, REN. 9-19-11. INT. CL. 9.
- MICHAEL-DAVID, LLC, LODI, CA:  
4,046,833, INT. CL. 33.
- MICHAEL'S CHICAGO-STYLE RED HOTS MANAGEMENT CO., HIGHLAND PARK, IL:  
1,654,671, REN. 9-17-11. INT. CL. 42.
- MICHELE PARRISH, FT. WAYNE, IN:  
4,044,935, PUB. 8-9-2011. INT. CL. 35.
- MICHIGAN TURKEY PRODUCERS, L.L.C., WYOMING, MI:  
2,927,067, CANC. INT. CL. 29.
- MICHIGAN WHEEL CORPORATION, GRAND RAPIDS, MI, MICHIGAN WHEEL CORPORATION, GRAND RAPIDS, MI:  
921,456, REN. 9-19-11. U.S. CL. 19 (INT. CL. 12).
- MICRO CHAMPIONSHIP WRESTLING, INC., ST. PETERSBURG, FL:  
4,045,422, PUB. 8-9-2011. INT. CL. 41.
- MICROAIRE SURGICAL INSTRUMENTS LLC, CHARLOTTEVILLE, VA:  
2,609,178, REN. 9-20-11. INT. CL. 10.
- MICROBLEND TECHNOLOGIES, INC., GILBERT, AZ:  
4,043,931, PUB. 8-9-2011. INT. CL. 35.
- MICROSOFT CORPORATION, REDMOND, WA:  
1,661,670, REN. 9-22-11. INT. CL. 16.
- MICROSTRAIN, INC., WILLISTON, VT:  
4,045,417, PUB. 8-9-2011. INT. CL. 9.
- MICROSYSTEMS TECHNOLOGY, INC., TAMPA, FL:  
4,045,539, PUB. 8-9-2011. INT. CL. 9.
- MIDKIFF, COLE, NORTH HOLLYWOOD, CA:  
4,044,668, PUB. 8-9-2011. INT. CL. 25.
- MIDLAB, INC., SWEETWATER, TN:  
4,045,197, PUB. 8-9-2011. INT. CL. 3.
- MIDRANGE PERFORMANCE GROUP, BOULDER, CO, AKA MPG:  
4,044,393, PUB. 8-9-2011. INT. CL. 9.
- MIDWEST INSTRUMENT CO., INC., HARTLAND, WI:  
4,046,530, INT. CL. 9.
- MIDWESTERN SECURITIES TRADING COMPANY, LLC, EAST PEORIA, IL:  
4,046,910, INT. CL. 36.
- MIDWESTERN-USA DATA, PLAINFIELD, IL:  
4,044,562, PUB. 8-9-2011. INT. CL. 42.
- MIER, JOHN DAVID, JACKSONVILLE, FL:  
4,044,421, PUB. 8-9-2011. INT. CL. 41.
- MIJ, INC., HAMMOND, IN:  
2,288,855, CANC. INT. CL. 42.
- MIKE STEWART, CUMMING, GA, DBA TEAM RV:  
4,044,133, PUB. 8-9-2011. INT. CL. 39.
- MIKE VAUGHN CUSTOM SPORTS, INC., OXFORD, MI:  
4,044,188, PUB. 8-9-2011. MULTIPLE CLASS, INT. CLS. 9, 18, 25 AND 28.  
4,044,189, PUB. 8-9-2011. MULTIPLE CLASS, INT. CLS. 9, 18, 25 AND 28.
- MIKROTIKLS, RIGA, LATVIA:  
4,043,951, PUB. 8-9-2011. INT. CL. 9.
- MIL 3, INC., BETHESDA, MD:  
2,428,187, CANC. INT. CL. 9.
- MILAN CLOTHING INC., LOS ANGELES, CA:  
3,960,135, CANC. INT. CL. 25.
- MILE, INC., WORTHINGTON, OH:  
2,428,085, CANC. INT. CL. 35.
- MILES-BRAMWELL EXECUTIVE SERVICES LIMITED, DERBYSHIRE, ENGLAND:  
4,043,737, PUB. 6-29-2010. MULTIPLE CLASS, INT. CLS. 18, 21, 28 AND 44.
- MILKROUND ONLINE LTD, LONDON, UNITED KINGDOM:  
4,043,633, PUB. 8-9-2011. INT. CL. 35.
- MILL WORKS FURNITURE LLC, ALPHARETTA, GA:  
4,045,442, PUB. 8-9-2011. INT. CL. 40.
- MILLBOWER, LENN, DAVENPORT, FL:  
2,495,827, REN. 9-18-11. INT. CL. 41.
- MILLENIUM PREVIEW, LLC, STAUNTON, VA, DBA EVERGREEN MARKETING:  
4,046,533, INT. CL. 35.
- MILLENNIUM LABORATORIES, INC., SAN DIEGO, CA:  
4,044,667, PUB. 8-9-2011. INT. CL. 16.
- MILLENNIUM LAWNS, INC., BEDFORD PARK, IL:  
2,479,980, REN. 9-16-11. INT. CL. 1.
- MILLER ZELL, INC., ATLANTA, GA:  
4,044,754, PUB. 8-9-2011. INT. CL. 42.
- MILLER, SHAUNA R., LOS ANGELES, CA:  
4,046,882, INT. CL. 41.
- MILLIKEN & COMPANY, SPARTANBURG, SC:  
1,170,296, REN. 9-22-11. INT. CL. 24.  
2,428,922, CANC. INT. CL. 24.
- MILLWARD BROWN UK LIMITED, WARWICK, WARWICKSHIRE, UNITED KINGDOM:  
1,637,080, REN. 9-21-11. INT. CL. 35.
- MILWAUKEE ELECTRIC TOOL CORPORATION, BROOKFIELD, WI, HART TOOL CO., INC., CITY OF INDUSTRY, CA:  
1,657,177, REN. 9-18-11. INT. CL. 8.
- MINERALKA D.O.O., CERKNICA, SLOVENIA:  
4,043,669, PUB. 8-9-2011. INT. CL. 19.
- MINNESOTA PUBLIC RADIO, ST. PAUL, MN:  
2,609,284, REN. 9-22-11. INT. CL. 41.
- MINOT AREA DEVELOPMENT CORPORATION, MINOT, ND:  
4,046,380, INT. CL. 35.
- MINOTERIE PAULIC, FRANCE:  
4,043,816, PUB. 8-9-2011. INT. CL. 30.
- MINTRA, 6 OF OCTOBER P.O.BOX62, EGYPT, AKA MISR FOR INDUSTRY AND TRADE:  
4,045,565, PUB. 8-9-2011. INT. CL. 16.
- MIPHARM S.P.A., MILANO, ITALY:  
2,487,445, REN. 9-16-11. INT. CL. 42.
- MIPS AB, SWEDEN:  
4,043,814, PUB. 8-9-2011. INT. CL. 9.
- MIRA DX, INC., NEW HAVEN, CT:  
4,046,118, INT. CL. 42.
- MIRIAM CARRIAZO, LOWELL, MA:  
4,047,265, INT. CL. 35.
- MISS UNIVERSE L.P., LLLP, NEW YORK, NY:  
720,283, REN. 9-19-11. U.S. CL. 22 (INT. CL. 28).
- MISS UNIVERSE L.P., LLP, NEW YORK, NY, MISS UNIVERSE, INC., LOS ANGELES, CA:  
1,660,124, REN. 9-22-11. INT. CL. 41.
- MISSING LINK COMMUNICATIONS, INC., SPRINGFIELD, VA:  
2,516,468, REN. 9-18-11. INT. CL. 42.
- MISSION INFORMATION RESOURCES, INC., LANCASTER, NH:  
4,045,334, PUB. 8-9-2011. INT. CL. 16.
- MISSOURI BASIN MUNICIPAL POWER AGENCY, SIOUX FALLS, SD, DBA MISSOURI RIVER ENERGY SERVICES:  
4,045,067, PUB. 8-9-2011. INT. CL. 39.  
4,045,110, PUB. 8-9-2011. INT. CL. 37.
- MISTER TONY ENTERTAINMENT LLC, GREER, SC, AKA MISTER TONY:  
4,044,569, PUB. 8-9-2011. INT. CL. 41.

- MITAC INTERNATIONAL CORP., HSINCHU HSIEN, TAIWAN:  
4,046,307, INT. CL. 9.
- MITEK HOLDINGS, INC., WILMINGTON, DE:  
2,423,840, REN. 9-20-11, INT. CL. 7.
- MITRATECH HOLDINGS, INC., LOS ANGELES, CA:  
4,047,155, INT. CL. 9.
- MITSUBISHI ELECTRIC CORPORATION, TOKYO, JAPAN:  
4,043,916, PUB. 8-9-2011, INT. CL. 11.
- MITSUBISHI SHINDOH CO., LTD., SHINAGAWA-KU, TOKYO, JAPAN, DBA MITSUBISHI SHINDOH CO., LTD.:  
2,479,029, REN. 9-19-11, INT. CL. 6.
- MITSUBISHI UFJ ASSET MANAGEMENT KABUSHIKI KAISHA A/T/A MITSUBISHI UFJ ASSET MANAGEMENT CO., LTD., CHIYODA-KU, TOKYO, JAPAN:  
4,046,620, INT. CL. 36.
- MITSUMI DENKI KABUSHIKI KAISHA, TOKYO, JAPAN:  
922,271, REN. 9-20-11, U.S. CL. 21 (INT. CLS. 7 AND 9).  
922,713, REN. 9-20-11, U.S. CL. 21 (INT. CLS. 7 AND 9).
- MIURA KOGYO KABUSHIKI KAISHA (MIURA CO., LTD.), EHIME 799-2696, JAPAN:  
4,045,843, MULTIPLE CLASS, INT. CLS. 37 AND 42.
- MIXED CHICKS LLC, CANOGA PARK, CA:  
4,045,525, PUB. 8-9-2011, MULTIPLE CLASS, INT. CLS. 3 AND 21.
- MIXER SYSTEMS, INC., PEWAUKEE, WI:  
1,714,596, REN. 9-21-11, INT. CL. 7.
- MIZUNO KABUSHIKI KAISHA, OSAKA, 541-8538, JAPAN, AKA MIZUNO CORPORATION:  
2,482,006, REN. 9-21-11, INT. CL. 25.
- MJ IMAGO, LLC, RICHMOND, VA:  
4,046,896, MULTIPLE CLASS, INT. CLS. 25 AND 44.
- MJC SUPPLY, LLC, DIAMOND BAR, CA:  
2,615,080, REN. 9-21-11, INT. CL. 11.
- MJK DISTRIBUTORS, LLC., NEW YORK, NY:  
4,045,856, INT. CL. 32.
- MJSI, INC., SHOREWOOD, IL:  
4,045,890, INT. CL. 11.
- MLINK TECHNOLOGIES, INC., LEWISVILLE, TX:  
2,587,684, REN. 9-20-11, INT. CL. 9.
- MLT TECHNOLOGY SERVICES, LLC, PARADISE VALLEY, AZ, MICROAGE COMPUTER STORES, INC., SCOTTSDALE, AZ:  
1,170,656, REN. 9-19-11, INT. CL. 42.
- MMI PRODUCTS, INC., HOUSTON, TX, SEMMERLING FENCE & SUPPLY, INC., WHEELING, IL:  
1,667,345, REN. 9-20-11, INT. CL. 6.
- MNB TECHNOLOGIES, INC., BLOOMINGTON, IN:  
4,047,244, INT. CL. 9.
- MOBILE FOUNDATIONS, INC., FALLS CHURCH, VA:  
2,926,832, CANC. INT. CL. 9.
- MOBILE MEDICAL DISASTER RELIEF, INC., BRENTWOOD, TN:  
4,044,938, PUB. 8-9-2011, INT. CL. 44.
- MOBILE RECYCLING USA, INC, CENTENNIAL, CO, DBA MOBILE RECYCLING:  
4,047,208, INT. CL. 40.
- MOBILE SHELTER SYSTEMS, INC., HELOTES, TX:  
4,044,131, PUB. 8-9-2011, INT. CL. 6.
- MOBILEATION, INC., ANTHEM, AZ:  
4,046,357, INT. CL. 35.
- MOCTEZUMA, ROBERTO, HOUSTON, TX:  
2,926,885, CANC. INT. CL. 9.
- MODE DESIGN GROUP, INC., NEW YORK, NY:  
4,044,116, PUB. 5-3-2011, MULTIPLE CLASS, INT. CLS. 35 AND 42.
- MODERN OPTICAL INTERNATIONAL, LTD., ROSELLE, IL:  
4,046,378, INT. CL. 9.
- MOET HENNESSY USA, INC., NEW YORK, NY:  
4,045,313, PUB. 8-9-2011, INT. CL. 33.
- MOGO MEDIA, LLC, ST. BONIFACIUS, MN:  
4,044,764, PUB. 8-9-2011, INT. CL. 41.
- MOHAJERIN SOHRAB, PLEASANTON, CA:  
4,046,091, INT. CL. 15.
- MOHAWK CARPET DISTRIBUTION, INC, CHATSWORTH, GA:  
2,482,360, REN. 9-19-11, INT. CL. 27.
- MOLINA HEALTHCARE, INC., LONG BEACH, CA:  
4,045,885, INT. CL. 36.
- MOMENTUM SOFTWARE, INC, AUSTIN, TX, DBA INDIGO SOLUTIONS:  
4,044,169, PUB. 8-9-2011, INT. CL. 35.
- MOMS IN MOTION, LLC, FRONT ROYAL, VA:  
4,044,170, PUB. 8-9-2011, INT. CL. 45.
- MONAVIE LLC, SOUTH JORDAN, UT:  
4,045,972, INT. CL. 18.  
4,046,498, INT. CL. 5.
- MONDOR LTEE/MONDOR LTD., ST-JEAN-SUR-RICHE-LIEU, CANADA:  
2,427,754, CANC. MULTIPLE CLASS, INT. CLS. 18 AND 25.
- MONEY QUOTIENT, INC., POULSBO, WA:  
2,926,532, CANC. INT. CL. 41.
- MONIQUE LAURA FRIEDMAN, CHICAGO, IL:  
4,046,808, INT. CL. 25.
- MONKEY DEPOT LLC, MESA, AZ:  
4,044,587, PUB. 8-9-2011, INT. CL. 28.
- MONOGRAM BIOSCIENCES, INC., SOUTH SAN FRANCISCO, CA:  
4,046,212, INT. CL. 44.
- MONOSOL LLC, MERRILLVILLE, IN:  
4,047,097, MULTIPLE CLASS, INT. CLS. 10, 17, 20, 40 AND 42.
- MONTANA PROFESSIONAL SPORTS, LLC, EASTSOUND, WA:  
2,926,797, CANC. MULTIPLE CLASS, INT. CLS. 25 AND 41.
- MONTECITO PICTURE COMPANY, LLC, THE, MONTECITO, CA:  
2,508,133, REN. 9-20-11, MULTIPLE CLASS, INT. CLS. 9 AND 41.
- MONTEFIBRE S.P.A., MILAN, ITALY:  
2,926,302, CANC. MULTIPLE CLASS, INT. CLS. 17, 19 AND 22.
- MONTEREY BAY CLOTHING COMPANY, INC., TUCSON, AZ:  
2,428,122, CANC. INT. CL. 35.
- MONTICELLO INTERNATIONAL, LLC, DALTON, GA:  
2,926,506, CANC. INT. CL. 23.
- MONTPETIT, PATRICE N., ST. PAUL, MN AND HAMILTON, NANCY J., ST. PAUL, MN:  
2,926,647, CANC. INT. CL. 9.
- MONUMENTAL LIFE INSURANCE COMPANY, BALTIMORE, MD:  
4,044,180, PUB. 8-9-2011, INT. CL. 36.
- MOORE, SHAYNE, WHEATON, IL:  
4,046,431, INT. CL. 41.
- MOORECO, INC., TEMPLE, TX:  
4,044,191, PUB. 5-3-2011, INT. CL. 9.
- MOREHEAD, STEVEN M., INDIANAPOLIS, IN:  
2,480,577, REN. 9-19-11, INT. CL. 21.
- MORGAN STANLEY, NEW YORK, NY:  
2,927,046, CANC. INT. CL. 16.
- MORGAN, LEWIS & BOCKIUS LLP, PHILADELPHIA, PA:  
2,469,580, REN. 9-20-11, INT. CL. 42.
- MORGAN, MORRIS, RIVERTON, UT:  
4,045,224, PUB. 8-9-2011, INT. CL. 37.
- MORGAN, ROSALIE, SPARKS, NV:  
4,046,934, INT. CL. 35.
- MORNINGLAND CORPORATION, LONG BEACH, CA, AKA MORNINGLANF:  
1,170,615, REN. 9-19-11, MULTIPLE CLASS, INT. CLS. 41 AND 42.
- MORRIS, RICHARD L. JR, MIAMI BEACH, FL:  
4,045,247, PUB. 8-9-2011, INT. CL. 35.
- MORRISSEY CONSTRUCTION COMPANY, GODFREY, IL:  
4,044,464, PUB. 8-9-2011, INT. CL. 37.
- MORTENSEN, MICHAEL G., BROOKFIELD, WI:  
2,491,145, REN. 9-19-11, INT. CL. 42.
- MORTGAGE MASTER SERVICE CORPORATION, KENT, WA:  
1,172,552, REN. 9-18-11, INT. CL. 36.
- MORUSUPALLI RAGHAVENDRA RAO, SAN JOSE, CA, DBA LENZMART:  
4,045,467, PUB. 8-9-2011, INT. CL. 35.

MOSAIC BRANDS OF NEW YORK, LLC, NEW YORK, NY:  
2,617,314. REN. 9-19-11. INT. CL. 29.

MOSHIRNOROOZI MASOUD, SAN DIEGO, CA, DBA SERI-ALIGHT:  
4,047,169. INT. CL. 11.

MOSKOW, ELIZABETH, BOULDER, CO:  
4,045,744. INT. CL. 3.

MOSS CONSTRUCTION COMPANY, INC., CHANTILLY, VA:  
4,045,273. PUB. 8-9-2011. INT. CL. 41.

MOTION PICTURE LICENSING CORPORATION, LOS ANGELES, CA:  
2,610,843. REN. 9-20-11. INT. CL. 42.

MOTOLIFE INC., PORTLAND, OR:  
4,046,410. INT. CL. 38.

MOTOVARIO S.P.A., 20121 MILANO(MI), ITALY:  
4,043,675. PUB. 8-9-2011. INT. CL. 7.

MOTT CORPORATION, FARMINGTON, CT:  
1,672,979. REN. 9-21-11. INT. CL. 11.

MOTTAHEDEH & COMPANY, INC., CRANBURY, NJ:  
2,513,056. REN. 9-22-11. INT. CL. 42.

MOUNT LUCAS MANAGEMENT CORPORATION, PRINCETON, NJ:  
2,428,112. CANC. INT. CL. 36.

MOUNTANOS BROTHERS COFFEE CO., SOUTH SAN FRANCISCO, CA:  
4,046,623. INT. CL. 30.

MOXI ENTERPRISES, LLC, SAINT LOUIS, MO:  
4,044,049. PUB. 8-9-2011. INT. CL. 24.

MPH ENTERTAINMENT, INC., BURBANK, CA:  
4,044,270. PUB. 8-9-2011. INT. CL. 44.

MPI RESEARCH, INC., MATTAWAN, MI:  
4,046,299. INT. CL. 42.

MR. GUTTERMAN, INC., BIRMINGHAM, AL:  
1,198,259. REN. 9-20-11. INT. CL. 37.

MSH SOUTH INC., WILMINGTON, DE:  
2,506,735. REN. 9-19-11. INT. CL. 42.

MSK VERPACKUNGS SYSTEME GESELLSCHAFT MIT BESCHRANKTER HAFTUNG, 47533 KLEVE, FED REP GERMANY:  
2,983,435. CANC. INT. CL. 8.

MT. EVEREST AIR, INC., GLEN CARBON, IL:  
2,602,764. REN. 9-19-11. INT. CL. 37.

MTX LLC, ESCONDIDO, CA:  
4,045,325. PUB. 8-9-2011. INT. CL. 45.

MUFFIN TOP STOPPER, WOODSIDE, NY:  
4,044,976. PUB. 8-9-2011. INT. CL. 25.

MUG AND PIA, LLC, HUNTINGTON, WV:  
4,044,643. PUB. 8-9-2011. INT. CL. 35.

MUHAMMAD, ENOCH, CHICAGO, IL, DBA HIP-HOP DETOXX:  
4,044,185. PUB. 8-9-2011. INT. CL. 41.

MUJAHID, RAJAE, ELLENWOOD, GA:  
2,926,768. CANC. INT. CL. 25.

MULARCZYK, KRZYSZTOF, WARSZAWA, POLAND:  
2,926,756. CANC. INT. CL. 29.

MULTI-CHEM GROUP, LLC, SAN ANGELO, TX:  
4,044,669. PUB. 8-9-2011. INT. CL. 1.

MUNCHAROO, LLC, KANSAS CITY, MO:  
4,044,654. PUB. 8-9-2011. INT. CL. 35.

MUNRO & COMPANY, INC., HOT SPRINGS, AR:  
2,926,740. CANC. INT. CL. 25.

MUR, INC. STUART, FL:  
4,044,306. PUB. 8-9-2011. INT. CL. 41.

MURAI LTED. CORP., HUMACAO, PUERTO RICO:  
4,046,728. INT. CL. 7.

MUROKI NAOTO, TOKYO, JAPAN:  
4,046,542. INT. CL. 28.  
4,046,543. INT. CL. 28.

MURTAZA LIAKATALI DATOO PARDAN, UNITED KINGDOM:  
4,043,819. PUB. 5-3-2011. INT. CL. 5.

MUSIC WATER OF THE WORLD, INC., AUSTIN, TX:  
4,044,494. PUB. 8-9-2011. INT. CL. 32.  
4,044,495. PUB. 8-9-2011. INT. CL. 32.

MVP GROUP INTERNATIONAL, INC., CHARLESTON, SC:  
4,046,390. INT. CL. 4.  
4,047,089. INT. CL. 4.

MWI CORPORATION, DEERFIELD BEACH, FL:  
4,044,376. PUB. 8-9-2011. INT. CL. 7.

MWI VETERINARY SUPPLY CO., MERIDIAN, ID:  
2,438,501. REN. 9-22-11. INT. CL. 35.

MY BEAST FRIENDS, LLC, CORAL GABLES, FL:  
4,046,064. INT. CL. 28.

MY INDOOR GARDEN CORPORATION, SEARSPORT, ME:  
4,044,400. PUB. 8-9-2011. INT. CL. 21.

MYBODY, L.L.C., PHOENIX, AZ:  
4,046,960. INT. CL. 5.

MYMUSE LLC, TOPANGA, CA:  
4,044,302. PUB. 8-9-2011. U.S. CL. B.

MYRIAD GENETICS, INC., SALT LAKE CITY, UT:  
4,045,782. INT. CL. 10.

MYSTIC WORLDWIDE, INC., PANAMA, PANAMA:  
4,047,119. INT. CL. 21.

N. CLARK BELL ASSOCIATES, INC., ALLENTOWN, PA, TA RENTALHUNTERS, RENTALHUNTERS, INC., ALLENTOWN, PA:  
1,646,256. REN. 9-21-11. INT. CL. 36.

N.V. PERRICONE LLC, MERIDEN, CT:  
4,046,796. INT. CL. 35.  
4,047,075. INT. CL. 3.  
4,047,076. INT. CL. 3.

N-K SCRATCH PADS, INC., ST. LOUIS, MO:  
1,165,525. REN. 9-21-11. INT. CL. 16.

NAAMLOZE VENNOOTSCHAP INTERNATIONAL SANITARY WARE - MANUFACTURING CY., SOCIETE ANONYME, IN HET KORT: "N.V. INTERSAN S.A.", KRUISHOUTEM, BELGIUM:  
1,669,292. REN. 9-20-11. INT. CL. 11.

NAHIP, LLC, HEBRON, CT:  
4,044,952. PUB. 8-9-2011. U.S. CL. B.

NANO-TEX, INC., EMERYVILLE, CA:  
2,926,588. CANC. INT. CL. 1.

NAP, INC., BOULDER, CO, DBA SLEEPY WRAP, INC.:  
4,045,452. PUB. 8-9-2011. INT. CL. 18.

NASCENTECHNOLOGY, INC., WATERTOWN, SD:  
4,044,573. PUB. 8-9-2011. INT. CL. 9.

NATALIA NUNEZ, FORT LEE, NJ:  
4,047,172. INT. CL. 35.

NATERRA INTERNATIONAL, INC., FLOWER MOUND, TX:  
4,045,916. INT. CL. 3.

NATIONAL ASSOCIATION FOR BLACK VETERANS, INC., MILWAUKEE, WI, AKA NABVETS:  
4,043,989. PUB. 8-9-2011. INT. CL. 35.

NATIONAL ASSOCIATION FOR STOCK CAR AUTO RACING, INC., DAYTONA BEACH, FL:  
4,046,789. INT. CL. 45.  
4,046,790. INT. CL. 45.

NATIONAL COALITION FOR CANCER SURVIVORSHIP, SILVER SPRING, MD:  
2,514,806. REN. 9-22-11. INT. CL. 42.

NATIONAL COALITION OF ONCOLOGY NURSE NAVIGATORS, INC., ROCKVILLE, MD:  
4,044,809. PUB. 8-9-2011. INT. CL. 35.

NATIONAL COLLEGIATE ATHLETIC ASSOCIATION, THE, SHAWNEE MISSION, KS:  
1,164,713. REN. 9-19-11. INT. CL. 25.

NATIONAL DEFAULT SERVICING, LLC, GLASTONBURY, CT:  
4,047,164. INT. CL. 35.

NATIONAL ELECTRICAL MANUFACTURERS ASSOCIATION, ROSSLYN, VA:  
4,046,348. U.S. CL. A.

NATIONAL ENDOWMENT FOR FINANCIAL EDUCATION, DENVER, CO:  
2,465,886. REN. 9-20-11. INT. CL. 9.

NATIONAL HELLENIC SOCIETY, INC., BETHESDA, MD:  
4,045,431. PUB. 8-9-2011. INT. CL. 42.

NATIONAL HOT ROD ASSOCIATION, GLENDORA, CA, AKA NHRA:  
4,046,183. INT. CL. 25.

NATIONAL HURRICANE MUSEUM AND SCIENCE CENTER, INC., LAKE CHARLES, LA:  
4,047,110. INT. CL. 41.

- NATIONAL INSTRUMENTS CORPORATION, AUSTIN, TX:  
4,045,566, PUB. 8-9-2011. INT. CL. 9.  
4,045,567, PUB. 8-9-2011. INT. CL. 9.
- NATIONAL MARKETING, INC., LAGUNA NIGUEL, CA:  
4,044,657, PUB. 8-9-2011. INT. CL. 5.
- NATIONAL MOLDING LLC., MIAMI LAKES, FL:  
4,046,500, INT. CL. 26.
- NATIONAL MUSEUM OF RACING, INC., SARATOGA SPRINGS, NY:  
2,600,329. REN. 9-20-11. INT. CL. 41.
- NATIONAL NONWOVENS, INC., EASTHAMPTON, MA:  
2,429,006, CANC. INT. CL. 24.
- NATIONAL PRODUCTS, INC., NORTH LITTLE ROCK, AR:  
4,044,359, PUB. 8-9-2011. INT. CL. 11.
- NATIONAL RAILROAD PASSENGER CORPORATION, WASHINGTON, DC:  
2,428,355, CANC. INT. CL. 39.  
2,457,320. REN. 9-20-11. INT. CL. 16.  
2,473,484. REN. 9-20-11. INT. CL. 39.  
2,475,333. REN. 9-20-11. INT. CL. 39.
- NATIONAL RAILWAY SUPPLY, LLC, SAVANNAH, GA:  
4,044,855, PUB. 8-9-2011. MULTIPLE CLASS, INT. CLS. 9 AND 35.
- NATIONAL RIFLE ASSOCIATION OF AMERICA, FAIRFAX, VA:  
1,713,548. REN. 9-18-11. INT. CL. 16.  
2,600,305. REN. 9-22-11. INT. CL. 42.
- NATIONAL SEPTEMBER 11 MEMORIAL & MUSEUM AT THE WORLD TRADE CENTER FOUNDATION, INC., NEW YORK, NY:  
4,043,887, PUB. 8-9-2011. INT. CL. 21.
- NATIONAL SHOOTING SPORTS FOUNDATION, INC., NEWTOWN, CT:  
4,047,239, INT. CL. 35.
- NATIONAL SOCIETY TO PREVENT BLINDNESS, CHICAGO, IL, DBA PREVENT BLINDNESS AMERICA:  
2,461,261. REN. 9-20-11. INT. CL. 36.
- NATIONAL STUDENT CLEARINGHOUSE, HERNDON, VA:  
4,045,215, PUB. 8-9-2011. INT. CL. 41.
- NATIONAL WHOLESALE SUPPLY, INC., DALLAS, TX, DBA NATIONAL HOT WATER:  
4,044,381, PUB. 8-9-2011. INT. CL. 11.
- NATURAL PRODUCTS FOR PETS, INC., CANOGA PARK, CA:  
2,476,773. REN. 9-20-11. INT. CL. 5.
- NATURAL RESOURCES DEFENSE COUNCIL, INC., NEW YORK, NY:  
2,341,920, CANC. INT. CL. 42.
- NATURALIA BY POLIGON S.L., UGENA - TOLEDO, SPAIN:  
4,046,482, INT. CL. 20.
- NATURE'S TREES, INC., BEDFORD HILLS, NY:  
4,044,309, PUB. 8-9-2011. INT. CL. 44.
- NAU HOLDING COMPANY, LLC, RAMSEY, MN:  
4,047,045, INT. CL. 36.
- NC JUNK REMOVAL, INC., LAKE ZURICH, IL, DBA JUNK REMEDY:  
4,044,970, PUB. 8-9-2011. INT. CL. 39.
- NCH CORPORATION, IRVING, TX:  
2,437,936. REN. 9-20-11. INT. CL. 7.
- NCL CORPORATION LTD., MIAMI, FL:  
2,428,532. REN. 9-20-11. INT. CL. 39.
- NEAL, INC., SAN ANTONIO, TX:  
1,149,157. REN. 9-20-11. INT. CL. 37.
- NEBRASKA STAR BEEF, LLC, HOLDREGE, NE:  
4,045,231, PUB. 8-9-2011. INT. CL. 29.
- NEBRASKA TRANSPORT CO. INC., GERING, NE:  
4,045,202, PUB. 8-9-2011. INT. CL. 39.
- NEDBOY, ROBIN L., NEW YORK, NY:  
4,045,541, PUB. 8-9-2011. INT. CL. 4.
- NEELEY, DIAMOND J, NAPLES, FL:  
4,045,696, INT. CL. 25.
- NEELY, CUBITH, V., INDIANAPOLIS, IN:  
2,926,928, CANC. INT. CL. 10.
- NEGOTIATION TECHNOLOGIES, LLC, CORAL SPRINGS, FL:  
4,046,263, MULTIPLE CLASS, INT. CLS. 35 AND 42.
- NELSEN, KAY, NORTHGLENN, CO:  
2,345,121, CANC. INT. CL. 14.
- NELSON STUD WELDING, INC., ELYRIA, OH:  
2,565,278. REN. 9-21-11. MULTIPLE CLASS, INT. CLS. 6, 7 AND 9.
- 2,565,278, COR. MULTIPLE CLASS, INT. CLS. 6, 7 AND 9.
- NELSON, KEITH, GRIMES, IA:  
4,045,038, PUB. 8-9-2011. INT. CL. 20.
- NEOGENIS LABORATORIES, INC, AUSTIN, TX:  
4,046,743, INT. CL. 5.
- NEOPETS, INC., NEW YORK, NY:  
4,044,069, PUB. 8-9-2011. INT. CL. 41.
- NEOSTRATA COMPANY, INC., PRINCETON, NJ:  
2,532,650. REN. 9-22-11. INT. CL. 3.
- NEOTERIC COSMETICS, INC., DENVER, CO:  
2,428,541, CANC. INT. CL. 3.
- NETSTAL-MASCHINEN AG (NETSTAL-MACHINES S.A., NETSTAL-MACHINERY LTD.), NAFELS, SWITZERLAND:  
4,044,366, PUB. 8-9-2011. INT. CL. 7.
- NETWORK APPLIANCE, INC., SUNNYVALE, CA:  
2,926,896, CANC. INT. CL. 9.
- NEUROTECH USA, INC., LINCOLN, RI:  
4,045,730, INT. CL. 10.
- NEVILOG, INC., VICTOR, MT, DBA NEVILLE LOG HOMES:  
2,428,310, CANC. INT. CL. 42.
- NEW BREED, INC., GREENSBORO, NC:  
2,491,744. REN. 9-19-11. MULTIPLE CLASS, INT. CLS. 35, 37, 39 AND 42.  
2,492,186. REN. 9-18-11. INT. CL. 42.
- NEW DIRECTIONS INTERNATIONAL, BURLINGTON, NC:  
4,045,866, INT. CL. 45.
- NEW EARTH SERVICES, INC., ANNAPOLIS, MD:  
2,926,676, CANC. INT. CL. 1.
- NEW ENGLAND CONFECTIONERY COMPANY, REVERE, MA:  
721,683. REN. 9-22-11. U.S. CL. 46 (INT. CL. 30).
- NEW FRONTIER MEDIA, INC., BOULDER, CO:  
2,610,524. REN. 9-20-11. INT. CL. 41.  
4,045,382, PUB. 8-9-2011. INT. CL. 41.
- NEW GLOBAL TELECOM, INC., GOLDEN, CO:  
2,428,105, CANC. INT. CL. 38.
- NEW HEIGHTS TRADING CO., INC., LITTLE ROCK, AR:  
2,926,381, CANC. INT. CL. 25.
- NEW HOME SALES COACH, LLC, SAVAGE, MN:  
4,046,762, MULTIPLE CLASS, INT. CLS. 37 AND 42.
- NEW IMAGE COATINGS, LLC, MANCHESTER, NH:  
4,044,856, PUB. 8-9-2011. INT. CL. 1.
- NEW JERSEY DEVILS LLC, EAST RUTHERFORD, NJ, MEADOWLANDERS, INC., EAST RUTHERFORD, NJ:  
1,653,628. REN. 9-21-11. MULTIPLE CLASS, INT. CLS. 16, 18, 20, 24, 25, 28 AND 41.
- NEW JERSEY DEVILS LLC, NEWARK, NJ, MEADOWLANDERS, INC., EAST RUTHERFORD, NJ:  
1,662,564. REN. 9-20-11. INT. CL. 25.
- NEW JERSEY STATE LEAGUE OF MUNICIPALITIES, INC., TRENTON, NJ, DBA MAYORS COMMITTEE FOR A GREEN FUTURE:  
3,991,309, COR. U.S. CL. B.
- NEW MILLENNIUM BUILDING SYSTEMS, LLC, FORT WAYNE, IN:  
4,046,628, INT. CL. 9.
- NEW ORLEANS EXCHANGE, INC., NEW ORLEANS, LA:  
4,044,689, PUB. 8-9-2011. INT. CL. 35.
- NEW SURFACE, INC., ALBUQUERQUE, NM:  
2,486,657. REN. 9-16-11. INT. CL. 40.
- NEW VINTAGE, INC., LOS ANGELES, CA:  
4,044,077, PUB. 8-9-2011. INT. CL. 25.
- NEW YORK - NEW YORK HOTEL & CASINO, LLC, LAS VEGAS, NV:  
4,046,574, INT. CL. 43.
- NEW YORK BOLD, LLC, OSWEGO, NY:  
2,926,707, CANC. INT. CL. 31.  
2,926,708, CANC. INT. CL. 31.
- NEWPORT AQUARIUM, LLC DBA NEWPORT AQUARIUM, NEWPORT, KY:  
2,493,615. REN. 9-21-11. INT. CL. 41.
- NEXEO SOLUTIONS, LLC, DUBLIN, OH:  
4,047,029, INT. CL. 39.



NEXIA BIOTECHNOLOGIES LTD., ALBERTA, CANADA:  
2,926,502, CANC. INT. CL. 1.

NEXT GENERATION FOCUS, INC., CUMMING, GA:  
4,044,965, PUB. 8-9-2011. INT. CL. 41.

NEXT HOLDINGS LIMITED, AUCKLAND, NEW ZEALAND:  
4,044,637, PUB. 8-9-2011. MULTIPLE CLASS, INT. CLS. 9 AND 42.

NEXTBODY LLC, ORLAND PARK, IL:  
3,680,234, CANC. MULTIPLE CLASS, INT. CLS. 5 AND 30.

NEZGODA, TERESA A., LAS VEGAS, NV, DBA UNEEK-COWGIRL DESIGNS:  
4,046,262, INT. CL. 25.

NFC FORUM, INC., WAKEFIELD, MA:  
4,046,199, INT. CL. 42.

NGUYEN, TUONG, WESTMINSTER, CA:  
4,043,617, PUB. 8-9-2011. INT. CL. 5.

NICARAGUA AMERICAN CIGAR, S.A., ESTELI NICARAGUA, NICARAGUA:  
4,046,757, INT. CL. 34.

NICHOLSON, EGERTON, BLAINE, WA:  
4,046,744, INT. CL. 10.

NICK CHEN, S. EL MONTE, CA:  
4,044,732, PUB. 8-9-2011. INT. CL. 25.  
4,045,130, PUB. 8-9-2011. INT. CL. 25.

NIELSEN & BAINBRIDGE L.L.C., PARAMUS, NJ, ESSELTE PENDAFLEX CORPORATION, PARAMUS, NJ:  
1,653,107, REN. 9-20-11, INT. CL. 20.

NIELSEN & BAINBRIDGE LLC, PARAMUS, NJ, ESSELTE PENDAFLEX CORPORATION, PARAMUS, NJ:  
1,651,515, REN. 9-20-11, INT. CL. 20.

NIKE, INC., BEAVERTON, OR:  
4,045,921, INT. CL. 25.

NINE WEST DEVELOPMENT CORPORATION, WILMINGTON, DE, FISHER-CAMUTO CORPORATION, STAMFORD, CT:  
1,170,312, REN. 9-19-11, INT. CL. 25.

NINE WEST DEVELOPMENT CORPORATION, WILMINGTON, DE:  
4,046,236, INT. CL. 25.

NINGBO BLUE STAR SEAFOOD CO., LTD., ZHEJIANG, CHINA:  
4,046,396, INT. CL. 29.

NINGBO LOCTEK IMP&EXP CO.,LTD, NINGBO, CHINA:  
4,046,314, INT. CL. 35.

NINTENDO OF AMERICA INC., REDMOND, WA:  
4,043,679, PUB. 7-20-2010. INT. CL. 38.  
4,043,680, PUB. 7-20-2010. INT. CL. 41.  
4,043,681, PUB. 7-20-2010. INT. CL. 42.  
4,045,614, INT. CL. 16.

NIPPON CHEMI-CON CORPORATION, TOKYO, JAPAN, NIPPON CHEMI-CON COMPANY, LTD., OME-SHI, TOKYO, JAPAN:  
1,172,056, REN. 9-21-11, INT. CL. 9.

NIROOMAND, ALIREZA, NEW YORK, NY:  
4,045,101, PUB. 8-9-2011. INT. CL. 31.

NISCAYAH, INC., DULUTH, GA:  
2,428,038, CANC. INT. CL. 9.

NITRO GAMES LTD, FINLAND:  
4,043,777, PUB. 8-9-2011. INT. CL. 9.

NITTANY CORPORATION, WILMINGTON, DE:  
4,045,203, PUB. 8-9-2011. INT. CL. 29.  
4,045,204, PUB. 8-9-2011. INT. CL. 29.

NITTO KOHKI CO., LTD., OHTA-KU, TOKYO, JAPAN:  
919,237, REN. 9-19-11. MULTIPLE CLASS, U.S. CLS. 13 (INT. CL. 6) AND 23 (INT. CL. 7).

NLOGIC, LLC, HUNTSVILLE, AL:  
4,044,963, PUB. 8-9-2011. INT. CL. 42.

NO CHOKE, LLC, LELAND, NC:  
4,046,949, INT. CL. 12.

NOAR FOUNDATION FOR GLOBAL COMMUNITY DEVELOPMENT, TOWSON, MD:  
4,046,820, INT. CL. 35.

NOBOLEIS VINEYARDS, L.L.C., CHESTERFIELD, MO:  
4,045,811, MULTIPLE CLASS, INT. CLS. 33 AND 40.

NOCAP, LLC, SALT LAKE CITY, UT:  
4,047,104, INT. CL. 5.

NOCO COMPANY, THE, CLEVELAND, OH:  
1,165,271, REN. 9-16-11. INT. CL. 8.

NODEN, HARRY, RAVENNA, OH:  
2,428,847, CANC. INT. CL. 9.

NONNEL'S SERVICES, LLC, CHICAGO, IL:  
4,046,148, MULTIPLE CLASS, INT. CLS. 42 AND 45.  
4,046,149, MULTIPLE CLASS, INT. CLS. 42 AND 45.

NORBORD INDUSTRIES INC.-INDUSTRIES NORBORD INC., TORONTO, ONTARIO, CANADA, NORTHWOOD PULP AND TIMBER LIMITED, PRINCE GEORGE, BRITISH COLUMBIA, CANADA:  
1,160,958, REN. 9-20-11. INT. CL. 19.

NORD-LOCK INTERNATIONAL AB, MALMO, SWEDEN:  
4,043,994, PUB. 8-9-2011. INT. CL. 6.

NORDSON CORPORATION, WESTLAKE, OH:  
2,926,713, CANC. INT. CL. 7.  
4,046,879, INT. CL. 10.

NORDSTROM, INC., SEATTLE, WA:  
4,045,704, INT. CL. 25.  
4,046,248, INT. CL. 18.

NOREK, JOSH, LAFAYETTE, CA:  
4,047,132, INT. CL. 38.

NORM THOMPSON OUTFITTERS, INC., HILLSBORO, OR:  
2,491,496, REN. 9-21-11. INT. CL. 25.

NORMARK CORPORATION, MINNETONKA, MN:  
1,657,514, REN. 9-21-11. INT. CL. 28.

NORTH AMERICAN EQUIPMENT DEALERS ASSN, FENTON, MO:  
4,045,606, INT. CL. 36.

NORTH AMERICAN PLYWOOD CORPORATION, SANTA FE SPRINGS, CA:  
4,045,056, PUB. 8-9-2011. INT. CL. 19.

NORTH AMERICAN SALT COMPANY, OVERLAND PARK, KS:  
4,046,061, INT. CL. 1.

NORTH AMERICAN SEMINARS INC, FRANKLIN, TN:  
4,044,960, PUB. 8-9-2011. INT. CL. 41.

NORTH COUNTY JUMPERS, ESCONDIDO, CA:  
4,047,237, INT. CL. 41.

NORTH KERRY MILK PRODUCTS LIMITED, LISTOWEL, IRELAND:  
1,169,770, REN. 9-16-11. INT. CL. 1.

NORTH SHORE-LONG ISLAND JEWISH HEALTH SYSTEM, INC., GREAT NECK, NY:  
2,481,017, REN. 9-16-11. MULTIPLE CLASS, INT. CLS. 41 AND 42.

NORTHMAN FLUID POWER, INC., CAROL STREAM, IL:  
2,926,626, CANC. INT. CL. 7.

NORTHRIM BANCORP, INC., ANCHORAGE, AK:  
4,044,297, PUB. 8-9-2011. INT. CL. 36.

NORTHROCK BICYCLES, LLC, WEST CHESTER, PA:  
4,045,323, PUB. 8-9-2011. INT. CL. 12.

NORTHSHORE SWIM SCIENCE, LLC, EVANSTON, IL:  
4,044,476, PUB. 8-9-2011. INT. CL. 41.

NORTHSTAR LABORATORIES, GALENA, IL:  
4,044,889, PUB. 8-9-2011. INT. CL. 10.

NORTHWEST BANK AND TRUST COMPANY, DAVENPORT, IA:  
4,047,219, INT. CL. 36.

NORTHWESTERN MUTUAL LIFE INSURANCE COMPANY, THE, MILWAUKEE, WI:  
2,492,052, REN. 9-19-11. INT. CL. 36.  
2,530,436, REN. 9-20-11. INT. CL. 36.

NORTON RECORDS, INC., BROOKLYN, NY:  
1,691,426, REN. 9-22-11. INT. CL. 16.

NOT ALONE, BEND, OR:  
4,047,069, INT. CL. 36.

NOURISHLIFE, LAKE FOREST, IL:  
4,044,064, PUB. 8-9-2011. INT. CL. 5.

NOVA GAMING, LLC, GREENVILLE, SC:  
4,046,590, INT. CL. 9.

NOVA UNIAO LLC, GILBERT, AZ:  
4,044,050, PUB. 8-9-2011. INT. CL. 25.

NOVA WINES, INC., ST. HELENA, CA:  
4,044,456, PUB. 8-9-2011. INT. CL. 33.

NOVALASH, INC., HOUSTON, TX:  
4,045,632, INT. CL. 3.

- NOVARTIS AG, BASEL, SWITZERLAND:  
2,926,802, CANC. INT. CL. 5.
- NOVASTAR FINANCIAL, INC., KANSAS CITY, MO:  
2,926,959, CANC. INT. CL. 36.
- NOVATROX AB, STOCKHOLM, SWEDEN:  
4,047,031, INT. CL. 9.
- NOW & ZEN, INC., BOULDER, CO:  
4,044,824, PUB. 8-9-2011. INT. CL. 9.
- NOYES, FREDERICK R., BLOOMINGTON, IL:  
1,164,925. REN. 9-20-11. INT. CL. 37.
- NP IP HOLDINGS LLC, LAS VEGAS, NV:  
4,045,411, PUB. 8-9-2011. INT. CL. 41.  
4,045,416, PUB. 8-9-2011. INT. CL. 43.
- NRRM, LLC, ST. PETERS, MO:  
4,047,171, MULTIPLE CLASS, INT. CLS. 35 AND 37.
- NSA, LLC, COLLIERVILLE, TN:  
2,474,348. REN. 9-19-11. INT. CL. 5.
- NU-ERA GROUP, LLC, THE, ST. LOUIS, MO:  
2,428,438, CANC. INT. CL. 35.
- NUCLEUS WORLDWIDE, LLC, HERMOSA BEACH, CA:  
4,045,987, INT. CL. 35.
- NUCRAFT COMPANY, LLC, ARLINGTON, VA:  
4,044,186, PUB. 8-9-2011. INT. CL. 35.  
4,044,187, PUB. 8-9-2011. INT. CL. 41.
- NUESOFT TECHNOLOGIES, INC., MARIETTA, GA:  
2,534,928. REN. 9-16-11. INT. CL. 9.  
2,537,371. REN. 9-16-11. INT. CL. 38.  
2,586,384. REN. 9-16-11. MULTIPLE CLASS, INT. CLS. 35  
AND 42.  
2,598,998. REN. 9-16-11. INT. CL. 35.
- NUTRASOURCE LLC, MIAMI, FL:  
4,047,180, INT. CL. 5.  
4,047,181, INT. CL. 5.
- NUTRI-JECT SYSTEMS, INC., HUDSON, IA:  
2,548,761. REN. 9-16-11. INT. CL. 40.
- NUTRI-PEA LIMITED, PORTAGE LA PRAIRIE, CANADA:  
2,926,670, CANC. INT. CL. 29.
- NUTRIENTS PLUS, L.L.C., VIRGINIA BEACH, VA:  
4,045,935, INT. CL. 1.
- NUTRIO.COM, INC., FT. LAUDERDALE, FL:  
2,437,552, AM. INT. CL. 42.
- NUTRITION & FITNESS, INC., FAYETTEVILLE, NC:  
2,459,567. REN. 9-19-11. INT. CL. 5.
- NUTRITION SERVICES, INC., YORK, NE:  
2,504,400. REN. 9-20-11. INT. CL. 31.
- NUTRITIONAL EXCELLENCE LLC, NEW CANAAN, CT:  
4,045,376, PUB. 8-9-2011. INT. CL. 44.
- NUVASIVE, INC., SAN DIEGO, CA:  
2,470,069. REN. 9-20-11. INT. CL. 5.  
4,046,106, INT. CL. 10.  
4,046,107, INT. CL. 10.  
4,046,749, MULTIPLE CLASS, INT. CLS. 35 AND 41.
- NUVO ACCESSORIES, LTD, NEW YORK, NY:  
2,428,124, CANC. MULTIPLE CLASS, INT. CLS. 9, 14, 21  
AND 28.
- NUVONYX INC, CARLSBAD, CA:  
4,044,029, PUB. 8-9-2011. INT. CL. 5.
- NUVOTON TECHNOLOGY CORPORATION, HSINCHU  
SCIENCE PARK, TAIWAN:  
4,046,556, INT. CL. 9.
- NVENTA INCORPORATED, SCOTTSDALE, AZ:  
4,044,870, PUB. 8-9-2011. INT. CL. 3.
- NYGARD INTERNATIONAL PARTNERSHIP, WINNIPEG,  
CANADA:  
1,628,390. REN. 9-20-11. INT. CL. 25.
- NYLE JOSEF COUTURE LLC, DALLAS, TX:  
4,043,616, PUB. 8-9-2011. INT. CL. 25.
- NYLOK LLC, MACOMB, MI:  
2,463,031. REN. 9-20-11. INT. CL. 6.  
2,463,032. REN. 9-20-11. INT. CL. 6.
- NYX, LOS ANGELES INC., COMMERCE, CA:  
4,044,027, PUB. 8-9-2011. MULTIPLE CLASS, INT. CLS. 3,  
18, 21, 25 AND 35.
- O.A.R.S. COMPANIES, INC., ANGELS CAMP, CA:  
4,044,506, PUB. 8-9-2011. MULTIPLE CLASS, INT. CLS. 39  
AND 43.
- O'BRIEN & O'BRIEN ENTERPRISES, LLC, CENTER POINT,  
IA, DBA O'BRIENS OWN:  
4,044,817, PUB. 8-9-2011. INT. CL. 30.
- O'CONNOR, NOELLE, CO. KILDARE, IRELAND:  
4,045,976, INT. CL. 3.
- O'NEIL, EDWARD G., HOLLYWOOD, CA:  
4,045,594, INT. CL. 41.
- OAKWOOD HOMES LLC, GREENWOOD VILLAGE, CO:  
2,926,154, CANC. INT. CL. 36.
- OAT SOLUTIONS, LLC, PALM BEACH GARDENS, FL:  
4,046,436, INT. CL. 30.  
4,046,437, INT. CL. 30.
- OBSHESTVO S OGRANICHENNOY OTVETSTVENNOS-  
TYU "SPLAT-COSMETICA", RUSSIAN FED.:  
4,043,863, PUB. 8-9-2011. INT. CL. 3.  
4,043,867, PUB. 8-9-2011. INT. CL. 3.
- OC AIR SHOW, LLC, COCOA BEACH, FL:  
4,047,251, INT. CL. 41.
- OCHO RIOS HOLDING CORP., MIAMI, FL:  
4,047,254, INT. CL. 30.
- OCULUS INNOVATIVE SCIENCES, INC., PETALUMA, CA:  
4,046,545, INT. CL. 5.
- OENOFOROS AB, SWEDEN:  
4,043,811, PUB. 8-9-2011. INT. CL. 33.
- OFF THE WALL VENTURES, LLC, RICHMOND, IN:  
4,046,570, INT. CL. 20.
- OGDEN DIRECTORIES OF PA, INC., ALTOONA, PA:  
4,046,552, MULTIPLE CLASS, INT. CLS. 16 AND 35.  
4,046,553, MULTIPLE CLASS, INT. CLS. 16 AND 35.
- OHIO MEDICAL CORPORATION, GURNEE, IL:  
4,045,828, INT. CL. 10.
- OK MOZART INC., BARTLESVILLE, OK:  
4,046,231, INT. CL. 36.
- OKANAGAN PLANT IMPROVEMENT HOLDING CO. LTD.,  
SUMMERLAND, BRITISH COLUMBIA, CANADA:  
2,456,571. REN. 9-19-11. INT. CL. 31.
- OKLAHOMA SAFETY EQUIPMENT COMPANY, INC.,  
BROKEN ARROW, OK:  
2,482,196. REN. 9-21-11. INT. CL. 9.  
2,490,384. REN. 9-20-11. INT. CL. 9.
- OKTA, INC., SAN FRANCISCO, CA:  
4,046,232, INT. CL. 9.  
4,046,944, MULTIPLE CLASS, INT. CLS. 42 AND 45.
- OKUMA FISHING TACKLE, ONTARIO, CA:  
4,047,033, INT. CL. 28.
- OLALDE, JOSE, CARACAS, VENEZUELA:  
4,044,284, PUB. 8-9-2011. INT. CL. 5.
- OLD BLUE, LLC, LAKE GENEVA, WI:  
4,045,842, INT. CL. 25.
- OLD LYME GOURMET COMPANY, OLD LYME, CT, DBA  
DEEP RIVER SNACKS:  
4,044,699, PUB. 8-9-2011. MULTIPLE CLASS, INT. CLS. 29  
AND 30.
- OLD OAK BEER CO. LLC, SAN FRANCISCO, CA:  
4,046,466, INT. CL. 32.
- OLD VIRGINIA BRICK COMPANY, INCORPORATED,  
SALEM, VA:  
4,044,743, PUB. 8-9-2011. INT. CL. 19.
- OLD WORLD IMPORTS, INC., PALM BEACH, FL:  
4,046,315, INT. CL. 14.
- OLDE GRANDDAD INDUSTRIES, INC., KEARNY, NJ:  
4,045,603, MULTIPLE CLASS, INT. CLS. 3 AND 5.
- OLIVE, BRADLEY, YORBA LINDA, CA:  
4,045,368, PUB. 8-9-2011. INT. CL. 9.
- OLIVIA GOSSETT, BRONXVILLE, NY AND RICHARD  
GOSSETT, BRONXVILLE, NY:  
4,044,733, PUB. 8-9-2011. MULTIPLE CLASS, INT. CLS. 35  
AND 45.
- OLYMPUS CORPORATION, TOKYO, JAPAN:  
4,046,991, INT. CL. 9.
- OMAHA ROYALS LIMITED PARTNERSHIP, OMAHA, NE:  
4,044,292, PUB. 8-9-2011. INT. CL. 25.  
4,044,296, PUB. 8-9-2011. INT. CL. 16.
- OMLAND, BRIAN R, ABERDEEN, SD:  
2,428,244, CANC. INT. CL. 40.
- OMNI INDUSTRIES, INC., GREENWELL SPRINGS, LA:  
4,047,105, MULTIPLE CLASS, INT. CLS. 1 AND 4.

OMNI REMANUFACTURING, INC., MINNEAPOLIS, MN:  
2,926,891, CANC. INT. CL. 20.

ONANTZIN CLOTHING LLC, LOS ANGELES, CA:  
4,046,474, INT. CL. 25.

ONE INCH ROUND INC., PORTLAND, OR:  
4,045,448, PUB. 8-9-2011. INT. CL. 26.

ONE MEDIA, LAKE FOREST, CA:  
2,615,541, REN. 9-22-11. INT. CL. 9.

ONE STEP, CARLSBAD, CA:  
4,046,839, INT. CL. 37.

ONECLICK CLEANERS INC, BROOKLYN, NY:  
4,044,503, PUB. 8-9-2011. INT. CL. 37.

ONEFASTBUFFALO CORP, DALLAS, TX:  
4,045,345, PUB. 8-9-2011. INT. CL. 28.

ONEOK, INC., TULSA, OK:  
2,985,073, CANC. MULTIPLE CLASS, INT. CLS. 37 AND 42.

ONEUP INNOVATIONS, INC., ATLANTA, GA:  
4,044,249, PUB. 8-9-2011. INT. CL. 20.

ONWEST BANK, F.S.B., PASADENA, CA, INDYMAC BANK, F.S.B., PASADENA, CA:  
2,487,050, REN. 9-19-11. INT. CL. 36.

ONION, INC., NEW YORK, NY:  
2,428,606, CANC. MULTIPLE CLASS, INT. CLS. 16 AND 42.

ONKEW TECHNOLOGY, LEAWOOD, KS:  
4,044,861, PUB. 8-9-2011. INT. CL. 42.

ONLINE BUDDIES, INC., CAMBRIDGE, MA:  
4,046,734, INT. CL. 45.  
4,046,735, INT. CL. 45.

ONSITE ELECTRONICS RECYCLING, LLC, STOCKTON, CA:  
4,044,373, PUB. 8-9-2011. INT. CL. 40.

OPEN SKY SOFTWARE, INC., AUSTIN, TX:  
2,926,803, CANC. INT. CL. 42.

OPENING TECHNOLOGIES, INC., CONCORD, CA:  
3,010,533, CANC. INT. CL. 41.

OPENSESAME INC., PORTLAND, OR:  
4,046,756, INT. CL. 35.

OPFER, SCOTT, SPRINGFIELD, MO:  
4,047,212, INT. CL. 35.

OPI PRODUCTS, INC., NORTH HOLLYWOOD, CA:  
2,922,439, CANC. INT. CL. 3.

OPTEX CO., LTD., SHIGA, JAPAN:  
2,926,595, CANC. INT. CL. 9.

OPTICARE MANAGED VISION INC., ROCKY MOUNT, NC:  
2,472,979, REN. 9-20-11. INT. CL. 36.  
2,472,979, CANC. MULTIPLE CLASS, INT. CLS. 35 AND 42.

OPTIMARKET, DARIEN, CT:  
2,544,980, REN. 9-19-11. INT. CL. 35.

OPTIMIZE INTERNATIONAL LLC, HOLLIS, NH:  
4,046,171, MULTIPLE CLASS, INT. CLS. 9, 16, 35 AND 41.

ORA LIVING, LLC, EVANSTON, IL:  
4,047,263, INT. CL. 21.

ORACLE AMERICA, INC., REDWOOD SHORES, CA:  
4,044,158, PUB. 8-9-2011. INT. CL. 9.

ORACLE INTERNATIONAL CORPORATION, REDWOOD CITY, CA:  
4,045,733, INT. CL. 9.

ORBIS TECHNOLOGIES, INC., ANNAPOLIS, MD:  
4,044,010, PUB. 5-3-2011. INT. CL. 9.  
4,044,011, PUB. 5-3-2011. INT. CL. 9.

ORBITAL WRAP SYSTEMS PTY LTD, EDWARDSTOWN, AUSTRALIA:  
4,046,819, INT. CL. 16.

ORCAWEST HOLDINGS, LLC, GLENDALE, CO:  
4,047,198, INT. CL. 10.

ORGA KARTENSYSTEME GMBH, PADERBORN, FED REP GERMANY:  
2,926,552, CANC. INT. CL. 9.

ORICA EXPLOSIVES TECHNOLOGY PTY LTD., MELBOURNE, VICTORIA, AUSTRALIA, ATLAS POWDER COMPANY, DALLAS, TX:  
1,169,195, REN. 9-18-11. INT. CL. 13.

ORION SEAFOOD INTERNATIONAL, INC., PORTSMOUTH, NH:  
4,045,717, INT. CL. 29.

ORLANDO BATHING SUIT LLC, ORLANDO, FL:  
4,044,341, PUB. 8-9-2011. INT. CL. 35.  
4,044,346, PUB. 8-9-2011. INT. CL. 35.

ORLANDO DINNER ENTERTAINMENT, INC., ORLANDO, FL:  
4,045,695, MULTIPLE CLASS, INT. CLS. 41 AND 43.

ORLY INTERNATIONAL, INC., VAN NUYS, CA:  
4,046,355, INT. CL. 3.  
4,046,356, INT. CL. 3.

ORNULF ERNIE NESS, BERGENFIELD, NJ, DBA SAPSEAL:  
4,045,218, PUB. 8-9-2011. INT. CL. 20.

ORPHAN FOUNDATION OF AMERICA, STERLING, VA, DBA ORPHAN FOUNDATION OF AMERICA:  
4,045,377, PUB. 8-9-2011. MULTIPLE CLASS, INT. CLS. 36 AND 41.

ORTERY TECHNOLOGIES, INC., PANCHIAO, TAIWAN:  
2,515,382, REN. 9-21-11. INT. CL. 9.

ORTHO ORGANIZERS, INC., CARLSBAD, CA:  
2,500,247, REN. 9-22-11. INT. CL. 10.

ORTHODYNAMICS INTERNATIONAL LLC, CROTON ON HUDSON, NY, DBA MYGOODHABIT:  
4,045,230, PUB. 8-9-2011. MULTIPLE CLASS, INT. CLS. 41 AND 44.

ORTHOPEDIC HOSPITAL, LTD., HOUSTON, TX:  
2,429,007, CANC. INT. CL. 16.

ORTHORELIEF, LLC, HASTINGS, NE:  
4,046,504, INT. CL. 10.

ORTIZ, DEREK, YONKERS, NY AND HYLAND, COURTNEY, NEW ROCHELLE, NY AND ARGONDISZA, MICHAEL, MASSAPEQUA, NY AND BILANCIA, NICHOLAS, YONKERS, NY AND MAURIELLO, ANTHONY, BAYVILLE, NJ AND GRIFFIN, SCOTT, SALISBURY, MD:  
4,046,998, MULTIPLE CLASS, INT. CLS. 9 AND 41.

ORTIZ, JUAN S, CHICAGO, IL:  
4,045,237, PUB. 8-9-2011. INT. CL. 41.

ORTUS SOLUTIONS, CORP, RANCHO CUCAMONGA, CA:  
4,044,275, PUB. 8-9-2011. MULTIPLE CLASS, INT. CLS. 41 AND 42.

OSHRY, SCOTT, NEW YORK, NY:  
4,045,604, INT. CL. 3.

OSK LTD., OSAKA, JAPAN:  
4,043,875, PUB. 8-9-2011. INT. CL. 7.

OSMENT MODELS, INC., LINN CREEK, MO:  
2,527,197, REN. 9-22-11. INT. CL. 28.

OSRAM GMBH, MUNICH, FED REP GERMANY, OSRAM G.M.B.H.:  
1,174,073, REN. 9-20-11. INT. CL. 11.

OSTBYE & ANDERSON, INC., PLYMOUTH, MN:  
4,047,057, INT. CL. 14.

OSTEON INC., SOMERS, NY:  
2,493,347, REN. 9-22-11. INT. CL. 30.  
2,505,269, REN. 9-22-11. INT. CL. 30.  
2,507,884, REN. 9-22-11. INT. CL. 30.  
2,532,781, REN. 9-22-11. INT. CL. 3.

OTC INTERNATIONAL, INC., LONG ISLAND CITY, NY:  
2,428,913, CANC. INT. CL. 14.

OUTDOOR RECREATION GROUP, THE, LOS ANGELES, CA:  
1,659,756, REN. 9-22-11. MULTIPLE CLASS, INT. CLS. 18 AND 25.  
1,659,757, REN. 9-17-11. MULTIPLE CLASS, INT. CLS. 18 AND 25.

OUTLAW HOBBY PRODUCTS, LLC, PENNSBORO, WV:  
4,045,918, INT. CL. 28.

OUTOKUMPU OYJ, FINLAND:  
4,043,858, PUB. 8-9-2011. INT. CL. 6.

OUTREACH, INC., VISTA, CA:  
4,046,295, MULTIPLE CLASS, INT. CLS. 16 AND 41.

OUTSET MEDIA CORPORATION, VICTORIA, BC, CANADA:  
4,045,727, INT. CL. 28.

OUTSPARK, INC., SAN FRANCISCO, CA:  
4,046,114, INT. CL. 45.

OVERHEAD DOOR CORPORATION, LEWISVILLE, TX:  
4,046,458, INT. CL. 19.

- OVIDIAN GROUP, LLC, BERKELEY, CA:  
 4,045,837, MULTIPLE CLASS, INT. CLS. 35, 36 AND 45.
- OWENS ONLINE, INC., TAMPA, FL:  
 4,046,089, INT. CL. 36.
- OWENS-CORNING FIBERGLAS TECHNOLOGY INC.,  
 SUMMIT, IL:  
 2,926,524, CANC. INT. CL. 37.
- OWENS, ROBIN, ROEBUCK, SC:  
 4,046,829, MULTIPLE CLASS, INT. CLS. 16 AND 25.
- OWENS, STEPHANIE R., WEDDINGTON, NC:  
 2,428,214, CANC. INT. CL. 36.
- P I COMPONENTS CORP., BRENHAM, TX:  
 1,650,629, REN. 9-20-11. INT. CL. 9.
- P II, INC., TAMPA, FL:  
 2,926,623, CANC. INT. CL. 3.
- P.T. INTERNATIONAL CORP., CHARLOTTE, NC:  
 4,044,294, PUB. 8-9-2011. INT. CL. 7.  
 4,044,295, PUB. 8-9-2011. INT. CL. 7.  
 4,044,299, PUB. 8-9-2011. INT. CL. 7.
- P&C GROUP, INC., NEW YORK, NY:  
 4,046,723, INT. CL. 42.
- P-CABLE 3D SEISMIC AS, N-0349 OSLO, NORWAY:  
 4,043,799, PUB. 8-9-2011. MULTIPLE CLASS, INT. CLS. 9,  
 35, 37 AND 42.
- P'ILLOPORTO LLC, PORTLAND, OR:  
 4,044,980, PUB. 8-9-2011. INT. CL. 20.
- PACIFIC BIOSCIENCE LABORATORIES, INC., BELLEVUE,  
 WA:  
 4,043,688, PUB. 3-8-2011. INT. CL. 3.
- PACIFIC CASCADE PARKING EQUIPMENT CORPORA-  
 TION, VANCOUVER, WA:  
 4,047,016, INT. CL. 20.  
 4,047,050, INT. CL. 20.  
 4,047,077, INT. CL. 20.
- PACIFIC ENTERMARK VERTRIEBSGESELLSCHAFT  
 MBH, HOCHDORF, FED REP GERMANY:  
 4,044,003, PUB. 8-9-2011. MULTIPLE CLASS, INT. CLS.  
 18, 25 AND 28.
- PACIFIC HANDY CUTTER, INC., COSTA MESA, CA:  
 2,926,701, CANC. INT. CL. 16.
- PACIFIC LIFE INSURANCE COMPANY, NEWPORT  
 BEACH, CA, PACIFIC MUTUAL LIFE INSURANCE  
 COMPANY, NEWPORT BEACH, CA:  
 1,672,059, REN. 9-20-11. INT. CL. 36.
- PACIFIC PRESS PUBLISHING ASSOCIATION, NAMPA, ID:  
 1,162,728, REN. 9-21-11. INT. CL. 16.
- PACIFIC TRADING VENTURES LLC, BROOKLYN, NY:  
 4,046,472, INT. CL. 25.
- PACTIV CORPORATION, LAKE FOREST, IL, PACKAGING  
 CORPORATION OF AMERICA, EVANSTON, IL:  
 1,658,244, REN. 9-22-11. INT. CL. 21.
- PACTIV CORPORATION, LAKE FOREST, IL:  
 4,046,802, INT. CL. 16.  
 4,046,803, INT. CL. 16.
- PADMA TEXTILES, LTD., SWIEQI, SWQ 3081, MALTA:  
 4,044,045, PUB. 8-9-2011. INT. CL. 25.
- PAGETRADER, LTD, SPEARFISH, SD:  
 4,045,228, PUB. 8-9-2011. INT. CL. 36.
- PALACIOS, JUDITH, VICTORVILLE, CA:  
 4,046,305, INT. CL. 3.
- PALAS SOFTWARE SYSTEMS, INC., CHARLESTON, SC:  
 4,046,947, INT. CL. 35.
- PALLADIUM ALLIANCE INTERNATIONAL, BILLINGS,  
 MT:  
 4,043,635, PUB. 5-13-2008. INT. CL. 35.
- PALM BEACH GARDENS COMMUNITY HOSPITAL, INC.,  
 DALLAS, TX:  
 4,046,241, INT. CL. 44.
- PALM, IRMGARD, 78465 KONSTANZ, FED REP GER-  
 MANY:  
 1,634,783, CANC. INT. CL. 14.
- PALO ALTO RESEARCH CENTER, INC., PALO ALTO, CA:  
 4,046,664, MULTIPLE CLASS, INT. CLS. 35 AND 42.
- PAN, FUZHONG, SHENYANG LIAO NING, CHINA:  
 4,044,142, PUB. 8-9-2011. INT. CL. 5.
- PANAMA JACK INTERNATIONAL, INC., ORLANDO, FL:  
 4,046,715, INT. CL. 18.
- PANDA UNIVERSITY LLC, MAPLEWOOD, NJ, DBA PAN-  
 DA UNIVERSITY LLC:  
 4,046,326, INT. CL. 25.
- PANG, TONY, ONTARIO, CA:  
 4,043,645, PUB. 8-9-2011. INT. CL. 25.
- PANORAK ADVENTURE NETWORK, LLC, DENVER, CO:  
 4,045,356, PUB. 8-9-2011. INT. CL. 45.
- PANORAMA ORTHOPEDICS AND SPINE CENTER, P.C.,  
 GOLDEN, CO:  
 2,523,318, REN. 9-21-11. INT. CL. 42.  
 2,523,318, CANC. INT. CL. 41.
- PAR NUCLEAR, INC., ST. PAUL, MN:  
 1,172,881, REN. 9-20-11. INT. CL. 7.
- PARADIGM ELECTRONICS INC., MISSISSAUGA, ONTAR-  
 IO, CANADA:  
 4,045,888, INT. CL. 9.
- PARADISE EMPIRE JEWELRY INC., NEW YORK, NY:  
 4,047,195, INT. CL. 35.
- PARADISE KIDS, LLC, GREENWICK, CT:  
 4,046,740, INT. CL. 28.
- PARAMOUNT PICTURES CORPORATION, HOLLYWOOD,  
 CA:  
 1,673,357, REN. 9-20-11. INT. CL. 9.
- PARAMOUNT PICTURES CORPORATION, LOS ANGELES,  
 CA:  
 1,707,295, REN. 9-21-11. INT. CL. 41.  
 2,516,047, REN. 9-20-11. INT. CL. 9.  
 2,516,047, CANC. MULTIPLE CLASS, INT. CLS. 14, 16, 21,  
 25, 28 AND 41.
- PARENTS, FAMILIES AND FRIENDS OF LESBIANS AND  
 GAYS, INC., WASHINGTON, DC, DBA PARENTS, FA-  
 MILIES AND FRIENDS OF LESBIANS AND GAYS, OR  
 PFLAG:  
 2,496,240, REN. 9-22-11. INT. CL. 42.
- PARETOLOGIC INC., VICTORIA, BC, CANADA:  
 4,045,425, PUB. 8-9-2011. INT. CL. 42.
- PARFUMS ROCHAS, S.A S, PARIS, FRANCE:  
 2,434,374, REN. 9-22-11. INT. CL. 3.
- PARIS ACCESSORIES, INC., NEW YORK, NY:  
 4,047,085, INT. CL. 25.
- PARK POULTRY, INC., CANTON, OH:  
 4,045,091, PUB. 8-9-2011. INT. CL. 29.
- PARK, STEVE, MOORESVILLE, NC:  
 2,427,858, CANC. INT. CL. 25.
- PARKER MCCRORY MFG. CO, KANSAS CITY, MO, BAY  
 MILLS LIMITED, BRAMPTON, ONTARIO, CANADA:  
 1,695,907, REN. 9-20-11. INT. CL. 9.
- PARKSBYNATURE NETWORK, LLC, NEW YORK, NY:  
 4,047,234, INT. CL. 16.
- PARSONS, PATRICIA JUNE, MANCHESTER, CT:  
 2,484,336, REN. 9-19-11. INT. CL. 3.
- PARTNERS IN LEADERSHIP IP, LLC, TEMECULA, CA:  
 2,522,489, REN. 9-20-11. MULTIPLE CLASS, INT. CLS. 35  
 AND 41.
- PARTNERSHIP FOR A DRUG-FREE NEW JERSEY, THE,  
 MILLBURN, NJ:  
 4,046,037, INT. CL. 35.
- PARTYDRAGON LIMITED, CENTRAL, HONG KONG:  
 4,044,592, PUB. 8-9-2011. INT. CL. 11.
- PARYSZ, LISA A, YARDLEY, PA, DBA THE GREAT  
 AMERICAN CHEESECAKE:  
 4,044,141, PUB. 8-9-2011. INT. CL. 30.
- PASCAL MOUAWAD, INC., LOS ANGELES, CA:  
 4,046,742, INT. CL. 14.
- PASSPORT HEALTH COMMUNICATIONS, INC., FRANK-  
 LIN, TN:  
 4,046,897, INT. CL. 44.
- PASTIFICIO SELMI S/A, SAO PAULO, BRAZIL:  
 4,044,955, PUB. 8-9-2011. INT. CL. 30.
- PASTORELLO, JOHN, ANAHEIM, CA:  
 2,543,618, REN. 9-22-11. INT. CL. 1.
- PASTOSA RAVIOLI, MACARONI & NOODLE CORP.,  
 BROOKLYN, NY:  
 2,479,335, REN. 9-19-11. INT. CL. 30.
- PATAGONIA SUR, LLC, EDGARTOWN, MA:  
 4,044,417, PUB. 8-9-2011. INT. CL. 36.  
 4,044,418, PUB. 8-9-2011. MULTIPLE CLASS, INT. CLS. 43

- AND 45.  
4,044,419, PUB. 8-9-2011. INT. CL. 36.
- PATAGONIA, INC., VENTURA, CA:  
1,189,402. REN. 9-19-11. INT. CL. 25.
- PATE CAPITAL GROUP, INC., DALLAS, TX:  
4,044,853, PUB. 8-9-2011. INT. CL. 35.
- PATEL, MIKE, NEWPORT BEACH, CA:  
4,046,750, INT. CL. 37.
- PATERNO IMPORTS, LTD., LAKE BLUFF, IL, DBA TERLATO WINES INTERNATIONAL:  
4,046,805, INT. CL. 33.
- PATH FOUNDATION, INC., ATLANTA, GA:  
2,498,636. REN. 9-22-11. MULTIPLE CLASS, INT. CLS. 25 AND 41.
- PATHFINDER SERVICES, INC., HUNTINGTON, IN:  
4,047,037, MULTIPLE CLASS, INT. CLS. 3 AND 5.
- PATINO, SANDRA P., DORAL, FL:  
4,043,885, PUB. 8-9-2011. INT. CL. 43.
- PATRICIA B. LOVE, GREENVILLE, SC:  
4,045,627, MULTIPLE CLASS, INT. CLS. 10 AND 25.
- PATRICK POULIN, ST CLOUD, FL:  
4,045,461, PUB. 8-9-2011. INT. CL. 41.
- PATRICK-GOUDREAU, COLLEEN A., OAKLAND, CA, DBA COMPASSIONATE COOKS, LLC:  
4,044,316, PUB. 8-9-2011. INT. CL. 35.
- PAUGH, JAMES J., WORCESTER, MA:  
4,044,429, PUB. 8-9-2011. MULTIPLE CLASS, INT. CLS. 35 AND 36.  
4,044,436, PUB. 8-9-2011. INT. CL. 35.
- PAUL A. SCHMITT MUSIC COMPANY, BROOKLYN CENTER, MN:  
2,502,047. REN. 9-21-11. INT. CL. 35.
- PAUL ESPINO, LOS ANGELES, CA:  
4,044,826, PUB. 8-9-2011. INT. CL. 25.
- PAUL H. BROOKES PUBLISHING CO., BALTIMORE, MD, DBA BROOKES PUBLISHING CO.:  
2,504,542. REN. 9-22-11. INT. CL. 16.
- PAUL J. GERSTENBERGER, WAIKOLOA, HI:  
4,044,196, PUB. 8-9-2011. INT. CL. 25.
- PAUL REBER GMBH & CO. KG, 83435 BAD REICHENHALL, FED REP GERMANY:  
1,653,822. REN. 9-19-11. INT. CL. 30.
- PAUL REED SMITH GUITARS, LIMITED PARTNERSHIP, STEVENSVILLE, MD:  
2,490,890. REN. 9-20-11. INT. CL. 15.
- PAUL RITCHIE, FORT LAUDERDALE, FL:  
4,045,241, PUB. 8-9-2011. INT. CL. 3.
- PAUL SMITH GROUP HOLDINGS LIMITED, NOTTINGHAM, UNITED KINGDOM:  
1,661,631. REN. 9-19-11. MULTIPLE CLASS, INT. CLS. 14 AND 18.
- PAULIST PRESS, MAHWAH, NJ:  
2,533,589. REN. 9-16-11. INT. CL. 16.
- PAVE TECH, INC., PRIOR LAKE, MN:  
1,653,083. REN. 9-20-11. INT. CL. 17.
- PAYMENT PROTECTION SYSTEMS, INC., TEMECULA, CA:  
2,428,268, CANC. INT. CL. 9.
- PDB SPORTS, LTD., ENGLEWOOD, CO:  
4,046,739, MULTIPLE CLASS, INT. CLS. 25 AND 41.
- PEABODY MANAGEMENT, INC., MEMPHIS, TN:  
2,428,842, CANC. INT. CL. 42.
- PEACELABS MUSIC, INC., SAN FRANCISCO, CA:  
4,045,680, INT. CL. 36.  
4,045,681, INT. CL. 35.  
4,045,682, INT. CL. 41.
- PEARLESSENCE, LTD., CLEVELAND, OH:  
2,926,954, CANC. INT. CL. 11.
- PEARSON CANADA INC., TORONTO, ONTARIO M3G 2T8, CANADA:  
2,531,517. REN. 9-21-11. INT. CL. 42.
- PEARSON, CHRIS, AUSTIN, TX:  
4,044,374, PUB. 8-9-2011. MULTIPLE CLASS, INT. CLS. 41 AND 42.
- PECO PALLET, INC., YONKERS, NY:  
2,482,694. REN. 9-17-11. INT. CL. 39.
- PECO, INC., PORTLAND, OR, DBA PECO MANUFACTURING CO., INC.:  
921,332. REN. 9-21-11. U.S. CL. 103 (INT. CL. 37).
- PECOWARE COMPANY, CHINO, CA:  
4,046,191, MULTIPLE CLASS, INT. CLS. 3, 14, 16 AND 25.
- PEDIATRIC VISION DEVELOPMENT CENTER OF GWINNETT, LLC, DACULA, GA:  
4,044,254, PUB. 8-9-2011. INT. CL. 44.  
4,044,255, PUB. 8-9-2011. INT. CL. 44.
- PEER GROUP INC., THE, KITCHENER, ONTARIO, CANADA, ATS AUTOMATION TOOLING SYSTEMS INC., KITCHENER, ONTARIO, CANADA:  
1,656,025. REN. 9-17-11. INT. CL. 9.
- PEERLESS MACHINE & TOOL CORPORATION, MARION, IN:  
1,654,747. REN. 9-21-11. INT. CL. 7.
- PEG PEREGO U.S.A., INC., FORT WAYNE, IN:  
4,044,618, PUB. 8-9-2011. MULTIPLE CLASS, INT. CLS. 12, 20 AND 28.
- PEIER, ELISABETH RACHAL, WOODLAND HILLS, CA, DBA PETITES FRITES AND PEIER, CURZON JEAN-CLAUDE, WOODLAND HILLS, CA, DBA PETITES FRITES:  
4,047,091, MULTIPLE CLASS, INT. CLS. 24 AND 25.
- PEIRES, GUY, NEW YORK, NY, DBA RELAYT:  
4,045,353, PUB. 8-9-2011. INT. CL. 42.
- PELCO ADVISORS LLC, WILTON, CT:  
4,045,923, MULTIPLE CLASS, INT. CLS. 35 AND 41.
- PELTON, ERIK MICHAEL, ARLINGTON, VA:  
3,384,695, AM. INT. CL. 45.
- PEM MANAGEMENT, INC., WILMINGTON, DE:  
2,485,933. REN. 9-22-11. INT. CL. 7.
- PEM SURFACE CREATIONS, INC., ST. LOUIS, MO:  
2,470,016. REN. 9-18-11. INT. CL. 27.
- PEN AIR FEDERAL CREDIT UNION, PENSACOLA, FL:  
4,044,694, PUB. 8-9-2011. INT. CL. 36.
- PENETONE CORPORATION, CARLSTADT, NJ, WEST DISINFECTING COMPANY, LONG ISLAND CITY, NY:  
563,636. REN. 9-16-11. U.S. CL. 52 (INT. CL. 3).
- PENGUIN GROUP (USA) INC., NEW YORK, NY, JOVE PUBLICATIONS, INC., NEW YORK, NY:  
1,186,698. REN. 9-22-11. INT. CL. 16.
- PENINSULA REGIONAL MEDICAL CENTER, SALISBURY, MD:  
4,046,659, INT. CL. 44.
- PENN BOTTLE AND SUPPLY CO., ESSINGTON, PA, TITAN PLASTICS, INC., CLIFTON, NJ:  
917,934. REN. 9-21-11. U.S. CL. 2 (INT. CL. 20).
- PENN ELCOM, INC., GARDEN GROVE, CA:  
2,481,443. REN. 9-22-11. INT. CL. 6.
- PENN FISHING TACKLE MFG. CO., PHILADELPHIA, PA:  
720,287. REN. 9-20-11. U.S. CL. 22 (INT. CL. 28).
- PENNSYLVANIA ASSOCIATION OF REALTORS, LEOMOYNE, PA:  
4,046,945, INT. CL. 35.
- PENSACOLA BAY BREWERY, LLC, TALLAHASSEE, FL:  
4,045,161, PUB. 8-9-2011. MULTIPLE CLASS, INT. CLS. 32 AND 40.
- PENTAIR FILTRATION, INC., SHEBOYAGN, WI:  
4,045,673, INT. CL. 11.
- PENTON MEDIA, INC., NEW YORK, NY:  
2,503,806. REN. 9-22-11. INT. CL. 16.
- PEOPLE DESIGN, INC., GRAND RAPIDS, MI:  
4,044,589, PUB. 8-9-2011. MULTIPLE CLASS, INT. CLS. 35 AND 42.
- PEPPER MEDICAL INCORPORATED, WEST CHESTER, PA:  
4,045,167, PUB. 8-9-2011. INT. CL. 10.
- PEPPER PATCH INC., FRANKLIN, TN, ALLIED OLD ENGLISH, INC., PORT READING, NJ:  
1,162,959. REN. 9-20-11. INT. CL. 30.
- PEPSICO, INC., PURCHASE, NY:  
4,046,613, INT. CL. 30.  
4,047,009, INT. CL. 32.
- PERALTA-JONES, LAURA, PASADENA, CA:  
4,044,622, PUB. 8-9-2011. INT. CL. 35.
- PERFECT TUTORS, LLC, OVERLAND PARK, KS:  
4,047,213, INT. CL. 41.

- PERFECT 10, INC., BEVERLY HILLS, CA:  
2,573,998. REN. 9-21-11. INT. CL. 41.
- PERFORMANCE FIBERS, INC., RICHMOND, VA:  
4,043,964. PUB. 8-9-2011. INT. CL. 22.  
4,043,965. PUB. 8-9-2011. INT. CL. 22.
- PERFORMANCE MANAGEMENT GROUP, INC., LAKE-  
LAND, FL:  
4,044,651. PUB. 8-9-2011. INT. CL. 41.
- PERFORMANCE, INC., CHAPEL HILL, NC:  
4,046,503. INT. CL. 12.
- PERKINS, ADAM L, DURHAM, NC:  
4,044,597. PUB. 8-9-2011. INT. CL. 25.
- PERLA, ANTHONY L., PORT SAINT LUCIE, FL, DBA  
EAGLE ZAP TECHNOLOGIES AND WONG, HINKMOND  
B., PORT SAINT LUCIE, FL, DBA EAGLE ZAP TECH-  
NOLOGIES:  
4,046,461. INT. CL. 9.
- PERLAGE SYSTEMS, INC., SEATTLE, WA:  
4,045,814. INT. CL. 21.
- PERMA-LINER INDUSTRIES, INC., CLEARWATER, FL:  
4,043,999. PUB. 8-9-2011. INT. CL. 19.  
4,044,006. PUB. 8-9-2011. INT. CL. 19.
- PERSEPHONE 11 INC., WEST ISLIP, NY:  
4,045,789. INT. CL. 35.  
4,045,791. INT. CL. 35.
- PERSHING INVESTMENTS LLC, NEWARK, DE:  
2,429,576. REN. 9-16-11. INT. CL. 36.
- PERSISTENT CACHE PTY LTD AS TRUSTEE FOR PERSIS-  
TENT CACHE UNIT TRUST, AUSTRALIA:  
4,043,806. PUB. 8-9-2011. MULTIPLE CLASS, INT. CLS. 9,  
16 AND 45.
- PERSONAL STRENGTHS PUBLISHING, INC., CARLSBAD,  
CA, PORTER, SARA M., PACIFIC PALISADES, CA, DBA  
TRUSTEE OF TRUST B OF THE PORTER REVOCABLE  
FAMILY TRUST, A TRUST OF CALIFORNIA:  
1,711,598. REN. 9-22-11. INT. CL. 16.
- PERSPECTIVE PARTNERING, LLC, MILTON, GA:  
4,047,023. INT. CL. 41.
- PERUVIAN IMPORT COMPANY, INC, PASSAIC, NJ:  
4,043,613. PUB. 8-9-2011. MULTIPLE CLASS, INT. CLS. 5  
AND 30.
- PET APPEAL, INC., CLACKAMAS, OR:  
4,046,417. MULTIPLE CLASS, INT. CLS. 3, 18, 28 AND 31.
- PETER GREEN, LA JOLLA, CA, DBA VOLGA CLOTHING:  
4,044,401. PUB. 8-9-2011. INT. CL. 25.
- PETER LAM JEWELLERY, LTD, HUNGHOM, KOWLOON,  
HONG KONG:  
2,438,533. REN. 9-21-11. INT. CL. 14.
- PETERSEN ALUMINUM CORPORATION, ELK GROVE  
VILLAGE, IL:  
4,046,432. INT. CL. 6.
- PETERSON TOOL COMPANY, NASHVILLE, TN:  
1,176,895. REN. 9-20-11. INT. CL. 7.
- PETERSON'S NELNET, LLC., LINCOLN, NE:  
2,490,568. REN. 9-20-11. INT. CL. 42.
- PETROLIAM NASIONAL BERHAD, 50088 KUALA LUM-  
PUR, MALAYSIA:  
2,932,662. CANC. INT. CL. 11.
- PETSPORT USA, INC., PITTSBURG, CA:  
4,045,502. PUB. 8-9-2011. INT. CL. 28.  
4,045,503. PUB. 8-9-2011. INT. CL. 28.
- PFIAFF INDUSTRIAL OF AMERICA, INC., NORCROSS, GA:  
4,046,718. INT. CL. 7.
- PFB DESIGNS, FAIRFAX, CA:  
4,047,197. INT. CL. 9.
- PFIP, LLC, NEWINGTON, NH:  
4,044,253. PUB. 8-9-2011. INT. CL. 41.
- PFIZER INC., NEW YORK, NY:  
2,926,848. CANC. MULTIPLE CLASS, INT. CLS. 16 AND  
44.
- PHADIA AB, UPPSALA, SWEDEN:  
4,043,713. PUB. 1-11-2011. MULTIPLE CLASS, INT. CLS.  
1, 5, 9 AND 10.
- PHARMACEUTICAL CREDIT CORPORATION, FRANK-  
LIN, TN:  
4,043,910. PUB. 8-9-2011. INT. CL. 35.
- PHARMACIA & UPIOHN COMPANY, PEAPACK, NJ:  
2,926,485. CANC. INT. CL. 5.
- PHI UPSILON OMICRON, INC., FAIRMONT, WV:  
4,045,387. PUB. 8-9-2011. U.S. CL. 200.  
4,045,392. PUB. 8-9-2011. U.S. CL. 200.
- PHILADELPHIA MEDIA NETWORK (DIGITAL) LLC, PHI-  
LADELPHIA, PA:  
4,045,756. MULTIPLE CLASS, INT. CLS. 41, 42 AND 45.
- PHILIPPE AUDI, DUBAI, UNITED ARAB EMIR.:  
4,046,621. INT. CL. 36.
- PHILIPS ELECTRONICS NORTH AMERICA CORPORA-  
TION, ANDOVER, MA, MAGNAVOX COMPANY, THE,  
FORT WAYNE, IN:  
536,242. REN. 9-20-11. U.S. CL. 21 (INT. CL. 9).
- PHILLIPS SCREW COMPANY, BURLINGTON, MA:  
721,903. REN. 9-16-11. U.S. CL. 26 (INT. CL. 9).
- PHILLIPS, JOHN, MARIETTA, GA:  
4,046,720. INT. CL. 41.
- PHILLIPS, MELISSA, MAMARONECK, NY, DBA MAD  
CHIC BOUTIQUE:  
4,043,973. PUB. 8-9-2011. INT. CL. 25.
- PHITEN CO., LTD., KYOTO CITY, KYOTO PREF, JAPAN:  
2,610,185. REN. 9-19-11. MULTIPLE CLASS, INT. CLS. 3,  
10, 14 AND 25.
- PHITEN CO., LTD., KYOTO CITY, KYOTO PREF., JAPAN:  
2,926,542. CANC. INT. CL. 5.
- PHM - PHILIPPE MORISSE SAS, OLORON-SAINTE-MARIE,  
FRANCE:  
4,046,615. INT. CL. 27.
- PHOENIX BRANDS LLC, STAMFORD, CT:  
2,505,418. REN. 9-20-11. INT. CL. 3.
- PHOENIX INTANGIBLES HOLDING COMPANY, GREEN-  
VILLE, PA, PHOENIX INTANGIBLES HOLDING COM-  
PANY, GREENVILLE, PA:  
2,612,939. REN. 9-22-11. MULTIPLE CLASS, INT. CLS. 29  
AND 30.
- PHOENIX SPEEDWAY CORPORATION, DAYTONA  
BEACH, FL:  
2,494,674. REN. 9-16-11. MULTIPLE CLASS, INT. CLS. 9,  
21, 25, 28 AND 41.
- PHOTOBIZ, LLC, GREENSBORO, NC:  
4,044,382. PUB. 8-9-2011. INT. CL. 42.
- PHOTOFLEX, INC., WATSONVILLE, CA:  
1,691,230. REN. 9-21-11. INT. CL. 9.  
1,700,270. REN. 9-20-11. INT. CL. 9.
- PHYSICIAN'S ADVICE SKIN CARE, INC., TAMPA, FL TO  
SIGNATURE CLUB A, TAMPA, FL:  
2,428,954. CANC. INT. CL. 3.
- PHYSICIANS CARE ALLIANCE, LLC, SCOTTSDALE, AZ,  
DBA PCA ADVANCED SKIN CARE SYSTEMS:  
2,486,790. REN. 9-18-11. INT. CL. 3.
- PHYSICIANS FORMULA, INC., AZUSA, CA:  
4,046,457. INT. CL. 3.
- PHYSIOAGE SYSTEMS LLC, NEW YORK, NY:  
4,045,112. PUB. 8-9-2011. INT. CL. 42.
- PI BETA PHI FRATERNITY, TOWN & COUNTRY, MO:  
1,709,526. REN. 9-16-11. INT. CL. 42.
- PIAGGIO & C. S.P.A., PONTEDERA (PISA), ITALY:  
4,044,333. PUB. 7-19-2011. MULTIPLE CLASS, INT. CLS.  
29, 30, 32, 33, 35 AND 43.
- PICKETT ROAD WINE COMPANY, LLC, CALISTOGA, CA:  
4,044,046. PUB. 3-8-2011. INT. CL. 33.
- PICSHIRT, CHATSWORTH, CA:  
4,044,936. PUB. 8-9-2011. MULTIPLE CLASS, INT. CLS. 25  
AND 35.
- PICTURE MARKETING, INC., NOVATO, CA:  
4,044,153. PUB. 8-9-2011. INT. CL. 35.
- PIERCE AGENCY OF PORTSMOUTH, INC., MIDDLE-  
TOWN, RI:  
4,044,098. PUB. 5-3-2011. INT. CL. 36.
- PILEUS, INC., HERNDON, VA:  
4,044,997. PUB. 8-9-2011. INT. CL. 42.
- PILKINGTON GROUP LIMITED, ST. HELENS, MERSEY-  
SIDE, UNITED KINGDOM, TRIPLEX SAFETY GLASS  
COMPANY LIMITED, ST. HELENS, MERSEYSIDE L37  
EHH, ENGLAND:  
935,953. REN. 9-21-11. U.S. CL. 19 (INT. CLS. 7, 12, 22  
AND 27).
- PILOT TRAVEL CENTERS LLC, KNOXVILLE, TN:  
4,046,487. INT. CL. 35.

PINEMEADOW GOLF PRODUCTS, INC., WILSONVILLE, OR:  
2,493,653. REN. 9-16-11. INT. CL. 28.

PINEROCK PRODUCTIONS, INC., RESTON, VA, PINE-ROCK PRODUCTIONS, INC., RESTON, VA:  
2,567,667. REN. 9-20-11. MULTIPLE CLASS, INT. CLS. 35 AND 41.

PINKOWSKI, ALLISON S., KANSAS CITY, MO, DBA DUMPSTER DIVA:  
4,044,439. PUB. 8-9-2011. INT. CL. 37.

PINNACLE FOODS GROUP LLC, PARSIPPANY, NJ, KRAFT GENERAL FOODS, INC., GLENVIEW, IL:  
1,679,044. REN. 9-22-11. INT. CL. 30.

PINTA INTERNATIONAL, INC., HAYWARD, CA:  
4,046,234. INT. CL. 21.

PIONEER HI-BRED INTERNATIONAL, INC., JOHNSTON, IA:  
2,451,703. REN. 9-20-11. INT. CL. 20.

PIONEER KABUSHIKI KAISHA, MEGURO-KU, TOKYO, JAPAN:  
2,926,825. CANC. INT. CL. 9.

PIONEER SURGICAL TECHNOLOGY, INC., MARQUETTE, MI:  
4,045,765. INT. CL. 5.

PIXELPIPE, INC., SEATTLE, WA:  
4,045,484. PUB. 8-9-2011. INT. CL. 9.  
4,045,485. PUB. 8-9-2011. INT. CL. 42.

PIZZA HUT, INC., PLANO, TX:  
2,523,071. REN. 9-20-11. INT. CL. 16.

PIZZA INN, INC., DALLAS, TX:  
2,491,085. REN. 9-21-11. INT. CL. 42.  
2,491,085. CANC. INT. CL. 30.

PIZZA SCREENS, INC., DEERFIELD, IL:  
2,926,884. CANC. INT. CL. 21.

PL POPCORN, LLC, FRISCO, TX:  
4,044,642. PUB. 8-9-2011. INT. CL. 30.

PLAN B, INC., CHICAGO, IL:  
4,044,304. PUB. 8-9-2011. INT. CL. 35.

PLANET VENTURES, INC., PORTLAND, ME:  
2,490,662. REN. 9-21-11. MULTIPLE CLASS, INT. CLS. 25, 28 AND 31.

PLANETHOPE, LLC, WEST PALM BEACH, FL:  
4,045,775. MULTIPLE CLASS, INT. CLS. 35 AND 41.

PLANT FOOD SYSTEMS, INC., ZELLWOOD, FL:  
4,044,695. PUB. 8-9-2011. INT. CL. 1.

PLANT PRODUCTS CO. LTD., BRAMPTON, ONTARIO, CANADA:  
2,486,016. REN. 9-21-11. INT. CL. 1.

PLASTIC INDUSTRIES, ATHENS, TN:  
4,047,138. INT. CL. 11.

PLATOON FITNESS TRAINING, LLC, BRYN MAWR, PA:  
2,432,809. REN. 9-20-11. INT. CL. 41.  
2,432,810. REN. 9-20-11. INT. CL. 41.

PLAYERGRID INC., FARMINGDALE, NY:  
4,045,074. PUB. 8-9-2011. INT. CL. 42.

PLAYPOWER LT FARMINGTON, INC., FARMINGTON, MO:  
4,044,729. PUB. 8-9-2011. INT. CL. 42.

PLRR, LLC, CHAPIN, SC:  
4,046,499. MULTIPLE CLASS, INT. CLS. 30 AND 43.  
4,046,506. MULTIPLE CLASS, INT. CLS. 30 AND 43.

PLUM ENTERPRISES, INC., VALLEY FORGE, PA:  
4,046,025. INT. CL. 9.

PLYMOUTH DIRECT, INC., MONTGOMERYVILLE, PA:  
2,926,675. CANC. INT. CL. 26.

PLYMOUTH PHARMACEUTICALS INC., TULSA, OK:  
4,044,831. PUB. 8-9-2011. INT. CL. 5.

PMC SIERRA.US INC., CAMPBELL, CA:  
2,427,877. CANC. INT. CL. 35.

PNY TECHNOLOGIES, INC., PARSIPPANY, NJ:  
2,428,341. CANC. INT. CL. 9.

POCKET VIDEOS, LLC, KENMORE, WA:  
4,044,278. PUB. 8-9-2011. INT. CL. 16.

POCKETMEDIA PROPERTIES, NEW YORK, NY:  
2,921,914. CANC. INT. CL. 9.

POGLIANI, WALTER, ISLAND PARK, NY:  
4,047,179. INT. CL. 25.

POLCHEIRA, ELIAS A. B., EVERETT, MA:  
4,044,281. PUB. 8-9-2011. INT. CL. 41.

POLEWKA, TAMMY L., SACRAMENTO, CA:  
4,046,007. INT. CL. 18.

POLIN SU PARKLARI VE HAVUZ SISTEMLERI ANONIM SIRKETI, TURKEY:  
4,043,828. PUB. 8-9-2011. INT. CL. 28.

POLVI, BRIAN ALLAN, COLORADO SPRINGS, CO:  
2,614,537. REN. 9-21-11. INT. CL. 42.

POLY-AMERICA, L.P., GRAND PRAIRIE, TX:  
4,045,998. INT. CL. 16.

POLYGLASS USA, INC., FERNLEY, NV:  
4,046,044. INT. CL. 17.  
4,046,045. INT. CL. 17.

POLYMER PRODUCTS COMPANY, INC., STOCKERTOWN, PA:  
4,045,366. PUB. 8-9-2011. INT. CL. 1.  
4,045,367. PUB. 8-9-2011. INT. CL. 1.

PONCE DECK, LLC, ALPHARETTA, GA:  
4,047,217. MULTIPLE CLASS, INT. CLS. 25 AND 43.

PONDER, LYNN, MIAMI, FL:  
4,044,047. PUB. 8-9-2011. INT. CL. 41.

PONZI, VINCENT, MADISON, TN:  
4,046,721. INT. CL. 25.

POP-IN-KINS, LTD., ALLIANCE, OH:  
4,045,684. MULTIPLE CLASS, INT. CLS. 16, 25 AND 28.

POPULAR, INC., SAN JUAN, PUERTO RICO:  
2,507,770. REN. 9-22-11. MULTIPLE CLASS, INT. CLS. 16 AND 36.

POROUS TECHNOLOGIES, LLC, NORTH YARMOUTH, ME:  
4,045,848. INT. CL. 19.

PORTER CORP., HOLLAND, MI, DBA PORTERCORP:  
1,161,328. REN. 9-20-11. INT. CL. 37.

PORTER, BRUCE R JR, ALEXANDRIA, VA:  
4,044,802. PUB. 8-9-2011. INT. CL. 35.

PORTERMAX, INC., RENO, NV:  
4,044,555. PUB. 8-9-2011. INT. CL. 9.

POS-T-VAC, DODGE CITY, KS:  
4,046,845. INT. CL. 10.

POSH FACE LLC, MANSFIELD, OH:  
4,046,147. INT. CL. 3.

POSITIVE COACHING ALLIANCE, MOUNTAIN VIEW, CA:  
4,045,781. INT. CL. 16.

POST-MARKS, INC., ALPHARETTA, GA:  
2,489,727. REN. 9-20-11. MULTIPLE CLASS, INT. CLS. 9 AND 25.

POST-NEWSWEEK STATIONS, HOUSTON, INC., HOUSTON, TX:  
4,043,923. PUB. 8-9-2011. INT. CL. 41.

POTTS, KATHI, CARLSBAD, CA:  
4,046,142. INT. CL. 5.

POWER BUYING DEALERS, USA, INC., DOWNERS GROVE, IL:  
2,673,060. CANC. INT. CL. 25.

POWER CITY ELECTRIC, INC., SPOKANE, WA:  
4,044,539. PUB. 8-9-2011. INT. CL. 37.

PPG INDUSTRIES OHIO, INC., CLEVELAND, OH:  
721,208. REN. 9-17-11. U.S. CL. 6 (INT. CL. 1).

PPG INDUSTRIES OHIO, INC., CLEVELAND, OH, PPG INDUSTRIES, INC., PITTSBURGH, PA:  
1,664,049. REN. 9-21-11. INT. CL. 12.

PRECIPICE DESIGN LIMITED, PEWSEY, WILTSHIRE, UNITED KINGDOM:  
4,044,311. PUB. 8-9-2011. INT. CL. 42.

PRECISE PROTECTIVE RESEACH INC., MIAMI, FL, DBA WHORUDATING.COM:  
4,045,006. PUB. 8-9-2011. INT. CL. 45.

PREMIER INNOVATIONS GROUP INC. CORAOPOLIS, PA:  
4,045,501. PUB. 8-9-2011. INT. CL. 33.

PREMIER NUTRITION, INC., CARLSBAD, CA:  
4,045,222. PUB. 8-9-2011. INT. CL. 5.

PREMIER STAR ENTERPRISES LLC, SANTA ANA, CA:  
4,046,222. INT. CL. 43.

PREMIUM DENIM, LLC, CULVER CITY, CA:  
4,046,193. INT. CL. 25.

PRESERVATION SCIENCES, INC., ST. PETERSBURG, FL:  
2,926,723. CANC. MULTIPLE CLASS, INT. CLS. 1 AND 5.

- PRESS1, LLC, MIAMI, FL:  
4,046,596, INT. CL. 25.
- PRESTIGE WORLDWIDE, SCOTTSDALE, AZ:  
4,044,199, PUB. 5-3-2011. INT. CL. 35.
- PRETTY UGLY LLC, EDISON, NJ AND HORVATH, DAVID,  
EDISON, NJ AND KIM, SUN-MIN, EDISON, NJ:  
4,044,598, PUB. 8-9-2011. INT. CL. 28.
- PREWITT, DR. MARY JULIA WIESS, FAYETTEVILLE, NC  
AND PREWITT, DR. JAMES ROBINSON, FAYETTE-  
VILLE, NC:  
4,044,583, PUB. 8-9-2011. INT. CL. 10.
- PRGCO, LLC, CHICAGO, IL, RECYCLED PAPER PRO-  
DUCTS, INC., CHICAGO, IL:  
1,653,076, REN. 9-20-11. INT. CL. 16.
- PRICE KING, INC., LONG ISLAND CITY, NY:  
4,044,551, PUB. 8-9-2011. INT. CL. 35.
- PRICE, JOANNE, SAN DIEGO, CA AND HARLOW, MELIS-  
SA, SAN DIEGO, CA:  
3,973,706, COR. INT. CL. 16.
- PRIMARY INVESTMENTS GROUP LIMITED, ROAD  
TOWN, TORTOLA, BR.VIRGIN ISLANDS:  
4,047,183, INT. CL. 5.
- PRIME GARMENTS, INC., NEW YORK, NY:  
4,046,666, INT. CL. 25.
- PRIME SENSE LTD., TEL AVIV, ISRAEL:  
4,045,996, INT. CL. 9.
- PRIMESOURCE BUILDING PRODUCTS, INC., IRVING, TX:  
4,046,169, INT. CL. 6.
- PRIMEX PLASTICS CORP., RICHMOND, IN:  
4,045,647, INT. CL. 17.
- PRIMUS ASSURANCE GROUP, SALT LAKE CITY, UT:  
4,046,104, INT. CL. 35.
- PRINCETON VIDEO IMAGE, INC., PRINCETON, NJ TO  
SPORTVISION, INC., CHICAGO, IL:  
2,538,443, CANC. INT. CL. 9.
- PRISMO ROAD MARKINGS LIMITED, LEEDS, UNITED  
KINGDOM:  
4,044,019, PUB. 8-9-2011. MULTIPLE CLASS, INT. CLS. 6,  
9 AND 19.
- PRISON FELLOWSHIP MINISTRIES, LANSDOWNE, VA:  
4,045,158, PUB. 8-9-2011. INT. CL. 35.  
4,045,165, PUB. 8-9-2011. INT. CL. 35.  
4,045,256, PUB. 8-9-2011. INT. CL. 35.
- PRIVATE LABEL PREMIUM CIGAR CO., ROSWELL, GA:  
3,005,841, CANC. INT. CL. 35.
- PRIZE CAPITAL, LLC, SAN DIEGO, CA:  
4,047,133, INT. CL. 35.
- PRN CORPORATION, SAN FRANCISCO, CA:  
4,044,386, PUB. 8-9-2011. INT. CL. 35.
- PRO FORM PRODUCTS LTD., MILTON, ONTARIO, CANA-  
DA:  
4,045,677, INT. CL. 1.
- PROBAT, INC., VERNON HILLS, IL:  
2,478,084, REN. 9-21-11. INT. CL. 11.
- PROCONGPS, INC., KNOXVILLE, TN:  
4,045,977, INT. CL. 38.
- PROCTER & GAMBLE BUSINESS SERVICES CANADA  
COMPANY, HALIFAX, NOVA SCOTIA, CANADA, COOP-  
ER LABORATORIES, INC., PALO ALTO, CA:  
1,197,304, REN. 9-20-11. INT. CL. 21.
- PROCTER & GAMBLE COMPANY, THE, CINCINNATI, OH,  
REDMOND PRODUCTS, INC., STAMFORD, CT:  
1,677,287, REN. 9-18-11. INT. CL. 3.
- PROCTOR FINANCIAL, INC., TROY, MI:  
2,465,341, REN. 9-20-11. INT. CL. 9.
- PRODEA SYSTEMS, INC., PLANO, TX:  
4,046,203, MULTIPLE CLASS, INT. CLS. 35, 38, 39, 41  
AND 45.
- PRODUCTION AND RIGGING RESOURCES, INC., DAL-  
LAS, TX:  
4,044,782, PUB. 8-9-2011. INT. CL. 37.
- PRODUCTS ONE LLC, CANTON, GA:  
2,926,649, CANC. INT. CL. 21.
- PROFERO SYSTEMS, INC., DALLAS, NC:  
2,513,844, REN. 9-20-11. INT. CL. 7.
- PROFESSIONAL DISPOSABLES INTERNATIONAL, INC.,  
ORANGEBURG, NY, PROFESSIONAL DISPOSABLES,  
INC., MT. VERNON, NY:  
1,163,330, REN. 9-16-11. INT. CL. 5.
- PROFILE PRODUCTS, LLC, BUFFALO GROVE, IL:  
4,046,528, INT. CL. 11.
- PROFILE, INC., CHICAGO, IL:  
2,428,195, CANC. INT. CL. 35.
- PROGENACELL, INC, IRVINE, CA:  
4,045,048, PUB. 8-9-2011. INT. CL. 42.
- PROGRESSIVE ENERGY SOLUTIONS, BELMONT, NC:  
4,047,191, INT. CL. 17.
- PROGRESSIVE MRI, LLC, FALLS CHURCH, VA, DBA  
PROGRESSIVE RADIOLOGY:  
4,047,194, INT. CL. 44.
- PROINNOVATIVE, INC., PHOENIX, AZ:  
2,484,631, REN. 9-22-11. INT. CL. 20.
- PROJECT HORIZON, INC., JACKSONVILLE, FL:  
2,427,891, CANC. INT. CL. 9.
- PROJECT MANAGEMENT LEADERSHIP GROUP, INC.,  
ATLANTA, GA:  
4,044,623, PUB. 8-9-2011. INT. CL. 9.
- PROJECTS PLUS, INC., NEW YORK, NY:  
2,490,341, REN. 9-21-11. INT. CL. 35.
- PROKARMA, INC., OMAHA, NE:  
4,044,660, PUB. 8-9-2011. INT. CL. 35.
- PROLEXIC TECHNOLOGIES, INC., HOLLYWOOD, FL:  
4,045,854, INT. CL. 45.
- PROMILA DHANUKA, MD, INC, REDDING, CA, DBA  
P.A.C.E CANCER CENTER:  
4,045,989, INT. CL. 36.
- PROMOTIONAL HEADWEAR INTERNATIONAL INC.,  
SHAWNEE, KS, DBA SPORTSMAN CAP NETWORK:  
4,044,217, PUB. 8-9-2011. INT. CL. 25.
- PRONOVA BIOPHARMA NORGE AS, NORWAY:  
4,043,813, PUB. 8-9-2011. INT. CL. 5.
- PROORBIS, LLC, CHESTER SPRINGS, PA:  
2,468,397, REN. 9-20-11. INT. CL. 35.
- PROQUEST LLC, ANN ARBOR, MI:  
2,468,946, REN. 9-19-11. INT. CL. 42.
- PROSTATE CANCER INSTITUTE LLC, NEWPORT BEACH,  
CA:  
4,046,893, INT. CL. 5.
- PROTEC GAMES, INC., LAS VEGAS, NV:  
4,045,183, PUB. 8-9-2011. INT. CL. 9.
- PROTECTED MOBILITY, LLC, HERNDON, VA:  
4,045,168, PUB. 8-9-2011. INT. CL. 9.  
4,045,171, PUB. 8-9-2011. INT. CL. 9.  
4,045,173, PUB. 8-9-2011. INT. CL. 9.  
4,045,177, PUB. 8-9-2011. INT. CL. 9.
- PROTEL, INC., LAKE LAND, FL:  
2,926,559, CANC. INT. CL. 9.
- PROTEUS, INC., WASHINGTON, DC:  
2,428,026, CANC. INT. CL. 42.  
2,428,027, CANC. INT. CL. 42.
- PROVEN DIRECT, INC., MILWAUKEE, WI:  
4,044,536, PUB. 8-9-2011. INT. CL. 35.
- PROVEN WINNERS NORTH AMERICA LLC, CAMPBELL,  
CA:  
4,046,732, INT. CL. 31.
- PROVIDE COMMERCE, INC., SAN DIEGO, CA:  
2,476,976, REN. 9-20-11. INT. CL. 35.
- PROVIMI NORTH AMERICA, INC., BROOKVILLE, OH:  
4,045,476, PUB. 8-9-2011. INT. CL. 5.  
4,045,547, PUB. 8-9-2011. INT. CL. 5.  
4,045,550, PUB. 8-9-2011. MULTIPLE CLASS, INT. CLS. 5  
AND 31.
- PROVING GROUND LLC, FOUNTAIN HILLS, AZ, DBA  
PROVING GROUND:  
4,045,018, PUB. 8-9-2011. INT. CL. 35.
- PROX INTER B.V., NIEUW VENNEP, NETHERLANDS:  
2,529,537, REN. 9-20-11. MULTIPLE CLASS, INT. CLS. 7  
AND 17.
- PRUDENTIAL INSURANCE COMPANY OF AMERICA,  
THE, NEWARK, NJ:  
1,660,076, REN. 9-18-11. INT. CL. 36.  
1,660,212, REN. 9-18-11. INT. CL. 42.



PRYOR PRODUCTS, OCEANSIDE, CA, PRYOR; JOHN W., SOLANA BEACH, CA, DBA PRYOR PRODUCTS: 1,174,047. REN. 9-16-11. INT. CL. 10.  
 PS SCHERVEN LLC, WAYZATA, MN: 4,044,044. PUB. 8-9-2011. INT. CL. 3.  
 PSYCHEMEDICS CORPORATION, ACTON, MA: 4,045,277. PUB. 8-9-2011. INT. CL. 44.  
 PSYCHOLOGICAL ASSOCIATES, INC, ST. LOUIS, MO: 4,045,601. INT. CL. 41.  
 PSYCHOLOGICAL ASSOCIATES, INC., ST. LOUIS, MO: 1,171,662. REN. 9-22-11. INT. CL. 41.  
 PT. GARUDAFOOD PUTRA PUTRI JAYA, JAKARTA 12240, INDONESIA: 2,926,688. CANC. INT. CL. 30.  
 PTV PLANUNG TRANSPORT VERKEHR AG, FED REP GERMANY: 4,043,815. PUB. 8-9-2011. MULTIPLE CLASS, INT. CLS. 9, 41 AND 42.  
 4,043,830. PUB. 8-9-2011. MULTIPLE CLASS, INT. CLS. 9, 41 AND 42.  
 PUBLIC RADIO PARTNERS, INC., PHOENIX, AZ: 4,046,256. INT. CL. 35.  
 PUBSHIFT, LLC, ANAHEIM, CA: 4,046,042. INT. CL. 42.  
 PUERTA DORADA, LLC, RUTHERFORD, CA: 4,047,167. INT. CL. 33.  
 PULL'R HOLDING COMPANY, LLC, ELK GROVE VILLAGE, IL: 2,606,813. REN. 9-19-11. INT. CL. 8.  
 PULSE NETWORK LLC, HOUSTON, TX: 2,924,757. CANC. INT. CL. 36.  
 PULSE VETERINARY TECHNOLOGIES, LLC, ALPHARETTA, GA: 4,046,605. INT. CL. 10.  
 PUNCH INC., PROVIDENCE, RI: 4,044,848. PUB. 8-9-2011. INT. CL. 41.  
 4,044,956. PUB. 8-9-2011. INT. CL. 41.  
 PURE & NATURAL COMPANY, SCOTTSDALE, AZ: 4,046,266. INT. CL. 3.  
 4,046,669. INT. CL. 3.  
 4,047,078. INT. CL. 3.  
 PURE NRG, LLC, TROY, MI: 4,043,990. PUB. 8-9-2011. INT. CL. 30.  
 PURE TROPIC, TIRUPUR, TAMIL NADU, INDIA: 4,045,030. PUB. 8-9-2011. INT. CL. 32.  
 PURESTYLE LIVING LLC, RENO, NV: 2,935,076. COR. INT. CL. 41.  
 PURPLE BOX JEWELRY, INC., CHANHASSEN, MN: 4,046,816. MULTIPLE CLASS, INT. CLS. 14 AND 35.  
 PUSHPA DISCOUNT STORE, INC., ROCK HILL, SC: 4,045,741. INT. CL. 25.  
 PYPPELINE HEALTH INC., VANCOUVER, B.C., CANADA: 4,044,876. PUB. 8-9-2011. INT. CL. 9.  
 QINTAR TECHNOLOGIES, INC., WESTLAKE VILLAGE, CA: 2,926,926. CANC. INT. CL. 9.  
 QN DIAGNOSTICS, LLC, DOYLESTOWN, PA: 2,428,650. CANC. INT. CL. 5.  
 QT TECHNOLOGY, INC., HAWTHORNE, CA: 2,926,680. CANC. INT. CL. 9.  
 QUAD FAB, INC., GREENSBORO, NC: 4,045,016. PUB. 8-9-2011. INT. CL. 7.  
 QUAKER CITY MERCANTILE, INC., PHILADELPHIA, PA: 2,926,500. CANC. MULTIPLE CLASS, INT. CLS. 9 AND 41.  
 QUALCOMM LABS, INC., SAN DIEGO, CA: 4,044,818. PUB. 8-9-2011. INT. CL. 9.  
 QUALITY BICYCLE PRODUCTS, INC., BLOOMINGTON, MN: 4,045,564. PUB. 8-9-2011. INT. CL. 25.  
 QUALITY CONFECTIONERY & FOOD PRODUCTS, LLC, CASTLE ROCK, CO, DBA BELVEDERE: 2,428,555. CANC. INT. CL. 30.  
 QUALITY DISTRIBUTORS, LLC, PHOENIX, AZ: 2,605,674. REN. 9-19-11. INT. CL. 38.  
 2,605,675. REN. 9-19-11. INT. CL. 35.  
 QUALITY MUSIC, LLC, SPOKANE, WA: 4,045,499. PUB. 8-9-2011. INT. CL. 41.  
 4,045,510. PUB. 8-9-2011. INT. CL. 41.  
 QUALITY TESTING, LLC, GILBERT, AZ: 4,045,424. PUB. 8-9-2011. MULTIPLE CLASS, INT. CLS. 37 AND 42.  
 QUALYS, INC., REDWOOD SHORES, CA: 4,046,131. INT. CL. 42.  
 QUANTUM CORPORATION, SAN JOSE, CA: 2,518,368. REN. 9-17-11. INT. CL. 9.  
 QUANTUM FUEL SYSTEMS TECHNOLOGIES WORLDWIDE, INC., IRVINE, CA: 4,045,582. INT. CL. 12.  
 QUEEN ANNE'S REVENGE, LLC, CHARLESTON, SC: 2,605,744. REN. 9-21-11. INT. CL. 42.  
 QUIET COMPANY MUSIC, LLC, AUSTIN, TX, AKA QUIET COMPANY: 4,045,205. PUB. 8-9-2011. MULTIPLE CLASS, INT. CLS. 9 AND 41.  
 QUILL PROFESSIONAL DEVELOPMENT LLC, EAST LANSING, MI AND WILLOW TREE WAY, LLC, EAST LANSING, MI: 4,045,901. INT. CL. 41.  
 QUINN SPECIALTY PRODUCTS, INC., DUNN, NC: 4,045,799. INT. CL. 5.  
 QUOC VIET FOODS, INC., WESTMINSTER, CA: 4,044,922. PUB. 8-9-2011. INT. CL. 29.  
 4,044,923. PUB. 8-9-2011. INT. CL. 29.  
 4,044,924. PUB. 8-9-2011. INT. CL. 29.  
 4,044,925. PUB. 8-9-2011. INT. CL. 29.  
 4,044,941. PUB. 8-9-2011. INT. CL. 29.  
 4,044,942. PUB. 8-9-2011. INT. CL. 29.  
 QVSSIP PTY LTD, AUSTRALIA: 4,043,748. PUB. 8-9-2011. MULTIPLE CLASS, INT. CLS. 3, 8, 21 AND 26.  
 QWEST COMMUNICATIONS INTERNATIONAL INC., DENVER, CO: 2,428,570. CANC. INT. CL. 38.  
 R. V. NUCCIO & ASSOCIATES INSURANCE BROKERS, INC., TOLUCA LAKE, CA: 4,044,173. PUB. 5-3-2011. INT. CL. 36.  
 R.A.B. FOOD GROUP, LLC, SECAUCUS, NJ, MRS. ADLER'S FOODS CORPORATION, BROOKLYN, NY: 931,878. REN. 9-22-11. U.S. CL. 46 (INT. CLS. 1, 5, 29, 30, 31 AND 32).  
 R.B.M. S.P.A., ITALY: 4,043,808. PUB. 8-9-2011. MULTIPLE CLASS, INT. CLS. 17 AND 20.  
 4,043,834. PUB. 8-9-2011. INT. CL. 11.  
 R.L. WINSTON ROD COMPANY, TWIN BRIDGES, MT: 4,045,190. PUB. 8-9-2011. INT. CL. 28.  
 4,045,193. PUB. 8-9-2011. INT. CL. 28.  
 R.N.C. INDUSTRIES, INC., LAWRENCEVILLE, GA: 4,044,533. PUB. 8-9-2011. INT. CL. 16.  
 R.S. LORDS, INC., FORT LAUDERDALE, FL: 2,926,947. CANC. INT. CL. 25.  
 R-O INTERNATIONAL CORPORATION, ROSELLE, IL: 1,166,303. REN. 9-19-11. INT. CL. 9.  
 R-STYL', LLC, COCONUT CREEK, FL: 3,048,937. AM. INT. CL. 41.  
 RAB LIGHTING INC., NORTHVALE, NJ: 4,045,983. INT. CL. 11.  
 RADIANS, INC., BARTLETT, TN: 4,045,268. PUB. 8-9-2011. INT. CL. 9.  
 4,045,270. PUB. 8-9-2011. INT. CL. 9.  
 RAGGLE, INC., OAK PARK, IL: 2,436,695. REN. 9-17-11. INT. CL. 25.  
 RAILROAD REVIVAL TOURING COMPANY, LLC, VENICE, CA: 4,044,415. PUB. 8-9-2011. INT. CL. 41.  
 RAINEY APPAREL MANUFACTURING, INC, ATLANTA, GA: 2,480,036. COR. INT. CL. 10.  
 RAINEY APPAREL MANUFACTURING, INC., ATLANTA, GA: 2,480,036. REN. 9-20-11. INT. CL. 10.  
 RAINFOREST CAFE, INC., HOUSTON, TX: 2,521,186. REN. 9-20-11. MULTIPLE CLASS, INT. CLS. 9,

- 18, 20 AND 26.  
 RAINY DAY FUND, LLC, CANBY, OR, DAVIDAVI, INC., NEW CANAAN, CT:  
 1,696,186. REN. 9-17-11. INT. CL. 25.  
 RAISING THE BLUES, LTD., MELROSE, MA:  
 4,045,687, INT. CL. 25.  
 RALEIGH AMERICA, INC., KENT, WA:  
 2,484,293. REN. 9-20-11. INT. CL. 12.  
 4,045,436, PUB. 8-9-2011. INT. CL. 12.  
 4,045,437, PUB. 8-9-2011. INT. CL. 12.  
 RAMÓN MANZANA, S.L., SPAIN:  
 4,043,752, PUB. 8-9-2011. INT. CL. 8.  
 RAMIREZ, RICHARD, HOUSTON, TX:  
 4,044,090, PUB. 8-9-2011. INT. CL. 9.  
 RAMJOHN, PATRICIA, MIAMI, FL:  
 4,046,108, INT. CL. 28.  
 RAMSEY, DAVID, SAN FRANCISCO, CA:  
 4,046,853, INT. CL. 9.  
 RAMVAC CORPORATION, SPEARFISH, SD:  
 2,499,974. REN. 9-17-11. INT. CL. 10.  
 RANDALL'S FOOD & DRUGS, LP, HOUSTON, TX, RANDALL'S FOOD & DRUGS, INC., HOUSTON, TX:  
 2,503,340. REN. 9-16-11. INT. CL. 42.  
 RAPID RACK INDUSTRIES, INC., CITY OF INDUSTRY, CA:  
 4,045,786, INT. CL. 20.  
 RAREPATH MARKETING GROUP, LLC, LOVELAND, OH:  
 2,926,478, CANC. INT. CL. 35.  
 RAVEN SECURITIES CORP., NEW YORK, NY:  
 4,046,376, MULTIPLE CLASS, INT. CLS. 35 AND 36.  
 RAWLINGS SPORTING GOODS COMPANY, INC., ST. LOUIS, MO:  
 4,045,745, INT. CL. 12.  
 4,046,261, INT. CL. 9.  
 4,047,216, INT. CL. 35.  
 RAY MARKS CO. LLC, NEW YORK, NY:  
 4,045,812, INT. CL. 21.  
 RAYMOND JAMES & ASSOCIATES, INC., ST. PETERSBURG, FL:  
 2,926,637, CANC. INT. CL. 9.  
 RAYMOND JAMES FINANCIAL SERVICES, INC., ST. PETERSBURG, FL:  
 2,926,641, CANC. INT. CL. 36.  
 RBC LIFE SCIENCES, INC., IRVING, TX:  
 4,044,008, PUB. 8-9-2011. INT. CL. 5.  
 RBC MINISTRIES, GRAND RAPIDS, MI:  
 1,681,170. REN. 9-22-11. MULTIPLE CLASS, INT. CLS. 16 AND 41.  
 REACHIT ADDA-POLE, INC., FEASTERVILLE, PA:  
 2,927,065, CANC. INT. CL. 7.  
 READER COUPONS, LLC, SAN DIEGO, CA:  
 4,046,644, INT. CL. 35.  
 READING ROCK, INC., CINCINNATI, OH:  
 2,493,942. REN. 9-19-11. INT. CL. 19.  
 READY PAC PRODUCE, INC., IRWINDALE, CA:  
 4,043,742, PUB. 8-9-2011. INT. CL. 29.  
 REALLY REALLY GOOD INC., EASTON, PA:  
 2,704,867, CANC. INT. CL. 41.  
 REBELPRO PRODUCTS, LLC, CAYUGA, IN:  
 4,044,072, PUB. 8-9-2011. INT. CL. 3.  
 RECAPS, LLC, BELLEVUE, WA:  
 2,926,484, CANC. INT. CL. 5.  
 RED & WHITE FOUNDATION, CHICAGO, IL:  
 720,117. REN. 9-21-11. U.S. CL. 52 (INT. CL. 3).  
 RED BRICK GUIDES, LLC, MANCHESTER, NH:  
 4,043,655, PUB. 8-9-2011. INT. CL. 35.  
 RED DEVIL INC., TULSA, OK:  
 921,393. REN. 9-20-11. U.S. CL. 12 (INT. CL. 17).  
 RED IDEA, LLC, BOULDER, CO:  
 4,044,773, PUB. 8-9-2011. INT. CL. 35.  
 REDANCO LTD., LONDON W1U 4JT, UNITED KINGDOM:  
 2,580,149. REN. 9-21-11. INT. CL. 16.  
 REDCO FOODS, INC., WINDSOR, CT, CHR. HANSEN'S LABORATORY, INC., LITTLE FALLS, NY:  
 152,719. REN. 9-21-11. U.S. CL. 46 (INT. CL. 29).  
 REDI-BOX, CHICAGO, IL:  
 4,044,851, PUB. 8-9-2011. INT. CL. 39.  
 REDMANE TECHNOLOGY LLC, CHICAGO, IL:  
 2,598,125. REN. 9-22-11. INT. CL. 42.  
 REDPOINT INTERNATIONAL, INC., VANCOUVER, WA:  
 4,047,062, INT. CL. 10.  
 REEBOK INTERNATIONAL LIMITED, LONDON, ENGLAND, REEBOK INTERNATIONAL LTD., BURY, GREATER MANCHESTER, ENGLAND:  
 1,196,293. REN. 9-19-11. INT. CL. 25.  
 REED AND BARTON CORPORATION, TAUNTON, MA:  
 1,169,923. REN. 9-20-11. INT. CL. 8.  
 1,170,102. REN. 9-20-11. INT. CL. 14.  
 REED ELSEVIER PROPERTIES INC., WILMINGTON, DE, COMMUNICATIONS TODAY, LTD., HIGH POINT, NC:  
 1,172,219. REN. 9-21-11. INT. CL. 16.  
 REED ELSEVIER PROPERTIES INC., WILMINGTON, DE:  
 2,613,894. REN. 9-19-11. INT. CL. 9.  
 REEFNEWS, INC., LOS ALAMOS, NM:  
 4,044,114, PUB. 8-9-2011. INT. CL. 16.  
 REEL FX, INC., DALLAS, TX:  
 4,045,620, INT. CL. 9.  
 4,045,621, INT. CL. 9.  
 REFLECTIONS BY CLAUDIA, INC., EAST LONGMEADOW, MA:  
 4,046,389, INT. CL. 11.  
 REFRESH GLASS, LLC, PHONENIX, AZ:  
 4,044,803, PUB. 8-9-2011. INT. CL. 21.  
 REGAL MEDIA GROUP, LLC, HOUSTON, TX:  
 4,044,084, PUB. 8-9-2011. INT. CL. 41.  
 REGAN, LISA, TULSA, OK:  
 2,427,860, CANC. MULTIPLE CLASS, INT. CLS. 6 AND 20.  
 REGENECA INTERNATIONAL, INC., IRVINE, CA, DBA REGENECA:  
 4,044,719, PUB. 8-9-2011. INT. CL. 5.  
 REGIONAL ECONOMIC MODELS, INC., AMHERST, MA:  
 4,044,499, PUB. 8-9-2011. INT. CL. 9.  
 REGISTROS INTERNACIONALES APLICADOS, S.L., BARCELONA, SPAIN:  
 2,477,235. REN. 9-21-11. INT. CL. 25.  
 REGROW, LLC, MIRAMAR BEACH, FL:  
 4,044,406, PUB. 8-9-2011. INT. CL. 41.  
 REHER-MORRISON RACING ENGINES INC., ARLINGTON, TX:  
 2,529,871. REN. 9-22-11. INT. CL. 12.  
 REINAUER TRANSPORTATION COMPANIES, LLC, STATEN ISLAND, NY:  
 4,044,871, PUB. 8-9-2011. INT. CL. 39.  
 4,044,872, PUB. 8-9-2011. INT. CL. 39.  
 RELENTLESS SOFTWARE LIMITED, BRIGHTON, ENGLAND:  
 4,043,700, PUB. 8-9-2011. MULTIPLE CLASS, INT. CLS. 9, 28 AND 41.  
 RENTHAL LIMITED, STOCKPORT, CHESHIRE, ENGLAND:  
 2,513,928. REN. 9-19-11. MULTIPLE CLASS, INT. CLS. 12, 16 AND 25.  
 2,513,929. REN. 9-19-11. MULTIPLE CLASS, INT. CLS. 12, 16 AND 25.  
 RENTSHARE INC, NEW YORK, NY:  
 4,045,962, INT. CL. 36.  
 REPAREL LLC, CINCINNATI, OH:  
 4,046,372, INT. CL. 25.  
 REPP, THOMAS ARTHUR, MT. CLEMENS, MI:  
 2,535,822. REN. 9-16-11. INT. CL. 41.  
 REPUBLIC OF BEANS, INC., NEW YORK, NY:  
 4,046,162, INT. CL. 41.  
 RESEARCH CATALYSTS, INC., CONROE, TX:  
 4,044,721, PUB. 8-9-2011. INT. CL. 1.  
 RESEARCH PANEL ASIA INC., SHIBUYA, TOKYO, JAPAN:  
 4,047,126, INT. CL. 35.  
 RESEARCH TRIANGLE INSTITUTE, RESEARCH TRIANGLE PARK, NC:  
 1,649,778. REN. 9-21-11. INT. CL. 42.  
 RESEARCH!AMERICA, ALEXANDRIA, VA:  
 4,045,859, MULTIPLE CLASS, INT. CLS. 35 AND 42.  
 4,045,860, MULTIPLE CLASS, INT. CLS. 35 AND 42.

RESOLUTE OIL, LLC, LEAGUE CITY, TX:  
4,045,246, PUB. 8-9-2011. INT. CL. 4.  
4,045,248, PUB. 8-9-2011. INT. CL. 4.  
4,045,249, PUB. 8-9-2011. INT. CL. 1.  
4,045,250, PUB. 8-9-2011. INT. CL. 1.  
4,045,251, PUB. 8-9-2011. INT. CL. 4.  
4,045,252, PUB. 8-9-2011. INT. CL. 1.

RESONATE ELIXIR LLC, SAN DIEGO, CA:  
4,044,574, PUB. 8-9-2011. INT. CL. 30.

RESTAT, LLC, MILWAUKEE, WI:  
4,045,920, INT. CL. 36.

RESTAURANT DEVELOPMENT GROUP, LLC, NORTH PALM BEACH, FL:  
4,046,987, INT. CL. 43.

RESTORATIVE ACTION, LLC, EDINA, MN:  
4,045,975, INT. CL. 41.

RETAIL ADVERTISING TRENDS, LC, SIOUX FALLS, SD:  
4,044,001, PUB. 8-9-2011. INT. CL. 35.

RESCO INDUSTRIES, INC., SANTA FE SPRINGS, CA:  
4,045,383, PUB. 8-9-2011. INT. CL. 9.  
4,045,385, PUB. 8-9-2011. INT. CL. 9.

REVIEW AND HERALD PUBLISHING ASSOCIATION, HAGERSTOWN, MD:  
1,167,262, REN. 9-16-11. INT. CL. 16.

REVLON CONSUMER PRODUCTS CORPORATION, NEW YORK, NY:  
4,045,797, INT. CL. 9.

REVO AMERICA CORPORATION, COPPELL, TX:  
4,043,955, PUB. 8-9-2011. INT. CL. 9.  
4,043,956, PUB. 8-9-2011. INT. CL. 9.  
4,043,957, PUB. 8-9-2011. INT. CL. 42.  
4,043,958, PUB. 8-9-2011. INT. CL. 9.

REVO INTERNATIONAL, LLC, CARTERSVILLE, GA:  
4,045,378, PUB. 8-9-2011. INT. CL. 37.

REVOLUTION PC, INC., NICHOLASVILLE, KY:  
4,043,895, PUB. 8-9-2011. INT. CL. 9.

REVOLUTIONARY VELO-WATTS, BURNT HILLS, NY:  
4,046,938, INT. CL. 41.

REYNOLDS INNOVATIONS INC., WINSTON-SALEM, NC:  
4,044,163, PUB. 8-9-2011. INT. CL. 34.

REYNOLDS, DOUGLAS, PORTLAND, OR:  
4,044,538, PUB. 8-9-2011. INT. CL. 33.

RGB COSMETICS, LLC, HIGHLAND PARK, IL:  
4,044,910, PUB. 8-9-2011. INT. CL. 3.

RHEUMATOLOGY RESEARCH INTERNATIONAL L.L.C., DALLAS, TX:  
2,096,573, CANC. INT. CL. 42.

RHINOBOOTS, S.A. DE C.V., PUREPERO, MICHOACAN, MEXICO:  
4,046,032, INT. CL. 9.

RHYTHM PHARMACEUTICALS, INC., BOSTON, MA:  
4,046,497, MULTIPLE CLASS, INT. CLS. 5 AND 42.

RIBONOMICS, INC., DURHAM, NC:  
2,926,859, CANC. INT. CL. 42.

RICE, SANCHEZ, HESPERIA, CA:  
4,046,825, INT. CL. 25.

RICH PRODUCTS CORPORATION, BUFFALO, NY:  
4,046,561, INT. CL. 30.

RICH RIGHT LTD. INC, ORLANDO, FL:  
4,047,036, MULTIPLE CLASS, INT. CLS. 10 AND 24.

RIDGID, INC., NEWARK, DE, EMERSON ELECTRIC CO., ST. LOUIS, MO:  
1,652,439, REN. 9-20-11. INT. CL. 20.

RIGGS, STEPHANIE, DENVER, CO:  
4,045,119, PUB. 8-9-2011. INT. CL. 35.

RIGHT THOUGHT PENS, INC., NASHVILLE, TN:  
2,926,869, CANC. INT. CL. 16.

RIGHT TRACK GLOBAL, LLC, IRVINE, CA:  
4,046,514, INT. CL. 5.

RIMAGE CORPORATION, EDINA, MN:  
4,044,625, PUB. 8-9-2011. INT. CL. 9.

RINALDI, FRANK JR, QUEENS VILLAGE, NY:  
4,045,454, PUB. 8-9-2011. INT. CL. 25.

RINCON, JUAN CARLOS, NEWTON, MA:  
4,047,113, INT. CL. 16.

RINEHART, DAVID GLENN, OAKLAND, CA:  
2,489,832, REN. 9-19-11. INT. CL. 16.

RINGER HUT CO. LTD., NAGASAKI-SHI, NAGASAKI, JAPAN, RINGER HUT U.S.A. CORPORATION, SAN JOSE, CA:  
1,695,009, REN. 9-20-11. INT. CL. 42.

RIPLEY ENTERTAINMENT INC., ORLANDO, FL:  
918,431, REN. 9-20-11. MULTIPLE CLASS, U.S. CLS. 22 (INT. CLS. 16, 18, 20, 22, 25 AND 28), 38 (INT. CLS. 9, 16 AND 28), 39 (INT. CL. 25), 101 (INT. CLS. 35, 36, 38, 41 AND 42) AND 107 (INT. CL. 41).  
918,431, CANC. U.S. CL. 28.

RISK MANAGEMENT SOLUTIONS, INC., NEWARK, CA:  
2,548,658, REN. 9-17-11. INT. CL. 9.

RITE-HITE HOLDING CORPORATION, MILWAUKEE, WI:  
2,522,343, REN. 9-19-11. INT. CL. 11.

RIVER LIGHT V, L.P., NEW YORK, NY:  
4,045,568, PUB. 8-9-2011. INT. CL. 9.

RIVER NORTH GROUP, LLC, CHICAGO, IL:  
4,047,187, INT. CL. 35.

RIVERAERIE CELLARS LLC, PROSSER, WA, DBA BUNNELL FAMILY CELLAR, RIVERAERIE:  
4,046,768, INT. CL. 33.

RIVERSIDE ENTERPRISES, LLC, CLARENDON HILLS, IL AND DEERFIELD ENTERPRISES, LLC, CLARENDON HILLS, IL:  
2,536,588, REN. 9-19-11. INT. CL. 42.

RIVIERA GOLF & TENNIS, INC., PACIFIC PALISADES, CA:  
4,045,124, PUB. 8-9-2011. INT. CL. 28.

RIZZOLI ORTOPIEDIA S.P.A., BUDRIO, ITALY:  
4,044,821, PUB. 8-9-2011. INT. CL. 10.

RJ/RG LLC, ST. LOUIS, MO:  
2,927,035, CANC. INT. CL. 9.

RJR POLYMERS, INC., OAKLAND, CA:  
2,529,221, REN. 9-21-11. INT. CL. 35.

ROACH, CHRISTINA M., TAMPA, FL:  
4,044,335, PUB. 8-9-2011. INT. CL. 45.

ROBBINS RESEARCH INTERNATIONAL, INC., SAN DIEGO, CA:  
2,551,974, REN. 9-18-11. INT. CL. 9.

ROBERSON, PAUL L., HUGHES SPRINGS, TX, DBA AMERICAN WING GIRLS:  
4,044,023, PUB. 8-9-2011. INT. CL. 25.

ROBERT BOSCH TOOL CORPORATION, MOUNT PROSPECT, IL:  
1,641,899, REN. 9-20-11. INT. CL. 7.

ROBERT L. O'BLOCK REVOCABLE TRUST, SPRINGFIELD, MO:  
2,603,233, REN. 9-21-11. INT. CL. 42.

ROBERT MCDAID, OLD BRIDGE, NJ:  
4,046,239, MULTIPLE CLASS, INT. CLS. 41 AND 43.

ROBERT ROWEN WESTERMAN, WINCHESTER, VA, DBA GOLD BOY MUSIC & PUBLICATION:  
4,043,728, PUB. 8-9-2011. INT. CL. 41.

ROBERT T. BOCK CONSULTANCY LLC, BREWSTER, NY:  
4,046,039, INT. CL. 21.

ROBERT WHOLEY & CO., INC., PITTSBURGH, PA:  
2,479,494, REN. 9-19-11. INT. CL. 29.

ROBERTS, JOHN B., HOLLY SPRINGS, NC:  
2,683,453, CANC. INT. CL. 35.

ROBIN OF GLEN ABBEY, INC., FLAGLER BEACH, FL:  
2,927,043, CANC. INT. CL. 43.

ROBIN RAMOS, LOS ANGELES, CA:  
4,045,213, PUB. 8-9-2011. INT. CL. 16.

ROCHESTER GAS AND ELECTRIC CORPORATION, ROCHESTER, NY:  
2,485,888, REN. 9-21-11. INT. CL. 40.

ROCHLING ENGINEERING PLASTICS LTD., VANCOUVER, CANADA:  
2,490,916, REN. 9-17-11. INT. CL. 27.

ROCK HILL TELEPHONE COMPANY, ROCK HILL, SC:  
2,493,386, REN. 9-20-11. MULTIPLE CLASS, INT. CLS. 16, 35, 37, 38, 41 AND 42.

ROCK THE RED INC., SAINT AUGUSTINE, FL, DBA ROCKING THE RED:  
4,044,937, PUB. 8-9-2011. INT. CL. 44.

ROCKAWAY RECYCLING, INC., ROCKAWAY, NJ:  
4,044,147, PUB. 5-3-2011. INT. CL. 40.

ROCKET GAMING SYSTEMS, LLC, GROVE, OK:  
4,044,276, PUB. 8-9-2011. INT. CL. 9.

- ROCKY MOUNT CORD COMPANY, ROCKY MOUNT, NC:  
2,428,614, CANC. INT. CL. 22.
- RODES, OSCAR, ARLINGTON, TX:  
2,830,403, CANC. INT. CL. 5.
- ROGOWSKI, MARK, PINE ISLAND, NY:  
4,044,109, PUB. 8-9-2011. MULTIPLE CLASS, INT. CLS. 29, 30 AND 31.
- ROLAND CORPORATION, SHIZUOKA, JAPAN:  
4,043,619, PUB. 8-9-2011. INT. CL. 9.  
4,043,620, PUB. 8-9-2011. INT. CL. 9.
- ROLLINGHOT, LLC., CENTENNIAL, CO:  
4,044,038, PUB. 8-9-2011. INT. CL. 9.
- ROMERO, IRENE, COACHELLA, CA:  
4,044,874, PUB. 8-9-2011. INT. CL. 41.
- RONNOCO COFFEE COMPANY, ST. LOUIS, MO:  
4,047,159, INT. CL. 30.
- ROSA MEXICANO BRANDS, INC., NEW YORK, NY:  
4,044,012, PUB. 8-9-2011. INT. CL. 43.
- ROSE ANN INTERNATIONAL OF J.C., INC., JERSEY CITY, NJ:  
2,890,480, CANC. INT. CL. 3.
- ROSEN PUBLISHING GROUP, INC., THE, NEW YORK, NY:  
2,603,818, REN. 9-21-11. INT. CL. 16.
- ROSENUIST GESTAO E SERVICOS LDA, 9000 - 029 FUNCHAL, MADEIRA, PORTUGAL:  
2,428,807, CANC. INT. CL. 25.
- ROSTRAM, US, LLC, BARRINGTON, IL:  
2,926,807, CANC. INT. CL. 5.
- ROTAM LTD., CHAI WAN, HONG KONG:  
4,045,668, INT. CL. 5.  
4,045,718, INT. CL. 5.
- ROTARY COMPOSTERS, LLC, DENVER, PA:  
4,047,065, INT. CL. 7.  
4,047,066, INT. CL. 7.
- ROTHBERG, SARANNE, TENAFLY, NJ:  
2,491,339, REN. 9-16-11. INT. CL. 41.
- ROTHBURY WINES PTY LTD., SOUTHBANK, VICTORIA, AUSTRALIA:  
2,518,931, REN. 9-19-11. INT. CL. 33.
- ROTOR CLIP COMPANY, INC., SOMERSET, NJ:  
4,046,121, INT. CL. 6.
- ROYAL HIP, SANTA MONICA, CA:  
2,926,939, CANC. INT. CL. 14.
- ROYAL NEIGHBORS OF AMERICA, ROCK ISLAND, IL:  
4,044,971, PUB. 8-9-2011. MULTIPLE CLASS, INT. CLS. 35 AND 36.
- ROYAL PET INCORPORATED, INVER GROVE HEIGHTS, MN:  
4,046,935, INT. CL. 21.
- ROYAL WINE CORPORATION, BAYONNE, NY:  
547,548, REN. 9-20-11. U.S. CL. 47 (INT. CL. 33).
- ROYAL WINE CORPORATION, BAYONNE, NJ:  
2,578,571, REN. 9-19-11. INT. CL. 33.
- RPC ACQUISITION CORP., MINNEAPOLIS, MN:  
4,047,034, INT. CL. 44.
- RTR FUNDING LLC, NORTH MIAMI, FL:  
2,926,489, CANC. MULTIPLE CLASS, INT. CLS. 35 AND 42.
- RUBBER HITS THE ROAD L.L.C., SAN DIEGO, CA:  
4,044,083, PUB. 8-9-2011. INT. CL. 44.
- RUBBER PAVEMENTS ASSOCIATION, INC., TEMPE, AZ:  
2,467,357, REN. 9-22-11. MULTIPLE CLASS, INT. CLS. 16, 41 AND 42.
- RUBBIES FOR KIDS, INC., BROOKLYN, NY:  
2,926,741, CANC. INT. CL. 25.
- RUBY COLLINS, BROOKLYN, NY, DBA SENG RECORDS:  
4,045,024, PUB. 8-9-2011. INT. CL. 9.
- RUDER FINN, INC., NEW YORK, NY:  
2,483,181, REN. 9-20-11. MULTIPLE CLASS, INT. CLS. 35 AND 42.
- RUFF, SHARON L., WASHINGTON, DC:  
2,471,595, REN. 9-18-11. INT. CL. 42.
- RUFUS & COCO PTY LTD, AUSTRALIA:  
4,043,760, PUB. 5-3-2011. MULTIPLE CLASS, INT. CLS. 3 AND 5.
- RUGER, LLC, CHEVY CHASE, MD:  
1,658,707, REN. 9-21-11. INT. CL. 30.
- RUGGEDCOM INC., WOODBRIDGE, CANADA:  
4,043,641, PUB. 8-9-2011. MULTIPLE CLASS, INT. CLS. 9, 35 AND 42.
- RUIZ, WALKIRIA, MORRIS PLAINS, NJ:  
4,044,883, PUB. 8-9-2011. INT. CL. 41.
- RULE INDUSTRIES, INC., GLOUCESTER, MA:  
2,926,732, CANC. INT. CL. 9.
- RUSING, STEPHEN E., SCOTTSDALE, AZ:  
4,045,395, PUB. 8-9-2011. INT. CL. 28.
- RUSSELL K. SCHAEFFER AND KARLA SCHAEFFER, LOUANN, AR:  
4,045,129, PUB. 8-9-2011. INT. CL. 15.  
4,045,138, PUB. 8-9-2011. INT. CL. 15.
- RUSSELL M. JAFFE, VIENNA, VA, SERAPHIM, INC., STERLING, VA:  
1,653,441, REN. 9-21-11. INT. CL. 5.
- RUTHERFORD INSTITUTE, THE, CHARLOTTESVILLE, VA:  
2,487,858, REN. 9-16-11. MULTIPLE CLASS, INT. CLS. 9, 16 AND 41.
- RYDER, TRACEY ANN, SANTA BARBARA, CA AND TOPALIAN, CAROLE JANE, SANTA BARBARA, CA:  
4,045,948, INT. CL. 35.
- RYESON CORPORATION, CAROL STREAM, IL:  
1,667,482, REN. 9-21-11. INT. CL. 9.
- R360 ENVIRONMENTAL SOLUTIONS, INC., HOUSTON, TX:  
4,044,751, PUB. 8-9-2011. MULTIPLE CLASS, INT. CLS. 37, 39 AND 40.
- S. C. JOHNSON & SON, INC., RACINE, WI, KIWI BRANDS INC., DOUGLASSVILLE, PA:  
1,657,773, REN. 9-19-11. INT. CL. 3.
- S. C. JOHNSON & SON, INC., RACINE, WI:  
4,044,130, PUB. 8-9-2011. MULTIPLE CLASS, INT. CLS. 2 AND 3.  
4,045,064, PUB. 8-9-2011. INT. CL. 5.  
4,046,777, MULTIPLE CLASS, INT. CLS. 4 AND 5.
- S. GOLDBERG & CO., INC., HACKENSACK, NJ:  
2,500,833, REN. 9-22-11. INT. CL. 25.
- S.W.B. APPAREL, INC., EAST RUTHERFORD, NJ:  
4,047,000, INT. CL. 25.
- S-GO INTERNATIONAL, INC., LOS ANGELES, CA:  
4,047,154, INT. CL. 25.
- SAATI S.P.A., APPIANO GENTILE (COMO), ITALY:  
1,654,355, REN. 9-17-11. INT. CL. 24.
- SABINSA CORPORATION, EAST WINDSOR, NJ:  
4,046,144, INT. CL. 1.
- SACHA LONDON, S.L., ELDA (ALICANTE), SPAIN, STASSA RICHEBE, NEE HADJI APOSTOLOS, PARIS, FRANCE:  
716,670, REN. 9-19-11. U.S. CL. 3 (INT. CL. 18).
- SAFARI PROGRAMS, INC., MIAMI GARDENS, FL:  
4,046,650, INT. CL. 28.
- SAFARILAND, LLC, JACKSONVILLE, FL:  
1,658,154, REN. 9-22-11. INT. CL. 13.
- SAFCO DENTAL SUPPLY CO., BUFFALO GROVE, IL:  
4,043,878, PUB. 8-9-2011. INT. CL. 10.
- SAFESTIMATE, GREENVILLE, SC:  
4,045,106, PUB. 8-9-2011. INT. CL. 35.
- SAFETEC OF AMERICA, INC., BUFFALO, NY:  
2,926,681, CANC. INT. CL. 1.  
2,926,682, CANC. INT. CL. 1.
- SAFRAN, PARIS, FRANCE:  
1,167,666, REN. 9-22-11. MULTIPLE CLASS, INT. CLS. 37 AND 42.
- SAGE MANUFACTURING CORPORATION, BAINBRIDGE ISLAND, WA:  
1,687,936, REN. 9-19-11. MULTIPLE CLASS, INT. CLS. 25 AND 28.
- SAIFAN BOSMAT LTD., TEL AVIV, ISRAEL:  
4,047,233, INT. CL. 30.
- SAINT-GOBAIN PERFORMANCE PLASTICS CORPORATION, WAYNE, NJ:  
1,657,766, REN. 9-21-11. MULTIPLE CLASS, INT. CLS. 7 AND 9.
- SAINMYSTERIES PRODUCTIONS, MISSION VIEJO, CA:  
4,044,781, PUB. 8-9-2011. INT. CL. 41.
- SALESFORCE.COM, INC., SAN FRANCISCO, CA:  
4,044,691, PUB. 8-9-2011. INT. CL. 42.

SALLY HERSHBERGER PROFESSIONAL HAIR CARE LLC, NEW YORK, NY:  
4,045,116, PUB. 8-9-2011. INT. CL. 3.  
4,045,120, PUB. 8-9-2011. INT. CL. 3.  
4,045,122, PUB. 8-9-2011. INT. CL. 3.

SALOMON S.A.S., METZ-TESSY, FRANCE:  
2,491,463. REN. 9-19-11. INT. CL. 25.

SALT COMMUNICATIONS LLC, CHICAGO, IL:  
4,047,018, INT. CL. 33.

SALTWORKS, INC., WOODINVILLE, WA:  
4,044,085, PUB. 8-9-2011. INT. CL. 30.

SAM ASH MUSIC CORPORATION, HICKSVILLE, NY:  
2,493,141. REN. 9-20-11. INT. CL. 15.  
2,493,141, CANC. MULTIPLE CLASS, INT. CLS. 3, 8 AND 9.

SAMBALATTE TORREFAZIONE LLC, LAS VEGAS, NV:  
4,044,154, PUB. 8-9-2011. MULTIPLE CLASS, INT. CLS. 30 AND 43.

SAMSILL CORPORATION, FORT WORTH, TX:  
4,046,905, INT. CL. 16.

SAMSON DISTRIBUTING INC., WELLINGTON, FL:  
2,599,631. REN. 9-20-11. INT. CL. 5.

SAMSONITE IP HOLDINGS S.A.R.L., LUXEMBOURG, LUXEMBOURG:  
2,437,537. REN. 9-18-11. MULTIPLE CLASS, INT. CLS. 6 AND 26.

SANDISK CORPORATION, MILPITAS, CA:  
4,045,667, INT. CL. 9.

SANDEX CORPORATION, WILKES-BARRE, PA:  
4,047,223, INT. CL. 25.

SANDY MARCUCCI INTERNATIONAL CAMPS, INC., WILLIAMSTOWN, NJ:  
4,047,176, INT. CL. 41.

SANOMEDICS DEVELOPMENT CORPORATION, MIAMI, FL:  
4,046,441, INT. CL. 9.  
4,046,776, INT. CL. 10.

SANRIO COMPANY, LTD., TOKYO 141, JAPAN:  
2,488,126. REN. 9-21-11. INT. CL. 32.

SANWA KAKO KABUSHIKI KAISHA, MINAMI-KU, KYOTO-SHI, KYOTO-FU, JAPAN, AKA SANWA KAKO CO., LTD.:  
1,700,056. REN. 9-21-11. INT. CL. 1.

SANYO NORTH AMERICA CORPORATION, CHATSWORTH, CA:  
2,927,050. CANC. INT. CL. 7.

SANYPET S.P.A., ITALY:  
4,043,795, PUB. 8-9-2011. MULTIPLE CLASS, INT. CLS. 5 AND 31.

SAPA EXTRUSIONS, INC., MOON TOWNSHIP, PA:  
2,479,540. REN. 9-19-11. INT. CL. 6.

SAPIEN TECHNOLOGIES, INC., NAPA, CA:  
2,574,892. REN. 9-16-11. INT. CL. 9.

SARCIO GROUP, LLC, KERRVILLE, TX:  
4,046,425, INT. CL. 9.

SARDELLA, LLC, ANNAPOLIS, MD:  
4,045,911, MULTIPLE CLASS, INT. CLS. 21 AND 25.

SARVARY, MARK, CARLSBAD, CA:  
4,047,148, INT. CL. 36.

SAT-7 MEDIA SERVICES LIMITED, NICOSIA, CYPRUS:  
4,044,078, PUB. 8-9-2011. INT. CL. 9.  
4,044,079, PUB. 8-9-2011. INT. CL. 9.

SATWEST CONSULTING, LLC, ALBUQUERQUE, NM:  
2,569,029. REN. 9-20-11. INT. CL. 38.

SAUER, DEBBIE DOUGLASS, OVERLAND PARK, KS:  
4,043,612, PUB. 8-9-2011. INT. CL. 35.

SAUL ZAENTZ COMPANY, THE, BERKELEY, CA, DBA TOLKIEN ENTERPRISES:  
2,989,895, CANC. MULTIPLE CLASS, INT. CLS. 6, 16 AND 25.  
2,989,896, CANC. INT. CL. 16.

SAVE OUR KIDS OUTREACH, WILMINGTON, NC:  
2,504,069. REN. 9-22-11. INT. CL. 42.

SAXTY, TREVOR J., ALAMEDA, CA:  
2,495,536. REN. 9-21-11. MULTIPLE CLASS, INT. CLS. 35 AND 41.

SBT NEWCO, INC., NEW YORK, NY:  
2,926,812, CANC. INT. CL. 10.

SCA HYGIENE PRODUCTS AB, SE-405 03 GOTEBORG, SWEDEN, MOLNLYCKE (NEDERLAND) B.V., AMSTELVEEN, NETHERLANDS:  
1,168,341. REN. 9-21-11. MULTIPLE CLASS, INT. CLS. 16 AND 21.

SCALA'S ORIGINAL BEEF & SAUSAGE COMPANY LLC, CHICAGO, IL:  
4,044,459, PUB. 8-9-2011. INT. CL. 29.  
4,044,461, PUB. 8-9-2011. INT. CL. 30.

SCANDINAVIAN TOBACCO GROUP NYKØBING APS, HOJBERG, DENMARK:  
4,043,900, PUB. 8-9-2011. INT. CL. 34.

SCENE, LLC, KALISPELL, MT:  
4,047,266, INT. CL. 38.

SCENTCO, LLC, THOMASVILLE, GA:  
4,046,846, INT. CL. 1.

SCHAFFER SYSTEMS INC., ADAIR, IA:  
2,926,735, CANC. INT. CL. 35.

SCHEL, CHARLES L., MCCORMICK, SC:  
4,047,203, INT. CL. 5.

SCHIFFMAYER SALES & ENGINEERING L.L.C., ALGONQUIN, IL:  
4,044,514, PUB. 8-9-2011. INT. CL. 20.  
4,044,516, PUB. 8-9-2011. INT. CL. 20.  
4,044,518, PUB. 8-9-2011. INT. CL. 21.

SCHINDLER AUFZUGE AG, EBikon, SWITZERLAND:  
2,522,001. REN. 9-19-11. INT. CL. 37.

SCHNABEL RESTAURANTS, LLC, NAVARRE, OH:  
4,046,349, INT. CL. 43.

SCHNEIDER ELECTRIC SA, RUEIL-MALMAISON, FRANCE:  
2,491,767. REN. 9-16-11. MULTIPLE CLASS, INT. CLS. 9, 11 AND 42.

SCHNUCK MARKETS, INC., ST. LOUIS, MO:  
4,045,650, MULTIPLE CLASS, INT. CLS. 35, 41 AND 43.

SCHOETTLER RESEARCH AND ENGINEERING CORPORATION, HUNTINGTON BEACH, CA:  
1,649,819. REN. 9-20-11. INT. CL. 9.

SCHOLASTIC INC., NEW YORK, NY:  
4,046,930, INT. CL. 9.  
4,046,931, INT. CL. 9.

SCHOTT AG, D-55122 MAINZ, FED REP GERMANY, JENAER GLASWERK SCHOTT & GEN., MAINZ 1, FED REP GERMANY:  
1,183,780. REN. 9-20-11. INT. CL. 19.

SCHRIFFEN LLC, NEW YORK, NY:  
4,047,190, INT. CL. 25.

SCHUTTE & KOERTING, LLC, TREVISO, PA:  
4,044,469, PUB. 8-9-2011. INT. CL. 9.

SCHWAN'S IP, LLC, MARSHALL, MN:  
1,601,271, CANC. INT. CL. 32.  
4,046,250, INT. CL. 30.

SCHWEITZER-MAUDUIT INTERNATIONAL, INC., ALPHARETTA, GA:  
4,044,223, PUB. 8-9-2011. INT. CL. 34.

SCIENCEFRIDAY, INC., STAMFORD, CT:  
4,046,163, INT. CL. 41.

SCOODEEZ, LLC, LA PALMA, CA:  
4,046,874, INT. CL. 25.

SCOT LUBRICANTS OF PENNSYLVANIA, INC., ALLENTOWN, PA:  
719,883. REN. 9-21-11. U.S. CL. 15 (INT. CL. 1).  
719,885. REN. 9-21-11. U.S. CL. 15 (INT. CL. 1).

SCOTT ABRAHAM, MIAMI BEACH, FL:  
4,044,313, PUB. 8-9-2011. INT. CL. 5.

SCOTT BADER COMPANY LIMITED, UNITED KINGDOM:  
4,043,861, PUB. 8-9-2011. INT. CL. 1.

SCOTT BRADLEY, NORTH SYDNEY NSW, AUSTRALIA AND ANTONIO ORENA-BARLIN, NORTH SYDNEY NSW, AUSTRALIA:  
4,043,913, PUB. 8-9-2011. MULTIPLE CLASS, INT. CLS. 35 AND 41.

SCOTT CUNNINGHAM, PROVINCETOWN, MA, DBA SCOTTCAKES:  
4,044,958, PUB. 8-9-2011. INT. CL. 30.

SCOTT FETZER COMPANY, THE, WESTLAKE, OH:  
940,356. REN. 9-22-11. U.S. CL. 21 (INT. CL. 9).

- SCOTT KAY, INC., TEANECK, NJ:  
4,046,047, INT. CL. 14.  
4,046,048, INT. CL. 14.  
4,046,049, INT. CL. 14.
- SCOTT, STEWART, POUGHKEEPSIE, NY:  
4,045,343, PUB. 8-9-2011. INT. CL. 25.
- SCREEN MEDIA VENTURES, LLC, NEW YORK, NY:  
4,045,201, PUB. 8-9-2011. INT. CL. 38.
- SCRIPTLOGIC CORPORATION, BOCA RATON, FL:  
2,472,329. REN. 9-21-11. INT. CL. 9.
- SCS INTERACTIVE, INC., DENVER, CO:  
4,047,111, INT. CL. 28.
- SCULLY, JAMES L, ZIMMERMAN, MN:  
4,046,775, MULTIPLE CLASS, INT. CLS. 16, 25 AND 28.
- SEA WORLD LLC, ORLANDO, FL:  
4,047,011, INT. CL. 41.
- SEACHEM LABORATORIES, INC., MADISON, GA:  
4,047,225, INT. CL. 1.
- SEAL AFTERMARKET PRODUCTS, LLC, PEMBROKE PARK, FL:  
4,044,501, PUB. 8-9-2011. INT. CL. 35.  
4,044,507, PUB. 8-9-2011. INT. CL. 35.  
4,045,517, PUB. 8-9-2011. INT. CL. 12.
- SEARS BRANDS, LLC, HOFFMAN ESTATES, IL:  
4,045,617, INT. CL. 9.
- SEATTLE TIMES COMPANY, SEATTLE, WA:  
2,489,202. REN. 9-17-11. MULTIPLE CLASS, INT. CLS. 35 AND 42.
- SEBRING PRODUCTS, INC., GARDENA, CA:  
2,428,275, CANC. INT. CL. 3.
- SECOND BITE FOODS, INC., SHAKOPEE, MN:  
4,043,624, PUB. 8-9-2011. INT. CL. 30.
- SECRET KISSES, LLC., WESLEY CHAPEL, FL:  
4,045,282, PUB. 8-9-2011. INT. CL. 3.
- SECURE DIGITAL SOLUTIONS, MINNETONKA, MN:  
4,044,218, PUB. 8-9-2011. INT. CL. 35.
- SECURERETURN, INC., DEL MAR, CA:  
4,045,927, INT. CL. 45.
- SECURITY CODE LTD., RU-127018 MOSCOW, RUSSIAN FED.:  
4,043,768, PUB. 8-9-2011. MULTIPLE CLASS, INT. CLS. 9 AND 42.
- SECURITY LOCKNUT LLC, MUNDELEIN, IL:  
2,502,847. REN. 9-20-11. INT. CL. 6.
- SEEDWELL LLC, SAN FRANCISCO, CA, DBA SEEDWELL VIDEO PRODUCTION:  
4,044,863, PUB. 8-9-2011. MULTIPLE CLASS, INT. CLS. 35 AND 41.
- SEIDENBERG, JACK W., WOODMERE, NY:  
3,117,748, CANC. INT. CL. 30.
- SEIKAGAKU KOGYO KABUSHIKI KAISHA (SEIKAGAKU CORPORATION), TOKYO, JAPAN:  
2,496,577. REN. 9-19-11. MULTIPLE CLASS, INT. CLS. 5 AND 10.
- SELECT INTELLECTUAL, LLC, PITTSBURGH, PA:  
4,046,957, INT. CL. 35.
- SELECTIVA SYSTEMS, INC., SAN JOSE, CA:  
4,044,058, PUB. 8-9-2011. INT. CL. 9.
- SELEE CORPORATION, HENDERSONVILLE, NC:  
2,531,697. REN. 9-16-11. INT. CL. 19.
- SEMANTIC SPACE TECHNOLOGIES LIMITED, HYDERABAD, INDIA:  
4,044,190, PUB. 5-3-2011. INT. CL. 42.
- SEMICONDUCTOR INSIGHTS INC., KANATA, ONTARIO, CANADA, SEMICONDUCTOR INSIGHTS INC., CARP, ONTARIO K0A 1L0, CANADA:  
1,654,669. REN. 9-20-11. INT. CL. 42.
- SENARIO LLC, WOODSTOCK, IL:  
4,044,446, PUB. 8-9-2011. INT. CL. 28.  
4,044,447, PUB. 8-9-2011. INT. CL. 28.  
4,044,449, PUB. 8-9-2011. INT. CL. 28.
- SENIOR INVESTMENTS, A.G., SCHASSHAUSEN, SWITZERLAND, PATHWAY BELLOWS, INC., OAK RIDGE, TN:  
909,948. REN. 9-21-11. U.S. CL. 13 (INT. CL. 6).
- SENIX CORPORATION, BRISTOL, VT:  
2,510,566. REN. 9-16-11. INT. CL. 9.
- SENSIBLE TECHNOLOGIES, INC., HOUSTON, TX:  
2,926,457, CANC. INT. CL. 9.
- SENSPA, LLC, SAN FRANCISCO, CA:  
4,045,512, PUB. 8-9-2011. INT. CL. 3.
- SENSUS HEALTHCARE LLC, BOCA RATON, FL:  
4,046,769, INT. CL. 10.
- SEQUOIA FINANCIAL ADVISORS, INC., PHOENIX, AZ:  
4,046,331, INT. CL. 36.
- SERCEL INC., HOUSTON, TX, MARK PRODUCTS, INC., HOUSTON, TX:  
1,168,194. REN. 9-19-11. INT. CL. 9.
- SERGEANT'S PET CARE PRODUCTS, INC., OMAHA, NE, CONAGRA PET PRODUCTS, INC., OMAHA, NE:  
1,673,167. REN. 9-21-11. INT. CL. 3.
- SERVICEMASTER BRANDS L.L.C., BURLINGTON, VT:  
4,045,518, PUB. 8-9-2011. INT. CL. 5.  
4,045,519, PUB. 8-9-2011. INT. CL. 7.  
4,045,520, PUB. 8-9-2011. INT. CL. 3.
- SERVICEMESH, INC., SANTA MONICA, CA:  
4,046,011, INT. CL. 42.  
4,046,012, INT. CL. 42.  
4,046,013, INT. CL. 42.  
4,046,014, INT. CL. 42.
- SERVICIOS TECNOLOGICOS SINGULARES, S.A., MADRID, SPAIN:  
4,043,642, PUB. 1-18-2011. MULTIPLE CLASS, INT. CLS. 9 AND 38.
- SESDERMA, S.L., SPAIN:  
4,043,831, PUB. 8-9-2011. MULTIPLE CLASS, INT. CLS. 3 AND 5.
- SETALIP LLC, PASADENA, CA:  
4,047,072, INT. CL. 28.
- SEVEN WOODS AUDIO, INC., BELMONT, MA:  
4,045,624, INT. CL. 9.
- SF (IP) LIMITED, HONG KONG SAR, HONG KONG:  
4,043,705, PUB. 4-26-2011. MULTIPLE CLASS, INT. CLS. 16, 37 AND 39.
- SGL ITALIA S.R.L., TORINO, ITALY:  
2,882,861, AM. INT. CL. 11.
- SHAD WILLIAMS EVANGELISTIC ASSOCIATION AND GLOBAL FIELD EVANGELISM, ADAMSVILLE, TN:  
2,557,731. REN. 9-19-11. INT. CL. 42.
- SHADYAC, TOM, BEVERLY HILLS, CA:  
2,926,836, CANC. INT. CL. 16.  
2,926,837, CANC. INT. CL. 36.
- SHADZ OF ESSENCE MOTORCYCLE CLUB, ROCK HILL, SC, AKA SHADZ:  
4,043,648, PUB. 12-15-2009. U.S. CL. 200.
- SHAH, SHASHEEN, CARY, NC:  
4,045,895, INT. CL. 45.
- SHAKLEE CORPORATION, PLEASANTON, CA, SHAKLEE CORPORATION, EMERYVILLE, CA:  
1,169,809. REN. 9-21-11. INT. CL. 3.
- SHAKOPEE MDEWAKANTON SIOUX COMMUNITY, PRIOR LAKE, MN:  
2,601,008. REN. 9-21-11. INT. CL. 28.
- SHAMMAS, MILO, WINTERS, CA:  
4,047,109, INT. CL. 1.
- SHANGHAI SOWIN INVESTMENT GROUP CO., LTD., SHANGHAI, CHINA:  
4,045,932, MULTIPLE CLASS, INT. CLS. 7 AND 8.
- SHAPING CHAMPIONS LLC, NORWICH, VT:  
4,045,635, INT. CL. 41.
- SHARAGA, LLOYD, WOODLAND HILLS, CA:  
4,047,051, INT. CL. 9.
- SHARMAHD COMPUTING INC., GLENDORA, CA:  
2,926,942, CANC. INT. CL. 9.
- SHARP-ROCK TECHNOLOGIES, INC., CYPRESS, TX:  
4,045,058, PUB. 8-9-2011. INT. CL. 1.
- SHARPER IMAGE ACQUISITION LLC, NEW YORK, NY, THALHEIMER COMPANY INC., SAN FRANCISCO, CA, DBA THE SHARPER IMAGE:  
1,171,695. REN. 9-21-11. INT. CL. 42.
- SHARXBYTE, INC., BOULDER, CO:  
4,045,057, PUB. 8-9-2011. INT. CL. 42.
- SHAW, BETH JUNE, HERMOSA BEACH, CA:  
2,926,520, CANC. INT. CL. 41.  
2,926,521, CANC. INT. CL. 41.

SHELBY GROUP INTERNATIONAL, INC., MEMPHIS, TN:  
2,488,050. REN. 9-21-11. INT. CL. 9.

SHEN, MD, JOSEPH T., PORT WASHINGTON, NY:  
4,045,788. INT. CL. 44.

SHENG-TAI TECHNOLOGY CO., LTD., TAIPEI CITY 10546,  
TAIWAN:  
4,044,888. PUB. 8-9-2011. INT. CL. 3.  
4,044,891. PUB. 8-9-2011. INT. CL. 3.

SHENZHEN JUSTTIDE TECH CO., LTD., SHENZHEN,  
GUANGDONG, CHINA:  
4,044,674. PUB. 8-9-2011. INT. CL. 9.

SHEREE ELIZABETH LLC, SAN DIEGO, CA:  
4,043,661. PUB. 12-15-2009. INT. CL. 3.

SHERRY LYNN CARTER, NORTH LAS VEGAS, NV, DBA  
EMERSON EAGLES INC.:  
4,047,246. INT. CL. 25.

SHERWOOD SCUBA, LLC, SANTA ANA, CA:  
2,450,820. REN. 9-21-11. MULTIPLE CLASS, INT. CLS. 8,  
18, 25 AND 28.

SHETKA, STANLEY J., WEBSTER, MN:  
1,637,151. REN. 9-22-11. INT. CL. 41.

SHIMANO AMERICAN CORPORATION, IRVINE, CA:  
4,047,027. INT. CL. 28.

SHIN, DONG GEUN, LITTLE NECK, NY:  
4,046,492. INT. CL. 43.

SHINANO KENSHI KABUSHIKI KAISHA, NAGANO 386-  
0498, JAPAN:  
2,926,982. CANC. INT. CL. 9.  
2,926,983. CANC. INT. CL. 9.  
2,926,984. CANC. INT. CL. 9.  
2,926,985. CANC. INT. CL. 9.

SHINN, ROBERT, GRAYSLAKE, IL AND ROBERT, DANA,  
GRAYSLAKE, IL:  
4,044,783. PUB. 8-9-2011. INT. CL. 42.

SHIRLEY, DEVIN, SHERWOOD, AR, DBA KRAV FIT:  
4,046,440. INT. CL. 41.

SHISEIDO COMPANY, LTD., TOKYO 104-10, JAPAN:  
2,520,951. REN. 9-19-11. INT. CL. 3.

SHISEIDO COMPANY, LTD., TOKYO, JAPAN:  
2,522,005. REN. 9-19-11. INT. CL. 3.

SHON ANDY KI, FULLERTON, CA:  
4,044,526. PUB. 8-9-2011. INT. CL. 3.

SHOOK, DANNY MARK, KILAUEA, HI:  
2,926,487. CANC. INT. CL. 31.

SHOP VAC CORPORATION, WILLIAMSPORT, PA:  
4,046,614. INT. CL. 7.

SHOPME, INC., KISSIMMEE, FL:  
4,045,094. PUB. 8-9-2011. INT. CL. 35.

SHOWA DENKO KABUSHIKI KAISHA, TOKYO, JAPAN,  
DBA SHOWA DENKO K.K.:  
1,657,900. REN. 9-21-11. INT. CL. 1.

SHOWCASE TECHNOLOGY, INC., TORRANCE, CA:  
4,045,874. MULTIPLE CLASS, INT. CLS. 35, 38 AND 42.  
4,045,875. MULTIPLE CLASS, INT. CLS. 35, 38 AND 42.

SHREDDISK, INC., GREENVILLE, SC:  
4,045,386. PUB. 8-9-2011. INT. CL. 42.

SHROCKIE LLC, OAKLAND, CA:  
4,044,307. PUB. 8-9-2011. INT. CL. 20.

SHUFFLE MASTER AUSTRALASIA PTY LIMITED, MIL-  
PERRA NSW, AUSTRALIA:  
4,046,794. INT. CL. 9.

SHUFFLE MASTER, INC., LAS VEGAS, NV:  
4,047,028. INT. CL. 28.  
4,047,052. INT. CL. 41.

SHUTTLEWORTH LLC, HUNTINGTON, IN:  
1,165,250. REN. 9-16-11. INT. CL. 7.

SIAA, INC., HAMPTON, NH:  
2,492,337. REN. 9-19-11. INT. CL. 36.  
2,492,338. REN. 9-19-11. INT. CL. 36.

SIDESHOW ENTERTAINMENT, INC., ALAMEDA, CA:  
4,047,193. INT. CL. 35.

SIEMENS HEALTHCARE DIAGNOSTICS PRODUCTS  
GMBH, MARBURG, FED REP GERMANY:  
2,505,173. REN. 9-21-11. INT. CL. 10.

SIEMENS INDUSTRY, INC., ALPHARETTA, GA:  
2,505,783. REN. 9-20-11. INT. CL. 9.  
4,045,947. INT. CL. 11.

SIGHT AND SOUND MINISTRIES, INC., STRASBURG, PA:  
4,044,697. PUB. 8-9-2011. INT. CL. 41.

SIGNAL INVESTMENT & MANAGEMENT CO., WILMING-  
TON, DE:  
4,046,736. INT. CL. 3.  
4,046,737. INT. CL. 3.

SIGNATURE TRAVEL NETWORK COOPERATIVE INC.,  
MARINA DEL REY, CA:  
4,044,124. PUB. 5-3-2011. MULTIPLE CLASS, U.S. CL. 200  
INT. CLS. 35 AND 39.

SIGNATURE WORLD CLASS CANVAS, LLC, KANSAS  
CITY, MO:  
2,428,774. CANC. INT. CL. 16.  
2,428,786. CANC. INT. CL. 16.

SIKA AG, CH-6341 BAAR, SWITZERLAND:  
2,515,663. REN. 9-19-11. INT. CL. 17.

SILCHEM INC., RICHMOND HILL, ONTARIO, CANADA:  
2,481,566. REN. 9-16-11. INT. CL. 1.

SILENT HEROES, WELLINGTON, FL:  
4,044,402. PUB. 8-9-2011. INT. CL. 16.

SILHOUETTES, LLC, WEBHAWKEN, NJ:  
2,498,097. REN. 9-21-11. INT. CL. 35.

SILICON IMAGE, INC., SUNNYVALE, CA:  
2,926,818. CANC. INT. CL. 9.

SILIPOS INC., NEW YORK, NY:  
2,510,088. REN. 9-19-11. INT. CL. 10.

SILLS, JERRY, VIRGINIA BEACH, VA:  
4,045,504. PUB. 8-9-2011. INT. CL. 35.

SILVER BULLET OF NEVADA, LLC, CARSON CITY, NV:  
4,044,328. PUB. 8-9-2011. MULTIPLE CLASS, INT. CLS. 41  
AND 43.

SILVER GOLD BULL, INC., ROCKY MOUNTAIN HOUSE,  
CANADA:  
4,044,271. PUB. 8-9-2011. INT. CL. 35.

SILVER LININGS, LLC, WILLIAMSBURG, VA:  
2,490,392. REN. 9-20-11. INT. CL. 42.

SILVER OWL, LLC, WALLA WALLA, WA, DBA SULEI  
CELLARS:  
4,044,857. PUB. 8-9-2011. INT. CL. 33.  
4,044,859. PUB. 8-9-2011. INT. CL. 33.

SILVER PALATE KITCHENS, INC., CRESSKILL, NJ, SIL-  
VER PALATE, INC., THE, NEW YORK, NY:  
1,163,938. REN. 9-20-11. MULTIPLE CLASS, INT. CLS. 29  
AND 30.

SILVER SPRING GARDENS, INC., EAU CLAIRE, WI:  
2,604,504. REN. 9-20-11. INT. CL. 30.

SILVER STAR INDUSTRIES, INC., BRAINERD, MN:  
4,044,244. PUB. 8-9-2011. MULTIPLE CLASS, INT. CLS. 35  
AND 37.

SILVER SUNBEAM LIMITED, ROAD TOWN, TORTOLA,  
BR. VIRGIN ISLANDS:  
4,045,661. MULTIPLE CLASS, INT. CLS. 25 AND 35.

SIMON GILBERT WINES LIMITED, AUSTRALIA:  
3,194,692. CANC. INT. CL. 33.

SIMON GOLF COMPANY, LLC, INDIANAPOLIS, IN:  
4,046,422. INT. CL. 28.

SIMPLESCRIPTS INC., BURLINGTON, MA:  
2,541,438. REN. 9-18-11. MULTIPLE CLASS, INT. CLS. 38  
AND 42.

SIMPLYFUN, LLC, BELLEVUE, WA:  
4,047,073. INT. CL. 28.  
4,047,074. INT. CL. 28.

SIMPLYSHE, INC., SAN FRANCISCO, CA:  
4,045,703. MULTIPLE CLASS, INT. CLS. 14 AND 24.

SIMPSON DOOR COMPANY, SEATTLE, WA, SIMPSON  
TIMBER COMPANY, SEATTLE, WA:  
1,170,231. REN. 9-19-11. INT. CL. 19.

SIMPSON'S GREENS & FLORAL DIST., INC., DORAL, FL:  
4,044,357. PUB. 8-9-2011. INT. CL. 35.

SIMULATED SURGICAL SYSTEMS, LLC, WILLIAMS-  
VILLE, NY:  
4,046,219. INT. CL. 9.

SINGER, ERIC, NEW YORK, NY:  
4,045,821. INT. CL. 9.

SINGLE BOUND PRODUCTIONS, INC., PASADENA, CA:  
4,044,475. PUB. 8-9-2011. INT. CL. 41.

SINGLE PROPERTY SITES INC, LITTLETON, CO:  
4,045,355. PUB. 8-9-2011. INT. CL. 42.

- SINGLETON MOMS, SCOTTSDALE, AZ:  
4,044,620, PUB. 8-9-2011. INT. CL. 45.
- SIRIUS XM RADIO INC., NEW YORK, NY:  
4,045,088, PUB. 8-9-2011. MULTIPLE CLASS, INT. CLS. 35, 38 AND 41.
- SIROB IMPORTS, INC., LINDENHURST, NY:  
4,046,033, INT. CL. 29.
- SIRONA DENTAL SYSTEMS GMBH, 64625 BENSHEIM, FED REP GERMANY, SIEMENS AG, BERLIN AND MUNICH, FED REP GERMANY:  
1,160,809, REN. 9-20-11. INT. CL. 10.
- SISTER CHRIS'S FRUIT FLAVORED PRODUCTS, LLC, MINNEAPOLIS, MN:  
4,045,926, INT. CL. 30.
- SISTER SAM, LLC, LOS ANGELES, CA:  
4,046,648, INT. CL. 25.  
4,046,649, INT. CL. 25.
- SISTER2SISTER, INC., WASHINGTON, DC:  
2,477,252, REN. 9-16-11. MULTIPLE CLASS, INT. CLS. 16 AND 41.
- SISYPHIAN LLC, CANOGA PARK, CA:  
3,044,492, CANC. INT. CL. 16.
- SITTERCITY, INC., CHICAGO, IL:  
4,046,932, INT. CL. 35.  
4,046,933, INT. CL. 35.
- SIX L'S PACKING COMPANY, INC., IMMOKALEE, FL:  
2,600,801, REN. 9-20-11. INT. CL. 31.
- SIX SWISS EXCHANGE AG, ZURICH 8001, SWITZERLAND:  
2,427,951, CANC. MULTIPLE CLASS, INT. CLS. 9, 16, 35, 36, 38, 41 AND 42.
- SKECHERS U.S.A., INC. II, MANHATTAN BEACH, CA:  
4,046,015, INT. CL. 25.
- SKILLERN, MAURICE, MEMPHIS, TN:  
4,044,102, PUB. 8-9-2011. INT. CL. 35.
- SKILLFUL PAWS, AUSTIN, TX:  
4,044,933, PUB. 8-9-2011. MULTIPLE CLASS, INT. CLS. 3 AND 44.
- SKIN INNOVATIONS INC., RICHMOND HILL, GA:  
2,926,685, CANC. INT. CL. 44.
- SKINSCIENCE LABS, INC., RIDGEFIELD, NJ:  
4,044,106, PUB. 3-8-2011. INT. CL. 3.
- SKIP HOP, INC., NEW YORK, NY:  
4,044,908, PUB. 8-9-2011. INT. CL. 25.  
4,044,915, PUB. 8-9-2011. INT. CL. 16.  
4,044,918, PUB. 8-9-2011. INT. CL. 21.
- SKY CLIMBER, LLC, DELAWARE, OH:  
4,046,887, INT. CL. 7.
- SKY RIDGE CONSULTING, INC., LOS GATOS, CA:  
4,046,967, INT. CL. 35.
- SKYUNION PTE. LTD., 159308, SINGAPORE:  
4,046,405, INT. CL. 9.  
4,046,406, INT. CL. 41.
- SKYWAY LUGGAGE COMPANY, SEATTLE, WA:  
1,658,977, REN. 9-21-11. INT. CL. 18.
- SL MEREDITH, LLC, CARLSBAD, CA:  
4,044,509, PUB. 8-9-2011. INT. CL. 3.  
4,044,512, PUB. 8-9-2011. INT. CL. 3.
- SLABY, CEASAR, WHEELING, IL:  
4,044,829, PUB. 8-9-2011. INT. CL. 39.
- SLEEMS CONSULTING, BRANDON, FL:  
4,044,435, PUB. 8-9-2011. INT. CL. 42.
- SLIPSTREAM COMMUNICATIONS, LLC, NEW YORK, NY:  
2,435,360, REN. 9-21-11. INT. CL. 35.
- SLOAN VALVE COMPANY, FRANKLIN PARK, IL:  
1,178,947, REN. 9-16-11. INT. CL. 9.
- SLOPE PAL, LLC, BOSTON, MA:  
4,044,752, PUB. 8-9-2011. INT. CL. 45.
- SMALL POTATOES URBAN DELIVERY INC., VANCOUVER, CANADA:  
4,045,087, PUB. 8-9-2011. INT. CL. 35.
- SMAPPS INC., WAYNESBORO, VA:  
4,046,872, INT. CL. 42.
- SMART CHOICE MARKETING GROUP LLC, FRISCO, TX:  
4,044,665, PUB. 8-9-2011. INT. CL. 9.
- SMART TRADE TECHNOLOGIES, F-13855 AIX-EN-PROVENCE, FRANCE:  
4,043,747, PUB. 5-3-2011. MULTIPLE CLASS, INT. CLS. 9, 37, 38 AND 42.
- SMARTBADGE, INC., LAGUNA HILLS, CA:  
2,926,584, CANC. INT. CL. 9.  
2,926,585, CANC. INT. CL. 9.
- SMARTDISK CORPORATION, NAPLES, FL:  
2,427,874, CANC. INT. CL. 9.
- SMARTKLEAN CORPORATION, MIAMI, FL, DBA SMARTKLEAN:  
4,044,032, PUB. 8-9-2011. INT. CL. 35.
- SMITH MICRO SOFTWARE, INC., ALISO VIEJO, CA:  
4,046,366, INT. CL. 9.  
4,046,367, MULTIPLE CLASS, INT. CLS. 38, 39 AND 42.
- SMITH, DAVID M, HUNTINGTON BEACH, CA:  
4,046,920, INT. CL. 28.  
4,046,921, INT. CL. 28.  
4,046,922, INT. CL. 28.
- SMITH, EDWARD, GRAND RAPIDS, MI:  
4,044,649, PUB. 8-9-2011. INT. CL. 28.
- SMITH, JAMES TODD, NEW YORK, NY:  
4,046,161, INT. CL. 14.
- SMITH, JOSEPH, WELLINGTON, FL:  
2,926,217, CANC. INT. CL. 5.
- SMITH, TRAVIS A., EDMONDS, WA:  
4,044,991, PUB. 8-9-2011. INT. CL. 41.
- SMITH'S FOOD & DRUG CENTERS, INC., SALT LAKE CITY, UT:  
1,692,137, REN. 9-19-11. INT. CL. 42.
- SMUGGLER'S EVENT MANAGEMENT, LLC, PUNTA GORDA, FL:  
4,047,170, INT. CL. 25.
- SNECMA, FRANCE:  
4,043,800, PUB. 8-9-2011. MULTIPLE CLASS, INT. CLS. 7, 35 AND 37.
- SNLUSA, VERNON, CA, DBA CUDDLE BARN:  
4,044,979, PUB. 8-9-2011. INT. CL. 28.
- SNOWBIRD JAMMERS NON-PROFIT ASSOCIATION, YUMA, AZ:  
4,044,916, PUB. 8-9-2011. INT. CL. 41.
- SO CAL SANITATION LLC, CITY OF INDUSTRY, CA:  
4,044,091, PUB. 8-9-2011. MULTIPLE CLASS, INT. CLS. 37 AND 44.
- SOCIAL FABRIC, LLC, BIRMINGHAM, AL:  
4,046,409, INT. CL. 25.  
4,046,468, INT. CL. 25.
- SOCIAL REPUBLIC, LLC, VALLEY VILLAGE, CA:  
4,045,957, INT. CL. 41.
- SOCIEDAD DE COMERCIALIZACION INTERNACIONAL FLORES PRISMA S.A., SANTA FE DE BOGOTA D.C., COLOMBIA:  
2,493,509, REN. 9-22-11. INT. CL. 31.
- SOCIETE BIC, CLICHY, FRANCE:  
4,046,626, INT. CL. 16.
- SOCIETE DES PRODUITS MARNIER LAPOSTOLLE, FRANCE:  
4,043,827, PUB. 8-9-2011. INT. CL. 33.
- SOCIETE DES PRODUITS NESTLE S.A., 1800 VEVEY, SWITZERLAND, DBA WILLY WONKA BRANDS:  
1,668,679, REN. 9-21-11. INT. CL. 30.
- SOCIETE MAXIME GIRARD, MONNERIE-LE-MONTEL, PUY-DE-DOME, FRANCE:  
833,983, CANC. U.S. CL. 23.
- SOFT COMPUTER CONSULTANTS, INC., CLEARWATER, FL, DBA SCC SOFT COMPUTER:  
4,043,618, PUB. 8-9-2011. INT. CL. 9.
- SOFTLINE LTD., ATHOLL EXT 12, SANDTON, 2031, SOUTH AFRICA:  
2,926,135, CANC. INT. CL. 42.
- SOFTSTUF, INC., PHILADELPHIA, PA:  
2,595,252, REN. 9-21-11. INT. CL. 9.
- SOH IP COMPANY, INC., PHOENIX, AZ:  
2,512,980, REN. 9-20-11. INT. CL. 30.
- SOIGNE K, LLC, NEW YORK, NY:  
4,045,602, INT. CL. 35.
- SOIL RETENTION SYSTEMS, INC., CARLSBAD, CA:  
2,926,997, CANC. INT. CL. 19.
- SOL 2-O, LLC, SADDLEBROOK, NJ:  
4,044,074, PUB. 8-9-2011. MULTIPLE CLASS, INT. CLS. 9 AND 11.



SOLVI BRAND, LLC, ROSWELL, GA:  
4,046,137, INT. CL. 33.

SOMEDIA SOLUTIONS INC., ROSWELL, GA:  
4,044,708, PUB. 8-9-2011. INT. CL. 35.

SOMETHING OLD, SOMETHING NEW, INC., EDGE-  
WATER, NJ:  
1,688,374. REN. 9-22-11. INT. CL. 14.

SOMETRICS, INC., EL SEGUNDO, CA:  
4,047,130, INT. CL. 36.

SONAC B.V., SON, NETHERLANDS:  
1,685,468. REN. 9-21-11. INT. CL. 29.

SONGCOMPANION.COM, LLC, ASHBURN, VA:  
4,044,920, PUB. 8-9-2011. INT. CL. 16.

SONNEBORN INC., MAHWAH, NJ, CROMPTON COR-  
PORATION, GREENWICH, DE:  
2,478,851. REN. 9-19-11. INT. CL. 4.

SONNY'S FRANCHISE COMPANY, ORLANDO, FL, SON-  
NY'S REAL PIT BAR B Q, INC., GAINESVILLE, FL:  
1,149,089. REN. 9-22-11. INT. CL. 30.

SONOVA HOLDING AG, 8712 STÄFA, SWITZERLAND:  
4,043,644, PUB. 1-25-2011. MULTIPLE CLASS, INT. CLS.  
10, 35, 41 AND 44.

SONY ERICSSON MOBILE COMMUNICATIONS AB,  
LUND, SWEDEN:  
4,046,146, INT. CL. 9.

SONY PICTURES TELEVISION INC., CULVER CITY, CA  
AND HARPO PRODUCTIONS, INC., CHICAGO, IL:  
4,046,629, INT. CL. 41.

SORRELS WHOLESALE, INC., LEXINGTON, TN:  
4,045,022, PUB. 8-9-2011. INT. CL. 28.

SOSLER, JAMES J., HAYDEN, ID:  
4,045,302, PUB. 8-9-2011. INT. CL. 41.

SOSNOWSKI, LESLIE LISHON, BOULDER, CO:  
4,044,198, PUB. 6-28-2011. INT. CL. 36.

SOTHYS INTERNATIONAL, PARIS 75008, FRANCE:  
2,491,118. REN. 9-17-11. INT. CL. 3.

SOUL HOLLYWOOD, L.L.C., COMMERCE, CA:  
4,045,685, INT. CL. 43.

SOUND ENHANCEMENT PRODUCTS, INC., CARY, IL,  
TEL-RAY ELECTRONICS MFG. CO., INC., HOLLY-  
WOOD, CA:  
1,164,466. REN. 9-20-11. INT. CL. 9.

SOURCE SOLUTIONS INTL., LTD., TAICHUNG, TAIWAN:  
4,045,137, PUB. 8-9-2011. INT. CL. 12.  
4,045,139, PUB. 8-9-2011. INT. CL. 12.

SOUTH BEACH BEVERAGE COMPANY, INC., NORWALK,  
CT:  
2,926,367, CANC. INT. CL. 32.

SOUTH BEND TRIBUNE CORPORATION, SOUTH BEND,  
IN:  
1,649,142. REN. 9-20-11. INT. CL. 16.

SOUTHCORP BRANDS PTY LIMITED, SOUTHBANK, VIC-  
TORIA, AUSTRALIA:  
2,495,226. REN. 9-20-11. INT. CL. 33.

SOUTHEAST LINEMAN TRAINING CENTER, LLC, TREN-  
TON, GA:  
4,045,243, PUB. 8-9-2011. INT. CL. 41.

SOUTHERN COMFORT PROPERTIES, INC., SAN RAFAEL,  
CA:  
4,046,214, INT. CL. 33.

SOUTHERN CROSS TECHNOLOGIES, INC., BOYNTON  
BEACH, FL:  
4,047,189, INT. CL. 19.

SOUTHWEST ENVIROTECH PARTNERS, LLC, JONES-  
TOWN, TX:  
2,926,937, CANC. INT. CL. 1.

SOUTHWEST ENVIROTECH SERVICES, INC., RICHARD-  
SON, TX:  
2,926,935, CANC. INT. CL. 1.  
2,926,936, CANC. INT. CL. 1.

SOUTHWEST TEXAS METHODIST HOSPITAL, SAN ANTO-  
NIO, TX:  
1,645,573. REN. 9-21-11. INT. CL. 41.

SOUTHWESTRE, ADDISON, TX:  
4,047,128, INT. CL. 36.

SOVEREIGN MILITARY HOSPITALLER ORDER OF ST.  
JOHN OF JERUSALEM OF RHODES AND OF MALTA,  
ROME, ITALY:  
4,043,673, PUB. 8-9-2011. MULTIPLE CLASS, INT. CLS.  
43, 44 AND 45.

SPACENAV, LLC, BOULDER, CO:  
4,047,156, INT. CL. 42.

SPADONI, STEFANO, NEW YORK, NY:  
4,043,974, PUB. 8-9-2011. INT. CL. 35.  
4,043,975, PUB. 8-9-2011. INT. CL. 41.

SPAFINDER, INC., NEW YORK, NY:  
4,046,713, INT. CL. 42.

SPAMFIGHTER APS, COPENHAGEN NV, DENMARK:  
4,045,269, PUB. 8-9-2011. INT. CL. 9.  
4,045,364, PUB. 8-9-2011. INT. CL. 9.

SPAN TECH LLC, GLASGOW, KY, SPAN TECH LLC,  
GLASGOW, KY:  
2,554,496. REN. 9-22-11. INT. CL. 7.

SPANGLER CANDY COMPANY, BRYAN, OH:  
4,046,917, INT. CL. 30.

SPARGO, CHRISTOPHER LYNN, SPOKANE, WA:  
2,927,002, CANC. INT. CL. 24.

SPARK INNOVATIONS, INC., KING CITY, CANADA:  
4,046,289, INT. CL. 11.

SPARTAN BRANDS, INC., NEW YORK, NY:  
4,046,604, INT. CL. 3.

SPATIAL HARMONICS GROUP, VENICE, CA:  
4,045,287, PUB. 8-9-2011. INT. CL. 41.

SPC RESOURCES, INC., HARTSVILLE, SC:  
4,046,815, INT. CL. 42.

SPECIAL AMERICA'S BBQ INC, MIAMI, FL:  
4,044,996, PUB. 8-9-2011. INT. CL. 29.

SPECIALTY BAKERS LLC, MARYSVILLE, PA:  
1,662,644. REN. 9-19-11. INT. CL. 30.

SPEED TO MARKET LIMITED, HONG KONG, HONG  
KONG:  
4,045,768, MULTIPLE CLASS, INT. CLS. 21 AND 24.

SPEEDCO, INC., CAYUGA, IN:  
2,521,146. REN. 9-19-11. INT. CL. 37.

SPEEDLEDGER AKTIEBOLAG, VÄSTRA FRÖLUNDA,  
SWEDEN:  
4,043,882, PUB. 8-9-2011. MULTIPLE CLASS, INT. CLS. 9,  
41 AND 42.

SPEEDWAY MOTORS, INC., LINCOLN, NE:  
4,045,066, PUB. 8-9-2011. MULTIPLE CLASS, INT. CLS. 28  
AND 35.

SPEEDWAY PROPERTIES COMPANY, LLC, LAS VEGAS,  
NV:  
2,491,098. REN. 9-22-11. MULTIPLE CLASS, INT. CLS. 6,  
14, 16, 18, 21, 24, 25, 28 AND 41.

SPENCER, KATHLEEN, BOXFORD, MA:  
4,045,169, PUB. 8-9-2011. INT. CL. 35.

SPERLING, NORMAN, SAN MATEO, CA:  
4,045,189, PUB. 8-9-2011. INT. CL. 16.

SPICE I2I LIMITED, 469001, SINGAPORE:  
4,044,081, PUB. 8-9-2011. MULTIPLE CLASS, INT. CLS. 9  
AND 38.

SPIGIT, INC., PLEASANTON, CA:  
4,045,389, PUB. 8-9-2011. INT. CL. 42.  
4,045,390, PUB. 8-9-2011. INT. CL. 42.  
4,045,391, PUB. 8-9-2011. INT. CL. 42.

SPIN MASTER LTD., TORONTO, ONTARIO, CANADA:  
2,926,696, CANC. INT. CL. 28.

SPINEFRONTIER, INC., BEVERLY, MA:  
4,046,830, INT. CL. 10.

SPIRAL INCORPORATED, CHANDLER, AZ, AKA SPIRAL:  
4,044,174, PUB. 8-9-2011. INT. CL. 35.

SPIRE, LLC, MONROE, CT:  
4,045,393, PUB. 8-9-2011. INT. CL. 35.

SPITZER MANAGEMENT, INC., ELYRIA, OH:  
2,488,979. REN. 9-19-11. INT. CL. 35.

SPOETTL, MARKUS, SALZBURG, AUSTRIA:  
2,927,062, CANC. INT. CL. 9.

- SPORTS NUTS, INC., PLANT CITY, FL:  
1,639,742. REN. 9-19-11. INT. CL. 16.  
1,639,743. REN. 9-19-11. INT. CL. 16.  
1,639,745. REN. 9-20-11. INT. CL. 16.  
1,641,260. REN. 9-19-11. INT. CL. 16.  
1,642,075. REN. 9-19-11. INT. CL. 16.
- SPORTSPIE, LLC, TUCSON, AZ:  
4,046,297. INT. CL. 41.
- SPORTVISION, INC., CHICAGO, IL, PRINCETON VIDEO  
IMAGE, INC., PRINCETON, NJ:  
2,538,443. REN. 9-18-11. INT. CL. 40.
- SPRING MILL BREAD CO., BETHESDA, MD:  
2,506,390. REN. 9-18-11. INT. CL. 30.
- SPRINGDELL ASSOCIATES, LLC, COATESVILLE, PA:  
4,046,832. INT. CL. 43.
- SPROUSE BUILDING PRODUCTS, INC., NEW MARTINS-  
VILLE, WV:  
2,609,271. REN. 9-21-11. INT. CL. 19.
- SPROUTSHOUT MEDIA CORPORATION, FITCHBURG,  
MA:  
4,045,457. PUB. 8-9-2011. INT. CL. 42.
- SPUR MARKETING LLC, HOUSTON, TX:  
2,926,624. CANC. INT. CL. 42.
- SPX CORPORATION, CHARLOTTE, NC, OWATONNA  
TOOL COMPANY, OWATONNA, MN:  
1,164,397. REN. 9-20-11. INT. CL. 7.
- SPX CORPORATION, CHARLOTTE, NC:  
2,490,406. REN. 9-21-11. INT. CL. 9.  
4,045,637. MULTIPLE CLASS, INT. CLS. 6, 7, 9, 11, 36, 37  
AND 40.
- SQI DIAGNOSTICS SYSTEMS INC., TORONTO, ONTARIO,  
CANADA:  
4,043,639. PUB. 7-19-2011. INT. CL. 5.
- SQUARE ONE PARACHUTES, INC., PERRIS, CA:  
2,428,041. CANC. INT. CL. 36.
- SRA INTERNATIONAL, INC., BUFORD, GA:  
4,044,547. PUB. 8-9-2011. INT. CL. 35.
- SRI INTERNATIONAL, MENLO PARK, CA:  
2,505,713. REN. 9-22-11. MULTIPLE CLASS, INT. CLS. 35,  
36 AND 42.
- SRS LABS, INC., SANTA ANA, CA:  
4,045,995. INT. CL. 9.
- SSM HEALTH CARE OF OKLAHOMA, INC., OKLAHOMA  
CITY, OK:  
4,044,621. PUB. 8-9-2011. INT. CL. 35.
- ST. FRANCIS WINERY AND VINEYARDS, L.P., SANTA  
ROSA, CA:  
4,044,020. PUB. 8-9-2011. INT. CL. 33.
- ST. GERMAIN, CLIF J., MANDEVILLE, LA:  
2,485,004. REN. 9-22-11. INT. CL. 16.
- ST. IVES LABORATORIES, INC., MELROSE PARK, IL, ST.  
IVES LABORATORIES, INC., MELROSE PARK, IL:  
1,172,768. REN. 9-20-11. INT. CL. 3.
- STA-RITE INDUSTRIES, LLC, DELAVAN, WI:  
1,654,752. REN. 9-20-11. INT. CL. 7.
- STAAB FUNERAL HOME, LTD., SPRINGFIELD, IL:  
2,495,994. REN. 9-22-11. INT. CL. 42.  
2,506,094. REN. 9-22-11. INT. CL. 42.
- STABILUS GMBH, 56070 KOBLENZ, FED REP GERMANY:  
2,492,875. REN. 9-20-11. INT. CL. 12.
- STACY RAY C/O LADON SWANN, MOBILE, AL:  
4,046,971. MULTIPLE CLASS, INT. CLS. 35 AND 41.
- STAMETS, JONATHAN P., TYLER HILL, PA:  
4,044,878. PUB. 8-9-2011. INT. CL. 41.
- STANDARD CHARTERED PLC, LONDON, EC2V 7SB,  
UNITED KINGDOM:  
4,046,311. MULTIPLE CLASS, INT. CLS. 16 AND 36.
- STANDARD HOMEOPATHIC COMPANY, LOS ANGELES,  
CA:  
4,046,058. INT. CL. 5.
- STANLEY LOGISTICS, INC., NEW BRITAIN, CT:  
2,926,639. CANC. MULTIPLE CLASS, INT. CLS. 9, 37  
AND 41.
- STANLEY SUPPLY & SERVICES, INC., ANDOVER, MA:  
2,509,637. REN. 9-22-11. INT. CL. 35.
- STAPLES THE OFFICE SUPERSTORE, LLC, FRAMING-  
HAM, MA:  
2,926,888. CANC. INT. CL. 16.
- STAR SIGHT INNOVATIONS, INC., LYMAN, WY:  
2,926,636. CANC. INT. CL. 20.
- STAR SINGLES, INC., HOLLYWOOD, FL:  
2,428,285. CANC. INT. CL. 16.
- STAR STRATEGIES, LLC, ST. LOUIS, MO:  
4,046,392. INT. CL. 35.  
4,046,394. INT. CL. 35.
- START COMMERCIAL LTD., EILAT, ISRAEL:  
4,044,215. PUB. 8-9-2011. MULTIPLE CLASS, INT. CLS. 9  
AND 45.
- STATE OF OREGON ACTING BY AND THROUGH THE  
STATE BOARD OF HIGHER EDUCATION ON BEHALF  
OF THE UNIVERSITY OF OREGON, EUGENE, OR:  
4,044,277. PUB. 8-9-2011. MULTIPLE CLASS, INT. CLS. 21  
AND 25.
- STATE UNIVERSITY OF NEW YORK AT NEW PALTZ,  
NEW PALTZ, NY:  
4,045,415. PUB. 8-9-2011. INT. CL. 41.
- STAY-GREEN, INC., SANTA CLARITA, CA:  
4,044,409. PUB. 8-9-2011. MULTIPLE CLASS, INT. CLS. 37  
AND 44.  
4,044,410. PUB. 8-9-2011. MULTIPLE CLASS, INT. CLS. 37  
AND 44.  
4,044,411. PUB. 8-9-2011. INT. CL. 44.  
4,044,412. PUB. 8-9-2011. INT. CL. 44.
- STEEL NETWORK, INC., THE, RALEIGH, NC:  
1,690,894. REN. 9-19-11. INT. CL. 37.
- STEIN TENNIS PRODUCTS LLC, LONG GROVE, IL:  
4,045,925. INT. CL. 28.
- STENGEL, ADAM M., NEW YORK, NY:  
4,045,871. MULTIPLE CLASS, INT. CLS. 16 AND 25.
- STEPAN COMPANY, NORTHFIELD, IL:  
723,173. REN. 9-19-11. U.S. CL. 46 (INT. CL. 29).
- STERNICK, SCOTT M., WEST NEW YORK, NJ:  
4,045,645. INT. CL. 21.
- STETSON UNIVERSITY, INC., DELAND, FL:  
2,256,156. AM. INT. CL. 16.
- STEUTE MEDITECH, INC., RIDGEFIELD, CT:  
4,046,490. INT. CL. 40.
- STEVE RINKENBERGER, PHOENIX, AZ:  
4,045,738. INT. CL. 35.
- STEVEN MADDEN, LTD., LONG ISLAND, NY:  
2,926,726. CANC. INT. CL. 26.
- STEVIES, INC., LONG ISLAND CITY, NY:  
2,926,124. CANC. INT. CL. 28.
- STI, INC., MEMPHIS, TN:  
4,045,946. INT. CL. 9.
- STILES, CHARLES RICHARD, COPPERHILL, TN:  
4,045,734. INT. CL. 16.
- STILL LIVIN LLC, MORGAN, UT:  
4,044,075. PUB. 8-9-2011. INT. CL. 16.
- STINSON MORRISON HECKER LLP, KANSAS CITY, MO:  
4,046,430. INT. CL. 45.
- STONEWALL KITCHEN, LLC, YORK, ME:  
4,043,969. PUB. 8-9-2011. MULTIPLE CLASS, INT. CLS. 3,  
21, 24, 29, 30, 32, 35 AND 43.
- STONYFIELD FARM, INC., LONDONDERRY, NH:  
4,045,508. PUB. 8-9-2011. MULTIPLE CLASS, INT. CLS. 5  
AND 29.
- STOPLIFT, INC., CAMBRIDGE, MA, DBA STOPLIFT  
CHECKOUT VISION SYSTEMS:  
4,043,986. PUB. 8-9-2011. INT. CL. 9.
- STORAGE BATTERY SYSTEMS, INC., BUTLER, WI:  
4,043,611. PUB. 8-9-2011. INT. CL. 16.
- STORMTECH LLC, WETHERSFIELD, CT:  
2,611,659. REN. 9-20-11. INT. CL. 11.
- STOUT O'BRIEN, WENDY, TRAVERSE CITY, MI:  
2,467,764. REN. 9-20-11. INT. CL. 16.
- STOUT STUFF, LLC, BENTONVILLE, AR:  
4,046,980. INT. CL. 28.
- STRANDS, LLC, PHOENIX, AZ:  
4,043,696. PUB. 8-9-2011. INT. CL. 35.
- STRANGER & STRANGER LIMITED, LONDON, UNITED  
KINGDOM:  
4,043,715. PUB. 1-18-2011. INT. CL. 33.  
4,043,716. PUB. 1-18-2011. INT. CL. 33.
- STRATEGIC PARTNERS, INC., PACOIMA, CA:  
2,926,678. CANC. INT. CL. 25.

STRATHMORE PARTNERS LP, CONCORD, NH:  
2,926,204, CANC. INT. CL. 35.

STRAUSS BRANDS INCORPORATED, HALES CORNERS,  
WI:  
4,045,694, INT. CL. 29.

STREAMLINE BY DESIGN, LLC, INDIANAPOLIS, IN:  
4,044,914, PUB. 8-9-2011. MULTIPLE CLASS, INT. CLS. 35  
AND 45.

STRECK, INC., OMAHA, NE:  
4,047,098, INT. CL. 9.  
4,047,099, INT. CL. 9.

STRENGTH SYSTEMS USA, LLC, LARGO, FL:  
2,926,690, CANC. INT. CL. 5.

STRIPES LLC, CORPUS CHRISTI, TX:  
4,045,109, PUB. 8-9-2011. INT. CL. 4.

STRIPT WAX BAR, LLC, SAN FRANCISCO, CA:  
4,045,047, PUB. 8-9-2011. INT. CL. 44.

STRONG CONSTRUCTION MACHINERY CO., LTD, SHAN-  
DONG 276000, CHINA:  
4,045,050, PUB. 8-9-2011. INT. CL. 7.

STUDIO MODERNA SA, LUGANO, SWITZERLAND:  
2,808,545, CANC. INT. CL. 20.

STURDY CORPORATION, WILMINGTON, DE, STURDY  
TRUCK EQUIPMENT, INC., WILMINGTON, NC:  
1,166,157, REN. 9-22-11. INT. CL. 7.

STURDY CORPORATION, WILMINGTON, NC, STURDY  
TRUCK EQUIPMENT, INC., WILMINGTON, NC:  
1,166,158, REN. 9-22-11. INT. CL. 7.

STURDY GIRL SPORTS, LLC, LOUISVILLE, CO:  
4,046,731, INT. CL. 25.

STURM FOODS, INC., MANAWA, WI:  
2,600,763, REN. 9-20-11. INT. CL. 40.

STYLE EYES, INC., COSTA MESA, CA:  
2,601,062, REN. 9-21-11. INT. CL. 9.  
2,604,756, REN. 9-21-11. INT. CL. 9.  
2,604,768, REN. 9-21-11. INT. CL. 9.  
2,607,545, REN. 9-21-11. INT. CL. 9.

SU, WEN CHIEH, TAIPEI COUNTY 235, TAIWAN:  
4,046,249, INT. CL. 9.

SUAREZ CORPORATION INDUSTRIES, N. CANTON, OH:  
2,927,029, CANC. INT. CL. 10.

SUBSTANCE ABUSE SPECIALTIES, INC., MARIETTA, GA:  
2,306,164, CANC. INT. CL. 5.

SUGAR MEMORIES, L.L.C., CLEVELAND, OH:  
2,496,107, REN. 9-21-11. INT. CL. 30.

SUGARGROVE HAM, LLC, VILAS, NC:  
4,045,495, PUB. 8-9-2011. INT. CL. 29.

SUMITOMO CHEMICAL CO., LTD., TOKYO, JAPAN:  
916,989, REN. 9-20-11. U.S. CL. 6 (INT. CL. 5).

SUMITOMO ELECTRIC INDUSTRIES, LTD., OSAKA-SHI  
OSAKA, JAPAN:  
1,649,936, REN. 9-19-11. INT. CL. 7.

SUMITOMO RUBBER INDUSTRIES, LTD., KOBE-SHI,  
HYOGO, JAPAN:  
2,488,128, REN. 9-17-11. INT. CL. 12.

SUMITOMO WAREHOUSE CO., LTD., THE, NISHI-KU,  
OSAKA, JAPAN:  
1,162,170, REN. 9-20-11. MULTIPLE CLASS, INT. CLS. 36  
AND 39.

SUMMER STREET CAPITAL PARTNERS, LLC, BUFFALO,  
NY:  
4,046,339, INT. CL. 36.

SUMMIT CAPITAL ADVISORS, INC., YAKIMA, WA:  
4,046,676, INT. CL. 36.

SUN JEWELRY CORPORATION, LOS ANGELES, CA:  
4,045,253, PUB. 8-9-2011. INT. CL. 35.  
4,045,258, PUB. 8-9-2011. INT. CL. 35.

SUN ON - SUNNEX INTERNATIONAL HOLDING LTD.,  
KOWLOON, HONG KONG:  
2,428,609, CANC. INT. CL. 25.

SUN SANDALS, LLC, MELBOURNE, FL:  
4,044,505, PUB. 8-9-2011. INT. CL. 14.

SUNCOAST SCHOOLS FEDERAL CREDIT UNION, TAM-  
PA, FL:  
4,046,268, INT. CL. 36.

SUNDECK PRODUCTS USA, INC., ARLINGTON, TX:  
2,576,167, REN. 9-20-11. MULTIPLE CLASS, INT. CLS. 19  
AND 40.

SUNFLOWER DERMATOLOGY AND DAY SPA, LLC,  
RIVERSIDE, MO:  
4,046,098, INT. CL. 3.  
4,046,099, INT. CL. 3.

SUNKIST APPAREL, INC., KEY WEST, FL, DBA TOUCHED  
BY THE SUN:  
2,736,736, CANC. MULTIPLE CLASS, INT. CLS. 3 AND  
35.

SUNMARKS, LLC, WILMINGTON, DE:  
2,504,441, REN. 9-19-11. INT. CL. 37.

SUNRAYSE, LLC, MENLO PARK, CA:  
4,044,487, PUB. 8-9-2011. INT. CL. 35.

SUPER BAKERY, INCORPORATED, PITTSBURGH, PA:  
4,045,945, INT. CL. 32.

SUPER DUPER, INC., GREENVILLE, SC, DBA SUPER  
DUPER PUBLICATIONS:  
2,504,141, CANC. INT. CL. 16.

SUPER SERIES BASEBALL OF AMERICA, INC., MESA, AZ:  
2,616,442, REN. 9-21-11. INT. CL. 41.

SUPER SWEEP, INC., BOYNTON BEACH, FL:  
4,044,352, PUB. 8-9-2011. MULTIPLE CLASS, INT. CLS. 6  
AND 21.

SUPERIOR AUTO WORKS, LLC, CARMEL, IN:  
4,044,273, PUB. 8-9-2011. INT. CL. 37.

SUPERIOR COMMUNICATIONS, INC., IRWINDALE, CA:  
4,044,092, PUB. 5-3-2011. INT. CL. 9.

SUPERIOR TATTOO EQUIPMENT CO., PHOENIX, AZ:  
2,454,754, REN. 9-19-11. INT. CL. 7.

SUPERMEDIA LLC, DALLAS/FORT WORTH AIRPORT,  
TX:  
2,927,010, CANC. INT. CL. 35.

SUPPLY CHAIN SERVICES, CORAL GABLES, FL:  
4,044,095, PUB. 8-9-2011. INT. CL. 9.

SUPPORT.COM, INC., REDWOOD CITY, CA, SUPPORT-  
COM, INC., REDWOOD CITY, CA:  
2,530,357, REN. 9-20-11. MULTIPLE CLASS, INT. CLS. 9  
AND 42.

SUREPAYROLL, INC., GLENVIEW, IL:  
3,117,964, AM. INT. CL. 35.

SURGITAL S.P.A., CONSELICE FRAZIONE LAVEZZOLA  
(RA, ITALY):  
4,043,778, PUB. 8-9-2011. MULTIPLE CLASS, INT. CLS. 29  
AND 30.

SURMODICS, INC., EDEN PRAIRIE, MN:  
4,046,414, INT. CL. 1.

SURRY COUNTY ECONOMIC DEVELOPMENT FOUNDA-  
TION, DOBSON, NC:  
4,045,988, MULTIPLE CLASS, INT. CLS. 35, 39 AND 40.

SURVEYMONKEY.COM, LLC, PALO ALTO, CA:  
4,046,068, MULTIPLE CLASS, INT. CLS. 35 AND 42.

SUSAN C. LARSON, MONTCLAIR, CA:  
4,045,971, INT. CL. 13.

SUSAN MURPHY PILIPCHUK, ROYAL OAK, MI, DBA  
CIRCLE R BRANDS AND WILLIAM C. PILIPCHUK,  
ROYAL OAK, MI, DBA CIRCLE R BRANDS:  
2,436,438, REN. 9-22-11. INT. CL. 35.

SUSAN STERN PUBLIC RELATIONS, INC., CRANFORD,  
NJ, DBA STERN + ASSOCIATES:  
4,046,857, INT. CL. 35.

SUSPENDED SOLUTIONS LLC, LEEDS, NY:  
4,045,903, INT. CL. 11.

SUSSEX BANCORP, FRANKLIN, NJ:  
4,044,907, PUB. 8-9-2011. INT. CL. 36.

SUZANNE KRYDER, INC., WASHINGTON, DC:  
4,044,890, PUB. 8-9-2011. INT. CL. 16.

SUZHOU SNAIL ELECTRONIC CO., LTD., CHINA:  
4,043,796, PUB. 8-9-2011. MULTIPLE CLASS, INT. CLS. 9,  
41 AND 42.

SWA HOLDING COMPANY, INC., WILMINGTON, DE:  
4,044,523, PUB. 8-9-2011. INT. CL. 19.

SWANSON, JOSEPH L., WYOMING, MI:  
2,926,490, CANC. INT. CL. 16.

SWEDECOLLECTION, LLC, COLLIERVILLE, TN:  
4,046,127, INT. CL. 20.

SWEET CHEEKS, INC., HOLLY SPRINGS, NC:  
4,046,940, INT. CL. 40.

- SWENSEN'S, INC., MARKHAM, ONTARIO, CANADA,  
SWENSEN'S ICE CREAM COMPANY, SAN FRANCISCO,  
CA:  
1,146,477. REN. 9-20-11. MULTIPLE CLASS, INT. CLS. 35  
AND 42.
- SWIMC, INC., NEWARK, DE:  
1,181,744. REN. 9-20-11. INT. CL. 2.
- SWIMC, INC., NEWARK, DE, WESTERN AUTOMOTIVE  
FINISHES COMPANY, GRAND PRAIRIE, TX:  
1,653,376. REN. 9-20-11. INT. CL. 1.
- SWISHER INTERNATIONAL, INC., JACKSONVILLE, FL:  
396,981. REN. 9-16-11. U.S. CL. 17 (INT. CL. 34).
- SWISHER INTERNATIONAL, INC., JACKSONVILLE, FL,  
JNO. H. SWISHER & SON, INC., JACKSONVILLE, FL:  
735,560. REN. 9-17-11. U.S. CL. 17 (INT. CL. 34).
- SWIT ELECTRONICS CO., LTD., NANJING, CHINA:  
4,044,640, PUB. 8-9-2011. INT. CL. 9.  
4,044,646, PUB. 8-9-2011. INT. CL. 11.
- SWORD-GROUP SA, NEW YORK, NY:  
4,043,634, PUB. 8-9-2011. MULTIPLE CLASS, INT. CLS. 35  
AND 42.
- SYAGE, INC., FULLERTON, CA:  
4,045,152, PUB. 8-9-2011. INT. CL. 38.
- SYDA FOUNDATION, SOUTH FALLSBURG, NY:  
4,045,542, PUB. 8-9-2011. INT. CL. 16.
- SYMETRA LIFE INSURANCE COMPANY, BELLEVUE, WA:  
2,926,968, CANC. INT. CL. 36.
- SYMONS, DOMINIC, PASADENA, CA:  
4,047,238, INT. CL. 9.
- SYNCRON INTERNATIONAL AB, MALMO, SWEDEN:  
2,500,310. REN. 9-19-11. INT. CL. 35.
- SYNTELLECT INC., PHOENIX, AZ:  
2,456,786. REN. 9-16-11. INT. CL. 41.
- SYSCO CORPORATION, HOUSTON, TX:  
2,927,003, CANC. INT. CL. 30.
- SYSMEX CORPORATION, KOBE, HYOGO, JAPAN:  
4,043,649, PUB. 8-9-2011. MULTIPLE CLASS, INT. CLS. 1,  
3, 5, 9, 10, 37, 39, 42 AND 44.  
4,043,656, PUB. 8-9-2011. MULTIPLE CLASS, INT. CLS. 1,  
3, 5, 9 AND 10.
- S2 YACHTS INC., HOLLAND, MI, DBA TIARA YACHTS:  
2,580,541. REN. 9-22-11. MULTIPLE CLASS, INT. CLS. 16  
AND 20.
- T J SMITH & NEPHEW LIMITED, HU3 2BN HULL, UNITED  
KINGDOM, PERSTORP AKTIEBOLAG, PERSTORP, SWE-  
DEN:  
1,165,168. REN. 9-20-11. INT. CL. 5.
- T T E TRANSCRIPTS WORLDWIDE, LTD., HUNTLEY, IL:  
4,046,186, INT. CL. 35.
- T.K. GARMENT SUPPLY CO., LTD., FUKUI-CITY, FUKUI-  
PREF, JAPAN:  
4,044,789, PUB. 8-9-2011. MULTIPLE CLASS, INT. CLS. 18  
AND 25.
- T&B ENTERPRISES INC., GARDNER, KS:  
4,047,201, MULTIPLE CLASS, INT. CLS. 35 AND 39.
- T-MOBILE USA, INC., BELLEVUE, WA:  
4,045,764, INT. CL. 9.
- TAFFY PRODUCTIONS, LLC, WOODLAND HILLS, CA:  
4,045,689, INT. CL. 9.  
4,045,690, INT. CL. 25.  
4,045,691, INT. CL. 28.
- TAGAWA GREENHOUSES, INC., BRIGHTON, CO:  
4,044,793, PUB. 8-9-2011. INT. CL. 1.
- TAGER, JEAN, FORT BRAGG, CA, DBA BURGLABAR:  
2,428,630, CANC. INT. CL. 20.
- TAGGLETOOTH LLC, HINTON, OK:  
4,044,322, PUB. 8-9-2011. INT. CL. 35.
- TAHOE BOARD WORKS, LLC, RENO, NV:  
4,046,463, INT. CL. 28.
- TAITEX ENTERPRISE CO., HOUSTON, TX:  
1,665,118. REN. 9-17-11. INT. CL. 28.
- TAIWAN LIPOSOME CO., LTD., TAIPEI, TAIWAN:  
4,045,749, INT. CL. 5.
- TAIYI PRECISION TECH CORP., TAIPEI HSIEN, TAIWAN:  
4,046,460, INT. CL. 42.
- TAIZHOU JULI TOOLS CO., LTD., CHINA:  
4,043,832, PUB. 8-9-2011. INT. CL. 7.
- TALENTGUARD, INC., AUSTIN, TX:  
4,045,400, PUB. 8-9-2011. MULTIPLE CLASS, INT. CLS.  
16, 35 AND 41.
- TALITHA ROSE LLC, WETMORE, KS, DBA THE YUM-  
YUM SHOPPE:  
4,043,721, PUB. 8-9-2011. INT. CL. 3.
- TALL GUY WINES, LLC, ST. HELENA, CA:  
4,046,901, INT. CL. 33.
- TALON HOLDINGS, LLC, LEO, IN:  
4,046,000, INT. CL. 1.  
4,046,001, INT. CL. 1.
- TAMPA BAY RAYS BASEBALL LTD., ST. PETERSBURG,  
FL:  
4,045,827, INT. CL. 14.  
4,046,421, INT. CL. 41.
- TANAKA DENTAL PRODUCTS, SKOKIE, IL:  
4,044,715, PUB. 8-9-2011. INT. CL. 2.  
4,044,717, PUB. 8-9-2011. INT. CL. 2.
- TANDBERG DATA HOLDINGS S.A.R.L., LUXEMBOURG,  
LUXEMBOURG:  
4,046,029, INT. CL. 9.
- TANGO ARGENTINO PRODUCTIONS, LLC, TAMPA, FL:  
4,044,951, PUB. 8-9-2011. INT. CL. 25.
- TAPCO, INC., CHATTANOOGA, TN:  
4,046,228, MULTIPLE CLASS, INT. CLS. 6 AND 18.
- TAQUERIA LOS OCAMPO, INC., ST. PAUL, MN:  
4,044,312, PUB. 8-9-2011. INT. CL. 43.
- TARA MARIE, INC., NEW YORK, NY:  
4,044,838, PUB. 8-9-2011. INT. CL. 41.
- TARGET BRANDS, INC., MINNEAPOLIS, MN:  
2,926,667, CANC. INT. CL. 28.  
2,926,668, CANC. INT. CL. 28.  
4,046,184, MULTIPLE CLASS, INT. CLS. 20, 21, 24, 25, 26  
AND 28.
- TASER INTERNATIONAL, INC., SCOTTSDALE, AZ:  
4,045,755, INT. CL. 9.  
4,045,908, INT. CL. 18.  
4,045,909, INT. CL. 41.
- TASLAKIAN PETER E., NORTH HILLS, CA:  
4,044,873, PUB. 8-9-2011. INT. CL. 30.
- TASTEFUL SELECTIONS, LLC, BANCROFT, WI:  
4,045,191, PUB. 8-9-2011. INT. CL. 31.
- TATUAJE CIGARS, INC., LOS ANGELES, CA:  
4,046,541, INT. CL. 34.  
4,046,625, INT. CL. 34.
- TAUBMAN COMPANY LLC, THE, BLOOMFIELD HILLS,  
MI:  
2,581,430. REN. 9-20-11. INT. CL. 35.
- TAVOLA S.P.A., 20141 MILANO, ITALY:  
2,926,640, CANC. INT. CL. 5.
- TAWA CHARITABLE FOUNDATION, BUENA PARK, CA:  
4,045,737, INT. CL. 36.
- TAYBANDZ, INC., SCARSDALE, NY:  
4,046,302, INT. CL. 36.  
4,047,100, INT. CL. 36.
- TAYFAN TEKSTIL SANAYI VE TICARET LIMITED SIRKE-  
TI, TURKEY:  
4,043,818, PUB. 8-9-2011. INT. CL. 25.
- TAYLOR ENGLISH DUMA LLP, ATLANTA, GA:  
4,047,017, INT. CL. 45.
- TAYLOR MADE GOLF COMPANY, INC., CARLSBAD, CA:  
2,557,111. REN. 9-22-11. MULTIPLE CLASS, INT. CLS. 18,  
25 AND 28.
- TAYLOR MADE GROUP, LLC, GLOVERSVILLE, NY:  
2,317,934, CANC. INT. CL. 6.
- TAZAKI FOODS LIMITED, LONDON N3 2SB, ENGLAND:  
4,043,930, PUB. 6-21-2011. MULTIPLE CLASS, INT. CLS.  
29, 30, 31, 32 AND 33.
- TCI AUTOMOTIVE, LLC, MEMPHIS, TN, TORQUE CON-  
VERTERS, INC., ASHLAND, MS:  
1,656,185. REN. 9-20-11. INT. CL. 12.
- TE KOOP LIMITED, UNITED KINGDOM:  
4,043,829, PUB. 8-9-2011. MULTIPLE CLASS, INT. CLS.  
19, 41 AND 42.
- TEAM SURVIVOR TAMPA BAY, INC., TAMPA, FL, AKA  
PINK DRAGON LADIES:  
4,044,557, PUB. 8-9-2011. INT. CL. 45.

TEAM TBA, INC., MILWAUKEE, WI:  
2,576,704. REN. 9-16-11. INT. CL. 35.

TEAMLAVA, LLC, REDWOOD CITY, CA:  
4,045,351. PUB. 8-9-2011. MULTIPLE CLASS, INT. CLS. 9  
AND 41.

TECHMARKET COMMUNICATIONS, LLC, SAN MATEO,  
CA:  
2,992,011. CANC. INT. CL. 41.

TECHTRONIC FLOOR CARE TECHNOLOGY LIMITED,  
ROAD TOWN, TORTOLA, BR. VIRGIN ISLANDS:  
4,046,685. INT. CL. 7.

TECHTRONIC OUTDOOR PRODUCTS TECHNOLOGY  
LIMITED, HAMILTON, BERMUDA:  
2,926,872. CANC. MULTIPLE CLASS, INT. CLS. 7 AND 8.

TECMO KOEI AMERICA CORPORATION, BURLINGAME,  
CA:  
4,045,853. INT. CL. 9.

TECMO KOEI GAMES CO., LTD., YOKOHAMA, KANAGA-  
WA, JAPAN:  
4,046,996. INT. CL. 9.

TECOMATE WILDLIFE SYSTEMS, LLC, SAN ANTONIO,  
TX:  
4,045,751. INT. CL. 41.

TEE FURY LLC, IRVINE, CA:  
4,044,738. PUB. 8-9-2011. MULTIPLE CLASS, INT. CLS. 25  
AND 35.

TEGRA MEDICAL HOLDINGS, LLC, FRANKLIN, MA:  
4,045,769. MULTIPLE CLASS, INT. CLS. 40 AND 42.

TEKNION LIMITED, DOWNVIEW, ONTARIO, CANADA,  
TEKNION FURNITURE SYSTEMS LIMITED, TORONTO,  
ONTARIO M3J M6, CANADA:  
2,485,554. REN. 9-20-11. INT. CL. 20.

TEKTRONIX CANADA INC., MARKHAM, ONTARIO,  
MINACOM LABS INC., MONTREAL, QUEBEC H2X 2T5,  
CANADA:  
2,448,303. REN. 9-18-11. INT. CL. 9.

TELARUS, INC., DRAPER, UT:  
4,044,986. PUB. 8-9-2011. INT. CL. 35.

TELCOR INC, LINCOLN, NE:  
4,044,177. PUB. 8-9-2011. INT. CL. 9.

TELECO, INC., GREENVILLE, SC:  
2,428,118. CANC. INT. CL. 9.

TELECOM SERVICE BUREAU, INC., OCALA, FL:  
4,044,471. PUB. 8-9-2011. INT. CL. 38.

TELEFLEX INCORPORATED, LIMERICK, PA:  
2,479,796. REN. 9-20-11. INT. CL. 10.

TELEMICS, INC., LOUISVILLE, KY:  
2,926,793. CANC. MULTIPLE CLASS, INT. CLS. 9, 37  
AND 42.

TELEVISION FOOD NETWORK, G.P., NEW YORK, NY:  
4,046,554. INT. CL. 41.

TELSOURCE CORPORATION, FAIRFIELD, NJ:  
4,046,026. MULTIPLE CLASS, INT. CLS. 37, 38 AND 42.

TENCENT HOLDINGS LIMITED, GEORGE TOWN, CAY-  
MAN ISLANDS:  
4,046,278. INT. CL. 41.

TENNECO AUTOMOTIVE OPERATING COMPANY INC.,  
LAKE FOREST, IL:  
4,047,020. INT. CL. 7.

TENNESSEE FARMERS COOPERATIVE, LAVERGNE, TN:  
4,046,455. INT. CL. 31.

TENNIS AND FRIENDS S.L., BARCELONA, SPAIN:  
4,043,961. PUB. 8-9-2011. MULTIPLE CLASS, INT. CLS. 25  
AND 41.

TENNRICH INTERNATIONAL CORP., TAOYUAN HSIEH,  
TAIWAN:  
4,044,805. PUB. 8-9-2011. INT. CL. 9.

TENSHON, LLC, MESA, AZ:  
4,047,150. INT. CL. 40.

TENSILICA, INC., SANTA CLARA, CA:  
2,550,384. REN. 9-20-11. INT. CL. 9.

TEOCALLI, LLC, INCLINE VILLAGE, NV:  
4,045,757. INT. CL. 5.

TERRA INDUSTRIES INC., SIOUX CITY, IA:  
2,995,902. COR. INT. CL. 42.

TERRAZAS, GUADALUPE, PEARLAND, TX:  
4,044,718. PUB. 8-9-2011. INT. CL. 37.

TERRE DA VINO S.P.A., I-12060 BAROLO (CN), ITALY:  
4,043,833. PUB. 8-9-2011. INT. CL. 33.

TESSCO COMMUNICATIONS INCORPORATED, HUNT  
VALLEY, MD:  
4,045,291. PUB. 8-9-2011. INT. CL. 35.

TETRA PHARM 1997 LTD., TEL AVIV, ISRAEL:  
4,046,308. INT. CL. 3.

TETRIS ONLINE, INC., HONOLULU, HI:  
4,046,397. INT. CL. 9.

TEVA PHARMACEUTICALS USA, INC., NORTH WALES,  
PA:  
4,046,272. INT. CL. 5.

TEXAS BEST SMOKEHOUSE, INC., WAXAHACHIE, TX:  
3,321,981. AM. MULTIPLE CLASS, INT. CLS. 29 AND 30.

TEXAS CHILDREN'S HOSPITAL, HOUSTON, TX:  
2,467,101. REN. 9-19-11. MULTIPLE CLASS, INT. CLS. 41  
AND 42.

TEXAS CHILDREN'S HOSPITAL, HOUSTON, TX:  
2,468,990. REN. 9-20-11. MULTIPLE CLASS, INT. CLS. 41  
AND 42.  
2,496,726. REN. 9-20-11. MULTIPLE CLASS, INT. CLS. 41  
AND 42.

TEXAS COUNSELING ASSOCIATION, AUSTIN, TX:  
4,043,707. PUB. 8-9-2011. INT. CL. 9.  
4,043,708. PUB. 8-9-2011. INT. CL. 35.

TEXAS STATE TECHNICAL COLLEGE, WACO, TX:  
4,044,104. PUB. 8-9-2011. INT. CL. 41.

TEXTRON INNOVATIONS INC., PROVIDENCE, RI:  
1,163,640. REN. 9-19-11. INT. CL. 12.

THALER, MIKE, WEST LINN, OR:  
2,428,742. CANC. INT. CL. 16.

THATCHER'S FUNERAL HOME, INC., KANSAS CITY, KS:  
4,044,543. PUB. 8-9-2011. INT. CL. 45.

THE ACI GROUP, INC., BALTIMORE, MD:  
4,044,371. PUB. 8-9-2011. INT. CL. 35.

THE ADVOCATE, LLC, DICKSON, TN:  
4,044,484. PUB. 8-9-2011. INT. CL. 45.

THE ANNAPOLIS GROUP, LTD., ANNAPOLIS, MD:  
4,047,145. MULTIPLE CLASS, INT. CLS. 35, 36, 37, 41, 42  
AND 45.

THE ARGEN CORPORATION, SAN DIEGO, CA:  
286,436. REN. 9-19-11. U.S. CL. 44 (INT. CL. 5).

THE BANK OF TOKYO-MITSUBISHI UFJ, LTD., NEW  
YORK, NY:  
2,926,919. CANC. INT. CL. 36.

THE BARE BOARD GROUP, INC., LARGO, FL:  
4,044,832. PUB. 8-9-2011. INT. CL. 35.

THE BIG ISLAND BEE COMPANY, LLC, KEALAKEKUA,  
HI:  
4,044,877. PUB. 8-9-2011. INT. CL. 30.

THE BODYGYM CORPORATION, HILLSBOROUGH, NJ:  
4,045,633. INT. CL. 25.

THE BRADY KOHN FOUNDATION, WILMINGTON, DE:  
4,044,835. PUB. 8-9-2011. INT. CL. 36.

THE BRAINY BABY COMPANY, LLC, SUWANEE, GA:  
4,046,077. INT. CL. 35.

THE CARTOON NETWORK, INC., ATLANTA, GA:  
4,046,154. INT. CL. 38.

THE CISCO COMPANIES, INDIANAPOLIS, IN:  
4,046,343. INT. CL. 35.

THE COCA-COLA COMPANY, ATLANTA, GA:  
4,045,847. INT. CL. 32.

THE CODEMASTERS SOFTWARE COMPANY LIMITED,  
WARWICKSHIRE, UNITED KINGDOM:  
4,045,835. INT. CL. 9.

THE COLLECTIVE MANAGEMENT GROUP LLC, BEV-  
ERLY HILLS, CA:  
4,044,480. PUB. 8-9-2011. INT. CL. 41.

THE COLMAN GROUP, INC., ELKHORN, WI:  
4,044,688. PUB. 8-9-2011. INT. CL. 21.

THE CPD CERTIFICATION SERVICE LIMITED, LONDON  
W5 5ER, UNITED KINGDOM:  
4,043,824. PUB. 8-9-2011. INT. CL. 41.

- THE CROWN IN RIGHT OF THE STATE OF VICTORIA, REPRESENTED BY AND ACTING THROUGH THE DEPARTMENT, THE DEPARTMENT OF EDUCATION AND EARLY CHILDHOOD DEVELOPMENT, AUSTRALIA:  
4,043,779, PUB. 8-9-2011. MULTIPLE CLASS, INT. CLS. 9, 16 AND 41.  
4,043,780, PUB. 8-9-2011. MULTIPLE CLASS, INT. CLS. 9, 16 AND 41.  
4,043,781, PUB. 8-9-2011. MULTIPLE CLASS, INT. CLS. 9, 16 AND 41.
- THE DELANEY CO., CUMMING, GA:  
4,046,798, INT. CL. 6.  
4,046,799, INT. CL. 6.  
4,047,158, INT. CL. 6.
- THE DEPARTMENT OF THE NAVY, ARLINGTON, VA:  
4,045,123, PUB. 8-9-2011. INT. CL. 41.  
4,045,199, PUB. 8-9-2011. INT. CL. 41.  
4,045,207, PUB. 8-9-2011. INT. CL. 41.
- THE DILLER CORPORATION, CINCINNATI, OH:  
1,654,320. REN. 9-16-11. INT. CL. 17.
- THE DIRECTV GROUP, INC., EL SEGUNDO, CA:  
2,481,355. REN. 9-20-11. INT. CL. 9.
- THE DOLLYWOOD COMPANY, PIGEON FORGE, TN:  
4,045,776, MULTIPLE CLASS, INT. CLS. 14 AND 41.
- THE DORSCHER GROUP, WEST HENRIETTA, NY, AKA DORSCHER AUTOMOTIVE GROUP:  
4,045,421, PUB. 8-9-2011. INT. CL. 35.  
4,045,423, PUB. 8-9-2011. INT. CL. 35.
- THE DUN & BRADSTREET CORPORATION, SHORT HILLS, NJ:  
4,046,521, MULTIPLE CLASS, INT. CLS. 35 AND 36.
- THE EI GROUP, INC., MORRISVILLE, NC:  
4,044,705, PUB. 8-9-2011. INT. CL. 42.  
4,044,706, PUB. 8-9-2011. INT. CL. 42.
- THE ELP GROUP, LLC, LONGBOAT KEY, FL:  
4,045,342, PUB. 8-9-2011. INT. CL. 7.
- THE ESCAPE BAND INC., NORRISTOWN, PA, FORMERLY REALITY STRICKEN INC.:  
4,043,886, PUB. 8-9-2011. INT. CL. 9.
- THE ETHER, HOLLYWOOD, CA:  
4,044,939, PUB. 8-9-2011. MULTIPLE CLASS, INT. CLS. 35, 41 AND 42.
- THE EXPRESS CAFE AND BAKERY, LLC, SAVANNAH, GA, DBA GOOSE FEATHERS:  
4,045,362, PUB. 8-9-2011. INT. CL. 30.
- THE FADER FINANCIAL GROUP, LTD, SILVER SPRING, MD, TA FADER FINANCIAL:  
4,044,387, PUB. 8-9-2011. INT. CL. 35.
- THE FINANCIAL INFORMATION GROUP INC., EATON-TOWN, NJ:  
4,046,040, MULTIPLE CLASS, INT. CLS. 9 AND 35.
- THE FLOWALKING COMPANY LLC, MUNSTER, IN:  
4,047,092, MULTIPLE CLASS, INT. CLS. 16 AND 41.  
4,047,094, INT. CL. 16.
- THE FONT BUREAU INC., BOSTON, MA:  
4,044,627, PUB. 8-9-2011. INT. CL. 9.  
4,044,629, PUB. 8-9-2011. INT. CL. 9.
- THE FONT BUREAU, INC., BOSTON, MA:  
4,044,210, PUB. 5-3-2011. INT. CL. 9.
- THE GENERAL HOSPITAL CORPORATION, BOSTON, MA:  
4,046,733, INT. CL. 16.
- THE GINGRICH TEAM, LLC, KNOXVILLE, TN:  
4,045,276, PUB. 8-9-2011. INT. CL. 35.
- THE GLENLIVET DISTILLERS LTD, LONDON W6 9RS, UNITED KINGDOM:  
4,043,691, PUB. 8-9-2011. INT. CL. 33.
- THE GLOBAL LAW GROUP, PLC, RICHMOND, VA:  
4,044,808, PUB. 8-9-2011. INT. CL. 45.
- THE GLOWACKI GROUP, LLC, LOS ANGELES, CA:  
4,044,553, PUB. 8-9-2011. INT. CL. 41.
- THE GOODYEAR TIRE & RUBBER COMPANY, AKRON, OH:  
4,044,693, PUB. 8-9-2011. INT. CL. 12.
- THE GRIEF RECOVERY INSTITUTE, LLC, SHERMAN OAKS, CA:  
2,019,818 NEW CERT. 10-25-2011. INT. CL. 41.
- THE H.D. LEE COMPANY, INC., WILMINGTON, DE:  
2,926,811, CANC. MULTIPLE CLASS, INT. CLS. 18 AND 25.
- THE H.T. HACKNEY CO., KNOXVILLE, TN:  
2,582,022. REN. 9-21-11. INT. CL. 32.
- THE HAITIAN PROJECT, INC., PROVIDENCE, RI:  
4,044,614, PUB. 8-9-2011. MULTIPLE CLASS, INT. CLS. 35, 36 AND 41.  
4,044,615, PUB. 8-9-2011. MULTIPLE CLASS, INT. CLS. 35, 36 AND 41.
- THE HAVEN GROUP, INC., LINTHICUM, MD:  
4,044,438, PUB. 8-9-2011. MULTIPLE CLASS, INT. CLS. 19 AND 37.
- THE HEALTH AND HOSPITAL CORPORATION OF MARION COUNTY, INDIANAPOLIS, IN, DBA WISHARD HEALTH SERVICES:  
4,046,850, INT. CL. 43.
- THE HENDLER LAW FIRM, P.C., AUSTIN, TX, DBA HENDLERLAW, P.C.:  
4,044,799, PUB. 8-9-2011. INT. CL. 45.  
4,044,801, PUB. 8-9-2011. INT. CL. 45.  
4,044,816, PUB. 8-9-2011. INT. CL. 45.
- THE HONG KONG WINALITE GROUP LIMITED, MON-GKOK, KOWLOON, HONG KONG:  
4,046,562, INT. CL. 11.
- THE INSTITUTE OF ELECTRICAL AND ELECTRONICS ENGINEERS, INC., PISCATAWAY, NJ:  
4,044,108, PUB. 8-9-2011. INT. CL. 41.
- THE INSURANCE EXCHANGE TRUST, INCORPORATED, WASHINGTON, DC:  
4,046,766, INT. CL. 36.  
4,046,767, INT. CL. 36.
- THE IRVINE COMPANY LLC, NEWPORT BEACH, CA:  
2,926,593, CANC. INT. CL. 36.
- THE JAMES SKINNER CO., OMAHA, NE:  
4,043,909, PUB. 8-9-2011. INT. CL. 30.
- THE JOHN W. JAMES AND RUSSELL P. FRIEDMAN PARTNERSHIP, SHERMAN OAKS, CA, DBA THE GRIEF RECOVERY INSTITUTE:  
3,939,289, COR. INT. CL. 41.
- THE KONG COMPANY LLC, GOLDEN, CO:  
2,926,598, CANC. INT. CL. 31.
- THE KROGER CO. OF MICHIGAN, NOVI, MI, FALLEY'S, INC., TOPEKA, KS:  
1,179,593. REN. 9-20-11. INT. CL. 42.
- THE LEARNING ANNEX, L.P., NEW YORK, NY:  
4,045,910, INT. CL. 41.
- THE LIBMAN COMPANY, ARCOLA, IL:  
4,045,967, INT. CL. 21.  
4,045,968, INT. CL. 21.
- THE LINCOLN NATIONAL LIFE INSURANCE COMPANY, FORT WAYNE, IN:  
4,045,554, PUB. 8-9-2011. INT. CL. 36.
- THE MARKETING COLLABORATIVE, LLC, CLARKSTON, MI:  
4,045,526, PUB. 8-9-2011. INT. CL. 44.
- THE MATES CONTENTS, S. A. DE C. V., MEXICO, D.F., MEXICO:  
4,043,668, PUB. 8-9-2011. MULTIPLE CLASS, INT. CLS. 35 AND 41.
- THE MCGRAW-HILL COMPANIES, INC., NEW YORK, NY, MCGRAW-HILL, INC., NEW YORK, NY:  
1,170,119. REN. 9-16-11. INT. CL. 16.
- THE MOTLEY FOOL HOLDINGS, INC., ALEXANDRIA, VA:  
2,501,854. REN. 9-21-11. INT. CL. 36.
- THE MRS. NETWORK LLC, SHOREWOOD, MN:  
4,047,247, MULTIPLE CLASS, INT. CLS. 9 AND 16.
- THE MUSICIAN NETWORK, LLC, OVERLAND PARK, KS, AKA THE MUSICIAN NETWORK:  
4,045,986, MULTIPLE CLASS, INT. CLS. 38, 41 AND 45.
- THE NATIONAL ACADEMY OF INVENTORS, INC., TAMPA, FL:  
4,043,724, PUB. 8-9-2011. INT. CL. 35.
- THE NURSE COMPANY, INC., NASHVILLE, TN:  
4,047,257, INT. CL. 42.
- THE NUTRO COMPANY, FRANKLIN, TN:  
4,045,515, PUB. 8-9-2011. INT. CL. 31.

THE OUTDOOR RECREATION GROUP, LOS ANGELES, CA:  
4,046,318, INT. CL. 28.

THE PENN MUTUAL LIFE INSURANCE COMPANY, HORSHAM, PA:  
4,046,729, INT. CL. 41.

THE PERSONNEL STORE, INC., AUSTIN, TX:  
4,045,478, PUB. 8-9-2011. INT. CL. 35.  
4,045,480, PUB. 8-9-2011. INT. CL. 35.

THE PILLSBURY COMPANY, LLC, MINNEAPOLIS, MN:  
4,046,702, INT. CL. 30.  
4,046,703, INT. CL. 30.

THE PLACENCIA GROUP, LTD., BOCA RATON, FL:  
4,044,269, PUB. 8-9-2011. MULTIPLE CLASS, INT. CLS. 36 AND 37.

THE PLAN9 GROUP, LLC, SANTA MONICA, CA:  
4,047,056, INT. CL. 35.

THE PLAYROOM ACADEMY OF MUSIC, LLC, CHARLOTTE, NC:  
4,046,754, INT. CL. 41.

THE PNC FINANCIAL SERVICES GROUP, INC., PITTSBURGH, PA:  
2,508,843. REN. 9-21-11. INT. CL. 36.  
4,045,285, PUB. 8-9-2011. INT. CL. 36.  
4,045,714, INT. CL. 36.

THE PROCTER & GAMBLE COMPANY, CINCINNATI, OH:  
4,046,113, INT. CL. 5.

THE PRUDENTIAL INSURANCE COMPANY OF AMERICA, NEWARK, NJ:  
4,044,037, PUB. 8-9-2011. INT. CL. 36.  
4,046,140, INT. CL. 36.  
4,046,141, INT. CL. 36.

THE QUINLAN COMPANIES, INC., PROVIDENCE, RI:  
4,045,492, PUB. 8-9-2011. INT. CL. 39.

THE RENTAL STORE, INC., SCOTTSDALE, AZ, AKA TRS, INC.:  
3,466,283, COR. INT. CL. 36.

THE RICHMAN GROUP, INC., GREENWICH, CT:  
4,043,945, PUB. 8-9-2011. INT. CL. 37.  
4,043,946, PUB. 8-9-2011. INT. CL. 37.

THE RUBICON PROJECT, INC., LOS ANGELES, CA:  
4,045,954, INT. CL. 42.

THE SAFE CIG, LLC, LOS ANGELES, CA:  
4,044,392, PUB. 8-9-2011. MULTIPLE CLASS, INT. CLS. 9, 16 AND 34.  
4,044,489, PUB. 8-9-2011. MULTIPLE CLASS, INT. CLS. 9 AND 34.

THE SILVERTON HOSPITAL, SILVERTON, OR:  
4,044,632, PUB. 8-9-2011. INT. CL. 44.

THE SMEAD MANUFACTURING COMPANY, HASTINGS, MN:  
4,046,284, INT. CL. 42.

THE SOURCE FOR LEARNING, INC., RESTON, VA:  
4,045,322, PUB. 8-9-2011. INT. CL. 41.  
4,045,328, PUB. 8-9-2011. INT. CL. 41.  
4,045,331, PUB. 8-9-2011. INT. CL. 41.

THE SPARK GROUP LLC, MOHEGAN LAKE, NY:  
4,045,114, PUB. 8-9-2011. INT. CL. 35.

THE SPOKESPEOPLE, CORPUS CHRISTI, TX:  
4,045,154, PUB. 8-9-2011. INT. CL. 35.

THE SPORN COMPANY, NEW YORK, NY:  
4,046,488, INT. CL. 26.  
4,046,707, INT. CL. 21.

THE STATE BAR OF CALIFORNIA, SAN FRANCISCO, CA:  
2,984,949, CANC. INT. CL. 41.

THE SUN PRODUCTS CORPORATION, WILTON, CT:  
4,044,246, PUB. 8-9-2011. INT. CL. 3.

THE SURETY & FIDELITY ASSOCIATION OF AMERICA, WASHINGTON, DC:  
4,044,510, PUB. 8-9-2011. INT. CL. 36.

THE TIPSY GOAT LLC, THOUSAND OAKS, CA:  
4,044,974, PUB. 8-9-2011. MULTIPLE CLASS, INT. CLS. 25 AND 43.

THE TJX COMPANIES, INC., FRAMINGHAM, MA:  
4,044,744, PUB. 8-9-2011. MULTIPLE CLASS, INT. CLS. 20 AND 24.

THE TRADITIONAL COMPANY, LLC, SALEM, OR:  
4,045,435, PUB. 8-9-2011. INT. CL. 33.

THE TRAVELERS INDEMNITY COMPANY, HARTFORD, CT:  
2,470,438, CANC. INT. CL. 36.

THE TRUSTEE OF THE MICHAEL H. COON REVOCABLE TRUST FORMED UNDER AGREEMENT DATED MARCH 4, 2011, AN IOWA TRUST, THE TRUSTEE COMPRISING MICHAEL H. COON, A UNITED STATES CITIZEN, LOHRVILLE, IA:  
4,045,235, PUB. 8-9-2011. INT. CL. 31.

THE TRUSTEES OF THE SHANTI INSURANCE TRUST, LAKE FOREST, IL, AKA SHANTI INSURANCE TRUST U/ T/A DTD 3/1/07:  
4,044,073, PUB. 8-9-2011. INT. CL. 3.

THE TWINERY, LLC, NORTH WALES, PA:  
4,045,163, PUB. 8-9-2011. INT. CL. 22.

THE TYROS, INC., PLAINFIELD, IN:  
4,044,931, PUB. 8-9-2011. INT. CL. 45.  
4,044,932, PUB. 8-9-2011. INT. CL. 45.

THE UNIVERSITY OF TULSA, TULSA, OK:  
4,043,871, PUB. 3-8-2011. MULTIPLE CLASS, INT. CLS. 16, 21, 22 AND 25.

THE UNIVERSITY OF WESTERN ONTARIO O/A WORLD-DISCOVERIES, LONDON, ONTARIO, CANADA:  
4,043,701, PUB. 8-9-2011. INT. CL. 9.

THE UPPER SKAGIT INDIAN TRIBE, BOW, WA, DBA SKAGIT VALLEY CASINO RESORT:  
4,045,521, PUB. 8-9-2011. MULTIPLE CLASS, INT. CLS. 41 AND 43.  
4,045,522, PUB. 8-9-2011. MULTIPLE CLASS, INT. CLS. 41 AND 43.

THE VILLAGE AT BRECKENRIDGE HOMEOWNERS ASSOCIATION, BRECKENRIDGE, CO:  
4,045,674, MULTIPLE CLASS, INT. CLS. 35 AND 36.

THE WASHINGTON UPDATE, LLC, MCLEAN, VA:  
4,047,221, MULTIPLE CLASS, INT. CLS. 35 AND 41.

THE WEATHER UNDERGROUND, INC., ANN ARBOR, MI:  
4,044,321, PUB. 8-9-2011. MULTIPLE CLASS, INT. CLS. 41 AND 42.  
4,044,550, PUB. 8-9-2011. INT. CL. 41.  
4,044,552, PUB. 8-9-2011. INT. CL. 41.

THE WILL-TO-LIVE FOUNDATION, INC., SUWANEE, GA:  
4,044,987, PUB. 8-9-2011. INT. CL. 36.

THE WINDWARD DESIGN GROUP, INC., SARASOTA, FL:  
4,045,429, PUB. 8-9-2011. INT. CL. 20.

THE WOODMANSEE GROUP, LLC, COLUMBUS, OH:  
4,045,428, PUB. 8-9-2011. INT. CL. 35.

THE 2112 STRATEGY GROUP LLC, PORT WASHINGTON, NY:  
4,044,969, PUB. 8-9-2011. INT. CL. 41.

THEIN, ROBERT K, LA CRESCENTA, CA:  
4,043,944, PUB. 8-9-2011. INT. CL. 44.

THEODORE, CHRIS P., BIRMINGHAM, MI:  
4,044,508, PUB. 8-9-2011. INT. CL. 12.

THERMA-TRU CORP., MAUMEE, OH:  
4,046,538, INT. CL. 19.

THERMASOURCE, LLC, SANTA ROSA, CA:  
4,044,579, PUB. 8-9-2011. MULTIPLE CLASS, INT. CLS. 35, 37 AND 42.

THERMO ELECTRON LIMITED, CAMBRIDGE CAMBRIDGESHIRE CB5 8HY, UNITED KINGDOM:  
2,926,463, CANC. INT. CL. 9.

THINK BIG NOW, INC., PLANTATION, FL, DBA COUPLES ON THE BRINK:  
4,045,482, PUB. 8-9-2011. INT. CL. 41.

THINKFUN INC., ALEXANDRIA, VA:  
2,926,895, CANC. INT. CL. 28.

THINKSHOP, INC., NORTH BEND, WA:  
4,044,862, PUB. 8-9-2011. MULTIPLE CLASS, INT. CLS. 16 AND 41.

THINWARE, INC., MCKINNEY, TX:  
4,044,675, PUB. 8-9-2011. INT. CL. 9.

THIRD NATION ENTERTAINMENT, HOUSTON, TX:  
4,044,517, PUB. 8-9-2011. INT. CL. 41.

THIRTEEN, NEW YORK, NY:  
2,476,756. REN. 9-19-11. INT. CL. 41.

THIS, LLC, MADISON, CT:  
4,046,041, INT. CL. 30.

- THOMAS JEFFERSON FOUNDATION, INC., CHARLOTTEVILLE, VA:  
4,046,741, MULTIPLE CLASS, INT. CLS. 16, 21, 35, 41 AND 43.
- THOMAS M RICH LLC, BERKELEY HEIGHTS, NJ:  
4,045,371, PUB. 8-9-2011. INT. CL. 41.
- THOMAS PUBLISHING COMPANY, NEW YORK, NY:  
2,428,236, CANC. INT. CL. 9.
- THOMAS, PAULA, LOS ANGELES, CA:  
4,045,284, PUB. 8-9-2011. MULTIPLE CLASS, INT. CLS. 18 AND 25.
- THOMPSON & CO. OF TAMPA, INC., TAMPA, FL:  
4,045,005, PUB. 8-9-2011. INT. CL. 34.
- THOMPSON, PETER D., HARRISBURG, PA:  
4,046,385, MULTIPLE CLASS, INT. CLS. 38 AND 41.
- THOMSON CANADA LIMITED, TORONTO, ONTARIO, CANADA:  
2,926,467, CANC. INT. CL. 35.
- THORNE BIOSCIENCE LLC, LOUISVILLE, KY:  
4,046,519, INT. CL. 5.
- THOUGHTFUL, INC., SEATTLE, WA:  
4,046,923, INT. CL. 45.  
4,046,924, INT. CL. 45.
- THRANE & THRANE A/S, LYNGBY, DENMARK:  
2,926,819, CANC. INT. CL. 9.
- THREE ROCKS GAMES LLC, WILMINGTON, DE:  
4,044,630, PUB. 8-9-2011. INT. CL. 42.
- THUMPER MASSAGER, INC., MARKHAM, ONTARIO, CANADA:  
4,045,379, PUB. 8-9-2011. INT. CL. 10.
- TIAMIYU, ADETOLA, ATLANTA, GA:  
4,044,631, PUB. 8-9-2011. INT. CL. 41.
- TIBCO SOFTWARE INC., PALO ALTO, CA:  
1,655,409, REN. 9-20-11. INT. CL. 9.
- TICK TACKLER, LLC, ASBURY, NJ:  
4,044,610, PUB. 8-9-2011. INT. CL. 44.
- TIECRAFTERS, INC., NEW YORK, NY:  
4,045,333, PUB. 8-9-2011. INT. CL. 37.
- TIEDEMANN WINES, LLC, ELKHART, IN:  
4,045,297, PUB. 8-9-2011. INT. CL. 33.
- TIERRAS DEL ANDE S.A., MENDOZA, ARGENTINA:  
4,046,083, INT. CL. 33.
- TIGER LILY, INC., LAS VEGAS, NV:  
2,612,442, REN. 9-20-11. INT. CL. 31.
- TING HSIN OIL & FAT INDUSTRIAL CO., LTD., CHANG HUA COUNTY, TAIWAN:  
2,926,476, CANC. INT. CL. 30.
- TINY SPARROW FOUNDATION, FRISCO, TX:  
4,045,098, PUB. 8-9-2011. INT. CL. 36.  
4,045,105, PUB. 8-9-2011. INT. CL. 41.
- TMC ORTHOPEDIC, L.P., HOUSTON, TX:  
4,043,872, PUB. 8-9-2011. INT. CL. 10.  
4,043,873, PUB. 8-9-2011. INT. CL. 10.
- TMFS HOLDINGS, LLC, OVERLAND PARK, KS:  
4,044,724, PUB. 8-9-2011. INT. CL. 41.
- TNMJ CALIBER, LLC, PRESCOTT, AZ:  
4,047,124, INT. CL. 12.  
4,047,125, INT. CL. 12.
- TOBO MARKETING GROUP, YORKTOWN HEIGHTS, NY:  
2,926,742, CANC. INT. CL. 14.
- TODD GOHMERT, PINEVILLE, LA:  
4,046,387, INT. CL. 25.
- TODD R SAUNDERS, GOBLES, MI:  
4,047,196, INT. CL. 38.
- TOILETTREE PRODUCTS, INC., UPPER NYACK, NY:  
4,044,015, PUB. 8-9-2011. INT. CL. 20.
- TOKUYAMA CORPORATION, SHUNAN-SHI, YAMAGUCHI, JAPAN:  
2,531,139, REN. 9-19-11. INT. CL. 5.
- TOKYO DENPA COMPANY, LTD., OHTA-KU, TOKYO (143), JAPAN:  
1,667,417, REN. 9-21-11. INT. CL. 9.
- TOKYO ELECTRON LIMITED, JAPAN:  
4,043,864, PUB. 8-9-2011. INT. CL. 7.
- TOM BOHAGER, PORT CHARLOTTE, FL:  
4,044,118, PUB. 8-9-2011. INT. CL. 5.
- TOM JOYNER ONLINE EDUCATION, LLC, DALLAS, TX:  
4,046,453, INT. CL. 35.
- TOMMY BAHAMA GROUP, INC., ATLANTA, GA:  
2,547,466, REN. 9-21-11. INT. CL. 16.
- TOMMY BAHAMA GROUP, INC., NEW YORK, NY:  
2,551,210, REN. 9-21-11. INT. CL. 14.  
4,046,194, INT. CL. 25.
- TONY DEMARIA ELECTRIC, INC., WILMINGTON, CA:  
4,045,275, PUB. 8-9-2011. MULTIPLE CLASS, INT. CLS. 25, 37, 41 AND 42.
- TOP NOTCH LIVING LLC, PLEASANT GROVE, UT:  
4,044,981, PUB. 8-9-2011. INT. CL. 25.
- TOP TOBACCO L.P., GLENVIEW, IL:  
4,044,807, PUB. 8-9-2011. INT. CL. 34.
- TOP TOBACCO, L.P., GLENVIEW, IL:  
2,578,598, REN. 9-16-11. INT. CL. 34.  
2,926,760, CANC. INT. CL. 34.
- TOPCON POSITIONING SYSTEMS, INC., LIVERMORE, CA:  
4,046,251, INT. CL. 9.
- TOPWIN CORPORATION, TORRANCE, CA:  
4,045,338, PUB. 8-9-2011. INT. CL. 25.
- TORRES SALCEDO, JOSÉ HIRAM, ZAPOPAN, MEXICO AND MARTÍNEZ DOMÍNGUEZ, CARLOS GERARDO, ZAPOPAN, MEXICO AND OCHOA, CAMBEROS ALEJANDRO, ZAPOPAN, MEXICO AND GONZÁLEZ, PÉREZ RICARDO, GUADALAJARA, MEXICO:  
4,045,770, INT. CL. 33.
- TOTAL DIABETES, LLC, MESA, AZ:  
4,044,502, PUB. 8-9-2011. INT. CL. 5.
- TOYO TIRE AND RUBBER CO., LTD., NISHI-KU, OSAKA, JAPAN, TOYO RUBBER INDUSTRY CO., LTD., THE, NISHI-KU, OSAKA, JAPAN:  
1,176,052, REN. 9-22-11. INT. CL. 12.
- TRA GLOBAL, INC., NEW YORK, NY, DBA TRA, INC.:  
4,046,688, INT. CL. 35.
- TRACFONE WIRELESS, INC., MIAMI, FL:  
4,046,641, INT. CL. 38.  
4,046,642, INT. CL. 35.
- TRADE UNION INTERNATIONAL, INC., MONTCLAIR, CA, DBA TOPLINE PRODUCTS:  
4,046,145, INT. CL. 12.
- TRAGON CORPORATION, REDWOOD SHORES, CA:  
4,044,912, PUB. 8-9-2011. INT. CL. 35.
- TRALY (U.S.A.) INC., BOCA RATON, FL:  
4,046,868, INT. CL. 28.
- TRAN, NGHE, BOTHELL, WA:  
4,046,755, INT. CL. 8.
- TRANCHIDA, JOSEPH G., CLINTON TOWNSHIP, MI:  
2,926,753, CANC. INT. CL. 41.
- TRANS FAMILY, INC., SAN GABRIEL, CA:  
4,045,536, PUB. 8-9-2011. INT. CL. 30.
- TRANS-LUX CORPORATION, NORWALK, CT:  
2,926,557, CANC. INT. CL. 9.
- TRANSCANADA TURBINES LTD., AIRDRIE, ALBERTA, CANADA:  
2,481,519, REN. 9-20-11. MULTIPLE CLASS, INT. CLS. 37 AND 42.
- TRANSCO INDUSTRIES, INC., NEW ROCHELLE, NY:  
2,458,324, REN. 9-19-11. INT. CL. 19.
- TRANZONIC COMPANIES, THE, CLEVELAND, OH:  
2,475,495, REN. 9-21-11. INT. CL. 5.
- TREASURE ISLAND, LLC, LAS VEGAS, NV:  
4,047,040, INT. CL. 43.
- TREE ISLAND WIRE (USA), INC., WALNUT, CA:  
4,047,102, INT. CL. 19.
- TREE QUEST LLC, VANCOUVER, WA, DBA TREADMILL WORLD:  
4,044,567, PUB. 8-9-2011. INT. CL. 35.
- TREFFILETTI, CORY, SAN FRANCISCO, CA:  
4,046,717, INT. CL. 35.
- TREGOED INC., PRINCETON, NJ:  
4,046,300, INT. CL. 41.  
4,046,309, INT. CL. 41.
- TRELLEBORG WHEEL SYSTEMS AMERICAS, INC., HARTVILLE, OH:  
2,926,525, CANC. INT. CL. 12.
- TREND ENTERPRISES, INC., NEW BRIGHTON, MN:  
1,205,440, REN. 9-19-11. INT. CL. 16.  
1,701,722, REN. 9-16-11. INT. CL. 16.



TREND VENTURES LLC, SEATTLE, WA:  
2,478,966. REN. 9-16-11. INT. CL. 42.

TRI-MEDIA PUBLICATIONS, INC., FORT WORTH, TX,  
DBA TRI-MEDIA MARKETING SERVICES:  
2,597,057. REN. 9-18-11. INT. CL. 35.

TRIAD DIGITAL MEDIA, LLC, SOUTHFIELD, MI:  
4,046,969. INT. CL. 35.

TRIAL CONSULTANTS, INC., GAINESVILLE, FL:  
4,047,067. INT. CL. 44.

TRICYBER, JACKSON, NJ:  
4,045,181. PUB. 8-9-2011. INT. CL. 9.

TRIDENT SEAFOODS CORPORATION, SEATTLE, WA:  
1,153,302. REN. 9-19-11. INT. CL. 29.

TRIDENT SPACE AND DEFENSE, LLC, TORRANCE, CA:  
4,044,205. PUB. 5-3-2011. INT. CL. 9.

TRIDIUM, INC., RICHMOND, VA:  
2,603,946. REN. 9-19-11. INT. CL. 42.

TRILABRY'S INTERACTIVE, INC., AUSTIN, TX:  
4,046,419. INT. CL. 41.

TRINITY MANAGEMENT SERVICES, SAN FRANCISCO,  
CA:  
2,612,557. REN. 9-20-11. MULTIPLE CLASS, INT. CLS. 37  
AND 37.

TRIPLE AUGHT DESIGN, LLC, SAN FRANCISCO, CA:  
4,044,776. PUB. 8-9-2011. INT. CL. 8.  
4,044,795. PUB. 8-9-2011. INT. CL. 26.

TRISTAR INDEMNITY LLC, CINCINNATI, OH:  
4,044,219. PUB. 8-9-2011. INT. CL. 36.

TRISTAR PICTURES, INC., CULVER CITY, CA:  
2,428,637. CANC. INT. CL. 16.

TRIUMPH LEARNING, LLC, WHITE PLAINS, NY:  
4,043,731. PUB. 8-9-2011. INT. CL. 9.

TROMBETTA & YOUNGS ENTERPRISES LIMITED, HON-  
OLULU, HI:  
1,152,717. REN. 9-19-11. INT. CL. 42.

TROPICAL SHORES INC., CAPE CORAL, FL, DBA EDISON  
LUNCH BOX:  
4,044,427. PUB. 8-9-2011. INT. CL. 43.

TROPICANA LAS VEGAS, INC., LAS VEGAS, NV:  
4,044,823. PUB. 8-9-2011. INT. CL. 41.

TROPICANA PRODUCTS, INC., BRADENTON, FL:  
4,045,883. INT. CL. 31.

TROTTA, GAIL, SANDPOINT, ID:  
4,047,001. INT. CL. 35.

TROXEL COMPANY, THE, MOSCOW, TN:  
1,657,623. REN. 9-21-11. MULTIPLE CLASS, INT. CLS. 37  
AND 40.

TROXEL CYCLING & FITNESS LLC, SAN DIEGO, CA:  
2,490,606. REN. 9-21-11. INT. CL. 9.  
2,490,681. REN. 9-22-11. INT. CL. 9.

TRS QUALITY, INC., FORT WORTH, TX, TECHNOLOGY  
PROPERTIES, INC., WILMINGTON, DE:  
1,655,078. REN. 9-21-11. INT. CL. 42.

TRUE GRIT ENTERTAINMENT, INC., CULVER CITY, CA:  
4,045,679. INT. CL. 25.

TRUE PROMISE BEAUTY, INC., OAK PARK, CA:  
4,045,419. PUB. 8-9-2011. INT. CL. 3.

TRUE TEXTILES, INC., GRAND RAPIDS, MI:  
4,045,662. INT. CL. 24.

TRUE UNIVERSAL STANDARDS EVERYWHERE, INC.,  
SAN FRANCISCO, CA:  
2,428,136. CANC. U.S. CL. B.

TRUE VALUE COMPANY, CHICAGO, IL:  
4,045,711. INT. CL. 6.  
4,045,712. INT. CL. 7.

TRUESHIP LLC, SCOTTSDALE, AZ:  
4,045,493. PUB. 8-9-2011. INT. CL. 9.

TRUSS, THEODORE T., ANNAPOLIS, MD, VINCENT  
FLACCOMIO AND JOSEPH V. FLACCOMIO, BALTI-  
MORE, MD:  
726,335. REN. 9-19-11. U.S. CL. 49 (INT. CL. 33).

TRUST ELEMENT, INC., NEW YORK, NY:  
4,045,953. MULTIPLE CLASS, INT. CLS. 35 AND 42.

TRUSTEES OF THE WINE SPECTATOR SCHOLARSHIP  
FOUNDATION, THE, NEW YORK, NY:  
1,662,000. REN. 9-20-11. INT. CL. 41.

TRUSTMARK NATIONAL BANK, JACKSON, MS:  
2,559,639. REN. 9-22-11. INT. CL. 36.

TS MANAGEMENT, WRIGHTSVILLE BEACH, NC:  
4,044,537. PUB. 8-9-2011. INT. CL. 42.

TSUI, PHILIP Y.W., FO TAN, HONG KONG:  
2,472,617. REN. 9-20-11. INT. CL. 9.

TTG, INC., BEDFORD, MA:  
2,548,454. REN. 9-19-11. INT. CL. 9.

TUFTS, GEORGETTE, ALISO VIEJO, CA:  
4,044,968. PUB. 8-9-2011. INT. CL. 28.

TUFTS, MARTIN, LONDON, UNITED KINGDOM AND  
WONG, GLORIA, LONDON, UNITED KINGDOM:  
4,043,739. PUB. 8-9-2011. INT. CL. 41.

TULIP CORPORATION, CITY OF INDUSTRY, CA:  
1,653,465. REN. 9-20-11. MULTIPLE CLASS, INT. CLS. 7,  
9 AND 37.

TULONG, LLC, LOVELAND, OH:  
4,045,878. INT. CL. 25.

TURF LINE FERTILIZER, INC., HENRIETTA, NY:  
1,176,736. REN. 9-22-11. INT. CL. 1.

TURK HAVA YOLLARI ANONIM ORTAKLIGI, TURKEY:  
4,043,807. PUB. 8-9-2011. MULTIPLE CLASS, INT. CLS.  
35, 38 AND 39.

TWELVE DOORS, LLC, ALBANY, NY:  
4,047,207. MULTIPLE CLASS, INT. CLS. 20, 35 AND 40.

TWENTIETH CENTURY FOX FILM CORPORATION, LOS  
ANGELES, CA:  
4,046,124. INT. CL. 41.  
4,046,907. INT. CL. 38.  
4,046,908. INT. CL. 41.

TWIGGES OF GALENA, LIMITED, GALENA, IL:  
2,428,143. CANC. INT. CL. 35.

TWO NEWTON PLACE, NEWTON, MA:  
4,044,351. PUB. 8-9-2011. MULTIPLE CLASS, INT. CLS. 35  
AND 38.

TYCO ELECTRONICS CORPORATION, BERWYN, PA,  
RAYCHEM CORPORATION, MENLO PARK, CA:  
1,157,911. REN. 9-20-11. INT. CL. 9.

TYCO HEALTHCARE GROUP LP, NEW HAVEN, CT:  
2,405,152. REN. 9-21-11. INT. CL. 10.  
2,545,149. REN. 9-20-11. INT. CL. 10.

TYCO HEALTHCARE GROUP, LP, MANSFIELD, MA:  
1,653,587. REN. 9-20-11. INT. CL. 10.

TYCO SAFETY PRODUCTS CANADA, LTD., CONCORD,  
ONTARIO, CANADA:  
4,043,660. PUB. 8-9-2011. INT. CL. 9.

TYCOONNAIRE HOLDING SA, LUXEMBOURG:  
4,043,785. PUB. 8-9-2011. MULTIPLE CLASS, INT. CLS. 3,  
9, 12, 16, 24, 25, 28, 32, 34, 35, 36, 38, 41, 43 AND 45.

TYLER, STEWART, MR., NORTHAMPTONSHIRE, UNITED  
KINGDOM:  
2,487,403. REN. 9-17-11. INT. CL. 9.

TYMCO, INC., WACO, TX:  
2,529,594. REN. 9-21-11. INT. CL. 7.

TYSON FRESH MEATS, INC., SPRINGDALE, AR:  
4,046,218. INT. CL. 18.

T3 PARTNERS, DENVER, CO, DBA TECHSTOP:  
4,045,884. INT. CL. 37.

U.S. DEPARTMENT OF COMMERCE, INTERNATIONAL  
TRADE ADMINISTRATION, WASHINGTON, DC:  
4,044,203. PUB. 8-9-2011. MULTIPLE CLASS, INT. CLS. 14  
AND 16.  
4,044,204. PUB. 8-9-2011. MULTIPLE CLASS, INT. CLS. 14  
AND 16.

U.S. DEPARTMENT OF HEALTH AND HUMAN SERVICES,  
BETHESDA, MD:  
4,045,085. PUB. 8-9-2011. INT. CL. 42.

U.S. FARMERS & RANCHERS ALLIANCE, INC., CHESTER-  
FIELD, MO:  
4,044,778. PUB. 8-9-2011. INT. CL. 35.  
4,044,845. PUB. 8-9-2011. INT. CL. 41.  
4,045,003. PUB. 8-9-2011. INT. CL. 26.

U.S. MARINE CORPS, A COMPONENT OF THE U.S.  
DEPARTMENT OF THE NAVY, WASHINGTON, DC:  
4,045,260. PUB. 8-9-2011. INT. CL. 9.  
4,045,266. PUB. 8-9-2011. INT. CL. 41.  
4,045,309. PUB. 8-9-2011. INT. CL. 16.

U.S. PAYMENTS, LLC, TULSA, OK:  
4,044,043. PUB. 8-9-2011. INT. CL. 36.

- U.S. VERIFY, INC., MEMPHIS, TN:  
4,043,699, PUB. 8-9-2011. MULTIPLE CLASS, INT. CLS. 35 AND 42.
- U.S. WATER SERVICES, INC., CAMBRIDGE, MN:  
4,043,658, PUB. 8-9-2011. MULTIPLE CLASS, INT. CLS. 1, 40 AND 42.
- U.S.A ABC TECHNOLOGY INC, SALT LAKE CITY, UT:  
4,046,420, INT. CL. 9.
- U.S.A. HARVEST, INC., LOUISVILLE, KY:  
4,046,966, INT. CL. 43.
- U-S. S. MEDICAL CORP., GARDENVILLE, PUERTO RICO:  
4,046,423, INT. CL. 5.
- UCB PHARMA, S.A., 1070 BRUXELLES, BELGIUM:  
4,045,372, PUB. 8-9-2011. INT. CL. 42.
- ULLUCUS HEAVEN, INC., OSAK, JAPAN:  
4,044,308, PUB. 8-9-2011. INT. CL. 9.
- ULTIMATE TRADING CORPORATION, ROSELAND, NJ:  
4,044,992, PUB. 8-9-2011. INT. CL. 14.
- ULTRA FLEX MOULDING, INC., ESCONDIDO, CA:  
2,427,976, CANC. INT. CL. 19.
- ULTRA PET COMPANY, INC., ANDERSON, SC:  
4,043,959, PUB. 8-9-2011. INT. CL. 31.
- UMAREX SPORTWAFFEN GMBH & CO. KG, ARNSBERG, FED REP GERMANY:  
4,044,839, PUB. 8-9-2011. INT. CL. 28.
- UNCAS MANUFACTURING COMPANY, PROVIDENCE, RI:  
156,769, REN. 9-16-11. U.S. CL. 28 (INT. CL. 14).
- UNCLE RAYS, LLC, DETROIT, MI:  
2,926,965, CANC. INT. CL. 29.
- UNDER THE RADAR PICKS, LLC, NEW YORK, NY:  
4,044,195, PUB. 8-9-2011. MULTIPLE CLASS, INT. CLS. 9 AND 41.
- UNIFORM SQUARE OF AMERICA LLC, PLANTATION, FL, DBA UNIFORM SQUARE:  
4,044,051, PUB. 3-8-2011. INT. CL. 35.
- UNIFRUITTI OF AMERICA, INC., PHILADELPHIA, PA:  
2,502,929, REN. 9-21-11. INT. CL. 31.  
2,502,930, REN. 9-21-11. INT. CL. 31.
- UNILEVER N.V., ROTTERDAM, NETHERLANDS:  
2,926,645, CANC. INT. CL. 30.
- UNILEVER SUPPLY CHAIN, INC., CLINTON, CT:  
4,045,869, INT. CL. 3.  
4,046,252, INT. CL. 3.  
4,046,270, INT. CL. 3.  
4,046,344, INT. CL. 3.
- UNIMIN CORPORATION, NEW CANAAN, CT:  
1,165,992, REN. 9-17-11. INT. CL. 1.
- UNIPLEX CORPORATION, PEWAUKEE, WI:  
2,607,046, REN. 9-20-11. MULTIPLE CLASS, INT. CLS. 40 AND 42.
- UNIQUE HOME DESIGNS, INC., GILBERT, AZ:  
3,895,082, CANC. INT. CL. 6.
- UNITED AMERICAN ELECTION SUPPLY CO., COLUMBIA, SC:  
2,926,767, CANC. INT. CL. 12.
- UNITED BUSINESS MEDIA LLC, MANHASSET, NY:  
2,926,650, CANC. INT. CL. 16.  
2,927,073, CANC. MULTIPLE CLASS, INT. CLS. 35 AND 41.
- UNITED COLORS INTERNATIONAL LIMITED, KWAI CHUNG, HONG KONG:  
4,043,657, PUB. 8-9-2011. MULTIPLE CLASS, INT. CLS. 3, 18, 25 AND 35.
- UNITED COMMUNICATIONS CORPORATION, KENOSHA, WI:  
4,046,128, MULTIPLE CLASS, INT. CLS. 9, 16, 36 AND 41.
- UNITED FOOTBALL LEAGUE, LLC, NEW YORK, NY:  
4,046,334, INT. CL. 25.  
4,046,335, INT. CL. 25.  
4,046,345, INT. CL. 25.
- UNITED HARDWARE DISTRIBUTING CO., MINNEAPOLIS, MN:  
1,672,213, REN. 9-21-11. INT. CL. 42.
- UNITED JEWISH APPEAL-FEDERATION OF JEWISH PHILANTHROPIES OF NEW YORK, INC., NEW YORK, NY:  
4,045,002, PUB. 8-9-2011. MULTIPLE CLASS, INT. CLS. 35, 36 AND 45.
- UNITED METHODIST PUBLISHING HOUSE, THE, NASHVILLE, TN:  
1,688,994, REN. 9-17-11. INT. CL. 16.
- UNITED PARCEL SERVICE OF AMERICA, INC., ATLANTA, GA:  
2,491,080, REN. 9-20-11. INT. CL. 36.  
2,491,124, REN. 9-20-11. INT. CL. 39.
- UNITED PROPANE GAS COMPANIES, INC., PADUCAH, KY:  
2,526,457, REN. 9-20-11. MULTIPLE CLASS, INT. CLS. 4, 35 AND 39.  
2,533,263, REN. 9-20-11. MULTIPLE CLASS, INT. CLS. 4, 35 AND 39.
- UNITED ROTARY BRUSH CORPORATION, MARYSVILLE, OH, SAVCOR, INC., LENEXA, KS:  
1,715,017, REN. 9-21-11. INT. CL. 7.
- UNITED SAFETY, LTD., AIRDRIE, ALBERTA, CANADA:  
4,047,141, INT. CL. 42.
- UNITED SERVICES AUTOMOBILE ASSOCIATION, SAN ANTONIO, TX:  
4,045,715, INT. CL. 36.
- UNITED STATES DEPARTMENT OF HOMELAND SECURITY, WASHINGTON, DC:  
4,045,881, MULTIPLE CLASS, INT. CLS. 36 AND 41.
- UNITED STATES DOG AGILITY ASSOCIATION, INC., RICHARDSON, TX:  
4,046,072, INT. CL. 25.  
4,046,073, INT. CL. 41.
- UNITED STATES OF AMERICA NATIONAL KARATE-DO FEDERATION, COLORADO SPRINGS, CO:  
4,044,944, PUB. 8-9-2011. INT. CL. 36.  
4,044,945, PUB. 8-9-2011. INT. CL. 41.
- UNITEX INTERNATIONAL, INC., DULUTH, GA:  
4,046,586, INT. CL. 21.
- UNITTURNS, LLC, WASHINGTON, DC:  
4,043,704, PUB. 8-9-2011. INT. CL. 37.
- UNIVERSAL ACOUSTIC & EMISSION TECHNOLOGIES, INC., STOUGHTON, WI:  
4,046,209, INT. CL. 7.
- UNIVERSAL INTERLOCK CORPORATION, EDISON, NJ:  
2,496,222, REN. 9-19-11. INT. CL. 35.
- UNIVERSAL MUSIC - MGB NA LLC, SANTA MONICA, CA, PRIMAT AMERICA, HOLLYWOOD, CA:  
1,716,792, REN. 9-19-11. INT. CL. 42.
- UNIVERSAL PRODUCTS, INC., ROCK HILL, SC:  
4,046,116, MULTIPLE CLASS, INT. CLS. 6 AND 20.
- UNIVERSITY CORPORATION FOR ATMOSPHERIC RESEARCH, BOULDER, CO:  
4,044,207, PUB. 8-9-2011. INT. CL. 9.
- UNIVERSITY OF MARYLAND, COLLEGE PARK, MD TO UNIVERSITY OF MARYLAND, COLLEGE PARK, MD:  
2,995,434, CANC. INT. CL. 16.
- UNIVERSITY OF MOUNT UNION, ALLIANCE, OH:  
4,046,407, MULTIPLE CLASS, INT. CLS. 25 AND 41.  
4,046,408, MULTIPLE CLASS, INT. CLS. 25 AND 41.
- UNIVERSITY OF SOUTH CAROLINA, COLUMBIA, SC:  
1,657,341, REN. 9-21-11. MULTIPLE CLASS, INT. CLS. 14, 16, 18, 20, 21, 25, 27 AND 28.
- UNIVERSITY OF SOUTHERN CALIFORNIA, LOS ANGELES, CA:  
2,926,474, CANC. INT. CL. 9.
- UNIVISION COMMUNICATIONS INC., LOS ANGELES, CA:  
4,044,700, PUB. 8-9-2011. INT. CL. 41.  
4,045,513, PUB. 8-9-2011. MULTIPLE CLASS, INT. CLS. 38 AND 41.
- UNREAL ESTATES, LLC, ENGLEWOOD CLIFFS, NJ:  
2,927,020, CANC. INT. CL. 37.
- UNVEILED, LLC, MOORESVILLE, NC, DBA WEDDINGS UNVEILED MAGAZINE:  
4,046,692, MULTIPLE CLASS, INT. CLS. 16, 35 AND 41.
- UPSHER-SMITH LABORATORIES, MAPLE GROVE, MN:  
4,046,667, INT. CL. 5.
- URBAN IMPACT FOUNDATION, PITTSBURGH, PA:  
4,044,763, PUB. 8-9-2011. INT. CL. 41.
- URNEX BRANDS, INC., YONKERS, NY:  
4,045,242, PUB. 8-9-2011. INT. CL. 3.
- UROUTDOORS, INC., ROCKY MOUNT, NC:  
4,045,665, MULTIPLE CLASS, INT. CLS. 35 AND 42.

US DATA MANAGEMENT LLC, VENTURA, CA:  
4,044,437, PUB. 8-9-2011. INT. CL. 35.

USADDRESS.COM INC., HILLSIDE, NJ:  
4,044,647, PUB. 8-9-2011. INT. CL. 39.

USG CORPORATION, CHICAGO, IL:  
4,045,404, PUB. 8-9-2011. INT. CL. 16.  
4,045,406, PUB. 8-9-2011. INT. CL. 7.

UTEX INDUSTRIES, INC., HOUSTON, TX:  
1,656,602, REN. 9-22-11. INT. CL. 7.

UTICA MUTUAL INSURANCE COMPANY, NEW HARTFORD, NY, DBA UTICA NATIONAL INSURANCE GROUP:  
2,606,436, REN. 9-16-11. INT. CL. 36.

UTILIMASTER CORPORATION, WAKARUSA, IN:  
4,045,506, PUB. 8-9-2011. INT. CL. 12.

UVIEW ULTRAVIOLET SYSTEMS INC., MISSISSAUGA, ONTARIO, CANADA:  
4,044,840, PUB. 8-9-2011. INT. CL. 1.

UZIN UTZ AKTIENGESELLSCHAFT, D-89079 ULM, FED REP GERMANY:  
2,926,469, CANC. INT. CL. 19.

V&S VIN & SPRIT AKTIEBOLAG, STOCKHOLM, SWEDEN:  
4,044,099, PUB. 8-9-2011. INT. CL. 33.

VADRUCCI ANDREA, POGGIARDO, ITALY, AKA VADRUM:  
4,045,051, PUB. 8-9-2011. INT. CL. 9.

VAISALA OYJ, 01670 VANTAA, FINLAND:  
1,169,938, REN. 9-17-11. INT. CL. 9.

VALENTINE TOOL & STAMPING, INC., NORTON, MA:  
2,490,692, REN. 9-19-11. INT. CL. 28.

VALIO LTD, 00370 HELSINKI, FINLAND:  
2,501,825, REN. 9-20-11. INT. CL. 29.

VALLEY VIEW INDUSTRIES H.C., CRESTWOOD, IL, VALLEY VIEW SPECIALTIES COMPANY, CRESTWOOD, IL:  
1,658,235, REN. 9-20-11. INT. CL. 20.

VALUE FAIR MARKET ST. PETE LLC, CLOSTER, NJ:  
4,044,462, PUB. 8-9-2011. INT. CL. 36.

VALUE QUEST FOODS, ATLANTA, GA:  
4,046,507, INT. CL. 29.

VAN EERDE, ROBERT, MIAMI, FL, DBA SHORT-TERM EXECUTIVE MANAGEMENT:  
4,046,341, INT. CL. 43.

VAN PUTTEN, ZANETTA, LOMA LINDA, CA:  
4,044,441, PUB. 8-9-2011. MULTIPLE CLASS, INT. CLS. 41 AND 44.

VAN VELZEN, JORIS, BERLIN, FED REP GERMANY:  
4,046,415, INT. CL. 32.

VAN-ZELLER, TERESA, WEST HILLS, CA:  
4,045,149, PUB. 8-9-2011. INT. CL. 41.

VANCE PUBLISHING CORPORATION, LINCOLNSHIRE, IL:  
4,044,135, PUB. 8-9-2011. INT. CL. 41.

VANTIS LIFE INSURANCE COMPANY, WINDSOR, CT:  
4,045,420, PUB. 8-9-2011. INT. CL. 36.

VARSHNEY, ANURAG, ISELIN, NJ:  
4,046,995, INT. CL. 41.

VASCULAR DESIGNS INC., SAN JOSE, CA:  
4,047,127, INT. CL. 10.

VASSE FELIX PTY LTD., WESTERN AUSTRALIA, AUSTRALIA:  
2,494,872, REN. 9-20-11. INT. CL. 33.

VEGA GRIESHABER KG, FED REP GERMANY:  
4,043,857, PUB. 8-9-2011. INT. CL. 9.  
4,043,862, PUB. 8-9-2011. INT. CL. 9.

VEGETARIANVITAMINS.COM LLC, STERRETT, AL:  
4,047,249, INT. CL. 35.

VELOCITY STANDARDBREDS, LLC, LEBANON, OH:  
4,044,216, PUB. 8-9-2011. INT. CL. 44.

VENNETT, M SEAN, TAMPA, FL:  
2,484,563, REN. 9-21-11. MULTIPLE CLASS, INT. CLS. 14, 16 AND 25.

VENTAJAS PUBLICATIONS LLC, CULPEPER, VA:  
4,044,959, PUB. 8-9-2011. INT. CL. 16.

VENTANA VINTNERS, LLC, MONTEREY, CA, VENTANA VINEYARDS, SOLEDAD, CA:  
1,196,401, REN. 9-20-11. INT. CL. 33.

VENTURA FOODS, LLC, BREA, CA:  
2,985,274, CANC. MULTIPLE CLASS, INT. CLS. 35 AND 40.

VEOLIA ES INDUSTRIAL SERVICES, INC., LEAGUE CITY, TX, ONYX INDUSTRIAL SERVICES, INC., BAYTOWN, TX:  
2,517,917, REN. 9-20-11. INT. CL. 37.

VEOLIA ES TECHNICAL SOLUTIONS, L.L.C., LOMBARD, IL:  
2,484,902, REN. 9-16-11. MULTIPLE CLASS, INT. CLS. 37 AND 40.

VERACITY PAYMENT SOLUTIONS, ATLANTA, GA:  
4,044,626, PUB. 8-9-2011. INT. CL. 36.

VERCO DECKING, INC., CHARLOTTE, NC, VERCO MANUFACTURING, INC., PHOENIX, AZ:  
1,165,202, REN. 9-20-11. INT. CL. 6.

VERDE REALTY OPERATING PARTNERSHIP L.P., EL PASO, TX:  
4,046,087, MULTIPLE CLASS, INT. CLS. 36 AND 37.

VERIMATRIX, INC., SAN DIEGO, CA:  
4,046,660, INT. CL. 9.

VERNE Q. POWELL FLUTES, INC., MAYNARD, MA:  
2,594,858, REN. 9-18-11. INT. CL. 15.

VERTSMAN, KONSTANTIN G, SANTA MONICA, CA:  
4,044,930, PUB. 8-9-2011. INT. CL. 45.

VEYANCE TECHNOLOGIES, INC., FAIRLAWN, OH:  
1,152,146, REN. 9-20-11. MULTIPLE CLASS, INT. CLS. 7 AND 12.

VICTORIA F. LEONARD, SAN FRANCISCO, CA:  
4,046,296, INT. CL. 25.

VICTORIA PRINCIPAL PRODUCTIONS, INC., NASHVILLE, TN:  
4,046,856, INT. CL. 14.

VICTORIA'S SECRET STORES BRAND MANAGEMENT, INC., REYNOLDSBURG, OH:  
4,045,790, INT. CL. 3.

VIDA DIAGNOSTICS, INC., CORALVILLE, IA:  
1,635,369, REN. 9-20-11. INT. CL. 9.

VIDEO DIRECT LIMITED, RODNEY STOKE, UNITED KINGDOM, TA VIDEOBUILDER.TV:  
4,044,745, PUB. 8-9-2011. INT. CL. 42.

VIDEOSHARE, INC., CAMBRIDGE, MA TO LIWERANT, GAD, CHESTNUT HILL, MA, DBA VIDEOSHARE:  
2,428,984, CANC. INT. CL. 9.

VIENNA BEEF LTD., CHICAGO, IL:  
1,150,556, REN. 9-20-11. INT. CL. 29.

VIGO IMPORTING COMPANY, TAMPA, FL:  
2,495,204, REN. 9-21-11. MULTIPLE CLASS, INT. CLS. 29 AND 30.

VILLA DE VARDA S.R.L. WITH ABBREVIATION VDV S.R.L., MEZZOLOMBARDO (TN), ITALY:  
2,446,022, REN. 9-20-11. INT. CL. 33.

VILLAFANE Y GUZMAN, SRL, MAIPU, MENDOZA, ARGENTINA:  
4,045,906, INT. CL. 33.

VILLAGE VENTURES, INC., WILLIAMSTOWN, MA, VILLAGE VENTURES, INC., WILLIAMSTOWN, MA:  
2,512,122, REN. 9-20-11. MULTIPLE CLASS, INT. CLS. 35 AND 36.

VILLALOBOS JIMENEZ, BENJAMIN, GUADALAJARA, MEXICO:  
3,984,333, CANC. IIRN. RESTORED TO S.N. 85-104,632.

VINA SANTA MARINA, S.L., MERIDA, SPAIN:  
2,496,047, REN. 9-16-11. INT. CL. 33.

VINEBURG LLC, VINEBURG, CA:  
4,046,594, INT. CL. 33.

VINNICO EXPORT S.L., JAVEA (ALICANTE), SPAIN:  
4,046,518, INT. CL. 33.

VINTAGE MARKETING, INC., SANTA MONICA, CA:  
4,046,942, INT. CL. 35.

VINTAGE PAINTBALL PARK, LLC, RIVER FALLS, WI:  
4,046,842, INT. CL. 41.

VINYARD ENTERTAINMENT, LLC, LONG ISLAND CITY, NY:  
4,044,293, PUB. 8-9-2011. INT. CL. 35.

VINYL WINDOW TECHNOLOGIES, INC., PADUCAH, KY:  
2,556,875, REN. 9-17-11. INT. CL. 19.

VIRGINIA GEORGE COMPANY, INC., VIRGINIA BEACH, VA:  
2,618,462, REN. 9-20-11. INT. CL. 42.

- VIRGO PUBLISHING, LLC, PHOENIX, AZ:  
4,046,902, INT. CL. 35.
- VIRTEK VISION INTERNATIONAL INC., WATERLOO, ONTARIO, CANADA:  
2,517,795, REN. 9-20-11, INT. CL. 9.
- VIRTUAL LEARNING INSTITUTE LLC, BIRMINGHAM, MI:  
2,926,709, CANC. MULTIPLE CLASS, INT. CLS. 9 AND 41.
- VIRTUAL UMBRELLA, LLC, SOMERSET, KY:  
4,044,766, PUB. 8-9-2011, MULTIPLE CLASS, INT. CLS. 41 AND 42.
- VIRTUOSO, LTD., FORT WORTH, TX, VIRTUOSO, LTD., FORT WORTH, TX:  
2,480,901, REN. 9-22-11, MULTIPLE CLASS, INT. CLS. 35, 38 AND 42.
- VIRTUS BENEFITS, INC., NASHVILLE, TN:  
4,045,142, PUB. 8-9-2011, INT. CL. 36.
- VISICS CORPORATION, WELLESLEY, MA:  
4,045,735, INT. CL. 9.
- VISIONITE GROUP AB, SWEDEN:  
4,043,849, PUB. 8-9-2011, MULTIPLE CLASS, INT. CLS. 41 AND 42.
- VISUALCUE TECHNOLOGIES, LLC, MELBOURNE, FL:  
4,046,800, INT. CL. 9.
- VITAL HEALTH PHARMACEUTICALS, INC., LAS VEGAS, NV:  
4,046,206, INT. CL. 5.  
4,046,207, INT. CL. 5.
- VIVOLINE MEDICAL AB, LUND, SWEDEN:  
4,044,122, PUB. 8-9-2011, MULTIPLE CLASS, INT. CLS. 10 AND 44.
- VMWARE, INC., PALO ALTO, CA:  
2,491,236, REN. 9-20-11, INT. CL. 16.
- VODE LIGHTING LLC, SONOMA, CA:  
4,047,144, INT. CL. 11.
- VOGELS, JAN EDWARD, LONG BEACH, CA:  
3,054,380, CANC. MULTIPLE CLASS, INT. CLS. 9, 16 AND 21.
- VOICE PLUS, INC., ROSEVILLE, CA, DBA VOICEPLUS:  
4,043,729, PUB. 8-9-2011, INT. CL. 38.
- VOLKSWAGEN AKTIENGESELLSCHAFT, FED REP GERMANY:  
2,992,649.
- VORWALLER, JOHN A., KELLER, TX:  
4,044,128, PUB. 5-3-2011, INT. CL. 5.
- W.B. MCCLLOUD & COMPANY, HOFFMAN ESTATES, IL:  
1,698,051, REN. 9-21-11, MULTIPLE CLASS, INT. CLS. 37 AND 42.
- W.M. TINDER, INC, MANASSAS, VA:  
2,485,876, REN. 9-21-11, INT. CL. 19.
- W.P. CROWHURST PTY. LTD., KILBURN, AUSTRALIA:  
2,926,554, CANC. INT. CL. 2.
- W.R. GRACE & CO.-CONN., COLUMBIA, MD:  
2,927,069, CANC. INT. CL. 6.
- W.R. MEADOWS, INC., HAMPSHIRE, IL:  
4,044,794, PUB. 8-9-2011, INT. CL. 19.
- WACHTEL, PETER, ANDREW, CAMARILLO, CA, AKA KID TOYOLOGY:  
4,044,599, PUB. 8-9-2011, INT. CL. 42.
- WACKER CHEMIE AG, FED REP GERMANY:  
4,043,744, PUB. 8-9-2011, MULTIPLE CLASS, INT. CLS. 1, 2 AND 17.
- WAHLER, ELIZABETH, NEWPORT BEACH, CA:  
4,044,239, PUB. 8-9-2011, INT. CL. 35.
- WAKAI & CO., LTD., HIGASHIOSAKA, OSAKA, JAPAN:  
2,504,718, REN. 9-19-11, INT. CL. 6.
- WAL-MART STORES, INC., BENTONVILLE, AR:  
2,926,603, CANC. INT. CL. 20.  
4,045,140, PUB. 8-9-2011, INT. CL. 31.  
4,045,545, PUB. 8-9-2011, INT. CL. 28.  
4,045,546, PUB. 8-9-2011, MULTIPLE CLASS, INT. CLS. 18 AND 28.  
4,045,886, INT. CL. 6.
- WALACH, CHRISTOPHER E., LAS VEGAS, NV:  
4,046,981, INT. CL. 35.
- WALGREEN CO., DEERFIELD, IL:  
4,044,330, PUB. 8-9-2011, INT. CL. 45.  
4,046,888, MULTIPLE CLASS, INT. CLS. 35 AND 36.
- WALIA, ROHIT, SHERMAN OAKS, CA:  
4,044,167, PUB. 5-3-2011, INT. CL. 25.
- WALKER-SPRY, JENNIFER E., DOUGLASSVILLE, PA:  
4,045,898, INT. CL. 14.
- WALKER, MORRIS, CORVALLIS, OR:  
4,046,354, INT. CL. 35.
- WALLACE BARNES COMPANY, THE, BRISTOL, CT, ASSOCIATED SPRING CORPORATION, BRISTOL, CT:  
920,688, REN. 9-22-11, U.S. CL. 34 (INT. CL. 6).
- WALLACE BARNES COMPANY, THE, BRISTOL, CT:  
2,495,676, REN. 9-17-11, INT. CL. 37.
- WALLINGFORD'S, INC., OAKLAND, ME:  
4,047,245, INT. CL. 6.
- WALTHER, JOHN, SWEETWATER, NJ:  
4,045,100, PUB. 8-9-2011, INT. CL. 9.
- WALZ, MARY D., SUNNYVALE, CA:  
2,926,842, CANC. MULTIPLE CLASS, INT. CLS. 25 AND 28.
- WANG, TERRY SHILIANG, WEST VANCOUVER, BC, CANADA:  
2,984,462, CANC. MULTIPLE CLASS, INT. CLS. 2 AND 35.
- WARFIELD, GRANT I., EDEN PRAIRIE, MN:  
2,472,363, REN. 9-20-11, INT. CL. 28.
- WARNACO U.S., INC., MILFORD, CT:  
2,927,007, CANC. INT. CL. 25.
- WARNER BROS. ENTERTAINMENT INC., BURBANK, CA:  
2,495,015, REN. 9-20-11, INT. CL. 25.  
2,927,004, CANC. INT. CL. 41.  
2,928,265, CANC. INT. CL. 28.  
2,931,803, CANC. INT. CL. 28.
- WARSAW ORTHOPEDIC, INC., WARSAW, IN:  
4,045,955, INT. CL. 10.
- WASHINGTON MUTUAL, INC., SEATTLE, WA:  
2,926,504, CANC. INT. CL. 41.
- WATER AND WELLNESS SOLUTIONS INC., RENO, NV:  
4,044,653, PUB. 8-9-2011, INT. CL. 5.
- WATERWHEEL LICENSING LLC, LOS ANGELES, CA, BRODERBUND SOFTWARE, INC., SAN RAFAEL, CA:  
1,646,934, REN. 9-21-11, INT. CL. 28.
- WATKINS ASSOCIATED INDUSTRIES, INC., LAKELAND, FL:  
4,044,152, PUB. 8-9-2011, INT. CL. 39.
- WATKINS GLEN INTERNATIONAL, INC., DAYTONA BEACH, FL:  
2,500,410, REN. 9-16-11, INT. CL. 41.
- WATSON PHARMACEUTICALS, INC., CORONA, CA:  
4,046,588, INT. CL. 5.
- WATSON-MARLOW LIMITED, CORNWALL, UNITED KINGDOM:  
4,043,687, PUB. 3-29-2011, MULTIPLE CLASS, INT. CLS. 7, 9, 10 AND 17.
- WAVEDIVISION HOLDINGS, LLC, KIRKLAND, WA:  
2,428,402, CANC. INT. CL. 38.
- WAYLOO, INC, DAVIE, FL:  
4,045,413, PUB. 8-9-2011, INT. CL. 35.
- WE MAKE THINGS GMBH, COLOGNE, FED REP GERMANY:  
2,984,942, CANC. INT. CL. 9.
- WEB LINK ENTERPRISES, LLC, WILTON, NH:  
4,045,104, PUB. 8-9-2011, INT. CL. 20.
- WEBER, CHERYL, NAPLES, FL:  
2,927,025, CANC. INT. CL. 9.
- WEDGE-LOC CO., INC., RIO RICO, AZ:  
1,691,160, REN. 9-20-11, INT. CL. 6.
- WEILERT PAMELA, HAYS, KS:  
4,046,085, INT. CL. 20.
- WEINBERG, MARCIA HAWVER, GAINESVILLE, FL:  
2,926,496, CANC. INT. CL. 35.
- WELL BLACK LLC, NEW YORK, NY:  
4,045,657, INT. CL. 33.
- WELLA CORPORATION, THE, WOODLAND HILLS, CA:  
1,643,295, REN. 9-19-11, INT. CL. 3.

WELLS FARGO & COMPANY, MINNEAPOLIS, MN:  
2,428,992, CANC. INT. CL. 36.  
2,590,047, REN. 9-20-11. MULTIPLE CLASS, INT. CLS. 35  
AND 36.

WELLS LAMONT LLC, NILES, IL:  
2,428,529, CANC. INT. CL. 25.  
2,926,698, CANC. INT. CL. 21.  
2,926,699, CANC. INT. CL. 21.

WELLS, KEVIN VINCENT GUSTAVUS, NEW YORK, NY:  
4,045,664, INT. CL. 35.

WELSON, CATHY, BLOOMFIELD, CT:  
4,046,494, INT. CL. 16.

WENDOH MEDIA, LAS VEGAS, NV:  
4,043,980, PUB. 8-9-2011. INT. CL. 41.

WENDY S. BERGER, NEW YORK, NY:  
4,047,002, INT. CL. 3.

WERNER TECHNOLOGIES, INC., WILMINGTON, DE:  
2,490,782, REN. 9-21-11. MULTIPLE CLASS, INT. CLS. 6  
AND 20.

WESC AB, STOCKHOLM, SWEDEN:  
2,988,897, CANC. INT. CL. 18.

WESSEL-WERK GMBH, 51580 REICHSHOF (WILDBER-  
GERHUTTE), FED REP GERMANY:  
2,494,908, REN. 9-22-11. INT. CL. 7.

WEST BEND MUTUAL INSURANCE COMPANY, WEST  
BEND, WI:  
4,046,123, INT. CL. 36.

WEST VIRGINIA RADIO CORPORATION OF CHARLES-  
TON, MORGANTOWN, WV, CAPITOL BROADCASTING  
CORPORATION, CHARLESTON, WV:  
1,708,811, REN. 9-17-11. INT. CL. 41.

WESTBLOCK SYSTEMS, INC., SALEM, OR:  
4,013,189, COR. INT. CL. 19.

WESTBRAE NATURAL, INC., MELVILLE, NY:  
4,047,101, INT. CL. 29.

WESTCOAST CONTEMPO FASHIONS LIMITED, BURNA-  
BY, B.C., CANADA:  
4,045,055, PUB. 8-9-2011. INT. CL. 18.

WESTERN HOLDINGS, LLC, CARSON CITY, NV:  
4,045,863, INT. CL. 5.

WESTLAKE SERVICES, INC., LOS ANGELES, CA:  
4,045,023, PUB. 8-9-2011. INT. CL. 36.

WESTON NURSERIES, INC., HOPKINGTON, MA:  
2,926,716, CANC. INT. CL. 31.

WESTWOOD ONE INC., NEW YORK, NY:  
1,177,625, REN. 9-21-11. INT. CL. 41.

WETTERSTROM, KERRY K., LANCASTER, PA:  
2,504,373, REN. 9-18-11. INT. CL. 16.  
2,527,271, REN. 9-18-11. INT. CL. 16.

WEVEEL LLC, HASLET, TX:  
4,046,915, INT. CL. 16.

WHAM-O, INC., EMERYVILLE, CA:  
4,046,202, MULTIPLE CLASS, INT. CLS. 6, 9, 14, 18, 20, 21,  
24, 25 AND 28.

WHAMSPOT, LLC, SAN FRANCISCO, CA:  
4,045,845, INT. CL. 41.

WHEELKRAFT NW, VANCOUVER, WA:  
4,047,226, INT. CL. 37.

WHEELS FINANCIAL GROUP, INC., ENCINO, CA:  
4,046,565, INT. CL. 36.

WHEELSNEXT INC, DORAL, FL, AKA WHEELSNEXT:  
4,044,340, PUB. 8-9-2011. INT. CL. 12.

WHINK PRODUCTS COMPANY, ELDORA, IA:  
668,134, CANC. U.S. CL. 52.

WHITE COFFEE CORPORATION, THE, LONG ISLAND  
CITY, NY:  
1,194,816, REN. 9-20-11. INT. CL. 30.

WHITE ROCK DISTILLERIES, INC., LEWISTON, ME:  
4,046,023, INT. CL. 33.

WHITE-BERARDI, TERI, SAN DIEGO, CA:  
4,046,701, INT. CL. 32.

WHITE, KARIANNE, BORDENTOWN, NJ AND WHITE,  
MATTHEW, BORDENTOWN, NJ:  
4,045,600, INT. CL. 16.

WHITELATCH-HOCH, LLC, KENNEWICK, WA:  
4,046,567, INT. CL. 33.  
4,046,568, INT. CL. 33.

WHITEWAVE SERVICES, INC., DALLAS, TX:  
4,046,873, INT. CL. 29.

WHITMIRE, ALISON, NEWCASTLE, WA:  
4,046,456, INT. CL. 35.

WHITMORE, STACEY, BEVERLY HILLS, CA:  
4,046,265, INT. CL. 14.

WHITTIER PLACE CAFE, LLC, DETROIT, MI, AKA WHIT-  
TIER PLACE CAFE AND CATERING, LLC:  
4,044,954, PUB. 8-9-2011. INT. CL. 43.

WHOLE HOG CAFE, INC., LITTLE ROCK, AR:  
4,044,580, PUB. 8-9-2011. INT. CL. 43.

WHOLESALE AUTOMOTIVE, INC., COMMERCE, CA:  
2,927,001, CANC. INT. CL. 11.

WHOSAY, INC., GERMANTOWN, NY:  
4,046,220, INT. CL. 35.

WHOUYOUHIRE, LLC, SANTA BARBARA, CA:  
4,044,577, PUB. 8-9-2011. INT. CL. 42.

WHYTE AND MACKAY LIMITED, GLASGOW, UNITED  
KINGDOM, WHYTE & MACKAY DISTILLERS LIMITED,  
GLASGOW, G2 5RG, SCOTLAND:  
1,658,463, REN. 9-18-11. INT. CL. 33.

WIBERG, LARS-ERIK, ROCKPORT, MA:  
2,531,459, REN. 9-21-11. INT. CL. 42.

WICHARD, THIERS, FRANCE:  
1,179,804, REN. 9-20-11. INT. CL. 6.

WICHITA BASEBALL INC., WICHITA, KS:  
2,427,813, CANC. MULTIPLE CLASS, INT. CLS. 16, 25, 28  
AND 41.

WICKED SKATEWEAR, HUNTINGTON BEACH, CA:  
4,045,471, PUB. 8-9-2011. INT. CL. 35.

WIDE BRIDGE, NEW YORK, NY:  
4,045,985, MULTIPLE CLASS, INT. CLS. 35 AND 36.

WIEBOLD-CONFISERIE GMBH & CO. KG, FED REP  
GERMANY:  
4,043,789, PUB. 8-9-2011. INT. CL. 30.

WIENCKOSKI, THOMAS, SATELLITE BEACH, FL AND  
ROSSI, TERRY, SATELLITE BEACH, FL:  
4,044,535, PUB. 8-9-2011. INT. CL. 31.

WIENER, ALITZAH, HACIENDA HEIGHTS, CA:  
4,045,952, INT. CL. 41.

WILDLIFE RESEARCH CENTER, INC., RAMSEY, MN:  
4,045,616, INT. CL. 28.

WILKINS, BILLY, WILMINGTON, NC:  
4,046,870, INT. CL. 16.

WILKINS, CYNTHIA MARIE, ONTARIO, CA:  
4,046,822, INT. CL. 16.

WILLIAM CARTER COMPANY, THE, ATLANTA, GA:  
2,926,479, CANC. MULTIPLE CLASS, INT. CLS. 12, 16, 20,  
24, 25 AND 28.

WILLIAM CODEN, COLD SPRING HARBOR, NY, FOR-  
MERLY WILLIAM COHEN:  
4,043,734, PUB. 8-9-2011. INT. CL. 41.

WILLIAM MARSH RICE UNIVERSITY, HOUSTON, TX:  
2,540,056, REN. 9-21-11. INT. CL. 16.  
2,540,067, REN. 9-18-11. INT. CL. 24.  
2,540,151, REN. 9-18-11. INT. CL. 16.

WILLIAMS SELYEM WINERY, HEALDSBURG, CA, DBA  
WILLIAMS & SELYEM WINERY:  
1,668,752, COR. INT. CL. 33.

WILLIAMS, CHUCK, WEST CHESTER, PA:  
4,045,041, PUB. 8-9-2011. INT. CL. 41.

WILLIAMS, DUNCAN & KIRK, INC., CARBONDALE, IL,  
DBA HUNTLY HOUSE:  
1,650,974, REN. 9-22-11. INT. CL. 33.

WILLIAMS, LESA G., SAN DIEGO, CA:  
4,045,346, PUB. 8-9-2011. INT. CL. 41.

WILMAR INDUSTRIES, INC., JACKSONVILLE, FL:  
2,428,395, CANC. INT. CL. 3.

WILSHIRE FASHIONS, INC., NEW YORK, NY:  
4,046,606, INT. CL. 14.  
4,046,607, INT. CL. 18.  
4,046,608, INT. CL. 25.  
4,046,609, INT. CL. 26.

WILSON COMAS, TAMARAC, FL:  
4,046,454, MULTIPLE CLASS, INT. CLS. 9, 25 AND 41.

WILTON INDUSTRIES, INC., WOODBRIDGE, IL, WILTON  
INDUSTRIES, INC., WOODBRIDGE, IL:  
1,654,345, REN. 9-19-11. INT. CL. 21.

- WILTON INDUSTRIES, INC., WOODRIDGE, IL:  
2,926,674, CANC. INT. CL. 21.
- WINFIELD SOLUTIONS, LLC, SHOREVIEW, MN:  
4,046,269, INT. CL. 31.
- WING ENTERPRISES, INC., SPRINGVILLE, UT:  
4,046,480, INT. CL. 20.
- WINNEBAGO OF INDIANA, LLC, FOREST CITY, IA:  
4,045,211, PUB. 8-9-2011. INT. CL. 12.
- WINNERS INTERNATIONAL RESTAURANTS FRANCHISE SERVICES, INC., FT WALTON BEACH, FL, VOLUNTEER CAPITAL CORPORATION, BRENTWOOD, TN:  
1,170,698, REN. 9-18-11. INT. CL. 42.  
1,174,630, REN. 9-21-11. INT. CL. 42.
- WINROCK INTERNATIONAL INSTITUTE FOR AGRICULTURAL DEVELOPMENT, LITTLE ROCK, AR:  
4,043,925, PUB. 8-9-2011. MULTIPLE CLASS, INT. CLS. 35, 36, 41, 42 AND 45.
- WINSOME FORGE, LLC, ROCHESTER, NH:  
4,044,686, PUB. 8-9-2011. INT. CL. 30.
- WINTERBORNE, INC., CHATSWORTH, CA:  
4,044,898, PUB. 8-9-2011. INT. CL. 16.
- WIPRO TRADEMARKS HOLDING LIMITED, BANGALORE, KARNATAKA, INDIA:  
2,933,907, CANC. INT. CL. 16.
- WIRELESS MATRIX USA, INC., A DELAWARE CORPORATION, RESTON, VA:  
2,927,075, CANC. INT. CL. 35.
- WIRTHCO ENGINEERING, INC., MINNEAPOLIS, MN:  
2,926,505, CANC. INT. CL. 9.
- WISCHOW, RENE' E, FORT COLLINS, CO, DBA LIVING IN SYNERGY:  
4,044,241, PUB. 8-9-2011. MULTIPLE CLASS, INT. CLS. 41 AND 45.
- WISCONSIN ALUMNI RESEARCH FOUNDATION (WARF), MADISON, WI:  
2,482,983, REN. 9-20-11. INT. CL. 9.
- WISCONSIN CHAMBER OF COMMERCE FOUNDATION, INC., MADISON, WI:  
2,926,850, CANC. INT. CL. 41.
- WITHIT INTERNATIONAL LICENSING LTD., TORTOLA, BR.VIRGIN ISLANDS:  
2,926,993, CANC. INT. CL. 9.
- WIZARD CO., INC., PARSIPPANY, NJ:  
1,649,696, REN. 9-20-11. INT. CL. 37.
- WIZARD INTERNATIONAL, INC., MUKILTEO, WA:  
4,044,165, PUB. 8-9-2011. INT. CL. 9.
- WIZARDS OF THE COAST LLC, PAWTUCKET, RI:  
4,046,531, INT. CL. 28.
- WLT SOFTWARE ENTERPRISES, INC., CLEARWATER, FL:  
4,044,842, PUB. 8-9-2011. INT. CL. 38.  
4,044,844, PUB. 8-9-2011. INT. CL. 35.
- WM. T. BURNETT IP, LLC, BALTIMORE, MD, STX, INC., BALTIMORE, MD:  
1,691,707, REN. 9-22-11. INT. CL. 28.
- WM. WRIGLEY JR. COMPANY, CHICAGO, IL:  
4,044,966, PUB. 8-9-2011. INT. CL. 30.
- WMS GAMING INC., CHICAGO, IL:  
2,491,340, REN. 9-19-11. INT. CL. 9.
- WNL, INC., CLACKAMAS, OR, DBA WESTLAND SALES:  
2,526,999, REN. 9-19-11. INT. CL. 7.
- WOLF CAMERA, INC., ALPHARETTA, GA TO RCI ACQUISITION, LLC, BELTSVILLE, MD:  
2,428,387, CANC. INT. CL. 35.
- WOLF FAMILY VINEYARDS, INC., SAN FRANCISCO, CA:  
2,503,072, REN. 9-22-11. INT. CL. 33.
- WOLF, FRED ALAN, SAN FRANCISCO, CA:  
4,044,331, PUB. 8-9-2011. INT. CL. 9.  
4,044,342, PUB. 8-9-2011. INT. CL. 41.
- WOLTERS KLUWER HEALTH, INC., PHILADELPHIA, PA:  
2,473,738, REN. 9-20-11. INT. CL. 16.  
4,044,375, PUB. 8-9-2011. INT. CL. 9.
- WOMEN'S GOLF ASSOCIATION OF NORTHERN CALIFORNIA, PLEASANTON, CA:  
4,044,033, PUB. 8-9-2011. INT. CL. 41.
- WOMP WORKS LLC, PALO ALTO, CA:  
4,045,221, PUB. 8-9-2011. INT. CL. 5.
- WONDERFUL, LTD., BEXLEY, OH:  
2,926,963, CANC. MULTIPLE CLASS, INT. CLS. 16 AND 42.
- WONTON MEDIA INC., VANCOUVER, BC, CANADA:  
4,045,233, PUB. 8-9-2011. INT. CL. 35.
- WORD VINEYARDS LLC, COSTA MESA, CA:  
4,046,004, INT. CL. 33.
- WORKOUT FACTORY B.V., NETHERLANDS:  
4,043,773, PUB. 5-3-2011. MULTIPLE CLASS, INT. CLS. 9, 16, 25, 28, 35, 38, 41 AND 42.
- WORKPLACE HELPLINE LLC, THE, BOSTON, MA:  
2,608,880, REN. 9-20-11. MULTIPLE CLASS, INT. CLS. 35 AND 39.
- WORLD AWARD, LLC, TIBURON, CA:  
4,047,211, INT. CL. 41.  
4,047,229, INT. CL. 41.
- WORLD CHOICE INVESTMENTS, LLC, PIGEON FORGE, TN:  
4,046,677, INT. CL. 41.  
4,046,678, INT. CL. 43.  
4,046,679, INT. CL. 35.  
4,046,680, INT. CL. 28.  
4,046,681, INT. CL. 25.  
4,046,682, INT. CL. 21.
- WORLD CLASS LEARNING MATERIALS, INC., BALTIMORE, MD:  
2,927,040, CANC. INT. CL. 9.
- WORLD IMPORT COMPANY, KENNESAW, GA:  
4,045,317, PUB. 8-9-2011. INT. CL. 18.
- WORLD OF CHILDREN, INC., PLEASANTON, CA:  
2,430,770, AM. INT. CL. 41.
- WORLD OF TILE INC., SPRINGFIELD, NJ:  
914,892, REN. 9-20-11. U.S. CL. 12 (INT. CL. 19).
- WORLD PUBLICATIONS, LLC, WINTER PARK, FL:  
4,047,264, INT. CL. 41.
- WORLD SCENTS, LLC, SEFFNER, FL:  
4,044,892, PUB. 8-9-2011. INT. CL. 3.
- WORLD TRIATHLON CORPORATION, TAMPA, FL:  
4,044,071, PUB. 8-9-2011. INT. CL. 9.
- WORLD WEAR PROJECT, LLC, DALLAS, TX:  
4,046,639, INT. CL. 36.  
4,046,640, INT. CL. 36.
- WORLD WRESTLING ENTERTAINMENT, INC., STAMFORD, CT:  
4,045,760, INT. CL. 25.  
4,046,290, INT. CL. 9.
- WORLDWIDE RESCUE AND SECURITY, INC., CARPINTERIA, CA:  
4,045,531, PUB. 8-9-2011. MULTIPLE CLASS, INT. CLS. 35, 39 AND 45.
- WORLDWIDE TRADE PARTNERS (NEW YORK) LLC, WHITE PLAINS, NY, DBA WTP ADVISORS:  
4,044,601, PUB. 8-9-2011. INT. CL. 35.  
4,044,602, PUB. 8-9-2011. INT. CL. 35.  
4,044,604, PUB. 8-9-2011. INT. CL. 35.
- WORTH THE HURT, INC., SAN FRANCISCO, CA:  
4,045,486, PUB. 8-9-2011. INT. CL. 36.  
4,045,488, PUB. 8-9-2011. INT. CL. 45.  
4,045,489, PUB. 8-9-2011. INT. CL. 25.  
4,045,490, PUB. 8-9-2011. INT. CL. 25.
- WOUND CARE INNOVATIONS, LLC, FORT WORTH, TX:  
4,043,942, PUB. 8-9-2011. INT. CL. 5.  
4,043,943, PUB. 8-9-2011. INT. CL. 5.
- WOW MEDIA INC., MIAMI BEACH, FL:  
4,045,831, MULTIPLE CLASS, INT. CLS. 14 AND 36.
- WPP PROPERTIES, NEW YORK, NY:  
4,044,125, PUB. 8-9-2011. INT. CL. 35.
- WREATH EQUITY, LLC, CARLSBAD, CA:  
4,046,943, INT. CL. 43.
- WRIGHT TOOTHPASTE, INC., ST. LOUIS, MO:  
4,046,686, INT. CL. 3.
- WRIGHT, MARK, MISSION VIEJO, CA AND WRIGHT, LAURA, MISSION VIEJO, CA:  
4,044,561, PUB. 8-9-2011. INT. CL. 43.
- WRITEPOLE LLC, LAS VEGAS, NV:  
4,045,196, PUB. 8-9-2011. INT. CL. 42.
- WS-INVENTION TRADE GMBH, WR. NEUDORF, AUSTRIA:  
4,044,594, PUB. 8-9-2011. INT. CL. 21.

WU, YAO-CHUAN, CHIAYI HSIEN, 621, TAIWAN:  
4,046,559, INT. CL. 20.

WUU JAU CO. INC., EDMOND, OK:  
4,047,185, INT. CL. 8.

WUXI SUNTECH POWER CO., LTD., WUXI, CHINA:  
4,045,766, INT. CL. 40.

WWRD IPCO LLC, WILMINGTON, DE:  
2,984,889, CANC. MULTIPLE CLASS, INT. CLS. 11 AND 24.

WWW VIAJEZ COM, S.A. DE C.V., ESTADO DE MEXICO, MEXICO:  
4,044,040, PUB. 7-12-2011. INT. CL. 42.

WYATT, STEVEN, RAPID CITY, SD:  
4,046,595, INT. CL. 3.

WYNDHAM TM CORP., PARSIPPANY, NJ:  
4,046,634, MULTIPLE CLASS, INT. CLS. 35 AND 43.

WYNES, STEPHANIE, DENVER, CO:  
2,926,964, CANC. INT. CL. 16.

WYO-BEN, INC., BILLINGS, MT:  
1,651,253, REN. 9-20-11. INT. CL. 1.

XAAR TECHNOLOGY LIMITED, CAMBRIDGE, CB4 0XR, ENGLAND:  
2,926,145, CANC. MULTIPLE CLASS, INT. CLS. 7, 9 AND 16.

XEROX CORPORATION, NORWALK, CT:  
917,675, REN. 9-19-11. U.S. CL. 37 (INT. CL. 16).

XINES S.R.L., ITALY:  
4,043,855, PUB. 8-9-2011. MULTIPLE CLASS, INT. CLS. 3, 9 AND 18.

XL GAMING, INC., WILLOUGHBY HILLS, OH, DBA LITTLE BIG GAMES:  
4,045,305, PUB. 8-9-2011. INT. CL. 28.

XTRA CORPORATION, ST. LOUIS, MO, XTRA, INC., PORTLAND, ME:  
1,161,356, REN. 9-20-11. INT. CL. 39.

XTREME POWER INC., KYLE, TX:  
4,045,179, PUB. 8-9-2011. INT. CL. 9.  
4,045,188, PUB. 8-9-2011. INT. CL. 9.

XYTEX CRYO INTERNATIONAL, LTD., AUGUSTA, GA:  
2,926,755, CANC. INT. CL. 44.

Y.Z.Y., INC., MIAMI, FL:  
2,428,072, CANC. INT. CL. 3.

YAFA A PEN COMPANY INC., CANOGA PARK, CA:  
4,043,626, PUB. 8-9-2011. INT. CL. 16.

YAHOO! INC., SUNNYVALE, CA, YAHOO! INC., SUNNYVALE, CA:  
2,482,907, REN. 9-20-11. INT. CL. 16.

YAHOO! INC., SUNNYVALE, CA:  
2,491,498, REN. 9-21-11. INT. CL. 18.  
2,491,498, CANC. MULTIPLE CLASS, INT. CLS. 9, 14 AND 16.

YAKE SOLAR POWER CORP., MIAMI, FL:  
4,047,210, INT. CL. 9.

YAKIRA L.L.C., NEW YORK, NY:  
2,927,076, CANC. INT. CL. 25.

YANKEE CANDLE COMPANY, INC., THE, SOUTH DEERFIELD, MA:  
2,926,553, CANC. INT. CL. 5.

YCC INTERNATIONAL, PULLMAN, WA:  
4,045,219, PUB. 8-9-2011. INT. CL. 9.

YI LIN MOTOR PARTS CO., LTD., CHANGHUA COUNTY 513, TAIWAN:  
2,565,832, REN. 9-18-11. INT. CL. 12.

YO FRESH LLC, NEW YORK, NY:  
4,044,726, PUB. 8-9-2011. INT. CL. 43.

YOASIS FRANCHISING SYSTEMS, LLC, SALT LAKE CITY, UT:  
4,043,966, PUB. 8-9-2011. INT. CL. 43.

YOEMAN'S CHICAGO CORPORATION, AURORA, IL, MORRIS PUMPS, INC., BALDWINVILLE, NY:  
1,162,493, REN. 9-21-11. INT. CL. 7.

YONDER NEIGHBORHOODS, LLC, LEXINGTON, KY, DBA YONDER INTERACTIVE NEIGHBORHOODS:  
4,044,226, PUB. 8-9-2011. INT. CL. 9.  
4,044,227, PUB. 8-9-2011. INT. CL. 9.

YORAMOS LTD., ISRAEL:  
4,043,810, PUB. 5-3-2011. INT. CL. 10.

YORK MANUFACTURING, INC., SANFORD, ME:  
4,045,570, PUB. 8-9-2011. INT. CL. 19.

YORKSHIRE FOOD SALES CORP., NEW HYDE PARK, NY:  
1,160,178, REN. 9-20-11. INT. CL. 29.

YOSEM (SIXTY NINE) INTERNATIONAL CO., LTD., TAIPEI COUNTY, TAIWAN:  
4,046,245, INT. CL. 28.

YOSEMITE FOUNDATION, SAN FRANCISCO, CA:  
4,043,997, PUB. 8-9-2011. INT. CL. 45.  
4,043,998, PUB. 8-9-2011. INT. CL. 36.

YOSHINOYA AMERICA, INC., TORRANCE, CA:  
4,044,760, PUB. 8-9-2011. INT. CL. 43.  
4,044,761, PUB. 8-9-2011. INT. CL. 43.

YOSHINOYA HOLDINGS CO., LTD., TOKYO, JAPAN:  
2,537,741, REN. 9-18-11. MULTIPLE CLASS, INT. CLS. 29, 30 AND 42.

YOUANDICANHELP, RYE, NH:  
4,044,460, PUB. 8-9-2011. INT. CL. 36.

YOUNG BROTHERS, LIMITED, HONOLULU, HI:  
4,045,025, PUB. 8-9-2011. INT. CL. 39.

YOUNG, KAREN, NEW YORK, NY:  
4,046,968, INT. CL. 41.

YOUR BABY CAN, LLC, CARLSBAD, CA:  
4,046,182, INT. CL. 41.

YOUR VITAMINS, INC., HENDERSON, NV, DBA PROCAPS LABORATORIES:  
4,046,383, INT. CL. 5.

YOW CHERN CO. LTD., KAOHSIUNG COUNTY, TAIWAN:  
4,045,126, PUB. 8-9-2011. INT. CL. 6.

YRC WORLDWIDE, INC., OVERLAND PARK, KS:  
1,671,364, REN. 9-21-11. INT. CL. 39.

YZ ENTERPRISES, INC., MAUMEE, OH:  
4,043,723, PUB. 8-9-2011. INT. CL. 30.  
4,044,314, PUB. 8-9-2011. INT. CL. 30.

YZY INC, MIAMI, FL:  
4,045,855, INT. CL. 3.

ZACCARDI, ROBERT J., DRACUT, MA:  
4,044,720, PUB. 8-9-2011. INT. CL. 25.

ZACKY FARMS, LLC, CITY OF INDUSTRY, CA:  
4,045,537, PUB. 8-9-2011. INT. CL. 29.

ZAHORIK FINANCIAL SERVICES, INC., PASADENA, CA:  
2,490,110, REN. 9-20-11. INT. CL. 36.

ZAKHARY, MAGED, GEORGE, NEWPORT BEACH, CA:  
2,926,846, CANC. INT. CL. 44.

ZAMRAY, LLC, WESTMINSTER, CO:  
4,044,788, PUB. 8-9-2011. INT. CL. 35.

ZAO LIVIZ, ST. PETERSBURG, RUSSIAN FED.:  
2,926,459, CANC. INT. CL. 33.

ZAPP AG, RATINGEN, FED REP GERMANY:  
4,046,017, INT. CL. 6.  
4,046,018, INT. CL. 6.  
4,046,019, INT. CL. 6.  
4,046,020, INT. CL. 6.  
4,046,021, INT. CL. 6.

ZAYAS, HECTOR, CASSELBERRY, FL:  
4,045,031, PUB. 8-9-2011. INT. CL. 25.

ZENITH INFOTECH INC., WARRENDALE, PA:  
4,046,237, INT. CL. 9.

ZENKAS, LTD., BRAINTREE, MA:  
4,046,911, INT. CL. 45.

ZENOK NV, WILLEMSTAD, NETHERLANDS ANTILLES:  
4,044,755, PUB. 8-9-2011. INT. CL. 42.

ZEPHYR MANUFACTURING CO., INC., INGLEWOOD, CA:  
1,168,048, REN. 9-22-11. MULTIPLE CLASS, INT. CLS. 7 AND 8.

ZEPPONI & COMPANY, SANTA ROSA, CA:  
4,045,136, PUB. 8-9-2011. INT. CL. 36.

ZHADANOV ELI, LINDEN, NJ:  
4,044,639, PUB. 8-9-2011. INT. CL. 21.

ZHEJIANG HANGZHOU XINFU PHARMACEUTICAL CO. LTD, ZHEJIANG, CHINA:  
4,044,570, PUB. 8-9-2011. INT. CL. 1.

ZHEJIANG RRR OPTOELECTRONIC TECHNOLOGY CO., LTD., WENZHOUE; 325000 ZHEJIANG, CHINA:  
4,043,837, PUB. 8-9-2011. MULTIPLE CLASS, INT. CLS. 9 AND 11.

- ZHEJIANG YIZHOU ELECTRONIC TECHNOLOGY CO., LTD., ZHEJIANG PROVINCE, CHINA:  
4,045,823, INT. CL. 9.
- ZINAS, PANOS, GR 17674 ATHENS, GREECE:  
2,498,579, REN. 9-19-11. INT. CL. 25.
- ZING TOYS, INC., BANKS, OR:  
4,044,678, PUB. 8-9-2011. INT. CL. 28.
- ZINK IMAGING, INC., BEDFORD, MA:  
4,045,628, MULTIPLE CLASS, INT. CLS. 9 AND 16.
- ZINUS INC., HAYWARD, CA, DBA VIVON LIFE:  
4,046,402, INT. CL. 20.
- ZIP-O-LOG MILLS, INC., EUGENE, OR:  
4,044,148, PUB. 8-9-2011. INT. CL. 19.
- ZIPPERSOURCE, INC., ROLLING MEADOWS, IL, ZIPPER-SOURCE, INC., ROLLING MEADOWS, IL:  
2,603,330, REN. 9-19-11. INT. CL. 26.
- ZOCDOC, INC., NEW YORK, NY:  
4,044,897, PUB. 8-9-2011. INT. CL. 35.
- ZOGENIX, INC., SAN DIEGO, CA:  
4,045,619, INT. CL. 5.
- ZOO CITY APPAREL INCORPORATED, MISSOULA, MT:  
4,046,785, INT. CL. 25.  
4,046,786, INT. CL. 25.
- ZOOGMA MUSIC, LLC, OXFORD, MS, DBA ZOOGMA:  
4,044,202, PUB. 8-9-2011. INT. CL. 41.
- ZOOM BAIT COMPANY, INC., BOGART, GA:  
4,044,590, PUB. 8-9-2011. INT. CL. 28.
- ZOTOS INTERNATIONAL, INC., DARIEN, CT:  
4,046,215, INT. CL. 3.
- ZUFFA, LLC, LAS VEGAS, NV:  
4,043,949, PUB. 8-9-2011. INT. CL. 9.  
4,043,953, PUB. 8-9-2011. INT. CL. 9.
- ZUK-MOYA, MELANIE I., SAN FRANCISCO, CA:  
4,045,319, PUB. 8-9-2011. INT. CL. 33.
- ZUNINO, MARK, WEST HOLLYWOOD, CA:  
4,044,814, PUB. 8-9-2011. INT. CL. 14.  
4,044,815, PUB. 8-9-2011. INT. CL. 14.
- ZURKO ENTERPRISES, INC., SHAWANO, WI:  
4,044,370, PUB. 8-9-2011. INT. CL. 35.
- ZURV LLC., RUTHERFORDTON, NC:  
4,045,035, PUB. 8-9-2011. MULTIPLE CLASS, INT. CLS. 35 AND 42.
- ZVELO, INC., GREENWOOD VILLAGE, CO:  
4,045,528, PUB. 8-9-2011. INT. CL. 9.
- ZWIRN, LAURENCE, LOS ANGELES, CA:  
4,045,223, PUB. 8-9-2011. INT. CL. 5.
- ZYVEX INSTRUMENTS, LLC, RICHARDSON, TX:  
2,926,622, CANC. INT. CL. 9.
- 1 LIFE LEGACY, EDEN, NC:  
4,046,979, INT. CL. 35.
- 1-800-FLOODED, INC., LAS VEGAS, NV:  
2,563,655, REN. 9-19-11. INT. CL. 37.
- 1-800-FLOWERS.COM, INC., CARLE PLACE, NY:  
4,046,696, MULTIPLE CLASS, INT. CLS. 30, 35 AND 45.  
4,046,697, MULTIPLE CLASS, INT. CLS. 30, 35 AND 45.
- 10TH MAGNITUDE, INC., GLENCOE, IL:  
4,044,070, PUB. 8-9-2011. INT. CL. 42.
- 103 GW12 LLC, NEW YORK, NY:  
4,046,525, INT. CL. 43.
- 13175 ENTERPRISES, INC., BROOKFIELD, WI:  
2,926,774, CANC. INT. CL. 43.
- 2DS, LLC, WEST SACRAMENTO, CA:  
2,926,634, CANC. INT. CL. 19.
- 2GO PRODUCTS, LLC, SAN DIEGO, CA:  
4,046,346, INT. CL. 11.
- 2TINGA INC., KITCHENER, ONTRIO, CANADA:  
4,046,136, MULTIPLE CLASS, INT. CLS. 12 AND 35.
- 20TEN SPORTS S.R.O., CZECH REPUBLIC:  
4,043,856, PUB. 8-9-2011. MULTIPLE CLASS, INT. CLS. 9, 25, 28 AND 35.
- 2020B LLC, AUSTIN, TX:  
4,045,107, PUB. 8-9-2011. INT. CL. 42.
- 21 ENTERTAINMENT GROUP INC., TORONTO, ONTARIO, CANADA:  
4,047,121, MULTIPLE CLASS, INT. CLS. 9, 35, 38 AND 41.
- 24 HOUR FITNESS USA, INC., SAN RAMON, CA:  
4,046,386, MULTIPLE CLASS, INT. CLS. 42 AND 44.
- 3BALLS.COM, INC., RAYNHAM, MA:  
2,478,235, REN. 9-20-11. INT. CL. 35.
- 3D DEVELOPMENT & HOLDINGS LLC, PHOENIX, AZ:  
4,046,880, INT. CL. 33.  
4,046,881, INT. CL. 33.
- 3M COMPANY, ST. PAUL, MN:  
919,634, REN. 9-20-11. U.S. CL. 5 (INT. CL. 17).  
1,177,064, REN. 9-16-11. INT. CL. 10.  
1,181,981, REN. 9-19-11. INT. CL. 10.  
2,534,562, REN. 9-22-11. INT. CL. 9.  
2,537,018, REN. 9-22-11. INT. CL. 9.
- 3TRACE, IRVINE, CA:  
4,046,283, INT. CL. 39.
- 3TRACE, IRVINE, CA, DBA TRACE 3:  
4,046,288, INT. CL. 39.
- 3V CORPORATION, MT. VERNON, MO:  
2,611,616, REN. 9-20-11. INT. CL. 42.
- 360 DEGREES INC., STAMFORD, CT:  
4,046,753, INT. CL. 3.
- 360TRAINING.COM, INC., AUSTIN, TX:  
4,045,244, PUB. 8-9-2011. MULTIPLE CLASS, INT. CLS. 9, 41 AND 42.
- 4 FP CONSULTING AB, SWEDEN:  
4,043,851, PUB. 8-9-2011. MULTIPLE CLASS, INT. CLS. 35 AND 41.
- 4 OVER, INC., GLENDALE, CA:  
4,045,299, PUB. 8-9-2011. MULTIPLE CLASS, INT. CLS. 9 AND 38.
- 4DK TECHNOLOGIES, INC., HERNDON, VA:  
4,043,636, PUB. 4-1-2008. INT. CL. 42.  
4,043,637, PUB. 4-1-2008. INT. CL. 42.  
4,043,638, PUB. 4-1-2008. INT. CL. 42.
- 4EMPOWERMENT.COM, INC., AUSTIN, TX:  
2,491,366, REN. 9-16-11. INT. CL. 41.
- 4ISOFT LLC, CERRITOS, CA, FORMERLY KOMPSOFT ENTERPRISE APPLICATIONS:  
4,044,065, PUB. 8-9-2011. INT. CL. 42.
- 4SIGHT SUNGLASSES, LLC, SAN FRANCISCO, CA:  
4,047,055, INT. CL. 9.
- 5 FOLD MEDIA, LLC, CICERO, NY:  
4,044,458, PUB. 8-9-2011. INT. CL. 16.
- 5IVE CREATIVE INC, SEATTLE, WA, AKA FIVE CREATIVE:  
4,045,146, PUB. 8-9-2011. INT. CL. 35.
- 5STONES HOLDINGS, LLC, VIENNA, VA:  
4,044,324, PUB. 8-9-2011. INT. CL. 33.
- 6THEORY MEDIA, LLC., TEANECK, NJ:  
4,044,769, PUB. 8-9-2011. INT. CL. 41.  
4,045,103, PUB. 8-9-2011. INT. CL. 41.
- 745 LLC, BOSTON, MA:  
4,047,070, INT. CL. 9.
- 88 INTERNATIONAL, INC., ALHAMBRA, CA:  
3,327,733, CANC. INT. CL. 25.
- 88 TEES HAWAII, INC., HONOLULU, HI:  
2,543,892, REN. 9-16-11. INT. CL. 25.
- 89 NORTH, INC., BURLINGTON, VT:  
4,046,055, INT. CL. 11.
- 9100-0554 QUÉBEC INC., MONTREAL, QUEBEC, CANADA, AKA GROUPE DAZMO:  
4,044,710, PUB. 8-9-2011. INT. CL. 9.
- 953 ASSOCIATES, LLC, NEW YORK, NY, DBA EATERY NYC:  
4,045,427, PUB. 8-9-2011. INT. CL. 35.
- 980009 ALBERTA LTD., CALGARY, ALBERTA, CANADA:  
4,044,110, PUB. 8-9-2011. INT. CL. 35.  
4,044,111, PUB. 8-9-2011. INT. CL. 35.